

# TS 100 544 V6.0.0 (1999-04)

---

*Technical Specification*

**Digital cellular telecommunications system (Phase 2+);  
Call Waiting (CW) and Call Hold (HOLD)  
supplementary services;  
Stage 2  
(GSM 03.83 version 6.0.0 Release 1997)**

---



**GSM**®  
GLOBAL SYSTEM FOR  
MOBILE COMMUNICATIONS

**ETSI** 

---

Reference

---

DTS/SMG-030383Q6 (51c03003.PDF)

Keywords

---

Digital cellular telecommunications system,  
Global System for Mobile communications (GSM)

**ETSI**

Postal address

---

F-06921 Sophia Antipolis Cedex - FRANCE

Office address

---

650 Route des Lucioles - Sophia Antipolis  
Valbonne - FRANCE  
Tel.: +33 4 92 94 42 00 Fax: +33 4 93 65 47 16  
Siret N° 348 623 562 00017 - NAF 742 C  
Association à but non lucratif enregistrée à la  
Sous-Préfecture de Grasse (06) N° 7803/88

Internet

---

[secretariat@etsi.fr](mailto:secretariat@etsi.fr)  
Individual copies of this ETSI deliverable  
can be downloaded from  
<http://www.etsi.org>  
If you find errors in the present document, send your  
comment to: [editor@etsi.fr](mailto:editor@etsi.fr)

---

**Copyright Notification**

---

No part may be reproduced except as authorized by written permission.  
The copyright and the foregoing restriction extend to reproduction in all media.

© European Telecommunications Standards Institute 1999.  
All rights reserved.

---

# Contents

Intellectual Property Rights.....	4
Foreword .....	4
0 Scope.....	5
0.1 References.....	5
0.2 Abbreviations.....	5
1 Call waiting (CW).....	5
1.1 Handling of call waiting.....	5
1.1.1 Activation.....	5
1.1.2 Deactivation .....	6
1.1.3 Interrogation.....	6
1.2 Functions and information flows.....	7
1.2.1 Description of overall SDL-diagram of call waiting .....	8
1.2.1.1 Behaviour during the "Pending Ack" state .....	8
1.2.1.2 Behaviour during the "Waiting" State .....	9
1.3 Information stored in the HLR.....	27
1.4 State transition model .....	27
1.5 Transfer of information from HLR to VLR .....	28
1.6 Information stored in the VLR.....	28
1.7 Handover .....	28
2 Call hold (HOLD).....	28
2.1 Functions and information flows.....	28
2.2 Information stored in the HLR.....	36
2.3 State transition model .....	36
2.4 Transfer of information from HLR to VLR .....	37
2.5 Information stored in the VLR.....	37
2.6 Handover .....	37
<b>Annex A (informative): Change Request History .....</b>	<b>38</b>
History .....	39

---

## Intellectual Property Rights

IPRs essential or potentially essential to the present document may have been declared to ETSI. The information pertaining to these essential IPRs, if any, is publicly available for **ETSI members and non-members**, and can be found in SR 000 314: "*Intellectual Property Rights (IPRs); Essential, or potentially Essential, IPRs notified to ETSI in respect of ETSI standards*", which is available **free of charge** from the ETSI Secretariat. Latest updates are available on the ETSI Web server (<http://www.etsi.org/ipr>).

Pursuant to the ETSI IPR Policy, no investigation, including IPR searches, has been carried out by ETSI. No guarantee can be given as to the existence of other IPRs not referenced in SR 000 314 (or the updates on the ETSI Web server) which are, or may be, or may become, essential to the present document.

---

## Foreword

This Technical Specification (TS) has been produced by the Special Mobile Group (SMG).

The present document defines the stage 2 of the Call Waiting (CW) and Call Hold (HOLD) supplementary services within the digital cellular telecommunications system.

The contents of the present document is subject to continuing work within SMG and may change following formal SMG approval. Should SMG modify the contents of the present document it will be re-released with an identifying change of release date and an increase in version number as follows:

Version 6.x.y

where:

- 6 indicates Release 1997 of GSM Phase 2+
- x the second digit is incremented for all changes of substance, i.e. technical enhancements, corrections, updates, etc.
- y the third digit is incremented when editorial only changes have been incorporated in the specification.

The specification from which the present document has been derived was originally based on CEPT documentation, hence the presentation of the present document may not be entirely in accordance with the ETSI/PNE rules.

---

## 0 Scope

The present document gives the stage 2 description of the call completion supplementary services.

The group of call completion supplementary services is divided into the following two supplementary services:

- Call waiting (CW) (clause 1);
- Call hold (HOLD) (clause 2).

### 0.1 References

The following documents contain provisions which, through reference in this text, constitute provisions of the present document.

- References are either specific (identified by date of publication, edition number, version number, etc.) or non-specific.
- For a specific reference, subsequent revisions do not apply.
- For a non-specific reference, the latest version applies.
- A non-specific reference to an ETS shall also be taken to refer to later versions published as an EN with the same number.
- For this Release 1997 document, references to GSM documents are for Release 1997 versions (version 6.x.y).

- [1] GSM 01.04: "Digital cellular telecommunications system (Phase 2+); Abbreviations and acronyms".
- [2] GSM 02.82: "Digital cellular telecommunications system (Phase 2+); Call Forwarding (CF) Supplementary Services - Stage 1".
- [3] GSM 03.11: "Digital cellular telecommunications system (Phase 2+); Technical realization of supplementary services".
- [4] GSM 04.08: "Digital cellular telecommunications system (Phase 2+); Mobile radio interface layer 3 specification".

### 0.2 Abbreviations

Abbreviations used in the present document are listed in GSM 01.04.

---

## 1 Call waiting (CW)

### 1.1 Handling of call waiting

#### 1.1.1 Activation

The call waiting supplementary service is activated at the request of the user. The activation request indicates the basic services to which the activation request refers.

The information flow for activation of call waiting is shown in figure 1.1.

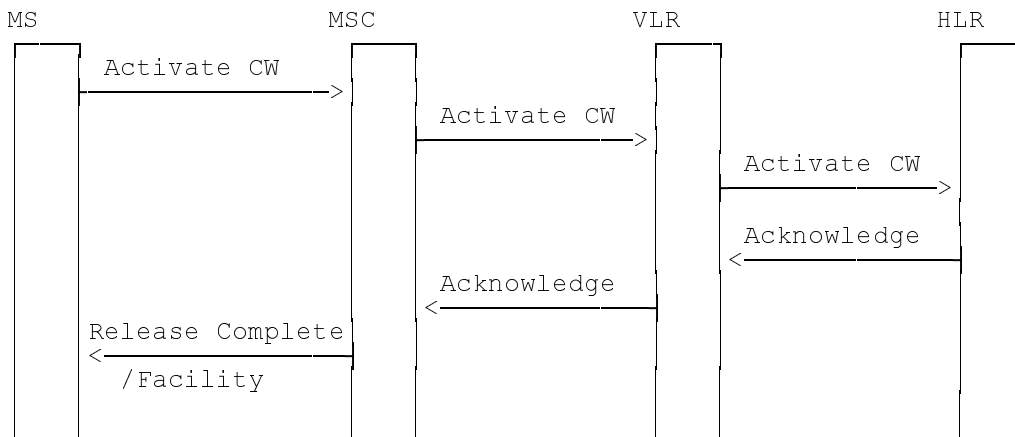

Figure 1.1: Activation of call waiting

### 1.1.2 Deactivation

The call waiting supplementary service is deactivated at the request of the user. The deactivation request indicates the basic services to which the deactivation request refers.

The information flow for deactivation of call waiting is shown in figure 1.2.

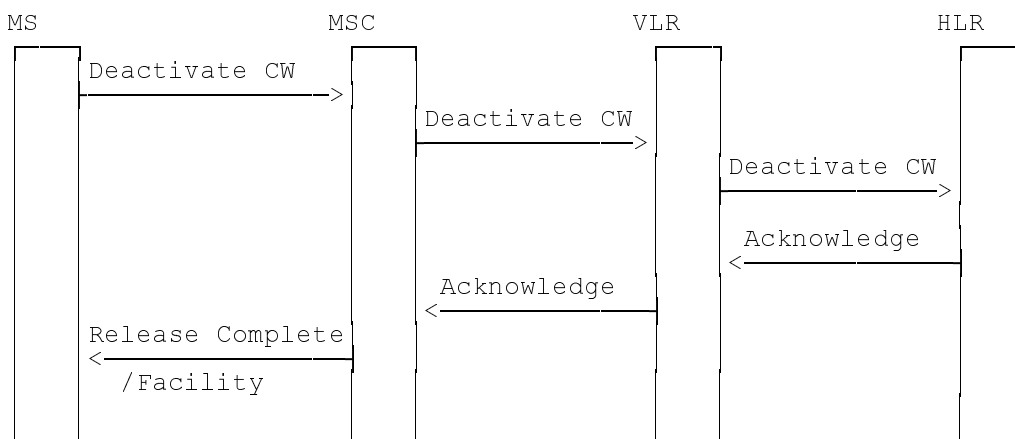

Figure 1.2: Deactivation of call waiting

### 1.1.3 Interrogation

#### Status check

The status check procedure enables the mobile subscriber to obtain information about the status of the call waiting supplementary service with respect to subscribed basic service groups.

The interrogation of call waiting is for all applicable basic services.

The information flow for interrogation of call waiting is shown in figure 1.3.

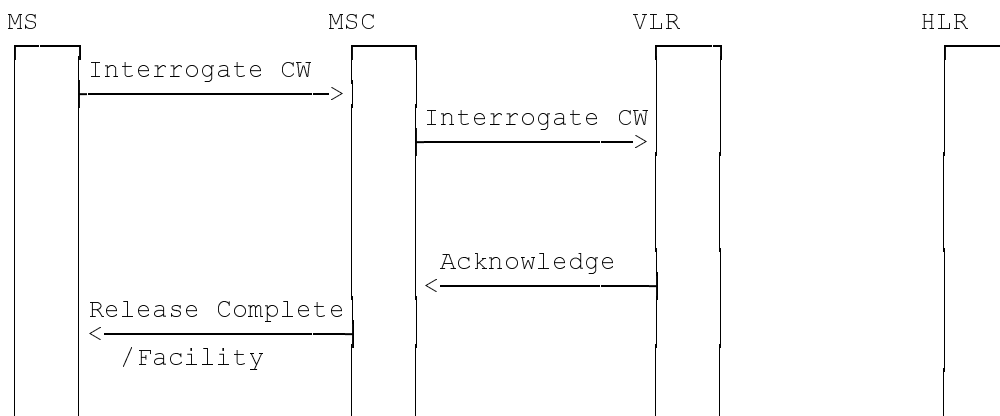

**Figure 1.3: Interrogation of call waiting**

## 1.2 Functions and information flows

GSM 04.08 specifies the procedures for call control. These shall also be used for waiting calls when applicable.

The following Mobile Additional Function has been identified for the call waiting service:

### MAF013

Call waiting related authorizations examination

The ability of a PLMN component to determine the authorizations relating to call waiting. See figure 1.4.

Location: VLR

Definitions:

Subscriber B:

The subscriber who is provided by the network with the call waiting supplementary service. The subscriber B is always a mobile subscriber.

User B:

The user who reacts to call waiting at subscriber B. The user B is always a mobile user.

User C:

The user who has originated a call to subscriber B which causes the call waiting supplementary service to be invoked. The user C may be a mobile user.

User A:

The user who is engaged in a call with user B. The user A may be a mobile user.

Timer T1:

This timer corresponds to T303 + T310 (as defined in GSM 04.08).

Timer T2:

Call Waiting Timer. This shall limit the duration of the call in the waiting condition.

Timer T3:

No Reply Condition Timer (see GSM 02.82).

CFNRc:

Call Forwarding on Not Reachable (see GSM 02.82).

CFNRy:

Call Forwarding on No Reply (see GSM 02.82).

CW:

Call Waiting.

The overall SDL diagram of call waiting is shown in figure 1.5. This represents the network as a whole.

The information flows are shown in figure 1.6. In these flows it is assumed that user A and user C are fixed users and that user B is a mobile user. Functions to be performed by the fixed ISDN are not shown in the information flows. Only the functions to be performed by the PLMN are shown.

## 1.2.1 Description of overall SDL-diagram of call waiting

In the SDL-diagrams the states are dimensioned in two dimensions. The first dimension is a normal basic call state, e.g. null or active. The second dimension is an auxiliary state associated with hold, e.g. idle or held. Active call is represented by (active, idle) state, held call by (active, held) state.

When call waiting is active and the subscriber is connected to at least one call (active or held), the arrival of a subsequent incoming call from user C to user B shall, if no other call is waiting, be signalled to the mobile equipment at B as described in GSM 04.08. The network shall then await an acknowledgement from the mobile termination at user B within a specific time period T1. In figure 1.5, the mobile terminated call from user C is described as being in the "Pending Ack" state during this period. The call waiting service is suspended for further incoming calls.

### 1.2.1.1 Behaviour during the "Pending Ack" state

#### Expiry of call control timers in T1

If no acknowledgement is received by the network from the mobile termination at user B within the time period T1 (timer T1 expires) then the network shall initiate clearing towards the calling user C and served user B in accordance with GSM 04.08. Following the expiry of call control timers in T1 the call waiting service shall be resumed for further incoming calls.

#### Release of active call

User A or B may release the active call between them in the normal manner. This does not change the state of the call from user C. Note that the MS has to indicate a normal ringing tone to the served subscriber.

#### Release of call by user C

User C may release the call to user B. In this case, call clearing shall take place in the normal manner, and the call waiting service shall be resumed for further incoming calls.

#### Call hold service

User B can operate the call hold service on any active calls in the normal manner.

#### Indication of UDUB

User B may release the call from user C using the indication of UDUB. In this case, if CFB is active the call from user C shall be forwarded, if CFB is not active the call from user C shall be cleared. The call waiting service is resumed for further incoming calls.

#### Rejection of call from user C

User B may reject the call from user C. In this case, the call from user C shall be cleared. The call waiting service is resumed for further incoming calls.



### Acknowledgement of call from user C

If the mobile termination at user B acknowledges the incoming call within the time period T1, a call is waiting indication shall be sent towards calling user C. Timer T1 is stopped. Upon reception of alerting the network shall await an acceptance from the controlling user B within the time period T2. In figure 1.5, the mobile terminated call is described as being in the "Waiting" state during this period. In case the controlling subscriber B has call forwarding on no reply active the network shall await an acceptance from user B within the time period  $T3 < T2$ . The call waiting service is still suspended for further incoming calls.

### 1.2.1.2 Behaviour during the "Waiting" State

#### Expiry of Timer T3

If no acceptance is received by the network within the time period T3 (timer T3 expires) the waiting call shall be forwarded on no reply and clearing shall be initiated towards the controlling user B. The call waiting service is resumed for further incoming calls.

#### Expiry of Timer T2

If call forwarding on no reply is not active and no acceptance is received within the time period T2 (timer T2 expires), the waiting call shall be cleared by the network towards the controlling user B and the calling user C. The call waiting service is resumed for further incoming calls.

#### Other Events

The following events are treated as described in subclause 1.2.1.1:

- release of active call;
- release of call by user C;
- call hold service;
- indication of UDUB;
- rejection of call from user C.

#### Acceptance of waiting call

A precondition for the acceptance of the waiting call is that there is no other call in the (active, idle) state. The user can achieve this by releasing active calls, or using the call hold service. When user B accepts the call from user C it becomes the (active, idle) call. Timer T2 or T3 is stopped. The call waiting service is resumed for further incoming calls.

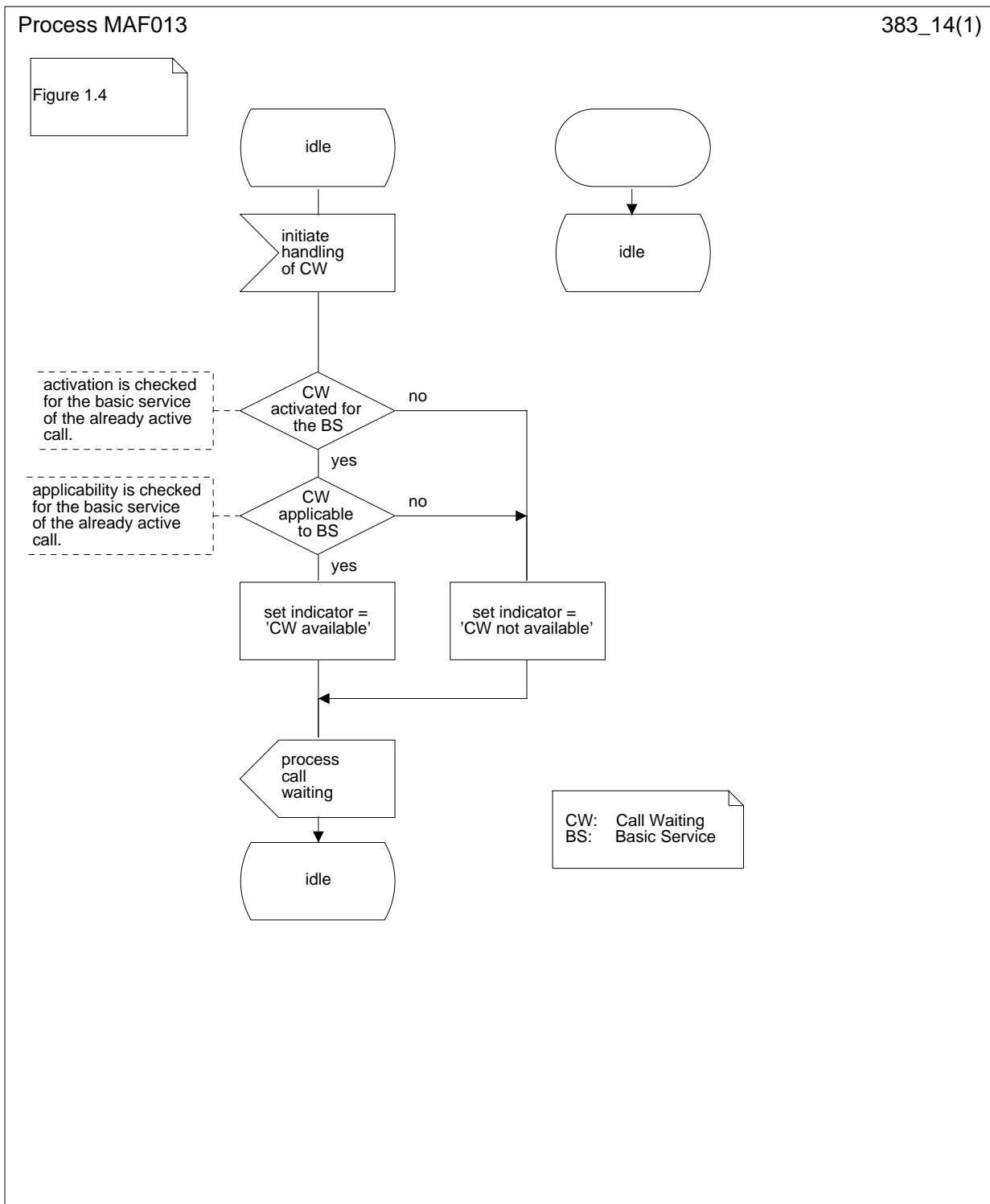

Figure 1.4: MAF013 Call waiting related authorisations examination (VLR)

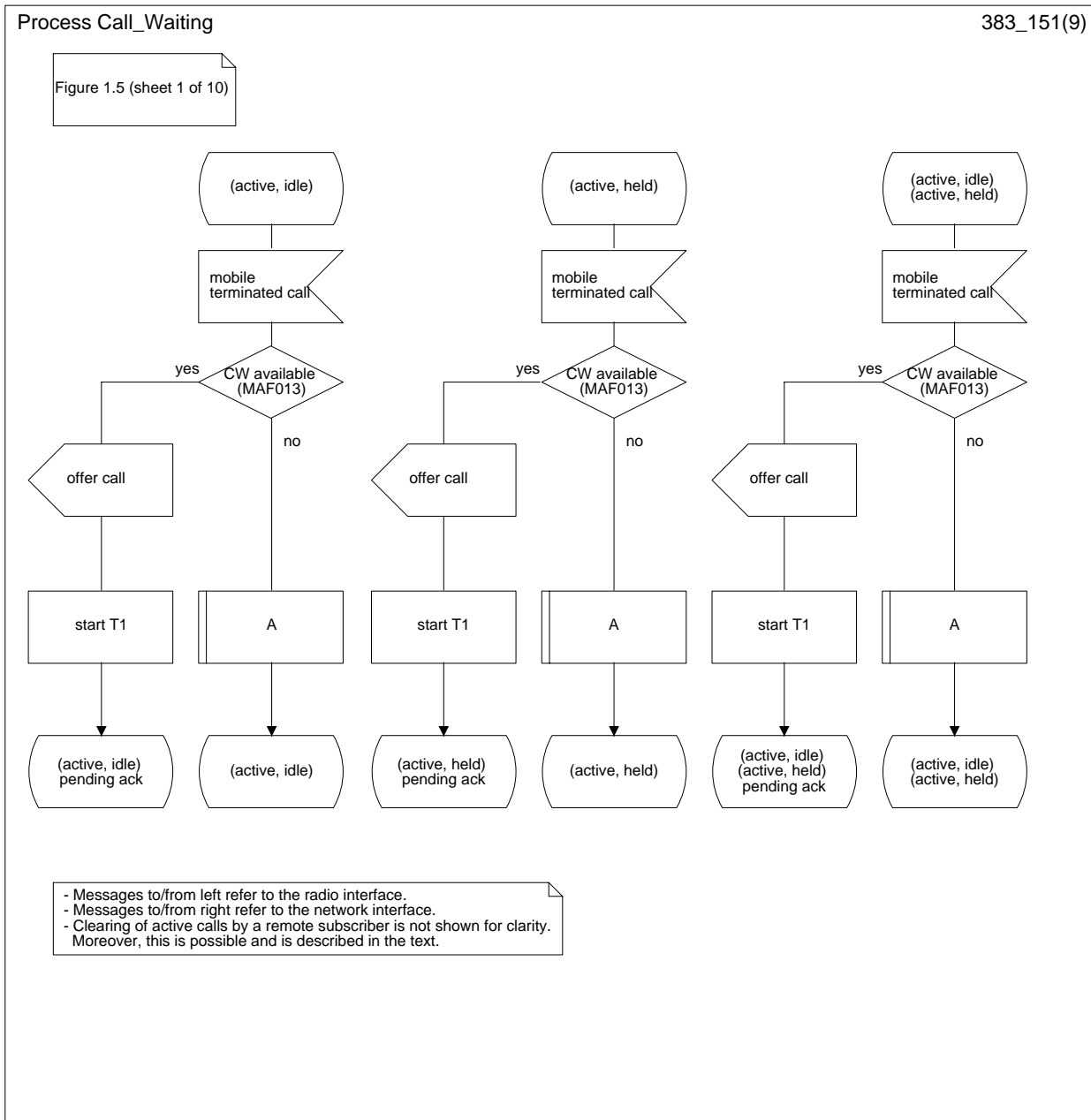

Figure 1.5 (sheet 1 of 10): Overall SDL diagram of call waiting

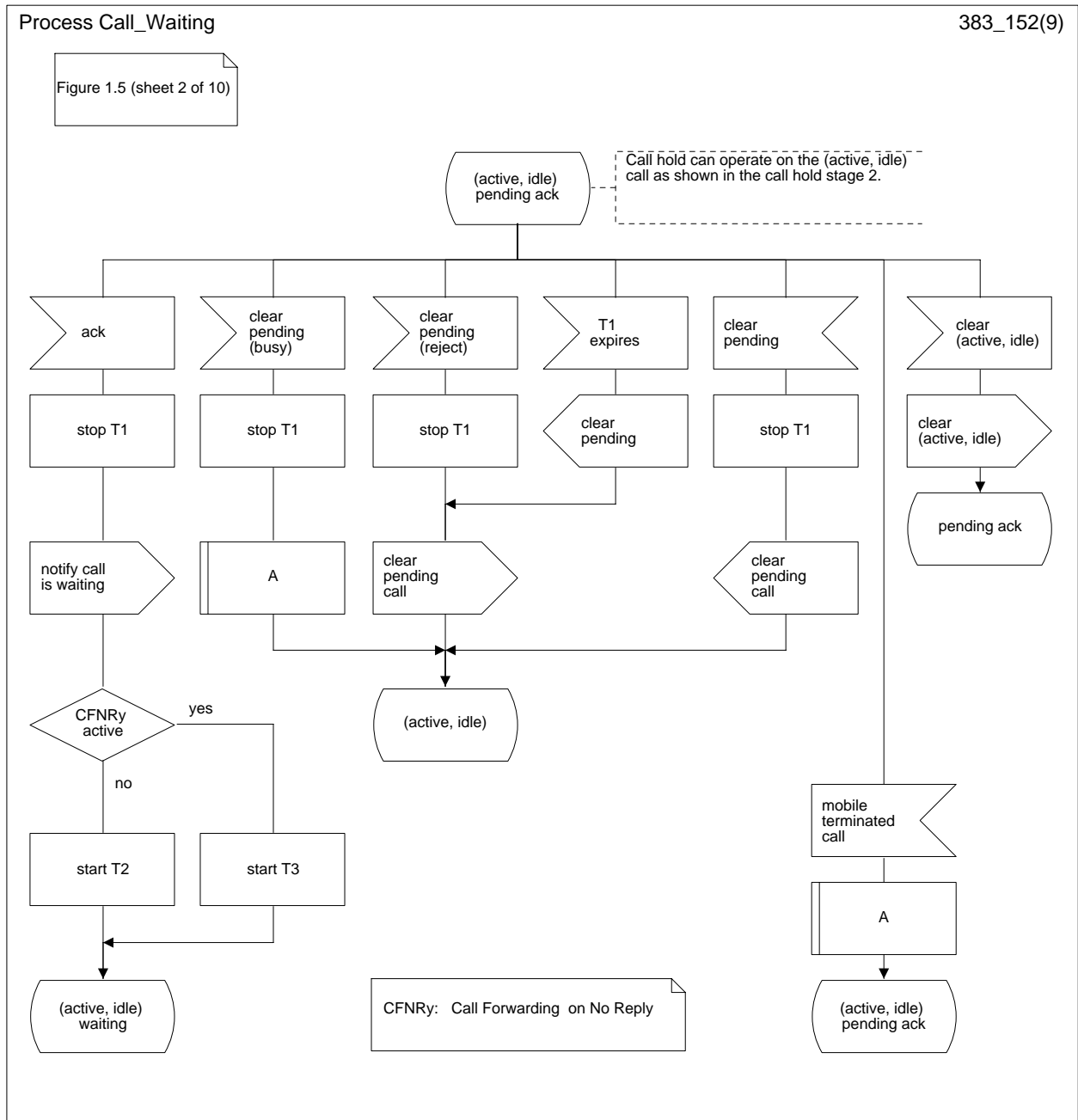

Figure 1.5 (sheet 2 of 10): Overall SDL diagram of call waiting

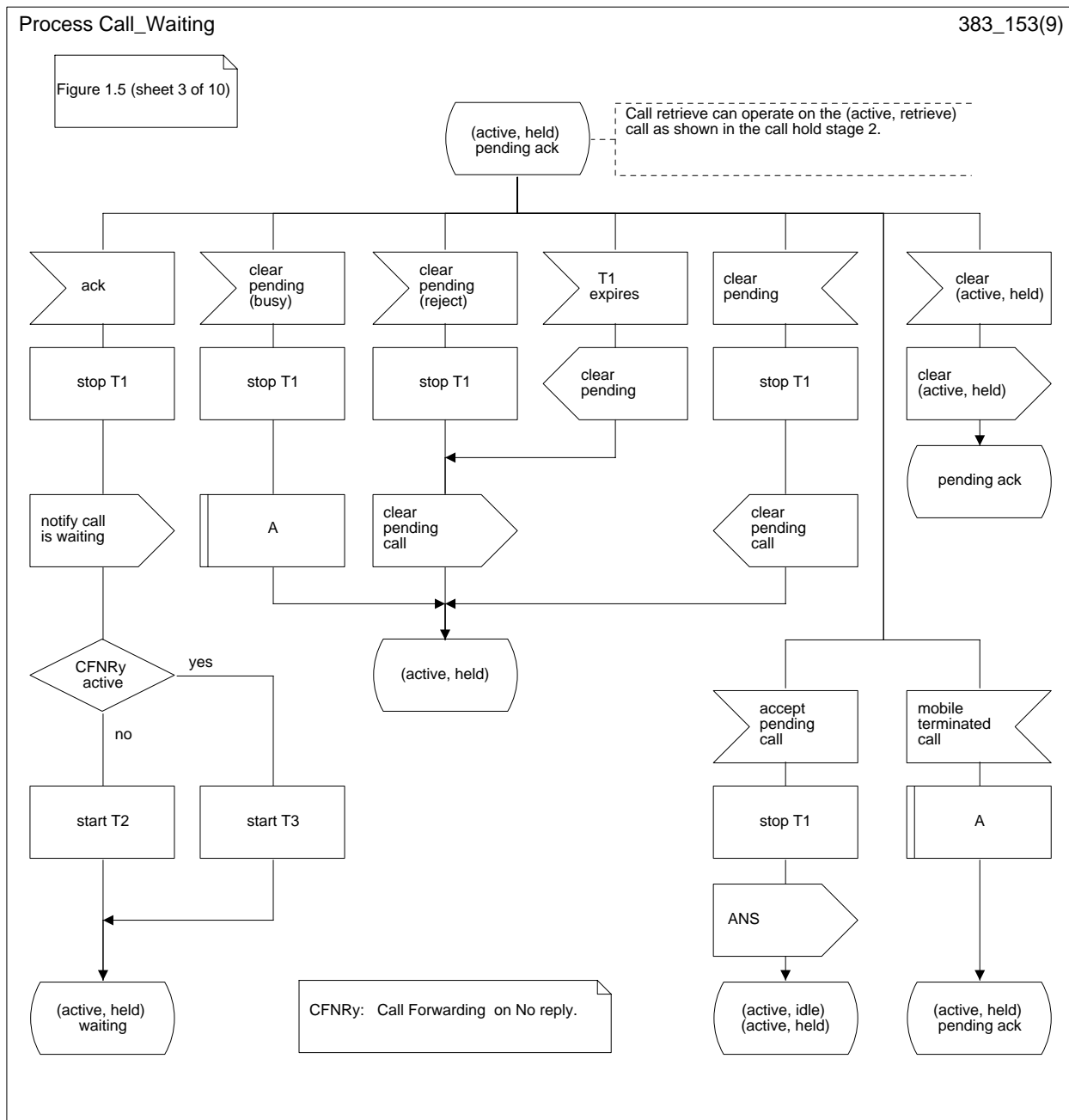

Figure 1.5 (sheet 3 of 10): Overall SDL diagram of call waiting

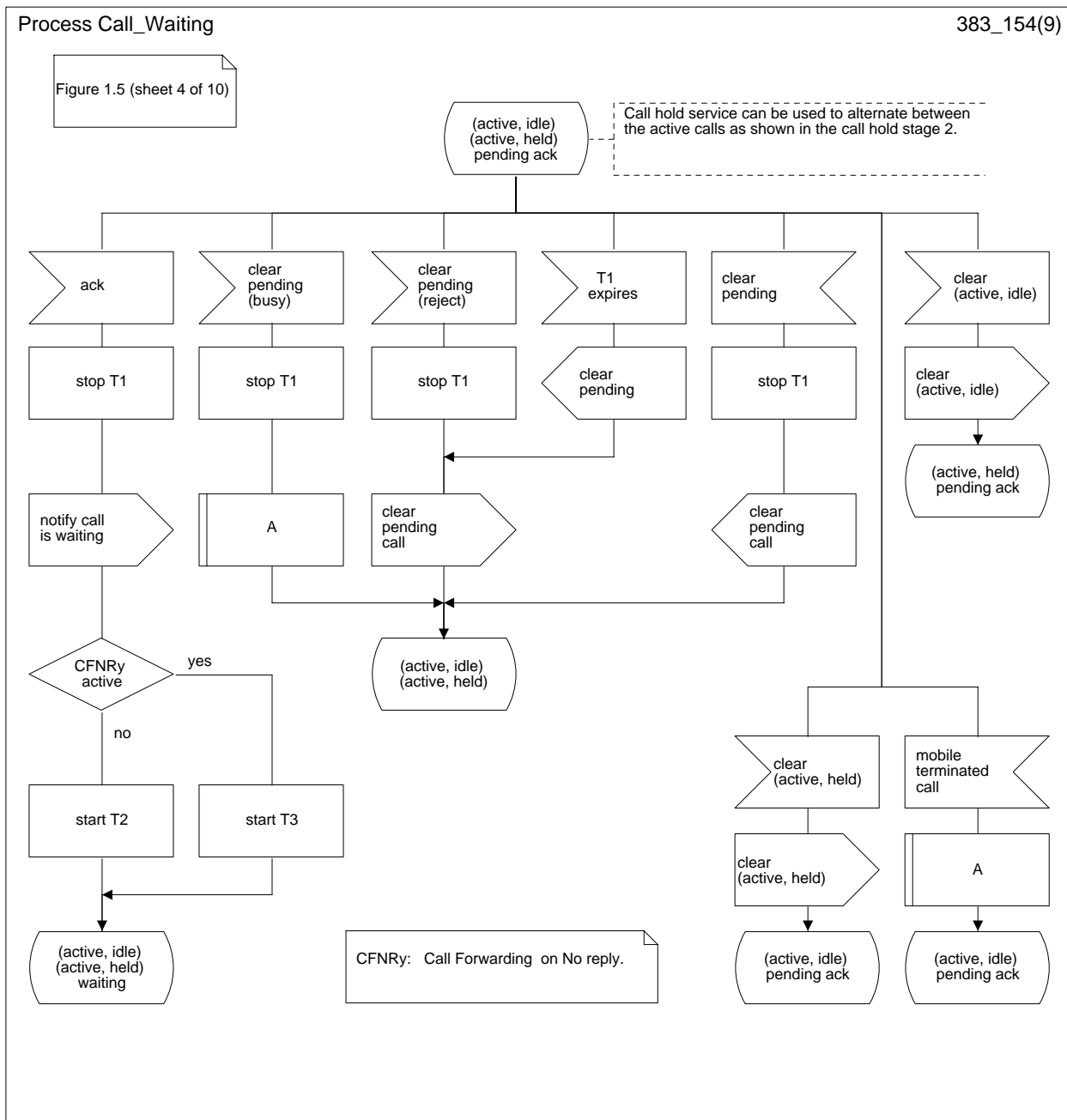

Figure 1.5 (sheet 4 of 10): Overall SDL diagram of call waiting

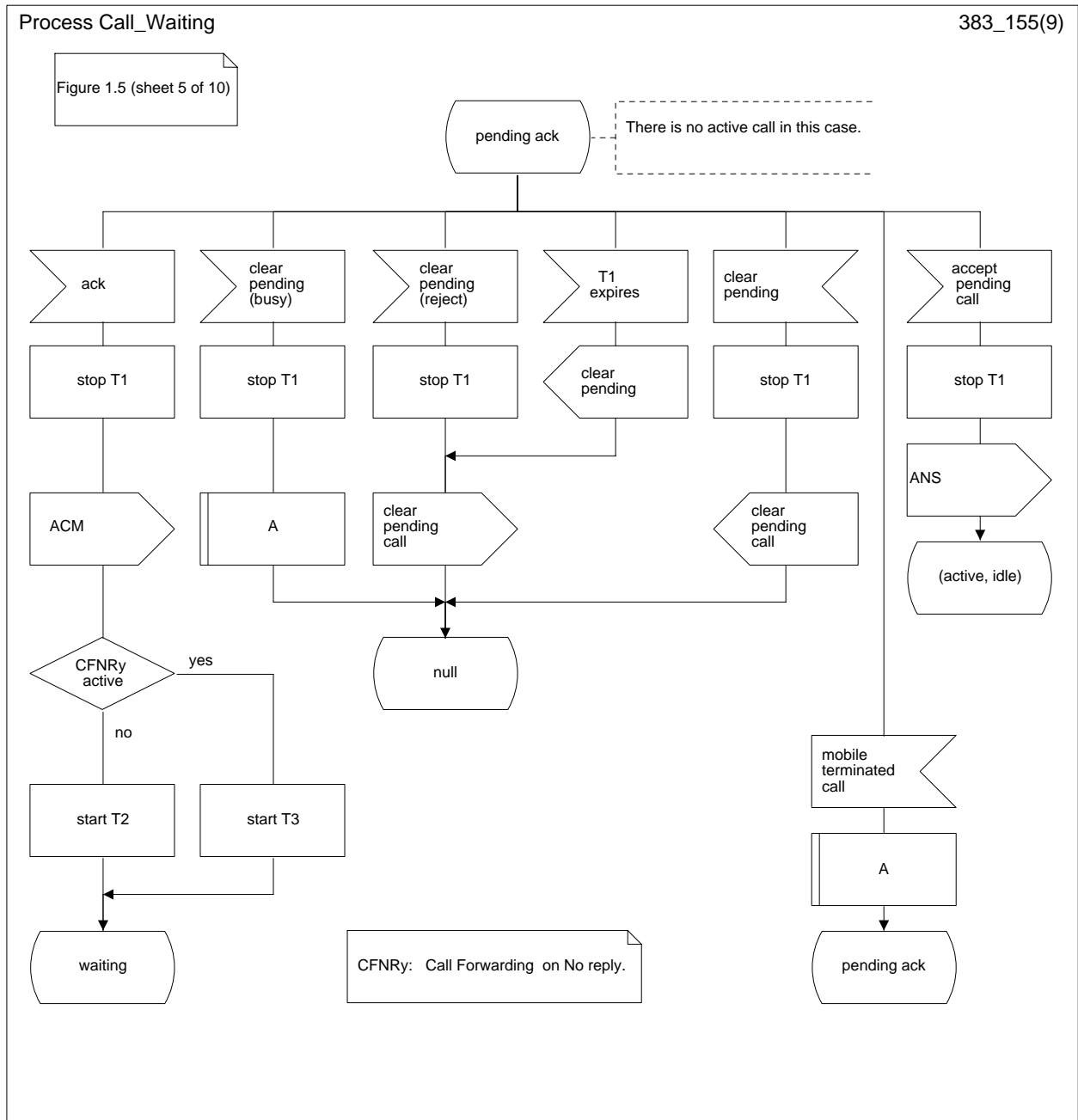

Figure 1.5 (sheet 5 of 10): Overall SDL diagram of call waiting

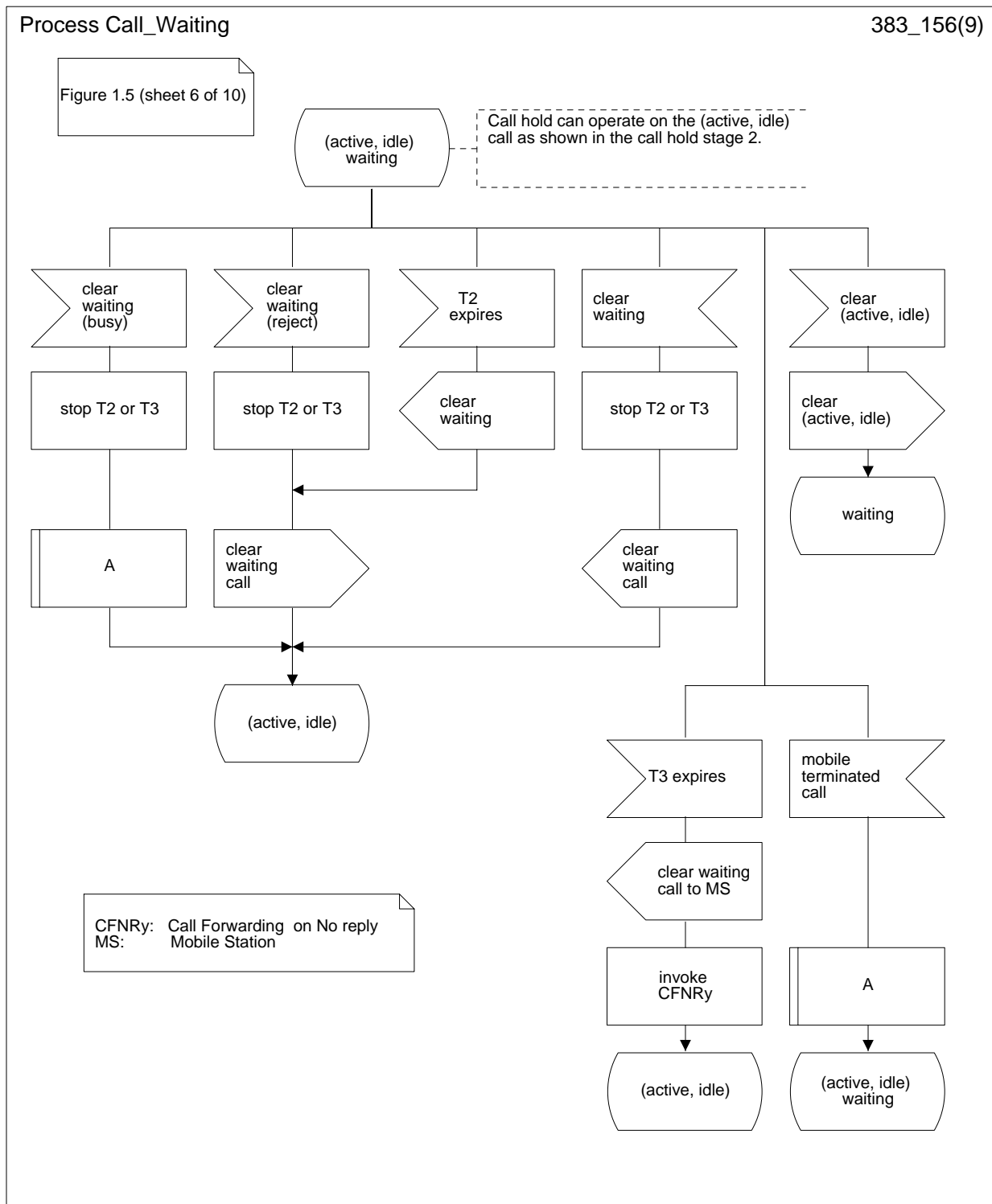

Figure 1.5 (sheet 6 of 10): Overall SDL diagram of call waiting



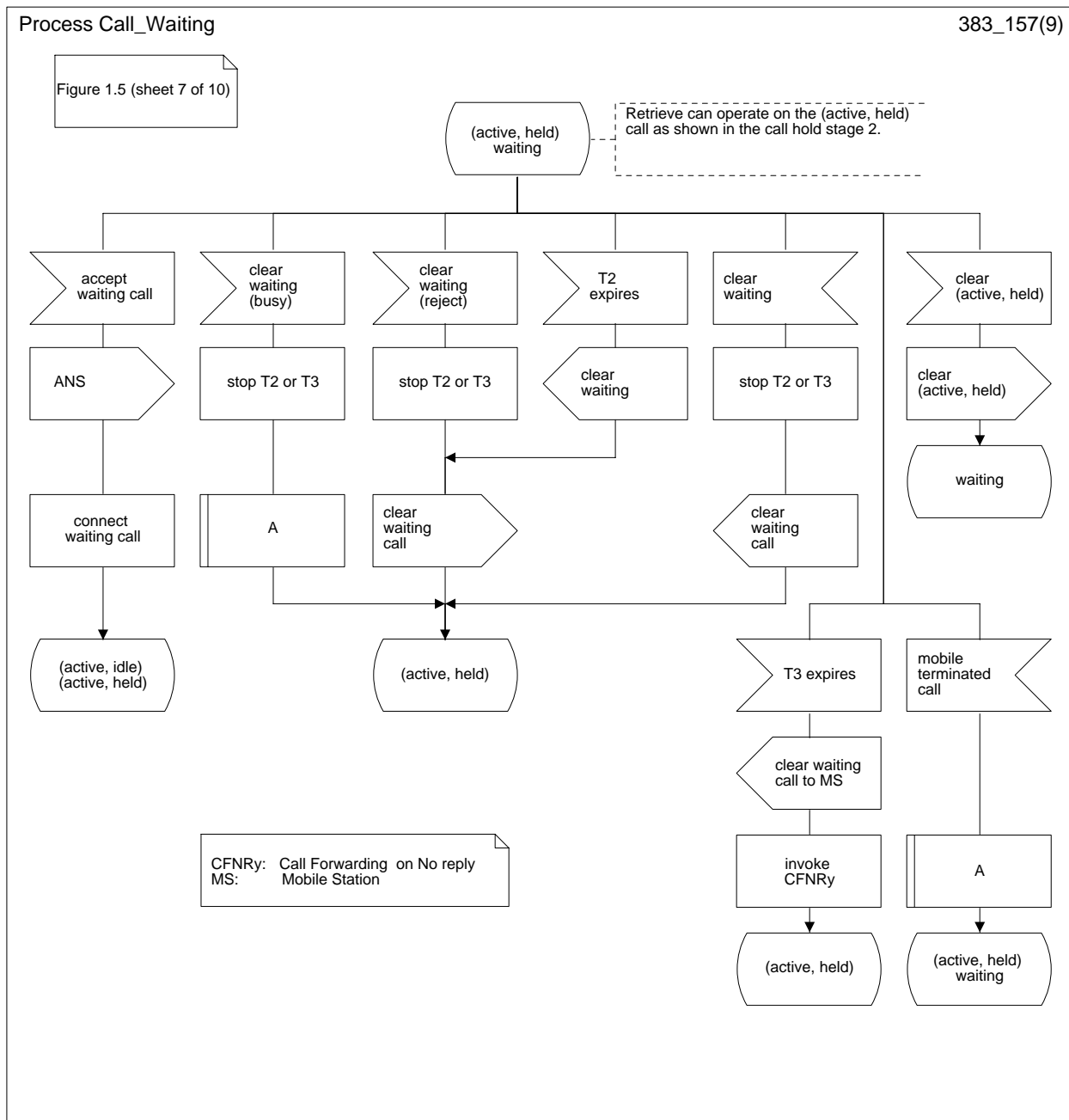

Figure 1.5 (sheet 7 of 10): Overall SDL diagram of call waiting

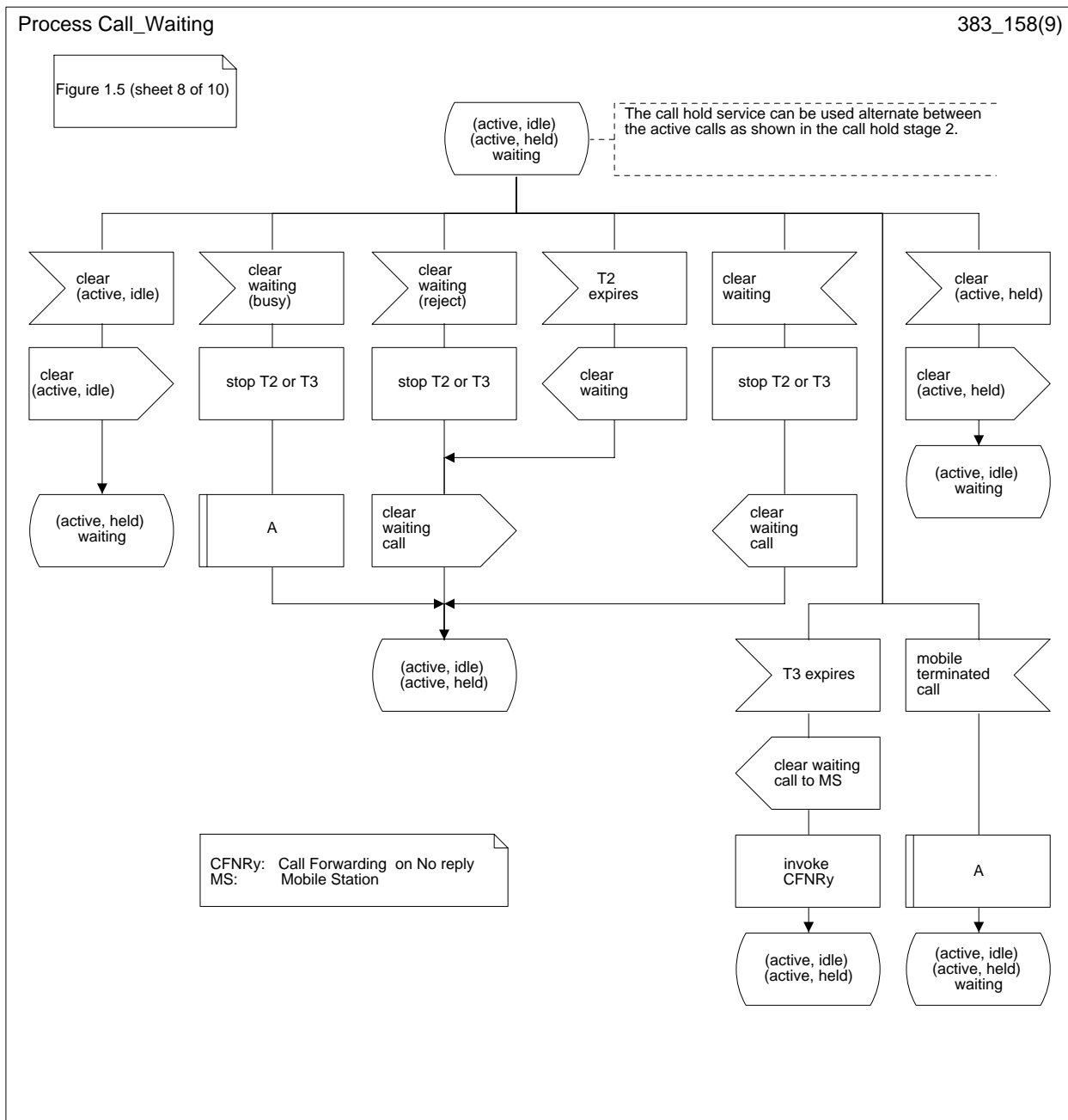

Figure 1.5 (sheet 8 of 10): Overall SDL diagram of call waiting

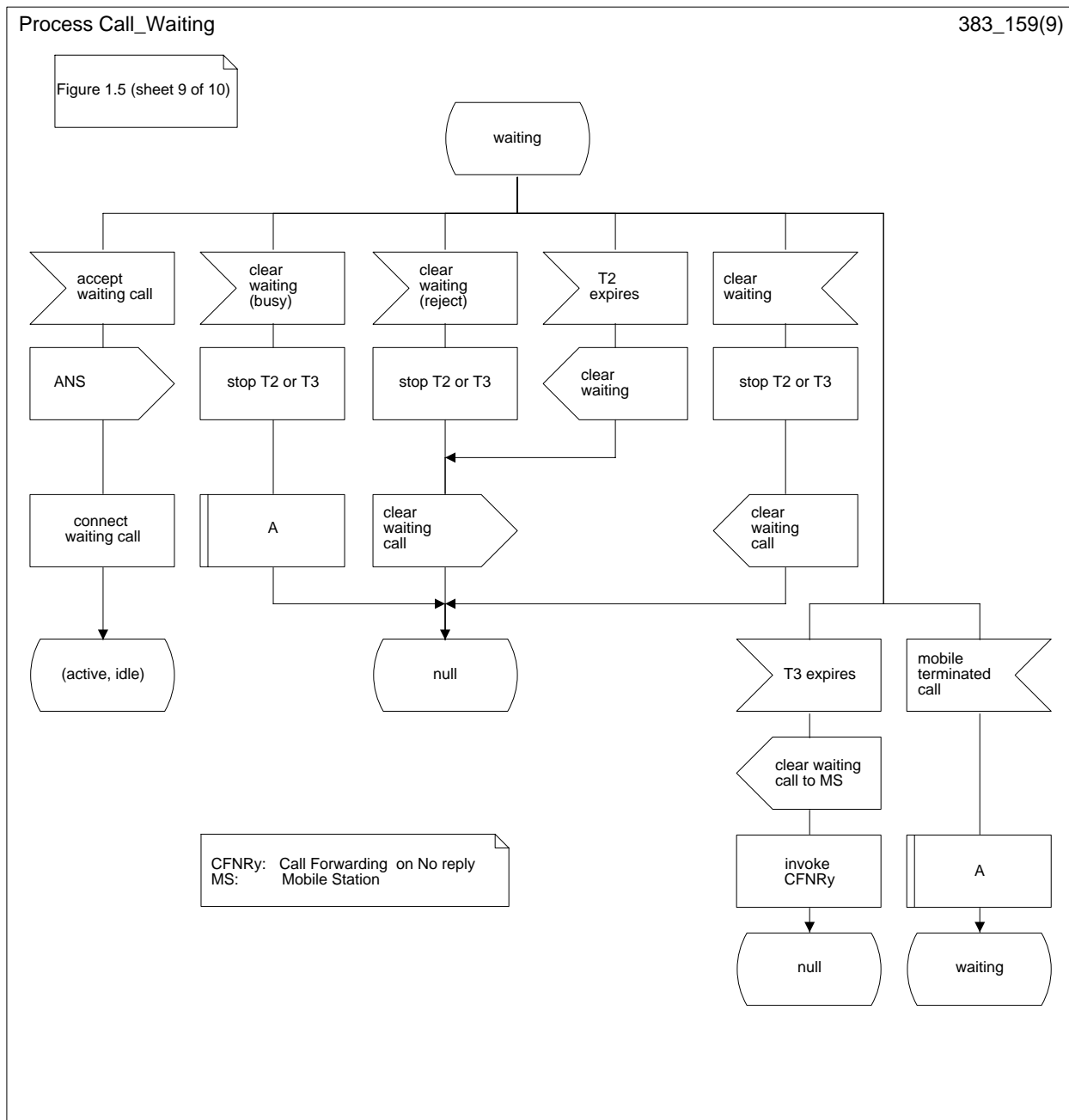

Figure 1.5 (sheet 9 of 10): Overall SDL diagram of call waiting

Macro CW\_Macro\_A

383\_15A(1)

Figure 1.5 (sheet 10 of 10)

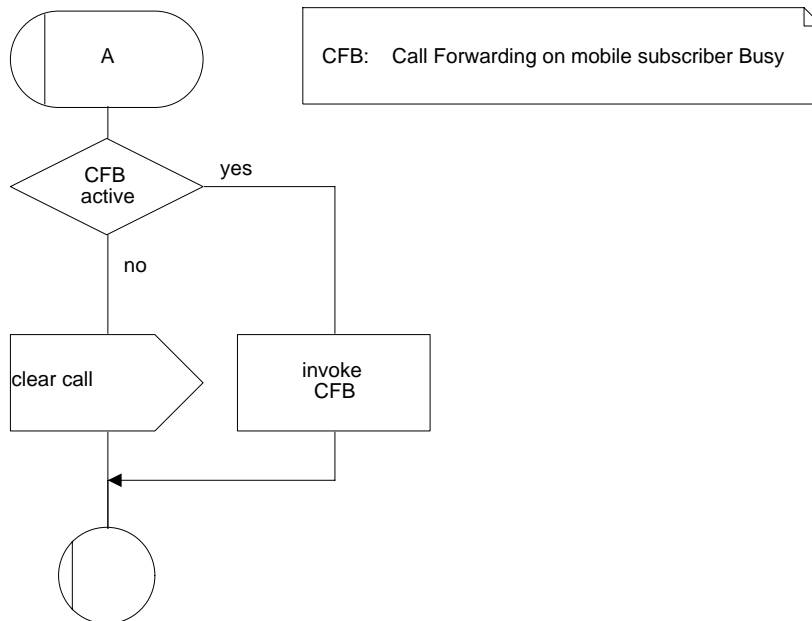
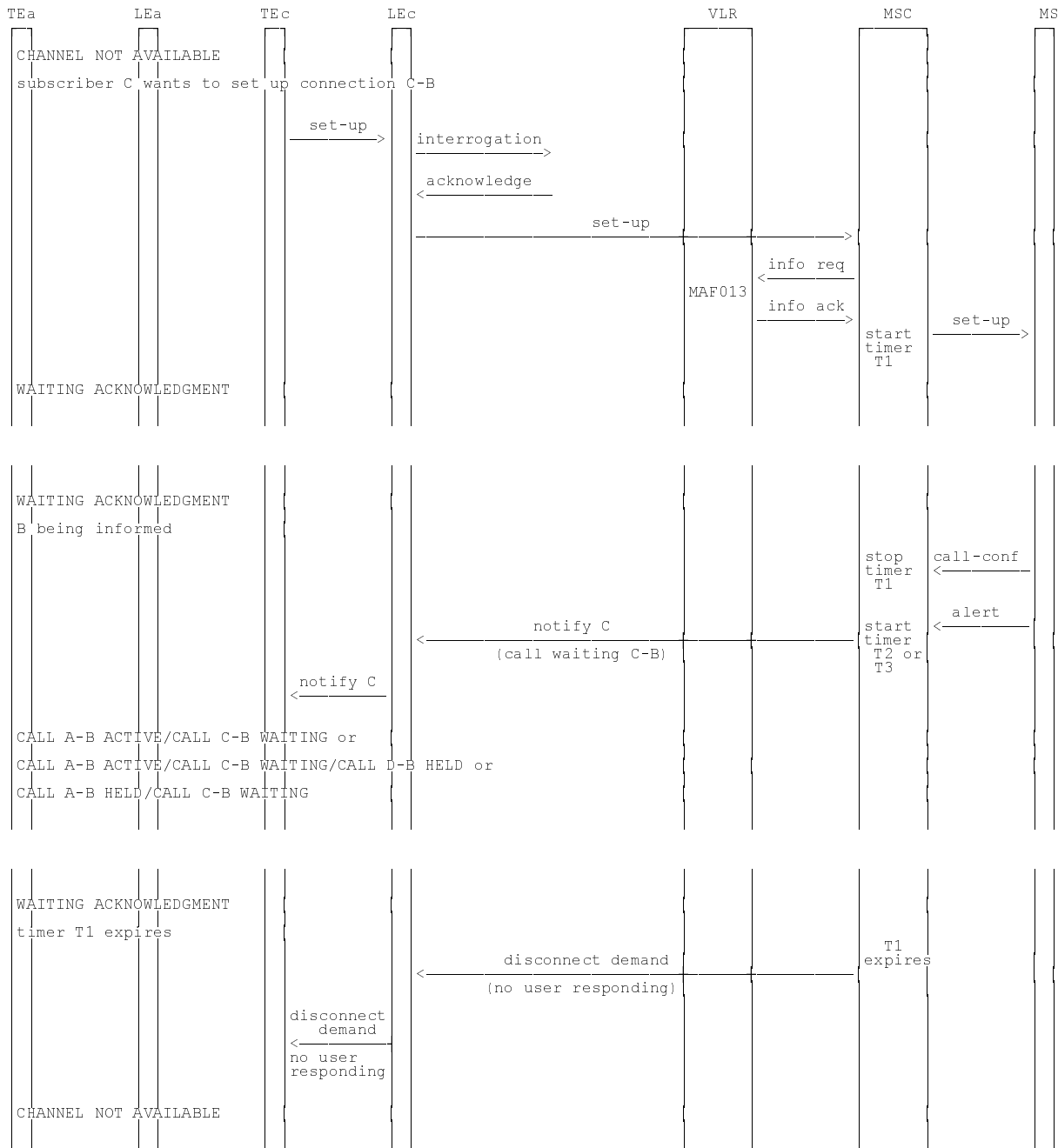
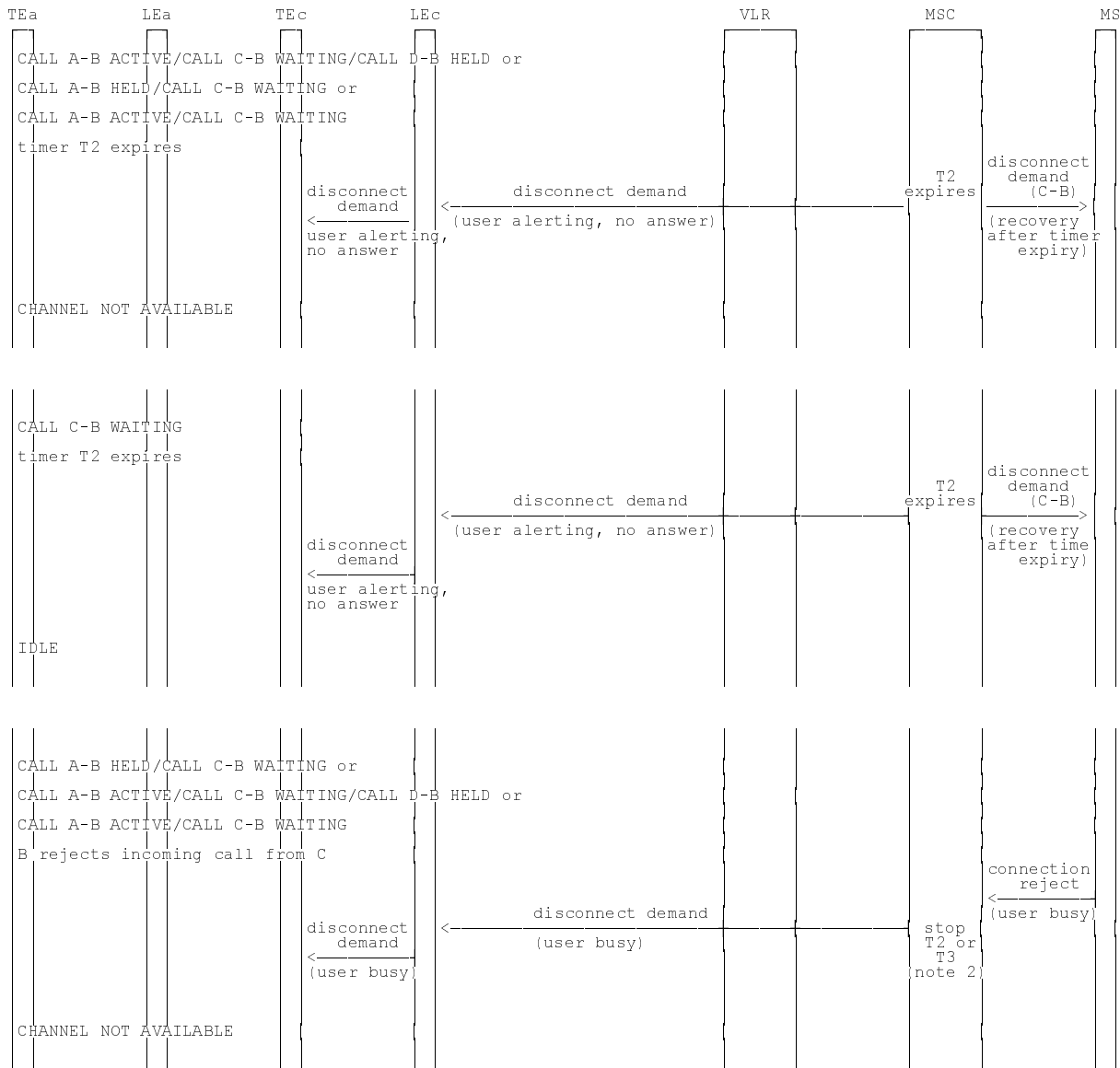

Figure 1.5 (sheet 10 of 10): Overall SDL diagram of call waiting



NOTE 1: info req: information request  
info ack: information acknowledge

Figure 1.6 (sheet 1 of 7): Information flow for call waiting



NOTE 2: The call shall be forwarded on mobile subscriber busy at this stage if activated.

Figure 1.6 (sheet 2 of 7): Information flow for call waiting

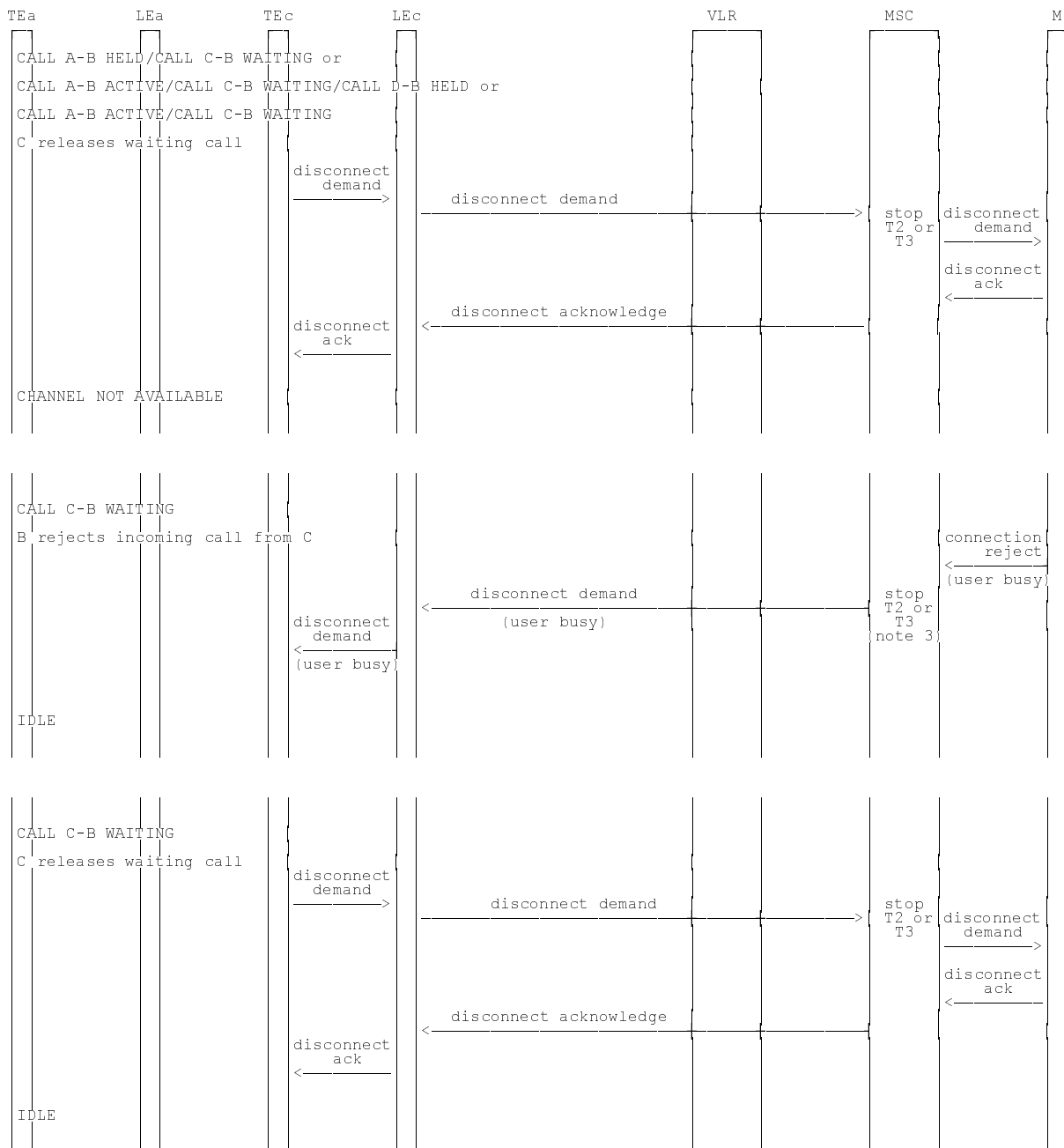

NOTE 3: The call shall be forwarded on mobile subscriber busy at this stage if activated.

Figure 1.6 (sheet 3 of 7): Information flow for call waiting

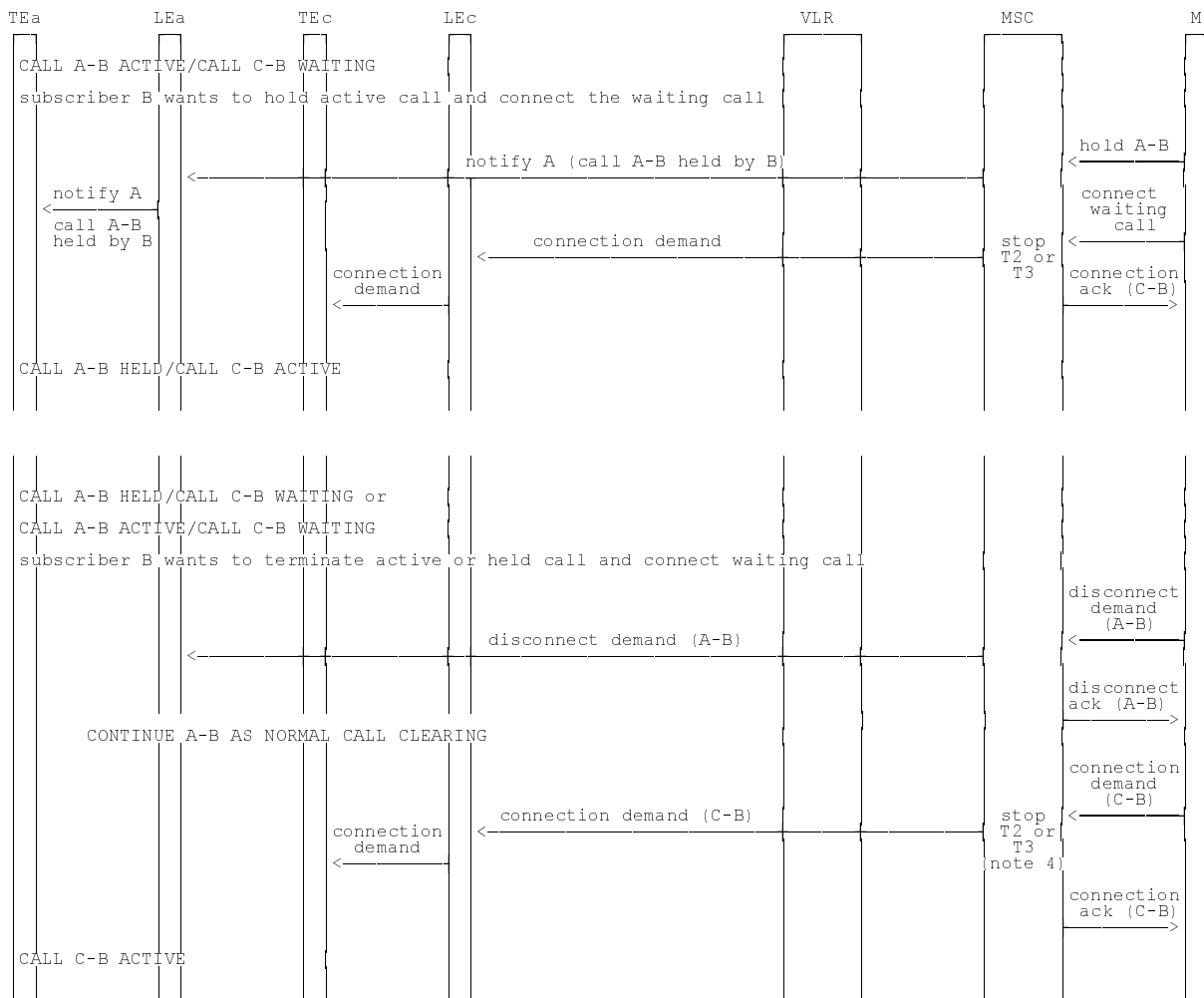

NOTE 4: If T2 or if applicable T3 expires before reception of connection demand in the MSC then call c-b shall be released with cause no reply and if it was T3 which expired the waiting call from C shall be forwarded on no reply.

Figure 1.6 (sheet 4 of 7): Information flow for call waiting



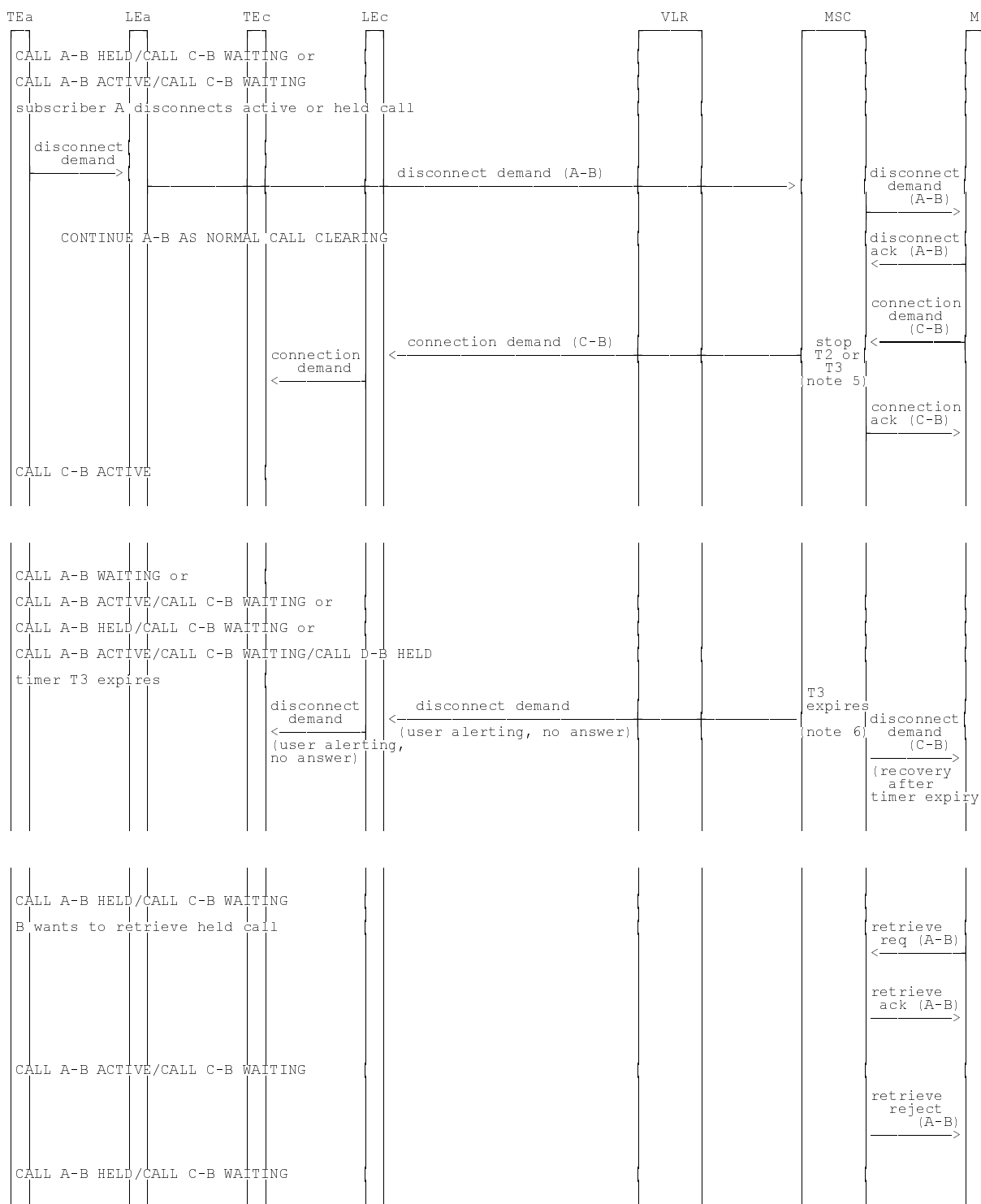

NOTE 5: The call shall be forwarded on mobile subscriber busy at this stage if activated.

NOTE 6: The call shall be forwarded on no reply.

Figure 1.6 (sheet 5 of 7): Information flow for call waiting

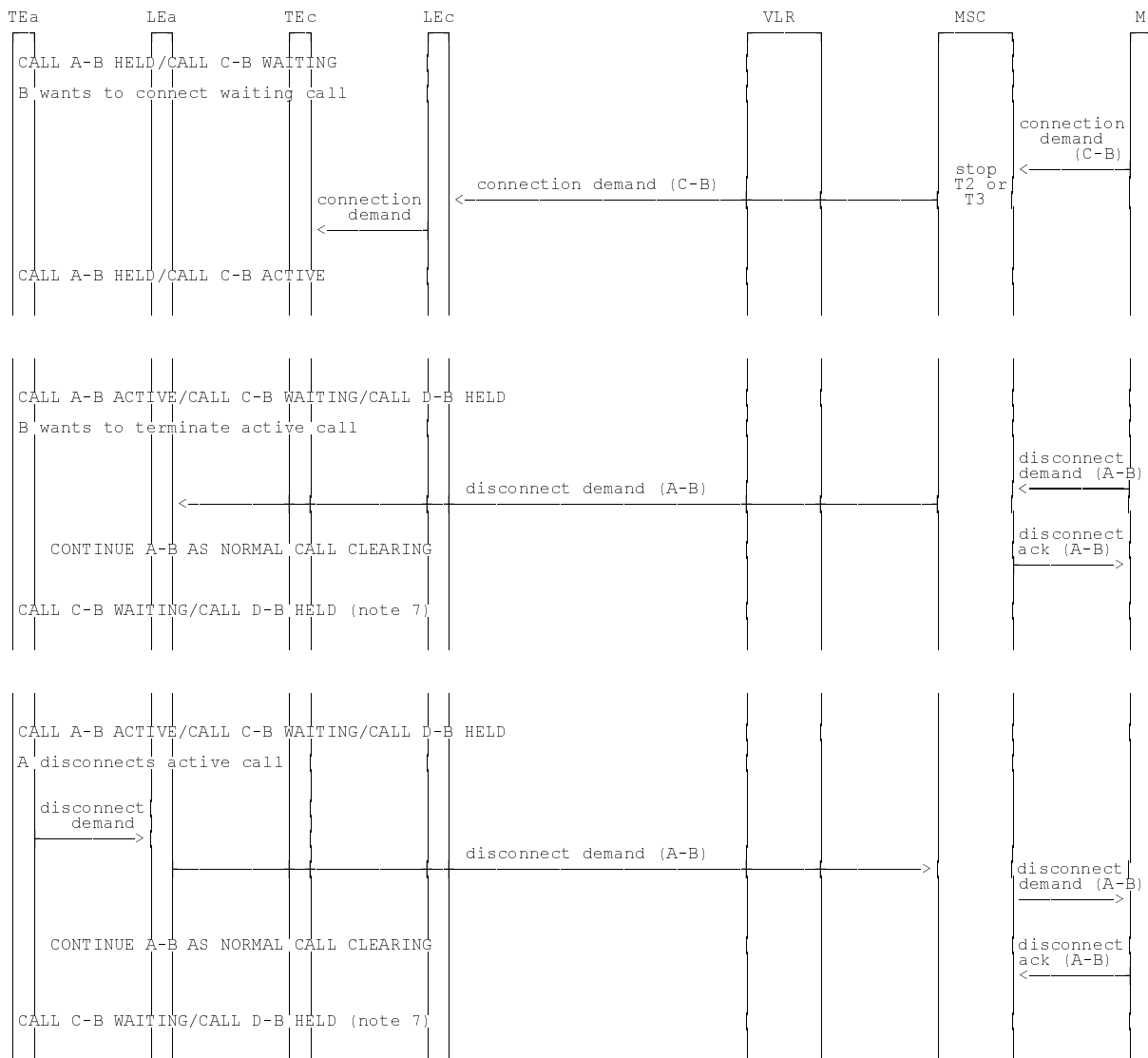

NOTE 7: This state can be treated as CALL C-B WAITING / CALL A-B HELD.

Figure 1.6 (sheet 6 of 7): Information flow for call waiting

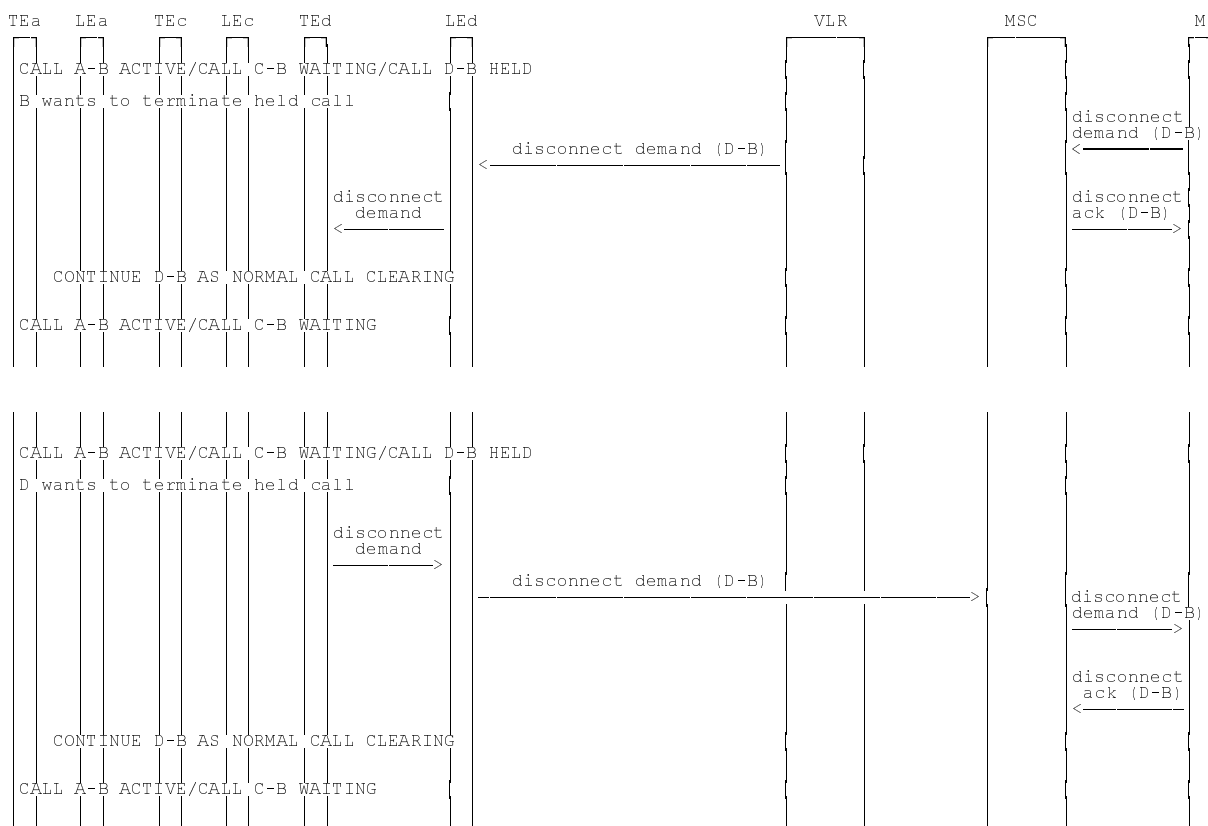

Figure 1.6 (sheet 7 of 7): Information flow for call waiting

### 1.3 Information stored in the HLR

Call waiting may have the following logical states (refer to GSM 03.11 for an explanation of the notation):

Provisioning State	Registration State	Activation State	HLR Induction State
(Not Provisioned,	Not Applicable,	Not Active,	Not Induced)
(Provisioned,	Not Applicable,	Not Active,	Not Induced)
(Provisioned,	Not Applicable,	Active and Operative,	Not Induced)

The activation state may be different for each applicable elementary basic service group.

The provisioning state shall be on a per subscriber basis, and hence the same for all basic service groups.

The HLR shall store the logical state of the call waiting service (which shall be one of the valid states listed above) on a per elementary basic service group.

### 1.4 State transition model

The following figure shows the successful cases of transition between the applicable logical states of call waiting. The state changes are either caused by actions of the service provider or the mobile user.

Note that error cases are not shown in the diagram as they normally do not cause a state change. Additionally, some successful requests may not cause a state change. Hence they are not shown in the diagram.

The diagram only shows operations on elementary basic service groups.

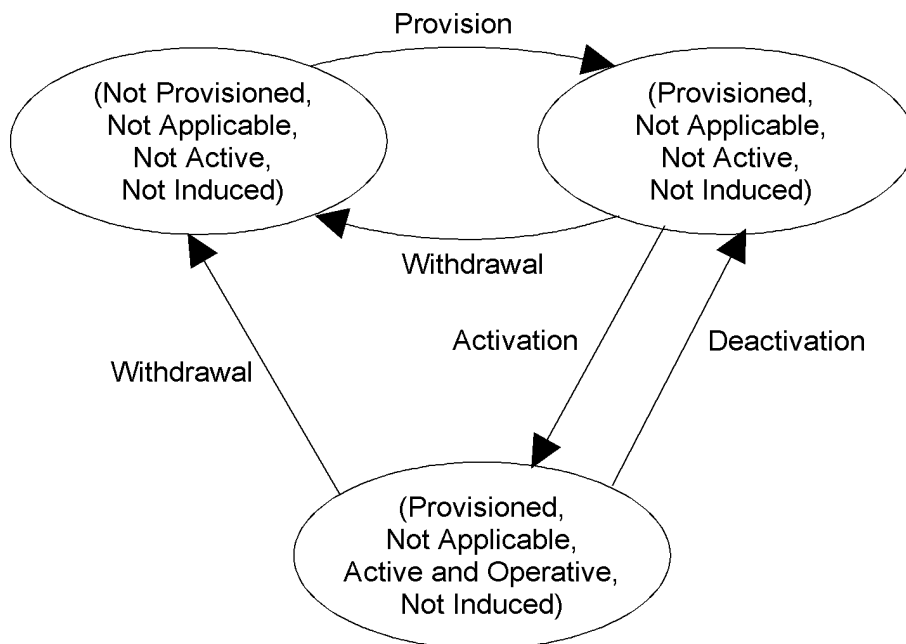

Figure 1.7: State transition model for call waiting

## 1.5 Transfer of information from HLR to VLR

If the provisioning state for call waiting is "Provisioned" then, when the subscriber registers on a VLR, the HLR shall send that VLR information about the logical state of call waiting.

If the logical state of call waiting is changed while a subscriber is registered on a VLR, then the HLR shall inform the VLR of the new logical state of call waiting.

## 1.6 Information stored in the VLR

For call waiting, the VLR shall store the service state information received from the HLR.

## 1.7 Handover

Handover will have no impact on the control procedures and the operation of the service.

---

# 2 Call hold (HOLD)

## 2.1 Functions and information flows

The following Mobile Additional Function has been identified for the call hold service:

### MAF024

Call hold related authorizations examination

The ability of a PLMN component to determine the authorizations relating to call hold. See figure 2.1.

Location: VLR

The overall SDL-diagram of call hold is shown in figure 2.2.

The information flows are shown in figure 2.3. In these flows it is assumed that the served user is a mobile user and that other users are fixed network users.

#### Description of overall SDL-diagram for call hold

In the SDL-diagrams the states are dimensioned in two dimensions. The first dimension is a normal basic call state e.g. null or active. The second dimension is an auxiliary state associated with hold.

Three auxiliary states are used:

- i) idle;
- ii) hold request (abbreviated hold req);
  - a request has been made for the hold function
- iii) call held (abbreviated held);
  - the call is held.

Several two-dimensional states in connection with hold are possible e.g. (active, idle), (active, held) or (null, idle).

When the served user wants to shuttle between an (active, idle) call and an (active, held) call, this is achieved by a hold request for the first call immediately followed by a retrieve request for the second. To avoid having two calls on hold at the same time, the reception of the retrieve request is supervised by a timer T ( $T = 5$  s).

The network may receive hold and retrieve requests not included in this overall SDL. These requests will be rejected by the network. For handling requests other than hold and retrieve requests look at descriptions of the other GSM supplementary services.

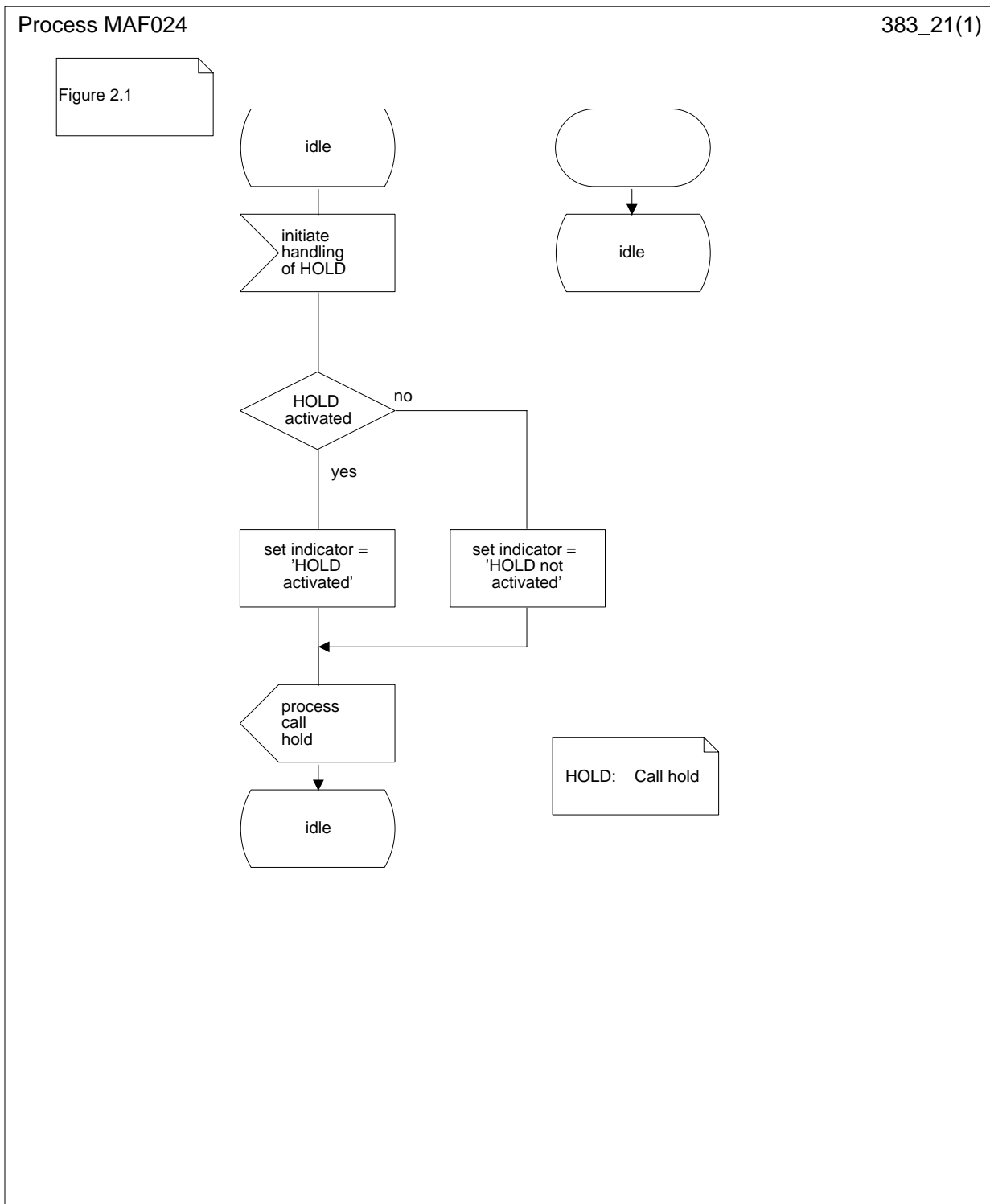

Figure 2.1: MAF024 Call hold related authorisations examination (VLR)

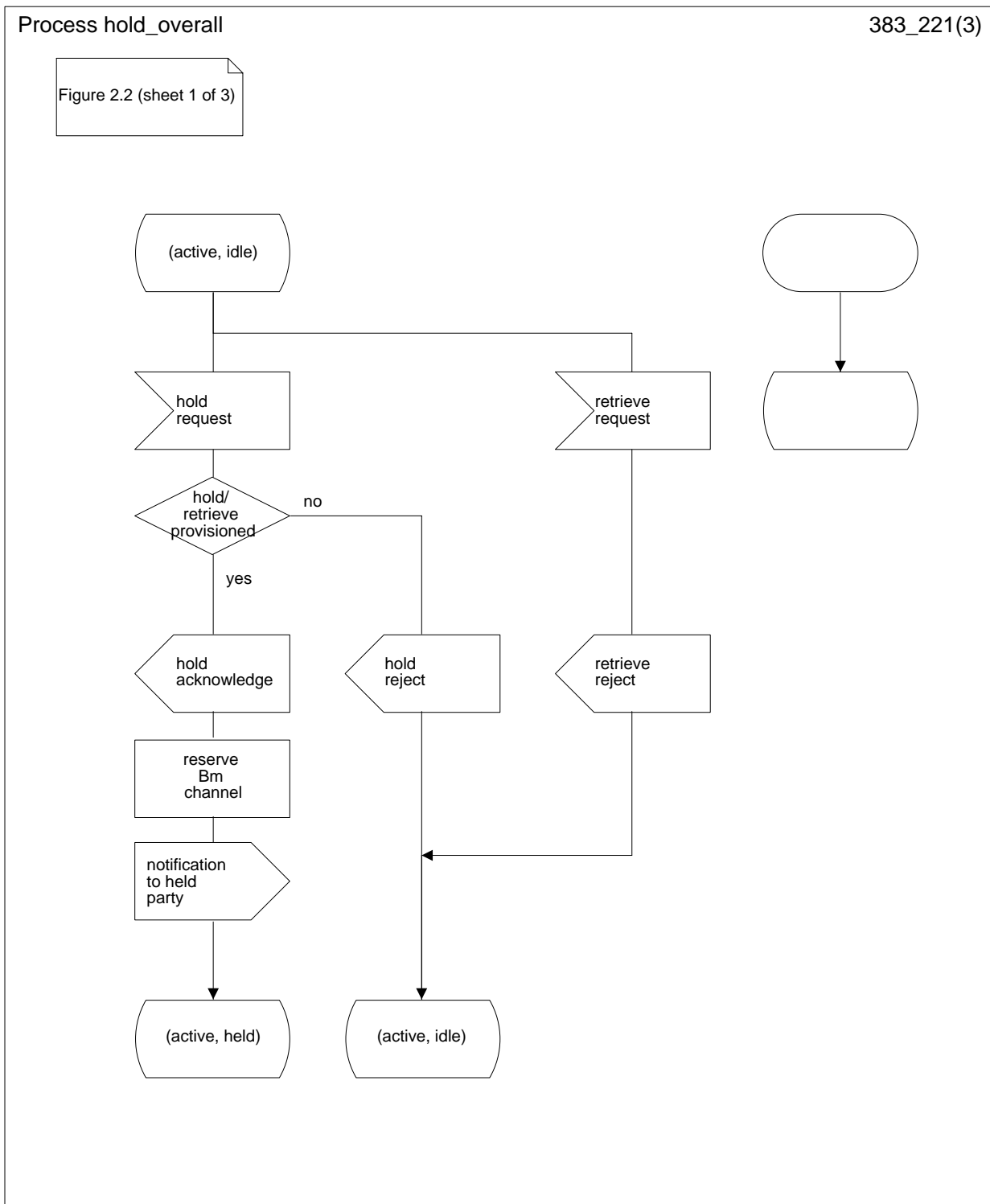

Figure 2.2 (sheet 1 of 3): Overall SDL diagram of call hold

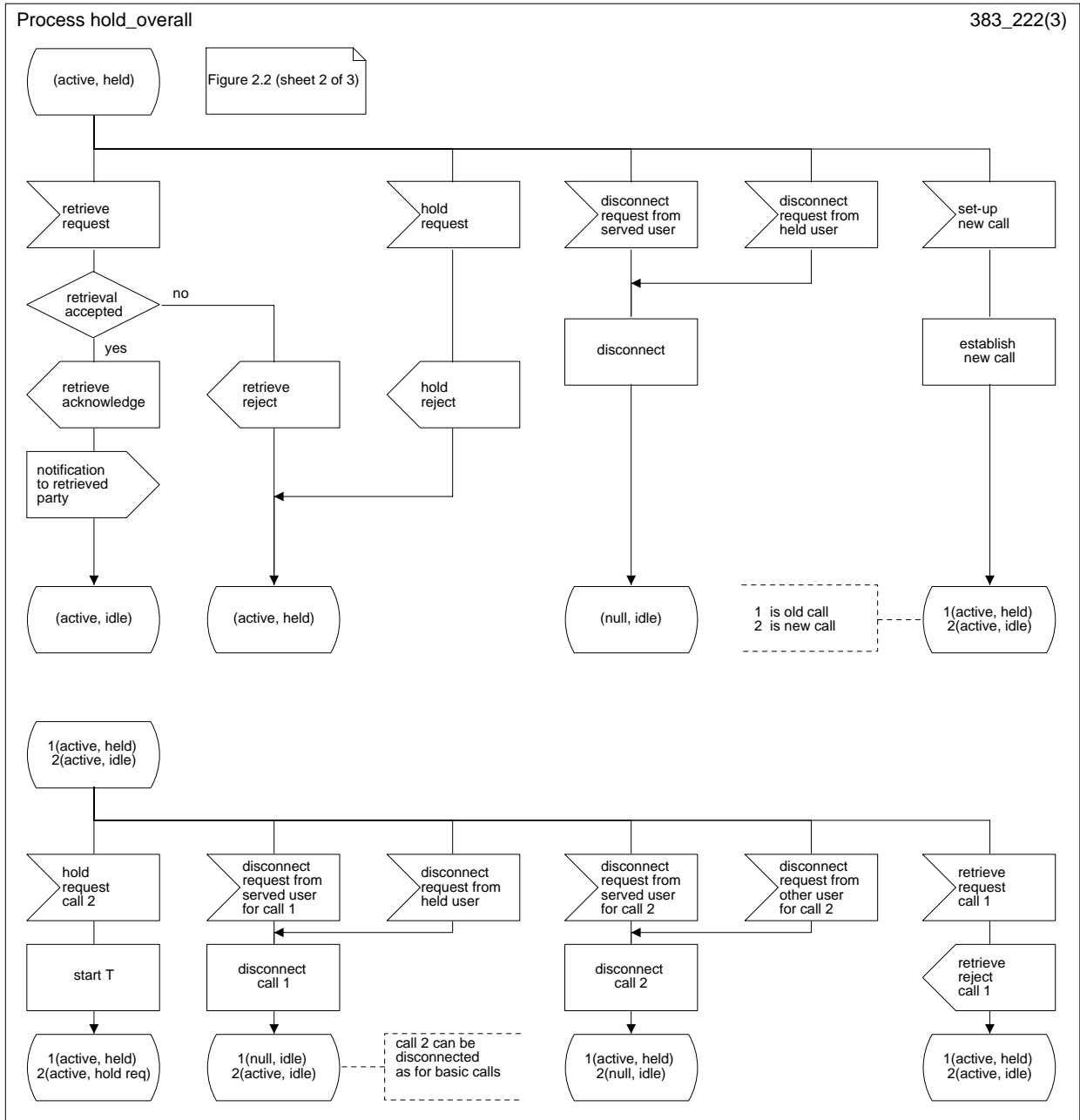

Figure 2.2 (sheet 2 of 3): Overall SDL diagram of call hold



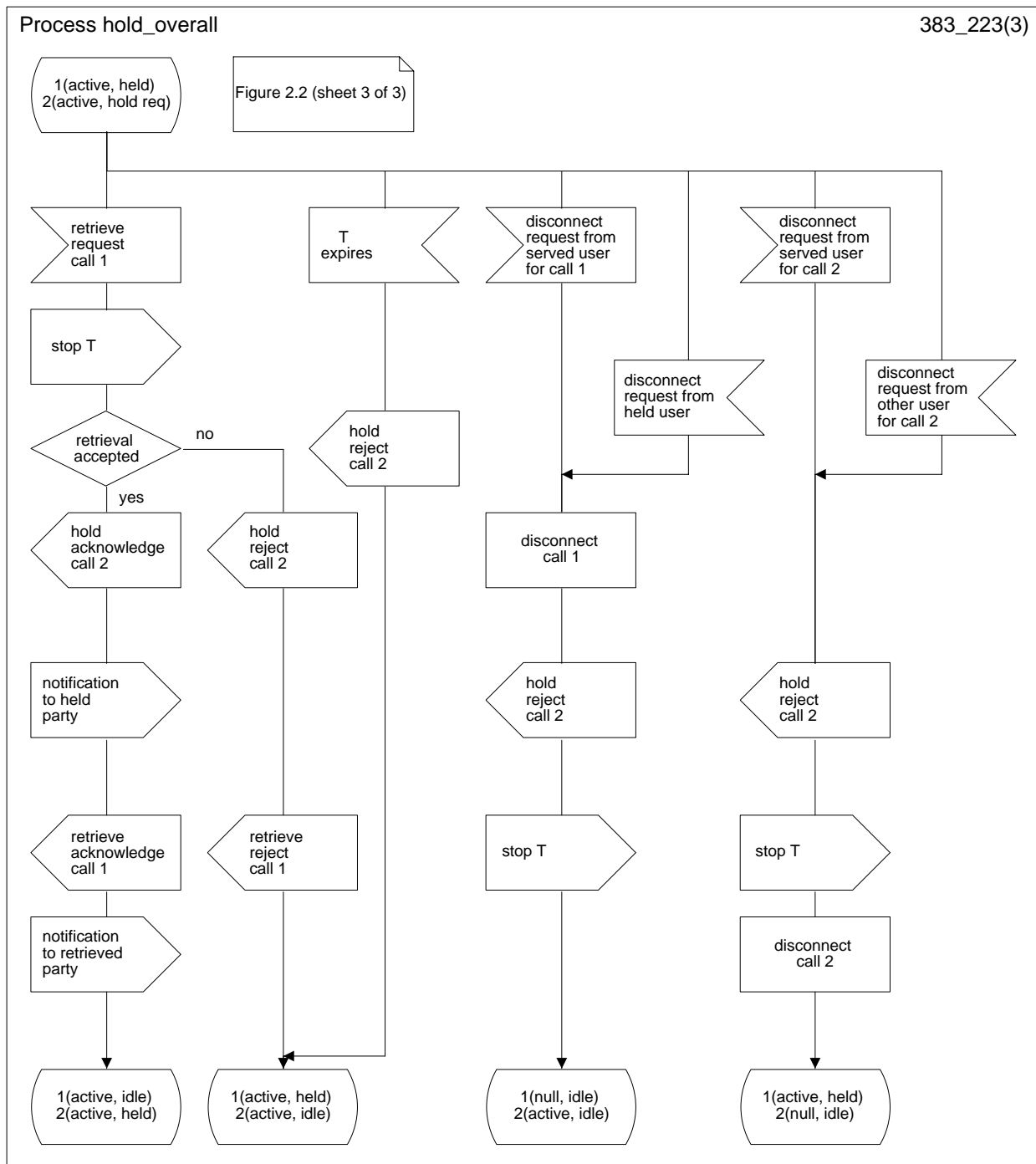
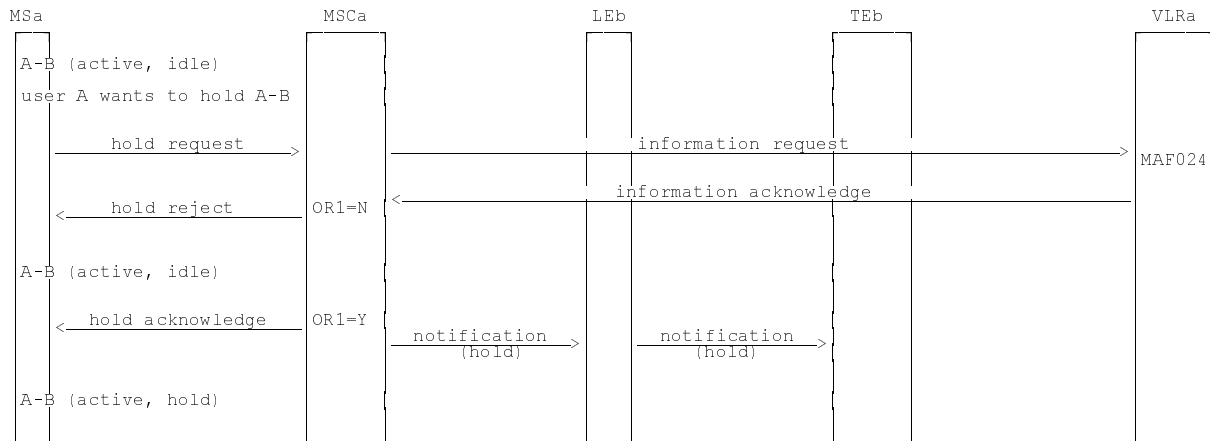

Figure 2.2 (sheet 3 of 3): Overall SDL diagram of call hold



NOTE: OR1: call hold (Y: yes N: no)

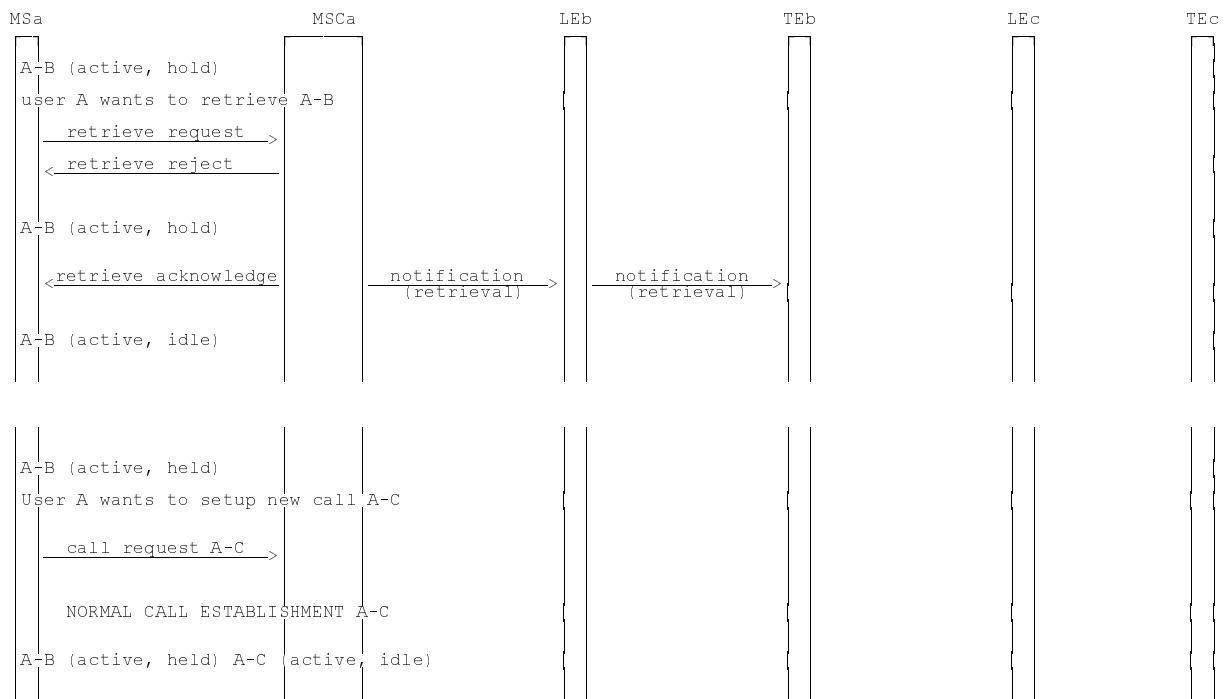

Figure 2.3 (sheet 1 of 3): Information flow for call hold

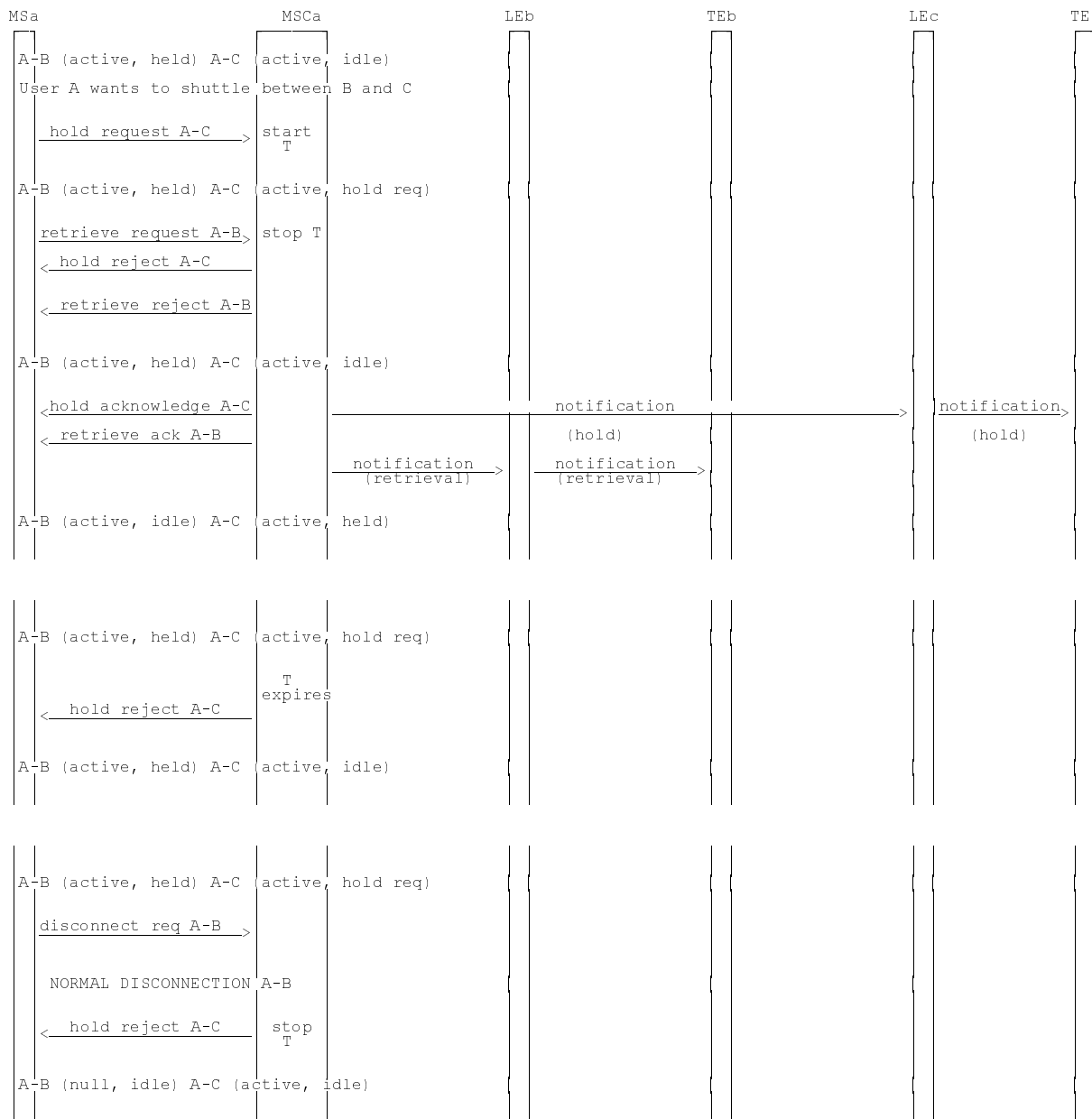

Figure 2.3 (sheet 2 of 3): Information flow for call hold

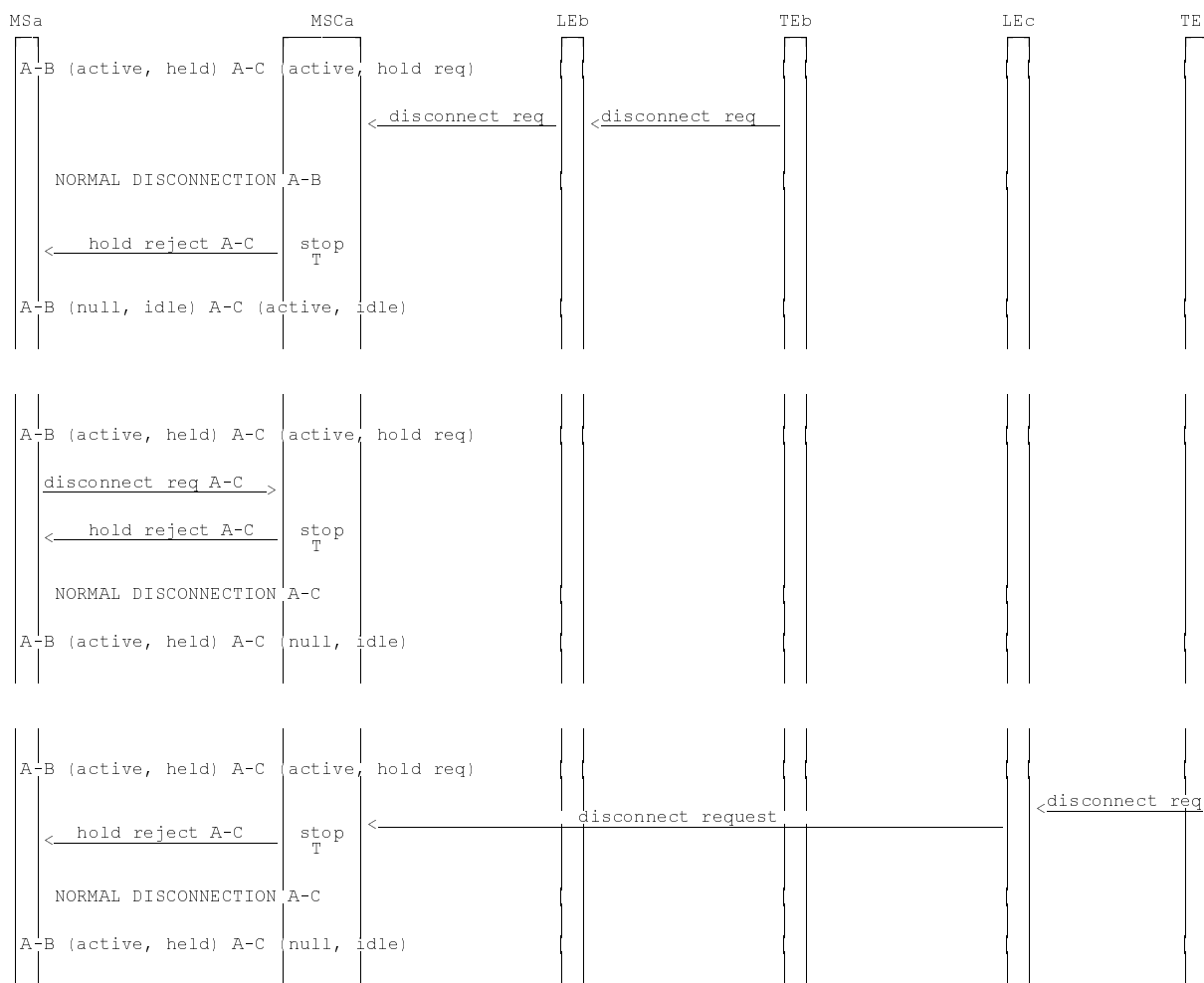

Figure 2.3 (sheet 3 of 3): Information flow for call hold

## 2.2 Information stored in the HLR

Call hold may have the following logical states (refer to GSM 03.11 for an explanation of the notation):

Provisioning State	Registration State	Activation State	HLR Induction State
(Not Provisioned,	Not Applicable,	Not Active,	Not Induced)
(Provisioned,	Not Applicable,	Active and Operative,	Not Induced)

The HLR shall store the logical state of the call hold service (which shall be one of the valid states listed above) on a per subscriber basis.

## 2.3 State transition model

The following figure shows the successful cases of transition between the applicable logical states of call hold. The state changes are caused by actions of the service provider.

Note that error cases are not shown in the diagram as they normally do not cause a state change. Additionally, some successful requests may not cause a state change. Hence they are not shown in the diagram.

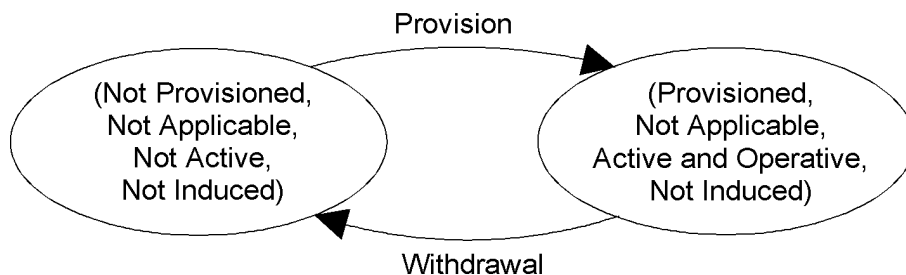

Figure 2.4: State transition model for call hold

## 2.4 Transfer of information from HLR to VLR

If the provisioning state for call hold is "Provisioned" then, when the subscriber registers on a VLR, the HLR shall send that VLR information about the logical state of call hold.

If the logical state of call hold is changed while a subscriber is registered on a VLR, then the HLR shall inform the VLR of the new logical state of call hold.

## 2.5 Information stored in the VLR

For call hold, the VLR shall store the service state information received from the HLR.

## 2.6 Handover

Handover will have no impact on the control procedures and the operation of the service.

## Annex A (informative): Change Request History

<b>Status of Technical Specification GSM 03.83</b>		
<b>Date</b>	<b>Version</b>	<b>Remarks</b>
		No phase 1 version
	version 4.0.0	TS approved by GSM#28
June 1991	version 4.1.0	CR 03.83-01 rev 1 (category C) approved by GSM#31 CR 03.83-02 rev 1 (category C)
January 1992	version 4.2.0	CR 03.83-03 rev 1 (category C) approved by SMG#01 CR 03.83-05 rev 1 (category C) CR 03.83-06 (category D)
January 1993	version 4.3.0	CR 03.83-09 rev 2 (category C) approved by SMG#05
		TS frozen for phase 2 by SMG#06
October 1993	version 4.3.1	Reference to CCBS removed Changed to draft prETS 300 544
July 1994	version 4.3.2	CR 03.83-12 (category D) approved by SMG#11
October 1994	version 4.4.0	CR 03.83-11 rev 5 (category F) approved by SMG#12 CR 03.83-13 (category D) CR 03.83-14 rev 1 (category D) Changed to final draft prETS 300 544
January 1995	version 4.4.1	TS changed to ETS 300 544 First edition July 1996 file converted from word5 to word6
December 1996	version 5.0.0	ETS changed to GTS for release '96
January 1999	version 6.0.0	Release 1997 version
<b>Text and flows: WinWord6</b> <b>Stylesheet: etsiw_70.dot</b>		

---

# History

<b>Document history</b>		
V6.0.0	April 1999	Publication