

TS 100 932 V6.0.0 (1999-04)

Technical Specification

**Digital cellular telecommunications system (Phase 2+);
enhanced Multi-Level Precedence and
Pre-emption service (eMLPP);
Stage 2
(GSM 03.67 version 6.0.0 Release 1997)**

GSM®

GLOBAL SYSTEM FOR
MOBILE COMMUNICATIONS



Reference

DTS/SMG-030367Q6 (8mo03003.PDF)

Keywords

Digital cellular telecommunications system,
Global System for Mobile communications (GSM)

ETSI

Postal address

F-06921 Sophia Antipolis Cedex - FRANCE

Office address

650 Route des Lucioles - Sophia Antipolis
Valbonne - FRANCE
Tel.: +33 4 92 94 42 00 Fax: +33 4 93 65 47 16
Siret N° 348 623 562 00017 - NAF 742 C
Association à but non lucratif enregistrée à la
Sous-Préfecture de Grasse (06) N° 7803/88

Internet

secretariat@etsi.fr
Individual copies of this ETSI deliverable
can be downloaded from
<http://www.etsi.org>
If you find errors in the present document, send your
comment to: editor@etsi.fr

Copyright Notification

No part may be reproduced except as authorized by written permission.
The copyright and the foregoing restriction extend to reproduction in all media.

© European Telecommunications Standards Institute 1999.
All rights reserved.

Contents

Intellectual Property Rights.....	5
Foreword	5
1 Scope.....	6
2 References.....	6
3 Definitions and abbreviations	7
3.1 Definitions	7
3.2 Abbreviations.....	7
4 Main concepts	7
5 General architecture	10
6 Compatibility issues.....	10
7 Transmission	10
8 Information storage	11
8.1 Stored in the HLR.....	11
8.1.1 State transition model.....	11
8.1.2 Transfer of information from HLR to VLR.....	11
8.2 Stored in the VLR.....	12
8.3 Stored in the MSC.....	12
8.4 Stored in the SIM.....	12
8.5 Stored in the GCR.....	12
9 Identities.....	12
10 Operation and maintenance aspects	13
11 Functions and information flow.....	13
11.1 Subscription	13
11.2 Change of subscription	13
11.3 Call set-up.....	13
11.3.1 Mobile originated calls.....	13
11.3.1.1 Indication of priority.....	13
11.3.1.2 Subscription checking.....	13
11.3.1.3 Authentication and ciphering.....	14
11.3.1.4 Indication of priority to the BSC	14
11.3.1.5 Choice of radio channel.....	14
11.3.1.6 Indication of priority to the Mobile Station	14
11.3.2 Mobile terminated calls	14
11.3.2.1 Indication of priority.....	14
11.3.2.2 Indication of priority to the BSC	15
11.3.2.3 Authentication and ciphering.....	15
11.3.2.4 Termination with called subscriber in idle mode or group receive mode	15
11.3.2.5 Termination with called subscriber in dedicated mode.....	15
11.3.3 Voice group call or voice broadcast call	15
11.3.3.1 Indication of priority to the related MSC.....	15
11.3.3.2 Authentication and ciphering.....	16
11.3.3.3 Indication of priority to the called Mobile Stations	16
11.4 Pre-emption.....	16
11.4.1 Choice of communication to pre-empt	16
11.4.2 Release procedures.....	16
11.5 Pre-emption at handover	16
11.6 Overview of call related signalling	16
11.7 Overview of call independent signalling.....	24
11.7.1 Registration	24

11.7.2 Interrogation..... 24

Annex A (informative): Change Request History25

History26

Intellectual Property Rights

IPRs essential or potentially essential to the present document may have been declared to ETSI. The information pertaining to these essential IPRs, if any, is publicly available for **ETSI members and non-members**, and can be found in SR 000 314: "*Intellectual Property Rights (IPRs); Essential, or potentially Essential, IPRs notified to ETSI in respect of ETSI standards*", which is available **free of charge** from the ETSI Secretariat. Latest updates are available on the ETSI Web server (<http://www.etsi.org/ipr>).

Pursuant to the ETSI IPR Policy, no investigation, including IPR searches, has been carried out by ETSI. No guarantee can be given as to the existence of other IPRs not referenced in SR 000 314 (or the updates on the ETSI Web server) which are, or may be, or may become, essential to the present document.

Foreword

This Technical Specification (TS) has been produced by the Special Mobile Group (SMG).

The present document specifies the stage two description of the enhanced Multi-Level Precedence and Pre-emption Service (eMLPP) within the digital cellular telecommunications system.

The contents of the present document is subject to continuing work within SMG and may change following formal SMG approval. Should SMG modify the contents of the present document, it will be re-released with an identifying change of release date and an increase in version number as follows:

Version 6.x.y

where:

- 6 indicates Release 1997 of GSM Phase 2+
- x the second digit is incremented for all changes of substance, i.e. technical enhancements, corrections, updates, etc.
- y the third digit is incremented when editorial only changes have been incorporated in the specification.

1 Scope

The present document specifies the stage 2 description of the enhanced Multi-Level Precedence and Pre-emption Service (eMLPP) which provides different call priorities in combination with fast call set-up and pre-emption for different applications according to GSM 02.67.

2 References

The following documents contain provisions which, through reference in this text, constitute provisions of the present document.

- References are either specific (identified by date of publication, edition number, version number, etc.) or non-specific.
- For a specific reference, subsequent revisions do not apply.
- For a non-specific reference, the latest version applies.
- A non-specific reference to an ETS shall also be taken to refer to later versions published as an EN with the same number.
- For this Release 1997 document, references to GSM documents are for Release 1997 versions (version 6.x.y).

- [1] GSM 01.04: "Digital cellular telecommunications system (Phase 2+); Abbreviations and acronyms".
- [2] GSM 02.40: "Digital cellular telecommunications system (Phase 2+); Procedures for call progress indications".
- [3] GSM 02.67: "Digital cellular telecommunications system (Phase 2+); enhanced Multi-Level Precedence and Pre-emption service (eMLPP) - Stage 1".
- [4] GSM 03.11: "Digital cellular telecommunications system (Phase 2+); Technical realization of supplementary services".
- [5] GSM 03.68: "Digital cellular telecommunications system (Phase 2+);Voice Group Call Service (VGCS) - Stage 2".
- [6] GSM 03.69: "Digital cellular telecommunications system (Phase 2+);Voice Broadcast Service (VBS) - Stage 2".
- [7] GSM 08.08: "Digital cellular telecommunications system (Phase 2+); Mobile Switching Centre - Base Station System (MSC - BSS) interface Layer 3 specification".
- [8] ITU-T recommendation Q.85: "Stage 2 description for community of interest supplementary services (clause 3: Multi-Level Precedence and Pre-emption MLPP)".
- [9] ITU-T recommendation Q.735: "Stage 3 description for community of interest supplementary services using SS No. 7 (clause 3: Multi-Level Precedence and Pre-emption (MLPP))".

3 Definitions and abbreviations

3.1 Definitions

Definitions used in the present document are also defined in GSM 02.67.

resource pre-emption: The termination of a call of a low priority user such that resources can be made available for a precedence call of higher priority. Resource pre-emption could be initiation resource pre-emption or handover resource pre-emption.

called-party pre-emption: Termination of a call to a particular user when a higher priority call is directed towards that specific user. Called party pre-emption is decided by the Mobile Station. In case of point-to-point calls, this shall be performed by Call Waiting with automatic acceptance of the waiting call by the Mobile Station.

compatible Mobile Station: Mobile stations which support eMLPP and therefore have precedence and pre-emption capabilities.

non-compatible Mobile Station: Mobile stations which do not support eMLPP.

3.2 Abbreviations

Abbreviations used in the present document are listed in GSM 01.04.

For the purpose of the present document, the following abbreviations apply:

eMLPP	enhanced Multi-Level Precedence and Pre-emption
VBS	Voice Broadcast Service
VGCS	Voice Group Call Service

4 Main concepts

The enhanced Multi-Level Precedence and Pre-emption service (eMLPP) provides different levels of precedence for call set-up and for call continuity in case of handover.

There are seven priority levels which are defined in GSM 02.67. The two highest levels are reserved for network internal use. These two levels can only be used locally, i.e. in the domain of one MSC. The other five priority levels are offered for subscription and can be applied globally, e.g. on inter switch trunks, if supported by all related network elements, and also for interworking with ISDN networks providing the MLPP service.

The seven priority levels are defined as follows:

- A (highest, for network internal use)
- B (for network internal use)
- 0 (for subscription)
- 1 (for subscription)
- 2 (for subscription)
- 3 (for subscription)
- 4 (lowest, for subscription).

Levels A and B shall be mapped to level 0 for priority treatment outside of the MSC area in which they are applied.

As a network specific configuration, the ability to pre-empt other calls of lower priority and the application of fast call set-up procedures can be assigned to each priority level. An example for an eMLPP configuration is given in GSM 02.67.

NOTE 1: The present specification defines the concepts for handling of priorities in the network including the indication whether pre-emption or fast call set-up procedures are to be applied. Note that the call set-up procedures themselves are specified in the corresponding stage 2 descriptions of the services where they are to be used. There is presently only a requirement for VBS and VGCS (GSM 03.69 and GSM 03.68, respectively).

NOTE 2: The network operator has to assure that the particular eMLPP configuration he applies and the subscriptions he issues are co-ordinated with the network planning (especially for blocking) and the implementation options applied (e.g. the use of OACSU) in order to guarantee the service performance for the subscriber.

Considering aspects of priority handling, the following issues can be considered for each call:

- a) contention during the initial random access (no specific definitions apply for eMLPP. Delays due to access collision have to be managed by a corresponding planning of the network resources);
- b) contention in gaining radio resources during the call set-up phase and during handover (this item relates to the assignment of SDCCH and TCH for which queuing and pre-emption mechanisms are applied for eMLPP);

A pre-emption might already be performed as a network option on the basis of the establishment cause if a network specific eMLPP configuration assigns a certain priority level to a particular establishment cause.
- c) contention in gaining terrestrial resources inside the GSM network (this item relates to the assignment of terrestrial channels between the GSM network nodes. Priority actions shall be performed on basis of the MLPP service implementations. The eMLPP priority levels A and B shall be mapped to the MLPP priority level 0. No further specific definitions apply for eMLPP);
- d) contention in gaining terrestrial resources in external networks (this item relates to interworking with external networks which shall be performed on basis of the MLPP service if provided in the related external networks.);
- e) application of different call set-up procedures in relation to the priority levels and the network specific configuration (three classes of set-up performance are defined in GSM 02.67, one very fast class for VBS or VGCS emergency call services, one class for fast but normal set-up times and one class allowing some delay in the set-up. The application of the corresponding procedures shall be decided by the network on the basis of the requested priority level);
- f) automatic answering of calls if the incoming call is of or exceeds a defined priority level, respectively, or called party pre-emption (if the called GSM subscriber is engaged in communication of a lower priority);
- g) the means by which the called user is informed of priority issues and is able to make appropriate decisions if no called party pre-emption applies;
- h) the accommodation of non-compatible Mobile Stations.

The definitions in the present specification focus on the issues under item b), e), f), g) and h). Items c) and d) are related to the MLPP service implementation for the signalling system No. 7 according to ITU-T Recommendations Q.85 and Q.735.

For a call establishment, a subscriber shall be able to select any one of the priority levels he has subscribed to.

Priorities shall be treated in the network as defined in GSM 02.67. Priority treatment is different for point-to-point calls and voice broadcast calls or voice group calls, respectively:

- mobile originated point-to-point call:

The priority level depends on the calling subscriber. If the user has no eMLPP subscription, the call shall have a default priority level defined in the network. If the user has an eMLPP subscription, the call shall have the priority level selected by the user at set-up or the priority level predefined by the subscriber as default priority level by registration.

- mobile terminated point-to-point calls:

The priority level depends on the calling party. For this, interworking with the ISDN MLPP service is required. If the call is not an MLPP call, i.e. no priority level is defined, the call shall be treated in the mobile network with a default priority level. If the call is an MLPP call, the call shall be treated with the priority level provided by the interfacing network.

- mobile to mobile point-to-point calls:

The priority shall be treated for the calling subscriber as for mobile originated calls and for the called subscriber as for mobile terminated calls. However, an interworking with MLPP is not required if both the calling subscriber and the called subscriber are located in the same MSC area.

- Voice Broadcast Calls (VBS) and Voice Group Calls (VGCS):

The link on the voice broadcast call channel or voice group call channel shall have the priority level as defined in the corresponding registration for the related voice broadcast call or voice group call in the GCR. At the early stage of a voice broadcast call or voice group call establishment, before the GCR request is made and the voice broadcast call channel or voice group call channels are assigned, the procedure shall be the same as for point-to-point calls.

Queuing and resource pre-emption shall then be applied as appropriate according to the network service configuration. In addition, automatic answering or called party pre-emption shall be applied as appropriated according to the Mobile Station's internal service configuration.

The MSC shall maintain a record of the priority level of each call in progress in its area such that it can arbitrate over resources in a defined manner.

The priority level can be included in the CM_SERVICE_REQUEST message in the case that a user establishing a point-to-point call is using a compatible Mobile Station (see clause 6).

If the subscriber has not selected a priority level for that call or uses a non compatible Mobile Station (see clause 6), the priority level shall be assigned according to the respective VLR data.

The priority level of a call shall be determined by the MSC. Accordingly, the MSC shall request channel assignment with an indication of the priority level and the pre-emption capability of that call. For this the MSC shall use the priority message element as defined in GSM 08.08. Mapping of the priority information in this message element on the network specific eMLPP configuration shall be performed in the MSC. Queuing and resource pre-emption shall be performed accordingly if necessary.

In addition to the priority signalling, the requirement for a direct assignment of a TCH shall be included in the establishment cause of the CHAN_REQ message in order to support a fast call set-up procedure in the BSC at the earliest possible stage of the call establishment for high priority calls if applicable.

Automatic answering or, if necessary, called-party pre-emption has to be performed by the Mobile Station as defined in the following:

- point-to-point calls:

If the user is in idle mode, the Mobile Station shall automatically connect to an incoming call of a sufficient priority level. The priority level shall be included in the paging message and in the set-up message. If the user is in dedicated mode and has a subscription to Call Waiting, a Call Waiting indication including the priority level of the call shall be given to the Mobile Station which automatically accepts the waiting call.

There is no called party pre-emption for point-to-point calls without Call Waiting.

- voice group calls and voice broadcast calls:

Notifications for other voice group calls, voice broadcast calls or information on paging for point-to-point calls shall be given to the Mobile Stations involved in on-going voice group calls or voice broadcast calls as defined in GSM 03.68 and GSM 03.69, respectively. The notifications include the related priority level of the call. In case of a notified call with higher priority where called-party pre-emption applies, the Mobile Station shall automatically leave the on-going voice group call or voice broadcast call and react according to the type of the notified call type.

For both cases, the priority level applied shall be included, either in the paging message or Call Waiting indication, or in the notification message, in order to enable the Mobile Station to decide on an automatic reaction (automatic answering or called-party pre-emption) or to indicate the incoming, non pre-empting call to the user.

The priority information of the assignment request shall also be applied for BSS internal handover. For external handover, the MSC shall include the priority information in the handover request according to the definition in GSM 08.08 in the same way as for the assignment request.

5 General architecture

No specific requirements are identified.

6 Compatibility issues

eMLPP cannot be applied with standard Phase 1 or Phase 2 Mobile Stations (non compatible Mobile Stations) with all service aspects. A dedicated Mobile Station (compatible Mobile Station) with eMLPP capability is required.

Specific functions a compatible Mobile Station shall provide are:

- priority selection via MMI for call establishment in case of an eMLPP subscription including priority levels above level 4;
- analysis of the priority level included in a paging message, Call Waiting indication or notification into a voice group call or voice broadcast call, respectively;
- automatic reaction on basis of the analysed priority level in case of an incoming call while in dedicated mode, group transmit mode or group receive mode, respectively, according to the user defined Mobile Station configuration (for each subscribed priority level the user shall be able to configure the Mobile Station for automatic acceptance or indication or rejection of an incoming call);

NOTE: Functions related to notifications are only required for Mobile Stations providing VBS or VGCS functions as defined in GSM 03.69 and GSM 03.68, respectively.

However, if eMLPP is provided in a network, it can be applied to non compatible Mobile Stations in the following way:

- calls of subscribers which have no specific eMLPP subscription shall be treated for resource pre-emption with a default priority level.

This shall also apply independent of the use of compatible or non compatible Mobile Stations;

- calls of eMLPP subscribers which use a non compatible Mobile Station shall be treated for resource pre-emption with the subscriber's default priority level;
- calls to eMLPP subscribers which use a non compatible Mobile Station shall be indicated to the user by Call Waiting as normal.

7 Transmission

No specific requirements are identified.

8 Information storage

8.1 Stored in the HLR

Information concerning the maximum priority level which a subscriber is entitled to use at call establishment shall be stored in the HLR.

If the maximum priority level is above level 4, one level shall be indicated as default level. This default level shall be used for mobile originated calls if no priority selection is performed by the user at call establishment.

The default selection can be performed by the subscriber by means of a registration procedure.

NOTE The priority levels in the subscription are related to point-to-point calls. VBS and VGCS calls are treated with the priority level defined in the GCR for a certain group ID in a certain group call area which can be different to the priority levels explicitly defined in the eMLPP subscription. However, these levels are then implicitly defined with the subscribed group IDs.

eMLPP may have the following logical states (refer to GSM 03.11 for an explanation of the notation):

Provisioning State	Registration State	Activation State	HLR Induction State
(Not Provisioned,	Not Registered,	Not Active	Not Induced)
(Provisioned,	Registered,	Active and Operative	Not Induced)

The HLR shall store the logical state of eMLPP (which shall be one of the valid states listed above) on a per subscriber basis.

8.1.1 State transition model

The following figure shows the successful cases of transition between the applicable logical states of eMLPP. The state changes are caused by actions of the service provider.

Note that error cases are not shown in the diagram as they normally do not cause a state change. Additionally, some successful requests may not cause a state change. Hence they are not shown in the diagram.

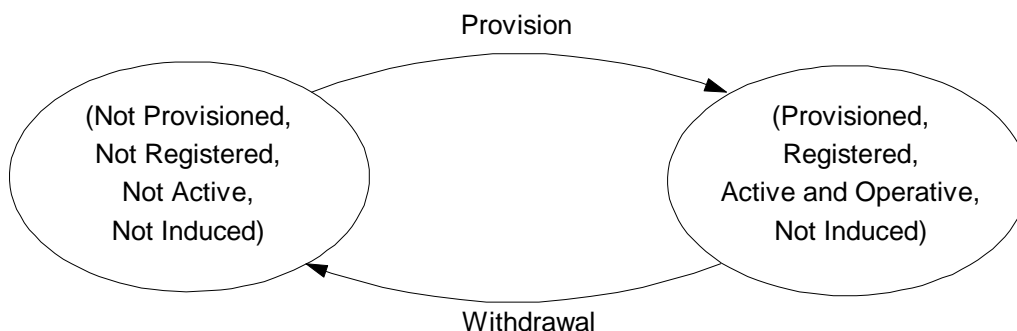

Figure 1: State transition model for eMLPP

8.1.2 Transfer of information from HLR to VLR

If the provisioning state for eMLPP is “Provisioned” then, when the subscriber registers on a VLR, the HLR shall send that VLR information about the logical state of eMLPP, the maximum priority level and the default priority level.

If any of the eMLPP subscriber data is changed, the HLR shall send to the VLR the complete eMLPP subscriber data.

8.2 Stored in the VLR

For eMLPP, the VLR shall store the service state information, the maximum priority level a subscriber is entitled to use and the default priority level received from the HLR.

8.3 Stored in the MSC

The network specific service configuration of eMLPP defined by the network operator as specified in GSM 02.67 shall be stored within each MSC. This includes information on resource pre-emption actions for any given levels of incoming and on-going call priority. An example for a network specific service configuration is given in GSM 02.67.

8.4 Stored in the SIM

Each compatible Mobile Station shall be aware of the automatic answering actions for any given levels of priority so that when in idle mode or dedicated mode or group receive mode or group transmit mode, it can decide on the necessary reactions to be taken according to the priority information of the incoming call.

For this, the SIM shall store the following data:

Priority level	Subscription available	Automatic answering applies	Fast set-up actions (note)
A	yes/no	yes/no	yes/no
B	yes/no	yes/no	yes/no
0	yes/no	yes/no	yes/no
1	yes/no	yes/no	yes/no
2	yes/no	yes/no	yes/no
3	yes/no	yes/no	yes/no
4	yes/no	--	yes/no

NOTE: Fast set-up actions which shall be performed by the Mobile Stations if indicated in the SIM data are the use of the appropriate establishment cause and the reaction on accelerated establishment procedures allowed by the network (see subclause 11.6).

The automatic reaction of the Mobile Station for automatic answering or called party pre-emption shall be predefined by the user via MMI. For each subscribed priority level the user shall be able to configure the Mobile Station for automatic acceptance or indication or rejection of an incoming call.

In addition, the Mobile Station shall verify a priority level selected by the user at call establishment against the priority levels stored on the SIM and act accordingly as defined in subclause 11.5.1.2.

The Mobile Station shall perform automatically the related functions for a fast call set-up if related with a selected priority.

8.5 Stored in the GCR

In the network, specific service configurations for VBS and VGCS calls which are registered in the GCR, a priority level shall be assigned to each voice broadcast call or voice group call configuration, according to GSM 03.69 and GSM 03.68, respectively.

9 Identities

No specific requirements are identified.

10 Operation and maintenance aspects

NOTE: A list and short description of the operation and maintenance aspects will be given. This includes the options and parameters which can be set by the operator.

- handling of timers;
- registration aspects etc.

11 Functions and information flow

11.1 Subscription

When the subscriber record is created in the HLR, the maximum priority level a subscriber is entitled to use shall be included.

11.2 Change of subscription

The network operator can change the maximum priority level of any eMLPP subscriber at any time. A change of subscription shall not affect any on-going calls at the moment of change. The subscriber cannot change the maximum priority level via the MMI.

11.3 Call set-up

11.3.1 Mobile originated calls

11.3.1.1 Indication of priority

The Mobile Station may indicate the priority of each call initiated. If no priority is indicated by the user or a non-compatible Mobile Station is used then the default priority level shall be applied which is stored in the VLR. The selection of priority shall be an MMI function.

Mobile stations indicate the priority of their call in the signalling that takes place during the call establishment process.

No preferential treatment will be possible during this initial random access until the point at which the priority information is received by the network (CM_SERV_REQ message). Alternatively, a resource pre-emption might already take place on basis of an establishment cause.

Prior to the indication of the selected priority level in the CM_SERV_REQ message, the BSC may decide on the assignment of an SDCCH or direct assignment of a TCH on the basis of the establishment cause in the CHAN_REQ message. This allows the BSC to support a fast call set-up at the earliest stage of the call establishment. The establishment cause for emergency calls or an establishment cause indicating the request for fast call set-up shall be able to trigger this function.

11.3.1.2 Subscription checking

The Mobile Station shall verify the selected priority level against the priority levels stored in the SIM. If the selected priority is not allowed, then the priority of the call shall be modified to that of the nearest allowed priority level below the requested level.

The MSC shall request the VLR to verify if the subscriber is allowed to use the selected priority level.

11.3.1.3 Authentication and ciphering

The user or the network may wish to omit or postpone authentication and ciphering in order to provide for a faster call set-up.

If the network decides to omit or postpone authentication and ciphering for a call it can send a CM_SERV_ACC message in reply to the CM_SERV_REQ message.

For further study:

The network, however, may allow the Mobile Station to send the SETUP message immediately or to wait for the AUTH_REQ message by an indication in the system information broadcasted on the BCCH. The Mobile Station shall be able to decide on the immediate sending of a SETUP message on the basis of the information received on the BCCH and the data stored in the SIM as defined in subclause 8.4.

NOTE: The postponed authentication by sending a CM_SERV_ACC message is an application of an available function. The provisional grant of the MM connection is a new function which is to be specified.

11.3.1.4 Indication of priority to the BSC

The channel assignment request to the BSC shall also include the priority level and pre-emption capability of the connection as defined in GSM 08.08. The MSC maps the eMLPP priority on these priority levels. In addition, the eMLPP priority shall be explicitly indicated to the BSC in the assignment request. The BSC shall store the priority level in order to decide on later actions, e.g. to arrange notifications to the Mobile Station according to priorities.

11.3.1.5 Choice of radio channel

If an appropriate radio channel is available the BSC shall assign it as normal. If no channels are available then the BSC shall perform queuing according to the priority levels. If the assignment request has a pre-emption capability indicator, pre-emption shall be performed.

In addition, the network related service configuration defines the set-up class in relation to a priority level and therefore the allowable delay of the call establishment (see GSM 02.67). By using this information, the MSC shall decide whether OACSU may be applied for a call or not.

11.3.1.6 Indication of priority to the Mobile Station

If the network assigns a priority level to the call different to the one requested by the user for any reasons or if the Mobile Station does not know what priority level will be applied since no priority was included in the service request, the network can inform the Mobile Station on the assigned priority level by sending a CALL_PROCEEDING message including a priority information element.

The Mobile Station shall store the priority level requested by the user, possibly overridden by the level received by the network, to perform automatic answering of calls or pre-emption of on-going calls.

11.3.2 Mobile terminated calls

11.3.2.1 Indication of priority

For a mobile terminated call, the priority level is defined in the ISUP set-up message to the VMSC. The priority and pre-emption indications used in the ISUP shall follow the definitions of the MLPP service as defined in the ITU-T recommendations Q.85 and Q.735, respectively.

11.3.2.2 Indication of priority to the BSC

The paging command message includes the requested priority.

The channel assignment request to the BSC shall include the priority level and pre-emption capability of the connection as defined in GSM 08.08. The MSC maps the eMLPP priority on these priority levels. In addition, the eMLPP priority shall be explicitly indicated to the BSC in the assignment request. The BSC shall store the priority level in order to decide on later actions, e.g. to arrange notifications to the Mobile Station according to priorities.

11.3.2.3 Authentication and ciphering

The network may wish to omit or postpone authentication and ciphering in order to provide for a faster call set-up according to the priority level to be applied for the call and the network specific service configuration stored in the MSC.

If the network decides to omit or postpone authentication and ciphering for a call it, can send the SETUP message immediately after reception of the initial layer 3 message.

11.3.2.4 Termination with called subscriber in idle mode or group receive mode

In this case the Mobile Station shall be paged in the normal manner, but with the paging messages also containing the priority level of the call. In addition, the priority level will be provided with the SETUP message.

The Mobile Station in group receive mode shall consult the internal service configuration list stored on the SIM to establish whether it should automatically respond to the paging request.

The Mobile Station in idle mode does not need to analyse the priority level from the paging request message but can derive it from the SETUP message and then decide on automatic acceptance of the call.

In the case where the called subscriber is using a non compatible Mobile Station, automatic answering is not possible.

11.3.2.5 Termination with called subscriber in dedicated mode

In the case where the called subscriber has a subscription for eMLPP and for Call Waiting and is using a compatible Mobile Station, the Mobile Station shall be informed of the priority of the new call together with the call waiting indication. The Mobile Station will then consult the internal service configuration list stored on the SIM to establish whether it should automatically accept the waiting call without consulting the user, or whether the call waiting facility will be used as normal.

In the case where the called subscriber has no subscription for Call Waiting, called party pre-emption is not possible.

In the case where the called subscriber is using a non compatible Mobile Station and has a subscription for Call Waiting, Call Waiting shall be performed as normal.

11.3.3 Voice group call or voice broadcast call

11.3.3.1 Indication of priority to the related MSC

For each voice group call or voice broadcast call service configuration registered in the GCR as defined in GSM 03.68 and GSM 03.69, respectively, a priority level is assigned at registration of the GCR data by the service provider. The priority level will be provided by the GCR together with the call attributes.

11.3.3.2 Authentication and ciphering

Authentication of the calling service subscriber shall be performed equivalent to the standard mobile originated call case as defined in subclause 11.5.1.3. The calling service subscriber shall be treated with his selected priority or with his default priority as known in the VLR as long as he has an own link with the network (see GSM 03.68 and GSM 03.69). The priority which applies to the voice group call channel or voice broadcast call channel is defined in the GCR.

Authentication and ciphering of the calling service subscriber might therefore be performed, omitted or postponed (see subclause 11.3.1.3).

11.3.3.3 Indication of priority to the called Mobile Stations

The priority level shall be indicated together with the related paging messages or notification messages and treated in the Mobile Station as defined in GSM 03.68 and GSM 03.69, respectively.

11.4 Pre-emption

11.4.1 Choice of communication to pre-empt

For all resources where pre-emption may be required, namely radio channels, A-interface channels and inter switch trunks, the network specific service configuration stored within the MSC shall be used to determine whether pre-emption should occur, and if so, which communication to pre-empt. The MSC shall inform the BSS about priority and pre-emption by using the priority message element in the assignment request as defined in GSM 08.08. Mapping of the priority information in this message element on the network specific eMLPP configuration shall be performed in the MSC.

11.4.2 Release procedures

Suitable messages shall be passed from the point at which the pre-emption is to occur, to other affected entities. In the case of fast call set-up, such pre-indication may need to be foregone to meet the required set-up time.

The indication to the pre-empted user shall be performed by an indication for congestion as defined in GSM 02.40.

11.5 Pre-emption at handover

When an on-going call is handed over into a fully used cell, the BSC shall perform queuing and pre-emption if necessary according to the priority and pre-emption capability information received with the assignment request.

In case of BSS external handover, the priority and pre-emption capability information shall be included in the handover request as defined in GSM 08.08.

11.6 Overview of call related signalling

In this overview, the message structure to implement the specified concept are identified, and brief details are given of each message.

A diagrammatic representation of the transport procedures to be used to carry the priority information in case of standard point-to-point calls are given in figures 1 to 6. The message flow is not represented completely.

The corresponding message flows in case of voice group calls or voice broadcast calls are given in GSM 03.68 and GSM 03.69, respectively.

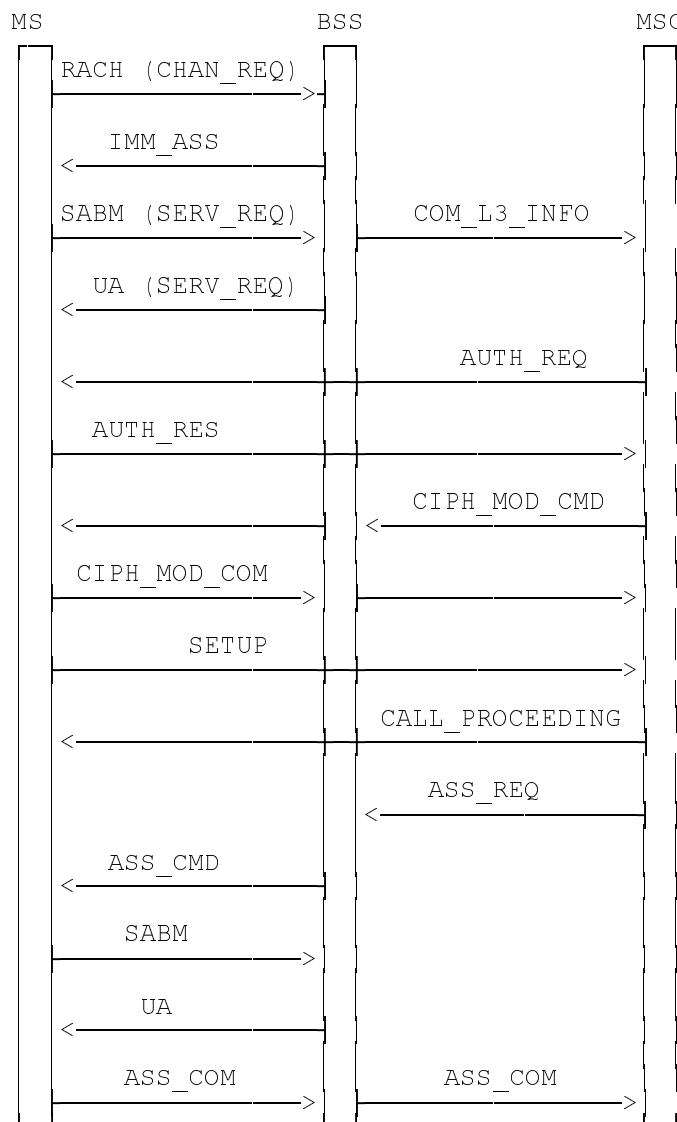

Figure 1: Signalling information required for the prioritisation at mobile originating call establishment without fast call set-up

Initial RACH CHAN_REQ: Standard message.

IMM_ASS: Standard message.

SABM (SERV_REQ): Modified form of the current L3-MM CM SERVICE REQUEST where the priority level is provided in addition if a priority selection is performed by the user. In case of no priority selection or use of a non-compatible Mobile Station the Mobile Station shall send a standard service request message and the network shall apply a default priority to their request.

UA (SERV_REQ): Standard message.

COM_L3_INFO: The MSC is provided with initial information about the requested service together with the selected priority level if applicable.

AUTH_REQ: Standard message.

AUTH_RES: Standard message.

CIPH_MOD_CMD: Standard message.

CIPH_MOD_COM: Standard message.

SETUP: Standard message.

CALL_PROCEEDING: The network may include the assigned priority level in a CALL_PROCEEDING message if no priority level was indicated in the CM_SERVICE_REQUEST message or the assigned priority level is different to the one requested.

ASS_REQ: This message is sent from the MSC to the BSC including the call priority and pre-emption capability to be applied as defined in GSM 08.08, according to the priority information the MSC has obtained from the service request or from the VLR data. In addition, the eMLPP level is included as explicit information.

ASS_CMD: Standard message.

SABM: Standard message.

UA: Standard message.

ASS_COM: Standard message.

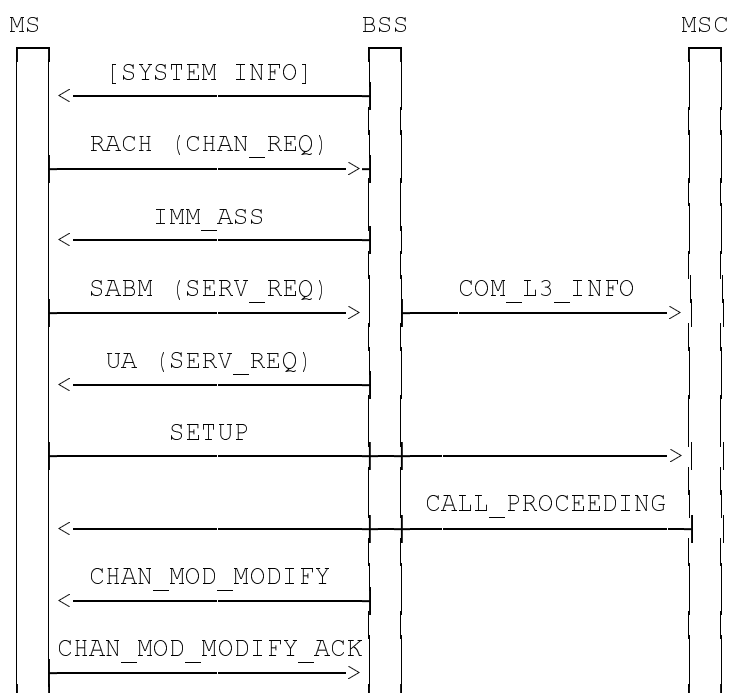

Figure 2: Signalling information required for the prioritisation at mobile originating call establishment with fast call set-up

For further study:

SYSTEM INFO: The network may provide information on the BCCH system information, that a MM connection is provisional granted after establishment of the main signalling link.

If such information is provided on the BCCH and the user has selected a fast call set-up, the Mobile Station shall immediately send a SETUP message to the network after the main signalling link is established.

Initial RACH CHAN_REQ: Standard message.

For further study:

A new establishment cause shall be provided to indicate the requirement for the direct assignment of a TCH (very early assignment) for the support of fast call set-up procedure.

IMM_ASS: Standard message.

SABM (SERV_REQ): Modified form of the current L3-MM CM SERVICE REQUEST where the priority level is provided in addition if a priority selection is performed by the user.

UA (SERV_REQ): Standard message.

COM_L3_INFO: The MSC is provided with initial information about the requested service together with the selected priority level if applicable.

If the network itself decides not to perform ciphering, it shall send an CM_SERV_ACC message.

SETUP: Standard message.

CALL_PROCEEDING: The network may include the assigned priority level in a CALL_PROCEEDING message if no priority level was indicated in the CM_SERVICE_REQUEST message or the assigned priority level is different to the one requested.

ASS_REQ: This standard message is sent from the MSC to the BSC including the call priority and pre-emption capability to be applied as defined in GSM 08.08, according to the priority information the MSC has obtained from the service request or from the VLR data. In addition, the eMLPP level is included as explicit information.

CHAN_MOD_MODIFY: Standard message.

CHAN_MOD_MODIFY_ACK: Standard message.

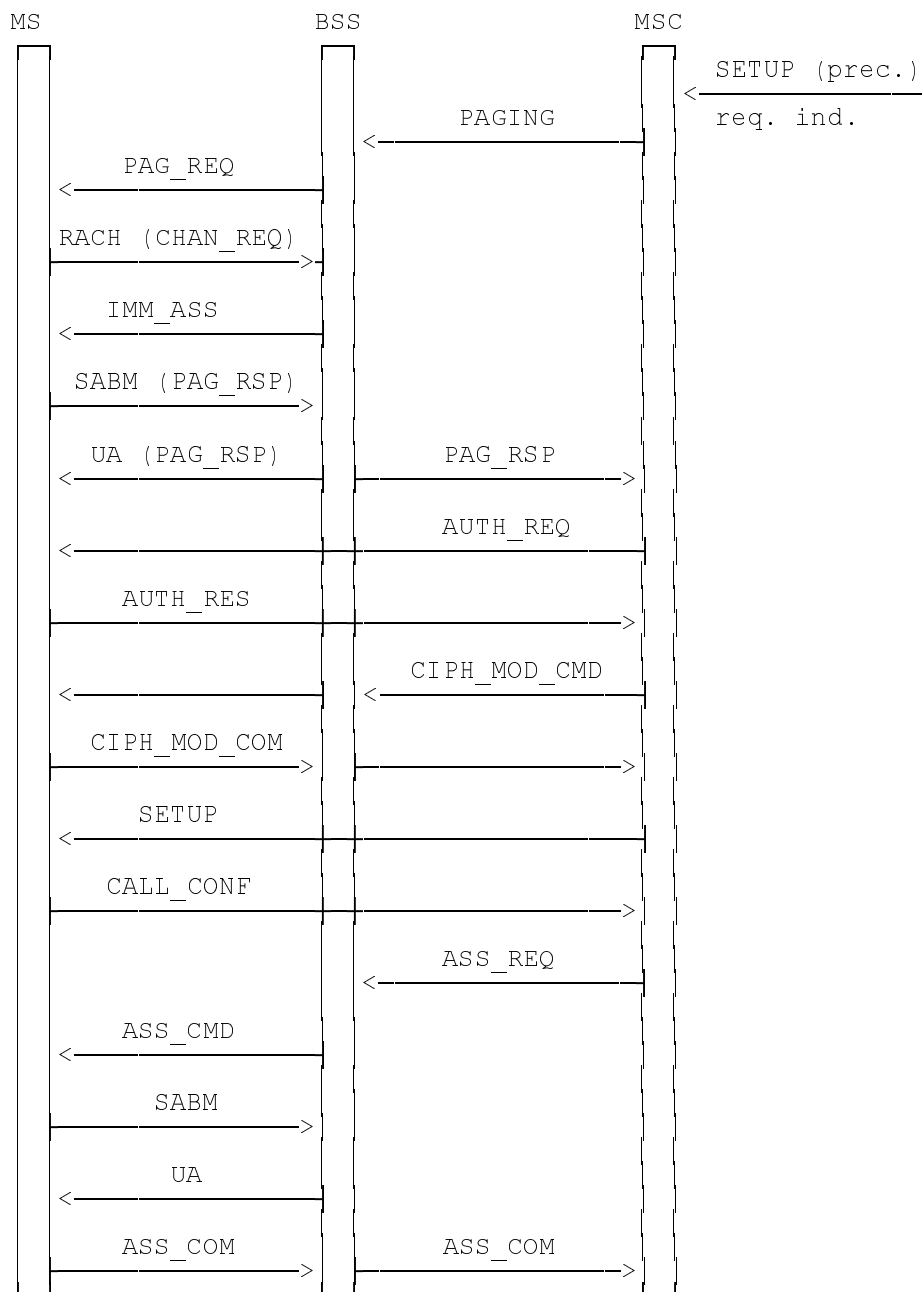

Figure 3: Signalling information required for the prioritisation at mobile terminating call establishment without fast call set-up and without called-party pre-emption

SETUP (prec.) req. ind.: In addition to the basic call requirements, the contents of the set-up information flow shall contain the information on the requested MLPP priority level.

PAGING: Modified paging command including the priority level to be applied.

PAG_REQ: Modified paging message including the related priority level.

Initial RACH CHAN_REQ: Standard message.

IMM_ASS: Standard message.

SABM (PAG_RSP): Standard message.

UA (PAG_RSP): Standard message.

PAG_RSP: Standard message.

AUTH_REQ: Standard message.

AUTH_RES: Standard message.

CIPH_MOD_CMD: Standard message.

CIPH_MOD_COM: Standard message.

SETUP: Standard message.

CALL_CONF: Standard message.

ASS_REQ: This standard message is sent from the MSC to the BSC including the call priority and pre-emption capability to be applied as defined in GSM 08.08, according to the priority information the MSC has obtained from the incoming set-up message. In addition, the eMLPP level is included as explicit information.

ASS_CMD: Standard message.

SABM: Standard message.

UA: Standard message.

ASS_COM: Standard message.

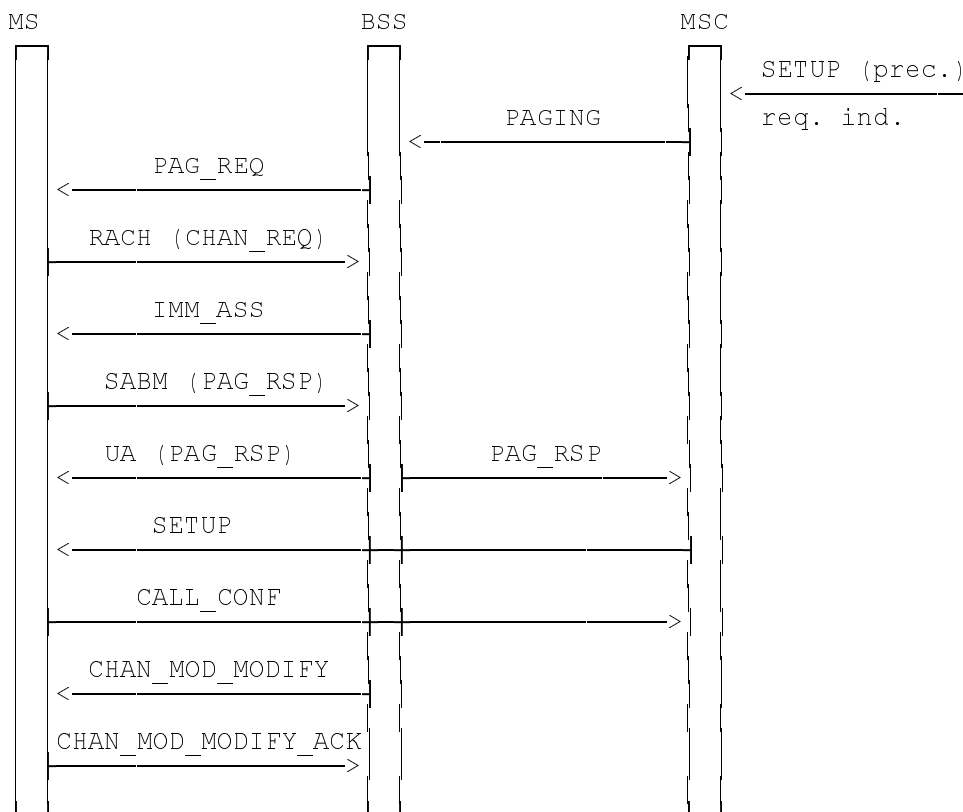

Figure 4: Signalling information required for the prioritisation at mobile terminating call establishment with fast call set-up and without called-party pre-emption

SETUP (prec.) req. ind.: In addition to the basic call requirements, the contents of the set-up information flow shall contain the information on the requested MLPP priority level.

PAGING: Modified paging command including the priority level to be applied.

PAG_REQ: Modified paging message including the related priority level.

Initial RACH CHAN_REQ: Standard message. A new establishment cause shall be provided to indicate the requirement for the direct assignment of a TCH (very early assignment) for the support of fast call set-up procedure.

IMM_ASS: Standard message.

SABM (PAG_RSP): Standard message.

UA (PAG_RSP): Standard message.

PAG_RSP: Standard message.

For fast call set-up the network shall immediately send a **SETUP** message to the Mobile Station. Authentication and ciphering may not be performed or delayed by the network.]

SETUP: Modified message with an indication of the priority level.

CALL_CONF: Standard message.

ASS_REQ: This standard message is sent from the MSC to the BSC including the call priority and pre-emption capability to be applied as defined in GSM 08.08, according to the priority information the MSC has obtained from incoming set-up message. In addition, the eMLPP level is included as explicit information.

CHAN_MOD_MODIFY: Standard message.

CHAN_MOD_MODIFY_ACK: Standard message.

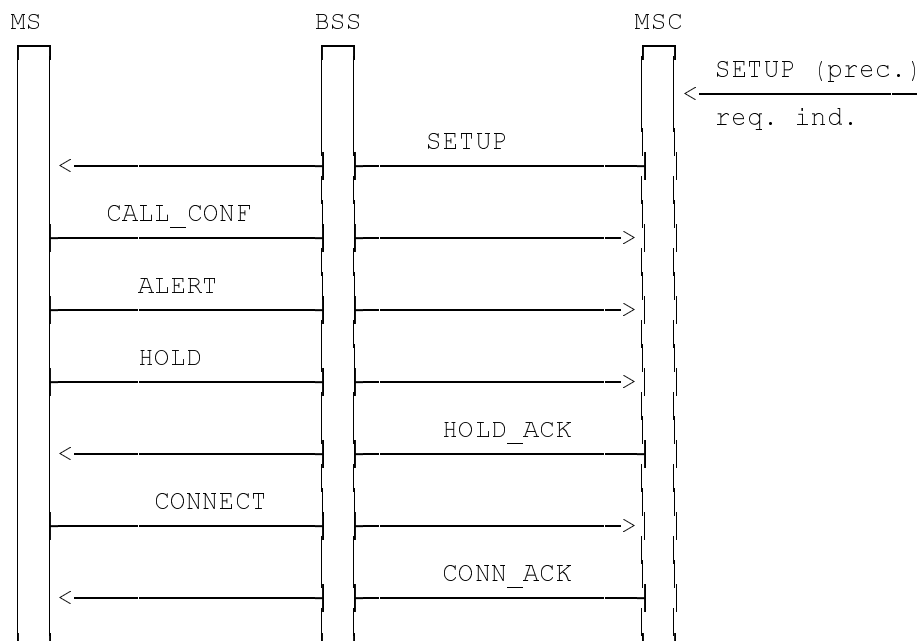

Figure 5: Signalling information required for the called-party pre-emption in case of an existing telephony call and subscription for HOLD

Call Waiting should always be subscribed together with eMLPP. If not, no called party pre-emption is possible for point-to-point calls.

SETUP (prec.) req. ind.: In addition to the basic call requirements, the contents of the set-up information flow shall contain the information on the requested MLPP priority level.

SETUP: Modified SETUP message with an indication of the priority level.

CALL_CONF: Standard message with cause user busy.

On reception of the **SETUP** message a compatible Mobile Station decides on called party pre-emption. If called party pre-emption applies, the Mobile Station shall automatically accept the waiting call and put the other call on hold.

A non compatible Mobile Station shall not be harmed by the priority information and shall perform Call Waiting functions as normal.

ALERT: Standard message. ALERTING may be omitted in case of called party pre-emption.

HOLD: Standard message. A new cause for called party pre-emption shall be included.

HOLD_ACK: Standard message.

CONNECT: Standard message.

CONN_ACK: Standard message.

NOTE: In case of an incoming data call a mode modify procedure has to be performed which is not included in figure 5.

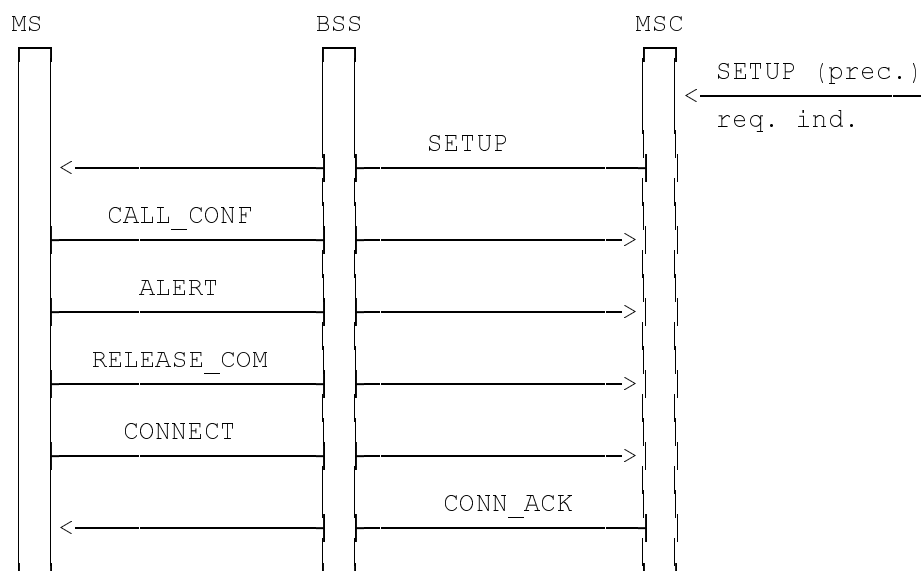

Figure 6: Signalling information required for the called-party pre-emption in case of point-to-point data calls or no subscription for HOLD

Call Waiting should always be subscribed together with eMLPP. If not, no called party pre-emption is possible for point-to-point calls.

SETUP (prec.) req. ind.: In addition to the basic call requirements, the contents of the set-up information flow shall contain the information on the requested MLPP priority level.

SETUP: Modified SETUP message with an indication of the priority level.

CALL_CONF: Standard message with cause user busy.

On reception of the SETUP message a compatible Mobile Station decides on called party pre-emption. If called party pre-emption applies, the Mobile Station shall automatically accept the waiting call and clear the existing data call.

A non compatible Mobile Station shall not be harmed by the priority information and shall perform Call Waiting functions as normal.

ALERT: Standard message. ALERTING may be omitted in case of called party pre-emption.

RELEASE_COM: Standard message which shall be send immediately after the ALERT with a new cause for called party pre-emption.

CONNECT: Standard message.

CONN_ACK: Standard message.

11.7 Overview of call independent signalling

11.7.1 Registration

At the beginning of registration subscription, provision of the supplementary service and sufficiency of registration information has to be checked.

The default priority level has to be registered in the network.

When the mobile subscriber registers eMLPP, the network shall attempt to register the service. The network will return notification of acceptance of the request. This notification will include the default priority level.

If the system cannot accept a registration request, the network sends a notification that eMLPP registration was not successful to the served mobile subscriber.

The information flow for registration of eMLPP is shown in figure 7.

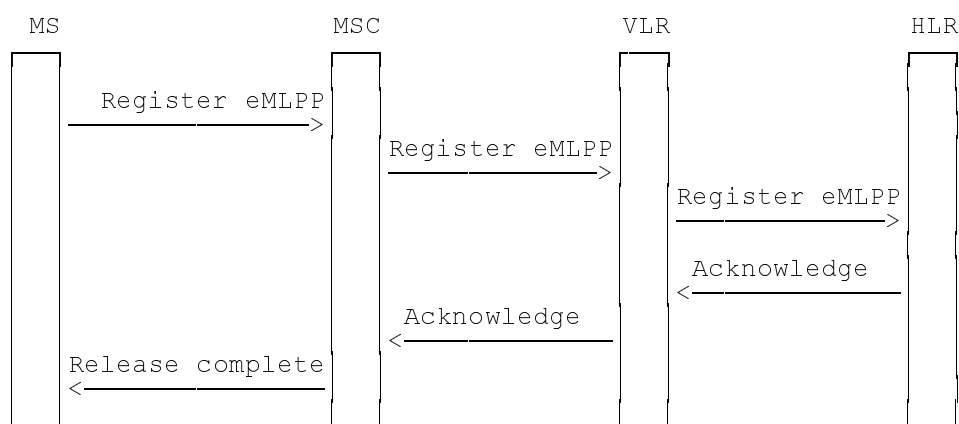

Figure 7: Registration of eMLPP

11.7.2 Interrogation

The mobile subscriber can request the status of the supplementary service, the maximum and default priority levels and be informed if the service is provided to him/her and on the actual maximum and default priority levels. This procedure is illustrated in figure 8.

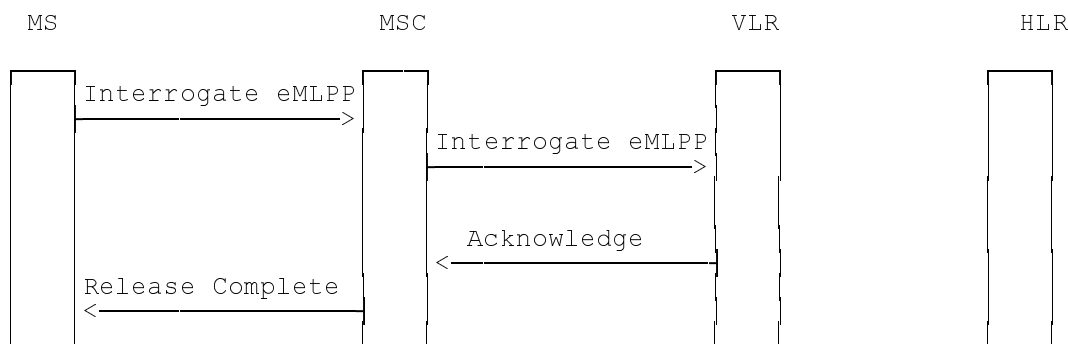

Figure 8: Interrogation of eMLPP

Annex A (informative): Change Request History

Status of Technical Specification GSM 03.67		
Date	Version	Remarks
		No phase 1 version
June 1994	version 1.0.0	TS for information to SMG#11
July 1995	version 4.0.0	TS approved by SMG#15
October 1995	version 5.0.0	TS changed to Phase 2+ TS
October 1996	version 5.1.0	CR 03.67-A001r2 (category B) approved by SMG#20 CR 03.67-A002r1 (category D) CR 03.67-A003r1 (category B)
December 1996	version 5.1.0	GTS converted to draft prETS 300 932
May 1997	version 5.1.1	ETS 300 924 first edition
January 1999	version 6.0.0	Release 1997 version
Text and figures: WinWord 6.0 Stylesheet: etsiw_70.dot		

History

Document history		
V6.0.0	April 1999	Publication