

ETSI TS 101 043 V6.4.0 (1999-07)

Technical Specification

**Digital cellular telecommunications system (Phase 2+);
Basic call handling;
Technical realization
(GSM 03.18 version 6.4.0 Release 1997)**

GSM®

GLOBAL SYSTEM FOR
MOBILE COMMUNICATIONS



Reference

RTS/SMG-030318Q6R3 (9no031c3.PDF)

Keywords

Digital cellular telecommunications system,
Global System for Mobile communications (GSM)

ETSI

Postal address

F-06921 Sophia Antipolis Cedex - FRANCE

Office address

650 Route des Lucioles - Sophia Antipolis
Valbonne - FRANCE
Tel.: +33 4 92 94 42 00 Fax: +33 4 93 65 47 16
Siret N° 348 623 562 00017 - NAF 742 C
Association à but non lucratif enregistrée à la
Sous-Préfecture de Grasse (06) N° 7803/88

Internet

secretariat@etsi.fr
Individual copies of this ETSI deliverable
can be downloaded from
<http://www.etsi.org>
If you find errors in the present document, send your
comment to: editor@etsi.fr

Copyright Notification

No part may be reproduced except as authorized by written permission.
The copyright and the foregoing restriction extend to reproduction in all media.

© European Telecommunications Standards Institute 1999.
All rights reserved.

Contents

Intellectual Property Rights.....	7
Foreword	7
1 Scope.....	8
2 References.....	8
3 Definitions and abbreviations	10
3.1 Definitions	10
3.2 Abbreviations.....	10
4 Architecture.....	11
4.1 Architecture for an MO call.....	11
4.2 Architecture for an MT call	12
5 Information flows.....	12
5.1 Information flow for an MO call.....	12
5.2 Information flow for retrieval of routing information for an MT call	14
5.3 Information flow for an MT call	15
6 Principles for interactions with supplementary services.....	17
6.1 Line identification services (GSM 03.81).....	18
6.1.1 Calling Line Identification Presentation (CLIP).....	18
6.1.2 Calling Line Identification Restriction (CLIR).....	18
6.1.3 Connected Line Identification Presentation (COLP).....	18
6.1.4 Connected Line Identification Restriction (COLR).....	18
6.2 Call forwarding services (GSM 03.82)	18
6.2.1 Call Forwarding Unconditional (CFU).....	18
6.2.2 Call Forwarding on mobile subscriber Busy (CFB)	18
6.2.3 Call Forwarding on No Reply (CFNRy).....	18
6.2.4 Call Forwarding on mobile subscriber Not Reachable (CFNRc)	18
6.3 Call wait (GSM 03.83).....	18
6.4 Call hold (GSM 03.83)	19
6.5 Multiparty (GSM 03.84)	19
6.6 Closed user group (GSM 03.85)	19
6.7 Advice of charge (GSM 03.86).....	19
6.8 Call barring (GSM 03.88).....	19
6.8.1 Barring of outgoing calls.....	19
6.8.2 Barring of incoming calls	19
6.9 Explicit Call Transfer (GSM 03.91)	19
6.10 Completion of Calls to Busy Subscriber (GSM 03.93).....	19
7 Functional requirements of network entities.....	20
7.1 MO call.....	20
7.1.1 Functional requirements of serving MSC.....	20
7.1.1.1 Process OCH_MSC	20
7.1.1.2 Procedure Process_Access_Request_MSC	21
7.1.1.3 Procedure OG_Call_Setup_MSC	21
7.1.1.4 Procedure Obtain_IMSI_MSC	22
7.1.1.5 Procedure Authenticate_MSC	22
7.1.1.6 Procedure Obtain_IMEI_MSC.....	22
7.1.1.7 Procedure Check_IMEI_MSC.....	22
7.1.1.8 Procedure Establish_Originating_TCH_If_Required	22
7.1.1.9 Procedure Set_CLI_Presentation_Indicator_MSC	22
7.1.1.10 Procedure Send_Alerting_If_Required.....	23
7.1.1.11 Procedure Set_COLP_Info_MSC.....	23
7.1.1.12 Procedure Send_Access_Connect_If_Required	23
7.1.1.13 Procedure Handle_AoC_MO_MSC	23
7.1.2 Functional requirements of VLR.....	46

7.1.2.1	Process OCH_VLR.....	46
7.1.2.2	Procedure Process_Access_Request_VLR.....	46
7.1.2.3	Procedure OG_Call_Subscription_Check_VLR.....	46
7.1.2.4	Procedure Obtain_Identity_VLR.....	46
7.1.2.5	Procedure Obtain_IMSI_VLR.....	46
7.1.2.6	Procedure Authenticate_VLR.....	46
7.1.2.7	Procedure Obtain_Authentication_Sets_VLR.....	47
7.1.2.8	Procedure Start_Tracing_VLR.....	47
7.1.2.9	Procedure Check_IMEI_VLR.....	47
7.1.2.10	Procedure Obtain_IMEI_VLR.....	47
7.1.2.11	Process Fetch_Authentication_Sets_VLR.....	47
7.1.2.12	Procedure Check_BAOC.....	47
7.1.2.13	Procedure OG_CUG_Check.....	47
7.1.2.14	Procedure Get_LI_Subscription_Info_MO_VLR.....	47
7.1.2.15	Procedure Get_AoC_Subscription_Info_VLR.....	47
7.1.2.16	Procedure Check_OG_Barring.....	47
7.2	Retrieval of routing information for MT call.....	73
7.2.1	Functional requirements of GMSC.....	73
7.2.1.1	Process MT_GMSC.....	73
7.2.1.2	Procedure Obtain_Routing_Address.....	74
7.2.1.3	Procedure Send_ACM_If_Required.....	75
7.2.1.4	Procedure Send_Answer_If_Required.....	75
7.2.1.5	Procedure Send_Network_Connect_If_Required.....	75
7.2.1.6	Procedure Handle_COLP_Forwarding_Interaction_MSC.....	75
7.2.1.7	Procedure Activate_CF_Process.....	75
7.2.1.8	Process MT_CF_MSC.....	75
7.2.2	Functional requirements of HLR.....	97
7.2.2.1	Process SRI_HLR.....	97
7.2.2.2	Procedure Check_Parameters.....	97
7.2.2.3	Procedure Subscription_Check_HLR.....	97
7.2.2.4	Procedure First_Forwarding_HLR.....	98
7.2.2.5	Procedure PRN_Error_HLR.....	98
7.2.2.6	Procedure Forward_CUG_Check.....	98
7.2.2.7	Procedure Derive_Requested_Basic_Service_HLR.....	98
7.2.2.8	Procedure Check_IC_Barring.....	98
7.2.2.9	Procedure IC_CUG_Check.....	98
7.2.2.10	Procedure Handle_CFU.....	98
7.2.2.11	Procedure Handle_CFNRC.....	98
7.2.3	Functional requirements of VLR.....	114
7.2.3.1	Process PRN_VLR.....	114
7.2.3.2	Process Restore_Subscriber_Data_VLR.....	114
7.2.3.3	Process PSI_VLR.....	114
7.2.3.4	Procedure Retrieve_Location_Info_VLR.....	114
7.2.4	Functional requirements of MSC.....	122
7.2.4.1	Process OSI_MSC.....	122
7.3	MT call.....	123
7.3.1	Functional requirements of serving MSC.....	123
7.3.1.1	Process ICH_MSC.....	123
7.3.1.2	Procedure Page_MS_MSC.....	124
7.3.1.3	Procedure Search_For_MS_MSC.....	124
7.3.1.4	Procedure Complete_Call_In_MSC.....	125
7.3.1.5	Procedure Process_Call_Waiting_MSC.....	125
7.3.1.6	Procedure Set_CLIP_Info_MSC.....	125
7.3.1.7	Procedure Derive_GSM_BC_MSC.....	126
7.3.1.8	Procedure Establish_Terminating_TCH_If_Required.....	126
7.3.1.9	Procedure Handle_AoC_MT_MSC.....	126
7.3.1.10	Procedure Set_COL_Presentation_Indicator_MSC.....	126
7.3.2	Functional requirements of VLR.....	150
7.3.2.1	Process ICH_VLR.....	150
7.3.2.2	Procedure Derive_Requested_Basic_Service_VLR.....	150

7.3.2.3	Procedure Search_For_MS_VLR.....	151
7.3.2.4	Procedure Get_CW_Subscription_Info_VLR.....	151
7.3.2.5	Procedure Get_LI_Subscription_Info_MT_VLR.....	151
7.3.2.6	Procedure Handle_CFB.....	151
7.3.2.7	Procedure Handle_CFNRY.....	151
8	Contents of messages.....	163
8.1	Messages on the B interface (MSC-VLR).....	164
8.1.1	Abort.....	164
8.1.2	Authenticate.....	164
8.1.3	Authenticate ack.....	164
8.1.4	Check IMEI.....	164
8.1.5	Check IMEI ack.....	164
8.1.6	Check IMEI negative response.....	164
8.1.7	Complete Call.....	165
8.1.8	Complete Call ack.....	166
8.1.9	Complete Call negative response.....	166
8.1.10	Forward New TMSI.....	166
8.1.11	Forward New TMSI ack.....	166
8.1.12	Forward New TMSI negative response.....	166
8.1.13	Obtain Subscriber Info.....	166
8.1.14	Obtain Subscriber Info ack.....	167
8.1.15	Page MS.....	167
8.1.16	Page MS negative response.....	167
8.1.17	Page MS via SGSN.....	167
8.1.18	Process Access Request.....	167
8.1.19	Process Access Request ack.....	168
8.1.20	Process Access Request negative response.....	168
8.1.21	Process Call Waiting.....	168
8.1.22	Process Call Waiting ack.....	169
8.1.23	Process Call Waiting negative response.....	169
8.1.24	Provide IMEI.....	169
8.1.25	Provide IMEI ack.....	169
8.1.26	Provide IMSI.....	169
8.1.27	Provide IMSI ack.....	169
8.1.28	Search For MS.....	170
8.1.29	Search For MS ack.....	170
8.1.30	Search For MS negative response.....	170
8.1.31	Search for MS via SGSN.....	170
8.1.32	Send Info For Incoming Call.....	171
8.1.33	Send Info For Incoming Call ack.....	171
8.1.34	Send Info For Incoming Call negative response.....	171
8.1.35	Send Info For Outgoing Call.....	172
8.1.36	Send Info For Outgoing Call negative response.....	172
8.1.37	Set ciphering mode.....	172
8.1.38	Trace subscriber activity.....	173
8.1.39	Use existing TMSI.....	173
8.2	Messages on the C interface (MSC-HLR).....	173
8.2.1	Send Routeing Info.....	173
8.2.2	Send Routeing Info ack.....	174
8.2.3	Send Routeing Info negative response.....	174
8.3	Messages on the D interface (VLR-HLR).....	175
8.3.1	Provide Roaming Number.....	175
8.3.2	Provide Roaming Number ack.....	175
8.3.3	Provide Roaming Number negative response.....	176
8.3.4	Provide Subscriber Info.....	176
8.3.5	Provide Subscriber Info ack.....	176
8.3.5.1	Location information.....	176
8.3.6	Provide Subscriber Info negative response.....	177
8.3.7	Restore Data.....	177
8.3.8	Restore Data ack.....	177

8.3.9	Restore Data negative response.....	177
8.4	Messages on the F interface (MSC-EIR)	178
8.4.1	Check IMEI.....	178
8.4.2	Check IMEI ack	178
8.4.3	Check IMEI negative response.....	178
8.5	Messages on the MSC internal interface.....	178
8.5.1	CF cancelled.....	178
8.5.2	Perform Call Forwarding.....	178
8.5.3	Perform Call Forwarding ack	178
8.5.4	Perform Call Forwarding negative response	178
8.6	Messages on the Gs interface.....	179
8.6.1	Page MS	179
8.6.2	Send MS information	179
8.6.3	Send MS information ack.....	179
8.6.4	Send MS information negative response	179
Annex A (informative):	Handling of an IAM at an MSC	180
Annex B (informative):	Change History	183
History		184

Intellectual Property Rights

IPRs essential or potentially essential to the present document may have been declared to ETSI. The information pertaining to these essential IPRs, if any, is publicly available for **ETSI members and non-members**, and can be found in SR 000 314: "*Intellectual Property Rights (IPRs); Essential, or potentially Essential, IPRs notified to ETSI in respect of ETSI standards*", which is available **free of charge** from the ETSI Secretariat. Latest updates are available on the ETSI Web server (<http://www.etsi.org/ipr>).

Pursuant to the ETSI IPR Policy, no investigation, including IPR searches, has been carried out by ETSI. No guarantee can be given as to the existence of other IPRs not referenced in SR 000 314 (or the updates on the ETSI Web server) which are, or may be, or may become, essential to the present document.

Foreword

This Technical Specification (TS) has been produced by the Special Mobile Group (SMG).

The present document specifies the technical realization of the handling of calls originated by a GSM mobile subscriber and calls directed to a GSM mobile subscriber, up to the point where the call is established within the digital cellular telecommunications system (Phase 2+).

The contents of the present document are subject to continuing work within SMG and may change following formal SMG approval. Should SMG modify the contents of the present document it will then be republished by ETSI with an identifying change of release date and an increase in version number as follows:

Version 6.x.y

where:

- 6 GSM Phase 2+ Release 1997
- x the second digit is incremented for changes of substance, i.e. technical enhancements, corrections, updates, etc.
- y the third digit is incremented when editorial only changes have been incorporated in the specification.

1 Scope

The present document specifies the technical realisation of the handling of calls originated by a GSM mobile subscriber and calls directed to a GSM mobile subscriber, up to the point where the call is established. Normal release of the call after establishment is also specified.

The handling of DTMF signalling and Off-Air Call set up (OACSU) are not described in the present document.

The details of the effects of GSM supplementary services on the handling of a call are described in the relevant GSM 03.8x and GSM 03.9x series of specifications.

The specification of the handling of a request from the HLR for subscriber information is not part of basic call handling, but is required for both CAMEL (GSM 03.78 [6]) and optimal routeing (GSM 03.79 [8]). The use of the Provide Subscriber Information message flow is shown in GSM 03.78 [6] and GSM 03.79 [8].

The specification of the handling of data calls re-routed to a SIWFS is described in GSM 03.54 [4].

The logical separation of the MSC and VLR (shown in clauses 4, 5 and 7), and the messages transferred between them (described in clause 8) are the basis of a model used to define the externally visible behaviour of the MSC/VLR, which is a single physical entity. They do not impose any requirement except the definition of the externally visible behaviour.

If there is any conflict between the present document and the corresponding stage 3 specifications (GSM 04.08 [17], GSM 08.08 [19] and GSM 09.02 [20]), the stage 3 specification shall prevail.

2 References

The following documents contain provisions which, through reference in this text, constitute provisions of the present document.

- References are either specific (identified by date of publication, edition number, version number, etc.) or non-specific.
- For a specific reference, subsequent revisions do not apply.
- For a non-specific reference, the latest version applies.
- A non-specific reference to an ETS shall also be taken to refer to later versions published as an EN with the same number.
- For this Release 1997 document, references to GSM documents are for Release 1997 versions (version 6.x.y).

- [1] GSM 02.01: "Digital cellular telecommunications system (Phase 2+); Principles of telecommunication services supported by a GSM Public Land Mobile Network (PLMN)".
- [2] GSM 03.03: " Digital cellular telecommunications system (Phase 2+); Numbering, addressing & identification".
- [3] GSM 03.20: " Digital cellular telecommunications system (Phase 2+); Security related network functions".
- [4] GSM 03.54 (TS 101 252) "Digital cellular telecommunications system (Phase 2+);Description for the use of a Shared Inter Working Function /SIWF) in a GSM PLMN Stage 2".
- [5] GSM 03.60: "Digital cellular telecommunications system (Phase 2+); General Packet Radio Service; Service description; Stage 2".
- [6] GSM 03.78 (TS 101 044): "Digital cellular telecommunications system (Phase 2+); Customized Applications for Mobile network Enhanced Logic (CAMEL) - Stage 2".
- [7] GSM 03.78: "Digital cellular telecommunications system (Phase 2+); Customized Applications for Mobile network Enhanced Logic (CAMEL) - Phase 2; Stage 2".

- [8] GSM 03.79 (TS 101 045): "Digital cellular telecommunications system (Phase 2+); Support of Optimal Routeing (SOR); Technical Realization".
- [9] GSM 03.81: " Digital cellular telecommunications system (Phase 2+); Line identification supplementary services - Stage 2 ".
- [10] GSM 03.82: "Digital cellular telecommunications system (Phase 2+); Call Forwarding (CF) supplementary services - Stage 2".
- [11] GSM 03.83: "Digital cellular telecommunications system (Phase 2+); Call Waiting (CW) and Call Hold (HOLD) supplementary services - Stage 2".
- [12] GSM 03.84: "Digital cellular telecommunications system (Phase 2+); Multi Party (MPTY) supplementary services - Stage 2".
- [13] GSM 03.85: "Digital cellular telecommunications system (Phase 2+); Closed User Group (CUG) supplementary services - Stage 2".
- [14] GSM 03.86: "Digital cellular telecommunications system (Phase 2+); Advice of Charge (AoC) supplementary services - Stage 2".
- [15] GSM 03.88: "Digital cellular telecommunications system (Phase 2+); Call Barring (CB) supplementary services - Stage 2 (GSM 03.88)".
- [16] GSM 03.93: "Digital cellular telecommunications system (Phase 2+); Technical realization of Completion of Calls to Busy Subscriber (CCBS) - Stage 2".
- [17] GSM 04.08: "Digital cellular telecommunications system (Phase 2+); Mobile radio interface layer 3 specification".
- [18] GSM 07.01: "Digital cellular telecommunications system (Phase 2+); General on Terminal Adaptation Functions (TAF) for Mobile Stations (MS)".
- [19] GSM 08.08: "Digital cellular telecommunications system (Phase 2+); Mobile-services Switching Centre - Base Station System (MSC - BSS) interface Layer 3 specification".
- [20] GSM 09.02: "Digital cellular telecommunications system (Phase 2+); Mobile Application Part (MAP) specification".
- [21] GSM 09.07: "Digital cellular telecommunications system (Phase 2+); General requirements on interworking between the Public Land Mobile Network (PLMN) and the Integrated Services Digital Network (ISDN) or Public Switched Telephone Network (PSTN)".
- [22] GSM 09.10 (1995): "Digital cellular telecommunications system (Phase 2+); Information element mapping between Mobile Station - Base Station System (MS - BSS) and Base Station System - Mobile-services Switching Centre (BSS - MSC) Signalling procedures and the Mobile Application Part (MAP) (GSM 09.10)".
- [23] GSM 12.08 (1996): "Digital cellular telecommunications system (Phase 2+); Subscriber and equipment trace (GSM 12.08)".
- [24] ETS 300 356-1 (1995): "Integrated Services Digital Network (ISDN); Signalling System No. 7; ISDN User Part (ISUP) version 2 for the international interface; Part 1: Basic services".
- [25] ITU-T Recommendation Q.850 (1996): "Usage of cause and location in the Digital Subscriber Signalling System No. 1 and the Signalling System No. 7 ISDN User Part".

3 Definitions and abbreviations

3.1 Definitions

For the purposes of the present document, the following terms and definitions apply.

A subscriber: The calling mobile subscriber.

B subscriber: The mobile subscriber originally called by the A subscriber.

C subscriber: The subscriber to whom the B subscriber has requested that calls be forwarded. The C subscriber may be fixed or mobile.

Location Information: Information to define the whereabouts of the MS, and the age of the information defining the whereabouts.

3.2 Abbreviations

For the purposes of the present document, the following abbreviations apply:

A&O	Active & Operative
ACM	Address Complete Message
ANM	ANswer Message
AoC	Advice of Charge
BC	Bearer Capability
BOIC-exHC&BOIZC	Barring of Outgoing International Calls except those directed to the HPLMN Country & Barring of Outgoing InterZonal Calls
BOIZC	Barring of Outgoing InterZonal Calls
BOIZC-exHC	Barring of Outgoing InterZonal Calls except those directed to the HPLMN Country
CCBS	Completion of Calls to Busy Subscriber
CFB	Call Forwarding on Busy
CFNRc	Call Forwarding on mobile subscriber Not Reachable
CFNRy	Call Forwarding on No Reply
CFU	Call Forwarding Unconditional
CLIP	Calling Line Identity Presentation
CLIR	Calling Line Identity Restriction
COLP	COnnected Line identity Presentation
COLR	COnnected Line identity Restriction
CUG	Closed User Group
CW	Call Waiting
FTN	Forwarded-To Number
FTNW	Forwarded-To NetWork
GMSCB	Gateway MSC of the B subscriber
GPRS	General Packet Radio Service
HLC	Higher Layer Compatibility
HLRB	The HLR of the B subscriber
HPLMNB	The HPLMN of the B subscriber
IAM	Initial Address Message
IPLMN	Interrogating PLMN - the PLMN containing GMSCB
IWU	Inter Working Unit
LLC	Lower Layer Compatibility
MO	Mobile Originated
MPTY	MultiParTY
MT	Mobile Terminated
NDUB	Network Determined User Busy
NRCT	No Reply Call Timer
PRN	Provide Roaming Number
SGSN	Serving GPRS support node
SIFIC	Send Information For Incoming Call

SIFOC	Send Information For Outgoing Call
SIWF	Shared Inter Working Function
SIWFS	SIWF Server. SIWFS is the entity where the used IWU is located.
SRI	Send Routeing Information
UDUB	User Determined User Busy
VLRA	The VLR of the A subscriber
VLRB	The VLR of the B subscriber
VMSCA	The Visited MSC of the A subscriber
VMSCB	The Visited MSC of the B subscriber
VPLMNA	The Visited PLMN of the A subscriber
VPLMNB	The Visited PLMN of the B subscriber

4 Architecture

Subclauses 4.1 and 4.2 show the architecture for handling a basic MO call and a basic MT call. A basic mobile-to-mobile call is treated as the concatenation of an MO call and an MT call.

4.1 Architecture for an MO call

A basic mobile originated call involves signalling between the MS and its VMSC via the BSS, between the VMSC and the VLR and between the VMSC and the destination exchange, as indicated in figure 1.

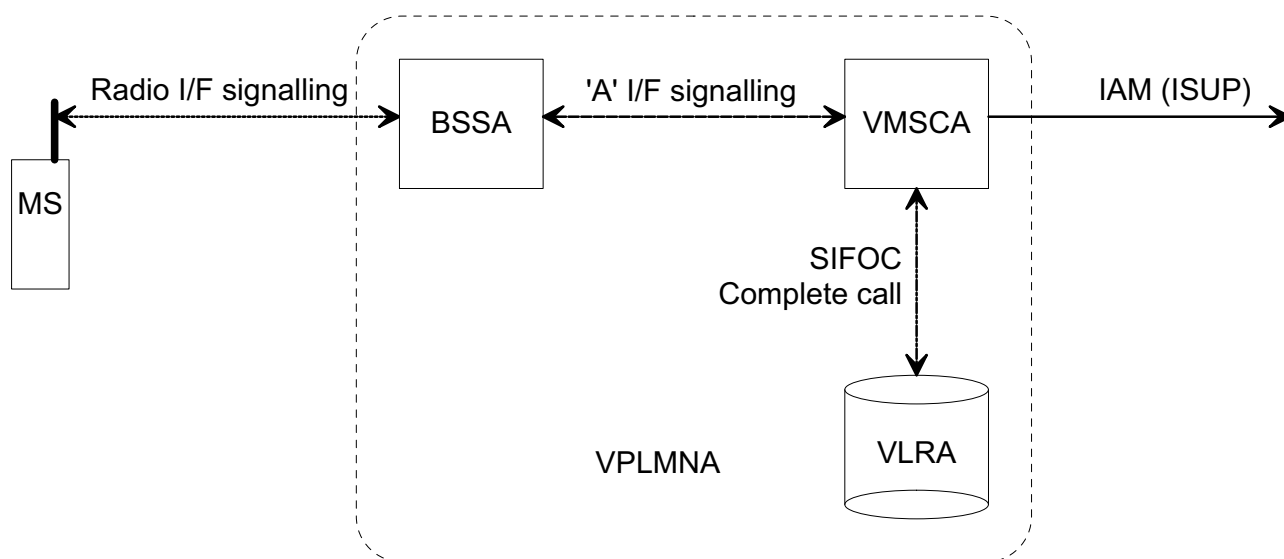

Figure 1: Architecture for a basic mobile originated call

In figure 1 and throughout the present document, the term ISUP is used to denote the telephony signalling system used between exchanges. In a given network, any telephony signalling system may be used.

When the user of an MS wishes to originate a call, the MS establishes communication with the network using radio interface signalling, and sends a message containing the address of the called party. VMSCA requests information to handle the outgoing call (SIFOC) from VLRA, over an internal interface of the MSC/VLR. If VLRA determines that the outgoing call is allowed, it responds with a Complete Call. VMSCA:

- establishes a traffic channel to the MS; and
- constructs an ISUP IAM using the called party address and sends it to the destination exchange.

NOTE: When the non-loop method is used for data calls, the IAM is sent to the SIWFS.

4.2 Architecture for an MT call

A basic mobile terminated call involves signalling as indicated in figure 2. Communication between VMSCB and the MS is via the BSS, as for the mobile originated case. If VPLMNB supports GPRS and the Gs interface between VLRB and the SGSN is implemented (see GSM 03.60 [5]) and there is an association between VLRB and the SGSN for the MS, the paging signal towards the MS goes from VMSCB via VLRB and the SGSN to the BSS. The IPLMN, containing GMSCB, is in principle distinct from HPLMNB, containing HLRB, but the practice for at least the majority of current GSM networks is that a call to a GSM MS will be routed to a GMSC in HPLMNB.

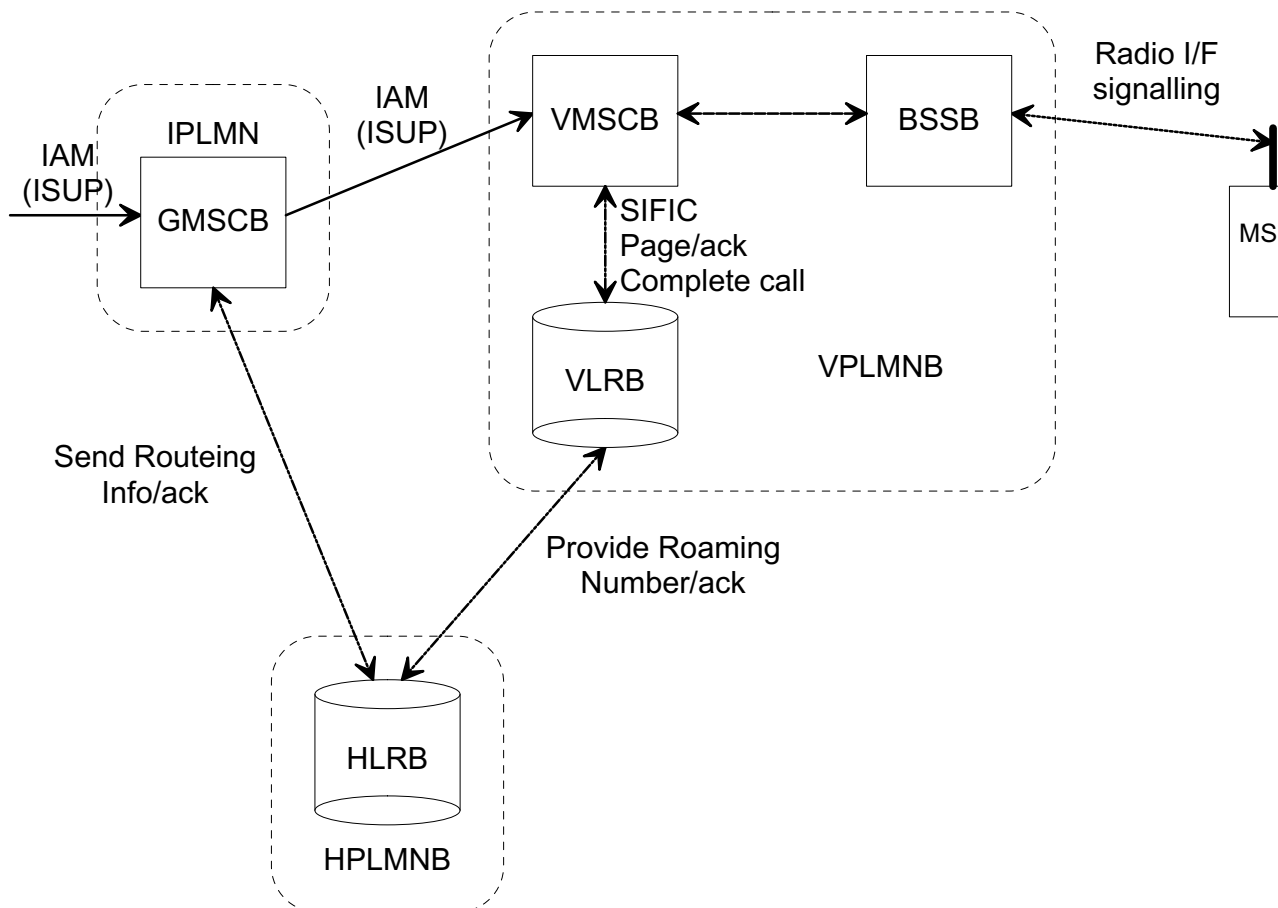

Figure 2: Architecture for a basic mobile terminated call

When GMSCB receives an ISUP IAM, it requests routing information from HLRB using the MAP protocol. HLRB requests a roaming number from VLRB, also using the MAP protocol, and VLRB returns a roaming number in the Provide Roaming Number Ack. HLRB returns the roaming number to GMSCB in the Send Routing Info ack. GMSCB uses the roaming number to construct an ISUP IAM, which it sends to VMSCB. When VMSCB receives the IAM, it requests information to handle the incoming call (SIFIC) from VLRB, over an internal interface of the MSC/VLR. If VLRB determines that the incoming call is allowed, it requests VMSCB to page the MS. VMSCB pages the MS using radio interface signalling. When the MS responds, VMSCB informs VLRB in the Page ack message. VLRB instructs VMSCB to connect the call in the Complete call, and VMSCB establishes a traffic channel to the MS.

5 Information flows

5.1 Information flow for an MO call

An example information flow for an MO call is shown in figure 3; many variations are possible. Signalling over the radio interface between MSA and BSSA or VMSCA is shown by dotted lines; signalling over the "A" interface between BSSA and VMSCA is shown by dashed lines; signalling over the B interface between VMSCA and VLRA is shown by chain lines; and ISUP signalling between VMSCA and the destination exchange is shown by solid lines.

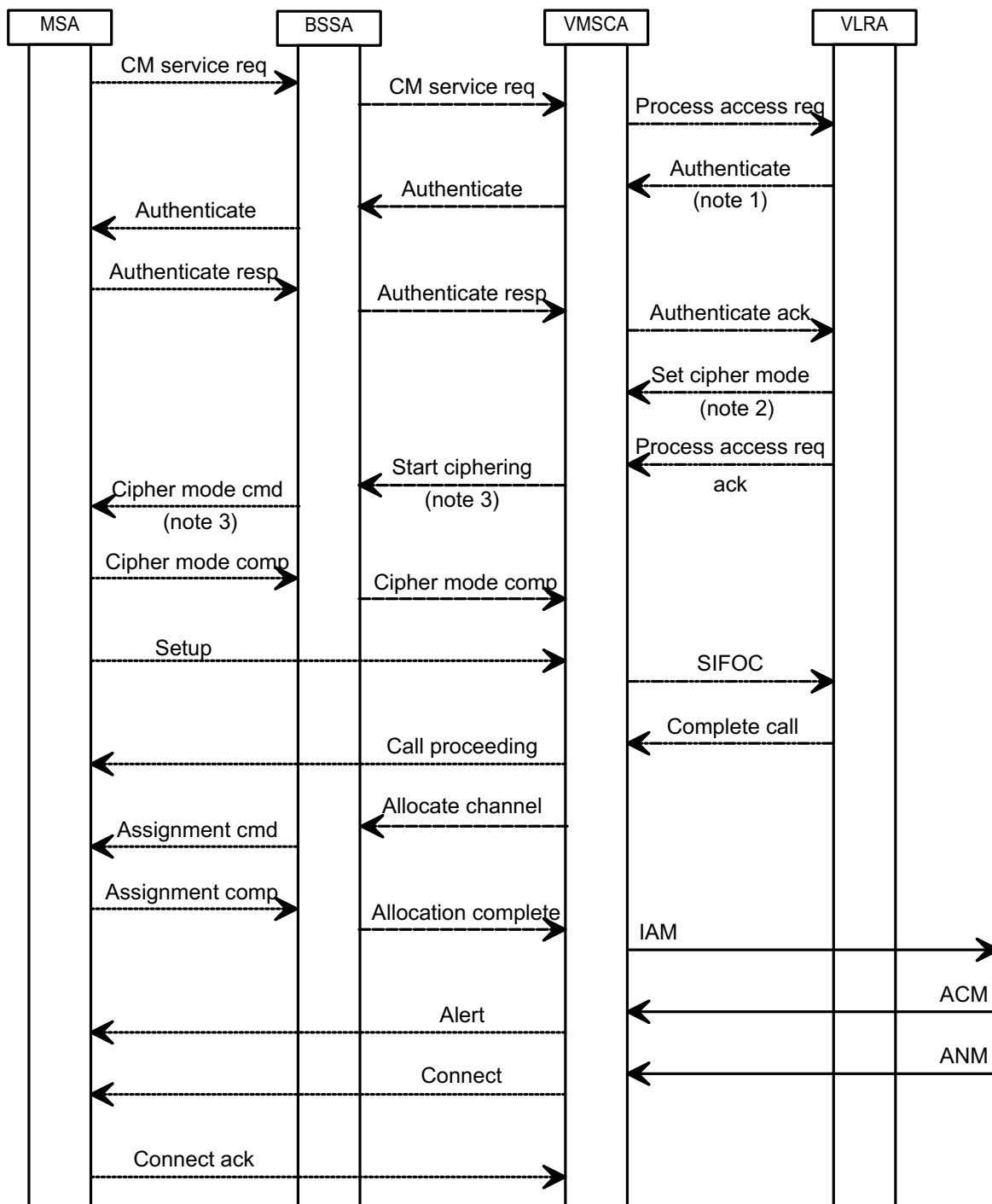

Figure 3: Information flow for a basic mobile originated call

NOTE 1: Authentication may occur at any stage during the establishment of an MO call; its position in this message flow diagram is an example.

NOTE 2: Ciphering may be initiated at any stage after authentication; its position in this message flow diagram is an example.

NOTE 3: If ciphering is not required, the MSC may send a CM service accept towards the MS; optionally it may instead send a "start ciphering" request indicating that no ciphering is required.

NOTE 4: The network may request the IMEI from the MS, and may check the IMEI, at any stage during the establishment of an MO call, either as part of the procedure to start ciphering or explicitly after ciphering has started; this is not shown in this message flow diagram.

When the user wishes to originate a call, MSA establishes a signalling connection with BSSA, and sends a Connection Management (CM) service request to BSSA, which relays it to VMSCA. VMSCA sends a Process access request to VLRA. VLRA may then initiate authentication, as described in GSM 03.20 [3]. VLRA may also initiate ciphering at this stage, as described in GSM 03.20 [3].

If VLRA determines that MSA is allowed service, it sends a Process access request ack to VMSCA. If VMSCA has received a Set cipher mode message from VLRA, the Process access request ack message triggers a Start ciphering command message towards BSSA; otherwise VMSCA sends a CM service accept message towards BSSA.

If BSSA receives a Start ciphering command from VMSCA, it initiates ciphering as described in GSM 03.20 [3]; when ciphering is successfully initiated, MSA interprets this in the same way as a CM service accept. If ciphering is not required at this stage, BSSA relays the CM service accept to MSA.

When MSA has received the CM service accept, or ciphering has been successfully initiated, MSA sends a Setup message containing the B subscriber address via BSSA to VMSCA. MSA also uses the Setup message to indicate the bearer capability required for the call; VMSCA translates this bearer capability into a GSM basic service, and determines whether an interworking function is required. VMSCA sends to VLRA a request for information to handle the outgoing call, using a Send Info For Outgoing Call (SIFOC) message containing the B subscriber address.

If VLRA determines that the call should be connected, it sends a Complete Call message to VMSCA. VMSCA sends a Call Proceeding message via BSSA to MSA, to indicate that the call request has been accepted, and sends an Allocate channel message to BSSA, to trigger BSSA and MSA to set up a traffic channel over the radio interface. The Call Proceeding message includes bearer capability information if any of the negotiable parameters of the bearer capability has to be changed. When the traffic channel assignment process is complete (indicated by the Allocation complete message from BSSA to VMSCA), VMSCA constructs an ISUP IAM using the B subscriber address, and sends it to the destination exchange.

When the destination exchange returns an ISUP Address Complete Message (ACM), VMSCA sends an Alert message via BSSA to MSA, to indicate to the calling user that the B subscriber is being alerted.

When the destination exchange returns an ISUP ANSwer Message (ANM), VMSCA sends a Connect message via BSSA to MSA, to instruct MSA to connect the speech path.

The network then waits for the call to be cleared.

For an emergency call, a different CM service type (emergency call) is used, and the mobile may identify itself by an IMEI. It is a network operator option whether to allow an emergency call when the mobile identifies itself by an IMEI. Details of the handling are shown in clause 7.

5.2 Information flow for retrieval of routing information for an MT call

The information flow for retrieval of routing information for an MT call is shown in figure 4. ISUP signalling between the originating exchange and GMSCB, and between GMSCB and VMSCB is shown by solid lines; signalling over the MAP interfaces between GMSCB and HLRB and between HLRB and VLRB is shown by chain lines.

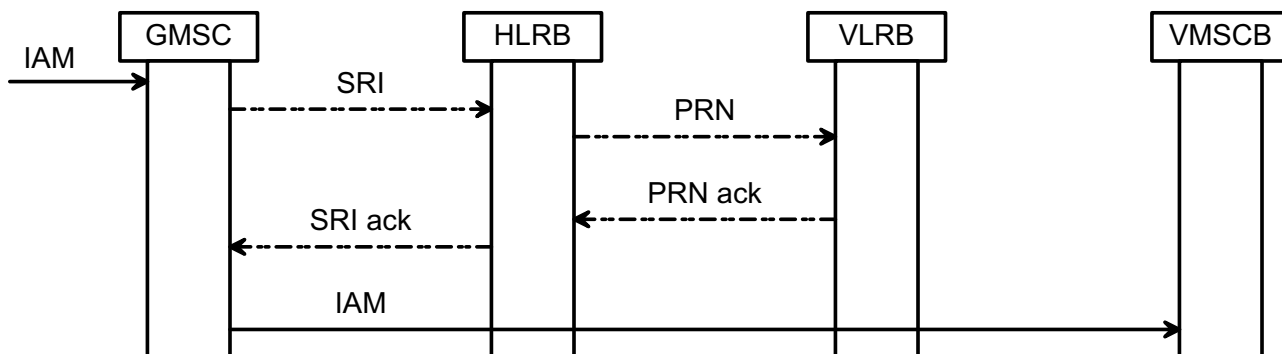

Figure 4: Information flow for retrieval of routing information for a basic mobile terminated call

When GMSCB receives an IAM, it analyses the called party address. If GMSCB can derive an HLR address from the B party address, it sends a request for routing information (SRI) to HLRB. HLRB sends a request for a roaming number (PRN) to VLRB. VLRB returns the roaming number in the PRN ack, and HLRB relays the roaming number to GMSCB in the SRI ack. GMSCB constructs an IAM using the roaming number, and sends it to VMSCB.

5.3 Information flow for an MT call

An example information flow for an MT call is shown in figure 5; many variations are possible. ISUP signalling between GMSCB and VMSCB is shown by solid lines; signalling over the B interface between VMSCB and VLRB is shown by chain lines; signalling over the "A" interface between VMSCB and BSSB is shown by dashed lines; and signalling over the radio interface between VMSCB or BSSB and MSB is shown by dotted lines.

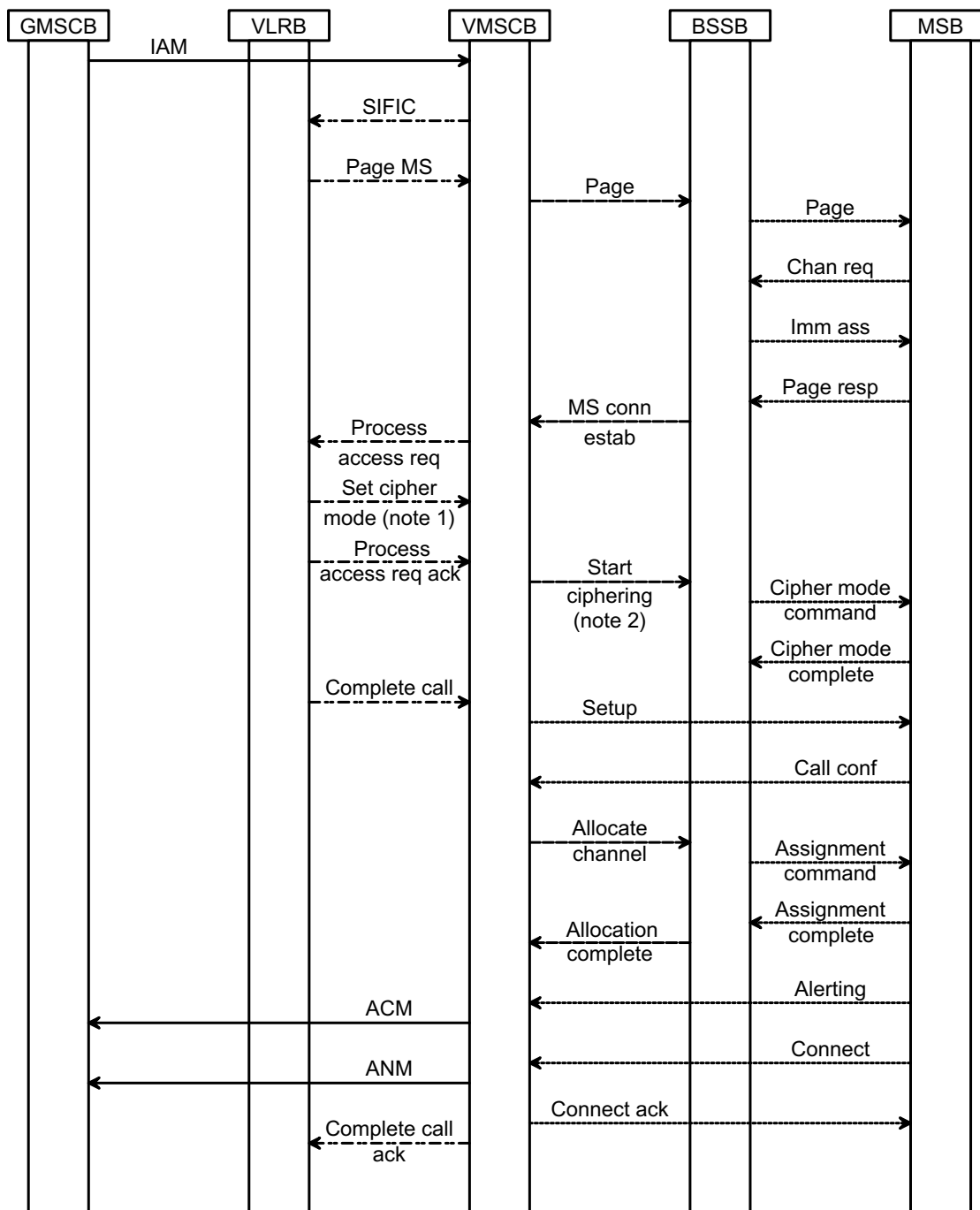

Figure 5: Information flow for a basic mobile terminated call

NOTE 1: Ciphering may be initiated at any stage after the network has accepted the page response; its position in this message flow diagram is an example.

NOTE 2: If ciphering is not required, the MSC may send a "start ciphering" request indicating that no ciphering is required.

NOTE 3: This message flow diagram assumes that the MS has already been authenticated on location registration. If this is not so (for the first MT call after VLR restoration), the network may initiate authentication after the MS responds to paging.

NOTE 4: The network may request the IMEI from the MS, and may check the IMEI, at any stage after the MS responds to paging, either as part of the procedure to start ciphering or explicitly after ciphering has started; this is not shown in this message flow diagram.

When VMSCB receives an IAM from GMSCB it sends to VLRB a request for information to handle the incoming call, using a Send Info For Incoming Call (SIFIC) message containing the roaming number received in the IAM.

If VLRB recognises the roaming number, and MSB is allowed service, it sends a request to VMSCB to page MSB. If a radio connection between the network and MSB is already established, VMSCB responds immediately to the page request. If no radio connection exists, VMSCB sends a page request to BSSB, and BSSB broadcasts the page on the paging channel. If VPLMNB supports GPRS and the Gs interface between VLRB and the SGSN is implemented (see GSM 03.60 [5]) and there is a valid association between VLRB and the SGSN for the MS, the paging signal towards the MS goes from VMSCB via VLRB and the SGSN to the BSS.

If MSB detects the page, it sends a channel request to BSSB, which responds with an immediate assignment command, to instruct MSB to use the specified signalling channel. MSB then sends a page response on the signalling channel; BSSB relays this to VMSCB. VMSCB sends a Process access request message to VLRB to indicate that MSB has responded to paging. VLRB may then initiate authentication, as described in GSM 03.20 [3]. VLRB may also initiate ciphering at this stage, as described in GSM 03.20 [3].

If VLRB determines that MSB is allowed service, it sends a Process access request ack to VMSCB. The Process access request ack message triggers a Start ciphering command message towards BSSB; if VMSCB has not received a Set cipher mode message from VLRB, the Start ciphering command indicates no ciphering.

VLRB then sends a Complete call message to VMSCB. VMSCB sends a Setup message towards MSB. The Setup message may include bearer capability information for the call.

When MSB receives the Setup message from BSSB, it responds with a Call confirmed message. The Call Confirmed message includes bearer capability information if any of the negotiable parameters of the bearer capability has to be changed. When VMSCB receives the Call confirmed message via BSSB, it sends an Allocate channel message to BSSB. BSSB instructs MSB to tune to a traffic channel by sending an Assignment command. When MSB has tuned to the specified traffic channel it responds with an Assignment complete, message, which BSSB relays to VMSCB as an Allocation complete, and sends an Alerting message to indicate that the called user is being alerted. VMSCB sends an ACM to GMSCB, which relays it to the originating exchange.

When the called user answers, MSB sends a Connect message, which BSSB relays to VMSCB. VMSCB:

- responds with a Connect ack message towards MSB;
- sends an ANM to GMSCB, which relays it to the originating exchange;
- sends a Complete call ack to VLRB.

The network then waits for the call to be cleared.

6 Principles for interactions with supplementary services

This clause specifies the principles used to describe the invocation of the GSM supplementary services which were standardized when the present document was drafted. Registration, erasure, activation, deactivation and interrogation are call-independent operations; they are therefore outside the scope of the present document. Descriptions may be found in the stage 2 specifications for each supplementary service.

In the modelling used in the present document, each supplementary service which a network entity supports is managed by a supplementary service handler, which handles data in the entity in which it runs. The call handling processes defined in the present document use the data to define the contents of messages to other entities. The basic call handling processes defined in the present document interact with the supplementary service handlers as shown in the SDL diagrams and the supporting text. If a network entity does not support a supplementary service, it bypasses the interaction with the handler for that supplementary service. Exceptions to this general principle are described later in this clause.

6.1 Line identification services (GSM 03.81)

6.1.1 Calling Line Identification Presentation (CLIP)

The basic call handling processes ICH_VLR and ICH_MSC interact with the processes CLIP_MAF001 and CLIP_MAF002 (GSM 03.81 [9]) as described in subclauses 7.3.2 and 7.3.1.

6.1.2 Calling Line Identification Restriction (CLIR)

The basic call handling processes OCH_MSC and OCH_VLR interact with the processes CLIR_MAF004 and CLIR_MAF003 (GSM 03.81 [9]) as described in subclauses 7.1.1 and 7.1.2.

6.1.3 Connected Line Identification Presentation (COLP)

The basic call handling processes OCH_MSC and OCH_VLR interact with the processes COLP_MAF006 and COLP_MAF005 (GSM 03.81 [9]) as described in subclauses 7.1.1 and 7.1.2.

The basic call handling processes MT_GMSC and ICH_MSC interact with the process COLP_MAF039 [9] as described in subclauses 7.2.1 and 7.3.1.

6.1.4 Connected Line Identification Restriction (COLR)

The basic call handling processes ICH_VLR and ICH_MSC interact with the processes COLR_MAF040 and COLR_MAF041 (GSM 03.81 [9]) as described in subclauses 7.3.2 and 7.3.1.

6.2 Call forwarding services (GSM 03.82)

6.2.1 Call Forwarding Unconditional (CFU)

The basic call handling process SRI_HLR interacts with the process MAF007(GSM 03.82 [10]) as described in subclause 7.2.2

6.2.2 Call Forwarding on mobile subscriber Busy (CFB)

The basic call handling process ICH_VLR interacts with the process MAF008 (GSM 03.82 [10]) as described in subclause 7.3.2

6.2.3 Call Forwarding on No Reply (CFNRy)

The basic call handling process ICH_VLR interacts with the process MAF009 (GSM 03.82 [10]) as described in subclause 7.3.2.

6.2.4 Call Forwarding on mobile subscriber Not Reachable (CFNRc)

The basic call handling processes SRI_HLR and ICH_VLR interact with the process MAF010 (GSM 03.82 [10]) as described in subclauses 7.2.2 and 7.3.2.

6.3 Call wait (GSM 03.83)

The basic call handling process ICH_VLR interacts with the process MAF013(GSM 03.83 [11]) as described in subclause 7.3.2. Further details of the handling of call waiting are given in subclauses 7.3.1 and 7.3.2..

6.4 Call hold (GSM 03.83)

Invocation of call hold before a basic call has been established will be rejected.

6.5 Multiparty (GSM 03.84)

Invocation of multiparty before a basic call has been established will be rejected.

6.6 Closed user group (GSM 03.85)

The basic call handling process OCH_VLR interacts with the process CUG_MAF014 (GSM 03.85 [13]) as described in subclause 7.1.2.

The basic call handling process SRI_HLR interacts with the process CUG_MAF015 (GSM 03.85 [13]) as described in subclause 7.2.2.

The interactions between call forwarding and CUG (GSM 03.85 [13]) are handled as described in subclause 7.2.2.6.

6.7 Advice of charge (GSM 03.86)

The interactions between Advice of Charge (GSM 03.86 [14]) and MO calls are handled as described in subclauses 7.1.1 and 7.1.2.

The interactions between Advice of Charge (GSM 03.86 [14]) and MT calls are handled as described in subclauses 7.3.1 and 7.3.2.

6.8 Call barring (GSM 03.88)

6.8.1 Barring of outgoing calls

The basic call handling process OCH_VLR interacts with the processes MAF017, MAF018 and MAF020 (GSM 03.88 [15]) as described in subclause 7.1.2.

6.8.2 Barring of incoming calls

The basic call handling process SRI_HLR interacts with the processes MAF022 and MAF023 (GSM 03.88 [15]) as described in subclause 7.2.2.

6.9 Explicit Call Transfer (GSM 03.91)

There is no interaction between Explicit Call Transfer and the basic call handling described in the present document.

6.10 Completion of Calls to Busy Subscriber (GSM 03.93)

The basic call handling processes OCH_MSC, OCH_VLR, MT_GMSC, SRI_HLR, PRN_VLR, ICH_MSC and ICH_VLR interact with the CCBS supplementary service as described in subclauses 7.1.1, 7.1.2, 7.2.1, 7.2.2, 7.2.3, 7.3.1 & 7.3.2 respectively.

7 Functional requirements of network entities

The text in this clause is a supplement to the definition in the SDL diagrams; it does not duplicate the information in the SDL diagrams.

The entities described in this clause interwork with other entities over three different types of interface:

- The A interface, used to interwork between the MSC and the BSS or the MS;
- The C, D & F interfaces, used to interwork between the MSC & HLR (C), VLR & HLR (D) and MSC & EIR (F);
- Telephony signalling interfaces, used to interwork between an MSC and another exchange.

The protocols used over the A interface are BSSMAP, which is specified in GSM 08.08 [19], for interworking with the BSS and DTAP, which is specified in GSM 04.08 [17], for interworking with the MS.

The protocol used over the C, D & F interfaces is MAP, which is specified in GSM 09.02 [20].

For the purposes of the present document, the protocol used over telephony signalling interfaces is ISUP, which is specified in ETS 300 356-1 [24]; other telephony signalling systems may be used instead.

The present document shows the call handling application processes interworking with a protocol handler for each of the protocols listed above. Each protocol defines supervision timers. If a supervision timer expires before a distant entity responds to a signal, the handling is as defined in the appropriate protocol specification. In general, the protocol handler reports timer expiry to the application as an error condition or negative response. Where a timer is shown in the present document, therefore, it is an **application** timer rather than a **protocol** timer. Interworking with the protocol handlers uses functional signal names which do not necessarily have a one-to-one correspondence with the names of messages used in the protocols.

An MSC which receives an IAM from an originating exchange may react in three different ways:

- It acts as a transit exchange, i.e. it relays the IAM to a destination exchange determined by analysis of the called party address, and thereafter relays other telephony signalling between the originating and destination exchange until the connection is released. This behaviour is not specific to GSM;
- It acts as a terminating exchange, i.e. it attempts to connect the call to an MS currently registered in the service area of the MSC;
- It acts as a GMSC, i.e. it interrogates an HLR for information to route the call. If the HLR returns routing information, the MSC uses the routing information from the HLR to construct an IAM, which it sends to a destination exchange determined by analysis of the routing information from the HLR.

Annex A describes the method which the MSC uses to decide how to process the IAM.

The SDL diagrams in this clause show the handling for a number of optional features and services. If the handling consists only of a call to a procedure specific to the feature or service, the procedure call is omitted if the entity does not support an optional feature or service. If the handling consists of more than a call to a procedure specific to the feature or service, the text associated with each SDL diagram specifies the handling which applies if the entity does not support an optional feature or service. For simplicity of description, it is assumed that support for Operator Determined Barring and the Call Forwarding and Call Barring supplementary services is mandatory.

For the entities which support CAMEL, the references to GSM 03.78 are to the version of GSM03.78 for the appropriate phase of CAMEL.

7.1 MO call

7.1.1 Functional requirements of serving MSC

7.1.1.1 Process OCH_MSC

The variable TCH allocated is global data, accessible to the procedure Establish_Originating_TCH_If_Required.

The procedures CCBS_Report_Not_Idle and CCBS_Check_Last_Call are specific to CCBS; they are specified in GSM 03.93 [16].

7.1.1.2 Procedure Process_Access_Request_MSC

Sheet 2: instead of using the explicit procedure Obtain_IMEI_MSC, the VMSC may encapsulate the request for the IMEI in the Start ciphering request; the BSS relays the response in the Cipher Mode complete message to the MSC.

Sheet 2: the VMSC maps the negative response received on the B interface to the appropriate reject cause according to the rules defined in ETS 300 607 [22].

Sheet 2: The Start ciphering request may indicate one of several ciphering algorithms, or no ciphering.

Sheet 2, sheet 3: At any stage, the MS may terminate the transaction with the network by sending a CM service abort message.

Sheet 2, sheet 3: if the VMSC receives a Setup message from the MS while the access request is being handled, the message is saved for processing after the access request has been handled.

7.1.1.3 Procedure OG_Call_Setup_MSC

Sheet 1: the variables Alerting sent, MS connected and Reconnect are global data, accessible to the procedures CCBS_Check_OG_Call, CCBS_OCH_Report_Failure, CCBS_OCH_Report_Success, CCBS_Check_If_CCBS_Possible, Send_Alerting_If_Required and Send_Access_Connect_If_Required.

Sheet 1: the VMSC converts the GSM bearer capability negotiated between the VMSC and the MS to a GSM basic service according to the rules defined in GSM 07.01 [18].

Sheet 1, sheet 2, sheet 5: the procedure CCBS_OCH_Report_Failure is specific to CCBS; it is specified in GSM 03.93 [16].

Sheet 1, sheet 5, sheet 6, sheet 8: at any stage after the Setup has been received, the MS may terminate the transaction with the network by sending a Release transaction request.

Sheet 2: the procedure Set_CLI_Presentation_Indicator_MSC is specific to CLIR. If the VMSC does not support CLIR, processing continues from the "Yes" exit of the test "Result=Call allowed?".

Sheet 2: the procedure CAMEL_OCH_MSC_INIT is specific to CAMEL; it is specified in GSM 03.78 for CAMEL Phase 1 [6] and GSM 03.78 for CAMEL Phase 2 [7]. If the VMSC does not support CAMEL, processing continues from the "Yes" exit of the test "Result=Pass?".

Sheet 2: the procedure CCBS_Check_OG_Call is specific to CCBS; it is specified in GSM 03.93 [16]. If the VMSC does not support CCBS, processing continues from the "Yes" exit of the test "Result=Pass?".

Sheet 3: the procedure CCBS_OCH_Report_Success is specific to CCBS; it is specified in GSM 03.93 [16].

Sheet 3, sheet 6: the procedures CAMEL_Start_TNRy and CAMEL_Stop_TNRy are specific to CAMEL phase 2; they are specified in GSM 03.78 for CAMEL Phase 2 [7].

Sheet 4: the procedure CAMEL_OCH_MSC_ANSWER is specific to CAMEL; it is specified in GSM 03.78 for CAMEL Phase 1 [6] and GSM 03.78 for CAMEL Phase 2 [7]. If the VMSC does not support CAMEL, processing continues from the "Yes" exit of the test "Result=Pass?".

Sheet 4: the procedure Set_COLP_Info_MSC is specific to COLP.

Sheet 4: the procedure Handle_AoC_MO_MSC is specific to AoC.

Sheet 5: the procedures CCBS_Check_If_CCBS_Possible and CCBS_Activation_MSC are specific to CCBS; they are specified in GSM 03.93 [16]. The task "Store CCBS Result" is executed only if the VMSC supports CCBS. If the VMSC does not support CCBS, processing continues from the "CCBS Not Possible" exit of the test "CCBS Result".

Sheet 5, sheet 6: the procedures CAMEL_OCH_MSC_DISC3 and CAMEL_OCH_MSC_DISC4 are specific to CAMEL; they are specified in GSM 03.78 for CAMEL Phase 1 [6] and GSM 03.78 for CAMEL Phase 2 [7] respectively.

Sheet 5, sheet 6: the procedure CAMEL_OCH_MSC1 is specific to CAMEL phase 2; it is specified in GSM 03.78 for CAMEL Phase 2 [7]. If the VMSC does not support CAMEL phase 2, processing continues from the "No" exit of the test "Result=Reconnect?"

Sheet 5, sheet 6, sheet 8: the processing in the branch beginning with the Int_Release_Call input will occur only if the MSC supports CAMEL.

Sheet 7: the input signal TNry expired and all the subsequent processing are specific to CAMEL phase 2, and will occur only if the VMSC supports CAMEL phase 2. The procedure CAMEL_OCH_MSC2 is specified in GSM 03.78 for CAMEL Phase 2 [7].

Sheet 8: the procedure CAMEL_OCH_MSC_DISC1 is specific to CAMEL; it is specified in GSM 03.78 for CAMEL Phase 1 [6] and GSM 03.78 for CAMEL Phase 2 [7]. If the VMSC does not support CAMEL, processing continues from the "No" exit of the test "Result=CAMEL handling?".

Sheet 8: the procedure CAMEL_OCH_MSC_DISC2 is specific to CAMEL; it is specified in GSM 03.78 for CAMEL Phase 1 [6] and GSM 03.78 for CAMEL Phase 2 [7]. If the VMSC does not support CAMEL, processing continues from the "No" exit of the test "Result=CAMEL handling?".

7.1.1.4 Procedure Obtain_IMSI_MSC

The MS may terminate the transaction with the network while the VMSC is waiting for the MS to return its IMSI. If a CC connection has not been established, the MS uses CM Service Abort; otherwise it uses a Release, Release Complete or Disconnect. The VMSC aborts the transaction with the VLR and returns an aborted result to the parent process.

7.1.1.5 Procedure Authenticate_MSC

The MS may terminate the transaction with the network while the VMSC is waiting for the MS to respond to an authentication request. If a CC connection has not been established, the MS uses CM Service Abort; otherwise it uses a Release, Release Complete or Disconnect. The VMSC aborts the transaction with the VLR and returns an aborted result to the parent process.

7.1.1.6 Procedure Obtain_IMEI_MSC

The MS may terminate the transaction with the network while the VMSC is waiting for the MS to return its IMEI. If a CC connection has not been established, the MS uses CM Service Abort; otherwise it uses a Release, Release Complete or Disconnect. The VMSC aborts the transaction with the VLR and returns an aborted result to the parent process.

7.1.1.7 Procedure Check_IMEI_MSC

The MS may terminate the transaction with the network while the VMSC is waiting for the MS to return its IMEI. If a CC connection has not been established, the MS uses CM Service Abort; otherwise it uses a Release, Release Complete or Disconnect. The VMSC aborts the transaction with the VLR and returns an aborted result to the parent process.

The MS may terminate the transaction with the network while the VMSC is waiting for the result of the IMEI check from the EIR. If a CC connection has not been established, the MS uses CM Service Abort; otherwise it uses a Release, Release Complete or Disconnect. The VMSC aborts the transaction with the VLR and returns an aborted result to the parent process.

7.1.1.8 Procedure Establish_Originating_TCH_If_Required

7.1.1.9 Procedure Set_CLI_Presentation_Indicator_MSC

The MS may terminate the transaction with the network by sending a Release transaction message while a response is awaited from the process CLIR_MAF004. The message is saved for processing after return from the procedure.

7.1.1.10 Procedure Send_Alerting_If_Required

The test "Backward call indicator=no indication" refers to the called party's status field in the backward call indicators parameter of the ISUP Address Complete message which triggered the call of the procedure Send_Alerting_If_Required.

If no useful information would be carried in the Progress message, it is not sent.

7.1.1.11 Procedure Set_COLP_Info_MSC

The MS may terminate the transaction with the network by sending a Release transaction message while a response is awaited from the process COLP_MAF006. The message is saved for processing after return from the procedure.

7.1.1.12 Procedure Send_Access_Connect_If_Required

The test "Acknowledgement required" refers to the result returned by the procedure Handle_AoC_MSC. If the VMSC does not support AoC, processing continues from the "No" exit of the test "Acknowledgement required".

If no useful information would be carried in the Facility message, it is not sent.

7.1.1.13 Procedure Handle_AoC_MO_MSC

The charging parameters and the Boolean variable Acknowledgement required are global data which can be read by the parent process.

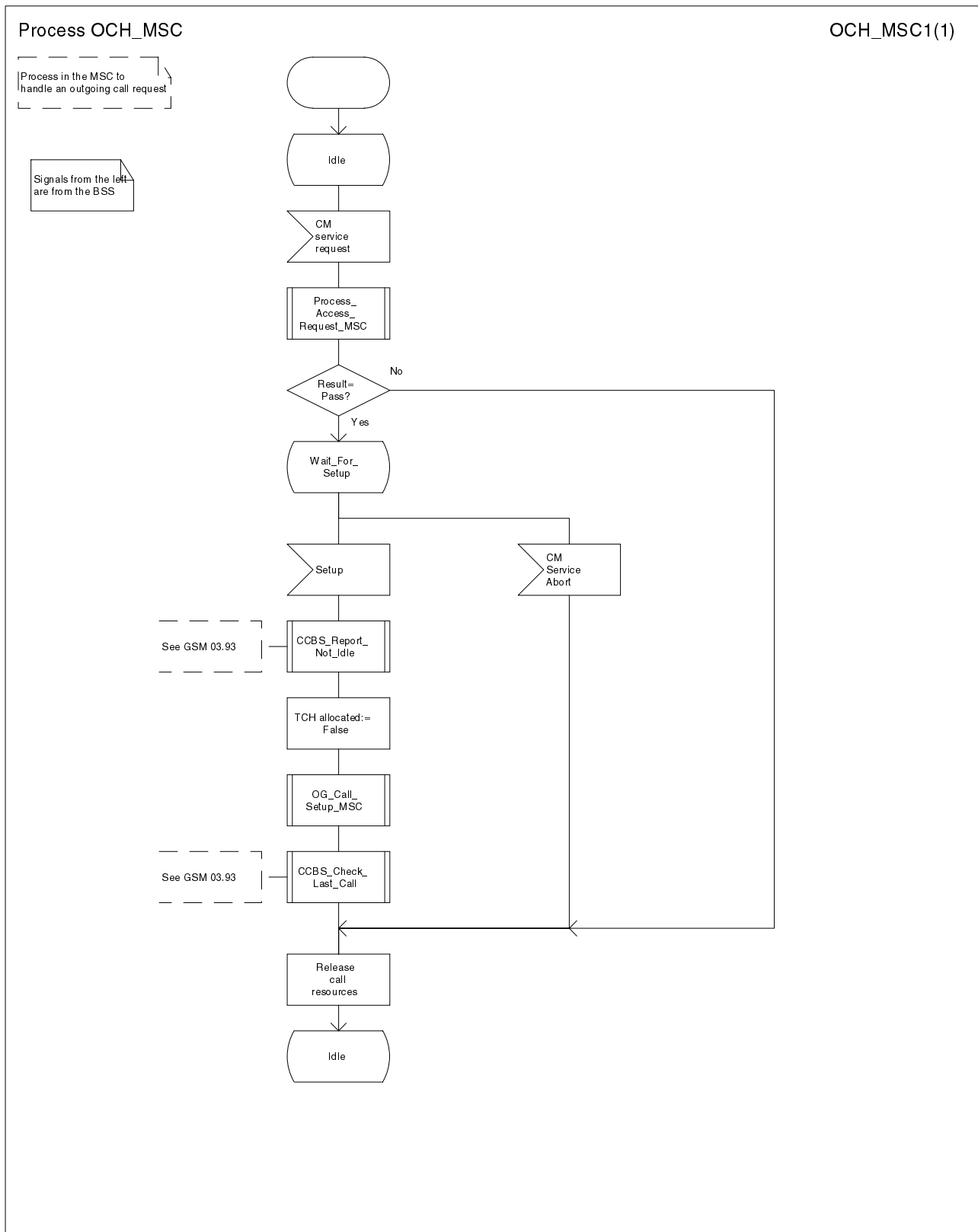

Figure 6: Process OCH_MSC

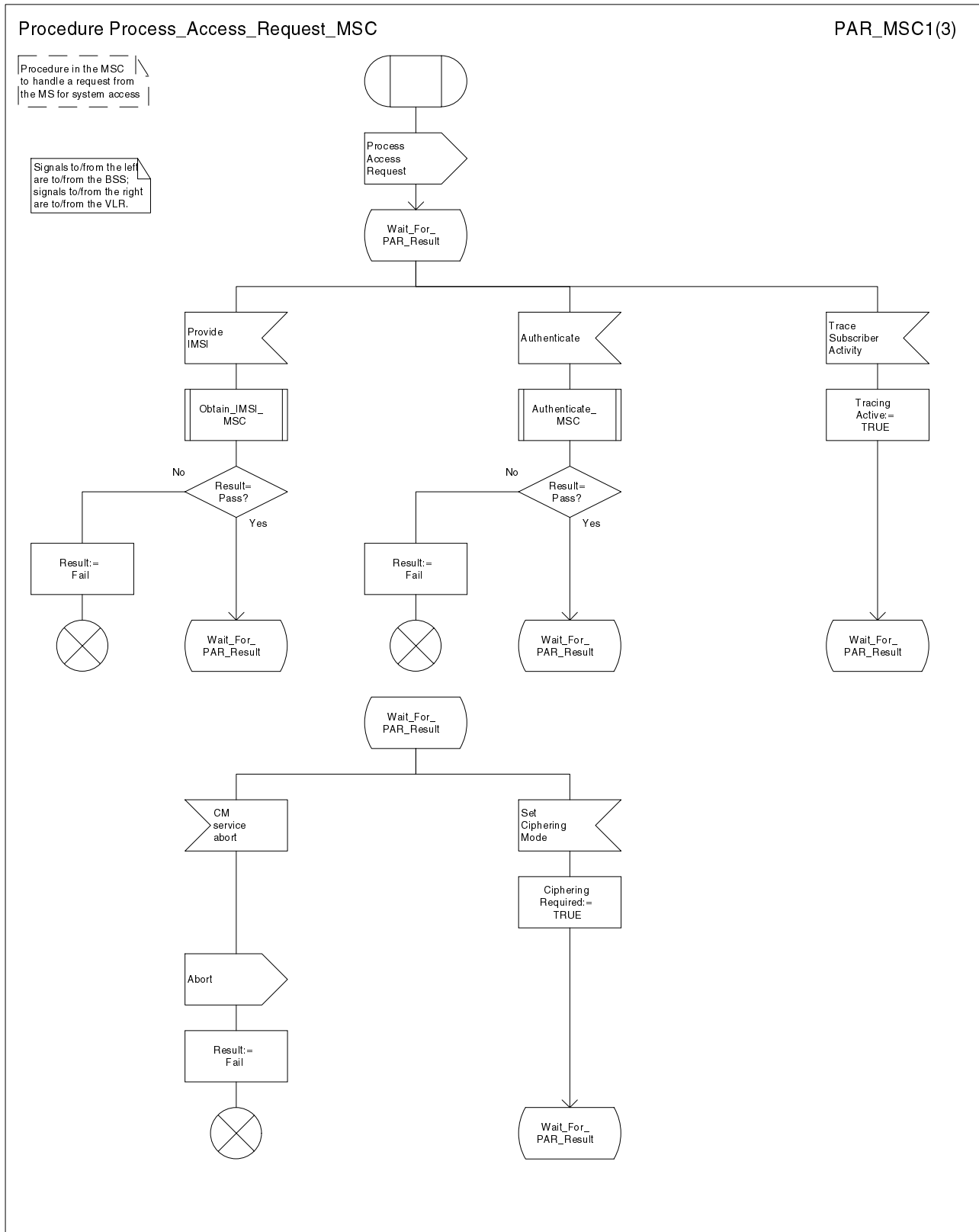

Figure 7a: Procedure Process_Access_Request_MSC (sheet 1)

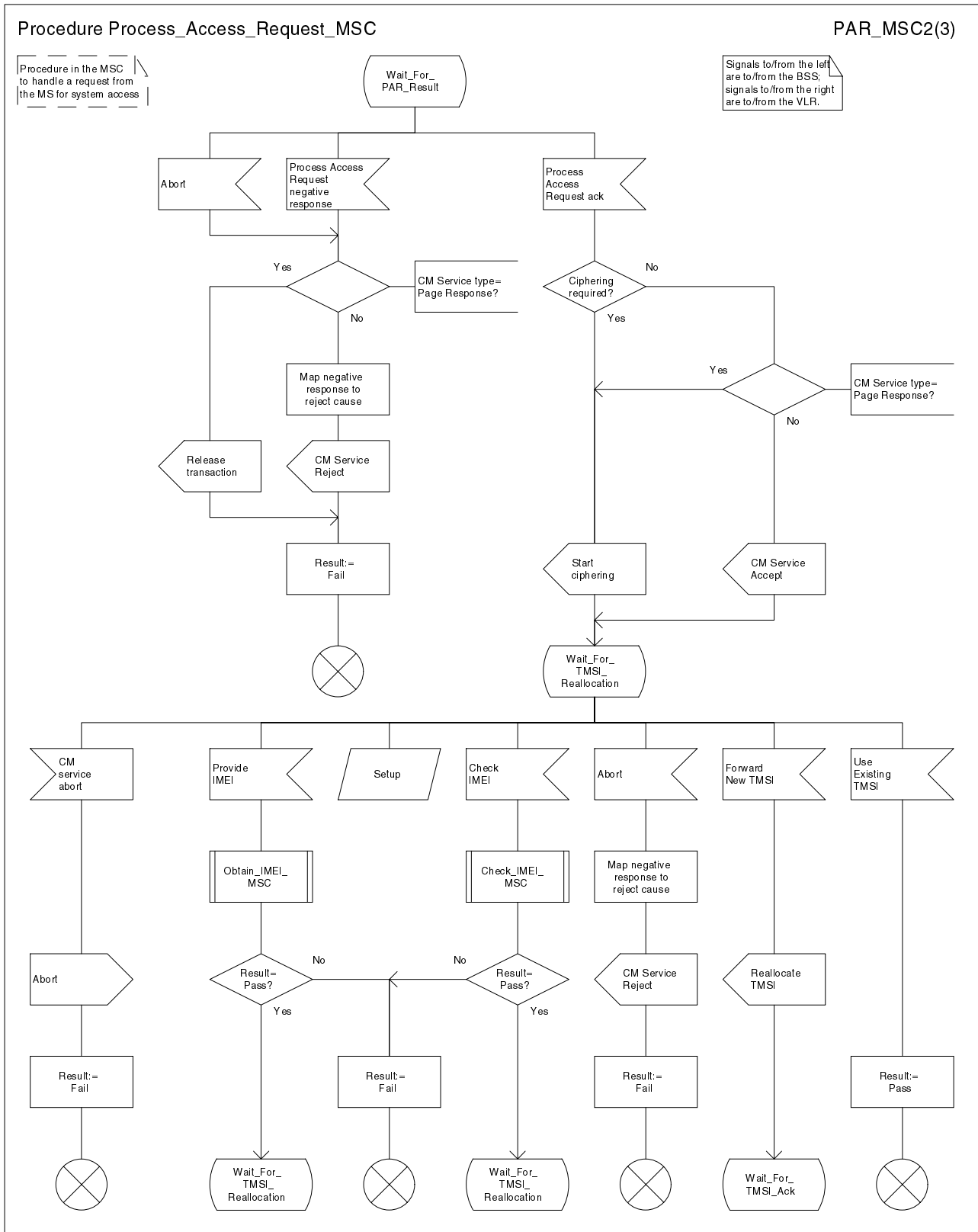

Figure 7b: Procedure Process_Access_Request_MSC (sheet 2)

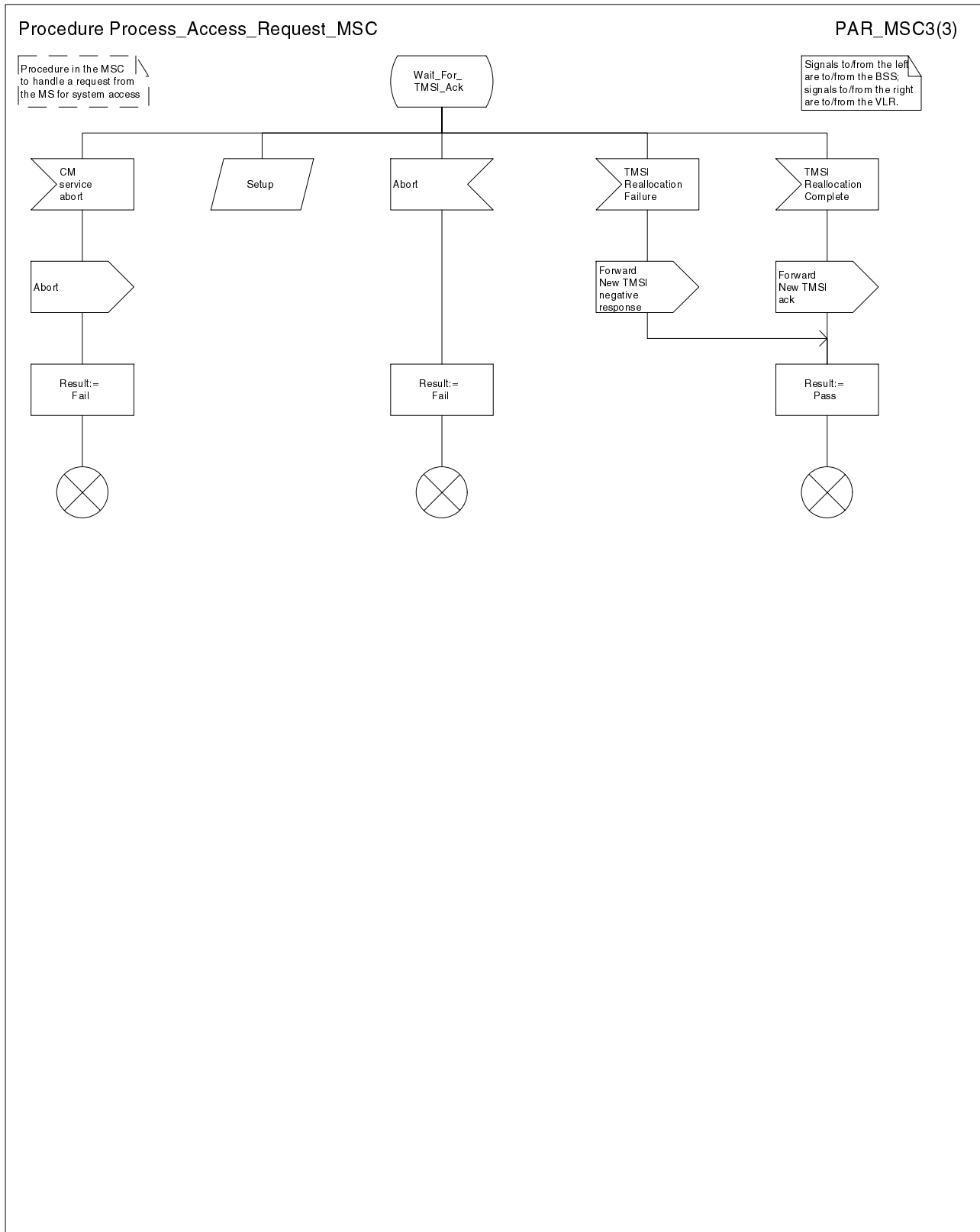

Figure 7c: Procedure Process_Access_Request_MSC (sheet 3)

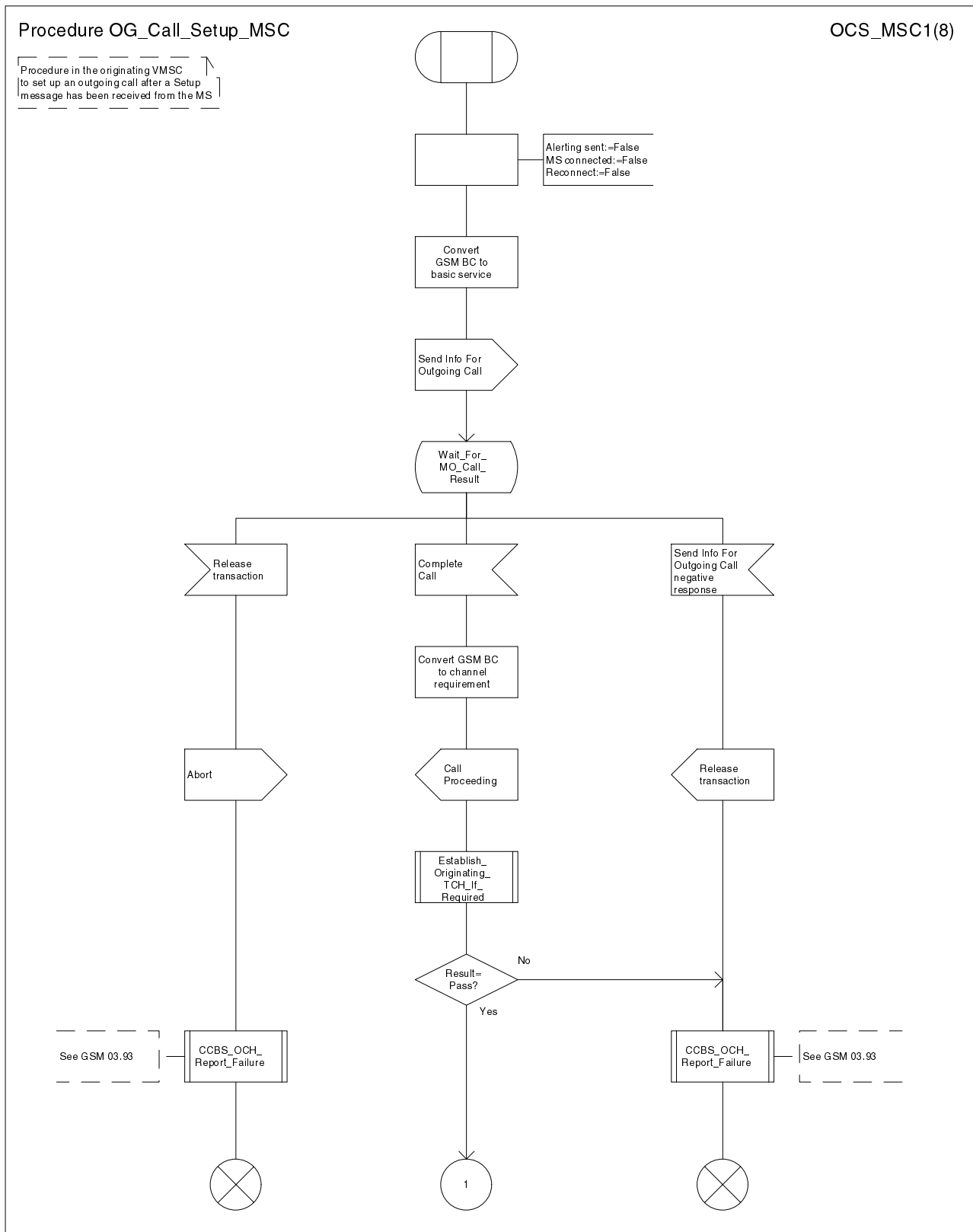

Figure 8a: Procedure Outgoing_Call_Setup_MSC (sheet 1)

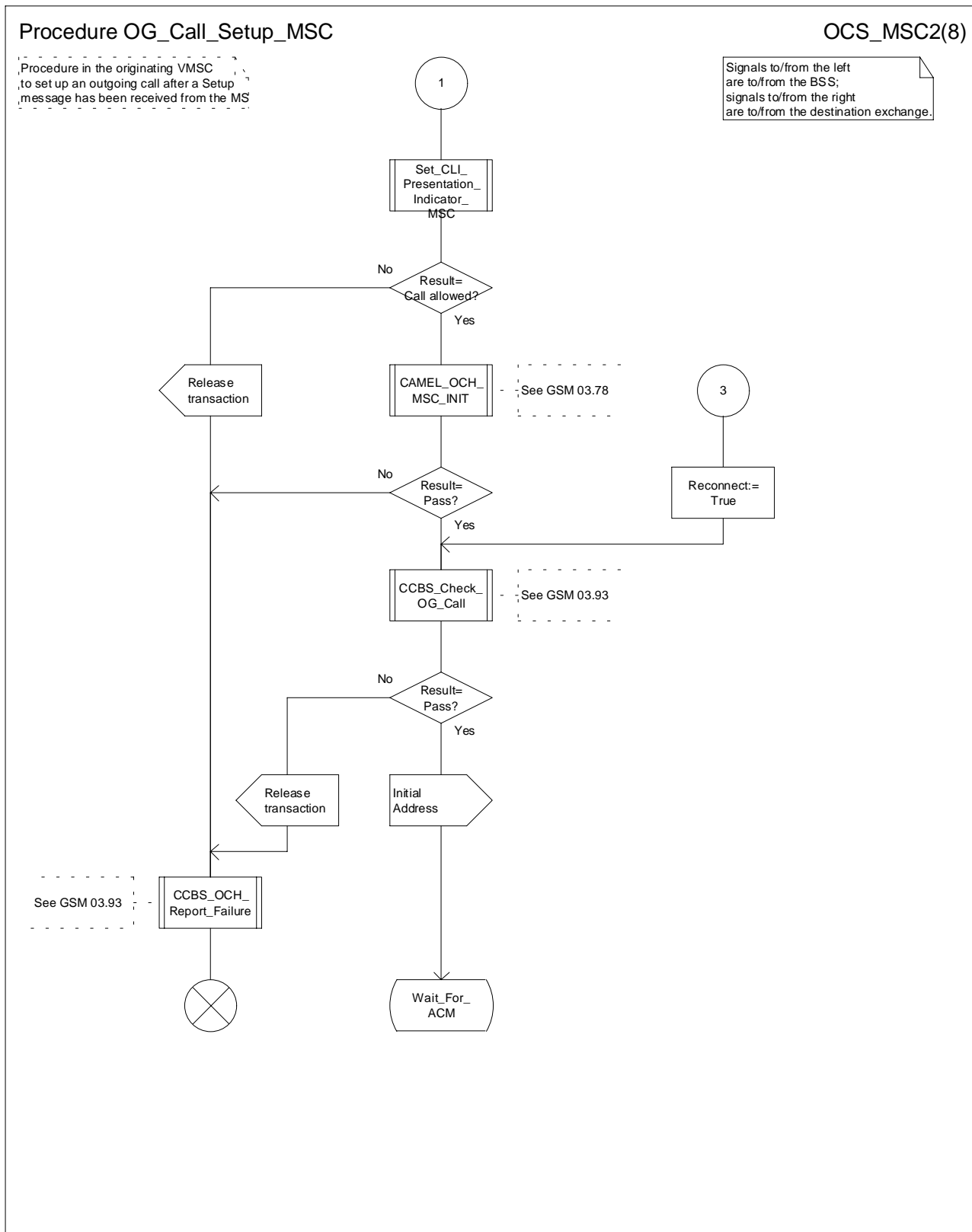

Figure 8b: Procedure Outgoing_Call_Setup_MSC (sheet 2)

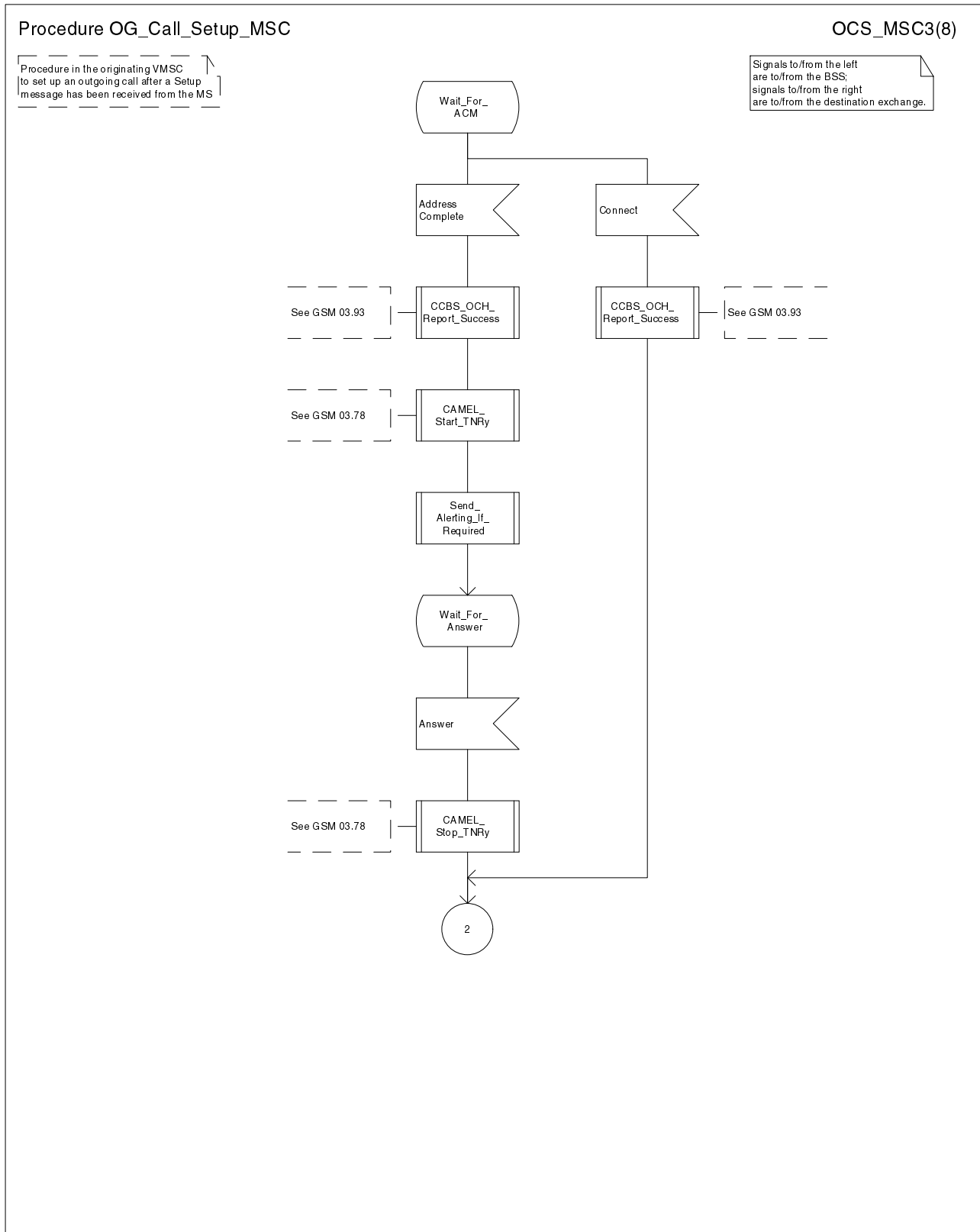

Figure 8c: Procedure Outgoing_Call_Setup_MSC (sheet 3)

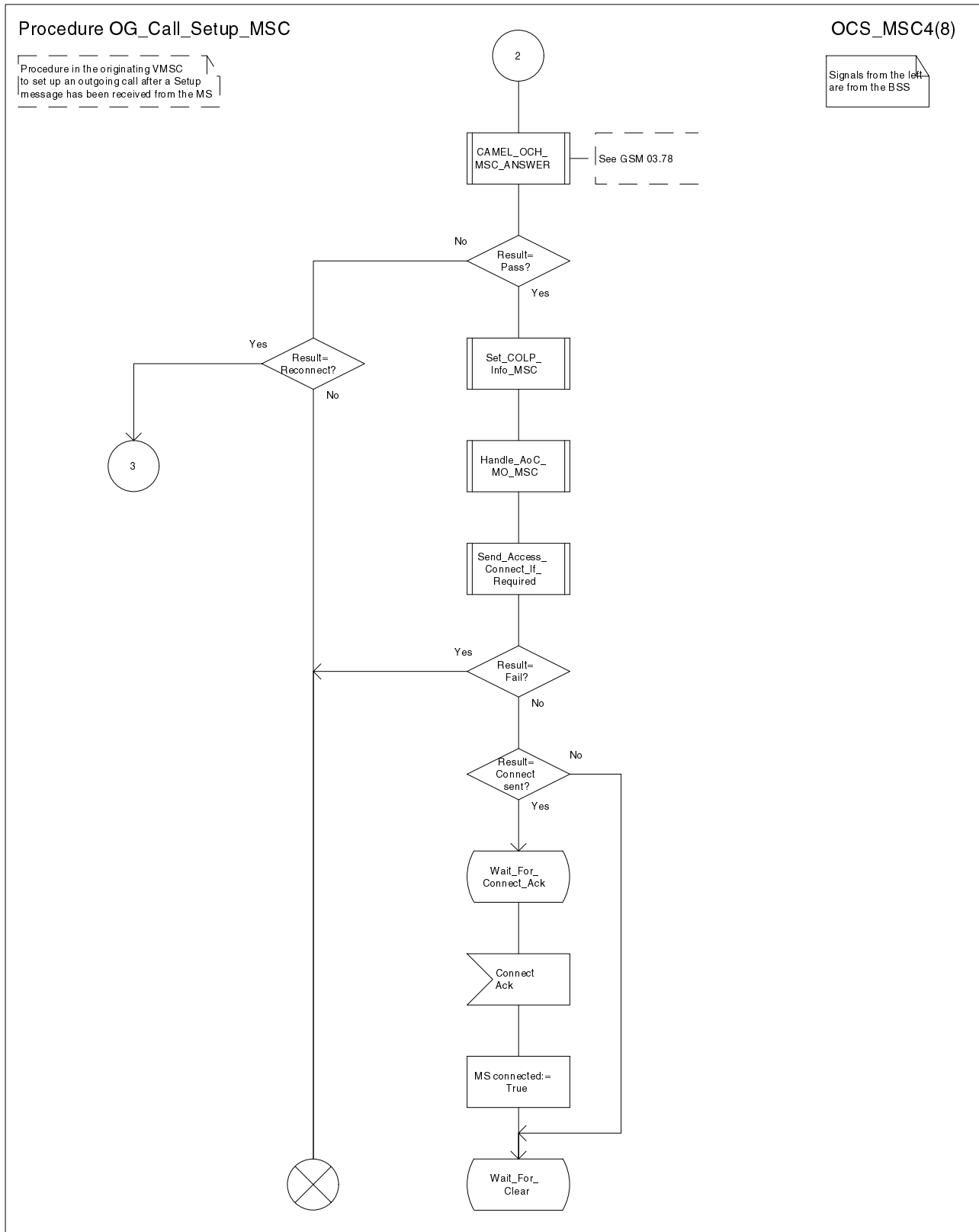

Figure 8d: Procedure Outgoing_Call_Setup_MSC (sheet 4)

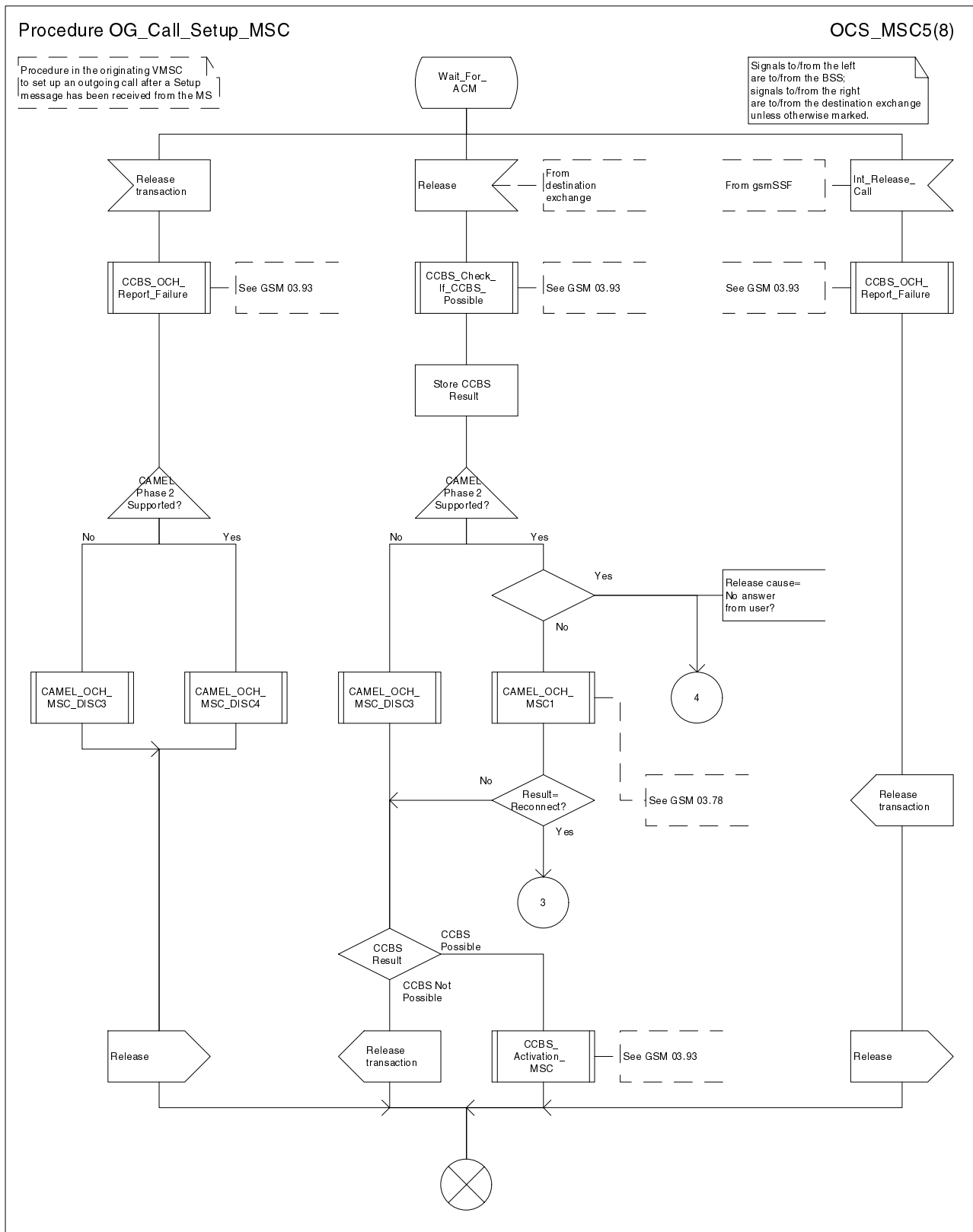

Figure 8e: Procedure Outgoing_Call_Setup_MSC (sheet 5)

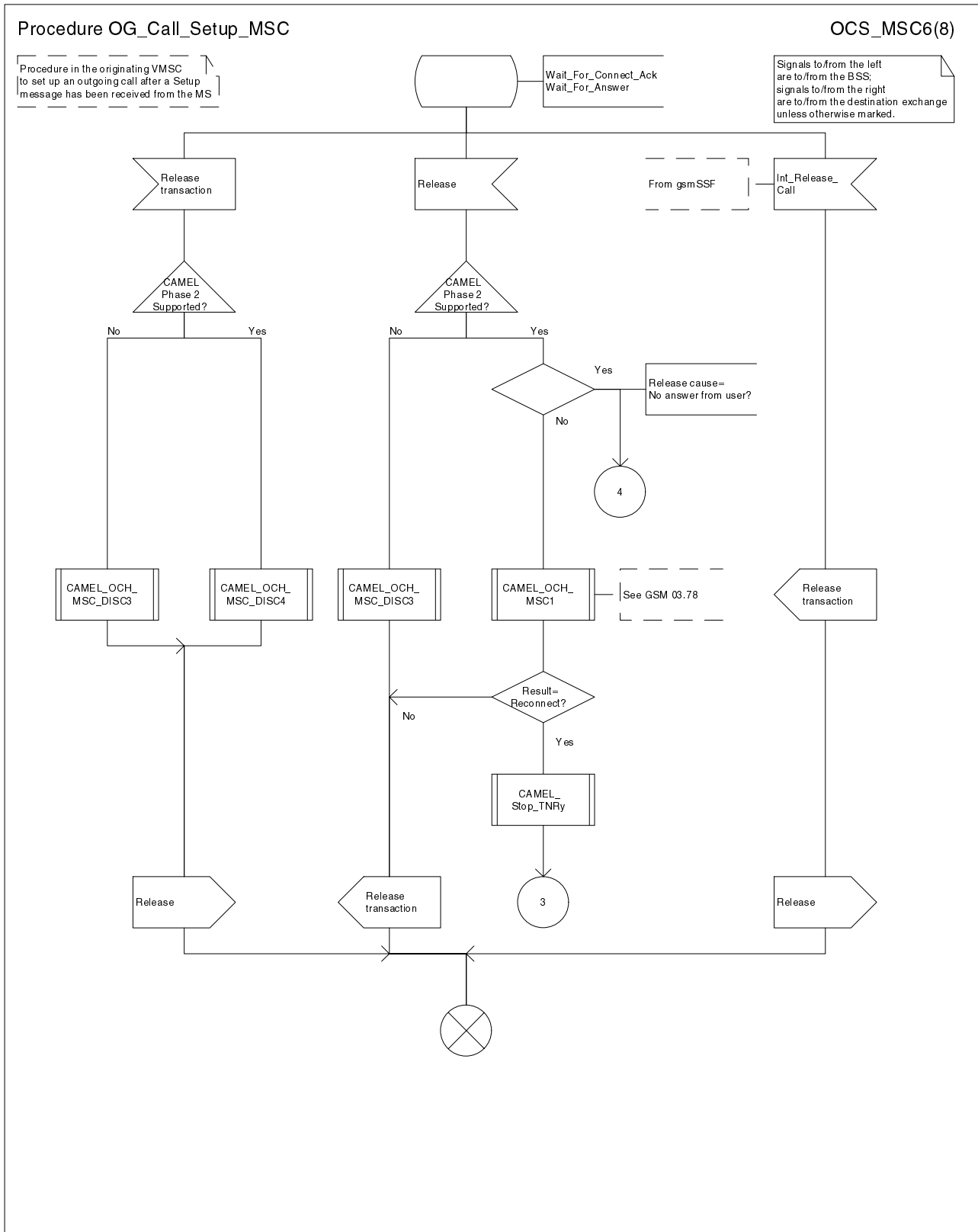

Figure 8f: Procedure Outgoing_Call_Setup_MSC (sheet 6)

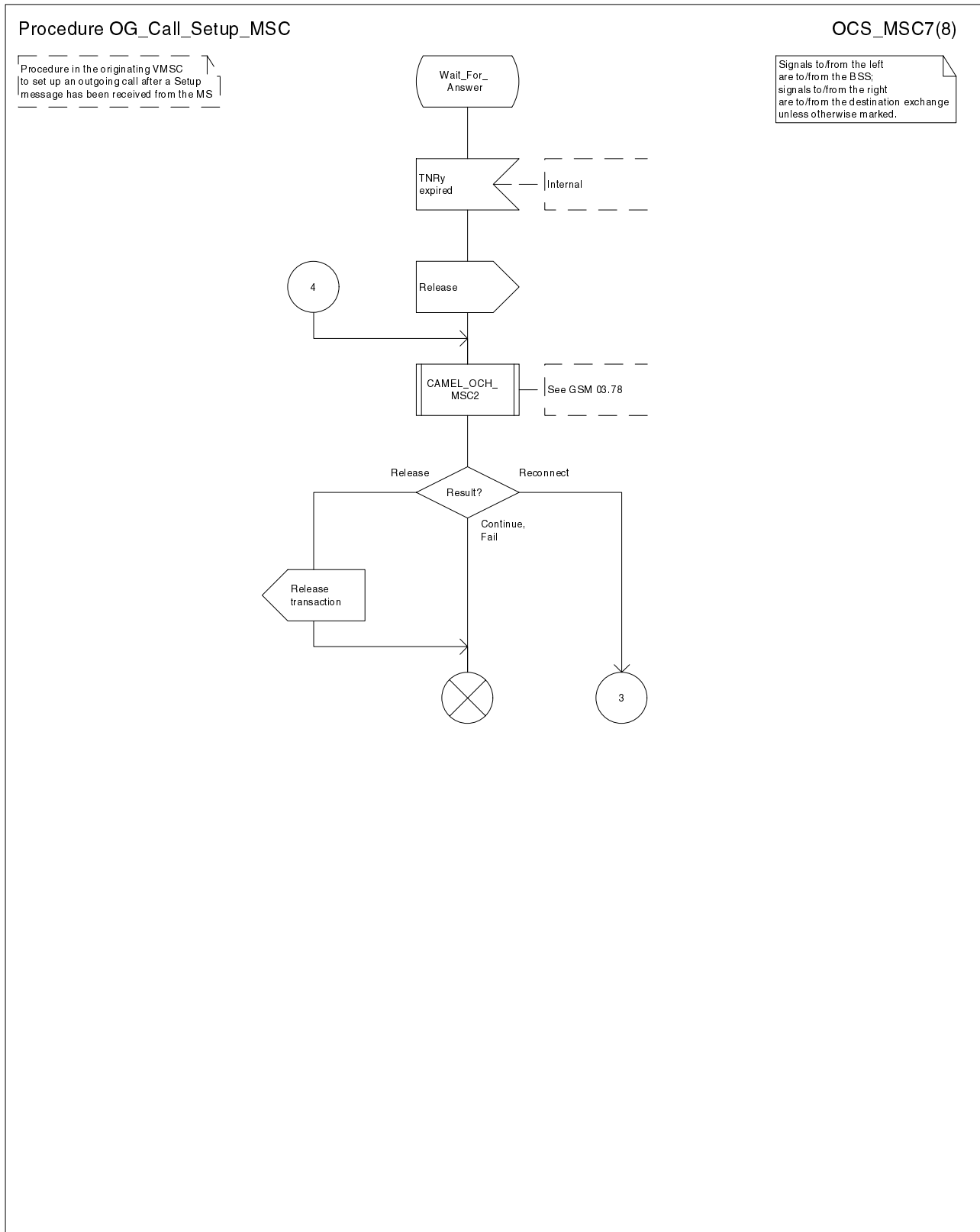

Figure 8g: Procedure Outgoing_Call_Setup_MSC (sheet 7)

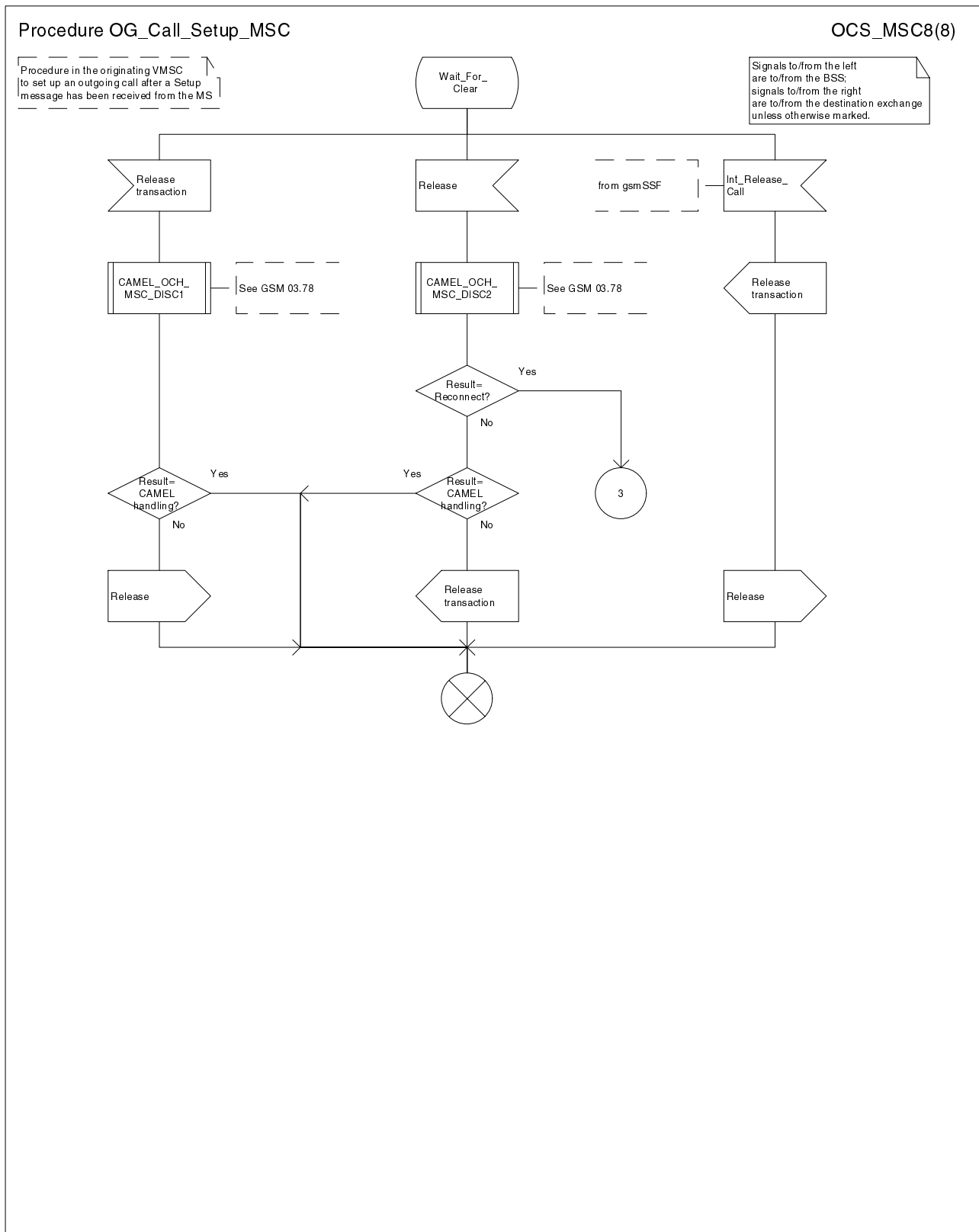

Figure 8h: Procedure Outgoing_Call_Setup_MSC (sheet 8)

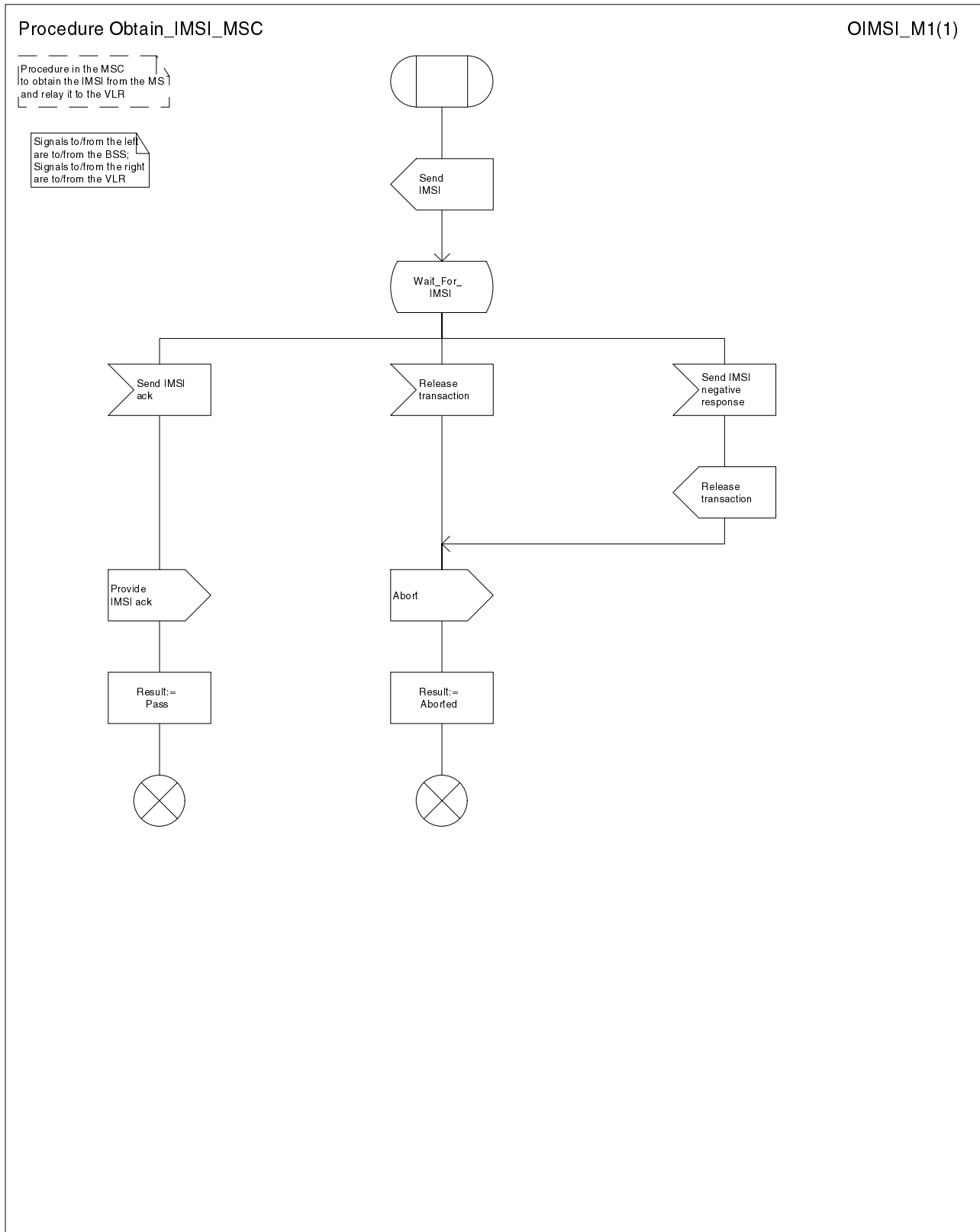

Figure 9: Procedure Obtain_IMSI_MSC

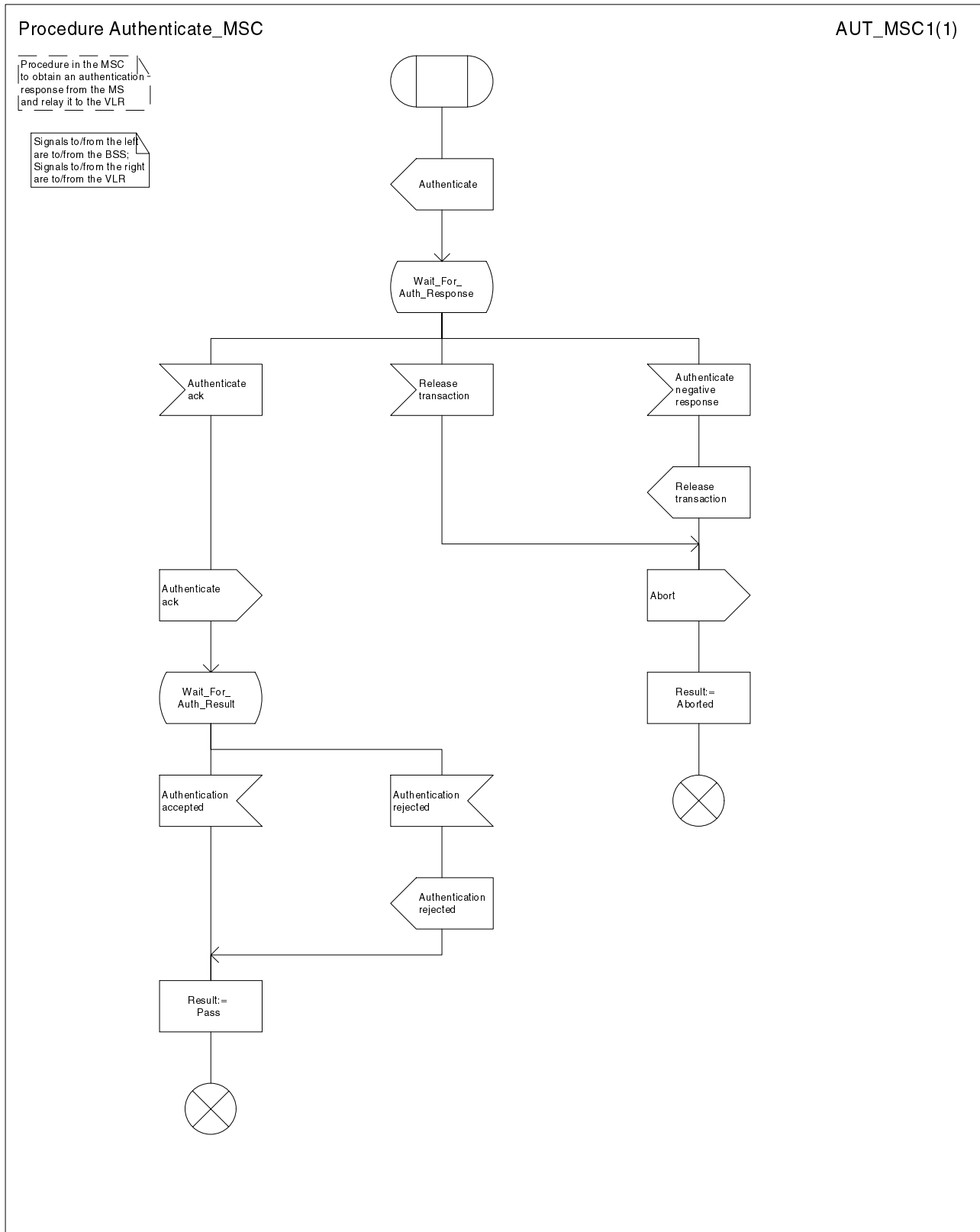

Figure 10: Procedure Authenticate_MSC

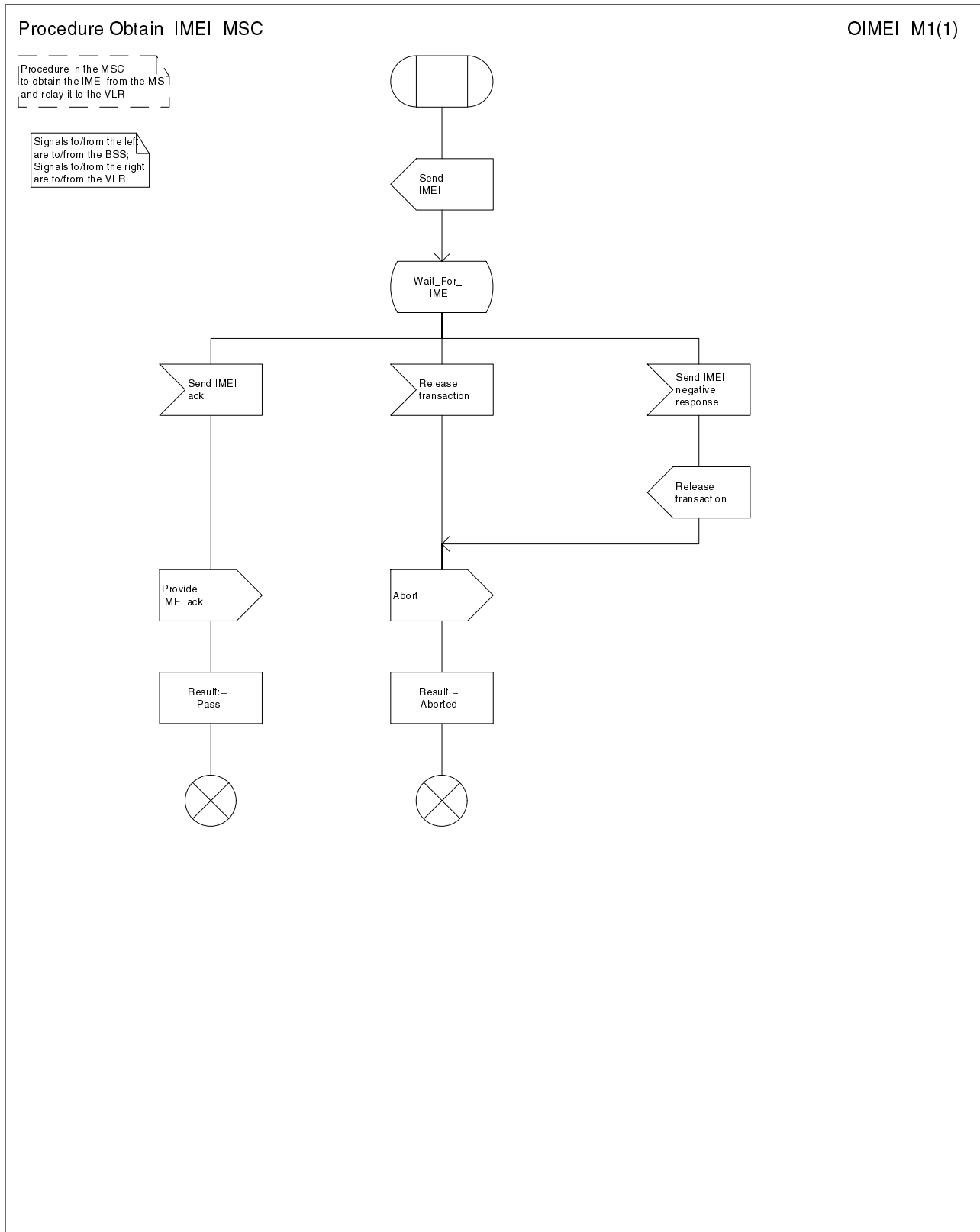

Figure 11: Procedure Obtain_IMEI_MSC

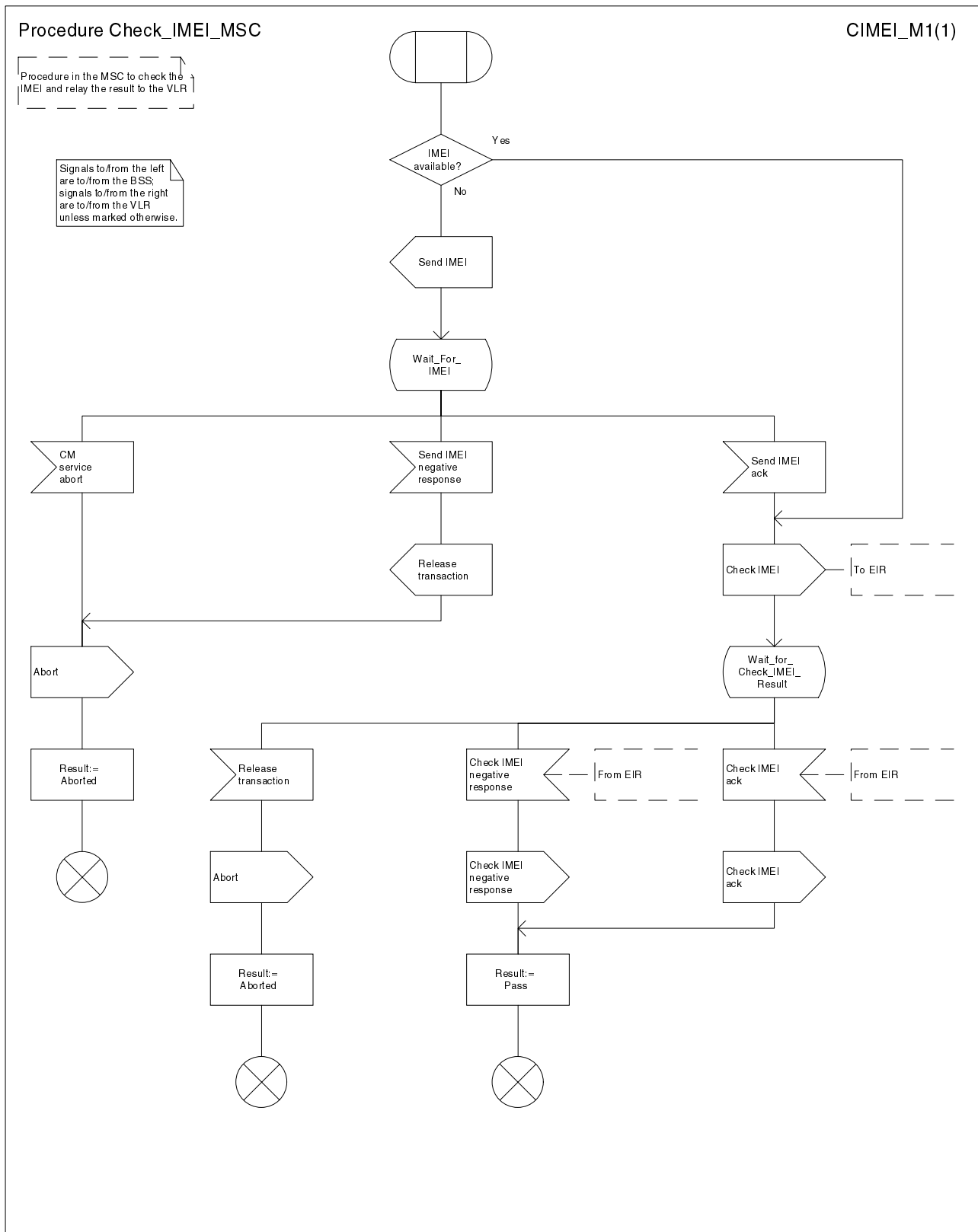

Figure 12: Procedure Check_IMEI_MSC

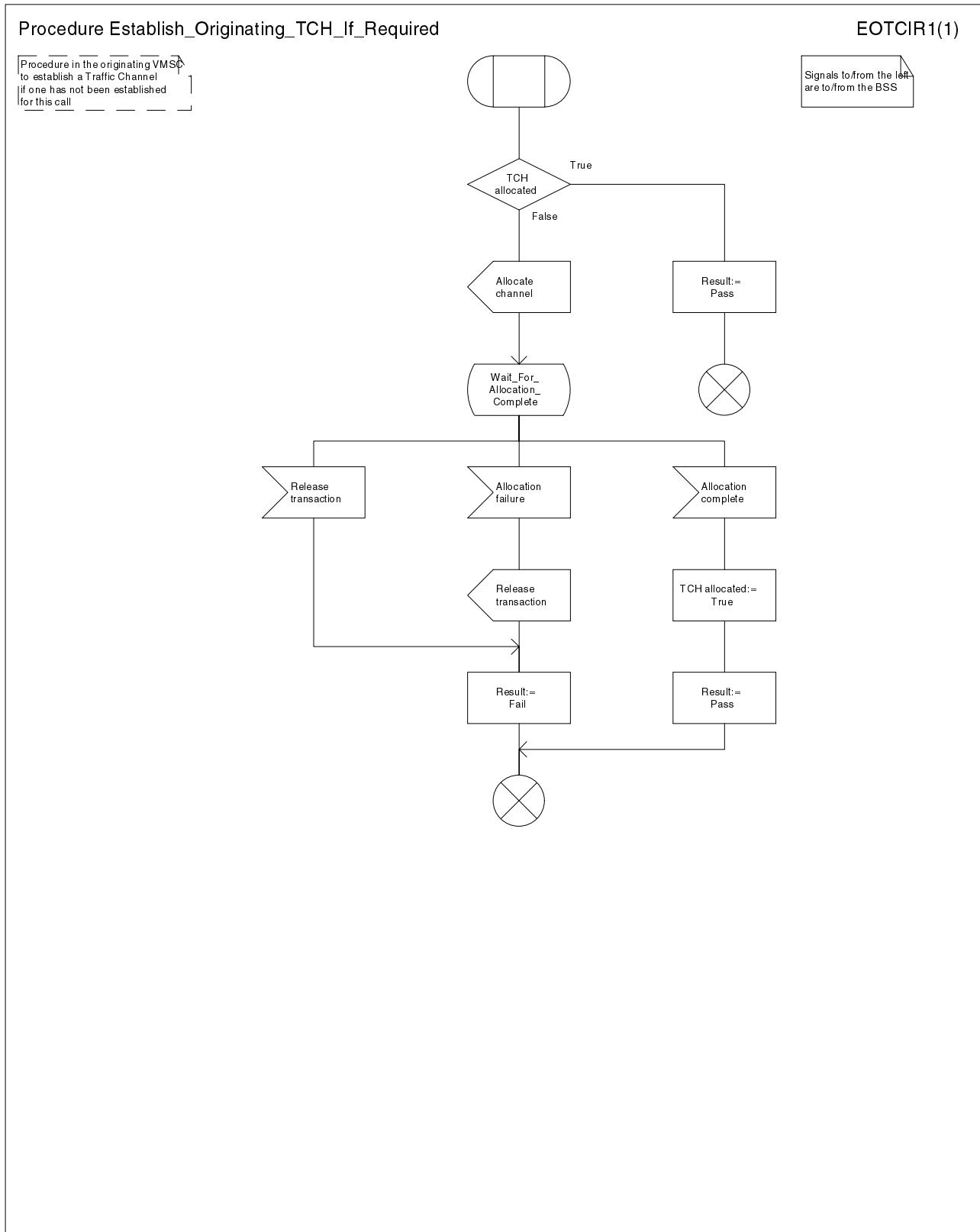

Figure 13: Procedure Establish_Originating_TCH_If_Required

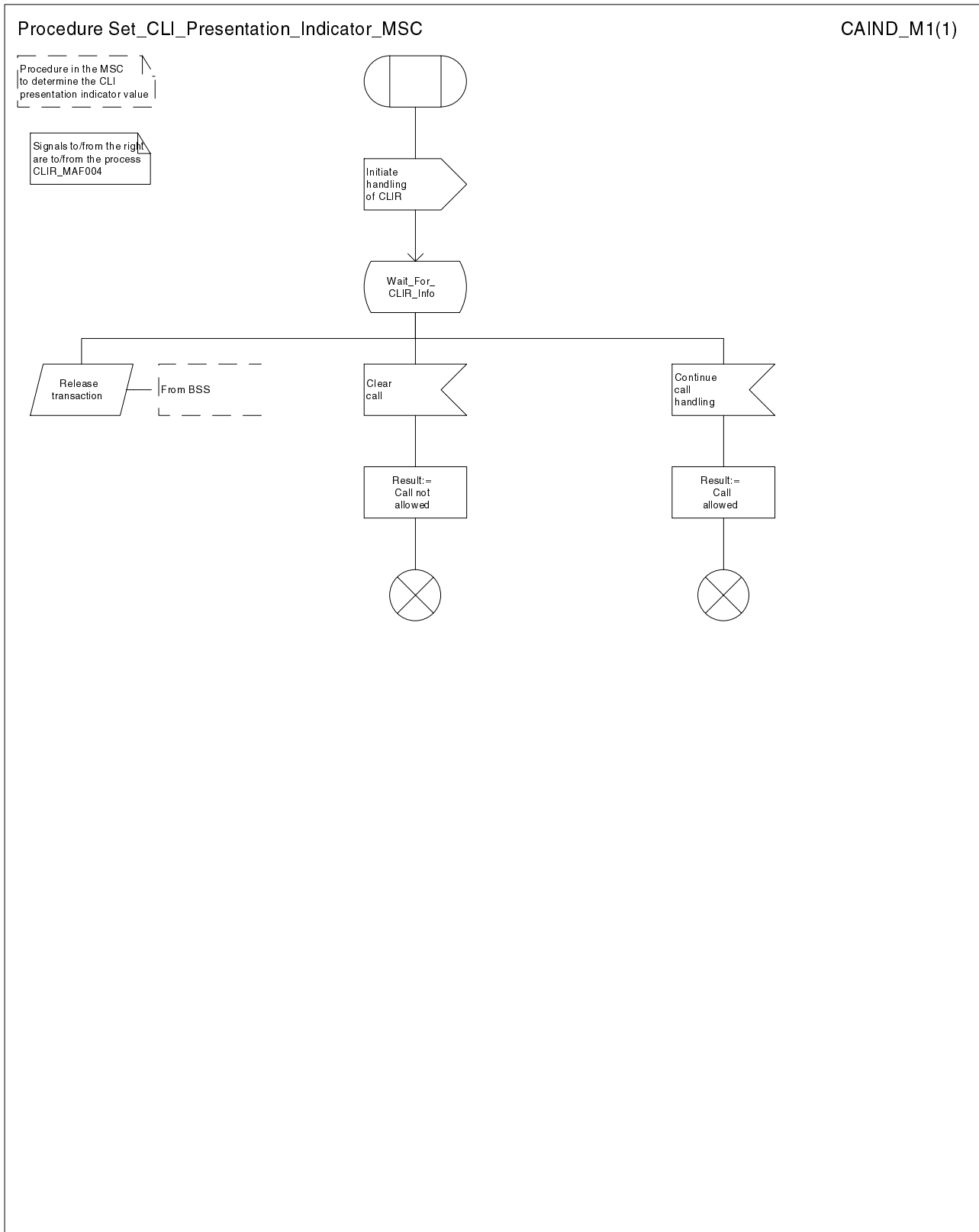

Figure 14: Procedure Set_CLI_Presentation_Indicator_MSC

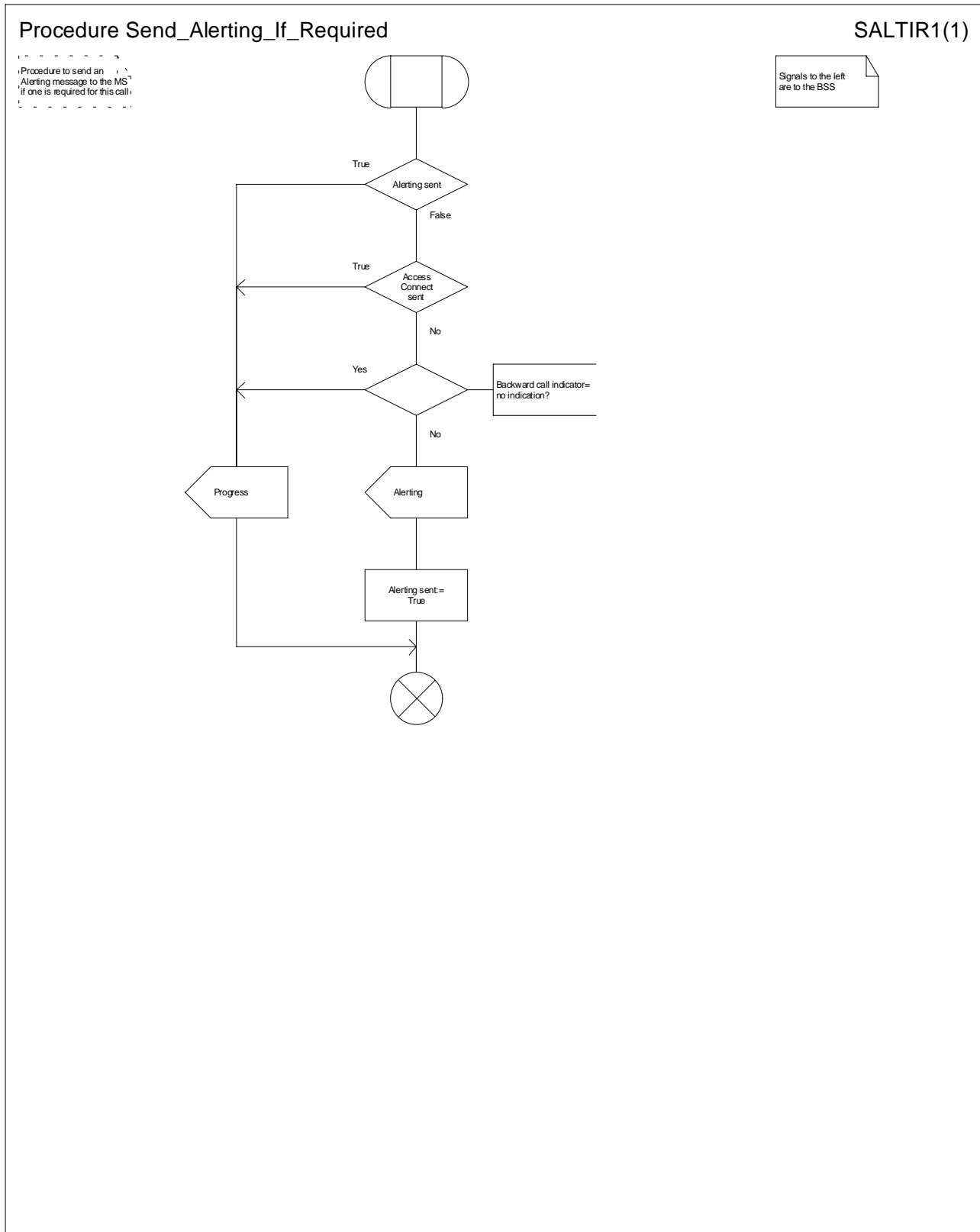

Figure 15: Procedure Send_Alerting_If_Required

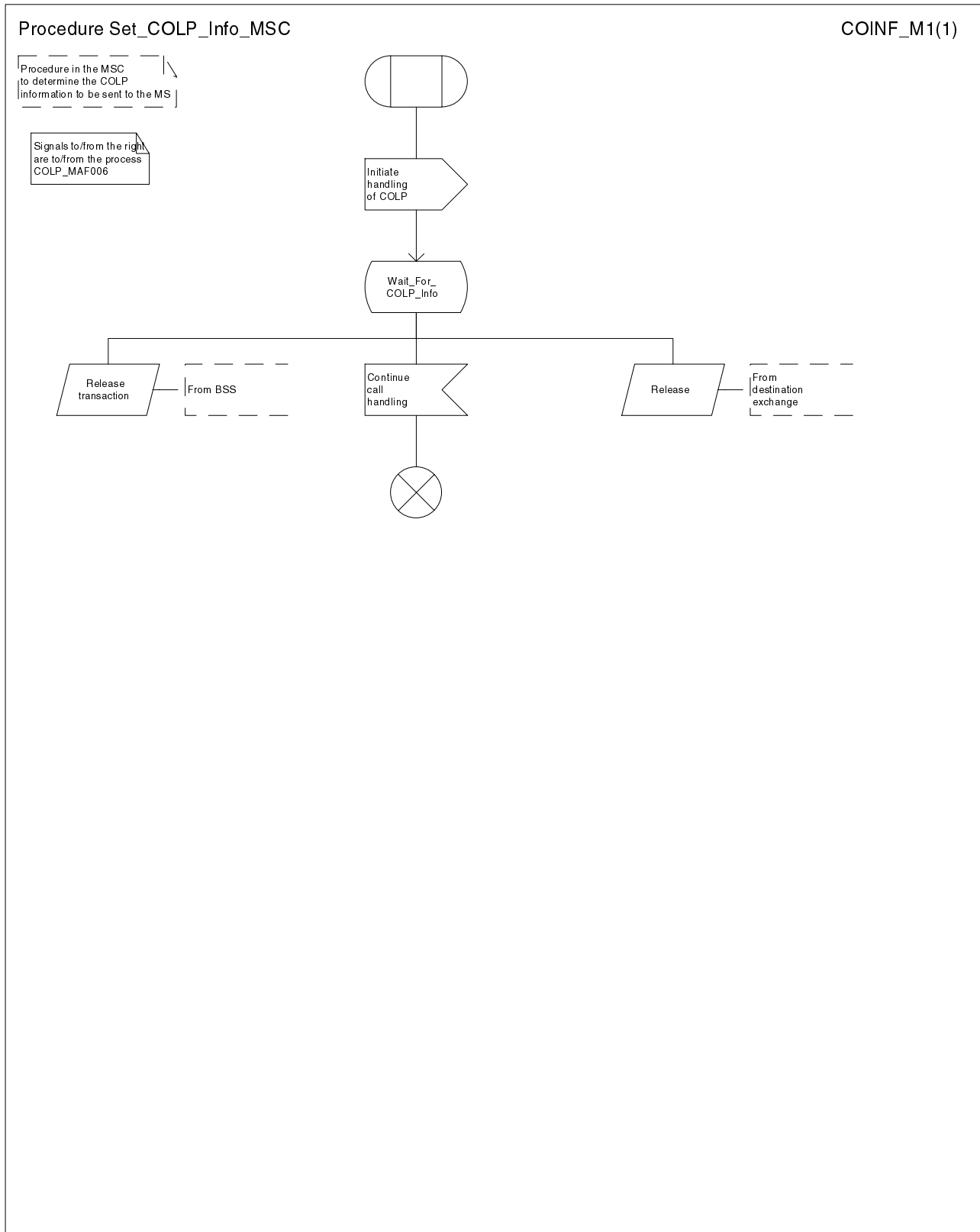

Figure 16: Procedure Set_COLP_Info_MSC

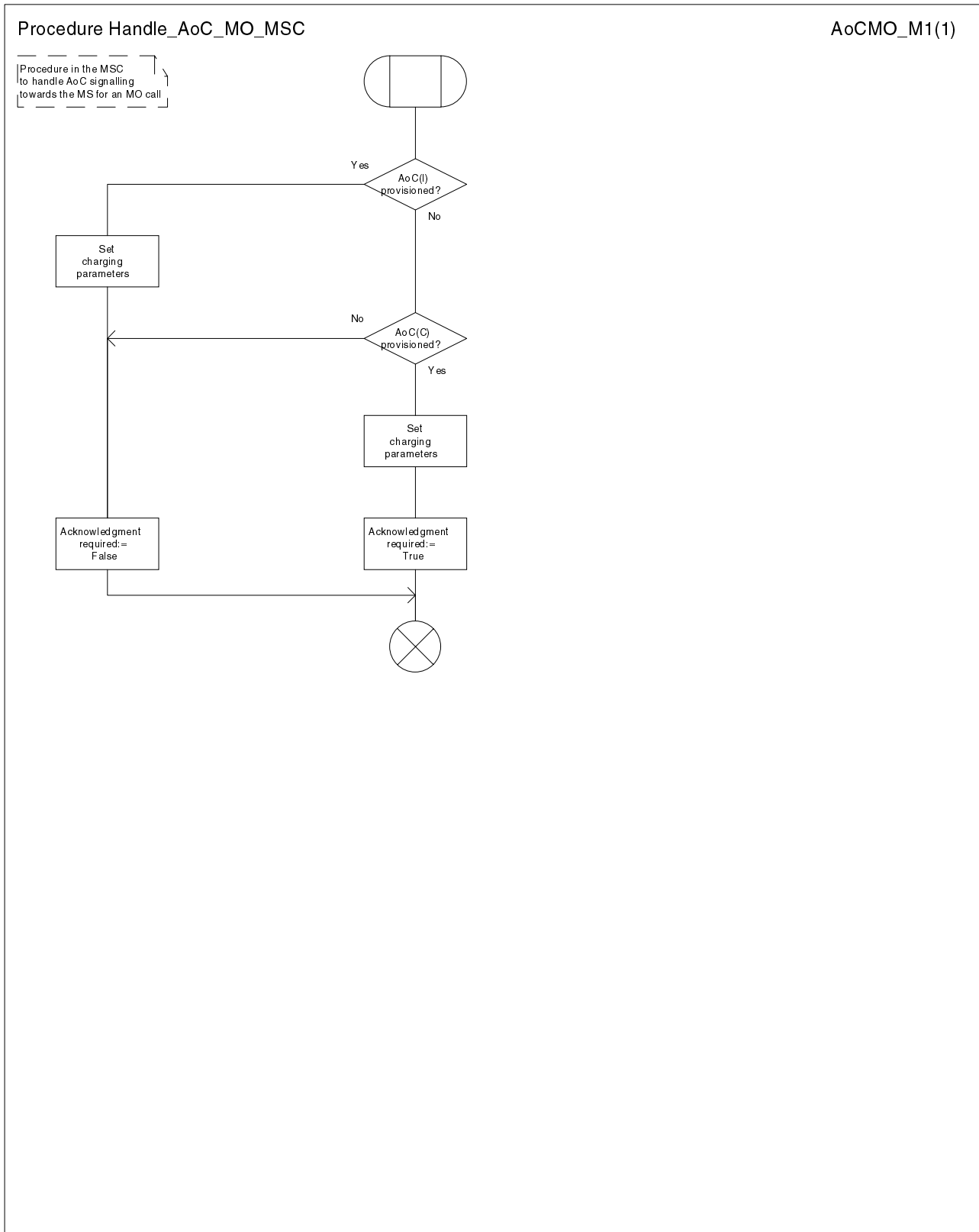

Figure 17: Procedure Handle_AoC_MO_MSC

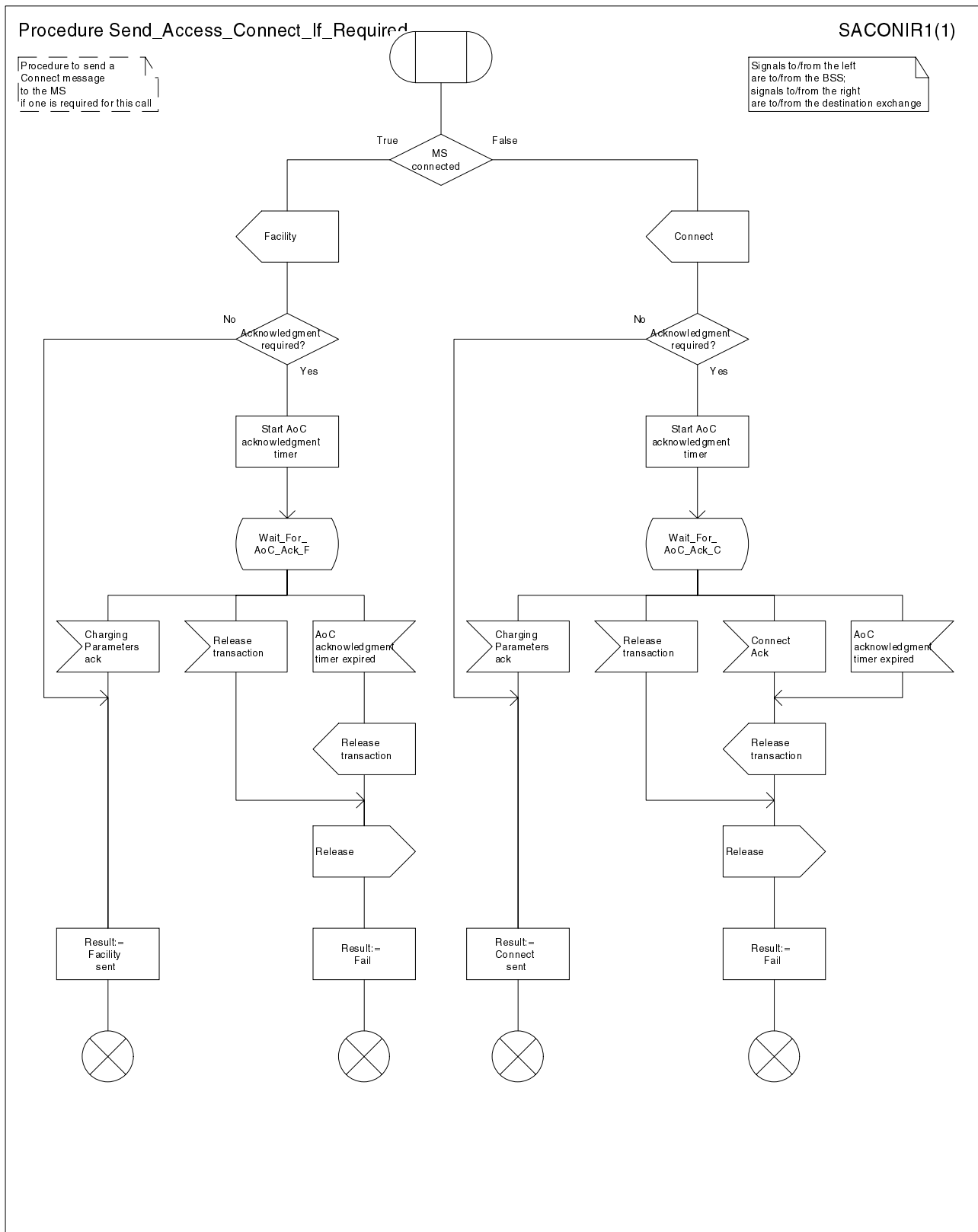

Figure 18: Procedure Send_Access_Connect_If_Required

7.1.2 Functional requirements of VLR

7.1.2.1 Process OCH_VLR

7.1.2.2 Procedure Process_Access_Request_VLR

Sheet 1: it is a network operator decision (subject to MoU requirements) how often an MS should be authenticated.

Sheet 2: the processes Update_Location_VLR and Subscriber_Present_VLR are described in GSM 09.02 [20].

Sheet 2: it is a network operator decision (subject to MoU requirements) whether a connection should be ciphered.

Sheet 3: it is a network operator decision (subject to MoU requirements) how often an IMEI should be checked.

Sheet 3, sheet 4, sheet 5: the procedure CCBS_Report_MS_Activity is specific to CCBS; it is specified in GSM 03.93 [16].

Sheet 5: it is a network operator decision whether emergency calls are allowed from an ME with no SIM.

7.1.2.3 Procedure OG_Call_Subscription_Check_VLR

Sheet 1: it is an implementation option to carry out the check for operator determined barring of all outgoing calls before the check on provisioning of the requested basic service.

Sheet 1: the procedure OG_CUG_Check is specific to CUG. If the VLR does not support CUG, processing continues from the "Yes" exit of the test "Result=Call allowed?".

Sheet 1: the procedure Get_LL_Subscription_Info_MO_VLR is specific to CLIR and COLP. If the VLR supports neither CLIR nor COLP, the procedure call is omitted.

Sheet 1: the procedure Get_AoC_Subscription_Info_VLR is specific to AoC.

Sheet 1: the procedure CAMEL_OCH_VLR is specific to CAMEL; it is specified in GSM 03.78 for CAMEL Phase 1 [6] and GSM 03.78 for CAMEL Phase 2 [7]. If the VLR does not support CAMEL, processing continues from connector 1 to the call to the procedure Check_OG_Barring.

Sheet 2: the negative response "call barred" indicates whether the reason is operator determined barring or supplementary service barring, according to the result returned by the procedure Check_OG_Barring.

7.1.2.4 Procedure Obtain_Identity_VLR

It is a network operator decision whether open (unciphered) identification of the MS by its IMSI is allowed.

7.1.2.5 Procedure Obtain_IMSI_VLR

7.1.2.6 Procedure Authenticate_VLR

Sheet 1: the number of unused authentication sets which triggers the VLR to request further authentication sets from the HLR is an operator option.

7.1.2.7 Procedure Obtain_Authentication_Sets_VLR

7.1.2.8 Procedure Start_Tracing_VLR

7.1.2.9 Procedure Check_IMEI_VLR

If the response from the EIR to a request to check an IMEI is:

- blacklisted, then service is not granted;
- greylisted, then service is granted, but the network operator may decide to initiate tracing;
- whitelisted, then service is granted.

7.1.2.10 Procedure Obtain_IMEI_VLR

7.1.2.11 Process Fetch_Authentication_Sets_VLR

7.1.2.12 Procedure Check_BAOC

Sheet 1: if the VLR receives an Abort message from the MSC while it is awaiting a response from the process MAF017, the message is saved for handling after return from the procedure.

7.1.2.13 Procedure OG_CUG_Check

If the VLR receives an Abort message from the MSC while it is awaiting a response from the process MAF014, the message is saved for handling after return from the procedure.

7.1.2.14 Procedure Get_LI_Subscription_Info_MO_VLR

If the VLR does not support CLIR, it omits the signal interchange with the process CLIR_MAF003.

If the VLR does not support COLP, it omits the signal interchange with the process COLP_MAF005.

If the VLR receives an Abort message from the MSC while it is awaiting a response from the process CLIR_MAF003 or the process COLP_MAF005, the message is saved for handling after return from the procedure.

7.1.2.15 Procedure Get_AoC_Subscription_Info_VLR

The indicator of whether or not AoC is provisioned is global data which can be read by the parent process.

7.1.2.16 Procedure Check_OG_Barring

Sheet 3: if the VLR receives an Abort message from the MSC while it is awaiting a response from the process MAF018 or MAF019, the message is saved for handling after return from the procedure.

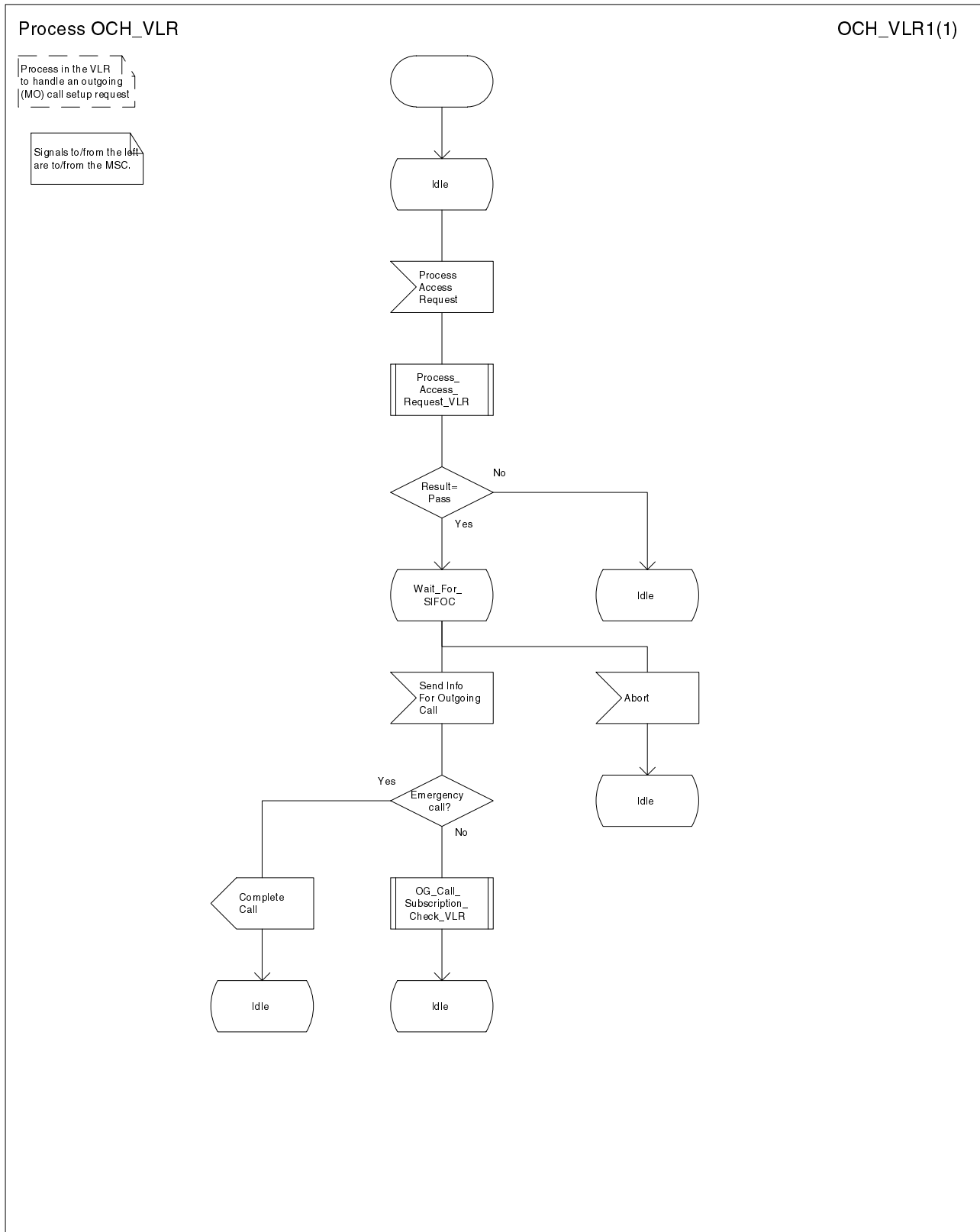

Figure 19: Process OCH_VLR

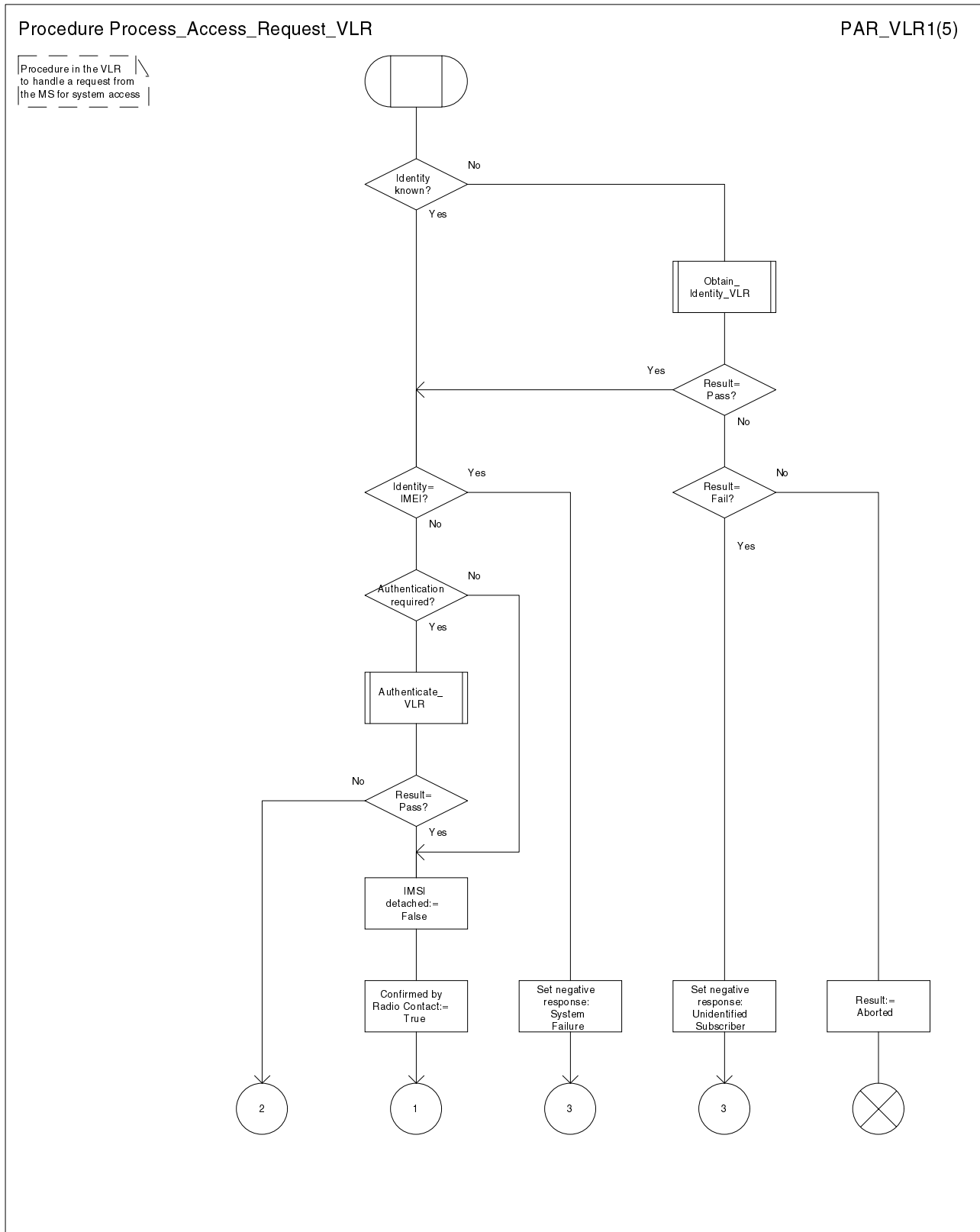

Figure 20a: Procedure Process_Access_Request_VLR (sheet 1)

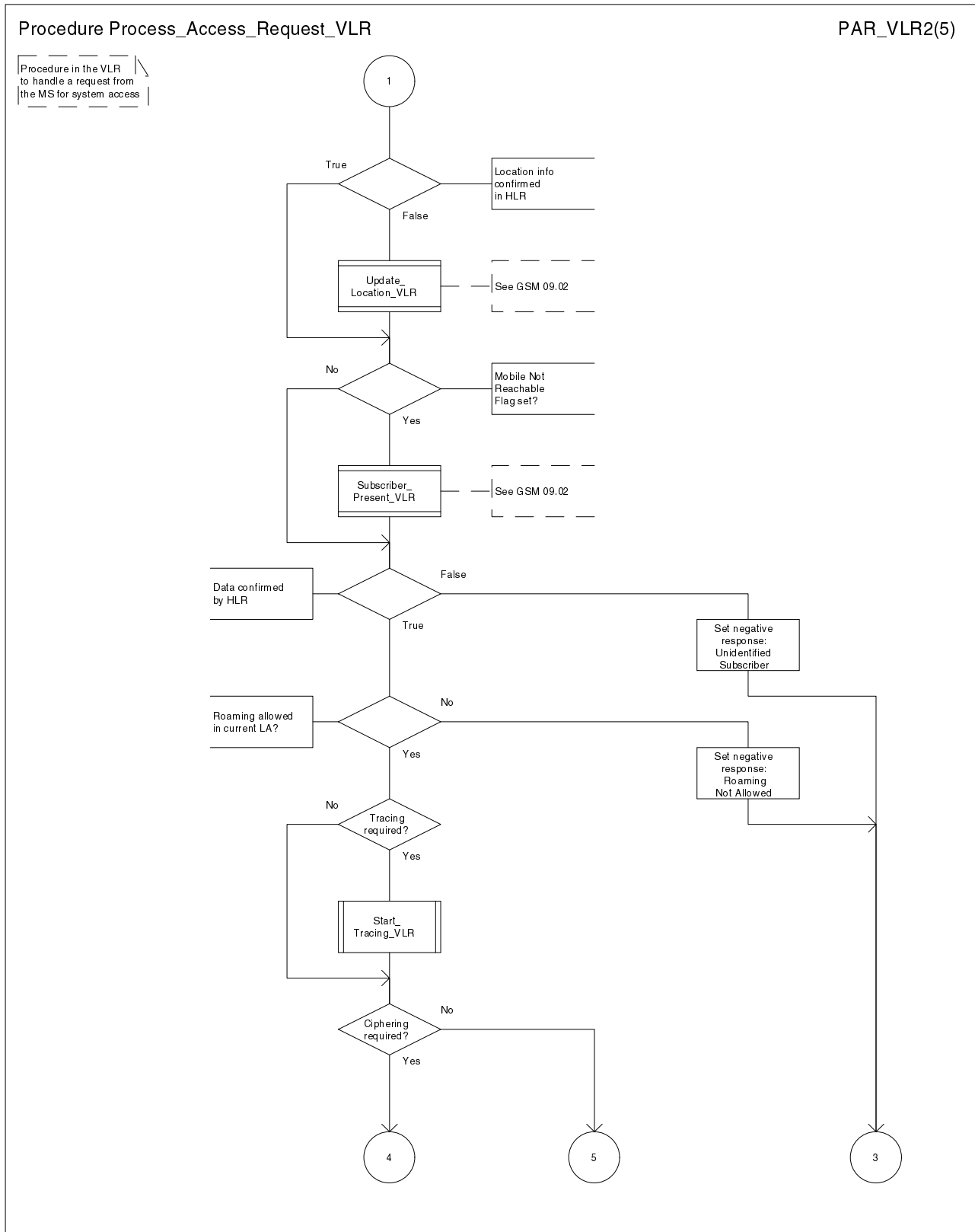

Figure 20b: Procedure Process_Access_Request_VLR (sheet 2)

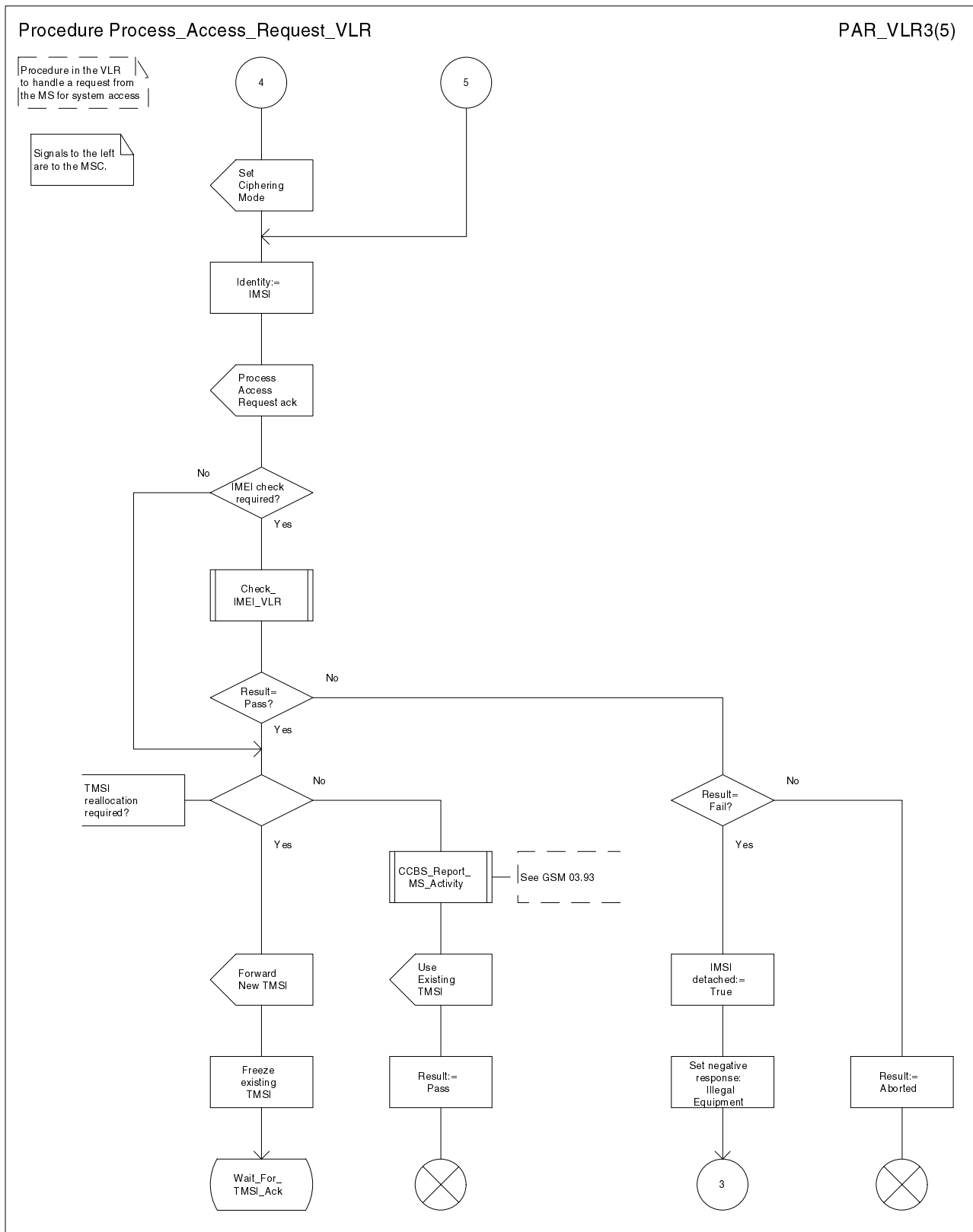

Figure 20c: Procedure Process_Access_Request_VLR (sheet 3)

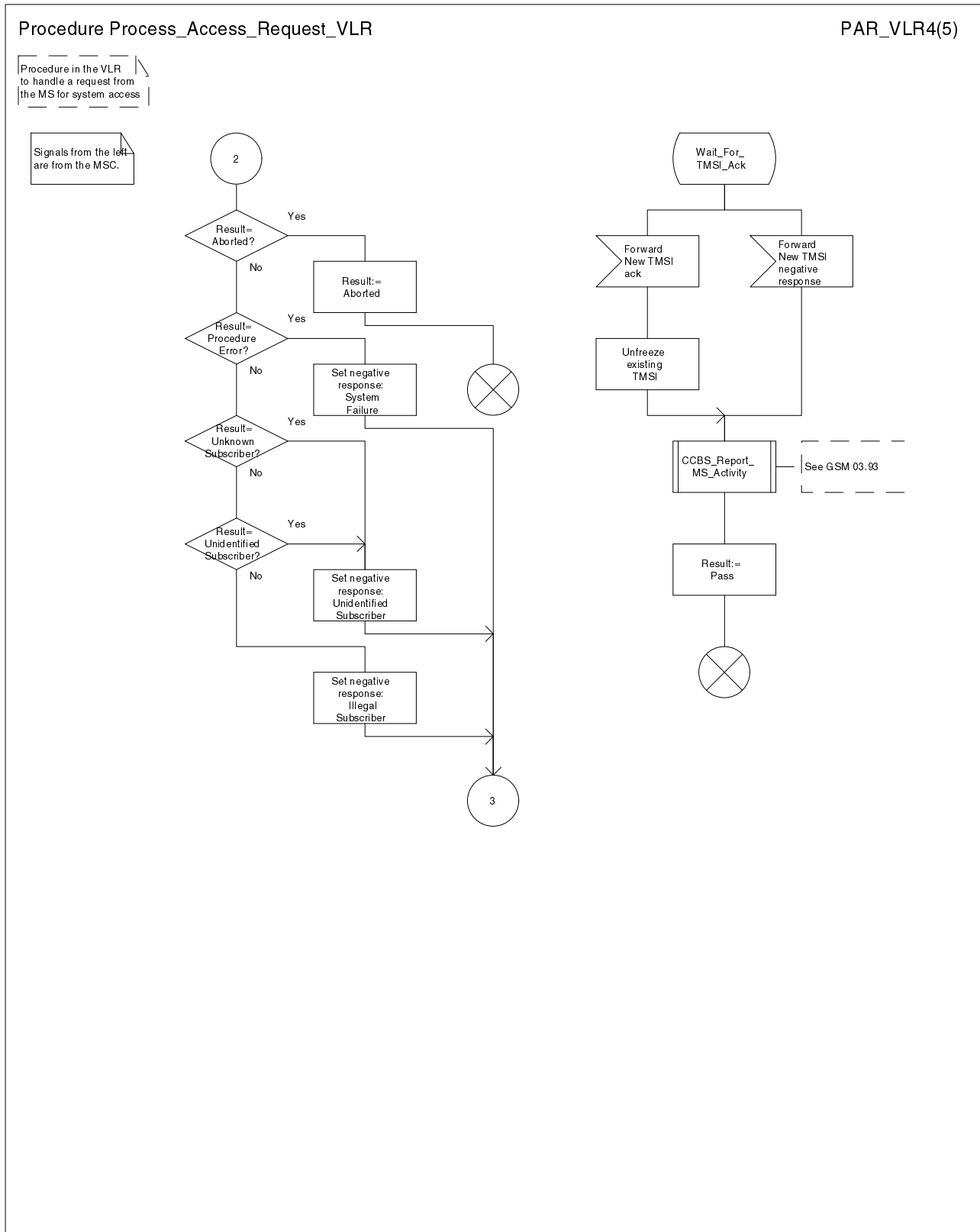

Figure 20d: Procedure Process_Access_Request_VLR (sheet 4)

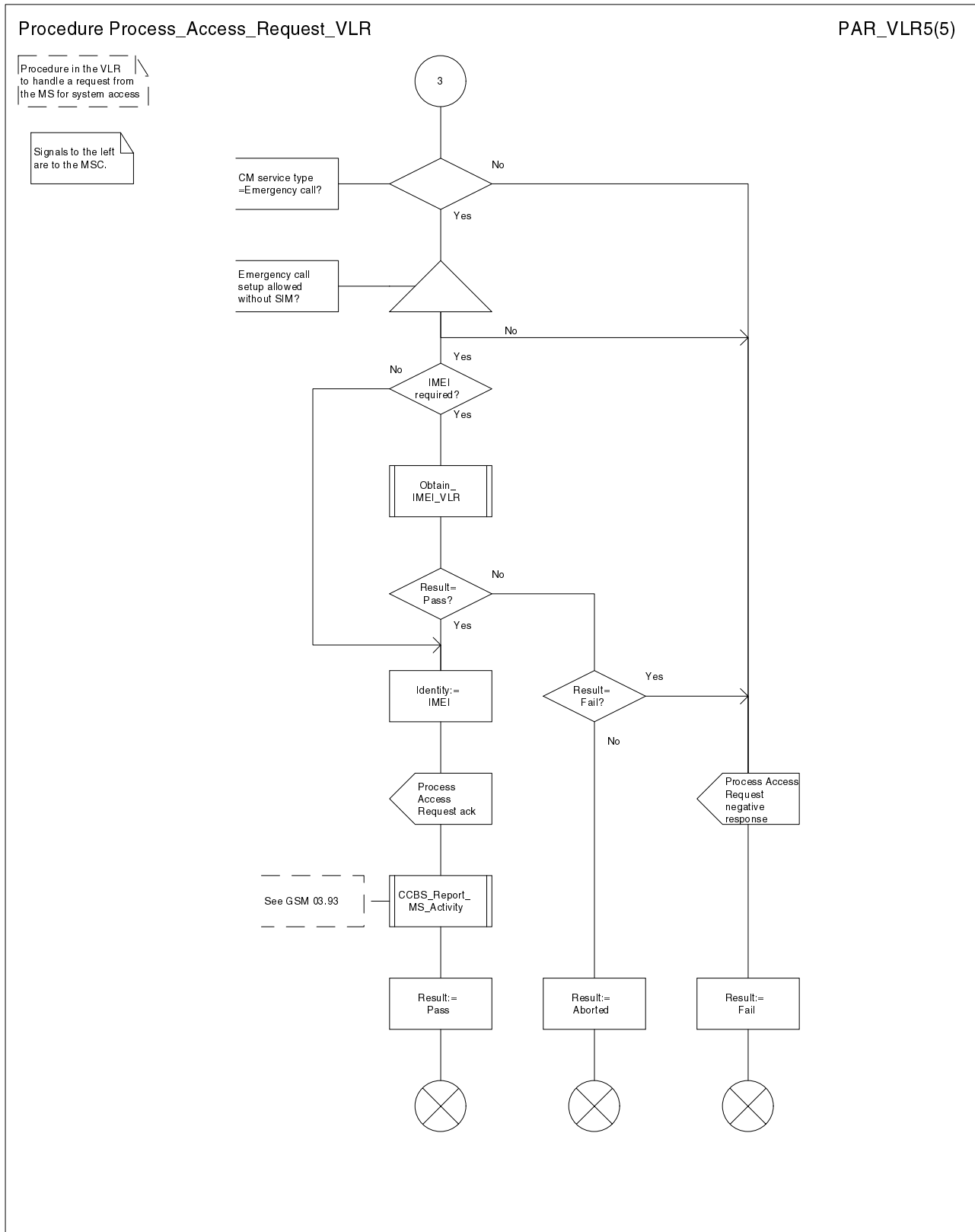

Figure 20e: Procedure Process_Access_Request_VLR (sheet 5)

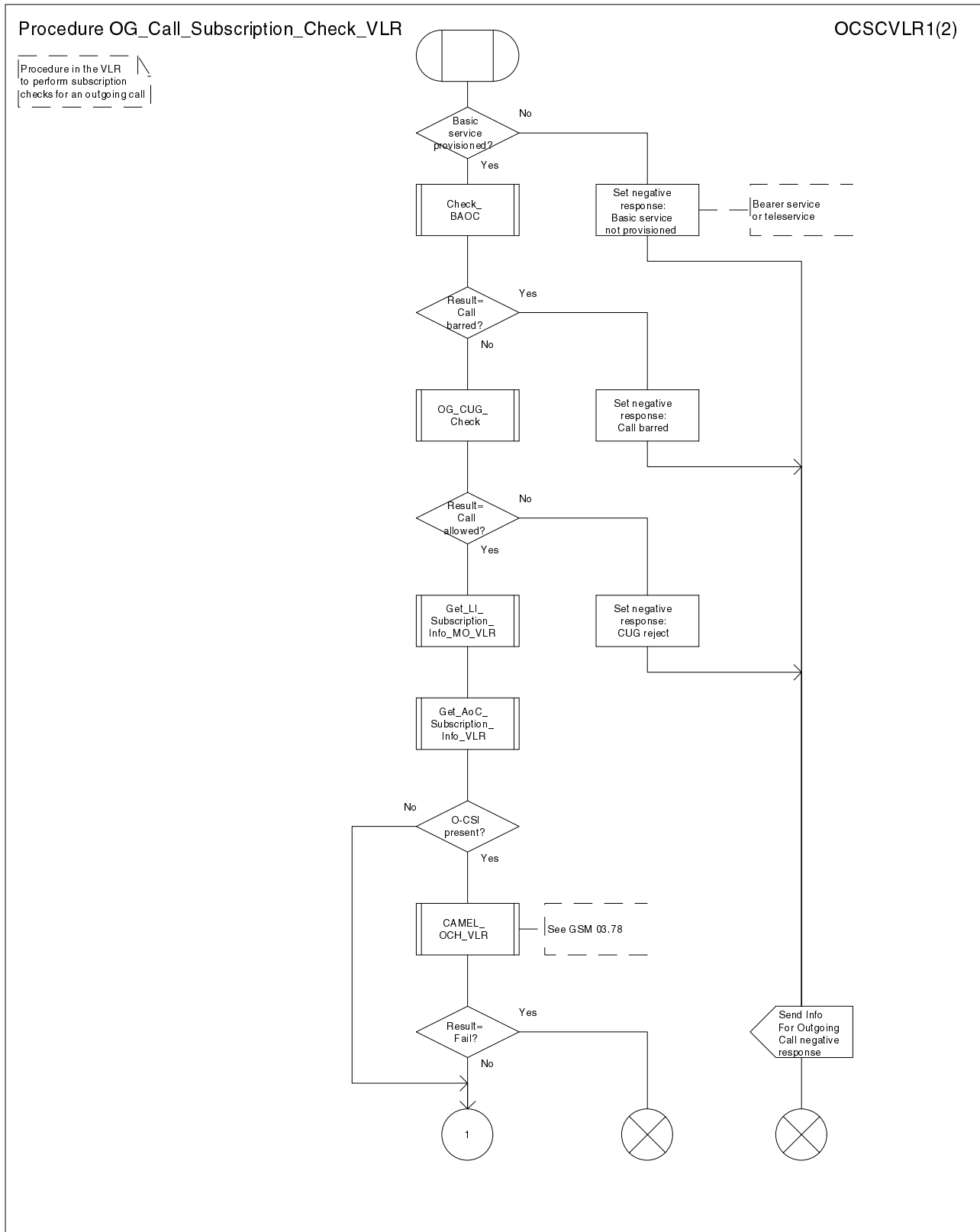

Figure 21a: Procedure OG_Call_Subscription_Check_VLR (sheet 1)

Procedure OG_Call_Subscription_Check_VLR

OCSCVLR2(2)

Procedure in the VLR to perform subscription checks for an outgoing call

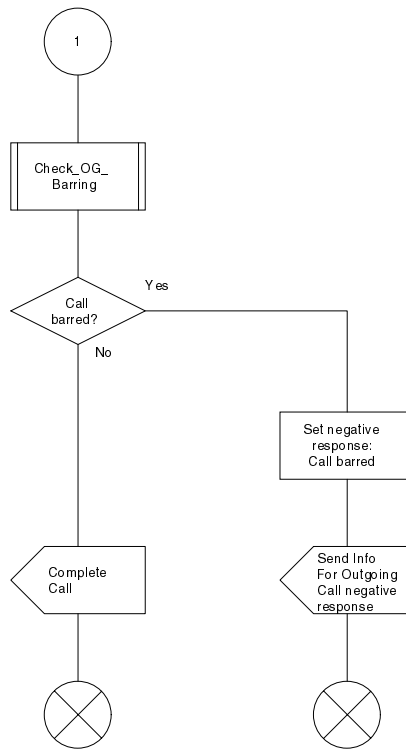

Figure 21b: Procedure OG_Call_Subscription_Check_VLR (sheet 2)

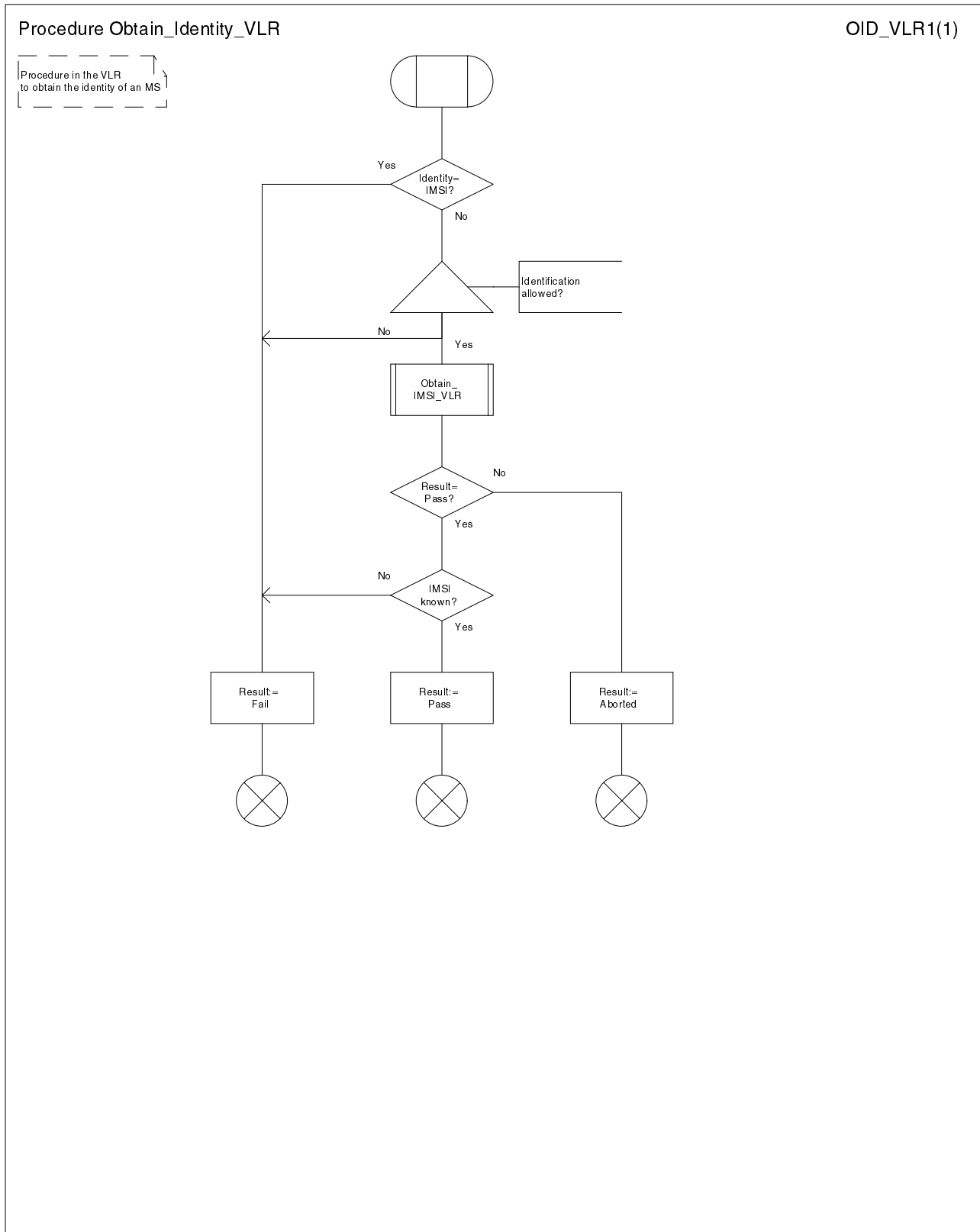

Figure 22: Procedure Obtain_Identity_VLR

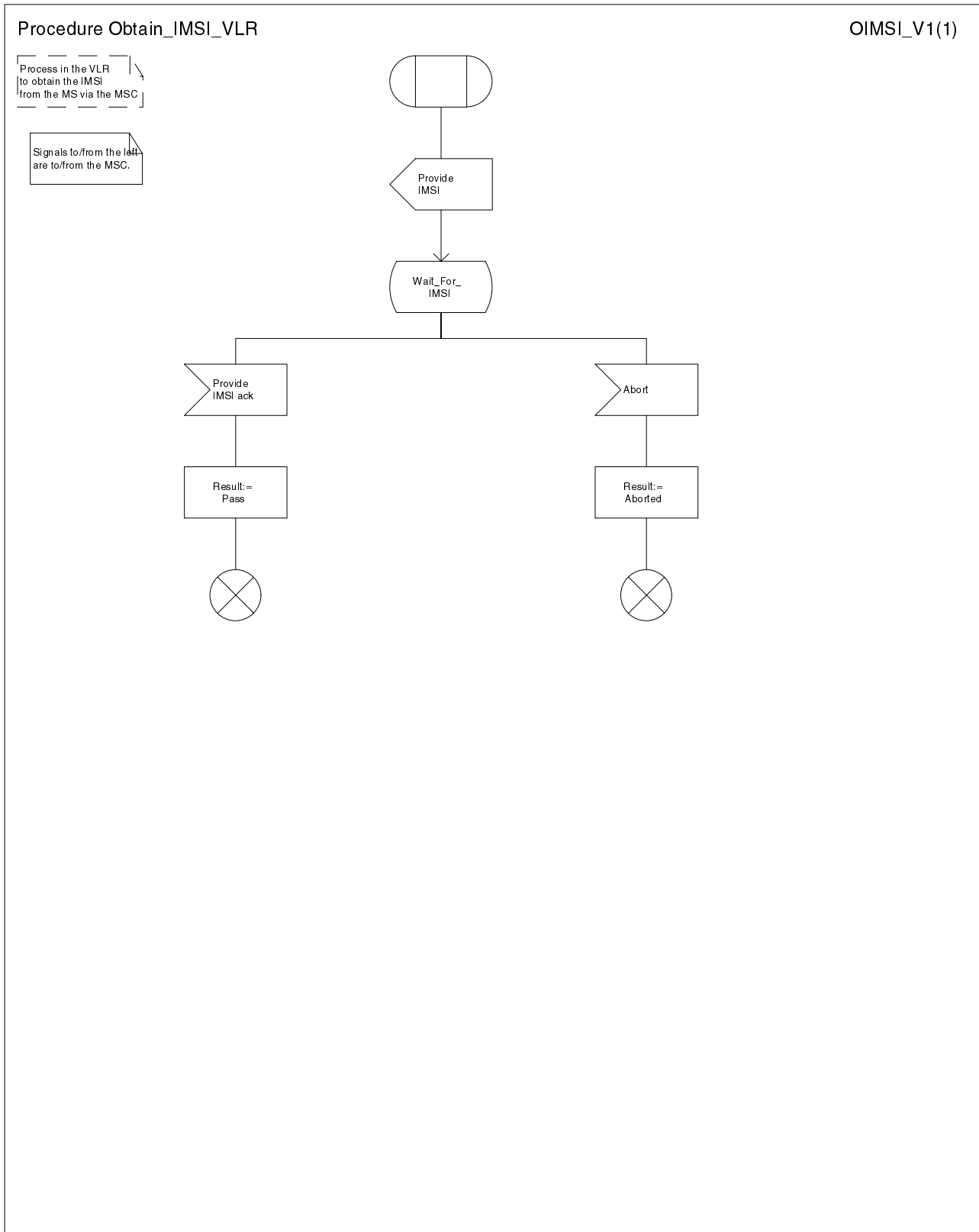

Figure 23: Procedure Obtain_IMSI_VLR

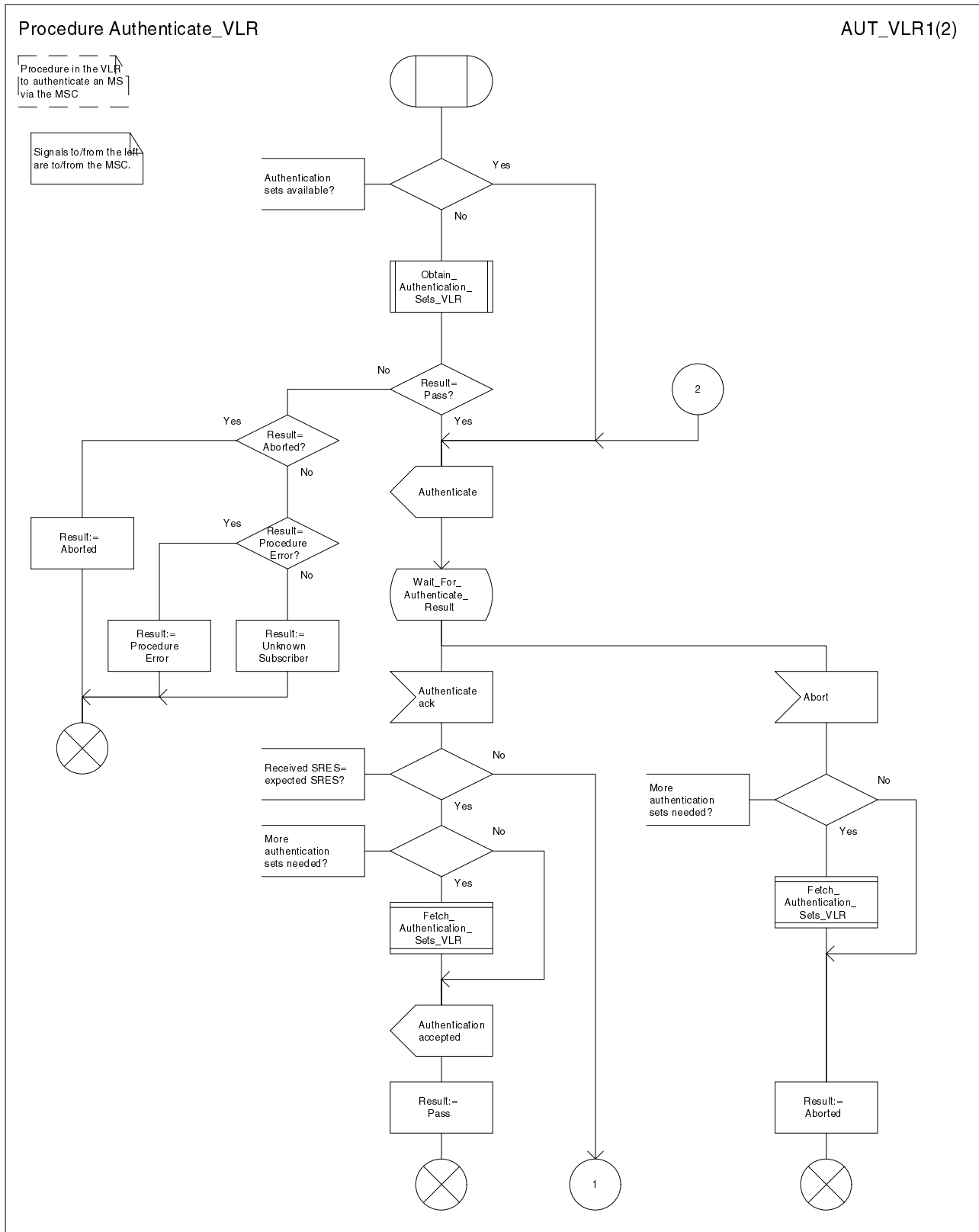

Figure 24a: Procedure Authenticate_VLR (sheet 1)

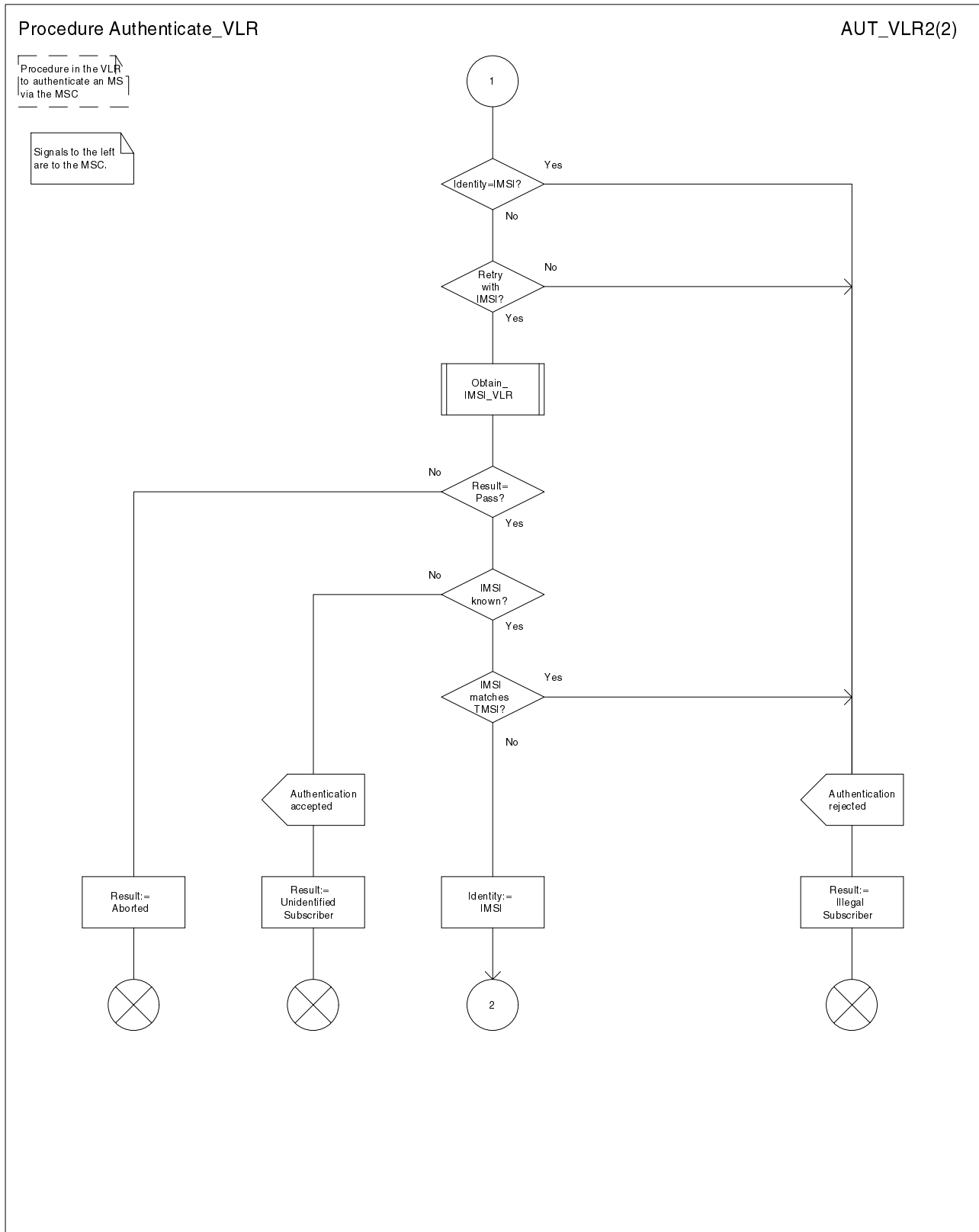

Figure 24b: Procedure Authenticate_VLR (sheet 2)

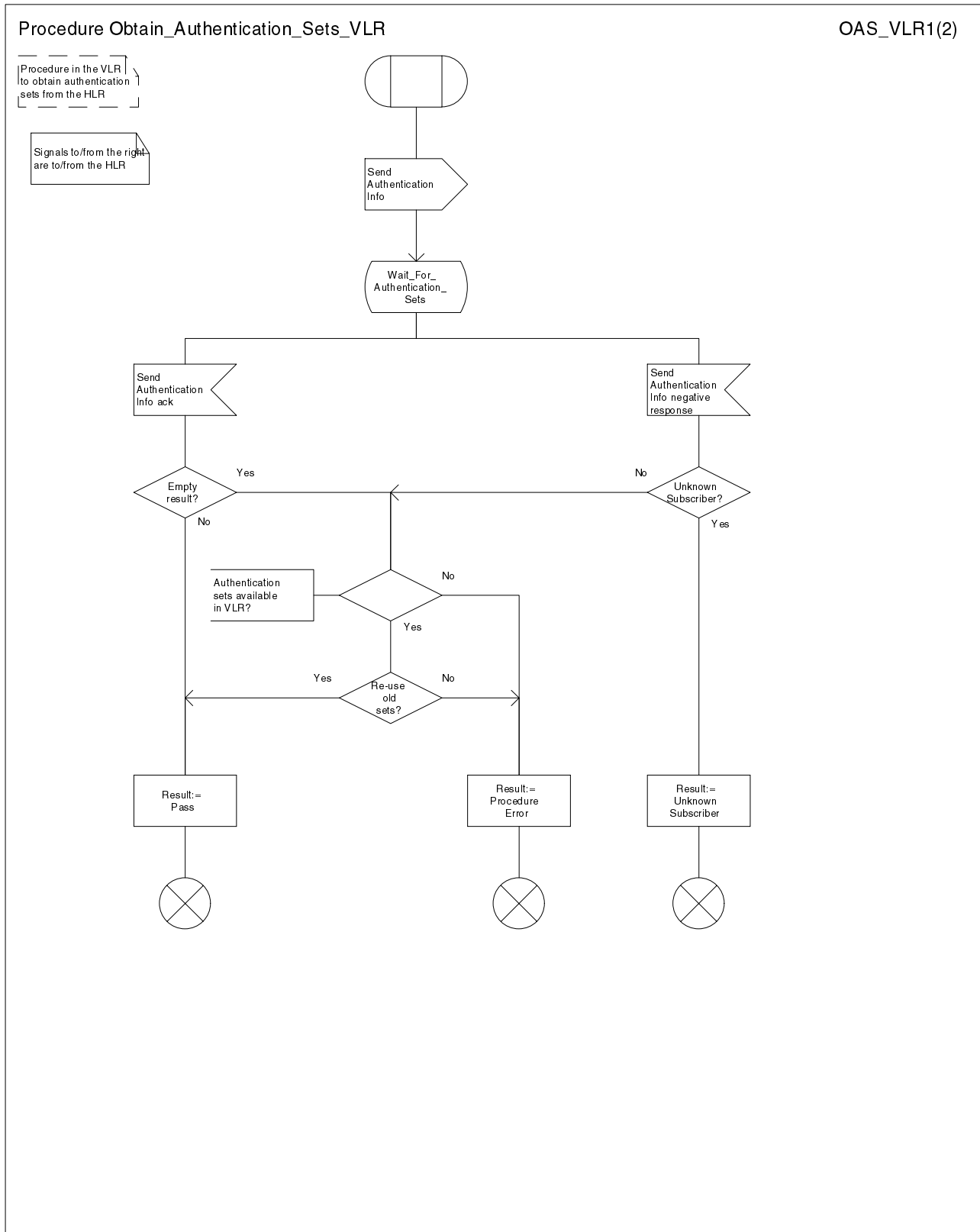

Figure 25a: Procedure Obtain_Authentication_Sets_VLR (sheet 1)

Procedure Obtain_Authentication_Sets_VLR

OAS_VLR2(2)

Procedure in the VLR to obtain authentication sets from the HLR

Signals to/from the left are to/from the MSC; Signals to/from the right are to/from the HLR

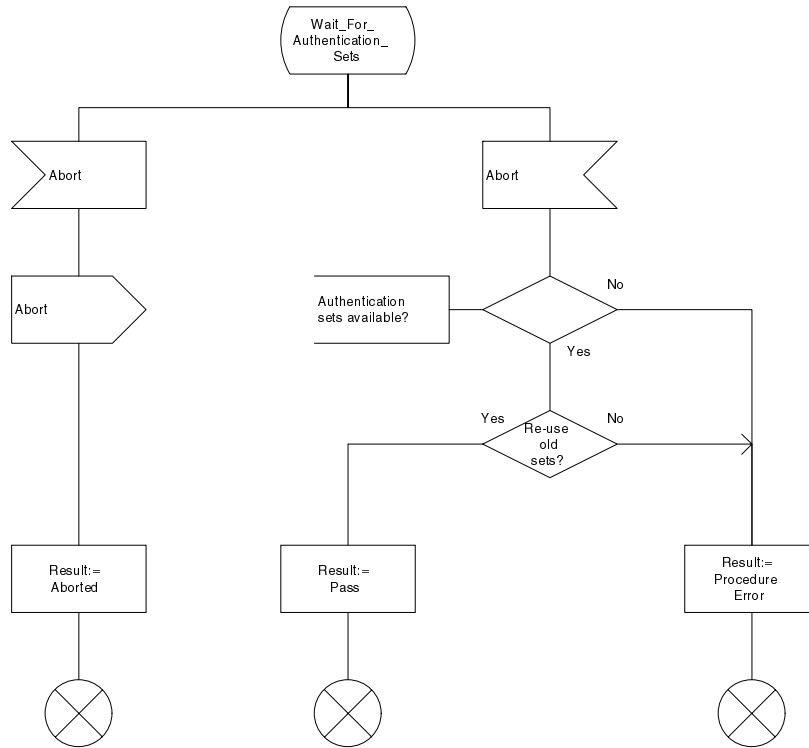

Figure 25b: Procedure Obtain_Authentication_Sets_VLR (sheet 2)

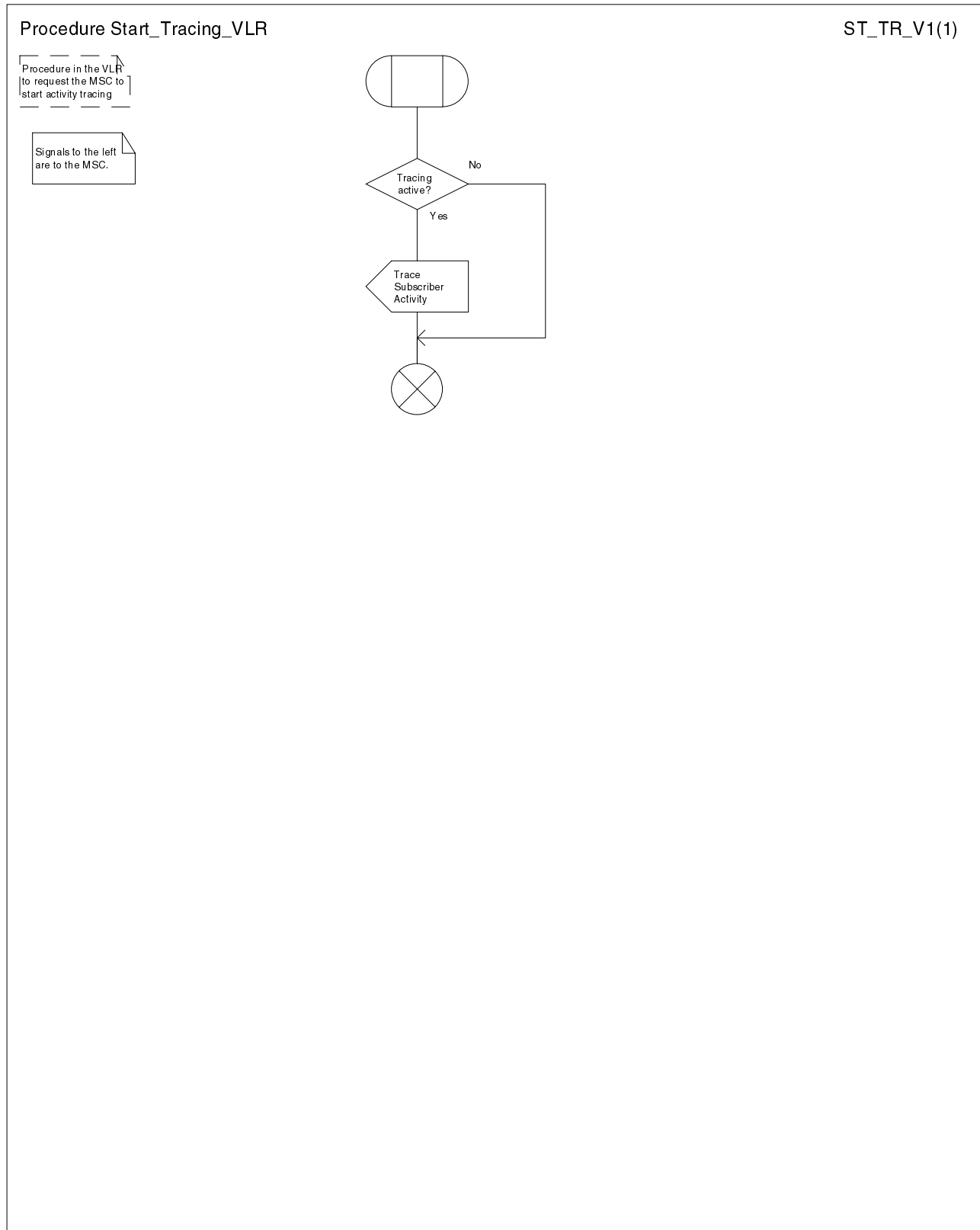

Figure 26: Procedure Start_Tracing_VLR

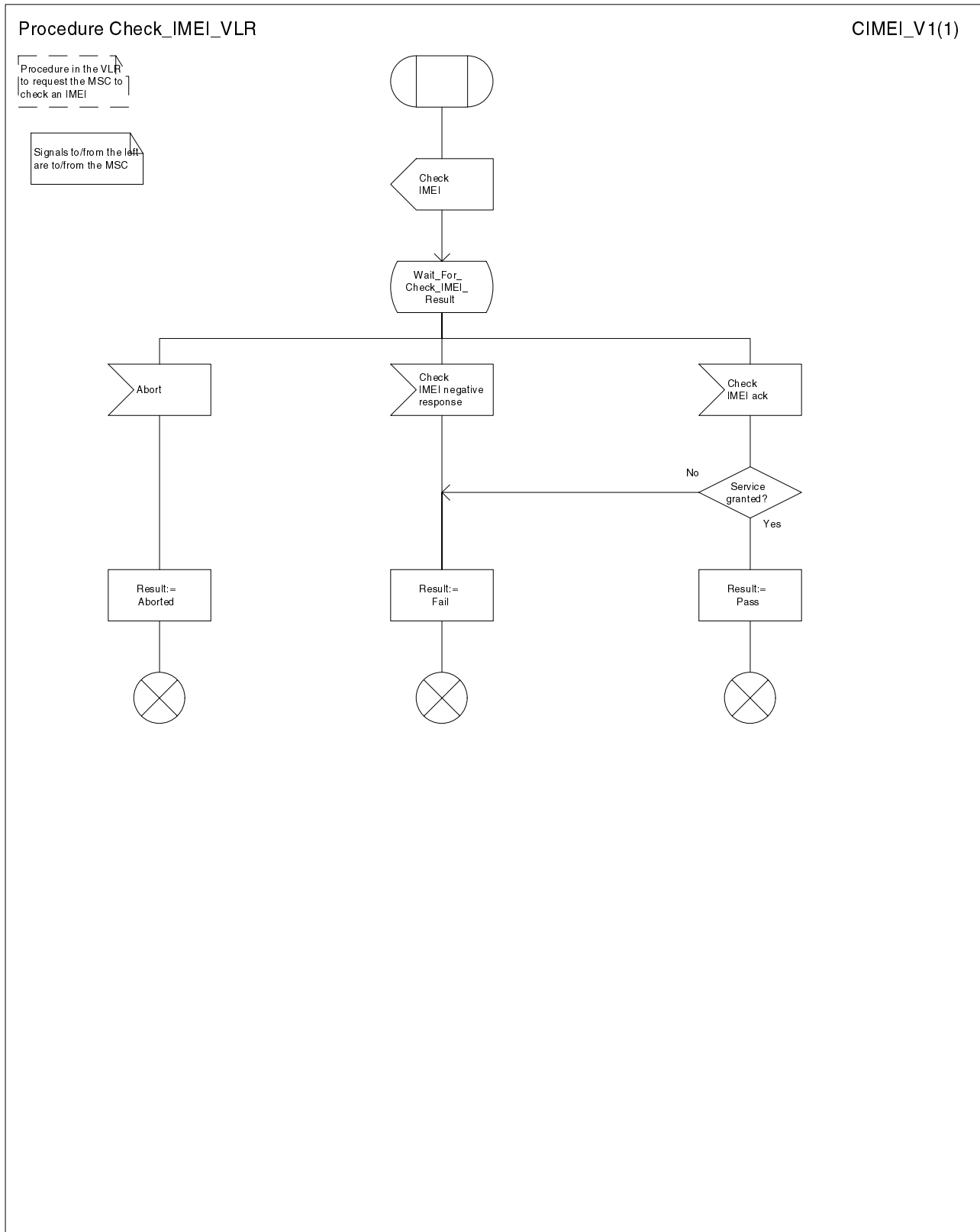

Figure 27: Procedure Check_IMEI_VLR

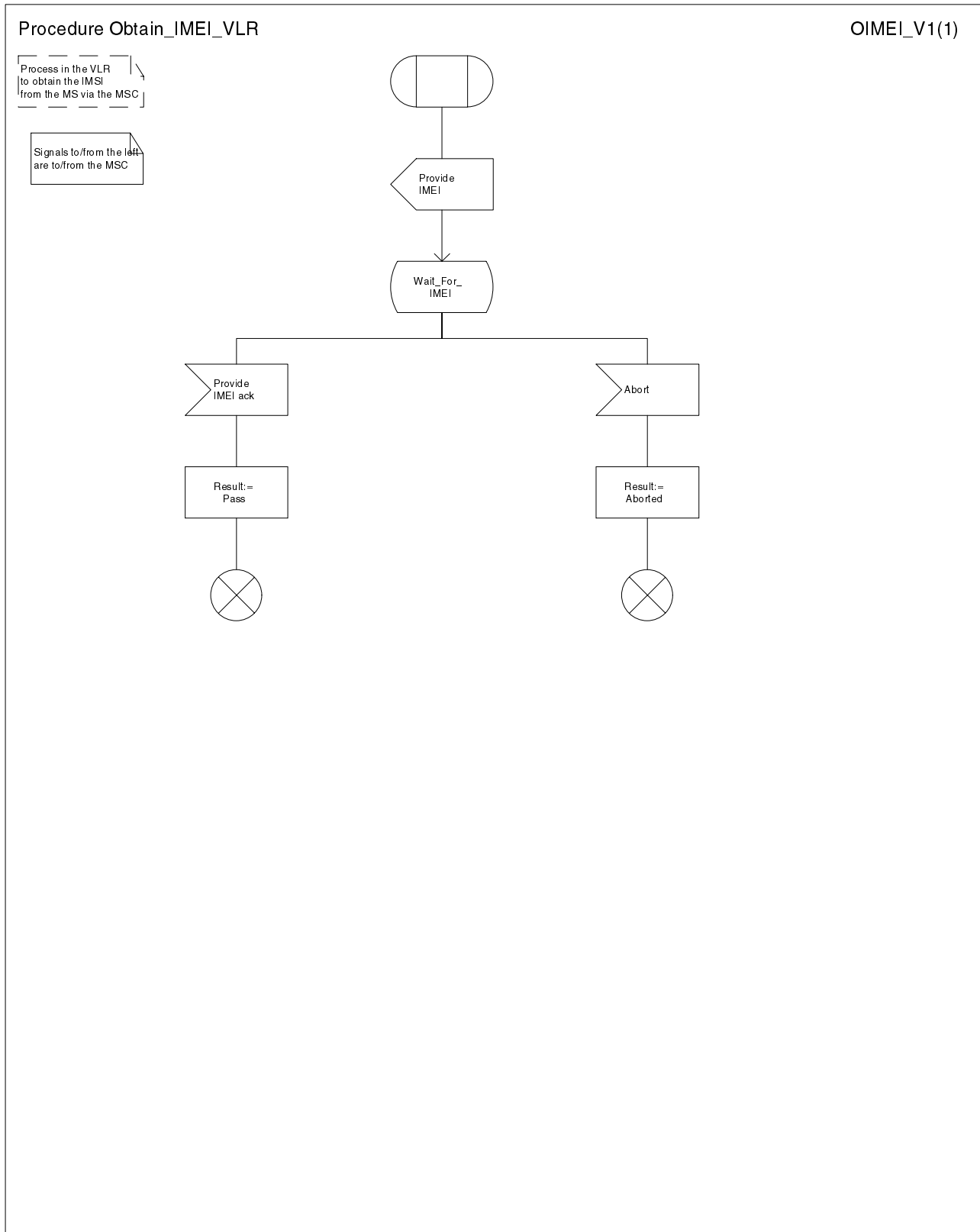

Figure 28: Procedure Obtain_IMEI_VLR

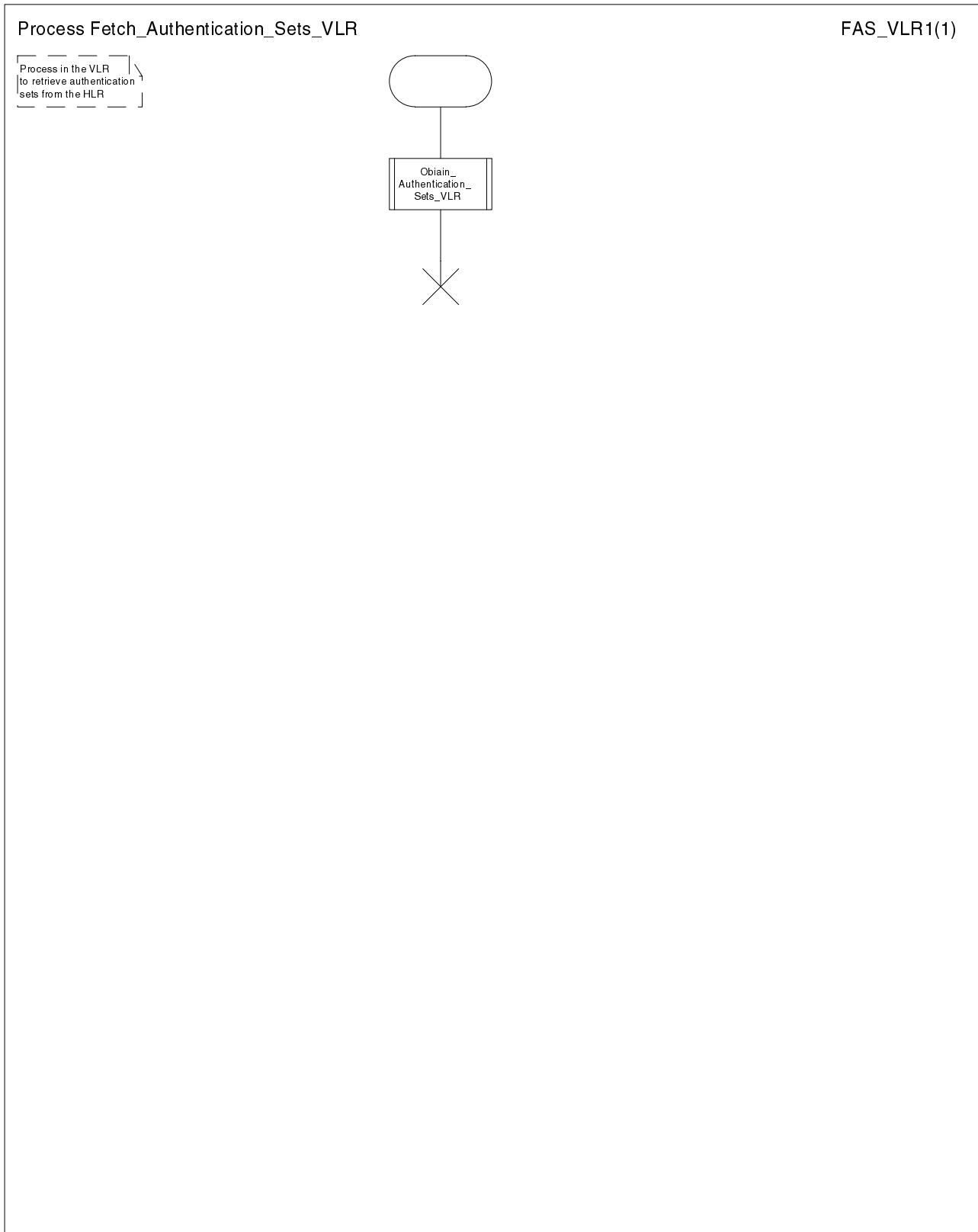

Figure 29: Process Fetch_Authentication_Sets_VLR

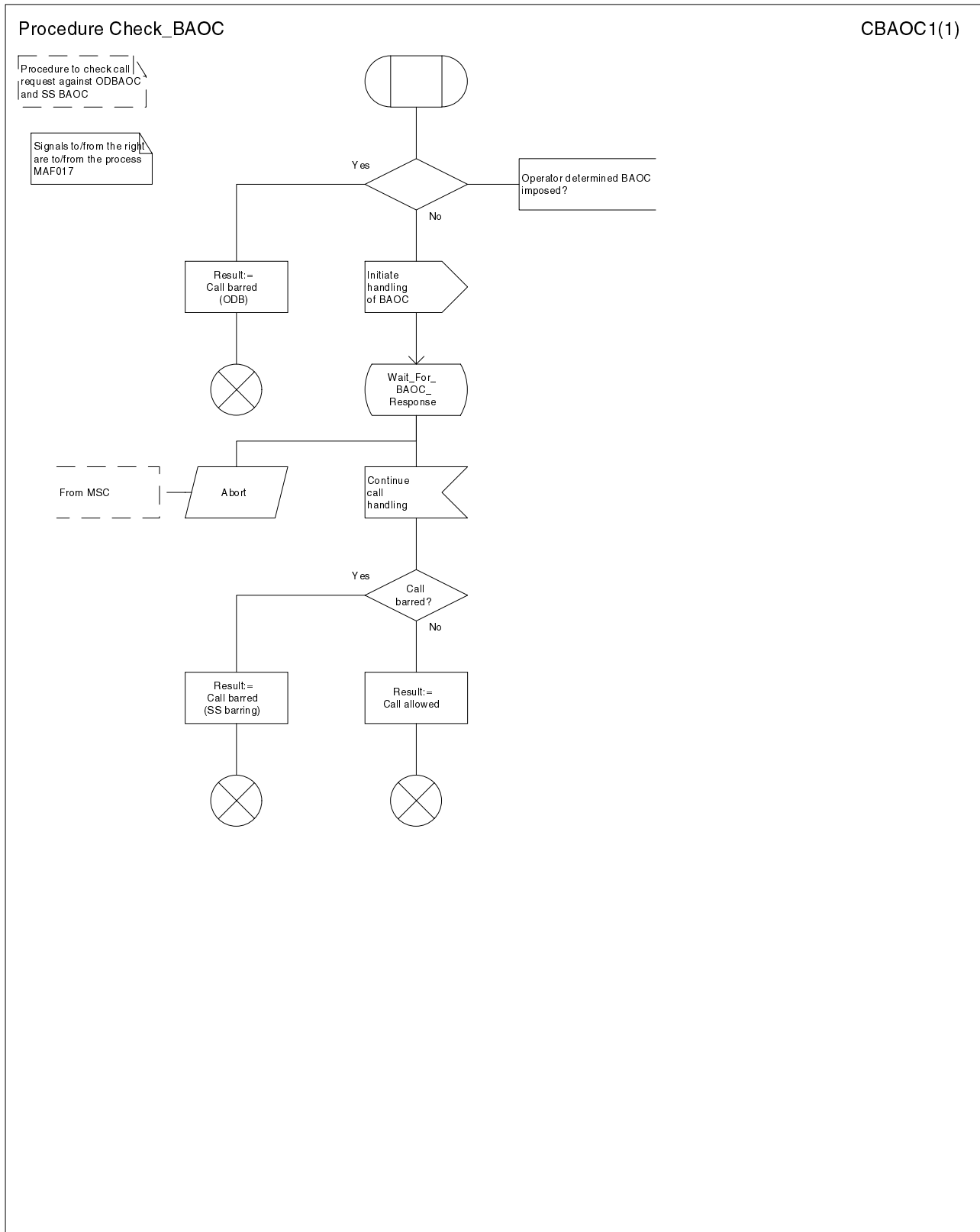

Figure 30: Procedure Check_BAOC

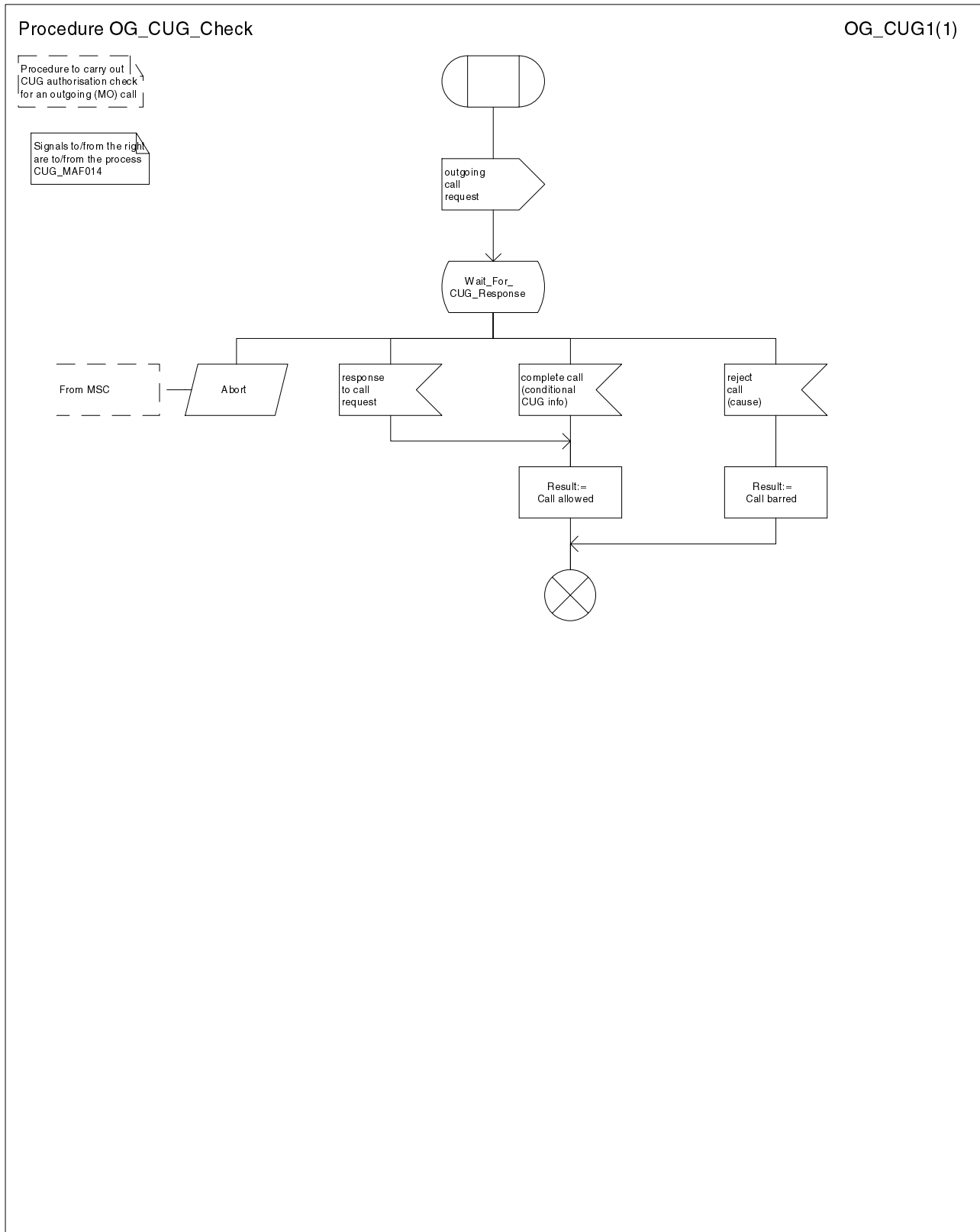

Figure 31: Procedure OG_CUG_Check

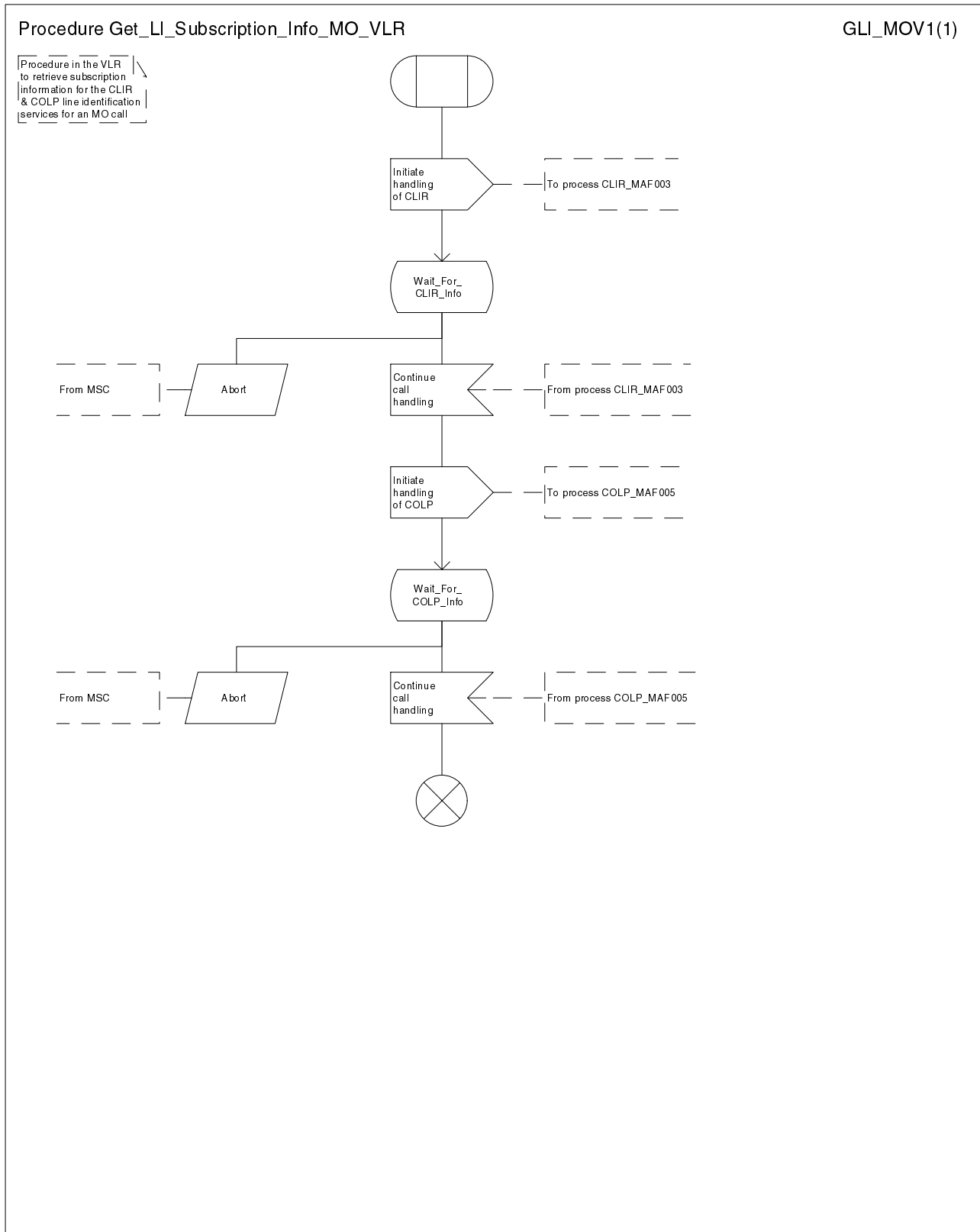

Figure 32: Procedure Get_LI_Subscription_Info_MO_VLR

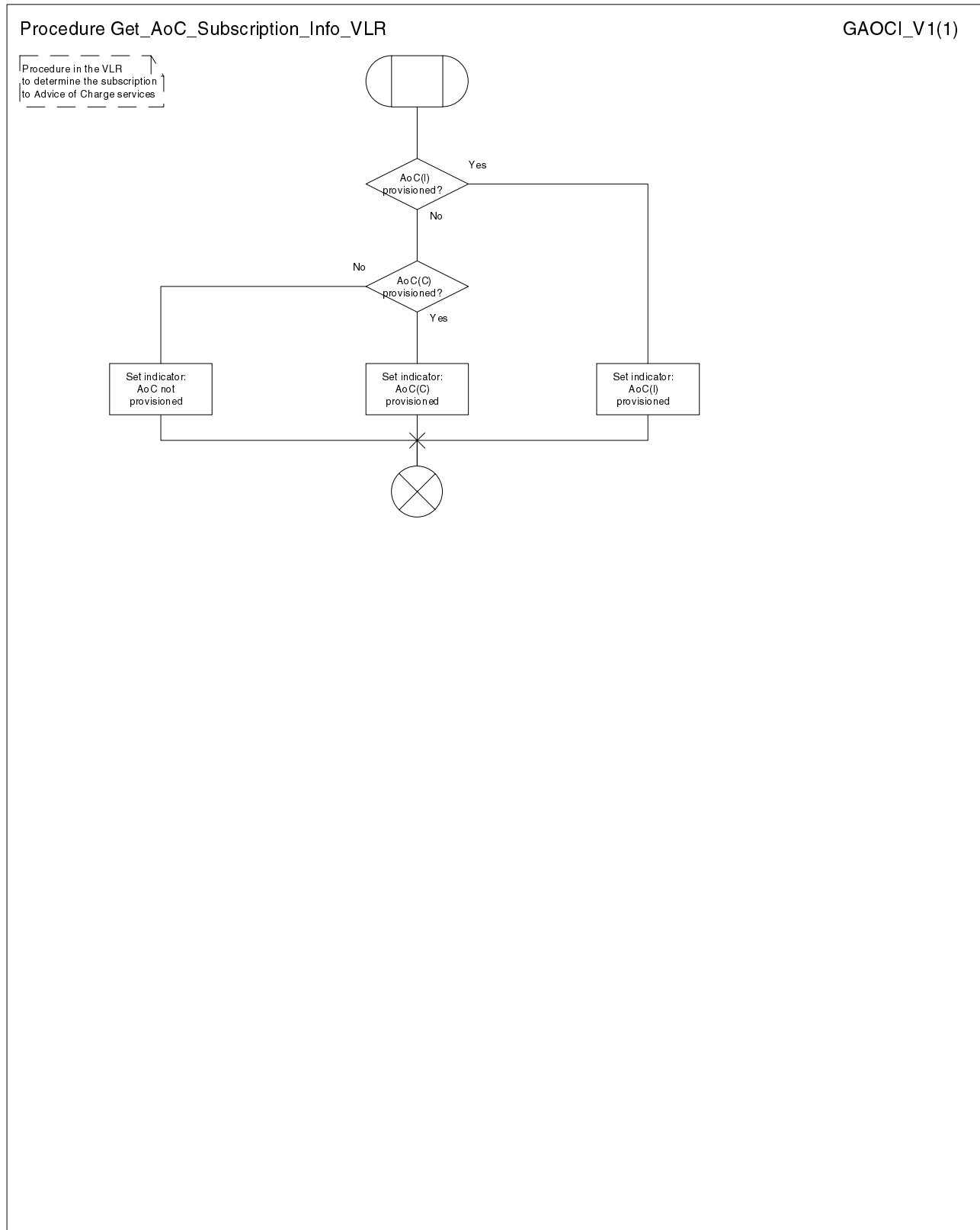

Figure 33: Procedure Get_AoC_Subscription_Info_VLR

Procedure Check_OG_Barring

COB1(3)

Procedure to check call request against SS barring and ODB categories

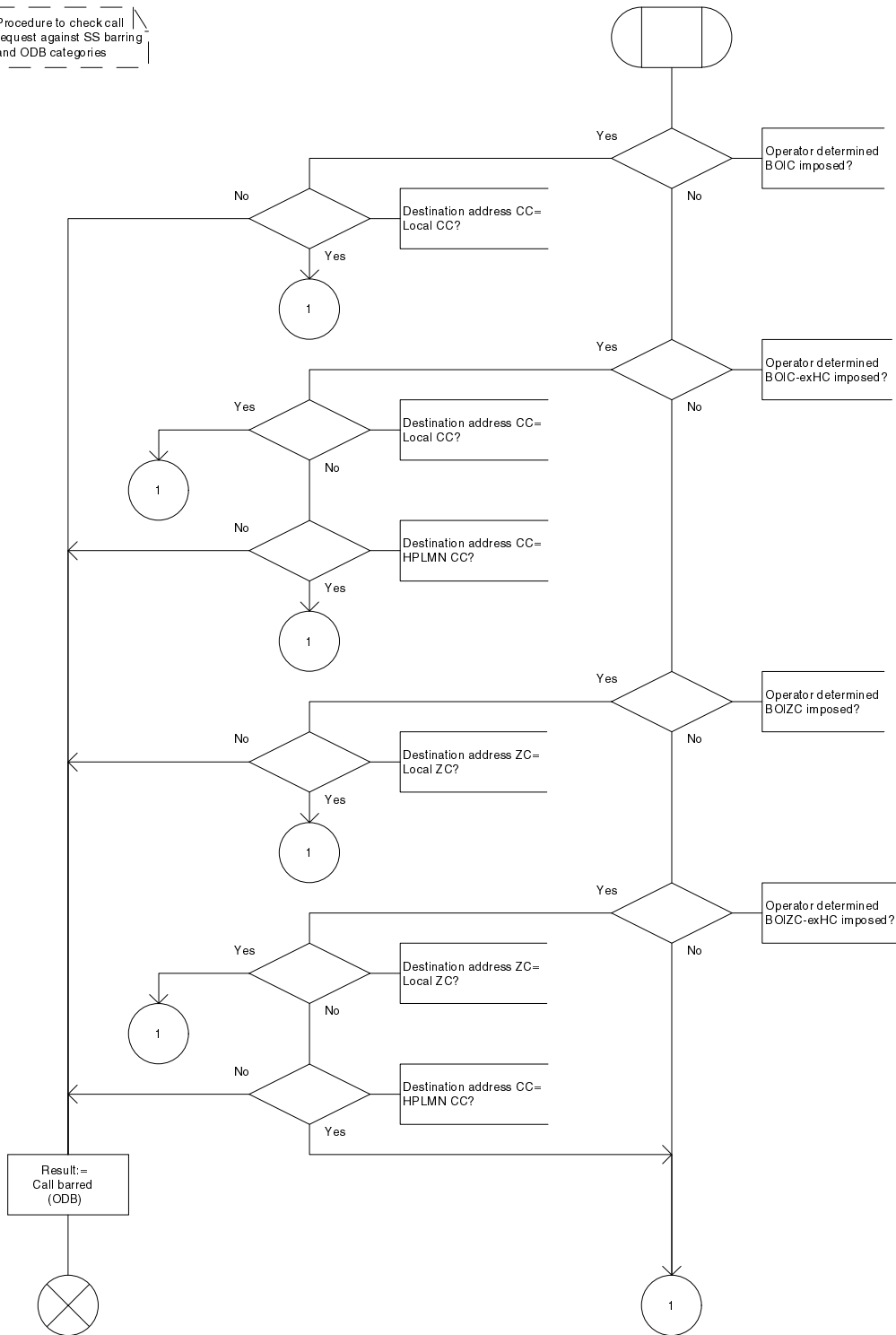

Figure 34a: Procedure Check_OG_Barring (sheet 1)

Procedure Check_OG_Barring

COB2(3)

Procedure to check call request against SS barring and ODB categories

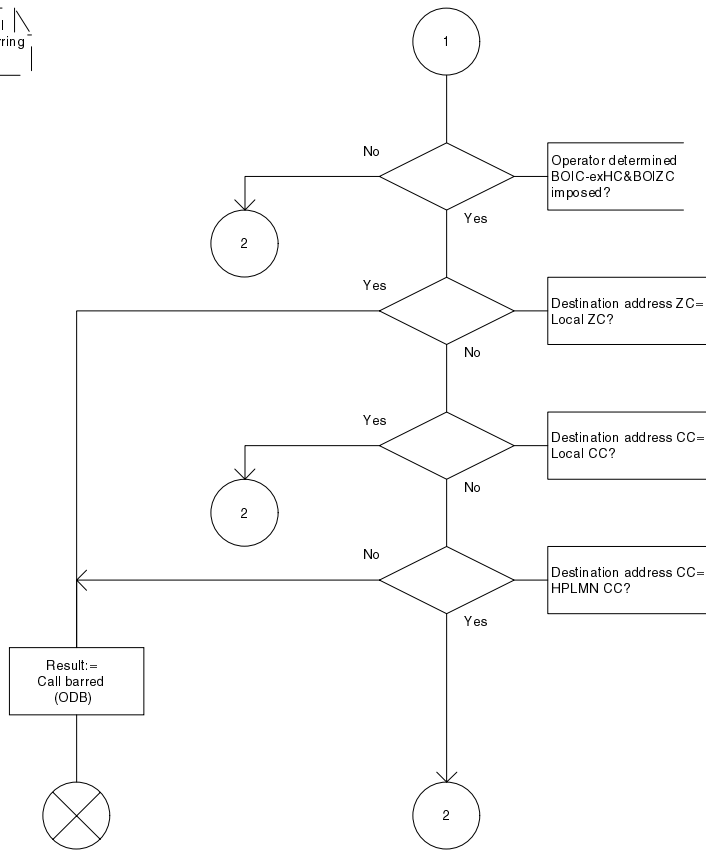

Figure 34b: Procedure Check_OG_Barring (sheet 2)

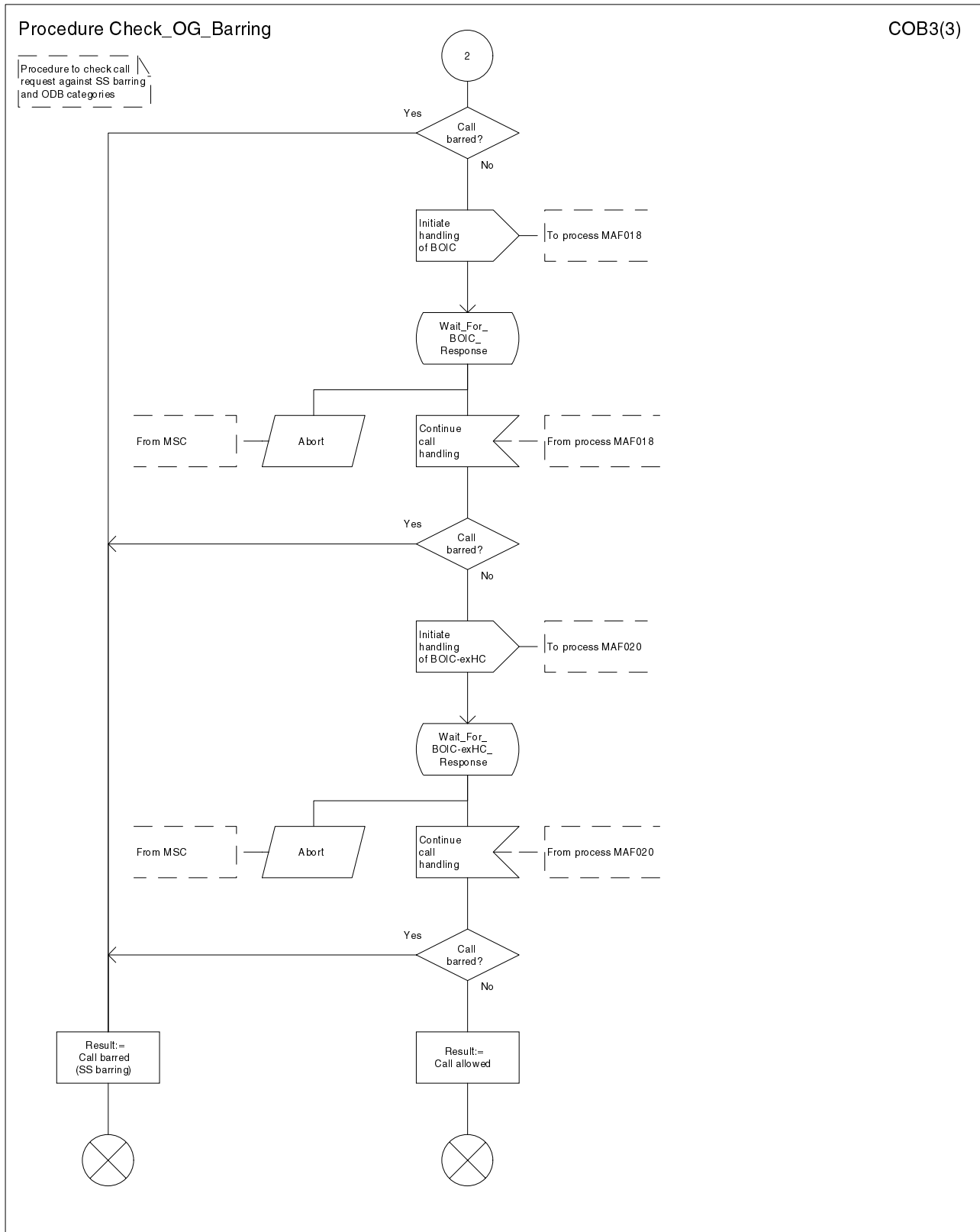

Figure 34c: Procedure Check_OG_Barring (sheet 3)

7.2 Retrieval of routing information for MT call

7.2.1 Functional requirements of GMSC

7.2.1.1 Process MT_GMSC

Sheet 1: the variables ACM sent, Answer sent, Network connect sent, Reconnect and Resume call are global data, accessible to the procedures CCBS_MT_GMSC_Check_CCBS Possible, CCBS_Set_Diagnostic_For_Release, Obtain_Routing_Address, Send_ACM_If_Required, Send_Answer_If_Required and Send_Network_Connect_If_Required.

Sheet 1: the procedure OR_Set_ORA_Parameters is specific to Support of Optimal Routing; it is specified in GSM 03.79 [8].

Sheet 1: the procedure CAMEL_Set_ORA_Parameters is specific to CAMEL; it is specified in GSM 03.78 for CAMEL Phase 1 [6] and GSM 03.78 for CAMEL Phase 2 [7].

Sheet 1: the parameters "Reference address", "OR" and "Own PLMN" are passed to the procedure Obtain_Routing_Address only if the GMSC supports Optimal Routing. The parameter "Destination address" is returned by the procedure Obtain_Routing_Address only if the GMSC supports Optimal Routing of mobile-to-mobile calls. The Send Routing Info negative response information element received in the execution of the procedure Obtain_Routing_Address is global data, available to the parent process.

Sheet 1: the suggested mapping from values of the Send Routing Info negative response information element to values of the ISUP release cause (see ITU-T Recommendation Q.850 [25]) is shown in table 1. The mapping used is a matter for the network operator, depending on the telephony signalling system used.

Table 1: Suggested mapping of Send Routing Info (SRI) negative responses to ISUP release causes

SRI negative response	ISUP release cause number	ISUP release cause name
Absent subscriber	20	Subscriber absent
Bearer service not provisioned	57	Bearer capability not authorised
Call barred (ODB)	21	Call rejected
Call barred (SS barring)	21	Call rejected
CUG reject (Called party SS interaction violation)	21	Call rejected
CUG reject (Incoming calls barred within CUG)	55	Incoming calls barred within CUG
CUG reject (Subscriber not member of CUG)	87	User not member of CUG
CUG reject (Requested basic service violates CUG constraints)	87	User not member of CUG
Data missing	111	Protocol error, unspecified
Facility not supported	69	Requested facility not implemented
Forwarding violation	21	Call rejected
Number changed	22	Number changed
System failure	111	Protocol error, unspecified
Teleservice not provisioned	57	Bearer capability not authorised
Unexpected data value	111	Protocol error, unspecified
Unknown subscriber	1	Unallocated (unassigned) number

Sheet 1: the called party address sent in the IAM to the process MT_CF_MSC is the Forwarded-to number received in the Perform Call Forwarding ack.

Sheet 1: the procedure CAMEL_MT_GMSC_Notify_CF is specific to CAMEL phase 2; it is specified in GSM 03.78 for CAMEL Phase 2 [7]. If the GMSC does not support CAMEL, processing continues from the "Continue" exit of the test "Result".

Sheet 1: it is an operator option whether to send an Address Complete message if the HLR returns forwarding information. If the GMSC sends an Address Complete message, it shall include the called party's status field of the Backward call indicator set to "no indication".

Sheet 2: the procedures CAMEL_Start_TNRy and CAMEL_Stop_TNRy are specific to CAMEL phase 2; they are specified in GSM 03.78 for CAMEL Phase 2 [7].

Sheet 2, sheet 3: the procedure CAMEL_MT_GMSC_ANSWER is specific to CAMEL; it is specified in GSM 03.78 for CAMEL Phase 1 [6] and GSM 03.78 for CAMEL Phase 2 [7]. If the GMSC does not support CAMEL, processing continues from the "Pass" exit of the test "Result".

Sheet 2, sheet 3: the task "Set destination address parameter" is executed only if the GMSC supports Optimal Routeing of mobile-to-mobile calls.

Sheet 3: the procedure Handle_COLP_Forwarding_Interaction is specific to COLP.

Sheet 4: the input signal Resume Call Handling and all the subsequent processing on this sheet are specific to Support of Optimal Routeing, and will occur only if the GMSC supports Optimal Routeing. The procedure OR_Handle_RCH is specified in GSM 03.79 [8].

Sheet 4, sheet 6: the procedure CCBS_MT_GMSC_Check_CCBS_Possible is specific to CCBS; it is specified in GSM 03.93 [16].

Sheet 5: the input signal TNRy expired and all the subsequent processing are specific to CAMEL phase 2, and will occur only if the GMSC supports CAMEL phase 2. The procedure CAMEL_MT_GMSC_DISC5 is specified in GSM 03.78 for CAMEL phase 2 [7].

Sheet 6: the procedures CAMEL_MT_GMSC_DISC3, CAMEL_MT_GMSC_DISC4 and CAMEL_MT_GMSC_DISC6 are specific to CAMEL; they are specified in GSM 03.78 for CAMEL Phase 1 [6] (CAMEL_MT_GMSC_DISC3) and GSM 03.78 for CAMEL Phase 2 [7] (CAMEL_MT_GMSC_DISC4 and CAMEL_MT_GMSC_DISC6)..

Sheet 6: the procedure CCBS_Set_Diagnostic_For_Release is specific to CCBS; it is specified in GSM 03.93 [16].

Sheet 5: the procedures CAMEL_MT_GMSC_DISC1 and CAMEL_MT_GMSC_DISC2 are specific to CAMEL; they are specified in GSM 03.78 [6]. If the GMSC does not support CAMEL, processing continues from the "No" exit of the test "Result=CAMEL handling?".

Sheet 6: the processing in the branch beginning with the Int_Release_Call input will occur only if the MSC supports CAMEL.

Sheet 7: the procedure CAMEL_MT_GMSC_DISC1 is specific to CAMEL; it is specified in GSM 03.78 for CAMEL Phase 1 [6] and GSM 03.78 for CAMEL Phase 2 [7]. If the GMSC does not support CAMEL, processing continues from the "No" exit of the test "Result=CAMEL handling?".

Sheet 7: the procedure CAMEL_MT_GMSC_DISC2 is specific to CAMEL; it is specified in GSM 03.78 for CAMEL Phase 1 [6] and GSM 03.78 for CAMEL Phase 2 [7]. If the GMSC does not support CAMEL, processing continues from the "Normal handling" exit of the test "Result?".

Sheet 7: in the upper subtree, the processing in the branch beginning with the Int_Release_Call input will occur only if the GMSC supports CAMEL.

Sheet 7: after the GMSC has sent an IAM to the destination VMSC or the forwarded-to exchange (via the process MT_CF_MSC), it acts as a relay for messages received from the originating exchange and the destination VMSC or the process MT_CF_MSC. Any message other than Address Complete, Connect, Answer or Release causes no change of state in the process MT_GMSC.

7.2.1.2 Procedure Obtain_Routeing_Address

Sheet 1: the procedures CCBS_MT_GMSC_Check_CCBS_Call and CCBS_MT_GMSC_Check_CCBS_Indicators are specific to CCBS; they are specified in GSM 03.93 [16].

Sheet 1: The procedure OR_Handle_SRI_Negative_Response is specific to Support of Optimal Routeing. It is specified in GSM 03.79 [8]. If the GMSC does not support Optimal Routeing, processing continues from the "No" exit of the test "Result=Pass?".

Sheet 1: the procedure CAMEL_MT_GMSC_INIT is specific to CAMEL; it is specified in GSM 03.78 for CAMEL Phase 1 [6] and GSM 03.78 for CAMEL Phase 2 [7].

Sheet 2: the task "Store Forwarding Interrogation Required indicator" is executed only if the GMSC supports Optimal Routeing.

Sheet 1: the task "Destination address:=VMSC address" is executed only if the GMSC supports Optimal Routeing of mobile-to-mobile calls.

Sheet 2: the procedures CCBS_MT_GMSC_Remove_Indicators and CCBS_MT_GMSC_Remove_Indicators_Store_FWT are specific to CCBS; they are specified in GSM 03.93 [16].

Sheet 2: the procedure Route_Permitted is specific to Support of Optimal Routeing. It is specified in GSM 03.79 [8]. If the GMSC does not support Optimal Routeing, processing continues from the "True" exit of the test "Route permitted".

Sheet 2: the tasks "Destination address:=FTN" and "OR:=True" are executed only if the GMSC supports Optimal Routeing of mobile-to-mobile calls.

Sheet 2: the procedures CAMEL_MT_MSC_DISC3 and CAMEL_MT_MSC_DISC4 are specific to CAMEL; they are specified in GSM 03.78 for CAMEL Phase 1 [6] and GSM 03.78 for CAMEL Phase 2 [7] respectively.

Sheet 2: if the GMSC does not support CAMEL and the Send Routeing Info ack contains neither an MSRN nor an FTN, processing continues from the "No" exit of the test "CMN?"

Sheet 2: the tasks "Destination address:=CMN" and "OR:= True" are executed only if the GMSC supports Optimal Routeing of mobile-to-mobile calls.

7.2.1.3 Procedure Send_ACM_If_Required

If no useful information would be carried in the Call Progress message, it is not sent.

7.2.1.4 Procedure Send_Answer_If_Required

If no useful information would be carried in the Call Progress message, it is not sent.

7.2.1.5 Procedure Send_Network_Connect_If_Required

If no useful information would be carried in the Call Progress message, it is not sent.

7.2.1.6 Procedure Handle_COLP_Forwarding_Interaction_MSC

The originating exchange or the destination exchange may release the call while a response is awaited from the process COLP_MAF039. The message is saved for processing after return from the procedure.

7.2.1.7 Procedure Activate_CF_Process

The processing in the branch beginning with the Int_Release_Call input will occur only if the MSC supports CAMEL.

7.2.1.8 Process MT_CF_MSC

Sheet 1: the procedure CAMEL_CF_MSC_INIT is specific to CAMEL; it is specified in GSM 03.78 for CAMEL Phase 1 [6] and GSM 03.78 for CAMEL Phase 2 [7]. If the MSC does not support CAMEL, processing continues from the "Yes" exit of the test "Result=Pass?".

Sheet 1: the procedures CAMEL_OCH_MSC_DISC3 and CAMEL_OCH_MSC_DISC4 are specific to CAMEL; they are specified in GSM 03.78 for CAMEL Phase 1 [6] and GSM 03.78 for CAMEL Phase 2 [7] respectively.

Sheet 2: the procedures CAMEL_Start_TNRy and CAMEL_Stop_TNRy are specific to CAMEL phase 2; they are specified in GSM 03.78 for CAMEL Phase 2 [7].

Sheet 2: the procedure CAMEL_CF_MSC_ANSWER is specific to CAMEL; it is specified in GSM 03.78 for CAMEL Phase 1 [6] and GSM 03.78 for CAMEL Phase 2 [7]. If the MSC does not support CAMEL, processing continues from the "Yes" exit of the test "Result=Pass?".

Sheet 3: the procedures CAMEL_OCH_MSC_DISC3 and CAMEL_OCH_MSC_DISC4 are specific to CAMEL; they are specified in GSM 03.78 for CAMEL Phase 1 [6] and GSM 03.78 for CAMEL Phase 2 [7] respectively.

Sheet 3: the procedure CAMEL_OCH_MSC1 is specific to CAMEL phase 2; it is specified in GSM 03.78 for CAMEL Phase 2 [7].

Sheet 3: the procedure CAMEL_Stop TNRY is specific to CAMEL phase 2; it is specified in GSM 03.78 for CAMEL Phase 2 [7].

Sheet 3: the processing in the branch beginning with the Int_O_Release input will occur only if the MSC supports CAMEL.

Sheet 4: the input signal TNRY expired and all the subsequent processing are specific to Support of CAMEL phase 2, and will occur only if the GMSC supports CAMEL phase 2. The procedure CAMEL_OCH_MSC2 is specified in GSM 03.78 for CAMEL Phase 2 [7].

Sheet 5: the procedure CAMEL_OCH_MSC_DISC1 is specific to CAMEL; it is specified in GSM 03.78 for CAMEL Phase 1 [6] and GSM 03.78 for CAMEL Phase 2 [7]. If the MSC does not support CAMEL, processing continues from the "No" exit of the test "Result=CAMEL handling?".

Sheet 5: the procedure CAMEL_OCH_MSC_DISC2 is specific to CAMEL; it is specified in GSM 03.78 for CAMEL Phase 1 [6] and GSM 03.78 for CAMEL Phase 2 [7]. If the MSC does not support CAMEL, processing continues from the "No" exit of the test "Result=Reconnect?".

Sheet 5: the processing in the branch beginning with the Int_O_Release input will occur only if the MSC supports CAMEL.

Sheet 5: after the process MT_CF_MSC has sent an IAM to the forwarded-to exchange, it acts as a relay for messages received from the parent process and the forwarded-to exchange. Any message other than Address Complete, Connect, Answer or Release causes no change of state in the process MT_GMSC

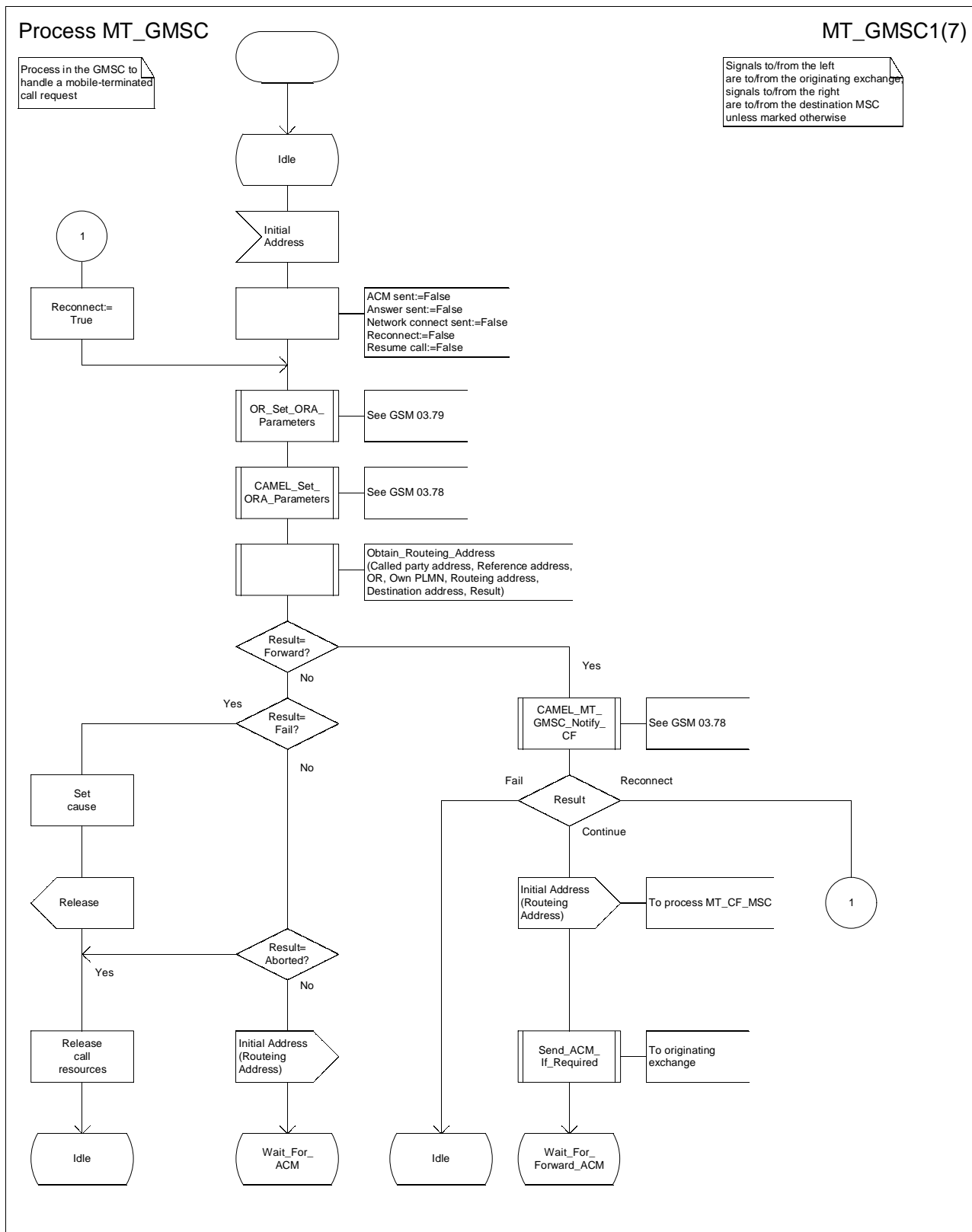

Figure 35a: Process MT_GMSC (sheet 1)

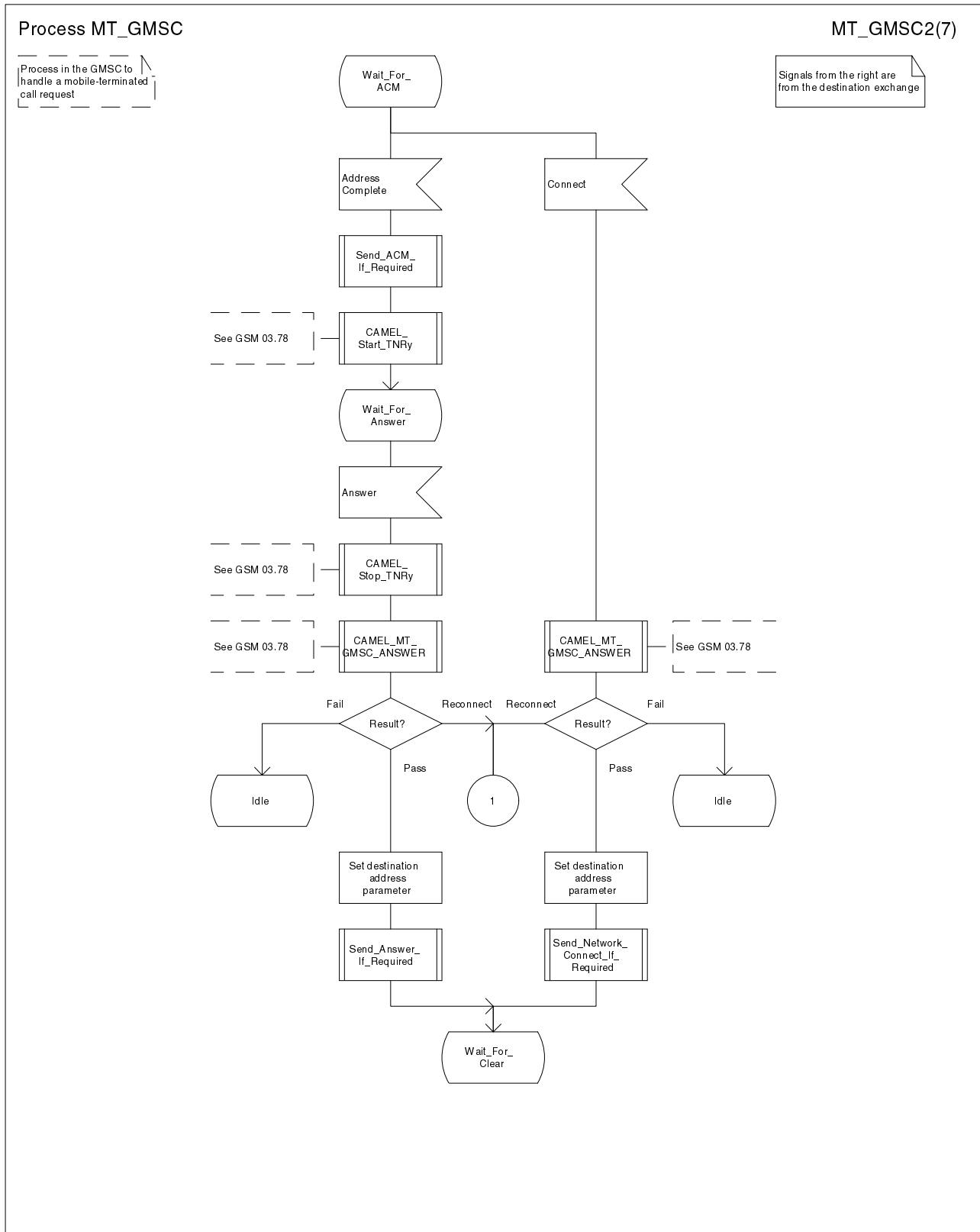

Figure 35b: Process MT_GMSC (sheet 2)

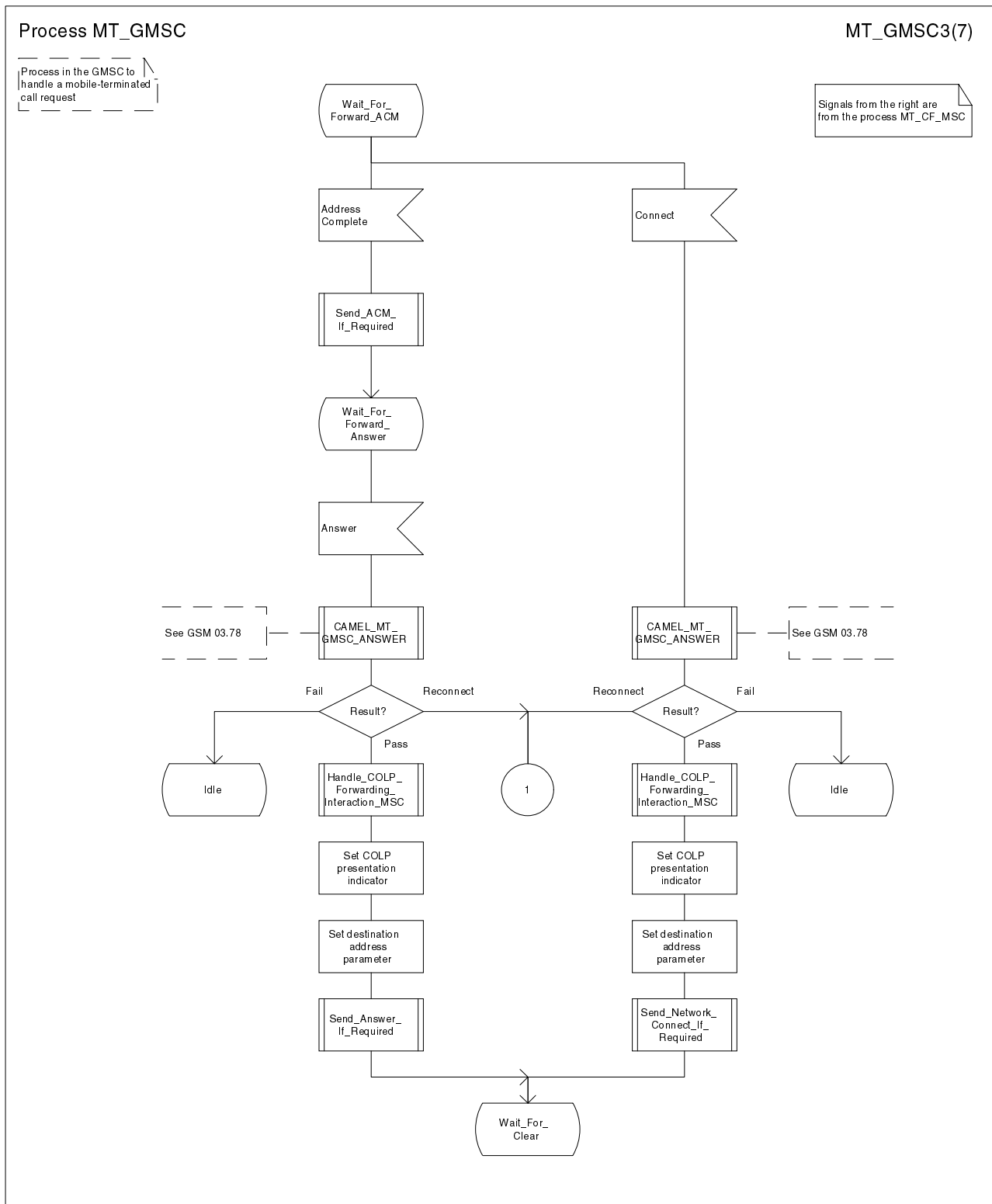

Figure 35c: Process MT_GMSC (sheet 3)

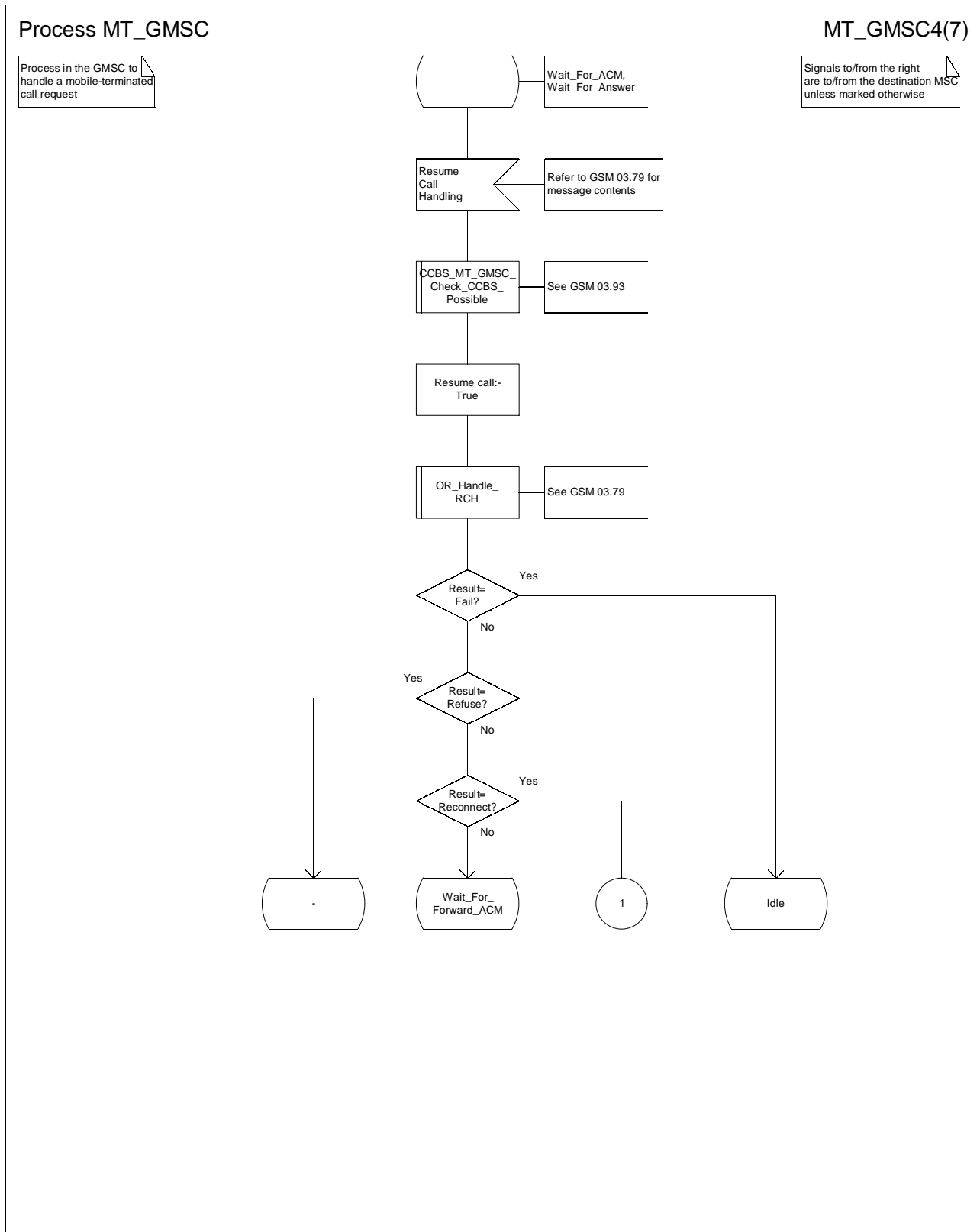

Figure 35d: Process MT_GMSC (sheet 4)

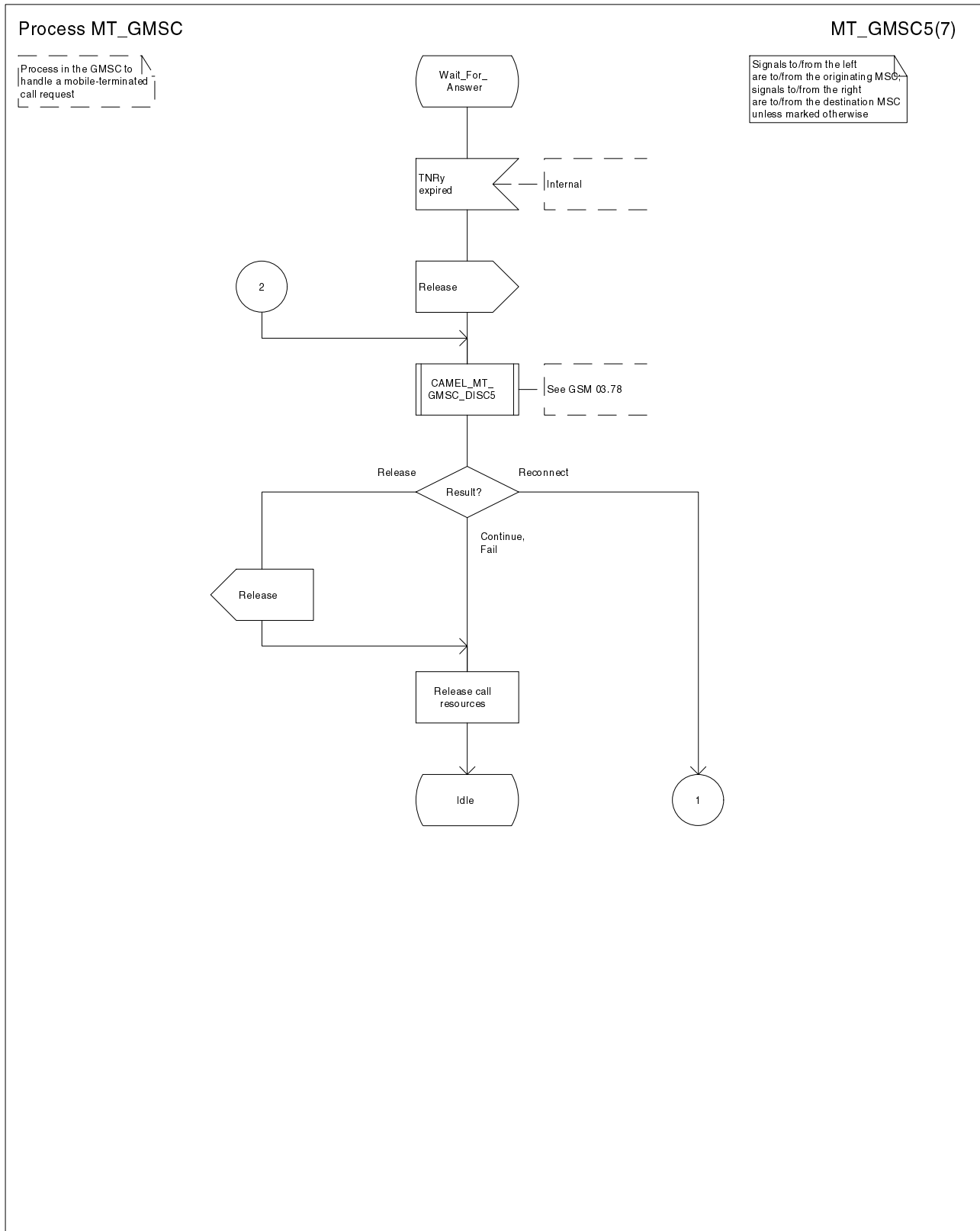

Figure 35e: Process MT_GMSC (sheet 5)

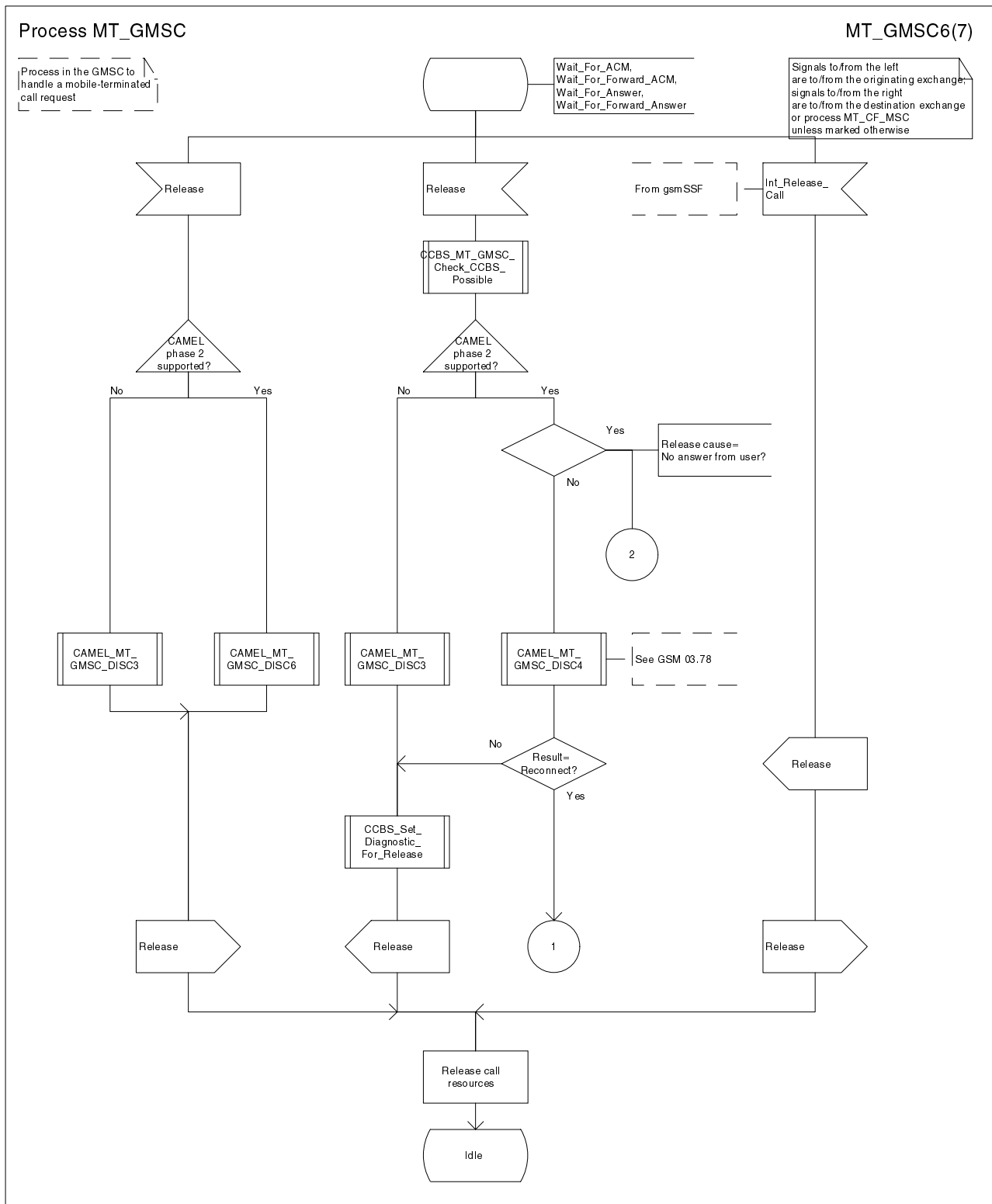

Figure 35f: Process MT_GMSC (sheet 6)

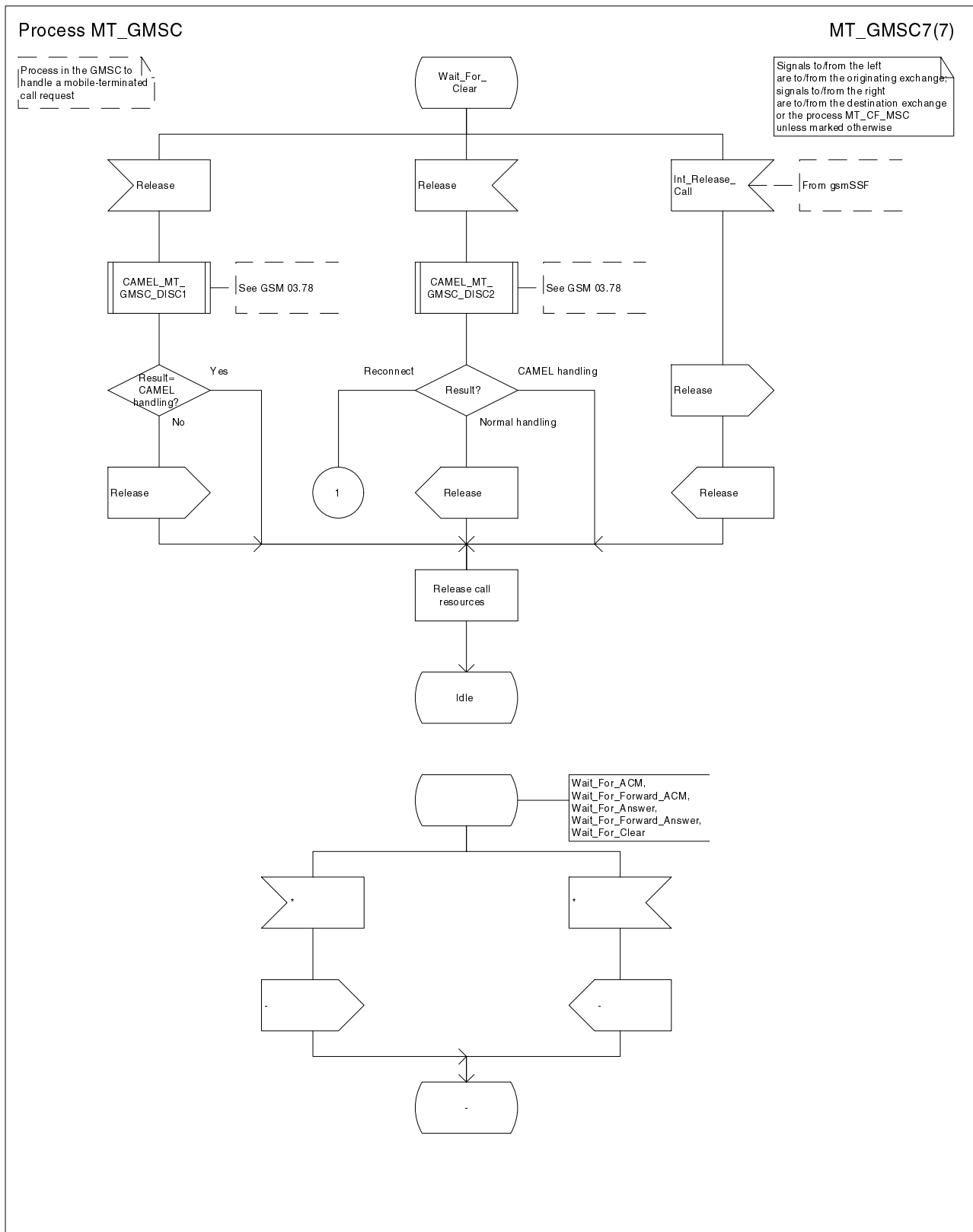

Figure 35g: Process MT_GMSC (sheet 7)

Procedure Obtain_Routeing_Address

ORA1(2)

Procedure in a GMSC to determine the address to which a call should be routed

Procedure Obtain_Routeing_Address
FPAR IN Input address, Reference address:
Own PLMN
IN/OUT Routing address,
Destination address, OR, Result

Signals to/from the left are to/from the originating exchange, signals to/from the right are to/from the HLR

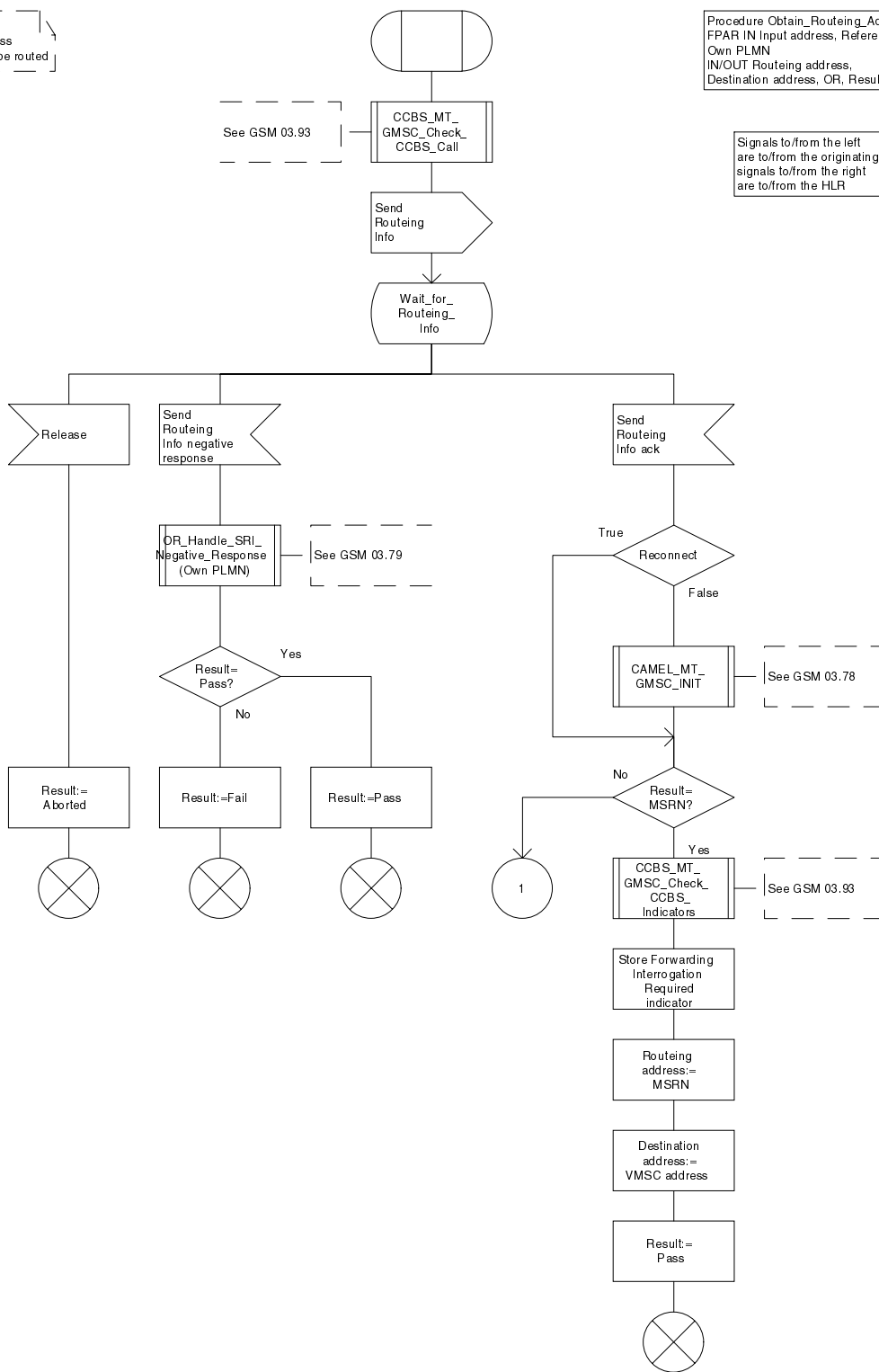

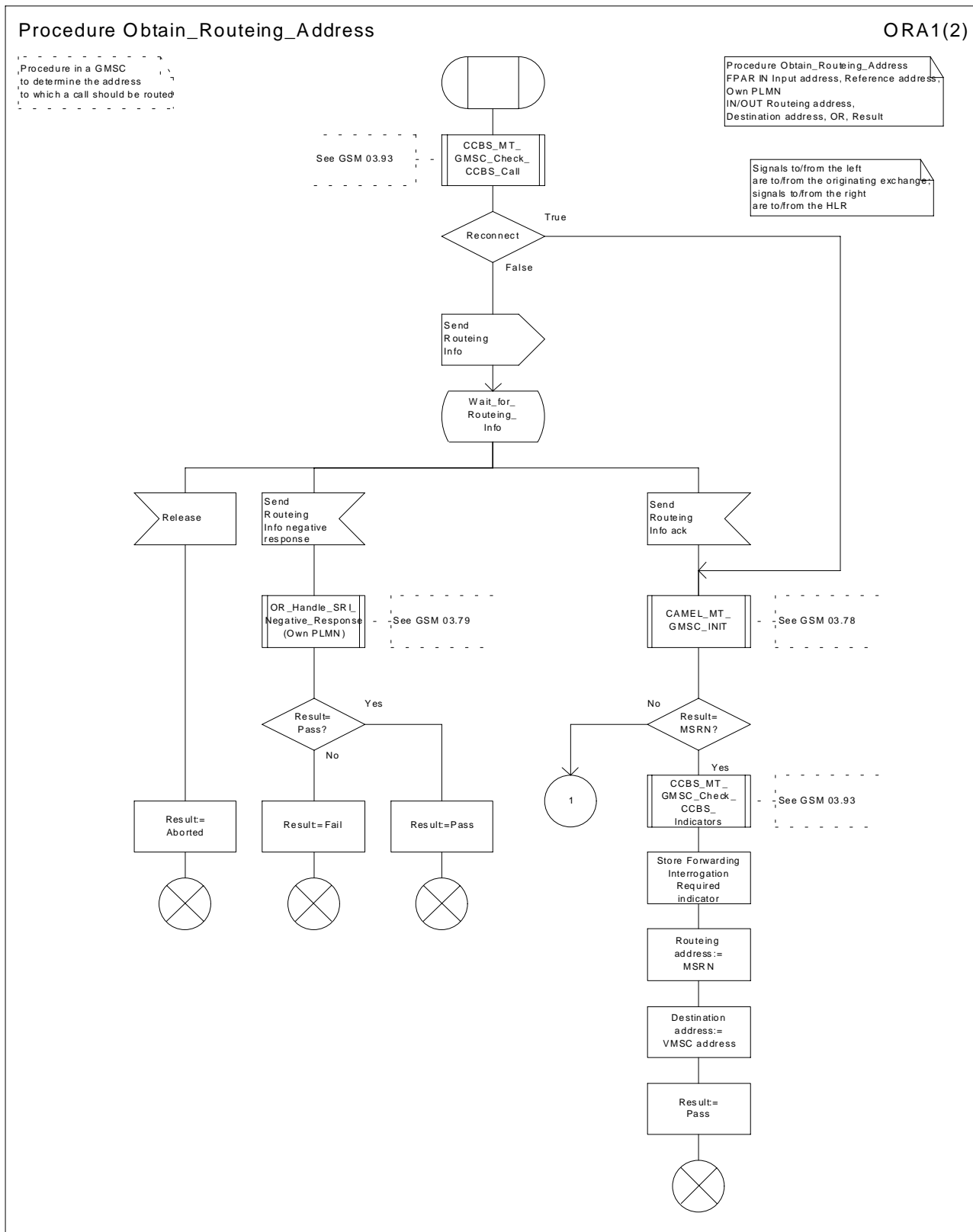

Figure 36a: Procedure Obtain_Routeing_Address (sheet 1)

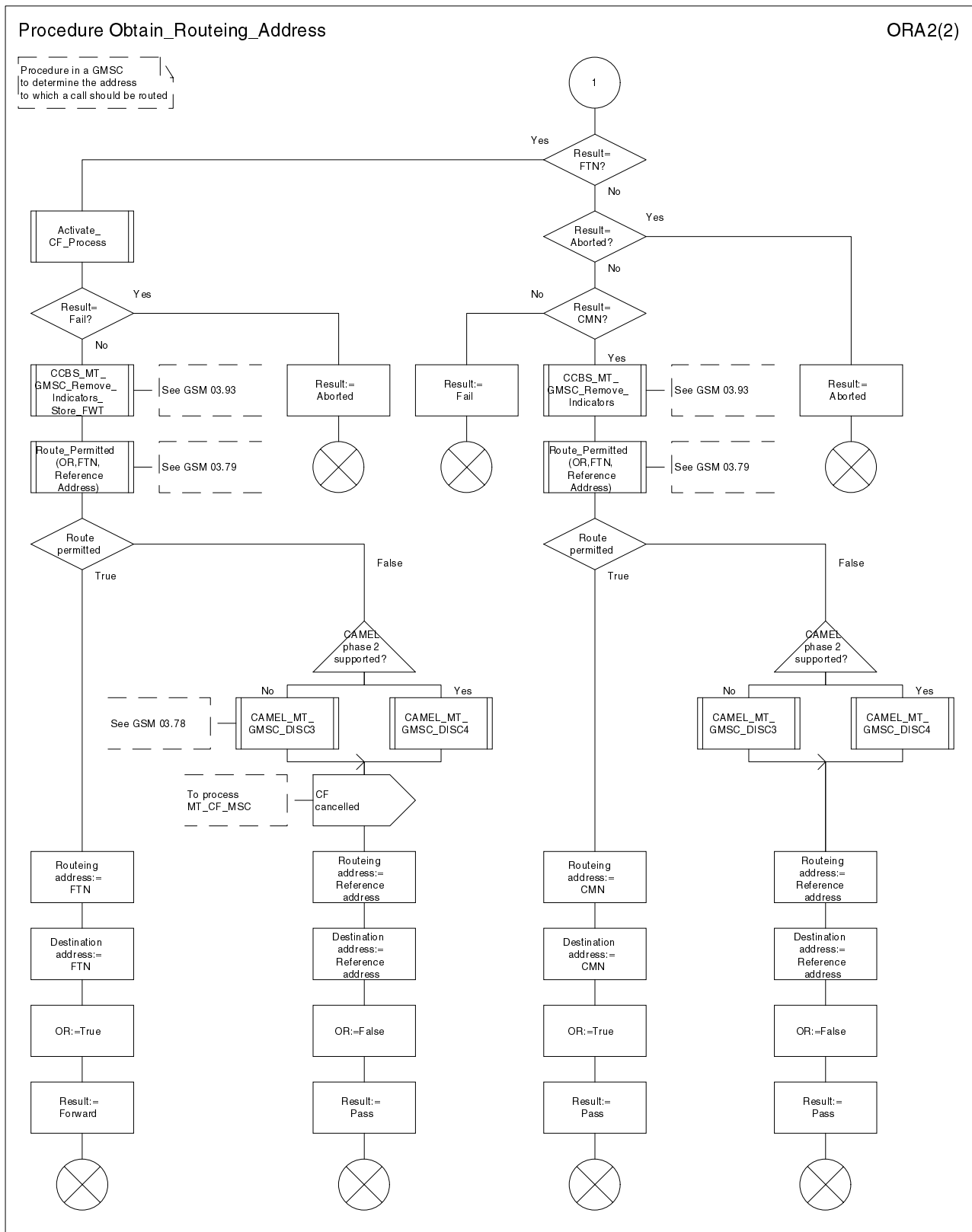

Figure 36b: Procedure Obtain_Routeing_Address (sheet 2)

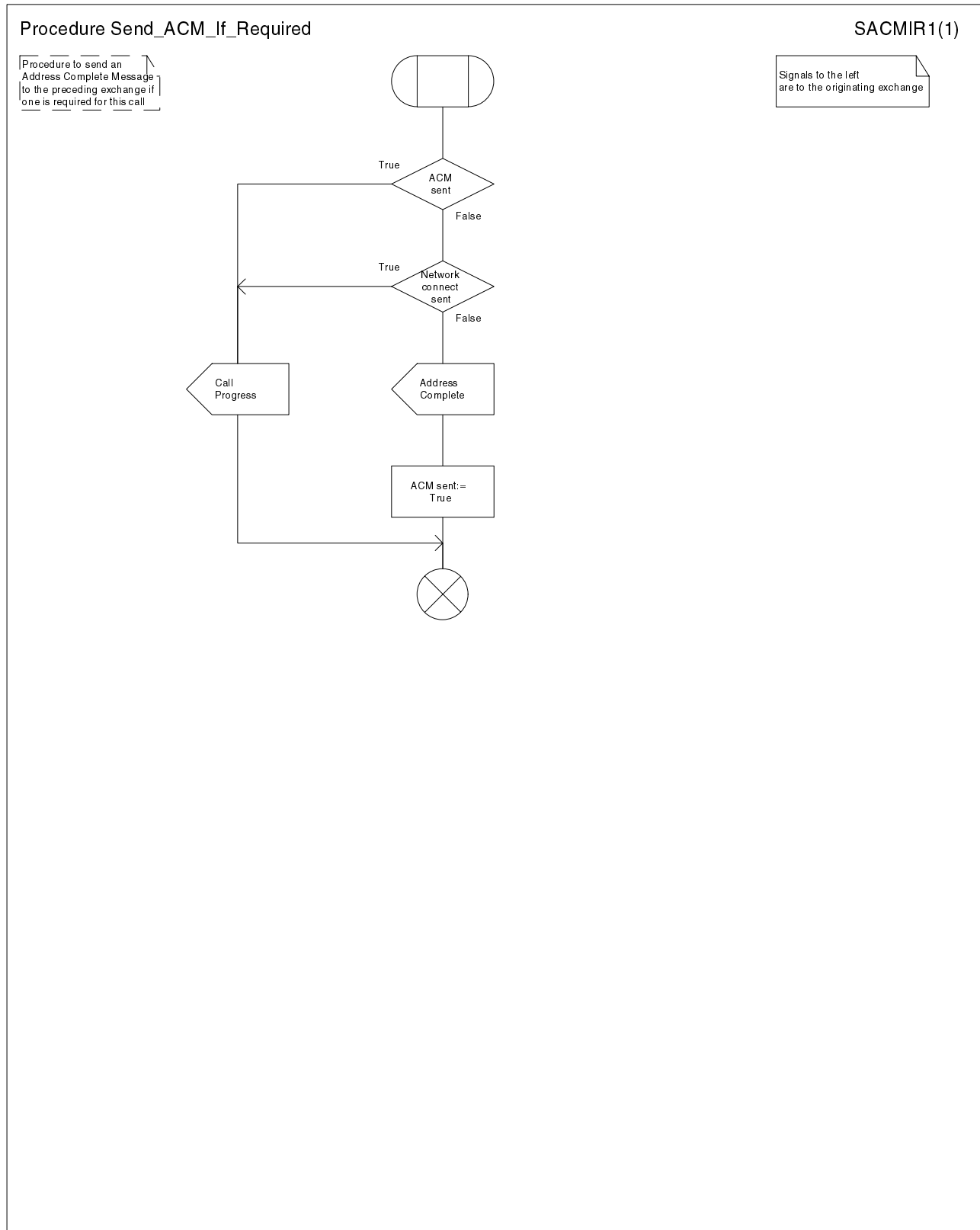

Figure 37: Procedure Send_ACM_If_Required

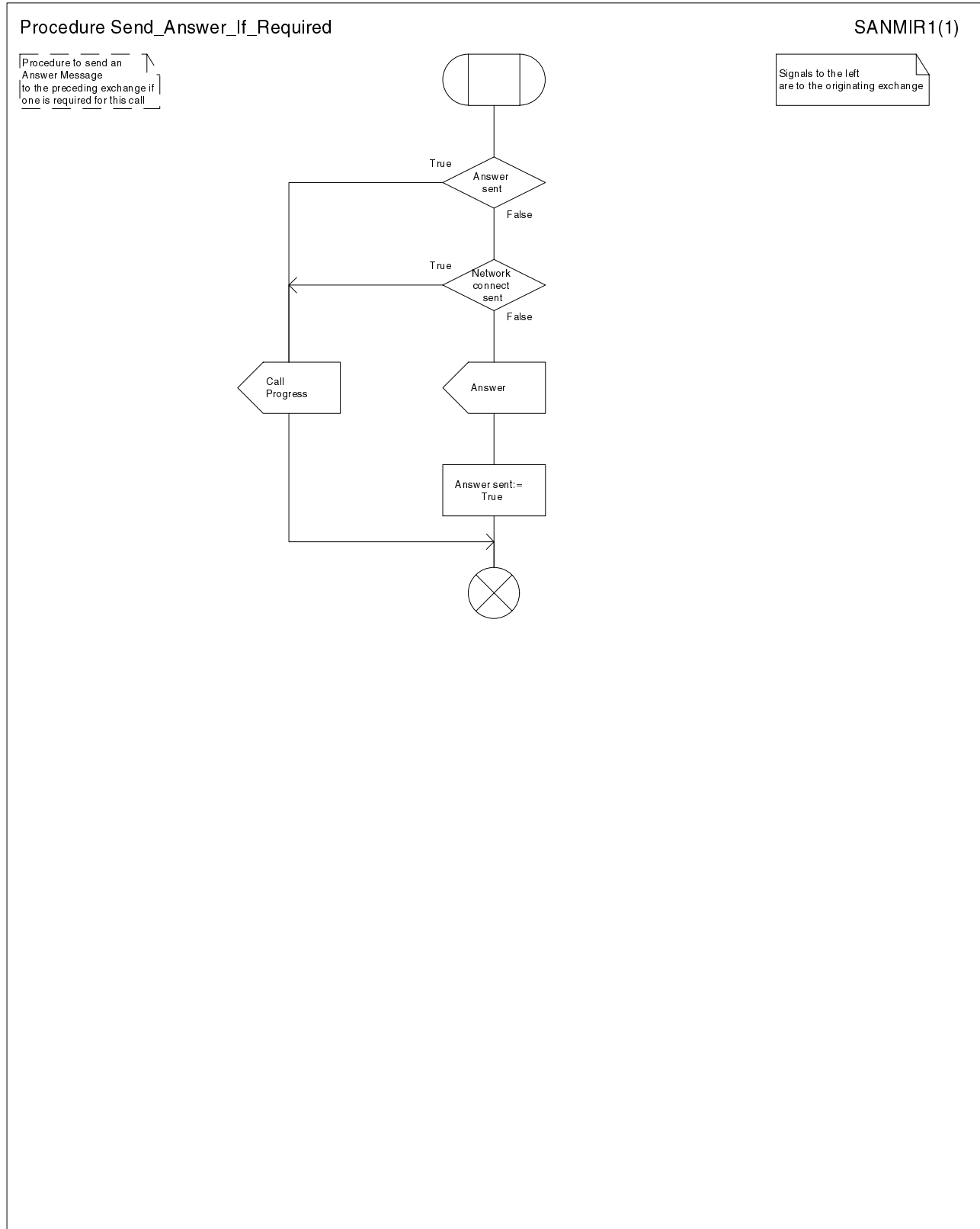

Figure 38: Procedure Send_Answer_If_Required

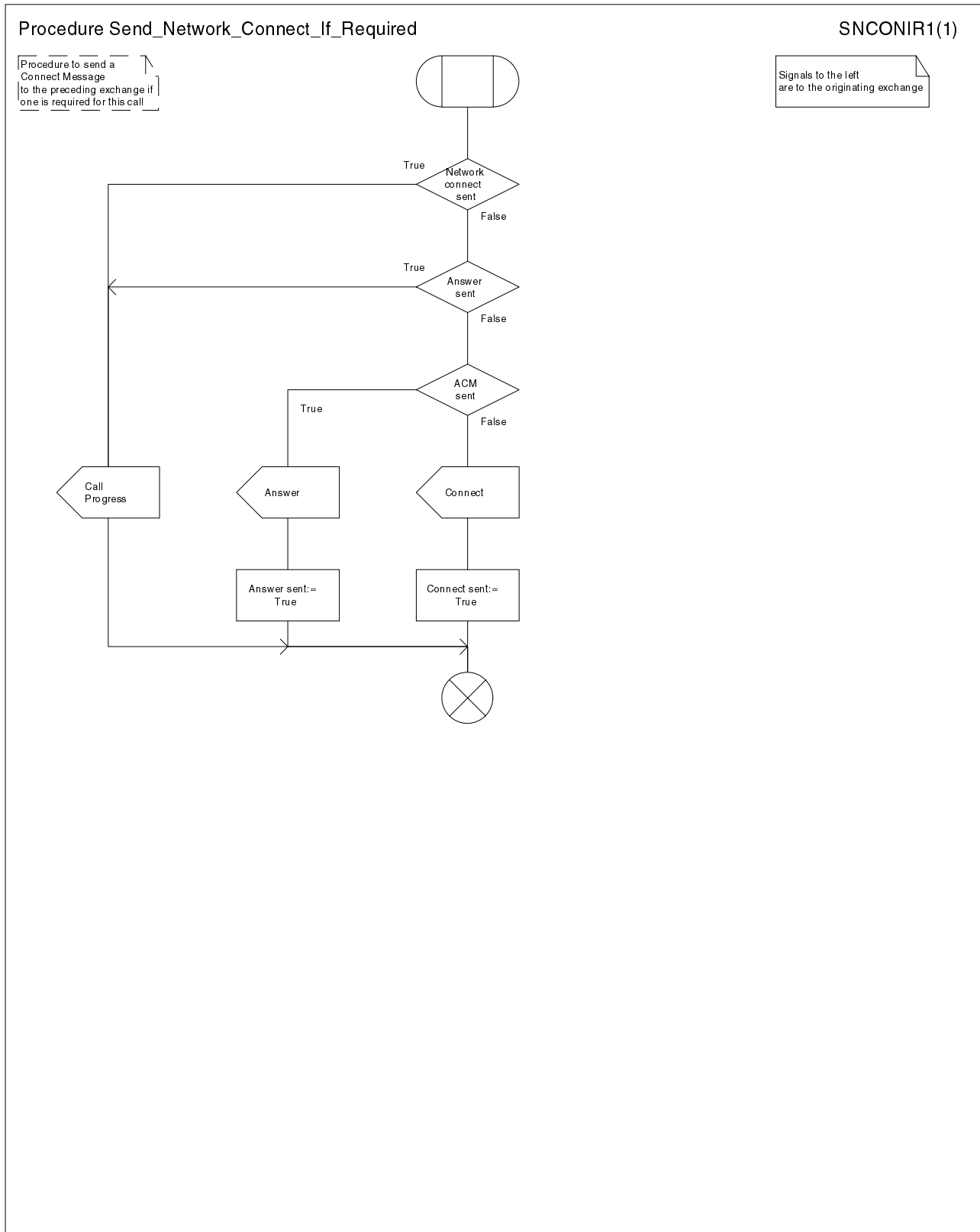

Figure 39: Procedure Send_Network_Connect_If_Required

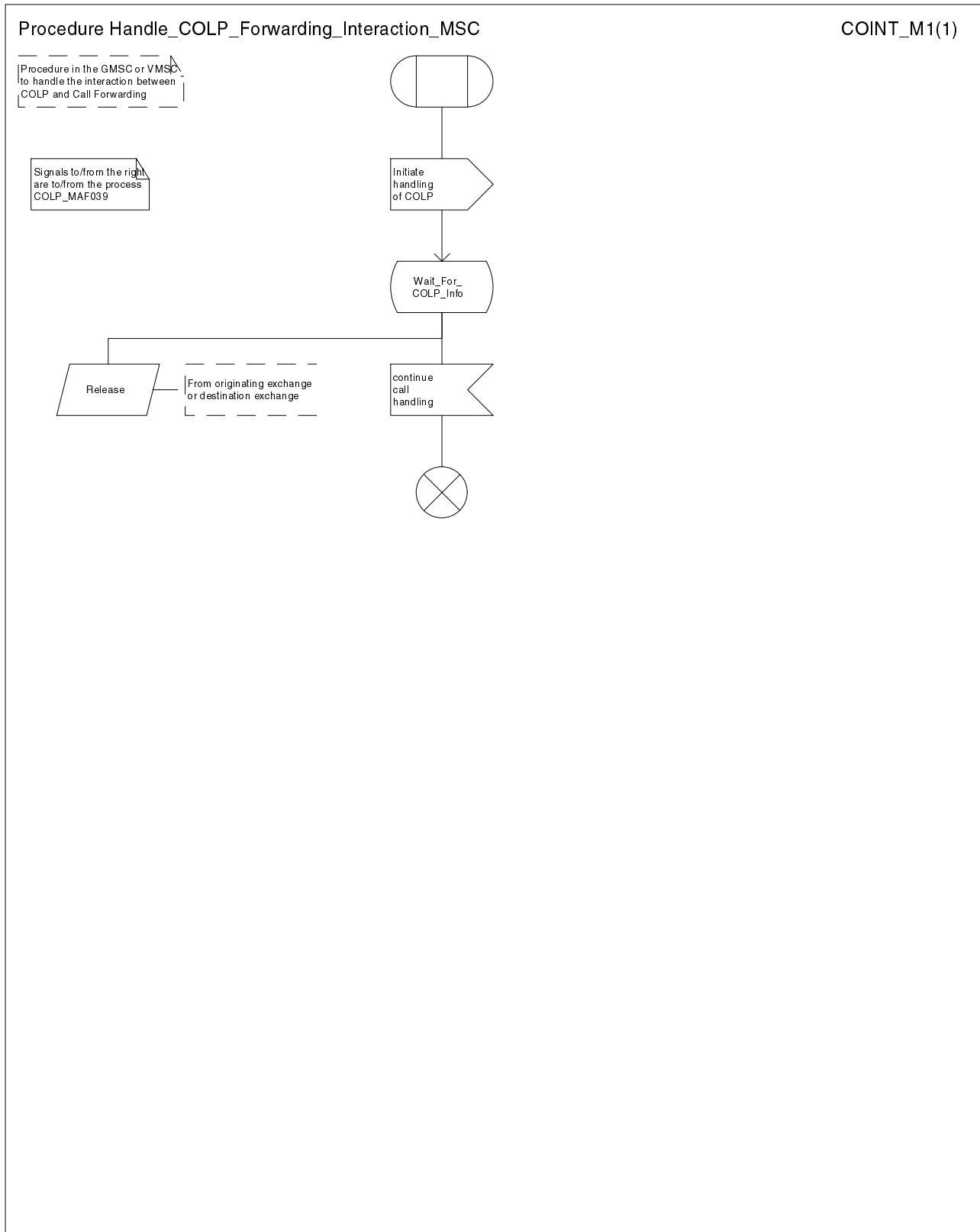

Figure 40: Procedure Handle_COLP_Forwarding_Interaction_MSC

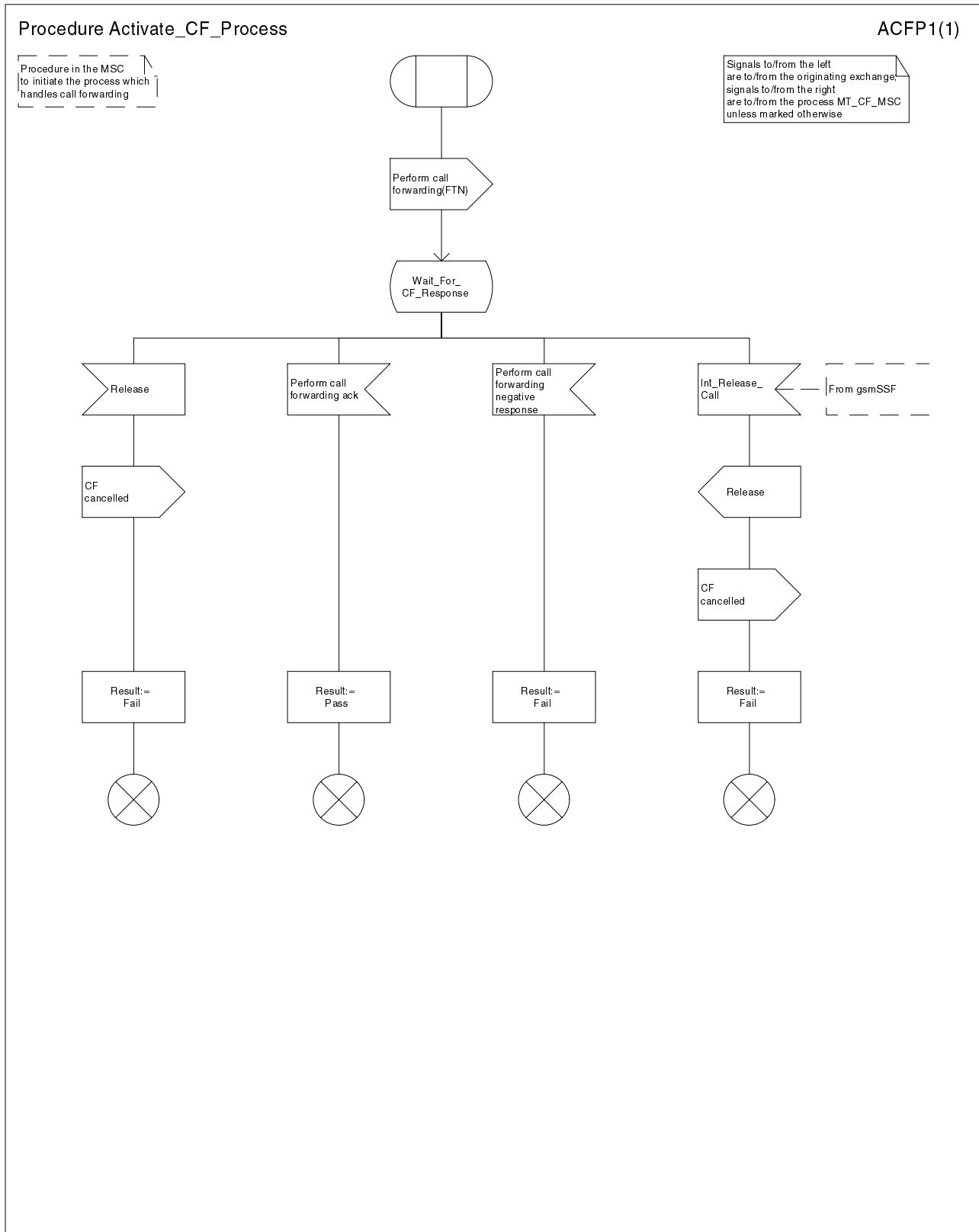

Figure 41: Procedure Activate_Call_Forwarding_Process

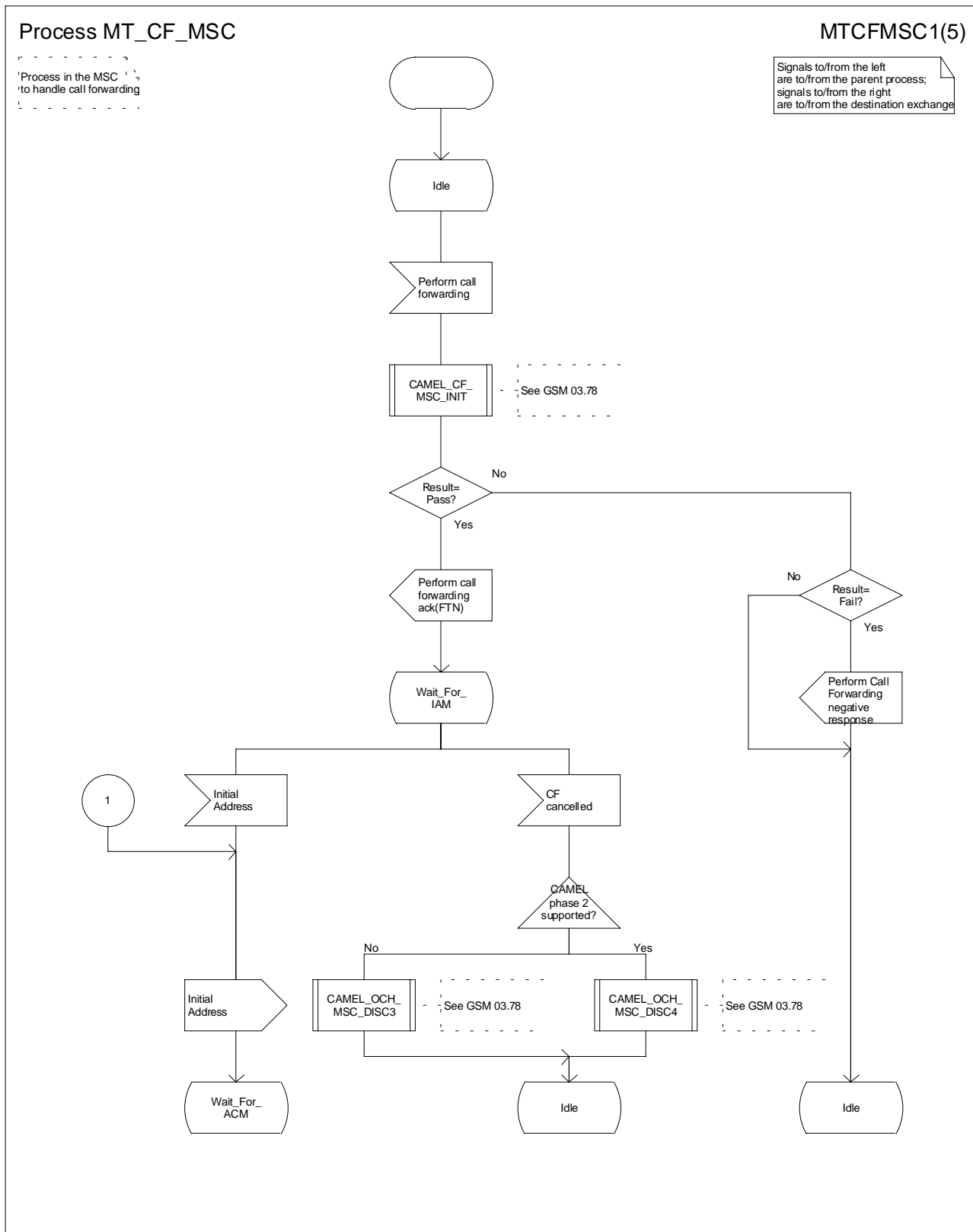

Figure 42a: Process MT_CF_MSC (sheet 1)

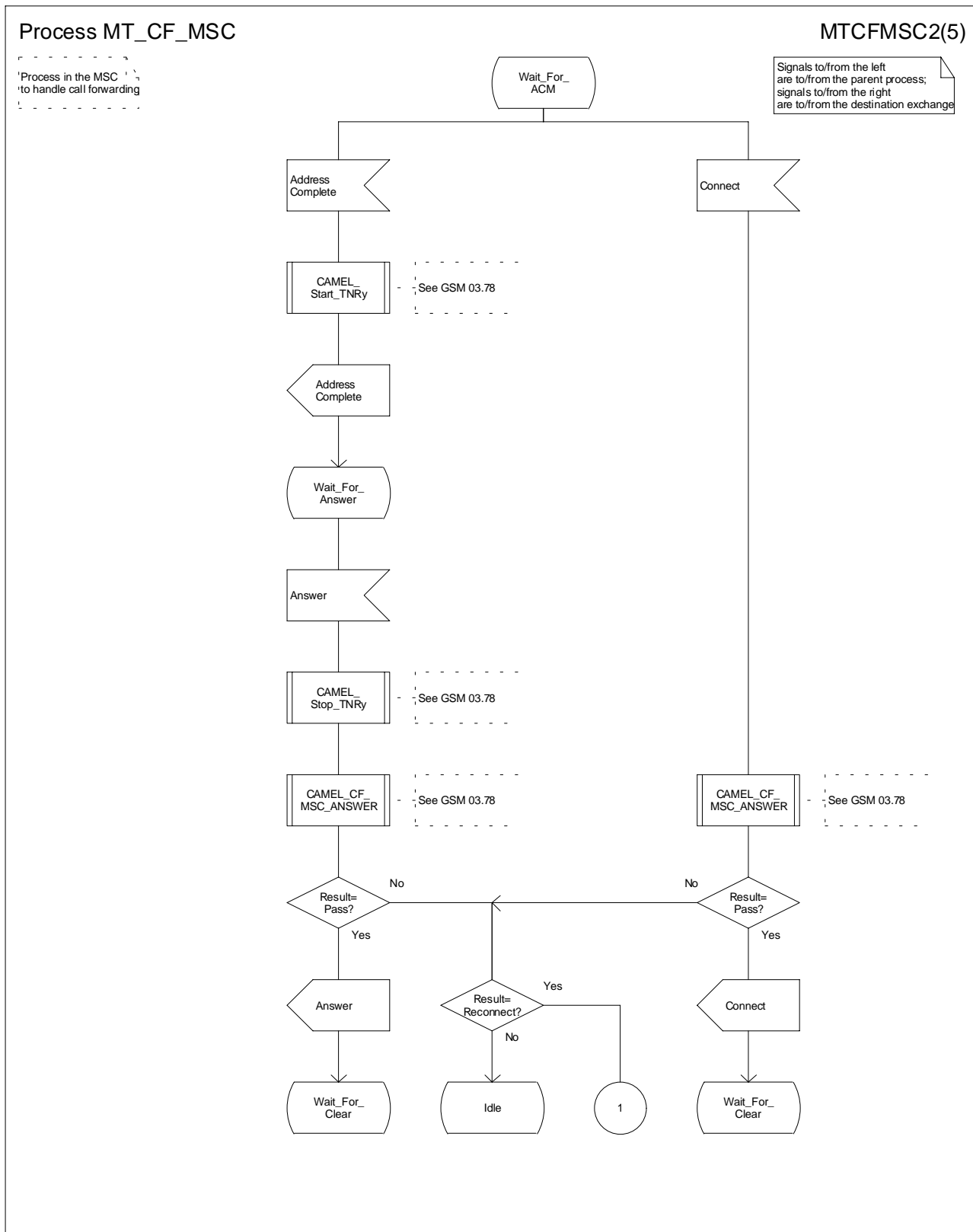

Figure 42b: Process MT_CF_MSC (sheet 2)

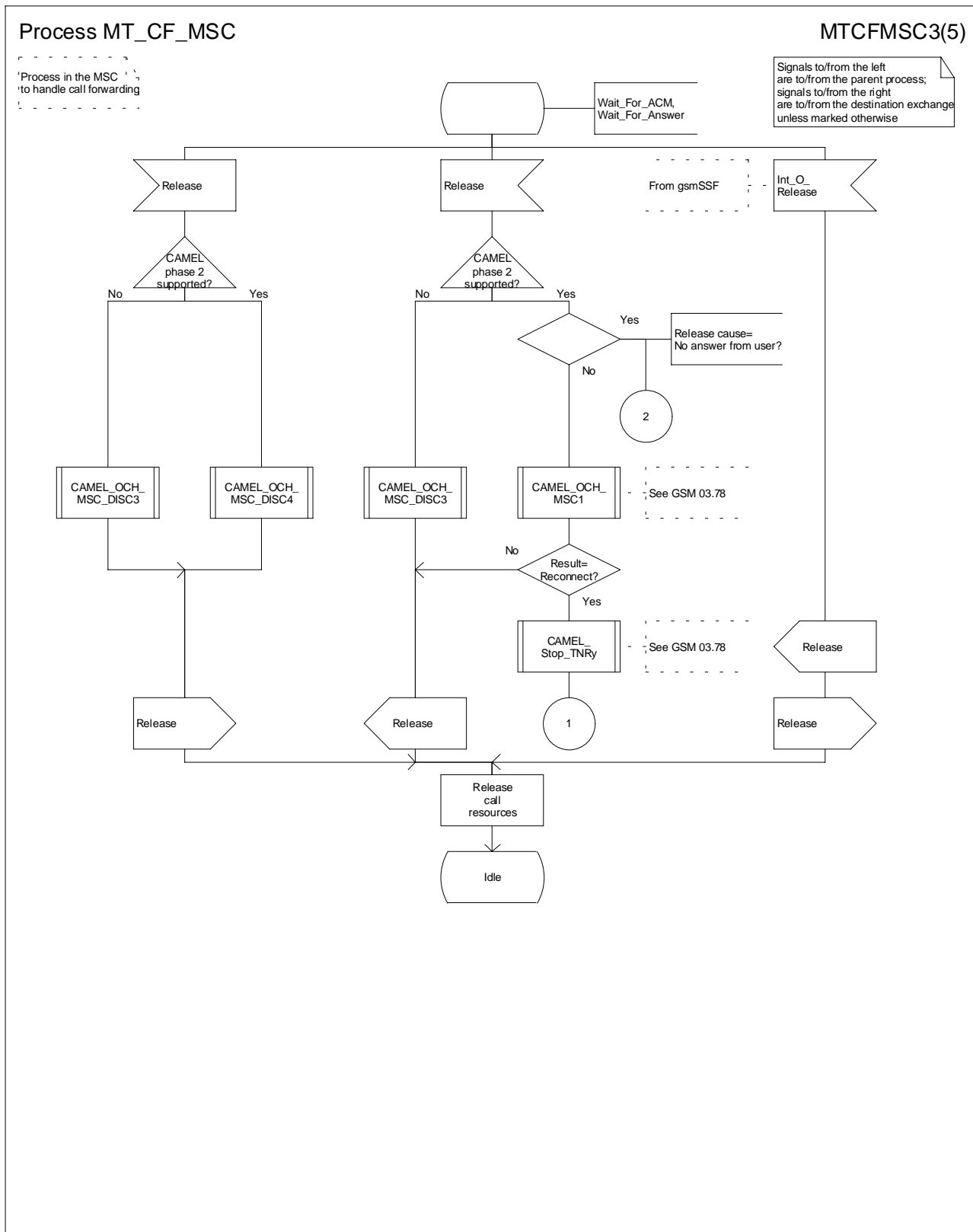

Figure 42c: Process MT_CF_MSC (sheet 3)

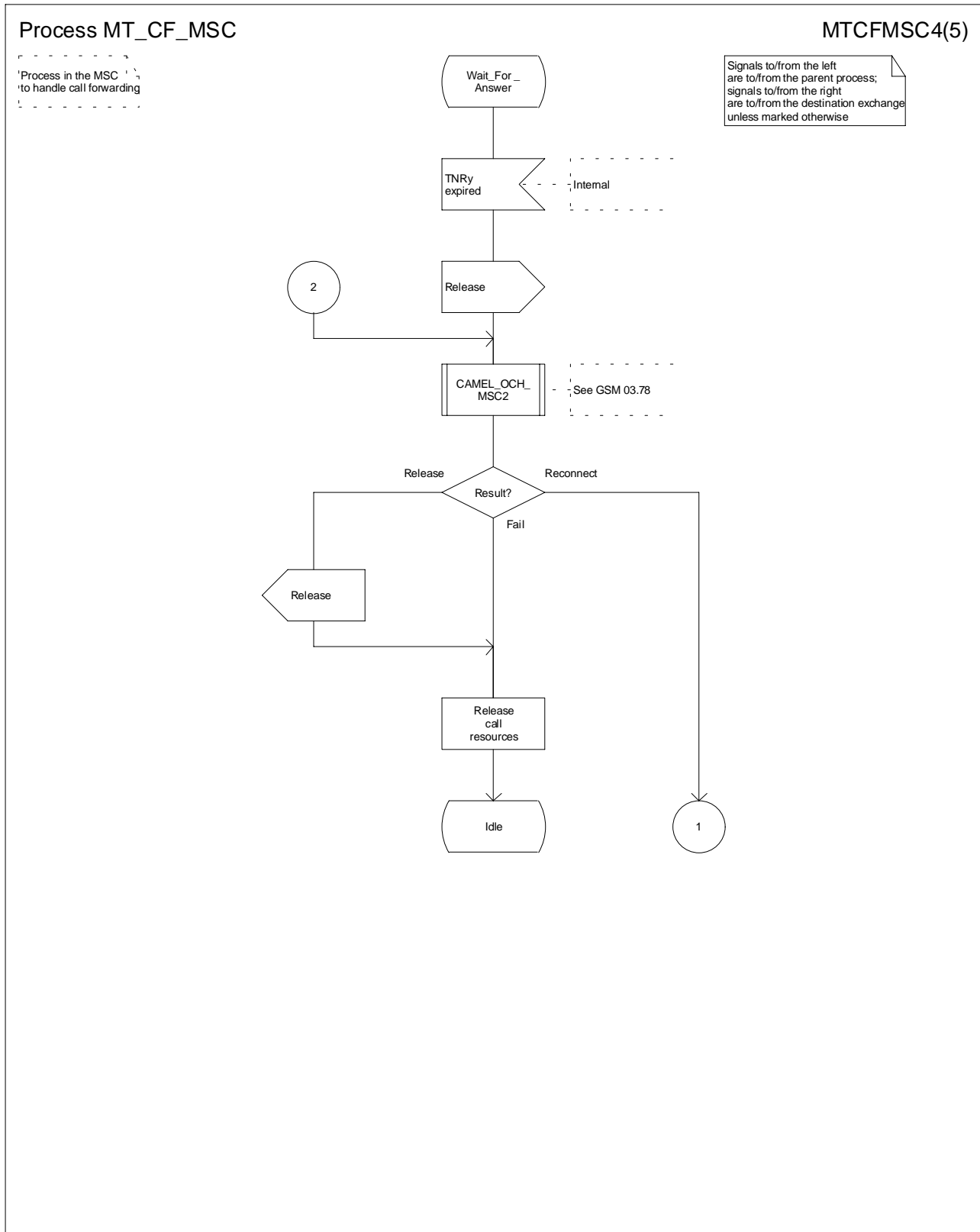

Figure 42d: Process MT_CF_MSC (sheet 4)

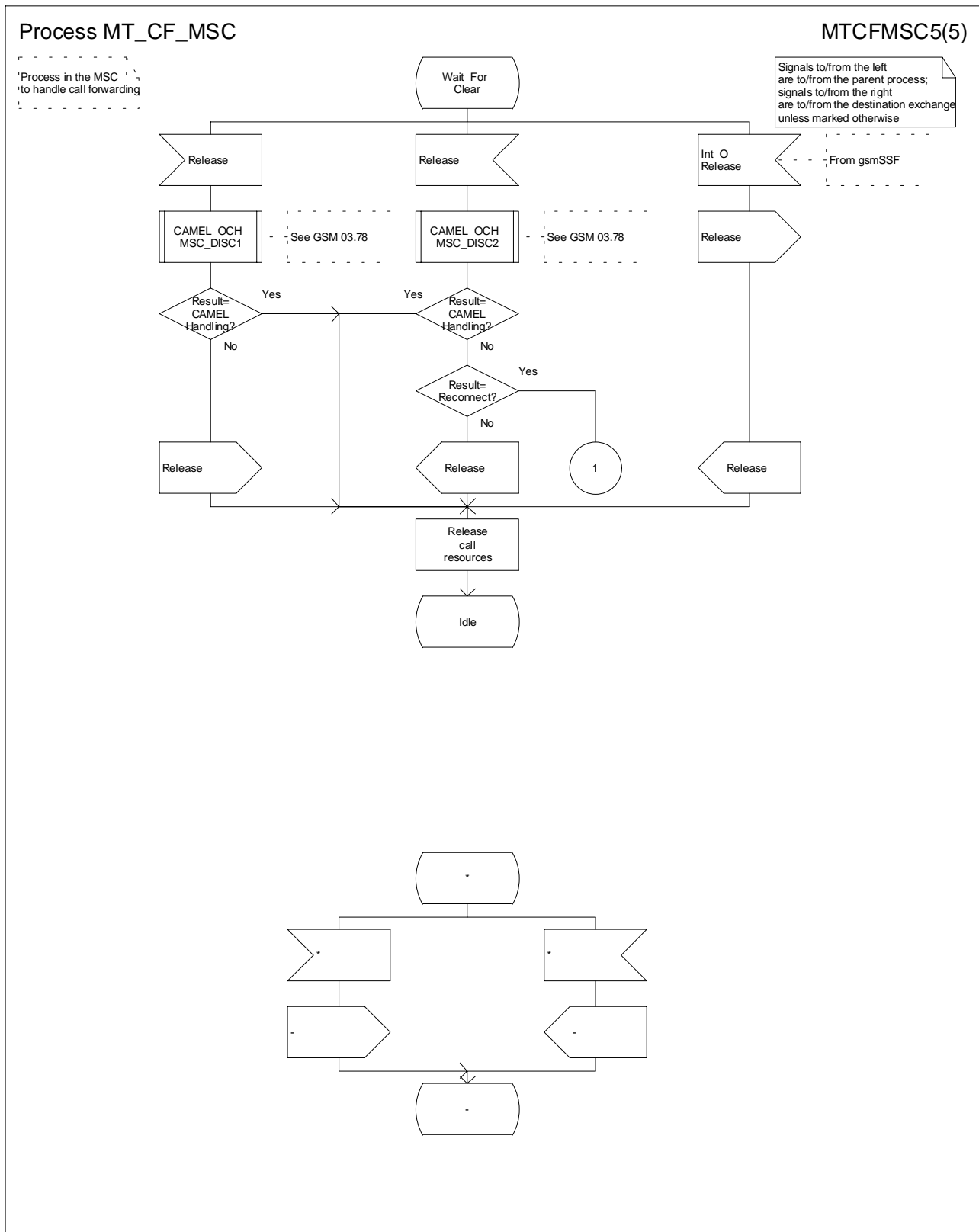

Figure 42e: Process MT_CF_MSC (sheet 5)

7.2.2 Functional requirements of HLR

7.2.2.1 Process SRI_HLR

Sheet 1: the procedures Check_Parameters, Subscription_Check_HLR, Handle_OR_HLR_CF and CAMEL_HLR_INIT can set the negative response parameter which is used by the process SRI_HLR to construct the Send Routeing Info negative response message. This negative response parameter is global data, accessible by the process SRI_HLR.

Sheet 1: the procedure Handle_OR_HLR_CF is specific to Support of Optimal Routeing; it is specified in GSM 03.79 [8]. If the HLR does not support Optimal Routeing, processing continues from the "No" exit of the test "Result=Forward?".

Sheet 1: the procedure CAMEL_HLR_INIT is specific to CAMEL; it is specified in GSM 03.78 for CAMEL Phase 1 [6] and GSM 03.78 for CAMEL Phase 2 [7]. If the HLR does not support CAMEL, processing continues from the "No" exit of the test "Result=Fail?".

Sheet 2: the procedure First_Forwarding_HLR can set the negative response parameter which is used by the process SRI_HLR to construct the Send Routeing Info negative response message. This negative response parameter is global data, accessible by the process SRI_HLR.

Sheet 2: the procedure CAMEL_CSI_Check_HLR is specific to CAMEL; it is specified in GSM 03.78 for CAMEL Phase 1 [6] and GSM 03.78 for CAMEL Phase 2 [7]. If the HLR does not support CAMEL, processing continues from the "No" exit of the test "Result=CSI active?".

Sheet 2: the procedure CCBS_Handling_HLR is specific to CCBS; it is specified in GSM 03.93 [16]. If the HLR does not support CCBS, processing continues from the "Yes" exit of the test "Result = OK?".

Sheet 3: the procedure OR_HLR_Interrogate_VLR is specific to Optimal Routeing. It is specified in GSM 03.79 [8]. If the HLR does not support Optimal Routeing, processing continues from the "No" exit of the test "Result=Forward".

Sheet 3: if the HLR does not support Network Indication of Alerting, the test "Alerting pattern required" and the task "Set Alerting Pattern" are omitted.

Sheet 4: the procedure PRN_Error_HLR can set the negative response parameter which is used by the process SRI_HLR to construct the Send Routeing Info negative response message. This negative response parameter is global data, accessible by the process SRI_HLR.

Sheet 4: the procedure Forward_CUG_Check is specific to CUG. If the HLR does not support CUG, processing continues from the "Yes" exit of the test "Result=Call allowed?".

Sheet 4: the test "Forwarding enquiry" is specific to Support of Optimal Routeing. If the HLR does not support Optimal Routeing, processing continues from the "No" exit of the test.

Sheet 4: the procedure CAMEL_CSI_Check_HLR is specific to CAMEL; it is specified in GSM 03.78 for CAMEL Phase 1 [6] and GSM 03.78 for CAMEL Phase 2 [7]. If the HLR does not support CAMEL, processing continues from the "No" exit of the test "Result=CSI active?".

Sheet 4: the procedures CAMEL_T_CSI_CHECK_HLR and CAMEL_O_CSI_CHECK_HLR are specific to CAMEL; they are specified in GSM 03.78 for CAMEL Phase 1 [6] and GSM 03.78 for CAMEL Phase 2 [7].

7.2.2.2 Procedure Check_Parameters

If any parameters required by the rules in clause 8 are missing from the message, the procedure sets the negative response to "Data missing". If any parameter has a value which is not in the set of values expected for the parameter, the procedure sets the negative response to "Unexpected data value".

7.2.2.3 Procedure Subscription_Check_HLR

It is an implementation option to carry out the check for operator determined barring of incoming calls before the check on provisioning of the requested basic service.

The negative response "Call barred" indicates whether the reason is operator determined barring or supplementary service barring, according to the result returned by the procedure Check_IC_Barring.

The procedure IC_CUG_Check is specific to CUG. If the HLR does not support CUG, processing continues from the "Yes" exit of the test "Result=Call allowed?".

The negative response "CUG reject" indicates whether the reason is:

- Incoming calls barred within CUG;
- Requested basic service violates CUG constraints;
- Subscriber not member of CUG

according to the cause returned by the procedure IC_CUG_Check.

7.2.2.4 Procedure First_Forwarding_HLR

The MS is not reachable if any of the following conditions is satisfied:

- The HLR has no location information for the subscriber;
- The subscriber record is marked as MS purged;
- The subscriber record is marked as MSC area restricted;
- The subscriber record is marked as Roaming Restricted due to Unsupported Feature;
- The subscriber is marked as deregistered because of subscription restrictions on roaming

7.2.2.5 Procedure PRN_Error_HLR

The procedure CCBS_Report_PRN_Failure is specific to CCBS; it is specified in GSM 03.93 [16]. The procedure does not return a value; the following tests are on the value of the Provide Roaming Number negative response.

If the HLR does not support Optimal Routing, processing starts with the test "Negative response=Facility not supported?".

7.2.2.6 Procedure Forward_CUG_Check

7.2.2.7 Procedure Derive_Requested_Basic_Service_HLR

The rules for deriving a GSM bearer capability from ISDN compatibility information or the MSISDN of the B subscriber are specified in GSM 09.07 [21]. If a GSM bearer capability cannot be derived from the ISDN compatibility information or the MSISDN of the B subscriber, the HLR applies a default basic service according to the requirements of the operator.

7.2.2.8 Procedure Check_IC_Barring

7.2.2.9 Procedure IC_CUG_Check

7.2.2.10 Procedure Handle_CFU

The test "Normal call" refers to the value of the indicator returned by the process MAF007.

7.2.2.11 Procedure Handle_CFNRC

The test "Mobile subscriber not reachable" refers to the value of the indicator returned by the process MAF010.

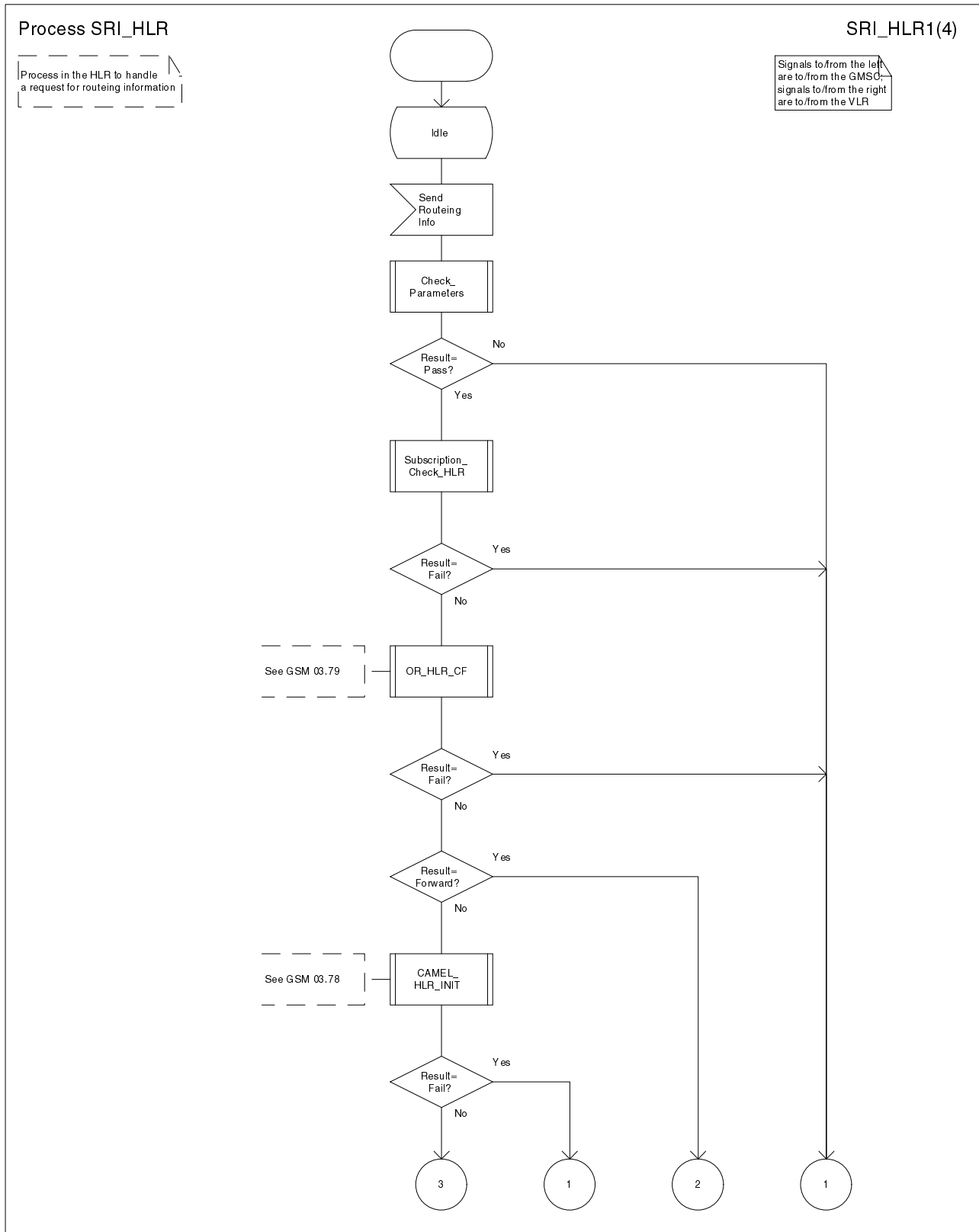

Figure 43a: Process SRI_HLR (sheet 1)

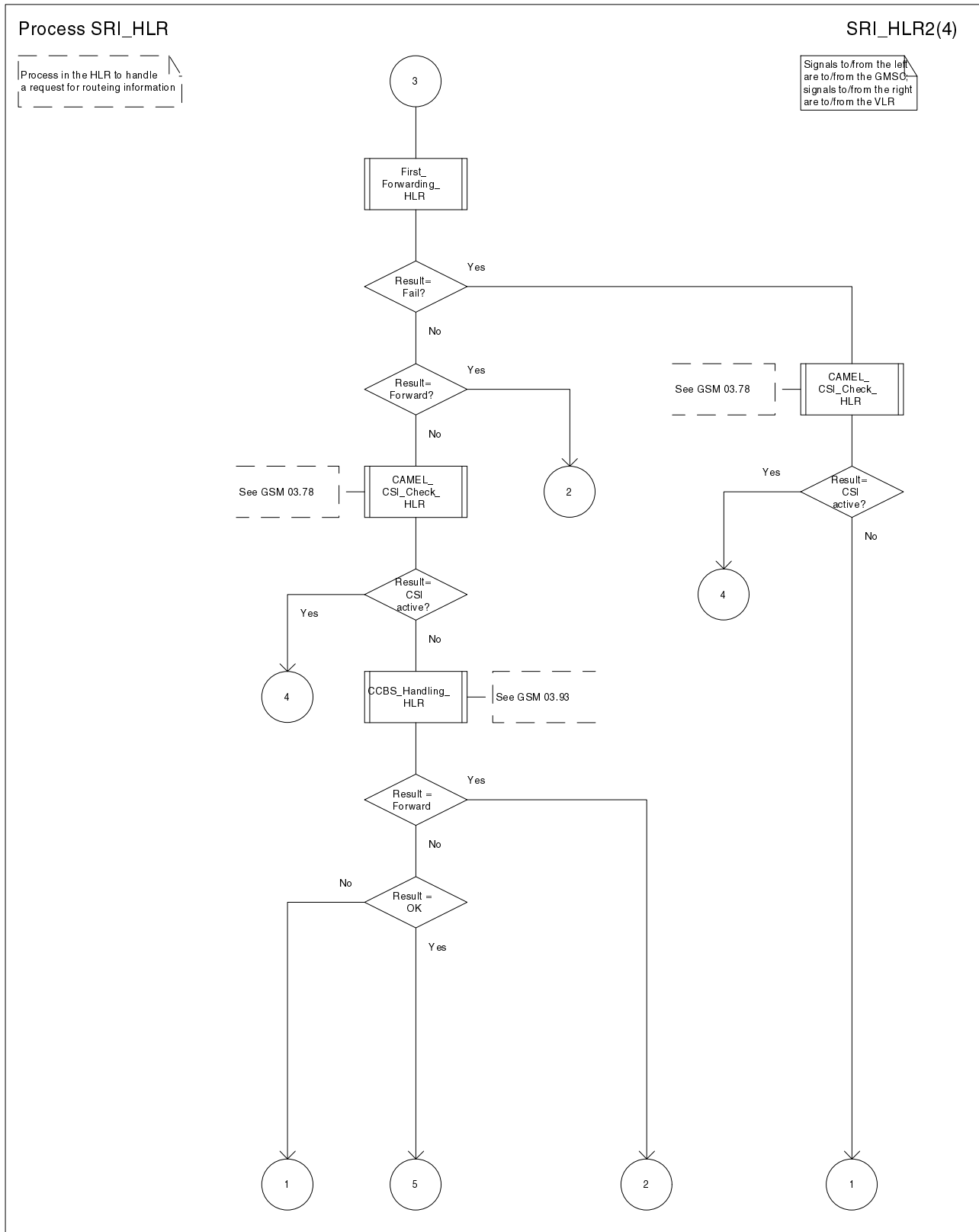

Figure 43b: Process SRI_HLR (sheet 2)

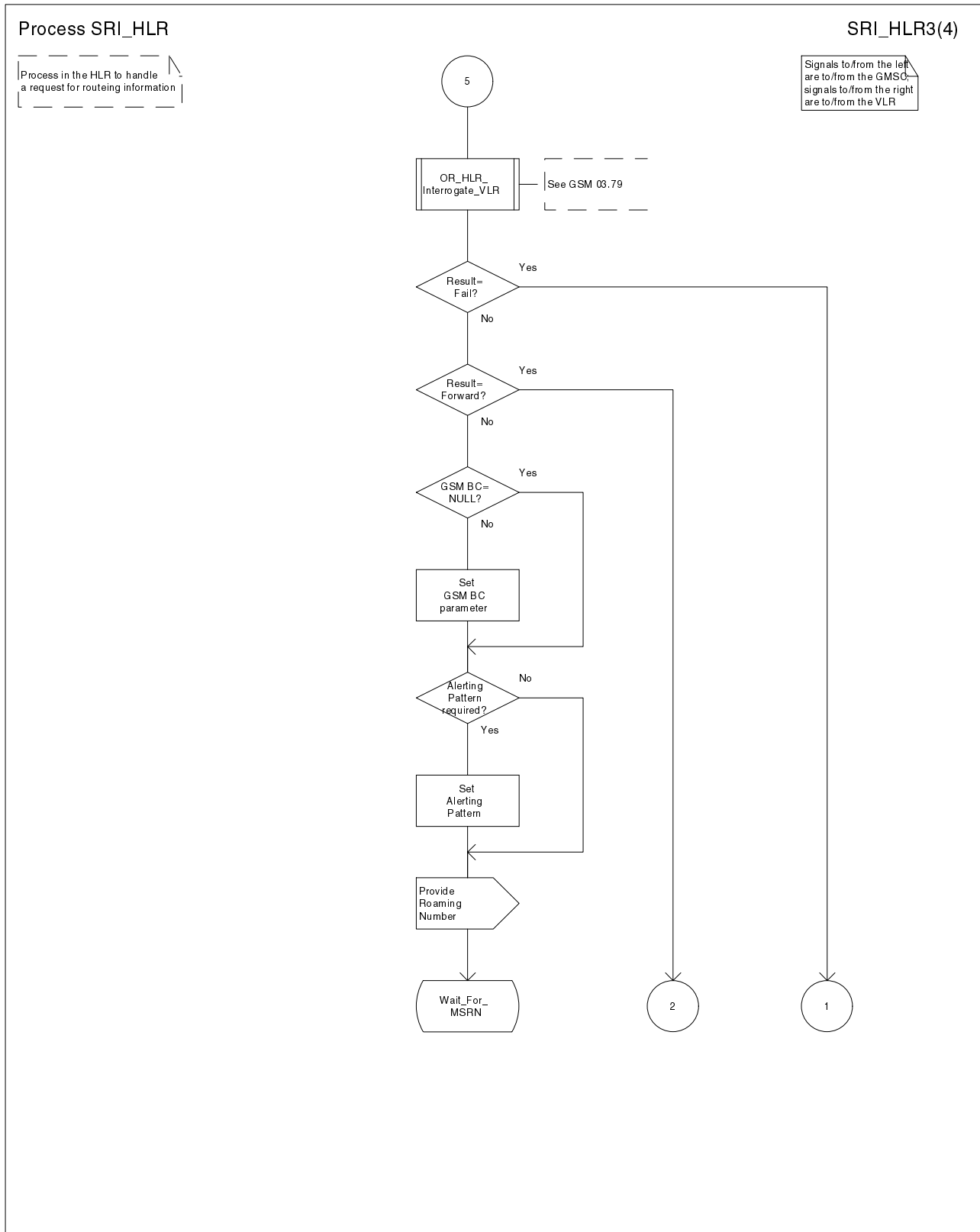

Figure 43c: Process SRI_HLR (sheet 3)

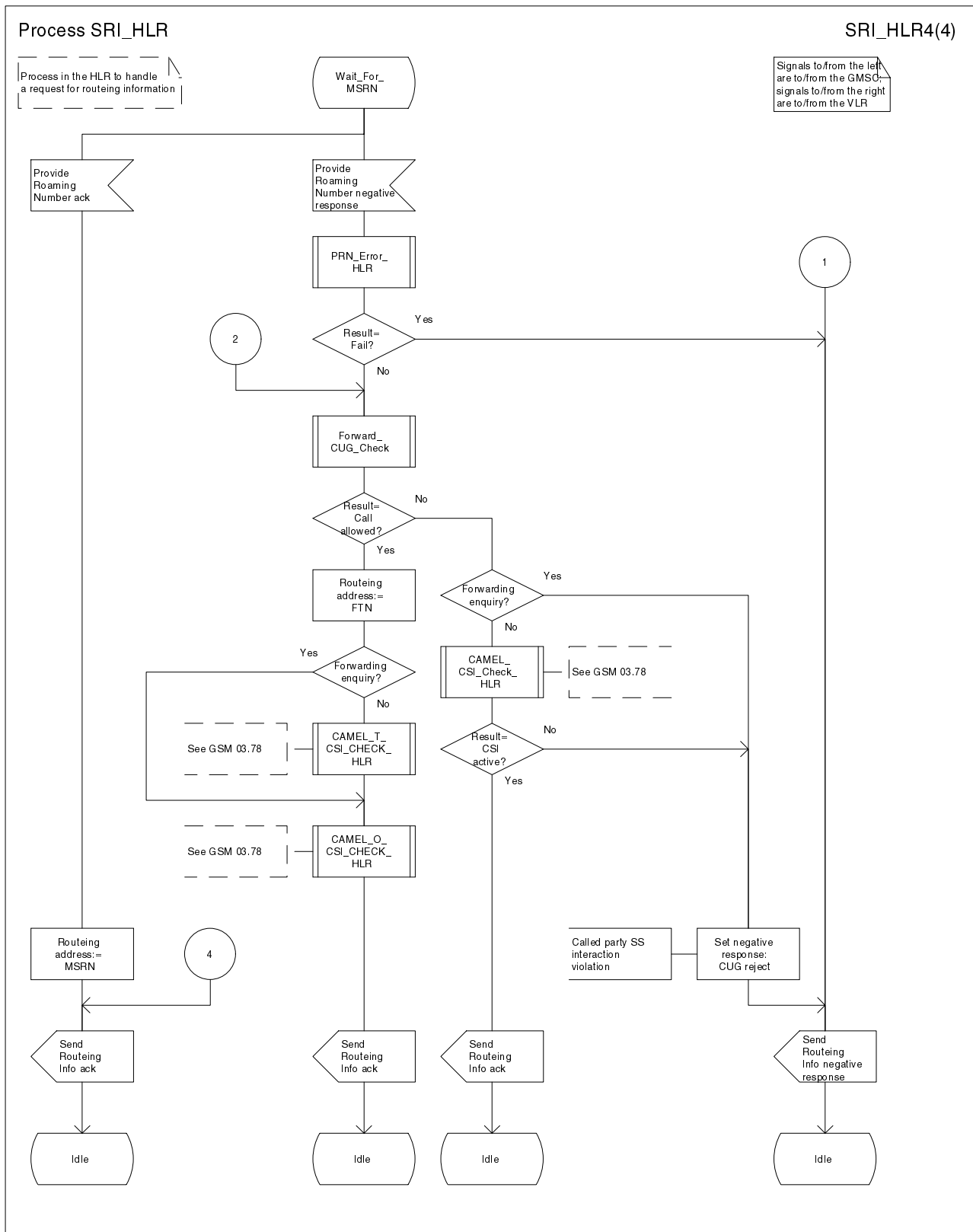

Figure 43d: Process SRI_HLR (sheet 4)

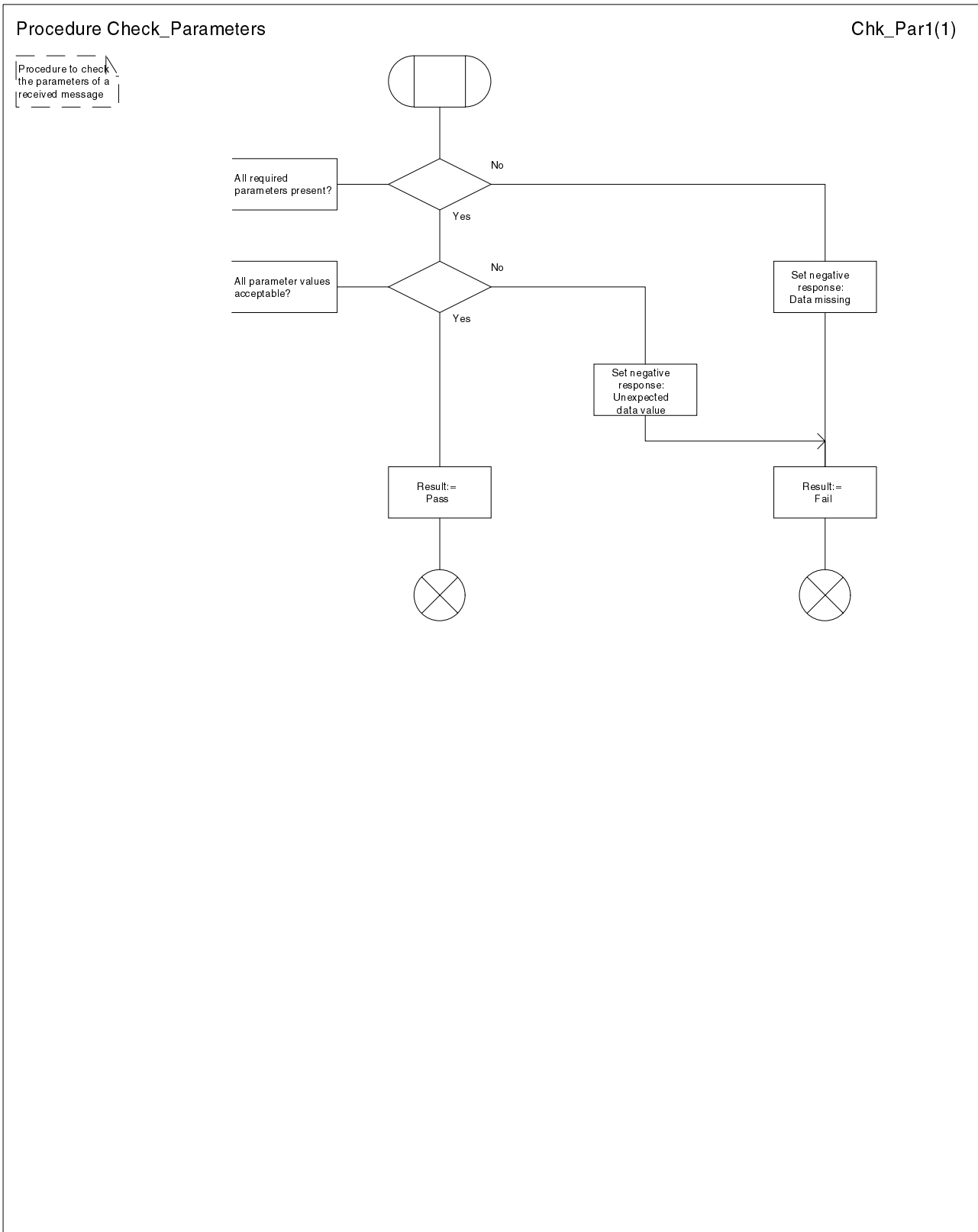

Figure 44: Procedure Check_Parameters

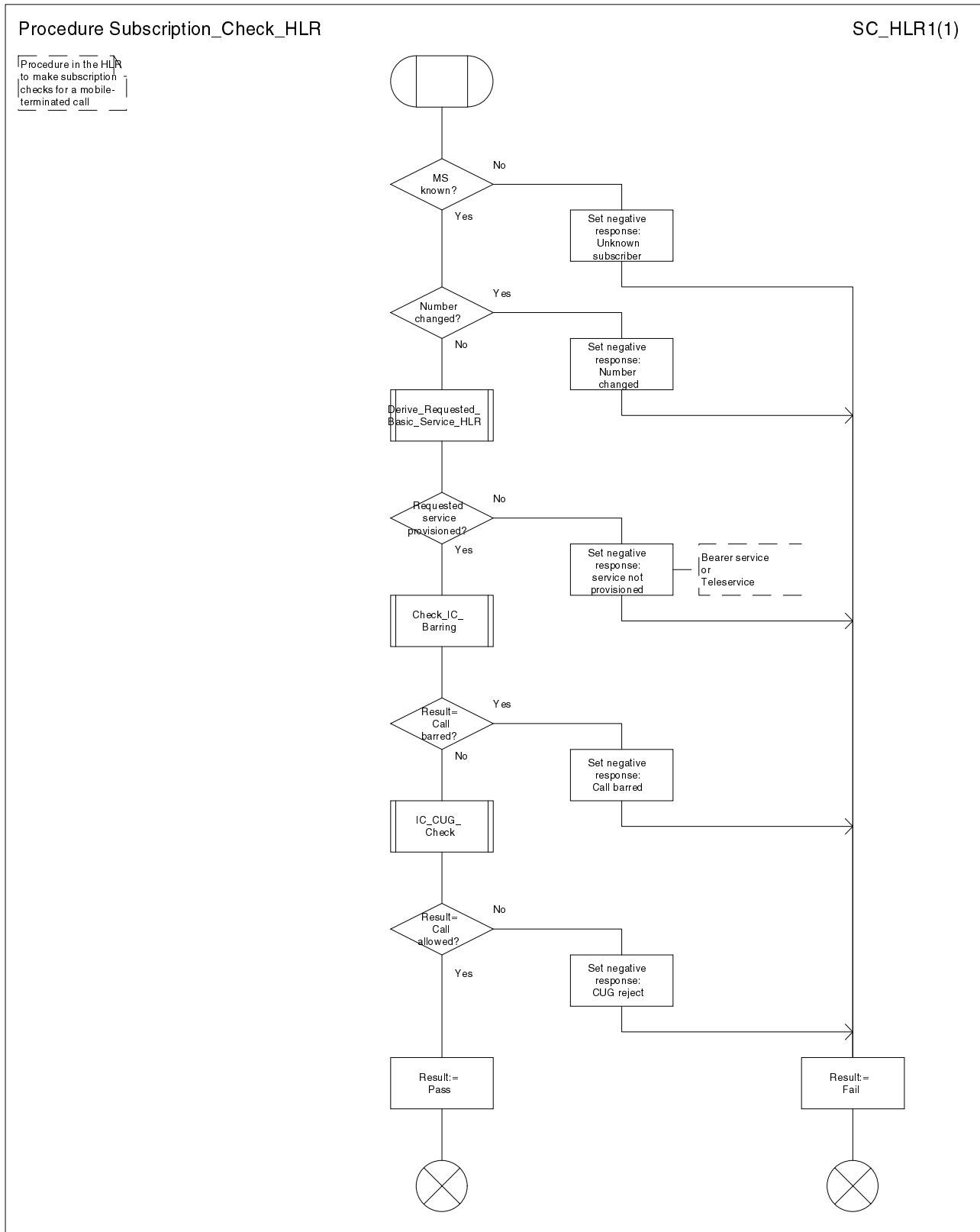

Figure 45: Procedure Subscription_Check_HLR

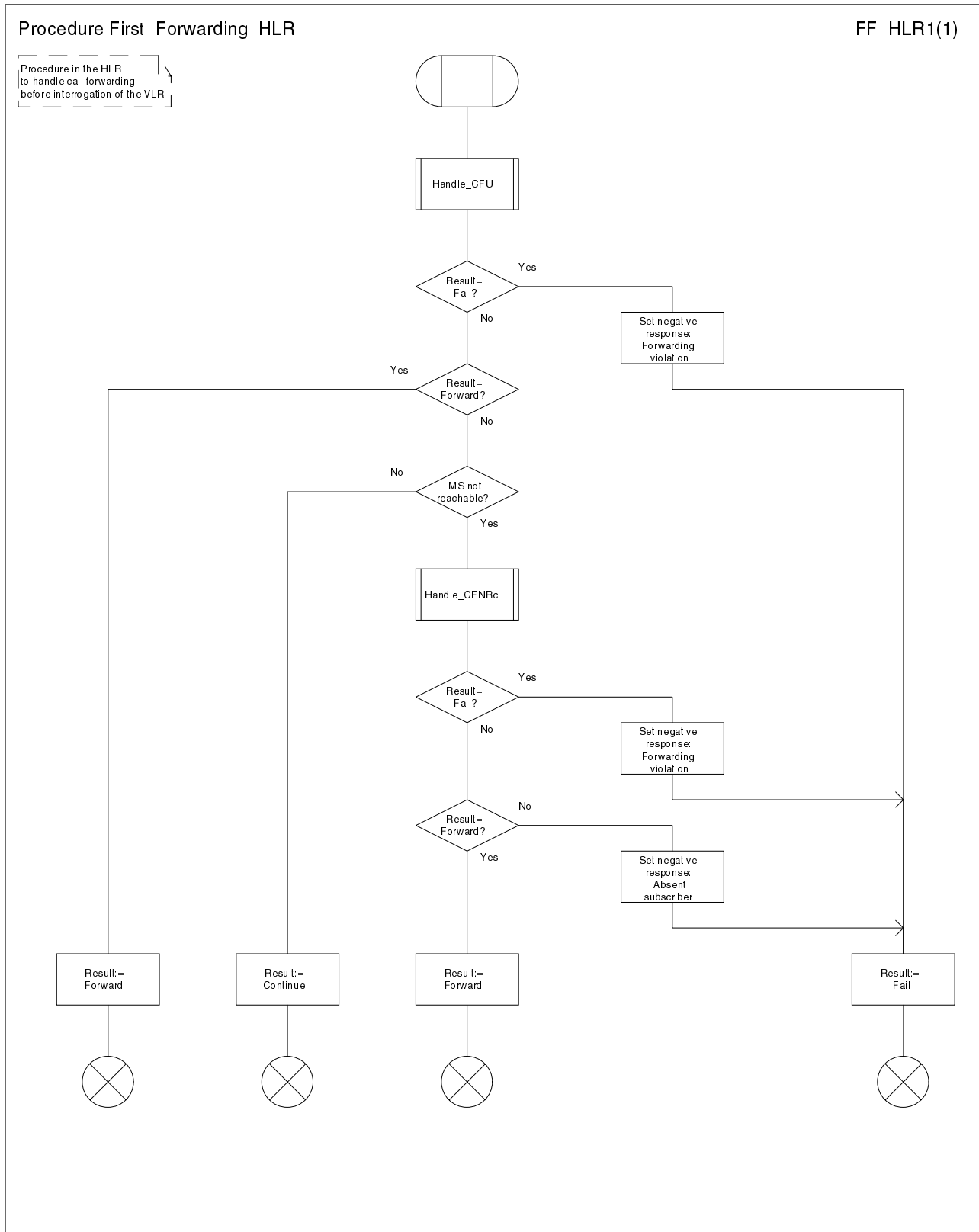

Figure 46: Procedure First_Forwarding_HLR

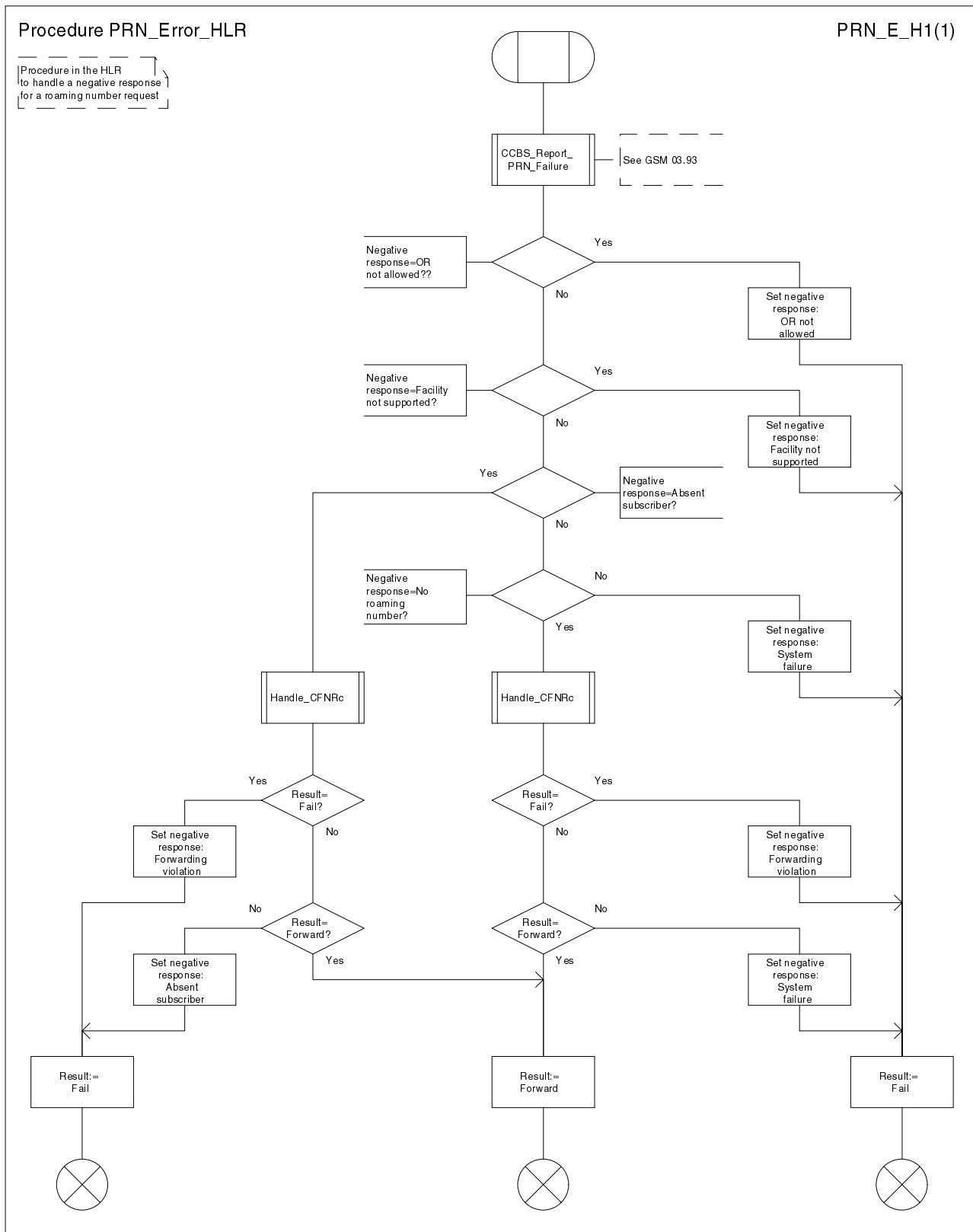

Figure 47: Procedure PRN_Error_HLR

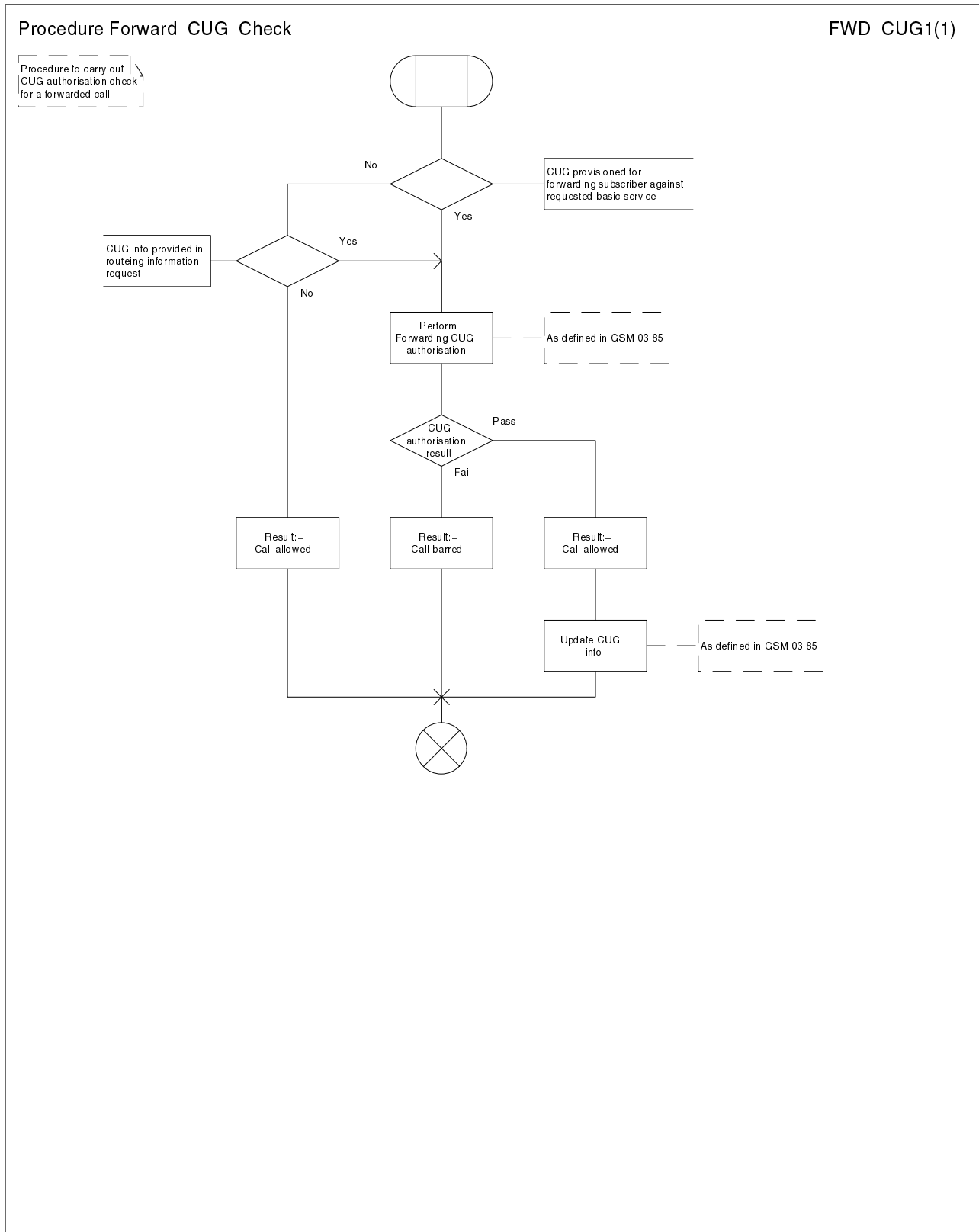

Figure 48: Procedure Forward_CUG_Check

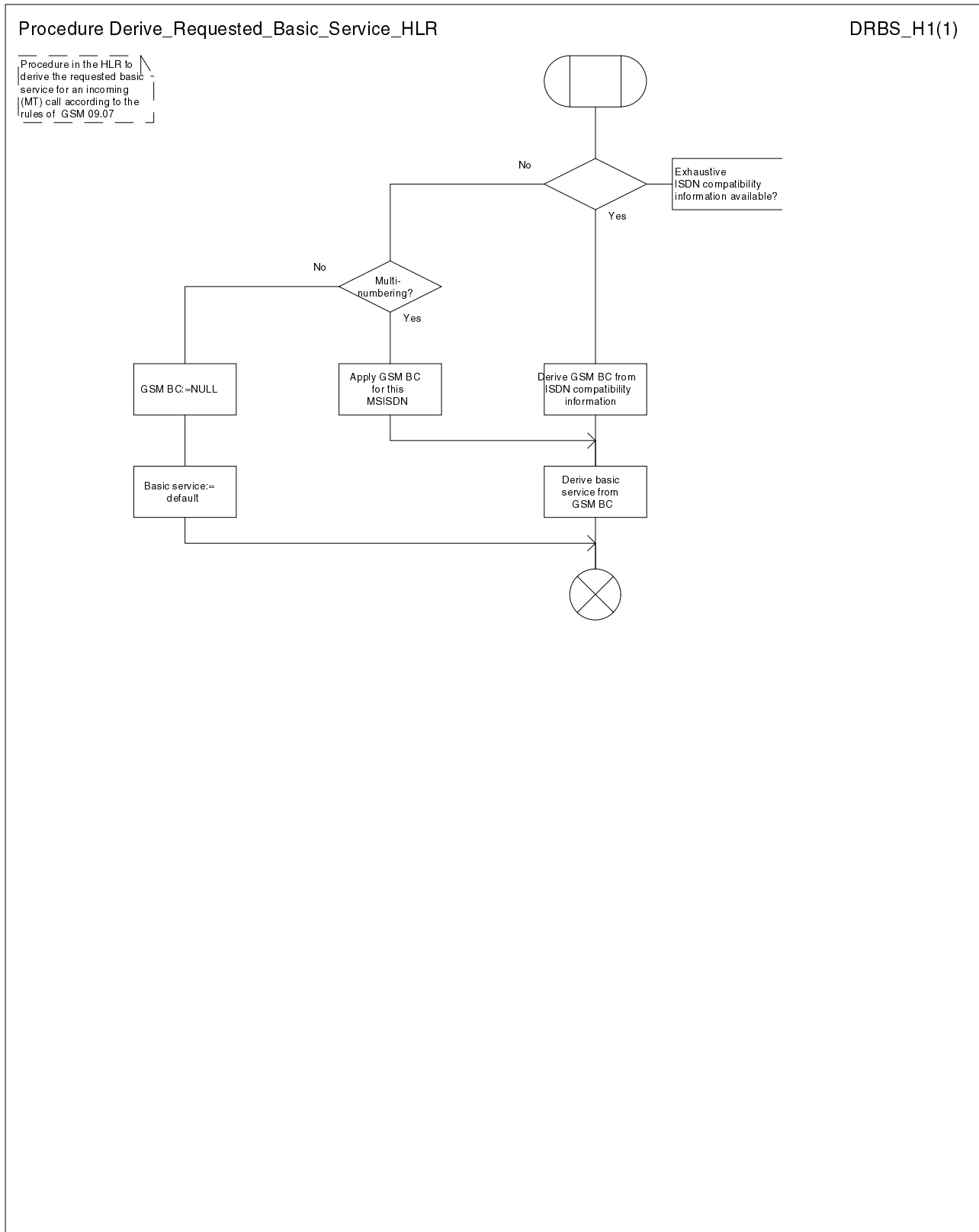

Figure 49: Procedure Derive_Requested_Basic_Service_HLR

Procedure Check_IC_Barring

CIB1(2)

Procedure to check call request against SS barring and ODB categories

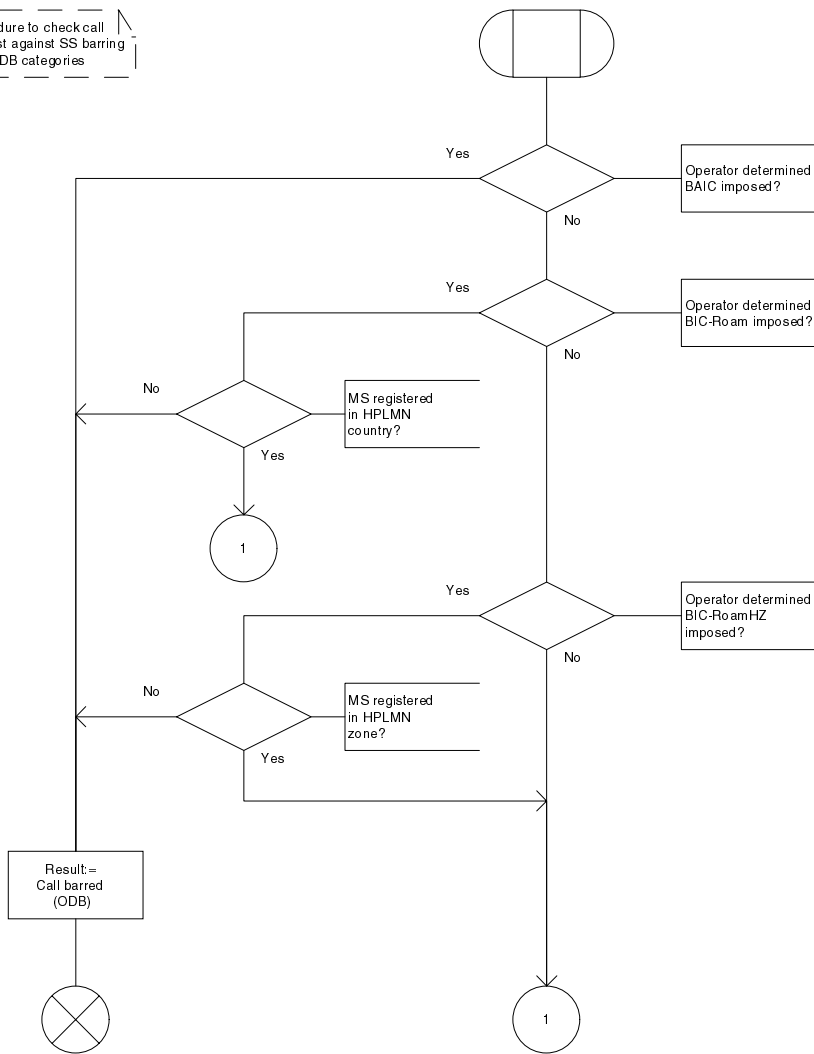

Figure 50a: Procedure Check_IC_Barring (sheet 1)

Procedure Check_IC_Barring

CIB2(2)

Procedure to check call request against SS barring and ODB categories

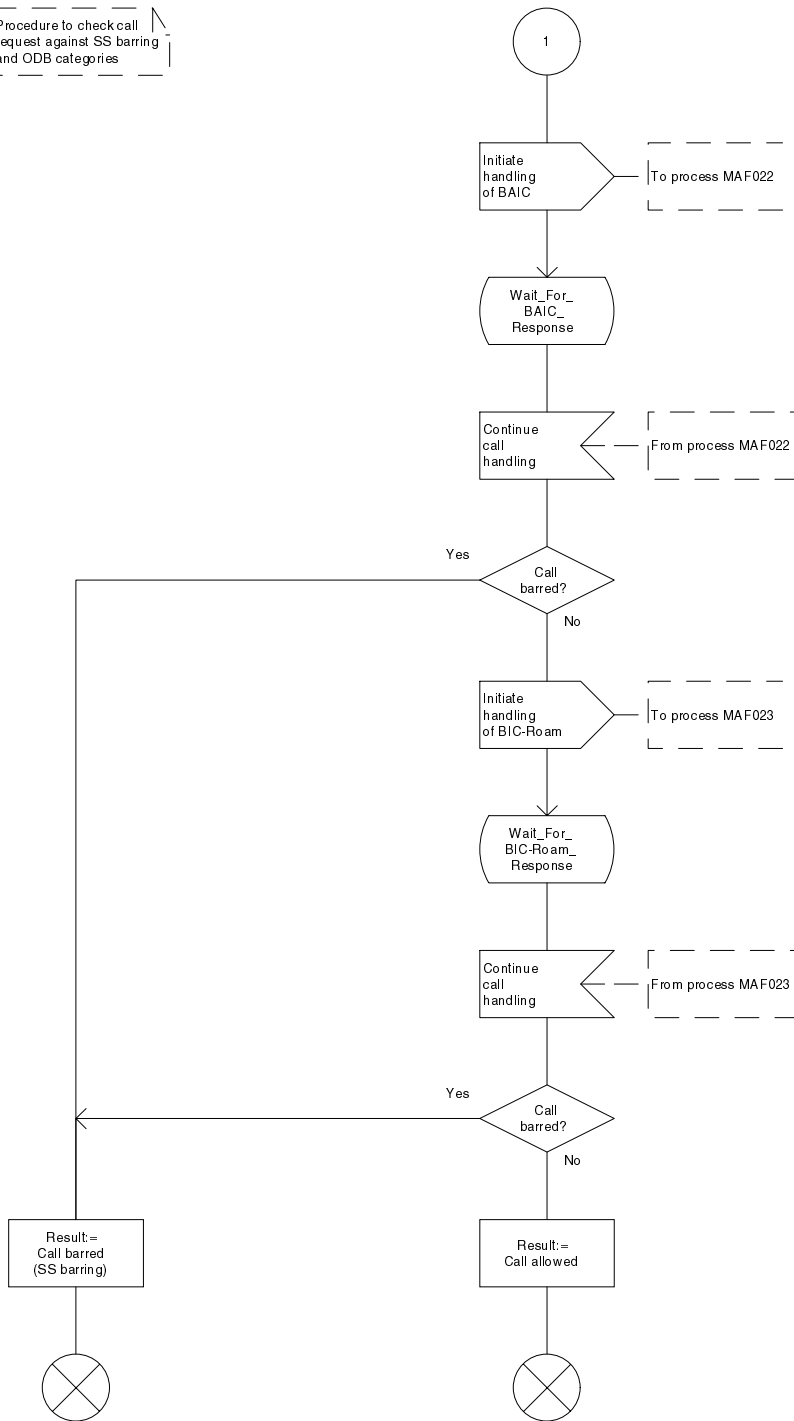

Figure 50b: Procedure Check_IC_Barring (sheet 2)

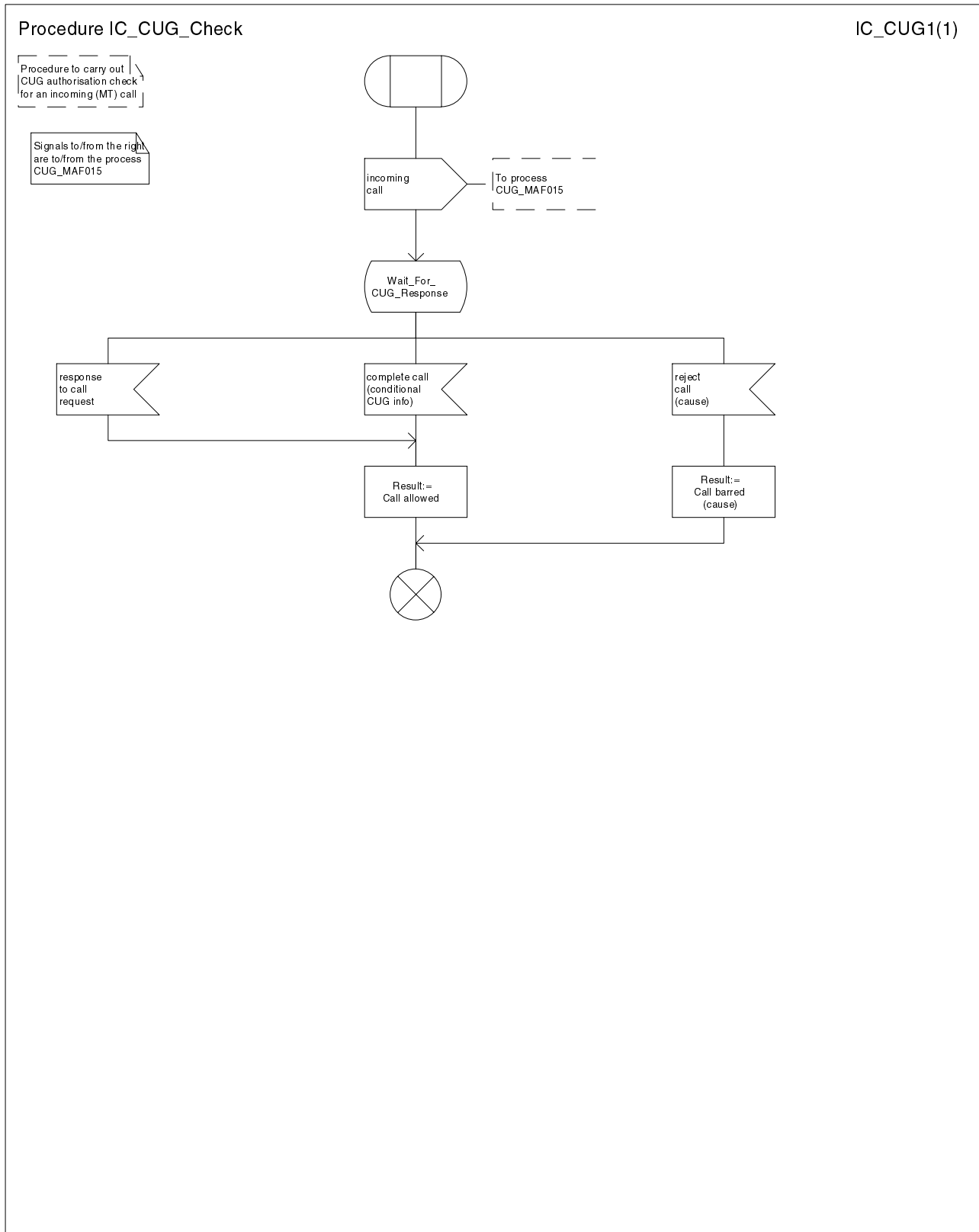

Figure 51: Procedure IC_CUG_Check

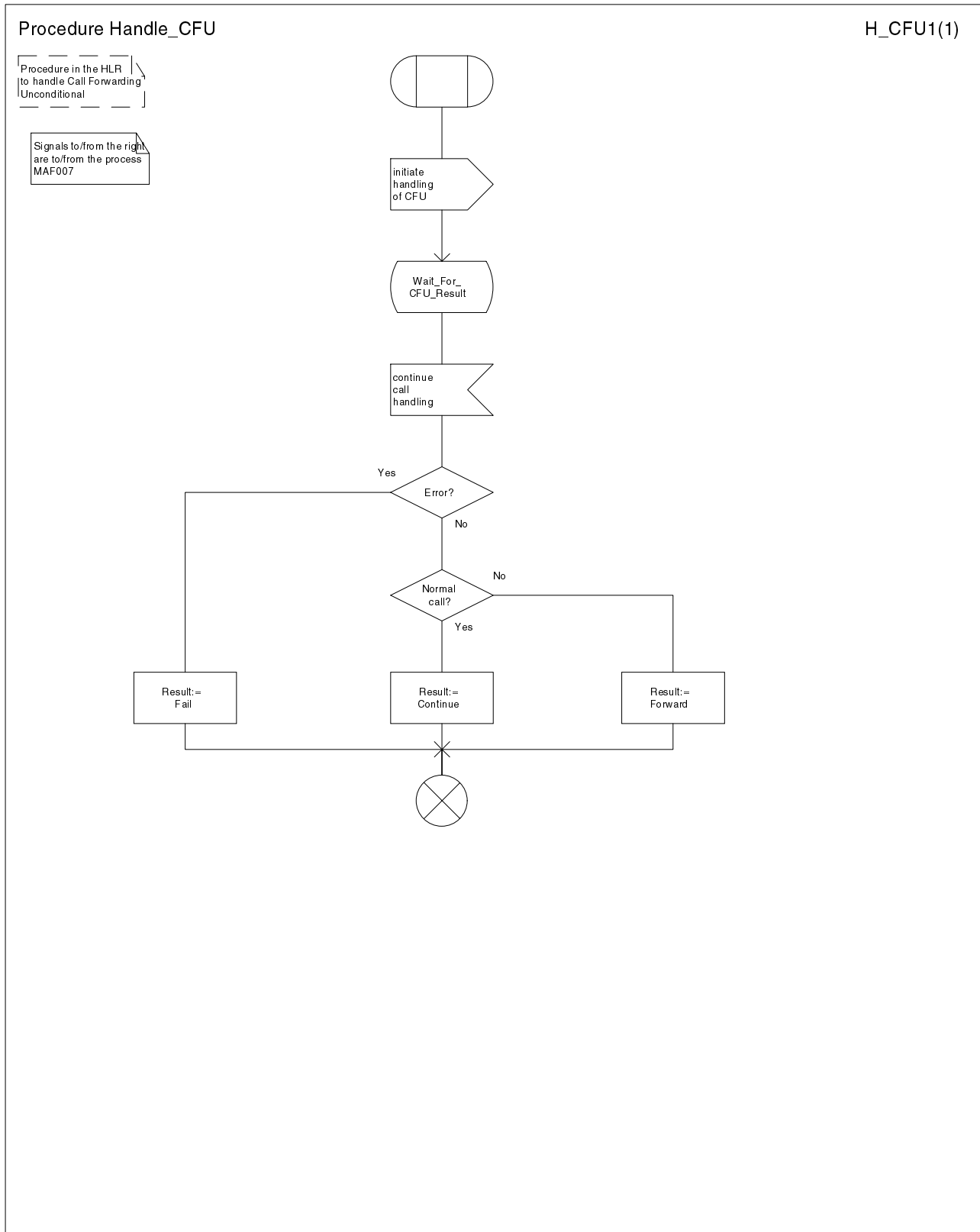

Figure 52: Procedure Handle_CFU

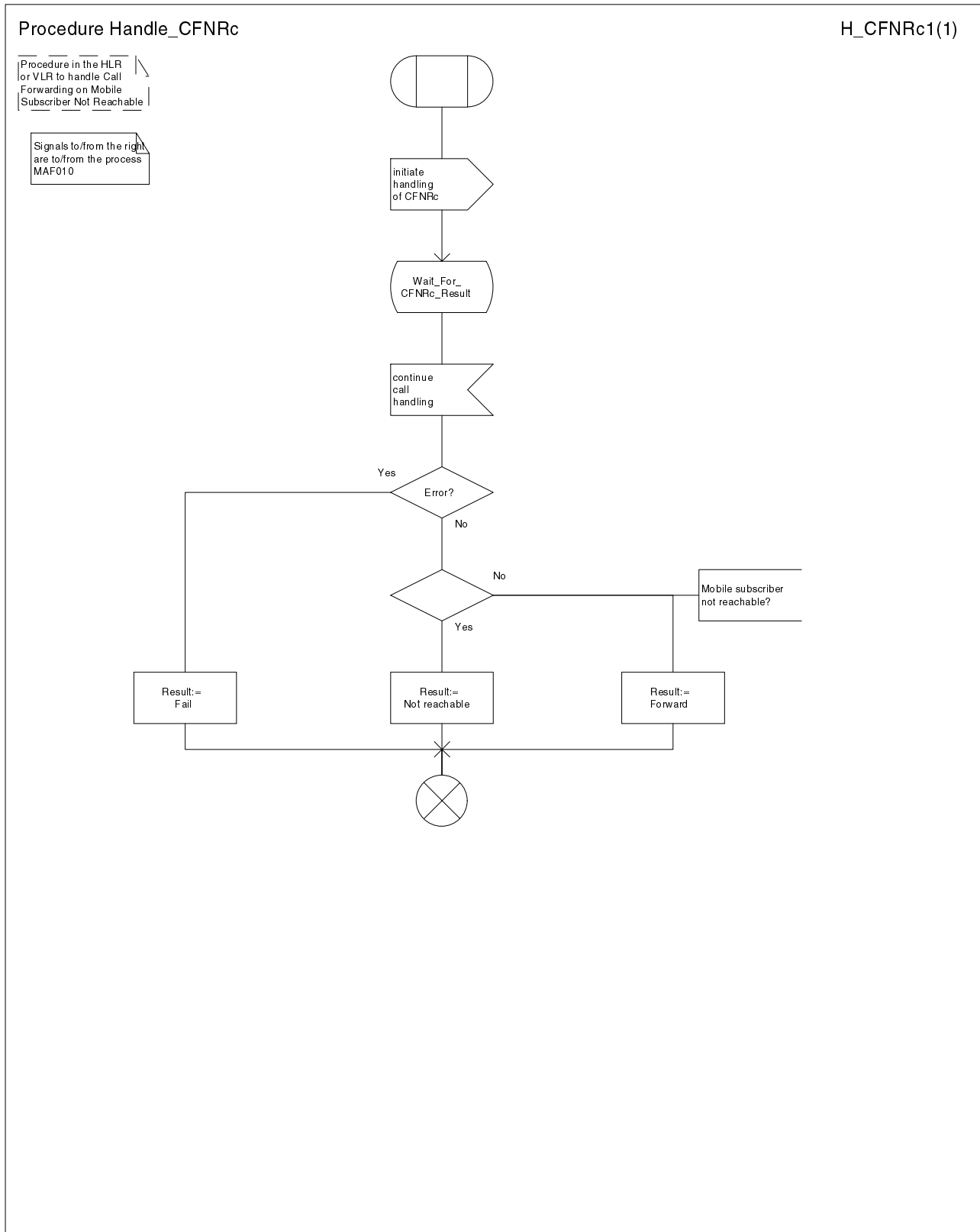

Figure 53: Procedure Handle_CFNRc

7.2.3 Functional requirements of VLR

7.2.3.1 Process PRN_VLR

Sheet 1: the procedure Check_Parameters is specified in subclause 7.2.2.2.

Sheet 1, sheet 3: the procedure CAMEL_SET_SOA is specific to CAMEL; it is specified in GSM 03.78 for CAMEL Phase 1 [6] and GSM 03.78 for CAMEL Phase 2 [7].

Sheet 2, sheet 3: the task "Store alerting pattern (if received)" is executed only if the VLR supports the feature Network Indication of Alerting.

Sheet 2, sheet 3: the procedure CCBS_Handle_PRN is specific to CCBS; it is specified in GSM 03.93 [16].

Sheet 2: the number of unused authentication sets which triggers the VLR to request further authentication sets from the HLR is an operator option.

Sheet 2: the process Fetch_Authentication_Sets_VLR is specified in subclause 7.1.2.11.

7.2.3.2 Process Restore_Subscriber_Data_VLR

7.2.3.3 Process PSI_VLR

Sheet 1: the procedure Check_Parameters is specified in subclause 7.2.2.2. If the HLR requests neither location information nor subscriber state, the VLR treats this as a missing parameter.

7.2.3.4 Procedure Retrieve_Location_Info_VLR

The test "Retrieve location info from SGSN" takes the "Yes" exit if:

- the Gs interface is implemented; and
- there is an association established between the MSC/VLR and the SGSN.

The stored location information consists of:

- the cell ID of the cell in which the MS last established radio contact;
- the location number and geographical information derived from the cell ID if the VLR is capable of doing so (the mapping from cell ID to location number is network-specific and outside the scope of the GSM standard);
- the age of the location information.

The output signal Send MS information towards the SGSN indicates that the required information is mobile location information.

The derivation of the location number and geographical information from the received cell ID is a VLR operator option (the mapping from cell ID to location number is network-specific and outside the scope of the GSM standard).

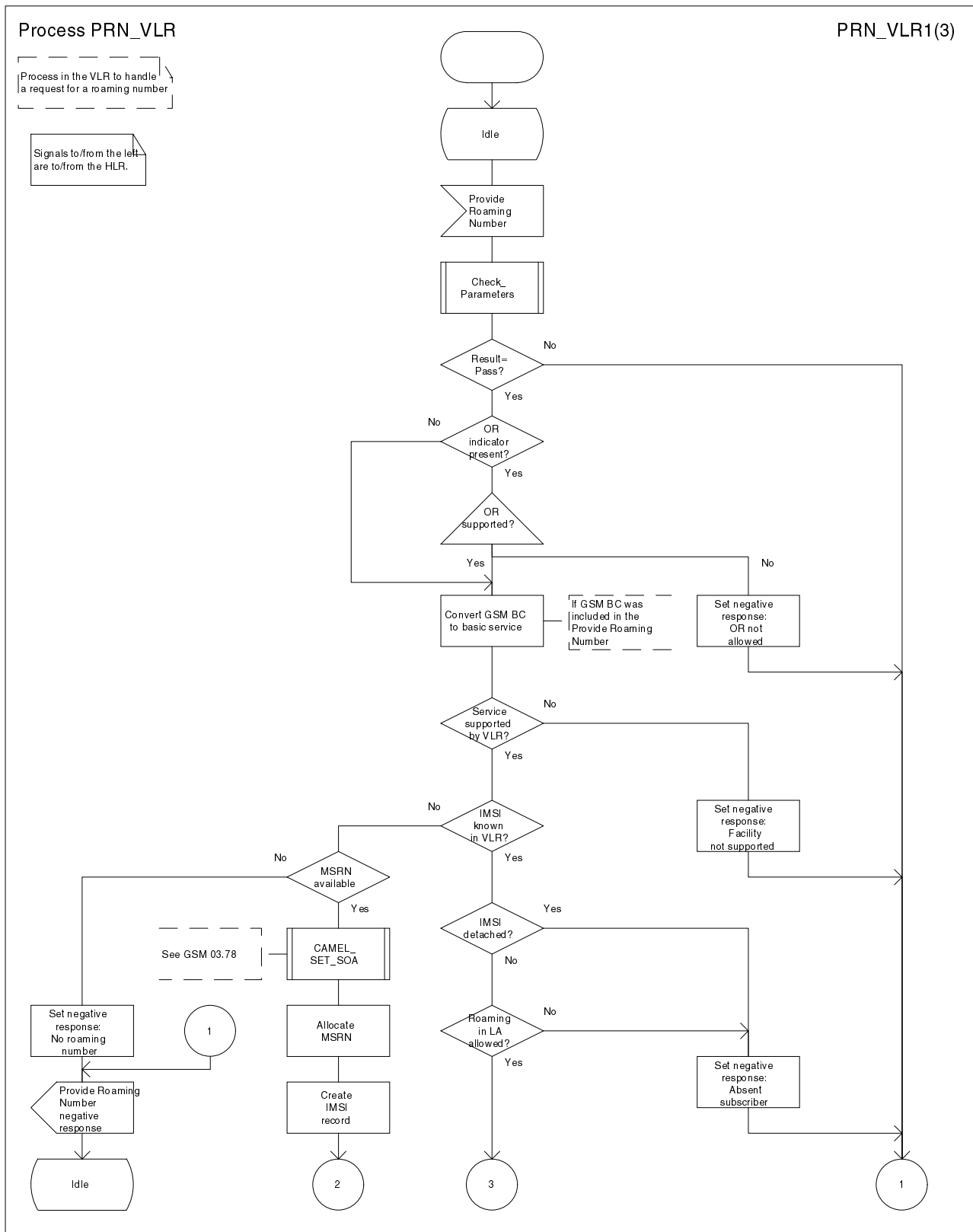

Figure 54a: Process PRN_VLR (sheet 1)

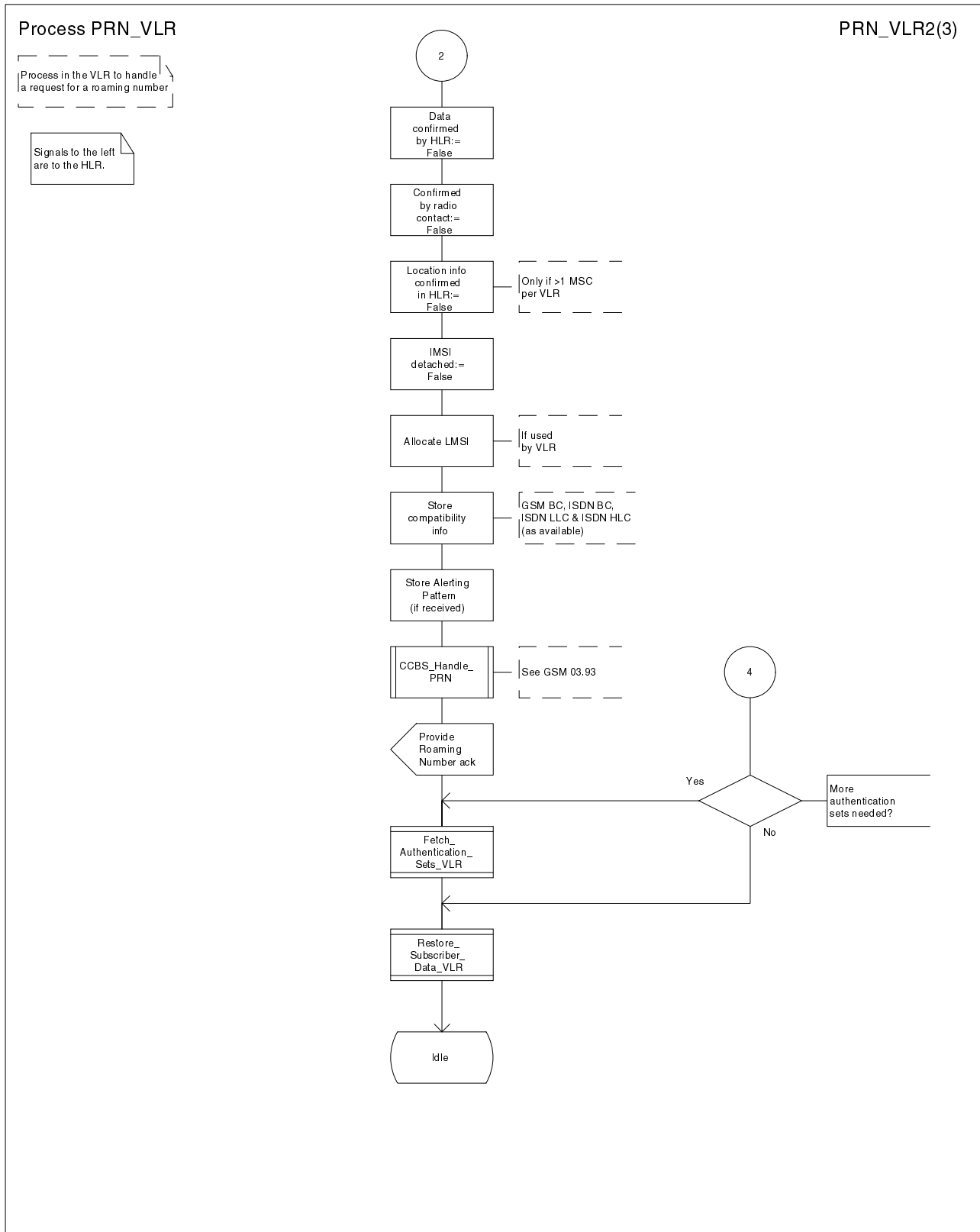

Figure 54b: Process PRN_VLR (sheet 2)

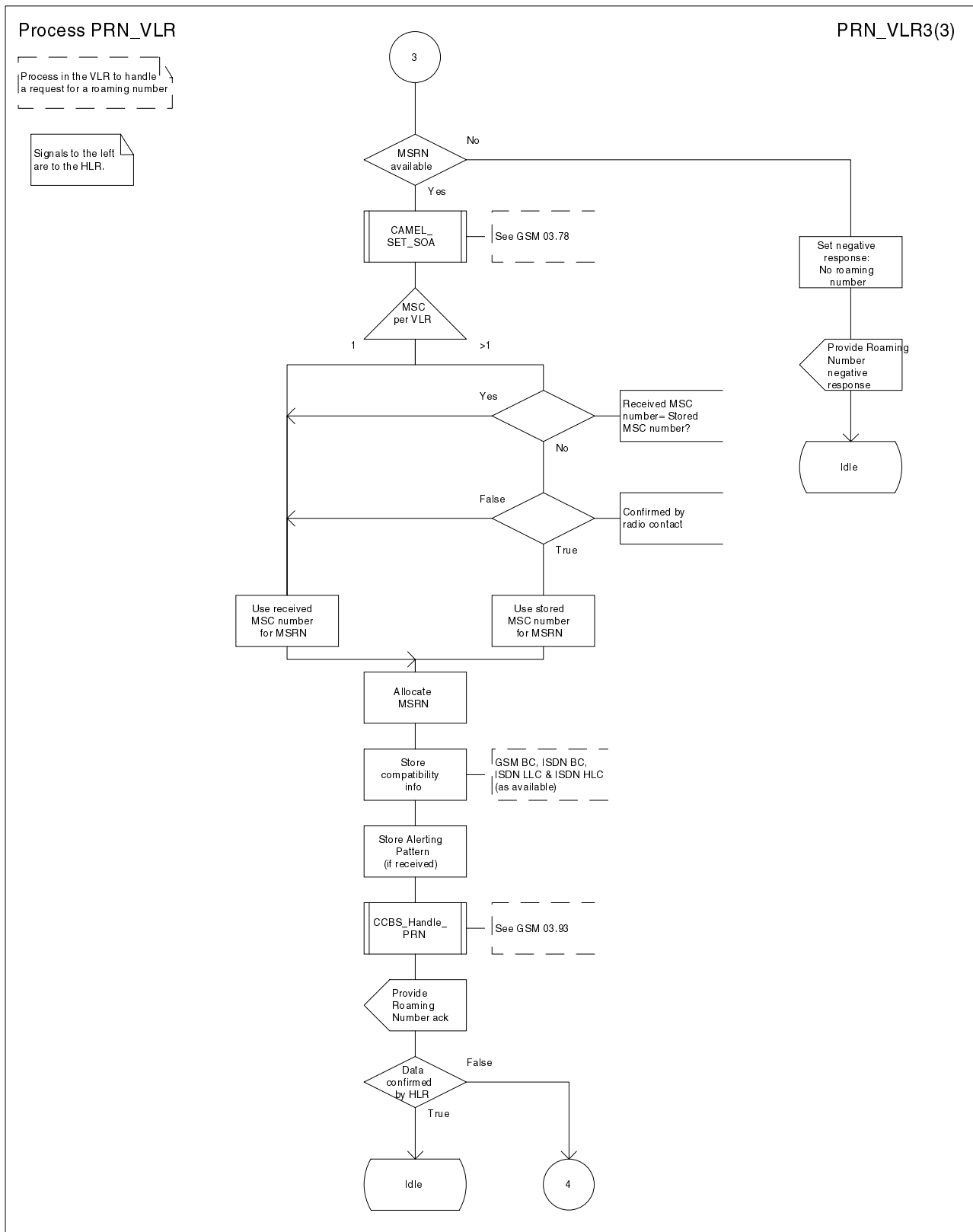

Figure 54c: Process PRN_VLR (sheet 3)

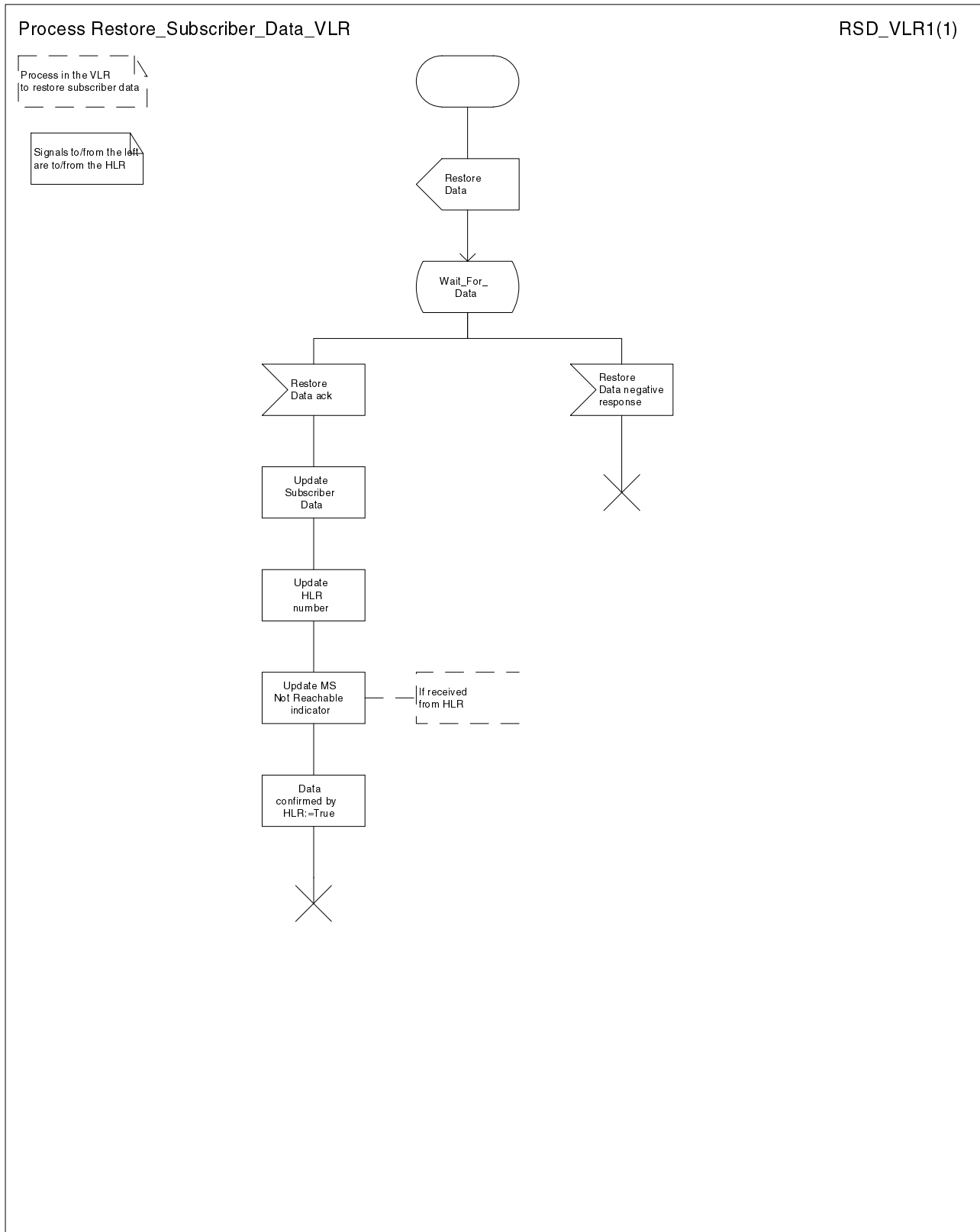

Figure 55: Process Restore_Subscriber_Data_VLR

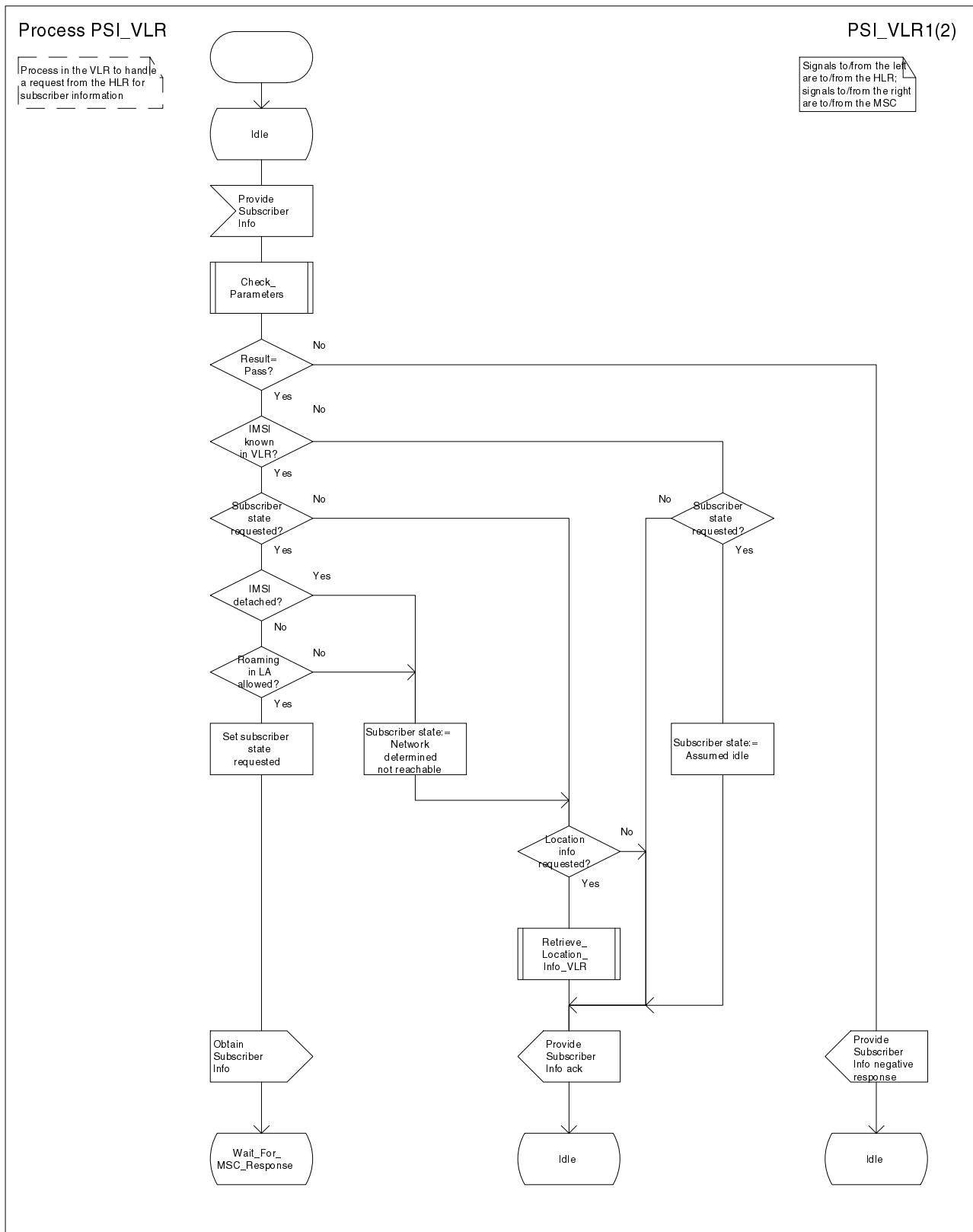

Figure 56a: Process PSI_VLR (sheet 1)

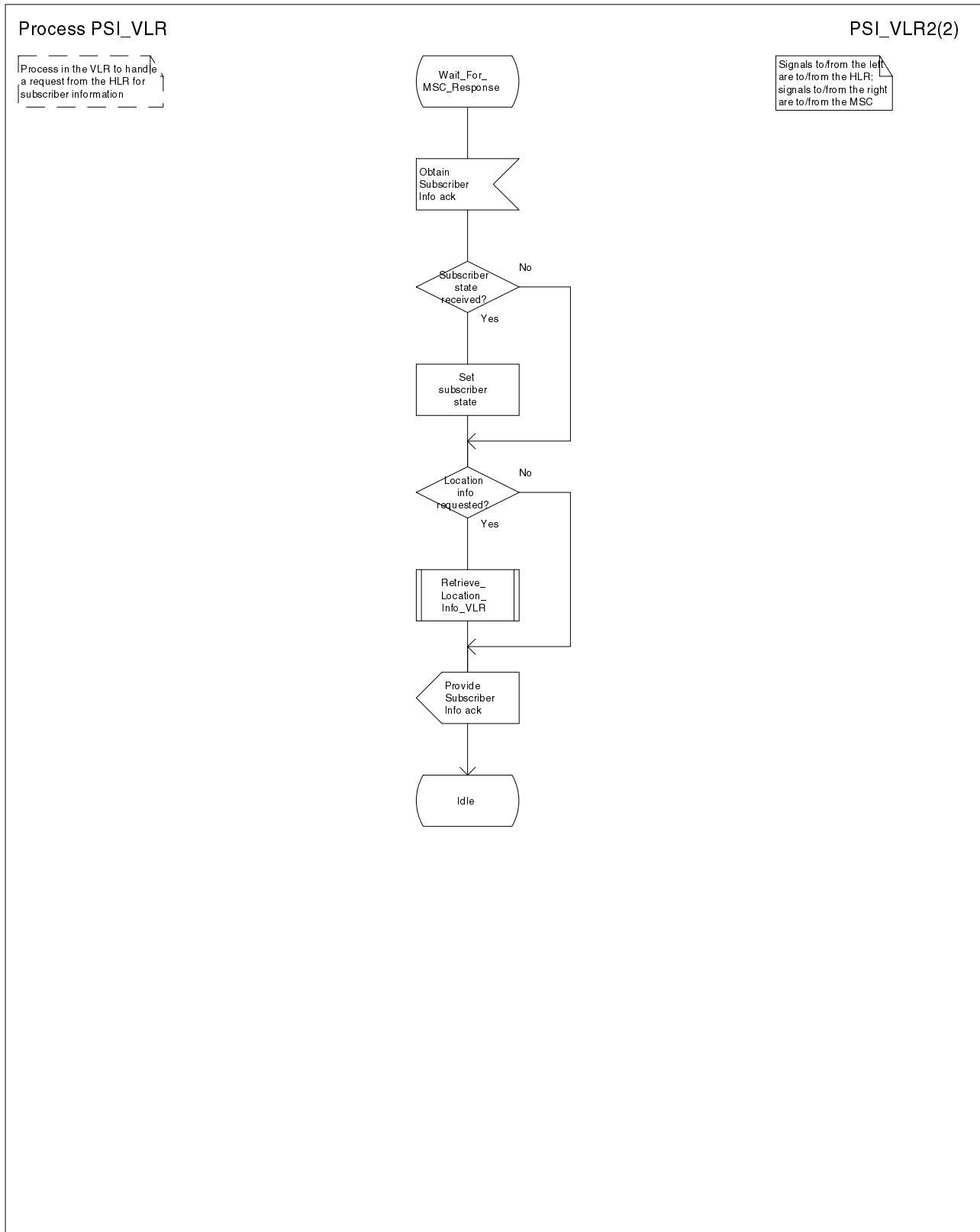

Figure 56b: Process PSI_VLR (sheet 2)

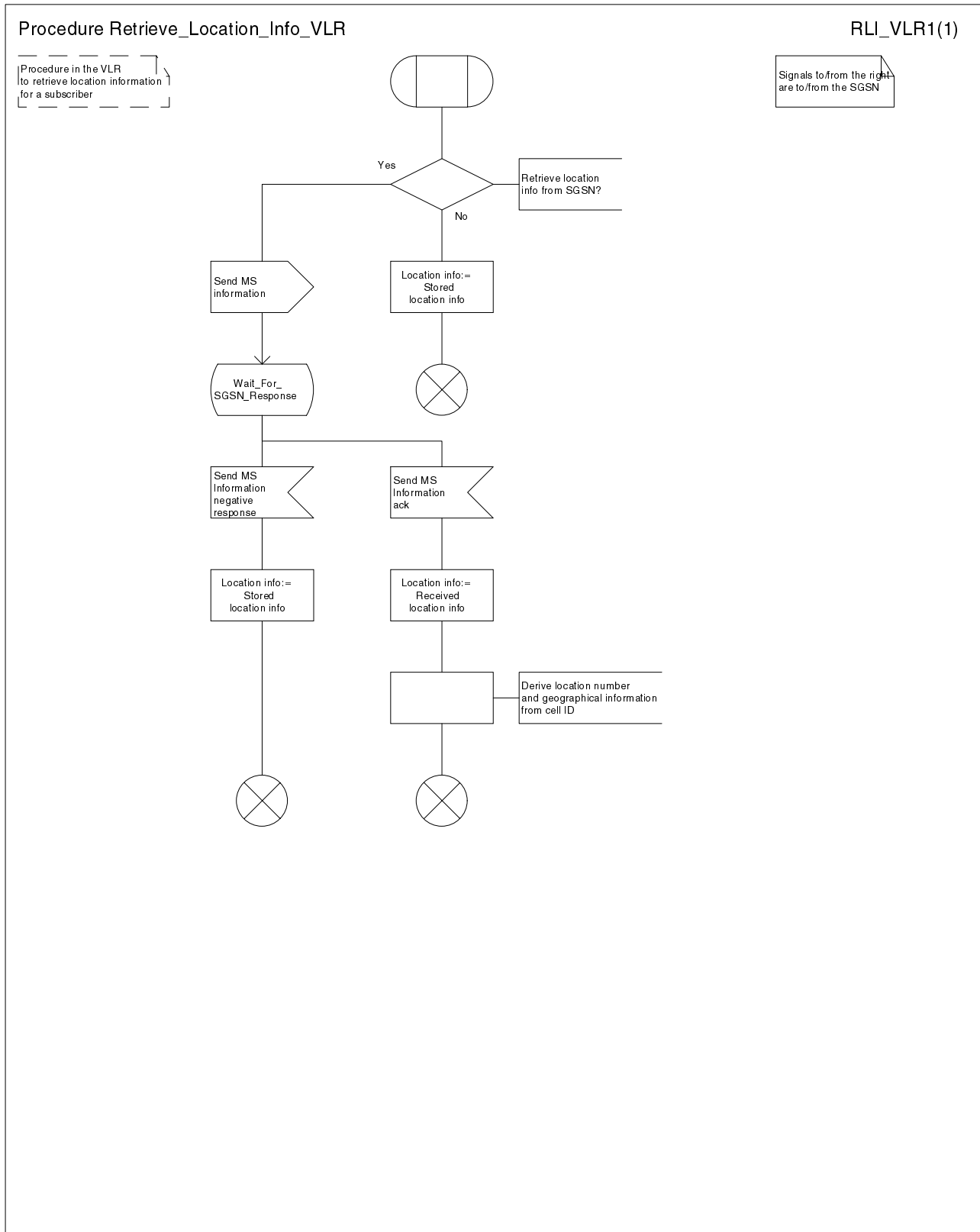

Figure 57: Procedure Retrieve_Location_Info_VLR

7.2.4 Functional requirements of MSC

7.2.4.1 Process OSI_MSC

If the MS is engaged on a circuit-switched call, the state is busy, otherwise assumed idle.

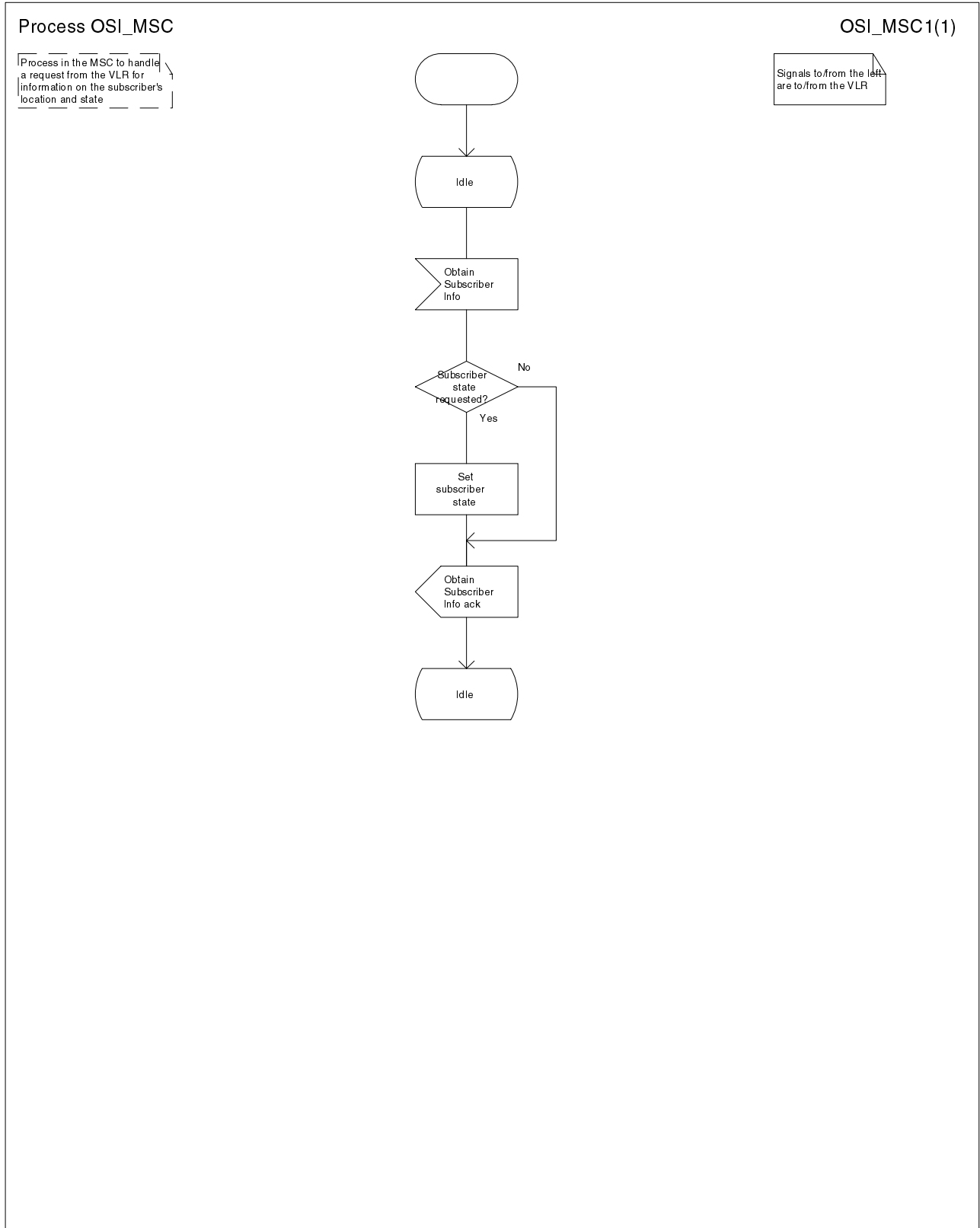

Figure 57: Process OSI_MSC

7.3 MT call

7.3.1 Functional requirements of serving MSC

7.3.1.1 Process ICH_MSC

Sheet 1: the rules for converting the ISDN BC/LLC/HLC to a GSM bearer service or teleservice are specified in GSM 09.07 [21].

Sheet 1: the variables TCH allocated, ACM sent, Answer sent and Network connect sent are global data, accessible to the procedures Establish_Terminating_TCH_If_Required, Send_ACM_If_Required, Send_Answer_If_Required and Send_Network_Connect_If_Required.

Sheet 1: the procedure Process_Access_Request_MSC is specified in subclause 7.1.1.2.

Sheet 1, sheet 2: the suggested mapping from values of the Send Info For Incoming Call negative response information element to values of the ISUP release cause (see ITU-T Recommendation Q.850 [25]) is shown in table 2. The mapping used is a matter for the network operator, depending on the telephony signalling system used.

Table 2: Suggested mapping of Send Info For Incoming Call (SIFIC) negative responses to ISUP release causes

SIFIC negative response	ISUP release cause number	ISUP release cause name
Absent subscriber	20	Subscriber absent
Busy subscriber	17	User busy
CUG reject (Called party SS interaction violation)	21	Call rejected
Forwarding violation	21	Call rejected
Impossible call completion	111	Protocol error, unspecified
No subscriber reply	19	No answer from user (user alerted)
System failure	111	Protocol error, unspecified
Unallocated roaming number	111	Protocol error, unspecified

Sheet 2: the processing in the branch starting with the input signal "Process Call Waiting" is specific to Call Wait. If the VMSC does not support CW this signal will not be received from the VLR.

Sheet 2, sheet 4: the procedure CCBS_Set_Diagnostic_For_Release is specific to CCBS; it is specified in GSM 03.93 [16].

Sheet 2, sheet 3, sheet 5: the procedure CCBS_Check_Last_Call is specific to CCBS; it is specified in GSM 03.93 [16].

Sheet 3: the procedure Handle_ORLCF_VMSC is specific to Support of Optimal Routeing. It is specified in TS 100 045 [8]. If the VMSC does not support Optimal Routeing, processing continues from the "No" exit of the test "Result=Aborted?".

Sheet 3: it is an operator option whether to send an Address Complete message if the VLR returns forwarding information. If the VMSC sends an Address Complete message, it shall include the called party's status field of the Backward call indicator set to "no indication".

Sheet 3, sheet 4: the procedure Send_ACM_If_Required is specified in subclause 7.2.1.3.

Sheet 3: the procedure Activate_CF_Process is specified in subclause 7.2.1.7.

Sheet 3: the called party address sent in the IAM to the process MT_CF_MSC is the Forwarded-to number received in the Perform Call Forwarding ack.

Sheet 4: the procedure CCBS_MT_MSC_Check_Forwarding is specific to CCBS; it is specified in GSM 03.93 [16].

Sheet 4: the procedure Handle_COLP_Forwarding_Interaction is specified in subclause 7.2.1.6.

Sheet 4: the procedure Send_Answer_If_Required is specified in subclause 7.2.1.4.

Sheet 4: the procedure `Send_Network_Connect_If_Required` is specified in subclause 7.2.1.5.

Sheet 6: after the VMSC has sent an IAM to the process `MT_CF_MSC`, it acts as a transparent relay for messages received from the GMSC and the process `MT_CF_MSC`. Any message other than Address Complete, Connect, Answer or Release causes no change of state in the process `ICH_MSC`.

7.3.1.2 Procedure `Page_MS_MSC`

Sheet 1: the test "MS connection exists" takes the "Yes" exit if there is a radio connection established between the MS and the network.

Sheet 1: for an SMS or SS page, the test "Call still exists" takes the "Yes" exit if the SMS or SS transaction which led to the page still exists.

Sheet 1: the test "SMS or SS page" is not required for the handling of circuit-switched calls, because the VLR will always use a page type of "circuit-switched call", but the more generalised procedure `Page_MS_MSC` is equally applicable to paging for SMS delivery or network-initiated SS procedures.

Sheet 1: the test "MS busy" takes the "Yes" exit if the MS is engaged on a circuit-switched call.

Sheet 1: the test "Call in setup" takes the "Yes" exit if the call on which the MS is engaged has not reached the established phase (called party answer).

Sheet 1: the test "Call waiting" takes the "Yes" exit if a waiting call has been offered to the subscriber but the outcome of offering the call has not been determined.

Sheet 1: the negative response Busy Subscriber (More calls possible) includes the basic service which applies for the established call.

Sheet 2: the signal input "MS connection established" indicates that the MS has responded to paging, or sent a CM service request for anything other than a circuit-switched call, or completed the location registration procedure.

7.3.1.3 Procedure `Search_For_MS_MSC`

Sheet 1: the test "MS connection exists" takes the "Yes" exit if there is a radio connection established between the MS and the network.

Sheet 1: for an SMS or SS page, the test "Call still exists" takes the "Yes" exit if the SMS or SS transaction which led to the page still exists.

Sheet 1: the test "SMS or SS page" is not required for the handling of circuit-switched calls, because the VLR will always use a page type of "circuit-switched call", but the more generalized procedure `Search_For_MS_MSC` is equally applicable to paging for SMS delivery or network-initiated SS procedures.

Sheet 1: the test "MS busy" takes the "Yes" exit if the MS is engaged on a circuit-switched call.

Sheet 1: the test "Call in setup" takes the "Yes" exit if the call on which the MS is engaged has not reached the established phase (called party answer).

Sheet 1: the test "Call waiting" takes the "Yes" exit if a waiting call has been offered to the subscriber but the outcome of offering the call has not been determined.

Sheet 1: the negative response Busy Subscriber (More calls possible) includes the basic service which applies for the established call.

Sheet 2: the signal input "MS connection established" indicates that the MS has responded to paging, or sent a CM service request for anything other than a circuit-switched call, or completed the location registration procedure.

7.3.1.4 Procedure Complete_Call_In_MSC

Sheet 1: the procedure Set_CLIP_Info_MSC is specific to CLIP.

Sheet 1: the VMSC and the MS may negotiate the bearer capability to be used for the call by the exchange of information in the Setup and Call Confirmed messages.

Sheet 1: the procedure CCBS_Report_Not_Idle is specific to CCBS; it is specified in GSM 03.93 [16].

Sheet 1, sheet 2, sheet 4: the procedure CCBS_ICH_MSC_Report_Failure is specific to CCBS; it is specified in GSM 03.93 [16].

Sheet 2: the procedure CCBS_ICH_MSC_Report_Success is specific to CCBS; it is specified in GSM 03.93 [16].

Sheet 2: the procedure Send_ACM_If_Required is specified in subclause 7.2.1.3.

Sheet 2, sheet 3: the procedure Handle_AoC_MT_MSC is specific to AoC. If the VMSC does not support AoC, processing continues from the "Yes" exit of the test "Result=Pass?".

Sheet 2, sheet 3: the procedure Set_COL_Presentation_Indicator_MSC is specific to COLP.

Sheet 2: the procedure Send_Network_Connect_If_Required is specified in subclause 7.2.1.5.

Sheet 3: the procedure Send_Answer_If_Required is specified in subclause 7.2.1.4.

7.3.1.5 Procedure Process_Call_Waiting_MSC

Sheet 1: the procedure Set_CLIP_Info_MSC is specific to CLIP.

Sheet 1: the VMSC and the MS may negotiate the bearer capability to be used for the call by the exchange of information in the Setup and Call Confirmed messages.

Sheet 1: the procedure CCBS_Report_Not_Idle is specific to CCBS; it is specified in GSM 03.93 [16].

Sheet 1: the procedure CCBS_ICH_MSC_Report_Success is specific to CCBS; it is specified in GSM 03.93 [16].

Sheet 1, sheet 3: the procedure CCBS_ICH_MSC_Report_Failure is specific to CCBS; it is specified in GSM 03.93 [16].

Sheet 1: the Call Confirmed message indicates "busy" for the successful case.

Sheet 1: the procedure Send_ACM_If_Required is specified in subclause 7.2.1.3.

Sheet 1, sheet 2: the Release transaction (reject) message covers all unsuccessful cases not otherwise indicated.

Sheet 2: the procedure Handle_AoC_MT_MSC is specific to AoC. If the VMSC does not support AoC, processing continues from the "Yes" exit of the test "Result=Pass?".

Sheet 2: the procedure Set_COL_Presentation_Indicator_MSC is specific to COLP.

Sheet 2: the procedure Send_Answer_If_Required is specified in subclause 7.2.1.4.

7.3.1.6 Procedure Set_CLIP_Info_MSC

The originating exchange may release the call or the MS may terminate the transaction with the network by sending a Release transaction message while a response is awaited from the process CLIP_MAF002. The message is saved for processing after return from the procedure.

7.3.1.7 Procedure Derive_GSM_BC_MSC

7.3.1.8 Procedure Establish_Terminating_TCH_If_Required

7.3.1.9 Procedure Handle_AoC_MT_MSC

7.3.1.10 Procedure Set_COL_Presentation_Indicator_MSC

The originating exchange may release the call or the MS may terminate the transaction with the network by sending a Release transaction message while a response is awaited from the process COLP_MAF041. The message is saved for processing after return from the procedure.

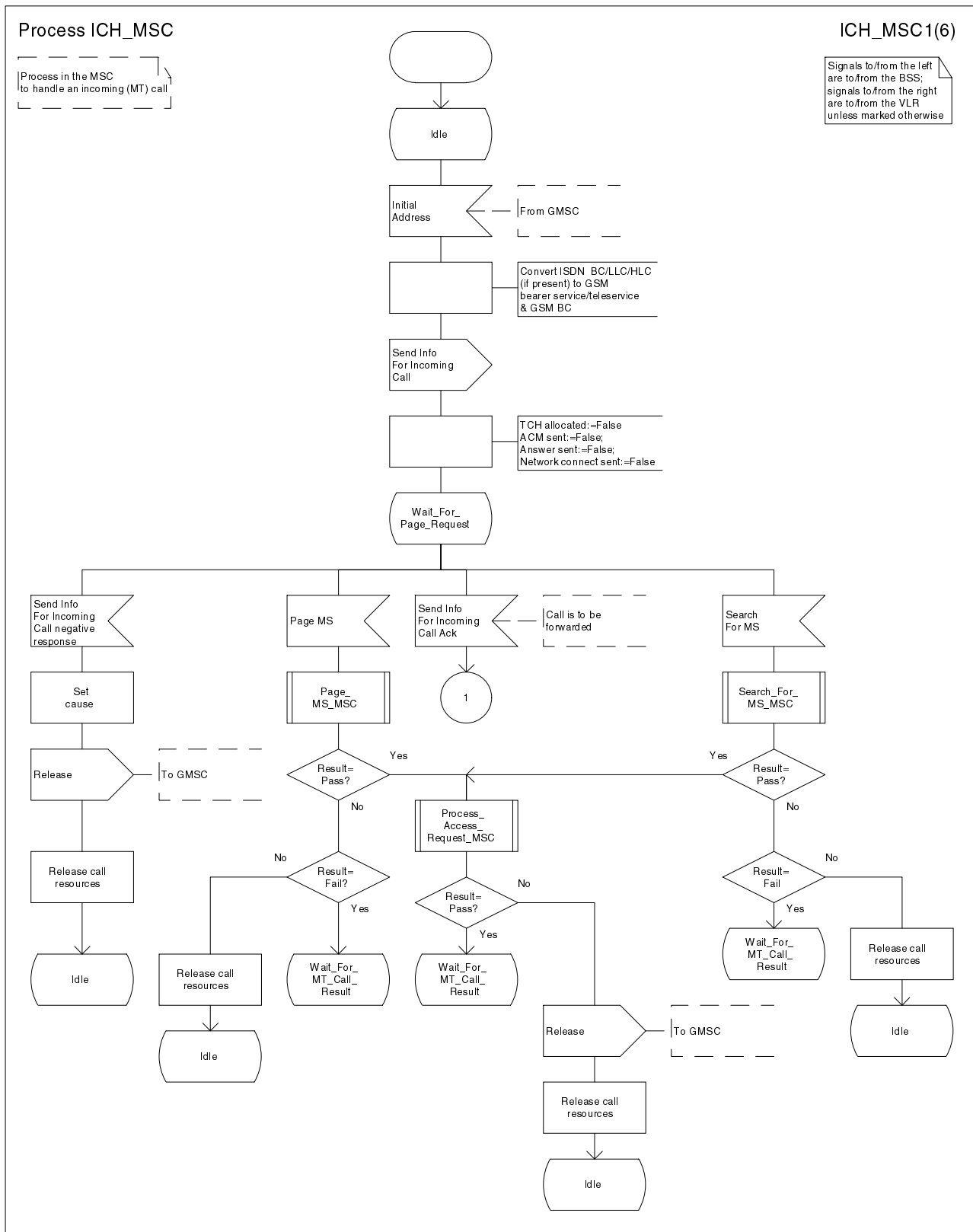

Figure 58a: Process ICH_MSC (sheet 1)

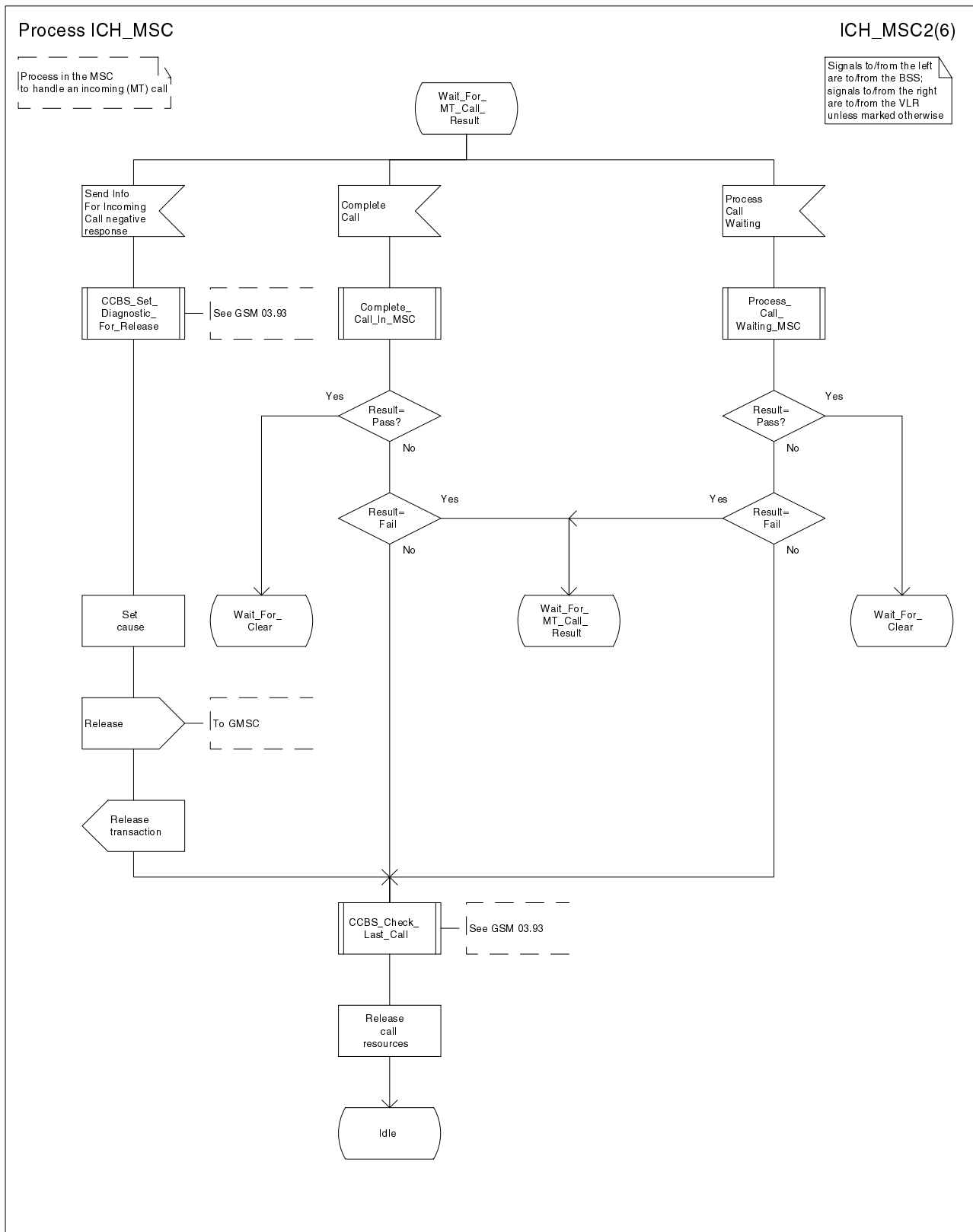

Figure 58b: Process ICH_MSC (sheet 2)

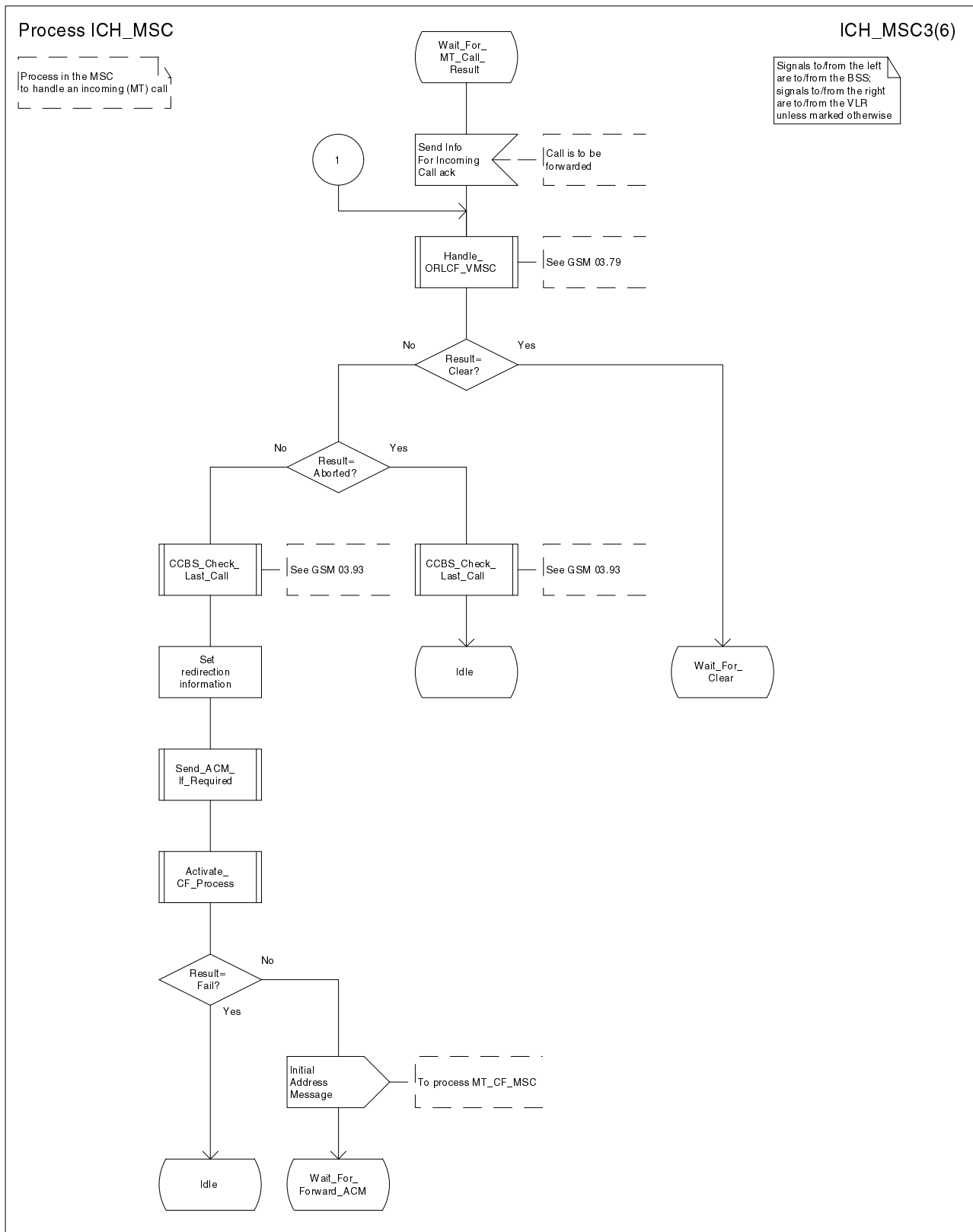

Figure 58c: Process ICH_MSC (sheet 3)

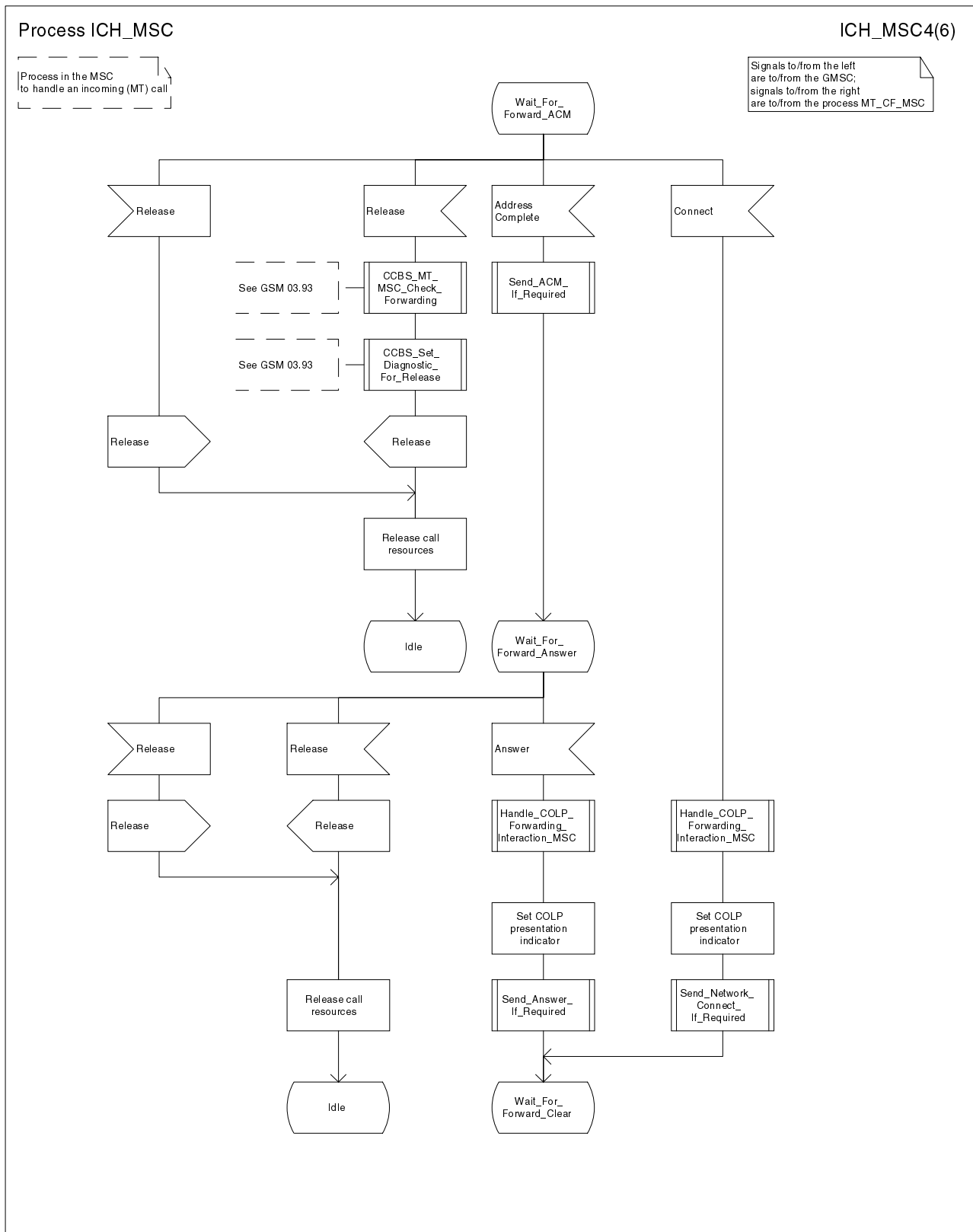

Figure 58d: Process ICH_MSC (sheet 4)

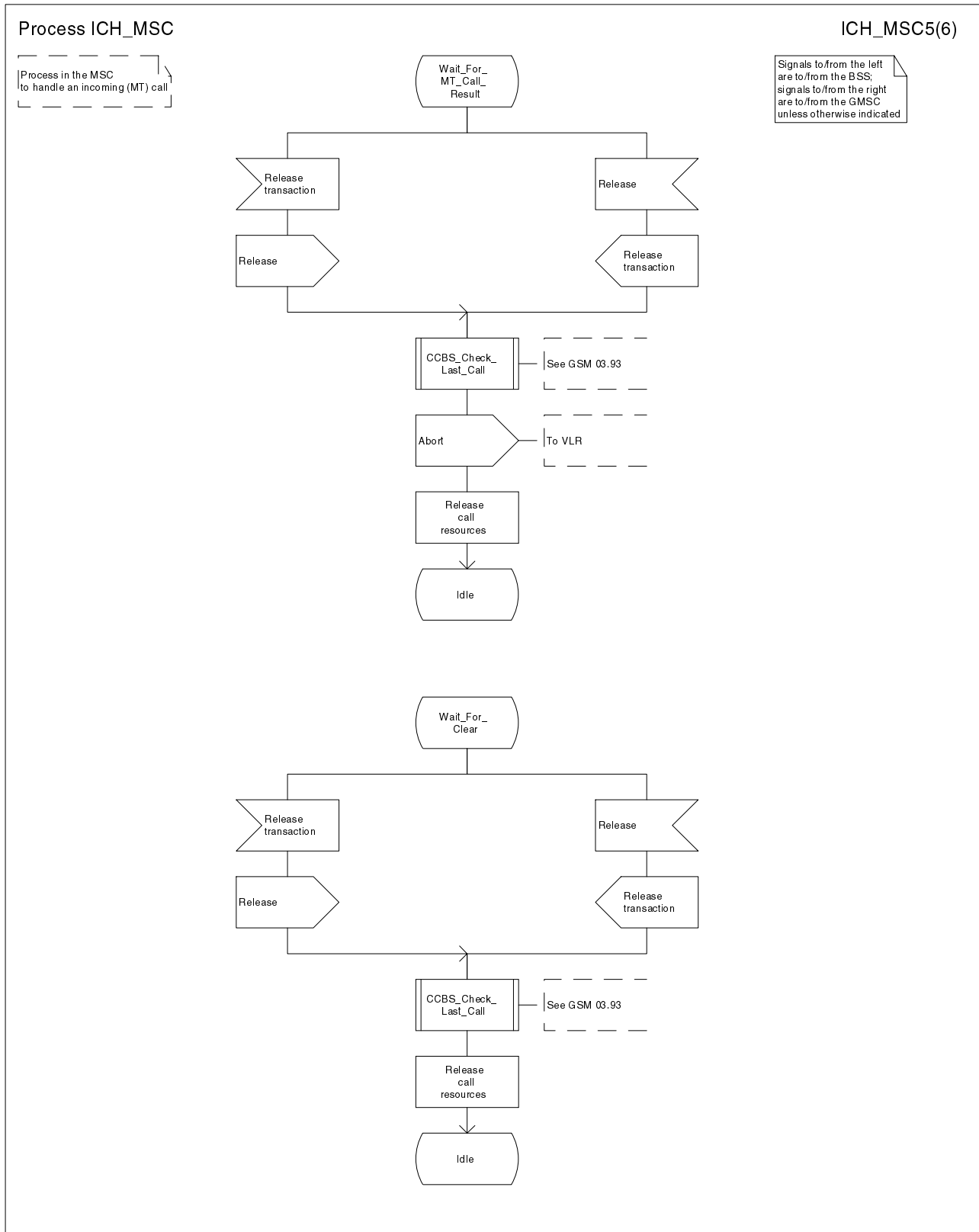

Figure 58e: Process ICH_MSC (sheet 5)

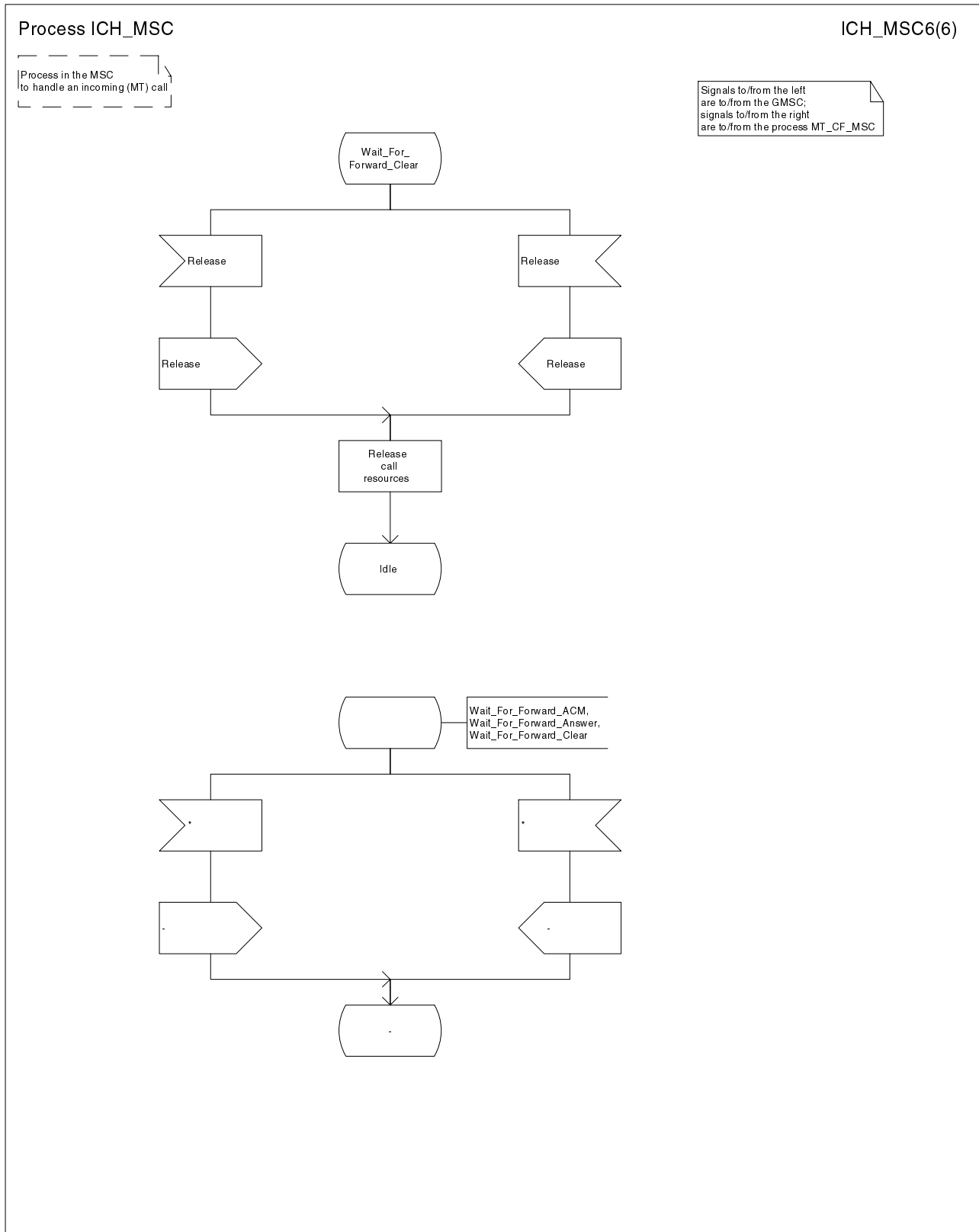

Figure 58f: Process ICH_MSC (sheet 6)

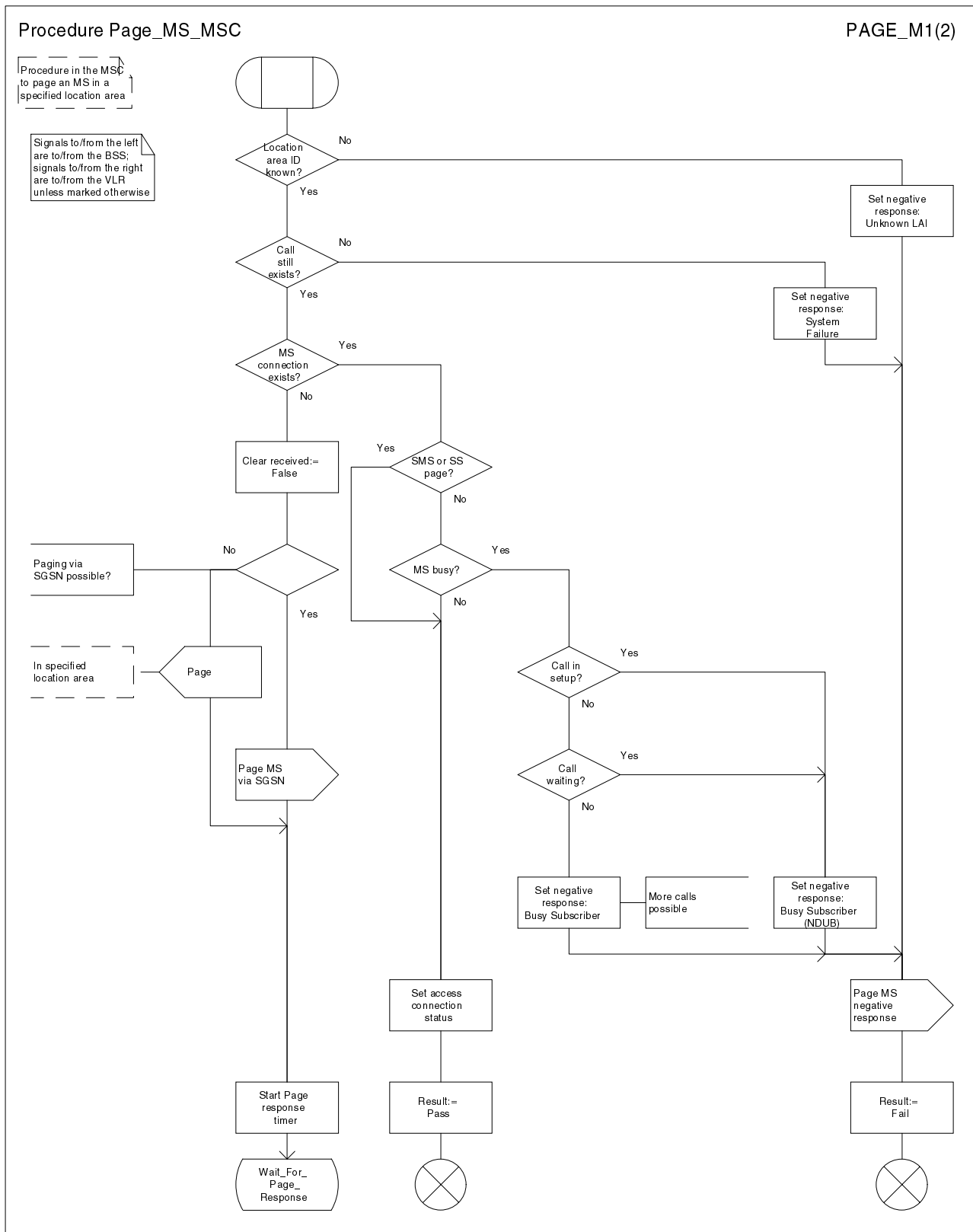

Figure 59a: Procedure Page_MS_MSC (sheet 1)

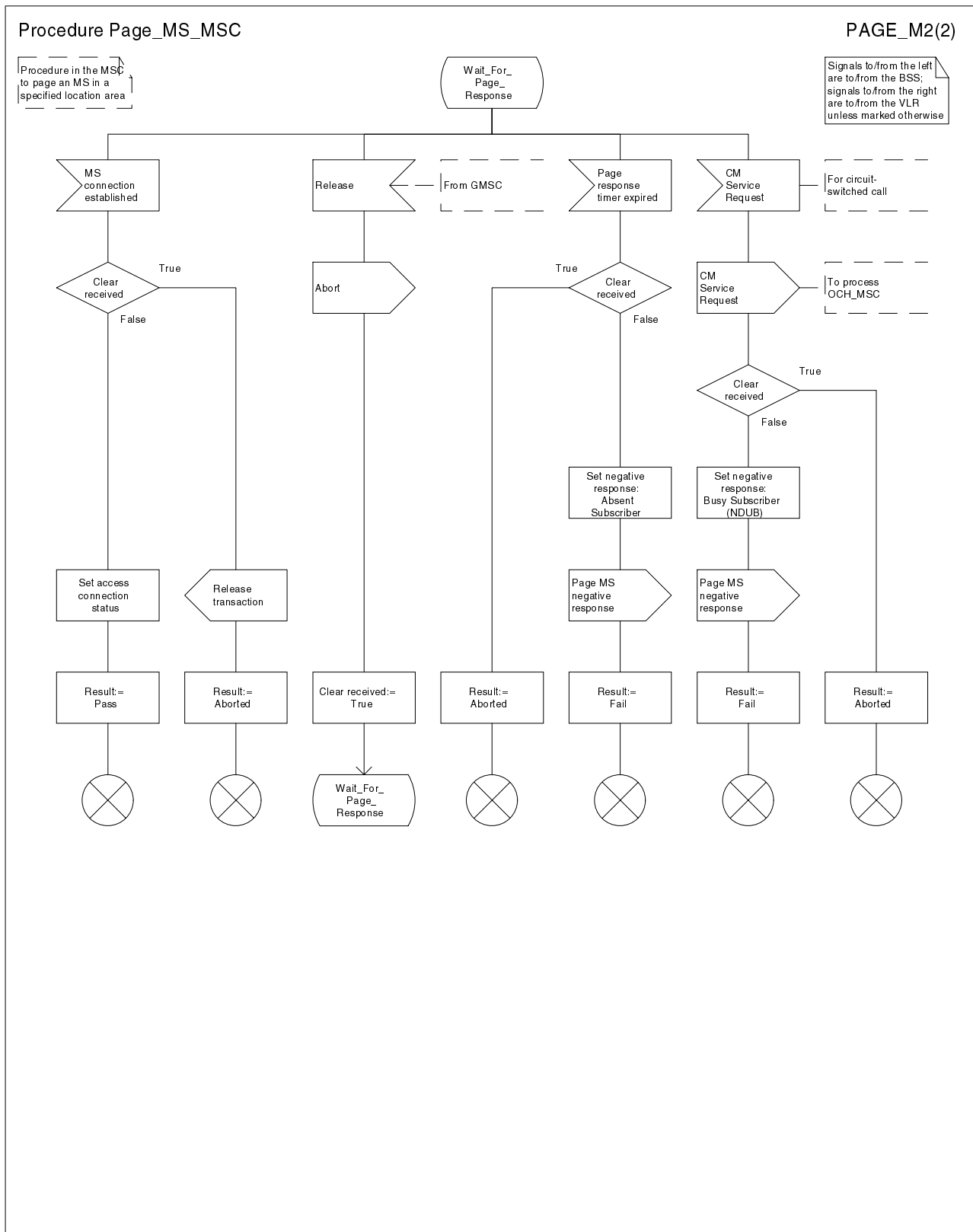

Figure 59b: Procedure Page_MS_MSC (sheet 2)

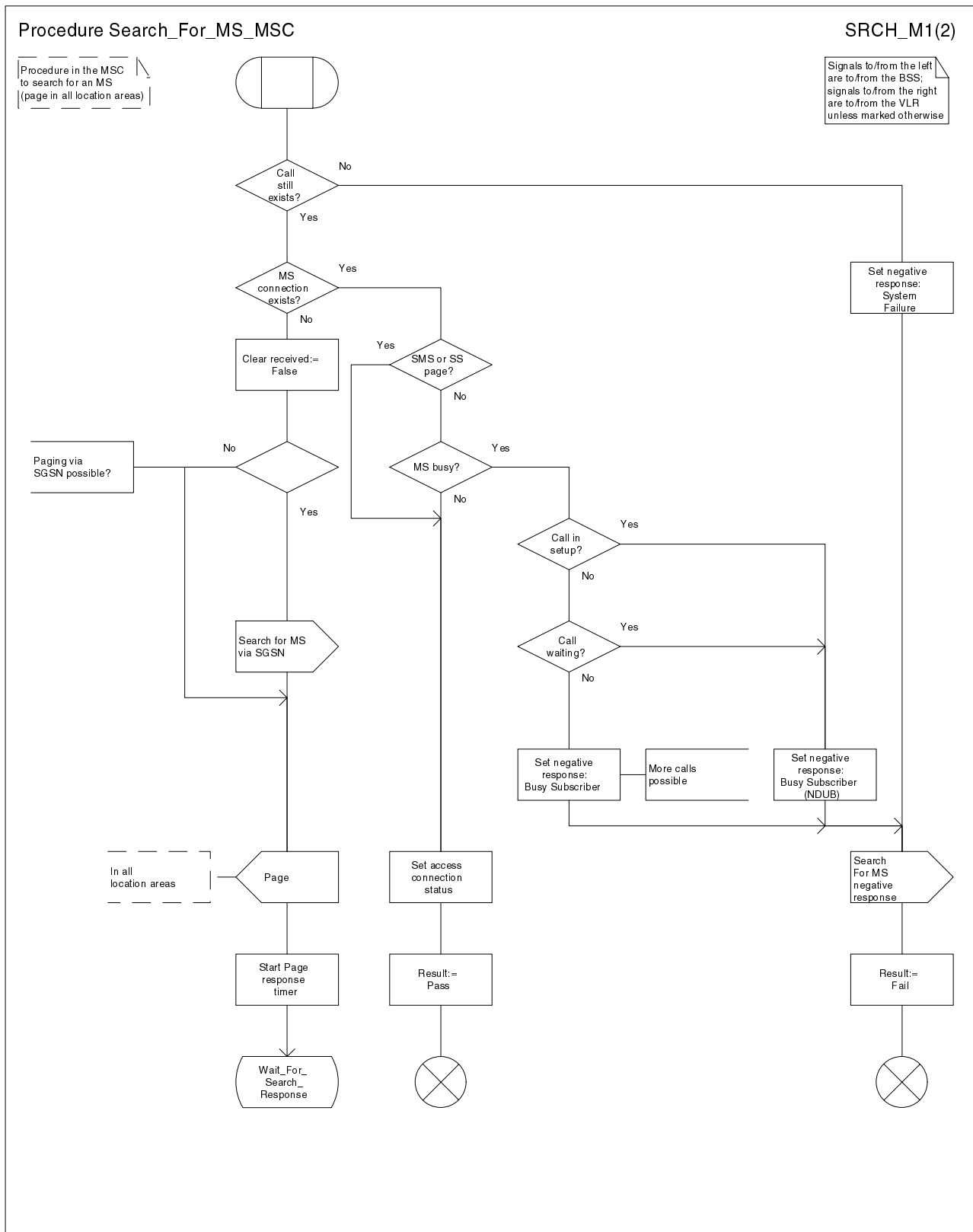

Figure 60a: Procedure Search_For_MS_MSC (sheet 1)

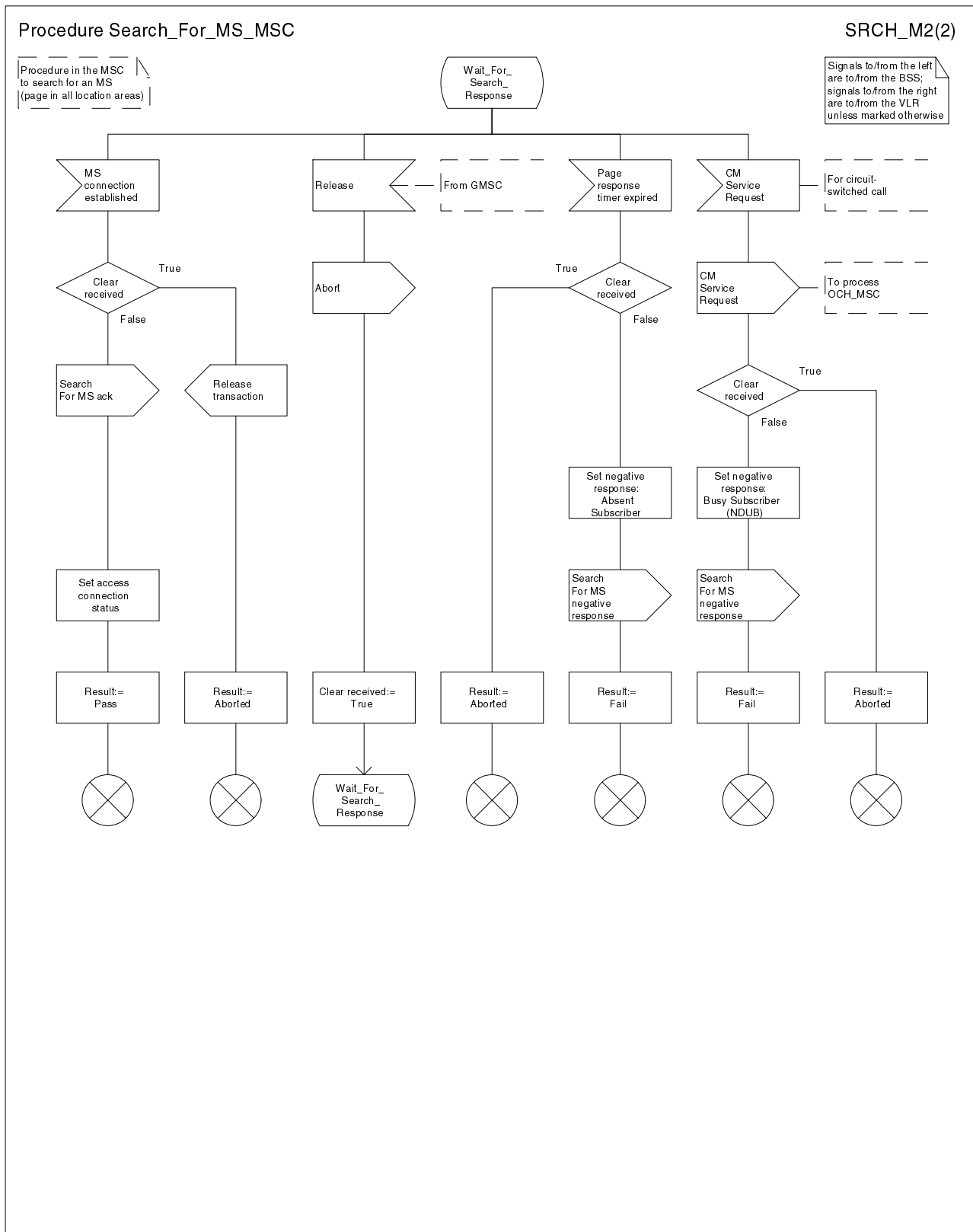

Figure 60b: Procedure Search_For_MS_MSC (sheet 2)

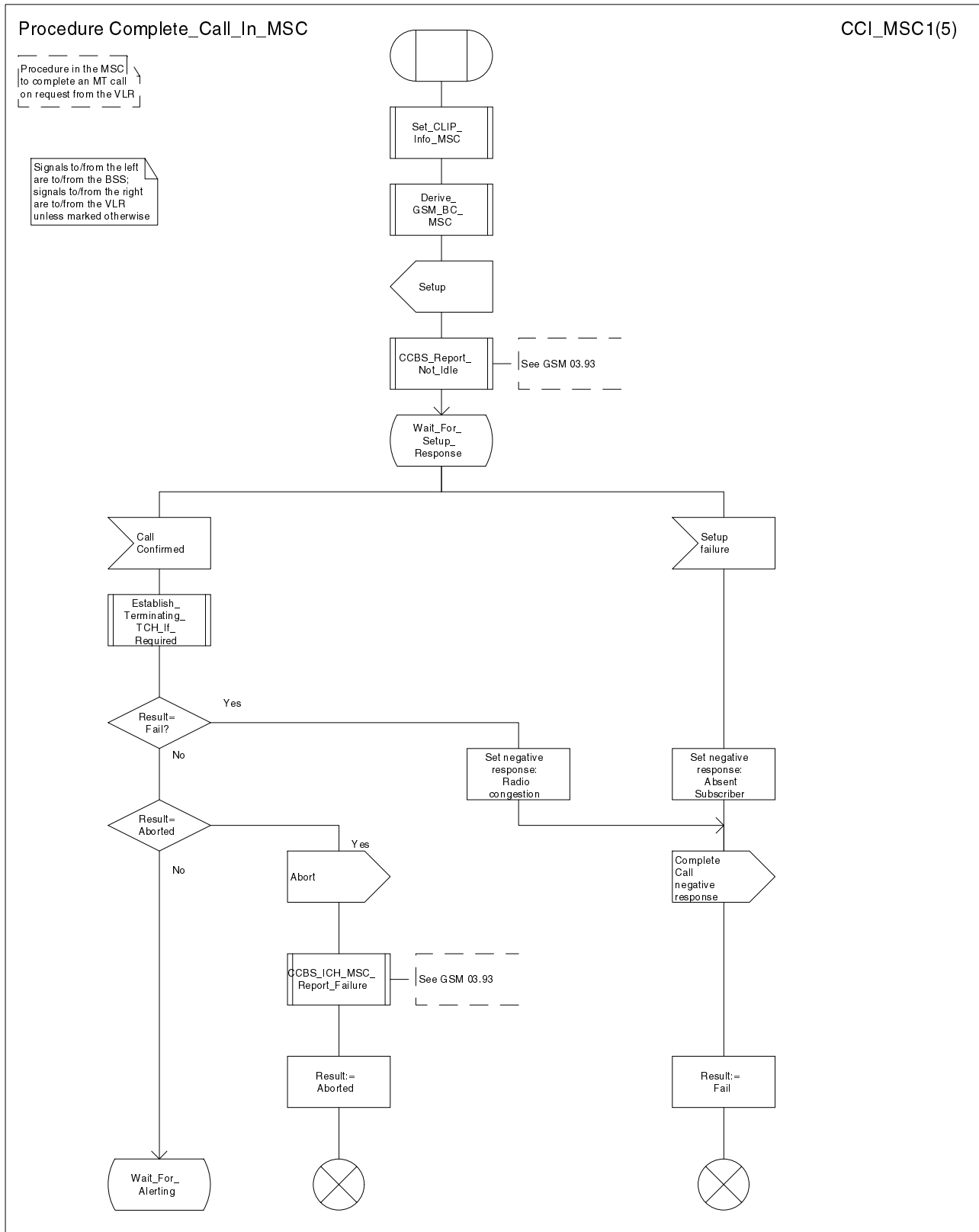

Figure 61a: Procedure Complete_Call_In_MSC (sheet 1)

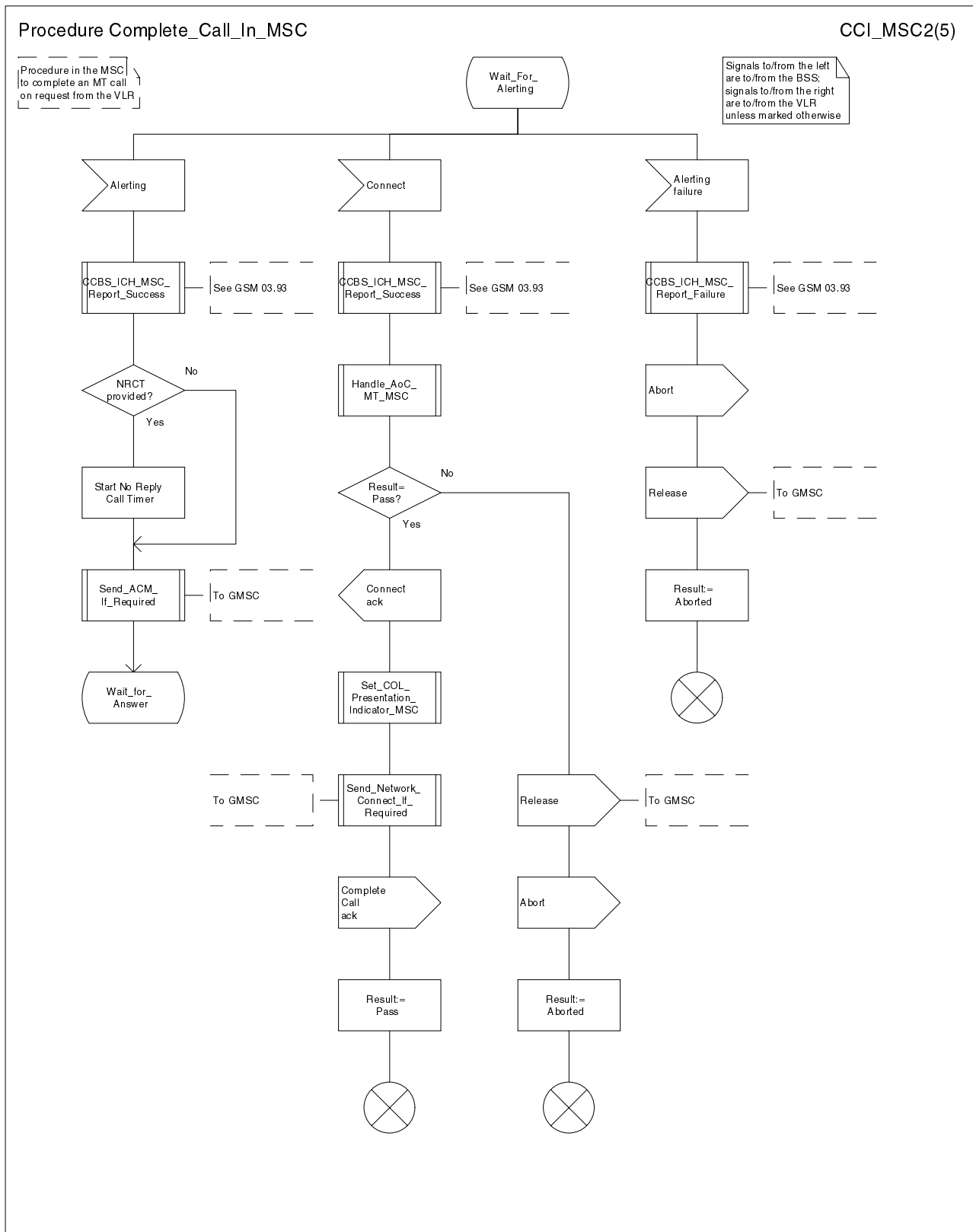

Figure 61b: Procedure Complete_Call_In_MSC (sheet 2)

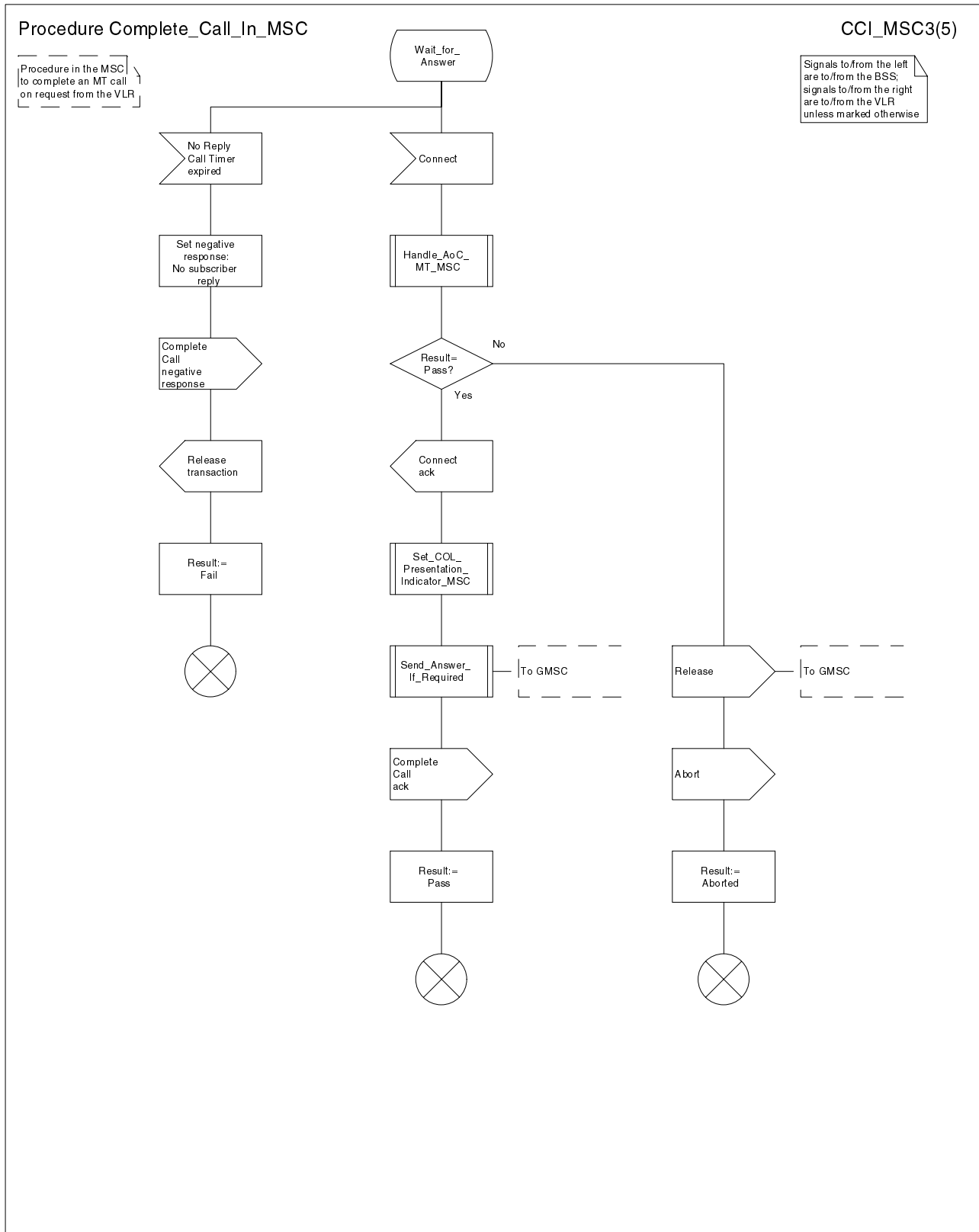

Figure 61c: Procedure Complete_Call_In_MSC (sheet 3)

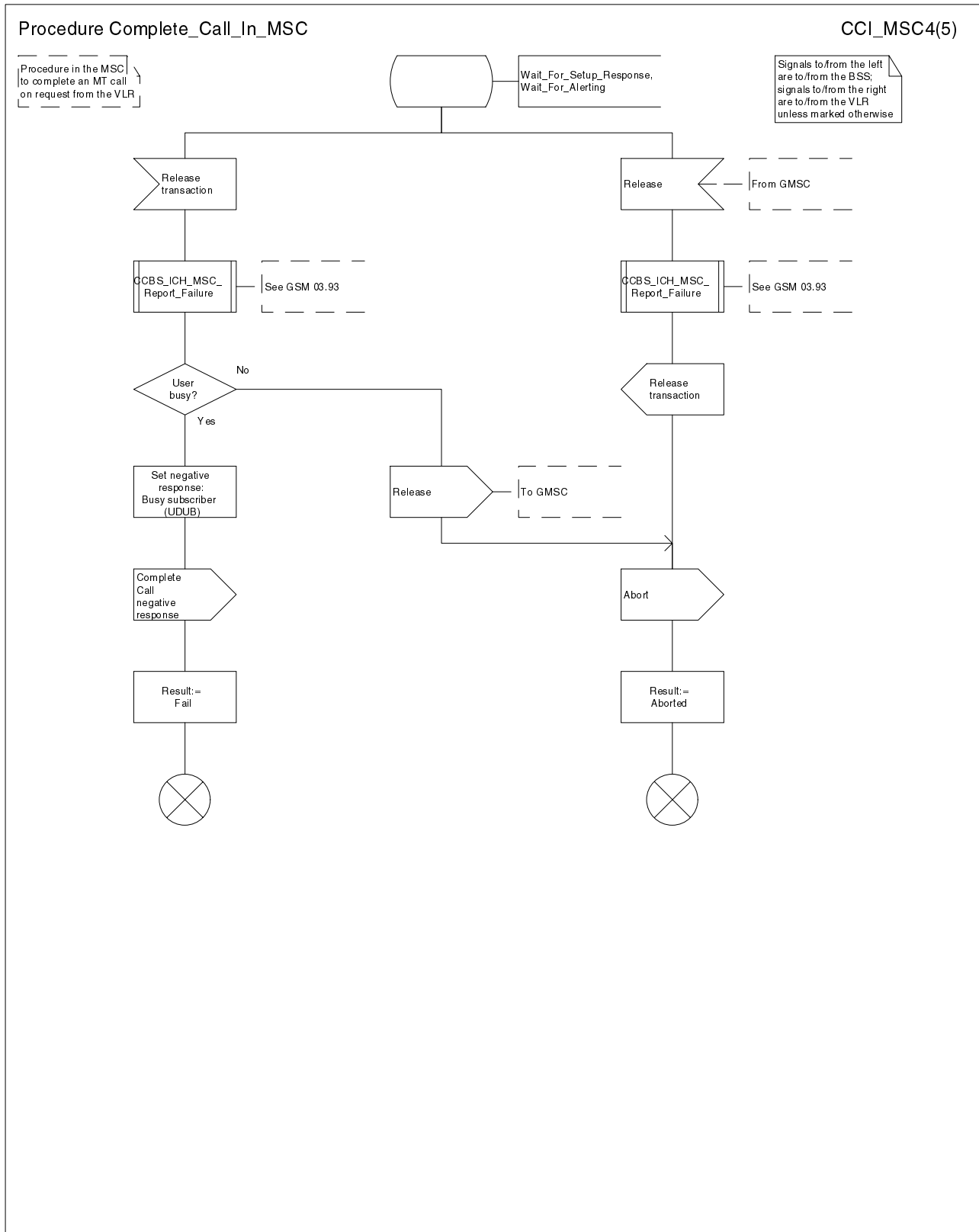

Figure 61d: Procedure Complete_Call_In_MSC (sheet 4)

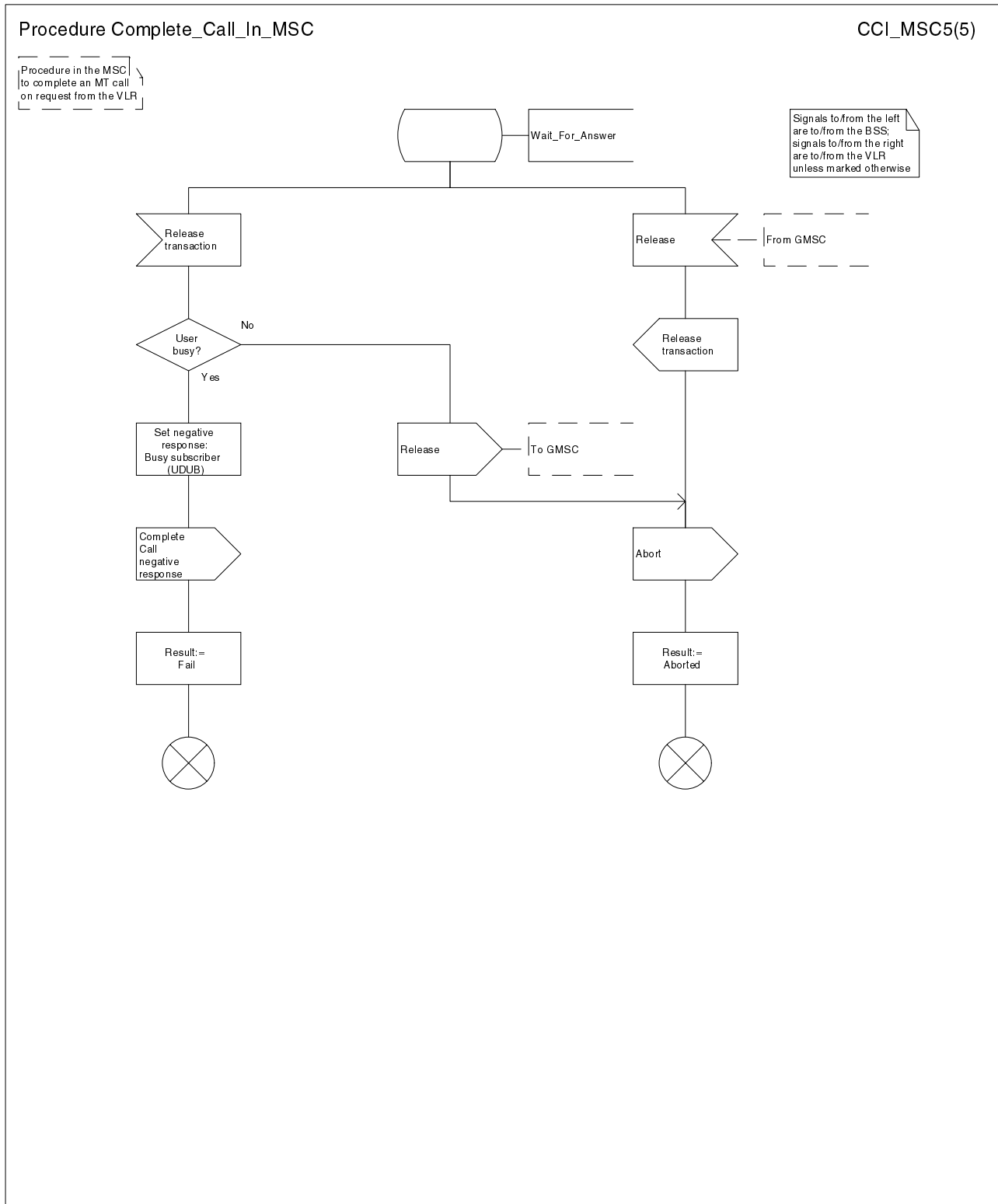

Figure 61e: Procedure Complete_Call_In_MSC (sheet 5)

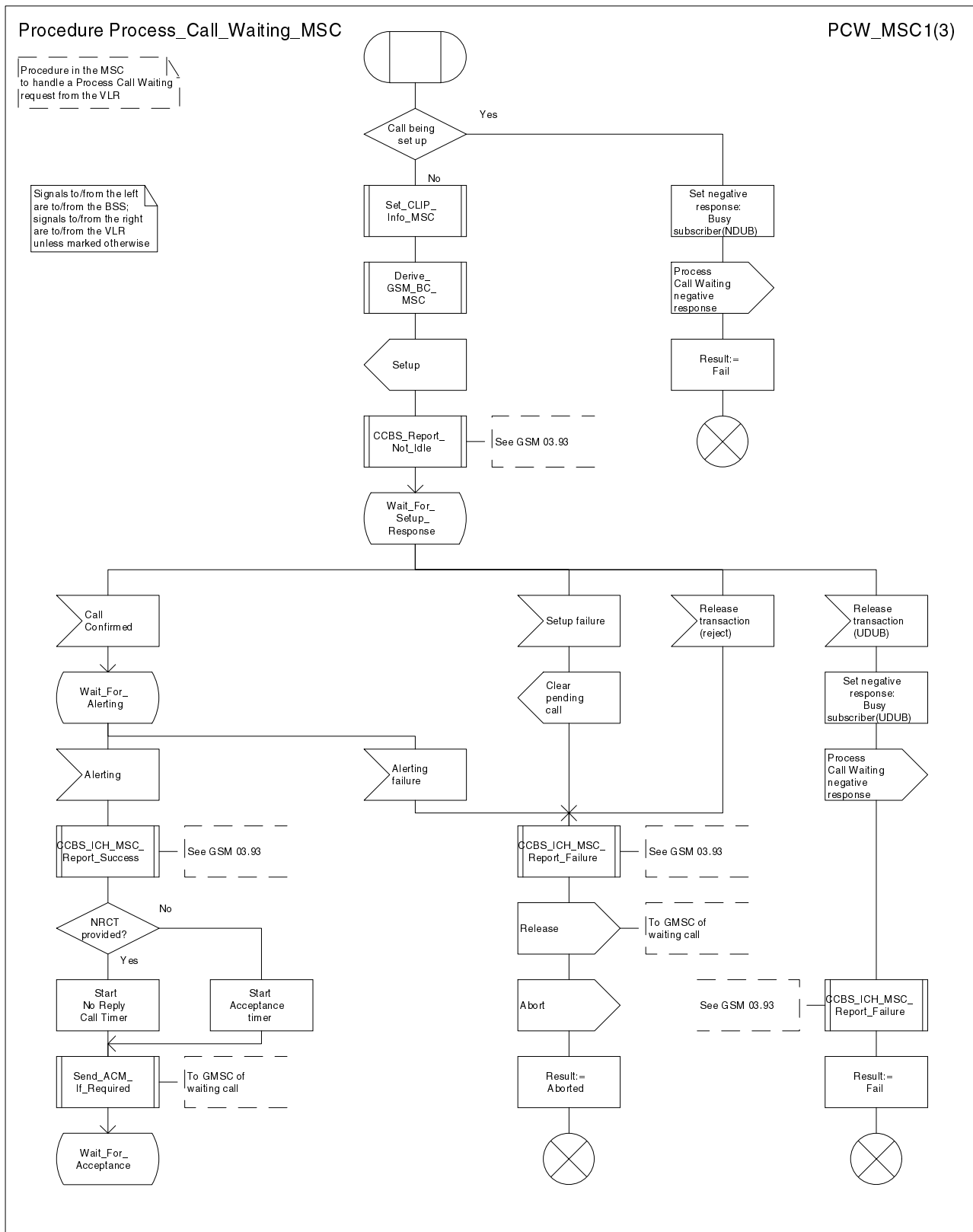

Figure 62a: Procedure Process_Call_Waiting_MSC (sheet 1)

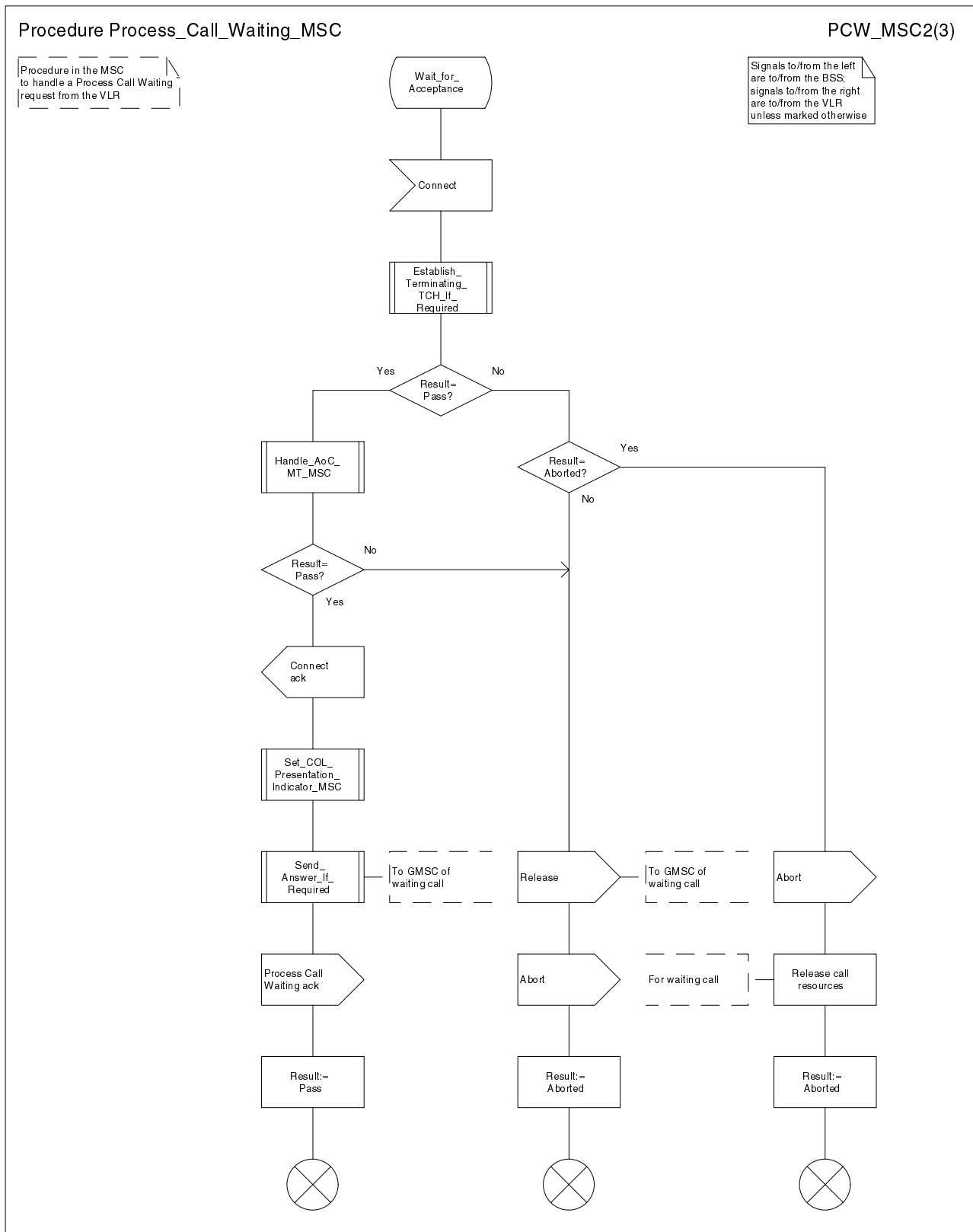

Figure 62b: Procedure Process_Call_Waiting_MSC (sheet 2)

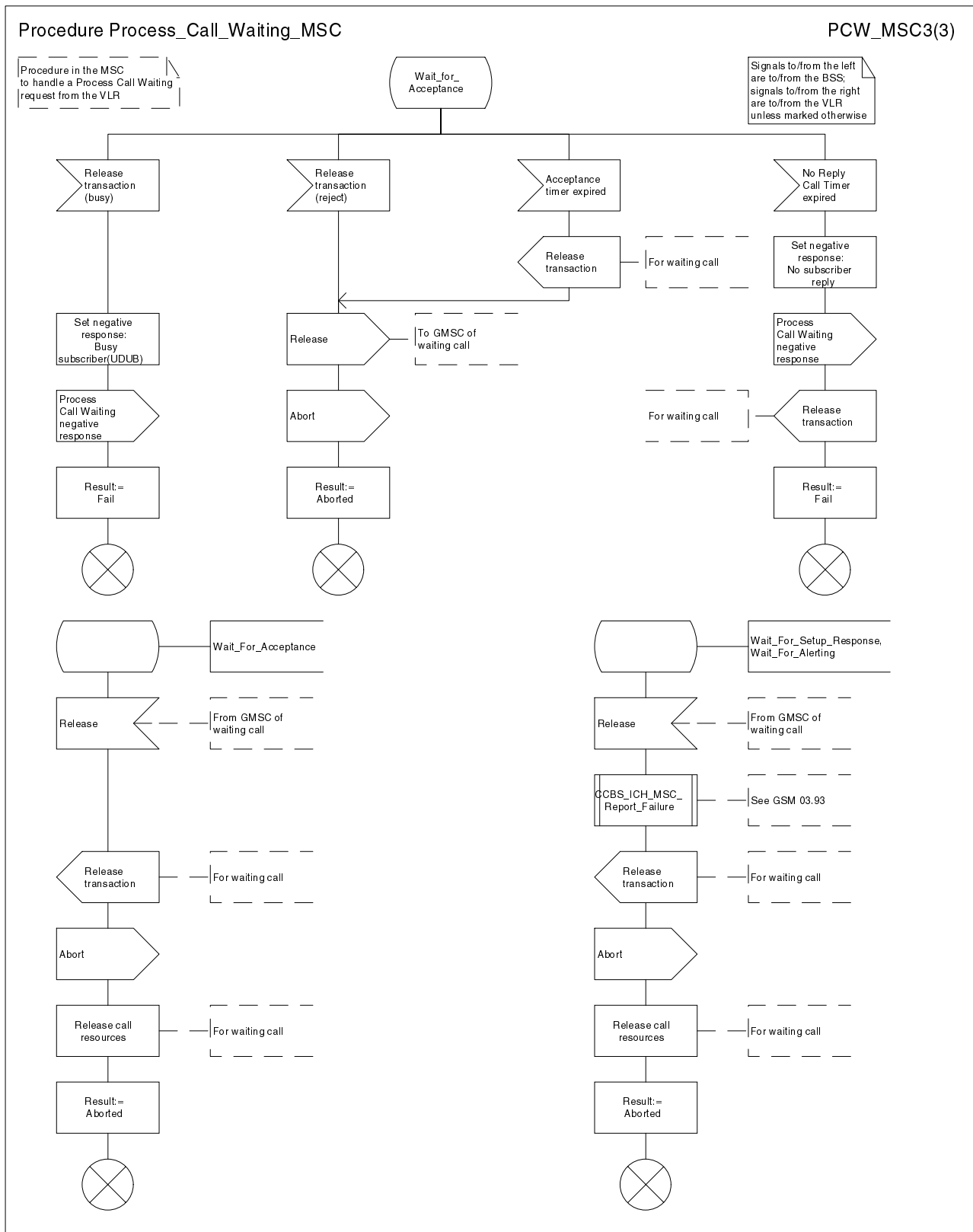

Figure 62c: Procedure Process_Call_Waiting_MSC(sheet 3)

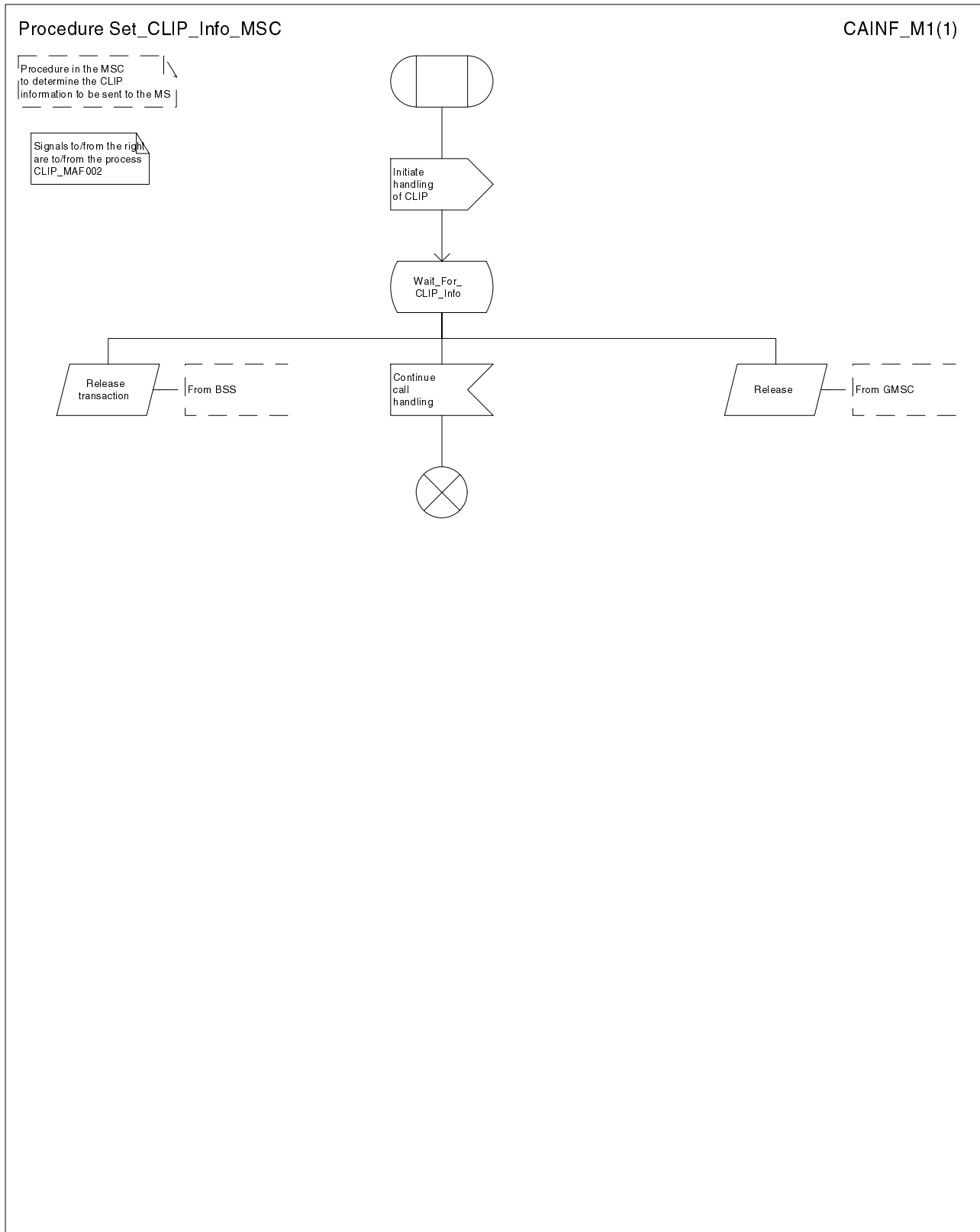

Figure 63: Procedure Set_CLIP_Info_MSC

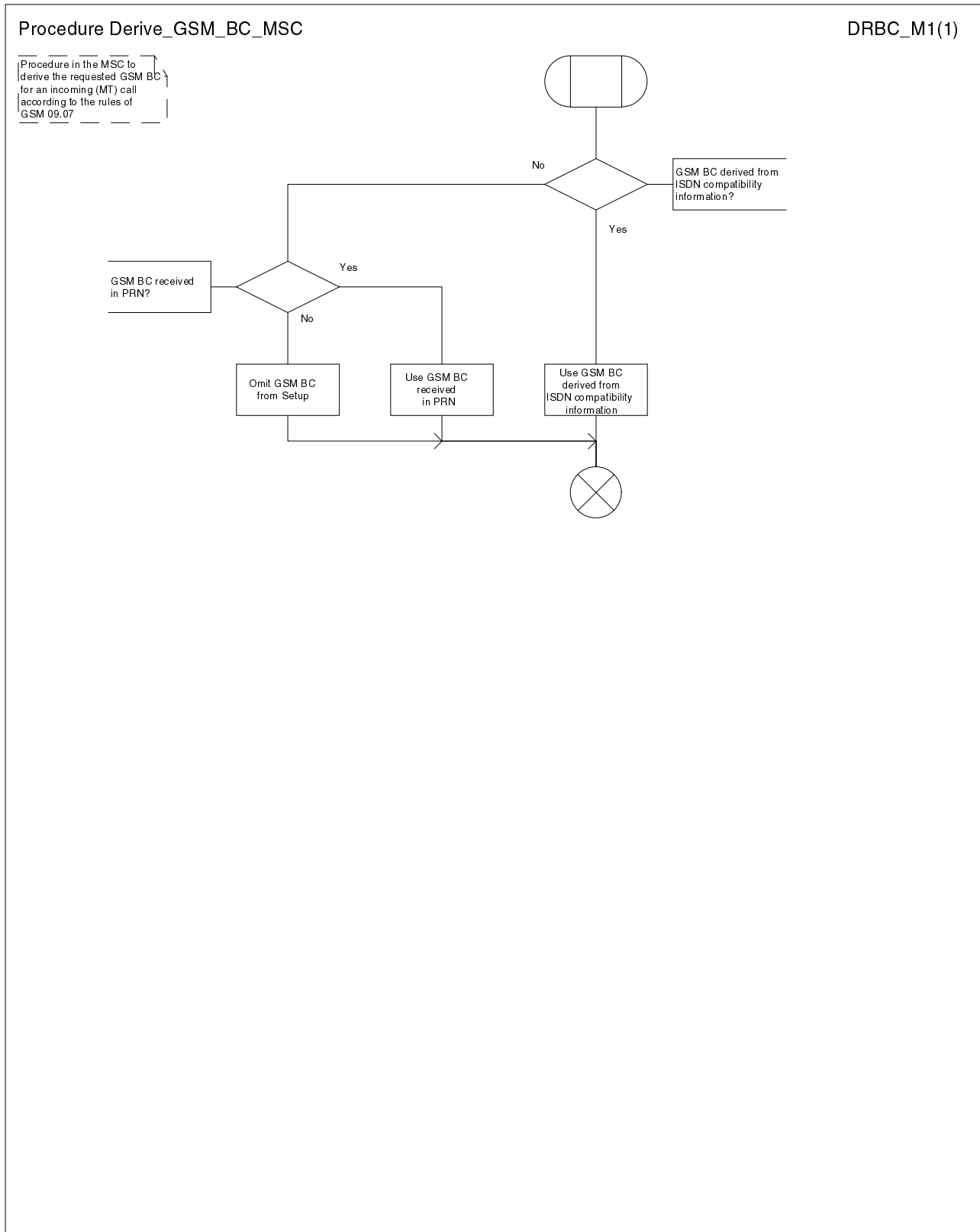

Figure 64: Derive_GSM_BC_MSC

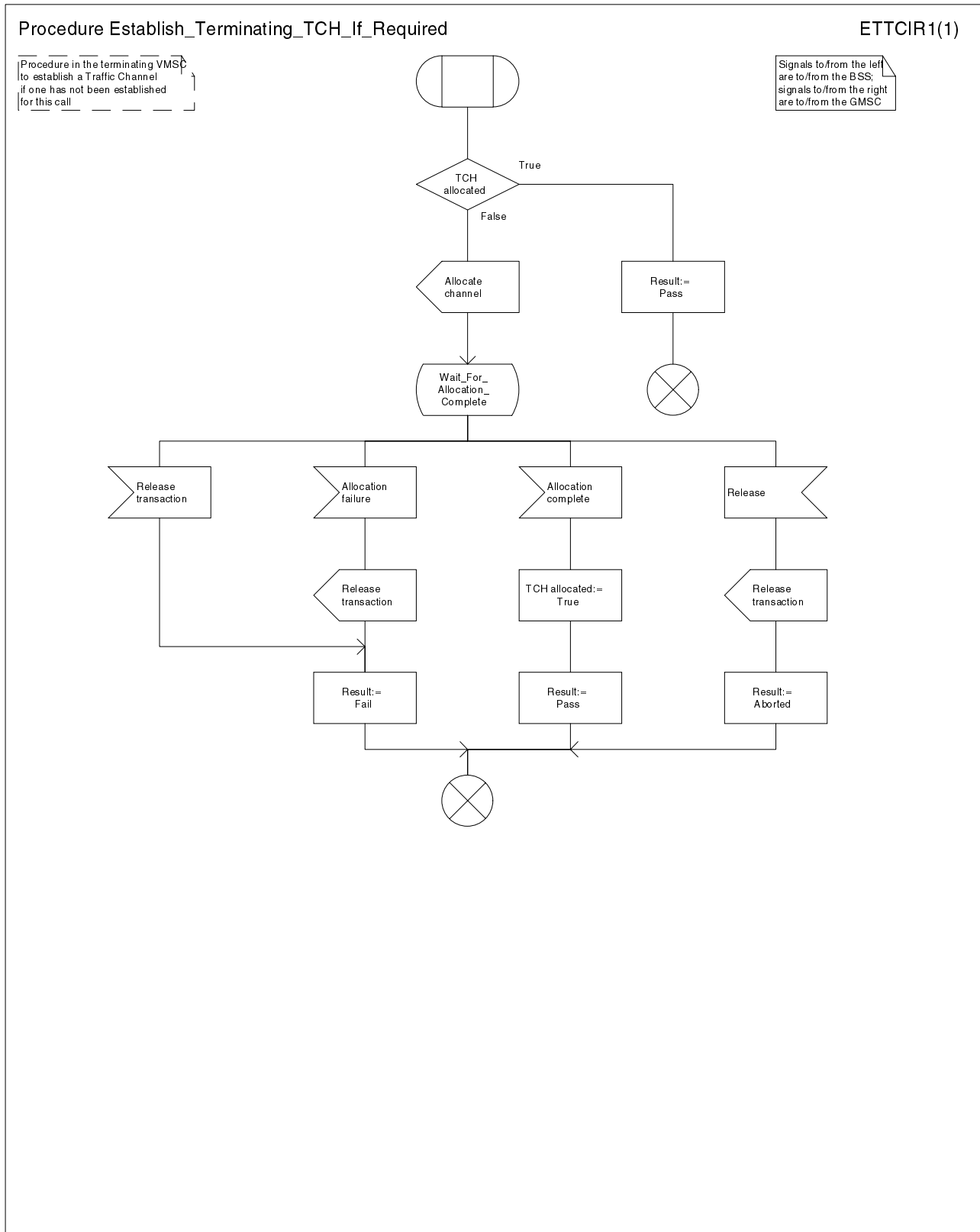

Figure 65: Procedure Establish_Terminating_TCH_If_Required

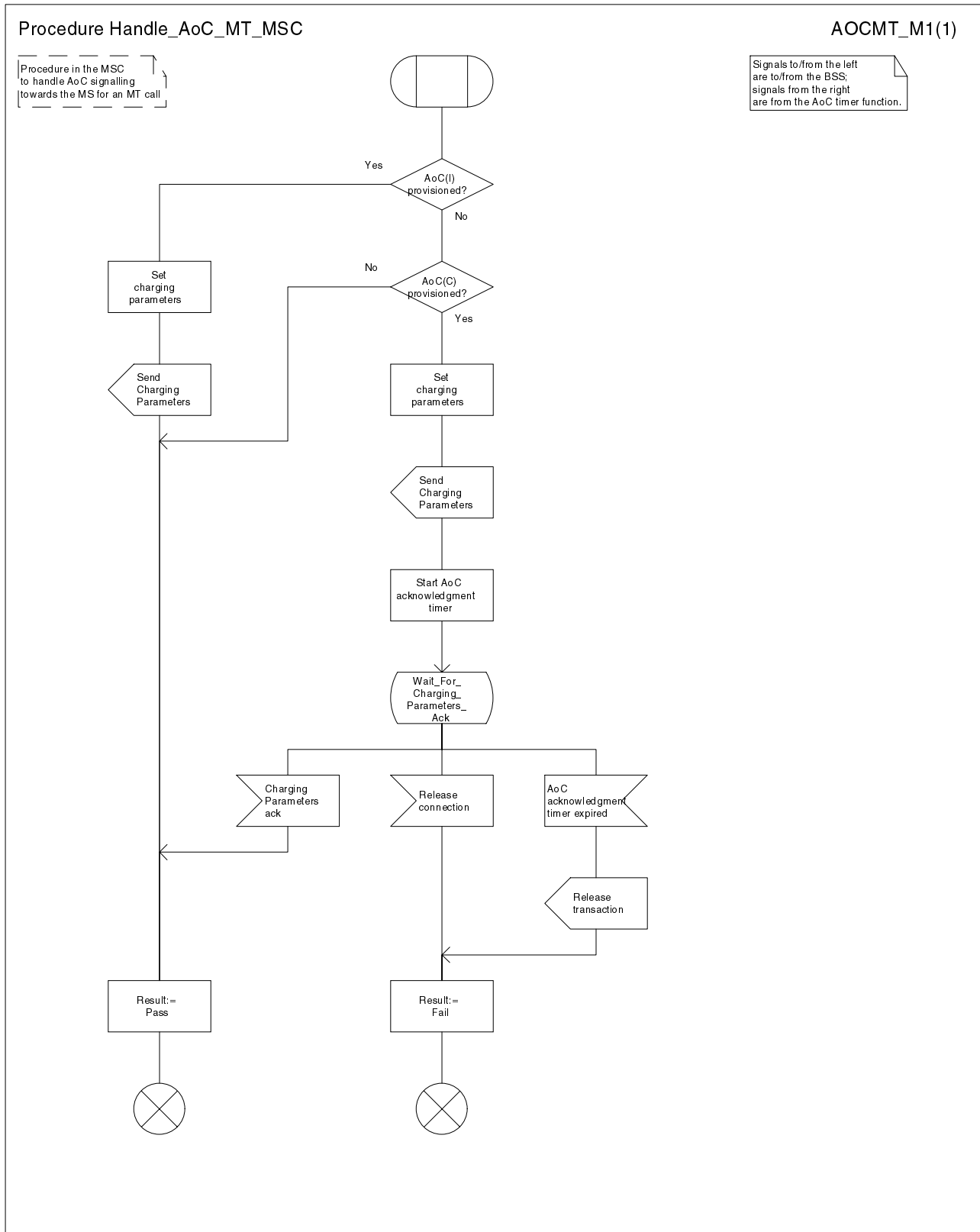

Figure 66: Procedure Handle_AoC_MT_MSC

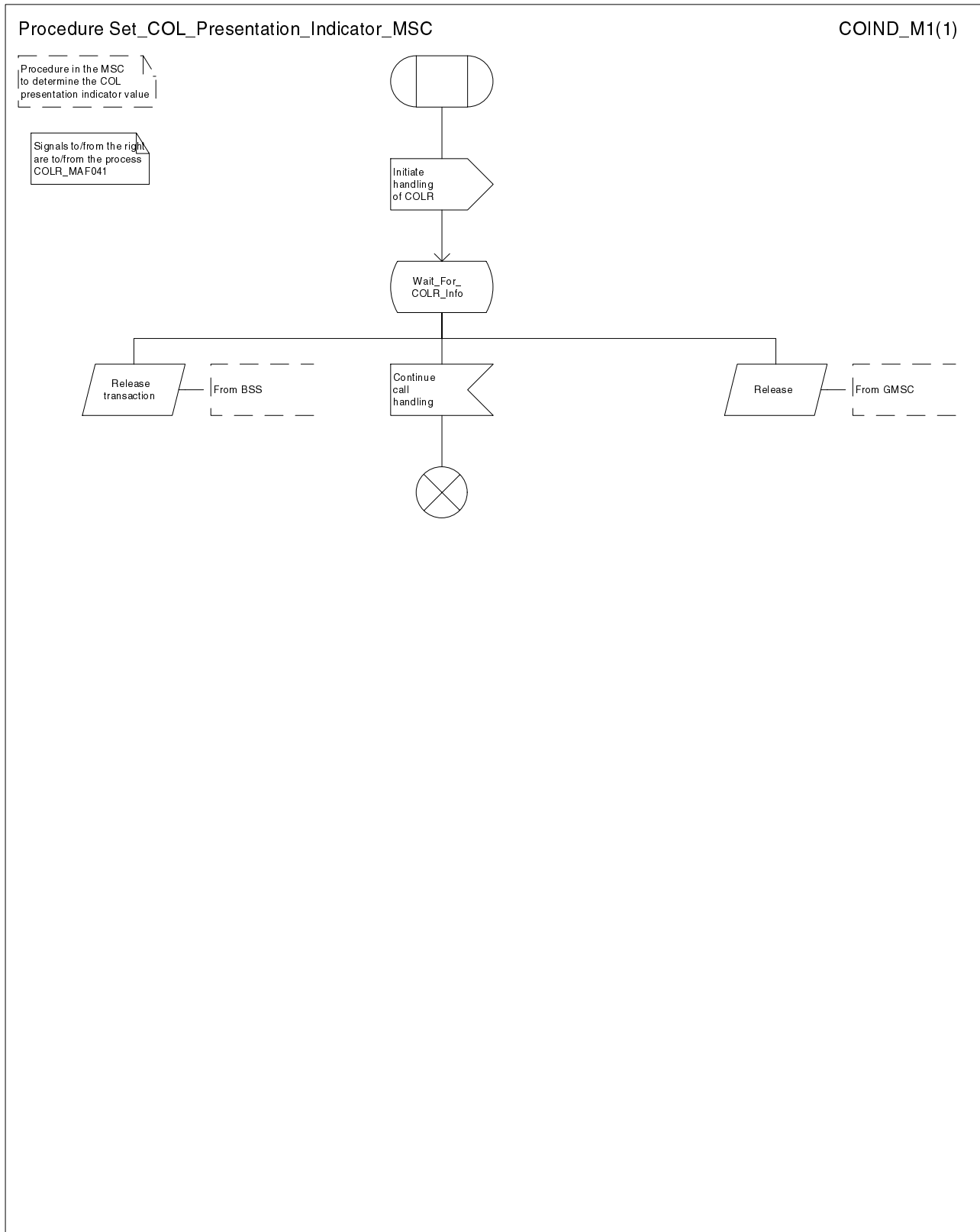

Figure 67: Procedure Set_COL_Presentation_Indicator MSC

7.3.2 Functional requirements of VLR

7.3.2.1 Process ICH_VLR

Sheet 1: if the MSRN received in the Send Info For Incoming Call is not allocated or there is no IMSI record for the IMSI identified by the MSRN, this is treated as an unknown MSRN.

Sheet 1: the procedure CCBS_ICH_Set_CCBS_Call_Indicator is specific to CCBS; it is specified in GSM 03.93 [16].

Sheet 1: the test "Paging via SGSN possible" takes the "yes" exit if:

- the Gs interface is implemented; and
- there is an association established for the MS between the MSC/VLR and the SGSN.

Sheet 1, sheet 2, sheet 3: the procedure CCBS_ICH_VLR_Report_Failure is specific to CCBS; it is specified in GSM 03.93 [16].

Sheet 1, sheet 2: the procedure CCBS_ICH_Report_Not_Reachable is specific to CCBS; it is specified in GSM 03.93 [16].

Sheet 2: the test "NDUB?" takes the "Yes" exit if the Page MS negative response or the Search for MS negative response had the value Busy Subscriber (NDUB).

Sheet 2: the procedure Get_CW_Subscription_Info_VLR is specific to Call Waiting. If the VLR does not support Call Waiting, processing continues from the "No" exit of the test "CW available?".

Sheet 2: the VLR uses the basic service returned in the Page MS negative response or the Search for MS negative response Busy Subscriber (More calls possible) to determine whether call waiting is available.

Sheet 2: the procedure Get_LI_Subscription_Info_MT_VLR is specific to CLIP and COLR. If the VLR supports neither CLIP nor COLR, the procedure call is omitted.

Sheet 2: the procedure Get_AoC_Subscription_Info_VLR is specific to AoC; it is specified in subclause 7.1.2.15.

Sheet 2: the procedure CCBS_ICH_Handle_NDUB is specific to CCBS; it is specified in GSM 03.93 [16]. If the VLR does not support CCBS, processing continues from the "Forward" exit of the test "Result".

Sheet 2: the procedure Process_Access_Request_VLR is specified in subclause 7.1.2.2.

Sheet 2: the output signal Page MS towards the SGSN includes the Location area identity parameter.

Sheet 2: if the VLR does not support CUG, handling continues from the "No" exit of the test "CUG info present?".

Sheet 3, sheet 4: the procedure CCBS_ICH_Handle_UDUB is specific to CCBS; it is specified in GSM 03.93 [16].

Sheet 4: the test "NDUB?" is executed only if the VLR supports CCBS. If the VLR does not support CCBS, processing continues from connector 5.

Sheet 5: the procedure CCBS_ICH_Set_CCBS_Target is specific to CCBS; it is specified in GSM 03.93 [16].

Sheet 5: the procedure Handle_CFNRC is specified in subclause 7.2.2.11.

Sheet 6: the procedure Forward_CUG_Check is specific to CUG; it is specified in subclause 7.2.2.6. If the VLR does not support CUG, processing continues from the "Yes" exit of the test "Result=Call allowed?".

7.3.2.2 Procedure Derive_Requested_Basic_Service_VLR

If the VLR did not receive a basic service for the call in the Send Info For Incoming Call, and did not receive a GSM bearer capability in the Provide Roaming Number, it applies a default basic service according to the requirements of the operator.

7.3.2.3 Procedure Search_For_MS_VLR

The test “Paging via SGSN possible” takes the “yes” exit if:

- the Gs interface is implemented; and
- the VLR configuration requires paging via the SGSN during VLR restoration.

The output signal Page MS towards the SGSN omits the Location area identity parameter. It is sent to every SGSN to which the VLR is connected.

7.3.2.4 Procedure Get_CW_Subscription_Info_VLR

The VMSC may abort the transaction with the VLR while a response is awaited from the process MAF013. The message is saved for processing after return from the procedure.

7.3.2.5 Procedure Get_LI_Subscription_Info_MT_VLR

The VMSC may abort the transaction with the VLR while a response is awaited from the process CLIP_MAF001 or the process COLR_MAF040. The message is saved for processing after return from the procedure.

7.3.2.6 Procedure Handle_CFB

The test “Normal call busy” refers to the value of the indicator returned by the process MAF008.

7.3.2.7 Procedure Handle_CFNRy

The test “Normal call” refers to the value of the indicator returned by the process MAF009.

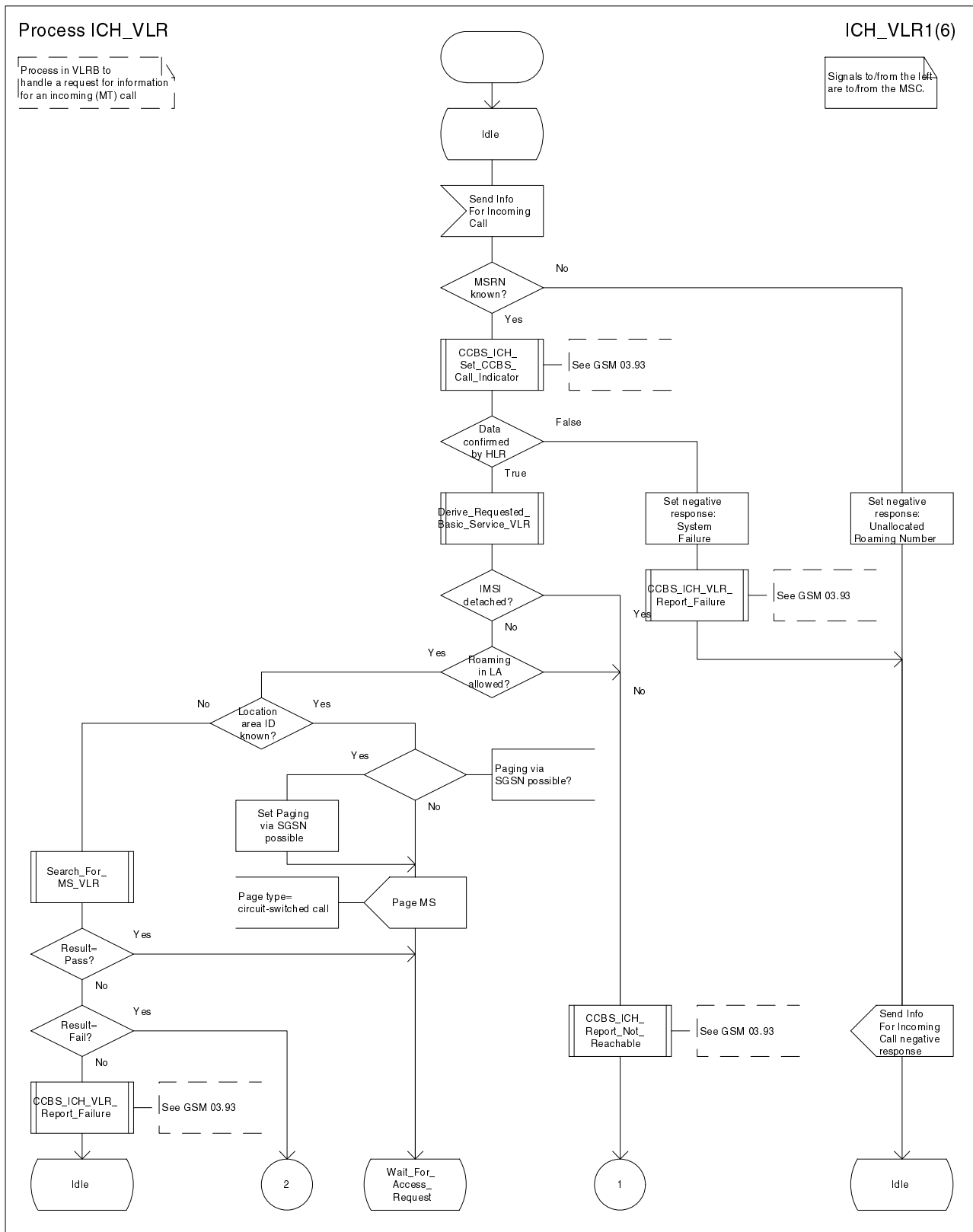

Figure 68a: Process ICH_VLR (sheet 1)

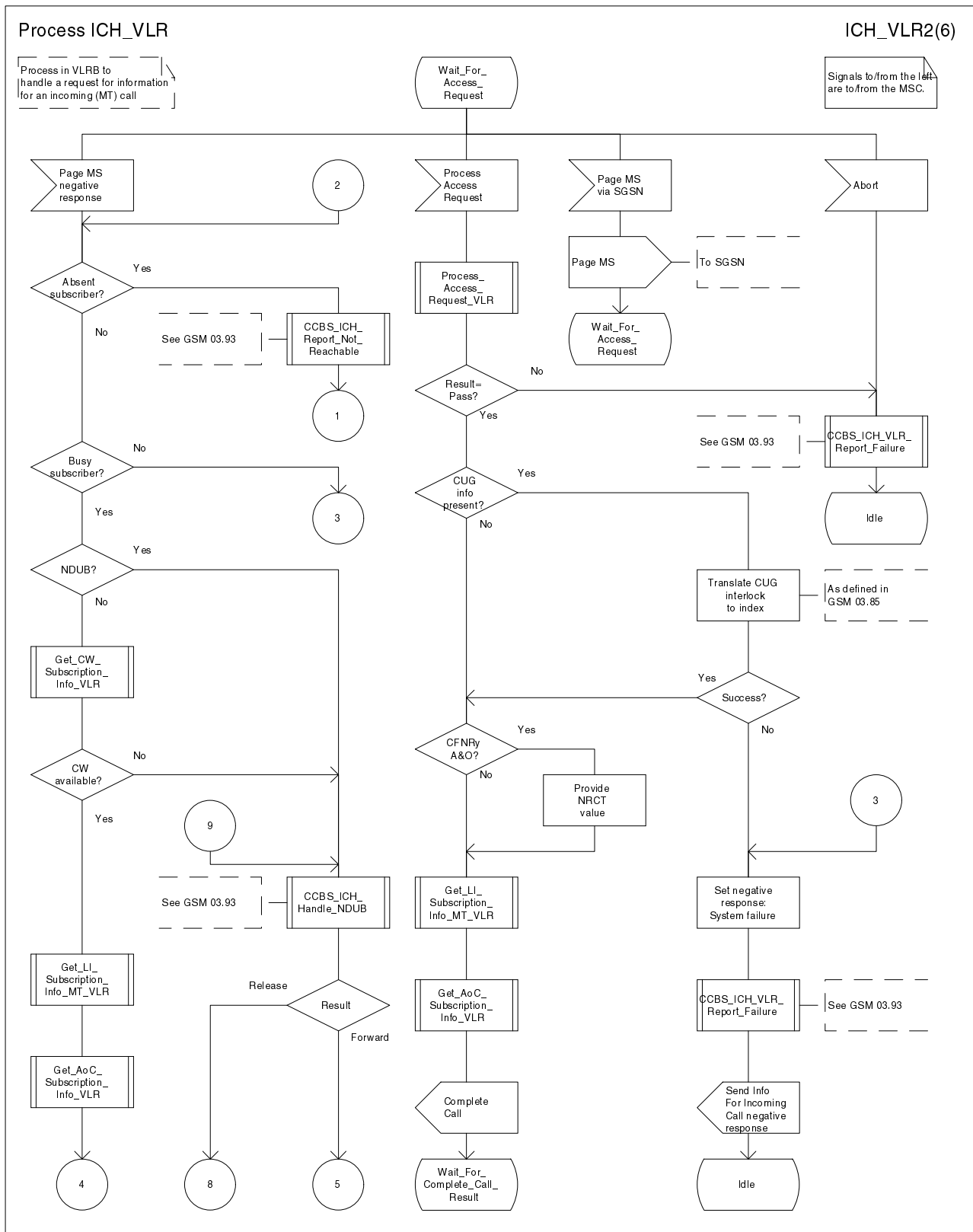

Figure 68b: Process ICH_VLR (sheet 2)

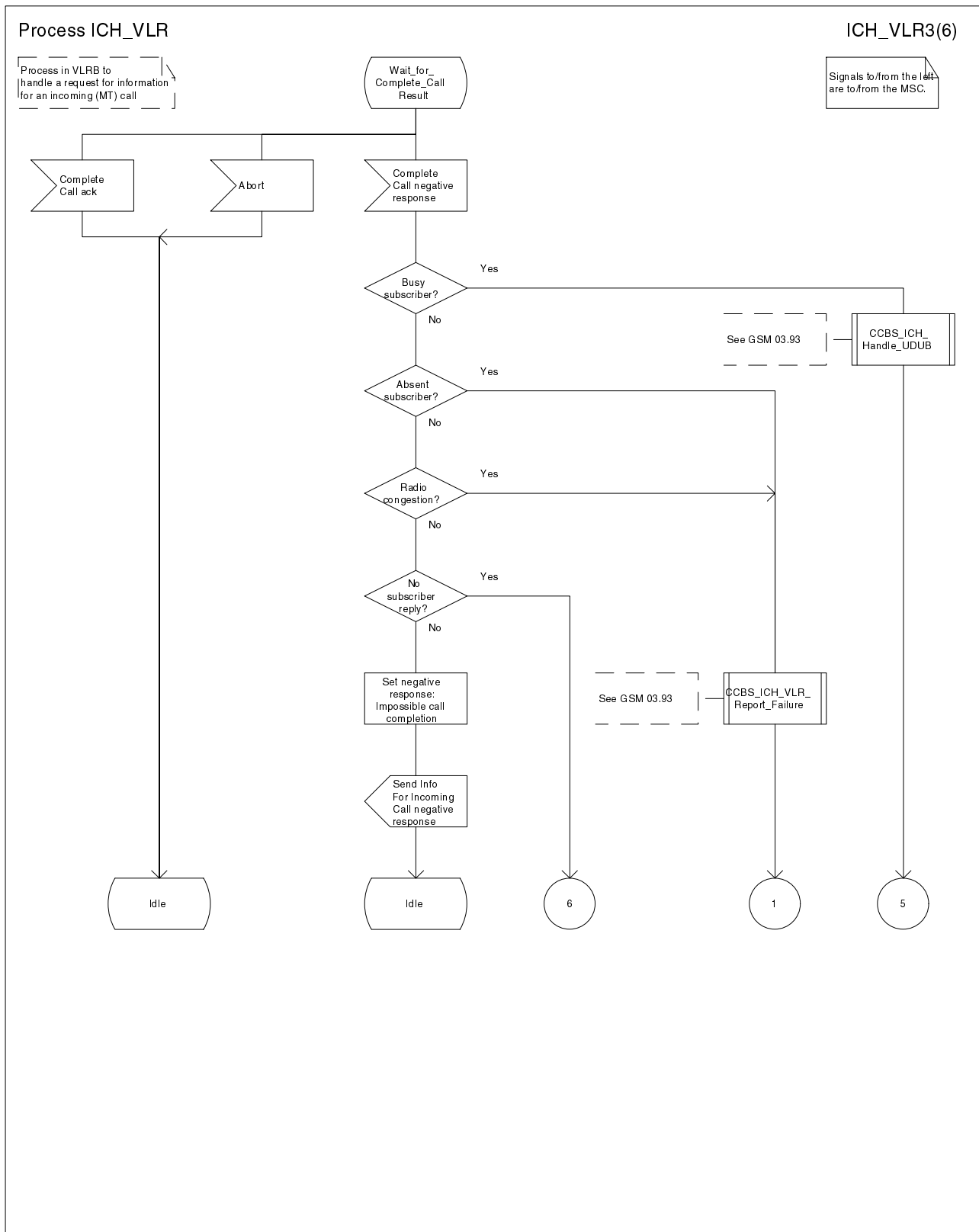

Figure 68c: Process ICH_VLR (sheet 3)

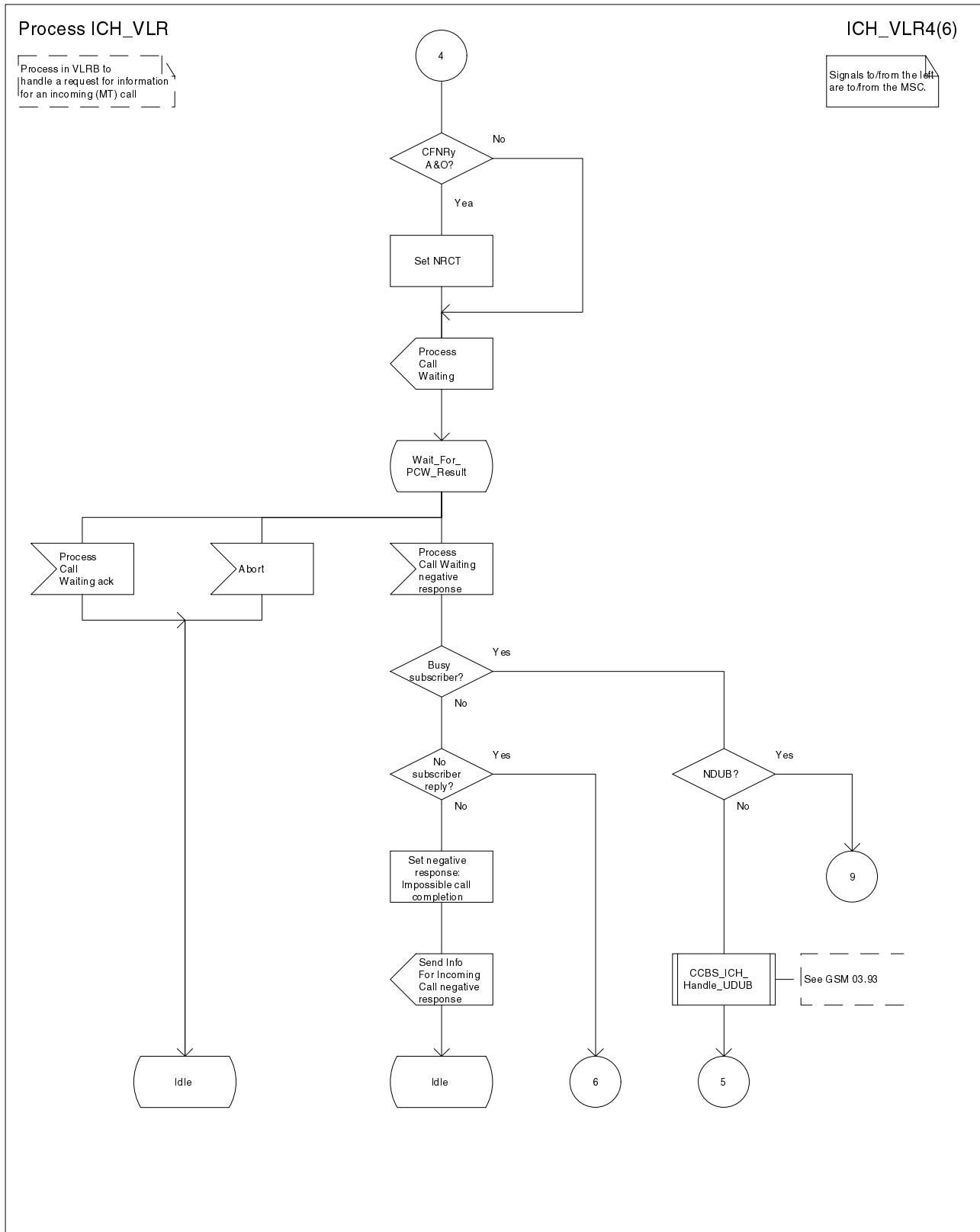

Figure 68d: Process ICH_VLR (sheet 4)

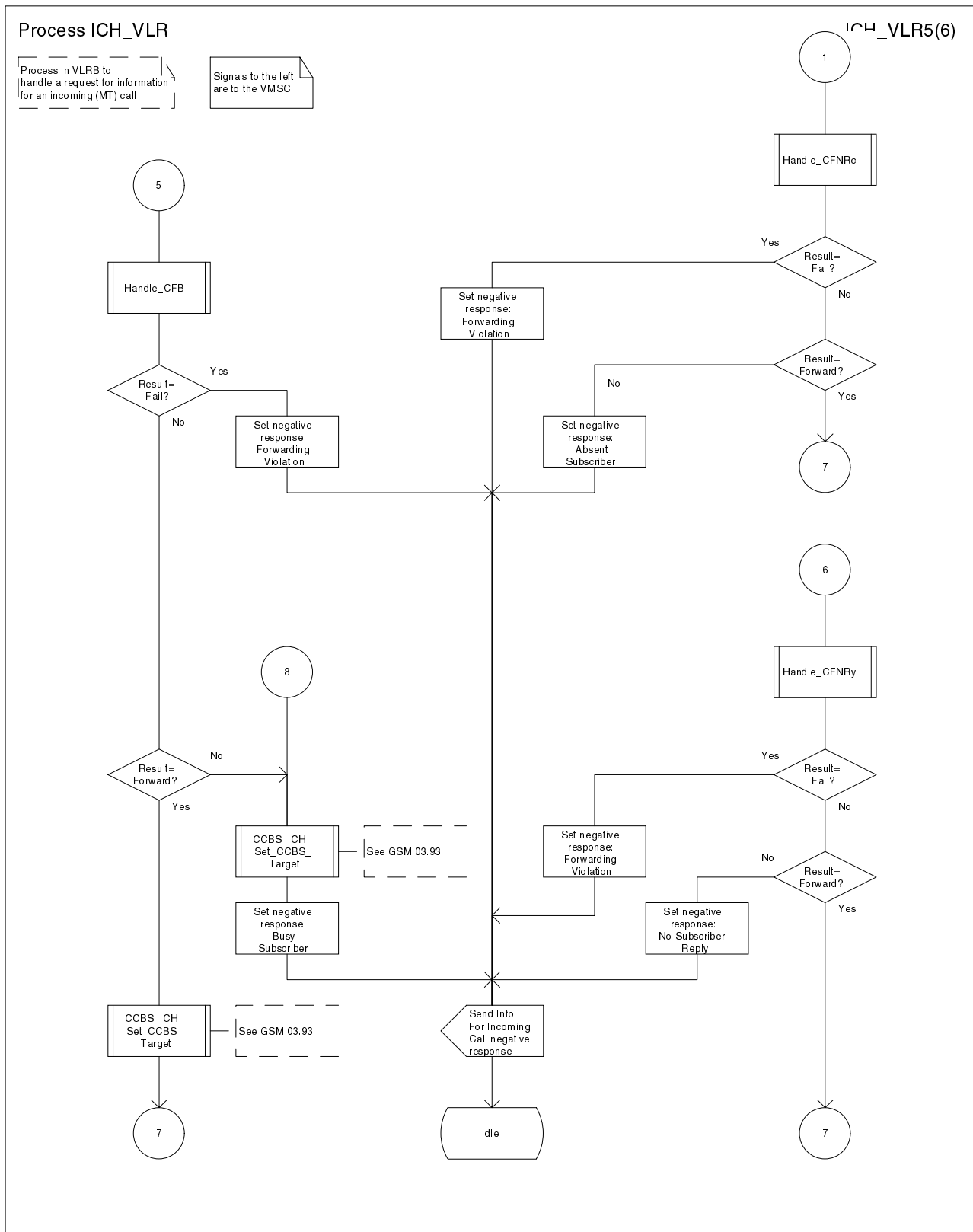

Figure 68e: Process ICH_VLR (sheet 5)

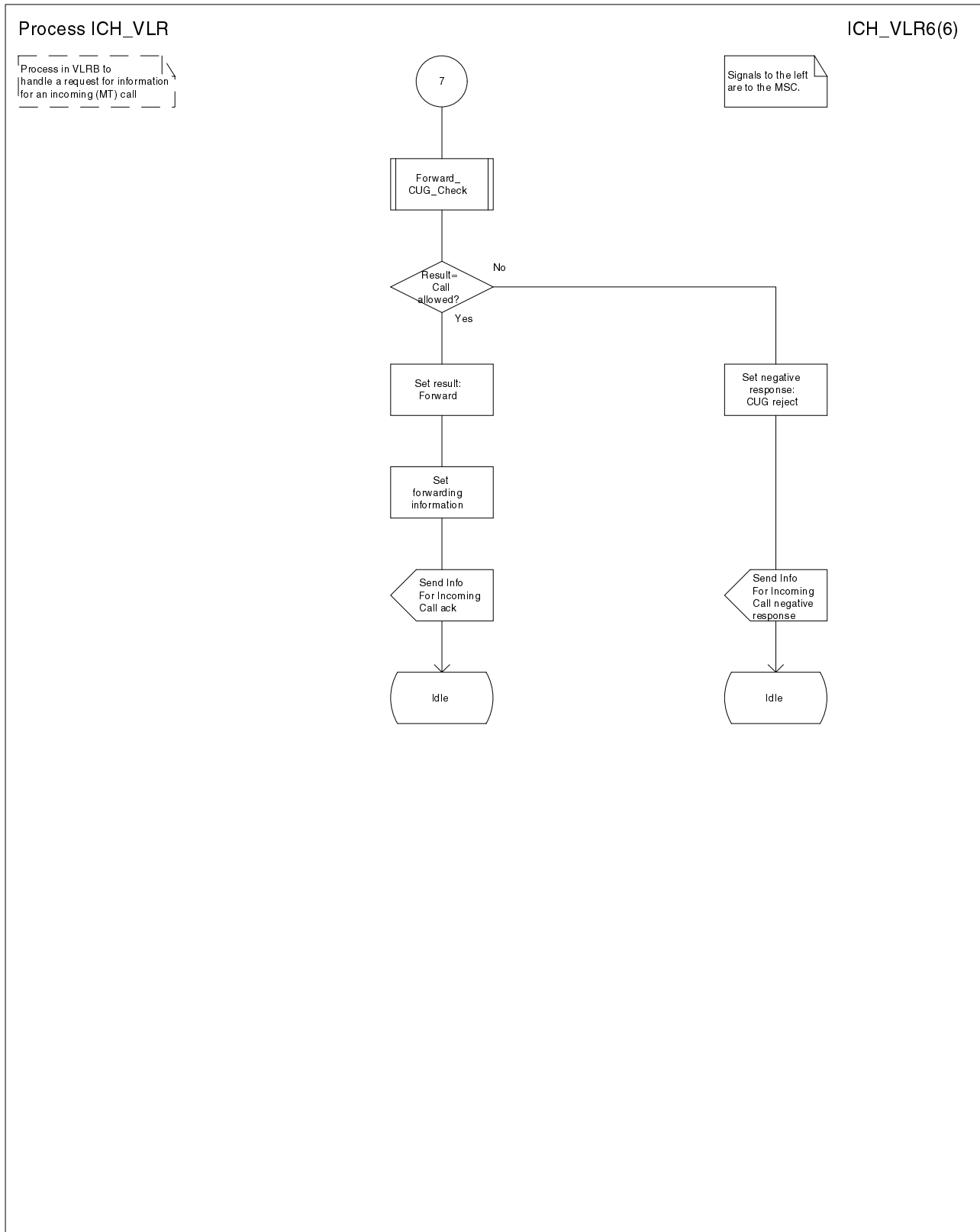

Figure 68f: Process ICH_VLR (sheet 6)

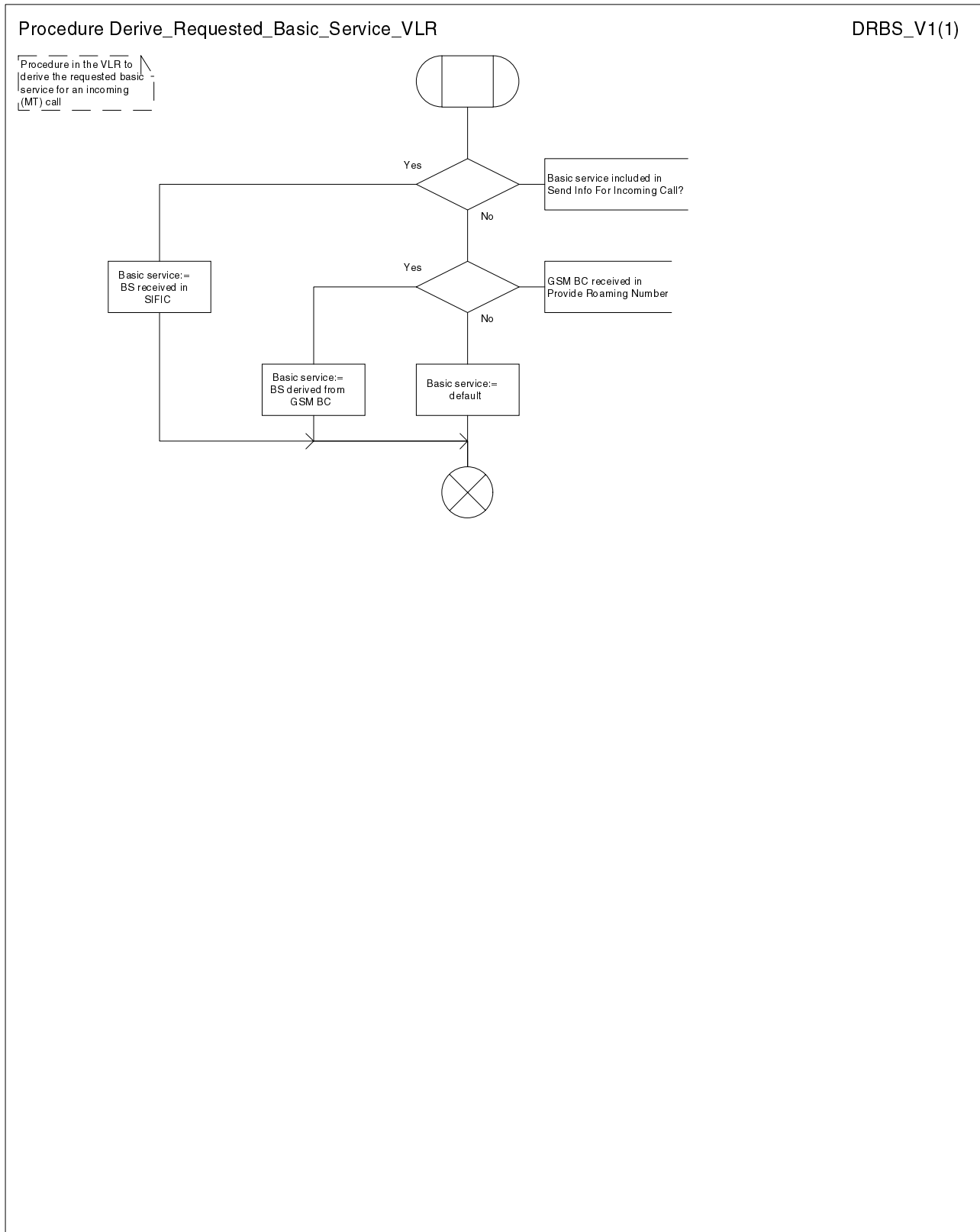

Figure 69: Procedure Derive_Requested_Basic_Service_VLR

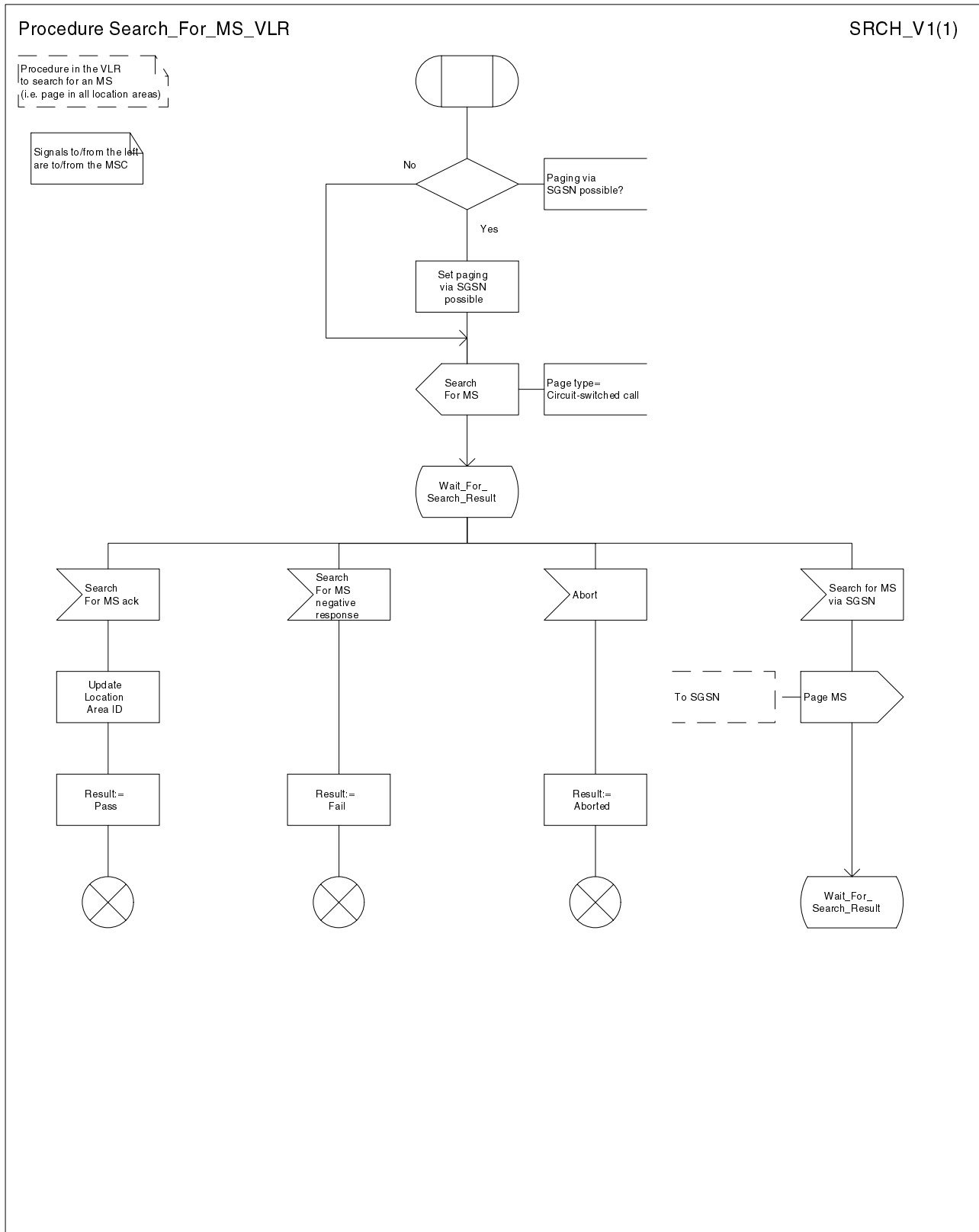

Figure 70: Procedure Search_For_MS_VLR

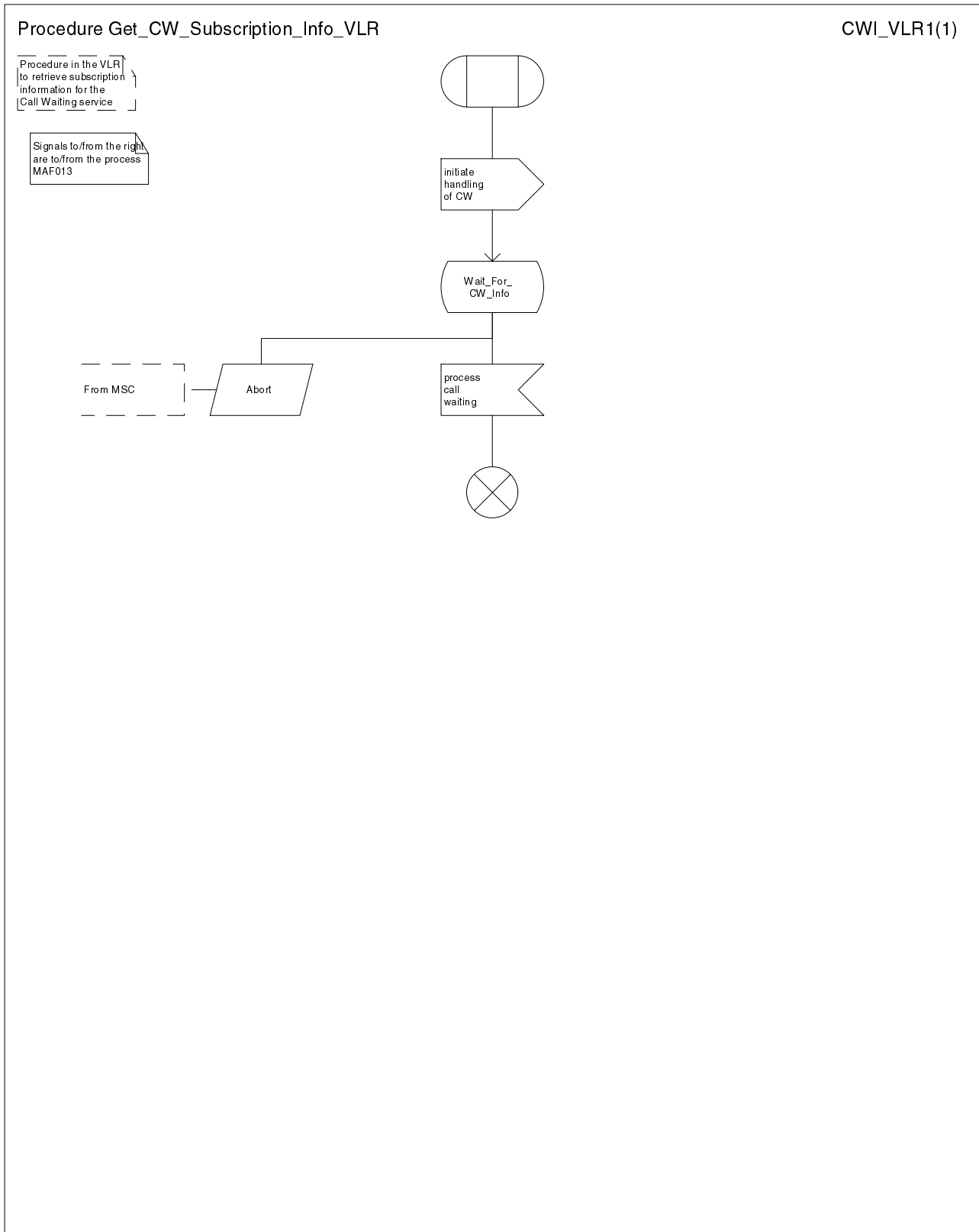

Figure 71: Procedure Get_CW_Subscription_Info_VLR

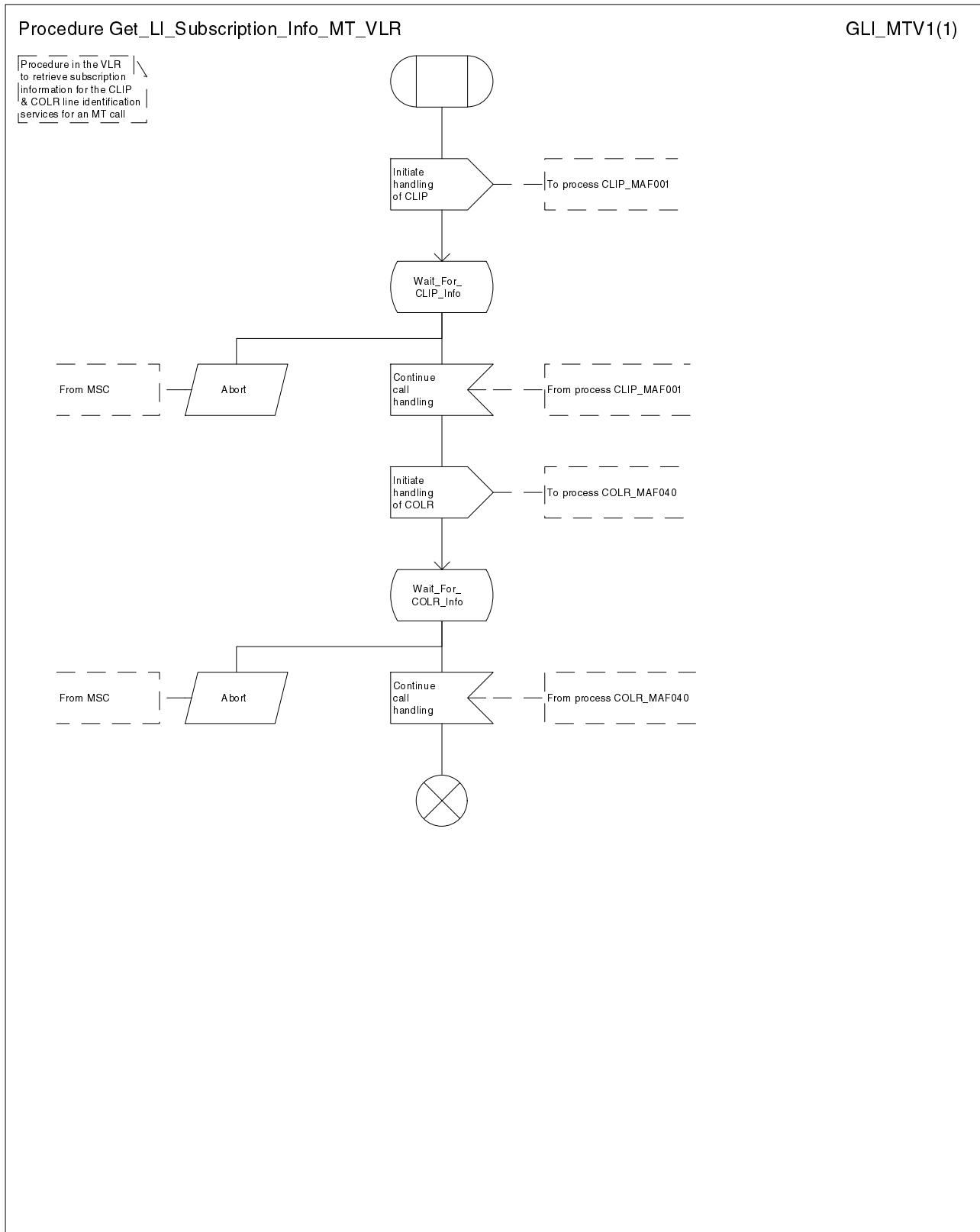

Figure 72: Procedure Get_LI_Subscription_Info_MT_VLR

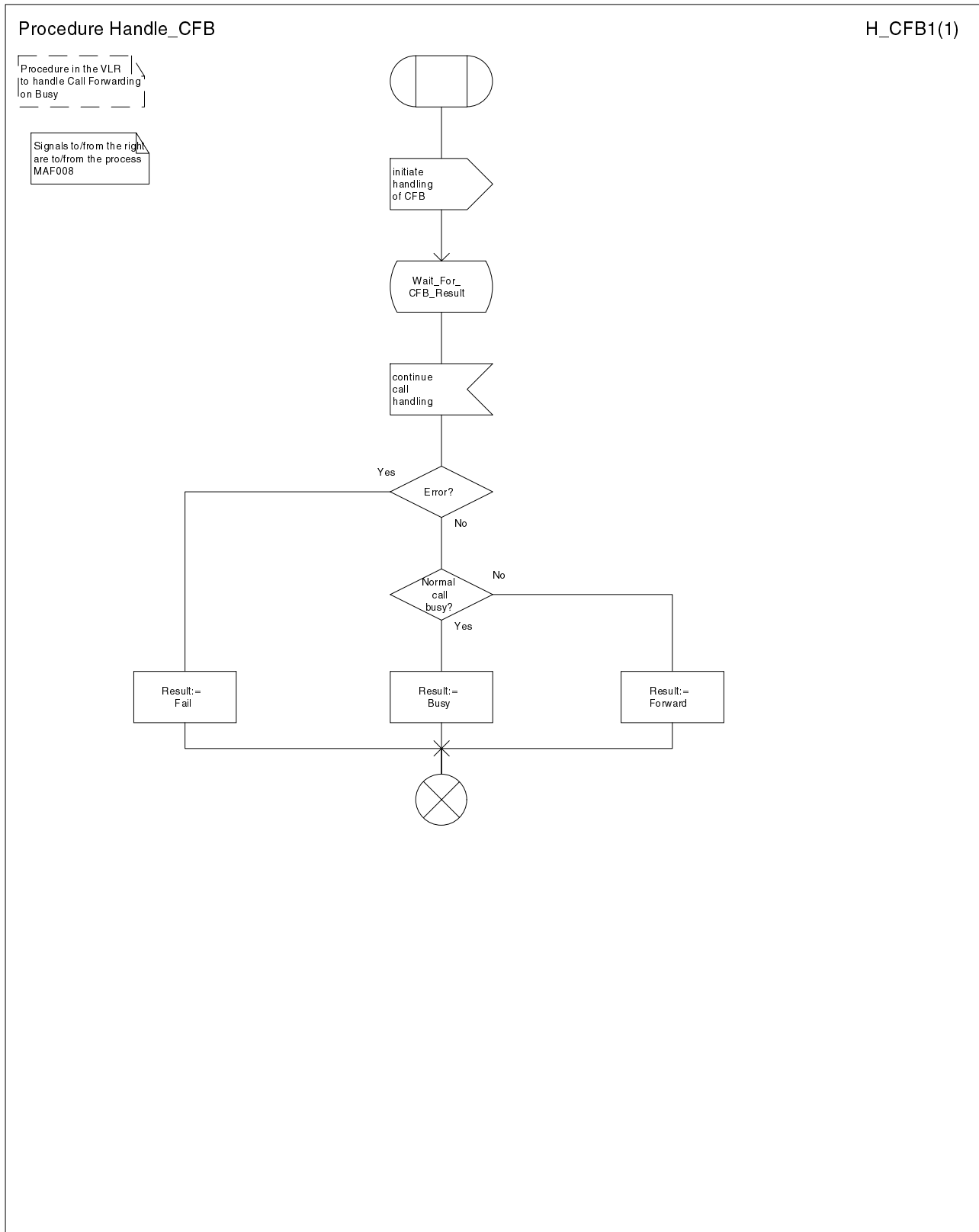

Figure 73: Procedure Handle_CFB

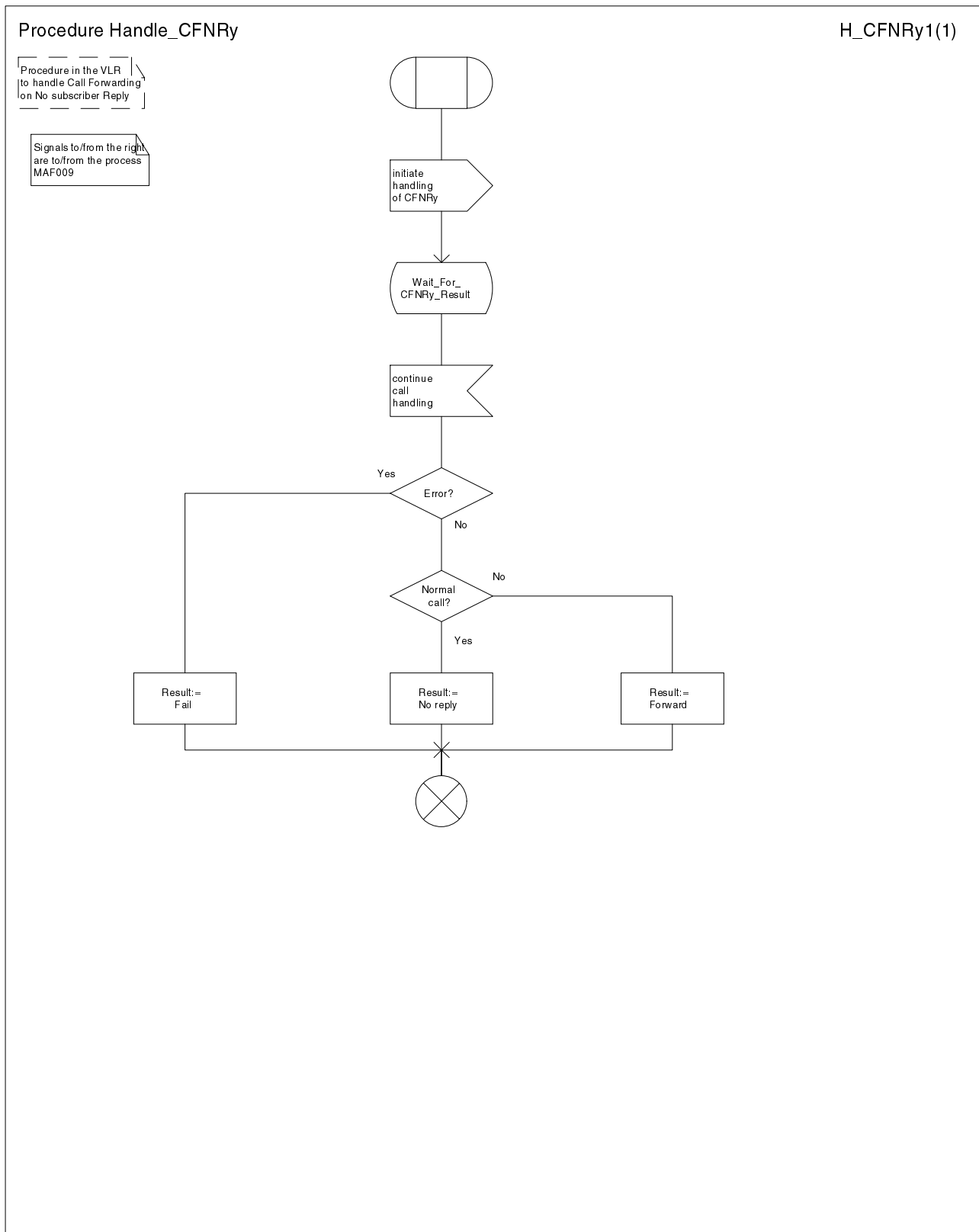

Figure 74: Procedure Handle_CFNry

8 Contents of messages

This clause specifies the content of each message shown in clauses 5 & 7, except for the following messages, which are not specific to call handling:

On the D interface (VLR-HLR):

- Abort;
- Activate Trace Mode
- Insert Subscriber Data
- Send Authentication Info;
- Send Authentication Info ack;
- Send Authentication Info negative response;

In the tables which follow, information elements are shown as mandatory (M), conditional © or optional (O). A mandatory information element shall always be present. A conditional information element shall be present if certain conditions are fulfilled; if those conditions are not fulfilled it shall be absent. An optional element may be present or absent, at the discretion of the application at the sending entity.

8.1 Messages on the B interface (MSC-VLR)

8.1.1 Abort

The following information element is required:

Information element name	Required	Description
Abort reason	M	Indicates the reason for the procedure being aborted.

8.1.2 Authenticate

The following information elements are required:

Information element name	Required	Description
RAND	M	Random number challenge to be sent to the MS (GSM 03.20 [3])
CKSN	M	Cipher key sequence number to be sent to the MS (GSM 03.20 [3])

8.1.3 Authenticate ack

The following information element is required:

Information element name	Required	Description
SRES	M	Signature result returned by the MS (GSM 03.20 [3])

8.1.4 Check IMEI

This message contains no information elements.

8.1.5 Check IMEI ack

The following information element is required:

Information element name	Required	Description
Equipment status	M	Indicates whether the ME is black-listed, grey-listed or white-listed

8.1.6 Check IMEI negative response

The negative response information element can take the following values:

- System failure;
- Unknown equipment.

8.1.7 Complete Call

The following information elements are required:

Information element name	Required	Description
MSISDN	C	MSISDN of the MS for which the Complete Call is sent. Shall be present for an ordinary MO call, for an MT call and for an emergency call when the MS is registered in the VLR; otherwise shall be absent.
IMEI	C	IMEI of the mobile for which the Complete Call is sent. Shall be present for an emergency call when the mobile is identified only by its IMEI; otherwise shall be absent.
Category	C	Category of the MS for which the Complete Call is sent. Shall be present for an ordinary MO call and for an emergency call when the MS is registered in the VLR; otherwise shall be absent.
GSM bearer capability	C	Shall be present for an MT call if it was received in the Provide Roaming Number; otherwise shall be absent.
ISDN bearer capability	C	Shall be present for an MT call if it was received in the Provide Roaming Number; otherwise shall be absent.
ISDN low layer compatibility	C	Shall be present for an MT call if it was received in the Provide Roaming Number; otherwise shall be absent.
ISDN high layer compatibility	C	Shall be present for an MT call if it was received in the Provide Roaming Number; otherwise shall be absent.
CLIP provision	C	Indicates that CLIP is provisioned. Shall be present for an MT call if CLIP is provisioned; otherwise shall be absent.
CLIR override provision	C	Indicates that the CLIR override subscription option of CLIP is provisioned. Shall be present for an MT call if CLIP is provisioned with the CLIR override subscription option and the MS is registered in the HPLMN country; otherwise shall be absent.
CLIR provision	C	Indicates that CLIR is provisioned. Shall be present for an MO call if CLIR is provisioned; otherwise shall be absent.
CLIR mode	C	Indicates the mode in which CLIR is provisioned: permanent, temporary (default presentation allowed) or temporary (default presentation restricted). Shall be present for an MO call if CLIR is provisioned; otherwise shall be absent.
COLP provision	C	Indicates that COLP is provisioned. Shall be present for an MO call if COLP is provisioned; otherwise shall be absent.
COLR override provision	C	Indicates that the COLR override subscription option of COLP is provisioned. Shall be present for an MO call if COLP is provisioned with the COLR override subscription option and the MS is registered in the HPLMN country; otherwise shall be absent.
COLR provision	C	Indicates that COLR is provisioned. Shall be present for an MT call if COLR is provisioned; otherwise shall be absent.
No Reply Condition Timer	C	Value of timer to be used to determine the No subscriber reply condition. Shall be present for an MT call if the Call Forwarding on No Reply service is active and operative; otherwise shall be absent.
CUG index	C	For the definition of this IE, see GSM 03.85 [13]. May be present (as a network operator option) for an ordinary MO call if the call is a CUG call; shall be present for an MT call if the call is a CUG call; otherwise shall be absent.
		(continued)

The following information elements are required (concluded):

Information element name	Required	Description
CUG interlock	C	For the definition of this IE, see GSM 03.85 [13]. Shall be present for an ordinary MO call if the call is a CUG call; otherwise shall be absent.
CUG outgoing access	C	For the definition of this IE, see GSM 03.85 [13]. Shall be present for an ordinary MO call if the call is a CUG call with outgoing access; otherwise shall be absent.
Advice of Charge provision	C	Indicates whether Advice of Charge (Information) or Advice of Charge (Charging) is provisioned. Shall be present for an ordinary MO call or an MT call if Advice of Charge is provisioned; otherwise shall be absent.
Alerting Pattern	C	Shall be present for an MT call if it was received in the Provide Roaming Number and if the feature is supported by the MSC/VLR; otherwise shall be absent.
<u>NAEA preferred Carrier Id</u>	O	The preferred carrier identity identifying the carrier to be used to route the interexchange call if the call requires routing via an interexchange carrier. This parameter may be included at the discretion of the VLR operator.

8.1.8 Complete Call ack

This message contains no information elements.

8.1.9 Complete Call negative response

The negative response information element can take the following values:

- Absent subscriber;
- Busy subscriber;
- No subscriber reply;
- Radio congestion.

8.1.10 Forward New TMSI

The following information element is required:

Information element name	Required	Description
TMSI	M	TMSI to be sent to the MS.

8.1.11 Forward New TMSI ack

This message contains no information elements.

8.1.12 Forward New TMSI negative response

The negative response information element can take the following value:

- TMSI reallocation failure.

8.1.13 Obtain Subscriber Info

The following information elements are required:

Information element name	Required	Description
IMSI	M	IMSI of the MS for which information is required.
Subscriber state requested	C	Indicates that the VLR requires state information for the MS. Shall be present if state information is required; otherwise shall be absent.

8.1.14 Obtain Subscriber Info ack

The following information elements are required:

Information element name	Required	Description
Subscriber state	C	Indicates whether the MS is busy (i.e. engaged on a circuit-switched call) or assumed idle. Shall be present if the VLR requested state information; otherwise shall be absent.

8.1.15 Page MS

The following information elements are required:

Information element name	Required	Description
IMSI	M	IMSI of the MS to be paged.
Location area ID	M	Location area in which the MS is to be paged.
Page type	M	Indicates whether the paging is for a circuit-switched call, MT SMS delivery or SS activity
Paging via SGSN possible	C	Indicates that paging via the SGSN is possible. Shall be present if the VLR determines that the MS can be paged via the SGSN; otherwise shall be absent.
TMSI	O	TMSI to be broadcast to identify the MS.

8.1.16 Page MS negative response

The negative response information element can take the following values:

- Absent subscriber;
- Busy subscriber (More calls possible);
- Busy subscriber (NDUB);
- System failure;
- Unknown location area ID.

The Page MS negative response Busy subscriber (More calls possible) also indicates the basic service which applies for the established call.

8.1.17 Page MS via SGSN

The following information elements are required:

Information element name	Required	Description
IMSI	M	IMSI of the MS to be paged.
EMLPP priority	O	Circuit-switched paging priority.
TMSI	O	TMSI to be broadcast to identify the MS.
Channel type	O	Type of channel required for the call.

8.1.18 Process Access Request

The following information elements are required:

Information element name	Required	Description
CM service type	M	Indicates the type of access required: normal MO call, emergency call or page response. Other values (short message service and SS request) defined for this IE are not considered in the present document.
Access connection status	M	Indicates whether or not the connection to the MS is ciphered and whether or not it is authenticated.
Current location area ID	M	Identity of the location area from which the access request was received.
Serving cell ID	M	Identity of the cell in use by the served subscriber.
IMSI	C	IMSI of the MS requesting the access. For normal MO call or page response, one of IMSI or TMSI shall be present. For emergency call, one of IMSI, TMSI or IMEI shall be present.
TMSI	C	TMSI of the MS requesting the access. For normal MO call or page response, one of IMSI or TMSI shall be present. For emergency call, one of IMSI, TMSI or IMEI shall be present.
IMEI	C	IMEI of the MS requesting the access. For normal MO call or page response, one of IMSI or TMSI shall be present. For emergency call, one of IMSI, TMSI or IMEI shall be present.
CKSN	C	Cipher key sequence number of the MS requesting the access. Shall be present if TMSI is present; otherwise shall be absent.

8.1.19 Process Access Request ack

The following information elements are required:

Information element name	Required	Description
IMSI	C	IMSI of the MS requesting the access. For normal MO call or page response, shall be present. For emergency call, one of IMSI or IMEI shall be present.
IMEI	C	IMEI of the MS requesting the access. For normal MO call or page response, shall be absent. For emergency call, one of IMSI or IMEI shall be present.
MSISDN	O	MSISDN of the MS requesting the access.

8.1.20 Process Access Request negative response

The negative response information element can take the following values:

- Roaming not allowed;
- System failure;
- Unidentified subscriber;
- Illegal equipment;
- Illegal subscriber.

8.1.21 Process Call Waiting

The following information elements are required:

Information element name	Required	Description
MSISDN	M	MSISDN of the MS for which the Process Call Waiting is sent.
GSM bearer capability	C	Shall be present if it was received in the Provide Roaming Number for the waiting call; otherwise shall be absent.
ISDN bearer capability	C	Shall be present if it was received in the Provide Roaming Number for the waiting call; otherwise shall be absent.
ISDN low layer compatibility	C	Shall be present if it was received in the Provide Roaming Number for the waiting call; otherwise shall be absent.
ISDN high layer compatibility	C	Shall be present if it was received in the Provide Roaming Number for the waiting call; otherwise shall be absent.
CLIP provision	C	Indicates that CLIP is provisioned. Shall be present if CLIP is provisioned; otherwise shall be absent.
CLIR override provision	C	Indicates that the CLIR override subscription option of CLIP is provisioned. Shall be present if CLIP is provisioned with the CLIR override subscription option and the MS is registered in the HPLMN country; otherwise shall be absent.
COLR provision	C	Indicates that COLR is provisioned. Shall be present if COLR is provisioned; otherwise shall be absent.
No Reply Condition Timer	C	Value of timer to be used to determine the No subscriber reply condition. Shall be present if the Call Forwarding on No Reply service is active and operative; otherwise shall be absent.
CUG index	C	For the definition of this IE, see GSM 03.85 [13]. Shall be present if the waiting call is a CUG call; otherwise shall be absent.
Advice of Charge provision	C	Indicates whether Advice of Charge (Information) or Advice of Charge (Charging) is provisioned. Shall be present if Advice of Charge is provisioned; otherwise shall be absent.

8.1.22 Process Call Waiting ack

This message contains no information elements.

8.1.23 Process Call Waiting negative response

The negative response information element can take the following values:

- Busy subscriber (UDUB);
- Busy subscriber (NDUB);
- No subscriber reply.

8.1.24 Provide IMEI

This message contains no information elements.

8.1.25 Provide IMEI ack

The following information element is required:

Information element name	Required	Description
IMEI	M	IMEI of the ME involved in the access request.

8.1.26 Provide IMSI

This message contains no information elements.

8.1.27 Provide IMSI ack

The following information element is required:

Information element name	Required	Description
IMSI	M	IMSI of the MS involved in the access request.

8.1.28 Search For MS

The following information elements are required:

Information element name	Required	Description
IMSI	M	IMSI of the MS to be paged in all location areas.
Page type	M	Indicates whether the paging is for a circuit-switched call, MT SMS delivery or SS activity
Paging via SGSN possible	C	Indicates that paging via the SGSN is possible. Shall be present if the VLR determines that the MS can be paged via the SGSN; otherwise shall be absent.
TMSI	O	TMSI to be broadcast to identify the MS.

8.1.29 Search For MS ack

The following information element is required:

Information element name	Required	Description
Location area ID	M	Location area in which the MS responded to the page.

8.1.30 Search For MS negative response

The negative response information element can take the following values:

- Absent subscriber;
- Busy subscriber (More calls possible);
- Busy subscriber (NDUB);
- System failure.

The Search For MS negative response Busy subscriber (More calls possible) also indicates the basic service which applies for the established call.

8.1.31 Search for MS via SGSN

The following information elements are required:

Information element name	Required	Description
IMSI	M	IMSI of the MS to be paged.
EMLPP priority	O	Circuit-switched paging priority.
TMSI	O	TMSI to be broadcast to identify the MS.
Channel type	O	Type of channel required for the call.

8.1.32 Send Info For Incoming Call

The following information elements are required:

Information element name	Required	Description
MSRN	M	Mobile Station Roaming Number received in the IAM.
Bearer service	C	GSM bearer service required for the MT call. Shall be present if the MSC was able to derive a GSM bearer service from ISDN BC/LC/HLC information received in the IAM; otherwise shall be absent.
Teleservice	C	GSM teleservice required for the MT call. Shall be present if the MSC was able to derive a GSM teleservice from ISDN BC/LC/HLC information received in the IAM; otherwise shall be absent.
Dialled number	C	Number dialled by the calling subscriber. Shall be present if it was received in the IAM; otherwise shall be absent.
Number of forwarding	C	Number of times the incoming call has already been forwarded. Shall be present if it was received in the IAM; otherwise shall be absent.
CUG interlock	C	For the definition of this IE, see GSM 03.85 [13]. Shall be present if it was received in the IAM; otherwise shall be absent.
CUG outgoing access	C	For the definition of this IE, see GSM 03.85 [13]. Shall be present if it was received in the IAM; otherwise shall be absent.

8.1.33 Send Info For Incoming Call ack

The following information elements are required:

Information element name	Required	Description
IMSI	M	IMSI of the B subscriber.
Forwarded-to number	M	E.164 number of the C subscriber.
Forwarding reason	M	Indication of why the call has been forwarded (on mobile subscriber busy, on mobile subscriber not reachable or on no subscriber reply).
Notification to calling party	M	Indication of whether the calling party is to be notified that the call has been forwarded.
Notification to forwarding party	C	Indication of whether the forwarding party is to be notified that the call has been forwarded. Shall be present if the call is to be forwarded on mobile subscriber busy or on no subscriber reply; otherwise shall be absent.
Forwarded-to subaddress	C	Subaddress of the C subscriber (see GSM 03.03 [2]). Shall be present if a forwarded-to subaddress is stored in the VLR in association with the forwarded-to number; otherwise shall be absent.
CUG interlock	C	For the definition of this IE, see GSM 03.85 [13]. Shall be present if the VLR has determined that the forwarded call is to be treated as a CUG call in accordance with the rules in GSM 03.85 [13], otherwise shall be absent.
CUG outgoing access	C	For the definition of this IE, see GSM 03.85 [13]. Shall be present if the VLR has determined that the forwarded call is to be treated as a CUG call with outgoing access in accordance with the rules in GSM 03.85 [13], otherwise shall be absent.
<u>NAEA preferred Carrier Id</u>	O	The preferred carrier identity identifying the carrier to be used to route the interexchange call if the forwarded call requires routing via an interexchange carrier. This parameter may be included at the discretion of the VLR operator.

8.1.34 Send Info For Incoming Call negative response

The negative response information element can take the following values:

- Absent subscriber;
- Busy subscriber;
- CUG reject (Called party SS interaction violation);

- Forwarding violation;
- Impossible call completion;
- No subscriber reply;
- System failure;
- Unallocated roaming number;

8.1.35 Send Info For Outgoing Call

The following information elements are required:

Information element name	Required	Description
Called number	M	E.164 number of the call destination.
Bearer service	C	Bearer service required for the MO call, derived from the GSM bearer capability information received in the setup request from the MS. One of bearer service or teleservice shall be present.
Teleservice	C	Teleservice required for the MO call, derived from the GSM bearer capability information received in the setup request from the MS or from the emergency setup request from the MS. One of bearer service or teleservice shall be present.
CUG index	C	For the definition of this IE, see GSM 03.85 [13]. Shall be present if it was received in the setup request from the MS.
Suppress preferential CUG	C	For the definition of this IE, see GSM 03.85 [13]. Shall be present if it was received in the setup request from the MS.
Suppress CUG outgoing access	C	For the definition of this IE, see GSM 03.85 [13]. Shall be present if it was received in the setup request from the MS.

8.1.36 Send Info For Outgoing Call negative response

The negative response information element can take the following values:

- Bearer service not provisioned;
- Call barred (Operator determined barring);
- Call barred (Supplementary service barring);
- CUG reject (Inconsistent access information – index incompatible with basic service);
- CUG reject (Inconsistent access information – no CUG selected);
- CUG reject (Outgoing calls barred within the CUG);
- CUG reject (Unknown CUG index);
- Teleservice not provisioned.

8.1.37 Set ciphering mode

The following information element is required:

Information element name	Required	Description
Ciphering mode	M	Indicates whether ciphering of the radio connection is required, and if so which ciphering algorithm is to be used.
Kc	C	Ciphering key to be used if ciphering of the radio connection is required. Shall be present if the ciphering mode indicates that ciphering of the radio connection is required, otherwise shall be absent.

8.1.38 Trace subscriber activity

The following information elements are required:

Information element name	Required	Description
Trace reference	M	Reference number to be included with tracing reports which the VMSC sends to the OMC
Trace type	M	For the definition of this IE, see GSM 12.08 [23]

8.1.39 Use existing TMSI

This message contains no information elements.

8.2 Messages on the C interface (MSC-HLR)

8.2.1 Send Routeing Info

The following information elements are required:

Information element name	Required	Description
MSISDN	M	MSISDN of the B subscriber (see GSM 03.03 [2]).
Alerting Pattern	C	Shall be present if received in a Connect operation from the gsmSCF; otherwise shall be absent.
CUG interlock	C	For the definition of this IE, see GSM 03.85 [13]. Shall be present if the GMSC received it in the IAM, otherwise shall be absent.
CUG outgoing access	C	For the definition of this IE, see GSM 03.85 [13]. Shall be present if the GMSC received it in the IAM, otherwise shall be absent.
Number of forwarding	C	Number of times the incoming call has already been forwarded. Shall be present if it was received in the IAM; otherwise shall be absent.
ISDN BC	C	ISDN bearer capability. Shall be present if the GMSC received it in the IAM, otherwise shall be absent.
ISDN LLC	C	ISDN lower layer compatibility. Shall be present if the GMSC received it in the IAM, otherwise shall be absent.
ISDN HLC	C	ISDN higher layer compatibility. Shall be present if the GMSC received it in the IAM, otherwise shall be absent.

8.2.2 Send Routeing Info ack

The following information elements are required:

Information element name	Required	Description
IMSI	M	IMSI of the B subscriber (see GSM 03.03 [2]).
Roaming number	C	E.164 number required to route the call to VMSCB (see GSM 03.03 [2]). Shall be present if the HLR received it in the Provide Roaming Number ack, otherwise shall be absent.
Forwarded-to number	C	E.164 number of the C subscriber. Shall be present if the HLR has determined that the call is to be forwarded, otherwise shall be absent.
Forwarded-to subaddress	C	Subaddress of the C subscriber (see GSM 03.03 [2]). Shall be present if the HLR has determined that the call is to be forwarded and a forwarded-to subaddress is stored in the HLR in association with the forwarded-to number, otherwise shall be absent.
Notification to calling party	C	Indication of whether the calling party is to be notified that the call has been forwarded. Shall be present if the HLR has determined that the call is to be forwarded, otherwise shall be absent.
Forwarding reason	C	Indication of why the call has been forwarded (unconditionally or on mobile subscriber not reachable). Shall be present if the HLR has determined that the call is to be forwarded, otherwise shall be absent.
CUG interlock	C	For the definition of this IE, see GSM 03.85 [13]. Shall be present if the HLR has determined that the call is to be treated as a CUG call in accordance with the rules in GSM 03.85 [13], otherwise shall be absent.
CUG outgoing access	C	For the definition of this IE, see GSM 03.85 [13]. Shall be present if the HLR has determined that the call is to be treated as a CUG call with outgoing access in accordance with the rules in GSM 03.85 [13], otherwise shall be absent.
<u>NAEA preferred Carrier Id</u>	O	The preferred carrier identity identifying the carrier to be used to route the interexchange call if the call requires routing via an interexchange carrier. This parameter may be included at the discretion of the HLR operator.

8.2.3 Send Routeing Info negative response

The negative response information element can take the following values:

- Absent subscriber;
- Bearer service not provisioned;
- Call barred (Operator determined barring);
- Call barred (Supplementary service barring);
- CUG reject (Called party SS interaction violation);

- CUG reject (Incoming calls barred within CUG);
- CUG reject (Requested basic service violates CUG constraints);
- CUG reject (Subscriber not member of CUG);
- Data missing;
- Facility not supported;
- Forwarding violation
- Number changed;
- System Failure;
- Teleservice not provisioned;
- Unexpected data value;
- Unknown subscriber.

8.3 Messages on the D interface (VLR-HLR)

8.3.1 Provide Roaming Number

The following information elements are required:

Information element name	Required	Description
IMSI	M	IMSI of the B subscriber (see GSM 03.03 [2]).
MSC number	M	E.164 number which identifies VMSCB (see GSM 03.03 [2]).
MSISDN	O	E.164 number which identifies the B subscriber. May be present if the HLR requires it to be included in the call data record.
LMSI	C	Local Mobile Subscriber Identity. Shall be present if the LMSI was sent to HLRB at location updating.
GSM bearer capability	C	Information to define the GSM bearer capability required for the call. For alternate speech/fax, alternate speech/data or speech followed by data calls this information element shall contain two GSM bearer capabilities, as specified in GSM 04.08. May be present if the HLR can determine the required GSM bearer capability from ISDN compatibility information received in the Send Routeing Info message, or from the MSISDN if a multi-numbering scheme is used; otherwise shall be absent. If the ISDN BC and ISDN LLC IEs are present, the GSM bearer capability IE shall be absent.
ISDN BC	C	ISDN bearer capability. May be present if the HLR received it in the Send Routeing Info message, otherwise shall be absent. If the GSM bearer capability IE is present, the ISDN BC IE shall be absent.
ISDN LLC	C	ISDN lower layer compatibility. May be present if the HLR received it in the Send Routeing Info message, otherwise shall be absent. If the GSM bearer capability IE is present, the ISDN LLC IE shall be absent.
ISDN HLC	C	ISDN higher layer compatibility. Shall be present if the HLR received it in the Send Routeing Info message, otherwise shall be absent.
Alerting Pattern	C	Shall be present if the HLR has determined an alerting category or an alerting level for the MT call configuration; otherwise shall be absent.

8.3.2 Provide Roaming Number ack

The following information element is required:

Information element name	Required	Description
Roaming number	M	E.164 number required to route the call to VMSCB (see GSM 03.03 [2]).

8.3.3 Provide Roaming Number negative response

The negative response information element can take the following values:

- Absent subscriber;
- Data missing;
- Facility not supported;
- No roaming number available;
- OR not allowed;
- Unexpected data value.

8.3.4 Provide Subscriber Info

The following information elements are required:

Information element name	Required	Description
IMSI	M	IMSI of the subscriber for whom information is requested (see GSM 03.03 [2]).
LMSI	C	Local Mobile Subscriber Identity. Shall be present if the LMSI was sent to the HLR at location updating.
Requested information	M	Indicates whether the HLR requires location information, subscriber state or both location information and subscriber state.

8.3.5 Provide Subscriber Info ack

The following information elements are required:

Information element name	Required	Description
Location information	C	Information to define the location of the MS: see definition in subclause 8.3.5.1. Shall be present if location information was requested and is available; otherwise shall be absent.
Subscriber state	C	Indicates whether the MS is busy (i.e. engaged on a circuit-switched call), network determined not reachable (IMSI detached or roaming in a prohibited location area) or assumed idle. Shall be present if subscriber state was requested; otherwise shall be absent.

8.3.5.1 Location information

The compound information element Location information consists of the following subordinate information elements:

Information element name	Required	Description
Location number	C	For a definition of this information element, see ETS 300 356-1 [24]. Shall be present if the VLR can derive it from the stored cell global identity or location area identity; otherwise shall be absent. The mapping from cell ID and location area to location number is network-specific and outside the scope of the GSM standard.
Cell ID	C	Cell global identity of the cell in which the MS is currently in radio contact or in which the MS was last in radio contact. Shall be present if the subscriber record is marked as confirmed by radio contact; otherwise shall be absent.
Geographical information	C	For a definition of this information element, see GSM 03.32 (Universal Geographical Area Description). Shall be present if the VLR can derive it from the stored cell global identity or location area identity; otherwise shall be absent.
VLR number	O	E.164 number which identifies the VLR (see GSM 03.03 [2]). If the HLR receives it from the VLR it shall ignore it.
Age of location information	C	Measured in minutes. Shall be present if available in the MSC/VLR; otherwise shall be absent.

8.3.6 Provide Subscriber Info negative response

The negative response information element can take the following values:

- Data missing;
- System failure;
- Unexpected data value.

8.3.7 Restore Data

The following information elements are required:

Information element name	Required	Description
IMSI	M	IMSI of the subscriber for whom data are to be restored (see GSM 03.03 [2]).
LMSI	O	LMSI of the subscriber for whom data are to be restored (see GSM 03.03 [2]). May be included if required by the requesting VLR.

8.3.8 Restore Data ack

The following information elements are required:

Information element name	Required	Description
HLR number	M	E.164 number which identifies the HLR (see GSM 03.03 [2]).
MS not reachable flag	C	Indicates whether the VLR should notify the HLR when the MS next establishes radio contact. Shall be present if the corresponding indicator is set in the HLR record for the subscriber; otherwise shall be absent.

8.3.9 Restore Data negative response

The negative response information element can take the following values:

- System failure;
- Unknown subscriber.

8.4 Messages on the F interface (MSC-EIR)

8.4.1 Check IMEI

The following information element is required:

Information element name	Required	Description
IMEI	M	IMEI of the ME whose status is to be checked (see GSM 03.03 [2]).

8.4.2 Check IMEI ack

The following information element is required:

Information element name	Required	Description
Equipment status	M	Indicates whether the ME is black-listed, grey-listed or white-listed

8.4.3 Check IMEI negative response

The negative response information element can take the following value:

- Unknown equipment.

8.5 Messages on the MSC internal interface

This interface can carry ISUP messages received from the process MT_GMSC or the process ICH_MSC and to be forwarded to a destination exchange, and ISUP messages received from the destination exchange and to be forwarded to the process MT_GMSC or the process ICH_MSC. In addition, it carries the following inter-process messages:

8.5.1 CF cancelled

This message contains no information elements.

8.5.2 Perform Call Forwarding

Information element name	Required	Description
Forwarded-to number	M	E.164 number of the C subscriber.

8.5.3 Perform Call Forwarding ack

Information element name	Required	Description
Forwarded-to number	M	E.164 number of the C subscriber. Note: this number may be different from the Forwarded-to number received in the Perform Call Forwarding, as a result of CAMEL handling.

8.5.4 Perform Call Forwarding negative response

The negative response information element can take the following value:

- Call forwarding failed.

8.6 Messages on the Gs interface

8.6.1 Page MS

The following information elements are required:

Information element name	Required	Description
IMSI	M	IMSI of the MS to be paged.
EMLPP priority	C	Circuit-switched paging priority. Shall be present if it was received in the Page MS via SGSN request or Search for MS via SGSN request; otherwise shall be absent.
TMSI	C	TMSI to be broadcast to identify the MS. Shall be present if it was received in the Page MS via SGSN request or Search for MS via SGSN request; otherwise shall be absent.
Location area identity	C	Location area identity of the location area where the mobile is registered, according to the subscriber data in the VLR. Shall be present if the VLR can supply it; otherwise shall be absent.
Channel type	C	Type of channel required for the call. Shall be present if it was received in the Page MS via SGSN request or Search for MS via SGSN request; otherwise shall be absent.

8.6.2 Send MS information

The following information elements are required:

Information element name	Required	Description
IMSI	M	IMSI of the MS for which information is required.
Information requested	M	Information required for the specified MS.

8.6.3 Send MS information ack

The following information elements are required:

Information element name	Required	Description
IMSI	M	IMSI of the MS for which information is required.
Cell ID	M (note)	Cell ID of the cell in which the MS last established radio contact
Location information age	M (note)	Time in minutes since the MS last established a radio transaction

NOTE: Although they are optional in the protocol, these Ies are mandatory in this context.

8.6.4 Send MS information negative response

The negative response information element can take the following value:

- No response from SGSN

Annex A (informative): Handling of an IAM at an MSC

An MSC which receives an IAM from an originating exchange may react in three different ways:

- It acts as a transit exchange, i.e. it relays the IAM to a destination exchange determined by analysis of the called party address, and thereafter relays other telephony signalling between the originating and destination exchange until the connection is released. This behaviour is not specific to GSM;
- It acts as a terminating exchange, i.e. it attempts to connect the call to an MS currently registered in the service area of the MSC;
- It acts as a GMSC, i.e. it interrogates an HLR for information to route the call. If the HLR returns routing information, the MSC uses the routing information from the HLR to construct an IAM, which it sends to a destination exchange determined by analysis of the routing information from the HLR.

Sheet 1: when the MSC co-ordinating process has decided whether the MSC is to act as a terminating VMSC, a GMSC or a transit exchange, it forwards the IAM to an idle instance of the appropriate process.

Sheet 2: after the MSC co-ordinating process has sent an IAM to an instance of the process MT_GMSC or ICH_MSC, it acts as a transparent relay for messages received from the originating exchange and the process instance (denoted by "offspring"). After the MSC co-ordinating process has relayed a Release message, it returns to the idle state.

Sheet 2: after the MSC co-ordinating process has sent an IAM to a destination exchange, it acts as a transparent relay for messages received from the originating exchange and the destination exchange. After the MSC co-ordinating process has relayed a Release message, it returns to the idle state.

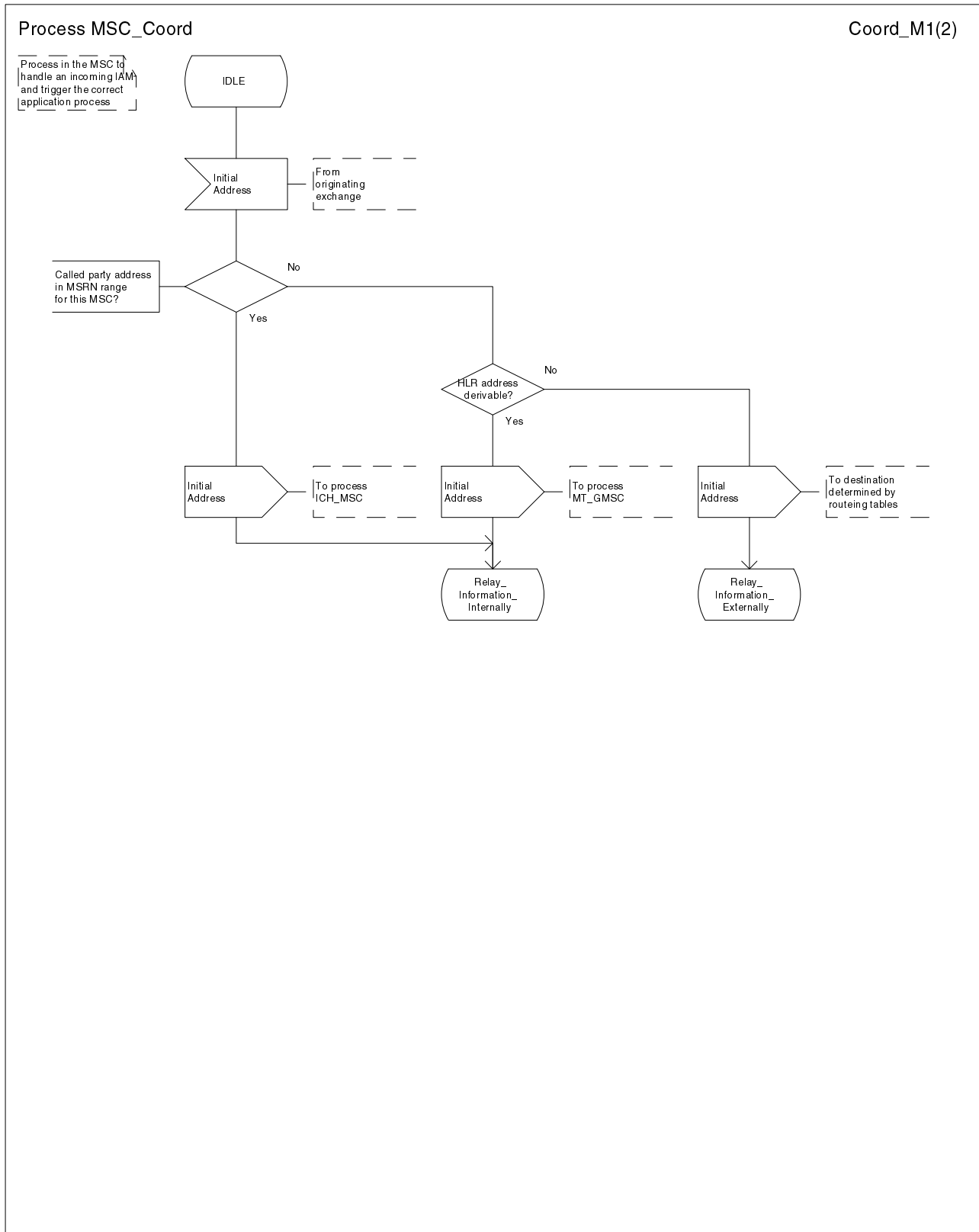

Figure 75a: Process MSC_Coord (sheet 1)

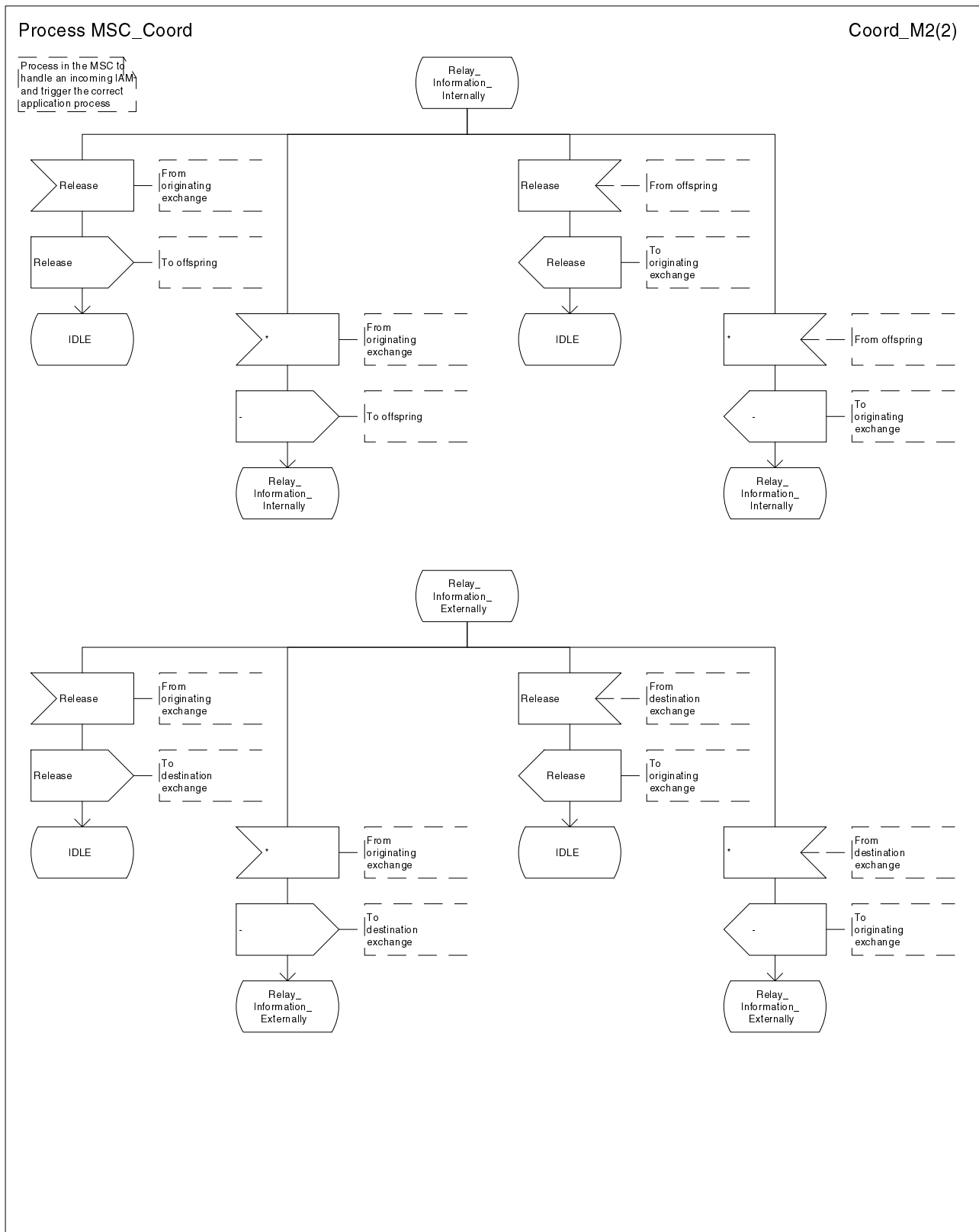

Figure 75b: Process MSC_Coord (sheet 2)

Annex B (informative): Change History

SPEC	SMG#	CR	PHASE	VERS	NEW_VERS	SUBJECT
03.18	s25	A019	R97	5.3.0	6.0.0	Network's Indication of Alerting
03.18	s26	A021	R97	6.0.0	6.1.0	Release by A party for forwarded calls and CAMEL
03.18	s27	A022r1	R97	6.1.0	6.2.0	Corrections and alignments for CAMEL Phase 2 & CCBS
6.1.0	s27	A024	R97	6.1.0	6.2.0	Provide Subscriber Info for GPRS subscribers
03.18	s27	A026	R97	6.1.0	6.2.0	Optionality of support for OR of basic mobile-to-mobile calls
03.18	s27	A027r1	R97	6.1.0	6.2.0	Suppression of alerting to originating MS in the case of early ACM
03.18	s27	A029	R97	6.1.0	6.2.0	Correction of handling for failure case of CCBS OG call handling
03.18	s28	A034	R97	6.2.0	6.3.0	Correction of the 03.18 SDLs for Reconnect in case for MTC
03.18	S29	A047	R97	6.3.0	6.4.0	Notification of Call Forwarding to the gsmSCF

History

Document history		
V6.1.0	August 1998	Publication
V6.2.0	November 1998	Publication
V6.3.0	April 1999	Publication
V6.4.0	July 1999	Publication