

TS 101 045 V6.0.0 (1999-04)

Technical Specification

**Digital cellular telecommunications system (Phase 2+);
Support of Optimal Routing (SOR);
Technical realisation
(GSM 03.79 version 6.0.0 Release 1997)**



GSM®
GLOBAL SYSTEM FOR
MOBILE COMMUNICATIONS

ETSI 

Reference

RTS/SMG-030379Q6 (9oc03003.PDF)

Keywords

Digital cellular telecommunications system,
Global System for Mobile communications (GSM)

ETSI

Postal address

F-06921 Sophia Antipolis Cedex - FRANCE

Office address

650 Route des Lucioles - Sophia Antipolis
Valbonne - FRANCE
Tel.: +33 4 92 94 42 00 Fax: +33 4 93 65 47 16
Siret N° 348 623 562 00017 - NAF 742 C
Association à but non lucratif enregistrée à la
Sous-Préfecture de Grasse (06) N° 7803/88

Internet

secretariat@etsi.fr
Individual copies of this ETSI deliverable
can be downloaded from
<http://www.etsi.org>
If you find errors in the present document, send your
comment to: editor@etsi.fr

Copyright Notification

No part may be reproduced except as authorized by written permission.
The copyright and the foregoing restriction extend to reproduction in all media.

© European Telecommunications Standards Institute 1999.
All rights reserved.

Contents

Intellectual Property Rights.....	5
Foreword	5
1 Scope.....	6
2 References.....	6
3 Definitions and abbreviations	7
3.1 Definitions	7
3.2 Abbreviations.....	7
4 Architecture.....	8
4.1 Optimal routing for basic mobile-to-mobile calls	8
4.2 Optimal routing for conditional call forwarding	10
5 Optimal routing for basic mobile-to-mobile calls: message flows.....	11
5.1 Successful outcome.....	11
5.2 Unsuccessful outcome.....	12
5.2.1 B subscriber address not recognised as belonging to a GSM PLMN.....	12
5.2.2 HLRB or VLRB does not support optimal routing.....	12
5.2.3 OR charging requirements contravened	12
6 Optimal routing for conditional call forwarding: message flows	13
6.1 Early call forwarding	13
6.1.1 Forwarding without interrogation of VLRB	13
6.1.1.1 Successful outcome	13
6.1.1.2 Unsuccessful outcome	14
6.1.2 Forwarding after interrogation of VLRB.....	14
6.1.2.1 Successful outcome	14
6.1.2.2 Unsuccessful outcome	15
6.2 Late call forwarding.....	16
6.2.1 Successful outcome	17
6.2.2 Unsuccessful outcome	17
6.2.2.1 GMSC does not support OR.....	17
6.2.2.2 HLRB does not support OR.....	17
6.2.2.3 VMSCB/VLRB does not support OR.....	17
6.2.2.4 OR charging requirements contravened.....	17
7 Interactions between optimal routing and supplementary services.....	18
7.1 Call forwarding.....	18
7.2 Closed User Group (CUG)	18
7.3 Advice of Charge	18
7.4 Call barring	18
7.5 Other supplementary services	19
8 Interactions between optimal routing and other network features	19
8.1 Operator determined barring.....	19
8.2 CAMEL	19
9 Functional requirements of entities performing optimal routing.....	20
9.1 Charging requirements for optimal routing	20
9.2 Functional behaviour of VMSCA	20
9.3 Functional behaviour of VLRA	20
9.4 Functional behaviour of GMSC.....	21
9.4.1 Procedure OR_Set_ORA_Parameters.....	21
9.4.2 Procedure OR_Handle_RCH	21
9.4.3 Procedure Route_Permitted.....	21
9.4.4 Procedure OR_Handle_SRI_Negative_Response.....	21
9.5 Functional behaviour of HLR	27
9.5.1 Procedure OR_HLR_CF.....	27

9.5.2 Procedure OR_HLR_Interrogate_VLR..... 27

9.6 Functional behaviour of VLRB..... 31

9.6.1 Functional behaviour of VLRB for provision of subscriber information 31

9.6.2 Functional behaviour of VLRB for roaming number allocation..... 31

9.6.3 Functional behaviour of VLRB when handling an incoming call..... 31

9.7 Functional behaviour of VMSCB 31

9.7.1 Procedure Handle_ORLFCF_VMSC 32

10 Contents of messages 33

10.1 Messages on the B interface (MSC-VLR) 33

10.1.1 Send Info For Outgoing Call 33

10.1.2 Send Info For Outgoing Call negative response 33

10.1.3 Send Info For Incoming Call..... 33

10.1.4 Send Info For Incoming Call ack 33

10.1.5 Send Info For Incoming Call negative response..... 33

10.1.6 Complete Call..... 34

10.1.7 Process Call Waiting 34

10.2 Messages on the C interface (MSC-HLR) 34

10.2.1 Send Routeing Info..... 34

10.2.2 Send Routeing Info ack 35

10.2.3 Send Routeing Info negative response 35

10.3 Messages on the D interface (VLR-HLR)..... 35

10.3.1 Provide Roaming Number 35

10.3.2 Provide Roaming Number ack 35

10.3.3 Provide Roaming Number negative response..... 35

10.3.4 Provide Subscriber Information 35

10.3.5 Provide Subscriber Information ack 36

10.4 Messages on the E interface (MSC-MSC) 36

10.4.1 Resume Call Handling..... 36

10.4.2 Resume Call Handling ack 36

10.4.3 Resume Call Handling negative response 36

Annex A (informative): Handling of an IAM at an MSC.....37

Annex B (informative): Change Request History38

History 39

Intellectual Property Rights

IPRs essential or potentially essential to the present document may have been declared to ETSI. The information pertaining to these essential IPRs, if any, is publicly available for **ETSI members and non-members**, and can be found in SR 000 314: "*Intellectual Property Rights (IPRs); Essential, or potentially Essential, IPRs notified to ETSI in respect of ETSI standards*", which is available **free of charge** from the ETSI Secretariat. Latest updates are available on the ETSI Web server (<http://www.etsi.org/ipr>).

Pursuant to the ETSI IPR Policy, no investigation, including IPR searches, has been carried out by ETSI. No guarantee can be given as to the existence of other IPRs not referenced in SR 000 314 (or the updates on the ETSI Web server) which are, or may be, or may become, essential to the present document.

Foreword

This Technical Specification (TS) has been produced by the Special Mobile Group (SMG).

The present document specifies the technical realisation of the first phase of the network feature Support of Optimal Routeing (SOR) within the digital cellular telecommunications system (Phase 2/Phase 2+).

The contents of the present document is subject to continuing work within SMG and may change following formal SMG approval. Should SMG modify the contents of the present document, it will be re-released with an identifying change of release date and an increase in version number as follows:

Version 6.x.y

where:

- 6 indicates Release 1997 of GSM Phase 2+
- x the second digit is incremented for all changes of substance, i.e. technical enhancements, corrections, updates, etc.
- y the third digit is incremented when editorial only changes have been incorporated in the specification.

1 Scope

The present document specifies the technical realisation of the first phase of the network feature Support of Optimal Routeing (SOR). The first phase of SOR provides:

- as a network operator option, a method to route a call from one mobile subscriber directly to another mobile subscriber who is in the same country as the calling mobile subscriber or in the called mobile subscriber's home country, without needing to connect the call via the HPLMN of the called subscriber, even though the called mobile subscriber has roamed outside his HPLMN;
- a method to forward calls when a called mobile subscriber who has roamed outside his home country is busy, or is not reachable, or does not reply, to a forwarded-to destination in the HPLMN country of the called subscriber or the VPLMN country of the called subscriber, without needing to connect the forwarded call via the VPLMN of the called subscriber;
- a method to combine the optimal routeing described in the first bullet point above with the optimal routeing described in the second bullet point above.

OR of a call is permitted only if all entities involved in handling the call support OR.

Other cases of optimal routeing (e.g. calls where the calling and called subscribers are in different countries, forwarding to a mobile subscriber or multiple forwarding) will be considered for inclusion in later phases.

2 References

The following documents contain provisions which, through reference in this text, constitute provisions of the present document.

- References are either specific (identified by date of publication, edition number, version number, etc.) or non-specific.
- For a specific reference, subsequent revisions do not apply.
- For a non-specific reference, the latest version applies.
- A non-specific reference to an ETS shall also be taken to refer to later versions published as an EN with the same number.
- For this Release 1997 document, references to GSM documents are for Release 1997 versions (version 6.x.y).

- [1] GSM 01.04: "Digital cellular telecommunications system (Phase 2+); Abbreviations and acronyms".
- [2] GSM 02.79: "Digital cellular telecommunications system (Phase 2+); Support of Optimal Routeing (SOR); Service definition (Stage 1)".
- [3] GSM 02.82: "Digital cellular telecommunications system (Phase 2+); Call Forwarding (CF) Supplementary Services - Stage 1".
- [4] GSM 03.03: "Digital cellular telecommunications system (Phase 2+); Numbering, addressing and identification".
- [5] GSM 03.04: "Digital cellular telecommunications system (Phase 2+); Signalling requirements relating to routeing of calls to mobile subscribers".
- [6] GSM 03.18: "Digital cellular telecommunications system (phase 2+); Basic call handling; Technical realisation".
- [7] GSM 03.78: "Digital cellular telecommunications system (phase 2+); Customised Applications for Mobile network Enhanced Logic (CAMEL) - Stage 2".

- [8] GSM 03.85: "Digital cellular telecommunications system (Phase 2+); Closed User Group (CUG) supplementary services - Stage 2".

3 Definitions and abbreviations

3.1 Definitions

A subscriber: The calling subscriber, who may be fixed or mobile.

B subscriber: The mobile subscriber originally called by the A subscriber.

C subscriber: The subscriber to whom the B subscriber has requested that calls be forwarded. The C subscriber may be fixed or mobile.

Direct route: A call takes the direct route if the route from the serving PLMN of the A subscriber to the serving PLMN of the B subscriber is defined by the MSRN of the B subscriber rather than by the MSISDN of the B subscriber.

Early call forwarding: call forwarding from the IPLMN before the call has been extended to the VPLMN of the forwarding subscriber.

HPLMN leg: The portion of the HPLMN route from the serving MSC of the A subscriber to an MSC in the HPLMN of the B subscriber.

HPLMN route: A call takes the HPLMN route if the route from the serving MSC of the A subscriber to the serving MSC of the B subscriber is defined by the MSISDN of the called subscriber. This forces the call to be routed via the HPLMN of the B subscriber.

Interrogating PLMN (IPLMN): The PLMN which interrogates the HPLMN of the B subscriber to obtain information to route the call to that subscriber or to the forwarded-to destination defined by the called mobile subscriber. The IPLMN is also the VPLMN of the A subscriber.

Late call forwarding: call forwarding after the call has been extended to the VPLMN of the forwarding subscriber. Late call forwarding may be invoked in the IPLMN or the VPLMN of the forwarding subscriber.

Reference address: The address which defines the maximum charge which the A party is prepared to pay for the call leg which he originates.

Routeing address: The address which the GMSC uses to route a call towards the B subscriber or the C subscriber.

3.2 Abbreviations

Abbreviations used in the present document are listed in GSM 01.04 [1].

For the purposes of the present document, the following abbreviations apply:

BOIZC	Barring of Outgoing InterZonal Calls
BOIZC-exHC	Barring of Outgoing InterZonal Calls except those directed to the HPLMN Country
CMN	CAMEL Modified Number
FTN	Forwarded-To Number
FTNW	Forwarded-To NetWork
GMSCA	The GMSC in the IPLMN, which may also be VMSCA
GMSCB	The GMSC in HPLMNB
GMSCC	The GMSC in HPLMNC
HLRB	The HLR of the B subscriber
HLRC	The HLR of the C subscriber
HPLMNB	The HPLMN of the B subscriber
HPLMNC	The HPLMN of the C subscriber
IAM	Initial Address Message
IPLMN	Interrogating PLMN

ORLCF	Optimal Routeing for Late Call Forwarding
PRN	Provide Roaming Number
PSI	Provide Subscriber Information
RCH	Resume Call Handling
SIFIC	Send Information For Incoming Call
SIFOC	Send Information For Outgoing Call
SRI(B)	Send Routeing Information (Basic call)
SRI(F)	Send Routeing Information (Forwarding information)
VLRA	The VLR of the A subscriber
VLRB	The VLR of the B subscriber
VMSCA	The VMSC of the A subscriber
VMSCB	The VMSC of the B subscriber

4 Architecture

4.1 Optimal routeing for basic mobile-to-mobile calls

It is a network operator option whether to implement optimal routeing for basic mobile-to-mobile calls.

The existing GSM architecture supports the primary technical requirement of optimal routeing for mobile-to-mobile calls (basic OR): that a GMSC can interrogate an HLR in a different PLMN to obtain routeing information for a mobile terminated call (see GSM 03.04 [5]). Three logically distinct PLMNs are involved in the handling of an optimally routed mobile-to-mobile call:

- the IPLMN, which is also the VPLMN of the calling mobile subscriber;
- the HPLMN of the called mobile subscriber (HPLMNB);
- the VPLMN of the called mobile subscriber (VPLMNB).

Any two or all three of these PLMNs may be identical; in figure 1 they are shown as distinct.

Figure 1 shows the communication between the IPLMN, HPLMNB and VPLMNB for an optimally routed mobile-to-mobile call.

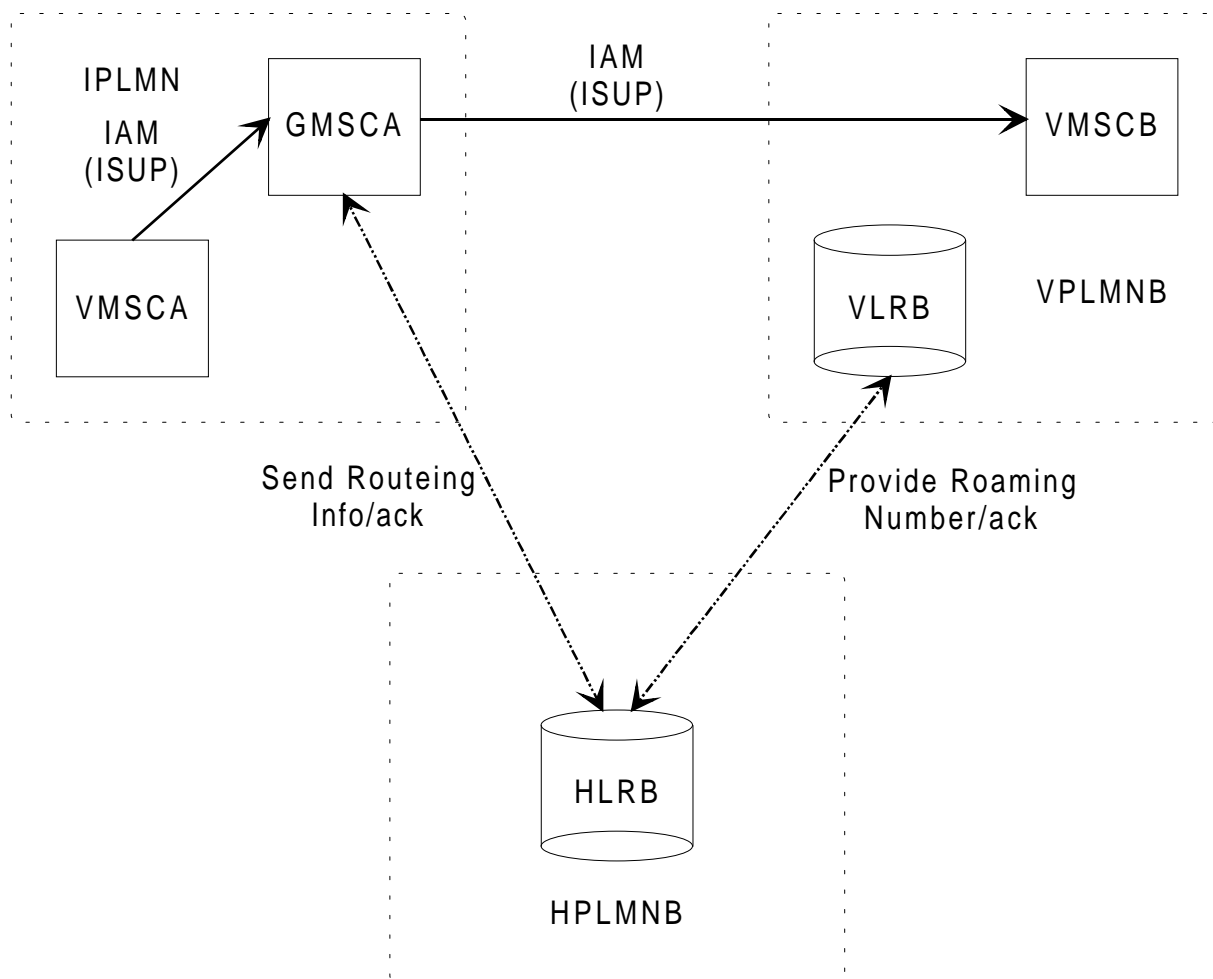

Figure 1: Architecture for optimal routing of basic mobile-to-mobile call

In figure 1 and throughout the present document, the term ISUP is used to denote the telephony signalling system used between exchanges. In a given network, any telephony signalling system may be used; the only additional requirement is that GMSCA must be able to signal to VMSCA the destination address which it has used to route the call.

If the VMSC of the calling mobile subscriber (VMSCA) is distinct from the GMSC, it constructs an ISUP Initial Address Message (IAM) using the MSISDN of the called subscriber and sends it to the GMSC. If the GMSC, which may be distinct from the VMSC of the calling mobile subscriber but is in the VPLMN of the calling mobile subscriber, is in a different PLMN from HLRB, it requests routing information from HLRB using the MAP protocol. If HLRB determines that the call can be routed directly from the GMSC to VMSCB without contravening the charging requirements for optimal routing given in subclause 9.1, it requests a roaming number from VLRB using the MAP protocol, and VLRB returns a roaming number in the Provide Roaming Number ack. HLRB returns the roaming number to the GMSC in the Send Routing Info ack. The GMSC uses the roaming number to construct an ISUP IAM, which it sends to VMSCB. The call is then handled according to the existing GSM procedures, except that if the call is answered GMSCA inserts in the ISUP Answer message the destination address which it used to route the call, to allow VMSCA to generate the correct charging record.

NOTE: If the GMSC returns an ISUP Answer message before it has received an Answer message from the final destination (e.g. because of an interaction with a Specialised Resource Function) an incorrect destination address (or no destination address) can be sent to VMSCA, even though the call is eventually optimally routed.

4.2 Optimal routeing for conditional call forwarding

Some cases of call forwarding on mobile subscriber not reachable (CFNRC) are handled in the IPLMN, without the call being extended to the VPLMN of the forwarding subscriber. For these cases, referred to in the present document as early call forwarding, the forwarding is already optimally routed.

When a call has been extended from the GMSC to VMSCB, the current GSM procedures lead to any conditional call forwarding being routed from VMSCB to the forwarded-to destination; this is referred to in the present document as late call forwarding. Optimal routeing for late call forwarding (ORLCF) allows VMSCB to return control of the call to the GMSC, which can then route the call to the forwarded-to destination.

Figure 2 shows the architecture for ORLCF. Phase 1 of SOR does not include optimal routeing of forwarding to a mobile subscriber, so optimal routeing of the forwarding leg is not considered.

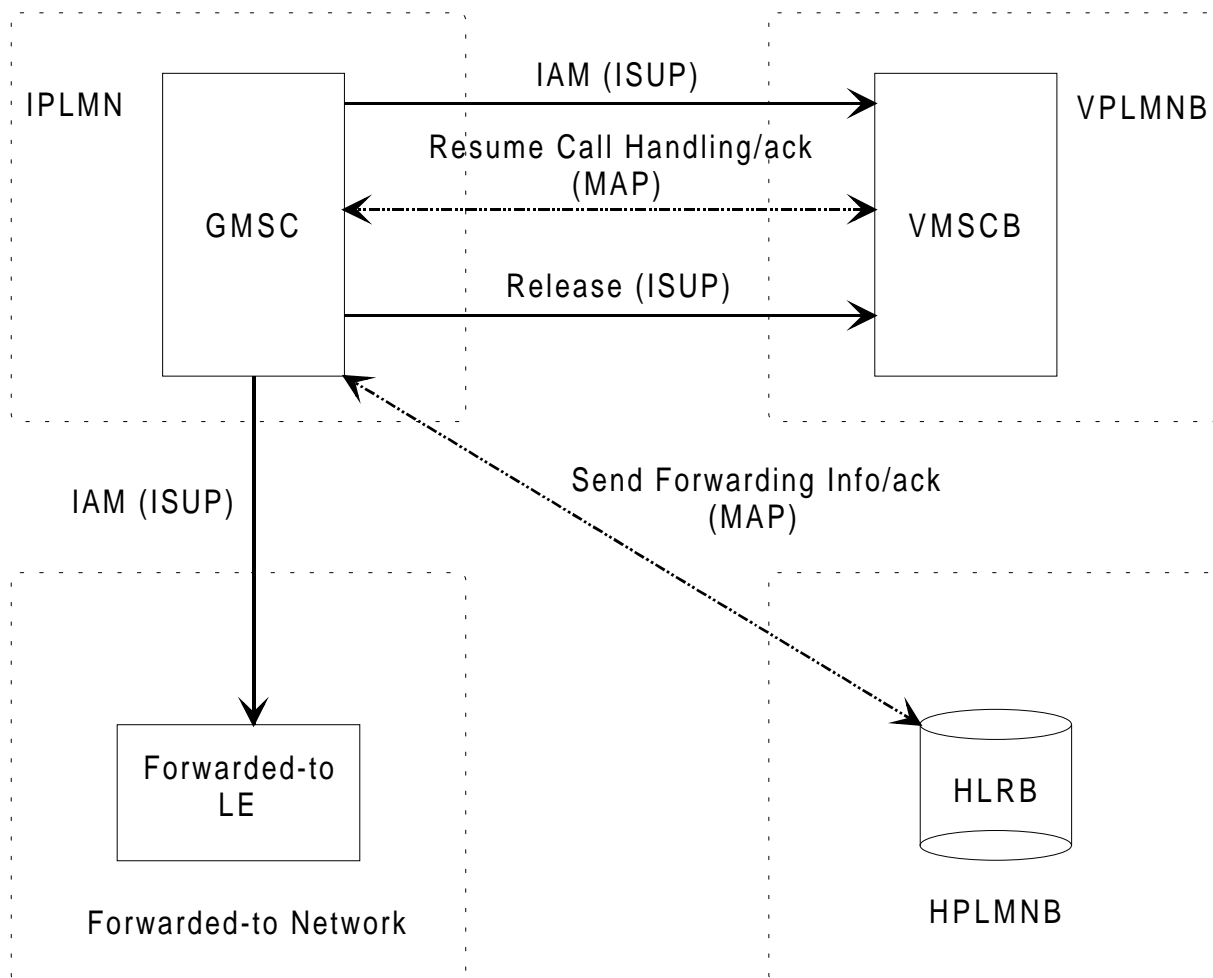

Figure 2: Architecture for optimal routeing of late call forwarding

After the call has been extended from the GMSC to VMSCB, if the VMSC/VLR determines that the call should be forwarded it requests the GMSC to resume call handling. The GMSC uses the forwarding information received in the request to resume call handling, or interrogates HLRB for forwarding information, depending on the indication received from the HLR with the roaming number. If the GMSC determines that the call can be routed directly to the forwarded-to destination without contravening the charging requirements for optimal routeing given in subclause 9.1 it acknowledges the request, clears the traffic connection to VMSCB and sends an ISUP IAM to the forwarded-to local exchange.

5 Optimal routing for basic mobile-to-mobile calls: message flows

It is a network operator option whether to implement optimal routing for basic mobile-to-mobile calls.

This clause does not consider the handling of calls to a fixed network B subscriber.

The message flow for an optimally routed call from one mobile subscriber to another mobile subscriber is shown in figure 3. For simplicity of description, it is assumed that forwarding of calls from the B subscriber is not required. Solid lines indicate circuit-associated signalling; dashed lines indicate connectionless signalling.

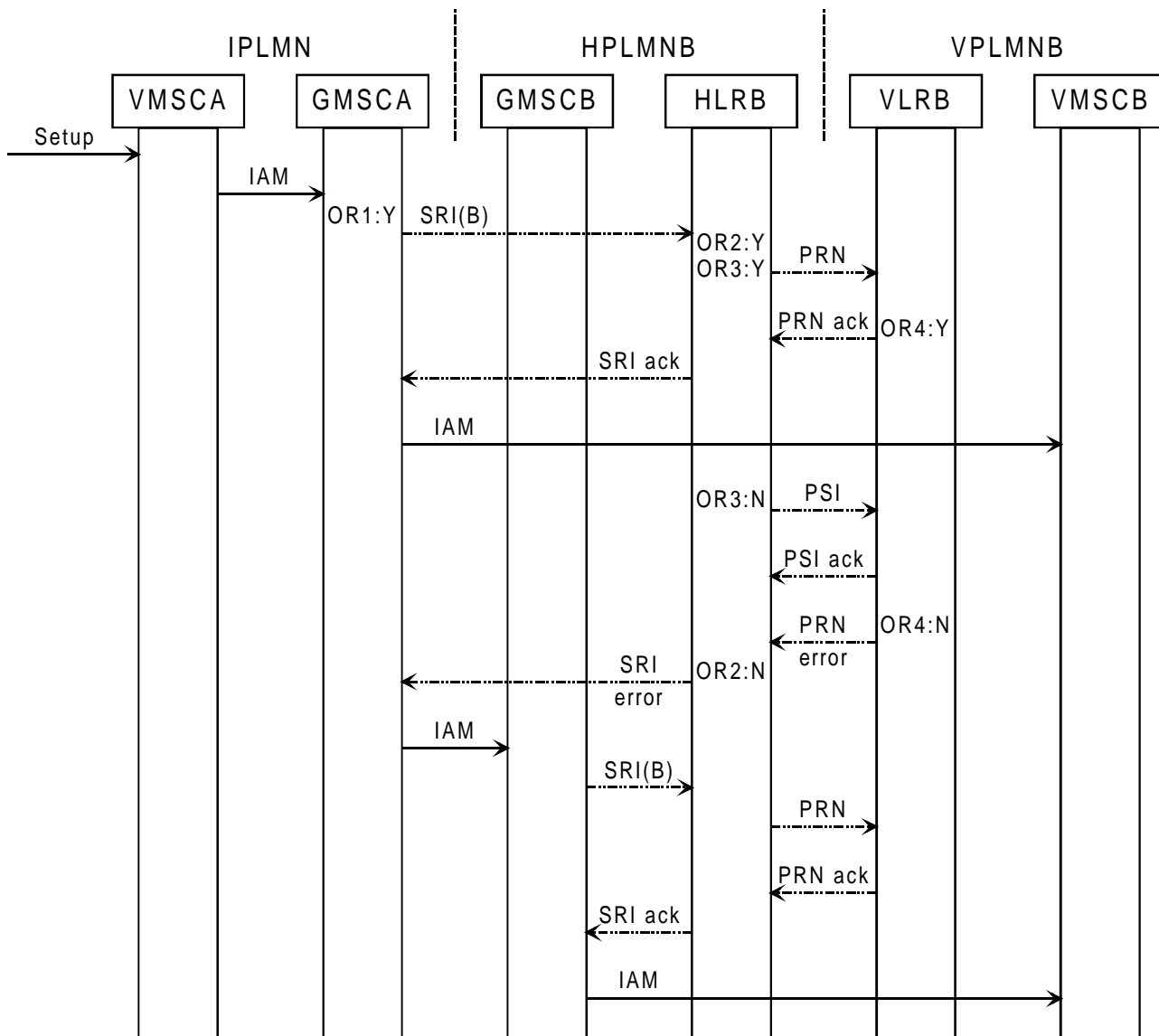

Figure 3: Message flow for optimal routing of basic mobile-to-mobile call

5.1 Successful outcome

When VMSCA receives a Setup message from the MS, it sends a request for information to handle the outgoing call to VLRA, according to the procedures described in GSM 03.18 [6]. If VLRA determines that the MS is allowed service, it returns a positive acknowledgement. When VMSCA receives the acknowledgement, it constructs an IAM using the B subscriber address and sends it to GMSCA.

If GMSCA recognises the B subscriber address as belonging to a GSM PLMN (decision OR1:Y), it checks the identity of HPLMNB. If GMSCA is in a different PLMN from HLRB, it then sends a request for routing information (SRI(B)) to HLRB; this request contains an indication that it is an optimal routing enquiry for information to route a basic call. If HLRB is prepared to accept an optimal routing enquiry from GMSCA (decision OR2:Y), it checks whether at least one of the three conditions:

- the GMSC is in the same country as VMSCB;
- the HLR is in the same country as VMSCB;
- the GMSC is in the same PLMN as the HLR.

is met. If it is (decision OR3:Y), HLRB sends a request for a roaming number (PRN) to VLRB; the request contains an indication that it is for an optimally routed call. If VLRB supports optimal routing (decision OR4:Y), it returns the roaming number in the PRN ack, and HLRB relays the roaming number in the SRI ack to GMSCA. GMSCA constructs an ISUP IAM using the roaming number, and sends it to VMSCB, which processes the incoming IAM according to the procedures described in GSM 03.18 [6].

5.2 Unsuccessful outcome

Error situations which lead to failure of the call, rather than non-optimal routing, are not described in this subclause.

5.2.1 B subscriber address not recognised as belonging to a GSM PLMN

If GMSCA does not support optimal routing for basic mobile-to-mobile calls, or does not recognise the B subscriber address as belonging to a GSM PLMN (decision OR1:N), it constructs an IAM using the B subscriber address and sends it to GMSCB in HPLMNB. GMSCB analyses the address received in the IAM, and sends a request for routing information (SRI(B)) to HLRB; this request contains an indication that it is not an optimal routing enquiry. Because GMSCB is in the same PLMN as HLRB, it will always be able to derive an HLR address. HLRB sends a request for a roaming number (PRN) to VLRB. VLRB returns the roaming number in the PRN ack, and HLRB relays the roaming number in the SRI ack to GMSCB. GMSCB constructs an ISUP IAM using the roaming number, and sends it to VMSCB, which processes the incoming IAM according to the procedures described in GSM 03.18 [6].

5.2.2 HLRB or VLRB does not support optimal routing

If HLRB is not prepared to accept an optimal routing enquiry from GMSCA, because:

- it does not support optimal routing for basic mobile-to-mobile calls, or
- because there is no agreement for optimal routing for basic mobile-to-mobile calls between the operators of GMSCA and HLRB, or
- because optimal routing of basic mobile-to-mobile calls to the specific B subscriber is not allowed

(decision OR2:N), it returns an SRI negative response (shown in figure 3 as 'SRI error'). This causes GMSCA to construct an IAM using the B subscriber address and send it to GMSCB, as described in subclause 5.2.1.

If VLRB does not support optimal routing (decision OR4:N), it returns a PRN negative response (shown in figure 3 as 'PRN error'). This causes HLRB to return an SRI negative response (shown in figure 3 as 'SRI error'), which in turn causes GMSCA to construct an IAM using the B subscriber address and send it to GMSCB, as described in subclause 5.2.1.

5.2.3 OR charging requirements contravened

If HLRB determines that the call cannot be routed directly from GMSCA to VMSCB without contravening the charging requirements for optimal routing given in subclause 9.1 (decision OR3:N) it sends a request for subscriber information (PSI) to VLRB. VLRB sends a response indicating whether the B subscriber is detached or in some other state. If the B subscriber is not detached, HLRB sends an SRI negative response (shown in figure 3 as 'SRI error') to GMSCA, which constructs an IAM using the B subscriber address and sends it to GMSCB, as described in subclause 5.2.1.

6 Optimal routing for conditional call forwarding: message flows

Two cases of conditional call forwarding are described in this clause:

- Early call forwarding to a fixed destination;
- Late call forwarding to a fixed destination;

For phase 1 of SOR, no attempt is made to route a call directly from the GMSC to a forwarded-to mobile subscriber; if the forwarded-to subscriber is mobile, the call is routed from the GMSC to a GMSC in the HPLMN of the forwarded-to subscriber.

6.1 Early call forwarding

Early call forwarding is defined as call forwarding from the IPLMN **before** the call has been extended to the VPLMN of the forwarding subscriber. CFU and CFNRC when the forwarding mobile subscriber is IMSI detached are examples of early call forwarding. Early call forwarding is effectively optimally routed, because the call takes the most direct route possible from the IPLMN to the forwarded-to destination.

The message flows for early call forwarding to a fixed destination are shown in figure 4a (forwarding without VLR interrogation) and figure 4b (forwarding after VLR interrogation). The IPLMN is shown as distinct from HPLMNB, on the assumption that the original call towards the B subscriber was optimally routed; however if optimal routing of basic mobile-to-mobile calls is not implemented, the IPLMN will be the same as HPLMNB. Solid lines indicate circuit-associated signalling; dashed lines indicate connectionless signalling.

6.1.1 Forwarding without interrogation of VLRB

6.1.1.1 Successful outcome

GMSCA sends a request for routing information (SRI(B)) to HLRB. If HLRB determines that the call is to be forwarded without needing to signal to VLRB then HLRB returns the forwarded-to number (FTN) in the SRI ack.

If GMSCA determines that the call can be forwarded to LEC without contravening the charging requirements for Support of Optimal Routing given in subclause 9.1 (decision OR:Y) it constructs an ISUP IAM using the FTN and sends it to LEC.

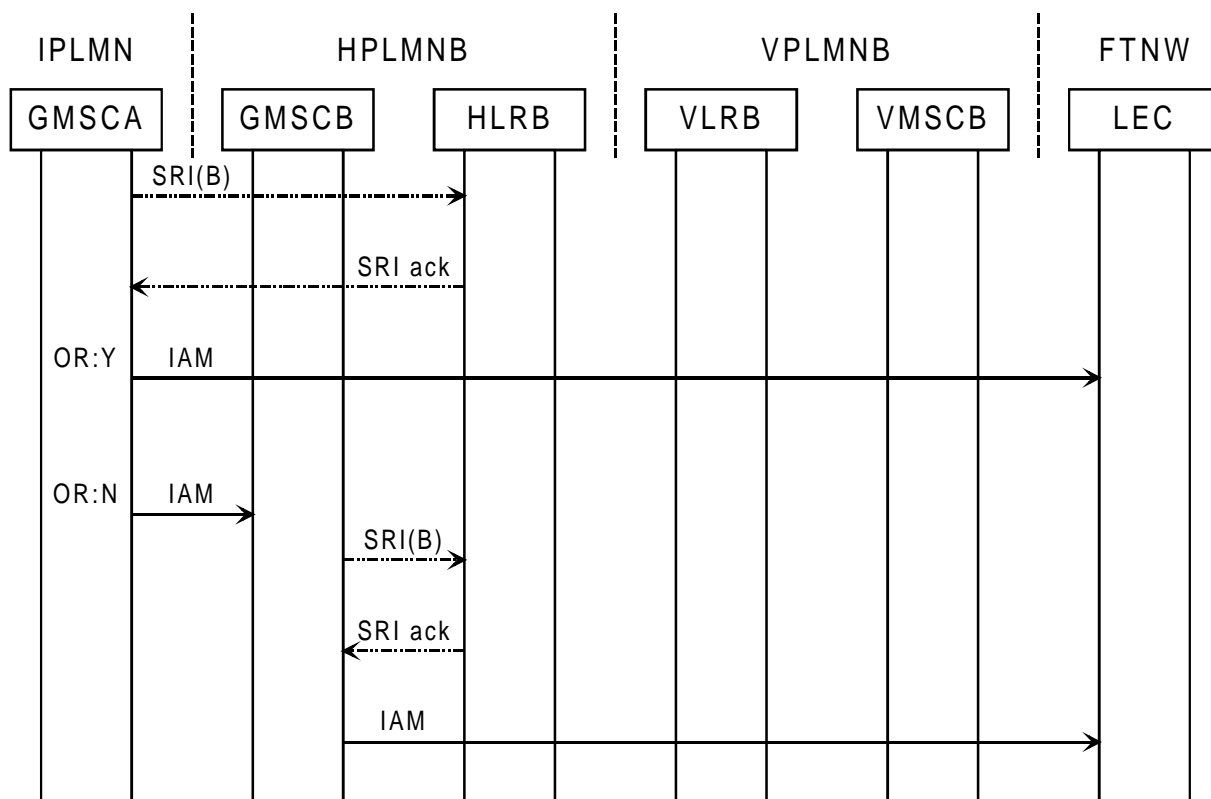

Figure 4a: Message flow for early call forwarding to a fixed destination - forwarding without interrogation of VLRB

6.1.1.2 Unsuccessful outcome

Error situations which lead to failure of the call, rather than non-optimal routing, are not described in this subclause.

If GMSCA determines that the call cannot be forwarded to LEC without contravening the charging requirements for Support of Optimal Routing given in subclause 9.1 (decision OR:N) it constructs an IAM using the B subscriber address and sends it to GMSCB.

GMSCB sends a request for routing information (SRI(B)) to HLRB. If HLRB determines that the call is to be forwarded, as described in subclause 6.1.1.1, it returns the FTN in the SRI ack.

GMSCB constructs an IAM using the FTN and sends it to LEC.

6.1.2 Forwarding after interrogation of VLRB

6.1.2.1 Successful outcome

GMSCA sends a request for routing information (SRI(B)) to HLRB. HLRB sends a request for the subscriber status (PSI) to VLRB. If the record in VLRB for the B subscriber shows that the B subscriber is IMSI detached, VLRB indicates this in the PSI ack. Alternatively, if HLRB determines that at least one of the three conditions:

- the GMSC is in the same country as VMSCB;
- the HLR is in the same country as VMSCB;
- the GMSC is in the same PLMN as the HLR

is met, it sends a request for a roaming number (PRN) to VLRB. If the record in VLRB for the B subscriber shows that the B subscriber is IMSI detached, VLRB indicates this in a PRN negative response. If HLRB determines that CFNRC should be invoked, it returns the forwarded-to number (FTN) in the SRI ack.

If GMSCA determines that the call can be forwarded to LEC without contravening the charging requirements for Support of Optimal Routeing given in subclause 9.1 (decision OR:Y) it constructs an ISUP IAM using the FTN and sends it to LEC.

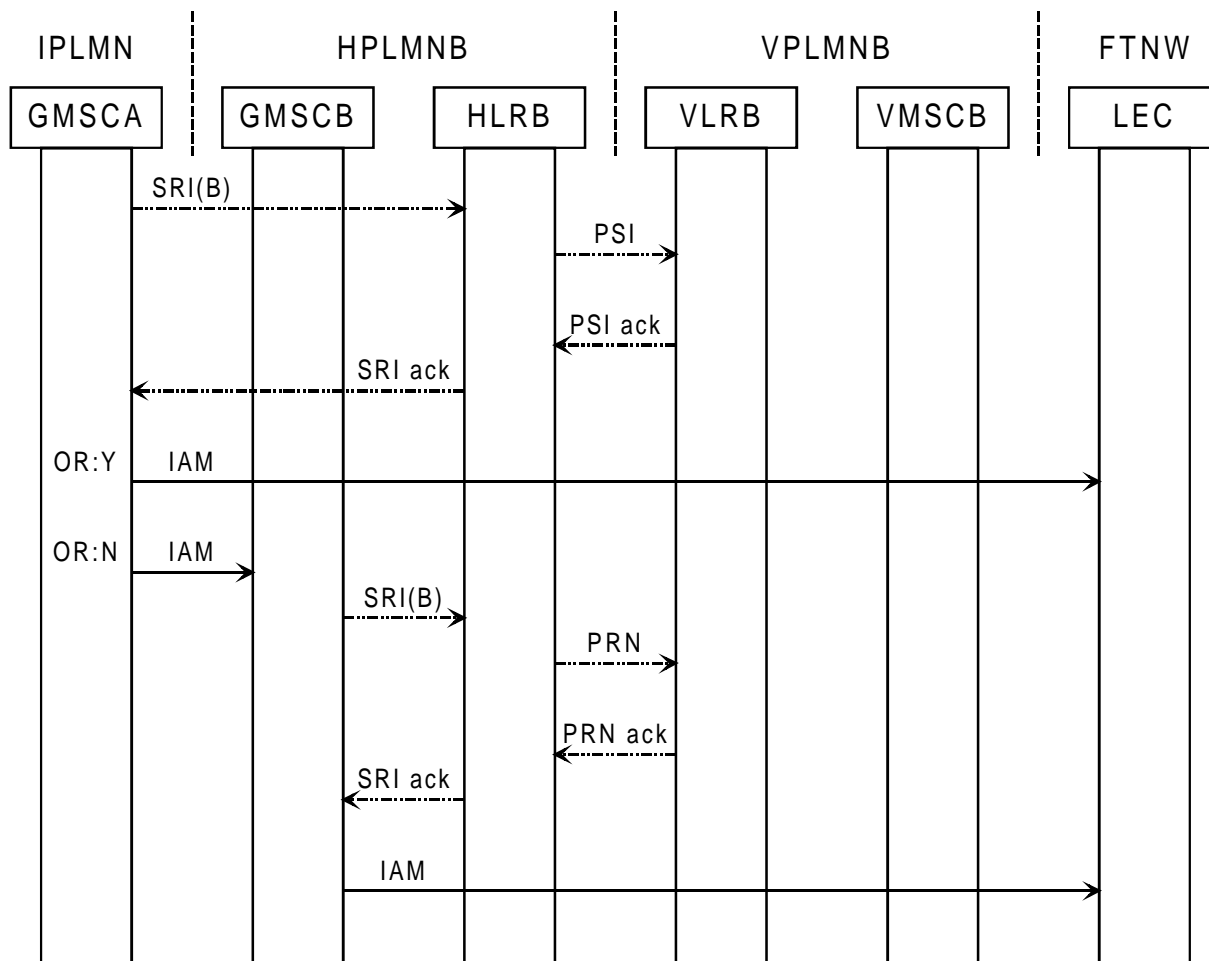

NOTE: HLRB may send a PRN to VLRB, and receive a PRN negative response indicating absent subscriber, to determine that CFNRc should be invoked.

Figure 4b: Message flow for early call forwarding to a fixed destination - forwarding after interrogation of VLRB

6.1.2.2 Unsuccessful outcome

Error situations which lead to failure of the call, rather than non-optimal routeing, are not described in this subclause.

If GMSCA determines that the call cannot be forwarded to LEC without contravening the charging requirements for Support of Optimal Routeing given in subclause 9.1 (decision OR:N), it constructs an ISUP IAM using the B subscriber address and sends it to GMSCB.

GMSCB sends a request for routing information (SRI(B)) to HLRB. HLRB sends a request for a roaming number (PRN) to VLRB. If the record in VLRB for the B subscriber shows that the B subscriber is IMSI detached, VLRB indicates this in the PRN ack. If HLRB determines that CFNRc should be invoked, it returns the forwarded-to number (FTN) in the SRI ack.

GMSCB constructs an IAM using the FTN and sends it to LEC.

6.2 Late call forwarding

Late call forwarding is defined as call forwarding **after** the call has been extended to the VPLMN of the forwarding subscriber. CFB, CFNRc on no response to paging and CFNRy are examples of late call forwarding. In the absence of OR, late call forwarding occurs in the VPLMN of the forwarding party; if OR applies, late call forwarding occurs in the IPLMN.

The message flow for optimal routing of late call forwarding to a fixed destination is shown in figure 5. The IPLMN may be distinct from HPLMNB or the same as HPLMNB, depending on whether or not the original call to VPLMNB was optimally routed, but this description assumes that the original call to VPLMNB was optimally routed. For simplicity of description, the separation of VMSCA and GMSCA (described in clause 5 & subclause 6.1) is omitted. Solid lines indicate circuit-associated signalling; dashed lines indicate connectionless signalling.

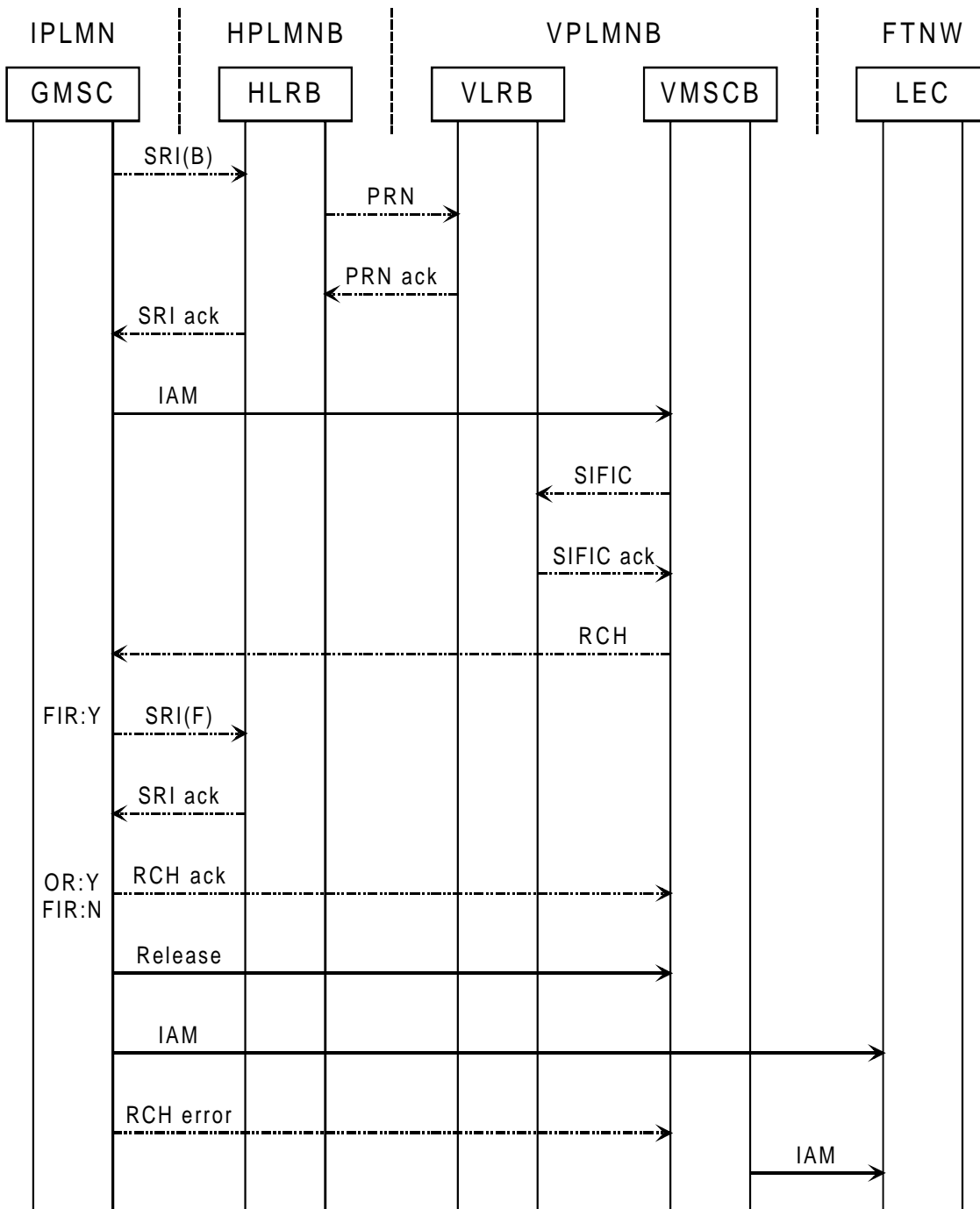

Figure 5: Message flow for optimal routing of late call forwarding to a fixed destination

6.2.1 Successful outcome

The GMSC obtains a roaming number from HLRB to route the call to VMSCB, as described in subclause 5.1. The SRI ack also includes an indication of whether the GMSC should interrogate the HLR for routing information for late call forwarding. The GMSC constructs an IAM using the roaming number, and sends it to VMSCB. When VMSCB receives the IAM, it requests subscriber information for the incoming call (SIFIC) from VLRB. If VLRB determines that the call should be forwarded, because the called mobile subscriber is busy, or is not reachable, or has not replied to the call before the no-reply call timer has expired, it returns a SIFIC ack containing the forwarded-to number, the forwarding reason, the GMSC address and the call reference number to VMSCB. VMSCB sends a request to resume call handling (RCH) to the GMSC; the RCH includes the forwarded-to number, the forwarding reason and the basic service information received in the SIFIC ack.

If the HLR indicated in the SRI ack which contained the MSRN that the GMSC should interrogate the HLR for forwarding information (FIR:Y), the GMSC then sends a request for forwarding information (SRI(F)), containing the forwarding reason and the basic service group which applies for this call, to HLRB. HLRB responds with the appropriate forwarded-to number.

If the HLR indicated in the SRI ack which contained the MSRN that the GMSC should not interrogate the HLR for forwarding information (FIR:N), the GMSC checks the forwarded-to number received in the RCH.

If the GMSC determines that the call can be forwarded to the forwarded-to destination without contravening the charging requirements for Support of Optimal Routing given in subclause 9.1 (decision OR:Y) it:

- sends an RCH ack to VMSCB to indicate that control of the call has been accepted;
- sends an ISUP Release message indicating normal clearing to VMSCB to release the traffic circuit;
- constructs an IAM using the forwarded-to number, and sends it to LEC.

6.2.2 Unsuccessful outcome

Error situations which lead to failure of the call, rather than non-optimal routing, are not described in this subclause.

6.2.2.1 GMSC does not support OR

If the GMSC does not support OR, it must be in the same PLMN as the HLR; it therefore omits its address and the call reference number from the SRI(B) request, so the GMSC address and call reference number are not relayed to VMSCB, and VMSCB cannot send the RCH to the GMSC. Instead, the call will be forwarded at VMSCB.

6.2.2.2 HLRB does not support OR

If HLRB does not support OR, it does not relay the GMSC address and the call reference number which it received in the SRI(B), so VMSCB cannot send the RCH to the GMSC. Instead, the call will be forwarded at VMSCB.

6.2.2.3 VMSCB/VLRB does not support OR

If VMSCB/VLRB does not support OR, VMSCB cannot send the RCH to the GMSC. Instead, the call will be forwarded at VMSCB.

6.2.2.4 OR charging requirements contravened

If the original call to VMSCB was optimally routed, the GMSC can route the call to the forwarded-to destination only if the charge to do so is no more than the charge to route the call to HPLMNB. If this requirement, determined as described in subclause 9.1, is not met (decision OR:N) the GMSC returns an RCH negative response (shown in figure 5 as 'RCH error') to VMSCB, which then forwards the call.

If the original call to VMSCB was not optimally routed, the GMSC can route the call directly to the forwarded-to destination only if the charge to do so is no more than the charge for the routing to VMSCB. If this requirement, determined as described in subclause 9.1, is not met (decision OR:N) the GMSC returns an RCH negative response (shown in figure 5 as 'RCH error') to VMSCB, which then forwards the call.

7 Interactions between optimal routing and supplementary services

7.1 Call forwarding

If an optimally routed call encounters early call forwarding, GMSCA attempts to route the call to the forwarded-to destination. The forwarded-to destination is the C subscriber if the C subscriber is not a mobile subscriber, or the HPLMN of the C subscriber if the C subscriber is a mobile subscriber. If GMSCA cannot route the call to the forwarded-to destination without contravening the charging requirements for Support of Optimal Routing given in subclause 9.1, the call is routed to a GMSC in the HPLMN of the B subscriber.

If an optimally routed call encounters late call forwarding, GMSCA attempts to route the call to the forwarded-to destination. The forwarded-to destination is the C subscriber if the C subscriber is not a mobile subscriber, or the HPLMN of the C subscriber if the C subscriber is a mobile subscriber. If GMSCA cannot route the call to the forwarded-to destination without contravening the charging requirements for Support of Optimal Routing given in subclause 9.1, the call is routed from VMSCB to the forwarded-to destination.

The handling of call forwarding at HLRB for optimally routed calls is encapsulated in the procedures First_Forwarding_HLR, PRN_Error_HLR, Handle_CFB, Handle_CFNRC and Handle_CFNRY, which are specified in GSM 03.18 [6].

7.2 Closed User Group (CUG)

The handling of CUG checking for outgoing calls at VLRA is encapsulated in the process OCH_VLR, which is specified in GSM 03.18 [6].

The handling of CUG checking at HLRB is encapsulated in the procedures Subscription_Check_HLR and Forward_CUG_Check, which are specified in GSM 03.18 [6].

7.3 Advice of Charge

Advice of Charge (Information) and Advice of Charge (Charging) do not take account of whether a call has been optimally routed.

7.4 Call barring

It has been accepted in principle that all supplementary service call barring programmes except for BAIC are applied for cost control reasons, and that therefore barring should be applied on the basis of the cost of the actual route taken by the call. For phase 1 of Support of Optimal Routing, this principle does not apply. Barring of outgoing calls is applied on the basis of the B subscriber number. Barring of all incoming calls will prevent a call to the served mobile subscriber, whether or not the call is optimally routed. If Barring of Incoming Calls when roaming outside the home PLMN country is active and operative it will prevent a call to the B subscriber even if the A subscriber pays to route the call to the VMSC of the B subscriber.

The handling of barring of outgoing calls at VLRA is encapsulated in the process OCH_VLR, which is specified in GSM 03.18 [6].

The handling of barring of incoming calls at HLRB is encapsulated in the procedure Subscription_Check_HLR, which is specified in GSM 03.18 [6].

The interactions between barring of outgoing calls and call forwarding for phase 1 of Support of Optimal Routing are defined in GSM 02.82 [3].

The interactions between BIC-Roam and call forwarding for phase 1 of Support of Optimal Routing are defined in GSM 02.82 [3].

7.5 Other supplementary services

The effects of the following supplementary services on optimally routed calls are identical to their effects on non-optimally routed calls, so they are omitted from the present document:

- CLIP, CLIR, COLP, COLR (GSM 03.81);
- CW, HOLD (GSM 03.83);
- MPTY (GSM 03.84);
- ECT (GSM 03.91).

8 Interactions between optimal routing and other network features

8.1 Operator determined barring

The principles for the interactions between operator determined barring and optimal routing are the same as those for interactions between supplementary service barring and optimal routing.

8.2 CAMEL

The principles for interactions between CAMEL services and optimal routing are specified in this subclause. The interworking between CAMEL processing and optimal routing in the GMSC and the terminating VMSC is specified in subclause 9.4 and GSM 03.18 [6].

If a mobile-originating CAMEL service modifies the number entered by the A subscriber, VMSCA treats the number returned by the CAMEL server in the same way as a number received in the SETUP message, i.e. it sends an IAM containing the modified number to the associated GMSC, which analyses it to find if it is an MSISDN.

If a mobile-terminating CAMEL service modifies the number received by the GMSC, the GMSC treats the number returned by the CAMEL server in the same way as a forwarded-to number, i.e. it checks it against the optimal routing criteria in subclause 9.1 but does not analyse it to find if it can derive an HLR address. If the number returned by the CAMEL server does not satisfy the optimal routing criteria in subclause 9.1 and the GMSC is not in the same PLMN as HLRB, the GMSC will route the call to a GMSC in the same PLMN as HLRB. This will lead to a repetition of the mobile terminating CAMEL interaction.

If the call is to be forwarded at the GMSC (whether by a GSM-standardised call forwarding service or by a CAMEL-based call forwarding service) and a mobile originating CAMEL service applies to the forwarding subscriber, the GMSC checks the number which results from the CAMEL service against the optimal routing criteria in subclause 9.1. If the number returned by the CAMEL server does not satisfy the optimal routing criteria in subclause 9.1, the GMSC will not route the call to the forwarded-to destination. For early call forwarding, the GMSC will route the call to a GMSC in the same PLMN as HLRB. This will lead to a repetition of the mobile originating CAMEL interaction. For optimal routing of late call forwarding, the GMSC will return a Resume Call Handling negative response towards VMSCB, which will forward the call. This will lead to a repetition of the mobile originating CAMEL interaction.

9 Functional requirements of entities performing optimal routing

9.1 Charging requirements for optimal routing

MoU have imposed two constraints for the charging of optimally routed calls:

- No subscriber shall pay more for a call which has been optimally routed than he would do under the present routing scheme described in GSM 03.04 [5] in the subclauses describing the call cases where the GMSC is in the same PLMN as the HLR;
- At least for the first phase of Support of Optimal Routing, the charge for one leg of a call shall be paid for entirely by one subscriber.

These constraints mean that the direct route for a call cannot always be used. For example, if the calling mobile subscriber (the A subscriber) is in Germany, and the B subscriber's HPLMN is in Switzerland but he has roamed to Finland, the charge payable by the A subscriber to route the call by the direct route to Finland would be greater than the charge payable to route the call to HPLMNB, so the HPLMN route must be used.

In the first phase of Support of Optimal Routing, it cannot be assumed that a GMSC is able to calculate the charge payable for the direct route and the charge payable for the HPLMN leg. The MoU requirements can be met by applying more stringent (but simpler) criteria for deciding whether the direct route may be used:

- If the country code of the destination exchange and the country code of the GMSC are the same, then the direct route may be used;
- Otherwise, for a call leg which is chargeable to the A subscriber, if the country code of the destination exchange and the country code of HPLMNB are the same, then the direct route may be used;
- Otherwise, the HPLMN route shall be used.

In certain cases, the second criterion above (equality of country codes for the HPLMN and the destination exchange) may not be enough to determine equality of the charges payable for the direct route and the HPLMN route. In these cases, analysis of the national destination code as well as the country code is required; however the principle is still that if the two numbers are the same to the depth of analysis required then the direct route may be used.

For optimal routing of late call forwarding, the constraints are satisfied if the following criteria are applied:

- If the country code of the forwarded-to exchange and the country code of the GMSC are the same, then the forwarded call may be routed directly from the GMSC to the forwarded-to exchange;
- Otherwise, if the country code of the forwarded-to exchange and the country code of HPLMNB are the same, then the forwarded call may be routed directly from the GMSC to the forwarded-to exchange;
- Otherwise, if the country code of the forwarded-to exchange and the country code of VPLMNB are the same, then the forwarded call may be routed directly from the GMSC to the forwarded-to exchange;
- Otherwise the forwarded call shall be routed through VPLMNB.

9.2 Functional behaviour of VMSCA

The functional behaviour of VMSCA is specified in GSM 03.18 [6]. The only function specific to optimal routing is the transfer of the destination address, if it is received in the ISUP Answer message, to the call data record, to allow the correct charge for the call to be made. This function is required only if VMSCA supports optimal routing of mobile-to-mobile calls.

9.3 Functional behaviour of VLRA

The functional behaviour of VLRA is specified in GSM 03.18 [6].

9.4 Functional behaviour of GMSC

It should be noted that if a call is being forwarded from VMSCB rather than from the MSC which acted as GMSC for the original call then VMSCB may use the services of an associated GMSC for the forwarding leg, i.e. the associated GMSC requests routing information from HLRC. In this case, the forwarding leg is processed in the same way as a mobile-originated call from mobile subscriber B.

The functional behaviour of a GMSC is specified in GSM 03.18 [6]. The procedures specific to Support of Optimal Routing are specified in this subclause.

9.4.1 Procedure OR_Set_ORA_Parameters

9.4.2 Procedure OR_Handle_RCH

Sheet 1: the procedure Activate_CF_Process is specified in GSM 03.18 [6].

Sheet 1: if the GMSC interrogates the HLR for a Forwarded-to number, the Routing address is the Forwarded-to number received in the Send Routing Info ack; otherwise the Routing address is the Forwarded-to number received in the Resume Call Handling.

Sheet 2: the task "Destination address:=FTN" is executed only if the GMSC supports optimal routing of basic mobile-to-mobile calls.

Sheet 2: the process MT_CF_MSC is specified in GSM 03.18 [6].

Sheet 2: the called party address sent in the IAM to the process MT_CF_MSC is the Forwarded-to number received in the Perform Call Forwarding ack.

9.4.3 Procedure Route_Permitted

9.4.4 Procedure OR_Handle_SRI_Negative_Response

'Non-fatal' error situations, which cause the call to be routed through a GMSC in the same PLMN as the HLR, are:

- Send Routing Info request rejected because the HLR does not support OR;
- Protocol error;
- System failure;
- Unexpected data value;
- Data missing;
- OR not allowed.

'Fatal' negative responses, which cause the GMSC to return a 'fail' result, are:

- Unknown subscriber;
- Number changed;
- Bearer service not provisioned;
- Teleservice not provisioned;
- Call barred;
- CUG reject;
- Forwarding violation;

- Facility not supported;
- Absent subscriber.

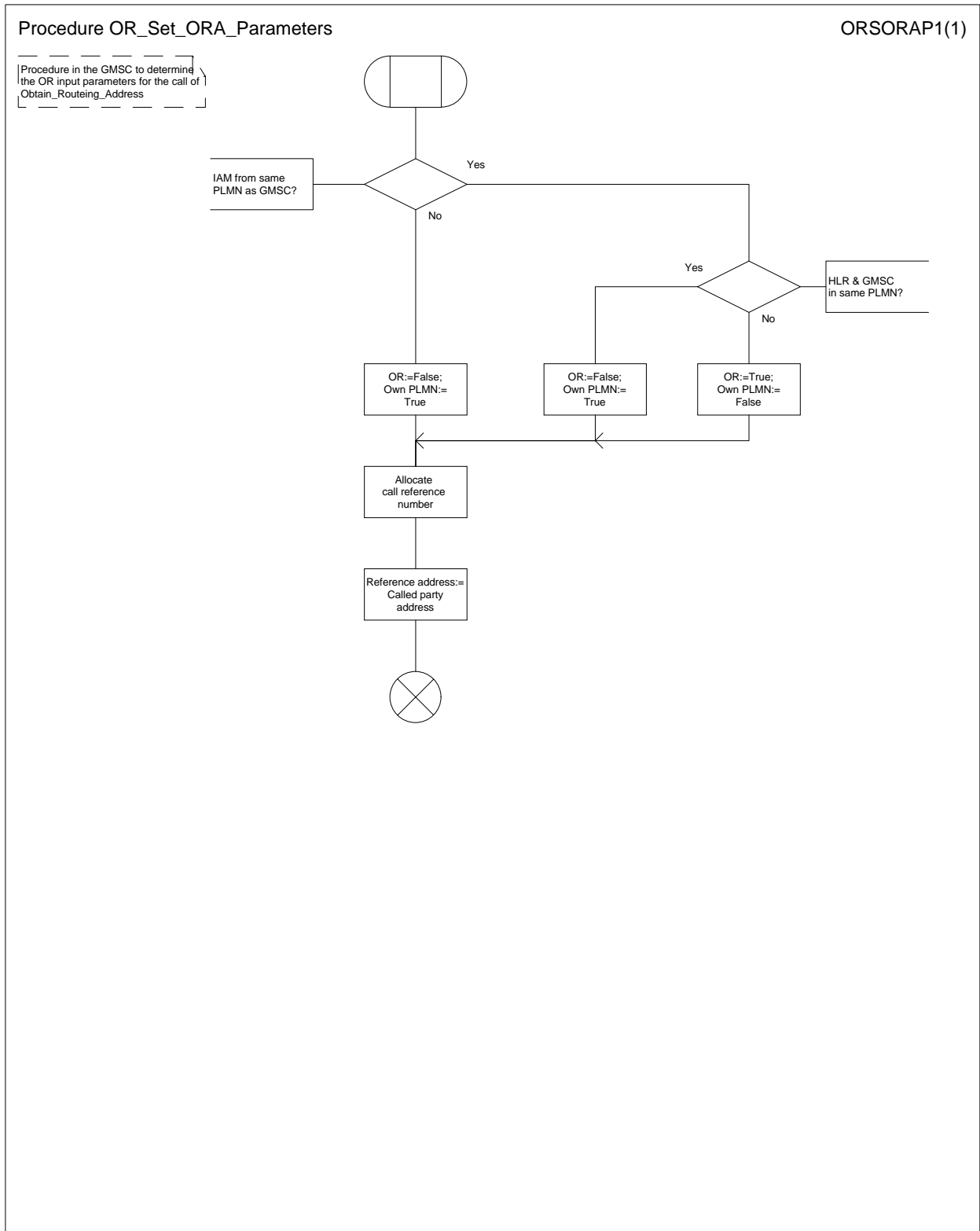

Figure 6: Procedure OR_Set_ORA_Parameters

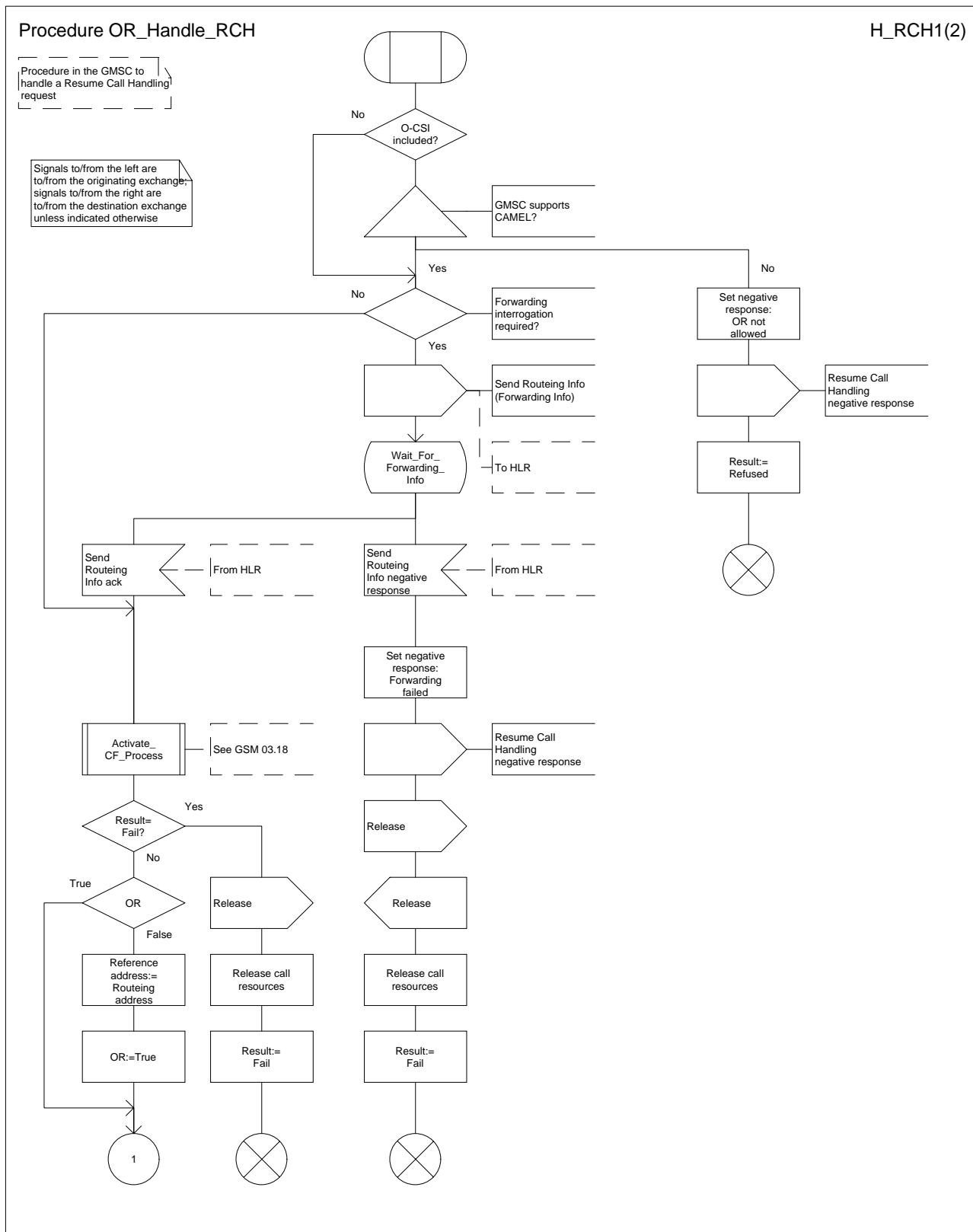

Figure 7a: Procedure OR_Handle_RCH (sheet 1)

Procedure OR_Handle_RCH

H_RCH2(2)

Procedure in the GMSC to handle a Resume Call Handling request

Signals to/from the left are to/from the originating exchange; signals to/from the right are to/from the destination exchange unless indicated otherwise

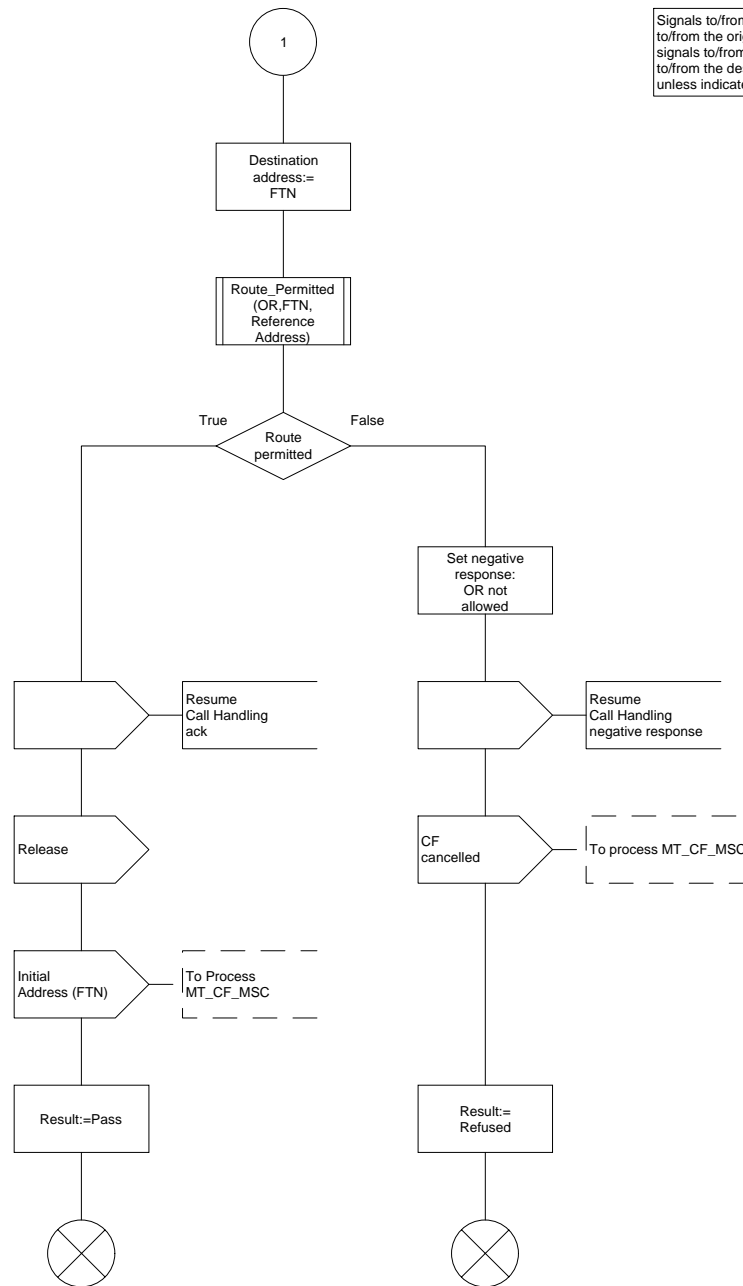

Figure 7b: Procedure OR_Handle_RCH (sheet 2)

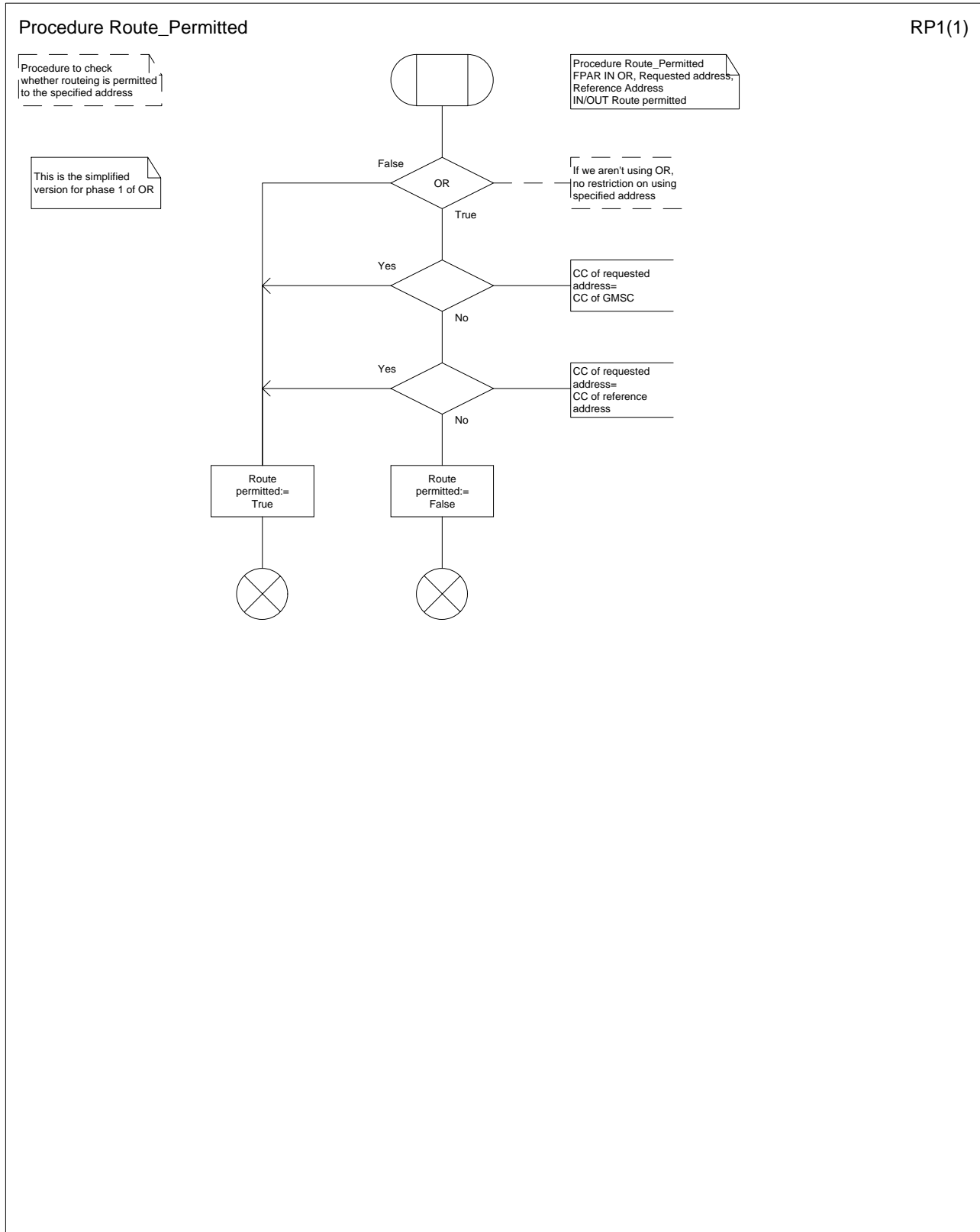

Figure 8: Procedure Route_Permitted

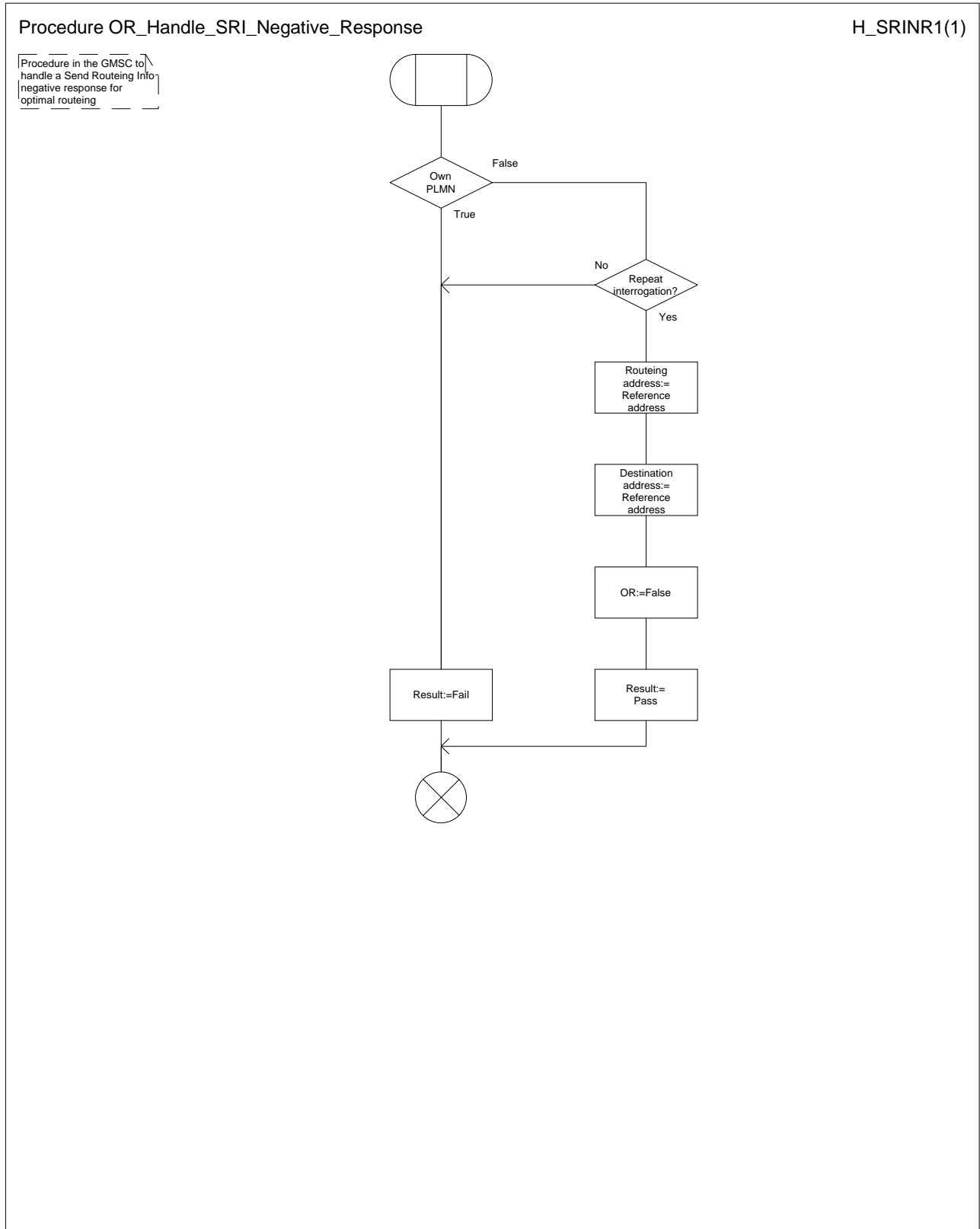

Figure 9: Procedure OR_Handle_SRI_Negative_Response

9.5 Functional behaviour of HLR

The functional behaviour of an HLR is specified in GSM 03.18 [6]. The procedures specific to Support of Optimal Routeing are specified in this subclause.

9.5.1 Procedure OR_HLR_CF

Sheet 1: if the HLR does not support optimal routeing of basic mobile-to-mobile calls, the test "Optimal routeing allowed" takes the "No" exit.

Sheet 2: the procedures Handle_CFB, Handle_CFNRC and Handle_CFNRY are specified in GSM 03.18 [6].

9.5.2 Procedure OR_HLR_Interrogate_VLR

If the HLR does not support optimal routeing of basic mobile-to-mobile calls, this procedure will be executed only if the Send Routeing Info was from a GMSC in the same PLMN as the HLR, i.e. this was not an Optimal Routeing enquiry.

The procedure Handle_CFNRC is specified in GSM 03.18 [6].

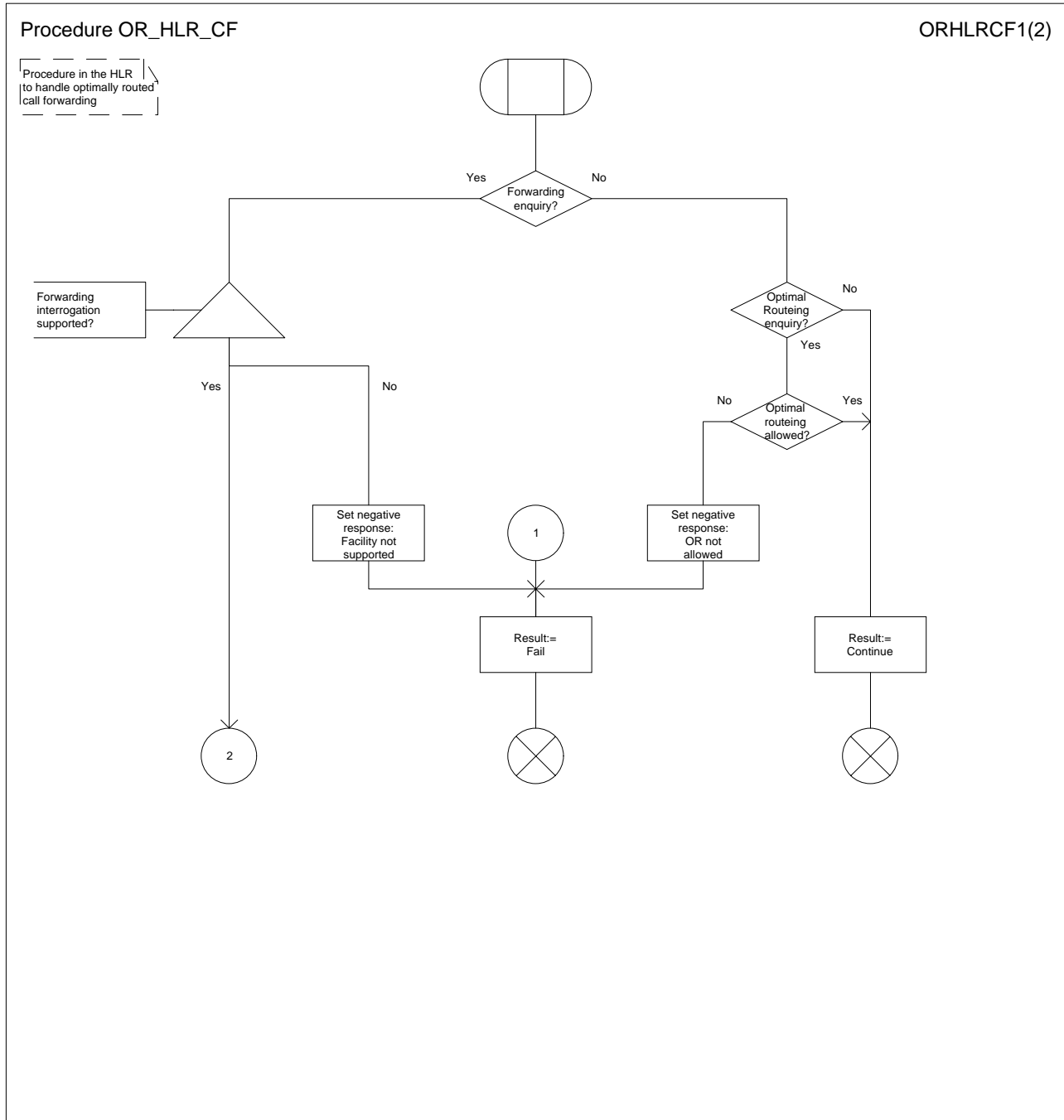

Figure 10a: Procedure OR_HLR_CF (sheet 1)

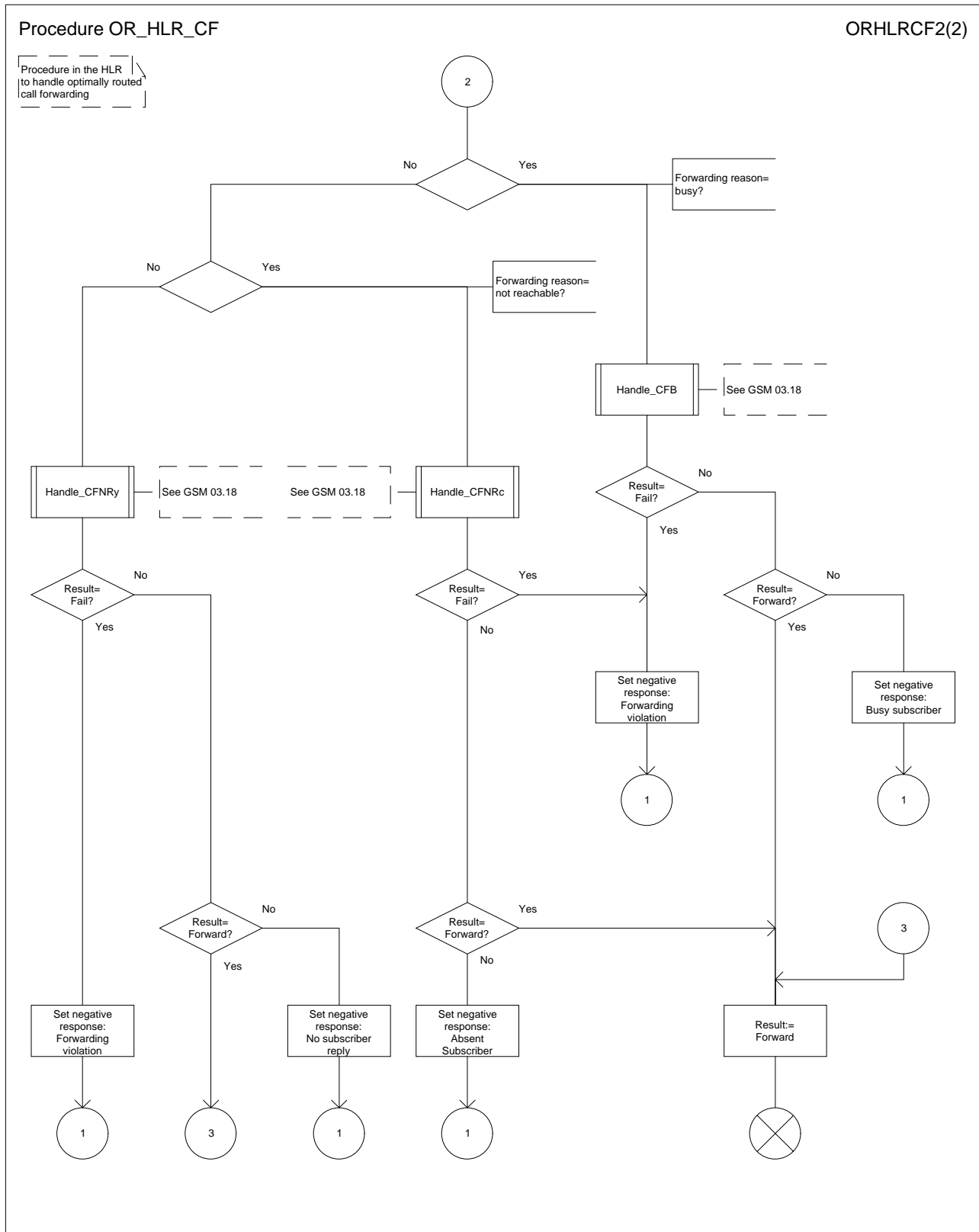

Figure 10b: Procedure OR_HLR_CF (sheet 2)

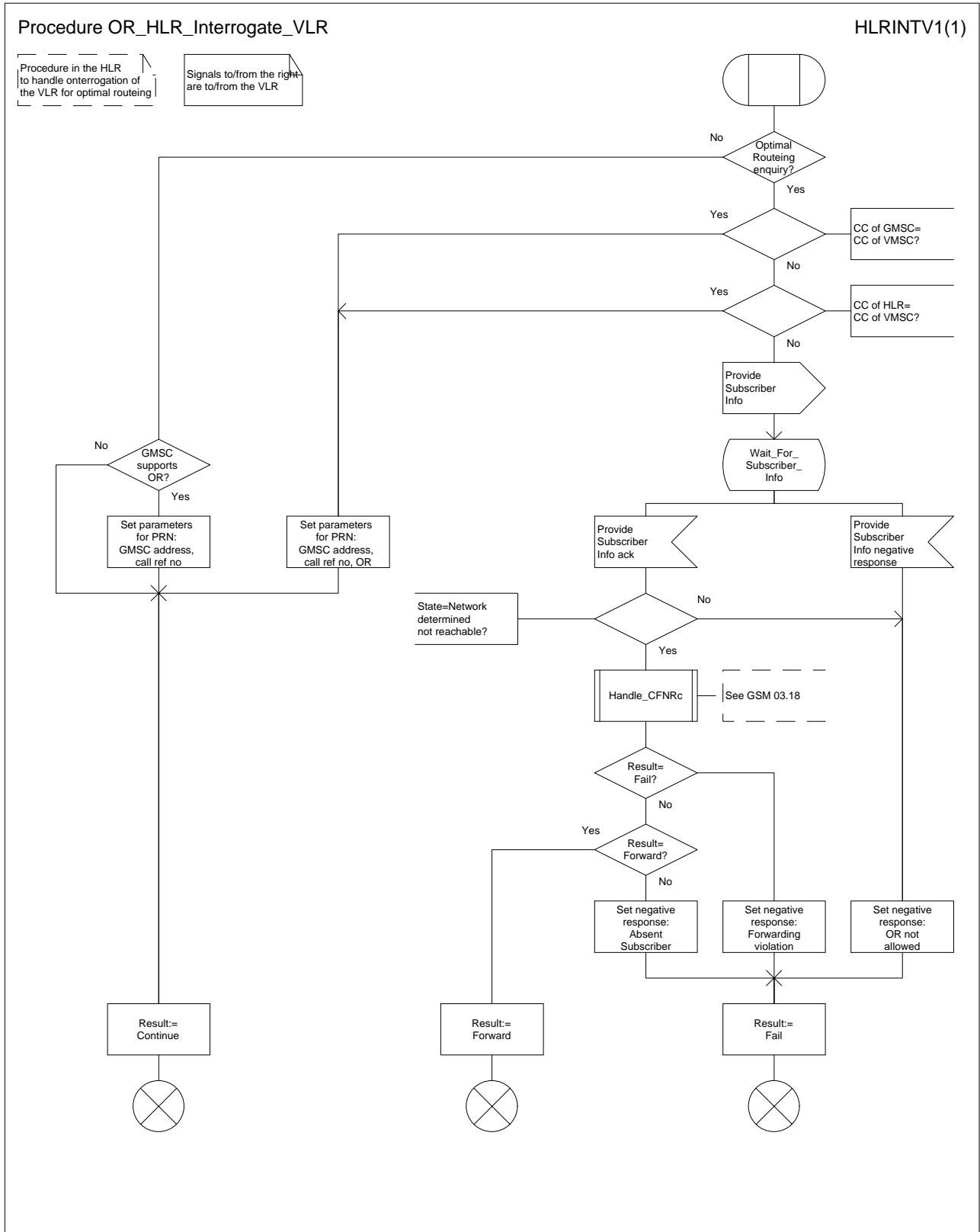

Figure 11: Procedure OR_HLR_Interrogate_VLR

9.6 Functional behaviour of VLRB

9.6.1 Functional behaviour of VLRB for provision of subscriber information

The functional behaviour of VLRB for provision of subscriber information is specified in GSM 03.18 [6].

9.6.2 Functional behaviour of VLRB for roaming number allocation

The functional behaviour of VLRB for roaming number allocation is specified in GSM 03.18 [6]. The only function specific to Support of Optimal Routeing is the storage of the OR indicator, the GMSC address and the call reference number if VLRB receives them in the Provide Roaming Number request.

9.6.3 Functional behaviour of VLRB when handling an incoming call

The functional behaviour of VLRB when handling a request for information to handle an incoming call is specified in GSM 03.18 [6]. The only functions specific to Support of Optimal Routeing are:

- the inclusion in the Complete Call or Process Call Waiting, if the call is to be offered to the B subscriber, of the OR indicator and the GMSC address if VLRB received them in the Provide Roaming Number request;
- the inclusion in the Send Info For Incoming Call response, if the call is to be forwarded, of:
 - the OR indicator, the GMSC address and the call reference number if VLRB received them in the Provide Roaming Number request;
 - the basic service which applies for this call.

9.7 Functional behaviour of VMSCB

The functional behaviour of VMSCB when it handles an incoming call is described in GSM 03.18 [6]. The procedure specific to Support of Optimal Routeing is specified in this subclause.

9.7.1 Procedure Handle_ORLCF_VMSC

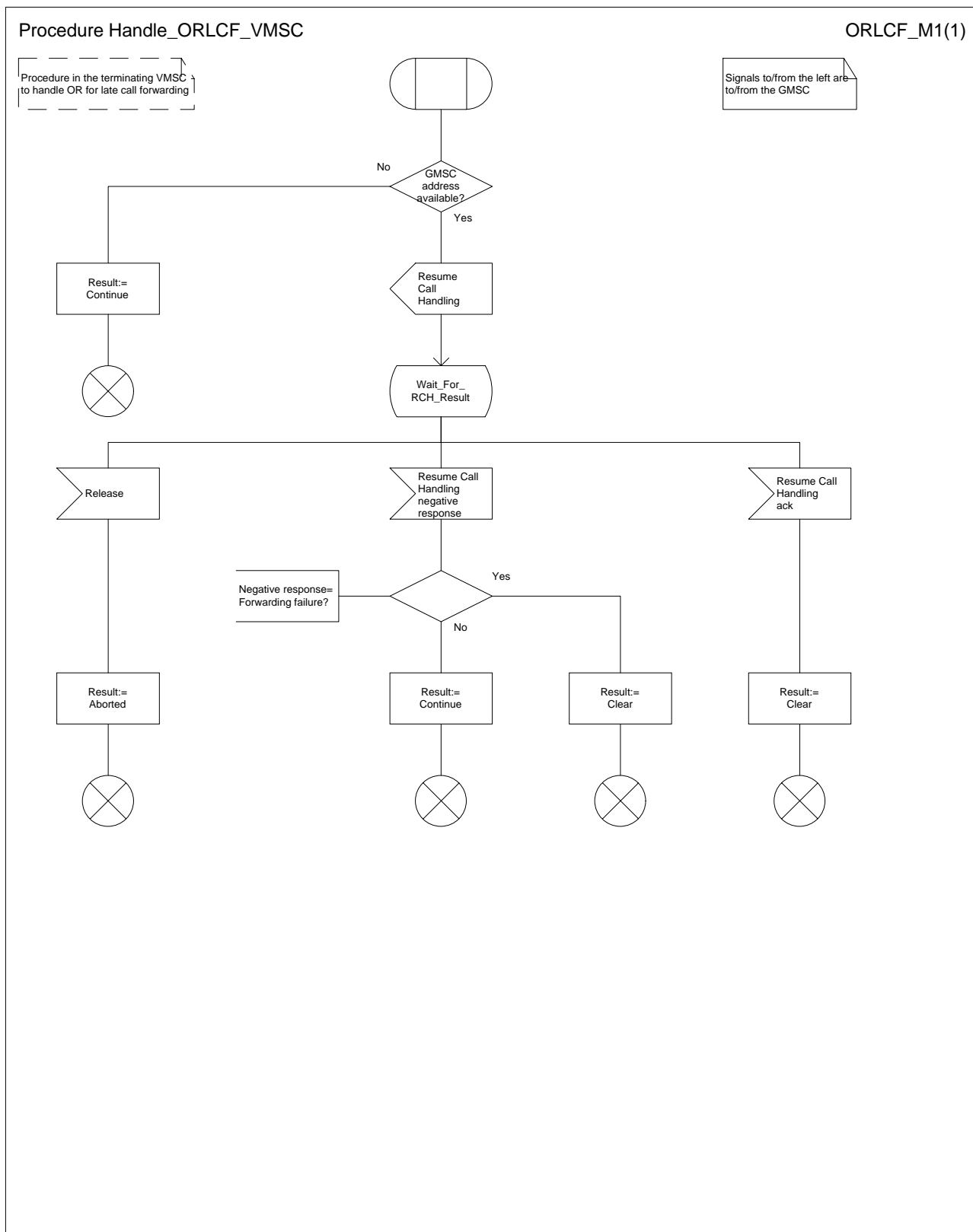

Figure 12: Procedure Handle_ORLCF_VMSC

10 Contents of messages

This clause specifies the changes to the content of each message shown in clauses 5, 6 and 9, including those messages which are already specified for GSM Phase 2 but which require changes for Optimal Routing. It should be read as a 'delta' on the corresponding clause of GSM 03.18; those information elements which are the same for SOR as for the basic call without OR are not specified in this clause.

In the tables which follow, information elements are shown as mandatory (M) or conditional (C). A mandatory information element shall always be present. A conditional information element shall be present if certain conditions are fulfilled; if those conditions are not fulfilled it shall be absent.

10.1 Messages on the B interface (MSC-VLR)

10.1.1 Send Info For Outgoing Call

This message is specified in GSM 03.18 [6].

10.1.2 Send Info For Outgoing Call negative response

This message is specified in GSM 03.18 [6].

10.1.3 Send Info For Incoming Call

This message is specified in GSM 03.18 [6].

10.1.4 Send Info For Incoming Call ack

This message is specified in GSM 03.18 [6]. The following additional information elements are required:

Information element name	Required	Description
OR indicator	C	Indicates whether the call has been routed directly from a GMSC not in the same PLMN as the HLR. Shall be present if it was received in the Provide Roaming Number, otherwise shall be absent.
GMSC address	C	E.164 address of the GMSC. Shall be present if it was received in the Provide Roaming Number, otherwise shall be absent.
Call reference number	C	Call reference number used by the GMSC for this call. Shall be present if it was received in the Provide Roaming Number, otherwise shall be absent.
Originating CSI	C	Originating CAMEL subscription information. Shall be present if the B subscriber has subscribed to originating CAMEL service and VMSCB supports CAMEL; otherwise shall be absent.

10.1.5 Send Info For Incoming Call negative response

This message is specified in GSM 03.18 [6].

10.1.6 Complete Call

This message is specified in GSM 03.18 [6]. The following additional information elements are required:

Information element name	Required	Description
OR indicator	C	Indicates whether the call has been routed directly from a GMSC not in the same PLMN as the HLR. Shall be present if it was received in the Provide Roaming Number, otherwise shall be absent.
GMSC address	C	E.164 address of the GMSC. Shall be present if it was received in the Provide Roaming Number, otherwise shall be absent.

10.1.7 Process Call Waiting

This message is specified in GSM 03.18 [6]. The following additional information elements are required:

Information element name	Required	Description
OR indicator	C	Indicates whether the call has been routed directly from a GMSC not in the same PLMN as the HLR. Shall be present if it was received in the Provide Roaming Number, otherwise shall be absent.
GMSC address	C	E.164 address of the GMSC. Shall be present if it was received in the Provide Roaming Number, otherwise shall be absent.

10.2 Messages on the C interface (MSC-HLR)

10.2.1 Send Routeing Info

This message is specified in GSM 03.18 [6]. The following additional information elements are required:

Information element name	Required	Description
Interrogation type	M	Indicates the type of interrogation: basic(for routeing information for an MT call) or forwarding (when the GMSC has been asked to resume call handling for OR of late call forwarding).
OR interrogation indicator	C	Indicates that the interrogation is from a GMSC not in the same PLMN as the HLR. Shall be present if the interrogation is from a GMSC not in the same PLMN as the HLR, otherwise shall be absent.
OR capability	C	Indicates the phase of OR which the GMSC supports. Shall be present if the GMSC supports OR, otherwise shall be absent.
GMSC address	M	E.164 address of the GMSC.
Call reference number	C	Call reference number used by the GMSC for this call. Shall be present if the interrogation type=basic call, otherwise shall be absent.
Forwarding reason	C	Indicates the reason for forwarding (on busy, on no subscriber reply, or on mobile subscriber not reachable). Shall be present if the Interrogation type=forwarding, otherwise shall be absent.
Basic service group	C	Basic service group which applies for this call. Shall be present if the Interrogation type=forwarding, otherwise shall be absent.

10.2.2 Send Routeing Info ack

This message is specified in GSM 03.18 [6]. Two new information elements are required, and the condition for the presence of one existing information element is changed, as shown in the following table.

Information element name	Required	Description
Forwarding interrogation required	C	Indicates that the GMSC shall interrogate the HLR for routeing information for late call forwarding. Shall be present if the SRI ack contains an MSRN and GMSC has to interrogate the HLR for routeing information for late call forwarding, otherwise shall be absent.
VMSC address	C	E.164 address of the VMSC in whose area the B subscriber is currently registered. Shall be present in the Send Routeing Info ack if the OR interrogation indicator in the Send Routeing Info was present and the HLR supports optimal routeing of basic mobile-to-mobile calls and the HLR has not determined that the call is to be forwarded, otherwise shall be absent.
Roaming number	C	E.164 address required to route the call to the VMSC of the B party. Shall be present in the Send Routeing Info ack which is sent in response to a Send Routeing Info with Interrogation type=basic if the HLR has determined that the charging requirements for optimal routeing are not contravened and that the call is not to be forwarded, otherwise shall be absent.

10.2.3 Send Routeing Info negative response

This message is specified in GSM 03.18 [6]. The negative response information element can take the following values in addition to those specified in GSM 03.18 [6]:

- OR not allowed
- Busy subscriber
- No subscriber reply

10.3 Messages on the D interface (VLR-HLR)

10.3.1 Provide Roaming Number

This message is specified in GSM 03.18 [6]. The following additional information elements are required:

Information element name	Required	Description
GMSC address	C	E.164 address of the GMSC. Shall be present if it was received by the HLR in the Send Routeing Info, otherwise shall be absent.
Call reference number	C	Call reference number used by the GMSC for this call. Shall be present if it was received by the HLR in the Send Routeing Info, otherwise shall be absent.
OR interrogation indicator	C	Indicates that the HLR received the corresponding Send Routeing Info from a GMSC not in the same PLMN as the HLR. Shall be present if the HLR received the Send Routeing Info from a GMSC not in the same PLMN as the HLR, otherwise shall be absent.

10.3.2 Provide Roaming Number ack

This message is specified in GSM 03.18 [6].

10.3.3 Provide Roaming Number negative response

This message is specified in GSM 03.18 [6].

10.3.4 Provide Subscriber Information

This message is specified in GSM 03.18 [6].

10.3.5 Provide Subscriber Information ack

This message is specified in GSM 03.18 [6].

10.4 Messages on the E interface (MSC-MSC)

10.4.1 Resume Call Handling

The following information elements are required:

Information element name	Required	Description
Call reference number	M	Call reference number used by the GMSC for this call.
Forwarding reason	M	Indicates the reason for forwarding (on busy, on no subscriber reply, or on mobile subscriber not reachable).
Basic service group	M	Basic service group which applies for this call.
IMSI	M	IMSI of the B subscriber.
Forwarded-to number	M	E.164 number of the C subscriber.
Notification to calling party	M	Indication of whether the calling party is to be notified that the call has been forwarded.
Forwarded-to subaddress	C	Subaddress of the C subscriber (see GSM 03.03 [4]). Shall be present if a forwarded-to subaddress is stored in the VLR in association with the forwarded-to number; otherwise shall be absent.
CUG interlock	C	For the definition of this IE, see GSM 03.85 [8]. Shall be present if the VLR has determined that the forwarded call is to be treated as a CUG call in accordance with the rules in GSM 03.85 [8], otherwise shall be absent.
CUG outgoing access	C	For the definition of this IE, see GSM 03.85 [8]. Shall be present if the VLR has determined that the forwarded call is to be treated as a CUG call with outgoing access in accordance with the rules in GSM 03.85 [8], otherwise shall be absent.
Originating CSI	C	Originating CAMEL subscription information. Shall be present if the B subscriber has subscribed to originating CAMEL service and VMSCB supports CAMEL; otherwise shall be absent.

10.4.2 Resume Call Handling ack

This message contains no information elements.

10.4.3 Resume Call Handling negative response

The negative response information element can take the following values:

- OR not allowed
- Forwarding failed

Annex A (informative): Handling of an IAM at an MSC

An MSC which receives an IAM from an originating exchange may react in three different ways:

- It acts as a transit exchange, i.e. it relays the IAM to a destination exchange determined by analysis of the called party address, and thereafter relays other ISUP signalling between the originating and destination exchange until the connection is released. This behaviour is not specific to GSM;
- It acts as a terminating exchange, i.e. it attempts to connect the call to an MS currently registered in the service area of the MSC;
- It acts as a GMSC, i.e. it interrogates an HLR for information to route the call. If the HLR returns routing information, the MSC uses the routing information from the HLR to construct an IAM, which it sends to a destination exchange determined by analysis of the routing information from the HLR.

The method which the MSC uses to determine how to handle the IAM is described in GSM 03.18 [6]. However, the number analysis required to derive the address of an HLR in a different PLMN from the MSC is much more extensive than that required to derive the address of an HLR in the same PLMN as the MSC - the MSC needs to be able to recognise the combination of country code and national destination code for every subscriber of every PLMN to which calls are to be optimally routed.

A PLMN operator may decide to implement the ability to recognise a called party address as belonging to a GSM PLMN which is not the PLMN of the MSC in only a subset of the MSCs in his PLMN. Other MSCs will route international calls to one of the MSCs which have the capability for extra number analysis.

When a GMSC has interrogated an HLR and received an MSRN, the GMSC may need to route the call to the HPLMN of the called subscriber. If the call is routed through an MSC which has the capability to analyse an address to derive an HLR address, a method must be provided to prevent the transit MSC from performing a further interrogation of the HLR, using the MSRN as an MSISDN. The method used to prevent this further interrogation is a matter for the PLMN operator.

Annex B (informative): Change Request History

SMG	TDoc	SPEC	VERS	NEW_VE	PHA	SUBJECT
s21	050/97	03.79	2.0.0	5.0.0	2+	Support of Optimal Routing phase 1 (stage 2)
s22	373/97	03.79	5.0.0	5.1.0	2+	Editorial alignment of interrogation types
s22	373/97	03.79	5.0.0	5.1.0	2+	Conditional parameters in Send Routing Info ack
s24	97-913	03.79	5.1.0	5.2.0	R96	Concentration of description of core call handling
s25	98-0086	03.79	5.2.0	5.3.0	R96	Correction to CAMEL phase 1 for forwarded calls
s27	98-0768	03.79	5.3.0	5.4.0	R96	Optionality for support of OR of basic mobile-mobile
s27			6.0.0			Release 1997 version

History

Document history		
V6.0.0	April 1999	Publication