

ETSI TS 101 154 V2.7.1 (2022-01)



**Digital Video Broadcasting (DVB);
Specification for the use of Video and
Audio Coding in Broadcast and Broadband Applications**

EBU DVB[®]

Reference

RTS/JTC-DVB-398

Keywordsbroadcasting, digital, DVB, MPEG, TV, UHDTV,
video**ETSI**650 Route des Lucioles
F-06921 Sophia Antipolis Cedex - FRANCE

Tel.: +33 4 92 94 42 00 Fax: +33 4 93 65 47 16

Siret N° 348 623 562 00017 - APE 7112B
Association à but non lucratif enregistrée à la
Sous-Préfecture de Grasse (06) N° w061004871

Important notice

The present document can be downloaded from:

<http://www.etsi.org/standards-search>

The present document may be made available in electronic versions and/or in print. The content of any electronic and/or print versions of the present document shall not be modified without the prior written authorization of ETSI. In case of any existing or perceived difference in contents between such versions and/or in print, the prevailing version of an ETSI deliverable is the one made publicly available in PDF format at www.etsi.org/deliver.

Users of the present document should be aware that the document may be subject to revision or change of status.

Information on the current status of this and other ETSI documents is available at

<https://portal.etsi.org/TB/ETSIDeliverableStatus.aspx>

If you find errors in the present document, please send your comment to one of the following services:

<https://portal.etsi.org/People/CommitteeSupportStaff.aspx>

Notice of disclaimer & limitation of liability

The information provided in the present deliverable is directed solely to professionals who have the appropriate degree of experience to understand and interpret its content in accordance with generally accepted engineering or other professional standard and applicable regulations.

No recommendation as to products and services or vendors is made or should be implied.

No representation or warranty is made that this deliverable is technically accurate or sufficient or conforms to any law and/or governmental rule and/or regulation and further, no representation or warranty is made of merchantability or fitness for any particular purpose or against infringement of intellectual property rights.

In no event shall ETSI be held liable for loss of profits or any other incidental or consequential damages.

Any software contained in this deliverable is provided "AS IS" with no warranties, express or implied, including but not limited to, the warranties of merchantability, fitness for a particular purpose and non-infringement of intellectual property rights and ETSI shall not be held liable in any event for any damages whatsoever (including, without limitation, damages for loss of profits, business interruption, loss of information, or any other pecuniary loss) arising out of or related to the use of or inability to use the software.

Copyright Notification

No part may be reproduced or utilized in any form or by any means, electronic or mechanical, including photocopying and microfilm except as authorized by written permission of ETSI.

The content of the PDF version shall not be modified without the written authorization of ETSI.

The copyright and the foregoing restriction extend to reproduction in all media.

© ETSI 2022.

© European Broadcasting Union 2022.

All rights reserved.

Contents

Intellectual Property Rights	17
Foreword.....	17
Modal verbs terminology.....	18
Introduction	18
1 Scope	21
2 References	21
2.1 Normative references	21
2.2 Informative references.....	23
3 Definition of terms, symbols and abbreviations.....	25
3.1 Terms.....	25
3.2 Symbols.....	34
3.3 Abbreviations	34
4 Systems layer.....	37
4.0 Introduction	37
4.1 Broadcast bitstreams and Baseline IRDs.....	37
4.1.0 General.....	37
4.1.1 Introduction (Recommendation ITU-T H.222.0 / ISO/IEC 13818-1 Introduction).....	37
4.1.2 Packetized Elementary Stream (PES) (Recommendation ITU-T H.222.0 / ISO/IEC 13818-1, clause Intro.4)	38
4.1.3 Transport stream system target decoder (Recommendation ITU-T H.222.0 / ISO/IEC 13818-1, clause 2.4.2).....	38
4.1.4 Transport packet layer (Recommendation ITU-T H.222.0 / ISO/IEC 13818-1, clause 2.4.3.2).....	38
4.1.4.1 Null packets.....	38
4.1.4.2 Transport packet header	38
4.1.4.2.1 Transport_error_indicator.....	38
4.1.4.2.2 Transport_priority.....	38
4.1.4.2.3 Transport_scrambling_control.....	38
4.1.4.2.4 Void.....	38
4.1.5 Adaptation field (Recommendation ITU-T H.222.0 / ISO/IEC 13818-1, clause 2.4.3.4)	39
4.1.5.1 Random_access_indicator.....	39
4.1.5.2 Elementary_stream_priority_indicator.....	40
4.1.5.3 Program Clock Reference (PCR)	41
4.1.5.4 Other fields.....	41
4.1.6 Packetized Elementary Stream (PES) Packet (Recommendation ITU-T H.222.0 / ISO/IEC 13818-1, clause 2.4.3.6)	42
4.1.6.1 stream_id and stream_type.....	42
4.1.6.2 PES_scrambling_control	43
4.1.6.3 PES_priority.....	43
4.1.6.4 Copyright and original_or_copy	43
4.1.6.5 Trick mode fields	43
4.1.6.6 additional_copy_info.....	44
4.1.6.7 Optional fields.....	44
4.1.6.8 PES_extension_field	44
4.1.6.9 Multiple video pictures per PES packet	45
4.1.6.10 Presentation Time Stamp and Decoding Time Stamp occurrence	46
4.1.6.11 STD audio buffer size	47
4.1.7 Program Specific Information (PSI) (Recommendation ITU-T H.222.0 / ISO/IEC 13818-1, clause 2.4.4).....	48
4.1.8 Use of program and elementary stream descriptors (Recommendation ITU-T H.222.0 / ISO/IEC 13818-1, clause 2.6).....	48
4.1.8.0 Introduction.....	48
4.1.8.1 video_stream_descriptor and audio_stream_descriptor	48
4.1.8.2 hierarchy_descriptor.....	48
4.1.8.3 registration_descriptor.....	49

4.1.8.4	data_stream_alignment_descriptor.....	49
4.1.8.5	target_background_grid_descriptor.....	49
4.1.8.6	video_window_descriptor	49
4.1.8.7	Conditional Access CA_descriptor	49
4.1.8.8	ISO_639_Language_descriptor.....	49
4.1.8.9	system_clock_descriptor	50
4.1.8.10	multiplex_buffer_utilization_descriptor.....	50
4.1.8.11	copyright_descriptor	50
4.1.8.12	maximum_bitrate_descriptor	50
4.1.8.13	private_data_indicator_descriptor	50
4.1.8.14	smoothing_buffer_descriptor	50
4.1.8.15	STD_descriptor	50
4.1.8.16	IBP_descriptor	50
4.1.8.17	MPEG-4_audio_descriptor	51
4.1.8.18	AVC_video_descriptor	51
4.1.8.19	SVC_extension_descriptor.....	51
4.1.8.19a	HEVC_video_descriptor	52
4.1.8.20	Void.....	52
4.1.8.21	Void.....	52
4.1.8.22	Void.....	52
4.1.8.23	Void.....	52
4.1.8.24	Void.....	52
4.1.8.24.1	Void	52
4.1.8.24.2	Void	52
4.1.8.24.3	Void	52
4.1.8.25	Void.....	52
4.1.8.26	Void.....	52
4.1.8.27	MPEG-4 audio extension descriptor	52
4.1.8.28	MVC_extension_descriptor	53
4.1.8.29	Void.....	53
4.1.8.30	Void.....	53
4.1.8.31	MPEG-H_3dAudio_descriptor.....	53
4.1.8.32	Void.....	54
4.1.9	Compatibility with ISO/IEC 11172-1 (Recommendation ITU-T H.222.0 / ISO/IEC 13818-1, clause 2.8).....	54
4.1.10	Storage Media Interoperability	54
4.2	Bitstreams from storage applications and IRDs with digital interfaces.....	54
4.2.0	Scope	54
4.2.1	Partial Transport Streams.....	54
4.2.2	Decoding of Trick Play data (Recommendation ITU-T H.222.0 / ISO/IEC 13818-1, clause 2.4.3.7).....	54
5	Video	55
5.0	Introduction	55
5.1	25 Hz MPEG-2 SDTV IRDs and Bitstreams	56
5.1.0	General.....	56
5.1.1	Profile and level	56
5.1.2	Frame rate	56
5.1.3	Aspect ratio	57
5.1.4	Luminance resolution	57
5.1.5	Chromaticity Parameters.....	59
5.1.6	Chrominance.....	59
5.1.7	Video sequence header	59
5.2	25 Hz MPEG-2 HDTV IRDs and Bitstreams.....	59
5.2.0	General.....	59
5.2.1	Profile and level	60
5.2.2	Frame rate	60
5.2.3	Aspect ratio	60
5.2.4	Luminance resolution	60
5.2.5	Chromaticity Parameters.....	61
5.2.6	Chrominance.....	62
5.2.7	Video sequence header	62

5.2.8	Backwards Compatibility	62
5.3	30 Hz MPEG-2 SDTV IRDs and Bitstreams	62
5.3.0	General.....	62
5.3.1	Profile and level.....	62
5.3.2	Frame rate	63
5.3.3	Aspect ratio.....	63
5.3.4	Luminance resolution	64
5.3.5	Chromaticity Parameters.....	65
5.3.6	Chrominance.....	66
5.3.7	Video sequence header	66
5.4	30 Hz MPEG-2 HDTV IRDs and Bitstreams.....	66
5.4.0	General.....	66
5.4.1	Profile and level.....	66
5.4.2	Frame rate	66
5.4.3	Aspect ratio.....	67
5.4.4	Luminance resolution	67
5.4.5	Chromaticity Parameters.....	68
5.4.6	Chrominance.....	68
5.4.7	Video sequence header	68
5.4.8	Backwards Compatibility	68
5.5	Specifications Common to all H.264/AVC IRDs and Bitstreams	69
5.5.0	Scope	69
5.5.1	General.....	69
5.5.2	Sequence Parameter Set and Picture Parameter Set.....	69
5.5.2.0	General	69
5.5.2.1	pic_width_in_mbs_minus1 and pic_height_in_map_units_minus1.....	69
5.5.3	Video Usability Information	70
5.5.3.0	General	70
5.5.3.1	Aspect Ratio Information.....	70
5.5.3.2	Colour Parameter Information	70
5.5.3.3	Chrominance Information	70
5.5.3.4	Timing Information.....	70
5.5.3.5	Picture Structure Information.....	71
5.5.4	Supplemental Enhancement Information.....	71
5.5.4.0	General.....	71
5.5.4.1	Picture Timing SEI Message.....	71
5.5.4.2	Pan-Scan Rectangle SEI Message.....	72
5.5.4.3	Still pictures	72
5.5.5	Random Access Point	72
5.5.5.0	General.....	72
5.5.5.1	Time Interval Between RAPs.....	73
5.6	H.264/AVC SDTV IRDs and Bitstreams	73
5.6.1	Specifications Common to all H.264/AVC SDTV IRDs and Bitstreams	73
5.6.1.0	Scope.....	73
5.6.1.1	Sequence Parameter Set and Picture Parameter Set.....	73
5.6.1.2	Profile and level	74
5.6.1.3	Aspect ratio	74
5.6.2	25 Hz H.264/AVC SDTV IRD and Bitstream.....	74
5.6.2.0	General	74
5.6.2.1	Colour Parameter Information	74
5.6.2.2	Frame rate	75
5.6.2.3	Luminance resolution.....	75
5.6.3	30 Hz H.264/AVC SDTV IRD and Bitstream.....	76
5.6.3.0	General.....	76
5.6.3.1	Colour Parameter Information	76
5.6.3.2	Frame rate	77
5.6.3.3	Luminance resolution.....	77
5.7	H.264/AVC HDTV IRDs and Bitstreams	78
5.7.1	Specifications common to all H.264/AVC HDTV IRDs and Bitstreams	78
5.7.1.0	Scope.....	78
5.7.1.1	Sequence Parameter Set and Picture Parameter Set.....	78
5.7.1.2	Aspect ratio	79

5.7.1.3	Colour Parameter Information	79
5.7.1.4	Luminance resolution	79
5.7.2	25 Hz H.264/AVC HDTV IRD and Bitstream	80
5.7.2.0	General	80
5.7.2.1	Profile and level	80
5.7.2.2	Frame rate	80
5.7.2.3	Backwards Compatibility	81
5.7.3	30 Hz H.264/AVC HDTV IRD and Bitstream	81
5.7.3.0	General	81
5.7.3.1	Profile and level	81
5.7.3.2	Frame rate	81
5.7.3.3	Backwards Compatibility	81
5.7.4	50 Hz H.264/AVC HDTV IRD and Bitstream	82
5.7.4.0	General	82
5.7.4.1	Profile and level	82
5.7.4.2	Frame rate	82
5.7.4.3	Backwards Compatibility	82
5.7.5	60 Hz H.264/AVC HDTV IRD and Bitstream	82
5.7.5.0	General	82
5.7.5.1	Profile and level	82
5.7.5.2	Frame rate	83
5.7.5.3	Backwards Compatibility	83
5.8	SVC HDTV IRDs and Bitstreams	83
5.8.1	Specifications common to all SVC HDTV IRDs and Bitstreams	83
5.8.1.0	Introduction	83
5.8.1.1	Classes of SVC operation	83
5.8.1.1.0	General	83
5.8.1.1.1	Class S Bitstream	84
5.8.1.1.2	Class Q Bitstream	84
5.8.1.1.3	Class M Bitstream	84
5.8.1.2	System Considerations	85
5.8.1.3	SVC Sequence Parameter Set and Picture Parameter Set	85
5.8.1.3.0	General	85
5.8.1.3.1	pic_width_in_mbs_minus1 and pic_height_in_map_units_minus1	85
5.8.1.3.2	Subset Sequence Parameter Set	86
5.8.1.4	Video Usability Information	86
5.8.1.4.0	General	86
5.8.1.4.1	Aspect Ratio Information	87
5.8.1.4.2	Colour Parameter Information	87
5.8.1.4.3	Chrominance Information	87
5.8.1.4.4	Timing Information	88
5.8.1.4.5	Picture Structure Information	88
5.8.1.5	Supplemental Enhancement Information	88
5.8.1.5.0	General	88
5.8.1.5.1	Picture Timing SEI Message	89
5.8.1.5.2	Pan-Scan Rectangle SEI Message	89
5.8.1.5.3	Scalable Nesting SEI Message	89
5.8.1.5.4	Still pictures	90
5.8.1.6	SVC Random Access Point	90
5.8.1.6.0	General	90
5.8.1.6.1	Time Interval Between SVC RAPs	91
5.8.2	25 Hz SVC HDTV IRD and Bitstream	91
5.8.2.0	General	91
5.8.2.1	Profile and level	91
5.8.2.2	25 Hz SVC base layer bitstream	92
5.8.2.3	Frame rate	92
5.8.2.4	Luminance resolution	92
5.8.2.5	Aspect Ratio Information	93
5.8.2.6	Backwards Compatibility	93
5.8.3	30 Hz SVC HDTV IRD and Bitstream	93
5.8.3.0	General	93
5.8.3.1	Profile and level	93

5.8.3.2	30 Hz SVC base layer bitstream	94
5.8.3.3	Frame rate	94
5.8.3.4	Luminance resolution.....	95
5.8.3.5	Aspect Ratio Information.....	95
5.8.3.6	Backwards Compatibility.....	95
5.8.4	50 Hz SVC HDTV IRD and Bitstream.....	95
5.8.4.0	General.....	95
5.8.4.1	Profile and level	96
5.8.4.2	50 Hz SVC base layer bitstream	96
5.8.4.3	Frame rate	96
5.8.4.4	Luminance resolution.....	97
5.8.4.5	Aspect Ratio Information.....	97
5.8.4.6	Backwards Compatibility.....	97
5.8.5	60 Hz SVC HDTV IRD and Bitstream.....	98
5.8.5.0	General.....	98
5.8.5.1	Profile and level	98
5.8.5.2	60 Hz SVC base layer bitstream	98
5.8.5.3	Frame rate	98
5.8.5.4	Luminance resolution.....	99
5.8.5.5	Aspect Ratio Information.....	99
5.8.5.6	Backwards Compatibility.....	100
5.9	25 Hz VC-1 SDTV IRDs and Bitstreams	100
5.9.0	General.....	100
5.9.1	Profile, Level and Colour Difference Format	100
5.9.2	Frame rate	100
5.9.3	Aspect ratio.....	100
5.9.4	Luminance resolution	101
5.9.5	Colour Parameter Information	101
5.9.6	Random Access Point	102
5.10	25 Hz VC-1 HDTV IRDs and Bitstreams	102
5.10.0	General.....	102
5.10.1	Profile, Level and Colour Difference Format	102
5.10.2	Frame rate	102
5.10.3	Aspect ratio.....	102
5.10.4	Luminance resolution	103
5.10.5	Colour Parameter Information	103
5.10.6	Random Access Point	103
5.10.7	Backwards Compatibility	104
5.11	30 Hz VC-1 SDTV IRDs and Bitstreams	104
5.11.0	General.....	104
5.11.1	Profile and level	104
5.11.2	Frame rate	104
5.11.3	Aspect ratio.....	104
5.11.4	Luminance resolution	105
5.11.5	Colour Parameter Information	105
5.11.6	Random Access Point.....	106
5.12	30 Hz VC-1 HDTV IRDs and Bitstreams	106
5.12.0	General.....	106
5.12.1	Profile, Level and Colour Difference Format	106
5.12.2	Frame rate	106
5.12.3	Aspect ratio.....	106
5.12.4	Luminance resolution	107
5.12.5	Colour Parameter Information	107
5.12.6	Random Access Point.....	107
5.12.7	Backwards Compatibility	108
5.13	MVC Stereo HDTV IRDs and Bitstreams	108
5.13.1	Specifications common to all MVC Stereo HDTV IRDs and Bitstreams.....	108
5.13.1.0	General.....	108
5.13.1.1	Introduction.....	108
5.13.1.2	Composition of MVC Stereo HDTV Bitstreams.....	108
5.13.1.3	MVC Sequence Parameter Set and Picture Parameter Set.....	109
5.13.1.4	pic_width_in_mbs_minus1 and pic_height_in_map_units_minus1.....	109

5.13.1.5	Subset Sequence Parameter Set.....	109
5.13.1.6	Video Usability Information	110
5.13.1.6.0	General	110
5.13.1.6.1	MVC VUI parameters	110
5.13.1.6.2	Aspect Ratio	110
5.13.1.6.3	Colour Parameter Information.....	111
5.13.1.6.4	Luminance Resolution.....	111
5.13.1.7	HRD Conformance.....	111
5.13.1.8	Supplemental Enhancement Information	112
5.13.1.8.0	General	112
5.13.1.8.1	Prohibited SEI messages	112
5.13.1.8.2	Order of SEI Messages.....	113
5.13.1.8.3	Multiview View Position SEI message	113
5.13.1.9	Random Access Point	113
5.13.1.9.0	General	113
5.13.1.9.1	Time Interval Between RAPs	114
5.13.1.10	Additional constraints	114
5.13.1.10.1	Constraints Common to Base and Dependent Views	114
5.13.1.10.2	MVC Stereo Base view constraints.....	115
5.13.1.10.3	MVC Stereo Dependent view constraints.....	115
5.13.1.11	Access Unit Structure.....	116
5.13.2	25 Hz MVC Stereo HDTV IRD and Bitstream	117
5.13.2.0	General	117
5.13.2.1	Profile and level	117
5.13.2.2	Frame rate	117
5.13.2.3	Backwards Compatibility.....	118
5.13.3	30 Hz MVC Stereo HDTV IRD and Bitstream	118
5.13.3.0	General	118
5.13.3.1	Profile and level	118
5.13.3.2	Frame rate	118
5.13.3.3	Backwards Compatibility.....	118
5.14	HEVC IRDs and Bitstreams	118
5.14.1	Specifications Common to all HEVC IRDs and Bitstreams	118
5.14.1.0	Scope.....	118
5.14.1.1	General.....	121
5.14.1.2	Video Parameter Set.....	121
5.14.1.3	Sequence Parameter Set	121
5.14.1.4	Picture Parameter Set	122
5.14.1.5	Video Usability Information	122
5.14.1.5.0	General	122
5.14.1.5.1	Aspect Ratio and Overscan Information.....	122
5.14.1.5.2	Video Range	123
5.14.1.5.3	Colour Parameter Information.....	123
5.14.1.5.4	Chrominance Information.....	123
5.14.1.5.5	Picture Structure Information	124
5.14.1.5.6	Default Display Window	124
5.14.1.5.7	Timing Information	125
5.14.1.6	Supplemental Enhancement Information	125
5.14.1.6.0	General	125
5.14.1.6.1	Picture Timing SEI Message	125
5.14.1.6.2	Recovery Point SEI Message	126
5.14.1.7	Frame rate	126
5.14.1.8	Random Access Point	128
5.14.1.8.0	General	128
5.14.1.8.1	Time Interval Between Random Access Points.....	129
5.14.1.9	Scalability.....	129
5.14.1.9.0	General	129
5.14.1.9.1	Temporal sub-layers	129
5.14.1.9.2	Layer Sets	130
5.14.1.10	HEVC Seamless splicing	130
5.14.2	HEVC HDTV IRDs and Bitstreams	130
5.14.2.0	General.....	130

5.14.2.1	Profile, tier and level	130
5.14.2.2	Luminance resolution	131
5.14.2.3	Colour Parameter Information	132
5.14.3	HEVC UHD TV IRDs and Bitstreams	132
5.14.3.0	General	132
5.14.3.1	Profile, tier and level	132
5.14.3.2	Luminance resolution	133
5.14.3.3	Colour Parameter Information	134
5.14.3.4	Backwards Compatibility	134
5.14.4	HEVC HDR UHD TV IRDs and Bitstreams	135
5.14.4.1	General	135
5.14.4.2	Profiles, Tiers and Levels	135
5.14.4.3	Luminance Resolutions	135
5.14.4.4	High Dynamic Range and Colour Parameter Information	136
5.14.4.4.1	Signalling of colour primaries and matrix coefficients	136
5.14.4.4.2	HEVC HDR UHD TV IRDs and Bitstreams using HLG10	136
5.14.4.4.3	HEVC HDR UHD TV IRDs and Bitstreams using PQ10	137
5.14.4.5	Frame Rates	142
5.14.4.6	Backwards Compatibility	142
5.14.5	HEVC HDR HFR UHD TV IRDs and Bitstreams and HEVC HFR UHD TV Bitstreams	143
5.14.5.1	General	143
5.14.5.2	Profiles, Tiers and Levels	143
5.14.5.2.1	Common	143
5.14.5.2.2	HFR Bitstreams using dual PID and temporal scalability	144
5.14.5.2.3	HFR Bitstreams using single PID	144
5.14.5.3	Luminance Resolutions	144
5.14.5.4	Colour Parameter Information	144
5.14.5.5	High Frame Rates	145
5.14.5.5.1	General	145
5.14.5.5.2	Dynamic Changes in Frame Rate	146
5.14.5.6	HEVC temporal sub-layers for HFR Bitstreams using dual PID and temporal scalability	146
5.14.5.7	HEVC encoding structure for HFR Bitstreams using dual PID and temporal scalability	147
5.14.5.8	Constraint on TemporalId	148
5.14.5.9	Backwards Compatibility	149
5.14.6	HEVC HDR UHD TV2 IRDs and Bitstreams	149
5.14.6.1	General	149
5.14.6.2	Profile, tier and level	149
5.14.6.3	Luminance resolution	150
5.14.6.4	Dynamic Range and Colour Parameter Information	150
5.14.6.5	Frame Rates	150
5.14.6.6	Backwards Compatibility	151
6	Audio	151
6.0	Introduction	151
6.1	MPEG-1 and MPEG-2 backward compatible audio	151
6.1.0	General	151
6.1.1	Audio mode	152
6.1.2	Layer	153
6.1.3	Bitrate	153
6.1.4	Sampling frequency	153
6.1.5	Emphasis	153
6.1.6	Cyclic redundancy code	153
6.1.7	Prediction	154
6.1.8	Multilingual	154
6.1.9	Extension Stream	154
6.1.10	Ancillary Data	154
6.1.11	MPEG Surround configurations, profiles and levels	154
6.2	AC-3 and Enhanced AC-3 audio	155
6.2.0	General	155
6.2.1	AC-3 and Enhanced AC-3 PES constraints	155
6.2.1.1	Encoding	155
6.2.1.2	Decoding	156

6.2.1.3	Byte-alignment	156
6.2.2	Enhanced AC-3 with multiple independent substreams - PES constraints	156
6.2.2.1	Encoding	156
6.2.2.2	Decoding	157
6.3	DTS Audio	158
6.3.0	General.....	158
6.3.1	DTS Audio and DTS-HD PES Constraints.....	158
6.3.1.1	Encoding	158
6.3.1.2	Decoding	158
6.3.1.3	Byte-alignment.....	158
6.4	MPEG-4 AAC, MPEG-4 HE AAC and MPEG-4 HE AAC v2 audio.....	159
6.4.0	Introduction.....	159
6.4.1	LATM/LOAS formatting.....	160
6.4.2	Profiles and Levels.....	161
6.4.2.1	Profiles and Levels for AAC, HE AAC and HE AAC v2.....	161
6.4.2.2	Profiles and Levels for MPEG Surround in combination AAC, HE AAC and HE AAC v2	162
6.4.3	Dynamic Range Control	162
6.5	Random Access Points with MPEG-4 Audio.....	162
6.5.0	General.....	162
6.5.1	Definition of RAP with MPEG-4 Audio.....	163
6.5.1.0	Introduction	163
6.5.1.1	RAP with the LATM/LOAS transport header.....	163
6.5.1.2	RAP with the AAC Profile.....	163
6.5.1.3	RAP with the HE AAC Profile	163
6.5.1.4	RAP with the HE AAC v2 Profile	164
6.5.1.5	RAP with AAC-LC / HE AAC plus MPEG Surround.....	164
6.5.1.6	RAP with Dynamic Range Control and MPEG-4 Audio ancillary data.....	164
6.5.2	Time interval Between RAPs.....	164
6.6	AC-4 channel-based audio	165
6.6.0	Introduction.....	165
6.6.1	General.....	165
6.6.2	PES packaging for AC-4 elementary streams	166
6.6.3	PES packaging for AC-4 for receiver mix audio	166
6.6.4	DRC and Loudness	166
6.6.5	Dialogue Enhancement	168
6.6.6	Audio/Video Synchronization	168
6.6.7	AC-4 Sync Frame Format.....	168
6.7	AC-4 for channel-based, immersive and personalized audio	169
6.7.1	AC-4 specific NGA concepts.....	169
6.7.2	General requirements.....	169
6.7.3	PES packaging for AC-4 elementary streams	170
6.7.4	Multiple audio programme components	171
6.7.4.1	General	171
6.7.4.2	Single-stream delivery	171
6.7.4.3	Multi-stream delivery.....	172
6.7.5	DRC and Loudness	172
6.7.6	Dialogue Enhancement	173
6.7.7	Audio/Video frame rate matching	174
6.8	MPEG-H Audio.....	174
6.8.1	Introduction.....	174
6.8.2	Profiles and Levels for MPEG-H Audio.....	175
6.8.3	MHAS elementary stream formatting.....	176
6.8.4	Random Access Points with MPEG-H Audio	176
6.8.4.1	Definition of RAP with MPEG-H Audio	176
6.8.4.2	Time interval Between RAPs.....	177
6.8.4.3	Tune-In at a RAP	177
6.8.5	Configuration Change and Audio/Video Alignment	177
6.8.6	Metadata Audio Elements and Audio Preselections	178
6.8.7	MPEG-H Multi-Stream Audio.....	178
6.8.7.1	Encoding and Decoding of MPEG-H Multi-Stream Audio	178
6.8.7.2	Example of MPEG-H Multi-Stream Audio.....	179
6.8.8	Loudness and Dynamic Range Control	179

6.8.9	User Interactivity and Personalization	180
6.8.9.1	Audio Scene and User Interactivity Information.....	180
6.8.9.2	User Interface Examples (informative)	181
6.8.9.2.1	Introduction	181
6.8.9.2.2	MPEG-H Audio Decoder API for User Interface.....	181
6.8.9.2.3	User Interface on Systems Level	181
6.9	DTS-UHD Audio	182
6.9.1	Overview	182
6.9.1.1	DTS-UHD Stream Structure	182
6.9.1.2	Decoders and Renderers.....	184
6.9.1.3	Sync Intervals.....	184
6.9.2	Multi-stream Playback	185
6.9.3	Detailed Requirements.....	186
6.9.3.1	DTS-UHD BroadcastChunk.....	186
6.9.3.2	Requirements for including the DTS-UHD BroadcastChunk	187
6.9.4	General Requirements for DTS-UHD.....	188
6.9.5	DTS-UHD PES Packaging	188
6.9.6	Loudness	189
6.9.7	Dynamic Range Personalization	189

Annex A (informative): Examples of Full screen luminance resolutions for SDTV and 25 Hz/30 Hz HDTV 190

Annex B (normative): Auxiliary Data in the Video Elementary Stream 193

B.1	Overview	193
B.2	Common Syntax and Semantics.....	193
B.3	Active Format Description (AFD)	194
B.3.0	Introduction	194
B.3.1	Coded Frame in MPEG-2 Video	195
B.3.2	Coded Frame in H264/AVC Video	195
B.3.3	Coded Frame in VC-1 Video.....	195
B.3.4	Common Semantics of AFD	195
B.3.5	Relationship with Pan Vectors	198
B.3.6	Coded Frame in HEVC Video.....	198
B.4	Bar data	198
B.4.0	Syntax and semantics	198
B.4.1	Recommended Receiver Response to Bar Data	200
B.4.2	Relationship Between Bar Data and AFD.....	200
B.5	Closed Captions.....	200
B.5.0	Introduction	200
B.5.1	Syntax and Semantics of cc_data().....	200
B.6	Auxiliary Data and MPEG-2 video	201
B.6.1	Coding	201
B.6.2	Syntax and Semantics.....	202
B.7	Auxiliary Data and H264/AVC, MVC Stereo or SVC video.....	202
B.7.1	Coding	202
B.7.2	Syntax and Semantics.....	202
B.7.3	Auxiliary Data in MVC Stereo HDTV Bitstreams	203
B.8	Auxiliary Data and VC-1 video.....	203
B.8.1	Coding	203
B.8.2	Syntax and Semantics.....	204
B.8a	Auxiliary Data and HEVC video.....	204
B.8a.1	Coding	204
B.8a.2	Syntax and Semantics.....	204
B.9	Relationship with Wide Screen Signalling (WSS).....	205

B.10	Aspect Ratio Ranges	205
B.11	Multi Region Disparity.....	205
B.11.0	Introduction	205
B.11.1	Syntax and Semantics of Multi Region Disparity	206
Annex C (normative): Implementation of Ancillary Data for MPEG Audio		210
C.1	Scope	210
C.2	Introduction	210
C.3	DVB Compliance	210
C.4	Detailed specification for MPEG1 and MPEG2	210
C.4.1	DVD-Video Ancillary Data.....	210
C.4.2	Extended ancillary data syntax	211
C.4.2.0	Syntax	211
C.4.2.1	ancillary_data_sync	212
C.4.2.2	bs_info	212
C.4.2.3	mpeg_audio_type.....	212
C.4.2.4	dolby_surround_mode	212
C.4.2.5	ancillary_data_bytes	212
C.4.2.6	ancillary_data_status.....	213
C.4.2.7	advanced_dynamic_range_control.....	213
C.4.2.8	dialog_normalization	214
C.4.2.8.0	Syntax	214
C.4.2.8.1	dialog_normalization_on.....	214
C.4.2.8.2	dialog_normalization_value	214
C.4.2.9	reproduction_level	214
C.4.2.9.0	Syntax	214
C.4.2.9.1	surround_reproduction_level	215
C.4.2.9.2	production_roomtype	215
C.4.2.9.3	reproduction_level_value	215
C.4.2.10	downmixing_levels_MPEG2.....	215
C.4.2.10.0	Syntax	215
C.4.2.10.1	center_mix_level_on.....	215
C.4.2.10.2	surround_mix_level_on.....	216
C.4.2.10.3	mix_level_value	216
C.4.2.11	audio_coding_mode.....	216
C.4.2.11.0	Syntax	216
C.4.2.11.1	compression_on	216
C.4.2.12	compression_value.....	217
C.4.2.13	coarse_grain_timecode	217
C.4.2.14	fine_grain_timecode	217
C.4.2.15	scale_factor_CRC	217
C.4.2.16	Void	218
C.4.2.17	Void	218
C.4.2.18	Void	218
C.4.3	Announcement Switching Data.....	218
C.4.4	Scale Factor Error Check	219
C.4.5	RDS data via UECP protocol	219
C.5	Detailed specification for MPEG4 AAC, HE AAC and HE AAC v2 Audio.....	220
C.5.1	Transmission of MPEG4 Audio ancillary data.....	220
C.5.2	MPEG4 Audio ancillary data syntax	221
C.5.2.0	Syntax	221
C.5.2.1	ancillary_data_sync	221
C.5.2.2	bs_info	221
C.5.2.2.0	Syntax	221
C.5.2.2.1	mpeg_audio_type.....	221
C.5.2.2.2	dolby_surround_mode.....	222
C.5.2.2.3	drc_presentation_mode	222
C.5.2.3	ancillary_data_status.....	222

C.5.2.4	downmixing_levels_MPEG4.....	223
C.5.2.4.0	General.....	223
C.5.2.4.1	center_mix_level_on.....	223
C.5.2.4.2	surround_mix_level_on.....	223
C.5.2.4.3	mix_level_value.....	224
C.5.2.5	audio_coding_mode.....	224
C.5.2.5.0	Syntax.....	224
C.5.2.5.1	compression_on.....	225
C.5.2.5.2	compression_value.....	225
C.5.2.6	coarse_grain_timecode.....	225
C.5.2.7	fine_grain_timecode.....	225
C.5.2.8	Persistence of MPEG4 ancillary data.....	225
C.5.3	Announcement Switching Data.....	226
C.5.4	DRC Presentation Mode.....	226

Annex D (normative): Coding of Data Fields in the Private Data Bytes of the Adaptation Field..... 229

D.1	Introduction.....	229
D.2	Private data bytes detailed specification.....	229
D.2.0	General.....	229
D.2.0a	DVB Compliance.....	230
D.2.1	Announcement Switching Data.....	230
D.2.2	AU_information.....	230
D.3	PVR assistance.....	235
D.3.1	Introduction (informative).....	235
D.3.2	Encoding of PVR assist information (normative).....	235
D.3.3	Tier framework.....	236
D.3.3.0	Introduction.....	236
D.3.3.1	Background (informative).....	236
D.3.3.2	Specification for H.264/AVC (normative).....	236
D.3.3.2a	Specification for HEVC (normative).....	237
D.3.3.3	Examples of tier number assignment for H.264/AVC and HEVC (informative).....	238
D.3.4	Sub-stream framework.....	240
D.3.4.1	Background (informative).....	240
D.3.4.2	Tier Signalling (normative).....	240
D.3.4.3	Playback speed information (normative).....	241
D.3.4.4	Sub-stream associated with a Playback speed (normative).....	241
D.3.4.5	Examples of sub-streams (informative).....	242
D.3.5	Segmentation signalling.....	242
D.3.6	PVR Assistance Signalling Syntax.....	243

Annex E (normative): Supplementary Audio Services..... 248

E.1	Overview.....	248
E.2	Syntax and semantics.....	248
E.3	Coding for Audio Description SA services.....	250
E.4	Coding for Clean Audio SA services.....	251
E.5	Decoder behaviour.....	252
E.6	Decoder user indicators.....	253
E.7	Advanced Clean Audio Services.....	253
E.7.0	Introduction.....	253
E.7.1	Basic Principle.....	253
E.7.2	Control Information.....	254
E.7.3	Coding for Dialogue Enhancement SA services.....	256
E.7.3.0	General.....	256
E.7.3.1	Supplementary SAOC-DE stream.....	257
E.7.4	Decoder and Renderer behaviour.....	257

E.7.4.0	Scope	257
E.7.4.1	Mono/Stereo service with Dialogue Enhancement	257
E.7.4.2	Multichannel service with Dialogue Enhancement.....	258
E.7.4.3	Loudness compensation.....	260

Annex F (informative): Encoding Guidelines to Enable Trick Play Support of H.264/AVC Streams 261

F.1	Introduction	261
F.1.1	Overview	261
F.1.2	Technical Requirements	261
F.2	Discardable Pictures	262
F.2.0	Introduction	262
F.2.1	MPEG-2 Discardable Pictures.....	262
F.2.2	H.264/AVC Discardable Pictures.....	263
F.2.3	Discardable Pictures and Trick Play Speeds	263
F.2.4	Smooth Trick Play and Compression Efficiency.....	264
F.2.5	Impact of Adaptive Encoding on Guidelines.....	265

Annex G (informative): Random Access Point Considerations for SVC..... 266

G.1	Scope	266
G.2	Overview	266
G.3	Encoder Implementation Guidelines	266
G.4	Decoder Implementation Guidelines.....	267
G.4.0	General	267
G.4.1	Decoding process with output picture skipping.....	267
G.4.2	Decoding process with seamless output	269
G.4.3	Display Process at a Transition from Base to Enhancement Layer Decoding.....	270

Annex H (normative): Frame Compatible Plano-Stereoscopic 3DTV 272

H.1	Scope	272
H.2	Frame compatible plano-stereoscopic 3DTV definition	272
H.3	System layer specifications common to all plano-stereoscopic 3DTV IRDs and Bitstreams	273
H.3.0	Scope	273
H.3.1	General	273
H.3.2	Frame compatible plano-stereoscopic 3DTV Specific Program Elementary Stream descriptor	273
H.3.2.1	AVC_video_descriptor	273
H.4	Video specifications Common to all frame compatible plano-stereoscopic 3DTV IRDs and Bitstreams.....	273
H.4.0	Scope	273
H.4.1	General	273
H.4.2	Supplemental Enhancement Information	274
H.4.2.0	General.....	274
H.4.2.1	Frame Packing Arrangement SEI Message	274

Annex I (normative): Considerations for Encoding and Random Access for MVC Stereo Video 277

I.0	Introduction	277
I.1	Video Sequence Structure	277
I.1.0	General	277
I.1.1	Closed Coded Video Sequence	278
I.1.2	Open Coded Video Sequence.....	279
I.2	Guidelines for TS Packet Multiplexing.....	280

Annex J (normative):	Service Frame Compatible Plano-Stereoscopic 3DTV with HEVC coding.....	281
J.1	Scope	281
J.2	Service frame compatible plano-stereoscopic 3DTV definition	281
J.3	System layer specifications common to all HEVC service frame compatible plano-stereoscopic 3DTV IRDs and Bitstreams	282
J.3.1	Scope	282
J.3.2	General	282
J.3.3	Service frame compatible plano-stereoscopic 3DTV Specific Program Elementary Stream descriptor.....	282
J.3.3.1	HEVC_video_descriptor.....	282
J.4	Video specifications common to all HEVC service frame compatible plano-stereoscopic 3DTV IRDs and Bitstreams.....	282
J.4.1	Scope	282
J.4.2	General	283
J.4.3	Supplemental Enhancement Information	283
J.4.3.1	General.....	283
J.4.3.2	Frame Packing Arrangement SEI Message	283
J.4.4	VUI - Default Display Window and service compatibility of frame compatible services	284
Annex K (informative):	Next-Generation Audio Overview	286
K.1	NGA Concepts	286
K.1.1	Introduction	286
K.1.2	Immersive audio	286
K.1.3	Preselections and Personalized audio	286
K.2	Examples	287
K.2.1	Audio Programme Examples.....	287
K.2.2	Audio Preselection Examples.....	287
K.3	Carriage of NGA	288
Annex L (normative):	Video codec profiles for DVB DASH	289
L.1	Introduction	289
L.2	H.264/AVC and HEVC player conformance points	289
L.2.1	Summary of player conformance points.....	289
L.2.2	Relationship with broadcast IRDs (informative).....	291
L.2.3	Constraints, relaxations and extensions common to all H.264/AVC player conformance points	291
L.2.4	avc_hd_50_level40.....	292
L.2.5	avc_hd_60_level40.....	292
L.2.6	avc_hd_50	292
L.2.7	avc_hd_60	293
L.2.8	Constraints, relaxations and extensions common to all HEVC player conformance points.....	293
L.2.9	hevc_hd_50_8	294
L.2.10	hevc_hd_60_8	294
L.2.11	hevc_hd_50_10	294
L.2.12	hevc_hd_60_10	294
L.2.13	hevc_uhd	295
L.2.14	hevc_uhd_hlg10	295
L.2.15	hevc_uhd_pq10	295
L.2.16	hevc_uhd_hfr_hlg10.....	296
L.2.17	hevc_uhd_hfr_pq10.....	296
L.2.18	hevc_uhd2_hdr	297
L.3	Content requirements	297
L.3.1	Content interoperability requirements	297
L.3.2	H.264/AVC bitstream requirements	298
L.3.2.1	General.....	298
L.3.2.2	Sequence Parameter Set.....	298

L.3.2.3	Video Usability Information	298
L.3.2.4	Aspect ratio	298
L.3.2.5	Colour parameter information.....	298
L.3.2.6	Chrominance information	299
L.3.2.7	Picture timing SEI message	299
L.3.2.8	Frame rate	299
L.3.3	HEVC bitstream requirements	299
L.3.3.1	General.....	299
L.3.3.2	Sequence Parameter Set.....	300
L.3.3.3	Video Usability Information	300
L.3.3.4	Aspect ratio	300
L.3.3.5	Video range.....	300
L.3.3.6	Colour parameter information.....	300
L.3.3.7	Chrominance information	301
L.3.3.8	Supplemental Enhancement Information.....	301
L.3.3.9	Picture timing SEI message	301
L.3.3.10	Optional SEI messages for HEVC HDR bitstreams using PQ10.....	302
L.3.3.10.1	General	302
L.3.3.10.2	Mastering display colour volume	302
L.3.3.10.3	Content light level information	302
L.3.3.10.4	DMI.....	302
L.3.3.10.4.1	General	302
L.3.3.10.4.2	SMPTE ST 2094-10 SEI message.....	303
L.3.3.10.4.3	SL-HDR2 SEI message	303
L.3.3.10.4.4	SMPTE ST 2094-40 SEI message.....	304
L.3.3.11	Frame rate	304
Annex M (informative):	Bibliography.....	305
Annex N (informative):	Change History	306
History		308

Intellectual Property Rights

Essential patents

IPRs essential or potentially essential to normative deliverables may have been declared to ETSI. The declarations pertaining to these essential IPRs, if any, are publicly available for **ETSI members and non-members**, and can be found in ETSI SR 000 314: "*Intellectual Property Rights (IPRs); Essential, or potentially Essential, IPRs notified to ETSI in respect of ETSI standards*", which is available from the ETSI Secretariat. Latest updates are available on the ETSI Web server (<https://ipr.etsi.org/>).

Pursuant to the ETSI Directives including the ETSI IPR Policy, no investigation regarding the essentiality of IPRs, including IPR searches, has been carried out by ETSI. No guarantee can be given as to the existence of other IPRs not referenced in ETSI SR 000 314 (or the updates on the ETSI Web server) which are, or may be, or may become, essential to the present document.

Trademarks

The present document may include trademarks and/or tradenames which are asserted and/or registered by their owners. ETSI claims no ownership of these except for any which are indicated as being the property of ETSI, and conveys no right to use or reproduce any trademark and/or tradename. Mention of those trademarks in the present document does not constitute an endorsement by ETSI of products, services or organizations associated with those trademarks.

DECT™, **PLUGTESTS™**, **UMTS™** and the ETSI logo are trademarks of ETSI registered for the benefit of its Members. **3GPP™** and **LTE™** are trademarks of ETSI registered for the benefit of its Members and of the 3GPP Organizational Partners. **oneM2M™** logo is a trademark of ETSI registered for the benefit of its Members and of the oneM2M Partners. **GSM®** and the GSM logo are trademarks registered and owned by the GSM Association.

Foreword

This Technical Specification (TS) has been produced by Joint Technical Committee (JTC) Broadcast of the European Broadcasting Union (EBU), Comité Européen de Normalisation ELEctrotechnique (CENELEC) and the European Telecommunications Standards Institute (ETSI).

For a history of the revisions of the present document, refer to annex N.

The revisions to the present document have been developed in a largely backwards compatible manner, i.e. no changes to the mandatory functionality of a previously defined IRD have been made between one edition of the present document and the next.

NOTE: The EBU/ETSI JTC Broadcast was established in 1990 to co-ordinate the drafting of standards in the specific field of broadcasting and related fields. Since 1995 the JTC Broadcast became a tripartite body by including in the Memorandum of Understanding also CENELEC, which is responsible for the standardization of radio and television receivers. The EBU is a professional association of broadcasting organizations whose work includes the co-ordination of its members' activities in the technical, legal, programme-making and programme-exchange domains. The EBU has active members in about 60 countries in the European broadcasting area; its headquarters is in Geneva.

European Broadcasting Union
CH-1218 GRAND SACONNEX (Geneva)
Switzerland
Tel: +41 22 717 21 11
Fax: +41 22 717 24 81

The Digital Video Broadcasting Project (DVB) is an industry-led consortium of broadcasters, manufacturers, network operators, software developers, regulatory bodies, content owners and others committed to designing global standards for the delivery of digital television and data services. DVB fosters market driven solutions that meet the needs and economic circumstances of broadcast industry stakeholders and consumers. DVB standards cover all aspects of digital television from transmission through interfacing, conditional access and interactivity for digital video, audio and data. The consortium came together in 1993 to provide global standardization, interoperability and future proof specifications.

Modal verbs terminology

In the present document "shall", "shall not", "should", "should not", "may", "need not", "will", "will not", "can" and "cannot" are to be interpreted as described in clause 3.2 of the [ETSI Drafting Rules](#) (Verbal forms for the expression of provisions).

"must" and "must not" are **NOT** allowed in ETSI deliverables except when used in direct citation.

Introduction

The present document presents guidelines covering coding and decoding using the MPEG-2 system layer, video coding and audio coding.

The guidelines presented in the present document for the Integrated Receiver-Decoder (IRD) are intended to represent a minimum functionality that all IRDs of a particular class are required to either meet or exceed. It is necessary to specify the minimum IRD functionality for basic parameters, if broadcasters are not to be prevented from ever using certain features. For example, if a significant population of IRDs were produced that supported only the Simple Profile, broadcasters would never be able to transmit Main Profile bitstreams.

IRDs are classified in five dimensions as:

- "25 Hz" ("50 Hz") or "30 Hz" ("60 Hz"), depending on whether the nominal video frame rates based on 25 Hz or 30 000/1 001 Hz (approximately 29,97 Hz) are supported. It is expected that 25 Hz IRDs and 50 Hz IRDs will be used in those countries where the existing analogue TV transmissions use 25 Hz frame rate and 30 Hz IRDs and 60 Hz IRDs will be used in countries where the analogue TV transmissions use 30 000/1 001 Hz frame rate. There are also likely to be "dual-standard" IRDs which have the capabilities of both 25 Hz (50 Hz) and 30 Hz (60 Hz) IRDs.
- "SDTV", "HDTV" or "UHDTV", depending on whether or not they are limited to decoding pictures of conventional TV resolution. The capabilities of an SDTV IRD are a sub-set of those of an HDTV IRD. An HDTV IRD capabilities are a sub set of those of an UHDTV IRD.
- "with digital interface" or "Baseline", depending on whether or not they are intended for use with a digital bitstream storage device such as a digital VCR. The capabilities of a Baseline IRD are a sub-set of those of an IRD with digital interface.
- MPEG-2 video, H.264/AVC, MVC, SVC, HEVC or VC-1 video coding formats.
- Audio coding formats according to clause 6.

To give a complete definition of an IRD, all five dimensions need to be specified, e.g.:

- 25 Hz SDTV Baseline IRD MPEG-2 video, MPEG-1 Layer II audio, for an IRD able to decode 720 × 576 interlaced 25 Hz video pictures.
- 30 Hz HDTV Baseline IRD H264/AVC video, HE AAC Level 4 audio, for an IRD able to decode up to 1 920 × 1 080 interlaced 30 Hz video pictures or 1 280 × 720 progressive 60 Hz video pictures.
- UHDTV IRD HEVC video, HE AAC Level 4 audio, for an IRD able to decode up to 3 840 × 2 160, 60 Hz video pictures.

All the formats supported by an IRD conforming to the present document are listed in annex A.

It should be noted that in DVB systems the source picture format, encoded picture format and display picture format do not need to be identical. For example, HDTV source material may be broadcast as an SDTV bitstream after down-conversion to SDTV resolution and encoding within the constraints of MPEG-2 video Main Profile at Main Level. The IRD receiving the bitstream may then up-convert the decoded picture for display at HDTV resolution.

Another notable feature of the DVB system is that a single Transport Stream may contain programme material intended for more than one type of IRD. A typical example of this is likely to be the simulcasting of SDTV and HDTV video material. In this case an SDTV IRD will decode and display SDTV pictures whilst an HDTV IRD will decode and display HDTV pictures from the same Transport Stream.

Where a feature described in the present document is mandatory, the word "shall" is used and the text is in italic; all other features are optional. The functionality is specified in the form of constraints on MPEG-2 systems, video and audio formats which the IRDs are required to decode correctly.

The specification of these baseline features in no way prohibits IRD manufacturers from including additional features, and should not be interpreted as stipulating any form of upper limit to the performance. The guidelines do not cover features, such as the IRDs up-sampling filter, which affect the quality of the displayed picture rather than whether the IRD is able to decode pictures at all. Such issues are left to the marketplace.

The guidelines presented for IRDs observe the following principles:

- wherever practical, IRDs should be designed to allow for future compatible extensions to the bitstream syntax;
- all "reserved" and "private" bits in MPEG-2 systems, video and audio formats should be ignored by IRDs not designed to make use of them.

The rules of operation for the encoders are features and constraints which the encoding system should adhere to in order to ensure that the transmissions can be correctly decoded. These constraints may be mandatory or optional.

Clauses 4 to 6 and the annexes, provide the guidelines for the Digital Video Broadcasting (DVB) systems layer, video and audio respectively. For information, some of the key features are summarized below, but clauses 4 to 6 and the annexes should be consulted for all definitions:

Systems:

- MPEG-2 Transport Stream (TS) is used.
- Service Information (SI) is based on MPEG-2 program-specific information.
- Scrambling is as defined in ETSI TS 100 289 [i.15].
- Conditional access uses the MPEG-2 Conditional Access CA_descriptor.
- Partial Transport Streams are used for digital VCR applications.

Video:

- MPEG-2 Main Profile at Main Level is used for MPEG-2 encoded SDTV.
- MPEG-2 Main Profile at High Level is used for MPEG-2 encoded HDTV.
- H.264/AVC Main Profile at Level 3 is used for H.264/AVC SDTV.
- H.264/AVC High Profile at Level 4 is used for 25 Hz and 30 Hz H.264/AVC HDTV.
- H.264/AVC High Profile at Level 4.2 is used for 50 Hz and 60 Hz H.264/AVC HDTV.
- H.264/AVC Scalable High Profile at Level 4 is used for 25 Hz and 30 Hz SVC HDTV.
- H.264/AVC Stereo High Profile at Level 4 is used for 25 Hz and 30 Hz MVC Stereo HDTV.
- H.264/AVC Scalable High Profile at Level 4.2 is used for 50 Hz and 60 Hz SVC HDTV.
- HEVC Main or Main 10 Profile at Level 4.1 is used for HEVC HDTV.
- HEVC Main 10 Profile at Level 5.1 is used for HEVC UHD TV and HEVC HDR UHD TV.
- HEVC Main 10 Profile at Level 5.2 is used for HEVC HFR UHD TV.
- VC-1 Advanced Profile at Level 1 is used for VC-1 SDTV.
- VC-1 Advanced Profile at Level 3 is used for VC-1 HDTV.
- The 25 Hz MPEG-2 SDTV IRD, 25 Hz H.264/AVC SDTV IRD and 25 Hz VC-1 SDTV IRD support 25 Hz frame rate.

- The 25 Hz MPEG-2 HDTV IRD, 25 Hz H.264/AVC HDTV IRD, 50 Hz HEVC HDTV IRD and 25 Hz VC-1 HDTV IRD support frame rates of 25 Hz or 50 Hz.
- The 30 Hz MPEG-2 SDTV IRD, 30 Hz H.264/AVC SDTV IRD and 30 Hz VC-1 SDTV IRD support frame rates of 24 000/1 001, 24, 30 000/1 001 and 30 Hz.
- The 30 Hz MPEG-2 HDTV IRD, 30 Hz H.264/AVC HDTV IRD, 60 Hz HEVC HDTV IRD and 30 Hz VC-1 HDTV IRD supports frame rates of 24 000/1 001, 24, 30 000/1 001, 30, 60 000/1 001 and 60 Hz.
- The HEVC UHD TV IRD and HEVC HDR UHD TV IRD support frame rates of 24 000/1 001, 24, 25, 30 000/1 001, 30, 50, 60 000/1 001 and 60 Hz.
- The HEVC HDR HFR UHD TV IRD supports frame rates of 24 000/1 001, 24, 25, 30 000/1 001, 30, 50, 60 000/1 001, 60, 100, 120 000/1 001 and 120 Hz.
- SDTV pictures may have either 4:3, 16:9 or 2.21:1 aspect ratio; IRDs support 4:3 and 16:9 and optionally 2.21:1 aspect ratio.
- MPEG-2 HDTV pictures have 16:9 or 2.21:1 aspect ratio; IRDs support 16:9 and optionally 2.21:1 aspect ratio.
- H.264/AVC HDTV pictures have 16:9 aspect ratio; IRDs support 16:9 aspect ratio.
- HEVC HDTV and UHD TV pictures have 16:9 aspect ratio; IRDs support 16:9 aspect ratio.
- SVC HDTV pictures have 16:9 aspect ratio; IRDs support 16:9 aspect ratio.
- MVC Stereo HDTV pictures have 16:9 aspect ratio; IRDs support 16:9 aspect ratio.
- VC-1 HDTV pictures have 16:9 aspect ratio; IRDs support 16:9 aspect ratio.
- MPEG-2 IRDs support the use of pan vectors to allow a 4:3 monitor to give a full-screen display of a 16:9 coded picture of SDTV resolution.
- IRDs may also optionally support the use of the Active Format Description (refer to annex B of the present document) as part of the logic to control the processing and positioning of the reconstructed image for display.
- IRDs may also optionally support frame compatible plano-stereoscopic 3DTV services (see annex H).
- IRDs may also optionally support service frame compatible plano-stereoscopic 3DTV services with HEVC coding (see annex J).

Audio:

- Audio content complies with MPEG-1 Layer I, MPEG-1 Layer II, MPEG-2 Layer II backward compatible, AC-3, Enhanced AC-3, AC-4, DTS Audio, DTS-HD, DTS-UHD, MPEG-4 AAC, MPEG-4 HE AAC, MPEG-4 HE AAC v2 or MPEG-H LC audio. MPEG-1 Layer II, MPEG-4 AAC, MPEG-4 HE AAC and MPEG-4 HE AAC v2 audio streams may optionally include MPEG Surround data.
- Sampling rates of 32 kHz, 44,1 kHz and 48 kHz are supported by IRDs.
- The encoded bitstream does not use emphasis.
- IRDs may also optionally support full multi-channel decoding of MPEG-2 Layer II backwards compatible multi-channel audio.
- The use of Layer II encoding is recommended for MPEG-1 audio bitstreams.
- IRDs may also optionally support the decoding of MPEG-1/-2/-4 audio streams which include ancillary data (see annex C).
- IRDs may also optionally support supplementary-mixed services (see annex E).

Annex L contains MPEG DASH player conformance points for H.264/AVC and HEVC video, designed to correspond to the IRD conformance points.

1 Scope

The present document provides implementation guidelines and conformance points for the use of audio-visual coding utilizing MPEG-2 Systems in satellite, cable and terrestrial broadcasting systems and in IP-based networks, and for the use of video coding for adaptive bitrate delivery over IP-based networks. The present document covers Standard Definition Television (SDTV), High Definition Television (HDTV), Plano Stereoscopic 3DTV and Ultra High Definition Television (UHDTV). More specifically, the present document covers the first and second phases of the DVB UHDTV specification, as well as the DVB Next Generation Audio specification.

2 References

2.1 Normative references

References are either specific (identified by date of publication and/or edition number or version number) or non-specific. For specific references, only the cited version applies. For non-specific references, the latest version of the referenced document (including any amendments) applies.

Referenced documents which are not found to be publicly available in the expected location might be found at <https://docbox.etsi.org/Reference>.

NOTE: While any hyperlinks included in this clause were valid at the time of publication, ETSI cannot guarantee their long term validity.

The following referenced documents are necessary for the application of the present document.

- [1] Recommendation ITU-T H.222.0 / ISO/IEC 13818-1: "Information technology - Generic Coding of moving pictures and associated audio information: Systems".

NOTE: Please refer whenever possible to the latest version and subsequent amendments.

- [2] Recommendation ITU-T H.262 / ISO/IEC 13818-2: "Information technology - Generic coding of moving pictures and associated audio information: Video".
- [3] ISO/IEC 13818-3: "Information technology -- Generic coding of moving pictures and associated audio information -- Part 3: Audio".
- [4] ISO/IEC 13818-9: "Information technology -- Generic coding of moving pictures and associated audio information -- Part 9: Extension for real time interface for systems decoders".
- [5] Void.
- [6] Void.
- [7] Void.
- [8] ISO/IEC 11172-1: "Information technology -- Coding of moving pictures and associated audio for digital storage media at up to about 1,5 Mbit/s -- Part 1: Systems".
- [9] ISO/IEC 11172-3: "Information technology -- Coding of moving pictures and associated audio for digital storage media at up to about 1,5 Mbit/s -- Part 3: Audio".
- [10] Recommendation ITU-T J.17: "Pre-emphasis used on sound-programme circuits".
- [11] EBU Recommendation R.68: "Alignment level in digital audio production equipment and in digital audio recorders".
- [12] ETSI TS 102 366: "Digital Audio Compression (AC-3, Enhanced AC-3) Standard".
- [13] Recommendation ITU-R BT.709: "Parameter values for the HDTV standards for production and international programme exchange".
- [14] ETSI EN 300 294: "Television systems; 625-line television Wide Screen Signalling (WSS)".

- [15] ETSI TS 102 114 (V1.4.1): "DTS Coherent Acoustics; Core and Extensions with Additional Profiles".
- [16] Recommendation ITU-T H.264 / ISO/IEC 14496-10:2014: "Information technology -- Coding of audio-visual objects -- Part 10: Advanced Video Coding".
- [17] ISO/IEC 14496-3:2009: "Information technology -- Coding of audio-visual objects -- Part 3: Audio".
- [18] ETSI EN 300 401: "Radio Broadcasting Systems; Digital Audio Broadcasting (DAB) to mobile, portable and fixed receivers".
- [19] Recommendation ITU-T T.35: "Procedure for the allocation of ITU-T defined codes for non-standard facilities".
- [20] SMPTE ST 421-2013: "VC-1 Compressed Video Bitstream Format and Decoding Process".
- [21] SMPTE RP 227: "VC-1 Bitstream Transport Encodings".
- [22] RDS-Forum SPB 490: "RDS Universal Encoder Communication Protocol", Final Version 6.02, September 2006.
- [23] SMPTE ST 2016-1:2009: "Format for Active Format Description and Bar Data".
- [24] CTA CEB16-B: "Active Format Description (AFD) & Bar Data Recommended Practice".
- [25] Recommendation ITU-R BT.1700: "Characteristics of composite video signals for conventional analogue television systems".
- [26] CTA 708-E: "Digital Television (DTV) Closed Captioning".
- [27] ISO 639-2: "Codes for the representation of names of languages -- Part 2: Alpha-3 code".
- [28] Void.
- [29] ISO/IEC 23003-1:2007: "Information technology -- MPEG audio technologies -- Part 1: MPEG Surround".
- [30] ISO/IEC 23003-1:2007/Cor 1:2008: "Information technology -- MPEG audio technologies -- Part 1: MPEG Surround", Technical corrigendum 1".
- [31] IEC 61966-2-4: "Multimedia systems and equipment - Colour measurement and management - Part 2-4: Colour management - Extended-gamut YCC colour space for video applications - xvYCC".
- [32] Void.
- [33] ETSI TS 101 547-2: "Digital Video Broadcasting (DVB); Plano-stereoscopic 3DTV; Part 2: Frame Compatible Plano-stereoscopic 3DTV".
- [34] Void.
- [35] Recommendation ITU-T H.265 / ISO/IEC 23008-2: "Information technology -- High efficiency coding and media delivery in heterogeneous environments -- Part 2: High efficiency video coding".
- [36] Recommendation ITU-R BT.2020: "Parameter values for ultra-high definition television systems for production and international programme exchange".
- [37] Void.
- [38] Recommendation ITU-R BT.601-7 (2011): "Studio encoding parameters of digital television for standard 4:3 and wide screen 16:9 aspect ratios".
- [39] ISO/IEC 23003-2: "Information technology -- MPEG audio technologies -- Part 2: Spatial Audio Object Coding (SAOC)".

- [40] Void.
- [41] ISO/IEC 14496-26: "Information technology -- Coding of audio-visual objects - Part 26: Audio conformance".
- [42] Void.
- [43] ETSI TS 103 190-1: "Digital Audio Compression (AC-4) Standard; Part 1: Channel based coding".
- [44] ETSI TS 101 547-4: "Digital Video Broadcasting (DVB); Plano-stereoscopic 3DTV; Part 4: Service frame compatible Plano-stereoscopic 3DTV for HEVC coded services".
- [45] Recommendation ITU-R BT.2100: "Image parameter values for high dynamic range television for use in production and international programme exchange".
- [46] ETSI TS 103 190-2: "Digital Audio Compression (AC-4) Standard; Part 2: Immersive and personalized audio".
- [47] ISO/IEC 23008-3: "Information technology -- High efficiency coding and media delivery in heterogeneous environments - Part 3: 3D audio".
- [48] ISO/IEC 23003-4: "Information technology -- MPEG audio technologies - Part 4: Dynamic Range Control".
- [49] ETSI TS 103 491: "DTS-UHD Audio Format; Delivery of Channels, Objects and Ambisonic Sound Fields".
- [50] ETSI TS 103 572: "HDR Signalling and Carriage of Dynamic Metadata for Colour Volume Transform; Application #1 for DVB compliant systems".
- [51] ETSI TS 103 433-2: "High-Performance Single Layer High Dynamic Range (HDR) System for use in Consumer Electronics devices; Part 2: Enhancements for Perceptual Quantization (PQ) transfer function based High Dynamic Range (HDR) Systems (SL-HDR2)".
- [52] CTA 861-H: "A DTV Profile for Uncompressed High Speed Digital Interfaces", January 2021.

2.2 Informative references

References are either specific (identified by date of publication and/or edition number or version number) or non-specific. For specific references, only the cited version applies. For non-specific references, the latest version of the referenced document (including any amendments) applies.

NOTE: While any hyperlinks included in this clause were valid at the time of publication, ETSI cannot guarantee their long term validity.

The following referenced documents are not necessary for the application of the present document but they assist the user with regard to a particular subject area.

- [i.1] Void.
- [i.2] Void.
- [i.3] Void.
- [i.4] Recommendation ITU-R BT.470: "Conventional Television Systems".

NOTE: The present document only references Systems B, G, and I.

- [i.5] Recommendation ITU-R BT.1358 (2007): "Studio parameters of 625 and 525 line progressive scan television systems".
- [i.6] Void.
- [i.7] Void.

- [i.8] SMPTE ST 125:2013: "SDTV Component Video Signal Coding 4:4:4 and 4:2:2 for 13.5 MHz and 18 MHz Systems".
- [i.9] SMPTE ST 170:2004: "Television - Composite Analog Video Signal - NTSC for Studio Applications".
- [i.10] SMPTE ST 267:1995: "Television - Bit-Parallel Digital Interface - Component Video Signal 4:2:2 16x9 Aspect Ratio".
- [i.11] SMPTE ST 274:2008: "Television - 1920 x 1080 Image Sample Structure, Digital Representation and Digital Timing Reference Sequences for Multiple Picture Rates".
- [i.12] SMPTE ST 293:2003: "Television - 720 x 483 Active Line at 59.94-Hz Progressive Scan Production - Digital Representation".
- [i.13] SMPTE ST 296:2012: "Television - 1280 x 720 Progressive Image Sample Structure - Analog and Digital Representation and Analog Interface (R2006)".
- [i.14] HDMI LLC: "High-Definition Multimedia Interface Specification Version 1.4a", March 4, 2010.
- [i.15] ETSI TS 100 289 (V1.2.1): "Digital Video Broadcasting (DVB); Support for use of the DVB Scrambling Algorithm version 3 within digital broadcasting systems".
- [i.16] Blu-ray Disc Association: "White Paper Blu-ray Disc™ Read-Only Format 2.B Audio Visual Application Format Specifications for BD-ROM Version 2.5", July 2011.
- [i.17] Recommendation ITU-R BS.1770: "Algorithms to measure audio programme loudness and true-peak audio level".
- [i.18] EBU Recommendation R 128:2014: "Loudness normalization and permitted maximum level of audio signals".
- [i.19] EBU Tech 3344:2014: "Guidelines for Distribution and Reproduction of Programmes in accordance with EBU R 128".
- [i.20] ANSI/SCTE 172:2011: "Constraints on AVC video coding for Digital Program Insertion".
- [i.21] Free TV Australia Operational Practice OP- 59:2013: "Measurement and Management of Loudness in Soundtracks for Television Broadcasting".
- [i.22] Recommendation ITU-R BS.1771-1 (2012): "Requirements for loudness and true-peak indicating meters".
- [i.23] EBU Tech 3342:2014: "Loudness Range: A measure to supplement loudness normalization in accordance with EBU R 128".
- [i.24] EBU Tech 3343:2014: "Practical guidelines for Production and Implementation in accordance with EBU R 128".
- [i.25] SMPTE ST 292-1:2012: "1.5 Gb/s Signal/Data Serial Interface".
- [i.26] SMPTE ST 2084: "High Dynamic Range Electro-Optical Transfer Function of Mastering Reference Displays".
- [i.27] ARIB STD-B67: "Essential Parameter Values for the Extended Image Dynamic Range Television (EIDRTV) System for Programme Production".
- [i.28] ETSI TS 103 448: "AC-4 Object Audio Renderer for Consumer Use".
- [i.29] SMPTE ST 2086: "Mastering Display Color Volume Metadata Supporting High Luminance and Wide Color Gamut Images".
- [i.30] Recommendation ITU-R BT.2073-0: "Use of the high efficiency video coding (HEVC) standard for UHDTV and HDTV broadcasting".
- [i.31] EBU Technical Recommendation R92: "Active picture area and picture centring in analogue and digital 625/50 television systems".

- [i.32] ETSI EN 300 468: "Digital Video Broadcasting (DVB); Specification for Service Information (SI) in DVB systems".
- [i.33] ISO/IEC 23009-1: "Information technology - Dynamic adaptive streaming over HTTP (DASH) - Part 1: Media presentation description and segment formats".
- [i.34] ETSI TS 103 285: "Digital Video Broadcasting (DVB); MPEG-DASH Profile for Transport of ISO BMFF Based DVB Services over IP Based Networks".
- [i.35] ETSI TS 103 584: "DTS-UHD Point Source Renderer".
- [i.36] ATSC: "Code point registry".
- NOTE: Available at <https://www.atsc.org/standards/other-technical-documents/code-point-registry/>.
- [i.37] SMPTE ST 2094-1:2016: "Dynamic Metadata for Color Volume Transform - Core Components".
- [i.38] SMPTE ST 2094-10:2016: "Dynamic Metadata for Color Volume Transform - Application #1".
- [i.39] SMPTE ST 2094-40:2020: "Dynamic Metadata for Color Volume Transform - Application #4".
- [i.40] ETSI TS 103 433-1: "High-Performance Single Layer High Dynamic Range (HDR) System for use in Consumer Electronics devices; Part 1: Directly Standard Dynamic Range (SDR) Compatible HDR System (SL-HDR1)".
- [i.41] Void.

3 Definition of terms, symbols and abbreviations

3.1 Terms

For the purposes of the present document, the following terms apply:

25 Hz H.264/AVC HDTV Bitstream: bitstream which contains only H.264/AVC High Profile at Level 4 (or simpler) video at 25 Hz or 50 Hz frame rates as specified in the present document

25 Hz H.264/AVC HDTV IRD: IRD that is capable of decoding and displaying pictures based on a nominal video frame rate of 25 Hz or 50 Hz from H.264/AVC High Profile at Level 4 bitstreams as specified in the present document, in addition to providing the functionality of a 25 Hz H.264/AVC SDTV IRD

25 Hz H.264/AVC SDTV Bitstream: bitstream which contains only H.264/AVC Main Profile at Level 3 video at 25 Hz frame rate as specified in the present document

25 Hz H.264/AVC SDTV IRD: IRD which is capable of decoding and displaying pictures based on a nominal video frame rate of 25 Hz from H.264/AVC Main Profile at Level 3 bitstreams as specified in the present document

25 Hz MPEG-2 HDTV Bitstream: bitstream which contains only MPEG-2 Main Profile, High Level (or simpler) video at 25 Hz or 50 Hz frame rates as specified in the present document

25 Hz MPEG-2 HDTV IRD: IRD that is capable of decoding and displaying pictures based on a nominal video frame rate of 25 Hz or 50 Hz from MPEG-2 Main Profile, High Level bitstreams as specified in the present document, in addition to providing the functionality of a 25 Hz SDTV IRD

25 Hz MPEG-2 SDTV Bitstream: bitstream which contains only MPEG-2 Main Profile, Main Level video at 25 Hz frame rate as specified in the present document

25 Hz MPEG-2 SDTV IRD: IRD which is capable of decoding and displaying pictures based on a nominal video frame rate of 25 Hz from MPEG-2 Main Profile, Main Level bitstreams as specified in the present document

25 Hz MVC Stereo HDTV Bitstream: MVC bitstream that contains a 25 Hz MVC Stereo Base view bitstream and a 25 Hz MVC Stereo Dependent view bitstream as specified in the present document

NOTE: A 25 Hz MVC Stereo Bitstream contains only H.264/AVC Stereo High Profile at Level 4 video at 25 or 50 Hz frame rates as specified in the present document.

25 Hz MVC Stereo HDTV IRD: IRD that is capable of decoding and displaying pictures based on nominal video frame rates of 25 or 50 Hz from H.264/AVC Stereo High Profile Level 4 bitstreams as specified in the present document, in addition to providing the functionality of a 25 Hz H.264/AVC HDTV IRD

25 Hz SVC HDTV Bitstream: SVC bitstream that contains a 25 Hz SVC HDTV Bitstream Subset as specified in the present document

25 Hz SVC HDTV Bitstream Subset: bitstream subset, of an SVC Bitstream, that contains coded slice NAL units with DQId greater than 0 and contains only H.264/AVC Scalable High Profile at Level 4 (or simpler) video at 25 Hz or 50 Hz frame rates as specified in the present document

25 Hz SVC HDTV IRD: IRD that is capable of decoding and displaying pictures based on nominal video frame rate of 25 Hz or 50 Hz from H.264/AVC Scalable High Profile Level 4 bitstreams as specified in the present document, in addition to providing the functionality of a 25 Hz H.264/AVC HDTV IRD

25 Hz VC-1 HDTV Bitstream: bitstream which contains only VC-1 Advanced Profile at Level 3 (or simpler) video at 25 Hz or 50 Hz frame rates as specified in the present document

25 Hz VC-1 HDTV IRD: IRD that is capable of decoding and displaying pictures based on a nominal video frame rate of 25 Hz or 50 Hz from VC-1 Advanced Profile at Level 3 bitstreams as specified in the present document, in addition to providing the functionality of a 25 Hz VC-1 SDTV IRD

25 Hz VC-1 SDTV Bitstream: bitstream which contains only VC-1 Advanced Profile at Level 1 video at 25 Hz frame rate as specified in the present document

25 Hz VC-1 SDTV IRD: IRD which is capable of decoding and displaying pictures based on a nominal video frame rate of 25 Hz from VC-1 Advanced Profile at Level 1 bitstreams as specified in the present document

30 Hz H.264/AVC HDTV Bitstream: bitstream which contains only H.264/AVC High Profile at Level 4 (or simpler) video at 24 000/1 001, 24, 30 000/1 001, 30, 60 000/1 001 or 60 Hz frame rates as specified in the present document

30 Hz H.264/AVC HDTV IRD: IRD that is capable of decoding and displaying pictures based on nominal video frame rates of 24 000/1 001, 24, 30 000/1 001, 30, 60 000/1 001 or 60 Hz from H.264/AVC High Profile at Level 4 bitstreams as specified in the present document, in addition to providing the functionality of a 30 Hz H.264/AVC SDTV IRD

30 Hz H.264/AVC SDTV Bitstream: bitstream which contains only H.264/AVC Main Profile at Level 3 video at 24 000/1 001, 24, 30 000/1 001 or 30 Hz frame rate as specified in the present document

30 Hz H.264/AVC SDTV IRD: IRD which is capable of decoding and displaying pictures based on a nominal video frame rate of 24 000/1 001 (approximately 23,98), 24, 30 000/1 001 (approximately 29,97) or 30 Hz from H.264/AVC Main Profile at Level 3 bitstreams as specified in the present document

30 Hz MPEG-2 HDTV Bitstream: bitstream which contains only MPEG-2 Main Profile, High Level (or simpler) video at 24 000/1 001, 24, 30 000/1 001, 30, 60 000/1 001 or 60 Hz frame rates as specified in the present document

30 Hz MPEG-2 HDTV IRD: IRD that is capable of decoding and displaying pictures based on nominal video frame rates of 24 000/1 001, 24, 30 000/1 001, 30, 60 000/1 001 or 60 Hz from MPEG-2 Main Profile, High Level bitstreams as specified in the present document, in addition to providing the functionality of a 30 Hz SDTV IRD

30 Hz MPEG-2 SDTV Bitstream: bitstream which contains only MPEG-2 Main Profile, Main Level video at 24 000/1 001, 24, 30 000/1 001 or 30 Hz frame rate as specified in the present document

30 Hz MPEG-2 SDTV IRD: IRD which is capable of decoding and displaying pictures based on a nominal video frame rate of 24 000/1 001 (approximately 23,98), 24, 30 000/1 001 (approximately 29,97) or 30 Hz from MPEG-2 Main Profile at Main Level bitstreams as specified in the present document

30 Hz MVC Stereo HDTV Bitstream: MVC bitstream that contains a 30 Hz MVC Stereo Base view bitstream and a 30 Hz MVC Stereo Dependent view bitstream as specified in the present document

NOTE: A 30 Hz MVC Stereo HDTV Bitstream contains only H.264/AVC Stereo High Profile at Level 4 video at 24 000/1 001, 24, 30 000/1 001, 30, 60 000/1 001 or 60 Hz frame rates as specified in the present document.

30 Hz MVC Stereo HDTV IRD: IRD that is capable of decoding and displaying pictures based on nominal video frame rates of 24 000/1001, 24, 30 000/1 001, 30, 60 000/1 001 or 60 Hz from H.264/AVC Stereo High Profile Level 4 bitstreams as specified in the present document, in addition to providing the functionality of a 30 Hz H.264/AVC HDTV IRD

30 Hz SVC HDTV Bitstream: SVC bitstream that contains a 30 Hz SVC HDTV Bitstream Subset as specified in the present document

30 Hz SVC HDTV Bitstream Subset: bitstream subset, of an SVC Bitstream, that contains coded slice NAL units with DQId greater than 0 and contains only H.264/AVC Scalable High Profile at Level 4 (or simpler) video at 24 000/1 001, 24, 30 000/1 001, 30, 60 000/1 001 or 60 Hz frame rates as specified in the present document

30 Hz SVC HDTV IRD: IRD that is capable of decoding and displaying pictures based on nominal video frame rates of 24 000/1 001, 24, 30 000/1 001, 30, 60 000/1 001 or 60 Hz from H.264/AVC Scalable High Profile Level 4 bitstreams as specified in the present document, in addition to providing the functionality of a 30 Hz H.264/AVC HDTV IRD

30 Hz VC-1 HDTV Bitstream: bitstream which contains only VC-1 Advanced Profile at Level 3 (or simpler) video at 24 000/1 001, 24, 30 000/1 001, 30, 60 000/1 001 or 60 Hz frame rates as specified in the present document

30 Hz VC-1 HDTV IRD: IRD that is capable of decoding and displaying pictures based on nominal video frame rates of 24 000/1 001, 24, 30 000/1 001, 30, 60 000/1 001 or 60 Hz from VC-1 Advanced Profile at Level 3 bitstreams as specified in the present document, in addition to providing the functionality of a 30 Hz SDTV IRD

30 Hz VC-1 SDTV Bitstream: bitstream which contains only VC-1 Advanced Profile at Level 1 video at 24 000/1 001, 24, 30 000/1 001 or 30 Hz frame rate as specified in the present document

30 Hz VC-1 SDTV IRD: IRD which is capable of decoding and displaying pictures based on a nominal video frame rate of 24 000/1 001 (approximately 23,98), 24, 30 000/1 001 (approximately 29,97) or 30 Hz from VC-1 Advanced Profile at Level 1 bitstreams as specified in the present document

3DTV: DVB frame compatible plano-stereoscopic three-dimensional television

50 Hz H.264/AVC HDTV Bitstream: bitstream which contains only H.264/AVC High Profile at Level 4.2 (or simpler) video at 25 Hz or 50 Hz frame rates as specified in the present document

50 Hz H.264/AVC HDTV IRD: IRD that is capable of decoding and displaying pictures based on a nominal video frame rate of 25 Hz or 50 Hz from H.264/AVC High Profile at Level 4.2 bitstreams as specified in the present document, in addition to providing the functionality of a 25 Hz H.264/AVC HDTV IRD

50 Hz HEVC HDTV 8-bit IRD: IRD that is capable of decoding and displaying pictures based on a nominal video frame rate of 25 Hz or 50 Hz from HEVC Main Profile HEVC HDTV Bitstreams as specified in the present document

50 Hz HEVC HDTV 10-bit IRD: IRD that is capable of decoding and displaying pictures based on a nominal video frame rate of 25 Hz or 50 Hz from HEVC HDTV Bitstreams as specified in the present document

50 Hz HEVC HDTV IRD: collective term referring to either a 50 Hz HEVC HDTV 10-bit IRD or a 50Hz HEVC HDTV 8-bit IRD

50 Hz SVC HDTV Bitstream: SVC bitstream that contains a 50 Hz SVC HDTV Bitstream Subset as specified in the present document

50 Hz SVC HDTV Bitstream Subset: bitstream subset, of an SVC Bitstream, that contains coded slice NAL units with DQId greater than 0 and contains only H.264/AVC Scalable High Profile at Level 4.2 (or simpler) video at 25 Hz or 50 Hz frame rates as specified in the present document

50 Hz SVC HDTV IRD: IRD that is capable of decoding and displaying pictures based on a nominal video frame rate of 25 Hz or 50 Hz from H.264/AVC High Profile at Level 4.2 bitstreams as specified in the present document, in addition to providing the functionality of a 50 Hz H.264/AVC HDTV IRD and a 25 Hz SVC HDTV IRD

60 Hz H.264/AVC HDTV Bitstream: bitstream which contains only H.264/AVC High Profile at Level 4.2 (or simpler) video at 24 000/1 001, 24, 30 000/1 001, 30, 60 000/1 001 or 60 Hz frame rates as specified in the present document

60 Hz H.264/AVC HDTV IRD: IRD that is capable of decoding and displaying pictures based on nominal video frame rates of 24 000/1 001, 24, 30 000/1 001, 30, 60 000/1 001 or 60 Hz from H.264/AVC High Profile at Level 4.2 bitstreams as specified in the present document, in addition to providing the functionality of a 30 Hz H.264/AVC HDTV IRD

60 Hz HEVC HDTV 8-bit IRD: IRD that is capable of decoding and displaying pictures based on a nominal video frame rate of 24 000/1 001, 24, 30 000/1 001, 30, 60 000/1 001 or 60 Hz from HEVC Main Profile HEVC HDTV Bitstreams as specified in the present document

60 Hz HEVC HDTV 10-bit IRD: IRD that is capable of decoding and displaying pictures based on a nominal video frame rate of 24 000/1 001, 24, 30 000/1 001, 30, 60 000/1 001 or 60 Hz from HEVC HDTV Bitstreams as specified in the present document

60 Hz HEVC HDTV IRD: collective term referring to either a 60 Hz HEVC HDTV 10-bit IRD or a 60Hz HEVC HDTV 8-bit IRD

60 Hz SVC HDTV Bitstream: SVC bitstream that contains a 60 Hz SVC HDTV Bitstream Subset as specified in the present document

60 Hz SVC HDTV Bitstream Subset: bitstream subset, of an SVC Bitstream, that contains coded slice NAL units with DQId greater than 0 and contains only H.264/AVC Scalable High Profile at Level 4.2 (or simpler) video at 24 000/1 001, 24, 30 000/1 001, 30, 60 000/1 001 or 60 Hz frame rates as specified in the present document

60 Hz SVC HDTV IRD: IRD that is capable of decoding and displaying pictures based on nominal video frame rates of 24 000/1 001, 24, 30 000/1 001, 30, 60 000/1 001 or 60 Hz from H.264/AVC Scalable High Profile Level 4.2 bitstreams as specified in the present document, in addition to providing the functionality of a 60 Hz H.264/AVC HDTV IRD and a 30 Hz SVC HDTV IRD

audio preselection: set of Audio Programme Components representing a version of the Audio Programme that may be selected by a user for simultaneous decoding

NOTE: An Audio Preselection is a sub-selection from all available Audio Programme Components of one Audio Programme. An Audio Preselection can be considered the NGA equivalent of audio services in predecessor systems, whereby each audio service comprises a complete audio mix.

audio presentation: audio preselection in the context of AC-4

audio preset: audio preselection in the context of MPEG-H Audio

audio programme: complete collection of all Audio Programme Components and a set of accompanying Audio Preselections

NOTE: Not all Audio Programme Components of one Audio Programme are necessarily meant to be presented at the same time. An Audio Programme may contain Audio Programme Components that are always presented, and it may include optional Audio Programme Components.

audio programme component: smallest addressable unit of an Audio Programme

auxiliary NGA stream: NGA stream delivered using NGA multi-stream delivery, and containing additional Audio Programme Components not contained in the main NGA stream

AVC video sub-bitstream of MVC: video sub-bitstream that contains only the base view, i.e. containing all VCL NAL units associated with the minimum value of view order index present in each AVC video sequence of the AVC video stream. The AVC video sub-bitstream conforms to the specification of a H.264/AVC HDTV Bitstream.

AVC video sub-bitstream of SVC: video sub-bitstream that contains the base layer as defined in annex G of Recommendation ITU-T H.264 / ISO/IEC 14496-10 [16] and that additionally contains NAL units with nal_unit_type equal to 14 (prefix NAL units)

NOTE: The AVC video sub-bitstream contains all VCL NAL units associated with dependency_id equal to 0.

baseline IRD: IRD which provides the minimum functionality to decode transmitted bitstreams as recommended in the present document

NOTE: It is not required to have the ability to decode Partial Transport Streams as may be received from a digital interface connected to digital bitstream storage device such as a digital VCR.

component group: group of audio programme components

default audio preselection: audio preselection including all Audio Programme Components to be decoded when IRD cannot make a selection amongst several preselections

dynamic mapping: dynamic adaptation of an HDR video signal to the characteristics of a display

dynamic mapping information: information associated with one or more frames of the video content as part of a DVB service that can guide dynamic mapping, as produced in a reference viewing environment or otherwise

frame compatible: arrangement of the Left and Right images in a spatial multiplex which results in an image which can be treated like a normal HDTV image by the receiver demodulator and compression decoder

H.264/AVC bitstream: collective term referring to the H.264/AVC SDTV Bitstream and the H.264/AVC HDTV Bitstream

H.264/AVC GOP: collection of H.264/AVC Access Units (AUs) starting at, and including the AU comprising the H.264/AVC RAP, and including all the AUs up to, but not including the next AU that is an H.264/AVC RAP

H.264/AVC HDTV bitstream: collective term referring to the 25 Hz H.264/AVC HDTV Bitstream, the 30 Hz H.264/AVC HDTV Bitstream, the 50 Hz H.264/AVC HDTV Bitstream and the 60 Hz H.264/AVC HDTV Bitstream

H.264/AVC HDTV IRD: collective term referring to the 25 Hz H.264/AVC HDTV IRD, the 30 Hz H.264/AVC HDTV IRD, the 50 Hz H.264/AVC HDTV IRD and the 60 Hz H.264/AVC HDTV IRD

H.264/AVC IRD: collective term referring to the H.264/AVC SDTV IRD and the H.264/AVC HDTV IRD

H.264/AVC SDTV bitstream: collective term referring to the 25 Hz H.264/AVC SDTV Bitstream and the 30 Hz H.264/AVC SDTV Bitstream

H.264/AVC SDTV IRD: collective term referring to the 25 Hz H.264/AVC SDTV IRD and the 30 Hz H.264/AVC SDTV IRD

H.264/AVC RAP: access unit with AU delimiter in an H.264/AVC Bitstream at which an IRD can begin decoding video successfully

NOTE: This access unit includes exactly one Sequence Parameter Set (that is active) with VUI and the Picture Parameter Set that is required for decoding the associated picture. The SPS also precedes any SEI NAL units in this access unit. This access unit contains an IDR picture or an I picture.

HEVC bitstream: collective term referring to either a HEVC HDTV Bitstream, a HEVC UHD TV Bitstream, a HEVC HDR UHD TV Bitstream, a HEVC HFR UHD TV Bitstream or a HEVC HDR HFR UHD TV Bitstream

HEVC DVB_RAP: access unit with AU delimiter in an HEVC Bitstream from which an IRD can decode and successfully reconstruct all pictures that follow in output order the HEVC DVB_RAP access unit, including the HEVC DVB_RAP

HEVC HDR HDTV bitstream: same as the HEVC HDR UHD TV bitstream with the difference that only resolutions up to and including 1 920 x 1 080 are supported

HEVC HDR HFR UHD TV bitstream: HEVC video stream which contains a HEVC Main 10 Profile High Dynamic Range video (i.e. using either the HLG or the PQ transfer characteristics) up to Level 5.2 (inclusive) at 100, 120 000/1 001 or 120 Hz as specified in the present document

HEVC HDR HFR UHD TV IRD: IRD that is capable of decoding and displaying pictures from HEVC HFR UHD TV Bitstreams or HEVC HDR HFR UHD TV Bitstreams as specified in the present document, in addition providing the abilities of the HEVC HDR UHD TV IRD

HEVC HDR UHD TV bitstream: HEVC video stream or HEVC temporal video sub-bitstream which contains HEVC Main 10 Profile High Dynamic Range video (i.e. using either the HLG or the PQ transfer characteristics) up to Level 5.1 (inclusive) as specified in the present document

HEVC HDR UHD TV2 bitstream: HEVC video stream or HEVC temporal video sub-bitstream which contains HEVC Main 10 Profile video up to Level 6.1 (inclusive) as specified in the present document

HEVC HDR UHD TV IRD: IRD that is capable of decoding and displaying pictures from HEVC HDR UHD TV Bitstreams as specified in the present document, in addition providing the abilities of the HEVC UHD TV IRD

HEVC HDR UHD TV2 IRD: IRD that is capable of decoding and displaying pictures from HEVC HDR UHD TV2 Bitstreams as specified in the present document, in addition providing the abilities of both the HEVC HDR UHD TV IRD using PQ10 and HEVC HDR UHD TV IRD using HLG10

HEVC HDTV 8-bit IRD: collective term referring to either a 50 Hz HEVC HDTV 8-bit IRD or a 60 Hz HEVC HDTV 8-bit IRD

HEVC HDTV 10-bit IRD: collective term referring to either a 50 Hz HEVC HDTV 10-bit IRD or a 60 Hz HEVC HDTV 10-bit IRD

HEVC HDTV bitstream: HEVC video stream or HEVC temporal video sub-bitstream which contains either HEVC Main 10 Profile or HEVC Main Profile encoded video up to Level 4.1 (inclusive) as specified in the present document

HEVC HDTV IRD: collective term referring either to a 50 Hz HEVC HDTV 10-bit IRD, a 50 Hz HEVC HDTV 8-bit IRD, a 60 Hz HEVC HDTV 10-bit IRD, or a 60 Hz HEVC HDTV 8-bit IRD

HEVC HFR UHD TV bitstream: HEVC video stream which contains a HEVC Main 10 Profile video up to Level 5.2 (inclusive) at 100, 120 000/1 001 or 120 Hz as specified in the present document

HEVC IRD: collective term referring to either a HEVC HDTV IRD, a HEVC UHD TV IRD, a HEVC HDR UHD TV IRD or a HEVC HDR HFR UHD TV IRD

HEVC layer set: As defined in Recommendation ITU-T H.265 / ISO/IEC 23008-2 [35], clause 3.

HEVC temporal sub-layer: As defined in Recommendation ITU-T H.265 [35] / ISO/IEC 23008-2 [35], clause 3.

HEVC temporal video sub-bitstream: As defined in Recommendation ITU-T H.222.0 / ISO/IEC 13818-1 [1], clause 2.1.106.

HEVC temporal video subset: As defined in Recommendation ITU-T H.222.0 / ISO/IEC 13818-1 [1], clause 2.1.107.

HEVC UHD TV bitstream: HEVC video stream or HEVC temporal video sub-bitstream which contains HEVC Main 10 Profile encoded video up to Level 5.1 (inclusive) as specified in the present document

HEVC UHD TV IRD: IRD that is capable of decoding and displaying pictures from HEVC UHD TV Bitstreams as specified in the present document, in addition providing the abilities of the HEVC HDTV IRD

HEVC video sub-bitstream: As defined in Recommendation ITU-T H.222.0 / ISO/IEC 13818-1 [1], clause 2.1.105.

HEVC video stream: As defined in Recommendation ITU-T H.222.0 / ISO/IEC 13818-1 [1], clause 2.1.95.

HFR bitstream: collective term referring to either a HEVC HFR UHD TV Bitstream or a HEVC HDR HFR UHD TV Bitstream

HLG10: HLG HDR solution with 10-bit coding, non-constant luminance YCbCr, narrow range and colour primaries, as defined in Recommendation ITU-R BT.2100 [45]

I picture: picture (frame or field) containing only intra macroblocks

IRD with Digital Interface: IRD which has the ability to decode Partial Transport Streams received from a digital interface connected to digital bitstream storage device such as a digital VCR as specified in the present document, in addition to providing the functionality of a Baseline IRD

main NGA stream: NGA stream delivered using NGA multi-stream delivery, and containing at least all the Audio Programme Components corresponding to the Default Audio Preselection

MPEG-2 bitstream: collective term referring to the 25 Hz MPEG-2 SDTV Bitstream, 30 Hz MPEG-2 SDTV Bitstream, 25 Hz MPEG-2 HDTV Bitstream, 30 Hz MPEG-2 HDTV Bitstream

MPEG-2 IRD: collective term referring to the 25 Hz MPEG-2 SDTV IRD, 30 Hz MPEG-2 SDTV IRD, 25 Hz MPEG-2 HDTV IRD, 30 Hz MPEG-2 HDTV IRD

MPEG-4 AAC, MPEG-4 HE AAC and MPEG-4 HE AAC v2 RAP: access unit in an MPEG-4 audio Bitstream at which an IRD can begin decoding and play-out audio with full fidelity

NOTE: This includes that all relevant metadata parameters are present in the AU.

MPEG DASH media presentation: As defined in ISO/IEC 23009-1 [i.33].

MPEG DASH player: hardware device or software component capable of playing an MPEG DASH Media Presentation and containing one or more media decoders

multi-stream delivery: method for carrying Audio Programme Components in several NGA streams

NOTE: E.g. when Audio Programme Components offering additional languages are carried in separate elementary streams to facilitate remultiplexing or service aggregation.

MVC stereo anchor picture: picture composed of exactly one base view component and exactly one dependent view component

NOTE: This is the MVC Stereo equivalent to an H.264/AVC RAP.

MVC stereo access unit: set of NAL units that are consecutive in decoding order and contain exactly one primary coded picture consisting of one base view component and one dependent view component

NOTE: In addition to the primary coded picture, an MVC Stereo access unit may also contain one or more redundant coded pictures, one auxiliary coded picture, or other NAL units not containing slices or slice data partitions of a coded picture. The decoding of an MVC Stereo access unit always results in one decoded picture consisting of one or two decoded view components. Clause 5.13 gives further details about the composition of the base view and dependent view components.

MVC stereo base view component: coded representation of the Base view in a single access unit

MVC stereo base view (or dependent view) bitstream: collection of all VCL NAL units and associated non-VCL NAL units associated with the value of view_id corresponding to the Base view (or the Dependent view), of a video bitstream conforming to the H.264/AVC Stereo High Profile Level 4, as defined in Recommendation ITU-T H.264 / ISO/IEC 14496-10 [16]

NOTE: The MVC Stereo Base view bitstream is the MVC Stereo equivalent to the AVC video sub-bitstream of MVC as per Recommendation ITU-T H.222.0 / ISO/IEC 13818-1 [1] (with the additional restrictions specified in clause 5.13 of the present document) and under the H.264/AVC Stereo High Profile Level 4 constraints. The MVC Stereo Dependent view bitstream is equivalent to the MVC video sub-bitstream in Recommendation ITU-T H.222.0 / ISO/IEC 13818-1 [1] under the H.264/AVC Stereo High Profile Level 4 constraints.

MVC stereo bitstream: bitstream that conforms to the H.264/AVC Stereo High Profile Level 4 specified in annex H of Recommendation ITU-T H.264 / ISO/IEC 14496-10 [16], and with the restrictions specified in the present document

MVC stereo corresponding (or associated) view component: opposite (Base/Dependent) view component with same value of Presentation Time Stamp (PTS)

MVC stereo coded video sequence: collection of MVC Stereo access units (AUs) starting at, and including the AU comprising the MVC Stereo RAP, and including all the AUs up to, but not including the next AU that is an MVC Stereo RAP

MVC stereo dependent unit: set of NAL units that are consecutive in decoding order and contain exactly one non-Base view component

NOTE: A dependent unit starts from a view and dependency representation delimiter NAL unit, VDRD_nal_unit (nal_unit_type = 24).

MVC stereo dependent view component: coded representation of Dependent view in a single access unit

MVC stereo HDTV bitstream: collective term referring to the 25 Hz MVC Stereo HDTV Bitstream, and the 30 Hz MVC Stereo HDTV Bitstream

MVC stereo HDTV IRD: collective term referring to the 25 Hz MVC Stereo HDTV IRD, and the 30 Hz MVC Stereo HDTV IRD [16]

MVC stereo HDTV sub-bitstream: collective term referring to either the MVC Stereo Base view bitstream or the MVC Stereo Dependent view bitstreams of 25 Hz MVC Stereo HDTV or 30 Hz MVC Stereo HDTV Bitstreams

NGA stream: audio elementary stream, containing one or more Audio Programme Components of one Audio Programme

pan vector: horizontal offset in video frame centre position specified by non-zero value in the `frame_centre_horizontal_offset` field in the MPEG video stream

partial transport stream: bitstream derived from an MPEG-2 Transport Stream by removing those Transport Stream Packets that are not relevant to one particular selected programme, or a number of selected programmes

plano-stereoscopic: three-dimensional picture that uses two single pictures, Left and Right, displayed on a single plane surface (the TV screen in the case of 3DTV)

player conformance point: set of decoding requirements that an MPEG DASH player may meet and thereby be able to decode bitstreams from an MPEG DASH presentation that (a) fall within the mandatory requirements of a player that supports the specific player conformance point and (b) comply with the general content requirements defined for the codec associated with the player conformance point

PQ10: PQ HDR solution with 10-bit coding, non-constant luminance YCbCr, narrow range and colour primaries, as defined in Recommendation ITU-R BT.2100 [45]

single-stream delivery: method for carrying all Audio Programme Components in a single NGA stream

SVC access unit: access unit as specified in annex G of Recommendation ITU-T H.264 / ISO/IEC 14496-10 [16]

NOTE: An SVC access unit results from re-assembling SVC dependency representations as specified in Recommendation ITU-T H.222.0 / ISO/IEC 13818-1 [1].

SVC base layer bitstream: bitstream subset of an SVC Bitstream that conforms to one or more H.264/AVC profiles specified in annex A of Recommendation ITU-T H.264 / ISO/IEC 14496-10 [16]

NOTE: The SVC base layer bitstream of an SVC bitstream is specified in clause G.8.8.2 of Recommendation ITU-T H.264 / ISO/IEC 14496-10 [16].

SVC base layer RAP: set of all NAL units that are present in the AVC video sub-bitstream of an SVC Access unit

NOTE: The SVC Base layer RAP obeys the constraints of the corresponding H.264/AVC RAP. Additionally the subset SPS of all enhancement layers follow the SPS of the SVC base layer RAP and are ordered with increasing value of DQId.

SVC bitstream: bitstream that conforms to one or more of the profiles specified in annex G of Recommendation ITU-T H.264 / ISO/IEC 14496-10 [16]

SVC dependency representation: collection of all VCL NAL units with the same value of `dependency_id` of an SVC access unit and the associated non-VCL NAL units

NOTE: Re-assembling SVC dependency representations in a consecutive order of `dependency_id` starting from the lowest value of `dependency_id` present in the access unit up to any value of `dependency_id` present in the access unit, while reordering the non-VCL NAL units conforming to the order of NAL units within an access unit as specified in annex G of Recommendation ITU-T H.264 / ISO/IEC 14496-10 [16], results in an SVC access unit.

SVC enhancement layer RAP: set of all NAL units that are present in the SVC video sub-bitstream of an SVC Access unit

NOTE: The subset SPS of all enhancement layers with `dependency_id` greater than the `dependency_id` of the SVC Enhancement layer RAP follow the subset SPS of this SVC Enhancement layer RAP and are ordered with increasing value of DQId.

SVC HDTV bitstream: collective term referring to the 25 Hz SVC HDTV Bitstream, the 30 Hz SVC HDTV Bitstream, the 50 Hz SVC HDTV Bitstream, and the 60 Hz SVC HDTV Bitstream

SVC HDTV bitstream subset: collective term referring to the 25 Hz SVC HDTV Bitstream Subset, the 30 Hz SVC HDTV Bitstream Subset, the 50 Hz SVC HDTV Bitstream Subset, and the 60 Hz SVC HDTV Bitstream Subset

SVC HDTV IRD: collective term referring to the 25 Hz SVC HDTV IRD, the 30 Hz SVC HDTV IRD, the 50 Hz SVC HDTV IRD, and the 60 Hz SVC HDTV IRD

SVC I picture: picture (frame or field) containing one or more SVC dependency representations that only consist of slices with slice_type equal to 2 or 7

NOTE: An SVC I picture is associated with one or more values of dependency_id. An SVC I picture for a particular value of dependency_id specifies that the SVC dependency representation with the particular value of dependency_id only consists of slices with slice_type equal to 2 or 7.

SVC IRD: alternative term referring to SVC HDTV IRD.

SVC IDR picture: picture (frame or field) containing one or more SVC dependency representations that have idr_flag equal to 1

NOTE: An SVC IDR picture is associated with one or more values of dependency_id. An SVC IDR picture for a particular value of dependency_id specifies that the SVC dependency representation with the particular value of dependency_id has idr_flag equal to 1. Each SVC IDR picture for a particular value of dependency_id is an SVC I picture for the particular value of dependency_id.

SVC layer picture: picture obtained from decoding a subset or the complete set of the SVC dependency representations present in an SVC access unit

NOTE: An SVC layer picture is associated with a particular value of dependency_id. An SVC layer picture for a particular value of dependency_id is the picture obtained by decoding all SVC dependency representations of an SVC access unit with dependency_id less than or equal to the particular value of dependency_id.

SVC layer representation: collection of all VCL NAL units with the same value of quality_id of an SVC dependency representation

SVC random access dependency representation (SVC RADP): SVC dependency representation of an SVC RAP for which dependency_id is equal to one of the values that are associated with the SVC RAP

SVC RAP: collective term for an SVC Base layer RAP or an SVC Enhancement layer RAP

NOTE: An SVC RAP for a particular value of dependency_id specifies that an IRD can begin decoding the SVC layer pictures for the particular value of dependency_id. An SVC RAP includes all SVC Sequence Parameter Sets including VUI and all Picture Parameter Sets that are referenced in the VCL NAL units of the access unit. The access unit does not contain any Sequence Parameter Set (nal_unit_type equal to 7) that is not referenced in the VCL NAL units of the access unit. Any SVC Sequence Parameter Set precedes any SEI NAL units in this access unit. An SVC RAP contains an SVC I picture (which may be an SVC IDR picture). An SVC RAP has temporal_id equal to 0.

SVC video sub-bitstream: video sub-bitstream that contains VCL NAL units with nal_unit_type equal to 20 with the same NAL unit header syntax element dependency_id not equal to 0

VC-1 access point: access unit in a VC-1 Bitstream at which an IRD can begin decoding video successfully

NOTE: This access unit contains a sequence header and can have no decoding dependence on any data preceding this point.

VC-1 bitstream: collective term referring to the VC-1 SDTV Bitstream and the VC-1 HDTV Bitstream

VC-1 HDTV bitstream: collective term referring to the 25 Hz VC-1 HDTV Bitstream and the 30 Hz VC-1 HDTV Bitstream

VC-1 HDTV IRD: collective term referring to the 25 Hz VC-1 HDTV IRD and the 30 Hz VC-1 HDTV IRD

VC-1 IRD: collective term referring to the VC-1 SDTV IRD and the VC-1 HDTV IRD

VC-1 SDTV bitstream: collective term referring to the 25 Hz VC-1 SDTV Bitstream and the 30 Hz VC-1 SDTV Bitstream

VC-1 SDTV IRD: collective term referring to the 25 Hz VC-1 SDTV IRD and the 30 Hz VC-1 SDTV IRD

video sub-bitstream: collection of all VCL NAL units associated with the same value of dependency_id of a video bitstream conforming to annex G of Recommendation ITU-T H.264 / ISO/IEC 14496-10 [16] and all associated non-VCL NAL units in decoding order as defined in Recommendation ITU-T H.264 / ISO/IEC 14496-10 [16]

NOTE: Re-assembling video sub-bitstreams in a consecutive order of dependency_id, starting from the dependency_id equal to 0 up to any value of dependency_id, results in a video bitstream conforming to annex G of Recommendation ITU-T H.264 / ISO/IEC 14496-10 [16].

3.2 Symbols

Void.

3.3 Abbreviations

For the purposes of the present document, the following abbreviations apply:

AAC Advanced Audio Coding

NOTE: According to ISO/IEC 14496-3 [17].

AAC-LC Advanced Audio Coding - Low Complexity

AC-3 Dolby AC-3 audio coding system

NOTE: According to ETSI TS 102 366 [12].

AC-4 Dolby AC-4 audio coding system

NOTE: According to ETSI TS 103 190-1 [43].

ACADE Advanced Clean Audio - Dialogue Enhancement

AD Audio Description

AFD Active Format Description

AOT Audio Object Type

AP Audio Programme

API Application Programming Interface

ASCII American Standard Code for Information Interchange

AU Access Unit

AVC Advanced Video Coding

BGO Background Object

BLA Broken Link Access

bslbf bit string, left bit first, where "left" is the order in which bit strings are written in the present document

CA Conditional Access

CEA Consumer Electronics Association

CPB Coded Picture Buffer

CRA Clean Random Access

CRC Cyclic Redundancy Check

DAB Digital Audio Broadcasting

DAR Display Aspect Ratio

DASH Dynamic Adaptive Streaming over HTTP

DE Dialogue Enhancement

DEP Decodability Entry Point

DMI Dynamic Mapping Information

DPB Decoded Picture Buffer

DRC Dynamic Range Control

NOTE: As defined in ISO/IEC 14496-3 [17].

DTH	Direct-To-Home
DTS	Decoding Time Stamp
DTS Audio	DTS® audio coding system
DTS-HD	Advanced DTS® audio coding system

NOTE: According to ETSI TS 102 114 [15].

DTS-UHD	DTS® UHD audio coding system
---------	------------------------------

NOTE: According to ETSI TS 103 491 [49].

DVB	Digital Video Broadcasting
DVB-SI	Digital Video Broadcasting – Service Information
DVD	Digital Versatile Disc
EBU	European Broadcasting Union
ES	Elementary Stream
ESCR	Elementary Stream Clock Reference
FGO	Foreground Object
FM	Frequency Modulation
GOP	Group Of Pictures
GUI	Graphical User Interface
H.264/AVC	Advanced Video Coding for Generic Audiovisual Services

NOTE: According to H.264/AVC [16].

HD	High Definition
HDMI	High-Definition Multimedia Interface
HDR	High Dynamic Range
HDTV	High Definition Television
HE AAC	High-Efficiency Advanced Audio Coding

NOTE: According to ISO/IEC 14496-3 [17].

HEVC	High Efficiency Video Coding
HFR	High Frame Rate
HLG	Hybrid Log-Gamma

NOTE: According to Recommendation ITU-R BT.2100 [45].

HRD	Hypothetical Reference Decoder
HOA	Higher Order Ambisonics
IDR	Instantaneous Decoding Refresh

NOTE: As defined in H.264/AVC [16].

IEC	International Electrotechnical Commission
I-frame	Intra-coded frame
IMDCT	Inverse Modified Discrete Cosine Transform
IP	Internet Protocol
IRAP	Intra Random Access Point
IRD	Integrated Receiver-Decoder
ISO	International Organization for Standardization
ISO BMFF	ISO Base Media File Format
ITU-R	International Telecommunications Union - Radiocommunications standardization sector
ITU-T	International Telecommunications Union - Telecommunications standardization sector
LATM	Low overhead Audio Transport Multiplex
LC	Low Complexity
LOAS	Low Overhead Audio Stream
lsb	less significant bit
LUFS	Loudness Units relative to Full Scale
MAE	MPEG-H Metadata Audio Element
MBAFF	Macroblock-Adaptive Frame-Field coding
MHAS	MPEG-H Audio Stream
MMCO	Memory Management Control Operation

MPD	Media Presentation Description
MPEG	Moving Pictures Experts Group
MPEG-H LC	MPEG-H Audio Low Complexity Profile

NOTE: As defined in ISO/IEC 23008-3 [47].

MRC	Modification Range Control
msb	most significant bit
MVC	Multi-View Coding
NAL	Network Abstraction Layer
NGA	Next-Generation Audio
PAT	Program Association Table
PCM	Pulse Code Modulation
PCR	Program Clock Reference
PES	Packetized Elementary Stream
PID	Packet Identifier
PLUGE	Picture Line Up Generation Equipment
PMT	Program Map Table
POC	Picture Order Count
PPS	Picture Parameter Set

NOTE: As defined in H.264/AVC [16].

PQ	Perceptual Quantization
PS	Parametric Stereo
PSI	Program Specific Information
PTS	Presentation Time Stamp
PVR	Personal Video Recorder
RAP	Random Access Point
RBSP	Raw Byte Sequence Payload
RDS	Radio Data System
SA	Supplementary Audio
SAOC	Spatial Audio Object Coding
SBR	Spectral Band Replication
SCTE	Society of Cable Telecommunications Engineers
SDR	Standard Dynamic Range
SDTV	Standard Definition Television
SEI	Supplemental Enhancement Information
SI	Service Information
SL-HDR	Single Layer High Dynamic Range
SMPTE	Society of Motion Pictures and Television Engineers
SPS	Sequence Parameter Set

NOTE: As defined in H.264/AVC [16].

STD	System Target Decoder
SVC	Scalable Video Coding

NOTE: As specified in annex G of H.264/AVC [16].

tcimsbf	two's complement integer, most significant bit first
TOC	Table Of Contents
TS	Transport Stream
T-STD	Transport stream-System Target Decoder
TV	Television
UECP	Universal Encoder Communication Protocol
UHDTV	Ultra High Definition Television
uimsbf	Unsigned integer, most significant bit first
VC-1	advanced Video Coding

NOTE: According to SMPTE ST 421 [20].

VCL	Video Coding Layer
VCR	Video Cassette Recorder

VPS	Video Parameter Set
VUI	Video Usability Information
WSS	Wide Screen Signalling

4 Systems layer

4.0 Introduction

This clause describes the guidelines for encoding the systems layer of MPEG-2 in DVB broadcast bitstreams, and for decoding this layer in the IRD. The source bitstream may be transmitted via a satellite, cable or terrestrial channel, or via a digital interface. Clause 4.1 applies to the encoding of all source bitstreams and their decoding by a Baseline IRD. Clause 4.2 gives specific information relating to bitstreams transmitted via a digital interface intended for VCR applications and decoding by IRDs equipped with such an interface.

4.1 Broadcast bitstreams and Baseline IRDs

4.1.0 General

The multiplexing of baseband signals and associated data conforms to Recommendation ITU-T H.222.0 / ISO/IEC 13818-1 [1]. Some of the parameters and fields are not used in the DVB System and these restrictions are described below.

To allow full compliance to Recommendation ITU-T H.222.0 / ISO/IEC 13818-1 [1] and upward compatibility with future enhanced versions, a DVB IRD shall be able to skip over data structures which are currently "reserved", or which correspond to functions not implemented by the IRD. As an example of this capability, a descriptor tag not yet defined within the DVB System shall be interpreted as a no-action tag, its length field correctly decoded and subsequent data skipped.

For the same reason, IRD design should be made under the assumption that any legal structure as permitted by Recommendation ITU-T H.222.0 / ISO/IEC 13818-1 [1] may occur in the broadcast stream even if presently reserved or unused. Therefore the following is assumed:

- *private data shall only be acted upon by decoders which are so enabled;*
- *filling out the bitstream shall be carried out using the normal stuffing mechanism. Reserved fields shall not be used for this purpose. Data of reserved fields shall be set to 0xFF.*

The headings in this clause are based on Recommendation ITU-T H.222.0 / ISO/IEC 13818-1 [1]. The numbers in brackets after the headings are the relevant chapter and clause headings of Recommendation ITU-T H.222.0 / ISO/IEC 13818-1 [1].

4.1.1 Introduction (Recommendation ITU-T H.222.0 / ISO/IEC 13818-1 Introduction)

MPEG-2 systems specify two types of multiplexed data stream: the transport stream and the program stream.

Encoding: *The transmitted multiplex shall use the transport stream.*

Decoding: *All Baseline IRDs shall be able to demultiplex the MPEG-2 transport stream. Demultiplexing of program streams (as described in clauses Intro.2 and Intro.3 of Recommendation ITU-T H.222.0 / ISO/IEC 13818-1 [1]) is optional.*

4.1.2 Packetized Elementary Stream (PES) (Recommendation ITU-T H.222.0 / ISO/IEC 13818-1, clause Intro.4)

Encoding: The creation of a physical Packetized Elementary Stream (PES) by an encoder is not required. ESCR fields and ES rate fields need not be coded.

Decoding: ESCR fields and ES rate fields need not be decoded.

4.1.3 Transport stream system target decoder (Recommendation ITU-T H.222.0 / ISO/IEC 13818-1, clause 2.4.2)

Encoding: *The system clock frequency shall conform to the tolerance specified in clause 2.4.2.1 of Recommendation ITU-T H.222.0 / ISO/IEC 13818-1 [1]. It is recommended that the tolerance is within 5 parts per million.*

Decoding: *The IRD shall operate over the full tolerance range of the system clock frequency specified in clause 2.4.2.1 of Recommendation ITU-T H.222.0 / ISO/IEC 13818-1 [1].*

4.1.4 Transport packet layer (Recommendation ITU-T H.222.0 / ISO/IEC 13818-1, clause 2.4.3.2)

4.1.4.1 Null packets

Encoding: *The encoding of null packets (those with PID value 0x1FFF) shall be as specified in Recommendation ITU-T H.222.0 / ISO/IEC 13818-1 [1].*

4.1.4.2 Transport packet header

4.1.4.2.1 Transport_error_indicator

Encoding: It is recommended that any error detecting devices in a transmission path should set the **transport_error_indicator** bit when uncorrectable errors are detected.

Decoding: Whenever the **transport_error_indicator** flag is set in the transmitted stream it is recommended that the IRD should then invoke a suitable concealment or error recovery mechanism.

4.1.4.2.2 Transport_priority

Decoding: The **transport_priority** bit has no meaning to the IRD, and may be ignored.

4.1.4.2.3 Transport_scrambling_control

Encoding: *The transport_scrambling_control bits shall be set according to clause 5.1 of ETSI TS 100 289 [i.15].*

Table 1: Void

Decoding: *These bits shall be read by the IRD, and the IRD shall respond in accordance with clause 5.1 of ETSI TS 100 289 [i.15].*

4.1.4.2.4 Void

4.1.5 Adaptation field (Recommendation ITU-T H.222.0 / ISO/IEC 13818-1, clause 2.4.3.4)

4.1.5.1 Random_access_indicator

For MPEG-2 Video Bitstreams, the following applies:

Encoding: It is recommended that the **random_access_indicator** bit is set whenever a random access point occurs in video streams (i.e. video sequence header immediately followed by an I-frame).

For H.264/AVC Bitstreams, the following applies:

Encoding: *The **random_access_indicator** bit shall be set whenever an H.264/AVC RAP occurs in video streams (see H.264/AVC RAP definition in clauses 3.1 and 5.5.5).*

Decoding: The **random_access_indicator** bit may be ignored by the IRD. It can be beneficially utilized together with the **elementary_stream_priority** indicator to identify RAP.

For SVC Bitstreams, the following applies:

Encoding: *The **random_access_indicator** bit shall be set whenever an SVC random access dependency representation (as part of an SVC RAP) occurs in video sub-bitstreams (see SVC random access dependency representation definition in clause 3.1 and SVC RAP definition in clauses 3.1 and 5.8.1.6).*

Decoding: The **random_access_indicator** bit may be ignored by the IRD. It can be beneficially utilized together with the **elementary_stream_priority** indicator to identify SVC random access dependency representations and SVC RAPs.

For VC-1 Bitstreams, the following applies:

Encoding: *The **random_access_indicator** bit shall be set whenever a VC-1 Access Point occurs in video streams (see **random_access_indicator** and VC-1 Access Point definitions in SMPTE RP 227 [21]).*

Decoding: The **random_access_indicator** bit may be ignored by the IRD. It can be beneficially utilized together with the **elementary_stream_priority** indicator to identify a VC-1 Access Point.

For MVC Bitstreams, the following applies:

Encoding: *The **random_access_indicator** bit shall be set whenever an MVC Stereo random access view component (as part of an MVC Stereo RAP) occurs in the MVC Bitstream (see MVC Stereo RAP definition in clause 3.1). Both Base and Dependent view components of an MVC Stereo RAP shall set this bit to "1".*

Decoding: *The **random_access_indicator** bit may be ignored by the IRD. It can be beneficially utilized together with the **elementary_stream_priority** indicator to identify MVC Stereo random access view components in Base and Dependent views.*

For HEVC Bitstreams, the following applies:

Encoding: *The **random_access_indicator** bit shall be set whenever an HEVC DVB_RAP occurs in video streams (see HEVC DVB_RAP definition in clauses 3.1 and 5.14.1.8).*

NOTE: The **random_access_indicator** bit should only be set in the transport packet containing PES packet containing the first byte of the HEVC DVB_RAP.

Decoding: The **random_access_indicator** bit may be ignored by the HEVC IRD.

For MPEG-4 AAC, MPEG-4 HE AAC and MPEG-4HE AAC v2 audio Bitstreams, the following applies:

Encoding: *The **random_access_indicator** bit shall be set whenever an MPEG-4 AAC, HE AAC or HE AAC v2 RAP occurs in audio streams (see MPEG-4 AAC, HE AAC or HE AAC v2 RAP definition in clause 6.5).*

Decoding: The **random_access_indicator** bit may be ignored by the IRD. It can be beneficially utilized together with the **elementary_stream_priority** indicator to identify RAP.

For MPEG-H Audio Bitstreams, the following applies:

Encoding: *The **random_access_indicator** bit shall be set whenever an MPEG-H Audio RAP occurs in audio streams (see MPEG-H Audio RAP definition in clause 6.8.4).*

Decoding: The **random_access_indicator** bit may be ignored by the IRD. It can be beneficially utilized together with the **elementary_stream_priority** indicator to identify RAP.

4.1.5.2 Elementary_stream_priority_indicator

For MPEG-2 Video Bitstreams, the following applies:

Decoding: The **elementary_stream_priority_indicator** bit may be ignored by the IRD.

For H.264/AVC Bitstreams, the following applies:

Encoding: *The **elementary_stream_priority_indicator** bit shall be set only when an access unit containing an I or IDR picture (all slices of the picture have a slice_type equal to 0x02 or 0x07) is present in H264/AVC video streams.*

*The **elementary_stream_priority_indicator** shall be set in the adaptation header of the transport packet that contains the first slice start code of this I or IDR picture (per Recommendation ITU-T H.222.0 / ISO/IEC 13818-1 [1]). This adaptation header may be in the transport packet immediately after the packet containing the **random_access_indicator**.*

Decoding: The **elementary_stream_priority_indicator** bit may be ignored by the IRD. It can be beneficially utilized to support trick modes.

For SVC Bitstreams, the following applies:

Encoding: *The **elementary_stream_priority_indicator** bit shall be set only when an SVC dependency representation that consists only of slices with slice_type equal to 0x02 or 0x07 is present in a video sub-bitstream.*

*The **elementary_stream_priority_indicator** shall be set in the adaptation header of the transport packet that contains the first slice start code of this SVC dependency representation (per Recommendation ITU-T H.222.0 / ISO/IEC 13818-1 [1]). This adaptation header may be in the transport packet immediately after the packet containing the **random_access_indicator**.*

Decoding: The **elementary_stream_priority_indicator** bit may be ignored by the IRD. It can be beneficially utilized to support trick modes.

For VC-1 Bitstreams, the following applies:

Encoding: *The **elementary_stream_priority_indicator** bit shall be set only when an access unit containing an I picture is present in VC-1 video streams (see **elementary_stream_priority_indicator** definition in SMPTE RP 227 [21]).*

Decoding: The **elementary_stream_priority_indicator** bit may be ignored by the IRD. It can be beneficially utilized to support trick modes.

For MVC Bitstreams, the following applies:

Encoding: *The **elementary_stream_priority_indicator** bit shall be set only when an I or an IDR picture (slice_type 0x02 or 0x07) is present in the MVC Base view or in the MVC Dependent view of an MVC Stereo access unit. If an I or an IDR picture is present in both base and dependent views of the same access unit, then this bit shall be set to "1" for both view components.*

*The **elementary_stream_priority_indicator** shall be set in the adaptation header of the transport packet that contains the first slice start code of this I or IDR picture (per Recommendation ITU-T H.222.0 / ISO/IEC 13818-1 [1]). This adaptation header may be in the transport packet immediately after the packet containing the **random_access_indicator**.*

Decoding: The **elementary_stream_priority_indicator** bit may be ignored by the IRD. It can be beneficially utilized to support trick modes.

For HEVC Bitstreams, the following applies:

Encoding: *The **elementary_stream_priority_indicator** bit shall be set only when an access unit containing an HEVC DVB_RAP picture is present in HEVC video streams.*

*The **elementary_stream_priority_indicator** shall be set in the adaptation header of the transport packet that contains the first slice start code of this picture (per Recommendation ITU-T H.222.0 / ISO/IEC 13818-1 [1]).*

NOTE: In some cases, the start of the access unit (**access_unit_delimiter**) and the start of the first slice may be separated by multiple transport packets. And hence the adaptation header may not be in the transport packet immediately after the packet containing the **random_access_indicator**.

Decoding: The **elementary_stream_priority_indicator** bit may be ignored by the HEVC IRD. It can be beneficially utilized to support trick modes.

4.1.5.3 Program Clock Reference (PCR)

Encoding: *The time interval between two consecutive PCR values of the same program shall not exceed 100 ms as specified in clause 2.7.2 of Recommendation ITU-T H.222.0 / ISO/IEC 13818-1 [1].*

For MVC Stereo Bitstreams, the PCR shall not be placed in the MVC Stereo Dependent bitstream, because legacy receivers might be unable to decode the (2D HDTV) MVC Stereo Base view bitstream.

Decoding: *The IRD shall operate correctly with PCRs for a program arriving at intervals not exceeding 100 ms.*

4.1.5.4 Other fields

This clause covers the following fields:

- **original_program_clock_reference_base**;
- **original_program_clock_reference_extension**;
- **splice_countdown**;
- **private_data_byte**;
- **adaptation_field_extension** (including fields within).

Encoding: These fields are optional in a DVB bitstream. *The flags that indicate the presence or absence of each of these fields shall be set appropriately.*

NOTE: *The usage of private_data_byte should comply with annex D of the present document.*

Decoding: *IRDs shall be able to accept bitstreams which contain these fields. IRDs may ignore the data within the fields.*

4.1.6 Packetized Elementary Stream (PES) Packet (Recommendation ITU-T H.222.0 / ISO/IEC 13818-1, clause 2.4.3.6)

4.1.6.1 stream_id and stream_type

Encoding: *Elementary streams shall be identified by stream_id and stream_type in accordance with Recommendation ITU-T H.222.0 / ISO/IEC 13818-1 [1], tables 2-22 and 2-34.*

For VC-1 Bitstreams, the following applies:

Encoding: *Elementary streams shall be identified by **stream_id** (with the extension mechanism) and **stream_type** in accordance with SMPTE RP 227 [21].*

*For VC-1 Bitstreams, the value of **stream_type** shall be set to 0xEA.*

Decoding: *IRDs shall be able to accept bitstreams which contain these encoded values.*

For MPEG-4 AAC, MPEG-4 HE AAC and MPEG-4 HE AAC v2 audio streams, the following applies:

Encoding: *The value of the **stream_id** field for LATM/LOAS formatted MPEG-4 AAC, MPEG-4 HE AAC and MPEG-4 HE AAC v2 packetized elementary streams shall be 110x xxxx, where each x can be either 0, or 1. The value of **stream_type** for MPEG-4 AAC, MPEG-4 HE AAC and MPEG-4 HE AAC v2 packetized elementary streams shall be 0x11 (indicating ISO/IEC 14496-3 [17] Audio with the LATM transport syntax).*

Decoding: *This field shall be read by the IRD, and the IRD shall interpret this field in accordance with MPEG systems syntax.*

For MPEG-H Audio streams, the following applies:

Encoding: *The value of the **stream_id** field for MHAS formatted MPEG-H Audio packetized elementary streams shall be 110x xxxx, where each x can be either 0, or 1. The value of **stream_type** for MPEG-H Audio packetized elementary streams shall be 0x2D or 0x2E (indicating ISO/IEC 23008-3 [47] Audio with MHAS transport syntax). The **stream_type** value 0x2D shall be used for NGA single-stream delivery or for the main stream in case of NGA multi-stream delivery. The **stream_type** value 0x2E shall be used for additional (auxiliary) stream in case of NGA multi-stream delivery (see clause 6.8.7 regarding multi-stream MPEG-H Audio).*

Decoding: *This field shall be read by the IRD, and the IRD shall interpret this field in accordance with MPEG systems syntax.*

For AC-3, Enhanced AC-3, AC-4, DTS Audio, DTS-HD or DTS-UHD audio streams, the following applies:

Encoding: *AC-3, Enhanced AC-3, AC-4, DTS Audio, DTS-HD and DTS-UHD packetized elementary streams shall conform to the requirements of a user private stream type 1, as described in Recommendation ITU-T H.222.0 / ISO/IEC 13818-1 [1]. The value of the **stream_id** field for an AC-3, Enhanced AC-3, AC-4, DTS Audio, DTS-HD or DTS-UHD elementary stream shall be 0xBD (indicating private_stream_1). The recommended value of **stream_type** for an AC-3, Enhanced AC-3, AC-4, DTS Audio, DTS-HD or DTS-UHD elementary stream shall be 0x06 (indicating PES packets containing private data). Multiple AC-3, Enhanced AC-3, AC-4, DTS Audio, DTS-HD or DTS-UHD streams may share the same value of **stream_id** since each stream is carried with a unique PID value. The mapping of values of PID to **stream_type** is indicated in the transport stream Program Map Table (PMT).*

Decoding: *These fields shall be read by the IRD, and the IRD shall interpret these fields in accordance with MPEG systems syntax.*

For MVC bitstreams, the following applies:

Encoding: *Elementary streams shall be identified by **stream_id** and **stream_type** in accordance with Recommendation ITU-T H.222.0 / ISO/IEC 13818-1 [1], tables 2-22 and 2-34. In case of an AVC video sub-bitstream of MVC, as defined in clauses 2.1.88 and 2.1.85 of Recommendation ITU-T H.222.0 / ISO/IEC 13818-1 [1] and in clause 3.1 of the present document, the **stream_type** for this elementary stream shall be equal to 0x1B. The MVC video sub-bitstream containing the Dependent View shall have the **stream_type** value equal to 0x20.*

*The value of **stream_id** for both Base and Dependent view bitstreams shall be equal to 1110 0000 (binary) as per Recommendation ITU-T H.222.0 / ISO/IEC 13818-1 [1].*

Decoding: *IRDs shall be able to accept bitstreams which contain these encoded values.*

For HEVC bitstreams, the value of **stream_type** is specified in clauses 5.14.1.9 and 5.14.5.6.

4.1.6.2 PES_scrambling_control

Encoding: *The **PES_scrambling_control** bits shall be set according to clause 5.1 of ETSI TS 100 289 [i.15].*

Table 2: Void

Decoding: *The **PES_scrambling_control** bits shall be read by the IRD, and the IRD shall respond in accordance with clause 5.1 of ETSI TS 100 289 [i.15].*

4.1.6.3 PES_priority

Decoding: The **PES_priority** bit may be ignored by the IRD.

4.1.6.4 Copyright and original_or_copy

Encoding: The copyright and **original_or_copy** bits may be set as appropriate.

Decoding: The IRD need not interpret these bits. *The setting of these bits shall not be altered in any digital output from the IRD.*

4.1.6.5 Trick mode fields

This clause covers the following fields:

- **trick_mode_control**;
- **field_id**;
- **intra_slice_refresh**;
- **frequency_truncation**;
- **field_rep_cntrl**.

Encoding: *These trick mode fields shall not be transmitted in a broadcast bitstream. Bitstreams for other applications (e.g. for non-broadcast interactive services, storage applications, etc.) may use these fields.*

Decoding: The IRD may skip over any data which is flagged as being in a trick mode, if it does not support decoding of trick modes. If the IRD has a digital interface intended for digital VCR applications, it is recommended that it supports decoding of trick modes as indicated in clause 4.2.2.

4.1.6.6 additional_copy_info

Encoding: This field may be used as appropriate.

Decoding: The IRD need not interpret this field. *The coding of the field shall not be altered in any digital output from the IRD.*

4.1.6.7 Optional fields

This clause covers the following fields:

- ESCR;
- ESCR_extension;
- ES_rate;
- previous_PES_packet_CRC;
- PES_private_data;
- pack_header();
- program_packet_sequence_counter;
- MPEG1_MPEG2_identifier;
- original_stuff_length;
- P-STD_buffer_scale;
- P-STD_buffer_size.

Encoding: These fields are optional in a DVB bitstream. *The flags that indicate the presence or absence of each of these fields shall be set appropriately.*

Decoding: *The IRD shall be able to accept bitstreams which contain these fields.* The IRD may ignore the data within the fields.

4.1.6.8 PES_extension_field

For MPEG-2 Video Bitstreams and H.264/AVC Bitstreams the **PES_extension_field** data field is currently "reserved".

Encoding: *This extension field shall not be coded unless specified in the future by MPEG.*

Decoding: *The IRD shall be able to accept bitstreams which contain this field.* The IRD may ignore the data within the field.

For SVC Bitstreams the **PES_extension_field** data field is used to provide the **TREF** field as defined in clauses 2.4.3.7 and 2.14.3.4 of Recommendation ITU-T H.222.0 / ISO/IEC 13818-1 [1] which identifies, if present, the corresponding SVC dependency representation of the same access unit in a corresponding video sub-bitstream.

Encoding: *This extension field shall be coded as specified in Recommendation ITU-T H.222.0 / ISO/IEC 13818-1 [1].*

Decoding: *The IRD shall be able to accept bitstreams which contain this field. The IRD shall use this field according to Recommendation ITU-T H.222.0 / ISO/IEC 13818-1 [1].*

For VC-1 Bitstreams the **PES_extension_field** data field is used to provide the **stream_id_extension** field which identifies this stream as a VC-1 bitstream.

Encoding: *This extension field shall be coded as defined in SMPTE RP 227 [21].*

Decoding: *The IRD shall be able to accept bitstreams which contain this field.*

4.1.6.9 Multiple video pictures per PES packet

For MPEG-2 video Bitstreams, while there is no restriction against multiple video pictures in a single PES packet, there may be some MPEG-2 decoders that do not support this.

- Encoding: The encoder should not put multiple video pictures in a single PES packet.
- Decoding: The IRD may be able to accept and decode bitstreams which contain multiple video pictures in a single PES.

For H.264/AVC Bitstreams, multiple video pictures are allowed in a single PES packet.

- Encoding: *A PES packet per access unit start shall be sent unless multiple access units can be placed in a single transport packet. In this last case, the encoder may put multiple complete access units in a single PES packet. In applications where the IRD is capable of decoding and displaying bitstreams that contain fractions of Access Units, the PES packet may contain fractions of Access Units and encoders are recommended to utilize this option for instance when bitrate savings can be achieved.*

An access unit with H.264/AVC RAP shall be the first access unit in the PES packet (see clause 4.1.5.1) and shall always be preceded by a PES header. Changes to picture size or frame rate cannot occur between access units in the same PES packet. The maximum increment in PTS values between two successive PES packets shall be less than 700 ms with the exception case where video is coded using still pictures where the spacing shall be less than 5 s. A single PES packet shall not contain multiple H.264/AVC Still pictures or multiple H.264/AVC RAPs.

NOTE 1: Usage of multiple pictures per PES packet as per the above represents a very constrained set of conditions under which this may occur. Use of this feature potentially introduces complexity in timing extraction. Therefore, it is recommended that this feature is only used where the consequential bitrate savings are essential and the potential system effects are considered.

- Decoding: *The IRD shall support decoding and displaying bitstreams, which contain multiple complete access units in a single PES packet. It is strongly recommended that the IRD also supports decoding and displaying bitstreams that contain fractions of access units in PES packet.*

For SVC Bitstreams, multiple video pictures are not allowed in a single PES packet.

- Encoding: *A single PES packet per SVC dependency representation shall be sent.*
- Decoding: *The IRD shall support decoding and displaying bitstreams, which contain a single complete SVC dependency representation in a single PES packet.*

For VC-1 Bitstreams, multiple video pictures are allowed in a single PES packet.

- Encoding: *A PES packet per access unit start shall be sent unless if multiple access units can be placed in a single transport packet. In this last case, the encoder may put multiple complete access units in a single PES packet. In applications where the IRD is capable of decoding and displaying bitstreams that contain fractions of access unit, the PES packet may contain fractions of access units and encoders are recommended to utilize this option for instance when bitrate savings can be achieved.*

An access unit with a VC-1 Access Point shall be the first access unit in the PES packet (see clause 4.1.5.1) and shall always be preceded by a PES header.

NOTE 2: Usage of multiple pictures per PES packet as per the above represents a very constrained set of conditions under which this may occur. Use of this feature potentially introduces complexity in timing extraction. Therefore, it is recommended that this feature is only used where the consequential bitrate savings are essential and the potential system effects are considered.

- Decoding: *The IRD shall support decoding and displaying bitstreams, which contain multiple complete access units in a single PES packet. It is strongly recommended that the IRD also supports decoding and displaying bitstreams that contain fractions of access units in PES packet.*

For MVC Bitstreams, multiple video pictures are not allowed in a single PES packet.

Encoding: *A single PES packet per MVC view component shall be sent. Additionally, the following applies:*

- *The first byte of a PES packet payload for the Base (Dependent) View video elementary stream shall be the first byte of the Base (Dependent) View component.*
- *If the coded picture has frame structure, one PES packet containing the view component shall contain only one frame.*
- *If the coded picture has field structure, one PES packet containing the view component shall contain a field picture.*

Decoding: *The IRD shall support decoding and displaying of MVC Stereo bitstreams, consisting of an MVC Stereo Base view bitstream and an MVC Stereo Dependent view bitstream, which are both sent in separate elementary streams.*

For HEVC Bitstreams, multiple video pictures are not allowed in a single PES packet.

Encoding: *Each PES packet shall contain exactly one complete AU. The first payload byte after the PES header shall be the start of the AU. The "data_alignment_indicator" in the PES header shall be set to a value of "1".*

Decoding: *The HEVC IRD shall support decoding and displaying bitstreams where each PES packet contains exactly one complete AU.*

4.1.6.10 Presentation Time Stamp and Decoding Time Stamp occurrence

For H.264/AVC Bitstreams:

Encoding: *Every PES header shall contain the Presentation Time Stamp and the Decoding Time Stamp (only if it differs from the Presentation Time Stamp) of the first access unit in the PES packet. The start of the first access unit shall occur in the same transport packet as the PES header or the packet of same PID immediately following the packet with the PES header, if the data preceding the access unit start code forces the access unit start code into the next transport packet. When a PES packet contains multiple access units, for any access units following the first access unit in the same PES packet the H.264/AVC syntax elements num_units_in_tick, time_scale, pic_struct (if present), and the value of the H.264/AVC variables TopFieldOrderCnt and BottomFieldOrderCnt of the access unit shall allow the derivation of Presentation Time Stamp and the Decoding Time Stamp for the access unit.*

Decoding: *If Presentation Time Stamp is available and Decoding Time Stamp is not available for the first access unit in the PES packet, the H.264/AVC IRD shall set the Decoding Time Stamp equal to the Presentation Time Stamp (per Recommendation ITU-T H.222.0 / ISO/IEC 13818-1 [1]). The Presentation Time Stamp and the Decoding Time Stamp of any access units following the first access unit in the same PES packet shall be derived using the H.264/AVC syntax elements num_units_in_tick, time_scale, pic_struct (if present), and the value of the H.264/AVC variables TopFieldOrderCnt and BottomFieldOrderCnt of the access unit.*

For SVC Bitstreams:

Encoding: *Every PES header shall contain the Presentation Time Stamp and the Decoding Time Stamp (only if it differs from the Presentation Time Stamp) of the SVC dependency representation in the PES packet. The start of the SVC dependency representation shall occur in the same transport packet as the PES header or the packet of same PID immediately following the packet with the PES header, if the data preceding the SVC dependency representation start code forces the SVC dependency representation code into the next transport packet.*

Decoding: *If a Presentation Time Stamp is available and a Decoding Time Stamp is not available for the SVC dependency representation in the PES packet, the SVC IRD shall set the Decoding Time Stamp equal to the Presentation Time Stamp (per Recommendation ITU-T H.222.0 / ISO/IEC 13818-1 [1]).*

For MVC Bitstreams:

Encoding: *Every PES header shall contain the Presentation Time Stamp and the Decoding Time Stamp (only if it differs from the Presentation Time Stamp) of the MVC Stereo AU in the PES packet.*

The PTS shall be the same for Base and Dependent view components within the same MVC Stereo AU, as per Recommendation ITU-T H.222.0 / ISO/IEC 13818-1 [1].

The DTS, when present, shall be the same for Base and Dependent view components within the same MVC Stereo AU, as per Recommendation ITU-T H.222.0 / ISO/IEC 13818-1 [1].

Decoding: *If a Presentation Time Stamp is available and a Decoding Time Stamp is not available for the MVC view component(s) in the PES packet, the MVC IRD shall set the Decoding Time Stamp equal to the Presentation Time Stamp (per Recommendation ITU-T H.222.0 / ISO/IEC 13818-1 [1]).*

For HEVC Bitstreams:

Encoding: *Every PES header shall contain the Presentation Time Stamp and the Decoding Time Stamp (only if it differs from the Presentation Time Stamp).*

Decoding: *If Presentation Time Stamp is available and Decoding Time Stamp is not available for the access unit in the PES packet, the HEVC IRD shall set the Decoding Time Stamp equal to the Presentation Time Stamp (per Recommendation ITU-T H.222.0 / ISO/IEC 13818-1 [1]).*

Within the accuracy of their respective clocks, the Decoding Time Stamp and Presentation Time Stamp shall indicate the same instant in time as the nominal CPB removal time and the DPB output time in the HRD respectively when picture timing SEI information is transmitted (per clause 2.4.3.7 of Recommendation ITU-T H.222.0 / ISO/IEC 13818-1 [1]). This ensures consistency between the STD model of Recommendation ITU-T H.222.0 / ISO/IEC 13818-1 [1] and the HRD model of Recommendation ITU-T H.264 / ISO/IEC 14496-10 [16]. See clause 5.13.1.7 for more details on HRD conformance.

4.1.6.11 STD audio buffer size

For AC-3 and Enhanced AC-3:

- It is recommended that for AC-3 and Enhanced AC-3 audio in a DVB system, the main audio buffer size (BS_n) has a fixed value of 5 696 bytes.

For AC-4:

- It is recommended that for AC-4 audio in a DVB system, the main audio buffer size (BS_n) has a fixed value of 131 072 bytes.

For DTS Audio:

- It is recommended that for DTS Audio in a DVB system, the main audio buffer size (BS_n) has a fixed value of 9 088 bytes.

For DTS-HD and DTS-UHD:

- It is recommended that for DTS-HD and DTS-UHD audio in a DVB system, the main audio buffer size (BS_n) has a fixed value of 66 434 bytes.

For MPEG-4 AAC, MPEG-4 HE AAC and MPEG-4 HE AAC v2:

- It is recommended that for MPEG-4 AAC, MPEG-4 HE AAC and MPEG-4 HE AAC v2 audio in a DVB system, the main audio buffer size (BS_n) has a value of 3 584 bytes for level 2 decoders and 8 976 bytes for level 4 decoders as defined in Recommendation ITU-T H.222.0 / ISO/IEC 13818-1 [1], clause 2.11.2.2.
- Refer to Recommendation ITU-T H.222.0 / ISO/IEC 13818-1 [1] for the derivation of (BS_n) for audio elementary streams.

For MPEG-H Audio:

- It is recommended that for MPEG-H Audio in a DVB system, the main audio buffer size (BS_n) has a value as defined in ISO/IEC 13818-1 [1], clause 2.19.3.
- Refer to Recommendation ITU-T H.222.0 / ISO/IEC 13818-1 [1] for the derivation of (BS_n) for audio elementary streams.

4.1.7 Program Specific Information (PSI) (Recommendation ITU-T H.222.0 / ISO/IEC 13818-1, clause 2.4.4)

The Program Association Table (PAT) and Program Map Table (PMT) should be repeated with a maximum time interval of 100 ms between repetitions. *In distribution applications, the maximum time interval between repetitions of each of these tables shall be 100 ms.*

4.1.8 Use of program and elementary stream descriptors (Recommendation ITU-T H.222.0 / ISO/IEC 13818-1, clause 2.6)

4.1.8.0 Introduction

This clause contains further constraints on using descriptors as defined in Recommendation ITU-T H.222.0 [1] / ISO/IEC 13818-1 [1]. Use of descriptors not defined in Recommendation ITU-T H.222.0 / ISO/IEC 13818-1 [1] is covered in ETSI EN 300 468 [i.32].

4.1.8.1 video_stream_descriptor and audio_stream_descriptor

For MPEG-2 Video Bitstreams:

Encoding: *The **video_stream_descriptor** shall be used to indicate video streams containing still picture data, otherwise these descriptors may be used when appropriate. If **profile_and_level_indication** is not present, then the video bitstream shall comply with the constraints of Main Profile at Main Level. The appropriate **profile_and_level_indication** field shall always be transmitted for Profiles and Levels other than Main Profile at Main Level.*

*If the **audio_stream_descriptor** is not present, then the audio bitstream shall not use sampling frequencies of 16 kHz, 22,05 kHz or 24 kHz, and all audio frames in the stream shall have the same bitrate.*

Decoding: The IRD may use these descriptors when present to determine if it is able to decode the streams.

4.1.8.2 hierarchy_descriptor

For audio Bitstreams:

Encoding: *The **hierarchy_descriptor** shall be used if, and only if, audio is coded as more than one hierarchical layer.*

For SVC Bitstreams:

Encoding: *The **hierarchy_descriptor** shall be used according to Recommendation ITU-T H.222.0 / ISO/IEC 13818-1 [1].*

Decoding: *The IRD shall use the **hierarchy_descriptor** according to Recommendation ITU-T H.222.0 / ISO/IEC 13818-1 [1].*

4.1.8.3 registration_descriptor

For MPEG-2 Video, H.264/AVC and SVC Bitstreams:

Encoding: The **registration_descriptor** may be used when appropriate.

Decoding: The IRD need not make use of this descriptor.

For VC-1 Bitstreams, the following applies:

Encoding: *A **registration_descriptor** shall be used for the signalling of VC-1 bitstreams as defined in SMPTE RP 227 [21]. One and only one **registration_descriptor** shall be present.*

Decoding: *VC-1 IRDs shall decode and process the registration descriptor conveying a VC-1 registration code to access information relevant to the encoded bitstream.*

4.1.8.4 data_stream_alignment_descriptor

For MPEG-2 Video, H.264/AVC, SVC and MVC Stereo Bitstreams:

Encoding: The **data_stream_alignment_descriptor** may be used when appropriate.

Decoding: The IRD need not make use of this descriptor.

For VC-1 Bitstreams, the following applies:

Encoding: *The **data_stream_alignment_descriptor** shall not be used. See SMPTE RP 227 [21] for a functional equivalent of the **data_stream_alignment_descriptor** that is specific to VC-1 bitstreams.*

4.1.8.5 target_background_grid_descriptor

Encoding: *The **target_background_grid_descriptor** shall be used when the horizontal or vertical resolution is other than 720×576 pixels for a 25 Hz bitstream or is other than 720×480 pixels for a 30 Hz bitstream, otherwise its use is optional.*

Decoding: *If this descriptor is absent, a default grid of 720×576 pixels shall be assumed by a 25 Hz IRD, a default grid of 720×480 pixels shall be assumed by a 30 Hz IRD. The display of correctly windowed video on background grids other than 720×576 pixels is optional for a 25 Hz SDTV IRD, the display of correctly windowed video on background grids other than 720×480 pixels is optional for a 30 Hz SDTV IRD. The HDTV IRD shall read this descriptor, when present, to override the default values.*

4.1.8.6 video_window_descriptor

Encoding: The **video_window_descriptor** may be used when appropriate, to indicate the required position of the video window on the screen.

Decoding: *When a **video_window_descriptor** is present, the IRD shall use the conveyed information to position the video window accordingly.*

4.1.8.7 Conditional Access CA_descriptor

Encoding: *The **CA_descriptor** shall be encoded as defined in ETSI TS 100 289 [i.15].*

Decoding: *The IRD shall interpret this descriptor as defined in ETSI TS 100 289 [i.15].*

4.1.8.8 ISO_639_Language_descriptor

Encoding: *The **ISO_639_Language_descriptor** shall be present if more than one audio (or video) stream with different languages is present within a program. It is optional otherwise. The use of the **ISO_639_Language_descriptor** is recommended for all audio, video and data streams.*

Decoding: *The IRD shall use the data from this descriptor to assist the selection of appropriate audio (or video) stream of program, if more than one stream is available.*

NOTE: Further rules for when this descriptor is used in conjunction with other DVB descriptors are given in ETSI EN 300 468 [i.32], in particular in annexes J and M.

4.1.8.9 system_clock_descriptor

Encoding: It is recommended that the **system_clock_descriptor** is included in the program_info part of the Program Map Table for each program.

Decoding: The IRD need not make use of this descriptor.

4.1.8.10 multiplex_buffer_utilization_descriptor

Encoding: The **multiplex_buffer_utilization_descriptor** may be used when appropriate.

Decoding: The IRD need not make use of this descriptor.

4.1.8.11 copyright_descriptor

Encoding: The **copyright_descriptor** may be used when appropriate.

Decoding: The IRD need not make use of this descriptor.

4.1.8.12 maximum_bitrate_descriptor

Encoding: The **maximum_bitrate_descriptor** may be used when appropriate.

Decoding: The IRD need not make use of this descriptor.

4.1.8.13 private_data_indicator_descriptor

Encoding: The **private_data_indicator_descriptor** may be used when appropriate.

Decoding: The IRD need not make use of this descriptor.

4.1.8.14 smoothing_buffer_descriptor

Encoding: It is recommended that the **smoothing_buffer_descriptor** is included in the program_info part of the Program Map Table for each program.

Decoding: The IRD need not make use of this descriptor, but the information may be of assistance to digital VCRs.

4.1.8.15 STD_descriptor

Encoding: *The **STD_descriptor** shall be used as specified in Recommendation ITU-T H.222.0 / ISO/IEC 13818-1 [1].*

Decoding: The IRD need not make use of this descriptor.

4.1.8.16 IBP_descriptor

Encoding: The **IBP_descriptor** may be used when appropriate.

Decoding: The IRD need not make use of this descriptor.

4.1.8.17 MPEG-4_audio_descriptor

For MPEG-4 AAC, MPEG-4 HE AAC and MPEG-4 HE AAC v2:

Encoding: The **MPEG-4_audio_descriptor** may be used when appropriate.

Decoding: The IRD need not make use of this descriptor.

4.1.8.18 AVC_video_descriptor

For H.264/AVC:

Encoding: The **AVC_video_descriptor** may be used when appropriate. *The AVC_video_descriptor shall be used to signal presence of H.264/AVC still pictures within the coded video sequence (see clause 5.5.4.3).*

Decoding: The IRD need not make use of this descriptor. However, the information may assist in support for H.264/AVC still pictures (see clause 5.5.4.3).

For SVC:

Encoding: The **AVC_video_descriptor** may be used when appropriate. *The AVC_video_descriptor shall be used to signal presence of H.264/AVC still pictures within the coded video sequence (see clause 5.5.4.3).*

Decoding: The IRD need not make use of this descriptor. However, the information may assist in support for H.264/AVC still pictures (see clause 5.5.4.3) and may assist the IRD in selecting the video sub-bitstreams to tune in.

For MVC:

Encoding: The **AVC_video_descriptor** may be used when appropriate. *The AVC_video_descriptor shall be used to signal presence of H.264/AVC still pictures within the MVC Stereo Base view coded video sequence (see clause 5.5.4.3).*

The AVC_video_descriptor shall not be associated with the MVC Stereo Dependent view bitstream.

Decoding: The IRD need not make use of this descriptor. However, the information may assist in support for H.264/AVC still pictures (see clause 5.5.4.3) and may assist the IRD in selecting the video sub-bitstreams to tune in.

4.1.8.19 SVC_extension_descriptor

For SVC:

Encoding: The **SVC_extension_descriptor** may be used when appropriate.

*If the SVC_extension_descriptor is present in an SVC video sub-bitstream (i.e. a video sub-bitstream with dependency_id greater than 0), then the syntax element **no_sei_nal_unit_present** shall be set equal to 1.*

Decoding: The IRD need not make use of this descriptor. However, the information conveyed assists the re-assembling process of video sub-bitstreams and may also assist the IRD in selecting the video sub-bitstreams to tune in.

4.1.8.19a HEVC_video_descriptor

For HEVC:

Encoding: *The **HEVC_video_descriptor** shall be present in the PMT. Per Recommendation ITU-T H.222.0 / ISO/IEC 13818-1 [1], it is conveyed in the descriptor loop for the respective elementary stream in the PMT. **temporal_layer_subset_flag** shall be set to "1", so that **temporal_id_min** and **temporal_id_max** are present.*

***temporal_id_min** shall be set to "0" for **stream_type** 0x24.*

NOTE: When temporal sub-layers are not used (all the NAL units in the associated elementary stream have nuh_temporal_id_plus1 equal to 1), the values of temporal_id_min and temporal_id_max are present, but both equal to "0".

*The **HEVC_still_present_flag** shall be equal to "0".*

Decoding: It is recommended that the HEVC IRD make use of this descriptor and evaluates the **level_idc**, **temporal_id_min** and **temporal_id_max** fields.

The HEVC IRD may ignore the **HEVC_still_present_flag**.

4.1.8.20 Void

NOTE: Moved to clause 4.1.6.11.

4.1.8.21 Void

4.1.8.22 Void

4.1.8.23 Void

4.1.8.24 Void

4.1.8.24.1 Void

4.1.8.24.2 Void

4.1.8.24.3 Void

4.1.8.25 Void

4.1.8.26 Void

4.1.8.27 MPEG-4 audio extension descriptor

Semantics: The **MPEG-4 audio extension descriptor** syntax provides information about presence of MPEG Surround data in conjunction with MPEG-1 Layer II, MPEG-4 AAC, MPEG-4 HE AAC or HE AAC v2 elementary streams within a DVB transport stream. The **MPEG-4 audio extension_descriptor** is located in the PMT and is defined in Recommendation ITU-T H.222.0 / ISO/IEC 13818-1 [1].

Encoding: *If MPEG Surround data according to [29] and [31] is transmitted in conjunction with MPEG-4 AAC, MPEG-4 HE AAC or MPEG-4 HE AAC v2 elementary streams, the **MPEG-4 audio extension descriptor** shall be included in a program map section at most once in relevant ES_info descriptor loop which describes an elementary stream carrying a MPEG-4 AAC, MPEG-4 HE AAC or MPEG-4 HE AAC v2 audio stream coded in accordance with ISO/IEC 14496-3 [17] that is included in a DVB transport stream. One **audio profile level indication** shall be specified for the AAC, HE AAC or HE AAC v2 part. Additionally, one **audio profile level indication** shall be specified for the MPEG Surround part. If MPEG Surround data according to [29] and [31] is transmitted in conjunction with MPEG-1 Layer II elementary streams, the **MPEG-4 audio extension descriptor** shall be included in a program map section at most once in each relevant ES_info descriptor loop which describes an elementary stream carrying a MPEG-1 Layer II audio stream coded in accordance with ISO/IEC 11172-3 [9] that is included in a DVB transport stream. One **audio profile level indication** for the MPEG Surround part shall be specified.*

Decoding: *In case the IRD is capable of decoding MPEG Surround, this descriptor shall be read and interpreted by the IRD.*

4.1.8.28 MVC_extension_descriptor

For MVC:

Encoding: *The MVC extension descriptor carried in the PMT shall be present for the Dependent view component.*

Also, the following applies:

- *The syntax element **no_prefix_nal_unit_present** shall be set equal to 1.*
- *The syntax of the **view_association_not_present** and **base_view_is_left_eyeview** shall be set accordingly to indicate which view, left or right, has been assigned to the Base view component by the content author.*

Decoding: *An IRD shall use this descriptor to determine the association of left view and right view to the Base and Dependent view components.*

*The two fields, **view_association_not_present** and **base_view_is_left_eyeview**, of the MVC extension descriptor shall be set in accordance with the Multiview view position SEI message.*

NOTE: In the case of inconsistencies between MVC extension descriptor and Multiview view position SEI message, the latter takes precedence.

4.1.8.29 Void

4.1.8.30 Void

4.1.8.31 MPEG-H_3dAudio_descriptor

Semantics: The **MPEG-H_3dAudio_descriptor** provides information about individual MPEG-H Audio elementary streams within a DVB transport stream that are to be identified in the PSI PMT sections. The **MPEG-H_3dAudio_descriptor** is defined in ISO/IEC 13818-1 [1], clause 2.6.106 and is located in the PMT.

Encoding: *The **MPEG-H_3dAudio_descriptor** shall be included in a program map section at most once in each relevant ES_info descriptor loop which describes an elementary stream carrying an MPEG-H Audio stream, coded in accordance with ISO/IEC 23008-3 [47], that is included in a DVB transport stream.*

*The profile and level value shall be signalled in the **mpegh3daProfileLevelIndication** field in the **MPEG-H_3dAudio_descriptor()** as specified in ISO/IEC 13818-1, clause 2.6.106 [1]. The values for LC Profile Level 1, 2 and 3 are "0x0B," "0x0C," and "0x0D", respectively, as specified in ISO/IEC 23008-3 [47], clause 5.3.2.*

Decoding: *This descriptor shall be read and interpreted by the IRD.*

4.1.8.32 Void

4.1.9 Compatibility with ISO/IEC 11172-1 (Recommendation ITU-T H.222.0 / ISO/IEC 13818-1, clause 2.8)

Decoding: Compatibility with ISO/IEC 11172-1 [8] (MPEG-1 Systems) is optional.

4.1.10 Storage Media Interoperability

It is recommended that the total bitrate of the set of components, associated PMT and PCR packets for an SDTV service anticipated to be recorded by a consumer, should not exceed 9 000 000 bit/s. It is recommended that the total bitrate of the set of components, associated PMT and PCR packets for an HDTV service anticipated to be recorded by a consumer, should not exceed 28 000 000 bit/s.

It is recommended that the parameters `sb_size` and `sb_leak_rate` in the `smoothing_buffer_descriptor` remain constant for the duration of an event. The value of the `sb_leak_rate` should be the peak attained during the event.

NOTE: The `short_smoothing_buffer_descriptor` may be included in DVB-SI tables to signal the bitrate for each event. It is defined in ETSI EN 300 468 [i.32].

4.2 Bitstreams from storage applications and IRDs with digital interfaces

4.2.0 Scope

This clause covers both the treatment of Partial Transport Streams which result from external program selection and Trick Play information received from a storage device. MPEG-2 PSI and DVB SI Tables for use specifically in storage applications are defined in ETSI EN 300 468 [i.32].

4.2.1 Partial Transport Streams

Partial transport streams for transfer on a digital interface, e.g. for digital VCR applications, have been defined in IEC CD - 100C/1883. A Partial Transport Stream may be created by selection of Transport Stream Packets from one or more program(s), including PSI Packets.

Encoding: *The Partial Transport Stream shall be fully MPEG compliant with reference to MPEG-2 "Extension for Real-Time-Interface for systems decoders" (ISO/IEC 13818-9 [4]).*

Decoding: *Devices equipped with a digital interface intended for digital VCR applications shall accept the bursty character of a Partial Transport Stream with gaps of variable length between the Transport Stream Packets.*

4.2.2 Decoding of Trick Play data (Recommendation ITU-T H.222.0 / ISO/IEC 13818-1, clause 2.4.3.7)

Encoding: *Trick mode operation shall be signalled by use of the `DSM_trick_mode` flag in the header of the video Packetized Elementary Stream (PES) packets. During trick mode playback the storage device shall construct a bitstream which is syntactically and semantically correct, except as outlined in the note below.*

Decoding: *It is recommended that devices decode the `DSM_trick_mode_flag` and the eight bit trick mode field. Devices which decode the trick mode data shall follow the normative requirements detailed in Recommendation ITU-T H.222.0 / ISO/IEC 13818-1 [1], 2 for all values of the `trick_mode_control` field.*

NOTE: Trick Mode Semantic Constraints.

The bitstream delivered to the decoder during trick mode shall comply with the syntax defined in the MPEG-2 standard. However, for the following video syntax elements, semantic exceptions apply in the presence of the DSM_trick_mode field:

- bit_rate;
- vbv_delay;
- repeat_first_field;
- v_axis_positive;
- field_sequence;
- subcarrier;
- burst_amplitude;
- subcarrier_phase.

A decoder cannot rely on the values encoded in these fields when in trick mode.

Similarly, for the systems layer, the following semantic exceptions apply in the presence of the DSM_trick_mode field:

- maximum spacing of PSI information may exceed 400 ms;
- maximum spacing of Presentation Time Stamp or Decoding Time Stamp occurrences may exceed 700 ms;
- PES packets may be void of video data to indicate a change in trick mode byte;
- a PES packet void of video data may contain a Presentation Time Stamp to indicate effective presentation time of new trick mode control;
- when trick_mode status is true, the elementary stream buffers in the T-STD may underflow.

5 Video

5.0 Introduction

This clause describes the guidelines for encoding MPEG-2 video, or H.264/AVC video, or HEVC video, or VC-1 video in DVB broadcast bitstreams, and for decoding this bitstream in the IRD.

Clause 5.1 applies to 25 Hz MPEG-2 SDTV IRDs and broadcasts intended for reception by such IRDs.

Clause 5.2 applies to 25 Hz MPEG-2 HDTV IRDs and broadcasts intended for reception by such IRDs.

Clause 5.3 applies to 30 Hz MPEG-2 SDTV IRDs and broadcasts intended for reception by such IRDs.

Clause 5.4 applies to 30 Hz MPEG-2 HDTV IRDs and broadcasts intended for reception by such IRDs.

Clause 5.5 applies to all H.264/AVC IRDs and broadcasts intended for reception by such IRDs.

Clause 5.6 applies to H.264/AVC SDTV IRDs and broadcasts intended for reception by such IRDs.

Clause 5.7 applies to H.264/AVC HDTV IRDs and broadcasts intended for reception by such IRDs.

Clause 5.8 applies to SVC HDTV IRDs and broadcasts intended for reception by such IRDs.

Clause 5.9 applies to 25 Hz VC-1 SDTV IRDs and broadcasts intended for reception by such IRDs.

Clause 5.10 applies to 25 Hz VC-1 HDTV IRDs and broadcasts intended for reception by such IRDs.

Clause 5.11 applies to 30 Hz VC-1 SDTV IRDs and broadcasts intended for reception by such IRDs.

Clause 5.12 applies to 30 Hz VC-1 HDTV IRDs and broadcasts intended for reception by such IRDs.

Clause 5.13.1 applies to all MVC Stereo HDTV IRDs and broadcasts intended for reception by such IRDs.

Clause 5.13.2 applies to 25 Hz MVC Stereo HDTV IRDs and broadcasts intended for reception by such IRDs.

Clause 5.13.3 applies to 30 Hz MVC Stereo HDTV IRDs and broadcasts intended for reception by such IRDs.

Clause 5.14 applies to all HEVC IRDs and broadcast intended for reception by such IRDs.

To allow full compliance to the MPEG-2, H.264/AVC, HEVC and VC-1 standards and upward compatibility with future enhanced versions, a DVB IRD shall be able to skip over data structures which are currently "reserved", or which correspond to functions not implemented by the IRD.

This clause is based on Recommendation ITU-T H.262 / ISO/IEC 13818-2 [2], Recommendation ITU-T H.264 / ISO/IEC 14496-10 [16], SMPTE ST 421 [20] and Recommendation ITU-T H.265 / ISO/IEC 23008-2 [35].

The following clauses do not imply that either MPEG-2 video, H.264/AVC video, HEVC video or VC-1 video are mandatory. *The codecs that a given IRD supports will define which of the following clauses the IRD shall comply with.*

5.1 25 Hz MPEG-2 SDTV IRDs and Bitstreams

5.1.0 General

The video encoding shall conform to Recommendation ITU-T H.262 / ISO/IEC 13818-2 [2]. Some of the parameters and fields are not used in the DVB System and these restrictions are described below. The IRD design shall be made under the assumption that any legal structure as permitted by Recommendation ITU-T H.262 / ISO/IEC 13818-2 [2] may occur in the broadcast stream even if presently reserved or unused.

5.1.1 Profile and level

Encoding: *Encoded bitstreams shall comply with the Main Profile Main Level restrictions, as described in Recommendation ITU-T H.262 / ISO/IEC 13818-2 [2], clause 8.2. The **profile_and_level_indication** is "01001000" or, if appropriate, "0nnnnnnn", where "0nnnnnnn">"01001000", indicating a "simpler" profile or level than Main Profile, Main Level.*

Decoding: *The 25 Hz MPEG-2 SDTV IRD shall support the decoding of Main Profile Main Level bitstreams. Support for profiles and levels beyond Main Profile, Main Level is optional. If the IRD encounters an extension which it cannot decode, such as one whose identification code is Reserved, Picture Sequence Scaleable, Picture Spatial Scaleable or Picture Temporal Scaleable, it shall discard the following data until the next start code (to allow backward compatible extensions to be added in the future).*

5.1.2 Frame rate

Encoding: *The frame rate shall be 25 Hz, i.e. **frame_rate_code** is "0011".*

Still pictures may be encoded by use of a video sequence consisting of a single intra-coded picture (see definition of still pictures in Recommendation ITU-T H.222.0 / ISO/IEC 13818-1 [1], clause 2.1.70).

Decoding: *All 25 Hz MPEG-2 SDTV IRDs shall support the decoding and display of video material with a frame rate of 25 Hz interlaced (i.e. **frame_rate_code** of "0011"). Support of other frame and field rates is optional.*

25 Hz MPEG-2 SDTV IRDs shall be capable of decoding and displaying still pictures, i.e. video sequences consisting of a single intra-coded picture (see definition of still pictures in Recommendation ITU-T H.222.0 / ISO/IEC 13818-1 [1], clause 2.1.70).

5.1.3 Aspect ratio

Encoding: *The source aspect ratio in 25 Hz MPEG-2 SDTV bitstreams shall be either 4:3, 16:9 or 2.21:1. Note that decoding of 2.21:1 aspect ratio is optional for the 25 Hz MPEG-2 SDTV IRD.*

*The **aspect_ratio_information** in the sequence header shall have one of the following three values:*

- 4:3 aspect ratio source: "0010";
- 16:9 aspect ratio source: "0011";
- 2.21:1 aspect ratio source: "0100".

It is recommended that pan vectors for a 4:3 window are included in the transmitted bitstream when the source aspect ratio is 16:9 or 2.21:1. *The vertical component of the transmitted pan vector shall be zero.*

*If pan vectors are transmitted then the **sequence_display_extension** shall be present in the bitstream and the **aspect_ratio_information** shall be set to '0010' (4:3 display). The **display_vertical_size** shall be equal to the **vertical_size**. The **display_horizontal_size** shall contain the resolution of the target 4:3 display. The value of the **display_horizontal_size** field may be calculated by the following equation:*

$$\text{display_horizontal_size} = \frac{4}{3} \times \frac{\text{horizontal_size}}{\text{source aspect ratio}}$$

Table 3 gives some typical examples.

Table 3: Values for display_horizontal_size

horizontal_size × vertical_size	Source aspect ratio	Display_horizontal_size
720 × 576	16:9	540
544 × 576	16:9	408
480 × 576	16:9	360
352 × 576	16:9	264
352 × 288	16:9	264

Decoding: *The 25 Hz MPEG-2 SDTV IRD shall be able to decode bitstreams with values of **aspect_ratio_information** of "0010" and "0011", corresponding to 4:3 and 16:9 aspect ratio respectively. If the IRD has a digital interface, this should be capable of outputting bitstreams with aspect ratios which are not directly supported by the IRD to allow their decoding and display via an external unit.*

All 25 Hz MPEG-2 SDTV IRDs shall support the use of pan vectors and up sampling to allow a 4:3 monitor to give a full-screen display of a selected portion of a 16:9 coded picture with the correct aspect ratio. IRDs implementing the 2.21:1 aspect ratio should support the use of pan vectors and up sampling to allow a 4:3 monitor to give a full-screen display of a selected portion of the 2.21:1 picture with the correct aspect ratio. Support for pan vectors with non-zero vertical components is optional. When no pan vectors are present in the transmitted bitstream, the central portion of the wide-screen picture shall be displayed. The support of vertical resampling to obtain the correct aspect ratio for a letterbox display of a 16:9 or 2.21:1 coded picture on a 4:3 monitor is optional.

5.1.4 Luminance resolution

Encoding: *The encoded picture shall have a full-screen luminance resolution (horizontal × vertical) of one of the following values:*

- 720 × 576;
- 544 × 576;
- 480 × 576;

- 352 × 576;
- 352 × 288.

In addition, non full-screen pictures may be encoded for display at less than full-size (when using one of the standard up-conversion ratios at the IRD), for example using 704 × 576.

NOTE: An encoded resolution of 704 × 576 pixels is often used to encode just the active 702 pixel portion of the video line, excluding the analogue blanking that may be present at the start and end of the full 720 pixel digital video line.

Decoding: The 25 Hz MPEG-2 SDTV IRD *shall be capable of decoding pictures with luminance resolutions as shown in table 4 and applying up sampling to allow the decoded pictures to be displayed at full-screen size. In addition, IRDs shall be capable of decoding lower picture resolutions and displaying them at less than full-size after using one of the standard up-conversions, e.g. a horizontal resolution of 704 pixels within the 720 pixels full-screen display.*

Table 4: Resolutions for Full-screen Display from 25 Hz MPEG-2 SDTV IRD

Coded Picture		Displayed Picture Horizontal up sampling	
Luminance resolution (horizontal × vertical)	Aspect Ratio	4:3 Monitors	16:9 Monitors
720 × 576	4:3	× 1	× 3/4 (see note 1)
	16:9	× 4/3 (see note 2)	× 1
	2.21:1	× 5/3 (see note 3)	× 5/4 (see note 4)
544 × 576	4:3	× 4/3	× 1 (see note 1)
	16:9	× 16/9 (see note 2)	× 4/3
	2.21:1	× 20/9 (see note 3)	× 5/3 (see note 4)
480 × 576	4:3	× 3/2	× 9/8 (see note 1)
	16:9	× 2 (see note 2)	× 3/2
	2.21:1	× 5/2 (see note 3)	× 15/8 (see note 4)
352 × 576	4:3	× 2	× 3/2 (see note 1)
	16:9	× 8/3 (see note 2)	× 2
	2.21:1	× 10/3 (see note 3)	× 5/2 (see note 4)
352 × 288	4:3	× 2	× 3/2 (see note 1)
	16:9	× 8/3 (see note 2)	× 2
	2.21:1	× 10/3 (see note 3)	× 5/2 (see note 4)
		(and vertical up sampling × 2)	(and vertical up sampling × 2)

NOTE 1: Up sampling of 4:3 pictures for display on a 16:9 monitor is optional in the IRD, as 16:9 monitors can be switched to operate in 4:3 mode.

NOTE 2: The up sampling with this value is applied to the pixels of the 16:9 picture to be displayed on a 4:3 monitor.

NOTE 3: The up sampling with this value is applied to the pixels of the 2.21:1 picture to be displayed on a 4:3 monitor. Up sampling from 2.21:1 pictures for display on a 4:3 monitor is optional in the IRD.

NOTE 4: The up sampling with this value is applied to the pixels of the 2.21:1 picture to be displayed on a 16:9 monitor. Up sampling from 2.21:1 pictures for display on a 16:9 monitor is optional in the IRD.

NOTE 5: It is recommended that luminance resolution of 704 pixels represents the "middle" of the picture, and that it be decoded to a 720 pixels full-screen display by placing 8 pixels of padding at each side. It is recommended that luminance resolutions, such as 352 pixels, that are natural scalings of 704 pixels, be upscaled to 704 pixels and padded as above. It is recommended that all other resolutions be scaled as indicated by the table above. Where this does not result in the expected 720 pixels full-screen display, it is recommended that the result of the scaling be clipped or padded symmetrically as required to produce a 720 pixels full-screen display.

NOTE 6: The 16x9 picture comprises only the 702 pixels in the centre of the 720 pixel wide digital line. To avoid aspect ratio distortions and blanking or padding pixels appearing on the left and right of the screen, it is recommended that the remaining 18 pixels are not displayed (see EBU Technical Recommendation R92 [i.31]).

5.1.5 Chromaticity Parameters

Encoding: It is recommended that the chromaticity co-ordinates of the ideal display, opto-electronic transfer characteristic of the ideal display and matrix coefficients used in deriving luminance and chrominance signals from the red, green and blue primaries be explicitly signalled in the encoded bitstream by setting the appropriate values for each of the following 3 parameters in the **sequence_display_extension()**: **colour_primaries**, **transfer_characteristics**, and **matrix_coefficients**.

*Within 25 Hz MPEG-2 SDTV bitstreams, if the **sequence_display_extension()** is not present in the bitstream or **colour_description** is zero, the chromaticity shall be implicitly defined to be that corresponding to **colour_primaries** having the value 5, the transfer characteristics shall be implicitly defined to be those corresponding to **transfer_characteristics** having the value 5 and the matrix coefficients shall be implicitly defined to be those corresponding **matrix_coefficients** having the value 5. This set of parameter values corresponds signals compliance with Recommendation ITU-R BT.1700 [25], Part B.*

NOTE: Previous editions of the present document referenced Recommendation ITU-R BT.470 [i.4] System B, G, I colorimetry. Recommendation ITU-R BT.1700 [25] replaces Recommendation ITU-R BT.470 [i.4].

5.1.6 Chrominance

Encoding: *The operation used to down sample the chrominance information from 4:2:2 to 4:2:0 shall be indicated by the parameter **chroma_420_type** in the picture coding extension. A value of zero indicates that the fields have been down sampled independently. A value of one indicates that the two fields have been combined into a single frame before down sampling. It is desirable that the fields are down sampled independently (i.e. **chroma_420_type** = 0) to allow the IRD to use less memory for picture reconstruction.*

Decoding: It is desirable that the operation used to up sample the chrominance information from 4:2:0 to 4:2:2 should be dependent on the parameter **chroma_420_type** in the picture coding extension.

5.1.7 Video sequence header

Encoding: It is recommended that a video sequence header, immediately followed by an I-frame, be encoded at least once every 500 ms. If quantizer matrices other than the default are used, the appropriate **intra_quantizer_matrix** and/or **non_intra_quantizer_matrix** are recommended to be included in every sequence header.

NOTE 1: Increasing the frequency of video sequence headers and I-frames will reduce channel hopping time but will reduce the efficiency of the video compression.

NOTE 2: Having a regular interval between I-frames may improve trick mode performance, but may reduce the efficiency of the video compression.

5.2 25 Hz MPEG-2 HDTV IRDs and Bitstreams

5.2.0 General

The video encoding shall conform to Recommendation ITU-T H.262 / ISO/IEC 13818-2 [2]. Some of the parameters and fields are not used in the DVB System and these restrictions are described below. The IRD design shall be made under the assumption that any legal structure as permitted by Recommendation ITU-T H.262 / ISO/IEC 13818-2 [2] may occur in the broadcast stream even if presently reserved or unused.

5.2.1 Profile and level

Encoding: *Encoded 25 Hz MPEG-2 HDTV bitstreams shall comply with the Main Profile High Level restrictions, as described in Recommendation ITU-T H.262 / ISO/IEC 13818-2 [2], clause 8.2. The **profile_and_level_indication** is "01000100" or, if appropriate, "Onnnnnnn", where "Onnnnnnn">"01000100", indicating a "simpler" profile or level than Main Profile, High Level.*

Decoding: *The 25 Hz MPEG-2 HDTV IRD shall support the decoding of Main Profile High Level bitstreams. This requirement includes support for "simpler" profiles and levels, including Main Profile at Main Level, as defined in table 8-15 of Recommendation ITU-T H.262 / ISO/IEC 13818-2 [2]. Support for profiles and levels beyond Main Profile, High Level is optional. If the IRD encounters an extension which it cannot decode, such as one whose identification code is Reserved, Picture Sequence Scaleable, Picture Spatial Scaleable or Picture Temporal Scaleable, it shall discard the following data until the next start code (to allow backward compatible extensions to be added in the future).*

5.2.2 Frame rate

Encoding: *The frame rate shall be 25 Hz or 50 Hz, i.e. **frame_rate_code** is "0011" or "0110".*

The source video format for 50 Hz frame rate material shall be progressive. The source video format for 25 Hz frame rate material may be interlaced or progressive.

Still pictures may be encoded by use of a video sequence consisting of a single intra-coded picture (see definition of still pictures in Recommendation ITU-T H.222.0 / ISO/IEC 13818-1 [1], clause 2.1.70).

Decoding: *All 25 Hz MPEG-2 HDTV IRDs shall support the decoding and display of video material with a frame rate of 25 Hz progressive, 25 Hz interlaced or 50 Hz progressive (i.e. **frame_rate_code** of "0011" or "0110") within the constraints of Main Profile at High Level. Support of other frame and field rates is optional.*

25 Hz MPEG-2 HDTV IRDs shall be capable of decoding and displaying still pictures, i.e. video sequences consisting of a single intra-coded picture (see definition of still pictures in Recommendation ITU-T H.222.0 / ISO/IEC 13818-1 [1], clause 2.1.70).

5.2.3 Aspect ratio

Encoding: *The source aspect ratio in 25 Hz MPEG-2 HDTV bitstreams shall be 16:9 or 2.21:1. Note that decoding of 2.21:1 aspect ratio is optional for the 25 Hz MPEG-2 HDTV IRD.*

*The **aspect_ratio_information** in the sequence header shall have the value "0011" or "0100".*

Decoding: *The 25 Hz MPEG-2 HDTV IRD shall be able to decode bitstreams with **aspect_ratio_information** of value "0011", corresponding to 16:9 aspect ratio. The support of the aspect ratio 2.21:1 is optional. If the IRD has a digital interface, this should be capable of outputting bitstreams with aspect ratios which are not directly supported by the IRD to allow their decoding and display via an external unit.*

5.2.4 Luminance resolution

Encoding: *The encoded picture shall have a full-screen luminance resolution within the constraints set by Main Profile at High Level, i.e. it shall not have more than:*

- 1 088 lines per frame;
- 1 920 luminance samples per line;
- 62 668 800 luminance samples per second.

It is recommended that the source video for 25 Hz MPEG-2 HDTV Bitstreams has a luminance resolution of:

- 1 080 lines per frame;
- 1 920 luminance samples per line;
- with an associated frame rate of 25 Hz, with two interlaced fields per frame.

The source video may or may not be down-sampled prior to encoding.

The use of other encoded video resolutions within the constraints of Main Profile at High Level is also permitted. Annex A of the present document provides examples of supported full-screen luminance resolutions. In addition, non full-screen pictures may be encoded for display at less than full-size.

NOTE 1: The limit of 62 668 800 luminance samples per second of Main Profile at High Level excludes the use of the maximum allowed picture resolution at 50 Hz frame rate.

NOTE 2: If the recommended source video format is encoded without down-sampling it gives 51 840 000 luminance samples per second and therefore falls within the allowed range for Main Profile at High Level.

Decoding: *The 25 Hz MPEG-2 HDTV IRD shall be capable of decoding and displaying pictures with luminance resolutions within the constraints set by Main Profile at High Level.*

5.2.5 Chromaticity Parameters

Encoding: *The chromaticity co-ordinates of the ideal display, opto-electronic transfer characteristic of the source picture and matrix coefficients used in deriving luminance and chrominance signals from the red, green and blue primaries shall be explicitly signalled in the encoded HDTV bitstream by setting the appropriate values for each of the following 3 parameters in the `sequence_display_extension()`: `colour_primaries`, `transfer_characteristics`, and `matrix_coefficients`.*

It is recommended that 25 Hz MPEG-2 HDTV bitstreams use either Recommendation ITU-R BT.709 [13] or IEC 61966-2-4 [31] colorimetry.

BT.709 [13] colorimetry usage is signalled by setting **colour_primaries** to the value 1, **transfer_characteristics** to the value 1 and **matrix_coefficients** to the value 1.

IEC 61966-2-4 [31] colorimetry usage is signalled by setting **colour_primaries** to the value 1, **transfer_characteristics** to the value 11 and **matrix_coefficients** to the value 1.

Decoding: *The 25 Hz MPEG-2 HDTV IRD shall be capable of decoding bitstreams that use Recommendation ITU-R BT.709 [13] colorimetry. It is recommended that appropriate processing be included for the accurate representation of pictures using Recommendation ITU-R BT.709 [13] colorimetry.*

The 25 Hz MPEG-2 HDTV IRD may be capable of decoding bitstreams that use IEC 61966-2-4 [31] colorimetry.

NOTE 1: The 25Hz MPEG-2 HDTV IRD may not include appropriate processing for the accurate representation of pictures that use IEC 61966-2-4 [31] colorimetry.

NOTE 2: For the 50 Hz 576P video format the colorimetry standard recommended is Recommendation ITU-R BT.1358 [i.5].

5.2.6 Chrominance

Encoding: *The operation used to down sample the chrominance information from 4:2:2 to 4:2:0 shall be indicated by the parameter **chroma_420_type** in the picture coding extension. A value of zero indicates that the fields have been down sampled independently. A value of one indicates that the two fields have been combined into a single frame before down sampling. It is desirable that the fields are down sampled independently (i.e. **chroma_420_type** = 0) to allow the IRD to use less memory for picture reconstruction.*

Decoding: *It is desirable that the operation used to up sample the chrominance information from 4:2:0 to 4:2:2 should be dependent on the parameter **chroma_420_type** in the picture coding extension.*

5.2.7 Video sequence header

Encoding: *It is recommended that a video sequence header, immediately followed by an I-frame, be encoded at least once every 500 ms. If quantizer matrices other than the default are used, the appropriate **intra_quantizer_matrix** and/or **non_intra_quantizer_matrix** are recommended to be included in every sequence header.*

NOTE 1: *Increasing the frequency of video sequence headers and I-frames will reduce channel hopping time but will reduce the efficiency of the video compression.*

NOTE 2: *Having a regular interval between I-frames may improve trick mode performance, but may reduce the efficiency of the video compression.*

5.2.8 Backwards Compatibility

Decoding: *In addition to the above, a 25 Hz MPEG-2 HDTV IRD shall be capable of decoding any bitstream that a 25 Hz MPEG-2 SDTV IRD is required to decode, as described in clause 5.1.*

5.3 30 Hz MPEG-2 SDTV IRDs and Bitstreams

5.3.0 General

The video encoding shall conform to Recommendation ITU-T H.262 / ISO/IEC 13818-2 [2]. Some of the parameters and fields are not used in the DVB System and these restrictions are described below. The IRD design shall be made under the assumption that any legal structure as permitted by Recommendation ITU-T H.262 / ISO/IEC 13818-2 [2] may occur in the broadcast stream even if presently reserved or unused.

5.3.1 Profile and level

Encoding: *Encoded bitstreams shall comply with the Main Profile Main Level restrictions, as described in Recommendation ITU-T H.262 / ISO/IEC 13818-2 [2], clause 8.2. The **profile_and_level_indication** is "01001000" or, if appropriate, "0nnnnnnn", where "0nnnnnnn">"01001000", indicating a "simpler" profile or level than Main Profile, Main Level.*

Decoding: *The IRD shall support the syntax of Main Profile. Support for profiles and levels beyond Main Profile, Main Level is optional. If the IRD encounters an extension which it cannot decode, such as one whose identification code is Reserved, Picture Sequence Scaleable, Picture Spatial Scaleable or Picture Temporal Scaleable, it shall discard the following data until the next start code (to allow backward compatible extensions to be added in the future).*

5.3.2 Frame rate

Encoding: *The frame rate shall be either 24 000/1 001, 24, 30 000/1 001 or 30 Hz, i.e. the **frame_rate_code** field shall be encoded with one of the following values: "0001", "0010", "0100" or "0101".*

Still pictures may be encoded by use of a video sequence consisting of a single intra-coded picture (see definition of still pictures in Recommendation ITU-T H.222.0 / ISO/IEC 13818-1 [1], clause 2.1.70).

Decoding: *All 30 Hz SDTV IRDs shall support the decoding and display of Main Profile @ Main Level video with a frame rate of 24 000/1 001, 24, 30 000/1 001 or 30 Hz. Support of other frame rates is optional.*

IRDs shall be capable of decoding and displaying still pictures, i.e. video sequences consisting of a single intra-coded picture (see definition of still pictures in Recommendation ITU-T H.222.0 / ISO/IEC 13818-1 [1], clause 2.1.70).

5.3.3 Aspect ratio

Encoding: *The source aspect ratio in 30 Hz MPEG-2 SDTV bitstreams shall be either 4:3, 16:9 or 2.21:1. Note that decoding of 2.21:1 aspect ratio is optional for the 30 Hz SDTV IRD.*

*The **aspect_ratio_information** in the sequence header shall have one of the following three values:*

- 4:3 aspect ratio source: "0010";
- 16:9 aspect ratio source: "0011";
- 2.21:1 aspect ratio source: "0100".

It is recommended that pan vectors for a 4:3 window are included in the transmitted bitstream when the source aspect ratio is 16:9 or 2.21:1. *The vertical component of the transmitted pan vector shall be zero.*

*If pan vectors are transmitted then the **sequence_display_extension** shall be present in the bitstream and the **aspect_ratio_information** shall be set to '0010' (4:3 display). The **display_vertical_size** shall be equal to the **vertical_size**. The **display_horizontal_size** shall contain the resolution of the target 4:3 display. The value of the **display_horizontal_size** field may be calculated by the following equation:*

$$\text{display_horizontal_size} = \frac{4}{3} \times \frac{\text{horizontal_size}}{\text{source aspect ratio}}$$

Table 5 gives some typical examples.

Table 5: Values for display_horizontal_size

horizontal_size × vertical_size	Source aspect ratio	Display_horizontal_size
720 × 480	16:9	540
640 × 480	16:9	480
544 × 480	16:9	408
480 × 480	16:9	360
352 × 480	16:9	264
352 × 240	16:9	264

Decoding: *The 30 Hz MPEG-2 SDTV IRD shall be able to decode bitstreams with values of **aspect_ratio_information** of "0010" and "0011", corresponding to 4:3 and 16:9 aspect ratio respectively. If the IRD has a digital interface, this should be capable of outputting bitstreams with aspect ratios which are not directly supported by the IRD to allow their decoding and display via an external unit.*

All 30 Hz MPEG-2 SDTV IRDs shall support the use of pan vectors and up sampling to allow a 4:3 monitor to give a full-screen display of a selected portion of a 16:9 coded picture with the correct aspect ratio. IRDs implementing the 2.21:1 aspect ratio should support the use of pan vectors and up sampling to allow a 4:3 monitor to give a full-screen display of a selected portion of the 2.21:1 picture with the correct aspect ratio. Support for pan vectors with non-zero vertical components is optional. When no pan vectors are present in the transmitted bitstream, the central portion of the wide-screen picture shall be displayed. The support of vertical resampling to obtain the correct aspect ratio for a letterbox display of a 16:9 or 2.21:1 coded picture on a 4:3 monitor is optional.

5.3.4 Luminance resolution

Encoding: *The encoded picture shall have a full-screen luminance resolution (horizontal \times vertical) of one of the following values:*

- 720 \times 480;
- 640 \times 480;
- 544 \times 480;
- 480 \times 480;
- 352 \times 480;
- 352 \times 240.

In addition, non full-screen pictures may be encoded for display at less than full-size (when using one of the standard up-conversion ratios at the IRD).

Decoding: *The 30 Hz MPEG-2 SDTV IRD shall be capable of decoding pictures with luminance resolutions as shown in table 6 and applying up sampling to allow the decoded pictures to be displayed at full-screen size. In addition, IRDs shall be capable of decoding lower picture resolutions and displaying them at less than full-size after using one of the standard up-conversions, e.g. a horizontal resolution of 704 pixels within the 720 pixels full-screen display.*

Table 6: Resolutions for Full-screen Display from 30 Hz MPEG-2 SDTV IRD

Coded Picture		Displayed Picture Horizontal up sampling	
Luminance resolution (horizontal × vertical)	Aspect Ratio	4:3 Monitors	16:9 Monitors
720 × 480	4:3	× 1	× 3/4 (see note 1)
	16:9	× 4/3 (see note 2)	× 1
	2:21:1	× 5/3 (see note 3)	× 5/4 (see note 4)
640 × 480	4:3	× 9/8	× 27/32 (see note 1)
544 × 480	4:3	× 4/3	× 1 (see note 1)
	16:9	× 16/9 (see note 2)	× 4/3
	2:21:1	× 20/9 (see note 3)	× 5/3 (see note 4)
480 × 480	4:3	× 3/2	× 9/8 (see note 1)
	16:9	× 2 (see note 2)	× 3/2
	2:21:1	× 5/2 (see note 3)	× 15/8 (see note 4)
352 × 480	4:3	× 2	× 3/2 (see note 1)
	16:9	× 8/3 (see note 2)	× 2
	2:21:1	× 10/3 (see note 3)	× 5/2 (see note 4)
352 × 240	4:3	× 2	× 3/2 (see note 1)
	16:9	× 8/3 (see note 2)	× 2
	2:21:1	× 10/3 (see note 3)	× 5/2 (see note 4)
		(and vertical up sampling × 2)	(and vertical up sampling × 2)

NOTE 1: Up sampling of 4:3 pictures for display on a 16:9 monitor is optional in the IRD, as 16:9 monitors can be switched to operate in 4:3 mode.

NOTE 2: The up sampling with this value is applied to the pixels of the 16:9 picture to be displayed on a 4:3 monitor.

NOTE 3: The up sampling with this value is applied to the pixels of the 2.21:1 picture to be displayed on a 4:3 monitor. Up sampling from 2.21:1 pictures for display on a 4:3 monitor is optional in the IRD.

NOTE 4: The up sampling with this value is applied to the pixels of the 2.21:1 picture to be displayed on a 16:9 monitor. Up sampling from 2.21:1 pictures for display on a 16:9 monitor is optional in the IRD.

NOTE 5: It is recommended that luminance resolution of 704 pixels represents the "middle" of the picture, and that it be decoded to a 720 pixels full-screen display by placing 8 pixels of padding at each side. It is recommended that luminance resolutions, such as 352 pixels, that are natural scalings of 704 pixels, be upscaled to 704 pixels and padded as above. It is recommended that all other resolutions be scaled as indicated by the table above. Where this does not result in the expected 720 pixels full-screen display, it is recommended that the result of the scaling be clipped or padded symmetrically as required to produce a 720 pixels full-screen display.

5.3.5 Chromaticity Parameters

Encoding: It is recommended that the chromaticity co-ordinates of the ideal display, opto-electronic transfer characteristic of the ideal display and matrix coefficients used in deriving luminance and chrominance signals from the red, green and blue primaries be explicitly signalled in the encoded bitstream by setting the appropriate values for each of the following 3 parameters in the **sequence_display_extension()**: **colour_primaries**, **transfer_characteristics**, and **matrix_coefficients**.

*Within 30 Hz SDTV bitstreams, if the **sequence_display_extension()** is not present in the bitstream or **colour_description** is zero, the chromaticity shall be implicitly defined to be that corresponding to **colour_primaries** having the value 6, the transfer characteristics shall be implicitly defined to be those corresponding to **transfer_characteristics** having the value 6 and the matrix coefficients shall be implicitly defined to be those corresponding **matrix_coefficients** having the value 6. This set of parameter values signals compliance with Recommendation ITU-R BT.1700 Part A [25].*

NOTE: Previous editions of the present document referenced SMPTE ST 170 colorimetry [i.9]. Recommendation ITU-R BT.1700 Part A [25] references SMPTE ST 170 [i.9].

5.3.6 Chrominance

Encoding: *The operation used to down sample the chrominance information from 4:2:2 to 4:2:0 shall be indicated by the parameter **chroma_420_type** in the picture coding extension. A value of zero indicates that the fields have been down sampled independently. A value of one indicates that the two fields have been combined into a single frame before down sampling. It is desirable that the fields are down sampled independently (i.e. **chroma_420_type** = 0) to allow the IRD to use less memory for picture reconstruction.*

Decoding: *It is desirable that the operation used to up sample the chrominance information from 4:2:0 to 4:2:2 should be dependent on the parameter **chroma_420_type** in the picture coding extension.*

5.3.7 Video sequence header

Encoding: *It is recommended that a video sequence header, immediately followed by an I-frame, be encoded at least once every 500 ms. If quantizer matrices other than the default are used, the appropriate **intra_quantizer_matrix** and/or **non_intra_quantizer_matrix** are recommended to be included in every sequence header.*

NOTE 1: *Increasing the frequency of video sequence headers and I-frames will reduce channel hopping time but will reduce the efficiency of the video compression.*

NOTE 2: *Having a regular interval between I-frames may improve trick mode performance, but may reduce the efficiency of the video compression.*

5.4 30 Hz MPEG-2 HDTV IRDs and Bitstreams

5.4.0 General

The video encoding shall conform to Recommendation ITU-T H.262 / ISO/IEC 13818-2 [2]. Some of the parameters and fields are not used in the DVB System and these restrictions are described below. The IRD design shall be made under the assumption that any legal structure as permitted by Recommendation ITU-T H.262 / ISO/IEC 13818-2 [2] may occur in the broadcast stream even if presently reserved or unused.

5.4.1 Profile and level

Encoding: *Encoded 30 Hz MPEG-2 HDTV bitstreams shall comply with the Main Profile High Level restrictions, as described in Recommendation ITU-T H.262 / ISO/IEC 13818-2 [2], clause 8.2.*

*The **profile_and_level_indication** is "01000100" or, if appropriate, "0nnnnnnn", where "0nnnnnnn">"01000100", indicating a "simpler" profile or level than Main Profile, High Level.*

Decoding: *The 30 Hz MPEG-2 HDTV IRD shall support the decoding of Main Profile High Level bitstreams. This requirement includes support for "simpler" profiles and levels, including Main Profile at Main Level, as defined in table 8-15 of Recommendation ITU-T H.262 / ISO/IEC 13818-2 [2]. Support for profiles and levels beyond Main Profile, High Level is optional. If the IRD encounters an extension which it cannot decode, such as one whose identification code is Reserved, Picture Sequence Scaleable, Picture Spatial Scaleable or Picture Temporal Scaleable, it shall discard the following data until the next start code (to allow backward compatible extensions to be added in the future).*

5.4.2 Frame rate

Encoding: *The frame rate shall be 24 000/1 001, 24, 30 000/1 001, 30, 60 000/1 001 or 60 Hz, i.e. **frame_rate_code** is "0001", "0010", "0100", "0101", "0111" or "1000".*

The source video format for 24 000/1 001, 24, 60 000/1 001 and 60 Hz frame rate material shall be progressive. The source video format for 30 000/1 001 and 30 Hz frame rate material may be interlaced or progressive.

Still pictures may be encoded by use of a video sequence consisting of a single intra-coded picture (see definition of still pictures in Recommendation ITU-T H.222.0 / ISO/IEC 13818-1 [1], clause 2.1.70).

Decoding: *All 30 Hz MPEG-2 HDTV IRDs shall support the decoding of video material with a frame rate of 24 000/1 001, 24, 30 000/1 001, 30, 60 000/1 001 or 60 Hz (i.e. **frame_rate_code** of "0001", "0010", "0100", "0101", "0111" or "1000") within the constraints of Main Profile at High Level. Support of other frame rates is optional.*

30 Hz MPEG-2 HDTV IRDs shall support the display of video whose source frame rate is 24 000/1 001, 24, 30 000/1 001, 30, 60 000/1 001 or 60 Hz progressive. 30 Hz MPEG-2 HDTV IRDs shall support the display of video whose source frame rate is 30 000/1 001 or 30 Hz interlaced.

30 Hz MPEG-2 HDTV IRDs shall be capable of decoding and displaying still pictures, i.e. video sequences consisting of a single intra-coded picture (see definition of still pictures in Recommendation ITU-T H.222.0 / ISO/IEC 13818-1 [1], clause 2.1.70).

5.4.3 Aspect ratio

Encoding: *The source aspect ratio in 30 Hz MPEG-2 HDTV bitstreams shall be 16:9 or 2.21:1. Note that decoding of 2.21:1 aspect ratio is optional for the 30 Hz MPEG-2 HDTV IRD.*

*The **aspect_ratio_information** field in the sequence header shall have the value "0011" or "0100".*

Decoding: *The 30 Hz MPEG-2 HDTV IRD shall be able to decode bitstreams with **aspect_ratio_information** of value "0011", corresponding to 16:9 aspect ratio. If the IRD has a digital interface, this should be capable of outputting bitstreams with aspect ratios which are not directly supported by the IRD to allow their decoding and display via an external unit.*

5.4.4 Luminance resolution

Encoding: *The encoded picture shall have a full-screen luminance resolution within the constraints set by Main Profile at High Level, i.e. it shall not have more than:*

- 1 088 lines per frame;
- 1 920 luminance samples per line;
- 62 668 800 luminance samples per second.

It is recommended that the source video for 30 Hz MPEG-2 HDTV Bitstreams has a luminance resolution of:

- 1 080 lines per frame and 1 920 luminance samples per line, with an associated frame rate of 30 000/1 001 (approximately 29,97) Hz with two interlaced fields per frame.
- The source video may or may not be down-sampled prior to encoding.
- The use of other encoded video resolutions within the constraints of Main Profile at High Level is also permitted. Annex A of the present document provides examples of supported full-screen luminance resolutions. In addition, non full-screen pictures may be encoded for display at less than full-size.
- The limit of 62 668 800 luminance samples per second of Main Profile at High Level excludes the use of the maximum allowed picture resolution at 60 Hz and 60 000/1 001 frame rates.

NOTE: If the recommended source video format is encoded without down-sampling it gives 62 145 854 luminance sample per second and therefore falls within the allowed range for Main Profile at High Level.

Decoding: *The 30 Hz MPEG-2 HDTV IRD shall be capable of decoding and displaying pictures with luminance resolutions within the constraints set by Main Profile at High Level.*

5.4.5 Chromaticity Parameters

Encoding: *The chromaticity co-ordinates of the ideal display, opto-electronic transfer characteristic of the source picture and matrix coefficients used in deriving luminance and chrominance signals from the red, green and blue primaries shall be explicitly signalled in the encoded HDTV bitstream by setting the appropriate values for each of the following 3 parameters in the `sequence_display_extension()`: **colour_primaries**, **transfer_characteristics**, and **matrix_coefficients**.*

It is recommended that 30 Hz MPEG-2 HDTV bitstreams use either Recommendation ITU-R BT.709 [13] or IEC 61966-2-4 [31] colorimetry.

BT.709 [13] colorimetry usage is signalled by setting **colour_primaries** to the value 1, **transfer_characteristics** to the value 1 and **matrix_coefficients** to the value 1.

IEC 61966-2-4 [31] colorimetry usage is signalled by setting **colour_primaries** to the value 1, **transfer_characteristics** to the value 11 and **matrix_coefficients** to the value 1.

Decoding: *The 30 Hz MPEG-2 HDTV IRD shall be capable of decoding bitstreams that use Recommendation ITU-R BT.709 [13] colorimetry. It is recommended that appropriate processing be included for the accurate representation of pictures using Recommendation ITU-R BT.709 [13] colorimetry.*

The 30 Hz MPEG-2 HDTV IRD may be capable of decoding bitstreams that use IEC 61966-2-4 [31] colorimetry.

NOTE 1: The 30 Hz MPEG-2 HDTV IRD may not include appropriate processing for the accurate representation of pictures that use IEC 61966-2-4 [31] colorimetry.

NOTE 2: For the 60 000/1 001 or 60 Hz 480P video format the colorimetry standard recommended is Recommendation ITU-R BT.1358 [i.5].

5.4.6 Chrominance

Encoding: *The operation used to down sample the chrominance information from 4:2:2 to 4:2:0 shall be indicated by the parameter **chroma_420_type** in the picture coding extension. A value of zero indicates that the fields have been down sampled independently. A value of one indicates that the two fields have been combined into a single frame before down sampling. It is desirable that the fields are down sampled independently (i.e. **chroma_420_type** = 0) to allow the IRD to use less memory for picture reconstruction.*

Decoding: It is desirable that the operation used to up sample the chrominance information from 4:2:0 to 4:2:2 should be dependent on the parameter **chroma_420_type** in the picture coding extension.

5.4.7 Video sequence header

Encoding: It is recommended that a video sequence header, immediately followed by an I-frame, be encoded at least once every 500 ms. If quantizer matrices other than the default are used, the appropriate **intra_quantizer_matrix** and/or **non_intra_quantizer_matrix** are recommended to be included in every sequence header.

NOTE 1: Increasing the frequency of video sequence headers and I-frames will reduce channel hopping time but will reduce the efficiency of the video compression.

NOTE 2: Having a regular interval between I-frames may improve trick mode performance, but may reduce the efficiency of the video compression.

5.4.8 Backwards Compatibility

Decoding: *In addition to the above, a 30 Hz MPEG-2 HDTV IRD shall be capable of decoding any bitstream that a 30 Hz MPEG-2 SDTV IRD is required to decode, as described in clause 5.3.*

5.5 Specifications Common to all H.264/AVC IRDs and Bitstreams

5.5.0 Scope

The specification in this clause applies to the following IRDs and Bitstreams:

- 25 Hz H.264/AVC SDTV IRD and Bitstream;
- 30 Hz H.264/AVC SDTV IRD and Bitstream;
- 25 Hz H.264/AVC HDTV IRD and Bitstream;
- 30 Hz H.264/AVC HDTV IRD and Bitstream;
- 50 Hz H.264/AVC HDTV IRD and Bitstream;
- 60 Hz H.264/AVC HDTV IRD and Bitstream;
- 25 Hz MVC Stereo HDTV IRD and Bitstream;
- 30 Hz MVC Stereo HDTV IRD and Bitstream.

5.5.1 General

The video encoding and video decoding shall conform to Recommendation ITU-T H.264 / ISO/IEC 14496-10 [16]. Some of the parameters and fields are not used in the DVB System and these restrictions are described below. H.264/AVC Bitstreams and IRDs shall support some parts of the "Supplemental Enhancement Information (SEI)" and the "Video usability information (VUI)" syntax elements as specified in Recommendation ITU-T H.264 / ISO/IEC 14496-10 [16], annexes D and E. The H.264/AVC IRD design shall be made under the assumption that any legal structure as permitted by Recommendation ITU-T H.264 / ISO/IEC 14496-10 [16] and the restrictions that are specified for the H.264/AVC IRDs may occur in the broadcast stream even if presently reserved or unused.

NOTE: To improve trick mode it is strongly recommended to disable non-paired fields in H.264/AVC Encoder.

5.5.2 Sequence Parameter Set and Picture Parameter Set

5.5.2.0 General

Encoding: More than one picture parameter set can be present in the bitstream between two H.264/AVC RAPs. *Between two H.264/AVC RAPs, the content of a picture parameter set with a particular **pic_parameter_set_id** shall not change. I.e. if more than one picture parameter set is present in the bitstream and these picture parameter sets are different from each other, then each picture parameter set shall have a different **pic_parameter_set_id**.*

Note that multiple PPSs may be present in the H.264/AVC RAP access unit and the number of PPS that may be present is constrained by clause 4.1.5.2 where the start of the access unit (access_unit_delimiter) and the start of the first slice of the access unit occurs either in the same transport packet or in 2 successive transport packets.

5.5.2.1 **pic_width_in_mbs_minus1** and **pic_height_in_map_units_minus1**

Encoding: *The time interval between two changes in pairs of **pic_width_in_mbs_minus1** and **pic_height_in_map_units_minus1** shall be greater than or equal to one second.* Changing the pair **pic_width_in_mbs_minus1** and **pic_height_in_map_units_minus1** requires software processing in the decoder. Limiting the frequency of this change is to constrain the IRD software processing required to support aspect ratio changes.

NOTE: A pair of **pic_width_in_mbs_minus1** and **pic_height_in_map_units_minus1** is distinct from another pair if one or both syntax element values **pic_width_in_mbs_minus1** and **pic_height_in_map_units_minus1** differ.

If the number of samples per row of the luminance component of the source picture is not an integer multiple of 16 and additional samples are padded to make the number of samples per row of the luminance component an integer multiple of 16, it is recommended that these samples are padded at the right side of the picture.

If the number of samples per column of the luminance component of the source picture is not an integer multiple of 16 and additional samples are padded to make the number of samples per column of the luminance component an integer multiple of 16, it is recommended that these samples are padded at the bottom of the picture.

5.5.3 Video Usability Information

5.5.3.0 General

The IRD shall support the use of Video Usability Information of the following syntax elements:

- Aspect Ratio Information (*aspect_ratio_idc*);
- Colour Parameter Information (*colour_primaries*, *transfer_characteristics*, and *matrix_coefficients*);
- Chrominance Information (*chroma_sample_loc_type_top_field* and *chroma_sample_loc_type_bottom_field*);
- Timing information (*time_scale*, *num_units_in_tick*, and *fixed_frame_rate_flag*);
- Picture Structure Information (*pic_struct_present_flag*).

5.5.3.1 Aspect Ratio Information

The support of **aspect_ratio_idc** values for H.264/AVC SDTV IRDs and Bitstreams is specified in clause 5.6.1.3 and for H.264/AVC HDTV IRDs and Bitstreams is specified in clause 5.7.1.2 and for MVC in clause 5.13.1.6.2.

5.5.3.2 Colour Parameter Information

The support of **colour_primaries**, **transfer_characteristics**, and **matrix_coefficients** values for the 25 Hz H.264/AVC SDTV IRD and Bitstream is specified in clause 5.6.2.1, for the 30 Hz H.264/AVC SDTV IRD and Bitstream is specified in clause 5.6.3.1, and for H.264/AVC HDTV IRDs and Bitstreams is specified in clause 5.7.1.3 and for MVC Stereo HDTV IRDs in clause 5.13.1.6.2.

5.5.3.3 Chrominance Information

Encoding: It is recommended to specify the chrominance locations using the syntax elements **chroma_sample_loc_type_top_field** and **chroma_sample_loc_type_bottom_field** in the VUI. It is recommended to use chroma sample type equal to 0 for both fields.

Decoding: *H.264/AVC IRDs shall support decoding any allowed values of **chroma_sample_loc_type_top_field** and **chroma_sample_loc_type_bottom_field**. It is recommended that appropriate processing be included for the display of pictures.*

5.5.3.4 Timing Information

The support of **time_scale** and **num_units_in_tick** values for the 25 Hz H.264/AVC SDTV IRD and Bitstream is specified in clause 5.6.2.2, for the 30 Hz H.264/AVC SDTV IRD and Bitstream is specified in clause 5.6.3.2, for the 25 Hz H.264/AVC HDTV IRD and Bitstream is specified in clause 5.7.2.2, for the 30 Hz H.264/AVC HDTV IRD and Bitstream is specified in clause 5.7.3.2, for the 50 Hz H.264/AVC HDTV IRD and Bitstream is specified in clause 5.7.4.2, for the 60 Hz H.264/AVC HDTV IRD and Bitstream is specified in clause 5.7.5.2, for the 25 Hz MVC Stereo HDTV IRD and Bitstream in clause 5.13.2.2 and for the 25 Hz MVC Stereo HDTV IRD and Bitstream in clause 5.13.3.2. *In the case of still picture the **fixed_frame_rate_flag** shall be equal to 0. In other cases, the **fixed_frame_rate_flag** shall be equal to 1.* The frame rate cannot be changed between two IDR access units.

5.5.3.5 Picture Structure Information

The support of **pic_struct_present_flag** in the Bitstream is specified in clause 5.5.4.1 related to use of Picture Structure information in the Picture Timing SEI and is common to all H.264/AVC IRDs and Bitstreams. For bitstreams that carry the picture structure information (such as film mode), it is recommended that the **pic_struct_present_flag** be set to "1" in the VUI and the picture timing SEI is associated with each access unit in the coded sequence. If the sequence does not require picture structure information, then the **pic_struct_present_flag** should be set to "0" in the VUI. Use of this flag bit in the VUI allows use of picture timing SEI with only the picture structure information without the need to include HRD information (such as CPB and DPB delay or initial values of the delay in the buffering period SEI).

5.5.4 Supplemental Enhancement Information

5.5.4.0 General

The IRD shall support the use of Supplemental Enhancement Information of the following message types:

- Picture Timing SEI Message;
- Pan-Scan Rectangle SEI Message;
- "User data registered by Recommendation ITU-T T.35 SEI message" syntactic element [19] **user_data_registered_itu_t_t35** as defined in clause B.7.

5.5.4.1 Picture Timing SEI Message

Encoding: It is recommended to transmit a picture timing SEI message for every access unit of a coded video sequence.

*If the H.264/AVC Bitstream contains picture structure information, then the **pic_struct_present_flag** shall be set to "1" in the VUI and a picture timing SEI message shall be associated with every access unit. Otherwise the **pic_struct_present_flag** shall be set to "0".*

NOTE 1: Setting **pic_struct_present_flag** to "1" indicates the presence of **pic_struct** that assists decoders in determining if the picture should be displayed as a frame or one or more fields. Possible values for **pic_struct** are defined in table D-1 of Recommendation ITU-T H.264 / ISO/IEC 14496-10 [16]. Progressive coded video sequences (with **frame_mbs_only** equal to 1) should only use **pic_struct** values of 0, 7, 8. Interlace coded video sequences (with **frame_mbs_only_flag** equal to 0) should only use **pic_struct** values of 1, 2, 3, 4, 5, 6.

It is recommended that bitstreams avoid mixing interlaced and progressive **pic_struct** values within a coded video sequence to allow decoders to maintain a consistent display.

Note that it is recommended to avoid using frame doubling or tripling modes when coding frames in MBAFF mode.

It is recommended that **ct_type** be explicitly transmitted to convey the original picture scan.

NOTE 2: Possible values for **ct_type** are defined in table D-2 of Recommendation ITU-T H.264 / ISO/IEC 14496-10 [16]. Setting **ct_type** to 2 may be used to indicate an unknown original picture scan. The **ct_type** field may change between progressive and interlaced within a sequence. Progressive **ct_types** values may be present within a coded video sequence with interlaced **pic_struct** values but it is recommended not to transmit interlaced **ct_type** values within a coded video sequence with progressive **pic_struct** values.

NOTE 3: The original picture scan can be quite useful for assisting operations such as deinterlacing and trick modes. Explicit transmission of the **ct_type** field is indicated when the **clock_timestamp_flag[i]** is set to 1:

- If a timecode is to be carried, it is recommended that the **full_timestamp_flag** is set to "1" and **hours_value**, **minutes_value**, **seconds_value** and **n_frames** are used to transport the timecode values. **Time_offset** may be ignored and normally carry the value "0", if present.

NOTE 4: The default value of `time_offset_length` is 24 unless specified otherwise by the VUI message HRD parameters, which in turn requires the presence of additional fields in the picture timing SEI message (`cpb_removal_delay` and `dpb_output_delay`).

Decoding: *H.264/AVC IRDs shall support all values defined in **pic_struct** including all modes requiring field and frame repetition. The H.264/AVC IRDs need not make use of any other syntax elements (except **pic_struct**) in the picture timing SEI message, if these elements are present.*

If `ct_type` is not present, then the value "2" (unknown) shall be inferred.

Note that if present, the picture structure information shall convey the picture output order in the same order as the Picture Order Count (POC) information in the H.264/AVC Bitstream (per clause D.2.2 of Recommendation ITU-T H.264 / ISO/IEC 14496-10 [16]). This ensures consistency between the SEI message and the HRD model of Recommendation ITU-T H.264 / ISO/IEC 14496-10 [16].

5.5.4.2 Pan-Scan Rectangle SEI Message

Encoding: The `pan_scan_rect` SEI may be used when appropriate.

Decoding: *H.264/AVC IRDs shall support all values specified in **pan_scan_rect**, except **pan_scan_rect_top_offset[i]** and **pan_scan_rect_bottom_offset[i]**. The IRD need not make use of **pan_scan_rect_top_offset[i]** and **pan_scan_rect_bottom_offset[i]** parameters in the **pan_scan_rect** SEI message.*

There may be more than one `pan_scan_rect` SEI message transmitted with an access unit. Any `pan_scan_rect` SEI messages after the first may be ignored.

The support of the use of `pan_scan_rect` for up sampling is specified to allow a 4:3 monitor to give a full-screen display of a selected portion of a 16:9 coded picture with the correct aspect ratio. The support of vertical resampling to obtain the correct aspect ratio for a letterbox display of a 16:9 coded picture on a 4:3 monitor is optional.

NOTE: Use of AFD as defined in clause B.3 and Bar Data as defined in clause B.4 may provide a more convenient mechanism for enabling the full screen display of a selected portion of the coded picture.

5.5.4.3 Still pictures

Encoding: *Still pictures shall comply with "AVC still picture" definition as per Recommendation ITU-T H.222.0 / ISO/IEC 13818-1 [1]. For Still pictures the frame rate specification for H264 AVC IRDs shall not apply. The **fixed_frame_rate_flag** shall be equal to 0.*

NOTE: For display that requires a fixed frame refresh according to the IRD frequency, the previously decoded picture should be displayed till the next picture is available.

5.5.5 Random Access Point

5.5.5.0 General

The definition for H.264/AVC RAP in clause 3 shall apply.

For MVC Stereo Bitstreams and MVC Stereo RAP guidelines, refer to clause 5.13.1.9.

Encoding: The time interval between H.264/AVC RAPs may vary between programs and also within a program. The broadcast requirements should set the time interval between H.264/AVC RAPs as specified in clause 5.5.5.1.

NOTE: The `AU_information_descriptor` described in annex D provides a means of signalling information about Random Access Points that may be used by some applications, and it is recommended that this is present.

All pictures with PTS greater than or equal to $PTS(rap)$ shall be fully reconstructible and displayable, where $PTS(rap)$ represents the Presentation Time Stamp of the picture of the H.264/AVC RAP. This means that decoders receiving the RAP shall not need to utilize data transmitted prior to the RAP to decode pictures displayed after the RAP.

To improve applications such as channel change, it is recommended that the Presentation Time Stamp of the picture of H.264/AVC RAP be less than or equal to [DTS(rap) + 0,5 seconds] where DTS(rap) represents the Decoding Time Stamp of the picture of H.264/AVC RAP.

Packetization of random access points shall comply with the following additional rule:

*A transport packet containing the PES header of a H.264/AVC RAP shall have an adaptation field. The **payload_unit_start_indicator** bit shall be set to "1" in the transport packet header and the **adaptation_field_control** bits shall be set to "11"(as per Recommendation ITU-T H.222.0 / ISO/IEC 13818-1 [1]). In addition, the **random_access_indicator** bit in the adaptation header shall be set to "1". The **elementary_stream_priority_indicator** bit shall also be set to "1" in the same adaptation header if this transport packet contains the slice start code of the H.264/AVC RAP access unit (see clauses 4.1.5.1 and 4.1.5.2).*

Decoding: *H.264/AVC IRDs shall be able to start decoding and displaying an H.264/AVC Bitstream at an H.264/AVC RAP.*

5.5.5.1 Time Interval Between RAPs

Encoding: *The encoder shall place H.264/AVC RAPs in the video elementary stream at least once every 5 s. It is recommended that H.264/AVC RAPs occur in the video elementary stream on average at least every 2 s. Where rapid channel change times are important or for applications such as PVR it may be appropriate for H.264/AVC RAPs to occur more frequently, such as every 500 ms. The time interval between successive RAPs shall be measured as the difference between their respective DTS values.*

NOTE 1: Decreasing the time interval between H.264/AVC RAPs may reduce channel hopping time and improve trick modes, but may reduce the efficiency of the video compression.

NOTE 2: Having a regular interval between H.264/AVC RAPs may improve trick mode performance, but may reduce the efficiency of the video compression.

5.6 H.264/AVC SDTV IRDs and Bitstreams

5.6.1 Specifications Common to all H.264/AVC SDTV IRDs and Bitstreams

5.6.1.0 Scope

The specification in this clause applies to the following IRDs and bitstreams:

- 25 Hz H.264/AVC SDTV IRD and Bitstream;
- 30 Hz H.264/AVC SDTV IRD and Bitstream.

5.6.1.1 Sequence Parameter Set and Picture Parameter Set

Encoding: *In addition to the provisions set forth in Recommendation ITU-T H.264 / ISO/IEC 14496-10 [16], the following restrictions shall apply for the fields in the sequence parameter set:*

profile_idc	= 77 (Main Profile)
profile_idc	= 100 when bitstream complies with High Profile. See clause 5.6.1.2 for details of when the bitstream may optionally comply with High Profile.
constraint_set0_flag	= 0
constraint_set1_flag	= 1 (when profile_idc = 77) or = 0 (when profile_idc = 100)
constraint_set2_flag	= 0

<i>constraint_set3_flag</i>	= 0 (when <i>profile_idc</i> = 100)
<i>gaps_in_frame_num_value_allowed_flag</i>	= 0 (gaps not allowed)
<i>vui_parameters_present_flag</i>	= 1

5.6.1.2 Profile and level

Encoding: *H.264/AVC SDTV Bitstreams shall comply with Main Profile Level 3 restrictions, as described in Recommendation ITU-T H.264 / ISO/IEC 14496-10 [16]. In addition, in applications where decoders support the High Profile, the encoded bitstream may optionally comply with the High Profile.*

The value of level_idc shall be equal to 30.

Decoding: *H.264/AVC SDTV IRDs shall support decoding and displaying of Main Profile Level 3 bitstreams. Support of the High Profile and other profiles beyond Main Profile is optional. Support of levels beyond Level 3 is optional. If the H.264/AVC SDTV IRD encounters an extension which it cannot decode, it shall discard the following data until the next start code prefix (to allow backward compatible extensions to be added in the future).*

5.6.1.3 Aspect ratio

Encoding: *The source aspect ratio in H.264/AVC SDTV Bitstreams shall be either 4:3 or 16:9.*

The frame cropping information in the Sequence Parameter Set may be used when appropriate.

Decoding: *H.264/AVC SDTV IRDs shall support decoding and displaying H.264/AVC SDTV Bitstreams with the values of aspect_ratio_idc and other constraints that are specified in clause 5.6.2 for the 25 Hz H.264/AVC SDTV IRDs and Bitstreams and clause 5.6.3 for the 30 Hz H.264/AVC SDTV IRDs and Bitstreams.*

*The source aspect ratio information shall be derived from the **pic_height_in_map_units_minus1** and the **pic_width_in_mbs_minus1** and the frame cropping information coded in the Sequence Parameter Set as well as the sample aspect ratio encoded with the **aspect_ratio_idc** value in the Video Usability Information (see values of **aspect_ratio_idc** in Recommendation ITU-T H.264 / ISO/IEC 14496-10 [16], table E-1).*

H.264/AVC SDTV IRDs shall support frame cropping.

5.6.2 25 Hz H.264/AVC SDTV IRD and Bitstream

5.6.2.0 General

This clause specifies the 25 Hz H.264/AVC SDTV IRD and Bitstream. *All specifications in clauses 5.5 and 5.6.1 shall apply.* The specification in the remainder of this clause only applies to the 25 Hz H.264/AVC SDTV IRD and Bitstream.

5.6.2.1 Colour Parameter Information

Encoding: *The chromaticity co-ordinates of the ideal display, opto-electronic transfer characteristic of the source picture and matrix coefficients used in deriving luminance and chrominance signals from the red, green and blue primaries shall be explicitly signalled in the encoded 25 Hz H.264/AVC SDTV Bitstream by setting the appropriate values for each of the following 3 parameters in the VUI: **colour_primaries**, **transfer_characteristics**, and **matrix_coefficients**.*

It is recommended that Recommendation ITU-R BT.1700 Part B [25] colorimetry is used in the H.264/AVC Bitstream, which is signalled by setting **colour_primaries** to the value 5, **transfer_characteristics** to the value 5 and **matrix_coefficients** to the value 5.

Decoding: *25 Hz H.264/AVC SDTV IRDs shall support decoding bitstreams with any allowed values of **colour primaries**, **transfer_characteristics** and **matrix_coefficients**. It is recommended that appropriate processing be included for the accurate representation of pictures using BT. Recommendation ITU-R BT.1700 Part B [25] colorimetry.*

NOTE: Previous editions of the present document referenced Recommendation ITU-R BT.470 [i.4] System B, G colorimetry. Recommendation ITU-R BT.1700 [25] replaces Recommendation ITU-R BT.470 [i.4].

5.6.2.2 Frame rate

Encoding: *The frame rate shall be 25 Hz in 25 Hz H.264/AVC Bitstreams. This shall be indicated in the VUI by setting **time_scale** and **num_units_in_tick** according to table 7. **Time_scale** and **num_units_in_tick** define the picture rate of the video.*

Table 7: time_scale and num_units_in_tick for Progressive and Interlace Frame Rates for 25 Hz H.264/AVC SDTV

Frame Rate	Interlaced or Progressive	time_scale	Num_units_in_tick
25	P	50	1
25	I	50	1

Decoding: *25 Hz H.264/AVC SDTV IRDs shall support decoding and displaying video with a frame rate of 25 Hz within the constraints of Main Profile at Level 3. Support of other frame rates is optional.*

5.6.2.3 Luminance resolution

Encoding: *25 Hz H.264/AVC SDTV Bitstreams shall represent video with luminance resolutions as shown in table 8. Non full-screen pictures may be encoded for display at less than full-size (when using one of the standard up-conversion ratios at the 25 Hz H.264/AVC SDTV IRD).*

Decoding: *25 Hz H.264/AVC SDTV IRDs shall be capable of decoding pictures with luminance resolutions as shown in table 8 and applying up sampling to allow the decoded pictures to be displayed at full-screen size. In addition, 25 Hz H.264/AVC SDTV IRDs shall be capable of decoding lower picture resolutions and displaying them at less than full-size after using one of the standard up-conversions, e.g. a horizontal resolution of 704 pixels within the 720 pixels full-screen display.*

Table 8: Resolutions for Full-screen Display from 25 Hz H.264/AVC SDTV IRD and supported by 25 Hz H.264/AVC HDTV IRD, 50 Hz H.264/AVC HDTV IRD, 25 Hz SVC HDTV IRD and 50 Hz SVC HDTV IRD

Coded Picture			Displayed Picture Horizontal up sampling	
Luminance resolution (horizontal × vertical)	Source Aspect Ratio	Aspect_ratio_idc	4:3 Monitors	16:9 Monitors
720 × 576	4:3	2	× 1	× 3/4 (see note 1)
	16:9	4	× 4/3 (see note 2)	× 1
544 × 576	4:3	4	× 4/3	× 1 (see note 1)
	16:9	12	× 16/9 (see note 2)	× 4/3
480 × 576	4:3	10	× 3/2	× 9/8 (see note 1)
	16:9	6	× 2 (see note 2)	× 3/2
352 × 576	4:3	6	× 2	× 3/2 (see note 1)
	16:9	8	× 8/3 (see note 2)	× 2
352 × 288	4:3	2	× 2	× 3/2 (see note 1)
	16:9	4	× 8/3 (see note 2) (and vertical up sampling × 2)	× 2 (and vertical up sampling × 2)

NOTE 1: Up sampling of 4:3 pictures for display on a 16:9 monitor is optional in the IRD, as 16:9 monitors can be switched to operate in 4:3 mode.

NOTE 2: The up sampling with this value is applied to the pixels of the 16:9 picture to be displayed on a 4:3 monitor.

NOTE 3: It is recommended that luminance resolution of 704 pixels represents the "middle" of the picture, and that it be decoded to a 720 pixels full-screen display by placing 8 pixels of padding at each side. It is recommended that luminance resolutions, such as 352 pixels, that are natural scalings of 704 pixels, be upscaled to 704 pixels and padded as above. It is recommended that all other resolutions be scaled as indicated by the table above. Where this does not result in the expected 720 pixels full-screen display, it is recommended that the result of the scaling be clipped or padded symmetrically as required to produce a 720 pixels full-screen display.

NOTE 4: The 16x9 picture comprises only the 702 pixels in the centre of the 720 pixel wide digital line. To avoid aspect ratio distortions and blanking or padding pixels appearing on the left and right of the screen, it is recommended that the remaining 18 pixels are not displayed (see EBU Technical Recommendation R92 [i.31]).

5.6.3 30 Hz H.264/AVC SDTV IRD and Bitstream

5.6.3.0 General

This clause specifies the 30 Hz H.264/AVC SDTV IRD and Bitstream. *All specifications in clauses 5.5 and 5.6.1 shall apply.* The specification in the remainder of this clause only applies to the 30 Hz H.264/AVC SDTV IRD and Bitstream.

5.6.3.1 Colour Parameter Information

Encoding: *The chromaticity co-ordinates of the ideal display, opto-electronic transfer characteristic of the source picture and matrix coefficients used in deriving luminance and chrominance signals from the red, green and blue primaries shall be explicitly signalled in the encoded H.264/AVC Bitstream by setting the appropriate values for each of the following 3 parameters in the VUI: colour_primaries, transfer_characteristics, and matrix_coefficients.*

It is recommended that Recommendation ITU-R BT.1700 [25], Part A colorimetry is used for video of all other vertical resolutions in the H.264/AVC Bitstream, which is signalled by setting **colour_primaries** to the value 6, **transfer_characteristics** to the value 6 and **matrix_coefficients** to the value 6.

Decoding: *The 30 Hz H.264/AVC SDTV IRD shall be capable of decoding bitstreams with any allowed values of colour_primaries, transfer_characteristics and matrix_coefficients.* It is recommended that appropriate processing be included for the accurate representation of pictures using Recommendation ITU-R BT.1700 [25], Part A colorimetry.

NOTE: Previous editions of the present document referenced SMPTE ST 170 colorimetry [i.9]. Recommendation ITU-R BT.1700 [25], Part A references SMPTE ST 170 [i.9].

5.6.3.2 Frame rate

Encoding: *The frame rate shall be 24 000/1 001, 24, 30 000/1 001, 30 Hz. This shall be indicated in the VUI by setting **time_scale** and **num_units_in_tick** according to table 9. Time_scale and num_units_in_tick define the picture rate of the video.*

Table 9: Time_scal and num_units_in_tick for Progressive and Interlace Frame Rates for 30 Hz H.264/AVC SDTV

Frame Rate	Interlaced or Progressive	time_scale	Num_units_in_tick
24 000/ 1 001	P	48 000	1 001
24	P	48	1
30 000/ 1 001	P	60 000	1 001
30	P	60	1
30 000/ 1 001	I	60 000	1 001
30	I	60	1

Decoding: *The 30 Hz H.264/AVC SDTV IRD shall support decoding and displaying video with a frame rate of 24 000/1 001, 24, 30 000/1 001 or 30 Hz within the constraints of Main Profile at Level 3. Support of other frame rates is optional.*

5.6.3.3 Luminance resolution

Encoding: *30 Hz H.264/AVC SDTV Bitstreams shall represent video with luminance resolutions as shown in table 10. Non full-screen pictures may be encoded for display at less than full-size (when using one of the standard up-conversion ratios at the 30 Hz H.264/AVC SDTV IRD).*

Decoding: *30 Hz H.264/AVC SDTV IRDs shall be capable of decoding pictures with luminance resolutions as shown in table 10 and applying up sampling to allow the decoded pictures to be displayed at full-screen size. In addition, 30 Hz H.264/AVC SDTV IRDs shall be capable of decoding lower picture resolutions and displaying them at less than full-size after using one of the standard up-conversions, e.g. a horizontal resolution of 704 pixels within the 720 pixels full-screen display.*

Table 10: Resolutions for Full-screen Display from 30 Hz H.264/AVC SDTV IRD, and supported by 30 Hz H.264/AVC HDTV IRD, 60 Hz H.264/AVC HDTV IRD, 30 Hz SVC HDTV IRD and 60 Hz SVC HDTV IRD

Coded Picture			Displayed Picture Horizontal up sampling	
Luminance resolution (horizontal x vertical)	Source Aspect Ratio	aspect_ratio _idc	4:3 Monitors	16:9 Monitors
720 x 480	4:3	3	x 1	x 3/4 (see note 1)
	16:9	5	x 4/3 (see note 2)	x 1
640 x 480	4:3	1	x 9/8	x 27/32 (see note 1)
	16:9	14	x 3/2	x 9/8
544 x 480	4:3	5	x 4/3	x 1 (see note 1)
	16:9	13	x 16/9 (see note 2)	x 4/3
480 x 480	4:3	11	x 3/2	x 9/8 (see note 1)
	16:9	7	x 2 (see note 2)	x 3/2
352 x 480	4:3	7	x 2	x 3/2 (see note 1)
	16:9	9	x 8/3 (see note 2)	x 2
352 x 240	4:3	3	x 2	x 3/2 (see note 1)
	16:9	5	x 8/3 (see note 2) (and vertical up sampling x 2)	x 2 (and vertical up sampling x 2)

NOTE 1: Up sampling of 4:3 pictures for display on a 16:9 monitor is optional in the IRD, as 16:9 monitors can be switched to operate in 4:3 mode.

NOTE 2: The up sampling with this value is applied to the pixels of the 16:9 picture to be displayed on a 4:3 monitor.

NOTE 3: It is recommended that luminance resolution of 704 pixels represents the "middle" of the picture, and that it be decoded to a 720 pixels full-screen display by placing 8 pixels of padding at each side. It is recommended that luminance resolutions, such as 352 pixels, that are natural scalings of 704 pixels, be upscaled to 704 pixels and padded as above. It is recommended that all other resolutions be scaled as indicated by the table above. Where this does not result in the expected 720 pixels full-screen display, it is recommended that the result of the scaling be clipped or padded symmetrically as required to produce a 720 pixels full-screen display.

5.7 H.264/AVC HDTV IRDs and Bitstreams

5.7.1 Specifications common to all H.264/AVC HDTV IRDs and Bitstreams

5.7.1.0 Scope

The specification in this clause applies to the following IRDs and bitstreams:

- 25 Hz H.264/AVC HDTV IRD and Bitstream;
- 30 Hz H.264/AVC HDTV IRD and Bitstream;
- 50 Hz H.264/AVC HDTV IRD and Bitstream;
- 60 Hz H.264/AVC HDTV IRD and Bitstream.

5.7.1.1 Sequence Parameter Set and Picture Parameter Set

Encoding: *In addition to the provisions set forth in Recommendation ITU-T H.264 / ISO/IEC 14496-10 [16], the following restrictions shall apply for the fields in the sequence parameter set:*

<i>profile_idc</i>	= 100 (High Profile [16])
<i>constraint_set0_flag</i>	= 0
<i>constraint_set1_flag</i>	= 0
<i>constraint_set2_flag</i>	= 0

<i>constraint_set3_flag</i>	= 0
<i>gaps_in_frame_num_value_allowed_flag</i>	= 0 (<i>gaps not allowed</i>)
<i>vui_parameters_present_flag</i>	= 1

5.7.1.2 Aspect ratio

Encoding: *The source aspect ratio in H.264/AVC HDTV Bitstreams shall be 16:9.*

*The source aspect ratio information shall be derived from the **aspect_ratio_idc** value in the Video Usability Information (see values of **aspect_ratio_idc** in Recommendation ITU-T H.264 / ISO/IEC 14496-10 [16], table E-1).*

The frame cropping information in the Sequence Parameter Set may be used when appropriate.

Decoding: *H.264/AVC HDTV IRDs shall support decoding and displaying H.264/AVC HDTV Bitstreams with the values of **aspect_ratio_idc** as specified in table 11.*

*The source aspect ratio information shall be derived from the **pic_height_in_map_units_minus1** and the **pic_width_in_mbs_minus1** and the frame cropping information coded in the Sequence Parameter Set as well as the sample aspect ratio encoded with the **aspect_ratio_idc** value in the Video Usability Information (see values of **aspect_ratio_idc** in Recommendation ITU-T H.264 / ISO/IEC 14496-10 [16], table E-1).*

H.264/AVC HDTV IRDs shall support frame cropping.

5.7.1.3 Colour Parameter Information

Encoding: *The chromaticity co-ordinates of the ideal display, opto-electronic transfer characteristic of the source picture and matrix coefficients used in deriving luminance and chrominance signals from the red, green and blue primaries shall be explicitly signalled in the encoded H.264/AVC HDTV Bitstream by setting the appropriate values for each of the following 3 parameters in the **VUI**: **colour_primaries**, **transfer_characteristics**, and **matrix_coefficients**.*

It is recommended that H.264/AVC HDTV bitstreams use either Recommendation ITU-R BT.709 [13] or IEC 61966-2-4 [31] colorimetry.

BT.709 [13] colorimetry usage is signalled by setting **colour_primaries** to the value 1, **transfer_characteristics** to the value 1 and **matrix_coefficients** to the value 1.

IEC 61966-2-4 [31] colorimetry usage is signalled by setting **colour_primaries** to the value 1, **transfer_characteristics** to the value 11 and **matrix_coefficients** to the value 1.

Decoding: *H.264/AVC HDTV IRDs shall be capable of decoding bitstreams with any allowed values of **colour_primaries**, **transfer_characteristics** and **matrix_coefficients**. It is recommended that appropriate processing be included for the accurate representation of pictures using Recommendation ITU-R BT.709 [13] colorimetry.*

H.264/AVC HDTV IRDs may be capable of decoding bitstreams that use IEC 61966-2-4 [31] colorimetry.

NOTE: The H.264/AVC HDTV IRD might not include appropriate processing for the accurate representation of pictures that use IEC 61966-2-4 [31] colorimetry.

5.7.1.4 Luminance resolution

Encoding: *H.264/AVC HDTV Bitstreams shall represent video with luminance resolutions as shown in table 11. Non full-screen pictures may be encoded for display at less than full-size (when using one of the standard up-conversion ratios at the H.264/AVC HDTV IRD).*

Decoding: *H.264/AVC HDTV IRDs shall be capable of decoding pictures with luminance resolutions as shown in table 11 and applying up sampling to allow the decoded pictures to be displayed at full-screen size.*

Table 11: Resolutions for Full-screen Display from H.264/AVC HDTV IRD and SVC HDTV IRD

Coded Picture			
Luminance resolution (horizontal x vertical)	Source Aspect Ratio	aspect_ratio_idc	16:9 Monitors Horizontal up sampling
1 920 x 1 080	16:9	1	x 1
1 440 x 1 080	16:9	14	x 4/3
1 280 x 1 080	16:9	15	x 3/2
960 x 1 080	16:9	16	x 2
1 280 x 720	16:9	1	x 1
960 x 720	16:9	14	x 4/3
640 x 720	16:9	16	x 2

5.7.2 25 Hz H.264/AVC HDTV IRD and Bitstream

5.7.2.0 General

This clause specifies the 25 Hz H.264/AVC HDTV IRD and Bitstream. *All specifications in clauses 5.5 and 5.7.1 shall apply.* The specification in the remainder of this clause only applies to the 25 Hz H.264/AVC HDTV IRD and Bitstream.

5.7.2.1 Profile and level

Encoding: 25 Hz H.264/AVC HDTV Bitstreams shall comply with the High Profile Level 4 restrictions, as specified in Recommendation ITU-T H.264 / ISO/IEC 14496-10 [16].

The value of level_idc shall be equal to 30, 31, 32 or 40.

Decoding: 25 Hz H.264/AVC HDTV IRDs shall support the decoding of High Profile Level 4 bitstreams. This requirement includes support for High Profile and levels 3 to 4. Support for profiles and levels other than High Profile, Level 3 to 4 is optional. *If the 25 Hz H.264/AVC HDTV IRD encounters an extension which it cannot decode, it shall discard the following data until the next start code prefix (to allow backward compatible extensions to be added in the future).*

5.7.2.2 Frame rate

Encoding: *The frame rate shall be 25 Hz or 50 Hz. This shall be indicated in the VUI by setting time_scale and num_units_in_tick according to table 12. Time_scale and num_units_in_tick define the picture rate of the video. The source video format for 50 Hz frame rate material shall be progressive. The source video format for 25 Hz frame rate material shall be interlaced or progressive.*

Table 12: Time_scal and num_units_in_tick for Progressive and Interlace Frame Rates for 25 Hz H.264/AVC HDTV, 50 Hz H.264/AVC HDTV, 25 Hz SVC HDTV, 50 Hz SVC HDTV and 25 Hz MVC Stereo HDTV

Frame Rate	Interlaced or Progressive	time_scale	num_units_in_tick
25	P	50	1
25	I	50	1
50	P	100	1

Decoding: 25 Hz H.264/AVC HDTV IRDs shall support decoding and displaying video with a frame rate of 25 Hz interlaced or progressive, or 50 Hz progressive within the constraints of High Profile at Level 4. Support of other frame rates is optional.

5.7.2.3 Backwards Compatibility

Decoding: *25 Hz H.264/AVC HDTV IRDs shall be capable of decoding any bitstream that a 25 Hz H.264/AVC SDTV IRD is required to decode and resulting in the same displayed pictures as the 25 Hz H.264/AVC SDTV IRD, as described in clause 5.6.2.*

5.7.3 30 Hz H.264/AVC HDTV IRD and Bitstream

5.7.3.0 General

This clause specifies the 30 Hz H.264/AVC HDTV IRD and Bitstream. *All specifications in clauses 5.5 and 5.7.1 shall apply.* The specification in the remainder of this clause only applies to the 30 Hz H.264/AVC HDTV IRD and Bitstream.

5.7.3.1 Profile and level

Encoding: *30 Hz H.264/AVC HDTV Bitstreams shall comply with the High Profile Level 4 restrictions, as specified in Recommendation ITU-T H.264 / ISO/IEC 14496-10 [16].*

The value of level_idc shall be equal to 30, 31, 32 or 40.

Decoding: *30 Hz H.264/AVC HDTV IRDs shall support the decoding of High Profile Level 4 bitstreams. This requirement includes support for High Profile and levels 3 to 4. Support for profiles and levels other than High Profile, Level 3 to 4 is optional. If the 30 Hz H.264/AVC HDTV IRD encounters an extension which it cannot decode, it shall discard the following data until the next start code prefix (to allow backward compatible extensions to be added in the future).*

5.7.3.2 Frame rate

Encoding: *The frame rate shall be 24 000/1 001, 24, 30 000/1 001, 30, 60 000/1 001 or 60 Hz. This shall be indicated in the VUI by setting time_scale and num_units_in_tick according to table 13. Time_scale and num_units_in_tick define the picture rate of the video. The source video format for 24 000/1 001, 24, 60 000/1 001 and 60 Hz frame rate material shall be progressive. The source video format for 30 000/1 001 and 30 Hz frame rate material shall be interlaced or progressive.*

Table 13: Time_scal and num_units_in_tick for Progressive and Interlace Frame Rates for 30 Hz H.264/AVC HDTV, 60 Hz H.264/AVC HDTV, 30 Hz SVC HDTV, 60 Hz SVC HDTV and 30 Hz MVC Stereo HDTV

Frame Rate	Interlaced or Progressive	time_scale	Num_units_in_tick
24 000/ 1 001	P	48 000	1 001
24	P	48	1
30 000/ 1 001	P	60 000	1 001
30	P	60	1
30 000/ 1 001	I	60 000	1 001
30	I	60	1
60 000/ 1 001	P	120 000	1 001
60	P	120	1

Decoding: *30 Hz H.264/AVC HDTV IRDs shall support decoding and displaying video with a frame rate of 30 000/1 001, 30 Hz interlaced or progressive, or 24 000/1 001, 24, 60 000/1 001 or 60 Hz progressive within the constraints of High Profile at Level 4. Support of other frame rates is optional.*

5.7.3.3 Backwards Compatibility

Decoding: *30 Hz H.264/AVC HDTV IRDs shall be capable of decoding any bitstream that a 30 Hz H.264/AVC SDTV IRD is required to decode and resulting in the same displayed pictures as the 30 Hz H.264/AVC SDTV IRD, as described in clause 5.7.2.*

5.7.4 50 Hz H.264/AVC HDTV IRD and Bitstream

5.7.4.0 General

This clause specifies the 50 Hz H.264/AVC HDTV IRD and Bitstream. *All specifications in clauses 5.5 and 5.7.1 shall apply.* The specification in the remainder of this clause only applies to the 50 Hz H.264/AVC HDTV IRD and Bitstream.

5.7.4.1 Profile and level

Encoding: *50 Hz H.264/AVC HDTV Bitstreams shall comply with the High Profile Level 4.2 restrictions, as specified in Recommendation ITU-T H.264 / ISO/IEC 14496-10 [16].*

*The value of **level_idc** shall be equal to 41 or 42.*

Decoding: *50 Hz H.264/AVC HDTV IRDs shall support the decoding of High Profile Level 4.2 bitstreams. This requirement includes support for High Profile and levels 4.1 and 4.2. Support for profiles and levels other than High Profile, Level 4.1 and 4.2 is optional. If the 50 Hz H.264/AVC HDTV IRD encounters an extension which it cannot decode, it shall discard the following data until the next start code prefix (to allow backward compatible extensions to be added in the future).*

5.7.4.2 Frame rate

Encoding: *The frame rate shall be 25 Hz or 50 Hz. This shall be indicated in the VUI by setting **time_scale** and **num_units_in_tick** according to table 12. Time_scale and num_units_in_tick define the picture rate of the video. The source video format for 50 Hz frame rate material shall be progressive. The source video format for 25 Hz frame rate material shall be interlaced or progressive.*

Decoding: *50 Hz H.264/AVC HDTV IRDs shall support decoding and displaying video with a frame rate of 25 Hz interlaced or progressive, or 50 Hz progressive within the constraints of High Profile at Level 4.2. Support of other frame rates is optional.*

5.7.4.3 Backwards Compatibility

Decoding: *50 Hz H.264/AVC HDTV IRDs shall be capable of decoding any bitstream that a 25 Hz H.264/AVC HDTV IRD is required to decode and resulting in the same displayed pictures as the 25 Hz H.264/AVC HDTV IRD, as described in clause 5.7.2.*

5.7.5 60 Hz H.264/AVC HDTV IRD and Bitstream

5.7.5.0 General

This clause specifies the 60 Hz H.264/AVC HDTV IRD and Bitstream. *All specifications in clauses 5.5 and 5.7.1 shall apply.* The specification in the remainder of this clause only applies to the 60 Hz H.264/AVC HDTV IRD and Bitstream.

5.7.5.1 Profile and level

Encoding: *60 Hz H.264/AVC HDTV Bitstreams shall comply with the High Profile Level 4.2 restrictions, as specified in Recommendation ITU-T H.264 / ISO/IEC 14496-10 [16].*

*The value of **level_idc** shall be equal to 41 or 42.*

Decoding: *60 Hz H.264/AVC HDTV IRDs shall support the decoding of High Profile Level 4.2 bitstreams. This requirement includes support for High Profile and levels 4.1 and 4.2. Support for profiles and levels other than High Profile, Level 4.1 and 4.2 is optional. If the 60 Hz H.264/AVC HDTV IRD encounters an extension which it cannot decode, it shall discard the following data until the next start code prefix (to allow backward compatible extensions to be added in the future).*

5.7.5.2 Frame rate

Encoding: *The frame rate shall be 24 000/1 001, 24, 30 000/1 001, 30, 60 000/1 001 or 60 Hz. This shall be indicated in the VUI by setting **time_scale** and **num_units_in_tick** according to table 13. Time_scale and num_units_in_tick define the picture rate of the video. The source video format for 24 000/1 001, 24, 60 000/1 001 and 60 Hz frame rate material shall be progressive. The source video format for 30 000/1 001 and 30 Hz frame rate material shall be interlaced or progressive.*

Decoding: *60 Hz H.264/AVC HDTV IRDs shall support decoding and displaying video with a frame rate of 30 000/1 001, 30 Hz interlaced or progressive, or 24 000/1 001, 24, 60 000/1 001 or 60 Hz progressive within the constraints of High Profile at Level 4.2. Support of other frame rates is optional.*

5.7.5.3 Backwards Compatibility

Decoding: *60 Hz H.264/AVC HDTV IRDs shall be capable of decoding any bitstream that a 30 Hz H.264/AVC HDTV IRD is required to decode and resulting in the same displayed pictures as the 30 Hz H.264/AVC HDTV IRD, as described in clause 5.7.3.*

5.8 SVC HDTV IRDs and Bitstreams

5.8.1 Specifications common to all SVC HDTV IRDs and Bitstreams

5.8.1.0 Introduction

The specification in this clause applies to the following IRDs and bitstreams:

- 25 Hz SVC HDTV IRD and Bitstream;
- 30 Hz SVC HDTV IRD and Bitstream;
- 50 Hz SVC HDTV IRD and Bitstream;
- 60 Hz SVC HDTV IRD and Bitstream.

The restrictions for SVC HDTV Bitstreams and the capabilities for SVC HDTV IRDs are partly specified via SVC HDTV Bitstream Subsets. An SVC HDTV Bitstream Subset is a subset of an SVC HDTV Bitstream that can be obtained from the SVC HDTV Bitstream by discarding one or more access units and/or one or more VCL NAL units, starting from VCL NAL units with the largest value of DQId, and associated non-VCL NAL units in one or more access units, similar to the process specified in clause G.8.8.1 of Recommendation ITU-T H.264 / ISO/IEC 14496-10 [16]. An SVC HDTV Bitstream Subset may be identical to the SVC HDTV Bitstream that contains the SVC HDTV Bitstream Subset. Some of the restriction for SVC HDTV Bitstreams and capabilities for SVC HDTV IRDs are specified by specifying restrictions for SVC HDTV Bitstream Subsets.

5.8.1.1 Classes of SVC operation

5.8.1.1.0 General

The video encoding and video decoding shall conform to Recommendation ITU-T H.264 / ISO/IEC 14496-10 [16]. Some of the parameters and fields are not used in the DVB System and these restrictions are described below. SVC Bitstreams and IRDs shall support some parts of the "Supplemental Enhancement Information (SEI)", the "Video usability information (VUI)", and the "SVC Video Usability Information extension (SVC VUI extension)" syntax elements as specified in Recommendation ITU-T H.264 / ISO/IEC 14496-10 [16], annexes D and E and clauses G.13 and G.14. The SVC IRD design shall be made under the assumption that any legal structure as permitted by Recommendation ITU-T H.264 / ISO/IEC 14496-10 [16] and the restrictions that are specified for the SVC IRDs may occur in the broadcast stream even if presently reserved or unused.

5.8.1.1.1 Class S Bitstream

Number of dependency representations:

Decoding: *Class S IRDs shall be capable of ignoring VCL NAL units (of an SVC Bitstream) that have dependency_id greater than 1.*

Class S IRDs shall be capable of decoding and rendering pictures that are represented by an SVC Bitstream Subset that does not contain VCL NAL units with dependency_id greater than 1.

Number of layer representations:

Encoding: *In class S Bitstreams, VCL NAL units with dependency_id equal to 1 and quality_id equal to 0 shall have ref_layer_dq_id equal to 0.*

Decoding: *Class S IRDs shall be capable of ignoring VCL NAL units (of an SVC Bitstream) that have quality_id greater than 0.*

Class S IRDs shall be capable of decoding and rendering pictures that are represented by an SVC Bitstream Subset that does not contain VCL NAL units with quality_id greater than 0.

store_ref_base_pic_flag:

Encoding: *In class S bitstreams, VCL NAL units with dependency_id less than or equal to 1 shall have store_ref_base_pic_flag equal to 0.*

5.8.1.1.2 Class Q Bitstream

Number of dependency representations:

Decoding: *Class Q IRDs shall be capable of ignoring VCL NAL units (of an SVC Bitstream) that have dependency_id greater than 0.*

Class Q IRDs shall be capable of decoding and rendering pictures that are represented by an SVC Bitstream Subset that does not contain VCL NAL units with dependency_id greater than 0.

Number of layer representations:

Decoding: *Class Q IRDs shall be capable of ignoring VCL NAL units (of an SVC Bitstream) that have quality_id greater than 3.*

Class Q IRDs shall be capable of decoding and rendering pictures that are represented by an SVC Bitstream Subset that does not contain VCL NAL units with quality_id greater than 3.

store_ref_base_pic_flag:

Encoding: *In class Q Bitstreams, time interval between any two SVC access units (in decoding order) that contain VCL NAL units with dependency_id equal to 0 and store_ref_base_pic_flag equal to 1 shall be greater than or equal to 100 ms.*

5.8.1.1.3 Class M Bitstream

Number of dependency representations:

Decoding: *Class M IRDs shall be capable of ignoring VCL NAL units (of an SVC Bitstream) that have dependency_id greater than 1.*

Class M IRDs shall be capable of decoding and rendering pictures that are represented by an SVC Bitstream Subset that does not contain VCL NAL units with dependency_id greater than 1.

Number of layer representations:

Encoding: *In class M Bitstreams, VCL NAL units with dependency_id equal to 1 and quality_id equal to 0 shall have ref_layer_dq_id less than 3.*

Decoding: *Class M IRDs shall be capable of discarding VCL NAL units (of an SVC Bitstream) in a way that the set of not discarded VCL NAL units does not contain more than 4 different values of DQId (the value of DQId for VCL NAL units is given by $16 \times \text{dependency_id} + \text{quality_id}$), before decoding and rendering pictures.*

Class M IRDs shall be capable of decoding and rendering pictures that are represented by an SVC Bitstream Subset that does not contain more than 4 different values of DQId (the value of DQId for VCL NAL units is given by $16 \times \text{dependency_id} + \text{quality_id}$).

store_ref_base_pic_flag:

Encoding: *In class M Bitstreams, time interval between any two SVC access units (in decoding order) that contain VCL NAL units with dependency_id equal to 0 or 1 and store_ref_base_pic_flag equal to 1 shall be greater than or equal to 100 ms.*

5.8.1.2 System Considerations

As provided below, certain aspects of an SVC system are signalled using "Video Usability Information" (VUI) parameters. These include picture colorimetry and picture Chrominance locations. When using SVC video coding, these parameters are strongly recommended to be identical within each layer of the AVC and SVC associated bitstreams. If they are not identical, then great care should be taken in system design and operation.

5.8.1.3 SVC Sequence Parameter Set and Picture Parameter Set

5.8.1.3.0 General

Encoding: *More than one picture parameter set can be present in the bitstreams between two SVC RAPs. Between two SVC RAPs for the same value of **dependency_id**, the content of a picture parameter set with a particular **pic_parameter_set_id** shall not change. I.e. if more than one picture parameter set is present in the bitstream and these picture parameter sets are different from each other, then each picture parameter set shall have a different **pic_parameter_set_id**.*

Note that multiple PPSs may be present in an SVC RAP access unit and the number of PPS that may be present is constrained by clause 4.1.5.2 where the start of the SVC dependency representation (which may be indicated by the Access Unit Delimiter or the SVC dependency representation delimiter) and the start of the first slice of the SVC dependency representation occurs either in the same transport packet or in 2 successive transport packets.

5.8.1.3.1 pic_width_in_mbs_minus1 and pic_height_in_map_units_minus1

Encoding: *The time interval between any two of the following changes shall be greater than or equal to one second:*

- a change of DependencyIdMax (DependencyIdMax specifies the maximum value of **dependency_id** present in an access unit);
- for any present value of dependency_id, a change of **pic_width_in_mbs_minus1** or **pic_height_in_map_units_minus1**;
- for any present value of dependency_id greater than 0, a change of **scaled_ref_layer_left_offset**, **scaled_ref_layer_right_offset**, **scaled_ref_layer_top_offset** or **scaled_ref_layer_bottom_offset** in the layer representations with quality_id equal to 0;
- for any present value of dependency_id greater than 0, a change of **ref_layer_dq_id** in the layer representations with quality_id equal to 0 and no_inter_layer_pred_flag equal to 0.

NOTE: Any of the above mentioned changes requires software processing in the decoder. Limiting the frequency of these changes is to constrain the IRD software processing.

If the number of samples per row of the luminance component of the source picture for any SVC dependency representation is not an integer multiple of 16 and additional samples are padded to make the number of samples per row of the luminance component an integer multiple of 16, it is recommended that these samples are padded at the right side of the picture.

If the number of samples per column of the luminance component of the source picture for any SVC dependency representation is not an integer multiple of 16 and additional samples are padded to make the number of samples per column of the luminance component an integer multiple of 16, it is recommended that these samples are padded at the bottom of the picture.

5.8.1.3.2 Subset Sequence Parameter Set

Encoding: *In addition to the provisions set forth in Recommendation ITU-T H.264 / ISO/IEC 14496-10 [16], the following restrictions shall apply for the fields in the subset sequence parameter sets (nal_unit_type is equal to 15):*

profile_idc	= 86 (Scalable High Profile [16])
constraint_set1_flag	= 1
constraint_set2_flag	= 0
gaps_in_frame_num_value_allowed_flag	= 0 (gaps not allowed)
vui_parameters_present_flag	= 1
svc_vui_parameters_present_flag	= 1
seq_ref_layer_chroma_phase_x_plus1_flag	= chroma_phase_x_plus1_flag
seq_ref_layer_chroma_phase_y_plus1	= chroma_phase_y_plus1

The SVC Video Usability Information extension shall include information for all present combinations of dependency_id, quality_id and temporal_id applicable for the subset sequence parameter set.

NOTE: Restrictions for sequence parameter sets (nal_unit_type equal to 7), which are referenced in VCL NAL units with dependency_id equal to 0 and quality_id equal to 0 are specified by the constraints for the SVC base layer bitstream in clauses 5.8.2.2, 5.8.3.2, 5.8.4.2 and 5.8.5.2.

5.8.1.4 Video Usability Information

5.8.1.4.0 General

The IRD shall support the use of the following syntax elements in the Video Usability Information of sequence parameter sets (nal_unit_type is equal to 7) and subset sequence parameter sets (nal_unit_type is equal to 15):

- Aspect Ratio Information (**aspect_ratio_idc**).
- Colour Parameter Information (**colour primaries**, **transfer characteristics**, and **matrix coefficients**).
- Chrominance Information (**chroma_sample_loc_type_top_field** and **chroma_sample_loc_type_bottom_field**).

The IRD shall support the use of the following syntax elements in the Video Usability Information of sequence parameter sets (nal_unit_type is equal to 7):

- Timing information (time_scale, num_units_in_tick, and fixed_frame_rate_flag).
- Picture Structure Information (pic_struct_present_flag).

The IRD shall support the use of the following syntax elements in the SVC Video Usability Information extension of subset sequence parameter sets (nal_unit_type is equal to 15), for each value i in the range of 0 to num_layers_minus1, inclusive, with num_layers_minus1 being the corresponding field in the SVC Video Usability Information extension:

- Timing information (time_scale[i], num_units_in_tick[i], and fixed_frame_rate_flag[i]).
- Picture Structure Information (pic_struct_present_flag[i]).

5.8.1.4.1 Aspect Ratio Information

The support of **aspect_ratio_idc** values for 25 Hz SVC HDTV IRDs and Bitstreams, 30 Hz SVC HDTV IRDs and Bitstreams, 50 Hz SVC HDTV IRDs and Bitstreams and 60 Hz SVC HDTV IRDs and Bitstreams is specified in clauses 5.8.2.5, 5.8.3.5, 5.8.4.5 and 5.8.5.5, respectively.

5.8.1.4.2 Colour Parameter Information

Encoding: *The chromaticity co-ordinates of the ideal display, opto-electronic transfer characteristic of the source picture and matrix coefficients used in deriving luminance and chrominance signals from the red, green and blue primaries shall be explicitly signalled in the encoded SVC HDTV Bitstream by setting the appropriate values for each of the following 3 parameters in the VUI of all SVC Sequence Parameter Sets: **colour_primaries**, **transfer_characteristics**, and **matrix_coefficients**.*

It is strongly recommended that the VUIs of all SVC Sequence Parameter Sets that are referenced in the VCL NAL units of any particular access unit include the same values of **colour_primaries**, **transfer_characteristics**, and **matrix_coefficients**.

Decoding: *SVC HDTV IRDs shall be capable of decoding bitstreams with any allowed values of **colour_primaries**, **transfer_characteristics** and **matrix_coefficients** in the VUI of the SVC Sequence Parameter Sets. It is recommended that appropriate processing be included for the accurate representation of pictures using Recommendation ITU-R BT.709 [13] colorimetry; and it is recommended that appropriate processing be included for the accurate representation of pictures using Recommendation ITU-R BT.1700 [25], Part B colorimetry for 25 Hz and 50 Hz SVC IRDs and Bitstreams and Recommendation ITU-R BT.1700 [25], Part A colorimetry for 30 Hz and 60 Hz SVC IRDs and Bitstreams.*

If a SVC IRD receives a SVC bitstream with an AVC video sub-bitstream and an SVC video sub-bitstream, and decodes only the AVC video sub-bitstream and outputs a scaled version of this video sub-bitstream at a resolution matching the SVC video sub-bitstream, it is recommended that the colour parameters of the AVC video sub-bitstream be converted, if they are different, to match those of the SVC video sub-bitstream.

5.8.1.4.3 Chrominance Information

Encoding: It is recommended to specify the chrominance locations using the syntax elements **chroma_sample_loc_type_top_field** and **chroma_sample_loc_type_bottom_field** in the VUI of each SVC Sequence Parameter set. It is recommended to use chroma sample type equal to 0 for both fields.

It is strongly recommended that the chrominance locations specified by the syntax elements **chroma_phase_x_plus1_flag** and **chroma_phase_y_plus1** of a subset sequence parameter set be consistent with the chrominance locations specified in the VUI of the same subset sequence parameter set, as per Recommendation ITU-T H.264 / ISO/IEC 14496-10 [16].

It is recommended that the reference layer chrominance locations specified by the syntax elements **ref_layer_chroma_phase_x_plus1_flag** and **ref_layer_chroma_phase_y_plus1** be consistent with the chrominance locations specified in the VUI of the SVC sequence parameter set that is referenced in the reference SVC layer representation (specified by **ref_layer_dq_id**), as per Recommendation ITU-T H.264 / ISO/IEC 14496-10 [16].

Decoding: *SVC HDTV IRDs shall support decoding any allowed values of **chroma_sample_loc_type_top_field** and **chroma_sample_loc_type_bottom_field**. It is recommended that appropriate processing be included for the display of pictures.*

If a SVC IRD receives a SVC bitstream with an AVC video sub-bitstream and an SVC video sub-bitstream, and decodes only the AVC video sub-bitstream and outputs a scaled version of this video sub-bitstream at a resolution matching the SVC video sub-bitstream, it is recommended that the chrominance parameters of the AVC video sub-bitstream be converted, if they are different, to match those of the SVC video sub-bitstream.

5.8.1.4.4 Timing Information

The support of **time_scale** and **num_units_in_tick** values in the VUI of sequence parameter sets and **time_scale[i]** and **num_units_in_tick[i]** values, for all present values of *i*, in the SVC VUI extension of subset sequence parameter sets for the 25 Hz SVC HDTV IRD and Bitstream is specified in clause 5.8.2.3, for the 30 Hz SVC HDTV IRD and Bitstream is specified in clause 5.8.3.3, for the 50 Hz SVC HDTV IRD and Bitstream is specified in clause 5.8.4.3, and for the 25 Hz SVC HDTV IRD and Bitstream is specified in clause 5.8.5.3. *In case of still picture, the value of **fixed_frame_rate_flag** in the VUI of sequence parameter sets and the value of **fixed_frame_rate_flag[i]**, for all present values of *i*, in the SVC VUI extension of subset sequence parameter sets shall be equal to 0. In other cases, the value of **fixed_frame_rate_flag** in the VUI of sequence parameter sets and the value of **fixed_frame_rate_flag[i]**, for all present values of *i*, in the SVC VUI extension of subset sequence parameter sets shall be equal to 1.* The frame rate for any video sub-bitstream cannot be changed between two access units that represent SVC IDR pictures for all present values of *dependency_id*.

5.8.1.4.5 Picture Structure Information

The support of **pic_struct_present_flag** in the VUI of sequence parameter sets and **pic_struct_present_flag[i]**, for the present values of *i*, in the SVC VUI extension of subset sequence parameter sets is specified in clause 5.8.1.5.1 related to use of Picture Structure information in the Picture Timing SEI and is common to all SVC HDTV IRDs and Bitstreams. For sequences that carry the picture structure information (such as film mode), it is recommended that the **pic_struct_present_flag** be set to 1 in the VUIs of the sequence parameter sets, the **pic_struct_present_flag[i]** be set equal to 1 for the present values of *i* in the SVC VUI extensions of the subset sequence parameter sets and corresponding picture timing SEI messages are associated with each access unit in the coded sequence. If the sequence does not require picture structure information, then the **pic_struct_present_flag** should be set to equal to 0 in the VUIs of the sequence parameter sets and the **pic_struct_present_flag[i]** should be set equal to 0 for the present values of *i* in the SVC VUI extensions of the subset sequence parameter sets. Use of the **pic_struct_present_flag** field in the VUI of sequence parameter sets and the **pic_struct_present_flag[i]** fields in the SVC VUI extension of subset sequence parameter sets allows use of corresponding picture timing SEI messages with only the picture structure information without the need to include HRD information (such as CPB and DPB delay or initial values of the delay in the corresponding buffering period SEI messages).

5.8.1.5 Supplemental Enhancement Information

5.8.1.5.0 General

The IRD shall support the use of Supplemental Enhancement Information of the following message types:

- Picture Timing SEI Message;
- Pan-Scan Rectangle SEI Message;
- "User data registered by Recommendation ITU-T T.35 SEI message" syntactic element [19] **user_data_registered_itu_t_35** as defined in clause B.7;
- Scalable Nesting SEI Message with nested SEI messages being Picture Timing or Pan-Scan Rectangle SEI messages.

Encoding: *The SVC video sub-bitstream shall not contain any NAL units with **nal_unit_type** equal to 6 (SEI NAL units).*

NOTE 1: All SEI messages that apply to SVC enhancement layers should be included in the AVC video sub-bitstream (i.e. the video sub-bitstream with *dependency_id* equal to 0). This ensures that the access unit re-assembling process does not require any re-ordering of NAL units.

NOTE 2: Even though SVC SEI messages other than those defined above are not precluded, transmission systems and broadcasters should take into account that the inclusion of any optional SEI messages could significantly increase the bitrate and buffer utilization of the base layer AVC video sub-bitstream. (Optional SEI messages include SEI messages other than the following: Picture Timing SEI message, Pan-Scan Rectangle SEI message, User data registered by Recommendation ITU-T T.35 [19] SEI message, Scalable Nesting SEI message with one or more of the nested SEI messages not being a Picture Timing SEI message or a Pan-Scan Rectangle SEI message).

5.8.1.5.1 Picture Timing SEI Message

Encoding: *If the SVC HDTV Bitstream contains picture structure information, then the **pic_struct_present_flag** shall be set equal to 1 in the VUI of the sequence parameter sets, the **pic_struct_present_flag[i]** shall be set equal to 1 for the present values of *i* in the SVC VUI extension of the subset sequence parameter sets and corresponding Picture Timing SEI messages shall be associated with every access unit. All Picture Timing SEI messages that apply to SVC layer representations of the same SVC dependency representation shall have the same value of **pic_struct**. If the SVC HDTV Bitstream does not contain picture structure information, the **pic_struct_present_flag** shall be set to 0 in the VUI of the sequence parameter sets and the **pic_struct_present_flag[i]** shall be set equal to 1 for the present values of *i* in the SVC VUI extension of the subset sequence parameter sets.*

Decoding: *SVC HDTV IRDs shall support all values defined in **pic_struct** including all modes requiring field and frame repetition. The SVC HDTV IRDs need not make use of any other syntax elements (except **pic_struct**) in the Picture Timing SEI messages, if these elements are present.*

NOTE: Picture Timing SEI messages are included in corresponding Scalable Nesting SEI messages when their presence is signalled by the field **pic_struct_present_flag[i]** in the SVC VUI extension of subset sequence parameter sets and Picture Timing SEI messages are not included in Scalable Nesting SEI messages when their presence is signalled by the field **pic_struct_present_flag** in the VUI of sequence parameter sets (per Recommendation ITU-T H.264 / ISO/IEC 14496-10 [16]).

If present, the picture structure information conveys the picture output order in the same order as the Picture Order Count (POC) information in the SVC HDTV Bitstream (per clause D.2.2 of Recommendation ITU-T H.264 / ISO/IEC 14496-10 [16]). This ensures consistency between the SEI message and the HRD model of Recommendation ITU-T H.264 / ISO/IEC 14496-10 [16].

5.8.1.5.2 Pan-Scan Rectangle SEI Message

Encoding: The **pan_scan_rect** SEI message may be used when appropriate.

Decoding: *SVC HDTV IRDs shall support all values specified in the **pan_scan_rect** SEI message for all video sub-bitstreams, except **pan_scan_rect_top_offset[i]** and **pan_scan_rect_bottom_offset[i]**. The SVC HDTV IRD need not make use of **pan_scan_rect_top_offset[i]** and **pan_scan_rect_bottom_offset[i]** parameters in the **pan_scan_rect** SEI message.*

The support of the use of **pan_scan_rect** for up sampling is specified to allow a 4:3 monitor to give a full-screen display of a selected portion of a 16:9 coded picture with the correct aspect ratio. The support of vertical resampling to obtain the correct aspect ratio for a letterbox display of a 16:9 coded picture on a 4:3 monitor is optional.

NOTE 1: Pan-Scan Rectangle SEI messages that apply to dependency representations with **dependency_id** greater than 0 are included in Scalable Nesting SEI messages.

NOTE 2: Use of AFD as defined in clause B.3 and Bar Data as defined in clause B.4 may provide a more convenient mechanism for enabling the full screen display of a selected portion of the coded picture.

5.8.1.5.3 Scalable Nesting SEI Message

Encoding: *SEI messages that are associated with SVC dependency representations with **dependency_id** greater than 0 or with SVC layer representations with **dependency_id** greater than 0 or **quality_id** greater than 0 or with particular bitstream subsets shall be included in Scalable Nesting SEI messages, as specified in Recommendation ITU-T H.264 / ISO/IEC 14496-10 [16].*

Decoding: *SVC HDTV IRDs shall support Scalable Nesting SEI messages and shall associate the nested SEI messages (i.e. SEI messages included in a Scalable Nesting SEI message) with the SVC dependency representations or SVC layer representations or particular bitstream subsets indicated by the parameters of the Scalable Nesting SEI message, as specified in Recommendation ITU-T H.264 / ISO/IEC 14496-10 [16].*

5.8.1.5.4 Still pictures

Encoding: *Still pictures shall comply with "AVC still picture" definition as per Recommendation ITU-T H.222.0 / ISO/IEC 13818-1 [1]. For Still pictures the frame rate specification for SVC HDTV IRDs shall not apply. The value of **fixed_frame_rate_flag** in the VUI of sequence parameter sets and the values of **fixed_frame_rate_flag[i]** in the SVC VUI extension of subset sequence parameter sets shall be equal to 0.*

For display that requires a fixed frame refresh according to the IRD frequency, the previously decoded picture should be displayed till the next picture is available.

5.8.1.6 SVC Random Access Point

5.8.1.6.0 General

The definitions of SVC RAP and SVC random access dependency representation in clause 3 shall apply.

Encoding: The time interval between SVC RAPs (for each particular value of dependency_id) may vary between programs and also within a program. The broadcast requirements should set the time interval between SVC RAPs as specified in clause 5.8.1.6.1.

NOTE: The AU_information_descriptor described in annex D provides a means of signalling information about Random Access Points that may be used by some applications, and it is recommended that this is present.

For each particular value of dependency_id, all SVC layer pictures with this particular value of dependency_id and PTS greater than or equal to PTS(rap) shall be fully reconstructible and displayable, where PTS(rap) represents the Presentation Time Stamp of the picture of the SVC RAP for this particular value of dependency_id. This means that decoders receiving an SVC RAP for a particular value of dependency_id shall not need to utilize data transmitted prior to this SVC RAP to decode SVC layer pictures with this particular value of dependency_id that are displayed after the SVC RAP.

If an SVC access unit represents an SVC RAP for a particular value of dependency_id, it shall also represent an SVC RAP for all values of dependency_id in the range from 0 to the particular value of dependency_id minus 1, inclusive.

If the maximum present value of dependency_id in an SVC access unit is different from the maximum present value of dependency_id in the previous SVC access unit in decoding order (when present), the SVC access unit shall represent an SVC RAP for all values of dependency_id present in the access unit.

To improve applications such as channel change, it is recommended that the Presentation Time Stamp of the picture of an SVC RAP be less than or equal to [DTS(rap) + 0,5 seconds] where DTS(rap) represents the Decoding Time Stamp of the picture of the SVC RAP.

Packetization of random access points shall comply with the following additional rule:

*A transport packet containing the PES header of an SVC random access dependency representation shall have an adaptation field. The **payload_unit_start_indicator** bit shall be set to "1" in the transport packet header and the **adaptation_field_control** bits shall be set to "11" (as per Recommendation ITU-T H.222.0 / ISO/IEC 13818-1 [1]). In addition, the **random_access_indicator** bit in the adaptation header shall be set to "1". The **elementary_stream_priority_indicator** bit shall also be set to "1" in the same adaptation header if this transport packet contains the slice start code of the SVC random access dependency representation (see clauses 4.1.5.1 and 4.1.5.2).*

Decoding: *SVC HDTV IRDs shall be capable of starting decoding and displaying pictures represented by an SVC HDTV Bitstream Subset, contained in an SVC HDTV Bitstream, at any SVC RAP with MaxDidRAP equal to MaxDid. MaxDidRAP represents the maximum value of dependency_id that is associated with the SVC RAP in the SVC HDTV Bitstream Subset and MaxDid represents the maximum value of dependency_id that is present in the SVC RAP in the SVC HDTV Bitstream Subset.*

5.8.1.6.1 Time Interval Between SVC RAPs

Encoding: *The encoder shall place SVC RAPs for dependency_id equal to 0 in the video elementary stream at least once every 5 s. It is recommended that SVC RAPs for dependency_id equal to 0 occur in the video elementary stream on average at least every 2 s. Where rapid channel change times are important or for applications such as PVR it may be appropriate for SVC RAPs for dependency_id equal to 0 to occur more frequently, such as every 500 ms.*

For each time interval in which dependency representations with any particular value of dependency_id greater than 0 are present in an SVC HDTV Bitstream, the encoder shall place SVC RAPs for this particular value of dependency_id in the video elementary stream at least once every 10 s. It is recommended that, for each time interval in which dependency representations with any particular value of dependency_id greater than 0 are present in an SVC HDTV Bitstream, SVC RAPs for this particular value of dependency_id occur in the video elementary stream on average at least every 5 s.

The time interval between successive RAPs for a particular value of dependency_id shall be measured as the difference between their respective DTS values.

NOTE 1: An SVC RAP for a particular value of dependency_id may or may not represent an SVC RAP for greater values of dependency_id.

NOTE 2: Decreasing the time interval between SVC RAPs may reduce channel hopping time and improve trick modes, but may reduce the efficiency of the video compression.

NOTE 3: Having a regular interval between SVC RAPs may improve trick mode performance, but may reduce the efficiency of the video compression.

5.8.2 25 Hz SVC HDTV IRD and Bitstream

5.8.2.0 General

This clause specifies the 25 Hz SVC HDTV IRD and Bitstream. *All specifications in clause 5.8.1 shall apply.* The specification in the remainder of this clause only applies to the 25 Hz SVC HDTV IRD and Bitstream.

5.8.2.1 Profile and level

Encoding: *25 Hz SVC HDTV Bitstream Subsets shall comply with the Scalable High Profile Level 4 restrictions, as specified in Recommendation ITU-T H.264 / ISO/IEC 14496-10 [16].*

The value of level_idc in all sequence parameter sets and subset sequence parameter sets that are referenced in VCL NAL units of a 25 Hz SVC HDTV Bitstream Subset shall be equal to 30, 31, 32 or 40.

25 Hz SVC HDTV Bitstreams shall conform to Recommendation ITU-T H.264 / ISO/IEC 14496-10 [16] and shall contain one or more 25 Hz SVC HDTV Bitstream Subsets. Optionally, 25 Hz SVC HDTV Bitstreams may contain additional VCL NAL units and associated non-VCL NAL units that do not belong to any 25 Hz SVC HDTV Bitstream Subset.

Decoding: *25 Hz SVC HDTV IRDs shall be capable of decoding and rendering pictures using 25 Hz SVC HDTV Bitstreams. Support for SVC Bitstreams that do not contain 25 Hz SVC HDTV Bitstream Subsets is optional.*

25 Hz SVC HDTV IRDs shall be capable of decoding and rendering pictures that are represented by 25 Hz SVC HDTV Bitstream Subsets contained in a 25 Hz SVC HDTV Bitstream. 25 Hz SVC HDTV IRDs shall be capable of discarding the VCL NAL units of a 25 Hz SVC HDTV Bitstream that do not belong to a 25 Hz SVC HDTV Bitstream Subset, before decoding and rendering pictures. Support for decoding and rendering of pictures that are represented by a SVC Bitstream Subset with a conformance point beyond the conformance point of 25 Hz SVC HDTV Bitstream Subsets is optional.

If the 25 Hz SVC HDTV IRD encounters an extension which it cannot decode, it shall discard the following data until the next start code prefix (to allow backward compatible extensions to be added in the future).

5.8.2.2 25 Hz SVC base layer bitstream

Encoding: *The SVC base layer bitstream of a 25 Hz SVC HDTV Bitstream (and a 25 Hz SVC HDTV Bitstream Subset) shall obey all constraints of a 25 Hz H.264/AVC SDTV Bitstream or all constraints of a 25 Hz H.264/AVC HDTV Bitstream.*

5.8.2.3 Frame rate

Encoding: *The frame rate of each video sub-bitstream of a 25 Hz SVC HDTV Bitstream Subset shall be 25 Hz or 50 Hz. This shall be indicated in the VUI of the sequence parameter sets referenced in VCL NAL units of the video sub-bitstream by setting **time_scale** and **num_units_in_tick** according to table 12 and the SVC VUI extension of the subset sequence parameter sets referenced in VCL NAL units of the video sub-bitstream by setting **time_scale[i]** and **num_units_in_tick[i]** for all present values of *i* according to table 12 with substituting **time_scale[i]** for **time_scale** and substituting **num_units_in_tick[i]** for **num_units_in_tick**. The fields **time_scale** and **num_units_in_tick** in the VUI of sequence parameter sets and the fields **time_scale[i]** and **num_units_in_tick[i]** in the SVC VUI extension of subset sequence parameter sets define the picture rate of the video.*

The source video format for 50 Hz frame rate video sub-bitstreams of a 25 Hz SVC HDTV Bitstream should be progressive. The source video format for 25 Hz frame rate video sub-bitstreams of a 25 Hz SVC Bitstream may be interlaced or progressive.

*The frame rate of any video sub-bitstream, of a 25 Hz SVC HDTV Bitstream, with a particular value of **dependency_id** greater than 0 shall be an integer multiple of the frame rates of all video sub-bitstreams with smaller values of **dependency_id**.*

*If a 25 Hz SVC HDTV Bitstream Subset contains a video sub-bitstream with **dependency_id** equal to 1 and the source format for this video sub-bitstream is interlaced, the source video format for the video sub-bitstream with **dependency_id** equal to 0 shall also be interlaced.*

Decoding: *25 Hz SVC HDTV IRDs shall support decoding and displaying video, represented by a 25 Hz SVC HDTV Bitstream Subset, with a frame rate of 25 Hz interlaced or progressive or 50 Hz progressive. Support of other frame rates is optional.*

5.8.2.4 Luminance resolution

Encoding: *Each video sub-bitstream of a 25 Hz SVC HDTV Bitstream Subset shall represent video with luminance resolutions as shown in table 8 and table 11. Non full-screen pictures may be encoded for display at less than full-size (when using one of the standard up-conversion ratios at the 25 Hz SVC HDTV IRD).*

*If a 25 Hz SVC HDTV Bitstream Subset contains a video sub-bitstream with **dependency_id** equal to 1 and this video sub-bitstream has **frame_mbs_only_flag** equal to 0, the value of **frame_mbs_only_flag** for the video sub-bitstream with **dependency_id** equal to 0 shall also be equal to 0.*

Decoding: *25 Hz SVC HDTV IRDs shall be capable of decoding pictures represented by a 25 Hz SVC HDTV Bitstream Subset with luminance resolutions as shown in table 8 and table 11 and applying up sampling to allow the decoded pictures to be displayed at full-screen size.*

5.8.2.5 Aspect Ratio Information

For the following specification in this clause, the source aspect ratio information shall be derived from the *pic_height_in_map_units_minus1* and the *pic_width_in_mbs_minus1* and the frame cropping information coded in the sequence parameter sets and subset sequence parameter sets referenced in the VCL NAL units of a video sub-bitstream as well as the sample aspect ratio encoded with the *aspect_ratio_idc* value in the Video Usability Information of the sequence parameter sets and subset sequence parameter sets referenced in the VCL NAL units of the video sub-bitstream (see values of *aspect_ratio_idc* in Recommendation ITU-T H.264 / ISO/IEC 14496-10 [16], table E-1).

Encoding: The source aspect ratio shall be the same for all video sub-bitstreams of a 25 Hz SVC HDTV Bitstream Subset.

The source aspect ratio for each video sub-bitstream, of a 25 Hz SVC HDTV Bitstream Subset, that represents pictures with one of the luminance resolutions shown in table 11 shall be 16:9.

The source aspect ratio for each video sub-bitstream, of a 25 Hz SVC HDTV Bitstream Subset, that represents pictures with one of the luminance resolutions shown in table 8 shall be either 4:3 or 16:9.

The frame cropping information in the SVC Sequence Parameter Sets may be used when appropriate.

Decoding: 25 Hz SVC HDTV IRDs shall support decoding and displaying pictures represented by 25 Hz SVC HDTV Bitstream Subsets in which each video sub-bitstream obeys the constraints for *aspect_ratio_idc* specified in table 11 or the constraints for *aspect_ratio_idc* specified in table 8 depending on the represented luminance resolution.

25 Hz SVC HDTV IRDs shall support frame cropping.

5.8.2.6 Backwards Compatibility

Decoding: 25 Hz SVC HDTV IRDs shall be capable of decoding any bitstream that a 25 Hz H.264/AVC HDTV IRD is required to decode and resulting in the same displayed pictures as the 25 Hz H.264/AVC HDTV IRD, as described in clause 5.7.2.

5.8.3 30 Hz SVC HDTV IRD and Bitstream

5.8.3.0 General

This clause specifies the 30 Hz SVC HDTV IRD and Bitstream. All specifications in clause 5.8.1 shall apply. The specification in the remainder of this clause only applies to the 30 Hz SVC HDTV IRD and Bitstream.

5.8.3.1 Profile and level

Encoding: 30 Hz SVC HDTV Bitstreams shall comply with the Scalable High Profile Level 4 restrictions, as specified in Recommendation ITU-T H.264 / ISO/IEC 14496-10 [16].

The value of *level_idc* in all sequence parameter sets and subset sequence parameter sets that are referenced in VCL NAL units of a 30 Hz SVC HDTV Bitstream Subset shall be equal to 30, 31, 32 or 40.

30 Hz SVC HDTV Bitstreams shall conform to Recommendation ITU-T H.264 / ISO/IEC 14496-10 [16] and shall contain one or more 30 Hz SVC HDTV Bitstream Subsets. Optionally, 30 Hz SVC HDTV Bitstreams may contain additional VCL NAL units and associated non-VCL NAL units that do not belong to any 30 Hz SVC HDTV Bitstream Subset.

Decoding: 30 Hz SVC HDTV IRDs shall be capable of decoding and rendering pictures using 30 Hz SVC HDTV Bitstreams. Support for SVC Bitstreams that do not contain 30 Hz SVC HDTV Bitstream Subsets is optional.

30 Hz SVC HDTV IRDs shall be capable of decoding and rendering pictures that are represented by 30 Hz SVC HDTV Bitstream Subsets contained in a 30 Hz SVC HDTV Bitstream. 30 Hz SVC HDTV IRDs shall be capable of discarding the VCL NAL units of a 30 Hz SVC HDTV Bitstream that do not belong to a 30 Hz SVC HDTV Bitstream Subset, before decoding and rendering pictures. Support for decoding and rendering of pictures that are represented by a SVC Bitstream Subset with a conformance point beyond the conformance point of 30 Hz SVC HDTV Bitstream Subsets is optional.

If the 30 Hz SVC HDTV IRD encounters an extension which it cannot decode, it shall discard the following data until the next start code prefix (to allow backward compatible extensions to be added in the future).

5.8.3.2 30 Hz SVC base layer bitstream

Encoding: *The SVC base layer bitstream of a 30 Hz SVC HDTV Bitstream (and a 30 Hz SVC HDTV Bitstream Subset) shall obey all constraints of a 30 Hz H.264/AVC SDTV Bitstream or all constraints of a 30 Hz H.264/AVC HDTV Bitstream.*

5.8.3.3 Frame rate

Encoding: *The frame rate of each video sub-bitstream of a 30 Hz SVC HDTV Bitstream Subset shall be 24 000/1 001, 24, 30 000/1 001, 30, 60 000/1 001 or 60 Hz. This shall be indicated in the VUI of the sequence parameter sets referenced in the VCL NAL units of the video sub-bitstream by setting **time_scale** and **num_units_in_tick** according to table 13 and the SVC VUI extension of the subset sequence parameter sets referenced in the VCL NAL units of the video sub-bitstream by setting **time_scale[i]** and **num_units_in_ticks[i]** for all present values of *i* according to table 13 with substituting **time_scale[i]** for **time_scale** and substituting **num_units_in_tick[i]** for **num_units_in_tick**. The fields **time_scale** and **num_units_in_tick** in the VUI of sequence parameter sets and the fields **time_scale[i]** and **num_units_in_tick[i]** in the SVC VUI extension of subset sequence parameter sets define the picture rate of the video.*

The source video format for 24 000/1 001, 24, 60 000/1 001 and 60 Hz frame rate video sub-bitstreams of a 30 Hz SVC HDTV Bitstream should be progressive. The source video format for 30 000/1 001 and 30 Hz frame rate video sub-bitstreams of a 30 Hz SVC HDTV Bitstream may be interlaced or progressive.

*The frame rate of any video sub-bitstream, of a 30 Hz SVC HDTV Bitstream, with a particular value of **dependency_id** greater than 0 shall be an integer multiple of the frame rates of all video sub-bitstreams with smaller values of **dependency_id**.*

*If a 30 Hz SVC HDTV Bitstream Subset contains a video sub-bitstream with **dependency_id** equal to 1 and the source format for this video sub-bitstream is interlaced, the source video format for the video sub-bitstream with **dependency_id** equal to 0 shall also be interlaced.*

Decoding: *30 Hz SVC HDTV IRDs shall support decoding and displaying video, represented by a 30 Hz SVC HDTV Bitstream Subset, with a frame rate of 30 000/1 001, 30 Hz interlaced or progressive or 24 000/1 001, 24, 60 000/1 001 or 60 Hz progressive. Support of other frame rates is optional.*

5.8.3.4 Luminance resolution

Encoding: *Each video sub-bitstream of a 30 Hz SVC HDTV Bitstream Subset shall represent video with luminance resolutions as shown in table 10 and table 11. Non full-screen pictures may be encoded for display at less than full-size (when using one of the standard up-conversion ratios at the 30 Hz SVC HDTV IRD).*

If a 30 Hz SVC HDTV Bitstream Subset contains a video sub-bitstream with `dependency_id` equal to 1 and this video sub-bitstream has `frame_mbs_only_flag` equal to 0, the value of `frame_mbs_only_flag` for the video sub-bitstream with `dependency_id` equal to 0 shall also be equal to 0.

Decoding: *30 Hz SVC HDTV IRDs shall be capable of decoding pictures represented by a 30 Hz SVC HDTV Bitstream Subset with luminance resolutions as shown in table 10 and table 11 and applying up sampling to allow the decoded pictures to be displayed at full-screen size.*

5.8.3.5 Aspect Ratio Information

For the following specification in this clause, the source aspect ratio information shall be derived from the `pic_height_in_map_units_minus1` and the `pic_width_in_mbs_minus1` and the frame cropping information coded in the sequence parameter sets and subset sequence parameter sets referenced in the VCL NAL units of a video sub-bitstream as well as the sample aspect ratio encoded with the `aspect_ratio_idc` value in the Video Usability Information of the sequence parameter sets and subset sequence parameter sets referenced in the VCL NAL units of the video sub-bitstream (see values of `aspect_ratio_idc` in Recommendation ITU-T H.264 / ISO/IEC 14496-10 [16], table E-1).

Encoding: *The source aspect ratio shall be the same for all video sub-bitstreams of a 30 Hz SVC HDTV Bitstream Subset.*

The source aspect ratio for each video sub-bitstream, of a 30 Hz SVC HDTV Bitstream Subset, that represents pictures with one of the luminance resolutions shown in table 11 shall be 16:9.

The source aspect ratio for each video sub-bitstream, of a 30 Hz SVC HDTV Bitstream Subset, that represents pictures with one of the luminance resolutions shown in table 10 shall be either 4:3 or 16:9.

The frame cropping information in the SVC Sequence Parameter Sets may be used when appropriate.

Decoding: *30 Hz SVC HDTV IRDs shall support decoding and displaying pictures represented by 30 Hz SVC HDTV Bitstream Subsets in which each video sub-bitstream obeys the constraints for `aspect_ratio_idc` specified in table 11 or the constraints for `aspect_ratio_idc` specified in table 10 depending on the represented luminance resolution.*

30 Hz SVC HDTV IRDs shall support frame cropping.

5.8.3.6 Backwards Compatibility

Decoding: *30 Hz SVC HDTV IRDs shall be capable of decoding any bitstream that a 30 Hz H.264/AVC HDTV IRD is required to decode and resulting in the same displayed pictures as the 30 Hz H.264/AVC HDTV IRD, as described in clause 5.7.3.*

5.8.4 50 Hz SVC HDTV IRD and Bitstream

5.8.4.0 General

This clause specifies the 50 Hz SVC HDTV IRD and Bitstream. *All specifications in clause 5.8.1 shall apply.* The specification in the remainder of this clause only applies to the 50 Hz SVC HDTV IRD and Bitstream.

5.8.4.1 Profile and level

Encoding: 50 Hz SVC HDTV Bitstream Subsets shall comply with the Scalable High Profile Level 4.2 restrictions, as specified in Recommendation ITU-T H.264 / ISO/IEC 14496-10 [16].

*The value of **level_idc** in all sequence parameter sets and subset sequence parameter sets that are referenced in VCL NAL units, of a 50 Hz SVC HDTV Bitstream Subset, that have dependency_id equal to 0 shall be equal to 30, 31, 32 or 40. The value of **level_idc** in all subset sequence parameter sets that are referenced in VCL NAL units, of a 50 Hz SVC HDTV Bitstream Subset, that have dependency_id equal to 1 shall be equal to 41 or 42.*

50 Hz SVC HDTV Bitstreams shall conform to Recommendation ITU-T H.264 / ISO/IEC 14496-10 [16] and shall contain one or more 50 Hz SVC HDTV Bitstream Subsets. Optionally, 50 Hz SVC HDTV Bitstreams may contain additional VCL NAL units and associated non-VCL NAL units that do not belong to any 50 Hz SVC HDTV Bitstream Subset.

Decoding: 50 Hz SVC HDTV IRDs shall be capable of decoding and rendering pictures using 50 Hz SVC HDTV Bitstreams. Support for SVC Bitstreams that do not contain 50 Hz SVC HDTV Bitstream Subsets is optional.

50 Hz SVC HDTV IRDs shall be capable of decoding and rendering pictures that are represented by 50 Hz SVC HDTV Bitstream Subsets contained in a 50 Hz SVC HDTV Bitstream. 50 Hz SVC HDTV IRDs shall be capable of discarding the VCL NAL units of a 50 Hz SVC HDTV Bitstream that do not belong to a 50 Hz SVC HDTV Bitstream Subset, before decoding and rendering pictures. Support for decoding and rendering of pictures that are represented by a SVC Bitstream Subset with a conformance point beyond the conformance point of 50 Hz SVC HDTV Bitstream Subsets is optional.

If the 50 Hz SVC HDTV IRD encounters an extension which it cannot decode, it shall discard the following data until the next start code prefix (to allow backward compatible extensions to be added in the future).

5.8.4.2 50 Hz SVC base layer bitstream

Encoding: The SVC base layer bitstream of a 50 Hz SVC HDTV Bitstream (and a 50 Hz SVC HDTV Bitstream Subset) shall obey all constraints of a 25 Hz H.264/AVC SDTV Bitstream or all constraints of a 25 Hz H.264/AVC HDTV Bitstream.

5.8.4.3 Frame rate

Encoding: The frame rate of each video sub-bitstream of a 50 Hz SVC HDTV Bitstream Subset shall be 25 Hz or 50 Hz. This shall be indicated in the VUI of the sequence parameter sets referenced in the VCL NAL units of the video sub-bitstream by setting **time_scale** and **num_units_in_tick** according to table 12 and the SVC VUI extension of the subset sequence parameter sets referenced in the VCL NAL units of the video sub-bitstream by setting **time_scale[i]** and **num_units_in_tick[i]** for all present values of *i* according to table 12 with substituting **time_scale[i]** for **time_scale** and substituting **num_units_in_tick[i]** for **num_units_in_tick**. The fields **time_scale** and **num_units_in_tick** in the VUI of sequence parameter sets and the fields **time_scale[i]** and **num_units_in_tick[i]** in the SVC VUI extension of subset sequence parameter sets define the picture rate of the video.

The source video format for 50 Hz frame rate video sub-bitstreams of a 50 Hz SVC HDTV Bitstream should be progressive. The source video format for 25 Hz frame rate video sub-bitstreams of a 50 Hz SVC HDTV Bitstream may be interlaced or progressive.

If a 50 Hz SVC HDTV Bitstream Subset contains a video sub-bitstream with dependency_id equal to 1, the source video format for this video sub-bitstream shall be progressive.

The frame rate of any video sub-bitstream, of a 50 Hz SVC HDTV Bitstream, with a particular value of dependency_id greater than 0 shall be an integer multiple of the frame rates of all video sub-bitstreams with smaller values of dependency_id.

Decoding: 50 Hz SVC HDTV IRDs shall support decoding and displaying video, represented by a 50 Hz SVC HDTV Bitstream Subset, with a frame rate of 25 Hz interlaced or progressive, or 50 Hz progressive. Support of other frame rates is optional.

5.8.4.4 Luminance resolution

Encoding: Each video sub-bitstream of a 50 Hz SVC HDTV Bitstream Subset shall represent video with luminance resolutions as shown in table 11. Non full-screen pictures may be encoded for display at less than full-size (when using one of the standard up-conversion ratios at the 50 Hz SVC HDTV IRD).

If a 50 Hz SVC HDTV Bitstream Subset contains a video sub-bitstream with *dependency_id* equal to 1, the field **frame_mbs_only_flag** shall be equal to 1 for this video sub-bitstream.

If a 50 Hz SVC HDTV Bitstream Subset contains a video sub-bitstream with *dependency_id* equal to 1 and the field **frame_mbs_only_flag** for the video sub-bitstream with *dependency_id* equal to 0 is equal to 0, the fields **pic_height_in_map_units_minus1**, **frame_crop_top_offset** and **frame_crop_bottom_offset** for the video sub-bitstream with *dependency_id* equal to 1 shall be equal to $2 \times (\text{picHeightInMapUnitsMinus1} + 1) - 1$, $2 \times \text{frameCropTopOffset} + 1$ and $2 \times \text{frameCropBottomOffset}$, respectively, with *picHeightInMapUnitsMinus1*, *frameCropTopOffset* and *frameCropBottomOffset* being the values of the fields **pic_height_in_map_units_minus1**, **frame_crop_top_offset** and **frame_crop_bottom_offset**, respectively, for the video sub-bitstream with *dependency_id* equal to 0.

NOTE: Scalability from an interlaced base layer (with *frame_mbs_only_flag* equal to 0) to a progressive enhancement layer (with *frame_mbs_only_flag* equal to 1) is only supported when the vertical luminance resolution is the same in both layers.

Decoding: 50 Hz SVC HDTV IRDs shall be capable of decoding pictures represented by a 50 Hz SVC HDTV Bitstream Subset with luminance resolutions as shown in table 11 and applying up sampling to allow the decoded pictures to be displayed at full-screen size.

5.8.4.5 Aspect Ratio Information

For the following specification in this clause, the source aspect ratio information shall be derived from the **pic_height_in_map_units_minus1** and the **pic_width_in_mbs_minus1** and the frame cropping information coded in the sequence parameter sets and subset sequence parameter sets referenced in the VCL NAL units of a video sub-bitstream as well as the sample aspect ratio encoded with the **aspect_ratio_idc** value in the Video Usability Information of the sequence parameter sets and subset sequence parameter sets referenced in the VCL NAL units of the video sub-bitstream (see values of **aspect_ratio_idc** in Recommendation ITU-T H.264 / ISO/IEC 14496-10 [16], table E-1).

Encoding: The source aspect ratio for each video sub-bitstream of a 50 Hz SVC HDTV Bitstream Subset shall be 16:9.

The frame cropping information in the SVC Sequence Parameter Sets may be used when appropriate.

Decoding: 50 Hz SVC HDTV IRDs shall support decoding and displaying pictures represented by 50 Hz SVC HDTV Bitstream Subsets in which each video sub-bitstream obeys the constraints for **aspect_ratio_idc** specified in table 11.

50 Hz SVC HDTV IRDs shall support frame cropping.

5.8.4.6 Backwards Compatibility

Decoding: 50 Hz SVC HDTV IRDs shall be capable of decoding any bitstream that a 50 Hz H.264/AVC HDTV IRD is required to decode and resulting in the same displayed pictures as the 50 Hz H.264/AVC HDTV IRD, as described in clause 5.7.4.

5.8.5 60 Hz SVC HDTV IRD and Bitstream

5.8.5.0 General

This clause specifies the 60 Hz SVC HDTV IRD and Bitstream. *All specifications in clause 5.8.1 shall apply.* The specification in the remainder of this clause only applies to the 60 Hz SVC HDTV IRD and Bitstream.

5.8.5.1 Profile and level

Encoding: 60 Hz SVC HDTV Bitstream Subsets shall comply with the Scalable High Profile Level 4.2 restrictions, as specified in Recommendation ITU-T H.264 / ISO/IEC 14496-10 [16].

*The value of **level_idc** in all sequence parameter sets and subset sequence parameter sets that are referenced in VCL NAL units, of a 60 Hz SVC HDTV Bitstream Subset, that have dependency_id equal to 0 shall be equal to 30, 31, 32 or 40. The value of **level_idc** in all subset sequence parameter sets that are referenced in VCL NAL units, of a 60 Hz SVC HDTV Bitstream Subset, that have dependency_id equal to 1 shall be equal to 41 or 42.*

60 Hz SVC HDTV Bitstreams shall conform to Recommendation ITU-T H.264 / ISO/IEC 14496-10 [16] and shall contain one or more 60 Hz SVC HDTV Bitstream Subsets. Optionally, 60 Hz SVC HDTV Bitstreams may contain additional VCL NAL units and associated non-VCL NAL units that do not belong to any 60 Hz SVC HDTV Bitstream Subset.

Decoding: 60 Hz SVC HDTV IRDs shall be capable of decoding and rendering pictures using 60 Hz SVC HDTV Bitstreams. Support for SVC Bitstreams that do not contain 60 Hz SVC HDTV Bitstream Subsets is optional.

60 Hz SVC HDTV IRDs shall be capable of decoding and rendering pictures that are represented by 60 Hz SVC HDTV Bitstream Subsets contained in a 60 Hz SVC HDTV Bitstream. 60 Hz SVC HDTV IRDs shall be capable of discarding the VCL NAL units of a 60 Hz SVC HDTV Bitstream that do not belong to a 60 Hz SVC HDTV Bitstream Subset, before decoding and rendering pictures. Support for decoding and rendering of pictures that are represented by a SVC Bitstream Subset with a conformance point beyond the conformance point of 60 Hz SVC HDTV Bitstream Subsets is optional.

If the 60 Hz SVC HDTV IRD encounters an extension which it cannot decode, it shall discard the following data until the next start code prefix (to allow backward compatible extensions to be added in the future).

5.8.5.2 60 Hz SVC base layer bitstream

Encoding: *The SVC base layer bitstream of a 60 Hz SVC HDTV Bitstream (and a 60 Hz SVC HDTV Bitstream Subset) shall obey all constraints of a 30 Hz H.264/AVC SDTV Bitstream or all constraints of a 30 Hz H.264/AVC HDTV Bitstream.*

5.8.5.3 Frame rate

Encoding: *The frame rate of each video sub-bitstream of a 60 Hz SVC HDTV Bitstream Subset shall be 24 000/1 001, 24, 30 000/1 001, 30, 60 000/1 001 or 60 Hz. This shall be indicated in the VUI of the sequence parameter sets referenced in the VCL NAL units of the video sub-bitstream by setting **time_scale** and **num_units_in_tick** according to table 13 and the SVC VUI extension of the subset sequence parameter sets referenced in the VCL NAL units of the video sub-bitstream by setting **time_scale[i]** and **num_units_in_tick[i]** according to table 13 with substituting **time_scale[i]** for **time_scale** and substituting **num_units_in_tick[i]** for **num_units_in_tick**. The fields **time_scale** and **num_units_in_tick** in the VUI of sequence parameter sets and the fields **time_scale[i]** and **num_units_in_tick[i]** in the SVC VUI extension of subset sequence parameter sets define the picture rate of the video.*

The source video format for 24 000/1 001, 24, 60 000/1 001 and 60 Hz frame rate video sub-bitstreams of a 60 Hz SVC HDTV Bitstream should be progressive. The source video format for 30 000/1 001 and 30 Hz frame rate video sub-bitstreams of a 60 Hz SVC HDTV Bitstream may be interlaced or progressive.

If a 60 Hz SVC HDTV Bitstream Subset contains a video sub-bitstream with dependency_id equal to 1, the source video format for this video sub-bitstream shall be progressive.

The frame rate of any video sub-bitstream, of a 60 Hz SVC HDTV Bitstream, with a particular value of dependency_id greater than 0 shall be an integer multiple of the frame rates of all video sub-bitstreams with smaller values of dependency_id.

Decoding: 60 Hz SVC HDTV IRDs shall support decoding and displaying video, represented by a 60 Hz SVC HDTV Bitstream Subset, with a frame rate of 30 000/1 001, 30 Hz interlaced or progressive or 24 000/1 001, 24, 60 000/1 001 or 60 Hz progressive. Support of other frame rates is optional.

5.8.5.4 Luminance resolution

Encoding: Each video sub-bitstream of a 60 Hz SVC HDTV Bitstream Subset shall represent video with luminance resolutions as shown in table 11. Non full-screen pictures may be encoded for display at less than full-size (when using one of the standard up-conversion ratios at the 60 Hz SVC HDTV IRD).

*If a 60 Hz SVC HDTV Bitstream Subset contains a video sub-bitstream with dependency_id equal to 1, the field **frame_mbs_only_flag** shall be equal to 1 for this video sub-bitstream.*

*If a 60 Hz SVC HDTV Bitstream Subset contains a video sub-bitstream with dependency_id equal to 1 and the field **frame_mbs_only_flag** for the video sub-bitstream with dependency_id equal to 0 is equal to 0, the fields **pic_height_in_map_units_minus1**, **frame_crop_top_offset** and **frame_crop_bottom_offset** for the video sub-bitstream with dependency_id equal to 1 shall be equal to $2 \times (\text{picHeightInMapUnitsMinus1DId0} + 1) - 1$, $2 \times \text{frameCropTopOffsetDId0}$ and $2 \times \text{frameCropBottomOffsetDId0}$, respectively, with **picHeightInMapUnitsMinus1DId0**, **frameCropTopOffsetDId0** and **frameCropBottomOffsetDId0** being the values of the fields **pic_height_in_map_units_minus1**, **frame_crop_top_offset** and **frame_crop_bottom_offset**, respectively, for the video sub-bitstream with dependency_id equal to 0.*

NOTE: Scalability from an interlaced base layer (with **frame_mbs_only_flag** equal to 0) to a progressive enhancement layer (with **frame_mbs_only_flag** equal to 1) is only supported when the vertical luminance resolution is the same in both layers.

Decoding: 60 Hz SVC HDTV IRDs shall be capable of decoding pictures represented by a 60 Hz SVC HDTV Bitstream Subset with luminance resolutions as shown in table 11 and applying up sampling to allow the decoded pictures to be displayed at full-screen size.

5.8.5.5 Aspect Ratio Information

*For the following specification in this clause, the source aspect ratio information shall be derived from the **pic_height_in_map_units_minus1** and the **pic_width_in_mbs_minus1** and the frame cropping information coded in the sequence parameter sets and subset sequence parameter sets referenced in the VCL NAL units of a video sub-bitstream as well as the sample aspect ratio encoded with the **aspect_ratio_idc** value in the Video Usability Information of the sequence parameter sets and subset sequence parameter sets referenced in the VCL NAL units of the video sub-bitstream (see values of **aspect_ratio_idc** in Recommendation ITU-T H.264 / ISO/IEC 14496-10 [16], table E-1).*

Encoding: The source aspect ratio for each video sub-bitstream of a 60 Hz SVC HDTV Bitstream Subset shall be 16:9.

The frame cropping information in the SVC Sequence Parameter Sets may be used when appropriate.

Decoding: *60 Hz SVC HDTV IRDs shall support decoding and displaying pictures represented by 60 Hz SVC HDTV Bitstream Subsets in which each video sub-bitstream obeys the constraints for **aspect_ratio_idc** specified in table 11.*

60 Hz SVC HDTV IRDs shall support frame cropping.

5.8.5.6 Backwards Compatibility

Decoding: *60 Hz SVC HDTV IRDs shall be capable of decoding any bitstream that a 60 Hz H.264/AVC HDTV IRD is required to decode and resulting in the same displayed pictures as the 60 Hz H.264/AVC HDTV IRD, as described in clause 5.7.5.*

5.9 25 Hz VC-1 SDTV IRDs and Bitstreams

5.9.0 General

The video encoding and video decoding shall conform to SMPTE ST 421 [20]. Some of the parameters and fields are not used in the DVB System and these restrictions are described below. The VC-1 IRD design shall be made under the assumption that any legal structure as permitted by SMPTE ST 421 [20] and the restrictions that are specified for the VC-1 IRDs may occur in the broadcast stream even if presently reserved or unused.

5.9.1 Profile, Level and Colour Difference Format

Encoding: *25 Hz VC-1 SDTV Bitstreams shall comply with the restrictions described in SMPTE ST 421 [20] for Advanced Profile at Level 1.*

*The value of **PROFILE** shall be equal to '11' indicating Advanced Profile. The value of **LEVEL** shall be equal to '001' indicating Level 1 or, if appropriate, '000' indicating Level 0.*

Decoding: *25 Hz VC-1 SDTV IRDs shall support decoding and displaying of Advanced Profile bitstreams at Level 1 using 4:2:0 colour difference format. Support of levels beyond Level 1 is optional. If the VC-1 IRD encounters an extension which it cannot decode, it shall discard the following data until the next start code prefix (to allow backward compatible extensions to be added in the future).*

5.9.2 Frame rate

Encoding: *The frame rate in 25 Hz VC-1 SDTV Bitstreams shall be 25 Hz. This shall be indicated by setting **FRAMERATENR** to 2 and **FRAMERATEDR** to 1.*

Decoding: *25 Hz VC-1 SDTV IRDs shall support decoding and displaying video with a frame rate of 25 Hz within the constraints of Advanced Profile at Level 1. Support of other frame rates is optional.*

5.9.3 Aspect ratio

Encoding: *The source aspect ratio in 25 Hz VC-1 SDTV Bitstreams shall be either 4:3 or 16:9. The display geometry information to optimally render the decoded picture shall be signalled by an appropriate combination of **DISP_HORIZ_SIZE**, **DISP_VERT_SIZE**, **ASPECT_RATIO**, **ASPECT_HORIZ_SIZE** and **ASPECT_VERT_SIZE**.*

Decoding: *25 Hz VC-1 SDTV IRDs shall support decoding and displaying 25 Hz VC-1 SDTV Bitstreams with source aspect ratios of either 4:3 or 16:9. It is recommended that the display process use the display geometry information signalled by **DISP_HORIZ_SIZE**, **DISP_VERT_SIZE**, **ASPECT_RATIO**, **ASPECT_HORIZ_SIZE** and **ASPECT_VERT_SIZE** to optimally render the decoded picture.*

5.9.4 Luminance resolution

Encoding: *25 Hz VC-1 SDTV Bitstreams shall represent coded video with luminance resolutions as shown in table 14. Non full-screen pictures may be encoded for display at less than full-size, when using one of the standard up-conversion ratios at the 25 Hz VC-1 SDTV IRD (e.g. a horizontal resolution of 704 pixels within the 720 pixels full-screen display).*

Decoding: *25 Hz VC-1 SDTV IRDs shall be capable of decoding pictures with luminance resolutions as shown in table 14 and applying up sampling to allow the decoded pictures to be displayed at full-screen size. In addition, 25 Hz VC-1 SDTV IRDs shall be capable of decoding lower picture resolutions and displaying them at less than full-size after using one of the standard up-conversions, e.g. a horizontal resolution of 704 pixels within the 720 pixels full-screen display.*

Table 14: Resolutions for Full-screen Display from 25 Hz VC-1 SDTV IRD

Coded Picture		Displayed Picture Horizontal up sampling	
Luminance resolution (horizontal x vertical)	Source Video Aspect Ratio	4:3 Monitors	16:9 Monitors
720 x 576	4:3 16:9	x 1 x 4/3 (see note 2)	x 3/4 (see note 1) x 1
544 x 576	4:3 16:9	x 4/3 x 16/9 (see note 2)	x 1 (see note 1) x 4/3
480 x 576	4:3 16:9	x 3/2 x 2 (see note 2)	x 9/8 (see note 1) x 3/2
352 x 576	4:3 16:9	x 2 x 8/3 (see note 2)	x 3/2 (see note 1) x 2
352 x 288	4:3 16:9	x 2 x 8/3 (see note 2) (and vertical up sampling x 2)	x 3/2 (see note 1) x 2 (and vertical up sampling x 2)

NOTE 1: Up sampling of 4:3 pictures for display on a 16:9 monitor is optional in the IRD, as 16:9 monitors can be switched to operate in 4:3 mode.

NOTE 2: The up sampling with this value is applied to the pixels of the 16:9 picture to be displayed on a 4:3 monitor.

NOTE 3: It is recommended that luminance resolution of 704 pixels represents the "middle" of the picture, and that it be decoded to a 720 pixels full-screen display by placing 8 pixels of padding at each side. It is recommended that luminance resolutions, such as 352 pixels, that are natural scalings of 704 pixels, be upscaled to 704 pixels and padded as above. It is recommended that all other resolutions be scaled as indicated by the table above. Where this does not result in the expected 720 pixels full-screen display, it is recommended that the result of the scaling be clipped or padded symmetrically as required to produce a 720 pixels full-screen display.

5.9.5 Colour Parameter Information

Encoding: *The chromaticity co-ordinates of the ideal display, opto-electronic transfer characteristic of the source picture and matrix coefficients used in deriving luminance and chrominance signals from the red, green and blue primaries shall be explicitly signalled in the encoded 25 Hz VC-1 SDTV Bitstream by setting the appropriate values for each of the following 3 parameters: **COLOR_PRIM**, **TRANSFER_CHAR** and **MATRIX_COEFF**.*

It is recommended that Recommendation ITU-R BT.1700 Part B [25] colorimetry is used in the 25 Hz VC-1 SDTV bitstream, which is signalled by setting **COLOR_PRIM** to the value 5, **TRANSFER_CHAR** to the value 5 and **MATRIX_COEFF** to the value 6.

Decoding: *25 Hz VC-1 SDTV IRDs shall support decoding bitstreams with any allowed values of **COLOR_PRIM**, **TRANSFER_CHAR** and **MATRIX_COEFF**. It is recommended that appropriate processing be included for the accurate representation of pictures using Recommendation ITU-R BT.1700 Part B [25] colorimetry.*

NOTE: Previous editions of the present document referenced Recommendation ITU-R BT.470 System B, G colorimetry [i.4]. Recommendation ITU-R BT.1700 [25] replaces Recommendation ITU-R BT.470 [i.4].

5.9.6 Random Access Point

Encoding: Where channel change times are important it is recommended that a Sequence Header and Entry-Point Header are encoded at least once every 500 ms. In applications where channel change time is an issue but coding efficiency is critical, it is recommended that a Sequence Header and Entry-Point Header are encoded at least once every 2 s. For those applications where channel change time is not an issue, it is recommended that a Sequence Header and Entry-Point Header are sent at least once every 5 s.

NOTE 1: Increasing the frequency of Sequence Header and Entry-Point Header will reduce channel hopping time but will reduce the efficiency of the video compression.

NOTE 2: Having a regular interval between Entry-Point Headers may improve trick mode performance, but may reduce the efficiency of the video compression.

NOTE 3: The AU_information_descriptor described in annex D provides a means of signalling information about Random Access Points that may be used by some applications, and it is recommended that this is present.

5.10 25 Hz VC-1 HDTV IRDs and Bitstreams

5.10.0 General

The video encoding and video decoding shall conform to SMPTE ST 421 [20]. Some of the parameters and fields are not used in the DVB System and these restrictions are described below. The VC-1 IRD design shall be made under the assumption that any legal structure as permitted by SMPTE ST 421 [20] and the restrictions that are specified for the VC-1 IRDs may occur in the broadcast stream even if presently reserved or unused.

5.10.1 Profile, Level and Colour Difference Format

Encoding: 25 Hz VC-1 HDTV Bitstreams shall comply with the restrictions described in SMPTE ST 421 [20] for Advanced Profile at Level 3.

*The value of **PROFILE** shall be equal to '11' indicating Advanced Profile. The value of **LEVEL** shall be equal to '011' indicating Level 3 or, if appropriate, '010' indicating Level 2, '001' indicating Level 1 or '000' indicating Level 0.*

Decoding: 25 Hz VC-1 HDTV IRDs shall support decoding and displaying of Advanced Profile bitstreams at Level 3 using 4:2:0 colour difference format. Support of levels beyond Level 3 is optional. If the VC-1 IRD encounters an extension which it cannot decode, it shall discard the following data until the next start code prefix (to allow backward compatible extensions to be added in the future).

5.10.2 Frame rate

Encoding: The frame rate in 25 Hz VC-1 HDTV Bitstreams shall be 25 Hz or 50 Hz. This shall be indicated by setting **FRAMERATENR** to 2 or 4, as appropriate, and **FRAMERATEDR** to 1.

Decoding: 25 Hz VC-1 HDTV IRDs shall support decoding and displaying video with a frame rate of 25 Hz or 50 Hz within the constraints of Advanced Profile at Level 3. Support of other frame rates is optional.

5.10.3 Aspect ratio

Encoding: The source aspect ratio in 25 Hz VC-1 HDTV Bitstreams shall be 16:9. The display geometry information to optimally render the decoded picture shall be signalled by an appropriate combination of **DISP_HORIZ_SIZE**, **DISP_VERT_SIZE**, **ASPECT_RATIO**, **ASPECT_HORIZ_SIZE** and **ASPECT_VERT_SIZE**.

Decoding: 25 Hz VC-1 HDTV IRDs shall support decoding and displaying 25 Hz VC-1 HDTV Bitstreams with source aspect ratios of 16:9. It is recommended that the display process use the display geometry information signalled by **DISP_HORIZ_SIZE**, **DISP_VERT_SIZE**, **ASPECT_RATIO**, **ASPECT_HORIZ_SIZE** and **ASPECT_VERT_SIZE** to optimally render the decoded picture.

5.10.4 Luminance resolution

Encoding: 25 Hz VC-1 HDTV Bitstreams shall represent video with luminance resolutions as shown in table 15. Non full-screen pictures may be encoded for display at less than full-size (when using one of the standard up-conversion ratios at the 25 Hz VC-1 HDTV IRD).

Decoding: 25 Hz VC-1 HDTV IRDs shall be capable of decoding pictures with luminance resolutions as shown in table 15 and applying up sampling to allow the decoded pictures to be displayed at full-screen size.

Table 15: Resolutions for Full-screen Display from 25 Hz VC-1 HDTV IRD

Luminance resolution (horizontal × vertical)	Coded Picture	
	Source Aspect Ratio	16:9 Monitors Horizontal up sampling
1 920 × 1 080	16:9	× 1
1 440 × 1 080	16:9	× 4/3
1 280 × 1 080	16:9	× 3/2
960 × 1 080	16:9	× 2
1 280 × 720	16:9	× 1
960 × 720	16:9	× 4/3
640 × 720	16:9	× 2

5.10.5 Colour Parameter Information

Encoding: The chromaticity co-ordinates of the ideal display, opto-electronic transfer characteristic of the source picture and matrix coefficients used in deriving luminance and chrominance signals from the red, green and blue primaries shall be explicitly signalled in the encoded 25 Hz VC-1 HDTV Bitstream by setting the appropriate values for each of the following 3 parameters: **COLOR_PRIM**, **TRANSFER_CHAR** and **MATRIX_COEFF**.

It is recommended that Recommendation ITU-R BT.709 [13] colorimetry is used for all 25 Hz VC-1 HDTV Bitstreams, which is signalled by setting **COLOR_PRIM** to the value 1, **TRANSFER_CHAR** to the value 1 and **MATRIX_COEFF** to the value 1.

Decoding: 25 Hz VC-1 HDTV IRDs shall support decoding bitstreams with any allowed values of **COLOR_PRIM**, **TRANSFER_CHAR** and **MATRIX_COEFF**. It is recommended that appropriate processing be included for the accurate representation of pictures using Recommendation ITU-R BT.709 [13] colorimetry.

5.10.6 Random Access Point

Encoding: Where channel change times are important it is recommended that a Sequence Header and Entry-Point Header are encoded at least once every 500 ms. In applications where channel change time is an issue but coding efficiency is critical, it is recommended that a Sequence Header and Entry-Point Header are encoded at least once every 2 s. For those applications where channel change time is not an issue, it is recommended that a Sequence Header and Entry-Point Header are sent at least once every 5 s.

NOTE 1: Increasing the frequency of Sequence Header and Entry-Point Header will reduce channel hopping time but will reduce the efficiency of the video compression.

NOTE 2: Having a regular interval between Entry-Point Headers may improve trick mode performance, but may reduce the efficiency of the video compression.

NOTE 3: The AU_information_descriptor described in annex D provides a means of signalling information about Random Access Points that may be used by some applications, and it is recommended that this is present.

5.10.7 Backwards Compatibility

Decoding: *25 Hz VC-1 HDTV IRDs shall be capable of decoding any bitstream that a 25 Hz VC-1 SDTV IRD is required to decode and resulting in the same displayed pictures as the 25 Hz VC-1 SDTV IRD.*

5.11 30 Hz VC-1 SDTV IRDs and Bitstreams

5.11.0 General

The video encoding and video decoding shall conform to SMPTE ST 421 [20]. Some of the parameters and fields are not used in the DVB System and these restrictions are described below. The VC-1 IRD design shall be made under the assumption that any legal structure as permitted by SMPTE ST 421 [20] and the restrictions that are specified for the VC-1 IRDs may occur in the broadcast stream even if presently reserved or unused.

5.11.1 Profile and level

Encoding: *30 Hz VC-1 SDTV Bitstreams shall comply with the restrictions described in SMPTE ST 421 [20] for Advanced Profile at Level 1.*

*The value of **PROFILE** shall be equal to '11' indicating Advanced Profile. The value of **LEVEL** shall be equal to '001' indicating Level 1 or, if appropriate, '000' indicating Level 0.*

Decoding: *30 Hz VC-1 SDTV IRDs shall support decoding and displaying of Advanced Profile bitstreams at Level 1 using 4:2:0 colour difference format. Support of levels beyond Level 1 is optional. If the VC-1 IRD encounters an extension which it cannot decode, it shall discard the following data until the next start code prefix (to allow backward compatible extensions to be added in the future).*

5.11.2 Frame rate

Encoding: *The frame rate in 30 Hz VC-1 SDTV Bitstreams shall be 24 000/1 001, 24, 30 000/1 0001 or 30 Hz. This shall be indicated by setting **FRAMERATENR** to 1 or 3 and **FRAMERATEDR** to 1 or 2, as appropriate.*

Decoding: *30 Hz VC-1 SDTV IRDs shall support decoding and displaying video with a frame rates of 24 000/1 001, 24, 30 000/1 0001 or 30 Hz within the constraints of Advanced Profile at Level 1. Support of other frame rates is optional.*

5.11.3 Aspect ratio

Encoding: *The source aspect ratio in 30 Hz VC-1 SDTV Bitstreams shall be either 4:3 or 16:9. The display geometry information to optimally render the decoded picture shall be signalled by an appropriate combination of **DISP_HORIZ_SIZE**, **DISP_VERT_SIZE**, **ASPECT_RATIO**, **ASPECT_HORIZ_SIZE** and **ASPECT_VERT_SIZE**.*

Decoding: *30 Hz VC-1 SDTV IRDs shall support decoding and displaying 30 Hz VC-1 SDTV Bitstreams with source aspect ratios of either 4:3 or 16:9. It is recommended that the display process use the display geometry information signalled by **DISP_HORIZ_SIZE**, **DISP_VERT_SIZE**, **ASPECT_RATIO**, **ASPECT_HORIZ_SIZE** and **ASPECT_VERT_SIZE** to optimally render the decoded picture.*

5.11.4 Luminance resolution

Encoding: *30 Hz VC-1 SDTV Bitstreams shall represent coded video with luminance resolutions as shown in table 16. Non full-screen pictures may be encoded for display at less than full-size, when using one of the standard up-conversion ratios at the 30 Hz VC-1 SDTV IRD (e.g. a horizontal resolution of 704 pixels within the 720 pixels full-screen display).*

Decoding: *30 Hz VC-1 SDTV IRDs shall be capable of decoding pictures with luminance resolutions as shown in table 16 and applying up sampling to allow the decoded pictures to be displayed at full-screen size. In addition, 30 Hz VC-1 SDTV IRDs shall be capable of decoding lower picture resolutions and displaying them at less than full-size after using one of the standard up-conversions, e.g. a horizontal resolution of 704 pixels within the 720 pixels full-screen display.*

Table 16: Resolutions for Full-screen Display from 30 Hz VC-1 SDTV IRD

Coded Picture		Displayed Picture Horizontal up sampling	
Luminance resolution (horizontal × vertical)	Source Video Aspect Ratio	4:3 Monitors	16:9 Monitors
720 × 480	4:3 16:9	× 1 × 4/3 (see note 2)	× 3/4 (see note 1) × 1
640 × 480	4:3 16:9	× 9/8 × 3/2	× 27/32 (see note 1) × 9/8
544 × 480	4:3 16:9	× 4/3 × 16/9 (see note 2)	× 1 (see note 1) × 4/3
480 × 480	4:3 16:9	× 3/2 × 2 (see note 2)	× 9/8 (see note 1) × 3/2
352 × 480	4:3 16:9	× 2 × 8/3 (see note 2)	× 3/2 (see note 1) × 2
352 × 240	4:3 16:9	× 2 × 8/3 (see note 2) (and vertical up sampling × 2)	× 3/2 (see note 1) × 2 (and vertical up sampling × 2)

NOTE 1: Up sampling of 4:3 pictures for display on a 16:9 monitor is optional in the IRD, as 16:9 monitors can be switched to operate in 4:3 mode.

NOTE 2: The up sampling with this value is applied to the pixels of the 16:9 picture to be displayed on a 4:3 monitor.

NOTE 3: It is recommended that luminance resolution of 704 pixels represents the "middle" of the picture, and that it be decoded to a 720 pixels full-screen display by placing 8 pixels of padding at each side. It is recommended that luminance resolutions, such as 352 pixels, that are natural scalings of 704 pixels, be upscaled to 704 pixels and padded as above. It is recommended that all other resolutions be scaled as indicated by the table above. Where this does not result in the expected 720 pixels full-screen display, it is recommended that the result of the scaling be clipped or padded symmetrically as required to produce a 720 pixels full-screen display.

5.11.5 Colour Parameter Information

Encoding: *The chromaticity co-ordinates of the ideal display, opto-electronic transfer characteristic of the source picture and matrix coefficients used in deriving luminance and chrominance signals from the red, green and blue primaries shall be explicitly signalled in the encoded 30 Hz VC-1 SDTV Bitstream by setting the appropriate values for each of the following 3 parameters: **COLOR_PRIM**, **TRANSFER_CHAR** and **MATRIX_COEFF**.*

It is recommended that Recommendation ITU-R BT.1700 Part A [25] colorimetry is used for 30 Hz VC-1 SDTV bitstreams, which is signalled by setting **COLOR_PRIM** to the value 6, **TRANSFER_CHAR** to the value 6 and **MATRIX_COEFF** to the value 6.

Decoding: *30 Hz VC-1 SDTV IRDs shall support decoding bitstreams with any allowed values of **COLOR_PRIM**, **TRANSFER_CHAR** and **MATRIX_COEFF**. It is recommended that appropriate processing be included for the accurate representation of pictures using Recommendation ITU-R BT.1700 Part A [25] colorimetry.*

NOTE: Previous editions of the present document referenced SMPTE ST 170 colorimetry [i.9]. Recommendation ITU-R BT.1700 Part A [25] references SMPTE ST 170 [i.9].

5.11.6 Random Access Point

Encoding: Where channel change times are important it is recommended that a Sequence Header and Entry-Point Header are encoded at least once every 500 ms. In applications where channel change time is an issue but coding efficiency is critical, it is recommended that a Sequence Header and Entry-Point Header are encoded at least once every 2 s. For those applications where channel change time is not an issue, it is recommended that a Sequence Header and Entry-Point Header are sent at least once every 5 s.

NOTE 1: Increasing the frequency of Sequence Header and Entry-Point Header will reduce channel hopping time but will reduce the efficiency of the video compression.

NOTE 2: Having a regular interval between Entry-Point Headers may improve trick mode performance, but may reduce the efficiency of the video compression.

NOTE 3: The AU_information_descriptor described in annex D provides a means of signalling information about Random Access Points that may be used by some applications, and it is recommended that this is present.

5.12 30 Hz VC-1 HDTV IRDs and Bitstreams

5.12.0 General

The video encoding and video decoding shall conform to SMPTE ST 421 [20]. Some of the parameters and fields are not used in the DVB System and these restrictions are described below. The VC-1 IRD design shall be made under the assumption that any legal structure as permitted by SMPTE ST 421 [20] and the restrictions that are specified for the VC-1 IRDs may occur in the broadcast stream even if presently reserved or unused.

5.12.1 Profile, Level and Colour Difference Format

Encoding: *30 Hz VC-1 HDTV Bitstreams shall comply with the restrictions described in SMPTE ST 421 [20] for Advanced Profile at Level 3.*

*The value of **PROFILE** shall be equal to '11' indicating Advanced Profile. The value of **LEVEL** shall be equal to '011' indicating Level 3 or, if appropriate, '010' indicating Level 2, '001' indicating Level 1 or '000' indicating Level 0.*

Decoding: *30 Hz VC-1 HDTV IRDs shall support decoding and displaying of Advanced Profile bitstreams at Level 3 using 4:2:0 colour difference format. Support of levels beyond Level 3 is optional. If the VC-1 IRD encounters an extension which it cannot decode, it shall discard the following data until the next start code prefix (to allow backward compatible extensions to be added in the future).*

5.12.2 Frame rate

Encoding: *The frame rate in 30 Hz VC-1 HDTV Bitstreams shall be 24 000/1 001, 24, 30 000/1 0001, 30, 60 000/1 000 or 60 Hz. This shall be indicated by setting **FRAMERATENR** to 1, 3 or 5 and **FRAMERATEDR** to 1 or 2, as appropriate.*

Decoding: *30 Hz VC-1 HDTV IRDs shall support decoding and displaying video with a frame rate of 24 000/1 001, 24, 30 000/1 0001, 30, 60 000/1 000 or 60 Hz within the constraints of Advanced Profile at Level 3. Support of other frame rates is optional.*

5.12.3 Aspect ratio

Encoding: *The source aspect ratio in 30 Hz VC-1 HDTV Bitstreams shall be 16:9. The display geometry information to optimally render the decoded picture shall be signalled by an appropriate combination of **DISP_HORIZ_SIZE**, **DISP_VERT_SIZE**, **ASPECT_RATIO**, **ASPECT_HORIZ_SIZE** and **ASPECT_VERT_SIZE**.*

Decoding: *30 Hz VC-1 HDTV IRDs shall support decoding and displaying 30 Hz VC-1 HDTV Bitstreams with source aspect ratios of 16:9. It is recommended that the display process use the display geometry information signalled by **DISP_HORIZ_SIZE**, **DISP_VERT_SIZE**, **ASPECT_RATIO**, **ASPECT_HORIZ_SIZE** and **ASPECT_VERT_SIZE** to optimally render the decoded picture.*

5.12.4 Luminance resolution

Encoding: *30 Hz VC-1 HDTV Bitstreams shall represent video with luminance resolutions as shown in table 17. Non full-screen pictures may be encoded for display at less than full-size (when using one of the standard up-conversion ratios at the 30 Hz VC-1 HDTV IRD).*

Decoding: *30 Hz VC-1 HDTV IRDs shall be capable of decoding pictures with luminance resolutions as shown in table 17 and applying up sampling to allow the decoded pictures to be displayed at full-screen size.*

Table 17: Resolutions for Full-screen Display from 30 Hz VC-1 HDTV IRD

Coded Picture		
Luminance resolution (horizontal × vertical)	Source Aspect Ratio	16:9 Monitors Horizontal up sampling
1 920 × 1 080	16:9	× 1
1 440 × 1 080	16:9	× 4/3
1 280 × 1 080	16:9	× 3/2
960 × 1 080	16:9	× 2
1 280 × 720	16:9	× 1
960 × 720	16:9	× 4/3
640 × 720	16:9	× 2

5.12.5 Colour Parameter Information

Encoding: *The chromaticity co-ordinates of the ideal display, opto-electronic transfer characteristic of the source picture and matrix coefficients used in deriving luminance and chrominance signals from the red, green and blue primaries shall be explicitly signalled in the encoded 30 Hz VC-1 HDTV Bitstream by setting the appropriate values for each of the following 3 parameters: **COLOR_PRIM**, **TRANSFER_CHAR** and **MATRIX_COEFF**.*

It is recommended that Recommendation ITU-R BT.709 [13] colorimetry is used for all 30 Hz VC-1 HDTV Bitstreams, which is signalled by setting **COLOR_PRIM** to the value 1, **TRANSFER_CHAR** to the value 1 and **MATRIX_COEFF** to the value 1.

Decoding: *30 Hz VC-1 HDTV IRDs shall support decoding bitstreams with any allowed values of **COLOR_PRIM**, **TRANSFER_CHAR** and **MATRIX_COEFF**. It is recommended that appropriate processing be included for the accurate representation of pictures using Recommendation ITU-R BT.709 [13] colorimetry.*

5.12.6 Random Access Point

Encoding: Where channel change times are important it is recommended that a Sequence Header and Entry-Point Header are encoded at least once every 500 ms. In applications where channel change time is an issue but coding efficiency is critical, it is recommended that a Sequence Header and Entry-Point Header are encoded at least once every 2 s. For those applications where channel change time is not an issue, it is recommended that a Sequence Header and Entry-Point Header are sent at least once every 5 s.

NOTE 1: Increasing the frequency of Sequence Header and Entry-Point Header will reduce channel hopping time but will reduce the efficiency of the video compression.

NOTE 2: Having a regular interval between Entry-Point Headers may improve trick mode performance, but may reduce the efficiency of the video compression.

NOTE 3: The AU_information_descriptor described in annex D provides a means of signalling information about Random Access Points that may be used by some applications, and it is recommended that this is present.

5.12.7 Backwards Compatibility

Decoding: *30 Hz VC-1 HDTV IRDs shall be capable of decoding any bitstream that a 30 Hz VC-1 SDTV IRD is required to decode and resulting in the same displayed pictures as the 30 Hz VC-1 SDTV IRD.*

5.13 MVC Stereo HDTV IRDs and Bitstreams

5.13.1 Specifications common to all MVC Stereo HDTV IRDs and Bitstreams

5.13.1.0 General

The specification in this clause applies to the following IRDs and Bitstreams:

- 25 Hz MVC Stereo HDTV IRD and Bitstream;
- 30 Hz MVC Stereo HDTV IRD and Bitstream.

In addition to the constraints applicable to the H.264/AVC Stereo High Profile Level 4 of Recommendation ITU-T H.264 / ISO/IEC 14496-10 [16], the constraints listed in the following clauses apply to the MVC Stereo HDTV IRDs and Bitstreams defined in the present document.

NOTE: The H.264/AVC HDTV IRD and Bitstream specification applies to MVC Stereo IRDs and Bitstreams as far as the Base view Bitstream of an MVC Stereo HDTV Bitstream is compliant with the H.264/AVC HDTV Bitstream specification.

5.13.1.1 Introduction

The video encoding and video decoding shall conform to Recommendation ITU-T H.264 / ISO/IEC 14496-10 [16]. Some of the parameters and fields are not used in the DVB System, or they shall take certain predetermined values. These restrictions are described below.

MVC Stereo HDTV Bitstreams and IRDs shall support some parts of the "Supplemental Enhancement Information (SEI)", the "Video usability information (VUI)", the "MVC SEI messages", and the "MVC Video Usability Information extension (MVC VUI extension)" syntax elements as specified in Recommendation ITU-T H.264 / ISO/IEC 14496-10 [16], annexes D and E and clauses H.13 and H.14.

5.13.1.2 Composition of MVC Stereo HDTV Bitstreams

Encoding: *MVC Stereo HDTV Bitstreams, as defined in the present document, shall contain a single MVC Stereo Base view bitstream and a single MVC Stereo Dependent view bitstream.*

The MVC Stereo Base view bitstream and the MVC Stereo Dependent view bitstream shall be sent in separate elementary streams and on separate PIDs.

Decoding: *MVC Stereo IRDs shall support the decoding of MVC Stereo HDTV Bitstreams, for which MVC Stereo Base view bitstream and MVC Stereo Dependent view bitstream are sent in separate elementary streams and on separate PIDs.*

5.13.1.3 MVC Sequence Parameter Set and Picture Parameter Set

The clause applies to MVC Base view video only.

Encoding: *In addition to the provisions relating to the MVC Stereo High Profile set forth in Recommendation ITU-T H.264 / ISO/IEC 14496-10 [16], the following restrictions apply for the fields in the sequence parameter set:*

<i>profile_idc</i>	<i>= 100 (High Profile [16])</i>
<i>constraint_set0_flag</i>	<i>= 0</i>
<i>constraint_set1_flag</i>	<i>= 0</i>
<i>constraint_set2_flag</i>	<i>= 0</i>
<i>constraint_set3_flag</i>	<i>= 0</i>
<i>gaps_in_frame_num_value_allowed_flag</i>	<i>= 0 (gaps not allowed)</i>
<i>vui_parameters_present_flag</i>	<i>= 1</i>

Both, the pic_parameter_set_id and the seq_parameter_set_id in the MVC Base view video stream may only refer to those PPSs and SPSs present in the MVC Base view video stream. Additionally, the values of the pic_parameter_set_id and the seq_parameter_set_id parameters shall not be re-used in the MVC Dependent view video stream.

More than one PPS can be present between two MVC Stereo RAPs in the bitstream.

Multiple PPSs may be present in an MVC Stereo RAP access unit. *Additionally, the following constraints apply:*

- *there shall be at least one and at most 30 PPSs in the first dependent unit in a coded video sequence;*
- *there shall be one or zero PPSs in each dependent unit, except for the first dependent unit in a coded video sequence.*

5.13.1.4 pic_width_in_mbs_minus1 and pic_height_in_map_units_minus1

Encoding: *The values of pic_width_in_mbs_minus1 and pic_height_in_map_units_minus1 shall not change in an MVC Stereo HDTV Bitstream and they shall take the same value in the Base and Dependent view bitstreams.*

If the number of samples per row of the luminance component of the source picture for any MVC view component is not an integer multiple of 16 and additional samples are padded to make the number of samples per row of the luminance component an integer multiple of 16, it is recommended that these samples are padded at the right side of the picture.

If the number of samples per column of the luminance component of the source picture for any MVC view component is not an integer multiple of 16 and additional samples are padded to make the number of samples per column of the luminance component an integer multiple of 16, it is recommended that these samples are padded at the bottom of the picture.

5.13.1.5 Subset Sequence Parameter Set

Encoding: *In addition to the provisions set forth in Recommendation ITU-T H.264 / ISO/IEC 14496-10 [16], the following restrictions shall apply for the fields in the subset sequence parameter sets (nal_unit_type is equal to 15):*

<i>mvc_vui_parameters_present_flag</i>	<i>= 1</i>
---	------------

In embedded sequence_parameter_set_data():

profile_idc = 128 (Stereo High Profile [16])

In embedded seq_parameter_set_mvc_extension():

num_level_values_signalled_minus1 = 0

In embedded mvc_vui_parameters_extension():

vui_mvc_num_ops_minus1 = 0

vui_mvc_low_delay_hrd_flag = 0 (if present)

vui_mvc_pic_struct_present_flag = 0/1 (same value as 'pic_struct_present_flag' SPS of Base view)

The SPS encoded in the Subset SPS shall take the same values as the SPS of the Base view, with the exception of seq_parameter_set_id, and profile_idc. Exactly one Subset SPS shall be provided in the first Dependent view component of every coded video sequence (in decoding order). This Subset SPS is referenced by all PPSs in a coded video sequence and no other Subset SPS shall appear in a coded video sequence.

5.13.1.6 Video Usability Information

5.13.1.6.0 General

In addition to the requirements specified in clause 5.5.3, the VUI parameters, vui_parameters(), which are encoded in SPS in Subset SPS for MVC Dependent view video stream, shall have the same values as the VUI parameters in SPS of the corresponding MVC Base view video stream, except for the following parameter, which if present, may take different values:

- hrd_parameters()
- max_dec_frame_buffering
- num_reorder_frames
- max_bytes_per_pic_denom

5.13.1.6.1 MVC VUI parameters

The MVC VUI parameters extension (mvc_vui_parameters_extension()), shall be present in the Dependent view bitstream and encoded in the Subset SPS, and they shall have the same values as VUI parameters in SPS for corresponding view bitstream except for the following parameters, which, if present, may take different values:

- hrd_parameters()

5.13.1.6.2 Aspect Ratio

Encoding: *The source aspect ratio in MVC Stereo HDTV Bitstreams shall be 16:9. The aspect ratio shall be the same for Base view and Dependent view video.*

*The source aspect ratio information shall be derived from the **aspect_ratio_idc** value in the Video Usability Information (see values of **aspect_ratio_idc** in Recommendation ITU-T H.264 / ISO/IEC 14496-10 [16], table E-1).*

The frame cropping information in the Sequence Parameter Set may be used when appropriate.

Decoding: *MVC Stereo HDTV IRDs shall support decoding and displaying MVC Stereo HDTV Bitstreams with the values of **aspect_ratio_idc** as specified in table 18.*

*The source aspect ratio information shall be derived from the **pic_height_in_map_units_minus1** and the **pic_width_in_mbs_minus1** and the frame cropping information coded in the Sequence Parameter Set as well as the sample aspect ratio encoded with the **aspect_ratio_idc** value in the Video Usability Information (see values of **aspect_ratio_idc** in Recommendation ITU-T H.264 / ISO/IEC 14496-10 [16], table E-1).*

MVC Stereo HDTV IRDs shall support frame cropping for the resolutions specified in table 18.

5.13.1.6.3 Colour Parameter Information

Encoding: *The chromaticity coordinates of the ideal display, opto-electronic transfer characteristic of the source picture and matrix coefficients used in deriving luminance and chrominance signals from the red, green and blue primaries shall be explicitly signalled in each of the encoded MVC Stereo Base view and Dependent view bitstreams by setting the appropriate values for each of the following 3 parameters in the VUI: **colour_primaries**, **transfer_characteristics**, and **matrix_coefficients**.*

These parameters shall take the same values for Base and Dependent view components.

It is recommended that Recommendation ITU-R BT.709 [13] colorimetry is used for all MVC Stereo HDTV bitstreams, which is signalled by setting **colour_primaries** to the value 1, **transfer_characteristics** to the value 1 and **matrix_coefficients** to the value 1.

Decoding: *MVC Stereo HDTV IRDs shall be capable of decoding MVC Bitstreams with any allowed values of **colour_primaries**, **transfer_characteristics** and **matrix_coefficients**. It is recommended that appropriate processing be included for the accurate representation of pictures using Recommendation ITU-R BT.709 [13] colorimetry.*

5.13.1.6.4 Luminance Resolution

Encoding: *MVC Stereo HDTV Bitstreams shall represent video with luminance resolutions as shown in table 18. Non full-screen pictures may be encoded for display at less than full-size (when using one of the standard up-conversion ratios at the MVC Stereo HDTV IRD).*

Decoding: *MVC Stereo HDTV IRDs shall be capable of decoding pictures with luminance resolutions as shown in table 18 and applying up sampling to allow the decoded pictures to be displayed at full-screen size.*

Table 18: Resolutions for Full-screen Display from MVC Stereo HDTV IRD

Coded Picture			
Luminance resolution (horizontal x vertical)	Source Aspect Ratio	aspect_ratio_idc	16:9 Monitors Horizontal up sampling
1 920 x 1 080	16:9	1	x 1
1 440 x 1 080	16:9	14	x 4/3
1 280 x 1 080	16:9	15	x 3/2
960 x 1 080	16:9	16	x 2
1 280 x 720	16:9	1	x 1
960 x 720	16:9	14	x 4/3
640 x 720	16:9	16	x 2

5.13.1.7 HRD Conformance

The MVC Stereo Dependent view video bitstream shall conform to Type 2 (NAL level) HRD conformance, with output timing conformance.

*The HRD parameters (*hrd_parameters()*), if present in VUI parameters (*vui_parameters()*), in SPS encoded in Subset SPS for MVC Stereo Dependent view video stream shall fulfill HRD conformance for the MVC Stereo Dependent view component.*

The HRD parameters (*hrd_parameters()*), if present in MVC VUI parameters encoded in Subset SPS, (*mvc_vui_parameters_extension()*) shall conform to HRD conformance for both MVC Stereo Base view component and MVC Stereo Dependent view component as MVC Stereo access unit. In other words, the timing for decoding and presentation shall be the same for Base and Dependent view components, even though the specific values for the *hrd_parameters()* might be different.

NOTE: As pointed out below, HRD parameters in *vui_parameters()*, when present, might be different from those HRD parameters in *mvc_vui_parameters_extensions()*.

Furthermore, for each of these view components independently, and within the accuracy of their respective clocks, the Decoding Time Stamp and Presentation Time Stamp shall indicate the same instant in time as the nominal CPB removal time and the DPB output time in the HRD respectively when picture timing SEI information is transmitted (per clause 2.4.3.7 of Recommendation ITU-T H.222.0 / ISO/IEC 13818-1 [1]). This ensures consistency between the STD model of Recommendation ITU-T H.222.0 / ISO/IEC 13818-1 [1] and the HRD model of Recommendation ITU-T H.264 / ISO/IEC 14496-10 [16].

5.13.1.8 Supplemental Enhancement Information

5.13.1.8.0 General

In addition to the requirements specified in clause 5.5.4, the IRD shall support the use of the following message type, which shall be sent in MVC Stereo Base view component:

- Multiview View Position SEI message, which is used to indicate which of base or dependent view corresponds to the left or right eye, as well as to indicate that the MVC Base view component containing the SEI message is part of an MVC Stereo HDTV bitstream and as such is associated to an MVC Dependent view component. Clause 5.13.1.8.3 gives further details on the Multiview View Position SEI message.

Furthermore, the IRD shall support the use of the following message type, which shall only be sent in MVC Stereo Dependent access units:

- Scalable Nesting SEI Message.

Additionally, the following applies:

- The IRD may support the use of the **multi_region_disparity** message, as specified in clause B.11, which, when present in the MVC Stereo HDTV Bitstream, shall be included in a "User data registered by Recommendation ITU-T T.35 [19] SEI message" contained in an MVC scalable nesting SEI message, and which shall be sent for every MVC Stereo Dependent view component.
- When Buffering Period SEI and/or Picture Timing SEI are encoded in the MVC Stereo Base view bitstream, same SEIs shall be encoded in the MVC scalable nesting SEI message of the MVC Stereo Dependent view bitstream with the same values, except for **seq_parameter_set_id**, which shall be different.
- If decoded reference picture marking syntax is repeated using a Decoded reference picture marking repetition SEI message in a MVC Stereo Base view component, then the same syntax shall be repeated in the Corresponding view component of the MVC Stereo Dependent view bitstream by using a Decoded reference picture marking repetition SEI.
- All SEI messages present for the Dependent view shall be placed inside the MVC scalable nesting SEI message.

5.13.1.8.1 Prohibited SEI messages

The following SEI messages shall not be present in the MVC Base view bitstream:

- Non-required view component SEI message (since all (two) views are used).
- View dependency change SEI message (because there is just one dependent view).
- MVC scalable nesting SEI message (because operating points are not used in MVC Stereo High Profile).

- User data registered by Recommendation ITU-T T.35 [19] SEI message containing the message `multi_region_disparity()`.

The following SEI messages shall not be present in the MVC Dependent view bitstream:

- *The MVC Dependent view bitstream shall not contain any SEI message outside the MVC scalable nesting SEI message.*
- *Following SEI messages shall not be present in the MVC scalable nesting SEI message:*
 - *Stereo video information SEI message.*
 - *Pan-scan rectangle SEI message.*
 - *Non-required view component SEI message.*
 - *View dependency change SEI message.*
 - *Multiview View Position SEI message (because it is already transmitted in the MVC Base view bitstream).*

5.13.1.8.2 Order of SEI Messages

SEI messages in the dependent unit shall be stored in the following order:

- MVC scalable nesting SEI message containing a Buffering period SEI message (if present).
- MVC scalable nesting SEI message containing a "User data registered by Recommendation ITU-T T.35 [19] SEI message", which itself contains the message `multi_region_disparity()` as defined in clause B.11. Multi region disparity may be sent in the Dependent view bitstream for each access unit.
- Other SEI messages in the MVC scalable nesting SEI message (if present).

5.13.1.8.3 Multiview View Position SEI message

Encoding: *The Multiview View Position SEI message shall be present in every access unit of an MVC Stereo Base view bitstream.*

Its presence signals that the H.264/AVC access unit containing the SEI message is an MVC Stereo Base view component associated to an MVC Stereo Dependent view component.

The Multiview View Position SEI message associates the base and dependent view to the left and right eye.

*The value of the syntax element **num_views_minus1** shall be set to '1'.*

Decoding: *MVC Stereo IRDs shall support the Multiview View Position SEI message.*

*MVC Stereo IRDs shall ignore Multiview View Position SEI messages with a value of **num_views_minus1** not equal to '1'.*

5.13.1.9 Random Access Point

5.13.1.9.0 General

The definition for MVC Stereo RAP in clause 3 shall apply.

Encoding: The time interval between MVC Stereo RAPs may vary between programs and also within a program. The broadcast requirements should set the time interval between MVC Stereo RAPs as specified in clause 5.13.1.9.1.

NOTE: The `AU_information_descriptor` described in annex D provides a means of signalling information about Random Access Points that may be used by some applications, and it is recommended that this is present.

The AU_information_descriptor may be present in the Base view bitstream and it shall not be present in the Dependent view bitstream.

All pictures with PTS greater than or equal to PTS(rap) shall be fully reconstructible and displayable, where PTS(rap) represents the Presentation Time Stamp of the picture of the MVC Stereo RAP. This means that decoders receiving the RAP shall not need to utilize data transmitted prior to the RAP to decode pictures displayed after the RAP, at either Base or Dependent view. See clause I.1 for details.

To improve applications such as channel change, it is recommended that the Presentation Time Stamp of the picture of MVC Stereo RAP be less than or equal to $[DTS(rap) + 0,5 \text{ seconds}]$ where DTS(rap) represents the Decoding Time Stamp of the picture of MVC Stereo RAP.

Packetization of random access points shall comply with the following additional rule:

*A transport packet containing the PES header of an MVC Stereo RAP or an MVC Stereo random access view component shall have an adaptation field. The **payload_unit_start_indicator** bit shall be set to "1" in the transport packet header and the **adaptation_field_control** bits shall be set to "11" (as per Recommendation ITU-T H.222.0 / ISO/IEC 13818-1 [1]). In addition, the **random_access_indicator** bit in the adaptation header shall be set to "1". The **elementary_stream_priority_indicator** bit shall also be set to "1" in the same adaptation header if this transport packet contains the slice start code of the MVC Stereo Base view component (see clauses 4.1.5.1 and 4.1.5.2).*

Decoding: *MVC Stereo IRDs shall be able to start decoding and displaying an MVC Stereo Bitstream at an MVC Stereo RAP.*

5.13.1.9.1 Time Interval Between RAPs

Encoding: *The encoder shall place MVC Stereo RAPs in the MVC Stereo bitstream at least once every 5 s. It is recommended that MVC Stereo RAPs occur in the MVC Stereo bitstream on average at least every 2 s. Where rapid channel change times are important or for applications such as PVR it may be appropriate for MVC Stereo RAPs to occur more frequently, such as every 500 ms. The time interval between successive RAPs shall be measured as the difference between their respective DTS values.*

NOTE 1: Decreasing the time interval between MVC Stereo RAPs may reduce channel hopping time and improve trick modes, but may reduce the efficiency of the video compression.

NOTE 2: Having a regular interval between MVC Stereo RAPs may improve trick mode performance, but may reduce the efficiency of the video compression.

NOTE 3: 3D trick-modes should be used with care, as they might cause the rendered video to deviate from the recommended production guidelines (e.g. fast-forwarding of 3D video).

5.13.1.10 Additional constraints

5.13.1.10.1 Constraints Common to Base and Dependent Views

In addition to Base and Dependent view adopting the same values (except if noted otherwise) for the parameters as described in previous clauses, the following parameter values shall not change for the duration of the presentation:

- *level_idc, which shall be equal to '40'.*
- *frame-rate, which shall be derived from $time_scale / num_units_in_tick / 2$.*
- *Coded Picture Buffer size (CPB), CpbSize[cpb_cnt_minus1], derived from cpb_size_scale and cpb_size_value_minus1, when hrd_parameters() are present).*
- *Maximum input bit-rate to the CPB. The maximum input bitrate is BitRate[cpb_cnt_minus1], derived from bit_rate_scale and bit_rate_value_minus1, when hrd_parameters() is present.*

NOTE: Base and Dependent views may have different values for hrd_parameters(), see clause 5.13.1.8.

- `frame_mbs_only_flag`.
- `entropy_coding_mode_flag`. *The `entropy_coding_mode_flag` shall have the same value for base and dependent view and shall not change in the bitstream.*
- `view_id` in the `nal_unit_header_mvc_extension()` in the Dependent view bitstream, which shall take a value different from zero. *View_id shall be set to zero, '0', for the Base view video, see clause 5.13.1.10.2.1.*

5.13.1.10.2 MVC Stereo Base view constraints

5.13.1.10.2.1 Prohibited NAL units

Following NAL units shall not be present in the MVC Stereo Base view component video for reasons of backwards-compatibility:

- Prefix NAL unit, `nal_unit_type` = 14: this NAL unit is specified in Recommendation ITU-T H.264 / ISO/IEC 14496-10 [16] to convey the `nal_unit_header_mvc_extension()` for MVC Base view video. However, the use of this NAL unit is disallowed for DVB services. *Therefore, the following constant values shall be assumed for the parameters in the `nal_unit_header_mvc_extension()`:*
 - **`non_idr_flag`** shall be set according to **`nal_unit_type`** of corresponding Base view component. E.g. if **`nal_unit_type`** of Base view component is set to '5' (IDR picture), **`non_idr_flag`** shall be set to '0', otherwise **`non_idr_flag`** shall be set to '1'.
 - **`priority_id`** shall be set to '0' (highest priority).
 - **`view_id`** shall be set to '0' (base view).
 - **`temporal_id`** in the Base and Dependent view components shall be set to the same value.
 - **`anchor_pic_flag`** in the Base and Dependent view components shall be set to the same value.
 - **`inter_view_flag`** shall be set to '1'.
- Coded slice extension NAL unit, `nal_unit_type` = 20.
- Subset Sequence Parameter set NAL unit, `nal_unit_type` = 15.

5.13.1.10.3 MVC Stereo Dependent view constraints

5.13.1.10.3.0 General

In the Coded slice extension NAL unit, `nal_unit_type` = 20, the `svc_extension_flag` shall be set to '0', meaning dependent video bitstream complies with annex H of Recommendation ITU-T H.264 / ISO/IEC 14496-10 [16].

Furthermore, the following clauses apply.

5.13.1.10.3.1 Prohibited NAL units

The following NAL units shall not be present in the MVC Stereo Dependent view component video for reasons of backwards-compatibility:

- Access unit delimiter NAL unit, `nal_unit_type` = 9.
- Sequence parameter set extension NAL unit, `nal_unit_type` = 13.
- Coded slice of the auxiliary coded picture without partitioning NAL unit, `nal_unit_type` = 19.

5.13.1.11 Access Unit Structure

For MVC Base view video, the AU structure is that of the H.264/AVC video, as per the present document.

For MVC Dependent view video, figure 1 shows an overview of the Dependent Unit structure for the first and subsequent Units in a coded video sequence.

First Dependent AU in coded video sequence

View Component of Dependent View

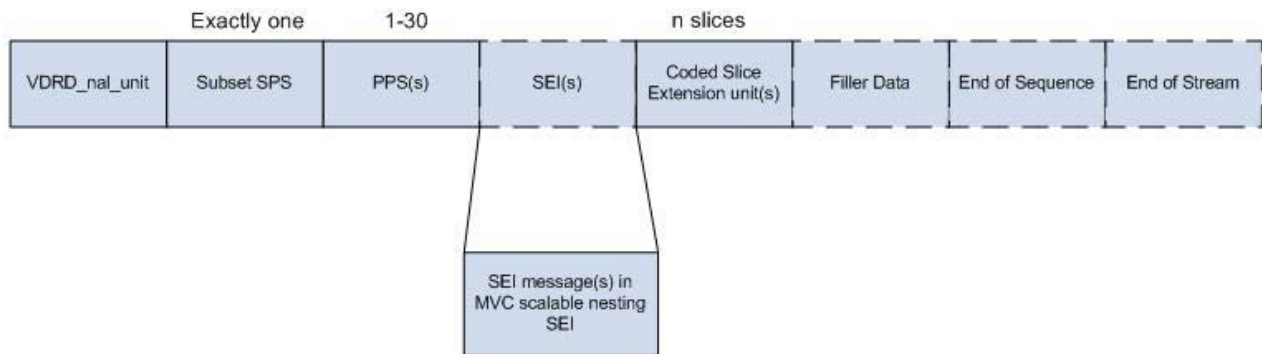

Subsequent Dependent AU in coded video sequence

View Component of Dependent View

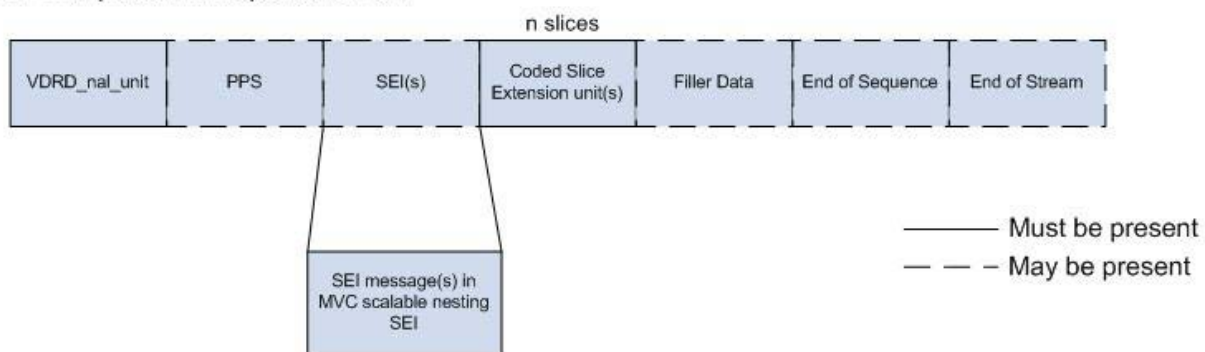

Figure 1: AU Structure for Dependent video

The first Dependent Unit in a coded video sequence of shall be composed of following NAL units, which shall be present in this order:

- View and dependency representation delimiter NAL unit, VDRD_nal_unit (nal_unit_type = 24).
- Exactly one Subset SPS NAL unit.
- One or more PPS NAL units.
- One or more SEI NAL units (if present).
- One or more coded slice extension NAL unit(s) (nal_unit_type = 20) as required by number of slices in the anchor picture.
- A Filler data NAL unit (if required).
- An End of sequence NAL unit (if applicable).
- An End of stream NAL unit (if applicable).

Any subsequent Dependent Units in a coded video sequence of MVC Dependent view video shall have following NAL units, in this order:

- Exactly one View and dependency representation delimiter NAL unit (nal_unit_type = 24).
- One or zero PPS NAL units.
- One or more SEI NAL units, if present.
- Following NAL unit is repeated by number of slices:
 - Coded slice extension NAL unit(s), i.e. coded slice of an anchor picture or a non-anchor picture.
- A Filler data NAL unit (if required).
- An End of sequence NAL unit (if applicable).
- An End of stream NAL unit (if applicable).

NOTE: Filler data NAL unit can be placed in any position unless it precedes the first slice NAL unit.

When an End of sequence NAL unit exists in MVC Stereo Base view component, an End of sequence NAL unit shall exist in MVC Stereo Dependent view component in a same access unit.

When an End of stream NAL unit exists in MVC Stereo Base view component, an End of stream NAL unit shall exist in MVC Stereo Dependent view component in a same access unit.

5.13.2 25 Hz MVC Stereo HDTV IRD and Bitstream

5.13.2.0 General

This clause specifies the 25 Hz MVC Stereo HDTV IRD and Bitstream. All specifications in clauses 5.5 and 5.13.1 shall apply.

5.13.2.1 Profile and level

Encoding: 25 Hz MVC Stereo HDTV Bitstreams shall comply with the Stereo High Profile Level 4 restrictions, as specified in Recommendation ITU-T H.264 / ISO/IEC 14496-10 [16].

The value of *level_idc* shall be equal to 40. Base and Dependent view bitstreams shall have the same *level_idc* value.

Decoding: 25 Hz MVC Stereo HDTV IRDs shall support the decoding of Stereo High Profile Level 4 bitstreams. This requirement includes support for Stereo High Profile and levels 3 to 4. Support for profiles and levels other than High Profile Level 3 to 4 is optional. If the 25 Hz MVC Stereo HDTV IRD encounters an extension which it cannot decode, it shall discard the following data until the next start code prefix (to allow backward compatible extensions to be added in the future).

5.13.2.2 Frame rate

Encoding: The frame rate shall be 25 Hz or 50 Hz. This shall be indicated in the VUI by setting *time_scale* and *num_units_in_tick* according to table 12. *Time_scale* and *num_units_in_tick* define the picture rate of the video. The source video format for 50 Hz frame rate material shall be progressive. The source video format for 25 Hz frame rate material shall be interlaced or progressive.

Decoding: 25 Hz MVC Stereo HDTV IRDs shall support decoding and displaying video with a frame rate of 25 Hz interlaced or progressive, or 50 Hz progressive within the constraints of High Profile at Level 4.

Support of other frame rates is optional.

5.13.2.3 Backwards Compatibility

Decoding: *25 Hz MVC Stereo HDTV IRDs shall be capable of decoding any bitstream that a 25 Hz H.264/AVC SDTV IRD and a H.264/AVC HDTV IRD are required to decode and resulting in the same displayed pictures as the 25 Hz H.264/AVC SDTV IRD and 25 Hz H.264/AVC HDTV IRD, as described in clauses 5.6.2 and 5.7.2.*

5.13.3 30 Hz MVC Stereo HDTV IRD and Bitstream

5.13.3.0 General

This clause specifies the 30 Hz MVC Stereo HDTV IRD and Bitstream. *All specifications in clauses 5.5 and 5.13.1 shall apply.* The specification in the remainder of this clause only applies to the 30 Hz MVC Stereo HDTV IRD and Bitstream.

5.13.3.1 Profile and level

Encoding: *30 Hz MVC Stereo HDTV sub-bitstreams shall comply with the Stereo High Profile Level 4 restrictions, as specified in Recommendation ITU-T H.264 / ISO/IEC 14496-10 [16].*

*The value of **level_idc** shall be equal to 40.*

Decoding: *30 Hz MVC Stereo HDTV IRDs shall support the decoding of Stereo High Profile Level 4 bitstreams. This requirement includes support for Stereo High Profile and levels 3 to 4. Support for profiles and levels other than Stereo High Profile, Level 3 to 4 is optional. If the 30 Hz MVC Stereo HDTV IRD encounters an extension which it cannot decode, it shall discard the following data until the next start code prefix (to allow backward compatible extensions to be added in the future).*

5.13.3.2 Frame rate

Encoding: *The frame rate shall be 24 000/1 001, 24, 30 000/1 001, 30, 60 000/1 001 or 60 Hz. This shall be indicated in the VUI by setting **time_scale** and **num_units_in_tick** according to table 13. Time_scale and num_units_in_tick define the picture rate of the video. The source video format for 24 000/1 001, 24, 60 000/1 001 and 60 Hz frame rate material shall be progressive. The source video format for 30 000/1 001 and 30 Hz frame rate material shall be interlaced or progressive.*

Decoding: *30 Hz MVC Stereo HDTV IRDs shall support decoding and displaying video with a frame rate of 30 000/1 001, 30 Hz interlaced or progressive, or 24 000/1 001, 24, 60 000/1 001 or 60 Hz progressive within the constraints of High Profile at Level 4.*

Support of other frame rates is optional.

5.13.3.3 Backwards Compatibility

Decoding: *30 Hz MVC Stereo HDTV IRDs shall be capable of decoding any bitstream that a 30 Hz H.264/AVC SDTV IRD and a 30 Hz H.264/AVC SDTV IRD are required to decode and resulting in the same displayed pictures as the 30 Hz H.264/AVC SDTV IRD and 30 Hz H.264/AVC SDTV IRD, as described in clauses 5.7.2 and 5.7.3.*

5.14 HEVC IRDs and Bitstreams

5.14.1 Specifications Common to all HEVC IRDs and Bitstreams

5.14.1.0 Scope

The specification in clause 5.14 applies to the following IRDs and bitstreams:

- HEVC HDTV IRD and Bitstream;

- HEVC UHD TV IRD and Bitstream;
- HEVC HDR UHD TV IRD and Bitstream;
- HEVC HDR HDTV Bitstream;
- HEVC HDR HFR UHD TV IRD and Bitstream;
- HEVC HDR UHD TV2 IRD and Bitstream.

Clause 5.14 specifies HEVC IRD conformance points and HEVC Bitstream conformance points for UHD TV as listed in table 18a and table 18b. Compliant HEVC IRDs may combine several of the capabilities from table 18a.

Table 18a: HEVC IRD conformance points specified in the present document

HEVC IRD type	Relevant clauses
50 Hz HEVC HDTV 8-bit IRD	5.14.1 (with constraints set as documented for 50 Hz HEVC HDTV IRDs in 5.14.1.7) 5.14.2 (with constraints set as documented for HEVC HDTV 8-bit IRDs in 5.14.2.1)
60 Hz HEVC HDTV 8-bit IRD	5.14.1 (with constraints set as documented for 60 Hz HEVC HDTV IRDs in 5.14.1.7) 5.14.2 (with constraints set as documented for HEVC HDTV 8-bit IRDs in 5.14.2.1)
50 Hz HEVC HDTV 10-bit IRD	5.14.1 (with constraints set as documented for 50 Hz HEVC HDTV IRDs in 5.14.1.7) 5.14.2 (with constraints set as documented for HEVC HDTV 10-bit IRDs in 5.14.2.1)
60 Hz HEVC HDTV 10-bit IRD	5.14.1 (with constraints set as documented for 60 Hz HEVC HDTV IRDs in 5.14.1.7) 5.14.2 (with constraints set as documented for HEVC HDTV 10-bit IRDs in 5.14.2.1)
HEVC UHD TV IRD	5.14.1 5.14.3
HEVC HDR UHD TV IRD using HLG10	5.14.1 5.14.4 (with constraints set as documented for HLG10 in 5.14.4.2)
HEVC HDR UHD TV IRD using PQ10	5.14.1 5.14.4 (with constraints set as documented for PQ10 in 5.14.4.3)
HEVC HDR HFR UHD TV IRD using HLG10	5.14.1 5.14.5 (with constraint set as documented for HLG10)
HEVC HDR HFR UHD TV IRD using PQ10	5.14.1 5.14.5 (with constraints set as documented for PQ10)
HEVC HDR UHD TV2 IRD	5.14.1 5.14.6

Table 18b: HEVC UHD TV Bitstream conformance points specified in the present document and the IRDs capable to decode them (where "yes" means that the IRD can decode the Bitstream and "no" means that the IRD cannot decode the Bitstream)

UHD TV Bitstream conformance points	HEVC UHD TV IRD	HEVC HDR UHD TV IRD using HLG10	HEVC HDR UHD TV IRD using PQ10	HEVC HDR HFR UHD TV IRD using HLG10	HEVC HDR HFR UHD TV IRD using PQ10	HEVC HDR UHD TV2 IRD
SDR Frame Rate up to 60 Hz Resolution up to 3 840 x 2 160	yes	yes	yes	yes	yes	yes
HDR with PQ10 Frame Rate up to 60 Hz Resolution up to 3 840 x 2 160	no	no	yes	no	yes	yes
HDR with HLG10 Frame rate up to 60 Hz Resolution up to 3 840 x 2 160	yes, but as SDR	yes	yes, but as SDR	yes	yes, but as SDR	yes
SDR HFR with single PID Resolution up to 3 840 x 2 160	no	no	no	yes	yes	no
HDR with PQ10 HFR with single PID Resolution up to 3 840 x 2 160	no	no	no	no	yes	no
HDR with HLG10 HFR with single PID Resolution up to 3 840 x 2 160	no	no	no	yes	yes, but as SDR	no
SDR HFR with dual PID and temporal scalability Resolution up to 3 840 x 2 160	yes, but at half frame rate	yes, but at half frame rate	yes, but at half frame rate	yes	yes	yes, but at half frame rate
HDR with PQ10 HFR with dual PID and temporal scalability Resolution up to 3 840 x 2 160	no	no	yes, but at half frame rate	no	yes	yes, but at half frame rate
HDR with HLG10 HFR with dual PID and temporal scalability Resolution up to 3 840 x 2 160	yes, but as SDR and at half frame rate	yes, but at half frame rate	yes, but as SDR and at half frame rate	yes	yes, but as SDR	yes, but at half frame rate
SDR Frame Rate up to 60 Hz Resolution up to 7 680 x 4 320	no	no	no	no	no	yes
HDR with PQ10 Frame Rate up to 60 Hz Resolution up to 7 680 x 4 320	no	no	no	no	no	yes
HDR with HLG10 Frame Rate up to 60 Hz Resolution up to 7 680 x 4 320	no	no	no	no	no	yes

5.14.1.1 General

The video encoding and video decoding shall conform to Recommendation ITU-T H.265 / ISO/IEC 23008-2 [35]. Some of the parameters and fields are not used in the DVB System and these restrictions are described below. HEVC Bitstreams and IRDs shall support some parts of the "Supplemental Enhancement Information (SEI)" and the "Video usability information (VUI)" syntax elements as specified in Recommendation ITU-T H.265 / ISO/IEC 23008-2 [35], annexes D and E. The HEVC IRD design shall be made under the assumption that any structure conforming to Recommendation ITU-T H.265 / ISO/IEC 23008-2 [35] and the restrictions that are specified for the HEVC IRDs may occur in the broadcast stream even if presently reserved or unused.

5.14.1.2 Video Parameter Set

Decoding: HEVC IRDs conforming to the present document may ignore the content of all VPS NAL units as defined in Recommendation ITU-T H.265 / ISO/IEC 23008-2 [35], clause 7.4.3.1. *Where the value of syntax elements in the VPS differ from those carried in or derived from the SPS, the SPS values (including derived values) shall take precedence.*

NOTE: Future versions of the present document may require use of the video parameter set, hence future IRDs may be required to process the video parameter set.

5.14.1.3 Sequence Parameter Set

Encoding: *The time interval between two successive changes in **general_profile_idc**, **general_tier_flag** or **level_idc** carried in the HEVC_descriptor shall be greater than or equal to one second.*

*When the value of **pic_height_in_luma_samples** is changed between 1 080 and 540, and the picture rate is changed between 25 and 50 or 30 000/1 001 and 60 000/1 001, **sps_max_num_reorder_pics[temporal_id_max]**, where **temporal_id_max** is signalled in the HEVC video descriptor, expressed in seconds shall be kept constant.*

*The value of **no_output_of_prior_pics_flag** shall be provided in the bitstream and not assumed to be inferred by the decoder.*

NOTE 1: Limiting the frequency of profile, tier or level changes is to constrain the IRD complexity, while enabling seamless switching between field and frame decoding when processing HEVC Bitstreams of interlaced video content. In addition, the recommended signalling is provided in order to help the IRD to perform a continuous "bumping" process (described in clause C.5.2.4 of Recommendation ITU-T H.265 / ISO/IEC 23008-2 [35]) at a frame and field transition.

If padding is required to align the number of samples per row, it is recommended that these samples are padded at the right side of the picture.

If padding is required to align the number of samples per column, it is recommended that these samples are padded at the bottom of the picture.

NOTE 2: Video formats with vertical sizes of 1 080 lines can be coded as either 1 080 lines or 1 088 lines with a conformance cropping window of 1 080 lines. If 1 088 lines is used to code 1 080 line pictures, the conformance cropping window is defined with **conf_win_top_offset** equal to 0 and **conf_win_bottom_offset** equal to 4. The formula to determine the number of lines to crop from the bottom is $\text{SubHeightC} \times \text{conf_win_bottom_offset}$ and **SubHeightC** has a value of 2 when **chroma_format_idc** equal 1.

Decoding: *When the value of **pic_height_in_luma_samples** is changed between 1 080 and 540, and the picture rate is changed between 25 and 50 or 30 000/1 001 and 60 000/1 001, the variable **NoOutputOfPriorPicsFlag** shall not be inferred to be equal to 1 and shall be set to the value of **no_output_of_prior_pics_flag**.*

*When **conformance_window_flag** is equal to 1, HEVC IRDs shall apply the conformance cropping window signalled with **conf_win_left_offset**, **conf_win_right_offset**, **conf_win_top_offset**, and **conf_win_bottom_offset**, as specified in Recommendation ITU-T H.265 / ISO/IEC 23008-2 [35], clause 7.4.3.2.*

5.14.1.4 Picture Parameter Set

Encoding: More than one picture parameter set can be present in the bitstream between two HEVC DVB_RAPs. *Between two HEVC DVB_RAPs, the content of a picture parameter set with a particular **pps_pic_parameter_set_id** shall not change. I.e. if more than one picture parameter set is present in the bitstream and these picture parameter sets are different from each other, then each picture parameter set shall have a different **pps_pic_parameter_set_id**.*

5.14.1.5 Video Usability Information

5.14.1.5.0 General

Encoding: *HEVC Bitstreams shall set **vui_parameters_present_flag** to 1 in the active Sequence Parameter Set, i.e. HEVC Bitstreams shall contain a Video Usability Information syntax structure.*

In the hrd_parameters, if present, the following restrictions shall apply:

sub_pic_hrd_params_present_flag = 0

Decoding: *The HEVC IRD shall support the use of Video Usability Information of the following syntax elements:*

- Aspect Ratio Information (**aspect_ratio_idc**);
- Overscan Information (**overscan_appropriate_flag**);
- Video Range (**video_full_range_flag**);
- Colour Parameter Information (**colour_primaries**, **transfer_characteristics**, and **matrix_coeffs**);
- Chrominance Information (**chroma_loc_info_present_flag**, **chroma_sample_loc_type_top_field** and **chroma_sample_loc_type_bottom_field**);
- Picture Structure Information (**frame_field_info_present_flag**);
- Default Display Window (**default_display_window_flag**, **def_disp_win_left_offset**, **def_disp_win_right_offset**, **def_disp_win_top_offset** and **def_disp_win_bottom_offset**);
- Timing information (**vui_time_scale** and **vui_num_units_in_tick**).

5.14.1.5.1 Aspect Ratio and Overscan Information

Encoding: *The display aspect ratio of the HEVC coded frame, after conformance cropping is applied, shall be 16:9. Where source images of other aspect ratios, such as letterboxed or pillarboxed, are formatted within 16:9 frames, signalling of AFD/Bar data documented in annex B, and Default Display Window documented in clause 5.14.1.5.6, are recommended. However, if AFD/Bar Data signalling documented in annex B does lead to an ambiguous determination of the active area, it is recommended not to use it.*

NOTE: When "decimated" sub-rasters as documented in clauses 5.14.2.2 and 5.14.3.2 are used, which decimate the production image in both horizontal and vertical axes to help with bitrate efficiency, AFD/Bar data might not work properly, and may therefore be considered ambiguous.

*The sample aspect ratio information shall be signalled in the bitstream using the **aspect_ratio_idc** value in the Video Usability Information (see values of **aspect_ratio_idc** in Recommendation ITU-T H.265 / ISO/IEC 23008-2 [35], table E-1).*

*HEVC Bitstreams shall represent square pixels indicated by **aspect_ratio_idc** equal to 1, except for the cases listed in table 20 and table 21.*

Decoding: *HEVC IRDs shall support decoding and displaying of 16:9 HEVC Bitstreams with the values of **aspect_ratio_idc** set to 1 and to the additional values specified in table 20 and table 21.*

HEVC IRDs shall support conformance cropping. Support of Default Display Window VUI is strongly recommended. HEVC IRDs may ignore AFD/Bar Data signalling.

*HEVC IRDs shall make use of **pic_width_in_luma_samples**, **pic_height_in_luma_samples**, **aspect_ratio_idc** and the conformance cropping window to (where necessary) rescale the coded video frame both horizontally and vertically to fill the 16:9 output raster.*

The IRD should signal the **overscan_appropriate_flag** and annex B AFD/Bar Data to the display, so that the display can optimize the presentation of the decoded video taking account of viewer preferences and the display aspect ratio. The IRD should not apply overscan scaling itself as overscan is a display function, and should only be applied once.

IRDs with integrated displays may combine the separate IRD and display scaling steps in to a single process.

5.14.1.5.2 Video Range

The Recommendation ITU-R BT.2020 [36], Recommendation ITU-R BT.709 [13], Recommendation ITU-R BT.601-7 [38] and Recommendation ITU-R BT.2100 [45] narrow range specifications provide additional headroom above the specified reference white level and below the specified reference black level to accommodate the small variations in signal level that occur in live TV production and to allow signal transients to pass through the system. This is signalled to an IRD by setting the **video_full_range_flag** equal to "0". It is important to maintain the additional headroom through to the output of the IRD in order to preserve detail in the highlights and lowlights of a scene.

Encoding: The **video_full_range_flag** shall equal "0".

Decoding: Regardless of the value of the **video_full_range_flag**, it is strongly recommended that the IRD preserves the full 8 or 10 bit signal range.

NOTE: When the **video_full_range_flag** is equal to "0", the HEVC IRD should not apply clipping at the indicated black and white reference levels or tone mapping between the indicated black and white reference levels.

5.14.1.5.3 Colour Parameter Information

Encoding: *The syntax element **colour_description_present_flag** shall be set to "1", so that **colour primaries**, **transfer_characteristics**, **matrix_coeffs** are present in the VUI.*

Decoding: *HEVC IRDs shall be capable of decoding Bitstreams with **colour_description_present_flag** equal to "1".*

The support of **colour primaries**, **transfer_characteristics**, and **matrix_coeffs** values for the HEVC HDTV IRDs and Bitstreams is specified in clause 5.14.2.3, for the HEVC UHD TV IRDs and Bitstreams in clause 5.14.3.3, for the HEVC HDR UHD TV IRDs and Bitstreams in clause 5.14.4.4 and for the HEVC HDR HFR UHD TV IRDs and Bitstreams in clause 5.14.5.4.

5.14.1.5.4 Chrominance Information

Encoding: *The chrominance locations shall be specified by setting **chroma_loc_info_present_flag** to 1 and using the syntax elements **chroma_sample_loc_type_top_field** and **chroma_sample_loc_type_bottom_field** in the VUI.*

It is recommended to use chroma sample type equal to 0 for progressive video conforming to Recommendation ITU-R BT.709 [13] or 2 for progressive video conforming to Recommendation ITU-R BT.2020 [36].

Chroma samples location may be modified prior to HEVC encoding when processing interlaced content. If chroma samples are displaced from their original location prior to HEVC encoding, the obtained chroma samples location is signalled in the VUI by setting **chroma_sample_loc_type_top_field** and **chroma_sample_loc_type_bottom_field** to the new location as described in Recommendation ITU-T H.265 / ISO/IEC 23008-2 [35], figure E-1.

Decoding: *HEVC IRDs shall support decoding any allowed values of **chroma_sample_loc_type_top_field** and **chroma_sample_loc_type_bottom_field**. It is recommended that appropriate processing be included for the display of pictures.*

5.14.1.5.5 Picture Structure Information

The support of **frame_field_info_present_flag** in HEVC Bitstreams is specified in clause 5.14.1.6.1 related to use of Picture Structure information in the Picture Timing SEI and is common to all HEVC IRDs and Bitstreams. Use of this flag bit in the VUI allows use of picture timing SEI with only the picture structure information without the need to include HRD information (such as CPB and DPB delay or initial values of the delay in the buffering period SEI).

Encoding: *HEVC Bitstreams shall set **frame_field_info_present_flag** to "1" in the VUI and a picture timing SEI message shall be associated with each access unit in the coded sequence.*

Decoding: *HEVC IRDs shall support decoding of the picture timing SEI message.*

5.14.1.5.6 Default Display Window

The support of Default Display Window specified in the VUI is intended to help HEVC IRDs to display the video according to the display characteristics.

Its first possible use is to signal the active area within the decoded picture. In this case, the default display window is provided as an option to replace annex B AFD/Bar Data signalling.

Encoding: To signal the active area, HEVC Bitstreams may set **default_display_window_flag** to "1" in the VUI and signal using **def_disp_win_left_offset**, **def_disp_win_right_offset**, **def_disp_win_top_offset**, and **def_disp_win_bottom_offset**, the active area of the decoded picture that is intended to be displayed. *If the default display window is used for this purpose, there shall not be any Frame Packing Arrangement SEI message present in the bitstream.*

If both annex B AFD/Bar Data and Default Display Window are signalled in the HEVC Bitstream for the purpose of signalling the active area, they are expected to describe the same active area. The use of Default Display Window is recommended over the use of annex B AFD/Bar Data.

Decoding: HEVC IRDs may use Default Display Window signalling to adjust the decoded picture display in the absence of annex B AFD/Bar Data signalling. If both Default Display Window and annex B AFD/Bar Data are signalled in the HEVC Bitstream, HEVC IRDs may ignore annex B AFD/Bar Data signalling as the Default Display Window signalling takes precedence.

NOTE: HEVC IRDs may blank parts of the pictures that are outside the Default Display Window.

Its second possible use is to allow the HEVC IRD to extract a 2D picture from a plano stereoscopic frame compatible arrangement. In this case, the default display window is used together with the Frame Packing Arrangement SEI message.

Encoding: To allow 2D compatibility of plano stereoscopic frame compatible arrangement, HEVC Bitstreams may set **default_display_window_flag** to "1" in the VUI and signal using **def_disp_win_left_offset**, **def_disp_win_right_offset**, **def_disp_win_top_offset**, and **def_disp_win_bottom_offset**, the area of the picture containing the view intended to be displayed as a 2D picture. *If the default display window is used for this purpose, a Frame Packing Arrangement SEI message shall be present in the bitstream for each access unit as specified in clause J.4.3.2 of the present document.*

Decoding: HEVC IRDs may use Default Display Window signalling to extract a 2D picture from a plano stereoscopic arrangement. If both annex B AFD/Bar Data and the Default Display Window are present in a bitstream that contains Frame Packing Arrangement SEI messages, HEVC IRDs may use the Default Display Window to extract a 2D picture from a plano-stereoscopic arrangement and may use AFD/Bar Data to extract the active area for display.

The above two signalling methods (signal the active area, and 2D compatibility of plano stereoscopic frame compatible arrangement) for the Default Display Window are intended as mutually exclusive.

5.14.1.5.7 Timing Information

The support of **vui_time_scale**, **vui_num_units_in_tick** and **elemental_duration_in_tc_minus1[temporal_id_max]** values for the HEVC IRDs and Bitstreams is specified in clause 5.14.1.7.

5.14.1.6 Supplemental Enhancement Information

5.14.1.6.0 General

Encoding: *All prefix SEIs shall not occur after the first VCL NAL unit of the access unit. All suffix SEIs shall not occur before the last VCL NAL unit of the access unit.*

NOTE: HEVC allows SEI messages (both prefix and suffix SEI) to occur between the first and the last VCL NAL units of an access unit. The constraint in the present clause forbids SEI messages from occurring between the first and the last VCL NAL units of an access unit.

Prefix SEI NAL units within an access unit shall be placed after all NAL units of type VPS_NUT, SPS_NUT and PPS_NUT.

Decoding: *HEVC IRDs shall support the use of Supplemental Enhancement Information of the following message types:*

- Picture Timing SEI Message;
- Recovery Point SEI Message;
- "User data registered by Recommendation ITU-T T.35 SEI message" syntactic element [19] `user_data_registered_itu_t_t35` as defined in clause B.8a.

5.14.1.6.1 Picture Timing SEI Message

Encoding: *HEVC Bitstreams shall contain a picture timing SEI message for every access unit of a coded video sequence and **frame_field_info_present_flag** shall be set to 1 in the VUI.*

*The value of **pic_struct** shall not be equal to 1 or 2.*

Before an encoding process, in order to achieve a higher frame rate than the frame rate of the original programme, additional pictures may be created e.g. by repeating or motion interpolating original programme pictures. It is recommended to use the **duplicate_flag** for this use case in a manner different to the usage documented in Recommendation ITU-T H.265 / ISO/IEC 23008-2 [35].

- If the current picture is not an original programme picture, it is recommended to set the value of **duplicate_flag** to 1.
- In the case of motion compensated Video Standard Conversion as a pre-process before encoding, e.g. from 50 Hz to 60 000/1 001 Hz or from 100 Hz to 120 000/1 001 Hz, there might not be any original programme pictures preserved at all, hence it is recommended that all pictures get **duplicate_flag** value 0 to avoid accidental deletion after decoding.
- In case of temporal layering of HFR, it is recommended that all the original programme pictures are contained in HEVC temporal video sub-bitstream as 50 Hz (60/1 001 Hz) capable IRD would not be able to extract the pictures from HEVC temporal video subset.

NOTE 1: Setting **frame_field_info_present_flag** to "1" indicates the presence of **pic_struct** to determine if the picture should be displayed as a frame or one or more fields. Possible values for **pic_struct** are defined in table D-2 of Recommendation ITU-T H.265 / ISO/IEC 23008-2 [35]. The **pic_struct** values 1 and 2 are not allowed in bitstreams since these values do not carry field relationship information which may be needed by the IRD to avoid field parity loss in presence of transmission errors. This implies that non-paired fields are to be avoided in HEVC Bitstreams, and that HEVC IRD may not be able to display correctly HEVC Bitstreams containing non-paired fields.

NOTE 2: In the context of HEVC, paired fields are two fields that are in consecutive access units in decoding order as two coded fields of opposite parity of the same frame, regardless their display order.

Decoding: *HEVC IRDs shall support all values defined in **pic_struct** including all modes requiring field and frame repetition except **pic_struct** values 1 and 2. The HEVC IRDs need not make use of any other syntax elements (except **pic_struct**) in the picture timing SEI message, if these elements are present.*

An IRD may utilize the values of **duplicate_flag** to identify and extract for display the original lower programme frame rate out of a received and decoded higher frame rate.

5.14.1.6.2 Recovery Point SEI Message

Encoding: *The recovery point SEI message shall not be present in access units that do not contain an HEVC DVB_RAP. When present, the **recovery_poc_cnt** shall be set to 0, **exact_match_flag** shall be set to 1, and **broken_link_flag** shall be set to 0.*

5.14.1.7 Frame rate

Encoding: *The frame rate for progressive material shall be 24 000/1 001, 24, 25, 30 000/1 001, 30, 50, 60 000/1 001 or 60 Hz for all allowed luminance resolutions.*

The frame rates for interlaced material shall be 25 and 30 000/1 001 Hz.

These two frame rates for interlaced material are only applicable to luminance resolutions with 1 080 lines.

The Decoding Time Stamps of access units in HEVC Bitstreams shall be inserted at a constant rate, such as every 1/50 s for 50 Hz HEVC Bitstreams or every 1/60 s for 60 Hz HEVC Bitstreams.

NOTE 1: 24 and 24 000/1 001 Hz content is carried within a 60 and 60 000/1 001 Hz bitstream respectively, using 3:2 pull-down (**pic_struct** values 7 and 8) - see clause 5.14.5.5.2. In which case the HEVC temporal video subset is not present and the DTS interval will be at multiples of 60 and 60 000/1 001 Hz.

*The frame rate shall be indicated in the VUI by setting **vui_time_scale**, **vui_num_units_in_tick** syntax elements and, if HEVC Temporal sub-layers are present, by setting **elemental_duration_in_tc_minus1[temporal_id_max]** in the **hrd_parameters()**, where **temporal_id_max** is signalled in the **HEVC video descriptor** (as per clause 4.1.8.19a).*

Table 19 lists the frame rates that shall be supported and the recommended values for signalling them.

Table 19: Progressive and Interlaced Frame Rates for HEVC Bitstreams and recommended values for signalling

Output Frame Rate	Interlaced or Progressive	elemental_duration_in_tc_minus1 [temporal_id_max (note 3)]	vui_time_scale	vui_num_units_in_tick	Allowed pic_struct
24 000/1 001	P	0	24 000	1 001	0,7,8
24	P	0	24	1	0,7,8
25	P	0	25	1	0,7,8
25	I (encoded as frames)	0	50	1	3,4,5,6
25	I (encoded as fields)	0	50	1	9,10,11,12
30 000/1 001	P	0	30 000	1 001	0,7,8
30 000/1 001	I (encoded as frames)	0	60 000	1 001	3,4,5,6
30 000/1 001	I (encoded as fields)	0	60 000	1 001	9,10,11,12
30	P	0	30	1	0,7,8
50	P	0	50	1	0,7,8
60 000/1 001	P	0	60 000	1 001	0,7,8
60	P	0	60	1	0,7,8

NOTE 2: The interlaced frame rates are only applicable to the luminance resolutions with 1 080 lines.

NOTE 3: Other values of **vui_time_scale**, **vui_num_units_in_tick** and **elemental_duration_in_tc_minus1[temporal_id_max]** may be used, for example where a lower frame rate signal is carried as an HEVC temporal video sub-bitstream of a higher frame rate HEVC bitstream (see clause 5.14.5.5). The note in clause 5.14.5.5.1 explains how to calculate the frame rate using **vui_time_scale**, **vui_num_units_in_tick** and **elemental_duration_in_tc_minus1[temporal_id_max]**.

Decoding: *50 Hz HEVC HDTV IRDs shall support decoding and displaying of video with an output frame rate of 25 interlaced or progressive; 50 Hz progressive. Support of other output frame rates is optional.*

60 Hz HEVC HDTV IRDs shall support decoding and displaying of video with an output frame rate of 30 000/1 001 interlaced or progressive; 24 000/1 001, 24, 30, 60 000/1 001 or 60 Hz progressive. Support of other output frame rates is optional.

HEVC UHD TV IRDs shall support decoding and displaying of video with the output frame rates supported by 50 Hz HEVC HDTV IRDs and 60 Hz HEVC HDTV IRDs.

The frame rate shall be calculated using the VUI and VUI hrd_parameters() syntax elements vui_time_scale, vui_num_units_in_tick and elemental_duration_in_tc_minus1[temporal_id_max]. The highest TemporalID to be decoded is indicated by temporal_id_max, carried in the HEVC video descriptor.

The frame rates that shall be supported and the recommended values for signalling them are listed in table 19.

NOTE 4: High Dynamic Range and/or High Frame Rates Bitstreams as defined in clauses 5.14.4 and 5.14.5 are not intended to be used with interlaced formats. Therefore, the use of interlaced formats in HEVC UHD TV Bitstreams will complicate any upgrade to HDR and/or HFR.

5.14.1.8 Random Access Point

5.14.1.8.0 General

Encoding: *An HEVC DVB_RAP shall include exactly one Video Parameter Set (that is active), exactly one Sequence Parameter Set (that is active) with VUI, at least one Picture Parameter Set, and optionally a recovery point SEI message which shall be present if the **nal_unit_type** of the HEVC DVB_RAP is equal to TRAIL_R. The VPS, SPS, and PPS that are required for decoding the associated picture shall precede SEI NAL units in this access unit. The recovery point SEI message, when present, shall precede all other SEI NAL units in an HEVC DVB_RAP.*

*The **nal_unit_type** of each VCL NAL unit of an HEVC DVB_RAP picture shall be equal to one of BLA_W_LP, BLA_W_RADL, BLA_N_LP, IDR_W_RADL, IDR_N_LP, CRA_NUT or TRAIL_R that contains only slices with **slice_type** equal to 2 (1 slice) (per Recommendation ITU-T H.265 / ISO/IEC 23008-2 [35]).*

*If a NAL unit contains a HEVC DVB_RAP, the value of **nuh_temporal_id_plus1** shall be equal to 1.*

NOTE 1: For progressive content coding, it is recommended that HEVC IRAP pictures (IDR, BLA or CRA) are used.

The time interval between HEVC DVB_RAPs may vary between programs and also within a program. The broadcast requirements should set the time interval between HEVC DVB_RAPs as specified in clause 5.14.1.8.1.

All pictures with PTS greater than or equal to PTS(rap) shall be fully reconstructible and displayable, where PTS(rap) represents the Presentation Time Stamp of the picture of the HEVC DVB_RAP. This means that decoders receiving the HEVC DVB_RAP shall not need to utilize data transmitted prior to the HEVC DVB_RAP to decode pictures displayed after the HEVC DVB_RAP.

To improve applications such as channel change, it is recommended that the Presentation Time Stamp of the picture of HEVC DVB_RAP be less than or equal to [DTS(rap) + 0,67 seconds] where DTS(rap) represents the Decoding Time Stamp of the picture of HEVC DVB_RAP.

Packetization of random access points shall comply with the following additional rule:

*A transport packet containing the PES header of a HEVC DVB_RAP shall have an adaptation field. The **payload_unit_start_indicator** bit shall be set to "1" in the transport packet header and the **adaptation_field_control** bits shall be set to "11" (as per Recommendation ITU-T H.222.0 / ISO/IEC 13818-1 [1]). In addition, the **random_access_indicator** bit in the adaptation header shall be set to "1". The **elementary_stream_priority_indicator** bit shall also be set to "1" in the same adaptation header if this transport packet contains the first slice start code of the HEVC DVB_RAP access unit (see clauses 4.1.5.1 and 4.1.5.2).*

*Both the **random_access_indicator** and **elementary_stream_priority_indicator** bits shall be set to "1" in the adaptation field of a transport packet containing the PES packet header of HEVC DVB_RAP if this transport packet also contains the first slice start code of HEVC DVB_RAP picture. Otherwise a transport packet with the **elementary_stream_priority_indicator** bit set to "1" may follow the transport packet with the **random_access_indicator** bit set to "1".*

Decoding: *HEVC IRDs shall be able to start decoding and displaying an HEVC Bitstream at an HEVC DVB_RAP.*

NOTE 2: In the case where **elementary_stream_priority_indicator** and **random_access_indicator** are used to identify the HEVC DVB_RAP, it should be noted that a VPS, SPS, PPS and any SEI may exceed one or more transport packet in length.

5.14.1.8.1 Time Interval Between Random Access Points

Encoding: *The encoder shall place HEVC DVB_RAPs in the video elementary stream at least once every 5 s. It is recommended that HEVC DVB_RAPs occur in the video elementary stream on average at least every 2 s. Where rapid channel change times are important or for applications such as PVR it may be appropriate for HEVC DVB_RAPs to occur more frequently, such as every 1 second. The time interval between successive HEVC DVB_RAPs shall be measured as the difference between their respective DTS values.*

NOTE 1: Decreasing the time interval between HEVC DVB_RAPs may reduce channel hopping time and improve trick modes, but may reduce the efficiency of the video compression.

NOTE 2: Having a regular interval between HEVC DVB_RAPs may improve trick mode performance, but may reduce the efficiency of the video compression.

NOTE 3: Due to the nature of video encoding, the HEVC DVB_RAP period may not be exactly aligned to whole seconds.

5.14.1.9 Scalability

5.14.1.9.0 General

HEVC Temporal sub-layers are components of a single bitstream, analogous to the tiers described in annex D of the present document, and signalled using the **nuh_temporal_id_plus1** in the NAL unit header. That is, each HEVC Temporal sub-layer represents a set of pictures that are only dependent upon pictures of an equivalent or lower numbered sub-layer. HEVC Temporal sub-layers can be beneficially used to assist trick modes.

Extensions might be added in future versions of the present document. It is expected that such extensions would use additional transport stream PIDs to allow such services to be introduced in a backwards compatible manner.

Decoding: *HEVC IRDs shall skip over data structures which are currently "reserved" (as per Recommendation ITU-T H.265 / ISO/IEC 23008-2 [35]), or which correspond to functions not implemented by the HEVC IRD.*

5.14.1.9.1 Temporal sub-layers

Encoding: *HEVC Bitstreams and HEVC temporal video sub-bitstreams shall be carried on a single Transport Stream PID with **stream_type** equal to 0x24. Only HEVC Bitstreams and HEVC temporal video sub-bitstreams:*

- *obeying the limits associated with level 4.1 for HDTV HEVC Bitstreams shall be carried within this PID;*
- *obeying the limits associated with level 5.1 for UHD TV HEVC Bitstreams or UHD TV HDR HEVC Bitstreams shall be carried within this PID.*

The Decoding Time Stamps of access units in HEVC Bitstreams and HEVC temporal video sub-bitstreams carried within this PID shall be inserted at a constant rate.

All Access Units of HEVC Bitstreams and HEVC temporal video sub-bitstreams carried within this PID shall have values of TemporalId lower than or equal to 4.

Decoding: *HEVC HDTV IRDs shall decode HEVC Bitstreams with **stream_type** equal to 0x24, obeying the limits associated with level 4.1.*

*HEVC UHD TV IRDs shall decode HEVC Bitstreams and HEVC temporal video sub-bitstreams with **stream_type** equal to 0x24, obeying the limits associated with level 5.1.*

*HEVC IRDs shall decode HEVC Bitstreams and HEVC temporal video sub-bitstreams with **sps_max_sub_layers_minus1** greater than 0.*

NOTE: HEVC IRDs are not required to use the temporal substream extraction process described in Recommendation ITU-T H.265 / ISO/IEC 23008-2 [35], clause 10 to decode and display the HEVC Bitstreams in the Transport Stream PID with **stream_type** equal to 0x24.

5.14.1.9.2 Layer Sets

Encoding: *HEVC Bitstreams and HEVC video sub-bitstreams shall set the NAL unit header **nuh_layer_id** equal to 0 for Transport Streams with **stream_type** equal to 0x24.*

Decoding: *HEVC IRDs may ignore all NAL units with values of **nuh_layer_id** not equal to 0.*

NOTE 1: It is possible that future versions of the present document may allow non-zero values, but that these streams should still be decodable by HEVC IRDs compliant with the present document.

NOTE 2: It is expected that NAL units with values of **nuh_layer_id** other than 0 would occur on a different PID (or separate but associate bitstream carriage) and so would not be expected to be seen by a decoder compliant to the present document.

NOTE 3: HEVC Layer sets may be used in future versions of the present document to support for example, high dynamic range, wide colour gamut, 3D or higher spatial resolution extensions.

5.14.1.10 HEVC Seamless splicing

Seamless splicing of HEVC video may be accomplished by conforming to the constraints of ANSI/SCTE 172 [i.20], "Constraints on AVC Video Coding for Digital Program Insertion".

NOTE: While ANSI/SCTE 172 is currently drafted with AVC in mind, the constraints are fully applicable to HEVC and DVB expects that SCTE will produce an updated document which explicitly includes HEVC.

5.14.2 HEVC HDTV IRDs and Bitstreams

5.14.2.0 General

This clause specifies the HEVC HDTV IRDs and Bitstreams. *All specifications in clause 5.14.1 shall apply.* The specification in the remainder of this clause only applies to the HEVC HDTV IRDs and Bitstreams.

Two HEVC HDTV IRDs are defined in the present document: HEVC HDTV 10-bit IRD and HEVC HDTV 8-bit IRD with the capabilities defined in the definitions.

NOTE: An additional HEVC HDR HDTV Bitstream conformance point is specified in clause 5.14.3, but without any corresponding IRD conformance point.

5.14.2.1 Profile, tier and level

Encoding: *In addition to the provisions set forth in Recommendation ITU-T H.265 / ISO/IEC 23008-2 [35], the following restrictions shall apply for the fields in the sequence parameter set:*

<i>bit_depth_luma_minus8</i>	<i>= 0 or 2</i>
<i>bit_depth_chroma_minus8</i>	<i>= bit_depth_luma_minus8</i>
<i>vui_parameters_present_flag</i>	<i>= 1</i>
<i>sps_extension_present_flag</i>	<i>= 0</i>

*In addition to the provisions set forth in Recommendation ITU-T H.265 / ISO/IEC 23008-2 [35], the following restrictions shall apply for the fields in the **profile_tier_level** syntax structure in the sequence parameter set:*

<i>general_tier_flag</i>	<i>= 0</i>
<i>general_profile_idc</i>	<i>= 1 (Main profile) or 2 (Main 10 profile)</i>

HEVC HDTV Bitstreams shall obey the limits in Recommendation ITU-T H.265 / ISO/IEC 23008-2 [35], table A.1 and table A.2 associated with Level 4.1.

***general_level_idc** shall be less than or equal to 123 (level 4.1), unless the HEVC Bitstream is a HEVC temporal video sub-bitstream. In this case, **sps_max_sub_layers_minus1** shall be greater than "0", **sub_layer_level_present_flag[i]** where 'i' is equal to **temporal_id_max** carried within the HEVC Video Descriptor shall be equal to "1", and **sub_layer_level_idc[i]** where 'i' is equal to **temporal_id_max** carried within the HEVC Video Descriptor shall be less than or equal to "123" (level 4.1).*

It is recommended that bitstreams which are compliant with the Main profile set **general_profile_compatibility_flag[1]** to 1.

*As specified in annex A of Recommendation ITU-T H.265 / ISO/IEC 23008-2 [35], the value of **bit_depth_luma_minus8** and **bit_depth_chroma_minus8** shall be equal to 0 when **general_profile_idc** is equal to 1 or **general_profile_compatibility_flag[1]** is equal to 1.*

NOTE 1: In the Main 10 Profile and the Main Profile, **chroma_format_idc** is equal to '1'.

Decoding: *HEVC HDTV 10-bit IRDs shall support the decoding of HEVC HDTV Bitstreams. HEVC HDTV 8-bit IRDs shall support the decoding of HEVC HDTV Bitstreams within the constraints of the definition.*

If temporal extensions are added in future versions of the present document, **general_level_idc** may be greater than 123 (level 4.1). *When **sps_max_sub_layers_minus1** is greater than "0", IRDs may ignore **general_level_idc** and shall make use of the **sub_layer_level_idc[i]** syntax element, where 'i' is equal to **temporal_id_max** carried within the HEVC Video Descriptor, to determine whether a bitstream or sub-bitstream can be decoded.*

The HEVC HDTV IRD may ignore sequence parameter set extensions signalled by **sps_extension_present_flag** set to "1".

NOTE 2: HEVC HDTV IRDs are not required to decode and display correctly HEVC Bitstreams or HEVC temporal video sub-bitstreams that do not obey the constraints and limits associated with the Main or Main 10 Profile, Main Tier, Level 4.1.

5.14.2.2 Luminance resolution

Encoding: *HEVC HDTV encoders shall, as a minimum, represent video with the luminance resolutions shown in table 20, where luminance resolution is to be understood as the video resolution after conformance cropping. Pictures may be down-scaled and encoded at less than full size using the reciprocal of the scaling ratios shown in the table. Additional luminance resolutions may be supported, but they shall be square pixel formats indicated by **aspect_ratio_idc** equal to "1".*

Where non 16:9 sources are re-formatted and encoded within a 16:9 frame, AFD/bar data defined in clause B.3 and default display window defined in clause 5.14.1.5.6 should be included within the bitstream to assist the IRD in displaying the content.

Decoding: *HEVC HDTV IRDs shall be capable of decoding pictures with luminance resolutions shown in table 20, where luminance resolution is to be understood as the video resolution after conformance cropping. HEVC IRDs shall be able to reconstruct the image size to allow the decoded pictures to be displayed at full-screen size.*

Table 20: Resolutions for Full-screen Display from HEVC HDTV IRD

Luminance resolution		Scan (interlace/ progressive)	Aspect ratio		Example up-sampling for 1 920 x 1 080 display	
Horizontal	Vertical		Coded Frame	Aspect_ratio_i dc	Horizontal	Vertical
1 920	1 080	I and P	16:9	1	x 1	x 1
1 440	1 080	I and P	16:9	14	x 4/3	x 1
1 600	900	P	16:9	1	x 6/5	x 6/5
1 280	720	P	16:9	1	x 3/2	x 3/2
960	720	P	16:9	14	x 2	x 3/2
960	540	P	16:9	1	x 2	x 2

5.14.2.3 Colour Parameter Information

Encoding: *The chromaticity co-ordinates of the ideal display, opto-electronic transfer characteristic of the source picture and matrix coefficients used in deriving luminance and chrominance signals from the red, green and blue primaries shall be explicitly signalled in the encoded HEVC HDTV Bitstream by setting the appropriate values for each of the following 3 parameters in the VUI: **colour_primaries**, **transfer_characteristics**, and **matrix_coeffs**.*

HEVC HDTV Bitstreams shall use Recommendation ITU-R BT.709 [13] or optionally IEC 61966-2-4 [31] colorimetry for luminance resolutions shown in table 20. For other luminance resolutions, usage of Recommendation ITU-R BT.709 [13] should be used except for interlaced resolutions with heights of 576 or 480 lines where Recommendation ITU-R BT.601-7 [38] is appropriate.

NOTE: Interlaced Standard Definition resolutions are not currently defined for HEVC bitstreams and IRDs in the present document. Nonetheless, the above clause states that Recommendation ITU-R BT.601-7 [38] colorimetry should be used if encoders support those resolutions.

Recommendation ITU-R BT.709 [13] colorimetry usage is signalled by setting **colour_primaries** to the value 1, **transfer_characteristics** to the value 1 and **matrix_coeffs** to the value 1.

IEC 61966-2-4 [31] colorimetry usage is signalled by setting **colour_primaries** to the value 1, **transfer_characteristics** to the value 11 and **matrix_coeffs** to the value 1.

Decoding: *HEVC HDTV IRDs shall be capable of decoding bitstreams that use Recommendation ITU-R BT.709 [13] colorimetry. It is recommended that appropriate processing be included for the accurate representation of pictures using Recommendation ITU-R BT.709 [13] colorimetry.*

HEVC HDTV IRDs may be capable of decoding bitstreams that use IEC 61966-2-4 [31] colorimetry.

5.14.3 HEVC UHD TV IRDs and Bitstreams

5.14.3.0 General

This clause specifies the HEVC UHD TV IRDs and Bitstreams. *All specifications in clause 5.14.1 shall apply.* The specification in the remainder of this clause only applies to the HEVC UHD TV IRDs and Bitstreams.

5.14.3.1 Profile, tier and level

Encoding: *In addition to the provisions set forth in Recommendation ITU-T H.265 / ISO/IEC 23008-2 [35], the following restrictions shall apply for the fields in the sequence parameter set:*

***bit_depth_luma_minus8** = 0 or 2*
bit_depth_chroma_minus8** = **bit_depth_luma_minus8
***vui_parameters_present_flag** = 1*

sps_extension_present_flag = 0

In addition to the provisions set forth in Recommendation ITU-T H.265 / ISO/IEC 23008-2 [35], the following restrictions shall apply for the fields in the *profile_tier_level* syntax structure in the sequence parameter set:

general_tier_flag = 0

general_profile_idc = 2 (Main 10 profile)

HEVC UHD TV Bitstreams shall obey the limits in Recommendation ITU-T H.265 / ISO/IEC 23008-2 [35], table A.1 and table A.2 associated with Level 5.1.

general_level_idc shall be less than or equal to 153 (level 5.1), unless the HEVC Bitstream is a HEVC temporal video sub-bitstream. In this case, **sps_max_sub_layers_minus1** shall be greater than "0", **sub_layer_level_present_flag[i]** where 'i' is equal to **temporal_id_max** carried within the HEVC Video Descriptor shall be equal to "1", and **sub_layer_level_idc[i]** where 'i' is equal to **temporal_id_max** carried within the HEVC Video Descriptor shall be less than or equal to "153" (level 5.1).

It is recommended that bitstreams which are compliant with the Main profile set **general_profile_compatibility_flag[1]** to 1.

NOTE 1: In the Main 10 Profile, **chroma_format_idc** is equal to '1'.

Decoding: HEVC UHD TV IRDs shall support the decoding of Main 10 Profile and Main Profile, Main Tier, Level 5.1 bitstreams within the constraints of the present document.

If temporal extensions are added in future versions of the present document, **general_level_idc** may be greater than 153 (level 5.1). When **sps_max_sub_layers_minus1** is greater than "0", IRDs may ignore **general_level_idc** and shall make use of the **sub_layer_level_idc[i]** syntax element, where 'i' is equal to **temporal_id_max** carried within the HEVC Video Descriptor, to determine whether a bitstream or sub-bitstream can be decoded.

HEVC UHD TV IRDs may ignore sequence parameter set extensions signalled by **sps_extension_present_flag** set to "1".

NOTE 2: HEVC UHD TV IRDs are not required to decode and display correctly HEVC Bitstreams or HEVC temporal video sub-bitstreams that do not obey the constraints and limits associated with the Main or Main 10 Profile, Main Tier, Level 5.1.

NOTE 3: High Dynamic Range and/or High Frame Rates Bitstreams as defined in clauses 5.14.4 and 5.14.5 are not intended to be used with a coding bit depth of 8 bits. Therefore, the use of a coding bit depth of 8 bits in HEVC UHD TV Bitstreams might complicate any upgrade to HDR and/or HFR.

5.14.3.2 Luminance resolution

Encoding: HEVC UHD TV encoders shall, as a minimum, represent video with the luminance resolutions shown in table 21 and the luminance resolutions shown in table 20, where luminance resolution is to be understood as the video resolution after conformance cropping. Pictures may be down-scaled and encoded at less than full size using the reciprocal of the scaling ratios shown in those two tables. Additional luminance resolutions may be supported, but they shall be square pixel formats indicated by **aspect_ratio_idc** equal to "1".

Where non 16:9 sources are re-formatted and encoded within a 16:9 frame, AFD/bar data defined in clause B.3 and default display window defined in clause 5.14.1.5.6 should be included within the bitstream to assist the IRD in displaying the content.

Decoding: HEVC UHD TV IRDs shall be capable of decoding pictures with luminance resolutions shown in table 21 and luminance resolutions shown in table 20, where luminance resolution is to be understood as the video resolution after conformance cropping. HEVC IRDs shall be able to reconstruct the image size to allow the decoded pictures to be displayed at full-screen size.

Table 21: Resolutions for Full-screen Display from HEVC UHD TV IRD

Luminance resolution		Scan (interlace/ progressive)	Aspect ratio		Example up-sampling for 3 840 x 2 160 display	
Horizontal	Vertical		Coded Frame	Aspect_ratio_i dc	Horizontal	Vertical
3 840	2 160	P	16x9	1	1	1
2 880	2 160	P	16x9	14	x 4/3	x 1
3 200	1 800	P	16x9	1	x 6/5	x 6/5
2 560	1 440	P	16x9	1	x 3/2	x 3/2

NOTE: High Dynamic Range and/or High Frame Rates Bitstreams as defined in clauses 5.14.4 and 5.14.5 are not intended to be used with non-square pixel formats (with **aspect_ratio_idc** not equal to "1"). Therefore, the use of non-square pixel formats in HEVC UHD TV Bitstreams might complicate any upgrade to HDR and/or HFR.

5.14.3.3 Colour Parameter Information

Encoding: *The chromaticity co-ordinates of the ideal display, opto-electronic transfer characteristic of the source picture and matrix coefficients used in deriving luminance and chrominance signals from the red, green and blue primaries shall be explicitly signalled in the encoded HEVC Bitstream by setting the appropriate values for each of the following 3 parameters in the VUI: **colour_primaries**, **transfer_characteristics**, and **matrix_coeffs**.*

HEVC UHD TV Bitstreams shall use Recommendation ITU-R BT.709 [13] or Recommendation ITU-R BT.2020 [36] non-constant luminance colorimetry.

BT.709 [13] colorimetry usage is signalled by setting **colour_primaries** to the value 1, **transfer_characteristics** to the value 1 and **matrix_coeffs** to the value 1.

BT.2020 [36] non-constant luminance colorimetry usage is signalled by setting **colour_primaries** to the value 9, **transfer_characteristics** to the value 14 and **matrix_coeffs** to the value 9.

Decoding: *HEVC UHD TV IRDs shall be capable of decoding bitstreams that use Recommendation ITU-R BT.709 [13] or Recommendation ITU-R BT.2020 [36] non-constant luminance colorimetry. It is recommended that appropriate processing be included for the accurate representation of pictures using Recommendation ITU-R BT.709 [13] colorimetry.*

NOTE 1: The HEVC UHD TV IRDs might not include appropriate processing for the accurate representation of pictures using Recommendation ITU-R BT.2020 [36] non-constant luminance colorimetry. DVB anticipates that BT.2020 colour primaries will be used together with future versions of the present document. Equipment makers should consider including the capability to map BT.2020 colour primaries for BT.709 displays.

NOTE 2: Where IRDs implement a transformation of the colour space of the coded bitstream to match the capabilities of the display (e.g. from a Recommendation ITU-R BT.2020 non-constant luminance [36] bitstream to a Recommendation ITU-R BT.709 [13] display), it is recommended that the colour space conversion does not:

- impose a hard limit such that all bitstream colours outside of the gamut of the display are placed on the outer boundary of the display gamut;
- linearly scale the wider gamut of the bitstream to fit within the gamut of the display.

NOTE 3: High Dynamic Range and/or High Frame Rates Bitstreams as defined in clauses 5.14.4 and 5.14.5 are not intended to be used with BT. 709 colour primaries. Therefore, the use of BT. 709 colour primaries in HEVC UHD TV Bitstreams might complicate any upgrade to HDR and/or HFR.

5.14.3.4 Backwards Compatibility

Decoding: *HEVC UHD TV IRDs shall be capable of decoding any bitstream that a HEVC HDTV IRD is required to decode and resulting in the same displayed pictures as the HEVC HDTV IRD, as described in clause 5.14.2.*

5.14.4 HEVC HDR UHD TV IRDs and Bitstreams

5.14.4.1 General

This clause specifies the HEVC HDR UHD TV IRDs and Bitstreams that add High Dynamic Range functionalities in addition to those supported in HEVC UHD TV IRDs and Bitstreams.

The present clause specifies two types of HEVC HDR UHD TV Bitstreams:

- Bitstreams using HLG10: the Bitstreams are specified in such a way that HEVC UHD TV IRDs as specified in clause 5.14.3 are expected to produce good images, although with a quality that may be lower than the one produced by HEVC HDR UHD TV IRDs.
- Bitstreams using PQ10: for such Bitstreams, HEVC UHD TV IRDs as specified in clause 5.14.3 are not expected to produce any picture at all.

HEVC HDR UHD TV IRDs may support one or both types of Bitstreams specified in the present clause.

All specifications in clause 5.14.1 shall apply. The specification in the remainder of this clause only applies to the HEVC HDR UHD TV IRDs and Bitstreams.

5.14.4.2 Profiles, Tiers and Levels

All specifications in clause 5.14.3.1 shall apply with the following restriction.

Encoding: *In addition to the provisions set forth in Recommendation ITU-T H.265 / ISO/IEC 23008-2 [35] and in clause 5.14.3.1, the following restriction shall apply for the fields in the sequence parameter set:*

$$\mathit{bit_depth_luma_minus8} = 2$$

5.14.4.3 Luminance Resolutions

Encoding: *HEVC HDR UHD TV encoders shall, as a minimum, represent video with the luminance resolutions shown in table 21a. Pictures may be downsampled and encoded at less than full size using the reciprocal of the scaling ratios shown in table 21a. Additional luminance resolutions may be supported, but they shall be square pixel formats indicated by **aspect_ratio_idc** equal to "1".*

HEVC HDR UHD TV encoders may represent video using only the luminance resolutions in the last four rows of Table 21a. Such HEVC HDR UHD TV Bitstreams are a subset of the HEVC HDR UHD TV Bitstream conformance point.

Decoding: *HEVC HDR UHD TV IRDs shall be capable of decoding pictures with luminance resolutions shown in table 21a. HEVC HDR UHD TV IRDs shall be capable to reconstruct the image size to allow the decoded pictures to be displayed at full-screen size.*

Table 21a: Resolutions for Full-screen Display from HEVC HDR UHD TV IRD

Luminance resolution		Scan (interlace/progressive)	Aspect ratio		Example up-sampling for 3 840 x 2 160 display	
Horizontal	Vertical		Coded Frame	Aspect_ratio_idc	Horizontal	Vertical
3 840	2 160	P	16:9	1	x 1	x 1
3 200	1 800	P	16:9	1	x 6/5	x 6/5
2 560	1 440	P	16:9	1	x 3/2	x 3/2
1 920	1 080	P	16:9	1	x 2	x 2
1 600	900	P	16:9	1	x 12/5	x 12/5
1 280	720	P	16:9	1	x 3	x 3
960	540	P	16:9	1	x 4	x 4

NOTE 1: Table 21a contains only progressive and square pixel formats. The interlaced and non-square pixel formats documented in tables 20 and 21 are therefore not meant to be used for HEVC HDR UHD TV Bitstreams and these formats are not guaranteed to be supported by HEVC HDR UHD TV IRDs, except if the bitstream fulfills all the constraints of an HEVC UHD TV Bitstream, as specified in clause 5.14.4.6 on Backwards Compatibility.

NOTE 2: There is no IRD conformance point corresponding to the HEVC HDR HDTV Bitstream conformance point, as all IRD supporting HDR are expected to be able to decode all resolutions listed in Table 21a.

5.14.4.4 High Dynamic Range and Colour Parameter Information

5.14.4.4.1 Signalling of colour primaries and matrix coefficients

Encoding: *HEVC HDR UHD TV Bitstreams shall use Recommendation ITU-R BT.2100 [45] colour primaries and non-constant luminance matrix coefficients, which shall be explicitly signalled to the IRD by setting the VUI **colour_primaries** equal to 9 and **matrix_coeffs** equal to 9. Content produced with different system colorimetry shall be mapped in to a BT.2100 colour container prior to HEVC encoding.*

NOTE: Recommendation ITU-R BT.2100 [45] colour primaries and non-constant luminance matrix coefficients are identical to Recommendation ITU-R BT.2020 [36] colour primaries and non-constant luminance matrix coefficients, so the same VUI parameter values are used.

Decoding: *HEVC HDR UHD TV IRDs shall be capable of decoding high dynamic range bitstreams with Recommendation ITU-R BT.2100 [45] colour primaries and non-constant luminance matrix coefficients.*

It is recommended that appropriate processing is performed for the representation of pictures using Recommendation ITU-R BT.2100 [45] colour primaries and non-constant luminance matrix coefficients.

5.14.4.4.2 HEVC HDR UHD TV IRDs and Bitstreams using HLG10

5.14.4.4.2.1 Signalling of transfer characteristics

HLG10 is specified for HDR bitstreams intended to be decodable by HEVC UHD TV IRDs. The HLG10 signalling specified below may also be used for HLG services where there is no requirement for the bitstreams to be decodable by HEVC UHD TV IRDs.

Encoding: *HEVC HDR UHD TV Bitstreams using HLG10 shall set VUI **transfer_characteristics** to the value "14" to signal the opto-electronic transfer function as Recommendation ITU-R BT.2020 [36] 10-bits.*

*HEVC HDR UHD TV Bitstreams using HLG10 shall also contain the **alternative_transfer_characteristics** SEI message. The **alternative_transfer_characteristics** SEI message shall be inserted on the HEVC DVB_RAP, and **preferred_transfer_characteristics** shall be set equal to "18", indicating Recommendation ITU-R BT. 2100 [45] HLG system.*

NOTE 1: Recommendation ITU-R BT.2100 [45] HLG system has an identical Opto-Electronic Transfer Function to ARIB STD-B67 [i.27], so the same **preferred_transfer_characteristics** value is used.

Decoding: *HEVC HDR UHD TV IRDs using HLG10 shall be capable of decoding high dynamic range bitstreams conforming to HLG10, as specified in Recommendation ITU-R BT.2100 [45].*

It is recommended that the IRD implements processing to map the large colour volume of the HLG10 signal to the potentially smaller colour volume of the display.

NOTE 2: At the time of writing, the ITU-R has not yet published Production Guidelines for Recommendation ITU-R BT.2100 [45] programmes. In the meantime, the reference level for graphics can be assumed to be 75 % of the narrow range signal. Similarly, when re-mapping SDR content into an HLG10 container (e.g. for output over HDMI), SDR 90 % of the narrow range signal can be mapped to HLG10 75 % of the narrow range signal.

5.14.4.4.2.2 Dynamic switching between SDR and HDR as a result of bitstream splicing

5.14.4.4.2.2.1 Introduction

Broadcast services are expected to be delivered in either a high dynamic range or a standard dynamic range format. However, bitstream splicing within a network may result in dynamic changes between high and standard dynamic range content at the IRD.

5.14.4.4.2.2.2 Transition from HDR to SDR

Encoding: HEVC HDR UHD TV Bitstreams may switch to a HEVC UHD TV Bitstream. *To improve the detectability of SDR switching for IRDs:*

- *If the HEVC UHD TV bitstream is using BT.709 colour primaries, the HEVC UHD TV bitstream shall alter the VUI **colour_primaries** to the value 1, **transfer_characteristics** to the value 1 and **matrix_coeffs** to the value 1. If an **alternative_transfer_characteristics** SEI message is present during the HEVC UHD TV bitstream transmission, it shall have **preferred_transfer_characteristics** set to 1.*
- *If the HEVC UHD TV bitstream is using BT.2020 colour primaries, the HEVC UHD TV bitstream shall contain the **alternative_transfer_characteristics** SEI message. The **alternative_transfer_characteristics** SEI message shall be inserted on the HEVC DVB_RAP (at least on the first one followed by SDR transmission), and **preferred_transfer_characteristics** shall be set equal to "14" to signal the opto-electronic transfer function as Recommendation ITU-R BT.2020 [36] 10-bits.*

Decoding: HEVC HDR UHD TV IRDs using HLG10 should be capable of handling such a change to HEVC UHD TV bitstream seamlessly.

NOTE: The above constraint on handling such a change seamlessly applies to the bitstream, and not to the display. The display may, for example, show a black screen temporarily when switching between different transfer characteristics and/or colour primaries.

5.14.4.4.2.2.3 Transition from SDR to HDR

Encoding: HEVC UHD TV Bitstreams may switch to a HEVC HDR UHD TV Bitstream. *The HEVC HDR UHD TV Bitstream shall be compliant with clause 5.14.4.4.2.1.*

Decoding: HEVC HDR UHD TV IRDs using HLG10 should be capable of handling such a change to HEVC HDR UHD TV bitstream seamlessly.

NOTE: The above constraint on handling such a change seamlessly applies to the bitstream, and not to the display. The display may, for example, show a black screen temporarily when switching between different transfer characteristics and/or colour primaries.

5.14.4.4.3 HEVC HDR UHD TV IRDs and Bitstreams using PQ10

5.14.4.4.3.1 General Introduction

The following clauses contain the specific signalling required for the transmission of PQ10 and optional supplemental enhancement information messages. Optional Supplemental Enhancement Information messages assist IRDs in post processing to adapt the picture to the rendering capabilities of displays with differing capabilities than the mastering display used to create the HDR content (including, but not limited to, displays intended to render SDR pictures). It is noted that different messages (or parts of them) may serve similar purposes.

NOTE: Optional Supplemental Enhancement Information message support is optional both in the bitstream and in the IRD. As Phase 2 IRDs will exist which do not take account of these optional SEI messages, broadcasters should be aware of this and take suitable measures to facilitate quality of HDR reproduction by IRDs not utilizing these optional SEI messages.

5.14.4.4.3.2 Signalling of transfer characteristics

Encoding: *HEVC HDR UHD TV Bitstreams using PQ10 shall set VUI **transfer_characteristics** to the value "16" to signal the electro-optical transfer function as Recommendation ITU-R BT.2100 [45] PQ system.*

NOTE: Recommendation ITU-R BT.2100 [45] PQ system has an identical Electro-Optical Transfer Function to SMPTE ST 2084 [i.26], so the same **transfer_characteristics** value is used.

Decoding: *HEVC HDR UHD TV IRDs using PQ10 shall be capable of decoding high dynamic range bitstreams that use Recommendation ITU-R BT.2100 [45] PQ system.*

It is recommended that appropriate processing is performed for the representation of pictures using Recommendation ITU-R BT.2100 [45] PQ transfer characteristics.

5.14.4.4.3.3 Optional Supplemental Enhancement Information messages

5.14.4.4.3.3.1 General

The present clause specifies restrictions applying to Supplemental Enhancement Information messages that are specified in Recommendation ITU-T H.265 / ISO/IEC 23008-2 [35] and that may be optionally present in HEVC HDR UHD TV Bitstreams using PQ10.

These Supplemental Enhancement Information messages provide a production or playout side controlled post processing in the IRD and do not preclude alternative postprocessing on the IRD side.

Decoding: HEVC HDR UHD TV IRDs are not required to support the SEI messages specified in the present clause.

5.14.4.4.3.3.2 Mastering Display Colour Volume SEI message

HEVC Mastering Display Colour Volume SEI message identifies the colour volume (primaries white point and luminance range) of a display considered to be the mastering display for the associated video content. The usage of this information may help improving colour reproduction of mastered content when represented in different colour volume or shown on other displays than the mastering display. The information conveyed in this SEI message is intended to be adequate for purposes corresponding to the use of Society of Motion Picture and Television Engineers ST 2086 [i.29] "Mastering Display Color Volume Metadata Supporting High Luminance and Wide Color Gamut Images".

Encoding: HEVC HDR UHD TV Bitstreams using PQ10 may contain a mastering display colour volume SEI message as specified in Recommendation ITU-T H.265 / ISO/IEC 23008-2 [35], annex D. *If a mastering display colour volume SEI message is present, it shall be transmitted with every HEVC DVB_RAP.*

It is recommended that HEVC HDR UHD TV Bitstreams set a valid number to `display primaries_x[c]`, `display primaries_y[c]`, `white_point_x`, `white_point_y`, `max_display_mastering_luminance`, `min_display_mastering_luminance` fields.

If the proper value for all these fields is unknown, it is recommended that no mastering display colour volume SEI message is present in the HEVC HDR UHD TV Bitstream; or if the proper value for any one of the following fields are unknown, `display primaries_x[c]`, `display primaries_y[c]`, `white_point_x`, `white_point_y` or `max_display_mastering_luminance`, it is recommended that the unknown field is set to 0.

The lowest value for `min_display_mastering_luminance` that is valid without ambiguity is 0,0001, when viewing a Reference Monitor calibrated while viewing a test pattern (such as PLUGE for example). Hence it is recommended that:

- an unknown value for **min_display_mastering_luminance** should be signalled with value 0;
- a known value for **min_display_mastering_luminance** should be signalled with a value larger than or equal to 0,0001.

5.14.4.4.3.3.3 Content Light Level Information SEI message

HEVC Content Light Level information SEI message identifies upper bounds for the nominal target brightness light level of the associated video content. The information conveyed in this SEI message is intended to be adequate for purposes corresponding to the use of the Consumer Technology Association standard CTA 861-H [52].

Encoding: HEVC HDR UHD TV Bitstreams using PQ10 may contain a content light level SEI message as specified in Recommendation ITU-T H.265 / ISO/IEC 23008-2 [35], annex D. *If a content light level information SEI message is present, it shall be transmitted with every HEVC DVB_RAP.*

NOTE: In some cases, such as live and linear broadcast, it may not be possible to calculate the values of **max_content_light_level** and **max_pic_average_light_level** fields.

If the value for these fields is known, it is recommended that HEVC HDR UHD TV Bitstreams include valid settings for the **max_content_light_level** and **max_pic_average_light_level** fields.

If the value for all these fields is unknown, it is recommended that no content light level information SEI message is present in the HEVC HDR UHD TV Bitstream; or if the value for any one of these fields is unknown, it is recommended that the unknown field is set to 0.

5.14.4.4.3.3.4 Optional Supplemental Enhancement Information messages carrying DMI

5.14.4.4.3.3.4.1 General

The present clause specifies restrictions applying to Supplemental Enhancement Information messages carrying DMI as specified in ETSI TS 103 572 [50] or ETSI TS 103 433-2 [51] or CTA 861-H[52], and that may be optionally present in HEVC HDR UHD TV Bitstreams using PQ10.

The Supplemental Enhancement Information messages carrying DMI defined in the present clause can guide dynamic mapping, as produced in a reference viewing environment or otherwise. A display that is cognizant of the DMI can use this information to adapt the rendering of the video content to its own display capabilities and/or to the viewing environment, including the possibility to replicate as closely as possible the intended appearance of that content as produced in the reference viewing environment.

Encoding: HEVC HDR UHD TV Bitstreams using PQ10 may contain Supplemental Enhancement Information messages carrying DMI according to the rules defined for each DMI format in the present clause.

HEVC HDR UHD TV Bitstreams using PQ10 may simultaneously include Supplemental Enhancement Information messages carrying DMI from multiple DMI formats defined in the present clause.

If DMI is included, it is recommended that the PQ10 Bitstream provides video quality at the level that can be expected from an HEVC HDR UHD TV IRD using PQ10 that does not support DMI, and that the DMI enables further enhancement of the video.

Decoding: HEVC HDR UHD TV IRDs are not required to support the SEI messages specified in the present clause.

HEVC HDR UHD TV IRDs may support one or more DMI formats defined in the present clause.

HEVC HDR UHD TV IRDs may optionally support processing based on DMI included in the SEI messages specified in the present clause, and alternative and/or additional processing may be applied.

5.14.4.4.3.3.4.2 Dynamic switching between bitstreams with and without DMI

Broadcast services may switch dynamically between bitstreams supporting different DMI formats or no DMI at all.

Encoding: HEVC HDR UHD TV Bitstreams using PQ10 with DMI may switch to HEVC HDR UHD TV Bitstreams using PQ10 with a different DMI format or without DMI. HEVC HDR UHD TV Bitstreams using PQ10 without DMI may switch to HEVC HDR UHD TV Bitstreams using PQ10 with DMI.

Decoding: If an HEVC HDR UHD TV IRD supports one or more DMI formats it should be capable of handling such a change seamlessly.

NOTE: The above constraint on handling such a change seamlessly applies to the bitstream, and not to the display. The display may, for example, show a black screen temporarily when switching.

5.14.4.4.3.3.4.3 SMPTE ST 2094-10 SEI message

SMPTE ST 2094-10 [i.38] DMI provides and describes dynamic information about the video signal. The information conveyed in the SEI message carrying SMPTE ST 2094-10 [i.38] DMI is adequate for purposes corresponding to the use of Society of Motion Picture and Television Engineers SMPTE ST 2094-1 [i.37] and SMPTE ST 2094-10 [i.38].

Encoding: HEVC HDR UHD TV Bitstreams using PQ10 may contain SEI messages carrying SMPTE ST 2094-10 DMI.

The SMPTE ST 2094-10 [i.38] DMI is carried in the video elementary stream as Supplemental Enhancement Information in HEVC's "User data registered by Recommendation ITU-T T.35 SEI message" syntactic element as defined in clause B.7.2.

If the "User data registered by a Recommendation ITU-T T.35 [19] SEI message" carrying SMPTE ST 2094-10 [i.38] DMI is present in an HEVC HDR UHD TV Bitstream using PQ10, the constraints defined below shall apply.

- *It shall be a prefix SEI message (i.e. **nal_unit_type** shall be equal to PREFIX_SEI_NUT) sent for every access unit of the HEVC HDR UHD TV Bitstream using PQ10.*
- *The HEVC HDR UHD TV Bitstream using PQ10 shall contain a Mastering Display Colour Volume SEI message as specified in clause 5.14.4.4.3.3.2.*

The following constraints shall apply to the syntactic element as defined in clause B.7.2 of the "User data registered by a Recommendation ITU-T T.35 [19] SEI message" carrying SMPTE ST 2094-10 [i.38] DMI:

- ***user_identifier** shall be set equal to "GA94" indicating a DVBI_data() structure as defined in clause B.2 of the present document.*
- ***user_data_type_code** referenced by the DVBI_data() structure shall be set equal to "0x09" indicating a ST2094-10_data() structure as defined in clause 4 of ETSI TS 103 572 [50].*

The following constraints shall apply to the ST2094-10_data() structure of the "User data registered by a Recommendation ITU-T T.35 [19] SEI message" carrying SMPTE ST 2094-10 DMI [i.38]:

- ***app_identifier** shall be set equal to "1".*
- ***app_version** shall be set equal to "0".*
- *The number of extension blocks with **ext_block_level** set equal to "1" shall be constrained to be equal to "1".*
- *The number of extension blocks with **ext_block_level** set equal to "2" shall be constrained to be less than or equal to "16".*
- *The number of extension blocks with **ext_block_level** set equal to "5" shall be constrained to be less than or equal to "1".*

5.14.4.4.3.3.4.4 SL-HDR2 SEI message

Dynamic mapping according to SL-HDR2 is specified in ETSI TS 103 433-2 [51] and provides a broadcaster with an HDR-to-HDR/SDR reference display mapping method to verify the intended result of the display mapping process. The defined reference display mapping method does not imply that the video signal will be mapped with the reference display mapping method nor does it enforce implementation on the IRD.

Encoding: HEVC HDR UHD TV Bitstreams using PQ10 may contain SEI messages carrying SL-HDR2 DMI.

The SL-HDR2 DMI is carried in the video elementary stream as Supplemental Enhancement Information in HEVC's "User data registered by Recommendation ITU-T T.35 SEI message" syntactic element. The syntax and semantics of SL-HDR2 DMI are specified in annex A of ETSI TS 103 433-2 [51].

NOTE 1: Annex A of ETSI TS 103 433-2 [51] refers to ETSI TS 103 433-1 [i.40] in which the syntax and semantics common to SL-HDR1 and SL-HDR2 is specified. It also provides additional constraints to SL-HDR2 DMI.

If the "User data registered by a Recommendation ITU-T T.35 [19] SEI message" carrying SL-HDR2 DMI is present in an HEVC HDR UHD TV Bitstream using PQ10, the following constraints shall apply.

- *It shall be a prefix SEI message (i.e. **nal_unit_type** shall be equal to PREFIX_SEI_NUT).*
- *All constraints specified in annex A of ETSI TS 103 433-2 [51] shall apply.*
- *It shall be transmitted at least with every HEVC DVB_RAP of the HEVC HDR UHD TV Bitstream using PQ10.*

NOTE 2: The persistence of the SL-HDR2 DMI is controlled by two flags that are included in the SEI message. The DMI may apply to the current picture only, until the next SL-HDR Information SEI message (or the end of the bitstream), or it may be cancelled.

- *If **src_mdcv_info_present_flag** is set equal to "1" and the HEVC HDR UHD TV Bitstream using PQ10 contains a Mastering Display Colour Volume SEI message, the values for the corresponding syntax elements should be identical.*

Decoding: It is recommended that the IRD implements either the reference display mapping method or a display mapping method that performs at least as well as the reference display mapping method given the capabilities of the IRD.

5.14.4.4.3.3.4.5 SMPTE ST 2094-40 SEI message

SMPTE ST 2094-40 [i.39] DMI provides and describes dynamic information about the video signal. The information conveyed in the SEI message carrying SMPTE ST 2094-40 [i.39] DMI is adequate for purposes corresponding to the use of Society of Motion Picture and Television Engineers SMPTE ST 2094-1 [i.37] and SMPTE ST 2094-40 [i.39].

Encoding HEVC HDR UHD TV Bitstreams using PQ10 may contain SEI messages carrying SMPTE ST 2094-40 [i.39] DMI.

The SMPTE ST 2094-40 [i.39] DMI is carried in the video elementary stream as Supplemental Enhancement Information in HEVC's "User data registered by Recommendation ITU-T T.35 SEI message" syntactic element. The syntax of the SEI message carrying the DMI based on SMPTE ST 2094-40 [i.39] is specified in CTA 861-H [52], clause S.2. The semantics of the SEI message carrying the DMI based on SMPTE ST 2094-40 [i.39] are specified in CTA 861-H [52], clause S.3. The additional constraints of clause S.4 shall apply.

If the "User data registered by a Recommendation ITU-T T.35 [19] SEI message" carrying SMPTE ST 2094-40 [i.39] DMI is present in an HEVC HDR UHD TV Bitstream using PQ10, the following constraints shall apply.

- *It shall be a prefix SEI message (i.e. **nal_unit_type** shall be equal to PREFIX_SEI_NUT) sent once for every access unit of the HEVC HDR UHD TV Bitstream using PQ10.*
- *The HEVC HDR UHD TV Bitstream using PQ10 shall contain a Mastering Display Colour Volume SEI message as specified in clause 5.14.4.4.3.3.2.*

5.14.4.4.3.4 Dynamic switching between SDR and HDR as a result of bitstream splicing

5.14.4.4.3.4.1 Introduction

Broadcast services are expected to be delivered in either a high dynamic range or a standard dynamic range format. However, bitstream splicing within a network may result in dynamic changes between high and standard dynamic range content at the IRD.

5.14.4.4.3.4.2 Transition from HDR to SDR

Encoding: HEVC HDR UHD TV Bitstreams may switch to a HEVC UHD TV Bitstream.

- *If the HEVC UHD TV bitstream is using BT.709 colour primaries, the HEVC UHD TV bitstream shall alter the VUI **colour_primaries** to the value 1, **transfer_characteristics** to the value 1 and **matrix_coeffs** to the value 1.*
- *If the HEVC UHD TV bitstream is using BT.2020 colour primaries, the HEVC UHD TV bitstream shall alter the VUI **colour_primaries** to the value 9, **transfer_characteristics** to the value 14 and **matrix_coeffs** to the value 9.*

Decoding: HEVC HDR UHD TV IRDs using PQ10 should be capable of handling such a change to HEVC UHD TV Bitstream seamlessly.

NOTE: The above constraint on handling such a change seamlessly applies to the bitstream, and not to the display. The display may, for example, show a black screen temporarily when switching between different transfer characteristics and/or colour primaries.

5.14.4.4.3.4.3 Transition from SDR to HDR

Encoding: HEVC UHD TV Bitstreams may switch to a HEVC HDR UHD TV Bitstream. *The HEVC HDR UHD TV Bitstream shall be compliant with clause 5.14.4.3.2.*

Decoding: HEVC HDR UHD TV IRDs using PQ10 should be capable of handling such a change to HEVC HDR UHD TV Bitstream seamlessly.

NOTE: The above constraint on handling such a change seamlessly applies to the bitstream, and not to the display. The display may, for example, show a black screen temporarily when switching between different transfer characteristics and/or colour primaries.

5.14.4.5 Frame Rates

All specifications in clause 5.14.1.7 shall apply with the following restrictions.

Encoding: *Only progressive frame rates shall be used, i.e. the value of **field_seq_flag** in the Video Usability Information shall be equal to 0.*

Decoding: *HEVC HDR UHD TV IRDs shall support decoding and displaying of video with an output frame rate of 24 000/1 001, 24, 25, 30 000/1 001, 30, 50, 60 000/1 001 or 60 Hz progressive.*

5.14.4.6 Backwards Compatibility

Decoding: *HEVC HDR UHD TV IRDs shall be capable of decoding any bitstream that a HEVC UHD TV IRD is required to decode and resulting in the same displayed pictures as the HEVC UHD TV IRD, as described in clause 5.14.3.*

5.14.5 HEVC HDR HFR UHDTV IRDs and Bitstreams and HEVC HFR UHDTV Bitstreams

5.14.5.1 General

This clause adds High Frame Rate (HFR) functionality in addition to the functionalities supported in HEVC UHDTV IRDs and Bitstreams or HEVC HDR UHDTV IRDs and Bitstreams.

The present clause specifies two types of Bitstreams that include the HFR functionality (where standard frame rates HEVC IRDs refer to HEVC IRDs that are capable to decode frame rates up to 60 Hz only, such as the HEVC UHDTV IRD or the HEVC HDR UHDTV IRD):

- HFR Bitstreams using dual PID and temporal scalability: the Bitstreams are specified in such a way that standard frame rates HEVC IRDs are expected to display fair motion portrayal, although the motion portrayal may not be as good as that reproduced by HEVC HDR HFR UHDTV IRDs.
- HFR Bitstreams using single PID: for such Bitstreams, standard frame rates HEVC IRDs are not expected to produce any picture at all.

The HEVC HDR HFR UHDTV IRD shall support the decoding of both of the HFR Bitstream types specified in the present clause.

All specifications in clause 5.14.1 shall apply.

It is assumed that all HEVC IRDs that support HFR will also support HDR, i.e. there is no specification of an IRD conformance point to support HFR but not HDR.

5.14.5.2 Profiles, Tiers and Levels

5.14.5.2.1 Common

Encoding: *In addition to the provisions set forth in Recommendation ITU-T H.265 / ISO/IEC 23008-2 [35], the following restrictions shall apply for the fields in the sequence parameter set:*

***bit_depth_luma_minus8** = 2*
bit_depth_chroma_minus8** = **bit_depth_luma_minus8
***vui_parameters_present_flag** = 1*

***sps_extension_present_flag** = 0*

In addition to the provisions set forth in Recommendation ITU-T H.265 / ISO/IEC 23008-2 [35], the following restrictions shall apply for the fields in the profile_tier_level syntax structure in the sequence parameter set:

***general_tier_flag** = 0*

***general_profile_idc** = 2 (Main 10 profile)*

***general_level_idc** shall be less than or equal to 156 (level 5.2)*

HEVC HDR HFR UHDTV Bitstreams and HEVC HFR UHDTV Bitstreams shall obey the limits in Recommendation ITU-T H.265 / ISO/IEC 23008-2 [35], table A.1 and table A.2 associated with Level 5.2.

NOTE: In the Main 10 Profile, **chroma_format_idc** is equal to '1'.

Decoding: *HEVC HDR HFR UHDTV IRDs shall support the decoding of Main 10 Profile, Main Tier, Level 5.2 bitstreams within the constraints of the present clause.*

HEVC HDR HFR UHD TV IRDs may ignore sequence parameter set extensions signalled by **sps_extension_present_flag** set to "1".

5.14.5.2.2 HFR Bitstreams using dual PID and temporal scalability

All specifications in clause 5.14.5.2.1 shall apply.

Encoding: **sps_max_sub_layers_minus1** shall be greater than "0".

sub_layer_level_present_flag[i] where 'i' is equal to **temporal_id_max** carried within the HEVC Video Descriptor for **stream_type** 0x24 shall be equal to "1", and

sub_layer_level_idc[i] where 'i' is equal to **temporal_id_max** carried within the HEVC Video Descriptor for **stream_type** 0x24 shall be less than or equal to "153" (level 5.1).

NOTE: HEVC UHD TV IRDs, specified in clause 5.14.3, are able to decode frame rates only up to 60 Hz. They are expected to be able to decode HEVC HFR UHD TV Bitstreams by receiving only the half frame rate HEVC temporal video sub-bitstream contained therein.

HEVC HDR UHD TV IRDs, specified in clause 5.14.4, are able to decode frame rates only up to 60 Hz. They are expected to be able to decode HEVC HDR HFR UHD TV and HEVC HFR UHD TV Bitstreams by receiving only the half frame rate HEVC temporal video sub-bitstream contained in the respective HFR Bitstream.

5.14.5.2.3 HFR Bitstreams using single PID

All specifications in clause 5.14.5.2.1 shall apply.

Encoding: **sps_max_sub_layers_minus1** may be greater than "0".

sub_layer_level_present_flag[i] where 'i' is equal to **temporal_id_max** carried within the HEVC Video Descriptor for the single PID with **stream_type** 0x24 may be equal to "1" or "0".

HFR Bitstreams using single PID are not required to include an HEVC UHD TV sub-bitstream. The details of **sps_max_sub_layers_minus1**, **sub_layer_level_present_flag[i]** and **sub_layer_level_idc[i]** allow for these values not to be set thereby allowing for a bitstream that does not include a HEVC temporal video sub-bitstream.

5.14.5.3 Luminance Resolutions

All specifications in clause 5.14.4.3 shall apply, i.e. HEVC HFR UHD TV Bitstreams and HEVC HFR HDR UHD TV Bitstreams shall represent the same luminance resolutions as HEVC HDR UHD TV Bitstreams.

5.14.5.4 Colour Parameter Information

Encoding: HEVC HFR UHD TV Bitstreams and HEVC HDR HFR UHD TV Bitstreams shall use Recommendation ITU-R BT.2100 [45] colour primaries and non-constant luminance matrix coefficients, which shall be explicitly signalled to the IRD by setting the VUI **colour_primaries** equal to 9 and **matrix_coeffs** equal to 9. Content produced with different system colorimetry shall be mapped in to a BT.2100 colour container prior to HEVC encoding.

NOTE: Recommendation ITU-R BT.2100 [45] colour primaries and non-constant luminance matrix coefficients are identical to Recommendation ITU-R BT.2020 [36] colour primaries and non-constant luminance matrix coefficients, so the same VUI parameter values are used.

HEVC HFR UHD TV Bitstreams shall use Recommendation ITU-R BT.2020 [36] opto-electronic transfer characteristics, which shall be explicitly signalled to the IRD by setting the VUI **transfer_characteristics** to the value 14.

HEVC HDR HFR UHD TV Bitstreams shall use specifications in clause 5.14.4.2 or clause 5.14.4.3.

Decoding: *HEVC HDR HFR UHD TV IRDs shall use specifications in clause 5.14.4.4.*

5.14.5.5 High Frame Rates

5.14.5.5.1 General

The present clause extends clause 5.14.1.7. *All specifications in clause 5.14.1.7 shall apply.*

Encoding: *The frame rate for progressive material shall be 24 000/1 001, 24, 25, 30 000/1 001, 30, 50, 60 000/1 001, 60, 100, 120 000/1 001 or 120 Hz for all allowed luminance resolutions.*

HEVC bitstreams encoded at 100, 120 000/1 001 or 120 Hz may exploit HEVC Temporal sub-layers to allow a partial decode of the bitstream at half of the native frame rate by an HEVC UHD TV IRD. *Where required, the bitstream shall be partitioned in to two HEVC video sub-bitstreams carrying alternate frames - an HEVC temporal video sub-bitstream targeting the HEVC UHD TV IRD and an HEVC temporal video subset comprising the remaining frames of the HEVC bitstream.* See clauses 5.14.5.6 and 5.14.5.7.

*The frame rate shall be indicated in the VUI by setting **vui_time_scale**, **vui_num_units_in_tick** syntax elements and, if HEVC Temporal sub-layers are present, by setting **elemental_duration_in_tc_minus1[temporal_id_max]** in the **hrd_parameters()**, where the **temporal_id_max** values are signalled in the HEVC video descriptors associated with each HEVC video sub bitstream (as per clause 4.1.8.19a).*

*The progressive scan shall be indicated in the VUI by setting **field_seq_flag** equal to 0.*

Table 21b is an extension to table 19 and lists the additional frame rates that shall be supported and the recommended values for signalling them.

Table 21b: Progressive Frame Rates for HEVC HFR UHD TV Bitstreams and recommended values for signalling

Output Frame Rate (fps)		Stream Type: 0x24 (HEVC bitstream and HEVC temporal video sub- bitstream)	Stream Type: 0x25 (HEVC temporal video subset)	vui_time_scale	vui_num_units_in_tick	Allowed pic_struct
HEVC UHD TV IRD	HEVC HDR HFR UHD TV IRD	elemental_ duration _in_tc_minus1 [temporal_id _max](0x24)	elemental_ duration _in_tc_minus1 [temporal_id _max](0x25)			
Not applicable	100	0	Not applicable	100	1	0,7,8
50	100	1	0	100	1	0,7,8
Not applicable	120 000/1 001	0	Not applicable	120 000	1 001	0,7,8
60 000/1 001	120 000/1 001	1	0	120 000	1 001	0,7,8
Not applicable	120	0	Not applicable	120	1	0,7,8
60	120	1	0	120	1	0,7,8

NOTE: If the HEVC temporal video subset is either not applicable, not present or not decoded, the HEVC Output Frame Rate is calculated using **vui_time_scale**, **vui_num_units_in_tick** and **elemental_duration_in_tc_minus1[temporal_id_max](0x24)**.

$$\text{HEVC Output Frame Rate (fps)} = \frac{\text{vui_time_scale}}{\left(1 + \text{elemental_duration_in_tc_minus1[temporal_id_max](0x24)}\right) * \text{vui_num_units_in_tick}}$$

If the HEVC temporal video subset is present and decoded, the HEVC Output Frame Rate is calculated using **vui_time_scale**, **vui_num_units_in_tick** and **elemental_duration_in_tc_minus1[temporal_id_max](0x25)**.

$$\text{HEVC Output Frame Rate (fps)} = \frac{\text{vui_time_scale}}{\left(\frac{1 + \text{elemental_duration_in_tc_minus1[temporal_id_max](0x25)}}{\text{vui_num_units_in_tick}} \right)}$$

Decoding: *HEVC HDR HFR UHD TV IRDs shall support decoding and displaying of video with the output frame rates supported by HEVC UHD TV IRDs and 100, 120 000/1 001 and 120 Hz in addition.*

*The frame rate shall be calculated using the VUI and VUI **hrd_parameters()** syntax elements **vui_time_scale**, **vui_num_units_in_tick** and **elemental_duration_in_tc_minus1[temporal_id_max]**. The highest TemporalID to be decoded is indicated by **temporal_id_max**, carried in the HEVC video descriptor.*

The frame rates that shall be supported and the recommended values for signalling them are listed in tables 19 and 21b.

5.14.5.5.2 Dynamic Changes in Frame Rate

Efficient encoding of "film-style" 24, 25, 30 000/1 001 and 30 Hz material is not currently possible within a full frame rate 100, 120 000/1 001 or 120 Hz HEVC video bitstream as the HEVC **pic_struct** parameter does not permit frame quadrupling and sextupling. In addition, high frame rate programmes may include inserts (e.g. from a radio camera) at standard frame rates. Thus, a restricted set of dynamic changes in frame rate are permitted:

Encoding: *The video frame rate indicated by the **vui_time_scale**, **vui_num_units_in_tick** and **elemental_duration_in_tc_minus1[temporal_id_max]** shall change only at an HEVC DVB_RAP. Such changes shall be restricted to either a doubling or halving of frame rate between 50, 60 000/1 001 or 60 Hz and 100, 120 000/1 001 or 120 Hz.*

Decoding: Changes in frame rate at the IRD output, indicated by the **vui_time_scale**, **vui_num_units_in_tick** and **elemental_duration_in_tc_minus1[temporal_id_max]**, should be seamless when they occur at an HEVC DVB_RAP and represent either a doubling or halving of frame rate between 50, 60 000/1 001 or 60 Hz and 100, 120 000/1 001 or 120 Hz.

NOTE: Where the output frame rate is halved from 100, 120 000/1 001 or 120 Hz to 50, 60 000/1 001 or 60 Hz, the HEVC temporal video subset will no longer be present.

5.14.5.6 HEVC temporal sub-layers for HFR Bitstreams using dual PID and temporal scalability

HEVC UHD TV IRDs are specified in clause 5.14.3 and are by definition capable to decode frame rates up to 60 Hz only. HEVC HDR UHD TV IRDs are specified in clause 5.14.4 and are by definition capable to decode frame rates up to 60 Hz only.

HEVC Temporal sub-layers enable the partial decoding of an HEVC bitstream at a submultiple of its native frame-rate.

Encoding: *Where a half frame rate component of a 100, 120 000/1 001 or 120 Hz HEVC bitstreams is required to be decoded by an HEVC UHD TV IRD or an HEVC HDR UHD TV IRD, the HEVC video bitstream shall be partitioned in to two sub-bitstreams carrying alternate frames:*

- *A half frame rate HEVC temporal video sub-bitstream comprising the lower temporal sub-layers with a frame rate equal to 50, 60 000/1 001 or 60 Hz as defined in the clause 5.14.1.9.1.*
- *An HEVC temporal video subset, comprising one temporal sub-layer and containing every second picture in display order as defined in the present clause.*

*HEVC temporal video subsets shall be carried on a single Transport Stream PID with **stream_type** equal to 0x25. Only HEVC temporal video subsets obeying the limits associated with level 5.2 for HEVC HDR HFR UHD TV Bitstreams or HEVC HFR UHD TV Bitstreams shall be carried within this PID.*

Decoding: *HEVC HDR HFR UHD TV IRDs shall decode HEVC Bitstreams and HEVC temporal video sub-bitstreams with **stream_type** equal to 0x24 and HEVC temporal video subsets with **stream_type** equal to 0x25, obeying the limits associated with level 5.2 for HEVC HDR HFR UHD TV Bitstreams or HEVC HFR UHD TV Bitstreams.*

5.14.5.7 HEVC encoding structure for HFR Bitstreams using dual PID and temporal scalability

HEVC UHD TV IRDs are specified in clause 5.14.3 and are by definition capable to decode frame rates up to 60 Hz only. HEVC HDR UHD TV IRDs are specified in clause 5.14.4 and are by definition capable to decode frame rates up to 60 Hz only.

Encoding: *Where a half frame rate component of a 100, 120 000/1 001 or 120 Hz HEVC bitstreams is required to be decoded by an HEVC UHD TV IRD or an HEVC HDR UHD TV IRD, the HEVC video bitstream shall be partitioned in to two sub-bitstreams carrying alternate pictures in display order:*

- *A half frame rate HEVC temporal video sub-bitstream comprising the lower temporal sub-layers with a frame rate equal to 50, 60 000/1 001 or 60 Hz as defined in the clause 5.14.1.9.1.*
- *An HEVC temporal video subset, comprising one temporal sub-layer and containing every second picture in display order.*

HEVC DVB_RAP pictures shall be included into the half frame rate HEVC temporal video sub-bitstream.

The Decoding Time Stamps of access units in the half frame rate HEVC temporal video sub-bitstream shall be in a constant rate, i.e. 60 Hz for 120 Hz HFR Bitstreams, 50 Hz for 100 Hz HFR Bitstreams.

NOTE 1: The constraint is introduced to ensure that the DTS value of an access unit in the HEVC temporal video sub-bitstream can be applied both to decoding of the half frame rate UHD TV video only, and decoding of the HFR UHD TV video. For information, an example of a coding structure that fulfils this constraint is documented in Recommendation ITU-R BT.2073-0 [i.30], annex 2.

NOTE 2: 24 and 24 000/1 001 Hz content is carried within a 60 and 60 000/1 001 Hz bitstream respectively, using 3:2 pull-down (**pic_struct** values 7 and 8) - see clause 5.14.5.5.2. In which case the HEVC temporal video subset is not present and the DTS interval will be at multiples of 60 and 60 000/1 001 Hz.

All aspects other than the frame rate (such as colour primaries, matrix coefficients, transfer characteristics, resolution, bit depth for example) shall stay the same in the half frame rate HEVC temporal video sub-bitstream and the HEVC temporal video subset.

Decoding: *HEVC HDR HFR UHD TV IRDs shall decode both the half frame rate HEVC temporal video sub-bitstream and the HEVC temporal video subset to reconstruct the HFR UHD TV video. HEVC UHD TV IRDs and HEVC HDR UHD TV IRDs are only required to decode the half frame rate HEVC temporal video sub-bitstream.*

5.14.5.8 Constraint on TemporalId

For HFR Bitstreams using dual PID and temporal scalability, the following constraints shall apply:

Encoding: *The values of TemporalId shall be assigned to the set of pictures as below, with TemporalId = nuh_temporal_id_plus1 - 1 as specified in Recommendation ITU-T H.265 / ISO/IEC 23008-2 [35]:*

<i>TemporalId = 6</i>	<i>Reserved for future extensions</i>
<i>TemporalId = [N+1]</i>	<i>Access Unit of the HEVC temporal video subset that only carries a picture for 100, 120 000/1 001 or 120 Hz</i>
<i>TemporalId = N</i>	<i>Access Unit of the HEVC temporal video sub-bitstream that carries a non-reference picture for standard frame rate equal to or lower than 60 Hz. This picture may be a reference picture for the HEVC temporal video subset when present</i>
<i>TemporalId = 0...[N-1]</i>	<i>Access Unit of the HEVC temporal video sub-bitstream that carries a reference picture for standard frame rate equal to or lower than 60 Hz</i>

The value of N is configured at the encoder. *The value of N shall be in the range 1 to 4 (inclusive) and shall remain static.*

The value of temporal_id_max in the HEVC video descriptor for stream_type 0x24 shall be equal to N.

The values of temporal_id_min and temporal_id_max in the HEVC video descriptor for stream_type 0x25, carrying the pictures for 100, 120 000/1 001 or 120 Hz, shall be equal to N+1.

When splicing between dual PID high frame rate and single PID standard frame rate bitstreams the HEVC video descriptor should remain static. Changes in the HEVC video descriptor at splice points may lead to unpredictable IRD behaviour.

For HFR Bitstreams using single PID, the following constraints shall apply:

Encoding: *If HEVC sub-layers are used, the values of TemporalId shall be assigned to the set of pictures as below, with TemporalId = nuh_temporal_id_plus1 - 1 as specified in Recommendation ITU-T H.265 / ISO/IEC 23008-2 [35]:*

<i>TemporalId = 6</i>	<i>Reserved for future extensions</i>
<i>TemporalId = [N+1]</i>	<i>Access Unit of the HEVC video bitstream that only carries a non-reference picture for 100, 120 000/1 001 or 120 Hz</i>
<i>TemporalId = 0...N</i>	<i>Access Unit of the HEVC video bitstream that carries a picture for standard frame rate equal to or lower than 60 Hz</i>

The value of N is configured at the encoder. *The value of N shall be in the range 1 to 4 (inclusive) and shall remain static.*

The value of temporal_id_max in the HEVC video descriptor for stream_type 0x24 shall be equal to N+1.

When splicing between single PID high frame rate and single PID standard frame rate bitstreams, the temporal_id_max for the high frame rate bitstream shall be higher than the temporal_id_max of the standard frame rate bitstream.

NOTE 1: There might be gaps in the values of TemporalId in use. For example, for HFR bitstreams using dual PID, the Access Units of a half frame rate HEVC temporal video sub-bitstreams may have values of TemporalId equal to 0, 1 or 2, and the Access Units of the HEVC temporal video subset may have TemporalId equal to 5. Therefore, there will be no Access Units with values of TemporalId equal to 3 or 4.

NOTE 2: TemporalId [N+1] will not be present when a high frame rate bitstream switches to standard frame rate. See clause 5.14.5.5.2 Dynamic Changes in Frame Rate.

5.14.5.9 Backwards Compatibility

Decoding: *HEVC HDR HFR UHD TV IRDs shall be capable of decoding any bitstream that a HEVC HDR UHD TV IRD is required to decode and resulting in the same displayed pictures as the HEVC HDR UHD TV IRD, as described in clause 5.14.4.*

5.14.6 HEVC HDR UHD TV2 IRDs and Bitstreams

5.14.6.1 General

This clause specifies the HEVC HDR UHD TV2 IRDs and Bitstreams. *All specifications in clause 5.14.1 shall apply.* The specification in the remainder of this clause only applies to the HEVC HDR UHD TV2 IRDs and Bitstreams.

5.14.6.2 Profile, tier and level

Encoding: *In addition to the provisions set forth in Recommendation ITU-T H.265 / ISO/IEC 23008-2 [35], the following restrictions shall apply for the fields in the sequence parameter set:*

***bit_depth_luma_minus8** = 2*
bit_depth_chroma_minus8** = **bit_depth_luma_minus8
***vui_parameters_present_flag** = 1*
***sps_extension_present_flag** = 0*

In addition to the provisions set forth in Recommendation ITU-T H.265 / ISO/IEC 23008-2 [35], the following restrictions shall apply for the fields in the profile_tier_level syntax structure in the sequence parameter set:

***general_tier_flag** = 0*
***general_profile_idc** = 2 (Main 10 profile)*

HEVC HDR UHD TV2 Bitstreams shall obey the limits in Recommendation ITU-T H.265 / ISO/IEC 23008-2 [35], table A.1 and table A.2 associated with Level 6.1.

***general_level_idc** shall be less than or equal to 183 (level 6.1), unless the HEVC Bitstream is a HEVC temporal video sub-bitstream. In this case, **sps_max_sub_layers_minus1** shall be greater than "0", **sub_layer_level_present_flag[i]** where 'i' is equal to **temporal_id_max** carried within the HEVC Video Descriptor shall be equal to "1", and **sub_layer_level_idc[i]** where 'i' is equal to **temporal_id_max** carried within the HEVC Video Descriptor shall be less than or equal to "183" (level 6.1).*

NOTE 1: In the Main 10 Profile, **chroma_format_idc** is equal to '1'.

Decoding: *HEVC HDR UHD TV2 IRDs shall support the decoding of Main 10 Profile, Main Tier, Level 6.1 bitstreams within the constraints of the present document.*

*If temporal extensions are added in future versions of the present document, **general_level_idc** may be greater than 183 (level 6.1). When **sps_max_sub_layers_minus1** is greater than "0", IRDs may ignore **general_level_idc** and shall make use of the **sub_layer_level_idc[i]** syntax element, where 'i' is equal to **temporal_id_max** carried within the HEVC Video Descriptor, to determine whether a bitstream or sub-bitstream can be decoded.*

*HEVC HDR UHD TV2 IRDs may ignore sequence parameter set extensions signalled by **sps_extension_present_flag** set to "1".*

NOTE 2: HEVC HDR UHD TV2 IRDs are not required to decode and display correctly HEVC Bitstreams or HEVC temporal video sub-bitstreams that do not obey the constraints and limits associated with the Main 10 Profile, Main Tier, Level 6.1.

5.14.6.3 Luminance resolution

Encoding: *HEVC HDR UHDTV2 encoders shall, as a minimum, represent video with the luminance resolutions shown in table 21c, where luminance resolution is to be understood as the video resolution after conformance cropping.*

Where non 16:9 sources are re-formatted and encoded within a 16:9 frame, AFD/bar data defined in clause B.3 and default display window defined in clause 5.14.1.5.6 should be included within the bitstream to assist the IRD in displaying the content.

Decoding: *HEVC HDR UHDTV2 IRDs shall be capable of decoding pictures with luminance resolutions shown in table 21c, where luminance resolution is to be understood as the video resolution after conformance cropping. HEVC IRDs shall be able to reconstruct the image size to allow the decoded pictures to be displayed at full-screen size.*

Table 21c: Resolutions for Full-screen Display from HEVC HDR UHDTV2 IRD

Luminance resolution		Scan (interlace/ progressive)	Aspect ratio		Example up-sampling for 7 680 x 4 320 display	
Horizontal	Vertical		Coded Frame	Aspect_ratio_i dc	Horizontal	Vertical
7 680	4 320	P	16x9	1	x 1	x 1
5 120	2 880	P	16x9	1	x 3/2	x 3/2
3 840	2 160	P	16x9	1	x 2	x 2
3 200	1 800	P	16x9	1	x 12/5	x 12/5
2 560	1 440	P	16x9	1	x 3	x 3
1 920	1 080	P	16x9	1	x 4	x 4
1 600	900	P	16:9	1	x 24/5	x 24/5
1 280	720	P	16:9	1	x 6	x 6
960	540	P	16:9	1	x 8	x 8

5.14.6.4 Dynamic Range and Colour Parameter Information

Encoding: *HEVC HDR UHDTV2 Bitstreams shall use specifications in clause 5.14.3.3 (for Standard Dynamic Range) or clause 5.14.4.4 (for High Dynamic Range) with the additional constraint that Standard Dynamic Range Bitstreams shall use only Recommendation ITU-R BT.2020 [36] non-constant luminance colorimetry.*

HEVC HDR UHDTV2 Bitstreams using HLG10 may signal the usage of the Recommendation ITU-R BT. 2100 [45] HLG system by setting **transfer_characteristics** in the VUI to the value 18.

Decoding: *HEVC HDR UHDTV2 IRDs shall use specifications in clause 5.14.3.3 (for Standard Dynamic Range Bitstreams) and clause 5.14.4.4 (for High Dynamic Range Bitstreams).*

*In addition to supporting signalling of the HLG System using the **alternative_transfer_characteristics** SEI message, HEVC HDR UHDTV2 IRDs shall support a value of **transfer_characteristics** in the VUI equal to 18.*

5.14.6.5 Frame Rates

All specifications in clause 5.14.1.7 shall apply with the following restrictions:

Encoding: *Only progressive frame rates shall be used, i.e. the value of **field_seq_flag** in the Video Usability Information shall be equal to 0.*

Decoding: *HEVC HDR UHDTV2 IRDs shall support decoding and displaying of video with an output frame rate of 24 000/1 001, 24, 25, 30 000/1 001, 30, 50, 60 000/1 001 or 60 Hz progressive.*

5.14.6.6 Backwards Compatibility

Decoding: *HEVC HDR UHDTV2 IRDs shall be capable of decoding any bitstream that a HEVC HDR UHDTV IRD using HLG10 and a HEVC HDR UHDTV IRD using PQ10 is required to decode and resulting in the same displayed pictures as the HEVC HDR UHDTV IRD, as described in clause 5.14.4.*

6 Audio

6.0 Introduction

This clause describes the guidelines for encoding MPEG-1 or MPEG-2 Layer II backward compatible audio, or AC-3 audio, or Enhanced AC-3 audio, or AC-4 audio, or DTS Audio, or DTS-HD audio, or DTS-UHD audio, or MPEG-4 AAC audio, or MPEG-4 HE AAC audio, or MPEG-4 HE AAC v2 audio, or MPEG-H audio, or combinations of MPEG Surround audio with MPEG-1 Layer II, MPEG-4 AAC audio, or MPEG-4 HE AAC audio, or MPEG-4 HE AAC v2 audio in DVB broadcast bitstreams, and for decoding this bitstream in the IRD.

The following clauses do not imply that either MPEG-1 audio, or MPEG-2 Layer II backward compatible audio, or AC-3 audio, or Enhanced AC-3 audio, or AC-4 audio, or DTS Audio, or DTS-HD audio, or DTS-UHD audio, or MPEG-4 AAC audio, or MPEG-4 HE AAC audio, or MPEG-4 HE AAC v2 audio, or combinations of MPEG Surround with MPEG-1 Layer II, MPEG-4 AAC audio, or MPEG-4 HE AAC audio, or MPEG-4 HE AAC v2 audio, or MPEG-H audio are mandatory. *The codecs that a given IRD supports will define which of the following clauses the IRD shall comply with.*

The recommended level for reference tones for transmission is 18 dB below clipping level, in accordance with EBU Recommendation R.68 [11].

It is recommended that IRDs handle loudness normalization in accordance with EBU Recommendation R 128 [i.18] and EBU Tech 3344 [i.19].

6.1 MPEG-1 and MPEG-2 backward compatible audio

6.1.0 General

MPEG-1 and MPEG-2 backward compatible audio encoding shall conform to either ISO/IEC 11172-3 [9] or ISO/IEC 13818-3 [3]. Some of the parameters and fields in ISO/IEC 11172-3 [9] and ISO/IEC 13818-3 [3] are not used in the DVB System and these restrictions are described below.

The design of an IRD compatible with MPEG-1 and/or MPEG-2 backward compatible audio should be made under the assumption that any legal structure as permitted by ISO/IEC 11172-3 [9] or ISO/IEC 13818-3 [3] may occur in the broadcast stream even if presently reserved or unused. *To allow full compliance to ISO/IEC 11172-3 [9] and ISO/IEC 13818-3 [3] and upward compatibility with future enhanced versions, a DVB IRD shall be able to skip over data structures which are currently "reserved", or which correspond to functions not implemented by the IRD. For example, an IRD which is not designed to make use of the ancillary data field shall skip over that portion of the bitstream.*

This clause is based on ISO/IEC 11172-3 [9] (MPEG-1 audio) and ISO/IEC 13818-3 [3] (MPEG-2 backward compatible audio).

Optionally, also the combination of MPEG-1 Layer II with MPEG Surround is supported. The encoding and decoding of MPEG Surround complies with ISO/IEC 23003-1 [29] and [31]. MPEG Surround creates a (mono or stereo) downmix from the multi-channel audio input signal. This downmix is encoded using a core audio codec, in this case MPEG-1 Layer II. In addition, MPEG Surround generates a spatial image parameter description of the multi-channel audio that is added as an ancillary data stream to the core audio codec. Legacy mono or stereo decoders ignore the ancillary data and play back a stereo respectively mono audio signal. MPEG Surround capable decoders will first decode the mono or stereo core codec audio signal and then use the spatial image parameters extracted from the ancillary data stream to generate a high quality multi-channel audio signal.

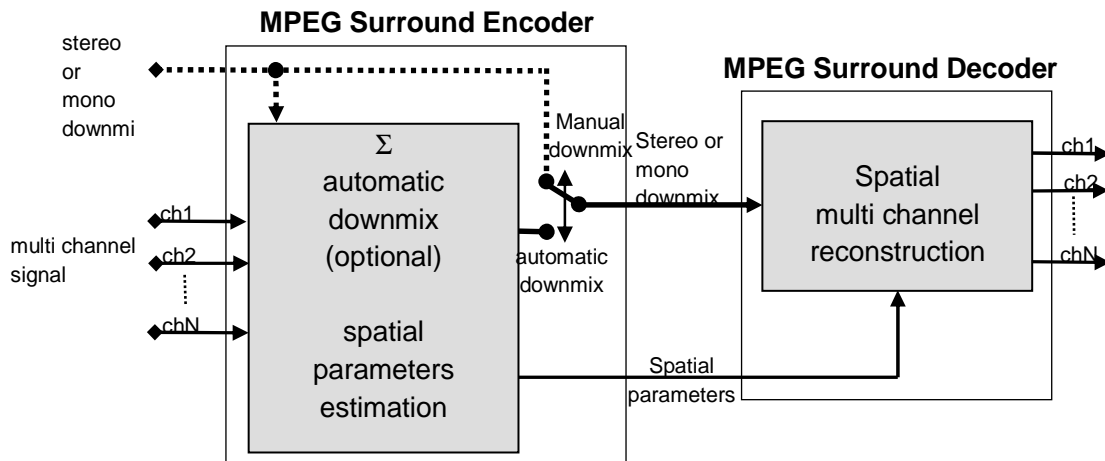

Figure 1a: Principle of MPEG Surround, the downmix is coded using MPEG-1 Layer II

This clause is based on ISO/IEC 11172-3 [9], Recommendation ITU-T H.222.0 / ISO/IEC 13818-1 [1] and IEC 61966-2-4 [31].

6.1.1 Audio mode

Encoding: *MPEG-1 and MPEG-2 backward compatible audio shall be encoded in one of the following modes:*

- ISO/IEC 11172-3 [9] single channel;
- ISO/IEC 11172-3 [9] joint stereo;
- ISO/IEC 11172-3 [9] stereo;
- ISO/IEC 13818-3 [3] multi-channel audio, backwards compatible to ISO/IEC 11172-3 [9] (dematrix procedure = 0, 1 or 2).

In addition, audio may be encoded in ISO/IEC 11172-3 [9] dual channel mode, in a transmission intended both as a contribution feed and for Direct-To-Home (DTH) reception. However, this is not recommended. Care needs to be taken to ensure that the optional dual channel decoding mode is supported in the DTH IRD. Furthermore, there may be problems due to the left/right channel selection being performed by different equipment from the decoding unit (e.g. decoding may be by a set-top-box but left/right channel selection and audio balance may be performed by the TV set).

Decoding: *IRDs compatible with MPEG-1 and/or MPEG-2 backward compatible audio shall be capable of decoding the following audio modes:*

- ISO/IEC 11172-3 [9] single channel;
- ISO/IEC 11172-3 [9] joint stereo;
- ISO/IEC 11172-3 [9] stereo.

IRDs compatible with MPEG-1 and/or MPEG-2 backward compatible audio shall be capable of decoding at least the ISO/IEC 11172-3 [9] compatible basic stereo information from an ISO/IEC 13818-3 [3] multi-channel audio bitstream. Full decoding of an ISO/IEC 13818-3 [3] multi-channel audio bitstream is optional.

Support for decoding of ISO/IEC 11172-3 [9] dual channel is optional.

6.1.2 Layer

Encoding: *An ISO/IEC 11172-3 [9] encoded bitstream shall use either Layer I or Layer II coding (**layer** = "11" or "10" respectively). Use of Layer II is recommended.*

*An ISO/IEC 13818-3 [3] multi-channel encoded bitstream shall use Layer II coding (**layer** = "10").*

Decoding: *IRDs shall be capable of decoding Layer I and Layer II. In case the IRD supports MPEG Surround decoding, it shall support the combination of MPEG-1 Layer II with MPEG Surround. The IRD shall interpret these formats in accordance with MPEG-1 and MPEG Surround audio syntax.*

6.1.3 Bitrate

Encoding: *The value of **bitrate_index** in the encoded bitstream shall be one of the 14 values from "0001" to "1110"(inclusive).*

For Layer I, these correspond to bitrates of: 32 kbits/s, 64 kbits/s, 96 kbits/s, 128 kbits/s, 160 kbits/s, 192 kbits/s, 224 kbits/s, 256 kbits/s, 288 kbits/s, 320 kbits/s, 352 kbits/s, 384 kbits/s, 416 kbits/s or 448 kbits/s.

For Layer II, these correspond to bitrates of: 32 kbits/s, 48 kbits/s, 56 kbits/s, 64 kbits/s, 80 kbits/s, 96 kbits/s, 112 kbits/s, 128 kbits/s, 160 kbits/s, 192 kbits/s, 224 kbits/s, 256 kbits/s, 320 kbits/s and 384 kbits/s.

For ISO/IEC 13818-3 [3] encoded bitstreams with total bitrates greater than 384 kbit/s, an extension bitstream shall be used. The bitrate of that extension may be in the range of 0 to 682 kbit/s.

Decoding: *IRDs shall be capable of decoding bitstreams with a value of **bitrate_index** from "0001" to "1110"(inclusive). Support for the free format bitrate (**bitrate_index** = "0000") is optional.*

6.1.4 Sampling frequency

Encoding: *The audio sampling rate of primary sound services shall be 32 kHz, 44,1 kHz or 48 kHz. Sampling rates of 16 kHz, 22,05 kHz, 24 kHz, 32 kHz, 44,1 kHz or 48 kHz may be used for secondary sound services.*

Decoding: *The IRD shall be capable of decoding audio with sampling rates of 32 kHz, 44,1 kHz and 48 kHz. Support for sampling rates of 16 kHz, 22,05 kHz and 24 kHz is optional.*

6.1.5 Emphasis

Encoding: *The encoded bitstream shall have no emphasis (**emphasis** = "00").*

Decoding: *The IRD shall be capable of decoding audio with no emphasis. Support for 50/15 microseconds de-emphasis and Recommendation ITU-T J.17 [10] de-emphasis (**emphasis** = "01" or "11") is optional.*

6.1.6 Cyclic redundancy code

Encoding: *The parity check word (**crc_check**) shall be included in the encoded bitstream.*

Decoding: *It is recommended that the IRD use **crc_check** to detect errors and subsequently invoke suitable concealment or muting mechanisms.*

6.1.7 Prediction

- Encoding: *ISO/IEC 13818-3 [3] multichannel encoded bitstreams shall not use mc_prediction (mc_prediction_on equals "0").*
- Decoding: *The IRD shall be capable of decoding ISO/IEC 13818-3 [3] multichannel encoded bitstreams which do not use mc_prediction.*

6.1.8 Multilingual

- Encoding: *ISO/IEC 13818-3 [3] multichannel encoded bitstreams shall not contain multilingual channels (no_of_multilingual_channels equals "0").*
- Decoding: *The IRD shall be capable of decoding ISO/IEC 13818-3 [3] multichannel encoded bitstreams which do not contain multilingual channels.*

6.1.9 Extension Stream

- Encoding: When an ISO/IEC 13818-3 [3] encoded bitstream uses an extension stream, it is recommended that a continuous stream of extension frames is maintained for the duration of a programme, even if a total bitrate of less than 384 kbits/s would be sufficient to encode individual frames. This prevents undesired resets of the audio decoder.

6.1.10 Ancillary Data

- Encoding: ISO/IEC 13818-3 [3] stereo or multichannel encoded bitstreams may contain ancillary data as described in annex C. It is recommended to include the data in the bitstream.
- In order to support the contribution of DAB signals, the ancillary data field may embed the DAB ancillary data field [18].
 - In order to support the transmission of RDS data to DVB receivers and analogue FM transmitters, the ancillary data field may embed RDS data via the UECP protocol.
 - If data fields according to DVD-Video extended ancillary data (as described in annex C) or ancillary data according to the DAB specification [18] are used, they have, for backward compatibility reasons, to be the first data field at the end of the audio frame. This means that a common usage of DVD-Video and DAB data is excluded.
- Decoding: The IRD may interpret the ancillary data field in an ISO/IEC 13818-3 [3] stereo or multichannel bitstream as described in annex C and it is recommended that the contribution IRD make use of this data.

6.1.11 MPEG Surround configurations, profiles and levels

The baseline MPEG Surround profile is defined in ISO/IEC 23003-1 [29] and ISO/IEC 23003-1:2007/Cor:2008, Technical Corrigendum 1 [30]. *For the combination of MPEG Surround with MPEG-1 Layer II, the baseline MPEG Surround profile shall be used together with the restrictions defined in clauses 6.1.1 to 6.1.10.*

The MPEG Surround bitstream payload shall comply with level 3 or 4 of the Baseline MPEG Surround profile.

- Encoding: *In case of the combination of MPEG-1 Layer II with MPEG Surround, the MPEG Surround bitstream shall be embedded into the ancillary data of the MPEG-1 Layer II bitstream using the AncDataElement() bitstream element as defined in ISO/IEC 23003-1 [29]. For MPEG-1 Layer II, the spatial frame length, indicated by the bsFrameLength parameter, shall correspond to the MPEG-1 Layer II frame length. Hence, the bsFrameLength shall be one of the following values: {17, 35}, resulting in effective MPEG Surround frame lengths of 1 152 and 2 304 time domain samples respectively.*

Decoding: *The IRD, if compatible with MPEG-1 Layer II audio and capable of decoding MPEG Surround and capable of providing 7.1 channels or more of output, shall be capable of providing decoder output according to MPEG Surround Baseline profile level 4.*

The IRD, if compatible with MPEG-1 Layer II audio and capable of decoding MPEG Surround and capable of providing more than two and up to 5.1 channels of output shall be capable of providing decoder output according to MPEG Surround Baseline profile level 3.

The IRD, if compatible with MPEG-1 Layer II audio and capable of decoding MPEG Surround and capable of providing 2.0 channels of output shall be capable of providing decoder output according to MPEG Surround Baseline profile level 1.

6.2 AC-3 and Enhanced AC-3 audio

6.2.0 General

The coding and decoding of AC-3 and Enhanced AC-3 elementary streams is based upon ETSI TS 102 366 [12].

IRDs compatible with AC-3 shall decode all bitrates and sample rates listed in ETSI TS 102 366 [12] (not including annex E).

IRDs compatible with Enhanced AC-3 shall additionally decode Enhanced AC-3 streams with data rates from 32 kbps to 3 024 kbps and support all sample rates listed in ETSI TS 102 366 [12], annex E.

Enhanced AC-3 bit streams are similar in nature to standard AC-3 bit streams, but are not backwards compatible (i.e. they are not decodable by standard AC-3 decoders). Some constraints are placed on the PES layer for the case of multiple audio streams intended to be reproduced in exact sample synchronism as described in clause 6.2.1.

6.2.1 AC-3 and Enhanced AC-3 PES constraints

6.2.1.1 Encoding

In some applications, the audio decoder may be capable of simultaneously decoding two elementary streams containing different programme elements, and then combining the programme elements into a complete programme.

Most of the programme elements are found in the main audio service. Another programme element (such as a spoken narration of the picture content intended for the visually impaired listener, a specially created dialogue based audio service for the hearing impaired listener, or additional audio services such as a spoken director's commentary or alternative languages) may be found in an associated audio service.

In order to have the audio from the two elementary streams reproduced in exact sample synchronism, it is necessary for the original audio elementary stream encoders to have encoded the two audio programme elements frame synchronously; i.e. if audio stream 1 has sample 0 of frame n taken at time t_0 , then audio stream 2 should also have frame n beginning with its sample 0 taken the identical time t_0 . *If the encoding of multiple audio services is done frame and sample synchronous, and decoding is intended to be frame and sample synchronous, then the PES packets of these audio services shall contain identical values of PTS, which refer to the audio access units intended for synchronous decoding.*

Audio services intended to be combined together for reproduction according to the mixing process defined in ETSI TS 102 366 [12] (annex E) shall meet the following constraints:

- *Audio services intended to be combined together for reproduction shall be encoded at an identical sample rate.*
- *The main programme audio shall be encoded as either an AC-3 or an Enhanced AC-3 elementary stream. The associated audio service shall be encoded as an Enhanced AC-3 elementary stream.*
- *The Enhanced AC-3 elementary stream carrying the associated audio service shall contain mixing metadata for use by the decoder to control the mixing process.*

- *When mixing metadata is present in the Enhanced AC-3 elementary stream, the AD_Descriptor defined in clause E.1 shall not be present in the PES encapsulation of the Enhanced AC-3 elementary stream.*
- *The main programme shall contain from 1 to 7.1 channels of audio. The Enhanced AC-3 elementary stream that carries the associated audio services to be mixed with the main programme audio shall contain no more than two audio channels, and shall not contain more audio channels than the main audio programme.*
- *Dual-mono coding mode is not supported for either the main programme or associated audio service.*
- *The encoding of the associated audio service and subsequent creation of the associated audio service elementary stream shall be done with knowledge of the encoding of the main programme stream.*
- *The pgmscl field in the associated programme bitstream should be set to a positive value. It is recommended this be positive 12 dB to match the default user volume adjustment setting in the decoder.*

6.2.1.2 Decoding

If audio access units from two audio services which are to be simultaneously decoded have identical values of PTS indicated in their corresponding PES headers, then the corresponding audio access units shall be presented to the audio decoder for simultaneous synchronous decoding. Synchronous decoding means that for corresponding audio frames (access units), corresponding audio samples are presented at the identical time.

If the PTS values do not match (indicating that the audio encoding was not frame synchronous) then the audio frames (access units) of the main audio service may be presented to the audio decoder for decoding and presentation at the time indicated by the PTS. An associated service, which is being simultaneously decoded, may have its audio frames (access units), which are in closest time alignment (as indicated by the PTS) to those of the main service being decoded, presented to the audio decoder for simultaneous decoding. In this case the associated service may be reproduced out of sync by as much as 1/2 of a frame time. (This is typically satisfactory; a visually impaired narration does not require highly precise timing.)

A minimum functionality mixer is described in clause E.4 of ETSI TS 102 366 [12]. *IRDs that implement this mixing method shall set the default user volume adjustment of the associated programme level to minus 12 dB.*

The IRD may use the ISO 639-2 [27] language descriptor to indicate the language of the content of the associated programme. As the associated services are carried in separate elementary streams to the main service different languages may be indicated for each programme stream.

6.2.1.3 Byte-alignment

The AC-3 and Enhanced AC-3 elementary stream shall be byte-aligned within the MPEG-2 data stream. This means that the initial 8 bits of an AC-3 or Enhanced AC-3 frame shall reside in a single byte, which is carried by the MPEG-2 data stream.

6.2.2 Enhanced AC-3 with multiple independent substreams - PES constraints

6.2.2.1 Encoding

In some applications, the audio decoder may be capable of simultaneously decoding two different programme elements, carried as separate independent substreams within a single Enhanced AC-3 elementary stream, and then combining the programme elements into a complete programme.

Most of the programme elements are found in the main audio service. Another programme element (such as a spoken narration of the picture content intended for the visually impaired listener, a specially created dialogue based audio service for the hearing impaired listener or additional audio services such as a spoken director's commentary) may be found in one or more independent substreams carried in the same Enhanced AC-3 bitstream as the main programme.

The Enhanced AC-3 elementary stream shall contain no more than three independent substreams in addition to the independent substream containing the main audio programme. The main audio programme shall only be delivered in independent substream 0.

When mixing metadata is present in one of more substreams of the Enhanced AC-3 elementary stream, the AD_Descriptor defined in clause E.1 shall not be present in the PES encapsulation of the Enhanced AC-3 elementary stream.

In order to have the independent substreams containing audio from the main programme and the associated audio service reproduced in exact sample synchronism, it is necessary for the Enhanced AC-3 encoder to have encoded all of the audio programme elements frame synchronously; i.e. if the independent substream 0 has sample 0 of frame n taken at time t_0 , then independent substream 1 should also have frame n beginning with its sample 0 taken the identical time t_0 .

Independent substreams intended to be combined together for reproduction according to the mixing process defined in ETSI TS 102 366 [12] (annex E) shall meet the following constraints:

- *Independent substreams intended to be combined together for reproduction shall be encoded at an identical sample rate.*
- *The independent substream carrying the associated audio service shall contain mixing metadata for use by the decoder to control the mixing process.*
- *The independent substream that carries the main programme shall contain from 1 to 5.1 channels of audio. The independent substream that carries the associated audio services to be mixed with the main programme audio shall contain no more than two audio channels, and shall not contain more audio channels than the main audio programme.*
- *Dual-mono coding mode is not supported for either the main programme or associated audio service.*
- *The encoding of the associated audio service and subsequent creation of the associated audio service substream shall be done with knowledge of the encoding of the main programme substream.*
- *The pgmscl field in the associated programme substream should be set to a positive value. It is recommended this be positive 12 dB to match the default user volume adjustment setting in the decoder.*

6.2.2.2 Decoding

IRDs shall be able to accept Enhanced AC-3 elementary streams that contain more than one independent substream.

For TV-broadcasting applications, noticeably public service broadcasting, there is often a requirement for commentary or narration audio services to provide for different languages or Visually Impaired or Hearing Impaired audiences. To allow cost effective transmission and reproduction of these services it is strongly recommended that IRDs be able to select additional independent substreams carried in an Enhanced AC-3 elementary stream and mix the selected independent substream with the main audio programme. A minimum functionality mixer is described in clause E.4 of ETSI TS 102 366 [12]. *IRDs that include this mixing capability shall set the default user volume adjustment of the associated programme level to minus 12 dB.*

The IRD may use the ISO 639-2 [27] language descriptor to indicate the language of the content of the main programme. *As the associated programmes are carried in the same elementary stream as the main programme, the IRD shall assume that the language of associated programmes carried in independent substreams is the same as that of the main programme. To deploy associated programmes with different languages than the main programme, separate Enhanced AC-3 elementary streams shall be used, as described in clauses 6.2.1.1 and 6.2.1.2.*

IRDs that support multiple different output-interfaces, for example headphone output or baseband analogue outputs, may optionally support separate mixes for each output created by multiple Enhanced AC-3 decoders.

6.3 DTS Audio

6.3.0 General

The coding and decoding of DTS Audio coded elementary streams is based upon ETSI TS 102 114 [15].

IRDs compatible with DTS Audio shall decode all bitrates and sample rates listed in ETSI TS 102 114 [15].

Some constraints are placed on the PES layer for the case of multiple audio streams intended to be reproduced in exact sample synchronism as described in clause 6.3.1.

6.3.1 DTS Audio and DTS-HD PES Constraints

6.3.1.1 Encoding

In some applications, the audio decoder may be capable of simultaneously decoding two elementary streams containing different programme elements, and then combining the programme elements into a complete programme.

Most of the programme elements are found in the main audio service. Another programme element (such as a narration of the picture content intended for the visually impaired listener) may be found in the associated audio service.

In order to have the audio from the two elementary streams reproduced in exact sample synchronism, it is necessary for the original audio elementary stream encoders to have encoded the two audio programme elements frame synchronously; i.e. if audio stream 1 has sample 0 of frame n taken at time t_0 , then audio stream 2 should also have frame n beginning with its sample 0 taken the identical time t_0 . *If the encoding of multiple audio services is done frame and sample synchronous, and decoding is intended to be frame and sample synchronous, then the PES packets of these audio services shall contain identical values of PTS, which refer to the audio access units intended for synchronous decoding.*

Audio services intended to be combined together for reproduction shall be encoded at an identical sample rate.

6.3.1.2 Decoding

If audio access units from two audio services which are to be simultaneously decoded have identical values of PTS indicated in their corresponding PES headers, then the corresponding audio access units shall be presented to the audio decoder for simultaneous synchronous decoding. Synchronous decoding means that for corresponding audio frames (access units), corresponding audio samples are presented at the identical time.

If the PTS values do not match (indicating that the audio encoding was not frame synchronous) then the audio frames (access units) of the main audio service may be presented to the audio decoder for decoding and presentation at the time indicated by the PTS. An associated service, which is being simultaneously decoded, may have its audio frames (access units), which are in closest time alignment (as indicated by the PTS) to those of the main service being decoded, presented to the audio decoder for simultaneous decoding. In this case the associated service may be reproduced out of sync by as much as 1/2 of a frame time. (This is typically satisfactory; a visually impaired narration does not require highly precise timing.)

6.3.1.3 Byte-alignment

The DTS Audio and DTS-HD elementary streams shall be byte-aligned within the MPEG-2 data stream. This means that the initial 8 bits of a DTS Audio/DTS-HD frame shall reside in a single byte, which is carried by the MPEG-2 data stream.

6.4 MPEG-4 AAC, MPEG-4 HE AAC and MPEG-4 HE AAC v2 audio

6.4.0 Introduction

The coding and decoding of MPEG-4 AAC, MPEG-4 HE AAC and MPEG-4 HE AAC v2 elementary streams is based upon ISO/IEC 14496-3 [17].

The MPEG-4 AAC and the MPEG-4 High Efficiency AAC Profiles are subsets of the MPEG-4 High Efficiency AAC v2 profile. HE AAC adds the AOT SBR to the MPEG-4 AAC Profile. HE AAC v2 adds the AOT PS to the MPEG-4 High Efficiency AAC profile to improve the audio quality at low bitrates. Every HE AAC decoder can decode an HE AAC v2 bitstream, but will not be able to use the parametric stereo information and will therefore replay on a mono signal.

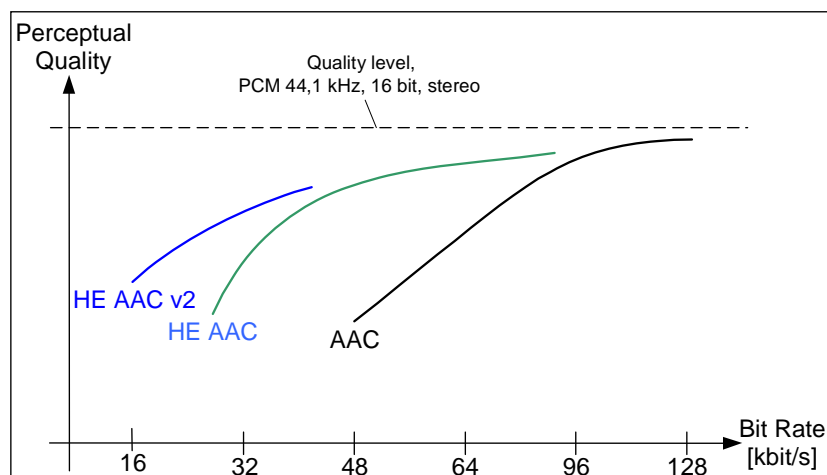

Figure 2: Typical bitrate range of the HE AAC v2, HE AAC and AAC for stereo

Figure 2 indicates the typical bitrate ranges for the use of MPEG-4 HE AAC v2, MPEG-4 HE AAC and MPEG-4 AAC on the encoder side for stereo. The actual bitrates for the use of the different tools is dependent from the encoder implementation.

Optionally, also the combination of MPEG-4 AAC, MPEG-4 HE AAC and MPEG-4 HE AAC v2 with MPEG Surround is supported. The encoding and decoding of MPEG Surround complies with ISO/IEC 23003-1:2007 [29] and ISO/IEC 23003-1:2007/Cor 1:2008 [30]. MPEG Surround creates a (mono or stereo) downmix from the multi-channel audio input signal. This downmix is encoded using a core audio codec, in this case MPEG-4 AAC, HE AAC or HE AAC v2. In addition, MPEG Surround generates a spatial image parameter description of the multi-channel audio that is added as an ancillary data stream to the core audio codec. Legacy mono or stereo decoders ignore the ancillary data and playback a stereo respectively mono audio signal. MPEG Surround capable decoders will first decode the mono or stereo core codec audio signal and then use the spatial image parameters extracted from the ancillary data stream to generate a high quality multi-channel audio signal.

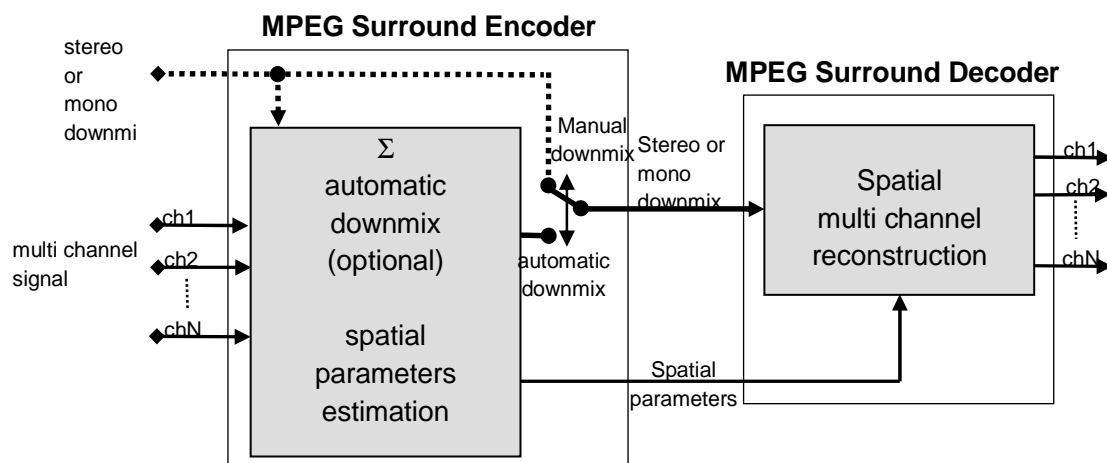

Figure 3: Principle of MPEG Surround, the downmix is coded using MPEG-4 AAC, HE AAC or HE AAC v2

6.4.1 LATM/LOAS formatting

The MPEG-4 HE AAC or HE AAC v2 elementary stream data shall be first encapsulated in the LATM multiplex format according to ISO/IEC 14496-3 [17].

When MPEG Surround is used then the combination of MPEG Surround as specified in ISO/IEC 23003-1 [29] and [31] with MPEG-4 AAC, MPEG-4 HE AAC or MPEG-4 HE AAC v2 as specified in ISO/IEC 14496-3 [17] is transmitted using LOAS/LATM, being also specified in ISO/IEC 14496-3 [17]. First, the combined MPEG-4 AAC/MPEG Surround, MPEG-4 HE AAC/MPEG Surround or MPEG-4 HE AAC v2/MPEG Surround shall be formatted using the LATM multiplex format.

The **AudioMuxElement()** multiplex element format shall be used.

The LATM formatted MPEG-4 HE AAC or HE AAC v2 elementary stream data shall be encapsulated in the LOAS transmission format according to ISO/IEC 14496-3 [17]. The **AudioSyncStream()** version shall be used.

AudioSyncStream() adds a sync word to the audio stream to allow for synchronization. Semantics: The semantics of the **AudioMuxElement()** and **AudioSyncStream()** formatting are described in ISO/IEC 14496-3 [17].

Encoding: The MPEG-4 HE AAC and HE AAC v2 elementary streams shall be formatted with **AudioMuxElement()** LATM multiplex format, and **AudioSyncStream()** LOAS transmission format.

The MPEG-4 AAC/MPEG Surround, MPEG-4 HE AAC/MPEG Surround and MPEG-4 HE AAC v2/MPEG Surround elementary streams shall be formatted with **AudioMuxElement()** LATM multiplex format, and **AudioSyncStream()** LOAS transmission format.

The following limitations to the LATM multiplex shall apply:

- **audioMuxVersion** shall be "0";
- **numLayer** shall be "0", as no scalable profile is used; When MPEG Surround is used this indicates that a single layer is present consisting of MPEG-4 AAC, MPEG-4 HE AAC or MPEG-4 HE AAC v2 with embedded MPEG Surround data;
- **numProgram** shall be "0", as there is only one audio program per LATM multiplex;
- **numSubFrames** shall be "0", as there is only one **PayloadMux()** (access unit) per LATM **AudioMuxElement()**;
- **allStreamsSameTimeFraming** shall be "1", as all payloads belong to the same access unit;
- the fields **taraBufferFullness** and **latmBufferFullness** shall be set to their largest respective value, indicating that buffer fullness measures are not used in DVB context;

- the value for **frameLengthFlag** contained in the **GASpecificConfig** shall be set to 0, indicating that the transform length of the IMDCT for AAC is 1 024 samples for long and 128 for short blocks.

In case of the combination MPEG-4 AAC with MPEG Surround, the Audio Object Type (AOT) element, **audioObjectType**, shall be set to the value 2 (indicating AAC-LC).

In case of the combination MPEG-4 HE AAC with MPEG Surround or the combination of MPEG-4 HE AAC v2 with MPEG Surround, the Audio Object Type (AOT) element, **audioObjectType**, shall be set to the value 5 (indicating SBR). Furthermore, separate fill elements shall be employed to embed the SBR(/PS) extension data elements **sbr_extension_data()**, described in ISO/IEC 14496-3 [17], and MPEG Surround spatial audio data **SpatialFrame()**, described in ISO/IEC 23003-1 [29] and [31].

The spatial frame length, indicated by the **bsFrameLength** parameter, shall correspond to the MPEG-4 AAC frame length. Hence, the **bsFrameLength** shall be any of the following values: {15, 31, 63}, resulting in effective MPEG Surround frame lengths of 1 024, 2 048 and 4 096 time domain samples respectively.

Decoding: These formats shall be read by the IRD, and the IRD shall interpret these formats in accordance with MPEG-4 audio syntax.

In case the IRD supports MPEG Surround decoding, these formats shall be read by the IRD, and the IRD shall interpret these formats in accordance with MPEG-4 and MPEG Surround audio syntax.

6.4.2 Profiles and Levels

6.4.2.1 Profiles and Levels for AAC, HE AAC and HE AAC v2

MPEG-4 AAC, HE AAC and HE AAC v2 are defined in ISO/IEC 14496-3 [17], clause 1.5.2 as AAC Profile, High Efficiency AAC Profile and High Efficiency AAC v2 Profile respectively.

Encoding: The encoder shall use either the MPEG-4 AAC Profile, the MPEG-4 High Efficiency AAC Profile or the MPEG-4 High Efficiency AAC v2 Profile. Use of the MPEG-4 HE AAC Profile is recommended.

Monaural, stereo and parametric stereo MPEG-4 HE AAC v2 bitstreams shall comply with level 2 restrictions.

Monaural and stereo MPEG-4 AAC and HE AAC bitstreams shall comply with level 2 restrictions, respectively.

Multichannel audio up to 5.1 channel bitstreams shall comply with the level 4 restrictions respectively. Coupling Channel Elements (CCEs) according to ISO/IEC 14496-3 [17] shall not be used.

Decoding: The IRD, if compatible with MPEG-4 AAC audio, shall be capable of decoding MPEG-4 AAC, MPEG-4 High Efficiency AAC or the MPEG-4 High Efficiency AAC v2 Profile bitstreams.

A MPEG-4 HE AAC v2 monaural, stereo and parametric stereo enabled decoder shall support decoding MPEG-4 HE AAC v2 Profile Level 2 bitstreams. This requirement does include support for lower levels, but not other profiles. Support for other profiles and for levels beyond Level 2 is optional.

A MPEG-4 AAC and HE AAC monaural and stereo enabled decoder shall support decoding MPEG-4 High Efficiency AAC Profile Level 2 bitstreams. This requirement does include support for lower levels, but not other profiles. Support for other profiles and for levels beyond Level 2 is optional.

MPEG-4 AAC, HE AAC or HE AAC v2 multi-channel enabled decoder shall support decoding MPEG-4 AAC Profile, MPEG-4 High Efficiency AAC Profile or High Efficiency AAC v2 Profile Level 4 bitstreams respectively. This requirement does include support for lower levels, but not other profiles. Support for other profiles and for levels beyond Level 4 is optional. Support for Coupling Channel Elements (CCEs) according to ISO/IEC 14496-3 [17] is optional. If an IRD supports higher levels than level 2 then it shall also support Matrix-Mixdown according to ISO/IEC 14496-3 [17], clause 4.5.1.2.2. It shall further support the application of downmixing_levels_MPEG4 in ancillary data (annex C).

6.4.2.2 Profiles and Levels for MPEG Surround in combination AAC, HE AAC and HE AAC v2

The Baseline MPEG Surround Profile is defined in ISO/IEC 23003-1 [29] and ISO/IEC 23003-1:2007/Cor:2008 [30]. For the combination of MPEG Surround with MPEG-4 AAC, MPEG-4 HE AAC or MPEG-4 HE AAC v2, the Baseline MPEG Surround Profile will be employed together with the AAC Profile, High Efficiency AAC Profile or High Efficiency AAC v2 Profile respectively. *The AAC or HE AAC or HE AAC v2 bitstream payloads shall comply with level 2 or level 4 of the respective profile. The MPEG Surround bitstream payload shall comply with level 3, 4 or 5 of the Baseline MPEG Surround profile.*

Encoding: *In combination with MPEG Surround, MPEG-4 AAC, MPEG-4 HE AAC or MPEG-4 HE AAC v2 bitstream payloads shall comply with the restrictions of level 2 of their respective profile. If the MPEG Surround bitstream payload complies to Level 5 of the Baseline MPEG Surround profile, bitstream payloads shall comply to Level 4 of the AAC or HE_AAC profile.*

Decoding: *The IRD, if compatible with MPEG-4 HE AAC audio at Level 4 and capable of decoding MPEG Surround and capable of providing 7.1 channels or more of output, shall be capable of providing decoder output according to MPEG Surround Baseline profile level 5.*

The IRD, if compatible with MPEG-4 HE AAC audio up to Level 3 and capable of decoding MPEG Surround and capable of providing 7.1 channels or more of output, shall be capable of providing decoder output according to MPEG Surround Baseline profile level 4.

The IRD, if compatible with MPEG-4 HE AAC audio and capable of decoding MPEG Surround and capable of providing more than two and up to 5.1 channels of output shall be capable of providing decoder output according to MPEG Surround Baseline profile level 3.

The IRD, if compatible with MPEG-4 HE AAC audio and capable of decoding MPEG Surround and capable of providing up to 2.0 channels of output shall be capable of providing decoder output according to MPEG Surround Baseline profile level 1.

6.4.3 Dynamic Range Control

The MPEG-4 AAC Dynamic Range Control (DRC) tool is defined in ISO/IEC 14496-3 [17], clause 4.5.2.7. For more detailed information on the MPEG-4 AAC Dynamic Range Control tool see ISO/IEC 14496-3 [17].

Encoding: It is strongly recommended that the encoder uses the MPEG-4 AAC Dynamic Range Control (DRC) tool.

Decoding: *The IRD shall support the MPEG-4 AAC Dynamic Range Control (DRC). If a program reference level is not transmitted in the bitstream, it is strongly recommended that a program reference level of -23 dB is assumed. It is strongly recommended that each IRD operates either at a target level of -23 dB or at a target level of -31 dB.*

Details of how Dynamic Range Control should be applied are specified in clause C.5.4.

6.5 Random Access Points with MPEG-4 Audio

6.5.0 General

The definition for MPEG-4 AAC, MPEG-4 HE AAC and MPEG-4 HE AAC v2 RAP in clause 3 shall apply.

6.5.1 Definition of RAP with MPEG-4 Audio

6.5.1.0 Introduction

In contrast to MPEG-2, MPEG-4 audio streams may not be accessible and decodable with full fidelity with each single access unit (AU). The reason for this is to save bit-rate by not transmitting static information with each AU. The following clause describes required constraints to start decoding of MPEG-4 audio at a given AU.

6.5.1.1 RAP with the LATM/LOAS transport header

The LATM/LOAS transport format carries the "StreamMuxConfig". This structure carries essential, but quasi-static information such as sampling rate or channel configuration. As these parameters change rather seldom in broadcast applications, this structure need not be transmitted with each access unit, but is expected to be present periodically to allow for random access to the stream.

Encoding: *For a RAP, within **AudioMuxElement()**, **useSameStreamMux** shall be set to "0"; i.e. **StreamMuxConfig()** is present.*

Within the scope of the present document, **useSameConfig** is always set to "0". See clause 6.4.1, where both, **numProgram** and **numLayer** shall be "0" yielding to **useSameConfig** to be set to "0" as well. In consequence an **AudioSpecificConfig()** is always contained in a **StreamMuxConfig()**.

6.5.1.2 RAP with the AAC Profile

AAC-LC is the only Audio Object Type used in the AAC Profile. In addition to the given constraints with the LATM/LOAS transport header (see clause 6.5.1.1), the following constraints shall be satisfied for this AOT.

Encoding: *If channel configuration 0 is used, the **ProgramConfigElement()** containing the actual channel configuration shall be present in the bitstream for a RAP.*

6.5.1.3 RAP with the HE AAC Profile

The HE AAC profile is based on the AAC profile and is extended by the Audio Object Type SBR; therefore all constraints from the AOT AAC-LC (see clause 6.5.1.2) shall also be fulfilled.

In contrast to the AAC configuration that is completely described by the **AudioSpecificConfig()**, the Audio Object Type SBR decoder needs additional configuration parameters. These parameters are transmitted inside the SBR header which is not required to be contained in every access unit.

To allow the decoder to access and instantaneously fully decode a HE AAC profile bit stream, it is necessary to transmit an **sbr_header()** in the first access unit after a RAP (RAP access unit).

Encoding: *For a RAP in case of the Audio Object Type SBR, the **bs_header_flag** shall be set to "1"; i.e. **sbr_header()** is present.*

NOTE 1: The use of tools that rely on preceding frames (i.e. time differential coding of parameters) is prohibited for frames containing an SBR header by the MPEG-4 Audio Conformance (ISO/IEC 14496-26 [41], clause 7.17.1.2.1.4). This restriction ensures that a RAP frame can be completely decoded and processed.

NOTE 2: According to ISO/IEC 14496-3 [17], clause 4.5.2.8.2.1, "as long as no SBR header part is present, the SBR decoder performs upsampling and delay adjustment only". Therefore, audio playback may start even if **sbr_header()** was not yet received, but only with reduced quality. Therefore, ISO/IEC 14496-3 [17] recommends: "In continuous broadcast applications, SBR extension data elements with an SBR header part are typically sent twice per second. In addition, a SBR header part can any time be inserted, if an instantaneous, possibly program dependent, change of header parameters is required" (see ISO/IEC 14496-3 [17], clause 4.5.2.8.2.1).

6.5.1.4 RAP with the HE AAC v2 Profile

The HE AAC v2 profile is based on the HE AAC profile and is extended by the Audio Object Type Parametric Stereo (PS); *therefore all constraints from the HE AAC profile (see clause 6.5.1.3) shall also be satisfied.*

As with the Audio Object Type SBR, the configuration parameters for the Audio Object Type PS payload are transmitted inside the PS header information, which is not required to be contained in every access unit.

To allow the decoder to access and instantaneously fully decode a HE AAC v2 profile bit stream, it is necessary to transmit PS header information in the first access unit of a sequence (RAP AU).

Encoding: For a RAP in case of the Audio Object Type Parametric Stereo, **enable_ps_header** should be set to "1", i.e. the PS decoder configuration data is transmitted.

NOTE 1: The use of tools that rely on preceding frames (i.e. time differential coding of parameters) for frames with **enable_ps_header** = 1 is prohibited by the MPEG-4 Audio Conformance (ISO/IEC 14496-26 [41], clause 7.18.1.3). This restriction ensures that an RAP frame can be completely decoded and processed.

NOTE 2: As the Audio Object Type Parametric Stereo conformance requires a PS header with every SBR header (see ISO/IEC 14496-26 [41], clause 7.18.1.3), this requirement is also implicitly inherited from the Audio Object Type SBR requirements.

NOTE 3: According to ISO/IEC 14496-3 [17], clause 8.6.5.1, mandates that a conformant decoder that receives PS data output the mono signal in the two output channels until a first ps_data() element with enable_ps_header == 1 is received and in which for all enabled parameters frequency differential coding is employed and num_env>0, ensuring that the PS data can be decoded correctly. Therefore audio playback may start even if ps_data() may not be decoded.

6.5.1.5 RAP with AAC-LC / HE AAC plus MPEG Surround

As MPEG Surround is based on an AAC-LC or HE AAC core coder, all restrictions for AAC-LC and HE AAC shall also apply for MPEG Surround respectively. Further restrictions are as follows, for details see ISO/IEC 23003-1 [29].

Encoding: For a RAP in case of MPEG Surround, the *SpatialSpecificConfig()* data structure shall be transmitted, i.e. in *sac_extension_data()*, *ancType* and *ancStart* shall be set to "1". Additionally, the coding of RAP frames shall be independent of previous frames. Therefore the bitstream payload element *bsIndependencyFlag* shall be set to "1".

6.5.1.6 RAP with Dynamic Range Control and MPEG-4 Audio ancillary data

Encoding: For a RAP, both *dynamic_range_info()* and *MPEG4_ancillary_data()* shall be present in access unit. Further, *prog_ref_level_present* shall be set to 0x1, i.e. the program reference level is present in *dynamic_range_info()*. In *MPEG4_ancillary_data()*, *downmixing_levels_MPEG4_status* shall be set to "1".

6.5.2 Time interval Between RAPs

Encoding: The encoder shall place MPEG-4 AAC, HE AAC or HE AAC v2 RAPs in the audio elementary stream at least every 2 s.

It is recommended that MPEG-4 AAC, HE AAC or HE AAC v2 RAPs occur in the audio elementary stream on average at least every 500 ms. Further it is recommended those audio frames in the audio elementary stream whose PTS values are closest to the PTS values of the RAPs of the associated video elementary stream are also coded as RAPs.

NOTE: PTS of HE AAC v2 RAP usually will not be identical to that of associated video elementary stream RAP, therefore the associated audio/video RAPs should have closest PTS values.

6.6 AC-4 channel-based audio

6.6.0 Introduction

Clause 6.6 specifies carriage of audio encoded using ETSI TS 103 190-1 [43], using **bitstream_version**=0. Carriage of audio with **bitstream_version**>0, encoded using ETSI TS 103 190-2 [46] is specified in clause 6.7 of the present document.

6.6.1 General

The coding and decoding of the raw AC-4 frames of an AC-4 elementary stream is based upon ETSI TS 103 190-1 [43]. AC-4 elementary streams consist of presentations, which define a set of one or more substreams to be presented simultaneously.

The following requirements apply for encoders and IRDs compatible with AC-4:

Encoding: *An AC-4 elementary stream shall contain at least one presentation. The first presentation (by order of appearance) shall contain main audio of up to 7.1 channels, plus an optional dialogue enhancement substream of up to 3 channels (L,C,R).*

The AC-4 elementary stream shall be encoded at an audio frame rate in the set {48 000/2 048, 24 000/1 001, 24, 25, 30 000/1 001, 30, 50, 60 000/1 001, 60} Hz. This set corresponds to all video frame rates as per clause 5.14.1.7 of the present document and additionally includes the native AC-4 frame rate.

An AC-4 elementary stream shall be encoded with a sampling rate of 48 kHz, 96 kHz or 192 kHz.

The raw AC-4 frames shall be encapsulated in the AC-4 Sync Frame format, as described in clause 6.6.6 of the present document. Frames encapsulated in this way are subsequently referred to as AC-4 frames.

*The **bitstream_version** field according to clause 4.3.3.2.1 of ETSI TS 103 190-1 [43] shall be set to the value 0.*

*The **presentation_version** field according to clause 4.3.3.4.1 of ETSI TS 103 190-1 [43] shall be set to the value 0.*

Decoding: *The IRD shall by default decode the first presentation. It may skip additional presentations contained in the AC-4 elementary stream.*

The IRD shall be capable of decoding a substream of main audio of up to 7.1 channels and a substream containing dialogue enhancement of up to 3 channels (L,C,R).

The IRD shall be able to decode all audio frame rates in the set {48 000/2 048, 24 000/1 001, 24, 25, 30 000/1 001, 30, 50, 60 000/1 001, 60} Hz. This set corresponds to all video frame rates as per clause 5.14.1.7 of the present document and additionally includes the native AC-4 frame rate.

The IRD may decode the 48 kHz substream of elementary streams encoded at 96 kHz or 192 kHz.

*The IRD may ignore AC-4 elementary streams with **bitstream_version** field not equal to 0.*

*The IRD may skip presentations if the **presentation_version** field is not 0.*

*The IRD may ignore **umd_payload_substreams** data as described in ETSI TS 103 190-1 [43], clause 4.3.3.6.1.*

*The IRD may ignore **protection_bits_primary** and **protection_bits_secondary** as defined in ETSI TS 103 190-1 [43], clause 4.3.15.3.1.*

*The IRD shall ignore **protection_bits_primary** and **protection_bits_secondary** as defined in ETSI TS 103 190-1 [43], clauses 4.3.15.3.1 and 4.3.15.3.2 if the **key_id** as defined in ETSI TS 103 190-1 [43], clause 4.3.3.6.2 is equal to 0x06.*

6.6.2 PES packaging for AC-4 elementary streams

With AC-4 elementary streams, frame sizes (in bytes) vary between AC-4 frames. In order to minimize overhead, AC-4 frames should be packaged into PES packets in a way to best fit them to the payload of the PES packets with minimum or no padding required.

To achieve this multiple AC-4 frames may be packed per PES packet. The number of AC-4 frames per PES packet may vary between PES packets, but *each PES packet shall contain an integer number of AC-4 frames only. AC-4 frames shall not be split over two or more PES packets.*

The AC-4 elementary stream shall be byte-aligned within the PES packet so that the first byte of the first AC-4 frame contained in the PES packet is located in the first byte of the PES packet payload.

*Encoders shall signal random access frames by setting the **random_access_indicator** in the **adaptation_field** in the MPEG 2 transport layer. Random access frames in AC-4 elementary streams are indicated by the **b_iframe_global** flag in ETSI TS 103 190-1 [43].*

Some additional constraints are placed on the PES layer for the case of multiple separate elementary streams intended to be reproduced in sync as described in clause 6.6.2 of the present document.

6.6.3 PES packaging for AC-4 for receiver mix audio

In some applications, the IRD may be capable of simultaneously decoding several different programme elements and subsequently combine them into a complete programme. This is referred to as "receiver-mix" audio in ETSI EN 300 468 [i.32].

In this use case, most of the programme elements are found in the main audio service. Some programme elements (such as a spoken narration of the picture content intended for the visually impaired listener, a specially created dialogue based audio service for the hearing impaired listener or additional audio services such as a spoken director's commentary) may be carried in separate AC-4 elementary streams.

In addition to the requirements for PES packaging of AC-4 elementary streams in clause 6.6.1 of the present document, the following constraints apply for two elementary streams containing programme elements which are to be combined in a "receiver-mix":

Encoding: *The elementary stream carrying the associated audio service shall only contain a single presentation, consisting of a single substream.*

The elementary stream carrying the associated audio service shall carry either mono or stereo content.

*The PES packets of the associated audio service shall carry the **AD_descriptor** as described in clause E.2 of the present document which contains the metadata for use by the decoder to control the mixing process, described in clause E.3 of the present document.*

NOTE: The signalling for receiver mix audio is defined in clause J.2 of ETSI EN 300 468 [i.32].

Decoding: Clause E.3 of the present document specifies that support for decoding supplementary audio is optional. If implemented, the decoder should follow the mixing process as described in clauses E.3 and E.5 of the present document.

6.6.4 DRC and Loudness

The AC-4 bitstream format has been designed to enable intelligent control of audio loudness processing algorithms found throughout today's media workflows and delivery chains to improve the overall quality of audio programmes for consumers.

The loudness metadata included in the AC-4 elementary stream allows the full range of parameters to be described, including:

- true peak and maximum true peak, as specified in Recommendation ITU-R BS.1770 [i.17];
- relative gated loudness values, as specified in Recommendation ITU-R BS.1770 [i.17];

- speech gated loudness values, as specified, e.g. in FreeTV OP-59 [i.21];
- the dialogue gating type, as specified in ETSI TS 103 190-1 [43];
- momentary and maximum momentary loudness, as specified in Recommendation ITU-R BS.1771-1 [i.22];
- short term and maximum short term loudness, as specified in Recommendation ITU-R BS.1771-1 [i.22]; and
- loudness range and its measurement practice type, as specified in EBU Tech Document 3342 [i.23].

The Dynamic Range Control (DRC) elements of AC-4 provide users and systems with a flexible range of dynamic range control options to address a wide range of device profiles and user applications.

In order to take full advantage of these features, it is strongly recommended to follow the recommendations in EBU R 128 [i.18], EBU Tech Doc 3343 [i.24] and EBU Tech Doc 3344 [i.19] or local loudness regulations, e.g. FreeTV OP-59 [i.21].

In order to comply with EBU R 128 [i.18], the following constraints apply:

Encoding: *The **dialnorm_bits** parameter shall be used to indicate the audio programme loudness measured according to local loudness regulations (EBU Tech 3344 [i.19], FreeTV OP-59 [i.21]). The **loud_prac_type** parameter shall accordingly be set to indicate the measurement practice used.*

*The **b_loudcorr_type** flag shall be set to zero, if the audio programme has been corrected with an infinite look-ahead (file-based). If the loudness correction was based on a combination of real-time loudness measurement and dynamic range compression, the flag shall be set to one.*

The **max_truepk** parameter should be set to the maximum true peak sample value of the audio programme, measured according to annex 2 of Recommendation ITU-R BS.1770 [i.17] and without metadata applied.

The **lra** parameter should be set to the loudness range of the audio programme as specified in EBU Tech Document 3342 [i.23].

The **loudrelgat** parameter may be used to signal the measurement of the integrated loudness of the audio programme, as specified in Recommendation ITU-R BS.1770 [i.17], without loudness or DRC metadata applied.

The **dialgate_prac_type** parameter may be set to the appropriate type if dialogue gating that was utilized to measure the audio programme loudness (indicated in **dialnorm_bits**) for normalizing the program prior to transmission.

The **max_loudstrm3s** parameter may be used to signal the maximum short-term loudness of the audio programme, measured as specified in Recommendation ITU-R BS.1771-1 [i.22], without loudness or DRC metadata applied.

The **max_loudmnty** parameter may be used to signal the maximum momentary loudness of the audio programme, measured as specified in Recommendation ITU-R BS.1771-1 [i.22], without loudness or DRC metadata applied.

*All 4 default DRC modes, indicated by **drc_decoder_mode_id** values 0 to 3 shall be included in the AC-4 elementary stream.*

Table 22: drc_decoder_mode_id supported by AC-4

Value of drc_decoder_mode_id	DRC decoder mode	Output level range in LUFS
0	Home Theatre	-31...-27
1	Flat panel TV	-26...-17
2	Portable - Speakers	-16...0
3	Portable - Headphones	-16...0

Decoding: *The IRD shall apply DRC and loudness metadata as specified in ETSI TS 103 190-1 [43].*

The IRD shall support all default DRC decoder modes as well as the EAC-3 profiles. The decoder shall also support parametric DRC curves as defined by ETSI TS 103 190-1 [43].

Table 23: (E-)AC-3 profiles supported by AC-4

drc_eac3_profile	Profile
0	None
1	Film standard
2	Film light
3	Music standard
4	Music light
5	Speech

It is strongly recommended for the IRD to operate at target level of -23 LUFS for IDTVs and set top boxes or -31 LUFS for Home Theatre systems to maintain full dynamic range.

6.6.5 Dialogue Enhancement

The AC-4 bitstream format features flexible and scalable dialogue enhancement capabilities, which are built into the codec. They are detailed in clause 5.7.8 of ETSI TS 103 190-1 [43]. The following constraints apply:

Encoding: An AC-4 elementary stream carrying an audio programme that contains dialogue (mixed into the main programme, or separate next to a music and effects track) should contain dialogue enhancement data.

Decoding: *The IRD shall be capable of applying dialogue enhancement carried in the AC-4 elementary stream as described in ETSI TS 103 190-1 [43].*

6.6.6 Audio/Video Synchronization

AC-4 is designed to facilitate keeping video and audio in sync throughout the distribution chain by providing the flexibility to encode the audio programme at the same frame rate as the video programme. This means that for every video frame there is a corresponding audio frame when this AC-4 feature is enabled.

When enabled, this optional AC-4 feature facilitates splicing workflows as well as use cases like transcoding from or to SMPTE ST 292-1 [i.25].

When the A/V sync feature of AC-4 is enabled, the following constraints apply:

Encoding: An AC-4 elementary stream should be encoded with a frame rate equal to the video frame rate.

Where an equal video frame rate is used, the PTS associated with the first AC-4 frame in each PES packet should match the PTS of the corresponding video frame. That means that for each video access unit there should be a matching audio access unit with the same (signalled or inferred) presentation time.

6.6.7 AC-4 Sync Frame Format

AC-4 frames shall be encapsulated as specified in ETSI TS 103 190-2 [46], annex C. Encapsulated AC-4 frames shall be carried in the PES_packet_data_byte section of the PES_packet structure as defined in Recommendation ITU-T H.222.0 / ISO/IEC 13818-1 [1].

Figure 4: Void

Table 24: Void

Table 25: Void

Table 26: Void

6.7 AC-4 for channel-based, immersive and personalized audio

6.7.1 AC-4 specific NGA concepts

Clause 4.5 of ETSI TS 103 190-2 [46] gives an in-detail view of the structure of AC-4. This clause serves as a brief introduction to AC-4 specific concepts as they relate to NGA.

AC-4 offers the possibility to carry many different components in one stream, and to combine these components into complete experiences in IRD. Therefore, receiver mix capabilities are fundamental to every AC-4 decoder.

The AC-4 elementary streams each carry a Table Of Contents (TOC) which lists the different experiences (called presentations) that can be derived.

In the context of clause 6.7, Audio Preselections are implemented as AC-4 presentations, and Audio Programme Components are implemented by substream groups.

AC-4 presentations aggregate substream groups. In a presentation, substream groups take on a specific role (such as M&E, dialogue, etc.). Substream groups, in turn, are aggregations of substreams.

It is important to note that there is a many to many relationship between these concepts. This provides flexibility to re-use substream groups and substreams many times over.

6.7.2 General requirements

The coding and decoding of the raw AC-4 frames of an AC-4 elementary stream is defined in ETSI TS 103 190-2 [46]. AC-4 elementary streams consist of presentations, which define a set of one or more substream groups to be presented simultaneously.

The following requirements apply for encoders and IRDs compatible with AC-4:

Encoding: *An AC-4 elementary stream shall contain at least one presentation, containing main audio. The **md_compat** field as defined by clause 6.3.2.2.3 of ETSI TS 103 190-2 [46] shall be less than or equal to three.*

If the video frame rate is less than or equal to 60 Hz or the video is encoded according to clauses 5.14.5.2.2, 5.14.5.6 and 5.14.5.7 of the present document., the AC-4 elementary stream shall be encoded at an audio frame rate in the set {48 000/2 048, 24 000/1 001, 24, 25, 30 000/1 001, 30, 50, 60 000/1 001, 60} Hz. This set corresponds to all video frame rates as per clause 5.14.1.7 of the present document and additionally includes the native AC-4 frame rate.

If the video frame rate is in the set {100, 120 000/1 001, 120} Hz and the video is encoded according to clause 5.14.5.2.3 of the present document, the AC-4 elementary stream shall be encoded at an audio frame rate in the set {48 000/2 048, 24 000/1 001, 24, 25, 30 000/1 001, 30, 50, 60 000/1 001, 60, 100, 120 000/1 001, 120} Hz.

NOTE 1: See also clause 6.7.7 for additional requirements if audio and video are to use matching frame rates.

An AC-4 elementary stream shall be encoded with a sampling rate of 48 kHz, 96 kHz or 192 kHz.

The raw AC-4 frames shall be encapsulated in the AC-4 Sync Frame format, as described in ETSI TS 103 190-2 [46], annex C. Frames encapsulated in this way are subsequently referred to as AC-4 frames.

*The **bitstream_version** field according to clause 6.2.1.1 of ETSI TS 103 190-2 [46] shall be set to the value 2.*

*The **presentation_version** field according to clause 6.2.1.3 of ETSI TS 103 190-2 [46] shall be set to the value 1.*

The number of presentations in an elementary stream shall be 64 or less.

A reference renderer provides a broadcaster a tool to verify the rendering performance of the generated NGA delivery signal. Defining a reference renderer does not imply that the signal will be rendered with the reference renderer nor does it enforce implementation requirements on the IRD.

Decoding: *The IRD shall, by default, and in the absence of any user preference data, decode the first presentation that it can decode as determined by the following paragraphs. It may ignore additional presentations contained in the AC-4 elementary stream.*

*The IRD shall be capable of decoding presentations where the **md_compat** field as defined by clause 6.3.2.2.3 of ETSI TS 103 190-2 [46] is less than or equal to three.*

The IRD shall be able to decode all audio frame rates in the set {48 000/2 048, 24 000/1 001, 24, 25, 30 000/1 001, 30, 50, 60 000/1 001, 60} Hz. This set corresponds to all video frame rates as per clause 5.14.1.7 of the present document and additionally includes the native AC-4 frame rate.

If the IRD supports video frame rates between 100 Hz and 120 Hz, it shall additionally be able to decode all audio frame rates in the set {100, 120 000/1 001, 120} Hz.

The IRD shall be able to decode elementary streams with a sample rate of 48 kHz, and the 48 kHz part of elementary streams with sample rates of 96 kHz and 192 kHz. The IRD may additionally support decoding into 96 kHz, or 192 kHz.

*The IRD shall decode AC-4 elementary streams with **bitstream_version** equal to 0 and AC-4 elementary streams with **bitstream_version** equal to 2. The IRD may decode or ignore AC-4 elementary streams with other values of **bitstream_version**.*

*The IRD shall be able to decode presentations with **presentation_version** equal to 0 and presentations with **presentation_version** equal to 1. It may decode or ignore presentations where the **presentation_version** field is greater than 1.*

The IRD may ignore **emdf_payload_substreams** data as described in ETSI TS 103 190-1 [43], clause 4.3.15.1.

The IRD may ignore **protection_bits_primary** and **protection_bits_secondary** as defined in ETSI TS 103 190-1 [43], clause 4.3.15.3.1.

*The IRD shall ignore **protection_bits_primary** and **protection_bits_secondary** as defined in ETSI TS 103 190-1 [43], clauses 4.3.15.3.1 and 4.3.15.3.2 if the **key_id** as defined in ETSI TS 103 190-1[43], clause 4.3.3.6.2 is equal to 0x06.*

It is recommended that the IRD implements either the reference renderer or a renderer that performs at least as well as the reference renderer given the capabilities of the IRD.

NOTE 2: The reference renderer for audio coded in accordance with ETSI TS 103 190-2 [46] is defined in ETSI TS 103 448 [i.28]. ETSI TS 103 448 [i.28] specifies the semantics of the metadata syntax contained in clause 6.3.9 of ETSI TS 103 190-2 [46].

6.7.3 PES packaging for AC-4 elementary streams

*AC-4 frames shall be encapsulated as specified in ETSI TS 103 190-2 [46], annex C. Encapsulated AC-4 frames shall be carried in the **PES_packet_data_byte** section of the **PES_packet** structure as defined in Recommendation ITU-T H.222.0 / ISO/IEC 13818-1 [1].*

In AC-4 elementary streams, frame sizes (in bytes of the encoded frame) can vary between AC-4 frames. In order to minimize overhead, AC-4 frames should be packaged into PES packets in a way to best fit them to the payload of the PES packets with minimum or no padding required.

To achieve this, multiple AC-4 frames may be packed per PES packet. The number of AC-4 frames per PES packet may vary between PES packets, but *each PES packet shall contain an integer number of AC-4 frames only. AC-4 frames shall not be split over two or more PES packets.*

The AC-4 elementary stream shall be byte-aligned within the PES packet so that the first byte of the first AC-4 frame contained in the PES packet is located in the first byte of the PES packet payload.

*Encoders shall signal random access frames by setting the **random_access_indicator** in the **adaptation_field** in the MPEG 2 transport layer. Random access frames in AC-4 elementary streams are indicated by the **b_iframe_global** flag as defined in ETSI TS 103 190-2 [46].*

Some additional constraints are placed on the PES layer for the case of multiple separate elementary streams intended to be reproduced in sync as described in clause 6.7.4.2 of the present document.

6.7.4 Multiple audio programme components

6.7.4.1 General

Multiple audio programme component use cases are a generalization of receiver-mix audio as defined in earlier versions of the present document: several audio components are decoded and mixed in the receiver. To implement these use cases, *the IRD shall be capable of simultaneously decoding several different audio components and subsequently combining them into a complete programme.*

In these use cases, most of the programme components may be multiplexed into the main audio service. Some other programme components (such as a spoken director's commentary) may additionally be carried as:

- separate substream groups within the same AC-4 elementary stream (see clause 6.7.4.2);
- separate AC-4 elementary streams (see clause 6.7.4.3);
- a combination of the above.

The additional programme components are referred to as supplementary audio components below.

NOTE 1: In this context, the following use-cases are covered: music+effects combined with one of multiple languages, spoken narration of the picture content intended for the visually impaired listener, a specially created dialogue based audio service for the hearing impaired listener or additional audio services such as a spoken director's commentary, or additional effects tracks.

The following requirements apply to all multiple audio programme component use cases:

Encoding: *At least one presentation shall be entirely contained within a single PES.*

Decoding: *The IRD shall support single-stream delivery as defined in clause 6.7.4.2.*

The IRD should support multi-stream delivery as defined in clause 6.7.4.3.

NOTE 2: This includes support for supplementary audio.

The presentation shall be decoded and its substreams combined as described in clause 4.8.4 in ETSI TS 103 190-2 [46].

*The IRD shall ignore the contents of the **AD_descriptor**, and instead use *pan & fade* values from the elementary stream, as specified in ETSI TS 103 190-2 [46], clause 6.2.7.4.*

6.7.4.2 Single-stream delivery

In this use case, the supplementary audio components are carried as separate substream groups in the same AC-4 elementary stream, and all presentations are contained in a single PES.

In addition to the requirements in clause 6.7.4.1, the following constraints apply.

Encoding: The **b_multi_pid** field as defined in ETSI TS 103 190-2 [46], clause 6.3.2.2.7 shall be set to 0.

*To provide I-Frames (see ETSI TS 103 190-2 [46], clause 4.5.2) flags **b_audio_ndot**, **b_pres_ndot**, **b_oamd_ndot** of substreams combined in one elementary stream shall be aligned.*

NOTE: Following this requirement ensures that muxing/splicing operations keep presentations intact that combine several substreams.

6.7.4.3 Multi-stream delivery

In this use case (often termed "multi PID"), most of the programme components are found in the main audio service, but at least one supplementary programme component (such as a narration of the picture content intended for the visually impaired listener) is carried in a separate PES.

NOTE 1: It follows that in this case at least some presentations span across separate PES.

Support for this case is optional.

- Encoding: Support of this case is optional for encoders. Encoders may encode all components into a single PES.
- Decoding: Support of this case is optional for IRDs. An IRD may ignore presentations that span separate PES.

When this case is supported, the following requirements apply.

NOTE 2: The term "contributing streams" is defined to be the set of all elementary streams that contain Audio Programme Components contributing to a presentation. A bitstream element is said to be contributing if it is contained in a contributing stream.

- Encoding: *For any presentation, all contributing elementary streams shall share the same frame rate. For any presentation, all contributing elementary streams shall be time aligned with each other, i.e. the PTS of audio frames (whether transmitted explicitly or implied) shall be identical.*

For any presentation, all contributing elementary streams shall have synchronized sequence numbers.

For any presentation, all contributing elementary streams should use identical i-framing to facilitate synchronous startup after a channel change.

*For any presentation, the **b_multi_pid** field in the contributing **ac4_presentation_v1_info** containers according to ETSI TS 103 190-2 [46], clause 6.3.2.2.7 shall be set to 1.*

*The presentation elements in the contributing TOCs shall be identical except for the actual substream group information. Specifically, the **presentation_group_index** elements shall match.*

- Decoding: The contributing elementary streams may be remixed into a single elementary stream as per the steps described in ETSI TS 103 190-2 [46], clause 5.1.2.

6.7.5 DRC and Loudness

The AC-4 bitstream format has been designed to enable intelligent control of audio loudness processing algorithms found throughout today's media workflows and delivery chains to improve the overall quality of audio programmes for consumers.

The loudness metadata included in the AC-4 elementary stream allows the full range of parameters to be described, including:

- true peak and maximum true peak, as specified in Recommendation ITU-R BS.1770 [i.17];
- relative gated loudness values, as specified in Recommendation ITU-R BS.1770 [i.17];
- speech gated loudness values, as specified, e.g. in Free TV OP-59 [i.21];
- the dialogue gating type, as specified in ETSI TS 103 190-1 [43];
- momentary and maximum momentary loudness, as specified in Recommendation ITU-R BS.1771-1 [i.22];
- short term and maximum short term loudness, as specified in Recommendation ITU-R BS.1771-1 [i.22]; and
- loudness range and its measurement practice type, as specified in EBU Tech Document 3342 [i.23].

The Dynamic Range Control (DRC) elements of AC-4 provide users and systems with a flexible range of dynamic range control options to address a wide range of device profiles and user applications.

In order to take full advantage of these features, it is strongly recommended to follow the recommendations in EBU R 128 [i.18], EBU Tech Doc 3343 [i.24] and EBU Tech Doc 3344 [i.19] or local loudness regulations, e.g. FreeTV OP-59 [i.21].

In order to comply with EBU R 128 [i.18], the following constraints apply:

Encoding: *The **dialnorm_bits** parameter shall be used to indicate the audio programme loudness measured according to local loudness regulations (EBU Tech 3344 [i.19], FreeTV OP-59 [i.21]). The **loud_prac_type** parameter shall accordingly be set to indicate the measurement practice used.*

*The **b_loudcorr_type** flag shall be set to zero, if the audio programme has been corrected with an infinite look-ahead (file-based). If the loudness correction was based on a combination of real-time loudness measurement and dynamic range compression, the flag shall be set to one.*

The **max_truepk** parameter should be set to the maximum true peak sample value of the audio programme, measured according to annex 2 of Recommendation ITU-R BS.1770 [i.17] and without metadata applied.

The **lra** parameter should be set to the loudness range of the audio programme as specified in EBU Tech Document 3342 [i.23].

The **loudrelgat** parameter may be used to signal the measurement of the integrated loudness of the audio programme, as specified in Recommendation ITU-R BS.1770 [i.17], without loudness or DRC metadata applied.

The **dialgate_prac_type** parameter may be set to the appropriate type if dialogue gating that was utilized to measure the audio programme loudness (indicated in **dialnorm_bits**) for normalizing the program prior to transmission.

The **max_loudstrm3s** parameter may be used to signal the maximum short-term loudness of the audio programme, measured as specified in Recommendation ITU-R BS.1771-1 [i.22], without loudness or DRC metadata applied.

The **max_loudmnty** parameter may be used to signal the maximum momentary loudness of the audio programme, measured as specified in Recommendation ITU-R BS.1771-1 [i.22], without loudness or DRC metadata applied.

*All 4 default DRC modes, indicated by **drc_decoder_mode_id** values 0 to 3 as defined in ETSI TS 103 190-1 [43], clause 4.3.13.3.1 shall be included in the AC-4 elementary stream.*

Decoding: *The IRD shall apply DRC and loudness metadata as specified in ETSI TS 103 190-2 [46].*

The IRD shall support the relevant DRC decoder modes as defined in ETSI TS 103 190-1 [43], clause 4.3.13.3.1.

NOTE 1: Different device types typically operate at different output reference levels (e.g. in a mobile phone, DRC decoder mode 2 might be found to be relevant, whereas for a TV, decoder mode 1 might).

NOTE 2: The E-AC-3 profiles as defined in ETSI TS 103 190-1 [43], clause 4.3.13.2.2 provide further provisions for the case that transcoding to E-AC-3 is supported by the IRD.

The decoder shall also support parametric DRC curves as defined by ETSI TS 103 190-1 [43], clause 4.3.13.4.

6.7.6 Dialogue Enhancement

The AC-4 bitstream format features flexible and scalable dialogue enhancement capabilities, which are built into the codec. They are detailed in clause 5.7.8 of ETSI TS 103 190-1 [43] and clause 5.8 of ETSI TS 103 190-2 [46]. The following constraints apply:

Encoding: An AC-4 elementary stream carrying an audio programme that contains dialogue mixed into the main programme should contain dialogue enhancement data.

Decoding: *The IRD shall be capable of applying dialogue enhancement carried in the AC-4 elementary stream as described in ETSI TS 103 190-1 [43] and ETSI TS 103 190-2 [46].*

6.7.7 Audio/Video frame rate matching

AC-4 is designed to facilitate keeping video and audio in sync throughout the distribution chain by providing the flexibility to encode the audio programme at the same frame rate as the video programme. This means that for every video frame there is a corresponding audio frame when this AC-4 feature is enabled.

When enabled, this optional AC-4 feature facilitates splicing workflows as well as use cases like transcoding from or to SMPTE ST 292-1 [i.25].

When the A/V sync feature of AC-4 is enabled for a programme, the following constraints apply to all elementary streams of that programme:

Encoding: *If Audio/Video frame rate matching is used:*

- If the video is encoded as specified in clauses 5.14.5.2.2, 5.14.5.6 and 5.14.5.7 of the present document, the audio frame rate shall be chosen to match the frame rate of the half frame rate HEVC temporal video sub-bitstream.
- Otherwise, an AC-4 elementary stream shall be encoded with a frame rate equal to the video frame rate.

The PTS associated with the first AC-4 frame in each PES packet should match the PTS of the corresponding video frame. That means that for each video access unit there should be a matching audio access unit with the same (signalled or inferred) presentation time. Table 27 summarizes the above constraints for informative purposes.

Table 27: Choosing the audio frame rate *afr* dependent on video frame rate *vfr*

Framerate	$vfr \leq 60$ Hz	$60 \text{ Hz} < vfr \leq 120$ Hz	
Video encoded per clause	Any	Clauses 5.14.5.{2,2, 6, 7}	Clause 5.14.5.2.3
Rate aligned	$afr = vfr$	$afr = vfr/2$	$afr = vfr$
Rate not aligned	$afr \in \{48\ 000/2\ 048, 24\ 000/1\ 001, 24, 25, 30\ 000/1\ 001, 30, 50, 60\ 000/1\ 001, 60\}$ Hz		$afr \in \{48\ 000/2\ 048, 24\ 000/1\ 001, 24, 25, 30\ 000/1\ 001, 30, 50, 60\ 000/1\ 001, 60, 100, 120\ 000/1\ 001, 120\}$ Hz

6.8 MPEG-H Audio

6.8.1 Introduction

MPEG-H Audio offers methods for coding of channel-based content, coding of object-based content, and coding of scene-based content (using Higher Order Ambisonics [HOA] as a sound-field representation). Figure 5 provides an overview of the signal flow in the MPEG-H Audio decoder from bit-stream input to loudspeaker or headphone outputs. The transmitted audio signals are decoded by the MPEG-H Audio Core Decoder. Channel-based signals are mapped to the target reproduction loudspeaker layout using the Format Conversion module. Object-based signals are decoded and rendered to the target reproduction loudspeaker layout by the Object Renderer module. HOA content is rendered to the target reproduction loudspeaker layout using the associated HOA metadata by a HOA decoder including renderer.

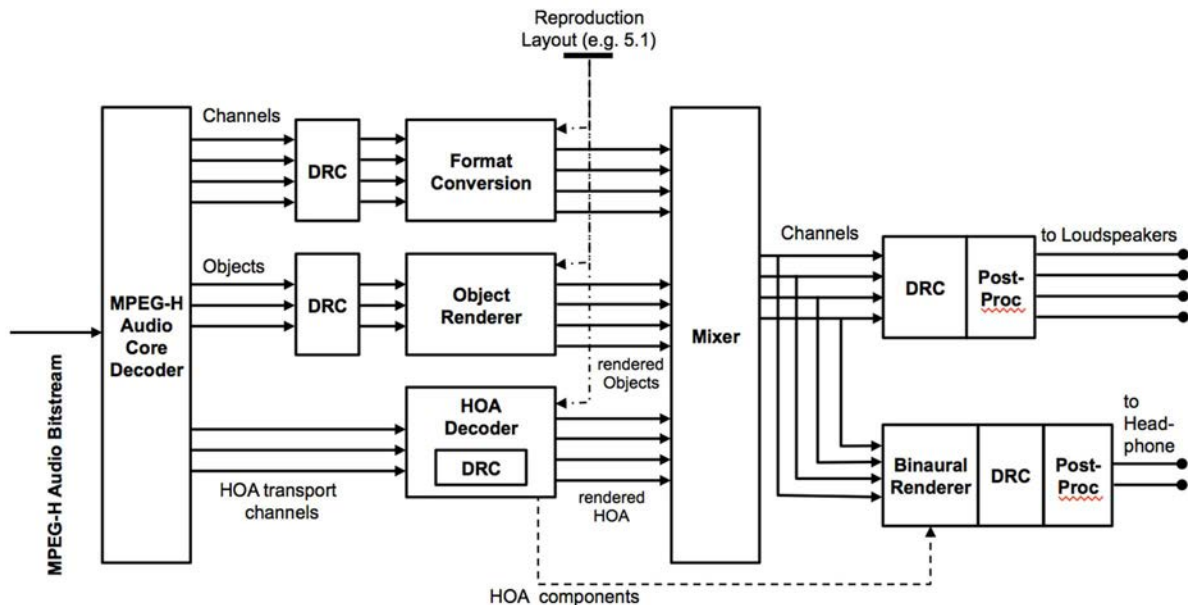

Figure 5: Top level block diagram of the MPEG-H Audio decoder

6.8.2 Profiles and Levels for MPEG-H Audio

Encoding: *Audio signals shall be encoded according to the MPEG-H Audio Low Complexity (LC) Profile as defined in ISO/IEC 23008-3 [47], clause 4.*

The encoder shall use the MPEG-H Audio LC Profile Level 1, Level 2 or Level 3.

*The **immersiveDownmixFlag** in the **downmixConfig()** structure shall be set to 0.*

The MPEG-H Audio LC Profile specifies a complete signal chain from bit-stream input to loudspeaker output including the decoding, rendering, mixing and loudness/DRC processing of MPEG-H Audio LC Profile Level 1, Level 2 and Level 3 bitstreams. The renderers for object and HOA signals specified in [47] are the reference renderers for audio object content and HOA content encoded in accordance with MPEG-H Audio LC Profile. The interface to the reference renderer for local setup information is defined in ISO/IEC 23008-3 [47], clauses 17.2, 17.3 and 17.5, the interface to the renderer for user interaction is defined in ISO/IEC 23008-3 [47], clauses 17.7 and 17.8.

A reference renderer provides a broadcaster a tool to verify the rendering performance of the generated NGA delivery signal. Defining a reference renderer does not imply that the signal will be rendered with the reference renderer nor does it enforce implementation requirements on the IRD.

Decoding: *The IRD shall be capable of decoding MPEG-H Audio LC Profile Level 1, Level 2 and Level 3 bitstreams with the following relaxations:*

- It is recommended that the IRD implements either the reference object renderer and the reference HOA renderer, or an object renderer and an HOA renderer that perform at least as well as the reference renderer given the capabilities of the IRD. This performance recommendation covers the behaviour of the IRD over the complete decoding and rendering chain, especially for the case of configuration changes as described in clause 6.8.5, mixing of channel, HOA and object content or DRC processing, loudness compensation and user interactivity.
- The user interaction interface as defined for the reference renderer in ISO/IEC 23008-3 [47], clause 17 is optional.
- The Generic Loudspeaker Rendering/Format Conversion defined in ISO/IEC 23008-3 [47], clause 10 is optional.
- The Immersive Renderer defined in ISO/IEC 23008-3 [47], clause 11 is optional.
- Binaural rendering defined in ISO/IEC 23008-3 [47], clause 13 is optional.

6.8.3 MHAS elementary stream formatting

Encoding: *The MPEG-H Audio elementary streams shall be encapsulated in the MPEG-H Audio Stream Format (MHAS) according to ISO/IEC 23008-3 [47], clause 14, with further specification in ISO/IEC 13818-1 [1], clause 2.19.2.*

MHAS packets of all types defined in ISO/IEC 23008-3 [47], clause 14, may be present in an MHAS elementary stream with the following exception:

MHAS packets with the types PACTYP_CRC16, PACTYP_CRC32, PACTYP_GLOBAL_CRC16 and PACTYP_GLOBAL_CRC32 shall not be present in an MHAS elementary stream.

Other MHAS packets may be present in the MHAS stream.

If Audio Scene Information, according to ISO/IEC 23008-3 [47], clause 15, is present, it shall always be encapsulated in an MHAS PACTYP_AUDIOSCENEINFO packet.

Audio Scene Information shall not be included in the mpeg3daConfig() structure in the MHAS PACTYP_MPEGH3DACFG packet.

Decoding: *The IRD shall read and process MHAS packets of the following types in accordance with ISO/IEC 23008-3 [47], clause 14: PACTYP_SYNC, PACTYP_MPEGH3DACFG, PACTYP_AUDIOSCENEINFO, PACTYP_AUDIOTRUNCATION, PACTYP_MPEGH3DAFRAME, PACTYP_USERINTERACTION and PACTYP_LOUDNESS_DRC (see clause 6.8.9 for further specifications regarding the last two packet types).*

The IRD may read and process MHAS packets of the following types: PACTYP_SYNCGAP, PACTYP_BUFFERINFO, PACTYP_MARKER and PACTYP_DESCRIPTOR.

It is optional for the IRD to process MHAS packets of the type PACTYP_SYSMETA and thus packets of this type may be ignored.

Other MHAS packets may be present in an MHAS elementary stream and may be ignored.

6.8.4 Random Access Points with MPEG-H Audio

6.8.4.1 Definition of RAP with MPEG-H Audio

Encoding: *All rules defined in ISO/IEC 13818-1 [1], clause 2.19.2 regarding Random Access Points (RAP) shall apply. Particularly, this clause specifies that a RAP into an MPEG-H Audio Stream consists of the following MHAS packets, in the following order:*

- PACTYP_SYNC
- PACTYP_MPEGH3DACFG
- PACTYP_MPEGH3DAFRAME

Additionally, the following rules apply:

- An MHAS PACTYP_BUFFERINFO packet shall be present before the MHAS PACTYP_MPEGH3DAFRAME packet.
- If Audio Scene Info is present, an MHAS PACTYP_AUDIOSCENEINFO packet shall directly follow the MHAS PACTYP_MPEGH3DACFG packet as defined in ISO/IEC 23008-3 [47], clause 14.

Furthermore, the audio data encapsulated in the MHAS packet PACTYP_MPEGH3DAFRAME shall follow the rules for a random access point as defined in ISO/IEC 23008-3 [47], clause 5.7.

Additional MHAS packets may be present in-between the above listed MHAS packets or after the MHAS PACTYP_MPEGH3DAFRAME packet, with one exception: when present the MHAS PACTYP_AUDIOSCENEINFO packet directly follows the MHAS PACTYP_MPEGH3DACFG packet.

6.8.4.2 Time interval Between RAPs

Encoding: *MPEG-H Audio RAPs shall be inserted in the audio elementary stream at least once in every 2 s. The minimum distance between two RAPs shall be 500 ms.*

It is recommended that those audio frames whose PTS values are closest to the PTS values of the RAPs of the associated video elementary stream are also coded as RAPs.

6.8.4.3 Tune-In at a RAP

A tune-in happens, for example when the IRD switches the service. The audio decoder is able to tune-in to a new audio stream at every random access point (RAP).

Starting with the RAP, the decoder receives MHAS packets. The configuration information (contained in the MHAS PACTYP_MPEGH3DACFG and PACTYP_AUDIOSCENEINFO packets) that is present at the RAP is used to initialize the audio decoder. After initialization, the audio decoder reads encoded audio frames (contained in the MHAS PACTYP_MPEGH3DAFRAME packet) and decodes them.

Decoding: *To optimize startup delay at tune-in the information from the MHAS PACTYP_BUFFERINFO packet should be taken into account. The input buffer should be filled at least to the state indicated in the MHAS PACTYP_BUFFERINFO packet before starting to decode audio frames.*

NOTE: *It may be necessary to feed several audio frames into the decoder before the first decoded PCM output buffer is available, as described in ISO/IEC 23008-3 [47], clause 4.*

It is recommended that on tune-in, the IRD performs a 100 ms fade-in on the first PCM output buffer that it receives from the audio decoder.

6.8.5 Configuration Change and Audio/Video Alignment

MPEG-H Audio enables seamless configuration changes in a broadcast environment. A configuration change takes place in an audio stream when the content setup or the Audio Scene Information changes (e.g. when changes occur in the channel layout, the number of objects, etc.) and, therefore, a new MHAS PACTYP_MPEGH3DACFG packet is required. Additionally, if the Audio Scene Information is present, a new MHAS PACTYP_AUDIOSCENEINFO packet is also required. Even though configuration changes usually happen at program boundaries, they are not restricted to that case and they may occur at any time within a program.

Encoding: *At each configuration change, the MHASPacketLabel shall be changed to a different value from the MHASPacketLabel in use before the configuration change occurred. The Access Unit that contains a configuration change shall be encoded as RAP as defined above.*

The values of the MHASPacketLabel shall be set according to ISO/IEC 23008-3 [47], clause 14.

Decoding: *If the decoder detects a configuration change in the bitstream, the decoder shall perform the configuration change according to ISO/IEC 23008-3 [47], clause 5.5.6.*

The configuration change can, for instance, be detected through the change of the MHASPacketLabel of the packet PACTYP_MPEGH3DACFG compared to the value of the MHASPacketLabel of previous MHAS packets.

If MHAS packets of type PACTYP_AUDIOTRUNCATION are present, they shall be used as described in ISO/IEC 23008-3 [47], clause 14.

The Access Unit that contains the configuration change and the last Access Unit before the configuration change may contain a truncation message (PACTYP_AUDIOTRUNCATION) as defined in ISO/IEC 23008-3 [47], clause 14. The MHAS packet of type PACTYP_AUDIOTRUNCATION enables synchronization between video and audio elementary streams at program boundaries. When used, sample-accurate splicing and reconfiguration of the audio stream are possible.

NOTE: A change in the `mpegh3daLoudnessInfoSet()` and `mpegh3daUniDrcConfig()` structures may occur without triggering a configuration change. Changes in `mpegh3daLoudnessInfoSet()` and `mpegh3daUniDrcConfig()` are handled as described in ISO/IEC 23003-4 [48], clause 6.8.

6.8.6 Metadata Audio Elements and Audio Preselections

MPEG-H Audio uses a set of static metadata, the "Metadata Audio Elements" (MAE), to define an "Audio Scene". An Audio Scene represents an Audio Programme.

Audio Programme Components are associated with metadata that contain all information necessary for personalization, interactive reproduction, and rendering in flexible reproduction layouts.

The metadata (MAE) is structured in several hierarchy levels. The top-level element of MAE is represented by the "`mae_AudioSceneInfo()`" structure. Sub-structures of the "`mae_AudioSceneInfo()`" structure contain "Groups," "Switch Groups," and "Presets". The Groups and Switch Groups represent Audio Programme Components, Presets represent Audio Preselections.

Encoding: *If the Audio Programme contains Audio Preselection description, the Audio Programme shall contain exactly one default Audio Preselection, i.e. the Audio Preselection containing the main audio to be decoded in the absence of any user preference data or any other system automatic selection information. This means that, if the Audio Programme contains Audio Preselection description, exactly one group preset shall have the **mae_groupPresetID** field equal to 0.*

*The number of Audio Preselections shall be equal with 31 or less, i.e. the **mae_numGroupPresets** field shall be set to a value between 0 and 31. If the Audio Programme does not contain Audio Preselection description the **mae_numGroupPresets** field shall be set 0.*

Decoding: *The IRD shall, by default, and in the absence of any user preference data or any other system automatic selection information, decode the default Audio Preselection, i.e. the IRD shall decode the Audio Programme Components contained in the group preset with the **mae_groupPresetID** field set to 0.*

The IRD shall be capable of decoding all Audio Preselections, i.e. decode all group presets signalled in the "`mae_GroupPresetDefinition()`" structure as defined in ISO/IEC 23008-3 [47], clause 15.

*If the IRD receives a Preselection ID value, the IRD shall decode the Audio Programme Components contained in the group preset with the **mae_groupPresetID** field equal to the received Preselection ID value.*

6.8.7 MPEG-H Multi-Stream Audio

6.8.7.1 Encoding and Decoding of MPEG-H Multi-Stream Audio

The multi-stream-enabled MPEG-H Audio System is capable of handling Audio Programme Components delivered in several different elementary streams (e.g. one MHAS stream containing one complete audio main, and one or more auxiliary MHAS streams, containing different languages and audio description).

The main MHAS stream (containing one complete audio main or the Audio Programme Components corresponding to the default Audio Preselection) and auxiliary MHAS streams (containing the Audio Programme Components corresponding to several other Audio Preselections) can be carried:

- within a single MPEG-H Audio elementary stream; or
- as separate MPEG-H Audio elementary streams.

The MAE information allows the MPEG-H Audio Decoder to correctly decode several MHAS streams. The MHAS streams can be provided directly to the MPEG-H Audio Decoder. Alternatively, the MHAS streams can be first merged into one single MHAS stream which is provided to the MPEG-H Audio Decoder.

Encoding: *For each MHAS stream, the MHASPacketLabel shall be set according to ISO/IEC 23008-3 [47], clause 14.6.*

*One MHAS stream shall be the main stream, i.e. in exactly one MHAS stream the Audio Scene Information shall have the **mae_isMainStream** field set to 1. In all other MHAS streams the **mae_isMainStream** shall be set to 0.*

*In each auxiliary MHAS stream (i.e. streams with **mae_isMainStream** field set to 0) the **mae_bsMetaDataElementIDoffset** field in the Audio Scene Information shall be set to the index of the first metadata element in the auxiliary MHAS stream minus one.*

All MHAS elementary streams that carry Audio Programme Components of one Audio Programme shall be time aligned, i.e. the PTS of those audio frames of the main and all auxiliary streams that correspond to the same time instance (whether transmitted explicitly or implied) shall be identical.

*In each auxiliary MHAS elementary stream (i.e. streams with **mae_isMainStream** field set to 0), RAPs shall be aligned to the RAPs present in the main stream (i.e. the stream with **mae_isMainStream** field set to 1).*

Decoding: *The IRD shall be capable of simultaneously decoding of Audio Programme Components from the main and up to 2 auxiliary MHAS streams and subsequently combining them into a single elementary stream by utilizing the field **mae_bsMetaDataElementIDoffset** in the Audio Scene Information as described in ISO/IEC 23008-3 [47], clause 14.6.*

6.8.7.2 Example of MPEG-H Multi-Stream Audio

Figure 6 illustrates an example of a multi-stream delivery scenario wherein, out of several incoming streams, the main stream (stream #0) and the third stream (stream #2) are selected and merged into a single stream, while the second stream (stream #1) is discarded, based on information obtained from the systems level.

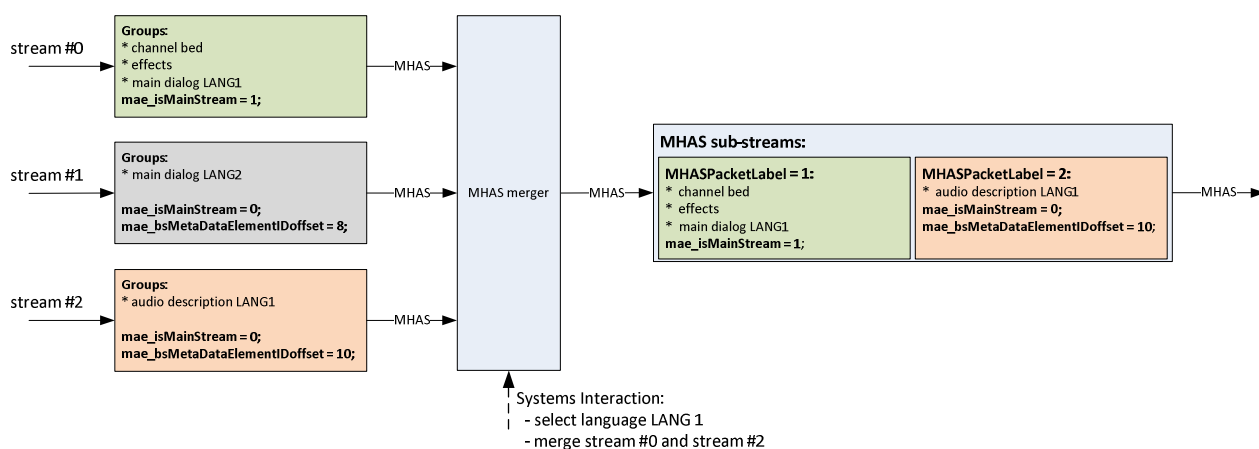

Figure 6: Example of switching and merging multiple incoming streams

6.8.8 Loudness and Dynamic Range Control

The MPEG-H Audio System includes advanced tools for loudness and dynamic range control inherited from ISO/IEC 23003-4 [48]. ISO/IEC 23003-4 defines a comprehensive and flexible metadata format that includes transmission of loudness metadata according to recommendations Recommendation ITU-R BS.1770 [i.17] and Recommendation ITU-R BS.1771-1 [i.22] amongst others. Further, ISO/IEC 23003-4 is compliant to worldwide loudness regulations including EBU Recommendation R 128 [i.18].

Encoding: *Loudness metadata shall be embedded within the `mpegh3daLoudnessInfoSet()` structure as defined in ISO/IEC 23008-3 [47], clause 6.3. Such loudness metadata shall include at least the loudness of the audio content rendered to the default rendering layout as indicated by the **referenceLayout** field (see ISO/IEC 23008-3 [47], clause 5.3.2). More precisely, the `mpegh3daLoudnessInfoSet()` structure shall include at least one `loudnessInfo()` structure with **loudnessInfoType** set to 0, whose **drcSetId** and **downmixId** fields are set to 0 and which includes at least one **methodValue** field with **methodDefinition** set to 1 or 2 (see ISO/IEC 23008-3 [47], clause 6.3.1 and ISO/IEC 23003-4 [48], clause 7.3). The indicated loudness value shall be measured according to local loudness regulations (e.g. EBU R 128 [i.18]).*

DRC metadata shall be embedded in the `mpegh3daUniDrcConfig()` and `uniDrcGain()` structures as defined in ISO/IEC 23008-3 [47], clause 6.3.

*For each included DRC set the **drcSetTargetLoudnessPresent** field shall be set to 1. The **bsDrcSetTargetLoudnessValueUpper** and **bsDrcSetTargetLoudnessValueLower** fields shall be configured to continuously cover the range of target loudness levels between -31 dB and 0 dB.*

*Loudness compensation information (`mae_LoudnessCompensationData()`) as defined in ISO/IEC 23008-3 [47], clause 15.5 shall be present in the Audio Scene Information if the **mae_allowGainInteractivity** field (according to ISO/IEC 23008-3 [47], clause 15.3) is set to 1 for at least one Group.*

Decoding: *The IRD shall apply loudness and DRC metadata as specified in ISO/IEC 23008-3 [47], clause 6.*

The loudness normalization feature of the MPEG-H Audio Decoder shall be enabled constantly.

NOTE: The target level for normalization is typically fixed and dependent on the specific receiving device (e.g. audio-video receiver, TV set, Mobile device).

6.8.9 User Interactivity and Personalization

6.8.9.1 Audio Scene and User Interactivity Information

If the MPEG-H Audio bitstream enables user interactivity, i.e. it contains an MHAS packet with type PACTYP_AUDIOSCENEINFO, the user may change certain aspects of the rendered audio scene during playback, e.g. change the gain or position of an audio object.

The Audio Scene Information as defined in ISO/IEC 23008-3 [47], clause 15 contains information as to what the user is allowed to change and by how much, e.g. which Audio Programme Components are enabled for interactivity and what the maximum allowed changes are (e.g. in terms of gain or position). The Audio Scene Information also may contain textual labels with descriptions of Audio Programme Components or presets that can be used in a Graphical User Interface (GUI).

Changes that result from user interactivity in the GUI are taken into account by the MPEG-H Audio Decoder during rendering of the audio scene.

Decoding: *If MHAS_PACTYP_USERINTERACTION and MHAS_PACTYP_LOUDNESS_DRC packets are present in the MHAS stream the IRD shall read and interpret these formats in accordance with ISO/IEC 23008-3 [47], clause 14.*

If the user interactivity results in gain changes of one or more Audio Programme Components in the audio scene, loudness compensation as defined in ISO/IEC 23008-3 [47], clause 15 shall be applied.

The preferred Loudness and DRC configuration shall be controlled by the `mpegh3daLoudnessDrcInterface()` structure as defined in ISO/IEC 23008-3 [47], clause 14.2.2 and ISO/IEC 23003-4 [48], annex B.

*The `mpegh3daLoudnessDrcInterface()` structure shall be restricted to parameter changes in the `loudnessNormalizationControlInterface()` and `dynamicRangeControlInterface()` sub-structures. The **loudnessNormalizationOn** field (part of `loudnessNormalizationControlInterface()`) and the **dynamicRangeControlOn** field (part of `dynamicRangeControlInterface()`) shall be set to 1 (see ISO/IEC 23003-4 [48], annex B).*

6.8.9.2 User Interface Examples (informative)

6.8.9.2.1 Introduction

Two examples are described how the Audio Scene Information can be provided to the GUI and how the user interactivity information can be provided from the GUI to the audio decoder:

- Through an interface (API) of the MPEG-H Audio Decoder, as further described in clause 6.8.9.2.2.
- Through a separate building block at systems level of the receiving device, as further described in clause 6.8.9.2.3.

6.8.9.2.2 MPEG-H Audio Decoder API for User Interface

In the scenario described in this clause the audio decoder has two interfaces:

- the data interface for the encoded bitstream data; and
- an additional interface for User Interactivity Information. This additional interface is defined in ISO/IEC 23008-3 [47], clause 17.7.

As shown in figure 7, the MPEG-H Audio Decoder makes the Audio Scene Information available to an application for usage in a GUI. In return, the MPEG-H Audio Decoder receives User Interactivity Information from the application through the `mpegh3daElementInteraction()` structure as defined in ISO/IEC 23008-3 [47], clause 17.7. The **ei_interactionMode** field in the `mpegh3daElementInteraction()` structure is set to one only if preset information is present in the bitstream.

Optionally, the MPEG-H Audio decoder may receive an `mpegh3daLoudnessDrcInterface()` structure as defined in ISO/IEC 23008-3 [47], clause 14.2.2 for selection of a preferred DRC and loudness configuration.

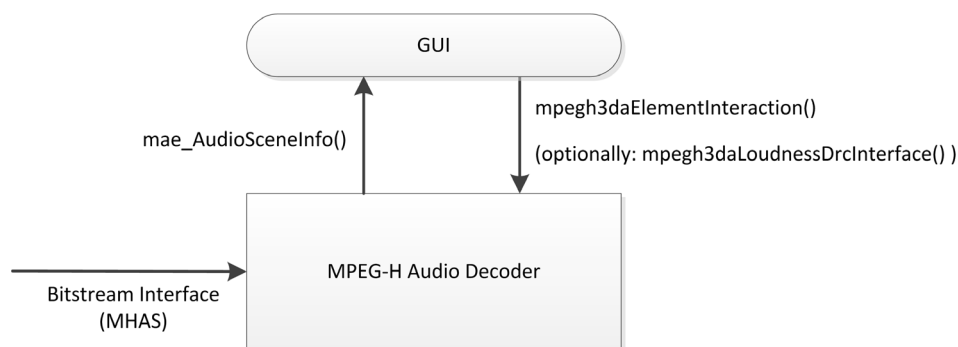

Figure 7: MPEG-H Audio Decoder Interface for User Interactivity

6.8.9.2.3 User Interface on Systems Level

In the scenario described in this clause the audio decoder has only the data interface for the encoded bitstream data and no additional interface for user interactivity. Two separate building blocks at systems level are connected to the GUI, an "MHAS Extractor" building block and an "MHAS Embedder" building block.

As shown in figure 8, the Audio Scene Information is extracted from the MPEG-H Audio bitstream at systems level. The "MHAS Extractor" building block parses the MHAS stream, extracts the MHAS PACTYP_AUDIOSCENEINFO packet and makes it available to the application for usage in a GUI.

In return the "MHAS Embedder" accepts the User Interactivity Information from the application layer. The User Interactivity Information is carried in the `mpegh3daElementInteraction()` structure which is further encapsulated in the MHAS PACTYP_USERINTERACTION packet, as defined in ISO/IEC 23008-3 [47], clause 14.4.9. The **ei_interactionMode** field in the `mpegh3daElementInteraction()` structure is set to one only if preset information is present in the bitstream.

The "MHAS Embedder" building block embeds the MHAS packet PACTYP_USERINTERACTION into the MHAS stream that is fed into the audio decoder. Optionally the MHAS packet PACTYP_LOUDNESS_DRC as defined in ISO/IEC 23008-3 [47], clause 14.4.10 is also embedded into the MHAS packet stream, if the preferred DRC and loudness configuration is intended to be changed in the GUI.

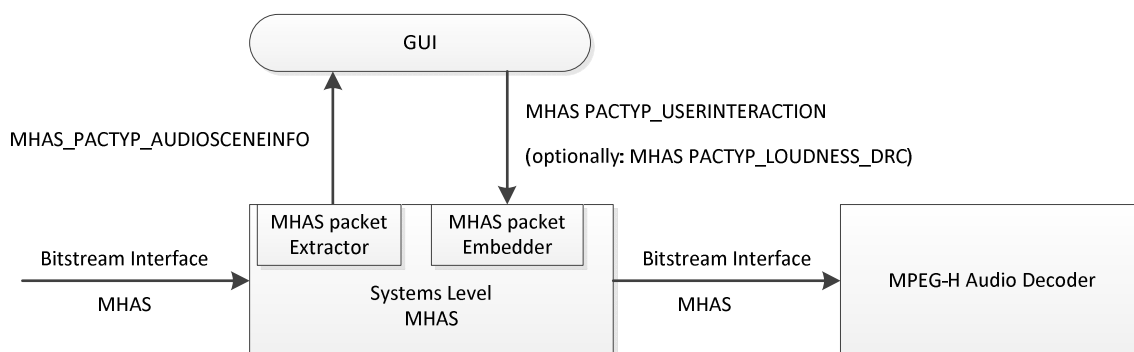

Figure 8: Interface on Systems Level for User Interactivity

6.9 DTS-UHD Audio

6.9.1 Overview

6.9.1.1 DTS-UHD Stream Structure

ETSI TS 103 491 [49] defines a DTS-UHD audio stream as a sequence of DTS-UHD audio frames. Each DTS-UHD audio frame, in turn, is composed of sets of coded waveforms (the audio essences) and metadata such as positional or loudness information.

In DTS-UHD, audio program components are organized into audio program component groups. Audio program components can be part of several audio program component groups; and each audio program component group contains one or more one audio program components. This allows the efficient construction of audio preselections. Figure 9 shows an example of how information within a DTS-UHD frame is organized.

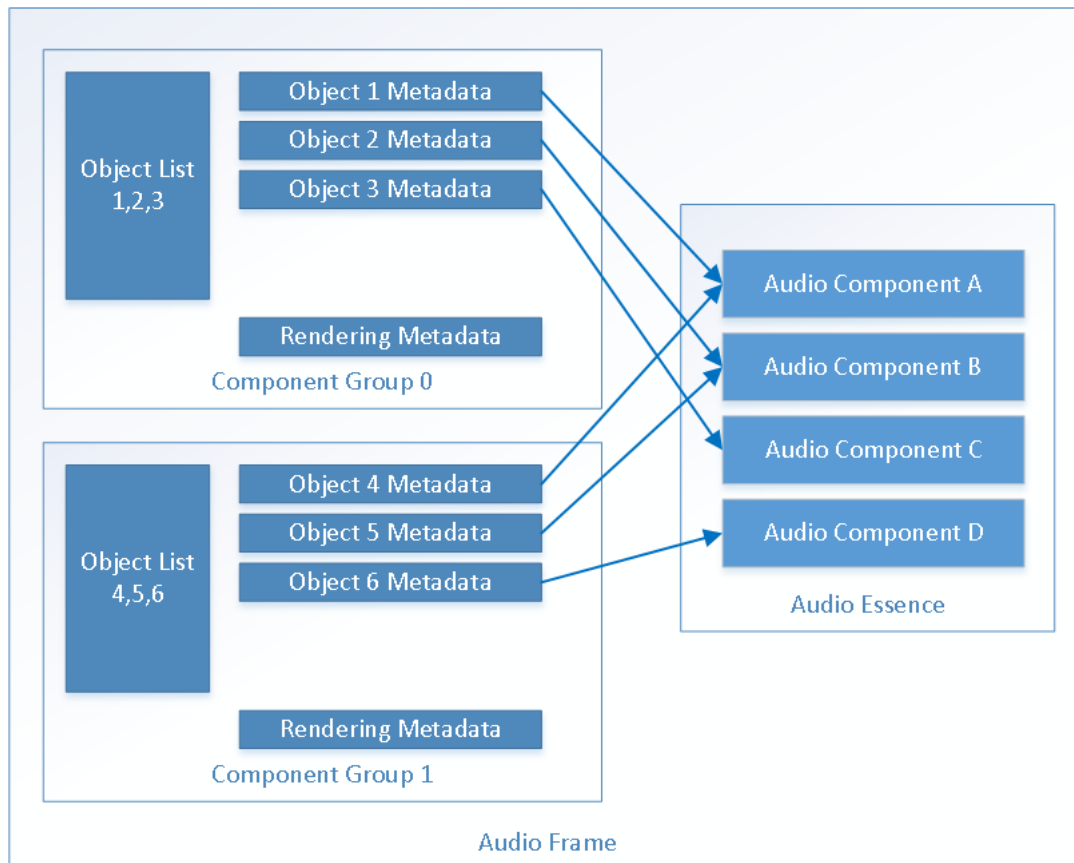

Figure 9: Organization Example of DTS-UHD Component Groups

Audio program component groups are completely contained within a particular DTS-UHD stream; that is, the audio program components all reside in the same DTS-UHD stream that also contains the audio program component group.

Audio preselections according to clause K.1.3 are combined from Audio Program Components.

NOTE: In DTS-UHD, this relationship is indirect as audio preselections are combined from audio program component groups.

When the audio preselection is made up of more than one audio program component group, each such group is contributed from a different DTS-UHD stream, as further specified in clause 6.9.2.

6.9.1.2 Decoders and Renderers

A DTS-UHD decoder is configured to decode a specific audio program component group, identified by configuration parameter **ucAudPresIndex**. The decoder then processes a selected DTS-UHD audio stream into sets of linear PCM waveforms. The waveforms are passed to a renderer along with the respective object metadata, plus additional metadata specific to the audio program component group. Figure 10 provides an illustration.

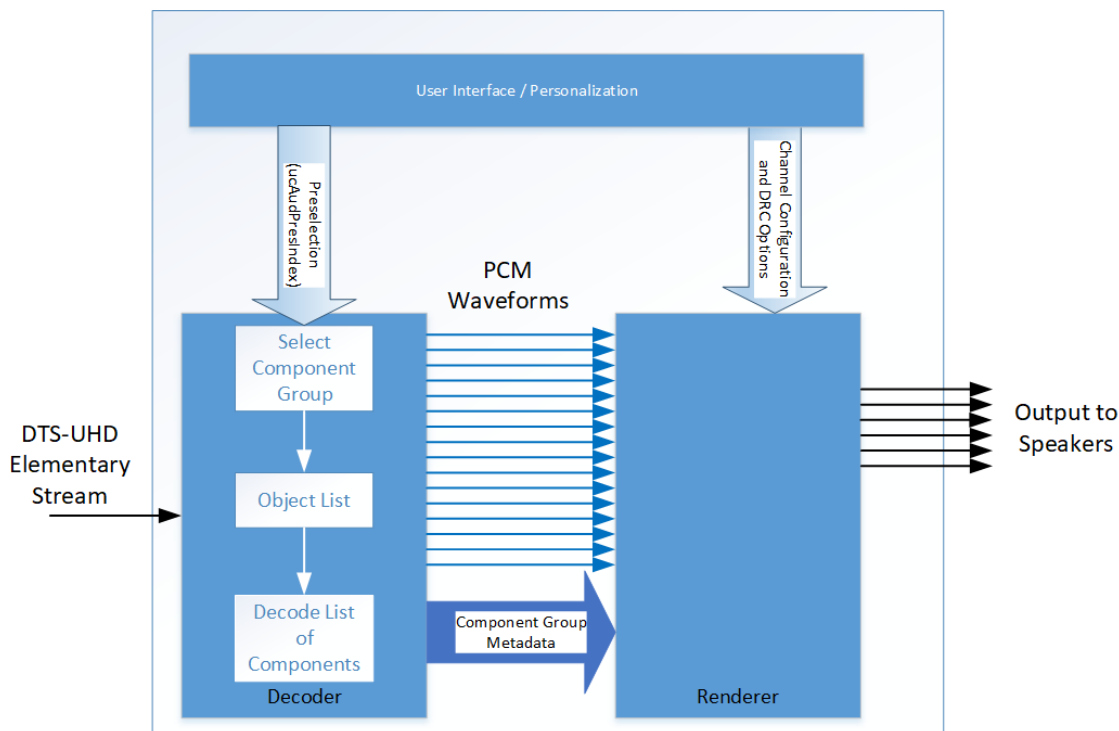

Figure 10: Component Group Selection Decoded and Rendered

The renderer applies the metadata to the essence from the given time interval and mixes all inputs together to generate the final output to the speakers.

A reference renderer provides a broadcaster a tool to verify the rendering performance of the generated NGA delivery signal. Defining a reference renderer does not imply that the signal will be rendered with the reference renderer nor does it enforce implementation requirements on the IRD.

It is recommended that the IRD implements either the reference renderer or a renderer that performs at least as well as the reference renderer given the capabilities of the IRD.

NOTE: A reference renderer for DTS-UHD can be found in ETSI TS 103 584 [i.35].

6.9.1.3 Sync Intervals

To enable break-in, the stream is partitioned into sync intervals. Sync intervals start and end at sync frames. The duration of the sync interval is unlimited, but is nominally between 500 ms and 2 s.

Sync frames are special DTS-UHD audio frames that represent the random access points for random navigation to a particular location in the bitstream as specified in ETSI TS 103 491 [49], clause 4.2.3. Decoding start with a sync frame and the decoder commences to decode the stream as configured by the parameter **ucAudPresIndex**.

Sync frames also mark the points where DTS-UHD BroadcastChunk data becomes valid as further detailed in clause 6.9.3.2.

6.9.2 Multi-stream Playback

The provisions of this clause apply to the case when an audio programme contains multiple elementary streams.

This case is characterized by the presence of one main stream and one or more auxiliary streams. *The audio program shall contain no more than a maximum of 8 DTS-UHD audio streams.* The stream with stream ID = 0 is called the "main stream"; all other streams are called "auxiliary streams".

In this case, Audio Preselections can be made up of more than one audio program component group, and the conceptual model assumed in the present document is such that the separate component groups are decoded by separate DTS-UHD decoders as defined in ETSI TS 103 491 [49].

NOTE: This does not preclude other implementations; an implementation choice may be a single decoder processing the frames from the various streams sequentially, then rendering all waveforms from the given time interval together to generate the final output to the speakers.

The individual audio component groups making up the preselection carry positional information for each waveform. Each audio component group also passes available loudness and dynamic metadata to the renderer. *The final rendering metadata for scaling the output shall always be provided by the highest ordered elementary stream in the sequence that contains such metadata.*

In the example of Figure 11 three elementary streams contribute to a particular preselection. Component #2 is from the highest ordered stream in a multi-stream preselection. The renderer will first look for metadata from Component #2 to perform the final scaling of the mix. If some metadata is missing, then the renderer looks at the metadata delivered with Component #1, and finally Component #0, in order, to fill in the missing metadata.

To illustrate this example, consider that the component from elementary stream #0 carries music and effects, the component from elementary stream #1 carries dialogue, and the component from elementary stream #2 adds spoken subtitles. Multiple dialogue objects might be able to use the same music and effects, so the mixing metadata with the dialogue will be preferred when only these two components are selected. Since the spoken subtitle is stored in stream #2, and was mastered with the M&E plus dialog, it was the only one mastered with the awareness of the other components. Therefore, the metadata in Component #2 can provide the best experience. In some scenarios, new mixing metadata may not be generated with the spoken subtitle, i.e. it was mastered in consideration of the stream #1 metadata. In this case, stream #1 metadata will be used for the final rendering.

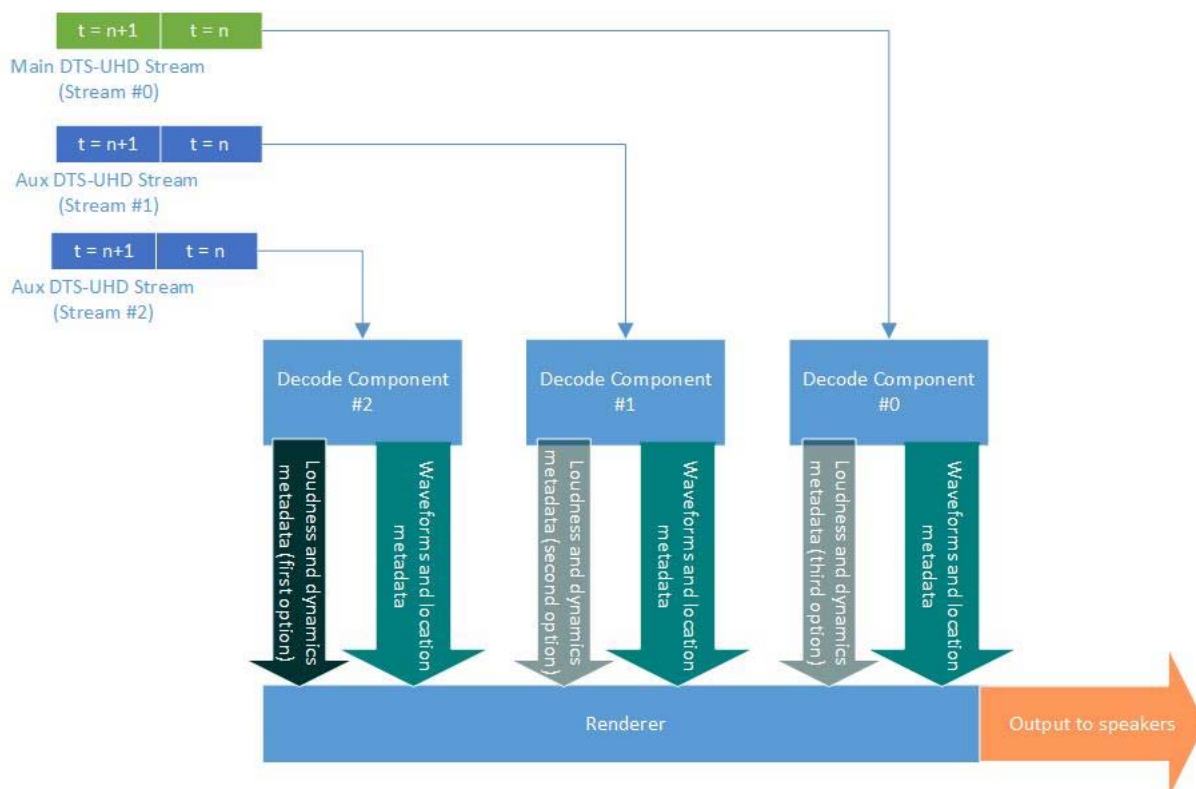

Figure 11: DTS-UHD Multi-stream Example

6.9.3 Detailed Requirements

6.9.3.1 DTS-UHD BroadcastChunk

The DTS-UHD BroadcastChunk is a map of the audio programme. It carries high-level information about the preselections available, and a mapping of the components to specific preselections.

The structure of the BroadcastChunk is defined in table 28. This metadata block is delivered in the main DTS-UHD stream and is carried between audio frames. If auxiliary streams are also present, these streams do not carry a BroadcastChunk. The components delivered in auxiliary streams are referenced by the BroadcastChunk in the main stream.

The BroadcastChunk is organized by language. For each language indicated there are one or more SelectionSets, each defining a preselection. Each SelectionSet is composed of two parts. The first part is a preamble that identifies certain properties of the preselection. The second part is a list of components needed to compose the preselection. The preamble has several pre-defined flags to indicate specific features, and an optional byte to further differentiate programme content. Each component is identified with a **StreamID** and a **ComponentID**.

Table 28: DTS-UHD BroadcastChunk

Syntax	Number of bits	Identifier
DTSUHD_BCHUNK	32	bslbf
ByteCount	8	uimsbf
Version	3	uimsbf
numLanguages	5	uimsbf
for (i=0; i ≤ numLanguages; i++) { // LanguageIndex = i		
ISO639_code // Language Table	24	bslbf
}		
for (i=0; i ≤ numLanguages; i++) { // Language Groups		
b_UserByte	1	bslbf
reserved_bits	2	bslbf
numSelectionSets [i] // Preselections per group	5	uimsbf
for (j = 0; j ≤ numSelectionSets [i]; j++) { // ProgramIndex = j		
AudioDescription // properties of Preselection	1	bslbf
SpokenSubtitle	1	bslbf
DialogueEnhancement	1	bslbf
if (b_UserByte)		
UserByte	8	bslbf
numComponents	3	uimsbf
reserved_bits	2	bslbf
for (k = 0; k ≤ numComponentGroups; k++) { // each Preselection		
StreamID	3	uimsbf
ComponentGroupID	5	uimsbf
} // numComponentGroups		
} // numSelectionSets		
} // numLanguages		
CRC16	16	bslbf

Semantics:

DTSUHD_BCHUNK is a 4-byte syncword identifying the broadcast chunk. *The value shall be as shown in table 29.*

ByteCount is the size, in bytes, of the DTS-UHD BroadcastChunk. *This value shall reflect the number of bytes in the BroadcastChunk excluding the syncword, but inclusive of ByteCount and CRC16.*

Version shall be set to 0.

numLanguages is a 5-bit unsigned integer representing the number of language codes in the language table.

numLanguages + 1 shall equal the number of language codes in the language table and the number of language groups defined in the BroadcastChunk.

ISO639_code shall be used to indicate the language of the preselections in the language group as a 3 byte language code according to ISO 639-2 [27].

b_UserByte indicates the presence of a user byte. If **b_UserByte** is equal to 1, then a user defined byte shall be included in each preselection preamble for the associated language group. If **b_UserByte** is equal to 0, a user defined byte shall not be present.

numSelectionSets[i] is a 5-bit unsigned integer representing the number of preselections defined for a particular language group. **numSelectionSets[i] + 1** shall equal the number of preselections listed in language group *i*.

AudioDescription shall be equal to 1 if the preselection includes scene descriptive audio. Otherwise, **AudioDescription** shall equal 0. Preselections including scene descriptive audio should contain an object where the corresponding **m_ucAssociatedAssetType** is set to ASSET_TYPE_VISUALLY_IMPAIRED, as described in clause 7.7.6.5.2 of ETSI TS 103 491 [49].

SpokenSubtitle shall be equal to 1 if the preselection includes spoken subtitles. Otherwise, **SpokenSubtitle** shall equal 0. Preselections including spoken subtitle should contain an object where the corresponding **m_ucAssociatedAssetType** is set to ASSET_TYPE_SPOKEN_SUBTITLE as described in clause 7.7.6.5.2 of ETSI TS 103 491 [49].

DialogueEnhancement shall be equal to 1 if the preselection includes dialogue that has been enhanced for improved voice clarity. Otherwise, **DialogueEnhancement** shall be set to 0. Preselections including dialogue enhancement should contain an object where the corresponding **m_ucAssociatedAssetType** is set to ASSET_TYPE_HEARING_IMPAIRED as described in clause 7.7.6.5.2 of ETSI TS 103 491 [49].

UserByte shall exist or not according to **b_UserByte**.

NumComponents is a 3-bit unsigned integer representing the number of components creating the given preselection. **NumComponents + 1** shall equal the total number of components listed by **StreamID** and **ComponentID** to define the given preselection.

reserved_bits are 2 bits reserved for future definition. They shall both be set to 0.

StreamID shall identify which elementary stream is contributing a given component. The value 0 is assigned to the main stream, which is the first stream in the TS multiplex. The value 1 represents the first auxiliary stream, and so on, to a maximum of 8 elementary streams.

ComponentGroupID shall identify a specific contribution within the stream indicated by **StreamID** with the corresponding value of **ucAudPresIndex**, as defined in ETSI TS 103 491 [49].

CRC16 : A **BroadcastChunk** shall be terminated with a 16-bit CRC starting from (including) **numLanguages**, through the last instance of **ComponentID**. The CRC shall be calculated by initializing to 0xFFFF and computed with the polynomial $x^{16} + x^{12} + x^5 + 1$.

6.9.3.2 Requirements for including the DTS-UHD BroadcastChunk

The following requirements and constraints apply to the use of the DTS-UHD BroadcastChunk:

- Encoding:
- The BroadcastChunk shall be present when a given audio programme uses multiple DTS-UHD elementary streams.*
 - The BroadcastChunk should be present when a single stream audio programme contains multiple preselections.*
 - When the BroadcastChunk is present, it shall be transmitted in the main elementary stream and shall be located before any audio frame.*
 - The BroadcastChunk shall not be encrypted.*
 - When the BroadcastChunk is required, it shall be present at least once per sync interval.*
 - If the BroadcastChunk is present more than once per sync interval, then all instances of the BroadcastChunk in that sync interval shall be identical.*
- Decoding:
- The BroadcastChunk shall always apply to the next sync interval.*

6.9.4 General Requirements for DTS-UHD

The following requirements apply to encoders and IRDs:

Encoding: *The elementary stream shall be constructed in compliance with ETSI TS 103 491 [49] with the following constraints:*

The main elementary stream shall contain a default preselection.

The default preselection shall be constrained to at most 16 full bandwidth waveforms and two LFE channels.

A sync frame shall be present at every random access point.

If DTS-UHD auxiliary streams are present in the Audio Programme, the sync frames of the auxiliary streams shall be aligned to the sync frames of the main stream.

At least one 48 kHz presentation shall be present in Audio Programme. Other audio sampling frequencies are optional.

Note that seamless playback requires that audio chunk type, audio frame duration and maximum audio sampling frequency in the elementary stream to remain constant.

Decoding: *The IRD shall be able to decode and render at least 16 full bandwidth waveforms and two LFE waveforms from the delivered DTS-UHD Audio Programme.*

The IRD shall be capable of decoding preselections with a sampling frequency of 48 kHz.

The IRD shall invoke playback according to table 4-1 in ETSI TS 103 491 [49] using either API PRES_SELECT_DEFAULT_AP, or API PRES_SELECT_SPECIFIC_AP. The IRD shall not invoke playback using API PRES_SELECT_OBJECT_ID_LIST.

6.9.5 DTS-UHD PES Packaging

Multiple access units are permitted in a PES packet. Audio access units begin with a valid DTS sync word. Valid DTS sync words are listed in table 29.

Table 29: DTS-UHD Syncwords

Name	Syncword	Description
DTSUHD_SYNC	0x40411BF2	DTS-UHD Sync Frame
DTSUHD_NOSYNC	0x71C442E8	DTS-UHD Non-sync Frame
DTSUHD_BCHUNK	0x2A3E2523	DTS-UHD BroadcastChunk

If a transport packet is designated to be a random-access point, the following conditions shall be satisfied according to ISO/IEC 13818-1 [1]:

- *PES header shall be present;*
- *PES header shall contain PTS;*
- ***Data_Alignment_Indicator** within the PES header shall be set to 1 and the syncword (DTSUHD_SYNC) shall immediately follow the PES header.*

A decoder session can only begin on a sync frame; therefore, only sync frames can be random access points. Note that only transport packets which are random access points require syncword alignment.

When a DTSUHD_BCHUNK is extracted from the TS, then it shall be delivered to the decoder promptly such that it will come into effect at the next Sync Frame.

6.9.6 Loudness

The DTS-UHD elementary stream is capable of carrying multiple loudness parameter sets, some of which include (nominally) the complete presentation, the speech components only, and composition of all components excluding the speech.

The loudness metadata will be contributed from the highest ordered stream containing such metadata for the entire preselection as indicated in clause 6.9.2.

Each loudness parameter set consists of 3 values:

- **m_rLoudness** is the measured loudness, stored with an associated asset type code
- **m_ucAssociatedAssetType** which describes the type of asset being measured
- **m_ucLoudnessMsrnType** which indicates the method used to calculate **m_rLoudness**

Details regarding loudness measurements and signaling for DTS-UHD are documented in ETSI TS 103 491 [49], clause 7.7.6.5.

6.9.7 Dynamic Range Personalization

Multiple selectable and custom dynamic range compression curves can be associated with an Audio Programme to facilitate adaptation to various listening environments. The presence of a selectable DRC curve is indicated by the bitstream metadata parameter **m_bCustomDRCurveMDPresent** as defined in ETSI TS 103 491 [49]. Different curves can be assigned to high, medium and low compression to accommodate various playback environments. More information about this can be found in ETSI TS 103 491 [49], clause 7.7.6.8.

Annex A (informative): Examples of Full screen luminance resolutions for SDTV and 25 Hz/30 Hz HDTV

Table A.1: Examples of MPEG-2 screen resolution

vertical_size value	horizontal_size value	aspect_ratio information	frame_rate code (see note)	Progressive or Interlace	Decodeable by MPEG-2 SDTV IRD
1 080	1 920	16:9	25	P	N
1 080	1 920	16:9	23,976; 24; 29,97; 30	P	N
1 080	1 920	16:9	25	I	N
1 080	1 920	16:9	29,97; 30	I	N
720	1 280	16:9	25; 50	P	N
720	1 280	16:9	23,976; 24; 29,97; 30; 59,94; 60	P	N
576	720	16:9	50	P	N
576	720	4:3, 16:9	25	P	Y
576	720	4:3, 16:9	25	I	Y
576	544	4:3, 16:9	25	P	Y
576	544	4:3, 16:9	25	I	Y
576	480	4:3, 16:9	25	P	Y
576	480	4:3, 16:9	25	I	Y
576	352	4:3, 16:9	25	P	Y
576	352	4:3, 16:9	25	I	Y
480	720	16:9	59,94; 60	P	N
480	720	4:3, 16:9	23,976; 24; 29,97; 30	P	Y
480	720	4:3, 16:9	29,97; 30	I	Y
480	640	4:3	23,976; 24; 29,97; 30	P	Y
480	640	4:3	29,97; 30	I	Y
480	544	4:3, 16:9	23,976; 29,97	P	Y
480	544	4:3, 16:9	29,97	I	Y
480	480	4:3, 16:9	23,976; 29,97	P	Y
480	480	4:3, 16:9	29,97	I	Y
480	352	4:3, 16:9	23,976; 29,97	P	Y
480	352	4:3, 16:9	29,97	I	Y
288	352	4:3, 16:9	25	P	Y
240	352	4:3, 16:9	23,976; 29,97	P	Y

NOTE: Shaded "frame_rate_code" values indicate 30 Hz bitstreams, clear values 25 Hz bitstreams.

Table A.2: Examples of H.264/AVC Screen Resolution

Vertical size	Horizontal size	Aspect ratio	Frame rate (see note)	Progressive or Interlaced	Decodable by H.264/AVC SDTV IRD
1 080	1 920, 1 440, 1 280, 960	16:9	23,976; 24	P	N
			25	I	N
			29,97; 30	P	N
			29,97; 30	I	N
720	1 280, 960, 640	16:9	25; 50	P	N
			23,976; 24; 29,97; 30; 59,94; 60	P	N
576	720	4:3, 16:9	25	P	Y
	544, 480, 352	4:3, 16:9	25	I	Y
				P	Y
480	720, 640, 544, 480, 352	4:3, 16:9	23,976; 24; 29,97; 30	P	Y
			29,97; 30	I	Y
288	352	4:3	25; 50	P	Y
			25	I	Y
240	352	4:3	23,976; 24; 29,97; 30; 59,94; 60	P	Y
			29,97; 30	I	Y

NOTE: Shaded "frame_rate_code" values indicate 30 Hz bitstreams, clear values 25 Hz bitstreams.

Table A.3: Examples of VC-1 screen resolution

Vertical size	Horizontal size	Aspect ratio	Frame rate (see note)	Progressive or Interlaced	Decodable by VC-1 SDTV IRD
1 080	1 920, 1 440, 1 280, 960	16:9	23,976; 24	P	N
			25	I	N
			29,97; 30	P	N
			29,97; 30	I	N
720	1 280, 960, 640	16:9	25; 50	P	N
			23,976; 24; 29,97; 30; 59,94; 60	P	N
576	720	4:3, 16:9	25	P	Y
	544, 480, 352	4:3, 16:9	25	I	Y
				P	Y
480	720, 640, 544, 480, 352	4:3, 16:9	23,976; 24; 29,97; 30	P	Y
			29,97; 30	I	Y
288	352	4:3	25; 50	P	Y
			25	I	Y
240	352	4:3	23,976; 24; 29,97; 30; 59,94; 60	P	Y
			29,97; 30	I	Y

NOTE: Shaded "frame_rate" values indicate 30 Hz bitstreams, clear values 25 Hz bitstreams.

Table A.4: Examples of HEVC Bitstreams Resolutions

Vertical size	Horizontal size	Display aspect ratio	Frame rate (see note)	Progressive or Interlaced	Decodable by HEVC HDTV IRD
2 160	3 840, 2 880	16:9	25, 50	P	N
			24 000/1 001, 24, 30 000/1 001, 30, 60 000/1 001, 60	P	N
1 800	3 200	16:9	25, 50	P	N
			24 000/1 001, 24, 30 000/1 001, 30, 60 000/1 001, 60	P	N
1 440	2 560	16:9	25, 50	P	N
			24 000/1 001, 24, 30 000/1 001, 30, 60 000/1 001, 60	P	N
1 080	1 920, 1 440	16:9	24 000/1 001, 24	P	Y
			25	I	Y
				P	Y
			50	P	Y
			30 000/1 001, 30	I	Y
				P	Y
900	1 600	16:9	25, 50	P	Y
			24 000/1 001, 24, 30 000/1 001, 30, 60 000/1 001, 60	P	Y
720	1 280, 960	16:9	25, 50	P	Y
			24 000/1 001, 24, 30 000/1 001, 30, 60 000/1 001, 60	P	Y
540	960	16:9	25, 50	P	Y
			24 000/1 001, 24, 30 000/1 001, 30, 60 000/1 001, 60	P	Y
NOTE: Shaded frame rate values indicate bitstreams that might not be able to be decoded by 50 Hz HEVC HDTV IRDs.					

Annex B (normative): Auxiliary Data in the Video Elementary Stream

B.1 Overview

Certain picture-related types of data may be carried in the video elementary stream. While the "outer wrapper" is codec dependent, the basic data structures are shared in common between MPEG-2, H.264/AVC, HEVC, and VC-1. These picture-related data types include Active Format Description (AFD), bar data, North American-style closed captions and disparity for graphics placement in plano-stereoscopic 3DTV.

Transmission of these descriptions and use of these descriptions by a receiver are both optional.

B.2 Common Syntax and Semantics

The payload is identified by use of several identifier values. Each one specifies the underlying payload syntax. In the case of the **DVB1_data()** structure, there is an additional sub-identifier and several sub-structures are used.

Table B.1: Values for user_identifier

user_identifier	user_structure()
0x47413934 ('GA94')	DVB1_data()
0x44544731 ('DTG1')	afd_data()

NOTE: Values of the user_identifier are registered with SMPTE-RA.

user_identifier: A 32 bit field whose value indicates the contents of the **user_structure()** as indicated in table B.1.

user_structure(): This is a variable length data structure defined by the value of **user_identifier** and table B.1. The two possible structures are shown in tables B.2 and B.3.

Table B.2: Afd_data() Syntax

Syntax	No. of Bits	Identifier
afd_data() {		
'0'	1	bslbf
active_format_flag	1	bslbf
reserved (set to '00 0001')	6	bslbf
if (active_format_flag == 1) {		
reserved (set to '1111')	4	bslbf
active_format	4	bslbf
}		
}		

active_format_flag: A 1 bit flag. A value of "1" indicates that an active format is described in this data structure.

active_format: A 4 bit field describing the "area of interest" in terms of its aspect ratio within the coded frame.

Table B.3: DVB1_data() Syntax

Syntax	No. of Bits	Identifier
DVB1_data() {		
user_data_type_code	8	uimsbf
user_data_type_structure()		
}		

user_data_type_code: An 8-bit value that identifies the type of user data to follow in the **user_data_type_structure()**. The values are defined in table B.4.

Table B.4: Values for user_data_type_code

user_data_type_code	user_data_type_structure()
0x00 to 0x02	Industry Reserved (see code point registry [i.36])
0x03	cc_data()
0x04	Industry Reserved (see code point registry [i.36])
0x05	Industry Reserved (see code point registry [i.36])
0x06	bar_data()
0x07	multi_region_disparity()
0x08	Industry Reserved (see code point registry [i.36])
0x09	ST2094-10_data()
0x0A to 0xFF	Industry Reserved (see code point registry [i.36])

user_data_type_structure: This is a variable length set of data defined by the value of **user_data_type_code** and table B.7 (bar data) or table B.9 (closed captions) or table B.14 (multi region disparity) or clause 4 of ETSI TS 103 572 [50] (SMPTE ST 2094-10 metadata [i.38]).

B.3 Active Format Description (AFD)

B.3.0 Introduction

The AFD describes the portion of the coded video frame that is "of interest". It is intended for use in networks that deliver mixed formats to a heterogeneous receiver population. The format descriptions are informative in nature and are provided to assist receiver systems to optimize their presentation of video. The AFD may be supplemented by "bar data", which describes the size of either a pair of top and bottom bars ("letterbox") or a pair of side bars ("pillar-box"). This permits a display of either 4:3 or 16:9 aspect ratio to best display a picture of any aspect ratio.

The AFD is intended for use where there are compatibility problems between the source format of a programme, the format used for the transmission of that programme, and the format of the target receiver population. For example, a wide-screen production may be transmitted as a 14:9 letter-box within a 4:3 coded frame, thus optimized for the viewer of a 4:3 TV, but causing problems to the viewer of a wide screen TV. The appropriate AFD may be transmitted with the video to indicate to the receiver the "area of interest" of the image, thereby enabling a receiver to present the image in an optimum fashion (which will depend on the format and functionality of the receiving equipment combined with the viewer's preferences). In this example, the functionality provided by the AFD is analogous to (but different from) that provided by Wide Screen Signalling (WSS) described in ETSI EN 300 294 [14].

In addition, the AFD extends WSS by allowing the "area of interest" of a full-frame 16:9 (anamorphic) image to be described, for example to indicate that the centre 4:3 portion of the image has been protected such that a set-top box connected to a 4:3 set may perform a centre cut-out without removing any essential picture information.

The AFD itself does not describe the aspect ratio of the coded frame (as this is described elsewhere in the MPEG-2, H264/AVC, HEVC, or SMPTE VC-1 video syntax).

B.3.1 Coded Frame in MPEG-2 Video

The `active_format` is used by the decoder in conjunction with the "source aspect ratio". The source aspect ratio is derived from the "Display Aspect Ratio" (DAR) signalled in the **aspect_ratio_information**, the **horizontal_size**, **vertical_size**, and **display_horizontal_size** and **display_vertical_size** if present (see Recommendation ITU-T H.262 / ISO/IEC 13818-2 [2]):

- If `sequence_display_extension()` is not present:

$$\text{source aspect ratio} = \text{DAR}$$

- If `sequence_display_extension()` is present:

$$\text{source aspect ratio} = \text{DAR} \times \frac{\text{display_horizontal_size}}{\text{display_vertical_size}} \times \frac{\text{vertical_size}}{\text{horizontal_size}}$$

B.3.2 Coded Frame in H264/AVC Video

The `active_format` is used by the receiver in conjunction with picture size and shape information as indicated in the "sequence parameter set Rbsp" and the **aspect_ratio_idc** field of the "VUI parameters". In particular, the picture width, picture height, frame cropping information, and sample aspect ratio are important for proper use of `active_format` (see ISO/IEC 14496-10 [16]).

The combination of source aspect ratio and `active_format` allows the receiver to identify whether the "area of interest" is the whole of the frame (e.g. source aspect ratio 16:9, `active_format` 16:9 center), a letterbox within the frame (e.g. source aspect ratio 4:3, `active_format` 16:9 center), or a "pillar-box" within the frame (e.g. source aspect ratio 16:9, `active_format` 4:3 center).

B.3.3 Coded Frame in VC-1 Video

The `active_format` is used by the decoder in conjunction with the sample aspect ratio signalled in a VC-1 elementary stream by means of the **ASPECT_RATIO** field in the sequence header as defined in SMPTE ST 421 [20].

The combination of sample aspect ratio and `active_format` allows the decoder to identify whether the "area of interest" is the whole of the frame (e.g. source aspect ratio 16:9, `active_format` 16:9 centre), a letterbox within the frame (e.g. source aspect ratio 4:3, `active_format` 16:9 centre), or a "pillar-box" within the frame (e.g. source aspect ratio 16:9, `active_format` 4:3 centre).

B.3.4 Common Semantics of AFD

The combination of source aspect ratio and `active_format` allows the decoder to identify whether the "area of interest" is the whole of the frame (e.g. source aspect ratio 16:9, `active_format` 16:9 centre), a letterbox within the frame (e.g. source aspect ratio 4:3, `active_format` 16:9 centre), or a "pillar-box" (see note) within the frame (e.g. source aspect ratio 16:9, `active_format` 4:3 centre).

NOTE: "Pillar-box" describes a frame that the image fails to fill horizontally, in the same way that a "Letterbox" describes a frame that the image fails to fill vertically.

Table B.5: Active_format

Active_format	Aspect ratio of the "area of interest"
0000	AFD unknown (see below)
0001	Reserved
0010	box 16:9 (top)
0011	box 14:9 (top)
0100	box > 16:9 (centre)
0101 to 0111	Reserved
1000	Active format is the same as the coded frame
1001	4:3 (centre)
1010	16:9 (centre)
1011	14:9 (centre)
1100	Reserved
1101	4:3 (with shoot and protect 14:9 centre)
1110	16:9 (with shoot and protect 14:9 centre)
1111	16:9 (with shoot and protect 4:3 centre)

AFD 0000 indicates that information is not available and is undefined. Unless bar data is available, receivers and video equipment should interpret the active format as being the same as the coded frame. AFD "0000", when accompanied by bar data, signals that the image's aspect ratio is narrower than 16:9, but is not either 4:3 or 14:9. The bar data should be used to determine the extent of the image.

AFD "0100", which should be accompanied by bar data, signals that the image's aspect ratio is wider than 16:9, as is typically the case with widescreen features. The bar data should be used to determine the height of the image.

The complete set of Active Formats described in the present document is illustrated in table B.6. Note that for each format two example illustrations have been given, corresponding to the source aspect ratio of the coded frame being 4:3 and 16:9. The AFD may also be used with coded frames of other aspect ratios. For example a coded frame of 2.21:1 with active_format 10 would represent a 16:9 image centred (pillar-box) within a 2.21:1 frame.

The Active Formats are illustrated using the following diagrammatic representation.

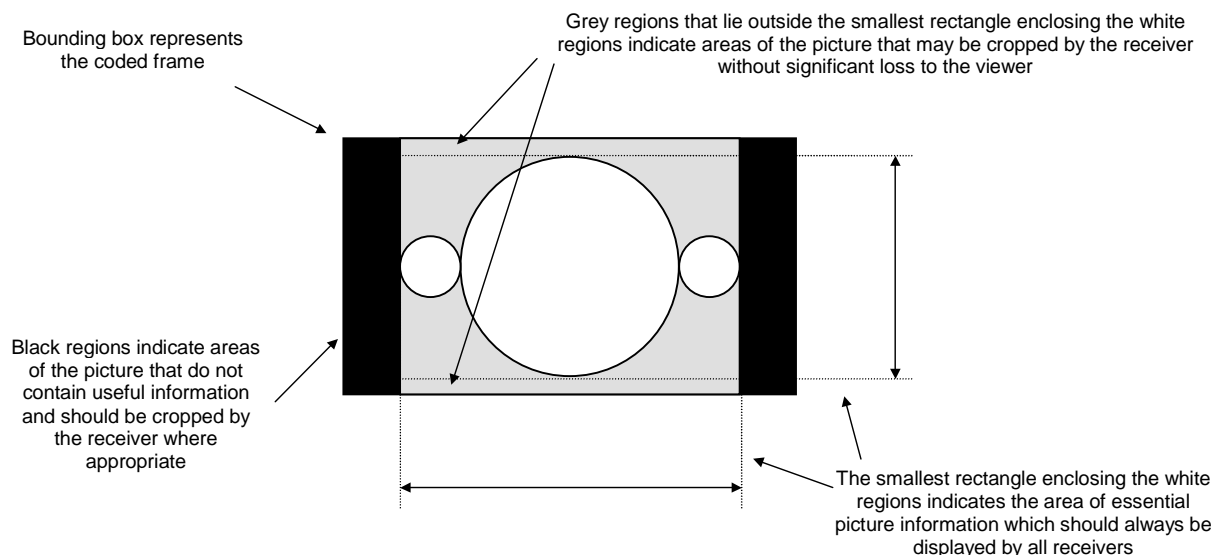
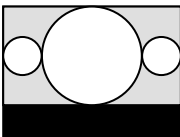
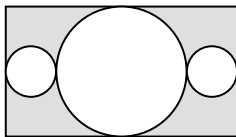
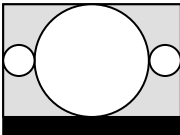
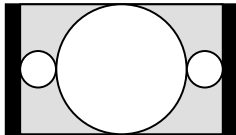
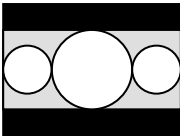
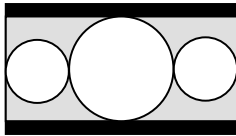
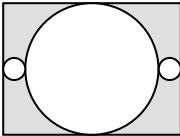
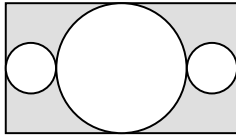
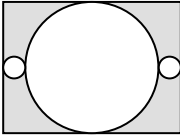
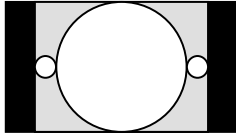
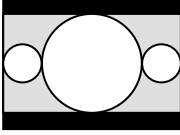
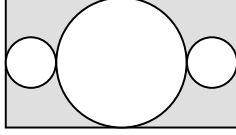
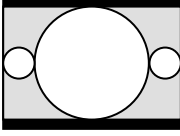
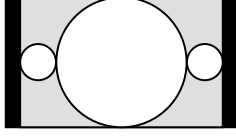
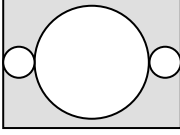
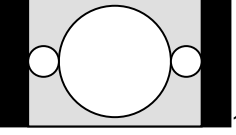
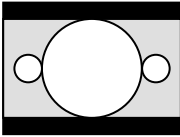
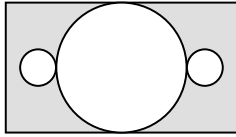
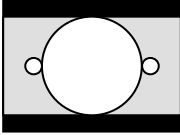
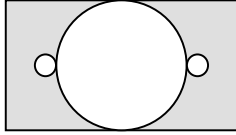

Figure B.1

Table B.6: Active Formats Illustrated

Active_format		Illustration of described format	
Value	Description	In 4:3 coded frame	In 16:9 coded frame
0000 to 0001	reserved		
0010	box 16:9 (top)		
0011	box 14:9 (top)		
0100	box > 16:9 (centre)		
0101 to 0111	reserved		
1000	As the coded frame		
1001	4:3 (centre)		 (see note)
1010	16:9 (centre)		
1011	14:9 (centre)		
1100	reserved		
1101	4:3 (with shoot and protect 14:9 centre)		 ₁
1110	16:9 (with shoot and protect 14:9 centre)		
1111	16:9 (with shoot and protect 4:3 centre)		

Active_format		Illustration of described format	
Value	Description	In 4:3 coded frame	In 16:9 coded frame
NOTE:	It is recommended to use the 4:3 coded frame mode to transmit 4:3 source material rather than using a pillar-box to transmit it in a 16:9 coded frame. This allows for higher horizontal resolution on both 4:3 and 16:9 sets.		

B.3.5 Relationship with Pan Vectors

- Encoding: Encoded bitstreams may optionally include pan vectors and AFDs.
- Decoding: The decoder may use the AFD as part of the logic that decides how the IRD processes and positions the reconstructed image for display on a monitor, where the monitor aspect ratio does not match the source aspect ratio (e.g. whether to use pan vectors, or generate a letterbox display).

B.3.6 Coded Frame in HEVC Video

The active_format is used by the receiver in conjunction with picture size and shape information as indicated in the "sequence parameter set RBSP" and the **aspect_ratio_idc** field of the "VUI parameters". In particular, the picture width, picture height, frame cropping information, and sample aspect ratio are important for proper use of active_format (see Recommendation ITU-R H.265 / ISO/IEC 23008-2 [35]).

The combination of the aspect ratio of the coded frame and active_format allows the receiver to identify whether the "area of interest" is the whole of the frame (e.g. aspect ratio 16:9, active_format 16:9 center), or a "pillar box" within the frame (e.g. aspect ratio 16:9, active_format 4:3 center).

B.4 Bar data

B.4.0 Syntax and semantics

Table B.7 describes the syntax of bar data. Bar data should be included in video user data whenever the rectangular picture area containing useful information does not extend to the full height or width of the coded frame and AFD alone is insufficient to describe the extent of the image. See clause B.3.4.

NOTE 1: Bar data is intended to facilitate a fixed-pixel display's picture optimization. Images are not expected to be resized or scaled, rather to permit backlights to be turned off in the signalled bar. See SMPTE ST 2016-1 [23] and clause B.4.2 for additional information.

NOTE 2: In the case of HEVC coded video, certain "decimated" sub-rasters are documented in clauses 5.14.2.2 and 5.14.3.2 which decimate the production image in both horizontal and vertical axes to help with bitrate efficiency. As AFD/Bar Data might not work properly in combination with such sub-rasters, the HEVC Default Display Window documented in clause 5.14.1.5.6 can be used as an alternative.

Bar data is constrained (below) to be signalled in pairs, either top and bottom bars or left and right bars, but not both pairs at once. Bars may be unequal in size. One bar of a pair may be zero width or height.

Table B.7: Bar Data Syntax

Syntax	No. of Bits	Identifier
bar_data() {		
top_bar_flag	1	bslbf
bottom_bar_flag	1	bslbf
left_bar_flag	1	bslbf
right_bar_flag	1	bslbf
reserved (set to "1111")	4	bslbf
if (top_bar_flag == "1") {		
marker_bits (set to "11")	2	bslbf
line_number_end_of_top_bar	14	uimsbf
}		
if (bottom_bar_flag == "1") {		
marker_bits (set to "11")	2	bslbf
line_number_start_of_bottom_bar	14	uimsbf
}		
if (left_bar_flag == "1") {		
marker_bits (set to "11")	2	bslbf
pixel_number_end_of_left_bar	14	uimsbf
}		
if (right_bar_flag == "1") {		
marker_bits (set to "11")	2	bslbf
pixel_number_start_of_right_bar	14	uimsbf
}		
}		

Designation of line numbers for *line_number_end_of_top_bar* and *line_number_start_of_bottom_bar* is video format-dependent and shall conform to the applicable standard indicated in table B.8.

NOTE 3: The range of line numbers and pixels within the coded frame for each image format is specified in table 2 of SMPTE ST 2016-1:2009 [23].

Table B.8: Line Number Designation

Video Format	Applicable Standard
480 Interlaced 4:3	SMPTE ST 125 [i.8]
480 Interlaced 16:9	SMPTE ST 267 [i.10]
480 Progressive	SMPTE ST 293 [i.12]
720 Progressive	SMPTE ST 296 [i.13]
1 080 Interlaced	SMPTE ST 274 [i.11]
1 080 Progressive	SMPTE ST 274 [i.11]

top_bar_flag: This flag shall indicate, when set to "1", that the top bar data is present. If *left_bar_flag* is "1", this flag shall be set to "0".

bottom_bar_flag: This flag shall indicate, when set to "1", that the bottom bar data is present. This flag shall have the same value as *top_bar_flag*.

left_bar_flag: This flag shall indicate, when set to "1", that the left bar data is present. If *top_bar_flag* is "1", this flag shall be set to "0".

right_bar_flag: This flag shall indicate, when set to "1", that the right bar data is present. This flag shall have the same value as *left_bar_flag*.

line_number_end_of_top_bar: A 14-bit unsigned integer value representing the last line of a horizontal letterbox bar area at the top of the reconstructed frame. Designation of line numbers shall be as defined per each applicable standard in table B.8.

line_number_start_of_bottom_bar: A 14-bit unsigned integer value representing the first [i.12] line of a horizontal letterbox bar area at the bottom of the reconstructed frame. Designation of line numbers shall be as defined per each applicable standard in table B.8.

pixel_number_end_of_left_bar: A 14-bit unsigned integer value representing the last horizontal luminance sample of a vertical pillar-box bar area at the left side of the reconstructed frame. *Pixels shall be numbered from zero, starting with the leftmost pixel.*

pixel_number_start_of_right_bar: A 14-bit unsigned integer value representing the first horizontal luminance sample of a vertical pillar-box bar area at the right side of the reconstructed frame. *Pixels shall be numbered from zero, starting with the leftmost pixel.*

additional_bar_data: Reserved for future DVB definition.

B.4.1 Recommended Receiver Response to Bar Data

Receiving device designers are strongly encouraged to study Consumer Electronics Association (CEA) bulletin CTA CEB16-B [24], which contains recommendations regarding the processing of bar data.

B.4.2 Relationship Between Bar Data and AFD

Certain combination of Active Format Description and bar data may be present in video user data (either, neither, or both). See clause 5 of SMPTE ST 2016-1 [23] for detailed guidance on this subject. Note that AFD data may not always exactly match bar data because AFD primarily deals with 4:3, 14:9, and 16:9 aspect ratios while bar data can represent nearly any aspect ratio.

NOTE: SMPTE ST 2016-1 [23] provides guidance for signaling aspect ratios other than 4:3, 14:9, and 16:9. In part it says "*AFD '0000', when accompanied by Bar Data, signals that the active image's aspect ratio is narrower than 16:9, but is not 4:3 or 14:9. ... AFD code '0100' signals that the active image aspect ratio is wider than 16:9.*" Content producers are expected to correctly code AFD/bar data with their source video images.

B.5 Closed Captions

B.5.0 Introduction

The caption data, (as well as AFD and bar data) is carried in the user data of the video elementary stream.

The underlying structure, `cc_data()`, is common across MPEG-2, H.264/AVC, HEVC and VC-1.

B.5.1 Syntax and Semantics of `cc_data()`

The syntax for `cc_data()` is shown in table B.9.

Table B.9: `cc_data` Syntax

Syntax	No. of Bits	Identifier
<code>cc_data() {</code>		
reserved (set to "1")	1	bslbf
process_cc_data_flag	1	bslbf
zero_bit (set to "0")	1	bslbf
cc_count	5	uimsbf
reserved (set to "1111 1111")	8	bslbf
for (i=0 ; i < cc_count ; i++) {		
one_bit (set to "1")	1	
reserved (set to "1111")	4	
cc_valid	1	bslbf
cc_type	2	bslbf
cc_data_1	8	bslbf
cc_data_2	8	bslbf
}		
marker_bits = "11111111"	8	bslbf
}		

process_cc_data_flag: This flag is set to indicate whether it is necessary to process the `cc_data`. If it is set to "1", the `cc_data` shall be parsed and its meaning processed. When it is set to "0", the `cc_data` shall be discarded.

zero_bit: This bit shall be "0" to maintain backwards compatibility with previous versions of CEA-708-E [26].

cc_count: This 5-bit integer indicates the number of closed caption constructs following this field. It can have values 0 through 31. The value of `cc_count` shall be set according to the frame rate and coded picture structure (field or frame) such that a fixed bandwidth of 9 600 bits per second is maintained for the closed caption payload data. Sixteen (16) bits of closed caption payload data are carried in each pair of the fields `cc_data_1` and `cc_data_2`.

one_bit: This bit shall be "1" to maintain backwards compatibility with previous versions of CEA-708-E [26].

cc_valid: This flag is set to "1" to indicate that the two closed caption data bytes that follow are valid. If set to "0" the two data bytes are invalid, as defined in CEA-708-E [26].

cc_type: Denotes the type of the two closed caption data bytes that follow, as defined in CEA-708-E [26].

cc_data_1: The first byte of a closed caption data pair as defined in CEA-708-E [26].

cc_data_2: The second byte of a closed caption data pair as defined in CEA-708-E [26].

B.6 Auxiliary Data and MPEG-2 video

B.6.1 Coding

The Auxiliary Data (AFD, bar data, and caption data) is carried in the video elementary stream at the picture level as shown in table B.10. The repetition rate of the Auxiliary Data depends upon its payload.

When present, caption data shall be carried in the data structure `cc_data()`, within the picture user data syntax as shown in table B.9, and shall be present for every picture. Receivers may ignore caption data.

When present, bar data shall be carried in the data structure `bar_data()`, within the picture user data syntax as shown in table B.7. After any `sequence_header()` such bar data shall appear before the next `picture_data()` within `extension_and_user_data(2)`. After introduction, such bar data shall remain in effect until:

- 1) the next `sequence_header()`; or
- 2) `extension_and_user_data(2)` containing a `bar_data()` structure which contains new bar data; or

- 3) **extension_and_user_data(2)** containing AFD per clause B.3.4.

After any *sequence_header()*, unless AFD data is present specifying otherwise, the absence of bar data shall indicate that the rectangular picture area containing useful information extends to the full height and width of the coded frame.

B.6.2 Syntax and Semantics

Table B.10 is provided to show the syntax that is required for picture extension and user data (specifically **extension_and_user_data(2)**) as defined by MPEG-2 video (ISO/IEC 13818-2 [2]).

Table B.10: Auxiliary Data for MPEG-2 video

Syntax	No. of Bits	Identifier
user_data() {		
user_data_start_code	32	bslbf
user_identifier	32	bslbf
user_structure()		
}		

In accordance with the bit stream syntax in table B.10, more than one picture user data construct may follow any given picture header. However, no more than one picture user data construct using the same **user_identifier** or **user_data_type_code** shall follow any given picture header.

Receiving devices are expected to silently discard any unrecognized video user data encountered in the video bit stream. For example, if an unrecognized 32-bit identifier is seen following the **user_data_start_code**, or an unrecognized 8-bit **user_data_type_code** is seen following the **DVB_identifier**, data should be discarded until another start code is seen.

user_data_start_code: This shall be set to 0x0000 01B2 per ISO/IEC 13818-2 [2].

user_identifier: This is a 32 bit code that indicates the contents of the **user_structure()** as indicated in table B.1.

user_structure(): This is a variable length data structure defined by the value of **user_identifier** and table B.1.

B.7 Auxiliary Data and H264/AVC, MVC Stereo or SVC video

B.7.1 Coding

The Auxiliary Data is carried in the data as Supplemental Enhancement Information in H.264/AVC's "User data registered by Recommendation ITU-T T.35 [19] SEI message" syntactic element (see clauses D.8.5 and D.9.5 of ISO/IEC 14496-10 [16]).

Encoding: Support for the encoding of Auxiliary Data is optional.

Decoding: Support for the decoding of Auxiliary Data is optional.

B.7.2 Syntax and Semantics

The Auxiliary Data (AFD, bar data, caption data and multi_region_disparity) is carried in the video elementary stream as Supplemental Enhancement Information in H.264/AVC's "User data registered by Recommendation ITU-T T.35 SEI message" syntactic element [19]. The syntax of Auxiliary Data is illustrated in table B.11.

Table B.11: Active Format Description for H264/AVC video

user_data_registered_itu_t_t35(payloadSize) {	Descriptor	Notes
itu_t_t35_country_code	b(8)	0xB5
itu_t_t35_provider_code	u(16)	0x0031
user_identifier	f(32)	
user_structure()		
}		

itu_t_t35_country_code: This 8 bit field shall have the value 0xB5.

itu_t_t35_provider_code: This 16 bit field shall have the value 0x0031.

user_identifier: This is a 32 bit code that indicates the contents of the **user_structure()** as indicated in table B.1.

NOTE: In MPEG-2, the only discriminator within **user_data** is this 32-bit value. In the context of H.264/AVC, the value of **user_identifier** is used in addition to country and provider codes to definitively identify this as Auxiliary Data.

user_structure(): This is a variable length data structure defined by the value of **user_identifier** and table B.1.

B.7.3 Auxiliary Data in MVC Stereo HDTV Bitstreams

When present in MVC Stereo HDTV Bitstreams, the active format descriptor, bar data and closed caption data shall be the same for both base and dependent view bitstreams and may be transmitted in the MVC Stereo Base view bitstream.

When present in MVC Stereo HDTV Bitstreams, the *multi_region_disparity()* data shall be sent in the *user_data_registered_itu_t_t35()* SEI message, which is contained in MVC scalable nesting SEI message of every MVC Stereo Dependent view component. When present in MVC Stereo HDTV Bitstreams, the multi region disparity data shall be present for every MVC Stereo Dependent view component.

B.8 Auxiliary Data and VC-1 video

B.8.1 Coding

The Auxiliary Data is carried in the user data of the video elementary stream as defined in SMPTE ST 421 [20]. After each sequence start (and repeat sequence start) the default aspect ratio of the area of interest is that signalled by the sequence header and sequence display extension parameters. When present, after introduction, an AFD or bar data persists until the next sequence start or until another AFD or different bar data is introduced.

Encoding: Support for the encoding of Auxiliary Data is optional.

The Auxiliary Data may be inserted in the video elementary stream as sequence level, entry-point level or frame level user data as specified in SMPTE ST 421 [20]. For example, it could be inserted once per sequence, once per entry-point, or once per frame. It may be changed for each frame. *Caption data, when present, shall be inserted once per frame.*

After introduction, such an AFD remains in effect until the next sequence start or until a new AFD is introduced.

Decoding: Support for the decoding of Auxiliary Data is optional.

A decoder that supports the decoding of Auxiliary Data shall be capable of decoding it from the sequence level, entry-point level and frame level locations specified in SMPTE ST 421 [20].

B.8.2 Syntax and Semantics

The Auxiliary Data is carried in the user data of the video elementary stream as defined in SMPTE ST 421 [20]. The syntax is illustrated in table B.12.

Table B.12: Auxiliary Data for VC-1 video

Syntax	No. of Bits	Identifier
user_data() {		
VC1_user_data_start_code	32	bslbf
user_identifier	32	bslbf
user_structure()		
}		

VC1_user_data_start_code: This 32-bit field shall be set to 0x0000011D to indicate the beginning of a user data structure in the VC-1 elementary stream.

user_identifier: This is a 32 bit code that indicates the contents of the **user_structure()** as indicated in table B.1.

user_structure(): This is a variable length data structure defined by the value of **user_identifier** and table B.1.

B.8a Auxiliary Data and HEVC video

B.8a.1 Coding

The Auxiliary Data is carried in the data as Supplemental Enhancement Information in HEVC's "User data registered by Recommendation ITU-T T.35 [19] SEI message" syntactic element (see clauses D.2.6 and D.3.6 of Recommendation ITU-T H.265 / ISO/IEC 23008-2 [35]).

Encoding: Support for the encoding of Auxiliary Data is optional.
*When the "User data registered by Recommendation ITU-T T.35 [19] SEI message" is present in an HEVC Bitstream, it shall be a prefix SEI message (i.e. **nal_unit_type** shall be equal to PREFIX_SEI_NUT).*

Decoding: Support for the decoding of Auxiliary Data is optional.

B.8a.2 Syntax and Semantics

The Auxiliary Data (AFD, bar data, caption data and multi_region_disparity) is carried in the video elementary stream as Supplemental Enhancement Information in HEVC's "User data registered by Recommendation ITU-T T.35 SEI message" syntactic element [19] which shall be the same as for H.264/AVC. See clause B.7.2 for the syntax and semantics.

B.9 Relationship with Wide Screen Signalling (WSS)

The AFD and bar data provide a super-set of the aspect ratio signalling specified in ETSI EN 300 294 [14]. The mapping of source aspect ratio and active_format to WSS Aspect Ratio is given in table B.13.

Table B.13: Support for WSS

Sequence Header	Active Format Description	WSS	
		Code (Bits 0-3)	Description
4:3	1001	0001	full format 4:3
	1011	1000	box 14:9 Centre
	0011	0100	box 14:9 Top
	1010	1101	box 16:9 Centre
	0010	0010	box 16:9 Top
	0100	1011	box > 16:9 Centre
	1101	0111	full format 4:3 (shoot and protect 14:9 Centre)
16:9	1010	1110	full format 16:9 (anamorphic)

As all-digital systems are constructed, there may remain legacy (or even regulatory) requirements to provide WSS support at some IRD outputs. It is recommended that transmission systems make use of SMPTE ST 2016-1:2009 [23] for signalling AFD and bar data in the incoming video, and that IRDs provide support for this on digital outputs.

Encoding: Incoming aspect ratio signalling (whether originating via WSS or AFD) should be placed in the video elementary stream per the present document. If desired, the encoder may also carry equivalent WSS data per ETSI EN 300 294 [14] in a separate PID.

Decoding: *IRDs shall pass AFD and bar data values to their digital video outputs.* Such values may be translated, per table B.13 into analogue WSS waveforms for appropriate placement on analogue outputs.

B.10 Aspect Ratio Ranges

The labels 4:3, 14:9, 16:9 and > 16:9 used in the AFD shall correspond to the aspect ratio ranges specified in ETSI EN 300 294 [14] (note that the corresponding active lines specified in ETSI EN 300 294 [14] do not, in general, apply).

B.11 Multi Region Disparity

B.11.0 Introduction

This clause describes how to convey depth information in the form of disparity values so as to enable the overlay of additional information (graphics, menus, etc.) such that a depth violation between the plano-stereoscopic video and graphics is avoided.

For each frame, one maximum disparity value is transmitted. Regions are defined according to a set of predefined image partitioning patterns. For each region of each frame, exactly one minimum disparity value is transmitted.

NOTE: The presence of multi region disparity information can be signalled using the video depth range descriptor, as is specified in clause 6.4.16 of ETSI EN 300 468 [i.32].

B.11.1 Syntax and Semantics of Multi Region Disparity

The syntax for `multi_region_disparity()` is shown in table B.14.

Table B.14: Multi Region Disparity Syntax

Syntax	No. of bits	Identifier
<code>multi_region_disparity() {</code>		
<code> multi_region_disparity_length</code>	8	uimsbf
<code> if (((multi_region_disparity_length > 1) && (multi_region_disparity_length < 6)) (multi_region_disparity_length == 10) (multi_region_disparity_length == 17)) {</code>		
<code> number_of_regions = multi_region_disparity_length - 1</code>		
<code> max_disparity_in_picture</code>	8	tcimsbf
<code> for (i=0; i<number_of_regions, i++) {</code>		
<code> min_disparity_in_region_i</code>	8	tcimsbf
<code> }</code>		
<code> } else if (multi_region_disparity_length == 0) {</code>		
<code> /* there is no disparity information to deliver */</code>		
<code> } else {</code>		
<code> for (i=0; i<N; i++) {</code>		
<code> reserved_for_future_use</code>	8	bslbf
<code> }</code>		
<code> }</code>		
<code>}</code>		

multi_region_disparity_length: The `multi_region_disparity_length` is an 8-bit field specifying the number of bytes in the `multi_region_disparity()` immediately following the byte defining the value of this field. Furthermore, it signals the type of region pattern. The `multi_region_disparity_length` field has a limited set of values that correspond to predefined image partitioning patterns specified below in table B.15, all other values are prohibited or reserved for future use.

Each image partitioning pattern defines several regions of the image. *The boundaries between the regions shall be located at one quarter, one half and three quarters of the coded image width and height before cropping (for example, for images of size 1 920 × 1 080, the size 1 920 × 1 088 shall be used to determine the position of the boundaries in the transmitted picture).* The different region partitioning patterns are all based on these partition boundaries. Each region is identified by a number increasing from left to right and from top to bottom.

Table B.15: Meaning of multi_region_disparity_length

Value	Meaning of the value
0	no disparity information is to be delivered
1	Prohibited
2	one <code>minimum_disparity_in_region</code> is coded as representing the minimum value in overall picture (see figure B.3)
3	two vertical <code>minimum_disparity_in_regions</code> are coded (see figure B.4)
4	three vertical <code>minimum_disparity_in_regions</code> are coded (see figure B.5)
5	four <code>minimum_disparity_in_regions</code> are coded (see figure B.6)
6 to 9	reserved for future use
10	nine <code>minimum_disparity_in_regions</code> are coded (see figure B.7)
11 to 16	reserved for future use
17	sixteen <code>minimum_disparity_in_regions</code> are coded (see figure B.2)
18 to 255	reserved for future use

NOTE 1: Each region is made up to align to the 4 x 4 partition boundaries as shown in figure B.2. The patterns defined in figures B.3 to B.7 are based on the pattern from figure B.2 by spatially combining some of the regions.

NOTE 2: When `multi_region_disparity_length` is set to 0, the IRD is recommended to use a safer display method while graphics are present, to avoid viewer's eye strain. One of the safer display methods is to switch video to 2D, while graphics are overlaid onto the video with a slight disparity, which can retain a viewer's 3D experience.

NOTE 3: The value of `multi_region_disparity_length` should not be modified within an event, except to switch to the value '0' on a frame-by-frame basis to indicate that no disparity value is signalled for a picture.

max_disparity_in_picture: this field specifies the maximum disparity value in a picture. The value signalled is a two's complement integer in the range [-128, +127].

min_disparity_in_region_i: this field specifies the minimum disparity value in region i. The value signalled is a two's complement integer in the range [-128, +127]. The identifier i for each region depends on the value of `multi_region_disparity_length`. Figures B.2 to B.7 show the regions and their associated number for each allowed pattern.

The disparity value is the difference between the horizontal positions of a pixel representing the same point in space in the right and left views. The difference is given in number of pixels relative to a screen with a horizontal size of 1 920 pixels. Particularly, if right position minus left position is a positive value, it refers to a point behind the display screen, and if it is a negative value, it refers to a point in front of the display screen. Max (maximum) disparity gives the farthest, while min (minimum) disparity gives the closest point in depth.

region 0 [R0]	region 1 [R1]	region 2 [R2]	region 3 [R3]
region 4 [R4]	region 5 [R5]	region 6 [R6]	region 7 [R7]
region 8 [R8]	region 9 [R9]	region 10 [R10]	region 11 [R11]
region 12 [R12]	region 13 [R13]	region 14 [R14]	region 15 [R15]

Figure B.2: Size and position of regions for `multi_region_disparity_length = 17`

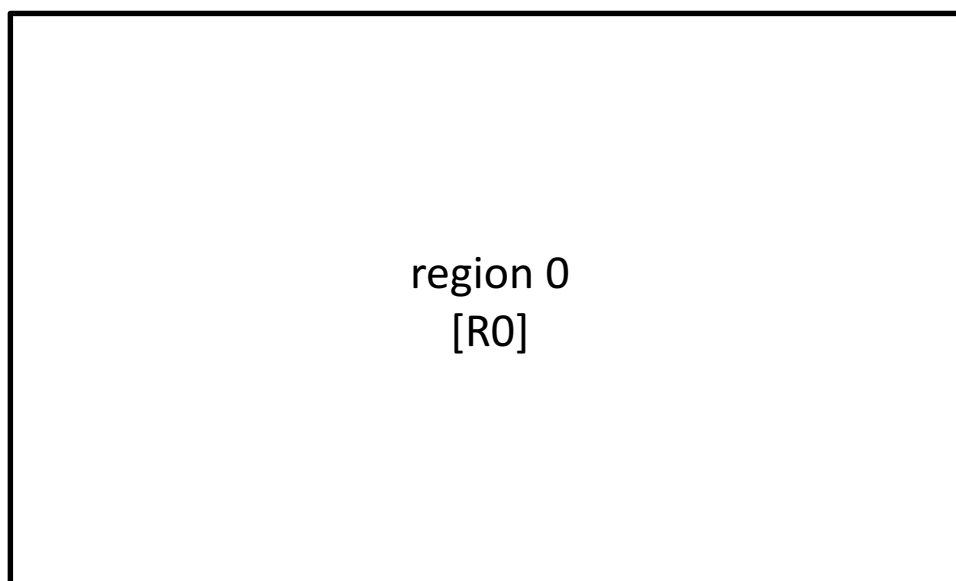

NOTE: R0 spatially encompasses all the regions defined in figure B.2.

Figure B.3: Size and position of regions for `multi_region_disparity_length = 2`

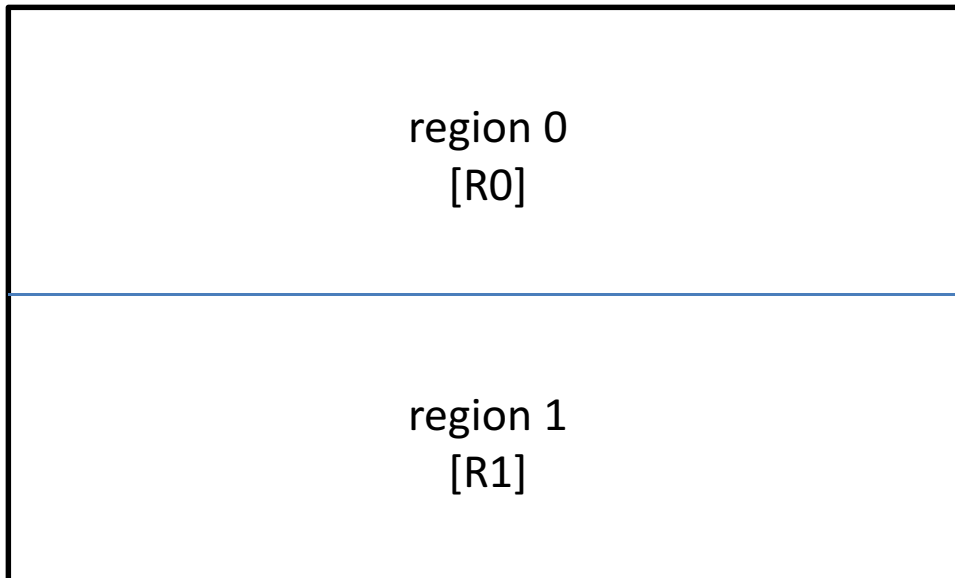

NOTE: R0 spatially encompasses the regions R0 to R7 defined in figure B.2 and R1 spatially encompasses the regions R8 to R15 defined in figure B.2.

Figure B.4: Size and position of regions for multi_region_disparity_length = 3

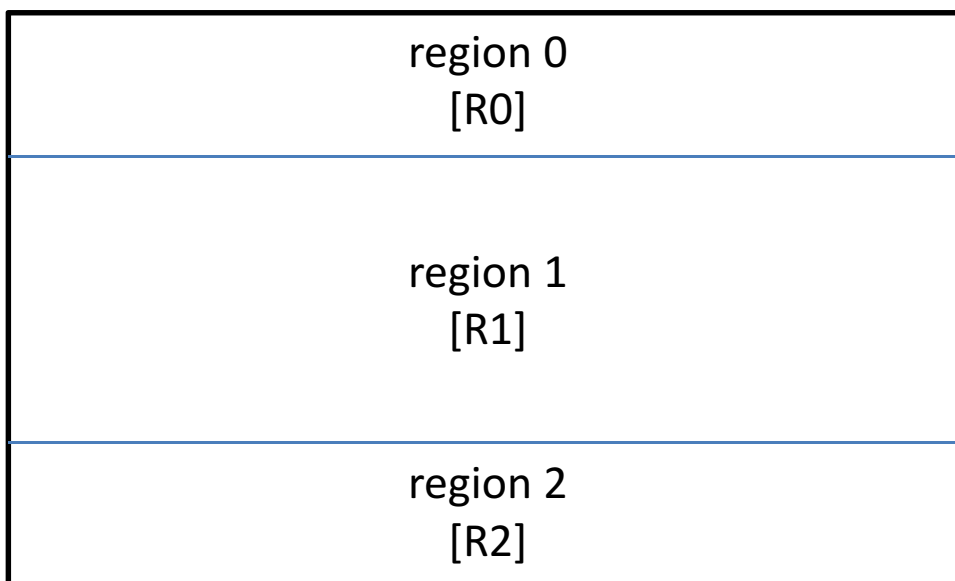

NOTE: R0 spatially encompasses the regions R0 to R3 defined in figure B.2, R1 spatially encompasses the regions R4 to R11 defined in figure B.2 and R2 spatially encompasses the regions R12 to R15 defined in figure B.2.

Figure B.5: Size and position of regions for multi_region_disparity_length = 4

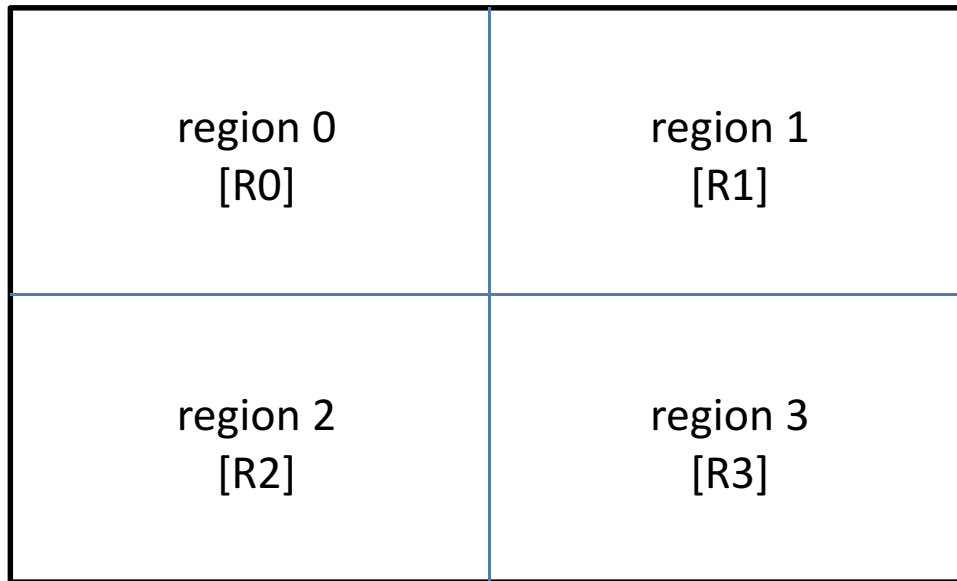

NOTE: R0 spatially encompasses the regions R0, R1, R4, R5 defined in figure B.2, R1 spatially encompasses the regions R2, R3, R6, R7 defined in figure B.2, R2 spatially encompasses the regions R8, R9, R12, R13 defined in figure B.2 and R3 spatially encompasses the regions R10, R11, R14, R15 defined in figure B.2.

Figure B.6: Size and position of regions for multi_region_disparity_length = 5

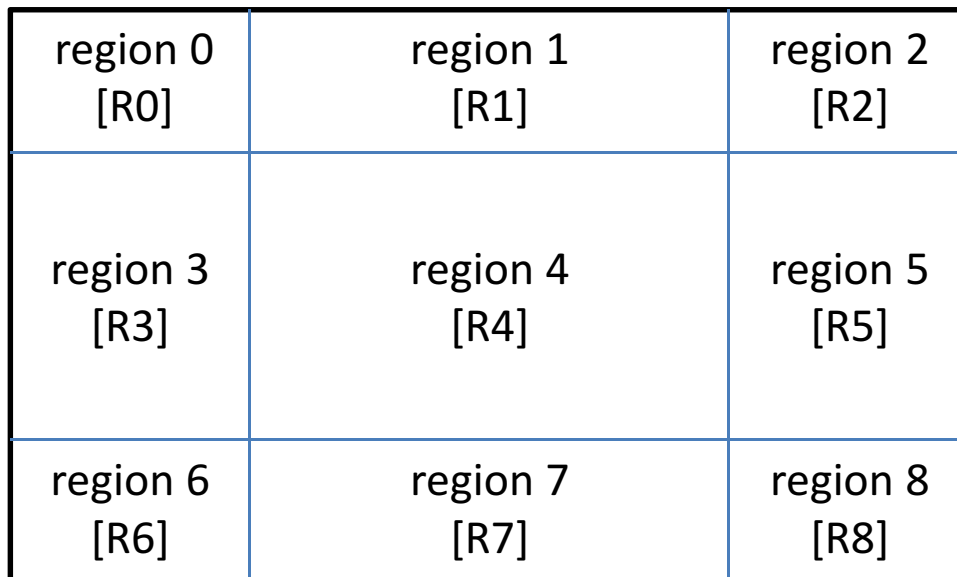

NOTE: R0 is identical to the region R0 defined in figure B.2, R1 spatially encompasses the regions R1 and R2 defined in figure B.2, R2 is identical to the region R3 defined in figure B.2, R3 spatially encompasses the regions R4 and R8 defined in figure B.2, R4 spatially encompasses the regions R5, R6, R9, R10 defined in figure B.2, R5 spatially encompasses the regions R7 and R11 defined in figure B.2, R6 is identical to the region R12 defined in figure B.2, R7 spatially encompasses the regions R13 and R14 defined in figure B.2 and R8 is identical to the region R15 defined in figure B.2.

Figure B.7: Size and position of regions for multi_region_disparity_length = 10

Annex C (normative): Implementation of Ancillary Data for MPEG Audio

C.1 Scope

This annex contains the guidelines required to include ancillary data in the MPEG-1, MPEG-2 or MPEG-4 Audio elementary stream.

The IRD design should be made under the assumption that any structure as permitted by this annex may occur in the broadcast stream. The IRD is not required to make use of this data but its use is recommended.

C.2 Introduction

An MPEG-1/-2/-4 audio elementary stream provides for the inclusion of ancillary data. This data can be used to convey specific information about the audio content to the decoder, allowing the broadcaster to control rendering of the content to a greater extent. The data includes dynamic range control information and dialogue normalization information.

In case of MPEG-1 streams or MPEG-2 streams without an extension stream (MPEG audio format 1), ancillary data described in this annex is placed at the end of each base frame.

In case of MPEG-2 streams with extension stream (MPEG audio format 2), the ancillary data described in this annex is placed at the end of each base frame.

In case of MPEG-4 streams in LATM/LOAS format, the ancillary data described in this annex is placed into **data_stream_element()** (see ISO/IEC 14496-3 [17], table 4.10).

C.3 DVB Compliance

The ancillary data format described in this annex does not introduce any additional elements to the DVB transport stream. It is compliant with the present document and compatible with all MPEG-1/-2/-4 audio decoders.

Presence and type of ancillary data in audio elementary streams is signalled in DVB SI Program Map Table by the ancillary data descriptor (see ETSI EN 300 468 [i.32], clause 6.2.2).

C.4 Detailed specification for MPEG1 and MPEG2

C.4.1 DVD-Video Ancillary Data

The transmission of "dynamic_range_control" in MPEG1 Layer I/II and MPEG2 Layer I audio is optional. *If applied, 16 bits of ancillary data [b15.b0] (situated at the end of each MPEG audio base frame) shall be used.*

Table C.1: DVD-Video ancillary data syntax

Syntax	No. of Bits	Mnemonic
dvd_ancillary_data() {		
dynamic_range_control	8	bslbf
dynamic_range_control_on	1	bslbf
reserved (set to "000 0000b")	7	bslbf
}		

Semantics: The 8-bit `dynamic_range_control` field leads to the following gain control value by considering the upper 3 bits as unsigned integer X and the binary value of the lower 5 bits as unsigned integer Y :

- linear: $G = 2^{4-(X + Y/30)}$
($0 \leq X \leq 7, 0 \leq Y \leq 29$)
- in dB: $G = 24,082 - 6,0206 X - 0,2007 Y$
($0 \leq X \leq 7, 0 \leq Y \leq 29$)

If the `dynamic_range_control_on` field is set to "0b", the `dynamic_range_control` field does not convey useful information.

Encoding: When dynamic range control is temporarily not applied, that value of `dynamic_range_control` shall be set to "1000 0000b" or `dynamic_range_control_on` shall be set to "0b".

Decoding: The decoder shall read this field, and the decoder shall interpret the value G as a gain value applied to all sub band samples, before the reconstruction filter. This value may be scaled in the decoder to allow user control of the amount of dynamic range compression that is applied.

C.4.2 Extended ancillary data syntax

C.4.2.0 Syntax

The syntax of the extended ancillary data field is described in table C.2.

The extended ancillary data is inserted beginning from the end of the base frame. It is recommended that it be parsed from the end. The description in table C.2 is in the reverse order of the transmission. The bit order in each byte is, however, such that the msb comes first in the transmission.

Table C.2: Extended ancillary data syntax

Syntax	No. of Bits	Mnemonic
extended_ancillary_data() {		
dvd_ancillary_data	16	bslbf
extended_ancillary_data_sync (set to 0xBC)	8	bslbf
bs_info	8	bslbf
ancillary_data_status	8	bslbf
if(advanced_dynamic_range_control_status == 1)		
advanced_dynamic_range_control	24	bslbf
if(dialog_normalization_status == 1)		
dialog_normalization	8	bslbf
if(reproduction_level_status == 1)		
reproduction_level	8	bslbf
if(downmixing_levels_MPEG2_status == 1)		
downmixing_levels_MPEG2	8	bslbf
if(audio_coding_mode_and_compression_status == 1) {		
audio_coding_mode	8	bslbf
Compression	8	bslbf
}		
if(coarse_grain_timecode_status == 1)		
coarse_grain_timecode	16	bslbf
if(fine_grain_timecode_status == 1)		
fine_grain_timecode	16	bslbf
if(scale_factor_CRC_status == 1)		
scale_factor_CRC	16 to 32	bslbf
}		

The elements of the ancillary data structure are described in the following clauses. The order of the bits is in transmission order, msb first.

C.4.2.1 ancillary_data_sync

Encoding: *This field shall be set to 0xBC.*

Decoding: The decoder may use this field to verify the availability of the extended ancillary data. If the IRD indicates that this information is present, this takes precedence.

C.4.2.2 bs_info

The detailed syntax is described in table C.3.

Table C.3: Bs_info syntax

Syntax	No. of Bits	Mnemonic
bs_info() {		
mpeg_audio_type	2	bslbf
dolby_surround_mode	2	bslbf
ancillary_data_bytes	4	uimsbf
}		

C.4.2.3 mpeg_audio_type

Table C.4: MPEG audio type Table

mpeg_audio_type	Description
"00"	Reserved
"01"	Only MPEG1 audio data
"10"	MPEG2 audio data
"11"	Reserved

Decoding: The decoder may ignore this field.

C.4.2.4 dolby_surround_mode

Table C.5: Dolby surround mode Table

mpeg_audio_type	Description
"00"	Reserved
"01"	MPEG1 part is not Dolby surround encoded
"10"	MPEG1 part is Dolby surround encoded
"11"	Reserved

Decoding: It is recommended that the decoder parse this field and provides this information to the reproduction set-up.

C.4.2.5 ancillary_data_bytes

This field indicates the amount of ancillary data bytes that precede this byte in the transmission. This field may be used by the decoder as an indication of how many bytes it needs to buffer.

C.4.2.6 ancillary_data_status

The detailed syntax is described on table C.6.

Table C.6: Ancillary_data_status syntax

Syntax	No. of Bits	Mnemonic
ancillary_data_status() {		
advanced_dynamic_range_control_status	1	bslbf
dialog_normalization_status	1	bslbf
reproduction_level_status	1	bslbf
downmix_levels_MPEG2_status	1	bslbf
scale_factor_CRC_status	1	bslbf
audio_coding_mode_and_compression_status	1	bslbf
coarse_grain_timecode_status	1	bslbf
fine_grain_timecode_status	1	bslbf
}		

Semantics: The bits in this field indicate the presence of the associated fields in the ancillary data.

Encoding: *A bit in this field shall be set to "1" if the associated field is present in the bitstream.*

Decoding: It is recommended that the decoder parse this field to allow parsing of the following fields in the ancillary data section.

C.4.2.7 advanced_dynamic_range_control

The detailed syntax is described on table C.7.

Table C.7: Advanced_dynamic_range_control syntax

Syntax	No. of Bits	Mnemonic
advanced_dynamic_range_control() {		
advanced_drc_part_0	8	bslbf
advanced_drc_part_1	8	bslbf
advanced_drc_part_2	8	bslbf
}		

Semantics: Each field consists of an unsigned integer value X in the three most significant bits and an unsigned integer value Y in the five less significant bits. The actual value is $24,082 - 6,0206 X - 0,2007 Y$ dB. The 1 152 samples of an MPEG2 frame are divided in 3 parts of 384 samples. The advanced_drc values are applicable for the corresponding part of the audio frame.

Decoding: *If this field is present and the decoder supports this type of dynamic range control, these values shall be used rather than the DVD-Video ancillary data. The decoder shall apply these values to the sub band samples, before the reconstruction filter. These values may be scaled in the decoder to allow user control of the amount of dynamic range compression that is applied.*

C.4.2.8 dialog_normalization

C.4.2.8.0 Syntax

The detailed syntax is described on table C.8.

Table C.8: Dialog_normalization syntax

Syntax	No. of Bits	Mnemonic
dialog_normalization() {		
dialog_normalization_on	2	bslbf
dialog_normalization_value	6	uimsbf
}		

C.4.2.8.1 dialog_normalization_on

Table C.9: Dialog normalization Table

dialog_normalization_on	Description
"00"	dialog_normalization_value is not valid
"01"	reserved
"10"	dialog_normalization_value is valid
"11"	Reserved

C.4.2.8.2 dialog_normalization_value

Semantics: This field represents the headroom in dB of the dialogue component in the MPEG1 compatible part, relative to full-scale sine wave. Values 41 through 63 are reserved. *When dialogue normalization is temporarily not applied, "Dialogue_Normalization_on" shall be set to "00" and "Dialog_Normalization_value" shall be set to "000000".*

Decoding: It is recommended that the decoder parse this field. The decoder should apply these values to the sub band samples, before the reconstruction filter, in order to allow reproduction of different programmes with the same dialogue level.

C.4.2.9 reproduction_level

C.4.2.9.0 Syntax

The detailed syntax is described on table C.10.

Table C.10: Reproduction_level syntax

Syntax	No. of Bits	Mnemonic
reproduction_level () {		
Surround_reproduction_level	1	bslbf
production_roomtype	2	bslbf
reproduction_level_value	5	uimsbf
}		

C.4.2.9.1 surround_reproduction_level

Table C.11: Surround reproduction level Table

surround_reproduction_level	Description
"0"	The surround channels have the correct level for reproduction
"1"	The surround channels should be attenuated by 3 dB during reproduction

Decoding: It is recommended that the decoder parse this field and pass the value to the reproduction unit to allow correct adjustment of the surround levels.

C.4.2.9.2 production_roomtype

Table C.12: Production room type Table

production_roomtype	Description
"00"	not indicated
"01"	large room
"10"	small room
"11"	reserved

Decoding: It is recommended that the decoder parse this field and pass the value to the reproduction unit to allow correct adjustment of the monitoring equipment.

C.4.2.9.3 reproduction_level_value

Semantics: This field represents the absolute acoustic sound pressure level in dB SPL during the final audio mixing session.

Decoding: The decoder may ignore this field.

C.4.2.10 downmixing_levels_MPEG2

C.4.2.10.0 Syntax

The detailed syntax is described on table C.13. The down mixing levels describe the down mix in the decoder for stereo reproduction.

Table C.13: Downmixing_levels_MPEG2 syntax

Syntax	No. of Bits	Mnemonic
downmixing_levels_MPEG2 () {		
center_mix_level_on	1	bslbf
center_mix_level_value	3	bslbf
Surround_mix_level_on	1	bslbf
Surround_mix_level_value	3	bslbf
}		

C.4.2.10.1 center_mix_level_on

Semantics: If this field is set to "1" the center_mix_value field indicates nominal down mix level of the centre channel with respect to the left and right front channels. *If this field is set to "0" the center_mix_value field shall be set to "000".*

Decoding: It is recommended that the decoder parse this field.

C.4.2.10.2 surround_mix_level_on

Semantics: If this field is set to "1" the surround_mix_value field indicates nominal down mix level of the surround channels with respect to the left and right front channels. *If this field is set to "0" the surround_mix_value field shall be set to "000".*

Decoding: It is recommended that the decoder parse this field.

C.4.2.10.3 mix_level_value

Table C.14: Mix level value Table

mix_level_value	Multiplication factor
"000"	1,000 (0,0 dB)
"001"	0,841 (-1,5 dB)
"010"	0,707 (-3,0 dB)
"011"	0,596 (-4,5 dB)
"100"	0,500 (-6,0 dB)
"101"	0,422 (-7,5 dB)
"110"	0,355 (-9,0 dB)
"111"	0,000 ($-\infty$ dB)

Decoding: The multi-channel decoder may apply these values as gain factors to the individual channels when a down mix for stereo listening has to be created. The values need to be scaled to avoid overload after the mixing process.

C.4.2.11 audio_coding_mode

C.4.2.11.0 Syntax

The detailed syntax is described in table C.15.

Table C.15: Audio coding mode syntax

Syntax	No. of bits	Mnemonic
audio_coding_mode () {		
MPEG2_extension_stream_present	1	bslbf
MPEG2_center	2	bslbf
MPEG2_surround	2	bslbf
MPEG2_lfeon	1	bslbf
MPEG2_copyright_ident_present	1	bslbf
compression_on	1	bslbf
}		

Semantics: The semantics of the fields MPEG2_extension_stream_present, MPEG2_center, MPEG2_surround and MPEG2_lfeon is as defined in the mc_header field in ISO/IEC 13818-3 [3].

If MPEG2_copyright_ident_present is set to "0" the copyright identification in the MPEG-2 mc_header is not filled in. If MPEG2_copyright_ident_present is set to "1" the copyright identification in the MPEG-2 mc_header is used.

Decoding: The decoder may ignore this field. It may be parsed by multiplexers and bitstream monitors to simplify extraction of these parameters from a bitstream.

C.4.2.11.1 compression_on

Semantics: If this field is set to "1" the compression_value field indicates the heavy compression factor used for monophonic down mix reproduction. *If this field is set to "0" the compression_value field shall be "0000 0000".*

Decoding: It is recommended that the decoder parse this field.

C.4.2.12 compression_value

Semantics: This field consists of a value X in the four most significant bits and a value Y in the four less significant bits. The actual value is $48,164 - 6,0206 X - 0,4014 Y$ dB.

Decoding: *These values shall be applied to the sub band samples, before the reconstruction filter when the decoder has to create a mix for monophonic listening where overloading of a subsequent analog transmission is highly undesirable.*

C.4.2.13 coarse_grain_timecode

The detailed syntax is described on table C.16.

Table C.16: Coarse grain time code syntax

Syntax	No. of Bits	Mnemonic
coarse_grain_timecode () {		
coarse_grain_timecode_on	2	bslbf
coarse_grain_timecode_value	14	bslbf
}		

Semantics: If coarse_grain_timecode_on is set to "10" the five most significant bits of this value represents the time in hours, the next six bits represent time in minutes, and the final three bits represent the time in eight second increments. *If coarse_grain_timecode_on is not set to "10" all the bits of coarse_grain_timecode_value shall be set to "0".*

Decoding: The decoder may ignore this field.

C.4.2.14 fine_grain_timecode

The detailed syntax is described in table C.17.

Table C.17: Fine grain time code syntax

Syntax	No. of Bits	Mnemonic
fine_grain_timecode () {		
fine_grain_timecode_on	2	bslbf
fine_grain_timecode_value	14	bslbf
}		

Semantics: If fine_grain_timecode_on is set to "10" the three most significant bits of this value represents the time in seconds, the next five bits represent time in video frames, and the final six bits represent the time in fractions of 1/64 of a video frame. *If fine_grain_timecode_on is not set to "10" all the bits of fine_grain_timecode_value shall be set to "0".*

Decoding: The decoder may ignore this field.

C.4.2.15 scale_factor_CRC

Semantics: The scale_factor_CRC permits to verify the integrity of the MPEG Audio scale factors. The coding is according to Recommendation ITU-T T.35 [19].

Encoding: It recommended that scale_factor_CRC be included for mobile applications.

Decoding: It is recommended to parse the data from the end. The length of the field depends on the bitrate index of the MPEG-1 header of the following frame. It is recommended to always parse the full 32 possible bits.

C.4.2.16 Void

C.4.2.17 Void

C.4.2.18 Void

C.4.3 Announcement Switching Data

The transmission of announcement switching data in the ancillary data field of MPEG audio frames is optional. The syntax of the announcement switching data field is described in table C.18. Note that the description in table C.18 is in the reverse order of the transmission. The bit order in each byte is, however, such that the msb comes first in the transmission. The data field length gives the number of bytes following this byte within this data field.

Table C.18: Announcement switching data field

Syntax	No. of Bits	Mnemonic
announcement_switching_data() {		
announcement_switching_data_sync	8	bslbf
data_field_length	8	bslbf
announcement_switching_flag_field_1	16	bslbf
announcement_switching_flag_field_2	16	bslbf
}		

Semantics: The announcement_switching_data_sync should be set to 0 x AD.

The announcement_switching_flag_fields are 16-bit flag fields specifying which type of announcements are actually running. *The association between the bits of the flag field and the announcement types shall be according to the announcement_support_indicator as specified in table C.18a. A bit shall be set to "1" if the announcement is running and it shall be set to "0" if the announcement is not running.*

Table C.18a: Coding of the announcement support indicator

Bit flag	Description
b ₀ (see note)	Emergency alarm
b ₁	Road Traffic flash
b ₂	Public Transport flash
b ₃	Warning message
b ₄	News flash
b ₅	Weather flash
b ₆	Event announcement
b ₇	Personal call
b ₈ to b ₁₅	Reserved for future use
NOTE:	This bit is transmitted last.

The announcement_switching_flag_field_1 shall be used for announcements within the audio elementary stream that is actually decoded.

The announcement_switching_flag_field_2 shall be used for announcements within other audio elementary streams. Corresponding links shall be provided by means of the announcement_support_descriptor as specified in table C.18a.

Encoding: The announcement_switching_data_field is allowed to be embedded at the end of a MPEG audio packet, between the end of the audio data and another data field that is part of the ancillary data field or between two other data fields that are part of the ancillary data field.

If data fields according to DVD-Video, extended ancillary data or ancillary data according to the DAB specification [18] are used, then the announcement_switching_data_field is not allowed to be inserted at the end of an audio packet.

Decoding: It is recommended to parse the data from the end.

C.4.4 Scale Factor Error Check

The transmission of a scale factor error check in the ancillary data field of MPEG audio frames is optional. The syntax of the corresponding data field is described in table C.19. Note that the description in table C.19 is in the reverse order of the transmission. The bit order in each byte is, however, such that the msb comes first in the transmission. The `data_field_length` gives the number of bytes following this byte within this data field.

Table C.19: Scale factor error check data field

Syntax	No. of Bits	Mnemonic
<code>scale_factor_error_check_data() {</code>		
<code>scale_factor_error_check_data_sync</code>	8	bslbf
<code>data_field_length</code>	8	bslbf
scale factor CRC	32	bslbf
<code>}</code>		

Semantics: The `scale_factor_error_check_data_sync` should be set to 0 x FE.

The `scale_factor CRC` permits to verify the integrity of the MPEG Audio scale factors.

Encoding: The `scale_factor_error_check` is allowed to be embedded at the end of a MPEG audio packet, between the end of the audio packet and another data field that is part of the ancillary data field or between two other data fields that are part of the ancillary data field.

If data fields according to DVD-Video extended ancillary data (as described in clause C.4.1) or ancillary data according to the DAB specification ETSI EN 300 401 [18] are used, then the `scale_factor_error_check_data_field` is not allowed to be inserted at the end of an audio packet.

Decoding: It is recommended to parse the data from the end.

C.4.5 RDS data via UECP protocol

The transmission of RDS data via the UECP protocol [22] in the ancillary data field of MPEG audio frames is optional. The syntax of the UECP data field is described in table C.20. Note that the description in table C.20 is in the reverse order of the transmission. The bit order in each byte is, however, such that the msb comes first in the transmission. The `data field length` gives the number of bytes following this byte within this data field.

Table C.20: UECP data field

Syntax	No. of Bits	Mnemonic
<code>UECP_data() {</code>		
<code>UECP_data_sync</code>	8	bslbf
<code>data_field_length</code>	8	bslbf
for (i=0; i<N; i++){		
<code>UECP_data_byte</code>	8	uimsbf
}		
<code>}</code>		

Semantics: The `UECP_data_sync` should be set to 0xFD.

The bytes in the `UECP_data_byte` field shall be byte aligned with the UECP data bytes. There is no need to align the `UECP_data_byte` field with the UECP frames. Consequently, one or more complete UECP frames and/or only parts of UECP frames may be contained in one `UECP_data_byte` field.

The length of the `UECP_data_byte` field can vary between consecutive audio packets.

Encoding: The encoding complies fully to the UECP specification [22].

The following addresses are assigned to DVB consumer receivers which are tuned to the indicated programme. For dual mono, the Terminal Address allows to assign different RDS information to the different audio channels.

NOTE: Within the DVB system the dual mono mode is generally deprecated. For legacy reasons, however, this option has been kept for RDS transmission.

Table C.21

Site Address	Terminal Address	DVB consumer receiver
0	0	All
1008	0	Stereo
	1	Dual Channel, ch. A
	2	Dual Channel, ch. B
	3	Single Channel (Mono)
	4 to 63	Not yet assigned

For professional decoding equipment at FM transmitters the addresses are individually assigned.

Decoding: It is recommended to parse the data from the end.

C.5 Detailed specification for MPEG4 AAC, HE AAC and HE AAC v2 Audio

C.5.1 Transmission of MPEG4 Audio ancillary data

MPEG4 ancillary data as defined in this annex shall be placed into a single *data_stream_element()* as defined in ISO/IEC 14496-3 [17], table 4.10.

The *data_stream_element()* <DSE> shall follow any combination of related <SCE>, <CPE>, <LFE>, and <FIL <EXT-SBR_DATA>> audio elements, to which the ancillary data applies.

The *element_instance_tag* of this *data_stream_element()* shall have the same value as the *element_instance_tag* of the first audio element to which the ancillary data applies.

Examples of possible streams are:

for a 2-channel program:

<CPE><DSE><FIL><TERM><CPE><DSE><FIL><TERM>...

for a 2-channel program with SBR:

<CPE><SBR(CPE)><DSE><FIL><TERM><CPE><SBR(CPE)><DSE><FIL><TERM>...

for a 5.1-channel program:

<SCE><CPE><CPE><LFE><DSE><FIL><TERM><SCE><CPE><CPE><LFE><DSE><FIL><TERM>...

For further reference see clauses 4.5.2.1.2 and 4.5.2.9.2 in ISO/IEC 14496-3 [17].

Decoding: The decoder may ignore this field.

C.5.2.2.2 dolby_surround_mode

Table C.25: Dolby surround mode Table

dolby_surround_mode	Description
"00"	Dolby surround mode not indicated
"01"	2-ch audio part is not Dolby surround encoded
"10"	2-ch audio part is Dolby surround encoded
"11"	Reserved

Semantics: In case of 2-channel audio streams it can be indicated, whether the audio signal is encoded in Dolby surround mode.

Encoding: This field may be provided by encoders when the audio stream is in 2-channel (stereo) format. *It shall be set to "00" for other than 2-channel audio streams.*

Decoding: It is strongly recommended that the decoder parses this field and provides this information to the reproduction set-up.

C.5.2.2.3 drc_presentation_mode

Table C.26: DRC presentation mode Table

drc_presentation_mode	Description
"00"	DRC presentation mode not indicated
"01"	DRC presentation mode 1
"10"	DRC presentation mode 2
"11"	Reserved

Semantics: This field indicates whether ISO/IEC 14496-3 [17] or clause C.5.2.5 dynamic range control takes priority on the outputs as defined in clause C.5.3.

To avoid disturbances in the audio output, it should not be changed within an elementary stream.

Encoding: This field may be provided by encoders. *It shall be set to "00" if the DRC presentation mode is not indicated.*

Decoding: It is strongly recommended that the decoder parses this field and makes use of this information.

C.5.2.3 ancillary_data_status

The detailed syntax is described on table C.27.

Table C.27: Ancillary_data_status syntax

Syntax	No. of Bits	Mnemonic
ancillary_data_status() {		
Reserved, set to "0"	1	bslbf
Reserved, set to "0"	1	bslbf
Reserved, set to "0"	1	bslbf
downmixing_levels_MPEG4_status	1	bslbf
Reserved, set to "0"	1	bslbf
audio_coding_mode_and_compression_status	1	bslbf
coarse_grain_timecode_status	1	bslbf
fine_grain_timecode_status	1	bslbf
}		

Semantics: The bits in this field indicate the presence of the associated fields in the ancillary data.

Encoding: *A bit in this field shall be set to "1" if the associated field is present in the bitstream.*

Decoding: It is strongly recommended that the decoder parse this field to allow parsing of the following fields in the ancillary data section.

C.5.2.4 downmixing_levels_MPEG4

C.5.2.4.0 General

When multichannel audio streams are decoded by an IRD and only 2-channel audio output is required, then matrix mix down shall be applied.

This part of the MPEG-4 ancillary data gives the possibility to transmit matrix mix down coefficients with higher resolution than defined in ISO/IEC 14496-3 [17]. The detailed syntax is described in table C.28.

Table C.28: Downmixing_levels_MPEG4 syntax

Syntax	No. of Bits	Mnemonic
downmixing_levels_MPEG4 () {		
center_mix_level_on	1	bslbf
center_mix_level_value	3	bslbf
surround_mix_level_on	1	bslbf
surround_mix_level_value	3	bslbf
}		

Encoding: It is strongly recommended that this matrix mix down information is supplied by the encoder and both, **center_mix_level_on** and **surround_mix_level_on** are set to "1" when multichannel audio is transmitted.

Decoding: It is strongly recommended that the decoder parses this field and uses the information in cases where matrix mix down is needed.

C.5.2.4.1 center_mix_level_on

Semantics: This field indicates, whether the **center_mix_value** field carries information for matrix mix down.

Encoding: *If this field is set to "1" the **center_mix_value** field shall indicate the matrix mix down level of the centre channel with respect to the left and right front channels. If this field is set to "0" the **center_mix_value** field shall be set to "000".*

Decoding: It is strongly recommended that the decoder parses and makes use of this field.

C.5.2.4.2 surround_mix_level_on

Semantics: This field indicates, whether the **surround_mix_value** field carries information for matrix mix down.

Encoding: *If this field is set to "1" the **surround_mix_value** field shall indicate the matrix mix down level of the surround channels with respect to the left and right front channels. If this field is set to "0" the **surround_mix_value** field shall be set to "000".*

Decoding: It is strongly recommended that the decoder parses and makes use of this field.

C.5.2.4.3 mix_level_value

Table C.29: Mix level value Table

mix_level_value	Multiplication factor
"000"	1,000 (0,0 dB)
"001"	0,841 (-1,5 dB)
"010"	0,707 (-3,0 dB)
"011"	0,596 (-4,5 dB)
"100"	0,500 (-6,0 dB)
"101"	0,422 (-7,5 dB)
"110"	0,355 (-9,0 dB)
"111"	0,000 (-∞ dB)

Encoding: *When provided, the values of **center_mix_level_value** and **surround_mix_level_value** shall be set to indicate the multiplication factors for 2-channel matrix mix down. The broadcaster shall ensure that sufficient headroom and/or dynamic range control values are included in the transmission to prevent any overload when downmixing. For further details refer to clause C.5.3.*

Decoding: The multi-channel decoder may apply these values as gain factors to the individual channels when a down mix for 2-channel stereo listening has to be created. The derived stereo signal can be generated within a matrix-mixdown decoder by use of the following equations:

$$Lo = L \times \text{center_mix_level} \times C \times \text{surround_mix_level} \times Ls$$

$$Ro = R \times \text{center_mix_level} \times C \times \text{surround_mix_level} \times Rs$$

where L, R, C, Ls and Rs are the transmitted source signals and Lo and Ro are the derived 2-channel stereo signals.

When a down-mix for 1-channel monophonic listening has to be created, a matrix mixdown decoder can make use of the following equation:

$$M = L \times R \times 2 \times \text{center_mix_level} \times C \times \text{surround_mix_level} \times (Ls \times Rs)$$

where L, R, C, Ls and Rs are the transmitted source signals and M is the derived mono signal.

To prevent any highly undesired overload, dynamic range control values shall be applied (see clause C.5.3).

C.5.2.5 audio_coding_mode

C.5.2.5.0 Syntax

The detailed syntax is described in table C.30.

Table C.30: Audio coding mode syntax

Syntax	No. of Bits	Mnemonic
audio_coding_mode () {		
reserved, set to "000 0000"	7	bslbf
compression_on	1	bslbf
}		

Decoding: It is recommended that the decoder parse this field.

C.5.2.5.1 compression_on

- Semantics: This field indicates, whether the **compression_value** field carries information.
- Encoding: If this field is set to "1" the **compression_value** field indicates the heavy compression factor. *If this field is set to "0" the **compression_value** field shall be "0000 0000".*
- Decoding: It is strongly recommended that the decoder parses and makes use of this field.

C.5.2.5.2 compression_value

- Semantics: This field consists of a value X in the four most significant bits and a value Y in the four less significant bits. The actual compression value is $48,164 - 6,0206 X - 0,4014 Y$ dB.
- The **compression_value** field indicates a heavy compression factor which may be applied instead of ISO/IEC 14496-3 [17] **dynamic_range_info()** on the decoder side when a strong dynamic range compression is desired.
- Encoding: The encoder may provide this information.
- If provided, besides possible artistic reduction of dynamic range, these values shall be suitable to prevent clipping for monophonic and stereophonic downmix and multichannel playout according to clause C.5.4.*
- Decoding: *If **compression_on** is set to "1", the IRD shall apply these values instead of the ISO/IEC 14496-3 [17] **dynamic_range_info()** when creating a monophonic RF modulated output or as required according to clause C.5.4.*

C.5.2.6 coarse_grain_timecode

See clause C.4.2.13.

C.5.2.7 fine_grain_timecode

See clause C.4.2.14.

C.5.2.8 Persistence of MPEG4 ancillary data

Though it may be appropriate to send the MPEG4 ancillary data periodically, it may not be required to send it with each audio frame.

Each value remains unchanged and in effect unless it is specifically overwritten by new transmitted data structures.

After synchronizing to a new stream, an IRD should assume the following values as default:

Table C.31: Default values after synchronization

Data field	Default value
dolby_surround_mode	"00"
drc_presentation_mode	"00"
center_mix_level_value	"010"
surround_mix_level_value	"010"
compression_on	"0"
compression_value	"0000 0000"
coarse_grain_timecode	"00 0000000000000000"
fine_grain_timecode	"00 0000000000000000"

NOTE: It may be desirable that any encoder sends MPEG4 ancillary data at least at each Random Access Point of the bitstream to start decoding with well-defined MPEG4 ancillary data. (PES packets which contain the **StreamMuxConfig()** at the beginning of an **AudioSyncFrame()** are Random Access Points of MPEG-4 Audio formatted according to clause 6.4).

C.5.3 Announcement Switching Data

The transmission of announcement switching data in MPEG4 ancillary data is optional. The syntax of the announcement switching data field is described in table C.32.

Table C.32: Announcement switching data field

Syntax	No. of Bits	Mnemonic
announcement_switching_data() {		
announcement_switching_data_sync	8	bslbf
data_field_length	8	bslbf
announcement_switching_flag_field_1	16	bslbf
announcement_switching_flag_field_2	16	bslbf
}		

Semantics: The **announcement_switching_data_sync** should be set to 0xAD.
The **data_field_length** gives the number of bytes following this byte within this data field.

The **announcement_switching_flag_fields** are 16-bit flag fields specifying which type of announcements are actually running. *The association between the bits of the flag field and the announcement types shall be according to the **announcement_support_indicator** as specified in table C.18a. A bit shall be set to "1" if the announcement is running and it shall be set to "0" if the announcement is not running.*

*The **announcement_switching_flag_field_1** shall be used for announcements within the audio elementary stream that is actually decoded.*

*The **announcement_switching_flag_field_2** shall be used for announcements within other audio elementary streams. Corresponding links are provided by means of the **announcement_support_descriptor** [i.32].*

Decoding: It is recommended that the decoder parse this field.

C.5.4 DRC Presentation Mode

Dynamic Range Control may either be used to limit the dynamic range of an audio signal to improve intelligibility under noisy listening environments or may be used to prevent highly undesired overloads. The latter may occur when audio is played back at a higher target level than its program reference level or when a reduction of the number of output channels has to be performed (i.e. downmixing).

To avoid these overloads, special constraints while producing audio signals should be maintained or appropriate dynamic range control values should be transmitted along with the audio as metadata. Besides the ISO/IEC 14496-3 [17] **dynamic_range_info()** also the **compression_value** of the present document (see clause C.5.2.5.2) can be used for this purpose.

Notes on ISO/IEC 14496-3 [17] **dynamic_range_info()**:

These values carry the "light compression" gains. According to ISO/IEC 14496-3 [17], these values may be scaled by factors between 0 and 1 prior to appliance to match individual circumstances. In ISO/IEC 14496-3 [17], scaling is differentiated for negative and positive gains. While scaling of positive gains (less increase of loudness) is always possible, scaling of negative gains (less attenuation) is prohibited under special circumstances in order to accomplish overload prevention.

Notes on **compression_value**:

This value carries the "heavy compression" gain. It is used when appliance of light compression according to ISO/IEC 14496-3 [17] **dynamic_range_info()** is not sufficient. No scaling is allowed for this value.

- Encoding: The broadcaster will mix programmes for DRC presentation mode 1 or DRC presentation mode 2 receivers. The use of these modes should be signalled by the encoder via the **drc_presentation_mode** field (see clause C.5.2.2.3). *If the DRC presentation mode is not indicated, the **drc_presentation_mode** field shall be set to "00".*
- DRC Presentation Mode 1:
 If 'DRC presentation mode 1' is signalled in the **drc_presentation_mode** field, the following applies:
Both dynamic range control data according to ISO/IEC 14496-3 [17] and to C.5.2.5 shall be transmitted.
To avoid any highly undesired overload for levelling and/or downmixing towards a target level of -23 dB (corresponding a value of 92), the broadcaster shall ensure that sufficient headroom and/or dynamic range control data according to clause C.5.2.5 are included in the transmission.
To avoid any highly undesired overload for levelling and/or downmixing towards a target level of -31 dB (corresponding a value of 124), the broadcaster shall ensure that sufficient headroom and/or dynamic range control data according to ISO/IEC 14496-3 [17] are included in the transmission.
- DRC Presentation Mode 2:
 If 'DRC presentation mode 2' is signalled in the **drc_presentation_mode** field, the following applies:
To avoid any highly undesired overload when levelling and/or providing a stereophonic downmix towards a target level of -23 dB (corresponding a value of 92), the broadcaster shall ensure that sufficient headroom and/or dynamic range control data according to ISO/IEC 14496-3 [17] are included in the transmission.
 To avoid any highly undesired overload when levelling and providing a monophonic downmix (e.g. RF modulated output) towards a target level of -23 dB (corresponding a value of 92), the broadcaster should ensure that sufficient headroom and/or dynamic range control data according to clause C.5.2.5 are included in the transmission.
- Decoding: According to clause 6.4.3, it is strongly recommended that the IRD operates at one of two different target levels.
- If the IRD supports the DRC presentation mode, the following rules shall apply:*
- Operation at target level -31 dB:*
If the IRD operates at a target level of -31 dB, dynamic range control data according to ISO/IEC 14496-3 [17] shall be applied if present.
If a downmix of multichannel audio is performed, scaling of negative gain words (ctrl1 as of chapter 4.5.2.7.2 of ISO/IEC 14496-3 [17]) is not permitted. Otherwise, scaling of DRC gain words is allowed.
- Operation at target level -23 dB:*
If the IRD operates at a target level of -23 dB and DRC presentation mode 1 is signalled, dynamic range control data according to clause C.5.2.5 shall be applied if present. Scaling of DRC gain words is not allowed in this case.
- If the IRD operates at a target level of -23 dB and DRC presentation mode 2 is signalled, dynamic range control data according to ISO/IEC 14496-3 [17] shall be applied if present on stereophonic and multi-channel outputs. Scaling of negative gain words (ctrl1 as of chapter 4.5.2.7.2 of ISO/IEC 14496-3 [17]) is not permitted (regardless of whether a downmix of multichannel audio is performed or not).*
When presentation mode 2 is signalled, dynamic range control data according to clause C.5.2.5 shall not be applied to stereophonic and multi-channel outputs.
- When downmixing for monophonic outputs, dynamic range control data according to clause C.5.2.5 shall be applied if present, otherwise dynamic range control data according to ISO/IEC 14496-3 [17] shall be applied if present. Scaling of DRC gain words is not allowed in this case.*

Table C.33 illustrates these two different DRC presentation modes.

Table C.33: Required Dynamic Range Control schemes for playback to prevent overload when DRC Presentation Modes is signalled

	Channels of playback system	Playback corresponding to a target level of -31 dB		Playback corresponding to a target level of -23 dB		
		5.1	2.0	5.1	2.0	1.0
DRC presentation mode 1	2-channel Stereo Audio content	<i>Not specified</i>	ISO DRC (scaling allowed) or Compression_value	<i>Not specified</i>	Compression_value	Compression_value
	Multichannel Audio content	ISO DRC (scaling allowed) or Compression_value	ISO DRC (scaling restricted) or Compression_value	Compression_value	Compression_value	Compression_value
DRC presentation mode 2	2-channel Stereo Audio content	<i>Not specified</i>	ISO DRC (scaling allowed)	<i>Not specified</i>	ISO DRC (scaling restricted)	Compression_value
	Multichannel Audio content	ISO DRC (scaling allowed)	ISO DRC (scaling restricted)	ISO DRC (scaling restricted)	ISO DRC (scaling restricted)	Compression_value
<p>NOTE 1: ISO DRC (scaling allowed): Dynamic range control data according to ISO/IEC 14496-3 [17] is applied. Scaling of both positive and negative gain words (ctrl1 and ctrl2 as of clause 4.5.2.7.2 of ISO/IEC 14496-3 [17]) is allowed.</p> <p>NOTE 2: ISO DRC (scaling restricted): Dynamic range control data according to ISO/IEC 14496-3 [17] is applied. Scaling of negative gain words (ctrl1 as of clause 4.5.2.7.2 of ISO/IEC 14496-3 [17]) is not permitted (i.e. ctrl1 has to be equal to 1). Scaling of positive gain words is still possible.</p> <p>NOTE 3: Compression_value: If dynamic range control data according to clause C.5.2.5 are present, these values are applied without any scaling. Appliance of dynamic range control data according to ISO/IEC 14496-3 [17] is only permitted if dynamic range control data according to clause C.5.2.5 are not present.</p>						

Annex D (normative): Coding of Data Fields in the Private Data Bytes of the Adaptation Field

D.1 Introduction

A compliant bitstream may contain data fields in the private data bytes of the adaptation field [1] for use in certain applications. *When such private data bytes are used in the manner described in clause D.2 of this annex or they are used in combination with PVR-assisting coding as described in clause D.3 (below) the bitstream shall conform to the provisions of this annex.* This annex does not apply to SVC bitstreams. In the case of an MVC transmission, this annex currently applies only to the base layer.

This annex contains the guidelines required to include and to decode data fields in the private data bytes of the adaptation field [1] for PVR and other applications.

D.2 Private data bytes detailed specification

D.2.0 General

Transport stream (TS) packets coded according to Recommendation ITU-T H.222.0 / ISO/IEC 13818-1 [1] may include an adaptation field. The presence of an adaptation field is indicated by means of the `adaptation_field_control`, i.e. a 2-bit field in the header of the TS packet. The adaptation field itself may contain `private_data_bytes`. The presence of private data bytes is signalled by means of the `transport_private_data_flag` coded at the beginning of the adaptation field. If private data bytes exist the total number of private data bytes is specified by means of the `transport_private_data_length`, an 8-bit field that is directly followed by the private data bytes. The private data bytes may be composed of one or more data fields as shown in figure D.1. Gaps are not allowed between two data fields.

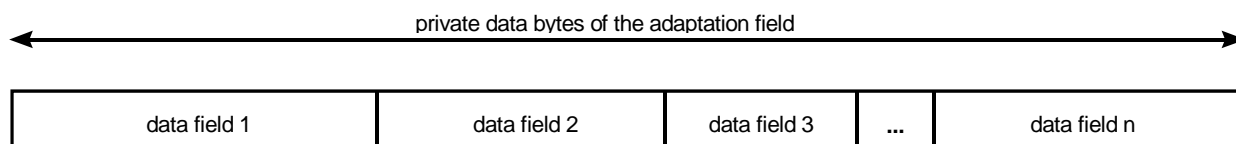

Figure D.1: Coding scheme for private data bytes within the adaptation field

Encoding: The following semantics apply to all data fields specified in this annex.

data_field_tag: The data field tag is an 8-bit field which identifies the type of each data field. The values of `data_field_tag` are defined in table D.1.

data_field_length: The data field length is an 8-bit field specifying the total number of bytes of the data portion of the data field following the byte defining the value of this field.

Table D.1: Allocation of data_field_tags

data_field_tag	Description
0x00	Reserved
0x01	Announcement switching data field
0x02	AU_information data field
0x03	PVR_assist_information data field
0x04	Void
0x05 to 0x9F	Reserved for future use
0xA0 to 0xFF	User defined

Decoding: The IRD design should be made under the assumption that any structure or combination of structures as permitted by this annex may occur in the broadcast stream. The IRD is not required to make use of this data.

D.2.0a DVB Compliance

The presence and encoding of data fields in the **private_data_bytes** in the adaptation field data according to the present document is signalled in DVB-SI Program Map Table by the adaptation field data descriptor (see ETSI EN 300 468 [i.32], clause 6.2.1).

D.2.1 Announcement Switching Data

The announcement switching data field is used to indicate whether spoken announcements are actually running or not. In comparison with that, the general support of announcements is indicated by means of the `announcement_support_descriptor` [i.32].

The transmission of the announcement switching data field is optional but it shall be continuously provided in those audio streams that may carry announcements at some point in time. The announcement switching data field shall be present at least every 100 ms. The syntax of the announcement switching data field is described in table D.2.

Table D.2: Announcement switching data field

Syntax	No. of Bits	Mnemonic
<code>announcement_switching_data() {</code>		
<code>data_field_tag</code>	8	uimsbf
<code>data_field_length</code>	8	uimsbf
<code>announcement_switching_flag_field</code>	16	bslbf
<code>}</code>		

Semantics: `announcement_switching_flag_field`: This 16-bit flag field specifies which type of announcements are actually running. *The association between the bits of the flag field and the announcement types shall be according to the announcement_support_indicator as specified in table C.18a. A bit shall be set to "1" if the announcement is running and it shall be set to "0" if the announcement is not running.*

D.2.2 AU_information

The `AU_information` data field is used to signal the presence of the start of an access unit in the payload of the transport packet containing the data field, and to convey information about that access unit that is of use to PVR applications. All the information provided in this adaptation data field should be considered "helper" information rather than definitive information. *Thus, if there are any conflicts between the information signalled in this adaptation data field and the actual stream, then the information in the stream shall take precedence over the information in this adaptation data field.* However, such a conflict should be considered an error condition and as such should not occur. It is recommended that the `AU_information` data field is present at the start of each access unit of an H.264/AVC [16] video streams. It is not recommended to use this structure with HEVC streams.

NOTE 1: The `PVR_assist` information defined in clause D.3 should normally be used in preference to the `AU_information`.

Where multiple access units occur in a transport packet, then multiple `AU_information` data fields may be used. *Each adaptation data field shall apply to the corresponding access unit in the transport packet. I.e. the first data field shall apply to the first access unit starting in the transport packet, the second data field shall apply to the second access unit starting in the transport packet, etc.*

The `AU_information` data field(s), when present, shall be the first data field(s) in the adaptation field.

There shall not be more adaptation data fields with the same data field tag value than there are access units starting in the packet.

Table D.3: AU_information data field

Syntax	No. of Bits	Mnemonic
AU_information () {		
data_field_tag	8	uimsbf
data_field_length	8	uimsbf
AU_coding_format	4	uimsbf
AU_coding_type_information	4	bslbf
AU_ref_pic_idc	2	uimsbf
AU_pic_struct	2	bslbf
AU_PTS_present_flag	1	bslbf
AU_profile_info_present_flag	1	bslbf
AU_stream_info_present_flag	1	bslbf
AU_trick_mode_info_present_flag	1	bslbf
if (AU_PTS_present_flag == "1") {		
AU_PTS_32	32	uimsbf
}		
if (AU_stream_info_present_flag == "1") {		
Reserved	4	"0000"
AU_frame_rate_code	4	uismbf
}		
if (AU_profile_info_present_flag == "1") {		
AU_profile	8	uismbf
AU_constraint_set0_flag	1	bslbf
AU_constraint_set1_flag	1	bslbf
AU_constraint_set2_flag	1	bslbf
AU_AVC_compatible_flags	5	bslbf
AU_level	8	uismbf
}		
if (AU_trick_mode_info_present_flag == "1") {		
AU_max_I_picture_size	12	uismbf
AU_nominal_I_period	8	uismbf
AU_max_I_period	8	uismbf
Reserved	4	"0000"
}		
if (data_parsed < data_field_length) {		
AU_Pulldown_info_present_flag	1	bslbf
AU_reserved_zero	6	'000000'
AU_flags_extension_1	1	bslbf
if (AU_Pulldown_info_present_flag == '1') {		
AU_reserved_zero	4	'0000'
AU_Pulldown_info	4	bslbf
}		
if (AU_flags_extension_1 == '1') {		
AU_reserved	8	bslbf
}		
}		
for(i=0; i<n; i++) {		
AU_reserved_byte	8	bslbf
}		
}		

Semantics:

data_field_tag: This shall have the value 0x02.

data_field_length: This indicates the length of the *adaptation data field*. The values 0 and 1 may be used to signal short versions of the *adaptation data field*. The value 0 means that no fields after the data_field_length are sent, and is used as a dummy *adaptation data field*. The value 1 means that only the fields AU_coding_format and AU_coding_type_information are present.

AU_coding_format: This shall signal the coding format used by the elementary stream carried on this packet. The values are as shown in table D.4.

Table D.4: AU_coding_format values

Value	Stream Type
0	Undefined
1	Recommendation ITU-T H.262 [2] / ISO/IEC 13818-2 [2] Video or ISO/IEC 11172-1 [8] constrained parameter video stream
2	H.264/AVC video stream as defined in Recommendation ITU-T H.264 / ISO/IEC 14496-10 [16] Video
3	VC-1 video stream as defined in SMPTE ST 421 [20]
4	HEVC video stream as defined in ISO/IEC 23008-2 [35] Video
5-0xF	Reserved

AU_coding_type_information: Indicates the coded picture/slice types present in the immediately following access unit. For Recommendation ITU-T H.264 / ISO/IEC 14496-10 [16] video, this field shall be interpreted as a four bit field with the syntax shown in table D.5.

Table D.5: AU_coding_type_information for Recommendation ITU-T H.264 / ISO/IEC 14496-10 video

Syntax	No. of Bits	Mnemonic
AU_IDR_slice_present_flag	1	bslbf
AU_I_slice_present_flag	1	bslbf
AU_P_slice_present_flag	1	bslbf
AU_B_slice_present_flag	1	bslbf

For Recommendation ITU-T H.262 / ISO/IEC 13818-2 [2] Video, this field shall be interpreted according to table D.6. These values are identical to (but one bit longer than) the values in table 6-12 of ISO/IEC 13818-2 [2].

For VC-1 (SMPTE ST 421 [20]), this field shall be interpreted as per table D.6.

Table D.6: AU_coding_type_information for Recommendation ITU-T H.262 / ISO/IEC 13818-2 video

Value	AU_coding_type_information
0	Undefined
1	I
2	P
3	B
4 to 0xF	Reserved

For HEVC video, this field shall be interpreted as per table D.6a.

Table D.6a: AU_coding_type_information for HEVC video

Syntax	No. of Bits	Mnemonic
Reserved_0	1	bslbf
AU_I_slice_present_flag	1	bslbf
AU_P_slice_present_flag	1	bslbf
AU_B_slice_present_flag	1	bslbf

NOTE 2: The slice present can be calculated from the slice_type field of the NAL units that comprise the AU.

AU_ref_pic_idc: This field indicates if any of the access unit is required in the reconstruction of other access units. The value "00" means that it is not used by other access units. In the case of Recommendation ITU-T H.264 / ISO/IEC 14496-10 [16], the value shall be the nal_ref_idc field in the NAL header used for any slice that makes up the access unit.

For VC-1 (SMPTE ST 421) [20], this shall take the value "00" for all pictures (and related headers) that are not used as reference, and shall not take the value "00" for all pictures that are used as reference.

For Recommendation ITU-T H.262 / ISO/IEC 13818-2 [2], this field shall take the value "00" for pictures (and related headers) that are not used as reference (i.e. B pictures), and shall not take the value "00" for all other pictures (and related headers).

For HEVC, this field shall take the value "00" only for pictures (and related headers) that are not used as reference. All other pictures (and related headers) shall not take the value "00". A picture shall be treated as not used for reference only when encoded using non-reference NAL unit types.

AU_pic_struct: This field shall be set to "01" if the access unit is a top field picture, "10" if it is a bottom field. Otherwise, it shall be set to "00". "11" value is reserved.

AU_PTS_present_flag: This field shall be set to "1" when the AU_PTS_32 value is present in the descriptor, otherwise it shall take the value "0".

AU_profile_info_present_flag: This field shall be set to "1" when the AU_profile_idc and AU_level_idc values are present in the descriptor, otherwise it shall take the value "0".

AU_stream_info_present_flag: This field shall be set to "1" when the AU_frame_rate_code value is present in the descriptor, otherwise it shall take the value "0".

AU_trick_mode_info_present_flag: This field shall be set to "1" when the AU_max_I_picture_size and AU_max_I_period are present in the descriptor.

AU_PTS_32: The 32 most significant bits of the 33-bit PTS encoded in the PES header immediately following this adaptation field, or of the value that applies to the access unit to which this descriptor applies, if no PES header is present.

AU_frame_rate_code: This field indicates the video frame rate in the stream carried on the current PID. In the case of video, this is encoded as in clause 6.3.3 of ISO/IEC 13818-2 [2], as shown in table 6-4 of the same. The values in this table are informatively replicated on table D.7.

Table D.7: Informative Frame Rate values taken from table 6-4 of ISO/IEC 13818-2

AU_frame_rate_code	Corresponding Frame Rate (Hz)
0	Forbidden
1	23,976
2	24
3	25
4	29,97
5	30
6	50
7	59,94
8	60
9 to 0xF	Reserved

AU_profile: This field conveys the profile used to which the access unit conforms.

For Recommendation ITU-T H.264 / ISO/IEC 14496-10 [16] video this contains the profile_idc value as defined ISO/IEC 14496-10 [16], annex A.

For Recommendation ITU-T H.262 / ISO/IEC 13818-2 [2] video the least significant 3 bits of this field carry the profile as defined in clause 8 of Recommendation ITU-T H.262 / ISO/IEC 13818-2 [2].

For VC-1 (SMPTE ST 421) [20] video the least significant bits of this field carry the profile as defined in SMPTE ST 421 [20].

For HEVC video this contains the general_profile_idc value as defined ISO/IEC 23008-2 [35], annex A.

Constraint_set0_flag, constraint_set1_flag, constraints_set2_flag, AVC_compatible_flags: These fields carry the same semantics as the fields of the same name in the AVC_video_descriptor in clause 2.6.64 of Recommendation ITU-T H.222.0 / ISO/IEC 13818-1 [1], which in turn have semantics defined in ISO/IEC 14496-10 [16], clause 7.4.2.1. Note that with High profile, the first bit in AVC_compatible_flags contains constraint_set3_flag.

For Recommendation ITU-T H.262 / ISO/IEC 13818-2 [2] video and VC-1 (SMPTE ST 421) [20] video these fields shall take the value "0".

For HEVC video these fields shall take the value of the fields *general_profile_flag[i]* for the values of *i* from 0 to 7.

AU_level: This field conveys the level used to which the access unit conforms.

For Recommendation ITU-T H.264 / ISO/IEC 14496-10 [16] video this carries the *level_idc* value as defined in ISO/IEC 14496-10 [16], annex A.

For Recommendation ITU-T H.262 / ISO/IEC 13818-2 [2] video the least significant 4 bits of this field carry the level as defined in clause 8 of Recommendation ITU-T H.262 / ISO/IEC 13818-2 [2].

For VC-1 (SMPTE ST 421) video, the least significant bits of this field shall carry the level as defined in SMPTE ST 421 [20].

For HEVC video this carries the **level_idc** value present in the HEVC_video_descriptor as defined in clause 4.1.8.19a of the present document.

AU_max_I_picture_size: This value indicates the buffer size, in units of 16×1024 bits, that is implemented by the encoder rate control, and thus the maximum intra picture size that can be found in the current bitstream. *This value, according to profile and level, shall comply with ISO/IEC 14496-10 [16], HEVC [35] and ISO/IEC 13818-2 [2] limits.* The value 0 is forbidden.

AU_nominal_I_period: This value indicates the nominal distance between two consecutive I/IDR pictures, on a frame picture count basis, and for HEVC the distance between two consecutive HEVC DVB_RAP pictures. The value 0 is forbidden.

AU_max_I_period: This value indicates the maximum distance that can be found in the stream between two consecutive I/IDR pictures, on a frame picture count basis. The value 0 is forbidden.

AU_Pulldown_info_present_flag: *This field shall be set to '1' if the AU_Pulldown_info field is present.*

AU_flags_extension_1: *This field shall be set to '1' if the AU_reserved bytes is used for additional flags.*

NOTE 3: This flag provides for future extensions. Whilst for the present document, the value of this flag should be '0', the value of '1' should be correctly processed.

AU_Pulldown_info: This field carries the four bits carried in the H.264/AVC structure signalling the AU's display characteristics, specifically the *pic_struct* field of the picture timing SEI message. *The default value for this field shall be the same as AU_pic_struct.* Table D.8 shows the default values to be used for Pulldown_info if the field is not transmitted.

Table D.8: AU_Pulldown_info default values

AU_pic_struct default	AU_Pulldown_info value
00	0
01	1
10	2

For HEVC, when present this field shall carry the values of the *pic_struct* field of the picture timing SEI message.

NOTE 4: The combination of "AU_pic_struct" and "AU_Pulldown_info" may only be correct when "AU_pic_struct" is set to "00" and "AU_Pulldown_info" is present and set equal to the "pic_struct" field of the picture timing SEI message for H.264/AVC. For VC-1 (SMPTE ST 421) and MPEG-2 ISO/IEC 13818-2 / Recommendation ITU-T H.262 [2], it is recommended that these syntax elements are set to 0.

D.3 PVR assistance

D.3.1 Introduction (informative)

The "PVR_assist_information" data field is used to signal information with the aim of helping PVR applications perform trick-play operations but does not mandate any specific PVR device behaviour. The information in this clause is specific to H.264/AVC, and HEVC and could be extended for use with other video codecs.

The "PVR_assist_information" data field may be used in addition to the "AU_information" data field, but it is recommended that it be used independently. It is recommended that the PVR assist information is present at the start of each video access unit.

PVR assist information is conveyed in 3 levels. The first level imposes minor encoding constraints in addition to what is specified, for H.264/AVC, in clauses 5.5, 5.6 and 5.7 of the present document, and for HEVC in clause 5.14 of the present document. See clause D.3.2 for these additional constraints. An application conveying just the first level of information sets the "data_field_length" value to "0" in the PVR assist information data and this may be conveyed at each picture or at a RAP. The second level of information includes the first level (encoding constraints) and adds signalling of picture interdependencies using the syntax element "PVR_assist_tier_pic_num". Coding of this syntax element is specified in clause D.3.3. An application conveying just the first and second levels of PVR assist information sets the syntax element "data_field_length" value to "0x01", includes a correct value for "PVR_assist_tier_pic_num" (tier number), conveys the "PVR_assist_tier_pic_num" syntax element for each picture and sets all the following syntax elements to "0":

- pvr_assist_block_trick_mode_present_flag.
- pvr_assist_pic_struct_present_flag.
- pvr_assist_tier_next_pic_in_tier_present_flag.
- pvr_assist_substream_info_present_flag.
- pvr_assist_extension_present_flag.

Based on the "PVR_assist_tier_pic_num" syntax element, the third level provides additional information aimed at assisting PVR applications with the ability to perform trick-play operations. The additional information includes the following two methods as specified in clauses D.3.3 and D.3.4:

- 1) Information related to a Tier framework which describes signalling for extractable and decodable sub-sequences based on pictures interdependencies. This allows the PVR application to efficiently select pictures when performing a given trick-mode.
- 2) Information related to a sub-stream framework which explicitly signals the achievable trick-play speeds and their associated subset of pictures.

Depending on the application, it is possible to use none, one or a combination of the two frameworks. When the PVR assist information includes signalling for both the frameworks, receivers are only expected to use either one of the signalled information.

In addition, the PVR assist information provides segmentation information and signalling to selectively block respective trick modes.

D.3.2 Encoding of PVR assist information (normative)

This clause describes and specifies a set of encoding guidelines that shall be used when PVR assist information is conveyed in the MPEG-2 transport stream.

In the following text RAP is used to mean "for H.264/AVC streams, RAP, and for HEVC streams, HEVC DVB_RAP". The equivalent negative term non-RAP is also used.

For H.264/AVC, in addition to the constraint of one video access unit (AU) start per PES packet, each PES packet shall contain exactly one AU. The first payload byte after the PES header shall be the start of the AU. The "data_alignment_indicator" in the PES header shall be set to a value of "1".

NOTE: For HEVC, this constraint is already present in clause 5.

If there are any conflicts between the information signalled in this PVR assist information and the actual stream, then the information in the stream shall take precedence over the information in this PVR assist information. However, such a conflict should be considered an error condition and as such should not occur.

When PVR assist information is present, it shall be located in the adaptation header's private data field of MPEG-2 transport stream packets containing the PES header of video access units. These MPEG-2 transport packets shall have their "payload_unit_start_indicator" (PUSI) flag set to a value of "1" and the adaptation control field set to a value of "11".

The PVR assist information uses a tag, length, value structure, consistent with the usage shown in clause D.2, with a "data_field_tag" value of "0x03". Note that when the "AU_information" with a "data_field_tag" value of "0x02" is present in the same adaptation field, it shall precede the PVR assist information. In this instance, there should be no conflicts between the information provided in both data fields. Any conflict shall be considered an error condition and the PVR assist information shall take priority.

For H.264/AVC or HEVC, the maximum time interval between successive RAP pictures shall be less than or equal to 1,28 s. This value accommodates variations either due to non-integer frame rates or GOP lengths that are a power of 2 up to 32 frames for interlaced video, and up to 64 frames for progressive video. While the 1,28 s value is derived for a GOP of 32 frames for 25 Hz, the corresponding value is 1,068 s for frame rates of 30 000/1 001 Hz. It is strongly recommended that the maximum time interval be less than or equal to 1,068 s for frame rates of 30 Hz, 30 000/1 001 Hz, 60 Hz and 60 000/1 001Hz.

Non-paired fields shall not be used in H.264/AVC Bitstreams or HEVC Bitstreams.

D.3.3 Tier framework

D.3.3.0 Introduction

The method is based on a tier system framework that conceptually parallels the data dependency hierarchy system described in clause D.2.11 of Recommendation ITU-T H.264 / ISO/IEC 14496-10 [16] to achieve independently decodable sub-sequences that can be extracted and used by PVR applications to fulfil trick modes.

The premise for the tier framework is to signal picture interdependencies to assist PVR applications in fulfilling trick modes. The method is flexible and adapts to the potentially elaborate picture interdependencies that may be present in an H.264/AVC stream or an HEVC stream. The tier framework extends its flexibility and adaptability without imposing encoding constraints.

D.3.3.1 Background (informative)

A hierarchy of data dependency tiers contains at most 7 tiers. For H.264/AVC, the tiers are ordered hierarchically from "1" to "7", and for HEVC the tiers are ordered hierarchically from "0" to the highest TemporalId value + 1, based on their "decodability" so that any picture with a particular tier number does not depend directly or indirectly on any picture with a higher tier number.

D.3.3.2 Specification for H.264/AVC (normative)

Each picture in the video stream may belong to one of the 7 tiers. For any value of $k = 1, \dots, 5$, any picture in the k^{th} tier shall not depend directly or indirectly on the processing or decoding of any picture in the $(k+1)^{\text{th}}$ tier or above.

This implies the following:

- A picture that depends on a reference picture cannot have a tier number smaller than the tier number of the reference picture.

- A picture that depends on a picture issuing an MMCO that affects its picture referencing cannot have a tier number smaller than the tier number of the picture issuing the MMCO.

Two field pictures belonging to the same frame shall have the same tier number. Starting at a RAP, the two field pictures belonging to the same frame may be found by checking the value of "PVR_assist_pic_struct", if present, in consecutive pictures.

Tier 1 consists of the first level of picture extractability, and each subsequent tier corresponds to the next level of picture extractability in the video stream. *All RAP pictures shall belong to Tier 1 and all Tier 1 pictures shall be RAP pictures.* Tier 5 is the largest tier number that may be assigned to reference pictures that are intended to be extracted for trick modes. Tiers 6 and 7 correspond to the last level of picture extractability such as discardable pictures and pictures that are not used as reference for trick-modes. Tiers 6 and 7 pictures are intended to be discardable for trick-mode purposes and do not depend on other Tier 6 and 7 pictures. *For H.264/AVC video, all pictures belonging to Tier 7 shall have "nal_ref_idc" equal to "0".* It should be noted, that some pictures with "nal_ref_idc" equal to "0" may either be signalled as Tier 6 or Tier 7 and some discardable pictures with "nal_ref_idc" not equal to "0" may be signalled as Tier 6.

Starting from a RAP picture and including the RAP picture, Tier 2 pictures can be decoded progressively and output independently of pictures in Tier 3 through Tier 7. More generally, for any value of $k = 1, \dots, 7$ a Tier k picture is decodable if all immediately-preceding Tier 1 through Tier k pictures, inclusive, in the video stream have been decoded. *This requires that for tier values $k = 2, 3, 4$ or 5 if a picture is signalled as Tier k , then there shall be at least one Tier $(k-1)$ picture signalled between this RAP and the next RAP in decode order.* The exception is for pictures with tiers 6 and 7 that do not depend on other tier 6 and 7 pictures.

Depending on the GOP structures, all tier numbers between 1 and 7 may not be allocated to pictures and there may be a gap between the highest tier number used for reference pictures (1, 2, 3, 4 or 5) and tier number 6 or 7. A single gap is permitted between the highest tier number used for reference pictures and tier number 6 or 7.

Tier number "0" is reserved for future use. "PVR_assist_tier_pic_num" field shall always be present for each picture when either tier framework and sub-stream framework or a combination is used. This also requires "data_field_length" to be set to a value greater than "0".

In the tier framework, if the tier number of a picture has a value of "6" or "7", then the picture shall be considered a discardable picture and may not belong to a decodable sub-sequence.

In addition, in the tier framework other parameters such as "PVR_assist_tier_m_cumulative_frames" and "PVR_assist_tier_m" are included to signal the minimum number for pictures intended to be extracted and decoded per each 1 second interval for a particular trick mode speed and higher. The following describes the use and setting of these syntax elements:

The number of pictures signalled from Tiers 1 through n where $1 < n < 6$ should be approximately half the number of pictures per every consecutive 1,0 second interval of the video stream, and the pictures should be evenly spread, to provide a smooth 2x trick mode. The complementary fields "PVR_assist_tier_m_cumulative_frames" and "PVR_assist_tier_m" may be signalled for this purpose.

The premise behind these two syntax elements is that if a sufficient number of pictures are provided to fulfil smooth 2x playback, then there will be a sufficient number of pictures to also render smooth playback of speeds higher than 2x. For example, if 30 of every 60 pictures per second are signalled with Tiers 1 to n with these complementary fields, then it is possible to provide a 2x playback of 60 pictures per second from the 30 signalled pictures in every 1,0 second interval, or equivalently 60 signalled pictures can be decoded from every 2,0 second interval. Likewise, smooth 4x playback can be fulfilled with 15 of the signalled pictures in every 1,0 second interval.

D.3.3.2a Specification for HEVC (normative)

HEVC supports a mechanism that can be made compatible with the tier framework through the ability to signal a video bitstream as comprising of a number of temporal sublayers, where each temporal sublayer has a TemporalId carried as the **nuh_temporal_id_plus1** field in the NAL_unit_header. The tier number may be used to signal the sublayers of HEVC consistently in accordance with their TemporalId values. Within the context of this annex, temporal sublayers refer only to temporal sublayers carried within a single PID. The tier number for each picture is derived from its TemporalId value. *The tier value of an HEVC DVB_RAP picture shall be 0. All pictures that are not HEVC DVB_RAP pictures shall have tier value equal to TemporalId +1.*

Additional constraints may be imposed on the tier framework if required, e.g. as defined in Recommendation ITU-T H.265 / ISO/IEC 23008-2 [35], clause 10 for subbitstream extraction. Utilizing the tier framework provides easy access to the sublayer information without requiring either access to, or parsing and decrypting of, the HEVC bitstream.

For HEVC Video, Tier 0 (i.e. TemporalId 0) consists of pictures which can all be extracted, and each subsequent tier corresponds to another level of pictures which can be additionally extracted to assist trick play operations. For HEVC, *all HEVC DVB_RAP pictures shall belong to Tier 0 and all Tier 0 pictures shall be HEVC DVB_RAP pictures.*

D.3.3.3 Examples of tier number assignment for H.264/AVC and HEVC (informative)

When a PVR application starts extracting a subsequence beginning at a RAP, its *decodability entry point* (DEP) is defined to be the RAP from which all pictures of this extracted subsequence can be fully reconstructed. Note that DEP is the RAP if it contains an IDR picture for H.264/AVC, or an IDR or CRA for HEVC; otherwise, the DEP could be the previous RAP.

For all values of k from 1 to 6, a Tier k picture after a RAP is decodable and can be fully reconstructed if the respective tier number is signalled for each and every picture belonging to Tiers 1 through k that are located between the Tier k picture's DEP and the Tier k picture.

The GOP depicted in figure D.2 illustrates that every other picture may be signalled with Tiers 1 through 4. In figure D.2, the first and second rows depict picture output order and decode order, respectively; the third row shows the respective tier number of each picture in decode order.

A wide range of playback speeds are possible from Tier 1 pictures only (i.e. very fast) to higher tier numbers. A PVR application may provide alternate speeds with the pictures in Tiers 1 to $(k-1)$ and a portion of the pictures in tier k . In some cases the display of some pictures may be repeated to avoid imposing the decoder to run beyond its capabilities; in other cases to maintain speed accuracy. Using the signalled tier numbers, a PVR application may select the appropriate set of pictures for a particular trick mode without causing a decoder to process pictures faster than 1x.

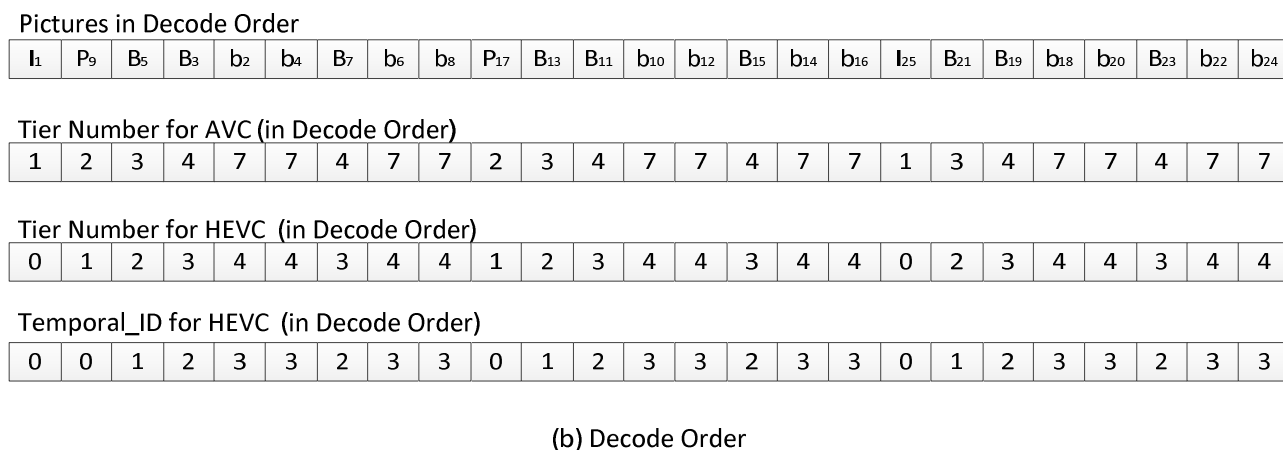
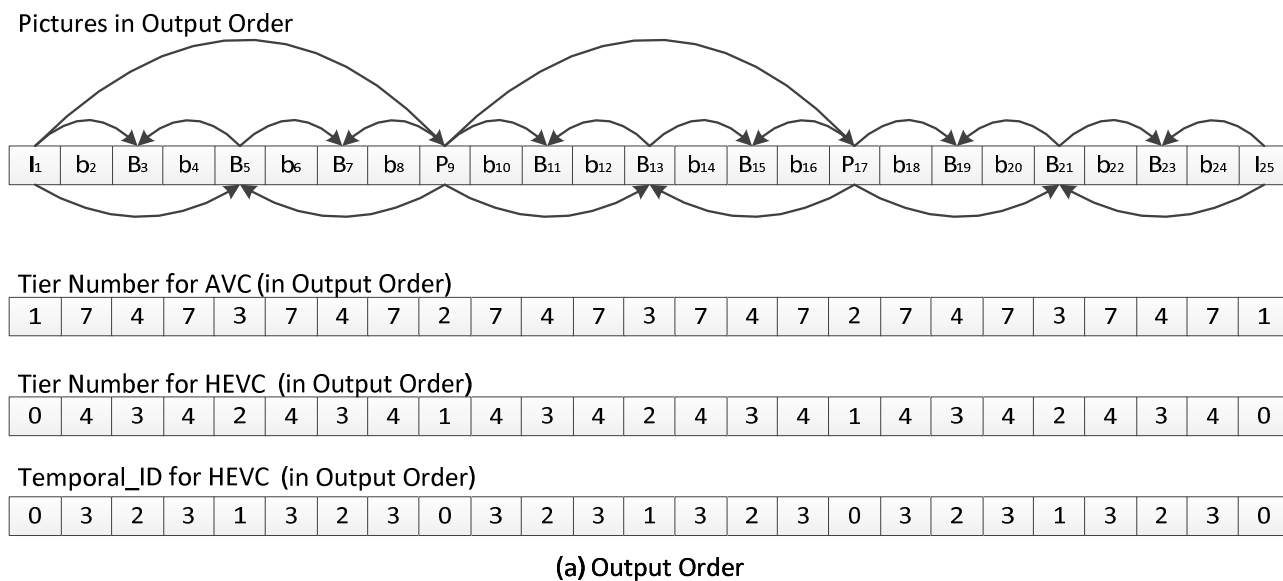

Figure D.2

In figure D.3, 2x trick mode may be rendered by decoding every other picture. In some cases, a PVR may render a 2x playback speed by decoding the pictures in tiers 1 to 3 and repeating the output of each picture once.

The tier framework can also be used to signal discardable pictures, or different categories of discardable pictures. For instance, with an MPEG-2 like GOP with three B pictures between reference pictures, the middle B picture of every trio can be signalled as a Tier "6" picture and the other two as Tier "7" pictures. This facilitates retention of the temporal sampling of the video when pictures need to be discarded.

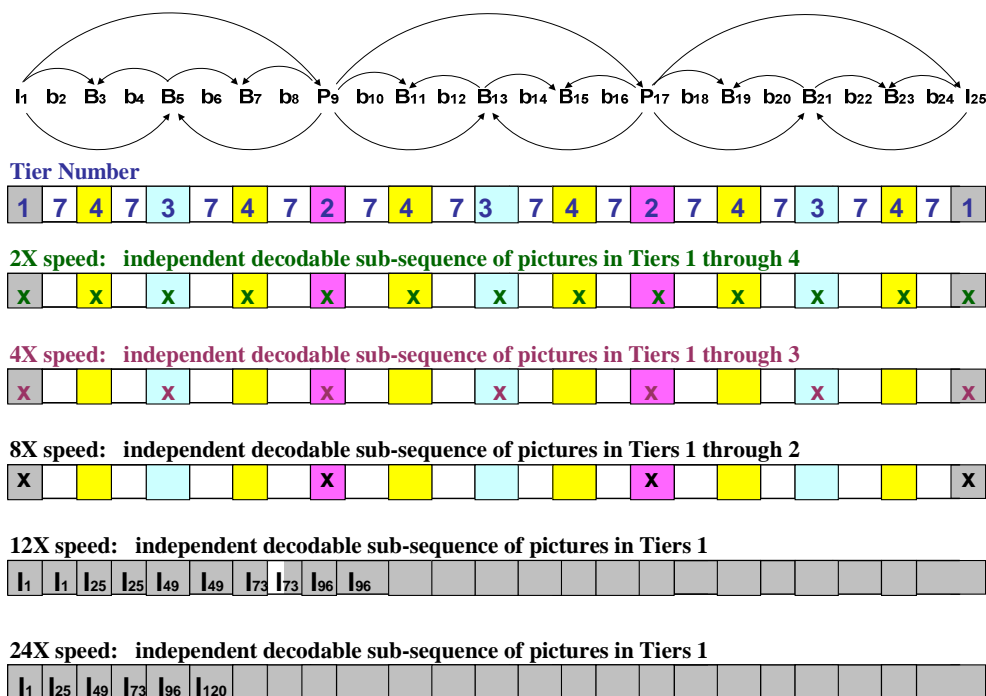

Figure D.3

D.3.4 Sub-stream framework

D.3.4.1 Background (informative)

This method is based on a sub-stream framework, which relieves the PVR device from the burden of determining the subset of pictures needed to fulfil a trick play speed. To achieve a pre-defined trick-mode speed, the PVR device is hypothetically supposed to decode a signalled sub-stream, select the pictures to display and choose their display duration. Each defined sub-stream is signalled on a picture basis, and may be guaranteed to be decodable by a compliant decoder. Note that this requires the "data_field_length" to be set to a value greater than "0" and the "PVR_assist_tier_pic_num" field be present for each picture.

This framework may also facilitate switching between different playback speeds on a real-time basis.

Playback speed information assists in signalling one or more sub-streams corresponding to respective pre-defined playback speeds. Up to four speeds may be signalled per picture to signal that this picture belongs to a corresponding extractable sub-stream, and each extractable sub-stream is associated with one of 15 playback speeds.

Furthermore, picture interdependencies as described in clause D.3.3, might be used by the PVR device to achieve intermediate playback speeds.

Note that playback speed information does not define the features, trick mode strategies or the effective trick mode speed achieved by the PVR device.

D.3.4.2 Tier Signalling (normative)

"PVR_assist_tier_pic_num" shall be present for each picture. Note that this requires the "data_field_length" to be set to a value greater than "0". Coding of "PVR_assist_tier_pic_num" is defined in clause D.3.3. *If the stream contains signalling for both the tier and substream frameworks, there shall be no conflict in the value signalled in syntax element "PVR_assist_tier_m_cumulative_frames" and a speed associated with 2x.* If a conflict occurs, it is recommended that "PVR_assist_tier_m_cumulative_frames_present_flag" be set to "0" when "PVR_assist_substream_info_present_flag" is set to "1".

D.3.4.3 Playback speed information (normative)

Playback speed information should be used to signal one or more sub-streams deemed best by the encoder to fulfil respective playback speeds.

If "PVR_assist_substream_1x_decodable_flag" is set to a value of "1", sub-streams do not require any additional resources and throughput capabilities of a 1x decoder (as defined in clause D.3.4.4) when played at their pre-defined trick-mode speeds.

D.3.4.4 Sub-stream associated with a Playback speed (normative)

The following defines a sub-stream that is signalled with playback speed information as it is constructed by the encoder.

- A sub-stream is a fully decodable subset of pictures that can be extracted from the original stream.
- A sub-stream where the "PVR_assist_substream_1x_decodable_flag" is set to "1" obeys the following constraints:
 - Max bitrate constraint: The sum of sizes of "Number of pictures per second" consecutively decoded pictures in the sub-stream does not exceed the "VCL max size" indicated in table D.9.
 - Jitter constraint: Let " S " be the intended playback speed of the sub-stream relative to the original stream from which the sub-stream is extracted. *The maximum number of pictures in the original stream between two consecutive signalled pictures in the sub-stream, in output order, shall not exceed the following values:*
 - 2 if $S < 2$
 - $2 \times \text{Ceil}(S-1)$ if $2 \leq S < 4$
 - $3 \times \text{Ceil}(S)$ if $4 \leq S < 19$
 - $4 \times \text{Ceil}(S)$ if $S \geq 19$

Where: "Ceil" is the upward rounding function.

Table D.9: VCL maximum size values

IRD	Frame rate (Hz)	Number of pictures per second	H.264/AVC VCL max size	HEVC VCL max size
25 Hz or 30 Hz H.264/AVC SDTV	24 or 24 000 / 1 001	24	10 Mbits	Not applicable
	25	25	10 Mbits	Not applicable
	30 or 30 000 / 1 001	30	10 Mbits	Not applicable
25 Hz or 30 Hz HDTV	24 or 24 000 / 1 001	24	25 Mbits	Not applicable
	25	25	25 Mbits	Not applicable
	30 or 30 000 / 1 001	30	25 Mbits	Not applicable
	50	50	25 Mbits	Not applicable
	60 or 60 000 / 1 001	60	25 Mbits	Not applicable
50 Hz or 60 Hz HDTV	24 or 24 000 / 1 001	24	62,5 Mbits	20 Mbits
	25	25	62,5 Mbits	20 Mbits
	30 or 30 000 / 1 001	30	62,5 Mbits	20 Mbits
	50	50	62,5 Mbits	20 Mbits
	60 or 60 000 / 1 001	60	62,5 Mbits	20 Mbits
UHDTV	24 or 24 000 / 1 001	24	Not applicable	40 Mbits
	25	25	Not applicable	40 Mbits
	30 or 30 000 / 1 001	30	Not applicable	40 Mbits
	50	50	Not applicable	40 Mbits
	60 or 60 000 / 1 001	60	Not applicable	40 Mbits

D.3.4.5 Examples of sub-streams (informative)

Sub-streams are constructed on the encoding side to help the PVR devices perform pre-defined trick-play speeds. The GOP structures chosen by the encoder are constrained such that trick-mode operation is possible considering the PVR device's capabilities. However, the present document does not impose specific GOP structures, and the encoder still has to derive them in order to maximize the coding efficiency and to obey other constraints.

The PVR device may choose different strategies to achieve the desired trick-mode speed. The most common are as follows:

- Display evenly distributed pictures. The sub-stream depicted in figure D.4 shows an example achieving a 2x trick-mode display speed using this strategy.
- Display RAP and the middle of the GOP pictures. The sub-stream depicted in figure D.5 illustrates an example to achieve a 4x trick-mode display speed.
- Display only RAP pictures.

While constructing Sub-streams, the encoder infers implicitly such a trick-mode strategy, and when "PVR_assist_substream_1x_decodable_flag" is set to "1", it ensures that even a 1x capable decoder may perform it.

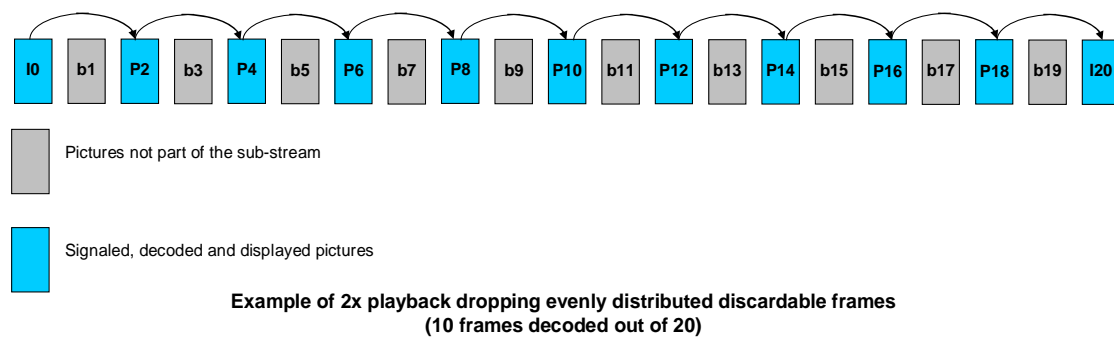

Figure D.4

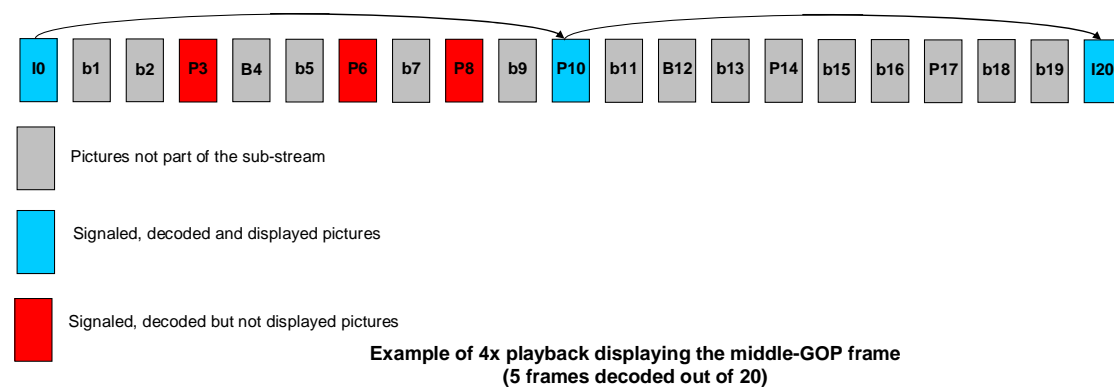

Figure D.5

D.3.5 Segmentation signalling

Segmentation information provided in the PVR assist information enhances the implementation of PVR applications with the following:

- 1) Segment (chapter) identification.
- 2) Program identification.
- 3) Start of a segment.

- 4) End of a segment.
- 5) Start of a program.
- 6) End of a program.
- 7) Location of scene change.

The rules for transmission of segmentation information and associated receiver behaviour are outside the scope of the present document.

NOTE: Other standards also supply methods to signal segmentation. It is possible multiple methods may be employed with a single service. In such case, the service operator should take care to ensure matching information is supplied via each method used. If a conflict exists, the method documented in this annex should be used.

D.3.6 PVR Assistance Signalling Syntax

Table D.10: PVR_assist_information data field

Syntax	No. bits	Mnemonic
PVR_assist_information() {		
data_field_tag	8	uimsbf
data_field_length	8	uimsbf
if (data_field_length > 0) {		
PVR_assist_tier_pic_num	3	uimsbf
PVR_assist_block_trick_mode_present_flag	1	bslbf
PVR_assist_pic_struct_present_flag	1	bslbf
PVR_assist_tier_next_pic_in_tier_present_flag	1	bslbf
PVR_assist_substream_info_present_flag	1	bslbf
PVR_assist_extension_present_flag	1	bslbf
if (PVR_assist_block_trick_mode_present_flag == "1") {		
PVR_assist_pause_disable_flag	1	bslbf
PVR_assist_fwd_slow_motion_disable_flag	1	bslbf
PVR_assist_fast_fwd_disable_flag	1	bslbf
PVR_assist_rewind_disable_flag	1	bslbf
PVR_assist_reserved_0	4	"0000"
}		
if (PVR_assist_pic_struct_present_flag == "1") {		
PVR_assist_pic_struct	4	uimsbf
PVR_assist_reserved_0	4	"0000"
}		
if (PVR_assist_tier_next_pic_in_tier_present_flag == "1") {		
PVR_assist_tier_next_pic_in_tier	7	uimsbf
PVR_assist_reserved_0	1	"0"
}		
if (PVR_assist_substream_info_present_flag == "1") {		
for (i = 0; i < 4; i++) {		
PVR_assist_substream_flag_i	1	bslbf
}		
PVR_assist_substream_speed_info_present_flag	1	bslbf
PVR_assist_substream_1x_decodable_flag	1	bslbf
PVR_assist_reserved_0	2	"00"
if (PVR_assist_substream_speed_info_present_flag == "1") {		
for (i = 0; i < 4; i++) {		
PVR_assist_substream_speed_idx_i	4	uimsbf
}		
}		
}		
if (PVR_assist_extension_present_flag == "1") {		
PVR_assist_segmentation_info_present_flag	1	bslbf
PVR_assist_tier_m_cumulative_frames_present_flag	1	bslbf
PVR_assist_tier_n_mmco_present_flag	1	bslbf
PVR_assist_temporal_id_info_present_flag	1	bslbf

Syntax	No. bits	Mnemonic
PVR_assist_reserved_0	4	"0000"
if (PVR_assist_segmentation_info_present_flag == "1") {		
PVR_assist_seg_id	8	uimsbf
PVR_assist_prq_id	16	uimsbf
PVR_assist_seg_start_flag	1	bslbf
PVR_assist_seg_end_flag	1	bslbf
PVR_assist_prq_start_flag	1	bslbf
PVR_assist_prq_stop_flag	1	bslbf
PVR_assist_scene_change_flag	1	bslbf
PVR_assist_reserved_0	3	"000"
}		
if (PVR_assist_tier_m_cumulative_frames_present_flag == "1") {		
PVR_assist_tier_m	3	uimsbf
PVR_assist_tier_m_cumulative_frames	5	uimsbf
}		
if (PVR_assist_tier_n_mmco_present_flag == "1") {		
PVR_assist_tier_n_mmco	3	uimsbf
PVR_assist_reserved_0	5	"00000"
}		
if (PVR_assist_temporal_id_info_present_flag == "1") {		
PVR_assist_max_temporal_id	3	uimsbf
PVR_assist_reserved_0	5	"00000"
}		
for (i=0; i<n; i++) {		
PVR_assist_reserved_byte	8	uimsbf
}		
}		

Semantics:

data_field_tag: This shall have the value "0x03".

data_field_length: This indicates the length of this descriptor excluding the "data_field_tag" and "data_field_length" fields. A value of "0" for this field indicates that the encoding constraints as specified in clause D.3.2 shall be met.

PVR_assist_tier_pic_num: For H.264/AVC streams, the tier number of the picture associated with this PVR assistive information equals this value. For H.264/AVC streams, the lowest tier number is equal to "1" and the highest tier number is equal to "7". For H.264/AVC streams, a value of "0" is reserved for future use.

For HEVC streams, this value shall be set as described in clause D.3.3.2a above.

PVR_assist_block_trick_mode_present_flag: This flag can be set to "1" at a non-RAP picture only if its value at the prior RAP picture was set to "1". It shall be set to "1" when the following flags are present:

- 1) PVR_assist_pause_disable_flag.
- 2) PVR_assist_fwd_slow_motion_disable_flag.
- 3) PVR_assist_fast_fwd_disable_flag.
- 4) PVR_assist_rewind_disable_flag.

PVR_assist_pic_struct_present_flag: This field shall be set to "1" only if the video stream is an AVC or HEVC stream and the "PVR_assist_pict_struct" field is present. Otherwise it shall be set to "0".

NOTE 1: If "PVR_assist_pict_struct_present_flag" is set to "0" and the AU_information data field is included, then "pict_struct" information may be available in the AU_information data field.

PVR_assist_tier_next_pic_in_tier_present_flag: This field shall be set to "1" when the "PVR_assist_tier_next_pic_in_tier" is present; otherwise it shall take the value "0".

PVR_assist_substream_info_present_flag: *This field shall be set to "1" when values are present for the four flags corresponding to "PVR_assist_substream_flag_i" = 0 to 3, and for "PVR_assist_substream_speed_info_present_flag".*

PVR_assist_extension_present_flag: *this field shall be set to "1" if any of the following flags is set to "1":*

- 1) PVR_assist_segmentation_info_present_flag.
- 2) PVR_assist_tier_m_cumulative_frames_present_flag.
- 3) PVR_assist_tier_n_mmco_present_flag.
- 4) PVR_assist_temporal_id_info_present_flag.

Otherwise it shall be set to "0". In some cases, these extension flags may be provided only with pictures corresponding to RAPs.

PVR_assist_pause_disable_flag: *The value of this flag shall be implied to be "0" unless provided explicitly in this field. This flag is set to "1" to signal disabling pause until the next RAP picture. The value of this flag at a non-RAP picture shall be equal to its value at the prior RAP picture.*

PVR_assist_fwd_slow_motion_disable_flag: *The value of this flag shall be implied to be "0" unless provided explicitly in this field. This flag is set to "1" to signal disabling forward slow motion, including frame stepping, until the next RAP picture. The value of this flag at a non-RAP picture shall be equal to its value at the prior RAP picture.*

PVR_assist_fast_fwd_disable_flag: *The value of this flag shall be implied to be "0" unless provided explicitly in this field. This flag is set to "1" to signal disabling fast forward until the next RAP picture. The value of this flag at a non-RAP picture shall be equal to its value at the prior RAP picture.*

PVR_assist_rewind_disable_flag: *The value of this flag shall be implied to be "0" unless provided explicitly in this field. This flag is set to "1" to signal disabling rewind, including reverse slow motion and frame stepping, until the next RAP picture. The value of this flag at a non-RAP picture shall be equal to its value at the prior RAP picture.*

PVR_assist_pic_struct: *This shall reflect the "pic_struct" value of the AU in the AVC elementary stream (ES). If the ES carries the "Picture Timing SEI Message" with the "pic_struct" field, this shall be equal to that value. If "pic_struct" is not carried within the ES, then for AVC this value should reflect that of table D-1 of Recommendation ITU-T H.264 / ISO/IEC 14496-10 [16], and for HEVC this value should reflect that of table D-2 of HEVC [35].*

PVR_assist_tier_next_pic_in_tier: *The value of this field indicates the relative location in decoding order of the next picture in the video stream with the tier number equal to "PVR_assist_tier_pic_num". A value of "0" indicates the next picture in decoding order. A value of "127" indicates that the relative location of the next picture sharing the same tier is not known.*

NOTE 2: The "PVR_assist_tier_next_pic_in_tier" field may be associated with any picture, but it is recommended that this field is not used in real-time applications where low encoding delay is desired.

PVR_assist_substream_flag_i: *This field shall be set to "1" to signal that the associated picture is to be extracted to construct the sub-stream whose playback speed is indicated by "PVR_assist_substream_speed_idx_i". This flag shall be set to "0" if "PVR_assist_substream_speed_idx_i" is equal to "0000".*

PVR_assist_substream_speed_info_present_flag: *This field shall be set to "1" when "PVR_assist_substream_speed_idx_i" is not equal to "0000" for 'i' in the range "0" through to "3" inclusive.*

PVR_assist_substream_1x_decodable_flag: *This field shall be set to "1" when all sub-streams follow the constraints in clause D.3.4.4.*

PVR_assist_substream_speed_idx_i: *When set to a non-zero value, this field provides the speed for the extractable sub-stream containing the pictures identified by "PVR_assist_substream_flag_i" = "1", while a zero value is used to avoid defining a sub-stream. The value of "PVR_assist_substream_speed_idx" is used to look-up the corresponding trick mode speed value in table D.11. A non-zero value of "PVR_assist_substream_speed_idx" indicates a sub-stream in accordance to clause D.3.4.4. The value of "PVR_assist_substream_speed_idx_i" at a non-RAP picture shall be equal to its value at the prior RAP picture.*

NOTE 3: "PVR_assist_substream_speed_idx_i" may be associated with any picture but it is recommended to be provided only with RAP pictures. If possible, it is also recommended to avoid changes to "PVR_assist_substream_speed_idx_i".

Table D.11: Trick mode index to speed values

Index	Trick Mode Speed
0	No defined sub-stream
1	1,25
2	1,5
3	2,0
4	2,5
5	3,0
6	4,0
7	5,0
8	6,0
9	8,0
10	10,0
11	12,0
12	16,0
13	20,0
14	24,0
15	30,0

PVR_assist_segmentation_info_present_flag: This field shall be set to "1" if the "PVR_assist_segmentation_info" field is present. Otherwise it shall be set to "0".

NOTE 4: The "PVR_assist_segmentation_info" field may be associated with any picture but it is recommended that "PVR_assist_segmentation_info" is only associated with the first and last pictures of each segment and when scene changes are indicated.

PVR_assist_tier_m_cumulative_frames_present_flag: This field shall be set to "1" if the "PVR_assist_tier_m" field and "PVR_assist_tier_m_cumulative_frames" are present. Otherwise it shall be set to "0". For HEVC, it is recommended that this flag is set to "0".

NOTE 5: The "PVR_assist_tier_m_cumulative_frames_present_flag" may be associated with any picture but it is recommended to be set only on RAP pictures.

PVR_assist_tier_n_mmco_present_flag: This field shall be set to "1" if the "PVR_assist_tier_n_mmco" field is present. Otherwise it shall be set to "0".

NOTE 6: The "PVR_assist_tier_n_mmco_present_flag" may be associated with any picture but it is recommended to be set only on RAP pictures.

For HEVC bitstreams, the "PVR_assist_tier_n_mmco_present_flag" shall be set to "0".

PVR_assist_temporal_id_info_present_flag: This field shall be set to "1" if "PVR_assist_max_temporal_id" is present. In some cases, this flag may be provided only with pictures corresponding to RAPs. This field shall be set to "0" for AVC streams.

PVR_assist_seg_id: This field conveys the "id" of the segment to which the picture belongs. "PVR_assist_seg_id" shall be sent in ascending order resuming at program start and beginning at 0. A value of "255" is used to indicate an undefined segment id.

PVR_assist_prg_id: This field conveys the "id" of the program to which the picture belongs. The information provided in this field can be used to obtain the title or other attributes of the program from program guide information. The "id" of a program for a particular program guide information service has to be available to the encoder to provide this field. A value of "65535" is used to indicate an undefined program id.

PVR_assist_seg_start_flag: This field shall be set to "1" on the first picture in presentation time order of a segment. Otherwise it shall be set to "0". This segment is identified by the "PVR_assist_seg_id" field.

PVR_assist_seg_end_flag: This field shall be set to "1" on the last picture in presentation time order of a segment. Otherwise it shall be set to "0". This segment is identified by the "PVR_assist_seg_id" field.

PVR_assist_prg_start_flag: This field shall be set to "1" on the first picture in presentation time order of a program. Otherwise it shall be set to "0". This program is identified by the "PVR_assist_prg_id" field.

PVR_assist_prg_stop_flag: *This field shall be set to "1" on the last picture in presentation time order of a program. Otherwise it shall be set to "0". This program is identified by the "PVR_assist_prg_id" field.*

PVR_assist_scene_change_flag: *This field shall be set to "1" at the first display-order picture of a new scene that carries this flag. Note that the present document does not define "scene change".*

PVR_assist_tier_m: This field is the tier number associated with "PVR_assist_tier_m_cumulative_frames". The value of this field should be chosen to signal a sufficient number of frames via "PVR_assist_tier_m_cumulative_frames" which would provide for smooth playback speeds of 2x and above. The value of this field should be chosen to provide less than or equal to half of the number of frames per second of the original frame rate.

NOTE 7: For HEVC this field is recommended not to be present.

PVR_assist_tier_m_cumulative_frames: This field conveys the value of the intended minimum number of extractable frames per second from tier 1 through "PVR_assist_tier_m".

NOTE 8: For HEVC this field is recommended not to be present.

PVR_assist_tier_n_mmco: This field represents the smallest tier number below which MMCOs can be ignored by decoders during trick-play modes. If this field is set to "7", then this signals that MMCOs could be present on any tier signalling reference pictures. If this field is set to "1", then this signals that the video stream does not contain MMCOs.

NOTE 9: For HEVC, this field is not present.

PVR_assist_max_temporal_id: The value of this field represents the maximum TemporalId of associated HEVC video stream. *This value shall be set to the same value as the field `sps_max_sub_layers_minus1` of the sequence parameter set corresponding to the frame to which this field applies. The value of "PVR_assist_max_temporal_id" shall be in the range of 0 to 6, inclusive.* The value of this field may be used to provide the information about trick mode speeds those are supported from the stream and corresponding ranges of TemporalId values.

NOTE 10: For AVC, this field is not present.

PVR_assist_reserved_byte: This field allows for future PVR assist information to be conveyed in the stream.

Annex E (normative): Supplementary Audio Services

E.1 Overview

Supplementary audio (SA) services provide an additional audio soundtrack that provides an additional feature or function over and above that provided by the main audio stream. The SA stream may be provided using one of two schemes:

- "Broadcast mix": pre-mixed by the broadcaster and offered as an alternative audio stream.
- "Receiver mixed": mixed in the receiver under the control of signalling provided by the broadcaster plus some limited control of the user.

This annex only deals with receiver-mixed SA services. Further information on the DVB-SI signalling for receiver-mixed SA services can be found in clause J.2 of ETSI EN 300 468 [i.32].

Examples of SA services include audio description for the visually impaired, audio for the hearing impaired ("Clean Audio") and a director's commentary. The language used in this annex is mainly in terms of an audio description service although it is equally applicable to all SA applications.

Audio Description (AD) delivers a description of the scene. It is intended to aid understanding and enjoyment particularly, but not exclusively, for viewers who have visual impairments.

Clean Audio refers to audio providing improved intelligibility. It is targeted for viewers with hearing impairments, but can as well serve as improvement for listening in noisy environments like airplanes.

Loud sound effects or music could make the added supplementary audio hard to discern so an important requirement is to adjust, on a passage-by-passage basis, the relative level of programme sound in the mix which the SA user hears. The programme maker is best able to determine the level under controlled conditions when authoring the SA information to modulate the level of programme sound in the SA-capable receiver so suitable SA information is thus transmitted within the SA stream.

Individual SA users will have different aural acuity, describers (of AD) will have different styles of delivery (voice pitch and timbre), several voices may be used to describe one programme and there are, in practice, differences in audio signal level for different home receivers. An essential requirement is for the user to be able to adjust the volume of the SA signal to suit his/her condition.

The ability to optionally mix one or more supplementary additional audio channels with the main programme sound can have other applications, including multi-language commentaries, use for interactivity, and educational purposes.

E.2 Syntax and semantics

SA control information is coded in PES_private_data within the PES encapsulation of the coded SA component in accordance with Recommendation ITU-T H.222.0 / ISO/IEC 13818-1 [1].

Table E.1: AD_descriptor

Syntax	value	No. of Bits	Identifier
AD_descriptor {			
Reserved	1111	4	bslbf
AD_descriptor_length		4	bslbf
AD_text_tag	0x4454474144	40	bslbf
version_text_tag		8	bslbf
AD_fade_byte	0xXX	8	bslbf
AD_pan_byte	0xYY	8	bslbf
if (version_text_tag == 0x31) {			
Reserved	0xFFFFFFFF	24	bslbf
}			
if (version_text_tag == 0x32) {			
AD_gain_byte center	0xUU	8	bslbf
AD_gain_byte front	0xVV	8	bslbf
AD_gain_byte surround	0xWW	8	bslbf
}			
Reserved	0xFFFFFFFF	32	bslbf
}			

AD_descriptor_length: The number of significant bytes following the length field (i.e. 8 or 11).

AD_text_tag: A string of 5 bytes forming a simple and unambiguous means of distinguishing this from any other PES_private_data. A receiver which fails to recognize this tag should not interpret this audio stream as audio description.

version_text_tag: The AD_text_tag is extended by a single ASCII character version designator (here "1" indicates revision 1). *Descriptors with the same AD_text_tag but a higher version number shall be backwards compatible with the present document* - the syntax and semantics of the fade and pan fields will be identical but some of the reserved bytes may be used for additional signalling.

AD_fade_byte: Takes values between 0x00 (representing no fade of the main programme sound) and 0xFF (representing a full fade). Over the range 0x00 to 0xFE one lsb represents a step in attenuation of the programme sound of 0,3 dB giving a range of 76,2 dB. The fade value of 0xFF represents no programme sound at all (i.e. mute). The rate of signalling and the expected behaviour of a decoder to changes in fade byte are described below.

AD_pan_byte: Takes values between 0x00 representing a central forward presentation of the audio description and 0xFF, each increment representing a $360/256$ degree step clockwise looking down on the listener (i.e. just over 1,4 degrees, see figure E.2). The rate of signalling and the expected behaviour of a decoder are described below.

AD_gain_byte_center: Represents a signed value in dB. Takes values between 0x7F (representing +76,2 dB boost of the main programme centre) and 0x80 (representing a full fade). Over the range 0x00 to 0x7F one lsb represents a step in boost of the programme centre of 0,6 dB giving a maximum boost of +76,2 dB. Over the range 0x81 to 0x00 one lsb represents a step in attenuation of the programme centre of 0,6 dB giving a maximum attenuation of -76,2 dB. The gain value of 0x80 represents no main centre level at all (i.e. mute). The rate of signalling and the expected behaviour of a decoder to changes in gain byte are described below.

AD_gain_byte_front: As AD_gain_byte_center, applied to left and right front channel.

AD_gain_byte_surround: As AD_gain_byte_center, applied to all surround channels.

The maximum rate of signalling of fade, pan and gain values is determined by the number of audio PES packets per second for that SA stream. For efficiency several Access Units (AUs) of audio are typically encapsulated within one PES packet and the fade and pan values in each AD_descriptor are deemed to apply to each AU encapsulated within, and which commences in, that PES packet. In typical efficient encapsulation fade and pan values are transmitted every 120 ms to 200 ms. This allows the control over the attack and decay of a fade where a particular gap in the narrative permits.

An AD decoder maintains the relative timing between the decoded AD signal and the decoded programme sound signal and between the appropriate fade, pan and gain values and the decoded description signal.

During programmes for which there is no description there is little reason to transmit an SA stream of continual silence; in these cases the bitrate accorded to SA may be reassigned for other purposes. Decoders should therefore be able to respond promptly to the restoration of the SA component at the start of a described programme.

In the case of AD, the streams for programme sound and for AD are distinguished in the PSI by the use of the ISO_639_language descriptor. The audio_type field within the descriptor associated with programme sound is typically assigned the value 0x00 ("undefined") whilst the equivalent descriptor associated with AD has its audio_type field assigned the value 0x03 ("visual impaired commentary"). If a service has AD in several languages the PMT reference to each stream will have the appropriate ISO_639_language_code and the AD-capable decoder should discriminate between them on the basis of the preferred language chosen in the user settings.

In the case of Clean Audio, the streams for programme sound and for Clean Audio are distinguished in the PSI by the use of the ISO_639_language descriptor. The audio_type field within the ISO_639_language descriptor associated with main programme sound is typically assigned the value 0x00 ("undefined") whilst the equivalent descriptor associated with Clean Audio has its audio_type field assigned the value 0x02 ("hearing impaired").

E.3 Coding for Audio Description SA services

AD content is voice-only and is conveyed as a mono signal coded in accordance with ISO/IEC 11172-3 [9] or ISO/IEC 14496-3 [17] or ETSI TS 102 366 [12] or ETSI TS 103 190-1 [43]. *The coding scheme used for the main audio service determines the coding scheme used for the description service (i.e. they shall use the same coding standard) and the sampling rate shall be the same for both services.*

The principles of processing in a SA decoder in the case of AD when main audio is stereo are shown diagrammatically in figure E.1.

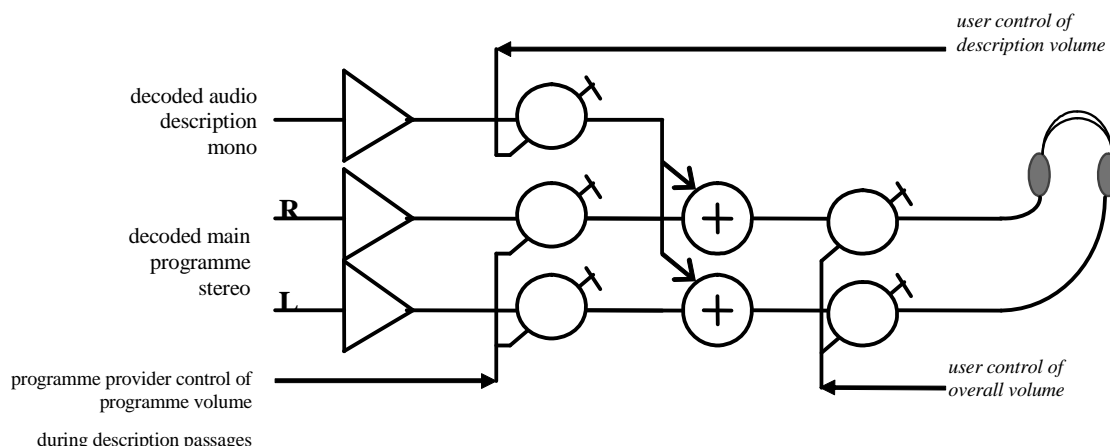

Figure E.1: Functionality of AD decoder processing

The level by which the main programme sound should be attenuated during a description passage is signalled in PES_private_data within the PES encapsulation of the coded SA component (as specified in Recommendation ITU-T H.222.0 / ISO/IEC 13818-1 [1]).

Encoding: Support for the encoding of AD is optional.

Decoding: Support for the decoding of AD is optional.

The signalled fade value is an unsigned byte value, 0x00 representing 0 dB, each increment representing a nominal 0,3 dB, 0xFE representing approximately -76,2 dB whilst the fade value 0xFF represents completely mute programme sound.

The signalled gain values for centre, front (L/R) and surround of the main programme represent a signed byte value, with 0x00 representing 0 dB, 0x7F representing +76,2 dB boost, 0x81 representing -76,2 dB and 0x80 complete mute. This allows a gain of -76,2 to +76,2 in steps of nominal 0,6 dB.

To obtain the attenuation/boost for left and right channel, the front gain value and the fade value are converted to factors and multiplied. This factor is then applied to left and right main channel. The attenuation/boost for a centre channel, if present, is obtained from centre gain value and fade value. The surround gain value is applied similarly to all present surround channels.

A pan control value is also included within the transmitted data structure, enabling the decoded SA signal (when delivered as a separate mono stream) to be panned around the sound stage of the main programme sound and thus allowing the programme maker to place the "describer" at any preferred position within the sound field. As with fade, transmitted pan is a byte value, 0x00 representing centre front where each increment represents about 1.4° clockwise looking down on the listener (see Figure E.2). For stereo the pan value will be restricted to $\pm 30^\circ$ of the centre front (i.e. to the range 0xEB..0xFF and 0x00..0x15) but the syntax of the signalling allows for any future use in which an AD component might be provided with a surround-sound main programme audio.

The values of fade, pan and gain are signalled in a PES packet apply to each access unit of AD sound contained within that same PES packet. This allows fade, pan and gain to be relatively gradual or to be abrupt as the programme material allows.

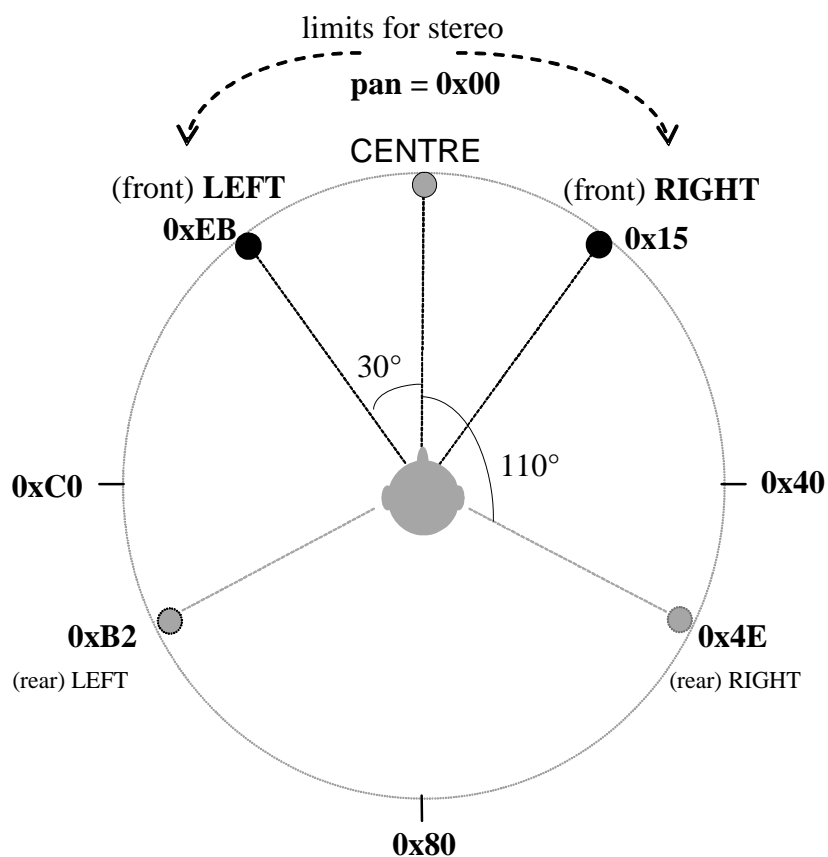

NOTE: Seen from above the listener; includes mapping onto multi-channel sound presentation.

Figure E.2: Interpretation of audio description pan value

E.4 Coding for Clean Audio SA services

In case an AD_descriptor is present in conjunction with a service signalled as audio_type 0x00 ("undefined"), the AD descriptor is utilized to provide a clean audio service. The level by which the main audio service should be attenuated for Clean Audio output is signalled in PES_private_data within the PES encapsulation of the main programme audio component (as specified in Recommendation ITU-T H.222.0 / ISO/IEC 13818-1 [1]). In this case, only **AD_gain_byte_center**, **AD_gain_byte_front** and **AD_gain_byte_surround** are evaluated. This allows for a dynamic level modification of channel groups in a surround sound setup.

Encoding: Support for the encoding of Clean Audio is optional.

Decoding: Support for the decoding of Clean Audio is optional.

The principles of processing in a SA decoder in the case of Clean Audio are shown diagrammatically in figure E.3.

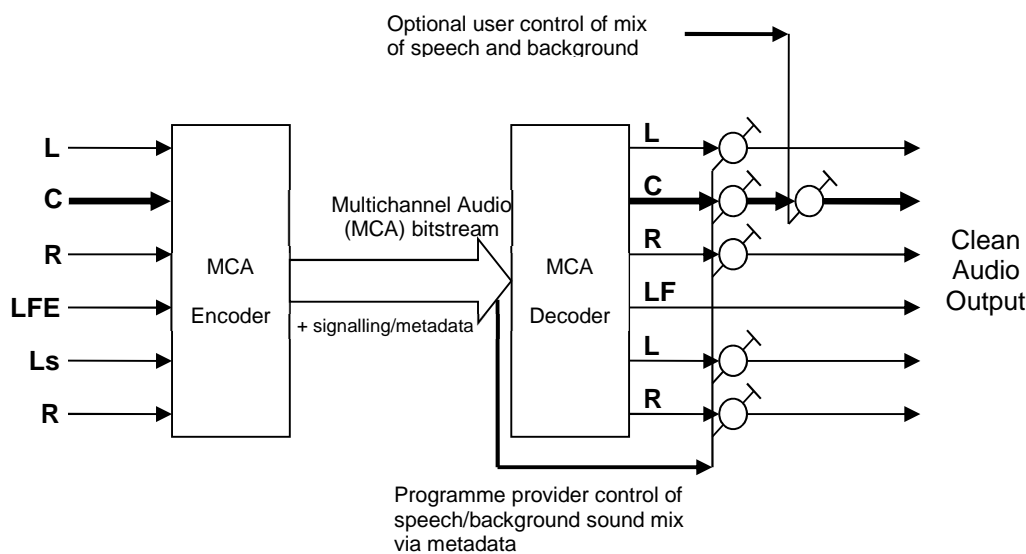

Figure E.3: Functionality of Clean Audio decoder processing

The audio processor should accentuate the level of the centre channel (containing the dialogue) and attenuate the other channels, according to the values signalled in the AD_descriptor. The level of the centre channel added should additionally be under user control to allow individual tailoring of the sound for audibility.

E.5 Decoder behaviour

If there is a valid AD descriptor in the encoded description signal for the selected service, the SA decoder should present the appropriate mix of programme sound and associate signal to the user, attenuating the programme sound by 0,3 dB per fade value increment and 0,6 dB per gain value step. If the SA decoder cannot support such small steps then the implemented attenuation should match the intended attenuation as closely as possible. For example if only -1 dB steps are possible then fade values of 0x00 and 0x01 should map to 0 dB, 0x02, 0x03 and 0x04 should map to -1 dB, 0x05, 0x06, 0x07 and 0x08 to -2 dB, etc.

When fade and gain values are 0x00 (or in the absence of an SA stream for AD) the programme sound level should be unattenuated. Care should be taken to ensure that the default levels of programme sound and supplementary signal are consistent when fed with streams coding standard level signals. It is also important that the mono supplementary audio is matrixed to the stereo output so as to achieve a constant perceived volume as the supplementary audio is panned from stereo left through stereo centre to stereo right.

NOTE 1: E.g. using a model based on constant power as the description is panned across the stereo sound stage.

NOTE 2: The perceived loudness level of the main programme audio may well vary between different broadcast services. If the main programme audio is derived from a system using gain control metadata, for example AC-3, then the perceived loudness of the programme dialogue should be constant but it is likely to be different to that of a service for which the programme sound is delivered as MPEG-1 Layer II. For any receiver which can decode main audio sources other than MPEG-1 Layer II, the manufacturer may need to consider implementing different default gain levels for the audio description signal to provide a reasonable match of loudness to that of the programme dialogue. The ability of the user to adjust the relative level of description should nevertheless be retained.

In a stereo environment the SA decoder should interpret any pan values outside the ranges 0xEB..0xFF and 0x00..0x15 in the following manner. Pan values from 0x16 to 0x7F inclusive should be mapped to the value 0x15 (i.e. stereo hard right). Pan values from 0x80 to 0xEA should be mapped to the value 0xEB (i.e. stereo hard left).

When the user selects a new service or if the SA decoder detects an error in, or absence of, the AD descriptor in the encoded SA signal, the SA decoder should have a strategy which leads to muting the decoded description signal, restoring the programme sound to its default unfaded amplitude and setting the effective fade, pan and gain values to 0x00. This restoration should not be abrupt - it is recommended that under such conditions the value of fade and of pan are ramped to the default values (0x00) over a period of at least 1 second. Equally, if the SA stream component is suddenly regained the implemented value of fade, pan and gain should be ramped to the signalled values from the default values (0x00) over a similar period.

E.6 Decoder user indicators

Description, in the case of AD, is typically confined to gaps in the programme narrative; these opportunities are therefore dependent on the programme. Some programmes are more suited to description than others; one may be effectively self-describing whilst another (e.g. news or a studio interview) might offer no opportunity for descriptive interpolation. Receiver implementations of SA should therefore allow the user to confirm that, in what may be extended gaps between description passages, description silence does not necessarily imply failure in delivery of the service or in the receiving equipment.

Many potential users of AD will be visually impaired. The user interface should not, therefore, rely solely on visual clues (lights or on-screen display logos) to indicate status (e.g. presence or absence of description). Audible indications are desirable and designers should consider how to distinguish different states using, for example, contrasting tones.

Conversely, many potential users of Clean Audio will be hearing impaired. The user interface, in this case, should rely more on visual feedback than audible indications.

E.7 Advanced Clean Audio Services

E.7.0 Introduction

The Clean Audio service as described in clause E.4 is only applicable to a multichannel audio service with the additional restriction that the dialogue is exclusively mixed into the center channel.

The Advanced Clean Audio supplemental audio service specified in this clause enables Dialogue Enhancement for stereo and multichannel audio services. In general, it is applicable to all channel layouts. For multichannel audio it can be used for dialogue that is mixed into all front channels or for center-only dialogue. It allows enhancing only the dialogue signal part of a channel's signal instead of the complete channel signal.

Dialogue Enhancement is based on MPEG SAOC (ISO/IEC 23003-2 [39]). MPEG SAOC is a very powerful technology that allows manipulation of audio objects during rendering for any number of audio objects. It does not only allow gain changes, but also re-panning of objects in the audio scene. The main principle is that all audio objects are mixed to one audio signal for transmission. Additional parametric side information enables the manipulation of the mixed audio signal in the decoder, based on user interaction.

A subset of the MPEG SAOC functionality is used for Dialogue Enhancement. This subset is specified in the MPEG SAOC Dialogue Enhancement Profile (SAOC-DE) in ISO/IEC 23003-2 [39].

E.7.1 Basic Principle

The SAOC-DE encoder receives the sources, analyses those sources in relation to the mixed audio signal and produces a stream of side information data from the signal analysis. The dialogue and background input signals can be mixed internally or (as shown in the Figure E.4) an external mix is used together with a clean dialogue or background signal. The mixed signal is encoded with an audio codec such as MPEG-4 AAC or HE AAC. The stream of SAOC-DE side information is embedded into the encoded audio bit stream.

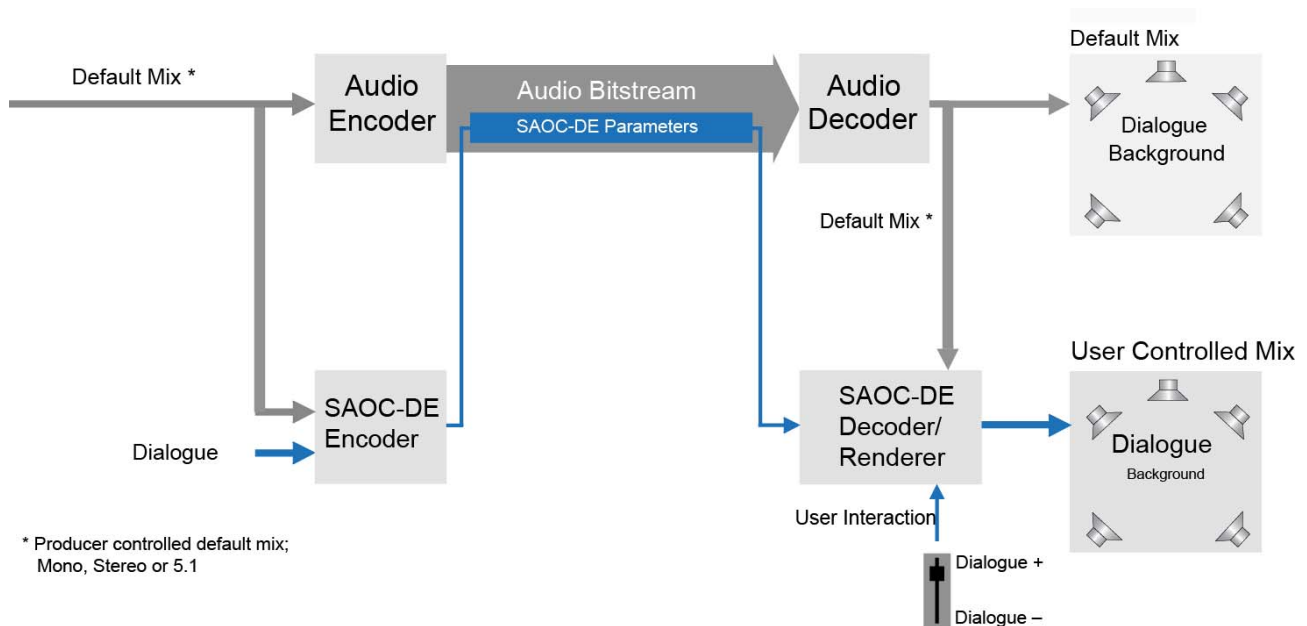

Figure E.4: Example Signal Flow Diagram

On the receiving side, after the audio bit stream is decoded, the SAOC-DE decoder takes the decoded mix signal and uses the descriptive data from the SAOC-DE side information stream to enable access to the audio sources. The user is then able to adjust the volume of the dialogue relative to the background, e.g. to improve the intelligibility of the dialogue.

There are two modes of operation for the SAOC-DE encoder: the "basic mode" with a parametric description of the audio sources as described above and the "enhanced mode" with additional residual information. The residual information can be used in the decoder and renderer to further increase the range where the volume of dialogue can be changed. The residual information is also part of the side information stream. Preset control data that easily configures one or more target sound scenes can also be transmitted in the side information.

The technology is fully compatible with existing transmission and playback equipment. Legacy devices that are not capable of decoding the parametric side information will play back the default mix signal and ignore the side information. The audio quality of the mix signal is not compromised.

All channel configurations defined in clause 6 are supported, including mono, stereo and multichannel 5.1. The number of rendered output channels for the user controlled mix is always equal to the number of channels of the default mix at the audio decoder output.

E.7.2 Control Information

*Advanced Clean Audio "Dialogue Enhancement" (DE) control information, when present, shall be coded as **DE_control_data** according to table E.2. This information shall be carried as **PES_private_data** within the PES packet header of the audio component that carries the coded SAOC-DE parametric data. The usage of the **PES_private_data** field is in accordance with Recommendation ITU-T H.222.0 / ISO/IEC 13818-1 [1].*

Note that the **PES_private_data** field has a fixed length of 16 Bytes, so that the **DE_control_data** structure needs to be padded at the end with **fill_byte** up to this length.

Table E.2: DE_control_data

Syntax	Value	No. of Bits	Identifier
DE_control_data {			
Reserved	1111	4	bslbf
DE_control_data_length		4	uimsbf
DE_text_tag	0x4143414445	40	bslbf
DE_version_text_tag		8	bslbf
if (DE_version_text_tag == 0x31) {			
DE_SAOC-DE_in_band		1	bslbf
DE_mode		4	uimsbf
DE_loudness_compensation_info		1	bslbf
Reserved	11	2	bslbf
DE_max_attenuation_dialogue		8	uimsbf
DE_max_attenuation_background		8	uimsbf
if (DE_loudness_compensation_info == 1) {			
DE_loudness_diff_dialogue		8	uimsbf
DE_loudness_diff_background		8	uimsbf
}			
}			
for (i=0; i<N; i++) {			
fill_byte	0xFF	8	bslbf
}			
}			

DE_control_data_length: The number of significant bytes (excluding any fill bytes) following the length field (i.e. 9 or 11).

DE_text_tag: A string of 5 bytes forming a simple and unambiguous means of distinguishing this from any other PES_private_data. A receiver, which fails to recognize this tag ("ACADE") should not interpret this audio elementary stream as carrying dialogue enhancement data (SAOC-DE).

NOTE: The **DE_text_tag** value corresponds to the string "ACADE" = "Advanced Clean Audio - Dialogue Enhancement".

DE_version_text_tag: The **DE_text_tag** is extended by a single ASCII character version designator (here the ASCII character "1", i.e. **DE_version_text_tag** == 0x31, indicates revision 1). A **DE_control_data** component with the same **DE_text_tag** but a higher version number shall be backwards compatible with the present document.

DE_SAOC-DE_in_band: This flag is set to **DE_SAOC-DE_in_band** == 1 if the SAOC-DE side information is embedded into the main audio bitstream. It is set to **DE_SAOC-DE_in_band** == 0 if the SAOC-DE side information is delivered as a separate bitstream.

DE_mode: Information which channels of the main audio service carry dialogue signal. In case of multichannel audio the channels which do not carry dialogue signals will not be processed by the SAOC-DE decoder but by-passed as described below.

Table E.3: DE_mode

Syntax	Value
Stereo service with dialogue on left and right channel	0
Multichannel service with dialogue on center channel	1
Multichannel service with dialogue on the left, center and right channels	2
Mono service	3
Reserved	4-15

DE_loudness_compensation_info: This field signals if loudness compensation information is present.

Table E.4: DE_loudness_compensation_info

Syntax	Value
No loudness compensation info present.	0
Loudness compensation info is present. Reference for loudness compensation info are the dialogue-only and background-only signals.	1

DE_max_attenuation_dialogue: Represents the maximum dialogue attenuation using an unsigned value in steps of 0,25 dB as $max_dialogue_att = DE_max_attenuation_dialogue \times 0,25$ dB. The maximum attenuation that can be signalled is 63,75 dB. A value of **DE_max_attenuation_dialogue** == 0 signals that no user-defined attenuation of the dialogue is allowed. *If DE_control_data is not present, the maximum attenuation shall have the default value of $max_dialogue_att = 63,75$.* The MRC values (Modification Range Control, see [39]) carried inside the SAOC-DE bitstream shall be set accordingly.

DE_max_attenuation_background: Represents the maximum background attenuation using an unsigned value in steps of 0,25 dB as $max_background_att = DE_max_attenuation_background \times 0,25$ dB. The maximum attenuation that can be signalled is 63,75 dB. A value of **DE_max_attenuation_background** == 0 signals that no user-defined attenuation of the background is allowed. *If DE_control_data is not present, the maximum attenuation shall have the default value of $max_background_att = 63,75$.* The MRC values (Modification Range Control, see [39]) carried inside the SAOC-DE bitstream shall be set accordingly.

DE_loudness_diff_dialogue: Represents the loudness difference of the dialogue-only signal compared to the default audio mix signal using an unsigned value in steps of 0,1 dB as $K_{FGO} = -(DE_loudness_diff_dialogue \times 0,1)$ dB. The largest difference value that can be signalled is -25,5 dB.

DE_loudness_diff_background: Represents the loudness difference of the background-only signal compared to the default audio mix signal using an unsigned value in steps of 0,1 dB as $K_{BGO} = -(DE_loudness_diff_background \times 0,1)$ dB. The largest difference value that can signalled is -25,5 dB.

The maximum rate of signalling **DE_control_data** is determined by the number of audio PES packets per second for the audio stream that carries the DE data. For efficiency several access units (AUs) of audio are typically encapsulated within one PES packet and the **DE_max_attenuation_dialogue/background** and **DE_loudness_diff_dialogue/background** values in each **DE_control_data** applies to each AU that starts in that PES packet.

E.7.3 Coding for Dialogue Enhancement SA services

E.7.3.0 General

If the SAOC-DE side information is embedded in the main audio stream (as described in clause E.7.1), the **DE_control_data** may be present in the PES_private_data of the main audio stream. In case the SAOC-DE side information is delivered in a separate supplementary audio stream, the **DE_control_data** is embedded in PES_private_data of this supplementary audio stream.

Encoding: Support for the encoding of SAOC-DE Dialogue Enhancement is optional. *If present, the SAOC-DE side information shall comply with the SAOC Dialogue Enhancement Profile, Level 1 or 2 [39].*

Decoding: Support for the decoding of SAOC-DE Dialogue Enhancement is optional. *If the IRD supports SAOC-DE, the IRD shall be capable of decoding SAOC Dialogue Enhancement Profile Level 2 bitstreams [39].*

The audio processor should accentuate the level of the dialogue signal in those channels that are signalled to contain dialogue (e.g. the left, centre and right channels) and attenuate the background signal parts in those channels. It should further attenuate accordingly the complete other channels containing no dialogue signal. *The dialogue signal shall be equally accentuated or attenuated in all channels that are signalled to contain dialogue. The background signal shall be equally accentuated or attenuated in all channels. The decoding and rendering process shall be performed as further described in clause E.7.4.*

The level change shall be under user control to allow individual tailoring of the sound for audibility. The values **DE_max_attenuation_dialogue** and **DE_max_attenuation_background** signalled in the **DE_control_data** represent the maximum boundaries the device may offer for attenuation of dialogue or background.

E.7.3.1 Supplementary SAOC-DE stream

As an alternative to embedding the SAOC-DE side information into the main audio stream, it may be delivered as a separate supplementary audio stream.

The SAOC data stream shall be encapsulated as an LATM/LOAS stream as described in ISO/IEC 14496-3 [17]. The SAOC data is embedded in Access Units, the Audio Specific Configuration signals only the SAOC-DE AOT (AOT=45) and consists only of the SaocDeSpecificConfiguration.

Note that in this case no encoded AAC audio data is presented in the LATM/LOAS stream.

Further note that the SAOC-DE supplementary audio stream is not a self-dependent audio stream. It is used by the SAOC decoder together with the PCM samples of the main audio as it is described for the case that the SAOC-DE data is embedded into the main audio stream. This is different to the case of e.g. receiver-mix AD as described in clause E.3 that can be decoded to PCM data and mixed with the main audio on PCM level.

To avoid confusion with MPEG-4 AAC data encapsulated in LATM/LOAS, the stream_type 0x11 (as defined in table 2-34 of Recommendation ITU-T H.222.0 / ISO/IEC 13818-1 [1] for ISO/IEC 14496-3 [17] Audio with the LATM transport syntax) should not be used for the supplementary audio SAOC-DE stream. Instead, the stream_type 0x06 (PES packets with private data) should be used.

E.7.4 Decoder and Renderer behaviour

E.7.4.0 Scope

This clause describes the decoding and rendering process if the SAOC-DE data is utilized.

E.7.4.1 Mono/Stereo service with Dialogue Enhancement

In case of a mono or stereo service the audio decoder first decodes the encoded audio data. The decoded audio data of the channels is then forwarded to the SAOC-DE decoder. Additionally, the SAOC-DE side information data that is either embedded in the main audio stream or in a separate supplemental audio stream is also forwarded to the SAOC-DE decoder as illustrated in figure E.5.

Based on user interactivity the gain level of the dialogue or the background may be changed in the SAOC-DE decoder. The user input dialogue gain g_{INPUT} (in decibels) is limited to the maximum modification boundaries defined by $max_dialogue_att$ and $max_background_att$. The limitation is done with:

$$g_{INPUT}^{LIM} = \begin{cases} \max(g_{INPUT}, -max_dialogue_att) & , \text{ if } g_{INPUT} \leq 0 \\ \min(g_{INPUT}, max_background_att) & , \text{ otherwise} \end{cases}$$

Note that when the SAOC preset parameter (predefined rendering information) is present and when it is selected by the user, the dialogue gain g_{INPUT} is set to the preset value.

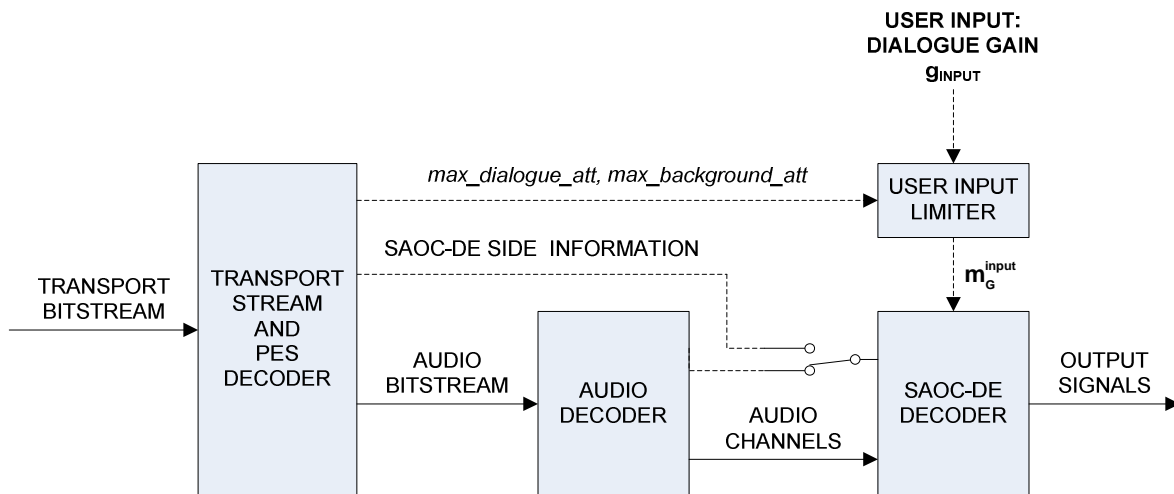

Figure E.5: Stereo service with Dialogue Enhancement

The Dialogue Gain input m_G^{input} to the SAOC-DE decoder is an unsigned float value in linear gain domain, and can be determined from the limited user input gain g_{INPUT}^{LIM} as:

$$m_G^{input} = 10^{0.05 g_{INPUT}^{LIM}}$$

A value of $m_G^{input} == 1$ is equivalent to no gain change to dialogue or background. If $m_G^{input} > 1$, the background is attenuated to enhance the dialogue part of the signal, and if $m_G^{input} < 1$, the dialogue part is attenuated.

Table E.5: Examples for mapping of dB values to input values for m_G^{input} to SAOC-DE Decoder

m_G^{input}	0,25	0,5	1	2	4
Background attenuation in dB	-	-	0	6 dB	12 dB
Dialogue attenuation in dB	12 dB	6 dB	0	-	-
NOTE:	dB values are rounded to integer values for those examples.				

Note that the SAOC-DE decoder only attenuates either the background or the dialogue part of the signal. Thus, there may be a loss in perceived loudness of the modified mix signal that is the output signal of the SAOC-DE decoder compared to the default downmix without any SAOC-DE processing.

*The renderer shall compensate the loss in loudness by a moderate enhancement of this modified mix if **DE_loudness_compensation_info** is set to "1" in **DE_control_data**. This process utilizes the values **DE_loudness_diff_dialogue** and **DE_loudness_diff_background** from **DE_control_data** and is described in clause E.7.4.3.*

E.7.4.2 Multichannel service with Dialogue Enhancement

In case of a multichannel service the audio decoder first decodes the encoded audio data. In contrast to a mono/stereo service the SAOC-DE decoder does not process all decoded audio channels, but only those that carry dialogue signals.

The number of processed channels depends on the value of **DE_mode** in **DE_control_data**:

- If **DE_mode** == 1, only the center channel is processed by the SAOC-DE decoder. The left, right, surround channels, and the LFE channel are by-passed.
- If **DE_mode** == 2, the left, center and right channels are processed by the SAOC-DE decoder. The surround channels and the LFE channel are by-passed.

The by-passed channels that do not carry dialogue need to be time-aligned to the SAOC-DE output channels, and the background modification gain m_{BGO} from the SAOC-DE processed channels has to be applied on them. To compensate for the delay of the SAOC-DE decoder processing, the by-passed channels are delayed by d samples. The delay d depends on the operation mode of the SAOC-DE decoder and may also be implementation dependent. Finally, all channels (the processed and the by-passed) are combined again to a complete multichannel output signal.

Figure E.6 illustrates the process taking place in the following steps:

- "Delay" block: The by-pass channels \mathbf{Y}_{BYPASS} are delayed by d samples to temporally align them with the SAOC-DE decoder output. In case of no additional implementation dependent delay, the delay value is $d = 1281$ samples in the case of High Quality mode, and $d = 1601$ samples in the case of Low Power mode, see clause 5.4.2.1 of ISO/IEC 23003-2 [39].
- "Gain mapping" block: Receive the limited gain value m_G from the SAOC-DE decoder (as defined in clause 12.8 "Modification range control for SAOC-DE" [39]), and determine the applied FGO/BGO gains:

$$\begin{cases} m_{FGO} = m_G, \text{ and } m_{BGO} = 1 & , \text{ if } m_G \leq 1 \\ m_{FGO} = 1, \text{ and } m_{BGO} = m_G^{-1} & , \text{ if } m_G > 1 \end{cases}$$
- "Gain adjust" block: The gain m_{BGO} applied on the background inside the SAOC-DE decoder is applied on the delay-adjusted "By-pass channels".
- "Channel combiner" block: Combine the "SAOC-DE output channels" from the SAOC-DE decoder and the "By-pass channels" into one output signal \mathbf{Y}_{FULL} of the correct dimensionality and channel order. *The channels of this signal shall be in the same order as the audio decoder output signal "Audio channels" provided for the "Channel splitter" implementing the selection of the channels to be processed with the SAOC-DE decoder and the by-pass channels.*

The renderer shall compensate the loss in loudness by a moderate enhancement of the output signal \mathbf{Y}_{FULL} if **DE_loudness_compensation_info** is set to "1" in **DE_control_data**. This process utilizes the values **DE_loudness_diff_dialogue** and **DE_loudness_diff_background** from **DE_control_data** and is described in clause E.7.4.3.

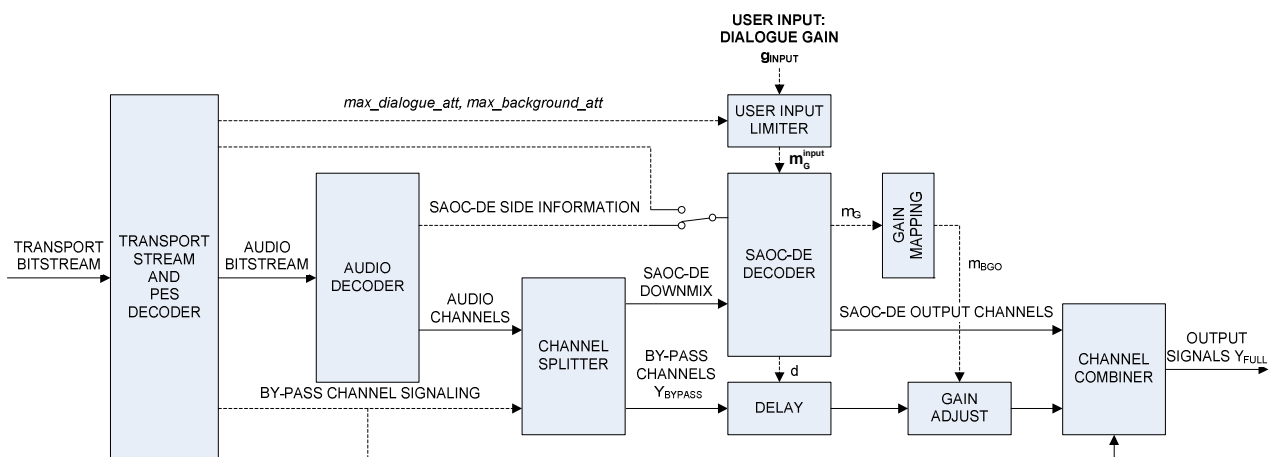

Figure E.6: Multichannel service with Dialogue Enhancement

In case of **DE_control_data** is not present, the information about the processed and by-passed channels may be implicitly derived from the **SAOCDESpecificConfig** during decoding the SAOC-DE data (see [39]). *If one processed channel is signalled in **SAOCDESpecificConfig**, the processed channel shall be assumed to be the center channel and the left, right, surround channels and the LFE channel are by-passed. If three processed channels are signalled in **SAOCDESpecificConfig**, the processed channels shall be assumed to be the left, center, and right channels, and the surround channels and the LFE channel are by-passed.*

E.7.4.3 Loudness compensation

This clause describes how the renderer compensates for the possible loss in loudness due to the signal modification with SAOC-DE using the values K_{FGO} and K_{BGO} decoded from **DE_loudness_diff_dialogue** and

DE_loudness_diff_background in **DE_control_data**. The loudness compensation is achieved by applying a gain value g_{Δ} on the SAOC-DE output channels and the by-passed channels (in the case of a multichannel signal).

This is done as follows:

- The (limited) dialogue modification gain value m_G obtained from the SAOC-DE decoder is used to determine the effective gains for the foreground object (FGO, e.g. dialogue) and for the background object (BGO, e.g. ambiance). This is done by the "Gain mapping" block which produces the gain values m_{FGO} and m_{BGO} .
- The "Output loudness estimator" block uses the loudness information K_{FGO} and K_{BGO} , and the effective gain values m_{FGO} and m_{BGO} to estimate this possible change in the loudness compared to the default downmix case. The change is then mapped into the "Loudness compensation factor" which is applied on the output for producing the final "Output signals".

The loudness compensation processing takes place in the following steps:

- Obtain the meta-object loudness information K_{FGO} and K_{BGO} .
- Calculate the change in the output loudness compared to the default downmix with:

$$\Delta L = 10 \log_{10} \frac{m_{FGO}^2 10^{K_{FGO}/10} + m_{BGO}^2 10^{K_{BGO}/10}}{10^{K_{FGO}/10} + 10^{K_{BGO}/10}}$$

- Calculate the loudness compensation gain $g_{\Delta} = 10^{-0.05\Delta L}$.
- Apply the scaling value g_{Δ} on the audio channels \mathbf{Y}_{FULL} .

Figure E.7 illustrates the complete process in case of a multichannel service from audio decoding to SAOC-DE decoding, delay compensation, gain adjustment and loudness compensation. Similar steps without the by-pass channel processing can be implemented for a mono/stereo service.

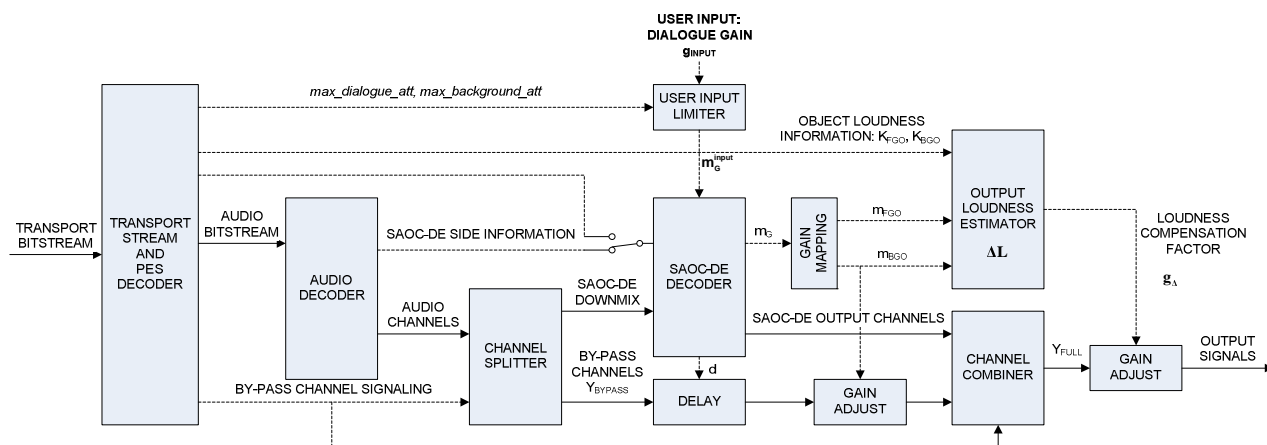

Figure E.7: Loudness compensation in the case of multichannel service with Dialogue Enhancement

Annex F (informative): Encoding Guidelines to Enable Trick Play Support of H.264/AVC Streams

F.1 Introduction

F.1.1 Overview

This annex discusses informative guidelines on the encoding of H.264/AVC Bitstreams to enable support of trick play modes. MPEG-2 personal video recording devices and services are increasingly being used in the marketplace and it is reasonable to expect this trend to continue. As industry migrates to the H.264/AVC standard, it is therefore also reasonable to believe that consumers will expect the functionality of their H.264/AVC PVR services to be at least as good as (and most likely better than) their MPEG-2 counterparts. It is important to recognize that the unofficial widely-adopted methods of MPEG-2 encoding directly enabled many of the techniques currently used to achieve trick mode functionality. The same is true of VC-1 encodings. Note that MPEG-2 video can be encoded in a manner that makes PVR very difficult but since most encoders encoded bitstreams in a "PVR-friendly" manner, this was not an issue with MPEG-2 Bitstreams. Again, the same is true of VC-1 encodings. Currently, the lack of syntax and semantics constraints on H.264/AVC Bitstreams combined with the rich set of video coding tools in H.264/AVC allows for a wide variety of potential bitstreams with some being very problematic for any type of sophisticated bitstream manipulation such as the trick modes in H.264/AVC PVR implementations. For these reasons, the guidelines in this appendix were constructed to assist encoders to create H.264/AVC Bitstreams that are "PVR-friendly" while not imposing significant constraints that would impact coding efficiency. Note that this annex is informative since it is understood that enabling trick play support is an optional feature that may or may not be appropriate depending on its intended use. In the case of an MVC transmission, this annex currently applies only to the base layer.

F.1.2 Technical Requirements

One class of trick play modes consists of the desire to play back the video at a speed that is a multiple of real-time playback. Let a Nx trick play mode (where N is a positive number greater than 1) represent video playback at a speed of N times real-time playback. For example, a $3x$ trick play mode may be desired which would allow a user to fast forward through a program three times as fast as normal playback, i.e. in one-third the time. It is often desired for these trick modes to be relatively "smooth", i.e. an Nx trick mode (where N is a positive integer) requires (at least approximately) every N th picture in the bitstream to be displayed. For example, repeating every thirtieth picture ten times would not constitute a "smooth" $3x$ trick mode using this definition. This "smooth" requirement may not be required for very fast trick modes like $15x$ or $30x$ fast forward since the human visual system cannot process such rapid motion. However, this requirement is desirable for trick modes such as $2x$ and $3x$ fast forward to obtain the satisfactory visual appearance of moving objects during the trick play.

In general, without any encoding constraints, the minimum requirement to implement trick modes is for the decoding to be done at the same speed as the desired trick mode to ensure that every prediction region is available for use in the motion compensation process, e.g. a decoder that runs at three times the normal speed of decoding is needed to guarantee $3x$ fast forward functionality. Note that this is a significant increase from the minimum requirement needed for normal playback. This approach has been done before for trick play with MPEG-2 standard definition content but is not practical or cost effective for many current and future applications. For example, decoding HD H.264/AVC video at three times the normal decoding speed is currently not possible in a cost-efficient fashion and even if this increased capability were made available in the future, it may not be desirable because of the increased cost relative to the minimum requirement for normal playback. This leads to a key technical assumption for the cost-effective implementation of trick play modes:

- Encoding intended for trick-play will be done in such a way that it does not burden decoders to decode pictures at a rate faster than normal playback to implement a trick play mode.

F.2 Discardable Pictures

F.2.0 Introduction

Many PVR implementations drop pictures in the bitstream (i.e. skip over and do not present these pictures to the decoder) to circumvent the need to decode bitstreams at speeds that are a multiple of real-time decoding. The visual effect of decoding at a multiple of real-time decoding can then be achieved using a normal decoder. This is only possible if a dropped picture is not needed for display and also not needed as a reference frame for another picture that is needed for display. These pictures are termed "discardable" pictures. The following clauses will discuss how the "discardable" pictures concept was exploited in MPEG-2 trick play implementations and then how this same concept can be used to implement H.264/AVC trick play.

F.2.1 MPEG-2 Discardable Pictures

In the MPEG-2 video standard, B-pictures are not allowed to be used as reference pictures for motion compensation. This has a significant benefit for trick play modes since any B-pictures in a MPEG-2 Bitstream can be dropped without affecting the decodability of other pictures. The "discardability" property of B-pictures is commonly used by many MPEG-2 trick mode implementations.

Figure F.1 illustrates the unofficial but widely-adopted MPEG-2 GOP structure, the IBBP GOP structure, which has two B-pictures placed between every pair of anchor I- and/or P-pictures. By dropping the B-pictures in this type of stream and passing the remaining pictures to the decoder, the visual effect of 3x fast forward trick play can be implemented with a decoder running at normal playback speed.

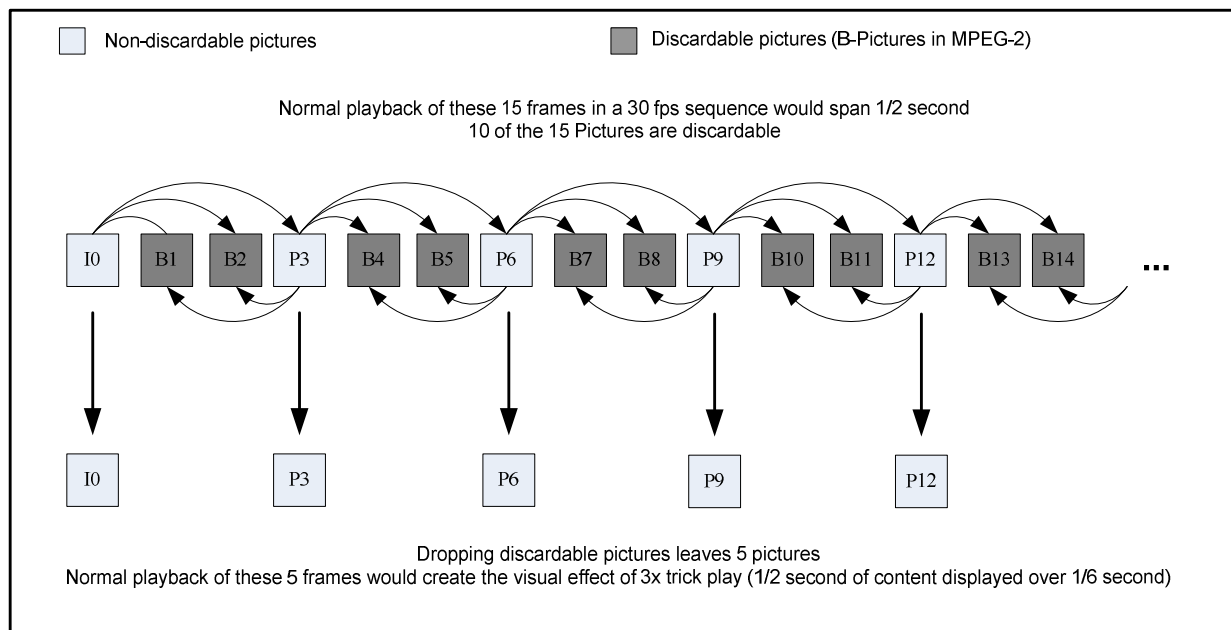

Figure F.1: Example of achieving a 3x trickplay mode from a common MPEG-2 GOP structure (IBBP)

Figure F.2 illustrates a MPEG-2 GOP structure, the IPPP GOP structure, where no B pictures are placed between every pair of anchor I- and/or P- pictures. Note that this structure is compliant to MPEG-2 but the technique of dropping B-pictures described above will not create a 3x trick play mode with this MPEG-2 coding structure since there are not enough B-pictures to drop (there is only one discardable picture at the end of the MPEG-2 GOP). In this case, a decoder that can run at N times normal decoding speed is necessary to support N times fast forward trick play since every picture is dependent on the previous picture in the MPEG-2 GOP.

Note that the problematic effect on PVR of a bitstream with a coding structure as shown in figure F.1 has often been overlooked and not usually an issue because this type of MPEG-2 GOP structure is rarely used in broadcast applications.

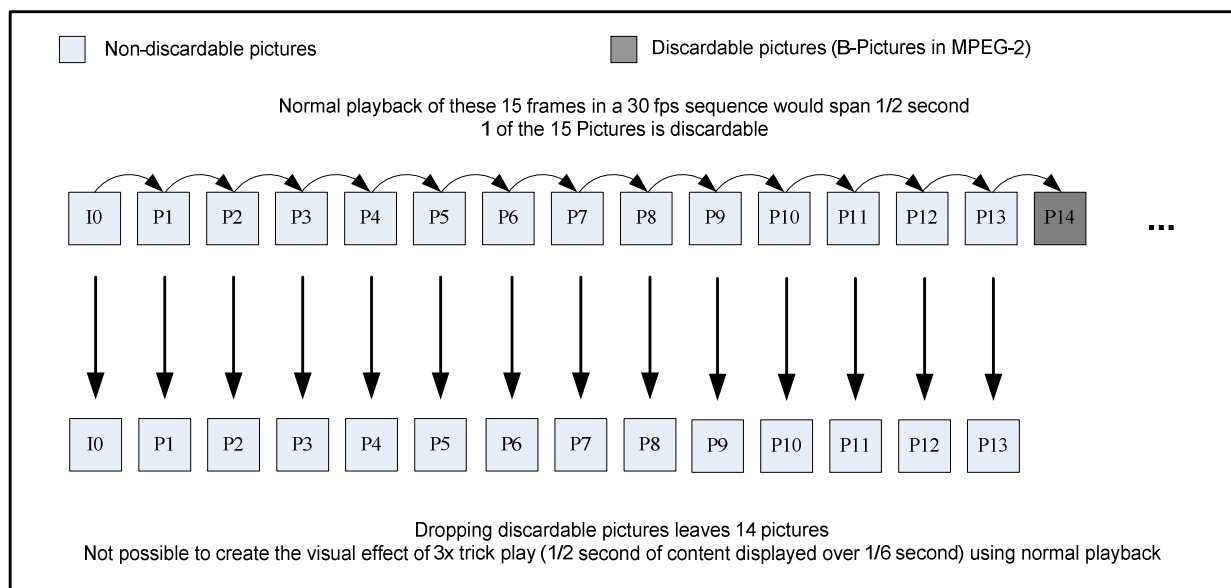

Figure F.2: Example of a compliant MPEG-2 GOP structure (IPPP) that cannot achieve 3x trick play by discarding pictures

F.2.2 H.264/AVC Discardable Pictures

The H.264/AVC compression standard has some substantial differences compared to MPEG-2 that significantly affect the picture coding structure and complicate trick mode implementations. These include the fact that B-pictures can be used as reference pictures for prediction, i.e. not all B-pictures are discardable as in MPEG-2. Note that the discardability of pictures is specifically indicated in the H.264/AVC standard by the `nal_ref_idc` flag in the NAL header (`nal_ref_idc = 0` indicates a discardable picture). Therefore, for H.264/AVC Bitstreams, the important factor in trick mode functionality is the location of discardable pictures, not the location of B-pictures as in MPEG-2. The presence of discardable pictures determines the feasibility of dropping pictures that are not needed for display to achieve the visual effect of a trick play mode.

F.2.3 Discardable Pictures and Trick Play Speeds

The percentage of pictures in the bitstream that are discardable determines the maximum trick play speed that could be achieved by just dropping discardable pictures while operating the decoder at normal processing speeds. The formula below can be used to associate the percentage of discardable pictures with the maximum trick play speed that could be achieved by dropping discardable pictures:

$$\text{Trick Play Speed} = 100 / (100 - X) \text{ where } X \text{ is the percentage of discardable pictures.}$$

Examples using common ratios of discardable pictures are listed in table F.1.

Table F.1: Discardable Picture Percentages and Maximum Achievable Trick Play Speeds by discard process

Percentage of Discardable Pictures	Maximum Trick Play Speed Achievable by Dropping Pictures
16 % (1/6 of the pictures)	1,2x
20 % (1/5 of the pictures)	1,25x
25 % (1/4 of the pictures)	1,33x
33 % (1/3 of the pictures)	1,5x
50 % (1/2 of the pictures)	2x
66 % (2/3 of the pictures)	3x
75 % (3/4 of the pictures)	4x

NOTE: Trick play speeds slower than the maximum achievable by dropping pictures can always be created by choosing to display some of the discardable pictures.

F.2.4 Smooth Trick Play and Compression Efficiency

Constraining a certain percentage of pictures in the bitstream to be discardable is necessary to enable the technique of dropping discardable pictures to achieve a trick play mode. However, it is important to recognize that determining the interval period between pictures where this percentage is constrained has a tradeoff between whether a smooth trick play is achieved and the coding structure which can impact coding efficiency. For example, figures F.3 and F.4 both illustrate coding structures with 66 % of its pictures as discardable pictures (in both cases 10 of the 15 total pictures are discarded).

Figure F.3 has a more regular discardable picture structure and represents the further requirement of 2 out of every 3 pictures to be discardable. Dropping the discardable pictures in figure F.3 will result in smooth 3x playback since every third picture in the original stream remains. However, note that the tradeoff for the ability to create a smooth 3x trick play is that the discardable picture structure places a tight constraint on the encoding which could reduce compression efficiency.

Ten out of the 15 total pictures in figure F.4 are discardable as in figure F.3, but its discardable picture structure is not as regular. Dropping the discardable pictures in figure F.4 will not result in a smooth trick play experience as in figure F.3. However, note that dropping discardable pictures can still be used to achieve the visual effect of playing through the content at three times the speed (since 5 frames remain) but without the serious constraint on the encoding.

NOTE: Although structure may not always guarantee smooth playback, there are methods that could create an appearance of smoother playback by means outside of this appendix.

To enable trick play support and still facilitate maximum compression efficiency, the percentage of discardable pictures will be calculated over the length of a H.264/AVC GOP (which, at the maximum 5 second time interval between the DTS of successive RAPs, may be up to 300 pictures). Encoding for the smoothest trick-play will distribute discardable pictures evenly in time throughout the H.264/AVC GOP.

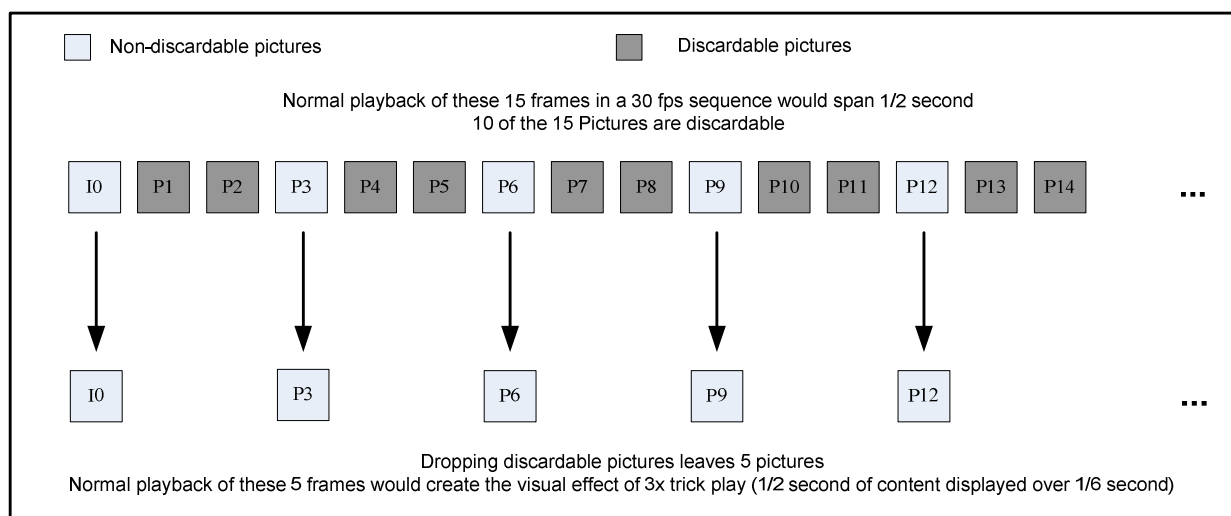
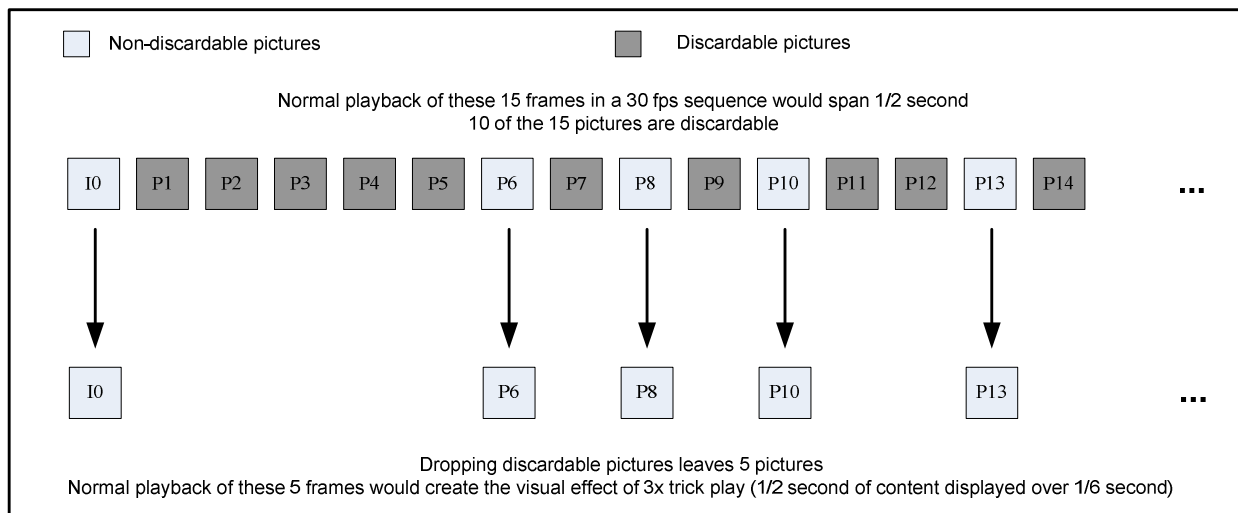

Figure F.3: Coding Structure with 2 Out of Every 3 Pictures as Discardable Pictures (the Discardable Pictures are inserted consistently)



**Figure F.4: Coding Structure with 10 out of Every 15 Pictures as Discardable Pictures
(The Discardable Pictures are not inserted consistently)**

F.2.5 Impact of Adaptive Encoding on Guidelines

It is well known that greater compression efficiency can be achieved by encoders that are able to dynamically adapt to content. This adaptation may occur in the middle of encoding a H.264/AVC GOP, especially with real-time encoders. For this reason, it is often difficult for an encoder to forecast a resulting property of the H.264/AVC GOP such as the number of discardable pictures in a H.264/AVC GOP before it actually encodes the H.264/AVC GOP since it may decide to change its methodology while encoding the H.264/AVC GOP. On the other hand, there is typically a general encoding methodology that will be used if the content being encoded is not drastically different from what the encoder is expecting.

Annex G (informative): Random Access Point Considerations for SVC

G.1 Scope

This annex contains encoder and decoder implementation guidelines to cover the cases where SVC Base layer RAPs are transmitted more frequently than SVC Enhancement layer RAPs. Note that decoder implementations that follow the guidelines in this annex may require additional complexity beyond typical SVC decoding.

G.2 Overview

The specification for SVC RAPs in clause 5.8.1.6 enables SVC Base layer RAPs to be transmitted more frequently than SVC Enhancement layer RAPs. Increasing the time interval between SVC Enhancement layer RAPs can significantly improve coding efficiency for enhancement layers, since more SVC Enhancement layer representations (SVC dependency representation with `dependency_id` greater than 0) can be inter-predicted using previously decoded pictures as references. However, increasing the time interval between SVC Enhancement layer RAPs also increases the average time before IRDs can start decoding the SVC Enhancement layer representations.

This annex specifies optional encoder and decoder implementation guidelines that enable SVC IRDs to reduce the time for an IRD to output decoded pictures of the complete SVC Bitstream by initially decoding the SVC Bitstream at the first SVC RAP that is received, irrespective of whether this SVC RAP represents an SVC Base layer RAP or an SVC Enhancement layer RAP. If the initial SVC RAP represents an SVC Base layer RAP only, the SVC IRD starts decoding and displaying the base layer and switches to enhancement layer decoding when the first SVC Enhancement layer RAP is received.

This method can be beneficially used in a number of transmission scenarios, which include all types of broadcast transmission systems, e.g. satellite, terrestrial, cable or IP channels. The benefits may include increased error resilience as well as reduced bitrate and channel change time.

Clause G.3 provides the encoder implementation guidelines while clause G.4 provides those for the decoder.

G.3 Encoder Implementation Guidelines

The following encoder implementation guidelines should be followed by an SVC encoder in order to enable SVC IRDs to implement the techniques in clause G.4 to efficiently start decoding at any received RAP:

- 1) Access units with PTS less than the PTS(rap) do not follow any access unit (in decoding order) with PTS greater than the PTS(rap), where PTS(rap) is the Presentation Time Stamp of an access unit that represents an SVC Enhancement layer RAP.
- 2) The dependency representations with a particular value of `dependency_id` greater than 0 in access units with PTS greater than PTS(rap) do not reference any picture with PTS less than PTS(rap) through inter-prediction, where PTS(rap) is the Presentation Time Stamp of an access unit that represents an SVC Enhancement layer RAP for that particular value of `dependency_id`.
- 3) The difference between the Presentation Time Stamp of an SVC Enhancement layer RAP with PTS(rap) and the Presentation Time Stamp of any access unit that follows the SVC Enhancement layer RAP in decoding order but precedes it in output order should not be greater than 150 milliseconds.
- 4) The number of required frame stores in the decoded picture buffer (specified by `max_dec_frame_buffering`, if present) for decoding a particular layer associated with a particular value of `dependency_id` does not exceed the value of `MaxDpbFrames` for any layer with `dependency_id` greater than the particular value of `dependency_id`.

Each of these constraints is designed to simplify the decoder implementation as specified in clause G.4. An SVC encoder may choose to omit any of these guidelines but should carefully consider the potential effect on decoder implementations that may depend on these constraints for robust implementation.

G.4 Decoder Implementation Guidelines

G.4.0 General

The following decoder implementation guidelines could be followed by an SVC IRD in order to start decoding at any received RAP.

It is suggested that an SVC IRD starts decoding an SVC Bitstream at the first SVC RAP that it receives, independent of whether this SVC RAP represents an SVC Base layer RAP or an SVC Enhancement layer RAP. If the initial SVC RAP represents an SVC Enhancement layer RAP, decoding can continue as normal.

If the initial SVC RAP represents an SVC Base layer RAP only, the SVC IRD can start decoding and displaying the base layer and switch to enhancement layer decoding when the first SVC Enhancement layer RAP is received. The switching from base layer decoding to enhancement layer decoding at a non IDR picture is not directly specified in annex G of Recommendation ITU-T H.264 / ISO/IEC 14496-10 [16] and could vary between different SVC IRD implementations resulting in different visual results for this transition.

For example, an SVC IRD capable of performing dual decoding (simultaneous parallel decoding of the base and enhancement layers) could decode the base layer starting with the SVC Base layer RAP and additionally decode the enhancement layer starting at the next SVC Enhancement layer RAP. For all access units that precede the SVC Enhancement layer RAP in output order, the SVC IRD can output the decoded SVC Base layer representations (SVC dependency representation with dependency_id equal to 0). For the SVC Enhancement layer RAP and all access units that follow the SVC Enhancement layer RAP in output order, the SVC IRD can output the decoded SVC Enhancement layer representations. This dual decoding system may not require the encoder implementation guidelines specified in clause G.3 to be followed but the use of dual decoding for a single stream may be computationally and/or cost prohibitive. The encoder implementation guidelines specified in clause G.3 are intended to simplify the switching between base and enhancement layer decoding and permit implementations with a single decoding process.

In clauses G.4.1 and G.4.2, two example decoding processes enabling the switching from base to enhancement layer decoding after random access are given. The guidelines in these clauses outline the main steps required for implementing the switching between base and enhancement layer decoding. Note that the clauses do not cover all the details required in an implementation and there may be different decoding processes to achieve similar results.

Clause G.4.1 outlines a decoding approach where pictures around the transition point may be skipped.

Clause G.4.2 outlines a decoding approach where there is a seamless transition between SVC Base layer pictures (SVC layer picture with dependency_id equal to 0) and SVC Enhancement layer pictures (SVC layer picture with dependency_id greater than 0) around the transition point.

Clause G.4.3 outlines approaches for reducing the visibility of the transition between displaying SVC Base layer pictures and SVC Enhancement layer pictures after accessing a bitstream at an SVC Base layer RAP.

For the following guidelines in this annex, MaxDIdRAP represents the maximum value of dependency_id that is associated with an SVC RAP in the SVC Bitstream and MaxDId represents the maximum value of dependency_id present in an SVC RAP in the SVC Bitstream. For a particular SVC RAP referred to as rapX, MaxDIdRAP and MaxDId may be specified by the functional relationships MaxDIdRAP(rapX) and MaxDId(rapX), respectively.

G.4.1 Decoding process with output picture skipping

If an SVC IRD starts decoding an SVC Bitstream at an SVC RAP with MaxDIdRAP less than MaxDId, which is referred to as rapA in the following text, the SVC IRD may use a decoding process similar to the following steps:

- 1) The SVC IRD decodes the SVC layer picture with dependency_id equal to MaxDIdRAP(rapA) for the SVC RAP rapA.

- 2) Where rapB represents the next SVC RAP in the SVC Bitstream that follows rapA in decoding order and has $\text{MaxDIdRAP}(\text{rapB})$ greater than $\text{MaxDIdRAP}(\text{rapA})$, the SVC IRD continues decoding all SVC layer pictures with dependency_id equal to $\text{MaxDId}(\text{rapA})$ of the access units that precede rapB in decoding order.
- 3) If rapB represents an IDR picture for dependency_id equal to $\text{MaxDIdRAP}(\text{rapB})$, the SVC layer picture with dependency_id equal to $\text{MaxDIdRAP}(\text{rapB})$ for rapB is decoded.
- 4) If rapB does not represent an IDR picture for dependency_id equal to $\text{MaxDIdRAP}(\text{rapB})$, SVC layer pictures with dependency_id equal to $\text{MaxDIdRAP}(\text{rapB})$ are decoded for rapB and all access units that follow rapB in decoding order but precede it in output order.
- 5) For each access unit with a Presentation Time Stamp greater than or equal to the Presentation Time Stamp of rapA and less than the Presentation Time Stamp of rapB, the SVC IRD outputs the decoded SVC layer pictures for dependency_id equal to $\text{MaxDIdRAP}(\text{rapA})$. If rapB does not represent an IDR picture for dependency_id equal to $\text{MaxDIdRAP}(\text{rapB})$, no pictures are output for the access units that follow the rapB in decoding order but precede it in output order.
- 6) For all access units for which SVC layer pictures with dependency_id less than $\text{MaxDId}(\text{rapA})$ are output, the decoded SVC layer pictures should be re-sampled, before displaying, in order to match the resolution of the dependency representation with dependency_id equal to $\text{MaxDId}(\text{rapA})$. The re-sampling operation is specified for a smooth transition at SVC RAPs by which the dependency_id of the decoded SVC layer pictures is increased. Note that the enhancement layer resolution is determined prior to the output of the first picture in the base layer for the SVC IRD to perform proper re-sampling.
- 7) If $\text{MaxDIdRAP}(\text{rapB})$ is less than $\text{MaxDId}(\text{rapB})$, the SVC IRD continues decoding with step 2, where the SVC RAP rapA is replaced with the SVC RAP rapB and the SVC RAP rapB is determined as specified in step 2. Note that this step is only applicable to systems with more than two dependency representations.
- 8) If $\text{MaxDIdRAP}(\text{rapB})$ is equal to $\text{MaxDId}(\text{rapB})$, the SVC IRD continues decoding as specified in Recommendation ITU-T H.264 / ISO/IEC 14496-10 [16].

In figure G.1, the decoding process is illustrated as an example for accessing an SVC Bitstream at an SVC Base layer RAP. The decoding process starts with decoding the SVC Base layer representation for the SVC Base layer RAP and all access units that follow the SVC Base layer RAP and precede the SVC Enhancement layer RAP in decoding order:

- For the SVC Enhancement layer RAP and all access units that follow the SVC Enhancement layer RAP in decoding order, the SVC enhancement layer representations are decoded.
- For the SVC Base layer RAP and all access units that follow the SVC Base layer RAP in output order and precede the SVC Enhancement layer RAP in decoding order, the SVC Base layer representations are output.
- For the SVC Enhancement layer RAP and all access units that follow the SVC Enhancement layer RAP in output order, the SVC Enhancement layer representations are output.
- No picture is output for the access units that follow the SVC Enhancement layer RAP in decoding order but precede it in output order.

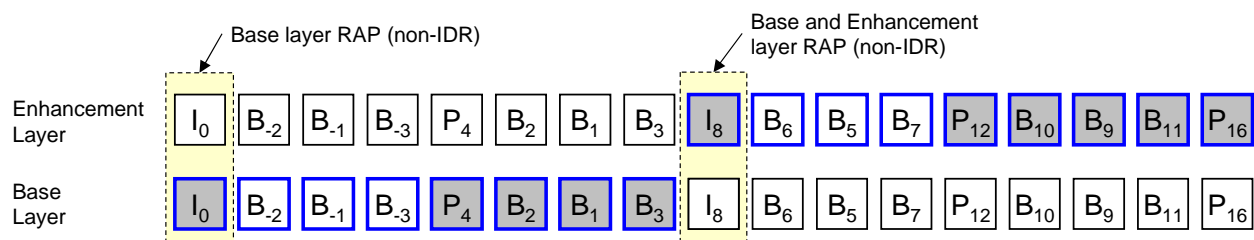

NOTE: The access units are displayed in decoding order (from left to right). The subscript numbers indicate the output order. The representations that are decoded are marked with blue frames; the representations that are output are marked grey.

Figure G.1: Illustration of the decoding process with output picture skipping when accessing a two-layer SVC Bitstream at an SVC Base layer RAP

G.4.2 Decoding process with seamless output

If an SVC IRD starts decoding an SVC Bitstream at an SVC RAP with MaxDIdRAP less than MaxDId , which is referred to as rapA in the following, the SVC IRD may use a decoding process similar to the following steps:

- 1) The SVC IRD decodes the SVC layer picture with dependency_id equal to $\text{MaxDIdRAP}(\text{rapA})$ for the SVC RAP rapA .
- 2) Where rapB represents the next SVC RAP in the SVC Bitstream that follows rapA in decoding order and has $\text{MaxDIdRAP}(\text{rapB})$ greater than $\text{MaxDIdRAP}(\text{rapA})$, the SVC IRD continues decoding all SVC layer pictures with dependency_id equal to $\text{MaxDId}(\text{rapA})$ of the access units that precede rapB in decoding order.
- 3) If rapB represents an IDR picture for dependency_id equal to $\text{MaxDIdRAP}(\text{rapB})$, the SVC layer picture with dependency_id equal to $\text{MaxDIdRAP}(\text{rapB})$ for rapB is decoded.
- 4) If rapB does not represent an IDR picture for dependency_id equal to $\text{MaxDIdRAP}(\text{rapB})$, the following steps apply:
 - a) For rapB , both the SVC layer picture with dependency_id equal to $\text{MaxDIdRAP}(\text{rapA})$ and the SVC layer picture with dependency_id equal to $\text{MaxDIdRAP}(\text{rapB})$ are decoded. The SVC layer picture with dependency_id equal to $\text{MaxDIdRAP}(\text{rapA})$ is inserted in the decoded picture buffer, while the SVC layer picture with dependency_id equal to $\text{MaxDIdRAP}(\text{rapB})$ is temporarily stored separately from the decoded picture buffer as decoding SVC layer pictures with dependency_id equal to $\text{MaxDIdRAP}(\text{rapA})$ continues.
 - b) The SVC IRD continues decoding all SVC layer pictures with dependency_id equal to $\text{MaxDIdRAP}(\text{rapA})$ of the SVC access units that follow rapB in decoding order and have a Presentation Time Stamp less than the Presentation Time Stamp of rapB .
 - c) All pictures in the decoded picture buffer are marked as "unused for reference" and the temporarily stored layer picture with dependency_id equal to $\text{MaxDIdRAP}(\text{rapB})$ for rapB is inserted in the decoded picture buffer in preparation for decoding SVC layer pictures with dependency_id equal to $\text{MaxDIdRAP}(\text{rapB})$.
- 5) For each access unit with a Presentation Time Stamp greater than or equal to the Presentation Time Stamp of rapA and less than the Presentation Time Stamp of rapB , the SVC IRD outputs the decoded SVC layer pictures for dependency_id equal to $\text{MaxDIdRAP}(\text{rapA})$.
- 6) For all access units for which SVC layer pictures with dependency_id less than $\text{MaxDId}(\text{rapA})$ are output, the decoded SVC layer pictures should be re-sampled, before displaying, in order to match the resolution of the dependency representation with dependency_id equal to $\text{MaxDId}(\text{rapA})$. The re-sampling operation is specified for a smooth transition at SVC RAPs by which the dependency_id of the decoded SVC layer pictures is increased. Note that the enhancement layer resolution is determined prior to the output of the first picture in the base layer for the SVC IRD to perform proper re-sampling.
- 7) If $\text{MaxDIdRAP}(\text{rapB})$ is less than $\text{MaxDId}(\text{rapB})$, the SVC IRD continues decoding with step 2, where the SVC RAP rapA is replaced with the SVC RAP rapB and the SVC RAP rapB is determined as specified in step 2. Note that this step is only applicable to systems with more than two dependency representations.
- 8) If $\text{MaxDIdRAP}(\text{rapB})$ is equal to $\text{MaxDId}(\text{rapB})$, the SVC IRD continues decoding as specified in Recommendation ITU-T H.264 / ISO/IEC 14496-10 [16].

In figure G.2 the decoding process is illustrated for an example of accessing an SVC Bitstream at an SVC Base layer RAP. The decoding process starts with decoding the SVC Base layer representation for the SVC Base layer RAP and all access units that follow the SVC Base layer RAP and precede the SVC Enhancement layer RAP in decoding order:

- For the SVC Enhancement layer RAP, both the SVC Base layer representation and SVC Enhancement layer representation are decoded. The decoded SVC Base layer representation is normally inserted in the decoded picture buffer while the decoded SVC Enhancement layer representation is stored in a temporary frame store.

- For the access units that follow the SVC Enhancement layer RAP in decoding order but precede it in output order, the IRD continues decoding the SVC Base layer representations. Before the first access unit that follows the SVC Enhancement layer RAP in both decoding and output order is decoded, all SVC Base layer representations in the decoded picture buffer are marked as "unused for reference" and the temporary stored SVC Enhancement layer representation (for the SVC Enhancement layer RAP) is inserted in the decoded picture buffer. The decoding process then continues with decoding the SVC Enhancement layer representations for all following access units.
- For the SVC Base layer RAP and all access units that follow the SVC Base layer RAP and precede the SVC Enhancement layer RAP in output order, the SVC Base layer representations are output. For the SVC Enhancement layer RAP and all access units that follow the SVC Enhancement layer RAP in output order, the SVC Enhancement layer representations are output.

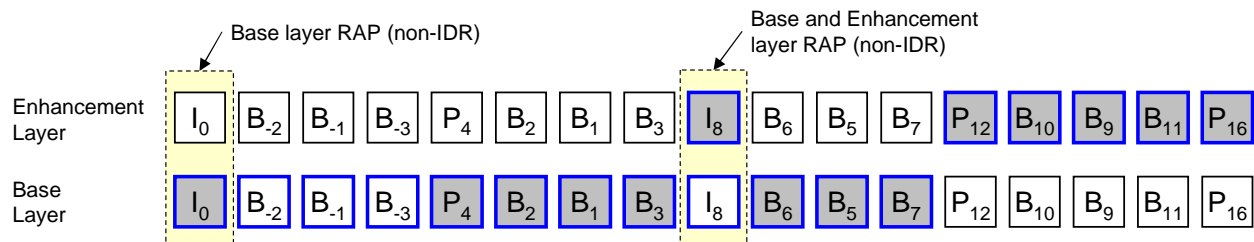

NOTE: The access units are displayed in decoding order (from left to right). The subscript numbers indicate the output order. The representations that are decoded are marked with blue frames; the representations that are output are marked grey.

Figure G.2: Illustration of the decoding process with seamless output when accessing a two-layer SVC Bitstream at an SVC Base layer RAP

G.4.3 Display Process at a Transition from Base to Enhancement Layer Decoding

This clause provides guidelines for reducing the visibility of the transition between displaying SVC Base layer pictures and SVC Enhancement layer pictures when accessing SVC Bitstream at an SVC Base layer RAP. An SVC IRD is not required to follow these guidelines.

For all pictures for which the SVC Base layer representations are output by the decoding process (see clauses G.4.1 and G.4.2), the decoded SVC Base layer representations should be re-sampled to the enhancement layer frame size before displaying.

If SVC Base layer pictures and SVC Enhancement layer pictures represent the same area of the source pictures, the transition between displaying re-sampled SVC Base layer pictures and SVC Enhancement pictures might be visible as a quality change in the displayed video signal. If the SVC Base layer pictures represent a subset of the source picture area that is represented by the SVC Enhancement layer pictures, the transition between displaying re-sampled SVC Base layer pictures and SVC Enhancement pictures might be more pronounced and appear to be a cut between different scenes. In the following text, two approaches are outlined which can be applied for reducing the visibility of a transition between displaying re-sampled SVC Base layer pictures and SVC Enhancement layer pictures:

- When SVC Base layer pictures and SVC Enhancement layer pictures represent the same area of the source pictures, the visibility of the transition between base and enhancement layer decoding can be reduced by applying a time-varying low-pass filter (before display) to the initial pictures that are displayed from the SVC Enhancement layer representation. For the first picture for which the SVC Enhancement layer representation is output, the cut-off frequency can be selected according to the ratio between the SVC Base layer picture and SVC Enhancement layer picture sizes. The cut-off frequency of the low-pass filter can then be continuously increased in output order until the SVC Enhancement layer pictures are displayed without the additional low-pass filtering. For example, this transition interval could be about 1 second.

- When the SVC Base layer picture represent a subset of the source picture area that is represented by the SVC Enhancement layer pictures, the visibility of the transition between base and enhancement layer decoding can be reduced by continuously increasing the cropping window for the initial pictures that are displayed from the SVC Enhancement layer representation. For the first SVC Enhancement layer representation that is output, only the portion of the picture that corresponds to the base layer cropping window can be displayed (after re-sampling it to the enhancement layer frame size). For the following SVC Enhancement layer representations, this cropping window can be continuously increased until it matches the enhancement layer cropping window specified in the bitstream. For example, this transition interval could be about 1 second. This approach of continuously increasing the cropping window could also be combined with the approach of applying a time-varying low-pass filter described above.

Annex H (normative): Frame Compatible Plano-Stereoscopic 3DTV

H.1 Scope

This annex contains encoder and decoder implementation guidelines for frame compatible plano-stereoscopic 3DTV systems. Such systems are built upon the existing H.264/AVC High Definition system and include the additional requirement and guidelines to deliver frame compatible plano-stereoscopic 3DTV services. Depending on the output resolution, interlace or progressive frame format, frame rate and 3DTV formatting arrangement, a frame compatible plano-stereoscopic 3DTV system supports the combinations described in the table H.1. All the other combinations that are not defined in the table H.1 remain optional and are left to the responsibility of the broadcaster or the service provider to ensure that systems for the proper delivery of services based on them are available. The term HDTV is used to refer to non-frame compatible plano-stereoscopic 3DTV services (i.e.: 2D services). For frame compatible plano-stereoscopic 3DTV implementation guidelines refer to ETSI TS 101 547-2 [33].

Table H.1: Frame compatible mandated 3DTV formats/structures

IRD Class	Output resolution/Format	Frame rate	Frame compatible arrangement type
25 Hz	720p	50 Hz	Top-and-Bottom, Side-by-Side
25 Hz	1 080i	25 Hz	Side-by-Side
30 Hz	720p	59,94/60 Hz	Top-and-Bottom, Side-by-Side
30 Hz	1 080i	29,97/30 Hz	Side-by-Side
30 Hz	1 080p	23,98/24 Hz	Top-and-Bottom, Side-by-Side

H.2 Frame compatible plano-stereoscopic 3DTV definition

25 Hz frame compatible plano-stereoscopic 3DTV IRD: IRD that is capable of decoding and displaying pictures based on a nominal video frame rate of 25 Hz or 50 Hz from H.264/AVC High Profile at Level 4 bitstreams as specified in the present document, in addition to providing the functionality of interpreting the specific plano-stereoscopic 3DTV signalling as specified in this annex.

25 Hz frame compatible plano-stereoscopic 3DTV Bitstream: bitstream which contains only H.264/AVC High Profile at Level 4 video at 25 Hz or 50 Hz frame rates as specified in the present document with the specific plano-stereoscopic 3DTV signalling as specified in this annex.

30 Hz frame compatible plano-stereoscopic 3DTV IRD: IRD that is capable of decoding and displaying pictures based on nominal video frame rates of 24 000/1 001 (approximately 23,98), 24, 30 000/1 001 (approximately 29,97), 30, 60 000/1 001 (approximately 59,94) or 60 Hz from H.264/AVC High Profile at Level 4 bitstreams as specified in the present document, in addition to providing the functionality of interpreting the specific plano-stereoscopic 3DTV signalling as specified in this annex.

30 Hz frame compatible plano-stereoscopic 3DTV Bitstream: bitstream which contains only H.264/AVC High Profile at Level 4 video at 24 000/1 001, 24, 30 000/1 001, 30, 60 000/1 001 or 60 Hz frame rates as specified in the present document with the specific plano-stereoscopic 3DTV signalling as specified in this annex.

H.3 System layer specifications common to all plano-stereoscopic 3DTV IRDs and Bitstreams

H.3.0 Scope

The specification in this clause applies to the following IRDs and Bitstreams:

- 25 Hz frame compatible plano-stereoscopic 3DTV IRD and Bitstream;
- 30 Hz frame compatible plano-stereoscopic 3DTV IRD and Bitstream.

H.3.1 General

Frame compatible plano-stereoscopic 3DTV IRDs and Bitstreams shall comply with the system layer specifications related to all H.264/AVC HDTV IRDs and bitstreams as defined in clause 4 with the extensions as specified in this annex.

H.3.2 Frame compatible plano-stereoscopic 3DTV Specific Program Elementary Stream descriptor

H.3.2.1 AVC_video_descriptor

For frame compatible plano-stereoscopic 3DTV:

Encoding: *The **AVC_video_descriptor**, as specified in Recommendation ITU-T H.222.0 / ISO/IEC 13818-1 [1], shall be used when appropriate. The syntax element **Frame_Packing_SEI_not_present_flag** shall be set to 0 in the **AVC_video_descriptor** to signal presence of frame packing arrangement SEI message within the coded video sequence (see clause H.4.2).*

Decoding: *The frame compatible plano-stereoscopic 3DTV IRD shall use this descriptor in order to identify the presence of the frame packing arrangement SEI message in the bitstream.*

H.4 Video specifications Common to all frame compatible plano-stereoscopic 3DTV IRDs and Bitstreams

H.4.0 Scope

The specification in this clause applies to the following IRDs and Bitstreams:

- 25 Hz frame compatible plano-stereoscopic 3DTV IRD and Bitstream;
- 30 Hz frame compatible plano-stereoscopic 3DTV IRD and Bitstream.

H.4.1 General

Frame compatible plano-stereoscopic 3DTV IRDs and Bitstreams shall comply with the common specifications to all H.264/AVC IRDs and bitstreams as defined in clause 5.5 with extensions as specified in this annex.

25 Hz frame compatible plano-stereoscopic 3DTV IRD and bitstreams shall comply with the specifications of 25 Hz H.264/AVC HDTV as defined in clause 5.7 with extensions as specified in this annex.

30 Hz frame compatible plano-stereoscopic 3DTV IRD and bitstreams shall comply with the specifications of 30 Hz H.264/AVC HDTV as defined in clause 5.7 with extensions as specified in this annex.

H.4.2 Supplemental Enhancement Information

H.4.2.0 General

Frame compatible plano-stereoscopic 3DTV IRDs shall support the use of frame packing arrangement SEI message in the conditions depicted in this clause.

Frame compatible plano-stereoscopic 3DTV bitstreams shall not use the Stereo Video information SEI message.

Frame compatible plano-stereoscopic 3DTV IRDs shall ignore any Stereo Video information SEI message.

H.4.2.1 Frame Packing Arrangement SEI Message

Encoding: The constraints defined below apply to frame compatible plano-stereoscopic 3DTV bitstreams and are made in order to support the formats listed in table H.1:

*When the AVC_video_descriptor has its **frame_packing_SEI_not_present_flag** syntax element equal to 0, the frame packing arrangement SEI shall be transmitted with each access unit. The syntax element **frame_packing_arrangement_repetition_period** shall be set to '0' (1b in Exp-Golomb code).*

*The syntax element **frame_packing_arrangement_id** shall be set to '0' (1b in Exp-Golomb code).*

The syntax element **frame_packing_arrangement_type** defines the arrangement of the left and right views inside an HDTV frame. In order to fulfil the frame compatible plano-stereoscopic 3DTV formats/structures listed in the table H.1, when present, **frame_packing_arrangement_type** should have one of the defined values: '3' for Side-by-Side, '4' for Top-and-Bottom, depending on the following conditions:

- for a 25 Hz frame compatible plano-stereoscopic 3DTV bitstream:
 - if the frame rate is 25 Hz interlaced and if the decoded video resolution is 1 080i, then the **frame_packing_arrangement_type** should be '3';
 - if the frame rate is 50 Hz progressive and if the decoded video resolution is 720p, then the **frame_packing_arrangement_type** should be either '3' or '4'.
- for a 30 Hz frame compatible plano-stereoscopic 3DTV bitstream:
 - if the frame rate is 23,98 Hz or 24 Hz progressive and if the decoded video resolution is 1 080p, then the **frame_packing_arrangement_type** should be either '3' or '4';
 - if the frame rate is 59,94 Hz or 60 Hz interlaced and if the decoded video resolution is 1 080i, then the **frame_packing_arrangement_type** should be '3';
 - if the frame rate is 60 Hz progressive and if the decoded video resolution is 720p, then the **frame_packing_arrangement_type** should be either '3' or '4'.

NOTE 1: The use of any other combination of frame format and frame packing arrangement type, not specified above is not required to be supported by frame compatible plano-stereoscopic 3DTV IRDs.

*Changes to frame packing arrangement SEI, including the **frame_packing_arrangement_type** shall only occur at a RAP with an IDR picture.*

NOTE 2: An IDR picture cancels all prior SEI messages. An IDR without a frame packing arrangement SEI indicates a switch in the video sequence from a frame compatible plano-stereoscopic 3DTV to an HDTV event.

NOTE 3: In the case of a switch from a frame compatible plano-stereoscopic 3DTV event to an HDTV event, transmission of a frame packing arrangement SEI with **frame_packing_arrangement_cancel_flag** = 1 starting at the first RAP with an IDR picture of the HDTV format content, may provide explicit confirmation at the video layer that such a format change has occurred. In the case of a switch from an HDTV event to a frame compatible plano-stereoscopic 3DTV event, transmission of a frame packing arrangement SEI with **frame_packing_arrangement_cancel_flag** = 1 starting at a RAP with an IDR picture of the HDTV format content, may provide an early indication of such a format change at the event boundary. Clause 6.5 of ETSI TS 101 547-2 [33] makes provisions concerning such format transitions.

- In order to be consistent with the minimum capabilities in HDMI 1.4a [i.14] for plano-stereoscopic 3DTV:
 - The syntax element **quincunx_sampling_flag** shall be set to '0'.
 - The syntax element **content_interpretation_type** shall be set to '1'.
 - The syntax elements **spatial_flipping_flag** and **frame0_flipped_flag** shall be set to '0'.

NOTE 4: The HDMI 1.4a specification does not provide all the information on the sub-sampling method, filters and how the views are ordered inside an HDTV frame. Therefore care should be taken on the use of any other value than the ones specified above.

The syntax elements **frame0_grid_position_x**, **frame0_grid_position_y**, **frame1_grid_position_x** and **frame1_grid_position_y** should be set to '0000'.

When **frame_packing_arrangement_type** is equal to '3' or '4', the following syntax elements shall be equal to '0':

- **field_views_flag**;
- **current_frame_is_frame0_flag**;
- **frame_packing_arrangement_extension_flag**.

NOTE 5: As specified in Recommendation ITU-T H.264 / ISO/IEC 14496-10 [16], any other value of the above listed syntax elements combined with a **frame_packing_arrangement_type** equal to '3' or '4' is reserved for future use.

The syntax elements **frame0_self_contained_flag** and **frame1_self_contained_flag** should be set to '0'.

Decoding: Frame compatible plano-stereoscopic 3DTV IRDs shall support the **frame_packing_arrangement** SEI message.

Frame compatible plano-stereoscopic 3DTV IRDs shall ignore frame packing arrangement SEI messages with a value of **frame_packing_arrangement_id** not equal to '0'.

25 Hz frame compatible plano-stereoscopic 3DTV IRDs shall support the following values of **frame_packing_arrangement_type**:

- **frame_packing_arrangement_type** value '3' (Side-by-Side) shall be supported for 25 Hz, 1 080 lines vertical resolution interlaced video.
- **frame_packing_arrangement_type** values '3' (Side-by-Side) and '4' (Top-and-Bottom) shall be supported for 50 Hz, 720 lines vertical resolution progressive video.
- 30 Hz frame compatible plano-stereoscopic 3DTV IRDs shall support the following values of **frame_packing_arrangement_type**:
- **frame_packing_arrangement_type** value '3' (Side-by-Side) and '4' (Top-and-Bottom) shall be supported for 23,98 Hz or 24 Hz, 1 080 lines vertical resolution progressive video.
- **frame_packing_arrangement_type** value '3' (Side-by-Side) shall be supported for 59,94 Hz or 60 Hz, 1 080 lines vertical resolution interlace video.

- **frame_packing_arrangement_type** value '3' (Side-by-Side) and '4' (Top-and-Bottom) shall be supported for 60 Hz, 720 lines vertical resolution progressive video.

*Frame compatible plano-stereoscopic 3DTV IRDs shall ignore the following syntax elements **field_views_flag, current_frame_is_frame0_flag, frame0_self_contained_flag, frame1_self_contained_flag, frame_packing_arrangement_extension_flag.***

Annex I (normative): Considerations for Encoding and Random Access for MVC Stereo Video

I.0 Introduction

The following clauses give guidelines for allowing easy random access within MVC Stereo bitstreams. These guidelines are based on the Blu-ray Disc™ White Paper [i.16].

I.1 Video Sequence Structure

I.1.0 General

Figure I.1 shows the typical coded video sequence structure and frame and view dependencies of MVC Stereo video, as stored on a Blu-ray Disc™. Broadcast video may, or may not, have a similar structure, though it is recommended. This is shown here for illustrative purposes.

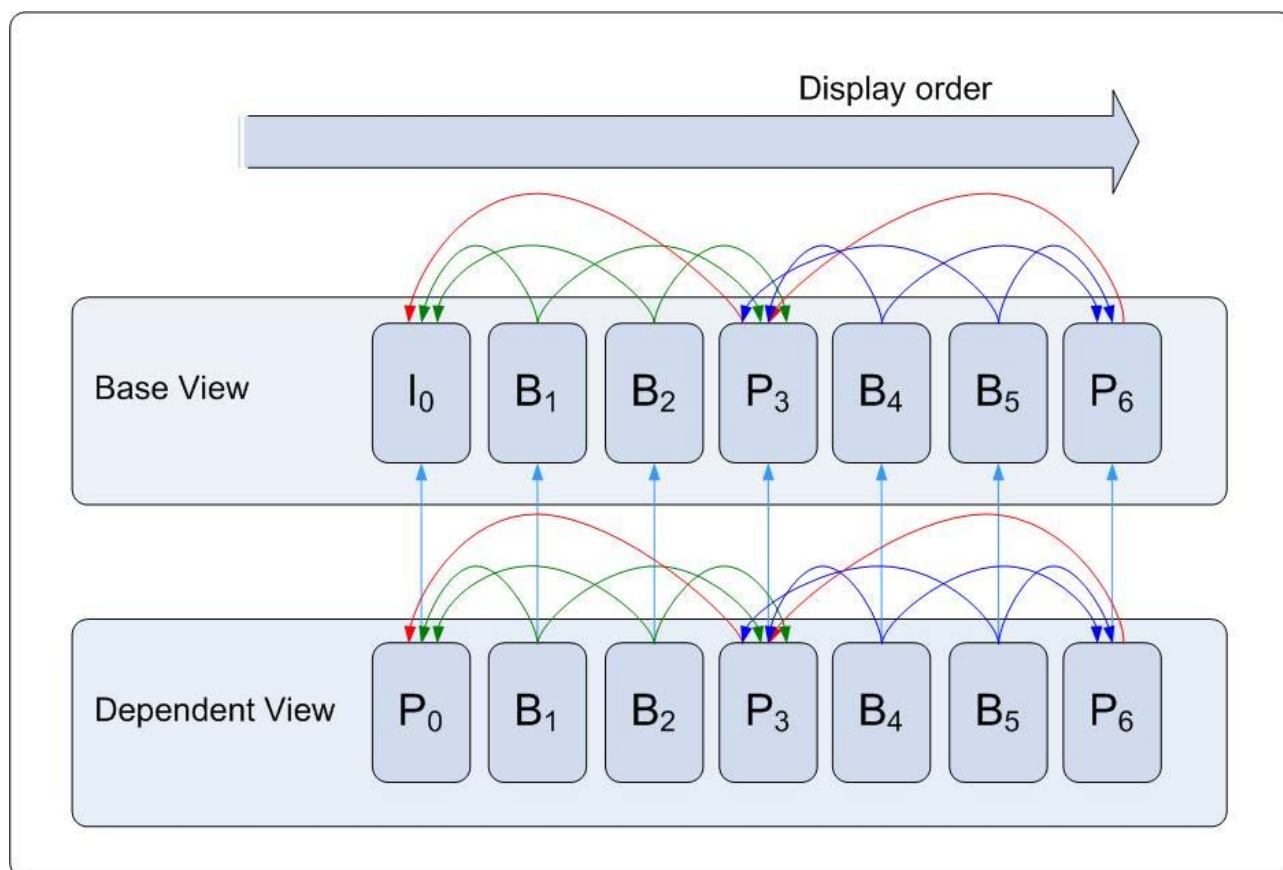

Figure I.1: Typical coded video sequence structure of MVC Stereo video

In order to enable quick random access, the following constraints apply:

- The first access unit in a coded video sequence in decoding order is an MVC Stereo RAP.
- In case the Dependent view component is a B picture component, then the corresponding view component of Base view video shall also be B picture component.

- In case the Dependent view component is a non-reference B picture component, the corresponding view component of Base view video shall also be a non-reference B picture component.
- The coded video sequence structure for Base view video stream and Dependent view video stream shall be the same, including:
 - whether it is open or closed coded video sequence structure;
 - the number of view components;
 - the values of `nal_ref_idc` of a NAL unit with slice data for Base view component and `nal_ref_idc` of a NAL unit with slice data for the corresponding Dependent view component shall be the same;
 - the display order of the pictures, i.e. Picture Order Count, POC;
 - the decoding delay, defined as the PTS of the first displayed picture in a coded video sequence minus its DTS.

I.1.1 Closed Coded Video Sequence

In the case of a closed coded video sequence (see figure I.2) the first Dependent view component in decoding order shall be an MVC Stereo anchor view component associated with a Base view component containing an IDR picture. An anchor view component associated with an IDR base view component prohibits view component referencing over coded video sequence boundary, hence, it shall be possible to decode correctly all view components in a closed coded video sequence, even when random access to this coded video sequence is executed.

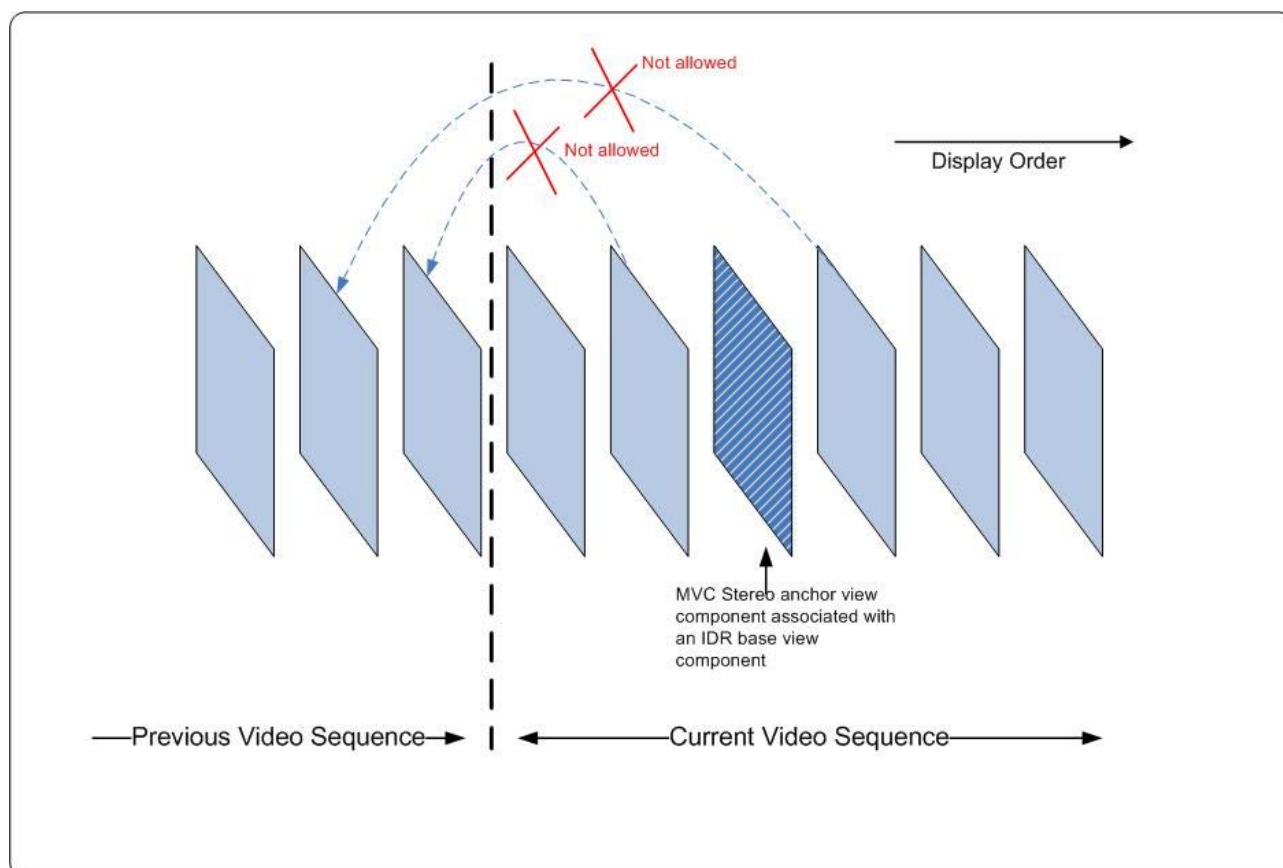

Figure I.2: Example of Closed coded video sequence for MVC Dependent view bitstream

I.1.2 Open Coded Video Sequence

In case of an open coded video sequence structure, (see figure I.3), the first Dependent view component in decoding order shall be an MVC Stereo anchor view component associated with a Base view component containing an (non-IDR) I picture. Since an anchor view component associated with a I picture does not prohibit view component referencing over coded video sequence boundary, it may be the case that view components prior to the I picture in display order cannot be correctly decoded when random access to this coded video sequence is executed.

If it is desirable to encode MVC sub-bitstream to correctly decode view components subsequent to the first Dependent anchor view component associated with a Base view component containing an I picture in display order, the following conditions shall be satisfied:

- Pictures prior to the first Dependent anchor view component associated with a Base view component containing an I picture in display order may use reference to past, future and Corresponding view components. It is assumed that these view components are not displayed in case of random access to an open coded video sequence.
- Pictures subsequent to the first Dependent anchor view component associated with a Base view component containing an I picture in display order may use references to past, future, and Corresponding view components, but these view components shall not use past reference to view components prior to the first anchor view components in display order.

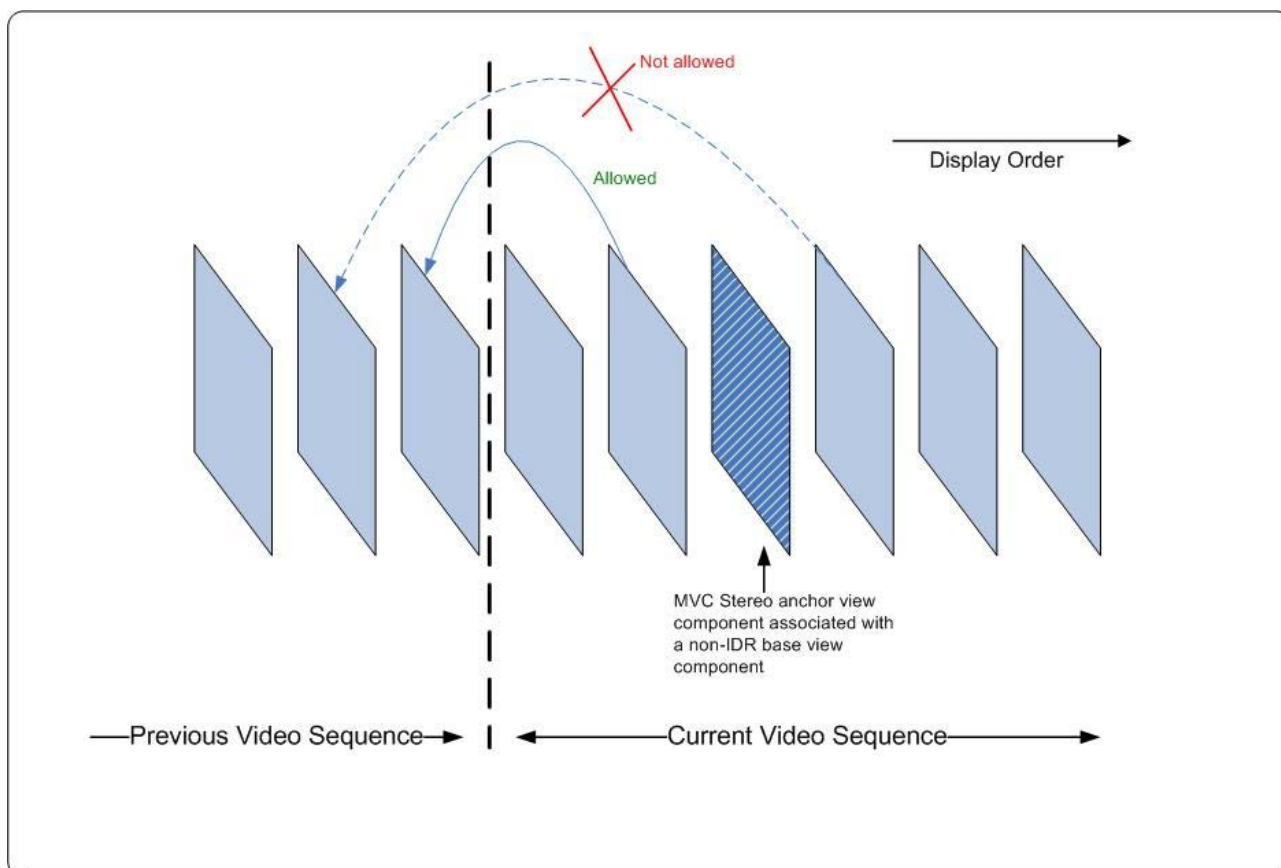

Figure I.3: Example of Open coded video sequence for MVC Dependent view bitstream

I.2 Guidelines for TS Packet Multiplexing

Re-multiplexing during transmission might alter the relative reception order of Base and Dependent transport stream packets (TS packets), when compared to the original transmission order. In the present document, this is called 'inter-PID reordering'. Figure I.4 represents a sample setup of a live broadcast system where re-multiplexing of TS packets might cause inter-PID reordering.

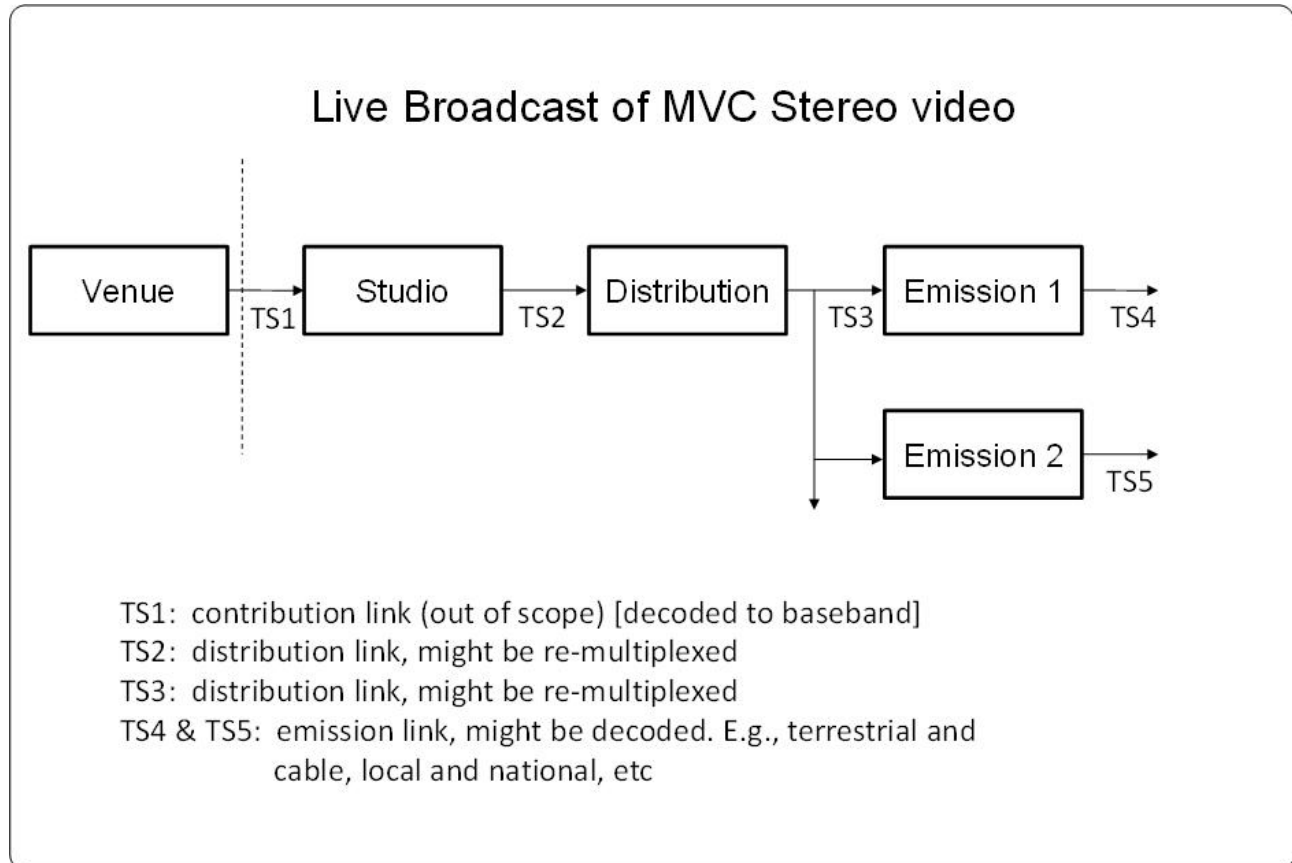

Figure I.4: Example of Live Broadcast where re-multiplexing might occur

Since the TS packet order affects random access, a transmission system should try to limit inter-PID re-ordering as much as possible. One possibility would be to satisfy the following conditions:

- The first transport packet of the PES packet header belonging to the MVC Stereo Base view component of the first Access Unit in a coded video sequence should precede the first transport packet of the PES packet header from the corresponding MVC Stereo Dependent view component.
- The last transport packet for the last Dependent Unit in the coded video sequence should precede the first transport packet of the PES packet header belonging to the MVC Stereo Base view component of the first Access Unit of the following coded video sequence.

Annex J (normative): Service Frame Compatible Plano-Stereoscopic 3DTV with HEVC coding

J.1 Scope

This annex contains encoder and decoder implementation guidelines for HEVC service frame compatible plano-stereoscopic 3DTV systems. Such systems are built upon the existing HEVC High Definition system and include the additional requirement and guidelines to deliver frame compatible plano-stereoscopic 3DTV services. Depending on the frame rate and 3DTV formatting arrangement, a service frame compatible plano-stereoscopic 3DTV system supports the combinations described in the table J.1. All the other combinations that are not defined in the table J.1 remain optional and are left to the responsibility of the broadcaster or the service provider to ensure that systems for the proper delivery of services based on them are available. The term HDTV is used to refer to non-frame compatible plano-stereoscopic 3DTV services (i.e. 2D services). For service frame compatible plano-stereoscopic 3DTV implementation guidelines refer to ETSI TS 101 547-4 [44].

Table J.1: Service frame compatible mandated 3DTV formats/structures

IRD Class	Output resolution/Format	Frame rate	Frame compatible arrangement type
50 Hz	1 080p	50 Hz	Top-and-Bottom
60 Hz	1 080p	59,94/60 Hz	Top-and-Bottom

J.2 Service frame compatible plano-stereoscopic 3DTV definition

50 Hz HEVC service frame compatible plano-stereoscopic 3DTV IRD: IRD that is capable of decoding and displaying pictures based on a nominal video frame rate of 50 Hz from up to HEVC Main 10 Profile at Level 4.1 bitstreams as specified in clause 5.14.2 of the present document, in addition to providing the functionality of interpreting the specific plano-stereoscopic 3DTV signalling as specified in the present annex.

50 Hz HEVC service frame compatible plano-stereoscopic 3DTV Bitstream: HEVC video stream which contains HEVC Main or Main 10 Profile encoded video at Level 4.1 at 50 Hz frame rates as specified in clause 5.14.2 of the present document with the specific plano-stereoscopic 3DTV signalling as specified in the present annex.

60 Hz HEVC service frame compatible plano-stereoscopic 3DTV IRD: IRD that is capable of decoding and displaying pictures based on nominal video frame rates of 60 000/1 001 (approximately 59,94) Hz or 60 Hz from up to HEVC Main 10 Profile at Level 4.1 bitstreams as specified in clause 5.14.2 of the present document, in addition to providing the functionality of interpreting the specific plano-stereoscopic 3DTV signalling as specified in the present annex.

60 Hz HEVC service frame compatible plano-stereoscopic 3DTV Bitstream: HEVC video stream which contains HEVC Main or Main 10 Profile encoded video at Level 4.1 at 60 000/1 001 or 60 Hz frame rates as specified in clause 5.14.2 of the present document with the specific plano-stereoscopic 3DTV signalling as specified in the present annex.

HEVC service frame compatible plano-stereoscopic 3DTV IRD: collective term referring to either a 50 Hz HEVC service frame compatible plano-stereoscopic 3DTV IRD or a 60 Hz HEVC service frame compatible plano-stereoscopic 3DTV IRD.

HEVC service frame compatible plano-stereoscopic 3DTV Bitstream: collective term referring to either a 50 Hz HEVC service frame compatible plano-stereoscopic 3DTV Bitstream or a 60 Hz HEVC service frame compatible plano-stereoscopic 3DTV Bitstream.

J.3 System layer specifications common to all HEVC service frame compatible plano-stereoscopic 3DTV IRDs and Bitstreams

J.3.1 Scope

The specification in this clause applies to the following IRDs and Bitstreams:

- 50 Hz HEVC service frame compatible plano-stereoscopic 3DTV IRD and Bitstream;
- 60 Hz HEVC service frame compatible plano-stereoscopic 3DTV IRD and Bitstream.

J.3.2 General

HEVC service frame compatible plano-stereoscopic 3DTV IRDs and Bitstreams shall comply with the system layer specifications related to all HEVC HDTV IRDs and bitstreams as defined in clause 4 with the extensions as specified in the present annex.

J.3.3 Service frame compatible plano-stereoscopic 3DTV Specific Program Elementary Stream descriptor

J.3.3.1 HEVC_video_descriptor

For service frame compatible plano-stereoscopic 3DTV:

Encoding: *The **HEVC_video_descriptor**, as specified in Recommendation ITU-T H.222.0 / ISO/IEC 13818-1 [1], shall be present in the PMT. The syntax element **non_packed_constraint_flag** shall be set to 0 in the **HEVC_video_descriptor** to signal the presence of the frame packing arrangement SEI message within the coded video sequence (see clause J.4.2).*

Decoding: *The HEVC service frame compatible plano-stereoscopic 3DTV IRD shall use this descriptor in order to identify the presence of the frame packing arrangement SEI message in the bitstream.*

J.4 Video specifications common to all HEVC service frame compatible plano-stereoscopic 3DTV IRDs and Bitstreams

J.4.1 Scope

The specification in this clause applies to the following IRDs and Bitstreams:

- 50 Hz HEVC service frame compatible plano-stereoscopic 3DTV IRD and Bitstream;
- 60 Hz HEVC service frame compatible plano-stereoscopic 3DTV IRD and Bitstream.

J.4.2 General

HEVC service frame compatible plano-stereoscopic 3DTV IRDs and Bitstreams shall comply with the common specifications to all HEVC IRDs and Bitstreams as defined in clause 5.14 of the present document with extensions as specified in the present annex.

50 Hz HEVC service frame compatible plano-stereoscopic 3DTV IRDs shall comply with the specifications of 50 Hz HEVC HDTV10-bit IRDs as defined in clause 5.14.2 of the present document with extensions as specified in the present annex.

60 Hz HEVC service frame compatible plano-stereoscopic 3DTV IRDs shall comply with the specifications of 60 Hz HEVC HDTV10-bit IRDs as defined in clause 5.14.2 of the present document with extensions as specified in the present annex.

HEVC service frame compatible plano-stereoscopic 3DTV Bitstreams shall comply with the specifications of HEVC HDTV Bitstreams as defined in clause 5.14.2 of the present document with extensions as specified in the present annex.

J.4.3 Supplemental Enhancement Information

J.4.3.1 General

HEVC service frame compatible plano-stereoscopic 3DTV IRDs shall support the use of frame packing arrangement SEI message in the conditions depicted in this clause.

NOTE: Other frame packing arrangement types might be added in future versions of the present document.

J.4.3.2 Frame Packing Arrangement SEI Message

Encoding: The constraints defined below apply to service frame compatible plano-stereoscopic 3DTV bitstreams and are made in order to support the formats listed in table J.1:

*When the **HEVC_video_descriptor** has its **non-packed-constraint_flag** syntax element equal to 0, the frame packing arrangement SEI shall be transmitted with each access unit.*

*The syntax element **frame_packing_arrangement_id** shall be set to '0' (1b in Exp-Golomb code).*

The syntax element **frame_packing_arrangement_type** defines the arrangement of the left and right views inside an HDTV frame. *In order to fulfil the service frame compatible plano-stereoscopic 3DTV formats/structures listed in the table J.1, when present, **frame_packing_arrangement_type** shall have the value '4' (Top-and-Bottom).*

NOTE 1: The use of any other frame packing arrangement type, not specified above, is not required to be supported by service frame compatible plano-stereoscopic 3DTV IRDs.

*Changes to frame packing arrangement SEI, including the **frame_packing_arrangement_type** shall only occur at a HEVC DVB_RAP.*

NOTE 2: An IDR picture cancels all prior SEI messages. An IDR without a frame packing arrangement SEI indicates a switch in the video sequence from a frame compatible plano-stereoscopic 3DTV to an HDTV event.

NOTE 3: In the case of a switch from a frame compatible plano-stereoscopic 3DTV event to an HDTV event, transmission of a frame packing arrangement SEI with **frame_packing_arrangement_cancel_flag** = 1 starting at the first RAP with an IDR picture of the HDTV format content, may provide explicit confirmation at the video layer that such a format change has occurred. In the case of a switch from an HDTV event to a frame compatible plano-stereoscopic 3DTV event, transmission of a frame packing arrangement SEI with **frame_packing_arrangement_cancel_flag** = 1 starting at a HEVC DVB_RAP of the HDTV format content, may provide an early indication of such a format change at the event boundary. Clause 6.5 of ETSI TS 101 547-4 [44] makes provisions concerning such format transitions.

In order to be consistent with the minimum capabilities in HDMI [i.14] for plano-stereoscopic 3DTV:

- the syntax element **quincunx_sampling_flag** shall be set to '0';
- the syntax element **content_interpretation_type** shall be set to '1';
- the syntax elements **spatial_flipping_flag** and **frame0_flipped_flag** shall be set to '0'.

NOTE 4: The HDMI specification does not provide all the information on the sub-sampling method, filters and how the views are ordered inside an HDTV frame. Therefore care should be taken on the use of any other value than the ones specified above.

The syntax elements **frame0_grid_position_x**, **frame0_grid_position_y**, **frame1_grid_position_x** and **frame1_grid_position_y** should be set to '0000'.

*When **frame_packing_arrangement_type** is equal to '4', the following syntax elements shall be equal to '0':*

- ***field_views_flag**;*
- ***current_frame_is_frame0_flag**.*

NOTE 5: As specified in Recommendation ITU-T H.265 / ISO/IEC 23008-2 [35], any other value of the above listed syntax elements combined with a **frame_packing_arrangement_type** equal to '4' is reserved for future use.

The syntax elements **frame0_self_contained_flag** and **frame1_self_contained_flag** should be set to '0'.

Decoding: *HEVC service frame compatible plano-stereoscopic 3DTV IRDs shall support the **frame_packing_arrangement_SEI** message.*

*HEVC service frame compatible plano-stereoscopic 3DTV IRDs shall ignore frame packing arrangement SEI messages with a value of **frame_packing_arrangement_id** not equal to '0'.*

*50 Hz HEVC service frame compatible plano-stereoscopic 3DTV IRDs shall support the following value of **frame_packing_arrangement_type**:*

- ***frame_packing_arrangement_type** value '4' (Top-and-Bottom).*

*60 Hz HEVC service frame compatible plano-stereoscopic 3DTV IRDs shall support the following value of **frame_packing_arrangement_type**:*

- ***frame_packing_arrangement_type** value '4' (Top-and-Bottom).*

*Frame compatible plano-stereoscopic 3DTV IRDs shall ignore the following syntax elements **field_views_flag**, **current_frame_is_frame0_flag**, **frame0_self_contained_flag**, **frame1_self_contained_flag**.*

J.4.4 VUI - Default Display Window and service compatibility of frame compatible services

The Default Display Window may be used to allow HEVC IRDs to extract one of the views for 2D display from a frame compatible format signalled by the Frame Packing Arrangement SEI message.

As an example, the values indicated in table J.2 might be used.

**Table J.2: Default Display Window parameter values
for service (2D) compatibility of Frame Compatible Formats**

Frame compatible plano-stereoscopic 3DTV video format	Default display window top offset (luma samples)	Default display window right offset (luma samples)	Default display window bottom offset (luma samples)	Default display window left offset (luma samples)
1 920 x 1 080p Top-and-Bottom	0	0	540	0

When the default display window is used to signal the 2D view to be extracted from the decoded picture (like in the example above), IRDs incognizant of frame compatible plano-stereoscopic 3DTV formats may apply the default display window as carried in the coded bitstream to crop the decoded picture. The cropped picture may be upscaled to the size of the conformance window. *IRDs cognizant of the stereoscopic formats shall output the content of the conformance cropping window if present in the coded bitstream (**conformance_window_flag** in the SPS is equal to 1). If the conformance cropping window is not present (**conformance_window_flag** in the SPS is equal to 0), the decoder shall output the whole decoded picture.*

Annex K (informative): Next-Generation Audio Overview

K.1 NGA Concepts

K.1.1 Introduction

Next Generation Audio (NGA) Systems provide Broadcasters, Operators and Content Providers with more flexibility to create and deliver their content. These NGA Systems introduce a number of new concepts and techniques, including:

- The capability to provide Immersive Audio with the addition of height elements.
- The capability to provide personalization options to broadcasters and consumers.
- The introduction of Audio Objects to facilitate immersive and personalized audio.

K.1.2 Immersive audio

Immersive Audio can be experienced with additional speakers adding the height elements (adding either direct speakers or simulating real speakers through various techniques such as sound frames or "up-firing" speakers). Using appropriate virtualization techniques, immersive audio can also be experienced through headphones.

The height elements may be carried either by additional audio channels, sound field representation, audio objects or a combination of these.

Audio objects can be conceptualized as either mono or stereo audio tracks with metadata that describes their properties e.g. type of content, positional and/or time metadata. These are delivered separately and are combined in the receiver, and are then matched to the final speaker layout of the user's reproduction equipment. Audio objects can be used to carry all of the Audio Programme Components of the Audio Programme, or their use can be restricted to a subset e.g. to speech elements.

K.1.3 Preselections and Personalized audio

As Audio Programme Components are combined at the receiver it is now possible to allow user interaction with the final mixing process. This can then allow the user to vary elements of the mix e.g. some constrained control over the relative level of dialogue with respect to the ambient music and effects.

In the hybrid configuration where Audio Programme Components can also be delivered in conjunction with the ambient sound, the receiver then combines the ambient sound and objects. This leads to a very efficient system where say the ambience is carried in an audio format that is optimized for ambient audio sources and the dialogue and speech related elements are transmitted as objects.

Audio Preselections are where alternative audio mixes are made available to the user for 'User Personalization'. These mixes could include existing service types such as alternative language versions or Audio Description services, but could also include new services such as a biased crowd and commentary mix at a sports event or a team channel. As some of the elements of the production may be shared between different Preselections, as these are combined at the receiver, this can also lead to a very efficient method of delivering these additional alternative services.

The signalling of preselections uses the audio preselection descriptor in DVB-SI, which is defined in clause 6.4.1 of ETSI EN 300 468 [i.32]. Further rules for its use are given in annex M of ETSI EN 300 468 [i.32].

K.2 Examples

K.2.1 Audio Programme Examples

A number of Audio Programme Components in the Audio Programme can be selected in different ways to create various audio experiences. Table K.1 provides two examples of such audio experiences (Audio Preselections) that could be specified by different broadcasters. The Audio Preselection information is essentially additional metadata which requires signaling at systems level and links to the Audio Programme Components to be played out together to form a predefined audio experience.

Table K.1: Example Broadcast Audio Preselections in an Audio Programme

Audio Programme	Input Elements	Audio Preselections	Components Referenced by Preselection
AP 1	5.1 M&E + D1 (EN) + D2 (DE) + AD (EN) + TeamRadio	English	M&E + D1
		English + AD	M&E + D1 + AD
		German	M&E + D2
		M&E + Team Radio	M&E + TeamRadio
		M&E Only	M&E
AP 2	7.1.4 M&E + D1 (EN) + D2 (DE) + AD (EN)	English	M&E + D1
		English + AD	M&E + D1 + AD
		German	M&E + D2
		M&E Only	M&E
AP 3	O(15).1 M&E + D1 (EN) + D2 (DE) + AD (EN)	English	M&E + D1
		English + AD	M&E + D1 + AD
		German	M&E + D2
		M&E Only	M&E
AP 4	HOA(6) M&E + D1 (EN) + D2 (DE) + AD (EN)	English	M&E + D1
		English + AD	M&E + D1 + AD
		German	M&E + D2
		M&E Only	M&E
NOTE:	Audio Programme examples 2, 3 and 4 are used only to illustrate the different immersive formats supported by NGA systems.		

K.2.2 Audio Preselection Examples

Figure K.1 illustrates the example of clause K.2.1 in more detail, assuming all Audio Programme Components and the Audio Preselection information are contained in the same stream (single-stream delivery case). Compared with legacy systems, this approach offers a bitrate efficient delivery, for example, of a multi-language program by using the same components in different Preselections (e.g. the M&E component) instead of several complete audio mixes ("complete mains").

Available Audio Preselections (Signaling Info.)	Audio Programme Components				
	M&E	Dialogue EN	Dialogue DE	AD EN	Team Radio
Default Preselection (English)	M&E	Dialogue EN	Dialogue DE	AD EN	Team Radio
German Preselection	M&E	Dialogue EN	Dialogue DE	AD EN	Team Radio
English Audio Description Preselection	M&E	Dialogue EN	Dialogue DE	AD EN	Team Radio
English Team Radio Preselection	M&E	Dialogue EN	Dialogue DE	AD EN	Team Radio
M&E Only Preselection	M&E	Dialogue EN	Dialogue DE	AD EN	Team Radio

Figure K.1: Example Broadcast Audio Preselections in an Audio Programme (AP 1)

For automatic selection the Preselection information contains language, accessibility and role attributes. Similarly "text labels" can be used for displaying the Preselections availability on the TV screen and allow manual selection.

K.3 Carriage of NGA

The simplest method for carrying the Audio Programme Components is to carry all components in a single elementary stream (linked to a single PID, i.e. single-stream delivery case). In this case all components are carried in the transport stream together with the signaling information of the available Audio Preselections. This example emphasizes one of the main differences of the NGA systems compared to the legacy systems, one PID can contain much more than one complete audio main. In legacy systems the multi-language functionality can be achieved using supplementary streams ("broadcast-mix" or "receiver-mix"). For NGA systems this is achieved in a much more bitrate efficient way using only one stream (linked to one PID) containing the independent components instead of complete mains.

In some applications the broadcaster might decide to embed some of the Audio Programme Components in individual elementary streams (separate elementary streams with separate PIDs, i.e. multi-stream delivery case). This method is used with non NGA codecs in the case of Audio Description, and a secondary language. In these use cases, the additional language or the Audio Description are placed on separate PIDs and all streams are multiplexed into the same transport stream for distribution.

Annex L (normative): Video codec profiles for DVB DASH

L.1 Introduction

This annex specifies DVB bitstream and decoder requirements for video content delivered using MPEG DASH.

DASH content is offered in the form of a DASH Media Presentation Description (MPD) that can target a range of device capabilities, with MPEG DASH players able to select those parts of the presentation that they can present and ignoring those that they cannot.

This model for interoperability calls for a different structure to the specification of content conformance points and player capabilities than is used for broadcast.

Clause L.2 defines the decoder requirements in terms of "player conformance points" that other specifications may reference. The player conformance points are specified by referencing the broadcast IRDs but with constraints, relaxations and extensions to account for the differing requirements of MPEG DASH delivery compared to use in a broadcast MPEG-2 Transport Stream.

Clause L.3 defines the content requirements, describing how content can be offered that is interoperable with one or more player conformance points and covering constraints on the use of each supported video codec.

This annex focusses on H.264/AVC and HEVC bitstream requirements that are the foundation of interoperability between encoders and decoders. It does not cover how bitstreams should be used within an MPEG DASH media presentation, nor does it cover requirements relating to bitstream switching, ISO BMFF system layer constraints or playback of MPEG DASH media presentations themselves. Those aspects, as they relate to DVB DASH, are covered in the DVB DASH specification ETSI TS 103 285 [i.34]. For these reasons, the decoder requirements specified in this annex are necessary but not sufficient for a decoder to be suitable for playback of DVB DASH content according to ETSI TS 103 285 [i.34] and reference shall also be made to that specification.

L.2 H.264/AVC and HEVC player conformance points

L.2.1 Summary of player conformance points

Table L.1 specifies the principal requirements of codec profile, colorimetry, resolution and frame rates that MPEG DASH players shall support for each of the defined player conformance points.

Table L.1: Player conformance points

Name	Codec	Frame formats	Colorimetry	Resolutions (notes 1 and 2)	Frame rates (notes 1 and 3)
avc_hd_50_level40	H.264/AVC Main and High Profile up to level 4.0	Interlaced and progressive	Recommendation ITU-R BT.709 [13]	Up to 1 920 x 1 080	50 Hz family
avc_hd_60_level40	H.264/AVC Main and High Profile up to level 4.0	Interlaced and progressive	Recommendation ITU-R BT.709 [13]	Up to 1 920 x 1 080	60 Hz family
avc_hd_50	H.264/AVC Main and High Profile up to level 4.2	Interlaced and progressive	Recommendation ITU-R BT.709 [13]	Up to 1 920 x 1 080	50 Hz family
avc_hd_60	H.264/AVC Main and High Profile up to level 4.2	Interlaced and progressive	Recommendation ITU-R BT.709 [13]	Up to 1 920 x 1 080	60 Hz family
hevc_hd_50_8	HEVC Main Profile up to level 4.1	Progressive	Recommendation ITU-R BT.709 [13]	Up to 1 920 x 1 080	50 Hz family
hevc_hd_60_8	HEVC Main Profile up to level 4.1	Progressive	Recommendation ITU-R BT.709 [13]	Up to 1 920 x 1 080	60 Hz family
hevc_hd_50_10	HEVC Main and Main 10 Profile up to level 4.1	Progressive	Recommendation ITU-R BT.709 [13]	Up to 1 920 x 1 080	50 Hz family
hevc_hd_60_10	HEVC Main and Main 10 Profile up to level 4.1	Progressive	Recommendation ITU-R BT.709 [13]	Up to 1 920 x 1 080	60 Hz family
hevc_uhd	HEVC Main and Main 10 Profile up to level 5.1	Progressive	Recommendations ITU-R BT.709 [13] and BT.2020 [36]	Up to 3 840 x 2 160	50 Hz and 60 Hz families
hevc_uhd_hlg10	HEVC Main 10 Profile up to level 5.1	Progressive	Recommendation ITU-R BT.2100 [45] HLG (note 4)	Up to 3 840 x 2 160	50 Hz and 60 Hz families
hevc_uhd_pq10	HEVC Main 10 Profile up to level 5.1	Progressive	Recommendation ITU-R BT.2100 [45] PQ (note 4)	Up to 3 840 x 2 160	50 Hz and 60 Hz families
hevc_uhd_hfr_hlg10	HEVC Main 10 Profile up to level 5.2	Progressive	Recommendation ITU-R BT.2100 [45] HLG (note 5)	Up to 3 840 x 2 160	50 Hz and 60 Hz families, and 100 Hz, 120/1 001 Hz, 120 Hz
hevc_uhd_hfr_pq10	HEVC Main 10 Profile up to level 5.2	Progressive	Recommendation ITU-R BT.2100 [45] PQ (note 5)	Up to 3 840 x 2 160	50 Hz and 60 Hz families, and 100 Hz, 120/1 001 Hz, 120 Hz
hevc_uhd2_hdr	HEVC Main 10 Profile up to level 6.1	Progressive	Recommendation ITU-R BT.2100 [45] (note 5)	Up to 7 680 x 4 320	50 Hz and 60 Hz families

NOTE 1: Only resolution and frame rate combinations which fall within the capabilities of the specified level are required. The highest frame rates may not be possible in combination with the highest resolutions.

NOTE 2: Specific resolutions for interoperability testing are defined in ETSI TS 103 285 [i.34], clause 10.3.

NOTE 3: "50 Hz family" refers to 6,25 Hz, 12,5 Hz, 25 Hz and 50 Hz; "60 Hz family" refers to 6 000/1 001 Hz, 6 Hz, 7 500/1 001 Hz, 7,5 Hz, 12 000/1 001 Hz, 12 Hz, 15 000/1 001 Hz, 15 Hz, 24 000/1 001 Hz, 24 Hz, 30 000/1 001 Hz, 30 Hz, 60 000/1 001 Hz and 60 Hz.

NOTE 4: These HDR player conformance points also support BT.709 and BT.2020 SDR transfer characteristics at the same resolutions and frame rates as for HDR.

NOTE 5: These HDR player conformance points also support BT.2020 SDR transfer characteristics at the same resolutions and frame rates as for HDR.

Requirements for the player conformance points and the relationships with relevant broadcast IRDs in clause 5 are specified in clauses L.2.2 to L.2.17.

Some player conformance points require support for others. Table L.2 summarizes these dependencies.

Table L.2: Conformance point dependencies

Player conformance point	Additional player conformance points required
avc_hd_50_level40	
avc_hd_60_level40	
avc_hd_50	avc_hd_50_level40 (note 1)
avc_hd_60	avc_hd_60_level40 (note 1)
hevc_hd_50_8	
hevc_hd_60_8	
hevc_hd_50_10	hevc_hd_50_8 (note 1)
hevc_hd_60_10	hevc_hd_60_8 (note 1)
hevc_uhd	hevc_hd_50_8, hevc_hd_60_8, hevc_hd_50_10 and hevc_hd_60_10 (note 1)
hevc_uhd_hlg10	hevc_uhd (note 2)
hevc_uhd_pq10	hevc_uhd (note 2)
hevc_uhd_hfr_hlg10	hevc_uhd_hlg10 (note 1)
hevc_uhd_hfr_pq10	hevc_uhd_pq10 (note 1)
hevc_uhd2_hdr	hevc_uhd_hlg10, hevc_uhd_pq10 (note 1)
NOTE 1: In this case, the additional player conformance point is a strict subset and is inherently included in the capabilities defined for the broader conformance point.	
NOTE 2: In this case, the additional player conformance point requires BT.709 and 8-bit support which means it is not a strict subset of the player conformance point in the left column.	

L.2.2 Relationship with broadcast IRDs (informative)

Each DASH player conformance point defined in the present annex is related to a broadcast IRD defined in clause 5. The requirements are not identical and a decoder conforming to one of the broadcast IRDs will not necessarily meet the requirements for the related DASH player conformance point.

Table L.3 lists the related broadcast IRD for each DASH player conformance point. This information may be helpful in selecting appropriate DASH player conformance points for a device that supports one or more broadcast IRDs, and vice versa.

Table L.3: Related IRDs for DASH player conformance points

DASH player conformance point	Related broadcast IRD
avc_hd_50_level40	25 Hz H.264/AVC HDTV IRD
avc_hd_60_level40	30 Hz H.264/AVC HDTV IRD
avc_hd_50	50 Hz H.264/AVC HDTV IRD
avc_hd_60	60 Hz H.264/AVC HDTV IRD
hevc_hd_50_8	50 Hz HEVC HDTV 8-bit IRD
hevc_hd_60_8	60 Hz HEVC HDTV 8-bit IRD
hevc_hd_50_10	50 Hz HEVC HDTV 10-bit IRD
hevc_hd_60_10	60 Hz HEVC HDTV 10-bit IRD
hevc_uhd	HEVC UHDTV IRD
hevc_uhd_hlg10	HEVC HDR UHDTV IRD using HLG10
hevc_uhd_pq10	HEVC HDR UHDTV IRD using PQ10
hevc_uhd_hfr_hlg10	HEVC HDR HFR UHDTV IRD using HLG10
hevc_uhd_hfr_pq10	HEVC HDR HFR UHDTV IRD using PQ10
hevc_uhd2_hdr	HEVC HDR UHDTV2 IRD

L.2.3 Constraints, relaxations and extensions common to all H.264/AVC player conformance points

Common decoder requirements for all H.264/AVC DASH player conformance points are those specified in the 'Decoding' paragraphs within clauses 5.5 and 5.7.1 subject to the following constraints, relaxations and extensions:

- Clause 5.5.5 does not apply to MPEG DASH players.

- In clause 5.7.1.2, the values of **aspect_ratio_idc** that are mandatory to support shall be replaced with the following: **aspect_ratio_idc** equal to 1 shall be supported, along with the resolution-specific **aspect_ratio_idc** values listed in table L.4.

Table L.4: Resolution specific aspect_ratio_idc values

Coded picture luminance resolution	aspect_ratio_idc
720 x 576, 704 x 576, 352 x 288	2, 4
544 x 576	4, 12

- Picture aspect ratios of 4:3 and 16:9 shall be supported (measured after conformance cropping is applied).
- In clause 5.7.1.3, content that does not contain colour parameter information should be considered as having BT.709 colorimetry.

NOTE: This is to give the widest interoperability with the existing content referred to in clause L.3.2.5.

- In clause 5.7.1.4, the reference to table 11 does not apply to MPEG DASH players. Resolutions for use with DVB DASH can be found in clause 10.3 of ETSI TS 103 285 [i.34].

L.2.4 avc_hd_50_level40

The decoder requirements for this DASH player conformance point correspond to the requirements for the 25 Hz H.264/AVC HDTV IRD specified in the 'Decoding' paragraphs included in and referenced from clause 5.7.2 with the following constraints, relaxations and extensions together with those in clause L.2.3:

- In clause 5.7.2.1, decoding of Main Profile shall also be supported. The final sentence "*If the ... IRD encounters an extension...*" does not apply to MPEG DASH players. If the decoder encounters an extension that it cannot parse, it shall discard the following data until the end of the NAL unit.
- In clause 5.7.2.2, frame rates of one half and one quarter of the specified values shall additionally be supported.

L.2.5 avc_hd_60_level40

The decoder requirements for this DASH player conformance point correspond to the requirements for the 30 Hz H.264/AVC HDTV IRD specified in the 'Decoding' paragraphs included in and referenced from clause 5.7.3 with the following constraints, relaxations and extensions together with those in clause L.2.3:

- In clause 5.7.3.1, decoding of Main Profile shall also be supported. The final sentence "*If the ... IRD encounters an extension...*" does not apply to MPEG DASH players. If the decoder encounters an extension that it cannot parse, it shall discard the following data until the end of the NAL unit.
- In clause 5.7.3.2, frame rates of one half and one quarter of the specified values shall additionally be supported.

L.2.6 avc_hd_50

The decoder requirements for this DASH player conformance point correspond to the requirements for the 50 Hz H.264/AVC HDTV IRD specified in the 'Decoding' paragraphs included in and referenced from clause 5.7.4 with the following constraints, relaxations and extensions together with those in clause L.2.3:

- In clause 5.7.4.1, decoding of Main Profile shall also be supported. The final sentence "*If the ... IRD encounters an extension...*" does not apply to MPEG DASH players. If the decoder encounters an extension that it cannot parse, it shall discard the following data until the end of the NAL unit.
- In clause 5.7.4.2, frame rates of one half and one quarter of the specified values shall additionally be supported.

- The backwards compatibility requirements of clause 5.7.4.3 do not apply. Decoders supporting this player conformance point implicitly support the `avc_hd_50_level40` conformance point as it is a strict subset.

L.2.7 `avc_hd_60`

The decoder requirements for this DASH player conformance point correspond to the requirements for the 60 Hz H.264/AVC HDTV IRD specified in the 'Decoding' paragraphs included in and referenced from clause 5.7.5 with the following constraints, relaxations and extensions together with those in clause L.2.3:

- In clause 5.7.5.1, decoding of Main Profile shall also be supported. The final sentence "*If the ... IRD encounters an extension...*" does not apply to MPEG DASH players. If the decoder encounters an extension that it cannot parse, it shall discard the following data until the end of the NAL unit.
- In clause 5.7.5.2, frame rates of one half and one quarter of the specified values shall additionally be supported.
- The backwards compatibility requirements of clause 5.7.5.3 do not apply. Decoders supporting this player conformance point implicitly support the `avc_hd_60_level40` conformance point as it is a strict subset.

L.2.8 Constraints, relaxations and extensions common to all HEVC player conformance points

Common decoder requirements for all HEVC DASH player conformance points are those specified in the 'Decoding' paragraphs within clause 5.14.1 subject to the following constraints, relaxations and extensions:

- In clause 5.14.1.3, the paragraph "*When the value of `pic_height_in_luma_samples` is changed...*" does not apply to MPEG DASH players.
- In clause 5.14.1.5.1, content with `aspect_ratio_idc` equal to 1 shall be supported. Other values may be supported.
- Picture aspect ratios of 4:3 and 16:9 shall be supported (measured after conformance cropping is applied).
- In clause 5.14.1.5.3, content that does not contain colour parameter information should be considered as having BT.709 colorimetry.

NOTE: This is to give the widest interoperability with the existing content referred to in clause L.3.3.6.

- In clause 5.14.1.6.0, support for the Recovery Point SEI Message is not required.
- In clause 5.14.1.6.1, support for `pic_struct` values other than 0 is not required.
- In clause 5.14.1.7, frame rates of one half and one quarter of the specified values shall additionally be supported. Support for interlaced content is not required. The sentence beginning "*The highest TemporalID...*" does not apply to MPEG DASH players; carriage of this variable for MPEG DASH is outside the scope of the present document.
- Clause 5.14.1.9.1 does not apply to MPEG DASH players.
- In clause 5.14.1.9.2, note 2 does not apply to MPEG DASH players.
- MPEG DASH players shall decode HEVC bitstreams with `sps_max_sub_layers_minus1` greater than 0.
- When `sps_max_sub_layers_minus1` is greater than "0", and where a value of `HighestTid` has been provided by an out of band mechanism (e.g. a DASH MPD), MPEG DASH players may ignore `general_level_idc` and shall make use of the `sub_layer_level_idc[i]` syntax element, where 'i' is equal to the value of `HighestTid` to determine whether a bitstream can be decoded.
- Clause 5.14.1.10 does not apply to MPEG DASH players.
- Sequence parameter set extensions signalled by `sps_extension_present_flag` set to "1" may be ignored.

- MPEG DASH players shall support HEVC bitstreams that meet the constraints and limits associated with the Main Tier.

L.2.9 hevc_hd_50_8

The decoder requirements for this DASH player conformance point consist of the common requirements specified in the 'Decoding' paragraphs within clause 5.14.1 with the constraints, relaxations and extensions listed in clause L.2.8, along with the requirements for the HEVC HDTV IRD specified in the 'Decoding' paragraphs within clause 5.14.2 with the following constraints, relaxations and extensions:

- Clause 5.14.2.1 does not apply to MPEG DASH players. Players supporting the hevc_hd_50_8 player conformance point shall support bitstreams that conform to the requirements of clause L.3.3 within the constraints defined for hevc_hd_50_8 in table L.1.
- In clause 5.14.2.2, the reference to table 20 does not apply to MPEG DASH players. Resolutions for use with DVB DASH can be found in clause 10.3 of ETSI TS 103 285 [i.34].

L.2.10 hevc_hd_60_8

The decoder requirements for this DASH player conformance point consist of the common requirements specified in the 'Decoding' paragraphs within clause 5.14.1 with the constraints, relaxations and extensions listed in clause L.2.8, along with the requirements for the HEVC HDTV IRD specified in the 'Decoding' paragraphs within clause 5.14.2 with the following constraints, relaxations and extensions:

- Clause 5.14.2.1 does not apply to MPEG DASH players. Players supporting the hevc_hd_60_8 player conformance point shall support bitstreams that conform to the requirements of clause L.3.3 within the constraints defined for hevc_hd_60_8 in table L.1.
- In clause 5.14.2.2, the reference to table 20 does not apply to MPEG DASH players. Resolutions for use with DVB DASH can be found in clause 10.3 of ETSI TS 103 285 [i.34].

L.2.11 hevc_hd_50_10

The decoder requirements for this DASH player conformance point consist of the common requirements specified in the 'Decoding' paragraphs within clause 5.14.1 with the constraints, relaxations and extensions listed in clause L.2.8, along with the requirements for the HEVC HDTV IRD specified in the 'Decoding' paragraphs within clause 5.14.2 with the following constraints, relaxations and extensions:

- Clause 5.14.2.1 does not apply to MPEG DASH players. Players supporting the hevc_hd_50_10 player conformance point shall support bitstreams that conform to the requirements of clause L.3.3 within the constraints defined for hevc_hd_50_10 in table L.1.
- In clause 5.14.2.2, the reference to table 20 does not apply to MPEG DASH players. Resolutions for use with DVB DASH can be found in clause 10.3 of ETSI TS 103 285 [i.34].
- Decoders supporting the hevc_hd_50_10 player conformance point implicitly support the hevc_hd_50_8 conformance point as it is a strict subset.

L.2.12 hevc_hd_60_10

The decoder requirements for this DASH player conformance point consist of the common requirements specified in the 'Decoding' paragraphs within clause 5.14.1 with the constraints, relaxations and extensions listed in clause L.2.8, along with the requirements for the HEVC HDTV IRD specified in the 'Decoding' paragraphs within clause 5.14.2 with the following constraints, relaxations and extensions:

- Clause 5.14.2.1 does not apply to MPEG DASH players. Players supporting the hevc_hd_60_10 player conformance point shall support bitstreams that conform to the requirements of clause L.3.3 within the constraints defined for hevc_hd_60_10 in table L.1.

- In clause 5.14.2.2, the reference to table 20 does not apply to MPEG DASH players. Resolutions for use with DVB DASH can be found in clause 10.3 of ETSI TS 103 285 [i.34].
- Decoders supporting hevc_hd_60_10 player conformance point implicitly support the hevc_hd_60_8 conformance point as it is a strict subset.

L.2.13 hevc_uhd

The decoder requirements for this DASH player conformance point consist of the common requirements specified in the 'Decoding' paragraphs within clause 5.14.1 with the constraints, relaxations and extensions listed in clause L.2.8, along with the requirements for the HEVC UHD TV IRD specified in the 'Decoding' paragraphs within clause 5.14.3 with the following constraints, relaxations and extensions:

- Clause 5.14.3.1 does not apply to MPEG DASH players. Players supporting the hevc_uhd player conformance point shall support bitstreams that conform to the requirements of clause L.3.3 within the constraints defined for hevc_uhd in table L.1.
- In clause 5.14.3.2, the reference to table 21 does not apply to MPEG DASH players. Resolutions for use with DVB DASH can be found in clause 10.3 of ETSI TS 103 285 [i.34].
- Decoders supporting the hevc_uhd player conformance point implicitly support the hevc_hd_50_8, hevc_hd_60_8, hevc_hd_50_10 and hevc_hd_60_10 conformance points as they are strict subsets.

L.2.14 hevc_uhd_hlg10

The decoder requirements for this DASH player conformance point consist of the common requirements specified in the 'Decoding' paragraphs within clause 5.14.1 with the constraints, relaxations and extensions listed in clause L.2.8, along with the requirements for the HEVC HDR UHD TV IRD using HLG10 specified in the 'Decoding' paragraphs within clause 5.14.4 with the following constraints, relaxations and extensions:

- Clause 5.14.4.2 does not apply to MPEG DASH players. Players supporting the hevc_uhd_hlg10 player conformance point shall support bitstreams that conform to the requirements of clause L.3.3 within the constraints defined for hevc_uhd_hlg10 in table L.1.
- In clause 5.14.4.3, the reference to table 21a does not apply to MPEG DASH players. Resolutions for use with DVB DASH can be found in clause 10.3 of ETSI TS 103 285 [i.34].
- Clause 5.14.4.2.2 does not apply to MPEG DASH players.

NOTE: Transitions between SDR and HDR transfer characteristics may occur only at a Period boundary in DVB DASH content and so there are no SDR/HDR splicing considerations to consider at the bitstream level.

- In clause 5.14.4.5, frame rates of one half and one quarter of the specified values shall additionally be supported.
- The backwards compatibility requirements of clause 5.14.4.6 do not apply. MPEG DASH players supporting the hevc_uhd_hlg10 player conformance point shall additionally support all of the requirements for the hevc_uhd player conformance point specified in clause L.2.13.

L.2.15 hevc_uhd_pq10

The decoder requirements for this DASH player conformance point consist of the common requirements specified in the 'Decoding' paragraphs within clause 5.14.1 with the constraints, relaxations and extensions listed in clause L.2.8, along with the requirements for the HEVC HDR UHD TV IRD using PQ10 specified in the 'Decoding' paragraphs within clause 5.14.4 with the following constraints, relaxations and extensions:

- Clause 5.14.4.2 does not apply to MPEG DASH players. Players supporting the hevc_uhd_pq10 player conformance point shall support bitstreams that conform to the requirements of clause L.3.3 within the constraints defined for hevc_uhd_pq10 in table L.1.

- In clause 5.14.4.3, the reference to table 21a does not apply to MPEG DASH players. Resolutions for use with DVB DASH can be found in clause 10.3 of ETSI TS 103 285 [i.34].
- Clause 5.14.4.3.4 does not apply to MPEG DASH players.

NOTE: Transitions between SDR and HDR transfer characteristics may occur only at a Period boundary in DVB DASH content and so there are no SDR/HDR splicing considerations to consider at the bitstream level.

- In clause 5.14.4.5, frame rates of one half and one quarter of the specified values shall additionally be supported.
- The backwards compatibility requirements of clause 5.14.4.6 do not apply. MPEG DASH players supporting the `hevc_uhd_pq10` player conformance point shall additionally support all of the requirements for the `hevc_uhd` player conformance point specified in clause L.2.13.

L.2.16 `hevc_uhd_hfr_hlg10`

The decoder requirements for this DASH player conformance point consist of the common requirements specified in the 'Decoding' paragraphs within clause 5.14.1 with the constraints, relaxations and extensions listed in clause L.2.8, along with the requirements for the HEVC HDR HFR UHDTV IRD using HLG10 specified in the 'Decoding' paragraphs within clause 5.14.5 with the following constraints, relaxations and extensions:

- Requirements relating to "HFR bitstreams using dual PID and temporal scalability" do not apply to MPEG DASH players and clauses 5.14.5.6, 5.14.5.7 and 5.14.5.8 do not apply.

NOTE: The use of temporal sub-layers within HFR bitstreams for MPEG DASH is described in ETSI TS 103 285 [i.34].

- Clause 5.14.5.2 does not apply to MPEG DASH players. Players supporting the `hevc_uhd_hfr_hlg10` player conformance point shall support bitstreams that conform to the requirements of clause L.3.3 within the constraints defined for `hevc_uhd_hfr_hlg10` in table L.1.
- In clause 5.14.4.3, referenced from 5.14.5.3, the reference to table 21a does not apply to MPEG DASH players. Resolutions for use with DVB DASH can be found in clause 10.3 of ETSI TS 103 285 [i.34].
- Clause 5.14.4.2.2, referenced from 5.14.5.4, does not apply to MPEG DASH players.
- In clause 5.14.5.5.1, frame rates of one half and one quarter of the specified values shall additionally be supported.
- Clause 5.14.5.5.2 does not apply to MPEG DASH players.
- The backwards compatibility requirements of clause 5.14.5.9 do not apply. MPEG DASH players supporting the `hevc_uhd_hfr_hlg10` player conformance point shall additionally support all of the requirements for the `hevc_uhd_hlg10` player conformance point specified in clause L.2.14.

L.2.17 `hevc_uhd_hfr_pq10`

The decoder requirements for this DASH player conformance point consist of the common requirements specified in the 'Decoding' paragraphs within clause 5.14.1 with the constraints, relaxations and extensions listed in clause L.2.8, along with the requirements for the HEVC HDR HFR UHDTV IRD using PQ10 specified in the 'Decoding' paragraphs within clause 5.14.5 with the following constraints, relaxations and extensions:

- Requirements relating to "HFR bitstreams using dual PID and temporal scalability" do not apply to MPEG DASH players and clauses 5.14.5.6, 5.14.5.7 and 5.14.5.8 do not apply.

NOTE: The use of temporal sub-layers within HFR bitstreams for MPEG DASH is described in ETSI TS 103 285 [i.34].

- Clause 5.14.5.2 does not apply to MPEG DASH players. Players supporting the `hevc_uhd_hfr_pq10` player conformance point shall support bitstreams that conform to the requirements of clause L.3.3 within the constraints defined for `hevc_uhd_hfr_pq10` in table L.1.

- In clause 5.14.4.3, referenced from 5.14.5.3, the reference to table 21a does not apply to MPEG DASH players. Resolutions for use with DVB DASH can be found in clause 10.3 of ETSI TS 103 285 [i.34].
- Clause 5.14.4.3.4, referenced from 5.14.5.4, does not apply to MPEG DASH players.
- In clause 5.14.5.5.1, frame rates of one half and one quarter of the specified values shall additionally be supported.
- Clause 5.14.5.5.2 does not apply to MPEG DASH players.
- The backwards compatibility requirements of clause 5.14.5.9 do not apply. MPEG DASH players supporting the `hevc_uhd_hfr_pq10` player conformance point shall additionally support all of the requirements for the `hevc_uhd_pq10` player conformance point specified in clause L.2.15.

L.2.18 `hevc_uhd2_hdr`

The decoder requirements for this DASH player conformance point consist of the common requirements specified in the 'Decoding' paragraphs within clause 5.14.1 with the constraints, relaxations and extensions listed in clause L.2.8, along with the requirements for the HEVC HDR UHD TV2 IRD specified in the 'Decoding' paragraphs within clause 5.14.6 with the following constraints, relaxations and extensions:

- Clause 5.14.6.2 does not apply to MPEG DASH players. Players supporting the `hevc_uhd2_hdr` player conformance point shall support bitstreams that conform to the requirements of clause L.3.3 within the constraints defined for `hevc_uhd2_hdr` in table L.1.
- In clause 5.14.6.3, the reference to table 21c does not apply to MPEG DASH players. Resolutions for use with DVB DASH can be found in clause 10.3 of ETSI TS 103 285 [i.34].
- Clause 5.14.4.4.2.2 referenced in clause 5.14.6.4 does not apply to MPEG DASH players.

NOTE: Transitions between SDR and HDR transfer characteristics may occur only at a Period boundary in DVB DASH content and so there are no SDR/HDR splicing considerations to consider at the bitstream level.

- The backwards compatibility requirements of clause 5.14.6.6 do not apply. MPEG DASH players supporting the `hevc_uhd2_hdr` player conformance point shall additionally support all of the requirements for the `hevc_uhd_hlg10` player conformance point specified in clause L.2.14, and for the `hevc_uhd_pq10` player conformance point specified in clause L.2.15.
- 16:9 picture aspect ratio shall be supported (measured after conformance cropping is applied). Support for 4:3 picture aspect ratio is not required for this DASH player conformance point.

L.3 Content requirements

L.3.1 Content interoperability requirements

MPEG DASH presentations include a number of Representations along with explicit signalling of codec used, profile and level information, frame rate and resolution, plus colorimetry information where necessary.

Content can be created that is interoperable *at the codec level* with any of the defined player conformance points defined in clause L.2. This is achieved by including within the DASH presentation one or more Representations that satisfy the general codec bitstream constraints in clause L.3.2 or L.3.3 and fall within the mandatory requirements of a player that supports the specific player conformance point from clause L.2 and summarized in table L.1.

Content providers may choose which player conformance points they wish to target.

L.3.2 H.264/AVC bitstream requirements

L.3.2.1 General

The video encoding shall conform to Recommendation ITU-T H.264 / ISO/IEC 14496-10 [16]. Some of the parameters and fields are not used in the DVB System and these restrictions are described below.

L.3.2.2 Sequence Parameter Set

In addition to the provisions set forth in Recommendation ITU-T H.264 / ISO/IEC 14496-10 [16], the following restrictions shall apply for the fields in the sequence parameter set:

gaps_in_frame_num_value_allowed_flag = 0 (gaps not allowed)

If the number of samples per row of the luminance component of the source picture is not an integer multiple of 16 and additional samples are padded to make the number of samples per row of the luminance component an integer multiple of 16, it is recommended that these samples are padded at the right side of the picture.

If the number of samples per column of the luminance component of the source picture is not an integer multiple of 16 and additional samples are padded to make the number of samples per column of the luminance component an integer multiple of 16, it is recommended that these samples are padded at the bottom of the picture.

L.3.2.3 Video Usability Information

H.264/AVC Bitstreams shall set **vui_parameters_present_flag** to 1 in the active Sequence Parameter Set, i.e. H.264/AVC Bitstreams shall contain a Video Usability Information syntax structure.

L.3.2.4 Aspect ratio

The present document does not restrict the picture aspect ratios that may be used by content. Content intended to be compatible with TV devices should use a 4:3 or 16:9 picture aspect ratio. Requirements for targeting other types of devices may differ.

NOTE 1: In order to be compatible with the mandatory requirements in the player conformance points defined in clause L.2, content needs to use either 4:3 or 16:9 aspect ratio.

The sample aspect ratio information shall be signalled in the bitstream using the **aspect_ratio_idc** value in the Video Usability Information.

NOTE 2: In order to be compatible with the mandatory requirements in the player conformance points defined in clause L.2, content needs to use one of the **aspect_ratio_idc** values described in clause L.2.3.

L.3.2.5 Colour parameter information

Except as stated in the present clause, the chromaticity co-ordinates of the ideal display, opto-electronic transfer characteristic of the source picture and matrix coefficients used in deriving luminance and chrominance signals from the red, green and blue primaries shall be explicitly signalled in the encoded bitstream by setting the appropriate values for each of the following 3 parameters in the VUI: **colour_primaries**, **transfer_characteristics**, and **matrix_coefficients**.

It is recognized that a significant amount of Video on Demand content existed prior to the publication of the present document that was produced and encoded with BT.709 colorimetry without colour parameter information being included. Such content shall be considered to comply with the present document but risks being presented with incorrect colorimetry by some MPEG DASH players. It is recommended that steps be taken to add colorimetry information to such content where it is commercially reasonable to do so.

It is recommended that Recommendation ITU-R BT.709 [13] colorimetry is used. Recommendation ITU-R BT.709 [13] colorimetry usage is signalled by setting **colour_primaries** to the value 1, **transfer_characteristics** to the value 1 and **matrix_coefficients** to the value 1.

L.3.2.6 Chrominance information

It is recommended to use chroma sample location type equal to 0 for both fields.

Where the chroma sample location type is not 0, the chrominance locations should be specified by setting **chroma_loc_info_present_flag** to 1 and using the syntax elements **chroma_sample_loc_type_top_field** and **chroma_sample_loc_type_bottom_field** in the VUI.

L.3.2.7 Picture timing SEI message

If the H.264/AVC Bitstream contains picture structure information, then the **pic_struct_present_flag** shall be set to "1" in the VUI and a picture timing SEI message shall be associated with every access unit. Otherwise the **pic_struct_present_flag** shall be set to "0".

NOTE 1: Setting **pic_struct_present_flag** to "1" indicates the presence of **pic_struct** that assists decoders in determining if the picture should be displayed as a frame or one or more fields. Possible values for **pic_struct** are defined in table D 1 of Recommendation ITU-T H.264 / ISO/IEC 14496-10 [16]. Progressive coded video sequences (with **frame_mbs_only** equal to 1) should only use **pic_struct** value of 0. Interlace coded video sequences (with **frame_mbs_only_flag** equal to 0) should only use **pic_struct** values of 1, 2, 3, 4, 5, 6.

It is recommended that **ct_type** be explicitly transmitted to convey the original picture scan.

NOTE 2: Possible values for **ct_type** are defined in table D 2 of Recommendation ITU-T H.264 / ISO/IEC 14496-10 [16]. Setting **ct_type** to 2 may be used to indicate an unknown original picture scan. The **ct_type** field may change between progressive and interlaced within a sequence. Progressive **ct_types** values may be present within a coded video sequence with interlaced **pic_struct** values but it is recommended not to transmit interlaced **ct_type** values within a coded video sequence with progressive **pic_struct** values.

NOTE 3: The original picture scan can be quite useful for assisting operations such as deinterlacing and trick modes. Explicit transmission of the **ct_type** field is indicated when the **clock_timestamp_flag[i]** is set to 1.

If a timecode is to be carried, it is recommended that the **full_timestamp_flag** is set to "1" and **hours_value**, **minutes_value**, **seconds_value** and **n_frames** are used to transport the timecode values. **Time_offset** may be ignored and normally carry the value "0", if present.

NOTE 4: The default value of **time_offset_length** is 24 unless specified otherwise by the VUI message HRD parameters, which in turn requires the presence of additional fields in the picture timing SEI message (**cpb_removal_delay** and **dpb_output_delay**).

Note that if present, the picture structure information shall convey the picture output order in the same order as the Picture Order Count (POC) information in the H.264/AVC Bitstream (per clause D.2.2 of Recommendation ITU-T H.264 / ISO/IEC 14496-10 [16]). This ensures consistency between the SEI message and the HRD model of Recommendation ITU-T H.264 / ISO/IEC 14496-10 [16].

L.3.2.8 Frame rate

Frame rate may be indicated in the VUI by setting **time_scale** and **num_units_in_tick** so as to correctly define the picture rate of the video.

The source video format shall be interlaced or progressive when the frame rate is 25 Hz, 30 Hz or 30 000 / 1 001 Hz. For all other frame rates, the source video format shall be progressive.

L.3.3 HEVC bitstream requirements

L.3.3.1 General

The video encoding shall conform to Recommendation ITU-T H.265 / ISO/IEC 23008-2 [35]. Some of the parameters and fields are not used in the DVB System and these restrictions are described below.

L.3.3.2 Sequence Parameter Set

Video shall be encoded as progressive frames. The **general_progressive_source_flag** shall be set to 1. The **general_interlaced_source_flag** shall be set to 0. The **general_frame_only_constraint_flag** shall be set to 1.

As specified in annex A of Recommendation ITU-T H.265 / ISO/IEC 23008-2 [35], when **general_profile_idc** is equal to 1 or **general_profile_compatibility_flag** [1] is equal to 1, i.e. when the bitstream indicates conformance with the Main Profile, the value of **bit_depth_luma_minus8** and **bit_depth_chroma_minus8** shall be equal to 0. HDR shall not be used with Main Profile.

When **general_profile_idc** is equal to 2 or **general_profile_compatibility_flag**[2] is equal to 1, i.e. when the bitstream indicates conformance with the Main 10 Profile, the value of **bit_depth_luma_minus8** shall be set to 0 or 2 and **bit_depth_chroma_minus8** shall be equal to the value of **bit_depth_luma_minus8**. HDR content using Main 10 Profile shall have **bit_depth_luma_minus8** and **bit_depth_chroma_minus8** set to 2.

If padding is required to align the number of samples per row, it is recommended that these samples are padded at the right side of the picture.

If padding is required to align the number of samples per column, it is recommended that these samples are padded at the bottom of the picture.

When video is encoded using temporal layers and a bitstream does not contain all of the temporal layers (for example if it contains only those layers that carry the standard frame rate part of high frame rate source material) then:

- The variable HighestTid, as defined in Recommendation ITU-T H.265 / ISO/IEC 23008-2 [35], shall be provided by an out of band mechanism, e.g. the DASH MPD in the case of MPEG DASH delivery. Carriage of this variable is outside the scope of the present document.
- If the level to which the bitstream conforms is different to that carried by **general_level_idc** then **sub_layer_level_idc[i]** shall be present and shall be set correctly for $i = \text{HighestTid}$.

L.3.3.3 Video Usability Information

HEVC Bitstreams shall set **vui_parameters_present_flag** to 1 in the active Sequence Parameter Set, i.e. HEVC Bitstreams shall contain a Video Usability Information syntax structure.

field_seq_flag shall be set to 0.

L.3.3.4 Aspect ratio

The present document does not restrict the picture aspect ratios that may be used by content. Content intended to be compatible with TV devices should use a 4:3 or 16:9 picture aspect ratio. Requirements for targeting other types of devices may differ.

NOTE 1: In order to be compatible with the mandatory requirements in the player conformance points defined in clause L.2, content needs to use either 4:3 or 16:9 aspect ratio.

The sample aspect ratio information shall be signalled in the bitstream using the **aspect_ratio_idc** value in the Video Usability Information.

NOTE 2: In order to be compatible with the mandatory requirements in the player conformance points defined in clause L.2, content needs to use an **aspect_ratio_idc** value of 1.

L.3.3.5 Video range

The **video_full_range_flag** shall equal "0".

L.3.3.6 Colour parameter information

Except as stated in the present clause, the syntax element **colour_description_present_flag** shall be set to "1", so that **colour_primaries**, **transfer_characteristics**, **matrix_coeffs** are present in the VUI.

It is recognized that a significant amount of Video on Demand content existed prior to the publication of the present document that was produced and encoded with BT.709 colorimetry without colour parameter information being included. Such content shall be considered to comply with the present document but risks being presented with incorrect colorimetry by some MPEG DASH players. It is recommended that steps be taken to add colorimetry information to such content where it is commercially reasonable to do so.

Recommendation ITU-R BT.709 [13] colorimetry usage is signalled by setting **colour primaries** to the value 1, **transfer_characteristics** to the value 1 and **matrix_coeffs** to the value 1.

Recommendation ITU-R BT.2020 [36] non-constant luminance colorimetry usage is signalled by setting **colour primaries** to the value 9, **transfer_characteristics** to the value 14 and **matrix_coeffs** to the value 9.

Recommendation ITU-R BT.2100 [45] high dynamic range content with non-constant luminance is signalled by setting **colour primaries** to the value 9 and **matrix_coeffs** to the value 9.

HEVC HDR bitstreams using HLG10 shall set VUI **transfer_characteristics** to the value 14 to signal the opto-electronic transfer function as Recommendation ITU-R BT.2020 [36] 10-bits. Such streams shall also contain the **alternative_transfer_characteristics** SEI message. The **preferred_transfer_characteristics** shall be set equal to 18, indicating Recommendation ITU-R BT. 2100 [45] HLG system.

HEVC HDR bitstreams using PQ10 shall set VUI **transfer_characteristics** to the value 16 to signal the electro-optical transfer function as Recommendation ITU-R BT.2100 [45] PQ system.

L.3.3.7 Chrominance information

It is recommended to use chroma sample location type equal to 0 for progressive video conforming to Recommendation ITU-R BT.709 [13] or 2 for progressive video conforming to Recommendation ITU-R BT.2020 [36].

Where the chroma sample location type is not 0, the chrominance locations shall be specified by setting **chroma_loc_info_present_flag** to 1 and using the syntax elements **chroma_sample_loc_type_top_field** and **chroma_sample_loc_type_bottom_field** in the VUI.

L.3.3.8 Supplemental Enhancement Information

All prefix SEI NAL units within an access unit shall be placed after all NAL units of type VPS_NUT, SPS_NUT and PPS_NUT and prior to the first VCL NAL unit of the access unit. All suffix SEIs shall not occur before the last VCL NAL unit of the access unit.

NOTE: HEVC allows SEI messages (both prefix and suffix SEI) to occur between the first and the last VCL NAL units of an access unit. The constraint in the present clause forbids SEI messages from occurring between the first and the last VCL NAL units of an access unit.

L.3.3.9 Picture timing SEI message

HEVC Bitstreams may contain a picture timing SEI message for every access unit of a coded video sequence and **frame_field_info_present_flag** may be set to 1 in the VUI.

The value of **pic_struct** shall be equal to 0.

Before an encoding process, in order to achieve a higher frame rate than the frame rate of the original programme, additional pictures may be created e.g. by repeating or motion interpolating original programme pictures. It is recommended to use the **duplicate_flag** for this use case in a manner different to the usage documented in Recommendation ITU-T H.265 / ISO/IEC 23008-2 [35].

- If the current picture is not an original programme picture, it is recommended to set the value of **duplicate_flag** to 1.
- In the case of motion compensated Video Standard Conversion as a pre-process before encoding, e.g. from 50 Hz to 60 000/1 001 Hz or from 100 Hz to 120 000/1 001 Hz, there might not be any original programme pictures preserved at all, hence it is recommended that all pictures get **duplicate_flag** value 0 to avoid accidental deletion after decoding.

L.3.3.10 Optional SEI messages for HEVC HDR bitstreams using PQ10

L.3.3.10.1 General

The present clause specifies restrictions applying to Supplemental Enhancement Information messages that are specified in Recommendation ITU-T H.265 / ISO/IEC 23008-2 [35] or Supplemental Enhancement Information messages carrying DMI as specified in ETSI TS 103 572 [50] or ETSI TS 103 433-2 [51] or CTA 861-H [52], and that may be optionally present in HEVC HDR bitstreams using PQ10.

These Supplemental Enhancement Information messages provide production or playout side controlled post processing in the MPEG DASH player and do not preclude alternative postprocessing on the player side.

L.3.3.10.2 Mastering display colour volume

HEVC HDR bitstreams using PQ10 may contain a mastering display colour volume SEI message as specified in Recommendation ITU-T H.265 / ISO/IEC 23008-2 [35], annex D.

It is recommended that HEVC HDR bitstreams set a valid number to **display primaries_x[c]**, **display primaries_y[c]**, **white_point_x**, **white_point_y**, **max_display_mastering_luminance**, **min_display_mastering_luminance** fields.

If the proper value for all these fields is unknown, it is recommended that no mastering display colour volume SEI message is present in the HEVC HDR bitstream; or if the proper value for any one of the following fields are unknown, **display primaries_x[c]**, **display primaries_y[c]**, **white_point_x**, **white_point_y** or **max_display_mastering_luminance**, it is recommended that the unknown field is set to 0.

The lowest value for **min_display_mastering_luminance** that is valid without ambiguity is 0,0001, when viewing a Reference Monitor calibrated while viewing a test pattern (such as PLUGE for example). Hence it is recommended that:

- an unknown value for **min_display_mastering_luminance** should be signalled with value 0;
- a known value for **min_display_mastering_luminance** should be signalled with a value larger than or equal to 0,0001.

L.3.3.10.3 Content light level information

HEVC HDR bitstreams using PQ10 may contain a content light level SEI message as specified in Recommendation ITU-T H.265 / ISO/IEC 23008-2 [35], annex D.

NOTE: In some cases, such as live and linear broadcast, it may not be possible to calculate the values of **max_content_light_level** and **max_pic_average_light_level** fields.

If the value for these fields is known, it is recommended that HEVC HDR bitstreams include valid settings for the **max_content_light_level** and **max_pic_average_light_level** fields.

If the value for all these fields is unknown, it is recommended that no content light level information SEI message is present in the HEVC HDR bitstream; or if the value for any one of these fields is unknown, it is recommended that the unknown field is set to 0.

L.3.3.10.4 DMI

L.3.3.10.4.1 General

The Supplemental Enhancement Information messages carrying DMI defined in the present clause can guide dynamic mapping, as produced in a reference viewing environment or otherwise. A display that is cognizant of the DMI can use this information to adapt the rendering of the video content to its own display capabilities and/or to the viewing environment, including the possibility to replicate as closely as possible the intended appearance of that content as produced in the reference viewing environment.

HEVC HDR Bitstreams using PQ10 may contain Supplemental Enhancement Information messages carrying DMI according to the rules defined for each DMI format in the present clause.

HEVC HDR Bitstreams using PQ10 may simultaneously include Supplemental Enhancement Information messages carrying DMI from multiple DMI formats defined in the present clause.

If DMI is included, it is recommended that the HEVC HDR Bitstream using PQ10 provides video quality at the level that can be expected from an MPEG DASH player using PQ10 that does not support DMI, and that the DMI enables further enhancement of the video.

L.3.3.10.4.2 SMPTE ST 2094-10 SEI message

SMPTE ST 2094-10 [i.38] DMI provides and describes dynamic information about the video signal. The information conveyed in the SEI message carrying SMPTE ST 2094-10 [i.38] DMI is adequate for purposes corresponding to the use of Society of Motion Picture and Television Engineers SMPTE ST 2094-1 [i.37] and SMPTE ST 2094-10 [i.38]. HEVC HDR Bitstreams using PQ10 may contain SEI messages carrying SMPTE ST 2094-10 [i.38] DMI.

The SMPTE ST 2094-10 [i.38] DMI is carried in the video elementary stream as Supplemental Enhancement Information in HEVC's "User data registered by Recommendation ITU-T T.35 SEI message" syntactic element as defined in clause B.7.2.

If the "User data registered by a Recommendation ITU-T T.35 [19] SEI message" carrying SMPTE ST 2094-10 [i.38] DMI is present in an HEVC HDR Bitstream using PQ10, the constraints defined below shall apply.

- *It shall be a prefix SEI message (i.e. **nal_unit_type** shall be equal to PREFIX_SEI_NUT) sent for every access unit of the HEVC HDR Bitstream using PQ10.*
- *The HEVC HDR Bitstream using PQ10 shall contain a Mastering Display Colour Volume SEI message as specified in clause L.3.3.10.2.*

The following constraints shall apply to the syntactic element as defined in clause B.7.2 of the "User data registered by a Recommendation ITU-T T.35 [19] SEI message" carrying SMPTE ST 2094-10 [i.38] DMI:

- ***user_identifier** shall be set equal to "GA94" indicating a DVBI_data() structure as defined in clause B.2 of the present document.*
- ***user_data_type_code** referenced by the DVBI_data() structure shall be set equal to "0x09" indicating a ST2094-10_data() structure as defined in clause 4 of ETSI TS 103 572 [50].*

The following constraints shall apply to the ST2094-10_data() structure of the "User data registered by a Recommendation ITU-T T.35 [19] SEI message" carrying SMPTE ST 2094-10 [i.38] DMI:

- ***app_identifier** shall be set equal to "1".*
- ***app_version** shall be set equal to "0".*
- *The number of extension blocks with **ext_block_level** set equal to "1" shall be constrained to be equal to "1".*
- *The number of extension blocks with **ext_block_level** set equal to "2" shall be constrained to be less than or equal to "16".*
- *The number of extension blocks with **ext_block_level** set equal to "5" shall be constrained to be less than or equal to "1".*

L.3.3.10.4.3 SL-HDR2 SEI message

Dynamic mapping according to SL-HDR2 is specified in ETSI TS 103 433-2 [51] and provides a broadcaster with an HDR-to-HDR/SDR reference display mapping method to verify the intended result of the display mapping process. The defined reference display mapping method does not imply that the video signal will be mapped with the reference display mapping method nor does it enforce implementation on the IRD.

HEVC HDR Bitstreams using PQ10 may contain SEI messages carrying SL-HDR2 DMI.

The SL-HDR2 DMI is carried in the video elementary stream as Supplemental Enhancement Information in HEVC's "User data registered by Recommendation ITU-T T.35 SEI message" syntactic element. The syntax and semantics of SL-HDR2 DMI are specified in annex A of ETSI TS 103 433-2 [51].

NOTE 1: Annex A of ETSI TS 103 433-2 [51] refers to ETSI TS 103 433-1 [i.40] in which the syntax and semantics common to SL-HDR1 and SL-HDR2 is specified. It also provides additional constraints to SL-HDR2 DMI.

If the "User data registered by a Recommendation ITU-T T.35 [19] SEI message" carrying SL-HDR2 DMI is present in an HEVC HDR Bitstream using PQ10, the following constraints shall apply.

- *It shall be a prefix SEI message (i.e. **nal_unit_type** shall be equal to PREFIX_SEI_NUT).*
- *All constraints specified in annex A of ETSI TS 103 433-2 [51] shall apply.*
- *It shall be transmitted at least with every HEVC IRAP as defined in Recommendation ITU-T H.265 / ISO/IEC 23008-2 [35] of the HEVC HDR Bitstream using PQ10.*

NOTE 2: The persistence of the SL-HDR2 DMI is controlled by two flags that are included in the SEI message. The DMI may apply to the current picture only, until the next SL-HDR Information SEI message (or the end of the bitstream), or it may be cancelled.

- If **src_mdvc_info_present_flag** is set equal to "1" and the HEVC HDR Bitstream using PQ10 contains a Mastering Display Colour Volume SEI message, the values for the corresponding syntax elements should be identical.

L.3.3.10.4.4 SMPTE ST 2094-40 SEI message

SMPTE ST 2094-40 [i.39] DMI provides and describes dynamic information about the video signal. The information conveyed in the SEI message carrying SMPTE ST 2094-40 [i.39] DMI is adequate for purposes corresponding to the use of Society of Motion Picture and Television Engineers SMPTE ST 2094-1 [i.37] and SMPTE ST 2094-40 [i.39].

HEVC HDR Bitstreams using PQ10 may contain SEI messages carrying SMPTE ST 2094-40 [i.39] DMI.

The SMPTE ST 2094-40 [i.39] DMI is carried in the video elementary stream as Supplemental Enhancement Information in HEVC's "User data registered by Recommendation ITU-T T.35 SEI message" syntactic element. The syntax of the SEI message carrying the DMI based on SMPTE ST 2094-40 [i.39] is specified in CTA 861-H [52], clause S.2. The semantics of the SEI message carrying the DMI based on SMPTE ST 2094-40 [i.39] are specified in CTA 861-H [52] Clause S.3. The additional constraints of clause S.4 shall apply.

If the "User data registered by a Recommendation ITU-T T.35 [19] SEI message" carrying SMPTE ST 2094-40 [i.39] DMI is present in an HEVC HDR Bitstream using PQ10, the following constraints shall apply.

- *It shall be a prefix SEI message (i.e. **nal_unit_type** shall be equal to PREFIX_SEI_NUT) sent once for every access unit of the HEVC HDR Bitstream using PQ10.*
- *The HEVC HDR Bitstream using PQ10 shall contain a Mastering Display Colour Volume SEI message as specified in clause L.3.3.10.2.*

L.3.3.11 Frame rate

The frame rate may be indicated in the VUI by setting **vui_time_scale**, **vui_num_units_in_tick** syntax elements and, if HEVC Temporal sub-layers are present, by setting **elemental_duration_in_tc_minus1[temporal_id_max]** in the **hrd_parameters()**.

Annex M (informative): Bibliography

- ETSI TR 101 162: "Digital broadcasting systems for television, sound and data services; Allocation of Service Information (SI) codes for Digital Video Broadcasting (DVB) systems".
- CEI/IEC 61883-1: "Consumer audio/video equipment - Digital interface - Part 1: General".
- CEI/IEC 61883-2: "Consumer audio/video equipment - Digital interface - Part 2: SD-SVCR data transmission".
- CEI/IEC 61883-3: "Consumer audio/video equipment - Digital interface - Part 3: HD-DVCR data transmission".
- CEI/IEC 61883-4: "Consumer audio/video equipment - Digital interface - Part 4: MPEG2-TS data transmission".
- IEC 62106:1999: "Radio Data System".
- ETSI TS 101 547-1: "Digital Video Broadcasting (DVB); Plano-stereoscopic 3DTV; Part 1: Overview of the multipart".
- ETSI TS 101 547-3: "Digital Video Broadcasting (DVB); Plano-stereoscopic 3DTV; Part 3: HDTV Service Compatible Plano-stereoscopic 3DTV".
- SMPTE ST 2036-1:2013: "Ultra High Definition Television - Image Parameter Values For Program Production".

Annex N (informative): Change History

Date	Version	Information about changes
January 1996	ETSI ETR 154 edition 1	Based on DVB BlueBook A001 <ul style="list-style-type: none"> - 25 Hz SDTV Baseline IRD - MPEG-2 video coding - MPEG-1 Layer II audio coding
October 1996	ETSI ETR 154 edition 2	Added 25 Hz SDTV IRD with a digital interface <ul style="list-style-type: none"> - intended for connection to a bitstream storage device (e.g. digital VCR)
September 1997	ETSI ETR 154 edition 3	Extended video to 30 Hz frame rates and HDTV resolution (1 080i and 720p) <ul style="list-style-type: none"> - Defined 15 Hz and 30 Hz IRDs - Defined SDTV and HDTV IRDs
July 2000	ETSI TR 101 154 v1.4.1	Added option of AC-3 audio and other enhancements <ul style="list-style-type: none"> - Active Format Description (Annex B) - Added AC-3 audio coding (Annex C) - Ancillary Data for MPEG audio (Annex D) - Coding of data in private data bytes of the adaptation field (Annex E)
May 2004	1.5.1	Added option of DTS audio and receiver-mixed audio <ul style="list-style-type: none"> - Added DTS audio coding (Annex F) - Receiver-mixed audio description (Annex G)
Janvier 2005	1.6.1	Added option of H.264/AVC video and HE-AAC audio coding <ul style="list-style-type: none"> - Added H.264/AVC video coding in clause 5 - MPEG-4 HE AAC audio coding (Annex H)
June 2005	1.7.1	Extended HE AAC to include HE AAC v2 <ul style="list-style-type: none"> - MPEG-4 HE AAC and HE AAC v2 audio coding (Annex H)
July 2007	1.8.1	Added option of VC-1 video coding and other enhancements, re-organized document <ul style="list-style-type: none"> - Added VC-1 video coding in clause 5 - All audio coding moved to clause 6 of the main document (AC-3, DTS and MPEG-4 HE AAC were previously in Annexes C, F and H respectively) - Annex B generalized to auxiliary data in video elementary streams - Annex C became ancillary data for MPEG audio (previously in annex D) - Annex D became coding of data in private data bytes of the adaptation field (previously in annex E) - Annex E became receiver-mixed audio description (previously in annex G) - Added annex F on encoding to enable trick mode play support of H.264/AVC
September 2009	1.9.1	Added option of scalable video, support for full-HD resolution and other enhancements <ul style="list-style-type: none"> - Added SVC video coding in clause 5 - Extended H.264/AVC video coding to Level 4.2 - Added MPEG Surround audio coding in clause 6 - Annex E generalized to supplementary audio services, including clean audio - Added annex G on random access point considerations for SVC
June 2011	1.10.1	Added optional support for frame-compatible 3D video and other enhancements <ul style="list-style-type: none"> - Added annex H on Frame Compatible Plano-Stereoscopic 3DTV
November 2012	1.11.1	Added optional support for service-compatible 3D video and other enhancements <ul style="list-style-type: none"> - Added MVC stereoscopic video coding in clause 5 - Added DTS-HD coding in clause 6 - Added annex I on consideration for encoding MVC stereoscopic video
March 2015	2.1.1	Added option of HEVC video coding and support for Ultra HD video resolution <ul style="list-style-type: none"> - Added HEVC video coding in clause 5 - Defined HEVC HDTV and HEVC UHD TV IRDs
June 2015	2.2.1	Added option of channel-based AC-4 audio coding and HEVC coding of 3D video <ul style="list-style-type: none"> - Added channel-based AC-4 audio coding in clause 6 - Added annex J on service frame compatible plano-stereoscopic 3D with HEVC coding
February 2017	2.3.1	Added optional support for High Dynamic Range (HDR) and High Frame Rate (HFR) video, and two options for coding Next Generation Audio <ul style="list-style-type: none"> - Added HEVC HDR coding using HLG10 and using PQ10 in clause 5 - Added HEVC HFR coding using single PID and using dual PID and temporal scalability in clause 5 - Defined HDR UHD TV IRDs and HDR HFR UHD TV IRDs - Added MPEG H audio coding in clause 6 - Added immersive and personalized AC-4 audio coding in clause 6

Date	Version	Information about changes
February 2018	2.4.1	Added H.264/AVC and HEVC video conformance points for DVB-DASH: <ul style="list-style-type: none"> - Annex L contains H.264/AVC and HEVC video conformance points to be referenced by ETSI TS 103 285 (DVB-DASH) - Editorial modifications to remove the circular normative references between the present document and ETSI EN 300 468
January 2019	2.5.1	Added DTS-UHD as additional audio coding standard for Next Generation Audio in clause 6.9, added some clarifications for the HEVC related text, and added clarification that the code points in Annex B are owned by ATSC.
September 2019	2.6.1	Added the following modifications: <ul style="list-style-type: none"> - HDR Dynamic Mapping support for broadcast and DVB-DASH (Annex L) - Harmonization of terms for HEVC HDR bitstreams in Annex L - Constraint on position of HEVC SEI NAL units - Clarifications for DTS-UHD
January 2022	2.7.1	Added the following modifications: <ul style="list-style-type: none"> - Change of reference from CTA 861-G to CTA 861-H for HDR Dynamic Mapping - Editorial clarification on HEVC HDR HDTV Bitstreams - Addition of HEVC HDR UHDTV2 IRDs and Bitstreams conformance points

History

Document history		
Edition 1	January 1996	Publication as ETSI ETR 154
Edition 2	October 1996	Publication as ETSI ETR 154
Edition 3	September 1997	Publication as ETSI ETR 154
V1.4.1	July 2000	Publication as ETSI TR 101 154
V1.5.1	May 2004	Publication
V1.6.1	January 2005	Publication
V1.7.1	June 2005	Publication
V1.8.1	July 2007	Publication
V1.9.1	September 2009	Publication
V1.10.1	June 2011	Publication
V1.11.1	November 2012	Publication
V2.1.1	March 2015	Publication
V2.2.1	June 2015	Publication
V2.3.1	February 2017	Publication
V2.4.1	February 2018	Publication
V2.5.1	January 2019	Publication
V2.6.1	September 2019	Publication
V2.7.1	January 2022	Publication