

ETSI TS 101 270-1 V1.3.1 (2003-07)

Technical Specification

Transmission and Multiplexing (TM); Access transmission systems on metallic access cables; Very high speed Digital Subscriber Line (VDSL); Part 1: Functional requirements



Reference

RTS/TM-06026-1

Keywords

access, ATM, B-ISDN, functional, IP,
transmission, VDSL, XDSL

ETSI

650 Route des Lucioles
F-06921 Sophia Antipolis Cedex - FRANCE

Tel.: +33 4 92 94 42 00 Fax: +33 4 93 65 47 16

Siret N° 348 623 562 00017 - NAF 742 C
Association à but non lucratif enregistrée à la
Sous-Préfecture de Grasse (06) N° 7803/88

Important notice

Individual copies of the present document can be downloaded from:

<http://www.etsi.org>

The present document may be made available in more than one electronic version or in print. In any case of existing or perceived difference in contents between such versions, the reference version is the Portable Document Format (PDF). In case of dispute, the reference shall be the printing on ETSI printers of the PDF version kept on a specific network drive within ETSI Secretariat.

Users of the present document should be aware that the document may be subject to revision or change of status. Information on the current status of this and other ETSI documents is available at

<http://portal.etsi.org/tb/status/status.asp>

If you find errors in the present document, send your comment to:

editor@etsi.org

Copyright Notification

No part may be reproduced except as authorized by written permission.
The copyright and the foregoing restriction extend to reproduction in all media.

© European Telecommunications Standards Institute 2003.
All rights reserved.

DECT™, **PLUGTESTS™** and **UMTS™** are Trade Marks of ETSI registered for the benefit of its Members.
TIPHON™ and the **TIPHON logo** are Trade Marks currently being registered by ETSI for the benefit of its Members.
3GPP™ is a Trade Mark of ETSI registered for the benefit of its Members and of the 3GPP Organizational Partners.

Contents

Intellectual Property Rights	6
Foreword.....	6
1 Scope	7
2 References	8
3 Definitions, symbols and abbreviations	9
3.1 Definitions	9
3.2 Symbols.....	9
3.3 Abbreviations	10
4 Reference configuration and description.....	11
4.1 General	11
4.2 Functional decomposition	14
4.2.1 The α and β interfaces	14
4.2.2 Elemental information flows across the α and β interfaces	15
4.2.2.1 Data flow.....	15
4.2.2.2 Synchronization flow	15
4.2.2.3 Link Control Flow.....	16
4.2.2.4 Link Performance and Path Characterization flow	16
5 Operations Administration and Maintenance (OAM).....	16
5.1 VDSL Link Control.....	16
5.2 Embedded Operations Channel (EOC).....	16
6 ElectroMagnetic Compatibility	16
7 Climatic requirements	17
8 Transceiver specific requirements	17
8.1 Transceiver interface	17
8.1.1 Impedance.....	17
8.1.2 Return loss	18
8.1.3 Balance about earth.....	18
8.1.4 Wideband launch power	18
8.1.5 Band allocation and power spectral density.....	19
8.1.5.1 General principles	19
8.1.5.2 Upstream and downstream bands.....	19
8.1.5.3 Power Spectral Density (PSD).....	20
8.1.5.3.1 Conformance criteria	23
8.1.5.3.2 PSD limits for optional regional-specific band allocation	26
8.1.5.4 Mask M1 (notched).....	29
8.1.5.5 Mask M2 (unnotched).....	29
8.1.6 Upstream power back-off	29
8.1.6.1 Upstream transmit nominal PSD requirement.....	29
8.1.7 A-B leg (tip-ring) reversal	30
8.2 Transceiver latency.....	30
8.2.1 Trade-off between channel latency and impulse noise immunity.....	30
8.2.2 Single latency mode.....	31
8.2.3 Dual latency mode	31
8.2.4 Measuring latency.....	31
8.3 Remote powering	31
8.4 Power-down mode.....	31
8.5 Repeated operation.....	31
8.6 Payload bit-rates	31
9 Transmission performance	32
9.1 Test procedure	32
9.1.1 Test set-up definition	32

9.1.2	Signal and noise level definitions	34
9.2	Test loops	34
9.2.1	Functional description.....	34
9.2.2	Test loop accuracy	37
9.3	Impairment generators.....	37
9.3.1	Functional description.....	37
9.3.2	Cable crosstalk models	39
9.3.3	Individual impairment generators.....	40
9.3.3.1	NEXT noise generator [G1].....	40
9.3.3.2	FEXT noise generator [G2].....	41
9.3.3.3	Background noise generator [G3]	41
9.3.3.4	White noise generator [G4].....	41
9.3.3.5	Broadcast RF noise generator [G5].....	41
9.3.3.6	Amateur RF noise generator [G6].....	42
9.3.3.6.1	Specification of Amateur RF noise generator.....	43
9.3.3.7	Impulse noise generator [G7].....	44
9.3.4	Profile of the individual impairment generators	44
9.3.4.1	Frequency domain profiles of generators G1 and G2	44
9.3.4.1.1	Self crosstalk profiles	44
9.3.4.1.2	Alien crosstalk profiles.....	45
9.3.4.2	Time domain profiles of generators G1 to G4.....	47
9.3.5	UPBO testing method	48
9.3.5.1	Performance test for UPBO.....	48
9.4	Transmission Performance tests	49
9.4.1	Electrical length requirements (insertion loss).....	49
9.4.2	Bit error ratio requirements.....	50
9.4.3	Measuring noise margin.....	50
9.4.4	Generator sets for different test scenarios.....	51
9.4.5	Upstream tests.....	51
9.4.6	Downstream tests	52
9.5	Micro interruptions.....	53
10	Transceiver core requirements	53
10.1	Activation/deactivation	53
10.1.1	Activation/deactivation definitions.....	53
10.1.2	Timing requirements.....	55
11	Spectral compatibility.....	55
11.1	Adjacent wire-pairs	55
11.2	Same wire-pair	56
12	Splitter filter requirements.....	56
13	Application specific requirements.....	56
13.1	ATM transport mode	56
13.1.1	OAM requirements	56
13.2	SDH transport mode at sub STM-1 rates.....	56
13.2.1	Dual Latency.....	57
13.2.2	OAM requirements	57
13.3	Packet Transport Mode	57
13.3.1	OAM requirements	57
13.4	Additional applications.....	57
13.4.1	Multiple PDH.....	57
13.4.2	Narrowband in-band	57
13.4.3	IP transport.....	57
13.4.4	Campus access reference models.....	57
Annex A (normative):	Line constants for the test loop-set.....	58
Annex B (informative):	Cable information.....	63
Annex C (informative):	Telephony matching impedance.....	64
C.1	Germany	64

C.2	United Kingdom	65
Annex D (informative):	Illustrative graphs of Peak PSD masks	66
Annex E (informative):	PSD Templates for VDSL	70
E.1	Introduction	70
E.1.1	Derivation of PSD templates	70
E.1.1.1	Upstream templates	70
E.1.1.2	Downstream FTTCab templates	71
E.1.1.3	Downstream FTTEEx templates	71
Annex F (informative):	Theoretical reach simulation results	78
Annex G (informative):	Bibliography	81
History		82

Intellectual Property Rights

IPRs essential or potentially essential to the present document may have been declared to ETSI. The information pertaining to these essential IPRs, if any, is publicly available for **ETSI members and non-members**, and can be found in ETSI SR 000 314: "*Intellectual Property Rights (IPRs); Essential, or potentially Essential, IPRs notified to ETSI in respect of ETSI standards*", which is available from the ETSI Secretariat. Latest updates are available on the ETSI Web server (<http://webapp.etsi.org/IPR/home.asp>).

Pursuant to the ETSI IPR Policy, no investigation, including IPR searches, has been carried out by ETSI. No guarantee can be given as to the existence of other IPRs not referenced in ETSI SR 000 314 (or the updates on the ETSI Web server) which are, or may be, or may become, essential to the present document.

Foreword

This Technical Specification (TS) has been produced by ETSI Technical Committee Transmission and Multiplexing (TM).

The present document is part1 of a multi-part deliverable covering the Transmission and Multiplexing (TM); Access transmission systems on metallic access cables; Very high speed Digital Subscriber Line (VDSL), as identified below:

The present document is currently intended to be a three part specification as follows:

Part 1: "Functional requirements";

Part 2: "Transceiver specification".

The present document includes clarification of the noise models, power spectral density masks and evaluation data rates.

1 Scope

The present document specifies requirements for transceivers providing very high bit-rate digital transmission on metallic, unshielded, access network wire pairs. The technology is referred to as Very high speed Digital Subscriber Line (VDSL).

The present document is part 1 of the specification for VDSL and is applicable to metallic access transmission systems designed to provide multi-megabit/s digital access over part of the existing, unshielded, metallic access network. It is concerned with the key functional and electrical requirements for VDSL. It is linecode independent and is intended to set the boundary requirements that all compliant VDSL transceivers shall meet. TS 101 270-2 is concerned with requirements of the linecode method that enable the requirements of the present document to be met.

The definition of physical interfaces is outside the scope of the present document. If an appropriate interface for a specific application exists it may be included to describe how these requirements map to it. The VDSL transmission system, in its most basic form, consists of an application independent core and an application specific block.

The core is purely an application independent bit-pump which transports information from one end of the metallic access link to the other. The digital data is mapped into a core frame that is defined logically and not physically. The core frame is therefore considered to be the interface between the application specific and the application independent part of the VDSL system. The application specific part may be subdivided into (at least) two smaller parts: mapping and interface.

The scope of the present document is shown graphically in figure 1 and figure 2, where the Network Termination (NT) and Line Termination (LT) are considered separately.

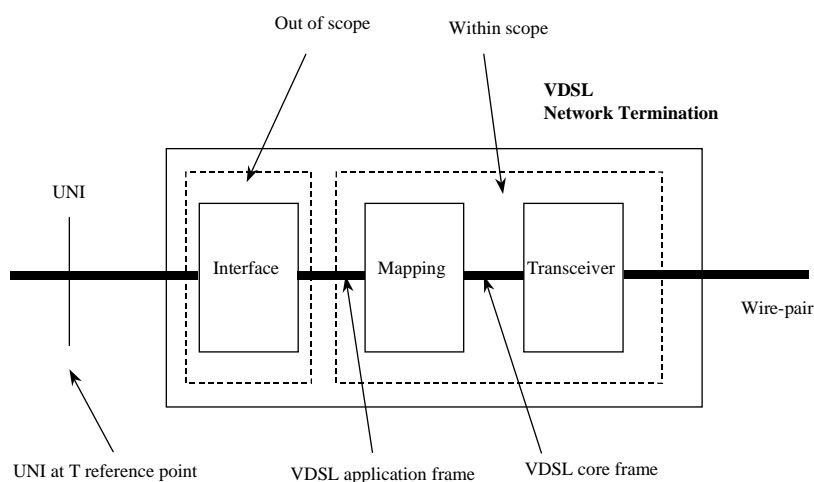

Figure 1: NT reference model scope

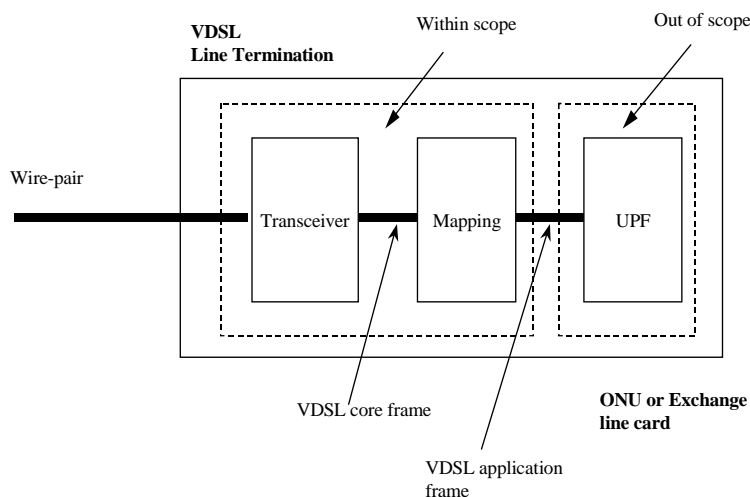

Figure 2: LT reference model scope

2 References

The following documents contain provisions which, through reference in this text, constitute provisions of the present document.

- References are either specific (identified by date of publication and/or edition number or version number) or non-specific.
- For a specific reference, subsequent revisions do not apply.
- For a non-specific reference, the latest version applies.

Referenced documents which are not found to be publicly available in the expected location might be found at <http://docbox.etsi.org/Reference>.

- [1] EN 55022 (1998): "Information technology equipment - Radio disturbance characteristics - Limits and methods of measurement".
- [2] EN 61000-4-6 (1996): "Electromagnetic compatibility (EMC) - Part 4-6: Testing and measurement techniques - Immunity to conducted disturbances, induced by radio-frequency fields".
- [3] ETSI TS 102 080: "Transmission and Multiplexing (TM); Integrated Services Digital Network (ISDN) basic rate access; Digital transmission system on metallic local lines".
- [4] ETSI EN 300 001: " Attachments to the Public Switched Telephone Network (PSTN); General technical requirements for equipment connected to an analogue subscriber interface in the PSTN".
- [5] ETSI TBR 021: "Terminal Equipment (TE); Attachment requirements for pan-European approval for connection to the analogue Public Switched Telephone Networks (PSTNs) of TE (excluding TE supporting the voice telephony service) in which network addressing, if provided, is by means of Dual Tone Multi Frequency (DTMF) signalling".
- [6] ETSI ETS 300 019-1: "Environmental Engineering (EE); Environmental conditions and environmental tests for telecommunications equipment; Part 1: Classification of environmental conditions".
- [7] ETSI ETS 300 019-1-3: "Environmental Engineering (EE); Environmental conditions and environmental tests for telecommunications equipment; Part 1-3: Classification of environmental conditions; Stationary use at weatherprotected locations".
- [8] ETSI ETS 300 019-2: "Equipment Engineering (EE); Environmental conditions and environmental tests for telecommunications equipment; Part 2: Specification of environmental tests".

- [9] ITU-T Recommendation G.703: "Physical/electrical characteristics of hierarchical digital interfaces".
- [10] ITU-T Recommendation G.704: "Synchronous frame structures used at 1 544, 6 312, 2 048, 8 448 and 44 736 kbit/s hierarchical levels".
- [11] ITU-T Recommendation G.117: "Transmission aspects of unbalance about earth".
- [12] ITU-T Recommendation G.227: "Conventional telephone signal".
- [13] ITU-T Recommendation O.9: "Measuring arrangements to assess the degree of unbalance about earth".
- [14] ITU-T Recommendation Q.552: "Transmission characteristics at 2-wire analogue interfaces of digital exchanges".
- [15] IETF RFC 2684 (1999): "Multiprotocol Encapsulation over ATM Adaptation Layer 5".
- [16] Council Directive 89/336/EEC of 3 May 1989 on the approximation of the laws of the Member States relating to electromagnetic compatibility. (EMC Directive).
- [17] ETSI TS 101 952: "Access network xDSL transmission filters".

3 Definitions, symbols and abbreviations

3.1 Definitions

For the purposes of the present document, the following terms and definitions apply:

clear channel: a transparent bit or byte pipe

crest factor: peak to rms voltage ratio

downstream: transmission in the direction of LT towards NT (network to customer premise)

FTTCab: used to define when VDSL LT transceivers are located physically at a node (normally the Cabinet or PCP) in the periphery of the access network

FTTEx: used to define when VDSL LT transceivers are located physically at the serving Local Exchange

payload bit rate: total data rate that is available to user data in any one direction

upstream: transmission in the direction of NT towards LT (customer premise to network)

xDSL: generic term covering the family of all DSL technologies, e.g. DSL, HDSL, SDSL, ADSL, VDSL

3.2 Symbols

For the purposes of the present document, the following symbols apply:

f_T	Test loop calibration frequency for setting the insertion loss of the loop
kbit/s	kilo-bits per second
kbps	kilo-bits per second (1 kbps = 1 000 bits per second = 1 kbit/s)
Mbps	Mega bits per second (1 Mbps = 1 000 kbps = 1000 kbit/s)
R_V	VDSL source/load design impedance (purely resistive)
Z_0	Characteristic impedance of the test loop
Z_M	Compromise reference impedance for the VDSL splitter (usually complex)

3.3 Abbreviations

For the purposes of the present document, the following abbreviations apply:

2B1Q	Baseband linecode for ISDN-BA (4-PAM)
4B3T	Alternative ISDN-BA baseband linecode with wider frequency spectrum than 2B1Q
ADSL	Asymmetric DSL (1,5 to 8 Mbps downstream, and up to 640 kbps upstream simultaneously over a single wire-pair carrying analogue POTS or ISDN).
AM	Amplitude Modulation
AMI	Alternate Mark Inversion
ATM	Asynchronous Transfer Mode
BER	Bit Error Ratio
CF	Crest Factor
CRC	Cyclic Redundancy Check
DC	Direct Current
DSL	Digital Subscriber Line (or Loop)
EMC	ElectroMagnetic Compatibility
EMI	ElectroMagnetic Interference
EOC	Embedded Operations Channel
FEC	Forward Error Correction
FEXT	Far-end crosstalk
FSAN	Full Services Access Network organization.
FTTCab	Fibre To The Cabinet (see definitions)
FTTEx	Fibre to the Exchange (see definitions)
HAPI	Hypothetical Application Independent Interface
HDB3	Linecode for ISDN-PRA, Digital Private or Trunk circuits (similar to AMI)
HDSL	High bit-rate Digital Subscriber Line (1, 2 or 3 wire-pairs presenting ITU-T Recommendations G.703 [9] and G.704 [10] 2 Mbps symmetric data rates or 2 wire-pairs carrying T1 to a DS1 interface).
IETF	Internet Engineering Task Force
IL	Insertion Loss
IP	Internet Protocol
ISDN	Integrated Services Digital Network
ISDN-BA	ISDN Basic-rate Access (2B+D)
ISDN-PRA	ISDN Primary Rate Access
LCTL	Longitudinal Conversion Transfer Loss
LT	Line Termination
NEXT	Near-end crosstalk
NT	Network Termination (at the customer premise end of the line)
OAM	Operations, Administration and Maintenance
O&M	Operations and Management
ONU	Optical Network Unit
PAM	Pulse Amplitude Modulation
PCP	Primary Cross-connect Point
PDH	Plesiochronous Digital Hierarchy
PEP	Peak Envelope Power
PLOAM	Physical Layer Operations, Administration and Maintenance
PMD	Physical Media Dependent
PMS	Physical Media Specific
PMS-TC	Physical Media Specific-Transmission Convergence
POTS	Plain Old Telephony Service
PPP	Point-to-Point Protocol
PRC	Payload Rate Change
PSD	Power Spectral Density (usually quoted in dBm/Hz, and in the present document is restricted to single sided PSDs).
PTM	Packet Transport Mode
PVC	Poly Vinyl Chloride
RF	Radio Frequency
RFC	Request for comment (stable specification from IETF)
RFI	Radio Frequency Interference
RMS	Root Mean Square

RS	Reed-Solomon
SDH	Synchronous Digital Hierarchy
SDSL	Symmetric Digital Subscriber Line
SNR	Signal to Noise Ratio
STM	Synchronous Transfer Mode
SW	Short Wave
TBD	To Be Decided
TC	Transmission Convergence
TE	Terminal Equipment
TELE	Telephone port for the VDSL splitter
TMN	Telecommunication Management Network
TPS	Transmission Protocol Specific
TPS-TC	Transmission Protocol Specific-Transmission Convergence
UNI	User Network Interface
UPF	User Port Function
VDSL	Very high speed Digital Subscriber Line

4 Reference configuration and description

4.1 General

Figures 3 and 4 show the reference model used for VDSL. It is essentially a Fibre to the Node architecture with an Optical Network Unit (ONU) sited in the existing metallic access network (or at the serving Local Exchange or Central Office). Existing unscreened twisted metallic access wire-pairs are used to convey the signals to and from the customer's premises. This architectural model covers both short and long-range options for the VDSL.

The model provides two or four data channels with bit rate under the control of the network operator, consisting of one or two downstream and one or two upstream channels. A single channel in each direction can be of high latency/low BER or lower latency/higher BER. Dual channels in each direction provide one channel of each type. The model assumes that Forward Error Correction (FEC) will be needed for part of the payload and that deep interleaving will be required to provide adequate protection against impulse noise for transport of digitally encoded motion picture signals. The VDSL transceiver shall also be required to transport delay sensitive services (e.g. POTS/Video conferencing). The model introduces service-split functional blocks to accommodate shared use of the physical transmission media for VDSL and either POTS or ISDN-BA. The rationale behind this is that network operators are then free to evolve their networks in one of two ways: complete change out or overlay. An active Network Termination (NT) provides termination of the point-to-point VDSL transmission system and presents a standardized set of User Network Interfaces (UNIs) at the customer's premises. The NT provides the network operator with the ability to test the network up to the UNI at the customer's premises in the event of a fault condition or via nighttime routining. The home wiring transmission system is currently outside the scope of the present document.

It is envisaged that VDSL will find applications in the transport of various protocols. For each application different functional requirements must be developed for the Transport Protocol Specific - Transmission Convergence Layer (TPS-TC). The present document covers the functional requirements for the transport of ATM, STM (SDH) and PTM. However the VDSL core transceiver shall be capable of supporting future additional Layer 2 protocols.

It is not a requirement that multiple Layer 2 protocols are transported simultaneously.

Any existing narrowband services shall not be affected by failure of power to the broadband NT. This may imply that the splitter filter is of a passive nature not requiring external power in order to provide frequency separation of the VDSL and existing narrowband signals. Further requirements concerning the splitter filter are found in the relevant sub-parts of TS 101 952 [17].

POTS shall continue to be powered from the existing exchange node and a DC path is required from the local exchange to the customer telephone. Similarly a DC path is required for ISDN-BA in order to provide remote power feeding to the ISDN-BA NT (and that emergency power can be provided by the local exchange for one ISDN terminal to function for lifeline service).

POTS and ISDN-BA cannot exist simultaneously on the same pair at present. Network Operators may provide one or the other but not both over a single wire-pair. Network Operators may choose to provide VDSL on access lines without any narrowband services.

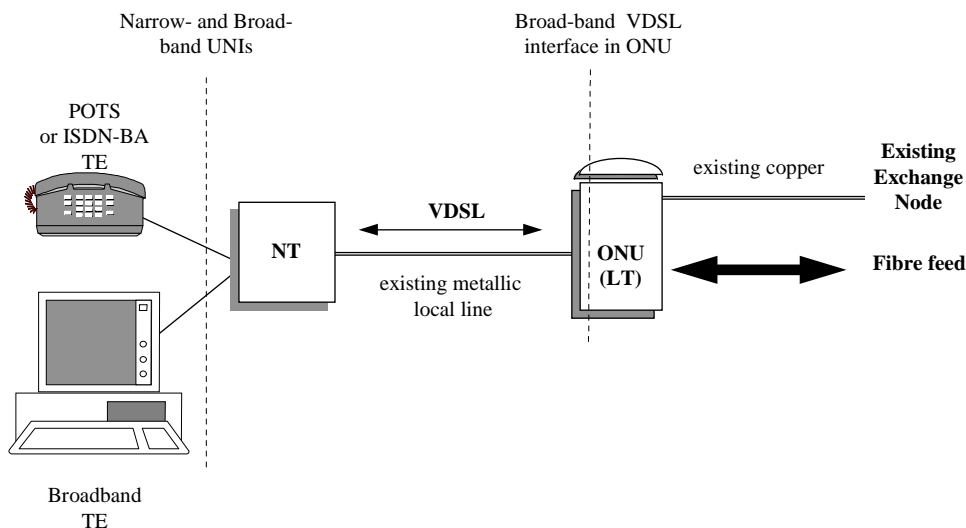
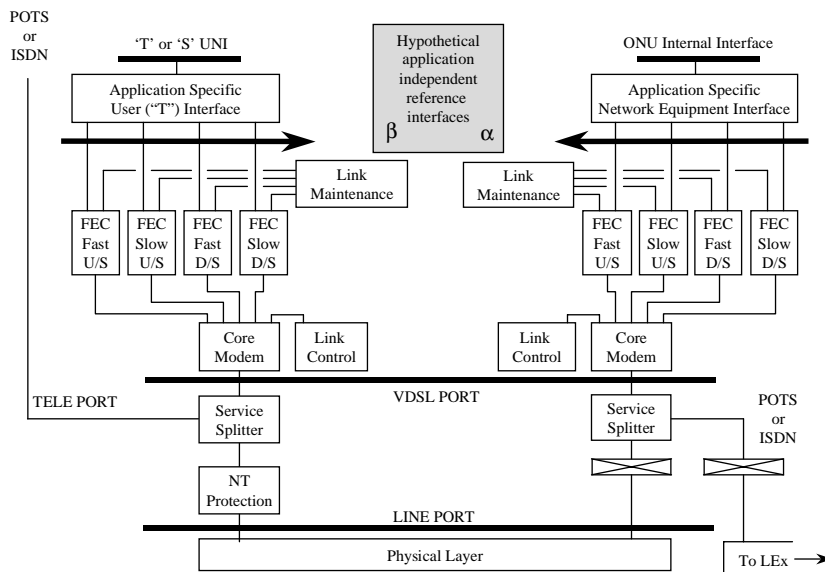

Figure 3: General reference model

Figure 4 shows the VDSL reference model and the various logical and physical interfaces between a VDSL transceiver at the NT and the LT ends of the access link. The reference points α and β of the HAPI are also shown. The HAPI is only required for performance evaluation purposes and may not be embodied in every VDSL transceiver. For convenience, dual latency paths are shown in both the up- and downstream directions (see note to figure 4).

A VDSL transceiver is not required to implement the ONU internal interface or the broadband UNI. However, this is not precluded by the present document. Link maintenance is required to enable Operations, Administration and Maintenance (OAM) information flows between the LT and NT transceivers. Figure 5 shows the VDSL application reference model and the functional elements covered by the present document.



NOTE: It is not compulsory to implement both the fast and slow channels. Single channels with programmable latency are equally acceptable.

Figure 4: VDSL reference model

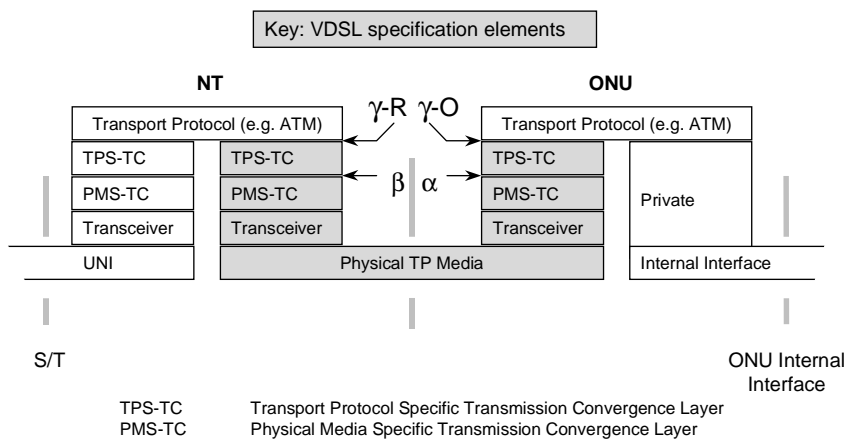

NOTE: The full definition of TPS-TC interfaces ($\gamma-R$ and $\gamma-O$) are outside the scope of the present document. However key functional requirements are listed with reference to the particular application under consideration (see clause 13).

Figure 5: VDSL application reference model

4.2 Functional decomposition

4.2.1 The α and β interfaces

The Hypothetical Application Independent Interface (HAPI) is embodied in the α and β interfaces which apply to the LT and NT ends of the VDSL link respectively. Further requirements relating to the HAPI are given in clause 13.

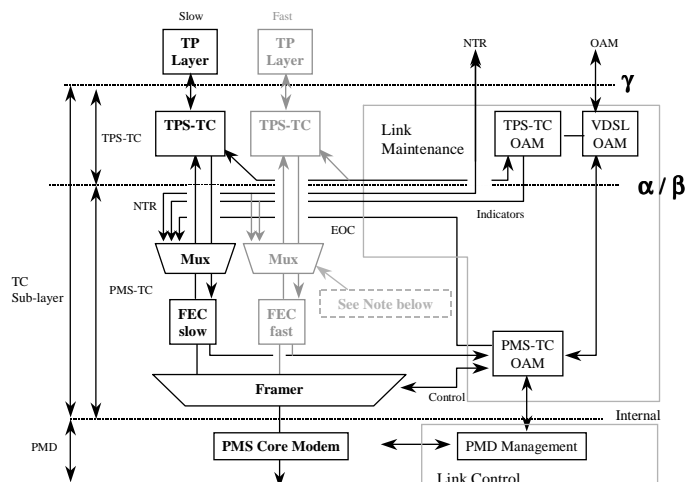

NOTE: It is not compulsory to implement both the fast and slow channels. A Single channel with programmable latency is equally acceptable.

Figure 6: Generic VDSL functional reference model

Figure 6 above shows the generic functional reference model which indicates the disposition of major functions partitioned by the α and β interfaces. These interfaces define the separation between the application dependent Transport Protocol Specific (TPS) part and the application independent Physical Media Specific (PMS) core transceiver parts of the VDSL transmission system.

The TPS part includes transport protocol layer functions outside the scope of the present document, and transport protocol specific transmission convergence layer functions (TPS-TC).

The application independent part contains Physical Media Specific transmission convergence layer functions (PMS-TC), and transceiver (PMD) functions.

By convention the PMS-TC, TPS-TC, and transceiver layers are assumed to include applicable OAM functions. The overall VDSL link maintenance functions are associated with the application dependent part. Figure 7 shows the VDSL reference points and the scope of the OAM.

The EOC shall be in the slow channel. The actual implementation of the EOC channel is modulation dependent and is described in TS 101 270-2.

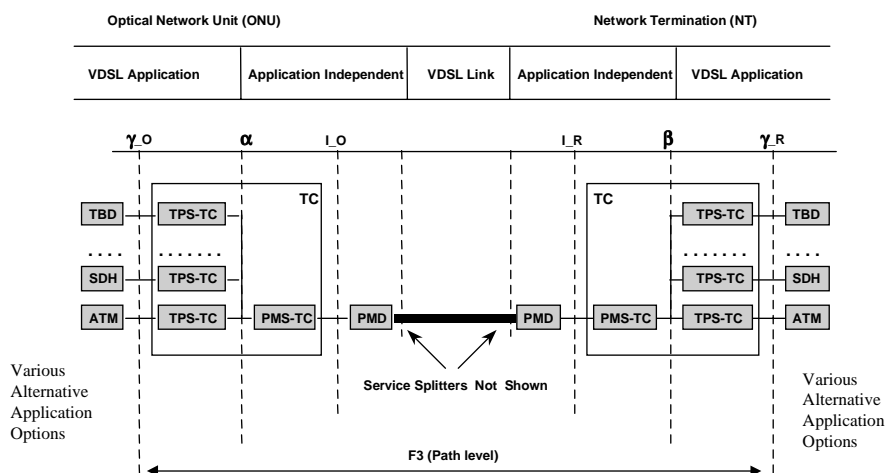

Figure 7: VDSL reference points and OAM scope

4.2.2 Elemental information flows across the α and β interfaces

Four elemental information flows across the α and β interfaces are identified:

- data flow;
- synchronization flow;
- link control flow;
- link performance and path characterization flow.

4.2.2.1 Data flow

The data flow shall be supported by one or two data pipes with different error protection properties and therefore different latency characteristics; it shall be byte oriented and the data shall be treated as unstructured by the application independent part.

4.2.2.2 Synchronization flow

This flow provides the means through which synchronization between the PMD level and the TC level is performed. The different considered items are:

- Data (bit synchronization or byte synchronization or other synchronization flows);
- Performance and Path Characterization Primitives;
- Control and Performance Parameters (asynchronous);
- Network Timing Reference.

With the exception of Control and Performance parameter passing synchronization flows are based on a fixed timing regime. Synchronization of Control and Performance Parameter passing is implied by a message transfer protocol.

4.2.2.3 Link Control Flow

The Link Control flow comprises all the relevant control, configuration and status messages for a VDSL link. A non-exhaustive list of Control Primitives is (common to both the α and β interfaces):

- Activation;
- Deactivation;
- Alarms and Anomalies (e.g. Dying Gasp);
- Link status;
- Synchronization status.

Control Parameters may include the Requested Data Rate, Link Status parameters and specific bandwidth allocation parameter (at the α interface).

4.2.2.4 Link Performance and Path Characterization flow

The Link Performance and Path Characterization flow provides all the relevant performance and physical characteristics of the VDSL link.

Performance Primitives typically report defects and errors (e.g. Loss of Signal, Loss of Frame, FEC anomalies etc.) and Performance Parameters include counts of errored blocks, CRC and FEC anomalies.

Typical Path Characterization Parameters are the line attenuation, the Signal to Noise Ratio (SNR) and the Return Loss.

5 Operations Administration and Maintenance (OAM)

5.1 VDSL Link Control

VDSL transceivers shall be capable of sending and receiving pre-defined messages intended for operation and maintenance of the VDSL transmission link. Successful reception of a message shall always be acknowledged by the receiving transceiver. The sending transceiver shall continue to repeat the message until it is successfully acknowledged by the receiving transceiver. The full definition of the protocol is outside the scope of the present document.

5.2 Embedded Operations Channel (EOC)

The application independent part shall provide a full duplex Embedded Operations Channel (EOC) capable of supporting OAM flows (Operations Administration and Maintenance (OAM) functions relating to the PMD and PMS-TC).

The EOC shall support the transport of indicator states to support the status and performance monitoring of the VDSL PMD layer. It shall provide a control channel to allow management of link characteristics (e.g. transport rates, latency, low-power mode, spectrum utilization etc.).

The payload data rate of the EOC shall not be less than 24 kbps for all payload bit rates specified in table 14. It shall be able to operate in a clear channel mode, which is a duplex, transparent bit or byte pipe.

6 ElectroMagnetic Compatibility

The system shall meet the European Union directive on ElectroMagnetic Compatibility (EMC) 89/336/EEC [16] as described in EN 55022 [1] and EN 61000-4-6 [2].

7 Climatic requirements

As VDSL may be deployed in the FTTCab model, it is necessary to specify the classes of climatic conditions in ETS 300 019-1 [6] and ETS 300 019-2 [8] that are applicable. ETS 300 019 consists of two main parts:

- Equipment Engineering; Environmental conditions and environmental tests for telecommunication equipment; Part 1: Classification of environmental conditions [6].
- Equipment Engineering; Environmental conditions and environmental tests for telecommunication equipment; Part 2: Specification of environmental tests [8].

For classification of environmental conditions, ETS 300 019-1-3 [7] contains five sub-classes, three of which are relevant to VDSL. These are:

- 3.1 Temperature controlled locations;
- 3.2 Partly temperature controlled locations;
- 3.3 Non-temperature controlled locations.

The requirements of the appropriate parts of ETS 300 019 relating to the design environment shall be met by VDSL transceivers.

8 Transceiver specific requirements

The transceiver related functional requirements detailed in this clause are independent of the application or service carried by the VDSL transceiver.

8.1 Transceiver interface

For compliance with the requirements of this clause the following interfaces are defined. These ports are shown in figure 8.

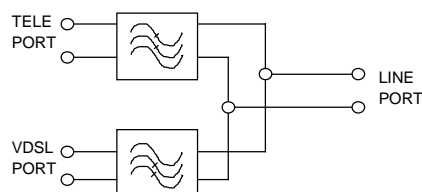

TELE port: The physical interface to POTS or ISDN-BA at the service splitter.

VDSL port: This port may be internal to the VDSL equipment where part(s) of the splitter are incorporated into ONU linecards or NTs. Physical access may or may not be available for test purposes.

LINE port: The physical interface to the wire-line.

Figure 8: Structure of the VDSL splitter filter

8.1.1 Impedance

A reference source/load impedance of $R_V = 135 \Omega$ (i.e. purely resistive, $135 + j0 \Omega$) over the complete VDSL frequency band shall be used for the design of both the LT and NT transceivers when matching to the metallic access wire-pair. This enables a compromise high-frequency impedance match to the various unshielded cable types encountered in European metallic access networks.

NOTE: The optional use of a more optimum impedance for specific countries or regions is not precluded.

8.1.2 Return loss

The minimum return loss requirement is defined to limit signal power uncertainties due to the tolerance of the line interface impedance.

NOTE 1: The return loss $1/\Gamma = (Z+R_V)/(Z-R_V)$ is an alternative way to specify an impedance (Z) normalized to the chosen design impedance. This makes impedance tolerance and minimum return loss similar quantities. Its definition is independent of the characteristic impedance Z_0 of the cable because VDSL can handle a wide range of cable types having significantly different Z_0 values.

The return loss of the VDSL transceiver, including the high pass part of the splitter (i.e. measured at the LINE port) shall be greater than or equal to 18 dB across the VDSL frequency band when measured against a reference impedance of R_V .

NOTE 2: The value of 18 dB specifies the more general case when an external POTS/ISDN splitter is involved and refers to the splitter output port (LINE port). Where a splitter is not used, the VDSL transceiver return loss may be as low as 12 dB. Where the splitter is an integral part of the VDSL transceiver, the return loss of the transceiver may be as low as 12 dB.

The splitter output port return loss requirements shall be met for the full range of possible values of both the input port (VDSL port) termination and POTS/ISDN port (TELE port) termination.

8.1.3 Balance about earth

The equipment balance should be better than the anticipated cable balance in order to minimize the unwanted emissions and susceptibility to external RFI. The typical worst case balance for an aerial dropwire has been observed to be in the range 30 dB to 35 dB, therefore the VDSL equipment should be significantly better than this.

The transmitter source balance about earth shall be evaluated according to the LCTL methods given in ITU-T Recommendations O.9 [13] and G.117 [11].

All exposed ports carrying a VDSL signal shall exhibit a balance of greater than 55 dB below f_0 (see figure 9), and then falling at 6 dB/octave until intercepting 43 dB which shall be sustained until 30 MHz. This shall be measured at any exposed port carrying a VDSL signal.

NOTE: A VDSL transceiver, when connected to poorly balanced aerial telephony wire-pairs, could emit levels of unwanted RF emissions which may, in some circumstances, cause interference to existing licensed users of the HF radio spectrum (e.g. SW listeners). The present document currently covers the requirements for VDSL transceivers operating over wire-pairs in normal operation (i.e. non-fault) where the balance of the wire-pair exceeds 30 dB.

8.1.4 Wideband launch power

For compliance with the requirements detailed in this clause the VDSL transceiver shall be terminated in the design impedance (R_V) and be configured to transmit pseudo-random data with any repetitive framing patterns enabled. Power shall be measured across the termination resistance of R_V .

The average wideband power of the VDSL downstream signal transmitted by a transceiver measured over the frequency range 138 kHz to 30 MHz shall be no greater than +14,5 dBm in the FTTEEx scenario and no greater than +11,5 dBm in the FTTCab scenario when terminated with an impedance of R_V . This shall be measured at the LINE port. There shall be no energy injected into the TELE port during this test.

NOTE: This power limit restricts the signal spectrum from making full use of the nominal PSD masks for downstream transmission from the exchange. This is because of current practical limitations. These masks enable wideband powers up to approximately +21 dBm. A future increase in wideband transmit power for downstream transmission from the exchange is for further study.

The average wideband power of the VDSL upstream signal transmitted by a transceiver measured over the frequency range 138 kHz to 30 MHz shall be no greater than +11,5 dBm when terminated with an impedance of R_V . This shall be measured at the LINE port. There shall be no energy injected into the TELE port during this test.

When the optional band from 25 kHz to 138 kHz is used (clause 8.1.5) the average wideband power of the VDSL upstream signal in this band shall be no greater than +11,5 dBm when terminated with impedance of R_v .

8.1.5 Band allocation and power spectral density

8.1.5.1 General principles

The generic boundary values for the VDSL transmission band are $f_0 = 25$ kHz and $f_5 = 12$ MHz. The frequency band from f_5 to 30 MHz is reserved for further study. The power spectral density upper limits attributed to the VDSL transceiver are specified further in clause 8.1.5.3.

VDSL signals shall be confined within these bands to power levels appropriate to ensure spectral compatibility with other xDSL metallic access systems such as ISDN-BA, HDSL, SDSL and ADSL, and to prevent unnecessary radiated emissions. Compatibility with ISDN-BA on the same pair will limit the transmitter PSD.

There are two alternate deployment scenarios that affect the transmitter PSD. The LT transceiver may be placed either in the Central Office Exchange (FTTEx) or at a street location (FTTCab).

EXAMPLE: In some FTTCab deployment scenarios where ADSL is deployed from the exchange it may be prudent to limit the transmitter PSD below 1,1 MHz.

NOTE 1: National regulations may preclude the use of certain frequency ranges.

NOTE 2: The values of the power spectral density limits shown in the present document may not be sufficient to fulfill the requirements for the radiation power limits specified by national frequency management entities.

8.1.5.2 Upstream and downstream bands

VDSL transceivers shall use Frequency Division Duplexing (FDD). This applies to single carrier and multi-carrier modulation methods.

Transceivers may use up to four bands denoted 1D, 2D, 1U and 2U (two for downstream and two for upstream respectively) as illustrated in figure 9. Use of the fifth band from f_0 to f_1 is optional and intended for transmission in the upstream direction only. The actual band allocation is defined by the values of transition frequencies $f_0 - f_5$.

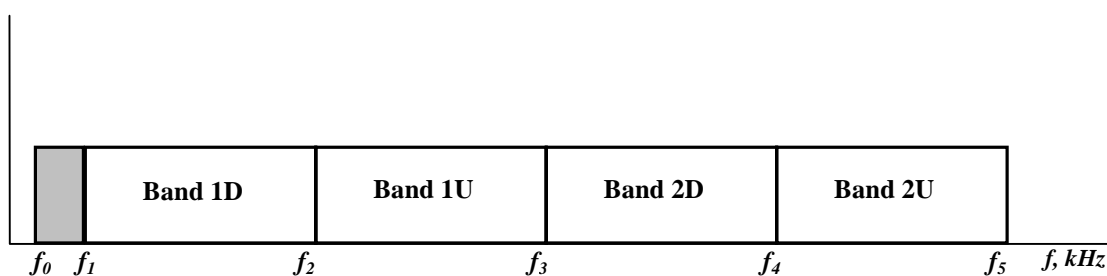
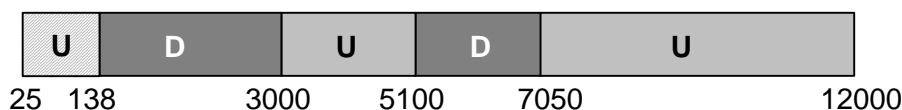

Figure 9: Illustrative VDSL Band Allocation

Table 1: Band transition frequencies

Band Transition Frequencies (kHz)	f_0	f_1	f_2	f_3	f_4	f_5
VDSL bands	25	138	3 000	5 100	7 050	12 000
Optional regional-specific bands	25	138	3 750	5 200	8 500	12 000
NOTE 1: Use of frequencies above f_5 but within the overall PSD masks is not covered in the present document and is for further study.						
NOTE 2: Use of frequencies between f_0 and f_1 in the upstream direction is optional and may be used under network management control. Use of frequencies between f_0 and f_1 in the downstream direction is for further study.						
NOTE 3: The VDSL bands correspond to the frequency plan formerly named 997 and the optional regional-specific bands correspond to the frequency plan formerly named 998.						

The band allocation for VDSL is shown in figure 10.

**Figure 10: VDSL Band Allocation**

Optionally, modems may use the band allocation shown in figure 11 to satisfy alternative regional requirements.

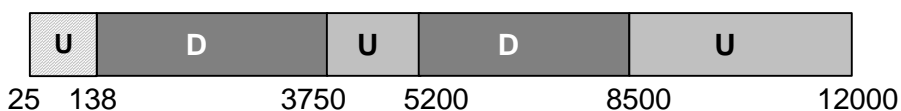
**Figure 11: Optional regional-specific VDSL Band Allocation**

8.1.5.3 Power Spectral Density (PSD)

A VDSL transceiver shall have the capability of operating according to the requirements of all the mandatory transmitter PSD limits described in this clause. The limits shall be measured at the LINE port when it is terminated by impedance R_v .

The location of the LT transceiver (FTTCab or FTTEEx) affects the allowable crosstalk and therefore the PSD limits.

- Since the first upstream band for the NT starts at 3 000 (or 3 750) kHz the crosstalk impact of the upstream transmission on other types of services can be ignored and the upstream transmit PSD limits for FTTCab and FTTEEx can be identical. There are two alternative PSD limits, M1 for EMC susceptible deployment scenarios (e.g. overhead cable plant) and M2 (see clauses 8.1.5.4 and 8.1.5.5). The symbolic names of the masks are shown in table 2 and their boundary values detailed in tables 5 to 8 (the boundary values for the regional-specific band allocation are detailed in tables 9 to 12).
- The PSD limits for LT will depend on the deployment scenario (FTTEEx and FTTCab). For each of these deployment scenarios there are two alternative PSD limits, M1 and M2 (see clauses 8.1.5.4 and 8.1.5.5), that shall apply.

In the case of FTTEEx only the "P" limits (baseband services on same wire pair) are applicable with a further distinction between "P1" (ADSL over ISDN present in the binder) and "P2" (ADSL over POTS present in the binder). The "D" limits (no baseband services on the same wire pair) are for further study.

Table 2: Overview of all PSDs

Transmit Direction	M1 (no power boost, with notches)	M2 (power boost, without notches)
Upstream	P.M1	P.M2
Downstream	Pcab.M1 Pex.P1.M1 Pex.P2.M1	Pcab.M2 Pex.P1.M2 Pex.P2.M2
The symbolic names refer to the detailed specifications in tables 3 to 6.		

For the purpose of compliance with the requirements on power spectral density of the VDSL transmit signal, the following objectives are defined:

- Peak PSD mask;
- Nominal PSD mask.

NOTE 1: Some of the nominal PSD masks have an envelope power in the order of +21 dBm. However, the maximum wideband power in clause 8.1.4 is restricted to a significantly lower level. This means that the transmit spectra can fill up this mask in various ways. This flexibility is included to allow for possible future increases in the transmit power.

NOTE 2: When the nominal PSD mask is defined in a frequency region bounded by edge frequencies F_{START} and F_{STOP} , the measured nominal PSD should be below the nominal PSD mask for all frequencies, f , such that $(F_{START} + RBW/2) < f < (F_{STOP} - RBW/2)$ where RBW is the resolution bandwidth of the test equipment.

A VDSL system shall comply with the restrictions that are imposed by both PSD masks. The values of the Peak and Nominal PSD masks are given in tables 5 to 12. Compliance shall be demonstrated as described below.

For checking compliance with the Peak PSD mask, the transmit PSD shall be measured with a resolution bandwidth $BW_{PEAK}(f)$ that depends on frequency. The values of $BW_{PEAK}(f)$ are given in table 3.

Table 3: Resolution bandwidth for Peak PSD mask

Frequency Band	Resolution Bandwidth
$0,5 \text{ kHz} \leq f \leq 10 \text{ kHz}$	1 kHz
$10 \text{ kHz} < f \leq 20 \text{ MHz}$	10 kHz
$20 \text{ MHz} < f \leq 29,95 \text{ MHz}$	100 kHz

NOTE 3: $BW_{PEAK}(f)$ and therefore the Peak PSD mask is not defined below 0,5 kHz and above 29,95 MHz

When the total power measured in a frequency region $BW_{PEAK}(f)$ is equal to $P(BW_{PEAK}(f))$, the measured PSD in dBm/Hz at frequency f shall be equal to:

$$PSD(f) = 10 \log_{10} \left(\frac{P(BW_{peak}(f))}{BW_{peak}(f)} \right).$$

For the VDSL system to be compliant, the measured PSD shall be below the Peak PSD mask at all frequencies for which the Peak PSD mask is defined.

For checking compliance with the Nominal PSD mask, the transmit PSD shall be measured with a resolution bandwidth $BW_{NOM}(f)$ that depends on frequency. The values of $BW_{NOM}(f)$ are given in table 4.

Table 4: Resolution bandwidth for Nominal PSD measurements

Frequency Band	Resolution Bandwidth
$10 \text{ kHz} \leq f \leq 138 \text{ kHz}$	10 kHz
$138 \text{ kHz} < f \leq 20 \text{ MHz}$	100 kHz
$20 \text{ MHz} < f \leq 29,5 \text{ MHz}$	1 000 kHz

NOTE 4: $BW_{NOM}(f)$ and therefore the Nominal PSD mask is not defined below 10 kHz and above 29,5 MHz

When the total power measured in a frequency region $BW_{NOM}(f)$ is equal to $P(BW_{NOM}(f))$, the measured PSD in dBm/Hz at frequency f shall be equal to:

$$PSD(f) = 10 \log_{10} \left(\frac{P(BW_{nom}(f))}{BW_{nom}(f)} \right).$$

For the VDSL system to be compliant, the measured PSD shall be below the Nominal PSD mask at all frequencies for which the Nominal PSD mask is defined.

For checking compliance with the Nominal PSD, the measured PSD can be obtained directly with a measurement bandwidth $BW_{NOM}(f)$ as shown above, but this would require a rectangular shaped resolution bandwidth filter.

Alternatively, by averaging the measurements obtained using the Peak PSD bandwidth $BW_{PEAK}(f)$ the Nominal PSD can be derived as follows.

The Peak PSD is denoted as $P_a(f)$ and is measured at frequencies $f(1) \dots f(N)$. Then the Nominal PSD can be calculated from:

$$PSD = 10 \log_{10} \left(\frac{\sum_n BW(n) \times 10^{P_a(f(n))/10}}{\sum_n BW(n)} \right).$$

Where the index n includes all of the frequencies $f(i)$ that fall within the measurement bandwidth $BW_{NOM}(f)$ around frequency f .

In addition to the Peak and Nominal PSD masks a PSD template is also defined. The PSD template is intended to be used for performance simulation and simplifying the definition of self-noise. The templates associated with the PSD masks can be found in annex E.

8.1.5.3.1 Conformance criteria

Three frequency regions are considered in the entire VDSL spectrum: in-band regions, out-of-band regions and transition band regions. For all regions the Peak PSD, the Nominal PSD, and both when appropriate, shall not exceed the values presented in tables 5 to 12.

The following tables shall be used as upper bounds for the PSD when joining the points using straight lines on a graph with a logarithmic frequency scale (Hz) and a linear power density scale (dBm/Hz).

Table 5: Upstream PSD limits

Frequency (kHz)	P.M1		P.M2	
	Peak PSD (dBm/Hz)	Nominal PSD (dBm/Hz)	Peak PSD (dBm/Hz)	Nominal PSD (dBm/Hz)
PSD limits when optional upstream band is used				
0	-110		-110	
4	-110		-110	
25	-38	-40	-38	-40
138	-38	-40	-38	-40
307	-90		-90	
482	-100		-100	
PSD limits when optional upstream band is not used				
0	-110		-110	
225	-110		-110	
226	-100		-100	
Common PSD limits				
2 825	-100		-100	
3 000	-80		-80	
3 001	-59	-61	-52,8	-54,8
5 099	-59	-61	-55,1	-57,1
5 100	-80		-80	
5 275	-100	-112	-100	-112
6 875	-100	-112	-100	-112
7 050	-80		-80	
7 051	-59	-61	-56,5	-58,5
10 000			-58	-60
11 999	-59	-61	-58	-60
12 000	-80		-80	
12 175	-100	-112	-100	-112
30 000	-100	-112	-100	-112
F_{START} and F_{STOP} edge frequencies for the nominal PSD limits are as follows: 25 kHz to 138 kHz. 3 001 kHz to 5 099 kHz. 5 275 kHz to 6 875 kHz. 7 051 kHz to 11 999 kHz. 12 175 kHz to 30 000 kHz.				

The FTTCab downstream PSD limits (peak and nominal) shall have two alternative but mandatory sets of values according to the following rules.

- Variant A minimizes the impact of VDSL deployed from the cabinet on ADSL services deployed from the Local Exchange. This applies to networks in which the ADSL has significant capacity in the band above 945 kHz for ADSL NTs located beyond the cabinet.
- Variant B is intended for deployment in networks where there is no significant ADSL capacity in the frequencies above 945 kHz for ADSL NTs located beyond the cabinet (e.g. when cabinets are located far from the Local Exchange).

Table 6: Downstream FTTCab PSD limits

Frequency (kHz)	Pcab.M1		Pcab.M2	
	Peak PSD (dBm/Hz)	Nominal PSD (dBm/Hz)	Peak PSD (dBm/Hz)	Nominal PSD (dBm/Hz)
PSD limits for variant A				
0	-110		-110	
225	-110		-110	
226	-100		-100	
929	-100		-100	
1 104	-80		-80	
PSD limits for variant B				
0	-110		-110	
225	-110		-110	
226	-100		-100	
770	-100		-100	
945	-80		-80	
946	-76,3	-78,3	-75,3	-77,3
947,2	-72,8	-74,8	-71,8	-73,8
949	-70	-72	-69	-71
958	-65,1	-67,1	-64,1	-66,1
1 104	-59	-61	-58	-60
Common PSD limits				
1 105	-59	-61	-58	-60
1 394			-49,4	-51,4
2 999	-59	-61	-52,8	-54,8
3 000	-80		-80	
3 175	-100	-110	-100	-110
4 925	-100	-110	-100	-110
5 100	-80		-80	
5 101	-59	-61	-55,1	-57,1
7 049	-59	-61	-56,5	-58,5
7 050	-80		-80	
7 225	-100	-112	-100	-112
30 000	-100	-112	-100	-112
F _{START} and F _{STOP} edge frequencies for the nominal PSD limits are as follows: 946 kHz to 2 999 kHz. 3 175 kHz to 4 925 kHz. 5 101 kHz to 7 049 kHz. 7 225 kHz to 30 000 kHz.				

Table 7: Downstream FTTE_x (ADSL over ISDN present in the binder) PSD limits

Frequency (kHz)	Pex.P1.M1		Pex.P1.M2	
	Peak PSD (dBm/Hz)	Nominal PSD (dBm/Hz)	Peak PSD (dBm/Hz)	Nominal PSD (dBm/Hz)
0	-97,5		-97,5	
3,99	-97,5		-97,5	
4	-90		-90	
138	-90		-90	
139	-59	-61	-59	-61
217	-59	-61	-59	-61
276	-38	-40	-38	-40
1 104	-38	-40	-38	-40
1 394			-49,4	-51,4
1 677	-59	-61		
2 999	-59	-61	-52,8	-54,8
3 000	-80		-80	
3 175	-100	-110	-100	-110
4 925	-100	-110	-100	-110
5 100	-80		-80	
5 101	-59	-61	-55,1	-57,1
7 049	-59	-61	-56,5	-58,5
7 050	-80		-80	
7 225	-100	-112	-100	-112
30 000	-100	-112	-100	-112

F_{START} and F_{STOP} edge frequencies for the nominal PSD limits are as follows:
139 kHz to 2 999 kHz.
3 175 kHz to 4 925 kHz.
5 101 kHz to 7 049 kHz.
7 225 kHz to 30 000 kHz.

Table 8: Downstream FTTE_x (ADSL over POTS present in the binder) PSD limits

Frequency (kHz)	Pex.P2.M1		Pex.P2.M2	
	Peak PSD (dBm/Hz)	Nominal PSD (dBm/Hz)	Peak PSD (dBm/Hz)	Nominal PSD (dBm/Hz)
0	-97,5		-97,5	
3,99	-97,5		-97,5	
4	-90		-90	
138	-90		-90	
139	-38	-40	-38	-40
1 104	-38	-40	-38	-40
1 394			-49,4	-51,4
1 677	-59	-61		
2 999	-59	-61	-52,8	-54,8
3 000	-80		-80	
3 175	-100	-110	-100	-110
4 925	-100	-110	-100	-110
5 100	-80		-80	
5 101	-59	-61	-55,1	-57,1
7 049	-59	-61	-56,5	-58,5
7 050	-80		-80	
7 225	-100	-112	-100	-112
30 000	-100	-112	-100	-112

F_{START} and F_{STOP} edge frequencies for the nominal PSD limits are as follows:
139 kHz to 2 999 kHz.
3 175 kHz to 4 925 kHz.
5 101 kHz to 7 049 kHz.
7 225 kHz to 30 000 kHz.

8.1.5.3.2

PSD limits for optional regional-specific band allocation

Table 9: Upstream PSD limits

Frequency (kHz)	P.M1		P.M2	
	Peak PSD (dBm/Hz)	Nominal PSD (dBm/Hz)	Peak PSD (dBm/Hz)	Nominal PSD (dBm/Hz)
PSD limits when optional upstream band is used				
0	-110		-110	
4	-110		-110	
25	-38	-40	-38	-40
138	-38	-40	-38	-40
307	-90		-90	
482	-100		-100	
PSD limits when optional upstream band is not used				
0	-110		-110	
225	-110		-110	
226	-100		-100	
Common PSD limits				
3 575	-100		-100	
3 750	-80		-80	
3 751	-59	-61	-53,7	-55,7
5 199	-59	-61	-55,2	-57,2
5 200	-80		-80	
5 375	-100	-112	-100	-112
8 325	-100	-112	-100	-112
8 500	-80		-80	
8 501	-59	-61	-57,3	-59,3
10 000			-58	-60
11 999	-59	-61	-58	-60
12 000	-80		-80	
12 175	-100	-112	-100	-112
30 000	-100	-112	-100	-112
F_{START} and F_{STOP} edge frequencies for the nominal PSD limits are as follows: 25 kHz to 138 kHz. 3 751 kHz to 5 199 kHz. 5 375 kHz to 8 325 kHz. 8 501 kHz to 11 999 kHz. 12 175 kHz to 30 000 kHz.				

Table 10: Downstream FTTCab PSD limits

Frequency (kHz)	Pcab.M1		Pcab.M2	
	Peak PSD (dBm/Hz)	Nominal PSD (dBm/Hz)	Peak PSD (dBm/Hz)	Nominal PSD (dBm/Hz)
PSD limits for variant A				
0	-110		-110	
225	-110		-110	
226	-100		-100	
929	-100		-100	
1 104	-80		-80	
PSD limits for variant B				
0	-110		-110	
225	-110		-110	
226	-100		-100	
770	-100		-100	
944,9	-80		-80	
946	-76,3	-78,3	-75,3	-77,3
947,2	-72,8	-74,8	-71,8	-73,8
949	-70	-72	-69	-71
958	-65,1	-67,1	-64,1	-66,1
1 104	-59	-61	-58	-60
Common PSD limits				
1 105	-59	-61	-58	-60
1 349			-49,4	-51,4
3 749	-59	-61	-53,7	-55,7
3 750	-80		-80	
3 925	-100	-110	-100	-110
5 025	-100	-110	-100	-110
5 200	-80		-80	
5 201	-59	-61	-55,2	-57,2
8 499	-59	-61	-57,3	-59,3
8 500	-80		-80	
8 675	-100	-112	-100	-112
30 000	-100	-112	-100	-112
F_{START} and F_{STOP} edge frequencies for the nominal PSD limits are as follows: 946 kHz to 3 749 kHz. 3 925 kHz to 5 025 kHz. 5 201 kHz to 8 499 kHz. 8 675 kHz to 30 000 kHz.				

Table 11: Downstream FTTE_x (ADSL over ISDN present in the binder) PSD limits

Frequency (kHz)	Pex.P1.M1		Pex.P1.M2	
	Peak PSD (dBm/Hz)	Nominal PSD (dBm/Hz)	Peak PSD (dBm/Hz)	Nominal PSD (dBm/Hz)
0	-97,5		-97,5	
3,99	-97,5		-97,5	
4	-90		-90	
138	-90		-90	
139	-59	-61	-59	-61
217	-59	-61	-59	-61
276	-38	-40	-38	-40
1 104	-38	-40	-38	-40
1 394			-49,4	-51,4
1 677	-59	-61		
3 749	-59	-61	-53,7	-55,7
3 750	-80		-80	
3 925	-100	-110	-100	-110
5 025	-100	-110	-100	-110
5 200	-80		-80	
5 201	-59	-61	-55,2	-57,2
8 499	-59	-61	-57,3	-59,3
8 500	-80		-80	
8 675	-100	-112	-100	-112
30 000	-100	-112	-100	-112

F_{START} and F_{STOP} edge frequencies for the nominal PSD limits are as follows:
139 kHz to 3 749 kHz.
3 925 kHz to 5 025 kHz.
5 201 kHz to 8 499 kHz.
8 675 kHz to 30 000 kHz.

Table 12: Downstream FTTE_x (ADSL over POTS present in the binder) PSD limits

Frequency (kHz)	Pex.P2.M1		Pex.P2.M2	
	Peak PSD (dBm/Hz)	Nominal PSD (dBm/Hz)	Peak PSD (dBm/Hz)	Nominal PSD (dBm/Hz)
0	-97,5		-97,5	
3,99	-97,5		-97,5	
4	-90		-90	
138	-90		-90	
139	-38	-40	-38	-40
1 104	-38	-40	-38	-40
1 394			-49,4	-51,4
1 677	-59	-61		
3 749	-59	-61	-53,7	-55,7
3 750	-80		-80	
3 925	-100	-110	-100	-110
5 025	-100	-110	-100	-110
5 200	-80		-80	
5 201	-59	-61	-55,2	-57,2
8 499	-59	-61	-57,3	-59,3
8 500	-80		-80	
8 675	-100	-112	-100	-112
30 000	-100	-112	-100	-112

F_{START} and F_{STOP} edge frequencies for the nominal PSD limits are as follows:
139 kHz to 3 749 kHz.
3 925 kHz to 5 025 kHz.
5 201 kHz to 8 499 kHz.
8 675 kHz to 30 000 kHz.

8.1.5.4 Mask M1 (notched)

Notching is implemented in the internationally standardized amateur radio bands (see table 17) to limit the transmitted PSD within these designated bands. The notching is provided to reduce the effect of unwanted radiated emissions from VDSL causing undue interference to existing licensed users of that part of the spectrum.

A VDSL transceiver conforming to the requirements of Mask M1 shall be able to reduce the PSD simultaneously to below -80 dBm/Hz in one or more of the internationally standardized Amateur Radio bands listed in table 17.

It is desirable to implement programmability of the notch frequencies to cater for national and regional variations.

8.1.5.5 Mask M2 (unnotched)

Mask M2 may be used when EMI effects are weak and therefore notching of the amateur radio bands is not required.

8.1.6 Upstream power back-off

This clause applies to all modulation schemes (single carrier and multi-carrier) and describes how power back-off shall be implemented.

Upstream Power Back-Off (UPBO) shall be applied to provide spectral compatibility between loops of different lengths deployed in the same binder. Only one mode shall be supported as described below.

- 1) It shall be possible for the network management system to set the limiting transmit PSD mask for the NT to one of the standard masks specified in the present document. The method to determine this limiting mask is for further study.
- 2) The NT shall perform UPBO as described in clause 8.1.6.1 autonomously, i.e. without sending any significant information to the LT until the UPBO is applied.
- 3) After UPBO has been applied as described in (2)), the LT shall be capable of adjusting the transmit PSD selected by the NT; the adjusted transmit PSD shall be subject to the limitations in clause 8.1.6.1.
- 4) To enable the NT to initiate a connection with the LT, which will occur before UPBO has been applied, the NT shall be allowed to cause more degradation to other loops than expected when using the mode described in clause 8.1.6.1. The mechanism by which the NT initiates a connection and the allowed additional degradation during initiation is for further study.

8.1.6.1 Upstream transmit nominal PSD requirement

The NT shall explicitly estimate the line parameter kl_0 , and use this value to calculate the nominal transmit PSD $TxPSD(kl_0, f)$. The NT shall then adapt its transmit signal to conform to this level while remaining below the PSD limit set by the management system as described in item (i) of clause 8.1.6.

$$TxPSD(kl_0, f) = PSD_{REF}(f) + kl_0 \sqrt{f}$$

Where $TxPSD$ is in dBm/Hz and f is in MHz.

NOTE 1: $kl_0 \sqrt{f}$ is a fair approximation of the loop attenuation (insertion loss) for homogeneous loops, especially at frequencies above about 1 MHz.

$PSD_{REF}(f)$ is a function of frequency and crosstalk but is independent of the length and type of the loop. Values for $PSD_{REF}(f)$ are given in table 13.

Table 13: Reference PSDs

Alien crosstalk profiles	Reference PSD (dBm/Hz, f in MHz)	
	Noise A & B	1U
2U		$-54 - 19,22\sqrt{f}$
Noise C	1U	$-47,3 - 21,14\sqrt{f}$
	2U	$-54 - 16,29\sqrt{f}$
Noise D	1U	$-47,3 - 26,21\sqrt{f}$
	2U	$-54 - 17,36\sqrt{f}$
Noise E	1U	$-47,3 - 27,27\sqrt{f}$
	2U	$-54 - 18,1\sqrt{f}$
Noise F	1U	$-47,3 - 19,77\sqrt{f}$
	2U	$-54 - 15,77\sqrt{f}$

The line parameter kl_0 is defined as:

$$kl_0 = \min \left\{ \frac{\text{loss}(f)}{\sqrt{f}} \right\}$$

The minimum is taken over the usable VDSL frequency band above 1 MHz. The function $\text{loss}(f)$ is the insertion loss in dB of the loop at the frequency f (MHz).

NOTE 2: This definition is abstract, implying an infinitely fine grid of frequencies. Elsewhere practical measurements will be specified with a finite frequency grid.

If the estimated value of kl_0 is smaller than 1,8 the modem shall be allowed to perform power back-off as if kl_0 was equal to 1,8.

NOTE 3: The current UPBO algorithm allows the in-band nominal PSD level to be reduced below the out-of-band PSD level. This is for further study.

8.1.7 A-B leg (tip-ring) reversal

All requirements in the present document shall be unaffected by reversal of the A and B leg (or tip and ring) connections.

8.2 Transceiver latency

There are currently two options defined. These are known as single latency mode and dual latency mode (see clauses 8.2.2 and 8.2.3). It is not intended that both options be implemented within the same transceiver.

8.2.1 Trade-off between channel latency and impulse noise immunity

VDSL systems shall provide protection against disturbance from impulse noise. The level of protection shall be set and controlled via the network management system. The lowest level of protection is required to support latency sensitive services such as voice, while the highest level is required to support burst error sensitive services such as entertainment video.

A fast (low-latency) VDSL channel shall exhibit a delay no greater than 1 ms (average of upstream and downstream) between the α and β interfaces.

A slow (high-latency) VDSL channel shall have a programmable delay between the α and β interfaces in the range 1 ms to 20 ms in approximately 1 ms increments. The slow channel shall be capable of correcting error bursts when the path is subject to a noise burst of up to 500 μ s (see clause 9.3.3.7). Configuration of the latency shall be via the network management system.

8.2.2 Single latency mode

In a single-latency configuration, all the VDSL system data payload capacity is dedicated to one (slow) channel.

8.2.3 Dual latency mode

In a dual-latency configuration the VDSL system data payload capacity is divided between two channels - the fast and slow channels.

A dual-latency VDSL system shall provide low-latency on the fast-channel and high-latency on the slow-channel concurrently.

The allocation of capacity between the fast-channel and slow-channel shall be configured at start-up via the network management system.

8.2.4 Measuring latency

Implementations shall provide the means to verify delay between the α and β interfaces for the purposes of laboratory design qualification testing, although this may require additional external hardware and software not required for normal use.

8.3 Remote powering

Remote powering (via. the wire-line) of the VDSL transceiver located in the NT is not required. Existing narrowband services carried in the baseband shall not be affected by removal of local power to the broadband NT.

8.4 Power-down mode

A low power and/or power down mode shall be provided when the transceiver is not in use (see clause 10.1).

8.5 Repeated operation

Repeated operation for VDSL transceivers is not required or desired for spectral compatibility reasons.

8.6 Payload bit-rates

The payload rates shown in table 14 shall be used to measure the transmission performance. The line rate is left to the vendor, but it shall be sufficient to carry the additional overhead necessary to ensure that the transmission performance requirements can be met. The overhead will include components necessary for Forward Error Correction, maintenance channel, synchronization, etc.

Selection of the payload bit rate shall be performed according to one of the following two methods:

- 1) The Network Operator performs selection at installation. The bit rate shall be fixed for the duration of service provision to the customer and would normally be governed by the Element Manager or TMN.
- 2) Selection is performed at installation as in method 1. However, the selected payload can be changed via a Payload Rate Change (PRC) procedure under the responsibility of an Operations and Management (O&M) entity under the control of the Network Operator. The purpose of this O&M is to guarantee that the PRC procedure will never induce network instability or increase spectral incompatibility between VDSL and other services.
- 3) There shall be no provision for customer control of the VDSL line rate including PRC procedure, or autonomous/dynamic rate adaptation as this would increase the likelihood of spectral incompatibility between different VDSL and other heritage xDSL systems operating in the same multi-pair cable.

Table 14: Payload bit-rates

Class of operation	Downstream (kbps)	Upstream (kbps)
A4	362 x 64 = 23 168	64 x 64 = 4 096
A3	226 x 64 = 14 464	48 x 64 = 3 072
A2	134 x 64 = 8 576	32 x 64 = 2 048
A1	100 x 64 = 6 400	32 x 64 = 2 048
S5	442 x 64 = 28 288	442 x 64 = 28 288
S4	362 x 64 = 23 168	362 x 64 = 23 168
S3	226 x 64 = 14 464	226 x 64 = 14 464
S2	134 x 64 = 8 576	134 x 64 = 8 576
S1	100 x 64 = 6 400	100 x 64 = 6 400
NOTE:	Optionally, other payload data rates may be provided to enhance the granularity of operation.	

9 Transmission performance

The performance requirements given in this clause shall be met by a VDSL transceiver operating in the specific payload mode outlined by the operation codes given in table 14.

9.1 Test procedure

This clause provides a specification of the test set-up, the insertion path and the definition of signal and noise levels. The tests focus on the noise margin when VDSL signals under test are attenuated by standard test-loops and suffer interference from standard crosstalk noise or impulse noise. This noise margin indicates what increase of crosstalk noise or impulse noise level can be tolerated by the VDSL system under test before the bit error ratio exceeds the design target.

9.1.1 Test set-up definition

Figure 8 illustrates the functional description of the test set-up. It includes:

- A data source capable of generating a Pseudo Random Bit Sequence (PRBS) with a minimum length of $2^{15}-1$ to the transmitter in the direction under test at the bitrate required. The transmitter in the opposing direction shall be fed with a similar PRBS signal, although there is no need to monitor the receiver output in this path.
- The test loops, as specified in clause 9.2.
- An adding element to add the common mode and differential mode impairment noise (a mix of random, impulsive and harmonic noise), as specified in clause 9.3.
- An impairment generator, as specified in clause 9.3, to generate both the differential mode and common mode impairment noise to be fed to the adding element.
- A high impedance and well balanced differential voltage probe (e.g. better than 60 dB across the whole VDSL band) connected with level detectors such as a spectrum analyzer or a true rms voltmeter.
- A high impedance and well balanced common mode voltage probe (e.g. better than 60 dB across the whole VDSL band) connected with level detectors such as a spectrum analyzer or a true rms voltmeter.

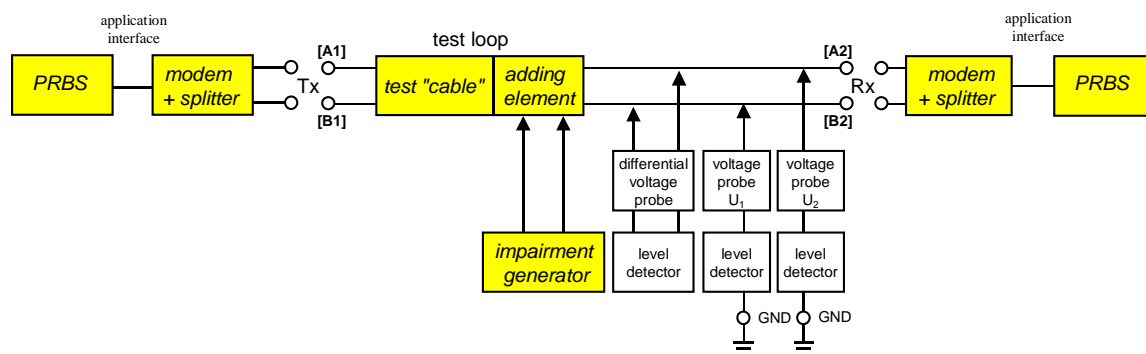

Figure 12: Functional description of the set-up of the performance tests

The two-port characteristics (transfer function, impedance) of the test-loop, as specified in clause 9.2, is defined between port Tx (node pairs A1, B1) and port Rx (node pair A2, B2). The consequence is that the two-port characteristics of the test "cable" in figure 12 must be properly adjusted to take full account of non-zero insertion loss and non-infinite shunt impedance of the adding element and impairment generator. This is to ensure that the insertion of the generated impairment signals does not appreciably load the line.

The balance about earth, observed at both ports and at the tips of the voltage probe shall exhibit a value that is 10 dB greater than the transceiver under test. This is to ensure that the impairment generator and monitor function does not appreciably deteriorate the balance about earth of the transceiver under test.

The signal flow through the test set-up is from port Tx to port Rx, which means that measuring upstream and downstream performance requires an interchange of transceiver position and test "cable" ends.

The received signal level at port Rx is the level, measured between node A2 and B2, when port Tx as well as port Rx are terminated with the VDSL transceivers under test. The impairment generator is switched off during this measurement.

Test Loop #0, as specified in clause 9.2, shall always be used for calibrating and verifying the correct settings of generators G1-G7, as specified in clause 9.3, during performance testing.

The transmitted signal level at port Tx is the level, measured between node A1 and B1, under the same conditions.

The impairment noise shall be a mix of random, impulsive and harmonic noise, as defined in clause 9.3. The level that is specified in clause 9.3 is the level at port Rx, measured between node A2 and B2, while port Tx as well as port Rx are terminated with the design impedance R_V . These impedances shall be passive when the transceiver impedance in the switched-off mode is different from this value.

9.1.2 Signal and noise level definitions

The signal and noise levels are probed with a well balanced differential voltage probe (U_2-U_1). The differential impedance between the tips of that probe shall be higher than the shunt impedance of 100 k Ω in parallel with 10 pF. Figure 12 shows the probe position when measuring the Rx signal level at the LT or NT receiver. Measuring the Tx signal level requires the connection of the tips to node pair (A1, B1).

The common mode signal and noise levels are probed with a well balanced common mode voltage probe as the voltage between nodes A2, B2 and ground. Figure 12 shows the position of the two voltage probes when measuring the common mode signal. The common mode voltage is defined as $1/2(U_1+U_2)$.

NOTE: The various levels (or spectral masks) of signal and noise that are specified in the present document are defined at the Tx or Rx side of this set-up. The various levels are defined while the set-up is terminated, as described above, with the normalised impedance R_V or with VDSL transceivers under test.

Probing an rms-voltage U_{rms} (V) in this set-up, over the full signal band, means a power level of P (dBm) that equals:

$$P = 10 \times \log_{10}(U_{rms}^2/R_V \times 1\,000) \text{ dBm}$$

Probing an rms-voltage U_{rms} (V) in this set-up, within a small frequency band of Δf (in Hertz), means an average spectral density level of P (dBm/Hz) within that filtered band that equals:

$$P = 10 \times \log_{10}(U_{rms}^2/R_V \times 1\,000/\Delta f) \text{ (dBm/Hz)}$$

The bandwidth Δf identifies the noise bandwidth of the filter, and not the -3 dB bandwidth.

9.2 Test loops

The purpose of the test loops shown in figure 13 are to stress VDSL transceivers under a wide range of different conditions that can be expected when deploying VDSL in real networks.

9.2.1 Functional description

The test loops in this clause are an artificial mixture of cable sections. A number of different loops have been used to represent a wide range of cable impedances, and to represent ripple in amplitude and phase characteristics of the test loop transfer function.

- The length of the individual loops have been chosen such that the transmission characteristics of all loops are comparable. This has been achieved by normalizing the *electrical* length of the loops (insertion loss at a well chosen test frequency [TBD]). The purpose of this is to stress the equaliser of the VDSL modem under test in a similar way over all loops, when testing at a specific bitrate. The total length of each loop is described in terms of *physical* length, and the length of the individual sections as a fixed fraction of this total. If the implementation tolerance of one test loop cause the *electrical* length to be out of specification, then its total physical length shall be scaled accordingly to correct this error.

The loops are defined as a combination of cable sections. Each section is defined by means of two-port cable models of the individual sections (see annexes A and B). Cable simulators as well as real cables can be used for these sections. The length of the individual loops are defined by the tables in clause 9.4.1.

- Loop #0 is a symbolic name for a loop with zero (or near zero) length, to prove that the VDSL transceiver under test can handle the potentially high signal levels when two transceivers are directly interconnected.
- The impedances of Loop #1 and #2 are nearly constant over a wide frequency interval. These two loops represent uniform distribution cables, one having a relatively low characteristic impedance and another having a relative high impedance (low capacitance per unit length). These impedance values are chosen to be the lowest and highest values of distribution cables that are commonly used in Europe.
- The impedances of Loop #3 and #4 follow frequency curves that are oscillating in nature. This represents the mismatch effects in distribution cables caused by a short extent with a cable that differs significantly in characteristic impedance. Loop #3 represents this at the LT side to stress downstream signals. Loop #4 does the same at the NT side to stress upstream signals.

Test loops 1 to 4 in figure 13 have equal *electrical* length (insertion loss at a specified test frequency), but differ in input impedance (see figure 14). It is these values for insertion loss and impedance that define an actual test loop set. The loops are not defined in terms of a specific *physical* length.

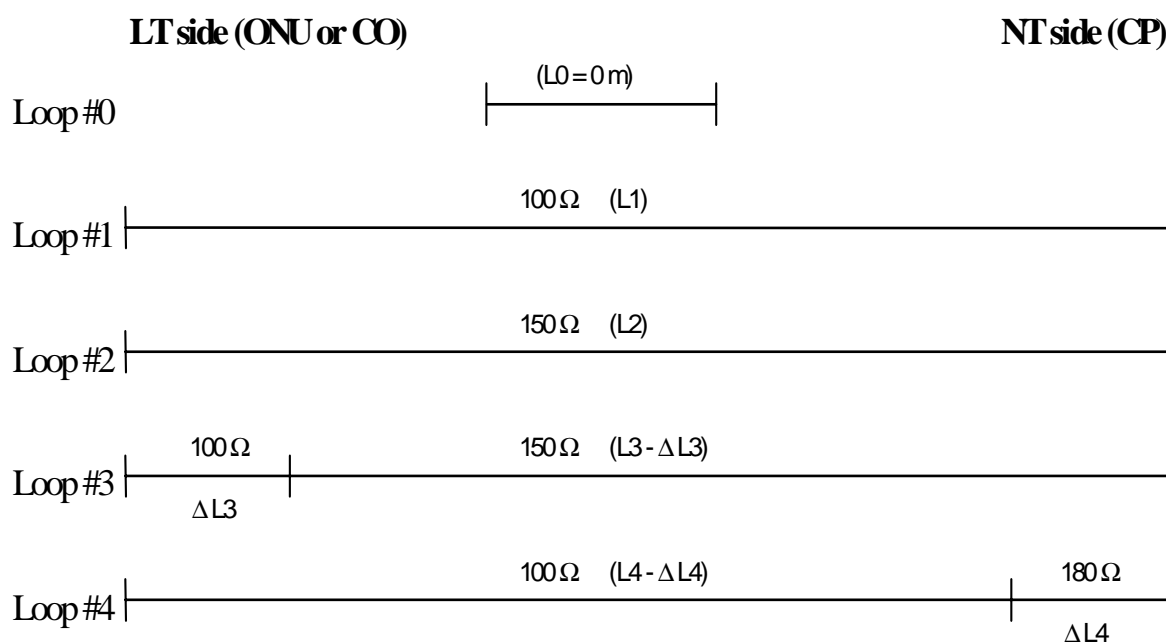

Figure 13: Test loop topology

The variation of input impedance for the various test loops is shown in figure 14. Some typical transfer functions of loops #1 to #4 are illustrated in figure 15. The test loops in this example are normalized in *electrical* length (or insertion loss) at an arbitrary chosen frequency. Five examples denoted by Q1 to Q5 are shown in figure 15. Loop-set Q1 has an insertion loss of 55 dB at 2 MHz and loop-set Q5 has an insertion loss of 18,5 dB at 10 MHz. The *physical* length of loop-set Q1 is in the range of 1 990 m to 2 100 m and for loop-set Q5 is in the range of 250 m to 300 m. The plot demonstrates the similarity of the transfer function of all the different loops when they are normalized.

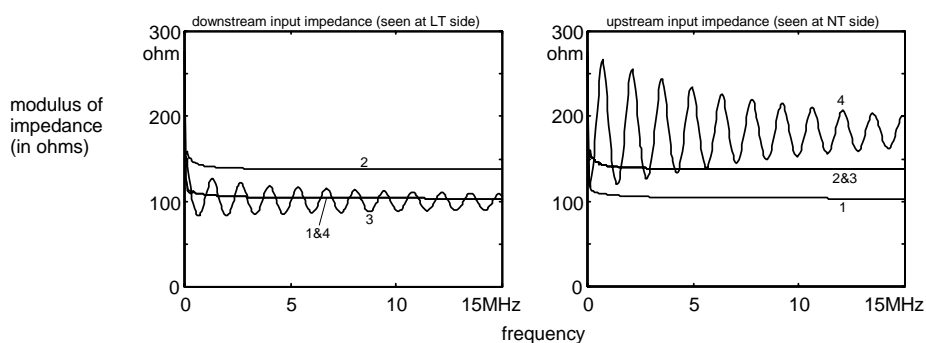

Figure 14: Calculated variation of input impedance, at a normalized loop length of 1 500 m

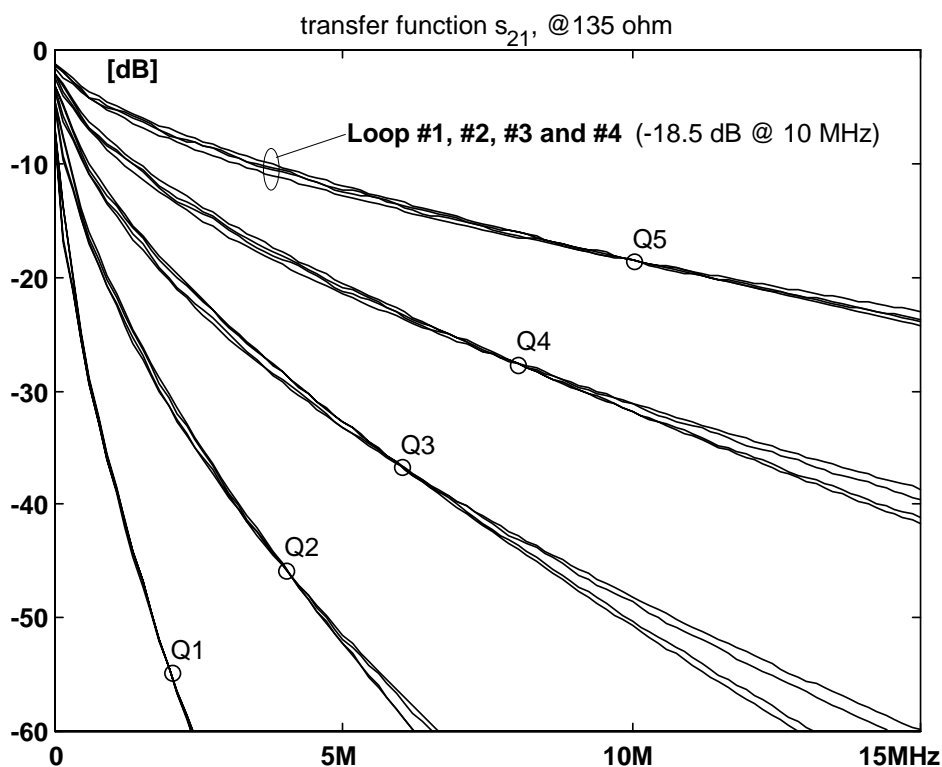

Figure 15: Typical transfer function (in 135 Ω) of the test loops when normalized in electrical length

The sections of the loops are defined in clause 9.2.2 by means of two-port cable models of the individual sections. Cable simulators as well as real cables can be used for these sections. To minimize the electrical differences between test loop configurations, their length is specified as *electrical* lengths instead of the physical length of the sections in cascade (meaningful only when real cables are used). The electrical length is equivalent to the insertion loss of the loop at a given test frequency and termination impedance.

The relationship between *electrical* length (insertion loss) and total *physical* length (when real cables are used) can be calculated from the two-port models. Examples are shown in annex A.

Table 15: Test-loop composition

Test loop	Distribution cable (L)	Extension cable (ΔL) LT or NT side	Extension length ΔL [m]
#0	-	-	-
#1	TP100	-	-
#2	TP150	-	-
#3	TP150	TP100x	70
#4	TP100	TP180x	70

NOTE: The labels "TPxxx" refer to the two-port cable models specified in annex A.

9.2.2 Test loop accuracy

The different cable sections are specified by two-port cable models that serve as a template for real twisted-pair cables. Cable simulators as well as real cables can be used for these test loops. The associated models and line constants are specified in annex A. The composition of the test-loops is specified in table 15.

The characteristics of each test loop, with cascaded sections, shall approximate the models within a specified accuracy. This accuracy specification does not hold for the individual sections.

- The magnitude of the test loop insertion loss shall approximate the insertion loss of the specified models within 3% on a dB scale, between f_0 and f_5 .
- The magnitude of the test loop characteristic impedance shall approximate the characteristic impedance of the specified models within 7% on a linear scale, between f_0 and f_5 .
- The group delay of the test loop shall approximate the group delay of the specified cascaded models within 3% on a linear scale, between f_0 and f_5 .

The *electrical* length (insertion loss at specified test frequency) shall be as specified in tables 24 and 25. If implementation tolerances of one test loop cause its *electrical* length to be out of specification, its total *physical* length shall be scaled accordingly to compensate for the error.

9.3 Impairment generators

The impairment generator produces the noise that is injected into the test set and includes the crosstalk noise, ingress noise and impulse noise.

The crosstalk noise power level varies with frequency, length of the test loop and transmit direction (upstream or downstream). Various crosstalk noise models are defined in the following clauses and they are applied according to the test scenarios given in clause 9.4.4.

The definition of the impairment noise for VDSL performance testing is very complex and for the purposes of the present document it has been broken down into smaller, more easily specified components. These components include equivalent disturbers and crosstalk coupling functions. These separate and uncorrelated components can be isolated and summed to form the impairment generator for the VDSL system under test. The detailed specifications of the components of the noise model(s) are given in the clauses below together with a brief explanation.

9.3.1 Functional description

Figure 16 defines a functional diagram of the composite impairment noise. It defines a functional description of the combined impairment noise, as it should appear at the test probes at the receiver input of the VDSL transceiver under test. Details of the measurement technique is defined in clause 9.1.2.

The functional diagram has the following elements:

- The seven impairment "generators" G1 to G7 generate noise as defined in clause 9.3.3. Their noise characteristics are independent of the test loops and bit-rates.
- The transfer function $H_1(f,L)$ models the length and frequency dependency of the NEXT impairment, as specified in clause 9.3.2. The transfer function is independent of the loop-set number, but changes with the electrical length of the test loop. Its transfer function changes with the frequency f , roughly according to $f^{0.75}$.
- The transfer function $H_2(f,L)$ models the length and frequency dependency of the FEXT impairment, as specified in clause 9.3.2. Its transfer function is independent of the loop-set number, but changes with the electrical length of the test loop. Its transfer function changes with the frequency f , roughly according to f times the cable transfer function.
- Switches S1-S7 determine whether or not a specific impairment generator contributes to the total impairment during a test.

- Amplifier A1 provides the facility to increase the level of some generators simultaneously to perform the noise margin tests as defined in clause 9.4.3. A value of x dB means a frequency independent increase of the level by x dB over the full VDSL band, from f_0 to f_5 (see clause 8). Unless otherwise specified, its gain is fixed at 0 dB.

In a practical implementation of the test set-up, there is no need to give access to any of the internal signals of the diagram in figure 16. These function blocks may be incorporated with the test-loop and the adding element as one integrated construction.

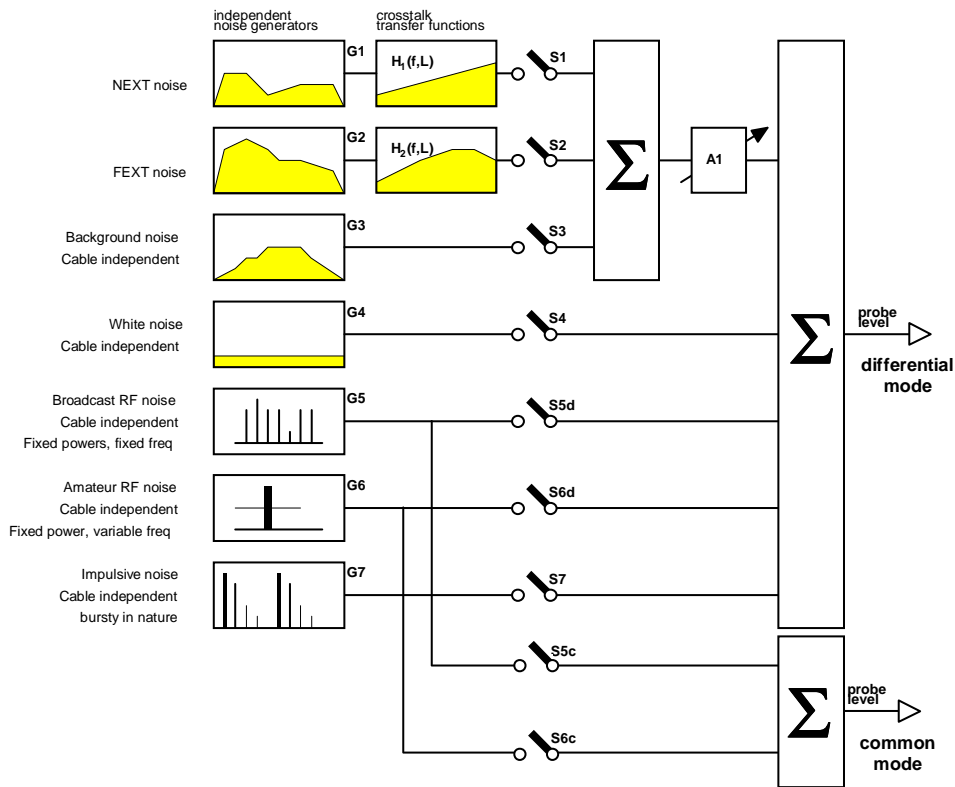

NOTE: Generator G7 is the only one that is symbolically shown in the time domain.

Figure 16: Functional diagram of the composition of the impairment noise

This functional diagram will be used for impairment tests in downstream and upstream directions. Several deployment scenarios have been identified that can be applied to VDSL testing. These scenarios are representative of the impairments that can be found in metallic access networks.

Each scenario (noise model) results in a length dependent PSD description of noise. Each noise model is sub-divided into two parts, one that is injected at the LT side and one that is injected at the NT side of the VDSL transceiver link under test. Some of the seven individual impairment "generators" G1 to G7 are used in more than one noise model with different values.

- **Type "A" models (Cabinet)** are intended to represent a *mixed scenario including full ADSL* where the VDSL system under test is placed in a distribution cable (up to tens of wire pairs) that is filled with many other transmission systems. The LT is located in a street cabinet (FTTCab) and the cable from the exchange to the cabinet attenuates the downstream PSDs of the disturbers.
- **Type "B" models (Cabinet)** are intended to represent a *mixed scenario including DSL-lite* where the VDSL system under test is placed in a distribution cable (up to tens of wire pairs) that is filled with many other transmission systems. The LT is located in a street cabinet (FTTCab) and the cable from the exchange to the cabinet attenuates the downstream PSDs of the disturbers.
- **Type "C" models (Cabinet)** are intended to represent a *legacy scenario* that accounts for systems such as ISDN-PRA (HDB3) in addition to the scenario of type "A" models.
- **Type "D" models (Exchange)** are intended to represent a *high penetration scenario* where the VDSL system under test is placed in a distribution cable (up to hundreds of wire pairs) that is filled with many other transmission systems and the LT is located in the exchange (FTTEx).
- **Type "E" models (Exchange)** are intended to represent a *medium penetration scenario* where the VDSL system under test is placed in a distribution cable (up to tens of wire pairs) that is filled with many other transmission systems and the LT is located in the exchange (FTTEx).
- **Type "F" models (Exchange)** are intended to represent a *legacy scenario* that accounts for systems such as ISDN-PRA (HDB3) in addition to the medium penetration scenario of type "E" models with the LT located in the exchange (FTTEx).

Each test has its own impairment specification that is described in clause 9.4. The overall impairment noise shall be characterized by the sum of the individual components as specified in the relevant sub-clauses. The combined impairment noise is applied to the receiver under test at either the LT (for upstream) or NT (for downstream) end of the test loop.

9.3.2 Cable crosstalk models

The purpose of the cable crosstalk models is to model both the length and frequency dependence of crosstalk measured in real cables. These crosstalk transfer functions adjust the level of the noise generators in figure 16 when the *electrical* length of the test-loops are changed. The frequency and length dependency of these functions is in accordance with observations from real cables. The specification is based on the following constants, parameters and functions:

- Variable f identifies the frequency in Hz.
- Constant f_0 identifies a chosen reference frequency, which was set to 1 MHz.
- Variable L identifies the physical length of the actual test loop in meters. This value is calculated from the cable models in annex A for a given insertion loss and test frequency. Tables A.4 and A.5 in annex A summarize the calculated values for each combination of payload bit-rate, noise model and test loop.
- Constant L_0 identifies a chosen reference length, which was set to 1 km.
- The function $s_T(f,L)$ represents the frequency and length dependent amplitude of the transmission function of the actual test loops. This value equals $s_T = |s_{21}|$, where s_{21} is the transmission s-parameter of the loop normalized to 135Ω as specified in annex A.
- Constant K_{xn} identifies an empirically obtained number that scales the NEXT transfer function $H_1(f,L)$. The resulting transfer function represents a power summed crosstalk model (see bibliography) of the NEXT as it was observed in a test cable. Although several disturbers and wire pairs were used, this function $H_1(f,L)$ is scaled down as if it originates from a single disturber in a single wire pair;

- Constant K_{xf} identifies an empirically obtained number that scales the FEXT transfer function $H_2(f,L)$. The resulting transfer function represents a power summed crosstalk model (see bibliography) of the FEXT as it was observed in a test cable. Although several disturbers and wire pairs were used, this function $H_2(f,L)$ is scaled down as if it originates from a single disturber in a single wire pair.

The transfer function equations below shall be used as crosstalk transfer functions in the impairment generator:

$$H_1(f, L) = K_{xn} \times (f/f_0)^{0.75} \times \sqrt{1 - |S_T(f, L)|^4}$$

$$H_2(f, L) = K_{xf} \times (f/f_0) \times \sqrt{(L/L_0)} \times |S_T(f, L)|$$

Where:

$$K_{xn} = 10^{(-50/20)} \approx 0.0032, \quad f_0 = 1 \text{ MHz}$$

$$K_{xf} = 10^{(-45/20)} \approx 0.0056, \quad L_0 = 1 \text{ km}$$

$$S_T(f, L) = |s_{21}| = \text{test loop transfer function}$$

9.3.3 Individual impairment generators

9.3.3.1 NEXT noise generator [G1]

The NEXT noise generator represents the equivalent disturbance of all impairments that are identified as crosstalk noise from a predominantly Near End origin. The noise when filtered by the NEXT crosstalk coupling function of clause 9.3.2 represents the contribution of all NEXT in the composite impairment noise of the test.

The PSD of the noise generator is a weighted sum of the self-crosstalk and alien crosstalk profiles as specified in clause 9.3.4.1.

- $G1.UP.\# = (XS.LT.\# \blacklozenge XA.LT.\#)$.
- $G1.DN.\# = (XS.NT.\# \blacklozenge XA.NT.\#)$.

The symbols in the above expressions are defined below:

- "#" is a placeholder for noise model "A", "B" ... "F";
- "XS.LT.#" and "XS.NT.#" refer to the self crosstalk profiles defined in clause 9.3.4.1;
- "XA.LT.#" and "XA.NT.#" refer to the alien crosstalk profiles defined in clause 9.3.4.1;
- "◆" refers to the FSAN crosstalk sum of two PSDs which is defined as $P_X = (P_{XS}^{Kn} + P_{XA}^{Kn})^{1/Kn}$ where P is the PSD in W/Hz and $Kn = 1/0,6$.

The PSD of this generator is independent of the cable because this is modeled separately as transfer function $H_1(f,L)$ as specified in clause 9.3.2.

The noise from this generator shall be uncorrelated with all other noise sources in the impairment generator and uncorrelated with the VDSL system under test. The noise shall be random in nature with a near Gaussian amplitude distribution as specified in clause 9.3.4.2.

9.3.3.2 FEXT noise generator [G2]

The FEXT noise generator represents the equivalent disturbance of all the impairments that are identified as crosstalk noise from a predominantly Far End origin. The noise when filtered by the FEXT crosstalk coupling function of clause 9.3.2 represents the contribution of all FEXT in the composite impairment noise of the test.

The PSD of the noise generator is a weighted sum of the self-crosstalk and alien crosstalk profiles as specified in clause 9.3.4.1.

- $G2.UP.\# = (XS.NT.\# \blacklozenge XA.NT.\#)$.
- $G2.DN.\# = (XS.LT.\# \blacklozenge XA.LT.\#)$.

The symbols in the above expressions are defined below:

- "#" is a placeholder for noise model "A", "B" ... "F";
- "XS.LT.#" and "XS.NT.#" refer to the self crosstalk profiles defined in clause 9.3.4.1;
- "XA.LT.#" and "XA.NT.#" refer to the alien crosstalk profiles defined in clause 9.3.4.1;
- "◆" refers to the FSAN crosstalk sum of two PSDs which is defined as $P_X = (P_{XS}^{Kn} + P_{XA}^{Kn})^{1/Kn}$ where P is the PSD in W/Hz and $Kn = 1/0,6$.

The PSD of this generator is independent of the cable because this is modeled separately as transfer function $H_2(f,L)$ as specified in clause 9.3.2.

The noise from this generator shall be uncorrelated with all other noise sources in the impairment generator and uncorrelated with the VDSL system under test. The noise shall be random in nature with a near Gaussian amplitude distribution as specified in clause 9.3.4.2.

9.3.3.3 Background noise generator [G3]

The background noise generator G3 is inactive and currently is set to zero.

9.3.3.4 White noise generator [G4]

The white noise generator has a fixed value of -140 dBm/Hz into 135 Ω and is frequency independent.

The noise from this generator shall be uncorrelated with all other noise sources in the impairment generator and uncorrelated with the VDSL system under test. The noise shall be random in nature with a near Gaussian amplitude distribution as specified in clause 9.3.4.2.

9.3.3.5 Broadcast RF noise generator [G5]

The broadcast RF noise generator represents the discrete tone-line interference caused by amplitude modulated broadcast transmissions in the SW, MW and LW bands which ingress into the cable. These interference sources have more temporal stability than the amateur/HAM interference because their carrier is not suppressed. Ingress causes differential mode as well as common mode interference.

Power levels of up to -40 dBm can occur on telephone lines in the distant vicinity of broadcast AM transmitters. The closest ten transmitters to the victim wire-pair typically dominate the noise.

The ingress noise signal for differential mode impairment (or common mode impairment) shall be a superposition of random modulated carriers (AM). The total voltage $U(t)$ of this signal is defined as:

$$U(t) = \sum_k U_k \times \cos(2\pi \cdot f_k \times t + \phi_k) \times (1 + m \times \alpha_k(t))$$

The individual components of this ingress noise signal $U(t)$ are defined as follows:

- U_k The voltage U_k of each individual carrier is specified in table 16 as power level P (dBm) into a resistive load of 135Ω . Note that a spectrum analyser will detect levels that are slightly higher than the value specified in table 16 when their resolution bandwidth is set to 10 kHz or more since they will detect the modulation power as well.
- f_k The frequency f_k of each individual carrier is specified in table 16. The values do not represent actual radio station broadcasts but they are chosen to cover the relevant frequency range of the VDSL modem under test. There is no harmonic relationship implied between the carriers.
- φ_k The phase offset φ_k of each individual carrier shall have a random value that is uncorrelated with the phase offset of each other carrier in the ingress noise signal.
- m The modulation depth m of each individually modulated carrier shall be 0,32 to create a modulation index of at least 80% during the peak levels of the modulation signal $m \times \alpha_k(t)$ having a crest factor of 2,5.
- $\alpha_k(t)$ The normalized modulation noise $\alpha_k(t)$ of each individually modulated carrier shall be random in nature with a near Gaussian distribution and an RMS value of $\alpha_{rms}=1$ and a crest factor of 2,5 or more. There shall be no correlation between the modulation noise of each modulated carrier in the noise signal.
- Δ_b The modulation width Δ_b of each modulated carrier shall be at least 2x5 kHz. This is equivalent to creating $\alpha_k(t)$ from white noise that has passed through a low-pass filter with a cut-off frequency at $1/2\Delta_b=5$ kHz. This modulation width covers the full band used by AM broadcast stations.

The ingress noise generator may have two distinct outputs, one contributing to the differential mode impairment and the other contributing to the common mode impairment.

Table 16: Noise generator G5 carrier frequencies and average power

Carrier Frequency (kHz)	Differential mode power (dBm)				Common mode power (dBm)
	[G5.UP.A]	[G5.DN.A]	[G5.UP.B]	[G5.DN.B]	
99	-70	-60	-80	-70	tbd
207	-70	-60	-80	-70	tbd
711	-70	-60	-80	-70	tbd
801	-70	-60	-80	-70	tbd
909	-70	-60	-80	-70	tbd
981	-50	-40	-60	-50	tbd
1 458	-50	-40	-60	-50	tbd
6 050	-50	-40	-60	-50	tbd
7 350	-50	-40	-60	-50	tbd
9 650	-50	-40	-60	-50	tbd

9.3.3.6 Amateur RF noise generator [G6]

The Amateur RF noise generator represents a large (almost impulse like) RF interference that has radically changing temporal characteristics due to the single-sideband suppressed nature of the amateur radio transmission. The interference exhibits severe temporal variations, can be high in amplitude (up to 0 dBm PEP), can occur anywhere within the internationally standardized HF amateur bands and at any time of day or night. Overhead wiring is especially susceptible to RF ingress of this nature. Coupling into twisted telephone wires is usually via the common mode and then into the differential mode.

This high-level interferer is designed to simulate the worst-case interference from Short Wave amateur radio transmissions coupling from nearby amateur radio transmissions into the differential or transmission mode of the unscreened twisted wire pair of the metallic access network which is being used for VDSL transmission.

This source of interference appears as a component of the noise entering the front-end of a VDSL receiver in the differential or transmission mode. It is very damaging to VDSL transmission because of:

- a) The adverse nature of the temporal characteristics of the single sideband suppressed carrier transmission;
- b) The close proximity of amateur radio transmitters to telephone network aerial cabling and home wiring;
- c) The high transmission powers, typically up to 400 W PEP (+26 dBW).

9.3.3.6.1 Specification of Amateur RF noise generator

In order to simulate this amateur radio interference, a carrier is amplitude modulated with speech or Morse like properties. The interfering noise shall be injected in the differential mode and set to 0 dBm Peak Envelope Power (PEP) at the VDSL receiver input in any internationally recognized amateur band (see table 17). The modulating signal shall be speech weighted noise (ITU-T Recommendation G.227 [12]) and shall be interrupted such that within each 15 s period it spends 5 s on and 10 s off to simulate speech activity. The resultant baseband signal shall be further interrupted such that within each period of 200 ms it spends 50 ms on and 150 ms off which corresponds to the syllabic rate. The resultant signal shall then be band-limited to 4 kHz with a 6 dB/octave pre-emphasis in-band. The carrier frequency should change by at least 50 kHz every 120 s. The amateur interferer can appear anywhere in the chosen amateur frequency bands listed in table 17.

This noise source shall be applied to the receiver under test at the LT side of the test-loops, when performing the upstream tests [G6.UP.x]. This noise source shall be applied to the receiver under test at the NT side of the test-loops, when performing the downstream tests [G6.DN.x].

The level of this noise model shall be no lower than that given in table 18 anywhere in the internationally standardized amateur radio bands given in table 17.

Table 17: International HF amateur radio bands

Band start (kHz)	Band stop (kHz)
1 810	2 000
3 500	3 800
7 000	7 100
10 100	10 150
14 000	14 350
18 068	18 168
21 000	21 450
24 890	24 990
28 000	29 100

Table 18: Amateur RF noise power (PEP) levels

Model	G6.UP.A	G6.DN.A	G6.UP.B	G6.DN.B
Power (dBm)	-10	0	-30	-20

9.3.3.7 Impulse noise generator [G7]

A test with this noise generator is required to prove the implementation of the forward error correcting coder which is specified to give some protection from impulse noise. The impulse noise generator shall inject noise bursts onto the line with sufficient power to ensure effective erasure of the data for the duration of the burst.

Tests using this generator are to stress the FEC coder which is specified as an RS block code with interleaving. The noise bursts are not representative of realistic noise.

The generator has three parameters, the length of the "on" and "off" time periods and the amplitude.

- T_1 This is the maximum duration of an isolated noise burst that the coder shall be able to correct.
- T_2 This is the minimum duration that the coder needs to recover from the previous noise burst.
- P_b This is the power level of the noise burst at which effective erasure of the the data signal is to be expected (the bit error ratio during the burst shall be 0,5).

Noise immunity shall be demonstrated on short and long loops in the presence of other noises that model crosstalk and RF ingress. The parameter values are specified in table 19.

Table 19: Impulse noise parameters

Parameter	T_1 (s)	T_2 (s)	P_b (dBm)
	tbd	1	tbd

9.3.4 Profile of the individual impairment generators

9.3.4.1 Frequency domain profiles of generators G1 and G2

Crosstalk noise represents all impairments that originate from systems connected to adjacent wire pairs that are coupled to the wires of the VDSL system under test. The noise spectrum varies with the electrical length of the test loop.

Noise generators G1 and G2 represent the equivalent of many disturbers in a real scenario with all disturbers co-located at the ends of the test loops. This approach simplifies the definition of crosstalk noise and isolates the NEXT and FEXT coupling functions of the cable from the PSD of the generators.

9.3.4.1.1 Self crosstalk profiles

The templates in annex E shall be used to model the VDSL signal spectrum and derive the self-crosstalk component of the noise. The effect of upstream power backoff shall also be taken into account when modeling the self-noise. It is assumed that all disturbers are at the same loop length as the one under test and apply power back-off using the appropriate reference PSD from table 13. The templates in annex E do not take into account upstream power back-off. They shall be modified in accordance with the following rules.

- In the in-band regions, at frequencies where the nominal level defined by the UPBO algorithm (see clause 8.1.6) does not exceed the template, this level shall be used.
- The nominal PSD level determined by the UPBO algorithm for the in-band regions shall be extended into the transition bands up to the intersection points with the template using the same slope.

NOTE: The current UPBO algorithm allows the in-band nominal PSD level to be reduced below the out-of-band PSD level. For the distances where this happens it is unrealistic to develop a template for modeling the self-noise.

Separate spectral profiles are used to describe the self-crosstalk at the LT end and at the NT end of the test loop. In the following text the "#" is a placeholder for models "A" to "F".

- The profiles XS.LT.# describe the self crosstalk portion of an equivalent disturber co-located at the LT end of the test loop. When testing the upstream this profile is applied to generator G1. When testing the downstream this profile is applied to generator G2. The self-crosstalk profile is specified in table 20.
- The profiles XS.NT.# describe the self-crosstalk portion of an equivalent disturber co-located at the NT end of the test loop. When testing the upstream this profile is applied to generator G2. When testing the downstream this profile is applied to generator G1. The self-crosstalk profile is specified in table 20.

Table 20: Definition of self-crosstalk

Cabinet	Model A	Model B	Model C
XS.LT.#	VDSL.LT.A + 8 dB	VDSL.LT.B + 8 dB	VDSL.LT.C + 8 dB
XS.NT.#	VDSL.NT.A + 8 dB	VDSL.NT.B + 8 dB	VDSL.NT.C + 8 dB

Exchange	Model D	Model E	Model F
XS.LT.#	VDSL.LT.D + 8 dB	VDSL.LT.E + 8 dB	VDSL.LT.F + 8 dB
XS.NT.#	VDSL.NT.D + 8 dB	VDSL.NT.E + 8 dB	VDSL.NT.F + 8 dB

NOTE 1: The addition of 8 dB simulates the approximate power generated by the sum of 20 similar VDSL systems operating in a multi-pair cable.

NOTE 2: The VDSL self-crosstalk is assumed to be generated by transceivers with a PSD equal to the templates given in annex E. Further study is required in cases where this assumption is not valid.

9.3.4.1.2 Alien crosstalk profiles

Separate spectral profiles are used to describe the alien crosstalk at the LT end and at the NT end of the test loop. In the following text the "#" is a placeholder for models "A" to "F".

- The profiles XA.LT.# describe the alien crosstalk portion of an equivalent disturber co-located at the LT end of the test loop. When testing the upstream this profile is applied to generator G1. When testing the downstream this profile is applied to generator G2. The alien crosstalk profiles are specified in table 21.
- The profiles XA.NT.# describe the alien crosstalk portion of an equivalent disturber co-located at the NT end of the test loop. When testing the upstream this profile is applied to generator G2. When testing the downstream this profile is applied to generator G1. The alien crosstalk profiles are specified in table 22.

The PSD profiles in tables 21 and 22 should be drawn using straight lines between the points specified on a graph with a logarithmic frequency scale (Hz) and a linear power density scale (dBm/Hz). The power level is defined into a resistive load impedance (R_V) of 135 Ω .

Table 21: PSD profile of alien noise spectra at the LT

VDSL from the Cabinet	
XA.LT.A (kHz)	PSD (dBm/Hz)
4	-22,2
50	-22,2
75	-30,6
100	-34,2
292	-35,3
400	-43,7
1 104	-52,6
2 500	-99,6
3 637	-111,3
30 000	-111,5

VDSL from the Cabinet	
XA.LT.B (kHz)	PSD (dBm/Hz)
4	-22,2
50	-22,2
75	-30,7
100	-34,4
135	-35,3
139	-35,1
292	-35,3
400	-43,7
552	-46,7
956	-74,5
1 800	-83,3
2 000	-93,1
3 637	-111,3
30 000	-111,5

VDSL from the Cabinet	
XA.LT.C (kHz)	PSD (dBm/Hz)
4	-22,2
50	-22,2
75	-30,6
100	-34,2
292	-35,3
400	-43,6
500	-45,4
900	-46,5
1 024	-46,9
1 400	-50,7
1 800	-60,6
16 500	-103,1
30 000	-109,8

VDSL from the Exchange	
XA.LT.D (kHz)	PSD (dBm/Hz)
4	-18,2
50	-18,2
75	-25,1
117	-26,6
138	-25,4
290	-25,4
330	-25,8
1 104	-26
2 500	-66
4 530	-96
30 000	-96,4

VDSL from the Exchange	
XA.LT.E (kHz)	PSD (dBm/Hz)
4	-22,2
50	-22,2
77	-30,9
117	-35
140	-30,2
292	-30,3
330	-30,6
550	-30,6
600	-32,5
700	-33,4
1 104	-33,5
4 530	-100,7
30 000	-101,1

VDSL from the Exchange	
XA.LT.F (kHz)	PSD (dBm/Hz)
4	-22,2
50	-22,2
74	-30,3
117	-35
140	-30,2
292	-30,3
330	-30,6
550	-30,6
600	-32,5
700	-33,4
1 104	-33,5
2 100	-64,6
2 450	-63,6
16 500	-99,1
30 000	-101

Table 22: PSD profile of alien noise spectra at the NT

VDSL from the Cabinet		VDSL from the Cabinet		VDSL from the Cabinet	
XA.NT.A (kHz)	PSD (dBm/Hz)	XA.NT.B (kHz)	PSD (dBm/Hz)	XA.NT.C (kHz)	PSD (dBm/Hz)
4	-22,2	4	-22,2	4	-22,2
50	-22,1	50	-22,1	50	-22,1
75	-29,3	75	-29,3	75	-29,3
100	-30,8	100	-30,8	100	-30,8
138	-31	138	-31	138	-31
150	-34,2	150	-34,2	150	-34,2
166	-35,3	166	-35,3	166	-35,3
292	-35,4	292	-35,4	292	-35,4
400	-46,3	400	-46,3	400	-46
900	-74,5	900	-74,5	500	-49,1
1 104	-79,6	1 104	-79,6	900	-47,1
1 400	-82	1 400	-82	1 024	-47,3
2 500	-99,8	2 500	-99,8	1 400	-50,7
3 200	-103,5	3 200	-103,5	1 800	-60,6
4 545	-103,9	4 545	-103,9	16 500	-101,7
30 000	-103,9	30 000	-103,9	30 000	-103,7

VDSL from the Exchange		VDSL from the Exchange		VDSL from the Exchange	
XA.NT.D (kHz)	PSD (dBm/Hz)	XA.NT.E (kHz)	PSD (dBm/Hz)	XA.NT.F (kHz)	PSD (dBm/Hz)
4	-18,2	4	-22,2	4	-22,2
50	-18,1	50	-22	50	-22
75	-24,2	71	-27,8	71	-27,8
275	-25,4	145	-30	145	-30
400	-40,6	175	-31	175	-31
600	-54,3	274	-31	274	-31
1 000	-71,6	400	-46,5	450	-47,5
2 750	-95,7	600	-60,3	900	-45,3
30 000	-96,4	1 000	-77,1	1 200	-46,7
		1 400	-82,2	1 500	-50,4
		2 800	-100,3	1 780	-58,3
		30 000	-101,1	16 500	-99,1
				30 000	-101

9.3.4.2 Time domain profiles of generators G1 to G4

The noise as specified in the frequency domain in clauses 9.3.3.1 to 9.3.3.4 shall be random in nature and near Gaussian distributed. This means that the amplitude distribution function of the combined impairment noise injected at the adding element (see figure 12) shall lie between the two boundaries as illustrated in figure 17 and defined in table 23.

The amplitude distribution function $F(a)$ of noise $u(t)$ is the fraction of the time that the absolute value of $u(t)$ exceeds the value "a". From this definition, it can be concluded that $F(0) = 1$ and that $F(a)$ monotonically decreases up to the point where "a" equals the peak value of the signal. From there on, $F(a)$ vanishes:

$$F(a) = 0, \text{ for } a \geq |u_{peak}|.$$

The boundaries on the amplitude distribution ensure that the noise is characterized by peak values that are occasionally significantly higher than the rms-value of that noise (up to 5 times the rms-value).

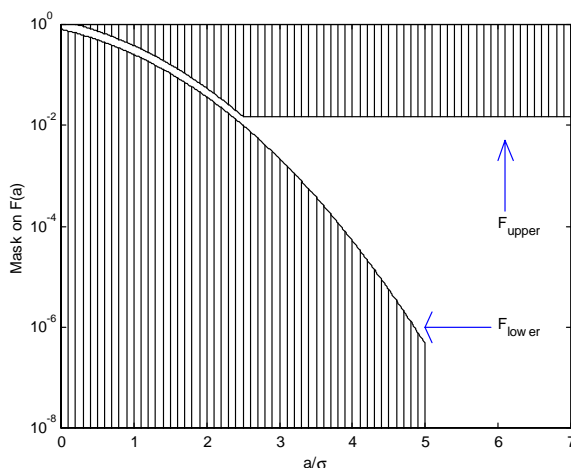

NOTE: The boundaries of the mask are specified in table 22.

**Figure 17: Mask for the Amplitude Distribution Function:
the non-shaded area is the allowed region**

Table 23: Upper and lower boundaries of the amplitude distribution function of the noise

Boundary (σ = rms value of noise)	interval	parameter	value
$F_{\text{lower}}(a) = (1 - \varepsilon) \times \{1 - \text{erf}((a/\sigma)/\sqrt{2})\}$	$0 \leq a/\sigma < CF$	crest factor	$CF = 5$
$F_{\text{lower}}(a) = 0$	$CF \leq a/\sigma < \infty$	Gaussian gap	$\varepsilon = 0,1$
$F_{\text{upper}}(a) = (1 + \varepsilon) \times \{1 - \text{erf}((a/\sigma)/\sqrt{2})\}$	$0 \leq a/\sigma < A$		$A = CF/2 = 2,5$
$F_{\text{upper}}(a) = (1 + \varepsilon) \times \{1 - \text{erf}(A/\sqrt{2})\}$	$A \leq a/\sigma < \infty$		

The meaning of the parameters in table 23 is as follows:

- CF denotes the minimum crest factor of the noise, that characterizes the ratio between the absolute peak value and rms value ($CF = |u_{\text{peak}}|/u_{\text{rms}}$);
- ε denotes the Gaussian gap that indicates how "close" near Gaussian noise approximates true Gaussian noise;
- A denotes the point beyond which the upper limit is alleviated to allow the use of noise signals of practicable repetition length.

9.3.5 UPBO testing method

The upstream PSD should be less than the calculated PSD for the applicable loop length according to the UPBO setting, at the maximum sustainable data rate at each reach, at various reaches from 100 m to the maximum self-crosstalk limited reach (with TBD disturbers) in steps of 100 m. This should be performed on test loops 1 and 4. The testing method is for further study.

9.3.5.1 Performance test for UPBO

For further study.

9.4 Transmission Performance tests

9.4.1 Electrical length requirements (insertion loss)

For each VDSL payload bit-rate, the electrical length of the individual test loop is defined in terms of the insertion loss in circuit resistance of R_V , at a test frequency (f_T). This frequency is chosen to be a typical high-band frequency that is used for transporting that payload bit-rate. The insertion loss is chosen as a typical maximum value that can be handled correctly by the VDSL transceiver. The higher the payload bit-rate, the lower the insertion loss is that can be handled in practice. This is because the crosstalk in real cables increases with the frequency. Tables 24 and 25 specifies these insertion loss values for the different VDSL payload bit-rates at a given test frequency.

Table 24: Test loop insertion loss as a function of payload rate, noise model and test frequency using PSD Mask M1 (notches not taken into account)

Payload Rate	Noise model A		Noise model B		Noise model C		Noise model D		Noise model E		Noise model F	
	f_T MHz	IL dB	f_T MHz	IL dB	f_T MHz	IL dB	f_T MHz	IL dB	f_T MHz	IL dB	f_T MHz	IL dB
S1												
S2												
S3												
S4												
S5												
A1												
A2												
A3												
A4												

NOTE 1: See clause 9.3.4 for the definition of the noise models.
 NOTE 2: The insertion loss values have been calculated based on an assumed set of parameters for the VDSL transceiver.
 NOTE 3: The notches defined for mask M1 (see clause 8.1.5.4) were not taken into account when calculating the insertion losses for the different payload rates.
 NOTE 4: Noise models A, B and C are used for evaluating performance in the FTTCab scenario.
 NOTE 5: Noise models D, E and F are used for evaluating performance in the FTTEEx scenario.
 NOTE 6: Symmetrical rates S4 and S5 have insufficient reach using mask M1 to be viable and so are left empty.

Table 25: Test loop insertion loss as a function of payload rate, noise model and test frequency using PSD Mask M2

Payload Rate	Noise model A		Noise model B		Noise model C		Noise model D		Noise model E		Noise model F	
	f_T MHz	IL dB	f_T MHz	IL dB	f_T MHz	IL dB	f_T MHz	IL dB	f_T MHz	IL dB	f_T MHz	IL dB
S1												
S2												
S3												
S4												
S5												
A1												
A2												
A3												
A4												

NOTE 1: See clause 9.3.4 for the definition of the noise models.
 NOTE 2: Noise models A, B and C are used for evaluating performance in the FTTCab scenario.
 NOTE 3: Noise models D, E and F are used for evaluating performance in the FTTEEx scenario.

Additional tables for the optional regional specific frequency plan together with values for tables 24 and 25 are for further study. Annex F contains simulation results indicative of the performance to be expected in the various deployment scenarios.

9.4.2 Bit error ratio requirements

The VDSL system shall operate with a noise margin of at least +6 dB and a long-term bit error ratio of < 1 in 10^7 when operated over any of the test loops with the noise models and test conditions as specified in this clause. Access to the relevant interfaces of the lower layers of the transceiver under test may be problematic and will be dependant on access to the γ interface and above, therefore the test methods are for further study.

The measurement period shall be at least 30 minutes and the amateur radio interferer (see clause 9.3.3.6) shall visit each amateur band at least twice (at different frequencies within the band) during the test period.

A long-term performance test shall be performed for a period of not less than 24 hours to ensure long-term temporal stability (see clauses 9.4.5 and 9.4.6).

9.4.3 Measuring noise margin

Before start-up of the VDSL transceiver under test the level and shape of the crosstalk noise or impulse noise is adjusted so that the level observed at port Rx (figure 12) meets the impairment level specification in clause 9.3. This relative level is referred to as 0 dB. The transceiver link is subsequently activated, and the bit error ratio of the link is monitored.

By adjusting the gain of amplifier A1 in figure 16 the crosstalk noise level of the impairment generators is then increased (equally over the full VDSL frequency band) until the bit error ratio is approximately 10^{-7} . This BER will be achieved at an increase of noise of x dB, with a small uncertainty of Δx dB. The value x is defined as the noise margin with respect to a standard noise model and may (optionally) be used to indicate the sensitivity of the system under test to changes in BER

NOTE: It is expected that the noise level that brings the BER to 10^{-7} is very close to the level associated with a BER of 10^{-5} (usually within a fraction of a dB for a coded system). In order to speed up the iterative search for noise margins, it is a practical approach to start the margin search for a BER of 10^{-5} , and then search for the noise level associated with a BER of 10^{-7} . The BER requirements of 10^{-7} in clause 9.4.2 remains valid in order to pass the transmission performance test.

The noise margins shall be measured for upstream as well as downstream transmission under test loops #1, #2, #3, and #4.

9.4.4 Generator sets for different test scenarios

Several VDSL performance tests shall be carried out to prove adequate upstream and downstream performance. The tests are split into two scenarios, FTTCab and FTTEEx. Not all RF noise models apply in each case. Figure 18 shows the upstream tests, a similar figure can be drawn for the downstream tests.

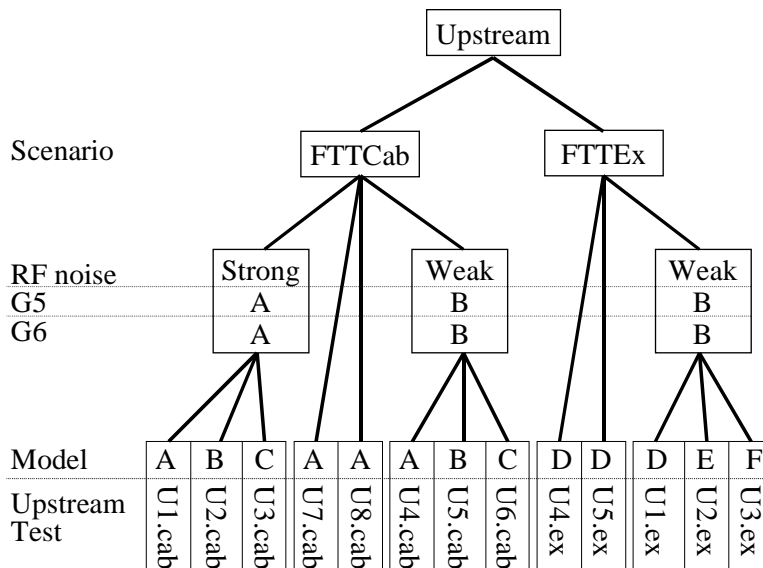

Figure 18: Upstream test scenarios and conditions

NOTE: The attenuation of the downstream ADSL generator contributions in the FTTEEx generator models A, B and C is equivalent to a 1 km length of cable of type A as defined in annex A.

9.4.5 Upstream tests

Several VDSL performance tests shall be carried out to prove adequate upstream performance. Each symbolic name in this table refers to a specified noise model as defined in clause 9.3. The injection of the impairment noise shall be at the LT side of the test-loop.

Transceivers operating in a FTTCab scenario shall pass all upstream test U1.cab to U8.cab in the table below for each relevant payload bit-rate (see tables 24 and 25) and PSD (see tables 5 to 12). The appropriate test loop attenuation (see tables 24 and 25) and associated combined impairment (as described in clause 9.3) shall be used for each test.

Table 26: Composition of noise models in the upstream tests for the FTTCab scenario

Test	Scenario	Loops	G1	G2	G3	G4	G5	G6	G7	Comments
U1.cab	FTTCab	0-4	G1.UP.A	G2.UP.A		G4	G5.UP.A	G6.UP.A		
U2.cab	FTTCab	0-4	G1.UP.B	G2.UP.B		G4	G5.UP.A	G6.UP.A		
U3.cab	FTTCab	0-4	G1.UP.C	G2.UP.C		G4	G5.UP.A	G6.UP.A		
U4.cab	FTTCab	0-4	G1.UP.A	G2.UP.A		G4	G5.UP.B	G6.UP.B		
U5.cab	FTTCab	0-4	G1.UP.B	G2.UP.B		G4	G5.UP.B	G6.UP.B		
U6.cab	FTTCab	0-4	G1.UP.C	G2.UP.C		G4	G5.UP.B	G6.UP.B		
U7.cab	FTTCab	4	G1.UP.A	G2.UP.A		G4			G7	
U8.cab	FTTCab	0 & 1	G1.UP.A	G2.UP.A		G4				24 hours

NOTE 1: Test U7.cab is a broadband impulse noise test.

NOTE 2: Test U8.cab is a long-term stability test with representative noise models.

Transceivers operating in a FTTEEx scenario shall pass all upstream test U1.ex to U5.ex in the table below for each relevant payload bit rate (see tables 24 and 25) and PSD (see tables 5 to 12). The appropriate test loop attenuation (see tables 24 and 25) and associated combined impairment (as described in clause 9.3) shall be used for each test.

Table 27: Composition of noise models in the upstream tests for the FTTEEx scenario

Test	Scenario	Loops	G1	G2	G3	G4	G5	G6	G7	Comments
U1.ex	FTTEEx	0-4	G1.UP.D	G2.UP.D		G4	G5.UP.B	G6.UP.B		
U2.ex	FTTEEx	0-4	G1.UP.E	G2.UP.E		G4	G5.UP.B	G6.UP.B		
U3.ex	FTTEEx	0-4	G1.UP.F	G2.UP.F		G4	G5.UP.B	G6.UP.B		
U4.ex	FTTEEx	4	G1.UP.D	G2.UP.D		G4			G7	
U5.ex	FTTEEx	0 & 1	G1.UP.D	G2.UP.D		G4				24 hours

NOTE 1: Test U4.ex is a broadband impulse noise test.
NOTE 2: Test U5.ex is a long-term stability test with representative noise models.

9.4.6 Downstream tests

Several VDSL performance tests shall be carried out to prove adequate downstream performance. Each symbolic name in this table refers to a specified noise model as defined in clause 9.3. The injection of the impairment noise shall be at the NT side of the test loop.

Transceivers operating in a FTTCab scenario shall pass all downstream test D1.cab to D8.cab in the table 28 for each relevant payload bit-rate (see tables 24 and 25) and PSD (see tables 5 to 12). The appropriate test loop attenuation (see tables 24 and 25) and associated combined impairment (as described in clause 9.3) shall be used for each test.

Table 28: Composition of noise models in the downstream tests for the FTTCab scenario

Test set	Scenario	Loops	G1	G2	G3	G4	G5	G6	G7	Comments
D1.cab	FTTCab	0-4	G1.DN.A	G2.DN.A		G4	G5.DN.A	G6.DN.A		
D2.cab	FTTCab	0-4	G1.DN.B	G2.DN.B		G4	G5.DN.A	G6.DN.A		
D3.cab	FTTCab	0-4	G1.DN.C	G2.DN.C		G4	G5.DN.A	G6.DN.A		
D4.cab	FTTCab	0-4	G1.DN.A	G2.DN.A		G4	G5.DN.B	G6.DN.B		
D5.cab	FTTCab	0-4	G1.DN.B	G2.DN.B		G4	G5.DN.B	G6.DN.B		
D6.cab	FTTCab	0-4	G1.DN.C	G2.DN.C		G4	G5.DN.B	G6.DN.B		
D7.cab	FTTCab	4	G1.DN.A	G2.DN.A		G4			G7	
D8.cab	FTTCab	0 & 1	G1.DN.A	G2.DN.A		G4				24 hours

NOTE 1: Test D7.cab is a broadband impulse noise test.
NOTE 2: Test D8.cab is a long-term stability test with representative noise models.

Transceivers operating in a FTTEEx scenario shall pass all downstream tests D1.ex to D5.ex in the table below for each relevant payload bit-rate (see tables 24 and 25) and PSD (see tables 5 to 12). The appropriate test loop attenuation (see tables 24 and 25) and associated combined impairment (as described in clause 9.3) shall be used for each test.

Table 29: Composition of noise models in the downstream tests for the FTTEEx scenario

Test set	Scenario	Loops	G1	G2	G3	G4	G5	G6	G7	Comments
D1.ex	FTTEEx	0-4	G1.DN.D	G2.DN.D		G4	G5.DN.B	G6.DN.B		
D2.ex	FTTEEx	0-4	G1.DN.E	G2.DN.E		G4	G5.DN.B	G6.DN.B		
D3.ex	FTTEEx	0-4	G1.DN.F	G2.DN.F		G4	G5.DN.B	G6.DN.B		
D4.ex	FTTEEx	4	G1.DN.D	G2.DN.D		G4			G7	
D5.ex	FTTEEx	0 & 1	G1.DN.D	G2.DN.D		G4				24 hours

NOTE 1: Test D4.ex is the broadband impulse noise test.
NOTE 2: Test D5.ex is a long-term stability test with representative noise models.

9.5 Micro interruptions

A micro interruption is a temporary line interruption due to external mechanical action on the copper wires constituting the transmission path, for example, at a cable splice. Splices can be hand-made wire-to-wire junctions, and during cable life oxidation phenomena and mechanical vibrations can induce micro interruptions at these critical points.

The effect of a micro interruption on the transmission system can be a failure of the digital transmission link, together with a failure of the power feeding (if provided) for the duration of the micro interruption.

The objective is that in the presence of a micro interruption of specified maximum length the VDSL transceiver should not reset, and the system should automatically reactivate (see clause 10.1).

The transceiver shall not be reset by a micro interruption event of duration $t = 10$ ms which shall occur at an event frequency of 0,2 Hz.

10 Transceiver core requirements

This clause details the functional requirements of the VDSL transceiver core.

10.1 Activation/deactivation

Activation and deactivation may be commanded by network management or result from autonomous actions caused by transmission anomalies. Additionally, where call-state information is available, activation may be linked to broadband call-state transitions. Such linkage is not applicable to SDH applications, and is not currently supported by ATM level standards. Methods may however be developed to enable the transmission performance advantages for VDSL to be exploited by ATM applications.

10.1.1 Activation/deactivation definitions

On first installation or service change, the start-up of a VDSL transceiver might be subject to an installation procedure under control of the network operator in order to check the spectral compatibility of the transceiver. Such tests are operator specific and designed to minimize disruption of existing services.

One purpose of the installation procedure is to check that the transceiver pair is correctly connected, correctly configured, and that the line is good.

NOTE 1: The "line is good" means that the channel characteristics are within the service provider's limits and are likely to support a viable service. The most important channel characteristic is the attenuation as any noise level observed during the tests is likely to increase with time as more systems are installed on adjacent pairs. The attenuation limits for service viability will differ for each service provider so they cannot be pre-programmed during transceiver manufacture.

Following a successful first installation, the activation procedures shall start. Four mandatory activation procedures shall exist.

NOTE 2: Further details of the state diagram can be found in TS 101 270-2.

The mandatory procedures are defined below and shown in figure 19:

Cold-Start: Cold-Start applies when power is first applied to the transceiver after intrusive maintenance or if there have been significant changes in line characteristics (e.g. due to thermal effects). Intrusive maintenance will also apply to the service level when transmission rates and other transmission parameters (e.g. margin, spectral masks, class of service, etc.) are altered. Failure to achieve steady state after T1 seconds constitutes a fault condition.

Warm-Start: This start applies when both transceivers start from the Power-Down state. Power-Down is reached when a transceiver had its AC removed on purpose via the Power-Down procedure, forced typically by the customer. Warm-start applies only if there have been little or no changes in line characteristics. This procedure applies also, when there is an accidental AC removal or failure at the customer, provided the transceiver could store all necessary data and parameters to avoid the Cold-Start.

Resume-on-Error: The start-up process that applies to transceivers which lose synchronization during transmission, e.g. due to a large impulse hit or an interruption longer than the specified micro-interruption (see clause 9.5). This applies only if there have been no changes in line characteristics, and when the clock-frequencies recovery circuits can still predict the sample timing. The event that leads to loss of synchronization shall be longer than a micro-interruption.

Warm-Resume: The start-up process that applies to transceivers that having reached synchronization have subsequently responded to a deactivation request. Warm-resume is the usual method of activating the VDSL transmission system on receipt of a first incoming or outgoing broadband call request.

Warm-Resume can only be initiated after a deactivation procedure, towards the Power-Saving state, which keeps both LT and NT VDSL transceivers in a power-saving sleeping mode.

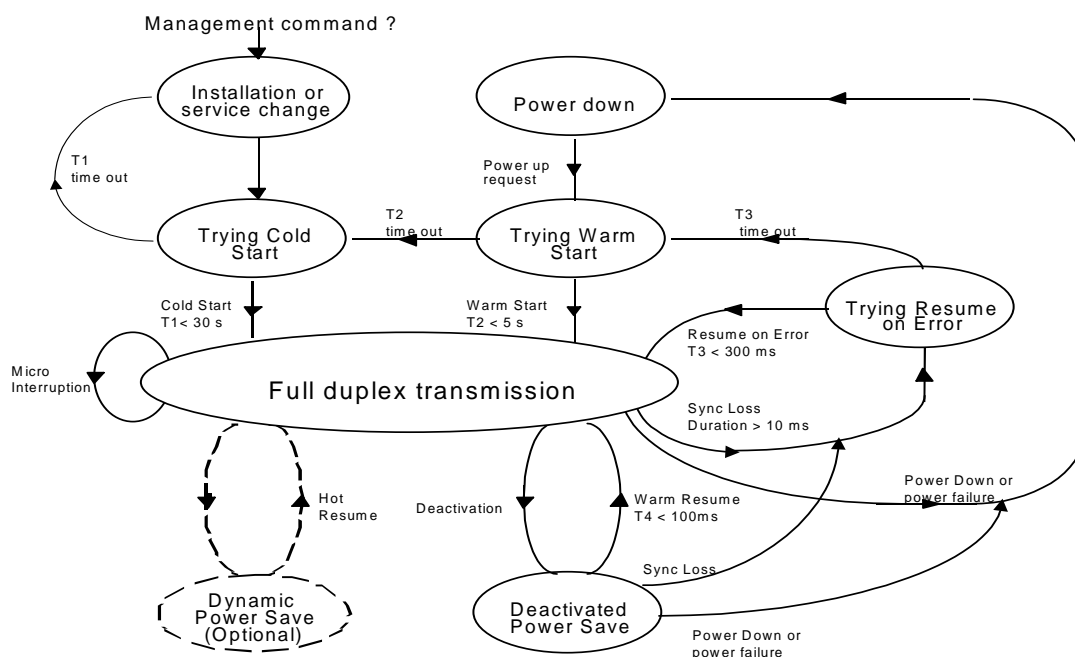

Figure 19: State and timing diagram

Steady State transmission: To achieve Steady State transmission all start-up processes should have been completed. This means full clock and frame synchronization have been achieved and DSP filter adaptations have been performed.

Dynamic Power Save State (optional): The Dynamic Power Save State is intended to reduce the overall power consumption of the VDSL LT transceiver, and to reduce the crosstalk level and RFI radiation of the VDSL system. It could be used when ATM or some other application links are active, but are not consuming the full bandwidth of the VDSL transmission. It alternates with the Steady State transmission. No loss of application data shall be tolerated when the VDSL transceiver moves back and forth between Steady State and Dynamic Power Save State. This state implies the use of the Hot-Resume process.

Hot-Resume (optional): The implied immediate power-ON, to resume transmission, whenever the VDSL transceiver alternates between Steady State and the optional Dynamic Power Save State.

Power-Down procedure: The process by which a pair of fully operational transceivers go to the Power-Down state. It is a guided procedure used e.g. when the customer wants to turn off the transceiver AC power, or when the LT can not go to the Power-Saving deactivation. The VDSL transceivers may store transmission related data, such as equalizer states, line characteristics, and service related parameters to be able to use the Warm-Start procedure later.

Deactivation: This is a process that places the VDSL transceiver into a power-saving state to save ONU power and reduce unwanted RF emissions. Included in this process is the confirmation towards UNI and the network side that the VDSL transmission is terminated. The Deactivation assumes the termination of all broadband traffic.

Power-Down state: The full removal of power at the NT or LT, or the state at the LT when the Power-Saving deactivated state can not be used and VDSL transmission shall be halted, e.g. for maintenance (hardware and/or software).

Deactivated Power-Saving state: This state is required to permit the digital transmission system to be placed in a low power consumption mode when no calls are in progress. The NT and LT consume less power but are capable of detecting a wake up signal from the network side and/or from the UNI, and execute a Warm-Resume. When enabled by the Network Management System, this state may be entered automatically after a programmable time after the last broadband call. During the deactivated Power-Saving state the transceivers could continue some (modulation dependent) form of synchronization on some of the following levels: clock-sync, frame-sync, equalizer checking and trimming, etc.

Delay to service start-up: The time from when Activation is requested or power is applied until the broadband dial tone is issued towards the UNI. The VDSL system shall have achieved Steady State transmission before the broadband dial tone (or equivalent) is issued.

10.1.2 Timing requirements

Delay to service start-up during Cold-Start conditions:	$T1 \leq 30$ s.
Delay to service start-up during Warm-Start conditions:	$T2 \leq 5$ s.
Delay to recovery of service by a successful Resume-on-Error:	$T3 < 300$ ms.
Delay to service start-up during Warm-Resume conditions:	$T4 < 100$ ms.

11 Spectral compatibility

Ensuring spectral compatibility with existing and future DSL transmission systems is of paramount importance to Network Operators. The following requirements are separated into those which apply to adjacent wire-pairs, and the same wire-pair, which may be used as transmission bearers for other forms of service (e.g. POTS, ISDN-BA, etc.).

NOTE: The operation of VDSL below the lower frequency limit (f_0) is not excluded, e.g. on new lines where existing narrowband services may not be present. The issue of VDSL transmit energy using parts of the spectrum occupied by other xDSL systems may preclude the use of lower frequencies.

11.1 Adjacent wire-pairs

VDSL systems shall be required to operate with a number of different DSL systems operating on adjacent wire-pairs in a multi-pair cable. Each of the other systems will generate crosstalk which will appear, to a lesser or greater extent, as unwanted noise at the front-end of a VDSL receiver.

VDSL systems shall be able to operate on different wire-pairs within a multi-pair cable. No special arrangements shall be required for pair selection.

All forms of VDSL are required to co-exist with an installed base of heritage xDSL systems (e.g. other VDSL, HDSL, ADSL, ISDN-BA, ISDN-PRA, etc.) operating in the same multi-pair cable.

NOTE: It is not advisable to deploy VDSL from both the cabinet and Local Exchange in the same cable binder.

11.2 Same wire-pair

VDSL is required to co-exist with some existing narrowband services that may be carried on the same wire-pair. This is to ensure that the VDSL system can provide a broadband overlay capability. In particular, VDSL shall be required to operate at frequencies above POTS as described in ETS 300 001 [4], TBR 021 [5], and both 2B1Q and 4B3T forms of ISDN-BA in Europe according to TS 102 080 [3].

The splitter filter characteristics are defined in clause 12.

Frequency separation shall be used to separate the VDSL signals from the existing narrowband signals.

12 Splitter filter requirements

The splitter filter shall comply with the relevant sub-parts of the specifications given in TS 101 952 [17].

13 Application specific requirements

This clause specifies additional application specific functional requirements where they differ from the application independent functional requirements detailed elsewhere in the present document.

13.1 ATM transport mode

ATM applications use the VDSL functional reference model shown in clause 4.2.1.

13.1.1 OAM requirements

The ATM TPS-TC shall implement loop-back test facilities by PLOAM cells, and the EOC shall provide a control channel to allow loop backs to be applied by the TPS-TC. Responses to other OAM cells may be specified later.

13.2 SDH transport mode at sub STM-1 rates

Figure 20 shows the VDSL functional reference model as applied to the SDH application.

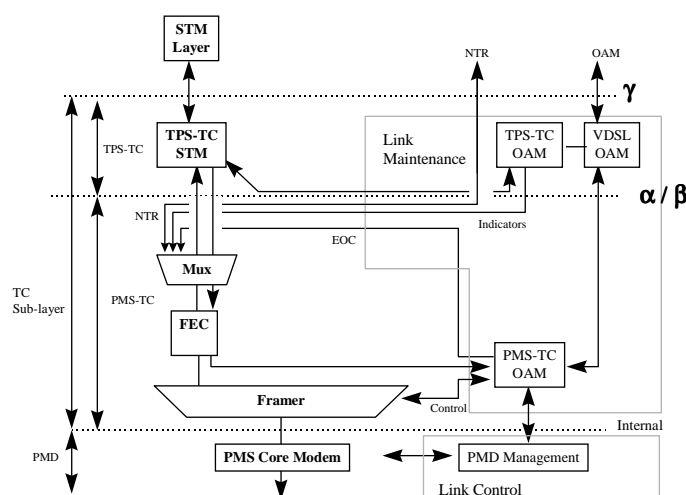

Figure 20: VDSL functional reference model applied to SDH

13.2.1 Dual Latency

Dual latency is not applicable to the SDH application. The latency may need to be programmable to suit the line characteristics. The limits need to be defined.

13.2.2 OAM requirements

The SDH TPS-TC shall implement loop-back functionality, and the EOC shall provide a control channel to allow loop backs to be applied by the TPS-TC.

13.3 Packet Transport Mode

PTM applications use the VDSL functional reference model shown in clause 4.2.1

13.3.1 OAM requirements

The path-related OAM flows (e.g. information on errored packets) shall be provided to the TPS-TC management entity so that all of the necessary OAM functions needed to support both TPS-TC can be provided.

13.4 Additional applications

Additional applications for VDSL are foreseen. The following list is provisional and all of these applications are for further study.

It is possible that a mixture of services may be supported simultaneously.

13.4.1 Multiple PDH

A number of ITU-T Recommendation G.703 [9] physical interfaces (T reference point) may provide ISDN-PRA (full or partially filled) or private network services. The VDSL link may also implement a native multiplexing scheme that provides section level performance monitoring and management capabilities equivalent to SDH.

13.4.2 Narrowband in-band

The VDSL link carries a number of N-ISDN channels with low latency over the VDSL link at the same time as broadband traffic. These may be presented to the customer on N-ISDN S/T interfaces or as analog POTS ports.

13.4.3 IP transport

IP packets will be transported by a variety of means. The IP/PPP/ATM method as developed by the ADSL Forum and IETF is particularly applicable to heritage data services. IP encapsulation on ATM is defined by RFC 2684 [15]. Native IP transport may be supported by well known frame encapsulation methods for PDH channels which may be provided by VDSL, or by PTM. The efficient transport of IP is provided by the Packet Transport Mode as defined in clause 13.3.

13.4.4 Campus access reference models

Both the existing and the additional applications listed here may be useful in campus applications where the existing reference model is not appropriate. These campus applications may benefit from allowing dynamic rate adaptation.

Annex A (normative): Line constants for the test loop-set

This annex details the typical line constants for the cable sections in the test loops. The cable types used to create this annex are representative of existing European metallic access networks. See bibliography for an overview of country specific line constants.

The primary cable parameters vary with frequency. Their typical values shall be calculated at any frequency (up to 30 MHz) by using the empirical models shown below. The line constants given in tables A.1 and A.2 shall be used (together with the equations) to calculate the values given in figure 15 and determine the transmission characteristics of the test loops contained in the main body of the present document.

NOTE 1: Conductance becomes significant at high frequencies and should not be ignored.

NOTE 2: Both models are equally valid from DC to 30 MHz when using the appropriate parameter sets and values.

The formal models for the cable parameters in the test loops are shown below:

TP100 and TP180x

$$Z_{s0}(f) = \sqrt[4]{R_{0c}^4 + a_c \times f^2} + j \times 2\pi \times f \times \left(\frac{L_0 + L_\infty \times \left(\frac{f}{f_m}\right)^{Nb}}{1 + \left(\frac{f}{f_m}\right)^{Nb}} \right) \quad [\Omega/\text{km}]$$

$$Y_{p0}(f) = (g_0 \times f^{N_{ge}}) + j \times 2\pi \times f \times \left(C_\infty + \frac{C_0}{f^{N_{ce}}} \right) \quad [\text{S}/\text{km}]$$

TP150 and TP100x

$$Z_{s0}(\omega) = \left(\frac{j\omega \times Z_{0\infty}}{c} + R_{ss00} \times \left(1 + K_l \times K_f \times \left(\chi \times \coth\left(\frac{4}{3} \times \chi\right) - \frac{3}{4} \right) \right) \right) \times 1000 \quad [\Omega/\text{km}]$$

$$Y_{p0}(\omega) = \left(\frac{j\omega}{Z_{0\infty} \times c} \times \left(1 + \frac{(K_c - 1)}{1 + \left(\frac{\omega}{\omega_{c0}}\right)^N} \right) + \frac{\tan(\phi)}{Z_{0\infty} \times c} \times \omega^M \right) \times 1000 \quad [\text{S}/\text{km}]$$

where:

$$\chi = \chi(\omega) = (1 + j) \times \sqrt{\frac{\omega}{2\pi} \times \frac{\mu_0}{R_{ss00}} \times \frac{1}{K_n \times K_f}}$$

$$\omega_{c0} = 2\pi \times f_{c0}$$

$$\mu_0 = 4\pi \times 10^{-7}$$

Table A.1: Line constants for the TP100 and TP180x cable sections in the test loops (per km)

Wire Type	Roc Nb	ac g0	Ros Nge	As Co	Lo C∞	L∞ Nce	fm
TP100	179 1,2	35,89 x 10 ⁻³ 0,5 x 10 ⁻⁹	1,033	1 x 10 ⁻⁹	0,695 x 10 ⁻³ 55 x 10 ⁻⁹	585 x 10 ⁻⁶ 0,1	1 x 10 ⁶
TP180x	41,16 1,1952665	1,2179771 x 10 ⁻³ 53 x 10 ⁻⁹	0,88	31,778569 x 10 ⁻⁹	1 x 10 ⁻³ 22,681213 x 10 ⁻⁹	910,505 x 10 ⁻⁶ 0,110866740	174877

Table A.2: Line constants for the TP150 and TP100x cable sections in the test loops (per metre)

	Z _{0∞}	c/c ₀	R _{ss00}	2π·tan(φ)	K _f	K _l	K _n	K _c	N	f _{c0}	M
TP150	136,651	0,79766	0,168145	0,13115	0,72	1,2	1	1,08258	0,7	4521710	1
TP100x	97,4969	0,639405	0,177728	0,0189898	0,5	1,14	1	1	1	100000	1

NOTE: Scaling constant c₀ = 3 x 10⁸ m/s and equals the velocity of light.

The transmission and reflection (or insertion loss and return loss) of the test loops shall be calculated from the primary cable parameters using the formulae below. Table A.3 may be used to verify the results of the calculations based on typical values for a 1 km length.

The test loops can be built using a combination of real cables and cable simulators. Tables A.4 and A.5 summarize the estimated length of real cables if they are used. Their actual lengths may deviate from this because real test loops have to meet the electrical length requirements (based on insertion loss) instead of physical length requirements.

The insertion loss and return loss at R_v = 135 Ω for an arbitrary length "L" can be calculated from {Z_{s0}, Y_{p0}} by evaluating the two-port s-parameters normalized to R_v using the formulae shown below.

To calculate the primary {Z_{s0}, Y_{p0}} and secondary {γ, Z₀} parameters:

$$\begin{aligned} Z_s &= L \times Z_{s0} & \gamma &= \sqrt{Z_s \cdot Y_p} & \alpha &= \text{real}(\gamma) & R_s &= \text{real}(Z_s) & G_p &= \text{real}(Y_p) \\ Y_p &= L \times Y_{p0} & Z_0 &= \sqrt{Z_s / Y_p} & \beta &= \text{imag}(\gamma) & L_s &= \text{imag}(Z_s / \omega) & C_p &= \text{imag}(Y_p / \omega) \end{aligned}$$

To calculate the two-port s-parameters:

$$\mathbf{s} = \begin{bmatrix} s_{11} & s_{12} \\ s_{21} & s_{22} \end{bmatrix} = \frac{1}{\left(\frac{Z_0}{R_v} + \frac{R_v}{Z_0}\right) \times \tanh(\gamma) + 2} \times \begin{bmatrix} \left(\frac{z_0}{R_v} - \frac{R_v}{z_0}\right) \times \tanh(\gamma) & \frac{2}{\cosh(\gamma)} \\ \frac{2}{\cosh(\gamma)} & \left(\frac{z_0}{R_v} - \frac{R_v}{z_0}\right) \times \tanh(\gamma) \end{bmatrix}$$

Transmission @ R_v: s₂₁ and s₁₂

Insertion loss @ R_v: 1/s₂₁ and 1/s₁₂

Reflection @ R_v: s₁₁ and s₂₂

Return loss @ R_v: 1/s₁₁ and 1/s₂₂

To calculate the two-port s-parameters of a cascaded cable of two sections "a" and "b":

$$\mathbf{s} = \begin{bmatrix} s_{11} & s_{12} \\ s_{21} & s_{22} \end{bmatrix} = \frac{1}{1 - s_{22a} \times s_{11b}} \cdot \begin{bmatrix} s_{11a} - \Delta_{sa} \times s_{11b} & s_{12b} \times s_{12a} \\ s_{21a} \times s_{21b} & s_{22b} - \Delta_{sb} \times s_{22a} \end{bmatrix} \quad \Delta_s = s_{11} \cdot s_{22} - s_{12} \cdot s_{21}$$

Table A.3: Predicted parameters computed from the cable models

	Frequency (kHz)	Resistance (Ω /km) R_{sx}	Inductance (μ H/km) L_{sx}	Capacitance (nF/km) C_{px}	Conductance (mS/km) G_{px}	Insertion loss (dB) @ 1km @ 135 Ω	Characteristic impedance (Ω) Z_0
TP100	1	179	694,972	55,501	0,0006	4,42	716,56
	10	179,16	694,564	55,398	0,0068	4,57	230,16
	100	192,93	688,471	55,316	0,0731	7,30	116,74
	1 000	438,33	640	55,251	0,7888	18,13	107,94
	10 000	1 376,49	591,529	55,200	8,5108	61,72	103,55
TP150	1	168,15	784,381	33,099	0,0040	4,21	899,29
	10	168,47	784,199	33,072	0,0401	4,26	290,62
	100	197,37	768,161	32,942	0,4011	5,77	158,71
	1 000	527,25	645,503	32,454	4,0107	18,66	141,61
	10 000	1 539,30	594,606	31,501	40,1067	72,59	137,43
TP100x	1	177,73	710,932	53,47	0,001	4,4	727,45
	10	178,15	710,611	53,47	0,0102	4,54	233,81
	100	212,24	685,002	53,47	0,1015	7,87	119,52
	1 000	482,66	568,898	53,47	1,0154	20,87	103,61
	10 000	1 306,43	527,442	53,47	10,1539	61,7	99,36
TP180x	1	41,16	999,814	37,456	0,0231	1,25	419,63
	10	41,59	997,166	34,128	0,1755	1,37	186,96
	100	62,28	969,667	31,549	1,3313	2,65	175,57
	1 000	186,92	920,407	29,551	10,0989	12,50	176,40
	10 000	590,76	911,210	28,003	76,6083	74,41	180,31

**Table A.4: Predicted physical length computed from the cable models
for the electrical length requirements of table 24
(PSD using M1 limits, notches not taken into account)**

Payload Rate	Noise model A (m)	Noise model B (m)	Noise model C (m)	Noise model D (m)	Noise model E (m)	Noise model F (m)
S1 - Loop #1 Loop #2 Loop #3 Loop #4						
S2 - Loop #1 Loop #2 Loop #3 Loop #4						
S3 - Loop #1 Loop #2 Loop #3 Loop #4						
S4 - Loop #1 Loop #2 Loop #3 Loop #4						
S5 - Loop #1 Loop #2 Loop #3 Loop #4						
A1 - Loop #1 Loop #2 Loop #3 Loop #4						
A2 - Loop #1 Loop #2 Loop #3 Loop #4						
A3 - Loop #1 Loop #2 Loop #3 Loop #4						
A4 - Loop #1 Loop #2 Loop #3 Loop #4						

**Table A.5: Predicted physical length computed from the cable models
for the electrical length requirements of table 25 using PSD using M2 limits**

Payload Rate	Noise model A (m)	Noise model B (m)	Noise model C (m)	Noise model D (m)	Noise model E (m)	Noise model F (m)
S1 - Loop #1 Loop #2 Loop #3 Loop #4						
S2 - Loop #1 Loop #2 Loop #3 Loop #4						
S3 - Loop #1 Loop #2 Loop #3 Loop #4						
S4 - Loop #1 Loop #2 Loop #3 Loop #4						
S5 - Loop #1 Loop #2 Loop #3 Loop #4						
A1 - Loop #1 Loop #2 Loop #3 Loop #4						
A2 - Loop #1 Loop #2 Loop #3 Loop #4						
A3 - Loop #1 Loop #2 Loop #3 Loop #4						
A4 - Loop #1 Loop #2 Loop #3 Loop #4						

Annex B (informative): Cable information

The following material though not specifically referenced in the body of the present document, gives supporting information regarding cable construction.

The cable sections in the test loops are representative of existing European metallic access cables. They represent the following cables (they are described in more detail in bibliography).

Cable type TP100 (equivalent to BT_dwug in bibliography)

This is a multi-pair cable with 0,5 mm solid copper conductors with Polyethylene insulation. It is predominantly used for underground distribution.

Cable type TP150 (equivalent to KPN_L1 distribution cable in bibliography)

Multiple quads (4 wires or two pairs), 0,5 mm solid copper conductors. Paper insulation. The cables are constructed in concentric layers, and each layer consists of a number of twisted quads. A shield of lead (connected to earth) provides mechanical protection for the bundle of quads. It is predominantly used for underground distribution.

This class covers cables containing up to 900 pairs (450 quads) in the same bundle. They are organized as 450 quads in 11 concentric layers (no binder groups). A 50 quad version has been used as a template for the models.

Cable type TP100x (equivalent to KPN_R2 indoor cable in bibliography)

Four twisted pairs of 0,5mm solid copper conductors shielded by a foil. It is suitable for use as Category 5 LAN cabling. It is used in Dutch local exchanges as indoor cable to connect from xDSL equipment to distribution cables (Polyethylene insulated).

Cable type TP180x (equivalent to BT_dw8 in bibliography)

Single pair dropwire consisting of a flat twin (i.e. untwisted) with 1,14 mm cadmium copper conductors with PVC insulation. This cable has no steel strengthening member.

Annex C (informative): Telephony matching impedance

The European harmonized matching impedance, Z_M , for non-voice terminals (e.g. voice-band transceivers), is given in figure C.1. This compromise impedance is detailed more fully in ITU-T Recommendation Q.552 [14].

Different three-element compromise impedances are used for voice terminal operation in different countries. The clauses below detail the reference impedances and any other country specific parameters. Component values are $\pm 0,1\%$ unless otherwise stated.

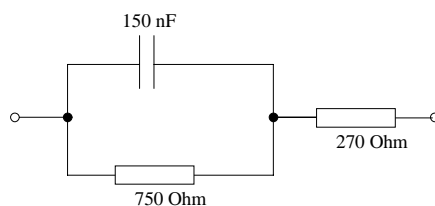

Figure C.1: Z_M compromise reference impedance (European harmonized - non voice terminals)

Unless otherwise required this voice-band matching impedance should be used for the design of the VDSL service splitter filter at voice-band frequencies. Where country specific requirements for the telephony matching impedance differ, they are described within the remainder of annex C.

NOTE: The harmonized matching impedance described above has been advocated in France (by France Telecom) and Spain (by Telefonica) for POTS matching.

C.1 Germany

For POTS operation in Germany, the following compromise matching impedance should be used when meeting the splitter requirements.

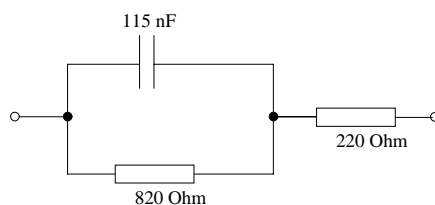

Figure C.2: Z_M compromise reference impedance used by Deutsche Telekom AG (voice terminals)

C.2 United Kingdom

For POTS operation in the UK, the following compromise matching impedance should be used when meeting the splitter requirements.

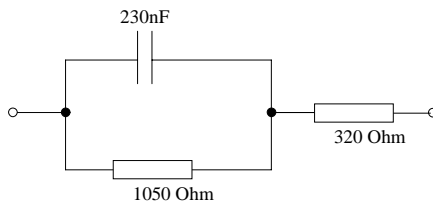

Figure C.3: Z_M compromise reference impedance used by British Telecommunications plc (voice terminals)

Annex D (informative): Illustrative graphs of Peak PSD masks

Figures D.1 to D.8 may be used to illustrate the Peak PSD masks given in clause 8.1.5.

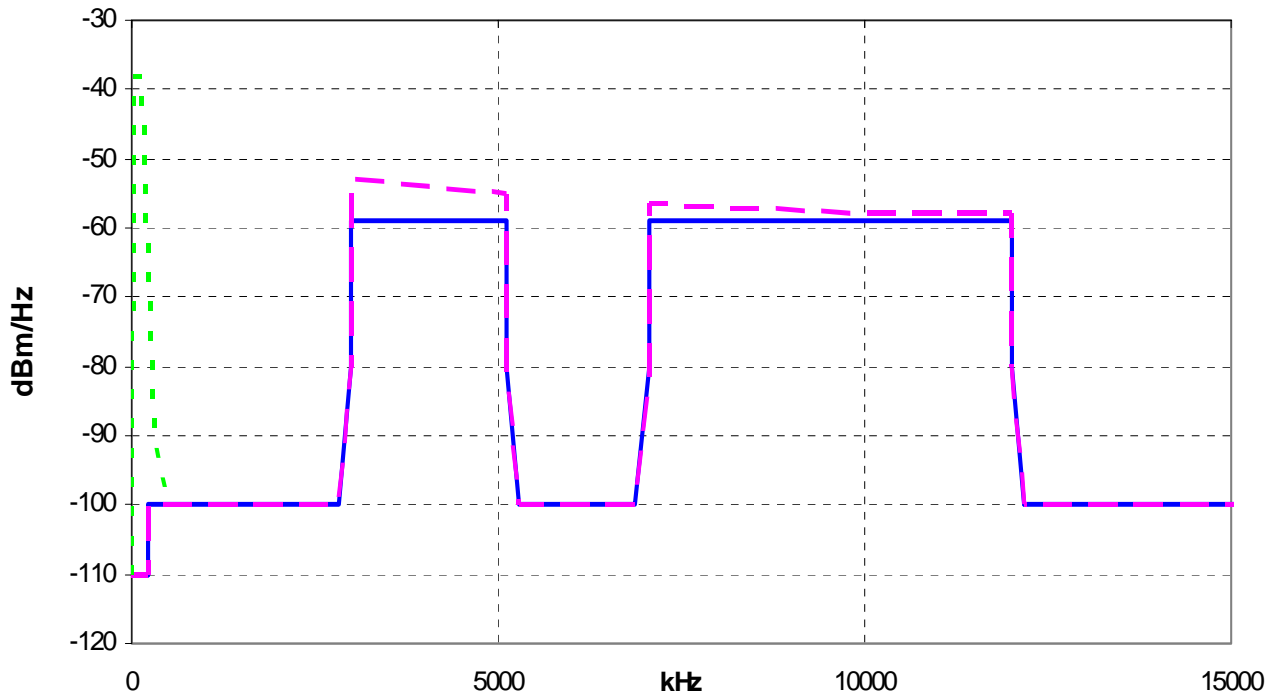

Figure D.1: P.M1 (solid line) and P.M2 (dashed line), optional upstream band is dotted line

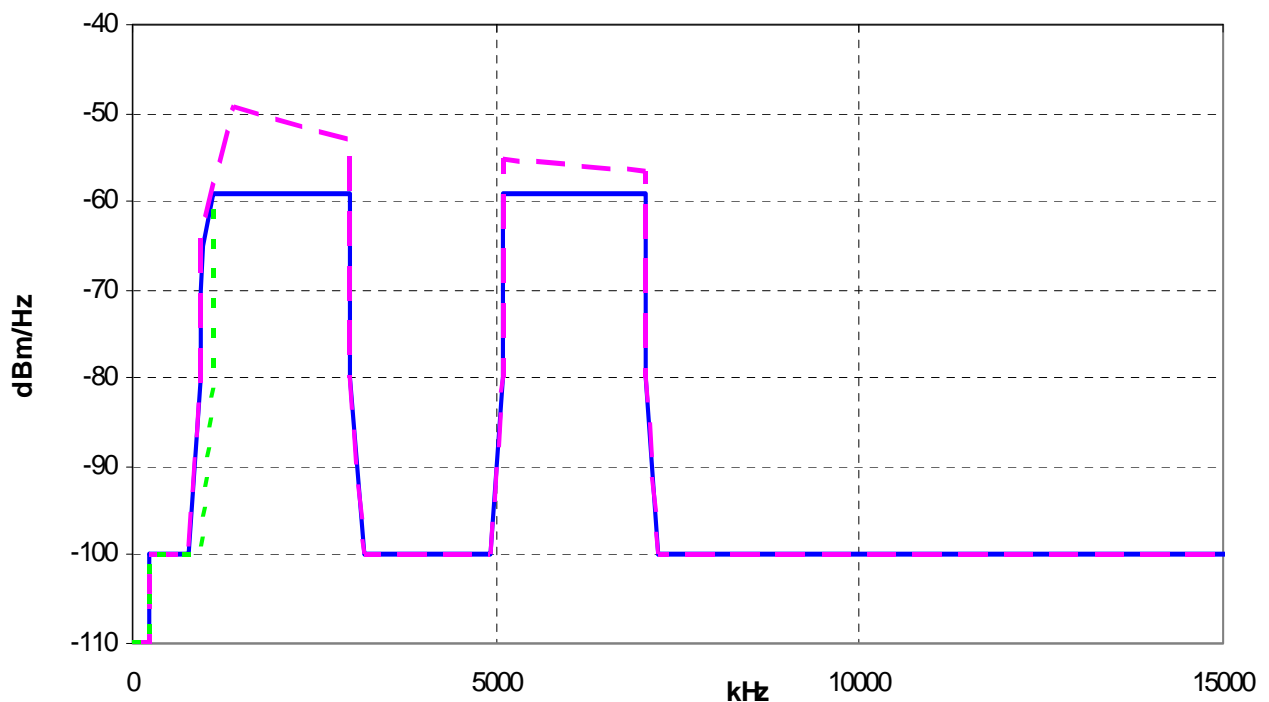

Figure D.2: Variant B Pcab.M1 (solid line) and Pcab.M2 (dashed line), variant A shown dotted

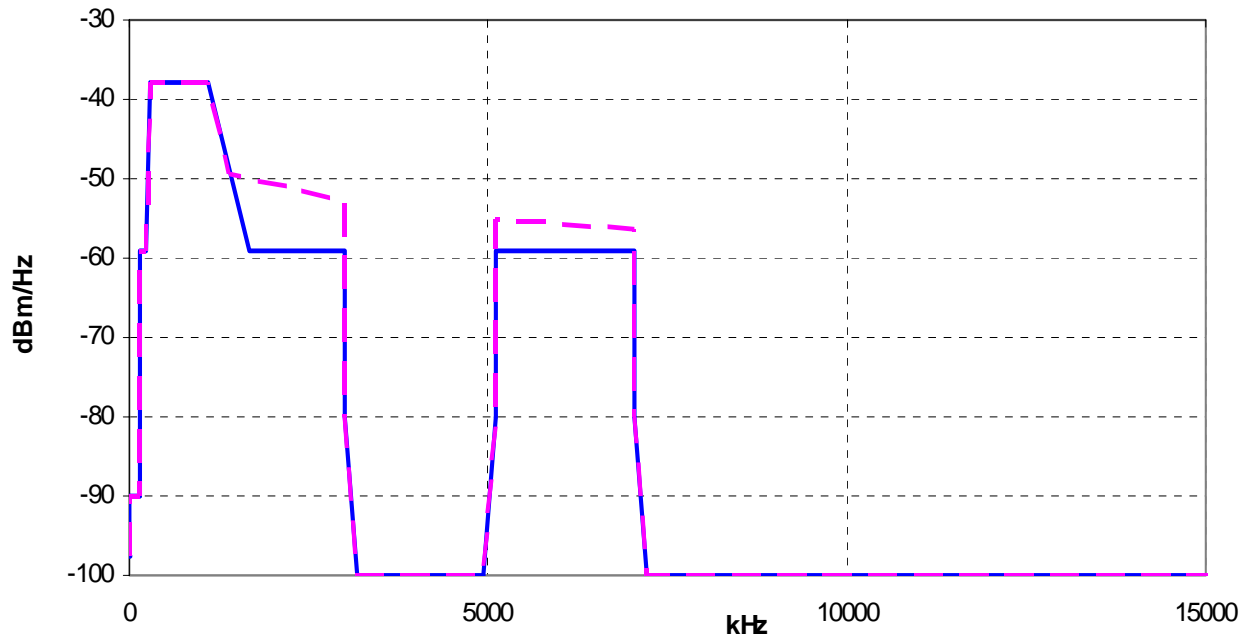

Figure D.3: Pex.P1.M1 (solid line) and Pex.P1.M2 (dashed line)

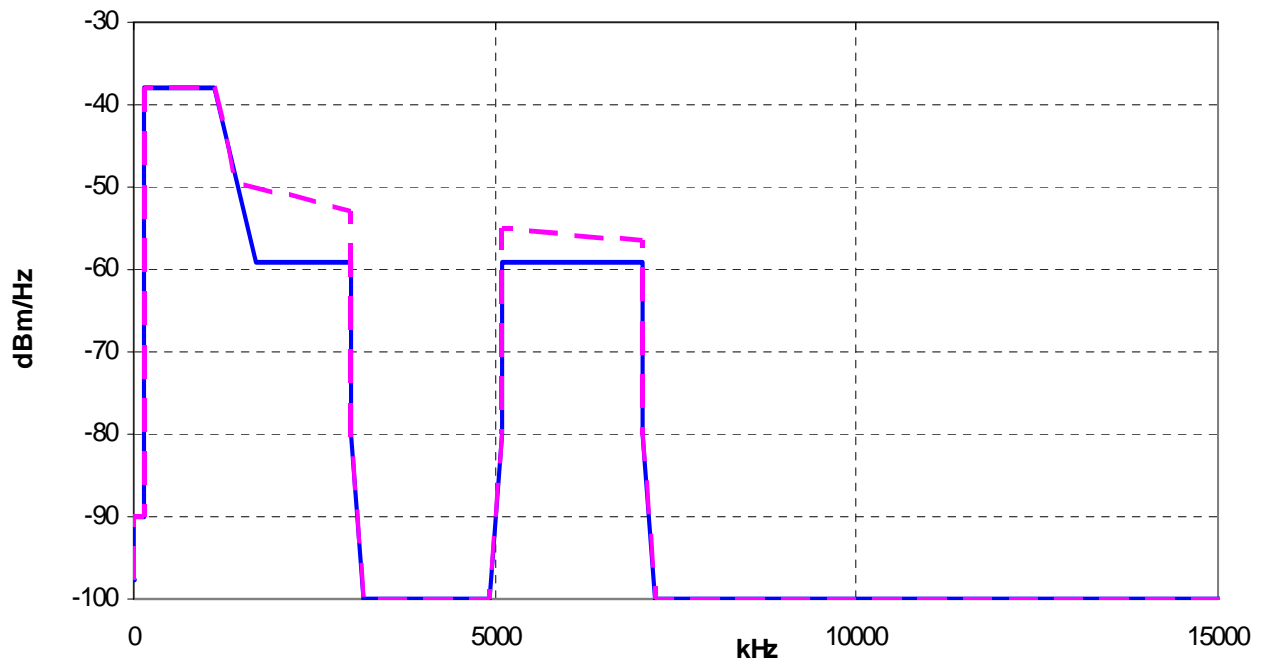

Figure D.4: Pex.P2.M1 (solid line) and Pex.P2.M2 (dashed line)

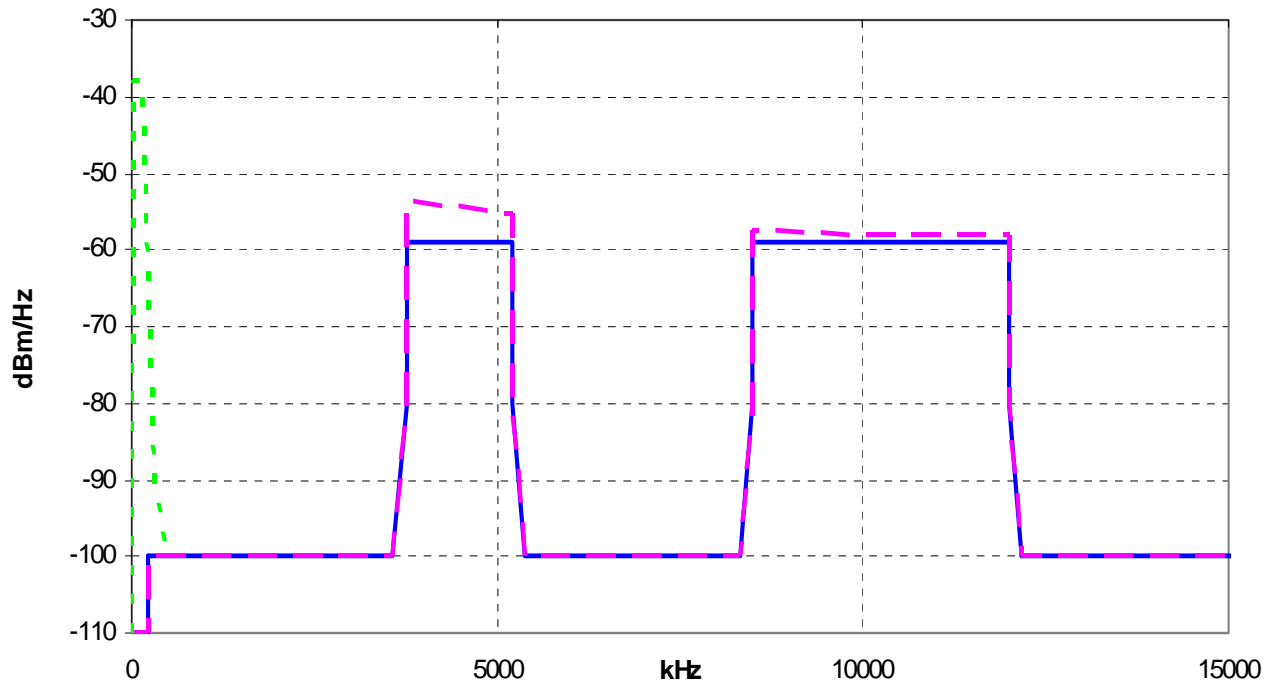

Figure D.5: Regional-specific P.M1 (solid line) and P.M2 (dashed line), optional band is dotted line

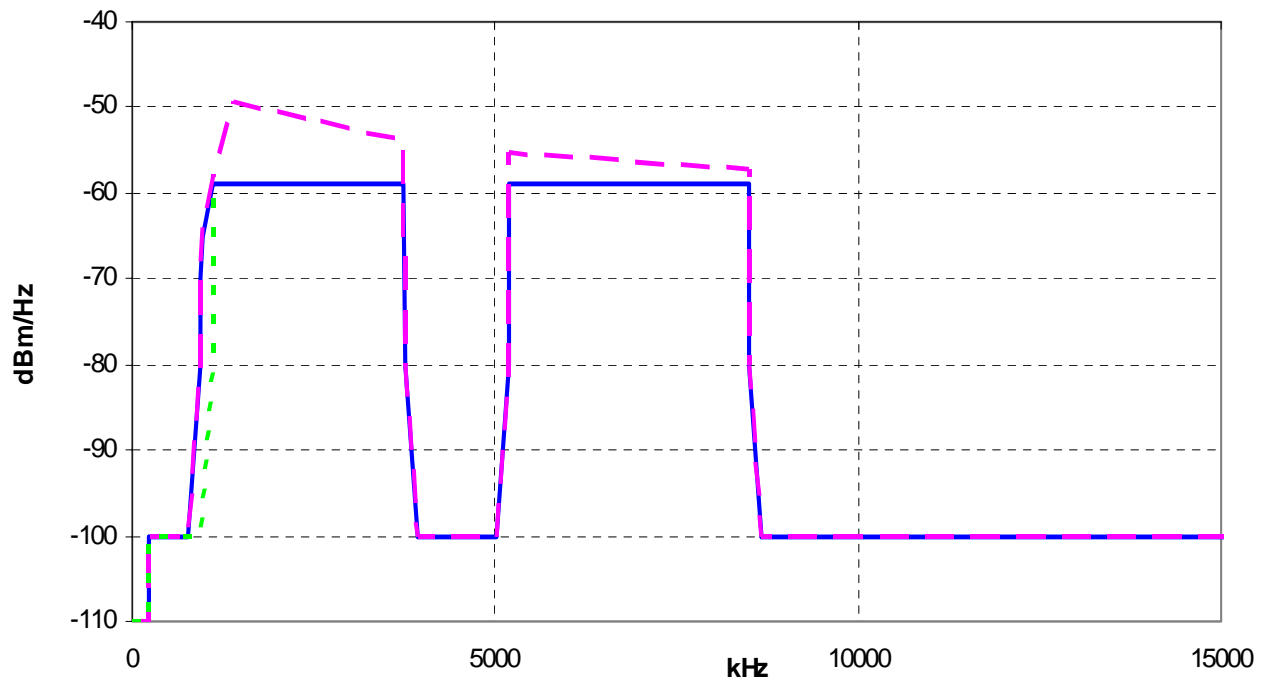

Figure D.6: Variant B regional-specific Pcab.M1 (solid line) and Pcab.M2 (dashed line), variant A shown dotted

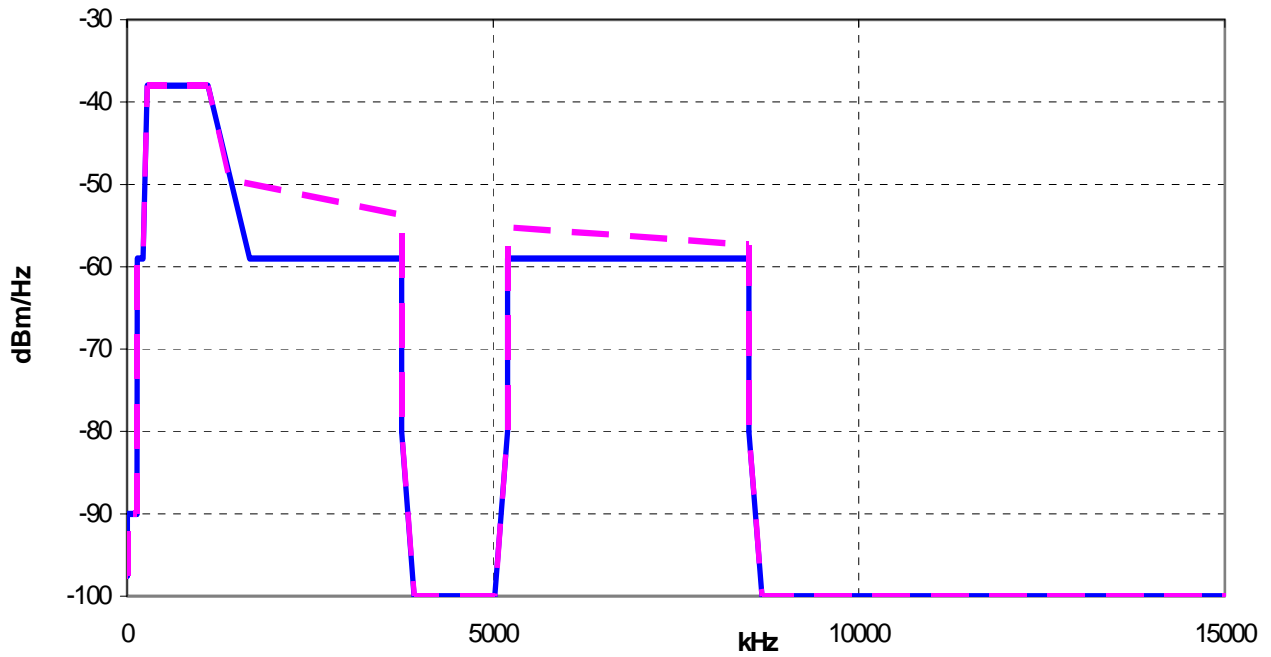

Figure D.7: Regional-specific Pex.P1.M1 (solid line) and Pex.P1.M2 (dashed line)

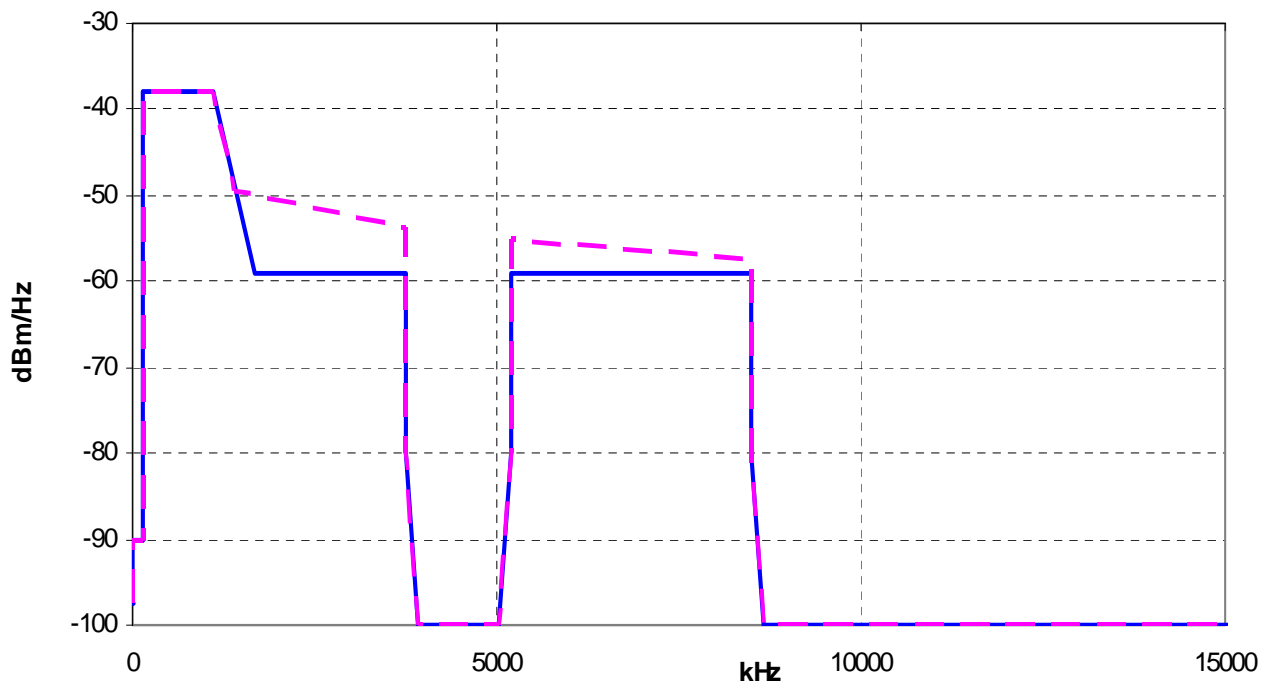

Figure D.8: Regional-specific Pex.P2.M1 (solid line) and Pex.P2.M2 (dashed line)

Annex E (informative): PSD Templates for VDSL

E.1 Introduction

The PSD templates for VDSL are used in performance simulation and for noise modeling. The templates are derived from the peak PSD mask, the nominal PSD mask and the wideband transmit power. The method used is described below.

NOTE 1: The templates in this annex assume that the VDSL spectrum will fill up the available PSD masks in such a way that the spectral density is roughly uniform below 1,1 MHz. Because of the additional flexibility allowed by the FTTE_x downstream masks, some VDSL transmit spectra may reach up to the nominal PSD mask over a limited frequency range. In these cases the templates in this annex may not be suitable for modelling and raising the template up to the nominal PSD mask may be a better approach. This is not thought to represent a significant problem because in many cases the alien noise is likely to dominate the self noise, e.g. with the noise models that are used in the document for performance testing.

NOTE 2: All the templates defined in this annex may appear to have slight violations of the corresponding peak PSD mask due to the non-zero resolution bandwidth of the measuring equipment. In addition there may be slight violations of the nominal PSD mask for the FTTE_x templates around the in-band corner frequency 1 677 kHz.

E.1.1 Derivation of PSD templates

The PSD templates are derived using general guidelines. These general guidelines are not applicable at all frequencies because the nominal PSD mask is not defined at all frequencies and in some cases it is necessary to apply further restrictions to make sure that the power under the template is consistent with the total power constraint. Therefore the following clause describes the general guidelines and the rationale behind the derivation of the various types of templates.

The general guidelines used to derive the templates are the following:

- 1) At frequencies where the nominal mask is defined (in-band and in some out-of-band regions of the spectrum), the template is equal to the nominal mask.
- 2) In the transition bands between two regions where the nominal mask is defined, the template is 2 dB lower than the peak mask.
- 3) In the out-of-band regions of the spectrum where the nominal mask is not defined, the template is equal to the peak mask.

In addition to the above guidelines, the various types of templates are derived according to the following rationales.

E.1.1.1 Upstream templates

- In the first transition band (which is located between an out-of-band region where the nominal mask is not defined and an in-band region where the nominal mask is defined) the template is equal to the peak mask.

Since the upstream templates derived in this way respect the total power constraint, no other operation is necessary.

E.1.1.2 Downstream FTTCab templates

For PSD mask variant A the following applies:

- The first transition band starts at 1 104 kHz. Following the same criteria used in the first transition band for deriving the upstream templates, the downstream FTTCab template is assumed to be equal to the peak mask in the first transition band.
- The band above 1 104 kHz is an in-band region and therefore the general guideline 1 is applied to derive the template.

For PSD mask variant B the following applies:-

- The first transition band is assumed to start at 770 kHz because at lower frequencies the peak mask has the same value as the out-of-band PSD. The downstream FTTCab template therefore equals the peak mask in the first transition band, i.e. in the region between 770 kHz and (770+175) kHz.
- The band above 945 kHz is - de facto - an in-band band and therefore the general guideline 1 is used to derive the template.

The downstream FTTCab templates derived according to the above rationale respect the total power constraint except in the case of the boosted mask (M2) of the optional regional band plan. Therefore, for this particular case, a further operation is carried out to derive a template consistent with the total power constraint.

- For the downstream FTTCab M2 mask of the optional regional band plan, the template is derived according to the above rationale with an additional flattening operation that consists of lowering **all the highest levels of the initial template** down such that the power under the resulting (**two-band**) template is equal to 11,5 dBm.

E.1.1.3 Downstream FTTEEx templates

The downstream FTTEEx templates derived according to the above general guidelines do not respect the total power constraint. Therefore, for all the FTTEEx downstream PSDs (Pex.P1.M1, Pex.P1.M2, Pex.P2.M1, Pex.P2.M2), a further operation is carried out to derive templates consistent with the total power constraint.

- For the downstream FTTEEx masks, the template is derived according to the above rationale with an additional flattening operation that consists in lowering **all the highest levels of the initial template** down such that the power under the resulting (**two-band**) template is equal to 14,5 dBm.

NOTE 1: The above rationale implies that the slope of the template in the transition bands is equal to the slope of the corresponding peak mask.

NOTE 2: The methodology used occasionally implies some brick walls at the frequencies between the transition and the out-of-band regions, but avoids any artefact in the templates (i.e. peaks at the corner frequencies, changes of the slope, etc.).

NOTE 3: For all the cases where it is necessary to perform a flattening operation to take into account the total power constraint, some corner frequencies that describe the template in DS1 are different from the ones that describe the corresponding peak mask.

Table E.1: Upstream PSD templates

P.M1		P.M2	
Frequency (kHz)	Template (dBm/Hz)	Frequency (kHz)	Template (dBm/Hz)
With optional band			
0	-110	0	-110
4	-110	4	-110
25	-40	25	-40
138	-40	138	-40
307	-90	307	-90
482	-100	482	-100
Without optional band			
0	-110	0	-110
225	-110	225	-110
226	-100	226	-100
Common PSD			
2 825	-100	2 825	-100
3 000	-80	3 000	-80
3 001	-61	3 001	-54,8
5 099	-61	5 099	-57,1
5 100	-82	5 100	-82
5 274	-102	5 274	-102
5 275	-112	5 275	-112
6 875	-112	6 875	-112
6 876	-102	6 876	-102
7 050	-82	7 050	-82
7 051	-61	7 051	-58,5
11 999	-61	10 000	-60
12 000	-82	11 999	-60
12 175	-102	12 000	-82
12 176	-112	12 175	-102
30 000	-112	12 176	-112
		30 000	-112

Table E.2: Downstream FTTCab templates

Pcab.M1		Pcab.M2	
Frequency (kHz)	Template (dBm/Hz)	Frequency (kHz)	Template (dBm/Hz)
Variant A			
0	-110	0	-110
225	-110	225	-110
226	-100	226	-100
929	-100	929	-100
1 104	-80	1 104	-80
Variant B			
0	-110	0	-110
225	-110	225	-110
226	-100	226	-100
770	-100	770	-100
945	-80	945	-80
946	-78,3	946	-77,3
947,2	-74,8	947,2	-73,8
949	-72	949	-71
958	-67,1	958	-66,1
1 104	-61	1 104	-60
Common			
1 105	-61	1 105	-60
2 999	-61	1 394	-51,4
3 000	-82	2 999	-54,8
3 174	-102	3 000	-82
3 175	-110	3 174	-102
4 925	-110	3 175	-110
4 926	-102	4 925	-110
5 100	-82	4 926	-102
5 101	-61	5 100	-82
7 049	-61	5 101	-57,1
7 050	-82	7 049	-58,5
7 224	-102	7 050	-82
7 225	-112	7 224	-102
30 000	-112	7 225	-112
		30 000	-112

Table E.3: Downstream FTTE templates (ADSL over ISDN present in the binder)

Pex.P1.M1		Pex.P1.M2	
Frequency (kHz)	Template (dBm/Hz)	Frequency (kHz)	Template (dBm/Hz)
0	-97,5	0	-97,5
3,99	-97,5	3,99	-97,5
4	-90	4	-90
138	-90	138	-90
139	-61	139	-61
217	-61	217	-61
256	-46,4	251	-48,2
1 254	-46,4	1 303	-48,2
1 677	-61	1 394	-51,4
2 999	-61	2 999	-54,8
3 000	-82	3 000	-82
3 174	-102	3 174	-102
3 175	-110	3 175	-110
4 925	-110	4 925	-110
4 926	-102	4 926	-102
5 100	-82	5 100	-82
5 101	-61	5 101	-57,1
7 049	-61	7 049	-58,5
7 050	-82	7 050	-82
7 224	-102	7 224	-102
7 225	-112	7 225	-112
30 000	-112	30 000	-112

Table E.4: Downstream FTTE templates (ADSL over POTS present in the binder)

Pex.P2.M1		Pex.P2.M2	
Frequency (kHz)	Template (dBm/Hz)	Frequency (kHz)	Template (dBm/Hz)
0	-97,5	0	-97,5
3,99	-97,5	3,99	-97,5
4	-90	4	-90
138	-90	138	-90
139	-46,9	139	-48,5
1 265	-46,9	1 314	-48,5
1 677	-61	1 394	-51,4
2 999	-61	2 999	-54,8
3 000	-82	3 000	-82
3 174	-102	3 174	-102
3 175	-110	3 175	-110
4 925	-110	4 925	-110
4 926	-102	4 926	-102
5 100	-82	5 100	-82
5 101	-61	5 101	-57,1
7 049	-61	7 049	-58,5
7 050	-82	7 050	-82
7 224	-102	7 224	-102
7 225	-112	7 225	-112
30 000	-112	30 000	-112

Table E.5: Regional-specific upstream PSD templates

P.M1		P.M2	
Frequency (kHz)	Template (dBm/Hz)	Frequency (kHz)	Template (dBm/Hz)
With optional band			
0	-110	0	-110
4	-110	4	-110
25	-40	25	-40
138	-40	138	-40
307	-90	307	-90
Without optional band			
0	-110	0	-110
225	-110	225	-110
226	-100	226	-100
Common PSD			
482	-100	482	-100
3 575	-100	3 575	-100
3 750	-80	3 750	-80
3 751	-61	3 751	-55,7
5 199	-61	5 199	-57,2
5 200	-82	5 200	-82
5 374	-102	5 374	-102
5 375	-112	5 375	-112
8 325	-112	8 325	-112
8 326	-102	8 326	-102
8 500	-82	8 500	-82
8 501	-61	8 501	-59,3
11 999	-61	10 000	-60
12 000	-82	11 999	-60
12 175	-102	12 000	-82
12 176	-112	12 175	-102
30 000	-112	12 176	-112
		30 000	-112

Table E.6: Regional-specific downstream FTTCab templates

Pcab.M1		Pcab.M2	
Frequency (kHz)	Template (dBm/Hz)	Frequency (kHz)	Template (dBm/Hz)
Variant A			
0	-110	0	-110
225	-110	225	-110
226	-100	226	-100
929	-100	929	-100
1 104	-80	1 104	-80
Variant B			
0	-110	0	-110
225	-110	225	-110
226	-100	226	-100
770	-100	770	-100
945	-80	945	-80
946	-78,3	946	-77,3
947,2	-74,8	947,2	-73,8
949	-72	949	-71
958	-67,1	958	-66,1
1 104	-61	1 104	-60
Common			
1 105	-61	1 105	-60
3 749	-61	1 295	-54,1
3 750	-82	2 603	-54,1
3 924	-102	3 749	-55,7
3 925	-110	3 750	-82
5 025	-110	3 924	-102
5 026	-102	3 925	-110
5 200	-82	5 025	-110
5 201	-61	5 026	-102
8 499	-61	5 200	-82
8 500	-82	5 201	-57,2
8 674	-102	8 499	-59,3
8 675	-112	8 500	-82
30 000	-112	8 674	-102
		8 675	-112
		30 000	-112

Table E.7: Regional-specific downstream FTTE templates (ADSL over ISDN present in the binder)

Pex.P1.M1		Pex.P1.M2	
Frequency (kHz)	Template (dBm/Hz)	Frequency (kHz)	Template (dBm/Hz)
0	-97,5	0	-97,5
3,99	-97,5	3,99	-97,5
4	-90	4	-90
138	-90	138	-90
139	-61	139	-61
217	-61	217	-61
255	-46,8	248	-49,4
1 262	-46,8	1 336	-49,4
1 677	-61	1 394	-51,4
3 749	-61	3 749	-55,7
3 750	-82	3 750	-82
3 924	-102	3 924	-102
3 925	-110	3 925	-110
5 025	-110	5 025	-110
5 026	-102	5 026	-102
5 200	-82	5 200	-82
5 201	-61	5 201	-57,2
8 499	-61	8 499	-59,3
8 500	-82	8 500	-82
8 674	-102	8 674	-102
8 675	-112	8 675	-112
30 000	-112	30 000	-112

Table E.8: Regional-specific downstream FTTE templates (ADSL over POTS present in the binder)

Pex.P2.M1		Pex.P2.M2	
Frequency (kHz)	Template (dBm/Hz)	Frequency (kHz)	Template (dBm/Hz)
0	-97,5	0	-97,5
3,99	-97,5	3,99	-97,5
4	-90	4	-90
138	-90	138	-90
139	-47,2	139	-49,7
1 273	-47,2	1 346	-49,7
1 677	-61	1 394	-51,4
3 749	-61	3 749	-55,7
3 750	-82	3 750	-82
3 924	-102	3 924	-102
3 925	-110	3 925	-110
5 025	-110	5 025	-110
5 026	-102	5 026	-102
5 200	-82	5 200	-82
5 201	-61	5 201	-57,2
8 499	-61	8 499	-59,3
8 500	-82	8 500	-82
8 674	-102	8 674	-102
8 675	-112	8 675	-112
30 000	-112	30 000	-112

Annex F (informative): Theoretical reach simulation results

The reach figures in this annex have been obtained by a theoretical simulation of the performance of VDSL systems. They are presented for information only and are not intended for use in conformance testing. The reach obtained in real deployments will depend on the specific local parameters. Where the reach is less than 100 m the cell in the tables has been left blank. The following limits and assumptions were made.

- Shannon gap 9,8 dB
- Coding gain 3,8 dB
- SNR margin 6 dB
- Implementation loss 2 dB
- Additional noise AWGN (-140 dBm/Hz)
- Maximum SNR 57 dB
- Power back-off assume equal length scenario for disturbers
- FEXT 20 VDSL
- Time domain overhead 12 %
- Transmit power 11,5 dBm for upstream and FTTCab downstream
14,5 dBm for FTTEEx downstream
- Number of bands 2 in each direction, optional upstream band not used
- Noise models A B C D E F
- FTTCab variant B
- Type of cable VDSL loop 2 (cable TP150)

Table F.1: Loop length (metres) as a function of payload rate and noise model using main band plan without power back-off

	S1	S2	S3	S4	A3	A4
Pcab.M1 Noise A	990	890	650		700	
Pcab.M2 Noise A	1 100	960	730	130	870	130
Pcab.M1 unnotched Noise A	1 060	930	720	130	840	130
Pcab.M1 Noise B	990	890	650	120	780	120
Pcab.M2 Noise B	1 100	960	730	160	930	160
Pcab.M2 unnotched Noise B	1 060	930	720	160	900	160
Pcab.M1 Noise C	780	720	370		370	
Pcab.M2 Noise C	860	790	570	100	570	100
Pcab.M1 unnotched Noise C	800	740	440		440	
Pex.P2.M1 Noise D	900	810	610	190	880	190
Pex.P2.M2 Noise D	1 000	880	670	240	1 000	240
Pex.P2.M1 unnotched Noise D	950	850	660	240	950	240
Pex.P2.M1 Noise E	950	850	640	210	1 120	330
Pex.P2.M2 Noise E	1 060	930	700	260	1 220	390
Pex.P2.M1 unnotched Noise E	1 010	900	690	260	1 190	410
Pex.P2.M1 Noise F	720	670	530	200	700	260
Pex.P2.M2 Noise F	800	730	590	260	810	340
Pex.P2.M1 unnotched Noise F	740	690	560	250	720	310

Table F.2: Loop length (metres) as a function of payload rate and noise model using regional specific band plan without power back-off

	S1	S2	S3	S4	A3	A4
Pcab.M1 Noise A	820	720	270		1 030	420
Pcab.M2 Noise A	840	730	280		1 160	570
Pcab.M1 unnotched Noise A	820	720	280		1 100	570
Pcab.M1 Noise B	820	720	270		1 050	470
Pcab.M2 Noise B	840	730	280		1 180	630
Pcab.M2 unnotched Noise B	820	720	280		1 120	620
Pcab.M1 Noise C	690	620	270		650	280
Pcab.M2 Noise C	720	640	280		790	440
Pcab.M1 unnotched Noise C	690	620	270		690	370
Pex.P2.M1 Noise D	750	650	270		1 030	570
Pex.P2.M2 Noise D	760	670	280		1 120	690
Pex.P2.M1 unnotched Noise D	750	660	280		1 030	690
Pex.P2.M1 Noise E	790	690	270		1 090	790
Pex.P2.M2 Noise E	810	710	280		1 170	880
Pex.P2.M1 unnotched Noise E	790	690	280		1 090	880
Pex.P2.M1 Noise F	640	570	260		760	540
Pex.P2.M2 Noise F	670	600	270		820	640
Pex.P2.M1 unnotched Noise F	640	570	270		760	580

Table F.3: Loop length (metres) as a function of payload rate and noise model using main band plan with power back-off

	S1	S2	S3	S4	A3	A4
Pcab.M1 Noise A	960	780	260		700	
Pcab.M2 Noise A	1 060	930	350		880	130
Pcab.M1 unnotched Noise A	1 030	910	350		850	130
Pcab.M1 Noise B	960	780	260		790	120
Pcab.M2 Noise B	1 060	930	350		940	160
Pcab.M2 unnotched Noise B	1 030	910	350		910	160
Pcab.M1 Noise C	780	620	160		370	
Pcab.M2 Noise C	840	720	230		570	100
Pcab.M1 unnotched Noise C	800	720	230		440	
Pex.P2.M1 Noise D	860	700	220		890	190
Pex.P2.M2 Noise D	930	830	280		1 000	240
Pex.P2.M1 unnotched Noise D	910	810	280		950	240
Pex.P2.M1 Noise E	920	790	270		1 130	330
Pex.P2.M2 Noise E	1 000	890	350		1 220	390
Pex.P2.M1 unnotched Noise E	980	860	350		1 200	410
Pex.P2.M1 Noise F	720	500			700	260
Pex.P2.M2 Noise F	780	610	140		810	340
Pex.P2.M1 unnotched Noise F	740	600	140		720	310

Table F.4: Loop length (metres) as a function of payload rate and noise model using regional specific band plan with power back-off

	S1	S2	S3	S4	A3	A4
Pcab.M1 Noise A	500	260			1 040	420
Pcab.M2 Noise A	500	270			1 080	570
Pcab.M1 unnotched Noise A	500	270			1 070	570
Pcab.M1 Noise B	500	260			1 060	470
Pcab.M2 Noise B	500	270			1 080	630
Pcab.M2 unnotched Noise B	500	270			1 070	620
Pcab.M1 Noise C	450	230			650	280
Pcab.M2 Noise C	460	240			790	440
Pcab.M1 unnotched Noise C	460	240			690	370
Pex.P2.M1 Noise D	490	250			1 000	570
Pex.P2.M2 Noise D	490	260			1 010	690
Pex.P2.M1 unnotched Noise D	490	260			1 000	690
Pex.P2.M1 Noise E	540	300			1 050	790
Pex.P2.M2 Noise E	550	300			1 060	880
Pex.P2.M1 unnotched Noise E	550	300			1 050	890
Pex.P2.M1 Noise F	360	140			760	540
Pex.P2.M2 Noise F	370	150			820	640
Pex.P2.M1 unnotched Noise F	370	150			760	580

Annex G (informative): Bibliography

- [I-1] "Cable reference models for simulating metallic access networks", R.F.M. van den Brink, ETSI TM6 Permanent document TM6 (97) 02 revision 3, Luleå, Sweden, June 1998.

History

Document history		
V1.1.1	April 1998	Publication
V1.1.2	June 1998	Publication
V1.2.1	October 1999	Publication
V1.3.1	July 2003	Publication