

ETSI TS 101 293 V7.2.0 (2000-10)

Technical Specification

**Digital cellular telecommunications system (Phase 2+);
Individual equipment type requirements and interworking;
Special conformance testing functions
(GSM 04.14 version 7.2.0 Release 1998)**

GSM®

GLOBAL SYSTEM FOR
MOBILE COMMUNICATIONS



Reference

RTS/SMG-020414Q7R2

Keywords

Digital cellular telecommunications system,
Global System for Mobile Communication (GSM)

ETSI

650 Route des Lucioles
F-06921 Sophia Antipolis Cedex - FRANCE

Tel.: +33 4 92 94 42 00 Fax: +33 4 93 65 47 16

Siret N° 348 623 562 00017 - NAF 742 C
Association à but non lucratif enregistrée à la
Sous-Préfecture de Grasse (06) N° 7803/88

Important notice

Individual copies of the present document can be downloaded from:

<http://www.etsi.org>

The present document may be made available in more than one electronic version or in print. In any case of existing or perceived difference in contents between such versions, the reference version is the Portable Document Format (PDF). In case of dispute, the reference shall be the printing on ETSI printers of the PDF version kept on a specific network drive within ETSI Secretariat.

Users of the present document should be aware that the document may be subject to revision or change of status. Information on the current status of this and other ETSI documents is available at <http://www.etsi.org/tb/status/>

If you find errors in the present document, send your comment to:
editor@etsi.fr

Copyright Notification

No part may be reproduced except as authorized by written permission.
The copyright and the foregoing restriction extend to reproduction in all media.

© European Telecommunications Standards Institute 2000.
All rights reserved.

Contents

| | |
|--|----|
| Intellectual Property Rights | 5 |
| Foreword..... | 5 |
| 1 Scope | 6 |
| 2 References | 6 |
| 3 Definitions, conventions, and applicability | 7 |
| 3.1 Mobile station definition and configurations..... | 7 |
| 3.2 Applicability..... | 7 |
| 4 Activation and deactivation of special test functions in the MS | 7 |
| 5 Internal test loops | 8 |
| 5.1 Single-slot TCH loops | 9 |
| 5.1.1 Purpose of Single-slot TCH loops | 9 |
| 5.1.2 TCH loop including signalling of erased frames (A)..... | 9 |
| 5.1.2.1 Procedure | 9 |
| 5.1.3 Speech TCH loop without signalling of erased frames (B) | 10 |
| 5.1.3.1 Procedure | 10 |
| 5.1.4 TCH burst-by-burst loop (C) | 10 |
| 5.1.4.1 Applicability..... | 10 |
| 5.1.4.2 Procedure | 10 |
| 5.1.4.3 Establishment | 10 |
| 5.1.4.4 Operation..... | 10 |
| 5.1.5 TCH loop including signalling of erased frames and unreliable frames (D) | 11 |
| 5.1.5.1 Procedure | 11 |
| 5.1.6 TCH loop including signalling of erased SID frames (E)..... | 11 |
| 5.1.6.1 Procedure | 11 |
| 5.1.7 TCH loop including signalling of erased valid SID frames (F) | 12 |
| 5.1.7.1 Procedure | 12 |
| 5.1.8 Additional non-mandatory operating characteristics for single-slot loops | 12 |
| 5.2 Multi-slot TCH loops | 12 |
| 5.2.1 Purpose of Multi-slot TCH loops..... | 12 |
| 5.2.2 Multi-slot TCH burst-by-burst loop (G) | 13 |
| 5.2.2.1 Procedure | 13 |
| 5.2.3 Multi-slot TCH loop including signalling of erased frames (H)..... | 14 |
| 5.2.3.1 Procedure | 14 |
| 5.3 Deactivating loops | 14 |
| 5.3.1 Deactivating Single-slot TCH loops | 14 |
| 5.3.2 Deactivating Multi-slot TCH loops | 14 |
| 5.4 Multi-slot test mode for GPRS | 15 |
| 5.4.1 Initiation..... | 15 |
| 5.4.1.1 MS Declaration | 15 |
| 5.4.1.2 Establishment of uplink TBF | 15 |
| 5.4.2 Operation | 15 |
| 5.4.2.1 MS Operating in mode a)..... | 15 |
| 5.4.2.2 MS Operating in mode b)..... | 16 |
| 5.4.2.3 Operational constraints applying to both modes | 16 |
| 5.4.3 Termination..... | 16 |
| 5.4.4 PN Sequence Definition..... | 16 |
| 5.4.5 Optional Multi-slot operation | 16 |
| 6 Activating and deactivating EMMI..... | 17 |
| 7 Activating and deactivating DAI tests..... | 17 |
| 8 Message definitions and contents..... | 17 |
| 8.1 CLOSE_TCH_LOOP_CMD | 18 |

| | | |
|---|--|-----------|
| 8.2 | CLOSE_TCH_LOOP_ACK..... | 18 |
| 8.3 | OPEN_LOOP_CMD..... | 19 |
| 8.4 | CLOSE_Multi-slot_LOOP_CMD..... | 19 |
| 8.5 | CLOSE_Multi-slot_LOOP_ACK..... | 20 |
| 8.6 | OPEN_Multi-slot_LOOP_CMD..... | 21 |
| 8.7 | OPEN_Multi-slot_LOOP_ACK..... | 21 |
| 8.8 | Command for the activation of the EMMI, ACT_EMMI_CMD..... | 21 |
| 8.9 | Acknowledge of the activation of the EMMI, ACT_EMMI_ACK..... | 22 |
| 8.10 | Deactivation of the EMMI, DEACT_EMMI..... | 22 |
| 8.11 | Test_Interface..... | 22 |
| 8.12 | Timer values..... | 23 |
| 8.13 | GPRS_TEST_MODE_CMD..... | 23 |
| 9 | Electrical Man Machine Interface (EMMI)..... | 24 |
| 9.1 | Use of the EMMI..... | 24 |
| 9.2 | Formal aspects..... | 25 |
| 9.3 | Layered structure of the interface..... | 25 |
| 9.4 | Terminology..... | 25 |
| 9.5 | Description of the EMMI..... | 25 |
| 9.5.1 | EMMI, Layer 1..... | 25 |
| 9.5.1.1 | Mechanical and electrical characteristics..... | 25 |
| 9.5.1.2 | Transmission and reception characteristics..... | 26 |
| 9.5.2 | EMMI, layer 2..... | 26 |
| 9.5.2.1 | General structure..... | 26 |
| 9.5.2.2 | Control frames..... | 26 |
| 9.5.2.3 | Frame structure..... | 26 |
| 9.5.2.4 | Flow of I-frames on layer 2..... | 27 |
| 9.5.2.4.1 | Transmission of frames..... | 27 |
| 9.5.2.4.2 | Reception of frames..... | 27 |
| 9.5.2.4.3 | Use of ACK and NAK on receiving side..... | 27 |
| 9.5.2.4.4 | Use of XON and XOF..... | 28 |
| 9.5.2.4.5 | Parameters on layer 2..... | 28 |
| 9.5.3 | EMMI, layer 3..... | 28 |
| 9.5.3.1 | Message structure..... | 28 |
| 9.5.3.2 | Definition of messages..... | 29 |
| 10 | Digital audio interface..... | 34 |
| 10.1 | General..... | 34 |
| 10.2 | Formal aspects..... | 34 |
| 10.3 | Hardware aspect of the interface..... | 34 |
| 10.3.1 | Mechanical characteristics of the interface..... | 35 |
| 10.3.2 | Electrical characteristics of the interface..... | 35 |
| 10.3.3 | Timing characteristics of the interface..... | 35 |
| 10.4 | Logical interface..... | 36 |
| 10.5 | Functionality of the DAI..... | 36 |
| 11 | SIM/ME test interface..... | 37 |
| 11.1 | General..... | 37 |
| 11.2 | Formal aspects..... | 37 |
| 11.3 | Hardware and logical aspects of the interface..... | 37 |
| 11.4 | Mechanical characteristics of the interface..... | 37 |
| Annex A (informative): Change Request History..... | | 39 |
| History..... | | 40 |

Intellectual Property Rights

IPRs essential or potentially essential to the present document may have been declared to ETSI. The information pertaining to these essential IPRs, if any, is publicly available for **ETSI members and non-members**, and can be found in ETSI SR 000 314: "*Intellectual Property Rights (IPRs); Essential, or potentially Essential, IPRs notified to ETSI in respect of ETSI standards*", which is available from the ETSI Secretariat. Latest updates are available on the ETSI Web server (<http://www.etsi.org/ipr>).

Pursuant to the ETSI IPR Policy, no investigation, including IPR searches, has been carried out by ETSI. No guarantee can be given as to the existence of other IPRs not referenced in ETSI SR 000 314 (or the updates on the ETSI Web server) which are, or may be, or may become, essential to the present document.

Foreword

This Technical Specification (TS) has been produced by ETSI Technical Committee Special Mobile Group (SMG).

The present document describes the special conformance testing functions required to be present in Mobile Stations (MSs), operating in the 900 MHz and 1 800 MHz frequency band (GSM 900 and DCS 1 800) within the digital cellular telecommunications system.

The contents of the present document may be subject to continuing work within SMG and may change following formal SMG approval. Should SMG modify the contents of the present document it will then be re-submitted for formal approval procedures by ETSI with an identifying change of release date and an increase in version number as follows:

Version 7.x.y

where:

- 7 indicates Release 1998 of GSM Phase 2+
- x the second digit is incremented for all changes of substance, i.e. technical enhancements, corrections, updates, etc.
- y the third digit is incremented when editorial only changes have been incorporated in the specification.

1 Scope

The present document specifies for Mobile Stations (MS), for the digital cellular communications system and Personal Communication Systems (PCS) operating in the 900 MHz and 1800 MHz band (GSM900 and DCS1800), standardized by ETSI SMG, those ME functions which are required for conformance testing purposes only. However, except for the Electrical Man Machine Interface (EMMI) and the Multi-slot TCH Loops, they are required for every mobile station.

For conformance tests, functions are activated via the radio interface, test SIM or dedicated pins. These functions must be capable of being activated when a test SIM is present but must not function with any other (e.g. network) SIM present except where otherwise stated within the present document. In this state, the MS must be able to perform all functions specified in the present document; in addition however, the special conformance testing functions must be operational.

The special conformance testing functions of the ME are enabled by use of a dedicated Subscriber Identity Module (test SIM, see GSM 11.10-1 Annex 4). SIM, in general, is described in GSM 11.11. The ME recognizes the test SIM by the Administrative Data Field.

The present document applies to the public land mobile radio service in the GSM900 and DCS1800 systems, using constant envelope modulation and operating on radio frequencies in the 900 and 1800 MHz bands respectively with a channel separation of 200 kHz and carrying 8 full rate channels or 16 half rate channels per carrier according to the TDMA principle.

The present document is part of the GSM-series of technical specifications. The present document neither replaces any of the other GSM technical specifications or GSM related TS, nor is it created to provide full understanding of (or parts of) the GSM900 and DCS1800 systems.

The present document applies to the unit which includes the hardware to establish a connection across the radio interface.

2 References

The following documents contain provisions which, through reference in this text, constitute provisions of the present document.

- References are either specific (identified by date of publication, edition number, version number, etc.) or non-specific.
- For a specific reference, subsequent revisions do not apply.
- For a non-specific reference, the latest version applies.
- A non-specific reference to an ETS shall also be taken to refer to later versions published as an EN with the same number.
- For this Release 1998 document, references to GSM documents are for Release 1998 versions (version 7.x.y).

- [1] GSM 01.04: "Digital cellular telecommunication system (Phase 2); Abbreviations and acronyms".
- [2] GSM 04.07: "Digital cellular telecommunication system (Phase 2); Mobile radio interface signalling layer 3 General aspects".
- [3] GSM 04.08: "Digital cellular telecommunication system (Phase 2); Mobile radio interface layer 3 specification".
- [4] GSM 11.10: "Digital cellular telecommunication system (Phase 2); Mobile Station (MS) conformance specification; Part 1: Conformance specification".
- [5] GSM 11.11: "Digital cellular telecommunication system (Phase 2); Specification of the Subscriber Identity Module - Mobile Equipment (SIM - ME) interface".

- [6] GSM 11.12: "Digital cellular telecommunications system (Phase 2); Specification of the 3 Volt Subscriber Identity Module - Mobile Equipment (SIM - ME) interface".

3 Definitions, conventions, and applicability

For abbreviations and acronyms, see GSM 01.04.

3.1 Mobile station definition and configurations

In the present document, a MS can be:

- a vehicle mounted station;
- a portable station;
- a handheld station;
- a vehicle mounted/portable station;
- a vehicle mounted/handheld station.

For a more detailed description of MS-configurations, see GSM 02.06.

3.2 Applicability

The present document is applicable to all MSs.

4 Activation and deactivation of special test functions in the MS

The functions described in the present document can be activated and deactivated from a SS by sending appropriate layer 3 commands to the MS. The protocol discriminator to be used is defined in GSM 04.08, clause 10.2.

The layer 3 commands are sent on the DCCH. On layer 2, SAPI 0 is used in acknowledged mode.

Apart from sending the appropriate deactivation command to the MS the functions can be deactivated by switching off the MS or removing the test SIM.

The following test functions can be activated (and deactivated):

- TCH Loop;
- TCH Burst-by-Burst Loop;
- Multi-slot Loop;
- Electrical MMI;
- Test via DAI.

The TCH loops and the test via DAI are test functions which are mutually exclusive.

5 Internal test loops

A number of internal test loops are required providing access to isolated functions of the MS without introducing new physical interfaces just for the reason of type approval testing. Fig 5-1 shows a functional block diagram of a reference MS containing the different test loops.

NOTE: It should be emphasized that these test loops only describe the functional behaviour of the MS with respect to its external interfaces; physical implementation of the loops is completely left open to the manufacturer.

A particular loop is activated in an MS by transmitting the appropriate command message to the MS.

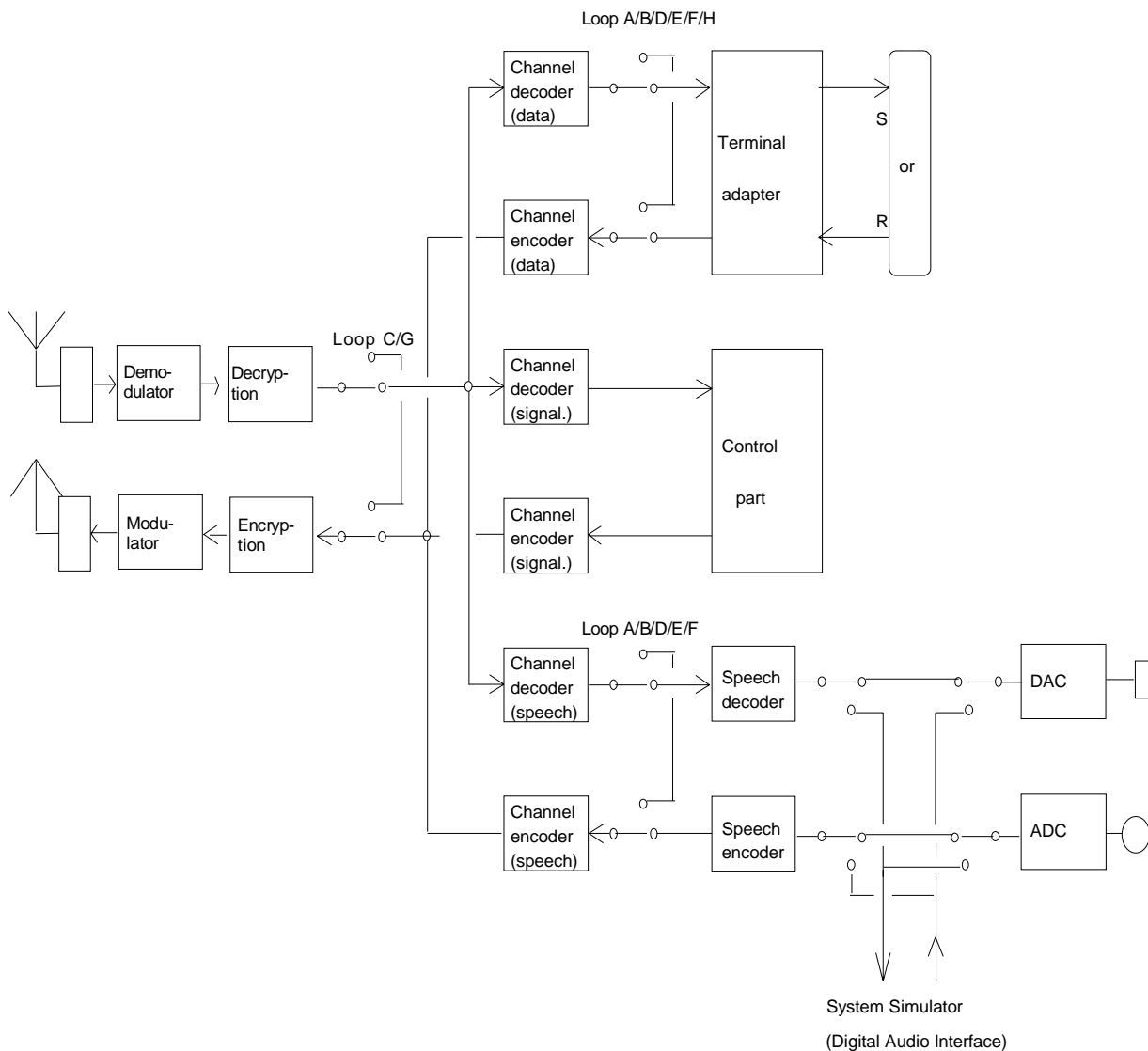

NOTE: In the case of loops A and B, when a TCH/EFS is used, the MS loops back 244 bits instead of 260 bits, see clauses 5.1.2.1 and 5.1.3.1.

Figure 1: Test loops in the MS

5.1 Single-slot TCH loops

5.1.1 Purpose of Single-slot TCH loops

To establish a transparent loop for TCH blocks a TCH must be active between the SS and MS. The TCH may be full or half rate, speech or data of any rate specified in the GSM system.

Six types of Single-slot TCH loop back are defined.

The first (A) includes the signalling of erased frames and is used to determine Frame Erasure Ratio (FER) and Residual Bit Error Ratio (RBER) for speech TCH and Bit Error Ratio (BER) for any data TCH.

The second type (B) is required to determine Class II bit error ratio for the speech TCH.

With the third loop (C) the 114 information bits of each TCH burst (excluding stealing flags) prior to applying benefit of the channel decoder, but after decryption, shall be transmitted in an uplink burst. (Equivalent error rate to TCH/FS Class II). All that is received shall be re-transmitted regardless of the state of the received midamble. The midamble in the uplink bursts shall be the normal midamble used by the MS. SACCH and idle bursts are not looped back.

The fourth loop (D) includes the signalling of erased frames and unreliable frames and is used to determine Unreliable Frame Ratio (UFR) and Residual Bit Error Ratio (RBER) for TCH/HS.

The fifth loop (E) includes the signalling of erased SID frames and is used to determine Erased SID Frame Rate (ESIDR) and Residual Bit Error Ratio (RBER) for TCH/HS.

The sixth loop (F) includes the signalling of erased valid SID frames and is used to determine Erased Valid SID Frame Rate (EVSIDR) and Residual Bit Error Ratio (RBER) for TCH/HS.

NOTE: Measurement of TCH/FS chip BER is approximately five times faster using loop C rather than loop B.

5.1.2 TCH loop including signalling of erased frames (A)

5.1.2.1 Procedure

The SS orders the MS to close its TCH loop by transmitting a CLOSE_TCH_LOOP_CMD message, specifying the TCH to be looped and that erased frames are to be signalled by the MS. The SS then starts timer TT01.

If no TCH is active, or any test loop is already closed, the MS shall ignore any CLOSE_TCH_LOOP_CMD message.

If a TCH is active, the MS shall close its TCH loop for the TCH specified and send back to the SS a CLOSE_TCH_LOOP_ACK message. Upon reception of that message the SS stops timer TT01.

After the MS has closed its TCH loop, every good speech frame or any user data frame received by the MS on the specified TCH (downlink) shall be taken from the output of the channel decoder, input to the channel encoder and transmitted on the same TCH (uplink).

In the case where TCH is TCH/FS or TCH/HS, the MS shall loop back the 260 bits after normal channel decoding.

In the case where TCH is TCH/EFS, the MS shall loop back the 244 bits after normal and preliminary channel decoding.

If the channel decoder detects a bad speech frame, then this shall be signalled to the SS by setting the input frame to the channel encoder to zero's, and transmitting on the TCH (uplink).

If the MS decodes stealing flags as indicating an FACCH frame, then there is no defined response for the MS to the channel encoder for transmission on the TCH (uplink). The FACCH channel shall operate as normal.

5.1.3 Speech TCH loop without signalling of erased frames (B)

5.1.3.1 Procedure

The SS orders the MS to close its TCH loop by transmitting a CLOSE_TCH_LOOP_CMD message, specifying the TCH to be looped. The SS then starts timer TT01.

If no TCH is active or any test loop is already closed, the MS shall ignore any CLOSE_TCH_LOOP_CMD message.

If a TCH is active, the MS shall close its TCH loop for the TCH specified and send back to the SS a CLOSE_TCH_LOOP_ACK. Upon reception of that message the SS stops timer TT01.

After the MS has closed its TCH loop, any speech frame received by the MS on the specified TCH (downlink) shall be taken from the output of the channel decoder, input to the channel encoder, and transmitted on the same TCH (uplink).

In the case where TCH is TCH/FS or TCH/HS, the MS shall loop back the 260 bits after normal channel decoding.

In the case where TCH is TCH/EFS, the MS shall loop back the 244 bits after normal and preliminary channel decoding.

The SS should avoid using the FACCH downlink in this situation until the test is complete.

5.1.4 TCH burst-by-burst loop (C)

5.1.4.1 Applicability

The test loop shall be implemented by all ME, supporting any TCH.

5.1.4.2 Procedure

Establishment and clearing of the loop is performed at ideal radio conditions.

5.1.4.3 Establishment

- The establishment shall be commanded by transmitting a CLOSE_TCH_LOOP_CMD message. The SS then starts timer TT01. This command shall be acknowledged by the MS with a CLOSE_TCH_LOOP_ACK message. Upon receipt of that message the SS stops timer TT01. The MS shall establish the loop within one reporting period [SACCH-block = 104 frames] from the sending of the CLOSE_TCH_LOOP_ACK.
- If no TCH is active or any test loop is already closed, the MS shall ignore any CLOSE_TCH_LOOP_CMD message.

5.1.4.4 Operation

- The round trip delay (RTD), which is the number of TCH frames between the reception of one burst at the MS, and the transmission of the same burst (on the uplink) shall be less than 26 TDMA frames. The actual value shall be declared for the implementation to be tested.

NOTE 1: The RTD can be as long as required to receive the number of interleaved burst for the relevant TCH.

NOTE 2: Example of RTD = 5

| | | | | | | | | | | | | | | | | | | |
|----------------|----|----|----|----|-----|----|----|----|----|-----|-----|-----|----|-----|----|-----|-----|-----|
| TDMA Frame No. | 1 | 2 | 3 | 4 | 5 | 6 | 7 | 8 | 9 | 10 | 11 | 12 | 13 | 14 | 15 | 16 | 17 | 18 |
| Downlink | T1 | T2 | T3 | T4 | T5 | T6 | T7 | T8 | T9 | T10 | T11 | T12 | Sd | ... | | | | |
| Uplink | | | | | ... | T1 | T2 | T3 | T4 | T5 | T6 | T7 | Su | T8 | T9 | T10 | T11 | T12 |

Sd = Downlink SACCH frame, Su = Uplink SACCH frame, Tn = TCH frame

Note from the above that TCH frames looped back prior to the uplink SACCH (or Idle) frame are delayed on the air interface by 5 TDMA frames, but the TCN frames following the SACCH frame are delayed by 6 TDMA frames. The RTD is therefore not to be confused with the TDMA frame delay for a TCH burst, which varies depending on whether the TCH burst is before or after the uplink SACCH frame. The reason for the variable TDMA time delay is to preserve the uplink SACCH frame position in the multi-frame. Note also that the uplink SACCH data is not a looped back version of the downlink SACCH data.

5.1.5 TCH loop including signalling of erased frames and unreliable frames (D)

5.1.5.1 Procedure

The SS orders the MS to close its TCH loop by transmitting a CLOSE_TCH_LOOP_CMD message, specifying the TCH to be looped and that erased frames and unreliable frames are to be signalled by the MS. The SS then starts timer TT01.

If no TCH is active, or any test loop is already closed, the MS shall ignore any CLOSE_TCH_LOOP_CMD message.

If a TCH is active, the MS shall close its TCH loop for the TCH specified and send back to the SS a CLOSE_TCH_LOOP_ACK. Upon reception of that message the SS stops timer TT01.

After the MS has closed its TCH loop, every reliable speech frame (UFI = 0) received by the MS on the specified TCH/HS (downlink) shall be taken from the output of the channel decoder, input to the channel encoder and transmitted on the same TCH (uplink).

If the channel decoder detects a bad speech frame or an unreliable frame (BFI = 1 or UFI = 1) or if the MS decodes the stealing flags as indicating an FACCH frame, then this shall be signalled to the SS by setting the input frame to the channel encoder to zero's, and transmitting on the TCH/HS (uplink). The FACCH channel shall operate normally.

5.1.6 TCH loop including signalling of erased SID frames (E)

5.1.6.1 Procedure

The SS orders the MS to close its TCH loop by transmitting a CLOSE_TCH_LOOP_CMD message, specifying the TCH to be looped and that erased SID frames are to be signalled by the MS. The SS then starts timer TT01.

If no TCH is active, or any test loop is already closed, the MS shall ignore any CLOSE_TCH_LOOP_CMD message.

If a TCH is active, the MS shall close its TCH loop for the TCH specified and send back to the SS a CLOSE_TCH_LOOP_ACK. Upon reception of that message the SS stops timer TT01.

After the MS has closed its TCH loop, every valid SID frame (SID = 2) or invalid SID frame (SID = 1) received by the MS on the specified TCH/HS (downlink), shall be taken from the output of the channel decoder, input to the channel encoder and transmitted on the same TCH/HS (uplink).

If the channel decoder detects an erased SID frame (SID = 0), then this shall be signalled to the SS, by setting the input frame to the channel encoder to zero's, and transmitting on the TCH/HS (uplink).

If the MS decodes the stealing flags as indicating an FACCH frame, then this shall be signalled to the SS by setting the input frame to the channel encoder to zero's, and transmitting on the TCH/HS (uplink). The FACCH channel shall operate normally.

5.1.7 TCH loop including signalling of erased valid SID frames (F)

5.1.7.1 Procedure

The SS orders the MS to close its TCH loop by transmitting a CLOSE_TCH_LOOP_CMD message, specifying the TCH to be looped and that erased valid SID frames are to be signalled by the MS. The SS then starts timer TT01.

If no TCH is active, or any test loop is already closed, the MS shall ignore any CLOSE_TCH_LOOP_CMD message.

If a TCH is active, the MS shall close its TCH loop for the TCH specified and send back to the SS a CLOSE_TCH_LOOP_ACK. Upon reception of that message the SS stops timer TT01.

After the MS has closed its TCH loop, every valid SID frame (SID = 2 and BFI = 0) received by the MS on the specified TCH/HS (downlink), shall be taken from the output of the channel decoder, input to the channel encoder and transmitted on the same TCH/HS (uplink).

If the channel decoder detects an erased valid SID frame (SID = 1) or (SID = 0) or ((BFI or UFI) = 1)), then this shall be signalled to the SS by setting the input frame to the channel encoder to zero's, and transmitting on the TCH/HS (uplink).

If the MS decodes the stealing flags as indicating an FACCH frame, then this shall be signalled to the SS by setting the input frame to the channel encoder to zero's, and transmitting on the TCH/HS (uplink). The FACCH channel shall operate normally.

5.1.8 Additional non-mandatory operating characteristics for single-slot loops

In order to optimise the speed and flexibility of mobile manufacturing and repair, the following non-mandatory characteristics of the test loops are suggested:

- The normal FACCH downlink and uplink functions should ideally be maintained when the test loop is closed. In particular, channel assignments or handovers, and call termination from either the mobile or the base station simulator.
- Following an assignment or handover, the loop should not open if it was closed prior to the handover.
- Following call dropping or deliberate call termination, the loop should be re-opened.
- The loopback functions should ideally operate with or without (i.e. no SIM) the test SIM present, but should not operate with a network SIM present.
- Audio muting should be enabled when the loop is closed.

5.2 Multi-slot TCH loops

5.2.1 Purpose of Multi-slot TCH loops

To establish a transparent loop for TCH blocks, from multiple slots, a TCH must be active between the SS and MS.

Two types of Multi-slot TCH loop back are defined.

With the first loop (G) the 114 information bits of each multi-slot TCH burst (excluding stealing flags) prior to applying benefit of the channel decoder, but after decryption (see Figure 1), shall be transmitted in an uplink burst. (Equivalent error rate to TCH/FS Class II). All that is received shall be re-transmitted regardless of the state of the received midamble. The midamble in the uplink bursts shall be the normal midamble used by the MS. SACCH and idle bursts are not looped back.

The second loop (H) includes the signalling of erased frames and is used to determine Frame Erasure Ratio (FER), Residual Bit Error Ratio (RBER) and Bit Error Ratio (BER) for any multi-slot configuration TCH.

Each of the two loops shall support the following mechanisms:

The first (Multi-slot mechanism 1) is used to loop the TCH data of slot X of the downlink onto the TCH of the main uplink slot (for HSCSD). This mechanism is needed to cover the case where there are more downlink slots than uplink slots.

The second (Multi-slot mechanism 2) is used to loop as many downlink slots as possible to the corresponding uplink slots, based on the following rules for HSCSD:

Loop back all bi-directional timeslots, and leave the unidirectional slots not looped back. This maintains the logical association with bi-directional timeslots.

It should be further noted:

The order of the data on the downlink shall be preserved on the uplink.

The OPEN_Multi-slot_LOOP_CMD message shall open all Multi-slot loops.

Assignment to a new multi-slot configuration shall be preceded by an OPEN_Multi-slot_LOOP_CMD message to open all loops.

It is the responsibility of the System Simulator (SS) to ensure that the correct configuration is enabled for the test. Test loops will be opened by the receipt of a OPEN_Multi-slot_LOOP_CMD or by disconnecting the call. Other behaviour, such as receiving a new TxLev or a channel assignment or handover to a new ARFCN will not affect the test loops. The SS should ensure that a new multislot configuration affecting an existing test loop is not included within channel assignment, handover or configuration change commands.

If the Multi-slot mechanism 1 is used and a downlink slot that is not part of the current multi-slot configuration is specified, the MS shall ignore the command and send a negative acknowledgment. The loopback state should not change.

Once a loop is closed, a further loopback command shall over-ride a previous command - multiple CLOSE_Multi-slot_LOOP_CMD messages are not additive.

Call disconnect for whatever reason shall open all loops. No OPEN_Multi-slot_LOOP_ACK message shall be sent.

The multi-slot loopback is restricted to the TCH logical channel only. The downlink and uplink FACCH and SACCH should work as if loopback did not exist.

The Multi-slot TCH loops are in **addition** to any Single-slot TCH loops already specified for the type of MS.

Support of the Multi-slot loops is mandatory for any MS supporting HSCSD.

Any MS supporting the Multi-Slot loops shall activate the functions defined in this clause of the specification regardless of the presence or not of a test SIM.

5.2.2 Multi-slot TCH burst-by-burst loop (G)

5.2.2.1 Procedure

The establishment shall be commanded by transmitting a CLOSE_Multi-slot_LOOP_CMD message. The SS then starts timer TT01. This command shall be acknowledged by the MS with a CLOSE_Multi-slot_LOOP_ACK message. Upon receipt of that message the SS stops timer TT01. The MS shall establish the loop within one reporting period [SACCH-block = 104 frames] from the sending of the CLOSE_Multi-slot_LOOP_ACK.

If no TCH is active or any test loop is already closed, the MS shall ignore any CLOSE_Multi-slot_LOOP_CMD message

RTD is as the same as clause 5.1.4.4.

5.2.3 Multi-slot TCH loop including signalling of erased frames (H)

5.2.3.1 Procedure

The SS orders the MS to close its Multi-slot TCH loop by transmitting a CLOSE_Multi-slot_LOOP_CMD message, specifying the TCH to be looped and that erased frames are to be signalled by the MS. The SS then starts timer TT01.

If no TCH is active, or any test loop is already closed, the MS shall ignore any CLOSE_Multi-slot_LOOP_CMD message.

If a TCH is active, the MS shall close its TCH loop for the TCH specified and send back to the SS a CLOSE_Multi-slot_LOOP_ACK message. Upon reception of that message the SS stops timer TT01.

After the MS has closed its TCH loop, every good speech frame or any user data frame received by the MS on the specified TCH (downlink) shall be taken from the output of the channel decoder, input to the channel encoder and transmitted on the same TCH (uplink).

If the channel decoder detects a bad speech frame, then this shall be signalled to the SS by setting the input frame to the channel encoder to zero's, and transmitting on the TCH (uplink).

If the MS decodes stealing flags as indicating an FACCH frame, then there is no defined response for the MS to the channel encoder for transmission on the TCH (uplink). The FACCH channel shall operate as normal.

5.3 Deactivating loops

5.3.1 Deactivating Single-slot TCH loops

The SS orders the MS to open any Single-slot TCH loop by transmitting an OPEN_LOOP_CMD message.

If no loop is closed the MS shall ignore any OPEN_LOOP_CMD message.

If a Single-slot TCH is looped, the MS shall open the loop.

If the loop opened was type C, the MS shall send an OPEN_LOOP_CMD message to the SS with bit 0 of the optional acknowledgement element set to 1.

All channels shall be open for normal use again.

5.3.2 Deactivating Multi-slot TCH loops

The SS orders the MS to open any Multi-slot TCH loop by transmitting an OPEN_Multi-slot_LOOP_CMD message.

If no loop is closed the MS shall ignore any OPEN_Multi-slot_LOOP_CMD message.

If a Multi-slot TCH is looped, the MS shall open the loop and send a OPEN_Multi-slot_LOOP_ACK message to the SS.

All channels shall be open for normal use again.

5.4 Multi-slot test mode for GPRS

5.4.1 Initiation

5.4.1.1 MS Declaration

The manufacturer shall declare the MS test mode capability before test mode initiation. The possible declarations are as follows:

- a) MS is capable of transmitting a pseudo-random data sequence in RLC data blocks
- b) MS is capable of transmitting looped-back RLC data blocks
- c) MS is capable of both a) and b).

The specifics of test mode initiation and operation depend on what capability the MS has declared.

5.4.1.2 Establishment of uplink TBF

The MS is assumed to be GPRS attached, in packet idle mode.

The SS establishes a downlink TBF on one timeslot, according to normal procedures as defined in 04.60.

The SS orders the MS into GPRS test mode by transmitting a GPRS_TEST_MODE_CMD (Layer 3 message, SAPI 1) with parameter PDU Description set to define the number of PDUs and number of octets within the PDUs that the MS is to transmit in the uplink during the test. The SS then starts timer TT02.

If the MS has declared c) capability in clause 5.4.1.1, then the M bit in the GPRS_TEST_MODE_CMD message shall determine whether the MS operates the test mode in mode a) or mode b).

This commands the MS to request the establishment of an uplink TBF in RLC unacknowledged mode, according to normal procedures as defined in 04.60. Upon receipt of the MS request for uplink resources, the SS stops timer TT02 and proceeds with the establishment of the uplink TBF, by assigning a Dynamic Allocation uplink TBF. If the MS is operating in mode a), the SS releases the downlink TBF according to normal procedures as defined in 04.60. If the MS is operating in mode b), the downlink TBF continues throughout test mode operation.

The SS shall not send a new GPRS_TEST_MODE_CMD to the MS unless the currently activated multi-slot test mode for GPRS is terminated.

When the MS has activated the multi-slot test mode for GPRS, the received RLC data blocks (on the MS side) shall not be passed to LLC.

5.4.2 Operation

5.4.2.1 MS Operating in mode a)

The SS sets the USF field in blocks transmitted on the downlink to address the MS. The MS shall transmit RLC data blocks obeying USF, according to the normal rules for transmission, as defined in 04.60.

For the uplink the data payload of the RLC data blocks shall contain a pseudorandom data sequence, as specified in clause 5.4.4. The blocks shall have valid MAC headers and may have valid RLC headers. The blocks shall be processed by Layer 1 in the normal manner.

Where multiple transmit timeslots are active, the same data as is carried in the RLC data block in the first timeslot may be used in RLC data blocks carried in subsequent time-slots. The blocks shall have valid MAC headers and may have valid RLC headers. The blocks shall be processed by Layer 1 in the normal manner.

5.4.2.2 MS Operating in mode b)

The SS shall transmit RLC data blocks on the downlink TBF containing a pseudorandom data sequence in the data payload of the block, as specified in clause 5.4.4. The blocks shall have valid MAC and RLC headers. The SS shall apply the same channel coding scheme on the downlink data blocks as the commanded coding scheme on the uplink. The blocks shall be processed by Layer 1 in the normal manner.

The SS sets the USF field in blocks transmitted on the downlink to address the MS. The MS shall transmit RLC data blocks obeying USF, according to the normal rules for transmission, as defined in 04.60.

For the uplink, the data payload of the RLC data blocks shall contain the data payload of the RLC data blocks transmitted on the downlink TBF. The blocks shall have valid MAC headers and may have valid RLC headers. The countdown procedure shall not be used for the uplink RLC data blocks (CV=15).

When RLC/MAC control blocks are received on the downlink, the MS may repeat on the uplink the pseudorandom sequence carried in the previous uplink RLC data blocks.

When RLC/MAC control blocks are sent on the uplink, the MS may discard the pseudorandom sequence that would otherwise have been transmitted at that time.

Where multiple transmit timeslots are active, and only one downlink timeslot is active, the same data as is carried in the RLC data block in the first timeslot may be used in RLC data blocks carried in subsequent time-slots. The blocks shall have valid MAC headers and may have valid RLC headers. The blocks shall be processed by Layer 1 in the normal manner.

5.4.2.3 Operational constraints applying to both modes

During test mode operation, the MS shall continue to receive RLC/MAC control blocks sent on the downlink, and shall respond normally.

5.4.3 Termination

Termination of the test mode occurs for test mode operating in mode a), either when the requested number of PDUs have been transmitted on the uplink TBF, or when the SS initiates TBF release. For test mode operating in mode b), termination of test mode occurs when the SS terminates the downlink TBF, or when the SS initiates PDCH release for the uplink TBF.

5.4.4 PN Sequence Definition

The data to be inserted into the data part of the RLC/MAC data blocks is generated using any binary pseudorandom sequence generator with a cycle of 32,767 bits or greater (for example CCITT defined PN15, PN22 etc.).

Example test patterns may be found in CCITT recommendation O.153 Fascicle IV.4, (Basic parameters for the measurement of error performance at bit rates below the primary rate, Melbourne 1988) clause 2.1.

5.4.5 Optional Multi-slot operation

To facilitate production tests and for other purposes, the MS may optionally implement the following extension to this test mode.

If the downlink TBF is established on more than one timeslot, the MS shall transmit in the second uplink timeslot (if present) RLC/MAC blocks received on the second downlink timeslot, and shall transmit in the third uplink timeslot (if present) RLC/MAC blocks received in the third downlink timeslot and so on.

If more transmit timeslots are present than receive timeslots, then the contents of uplink timeslots that do not map to downlink timeslots shall be the same as in the last timeslot that maps to downlink.

However, if the downlink TBF contains only a single timeslot the MS must fill all uplink timeslots as defined in clause 5.4.2.

In this description, downlink timeslots are counted from the "Downlink Timeslot Offset" in the mode flag of the GPRS_TEST_MODE_CMD. For example, if the "Downlink Timeslot Offset" is set to 3, TN3 shall be treated as the first downlink timeslot if a TBF is established in TN3. If TN3 does not support a TBF, the first active timeslot after TN3 shall be treated as the first downlink timeslot. The counting sequence is continuous through TN7 and TN0.

Uplink timeslots are always counted from TN0.

6 Activating and deactivating EMMI

Activating EMMI requires the presence of a test SIM. EMMI shall be activated by any of the following:

- switching on the MS;
- inserting a test SIM;
- layer 3 message on the radio interface (ACT_EMMI_CMD).

When the MS is ready to receive frames, it shall send one XON message.

EMMI shall be deactivated by any of the following:

- switching off the MS;
- removing the test SIM;
- layer 3 message on the radio interface (DEACT_EMMI).

NOTE: No XOF shall be sent after deactivation.

The L3 message used on the radio interface to activate the EMMI is the activation command ACT_EMMI_CMD (see clause 8.4). This message has to be acknowledged by the message ACT_EMMI_ACK on the radio interface sent by the MS (see clause 8.5).

For deactivation of the EMMI in the MS through the radio interface, the message DEACT_EMMI is defined in clause 8.6. An acknowledgement of this message is not required.

7 Activating and deactivating DAI tests

Purpose: to determine the routing of speech data (DAI or internal, i.e. normal mode) and which device is being tested (speech transcoder / DTX functions or A/D & D/A).

Prerequisites: a dedicated channel must be established if the manufacturer has stated that the DAI is activated by means of the layer 3 message.

Procedure: the SS sends a TEST_INTERFACE message if the manufacturer has stated that the DAI is activated by means of the layer 3 message or applies the appropriate control signal on the DAI if the manufacturer has declared that the DAI is activated this way.

When the test mode is established i.e. speech data comes from test interface, each new test function overrides the previous one.

8 Message definitions and contents

NOTE 1: A message received with skip indicator different from 0 will be ignored.

NOTE 2: For definition of "Presence" and "Format", see GSM 04.07 clauses 11.4 and 11.1.1.

8.1 CLOSE_TCH_LOOP_CMD

This message is only sent in the direction SS to MS.

| Information Element | Reference | Presence | Format | Length |
|------------------------|------------------------|----------|--------|--------|
| Protocol discriminator | GSM 04.07 sect. 11.2.1 | M | V | ½ |
| Skip indicator | GSM 04.07 sect. 11.2.2 | M | V | ½ |
| Message type | | M | V | 1 |
| Sub-channel | | M | V | 1 |

where message type is:

| 8 | 7 | 6 | 5 | 4 | 3 | 2 | 1 | bit no. |
|---|---|---|---|---|---|---|---|---------|
| 0 | 0 | 0 | 0 | 0 | 0 | 0 | 0 | octet 1 |

and Sub-channel is:

| 8 | 7 | 6 | 5 | 4 | 3 | 2 | 1 | bit no. |
|------------|------------|------------|---|---|---|---|---|---------|
| 0 spare | 0 spare | 0 spare | B | A | Z | Y | X | octet 1 |

X = 0 If there is only one TCH active (so there is no choice) or if sub-channel 0 of two half rate channels is to be looped.

X = 1 If sub-channel 1 of two half rate channels is to be used.

Y = 0 If the looped TCH is a speech channel then the frame erasure is to be signalled, type A.

Y = 1 If the looped TCH is a speech channel then frame erasure is not signalled, type B.

Z = 0 The type of the loop is determined by the value Y.

Z = 1 The Burst-by-Burst loop is activated, type C. The value of Y is disregarded.

A = 0 and B = 0 The loop is determined by the values Z, Y and X.

A = 1 and B = 0 If the looped TCH is a half rate speech channel then frame erasure and unreliable frames have to be signalled, type D. The values of Y and Z are disregarded.

A = 0 and B = 1 If the looped TCH is a half rate channel sending SID frames then SID frame erasure is to be signalled, type E. The values of Y and Z are disregarded.

A = 1 and B = 1 If the looped TCH is a half rate channel sending SID frames then valid SID frame erasure is to be signalled, type F. The values of Y and Z are disregarded.

8.2 CLOSE_TCH_LOOP_ACK

This message is only sent in the direction MS to SS.

| Information Element | Reference | Presence | Format | Length |
|------------------------|------------------------|----------|--------|--------|
| Protocol discriminator | GSM 04.07 sect. 11.2.1 | M | V | ½ |
| Skip indicator | GSM 04.07 sect. 11.2.2 | M | V | ½ |
| Message type | | M | V | 1 |

where message type is:

| | | | | | | | | |
|----------|----------|----------|----------|----------|----------|----------|----------|---------------------------|
| 8 | 7 | 6 | 5 | 4 | 3 | 2 | 1 | bit no. Octet 1 |
| 0 | 0 | 0 | 0 | 0 | 0 | 0 | 1 | |

8.3 OPEN_LOOP_CMD

This message is only sent in the direction SS to MS

| Information Element | Reference | Presence | Format | Length |
|------------------------|------------------------|----------|--------|--------|
| Protocol discriminator | GSM 04.07 sect. 11.2.1 | M | V | ½ |
| Skip indicator | GSM 04.07 sect. 11.2.2 | M | V | ½ |
| Message type | | M | V | 1 |
| Acknowledge | | O | TV | 1 |

where message type is:

| | | | | | | | | |
|----------|----------|----------|----------|----------|----------|----------|----------|---------------------------|
| 8 | 7 | 6 | 5 | 4 | 3 | 2 | 1 | Bit no. Octet 1 |
| 0 | 0 | 0 | 0 | 0 | 1 | 1 | 0 | |

where Acknowledge Information Element Identifier is:

| | | | | | | | | |
|----------|----------|----------|----------|----------|----------|----------|----------|---------------------------|
| 8 | 7 | 6 | 5 | 4 | 3 | 2 | 1 | Bit no. Octet 1 |
| 1 | 0 | 0 | 0 | | | | | |

and the Acknowledge Information Element contents are:

| | | | | |
|------------|------------|------------|----------|---------------------------|
| 4 | 3 | 2 | 1 | Bit no. Octet 1 |
| 0 spare | 0 spare | 0 spare | 1 | |

8.4 CLOSE_Multi-slot_LOOP_CMD

This message is only sent in the direction SS to MS.

| Information Element | Reference | Presence | Format | Length |
|------------------------|------------------------|----------|--------|--------|
| Protocol discriminator | GSM 04.07 sect. 11.2.1 | M | V | ½ |
| Skip indicator | GSM 04.07 sect. 11.2.2 | M | V | ½ |
| Message type | | M | V | 1 |
| Loop type | | M | V | 1 |

where message type is:

| | | | | | | | | |
|----------|----------|----------|----------|----------|----------|----------|----------|---------------------------|
| 8 | 7 | 6 | 5 | 4 | 3 | 2 | 1 | bit no. octet 1 |
| 0 | 0 | 1 | 0 | 0 | 0 | 0 | 0 | |

and Loop type is:

| | | | | | | | | |
|----------|----------|----------|----------------|----------|----------|----------|----------|---------------------------|
| 8 | 7 | 6 | 5 | 4 | 3 | 2 | 1 | bit no. octet 1 |
| TN | | | Loop mechanism | | | CHC | | |

CHC, Channel coding

00 = channel coding not needed. The Burst-by-Burst loop is activated, type G

01 = channel coding needed. Frame error is to be signalled, type H

All other values reserved

Loop mechanism

000 = Multi-slot mechanism 1

001 = Multi-slot mechanism 2

All other values reserved

TN, Timeslot number

Timeslot number used only if Loop mechanism indicates Multi-slot mechanism 1

The TN field is coded as the binary representation of the timeslot number as defined in GSM 05.10.

Range: 0 to 7

8.5 CLOSE_Multi-slot_LOOP_ACK

This message is only sent in the direction MS to SS.

| Information Element | Reference | Presence | Format | Length |
|------------------------|------------------------|----------|--------|--------|
| Protocol discriminator | GSM 04.07 sect. 11.2.1 | M | V | 1/2 |
| Skip indicator | GSM 04.07 sect. 11.2.2 | M | V | 1/2 |
| Message type | | M | V | 1 |
| Result | | M | V | 1 |

where message type is:

| | | | | | | | | |
|----------|----------|----------|----------|----------|----------|----------|----------|----------------|
| 8 | 7 | 6 | 5 | 4 | 3 | 2 | 1 | bit no. |
| 0 | 0 | 1 | 0 | 0 | 0 | 0 | 1 | Octet 1 |

and Result is:

| | | | | | | | | |
|------------|------------|----------|----------|----------------|----------|-----------|----------|----------------|
| 8 | 7 | 6 | 5 | 4 | 3 | 2 | 1 | bit no. |
| 0 spare | 0 spare | CHC | | Loop mechanism | | Error Ind | | octet 1 |

CHC, Channel coding

00 = channel coding not needed. The Burst-by-Burst loop is activated, type G

01 = channel coding needed. Frame error is to be signalled, type H

All other values reserved

Loop mechanism

000 = Multi-slot mechanism 1

001 = Multi-slot mechanism 2

All other values reserved

Error Ind, Error indication

0 = Multi-slot TCH loop was closed successfully

1 = Multi-slot TCH loop was not closed due to error

8.6 OPEN_Multi-slot_LOOP_CMD

This message is only sent in the direction SS to MS.

| Information Element | Reference | Presence | Format | Length |
|------------------------|------------------------|----------|--------|--------|
| Protocol discriminator | GSM 04.07 sect. 11.2.1 | M | V | ½ |
| Skip indicator | GSM 04.07 sect. 11.2.2 | M | V | ½ |
| Message type | | M | V | 1 |

where message type is:

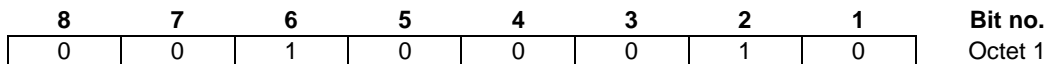

8.7 OPEN_Multi-slot_LOOP_ACK

This message is only sent in the direction MS to SS

| Information Element | Reference | Presence | Format | Length |
|------------------------|------------------------|----------|--------|--------|
| Protocol discriminator | GSM 04.07 sect. 11.2.1 | M | V | ½ |
| Skip indicator | GSM 04.07 sect. 11.2.2 | M | V | ½ |
| Message type | | M | V | 1 |

where message type is:

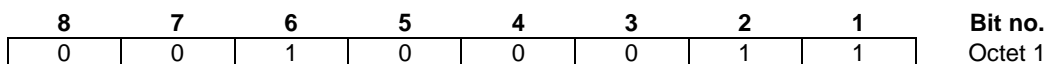

8.8 Command for the activation of the EMMI, ACT_EMMI_CMD

This message is only sent in the direction SS to MS.

| Information Element | Reference | Presence | Format | Length |
|------------------------|------------------------|----------|--------|--------|
| Protocol discriminator | GSM 04.07 sect. 11.2.1 | M | V | ½ |
| Skip indicator | GSM 04.07 sect. 11.2.2 | M | V | ½ |
| Message type | | M | V | 1 |

where message type is:

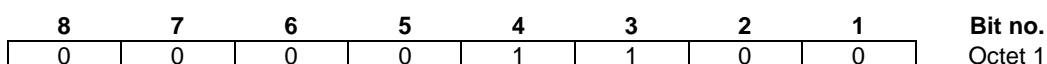

8.9 Acknowledge of the activation of the EMMI, ACT_EMMI_ACK

This message is only sent in the direction MS to SS.

| Information Element | Reference | Presence | Format | Length |
|------------------------|------------------------|----------|--------|--------|
| Protocol discriminator | GSM 04.07 sect. 11.2.1 | M | V | 1/2 |
| Skip indicator | GSM 04.07 sect. 11.2.2 | M | V | 1/2 |
| Message type | | M | V | 1 |

where message type is:

| | | | | | | | | |
|---|---|---|---|---|---|---|---|---------------------------|
| 8 | 7 | 6 | 5 | 4 | 3 | 2 | 1 | Bit no. Octet 1 |
| 0 | 0 | 0 | 0 | 1 | 1 | 0 | 1 | |

8.10 Deactivation of the EMMI, DEACT_EMMI

This message is only sent in the direction SS to MS.

| Information Element | Reference | Presence | Format | Length |
|------------------------|------------------------|----------|--------|--------|
| Protocol discriminator | GSM 04.07 sect. 11.2.1 | M | V | 1/2 |
| Skip indicator | GSM 04.07 sect. 11.2.2 | M | V | 1/2 |
| Message type | | M | V | 1 |

where message type is:

| | | | | | | | | |
|---|---|---|---|---|---|---|---|---------------------------|
| 8 | 7 | 6 | 5 | 4 | 3 | 2 | 1 | Bit no. Octet 1 |
| 0 | 0 | 0 | 1 | 0 | 0 | 0 | 0 | |

8.11 Test_Interface

This message is only sent in the direction SS to MS.

| Information Element | Reference | Presence | Format | Length |
|------------------------|------------------------|----------|--------|--------|
| Protocol discriminator | GSM 04.07 sect. 11.2.1 | M | V | 1/2 |
| Skip indicator | GSM 04.07 sect. 11.2.2 | M | V | 1/2 |
| Message type | | M | V | 1 |
| Tested device | | M | V | 1 |

where message type is:

| | | | | | | | | |
|---|---|---|---|---|---|---|---|---------------------------|
| 8 | 7 | 6 | 5 | 4 | 3 | 2 | 1 | Bit no. Octet 1 |
| 0 | 0 | 0 | 1 | 0 | 1 | 0 | 0 | |

and Tested device is:

| | | | | | | | | |
|------------|------------|------------|------------|------------|----------------|---|---|---------------------------|
| 8 | 7 | 6 | 5 | 4 | 3 | 2 | 1 | Bit no. Octet 1 |
| 0 spare | 0 spare | 0 spare | 0 spare | 0 spare | Tested devices | | | |

Tested devices:

- 000 = normal operation (no tested device via DAI)
- 001 = test of speech decoder / DTX functions (downlink)
- 010 = test of speech encoder / DTX functions (uplink)
- 100 = test of acoustic devices and A/D & D/A.

All other values are reserved.

8.12 Timer values

TT01: To be started when a CLOSE_TCH_LOOP_CMD or CLOSE_Multi-slot_LOOP_CMD is sent. To be stopped when the corresponding CLOSE_TCH_LOOP_ACK or CLOSE_Multi-slot_LOOP_ACK is received.

Recommended value: [2.5 seconds].

TT02: To be started when a GPRS_TEST_MODE_CMD is sent. To be stopped when the MS requests uplink resources.

Recommended value: [2.5 seconds].

8.13 GPRS_TEST_MODE_CMD

This message is only sent in the direction SS to MS.

| Information Element | Reference | Presence | Format | Length |
|------------------------|------------------------|----------|--------|--------|
| Protocol discriminator | GSM 04.07 sect. 11.2.1 | M | V | 1/2 |
| Skip indicator | GSM 04.07 sect. 11.2.2 | M | V | 1/2 |
| Message type | | M | V | 1 |
| PDU description | | M | V | 2 |
| Mode Flag | | M | V | 1 |

where message type is:

| | | | | | | | | |
|----------|----------|----------|----------|----------|----------|----------|----------|----------------|
| 8 | 7 | 6 | 5 | 4 | 3 | 2 | 1 | bit no. |
| 0 | 0 | 1 | 0 | 0 | 1 | 0 | 0 | Octet 1 |

PDU Description is:

| | | | | | | | | |
|----------|----------|----------|----------|----------|----------|----------|----------|----------------|
| 8 | 7 | 6 | 5 | 4 | 3 | 2 | 1 | bit no. |
| L | 0 | 0 | 0 | d11 | d10 | d9 | d8 | Octet 1 |
| | Spare | Spare | Spare | | | | | |
| d7 | d6 | d5 | d4 | d3 | d2 | d1 | d0 | Octet 2 |

PDU Description only applies if the MS is operating in mode a). The PDU consists of the pseudorandom data sequence only, ie, it shall not contain any header information or FCS field.

L = 1 PDUs of constant length from 140 up to 1560 octets shall be transferred. The maximum length of the PDU is an implementation specific issue and shall be declared for the implementation to be tested. The number of PDUs to be transmitted is expressed by d11 – d0 as a binary representation. Range is 1 to 4095.

| | | | | | | | | | | | | |
|-----|-----|----|----|----|----|----|----|----|----|----|----|------------|
| d11 | d10 | d9 | d8 | d7 | d6 | d5 | d4 | d3 | d2 | d1 | d0 | |
| 0 | 0 | 0 | 0 | 0 | 0 | 0 | 0 | 0 | 0 | 0 | 0 | = See Note |
| 0 | 0 | 0 | 0 | 0 | 0 | 0 | 0 | 0 | 0 | 0 | 1 | = 1 |
| 0 | 0 | 0 | 0 | 0 | 0 | 0 | 0 | 0 | 0 | 1 | 0 | = 2 |
| 0 | 0 | 0 | 0 | 0 | 0 | 0 | 0 | 0 | 0 | 1 | 1 | = 3 |
| ... | | | | | | | | | | | | |
| 1 | 1 | 1 | 1 | 1 | 1 | 1 | 1 | 1 | 1 | 1 | 1 | = 4095 |

NOTE: When the number of PDUs is set to zero, it may optionally be interpreted by the MS as meaning an infinite number of PDUs to be transmitted in the TBF. Infinite duration TBFs are not supported through normal RLC/MAC operation. Therefore, implementation of this feature is left as optional.

L = 0 Reserved

Mode Flag is:

| | | | | | | | | |
|----------|----------|----------|----------|--------------------------|----------|----------|----------|----------------|
| 8 | 7 | 6 | 5 | 4 | 3 | 2 | 1 | bit no. |
| 0 | 0 | 0 | 0 | Downlink Timeslot Offset | | | M | Octet 1 |
| Spare | Spare | Spare | Spare | | | | | |

M = 0 If the MS implements both looping the received data back to the transmitter and internally generating the pseudorandom data, then if this bit is set to '0' the MS shall itself generate the pseudorandom data. Otherwise the MS may ignore this bit.

M = 1 If the MS implements both looping the received data back to the transmitter and internally generating the pseudorandom data, then if this bit is set to '1' the MS shall select the loop back option. Otherwise the MS may ignore this bit.

Downlink Timeslot Offset –field shall be coded as binary representation of the timeslot number as follows:

- 000 = TN0
- 001 = TN1
- 010 = TN2
- 011 = TN3
- 100 = TN4
- 101 = TN5
- 110 = TN6
- 111 = TN7

9 Electrical Man Machine Interface (EMMI)

9.1 Use of the EMMI

Conformity tests of mobile stations are made using the system simulator specified in [Annex 4].

Test signals are sent on the Um interface, and actions of the MS are registered. The Electrical Man Machine Interface (EMMI) is a half duplex communication link between the SS and the MS by which it is possible to automatically register the status, indications and performance of the MS.

It is also possible to simulate actions normally made by the user on the keyboard of the MS.

9.2 Formal aspects

- i) The EMMI is optional for the ME.
- ii) The EMMI is mandatory for the SS.
- iii) If the EMMI is to be used in conformance testing of an MS, it shall be possible to connect the SS to a connector on the MS, or to an adapter connected to the same MS. If an adapter is to be used, it shall be provided by the manufacturer.
- iv) If the MS fulfils the requirements performed with the use of an EMMI, the MS is regarded as having passed that test.
- v) If the MS is rejected in a test performed with EMMI, the test shall be repeated on the same mobile with the device carrying the EMMI to the MS removed. The MS shall be regarded as fulfilling the requirements, if it then passes the test.
- vi) When using the EMMI, the MS does not necessarily conform to the RF requirements. Therefore, tests concerning Rx and Tx parameters on MS with integral antenna and cabinet radiation tests for all types of MS will never be performed with the use of the EMMI.

9.3 Layered structure of the interface

The definition of the EMMI is divided into three different layers. On layer 1 the use of a 25-pole socket with standard electrical characteristics for serial communication is defined. On layer 2, an extremely simple frame oriented protocol is defined. On layer 3, messages for control and verification of functions and indications are defined. Each layer is defined independently of surrounding layers, and is therefore easy to replace.

The EMMI protocol structure takes into account that the SS only sends and receives layer 3 frames when the corresponding step within a test case is to be performed.

9.4 Terminology

| | |
|---------|--|
| EMMI | Electrical Man Machine Interface |
| MI | Message Identifier |
| ME | Mobile Equipment |
| MS | Mobile Station |
| SS | System Simulator |
| Frame | Used on layer 2 to transfer messages to and from layer 3 |
| Message | Information on layer 3 |

9.5 Description of the EMMI

9.5.1 EMMI, Layer 1

9.5.1.1 Mechanical and electrical characteristics

If implemented, the EMMI interface shall use the same connector as the Digital Audio Interface (DAI), described in clause 10.3.

The pin assignments for the EMMI shall be as follows:

| Pin | Function | Source |
|-----|--------------------|--------|
| 2 | Transmitted data | SS |
| 3 | Received data | MS |
| 7 | EMMI signal ground | |

The electrical characteristics of the interface shall be as given in clause 10.3.2.

9.5.1.2 Transmission and reception characteristics

The EMMI uses asynchronous serial data transmission with 1 start bit (S), 8 data bits (D1 to D8), no parity and 1 stop bit (E).

Table 3: Use of start and stop bits

| | | | | | | | | | |
|---|----|----|----|----|----|----|----|----|---|
| S | D1 | D2 | D3 | D4 | D5 | D6 | D7 | D8 | E |
|---|----|----|----|----|----|----|----|----|---|

The conditions on start and stop characters are defined in REC CCITT V.1.

The transmission rates are: 600, 1200, 2400, 4800, 9600 bits per second. The ME shall support at least one of these speeds.

The SS will adapt its rate (manually or by MMI) to this ME rate.

9.5.2 EMMI, layer 2

9.5.2.1 General structure

On layer 2, frames are used to carry data from higher layers. Frames consist of one or several octets. One frame with variable length is used to carry data from higher layers, and four other frames with the length of one character is used to control the flow of frames.

9.5.2.2 Control frames

Special frames have been assigned to control the flow of frames on layer 2. They are only one octet long.

Table 4: Characters for flow control

| Abbr. | Meaning | Dec.value | Bit pattern |
|-------|---------------------|-----------|-------------|
| ACK | Acknowledge | 06 | 0000 0110 |
| NAK | Not Acknowledge | 21 | 0001 0101 |
| XON | Resume sending data | 17 | 0001 0001 |
| XOF | Stop sending data | 19 | 0001 0011 |

9.5.2.3 Frame structure

Two octets, called characters, indicate start and stop of I-frames.

Table 5: Start and stop characters

| Abbr. | Meaning | Dec.value | Bit pattern |
|-------|---------------|-----------|-------------|
| STX | Start of data | 02 | 0000 0010 |
| ETX | End of data | 03 | 0000 0011 |

Information from higher layers are transferred in I-frames with the following structure.

Table 6: Information structure in I-frames

| Field name | No of octet | Value | Start at octet no | Note |
|------------|-------------|-----------------|-------------------|------|
| Start | 1 | Character STX | 1 | - |
| Length | 1 | Length of data | 2 | a1) |
| Data | 0-255 | Content of data | 3 | a2) |
| Check | 1 | Error detection | Length+2 | a3) |
| End | 1 | Character ETX | Length+3 | |

NOTES:

- a1) Length: The total number of data octets in the data field of the frame is calculated. The value shall be in the range of (0..255 decimal). The corresponding binary value is put into the length field.
- a2) Data: Data to and from higher layers are in the form of octets (groups of 8 digital bits).
- a3) Check: Longitudinal checksum is created by exclusive OR on all characters starting with the Start field and ending with the last octet before the Check field. The value, one octet, is mapped into the Check field.

9.5.2.4 Flow of I-frames on layer 2

9.5.2.4.1 Transmission of frames

A multiple frame starts with the first octet being the character STX and stops with the last octet with content ETX. The time between the start bits of two consecutive octets shall not be longer than T22.



The time between two frames is measured from the start bit of the last octet of the nth frame to the start bit of the first octet of the n+1st frame. The time between two consecutive frames shall not be less than T23.

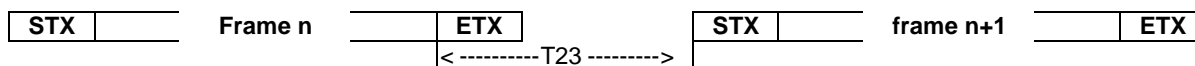

9.5.2.4.2 Reception of frames

Start of a frame is defined as (more than $T22*2$ since previous reception of octet) AND (reception of STX).

End of a frame is defined as (reception of ETX in octet number (length+2)) OR (more than $T22*2$ since last reception of octet).

9.5.2.4.3 Use of ACK and NAK on receiving side

ACK is used by the MS to acknowledge a frame on receiving side if all the following conditions are fulfilled. Otherwise NAK is used.

- 1) The content of Start field is STX.
- 2) The content of Check field corresponds to the exclusive OR sum of previous octets in the frame.
- 3) The content of the last octet is ETX.

NAK is used by the SS to request retransmission of a frame. Otherwise ACK is used.

NOTE: NAK shall not be used for layer 3 errors, if the layer 2 frame is correct. If the meaning of a layer 3 message is undefined or not performable, then the problem is solved with layer 3 messages.

9.5.2.4.4 Use of XON and XOF

XON and XOF are used for flow control of layer 2.

XOF is sent if the unit (MS or SS) due to internal processing is not capable of receiving a following frame when a frame is being received.

XON is sent if XOF has been sent previously, but the reason for that XOF-transmission no longer exists.

9.5.2.4.5 Parameters on layer 2

Table 7: Timer values on layer 2

| Bit rate | Value of T22 | Value of T23 |
|----------|--------------|--------------|
| 600 | 25.0 ms | 58.3 ms |
| 1200 | 12.5 ms | 29.2 ms |
| 2400 | 6.3 ms | 14.6 ms |
| 4800 | 3.1 ms | 7.3 ms |
| 9600 | 1.6 ms | 3.6 ms |

9.5.3 EMMI, layer 3

9.5.3.1 Message structure

Messages are used on layer 3. They are defined by Message Identifiers (MI) in the range of (0..255). The message identifier is always the first, and often the only, octet of the message.

Table 8: Use of message identifiers

| MI | Use |
|---------|--|
| 0-49 | Not used. |
| 50-179 | General messages. All undefined values reserved for further evolution of the EMMI. |
| 180-209 | ME-type dependent blocks, may be used by the SS as a sender or receiver, if so requested by the manufacturer. Undefined values available for the manufacturer. |
| 210-239 | ME-type dependent blocks, never to be used by the SS in conformance testing. Undefined values available for the manufacturer. |
| 240-255 | Reserved for L3 error handling. All undefined values reserved for further evolution of the EMMI. |

NOTE 1: Layer 2 is transparent, but to avoid unnecessary interference from layer 3, MI with the same value as control frames on layer 2 are not used.

Most of the messages, especially in the direction SS - MS contain only one octet, the message indicator. Some of the messages, especially in the direction MS - SS are quite long.

NOTE 2: If the interface is limited only to the minimum required for automatic conformity testing with the electrical man machine interface, then the included L3 messages should be RQTI, KEYS, BEL1, BELO, HOK1, HOK0, BCAP and RSTI.

Table 9: Block types

| MI | Value | Abbr. | Meaning | Source | |
|-----|-------|-------|-------------------------------------|--------|----|
| | | | | MS | SS |
| 051 | VOL1 | | Increase volume (***) | | X |
| 052 | VOL0 | | Decrease volume (***) | | X |
| 053 | RQTS | | Request for table, status | | X |
| 054 | RQTI | | Request for table, indication | | X |
| 055 | RQPL | | Request for power level | | X |
| 056 | RQBE | | Request for bell status | | X |
| 057 | RQSM | | Request for short message | | X |
| 058 | KEYS | | Perform keystroke sequence | | X |
| 060 | BEL1 | | Indication user alert on | X | |
| 061 | BEL0 | | Indication user alert off | X | |
| 064 | HOK1 | | Hook on | | X |
| 065 | HOK0 | | Hook off | | X |
| 070 | BCAP | | Selection of bearer capability | | X |
| 080 | STPO | | Set power level | | X |
| 091 | RSTS | | Response table, status | X | |
| 092 | RSTI | | Response table, indication | X | |
| 093 | RSPO | | Response, power level | X | |
| 101 | RXSM | | Received short message | X | |
| 102 | RXSN | | No short message received | X | |
| 240 | ER00 | | Internal malfunction detected | X | |
| 241 | ER01 | | L3 message not recognized | X | X |
| 242 | ER02 | | L3 message not performable | X | |
| 255 | RESE | | Perform hardware and software reset | | X |

NOTE 3: Functioning of this should be verified, as the volume control in the ME might be of another type (non-incremental).

9.5.3.2 Definition of messages

Messages are defined in the order of the value of the message identifier.

051 VOL1 Increase volume

052 VOL0 Decrease volume

Increase/decrease volume in the loudspeaker by one step.

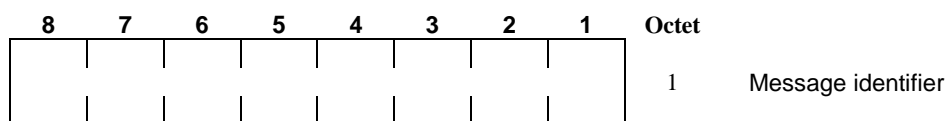

053 RQTS Request for table, status

054 RQTI Request for table, indication

055 RQPL Request for power level

On receiving a request message RQxy, the corresponding table RSxy shall be sent.

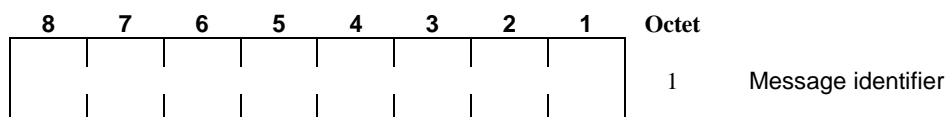

056 RQBE Request for bell status

On receiving a request message RQBE, the internal user alert status (BEL1 or BEL0) shall be sent. BEL1 and BEL0 will indicate whether the ringing or alert procedure has been activated or not. (See also the definition of BEL1 and BEL0).

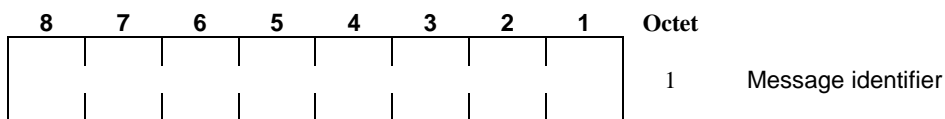

057 RQSM Request for short message

In response to the RQSM request the MS shall send either the short message type using the message RXSM or, in case of no short message received, the message RXSN.

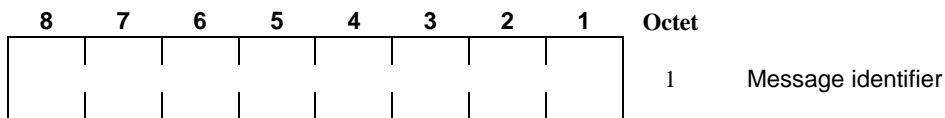

058 KEYS Perform keystroke sequence

Perform the MS function related to the received keystroke sequence.

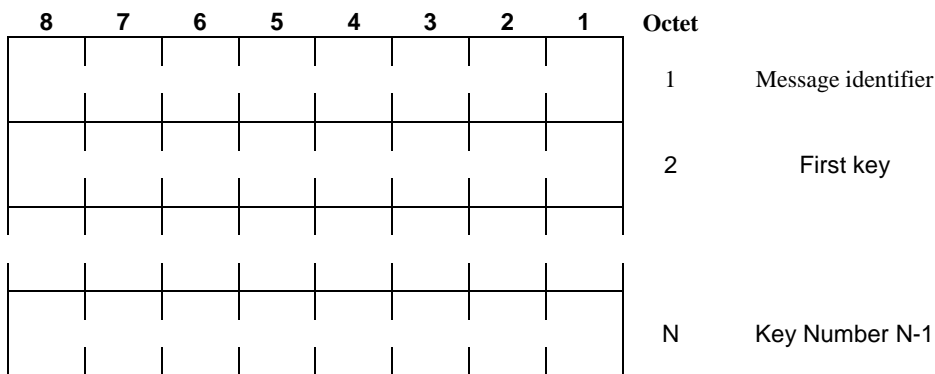

The possible keystroke sequences are based on the basic public man machine interface as defined in GSM 02.30. There exists a minimum set of key characters.

The codes associated with these characters are defined as follows:

| <u>Key</u> | <u>Code (decimal)</u> |
|-----------------|-----------------------|
| # | 35 |
| * | 42 |
| + | 43 |
| 0 | 48 |
| 1 | 49 |
| 2 | 50 |
| 3 | 51 |
| 4 | 52 |
| 5 | 53 |
| 6 | 54 |
| 7 | 55 |
| 8 | 56 |
| 9 | 57 |
| END (function) | 18 |
| SEND (function) | 20 |

060 BEL1 Indication user alert on
 061 BEL0 Indication user alert off

Indication user alert shall indicate, on request of the SS, the internal status of the alert or ringing procedure. For this purpose, the SS shall send the RQBE (request for bell status) message to the MS.

BEL1 shall indicate that the alert procedure is active.

BEL0 shall indicate that the alert procedure is not active.

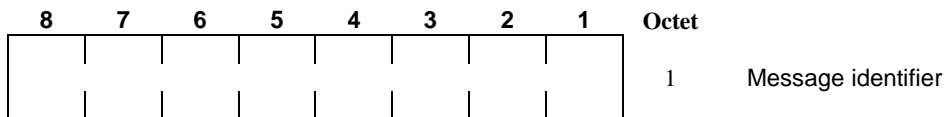

064 HOK1 Hook on
 065 HOK0 Hook off

Control of the hook. The hook on/off command shall action the normal procedure associated with physically lifting the handset and replacing it whatever that maybe.

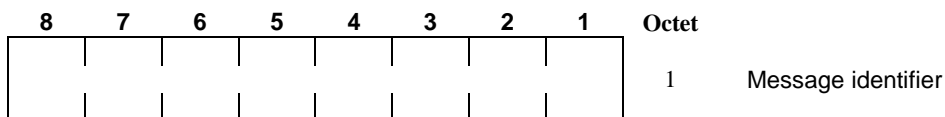

070 BCAP Selection of bearer capability

The EMMI BCAP message shall change the default bearer capability on all future calls made via the EMMI "perform keystroke sequence" message. The new default bearer capability shall be in effect until the ME is switched off or until the ME receives another EMMI BCAP message.

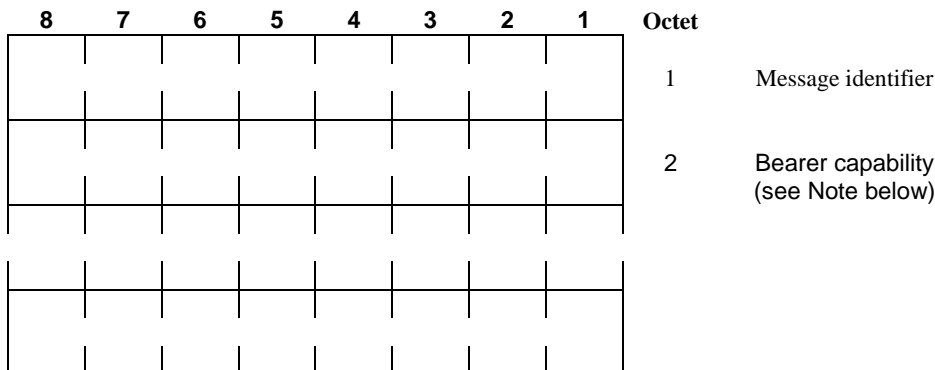

NOTE 1: The field "bearer capability" in the BCAP message is mandatory and is coded bit for bit exactly as the "bearer capability" information element as described in GSM 04.08 clause 10.5.4.4, beginning with octet 2 (length of the bearer capability contents). Because the "bearer capability" is mandatory, the first byte of the field shall be the length of the bearer capability content and not the bearer capability information element identifier.

080 STPO Set power level

Used to control the Tx power level of the ME.

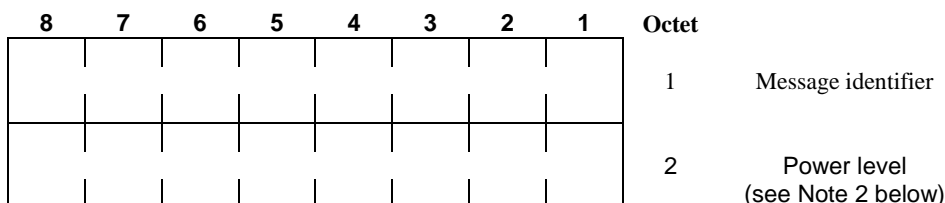

NOTE 2: The power level is defined as the 2nd octet of the power command information element in GSM 04.08.

091 RSTS Response table, status

Response table status is sent as an answer to the corresponding request.

| 8 | 7 | 6 | 5 | 4 | 3 | 2 | 1 | Octet | |
|----|---|---|---|----|---|---|---|-------|------------------------------------|
| | | | | | | | | 1 | Message identifier |
| | | | | | | | | 2 | Status field (see Note 3 below) |
| F1 | | | | F2 | | | | | |
| F3 | | | | | | | | | |

NOTE 3:

F1
0 0 0 0 Spare

F2 (1=yes, 0=no)
Bit 4 L2 link on SACCH established
Bit 3 Speech connection on TCH establ
Bit 2 Listening to BCCH
Bit 1 SDCCH established

F3
Bit 8 Frequency hopping (yes/no)
Bit 7-1 ARFCN of BCCH of serving cell

092 RSTI Response table, indication

Response table indication send as an answer to the corresponding request.

| 8 | 7 | 6 | 5 | 4 | 3 | 2 | 1 | Octet | |
|----|---|---|---|----|---|---|---|-------|--|
| | | | | | | | | 1 | Message identifier |
| | | | | | | | | 2 | Indication field (see Note 4 below) |
| F1 | | | | F2 | | | | | |

NOTE 4:

F1
0000000 Spare

F2 (yes=1, no=0)
Bit 1 Service indication On (yes/no)

093 RSPO Response, power level

Response power level is sent as an answer to the corresponding request.

| 8 | 7 | 6 | 5 | 4 | 3 | 2 | 1 | Octet | |
|----|---|---|---|----|---|---|---|-------|-----------------------------------|
| | | | | | | | | 1 | Message identifier |
| | | | | | | | | 2 | Power Level (see Note 5 below) |
| F1 | | | | F2 | | | | | |

NOTE 5: The power level is defined as the 2nd octet of the power command information element in GSM 04.08.

101 RXSM Received short message

The message RXSM has to be sent by the MS in response to the RQSM request if a short message has been received.

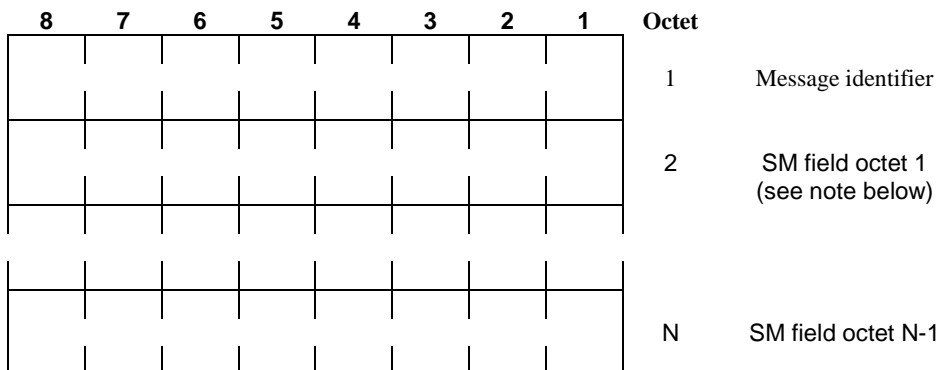

NOTE 6: The SM field is defined as the content of the data field short message storage defined in GSM 11.11 paragraph 3.5.1, excluding byte 1, as follows:

- 1 byte NULL value
- 12 bytes TP Originating Address
- 12 bytes TS Service Centre Address
- 1 byte TP Protocol Identifier
- 1 byte TP Data Coding Scheme
- 7 bytes TP Service Centre Time Stamp
- 1 byte TP User Data Length
- up to 140 bytes TP User Data.

If the length of the address for TP and for TS service centre is less than 12 bytes, the remaining bytes are filled with null values.

102 RXSN No short message received

The message RXSN has to be sent by the MS in response to the RQSM request if no short message has been received.

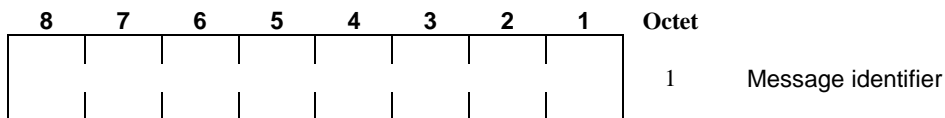

240 ER00 Internal malfunction detected

Used to indicate to the SS that the MS has discovered an internal error. This error message is to be handled in the same manner as the layer 3 error messages (only to be sent to the SS in response to a Layer 3 message received at the MS).

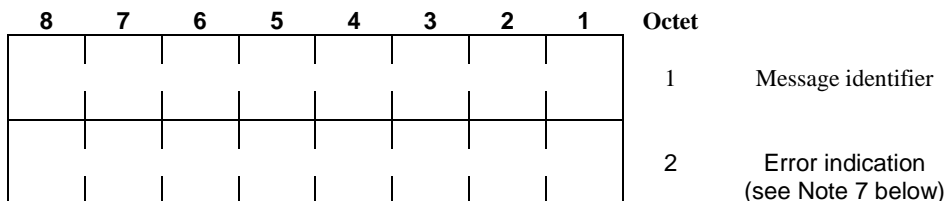

NOTE 7: The error indicator is defined by the manufacturer of the ME.

241 ER01 L3 message not recognized

Used by the receiver to indicate to the sender that the message was correctly received, but ignored due to the fact that it was not understandable (e.g. a KEYS message with one or many values which are not part of the standard set of keys for the MSE). The message to the MS implies a request for re-sending the latest message sent.

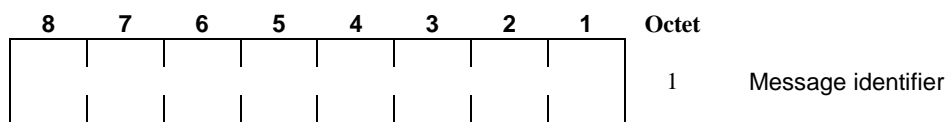

242 ER02 L3 message not performable

Used by the receiver to indicate to the sender that the message was understood, but not performable due to intentional lack of functionality in the MS (e.g. as answer to a CALL message containing a type of service which the MS is not able to use) or to a message requesting a change to a state already existent.

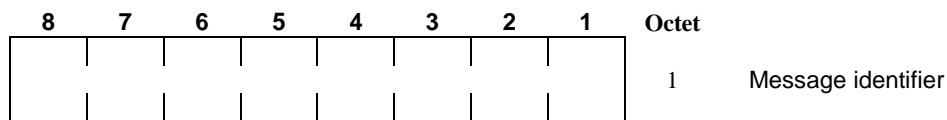

255 RESE Perform HW and SW reset

The MS shall perform a total reset. The MS shall behave as if it has been switched "off" and "on".

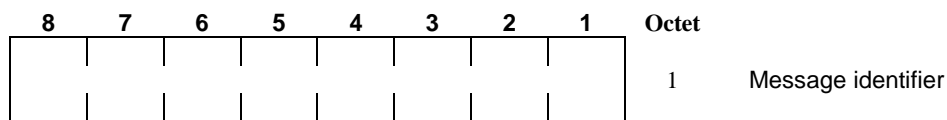

10 Digital audio interface

10.1 General

A special interface is required in order to perform the bit exact test of the speech coder/decoder and to test the SLR/RLR performance of the analogue and acoustic devices. It shall be possible to insert and extract speech data in both the transmit and receive directions. The interruption of the normal speech data paths can be commanded either by a layer 3 message over the air interface or by special control lines in the test interface. The MS need react to only one of these command methods. The manufacturer shall state which method is to be used.

10.2 Formal aspects

It shall be possible to connect the SS to the ME or to an adapter connected to the ME. If an adapter is to be used, it shall be provided by the manufacturer of the ME.

When using the DAI, the MS does not necessarily conform to all RF requirements.

When the DAI is connected the MS shall be able to correctly send and receive on a TCH and associated channels under ideal radio conditions.

NOTE: Prior to tests of the speech coder, other functional entities involved in the tests, such as the channel codec or RF units must have been verified successfully.

10.3 Hardware aspect of the interface

The data exchanged on the interface are 13 bit linear PCM at 8000 samples per second, which, in order to keep the pin count low, are transferred on a duplex set of serial lines at 104 kbit/s.

One additional line resets the speech transcoder and the speech A/D and D/A functions. Two lines control the data flow direction and working mode of the interface, one mode being normal operation of the MS. These lines are controlled by the SS. Another line, controlled by the MS, clocks the data as required or available.

This is described in detail below.

10.3.1 Mechanical characteristics of the interface

The interface shall use a 25-pin DSUB socket, detailed in the ISO 2110 document. The ME shall use a female part.

The manufacturer may provide this interface on an external test "adapter".

The pin assignment of the connector shall be as follows.

| Pin | Use | Function | Source |
|-------|----------|----------------------|--------|
| 1 | | Chassis ground | ME |
| 2-3 | EMMI | Signals | |
| 4-6 | Not used | | |
| 7 | EMMI | Signal ground | |
| 8-10 | Not used | | |
| 11 | DAI | Test control 1 | SS |
| 12 | DAI | Signal ground | |
| 13 | DAI | Test control 2 | SS |
| 14-21 | Not used | | |
| 22 | DAI | Reset | SS |
| 23 | DAI | Data | ME |
| 24 | DAI | Data clock (104 kHz) | ME |
| 25 | DAI | Data | SS |

NOTE: The EMMI interface is optional and is described in clause 9.

10.3.2 Electrical characteristics of the interface

The state of a signal pin is defined by the voltage (V) between the pin and its associated ground as follows.

| Logical state | Voltage v |
|----------------------|---------------------------------------|
| 0 or "LOW" or "ON" | $0\text{ V} < v < + 0,8\text{ V}$ |
| 1 or "HIGH" or "OFF" | $+ 3,5\text{ V} < v < + 5\text{ V}$ |
| undefined | $+ 0,8\text{ V} < v < + 3,5\text{ V}$ |
| forbidden | $v < 0\text{ V}, v > + 5\text{ V}$ |

10.3.3 Timing characteristics of the interface

The following timing applies.

| Parameter | Value |
|-------------------------|--------------------|
| Clock frequency | 104 kHz +/- 20 ppm |
| Duty cycle | 40 to 60 % |
| Clock rising edge time | < 1 microsecond |
| Clock falling edge time | < 1 microsecond |
| Reset pulse duration | >= 4 millisecond |

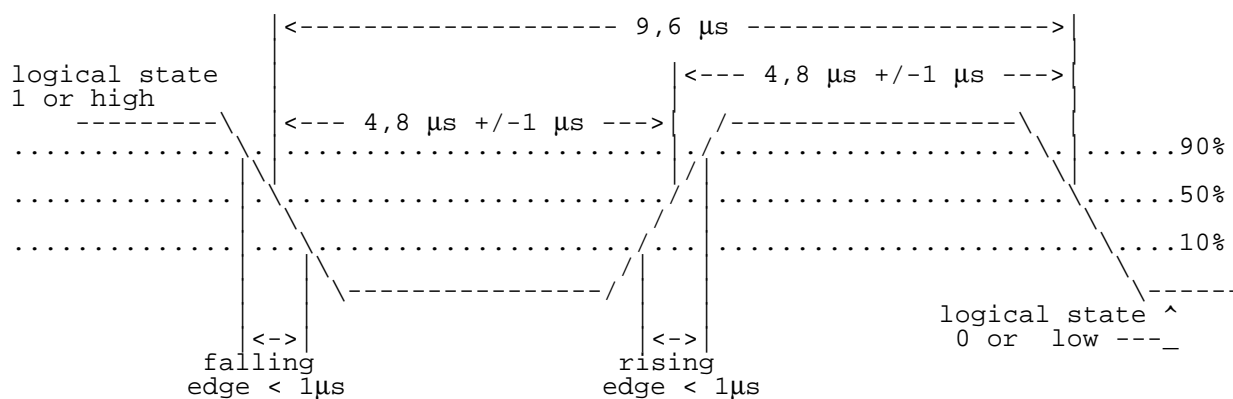

Data shall be stable during the period between 3 microseconds before and 1 microsecond after the rising edge of the clock (50% level).

10.4 Logical interface

The reset signal is active low.

The data consists of 13 bit words in two's complement format, with the most significant bit transmitted first.

Data are read in by the MS or SS at the rising edge and are output by the SS or MS at the falling edge of the clock, as defined in Figure 2.

The clock signal is high when inactive.

The two test control lines determine the routing of the speech data (DAI or internal, i.e. normal mode) and which device is being tested (speech transcoder/DTX functions or A/D & D/A) as follows:

| Test control line | | Function |
|-------------------|------|---|
| 1 | 2 | |
| Low | Low | Normal operation |
| Low | High | Test of speech decoder / DTX functions (downlink) |
| High | Low | Test of speech encoder / DTX functions (uplink) |
| High | High | Test of acoustic devices and A/D & D/A |

The same test setup may be achieved by the layer 3 TEST_INTERFACE message (see 7 and 8.7).

10.5 Functionality of the DAI

To initiate a test, the SS shall apply the appropriate test control signals or send the appropriate layer 3 messages and then, more than 1 second later, apply a reset pulse.

Upon release of the reset pulse, the MS subsequently starts the test by issuing clock pulses when data are required or are ready.

When testing uplink speech transcoding or DTX functions, the first falling clock edge shall request from the SS the first bit of the speech samples to be encoded, the transmission of which shall start at the next earliest possible interleaved block TDMA frame (as defined in GSM 05.02) after the release of the reset pulse.

When testing downlink speech transcoding or DTX functions, the first falling clock edge shall output to the SS the first bit of the speech samples decoded from the first interleaved block TDMA frames, the reception of which is completed subsequently to the release of the reset pulse.

The MS speech transcoders shall be reset by the end of the reset pulse, whenever it occurs, whilst the DAI is in one of the active states (Test of speech decoder / DTX functions (downlink), Test of speech encoder / DTX functions (uplink), Test of acoustic devices and A/D and D/A).

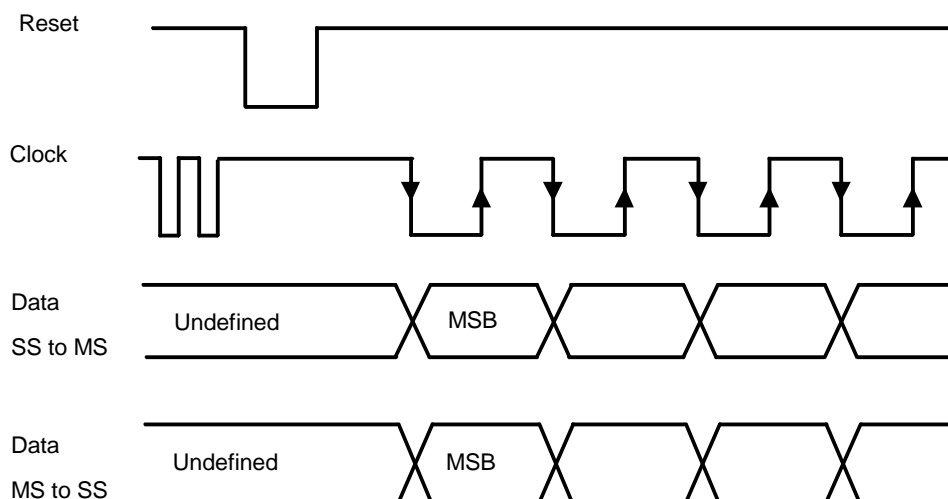

Figure 2: DAI Timing

11 SIM/ME test interface

11.1 General

A special interface is required in order to perform the tests of the SIM/ME interface.

11.2 Formal aspects

It shall be possible to connect the SIM simulator to the ME. If an adapter is to be used, it shall be provided by the manufacturer of the ME.

When using the SIM simulator, the ME does not necessarily conform to all RF requirements.

When the SIM simulator is connected the ME shall be able to correctly send and receive on a TCH and associated channels under ideal radio conditions (according to GC3 of Annex 1).

11.3 Hardware and logical aspects of the interface

The signals on this interface are specified in GSM 11.11.

11.4 Mechanical characteristics of the interface

The interface of the SIM-simulator offers two connection types :

- i) a paddle which is inserted into the ME under test in place of an IC card SIM, and connects with wires to the measuring equipment. The dimensions of the paddle are shown in figure 3.
- ii) a connector with leads of length 12cm, terminated directly at the contacting elements inside the ME under test.

For ME which use the plug in SIM, or when the paddle cannot be inserted due to constraints imposed by the ME design, then the ME manufacturer shall, for the purpose of testing the SIM/ME interface only, provide the ME with the connector of type ii) and the leads attached directly to the contacting elements. This connector with the flying leads shall be delivered by the test house.

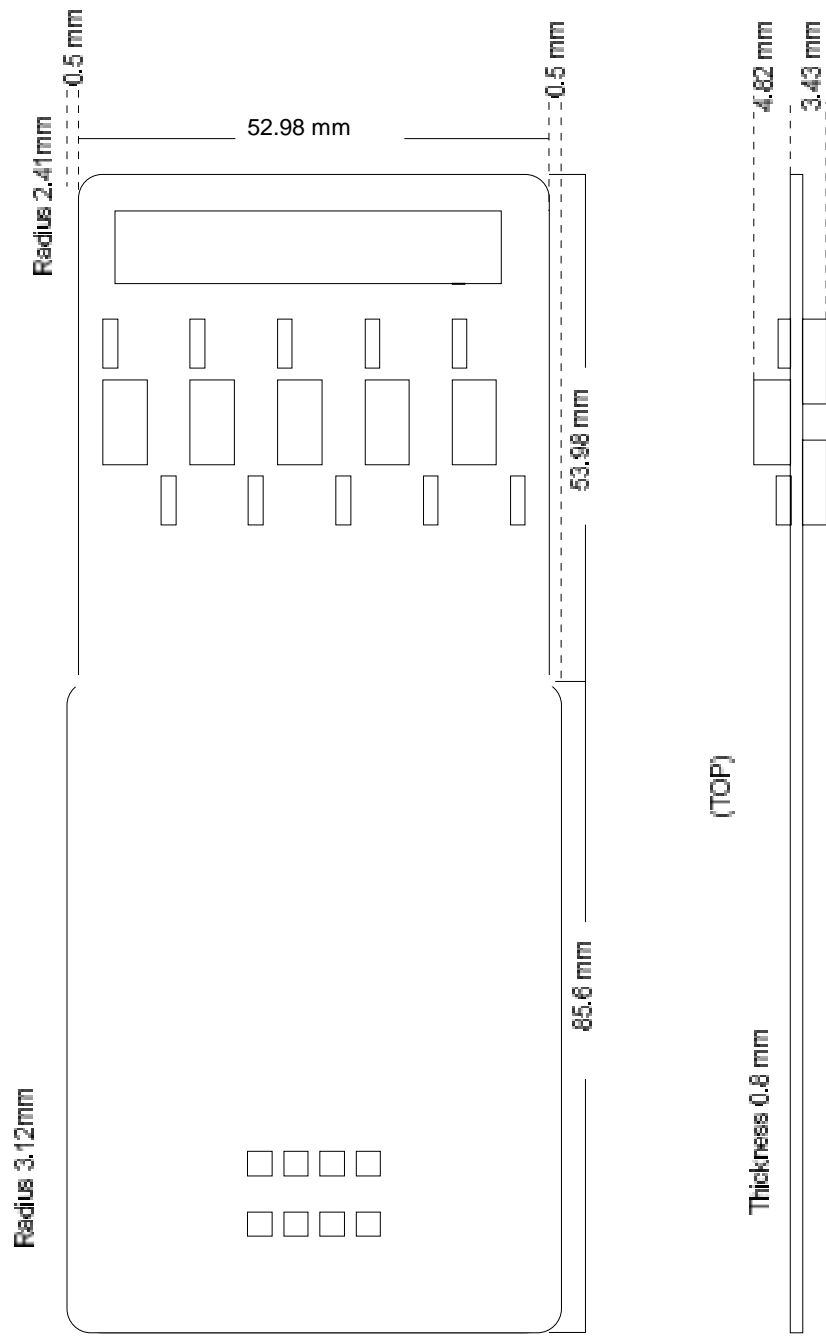

Figure 3: Dimensions of full size paddle

Annex A (informative): Change Request History

| Status of Technical Specification GSM 04.14 | | |
|--|----------------|--|
| Date | Version | Remarks |
| October 1998 | 5.1.0 | change requests agreed by SMG#27: CR 04.14-A002 Changes to 04.14 |
| SMG#27 | 6.0.0 | Release 1997 version |
| SMG#29 | 7.0.0 | Release 1998 version |
| SMG#30 | 7.1.0 | CR 04.14-A004 GPRS test mode |
| SMG#32 | 7.2.0 | CR 04.14-A009 GPRS test mode corrections |
| Text: WinWord 7.0 Stylesheet: etsiw_70.dot Rapporteur: Andrew Howell (Motorola) | | |

History

| Document history | | |
|-------------------------|---------------|-------------|
| V7.0.0 | August 1999 | Publication |
| V7.1.0 | November 1999 | Publication |
| V7.2.0 | October 2000 | Publication |
| | | |
| | | |