

ETSI TS 101 344 V7.7.0 (2001-06)

Technical Specification

**Digital cellular telecommunications system (Phase 2+);
General Packet Radio Service (GPRS);
Service description;
Stage 2
(3GPP TS 03.60 version 7.7.0 Release 1998)**

GSM®
GLOBAL SYSTEM FOR
MOBILE COMMUNICATIONS

3GPP

ETSI 

Reference

RTS/TSGS-020360Q7R5

Keywords

GSM

ETSI

650 Route des Lucioles
F-06921 Sophia Antipolis Cedex - FRANCE

Tel.: +33 4 92 94 42 00 Fax: +33 4 93 65 47 16

Siret N° 348 623 562 00017 - NAF 742 C
Association à but non lucratif enregistrée à la
Sous-Préfecture de Grasse (06) N° 7803/88

Important notice

Individual copies of the present document can be downloaded from:

<http://www.etsi.org>

The present document may be made available in more than one electronic version or in print. In any case of existing or perceived difference in contents between such versions, the reference version is the Portable Document Format (PDF). In case of dispute, the reference shall be the printing on ETSI printers of the PDF version kept on a specific network drive within ETSI Secretariat.

Users of the present document should be aware that the document may be subject to revision or change of status. Information on the current status of this and other ETSI documents is available at

<http://portal.etsi.org/tb/status/status.asp>

If you find errors in the present document, send your comment to:

editor@etsi.fr

Copyright Notification

No part may be reproduced except as authorized by written permission.
The copyright and the foregoing restriction extend to reproduction in all media.

© European Telecommunications Standards Institute 2001.
All rights reserved.

Intellectual Property Rights

IPRs essential or potentially essential to the present document may have been declared to ETSI. The information pertaining to these essential IPRs, if any, is publicly available for **ETSI members and non-members**, and can be found in ETSI SR 000 314: "*Intellectual Property Rights (IPRs); Essential, or potentially Essential, IPRs notified to ETSI in respect of ETSI standards*", which is available from the ETSI Secretariat. Latest updates are available on the ETSI Web server (<http://webapp.etsi.org/IPR/home.asp>).

Pursuant to the ETSI IPR Policy, no investigation, including IPR searches, has been carried out by ETSI. No guarantee can be given as to the existence of other IPRs not referenced in ETSI SR 000 314 (or the updates on the ETSI Web server) which are, or may be, or may become, essential to the present document.

Foreword

This Technical Specification (TS) has been produced by ETSI 3rd Generation Partnership Project (3GPP).

The present document may refer to technical specifications or reports using their 3GPP identities, UMTS identities or GSM identities. These should be interpreted as being references to the corresponding ETSI deliverables.

The cross reference between GSM, UMTS, 3GPP and ETSI identities can be found under www.etsi.org/key.

Contents

Intellectual Property Rights	2
Foreword.....	2
Foreword.....	8
1 Scope	9
2 References	9
3 Definitions, abbreviations and symbols	11
3.1 Definitions	11
3.2 Abbreviations	11
3.3 Symbols.....	12
4 Main Concepts.....	13
5 General GPRS Architecture and Transmission Mechanism.....	14
5.1 GPRS Access Interfaces and Reference Points	14
5.2 Network Interworking	14
5.2.1 PSPDN Interworking	15
5.2.2 Internet (IP) Interworking.....	15
5.3 High-Level Functions Required for GPRS.....	15
5.3.1 Network Access Control Functions	15
5.3.1.1 Registration Function	16
5.3.1.2 Authentication and Authorisation Function	16
5.3.1.3 Admission Control Function	16
5.3.1.4 Message Screening Function.....	16
5.3.1.5 Packet Terminal Adaptation Function.....	16
5.3.1.6 Charging Data Collection Function.....	16
5.3.2 Packet Routeing and Transfer Functions	16
5.3.2.1 Relay Function	16
5.3.2.2 Routeing Function.....	16
5.3.2.3 Address Translation and Mapping Function	17
5.3.2.4 Encapsulation Function	17
5.3.2.5 Tunnelling Function	17
5.3.2.6 Compression Function	17
5.3.2.7 Ciphering Function.....	17
5.3.2.8 Domain Name Server Function.....	17
5.3.3 Mobility Management Functions	17
5.3.4 Logical Link Management Functions	17
5.3.4.1 Logical Link Establishment Function	17
5.3.4.2 Logical Link Maintenance Functions.....	18
5.3.4.3 Logical Link Release Function	18
5.3.5 Radio Resource Management Functions.....	18
5.3.5.1 Um Management Function.....	18
5.3.5.2 Cell Selection Function	18
5.3.5.3 Um-tranx Function	18
5.3.5.4 Path Management Function.....	18
5.3.6 Network Management Functions	18
5.4 Logical Architecture.....	18
5.4.1 GPRS Support Nodes.....	19
5.4.2 GPRS Backbone Networks	19
5.4.3 HLR	20
5.4.4 SMS-GMSC and SMS-IWMSC	20
5.4.5 GPRS Mobile Stations	20
5.4.6 Charging Gateway Functionality	21
5.5 Assignment of Functions to General Logical Architecture	21
5.6 Transmission and Signalling Planes	21
5.6.1 Transmission Plane	21

5.6.2	Signalling Plane	22
5.6.2.1	MS - SGSN	23
5.6.2.2	SGSN - HLR	23
5.6.2.3	SGSN - MSC/VLR.....	23
5.6.2.4	SGSN - EIR.....	24
5.6.2.5	SGSN - SMS-GMSC or SMS-IW MSC.....	24
5.6.2.6	GSN - GSN	24
5.6.2.7	GGSN - HLR	25
5.6.2.7.1	MAP-based GGSN - HLR Signalling.....	25
5.6.2.7.2	GTP and MAP-based GGSN - HLR Signalling	25
6	Mobility Management Functionality	26
6.1	Definition of Mobility Management States	26
6.1.1	IDLE (GPRS) State.....	26
6.1.2	STANDBY State	26
6.1.3	READY State.....	26
6.2	IDLE / STANDBY / READY State Functionality	27
6.2.1	State Transitions and Functions	27
6.2.2	READY Timer Function.....	29
6.2.3	Periodic RA Update Timer Function	29
6.2.4	Mobile Reachable Timer Function	30
6.3	Interactions Between SGSN and MSC/VLR	30
6.3.1	Administration of the SGSN - MSC/VLR Association	30
6.3.2	Combined RA / LA Updating	31
6.3.3	CS Paging	32
6.3.3.1	Paging Co-ordination	33
6.3.4	Non-GPRS Alert	33
6.3.5	MS Information Procedure	34
6.3.6	MM Information Procedure	34
6.4	MM Procedures	35
6.5	Attach Function	35
6.6	Detach Function	38
6.6.1	MS-Initiated Detach Procedure.....	39
6.6.2	Network-Initiated Detach Procedure	39
6.6.2.1	SGSN-Initiated Detach Procedure	39
6.6.2.2	HLR-Initiated Detach Procedure.....	40
6.7	Purge Function	40
6.8	Security Function	41
6.8.1	Authentication of Subscriber	41
6.8.2	User Identity Confidentiality	42
6.8.2.1	P-TMSI Signature	42
6.8.2.2	P-TMSI Reallocation Procedure	42
6.8.3	User Data and GMM/SM Signalling Confidentiality	42
6.8.3.1	Scope of Ciphering.....	42
6.8.3.2	GPRS Ciphering Algorithm	43
6.8.4	Identity Check Procedures.....	43
6.9	Location Management Function.....	43
6.9.1	Location Management Procedures.....	44
6.9.1.1	Cell Update Procedure	44
6.9.1.2	Routeing Area Update Procedure.....	44
6.9.1.2.1	Intra SGSN Routeing Area Update.....	45
6.9.1.2.2	Inter SGSN Routeing Area Update.....	46
6.9.1.3	Combined RA / LA Update Procedure.....	48
6.9.1.3.1	Combined Intra SGSN RA / LA Update	48
6.9.1.3.2	Combined Inter SGSN RA / LA Update	50
6.9.1.4	Periodic RA and LA Updates.....	53
6.10	Subscriber Management Function.....	53
6.10.1	Subscriber Management Procedures	53
6.10.1.1	Insert Subscriber Data Procedure	53
6.10.1.2	Delete Subscriber Data Procedure.....	54
6.11	Classmark Handling	54
6.11.1	Radio Access Classmark.....	55

6.11.2	SGSN Classmark	55
7	Network Management Functionality	55
8	Radio Resource Functionality	55
8.1	Cell Selection and Reselection	55
8.2	Discontinuous Reception	55
8.3	Radio Resource Management	56
8.3.1	Layer Functions	56
8.3.2	Model of Operation	56
8.3.2.1	Dynamic Allocation of Radio Resources	56
8.4	Paging for GPRS Downlink Transfer	56
9	Packet Routing and Transfer Functionality	57
9.1	Definition of Packet Data Protocol States	57
9.1.1	INACTIVE State	57
9.1.2	ACTIVE State	57
9.2	PDP Context Activation, Modification, and Deactivation Functions	58
9.2.1	Static and Dynamic PDP Addresses	58
9.2.2	Activation Procedures	59
9.2.2.1	PDP Context Activation Procedure	59
9.2.2.2	Network-Requested PDP Context Activation Procedure	60
9.2.2.2.1	Successful Network-Requested PDP Context Activation Procedure	61
9.2.2.2.2	Unsuccessful Network-Requested PDP Context Activation Procedure	62
9.2.2.3	Anonymous Access PDP Context Activation Procedure	63
9.2.3	Modification Procedures	64
9.2.3.1	PDP Context Modification Procedure	65
9.2.4	Deactivation Procedures	65
9.2.4.1	PDP Context Deactivation Initiated by MS Procedure	65
9.2.4.2	PDP Context Deactivation Initiated by SGSN Procedure	66
9.2.4.3	PDP Context Deactivation Initiated by GGSN Procedure	66
9.2.4.4	Anonymous Access PDP Context Deactivation Initiated by MS Procedure	67
9.2.4.5	Anonymous Access PDP Context Deactivation Initiated by GGSN Procedure	67
9.3	Packet Routing and Transfer Function	68
9.4	Relay Function	68
9.5	Packet Terminal Adaptation Function	68
9.6	Encapsulation Function	69
9.6.1	Encapsulation Between SGSN and GGSN	69
9.6.2	Encapsulation Between SGSN and MS	69
10	Message Screening Functionality	69
11	Compatibility Issues	69
12	Transmission	70
12.1	Transmission Modes	70
12.1.1	GTP Transmission Modes	70
12.1.2	LLC Transmission Modes	70
12.1.3	RLC Transmission Modes	70
12.2	Logical Link Control Functionality	70
12.2.1	Addressing	70
12.2.2	Services	70
12.2.3	Functions	71
12.3	Subnetwork Dependent Convergence Functionality	71
12.3.1	Services	72
12.3.2	Subfunctions	72
12.4	Point-to-Point Protocol Functionality	73
12.4.1	Transmission Plane for PDP Type PPP	73
12.4.2	Functions	73
12.5	Gb Interface	74
12.5.1	Physical Layer Protocol	74
12.5.2	Link Layer Protocols	74
12.5.3	BSS GPRS Protocol	74
12.5.3.1	Inter-dependency of the BSSGP and LLC Functions	75

12.5.3.2	BSSGP Addressing	75
12.5.3.3	BVCI Contexts in BSS and in SGSN	76
12.5.3.4	Flow Control Between SGSN and BSS over the Gb Interface.....	76
12.6	Abis Interface	76
12.6.1	Remote Packet Control Unit	77
13	Information Storage.....	77
13.1	HLR.....	78
13.2	SGSN.....	79
13.3	GGSN	80
13.4	MS	81
13.5	MSC/VLR	82
13.6	Recovery and Restoration Procedures	82
13.6.1	HLR Failure	83
13.6.2	SGSN Failure.....	83
13.6.3	GGSN Failure	83
13.6.4	VLR Failure	83
14	Identities	84
14.1	IMSI	84
14.2	Packet TMSI.....	84
14.3	NSAPI and TLLI.....	84
14.4	PDP Address	85
14.5	TID	85
14.6	Routeing Area Identity	85
14.7	Cell Identity.....	86
14.8	GSN Addresses	86
14.8.1	GSN Address	86
14.8.2	GSN Number	86
14.9	Access Point Name.....	86
15	Operational Aspects	87
15.1	Charging.....	87
15.1.1	Charging Information	87
15.1.2	Reverse Charging.....	87
15.2	Quality of Service Profile.....	87
15.2.1	Precedence Class	88
15.2.2	Delay Class	88
15.2.3	Reliability Class.....	88
15.2.4	Throughput Classes.....	89
15.2.4.1	Peak Throughput Class	89
15.2.4.2	Mean Throughput Class	90
16	Interactions with Other GSM Services.....	90
16.1	Point-to-point Short Message Service	90
16.1.1	Mobile-terminated SMS Transfer.....	91
16.1.1.1	Unsuccessful Mobile-terminated SMS Transfer	91
16.1.2	Mobile-originated SMS Transfer.....	93
16.2	Circuit-switched Services.....	93
16.2.1	Suspension of GPRS Services	94
16.2.2	GPRS and Dedicated Mode Priority Handling	95
16.3	Supplementary Services	95
Annex A (normative): APN and GGSN Selection		96
A.1	Definitions.....	96
A.2	APN Selection Rules.....	96
Annex B (informative): Data Transmission Routeing Examples		103
B.1	Data Routeing for an MS in its Home PLMN to and from an External PDN.....	103
B.2	Data Routeing for a Roaming MS to and from an External PDN	104

B.3	MS-to-MS Data Routeing via the Same GGSN	104
B.4	MS-to-MS Data Routeing via Different GGSNs.....	105
Annex C (informative): Figures	107
Annex E (informative): Tables	109
Annex F (informative): Document history	110
History	111

Foreword

This Technical Specification has been produced by the 3rd Generation Partnership Project (3GPP).

The contents of the present document are subject to continuing work within the TSG and may change following formal TSG approval. Should the TSG modify the contents of the present document, it will be re-released by the TSG with an identifying change of release date and an increase in version number as follows:

Version x.y.z

where:

- x the first digit:
 - 1 presented to TSG for information;
 - 2 presented to TSG for approval;
 - 3 or greater indicates TSG approved document under change control.
- y the second digit is incremented for all changes of substance, i.e. technical enhancements, corrections, updates, etc.
- z the third digit is incremented when editorial only changes have been incorporated in the document.

1 Scope

The present document defines the stage-2 service description for a General Packet Radio Service (GPRS) on GSM. CCITT I.130 [29] describes a three-stage method for characterisation of telecommunication services, and CCITT Q.65 [31] defines stage 2 of the method.

This version of the stage-2 service description covers the first phase of GPRS, and does not meet all the services and functionality described in GSM 02.60 [3].

The present document does not cover the lower layers of the GPRS GSM radio interface. GSM 03.64 [9] contains an overall description of the radio interface.

2 References

The following documents contain provisions which, through reference in this text, constitute provisions of the present document.

- References are either specific (identified by date of publication, edition number, version number, etc.) or non-specific.
- For a specific reference, subsequent revisions do not apply.
- For a non-specific reference, the latest version applies. In the case of a reference to a 3GPP document (including a GSM document), a non-specific reference implicitly refers to the latest version of that document *in the same Release as the present document*.

- [1] GSM 01.04: "Digital cellular telecommunications system (Phase 2+); Abbreviations and acronyms".
- [2] GSM 01.61: "Digital cellular telecommunications system (Phase 2+); GPRS ciphering algorithm requirements".
- [3] GSM 02.60: "Digital cellular telecommunications system (Phase 2+); General Packet Radio Service (GPRS); Service description; Stage 1".
- [4] GSM 03.03: "Digital cellular telecommunications system (Phase 2+); Numbering, addressing and identification".
- [5] GSM 03.07: "Digital cellular telecommunications system (Phase 2+); Restoration procedures".
- [6] GSM 03.20: "Digital cellular telecommunications system (Phase 2+); Security related network functions".
- [7] GSM 03.22: "Digital cellular telecommunications system (Phase 2+); Functions related to Mobile Station (MS) in idle mode and group receive mode".
- [8] GSM 03.40: "Digital cellular telecommunications system (Phase 2+); Technical realization of the Short Message Service (SMS); Point-to-Point (PP)".
- [9] GSM 03.64: "Digital cellular telecommunications system (Phase 2+); Overall description of the General Packet Radio Service (GPRS) Radio interface; Stage 2".
- [10] GSM 04.07: "Digital cellular telecommunications system (Phase 2+); Mobile radio interface signalling layer 3; General aspects".
- [11] GSM 04.08: "Digital cellular telecommunications system (Phase 2+); Mobile radio interface layer 3 specification".
- [12] GSM 04.60: "Digital cellular telecommunications system (Phase 2+); General Packet Radio Service (GPRS); Mobile Station (MS) - Base Station System (BSS) interface; Radio Link Control / Medium Access Control (RLC/MAC) protocol".

- [13] GSM 04.64: "Digital cellular telecommunications system (Phase 2+); General Packet Radio Service (GPRS); Mobile Station – Serving GPRS Support Node (MS - SGSN) Logical Link Control (LLC) layer specification".
- [14] GSM 04.65: "Digital cellular telecommunications system (Phase 2+); General Packet Radio Service (GPRS); Mobile Station (MS) – Serving GPRS Support Node (SGSN); Subnetwork Dependent Convergence Protocol (SNDCP)".
- [15] GSM 05.08: "Digital cellular telecommunications system (Phase 2+); Radio subsystem link control".
- [16] GSM 07.60: "Digital cellular telecommunications system (Phase 2+); General Packet Radio Service (GPRS); Mobile Station (MS) supporting GPRS".
- [17] GSM 08.08: "Digital cellular telecommunications system (Phase 2+); Mobile Switching Centre - Base Station System (MSC - BSS) interface: Layer 3 specification".
- [18] GSM 08.14: "Digital cellular telecommunications system (Phase 2+); General Packet Radio Service (GPRS); Base Station System (BSS) - Serving GPRS Support Node (SGSN) interface; Gb interface layer 1".
- [19] GSM 08.16: "Digital cellular telecommunications system (Phase 2+); General Packet Radio Service (GPRS); Base Station System (BSS) - Serving GPRS Support Node (SGSN) interface; Network Service".
- [20] GSM 08.18: "Digital cellular telecommunications system (Phase 2+); General Packet Radio Service (GPRS); Base Station System (BSS) - Serving GPRS Support Node (SGSN); BSS GPRS Protocol (BSSGP)".
- [21] GSM 08.60: "Digital cellular telecommunications system (Phase 2+); Inband control of remote transcoders and rate adaptors for Enhanced Full Rate (EFR) and full rate traffic channels."
- [22] GSM 09.02: "Digital cellular telecommunications system (Phase 2+); Mobile Application Part (MAP) specification".
- [23] GSM 09.16: "Digital cellular telecommunications system (Phase 2+); General Packet Radio Service (GPRS); Serving GPRS Support Node (SGSN) - Visitors Location Register (VLR); Gs interface network service specification".
- [24] GSM 09.18: "Digital cellular telecommunications system (Phase 2+); General Packet Radio Service (GPRS); Serving GPRS Support Node (SGSN) - Visitors Location Register (VLR); Gs interface layer 3 specification".
- [25] GSM 09.60: "Digital cellular telecommunications system (Phase 2+); General Packet Radio Service (GPRS); GPRS Tunnelling Protocol (GTP) across the Gn and Gp Interface".
- [26] GSM 09.61: "Digital cellular telecommunications system (Phase 2+); General Packet Radio Service (GPRS); Interworking between the Public Land Mobile Network (PLMN) supporting GPRS and Packet Data Networks (PDN)".
- [27] GSM 11.11: "Digital cellular telecommunications system (Phase 2+); Specification of the Subscriber Identity Module - Mobile Equipment (SIM - ME) interface".
- [28] GSM 12.15: "Digital cellular telecommunications system (Phase 2+); General Packet Radio Service (GPRS); GPRS Charging".
- [29] CCITT Recommendations I.130: "General modelling methods – Method for the characterisation of telecommunication services supported by an ISDN and network capabilities of an ISDN".
- [30] CCITT Recommendation E.164: "Numbering plan for the ISDN era".
- [31] CCITT Recommendation Q.65: "Methodology – Stage 2 of the method for the characterization of services supported by an ISDN".

- [32] CCITT Recommendation V.42 bis: "Data communication over the telephone network – Data compression procedures for data circuit-terminating equipment (DCE) using error correction procedures".
- [33] CCITT Recommendation X.3: "Packet assembly disassembly facility (PAD) in a public data network".
- [34] CCITT Recommendation X.25: "Interface between data terminal equipment (DTE) and data circuit-terminating equipment (DCE) for terminals operating in the packet mode and connected to public data networks by dedicated circuit".
- [35] CCITT Recommendation X.28: "DTE / DCE interface for a start-stop mode data terminal equipment accessing the packet assembly / disassembly facility (PAD) in a public data network situated in the same country".
- [36] CCITT Recommendation X.29: "Procedures for the exchange of control information and user data between a packet assembly / disassembly (PAD) facility and a packet mode DTE or another PAD".
- [37] CCITT Recommendation X.75: "Packet-switched signalling system between public networks providing data transmission services".
- [38] CCITT Recommendation X.121: "International Numbering Plan for Public Data Networks".
- [39] IETF RFC 768 (1980): "User Datagram Protocol" (STD 6).
- [40] IETF RFC 791 (1981): "Internet Protocol" (STD 5).
- [41] IETF RFC 792 (1981): "Internet Control Message Protocol" (STD 5).
- [42] IETF RFC 793 (1981): "Transmission Control Protocol" (STD 7).
- [43] IETF RFC 1034 (1987): "Domain Names – Concepts and Facilities" (STD 7).
- [44] IETF RFC 1661 (1994): "The Point-to-Point Protocol (PPP)" (STD 51).
- [45] Bellcore GR-000301 Issue 2 December 1997: "Public Packet Switched Network Generic Requirements (PPSNGR)".

3 Definitions, abbreviations and symbols

3.1 Definitions

For the purposes of the present document, the terms and definitions given in GSM 02.60 apply.

3.2 Abbreviations

For the purposes of the present document the following abbreviations apply. Additional applicable abbreviations can be found in GSM 01.04 [1].

AA	Anonymous Access
APN	Access Point Name
ATM	Asynchronous Transfer Mode
BG	Border Gateway
BSSAP+	Base Station System Application Part +
BSSGP	Base Station System GPRS Protocol
BVCI	BSSGP Virtual Connection Identifier
CCU	Channel Codec Unit
CDR	Call Detail Record
CGF	Charging Gateway Functionality
CGI	Cell Global Identification
CS	Circuit Switched

DNS	Domain Name System
GGSN	Gateway GPRS Support Node
GMM/SM	GPRS Mobility Management and Session Management
GSN	GPRS Support Node
GTP	GPRS Tunnelling Protocol
ICMP	Internet Control Message Protocol
IETF	Internet Engineering Task Force
IHOSS	Internet-Hosted Octet Stream Service
IP	Internet Protocol
IPv4	Internet Protocol version 4
IPv6	Internet Protocol version 6
IPX	Internet Packet eXchange
ISP	Internet Service Provider
L2TP	Layer-2 Tunnelling Protocol
LL-PDU	LLC PDU
LLC	Logical Link Control
MAC	Medium Access Control
MNRF	Mobile station Not Reachable Flag
MNRG	Mobile station Not Reachable for GPRS flag
MNRR	Mobile station Not Reachable Reason
MTP2	Message Transfer Part layer 2
MTP3	Message Transfer Part layer 3
NGAF	Non-GPRS Alert Flag
NS	Network Service
NSAPI	Network layer Service Access Point Identifier
NSS	Network SubSystem
P-TMSI	Packet TMSI
PCU	Packet Control Unit
PDCH	Packet Data CHannel
PDN	Packet Data Network
PDP	Packet Data Protocol, e.g., IP or X.25 [34]
PDU	Protocol Data Unit
PPF	Paging Proceed Flag
PPP	Point-to-Point Protocol
PVC	Permanent Virtual Circuit
RA	Routeing Area
RAC	Routeing Area Code
RAI	Routeing Area Identity
RLC	Radio Link Control
SGSN	Serving GPRS Support Node
SM	Short Message
SM-SC	Short Message service Service Centre
SMS-GMSC	Short Message Service Gateway MSC
SMS-IWMSC	Short Message Service Interworking MSC
SN-PDU	SNDCP PDU
SNDC	SubNetwork Dependent Convergence
SNDCP	SubNetwork Dependent Convergence Protocol
TCAP	Transaction Capabilities Application Part
TCP	Transmission Control Protocol
TID	Tunnel Identifier
TLLI	Temporary Logical Link Identity
TRAU	Transcoder and Rate Adaptor Unit
UDP	User Datagram Protocol

3.3 Symbols

For the purposes of the present document, the following symbols apply:

Ga	Charging data collection interface between a CDR transmitting unit (e.g., an SGSN or a GGSN) and a CDR receiving functionality (a CGF).
Gb	Interface between an SGSN and a BSS.

Gc	Interface between a GGSN and an HLR.
Gd	Interface between a SMS-GMSC and an SGSN, and between a SMS-IW MSC and an SGSN.
Gf	Interface between an SGSN and an EIR.
Gi	Reference point between GPRS and an external packet data network.
Gn	Interface between two GSNs within the same PLMN.
Gp	Interface between two GSNs in different PLMNs. The Gp interface allows support of GPRS network services across areas served by the co-operating GPRS PLMNs.
Gr	Interface between an SGSN and an HLR.
Gs	Interface between an SGSN and an MSC/VLR.
kbit/s	Kilobits per second.
R	Reference point between a non-ISDN compatible TE and MT. Typically this reference point supports a standard serial interface.
Um	Interface between the mobile station (MS) and the GPRS fixed network part. The Um interface is the GPRS network interface for providing packet data services over the radio to the MS. The MT part of the MS is used to access the GPRS services through this interface.

4 Main Concepts

GPRS uses a packet-mode technique to transfer high-speed and low-speed data and signalling in an efficient manner. GPRS optimises the use of network and radio resources. Strict separation between the radio subsystem and network subsystem is maintained, allowing the network subsystem to be reused with other radio access technologies. GPRS does not mandate changes to an installed MSC base.

New GPRS radio channels are defined, and the allocation of these channels is flexible: from 1 to 8 radio interface timeslots can be allocated per TDMA frame, timeslots are shared by the active users, and up and downlink are allocated separately. The radio interface resources can be shared dynamically between speech and data services as a function of service load and operator preference. Various radio channel coding schemes are specified to allow bitrates from 9 to more than 150 kbit/s per user.

Applications based on standard data protocols are supported, and interworking is defined with IP networks and X.25 networks. GPRS allows SMS transfer over GPRS radio channels.

GPRS is designed to support from intermittent and bursty data transfers through to occasional transmission of large volumes of data. Several quality of service profiles are supported. GPRS is designed for fast reservation to begin transmission of packets, typically 0,5 to 1 second. Charging should typically be based on the amount of data transferred.

Three GPRS MS modes of operation are supported: An MS in class-A mode of operation operates GPRS and other GSM services simultaneously. An MS in class-B mode of operation monitors control channels for GPRS and other GSM services simultaneously, but can only operate one set of services at one time. An MS in class-C mode of operation exclusively operates GPRS services.

GPRS introduces two new network nodes in the GSM PLMN: The Serving GPRS Support Node (SGSN), which is at the same hierarchical level as the MSC, keeps track of the individual MSs' location and performs security functions and access control. The SGSN is connected to the base station system with Frame Relay. The Gateway GSN (GGSN) provides interworking with external packet-switched networks, and is connected with SGSNs via an IP-based GPRS backbone network. The HLR is enhanced with GPRS subscriber information, and the SMS-GMSCs and SMS-IW MSCs are upgraded to support SMS transmission via the SGSN. Optionally, the MSC/VLR can be enhanced for more-efficient co-ordination of GPRS and non-GPRS services and functionality: e.g., paging for circuit-switched calls that can be performed more efficiently via the SGSN, and combined GPRS and non-GPRS location updates.

GPRS security functionality is equivalent to the existing GSM security. The SGSN performs authentication and cipher setting procedures based on the same algorithms, keys, and criteria as in existing GSM. GPRS uses a ciphering algorithm optimised for packet data transmission. A GPRS ME can access the GPRS services with SIMs that are not GPRS-aware, and with GPRS-aware SIMs.

Cell selection may be performed autonomously by an MS, or the base station system instructs the MS to select a certain cell. The MS informs the network when it re-selects another cell or group of cells known as a routeing area.

In order to access the GPRS services, an MS shall first make its presence known to the network by performing a GPRS attach. This operation establishes a logical link between the MS and the SGSN, and makes the MS available for SMS over GPRS, paging via SGSN, and notification of incoming GPRS data.

In order to send and receive GPRS data, the MS shall activate the packet data address that it wants to use. This operation makes the MS known in the corresponding GGSN, and interworking with external data networks can commence.

User data is transferred transparently between the MS and the external data networks with a method known as encapsulation and tunnelling: data packets are equipped with GPRS-specific protocol information and transferred between the MS and GGSN. This transparent transfer method lessens the requirement for the GPRS PLMN to interpret external data protocols, and it enables easy introduction of additional interworking protocols in the future. User data can be compressed and protected with retransmission protocols for efficiency and reliability.

5 General GPRS Architecture and Transmission Mechanism

5.1 GPRS Access Interfaces and Reference Points

Each GPRS PLMN has two access points, the Um used for mobile access and the R reference point used for origination or reception of messages. The R reference point for the GPRS MSs is defined in GSM 07.60 [16].

An interface differs from a reference point in that an interface is defined where specific GPRS information is exchanged and needs to be fully recognised.

There is an inter-GPRS PLMN interface called Gp that connects two independent GPRS networks for message exchange.

There is also a GPRS PLMN to fixed network (typically a packet data network) reference point called Gi. Gi is defined in GSM 09.61 [26].

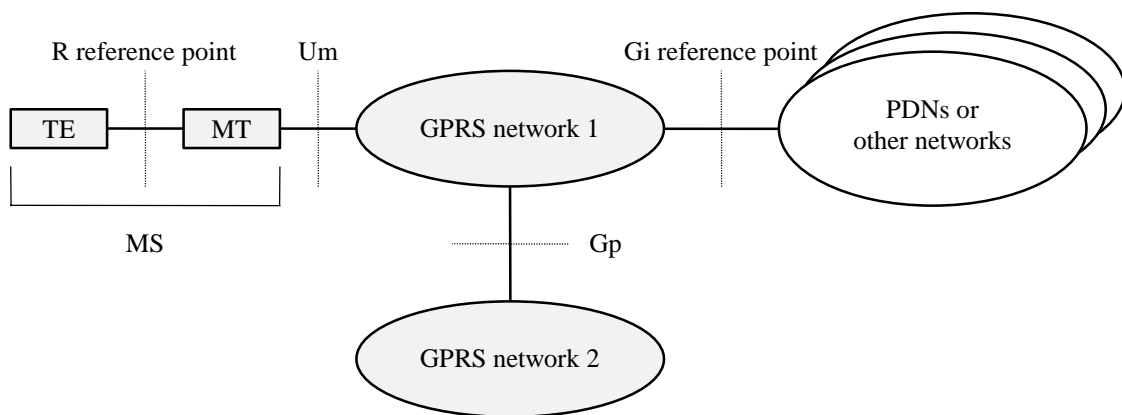

Figure 1: GPRS Access Interfaces and Reference Points

There may be more than a single GPRS network interface to several different packet data (or other) networks. These networks may both differ in ownership as well as in communications protocol (e.g., X.25, TCP/IP etc.). The network operator should define and negotiate interconnect with each external (PDN or other) network.

5.2 Network Interworking

Network interworking is required whenever a PLMN supporting GPRS and any other network are involved in the execution of a GPRS service request. With reference to Figure 1, interworking takes place through the Gi reference point and the Gp interface.

The GPRS internal mechanism for conveying the PDP PDU through the GSM PLMN is managed by the GSM GPRS network operator and is not apparent to the data user. The use of this GSM data service may have an impact on and increase the transfer time normally found for a message when communicated through a fixed packet data network.

5.2.1 PSPDN Interworking

GPRS shall support interworking with PSPDN networks. The interworking may be either direct or through a transit network (e.g., ISDN). GPRS shall support both X.121 [38] and E.164 [30] addresses.

GPRS shall provide support for X.25 virtual circuits and X.25 fast select. X.75 [37] or X.75' [45] may be used for interworking with X.25 PDNs.

The GPRS TEs have addresses provided by the GSM PLMN GPRS service operator and belong to the GPRS service domain. The PSPDN TE sends data to the GPRS TE by use of the GSM PLMN GPRS DNIC (Data Network Identification Code) or equivalent that uniquely identifies the GPRS network.

5.2.2 Internet (IP) Interworking

GPRS shall support interworking with networks based on the internet protocol (IP). IP is defined in RFC 791 [40]. GPRS may provide compression of the TCP/IP header when an IP-datagram is used within the context of a TCP connection.

In a similar way to the PSPDN X.25 case, the GSM PLMN GPRS service is an IP domain, and mobile terminals offered service by a GSM service provider may be globally addressable through the network operator's addressing scheme.

5.3 High-Level Functions Required for GPRS

The following list gives the logical functions performed within the GPRS network. Several functional groupings (meta-functions) are defined which each encompasses a number of individual functions:

- Network Access Control Functions;
- Packet Routing and Transfer Functions;
- Mobility Management Functions;
- Logical Link Management Functions;
- Radio Resource Management Functions;
- Network Management Functions.

5.3.1 Network Access Control Functions

Network access is the means by which a user is connected to a telecommunication network in order to use the services and/or facilities of that network. An access protocol is a defined set of procedures that enables the user to employ the services and/or facilities of the network.

User network access may occur from either the mobile side or the fixed side of the GPRS network. The fixed network interface may support multiple access protocols to external data networks, for example X.25 or IP. The set of access protocols to be supported is determined by the PLMN operator.

Individual PLMN administrations may require specific access-control procedures in order to limit the set of users permitted to access the network, or to restrict the capabilities of individual users, for example by limiting the type of service available to an individual subscriber. Such access control procedures are beyond the scope of the GPRS specifications.

In addition to the standard data transfer, GPRS may support anonymous access to the network. The service allows an MS to exchange data packets with a predefined host that can be addressed by the supported interworking protocols. Only a limited number of destination PDP addresses can be used within this service. IMSI or IMEI shall not be used when accessing the network thus guaranteeing a high level of anonymity. Therefore, no authentication and ciphering functionalities are foreseen for anonymous access.

5.3.1.1 Registration Function

Registration is the means by which a user's Mobile Id is associated with the user's packet data protocol(s) and address(es) within the PLMN, and with the user's access point(s) to the external PDP network. The association can be static, i.e., stored in an HLR, or dynamic, i.e., allocated on a per need basis.

5.3.1.2 Authentication and Authorisation Function

This function performs the identification and authentication of the service requester, and the validation of the service request type to ensure that the user is authorised to use the particular network services. The authentication function is performed in association with the Mobility Management functions.

5.3.1.3 Admission Control Function

The purpose of admission control is to calculate which network resources are required to provide the quality of service (QoS) requested, determine if those resources are available, and then reserve those resources. Admission control is performed in association with the Radio Resource Management functions in order to estimate the radio resource requirements within each cell.

5.3.1.4 Message Screening Function

A screening function concerned with filtering out unauthorised or unsolicited messages is required. This should be supported through packet filtering functions. Network-controlled screening is supported in the first phase of GPRS. Subscription-controlled and user-controlled screening may be provided in a later phase.

5.3.1.5 Packet Terminal Adaptation Function

This function adapts data packets received / transmitted from / to terminal equipment to a form suitable for transmission across the GPRS network.

5.3.1.6 Charging Data Collection Function

This function collects data necessary to support subscription and/or traffic fees.

5.3.2 Packet Routing and Transfer Functions

A route is an ordered list of nodes used for the transfer of messages within and between the PLMN(s). Each route consists of the originating node, zero or more relay nodes and the destination node. Routing is the process of determining and using, in accordance with a set of rules, the route for transmission of a message within and between the PLMN(s).

5.3.2.1 Relay Function

The relay function is the means by which a node forwards data received from one node to the next node in the route.

5.3.2.2 Routing Function

The routing function determines the network node to which a message should be forwarded and the underlying service(s) used to reach that GPRS Support Node (GSN), using the destination address of the message. The routing function selects the transmission path for the "next hop" in the route.

Data transmission between GSNS may occur across external data networks that provide their own internal routing functions, for example X.25, Frame Relay or ATM networks.

5.3.2.3 Address Translation and Mapping Function

Address translation is the conversion of one address to another address of a different type. Address translation may be used to convert an external network protocol address into an internal network address that can be used for routing packets within and between the PLMN(s).

Address mapping is used to map a network address to another network address of the same type for the routing and relaying of messages within and between the PLMN(s), for example to forward packets from one network node to another.

5.3.2.4 Encapsulation Function

Encapsulation is the addition of address and control information to a data unit for routing packets within and between the PLMN(s). Decapsulation is the removal of the addressing and control information from a packet to reveal the original data unit.

Encapsulation and decapsulation are performed between the support nodes of the GPRS PLMN(s), and between the serving support node and the MS.

5.3.2.5 Tunnelling Function

Tunnelling is the transfer of encapsulated data units within and between the PLMN(s) from the point of encapsulation to the point of decapsulation. A tunnel is a two-way point-to-point path. Only the tunnel endpoints are identified.

5.3.2.6 Compression Function

The compression function optimises use of radio path capacity by transmitting as little of the SDU (i.e., the exterior PDP PDU) as possible while at the same time as preserving the information contained within it.

5.3.2.7 Ciphering Function

The ciphering function preserves the confidentiality of user data and signalling across the radio channels and inherently protects the PLMN from intruders.

5.3.2.8 Domain Name Server Function

The Domain Name Server function resolves logical GSN names to GSN addresses. This function is standard Internet functionality according to RFC 1034 [43], which allows to resolve any name for GSNs and other GPRS nodes within the GPRS backbone networks.

5.3.3 Mobility Management Functions

The mobility management functions are used to keep track of the current location of an MS within the PLMN or within another PLMN.

5.3.4 Logical Link Management Functions

Logical link management functions are concerned with the maintenance of a communication channel between an individual MS and the PLMN across the radio interface. These functions involve the co-ordination of link state information between the MS and the PLMN as well as the supervision of data transfer activity over the logical link.

Refer to GSM 04.64 [13] for further information.

5.3.4.1 Logical Link Establishment Function

Logical link establishment is performed when the MS attaches to the GPRS service.

5.3.4.2 Logical Link Maintenance Functions

Logical link maintenance functions supervise the logical link status and control link state changes.

5.3.4.3 Logical Link Release Function

The logical link release function is used to de-allocate resources associated with the logical link connection.

5.3.5 Radio Resource Management Functions

Radio resource management functions are concerned with the allocation and maintenance of radio communication paths. GSM radio resources is shared between the circuit mode (voice and data) services and the GPRS.

Refer to GSM 03.64 for further information.

5.3.5.1 Um Management Function

This function manages the set of physical channels used in each cell and determines the amount of radio resources to be allocated for GPRS use. The amount of radio resources allocated for GPRS may vary from cell to cell depending upon local user demand or other policies established by the PLMN operator.

5.3.5.2 Cell Selection Function

This function enables the MS to select the optimal cell for use in establishing a communication path with the PLMN. This involves the measurement and evaluation of signal quality from nearby cells as well as the detection and avoidance of congestion within candidate cells.

Refer to GSM 03.22 [7] and GSM 03.64 for further information.

5.3.5.3 Um-tranx Function

The Um-tranx function provides packet data transfer capability across the radio interface between the MS and the BSS. This function includes procedures that:

- Provide medium access control over radio channels;
- Provide packet multiplexing over common physical radio channels;
- Provide packet discrimination within the MS;
- Provide error detection and correction;
- Provide flow control procedures.

5.3.5.4 Path Management Function

This function manages the packet data communication paths between the BSS and the serving GSN nodes. The establishment and release of these paths may be dynamic based upon the amount of data traffic or may be static based upon the maximum expected load within each cell.

5.3.6 Network Management Functions

Network management functions provide mechanisms to support O&M functions related to GPRS.

5.4 Logical Architecture

GPRS is logically implemented on the GSM structure through the addition of two network nodes, the Serving GPRS Support Node and the Gateway GPRS Support Node. It is necessary to name a number of new interfaces. No inference should be drawn about the physical configuration on an interface from Figure 2.

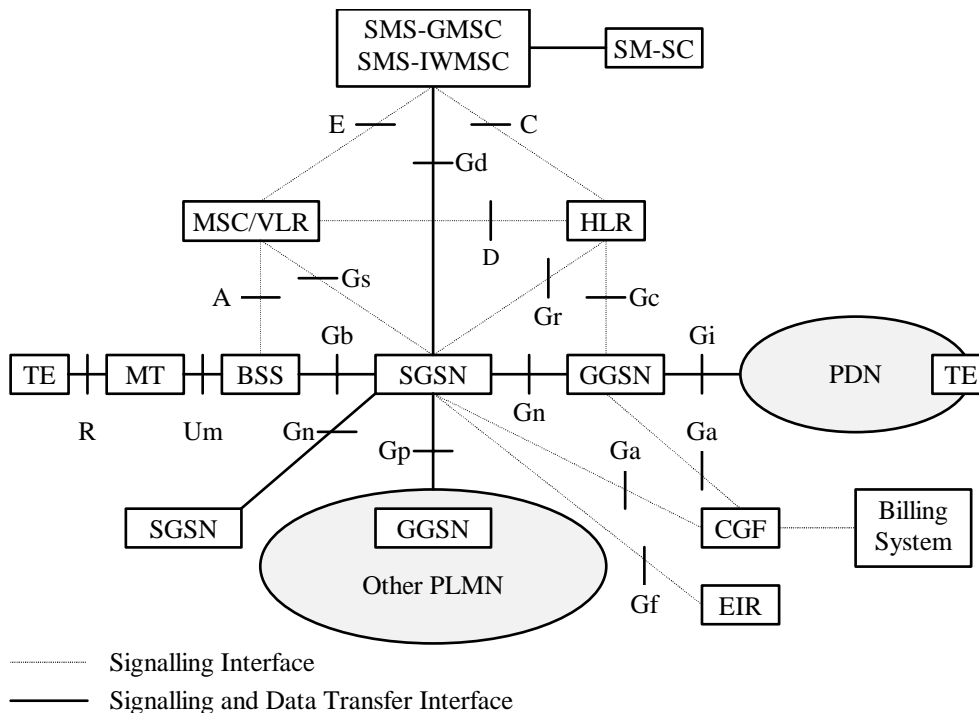

Figure 2: Overview of the GPRS Logical Architecture

5.4.1 GPRS Support Nodes

A GPRS Support Node (GSN) contains functionality required to support GPRS. In one PLMN, there may be more than one GSN.

The Gateway GPRS Support Node (GGSN) is the node that is accessed by the packet data network due to evaluation of the PDP address. It contains routing information for attached GPRS users. The routing information is used to tunnel N-PDUs to the MS's current point of attachment, i.e., the Serving GPRS Support Node. The GGSN may request location information from the HLR via the optional Gc interface. The GGSN is the first point of PDN interconnection with a GSM PLMN supporting GPRS (i.e., the Gi reference point is supported by the GGSN).

The Serving GPRS Support Node (SGSN) is the node that is serving the MS (i.e., the Gb interface is supported by the SGSN). At GPRS attach, the SGSN establishes a mobility management context containing information pertaining to e.g., mobility and security for the MS. At PDP Context Activation, the SGSN establishes a PDP context, to be used for routing purposes, with the GGSN that the GPRS subscriber will be using.

The SGSN and GGSN functionalities may be combined in the same physical node, or they may reside in different physical nodes. SGSN and GGSN contain IP routing functionality, and they may be interconnected with IP routers. When SGSN and GGSN are in different PLMNs, they are interconnected via the Gp interface. The Gp interface provides the functionality of the Gn interface, plus security functionality required for inter-PLMN communication. The security functionality is based on mutual agreements between operators.

The SGSN may send location information to the MSC/VLR via the optional Gs interface. The SGSN may receive paging requests from the MSC/VLR via the Gs interface.

5.4.2 GPRS Backbone Networks

There are two kinds of GPRS backbone networks. These are called:

- intra-PLMN backbone network; and
- inter-PLMN backbone network.

The intra-PLMN backbone network is the IP network interconnecting GSNs within the same PLMN.

The inter-PLMN backbone network is the IP network interconnecting GSNs and intra-PLMN backbone networks in different PLMNs.

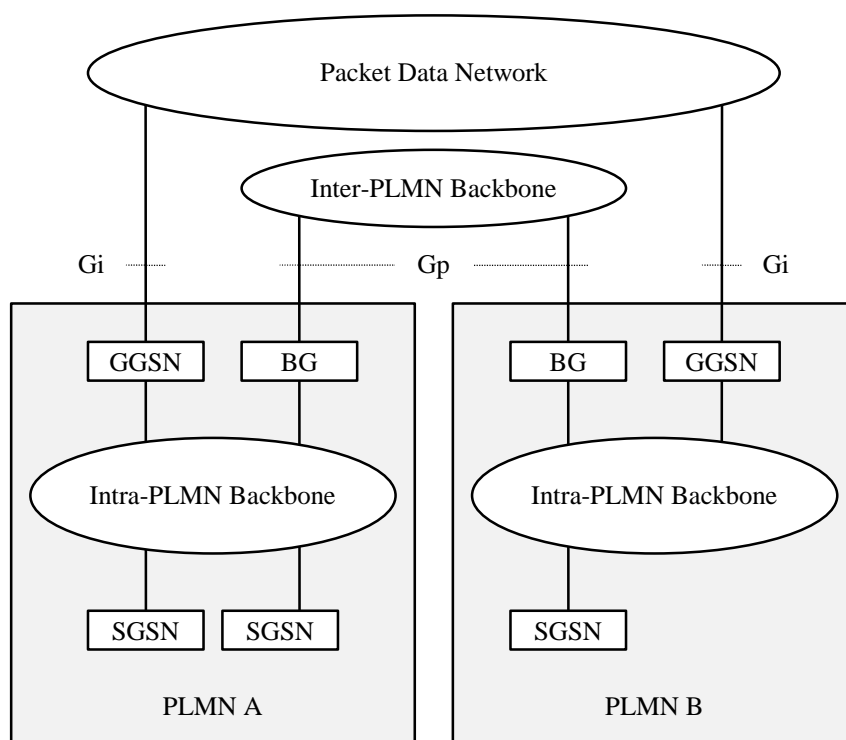

Figure 3: Intra- and Inter-PLMN Backbone Networks

Every intra-PLMN backbone network is a private IP network intended for GPRS data and GPRS signalling only. A private IP network is an IP network to which some access control mechanism is applied in order to achieve a required level of security. Two intra-PLMN backbone networks are connected via the Gp interface using Border Gateways (BGs) and an inter-PLMN backbone network. The inter-PLMN backbone network is selected by a roaming agreement that includes the BG security functionality. The BG is not defined within the scope of GPRS. The inter-PLMN backbone can be a Packet Data Network, e.g., the public Internet or a leased line.

5.4.3 HLR

The HLR contains GPRS subscription data and routing information. The HLR is accessible from the SGSN via the Gr interface and from the GGSN via the Gc interface. For roaming MSs, HLR may be in a different PLMN than the current SGSN.

5.4.4 SMS-GMSC and SMS-IWMSC

The SMS-GMSC and SMS-IWMSC are connected to the SGSN via the Gd interface to enable GPRS MSs to send and receive SMSs over GPRS radio channels.

5.4.5 GPRS Mobile Stations

A GPRS MS can operate in one of three modes of operation. The mode of operation depends on the services that the MS is attached to, i.e., only GPRS or both GPRS and other GSM services, and upon the MS's capabilities to operate GPRS and other GSM services simultaneously.

- Class-A mode of operation: The MS is attached to both GPRS and other GSM services, and the MS supports simultaneous operation of GPRS and other GSM services.
- Class-B mode of operation: The MS is attached to both GPRS and other GSM services, but the MS can only operate one set of services at a time.
- Class-C mode of operation: The MS is exclusively attached to GPRS services.

The three modes of operation are defined in GSM 02.60.

NOTE: Other GSM technical specifications may refer to the MS modes of operation as GPRS class-A MS, GPRS class-B MS, and GPRS class-C MS.

5.4.6 Charging Gateway Functionality

The Charging Gateway Functionality (CGF) is described in GSM 12.15 [28].

5.5 Assignment of Functions to General Logical Architecture

The functions identified in the functional model are assigned to the logical architecture.

Table 1: Mapping of Functions to Logical Architecture

Function	MS	BSS	SGSN	GGSN	HLR
Network Access Control:					
Registration					X
Authentication and Authorisation	X		X		X
Admission Control	X	X	X		
Message Screening				X	
Packet Terminal Adaptation	X				
Charging Data Collection			X	X	
Packet Routing & Transfer:					
Relay	X	X	X	X	
Routing	X	X	X	X	
Address Translation and Mapping	X		X	X	
Encapsulation	X		X	X	
Tunnelling			X	X	
Compression	X		X		
Ciphering	X		X		X
Mobility Management:	X		X	X	X
Logical Link Management:					
Logical Link Establishment	X		X		
Logical Link Maintenance	X		X		
Logical Link Release	X		X		
Radio Resource Management:					
Um Management	X	X			
Cell Selection	X	X			
Um-Tranx	X	X			
Path Management		X	X		

5.6 Transmission and Signalling Planes

5.6.1 Transmission Plane

The transmission plane consists of a layered protocol structure providing user information transfer, along with associated information transfer control procedures (e.g., flow control, error detection, error correction and error recovery). The transmission plane independence of the Network Subsystem (NSS) platform from the underlying radio interface is preserved via the Gb interface. The following transmission plane is used in GPRS:

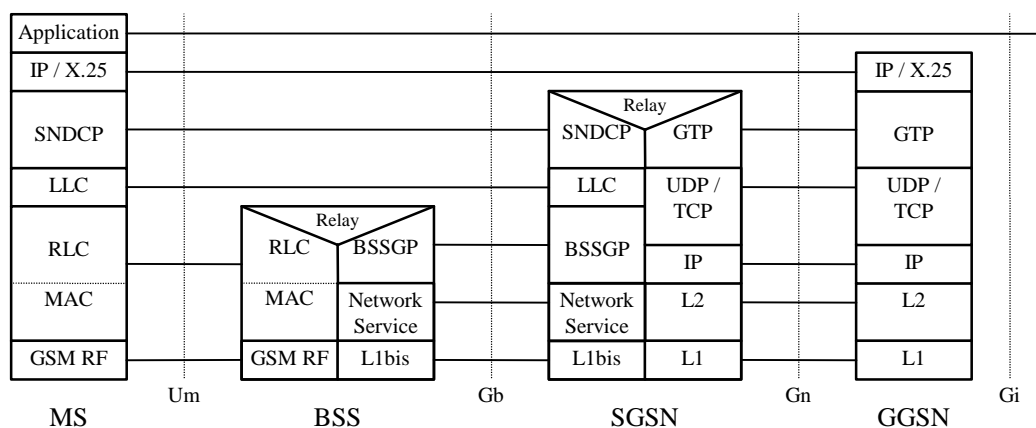

Figure 4: Transmission Plane

Legend:

- GPRS Tunnelling Protocol (GTP): This protocol tunnels user data and signalling between GPRS Support Nodes in the GPRS backbone network. All PDP PDUs shall be encapsulated by the GPRS Tunnelling Protocol. GTP is specified in GSM 09.60 [25].
- TCP carries GTP PDUs in the GPRS backbone network for protocols that need a reliable data link (e.g., X.25), and UDP carries GTP PDUs for protocols that do not need a reliable data link (e.g., IP). TCP provides flow control and protection against lost and corrupted GTP PDUs. UDP provides protection against corrupted GTP PDUs. TCP is defined in RFC 793 [42]. UDP is defined in RFC 768 [39].
- IP: This is the GPRS backbone network protocol used for routing user data and control signalling. The GPRS backbone network may initially be based on the IP version 4 protocol. Ultimately, IP version 6 shall be used. IP version 4 is defined in RFC 791.
- Subnetwork Dependent Convergence Protocol (SNDCP): This transmission functionality maps network-level characteristics onto the characteristics of the underlying network. SNDCP is specified in GSM 04.65 [14].
- Logical Link Control (LLC): This layer provides a highly reliable ciphered logical link. LLC shall be independent of the underlying radio interface protocols in order to allow introduction of alternative GPRS radio solutions with minimum changes to the NSS. LLC is specified in GSM 04.64.
- Relay: In the BSS, this function relays LLC PDUs between the Um and Gb interfaces. In the SGSN, this function relays PDP PDUs between the Gb and Gn interfaces.
- Base Station System GPRS Protocol (BSSGP): This layer conveys routing- and QoS-related information between BSS and SGSN. BSSGP does not perform error correction. BSSGP is specified in GSM 08.18 [20].
- Network Service (NS): This layer transports BSSGP PDUs. NS is based on the Frame Relay connection between BSS and SGSN, and may be multi-hop and traverse a network of Frame Relay switching nodes. NS is specified in GSM 08.16 [19].
- RLC/MAC: This layer contains two functions: The Radio Link Control function provides a radio-solution-dependent reliable link. The Medium Access Control function controls the access signalling (request and grant) procedures for the radio channel, and the mapping of LLC frames onto the GSM physical channel. RLC/MAC is defined in GSM 04.60 [12].
- GSM RF: As defined in GSM 05 series.

5.6.2 Signalling Plane

The signalling plane consists of protocols for control and support of the transmission plane functions:

- controlling the GPRS network access connections, such as attaching to and detaching from the GPRS network;
- controlling the attributes of an established network access connection, such as activation of a PDP address;
- controlling the routing path of an established network connection in order to support user mobility; and

- controlling the assignment of network resources to meet changing user demands.

The following signalling planes are used in GPRS:

5.6.2.1 MS - SGSN

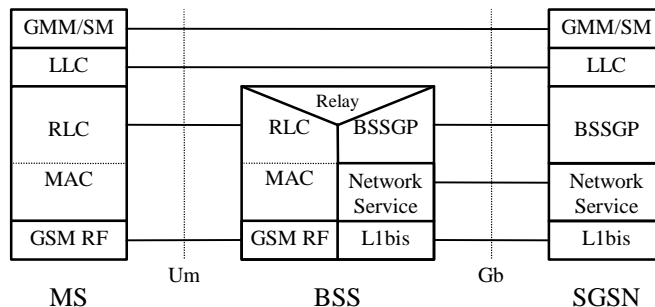

Figure 5: Signalling Plane MS - SGSN

Legend:

- GPRS Mobility Management and Session Management (GMM/SM): This protocol supports mobility management functionality such as GPRS attach, GPRS detach, security, routing area update, location update, PDP context activation, and PDP context deactivation, as described in subclauses "Mobility Management Functionality" and "PDP Context Activation, Modification, and Deactivation Functions".

5.6.2.2 SGSN - HLR

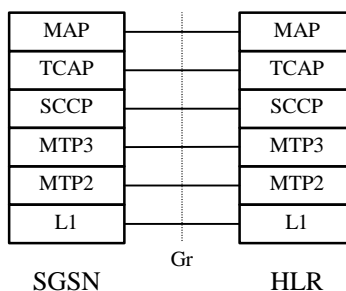

Figure 6: Signalling Plane SGSN - HLR

Legend:

- Mobile Application Part (MAP): This protocol supports signalling exchange with the HLR, as defined in GSM 09.02 [22], with enhancements for GPRS as described in the present document.
- TCAP, SCCP, MTP3, and MTP2 are the same protocols as used to support MAP in non-GPRS GSM PLMNs.

5.6.2.3 SGSN - MSC/VLR

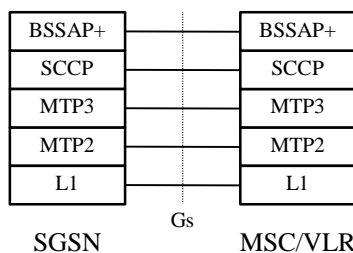

Figure 7: Signalling Plane SGSN - MSC/VLR

Legend:

- Base Station System Application Part + (BSSAP+): A subset of BSSAP procedures supports signalling between the SGSN and MSC/VLR, as described in subclause "Mobility Management Functionality" and in GSM 09.18 [24]. The requirements for the lower layers are specified in GSM 09.16 [23].

5.6.2.4 SGSN - EIR

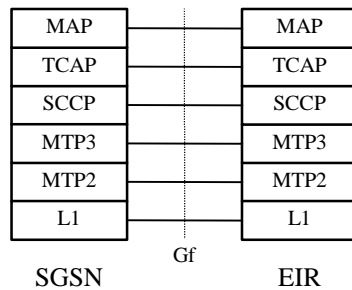

Figure 8: Signalling Plane SGSN - EIR

Legend:

- Mobile Application Part (MAP): This protocol supports signalling between the SGSN and the EIR, as described in subclause "Identity Check Procedures".

5.6.2.5 SGSN - SMS-GMSC or SMS-IWMSC

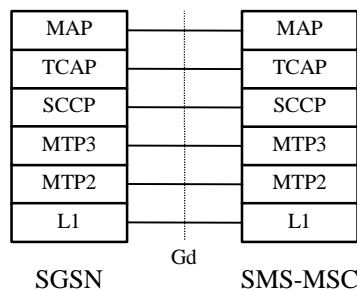

Figure 9: Signalling Plane SGSN - SMS-GMSC and SGSN - SMS-IWMSC

Legend:

- Mobile Application Part (MAP): This protocol supports signalling between the SGSN and SMS-GMSC or SMS-IWMSC, as described in subclause "Point-to-point Short Message Service".

5.6.2.6 GSN - GSN

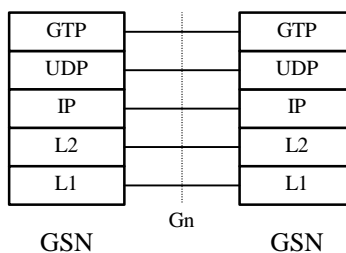

Figure 10: Signalling Plane GSN - GSN

Legend:

- GPRS Tunnelling Protocol (GTP): This protocol tunnels user data and signalling messages between SGSNs and GGSNs, and between SGSNs, in the GPRS backbone network.
- User Datagram Protocol (UDP): This protocol transfers signalling messages between GSNs. UDP is defined in RFC 768.

5.6.2.7 GGSN - HLR

This optional signalling path allows a GGSN to exchange signalling information with an HLR. There are two alternative ways to implement this signalling path:

- If a SS7 interface is installed in the GGSN, the MAP protocol can be used between the GGSN and an HLR.
- If a SS7 interface is not installed in the GGSN, any GSN with a SS7 interface installed in the same PLMN as the GGSN can be used as a GTP-to-MAP protocol converter to allow signalling between the GGSN and an HLR.

5.6.2.7.1 MAP-based GGSN - HLR Signalling

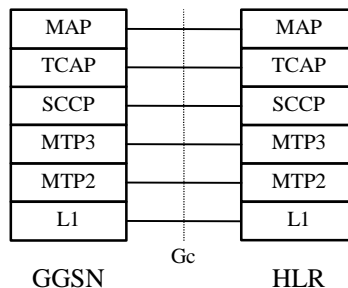

Figure 11: Signalling Plane GGSN - HLR Using MAP

Legend:

- Mobile Application Part (MAP): This protocol supports signalling exchange with the HLR, as described in subclause "Network-Requested PDP Context Activation Procedure".

5.6.2.7.2 GTP and MAP-based GGSN - HLR Signalling

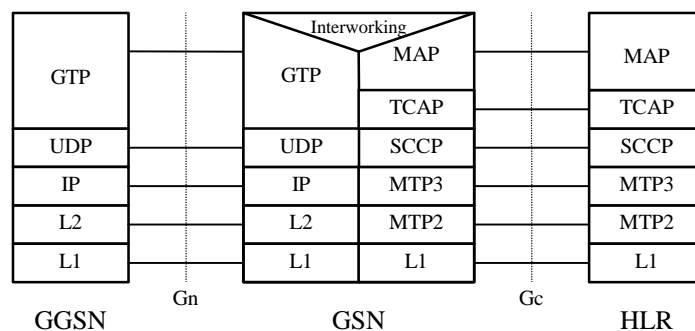

Figure 12: Signalling Plane GGSN - HLR Using GTP and MAP

Legend:

- GPRS Tunnelling Protocol (GTP): This protocol tunnels signalling messages between the GGSN and the protocol-converting GSN in the GPRS backbone network.
- Interworking: This function provides interworking between GTP and MAP for GGSN - HLR signalling.

6 Mobility Management Functionality

6.1 Definition of Mobility Management States

The Mobility Management (MM) activities related to a GPRS subscriber are characterised by one of three different MM states. Each state describes a certain level of functionality and information allocated. The information sets held at the MS and SGSN are denoted MM context.

In the non-anonymous access case, the MM state relates only to GPRS MM activities of a subscriber. The MM state is independent of the number and state of PDP contexts for that subscriber.

In the anonymous access case, the MM state relates to GPRS MM activities of an MS represented only by an Auxiliary TLLI.

6.1.1 IDLE (GPRS) State

In GPRS IDLE state, the subscriber is not attached to the GPRS mobility management. The MS and SGSN context hold no valid location or routing information for the subscriber. The subscriber-related mobility management procedures are not performed.

PLMN selection and GPRS cell selection and re-selection processes are performed by the MS.

Data transmission to and from the mobile subscriber and the paging of the subscriber are not possible. The GPRS MS is seen as not reachable in this case.

In order to establish MM contexts in the MS and the SGSN, the MS shall perform the GPRS Attach procedure.

6.1.2 STANDBY State

In STANDBY state, the subscriber is attached to GPRS mobility management. The MS and SGSN have established MM contexts for the subscriber's IMSI as described in clause "Information Storage".

Pages for data or signalling information transfers may be received. It is also possible to receive pages for the CS services via the SGSN. Data reception and transmission are not possible in this state.

The MS performs GPRS Routing Area (RA) and GPRS cell selection and re-selection locally. The MS executes mobility management procedures to inform the SGSN when it has entered a new RA. The MS does not inform the SGSN on a change of cell in the same RA. Therefore, the location information in the SGSN MM context contains only the GPRS RAI for MSs in STANDBY state.

The MS may initiate activation or deactivation of PDP contexts while in STANDBY state. A PDP context shall be activated before data can be transmitted or received for this PDP context.

The SGSN may have to send data or signalling information to an MS in STANDBY state. The SGSN then sends a Paging Request in the routing area where the MS is located if PPF is set. If PPF is cleared, then paging is not done. The MM state in the MS is changed to READY when the MS responds to the page, and in the SGSN when the page response is received. Also, the MM state in the MS is changed to READY when data or signalling information is sent from the MS and, accordingly, the MM state in the SGSN is changed to READY when data or signalling information is received from the MS.

The MS or the network may initiate the GPRS Detach procedure to move to the IDLE state. After expiry of the mobile reachable timer the SGSN may perform an implicit detach in order to return the MM contexts in the SGSN to IDLE state. The MM and PDP contexts may then be deleted.

6.1.3 READY State

In READY state, the SGSN MM context corresponds to the STANDBY MM context extended by location information for the subscriber on cell level. The MS performs mobility management procedures to provide the network with the actual selected cell. GPRS cell selection and re-selection is done locally by the MS, or may optionally be controlled by the network.

An identifier of the cell, the Cell Global Identity including RAC and LAC, is included in the BSSGP header of the data packet from the MS, see GSM 08.18.

The MS may send and receive PDP PDUs in this state. The network initiates no GPRS pages for an MS in READY state, pages for other services may be done via the SGSN. The SGSN transfers downlink data to the BSS responsible for the subscriber's actual GPRS cell.

The MS may activate or deactivate PDP contexts while in READY state

Regardless if a radio resource is allocated to the subscriber or not, the MM context remains in the READY state even when there is no data being communicated. The READY state is supervised by a timer. An MM context moves from READY state to STANDBY state when the READY timer expires. In order to move from READY state to IDLE state, the MS initiates the GPRS Detach procedure.

6.2 IDLE / STANDBY / READY State Functionality

6.2.1 State Transitions and Functions

The movement from one state to the next is dependent on the current state (IDLE, STANDBY, or READY) and the event occurred (e.g., GPRS attach).

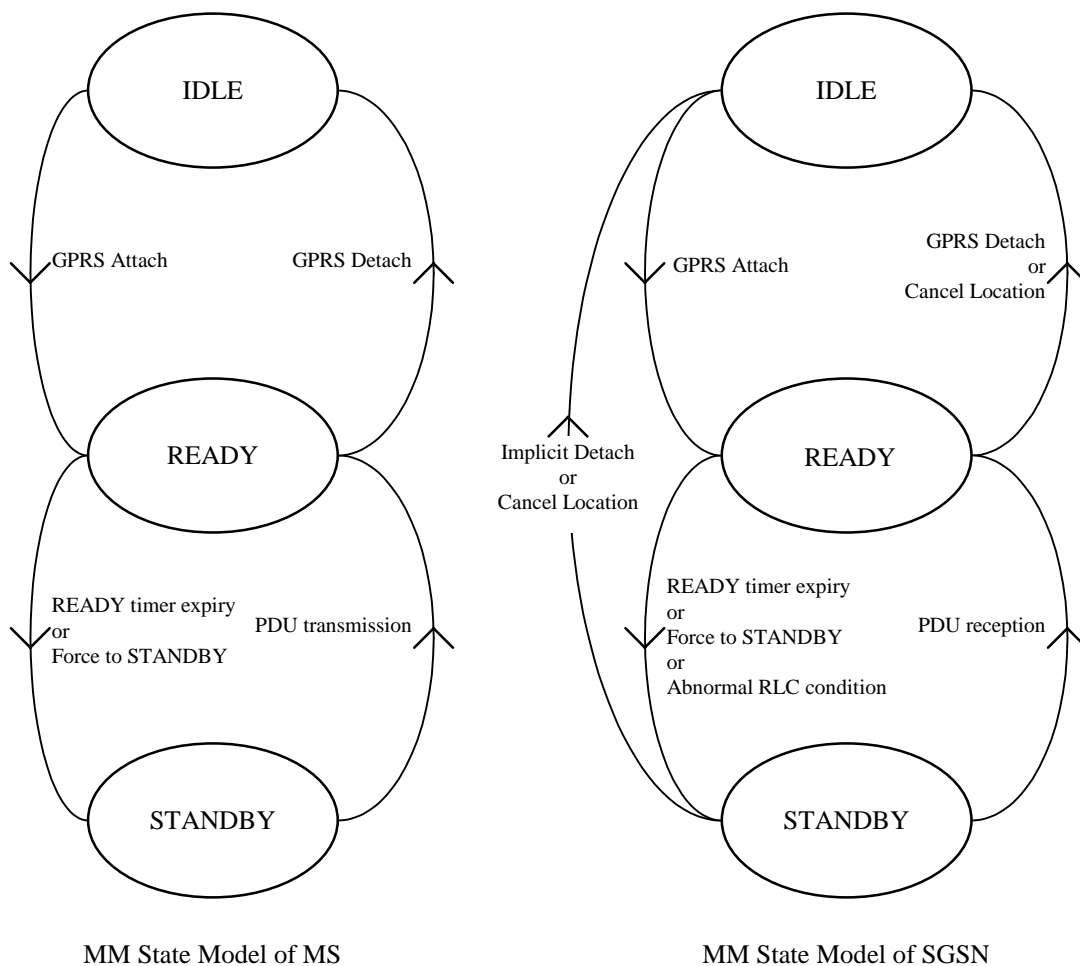

Figure 13: Functional Mobility Management State Model

Figure 13 describes the following state transitions:

Moving from IDLE to READY:

- GPRS Attach: The MS requests access and a logical link to an SGSN is initiated. MM contexts are established at the MS and SGSN.

Moving from STANDBY to IDLE:

- Implicit Detach: The MM and PDP contexts in the SGSN shall return to IDLE and INACTIVE state. The MM and PDP contexts in the SGSN may be deleted. The GGSN PDP contexts shall be deleted.
- Cancel Location: The SGSN receives a MAP Cancel Location message from the HLR, and removes the MM and PDP contexts.

Moving from STANDBY to READY:

- PDU transmission: The MS sends an LLC PDU to the SGSN, possibly in response to a page.
- PDU reception: The SGSN receives an LLC PDU from the MS.

Moving from READY to STANDBY:

- READY timer expiry: The MS and the SGSN MM contexts return to STANDBY state.
- Force to STANDBY: The SGSN indicates an immediate return to STANDBY state before the READY timer expires.
- Abnormal RLC condition: The SGSN MM context returns to STANDBY state in case of delivery problems on the radio interface or in case of irrecoverable disruption of a radio transmission.

Moving from READY to IDLE:

- GPRS Detach: The MS or the network requests that the MM contexts return to IDLE state and that the PDP contexts return to INACTIVE state. The SGSN may delete the MM and PDP contexts. The PDP contexts in the GGSN shall be deleted.
- Cancel Location: The SGSN receives a MAP Cancel Location message from the HLR, and removes the MM and PDP contexts.

For anonymous access, a reduced Mobility Management State Model consisting of IDLE and READY states is used. The AA MM state machine is independently handled by the MS and the network and may coexist with an IMSI-based MM state machine. Several AA MM state machines may coexist in the same MS and SGSN simultaneously.

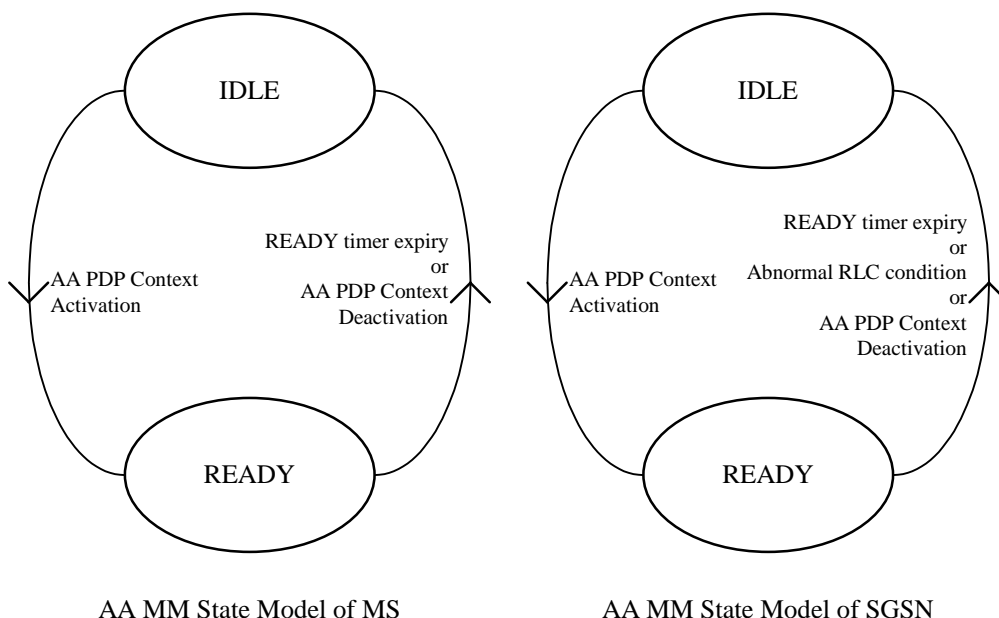

Figure 14: Functional Anonymous Access Mobility Management State Model

Figure 14 describes the following state transitions for anonymous access:

Moving from IDLE to READY:

- AA PDP Context Activation: The MS requests an anonymous access and a logical link to an SGSN is initiated. MM contexts are established at the MS and SGSN, and PDP contexts are established at the MS, the SGSN, and a GGSN.

Moving from READY to IDLE:

- READY timer expiry: The MM and PDP contexts in the MS, the SGSN, and the GGSN are deleted.
- Abnormal RLC condition: The SGSN MM context shall be deleted in case of delivery problems on the radio interface or in case of irrecoverable disruption of a radio transmission.
- AA PDP Context Deactivation: The network (either the SGSN or the GGSN) initiates the AA PDP Context Deactivation procedure, e.g., due to malicious usage of the anonymous service. The MM and PDP contexts in the MS, the SGSN, and the GGSN shall be deleted.

6.2.2 READY Timer Function

The READY timer function maintains the READY timer in the MS and SGSN. The READY timer controls the time an MS remains in READY state in the MS and the SGSN. The READY timer shall be reset and begin running in the MS when an LLC PDU is transmitted, and in the SGSN when an LLC PDU is correctly received. When the READY timer expires, the MS and SGSN MM contexts shall return to STANDBY state. In case of anonymous access the MM context shall be deleted.

The length of the READY timer shall be the same in the MS and SGSN. The initial length of the READY timer shall be defined by a default value. The SGSN, and only the SGSN, may change the length of the READY timer by transmitting a new value in the Attach Accept, Routeing Area Update Accept, or AA PDP Context Accept messages.

If the READY timer length is set to zero, the MS shall immediately be forced into STANDBY state. If the timer length is set to all 1s (binary), then the READY timer function shall be deactivated, i.e., the timer no longer runs and the MS remains in READY state.

6.2.3 Periodic RA Update Timer Function

The Periodic RA Update Timer function monitors the periodic RA update procedure in the MS. The length of the periodic RA update timer is sent in the Routeing Area Update Accept or Attach Accept message. The periodic RA update timer is unique within an RA. Upon expiry of the periodic RA update timer, the MS shall start a periodic routeing area update procedure.

If the MS is in coverage but out of GPRS coverage when the periodic RA update timer expires, then, if the MS is IMSI-attached to a network in network operation mode I, the periodic location update procedure (or other appropriate location update procedure) shall be started immediately. In addition, and irrespective of whether or not the MS was IMSI-attached, regardless of the network operation mode, the periodic RA update procedure (or other appropriate update procedure) shall be started as soon as the MS returns to GPRS coverage.

If the MS is out of coverage when the periodic RA update timer expires then:

- if the MS is both IMSI and GPRS-attached and returns to coverage in a cell that supports GPRS in network operation mode I, then the combined RA / LA update procedure with IMSI attach requested shall be started as soon as the MS returns to coverage;
- if the MS is both IMSI and GPRS-attached and returns to coverage in a cell that supports GPRS in network operation mode II or III, or if a GPRS only-attached MS returns to coverage in a cell that supports GPRS, then the periodic RA update procedure shall be started as soon as the MS returns to coverage; or
- if the MS returns to coverage in a cell that does not support GPRS, and if the MS is IMSI-attached, then the periodic location update procedure (or other appropriate location update procedure) shall be started as soon as the MS returns to coverage in that cell. In addition, and irrespective of whether or not the MS was IMSI-attached, the periodic RA update procedure (or other appropriate update procedure) shall be started as soon as the MS returns to GPRS coverage.

If the MS lost GPRS coverage but the periodic RA update timer did not expire while out of GPRS coverage, then, the MS shall not perform the periodic RA update procedure because of the MS's return to GPRS coverage.

If the MS lost coverage but the periodic RA update timer did not expire while out of coverage, then the MS shall not perform the periodic RA update procedure because of the MS's return to coverage.

6.2.4 Mobile Reachable Timer Function

The Mobile Reachable Timer function monitors the periodic RA update procedure in the SGSN. The mobile reachable timer shall be slightly longer than the periodic RA update timer used by an MS.

The mobile reachable timer is stopped when the READY state is entered. The mobile reachable timer is reset and started when the state returns to STANDBY.

If the mobile reachable timer expires, the SGSN shall clear PPF. Typically, this causes the SGSN to stop sending GPRS paging or CS paging messages to the MS, but other features (e.g., MSC/VLR-based call forwarding) may happen immediately. PPF is set when the next activity from the MS is detected. The MM and PDP contexts shall be kept in the SGSN.

When an MS first registers in an SGSN, then PPF is set.

6.3 Interactions Between SGSN and MSC/VLR

The interactions described in this subclause shall be supported if the optional Gs interface is installed.

An association is created between SGSN and MSC/VLR to provide for interactions between SGSN and MSC/VLR. The association is created when the VLR stores the SGSN number and the SGSN stores the VLR number. The association is used for co-ordinating MSs that are both GPRS-attached and IMSI-attached.

The association supports the following actions:

- IMSI attach and detach via SGSN. This makes combined GPRS / IMSI attach and combined GPRS / IMSI detach possible, thus saving radio resources.
- Co-ordination of LA update and RA update, including periodic updates, thus saving radio resources. A combined RA / LA update is sent from the MS to the SGSN. SGSN forwards the LA update to the VLR.
- Paging for a CS connection via the SGSN.
- Alert procedures for non-GPRS services.
- Identification procedure.
- MM Information procedure.

6.3.1 Administration of the SGSN - MSC/VLR Association

The SGSN - MSC/VLR association is created at the following occasions:

- Combined IMSI / GPRS attach;
- GPRS attach when the MS is already IMSI-attached;
- Combined RA / LA update when the MS performs IMSI attach and is already GPRS-attached;

Combined RA / LA update when an IMSI and GPRS-attached MS changes from an area of network operation mode II or III to an area of network operation mode I.

The association is initiated by the SGSN. The SGSN creates an association by sending a BSSAP+ message concerning a particular MS to the VLR. To get the VLR number, the SGSN translates the current RAI to a VLR number via a translation table. During a CS connection, an MS in class-B mode of operation cannot perform GPRS attach nor routing area updates, only MSs in class-A mode of operation can perform these procedures. If a GPRS attach was

made during a CS connection, the association shall be initiated by a combined RA / LA update after the CS connection has been released.

The association is updated on the following occasions:

- when an MS changes VLR;
- when an MS changes SGSN.

The association is not updated during a CS connection.

When the MS is in idle mode (see GSM 03.22), the association is updated with the combined RA / LA updates procedure.

In relation with a CS connection, the association is managed in the following way:

MS in class-A mode of operation:

An MS in class-A mode of operation makes RA updates but no combined RA / LA updates during the CS connection. In the case when the MS changes SGSN, the SGSN (according to normal RA update procedures, see subclause "Inter SGSN Routeing Area Update") updates the HLR and the GGSN, but not the VLR, about the new SGSN number.

In the case when the MS changes MSC during the CS connection, the subscriber data still remains in the old VLR until the CS connection is released and a combined RA / LA update or LA update is made. The association is also not updated during the CS connection.

After the CS connection has been released, a combined RA / LA update is performed (if there has been a change of RA, or if a GPRS attach was performed and the new cell indicates network operation mode I), and the association is updated according to combined RA / LA update procedures, see subclause "Combined RA / LA Update Procedure". If the new cell indicates network operation mode II or III, then the MS performs an LA update.

MS in class-B mode of operation:

An MS in class-B mode of operation does not make any RA updates during a CS connection. The SGSN number therefore remains the same during the CS connection and needs not be updated in the VLR. In the case when the MS changes MSC during the CS connection, the subscriber data still remains in the old VLR until the CS connection has been released and a combined RA / LA update or LA update is made. Therefore, the VLR number remains the same during the CS connection. After the CS connection has been released, the MS shall perform an RA update and an LA update if the RA has changed and the new cell indicates network operation mode II or III, or a combined RA / LA update if the RA has changed and the new cell indicates network operation mode I. The association is updated according to the combined RA / LA update procedures, see subclauses "Inter SGSN Routeing Area Update" and "Combined RA / LA Update Procedure".

The SGSN - MSC/VLR association is removed at the following occasions:

- At IMSI detach.
- At GPRS detach.

When the MSC/VLR receives an LA update via the A interface from an MS for which an association exists, then the MSC/VLR shall remove the association without notifying the SGSN. When the SGSN receives a (non-combined) RA update from an MS for which an association exists, then the SGSN shall remove the association without notifying the MSC/VLR. When the MSC/VLR receives a BSSAP+ MS Unreachable message from the SGSN indicating that PPF is cleared, then the state of the association shall not be changed at the MSC/VLR.

6.3.2 Combined RA / LA Updating

When the MS is both IMSI and GPRS-attached, the LA and RA updating is done in a co-ordinated way to save radio resources if supported by the network operation mode. When the MS enters a new RA in network operation mode I, then the MS sends a Routeing Area Update Request message to the SGSN, as described in subclause "Combined RA / LA Update Procedure". The LA update is included in the RA update. The SGSN then forwards the LA update to the MSC/VLR. The MSC/VLR optionally returns a new VLR TMSI that is sent to the MS via the SGSN.

An MS in class-A mode of operation involved in a CS connection makes only RA updates and no combined RA / LA updates to the SGSN.

An MS in class-B mode of operation involved in a CS connection does not make any updates during the CS connection.

An MS in class-C mode of operation never makes combined RA / LA updates.

6.3.3 CS Paging

When an MS is both IMSI and GPRS-attached in a network that operates in mode I, then the MSC/VLR executes paging for circuit-switched services via the SGSN. If the MS is in STANDBY state, then it is paged in the routing area and in the null routing area (see subclause "Routing Area Identity "). If the MS is in READY state, then it is paged in the cell. The paging procedure is supervised in the MSC by a paging timer. The SGSN converts the MSC paging message into an SGSN paging message.

The CS Paging procedure is illustrated in Figure 15. Each step is explained in the following list.

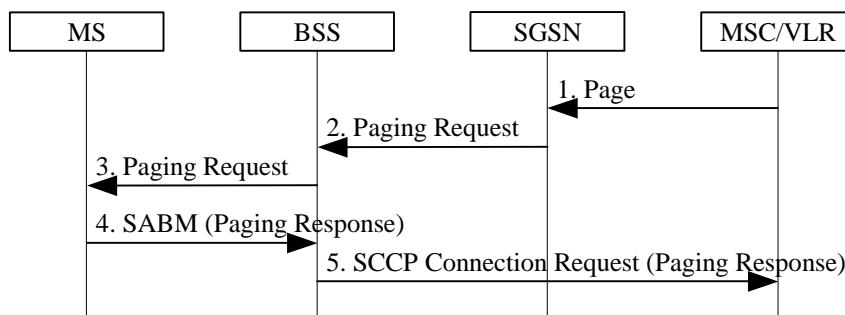

Figure 15: CS Paging Procedure

- 1) The SGSN receives a Page (IMSI, VLR TMSI, Channel Needed, Priority, Location Information) message from the MSC. Channel Needed is defined in GSM 08.08 [17] and indicates to the MS which type of CS channel is needed to be requested in the response. VLR TMSI and Channel Needed are optional parameters. Priority is the circuit-switched paging priority parameter as defined in GSM 08.08. The SGSN maps Priority to QoS.
- 2) The SGSN sends a BSSGP Paging Request (IMSI, TLLI, VLR TMSI, Area, Channel Needed, QoS) message to the BSS serving the MS. Area is derived from either the MS's MM context in the SGSN or, if no such information is available, from the Location Information received from the MSC/VLR. Area indicates a single cell for a READY state MS or a routing area for a STANDBY state MS. VLR TMSI and Channel Needed are included if received from the MSC. If Channel Needed was not received from the MSC, then a default Channel Needed parameter indicating circuit-switched paging is included by the SGSN. QoS indicates the priority of this Paging Request relative to other Paging Request messages buffered in the BSS. If the location area where the MS was last known to be located has an associated null routing area, then the SGSN shall send an additional BSSGP Paging Request message to each BSS serving this null RA.
- 3) The BSS translates the incoming BSSGP Paging Request message into one radio Paging Request message per cell. If a dedicated radio resource is assigned to the MS in a cell, then the BSS transmits one Paging Request (VLR TMSI or IMSI, Channel Needed) message on this radio resource, without stopping possibly ongoing data transfers for the MS. Otherwise, the BSS pages the MS with one Paging Request (VLR TMSI or IMSI, Channel Needed) message on the appropriate paging channel in each addressed cell. This is described in GSM 03.64.
- 4) Upon receipt of a Paging Request message for a circuit-switched service the MS may accept to respond to this request and shall then follow the CS procedures for paging response (random access, immediate assignment, and paging response) as specified in GSM 04.08 [11].
- 5) When received at the BSS, the Paging Response message is sent to the MSC which shall then stop the paging response timer.

6.3.3.1 Paging Co-ordination

The network may provide co-ordination of paging for circuit-switched and packet-switched services. Paging co-ordination means that the network sends paging messages for circuit-switched services on the same channel as used for packet-switched services, i.e., on the GPRS paging channel or on the GPRS traffic channel, and the MS needs only to monitor that channel. Three network operation modes are defined.

- Network operation mode I: the network sends a CS paging message for a GPRS-attached MS, either on the same channel as the GPRS paging channel (i.e., the packet paging channel or the CCCH paging channel), or on a GPRS traffic channel. This means that the MS needs only to monitor one paging channel, and that it receives CS paging messages on the packet data channel when it has been assigned a packet data channel.
- Network operation mode II: the network sends a CS paging message for a GPRS-attached MS on the CCCH paging channel, and this channel is also used for GPRS paging. This means that the MS needs only to monitor the CCCH paging channel, but that CS paging continues on this paging channel even if the MS has been assigned a packet data channel.
- Network operation mode III: the network sends a CS paging message for a GPRS-attached MS on the CCCH paging channel, and sends a GPRS paging message on either the packet paging channel (if allocated in the cell) or on the CCCH paging channel. This means that an MS that wants to receive pages for both circuit-switched and packet-switched services shall monitor both paging channels if the packet paging channel is allocated in the cell. No paging co-ordination is performed by the network.

Table 2: Network Operation Modes

Mode	Circuit Paging Channel	GPRS Paging Channel	Paging co-ordination
I	Packet Paging Channel	Packet Paging Channel	Yes
	CCCH Paging Channel	CCCH Paging Channel	
	Packet Data Channel	Not Applicable	
II	CCCH Paging Channel	CCCH Paging Channel	No
III	CCCH Paging Channel	Packet Paging Channel	No
	CCCH Paging Channel	CCCH Paging Channel	

When the Gs interface is present, all MSC-originated paging of GPRS-attached MSs shall go via the SGSN, thus allowing network co-ordination of paging. Paging co-ordination shall be made by the SGSN based on the IMSI, and is provided independently of whether the MS is in STANDBY or in READY state. The network operates in mode I.

When the Gs interface is not present, all MSC-originated paging of GPRS-attached MSs shall go via the A interface, and co-ordination of paging cannot be performed. The network shall then either:

- operate in mode II, meaning that the packet common control channel shall not be allocated in the cell; or
- operate in mode III, meaning that the packet common control channel shall be used for GPRS paging when the packet paging channel is allocated in the cell.

The network operation mode (mode I, II, or III) shall be indicated as system information to MSs. For proper operation, the mode of operation should be the same in each cell of a routing area.

Based on the mode of operation provided by the network, the MS can then choose, according to its capabilities, whether it can attach to GPRS services, to non-GPRS services, or to both.

6.3.4 Non-GPRS Alert

The MSC/VLR may request an SGSN to report activity from a specific MS. In this case, the MSC/VLR shall send a BSSAP+ Alert Request (IMSI) message to the SGSN where the MS is currently GPRS-attached.

Upon reception of the Alert Request (IMSI) message, the SGSN shall set NGAF. If NGAF is set for an MS, the SGSN shall inform the MSC/VLR when the next activity from that MS (and the MS is both IMSI- and GPRS-attached) is detected, and shall clear NGAF.

If the activity detected by the SGSN leads to a procedure towards the MSC/VLR, the SGSN shall just follow this procedure. If the activity detected by the SGSN does not lead to any procedure towards the MSC/VLR, the SGSN shall send an MS Activity Indication (IMSI) message towards the MSC/VLR.

6.3.5 MS Information Procedure

When the MS is marked at the VLR as both IMSI and GPRS attached, the VLR may perform the MS Information procedure via the SGSN. If the information requested by the VLR in the MS Information procedure is known by the SGSN, then the SGSN shall return this information to the VLR without interrogating the MS.

If the information requested is MS identity information (e.g., IMEI) that is not known by the SGSN but is known by the MS, then the SGSN shall interrogate the MS in a similar manner to that described in subclause "Identity Check Procedures".

The MS Information procedure is illustrated in Figure 16. Each step is explained in the following list.

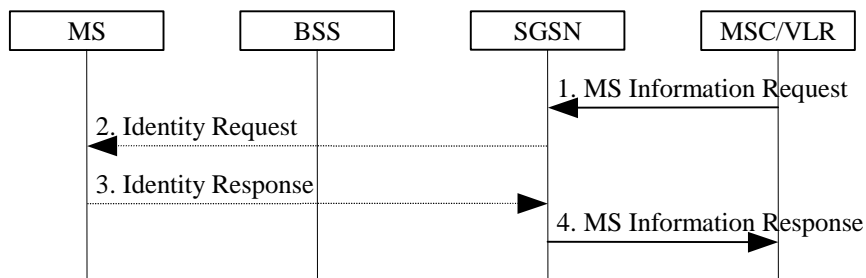

Figure 16: MS Information Procedure

- 1) The MSC/VLR sends an MS Information Request (IMSI, Information Type) message to the SGSN. Information Type indicates the information that the MSC/VLR is requesting for that IMSI.
- 2) If the information requested is not known by the SGSN but should be known by the MS, then the SGSN interrogates the MS in a similar manner to that described in the subclause "Identity Check Procedures". The SGSN sends an Identity Request (Identity Type) message to the MS.
- 3) The MS responds with an Identity Response (Mobile Identity) message to the SGSN.
- 4) The SGSN sends an MS Information Response (IMSI, Information) message to the MSC/VLR. Information contains the information requested by the MSC/VLR.

6.3.6 MM Information Procedure

When the MS is marked at the VLR as both IMSI and GPRS attached, the VLR may perform the MM Information procedure via the SGSN. The MM Information procedure is typically used to inform the MS about such things as the network name and the local timezone of the mobile.

The MM Information procedure is illustrated in Figure 17. Each step is explained in the following list.

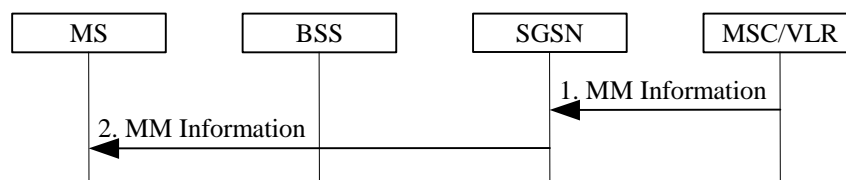

Figure 17: MM Information Procedure

- 1) The SGSN receives an MM Information (IMSI, Information) message from the MSC/VLR. Information is the information that the MSC/VLR is sending to the MS.
- 2) The SGSN sends an MM Information (Information) message to the MS including the information received by the MSC/VLR.

6.4 MM Procedures

The GPRS and combined GPRS / CS MM procedures in the following subclauses shall use the LLC and RLC/MAC protocols for message transmission across the Um interface. The MM procedures shall provide information to the underlying layers to enable reliable transmission of MM messages on the Um interface. GSM 03.64 defines the mapping between LLC and the radio channels used.

Furthermore, the MM procedures use MAP interfaces between SGSN and HLR (Gr), and between SGSN and EIR (Gf), and a BSSAP+ interface between SGSN and MSC/VLR (Gs).

User data can in general be transmitted during MM signalling procedures. User data transmitted during attach, authentication, and routing area update procedures may be lost and may therefore have to be retransmitted. In order to minimise the need for retransmission, the MS and SGSN should not transmit user data during the attach, authentication, and routing area update procedures.

6.5 Attach Function

A GPRS attach is made to the SGSN. A GPRS-attached MS makes IMSI attach via the SGSN with the combined RA / LA update procedure if the network operation mode is I. In network operation modes II and III, or if the MS is not GPRS-attached, then the MS makes IMSI attach as already defined in GSM. An IMSI-attached MS in class-A mode of operation engaged in a CS connection shall use the (non-combined) GPRS Attach procedure when it performs a GPRS attach.

In the attach procedure, the MS shall provide its identity and an indication of which type of attach that is to be executed. The identity provided to the network shall be the MS's Packet TMSI (P-TMSI) or IMSI. P-TMSI and the RAI associated with the P-TMSI shall be provided if the MS has a valid P-TMSI. If the MS does not have a valid P-TMSI, then the MS shall provide its IMSI. The different types of attach are GPRS attach and combined GPRS / IMSI attach.

At the RLC/MAC layer, the MS shall identify itself with a Local or Foreign TLLI if the MS is already GPRS-attached and is performing an IMSI attach. Otherwise, the MS shall identify itself with a Foreign TLLI, or a Random TLLI if a valid P-TMSI is not available. The Foreign or Random TLLI is used as an identifier during the attach procedure until a new P-TMSI is allocated.

After having executed the GPRS attach, the MS is in READY state and MM contexts are established in the MS and the SGSN. The MS may then activate PDP contexts as described in subclause "Activation Procedures".

An IMSI-attached MS that can only operate in class-C mode of operation shall follow the normal IMSI detach procedure before it makes a GPRS attach. A GPRS-attached MS in class-C mode of operation shall always perform a GPRS detach before it makes an IMSI attach.

If the network operates in mode I (see subclause "Paging Co-ordination"), then an MS that is both GPRS-attached and IMSI-attached shall perform the Combined RA / LA Update procedures.

If the network operates in mode II or III, then a GPRS-attached MS that has the capability to be simultaneously GPRS-attached and IMSI-attached shall perform the (non-combined) Routing Area Update procedures, and either:

- access the non-GPRS common control channels for CS operation (the way that CS operation is performed in parallel with GPRS operation is an MS implementation issue outside the scope of the present document); or
- if CS operation is not desired, depending on system information that defines whether or not explicit detach shall be used, either:
 - avoid all CS signalling (in which case the MS may be implicitly IMSI detached after a while); or
 - perform an explicit IMSI detach via the non-GPRS common control channels (if the MS was already IMSI-attached).

The Combined GPRS / IMSI Attach procedure is illustrated in Figure 18. Each step is explained in the following list.

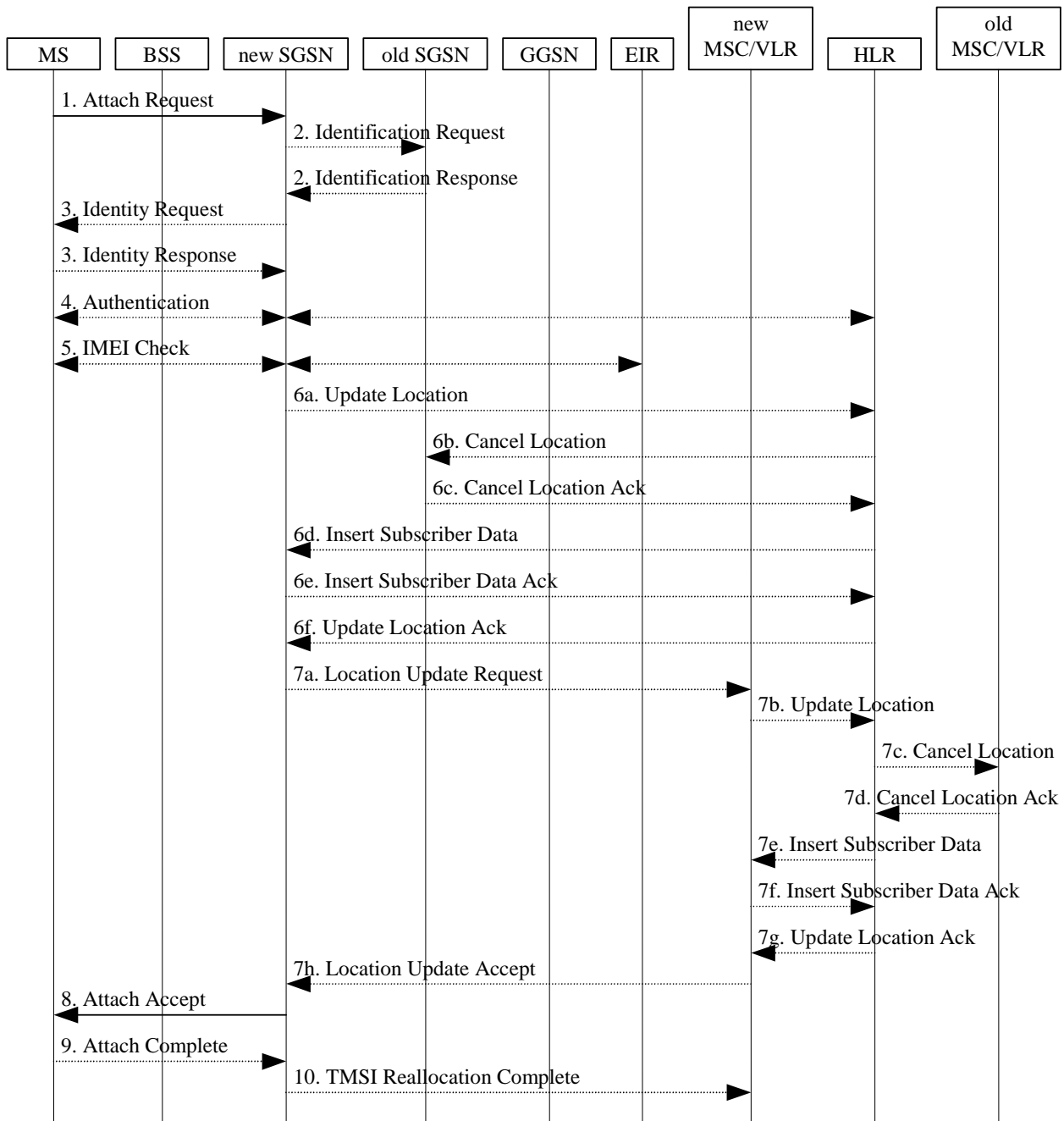

Figure 18: Combined GPRS / IMSI Attach Procedure

- 1) The MS initiates the attach procedure by the transmission of an Attach Request (IMSI or P-TMSI and old RAI, Classmark, CKSN, Attach Type, DRX Parameters, old P-TMSI Signature) message to the SGSN. IMSI shall be included if the MS does not have a valid P-TMSI available. If the MS has a valid P-TMSI, then P-TMSI and the old RAI associated with P-TMSI shall be included. Classmark contains the MS's GPRS multislot capabilities and supported GPRS ciphering algorithms in addition to the existing classmark parameters defined in GSM 04.08. Attach Type indicates which type of attach that is to be performed, i.e., GPRS attach only, GPRS Attach while already IMSI attached, or combined GPRS / IMSI attach. DRX Parameters indicates whether the MS uses discontinuous reception or not. If the MS uses discontinuous reception, then DRX Parameters also indicate when the MS is in a non-sleep mode able to receive paging requests and channel assignments. If the MS uses P-TMSI for identifying itself and if it has also stored its old P-TMSI Signature, then the MS shall include the old P-TMSI Signature in the Attach Request message.
- 2) If the MS identifies itself with P-TMSI and the SGSN has changed since detach, the new SGSN sends an Identification Request (P-TMSI, old RAI, old P-TMSI Signature) to the old SGSN to request the IMSI. The old SGSN responds with Identification Response (IMSI, Authentication Triplets). If the MS is not known in the old

SGSN, the old SGSN responds with an appropriate error cause. The old SGSN also validates the old P-TMSI Signature and responds with an appropriate error cause if it does not match the value stored in the old SGSN.

- 3) If the MS is unknown in both the old and new SGSN, the SGSN sends an Identity Request (Identity Type = IMSI) to the MS. The MS responds with Identity Response (IMSI).
- 4) The authentication functions are defined in the subclause "Security Function". If no MM context for the MS exists anywhere in the network, then authentication is mandatory. Ciphering procedures are described in subclause "Security Function". If P-TMSI allocation is going to be done, and if ciphering is supported by the network, ciphering mode shall be set.
- 5) The equipment checking functions are defined in the subclause "Identity Check Procedures". Equipment checking is optional.
- 6) If the SGSN number has changed since the GPRS detach, or if it is the very first attach, then the SGSN informs the HLR:
 - a) The SGSN sends an Update Location (SGSN Number, SGSN Address, IMSI) to the HLR.
 - b) The HLR sends Cancel Location (IMSI, Cancellation Type) to the old SGSN with Cancellation Type set to Update Procedure.
 - c) The old SGSN acknowledges with Cancel Location Ack (IMSI). If there are any ongoing procedures for that MS, the old SGSN shall wait until these procedures are finished before removing the MM and PDP contexts.
 - d) The HLR sends Insert Subscriber Data (IMSI, GPRS subscription data) to the new SGSN.
 - e) The new SGSN validates the MS's presence in the (new) RA. If due to regional subscription restrictions the MS is not allowed to attach in the RA, the SGSN rejects the Attach Request with an appropriate cause, and may return an Insert Subscriber Data Ack (IMSI, SGSN Area Restricted) message to the HLR. If subscription checking fails for other reasons, the SGSN rejects the Attach Request with an appropriate cause and returns an Insert Subscriber Data Ack (IMSI, Cause) message to the HLR. If all checks are successful then the SGSN constructs an MM context for the MS and returns an Insert Subscriber Data Ack (IMSI) message to the HLR.
 - f) The HLR acknowledges the Update Location message by sending an Update Location Ack to the SGSN after the cancelling of old MM context and insertion of new MM context are finished. If the Update Location is rejected by the HLR, the SGSN rejects the Attach Request from the MS with an appropriate cause.
- 7) If Attach Type in step 1 indicated GPRS Attach while already IMSI attached, or combined GPRS / IMSI attach, then the VLR shall be updated if the Gs interface is installed. The VLR number is derived from the RA information. The SGSN starts the location update procedure towards the new MSC/VLR upon receipt of the first Insert Subscriber Data message from the HLR in step 6 d). This operation marks the MS as GPRS-attached in the VLR.
 - a) The SGSN sends a Location Update Request (new LAI, IMSI, SGSN Number, Location Update Type) message to the VLR. Location Update Type shall indicate IMSI attach if Attach Type indicated combined GPRS / IMSI attach. Otherwise, Location Update Type shall indicate normal location update. The VLR creates an association with the SGSN by storing SGSN Number.
 - b) If the LA update is inter-MSC, the new VLR sends Update Location (IMSI, new VLR) to the HLR.
 - c) If the LA update is inter-MSC, the HLR sends a Cancel Location (IMSI) to the old VLR.
 - d) The old VLR acknowledges with Cancel Location Ack (IMSI).
 - e) If the LA update is inter-MSC, the HLR sends Insert Subscriber Data (IMSI, GSM subscriber data) to the new VLR.
 - f) The VLR acknowledges with Insert Subscriber Data Ack (IMSI).
 - g) After finishing the inter-MSC location update procedures, the HLR responds with Update Location Ack (IMSI) to the new VLR.
 - h) The VLR responds with Location Update Accept (VLR TMSI) to the SGSN.

- 8) The SGSN selects Radio Priority SMS, and sends an Attach Accept (P-TMSI, VLR TMSI, P-TMSI Signature, Radio Priority SMS) message to the MS. P-TMSI is included if the SGSN allocates a new P-TMSI.
- 9) If P-TMSI or VLR TMSI was changed, the MS acknowledges the received TMSI(s) by returning an Attach Complete message to the SGSN.
- 10) If VLR TMSI was changed, the SGSN confirms the VLR TMSI re-allocation by sending a TMSI Reallocation Complete message to the VLR.

If the Attach Request cannot be accepted, the SGSN returns an Attach Reject (IMSI, Cause) message to the MS.

6.6 Detach Function

The Detach function allows an MS to inform the network that it wants to make a GPRS and/or IMSI detach, and it allows the network to inform an MS that it has been GPRS-detached or IMSI-detached by the network. The different types of detach are:

- IMSI detach;
- GPRS detach; and
- combined GPRS / IMSI detach (MS-initiated only).

The MS is detached from GPRS either explicitly or implicitly:

- Explicit detach: The network or the MS explicitly requests detach.
- Implicit detach: The network detaches the MS, without notifying the MS, a configuration-dependent time after the mobile reachable timer expired, or after an irrecoverable radio error causes disconnection of the logical link.

In the explicit detach case, a Detach Request (Cause) is sent by the SGSN to the MS, or by the MS to the SGSN.

The MS can make an IMSI detach in one of two ways depending on if it is GPRS-attached or not:

- A GPRS-attached MS sends a Detach Request message to the SGSN, indicating an IMSI detach. This can be made in combination with GPRS detach.
- An MS not attached to the GPRS makes the IMSI detach as already defined in GSM.

In the MO Detach Request message there is an indication to tell if the detach is due to switch off or not. The indication is needed to know whether a Detach Accept message should be returned or not.

In the network-originated Detach Request message there may be an indication to tell the MS that it is requested to initiate GPRS Attach and PDP Context Activation procedures for the previously activated PDP contexts.

6.6.1 MS-Initiated Detach Procedure

The MS-Initiated Detach procedure when initiated by the MS is illustrated in Figure 19. Each step is explained in the following list.

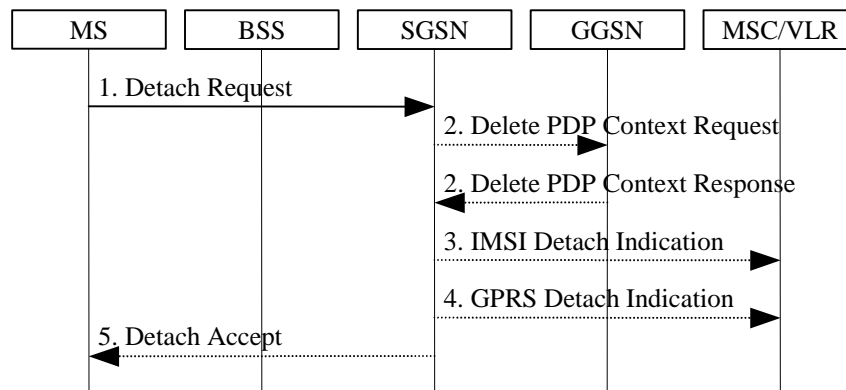

Figure 19: MS-Initiated Combined GPRS / IMSI Detach Procedure

- 1) The MS detaches by sending Detach Request (Detach Type, Switch Off) to the SGSN. Detach Type indicates which type of detach that is to be performed, i.e., GPRS Detach only, IMSI Detach only or combined GPRS and IMSI Detach. Switch Off indicates whether the detach is due to a switch off situation or not.
- 2) If GPRS detach, the active PDP contexts in the GGSNs regarding this particular MS are deactivated by the SGSN sending Delete PDP Context Request (TID) to the GGSNs. The GGSNs acknowledge with Delete PDP Context Response (TID).
- 3) If IMSI detach, the SGSN sends IMSI Detach Indication (IMSI) to the VLR.
- 4) If the MS wants to remain IMSI-attached and is doing a GPRS detach, the SGSN sends a GPRS Detach Indication (IMSI) message to the VLR. The VLR removes the association with the SGSN and handles paging and location update without going via the SGSN.
- 5) If Switch Off indicates that the detach is not due to a switch off situation, the SGSN sends a Detach Accept to the MS.

6.6.2 Network-Initiated Detach Procedure

6.6.2.1 SGSN-Initiated Detach Procedure

The SGSN-Initiated Detach procedure when initiated by the SGSN is illustrated in Figure 20. Each step is explained in the following list.

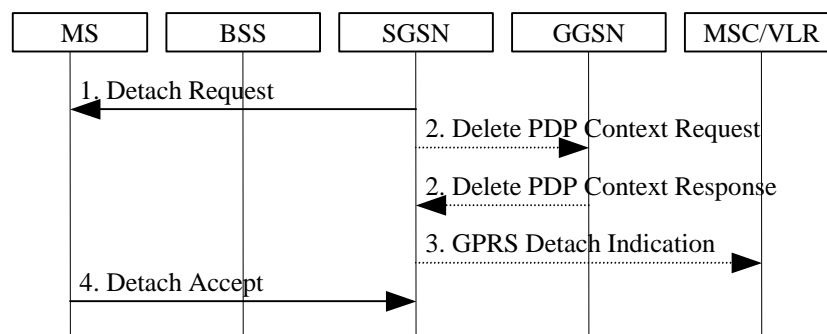

Figure 20: SGSN-Initiated GPRS Detach Procedure

- 1) The SGSN informs the MS that it has been detached by sending Detach Request (Detach Type) to the MS. Detach Type indicates if the MS is requested to make a new attach and PDP context activation for the previously activated PDP contexts. If so, the attach procedure shall be initiated when the detach procedure is completed.

- 2) The active PDP contexts in the GGSNs regarding this particular MS are deactivated by the SGSN sending Delete PDP Context Request (TID) messages to the GGSNs. The GGSNs acknowledge with Delete PDP Context Response (TID) messages.
- 3) If the MS was both IMSI- and GPRS-attached, the SGSN sends a GPRS Detach Indication (IMSI) message to the VLR. The VLR removes the association with the SGSN and handles paging and location update without going via the SGSN.
- 4) The MS sends a Detach Accept message to the SGSN any time after step 1.

6.6.2.2 HLR-Initiated Detach Procedure

The HLR-Initiated Detach procedure is initiated by the HLR. The HLR uses this procedure for operator-determined purposes to request the removal of a subscriber's MM and PDP contexts at the SGSN. The HLR-Initiated Detach Procedure is illustrated in Figure 21. Each step is explained in the following list.

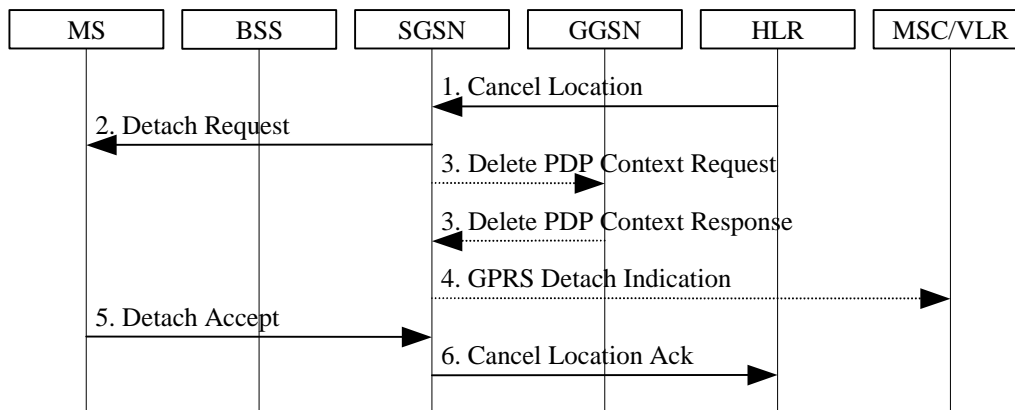

Figure 21: HLR-Initiated GPRS Detach Procedure

- 1) If the HLR wants to request the immediate deletion of a subscriber's MM and PDP contexts from the SGSN, the HLR shall send a Cancel Location (IMSI, Cancellation Type) message to the SGSN with Cancellation Type set to Subscription Withdrawn.
- 2) The SGSN informs the MS that it has been detached by sending Detach Request (Detach Type) to the MS. Detach Type shall indicate that the MS is not requested to make a new attach and PDP context activation.
- 3) The active PDP contexts in the GGSNs regarding this particular MS are deactivated by the SGSN sending Delete PDP Context Request (TID) messages to the GGSNs. The GGSNs acknowledge with Delete PDP Context Response (TID) messages.
- 4) If the MS was both IMSI- and GPRS-attached, the SGSN sends a GPRS Detach Indication (IMSI) message to the VLR. The VLR removes the association with the SGSN and handles paging and location update without going via the SGSN.
- 5) The MS sends a Detach Accept message to the SGSN any time after step 2.
- 6) The SGSN shall confirm the deletion of the MM and PDP contexts with a Cancel Location Ack (IMSI) message.

6.7 Purge Function

The Purge function allows an SGSN to inform the HLR that it has deleted the MM and PDP contexts of a detached MS. The SGSN may, as an implementation option, delete the MM and PDP contexts of an MS immediately after the implicit or explicit detach of the MS. Alternatively, the SGSN may keep for some time the MM and PDP contexts and the authentication triplets of the detached MS, so that the contexts can be reused at a later GPRS attach without accessing the HLR.

When the SGSN deletes the MM and PDP contexts, it shall initiate the Purge procedure as illustrated in Figure 22. Each step is explained in the following list.

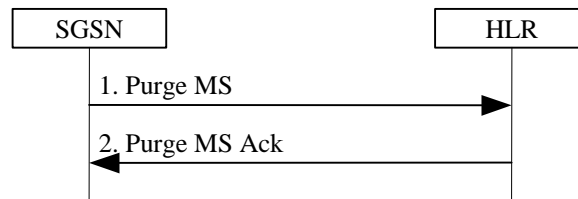

Figure 22: Purge Procedure

- 1) After deleting the MM and PDP contexts of a detached MS, the SGSN sends a Purge MS (IMSI) message to the HLR.
- 2) The HLR sets the MS Purged for GPRS flag and acknowledges with a Purge MS Ack message.

6.8 Security Function

The Security function:

- Guards against unauthorised GPRS service usage (authentication and service request validation).
- Provides user identity confidentiality (temporary identification and ciphering).
- Provides user data confidentiality (ciphering).

6.8.1 Authentication of Subscriber

Authentication procedures already defined in GSM shall be used, with the distinction that the procedures are executed from the SGSN. The GPRS Authentication procedure performs subscriber authentication, or selection of the ciphering algorithm and the synchronisation of the start of ciphering, or both. Authentication triplets are stored in the SGSN. The MSC/VLR shall not authenticate the MS via the SGSN upon IMSI attach, nor location update, but may authenticate the MS during CS connection establishment. Security-related network functions are described in GSM 03.20 [6].

The Authentication procedure is illustrated in Figure 23. Each step is explained in the following list.

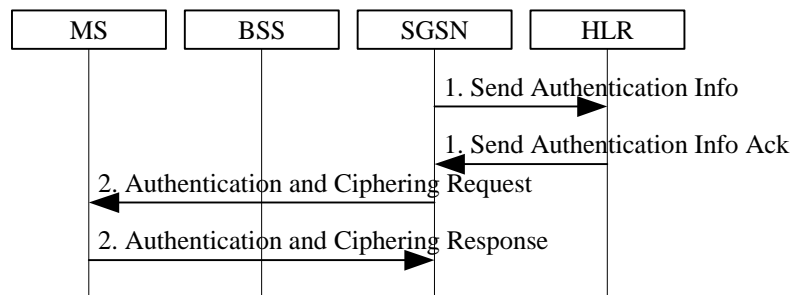

Figure 23: Authentication Procedure

- 1) If the SGSN does not have previously stored authentication triplets, a Send Authentication Info (IMSI) message is sent to the HLR. The HLR responds with a Send Authentication Info Ack (Authentication Triplets) message. Each Authentication Triplet includes RAND, SRES, and Kc.
- 2) The SGSN sends an Authentication and Ciphering Request (RAND, CKSN, Ciphering Algorithm) message to the MS. The MS responds with an Authentication and Ciphering Response (SRES) message.

The MS starts ciphering after sending the Authentication and Ciphering Response message. The SGSN starts ciphering when a valid Authentication and Ciphering Response is received from the MS. In the routing area update case, if ciphering was used before the routing area update, and if the Authentication procedure is omitted, then the SGSN shall resume ciphering with the same algorithm when a ciphered Routing Area Update Accept message is sent, and the MS shall resume ciphering when a ciphered Routing Area Update Accept message is received. If the SGSN cannot determine the HLR address in order to establish the Send Authentication Info dialogue, the Authentication Procedure fails.

6.8.2 User Identity Confidentiality

A Temporary Logical Link Identity (TLLI) identifies a GPRS user. The relationship between TLLI and IMSI is known only in the MS and in the SGSN. TLLI is derived from the P-TMSI allocated by the SGSN or built by the MS as described in subclause "NSAPI and TLLI".

The SGSN may reallocate the P-TMSI at any time when the MS is in READY state. The reallocation procedure can be performed by the P-TMSI Reallocation procedure, or it can be included in the Attach or Routeing Area Update procedures.

6.8.2.1 P-TMSI Signature

P-TMSI Signature is optionally sent by the SGSN to the MS in Attach Accept and Routeing Area Update Accept messages. If the P-TMSI Signature has been sent by the SGSN to the MS since the current P-TMSI was allocated, then the MS shall include the P-TMSI Signature in the next Routeing Area Update Request and Attach Request for identification checking purposes. In the Attach and Routeing Area Update procedures, the SGSN shall compare the P-TMSI Signature sent by the MS with the signature stored in the SGSN. If the values do not match, the SGSN should use the security functions to authenticate the MS. If the values match or if the P-TMSI Signature is missing, the SGSN may use the security functions to authenticate the MS. The P-TMSI Signature parameter has only local significance in the SGSN that allocated the signature.

If ciphering is supported by the network, the SGSN shall send the P-TMSI Signature ciphered to the MS. Routeing Area Update Request and Attach Request, into which the MS includes the P-TMSI Signature, are not ciphered.

6.8.2.2 P-TMSI Reallocation Procedure

The P-TMSI Reallocation procedure is illustrated in Figure 24. Each step is explained in the following list.

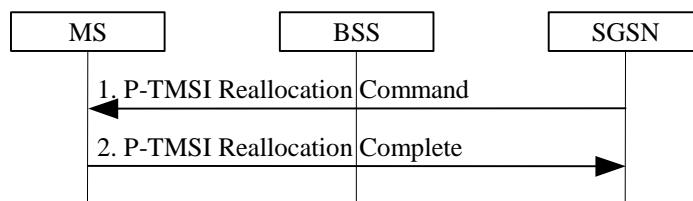

Figure 24: P-TMSI Reallocation Procedure

- 1) The SGSN sends a P-TMSI Reallocation Command (new P-TMSI, P-TMSI Signature, RAI) message to the MS. P-TMSI Signature is an optional parameter that the MS, if received, shall return to the SGSN in the next Attach and Routeing Area Update procedures.
- 2) The MS returns a P-TMSI Reallocation Complete message to the SGSN.

6.8.3 User Data and GMM/SM Signalling Confidentiality

6.8.3.1 Scope of Ciphering

In contrast to the scope of ciphering in existing GSM (a single logical channel between BTS and MS), the scope of GPRS ciphering is from the ciphering function at the SGSN to the ciphering function in the MS.

Ciphering is done in the LLC layer, and from the perspective of the existing GSM MS-BTS radio path, an LLC PDU is transmitted as plain text.

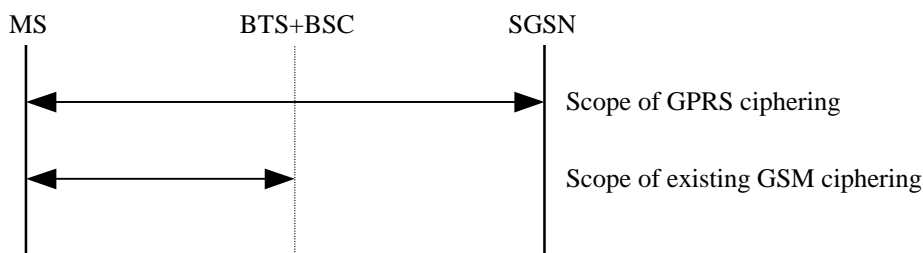

Figure 25: Scope of GPRS Ciphering

6.8.3.2 GPRS Ciphering Algorithm

A ciphering algorithm to be used for GPRS ciphering shall be selected. A new ciphering algorithm may be designed. GSM 01.61 [2] contains the requirements for the GPRS ciphering algorithm. The TDMA frame number is not known at the SGSN. Therefore, a Logical Link Control frame number may replace the TDMA frame number as an input to the algorithm.

The standard key management procedures for the Kc shall be used.

6.8.4 Identity Check Procedures

MS identity check procedures already defined in GSM shall be used, with the distinction that the procedures are executed from the SGSN.

The Identity Check procedure is illustrated in Figure 26. Each step is explained in the following list.

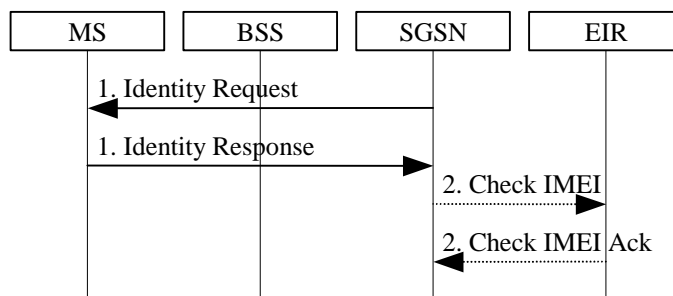

Figure 26: Identity Check Procedure

- 1) The SGSN sends Identity Request (Identity Type) to the MS. The MS responds with Identity Response (Mobile Identity).
- 2) If the SGSN decides to check the IMEI against the EIR, it sends Check IMEI (IMEI) to EIR. The EIR responds with Check IMEI Ack (IMEI).

6.9 Location Management Function

The Location Management function:

- provides mechanisms for cell and PLMN selection;
- provides a mechanism for the network to know the Routeing Area for MSs in STANDBY and READY states; and
- provides a mechanism for the network to know the cell identity for MSs in READY state.

Routeing Area (RA) is defined in subclause "Routeing Area Identity".

6.9.1 Location Management Procedures

The PLMN shall provide information for the MS to be able to:

- detect when it has entered a new cell or a new RA; and
- determine when to perform periodic RA updates.

The MS detects that a new cell has been entered by comparing the cell's identity with the cell identity stored in the MS's MM context. The MS detects that a new RA has been entered by periodically comparing the RAI stored in its MM context with that received from the new cell. The MS shall consider hysteresis in signal strength measurements.

When the MS camps on a new cell, possibly in a new RA, this indicates one of three possible scenarios:

- a cell update is required;
- a routeing area update is required; or
- a combined routeing area and location area update is required.

In all three scenarios the MS stores the cell identity in its MM context.

If the MS enters a new PLMN, the MS shall either perform a routeing area update, or enter IDLE state.

In network mode of operation II and III, whenever an MS determines that it shall perform both an LA update and an RA update, the MS shall perform the LA update first.

Routeing Area Update Request messages shall be sent unciphered, since in the inter SGSN routeing area update case the new SGSN shall be able to process the request.

6.9.1.1 Cell Update Procedure

A cell update takes place when the MS enters a new cell inside the current RA and the MS is in READY state. If the RA has changed, a routeing area update is executed instead of a cell update.

The MS performs the cell update procedure by sending an uplink LLC frame of any type containing the MS's identity to the SGSN. In the direction towards the SGSN, the BSS shall add the Cell Global Identity including RAC and LAC to all BSSGP frames, see GSM 08.18. A cell update is any correctly received and valid LLC PDU carried inside a BSSGP PDU containing a new identifier of the cell.

The SGSN records this MS's change of cell, and further traffic directed towards the MS is conveyed over the new cell.

6.9.1.2 Routeing Area Update Procedure

A routeing area update takes place when a GPRS-attached MS detects that it has entered a new RA, when the periodic RA update timer has expired, or when the MS indicates changed access capabilities to the network, or when a suspended MS is not resumed by the BSS (see subclause "Suspension of GPRS Services"). The SGSN detects that it is an intra SGSN routeing area update by noticing that it also handles the old RA. In this case, the SGSN has the necessary information about the MS and there is no need to inform the GGSNs or the HLR about the new MS location. A periodic RA update is always an intra SGSN routeing area update.

An MS in READY state due to anonymous access shall not perform routeing area updates for the AA MM context. If the MS has entered a new routeing area, a new Anonymous Access PDP Context Activation procedure shall be initiated. The old context is implicitly deleted upon expiry of the READY timer.

6.9.1.2.1 Intra SGSN Routing Area Update

The Intra SGSN Routing Area Update procedure is illustrated in Figure 27. Each step is explained in the following list.

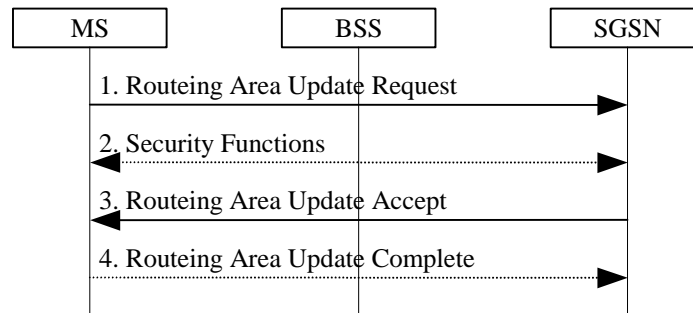

Figure 27: Intra SGSN Routing Area Update Procedure

- 1) The MS sends a Routing Area Update Request (old RAI, old P-TMSI Signature, Update Type) to the SGSN. Update Type shall indicate RA update or periodic RA update. The BSS shall add the Cell Global Identity including the RAC and LAC of the cell where the message was received before passing the message to the SGSN, see GSM 08.18.
- 2) Security functions may be executed. These procedures are defined in subclause "Security Function".
- 3) The SGSN validates the MS's presence in the new RA. If due to regional subscription restrictions the MS is not allowed to be attached in the RA, or if subscription checking fails, then the SGSN rejects the routing area update with an appropriate cause. If all checks are successful then the SGSN updates the MM context for the MS. A new P-TMSI may be allocated. A Routing Area Update Accept (P-TMSI, P-TMSI Signature) is returned to the MS.
- 4) If P-TMSI was reallocated, the MS acknowledges the new P-TMSI by returning a Routing Area Update Complete message to the SGSN.

If the routing area update procedure fails a maximum allowable number of times, or if the SGSN returns a Routing Area Update Reject (Cause) message, the MS shall enter IDLE state.

6.9.1.2.2 Inter SGSN Routing Area Update

The Inter SGSN Routing Area Update procedure is illustrated in Figure 28. Each step is explained in the following list.

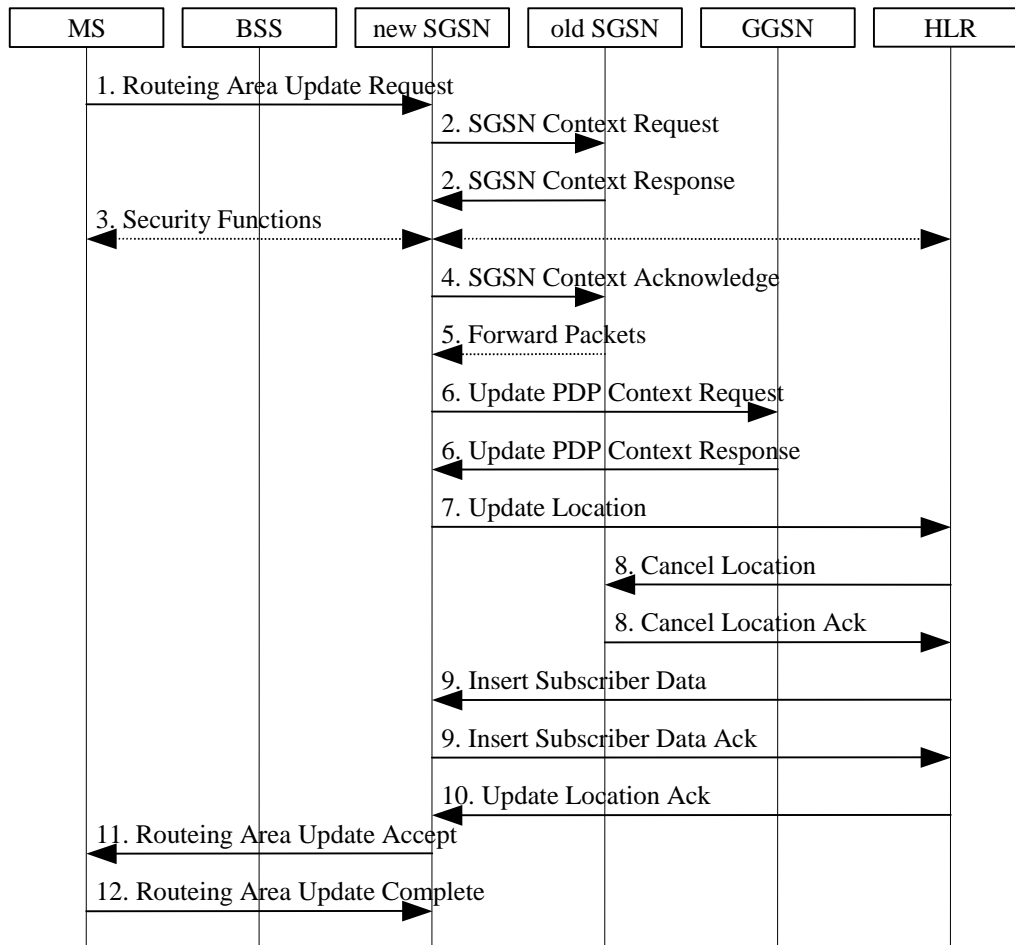

Figure 28: Inter SGSN Routing Area Update Procedure

- 1) The MS sends a Routing Area Update Request (old RAI, old P-TMSI Signature, Update Type) to the new SGSN. Update Type shall indicate RA update or periodic RA update. The BSS shall add the Cell Global Identity including the RAC and LAC of the cell where the message was received before passing the message to the SGSN.
- 2) The new SGSN sends SGSN Context Request (old RAI, TLLI, old P-TMSI Signature, New SGSN Address) to the old SGSN to get the MM and PDP contexts for the MS. The old SGSN validates the old P-TMSI Signature and responds with an appropriate error cause if it does not match the value stored in the old SGSN. This should initiate the security functions in the new SGSN. If the security functions authenticate the MS correctly, the new SGSN shall send an SGSN Context Request (old RAI, TLLI, MS Validated, New SGSN Address) message to the old SGSN. MS Validated indicates that the new SGSN has authenticated the MS. If the old P-TMSI Signature was valid or if the new SGSN indicates that it has authenticated the MS, the old SGSN stops assigning SDCP N-PDU numbers to downlink N-PDUs received, and responds with SGSN Context Response (MM Context, PDP Contexts). If the MS is not known in the old SGSN, the old SGSN responds with an appropriate error cause. The old SGSN stores New SGSN Address, to allow the old SGSN to forward data packets to the new SGSN. Each PDP Context includes the SDCP Send N-PDU Number for the next downlink N-PDU to be sent in acknowledged mode to the MS, the SDCP Receive N-PDU Number for the next uplink N-PDU to be received in acknowledged mode from the MS, the GTP sequence number for the next downlink N-PDU to be sent to the MS and the GTP sequence number for the next uplink N-PDU to be tunnelled to the GGSN. The old SGSN starts a timer and stops the transmission of N-PDUs to the MS.
- 3) Security functions may be executed. These procedures are defined in sub-clause "Security Function". Ciphering mode shall be set if ciphering is supported. If the security functions fail (e.g. because the SGSN cannot determine the HLR address to establish the Send Authentication Info dialogue), the Inter SGSN RAU Update procedure fails. A reject shall be returned to the MS with an appropriate cause.

- 4) The new SGSN sends an SGSN Context Acknowledge message to the old SGSN. This informs the old SGSN that the new SGSN is ready to receive data packets belonging to the activated PDP contexts. The old SGSN marks in its context that the MSC/VLR association and the information in the GGSNs and the HLR are invalid. This triggers the MSC/VLR, the GGSNs, and the HLR to be updated if the MS initiates a routing area update procedure back to the old SGSN before completing the ongoing routing area update procedure. If the security functions do not authenticate the MS correctly, then the routing area update shall be rejected, and the new SGSN shall send a reject indication to the old SGSN. The old SGSN shall continue as if the SGSN Context Request was never received.
- 5) The old SGSN duplicates the buffered N-PDUs and starts tunnelling them to the new SGSN. Additional N-PDUs received from the GGSN before the timer described in step 2 expires are also duplicated and tunnelled to the new SGSN. N-PDUs that were already sent to the MS in acknowledged mode and that are not yet acknowledged by the MS are tunnelled together with the SNDCP N-PDU number. No N-PDUs shall be forwarded to the new SGSN after expiry of the timer described in step 2.
- 6) The new SGSN sends Update PDP Context Request (new SGSN Address, TID, QoS Negotiated) to the GGSNs concerned. The GGSNs update their PDP context fields and return Update PDP Context Response (TID).
- 7) The new SGSN informs the HLR of the change of SGSN by sending Update Location (SGSN Number, SGSN Address, IMSI) to the HLR.
- 8) The HLR sends Cancel Location (IMSI, Cancellation Type) to the old SGSN with Cancellation Type set to Update Procedure. If the timer described in step 2 is not running, then the old SGSN removes the MM and PDP contexts. Otherwise, the contexts are removed only when the timer expires. This allows the old SGSN to complete the forwarding of N-PDUs. It also ensures that the MM and PDP contexts are kept in the old SGSN in case the MS initiates another inter SGSN routing area update before completing the ongoing routing area update to the new SGSN. The old SGSN acknowledges with Cancel Location Ack (IMSI).
- 9) The HLR sends Insert Subscriber Data (IMSI, GPRS subscription data) to the new SGSN. The new SGSN validates the MS's presence in the (new) RA. If due to regional subscription restrictions the MS is not allowed to be attached in the RA, the SGSN rejects the Routing Area Update Request with an appropriate cause, and may return an Insert Subscriber Data Ack (IMSI, SGSN Area Restricted) message to the HLR. If all checks are successful then the SGSN constructs an MM context for the MS and returns an Insert Subscriber Data Ack (IMSI) message to the HLR.
- 10) The HLR acknowledges the Update Location by sending Update Location Ack (IMSI) to the new SGSN.
- 11) The new SGSN validates the MS's presence in the new RA. If due to roaming restrictions the MS is not allowed to be attached in the SGSN, or if subscription checking fails, then the new SGSN rejects the routing area update with an appropriate cause. If all checks are successful then the new SGSN constructs MM and PDP contexts for the MS. A logical link is established between the new SGSN and the MS. The new SGSN responds to the MS with Routing Area Update Accept (P-TMSI, P-TMSI Signature, Receive N-PDU Number). Receive N-PDU Number contains the acknowledgements for each acknowledged-mode NSAPI used by the MS, thereby confirming all mobile-originated N-PDUs successfully transferred before the start of the update procedure.
- 12) The MS acknowledges the new P-TMSI by returning a Routing Area Update Complete (Receive N-PDU Number) message to the SGSN. Receive N-PDU Number contains the acknowledgements for each acknowledged-mode NSAPI used by the MS, thereby confirming all mobile-terminated N-PDUs successfully transferred before the start of the update procedure. If Receive N-PDU Number confirms reception of N-PDUs that were forwarded from the old SGSN, then these N-PDUs shall be discarded by the new SGSN. LLC and SNDCP in the MS are reset.

In the case of a rejected routing area update operation, due to regional subscription or roaming restrictions, or because the SGSN cannot determine the HLR address to establish the locating updating dialogue, the new SGSN shall not construct an MM context. A reject shall be returned to the MS with an appropriate cause. The MS shall not re-attempt a routing area update to that RA. The RAI value shall be deleted when the MS is powered-up.

If the SGSN is unable to update the PDP context in one or more GGSNs, then the SGSN shall deactivate the corresponding PDP contexts as described in subclause "PDP Context Deactivation Initiated by SGSN Procedure". This shall not cause the SGSN to reject the routing area update.

If the timer described in step 2 expires and no Cancel Location (IMSI) was received from the HLR, then the old SGSN shall stop forwarding N-PDUs to the new SGSN.

If the routing area update procedure fails a maximum allowable number of times, or if the SGSN returns a Routing Area Update Reject (Cause) message, the MS shall enter IDLE state.

6.9.1.3 Combined RA / LA Update Procedure

A combined RA / LA update takes place in network operation mode I when the MS enters a new RA or when a GPRS-attached MS performs IMSI attach, or when the MS indicates changed access capabilities to the network. The MS sends a Routing Area Update Request indicating that an LA update may also need to be performed, in which case the SGSN forwards the LA update to the VLR. This concerns only idle mode (see GSM 03.22), as no combined RA / LA updates are performed during a CS connection.

6.9.1.3.1 Combined Intra SGSN RA / LA Update

The Combined RA / LA Update (intra SGSN) procedure is illustrated in Figure 29. Each step is explained in the following list.

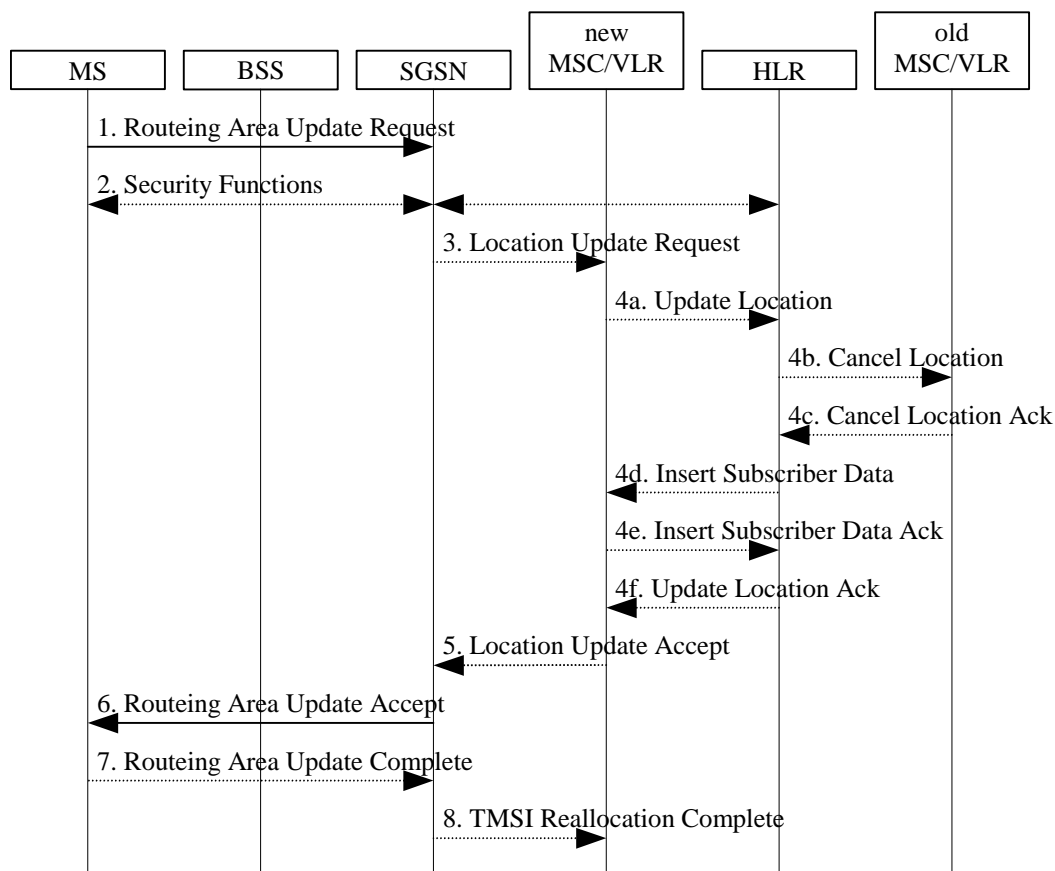

Figure 29: Combined RA / LA Update in the Case of Intra SGSN RA Update Procedure

- 1) The MS sends a Routing Area Update Request (old RAI, old P-TMSI Signature, Update Type) to the SGSN. Update Type shall indicate combined RA / LA update, or, if the MS wants to perform an IMSI attach, combined RA / LA update with IMSI attach requested. The BSS shall add the Cell Global Identity including the RAC and LAC of the cell where the message was received before passing the message to the SGSN.
- 2) Security functions may be executed. This procedure is defined in sub-clause "Security Function". If the security functions fail (e.g. because the SGSN cannot determine the HLR address to establish the Send Authentication Info dialogue), the Inter SGSN RAU Update procedure fails. A reject shall be returned to the MS with an appropriate cause.
- 3) If the association has to be established, if Update Type indicates combined RA / LA update with IMSI attach requested, or if the LA changed with the routing area update, then the SGSN sends a Location Update Request (new LAI, IMSI, SGSN Number, Location Update Type) to the VLR. Location Update Type shall indicate IMSI attach if Update Type in step 1 indicated combined RA / LA update with IMSI attach requested. Otherwise,

Location Update Type shall indicate normal location update. The VLR number is translated from the RAI via a table in the SGSN. The VLR creates or updates the association with the SGSN by storing SGSN Number.

- 4) If the subscriber data in the VLR is marked as not confirmed by the HLR, then the new VLR informs the HLR. The HLR cancels the data in the old VLR and inserts subscriber data in the new VLR (this signalling is not modified from existing GSM signalling and is included here for illustrative purposes):
 - a) The new VLR sends an Update Location (new VLR) to the HLR.
 - b) The HLR cancels the data in the old VLR by sending Cancel Location (IMSI) to the old VLR.
 - c) The old VLR acknowledges with Cancel Location Ack (IMSI).
 - d) The HLR sends Insert Subscriber Data (IMSI, GSM subscriber data) to the new VLR.
 - e) The new VLR acknowledges with Insert Subscriber Data Ack (IMSI).
 - f) The HLR responds with Update Location Ack (IMSI) to the new VLR.
- 5) The new VLR allocates a new VLR TMSI and responds with Location Update Accept (VLR TMSI) to the SGSN. VLR TMSI is optional if the VLR has not changed.
- 6) The SGSN validates the MS's presence in the new RA. If due to regional subscription restrictions the MS is not allowed to be attached in the RA, or if subscription checking fails, then the SGSN rejects the routeing area update with an appropriate cause. If all checks are successful then the SGSN updates the MM context for the MS. A new P-TMSI may be allocated. The SGSN responds to the MS with Routeing Area Update Accept (P-TMSI, VLR TMSI, P-TMSI Signature).
- 7) If a new P-TMSI or VLR TMSI was received, then the MS confirms the reallocation of the TMSIs by returning a Routeing Area Update Complete message to the SGSN.
- 8) The SGSN sends a TMSI Reallocation Complete message to the VLR if the VLR TMSI is confirmed by the MS.

If the routeing area update procedure fails a maximum allowable number of times, or if the SGSN returns a Routeing Area Update Reject (Cause) message, the MS shall enter IDLE state.

If the Location Update Accept message indicates a reject, then this should be indicated to the MS, and the MS shall not access non-GPRS services until a successful Location Update is performed.

6.9.1.3.2 Combined Inter SGSN RA / LA Update

The Combined RA / LA Update (inter SGSN) procedure is illustrated in Figure 30. Each step is explained in the following list.

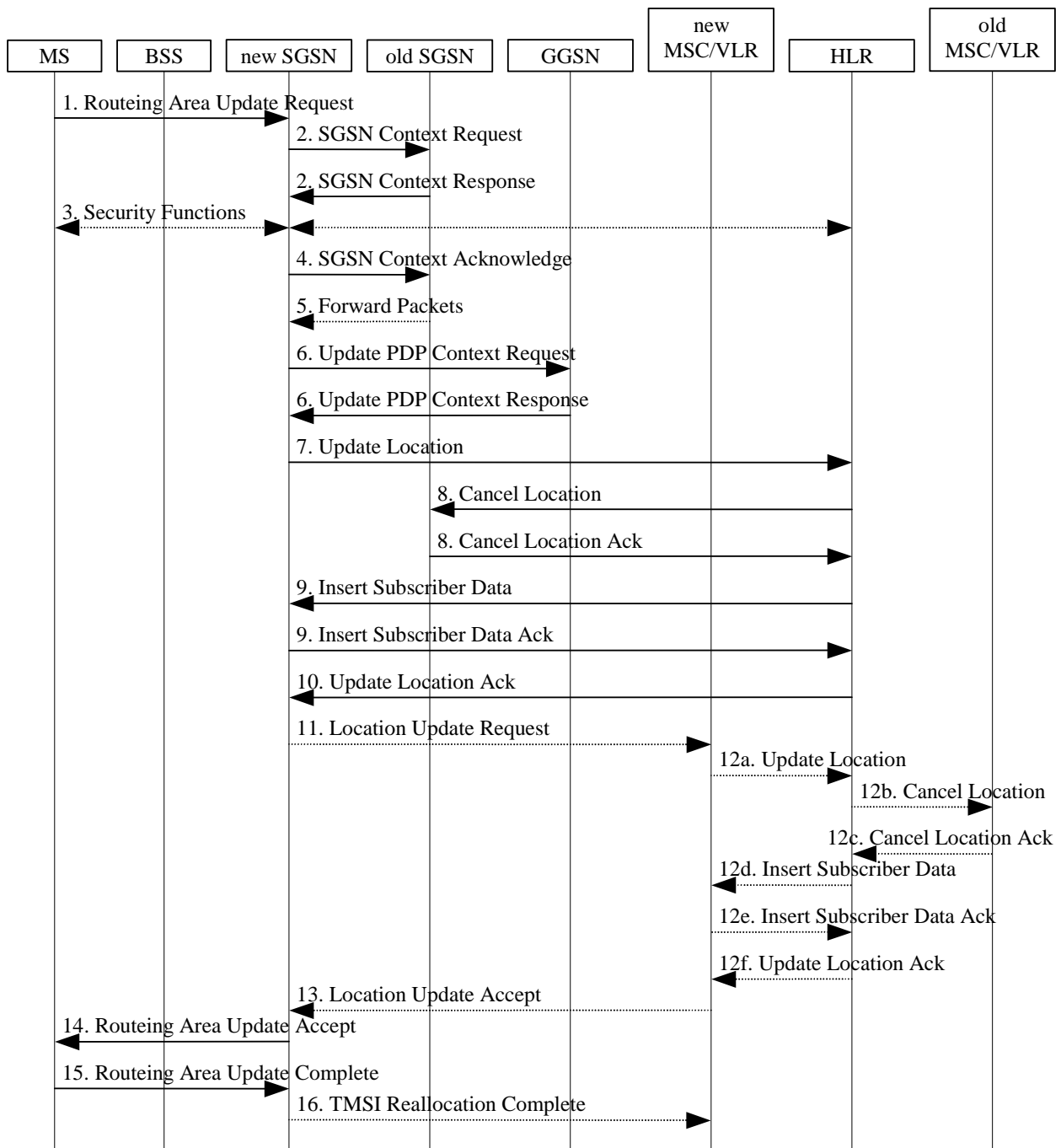

Figure 30: Combined RA / LA Update in the Case of Inter SGSN RA Update Procedure

- 1) The MS sends a Routing Area Update Request (old RAI, old P-TMSI Signature, Update Type) to the new SGSN. Update Type shall indicate combined RA / LA update, or, if the MS wants to perform an IMSI attach, combined RA / LA update with IMSI attach requested. The BSS shall add the Cell Global Identity including the RAC and LAC of the cell where the message was received before passing the message to the SGSN.

- 2) The new SGSN sends SGSN Context Request (old RAI, TLLI, old P-TMSI Signature, New SGSN Address) to the old SGSN to get the MM and PDP contexts for the MS. The old SGSN validates the old P-TMSI Signature and responds with an appropriate error cause if it does not match the value stored in the old SGSN. This should initiate the security functions in the new SGSN. If the security functions authenticate the MS correctly, the new SGSN shall send an SGSN Context Request (old RAI, TLLI, MS Validated, New SGSN Address) message to the old SGSN. MS Validated indicates that the new SGSN has authenticated the MS. If the old P-TMSI Signature was valid or if the new SGSN indicates that it has authenticated the MS, the old SGSN stops assigning SDCP N-PDU numbers to downlink N-PDUs received, and responds with SGSN Context Response (MM Context, PDP Contexts). If the MS is not known in the old SGSN, the old SGSN responds with an appropriate error cause. The old SGSN stores New SGSN Address until the old MM context is cancelled, to allow the old SGSN to forward data packets to the new SGSN. Each PDP Context includes the SDCP Send N-PDU Number for the next downlink N-PDU to be sent in acknowledged mode to the MS, the SDCP Receive N-PDU Number for the next uplink N-PDU to be received in acknowledged mode from the MS, the GTP sequence number for the next downlink N-PDU to be sent to the MS and the GTP sequence number for the next uplink N-PDU to be tunnelled to the GGSN. The old SGSN starts a timer and stops the downlink transfer.
- 3) Security functions may be executed. These procedures are defined in subclause "Security Function". Ciphering mode shall be set if ciphering is supported. If the security functions fail (e.g. because the SGSN cannot determine the HLR address to establish the Send Authentication Info dialogue), the Inter SGSN RAU Update procedure fails. A reject shall be returned to the MS with an appropriate cause.
- 4) The new SGSN sends an SGSN Context Acknowledge message to the old SGSN. This informs the old SGSN that the new SGSN is ready to receive data packets belonging to the activated PDP contexts. The old SGSN marks in its context that the MSC/VLR association and the information in the GGSNs and the HLR are invalid. This triggers the MSC/VLR, the GGSNs, and the HLR to be updated if the MS initiates a routeing area update procedure back to the old SGSN before completing the ongoing routeing area update procedure. If the security functions do not authenticate the MS correctly, then the routeing area update shall be rejected, and the new SGSN shall send a reject indication to the old SGSN. The old SGSN shall continue as if the SGSN Context Request was never received.
- 5) The old SGSN duplicates the buffered N-PDUs and starts tunnelling them to the new SGSN. Additional N-PDUs received from the GGSN before the timer described in step 2 expires are also duplicated and tunnelled to the new SGSN. N-PDUs that were already sent to the MS in acknowledged mode and that are not yet acknowledged by the MS are tunnelled together with the SDCP N-PDU number. No N-PDUs shall be forwarded to the new SGSN after expiry of the timer described in step 2.
- 6) The new SGSN sends Update PDP Context Request (new SGSN Address, TID, QoS Negotiated) to the GGSNs concerned. The GGSNs update their PDP context fields and return an Update PDP Context Response (TID).
- 7) The new SGSN informs the HLR of the change of SGSN by sending Update Location (SGSN Number, SGSN Address, IMSI) to the HLR.
- 8) The HLR sends Cancel Location (IMSI, Cancellation Type) to the old SGSN with Cancellation Type set to Update Procedure. If the timer described in step 2 is not running, then the old SGSN removes the MM and PDP contexts. Otherwise, the contexts are removed only when the timer expires. This allows the old SGSN to complete the forwarding of N-PDUs. It also ensures that the MM and PDP contexts are kept in the old SGSN in case the MS initiates another inter SGSN routeing area update before completing the ongoing routeing area update to the new SGSN. The old SGSN acknowledges with Cancel Location Ack (IMSI).
- 9) The HLR sends Insert Subscriber Data (IMSI, GPRS subscription data) to the new SGSN. The new SGSN validates the MS's presence in the (new) RA. If due to regional subscription restrictions the MS is not allowed to be attached in the RA, the SGSN rejects the Routeing Area Update Request with an appropriate cause, and may return an Insert Subscriber Data Ack (IMSI, SGSN Area Restricted) message to the HLR. If all checks are successful then the SGSN constructs an MM context for the MS and returns an Insert Subscriber Data Ack (IMSI) message to the HLR.
- 10) The HLR acknowledges the Update Location by sending Update Location Ack (IMSI) to the new SGSN.
- 11) If the association has to be established, if Update Type indicates combined RA / LA update with IMSI attach requested, or if the LA changed with the routeing area update, then the new SGSN sends a Location Update Request (new LAI, IMSI, SGSN Number, Location Update Type) to the VLR. Location Update Type shall indicate IMSI attach if Update Type in step 1 indicated combined RA / LA update with IMSI attach requested. Otherwise, Location Update Type shall indicate normal location update. The VLR number is translated from the RAI via a table in the SGSN. The SGSN starts the location update procedure towards the new MSC/VLR upon

receipt of the first Insert Subscriber Data message from the HLR in step 9). The VLR creates or updates the association with the SGSN by storing SGSN Number.

- 12) If the subscriber data in the VLR is marked as not confirmed by the HLR, the new VLR informs the HLR. The HLR cancels the old VLR and inserts subscriber data in the new VLR (this signalling is not modified from existing GSM signalling and is included here for illustrative purposes):
 - a) The new VLR sends an Update Location (new VLR) to the HLR.
 - b) The HLR cancels the data in the old VLR by sending Cancel Location (IMSI) to the old VLR.
 - c) The old VLR acknowledges with Cancel Location Ack (IMSI).
 - d) The HLR sends Insert Subscriber Data (IMSI, GSM subscriber data) to the new VLR.
 - e) The new VLR acknowledges with Insert Subscriber Data Ack (IMSI).
 - f) The HLR responds with Update Location Ack (IMSI) to the new VLR.
- 13) The new VLR allocates a new TMSI and responds with Location Update Accept (VLR TMSI) to the SGSN. VLR TMSI is optional if the VLR has not changed.
- 14) The new SGSN validates the MS's presence in the new RA. If due to roaming restrictions the MS is not allowed to be attached in the SGSN, or if subscription checking fails, then the SGSN rejects the routing area update with an appropriate cause. If all checks are successful then the new SGSN establishes MM and PDP contexts for the MS. A logical link is established between the new SGSN and the MS. The new SGSN responds to the MS with Routing Area Update Accept (P-TMSI, VLR TMSI, P-TMSI Signature, Receive N-PDU Number). Receive N-PDU Number contains the acknowledgements for each acknowledged-mode NSAPI used by the MS, thereby confirming all mobile-originated N-PDUs successfully transferred before the start of the update procedure.
- 15) The MS confirms the reallocation of the TMSIs by returning a Routing Area Update Complete (Receive N-PDU Number) message to the SGSN. Receive N-PDU Number contains the acknowledgements for each acknowledged-mode NSAPI used by the MS, thereby confirming all mobile-terminated N-PDUs successfully transferred before the start of the update procedure. If Receive N-PDU Number confirms reception of N-PDUs that were forwarded from the old SGSN, then these N-PDUs shall be discarded by the new SGSN. LLC and SNDCP in the MS are reset.
- 16) The new SGSN sends a TMSI Reallocation Complete message to the new VLR if the VLR TMSI is confirmed by the MS.

In the case of a rejected routing area update operation, due to regional subscription or roaming restrictions, or because the SGSN cannot determine the HLR address to establish the locating updating dialogue, the new SGSN shall not construct an MM context. A reject shall be returned to the MS with an appropriate cause. The MS shall not re-attempt a routing area update to that RA. The RAI value shall be deleted when the MS is powered-up.

If the SGSN is unable to update the PDP context in one or more GGSNs, then the SGSN shall deactivate the corresponding PDP contexts as described in subclause "PDP Context Deactivation Initiated by SGSN Procedure". This shall not cause the SGSN to reject the routing area update.

If the routing area update procedure fails a maximum allowable number of times, or if the SGSN returns a Routing Area Update Reject (Cause) message, the MS shall enter IDLE state.

If the timer described in step 2 expires and no Cancel Location (IMSI) was received from the HLR, then the old SGSN shall stop forwarding N-PDUs to the new SGSN.

If the Location Update Accept message indicates a reject, then this should be indicated to the MS, and the MS shall not access non-GPRS services until a successful location update is performed.

6.9.1.4 Periodic RA and LA Updates

All GPRS-attached MSs, except MSs in class-B mode of operation engaged in CS communication, shall perform periodic RA updates. MSs that are IMSI-attached and not GPRS-attached shall perform periodic LA updates. Periodic RA updates are equivalent to intra SGSN routing area updates as described in subclause "Intra SGSN Routing Area Update", with Update Type indicating periodic RA update. For MSs that are both IMSI-attached and GPRS-attached, the periodic updates depend on the mode of operation of the network.

- If the network operates in mode I, periodic RA updates shall be performed, and periodic LA updates shall not be performed. In this case, the MSC/VLR shall disable implicit detach for GPRS-attached MSs and instead rely on the SGSN to receive periodic RA updates. If periodic RA updates are not received in the SGSN and the SGSN detaches the MS, the SGSN shall notify the MSC/VLR by sending an IMSI Detach Indication message.
- If the network operates in mode II or mode III, both periodic RA updates and periodic LA updates shall be performed independently. RA updates are performed via the Gb interface, and LA updates are performed via the A interface.

The periodic RA update timer in the MS is stopped when an LLC PDU is sent since all sent LLC PDUs set the MM context state to READY. The periodic RA update timer is reset and started when the state returns to STANDBY.

If the MS could not successfully complete the periodic RA update procedure after a retry scheme while the MS was in GPRS coverage, then the MS shall wait a backoff time equal to the periodic LA update timer broadcast by the network before re-starting the periodic RA update procedure.

6.10 Subscriber Management Function

The Subscriber Management function provides a mechanism to inform the GPRS nodes about changes of the GPRS subscription data for a specific GPRS subscriber.

6.10.1 Subscriber Management Procedures

Whenever the GPRS subscription data is changed for a GPRS subscriber in the HLR, and the changes affect the GPRS subscription data stored in the SGSN, then the SGSN node shall be informed about these changes by means of the following procedures:

- Insert Subscriber Data procedure, used to add or modify GPRS subscription data in the SGSN; or
- Delete Subscriber Data procedure, used to remove GPRS subscription data in the SGSN.

6.10.1.1 Insert Subscriber Data Procedure

In addition to the insertion and modification of general GPRS subscription data for a GPRS subscriber, see GSM 09.02, the HLR may request the insertion or modification of one or several new or existing PDP contexts in the SGSN. It should be noted that the modification may trigger a PDP Context Modification procedure as described in subclause "Modification Procedures". In particular, the following PDP context parameters may be modified by the HLR:

- QoS Profile Subscribed; and
- VPLMN Address Allowed.

The Insert Subscriber Data procedure is illustrated in Figure 31. Each step is explained in the following list.

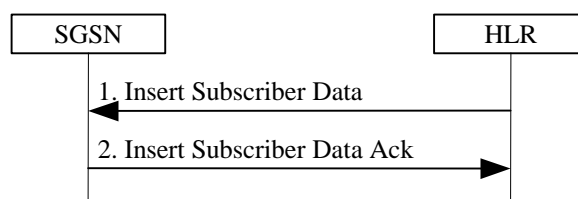

Figure 31: Insert Subscriber Data Procedure

- 1) The HLR sends an Insert Subscriber Data (IMSI, GPRS Subscription Data) message to the SGSN.

- 2) The SGSN updates its GPRS subscription data and acknowledges the Insert Subscriber Data message by returning an Insert Subscriber Data Ack (IMSI) message. For each PDP context that is included in GPRS Subscription Data the SGSN shall check whether it is a new, an active, or an inactive PDP context:
- For a new or inactive PDP context, no further action is required except storage in the SGSN.
 - For an active PDP context, the SGSN shall in addition compare the new QoS Subscribed with QoS Negotiated and shall, if necessary, initiate a PDP Context Modification procedure as described in subclause "Modification Procedures". Furthermore, if VPLMN Address Allowed is changed, the SGSN shall, if necessary (e.g., if the PDP context is currently routed via a GGSN in the VPLMN and VPLMN Address Allowed is changed to not allowed), initiate a PDP Context Deactivation procedure as explained in subclause "Deactivation Procedures".

6.10.1.2 Delete Subscriber Data Procedure

In addition to the deletion of general GPRS subscription data for a GPRS subscriber, see GSM 09.02, the HLR may request the deletion of one or several PDP contexts from the SGSN.

The Delete Subscriber Data procedure is illustrated in Figure 32. Each step is explained in the following list.

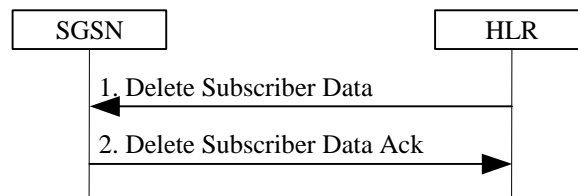

Figure 32: Delete Subscriber Data Procedure

- 1) The HLR sends a Delete Subscriber Data (IMSI, PDP Context Identifiers List) message to the SGSN.
- 2) The SGSN acknowledges the Delete Subscriber Data message by returning a Delete Subscriber Data Ack (IMSI) message. For each PDP context identifier included in PDP Context Identifiers List, the SGSN shall check whether it belongs to an active or an inactive PDP context:
 - for an inactive PDP context no further action is required except deletion of the PDP context;
 - for an active PDP context, the SGSN shall initiate the PDP Context Deactivation Initiated by SGSN procedure as explained in subclause "Deactivation Procedures" before the PDP context is deleted.

6.11 Classmark Handling

To support efficient radio interface usage in GPRS, the MS classmark is handled differently for SGSN-based services than for MSC-based services. In particular, the classmark is sent in MM messages to the network and stored in the network as long as the MS is GPRS-attached, avoiding redundant classmark retransmissions over the radio interface. This is sometimes called the "idle-mode classmark" principle.

In order to allow introduction of new radio access technologies in the future, the MS classmark is split into two distinct and independent information elements, the radio access classmark, and the SGSN classmark.

6.11.1 Radio Access Classmark

The radio access classmark contains the radio capabilities of the MS (e.g., multislot capability, power class), and more generally all the information that should be known by the BSS in order to handle radio resources for that MS.

The radio access classmark is a container for a multiplicity of radio access technology-dependent information, i.e., within the radio access classmark there are independent sub-fields for various technologies such as GSM 900, GSM 1800, Satellite, UMTS, etc. The coding shall allow a BSS to extract only the sub-fields relevant to it without interpreting the other sub-fields. This ensures that the radio classmark does not need to be interpreted by the NSS, and the full radio classmark is always sent by the MS to the SGSN, and thereafter provided to the BSS irrespective of the actual BSS capabilities.

The SGSN shall provide the radio access classmark as an information element on the Gb interface. It is the responsibility of the SGSN to provide the BSS with the most recent classmark received from the MS. The classmark information element can be included in a downlink transfer request, or be sent in a specific message that updates the radio classmark information in the BSS. The BSS may at any time request the radio classmark for a given MS to be transmitted from the SGSN to the BSS.

A specific optimisation allows the BSS to receive a reduced radio access classmark at initial access directly from the MS. This enables the BSS not to wait for the full radio access classmark to be provided by the SGSN, and is therefore quicker for the initial MS-originated transmission. The reduced classmark can be carried in several RR messages depending on the access method, e.g., in the initial random access message, or in the first uplink radio block. Details are provided in GSM 04.08 and GSM 04.60.

6.11.2 SGSN Classmark

The SGSN classmark contains non radio-related capabilities, e.g., the ciphering capability. The SGSN stores the SGSN classmark which is used both locally by the SGSN and for transfer to the new SGSN at all types of inter SGSN RA update.

7 Network Management Functionality

The Network Management function provides mechanisms to support O&M functions related to GPRS.

8 Radio Resource Functionality

8.1 Cell Selection and Reselection

An MS (in any mode of operation (A, B, or C)) cannot camp on more than one cell. If the MS is in idle mode, see GSM 03.22, then it shall use cell selection and reselection procedures as described in GSM 03.64 and specified in GSM 03.22 and GSM 05.08 [15].

8.2 Discontinuous Reception

A GPRS MS may be able to choose if it wants to use discontinuous reception (DRX) or not. If using DRX, the MS shall also be able to specify other DRX parameters that indicate the delay for the network to send a page request or a channel assignment to the MS (see GSM 03.64).

The DRX parameters shall be indicated by the MS in the attach procedure. The SGSN shall then in each page request send these parameters to the BSS that uses this information and the IMSI to calculate the correct paging group.

DRX usage is independent of the MM states IDLE, STANDBY and READY. As DRX can be used by a GPRS MS in READY state, DRX has to be considered also when assigning a packet data channel for downlink transfer. The SGSN shall therefore indicate the DRX parameters for the MS in all packet transmission requests to the BSS.

A GPRS MS shall not apply DRX in READY state during the GPRS attach and routing area update procedures.

8.3 Radio Resource Management

GSM Radio Resource Management functions are defined in GSM 04.07 [10]. The radio interface layer 3 protocol is specified in GSM 04.08.

8.3.1 Layer Functions

GPRS radio resource management procedures are required for the following functions:

- allocation and release of physical resources (i.e., timeslots) associated with a GPRS channel;
- monitoring GPRS channel utilisation to detect under-utilised or congested GPRS channels;
- initiating congestion control procedures; and
- distribution of GPRS channel configuration information for broadcasting to the MSs.

8.3.2 Model of Operation

8.3.2.1 Dynamic Allocation of Radio Resources

A cell may or may not support GPRS.

A cell supporting GPRS may have GPRS radio resources allocated at a given instance. If no GPRS radio resources are allocated, an MS can request allocation of such resources. MSs may then use these radio resources. The PLMN may dynamically increase, to a PLMN operator-defined maximum, or, decrease to an operator-defined minimum, the radio resources allocated.

The network broadcasts GPRS system information on the common control channels.

GSM radio resources are dynamically shared between GPRS and other GSM services.

8.4 Paging for GPRS Downlink Transfer

An MS in STANDBY state is paged by the SGSN before a downlink transfer to that MS. The paging procedure shall move the MM state to READY to allow the SGSN to forward downlink data to the radio resource. Therefore, any uplink data from the MS that moves the MM context at the SGSN to READY state is a valid response to paging.

The SGSN supervises the paging procedure with a timer. If the SGSN receives no response from the MS to the Paging Request message, it shall repeat the paging. The repetition strategy is implementation dependent.

The MS shall accept pages also in READY state if no radio resource is assigned. This supports recovery from inconsistent MM states in MS and SGSN.

The GPRS Paging procedure is illustrated in Figure 33. Each step is explained in the following list.

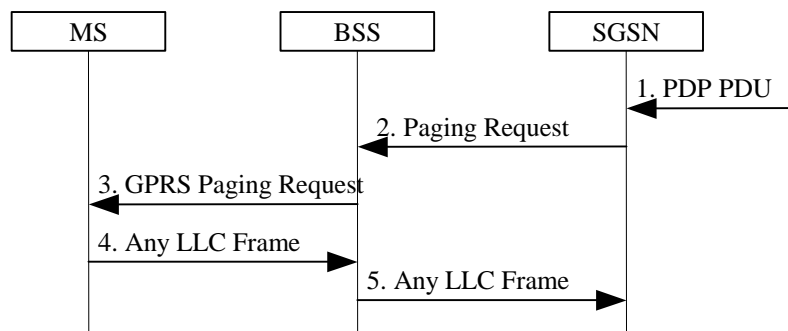

Figure 33: GPRS Paging Procedure

- 1) The SGSN receives a downlink PDP PDU for an MS in STANDBY state. Downlink signalling to a STANDBY state MS initiates paging as well.
- 2) The SGSN sends a BSSGP Paging Request (IMSI, P-TMSI, Area, Channel Needed, QoS, DRX Parameters) message to the BSS serving the MS. IMSI is needed by the BSS in order to calculate the MS paging group. P-TMSI is the identifier by which the MS is paged. Area indicates the routing area in which the MS is paged. Channel Needed indicates GPRS paging. QoS is the negotiated QoS for the PDP context that initiates the paging procedure, and indicates the priority of this Paging Request relative to other Paging Request messages buffered in the BSS. DRX Parameters indicates whether the MS uses discontinuous reception or not. If the MS uses discontinuous reception, then DRX Parameters also indicate when the MS is in a non-sleep mode able to receive paging requests.
- 3) The BSS pages the MS with one Paging Request (P-TMSI, Channel Needed) message in each cell belonging to the addressed routing area. This is described in GSM 03.64.
- 4) Upon receipt of a GPRS Paging Request message, the MS shall respond with either any single valid LLC frame (e.g., a Receive Ready or Information frame) that implicitly is interpreted as a page response message by the SGSN. When responding, the MS changes MM state to READY. The response is preceded by the Packet Channel Request and Packet Immediate Assignment procedures as described in GSM 03.64.
- 5) Upon reception of the LLC frame, the BSS adds the Cell Global Identity including the RAC and LAC of the cell and sends the LLC frame to the SGSN. The SGSN shall then consider the LLC frame to be an implicit paging response message and stop the paging response timer.

9 Packet Routing and Transfer Functionality

9.1 Definition of Packet Data Protocol States

A GPRS subscription contains the subscription of one or more PDP addresses. Each PDP address is described by an individual PDP context in the MS, the SGSN, and the GGSN. Every PDP context exists independently in one of two PDP states. The PDP state indicates whether the PDP address is activated for data transfer or not. Activation and deactivation are described in subclause "PDP Context Activation, Modification, and Deactivation Functions". All PDP contexts of a subscriber are associated with the same MM context for the IMSI of that subscriber.

9.1.1 INACTIVE State

The INACTIVE state characterises the data service for a certain PDP address of the subscriber as not activated. The PDP context contains no routing or mapping information to process PDP PDUs related to that PDP address. No data can be transferred. A changing location of a subscriber causes no update for the PDP context in INACTIVE state even if the subscriber is attached to the GPRS MM.

Mobile-terminated PDP PDUs received in INACTIVE state by the GGSN may initiate the Network-Requested PDP Context Activation procedure if the GGSN is allowed to initiate the activation of the PDP context for that PDP address. Otherwise, mobile-terminated PDP PDUs received in INACTIVE state invoke error procedures in the GGSN relevant to the external network protocol, for example, an IP packet is discarded and an ICMP (see RFC 792 [41]) packet (error notification) is returned to the source of the received packet. Other error procedures may be introduced on the application level, but this is outside the scope of the present document.

The MS initiates the movement from INACTIVE to ACTIVE state by initiating the PDP Context Activation procedure.

9.1.2 ACTIVE State

In ACTIVE state, the PDP context for the PDP address in use is activated in MS, SGSN and GGSN. The PDP context contains mapping and routing information for transferring PDP PDUs for that particular PDP address between MS and GGSN. The PDP state ACTIVE is permitted only when the mobility management state of the subscriber is STANDBY or READY.

An active PDP context for an MS is moved to INACTIVE state when the deactivation procedure is initiated.

All active PDP contexts for an MS are moved to INACTIVE state when the MM state changes to IDLE.

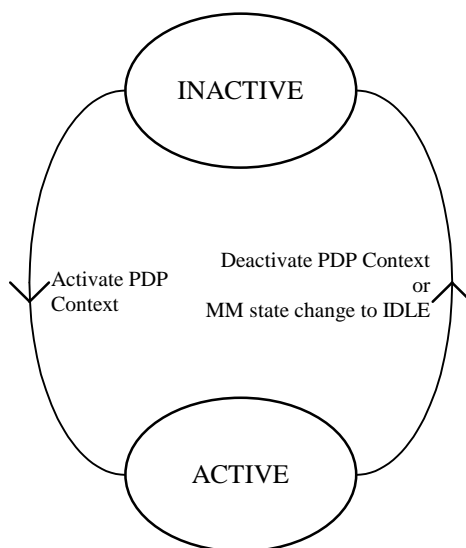

Figure 34: Functional PDP State Model

9.2 PDP Context Activation, Modification, and Deactivation Functions

These functions are only meaningful at the NSS level and in the MS, and do not directly involve the BSS. An MS in STANDBY or READY state can initiate these functions at any time to activate or deactivate a PDP context in the MS, the SGSN, and the GGSN. A GGSN may request the activation of a PDP context to a GPRS-attached subscriber. A GGSN may initiate the deactivation of a PDP context.

Upon receiving an Activate PDP Context Request message, the SGSN shall initiate procedures to set up PDP contexts. Upon receiving a Deactivate PDP Context Request message, the SGSN shall initiate procedures to deactivate PDP contexts.

An MS does not have to receive the (De-)Activate PDP Context Accept message before issuing another (De-)Activate PDP Context Request. However, only one request can be outstanding for every NSAPI.

9.2.1 Static and Dynamic PDP Addresses

PDP addresses can be allocated to an MS in three different ways:

- the HPLMN operator assigns a PDP address permanently to the MS (static PDP address);
- the HPLMN operator assigns a PDP address to the MS when a PDP context is activated (dynamic HPLMN PDP address); or
- the VPLMN operator assigns a PDP address to the MS when a PDP context is activated (dynamic VPLMN PDP address).

It is the HPLMN operator that defines in the subscription whether a dynamic HPLMN or VPLMN PDP address can be used.

For every IMSI, zero, one, or more dynamic PDP address per PDP type can be assigned. For every IMSI, zero, one, or more static PDP addresses per PDP type can be subscribed to.

When dynamic addressing is used, it is the responsibility of the GGSN to allocate and release the dynamic PDP address.

Only static PDP addressing is applicable in the network-requested PDP context activation case.

9.2.2 Activation Procedures

9.2.2.1 PDP Context Activation Procedure

The PDP Context Activation procedure is illustrated in Figure 35. Each step is explained in the following list.

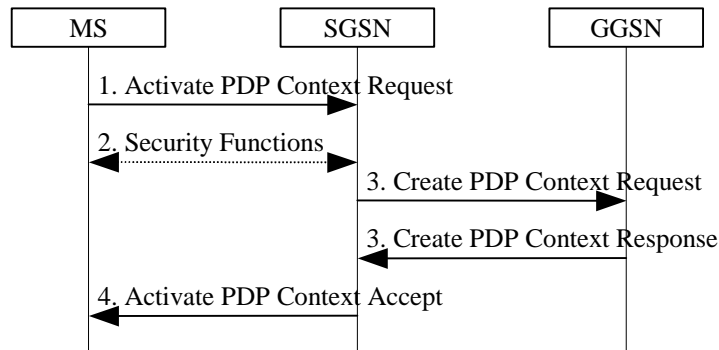

Figure 35: PDP Context Activation Procedure

- 1) The MS sends an Activate PDP Context Request (NSAPI, TI, PDP Type, PDP Address, Access Point Name, QoS Requested, PDP Configuration Options) message to the SGSN. The MS shall use PDP Address to indicate whether it requires the use of a static PDP address or whether it requires the use of a dynamic PDP address. The MS shall leave PDP Address empty to request a dynamic PDP address. The MS may use Access Point Name to select a reference point to a certain external network. Access Point Name is a logical name referring to the external packet data network that the subscriber wishes to connect to. QoS Requested indicates the desired QoS profile. PDP Configuration Options may be used to request optional PDP parameters from the GGSN (see GSM 09.60). PDP Configuration Options is sent transparently through the SGSN.
- 2) Security functions may be executed. These procedures are defined in subclause "Security Function".
- 3) The SGSN validates the Activate PDP Context Request using PDP Type (optional), PDP Address (optional), and Access Point Name (optional) provided by the MS and the PDP context subscription records. The validation criteria, the APN selection criteria, and the mapping from APN to a GGSN are described in annex A.

If no GGSN address can be derived or if the SGSN has determined that the Activate PDP Context Request is not valid according to the rules described in annex A, then the SGSN rejects the PDP context activation request.

If a GGSN address can be derived, the SGSN creates a TID for the requested PDP context by combining the IMSI stored in the MM context with the NSAPI received from the MS. If the MS requests a dynamic address, then the SGSN lets a GGSN allocate the dynamic address. The SGSN may restrict the requested QoS attributes given its capabilities, the current load, and the subscribed QoS profile. The SGSN sends a Create PDP Context Request (PDP Type, PDP Address, Access Point Name, QoS Negotiated, TID, MSISDN, Selection Mode, PDP Configuration Options) message to the affected GGSN. Access Point Name shall be the APN Network Identifier of the APN selected according to the procedure described in annex A. PDP Address shall be empty if a dynamic address is requested. The GGSN may use Access Point Name to find an external network. Selection Mode indicates whether a subscribed APN was selected, or whether a non-subscribed APN sent by MS or a non-subscribed APN chosen by SGSN was selected. Selection Mode is set according to annex A. The GGSN may use Selection Mode when deciding whether to accept or reject the PDP context activation. For example, if an APN requires subscription, then the GGSN is configured to accept only the PDP context activation that requests a subscribed APN as indicated by the SGSN with Selection Mode. The GGSN creates a new entry in its PDP context table and generates a Charging Id. The new entry allows the GGSN to route PDP PDUs between the SGSN and the external PDP network, and to start charging. The GGSN may further restrict QoS Negotiated given its capabilities and the current load. The GGSN then returns a Create PDP Context Response (TID, PDP Address, Reordering Required, PDP Configuration Options, QoS Negotiated, Charging Id, Cause) message to the SGSN. PDP Address is included if the GGSN allocated a PDP address. Reordering Required indicates whether the SGSN shall reorder N-PDUs before delivering the N-PDUs to the MS. PDP Configuration Options contain optional PDP parameters that the GGSN may transfer to the MS. These optional PDP parameters may be requested by the MS in the Activate PDP Context Request message, or may be sent unsolicited by the GGSN. PDP Configuration Options is sent transparently through the SGSN. The Create PDP Context messages are sent over the GPRS backbone network.

If QoS Negotiated received from the SGSN is incompatible with the PDP context being activated (e.g., the reliability class is insufficient to support the PDP type), then the GGSN rejects the Create PDP Context Request message. The compatible QoS profiles are configured by the GGSN operator.

- 4) The SGSN inserts the NSAPI along with the GGSN address in its PDP context. If the MS has requested a dynamic address, the PDP address received from the GGSN is inserted in the PDP context. The SGSN selects Radio Priority based on QoS Negotiated, and returns an Activate PDP Context Accept (PDP Type, PDP Address, TI, QoS Negotiated, Radio Priority, PDP Configuration Options) message to the MS. The SGSN is now able to route PDP PDUs between the GGSN and the MS, and to start charging.

For each PDP Address a different quality of service (QoS) profile may be requested. For example, some PDP addresses may be associated with E-mail that can tolerate lengthy response times. Other applications cannot tolerate delay and demand a very high level of throughput, interactive applications being one example. These different requirements are reflected in the QoS profile. The QoS profile is defined in subclause "Quality of Service Profile". If a QoS requirement is beyond the capabilities of a PLMN, the PLMN negotiates the QoS profile as close as possible to the requested QoS profile. The MS either accepts the negotiated QoS profile, or deactivates the PDP context.

After an SGSN has successfully updated the GGSN, the PDP contexts associated with an MS is distributed as shown in clause "Information Storage".

If the PDP Context Activation Procedure fails or if the SGSN returns an Activate PDP Context Reject (Cause, PDP Configuration Options) message, then the MS may attempt another activation to the same APN up to a maximum number of attempts.

9.2.2.2 Network-Requested PDP Context Activation Procedure

The Network-Requested PDP Context Activation procedure allows the GGSN to initiate the activation of a PDP context. When receiving a PDP PDU the GGSN checks if a PDP context is established for that PDP address. If no PDP context has been previously established the GGSN may try to deliver the PDP PDU by initiating the Network-Requested PDP Context Activation procedure. The criteria used by the GGSN to determine whether trying to deliver the PDP PDU to the MS may be based on subscription information and are outside the scope of GPRS standardisation.

To support Network-Requested PDP Context Activation the GGSN has to have static PDP information about the PDP address. To determine whether Network-Requested PDP Context Activation is supported for a PDP address the GGSN checks if there is static PDP information for that PDP address.

Once these checks have been performed the GGSN may initiate the Network-Requested PDP Context Activation procedure.

The network operator may implement the following techniques to prevent unnecessary enquires to the HLR:

- implementation of the Mobile station Not Reachable for GPRS flag (MNRG) technique in GGSN, SGSN, and HLR (see subclause "Unsuccessful Network-Requested PDP Context Activation Procedure");
- the GGSN may reject or discard PDP PDUs after a previous unsuccessful delivery attempt. This systematic rejection of PDP PDUs would be performed during a certain time after the unsuccessful delivery;
- the GGSN may store the address of the SGSN with which the GGSN established the last PDP context. This would prevent an enquiry to the HLR. This SGSN address would be considered as valid during a certain time.

9.2.2.2.1 Successful Network-Requested PDP Context Activation Procedure

The Successful Network-Requested PDP Context Activation procedure is illustrated in Figure 36. Each step is explained in the following list.

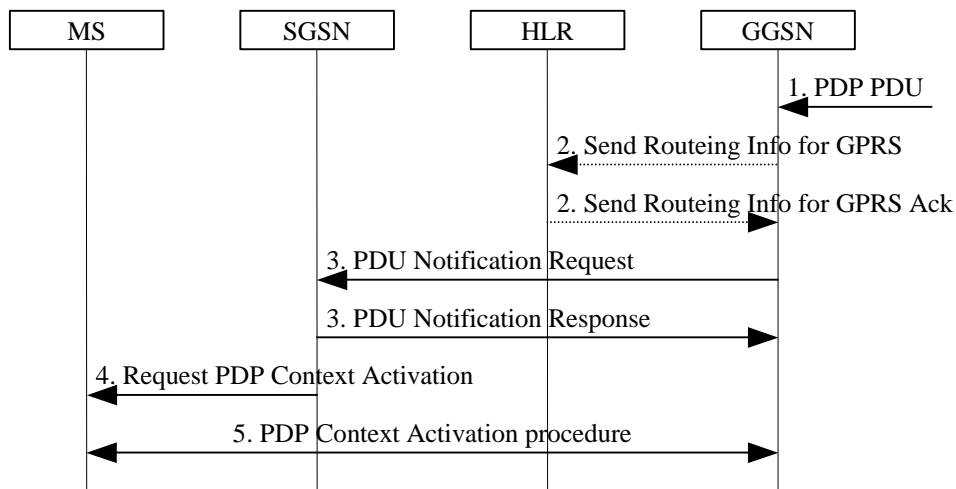

Figure 36: Successful Network-Requested PDP Context Activation Procedure

- 1) When receiving a PDP PDU the GGSN determines if the Network-Requested PDP Context Activation procedure has to be initiated. The GGSN may store subsequent PDP PDUs received for the same PDP address.
- 2) The GGSN may send a Send Routing Information for GPRS (IMSI) message to the HLR. If the HLR determines that the request can be served, it returns a Send Routing Information for GPRS Ack (IMSI, SGSN Address, Mobile Station Not Reachable Reason) message to the GGSN. The Mobile Station Not Reachable Reason parameter is included if the MNRG flag is set in the HLR. The Mobile Station Not Reachable Reason parameter indicates the reason for the setting of the MNRG flag as stored in the MNRR record (see GSM 03.40). If the MNRR record indicates a reason other than 'No Paging Response', the HLR shall include the GGSN number in the GGSN-list of the subscriber.

If the HLR determines that the request cannot be served (e.g., IMSI unknown in HLR), the HLR shall send a Send Routing Information for GPRS Ack (IMSI, MAP Error Cause) message. Map Error Cause indicates the reason for the negative response.

- 3) If the SGSN address is present and either Mobile Station Not Reachable Reason is not present or Mobile Station Not Reachable Reason indicates 'No Paging Response', the GGSN shall send a PDU Notification Request (IMSI, PDP Type, PDP Address) message to the SGSN indicated by the HLR. Otherwise, the GGSN shall set the MNRG flag for that MS. The SGSN returns a PDU Notification Response (Cause) message to the GGSN in order to acknowledge that it shall request the MS to activate the PDP context indicated with PDP Address.
- 4) The SGSN sends a Request PDP Context Activation (TI, PDP Type, PDP Address) message to request the MS to activate the indicated PDP context.
- 5) The PDP context is activated with the PDP Context Activation procedure (see subclause "PDP Context Activation Procedure").

9.2.2.2.2 Unsuccessful Network-Requested PDP Context Activation Procedure

If the PDP context requested by the GGSN cannot be established, the SGSN sends a PDU Notification Response (Cause) or a PDU Notification Reject Request (IMSI, PDP Type, PDP Address, Cause) message to the GGSN depending on if the context activation fails before or after the SGSN has sent a Request PDP Context Activation message to the MS. Cause indicates the reason why the PDP context could not be established:

- 'IMSI Not Known'. The SGSN has no MM context for that IMSI (Cause in PDU Notification Response);
- 'MS GPRS Detached'. The MM state of the MS is IDLE (Cause in PDU Notification Response);
- 'MS Not GPRS Responding'. The MS is GPRS-attached to the SGSN but the MS does not respond. This may be due to the lack of a response to a GPRS Paging Request, due to an Abnormal RLC condition, or due to no Activate PDP Context Request message received within a certain time after the Request PDP Context Activation message was delivered to the MS (Cause in PDU Notification Reject Request);
- 'MS Refuses'. The MS refuses explicitly the network-requested PDP context (Cause in PDU Notification Reject Request).

When receiving the PDU Notification Response or the PDU Notification Reject Request message the GGSN may reject or discard the PDP PDU depending on the PDP type.

After an unsuccessful Network-Requested PDP Context Activation procedure the network may perform some actions to prevent unnecessary enquires to the HLR. The actions taken depend on the cause of the delivery failure.

- If the MS is not reachable or if the MS refuses the PDP PDU (Cause value 'MS Not GPRS Responding' or 'MS Refuses'), then the SGSN shall not change the setting of MNRG for this MS. The GGSN may refuse any PDP PDU for that PDP address during a certain period. The GGSN may store the SGSN address during a certain period and send subsequent PDU Notification Request messages to that SGSN.
- If the MS is GPRS-detached or if the IMSI is not known in the SGSN (Cause value 'MS GPRS Detached' or 'IMSI Not Known'), then the SGSN, the GGSN, and the HLR may perform the Protection and Mobile User Activity procedures.

The Protection procedure is illustrated in Figure 37. Each step is explained in the following list.

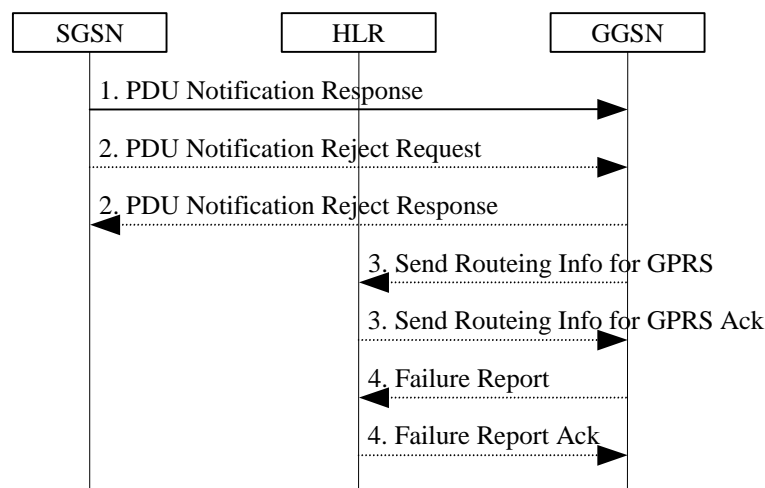

Figure 37: Protection Procedure

- 1) If the MM context of the mobile is IDLE or if the SGSN has no information about that user, the SGSN returns a PDU Notification Response (Cause) message to the GGSN with Cause equal to 'MS GPRS Detached' or 'IMSI Not Known', otherwise the Cause shall be 'Activation Proceeds'. If the Cause is 'MS GPRS Detached' or 'IMSI Not Known' and if the SGSN has an MM context for that user, the SGSN sets MNRG to indicate the need to report to the HLR when the next contact with that MS is performed.
- 2) If the MS does not respond or refuses the activation request, the SGSN sends a PDU Notification Reject Request (IMSI, PDP Type, PDP Address, Cause) message to the GGSN with Cause equal to 'MS Not GPRS Responding' or 'MS Refuses'. The GGSN returns a PDU Notification Reject Response message to the SGSN.

- 3) If Cause equals 'IMSI Not Known' the GGSN may send a Send Routing Information for GPRS (IMSI) message to the HLR. The HLR returns a Send Routing Information for GPRS Ack (IMSI, SGSN Address, Cause) message to the GGSN indicating the address of the SGSN that currently serves the MS. If SGSN Address is different from the one previously stored by the GGSN, then steps 3, 4, and 5 in Figure 36 are followed.
- 4) If SGSN Address is the same as the one previously stored in the GGSN, or if the Cause value returned in step 1 equals 'MS GPRS Detached', then the GGSN sets MNRG for that PDP address and sends a Failure Report (IMSI, GGSN Number, GGSN Address) message to the HLR to request MNRG to be set in the HLR. The HLR sets (if not already set) MNRG for the IMSI and adds GGSN Number and GGSN Address to the list of GGSNs to report to when activity from that IMSI is detected. GGSN Number is either the number of the GGSN, or, if a protocol-converting GSN is used as an intermediate node, the number of the protocol-converting GSN. GGSN Address is an optional parameter that shall be included if a protocol-converting GSN is used.

The Mobile User Activity procedure is illustrated in Figure 38. Each step is explained in the following list.

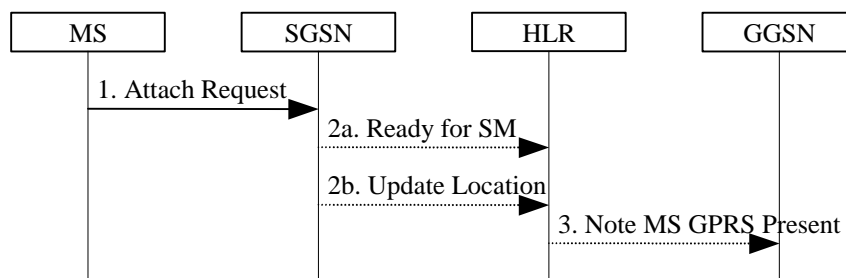

Figure 38: Mobile User Activity Procedure

- 1) The SGSN receives an indication that an MS is reachable, e.g., an Attach Request message from the MS.
- 2a) If the SGSN contains an MM context of the MS and MNRG for that MS is set, the SGSN shall send a Ready for SM (IMSI, MS Reachable) message to the HLR and clears MNRG for that MS.
- 2b) If the SGSN does not keep the MM context of the MS, the SGSN shall send an Update Location message (see subclause "Attach Function") to the HLR.
- 3) When the HLR receives the Ready for SM message or the Update Location message for an MS that has MNRG set, it clears MNRG for that MS and sends a Note MS GPRS Present (IMSI, SGSN Address) message to all the GGSNs in the list of the subscriber. (The Ready for SM message also triggers the SMS alert procedure as described in subclause "Unsuccessful Mobile-terminated SMS Transfer".) SGSN Address contains the address of the SGSN that currently serves the MS. Upon reception of Note MS Present, each GGSN shall clear MNRG.

9.2.2.3 Anonymous Access PDP Context Activation Procedure

The MS can anonymously initiate PDP Context Activation in IDLE, STANDBY, and READY states. An existing MM context in the SGSN is neither required nor used in this case. Only dynamic PDP addressing is applicable.

The Anonymous Access PDP Context Activation procedure is illustrated in Figure 39. Each step is explained in the following list.

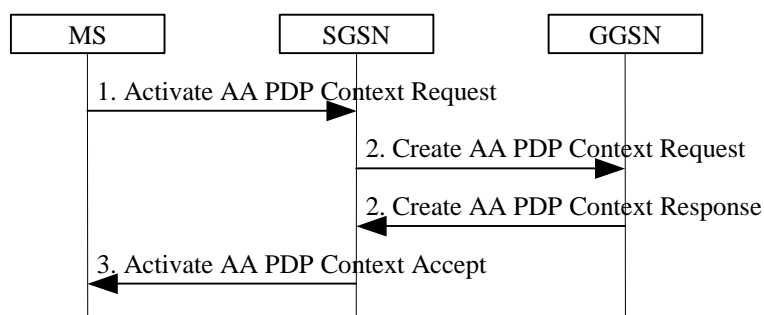

Figure 39: Anonymous Access PDP Context Activation Procedure

- 1) The MS sends an Activate AA PDP Context Request (NSAPI, TI, PDP Type, PDP Address, Access Point Name, QoS Requested, PDP Configuration Options) message to the SGSN. The MS shall use a Random TLLI at the RLC/MAC layer for identification purposes. The MS shall use PDP Address to indicate that it requires the use of a dynamic PDP address. The MS shall use Access Point Name to select a reference point to a certain external network that provides anonymous services. QoS Requested indicates the desired QoS profile. PDP Configuration Options may be used to request optional PDP parameters from the GGSN (see GSM 09.60). PDP Configuration Options is sent transparently through the SGSN.
- 2) The SGSN may restrict the requested QoS value given its capabilities and the current load. The SGSN assigns an Auxiliary TLLI and creates an AA-TID for the PDP-Context. The SGSN sends a Create AA PDP Context Request (PDP Type, PDP Address, Access Point Name, QoS Negotiated, AA-TID, Selection Mode, PDP Configuration Options) message to the GGSN indicated by Access Point Name in the Activate AA PDP Context Request message. Selection Mode indicates how the APN was selected. The GGSN creates a new entry in its PDP context table and generates a Charging Id. The new entry allows the GGSN to route PDP PDUs between the SGSN and the server(s) that provide services for anonymous MSs, and to start charging. The GGSN may use Access Point Name to find an external network that provides anonymous services. The GGSN may further restrict QoS Negotiated given its capabilities and the current load. The GGSN then allocates a dynamic PDP Address and returns a Create AA PDP Context Response (AA-TID, PDP Address, Reordering Required, PDP Configuration Options, QoS Negotiated, Charging Id, Cause) message to the SGSN. Reordering Required indicates whether the SGSN shall reorder N-PDUs before delivering the N-PDUs to the MS. PDP Configuration Options contain optional PDP parameters that the GGSN may transfer to the MS. These optional PDP parameters may be requested by the MS in the Activate PDP Context Request, or may be sent unsolicited by the GGSN. PDP Configuration Options is sent transparently through the SGSN. The GGSN shall check the source and destination address in all subsequent anonymous MO PDP PDUs received from the SGSN. If the GGSN detects a not allowed address in an MO PDP PDU, then the PDP PDU shall be discarded and the MM and PDP contexts shall be deleted in the GGSN, SGSN, and MS, as defined in subclause "Anonymous Access PDP Context Deactivation Initiated by GGSN Procedure".

If QoS Negotiated received from the SGSN is incompatible with the PDP context being activated (e.g., the reliability class is insufficient to support the PDP type), then the GGSN rejects the Create AA PDP Context Request message. The compatible QoS profiles are configured by the GGSN operator.

- 3) The SGSN inserts the NSAPI along with the PDP address received from the GGSN in its PDP context. The SGSN selects Radio Priority based on QoS Negotiated and returns an Activate AA PDP Context Accept (A-TLLI, PDP Type, PDP Address, TI, QoS Negotiated, Radio Priority, PDP Configuration Options) message to the MS. The SGSN is now able to route anonymous PDP PDUs between the GGSN and the MS and to start charging.

After an SGSN has successfully updated the GGSN, the MM and PDP contexts associated with an MS is distributed as shown in clause "Information Storage".

If the AA PDP Context Activation procedure fails or if the SGSN returns an Activate AA PDP Context Reject (Cause, PDP Configuration Options) message, then the MS may attempt another activation to the same GGSN up to a maximum number of attempts.

9.2.3 Modification Procedures

An SGSN can decide, possibly triggered by the HLR as explained in subclause "Insert Subscriber Data Procedure", to modify parameters that were negotiated during an activation procedure for one or several PDP contexts. The following parameters can be modified:

- QoS Negotiated; and
- Radio Priority.

The SGSN can request the modification of parameters by sending a Modify PDP Context Request message to the MS.

9.2.3.1 PDP Context Modification Procedure

The PDP Context Modification procedure is illustrated in Figure 40. Each step is explained in the following list.

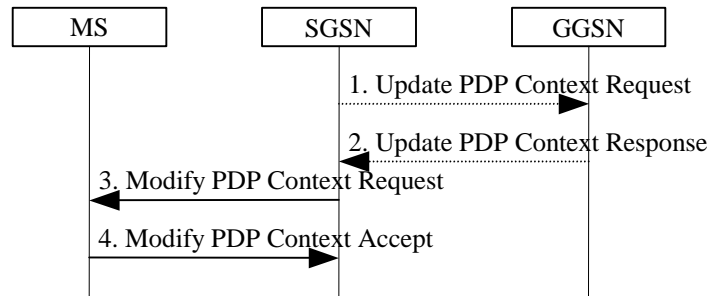

Figure 40: PDP Context Modification Procedure

- 1) The SGSN may send an Update PDP Context Request (TID, QoS Negotiated) message to the GGSN. If QoS Negotiated received from the SGSN is incompatible with the PDP context being modified (e.g., the reliability class is insufficient to support the PDP type), then the GGSN rejects the Update PDP Context Request. The compatible QoS profiles are configured by the GGSN operator.
- 2) The GGSN may restrict QoS Negotiated given its capabilities and the current load. The GGSN stores QoS Negotiated and returns an Update PDP Context Response (TID, QoS Negotiated) message.
- 3) The SGSN sends a Modify PDP Context Request (TI, QoS Negotiated, Radio Priority) message to the MS.
- 4) The MS acknowledges by returning a Modify PDP Context Accept message. If the MS does not accept the new QoS Negotiated it shall de-activate the PDP context with the PDP Context Deactivation Initiated by MS procedure.

9.2.4 Deactivation Procedures

9.2.4.1 PDP Context Deactivation Initiated by MS Procedure

The PDP Context Deactivation Initiated by MS procedure is illustrated in Figure 41. Each step is explained in the following list.

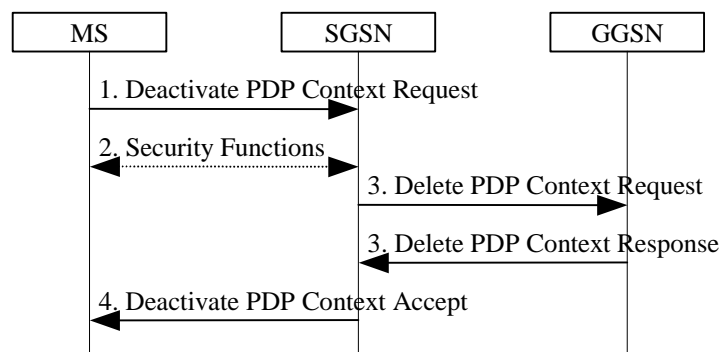

Figure 41: PDP Context Deactivation Initiated by MS Procedure

- 1) The MS sends a Deactivate PDP Context Request (TI) message to the SGSN.
- 2) Security functions may be executed. These procedures are defined in subclause "Security Function".
- 3) The SGSN sends a Delete PDP Context Request (TID) message to the GGSN. The GGSN removes the PDP context and returns a Delete PDP Context Response (TID) message to the SGSN. If the MS was using a dynamic PDP address, then the GGSN releases this PDP address and makes it available for subsequent activation by other MSs. The Delete PDP Context messages are sent over the GPRS backbone network.
- 4) The SGSN returns a Deactivate PDP Context Accept (TI) message to the MS.

At GPRS detach, all PDP contexts for the MS are implicitly deactivated.

If the SGSN receives a Deactivate PDP Context Request (TI) message for a PDP context that is currently being activated, then the SGSN shall stop the PDP Context Activation procedure without responding to the MS, and continue with the PDP Context Deactivation initiated by MS procedure.

9.2.4.2 PDP Context Deactivation Initiated by SGSN Procedure

The PDP Context Deactivation Initiated by SGSN procedure is illustrated in Figure 42. Each step is explained in the following list.

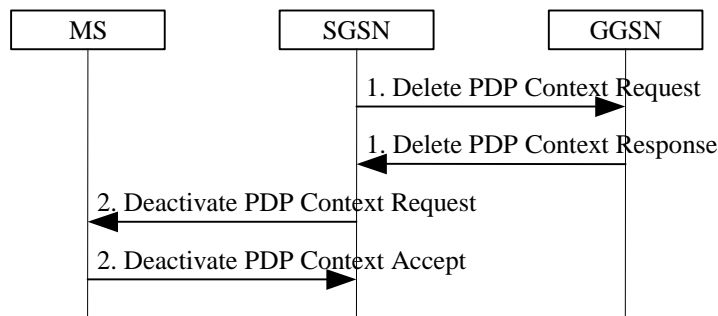

Figure 42: PDP Context Deactivation Initiated by SGSN Procedure

- 1) The SGSN sends a Delete PDP Context Request (TID) message to the GGSN. The GGSN removes the PDP context and returns a Delete PDP Context Response (TID) message to the SGSN. If the MS was using a dynamic PDP address, then the GGSN releases this PDP address and makes it available for subsequent activation by other MSs. The Delete PDP Context messages are sent over the GPRS backbone network. The SGSN may not wait for the response from the GGSN before sending the Deactivate PDP Context Request message.
- 2) The SGSN sends a Deactivate PDP Context Request (TI) message to the MS. The MS removes the PDP context and returns a Deactivate PDP Context Accept (TI) message to the SGSN.

9.2.4.3 PDP Context Deactivation Initiated by GGSN Procedure

The PDP Context Deactivation Initiated by GGSN procedure is illustrated in Figure 43. Each step is explained in the following list.

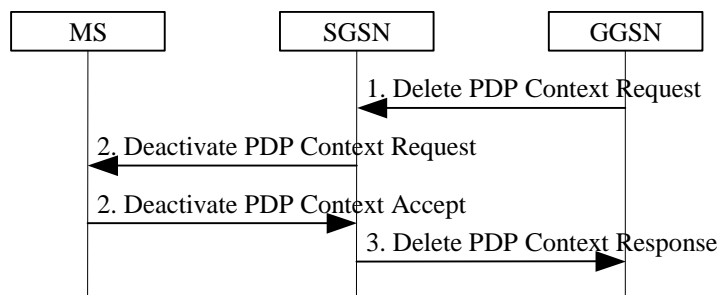

Figure 43: PDP Context Deactivation Initiated by GGSN Procedure

- 1) The GGSN sends a Delete PDP Context Request (TID) message to the SGSN.
- 2) The SGSN sends a Deactivate PDP Context Request (TI) message to the MS. The MS removes the PDP context and returns a Deactivate PDP Context Accept (TI) message to the SGSN.
- 3) The SGSN returns a Delete PDP Context Response (TID) message to the GGSN. If the MS was using a dynamic PDP address, then the GGSN releases this PDP address and makes it available for subsequent activation by other MSs. The Delete PDP Context messages are sent over the GPRS backbone network. The SGSN may not wait for the response from the MS before sending the Delete PDP Context Response message.

9.2.4.4 Anonymous Access PDP Context Deactivation Initiated by MS Procedure

The MS shall not issue explicit deactivation request messages to delete anonymous contexts in the network. Instead, the READY timer shall be used as an implicit deactivation timer to save signalling traffic on the radio interface.

The Anonymous Access PDP Context Deactivation Initiated by MS procedure is illustrated in Figure 44. Each step is explained in the following list.

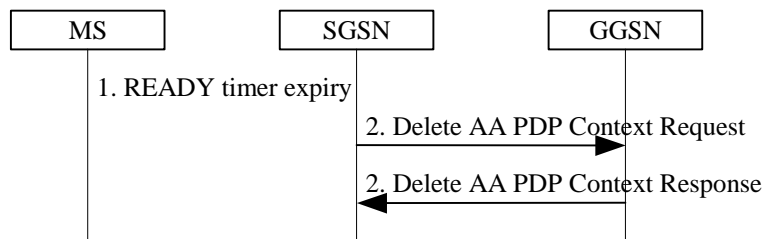

Figure 44: Anonymous Access PDP Context Deactivation Initiated by MS Procedure

- 1) The READY timer expires in the MS and SGSN.
- 2) The SGSN sends a Delete AA PDP Context Request (AA-TID) message. The GGSN removes the PDP context and returns a Delete AA PDP Context Response (AA-TID) message to the SGSN. The GGSN releases this PDP address and makes it available for subsequent anonymous activation by other MSs.

9.2.4.5 Anonymous Access PDP Context Deactivation Initiated by GGSN Procedure

If the GGSN detects a misuse or fraud of the anonymous context as described in subclause "Anonymous Access PDP Context Activation Procedure", step 2, it shall initiate the deactivation independently of the READY timer expiry.

If the anonymous server detects a misuse or fraud, it may request the GGSN to deactivate the AA context. The method that the anonymous server uses to inform the GGSN is outside the scope of the GSM specifications.

The Anonymous Access PDP Context Deactivation Initiated by GGSN procedure is illustrated in Figure 45. Each step is explained in the following list.

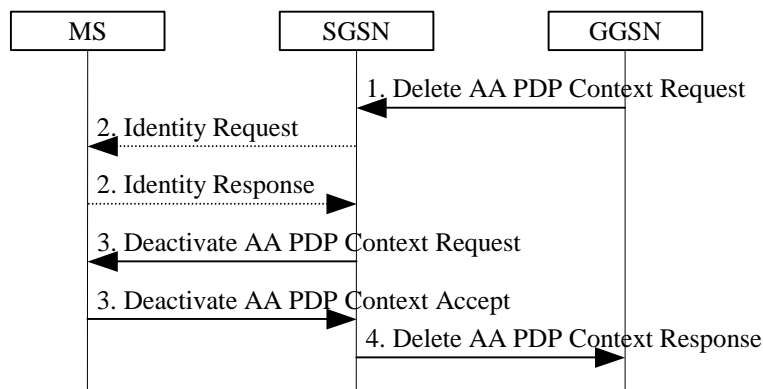

Figure 45: Anonymous Access PDP Context Deactivation Initiated by GGSN Procedure

- 1) The GGSN sends a Delete AA PDP Context Request (AA-TID) message to the SGSN.
- 2) The SGSN may send an Identity Request (Identity Type = IMSI or IMEI) message to the MS. The MS shall respond with an Identity Response (IMSI or IMEI) message.
- 3) The SGSN sends a Deactivate AA PDP Context Request (TI) message to the MS. The MS removes the PDP context and returns a Deactivate AA PDP Context Accept (TI) message to the SGSN.
- 4) The SGSN returns a Delete AA PDP Context Response (AA-TID) message to the GGSN. The GGSN releases this PDP address and makes it available for subsequent activation by other MSs. The Delete AA PDP Context messages are sent over the GPRS backbone network. The SGSN may not wait for the accept from the MS before sending the Delete AA PDP Context Response message.

9.3 Packet Routing and Transfer Function

The packet routing and transfer function:

- routes and transfers packets between a mobile TE and an external network, i.e., between reference point R and reference point Gi;
- routes and transfers packets between mobile TE and other GPRS PLMN, i.e., between reference point R and reference point Gi via interface Gp; and
- routes and transfers packets between TEs, i.e., between the R reference point in different MSs.

The PDP PDUs shall be routed and transferred between the MS and the GGSN as N-PDUs. In case of PDP type PPP, the maximum size of each N-PDU shall be 1 502 octets. In other cases, the maximum size of each N-PDU shall be 1 500 octets. When the MS or the GGSN receives a PDP PDU that results in an N-PDU that is not larger than the maximum N-PDU size, then the PDP PDU shall be routed and transferred as one N-PDU. When the MS or the GGSN receives a PDP PDU that results in an N-PDU that is larger than the maximum N-PDU size, then the PDP PDU shall be segmented, discarded or rejected, depending on the PDP type and the implementation. The packet data protocol in the MS may limit the maximum size of the PDP PDUs that are routed and transferred, e.g., due to MS memory limitations.

Between the SGSN and the MS, PDP PDUs are transferred with the SNDCP.

Between the SGSN and the GGSN, PDP PDUs are routed and transferred with either the TCP/IP or the UDP/IP protocols. The GPRS Tunnelling Protocol transfers data through tunnels. A tunnel is identified by a tunnel identifier (TID) and a GSN address.

To support roaming GPRS subscribers, and for forward compatibility, the SGSN is not required to know the tunnelled PDP. Every SGSN shall have the capability to transfer PDUs belonging to PDPs not supported in the PLMN of the SGSN.

9.4 Relay Function

The relay function of a network node transfers the PDP PDUs received from the incoming link to the appropriate outgoing link. At SGSN and GGSN the relay function stores all valid PDP PDUs until they are forwarded to the next network node or until the maximum holding time of the PDP PDUs is reached. The PDP PDUs are discarded when buffering is longer than their maximum holding time. This maximum holding time is implementation dependent and can be influenced by the PDP type, the QoS of the PDP PDU, the resource load status, and by buffer conditions. The discarding protects resources from useless transfer attempts, especially the radio resource. Impacts on user protocol operation by too short holding time shall be avoided.

The SGSN and GGSN relay functions add sequence numbers to PDP PDUs received from SNDCP and from the Gi reference point, respectively. The SGSN relay function may perform re-sequencing of PDP PDUs before passing the PDP PDUs to SNDCP. The GGSN relay function may perform re-sequencing of PDP PDUs before passing the PDP PDUs to the Gi reference point.

9.5 Packet Terminal Adaptation Function

The Packet Terminal Adaptation function adapts packets received from and transmitted to the Terminal Equipment to a form suitable for transmission within GSM.

A range of MT versions providing different standard interfaces towards the TE can be used, e.g.:

- MT with asynchronous serial interface and PAD (Packet Assembly / Disassembly) support (e.g., AT command set PAD, X.28 [35] / X.29 [36] / X.3 [33] PAD). In the case when the PAD function does not exist in the MT, it exists in the TE;
- "Embedded MT" integrated with the TE, possibly via an industry-standard application program interface;
- MT with synchronous serial interface.

9.6 Encapsulation Function

GPRS transparently transports PDP PDUs between external networks and MSs. All PDP PDUs are encapsulated and decapsulated for GPRS routing purposes. Encapsulation functionality exists at the MS, at the SGSN, and at the GGSN. Encapsulation allows PDP PDUs to be delivered to and associated with the correct PDP context in the MS, the SGSN, or the GGSN. Two different encapsulation schemes are used; one for the GPRS backbone network between two GSNs, and one for the GPRS connection between SGSN and MS.

Encapsulation requires that the MS is attached to GPRS, and that the PDP Context Activation procedure has been executed. If the GPRS Attach or PDP Context Activation procedures cannot be successfully executed, then uplink PDP PDUs are discarded in the MS. If these procedures have not been executed when a downlink PDP PDU arrives in the GGSN, then the downlink PDP PDU shall be discarded, rejected, or the Network-Requested PDP Context Activation procedure shall be initiated.

9.6.1 Encapsulation Between SGSN and GGSN

The GPRS backbone network encapsulates a PDP PDU with a GPRS Tunneling Protocol header, and inserts this GTP PDU in a TCP PDU or UDP PDU that again is inserted in an IP PDU. The IP and GTP PDU headers contain the GSN addresses and tunnel endpoint identifier necessary to uniquely address a GSN PDP context.

9.6.2 Encapsulation Between SGSN and MS

Between SGSN and MS, an SGSN or MS PDP context is uniquely addressed with a temporary logical link identity and a network layer service access point identifier pair. TLLI is derived from the P-TMSI. An NSAPI is assigned when the MS initiates the PDP Context Activation function. The relationship between TLLI / NSAPI and LLC / SNDCP is illustrated in Figure 46. TLLI and NSAPI are described in subclause "NSAPI and TLLI".

10 Message Screening Functionality

This screening mechanism may be performed by routers and firewalls, and performs the selection of which packets to allow and which to deny.

Only network-controlled message screening shall be supported. Network-controlled screening is used to protect the GPRS network from known security problems, and the screening provided by a certain PLMN is applied independently of the MS user. Network-controlled screening is outside the scope of GPRS standardisation.

11 Compatibility Issues

Non-GPRS MSs in GSM PLMNs that support GPRS shall, without changes, be able to continue operation.

GSM PLMNs that do not support GPRS shall, without changes, be able to continue interworking with GSM PLMNs that do support GPRS.

A GPRS ME shall be able to access GPRS services with GPRS-aware SIMs, and with SIMs that are not GPRS-aware. A GPRS-aware SIM is able to store information in the elementary files EF_{KcGPRS} and EF_{LOCIGPRS}, as defined in GSM 11.11 [27].

GPRS Release 98 shall be backwards compatible with Release 97. Messages, information elements, and code points that are not recognised by Release 97 equipment shall be rejected with appropriate error causes.

12 Transmission

12.1 Transmission Modes

The GTP, LLC, and RLC protocols offer various transmission modes. The combinations of the GTP, LLC, and RLC transmission modes define the QoS reliability classes (see subclause "Reliability Class").

12.1.1 GTP Transmission Modes

Two modes of operation of the GTP layer are supported for information transfer between the GGSN and SGSN; unacknowledged (UDP/IP) and acknowledged (TCP/IP). The GTP layer shall support both modes simultaneously.

12.1.2 LLC Transmission Modes

Two modes of operation of the LLC layer are defined for information transfer; unacknowledged and acknowledged. The LLC layer shall support both modes simultaneously.

- In acknowledged mode, the receipt of LL-PDUs are confirmed. The LLC layer retransmits LL-PDUs if confirmation has not been received within a timeout period.
- In unacknowledged mode, there is no confirmation required for LL-PDUs.

Signalling and SMS shall be transferred in unacknowledged mode.

In unacknowledged mode, the LLC layer shall offer the following two options:

- transport of "protected" information, such that errors within the LLC information field result in the frame being discarded; and
- transport of "unprotected" information, such that errors within the LLC information field do not result in the frame being discarded.

The LLC layer shall support several different QoS delay classes with different transfer delay characteristics.

12.1.3 RLC Transmission Modes

Two modes of operation of the RLC layer are defined for information transfer; unacknowledged and acknowledged. The RLC layer shall support both modes simultaneously.

12.2 Logical Link Control Functionality

The Logical Link Control (LLC) protocol provides a reliable logical link between the MS and its SGSN. As shown in subclause "Transmission and Signalling Planes", the LLC layer is situated below the SNDC layer.

12.2.1 Addressing

TLLI is used for addressing at the LLC layer. TLLI is described in subclause "NSAPI and TLLI".

12.2.2 Services

LLC provides the services necessary to maintain a ciphered data link between an MS and an SGSN. The LLC layer does not support direct communication between two MSs.

The LLC connection is maintained as the MS moves between cells served by the same SGSN. When the MS moves to a cell being served by a different SGSN, the existing connection is released and a new logical connection is established with the new SGSN.

LLC shall be independent of the underlying radio interface protocols. In order to allow LLC to operate with a variety of different radio interface protocols, and to ensure optimum performance, it may be necessary to adjust e.g., the maximum LLC PDU length and the LLC protocol timer values. Such adjustments can be made through negotiation between the MS and the SGSN. The maximum length of an LLC PDU shall not be greater than 1 600 octets minus the BSSGP protocol control information.

12.2.3 Functions

The Logical Link Control layer supports:

- service primitives allowing the transfer of SNDCP Protocol Data Units (SN-PDUs) between the Subnetwork Dependent Convergence layer and the Logical Link Control layer;
- procedures for transferring LL-PDUs between the MS and SGSN, including:
 - procedures for unacknowledged delivery of LL-PDUs between the MS and the SGSN; and
 - procedures for acknowledged, reliable delivery of LL-PDUs between the MS and SGSN;
- procedures for detecting and recovering from lost or corrupted LL-PDUs;
- procedures for flow control of LL-PDUs between the MS and the SGSN; and
- procedures for ciphering of LL-PDUs. The procedures are applicable to both unacknowledged and acknowledged LL-PDU delivery.

The layer functions are organised in such a way that ciphering resides immediately above the RLC/MAC layer in the MS, and immediately above the BSSGP layer in the SGSN.

12.3 Subnetwork Dependent Convergence Functionality

The Subnetwork Dependent Convergence (SNDC) protocol is situated below the network layer and above the Logical Link Control layer in the MS and the SGSN, as shown in subclause "Transmission and Signalling Planes". A variety of network layers are supported, e.g., IP and X.25. The network-layer packet data protocols share the same SNDCP, that then performs multiplexing of data coming from the different sources to be sent across LLC. This is illustrated in Figure 46.

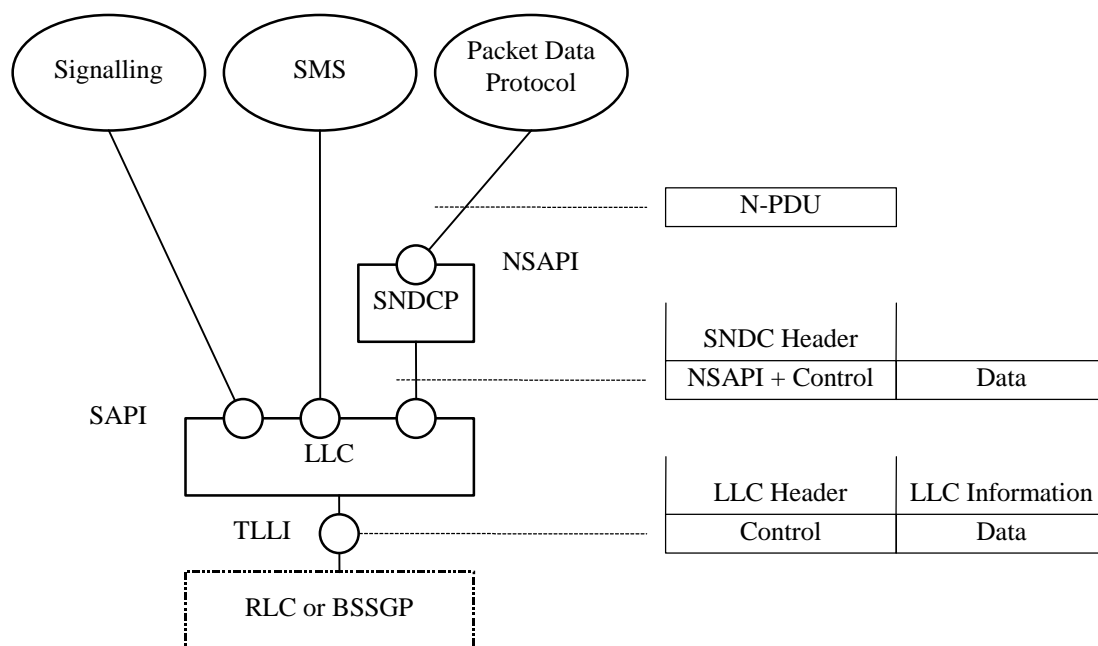

Figure 46: Multiplexing of Network Protocols

The following identities and control information is needed:

- NSAPI identifies the network layer. The SNDCP control part contains compression information.
- TLLI identifies the MS. The LLC control part contains the rest of the LLC protocol header including ciphering information.

The Subnetwork Dependent Convergence function is defined in terms of offered services and sub-functions.

12.3.1 Services

The SNDC function provides the following services to the network layer:

- transmission and reception of N-PDUs in acknowledged and unacknowledged LLC mode. In acknowledged mode, the receipt of data shall be confirmed at the LLC layer, and the data shall be transmitted and received in order per NSAPI. In unacknowledged mode, the receipt of data shall not be confirmed at the SNDCP layer nor at the LLC layer;
- transmission and reception between the MS and SGSN of variable-length N-PDUs;
- transmission and reception of N-PDUs between the SGSN and MS according to the negotiated QoS profile;
- transfer of the minimum amount of data possible between the SGSN and MS through compression techniques.

The SNDC function requires the following services from the LLC layer:

- acknowledged and unacknowledged data transfer;
- ciphered transmission of SN-PDUs;
- in-order delivery of SN-PDUs per LLC SAPI;
- support for variable-length SN-PDUs.

12.3.2 Subfunctions

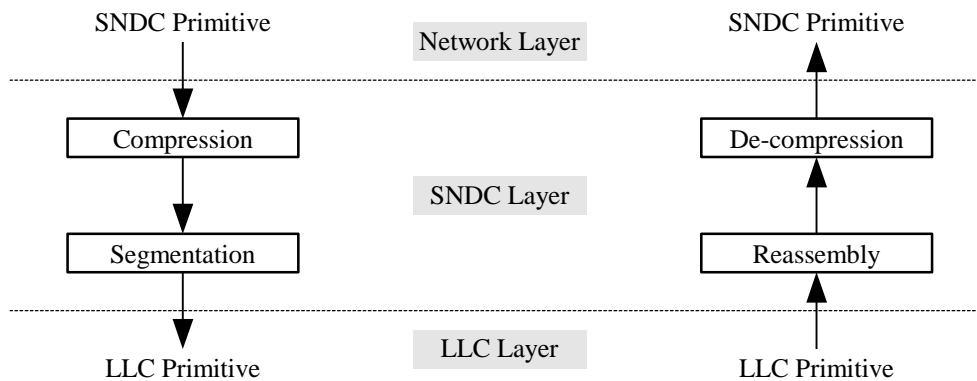

Figure 47: Sequential Invocation of SNDC Functionality

SNDCP performs the following subfunctions:

- mapping of SNDC primitives received from the network layer into corresponding LLC primitives to be passed to the LLC layer, and vice versa;
- multiplexing of N-PDUs from one or several NSAPIs onto one LLC SAPI. NSAPIs that are multiplexed onto the same SAPI shall use the same radio priority level, QoS delay class, and precedence class;
- compression of redundant protocol control information and user data. This may include e.g., TCP/IP header compression and V.42 bis [32] data compression. Compression may be performed independently for each QoS delay class and precedence class. If several network layers use the same QoS delay class and precedence class, then one common compressor may be used for these network layers. The relationship between NSAPIs, compressors, and SAPIs is defined in GSM 04.65. Compression parameters are negotiated between the MS and the SGSN. Compression is an optional SNDC function;
- segmentation and reassembly. The output of the compression subfunctions are segmented to maximum-length LLC frames.

12.4 Point-to-Point Protocol Functionality

The PPP protocol is specified in RFC 1661 [44].

12.4.1 Transmission Plane for PDP Type PPP

The transmission plane for the PDP type PPP consists of a PPP protocol stack above SNDCP in the MS and above GTP in the GGSN. The GGSN may either terminate the PPP protocol and access the packet data network at the IP level, or further tunnel PPP PDUs via e.g., L2TP.

In case the application above PPP uses a different protocol than IP (e.g., IPX or AppleTalk), the interconnection to the packet data network is outside the scope of this specification.

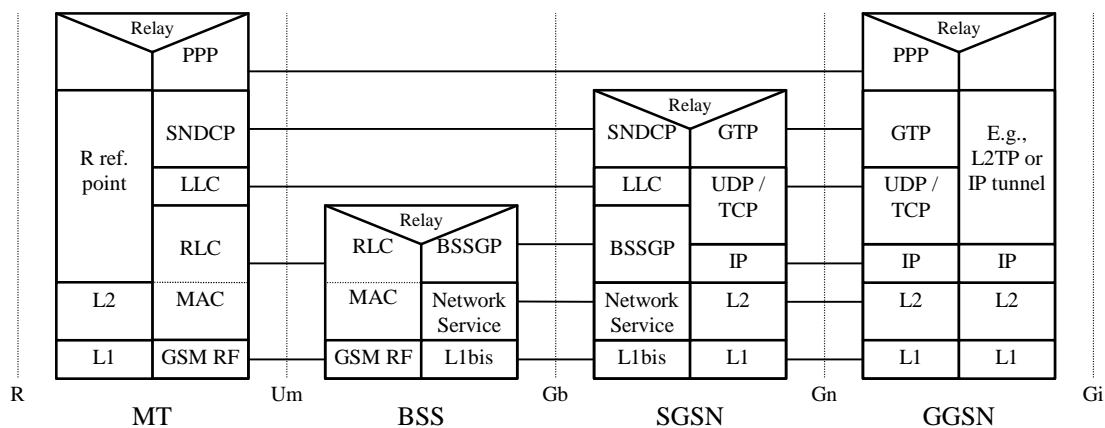

Figure 48: Transmission Plane for PDP Type PPP

12.4.2 Functions

The PPP peers at the MS and GGSN handle the PPP protocol as specified in RFC 1661. PPP requires in-sequence packet delivery by the underlying protocols. Concerning GTP, this shall be achieved by enabling Reordering Required upon GTP tunnel establishment. Concerning SNDCP, out-of-sequence packets, which may be present if LLC operates in unacknowledged mode, shall be discarded. SNDCP shall not use TCP/IP header compression because PPP may not carry IP packets at all, or because PPP may carry IP packets with already compressed TCP/IP headers. These PPP options are negotiated during the RFC 1661 Network Control Protocol establishment phase.

12.5 Gb Interface

The Gb interface connects the BSS and the SGSN, allowing the exchange of signalling information and user data. The Gb interface shall allow many users to be multiplexed over the same physical resource. Resources are given to a user upon activity (when data is sent or received) and are reallocated immediately thereafter. This is in contrast to the A interface where a single user has the sole use of a dedicated physical resource throughout the lifetime of a call irrespective of activity.

GPRS signalling and user data are sent in the same transmission plane. No dedicated physical resources are required to be allocated for signalling purposes.

Access rates per user may vary without restriction from zero data to the maximum possible line rate (e.g., 1 984 kbit/s for the available bitrate of an E1 trunk).

12.5.1 Physical Layer Protocol

Several physical layer configurations and protocols are possible, as defined in GSM 08.14 [18].

The physical resources shall be allocated by O&M procedures.

12.5.2 Link Layer Protocols

The Gb interface link layer is based on Frame Relay, as defined in GSM 08.16. Frame Relay virtual circuits are established between SGSN and BSS. LLC PDUs from many users are multiplexed on these virtual circuits. The virtual circuits may be multi-hop and traverse a network of Frame Relay switching nodes. Frame Relay shall be used for signalling and data transmission.

The following characteristics apply for the Frame Relay connection:

- the maximum Frame Relay information field size shall be 1 600 octets;
- the Frame Relay address length shall be 2 octets;
- the BSS and the SGSN shall both implement Frame Relay DTE functionality. The SGSN may optionally also implement DCE functionality;
- frame Relay PVCs shall be used;
- the Frame Relay layer offers detection of but no recovery from transmission errors;
- one or more Frame Relay PVCs shall be used between one SGSN and one BSS to transport BSSGP PDUs.

12.5.3 BSS GPRS Protocol

The primary function of BSSGP is to provide the radio-related, QoS, and routing information that is required to transmit user data between a BSS and an SGSN. In the BSS, it acts as an interface between LLC frames and RLC/MAC blocks. In the SGSN, it forms an interface between RLC/MAC-derived information and LLC frames. A secondary function is to enable two physically distinct nodes, the SGSN and BSS, to operate node management control functions.

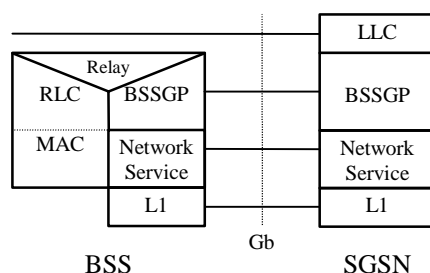

Figure 49: BSSGP Protocol Position

There is a one-to-one relationship between the BSSGP protocol in the SGSN and in the BSS. If one SGSN handles multiple BSSs, the SGSN has to have one BSSGP protocol machine for each BSS.

The main functions for the BSSGP protocol are to:

- provide a connection-less link between the SGSN and the BSS;
- transfer data unconfirmed between the SGSN and the BSS;
- provide tools for bi-directional control of the flow of data between the SGSN and the BSS;
- handle paging requests from the SGSN to the BSS;
- give support for flushing of old messages in the BSS e.g., when an MS changes BSS; and
- support multiple layer 2 links between the SGSN and one BSS.

BSSGP is defined in GSM 08.18.

12.5.3.1 Inter-dependency of the BSSGP and LLC Functions

The functions of the BSSGP shall be defined in the context of the LLC function in order to avoid duplication of functions and information flows. The following functional model indicates each layer's functional responsibilities.

Table 3: Mapping of High-level Functions Across the Gb Architecture

Network Node and Function	MS	BSS	SGSN
LLC: GSM 04.64	Same as for the SGSN.		Provides transfer of frames between the SGSN and MS.
BSSGP: GSM 08.18		<p>MS←PLMN: Using BSSGP information, RLC/MAC operations are invoked.</p> <p>MS→PLMN: Using RLC/MAC-derived information, a BSSGP PDU is constructed. An identifier of the cell including RAC and LAC in which an LLC frame was received is inserted into the BSSGP PDU.</p> <p>Same as for SGSN.</p>	<p>Individual MS radio-related information is used by the BSS to transfer LLC frames across the Gb and Um.</p> <p>Provides flow control and unconfirmed data delivery services across the Gb interface (not the Um – this is the function of the LLC and RLC/MAC function).</p> <p>Provides SGSN-BSS node management functions.</p>
Network Service: GSM 08.16		Same as for SGSN	Provides a multiplexing, variable-bandwidth, frame-based, link layer transport mechanism across the Gb interface, and load balancing.

12.5.3.2 BSSGP Addressing

For information transfer between the SGSN and the BSS the BSSGP is using a BSSGP Virtual Connection Identifier (BVCI) for addressing. Additionally, QoS profile, and the MS identification, e.g., TLLI, may be used to create queues and contexts in both the SGSN and the BSS. The flow control mechanism is then based on these queues and contexts.

12.5.3.3 BVC I Contexts in BSS and in SGSN

A BVC I context in the BSS consists of at least one queue for LLC PDUs and of the available radio resource capacity.

The BVC I context in the BSS is allocated for each cell supporting GPRS. For each new GPRS cell introduced in the BSS area, a new BVC I context shall be allocated.

In the SGSN the BVC I context consists of at least one queue for LLC PDUs and the allowed throughput on BSSGP. The allowed throughput is updated by BSSGP flow control messages.

12.5.3.4 Flow Control Between SGSN and BSS over the Gb Interface

The flow control mechanism controls the loading of the BSS LLC PDU queues per BVC I and per MS between the SGSN and the BSS in the downlink direction. No flow control is performed in the uplink direction. Buffers and link capacity shall be dimensioned to avoid loss of uplink data.

The downlink flow control mechanism is based on the following principles:

- in the SGSN, queues for LLC PDUs are provided per BVC I. These queues may be split further, e.g., per MS or per QoS delay class or precedence class. The SGSN shall pass LLC PDUs to LLC via BSSGP to the BSS as long as the allowed BSSGP throughput is not exceeded. The allowed BSSGP throughput is given per BVC I and for a single MS on that BVC I. The SGSN schedules the BSSGP downlink traffic of all MSs of a BVC I according to both throughput parameters and to the QoS profile related to each LLC PDU. The scheduling algorithm is implementation dependent;
- in the BSS, queues per BVC I are provided at the BSSGP level. These queues may be split further, e.g., per MS or per QoS delay class or precedence class. Depending on the queuing conditions and the available radio resource capacity in the cell the BSS indicates the allowed BSSGP throughput per BVC I and the default allowed BSSGP throughput for each individual MS of that BVC I by BSSGP flow control messages to the SGSN. Additionally, the BSS may change the allowed BSSGP throughput for an individual MS by a BSSGP flow control message.

12.6 Abis Interface

When the GPRS MAC and RLC layer functions are positioned remote to the BTS the information between the Channel Codec Unit (CCU) and the remote GPRS Packet Control Unit (PCU) is transferred in frames with a fixed length of 320 bits (20 ms). In the present document these frames are denoted "PCU Frames" and are an extension to the "TRAU frames" defined in GSM 08.60 [21]. Within these frames both GPRS data and the GPRS RLC/MAC associated control signals are transferred.

The Abis interface should be the same if the PCU is positioned at the BSC site (option B in Figure 50) or at the SGSN site (option C in Figure 50). In option B, the PCU could be implemented as an adjunct unit to the BSC. In option C, the BSC should be considered as transparent for 16+ kbit/s channels. In configurations B and C the PCU is referred to as being a remote PCU.

The remote PCU is considered a part of the BSC, and the signalling between the BSC and the PCU may be performed by using BSC internal signals. The inband signalling between the CCU and the PCU functions, using PCU frames is required when the Abis interface is applied (options B and C in Figure 50).

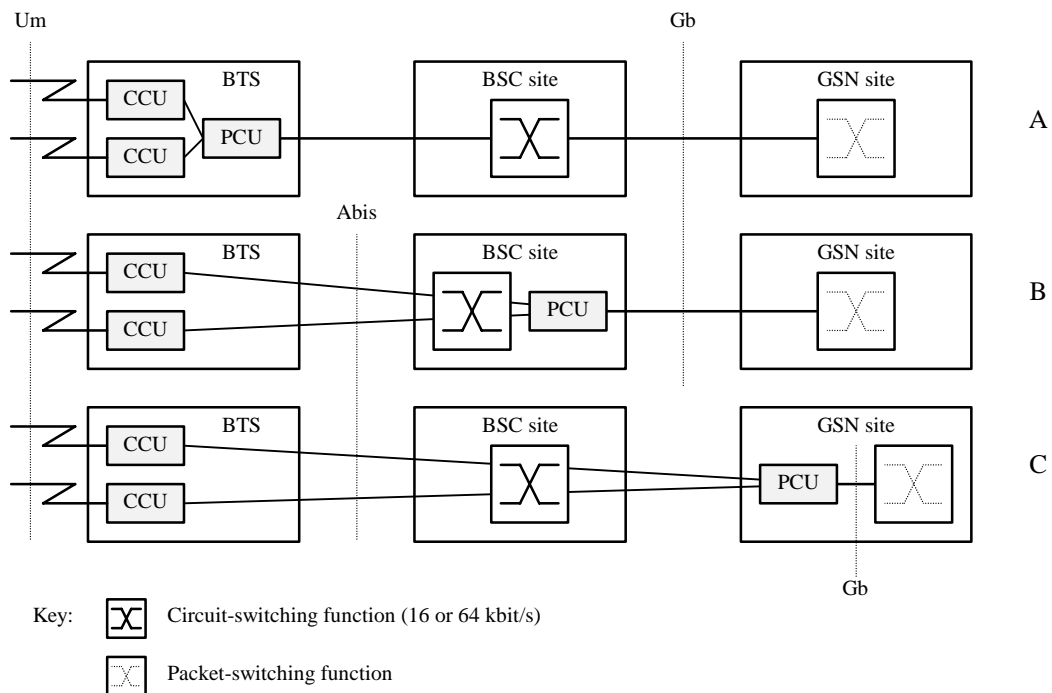

Figure 50: Remote Packet Control Unit (PCU) Positions

The PCU is responsible for the following GPRS MAC and RLC layer functions as defined in GSM 03.64:

- LLC layer PDU segmentation into RLC blocks for downlink transmission;
- LLC layer PDU reassembly from RLC blocks for uplink transmissions;
- PDCH scheduling functions for the uplink and downlink data transfers;
- PDCH uplink ARQ functions, including RLC block ack / nak;
- PDCH downlink ARQ function, including buffering and retransmission of RLC blocks;
- channel access control functions, e.g., access requests and grants; and
- radio channel management functions, e.g., power control, congestion control, broadcast control information, etc.

The functions inside the Channel Codec Unit (CCU) are:

- the channel coding functions, including FEC and interleaving; and
- radio channel measurement functions, including received quality level, received signal level and information related to timing advance measurements.

The BSS is responsible for allocation and de-allocation of radio resources. A PCU frame shall be transferred between the PCU and the CCU every 20 ms.

12.6.1 Remote Packet Control Unit

When the Packet Control Unit (PCU) is remote to the BTS, the Channel Codec Unit (CCU) in the BTS may control some of the functions in the remote PCU in the BSC. As well, the PCU may control some of the functions of the CCU. This remote control is performed by inband signalling carried by the control bits (C-bits) in each PCU frame.

13 Information Storage

This clause describes information storage structures required for GPRS, and the recovery and restoration procedures needed to maintain service if inconsistencies in databases occur and at lost or invalid database information.

13.1 HLR

IMSI is the prime key to the GPRS subscription data stored in the HLR. There may be several sets of GPRS subscription data per IMSI. This is illustrated in Figure 51.

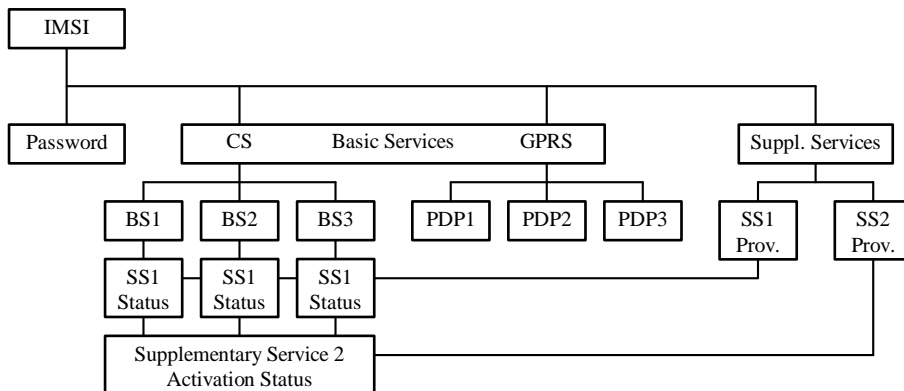

Figure 51: GPRS Subscription Data

As Figure 51 indicates, the GPRS subscription data is at the same level as basic services. Each PDP subscription is seen as a basic service. Supplementary services are provisioned as part of the overall subscription. Activation of SSs is either at the basic service level (SS1) or at the overall subscription level (SS2).

Table 4 shows the GPRS subscription data contained in the HLR.

Table 4: HLR GPRS Subscription Data

Field	Description
IMSI	IMSI is the main reference key.
MSISDN	The basic MSISDN of the MS.
SGSN Number	The SS7 number of the SGSN currently serving this MS.
SGSN Address	The IP address of the SGSN currently serving this MS.
SMS Parameters	SMS-related parameters, e.g., operator-determined barring.
MS Purged for GPRS	Indicates that the MM and PDP contexts of the MS are deleted from the SGSN.
MNRG	Indicates that the MS is not reachable through an SGSN, and that the MS is marked as not reachable for GPRS at the SGSN and possibly at the GGSN.
GGSN-list	The GSN number and optional IP address pair related to the GGSN that shall be contacted when activity from the MS is detected and MNRG is set. The GSN number shall be either the number of the GGSN or the protocol-converting GSN as described in the subclauses "MAP-based GGSN - HLR Signalling" and "GTP and MAP-based GGSN - HLR Signalling".
Each IMSI contains zero or more of the following PDP context subscription records:	
PDP Context Identifier	Index of the PDP context.
PDP Type	PDP type, e.g., X.25, PPP, or IP.
PDP Address	PDP address, e.g., an X.121 address. This field shall be empty if dynamic addressing is allowed.
Access Point Name	A label according to DNS naming conventions describing the access point to the external packet data network.
QoS Profile Subscribed	The quality of service profile subscribed. QoS Profile Subscribed is the default level if a particular QoS profile is not requested.
VPLMN Address Allowed	Specifies whether the MS is allowed to use the APN in the domain of the HPLMN only, or additionally the APN in the domain of the VPLMN.

13.2 SGSN

SGSN maintains MM context and PDP context information for MSs in STANDBY and READY states. Table 5 shows the context fields for one MS.

Table 5: SGSN MM and PDP Contexts

Field	Description
IMSI	IMSI is the main reference key.
MM State	Mobility management state, IDLE, STANDBY, or READY.
P-TMSI	Packet Temporary Mobile Subscriber Identity.
P-TMSI Signature	A signature used for identification checking purposes.
IMEI	International Mobile Equipment Identity
MSISDN	The basic MSISDN of the MS.
Routeing Area	Current routeing area.
Cell Identity	Current cell in READY state, last known cell in STANDBY or IDLE state.
Cell Identity Age	Time elapsed since the last LLC PDU was received from the MS at the SGSN.
VLR Number	The VLR number of the MSC/VLR currently serving this MS.
New SGSN Address	The IP address of the new SGSN where buffered and not sent N-PDUs should be forwarded to.
Authentication Triplets	Authentication and ciphering parameters.
Kc	Currently used ciphering key.
CKSN	Ciphering key sequence number of Kc.
Ciphering algorithm	Selected ciphering algorithm.
Radio Access Classmark	MS radio access capabilities.
SGSN Classmark	MS network capabilities.
DRX Parameters	Discontinuous reception parameters.
MNRG	Indicates whether activity from the MS shall be reported to the HLR.
NGAF	Indicates whether activity from the MS shall be reported to the MSC/VLR.
PPF	Indicates whether paging for GPRS and non-GPRS services can be initiated.
SMS Parameters	SMS-related parameters, e.g., operator-determined barring.
Recovery	Indicates if HLR or VLR is performing database recovery.
Radio Priority SMS	The RLC/MAC radio priority level for uplink SMS transmission.
Each MM context contains zero or more of the following PDP contexts:	
PDP Context Identifier	Index of the PDP context.
PDP State	Packet data protocol state, INACTIVE or ACTIVE.
PDP Type	PDP type, e.g., X.25, PPP, or IP.
PDP Address	PDP address, e.g., an X.121 address.
APN Subscribed	The APN received from the HLR.
APN in Use	The APN currently used.
NSAPI	Network layer Service Access Point Identifier.
TI	Transaction Identifier.
GGSN Address in Use	The IP address of the GGSN currently used.
VPLMN Address Allowed	Specifies whether the MS is allowed to use the APN in the domain of the HPLMN only, or additionally the APN in the domain of the VPLMN.
QoS Profile Subscribed	The quality of service profile subscribed.
QoS Profile Requested	The quality of service profile requested.
QoS Profile Negotiated	The quality of service profile negotiated.
Radio Priority	The RLC/MAC radio priority level for uplink user data transmission.
Send N-PDU Number	SNDCP sequence number of the next downlink N-PDU to be sent to the MS.
Receive N-PDU Number	SNDCP sequence number of the next uplink N-PDU expected from the MS.
SND	GTP sequence number of the next downlink N-PDU to be sent to the MS.
SNU	GTP sequence number of the next uplink N-PDU to be sent to the GGSN.
Charging Id	Charging identifier, identifies charging records generated by SGSN and GGSN.
Reordering Required	Specifies whether the SGSN shall reorder N-PDUs before delivering the N-PDUs to the MS.

In case of anonymous access the SGSN maintains the MM context and PDP context information for MSs in READY state. Table 6 shows the context fields for one MS.

Table 6: SGSN MM and PDP Contexts for Anonymous Access

Field	Description
A-TLLI	Auxiliary Temporary Logical Link Identity.
AA-TID	Anonymous Access Tunnel Identifier.
Routeing Area	Current routeing area.
Cell Identity	Current cell.
PDP Type	PDP type, e.g., X.25, PPP, or IP.
PDP Address	PDP address, e.g., an X.121 address.
APN in Use	The APN currently used.
NSAPI	Network layer Service Access Point Identifier.
TI	Transaction Identifier.
GGSN Address in Use	The IP address of the GGSN currently used.
QoS Profile Requested	The quality of service profile requested.
QoS Profile Negotiated	The quality of service profile negotiated.
Radio Priority	The RLC/MAC radio priority level for uplink user data transmission.
Send N-PDU Number	SNDCP sequence number of the next downlink N-PDU to be sent to the MS.
Receive N-PDU Number	SNDCP sequence number of the next uplink N-PDU expected from the MS.
SND	GTP sequence number of the next downlink N-PDU to be sent to the MS.
SNU	GTP sequence number of the next uplink N-PDU to be sent to the GGSN.
Charging Id	Charging identifier, identifies charging records generated by SGSN and GGSN.
Reordering Required	Specifies whether the SGSN shall reorder N-PDUs before delivering the N-PDUs to the MS.

13.3 GGSN

GGSN maintains activated PDP contexts. Table 7 shows the PDP context fields for one PDP Address.

Table 7: GGSN PDP Context

Field	Description
IMSI	International Mobile Subscriber Identity.
NSAPI	Network layer Service Access Point Identifier.
MSISDN	The basic MSISDN of the MS.
PDP Type	PDP type, e.g., X.25, PPP, or IP.
PDP Address	PDP address, e.g., an X.121 address.
Dynamic Address	Indicates whether PDP Address is static or dynamic.
APN in Use	The APN Network Identifier currently used.
QoS Profile Negotiated	The quality of service profile negotiated.
SGSN Address	The IP address of the SGSN currently serving this MS.
MNRG	Indicates whether the MS is marked as not reachable for GPRS at the HLR.
Recovery	Indicates if the SGSN is performing database recovery.
SND	GTP sequence number of the next downlink N-PDU to be sent to the SGSN.
SNU	GTP sequence number of the next uplink N-PDU to be received from the SGSN.
Charging Id	Charging identifier, identifies charging records generated by SGSN and GGSN.
Reordering Required	Specifies whether the GGSN shall reorder N-PDUs received from the SGSN.

If a PDP context is enabled for network-requested PDP context activation, then IMSI, PDP Type, PDP Address, SGSN Address and MNRG contain valid information also when the PDP context is inactive and when the MS is GPRS-detached.

In case of anonymous access the GGSN maintains activated PDP contexts. Table 8 shows the PDP context fields for one MS.

Table 8: GGSN PDP Context for Anonymous Access

Field	Description
AA-TID	Anonymous Access Tunnel Identifier.
PDP Type	PDP type, e.g., X.25, PPP, or IP.
PDP Address	PDP address, e.g., an X.121 address.
APN in Use	The APN Network Identifier currently used.
QoS Profile Negotiated	The quality of service profile negotiated.
SGSN Address	The IP address of the SGSN serving this MS.
SND	GTP sequence number of the next downlink N-PDU to be sent to the SGSN.
SNU	GTP sequence number of the next uplink N-PDU to be received from the SGSN.
Charging Id	Charging identifier, identifies charging records generated by SGSN and GGSN.
Reordering Required	Specifies whether the GGSN shall reorder N-PDUs received from the SGSN.

A GGSN that supports anonymous access shall have a list of server addresses that are allowed to be accessed by anonymous MSs. The method to maintain the list of the servers is outside the scope of the present document.

13.4 MS

Each GPRS MS maintains MM and PDP context information in IDLE, STANDBY and READY states. The information may be contained in the MS and the TE. Table 9 shows the MS context fields.

Table 9: MS MM and PDP Contexts

Field	SIM	Description
IMSI	X	International Mobile Subscriber Identity.
MM State		Mobility management state, IDLE, STANDBY, or READY.
P-TMSI	X	Packet Temporary Mobile Subscriber Identity.
P-TMSI Signature	X	A signature used for identification checking purposes.
Routeing Area	X	Current routeing area.
Cell Identity		Current cell.
Kc	X	Currently used ciphering key.
CKSN	X	Ciphering key sequence number of Kc.
Ciphering algorithm		Selected ciphering algorithm.
Classmark		MS classmark.
DRX Parameters		Discontinuous reception parameters.
Radio Priority SMS		The RLC/MAC radio priority level for uplink SMS transmission.
Each MM context contains zero or more of the following PDP contexts:		
PDP Type		PDP type, e.g., X.25, PPP, or IP.
PDP Address		PDP address, e.g., an X.121 address.
PDP State		Packet data protocol state, INACTIVE or ACTIVE.
Dynamic Address Allowed		Specifies whether the MS is allowed to use a dynamic address.
APN Requested		The APN requested.
NSAPI		Network layer Service Access Point Identifier.
TI		Transaction Identifier.
QoS Profile Requested		The quality of service profile requested.
QoS Profile Negotiated		The quality of service profile negotiated.
Radio Priority		The RLC/MAC radio priority level for uplink user data transmission.
Send N-PDU Number		SNDCP sequence number of the next uplink N-PDU to be sent to the SGSN.
Receive N-PDU Number		SNDCP sequence number of the next downlink N-PDU expected from the SGSN.

The information marked with an "X" in Table 9:

- shall be stored in the SIM if the connected SIM is GPRS-aware; and
- may be stored in the ME after GPRS detach if the connected SIM is not GPRS-aware.

If the SIM is GPRS-aware, then the IMSI, P-TMSI, P-TMSI Signature, Routeing Area, Kc, and CKSN stored in the SIM shall be used when accessing the GPRS services.

If the SIM is not GPRS-aware, then the P-TMSI, P-TMSI Signature, Routeing Area, Kc, and CKSN stored in the ME shall be used if and only if the IMSI stored in the SIM is identical to the IMSI image maintained in the ME. If the IMSI stored in the SIM is different from the IMSI image in the ME, then the IMSI image in the ME shall not be used, and the MS shall identify itself with the IMSI stored in the SIM when performing a GPRS attach. IMSI, P-TMSI, P-TMSI Signature, Routeing Area, Kc, and CKSN may be stored in the ME after the GPRS attach has been successfully performed.

For anonymous access each GPRS MS maintains MM and PDP context information in READY state. The information may be contained in the ME and the TE. Table 10 shows the MS context fields.

Table 10: MS MM and PDP Contexts for Anonymous Access

Field	Description
A-TLLI	Auxiliary Temporary Logical Link Identity.
Routeing Area	Current routeing area.
Cell Identity	Current cell.
PDP Type	PDP type, e.g., X.25, PPP, or IP.
PDP Address	PDP address, e.g., an X.121 address.
NSAPI	Network layer Service Access Point Identifier.
TI	Transaction Identifier.
APN Requested	The APN requested.
QoS Profile Requested	The quality of service profile requested.
QoS Profile Negotiated	The quality of service profile negotiated.
Radio Priority	The RLC/MAC radio priority level for uplink user data transmission.
Send N-PDU Number	SNDCP sequence number of the next uplink N-PDU to be sent to the SGSN.
Receive N-PDU Number	SNDCP sequence number of the next downlink N-PDU expected from the SGSN.

13.5 MSC/VLR

The MSC/VLR may store the SGSN number of GPRS-attached MSs that are also IMSI-attached. Table 11 shows the MSC/VLR association for one MS.

Table 11: MSC/VLR Association

Field	Description
IMSI	IMSI is the main reference key.
SGSN Number	The SGSN number of the SGSN currently serving this MS.

13.6 Recovery and Restoration Procedures

The recovery and restoration procedures are intended to maintain service if inconsistencies in databases occur and at lost or invalid database information. "Invalid" in this context means that the database entry cannot be regarded as reliable.

13.6.1 HLR Failure

When an HLR restarts, it sends to each SGSN where one or more of its MSs are registered a Reset message. This causes the SGSN to mark the relevant MM contexts as invalid, and to set NGAF if an SGSN – MSC/VLR association exists. After receipt of the first valid LLC frame from a marked MS, the SGSN performs an update location to the HLR as in the attach or inter SGSN RA update procedures, and, if NGAF is set, the procedure in subclause "Non-GPRS Alert" is followed. The update location procedure and the procedure towards the MSC/VLR may be delayed by the SGSN for a maximum operator configuration-depending time period to avoid high signalling load. The periodic back-up of HLR data to non-volatile storage is mandatory as described in GSM 03.07 [5].

13.6.2 SGSN Failure

When an SGSN fails, it deletes all MM and PDP contexts affected by the failure. SGSN storage of subscriber data is volatile. Based on configuration data, the SGSN shall send a Reset message to each of its associated VLRs. The VLRs shall mark all associations containing the restarted SGSN as unreliable. See GSM 03.07.

If data or signalling, except GPRS attach and RA update, is received in an SGSN from an MS for which no MM context exists in the SGSN, then the SGSN shall discard the data or signalling.

If an RA update request is received in an SGSN from an MS for which no MM context exists neither in the SGSN, nor in the old SGSN for the inter-SGSN RA update case, then the SGSN shall reject the RA update with an appropriate cause. In order to remain GPRS-attached, the MS shall then perform a new GPRS attach and should (re-)activate PDP contexts.

NOTE: In some cases, user interaction may be required, and then the MS cannot (re-)activate the PDP contexts automatically.

When the SGSN receives a GTP PDU for which no PDP context exists it discards the GTP PDU and sends an error indication to the originating GGSN. The GGSN marks the related PDP context as invalid. If there is no MM context for the MS, the SGSN may search the MS by paging with the IMSI in the SGSN area. An MS that is paged for GPRS services with IMSI as the identifier shall perform a new GPRS attach and should (re-)activate PDP contexts.

When the SGSN receives a mobile-terminated SM from the SMS-GMSC for an IMSI unknown in the SGSN, it rejects the request.

When the SGSN receives a paging request over the Gs interface for an IMSI unknown in the SGSN and the SGSN has not completed recovery, then the SGSN may page the MS for packet services with IMSI as identifier in the area specified by the location information provided by the MSC/VLR. If no such location information is provided, then the SGSN may page the MS in the routing areas corresponding to that MSC/VLR. After the MS performs a combined GPRS attach, the SGSN may continue serving the Gs interface paging request.

13.6.3 GGSN Failure

When a GGSN fails, all its PDP contexts affected by the failure become invalid and may be deleted. GGSN storage of subscriber data is volatile.

When the GGSN receives a GTP PDU for which no PDP context exists, it shall discard the GTP PDU and return an error indication to the originating SGSN. The SGSN shall mark the related PDP context as invalid and send a Deactivate PDP Context Request message to the MS. The MS may then reactivate the PDP context.

13.6.4 VLR Failure

When a VLR fails, all its associations with SGSNs affected by the failure become invalid and may be deleted. Based on configuration data, the MSC/VLR sends a BSSAP+ Reset message to each of its associated SGSNs. The SGSNs mark all associations containing the restarted VLR as invalid. After receipt of the first valid LLC frame from an MS that is both GPRS-attached and IMSI-attached, the SGSN shall return a Detach Request (Detach Type) message in order to request the MS to perform a combined RA / LA update. Detach Type shall be set to IMSI Detach. The detach procedure may be delayed by the SGSN for a maximum operator-configuration depending time period to avoid high signalling load.

14 Identities

14.1 IMSI

A unique International Mobile Subscriber Identity (IMSI) shall be allocated to each mobile subscriber in GSM. This is also the case for GPRS-only mobile subscribers, except for anonymous-only access subscribers. IMSI is defined in GSM 03.03 [4].

14.2 Packet TMSI

A Packet Temporary Mobile Subscriber Identity shall be allocated to each GPRS-attached MS. P-TMSI is defined in GSM 03.03.

14.3 NSAPI and TLLI

The Network layer Service Access Point Identifier (NSAPI) and Temporary Logical Link Identity (TLLI) are used for network layer routing. An NSAPI / TLLI pair is unambiguous within a routing area.

In the MS, NSAPI identifies the PDP-SAP. In the SGSN and GGSN, NSAPI identifies the PDP context associated with a PDP address. Between the MS and SGSN, TLLI unambiguously identifies the logical link.

When the MS requests the activation of a PDP context, the MS selects one of its unused NSAPIs.

NSAPI is a part of the tunnel identifier (TID).

For example (shown figuratively below), an X.25 packet is received by the MS from a connected TE at the X.121 address SAP. The X.25 PDU is encapsulated and NSAPI is initialised to NSAPI-1. TLLI is set to the MS's TLLI before the encapsulated X.25 packet is passed to the SNDC function.

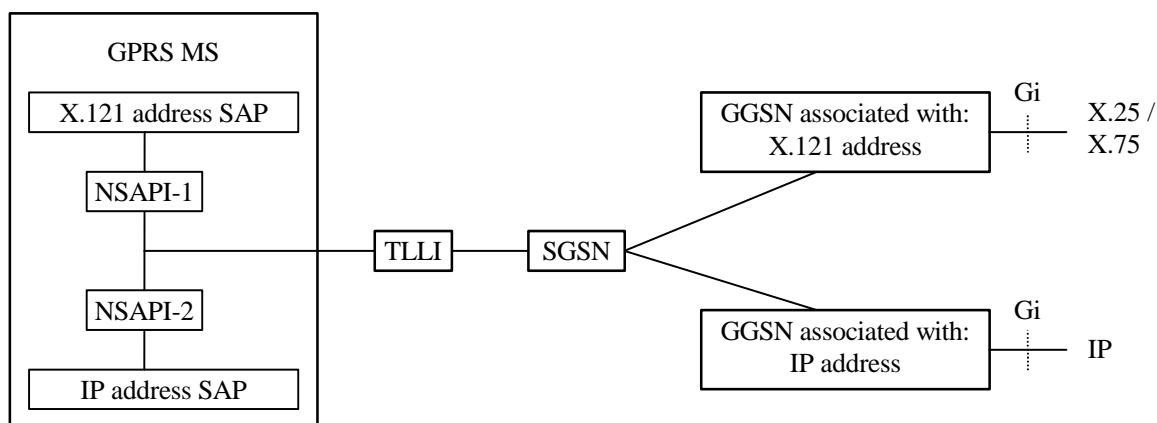

Figure 52: Use of NSAPI and TLLI

Within a routing area, there is a one-to-one correspondence between TLLI and IMSI that is only known in the MS and SGSN. If it is not clear from the context which routing area a TLLI belongs to, then TLLI is used together with RAI. TLLI is derived from a P-TMSI, and does then provide user identity confidentiality as described in subclause "User Identity Confidentiality".

The TLLI address range is divided into four ranges: Local, Foreign, Random, and Auxiliary. The TLLI structure allows the MS and SGSN to deduce the range that a TLLI belongs to. A Local TLLI is derived from the P-TMSI allocated by the SGSN, and is valid only in the RA associated with the P-TMSI. A Foreign TLLI is derived from a P-TMSI allocated in another RA. A Random TLLI is selected randomly by the MS, and is used when the MS does not have a valid P-TMSI available, or when the MS originates an anonymous access. An Auxiliary TLLI is selected by the SGSN and is used by the SGSN and MS to unambiguously identify an Anonymous Access MM and PDP Context.

If the MS has a valid P-TMSI associated with the RA where the MS is currently located, then the MS shall use a Local TLLI derived from its P-TMSI, unless the MS performs a GPRS attach.

If the MS does not have a valid P-TMSI associated with the current RA, or if the MS performs a GPRS attach, then it shall derive a Foreign TLLI from its P-TMSI, or allocate a Random TLLI if no valid P-TMSI is available.

When a TLLI is exchanged between the MS and an SGSN, then the TLLI is transmitted at the RLC/MAC layer within the Um protocol stack, and at the BSSGP layer within the Gb protocol stack. NSAPI is transmitted within the SNDCP layer in the transmission plane, and within the GMM/SM layer in the signalling plane. NSAPI is represented by a transaction identifier (TI) in some SM signalling messages. The TI is dynamically allocated by the MS for MS-requested (AA) PDP context activation, and by the network for network-requested PDP context activation. The TI is deallocated when a PDP context has been deactivated. TI usage is defined in GSM 04.07 and GSM 04.08.

By default, unless explicitly specified in the procedures, the TLLI transmitted at the RLC/MAC and BSSGP layers shall be used to identify the MS.

14.4 PDP Address

A GPRS subscriber identified by an IMSI, shall have one or more network layer addresses, i.e., PDP addresses, temporarily and/or permanently associated with it that conforms to the standard addressing scheme of the respective network layer service used, e.g.:

- an IP version 4 address;
- an IP version 6 address; or
- an X.121 address.

PDP addresses are activated and deactivated through MM procedures described in subclause "PDP Context Activation, Modification, and Deactivation Functions".

14.5 TID

A Tunnel Identifier (TID) is used by the GPRS Tunnelling protocol between GSNs to identify a PDP context. A TID consists of an IMSI and an NSAPI. The combination of IMSI and NSAPI uniquely identifies a single PDP context.

The TID is forwarded to the GGSN upon PDP Context Activation and it is used in subsequent tunnelling of user data between the GGSN and the SGSN to identify the MS's PDP contexts in the SGSN and GGSN. The TID is also used to forward N-PDUs from the old SGSN to the new SGSN at and after an inter SGSN routing area update.

In the anonymous access case, AA-TID is allocated locally by the SGSN. An AA-TID consists of an A-TLLI and an NSAPI similar to TID. Since the IMSI is longer than A-TLLI, the unused digits shall be used to create a unique identity within one PLMN. The allocated AA-TID shall not collide with the TID address space.

14.6 Routing Area Identity

Routing Area Identity (RAI), defined by an operator, identifies one or several cells. RAI is broadcast as system information and is used by the MS to determine, when changing cell, if an RA border was crossed. If that was the case, the MS initiates the RA update procedure.

The location of an MS in STANDBY state is known in the SGSN on an RA level. Cells that do not support GPRS within an LA are grouped by the SGSN and BSS into a null RA. The MS is paged for packet services in the RA where the MS is located when mobile-terminated traffic arrives in the SGSN. The MS is paged for circuit-switched services by the SGSN in the last known RA plus in the null RA.

NOTE: Cells not supporting GPRS and served by a BSC without a Gb interface should not be included in the same location area as cells not supporting GPRS and served by a BSC with a Gb interface.

A Routing Area is a subset of one, and only one, Location Area (LA), meaning that an RA cannot span more than one LA. An RA is served by only one SGSN.

The following rules apply for the Routing Area Identity:

- RAC is only unique when presented together with LAI;
- CI is only unique when presented together with LAI or RAI;
- LAI = MCC + MNC + LAC;
- RAI = MCC + MNC + LAC + RAC;
- CGI = LAI + CI.

14.7 Cell Identity

Cell Identity (CI) identifies one cell. CI is defined in GSM 03.03.

14.8 GSN Addresses

14.8.1 GSN Address

Each SGSN and GGSN shall have an IP address, either of type IPv4 or IPv6, for inter-communication over the GPRS backbone network. The IP addresses of GSNs and other GPRS backbone nodes of all PLMNs build a private address space that is not accessible from the public Internet. For the GGSN and the SGSN, this IP address may also correspond to one or more DNS-type logical GSN names.

14.8.2 GSN Number

Each SGSN shall have an SGSN number for communication with e.g., HLR and EIR.

Each GGSN that supports the optional SS7-based Gc interface shall have a GGSN number for communication with HLRs.

14.9 Access Point Name

In the GPRS backbone, Access Point Name is a reference to the GGSN to be used. In addition, Access Point Name may, in the GGSN, identify the external network. Access Point Name is composed of two parts as defined in GSM 03.03:

- the APN Network Identifier is mandatory and is a label (for example "corporation") or a set of labels separated by dots which is a fully qualified domain name according to the DNS naming conventions (for example "company.com"). In order to guarantee the uniqueness of the APN, the GPRS PLMN should allocate, to an ISP or corporation, an APN Network Identifier identical to their domain name in the public Internet. The APN Network Identifier shall not end with ".gprs";
- the APN Operator Identifier is optional. It is a fully qualified domain name according to the DNS naming conventions, and consists of three labels. The APN Operator Identifier shall end in ".gprs". For example, it may be "MNCyyy.MCCzzzz.gprs". The exact format is defined in GSM 09.60.

The APN stored in the HLR shall not contain the APN Operator Identifier. A wild card may be stored in the HLR instead of the APN. This wild card indicates that the user may select an APN that is not stored in the HLR. The use of the wild card is described in annex A.

15 Operational Aspects

15.1 Charging

Charging information in the GPRS network is collected for each MS by SGSNs and GGSNs that are serving the MS.

The information that the operator uses to generate a bill to a subscriber is operator-specific. Billing aspects, e.g., a regular fee for a fixed period, are outside the scope of the present document.

Every GPRS operator collects and processes their own charging information.

The SGSN collects charging information for each MS related with the radio network usage while the GGSN collects charging information for each MS related with the external data network usage. Both GSNs also collect charging information on usage of the GPRS network resources.

15.1.1 Charging Information

Charging information is collected for the GPRS subscriber.

As a minimum, the SGSN shall collect the following charging information:

- usage of the radio interface: the charging information shall describe the amount of data transmitted in MO and MT directions categorised with QoS and user protocols;
- usage of the packet data protocol addresses: the charging information shall describe how long the MS has used the packet data protocol addresses;
- usage of the general GPRS resources: the charging information shall describe the usage of other GPRS-related resources and the MS's GPRS network activity (e.g., mobility management); and
- location of MS: HPLMN, VPLMN, plus optional higher-accuracy location information.

As a minimum, the GGSN shall collect the following charging information:

- destination and source: the charging information shall describe the destination and source addresses with a level of accuracy as defined by the GPRS operator;
- usage of the external data networks: the charging information shall describe the amount of data sent and received to and from the external data network;
- usage of the packet data protocol addresses: the charging information shall describe how long the MS has used the PDP addresses; and
- location of MS: HPLMN, VPLMN, plus optional higher-accuracy location information.

15.1.2 Reverse Charging

It shall be possible to provide reverse charging as a subscription option. However, reverse charging may not be applicable to certain external data network protocols.

15.2 Quality of Service Profile

A QoS profile is associated with each PDP context. The QoS profile is considered to be a single parameter with multiple data transfer attributes. It defines the quality of service expected in terms the following attributes:

- precedence class;
- delay class;
- reliability class;

- peak throughput class; and
- mean throughput class.

There are many possible QoS profiles defined by the combinations of the attributes. A PLMN may support only a limited subset of the possible QoS profiles.

During the QoS profile negotiation defined in subclause "Activation Procedures", it shall be possible for the MS to request a value for each of the QoS attributes, including the HLR-stored subscribed default values. The network shall negotiate each attribute to a level that is in accordance with the available GPRS resources. The network shall always attempt to provide adequate resources to support the negotiated QoS profiles.

The RLC/MAC layer supports four radio priority levels and an additional level for signalling messages as defined in GSM 03.64 and GSM 04.60. Upon uplink access the MS can indicate one of the four priority levels, and whether the cause for the uplink access is user data or signalling message transmission. This information is used by the BSS to determine the radio access precedence (i.e., access priority) and the service precedence (i.e., transfer priority under congested situation), see GSM 04.60. The radio priority levels to be used for transmission of MO SMS shall be determined by the SGSN and delivered to the MS in the Attach Accept message. The radio priority level to be used for user data transmission shall be determined by the SGSN based on the negotiated QoS profile and shall be delivered to the MS during the PDP Context Activation and PDP Context Modification procedures.

15.2.1 Precedence Class

Under normal operating conditions, the network shall attempt to meet the service commitments of all QoS profiles. The service precedence indicates the relative importance of maintaining the service commitments under abnormal conditions, for example which packets are discarded in the event of problems such as limited resources or network congestion. The precedence classes are defined in Table 12.

Table 12: Precedence Classes

Precedence	Precedence Name	Interpretation
1	High priority	Service commitments shall be maintained ahead of precedence classes 2 and 3.
2	Normal priority	Service commitments shall be maintained ahead of precedence class 3.
3	Low priority	Service commitments shall be maintained after precedence classes 1 and 2.

15.2.2 Delay Class

GSM 02.60 defines four delay classes (1 to 4). The network operator should provision adequate transmission resources on the radio and network communication channels in order to support the expected number of subscribers within each cell at a given delay class. A PLMN may support only a subset of the delay classes. As a minimum, the PLMN shall support the best effort delay class (4).

15.2.3 Reliability Class

Data reliability is defined in terms of the residual error rates for the following cases (see GSM 02.60):

- probability of data loss;
- probability of data delivered out of sequence;
- probability of duplicate data delivery; and
- probability of corrupted data.

The reliability class specifies the requirements of the various network protocol layers. The combinations of the GTP, LLC, and RLC transmission modes support the reliability class performance requirements. TCP is used to transport user data on the GPRS backbone network in acknowledged GTP mode, while UDP is used in unacknowledged GTP mode. The reliability classes are summarised in Table 13.

Table 13: Reliability Classes

Reliability Class	GTP Mode	LLC Frame Mode	LLC Data Protection	RLC Block Mode	Traffic Type
1	Acknowledged	Acknowledged	Protected	Acknowledged	Non real-time traffic, error-sensitive application that cannot cope with data loss.
2	Unacknowledged	Acknowledged	Protected	Acknowledged	Non real-time traffic, error-sensitive application that can cope with infrequent data loss.
3	Unacknowledged	Unacknowledged	Protected	Acknowledged	Non real-time traffic, error-sensitive application that can cope with data loss, GMM/SM, and SMS.
4	Unacknowledged	Unacknowledged	Protected	Unacknowledged	Real-time traffic, error-sensitive application that can cope with data loss.
5	Unacknowledged	Unacknowledged	Unprotected	Unacknowledged	Real-time traffic, error non-sensitive application that can cope with data loss.

NOTE: For real-time traffic, the QoS profile also requires appropriate settings for delay and throughput.

Each reliability class in combination with the Reordering Required information specifies the target residual error rates for a PDP context. The residual error rate targets are given in GSM 02.60. A PLMN may support only a subset of the reliability classes. Signalling and SMS shall be transferred with reliability class 3.

15.2.4 Throughput Classes

User data throughput is specified in terms of a set of throughput classes that characterise the expected bandwidth required for a PDP context. The throughput is defined by both peak and mean classes.

15.2.4.1 Peak Throughput Class

The peak throughput is measured at the Gi and R reference points in units of octets per second. It specifies the maximum rate at which data is expected to be transferred across the network for an individual PDP context. There is no guarantee that this peak rate can be achieved or sustained for any time period, this depends upon the MS capability and available radio resources. The network may limit the subscriber to the negotiated peak data rate, even if additional transmission capacity is available. The peak throughput is independent of the delay class, that determines the per-packet GPRS network transit delay. The peak throughput classes are defined in Table 14.

Table 14: Peak Throughput Classes

Peak Throughput Class	Peak Throughput in octets per second
1	Up to 1 000 (8 kbit/s).
2	Up to 2 000 (16 kbit/s).
3	Up to 4 000 (32 kbit/s).
4	Up to 8 000 (64 kbit/s).
5	Up to 16 000 (128 kbit/s).
6	Up to 32 000 (256 kbit/s).
7	Up to 64 000 (512 kbit/s).
8	Up to 128 000 (1 024 kbit/s).
9	Up to 256 000 (2 048 kbit/s).

15.2.4.2 Mean Throughput Class

The mean throughput is measured at the Gi and R reference points in units of octets per hour. It specifies the average rate at which data is expected to be transferred across the GPRS network during the remaining lifetime of an activated PDP context. The network may limit the subscriber to the negotiated mean data rate (e.g., for flat-rate charging), even if additional transmission capacity is available. A "best effort" mean throughput class may be negotiated, and means that throughput shall be made available to the MS on a per need and availability basis.

The mean throughput classes are defined in Table 15.

Table 15: Mean Throughput Classes

Mean Throughput Class	Mean Throughput in octets per hour
1	100 (~0.22 bit/s).
2	200 (~0.44 bit/s).
3	500 (~1.11 bit/s).
4	1 000 (~2.2 bit/s).
5	2 000 (~4.4 bit/s).
6	5 000 (~11.1 bit/s).
7	10 000 (~22 bit/s).
8	20 000 (~44 bit/s).
9	50 000 (~111 bit/s).
10	100 000 (~0.22 kbit/s).
11	200 000 (~0.44 kbit/s).
12	500 000 (~1.11 kbit/s).
13	1 000 000 (~2.2 kbit/s).
14	2 000 000 (~4.4 kbit/s).
15	5 000 000 (~11.1 kbit/s).
16	10 000 000 (~22 kbit/s).
17	20 000 000 (~44 kbit/s).
18	50 000 000 (~111 kbit/s).
31	Best effort.

16 Interactions with Other GSM Services

This clause describes the interaction between GPRS and the following other GSM services:

- point-to-point Short Message Service (SMS);
- circuit-switched services; and
- supplementary services.

16.1 Point-to-point Short Message Service

It shall be possible for a GPRS-attached MS to send and receive short messages over GPRS radio channels. An MS that is GPRS-attached and not IMSI-attached shall transfer SMs over GPRS channels. MSs that are both GPRS-attached and IMSI-attached shall transfer SMs over GPRS channels or over non-GPRS control channels (if non-GPRS control channels are used, then paging for MT SMS may go through the SGSN).

The following two subclauses define the operation of mobile-terminated and mobile-originated SMS routing and transfer over GPRS radio channels. More detailed definitions are contained in GSM 03.40 [8].

16.1.1 Mobile-terminated SMS Transfer

Figure 53 and the description below show an example of a successful delivery of a SM to an MS over a GPRS radio channel.

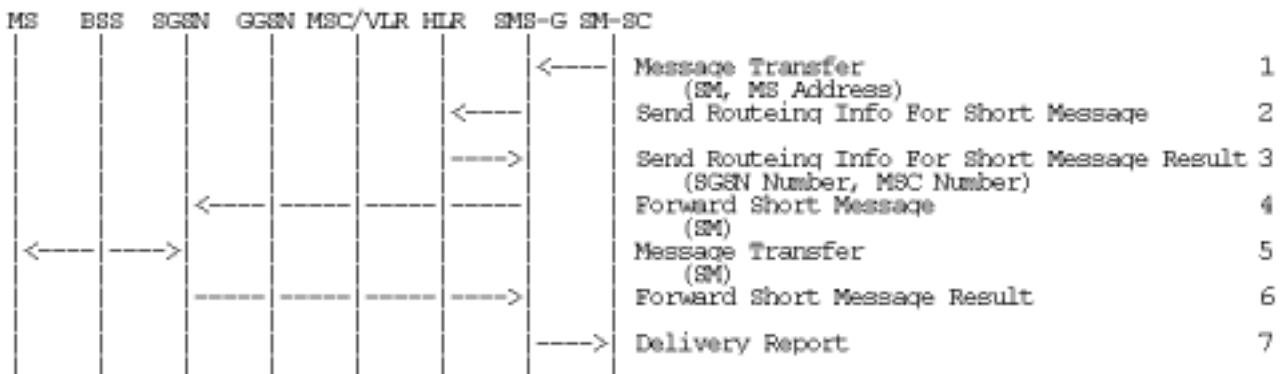

Figure 53: MT SMS Transfer, Successful

- 1) The short message service centre determines it shall send a SM to an MS. SM-SC forwards the SM to a SMS gateway MSC (SMS-GMSC).
- 2) SMS-GMSC examines the destination MS Address, and sends a Send Routing Info For Short Message message to the relevant HLR.
- 3) HLR returns a Send Routing Info For Short Message Result message to the SMS-GMSC. The result may contain the MS's current SGSN Number, the MSC Number, or both. If the result does not contain an SGSN Number (i.e., the HLR knows that the MS is not reachable via an SGSN), and if the result does contain an MSC Number, then non-GPRS SMS delivery procedures are followed. If the result contains an SGSN Number, the SMS transfer proceeds according to the following events.

NOTE: SMS delivery via the SGSN is normally more radio resource efficient than SMS delivery via the MSC/VLR. The preferred delivery path is selected by SMS-GMSC operator-specific action.

- 4) SMS-GMSC forwards the SM to the SGSN.
- 5) SGSN transfers the SM to the MS on the RP, CP, LLC layers, as defined in GSM 04.11 and GSM 04.64.
- 6) SGSN returns a Forward Short Message Result message to the SMS-GMSC indicating successful delivery of the SM.
- 7) SMS-GMSC returns a Delivery Report to the SM-SC indicating successful delivery of the SM.

16.1.1.1 Unsuccessful Mobile-terminated SMS Transfer

The SGSN may not be able to deliver the SM to the MS. This may for example happen when the MS is not attached to GPRS, or when the radio channel conditions are bad.

When the SGSN cannot deliver the SM to the MS, the SGSN sets the Mobile station Not Reachable for GPRS flag (MNRG), and returns a failure report to the SMS-GMSC. Based on the routing information received from the HLR, the SMS-GMSC shall do one of the following:

- If an MSC/VLR is available for the MS, the SM is forwarded to the MS via the MSC/VLR. A successful delivery report shall be returned to the SM-SC.
- If an MSC/VLR is not available for the MS, the Message Waiting Indication information in the HLR shall be updated and an unsuccessful delivery report shall be returned to the SM-SC.

Figure 54 illustrates one possible traffic scenario when neither the SGSN nor the MSC is able to deliver the SM.

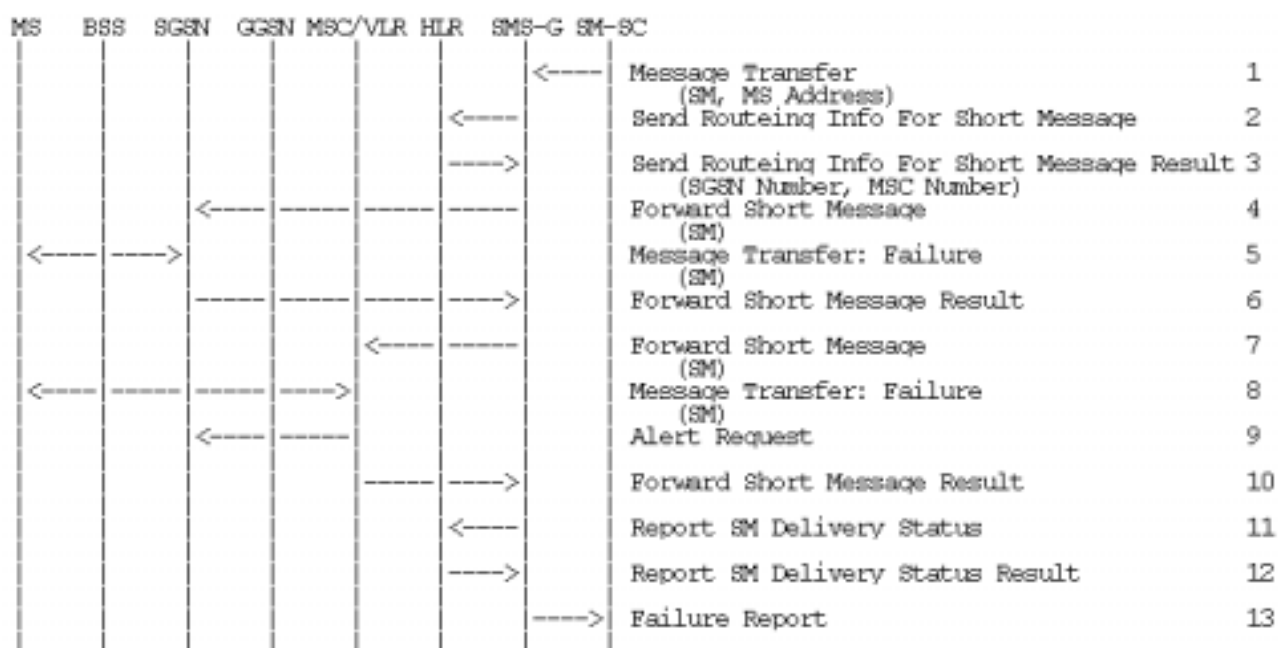

Figure 54: MT SMS Transfer, Unsuccessful

- 1) The short message service centre determines it shall send a SM to an MS. SM-SC forwards the SM to a SMS-GMSC.
- 2) SMS-GMSC examines the destination MS Address, and sends a Send Routing Info For Short Message message to the relevant HLR.
- 3) HLR returns a Send Routing Info For Short Message Result message to the SMS-GMSC. The Result contains an SGSN Number and an MSC Number.
- 4) SMS-GMSC forwards the SM to the SGSN.
- 5) SGSN attempts to transfer the SM to the MS, but fails.
- 6) SGSN sets MNRG and returns a Forward Short Message Result message to SMS-GMSC indicating unsuccessful delivery of the SM.
- 7) SMS-GMSC selects an alternative route for the SMS, and forwards the SM to the MSC/VLR.
- 8) MSC/VLR attempts to transfer the SM to the MS, but fails.
- 9) The MSC/VLR requests the setting of the NGAF at the SGSN.
- 10) VLR sets MNRF and returns a Forward Short Message Result message to the SMS-GMSC indicating unsuccessful delivery of the SM.
- 11) SMS-GMSC sends a Report SM Delivery message to the HLR.
- 12) HLR updates its Message Waiting Indication fields and returns a Report SM Delivery Result message to the SMS-GMSC.
- 13) SMS-GMSC returns a Failure Report to the SM-SC indicating unsuccessful delivery of the SM.

Figure 38 shows that the SGSN sends a Ready for SM (MS Reachable) message to the HLR when the MS becomes reachable and MNRG is set in the SGSN. The SGSN indicates also to the MSC/VLR when the MS becomes reachable and NGAF is set in the SGSN. If the MNRF is set at the MSC/VLR, the MSC/VLR sends a Ready for SM (MS Reachable) message to the HLR. Reception of a Ready for SM message or Update Location message when MNRG is set in the HLR shall trigger the SMS alert procedure as defined in GSM 03.40.

MNRG remains set in the SGSN independently of whether the MSC/VLR was successful in delivering the SM or not. This means that the SGSN in certain cases sends a Ready for SM message to the HLR when an MS becomes reachable via the SGSN, even if no SM is waiting. This causes a small amount of duplicate signalling between SGSN and HLR only.

16.1.2 Mobile-originated SMS Transfer

Figure 55 and the description below explain the steps involved in sending a SM from an MS over a GPRS radio channel.

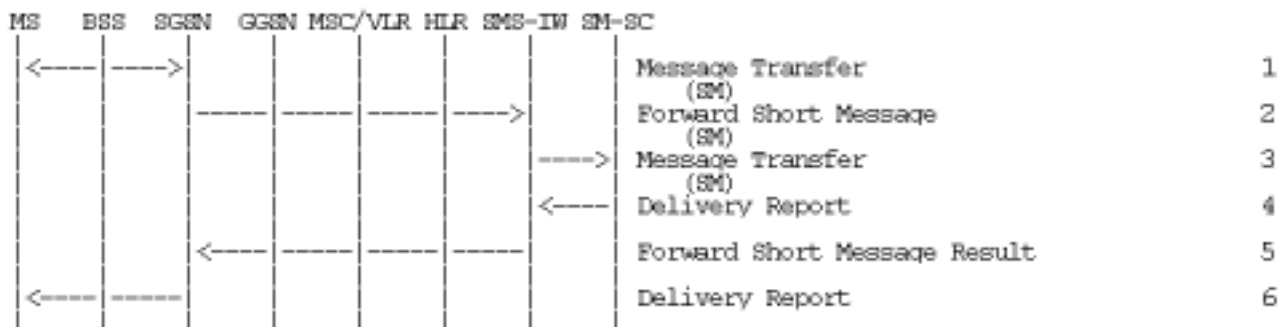

Figure 55: MO SMS Transfer, Successful

- 1) The MS has a SM to send, and transfers the SM to the SGSN via RP, CP, and LLC.
- 2) SGSN checks the MS subscription data, and determines that the MS is allowed to originate the SMS. SGSN forwards the SM to a SMS interworking MSC (SMS-IWMSC).
- 3) SMS-IWMSC passes the SM to the addressed SM-SC.
- 4) SM-SC returns a Delivery Report to the SMS-IWMSC indicating successful delivery of the SM.
- 5) SMS-IWMSC returns a Forward Short Message Result message to the SGSN indicating successful delivery of the SM.
- 6) SGSN returns a Delivery Report to the MS indicating successful delivery of the SM.

16.2 Circuit-switched Services

The ability for a GPRS user to access circuit-switched services depends on the subscription held, the network capabilities, and the MS capabilities. Interaction between GPRS and circuit-switched services is described in subclause "Interactions Between SGSN and MSC/VLR".

16.2.1 Suspension of GPRS Services

When a GPRS-attached MS enters dedicated mode, and when the MS limitations make it unable to communicate on GPRS channels, the MS shall request the network for suspension of GPRS services. The Suspend and Resume procedure is illustrated in Figure 56. Each step is explained in the following list.

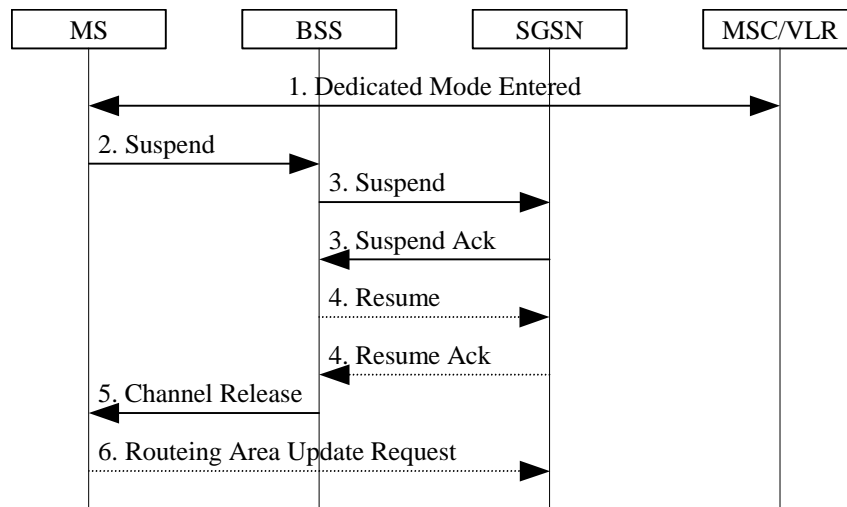

Figure 56: Suspend and Resume Procedure

- 1) The MS enters dedicated mode.
- 2) The MS sends an RR Suspend (TLLI, RAI) message to the BSS. The BSS may terminate any ongoing GPRS traffic for this TLLI.
- 3) The BSS sends a Suspend (TLLI, RAI) message to the SGSN, and the SGSN acknowledges by returning Suspend Ack. The BSS shall store TLLI and RAI in order to be able to request the SGSN to resume GPRS services when the MS leaves dedicated mode.
- 4) Eventually, the BSS determines that the circuit-switched radio channel shall be released. If the BSS is able to request the SGSN to resume GPRS services, the BSS shall send a Resume (TLLI, RAI) message to the SGSN. The SGSN acknowledges the successful outcome of the resume by returning Resume Ack.
- 5) The BSS sends an RR Channel Release (Resume) message to the MS. Resume indicates whether the BSS has successfully requested the SGSN to resume GPRS services for the MS, i.e., whether Resume Ack was received in the BSS before the RR Channel Release message was transmitted. The MS leaves dedicated mode.
- 6) If the BSS did not successfully request the SGSN to resume GPRS services, or if the RR Channel Release message was not received before the MS left dedicated mode, then the MS shall resume GPRS services by sending a Routeing Area Update Request message to the SGSN, as described in subclause "Routeing Area Update Procedure".

The full handling of suspended MSs in the BSS and the SGSN is implementation dependent. Typically, the SGSN should not page suspended MSs.

If the MS performs an inter-BSC handover while suspended, then TLLI and RAI should be transferred as BSC-to-BSC information in the Handover Required and Handover Request messages, see GSM 08.08. This allows the new BSC to initiate the Resume request procedure to the SGSN. In the case where the BSC-to-BSC information was not transferred or not understood, then the MS doesn't receive an indication that resumption has been successful, and the MS shall resume GPRS services by initiating a Routeing Area Update Request procedure as described in step 6.

16.2.2 GPRS and Dedicated Mode Priority Handling

An MS in class-B mode of operation that communicates on GPRS radio channels when a dedicated channel is needed, shall immediately abort the GPRS communication and trigger the Suspend and Resume procedure.

Response to circuit-switched paging, non-emergency MO circuit-switched calls, MO SMS, and MO supplementary services are exceptions to the above rule. In these cases, it is an implementation choice whether to immediately abort GPRS communication or to delay the dedicated mode establishment.

16.3 Supplementary Services

No supplementary services are defined for GPRS. Supplementary services may be available in the interworked-with networks (e.g., the X.25 Call Redirection user facility), but this is outside the scope of this specification.

Annex A (normative): APN and GGSN Selection

This annex contains the rules applied upon PDP context activation to determine the APN and the corresponding GGSN.

A.1 Definitions

The SGSN knows from the subscription data the parameters (S for Subscribed): PDP type (S), PDP address (S), APN (S), and VPLMN address allowed.

The SGSN may know from configuration the default APN supporting a given PDP type. This APN is called APN (SGSN) and does not include an APN Operator Identifier.

The SGSN knows the parameters requested by the MS (R for Requested): PDP type (R), PDP address (R), and APN (R). APN (R) is the APN Network Identifier requested by the MS.

In case of "an APN chosen by the SGSN" the activated PDP context is always linked with a dynamic PDP address.

An MS may have multiple subscription records for the same PDP type and the same PDP address, but with different APNs.

An MS may have one or two subscription records with the same PDP type and the same APN: one with a static PDP address, one with a dynamic PDP address.

When the MS is in its HPLMN, if the MS requests an APN that does not correspond to any GGSN of its HPLMN, the request shall be rejected by SGSN. When the MS is in a VPLMN, if the MS requests an APN that does not correspond to any GGSN of its HPLMN nor of this VPLMN, the request shall be rejected by SGSN.

If APN (S) = wild card (see GSM 03.03), it means either:

- that a default APN (a default PDN) has to be chosen by the SGSN (APN (SGSN)) if no APN (R) has been provided; or
- that a PDP context with dynamic PDP address may be activated towards any APN requested by the MS.

In order to derive APN (R) from the APN sent by the MS, the SGSN shall check if the APN sent by the user ends with ".gprs". If not, then APN (R) is equal to APN sent by the MS. If yes, then APN (R) is the APN sent by the MS without the three last labels. If yes, then the APN-OI shall be saved for later use, see Figure A.4.

A.2 APN Selection Rules

The SGSN shall select the APN to be used to derive the GGSN address, and set the selection mode parameter according to the rules in the SDL diagrams in this subclause. The following definitions apply to the SDL diagrams:

AddrMode: Addressing Mode.

APN-OI: APN Operator Identifier.

HPLMN-OI: HPLMN APN Operator Identifier (derived from IMSI).

Number <condition>: determines the PDP context subscription records that satisfy the given condition.

PDPaddr: PDP address.

SelMode := ChosenBySGSN: Network-provided APN, subscription not verified.

SelMode := SentByMS: MS-provided APN, subscription not verified.

SelMode := Subscribed: MS or Network-provided APN, subscription verified.

SelMode: Selection Mode.

VPLMN-OI: VPLMN APN Operator Identifier.

+: concatenation operation.

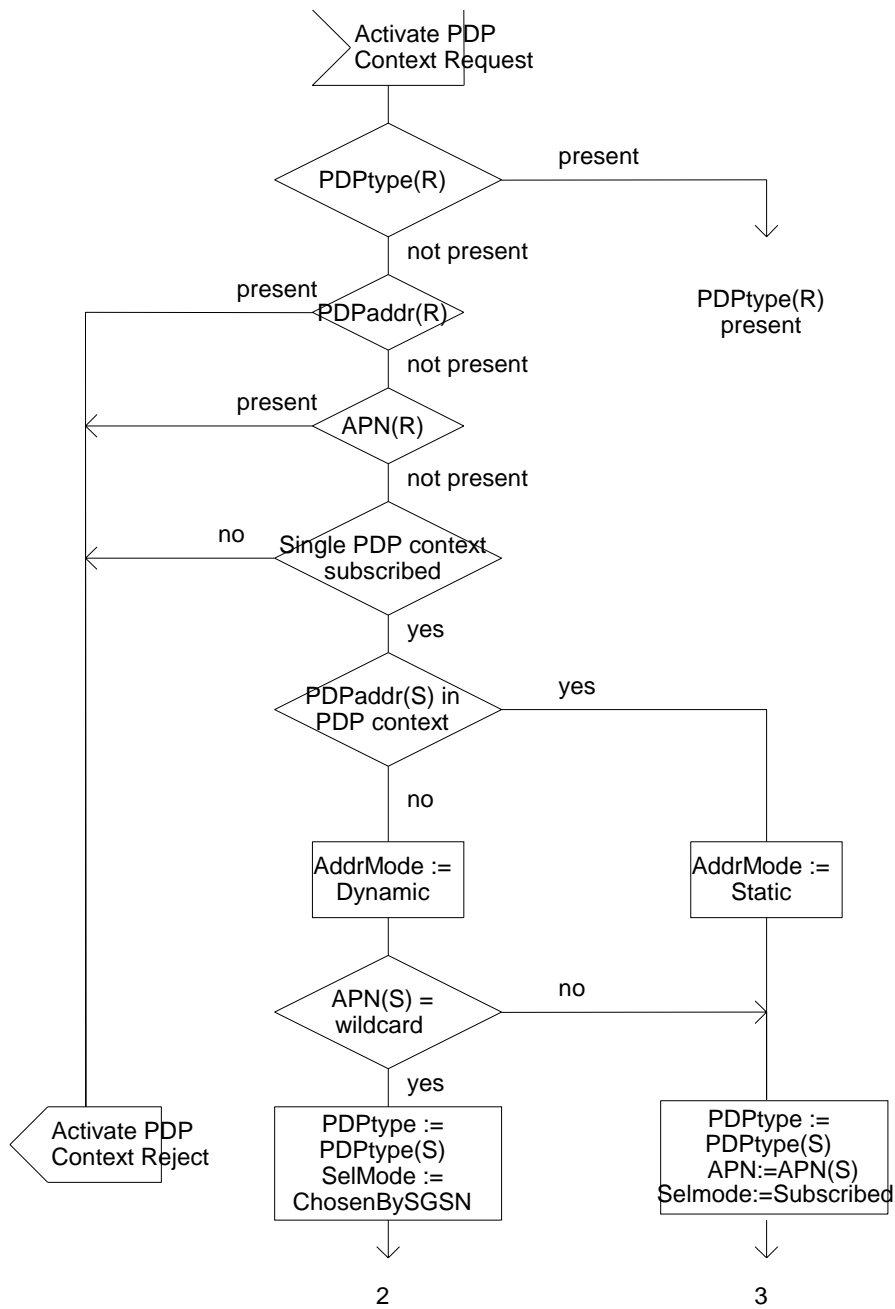

Figure A.1: SDL Diagram 1

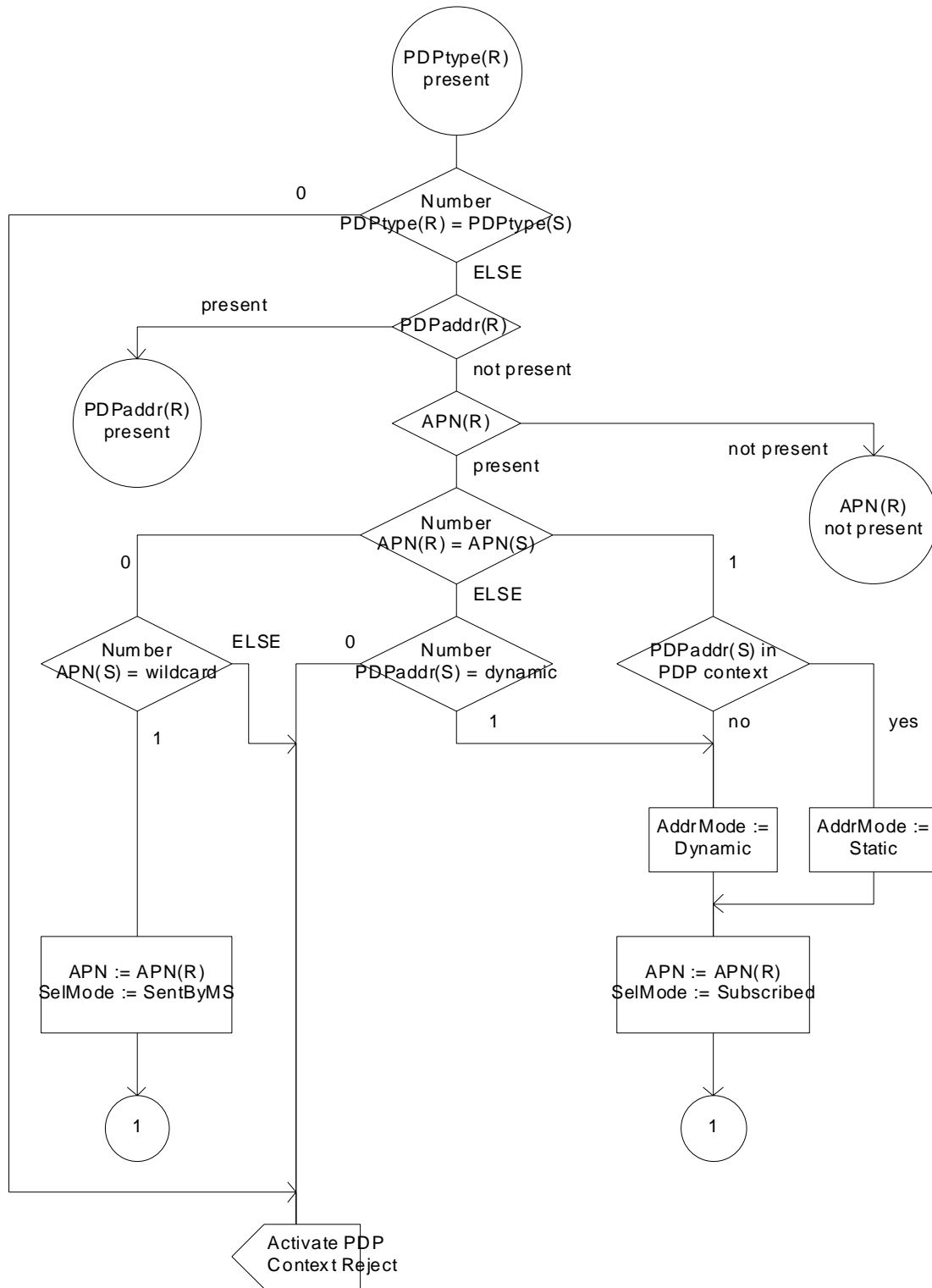

Figure A.2: SDL Diagram 2

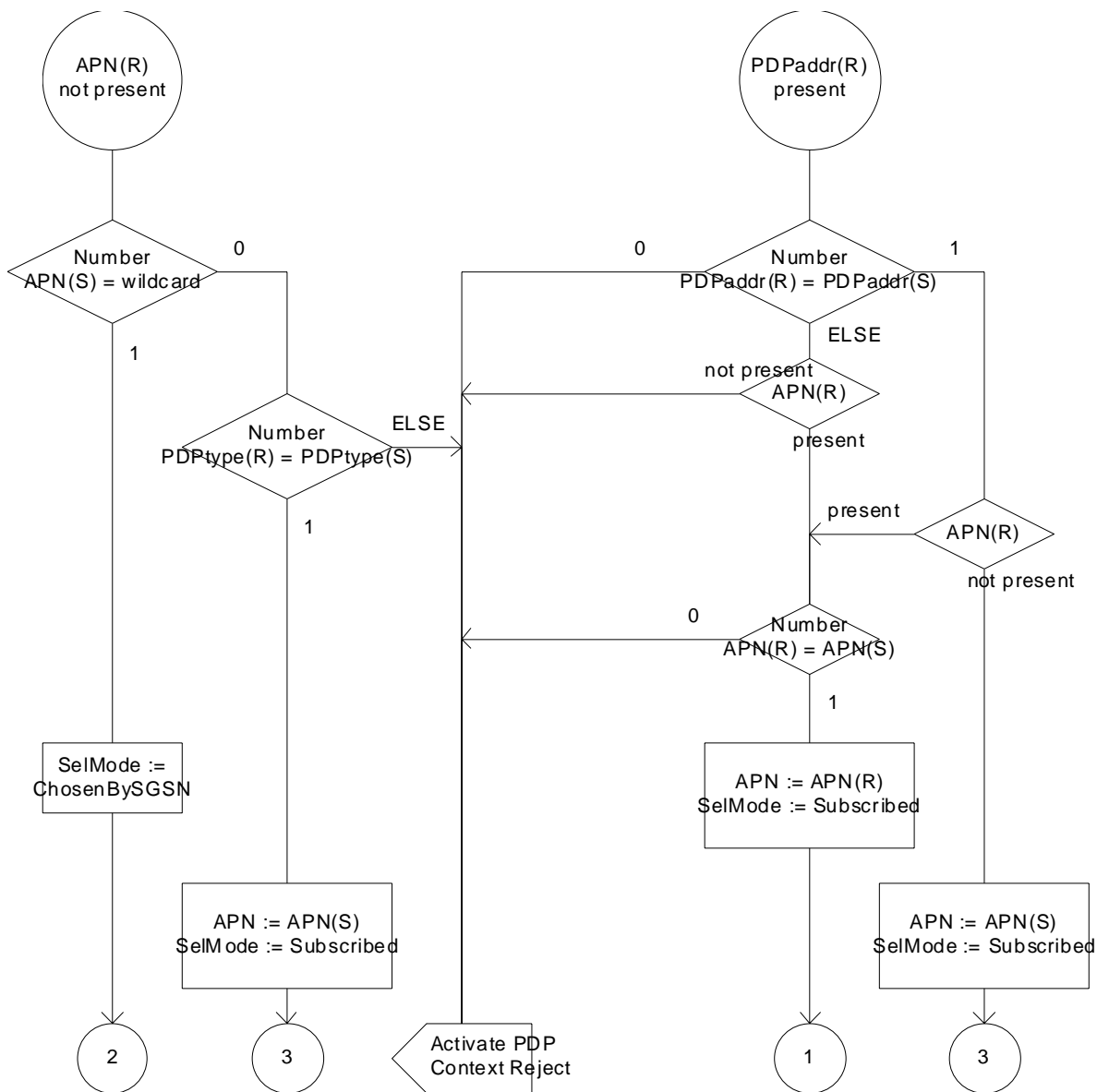

Figure A.3: SDL Diagram 3

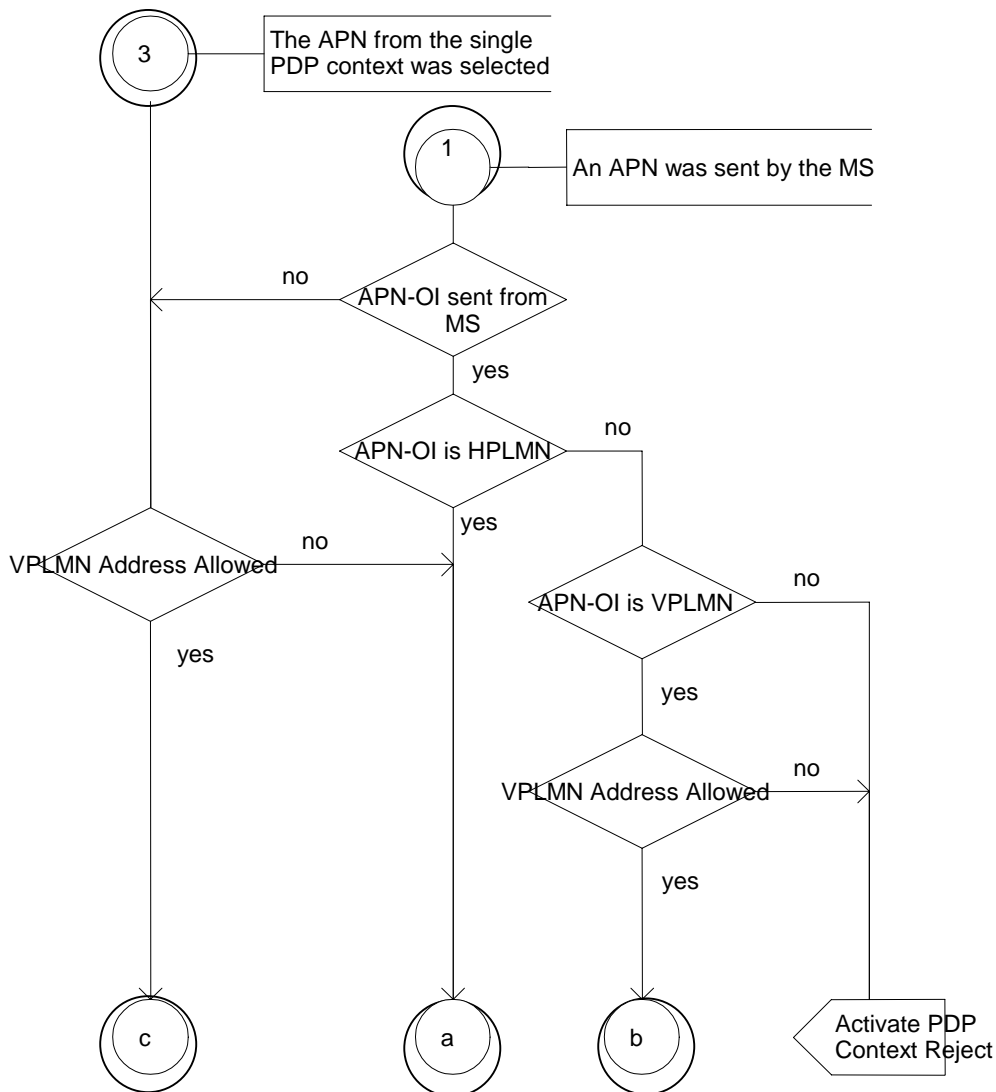

Figure A.4: SDL Diagram 4

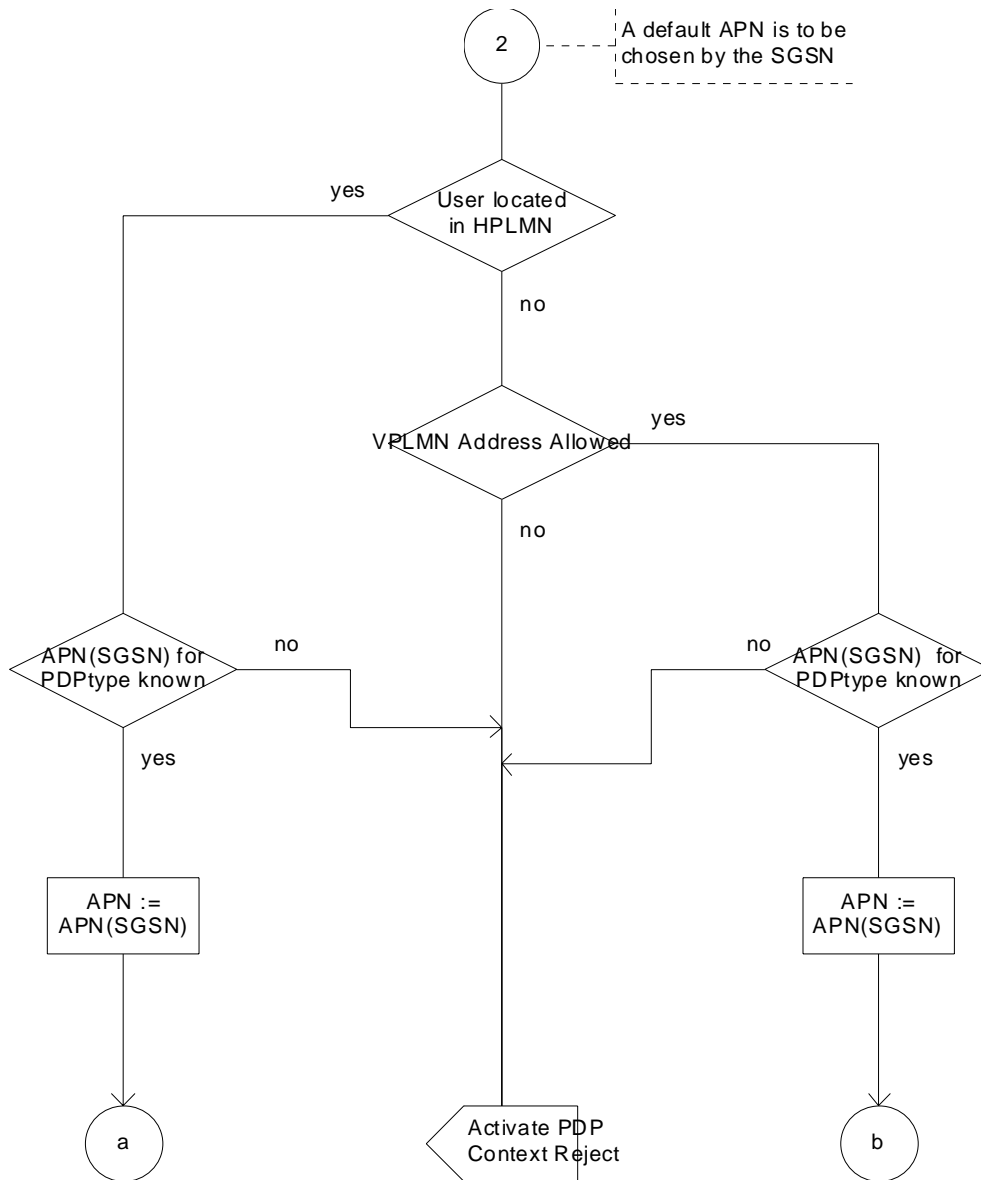

Figure A.5: SDL Diagram 5

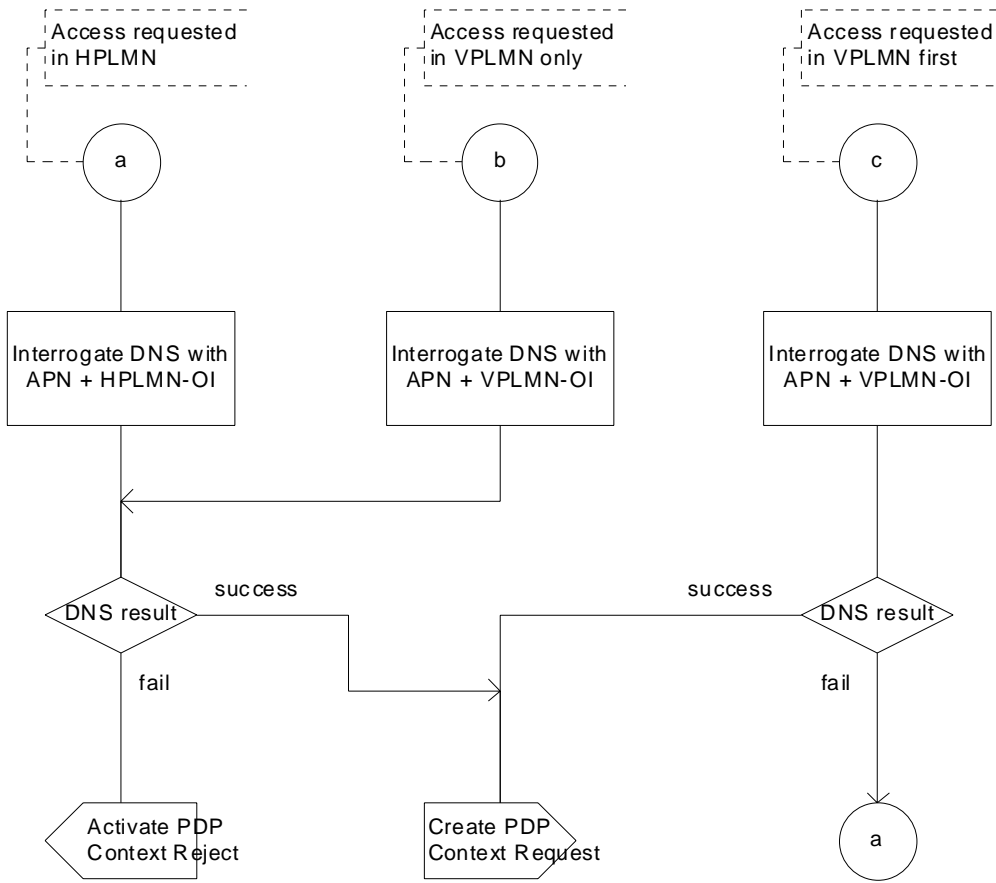

Figure A.6: SDL Diagram 6

Annex B (informative): Data Transmission Routeing Examples

Examples of the PDP PDU routeing are given below to clarify the GPRS routeing concept. It is assumed here that the MS has subscribed to a PDP type and a PDP address in the home PLMN and that this PDP address has been activated.

The contexts and the main parameters in the figures indicate which information is used to route the data to the correct network nodes.

B.1 Data Routeing for an MS in its Home PLMN to and from an External PDN

Figure C.1 describes how the MS sends a PDP PDU (data packet) to an external data network and how PDP PDUs from an external data network are sent to an MS.

- TLLI and NSAPI identify the PDP context of the MS in the SGSN.
- TID identifies the PDP context in the SGSN and GGSN.
- To route MO packets, an SGSN needs to have a mapping from TLLI + NSAPI to GGSN + TID.
- To route MT packets, an SGSN needs to have a mapping from TID to TLLI + NSAPI.

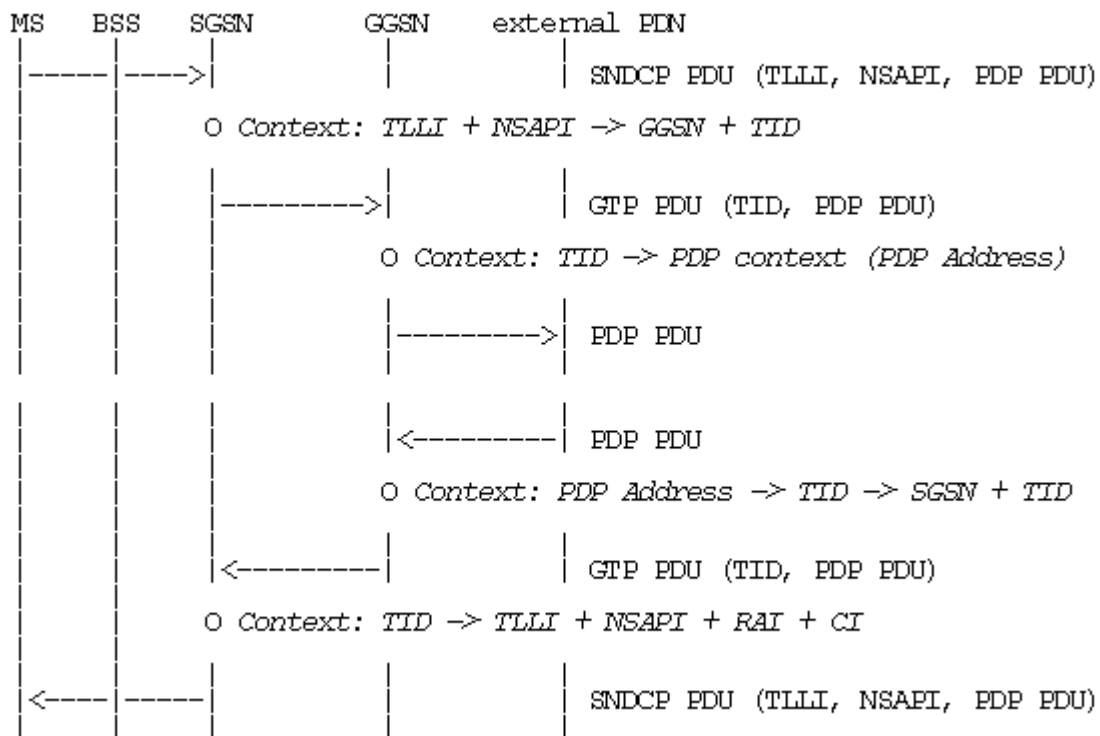

Figure C.1: Data Routeing in HPLMN to and from an External PDN

B.2 Data Routeing for a Roaming MS to and from an External PDN

This example is almost the same as the previous one. In this case, the MS has roamed to another PLMN and the SGSN that is currently serving the MS is in a visited PLMN while the GGSN is in the home PLMN.

A mobile-terminated GTP PDU is carried from the GGSN to the SGSN via the home intra-PLMN backbone network to the inter-PLMN backbone network and finally to the visited intra-PLMN backbone network.

- The routing for MO and MT packets can be optimised if the activated PDP address is dynamically assigned by the visited PLMN.

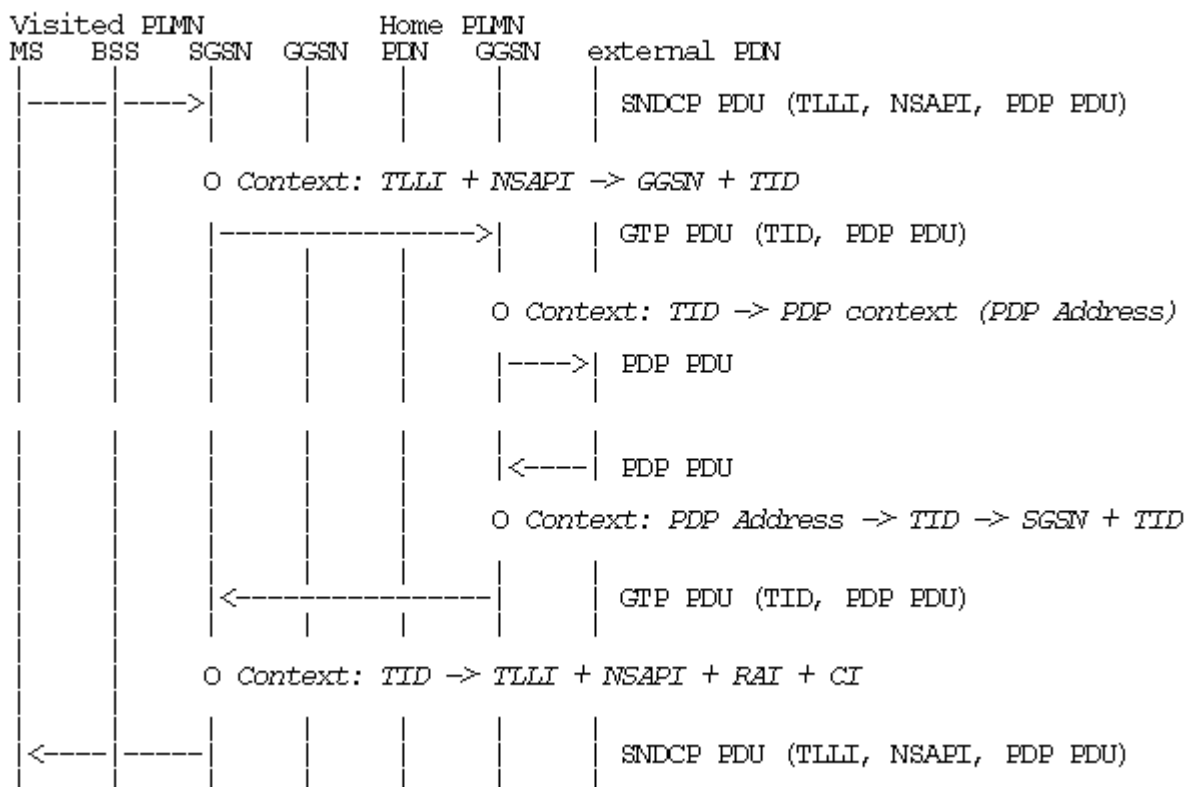

Figure C.2: Data Routeing for a Roaming MS to and from an External PDN

B.3 MS-to-MS Data Routeing via the Same GGSN

This example is basically the same as described in subclause "Data Routeing for an MS in its Home PLMN to and from an External PDN". When the GGSN receives the GTP PDU and decapsulates the PDP PDU, it detects that the destination address is also in the GPRS network. Then, the PDP PDU that is sent by one MS is treated the same way as the PDP PDU that is received from the external data network.

- In case of connection-oriented protocols (e.g., X.25) an additional DTE/DCE conversion may need to be performed in the GGSN.

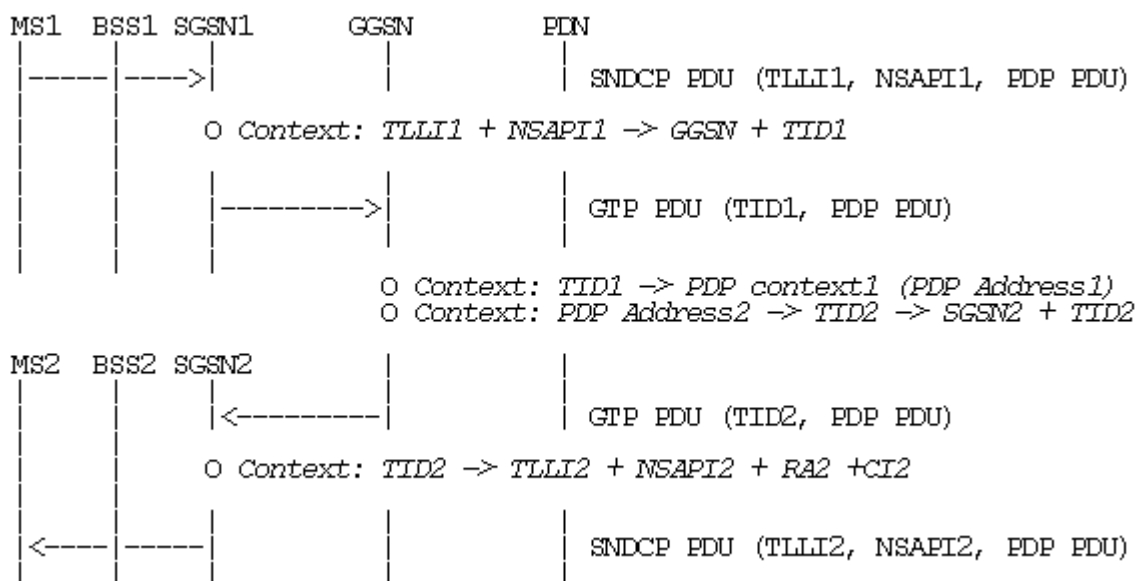

Figure C.3: MS-to-MS Data Routing via the Same GGSN

B.4 MS-to-MS Data Routing via Different GGSNs

This example is basically the same as described in subclause "MS-to-MS Data Routing via the Same GGSN", with the difference that the same GGSN is not handling the first MS's outgoing traffic and the second MS's incoming traffic. In practice, this means that when the first GGSN has extracted the destination address from the PDP PDU and detected the destination subnetwork, its routing table has a "short-cut" to the second GGSN. Instead of routing the PDP PDU via an external data network, it is possible to route it via the inter-PLMN backbone network.

- If the first GGSN does not know the short-cut from one operator to another, the PDP PDUs are transmitted via the external data network. From the first GGSN's point of view, the second MS then resembles a normal fixed network node.
- In case of connection-oriented protocols (e.g., X.25) an additional DTE / DCE conversion may need to be performed in the GGSN.

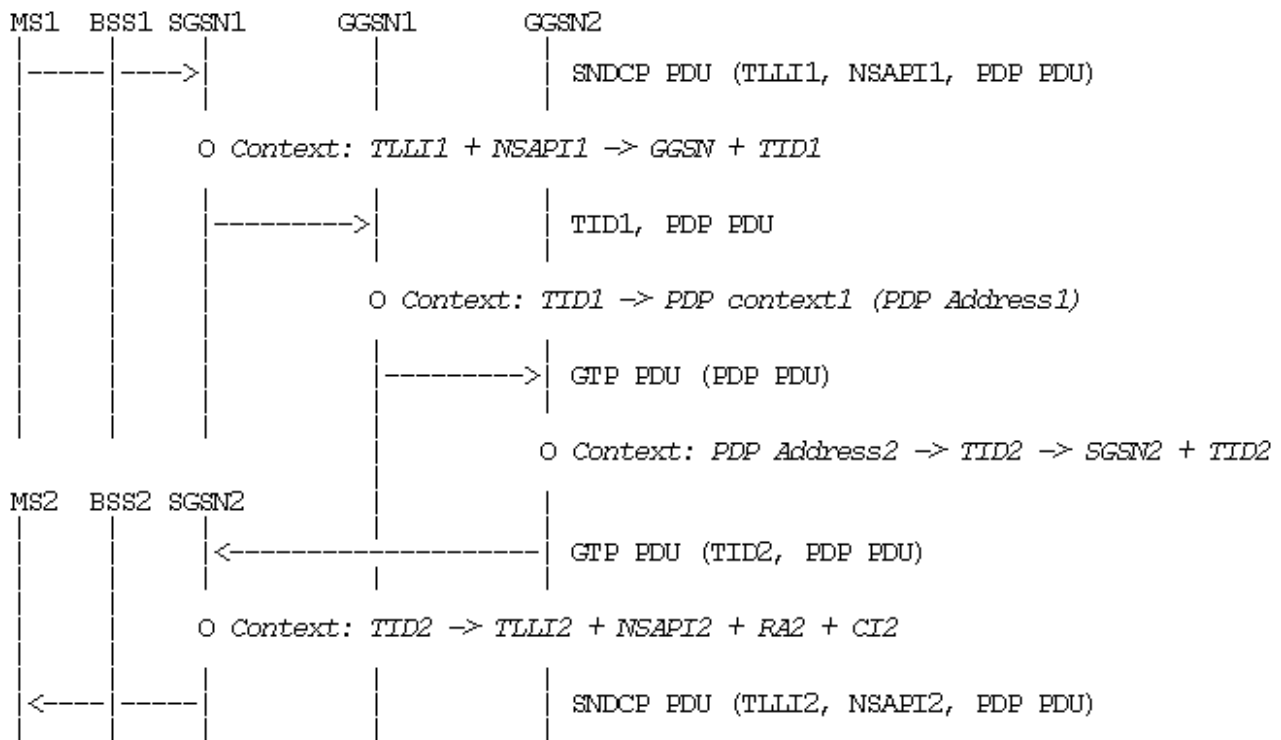

Figure C.4: MS-to-MS Data Routing via Different GGSNs

Annex C (informative): Figures

Figure 1: GPRS Access Interfaces and Reference Points.....	14
Figure 2: Overview of the GPRS Logical Architecture.....	19
Figure 3: Intra- and Inter-PLMN Backbone Networks.....	20
Figure 4: Transmission Plane	22
Figure 5: Signalling Plane MS - SGSN	23
Figure 6: Signalling Plane SGSN - HLR.....	23
Figure 7: Signalling Plane SGSN - MSC/VLR	23
Figure 8: Signalling Plane SGSN - EIR	24
Figure 9: Signalling Plane SGSN - SMS-GMSC and SGSN - SMS-IW MSC	24
Figure 10: Signalling Plane GSN - GSN.....	24
Figure 11: Signalling Plane GGSN - HLR Using MAP	25
Figure 12: Signalling Plane GGSN - HLR Using GTP and MAP.....	25
Figure 13: Functional Mobility Management State Model	27
Figure 14: Functional Anonymous Access Mobility Management State Model.....	28
Figure 15: CS Paging Procedure	32
Figure 16: MS Information Procedure	34
Figure 17: MM Information Procedure	34
Figure 18: Combined GPRS / IMSI Attach Procedure.....	36
Figure 19: MS-Initiated Combined GPRS / IMSI Detach Procedure.....	39
Figure 20: SGSN-Initiated GPRS Detach Procedure	39
Figure 21: HLR-Initiated GPRS Detach Procedure	40
Figure 22: Purge Procedure.....	41
Figure 23: Authentication Procedure.....	41
Figure 24: P-TMSI Reallocation Procedure	42
Figure 25: Scope of GPRS Ciphering	43
Figure 26: Identity Check Procedure.....	43
Figure 27: Intra SGSN Routing Area Update Procedure.....	45
Figure 28: Inter SGSN Routing Area Update Procedure.....	46
Figure 29: Combined RA / LA Update in the Case of Intra SGSN RA Update Procedure.....	48
Figure 30: Combined RA / LA Update in the Case of Inter SGSN RA Update Procedure.....	50
Figure 31: Insert Subscriber Data Procedure.....	53
Figure 32: Delete Subscriber Data Procedure	54

Figure 33: GPRS Paging Procedure	56
Figure 34: Functional PDP State Model.....	58
Figure 35: PDP Context Activation Procedure.....	59
Figure 36: Successful Network-Requested PDP Context Activation Procedure.....	61
Figure 37: Protection Procedure.....	62
Figure 38: Mobile User Activity Procedure	63
Figure 39: Anonymous Access PDP Context Activation Procedure	63
Figure 40: PDP Context Modification Procedure.....	65
Figure 41: PDP Context Deactivation Initiated by MS Procedure	65
Figure 42: PDP Context Deactivation Initiated by SGSN Procedure.....	66
Figure 43: PDP Context Deactivation Initiated by GGSN Procedure	66
Figure 44: Anonymous Access PDP Context Deactivation Initiated by MS Procedure	67
Figure 45: Anonymous Access PDP Context Deactivation Initiated by GGSN Procedure	67
Figure 46: Multiplexing of Network Protocols	71
Figure 47: Sequential Invocation of SNDC Functionality	72
Figure 48: Transmission Plane for PDP Type PPP	73
Figure 49: BSSGP Protocol Position.....	74
Figure 50: Remote Packet Control Unit (PCU) Positions	77
Figure 51: GPRS Subscription Data.....	78
Figure 52: Use of NSAPI and TLLI	84
Figure 53: MT SMS Transfer, Successful	91
Figure 54: MT SMS Transfer, Unsuccessful.....	92
Figure 55: MO SMS Transfer, Successful	93
Figure 56: Suspend and Resume Procedure	94

Annex E (informative): Tables

Table 1: Mapping of Functions to Logical Architecture	21
Table 2: Network Operation Modes	33
Table 3: Mapping of High-level Functions Across the Gb Architecture	75
Table 4: HLR GPRS Subscription Data	78
Table 5: SGSN MM and PDP Contexts	79
Table 6: SGSN MM and PDP Contexts for Anonymous Access	80
Table 7: GGSN PDP Context	80
Table 8: GGSN PDP Context for Anonymous Access	81
Table 9: MS MM and PDP Contexts	81
Table 10: MS MM and PDP Contexts for Anonymous Access	82
Table 11: MSC/VLR Association	82
Table 12: Precedence Classes	88
Table 13: Reliability Classes	89
Table 14: Peak Throughput Classes	89
Table 15: Mean Throughput Classes	90

Annex F (informative): Document history

Version	Date	Information about changes
5.0.0	June 1997	SMG#22 approved.
5.1.0	October 1997	Included SMG#23 approved change requests A001 through A010.
5.2.0	December 1997	Included SMG#24 approved change requests A011 through A019, A021 through A026, A028, A030 through A033, and A035.
5.3.0	March 1998	Included SMG#25 approved change requests A027, A036 through A038, A040, A042, and A043.
6.0.0	March 1998	Included SMG#25 approved change request A044.
6.1.0	June 1998	Included SMG#26 approved change requests A045 through A048, A050 through A055, and A057 through A062.
6.1.1	August 1998	ETSI version change due to change of Public Enquiry dates.
6.2.0	October 1998	Included SMG#27 approved change requests A065, A066, A068 through A080, A082, A088, and A090.
6.3.0	February 1999	Included SMG#28 approved change requests A092, A093, A095 through A098, A100 through A102, A105, and A108.
6.3.1	April 1999	Editorial correction.
7.0.0	April 1999	Included SMG#28 approved Release 98 change requests A087 and A091.
7.1.0	August 1999	Included SMG#29 approved Release 98 change requests A104, A115 and A150 through A158.
7.2.0	October 1999	Included TSG CN#5 and SA#5 approved change requests A163r1, A167, A168r2, A169, and A171r2.
7.3.0	December 1999	Included TSG SA#6 approved change requests A173, A175, A177, A179, A181, and A182.
7.4.0	March 2000	Included TSG SA#7 approved change requests A183 and A185.
7.5.0	October 2000	Included TSG SA#9 approved change request A188. Updated to 3GPP format.
7.6.0	March 2001	Incorporation of the change requests approved at TSG SA#11.
7.7.0	June 2001	Incorporation of CR#A206r1 on "Using RAU procedure for MS RAC IE update"

History

Document history				
V7.1.0	August 1999	One-step Approval Procedure	OAP 9956:	1999-08-25 to 1999-12-24
V7.1.1	January 2000	Publication as EN 301 344		
V7.3.0	February 2000	One-step Approval Procedure	OAP 200024:	2000-02-16 to 2000-06-16
V7.4.0	April 2000	One-step Approval Procedure	OAP 20000818:	2000-04-19 to 2000-08-18
V7.3.1	July 2000	Publication as EN 301 344		
V7.4.1	September 2000	Publication as EN 301 344		
V7.5.0	January 2001	Publication		
V7.6.0	March 2001	Publication		
V7.7.0	June 2001	Publication		