

# ETSI TS 101 376-3-22 V3.2.1 (2011-02)

---

*Technical Specification*

**GEO-Mobile Radio Interface Specifications (Release 3);  
Third Generation Satellite Packet Radio Service;  
Part 3: Network specifications;  
Sub-part 22: Overall description of  
the GMPRS radio interface;  
Stage 2;  
GMR-1 3G 43.064**

---



---

Reference

RTS/SES-00315-3-22

---

Keywords

3G, earth station, GMPRS, GMR, GPRS, GSM,  
GSO, MES, mobile, MSS, radio, satellite

**ETSI**

650 Route des Lucioles  
F-06921 Sophia Antipolis Cedex - FRANCE

Tel.: +33 4 92 94 42 00 Fax: +33 4 93 65 47 16

Siret N° 348 623 562 00017 - NAF 742 C  
Association à but non lucratif enregistrée à la  
Sous-Préfecture de Grasse (06) N° 7803/88

---

**Important notice**

Individual copies of the present document can be downloaded from:

<http://www.etsi.org>

The present document may be made available in more than one electronic version or in print. In any case of existing or perceived difference in contents between such versions, the reference version is the Portable Document Format (PDF). In case of dispute, the reference shall be the printing on ETSI printers of the PDF version kept on a specific network drive within ETSI Secretariat.

Users of the present document should be aware that the document may be subject to revision or change of status. Information on the current status of this and other ETSI documents is available at

<http://portal.etsi.org/tb/status/status.asp>

If you find errors in the present document, please send your comment to one of the following services:

[http://portal.etsi.org/chaicor/ETSI\\_support.asp](http://portal.etsi.org/chaicor/ETSI_support.asp)

---

**Copyright Notification**

No part may be reproduced except as authorized by written permission.  
The copyright and the foregoing restriction extend to reproduction in all media.

© European Telecommunications Standards Institute 2011.  
All rights reserved.

**DECT™**, **PLUGTESTS™**, **UMTS™**, **TIPHON™**, the TIPHON logo and the ETSI logo are Trade Marks of ETSI registered for the benefit of its Members.

**3GPP™** is a Trade Mark of ETSI registered for the benefit of its Members and of the 3GPP Organizational Partners.

**LTE™** is a Trade Mark of ETSI currently being registered

for the benefit of its Members and of the 3GPP Organizational Partners.

**GSM®** and the GSM logo are Trade Marks registered and owned by the GSM Association.

# Contents

Intellectual Property Rights .....	6
Foreword.....	6
Introduction .....	7
1 Scope .....	9
2 References .....	10
2.1 Normative references .....	10
2.2 Informative references.....	11
3 Definitions, symbols and abbreviations .....	11
3.1 Definitions.....	11
3.2 Symbols.....	12
3.3 Abbreviations .....	12
4 Packet data logical channels.....	12
4.1 General .....	12
4.2 Packet Common Control Channel (PCCCH) .....	12
4.2.1 Packet Random Access Channels (PRACH) - uplink only.....	12
4.2.2 Packet Paging Channel (PPCH) - downlink only .....	12
4.2.3 Packet Access Grant Channel (PAGCH) - downlink only.....	13
4.2.4 Packet Notification Channel (PNCH) and compact packet notification channel - downlink only .....	13
4.3 Packet Broadcast Control Channel (PBCCH) - downlink only.....	13
4.4 Packet traffic channels.....	13
4.4.1 Packet Data Traffic Channels (PDTCH).....	13
4.5 Packet dedicated control channels.....	13
4.5.1 Packet Associated Control Channel (PACCH).....	13
4.5.2 Packet Timing Advance Control Channel, Uplink (PTCCH/U) (A/Gb mode only).....	13
4.5.3 Packet Timing Advance Control Channel, Downlink (PTCCH/D) (A/Gb mode only).....	13
4.5.4 Packet mode dedicated channels (DTCH) (Iu mode only) .....	13
5 Mapping of packet data logical channels onto physical channels.....	14
5.1 General .....	14
5.2 Packet Common Control Channels (PCCCH).....	14
5.2.1 Packet Random Access Channel (PRACH).....	14
5.2.1.1 PRACH on the same carrier .....	14
5.2.1.2 PRACH on a separate carrier .....	15
5.2.2 Packet Paging Channel (PPCH).....	15
5.2.3 Packet Access Grant Channel (PAGCH) .....	15
5.2.4 Packet Notification Channel (PNCH).....	15
5.3 Packet Broadcast Control Channel (PBCCH) .....	15
5.3.1 Compact Frequency Correction Channel (CFCC) .....	15
5.3.2 Compact Synchronization Channel (CSCH).....	15
5.4 Packet Timing Advance Control Channel (PTCCH) (A/Gb mode only) .....	15
5.5 Packet traffic channels.....	16
5.5.1 Packet Data Traffic Channel (PDTCH and PDTCH2) (A/Gb mode only) .....	16
5.5.1a Packet Data Traffic Channel (PDTCH3) (Iu mode only) .....	16
5.5.2 Packet Associated Control Channel (PACCH) .....	16
5.6 Downlink resource sharing.....	17
5.7 Uplink resource sharing (A/Gb mode) .....	17
5.7a Uplink resource sharing (Iu mode).....	17
5.8 Asymmetrical Pairing of PDCH/D(2,m) with PDCH/U(1,m) .....	17
6 Radio interface .....	17
6.1 Radio resource management principles.....	18
6.1.1 Allocation of resources for GMR-1 3G .....	18
6.1.1.1 Master-slave concept.....	18
6.1.1.2 Capacity on demand concept.....	18

6.1.1.3	Procedures to support capacity on demand .....	18
6.1.1.4	Release of PDCH not carrying PCCCH .....	19
6.1.2	Multiframe structure for PDCH .....	19
6.2	Radio resource operating modes .....	19
6.2.1	Packet idle mode .....	19
6.2.2	Packet transfer mode .....	20
6.2.3	Correspondence between radio resource operating modes and mobility management states .....	20
6.3	Layered overview of radio interface (A/Gb mode only) .....	20
6.4	Physical RF layer .....	21
6.5	Physical link layer .....	21
6.5.1	Layer services .....	21
6.5.2	Layer functions .....	21
6.5.3	Service primitives .....	22
6.5.4	Radio burst structure .....	22
6.5.5	Channel coding (A/Gb mode) .....	23
6.5.5.1	Channel coding for PDTCH and PDTCH2 .....	24
6.5.5.1.1	Channel coding for PDTCH .....	24
6.5.5.2	Channel coding for PACCH, PAGCH and PTCCH .....	28
6.5.5.3	Channel coding for the PRACH .....	28
6.5.5.3.1	Coding of the 64 data bit packet access burst .....	28
6.5.5a	Channel coding (Iu mode) .....	28
6.5.5a.1	Channel coding for PDTCH3 .....	29
6.5.5a.1.1	Channel coding for PDTCH3 .....	29
6.5.5a.2	Channel coding for PACCH, and PAGCH .....	31
6.5.5a.3	Channel coding for the PRACH3 .....	31
6.5.5a.3.1	Coding of the 40 data bit packet access burst .....	31
6.5.6	Spotbeam reselection .....	31
6.5.7	Timing and frequency update procedure .....	31
6.5.7.1	Initial timing advance estimation .....	32
6.5.7.2	Continuous timing and frequency update procedure .....	32
6.5.8	Power control procedure .....	33
6.5.8.1	MES output power .....	33
6.5.8.2	BSS output power .....	33
6.5.8.3	Measurements at MES side .....	33
6.5.8.4	Measurements at BSS side .....	33
6.5.9	Void .....	33
6.5.10	Discontinuous Reception (DRX) .....	34
6.5.11	Rate adaptation .....	34
6.5.12	UpLink Quality Reports .....	34
6.6	Medium access control and radio link control layer .....	34
6.6.1	Layer services .....	34
6.6.2	Layer functions .....	34
6.6.3	Service primitives .....	35
6.6.4	Mode of operation .....	35
6.6.4.1	Multiplexing MESs on the same PDCH .....	36
6.6.4.1.1	Uplink state flag: dynamic allocation .....	36
6.6.4.2	Temporary block flow .....	37
6.6.4.2.1	Support for Streaming traffic .....	37
6.6.4.3	Temporary flow identity .....	37
6.6.4.4	Medium access modes .....	37
6.6.4.5	Acknowledged mode for RLC/MAC operation .....	37
6.6.4.5.1	GMR-1 3G .....	37
6.6.4.6	Unacknowledged mode for RLC/MAC operation .....	38
6.6.4.7	Mobile originated packet transfer .....	38
6.6.4.7.1	Uplink access .....	38
6.6.4.7.2	Dynamic allocation .....	39
6.6.4.7.3	Void .....	39
6.6.4.7.4	Contention resolution .....	40
6.6.4.7.5	Piggybacked messages and unsolicited resource grant .....	40
6.6.4.8	Mobile terminated packet transfer .....	41
6.6.4.8.1	Packet paging .....	41
6.6.4.8.2	Downlink packet transfer .....	41

6.6.4.8.3 Release of the resources .....42  
6.6.4.9 Simultaneous uplink and downlink packet transfer.....42  
6.7 Abnormal cases in MES ready state .....43  
**Annex A (informative): Bibliography.....44**  
History .....45

---

# Intellectual Property Rights

IPRs essential or potentially essential to the present document may have been declared to ETSI. The information pertaining to these essential IPRs, if any, is publicly available for **ETSI members and non-members**, and can be found in ETSI SR 000 314: *"Intellectual Property Rights (IPRs); Essential, or potentially Essential, IPRs notified to ETSI in respect of ETSI standards"*, which is available from the ETSI Secretariat. Latest updates are available on the ETSI Web server (<http://webapp.etsi.org/IPR/home.asp>).

Pursuant to the ETSI IPR Policy, no investigation, including IPR searches, has been carried out by ETSI. No guarantee can be given as to the existence of other IPRs not referenced in ETSI SR 000 314 (or the updates on the ETSI Web server) which are, or may be, or may become, essential to the present document.

---

## Foreword

This Technical Specification (TS) has been produced by ETSI Technical Committee Satellite Earth Stations and Systems (SES).

The contents of the present document are subject to continuing work within TC-SES and may change following formal TC-SES approval. Should TC-SES modify the contents of the present document it will then be republished by ETSI with an identifying change of release date and an increase in version number as follows:

Version 3.m.n

where:

- the third digit (n) is incremented when editorial only changes have been incorporated in the specification;
- the second digit (m) is incremented for all other types of changes, i.e. technical enhancements, corrections, updates, etc.

The present document is part 3, sub-part 22 of a multi-part deliverable covering the GEO-Mobile Radio Interface Specifications (Release 3); Third Generation Satellite Packet Radio Service, as identified below:

Part 1: "General specifications";

Part 2: "Service specifications";

**Part 3: "Network specifications":**

Sub-part 1: "Network Functions";

Sub-part 2: "Network Architecture";

Sub-part 3: "Numbering, addressing and identification";

Sub-part 4: "Organization of Subscriber Data";

Sub-part 5: "Technical realization of Supplementary Services";

Sub-part 6: "Location Registration and Position Identification Procedures";

Sub-part 7: "Discontinuous Reception (DRX)";

Sub-part 8: "Support of Dual-Tone Multifrequency Signalling (DTMF)";

Sub-part 9: "Security related Network Functions";

Sub-part 10: "Functions related to Mobile Earth Station (MES) in idle mode";

Sub-part 11: "Technical realization of the Short Message Service (SMS) Point-to-Point (PP)";

Sub-part 12: "Technical realization of the Short Message Service Cell Broadcast (SMSCB)";

- Sub-part 13: "Technical realization of group 3 facsimile using transparent mode of transmission";
- Sub-part 14: "Transmission Planning Aspects of the Speech Service in the GMR-1 system";
- Sub-part 15: "Line Identification supplementary service - Stage 2";
- Sub-part 16: "Call Barring (CB) supplementary services - Stage 2";
- Sub-part 17: "Unstructured Supplementary Service Data (USSD) - Stage 2";
- Sub-part 18: "Terminal-to-Terminal Call (TtT)";
- Sub-part 19: "Optimal Routing technical realization";
- Sub-part 20: "Technical realization of High-Penetration Alerting";
- Sub-part 21: "Position Reporting services; Stage 2 Service description";
- Sub-part 22: "Overall description of the GMPRS radio interface; Stage 2";**
- Sub-part 23: "Radio Access Network; Overall description - Stage 2";
- Part 4: "Radio interface protocol specifications";
- Part 5: "Radio interface physical layer specifications";
- Part 6: "Speech coding specifications";
- Part 7: "Terminal adaptor specifications".

---

## Introduction

GMR stands for GEO (Geostationary Earth Orbit) Mobile Radio interface, which is used for Mobile Satellite Services (MSS) utilizing geostationary satellite(s). GMR is derived from the terrestrial digital cellular standard GSM and supports access to GSM core networks.

The present document is part of the GMR Release 3 specifications. Release 3 specifications are identified in the title and can also be identified by the version number:

- Release 1 specifications have a GMR 1 prefix in the title and a version number starting with "1" (V1.x.x).
- Release 2 specifications have a GMPRS 1 prefix in the title and a version number starting with "2" (V2.x.x).
- Release 3 specifications have a GMR-1 3G prefix in the title and a version number starting with "3" (V3.x.x).

The GMR release 1 specifications introduce the GEO Mobile Radio interface specifications for circuit mode Mobile Satellite Services (MSS) utilizing geostationary satellite(s). GMR release 1 is derived from the terrestrial digital cellular standard GSM (phase 2) and it supports access to GSM core networks.

The GMR release 2 specifications add packet mode services to GMR release 1. The GMR release 2 specifications introduce the GEO Mobile Packet Radio Service (GMPRS). GMPRS is derived from the terrestrial digital cellular standard GPRS (included in GSM Phase 2+) and it supports access to GSM/GPRS core networks.

The GMR release 3 specifications evolve packet mode services of GMR release 2 to 3rd generation UMTS compatible services. The GMR release 3 specifications introduce the GEO-Mobile Radio Third Generation (GMR-1 3G) service. Where applicable, GMR-1 3G is derived from the terrestrial digital cellular standard 3GPP and it supports access to 3GPP core networks.

Due to the differences between terrestrial and satellite channels, some modifications to the GSM or 3GPP standard are necessary. Some GSM and 3GPP specifications are directly applicable, whereas others are applicable with modifications. Similarly, some GSM and 3GPP specifications do not apply, while some GMR specifications have no corresponding GSM or 3GPP specification.

Since GMR is derived from GSM and 3GPP, the organization of the GMR specifications closely follows that of GSM or 3GPP as appropriate. The GMR numbers have been designed to correspond to the GSM and 3GPP numbering system. All GMR specifications are allocated a unique GMR number. This GMR number has a different prefix for Release 2 and Release 3 specifications as follows:

- Release 1: GMR n xx.zyy
- Release 2: GMPRS n xx.zyy
- Release 3: GMR-1 3G xx.zyy

where:

- xx.0yy ( $z = 0$ ) is used for GMR specifications that have a corresponding GSM or 3GPP specification. In this case, the numbers xx and yy correspond to the GSM or 3GPP numbering scheme.
- xx.2yy ( $z = 2$ ) is used for GMR specifications that do not correspond to a GSM or 3GPP specification. In this case, only the number xx corresponds to the GSM or 3GPP numbering scheme and the number yy is allocated by GMR.
- n denotes the first ( $n = 1$ ) or second ( $n = 2$ ) family of GMR specifications.

A GMR system is defined by the combination of a family of GMR specifications and GSM and 3GPP specifications as follows:

- If a GMR specification exists it takes precedence over the corresponding GSM or 3GPP specification (if any). This precedence rule applies to any references in the corresponding GSM or 3GPP specifications.

NOTE: Any references to GSM or 3GPP specifications within the GMR or 3GPP specifications are not subject to this precedence rule. For example, a GMR or 3GPP specification may contain specific references to the corresponding GSM or 3GPP specification.

- If a GMR specification does not exist, the corresponding GSM or 3GPP specification may or may not apply. The applicability of the GSM or 3GPP specifications is defined in GMR-1 3G 41.201 [10].



---

# 1 Scope

The present document provides the overall description for lower-layer functions of the GEO-Mobile Radio Third Generation Satellite Packet Radio Service (GMR-1 3G) radio interface.

The overall description provides the following information:

- The services offered to higher-layer functions.
- The distribution of required functions into functional groups.
- A definition of the capabilities of each functional group.
- Service primitives for each functional group, including a description of what services and information flows are to be provided.
- A model of operation for information flows within and between the functions.

The present document is applicable to the following GMR-1 3G functional layers:

- Radio Link Control functions.
- Medium Access Control functions.
- Physical Link Control functions.

The present document describes the information transfer and control functions to be used across the GMR-1 3G radio interface for communication between the MES and the Network (see figure 1).

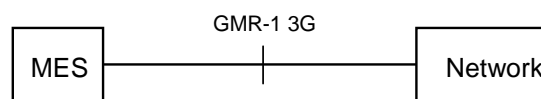

**Figure 1: Scope of GMR-1 3G logical radio interface architecture**

The overall GMR-1 3G logical architecture and the GMR-1 3G functional layers above the Radio Link Control and Medium Access Control layer are the same as GSM/GPRS as described in 3GPP TS 23.060 [3].

GMR-1 3G 24.007 [5] contains a description in general terms of the structured functions and procedures of this protocol and the relationship of this protocol with other layers and entities.

GMR-1 3G 44.008 [6] contains the definition of GMR-1 3G RLC/MAC procedures when operating on the Common Control Channel (CCCH).

GMR-1 3G 44.060 [7] contains the definition of RLC/MAC functions when operating on a Packet Data Channel (PDCH).

The functional procedures for the Logical Link Control (LLC) layer above the RLC/MAC are the same as GSM/GPRS as described in 3GPP TS 44.064 [8].

GMR-1 05.001 and the GMR-1 3G 45-series defines the Physical Link layer and Physical RF layer (see [11] to [17]).

---

## 2 References

References are either specific (identified by date of publication and/or edition number or version number) or non-specific. For specific references, only the cited version applies. For non-specific references, the latest version of the reference document (including any amendments) applies.

Referenced documents which are not found to be publicly available in the expected location might be found at <http://docbox.etsi.org/Reference>.

NOTE: While any hyperlinks included in this clause were valid at the time of publication ETSI cannot guarantee their long term validity.

### 2.1 Normative references

The following referenced documents are necessary for the application of the present document.

In the case of a reference to a 3GPP document (including a GSM document), a non-specific reference implicitly refers to the latest version of that document *in the same Release as the present document*.

- [1] GMPRS-1 01.004 (ETSI TS 101 376-1-1): "GEO-Mobile Radio Interface Specifications (Release 2) General Packet Radio Service; Part 1: General specifications; Sub-part 1: Abbreviations and acronyms".

NOTE: This is a reference to a GMR-1 Release 2 specification. See the introduction for more details.

- [2] 3GPP TS 22.060 (ETSI TS 122 060): "3rd Generation Partnership Project; Technical Specification Group Services and System Aspects; General Packet Radio Service (GPRS); Service description, Stage 1 (Release 6)".
- [3] 3GPP TS 23.060 (ETSI TS 123 060): "3rd Generation Partnership Project; Technical Specification Group Services and System Aspects; General Packet Radio Service (GPRS); Service description; Stage 2 (Release 6)".
- [4] GMR-1 3G 44.004 (ETSI TS 101 376-4-4): "GEO-Mobile Radio Interface Specifications (Release 3); Third Generation Satellite Packet Radio Service; Part 4: Radio interface protocol specifications; Sub-part 4: Layer 1 General Requirements".
- [5] GMR-1 3G 24.007 (ETSI TS 101 376-4-7): "GEO-Mobile Radio Interface Specifications (Release 3); Third Generation Satellite Packet Radio Service; Part 4: Radio interface protocol specifications; Sub-part 7: Mobile Radio Interface Signalling Layer 3 General Aspects".
- [6] GMR-1 3G 44.008 (ETSI TS 101 376-4-8): "GEO-Mobile Radio Interface Specifications (Release 3); Third Generation Satellite Packet Radio Service; Part 4: Radio interface protocol specifications; Sub-part 8: Mobile Radio Interface Layer 3 Specifications".
- [7] GMR-1 3G 44.060 (ETSI TS 101 376-4-12): "GEO-Mobile Radio Interface Specifications (Release 3); Third Generation Satellite Packet Radio Service; Part 4: Radio interface protocol specifications; Sub-part 12: Mobile Earth Station (MES) - Base Station System (BSS) interface; Radio Link Control/Medium Access Control (RLC/MAC) protocol".
- [8] 3GPP TS 44.064 (ETSI TS 144 064): "3rd Generation Partnership Project; Technical Specification Group Core Network; Mobile Station - Serving GPRS Support Node (MS-SGSN); Logical Link Control (LLC) layer specification; (Release 6)".
- [9] 3GPP TS 44.065 (ETSI TS 144 065): "3rd Generation Partnership Project; Technical Specification Group Core Network and Terminals; Mobile Station (MS) - Serving GPRS Support Node (SGSN); Subnetwork Dependent Convergence Protocol (SNDPCP) (Release 6)".
- [10] GMR-1 3G 41.201 (ETSI TS 101 376-1-2): "GEO-Mobile Radio Interface Specifications (Release 3); Third Generation Satellite Packet Radio Service; Part 1: General specifications; Sub-part 2: Introduction to the GMR-1 family".

- [11] GMR-1 05.001 (ETSI TS 101 376-5-1): "GEO-Mobile Radio Interface Specifications (Release 1); Part 5: Radio interface physical layer specifications; Sub-part 1: Physical Layer on the Radio Path: General Description".

NOTE: This is a reference to a GMR-1 Release 1 specification. See the introduction for more details.

- [12] GMR-1 3G 45.002 (ETSI TS 101 376-5-2): "GEO-Mobile Radio Interface Specifications (Release 3); Third Generation Satellite Packet Radio Service; Part 5: Radio interface physical layer specifications; Sub-part 2: Multiplexing and Multiple Access; Stage 2 Service Description".
- [13] GMR-1 3G 45.003 (ETSI TS 101 376-5-3): "GEO-Mobile Radio Interface Specifications (Release 3); Third Generation Satellite Packet Radio Service; Part 5: Radio interface physical layer specifications; Sub-part 3: Channel Coding".
- [14] GMR-1 3G 45.004 (ETSI TS 101 376-5-4): "GEO-Mobile Radio Interface Specifications (Release 3); Third Generation Satellite Packet Radio Service; Part 5: Radio interface physical layer specifications; Sub-part 4: Modulation".
- [15] GMR-1 3G 45.005 (ETSI TS 101 376-5-5): "GEO-Mobile Radio Interface Specifications (Release 3); Third Generation Satellite Packet Radio Service; Part 5: Radio interface physical layer specifications; Sub-part 5: Radio Transmission and Reception".
- [16] GMR-1 3G 45.008 (ETSI TS 101 376-5-6): "GEO-Mobile Radio Interface Specifications (Release 3); Third Generation Satellite Packet Radio Service; Part 5: Radio interface physical layer specifications; Sub-part 6: Radio Subsystem Link Control".
- [17] GMR-1 3G 45.010 (ETSI TS 101 376-5-7): "GEO-Mobile Radio Interface Specifications (Release 3); Third Generation Satellite Packet Radio Service; Part 5: Radio interface physical layer specifications; Sub-part 7: Radio Subsystem Synchronization".
- [18] GMR-1 3G 43.022 (ETSI TS 101 376-3-10): "GEO-Mobile Radio Interface Specifications (Release 3); Third Generation Satellite Packet Radio Service; Part 3: Network specifications; Sub-part 10: Functions related to Mobile Earth Station (MES) in idle mode".
- [19] GMR-1 3G 43.051 (ETSI TS 101 376-3-23): "GEO-Mobile Radio Interface Specifications (Release 3); Third Generation Satellite Packet Radio Service; Part 3: Network specifications; Sub-part 23: Radio Access Network; Overall description - Stage 2".

## 2.2 Informative references

The following referenced documents are not necessary for the application of the present document but they assist the user with regard to a particular subject area.

Not applicable.

---

# 3 Definitions, symbols and abbreviations

## 3.1 Definitions

For the purposes of the present document, the terms and definitions given in GMR-1 3G 41.201 [10], 3GPP TS 22.060 [2] and 3GPP TS 23.060 [3] and the following apply:

**A/Gb mode:** mode of operation of the MES when connected to the Core Network via GERAN and the A and/or Gb interfaces

**Iu mode:** mode of operation of the MES when connected to the Core Network via GERAN or UTRAN and the Iu interface

## 3.2 Symbols

For the purposes of the present document, the following symbols apply:

GMR-1 3G      Interface between MES and Satellite BSS

## 3.3 Abbreviations

For the purposes of the present document, the abbreviations given in GMPRS-1 01.004 [1] and the following apply:

UAT              Uplink Allocation Type

---

# 4 Packet data logical channels

NOTE: The text in this clause is informative. The normative text is in GMR-1 3G 45.002 [12]. Where there is a conflict between these descriptions, the normative text has precedence.

## 4.1 General

This clause describes the packet data logical channels that are supported by the radio subsystem. The packet data logical channels are mapped onto the physical channels that are dedicated to packet data.

The physical channel dedicated to packet data traffic is called a Packet Data Channel (PDCH) for A/Gb mode and PDCH3 for Iu mode. A PDCH or PDCH3 can carry common control channel (PCCCH) with the data and dedicated control channels.

Packet channels are defined for PDCH for 125 kHz and for 156,25 kHz carriers, which are each three timeslots or for 156,25 kHz which are twelve timeslots wide. Packet channels are also defined for PDCH for uplink 31,25 kHz carriers and downlink 62,5 kHz carriers, which are six timeslots wide.

Packet channels are defined for PDCH3 for 156,25 and 312,5 kHz which are each three timeslots wide or for 31,25 and 62,5 kHz which are each six timeslots wide or for 156,25 kHz which are twelve timeslots wide. Timeslots are defined in GMR-1 3G 45.002 [12].

In the context of RLC/MAC and other higher layers, the term *MAC-slot* is used to define a triad of timeslots containing a single Packet Access Burst or Packet Normal Burst. Thus there can be eight packet channels or one or more CCCH and packet channels carrying PCCCH in a 24 slot (8 MAC-slot) frame. The term 4-MAC-slot is used to define four consecutive MAC slots or twelve consecutive timeslots. The starting MAC-slot of a 4-MAC-slot can be any one of the eight MAC-slots in a frame. Depending on the starting MAC-slot, a 4-MAC-slot may span two consecutive frames.

An additional term is defined, which is the dual MAC-slot abbreviated as D-MAC-slot. A D-MAC-slot represents two consecutive MAC slots or six consecutive timeslots. A D-MAC slot  $k$  ( $0 \leq k \leq 3$ ) can be defined as a combination of MAC-slot  $2k$  and MAC-slot  $2k + 1$ .

## 4.2 Packet Common Control Channel (PCCCH)

PCCCH comprise logical channels for common control signalling used for packet data as described in the following clauses.

### 4.2.1 Packet Random Access Channels (PRACH) - uplink only

PRACH (A/Gb mode) or PRACH3 (Iu mode) are used by MES to initiate uplink transfer for sending data or signalling information. Packet Access Burst (PAB) is used on PRACH and PAB3 is used on PRACH3.

### 4.2.2 Packet Paging Channel (PPCH) - downlink only

PPCH is not supported in the GMR-1 3G.

### 4.2.3 Packet Access Grant Channel (PAGCH) - downlink only

PAGCH is used in the packet transfer establishment phase to send resource assignment to an MES prior to packet transfer.

### 4.2.4 Packet Notification Channel (PNCH) and compact packet notification channel - downlink only

These logical channels are currently not supported.

## 4.3 Packet Broadcast Control Channel (PBCCH) - downlink only

This logical channel is currently not supported.

For details of system information transmission for the GMR-1 3G air interface supporting packet data, refer to GMR-1 3G 44.008 [6] for details.

## 4.4 Packet traffic channels

### 4.4.1 Packet Data Traffic Channels (PDTCH)

PDTCH, PDTCH2 and PDTCH3 are channels allocated for data transfer. In the multislot operation, one MES may use multiple PDTCHs in parallel for individual packet transfer.

All packet data traffic channels are uni-directional, either uplink (PDTCH/U), for a mobile originated packet transfer or downlink (PDTCH/D) for a mobile terminated packet transfer.

## 4.5 Packet dedicated control channels

### 4.5.1 Packet Associated Control Channel (PACCH)

PACCH conveys signalling information related to a given MES. The signalling information includes examples of acknowledgments and power control information. PACCH also carries resource assignment and reassignment messages, comprising the assignment of a capacity for PDTCH(s) and for further occurrences of PACCH. The PACCH shares resources with PDTCHs that are currently assigned to one MES.

### 4.5.2 Packet Timing Advance Control Channel, Uplink (PTCCH/U) (A/Gb mode only)

PTCCH/U is used to transmit packet normal burst to allow estimation of the timing advance for one MES in packet transfer mode.

### 4.5.3 Packet Timing Advance Control Channel, Downlink (PTCCH/D) (A/Gb mode only)

PTCCH/D is used to transmit timing advance information updates to several MES. One PTCCH/D is paired with up to four PTCCH/Us. PTCCH/D is only transmitted on MAC slot 0.

### 4.5.4 Packet mode dedicated channels (DTCH) (lu mode only)

A dedicated traffic channel is used to carry user traffic when a dedicated channel (DCH) is allocated to the MES. DTCH are defined for 31,25 kHz carriers and are three, six or eight timeslots wide.

## 5 Mapping of packet data logical channels onto physical channels

NOTE: The text in this clause is informative. The normative text is in GMR-1 3G 45.002 [12]. Where there is a conflict between these descriptions, the normative text has precedence.

### 5.1 General

Different packet data logical channels can occur on the same physical channel (PDCH for A/Gb mode or PDCH3 for Iu mode). The sharing of the physical channel is based on MAC-slots, each of which corresponds to a single burst. The mapping in frequency of PDCH or PDCH3 on to the physical channel shall be as defined in GMR-1 3G 45.002 [12].

On PRACH or PRACH3, packet access bursts (PAB or PAB3) are used. On all other packet data logical channels, MAC/RLC blocks comprising a single Packet Normal Burst PNB(m, n), PNB2(m, n) or PNB3(m, n) is used, corresponding to the PDCH, in the case of PNB or PNB2, or PDCH 3, in the case of PNB3 on which the logical channel is allocated.

### 5.2 Packet Common Control Channels (PCCCH)

At a given time, the logical channels of the PCCCH are mapped on different physical resources than the logical channels of the CCCH.

The PCCCH does not have to be allocated permanently in the cell.

One given MES may use only a subset of the PCCCH, the subset being mapped onto one physical channel (PDCH or PDCH3).

The PCCCH, when it exists, is mapped on one or several physical channels according to a 16-multiframe; in that case the PCCCH shares the same PDCH with PDTCH or PDTCH2 or the same PDCH3 with PDTCH3.

The existence and location of the PCCCH shall be broadcast on the BCCH in the spotbeam. The BCCH identifies each frequency that carries the PCCCH and further information which helps the MES access the PCCCH.

#### 5.2.1 Packet Random Access Channel (PRACH)

The PRACH is mapped on one or several physical channels. The physical channels on which the PRACH is mapped are derived by the MES from information broadcast on the BCCH.

The MES can send a PRACH to the network in the following two ways as described in clauses 5.2.1.1 and 5.2.1.2.

##### 5.2.1.1 PRACH on the same carrier

PRACH is determined by the Uplink State Flag, marked as "free", that is broadcast continuously on the corresponding downlink (see clause 6.6.4.1).

Since the PRACH uses a bandwidth of only 31,25 kHz, whereas the PDCH uses bandwidths that are  $m \times 31,25$  kHz ( $m = 1, 2, 4, 5, 10$ ), it is possible to overlay multiple PRACH slots over a single unused PDCH slot, with each PRACH slot using one 31,25 kHz chunk of the PDCH bandwidth. The BCCH system information parameter PRACH\_OVERLAY indicates whether this feature is supported or not. If this feature is supported, the system information parameter PRACH\_OVERLAY\_CHAN indicates the maximum number of PRACHs that may be overlaid on a single PDCH slot; i.e. the number of overlaid PRACH slots may be less, depending on the network capabilities and PRACH demand. If multiple PRACH overlay is activated, the PRACH slots are allocated from the lower edge of the sub-band (see GMR-1 3G 45.002 [12] for more details). The MES should randomly choose one of the overlaid frequencies for transmission of the Packet Access Burst (PAB). In case of failure, the MES should continue to use the same frequency and wait for subsequent empty slots.

If the USF on the corresponding downlink burst indicates that the PRACH slot is free, it indicates that all the permitted overlaid slots are free for PRACH transmission.

### 5.2.1.2 PRACH on a separate carrier

The MES has PRACH opportunities in every frame on the ARFCN and in any MAC slot from the MAC slots assigned by the network as specified in the BCCH SI (see GMR-1 3G 44.008 [6]). The choice of the MAC slot among the assigned MAC slots is made randomly.

## 5.2.2 Packet Paging Channel (PPCH)

The Packet Paging Channel is not supported in the GMR-1 3G system. For details of paging for packet terminals, refer to GMR-1 3G 44.008 [6].

## 5.2.3 Packet Access Grant Channel (PAGCH)

The PAGCH is mapped on one or several physical channels. The exact mapping on each physical channel follows a predefined rule (see clause 6.1.2).

The physical channels on which the PAGCH is mapped, as well as the rule that is followed on the physical channels, are derived by the MES from information broadcast on the BCCH.

## 5.2.4 Packet Notification Channel (PNCH)

These channels are not used in GMR-1 3G.

## 5.3 Packet Broadcast Control Channel (PBCCH)

These channels are not used in GMR-1 3G.

### 5.3.1 Compact Frequency Correction Channel (CFCCH)

This channel is not used in GMR-1 3G.

### 5.3.2 Compact Synchronization Channel (CSCH)

This channel is not used in GMR-1 3G.

## 5.4 Packet Timing Advance Control Channel (PTCCH) (A/Gb mode only)

The PTCCH shall be present on any given PDCH in A/Gb mode only. For even-numbered multiframes (counting from the beginning of every hyperframe), the PTCCH/U shall be present on PDCH corresponding to MAC-slots 0, 2, 4 and 6 and on odd numbered multiframes, it shall be present on PDCH corresponding to MAC-slots 1, 3, 5, 7 in the MAC-slot B9. The PTCCH/D occurs, if necessary on the 0<sup>th</sup> MAC-slot of a fixed frame (as defined in GMR-1 3G 45.010 [17]) of each multiframe and corresponds to all the PTCCH/U transmissions of the previous multiframe. It is dynamically multiplexed with PDTCH and PACCH on the same PDCH i.e. if there is no PTCCH allocated, the corresponding block is used for PDTCH or PACCH.

On PTCCH/D, a single Packet Normal Burst is used, corresponding to the nature of the PDCH on which the channel is multiplexed. The PTCCH/D transmission is identified by a message type. Answers to multiple PTCCH/U bursts come on the same PTCCH/D channel. On PTCCH/D most robust modulation and coding available in downlink direction shall be used. For details, refer to GMR-1 3G 45.010 [17].

PTCCH is not used in Iu mode.

## 5.5 Packet traffic channels

### 5.5.1 Packet Data Traffic Channel (PDTCH and PDTCH2) (A/Gb mode only)

One PDTCH or PDTCH2 is mapped onto one physical channel.

Up to eight PDTCHs within a PDCH(4,3) or PDCH(5,3), with different MAC-slots but with the same frequency parameters, may be allocated to one MES at the same time. The frequency parameters include both the carrier as well as the bandwidth.

Up to two PDTCHs within a PDCH(5,12) with different 4-MAC-slots but with the same frequency parameters may be allocated to one MES at the same time. The frequency parameters include both the carrier as well as the bandwidth.

Up to four PDTCHs within a PDCH/D(2,6) or PDCH/U(1,6), with different D-MAC-slots but with the same frequency parameters, may be allocated to one MES at the same time. The frequency parameters include both the carrier as well as the bandwidth.

#### 5.5.1a Packet Data Traffic Channel (PDTCH3) (Iu mode only)

One PDTCH3 is mapped onto one physical channel.

Up to eight PDTCH3s within a PDCH3(5,3) or PDCH3(10,3), with different MAC-slots but with the same frequency parameters, may be allocated to one MES at the same time on the downlink. The frequency parameters include both the carrier as well as the bandwidth.

Up to two PDTCH3s within a PDCH3(5,12) with different 4-MAC-slots but with the same frequency parameters may be allocated to one MES at the same time on the downlink. The frequency parameters include both the carrier as well as the bandwidth.

Up to four PDTCHs within a PDCH3(2,6) or PDCH3(1,6), with different D-MAC-slots but with the same frequency parameters, may be allocated to one MES at the same time on the downlink. The frequency parameters include both the carrier as well as the bandwidth.

Any combination of PDTCH3(m,n) bursts may be mapped onto a PDCH3(2,n) or PDCH3(5,n) on the uplink provided the allocations are non-overlapping in time and frequency.

Any combination of PDCH3/U may be paired with a PDCH3/D provided the total bandwidth of the uplink channels is equal to or less than the bandwidth of the downlink PDCH3.

Additionally, dedicated traffic channels (DTCH) may be multiplexed with PDTCH3 packet data channels on the same carrier.

### 5.5.2 Packet Associated Control Channel (PACCH)

PACCH is dynamically allocated on the same physical channel as carrying PDTCHs, PDTCH2s, or PDTCH3s.

PACCH is of a bi-directional nature, i.e. it can dynamically be allocated both on the uplink and on the downlink irrespective of whether the corresponding PDTCH assignment is for uplink or downlink.

When PDTCH(s) is assigned on the uplink, the corresponding downlink MAC-slot on all frames have to be continuously monitored by the MES for possible occurrences of PACCH in the downlink direction. The MES can use the uplink assignment for sending PACCH transmissions whenever needed. However, if the network polls the MES for control information the response has to go on the allocated resource.

When PDTCH(s) is assigned on the downlink, every occurrence of an uplink PACCH MAC/RLC block is determined by polling in the preceding corresponding downlink MAC-slot (transferred on the same PDCH) by setting the appropriate bits in the RLC/MAC header. The network can use the downlink assignment for sending PACCH transmissions whenever needed. Downlink MAC/RLC blocks containing PACCH are transmitted by the network as part of the downlink transmission in the PDTCH, using "burst stealing" mechanism.



## 5.6 Downlink resource sharing

Different packet data logical channels can be multiplexed on the downlink on the same physical channel (PDCH). See details in GMR-1 3G 45.002 [12]. The type of message indicated in the RLC/MAC control block allows differentiation between the logical channels. Additionally, the MES identity allows the MES to determine if the received PDTCHs and PACCH were directed to it.

In A/Gb mode, in addition to the multiplexing of data logical channels, a downlink 156,25 kHz PDCH carrier can be used to dynamically multiplex PDCH(5,3) and PDCH(5,12) physical channels. Information contained in the radio burst header allows differentiation between downlink PDCH(5,3) and PDCH(5,12).

In Iu mode, in addition to the multiplexing of data logical channels, a downlink 156,25 kHz PDCH3 carrier can be used to dynamically multiplex PDCH3(5,3) and PDCH3(5,12) physical channels. Information contained in the radio burst header allows differentiation between downlink PDCH3(5,3) and PDCH3(5,12).

## 5.7 Uplink resource sharing (A/Gb mode)

Different packet data logical channels can be multiplexed on the uplink of the same physical channel (PDCH). See details in GMR-1 3G 45.002 [12]. The type of message that is indicated in the RLC/MAC block header allows differentiation between the logical channels. Additionally, the MES identity allows differentiation between PDTCHs and PACCHs assigned to different MESs.

In addition to the multiplexing of data logical channels, an uplink 156,25 kHz PDCH carrier can be used to dynamically multiplex PDCH(5,3) and PDCH(5,12) physical channels. Information contained in the radio burst header allows differentiation between uplink PDCH(5,3) and PDCH(5,12).

### 5.7a Uplink resource sharing (Iu mode)

Different packet data logical channels can be multiplexed on the uplink of the same physical channel (PDCH3). See details in GMR-1 3G 45.002 [12]. The type of message that is indicated in the RLC/MAC block header allows differentiation between the logical channels. Additionally, the MES identity allows differentiation between PDTCHs and PACCHs assigned to different MESs.

In addition to the multiplexing of data logical channels, an uplink PDCH3 carrier can be used to dynamically multiplex PDCH3(1,6), PDCH3(2,6), PDCH3(5,3) and PDCH3(5,12) physical channels. Information contained in the radio burst header allows differentiation between uplink PDCH(5,3) and PDCH(5,12).

## 5.8 Asymmetrical Pairing of PDCH/D(2,m) with PDCH/U(1,m)

The downlink 62,5 kHz PDCH carrier (carrying PDCH(2,m)) is paired with two uplink 31,25 kHz carriers; one carrying PDCH(1,6) and the other carrying PRACH. Refer to GMR-1 3G 45.002 [12] for further information regarding pairing of two uplink 31,25 kHz carriers with one downlink 62,5 kHz carrier. Refer to GMR-1 3G 44.008 [6] for description on how the network conveys the information to the MES regarding its assignment of the one downlink 62,5 kHz channel and the corresponding two uplink 31,25 kHz channels.

---

## 6 Radio interface

The logical architecture of the GMR-1 3G radio interface can be described using a reference model consisting of functional layers as shown in figure 3. Layering provides a mechanism for partitioning communications functions into manageable subsets.

Communication between the MES and the Network occurs at the Physical RF, Physical Link, Radio Link Control/Medium Access Control (RLC/MAC), Logical Link Control (LLC), and SubNetwork Dependent Convergence Protocol (SNDCP) layers.

## 6.1 Radio resource management principles

### 6.1.1 Allocation of resources for GMR-1 3G

A spotbeam supporting GMPRS may allocate resources on one or several physical channels in order to support the GMPRS traffic. Those physical channels (PDCHs), shared by the MESSs, are taken from the common pool of physical channels available in the spotbeam. The allocation of physical channels to circuit switched services and GMPRS is done dynamically, according to the "capacity on demand" principles described below.

Common control signalling required by GMPRS in the initial phase of the packet transfer is conveyed on PCCCH, or on CCCH.

The main control channels are the BCCH, PCH, RACH, and AGCH, which are carried on a channel, as in the circuit switched air interface, as described in GMR-1 3G 44.008 [6]. PRACH and PAGCH may be present on one or more PDCHs on one or more sub-bands in the spotbeam. However, their operation is independent of each other. There will be one channel in each spotbeam that carries the BCCH on the downlink. There will be at least one physical channel in each cell which carries the AGCH and PCH on the downlink and the RACH on the uplink, which may be paired with the BCCH. This channel is to be used by all MESSs accessing the system and whose current state does not conform to the PRACH usage requirements as described in GMR-1 3G.44.060 [7] and GMR-1 3G 45.010 [17]. This channel shall also be used by all MESSs that have moved into this spot-beam for the first time.

#### 6.1.1.1 Master-slave concept

There is no master-slave concept in the GMR-1 3G air interface.

#### 6.1.1.2 Capacity on demand concept

GMR-1 3G does not require permanently allocated PDCHs. The allocation of capacity for GMR-1 3G can be based on the needs for actual packet transfers which are here referred to as the "capacity on demand" principle. The operator can, as well, decide to dedicate permanently or temporarily some physical resources (PDCHs) for the GMPRS traffic.

When the PDCHs are congested due to the GMPRS traffic load and more resources are available in the spotbeam, the Network can allocate more physical channels as PDCHs.

However, the existence of PDCHs does not imply the existence of PCCCH. The PDCHs which do carry PCCCH are indicated as part of the system information transmission.

All MESSs are required to camp on the CCCH which carries the PCH. There will be one CCCH per spotbeam at least.

In response to a Packet Channel Request sent on CCCH from the MES that wants to transmit GMPRS packets, the network can assign resources on PDCHs for the uplink transfer. After the transfer, the MES returns to CCCH.

The information about PCCCH is broadcast on BCCH. When the PCCCH capacity is inadequate, it is possible to allocate additional PCCCH resources on one or several PDCHs.

#### 6.1.1.3 Procedures to support capacity on demand

The number of allocated PDCHs in a spotbeam can be increased or decreased according to demand. The following principles can be used for the allocation:

- Load supervision:
  - A load supervision function may monitor the load of the PDCHs and the number of allocated PDCHs in a spotbeam can be increased or decreased according to demand. Load supervision function may be implemented as a part of the Medium Access Control (MAC) functionality or as a generic resource management functionality. The common channel allocation function located in BSC is used for the circuit switched services.
- Dynamic allocation of PDCHs:
  - Unused channels can be allocated as PDCHs to increase the overall quality of service for GMR-1 3G.

- Upon resource demand for other services with higher priority, de-allocation of PDCHs can take place.

#### 6.1.1.4 Release of PDCH not carrying PCCCH

The fast release of PDCH is an important feature for the possibility to dynamically share the same pool of radio resources for packet and circuit-switched services.

There are the following possibilities:

- **Wait for all the assignments to terminate on that PDCH** if necessary, the network can force a release by sending a PACKET TBF RELEASE.
- **Individually notify all the users that have assignment on that PDCH.**

In practice, a combination of both the methods can be used.

The case may occur where an MES remains unaware of the released PDCH. In that case, such MES may cause some interference when wrongly assuming that the decoded Uplink State Flag (see clause 6.6.4.1) denotes the following uplink MAC-slot/D-MAC-slot/4-MAC-slot reserved to it. This would cause both MESs to transmit in the same MAC-slot/D-MAC-slot/4-MAC-slot and neither the transmissions would get through. After not getting proper response from the network, the MES would self-break the RLC connection. For an unacknowledged mode transfer, the network itself would detect that the allocations are not being used and would, based on its internal counters, tear down the TBF.

### 6.1.2 Multiframe structure for PDCH

NOTE: The text in this clause is informative. The normative text is in GMR-1 3G 45.002 [12]. Where there is a conflict between these descriptions, the normative text has precedence.

The mapping in time of the logical channels is defined by a multiframe structure. The multiframe structure for PDCH consists of 16 TDMA frames according to figure 2. The consecutive MAC-slots in the successive frames are numbered as shown below.

B0	B1	B2	B3	B4	B5	B6	B7	B8	B9	B10	B11	B12	B13	B14	B15
----	----	----	----	----	----	----	----	----	----	-----	-----	-----	-----	-----	-----

**Figure 2: Multiframe structure for PDCH**

Note that if a PDCH is marked as carrying PCCCH the MES shall assume that all MAC-slots on the uplink may support PRACH (marked by USF\_FREE) and all MAC-slots on the downlink may carry PAGCH.

On all PDCHs the MAC-slot marked B8 is reserved for PTCCH/D and all other MAC-slots can be used as PDTCH or PACCH on the downlink. The actual usage is indicated by the message type. On the uplink, the last MAC-slot can be reserved for PTCCH/U on a multiframe to multiframe basis and the remaining MAC-slot are to be used for PDTCH and PACCH. If a given MAC-slot is allocated for PTCCH/U, it shall be marked with the USF value of RESERVED in the previous corresponding downlink frame.

## 6.2 Radio resource operating modes

Radio Resource (RR) management procedures are characterized by two different RR operating modes. Each mode describes a certain amount of functionality and information allocated. RR procedures and RR operating modes are specified in GMR-1 3G 24.007 [5].

### 6.2.1 Packet idle mode

In packet idle mode no Temporary Block Flow (see clause 6.6.4.2) exists. Upper layers can require the transfer of a LLC PDU which, implicitly, may trigger the establishment of TBF and transition to packet transfer mode.

In packet idle mode, the MES listens to the BCCH and to the paging sub-channel for the paging group the MES belongs to in idle mode.

## 6.2.2 Packet transfer mode

In packet transfer mode, the mobile earth station is allocated radio resource providing a Temporary Block Flow on one or more physical data channels. Continuous transfer of one or more LLC PDUs is possible. Concurrent TBFs may be established in opposite directions. Refer to GMR-1 3G.44.060 [7]. Transfer of LLC PDUs in RLC acknowledged or RLC unacknowledged mode is provided.

## 6.2.3 Correspondence between radio resource operating modes and mobility management states

The Mobility Management states are the same as GSM/GPRS as defined in 3GPP TS 23.060 [3]. Table 1 provides the correspondence between Radio Resource states and Mobility Management states.

**Table 1: Correspondence between RR operating modes and MM states**

<b>Radio Resource BSS</b>	Packet transfer mode	No state	No state
<b>Radio Resource MES</b>	Packet transfer mode	Packet idle mode	Packet idle mode
<b>Mobility Management BSS and MES</b>	Ready		Standby

Each state is protected by a timer. The timers run in the MES and the network.

Packet transfer mode is guarded by RLC protocol timers. Note that the transition of mobility management at the BSS may be slightly out of synchronization with the state of the MES at the radio-resource level. For example, the Mobility Management state at the BSS may transit to Standby, even as the MES is in the process of setting up a radio-level connection to the BSS to transmit an LLC PDU.

## 6.3 Layered overview of radio interface (A/Gb mode only)

This clause applies only to the A/Gb mode. For Iu mode see GMR-1 3G 43.051 [19].

The GMR-1 3G radio interface can be modelled as a hierarchy of logical layers with specific functions. An example of such layering is shown in figure 3. The various layers are briefly described in the following clauses.

The physical layer has been separated into two distinct sub-layers defined by their functions:

- Physical RF layer performs the modulation of the physical waveforms based on the sequence of bits received from the Physical Link layer. The Physical RF layer also demodulates received waveforms into a sequence of bits which are transferred to the Physical Link layer for interpretation.
- Physical Link layer provides services for information transfer over a physical channel between the MES and the Network. These functions include data unit framing, data coding, and the detection and correction of physical medium transmission errors. The Physical Link layer uses the services of the Physical RF layer.

The lower part of the data link layer is defined by the following functions:

- The RLC/MAC layer provides services for information transfer over the physical layer of the GMR-1 3G radio interface. This information includes both user data, RLC signalling, and also signalling relating to radio resource management functions. These functions include backward error correction procedures enabled by the selective retransmission of erroneous blocks. The MAC function arbitrates access to the shared medium between a multitude of MESs and the Network. The RLC/MAC layer uses the services of the Physical Link layer. The layer above RLC/MAC (i.e. LLC described in 3GPP TS 23.060 [3] and defined in 3GPP TS 44.064 [8]) uses the services of the RLC/MAC layer on the GMR-1 3G radio interface.

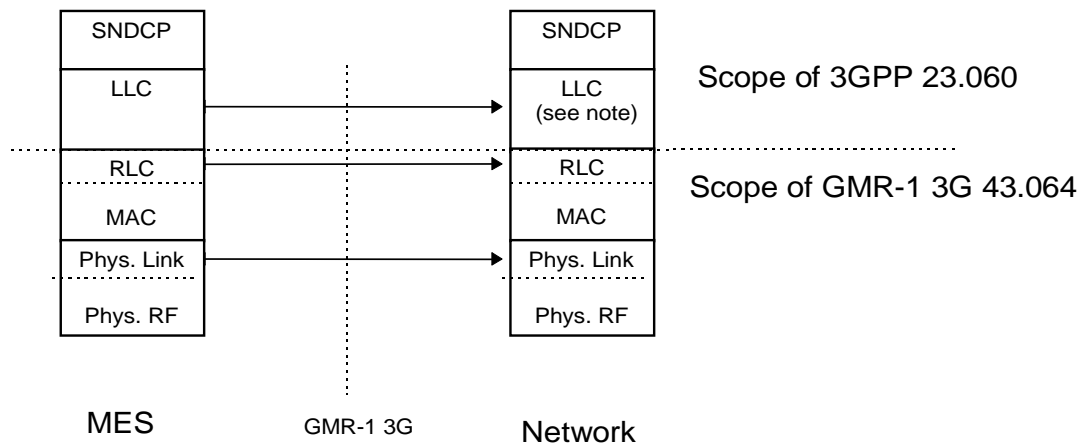

NOTE: In the network the LLC is split between Satellite BSS and SGSN.

**Figure 3: MES - Network reference model for A/Gb mode**

## 6.4 Physical RF layer

The Physical layer is defined in GMR-1 3G 45 series recommendations, which specify among other things:

- the carrier frequencies characteristics and GMR-1 3G radio channel structures (GMR-1 3G 45.002 [12]);
- the modulation of the transmitted wave forms and the raw data rates of GMR-1 3G channels (GMR-1 3G 45.004 [14]); and
- the transmitter and receiver characteristics and performance requirements (GMR-1 3G 45.005 [15]).

## 6.5 Physical link layer

The Physical Link layer operates above the physical RF layer to provide a physical channel between the MES and the Network.

### 6.5.1 Layer services

The purpose of the Physical Link layer is to convey information across the GMR-1 3G radio interface, including RLC/MAC information. The Physical Link layer supports multiple MESs sharing a single physical channel.

The Physical Link layer provides communication between MESs and the Network.

The Physical Link layer control functions provide the services necessary to maintain communications capability over the physical radio channel between the Network and MESs. Radio subsystem link control procedures are currently specified in GMR-1 3G 45.008 [16]. Handovers are not supported in the GMR-1 3G service at the radio-link level. MES performed spotbeam reselection is used as defined in GMR-1 3G 43.022 [18].

### 6.5.2 Layer functions

The Physical Link layer is responsible for:

- Forward Error Correction (FEC) coding, allowing the detection and correction of transmitted code words. The coding schemes are described in clause 6.5.5.
- Burst building of different sizes for different PDCHs, based on the bandwidth of the associated carrier.
- Procedures for detecting physical link congestion.
- FCS computation and checking.

The Physical Link layer control functions include:

- Synchronization procedures, including means for determining and adjusting the MES Timing Advance to correct for variances in propagation delay, GMR-1 3G 45.010 [17].
- Monitoring and evaluation procedures for radio link signal quality.
- Spotbeam selection and reselection procedures.
- Transmitter power control procedures.
- Battery power conservation procedures, e.g. Discontinuous Reception (DRX) procedures.

### 6.5.3 Service primitives

Table 2 lists the service primitives provided by the Physical Link layer to RLC/MAC layer. More detailed description is given in GMR-1 3G 44.004 [4].

**Table 2: Service primitives provided by the physical link layer**

Name	Request	Indication	Response	Confirm	Comments
PH-DATA	X	X			Used to pass message units containing frames used for RLC/MAC layer respective peer-to-peer communications to and from the physical layer.
PH-RANDOM ACCESS	X	X		X	Used to request and confirm (in the MES) the sending of a random access frame and to indicate (in the network) the arrival of a random access frame.
PH-CONNECT		X			Used to indicate that the physical connection on the packet data physical channel has been established.
PH-READY-TO-SEND	X				Used by the physical layer to trigger (if applicable) piggy backing, the start of timer for the RLC/MAC layer, and the forwarding of data unit to the physical layer.
PH-EMPTY-FRAME	X				Used by the RLC/MAC layer to indicate that no frame has to be transmitted after receiving the PH-READY-TO-SEND primitive.

### 6.5.4 Radio burst structure

Different radio burst structures for data transfer and control message transfer purposes are defined. The radio burst structure varies in dimensions for each class of PDCH or PDCH3, depending on the payload of the burst associated with that PDCH or PDCH3. For detailed definition of radio burst structure, see GMR-1 3G.44.060 [7].

For A/Gb mode, except for downlink PDCH(5,12) a radio burst for data transfer has two sections which carry payload bits. One is the PUI and the other is the PRI. Downlink PDCH(5,12) contains three sections, PUI, Extended PUI and PRI. The extended PUI section contains 30 bits, which contains the PUI type (and optionally a PUI subtype), two or three additional USFs and an 8 bit CRC field. The PUI contains 12 bits of information, which contains the USF, the modulation and coding scheme identifier and some other information. The PRI consists of one MAC/RLC header (5 bytes) and up to two optional control blocks of fixed size followed by the payload portion. The MAC/RLC header and the RLC block are protected by a 16 bit CRC footer. The entire radio block is always carried on a single Packet Normal Burst. The PUI and the PRI are separated by transition bits. Refer to GMR-1 3G 45.002 [12] for details.

For Iu mode, a radio burst for data transfer contains the PUI and PRI. In addition, a radio burst for PDCH3(5,n) or PDCH3(10,3) on the downlink may also contain an uplink map (UL-MAP). Radio bursts used for PDCH3 do not contain extended PRI.

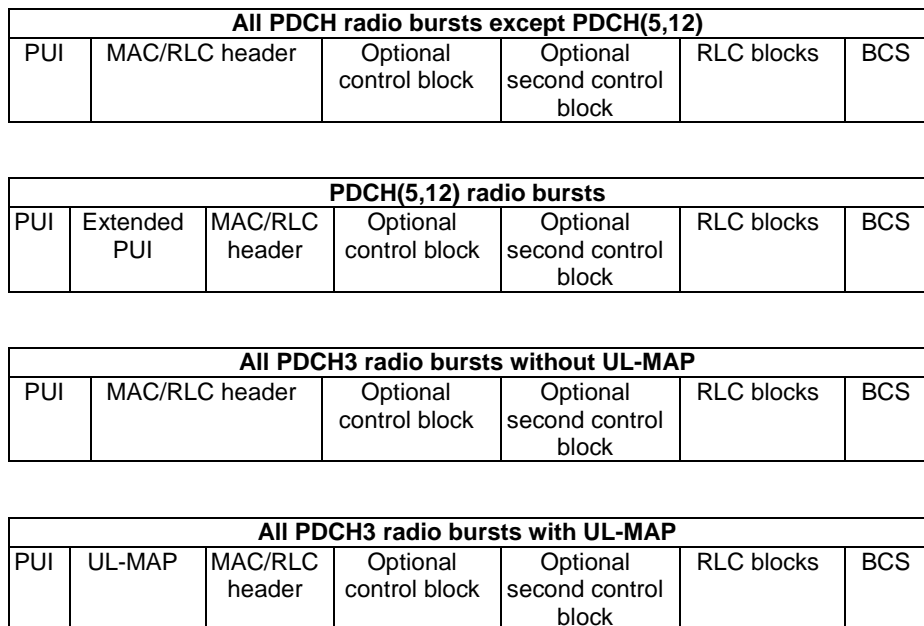

**Figure 4: Radio burst structures for data transfer for GMR-1 3G**

The MAC/RLC header contains control fields which are different for uplink and downlink directions. The MAC header has constant length, 40 bits.

The RLC data field contains octets from one or more LLC PDUs.

The Block Check Sequence (BCS) is used for error detection. There may be one or two optional control blocks inserted at the head of the message. Each control block has a fixed size of 18 octets and is independently coded. Either or both of them may be padded out to 18 octets, if there is insufficient control information to be filled in. The presence of the first control block is given by the payload type field in the MAC/RLC header. The presence of the second control block is given in the CBF bit of the previous control block. The rest of the burst may be blank if there is nothing else to be transmitted.

### 6.5.5 Channel coding (A/Gb mode)

**NOTE:** The text in this clause is informative. The normative text is in GMR-1 3G 45.003 [13]. Where there is a conflict between these descriptions, the normative text has precedence.

Many coding schemes are defined for the GMR-1 3G packet data traffic channels to support A/Gb mode. The GMR-1 3G air interface supports PDCHs of four different bandwidths ( $m = 1, 2, 4, \text{ or } 5$ ) defined as integrals multiples ( $m \times 31,25$  kHz) of the common channel size of 31,25 kHz. For all the downlink control messages, the basic modulation and coding scheme defined for the bandwidth of the associated PDCH is always used. For all GMR-1 3G packet control channels on the uplink other than Packet Random Access Channel (PRACH), the same modulation and coding scheme as assigned by the network for data transfer shall be used. For access bursts on PRACH, the modulation and coding scheme associated with the Packet Access Burst is used.

The basic modulation and coding scheme for any value of  $m$  is the most robust modulation and coding scheme available in a given direction. For details, refer to GMR-1 3G 44.060 [7]. Note that not all modulation and coding scheme combinations are supported in any given direction.

The MES has to support transmission/reception of the basic modulation and coding scheme for all bandwidth sizes that it supports wherever more than one modulation scheme is defined in a given direction and for a given value of " $m$ ". The basic coding scheme for all bandwidth sizes is mandatory for a network supporting GMR-1 3G.

Except for bursts on downlink PDCH(5,12), all bursts have two parts, a Public Information Part (PUI) and a user-payload. The public information (hereafter referred to as PUI) part is to be read and decoded by all MESs that are monitoring that particular PDCH. It is always coded in the same format, regardless of the coding of the rest of the burst. For details, refer to GMR-1 3G 45.003 [13]. Bursts on downlink PDCH(5,12) contains extended PUI part in addition to the PUI and the PRI.

The PUI contains the USF bits. It also contains the MCS bits which indicate the modulation, coding type, and coding rate used for the rest of the burst. The extended PUI contains two or three additional USF fields. The receiver itself must correlate the bandwidth and the contents of the MCS bits to identify the correct puncturing pattern. The PUI and extended PUI is always transmitted using  $\pi/4$ -CQPSK modulation and are encoded as defined in clause 6.5.5.1.1.1. All MESs shall have the capability to decode the PUI field for all bursts that it receives. The extended PUI shall be read and decoded by all MESs that are monitoring a particular downlink PDCH(5,12).

The coding for MCS bits is defined in GMR-1 3G 44.060 [7].

### 6.5.5.1 Channel coding for PDTCH and PDTCH2

#### 6.5.5.1.1 Channel coding for PDTCH

Each of the coding schemes for GMR-1 3G is built in the same way. The difference in coding rates is achieved by using different coding polynomials and different output burst sizes, depending on the bandwidth of the associated channels. The polynomials and output bursts are defined in GMR-1 3G 45.003 [13]. Figures 5 and 5a give the basic block structure.

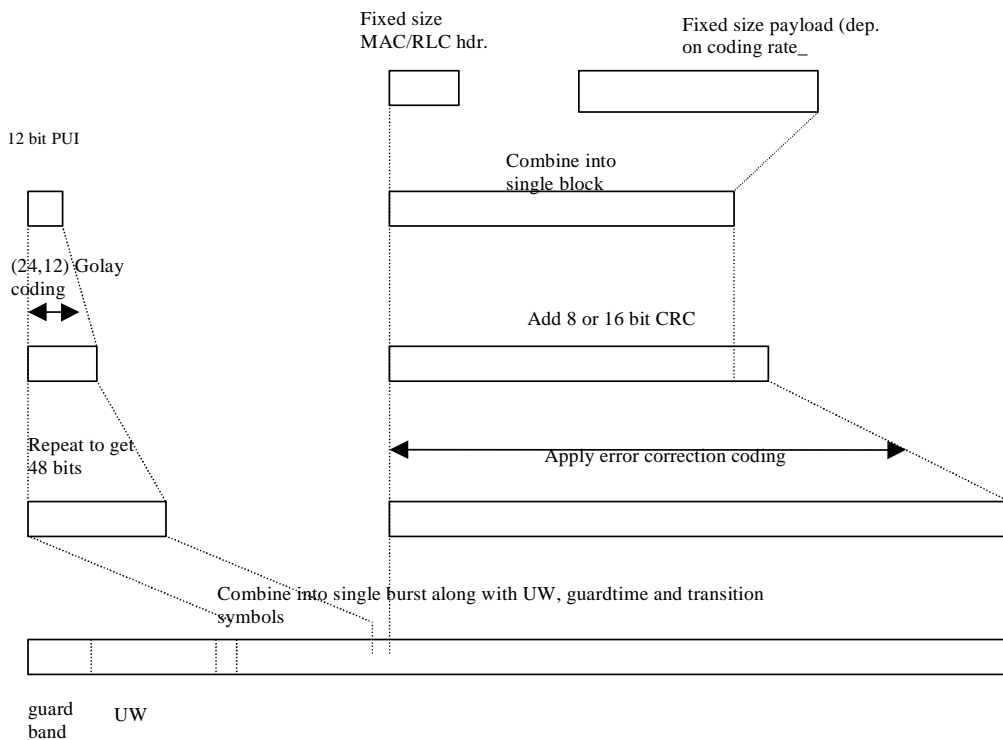

Figure 5: Downlink radio block structure for all MCS except PDCH(5,12)



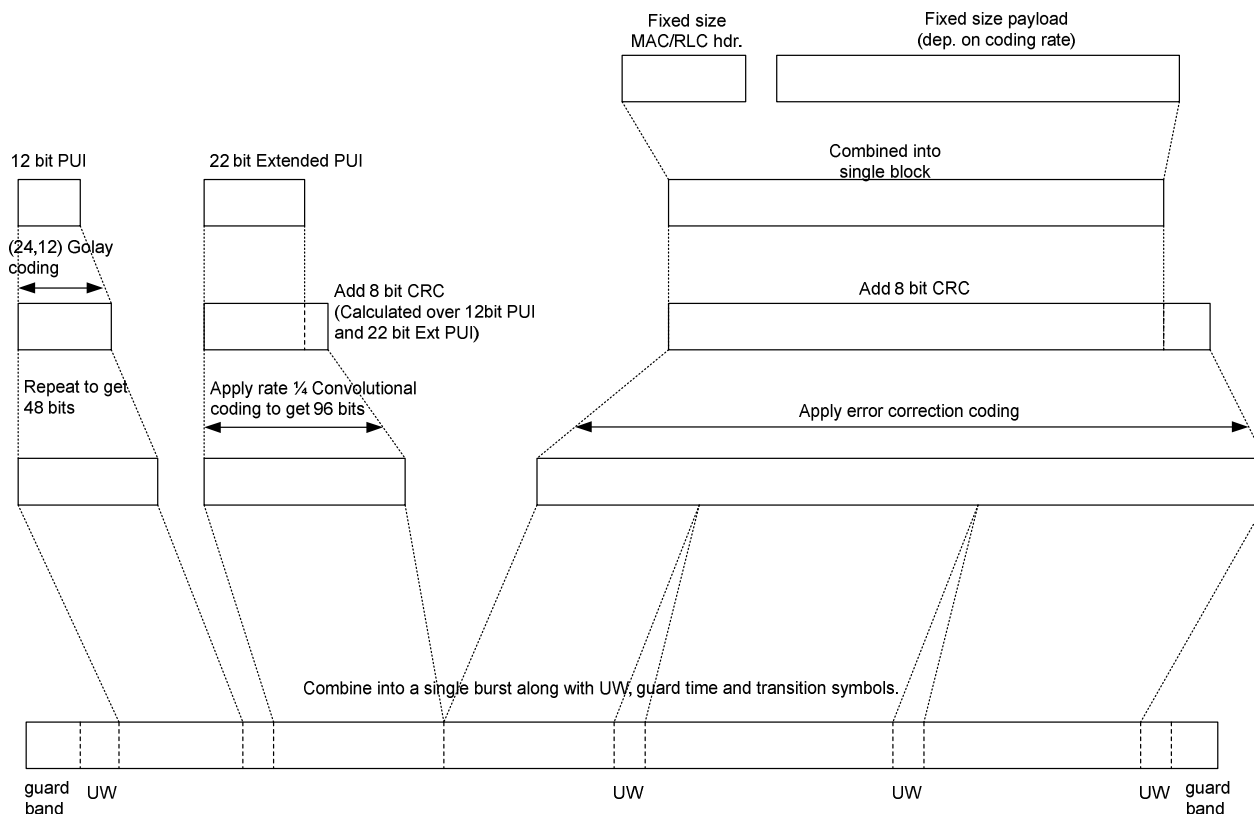

Figure 5a: Downlink radio block structure for PDCH(5,12)

6.5.5.1.1.1 Public information bits

The PUI consists of 12 bits. The format of PUI coding depends on the type of PDCH as well the direction. PUI coding formats are shown in tables 4a to 4e (the MSB is on the left hand side).

Table 3: Void

Table 4a: Downlink PUI field coding for PDCH(4,3) and PDCH(5,3)

MCS bits ( $b_{11} - b_8$ )	USF bits ( $b_7 - b_2$ )	Downlink Burst Duration ( $b_1$ )	USF Allocation Duration ( $b_0$ )
-----------------------------	--------------------------	-----------------------------------	-----------------------------------

Table 4b: Uplink PUI field coding for PDCH(4,n) and PDCH(5,n)

MCS bits ( $b_{11} - b_8$ )	Uplink PAN field ( $b_7 - b_2$ )	Uplink Burst Duration ( $b_1$ )	Spare ( $b_0$ )
-----------------------------	----------------------------------	---------------------------------	-----------------

Table 4c: Downlink PUI field coding for PDCH(2,n)

MCS bits ( $b_{11} - b_9$ )	USF bits ( $b_8 - b_4$ )	EXT bits ( $b_3 - b_1$ )	Spare ( $b_0$ )
-----------------------------	--------------------------	--------------------------	-----------------

Table 4d: Uplink PUI field coding for PDCH(1,n)

MCS bits ( $b_{11} - b_9$ )	Uplink PAN field ( $b_8 - b_3$ )	Spare ( $b_2 - b_0$ )
-----------------------------	----------------------------------	-----------------------

Table 4e: Downlink PUI field coding for PDCH(5,12)

MCS bits ( $b_{11} - b_8$ )	USF bits ( $b_7 - b_2$ )	Downlink Burst Duration ( $b_1$ )	Spare ( $b_0$ )
-----------------------------	--------------------------	-----------------------------------	-----------------

The MCS bits indicate the modulation, coding type, and coding rate used as indicated above. The USF bits are for uplink resource allocation and are only present in the downlink (forward direction); these are described subsequently. Uplink burst duration and Downlink burst duration bits are used only on PDCH(4,n), PDCH(5,n) and PDCH(5,12). These fields indicate the duration (5 ms or 20 ms) of the radio burst including the PUI. USF allocation duration bit is used only on downlink PDCH(4,3) and PDCH(5,3) to indicate if uplink allocation is on PDCH(4,3)/PDCH(5,3) or PDCH(5,12). The PAN bits are used to indicate transmitted power level of the MES to the network. The details are provided in GMR-1 3G 45.008 [16]. The EXT bits indicate the number of consecutive D-MAC slots the MES will transmit on the uplink upon detection of its USF in the downlink (see GMR-1 3G 44.060 [7]).

The 12 bit PUI header is subsequently Golay coded using a (24,12) Golay code. The Golay code output is repeated once to get a block of 48 bits.

#### 6.5.5.1.1.1a Extended Public information bits

The Extended PUI consists of 30 bits. There are two extended PUI coding formats. These are shown in tables 4f and 4g. USF2, USF3 and USF4 fields are used for signalling uplink resource allocation to multiple MESs (see GMR-1 3G 44.060 [7]). The 30-bit extended PUI is encoded using rate  $\frac{1}{4}$  convolutional code to obtain a 96 bit coded block. For details, refer to GMR-1 3G 45.003 [13].

**Table 4f: Downlink Extended PUI field coding for PDCH(5,12) with three USFs**

PUI Type (b <sub>29</sub> -b <sub>28</sub> )	USF2 (b <sub>27</sub> -b <sub>22</sub> )	USF3 (b <sub>21</sub> -b <sub>16</sub> )	USF4 (b <sub>15</sub> -b <sub>10</sub> )	Spare (b <sub>9</sub> -b <sub>8</sub> )	CRC (b <sub>7</sub> -b <sub>0</sub> )
--	--	--	--	---	---------------------------------------

**Table 4g: Downlink Extended PUI field coding for PDCH(5,12) with two USFs**

PUI Type (b <sub>29</sub> -b <sub>28</sub> )	PUI Subtype (b <sub>27</sub> -b <sub>25</sub> )	Reserved (b <sub>24</sub> -b <sub>22</sub> )	USF <sub>2</sub> (b <sub>21</sub> -b <sub>16</sub> )	USF <sub>3</sub> (b <sub>15</sub> -b <sub>10</sub> )	Spare (b <sub>9</sub> -b <sub>8</sub> )	CRC (b <sub>7</sub> -b <sub>0</sub> )
--	---	--	--	--	---	---------------------------------------

#### 6.5.5.1.1.2 Coding of user payload

The user payload consists of a fixed size MAC/RLC header, followed by up to two optional control blocks (each of a fixed size of 18 octets) followed by a single data payload.

For the user data payload, the first step of the coding procedure is to add a 16 bit Block Check Sequence (BCS) for error detection.

The second step consists of adding eight tail bits and applying a convolutional coder or applying LDPC coder without any tail bits. The coder polynomial varies according to the burst size and the burst class, as described in GMR-1 3G 45.003 [13]. The PUI bits, extended PUI bits (if applicable) and the coded user data are subsequently combined with the unique word, guard band, and transition ramp to create the output burst. The unique word bits are 44, 68, 40, 50 and 132 corresponding to PNB(1,6), PNB(2,6), PNB(4,3), PNB(5,3) and PNB(5,12) bursts. The guard bits are 10, 10, 40 and 50, respectively, for bandwidths of  $m = 1, 2, 4,$  and  $5,$  respectively.

The details of the codes are shown in table 5, including:

- The length of each field.
- The number of coded bits (after adding tail bits and convolutional coding).
- The number of punctured bits.
- The peak user data rate, including the RLC header and RLC information. This is the user data rate that can be achieved if the user is allocated all slots in all frames of a given PDCH of the corresponding bandwidth.

Table 5: Coding parameters for the PDCH coding schemes

B/W used	Modulation	Code Rate (CS)	Coding Type	Burst Duration (ms)	Coded Bits	Tail Bits	User Data in bytes	Uplink/ Downlink	Peak Data rate kbps
4	$\pi/4$ -CQPSK	0,747	Convolutional	5	792	8	71	U/D	113,6
4	$\pi/4$ -CQPSK	0,626	Convolutional	5	792	8	59	U/D	94,4
4	$\pi/4$ -CQPSK	0,505	Convolutional	5	792	8	47	U/D	75,2
5	$\pi/4$ -CQPSK	0,750	Convolutional	5	1 002	8	91	U/D	145,6
5	$\pi/4$ -CQPSK	0,631	Convolutional	5	1 002	8	76	U/D	121,6
5	$\pi/4$ -CQPSK	0,503	Convolutional	5	1 002	8	60	U/D	96,0
2	$\pi/4$ -CQPSK	0,592	Convolutional	5	810	8	59	D	47,2
2	$\pi/4$ -CQPSK	0,701	Convolutional	5	810	8	70	D	56,0
2	$\pi/4$ -CQPSK	0,809	Convolutional	5	810	8	80	D	64,0
1	$\pi/4$ -CQPSK	0,590	Convolutional	5	366	8	26	U	20,8
1	$\pi/4$ -CQPSK	0,699	Convolutional	5	366	8	31	U	24,8
1	$\pi/4$ -CQPSK	0,809	Convolutional	5	366	8	36	U	28,8
5	$\pi/4$ -CQPSK	0,509	LDPC	5	958	0	60	U/D	97,6
5	$\pi/4$ -CQPSK	0,660	LDPC	5	958	0	78	U/D	126,4
5	$\pi/4$ -CQPSK	0,793	LDPC	5	958	0	94	U/D	152,0
5	$\pi/4$ -CQPSK	0,894	LDPC	5	958	0	106	U/D	171,2
5	16 APSK	0,664	LDPC	5	1 916	0	158	U/D	254,4
5	16 APSK	0,797	LDPC	5	1 916	0	190	U/D	305,6
5	16 APSK	0,898	LDPC	5	1 916	0	214	U	344,0
5	32 APSK	0,748	LDPC	5	2 395	0	223	D	358,4
5	32 APSK	0,798	LDPC	5	2 395	0	238	D	382,4
5	$\pi/4$ -CQPSK	0,497	LDPC	20	4 440	0	275	U	110,4
5	$\pi/4$ -CQPSK	0,508	LDPC	20	4 344	0	275	D	110,4
5	$\pi/4$ -CQPSK	0,667	LDPC	20	4 440	0	369	U	148,0
5	$\pi/4$ -CQPSK	0,681	LDPC	20	4 344	0	369	D	148,0
5	$\pi/4$ -CQPSK	0,800	LDPC	20	4 440	0	443	U	177,6
5	$\pi/4$ -CQPSK	0,818	LDPC	20	4 344	0	443	D	177,6
5	$\pi/4$ -CQPSK	0,899	LDPC	20	4 440	0	498	U	199,6
5	$\pi/4$ -CQPSK	0,919	LDPC	20	4 344	0	498	D	199,6
5	16 APSK	0,667	LDPC	20	8 880	0	741	U	296,0
5	16 APSK	0,681	LDPC	20	8 688	0	741	D	296,0
5	16 APSK	0,800	LDPC	20	8 880	0	887	U	355,2
5	16 APSK	0,818	LDPC	20	8 688	0	887	D	355,2
5	16 APSK	0,900	LDPC	20	8 880	0	998	U	399,6
5	32 APSK	0,765	LDPC	20	10 860	0	1 038	D	406,6
5	32 APSK	0,818	LDPC	20	10 860	0	1 109	D	444,0

Transmission of PACCH messages, including global PACCH messages and all common control messages and excluding messages containing multiplexed data, will always use the basic modulation and coding scheme. The basic modulation and coding scheme is the most robust scheme in a given direction. Table 6 provides the basic modulation and coding schemes.

Table 6: Basic coding rates for various channels and directions

Direction	Bandwidth	Basic scheme
Up	4 × 31,25 kHz	$\pi/4$ CQPSK, coding rate 0,505
Up	5 × 31,25 kHz	$\pi/4$ CQPSK, coding rate 0,509
Down	4 × 31,25 kHz	$\pi/4$ CQPSK, coding rate 0,505
Down	5 × 31,25 kHz	$\pi/4$ CQPSK, coding rate 0,509
Up	1 × 31,25 kHz	$\pi/4$ CQPSK, coding rate 0,590
Down	2 × 31,25 kHz	$\pi/4$ CQPSK, coding rate 0,592

### 6.5.5.2 Channel coding for PACCH, PAGCH and PTCCH

The channel coding for the PACCH, PAGCH, and downlink PTCCH transmission is the basic modulation and coding scheme for the corresponding PDCH. The message contents themselves are of variable size but have the same coding format. All control messages have a header which identifies the message type. All control messages are padded out with zeroes to fill the block up to the fixed size of 18 octets. PBCCH and PPCH are not supported in GMR-1 3G.

For RLC/MAC bursts containing control and data multiplexed together, the assigned coding scheme for the PDTCH shall be used. The multiplexed control blocks are non-critical and can be recovered in case of packet loss. The control blocks shall be padded out with zeroes if necessary as described above.

### 6.5.5.3 Channel coding for the PRACH

The PRACH uses the Packet Access Burst (PAB) as defined below.

#### 6.5.5.3.1 Coding of the 64 data bit packet access burst

The channel coding used for the burst carrying the 64 data bit packet resource request message is shown in table 7. The details are given in GMR-1 3G 45.003 [13].

**Table 7: Channel coding for PRACH**

Tx rate in kbps	Tx time in ms	Raw bits	UW and CW	Physical payload	Modulation
23,4	4,27 ms	202	96 bits	64 bits	$\pi/4$ CQPSK

### 6.5.5a Channel coding (Iu mode)

NOTE: The text in this clause is informative. The normative text is in GMR-1 3G 45.003 [13]. Where there is a conflict between these descriptions, the normative text has precedence.

Additional coding schemes are defined for the GMR-1 3G packet data traffic channels to support Iu mode. The GMR-1 3G air interface supports PDCHs of four different bandwidths ( $m = 1, 2, 5, \text{ or } 10$ ) defined as integrals multiples ( $m \times 31,25$  kHz) of the common channel size of 31,25 kHz. For all the downlink control messages, the basic modulation and coding scheme defined for the bandwidth of the associated PDCH is always used. For all GMR-1 3G packet control channels on the uplink other than Packet Random Access Channel (PRACH3), the same modulation and coding scheme as assigned by the network for data transfer shall be used. For access bursts on PRACH3, the modulation and coding scheme associated with the Packet Access Burst (PAB3) is used.

The basic modulation and coding scheme for any value of  $m$  is the most robust modulation and coding scheme available in a given direction. For details, refer to GMR-1 3G 44.060 [7]. Note that not all modulation and coding scheme combinations are supported in any given direction.

The MES has to support transmission/reception of the basic modulation and coding scheme for all bandwidth sizes that it supports wherever more than one modulation scheme is defined in a given direction and for a given value of " $m$ ". The basic coding scheme for all bandwidth sizes is mandatory for a network supporting GMR-1 3G.

All PNB3 bursts have at least two parts, a Public Information Part (PUI) and a user-payload. The public information (hereafter referred to as PUI) part is to be read and decoded by all MESs that are monitoring that particular PDCH3. It is always coded in the same format, regardless of the coding of the rest of the burst. For details, refer to GMR-1 3G 45.003 [13]. Certain downlink PNB3 bursts may optionally contain an UL-MAP. These bursts are the PNB3(5,3), PNB3(5,12) and PNB3(10,3).

The PUI contains the USF bits. It also contains the MCS bits which indicate the modulation, coding type, and coding rate used for the rest of the burst. The UL-MAP contains additional USF fields. The receiver itself must correlate the bandwidth and the contents of the MCS bits to identify the correct puncturing pattern. The PUI and UL-MAP are always transmitted using  $\pi/4$ -CQPSK modulation and are encoded as defined in clause 6.5.5a.1.1.1. All MESs shall have the capability to decode the PUI field for all bursts that it receives. The UL-MAP, if present, shall be read and decoded by all MESs that are monitoring a particular downlink PDCH(5,3), PDCH(5,12) and PDCH(10,3).

The coding for MCS bits is defined in GMR-1 3G 44.060 [7].

6.5.5a.1 Channel coding for PDTCH3

6.5.5a.1.1 Channel coding for PDTCH3

Each of the coding schemes for GMR-1 3G are built in the same way. The difference in coding rates is achieved by using different coding polynomials and different output burst sizes, depending on the bandwidth of the associated channels. The polynomials and output bursts are defined in GMR-1 3G 45.003 [13]. Figure 5b gives the basic block structure.

NOTE: The UL-MAP is optional on the downlink bursts.

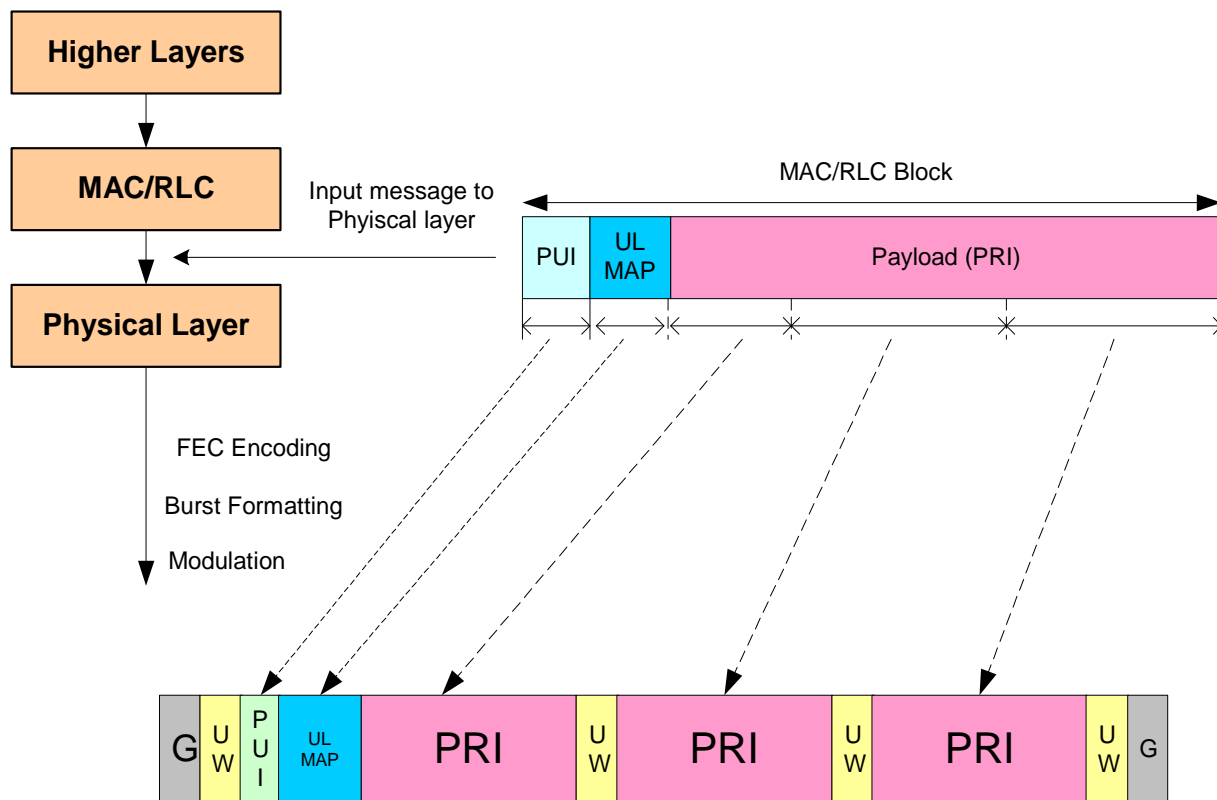

Figure 5b: Downlink radio block structure for all MCS used on PDCH3

6.5.5a.1.1.1 Public information bits

As with the PDCH, the PUI for PDCH3 consists of 12 bits. The format of PUI coding depends on the type of PDCH3 as well the direction. PUI coding formats are given in tables 7a through 7j.

Table 7a: Uplink PUI field coding for PDCH3(5,n)

MCS bits ( $b_{11} - b_8$ )	Uplink PAN field ( $b_7 - b_2$ )	Uplink Burst Duration ( $b_1$ )	Spare ( $b_0$ )
-----------------------------	----------------------------------	---------------------------------	-----------------

Table 7b: Downlink PUI field coding for PKAB3(1,6) and PDCH3(1,6)

MCS bits ( $b_{11} - b_9$ )	USF bits ( $b_8 - b_4$ )	EXT bits ( $b_3 - b_1$ )	Spare ( $b_0$ )
-----------------------------	--------------------------	--------------------------	-----------------

Table 7c: Uplink PUI field coding for PDCH(1,6), PDCH3(1,6) and PDCH3(2,6)

MCS bits ( $b_{11} - b_9$ )	Uplink PAN field ( $b_8 - b_3$ )	Spare ( $b_2 - b_0$ )
-----------------------------	----------------------------------	-----------------------

**Table 7d: Downlink PUI field coding for PDCH3(5,3) with 1 USF in PUI**

E = 0 (b <sub>22</sub> )	MCS (b <sub>21</sub> -b <sub>18</sub> )	DL Burst Duration (b <sub>17</sub> )	UAT (b <sub>16</sub> -b <sub>14</sub> )	USF (b <sub>13</sub> -b <sub>6</sub> )	Spare (b <sub>5</sub> -b <sub>3</sub> )	CRC (b <sub>2</sub> -b <sub>0</sub> )
-----------------------------	--	---	--	---	--	--

**Table 7e: Downlink PUI field coding for PDCH3(5,3) with 2 USFs in PUI**

E = 0 (b <sub>22</sub> )	MCS (b <sub>21</sub> -b <sub>18</sub> )	DL Burst Duration (b <sub>17</sub> )	UAT (b <sub>16</sub> -b <sub>14</sub> )	USF1 (b <sub>13</sub> -b <sub>9</sub> )	USF2 (b <sub>8</sub> -b <sub>4</sub> )	Spare (b <sub>3</sub> )	CRC (b <sub>2</sub> -b <sub>0</sub> )
-----------------------------	--	---	--	--	---	----------------------------	--

**Table 7f: Downlink PUI field coding for PDCH3(5,12)**

E = 0 (b <sub>22</sub> )	MCS (b <sub>21</sub> -b <sub>18</sub> )	DL Burst Duration (b <sub>17</sub> )	UAT (b <sub>16</sub> -b <sub>13</sub> )	USF (b <sub>12</sub> -b <sub>5</sub> )	Spare (b <sub>4</sub> -b <sub>3</sub> )	CRC (b <sub>2</sub> -b <sub>0</sub> )
-----------------------------	--	---	--	---	--	--

**Table 7g: Downlink PUI field coding for PKAB3(2,6) and PDCH3(2,6)**

E = 0 (b <sub>20</sub> )	MCS (b <sub>19</sub> -b <sub>17</sub> )	USF1 (b <sub>16</sub> -b <sub>12</sub> )	EXT1 (b <sub>11</sub> -b <sub>10</sub> )	USF2 (b <sub>9</sub> -b <sub>5</sub> )	EXT2 (b <sub>4</sub> -b <sub>3</sub> )	CRC (b <sub>2</sub> -b <sub>0</sub> )
-----------------------------	--	---	---	---	---	--

**Table 7h: Downlink PUI field coding for PKAB3(10,3) and PDCH3(10,3)**

E = 0 (b <sub>29</sub> )	MCS (b <sub>28</sub> -b <sub>25</sub> )	UAT (b <sub>24</sub> -b <sub>21</sub> )	USF1 (b <sub>20</sub> -b <sub>13</sub> )	USF2 (b <sub>12</sub> -b <sub>5</sub> )	Spare (b <sub>4</sub> -b <sub>3</sub> )	CRC (b <sub>2</sub> -b <sub>0</sub> )
-----------------------------	--	--	---	--	--	--

**Table 7i: Downlink PUI field coding for PKAB3(5,3) with 1 USF is PUI**

E = 0 (b <sub>22</sub> )	MCS='1111'b (b <sub>21</sub> -b <sub>18</sub> )	Spare (b <sub>17</sub> )	UAT (b <sub>16</sub> -b <sub>14</sub> )	USF (b <sub>13</sub> -b <sub>6</sub> )	Spare (b <sub>5</sub> -b <sub>3</sub> )	CRC (b <sub>2</sub> -b <sub>0</sub> )
-----------------------------	--	-----------------------------	--	---	--	--

**Table 7j: Downlink PUI field coding for PKAB3(5,3) with 2 USFs in PUI**

E = 0 (b <sub>22</sub> )	MCS='1111'b (b <sub>21</sub> -b <sub>18</sub> )	Spare (b <sub>17</sub> )	UAT (b <sub>16</sub> -b <sub>14</sub> )	USF1 (b <sub>13</sub> -b <sub>9</sub> )	USF2 (b <sub>8</sub> -b <sub>4</sub> )	Spare (b <sub>3</sub> )	CRC (b <sub>2</sub> -b <sub>0</sub> )
-----------------------------	--	-----------------------------	--	--	---	----------------------------	--

The definitions of the PUI and Uplink Allocation Type (UAT) fields are given in GMR-1 3G 44.060 [7].

The 12 bit PUI header is subsequently Golay coded using a (24,12) Golay code. The Golay code output is repeated once to get a block of 48 bits.

#### 6.5.5a.1.1.1a UL-MAP

The UL-MAP is used for signalling uplink resource allocation to multiple MESs (see GMR-1 3G 44.060 [7]). The UL-MAP is coded as defined in GMR-1 3G 45.003 [13].

#### 6.5.5a.1.1.2 Coding of user payload

The user payload consists of a combination of fixed size MAC/RLC headers, optional control blocks and data payloads.

The coder polynomial varies according to the burst size and the burst class, as described in GMR-1 3G 45.003 [13]. A summary of the peak data rates of the codes are shown in table 7k.

**Table 7k: Coding parameters for the PDCH3 coding schemes**

Channels	Direction (U: Uplink, D: Downlink)	Transmission symbol rate (ksps)	Channel Coding	Modulation	Transmission bandwidth (kHz)	Peak payload transmission rate (without CRC) (kbps)
PDTCH(1,6)	U/D	23,4	Conv.	$\pi/4$ -QPSK	31,25	27,2
DTCH(1,3)	U/D	23,4	Conv.	$\pi/4$ -QPSK	31,25	28,8
DTCH(1,6)	U/D	23,4	Conv.	$\pi/2$ -BPSK	31,25	14,4
DTCH(1,6)	U/D	23,4	Conv.	$\pi/4$ -QPSK	31,25	8,8
DTCH(1,8)	U/D	23,4	Conv.	$\pi/2$ -BPSK	31,25	10,8
PDTCH3(2,6)	U/D	46,8	Turbo	$\pi/4$ -QPSK	62,5	62,4
PDTCH3(5,3)	U/D	117,0	Turbo	$\pi/4$ -QPSK	156,25	156,80
PDTCH3(5,3)	D	117,0	Turbo	16-APSK	156,25	252,80
PDTCH3(5,12)	U/D	117,0	Turbo	$\pi/4$ -QPSK	156,25	185,2
PDTCH3(5,12)	D	117,0	Turbo	16-APSK	156,25	295,2
PDTCH3(10,3)	D	234,0	Turbo	$\pi/4$ -QPSK	312,50	344,0
PDTCH3(10,3)	D	234,0	Turbo	16-APSK	312,50	587,20

### 6.5.5a.2 Channel coding for PACCH, and PAGCH

The channel coding for the PACCH and PAGCH transmission is the basic modulation and coding scheme for the corresponding PDCH3. The message contents themselves are of variable size but have the same coding format. All control messages have a header which identifies the message type. All control messages are padded out with zeroes to fill the block up to the fixed size of 18 octets. PBCCH and PPCH are not supported in GMR-1 3G.

For RLC/MAC bursts containing control and data multiplexed together, the assigned coding scheme for the PDTCH3 shall be used. The multiplexed control blocks are non-critical and can be recovered in case of packet loss. The control blocks shall be padded out with zeroes if necessary as described above.

### 6.5.5a.3 Channel coding for the PRACH3

The PRACH3 uses the Packet Access Burst (PAB3) as defined below.

#### 6.5.5a.3.1 Coding of the 40 data bit packet access burst

The channel coding used for the burst carrying the 40 data bit packet resource request message is shown in table 7. The details are given in GMR-1 3G 45.003 [13].

**Table 7l: Channel coding for PRACH3**

Tx rate in ksps	Tx time in ms	Raw bits	UW and CW	Physical payload	Modulation
23,4	4,27 ms	202	96 bits	40 bits	$\pi/4$ CQPSK

### 6.5.6 Spotbeam reselection

Spotbeam reselection in GMR-1 3G is defined in GMR-1 3G 43.022 [18].

### 6.5.7 Timing and frequency update procedure

NOTE: The text in this clause is normative except when referring to GMR-1 3G 45.002 [12].

The continuous timing and frequency update procedure is used to derive the correct value for timing and frequency adjustment that the MES must use for the uplink transmission of radio blocks.

The timing advance procedure comprises two parts:

- Initial estimation.
- Continuous update.

### 6.5.7.1 Initial timing advance estimation

The initial estimation is based on the single access burst carrying the Packet Channel Request on the PRACH or the Channel Request on the RACH. The Packet Uplink Assignment or Packet Downlink Assignment then carries the estimated adjustment values for both timing and frequency to the MES. This value shall be used by the MES for the uplink transmissions until the continuous timing advance update provides a new value (see clause 6.5.7.2). The following special case exists:

- When Packet Downlink Assignment is to be sent without prior paging (i.e. in the Ready state), no valid timing advance value may be available.
- For Packet Downlink assignment, the mobile earth station is required to send a single PRACH with cause code, "Initial Correction". If the mobile earth station timing is good enough to transmit this PRACH, it does so and is responded to with a link synchronization message which contains the correction information. Note that this is also required for the network to know when the terminal has received the Packet Downlink assignment and so it is mandatory for all Packet Downlink Assignments in the ready-state. If not, ignores the Packet Downlink Assignment.
- For the case where link synchronization information is not provided in the assignment message, the mobile is not allowed to send normal bursts on the uplink until it receives a valid adjustment values either in Packet Link Synchronization message or through the PRACH process on the uplink.

### 6.5.7.2 Continuous timing and frequency update procedure

MES in Packet transfer mode shall use the continuous timing and frequency update procedure to maintain both timing and frequency synchronization to the network. The continuous timing and frequency updated procedure is carried on the PTCCH allocated to the MES, using synchronization messages.

For uplink or downlink packet transfer within the Packet Uplink/Downlink Assignment, the MES is assigned the Continuous Timing/Frequency advance period in the PKT\_LINK\_CORR\_CYCLE variable in the System information and the Timing Advance Index (TAI) as part of its assignment information. The Continuous Timing/Frequency advance Period indicates the number of multiframes after which the MES is to repeat the procedure i.e. the repetition cycle duration. The Timing Advance Index is used to compute the next slot in which the MES sends its next Link synchronization transmission using the method indicated in GMR-1 3G 45.010 [17].

The Timing Advance Index value ranges from 0 to 127. The MES first uses the advance period to determine the boundaries of the correction cycle. i.e. a value of 20 will indicate that the correction cycle starts on the 0<sup>th</sup>, 20<sup>th</sup>, 40<sup>th</sup> multiframe, etc. The TAI contains both the time-slot assignment and the multiframe assignment. The MAC-slot assignment is computed by taking the last two bits of the TAI. This identifies the PTCCH/U slot. The remaining bits identify the multiframe within the periodic cycle. Thus, if the remaining bits have a value 17, and the current frame is 13<sup>th</sup> within the current repetition period, the mobile earth stations next opportunity is 4 multiframes later. The PTCCH/U channel assignment can be 0 to 3. In the above case, since the multiframe number is odd, the PTCCH/U channels are mapped on MAC-slots 1, 3, 5, 7 respectively. Else they are mapped on MAC-slots 0, 2, 4 and 6.

On the uplink, the MES shall transmit in the assigned PTCCH slot which is used by the network to derive the timing and frequency adjustments.

The network analyses the received access burst and determines new timing advance and frequency adjustment values for all MESs performing the continuous timing and frequency update procedure on that PDCH. The new link adjustment values shall be sent via a downlink PTCCH/D message on PTCCH/D. Network may also send timing and frequency update information asynchronously in Packet Link Synchronization and Packet Uplink Ack/Nack messages on PACCH.



After transmitting the Link synchronization message, the MES shall continuously monitor the MAC-slot/D-MAC-slot/4-MAC-slot allocated to it for receipt of control messages. The MES shall not retry the procedure, other than at the allocated frame and MAC-slot/D-MAC-slot/4-MAC-slot after the expiry of the Continuous Timing/Frequency Update Period. When it receives a PTCCCH/D message, it shall check the information element corresponding to the slot in which it made the transmission to see whether it has received valid correction information. In case no valid correction information is received after two invocations of the procedure, it shall perform an abnormal release, regardless of the state of the TBF or other messages received from the network.

## 6.5.8 Power control procedure

Power control shall be supported in order to improve the spectrum efficiency and to reduce the power consumption in the MES and the uplink interference.

For the uplink, the MES shall follow a flexible power control algorithm, which the network can optimize through a set of parameters. It can be used for both open loop and closed loop power control.

For the downlink, there is no power control on a per-MES basis. For any given physical channel, the network shall transmit at a fixed power level. In addition, the network uses discontinuous transmission by transmitting only the physical header if there is no data to transmit. A single bit in the physical header indicates whether or not there is any payload.

For the detailed specification of power control see GMR-1 3G 45.008 [16].

### 6.5.8.1 MES output power

The initial MES output power level shall be indicated by the network in the Power Attenuation Request (PAN) field of the RLC header of the burst carrying the initial assignment message. It can be subsequently modified by the network by modifying the PAN field in the RLC header in any RLC message that it transmits to that MES. The MES reports its transmit power back to the network by using the Power Attenuation Notification (PAN) field in the PUI on the uplink. For details of this procedure see GMR-1 3G 45.008 [16].

### 6.5.8.2 BSS output power

The BSS shall use constant power on all PDCHs.

Additionally, the network uses discontinuous transmission, by transmitting only the header when there is no user payload to transmit. A special code-point in the MCS bits tells the MES whether or not there is any payload transmitted or not.

### 6.5.8.3 Measurements at MES side

A procedure shall be implemented in the MES to monitor periodically the downlink RX signal level and quality from its serving cell.

### 6.5.8.4 Measurements at BSS side

A procedure shall be implemented in the BSS to monitor the uplink RX signal level and quality on each uplink PDCH, active as well as inactive. In RLC acknowledged mode, the BSS may use the packet losses as reported by the MES for this purpose as well.

The BSS shall also measure the RX signal level and the quality of a specific MES packet transfer. The algorithm to do so is implementation specific.

## 6.5.9 Void

## 6.5.10 Discontinuous Reception (DRX)

NOTE: The text in this clause is informative. The normative text is in GMR-1 3G 45.002 [12]. Where there is a conflict between these descriptions, the normative text has precedence.

Discontinuous reception is used by the MES to conserve power when in idle mode. This function is described in GMR-1 3G 44.060 [7] and GMR-1 3G 45.002 [12].

## 6.5.11 Rate adaptation

Transmission rate control can take place on both uplink and downlink direction when the MES is in the transfer mode. The modulation and coding rate can be adapted using the feedback from the RACH/PRACH link performance of the ongoing TBF and the stored information about the performance of the link in the previous TBF. Refer to GMR-1 3G 45.008 [16] for details.

## 6.5.12 UpLink Quality Reports

The UpLink Quality Report (ULQR) is a message that is transmitted periodically by the MES to the network, providing information about the state of the downlink transmission. This message is transmitted periodically to the network, on every PTCCH/U opportunity as a PNB burst. If there is space in the payload, the mobile station may also send pending control and data. The ULQR contains mobile identification, type and a report on the signal quality. Details about this procedure are given in GMR-1 3G 44.060 [7]. The method for computing the signal quality is provided in GMR-1 3G 45.008 [16].

# 6.6 Medium access control and radio link control layer

The Medium Access Control (MAC) and Radio Link Control (RLC) layer operates above the Physical Link layer in the reference architecture. MAC/RLC layer messages and signalling procedures are defined in GMR-1 3G 44.060 [7] and GMR-1 3G 44.008 [6].

## 6.6.1 Layer services

The MAC function defines the procedures that enable multiple MESs to share a common transmission medium, which may consist of several physical channels. The MAC function provides arbitration between multiple MESs attempting to transmit simultaneously and provides collision avoidance, detection, and recovery procedures. The operations of the MAC function may allow a single MES to use several Packet Data CHannels (PDCHs) in parallel.

The RLC function defines the procedures for a selective retransmission of unsuccessfully delivered RLC Data Blocks.

The RLC/MAC function provides two modes of operation:

- unacknowledged operation; and
- acknowledged operation.

## 6.6.2 Layer functions

The GMR-1 3G MAC function is responsible for:

- Providing efficient multiplexing of data and control signalling on both uplink and downlink, the control of which resides on the Network side. On the downlink, multiplexing is controlled by a scheduling mechanism. On the uplink, multiplexing is controlled by medium allocation to individual users (e.g. in response to service request). Note that this multiplexing refers to use of the same physical channel for control and data purposes. An additional level of multiplexing allows both control and data traffic to be sent in the same data burst. This is an RLC responsibility as defined below.
- For mobile terminated channel access, scheduling of access attempts.
- Priority handling.

The GMR-1 3G RLC function is responsible for:

- Interface primitives allowing the transfer of Logical Link Control layer PDUs (LLC-PDU) between the LLC layer and the MAC function.
- Segmentation of LLC PDUs into RLC Blocks and reassembly of RLC Blocks into LLC PDUs. The segmentation and reassembly function has to be tuned to match the PDCH type of the logical channel on which the RLC Data Blocks are being transmitted because the block sizes vary depending on the type of the PDCH.
- Multiplexing of data and control traffic into a single radio-block and extracting these at the receiver end.
- Handling of unsolicited grants.
- Support of one concurrent TBF in each direction.
- Backward Error Correction (BEC) procedures enabling the selective retransmission of uncorrectable code words.
- Receipt of signal quality indications from the MES and transmission of power control information/commands.

NOTE: The Block Check sequence for error detection is provided by the Physical Link layer.

### 6.6.3 Service primitives

Table 8 lists the service primitives provided by the RLC/MAC layer to the upper layers.

**Table 8: Service primitives provided by the RLC/MAC layer to the upper layers**

Name	Request	Indication	Response	Confirm	Comments
RLC/MAC-DATA	X	X			Used for the transfer of upper layer PDUs. Acknowledged mode of operation in RLC is used. The upper layer shall be able to request high transmission quality via a primitive parameter.
RLC/MAC-UNITDATA	X	X			Used for the transfer of upper layer PDUs. Unacknowledged mode of operation in RLC is used.
RLC/MAC-STATUS		X			Used to indicate that an error has occurred on the radio interface. The cause for the failure is indicated.

### 6.6.4 Mode of operation

Each PDCH is a shared medium between multiple MESs and the network. Direct communication is possible only between an MES and the network.

The GMR-1 3G radio interface consists of asymmetric and independent uplink and downlink channels. The downlink carries transmissions from the network to multiple MESs and does not require contention arbitration. The uplink is shared among multiple MESs and requires collision resolution procedures.

The allocation of radio resources by the PLMN and the use of these resources by the MESs can be broken down into two parts:

- The PLMN allocates radio resources for the GMR-1 3G (uplink and downlink) in a symmetric manner.
- Dependent allocation of uplink and downlink shall be possible, in order to allow simple MESs to transfer data simultaneously in both directions. Allocation of several PDCHs for one MES is possible.

The access to the GMR-1 3G uplink uses a Slotted-Aloha based reservation protocol.

The Network Protocol Data Units (N-PDU) are segmented into the SubNetwork Protocol Data Units (SN-PDU) by the SubNetwork Dependent Convergence Protocol (SND CP) and SN-PDUs are encapsulated into one or several LLC frames. See 3GPP TS 23.060 [3] for information on SND CP and LLC. The details on SND CP can be found in 3GPP TS 44.065 [9], and the details on LLC can be found in 3GPP TS 44.064 [8]. LLC frames are segmented into RLC Data Blocks. At the RLC/MAC layer, a selective ARQ protocol (including block numbering) between the MES and the network provides retransmission of erroneous RLC Data Blocks. When a complete LLC frame is successfully transferred across the RLC layer, it is forwarded to the LLC layer on the receiver.

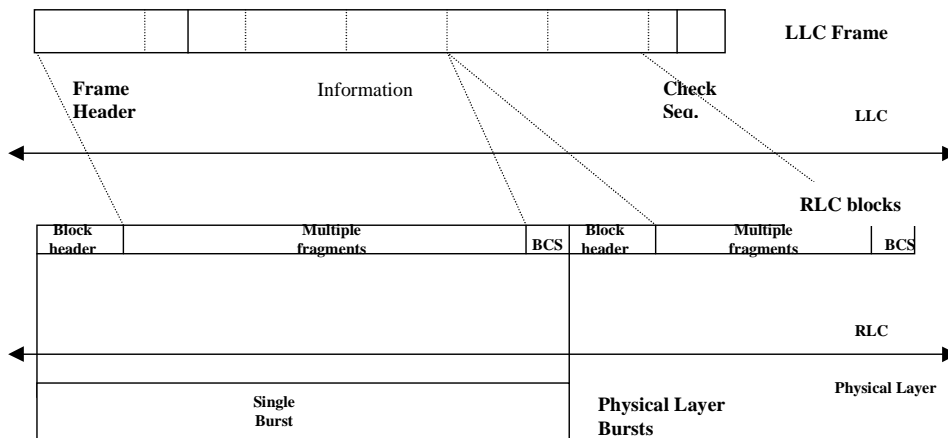

Figure 6: Transmission and reception data flow for GMR-1 3G

6.6.4.1 Multiplexing MESs on the same PDCH

6.6.4.1.1 Uplink state flag: dynamic allocation

6.6.4.1.1.1 Multiplexing of MESs

The Uplink State Flag (USF) is used on PDCH to allow multiplexing of Radio Blocks from a number of MESs. USF is used in dynamic and extended dynamic medium access modes. USF is used only in downlink direction.

The USF comprises 6 bits for a PDCH(4,3), PDCH(5,3) and PDCH(5,12) or 5 bits for a PDCH(2,6) at the beginning of each Radio Block that is sent on the downlink. It enables the coding of 64 different USF states for a PDCH(4,3), PDCH(5,3) and PDCH(5,12), or 32 USF states for a PDCH(2,6) which are used to multiplex the uplink traffic. On all PDCHs, one USF value is reserved for marking a time-slot busy. This is used to prevent collision on uplink channel, when MES without USF is using uplink channel i.e. for PACCH/D. On PDCH(5,3), PDCH(5,12) or a PDCH(4,3) carrying PCCCH, one USF value is used to denote PRACH. The other sixty two USF values are used to reserve the uplink for different MESs. On PDCH(4,3), PDCH(5,3) or a PDCH(5,12) not carrying PCCCH, the sixty three USF values are used to reserve the uplink for different MESs. The USF points to the next uplink MAC-slot (see GMR-1 3G 45.010 [17]) for PDCH(4,3), PDCH(5,3), PDCH(5,12) or to a sequence of "N" consecutive uplink D-MAC-slots beginning from the next uplink D-MAC-slot for a PDCH(1,n) where "N" depends on the EXT bits in the PUI (see GMR-1 3G 44.060 [7]). On PDCH(5,3) or PDCH(5,12), the USF may be used allocate the next 4-MAC-slot on an uplink PDCH(5,12). The separation between the slot in which the USF was received and the first block in which the MES has to transmit is controlled by the USF\_DELAY parameter. The rule is that the MES must transmit so that the USF is responded to in the same MAC-slot/D-MAC-slot/4-MAC-slot of the frame USF\_DELAY frames. Refer to GMR-1 3G 45.010 [17] for a detailed description.

The network transmits USF on a PDCH(2,6) on D-MAC-slots 0, 1, 2, 3. The MES transmits on a PDCH(1,6) on D-MAC-slots 0, 1, 2, 3.

Each downlink burst on PDCH(2,6), PDCH(4,3) and PDCH(5,3) can indicate uplink allocation for only one MES. However, on PDCH(5,12) the network can indicate uplink allocation for up to four MES in a single downlink burst.

## 6.6.4.2 Temporary block flow

A Temporary Block Flow (TBF) is a physical connection used by the two RR entities to support the unidirectional transfer of LLC PDUs on packet data physical channels. The TBF is allocated radio resource on one or more PDCHs and comprises a number of RLC/MAC blocks carrying one or more LLC PDUs. A TBF is temporary and is maintained only for the duration of the data transfer. The termination is typically network controlled and may be maintained a limited while longer, in anticipation of further traffic.

### 6.6.4.2.1 Support for Streaming traffic

During TBF establishment, a MES can indicate to the network that TBF is being requested to handle streaming traffic. If sufficient resources are available, the network will reserve or prioritize the radio resources allocated to the MES to guarantee the streaming bit rate. If the MES does not indicate streaming bit rate requirement during TBF establishment, the network will handle resource allocation for the MES on a best effort basis.

The MES can request different streaming bit rates for uplink and downlink. The network will handle the resources allocation independently for uplink and the downlink. Additionally the MES can indicate streaming bit rate only in one direction, in such cases the data transfer on the other direction will handled on a best effort basis.

## 6.6.4.3 Temporary flow identity

Each TBF is assigned a Temporary Flow Identity (TFI) by the network. The assigned TFI is unique among concurrent TBFs in each direction and is used instead of the MES identity in the RLC/MAC layer. The same TFI value may be used concurrently for TBFs in opposite directions. The TFI is assigned in a resource assignment message that precedes the transfer of LLC frames belonging to one TBF to/from the MES. The same TFI is included in every RLC header belonging to a particular TBF as well as in the control messages associated to the LLC frame transfer (e.g. acknowledgements) in order to address the peer RLC entities.

## 6.6.4.4 Medium access modes

The medium access modes supported in GMR-1 3G is called:

- Dynamic allocation.

The Dynamic allocation medium access mode shall be supported by all networks that support GMR-1 3G.

The Dynamic allocation mode shall be supported in all mobile earth stations.

## 6.6.4.5 Acknowledged mode for RLC/MAC operation

### 6.6.4.5.1 GMR-1 3G

The transfer of RLC Data Blocks in the acknowledged RLC/MAC mode is controlled by a selective ARQ mechanism coupled with the numbering of the RLC Data Blocks within one Temporary Block Flow. The sending side (the MES or the network) transmits blocks within a window and the receiving side sends Packet Uplink Ack/Nack or Packet Downlink Ack/Nack message when needed. Every such message acknowledges all correctly received RLC Data Blocks up to an indicated Block Sequence Number (BSN), thus "moving" the beginning of the sending window on the sending side. Additionally, the message can be used to selectively request erroneously received RLC Data Blocks for retransmission. The sending side then retransmits the erroneous RLC Blocks, eventually resulting in further sliding of the sending window.

The Packet Ack/Nack message does not include any change in the current assignment; however, it may contain a multiplexed user data. A missing Packet Ack/Nack with no multiplexed data is not critical and does not need to be acknowledged explicitly by the other side unless specifically requested. In Packet Downlink Ack/Nack message, the MES may optionally request initiation of an uplink TBF. In response, the network may assign uplink resources for mobile earth station.

When receiving uplink data from a MES the network shall, based on erroneous blocks received from the MES, allocate additional resources for retransmission.

The acknowledgement procedure of the LLC layer is not combined with the acknowledgement procedure on the underlying RLC/MAC layer.

### 6.6.4.6 Unacknowledged mode for RLC/MAC operation

The transfer of RLC Data Blocks in the unacknowledged RLC/MAC mode is controlled by the numbering of the RLC Data Blocks within one Temporary Block Flow and does not include any retransmissions. The receiving side extracts user data from the received RLC Data Blocks and attempts to preserve the user information length by replacing missing RLC Data Blocks with dummy information bits.

Control messages are transmitted by the network using the block-stealing mechanism. From the MES side, the only control messages expected are the UTLQR messages and these are transmitted on the PTCCH/U. Transmission of other control messages are under the control of the network, which polls the MES appropriately.

### 6.6.4.7 Mobile originated packet transfer

#### 6.6.4.7.1 Uplink access

##### 6.6.4.7.1.1 Initial access

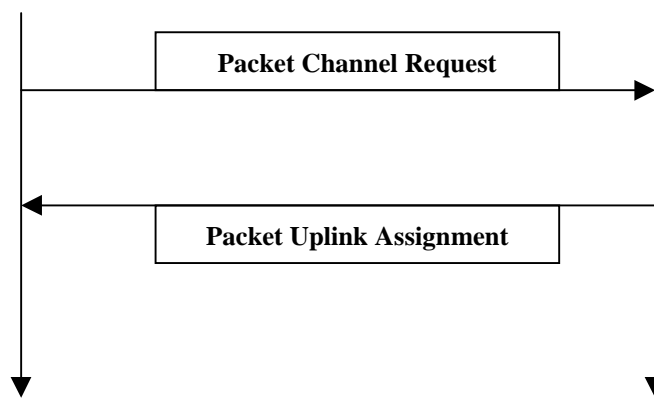

**Figure 7: Access and allocation for the packet access, uplink packet transfer**

An MES initiates a packet transfer by making a Packet Channel Request on PRACH or a Channel Request on RACH as described in GMR-1 3G 44.008 [6]. The conditions as to when the MES can use the PRACH are a function of the time since the MES last got a timing correction from the network the MES timing synchronization, and previous history of MES access successes. If the MES fulfils these conditions, it shall use a PRACH for initial access if a PRACH channel is available. In all other cases, it uses the RACH. The MES should preferentially try to use any available PRACH on the same sub-band on which it completed its last TBF. If this is not possible for any reason, it shall use the CCCH. The network responds on PAGCH or AGCH for a channel request received on PRACH or RACH respectively.

In the one phase access, the Packet Channel Request is responded by the network with the Packet Uplink Assignment allocating the resources on PDCH(s) for uplink transfer of a number of MAC/RLC blocks. The reservation is done accordingly to the information about the requested resources that is comprised in the Packet Channel Request. The Packet Channel Request shall contain adequate information about the requested resources and, consequently, uplink resources on one or several PDCHs can be assigned by using the Packet Uplink Assignment message.

If the MES uses a RACH for packet access initiation and only the Class 1 bits are received by the network, the network has insufficient information about the nature of the request to make a full allocation. In this case the network shall reject the RACH and supply adequate timing correction information. In response, the mobile earth station shall apply this correction and try again.

If there is no response to the Packet Channel Request within a predefined time period, the MES makes a retry after a random backoff time.

The PRACH algorithm uses the value of M, R, S and T derived from the PRACH control parameters, some of which also depends on the priority level of the packet to be transmitted. Note that the access classes broadcast in the SI are equally applicable on the RACH and the PRACH. Also, the initial random backoff from SI decoding is not used for PRACH access. The persistence level and reduced persistence level parameters for the PRACH are currently not used. On RACH, the existing backoff algorithm shall be used.

#### 6.6.4.7.1.2 Follow-on resource requests

The MES can continuously keep the network updated as to the amount of pending data that it has yet to transmit. This is done by using a seven-bit field in the MAC/RLC header. This field is coded to indicate the amount of data to be transmitted by the MES, in units of RLC Blocks. The network shall use this information, otherwise known as the unsatisfied demand to assist in the uplink resource allocation algorithm in dynamic mode of allocation. The coding of this field is defined in GMR-1 3G 44.060 [7].

#### 6.6.4.7.2 Dynamic allocation

##### 6.6.4.7.2.1 Uplink packet transfer

The Packet Uplink Assignment message includes the list of PDCHs to be used for transmission and a single USF value that is valid across all the PDCHs. A unique TFI is allocated and is thereafter included in each RLC Data and Control Block related to that Temporary Block Flow. The MES monitors the PUI on all the downlink bursts on the allocated PDCHs and transmits MAC/RLC blocks in the corresponding uplink burst on those which currently bear the USF value reserved for the usage of the MES.

The MES may be allowed to use the uplink resources as long as there is queued data on the RLC/MAC layer to be sent from the MES. It can comprise a number of LLC frames. In that sense the radio resources are assigned on the initially "unlimited" time basis. Alternatively, the uplink assignment for each assignment may be limited to a number of MAC/RLC blocks (e.g. in order to offer more fair access to the medium at higher loads).

Follow-on requests are permitted to extend a given TBF as long as there is data in the MES queue for transfer. See clause 6.5.12.7.1.2 for details. The selective ARQ operation for the acknowledged RLC/MAC mode is described in clause 6.6.4.5. The unacknowledged RLC/MAC mode operation is described in clause 6.6.4.6.

##### 6.6.4.7.2.2 Release of the resources

The release of the resources is normally controlled by the network. The mobile earth station indicates when it has no data in its queue by sending an unsatisfied demand value of zero, or by setting a particular bit in the header.

For the normal release of resources for RLC connection carrying a mobile originated packet transfer, the mechanism based on acknowledged final Packet Uplink Ack/Nack combined with timers is used.

After the MES has sent its last RLC Data Block (indicated by a zero value of the UD field or by the ITR bit), the acknowledgement is expected from the network side.

The next step, in the case of all RLC Data Blocks being correctly received, is that the network sends Packet Uplink Ack/Nack which is to be immediately acknowledged by the MES in the reserved uplink block period. If the Packet Uplink Ack/Nack has the FAI bit set, the TBF is considered released. Otherwise, the mobile earth station continues monitoring the same PDCHs. Depending upon radio-resources it is given allocations intermittently - if fresh data comes in, the mobile earth station may continue the TBF by transmitting more data in these slots. The TFI can be reused for another assignment either upon the reception of the acknowledgement for Packet Ack/Nack or after expiry of the guard timer.

Further, the premature release or change of assignment for one MES can be initiated by the network. In the case of release, the MES is ordered to interrupt the Temporary Block Flow. The MES shall then reorganize the uplink buffer and issue a new Packet Channel Request to continue the uplink transfer with the RLC Data Blocks containing partially or fully untransferred (i.e. on the RLC/MAC layer unacknowledged) LLC frames. In the case of the change in assignment, the Packet Uplink Assignment message is issued.

The mobile earth station may itself request immediate termination of a flow by setting the "ITR" bit in the RLC/MAC header. This is a request to the network to close the TBF immediately.

##### 6.6.4.7.3 Void

6.6.4.7.4 Contention resolution

Contention resolution is an important part of RLC/MAC protocol operation, especially because one channel allocation can be used to transfer a number of LLC frames.

There are two basic access possibilities, the normal mode and the two phase access procedure that is used as defined in clause 6.6.4.7.1.

The normal access is inherently immune for possibility that two MESs can perceive the same channel allocation as their own. The Packet Channel Request contains the TLLI of the MES which is included in the corresponding Assignment message.

In some cases, the RACH may be transmitted so that only the Class 1 bits are received. In this case, the RACH is rejected with adequate timing correction so that the mobile can try again.

6.6.4.7.5 Piggybacked messages and unsolicited resource grant

These are additional mechanisms designed to reduce the latency of access of the uplink. The design of the RLC/MAC block allows for control and data segments to be embedded in a single block. The RLC/MAC entity in the MES may embed both control and data information in the same RLC/MAC message. Optionally, one or two control blocks of a fixed size of 18 octets can be embedded into the head of the block, with all the subsequent payload being used for data. Thus if the network polls the MES for a control message, i.e. uplink PACCH/U, the MES can fit pending user data blocks into the same packet when it is responding.

In addition, the network may allocate multiple consecutive uplink blocks to the MES when it polls it for an uplink PACCH message. The algorithm as to when it does this and when it does not is implementation dependent. The MES can use these blocks for both transferring queued data packets and making additional requests for uplink resources as described above.

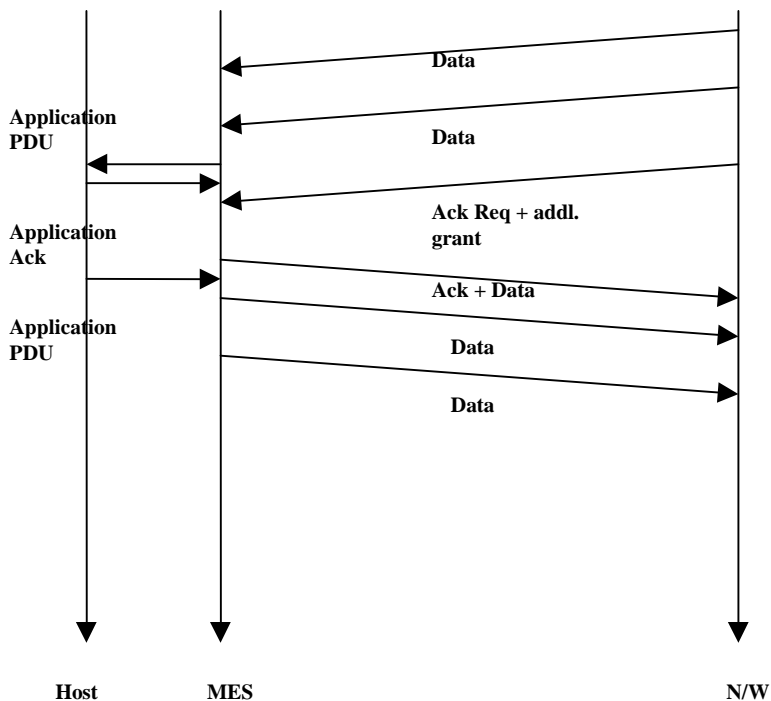

Figure 8: Piggybacked messages and unsolicited grant mechanism



6.6.4.8 Mobile terminated packet transfer

6.6.4.8.1 Packet paging

The network initiates a packet transfer to an MES that is in the Standby state by sending one or more packet paging request messages on the downlink PCH. The MES responds to one packet paging request message by initiating an access procedure, as described in clause 6.6.4.7. The MES will use the PRACH or RACH channel as appropriate to its synchronization state. The message sequence described in figure 9 is conveyed either on PCCCH or on CCCH. After the packet paging response is sent by the MES and received by the network, the mobility management state of the MES is Ready.

The network can then assign some radio resources to the MES and perform the downlink data transfer as described in clause 6.6.4.8.2.

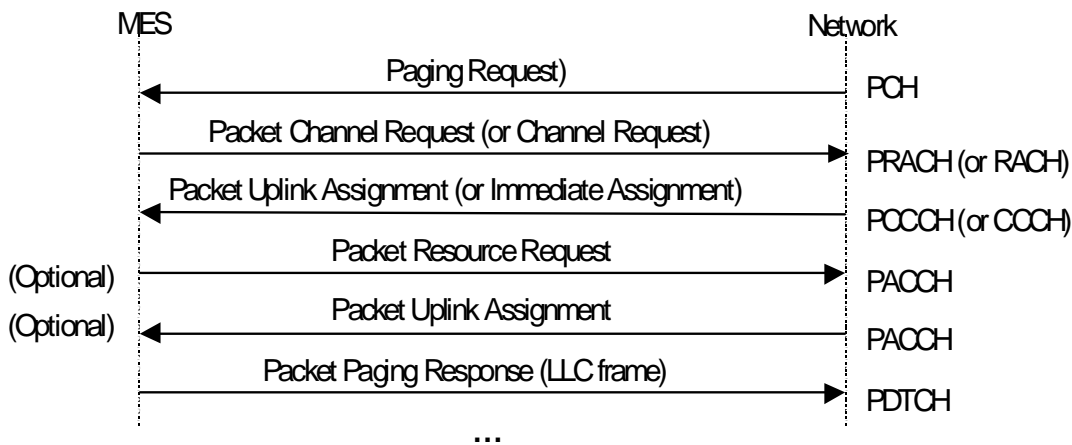

Figure 9: Paging message sequence for paging, downlink packet transfer

6.6.4.8.2 Downlink packet transfer

The transmission of a packet to an MES in the Ready state is initiated by the network using a packet downlink assignment message. In case there is an uplink packet transfer in progress, the packet downlink assignment message is transmitted on PACCH. Else the same message is transmitted on CCCH. The MES is required to respond with a Packet Channel Request on any available timeslots of one of the allocated PDCH with cause code "Initial Correction". In response to this, the network sends it back initial timing correction. The MES multislot capability needs to be considered.

The network sends the RLC/MAC blocks belonging to one Temporary Block Flow on downlink on the assigned downlink channels.

Multiplexing the RLC/MAC blocks destined for different MESs on the same PDCH downlink is enabled with an identifier, e.g. TFI, included in each RLC/MAC block. The interruption of data transmission to one MES is possible.

The acknowledged (i.e. selective ARQ operation) and unacknowledged RLC/MAC mode operation is described in clauses 6.6.4.5 and 6.6.4.6. The sending of the Packet Downlink Ack/Nack message is obtained by the occasional network initiated polling of the MES. The MES sends the Packet Downlink Ack/Nack message in a reserved MAC/RLC block which is allocated together with polling. Unassigned USF value is used in the downlink MAC/RLC block which corresponds to the reserved uplink MAC/RLC blocks. Further, if the MES wants to send some additional signalling or uplink data, it may be indicated in the Packet Downlink Ack/Nack message.

Figure 10 shows an example of message sequence for (multislot) downlink data transfer with possible RLC Data Block re-transmissions.

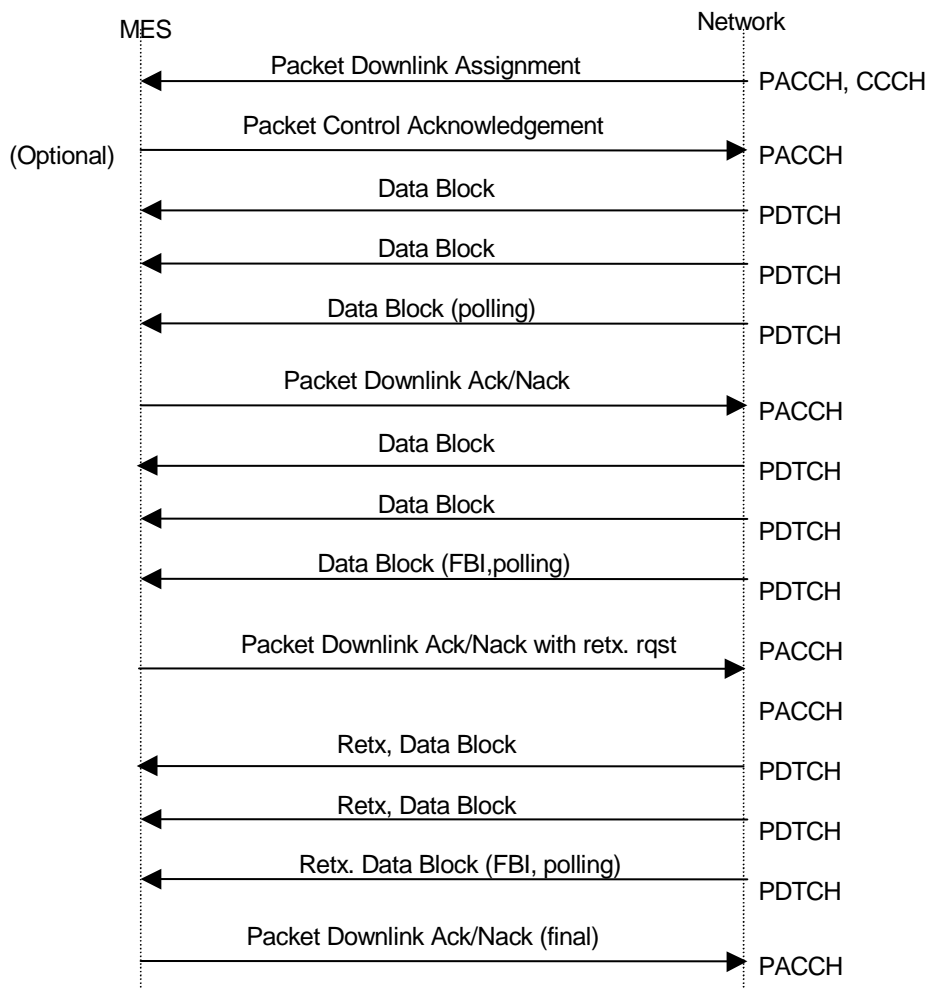

Figure 10: An example of downlink data transfer

6.6.4.8.3 Release of the resources

The release of the resources is initiated by the network by terminating the downlink transfer and polling the MES for a final Packet Downlink ACK/NACK message. The transmission of the final block is indicated by setting the FBI bit. The network may choose to delay this, by not setting the FBI bit in the last block, but subsequently following it up (after the delay period has expired) with a dummy block with FBI set.

The handling of TFI is steered with the same timer that runs on both the MES and the network side after the last RLC Data Block is sent to the MES. When it expires, the current assignment becomes invalid for the MES and TFI can be reused by the network. Further, upon the reception of the final Packet Downlink Ack/Nack from the MES, another timer is started on network side. When it expires, the current assignment becomes invalid for the MES and TFI can be reused by the network.

6.6.4.9 Simultaneous uplink and downlink packet transfer

During the ongoing uplink Temporary Block Flow, the MES continuously monitors one downlink PDCH for possible occurrences of Packet Downlink Assignment messages on PACCH. The MES is therefore reachable for downlink packet transfers that can then be conveyed simultaneously on the PDCH(s) that respect the MES multislot capability.

If the MES wants to send packets to the network during the ongoing downlink Temporary Block Flow, it can be indicated in the UD field of the same burst that is also carrying the acknowledgement that is sent from the MES. By doing so, no explicit Packet Channel Requests have to be sent to the network - this reduces the load on the contention channel. Further, the network already has the knowledge of which PDCH(s) that particular MES is currently using so that the uplink resources can be assigned on the PDCH(s) that respect the MES multislot capability. This method may introduce an extra delay when initiating the uplink packet transfer but only for the first LLC frame in a sequence.

## 6.7 Abnormal cases in MES ready state

The RLC/MAC error causes and procedures to handle these can be found in GMR-1 3G 44.008 [6], GMR-1 3G 44.060 [7] and GMR-1 3G 45.008 [16].

---

## Annex A (informative): Bibliography

3GPP TS 43.064 (ETSI TS 143 064): "3rd Generation Partnership Project; Technical Specification Group GSM/EDGE Radio Access Network; General Packet Radio Service (GPRS); Overall description of the GPRS radio interface; Stage 2 (Release 6)".

ITU-T Recommendation I.130: "Method for the Characterization of Telecommunication Services Supported by an ISDN".

ITU-T Recommendation Q.65: "Stage 2 of the Method for Characterization of the Services Supported by an ISDN".

DIS 8886: "OSI Data Link Service Definition".

DIS 10022: "OSI Physical Service Definition".

ISO 10039: "Medium Access Control Service Definition".

ISO 4335: "HDLC Procedures".

ISO 7478: "Multilink Procedures".

ISO 7498: "OSI Basic Reference Model and Layer Service Conventions".

---

## History

<b>Document history</b>		
V3.1.1	July 2009	Publication
V3.2.1	February 2011	Publication