

ETSI TS 102 178 V1.4.1 (2007-11)

Technical Specification

**Broadband Radio Access Networks (BRAN);
HiperMAN;
Data Link Control (DLC) layer**



Reference

RTS/BRAN-0040002r4

Keywords

access, broadband, BWA, FWA, HiperMAN,
layer2, MAN, nomadic, radio

ETSI

650 Route des Lucioles
F-06921 Sophia Antipolis Cedex - FRANCE

Tel.: +33 4 92 94 42 00 Fax: +33 4 93 65 47 16

Siret N° 348 623 562 00017 - NAF 742 C
Association à but non lucratif enregistrée à la
Sous-Préfecture de Grasse (06) N° 7803/88

Important notice

Individual copies of the present document can be downloaded from:

<http://www.etsi.org>

The present document may be made available in more than one electronic version or in print. In any case of existing or perceived difference in contents between such versions, the reference version is the Portable Document Format (PDF). In case of dispute, the reference shall be the printing on ETSI printers of the PDF version kept on a specific network drive within ETSI Secretariat.

Users of the present document should be aware that the document may be subject to revision or change of status. Information on the current status of this and other ETSI documents is available at

<http://portal.etsi.org/tb/status/status.asp>

If you find errors in the present document, please send your comment to one of the following services:

http://portal.etsi.org/chaicor/ETSI_support.asp

Copyright Notification

No part may be reproduced except as authorized by written permission.
The copyright and the foregoing restriction extend to reproduction in all media.

© European Telecommunications Standards Institute 2007.
All rights reserved.

DECTTM, **PLUGTESTS**TM and **UMTS**TM are Trade Marks of ETSI registered for the benefit of its Members.
TIPHONTM and the **TIPHON logo** are Trade Marks currently being registered by ETSI for the benefit of its Members.
3GPPTM is a Trade Mark of ETSI registered for the benefit of its Members and of the 3GPP Organizational Partners.

Contents

Intellectual Property Rights	7
Foreword.....	7
1 Scope	8
2 References	8
2.1 Normative references	8
3 Definitions, symbols and abbreviations	9
3.1 Definitions	9
3.2 Symbols.....	10
3.3 Abbreviations	11
4 Packet Convergence Sublayer	12
4.1 DLC SDU format	12
4.2 Classification	12
4.3 Payload Header Suppression (PHS)	12
4.4 Ethernet specific part.....	12
4.5 Virtual local area network (VLAN) specific part	12
4.6 IP specific part.....	12
5 DLC common part sublayer	13
5.1 Point to Multi Point	13
5.2 Mesh.....	13
6 Data/Control plane	13
7 PDU formats.....	13
7.1 DLC header formats	13
7.2 DLC header type encodings	15
7.2.1 Type encodings	15
7.2.2 Bandwidth request header.....	15
7.2.3 Header Check Sequence (HCS) encoding	16
7.3 DLC subheaders	16
7.3.1 Mesh subheader	16
7.3.2 ARQ feedback payload	16
7.3.3 Fragmentation subheader	17
7.3.4 Grant Management subheader	17
7.3.5 Packing subheader	18
7.3.6 FAST-FEEDBACK allocation subheader	18
7.4 DLC management messages.....	19
7.4.1 Supplemental DLC management messages	20
7.4.2 Type 1/3: DL/UL Channel Descriptor (DCD/UCD) message	21
7.4.3 Type 2: DL-MAP message	24
7.4.3.1 DL-MAP PHY Synchronization Field	25
7.4.3.2 DL-MAP IE format	25
7.4.3.2.1 DIUC allocations	26
7.4.3.2.2 DL-MAP extended IE format	26
7.4.3.2.3 Channel measurement DL-MAP IE format	26
7.4.3.2.4 DL-MAP AAS IE format	27
7.4.3.2.5 DL-MAP STC IE format	27
7.4.3.2.6 DL-MAP DUMMY IE format.....	27
7.4.3.2.7 DL SUBCH_IE format	28
7.4.4 Type 3: UL-MAP message	28
7.4.4.1 UL-MAP IE format	29
7.4.4.1.1 UIUC allocations	30
7.4.4.1.2 UL-MAP focused contention IE format	30
7.4.4.1.3 UL-MAP AAS IE format	31
7.4.4.1.4 UL-MAP subchannelization IE format.....	31

7.4.4.1.5	UL-MAP STC IE format	31
7.4.4.1.6	UL-MAP DUMMY IE format	31
7.4.4.1.7	Fast_Ranging_IE	32
7.4.4.1.8	UL-MAP Fast Tracking IE	32
7.4.4.2	Compressed private maps	33
7.4.4.2.1	Compressed private DL-MAP	33
7.4.4.2.2	Compressed private UL-MAP	33
7.4.4.3	Reduced private maps	33
7.4.4.3.1	Reduced private DL-MAP	33
7.4.4.3.2	Reduced private UL-MAP	33
7.4.5	Type 4/5: RaNGing REQuest/ReSPonse (RNG-REQ/RSP) message	34
7.4.5.1	AAS Support	34
7.4.5.2	Power management support	35
7.4.6	Type 6: REGistration-REQuest (REG-REQ) message	35
7.4.7	Type 7: REGistration-ReSPonse (REG-RSP) message	36
7.4.8	Type 9/10: Privacy Key Management (PKM-REQ/RSP) messages	36
7.4.9	Type 11: Dynamic Service Addition-Request (DSA-REQ)	38
7.4.10	Type 12: Dynamic Service Addition-ReSPonse (DSA-RSP)	38
7.4.11	Type 13: Dynamic Service Addition-ACKnowledgement (DSA-ACK)	38
7.4.12	Type 14: Dynamic Service Change-REQuest (DSC-REQ)	38
7.4.13	Type 15: Dynamic Service Change-ReSPonse (DSC-RSP)	38
7.4.14	Type 16: Dynamic Service Change-ACKnowledge (DSC-ACK)	38
7.4.15	Type 17: Dynamic Service Delete-REQuest (DSD-REQ)	38
7.4.16	Type 18: Dynamic Service Delete-ReSPonse (DSD-RSP)	39
7.4.17	Type 21: MultiCast polling Assignment REQuest (MCA-REQ)	39
7.4.18	Type 22: MultiCast polling Assignment ReSPonse (MCA-RSP)	39
7.4.19	Type 23: Downlink Burst Profile Change-REQuest (DBPC-REQ)	39
7.4.20	Type 24: Downlink Bust Profile Change-ReSPonse (DBPC-RSP)	39
7.4.21	Type 25: RESet CoMmanD (RES-CMD)	39
7.4.22	Type 26/27: SS Basic Capability-REQuest/ReSPonse (SBC-REQ/RSP)	39
7.4.22.1	OFDM demodulator	39
7.4.22.2	OFDM modulator	39
7.4.22.3	Subscriber transition gaps	40
7.4.22.4	Bandwidth allocation support	40
7.4.23	Type 33: ARQ Feedback message	40
7.4.24	Type 34: ARQ_Discard message	40
7.4.25	Type 35: ARQ_Reset message	41
7.4.26	Type 36/37: Report-Request (REP-REQ/RSP) message	41
7.4.27	Type 38: Fast Power Control (FPC) message	42
7.4.28	Type 39: MeSH Network ConFiGuration (MSH-NCFG) message	43
7.4.28.1	Nbr Physical Information Element	45
7.4.28.2	Nbr Logical Information Element	45
7.4.28.3	Embedded data	46
7.4.28.3.1	Network Descriptor Embedded Data Information Element	46
7.4.28.3.2	Network Entry Open Embedded Data Information Element	48
7.4.28.3.3	Network Entry Reject Embedded Data Information Element	48
7.4.28.3.4	Neighbour Link Establishment Embedded Data Information Element	48
7.4.29	Type 40: MeSH-Network ENTRy (MSH-NENT) message	49
7.4.30	Type 41: MeSH-Distributed SCHEDuling (MSH-DSCH) message	49
7.4.30.1	MSH-DSCH Scheduling Information Element	50
7.4.30.2	MSH-DSCH Scheduling Information Element	51
7.4.30.3	MSH-DSCH Availability Information Element	52
7.4.30.4	MSH-DSCH Grant Information Element	52
7.4.31	Type 42: MeSH-Centralized SCHEDuling (MSH-CSCH) message	52
7.4.32	Type 43: MeSH-Centralized Scheduling ConFiGuration (MSH-CSCF) message	54
7.4.33	Type 44/45: AAS-FeedBaCK REQuest/ReSPonse (AAS-FBCK REQ/RSP) message	55
7.4.34	Type 46 to 255: DUMMY message	56
8	Automatic Repeat reQuest (ARQ)	56
8.1	Packing for ARQ-enabled connections	56
8.1.1	Interaction of packing with fragmentation	56
8.1.2	Packing ARQ Feedback Information Elements	57

8.2	ARQ parameters	58
8.3	ARQ variables	59
8.4	ARQ operation	59
8.4.1	ARQ block usage	59
8.4.2	Comparison of BSNs	60
8.4.3	Transmitter state machine	61
8.4.4	Receiver state machine	62
8.4.5	Resetting the ARQ state machine	63
8.5	ARQ service flow TLVs	65
9	Mesh topology support	67
9.1	Introduction	67
9.2	Addressing and connections	68
9.3	DLC service definition	69
9.3.1	Primitives	69
9.3.2	MAC_CREATE_CONNECTION.indication	70
9.3.3	MAC_CHANGE_CONNECTION.indication	70
9.3.4	MAC_TERMINATE_CONNECTION.request	71
9.3.5	MAC_TERMINATE_CONNECTION.indication	71
9.3.6	MAC_DATA.request	72
9.3.7	MAC_DATA.indication	72
9.3.8	MAC_FORWARDING_UPDATE.request	73
9.3.9	MAC_FORWARDING_UPDATE.indication	74
9.4	DLC management message applicability	74
9.5	Network synchronization	76
9.5.1	Physical neighbour list	76
9.5.2	MSH-NCFG/MSH-NENT transmission channel and timing	77
9.5.2.1	MSH-NCFG next transmission scheduling	77
9.5.2.2	MSH-NENT next transmission scheduling	78
9.6	Network entry and synchronization	79
9.6.1	DLC management message tunnelling	79
9.6.2	Scanning and coarse synchronization to network	80
9.6.3	Obtaining network parameters	81
9.6.4	Opening sponsor channel	82
9.6.5	Negotiating basic capabilities	85
9.6.6	Node Authorization	85
9.6.7	Node Registration	85
9.6.8	Establishing IP connectivity	86
9.6.9	Establishing time of day	87
9.6.10	Transfer of operational parameters	87
9.7	Privacy sublayer	87
9.7.1	TEK exchange overview	87
9.7.2	Node Re-Authorization	87
9.7.3	TEK usage	88
9.7.4	Usage of operator shared key	88
9.7.5	HMAC authentication keys and calculation of HMAC digests	88
9.8	Data scheduling	88
9.8.1	Distributed scheduling	88
9.8.2	Centralized scheduling	89
10	DLC support of PHY	91
10.1	Uplink timing	91
10.2	Uplink allocation	92
11	Network Entry and Initialization	92
11.1	Initial ranging and automatic adjustments	92
11.1.1	Contention based Initial ranging and automatic adjustments	92
12	Extended DLC Support	95
13	Extended Privacy/Security	95
14	DLC Support of OFDMA PHY	95

15	Parameters and constants.....	95
16	TLV encoding	95
	History	96

Intellectual Property Rights

IPRs essential or potentially essential to the present document may have been declared to ETSI. The information pertaining to these essential IPRs, if any, is publicly available for **ETSI members and non-members**, and can be found in ETSI SR 000 314: "*Intellectual Property Rights (IPRs); Essential, or potentially Essential, IPRs notified to ETSI in respect of ETSI standards*", which is available from the ETSI Secretariat. Latest updates are available on the ETSI Web server (<http://webapp.etsi.org/IPR/home.asp>).

Pursuant to the ETSI IPR Policy, no investigation, including IPR searches, has been carried out by ETSI. No guarantee can be given as to the existence of other IPRs not referenced in ETSI SR 000 314 (or the updates on the ETSI Web server) which are, or may be, or may become, essential to the present document.

Foreword

This Technical Specification (TS) has been produced by ETSI Technical Committee Broadband Radio Access Networks (BRAN).

The present document describes the supplemental data transport and radio control functions of the Data Link Control (DLC) of High Performance Radio Metropolitan Area Network (HiperMAN) systems. A separate ETSI document, TS 102 177 [2], specifies the Physical (PHY).

With permission of IEEE® (on file as BRAN43d016), portions of the present document are excerpted from IEEE 802.16 [1] and IEEE 802.16e [3].

1 Scope

The present document defines the Data Link Control (DLC) of HiperMAN to support PMP and optionally Mesh network topologies. The present document provides the DLC functions required for Fixed applications, in frequencies below 11 GHz, and Nomadic and converged Fixed-Nomadic applications, in frequencies below 6 GHz.

2 References

References are either specific (identified by date of publication and/or edition number or version number) or non-specific.

- For a specific reference, subsequent revisions do not apply.
- Non-specific reference may be made only to a complete document or a part thereof and only in the following cases:
 - if it is accepted that it will be possible to use all future changes of the referenced document for the purposes of the referring document;
 - for informative references.

Referenced documents which are not found to be publicly available in the expected location might be found at <http://docbox.etsi.org/Reference>.

For online referenced documents, information sufficient to identify and locate the source shall be provided. Preferably, the primary source of the referenced document should be cited, in order to ensure traceability. Furthermore, the reference should, as far as possible, remain valid for the expected life of the document. The reference shall include the method of access to the referenced document and the full network address, with the same punctuation and use of upper case and lower case letters.

NOTE: While any hyperlinks included in this clause were valid at the time of publication ETSI cannot guarantee their long term validity.

2.1 Normative references

The following referenced documents are indispensable for the application of the present document. For dated references, only the edition cited applies. For non-specific references, the latest edition of the referenced document (including any amendments) applies.

- [1] IEEE 802.16-2004: "IEEE Standard for Local and Metropolitan Area Networks - Part 16: Air Interface for Fixed Broadband Wireless Access Systems".
- [2] ETSI TS 102 177: "Broadband Radio Access Networks (BRAN); HiperMAN; Physical (PHY) layer".
- [3] IEEE 802.16e-2005: "IEEE Standard for Local and Metropolitan Area Networks - Part 16: Air Interface for Fixed and Mobile Broadband Wireless Access Systems - Amendment 2 - Physical and Medium Access Control Layers for Combined Fixed and Mobile Operation in Licensed Bands, And Corrigendum 1".
- [4] IEEE 802.3-2005: "IEEE Standard for Information technology - Telecommunications and information exchange between systems - Local and metropolitan area networks - specific requirements Part 3: Carrier Sense Multiple Access with Collision Detection (CSMA/CD) Access Method and Physical Layer Specification".
- [5] IEEE P802.16-2004/Cor2/D4: "Draft IEEE Standard for Local and metropolitan area networks to IEEE Standard for Local and Metropolitan Area Networks - Part 16: Air Interface for Fixed Broadband Wireless Access Systems Corrigendum 2".

3 Definitions, symbols and abbreviations

3.1 Definitions

For the purposes of the present document, the following terms and definitions apply:

Adaptive Antenna System (AAS): system adaptively exploiting more than one antenna to improve the coverage and the system capacity

NOTE: AAS-enabled in the context of a PMP BS denotes the implementation of AAS as defined. AAS-enabled in the context of a PMP SS denotes the ability to communicate with an AAS-enabled BS using the AAS specific mechanisms. Though a PMP SS may itself implement AAS as defined, this has no impact on the air interface and hence no specific differentiation is made.

adaptive modulation: system's ability to communicate with another system using multiple burst profiles and a system's ability to subsequently communicate with multiple systems using different burst profiles

ARQ Block: distinct unit of data that is carried on an ARQ-enabled connection

NOTE: Such a unit is assigned a sequence number, and is managed as a distinct entity by the ARQ state machines.

bandwidth stealing: use, by a subscriber station operating on a grant per subscriber station basis, of a portion of the bandwidth allocated in response to a bandwidth request for a connection to send a bandwidth request or data for any of its connections

NOTE: *See also:* grant per subscriber station.

broadcast connection: management connection used by the Base Station (BS) to send Data Link Control (DLC) management messages on a downlink to all Subscriber Station (SS)

NOTE: The broadcast connection is identified by a well-known Connection Identifier (CID). A fragmentable broadcast connection is a connection that allows fragmentation of broadcast DLC management messages.

connection: unidirectional mapping between Base Station (BS) and Subscriber Station (SS) Data Link Control (DLC) peers

NOTE: Connections are identified by a Connection Identifier (CID). The DLC defines two kinds of connections: management connections and transport connections. *See also:* **connection identifier**.

Connection Identifier (CID): 16-bit value that identifies a transport connection or an uplink (UL)/downlink (DL) pair of associated management connections (i.e. belonging to the same subscriber station) to equivalent peers in the DLC of the Base Station (BS) and Subscriber Station (SS)

NOTE: The Connection Identifier (CID) address space is common (i.e. shared) between UL and DL and IEEE 802.16 [1], table 345 as amended by IEEE 802.16e [3] specifies how it is partitioned among the different types of connections. Security Associations (SAs) also exist between keying material and CIDs. *See also:* **connection**.

DC carrier: in an OFDM or OFDMA signal, the carrier whose frequency would be equal to the RF centre frequency of the station

Dynamic Frequency Selection (DFS): ability of a system to switch to different physical RF channels based on channel measurement criteria to conform to particular regulatory requirements

initial ranging connection identifier: management connection used by the Subscriber Station (SS) and the Base Station (BS) during the initial ranging process

NOTE: The initial ranging connection is identified by a well-known Connection Identifier (CID) (see IEEE 802.16 [1], table 345 as amended by IEEE 802.16e [3]). This CID is defined as constant value within the protocol since an SS has no addressing information available until the initial ranging process is complete.

management connection: connection used for the purpose of transporting Data Link Control (DLC) management messages (see: basic connection, primary management connection, broadcast connection, initial ranging connection) or standards-based messages (see: secondary management connection) required by the DLC layer

MeSH (MSH): network architecture, wherein systems are capable of forwarding traffic from and to multiple other systems

Multiple Input Multiple Output (MIMO): system employing at least two transmit antennas and at least two receive antennas to improve the system capacity, coverage or throughput

Payload Header Suppression Mask (PHSM): 8 bit value that references the Payload Header Suppression (PHS) rule

RF centre frequency: centre of the frequency band in which a BS or SS is intended to transmit

BS Rx/Tx Transition Gap (RTG): gap, used by TDD and H-FDD systems, between the last sample of the uplink burst and the first sample of the subsequent downlink burst at the antenna port of the base station in a time division duplex transceiver

NOTE: This gap allows time for the BS to switch from receive to transmit mode and SSs to switch from transmit to receive mode. During this gap, the BS is not transmitting modulated data but simply allowing the BS transmitter carrier to ramp up, the Tx/Rx antenna switch to actuate. Not applicable to frequency division duplex systems.

SS Rx/Tx Gap (SSRTG): minimum receive to transmit turnaround gap

NOTE: SSRTG is measured from the time of the last sample of the received burst to the first sample of the transmitted burst, at the antenna port of the SS.

SS Tx/Rx Gap (SSTTG): minimum transmit to receive turnaround gap

NOTE: SSTTG is measured from the time of the last sample of the transmitted burst to the first sample of the transmitted burst, at the antenna port of the SS.

turbo decoding: iterative decoding, using soft inputs and soft outputs

BS Tx/Rx Transition Gap (TTG): gap, used by TDD and H-FDD systems, between the last sample of the downlink burst and the first sample of the subsequent uplink burst at the antenna port of the base station in a time division duplex transceiver

NOTE: This gap allows time for the BS to switch from transmit to receive mode. During this gap, the BS is not transmitting modulated data but simply allowing the BS transmitter carrier to ramp down, the Tx/Rx antenna switch to actuate, and the BS receiver section to activate. Not applicable to frequency division duplex systems.

transport connection: connection used to transport user data

NOTE: It does not include any traffic over the basic, primary or secondary management connections. A fragmentable transport connection is a connection that allows fragmentation of Service Data Units (SDUs).

transport connection identifier: unique identifier taken from the Connection Identifier (CID) address space that uniquely identifies the transport connection

NOTE: All user data traffic is carried on transport connections, even for service flows that implement connectionless protocols, such as Internet Protocol (IP). An active or admitted service flow (identified by a Service Flow ID (SFID)) maps to a transport Connection Identifier (transport CID) assigned by the BS.

3.2 Symbols

For the purposes of the present document, the following symbols apply:

α_{avg}	Averaging parameter for CINR and RSSI computations
$RSS_{\text{IR,max}}$	Initial Ranging Max. Received Signal Strength at BS

3.3 Abbreviations

For the purposes of the present document, the following abbreviations apply:

AAS	Adaptive Antenna System
ACK	ACKnowledgement
AMC	Adaptive Modulation Coding
ARQ	Automatic Repeat reQuest
BR	Bandwidth Request
BS	Base Station
BSN	Block Sequence Number
BTC	Block Turbo Code
BW	BandWidth
CID	Connection IDentifier
CINR	Carrier to noise and INterference Ratio
CRC	Cyclic Redundancy Check
CS	Convergence Sublayer
CSCF	Centralized Scheduling ConFIGuration
CSCH	Centralized SCHEDULE
CTC	Convolutional Turbo Code
dBm	deciBels relative to one milliwatt
DCD	DL Channel Descriptor
DFS	Dynamic Frequency Selection
DIUC	Downlink Interval Usage Code
DL	DownLink
DLC	Data Link Control
DSA-RSP	Dynamic Service Addition - ReSPonse
DSCH	Distributed SCHEDULE
DSC-REQ	Dynamic Service Change - REQuest
DSC-RSP	Dynamic Service Change - ReSPonse
FDD	Frequency Division Duplexing
FPC	Fast Power Control
FSN	Fragment Sequence Number
FWA	Fixed Wireless Access
HCS	Header Check Sequence
H-FDD	Half-duplex FDD
HIPERMAN	HIgh PErformance Radio Metropolitan Area Network
HT	Header Type
ID	IDentifier
IE	Information Element
Im	Imaginary
IP	Internet Protocol
LSB	Least Significant Beat
MAC	Media Access Control
MIMO	Multiple Input Multiple Output
MSB	Most Significant Bit
MSH	MeSH
NCFG	Network ConFiGuration
NENT	Network ENTry
OFDM	Orthogonal Frequency Division Multiplexing
OFDMA	Orthogonal Frequency Division Multiple Access
PDU	Protocol Data Unit
PHS	Payload Header Suppression
PHSM	Payload Header Suppression Mask
PHY	PHYSical layer
PKM	Privacy Key Management
PMP	Point-to-MultiPoint
PUSC	Partial Usage of SubChannels
QoS	Quality of Service
Re	Real
REQ	REQuest

RNG	RaNGing
RRPT	Ranging Response Processing Time
RSP	ReSPonse
RSSI	Received Signal Strength Indicator
RTG	Receive/transmit Transition Gap
SA	Security Association
SDU	Service Data Unit
SFID	Service Flow IDentifier
SS	Subscriber Station
STC	Space Time Coding
TEK	Traffic Encryption Key
TLV	Type Length Value
TTG	Transmit/receive Transition Gap
UCD	UL Channel Descriptor
UDP	User Datagram Protocol
UIUC	Uplink Interval Usage Code
UL	UpLink
VLAN	Virtual Local Area Network

4 Packet Convergence Sublayer

The packet Convergence Sublayer (CS) resides on top of the DLC common part sublayer. The CS performs the following functions, utilizing the services of the DLC:

- a) Classification of the higher-layer protocol PDU into the appropriate transport connection. Suppression of payload header information (optional).
- b) Delivery of the resulting CS PDU to the DLC SAP associated with the service flow for transport to the peer DLC SAP.
- c) Receipt of the CS PDU from the peer DLC SAP.
- d) Rebuilding of any suppressed payload header information (optional).

The sending CS is responsible for delivering the DLC SDU to the DLC SAP. The DLC is responsible for delivery of the DLC SDU to peer DLC SAP in accordance with the QoS, fragmentation, concatenation and other transport functions associated with a particular connection's service flow characteristics. The receiving CS is responsible for accepting the DLC SDU from the peer DLC SAP and delivering it to a higher layer entity.

The packet CS is used for transport for all packet-based protocols as defined in IEEE 802.16 [1], clause 11.13.19.3 as modified by IEEE 802.16e [3].

4.1 DLC SDU format

DLC SDU format is according to IEEE 802.16 [1], clause 5.2.1 as modified by IEEE 802.16e [3].

4.2 Classification

Packet classification is according to IEEE 802.16 [1], clause 5.2.2 as modified by IEEE 802.16e [3].

4.3 Payload Header Suppression (PHS)

Payload Header Suppression is according to IEEE 802.16 [1], clause 5.2.3 as modified by IEEE 802.16e [3].

4.4 Ethernet specific part

Ethernet specific part is according to IEEE 802.16 [1], clause 5.2.4 as modified by IEEE 802.16e [3].

4.5 Virtual Local Area Network (VLAN) specific part

Virtual local area network specific part is according to IEEE 802.16 [1], clause 5.2.5 as modified by IEEE 802.16e [3].

4.6 IP specific part

IP specific part is according to IEEE 802.16 [1], clause 5.2.6 as modified by IEEE 802.16e [3].

5 DLC common part sublayer

5.1 Point to MultiPoint

Point to MultiPoint is according to IEEE 802.16 [1], clause 6.1 as modified by IEEE 802.16e [3].

5.2 Mesh

Mesh is according to IEEE 802.16 [1], clause 6.2 as modified by IEEE 802.16e [3].

6 Data/Control plane

The data/control plane is according to IEEE 802.16 [1], clause 6.3 as modified by IEEE 802.16e [3].

7 PDU formats

DLC PDUs shall be of the form illustrated in figure 1. Each PDU shall begin with a fixed-length generic DLC header. The header may be followed by the Payload of the DLC PDU. If present, the Payload shall consist of zero or more subheaders and zero or more DLC SDUs and/or fragments thereof. The payload information may vary in length, so that a DLC PDU may represent a variable number of bytes. This allows the DLC to tunnel various higher layer traffic types without knowledge of the formats or bit patterns of those messages. All reserved fields shall be set to zero on transmission and ignored on reception.

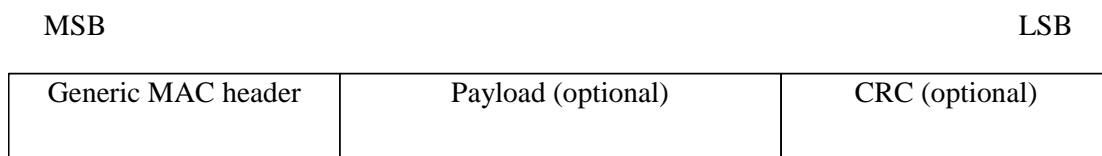

Figure 1: DLC PDU formats

A DLC PDU may contain a CRC. In the case where a CRC is included, for each DLC PDU with HT=0, a CRC, as defined in IEEE 802.3 [4], shall be appended to the payload of the DLC PDU; i.e. request DLC PDUs are unprotected. The CRC shall cover the generic DLC header and the Payload of the DLC PDU. The CRC shall be calculated after encryption; i.e. the CRC protects the Generic Header and the ciphered Payload. Implementation of CRC capability is mandatory.

7.1 DLC header formats

Two DLC header formats are defined. The first is the generic DLC header that begins each DLC PDU containing either DLC management messages or CS data. The second is the bandwidth request header used to request additional bandwidth. The single-bit Header Type (HT) field distinguishes the generic DLC header and bandwidth request header formats. The HT field shall be set to zero for the Generic Header and to one for a bandwidth request header.

The generic DLC header format is defined in table 1.

Table 1: DLC header format

Syntax	Size	Notes
MAC Header () {		
HT	1 bit	0b0 = Generic DLC header 0b1 = Bandwidth request header
EC	1 bit	if HT = 0b1, EC = 0b0
if (HT == 0) {		
Type	6 bits	
reserved	1 bit	Shall be set to 0b0
CI	1 bit	
EKS	2 bits	
reserved	1 bit	Shall be set to 0b0
LEN	11 bits	
} else {		
Type	3 bits	
BR	19 bits	
}	16 bits	
CID		
HCS	8 bits	
}		

- CRC indicator (CI):
 - 0b1 = CRC is included in the PDU by appending it to the PDU payload after encryption, if any.
 - 0b0 = CRC is not included.
- Connection identifier (CID).
- Encryption Control (EC):
 - 0b0 = Payload is not encrypted.
 - 0b1 = Payload is encrypted.
- Encryption Key Sequence (EKS):
 - The index of the Traffic Encryption Key (TEK) and Initialization Vector used to encrypt the payload. This field is only meaningful if the EC field is set to 1.
- Header Check Sequence (HCS):
 - An 8-bit field used to detect errors in the header. The transmitter shall calculate the HCS value for the first five bytes of the cell header, and insert the result into the HCS field (the last byte of the DLC header). It shall be the remainder of the division (Modulo 2) by the generator polynomial $g(D)=D^8+D^2+D+1$ of the polynomial D^8 multiplied by the content of the header excluding the HCS field. (Example: [HT EC Type]=0x80, BR=0xAAAA, CID=0x0F0F; HCS should then be set to 0xD5).
- Header Type (HT):
 - Shall be set to zero.
- LEN:
 - The length in bytes of the DLC PDU including DLC header and CRC, if present.
- Type:
 - Indicates the subheaders and special payload types are present in the message payload.

7.2 DLC header type encodings

7.2.1 Type encodings

The Type field in the Generic DLC Header shall indicate the presence of subheaders and payload as shown in table 2.

Table 2: Type encodings

Type bit	Value
#0 (LSB)	UL: Grant Management Subheader DL: FAST-FEEDBACK allocation subheader 1 = present, 0 = absent
#1	Packing Subheader 1 = present, 0 = absent
#2	Fragmentation Subheader 1 = present, 0 = absent
#3	Extended Type indicates whether the present Packing/Fragmentation Subheader is extended. 1 = extended, 0 = not extended For ARQ enabled connections, this bit shall be set to 0b1
#4	ARQ Feedback Payload 1 = present, 0 = absent
#5 (MSB)	Mesh Subheader 1 = present, 0 = absent

Four types of Subheaders may be present. The per-PDU subheaders (the Mesh subheader, the Fragmentation subheader and the Grant Management subheader) may be inserted in DLC PDUs immediately following the Generic DLC. If both the Fragmentation Subheader and Grant Management Subheader are indicated, the Grant Management Subheader shall come first. If the Mesh Subheader is indicated, it shall precede all other subheaders.

7.2.2 Bandwidth request header

The Bandwidth Request PDU shall consist of bandwidth request header alone and shall not contain a payload. The bandwidth request header is illustrated in figure 2.

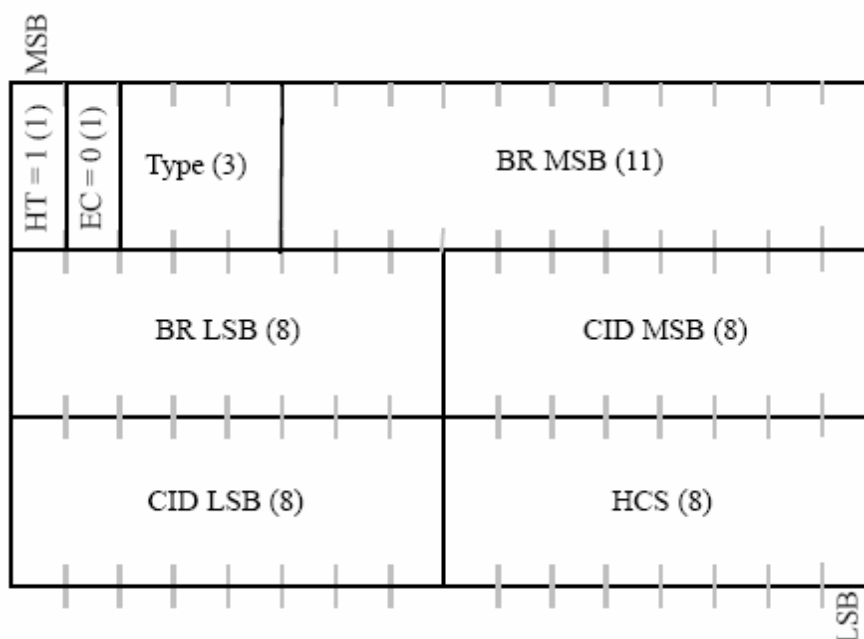

Figure 2: Bandwidth request header format

The Bandwidth Request shall have the following properties:

- a) The length of the header shall always be 6 bytes.
- b) The EC field shall be set to 0, indicating no encryption.
- c) The CID shall indicate the connection for which uplink bandwidth is requested.
- d) The Bandwidth Request (BR) field shall indicate the number of bytes requested.
- e) The allowed types for bandwidth requests are "000" for incremental and "001" for aggregate.

An SS receiving a bandwidth request header on the downlink shall discard the PDU.

The fields of the bandwidth request header are defined in table 3. Every header is encoded, starting with the HT and EC fields. The coding of these fields is such that the first byte of a DLC header shall never have the value of 0xFF. This prevents false detection of the stuff byte.

Table 3: Bandwidth request header fields

Name	Length (bits)	Description
BR	19	Bandwidth Request: The number of bytes of uplink bandwidth requested by the SS. The bandwidth request is for the CID. The request shall not include any PHY overhead
CID	16	Connection identifier
EC	1	Always set to zero
HCS	8	Header Check Sequence
HT	1	Header Type = 0b1
Type	3	Indicates the type of bandwidth request header

7.2.3 Header Check Sequence (HCS) encoding

The transmitter shall calculate the HCS value for the first five octets of the cell header, and insert the result into the HCS field (the last octet of the DLC header). It shall be the remainder of the division (Modulo 2) by the generator polynomial $g(D) = D^8 + D^2 + D + 1$ of the polynomial D^8 multiplied by the content of the header excluding the HCS field.

EXAMPLE: [HT EC Type] = 0x80, BR = 0xAAAA, CID = 0x0F0F; HCS should then be set to 0xD5.

7.3 DLC subheaders

7.3.1 Mesh subheader

The Mesh subheader as shown in table 4 shall always immediately follow the generic DLC header when operating in mesh mode, but shall not be used when operating in PMP mode.

Table 4: Mesh subheader format

Syntax	Size	Notes
Mesh Subheader() {		
Xmt Node Id	16 bits	Node Id of the originating mesh node
}		

7.3.2 ARQ feedback payload

If the ARQ feedback payload bit in the DLC Header Type field (see table 2) is set, the ARQ Feedback Payload shall be transported. If packing is used, it shall be transported as the first packed payload. See clause 8.1.2. Note that this bit does not address the ARQ Feedback payload contained inside an ARQ Feedback message.

7.3.3 Fragmentation subheader

The fragmentation subheader is shown in table 5.

Table 5: Fragmentation subheader format

Syntax	Size	Notes
Fragmentation Subheader() { Fragmentation Control (FC)	2 bits	Indicates the fragmentation state of the payload: 00 = no fragmentation 01 = last fragment 10 = first fragment 11 = continuing (middle) fragment
if {ARQ enabled Connection}		
BSN	11 bits	Sequence number of the first block in the current SDU fragment
} else {		
if (Type bit#3 (Extended Type) == 0)		See table 2
Fragmentation Sequence Number (FSN)	11 bits	Sequence number of the current SDU fragment. This field increments by one (modulo 2048) for each fragment, including unfragmented SDUs. Applicable to connections where ARQ is not enabled
}Else{		
Fragment Block Sequence Number (FSN)	3 bits	Sequence number of the first block in the current SDU or SDU fragment. This field shall increment by one (modulo 8) for each fragment, including unfragmented SDUs. Applicable to connections where ARQ is enabled
}		
Reserved	3 bits	Shall be set to 0b000
}		

7.3.4 Grant Management subheader

The Grant Management subheader is two bytes in length and is used by the SS to convey bandwidth management needs to the BS. This subheader is encoded differently based upon the type of uplink scheduling service for the connection (as given by the CID). The use of this subheader is defined in clause 6.3.6 of IEEE 802.16 [1], as modified by IEEE 802.16e [3]. The Grant Management subheader is shown in table 6. The capability of Grant Management subheader at both BS and SS is optional.

Table 6: Grant management subheader format

Syntax	Size	Notes
Grant Management Subheader () {		
if (scheduling service type == UGS) {		
SI	1 bit	Slip Indicator 0 = No action 1 = Used by the SS to indicate a slip of uplink grants relative to the uplink queue depth
PM	1 bit	Poll-Me 0 = No action 1 = Used by the SS to request bandwidth poll
<i>reserved</i>	14 bits	Shall be set to zero
}		
else {		
PiggyBack Request	16 bits	The number of bytes of uplink bandwidth requested by the SS. The bandwidth request is for the CID. The request shall not include any PHY overhead. The request shall be incremental
}		
}		

7.3.5 Packing subheader

When Packing is used, multiple SDUs may be packed into a single DLC PDU. When packing variable-length DLC SDUs, the DLC precedes each one with a Packing subheader as shown in table 7.

Table 7: Packing subheader format

Syntax	Size	Notes
Packing Subheader() {		
Fragmentation Control	2 bits	Indicates the fragmentation state of the payload: 00 = no fragmentation 01 = last fragment 10 = first fragment 11 = continuing (middle) fragment
if (ARQ enabled connection) {		
BSN	11 bits	Sequence number of first block in the current SDU fragment
} else {		
If (Type bit#3 == 0){		See table 2
FSN	11 bits	Sequence number of the current SDU fragment. This field increments by one (modulo 2048) for each fragment, including unfragmented SDUs. Applicable to connections where ARQ is not enabled
}Else{		
FSN	3 bits	Sequence number of the first block in the current SDU fragment. This field shall increment by one (modulo 8) for each fragment, including unfragmented SDUs. Applicable to connections where ARQ is enabled
Length	11 bits	The length in bytes of the DLC SDU or SDU fragment, including the length of the Packing Subheader
}		
}		

7.3.6 FAST-FEEDBACK allocation subheader

The format of the FAST-FEEDBACK allocation subheader is specified in table 8. The FAST-FEEDBACK allocation subheader, when used, shall always be the last per-PDU subheader as specified in IEEE 802.16 [1], clause 6.3.2.2. The support of the FAST-FEEDBACK allocation subheader is PHY specification specific.

Table 8: FAST-FEEDBACK allocation header format

Syntax	Size	Notes
FAST-FEEDBACK allocation Subheader {		
Allocation offset	6 bits	
Feedback type	2 bits	0b00 - Fast DL measurement 0b01 - Fast MIMO feedback, antenna #0 0b10 - Fast MIMO feedback, antenna #1 0b11 - MIMO mode and permutation mode feedback
}		

- Allocation offset:
 - Defines the offset in units of slots, from the beginning of the FAST-FEEDBACK uplink bandwidth allocation IEEE 802.16 [1], clause 8.4.5.4.9, as amended by IEEE 802.16e [3], of the slot in which the SS servicing the CID appearing in the DLC generic header, must send a FAST-FEEDBACK feedback message. Range of values 0 to 63. The allocation applies to the UL subframe two frames after the frame indicating the fast feedback allocation subheader.

7.4 DLC management messages

TLVs within DLC Management messages shall be ordered as follows. Parameters for optional features shall occur after those listed for support of mandatory features. Features that are defined optional, but are mandated by the implemented System Profile, if any, shall be ordered as optional. Both mandatory and optional TLVs shall subsequently be sequenced in order of increasing Type value. Parameters with defined default values should be omitted if the desired value coincides with the default one.

When reporting parameters in DLC Management messages, service class names should not be used.

A set of DLC management messages are defined. These messages shall be carried in the Payload of the DLC PDU. All DLC Management messages begin with a Management Message Type field and may contain additional fields. DLC management messages on the Basic, Broadcast, and Initial Ranging connections shall neither be fragmented nor packed. DLC management messages on the Fragmentable Broadcast connection may be packed and/or fragmented. Management messages carried on the Initial Ranging, Broadcast, Fragmentable Broadcast, Basic, and Primary Management connections shall have CRC usage enabled. The format of the management message is given in figure 3. The encoding of the Management Message Type field is given in table 9. DLC management messages shall not be carried on Transport Connections. DLC management messages that have a Type value specified in table 9 as "*reserved*" or those not containing all required parameters or containing erroneously encoded parameters shall be silently discarded.



Figure 3: DLC Management message format

Table 9: DLC Management messages

Type	Message	Connection	Description
0	UCD	Fragmentable Broadcast	Uplink Channel Descriptor
1	DCD	Fragmentable Broadcast	Downlink Channel Descriptor
2	DL-MAP	Broadcast	Downlink Access Definition
3	UL-MAP	Broadcast	Uplink Access Definition
4	RNG-REQ	Initial Ranging or Basic	Ranging Request
5	RNG-RSP	Initial Ranging or Basic	Ranging Response
6	REG-REQ	Primary Management	Registration Request
7	REG-RSP	Primary Management	Registration Response
8	<i>reserved</i>		
9	PKM-REQ	Primary Management	Privacy Key Management Request
10	PKM-RSP	Primary Management	Privacy Key Management Response
11	DSA-REQ	Primary Management	Dynamic Service Addition Request
12	DSA-RSP	Primary Management	Dynamic Service Addition Response
13	DSA-ACK	Primary Management	Dynamic Service Addition Acknowledge
14	DSC REQ	Primary Management	Dynamic Service Change Request
15	DSC-RSP	Primary Management	Dynamic Service Change Response
16	DSC-ACK	Primary Management	Dynamic Service Change Acknowledge
17	DSD-REQ	Primary Management	Dynamic Service Delete Request

Type	Message	Connection	Description
18	DSD-RSP	Primary Management	Dynamic Service Delete Response
19	<i>reserved</i>		
20	<i>reserved</i>		
21	MCA-REQ	Primary Management	Multicast Assignment Request
22	MCA-RSP	Primary Management	Multicast Assignment Response
23	DBPC-REQ	Basic	Downlink Burst Profile Change Request
24	DBPC-RSP	Basic	Downlink Burst Profile Change Response
25	RES-CMD	Basic	Reset Command
26	SBC-REQ	Basic	SS Basic Capability Request
27	SBC-RSP	Basic	SS Basic Capability Response
28	CLK-CMP	Broadcast	SS network clock comparison
29	DREG-CMD	Basic	De/Re-register Command
30	DSX-RVD	Primary Management	DSx Received Message
31	TFTP-CPLT	Primary Management	Config file TFTP Complete Message
32	TFTP-RSP	Primary Management	Config file TFTP Complete Response

7.4.1 Supplemental DLC management messages

As shown in table 10, supplemental DLC management messages are defined to facilitate ARQ, channel measurements and mesh functionality.

Table 10: DLC supplemental management messages

Type	Message	Connection	Description
33	ARQ-Feedback	Basic	Stand alone ARQ Feedback
34	ARQ-Discard	Basic	ARQ Discard message
35	ARQ-Reset	Basic	ARQ Rest message
36	REP-REQ	Basic	Channel measurement Report Request
37	REP-RSP	Basic	Channel measurement Report Response
38	FPC	Broadcast	Fast Power Control
39	MSH-NCFG	Broadcast	Mesh Network Configuration
40	MSH-NENT	Basic	Mesh Network Entry
41	MSH-DSCH	Broadcast	Mesh Distributed Schedule
42	MSH-CSCH	Broadcast	Mesh Centralized Schedule
43	MSH-CSCF	Broadcast	Mesh Centralized Schedule Configuration
44	AAS-FBCK-REQ	Basic	AAS Feedback Request
45	AAS-FBCK-RSP	Basic	AAS Feedback Response
46	AAS_Beam_Select	Basic	AAS Beam Select message
47	AAS_BEAM_REQ	Basic	AAS Beam Request message
48	AAS_BEAM_RSP	Basic	AAS Beam Response message
49	DREG_REQ	Basic	SS De-registration message
50 to 255	Reserved		

During the Adaptive Antenna System (AAS) portion of the frame, DL-MAP, UL-MAP, DCD, UCD, and CLK-CMP messages may be sent using the basic CID.

7.4.2 Type 1/3: DL/UL Channel Descriptor (DCD/UCD) message

A DCD shall be transmitted by the BS at a periodic interval (IEEE 802.16 [1], table 342 as amended by IEEE 802.16e [3]) to define the characteristics of a downlink physical channel.

Table 11: DCD message format

Syntax	Size	Notes
DCD_Message_Format () {		
Management Message Type = 1	8 bits	
<i>reserved</i>	8 bits	Shall be set to zero
Configuration Change Count	8 bits	
TLV Encoded information for the overall channel	<i>variable</i>	TLV specific
Begin PHY Specific Section {		See applicable PHY section
for (<i>i</i> = 1; <i>i</i> <= <i>n</i> ; <i>i</i> ++) {		For each downlink burst profile 1 to <i>n</i>
Downlink_Burst_Profile		PHY specific
}		
}		
}		

A BS shall generate DCDs in the format shown in table 11, including all of the following parameters:

- Configuration Change Count:
 - Incremented by one (modulo 256) by the BS whenever any of the values, except the Frame Number, of this channel descriptor change. If the value of this count in a subsequent DCD remains the same, the SS can quickly decide that the remaining fields have not changed and may be able to disregard the remainder of the message.

For OFDM PHY, the following shall be included in the DCD message:

- Frame Duration Code.
- Frame Number.

The message parameters following the Configuration Change Count shall be encoded in a TLV form. All channel encodings shall appear first before the Downlink_Burst_Profile encodings.

The Downlink_Burst_Profile is a compound TLV encoding that defines, and associates with a particular Downlink Interval Usage Code (DIUC), the PHY characteristics that shall be used with that DIUC. Within each Downlink_Burst_Profile shall be an unordered list of PHY attributes, encoded as TLV values. Each interval is assigned a DIUC by the DL-MAP message. A Downlink_Burst_Profile shall be included for each DIUC to be used in the DL-MAP unless the PHY's Downlink_Burst_Profile is explicitly known.

Downlink_Burst_Profile contents are defined in TS 102 177 [2].

TLVs which may be included in the DCD message shall be limited to those listed in table 12.

Table 12: DL Channel Descriptor TLVs

Name	Type	Length	Value
Burst Profile	1	variable	May appear more than once. The length is the number of bytes in the overall object, including embedded TLV items. See table 16
BS EIRP	2	2	Signed in units of 1 dBm
TTG	7	1	TTG (in PSs). See TS 102 177 [2]
RTG	8	1	RTG (in PSs). See TS 102 177 [2]
$RSS_{R,max}$	9	2	Initial Ranging Max. Received Signal Strength at BS Signed in units of 1 dBm. Signed integer
Frame Duration Code	14	1	The duration of the frame. The frame duration code values are specified in table 11, in TS 102 177 [2]
Frame Number	15	3	The number of the frame containing the DCD
MAC Version	18	1	

Burst Profile encodings which may be included in the DCD message shall be limited those shown in table 13.

Table 13: DL burst profile TLVs

Name	Type	Length	Value
FEC Code type	150	1	0 = BPSK (CC) 1/2 11 = 64QAM (BTC) 2/3 1 = QPSK (RS+CC/CC) 1/2 12 = 64QAM (BTC) 5/6 2 = QPSK (RS+CC/CC) 3/4 13 = QPSK (CTC) 1/2 3 = 16QAM (RS+CC/CC) 1/2 14 = QPSK (CTC) 2/3 4 = 16QAM (RS+CC/CC) 3/4 15 = QPSK (CTC) 3/4 5 = 64QAM (RS+CC/CC) 2/3 16 = 16QAM (CTC) 1/2 6 = 64QAM (RS+CC/CC) 3/4 17 = 16QAM (CTC) 3/4 7 = QPSK (BTC) 1/2 18 = 64QAM (CTC) 2/3 8 = QPSK (BTC) 3/4 or 2/3 19 = 64QAM (CTC) 3/4 9 = 16QAM (BTC) 3/5 20 to 55 = Reserved 10 = 16QAM (BTC) 4/5
DIUC Mandatory Exit Threshold	151	1	0 to 63. 75 dB C/(N+I) at or below which this DIUC can no longer be used and at which a change to a more robust DIUC is required, in 0,25 dB units
DIUC Mandatory Entry Threshold	152	1	0 to 63. 75 dB The minimum C/(N+I) required to start using this DIUC when changing from a more robust DIUC is required, in 0,25 dB units
TCS_enable	153		0 = TCS disabled 1 = TCS enabled 2 to 255 = Reserved

TLVs which may be included in the UCD message shall be limited to those listed in table 14.

Table 14: UL Channel Descriptor TLVs

Name	Type	Length	Value
Burst Profile	1	variable	May appear more than once. The length is the number of bytes in the overall object, including embedded TLV items. See table 16
Frequency	5	4	Uplink centre frequency (kHz)
Contention-based Reservation Timeout	2	1	Number of UL-MAPs to receive before contention-based reservation is attempted again for the same connection
Subchannelized initial ranging	18	1	Indicates whether subchannelized initial ranging is supported 0 = Not supported 1 = Supported
Subchannelization focused contention codes	151	1	Number of contention codes (C_{SE}) that shall only be used to request a subchannelized allocation. Default value 0. Allowed values 0 to 8
Subchannelized REQ-Region-Full Parameters	150	1	Bits 0 to 2 Number of subchannels used by each transmit opportunity when REQ Region-Full is allocated in subchannelization region, per the following enumeration: 0: 1 Subchannel 1: 2 Subchannels 2: 4 Subchannels 3: 8 Subchannels 4: 16 Subchannels 5 to 7: Shall not be used Bits 3 to 7: Number of OFDM symbols used by each transmit opportunity when REQ Region-Full is allocated in subchannelization region

Burst Profile encodings which may be included in the UCD message shall be limited those shown in table 15.

Table 15: UL burst profile TLVs

Name	Type	Length	Value
FEC Code type	150	1	0 = BPSK (CC) 1/2 11 = 64QAM (BTC) 2/3 1 = QPSK (RS+CC/CC) 1/2 12 = 64QAM (BTC) 5/6 2 = QPSK (RS+CC/CC) 3/4 13 = QPSK (CTC) 1/2 3 = 16QAM (RS+CC/CC) 1/2 14 = QPSK (CTC) 2/3 4 = 16QAM (RS+CC/CC) 3/4 15 = QPSK (CTC) 3/4 5 = 64QAM (RS+CC/CC) 2/3 16 = 16QAM (CTC) 1/2 6 = 64QAM (RS+CC/CC) 3/4 17 = 16QAM (CTC) 3/4 7 = QPSK (BTC) 1/2 18 = 64QAM (CTC) 2/3 8 = QPSK (BTC) 3/4 or 2/3 19 = 64QAM (CTC) 3/4 9 = 16QAM (BTC) 3/5 20 to 255 = Reserved 10 = 16QAM (BTC) 4/5
Focused Contention Power Boost	151	1	The power boost in dB of focused contention carriers See TS 102 177 [2] for details

Table 16 defines the format of the Burst_Profile, which is used in both DCD and UCD messages.

The Burst Profile is encoded with a Type of 1, an 8-bit length, and a 4-bit DIUC/UIUC which is associated with the Burst Profile and Thresholds. The DIUC/UIUC value is used in the DL-MAP respectively UL-MAP message to specify the Burst Profile to be used for a specific burst.

Table 16: Burst profile format

Syntax	Size	Notes
DL/UL_Burst_Profile_format {		
Type = 1	8 bits	
Length	8 bits	
Reserved	4 bits	Shall be set to 0
DIUC/UIUC	4 bits	
TLV encoded information	variable	
}		

7.4.3 Type 2: DL-MAP message

The DL-MAP message defines the access to the downlink information. If the length of the DL-MAP message is a non-integral number of bytes, the LEN field in the DLC header is rounded up to the next integral number of bytes. The message shall be padded to match this length, but the SS shall disregard the 4 pad bits.

A BS shall generate DL-MAP messages in the format shown in table 17, including all of the following parameters:

- PHY Synchronization:
 - The PHY synchronization field is dependent on the PHY specification used. The encoding of this field is given in each PHY specification separately.
- DCD Count:
 - Matches the value of the configuration change count of the DCD, which describes the downlink burst profiles that apply to this map.
- Base Station ID:
 - The Base Station ID is a 48-bit long field identifying the BS. The Base Station ID shall be programmable. The most significant 24 bits shall be used as the operator ID. This is a network management hook that can be sent with the DCD message for handling edge-of-sector and edge-of-cell situations.

The encoding of the remaining portions of the DL-MAP message is PHY-specification dependent and may be absent. Refer to the appropriate PHY specification.

Table 17: DL-MAP message format

Syntax	Size	Notes
DL-MAP_Message_format {		
Management Message Type = 2	8 bits	
PHY Synchronization Field	variable	
DCD Count	8 bits	
Base Station ID	48 bits	
Begin PHY Specific Section {		
if (OFDMA) {		
Number of OFDMA symbols	8 bits	Number of OFDMA symbols in the DL subframe including all AAS/permutation zones
}		
for (i = 1; i <= n; i++) {		For each DL-MAP element 1 to n
DL-MAP_IE()	variable	
}		
}		
if !(byte boundary) {		
Padding Nibble	4 bits	Padding to reach byte boundary
}		
}		

The DL-MAP_IEs in the DL-MAP shall be ordered in the increasing order of the transmission start time of the relevant PHY burst. The transmission start time is conveyed by the contents of the DL_MAP_IE in a manner which is PHY dependant.

The logical order in which DLC PDUs are mapped to the PHY layer bursts in the downlink is defined as the order of DL-MAP_IEs in the DL-MAP message.

The following formats shall be used in the DL-MAP and UL-MAP messages.

7.4.3.1 DL-MAP PHY Synchronization Field

The PHY Synchronization Field of the DL-MAP message shall have the format shown in table 18.

Table 18: PHY synchronization field

Syntax	Size	Notes
PHY_synchronization_field() {		
		The DL-MAP PHY synchronization field is empty (zero bytes long) for the OFDM PHY
}		

7.4.3.2 DL-MAP IE format

DL-MAP Information Elements shall have the format shown in table 19.

Table 19: DL-MAP information element

Syntax	Size	Notes
DL-MAP_information_element() {		
CID	16 bits	
DIUC	4 bits	
Preamble present	1 bit	0 = not present, 1 = present if DIUC == 15 and not Extended DIUC = 3, shall be 0
Start Time	11 bits	
if (DIUC == 15)		
Extended DIUC dependent IE	variable	Report_IE() or AAS_DL_IE() or STC_IE()
Padding nibble, if needed	4 bits	Completing to nearest byte
}		

- Connection Identifier (CID):
 - Represents the assignment of the IE to a broadcast, multicast, or unicast address. If the broadcast or multicast CID is used then it is possible to concatenate unicast DLC PDUs (with different CIDs) into a single DL burst. During a broadcast or multicast DL burst it is the responsibility of the BS to ensure that any bursts sent to an HFDD SS do not overlap (in time; taking SSTG and SSRTG into account) any UL allocations for that SS. An HFDD SS for which a DL MAP IE and UL MAP IE overlap in time shall use the UL allocation and discard DL traffic during the overlapping period.
- Downlink Interval Usage Code (DIUC):
 - A four-bit Downlink Interval Usage Code (DIUC) shall be used to define the burst type associated with that time interval. Burst Descriptor shall be included into DCD Message for each DIUC used in the DL-MAP except those associated with Gap, End of Map and Extended. The DIUC shall be one of the values defined in table 20.
- Preamble present:
 - If set, the indicated burst shall start with the short preamble.

- Start Time:
 - If transmitted in a private map (for compressed private map see IEEE 802.16 [1], clause 8.3.6.6 as amended by IEEE 802.16e [3], for reduced private map (see IEEE 802.16 [1], clause 8.3.6.7 as amended by IEEE 802.16e [3]) within an AAS zone, this field indicates the start time, in units of symbol duration, relative to the beginning of the subsequent AAS zone (including preamble) where the DL-MAP message is transmitted. If transmitted in a compressed private map (see IEEE 802.16 [1], clause 8.3.6.6 as amended by IEEE 802.16e [3]), this field indicates the start time, in units of symbol duration, relative to the beginning of the subsequent downlink frame (including preamble). The end of the last allocated burst is indicated by allocating a NULL burst (DIUC = 14) with zero duration. The time instants indicated by the Start Time values are the transmission times of the first symbol of the burst including preamble (if present).
- Boosting:
 - Indication whether the subcarriers for this allocation are power boosted. The field shall be zero when describing allocations that use the AMC or PUSC-ASCA permutations in a zone using "Dedicated Pilots".

7.4.3.2.1 DIUC allocations

Table 20 contains the DIUC values used in DL-MAP_IE().

Table 20: OFDM DIUC values

DIUC	Usage
0	STC zone
1 to 11	Burst Profiles
12	Reserved
13	Gap
14	End of Map
15	Extended DIUC

7.4.3.2.2 DL-MAP extended IE format

A DL-MAP IE entry with a DIUC value of 15, indicates that the IE carries special information and conforms to the structure shown in table 21. A station shall ignore an extended IE entry with an extended DIUC value for which the station has no knowledge. In the case of a known extended DIUC value but with a length field longer than expected, the station shall process information up to the known length and ignore the remainder of the IE.

Table 21: DL MAP extended IE format

Syntax	Size (bits)	Notes
DL_Extended_IE() {		
Extended DIUC	4	0x00 to 0x0F
Length	4	Length in bytes of Unspecified data field
Unspecified data	variable	
}		

7.4.3.2.3 Channel measurement DL-MAP IE format

An extended IE with an extended DIUC value of 0x00 is issued by the BS to request a channel measurement (see IEEE 802.16 [1], clause 6.3.2.3.33, as amended by IEEE 802.16e [3]). The IE includes an 8-bit Channel Nr value as shown in table 22. The IE shall be followed by the End of Map IE (DIUC = 14).

Table 22: Channel measurement Information Element format

Syntax	Size	Notes
Channel_Measurement_Information_Element() {		
extended DIUC code	4 bits	Channel measurement = 0x0
Length	4 bits	Length = 0x1
Channel Nr	8 bits	Channel number Shall be set to 0x00 for licensed bands
}		

7.4.3.2.4 DL-MAP AAS IE format

Within a frame, the switch from non-AAS to AAS-enabled traffic is marked by using the extended DIUC = 15 with the AAS_IE() shown in table 23 to indicate that the subsequent allocations, until the start of the first UL-MAP allocation using TDD, and until the end of the frame using FDD, shall be for AAS traffic. When used, the CID in the DL-MAP_IE() shall be set to the broadcast CID. Subsequent AAS PHY bursts shall all start with the short preamble.

Table 23: AAS DL Information Element format

Syntax	Size	Notes
AAS_DL_Information_element() {		
extended DIUC	4 bits	AAS = 0x2
Length	4 bits	Length = 0x0
}		

7.4.3.2.5 DL-MAP STC IE format

In the DL-MAP, an STC enabled BS may transmit DIUC = 15 with the STC_IE() shown in table 24 to indicate that the subsequent allocations shall be STC encoded. No preceding DL allocations shall be STC encoded and all subsequent DL allocations until the end of the frame shall be STC encoded. After this allocation, the BS shall transmit from both its antennas until the end of the frame. The first DL allocation following the STC_IE shall contain a preamble. The number of OFDM data symbols between two preambles and the number of OFDM data symbols between the last preamble and the end of the DL subframe must be even.

Table 24: STC Information Element format

Syntax	Size	Notes
STC_Information_element() {		
extended DIUC code	4 bits	STC = 0x4
Length	4 bits	Length = 0x0
}		

7.4.3.2.6 DL-MAP DUMMY IE format

A SS shall be able to decode the DL-MAP DUMMY IE for forward compatibility. A BS shall not transmit this IE (unless under test). A SS may skip decoding DL bursts scheduled after the Start Time of this IE within the current frame.

Table 25: DL-MAP DUMMY Information Element format

Syntax	Size	Notes
DUMMY_Information_element() {		
extended DIUC	4 bits	0x6 to 0xF
Length	4 bits	0 to 15
Unspecified data	<i>variable</i>	The Length field specifies the size of this field in bytes
}		

7.4.3.2.7 DL SUBCH_IE format

In the DL-MAP a DL subchannelization enabled BS (see IEEE 802.16 [1], clause 8.3.5.3, as amended by IEEE 802.16e [3]) may transmit an extended IE with value of 0x05 to indicate that subsequent allocations use DL subchannelization.

Table 26: DL SUBCH_IE format

Syntax	Size	Notes
DL_SUBCH_Information_element() {		
extended DIUC	4 bits	DL SUBCH = 0x5
Length	4 bits	Length = 0x0
}		

7.4.4 Type 3: UL-MAP message

The UL-MAP message allocates access to the uplink channel. The UL-MAP message shall be as shown in table 27.

Table 27: UL-MAP message format

Syntax	Size	Notes
UL-MAP_Message_format {		
Management Message Type = 3	8 bits	
<i>reserved</i>	8 bits	Shall be set to zero
UCD Count	8 bits	
Allocation Start Time	32 bits	
Begin PHY Specific Section {		
if (OFDMA) {		
Number of OFDMA symbols	8 bits	Number of OFDMA symbols in the UL subframe
}		
for (i = 1; i <= n; i++) {		For each UL-MAP element 1 to n
UL-MAP_IE()	variable	See corresponding PHY specification
}		
}		
if !(byte boundary) {		
Padding Nibble	4 bits	Padding to reach byte boundary
}		
}		

The BS shall generate the UL-MAP with the following parameters:

- UCD Count:
 - Matches the value of the Configuration Change Count of the UCD which describes the uplink burst profiles which apply to this map.
- Allocation Start Time:
 - Effective start time of the uplink allocation defined by the UL-MAP (units are PHY-specific).
- Map IEs:
 - The contents of a UL-MAP IE is PHY-specification dependent.

IEs define uplink bandwidth allocations. Each UL-MAP message (except when the PHY layer is OFDMA) shall contain at least one IE that marks the end of the last allocated burst. Ordering of IEs carried by the UL-MAP is PHY-specific.

The CID represents the assignment of the IE to either a unicast, multicast, or broadcast address. When specifically addressed to allocate a bandwidth grant, the CID shall be the Basic CID of the SS. A UIUC shall be used to define the type of uplink access and the uplink burst profile associated with that access. An Uplink_Burst_Profile shall be included in the UCD for each UIUC to be used in the UL-MAP.

For the OFDMA PHY the UL-MAP message (if such exists) shall always be transmitted on the burst described by the first DL_MAP_IE (and following the H-ARQ_MAP_Pointer_IE, if such exists in the OFDMA PHY) of the DL-MAP message. If there are multiple PDUs in the burst described by the first DL_MAP_IE, the UL-MAP message shall be the first one.

The logical order in which DLC PDUs are mapped to the PHY layer bursts in the uplink is defined as the order of UL-MAP_IEs in the UL-MAP message.

7.4.4.1 UL-MAP IE format

The UL-MAP Information Element defines the physical parameters and the start time for UL PHY bursts. The format of UL-MAP elements is shown in table 28.

When subchannelization is active, UIUC 3 shall not be used.

Table 28: OFDM UL-MAP Information Element format

Syntax	Size	Notes
UL-MAP_information_element() {		
CID	16 bits	
Start Time	11 bits	
Subchannel Index	5 bits	
UIUC	4 bits	
Duration	10 bits	
Midamble repetition interval	2 bits	0b00 = Preamble only 0b01 = Midambles after every 8 data symbols 0b10 = Midambles after every 16 data symbols 0b11 = Midambles after every 32 data symbols
if (UIUC == 4)		
Focused_contention_IE()	16 bits	
if (UIUC == 13)		
Subchannelized_Network_Entry_IE()	12 bits	
if (UIUC == 15)		
Extended_UIUC_dependent_IE	Variable	
}		
Padding nibble	0/4 bits	Shall be set to 0x0
}		

- Connection Identifier (CID):
 - Represents the assignment of the IE to a unicast, multicast, or broadcast address. When specifically addressed to allocate a bandwidth grant, the CID may be either the Basic CID of the SS or a Traffic CID for one of the connections of the SS.
- Uplink Interval Usage Code (UIUC):
 - Shall be used to define the type of uplink access and the burst type associated with that access. A Burst Descriptor shall be included into an UCD message for each Uplink Interval Usage Code that is to be used in the UL-MAP. The UIUC shall be one of the values defined in table 29.
- Start Time:
 - Indicates the start time, in units of symbol duration, relative to the Allocation Start Time given in the UL-MAP message. For non-subchannelized allocations, the duration of the burst is indicated as the difference between the start times of current and next map elements. The end of the last allocated burst is indicated by allocating a NULL burst (CID = 0 and UIUC = 14). The time instant indicated by the Start Time value is the start of the transmission of the preamble.
- Duration:
 - Indicates the duration, in units of OFDM symbols, of the subchannelized allocation. The duration is inclusive of the preamble and the midambles contained in the allocation.

- Subchannel Index:
 - See table 1.
- Midamble repetition interval:
 - Indicates the preamble repetition interval in OFDM symbols.

7.4.4.1.1 UIUC allocations

Table 29 contains the UIUC values used in the UL-MAP_IE().

Table 29: UIUC values

UIUC	Usage
0	Reserved
1	initial ranging
2	REQ Region Full
3	REQ Region Focused
4	Focused Contention IE
5 to 12	Burst Profiles
13	Gap
14	End of Map
15	Extended UIUC

7.4.4.1.2 UL-MAP focused contention IE format

Table 30 defines the UL-MAP IE for allocation Bandwidth (BW) for a SS that requested bandwidth using Focused Contention Reservation Requests. This UL-MAP IE is identified by UIUC = 4 (see table 29). A SS responding to a bandwidth allocation using the Focused Contention IE shall start its burst with a short preamble and use only the most robust mandatory burst profile in that burst.

Table 30: Focused contention Information Element format

Syntax	Size	Notes
Focused_Contention_IE() {		
Frame number Index	4 bits	
Transmit Opportunity Index	3 bits	
Contention Channel Index	6 bits	
Contention Code Index	3 bits	
}		

- Transmit Opportunity Index:
 - Index number of the Transmit Opportunity that was used in the Bandwidth Request, which this message is responding to. Focused Contention Reservation Requests Transmit Opportunities are numbered from 63 to 0, starting from the beginning of the frame where the UL-MAP is transmitted.
- Contention Channel Index:
 - Index number of the Contention Channel that was used in the Bandwidth Request, which this message is responding to.
- Contention Code Index:
 - Index number of the Contention Code that was used in the Bandwidth Request, which this message is responding to.

7.4.4.1.3 UL-MAP AAS IE format

Within a frame, indication of AAS-enabled traffic is marked by using the extended UIUC = 15 with the AAS_IE() shown in table 31 to indicate that the subsequent allocations be for AAS traffic. When used, the CID in the UL-MAP_IE() shall be set to the broadcast CID. Subsequent AAS PHY bursts shall all start with the short preamble. Stations not supporting the AAS functionality may treat the AAS_IE as a start of gap. The AAS_IE() shall not be used in AAS private map messages.

Table 31: AAS UL IE format

Syntax	Size	Notes
AAS_Information_element() {		
extended UIUC code	4 bits	AAS = 0x02
Length	4 bits	Length = 0x0
}		

7.4.4.1.4 UL-MAP subchannelization IE format

Within a frame, the BS may allocate a portion of the UL allocations to subchannelized traffic.

Table 32: Subchannelization IE format

Syntax	Size	Notes
Subchannelization_Information_element() {		
extended UIUC code	4 bits	Subchannelization = 0x03
Length	4 bits	Length = 0x2
Length of Allocations	16 bits	
}		

- Length of allocations:
 - The number of bytes, following the subchannelization_IE that are used to define subchannelized allocations. A SS not capable of using subchannelization may skip interpreting this number of bytes in the UL-MAP.

7.4.4.1.5 UL-MAP STC IE format

Within a frame, indication of STC-enabled traffic is marked by using the extended UIUC = 15 with the STC_IE() shown in table 33 to indicate that the subsequent allocations be for STC traffic. When used, the CID in the UL-MAP_IE() shall be set to the broadcast CID. Subsequent STC PHY bursts shall all start with the short preamble. Stations not supporting the STC functionality may treat the STC_IE as a start of gap. The STC_IE() shall not be used in STC private map messages.

Table 33: UL-MAP STC Information Element format

Syntax	Size	Notes
STC_Information_element() {		
Extended UIUC code	4 bits	STC = 0x4
Length	4 bits	0x00
}		

7.4.4.1.6 UL-MAP DUMMY IE format

An SS shall be able to decode the UL-MAP DUMMY IE for forward compatibility. A BS shall not transmit this IE (unless under test).

Table 34: UL-MAP DUMMY Information Element format

Syntax	Size	Notes
DUMMY_Information_element() {		
extended UIUC	4 bits	0x5 to 0xF
Length	4 bits	0 to 15
Unspecified data	<i>variable</i>	The Length field specifies the size of this field in bytes
}		

7.4.4.1.7 Fast_Ranging_IE

A Fast_Ranging_IE may be placed in the UL-MAP message by a BS to provide a non-contention based initial-ranging opportunity. The Fast_Ranging_IE shall be placed in the extend UIUC (extension code = 0x03) within a UL-MAP IE. The Fast_Ranging_IE shall be assigned to the initial ranging CID=0x0000.

Table 35: OFDM Fast_Ranging_IE format

Syntax	Size	Notes
Fast_Ranging_Information_element() {		
extended UIUC	4 bits	0x3
Length	4 bits	0x8
MAC address	48 bits	SS's MAC address as provided on the RNG-REQ message on initial entry
UIUC	4 bits	UIUC ≠ 15. A code used to define the type of uplink access and the first type associated with that access
Duration	12 bits	The length, in units of OFDM symbols, of the allocation. The start time of the first allocation shall be the Allocation Start Time given in the UL-MAP message
}		

BS may assign subchannel indices other than 0b10000, only to SS which entered the network using the subchannelized network entry (see IEEE 802.16 [1], clause 8.3.6.3.3, as amended by IEEE 802.16e [3]).

7.4.4.1.8 UL-MAP Fast Tracking IE

The UL-MAP Fast tracking information element in an UL-MAP entry is used to provide fast power, time and frequency indications/corrections to SS s that have transmitted in the previous frame.

The extended UIUC=15 shall be used for this IE with sub-code 0x04.

The CID used in the Information Element shall be a broadcast CID.

Table 36: UL fast tracking IE format

Syntax	Size	Notes
Fast_Tracking_Information_element() {		
extended_UIUC	4 bits	0x4
Length	4 bits	Variable
for (i = 1; i<n; i++) {		
Power correction	2 bits	Power correction indication: 0b00: no change 0b01: +2 dB 0b10: -1 dB 0b11: -2 dB
Frequency correction	4 bits	The correction is 0,1 % of the carrier spacing multiplied by the 4-bit number interpreted as a signed integer (i.e. 0b1000: -8; 0b0000: 0; 0b0111: 7)
Time correction	2 bits	The correction is floor(2/Fs) multiplied by 0b00: 0 0b01: 1 0b10: -1 0b11: Not used
}		
}		

The UL Fast tracking IE is optional in the UL-MAP. When this IE is sent, it provides an indication about corrections that should be applied by SS s that have transmitted in the previous UL frame. Each indication byte shall correspond to one unicast allocation-IE that has indicated an UL burst allocation in the previous UL-MAP. The order of the indication bytes shall be the same as the order of the unicast allocation-IE in the UL-MAP.

The response time for corrections following receipt of this IE shall be equal to Ranging Response Processing Time (RRPT) as defined in IEEE 802.16 [1], clause 10.1, as amended by IEEE 802.16e [3].

7.4.4.2 Compressed private maps

Compressed private maps are defined in IEEE 802.16e [3], clause 8.3.6.6.

7.4.4.2.1 Compressed private DL-MAP

Compressed private DL-MAP is defined in IEEE 802.16e [3], clause 8.3.6.6.1.

7.4.4.2.2 Compressed private UL-MAP

Compressed private UL-MAP is defined in IEEE 802.16e [3], clause 8.3.6.6.2.

7.4.4.3 Reduced private maps

Reduced private maps are defined in IEEE 802.16e [3], clause 8.3.6.7.

7.4.4.3.1 Reduced private DL-MAP

Reduced private DL-MAP is defined in IEEE 802.16e [3], clause 8.3.6.7.1.

7.4.4.3.2 Reduced private UL-MAP

Reduced private UL-MAP is defined in IEEE 802.16e [3], clause 8.3.6.7.2.

7.4.5 Type 4/5: RaNGing REQuest/ReSPonse (RNG-REQ/RSP) message

The RNG-REQ message is as defined in IEEE 802.16 [1], clause 6.3.2.3.5, as amended by IEEE 802.16e [3].

The RNG-RSP message is as defined in IEEE 802.16 [1], clause 6.3.2.3.6, as amended by IEEE 802.16e [3].

In addition to the TLVs listed in IEEE 802.16 [1] as amended by IEEE 802.16e [3], the following TLVs are defined.

7.4.5.1 AAS Support

To indicate whether it can receive broadcast transmissions, an AAS-enabled SS may include the following TLV in RNG-REQ messages:

- AAS Broadcast Capability.

Table 37: Supplemental RNG-REQ TLVs

Name	Type	Length	Value
AAS broadcast capability	4	1	0 = SS can receive broadcast messages 1 = SS cannot receive broadcast messages

To indicate whether an SS, which set the AAS Broadcast Capability, may issue contention-based BW requests, an AAS-enabled BS may use the following TLV in RNG-RSP messages:

- AAS Broadcast Permission.

The following RNG-RSP TLVs may be sent by the BS to indicate the reception of an undecodable initial ranging (RNG-REQ) attempt or to indicate the reception of a subchannelized initial ranging attempt.

- Frame Number:
 - Initial Ranging Opportunity Number.

Table 38: Supplemental RNG-RSP TLVs

Name	Type	Length	Value
Timing Adjust	1	4	Tx timing offset adjustment (signed 32-bit). The time by which to advance SS transmission so that frames arrive at the expected time instance at the BS See TS 102 177 [2], clause 14 for unit definition
AAS broadcast permission	11	1	0 = SS may issue in contention-based BW requests 1 = SS may not issue in contention-based BW requests
Frame Number	12	3	Frame number in which the undecodable initial ranging or subchannelized initial ranging attempt was detected by the BS. Usage is mutually exclusive with SS MAC Address. The opportunity within the frame is assumed to be 1 (the first) if the Initial Ranging Opportunity Number field is not supplied
Initial Ranging Opportunity Number	13	1	Initial Ranging opportunity (1 to 255) in which the undecodable initial ranging or subchannelized initial ranging attempt was detected by the BS. Usage is mutually exclusive with SS MAC Address

7.4.5.2 Power management support

Table 39: TLVs for power management

Name	Type (1 byte)	Length	Value (Variable Length)
Power level Adjust	2	1	<p>Tx Power offset adjustment (signed 8-bit, 0,25 dB units). Specifies the relative change in transmission power level that the SS is to make in order that transmissions arrive at the BS at the desired power</p> <p>When subchannelization is employed, The subscriber shall interpret the power offset adjustment as a required change to the transmitted power density</p>

7.4.6 Type 6: REGistration-REQuest (REG-REQ) message

In PMP mode during Registration, the SS shall generate REG-REQ messages including the following parameter in addition to those specified in IEEE 802.16 [1], clause 6.3.2.3.7, as amended by IEEE 802.16e [3]:

- MAC Version.
- Maximum transmit power.
- Amplifier backoffs.
- Current transmitted power.

The transmitted power parameters are defined in table 40.

Table 40: Transmitted power parameters

Name	Type (1 byte)	Length	Value (variable length)	Scope
Maximum Tx power	5.23	1	Achievable transmit power (peak) signed, 0,5 dB increments	
Amplifier backoffs	5.24	3	<p>Byte 0: QPSK</p> <p>Byte 1: 16QAM</p> <p>Byte 2: 64QAM (report as 0x0 if not supported). Backoff values in 0,25 dB increments</p>	
Current Tx power	5.25	1	Current transmit power (peak) signed, 0,5 dB increments	

In Mesh mode during Registration, the Candidate Node shall generate REG-REQ messages including the following parameters:

- SS MAC Address.
- MAC Version:
 - The MAC Version implemented in the Candidate Node.
- HMAC Tuple:
 - Message digest calculated using HMAC_KEY_U.

Both in PMP and Mesh mode, the REG-REQ may in addition contain the following parameters:

- IP Version.
- SS Capabilities Encodings.
- Vendor ID Encoding.

7.4.7 Type 7: REGistration-ReSPonse (REG-RSP) message

In Mesh mode during Registration, the Registration Node shall generate REG-RSP messages including the following parameters:

- Node ID.
- MAC Version:
 - MAC Version used in the network.
- HMAC Tuple:
 - Message digest calculated using HMAC_KEY_D.

In Mesh mode, the REG-RSP is as defined in IEEE 802.16 [1], clause 6.3.2.3.8 as amended by IEEE 802.16e [3] and may in addition contain the following parameters:

- IP Version.
- SS Capabilities Encodings:
 - Capabilities returned in the REG-RSP shall not be set to require greater capability of the Node than is reported in the REG-REQ.
- Vendor Specific Extensions.

7.4.8 Type 9/10: Privacy Key Management (PKM-REQ/RSP) messages

PKM employs two DLC message types: PKM Request (PKM-REQ) and PKM Response (PKM-RSP), as described in table 41.

Table 41: PKM DLC messages

Type Value	Message	Description
9	PKM-REQ	Privacy Key Management Request (SS to BS)
10	PKM-RSP	Privacy Key Management Response (BS to SS)

These DLC management message types distinguish between PKM requests (SS to BS) and PKM responses (BS to SS). Each message encapsulates one PKM message in the Management Message Payload.

PKM protocol messages transmitted from the SS to the BS shall use the form shown in table 42. They are transmitted on the SSs Primary Management Connection.

Table 42: PKM request message format

Syntax	Size	Notes
PKM-REQ_Message_Format () {		
Management Message Type = 9	8 bits	
Code	8 bits	
PKM Identifier	8 bits	
TLV Encoded Attributes	<i>variable</i>	TLV specific
}		

Table 43: PKM response message format

Syntax	Size	Notes
PKM-RSP_Message_Format () {		
Management Message Type = 10	8 bits	
Code	8 bits	
PKM Identifier	8 bits	
TLV Encoded Attributes	<i>variable</i>	TLV specific
}		

- Code:
 - The Code is one byte and identifies the type of PKM packet. When a packet is received with an invalid Code, it shall be silently discarded. The code values are defined in table 44.
- PKM Identifier:
 - The Identifier field is one byte. An SS uses the identifier to match a BS response to the SS's requests.

The SS shall increment (modulo 256) the Identifier field whenever it issues a new PKM message. A "new" message is an Authorization Request or Key Request that is not a retransmission being sent in response to a Timeout event. For retransmissions, the Identifier field shall remain unchanged.

The Identifier field in Authentication Information messages, which are informative and do not effect any response messaging, shall be set to zero. The Identifier field in a BS's PKM-RSP message shall match the Identifier field of the PKM-REQ message the BS is responding to. The Identifier field in TEK Invalid messages, which are not sent in response to PKM-REQs, shall be set to zero. The Identifier field in unsolicited Authorization Invalid messages shall be set to zero.

On reception of a PKM-RSP message, the SS associates the message with a particular state machine (the Authorization state machine in the case of Authorization Replies, Authorization Rejects, and Authorization Invalids; a particular TEK state machine in the case of Key Replies, Key Rejects and TEK Invalids).

An SS shall keep track of the identifier of its latest, pending Authorization Request. The SS shall discard Authorization Reply and Authorization Reject messages with Identifier fields not matching that of the pending Authorization Request.

An SS shall keep track of the identifiers of its latest, pending Key Request for each SA. The SS shall discard Key Reply and Key Reject messages with Identifier fields not matching those of the pending Key Request messages.

- Attributes:
 - PKM attributes carry the specific authentication, authorization, and key management data exchanged between client and server. Each PKM packet type has its own set of required and optional attributes. Unless explicitly stated, there are no requirements on the ordering of attributes within a PKM message. The end of the list of attributes is indicated by the LEN field of the DLC PDU header.

Table 44: PKM message codes

Code	PKM message type	Name
0-2	<i>reserved</i>	
3	SA Add	PKM-RSP
4	Auth Request	PKM-REQ
5	Auth Reply	PKM-RSP
6	Auth Reject	PKM-RSP
7	Key Request	PKM-REQ
8	Key Reply	PKM-RSP
9	Key Reject	PKM-RSP
10	Auth Invalid	PKM-RSP
11	TEK Invalid	PKM-RSP
12	Auth Info	PKM-REQ
13-255	<i>reserved</i>	

Formats for each of the PKM messages are described in IEEE 802.16 [1], clause 6.3.2.3.9 as amended by IEEE 802.16e [3].

In Mesh mode, the Authorization reply attributes and the Key request attributes listed in tables 45 and 46 shall be used. The HMAC-Digest's authentication key is derived from the Authorization key or the Operator Shared Secret.

Table 45: Authorization Reply attributes

Attribute	Contents
Operator Shared Secret	Key known to all nodes
Key-Sequence-Number	Operator Shared Secret's sequence number
Key-Lifetime	Operator Shared Secret's active lifetime

Table 46: Key Request attributes

Attribute	Contents
SS Certificate	X.509 Certificate of the node
SAID	SA Identifier
HMAC-Digest	HMAC using HMAC_KEY_S

7.4.9 Type 11: Dynamic Service Addition-Request (DSA-REQ)

A DSA-REQ message is defined as in IEEE 802.16 [1], clause 6.3.2.3.10 as amended by IEEE 802.16e [3].

7.4.10 Type 12: Dynamic Service Addition-ReSPonse (DSA-RSP)

A DSA-RSP message is defined as in IEEE 802.16 [1], clause 6.3.2.3.11 as amended by IEEE 802.16e [3].

No TLVs besides Error Encodings and HMAC Tuples shall be reported back in DSA-RSP.

7.4.11 Type 13: Dynamic Service Addition-ACKnowledgement (DSA-ACK)

A DSA-ACK message is defined as in IEEE 802.16 [1], clause 6.3.2.3.12 as amended by IEEE 802.16e [3].

No TLVs besides HMAC Tuples shall be reported back in DSA-ACK messages.

7.4.12 Type 14: Dynamic Service Change-REQuest (DSC-REQ)

A DSC-REQ message is defined as in IEEE 802.16 [1], clause 6.3.2.3.13 as amended by IEEE 802.16e [3].

DSC-REQ messages shall not contain Request/Transmission Policy, Fixed vs. Variable Length SDU Indicator, SDU Size, ATM Switching, or Convergence Sublayer Specification TLVs.

7.4.13 Type 15: Dynamic Service Change-ReSPonse (DSC-RSP)

A DSC-RSP message is defined as in IEEE 802.16 [1], clause 6.3.2.3.14 as amended by IEEE 802.16e [3].

No TLVs besides Error Encodings and HMAC Tuples shall be reported back in DSC-RSP.

7.4.14 Type 16: Dynamic Service Change-ACKnowledge (DSC-ACK)

A DSC-ACK message is defined as in IEEE 802.16 [1], clause 6.3.2.15 as amended by IEEE 802.16e [3].

7.4.15 Type 17: Dynamic Service Delete-REQuest (DSD-REQ)

A DSD-REQ message is defined as in IEEE 802.16 [1], clause 6.3.2.3.16 as amended by IEEE 802.16e [3].

7.4.16 Type 18: Dynamic Service Delete-ReSPonse (DSD-RSP)

A DSD-RSP message is defined as in IEEE 802.16 [1], clause 6.3.2.3.17 as amended by IEEE 802.16e [3].

7.4.17 Type 21: MultiCast polling Assignment REQuest (MCA-REQ)

A MCA-REQ message is defined as in IEEE 802.16 [1], clause 6.3.2.3.18 as amended by IEEE 802.16e [3].

7.4.18 Type 22: MultiCast polling Assignment ReSPonse (MCA-RSP)

A MCA-RSP message is defined as in IEEE 802.16 [1], clause 6.3.2.3.19 as amended by IEEE 802.16e [3].

7.4.19 Type 23: Downlink Burst Profile Change-REQuest (DBPC-REQ)

A DBPC-REQ message is defined as in IEEE 802.16 [1], clause 6.3.2.3.20 as amended by IEEE 802.16e [3].

7.4.20 Type 24: Downlink Bust Profile Change-ReSPonse (DBPC-RSP)

A DBPC-RSP message is defined as in IEEE 802.16 [1], clause 6.3.2.3.21 as amended by IEEE 802.16e [3].

7.4.21 Type 25: RESet CoMmanD (RES-CMD)

A RES-CMD message is defined as in IEEE 802.16 [1], clause 6.3.2.3.22 as amended by IEEE 802.16e [3].

7.4.22 Type 26/27: SS Basic Capability-REQuest/ReSPonse (SBC-REQ/RSP)

The following Physical Parameter encodings shall be available for use with SBC-REQ and SBC-RSP. The Physical Parameters listed in IEEE 802.16 [1], clause 11.8.3 as amended by IEEE 802.16e [3] shall not be used.

7.4.22.1 OFDM demodulator

This field indicates the different demodulator options supported by a SS for DL reception. A bit value of 0 indicates "not supported" while 1 indicates "supported".

Type	Length	Value	Scope
5.12.28	1	bit#0 64QAM bit#1 Reserved. Set to 0 bit#2 CTC bit#3 STC bit#4 AAS bit#5 to 7 Reserved. Set to 0	SBC-REQ SBC-RSP

7.4.22.2 OFDM modulator

This field indicates the different modulator options supported by a SS for UL transmission. A bit value of 0 indicates "not supported" while 1 indicates "supported".

Type	Length	Value	Scope
5.12.29	1	bit#0 64QAM bit#1 Reserved. Set to 0 bit#2 CTC bit#3 Subchannelization bit#4 Focused contention BW request bit#5 UL preamble / Midamble cyclic delay bit#6 UL STC bit#7 Reserved. Set to 0	SBC-REQ SBC-RSP

7.4.22.3 Subscriber transition gaps

This field indicates the transition speed SSTG and SSRTG for TDD and H-FDD SSs.

Type	Length	Value	Scope
5.12.30	2	Bit #0 to 7: SSTG (μ s) Bit #8 to 15: SSRTG (μ s) Allowed values: OFDM: TDD and H-FDD: 0 to 100 μ s OFDMA: TDD 0 to 50 μ s; H-FDD 1 to 100 μ s	SBC-REQ SBC-RSP

7.4.22.4 Bandwidth allocation support

This field indicates the different BW allocation options supported by a SS. A bit value of 0 indicates "not supported" while 1 indicates "supported".

Type	Length	Value	Scope
5.15	1	bit #0: Reserved. Set to 0 bit #1 = 0: Half-Duplex (FDD only) bit #1 = 1: Full-Duplex (FDD only) bit #2-7: reserved; shall be set to zero	SBC-REQ SBC-RSP

7.4.23 Type 33: ARQ Feedback message

A system supporting ARQ shall be able to receive and process the ARQ Feedback message.

The ARQ Feedback message, as shown in table 47, can be used to signal any combination of different ARQ ACKs (cumulative, selective, selective with cumulative). The message shall be sent on the appropriate basic management connection.

Table 47: ARQ Feedback message format

Syntax	Size	Notes
ARQ_Feedback_Message_Format() {		
Management Message Type = 33	8 bits	
ARQ_Feedback_Payload	variable	See table 77
}		

ARQ Feedback information shall be either sent using this ARQ Feedback message or by packing the ARQ_Feedback_Payload as described in clause 8.1.2.

7.4.24 Type 34: ARQ_Discard message

This message is applicable to ARQ-enabled connections only.

The transmitter sends this message when it wants to skip a certain number of ARQ blocks. The ARQ Discard message shown in table 48 shall be sent as a DLC management message on the basic management connection of the appropriate direction.

Table 48: ARQ Discard message format

Syntax	Size	Notes
ARQ_Discard_Message_Format() {		
Management Message Type = 34	8 bits	
Connection ID	16 bits	Applicable CID
Reserved	5 bits	
Block Sequence Number	11 bits	Sequence number of the last block in the transmission window to be discarded
}		

7.4.25 Type 35: ARQ_Reset message

This message is applicable to ARQ-enabled connections only.

The transmitter or the receiver may send this message. The message is used in a three-part dialog to reset the parent connection's ARQ transmitter and receiver state machines. The ARQ Reset message, as shown in table 49, shall be sent as a DLC management message on the basic management connection of the appropriate direction.

Table 49: ARQ_Reset message format

Syntax	Size	Notes
ARQ_Reset_Message_Format() {		
Management Message Type = 36	8 bits	
Connection ID	16 bits	Applicable CID
Type	2 bits	00 = Original Message from Initiator 01 = Acknowledgement from Responder 10 = Confirmation from Initiator 11 = Reserved
Reserved	6 bits	
}		

7.4.26 Type 36/37: Report-Request (REP-REQ/RSP) message

The Report Request message, shown in table 50, shall be used by the BS to request RSSI and CINR channel measurement reports.

Table 50: REP-REQ message format

Syntax	Size	Notes
Report_Request_Message_Format() {		
Management Message Type = 36	8 bits	
Report Request TLV	variable	
}		

The Report Request TLV shall have the format shown in table 51.

Table 51: Report Request TLV

Name	Type	Length	Value
Report Request	1	Variable	

The Report Request shall consist of the parameters in table 52.

Table 52: Report Request parameters

Name	Type	Length	Value
Report Type	1.1	1	Bit #0 Reserved, shall be set to 0 bit #1 1 = Include CINR report bit #2 1 = Include RSSI report bit #3 to 6 α_{avg} in multiples of 1/32 (range [1/32, 16/32]) bit #7 1 = Report background noise

When bit#7 is set, bit#1 shall be 0 and bit#2 shall be 1. The response shall contain the RSSI as measured during the period indicated by the last DL-MAP Report IE.

The Report Response message, shown in table 53 shall be used by the SS to respond with the channel measurements requested in the last received Report Request.

Table 53: REP-RSP message format

Syntax	Size	Notes
Report_Response_Message_Format() {		
Management Message Type = 37	8 bits	
Current Tx Power	8 bits	Current transmit power (peak) in 0,5 dB increments
Report Response TLV	variable	Compound TLV that shall contain the measurement Report in accordance with the Report Request
}		

The Report Response TLV shall have the format shown in table 54.

Table 54: Report Response TLV

Name	Type	Length	Value
Report Response	1	Variable	

The Report Response shall consist of the parameters in table 55.

Table 55: Report Response parameters

Name	Type	Length	Value
CINR Report	1.3	2	Insert if REP-REQ bit#1 = 1 1 byte CINR mean 1 byte CINR standard deviation
RSSI Report	1.4	2	Insert if REP-REQ bit#2 = 1 1 byte RSSI mean 1 byte RSSI standard deviation

7.4.27 Type 38: Fast Power Control (FPC) message

Power control shall be provisioned by the use of periodic ranging. In addition, the BS may adjust the power levels of multiple subscribers simultaneously with the Fast Power Control (FPC) message. SSS shall apply the indicated change within the "SS DL management message processing time". PFC shall be sent on the broadcast CID.

Table 56: Fast Power Control message format

Syntax	Size	Notes
Fast_Power_Control message format () {		
Management message type = 38	8 bits	
Number of stations	8 bits	
for (i = 0; i < Number of stations; i++) {		
Basic CID	16 bits	
Power Adjust	8 bits	
}		
}		

- Number of stations:
 - Number of CID and Power Adjust tuples contained in this message.
- Basic CID:
 - Basic connection identifier associated with the SS.
- Power Adjust:
 - Signed integer, which expresses the change in power level (in multiples of 0,25 dB) that the SS shall apply to its current transmission power.

7.4.28 Type 39: MeSH Network ConFiGuration (MSH-NCFG) message

MeSH Network ConFiGuration (MSH-NCFG) messages provide a basic level of communication between nodes in different nearby networks whether from the same or different equipment vendors or wireless operators.

The MSH-NCFG packets shall be used to convey information about network status and configuration such as:

- synchronization across multiple mesh networks;
- communication of channels in use across multiple networks; and
- support of network entry for new or mobile nodes.

All the nodes shall generate MSH-NCFGs in the format shown in table 57.

Table 57: MSH-NCFG message format

Syntax	Size	Notes
Report_Response_Message_Format() {		
Management Message Type = 39	8 bits	
NumNbrEntries	5 bits	
NumBSEntries	2 bits	Number of mesh BS neighbours to be reported on
Embedded_Packet_Flag	1 bit	1 = present, 0 = not present
Xmt Power	4 bits	In 2 dBm steps, starting from 0x0 = 8 dBm
Xmt Antenna	3 bits	Antenna used for transmission of this message
NetEntry_MAC_Address_Flag	1 bit	1 = present, 0 = not present
Network Base Channel Logical Number	4 bits	
Reserved	4 bits	
NetConfig Counter	4 bits	Incremented by 1 for every transmitted MSH-NCFG
TimeStamp		
Frame_Number	12 bits	
Network Ctrl Slot Number in frame	4 bits	
Number of hops to master sync. node	8 bits	
NetConfig Schedule Info		
Next Xmt Mx	3 bits	
Xmt Holdoff Exponent	5 bits	
If (NetEntry_MAC_Address_Flag)		
NetEntry MAC Address	48 bits	
for (i = 0; i < NumBSEntries; ++i) {		
BS Node ID	16 bits	Node ID of the mesh BS reported on
Number of hops to BS	3 bits	Number of hops to this mesh BS
Xmt energy/bit to BS	5 bits	
}		
for (i = 0; i < NumNbrEntries; ++i) {		
Nbr Node ID	16 bits	Node ID of the neighbour node reported on
MSH-NCFG_Nbr_Physical_IE()	16 bits	See table 58
if (Logical_Link_Info_Present)		
MSH-NCFG_Nbr_Logical_IE()	16 bits	Indicated in preceding MSH-Nbr_Physical_IE() See table 59
}		
If (Embedded_Packet_Flag)		
MSH-NCFG_embedded_data()	variable	
}		

- NumNbrEntries:
 - Number of neighbours reported on in the message. The number of neighbours reported on may be a fraction of the whole set of neighbours known to this node. A node can report on subsequent subsets of neighbours in its subsequent MSH-NCFG transmissions.

The following procedure is used to select the list neighbours of which only the Physical IE is reported:

- i) All neighbour entries with the "Reported Flag" set to TRUE are excluded as defined below.
- ii) The remaining neighbour entries are ordered by the Next Xmt Time and those with the Next Xmt Time the furthest in the future are reported in this MSH-NCFG packet. (In general, learning of nodes with Next Xmt Times furthest into the future is more valuable than learning of nodes with Next Xmt Times approaching soon, since the neighbours will have more time to use this ineligibility information before it is stale.)

The "Reported Flag" for all neighbours in either of the above neighbour lists is set to TRUE upon transmission of this MSH-NCFG packet. It is set to FALSE as described in clause 9.5.1.

- Network Base Channel Logical Number:
 - The logical number of the base channel being used in this node's network, which is the logical number of the physical channel which shall be used to broadcast schedule control information. The possible physical channel numbers is mapped to logical channels in the Network Descriptor (see clause 7.4.28.3.1).
- Netconfig counter:
 - Counter of MSH-NCFG packets transmitted by this node. Used by neighbours to detect missed transmissions. Incremented by 1 for every MSH-NCFG transmission by this node.
- Frame number:
 - A modulo 2^{12} number, which shall be increased by one for every frame.
- Network Control Slot Number in frame:
 - See TS 102 177 [2] for details.
- Number of hops to master sync. node:
 - This counter is used to determine superiority between nodes when synchronizing the network. Nodes can be assigned as master time keepers, which are synchronized externally (for example using GPS). Nodes shall synchronize to the node with the lowest number of hops to master sync. node, or if counts are the same, to the node with the lower Node ID.
- Netconfig Schedule Info.
- Xmt Holdoff Exponent:
 - The Xmt Holdoff Time is the number of MSH-NCFG transmit opportunities after Next Xmt Time (there are *MSH-CTRL-LEN* - 1 opportunities per network control subframe), that this node is not eligible not transmit MSH-NCFG packets.

$$\text{Xmt Holdoff Time} = 2^{(\text{Xmt Holdoff Exponent}+4)} \quad (1)$$

- Next Xmt Mx:
 - Next Xmt Time is the next MSH-NCFG eligibility interval for this neighbour and computed as the range:

$$2^{\text{XmtHoldoffExponent}} \times \text{NextXmtMx} < \text{NextXmtTime} \leq 2^{\text{XmtHoldoffExponent}} \times (\text{NextXmtMx} + 1) \quad (2)$$

EXAMPLE: If Next Xmt Mx = 3 and Xmt Holdoff Exponent = 4, then the node shall be considered eligible for its next MSH-NCFG transmission between 49 and 64 (due to the granularity) transmission opportunities away and ineligible before that time.

- If the Next Xmt Mx field is set to 0x1F (all ones), then the neighbour should be considered to be eligible to transmit from the time indicated by this value and every MSH-NCFG opportunity thereafter (i.e. treat Xmt Holdoff Time = 0).

- NetEntry MAC Address:
 - Indicates presence or sponsorship of new node. See MSH-NENT message in clause 7.4.29 and network entry in clause 9.6.
- Xmt energy/bit factor:
 - Indication of energy/bit needed to reach mesh BS through this node. Xmt energy/bit is computed as:

$$E_i = \min_{j \in N_i} [P_{Tx} / R_{i \rightarrow j} + E_j] \text{ mW}\mu\text{s} \quad (3)$$

- where: N is the set of neighbours reporting this mesh BS:

P_{Tx} is the transmission power in mW from node i to node j

$R_{i \rightarrow j}$ is the datarate in Mbps from node i to node j

E_j is the Xmt energy/bit reported by neighbour j

The reported Xmt energy/bit factor is computed as:

$$\text{Xmt energy/bit factor} = \text{Xmt energy/bit} / 2^{(\text{XmtEnergyUnitExponent}-4)} \quad (4)$$

where XmtEnergyUnitExponent is a 4-bit field reported in the most recent Network Descriptor.

7.4.28.1 Nbr Physical Information Element

Table 58: MSH-NCFG_Nbr_Physical_Information_Element

Syntax	Size	Notes
MSH-NCFG_Nbr_Physical_IE() {		
Logical Link Info Present	1 bit	Indicates whether MSH-NCFG_Nbr_Logical_IE follows
Logical Link requested	1 bit	1 = Yes, 0 = No
Logical Link Accepted	1 bit	1 = Yes, 0 = No
Hops to Nbr	1 bit	0 = 1 hop (direct neighbour), 1 = 2 hops
Propagation delay	4 bits	Estimated propagation delay in μs
Nbr NetConfig Schedule Info		
Nbr Next Xmt Mx	5 bits	
Nbr Xmt Holdoff Exponent	3 bits	
}		

7.4.28.2 Nbr Logical Information Element

Table 59: MSH-NCFG_Nbr_Logical_Information_Element

Syntax	Size	Notes
MSH-NCFG_Nbr_Logical_IE() {		
Rcv Link Quality	3 bits	
Nbr Burst Profile	4 bits	
Excess Traffic Demand	1 bit	1 = Yes, 0 = No
Nbr Xmt Power	4 bits	(see table 57)
Nbr Xmt Antenna	3 bits	(see table 57)
Short Preamble Flag	1 bit	0 = do not use, 1 = use requested/confirmed
}		

- Rcv Link Quality:
 - Measure of the receive link reliability, indicating the reliability of MSH-NCFG size packets using the indicated burst profile. The estimated reliability is indicated as:

$$\text{reliability} = 100 \times \left(1 - 10^{-(\text{Rcv Link Quality} + 1)/4} \right) \% \quad (5)$$
- Nbr burst profile:
 - Indicated the burst profile the indicated node should use when sending data bursts to the reporting node.
- Excess traffic demand:
 - May be used to indicate to the neighbour that the current schedule is insufficient to transfer pending traffic.
- Short Preamble flag:
 - A node may optionally set this bit to notify the neighbour to use the short preamble for transmissions in the data portion of the frame. Capability to transmit the short preamble is mandatory. Capability to receive it is optional.

7.4.28.3 Embedded data

The Embedded_Data shall consist of the form shown in table 60.

Table 60: MSH-NCFG_Embedded_Data

Syntax	Size	Notes
MSH-NCFG_Embedded_Data() {		
Extended_embedded_data	1 bit	Indicates whether this embedded IE is followed by another one 0 = No, 1 = Yes
Reserved	3 bits	
Embedded_Data_IE_Type	4 bits	0x0 = Reserved 0x1 = Network Descriptor 0x2 = Network Entry Open 0x3 = Network Entry Reject 0x4 = Network Entry Ack (Length shall be set to 0) 0x5 = Neighbour Link Establishment Protocol
Length	8 bits	Length of the MSH-NCFG_Embedded_Data_IE in bytes, exclusive this header
MSH-NCFG_Embedded_data_IE()	variable	Embedded_Data_IE_Type dependent
}		

7.4.28.3.1 Network Descriptor Embedded Data Information Element

The Network Descriptor Embedded_data_IE shall contain the shown in table 61.

Table 61: Network Descriptor Information Element

Syntax	Size	Notes
MSH-NCFG_Embedded_Data_IE() {		
Frame Length Code	4 bits	4 LSB of Frame Duration Code. See TS 102 177 [2]
MSH-CTRL-LEN	4 bits	Control subframe length
MSH-DSCH-NUM	4 bits	Number of DSCH opportunities in schedule control subframe
MSH-CSCH-DATA-FRACTION	4 bits	
Scheduling Frames	4 bits	Defines how many frames have a schedule control subframe between two frames with network control subframes in multiples of 4 frames 0 = 0 frames; 1 = 4 frames, etc.
Num_Burst_Profiles	4 bits	
Operator ID	16 bits	
XmtEnergyUnitsExponent	4 bits	
Num_Channels	4 bits	Number of logical channels
MinCSForwardingDelay	7 bits	Number of OFDM symbols delay inserted between receiving and forwarding control packets
ExtendedNeighborhoodType	1 bit	0 = 2-hop neighbourhood 1 = 3-hop neighbourhood
If (Num_Channels)		
MSH-NCFG_NetDesc_Channel_IE()	variable	
for (i = 0; i < BurstProfileCount; i++) {		
FEC Code Type	8 bits	
Mandatory Exit Threshold	8 bits	See table 14
Mandatory Entry Threshold	8 bits	
}		
}		

- MSH-CSCH-DATA-FRACTION:
 - Maximum percentage (value $\times 6,67$) of minislots in the data-subframe allocated to centralized scheduling. The number of minislots is rounded to the nearest whole number of minislots and allocated starting from the beginning of the data subframe. The remainder of the data subframe, as well as any minislots not occupied by the current centralized schedule, may be used for distributed scheduling.
- ExtendedNeighborhoodType:
 - If value 0, then only nodes with Hops to Neighbour = 0 are reported, if value 1, then also nodes with Hops to Neighbour = 1 are reported.
- MinCSForwardingDelay:
 - The minimum delay in OFDM symbols that shall be inserted between the end of reception and the start of transmission of a Centralized Scheduling message (i.e. MSH-CSCH and MSH-CSCF) by any node.

Table 62: MSH-NCFG_NetDesc_Channel Information Element

Syntax	Size	Notes
MSH-NCFG_NetDesc_Channel_IE() {		
for (i = 0; i < Channels; ++i) {		PHY dependent. Index "i" corresponds to logical channel
Physical channel centre frequency	24 bits	Positive integer in kHz
Physical channel width	8 bits	Positive integer in 100 kHz
}		
Channel Re-use	3 bits	Minimum number of hops of separation between links, before a channel can be re-used by the centralized scheduling algorithm. Range is 1 hop to 7 hops, 0 for no re-use
Reserved	5 bits	
}		

7.4.28.3.2 Network Entry Open Embedded Data Information Element

The Network Entry Open, which is used to respond to MSH-NENT request messages, shall contain the form as shown in table 63.

Table 63: Network Entry Open Information Element

Syntax	Size	Notes
MSH-NCFG_Embedded_Data_IE() {		
Minislot Start	8 bits	Schedule start for upper layer network entry
Minislot Range	8 bits	Schedule range for upper layer network entry
Frame number	12 bits	Frame number this schedule becomes valid
Channel	4 bits	Logical channel for new node to Xmt in above Minislot Range
Schedule validity	12 bits	Validity of Schedule in frames
Channel	4 bits	Logical Rcv channel for new node
Estimated Propagation Delay	4 bits	In μ s
Reserved	4 bits	
}		

7.4.28.3.3 Network Entry Reject Embedded Data Information Element

The Network Entry Reject, which is used to reject MSH-NENT request messages, shall contain the form as shown in table 64.

Table 64: Network Entry Reject Information Element

Syntax	Size	Notes
MSH-NCFG_Embedded_Data_IE() {		
Rejection Code	8 bits	0x0: Operator Authentication Value Invalid 0x1: Excess Propagation delay 0x2: Select new sponsor
Rejection Reason	160 bits	ASCII string
}		

7.4.28.3.4 Neighbour Link Establishment Embedded Data Information Element

The Neighbour Link Establishment, which is used to establish links between nodes as described in clause 9.2, shall contain the form as shown in table 65.

Table 65: Link Establishment Information Element

Syntax	Size	Notes
MSH-NCFG_Embedded_Data_IE() {		
Action Code	2 bits	0x0 = Challenge 0x1 = Challenge Response 0x2 = Accept 0x3 = Reject
Reserved	6 bits	
if (Action Code == 0x0 or 0x1) Nbr Authentication Value	32 bits	
if (Action Code == 0x1 or 0x2) Link ID	8 bits	Transmitting node's Link ID for this link
}		

Nbr Authentication Value:

$$\text{Nbr Authentication Value} = \text{HMAC}\{\text{Authorization Key} | \text{Frame Number} | \text{Node ID self} | \text{Node ID other}\} \quad (6)$$

where the Authorization Key is a secret key (obtained from Operator).

7.4.29 Type 40: MeSH-Network ENTry (MSH-NENT) message

MeSH Network ENTry (MSH-NENT) messages provide the means for a new node to gain synchronization and initial network entry into a mesh network. When a MSH-NENT message, shown in table 66, is sent, the mesh Subheader is set to 0x0000 until the node has been assigned a node ID. In the Mesh CID, The Network ID is set the sponsor's network code or to 0x0000 if not known and the Link ID is set to 0xFF (Broadcast).

Table 66: MSH-NENT message format

Syntax	Size	Notes
MSH-NENT_Message_Format() {		
MAC Management Message Type = 40	8 bits	
MSH-NENT_Type	3 bits	0x0 = Reserved 0x1 = NetEntryAck 0x2 = NetEntryRequest 0x3 = NetEntryClose
if (MSH-NENT_Type == 0x1) MSH-NENT_Type being Ack-ed else	3 bits	
Xmt counter for this MSH-NENT_Type	3 bits	
Reserved	2 bits	
Sponsor Node ID	16 bits	ID of the node sought to assist the requesting node in entering the network
Xmt Power	4 bits	See table 57
Xmt Antenna	3 bits	See table 57
Reserved	1 bit	
if (MSH-NENT_Type == 0x2)		
MAC Address	48 bits	MAC Address of the new node sending the request
OpConflInfo	64 bits	Operator Configuration Information (obtained from Operator)
Operator Authentication Value	32 bits	
Node Serial Number	32 bits	
}		
}		

Operator Authentication Value:

$$\text{Operator Authentication Value} = \text{HMAC}\{\text{MAC Address} | \text{Node Serial Number} | \text{Authorization Key}\} \quad (7)$$

where the Authorization Key is a secret key (obtained from Operator)

7.4.30 Type 41: MeSH-Distributed SCheduling (MSH-DSCH) message

MeSH Distributed SCheduling (MSH-DSCH) messages shall be transmitted in mesh mode when using distributed scheduling. In coordinated distributed scheduling, all the nodes shall transmit a MSH-DSCH, shown in table 67 at a regular interval to inform all the neighbours of the schedule of the transmitting station. This transmission time is determined by the same algorithm used for MSH-NCFG messages. In both coordinated and uncoordinated scheduling, MSH-DSCH messages shall be used to convey resource requests and grants to the neighbours. Further the MSH-DSCH messages shall be used to convey information about free resources that the neighbours can issue grants in. This message shall not be fragmented.

Table 67: MSH-DSCH message format

Syntax	Size	Notes
MSH-DSCH_Message_Format() {		
DLC Management Message Type = 41	8 bits	
Coordination Flag	1 bit	0 = Coordinated 1 = Uncoordinated
Grant/Request Flag	1 bit	0 = Request message 1 = Grant message (also used as Grant confirmation)
MSH-DSCH Sequence Counter	6 bits	
Num_Requests	4 bits	Number of Request IEs in the message
Num_Availabilities	4 bits	Number of Availability IEs in the message. The Availability IEs are used to indicate free minislot ranges that neighbours could issue Grants in
Num_Grants	6 bits	Number of Grant IEs in this message
Reserved	2 bits	
if (Coordination Flag == 0x0)		
MSH-DSCH_Scheduling_IE()	variable	
for (i = 0; i < Num_Requests; ++i)		
MSH-DSCH_Request_IE()	16 bits	
for (i = 0; i < Num_Availabilities; ++i)		
MSH-DSCH_Availability_IE()	32 bits	
for (i = 0; i < Num_Grants; ++i)		
MSH-DSCH_Grant_IE()	40 bits	
}		

- Co-ordination Flag:
 - Coordinated MSH-DSCH transmissions take place in the control subframe. Uncoordinated MSH-DSCH transmissions take place in the data subframe. Both the cases require a three-way handshake (Request, Grant and Grant confirmation) to establish a valid schedule. Uncoordinated scheduling may only take place in minislots which cause no interference with the coordinated schedule.
- Grant/Request Flag:
 - The Request Type indicates that a new Request is made of one or more other nodes. The No. Requests shall be non-zero in this case. The message may also contain Availabilities and Grants. The Grant Type indicates that one or more Grants are given or confirmed. The Num_Grants shall be non-zero in this case. The message may also contain Availabilities and Requests. Requests in this type of message indicate pending demand to the indicated node(s), but do not solicit a Grant from this node. This flag is always set to 0 for coordinated distributed scheduling.
- MSH-DSCH Sequence Counter:
 - Sequentially increased counter for solicit messages in uncoordinated scheduling (used as multiple solicit might be outstanding). In coordinated scheduling, it allows nodes to detect missed scheduling messages. Independent counters are used for the coordinated and uncoordinated messages.

7.4.30.1 MSH-DSCH Scheduling Information Element

The Coordinated distributed scheduling information carried in the MSH-DSCH message, shown in table 68, shall be used to distribute information needed to determine transmission timing of the MSH-DSCH messages with coordinated distributed scheduling. Each node shall report the two related parameters both of its own and all its neighbours.

Table 68: MSH-DSCH Scheduling Information Element

Syntax	Size	Notes
MSH-DSCH_Scheduling_IE() {		
DSCH Schedule Info		
Next Xmt Mx	3 bits	
Xmt Holdoff Exponent	5 bits	
Num_SchedEntries	8 bits	Number of Neighbour MSH-DSCH Scheduling Entries in the message
for (i = 0; i < Num_SchedEntries; ++i) {		
Nbr Node ID	16 bits	The Node ID of the neighbour being reported on
Nbr DSCH Schedule Info		Advertise as reported by neighbour
Nbr Next Xmt Mx	3 bits	
Nbr Xmt Holdoff Exponent	5 bits	
}		
}		

- DSCH Schedule Info.
- Xmt Holdoff Exponent:
 - The Xmt Holdoff Time is the number of MSH-DSCH transmit opportunities after Next Xmt Time (there are *MSH-CTRL-LEN - 1* opportunities per network control subframe, that this node is not eligible not transmit MSH-DSCH packets.

$$\text{Xmt Holdoff Time} = 2^{(\text{Xmt Holdoff Exponent}+4)} \quad (8)$$

- Next Xmt Mx:
 - Next Xmt Time is the next MSH-DSCH eligibility interval for this neighbour and computed as the range:

$$2^{\text{Xmt Holdoff Exponent}} \times \text{Next Xmt Mx} < \text{Next Xmt Time} \leq 2^{\text{Xmt Holdoff Exponent}} \times (\text{Next Xmt Mx} + 1) \quad (9)$$

EXAMPLE: If Next Xmt Mx = 3 and Xmt Holdoff Exponent = 4, then the node shall be considered eligible for its next MSH-DSCH transmission between 49 and 64 (due to the granularity) transmission opportunities away and ineligible before that time.

- If the Next Xmt Mx field is set to 0x1F (all ones), then the neighbour should be considered to be eligible to transmit from the time indicated by this value and every MSH-DSCH opportunity thereafter (i.e. treat Xmt Holdoff Time = 0).

7.4.30.2 MSH-DSCH Scheduling Information Element

The Requests carried in the MSH-DSCH message shall convey resource requests on per link basis, as shown in table 69.

Table 69: MSH-DSCH Request Information Element

Syntax	Size	Notes
MSH-DSCH_Request_IE() {		
Link ID	8 bits	The ID assigned by the transmitting node to the link to this neighbour that this request involves
Demand Level	8 bits	Demand in minislots (assuming the current burst profile)
Persistence	3 bits	Persistency field for demands. Number of frames over which the demand exists 0 = cancel reservation, 1 = single frame, 2 = 2 frames, 3 = 4 frames, 4 = 8 frames, 5 = 32 frames, 6 = 128 frames, 7 = Good until cancelled or reduced
Reserved	1 bit	
}		

7.4.30.3 MSH-DSCH Availability Information Element

The Availabilities carried in the MSH-DSCH message shall be used to indicate free minislot ranges that neighbours could issue Grants in. Each Availability shall be indicated using the IE shown in table 70.

Table 70: MSH-DSCH Availability Information Element

Syntax	Size	Notes
MSH-DSCH_Availability_IE() {		
Start Frame Number	8 bits	Indicates lowest 8 bits of frame number in which the availability starts
Minislot start	8 bits	The start position of the availability within the frame
Minislot Range	7 bits	The number of consecutive available minislots
Direction	2 bits	0 = Minislot range is unavailable 1 = Available for transmission in this minislot range 2 = Available for reception in this minislot range 3 = Available for either transmission or reception
Persistence	3 bits	Persistency field for Availabilities. Number of frames over which the Availability is valid 0 = cancel availability, 1 = single frame, 2 = 2 frames, 3 = 4 frames, 4 = 8 frames, 5 = 32 frames, 6 = 128 frames, 7 = Good until cancelled or reduced
Channel	4 bits	Logical channel number on which the availability exists
}		

7.4.30.4 MSH-DSCH Grant Information Element

The Grants carried in the MSH-DSCH message shall convey information, as shown in table 71, about a granted minislot range selected from the range reported as available. Grants shall be used both to grant and confirm a grant.

Table 71: MSH-DSCH Grant Information Element

Syntax	Size	Notes
MSH-DSCH_Grant_IE() {		
Link ID		The ID assigned by the transmitting node to the neighbour that this Grant involves
Start Frame Number	8 bits	Indicates lowest 8 bits of frame number in which the Grant starts
Minislot start	8 bits	The start position of the Grant within the frame
Minislot Range	7 bits	The number of consecutive minislots granted
Direction	2 bits	0 = From requester to granter 1 = To requester from granter
Persistence	3 bits	Persistency field for Grants. Number of frames over which the Availability is valid 0 = cancel reservation, 1 = single frame, 2 = 2 frames, 3 = 4 frames, 4 = 8 frames, 5 = 32 frames, 6 = 128 frames, 7 = Good until cancelled or reduced
Channel	4 bits	Logical channel number on which the availability exists
}		

7.4.31 Type 42: MeSH-Centralized Scheduling (MSH-CSCH) message

A MeSH Centralized Scheduling (MSH-CSCH) message shall be created by a mesh BS when using centralized scheduling. The BS shall broadcast the MSH-CSCH message, as shown in table 72, to all its neighbours, and all the nodes with hop count lower than HOPRANGE_THRESHOLD shall forward the MSH-CSCH message to their neighbours that have a higher hop count. In all these cases, the Grant/Request Flag = 0. HOPRANGE_THRESHOLD is a configuration value that need only be known to the mesh BS, as it can be derived by the other nodes from the MSH-CSCF message.

Nodes can use MSH-CSCH messages to request bandwidth from the mesh BS setting the Grant/Request Flag = 1. Each node reports the individual traffic demand requests of each "child" node in its subtree from the BS. The nodes in the subtree are those in the current scheduling tree to and from them mesh BS, known to all nodes in the network, and ordered by node ID.

Table 72: MSH-CSCH message format

Syntax	Size	Notes
MSH-CSCH_Message_Format() {		
DLC Management Message Type = 42	8 bits	
MSH-CSCF Sequence Number	3 bits	Indicates the configuration, which shall be used to interpret this packet
Grant/Request Flag	1 bit	0 = Grant message (transmitted up the tree) 1 = Request message (transmitted down the tree)
Frame Schedule Flag	1 bit	If this flag is set, the allocation of flows shall occur over two frames, rather than one
Configuration Flag	1 bit	
Reserved	2 bits	
Num_FlowEntries	8 bits	
for (i = 0; i < Num_FlowEntries; ++i) {		
UL_Flow	4 bits	
If (Grant/Request Flag == 0)		
DL_Flow	4 bits	
}		
FlowScale Exponent	4 bits	
Padding Nibble	4 bits	Pad till byte boundary
If (Grant/Request Flag == 1) {		
Num_LinkUpdates	4 bits	
for (i = 0; i < Num_LinkUpdates; ++i) {		
Node Index self	8 bits	Index self in MSH-CSCF list
Node Index parent	8 bits	Index parent in MSH-CSCF list
UL Burst Profile	4 bits	Burst Profile for transmitting up the tree
DL Burst Profile	4 bits	Burst Profile for transmitting down the tree
}		
} else {		Sponsor Node Request
Sponsor Node	8 bits	index in MSH-CSCF list
DL Burst Profile	4 bits	
UL Burst Profile	4 bits	
}		
}		

- Sponsor Node Request:
 - Three parameters (Sponsor Node, and Burst Profiles) shall be set to 0, except by nodes which wish to reserve an allocation for the "upper DLC initialization" as specified in clause 9.6.4. A node may only set these values if all its children report these values as 0. The Mesh BS shall in response provide a grant to Node Index 0x00, which shall be reserved for this purpose.
- Configuration Flag:
 - Indicates which centralized scheduling control message type (CSCH or CSCF) will be transmitted next by the Mesh BS. This bit may be set to aid the nodes in computing the validity of the schedule indicated in the current message (see clause 9.8.2).
- FlowScale Exponent:
 - Determines scale of the granted bandwidth. Its value typically depends on the number of nodes in the network, the achievable PHY bitrate, the traffic demand and the provided service. For the DL, this gives the absolute values of flow granted, so the total minislots range allowed for centralized scheduling need not be used if not needed, with the remainder set aside for distributed scheduling. For the UL, the lowest exponent possible is used at each hop, with quantization of forwarded requests rounded up (e.g. avoids reducing any requests to zero).

- NumFlowEntries:
 - Number of 8-bit assignment fields followed, ordered according to appearance in MSH-CSCF. This number shall match the number of entries in the most recent MSH-CSCF message.
- UL_Flow.
- DL_Flow:
 - Base of the granted/requested bandwidth as bits/s for DL respectively UL traffic of the node in the BS's scheduling tree. The flow only indicates traffic that initiates or terminates in the node itself (i.e. forwarded traffic is not included), except for traffic forwarded from/to nodes not part of the MSH-CSCF tree. The actual granted/requested bandwidth shall be calculated as:

$$\begin{aligned} BW_{UL} &= UL_Flow \times \left(2^{\text{FlowScale Exponent} + 14} \right) \text{ bits/s} \\ BW_{DL} &= DL_Flow \times \left(2^{\text{FlowScale Exponent} + 14} \right) \text{ bits/s} \end{aligned} \quad (10)$$
 - The assignments in the list are ordered according to the order in the MSH-CSCF message.
- Num_LinkUpdates:
 - Link updates are inserted by the mesh BS if the number of link tree changes does not warrant a MSH-CSCF broadcast. The mesh BS shall repeat the link update in every MSH-CSCH either until the update becomes invalid, or until the change is reflected in a MSH-CSCF message.

7.4.32 Type 43: MeSH-Centralized Scheduling ConFiguRation (MSH-CSCF) message

A MeSH Centralized Scheduling ConFiguRation (MSH-CSCF) message shall be broadcast in mesh mode when using centralized scheduling. The mesh BS shall broadcast the MSH-CSCF message, as shown in table 73, to all its neighbours, and all nodes shall forward (rebroadcast) the message according to its index number specified in the message.

Table 73: MSH-CSCF message format

Syntax	Size	Notes
MSH-CSCF_Message_Format() {		
DLC Management Message Type = 43	8 bits	
MSH-CSCF Sequence Number	4 bits	The BS shall increment this number by one for every MSH-CSCF message it transmits
Num_Channels	4 bits	Number of channels available for centralized scheduling
for (i = 0; i < Num_Channels; ++i) {		
Logical Channel Number	4 bits	The logical index of the Physical channel, as reported in MSH-NCFG Network Descriptor
Padding nibble	0/4 bits	Pad till byte boundary
Num_Nodes	8 bits	
for (i = 0; i < Num_Nodes; ++i) {		
Node ID	16 bits	Unique node identifier assigned to node
Num_Children	8 bits	
for (j = 0; j < Num_Children; ++j) {		
Child Index	8 bits	Index child in Node list
UL Burst Profile	4 bits	Burst Profile for transmitting up the tree from this child
DL Burst Profile	4 bits	Burst Profile for transmitting down the tree to this child
}		
}		
}		

7.4.33 Type 44/45: AAS-FeedBaCK REQuest/ReSPonse (AAS-FBCK REQ/RSP) message

AAS Feedback messages as shown in tables 74 and 75 are used to obtain channel state information as described in clause 7.4.

Table 74: AAS-FeedBaCK REQuest (AAS-FBCK-REQ) message format

Syntax	Size	Notes
AAS_Feedback_Request_Message_Format() {		
Management Message Type = 44	8 bits	
Frame Number	24 bits	
Number of Frames	7 bits	
Measurement Data Type	1 bit	0 = measure on DL preamble only 1 = measure on DL data (for this SS) only
Feedback Request Counter	6 bits	
Frequency Measurement Subcarrier Resolution	2 bits	0b00 = 4 0b01 = 8 0b10 = 16 0b11 = 32
}		

- Frame Number:
 - The Frame Number in which the measurement shall be started.
- Number of Frames:
 - The number of frames over which the measurement shall be averaged.
- Frequency Measurement Subcarrier Resolution:
 - Indicates the frequency measurement points to report on. Measurement points shall be on the frequencies corresponding to the negative subcarrier offset indices $-N_{\text{used}}/2$ plus n times the indicated subcarrier resolution and corresponding to the positive subcarrier offset indices $N_{\text{used}}/2$ minus n times the indicated subcarrier resolution where n a positive integer. See TS 102 177 [2], clause 4.2.
- Feedback Request Counter:
 - Increased by one every time an AAS-FBCK-REQ is sent to the SS. Individual counters shall be maintained for each SS.

Table 75: AAS-FeedBaCK-ReSPonse (AAS-FBCK-RSP) message format

Syntax	Size	Notes
AAS_Feedback_Response_Message_Format() {		
Management Message Type = 45	8 bits	
Reserved	2 bits	Set to 0b00
Feedback Request Counter	6 bits	
for (i = 0; i < Number of Frequencies; i++) {		According to Frequency Measurement Subcarrier Resolution
Re(Frequency[i])	8 bits	
Im(Frequency[i])	8 bits	
}		
}		

- Feedback Request Counter:
 - Counter from the AAS-FBCK-REQ messages to which this is the response.

- Frequency:
 - The Real (Re) and Imaginary (Im) part of the measured amplitude on the frequency measurement point (low to high frequency) in signed integer fixed point format ([±][4 bits].[4 bits]).

7.4.34 Type 46 to 255: DUMMY message

A SS shall be capable of decoding the DUMMY message shown in table 76. A BS shall not transmit this message unless in test mode. A SS shall not transmit this message.

Table 76: DUMMY message format

Syntax	Size	Notes
DUMMY_Message_Format() {		
Management Message Type = 46 to 255	8 bits	
Length	8 bits	
Unspecified data	Length x 8 bits	
}		

- Length:
 - The Length in bytes of the following "Unspecified data".

8 Automatic Repeat reQuest (ARQ)

The ARQ mechanism is an optional part of the DLC layer and can be enabled on a per-connection basis. The per-connection ARQ and associated parameters shall be specified and negotiated during connection creation or change. A connection cannot have a mixture of ARQ and non-ARQ traffic. Similar to other properties of the DLC protocol the scope of a specific instance of ARQ is limited to one unidirectional connection.

For ARQ-enabled connections, enabling of fragmentation is optional. When fragmentation is enabled, the transmitter may partition each SDU into fragments for separate transmission based on the value of the ARQ_BLOCK_SIZE parameter.

Connections are set and defined dynamically through the DSA/DSC class of messages. CRC-32 shall be used for error detection of PDUs for all ARQ-enabled connections. All ARQ parameters (see clause 8.2 ARQ parameters) shall be set and all ARQ variables (see clause 8.3 ARQ variables) shall be reset (set to 0) on connection setup.

ARQ feedback information can be sent as a standalone DLC management message (see table 47) on the appropriate basic management connection, or can be piggybacked on an existing connection using the ARQ Feedback Payload (see table 77). ARQ Feedback message shall not be fragmented.

8.1 Packing for ARQ-enabled connections

The use of packing subheaders for ARQ-enabled connections is similar to that for non-ARQ connections, except that ARQ-enabled connections use Packing or Fragmentation Subheaders of Extended Type, so bit#3 in the general DLC header's Type field shall be set (see table 2). DLC PDUs transmitted at ARQ-enabled connections must have either Fragmentation Subheader or Packing Subheaders to provide each payload with block sequence numbers information. If packing is turned on for a connection, the DLC may pack multiple DLC SDUs or fragments thereof into a single DLC PDU. The transmitting side has full discretion whether or not to pack a group of DLC SDUs and/or fragments in a single DLC PDU. The packing of variable-length DLC SDUs for the ARQ-enabled connections is similar to that of non-ARQ connections, when fragmentation is enabled. The BSN of the Packing Subheader shall be used by the ARQ protocol to identify and retransmit lost fragments.

8.1.1 Interaction of packing with fragmentation

For ARQ-enabled connections, when the general DLC header's Type (see table 2) indicates packing is used (i.e. when bit#5 is set), fragmentation information for each individual DLC SDU or DLC SDU fragment is contained in the associated Packing Subheader.

When the Type field indicates that packing is not used, fragmentation information for the DLC PDU's single payload (DLC SDU or DLC SDU fragment) is contained in the Fragmentation Subheader. Each of the packed DLC SDU or DLC SDU fragments or ARQ feedback payload shall have its own packing subheader and some of them may be transmissions while others are re-transmissions.

8.1.2 Packing ARQ Feedback Information Elements

An ARQ Feedback Payload (see table 77) consists of one or more ARQ Feedback Information Elements (see table 78). The ARQ Feedback Payload may be sent on an ARQ or non-ARQ connection. However, policies based on implementation and/or QoS constraints may restrict the use of certain connections for transporting the ARQ Feedback Payload. The ARQ Feedback Payload is treated like any other payload (SDU or fragments) from the packing perspective, except that only one ARQ Feedback Payload shall be present within a single DLC PDU.

Table 77: ARQ Feedback Payload

Syntax	Size	Notes
ARQ Feedback Payload {		
do		
ARQ_Feedback_IE(last)	variable	Insert as many as desired, until last == TRUE
until (last)		
}		

The presence of an ACK Feedback Payload in a DLC PDU is indicated by the value of bit #4 of the Type field in the generic DLC header. When present, the first packed payload shall be the ARQ Feedback Payload. The Packing Subheader preceding the ARQ Feedback Payload indicates the total length of the payload including the Packing Subheader and all ARQ Feedback Information Elements within the payload. The FSN/BSN field of the Packing Subheader shall be ignored for the ARQ Feedback Payload and the FC bits shall be set to 0b00.

Table 78: ARQ Feedback Information Element

Syntax	Size	Notes
ARQ_feedback_IE (last) {	variable	
CID	16 bits	The ID of the connection being referenced
Last	1 bit	0 = More ARQ feedback IE in the list 1 = Last ARQ feedback IE in the list
ACK Type	2 bits	0x0 = Selective ACK entry; 0x1 = Cumulative ACK entry; 0x2 = Cumulative with Selective ACK entry; 0x3 = Cumulative ACK with Block Sequence Ack entry
BSN	11 bits	
Num_ACK_Maps	2 bits	If ACK Type == 01, the field is reserved and set to 00 Otherwise the field indicates the number of ACK maps: 0x0 = 1; 0x1 = 2; 0x2 = 3; 0x3 = 4
if (ACK Type! = 01) {		
for (i = 0; i < NUM_ACK_Maps; ++i) {		
if (ACK Type! = 03) {		
Selective ACK Map	16 bits	
}		
}		
else {		
Sequence Format	1 bit	Number of block sequences associated with descriptor 0: 2 block sequences 1: 3 block sequences
if (Sequence Format = 0) {		
Sequence ACK Map	2 bits	
Sequence 1 Length	6 bits	
Sequence 2 Length	6 bits	
Reserved	1 bit	
}		

- ARQ_BSN_MODULUS:
 - ARQ_BSN_MODULUS is equal to the number of unique BSN values, i.e. 2 048.
- ARQ_WINDOW_SIZE:
 - ARQ_WINDOW_SIZE is the maximum number of the unacknowledged ARQ blocks at any given time, which shall be less than or equal to half of ARQ_BSN_MODULUS. An ARQ block is unacknowledged if it has been transmitted but no acknowledgement has been received.
- ARQ_BLOCK_LIFETIME:
 - ARQ_BLOCK_LIFETIME is the maximum time interval beyond which a transmitter shall discard unacknowledged ARQ blocks.
- ARQ_RETRY_TIMEOUT:
 - ARQ_RETRY_TIMEOUT is the minimum time interval a transmitter shall wait before retransmitting an unacknowledged ARQ block.
- ARQ_SYNC_LOSS_TIMEOUT:
 - ARQ_SYNC_LOSS_TIMEOUT is the length of a time interval from last transmitted/received SDU, in which at least one DLC PDU was transmitted/received with no change in the position of ARQ Tx/Rx window, after this time interval passed, ARQ synchronization shall be considered lost.
- ARQ_RX_PURGE_TIMEOUT:
 - ARQ_RX_PURGE_TIMEOUT is the time interval the receiver shall wait after successful reception of a block that does not result in advancement of ARQ_RX_WINDOW_START, before advancing ARQ_RX_WINDOW_START.

8.3 ARQ variables

- ARQ_TX_WINDOW_START:

All BSN up to (ARQ_TX_WINDOW_START - 1) have been acknowledged.
- ARQ_TX_NEXT_BSN:

BSN of the next block to send. This value shall be between ARQ_TX_WINDOW_START and (ARQ_TX_WINDOW_START + ARQ_WINDOW_SIZE).
- ARQ_RX_WINDOW_START:

All BSN up to (ARQ_RX_WINDOW_START - 1) have been correctly received.
- ARQ_RX_HIGHEST_BSN:

BSN of the highest block received, plus one. This value shall be between ARQ_RX_WINDOW_START and (ARQ_RX_WINDOW_START + ARQ_WINDOW_SIZE).

8.4 ARQ operation

8.4.1 ARQ block usage

The clause describes the use of blocks for ARQ. A DLC SDU is logically divided into blocks of given ARQ_BLOCK_SIZE. The last block of a DLC SDU may be smaller than ARQ_BLOCK_SIZE. Once defined, the block never changes.

This value of the ARQ_BLOCK_SIZE TLV specifies the ARQ block size. This parameter is negotiated upon connection setup. The DSA-REQ shall contain the suggested value of this parameter. The DSA-RSP message shall contain the confirmation value or an alternate value for this parameter.

A set of blocks selected for transmission or retransmission is encapsulated into a PDU. A PDU may contain blocks that are transmitted for the first time as well as retransmitted blocks. If fragmentation is enabled for this connection, the fragmentation shall occur only on ARQ block boundaries. If a PDU is not packed, all the blocks in that PDU must have contiguous block numbers. When a PDU is packed, any sequence of blocks between DLC subheaders and the sequence of blocks after the last packing subheader must have contiguous block numbers.

If ARQ is enabled at the connection, Fragmentation and Packing subheaders contain a BSN, which is the sequence number of the first ARQ block in the sequence of blocks following this subheader. It is a matter of transmitter's policy whether a set of blocks once transmitted as a single PDU should be retransmitted also as a single PDU or not. Figure 4 illustrates the use of blocks for ARQ transmissions and retransmissions; two options for retransmission presented: with and without rearrangements of blocks.

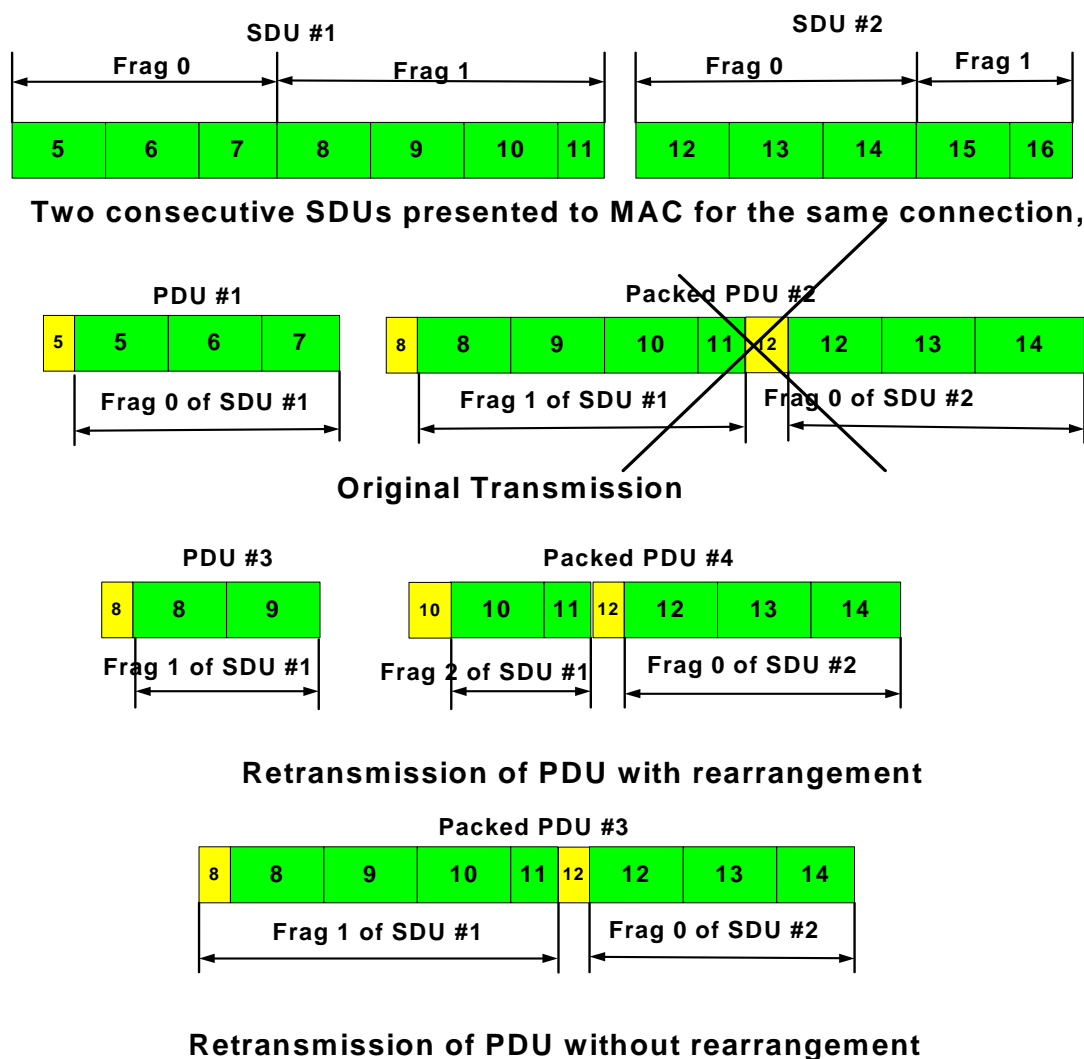

Figure 4: Block usage examples for ARQ transmissions and retransmissions

8.4.2 Comparison of BSNs

As numbers assigned to blocks occasionally wrap around zero, BSNs cannot be compared by directly comparing their values. Instead, both BSNs need to be normalized before a comparison can be made. Normalization of a BSN on the transmit side is accomplished using the expression:

$$\text{bsn}' = (\text{bsn} - \text{BSN_base}) \bmod \text{ARQ_BSN_MODULUS} \quad (11)$$

The base values for the receiver and transmitter state machines are ARQ_TX_WINDOW_START and ARQ_RX_WINDOW_START, respectively.

8.4.3 Transmitter state machine

An ARQ block may be in one of the following three states: *Not-sent*, *Outstanding*, *Discarded*, *Waiting-for-retransmit*. Any ARQ block begins as *Not-sent*, and transfers to other states as shown in figure 5.

For a given connection, the transmitter shall first handle (transmit or discard) blocks in *Waiting-for-retransmit* state and only then blocks in *Not-sent* state. Blocks in *Outstanding*, *Discarded*, or *Done* state shall not be transmitted. When blocks are retransmitted, the block with the lowest FSN shall be retransmitted first.

When a block in *not-sent* state is included in a DLC PDU, it is assigned the current value of ARQ_TX_NEXT_BSN, which is then incremented.

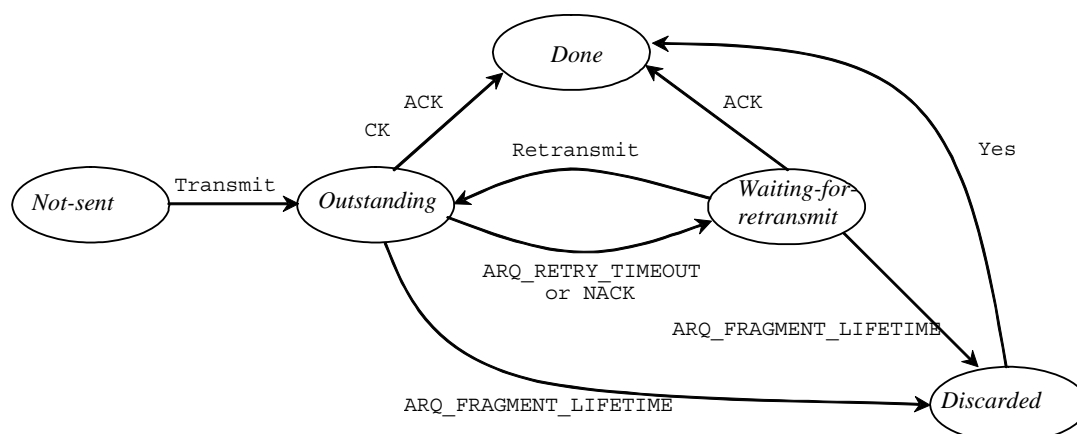

Figure 5: Transmitter ARQ state machine

When any acknowledgement is received, the transmitter shall check the validity of the BSN(s). A BSN is valid if:

$$ARQ_TX_WINDOW_START \leq BSN \leq ARQ_TX_NEXT_BSN-1 \quad (12)$$

If the BSN is invalid, the transmitter shall ignore the acknowledgement. All timers associated with acknowledged blocks shall be cancelled.

When a cumulative acknowledgement with a valid BSN is received, the transmitter shall consider all blocks in the interval ARQ_TX_WINDOW_START to BSN (inclusive) as acknowledged and set ARQ_TX_WINDOW_START to BSN+1.

When a selective acknowledgement is received, the transmitter shall consider as acknowledged all blocks so indicated by the entries in the bitmap for valid BSN values. As the bitmap entries are processed in increasing BSN order, ARQ_TX_WINDOW_START shall be incremented each time the BSN of an acknowledged block equals ARQ_TX_WINDOW_START.

When ARQ_TX_WINDOW_START has been advanced by either of the above methods and acknowledgement of reception has already been received for the fragment with the BSN value now assigned to ARQ_TX_WINDOW_START, the value of ARQ_TX_WINDOW_START shall be incremented until a BSN value is reached for which no acknowledgement has been received.

A bitmap entry not indicating acknowledgement shall be considered a NACK for the corresponding blocks.

When a cumulative with selective acknowledgement with a valid BSN is received, the transmitter performs the actions described above for cumulative acknowledgement, followed by those for a selective acknowledgement.

All timers associated with acknowledged blocks shall be cancelled.

A Discard message shall be sent following violation of ARQ_BLOCK_LIFETIME. The message may be sent immediately or may be delayed up to ARQ_RX_PURGE_TIMEOUT + ARQ_RETRY_TIMEOUT. Following the first transmission, subsequent discard orders shall be sent to the receiver at intervals of ARQ_RETRY_TIMEOUT until an acknowledgment to the discarded BSN has been received. Discard orders for adjacent BSN values may be accumulated in a single Discard message.

8.4.4 Receiver state machine

When a PDU is received, its integrity shall be determined based on the CRC-32 checksum. If a PDU passes the checksum, it is unpacked and de-fragmented, if necessary. The receiver maintains a sliding-window defined by ARQ_RX_WINDOW_START state variable and the ARQ_WINDOW_SIZE parameter. When an ARQ block with a number that falls in the range defined by the sliding window is received, the receiver shall accept it. ARQ blocks with numbers outside the sliding window shall be rejected. The receiver should discard duplicate ARQ blocks (i.e. ARQ blocks that were already received correctly) within the window.

The sliding window is maintained such that the ARQ_RX_WINDOW_START variable always points to the lowest numbered ARQ block that has not been received or has been received with errors. When an ARQ block with a number corresponding to the ARQ_RX_WINDOW_START is received, the window is advanced (i.e. ARQ_RX_WINDOW_START is incremented modulo ARQ_BSN_MODULUS) such that the ARQ_RX_WINDOW_START variable points to the next lowest numbered ARQ block that has not been received or has been received with errors. The timer associated with ARQ_SYNC_LOSS_TIMEOUT shall be reset.

As each block is received, a timer is started for that block. When the value of the timer for a block exceeds ARQ_RX_PURGE_TIMEOUT, the timeout condition is marked. When this occurs, ARQ_RX_WINDOW_START is advanced to the BSN of the next block not yet received after the marked block. Timers for delivered blocks remain active and are monitored for timeout until the BSN values are outside the receive window.

When ARQ_RX_WINDOW_START is advanced, any BSN values corresponding to blocks that have not yet been received residing in the interval between the previous and current ARQ_RX_WINDOW_START value shall be marked as received and the receiver shall send an ARQ Feedback IE to the transmitter with the updated information. Any blocks belonging to complete SDUs shall be delivered. Blocks from partial SDUs shall be discarded.

When a discard message is received from the transmitter, the receiver shall discard the specified blocks, advance ARQ_RX_WINDOW_START to the BSN of the first block not yet received after the BSN provided in the Discard message, and mark all not received blocks in the interval from the previous to new ARQ_RX_WINDOW_START values as received for ARQ feedback IE reporting.

For each ARQ block received, an acknowledgment shall be sent to the transmitter. Acknowledgment for blocks outside the sliding window shall be cumulative. Acknowledgments for blocks within the sliding window may be either for specific ARQ blocks (i.e. contain information on the acknowledged ARQ block numbers), or cumulative (i.e. contain the highest ARQ block number below which all ARQ blocks have been received correctly) or a combination of both (i.e. cumulative with selective). Acknowledgments shall be sent in the order of the ARQ block numbers they acknowledge. The frequency of acknowledgement generation is not specified here and is implementation dependent.

A DLC SDU is ready to be handed to the upper layers when all of the ARQ blocks of the DLC SDU have been correctly received within the time-out values defined.

When ARQ_DELIVER_IN_ORDER is enabled, a DLC SDU is handed to the upper layers as soon as all the ARQ blocks of the DLC SDU have been correctly received within the defined time-out values and all blocks with sequence numbers smaller than those of the completed message have either been discarded due to time-out violation or delivered to the upper layers.

When ARQ_DELIVER_IN_ORDER is not enabled, DLC SDUs are handed to the upper layers as soon as all blocks of the DLC SDU have been successfully received within the defined time-out values.

The actions to be taken by the receiver state machine when an ARQ Reset message is received are provided in figure 4. The actions to be taken by the receiver state machine when it wants to initiate a reset of the transmitter ARQ state machine are provided in figure 5. Synchronization of the ARQ state machines is governed by a timer managed by the receiver state machine. Each time ARQ_RX_WINDOW_START is updated, the timer is set to zero. When the timer exceeds the value of ARQ_SYNC_LOSS_TIMEOUT the receiver state machine shall initiate a reset of the connection's state machines as described in figure 5.

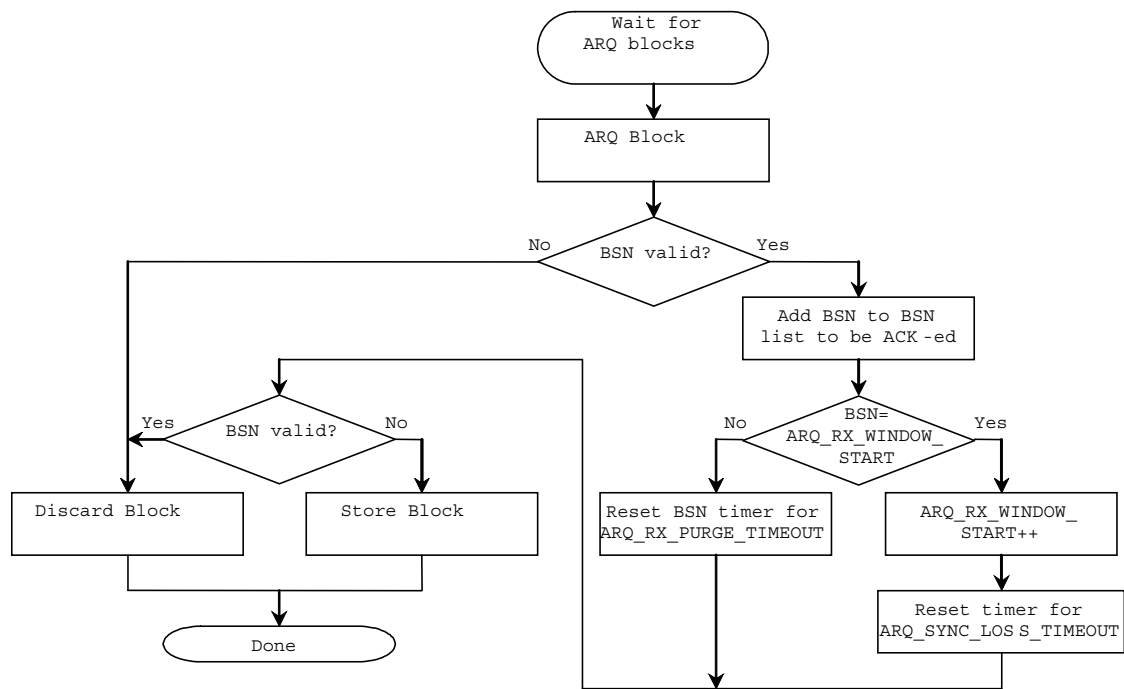

Figure 6: ARQ block reception

8.4.5 Resetting the ARQ state machine

Synchronization of the ARQ state machines is governed by timers managed by the transmitter and receiver state machine. Each time `ARQ_TX_WINDOW_START` is updated, the transmitter timer is reset (set to zero). Each time `ARQ_RX_WINDOW_START` is updated, the transmitter timer is reset.

When the timer exceeds the value of `ARQ_SYNC_LOSS_TIMEOUT` the state machine shall initiate the ARQ Reset process for that connection. The process of executing an ARQ Reset on a connection is shown in figures 7 and 8.

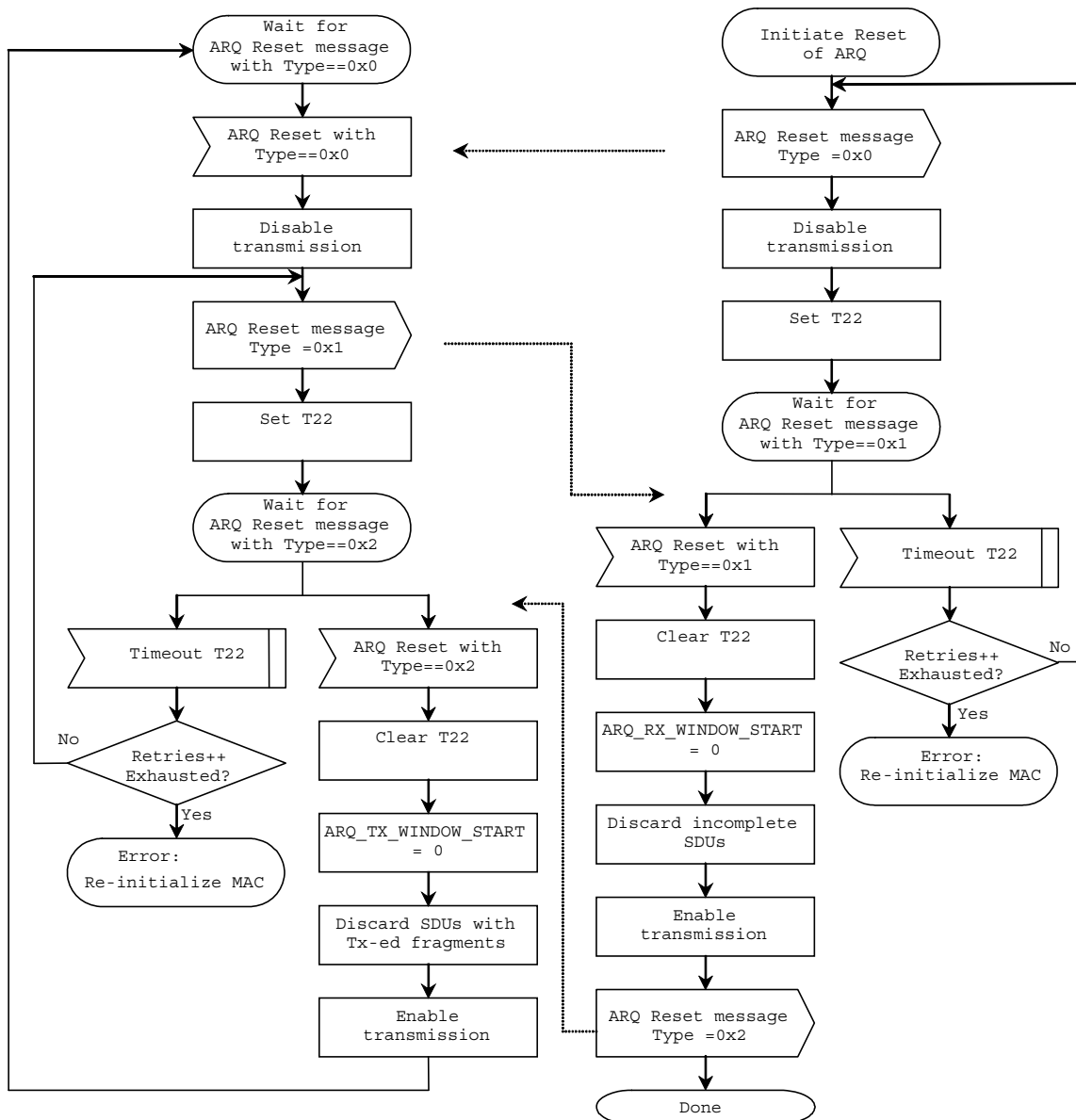

Figure 7: Receiver initiated ARQ Reset

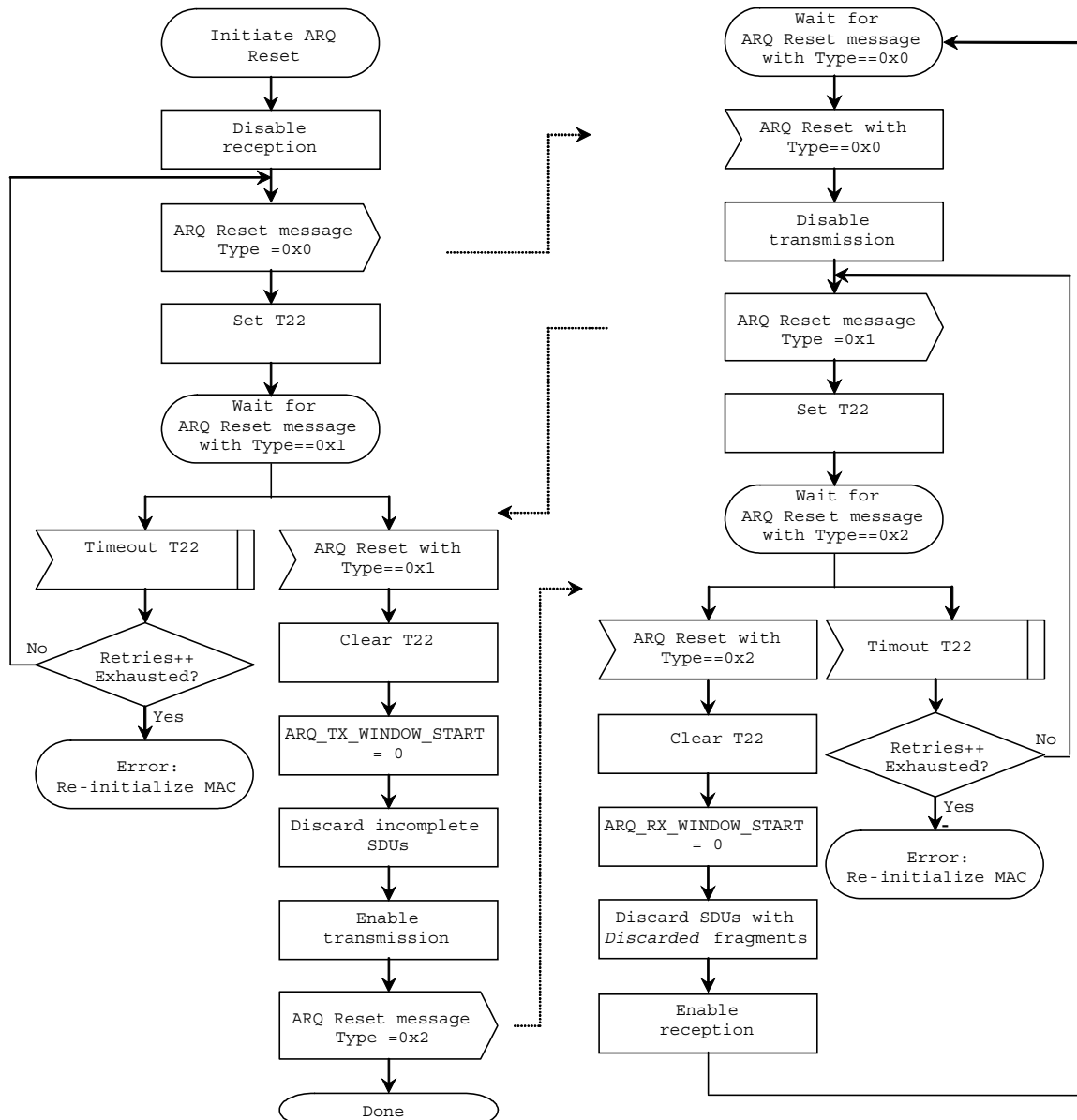

Figure 8: Transmitter initiated ARQ Reset

8.5 ARQ service flow TLVs

The following TLV encodings shall be available.

- ARQ SUPPORT:
 - The ARQ SUPPORT indicates whether or not ARQ is supported by the system. When the system supports ARQ, this TLV shall be included in the REG-REQ by the SS whereas the BS shall indicate acceptance or rejection of the ability. ARQ shall be available for connections only if both sides support it.

- ARQ ENABLE:
 - The ARQ ENABLE TLV indicates whether or not ARQ is available for the connection that is being setup. The DSA-REQ shall contain the request to use ARQ or not. The DSA-RSP message shall contain the acceptance or rejection of the request. ARQ shall be enabled for this connection only if both sides support it. When a DSA-REQ is issued by the BS, the use of ARQ may be mandated for the requested connection (if ARQ availability was confirmed during registration). In that case, the SS shall either reject the connection or accept the connection with ARQ.
- ARQ WINDOW SIZE:
 - This parameter is negotiated upon connection setup. The DSA-REQ/DSC-REQ message shall contain the suggested value for this parameter. The DSA-RSP/DSC-RSP message shall contain the confirmation value or an alternate value for this parameter. The smaller of the two shall be used as the actual ARQ_WINDOW_SIZE.
- ARQ RETRY TIMEOUT:
 - The ARQ retry timeout should account for the transmitter and receiver processing delays and any other delays relevant to the system. This is achieved through the use of the following two TLVs:
 - ARQ_TX_DELAY: This is the total estimated transmitter delay, including sending (e.g. DLC PDUs) and receiving (e.g. ARQ feedback) delays and other implementation dependent processing delays. If the transmitter is the BS, it may include other delays such as scheduling and propagation delay.
 - ARQ_RX_DELAY: This is the total estimated receiver delay, including receiving (e.g. DLC PDUs) and sending (e.g. ARQ feedback) delays and other implementation dependent processing delays. If the receiver is the BS, it may include other delays such as scheduling and propagation delay.
 - The DSA-REQ and DSA-RSP messages shall contain the values for these parameters, where the receiver and transmitter each declare their capabilities. When the DSA handshake is completed, each party shall calculate:

$$ARQ_RETRY_TIMEOUT = ARQ_TX_DELAY + ARQ_RX_DELAY \quad (13)$$
- ARQ BLOCK LIFETIME:
 - The BS shall set this parameter. The DSA-REQ or DSA-RSP messages shall contain the value of this parameter as set by the BS. If this parameter is set to 0, then the ARQ_BLOCK_LIFETIME value shall be considered infinite.
- ARQ_SYNC_LOSS_TIMEOUT:
 - The BS shall set this parameter. The DSA-REQ or DSA-RSP messages shall contain the value of this parameter as set by the BS. If this parameter is set to 0, then the ARQ_SYNC_LOSS_TIMEOUT value shall be considered infinite.
- ARQ_DELIVER_IN_ORDER:
 - The transmitter shall set this parameter. The DSA-REQ or DSA-RSP messages shall contain the value of this parameter. This TLV indicates whether or not data is to be delivered by the receiving DLC to its client application in the order in which the data was handed off to the originating DLC.
- ARQ_RX_PURGE_TIMEOUT:
 - The BS shall set this parameter. The DSA-REQ or DSA-RSP messages shall contain the value of this parameter as set by the BS. If this parameter is set to 0, then the ARQ_RX_PURGE_TIMEOUT value shall be considered infinite.

Table 79: ARQ TLVs

Name	Type	Length	Value	Scope
ARQ_SUPPORT	5.21	1	0: No ARQ support capability 1 to 254: Max. simultaneous connections for which ARQ can be supported 255: 255 or more simultaneously supportable ARQ connections	REG-REQ REG-RSP
ARQ_ENABLE	[24/25].11	1	0 = ARQ not support 1 = ARQ supported 2 = ARQ mandated (BS in DSA-REQ only)	DSA-REQ DSA-RSP
ARQ_WINDOW_SIZE	[24/25].12	2	1-(ARQ_BSN_MODULUS/2)	DSx-REQ DSx-RSP
ARQ_TX_DELAY	[24/25].13	2	Estimated transmitter delay 0 to 655 350 (10 μ s granularity)	DSA-REQ DSA-RSP
ARQ_RX_DELAY	[24/25].22	2	Estimated receiver delay 0 to 655 350 (10 μ s granularity)	DSA-REQ DSA-RSP
ARQ_BLOCK_LIFETIME	[24/25].17	2	0 = Infinite 1 to 655 350 (10 μ s granularity)	DSA-REQ DSA-RSP
ARQ_SYNC_LOSS_TIMEOUT	[24/25].19	2	0 = Infinite 1 to 655 350 (10 μ s granularity)	DSA-REQ DSA-RSP
ARQ_DELIVER_IN_ORDER	[24/25].20	1	0 = Order of delivery is not preserved 1 = Order of delivery is preserved	DSA-REQ DSA-RSP
ARQ_RX_PURGE_TIMEOUT	[24/25].21	2	0 = Infinite 1 to 655 350 (10 μ s granularity)	DSA-REQ DSA-RSP
ARQ_BLOCK_SIZE	[24/25].22	1	Length of ARQ block, bytes	DSA-REQ DSA-RSP

9 Mesh topology support

9.1 Introduction

The main difference between the PMP and optional Mesh modes is that in the PMP mode, traffic only occurs between the BS and SSs, while in the Mesh mode traffic can be routed through other SSs and can occur directly between SSs. Depending on the transmission protocol algorithm used, sharing of channel resources can be done on the basis of equality using distributed scheduling, or on the basis of superiority of the mesh BS, which effectively results in centralized scheduling, or on a combination of both.

Where optional mesh systems are addressed, a system consists of an DLC and PHY implementation with at least two mesh nodes communicating via a multipoint-to-multipoint radio air interface, along with the interfaces to external networks and services transported by the DLC and PHY.

Within a mesh network, a system that has a direct connection to backhaul services outside the mesh network, is termed a mesh BS. All the other systems of a mesh network are termed mesh SS. In general, the systems of a mesh network are termed nodes. Within mesh context, uplink and downlink are defined as traffic in the direction of the mesh BS and traffic away from the mesh BS respectively.

The other three important terms of mesh systems are neighbour, neighbourhood and extended neighbourhood. The stations with which a node has direct links are called neighbours. Neighbours of a node shall form a neighbourhood. A node's neighbours are considered to be "one hop" away from the node. An extended neighbourhood contains, additionally, all the neighbours of the neighbourhood.

Using distributed scheduling, all the nodes including the mesh BS shall coordinate their transmissions in their two-hop neighbourhood and shall broadcast their schedules (available resources, requests and grants) to all their neighbours. Optionally the schedule may also be established by directed un-coordinated requests and grants between two nodes. Nodes shall ensure that the resulting transmissions do not cause collisions with the data and control traffic scheduled by any other node in the two-hop neighbourhood. There is no difference in the mechanism used in determining the schedule for downlink and uplink.

In the mode of operation with centralized scheduling, resources are granted in a more centralized manner. The mesh BS shall gather resource requests from all the mesh SSs within a certain hop range. It shall determine amount of granted resources for each link in the network both in downlink and uplink, and communicates these grants to all the mesh SSs within the hop range. The grant messages do not contain the actual schedule but each node shall compute it by using the predetermined algorithm with given parameters.

All the communications are in the context of a link, which is established between two nodes. One link shall be used for all the data transmissions between the two nodes. QoS is provisioned over links on a message by message basis. No service or QoS parameters are associated with a link but each unicast message has service parameters in the header. Traffic classification and flow regulation are performed at ingress node by upper-layer classification/regulation protocol. The service parameters associated with each message shall be communicated together with the message content via the DLC SAP.

Mesh systems typically use omni directional or 360° steerable antennas, but can also be co-located using sector antennas. At the edge of the coverage area of the mesh network, where only a connection to a single point is needed, even highly directional antennas can be used.

9.2 Addressing and connections

Each node shall have a 48-bit universal MAC Address. The address uniquely defines the node from within the set of all possible vendors and equipment types. This address is used during the network entry process and as part of the authorization process by which the candidate node and the network verify the identity of each other.

When authorized to the network the candidate node shall receive a 16-bit Node Identifier (Node ID) upon a request to the mesh BS. Node ID is the basis for identifying nodes during normal operation. The Node ID is transferred in the Mesh subheader, which follows the Generic DLC header, in both unicast and broadcast messages.

For addressing nodes in the local neighbourhood, 8-bit link identifiers (Link IDs) shall be used. Each node shall assign an ID for each link it has established to its neighbours. The Link IDs are communicated during the Link Establishment process as neighbouring nodes establish new links. The Link ID is transmitted as part of the CID in the Generic DLC header in unicast messages. The Link IDs shall be used in distributed scheduling to identify resource requests and grants. Since these messages are broadcast, the receiver nodes shall be able to identify the schedule of their own using both the transmitter's Node ID in the Mesh subheader, and the Link ID in the MSH-DSCH payload.

After entering the network, a node can establish links with nodes other than its sponsor by following the secure process as defined in table 80. This process uses the MSH-NCFG Neighbour Link Establishment IE (see table 65).

- 1) Node A sends a challenge (action code = 0x0) containing:

$$\text{HMAC}\{\text{Operator Shared Secret, frame number, Node ID of node A, Node ID of node B}\} \quad (14)$$

in which the Operator Shared Secret is a private key obtained from the provider (which is also used to enter the network) and the frame number is the last known frame number in which Node B send a MSH-NCFG message.

- 2) Node B, upon reception, computes the same value (it may also attempt some earlier frame numbers in which it sent MSH-NCFG messages, in case node A missed the last of its MSH-NCFGs) as above and compares. If the values do not match, a rejection (action code = 0x3) is returned. If a match is achieved, Node B sends, implicitly accepting the link, a challenge response (action code = 0x1) containing:

$$\text{HMAC}\{\text{Operator Shared Secret, frame number, Node ID of node B, Node ID of node A}\} \quad (15)$$

in which the frame number is the frame number in which Node A sent the MSH-NCFG message with challenge. It also randomly selects and includes an unused link ID, which shall from this point forward indicate the link from node B to node A.

- 3) Node A, upon reception, computes the same value as above and compares. If the values do not match a rejection (action code = 0x3) is returned. If a match is achieved, Node A sends an Accept. It also randomly selects and includes an unused link ID, which shall from this point forward indicate the link from node A to node B.

Table 80: Link establishment

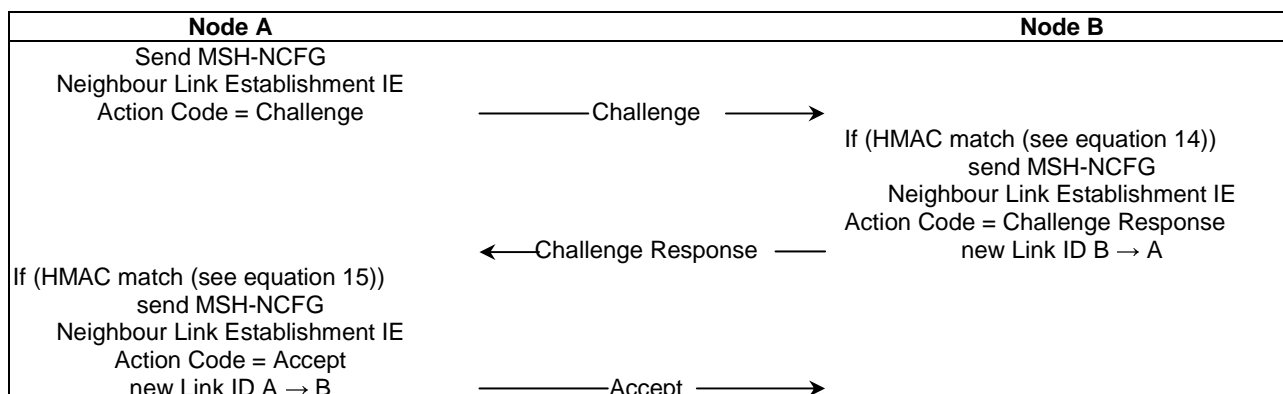

The Connection ID in mesh mode is specified as shown in table 81 to convey broadcast/unicast, service parameters and the link identification.

Table 81: Connection ID

Syntax	Size	Notes
CID() {		
if (Xmt Link ID == 0xFF) {		
Logical Network ID	8 bits	0x00 All-net Broadcast
} else {		
Type	2 bits	0x0 DLC Management 0x1 IP 0x2 to 0x3 Reserved
Reliability	1 bit	0x0 No retransmissions 0x1 Up to 4 retransmissions
Priority/Class	3 bits	Indicates message class
Drop Precedence	2 bits	Messages with larger Drop Precedence shall have higher dropping likelihood during congestion
}		
Xmt Link ID	8 bits	0xFF DLC management broadcast
}		

9.3 DLC service definition

9.3.1 Primitives

The following primitives are supported at the DLC Service Access Point in mesh mode:

- MAC_CREATE_CONNECTION.indication.
- MAC_CHANGE_CONNECTION.indication.
- MAC_TERMINATE_CONNECTION.request.
- MAC_TERMINATE_CONNECTION.indication.
- MAC_DATA.request.
- MAC_DATA.indication.
- MAC_FORWARDING_UPDATE.request.
- MAC_FORWARDING_UPDATE.indication.

In mesh mode none of the actions cause the initiating CS to send a REQUEST primitive to its DLC sublayer. They are either indications of the results from the processes handled by the DLC common part sublayer management entity, or data delivery actions needed to convey information to the peer CS.

9.3.2 MAC_CREATE_CONNECTION.indication

- Function:
 - This primitive is issued by a DLC entity to the CS, to report a new link established to a neighbour node.
- Generation:
 - This primitive is generated whenever a new link has been established to a neighbour node.
- Effect of receipt:
 - The receipt of the primitive is an indication to the CS that a link to the given neighbour node is up and can be used for data delivery.

Semantics:

```
MAC_CREATE_CONNECTION.indication
{
    CID,
    max length,
    service flow parameters,
    encryption flag
}
```

- The CID is the Connection ID in Mesh as conveyed in the Generic DLC header.
- The max length parameter specifies the maximum length of SDUs that are allowed over the link.
- The service flow parameters include information on:
 - Data rate (Mbps):
 - Data rate associated with the burst profile for the physical link over which the connection is created.
 - Transmit power (dB):
 - Transmit power at the antenna port for the physical link over which the connection is created.
- Estimate of packet error rate for 256-byte packets:
 - The encryption flag specifies that the data carried over this link is encrypted, if ON, If OFF, then no encryption is used.

9.3.3 MAC_CHANGE_CONNECTION.indication

- Function:
 - This primitive is issued by a DLC entity to the CS, to report new parameters of an existing link to a neighbour node.
- Generation:
 - This primitive is generated whenever parameters of an existing link has changed.
- Effect of receipt:
 - The CS shall take into account new link parameters in the use of the link.

Semantics:

```
MAC_CHANGE_CONNECTION.indication
{
    CID,
    max length,
    service parameters,
    encryption flag
}
```

- The CID is the Connection ID in Mesh as conveyed in the Generic DLC header.
- The max length parameter specifies the maximum length of SDUs that are allowed over the link.
- The service parameters include information on:
 - Target data rate for the link in Mbps.
 - Transmit energy for the link.
 - Estimate of packet error rate for 256-byte packets.
 - The encryption flag specifies that over this link encryption is possible, if ON, If OFF, then no encryption is possible.

9.3.4 MAC_TERMINATE_CONNECTION.request

- Function:
 - This primitive is issued by a CS, to terminate an existing link to a neighbour node.
- Generation:
 - This primitive is generated to bring down an existing link to a neighbour node.
- Effect of receipt:
 - The receipt of the primitive causes the DLC to terminate the connection and report that to the DLC entity in the neighbour the link was to.

Semantics:

```
MAC_TERMINATE_CONNECTION.request
{
    CID
}
```

The CID is the Connection ID in Mesh as conveyed in the Generic DLC header.

9.3.5 MAC_TERMINATE_CONNECTION.indication

- Function:
 - This primitive is issued by the DLC entity of the non-initiating side to indicate termination of the link to a neighbour node.
- Generation:
 - This primitive is generated by the DLC sublayer when it receives an indication in a MSH-NCFG message.
- Effect of receipt:
 - The receipt of the primitive is an indication to the CS that the link to the given neighbour node is down and cannot be used for data delivery.

Semantics:

```
MAC_TERMINATE_CONNECTION.indication
{
    CID,
}
```

- The CID is the Connection ID in Mesh as conveyed in the Generic DLC header.

9.3.6 MAC_DATA.request

- Function:
 - This primitive defines the transfer of data to the DLC entity from a convergence sublayer service access point.
- Generation:
 - This primitive is generated by a convergence sublayer whenever an DLC SDU is to be transferred to a peer entity.
- Effect of receipt:
 - The receipt of the primitive causes the DLC entity to process the DLC SDU through the DLC sublayer and pass the appropriately formatted PDUs to the PHY layer for transfer to the peer DLC sublayer entity, using the Node ID specified.

Semantics:

```
MAC_DATA.request
{
    CID,
    length,
    data,
    encryption flag
}
```

- The CID is the Connection ID in Mesh as conveyed in the Generic DLC header.
- The length parameter specifies the length of the DLC SDU in bytes.
- The data parameter specifies the DLC SDU as received by the local DLC entity.
- The priority/class parameter embedded in the CID specifies priority class of the DLC SDU.
- The reliability parameter embedded in the CID specifies maximum number of transmission attempts at each link.
- The drop precedence parameter embedded in the CID indicates relative MSDU dropping likelihood.
- The encryption flag specifies that the data sent over this link is to be encrypted, if ON. If OFF, then no encryption is used.

9.3.7 MAC_DATA.indication

- Function:
 - This primitive defines the transfer of data from the DLC to the convergence sublayer.
- Generation:
 - This primitive is generated whenever an DLC SDU is to be transferred to a peer convergence entity.
- Effect of receipt:
 - The effect of receipt of this primitive by a convergence entity is dependent on the validity and content of the DLC SDU.

Semantics:

```
MAC_DATA.request
{
  CID
  length,
  data,
  reception status,
  encryption flag
}
```

- The CID is the Connection ID in Mesh as conveyed in the Generic DLC header.
- The length parameter specifies the length of the DLC SDU in bytes.
- The data parameter specifies the DLC SDU as received by the local DLC entity.
- The reception status parameter indicates transmission success or failure for those PDUs received via the MAC_DATA.indication.

9.3.8 MAC_FORWARDING_UPDATE.request

- Function:
 - This primitive defines the transfer of the centralized scheduling configuration to the DLC entity from a convergence sublayer service access point in the mesh BS.
- Generation:
 - This primitive is generated in the mesh BS whenever it has changed the schedule tree.
- Effect of receipt:
 - The receipt of this primitive causes the DLC to generate a MSH-CSCF message with the given information. The message shall be distributed to all the nodes listed in the tree.
- Semantics:
 - The parameters of the primitive are as follows:

```
MAC_FORWARDING_UPDATE.request
{
  number of nodes,
  node parameters[number of nodes]
}
```

- The number of nodes parameter indicates number of nodes in the scheduling tree of this mesh BS.
- The node parameters entry shall contain the following information:
 - Node ID: The Node ID parameter indicates the node.
 - Number of children: The number of nodes parameter indicates number of children the given node.
 - Child parameters [number of children].
 - Each child parameters entry shall containing the following information:
 - child index: The child index indicates index into the list of Node IDs;
 - uplink burst profile: The uplink burst profile indicates burst profile of link to child node;
 - downlink burst profile: The downlink burst profile indicates burst profile of link from child node.

9.3.9 MAC_FORWARDING_UPDATE.indication

- Function:
 - This primitive defines the transfer of the centralized scheduling configuration from the DLC to the convergence sublayer.
- Generation:
 - This primitive is generated by the DLC sublayer at all the nodes, which have received the MSH-CSCF message, when new centralized schedule with revised schedule tree takes effect.
- Effect of receipt:
 - The receipt of this primitive synchronizes the forwarder and DLC scheduler to routing changes.

Semantics:

```
MAC_FORWARDING_UPDATE.indication
{
  Node ID self
  number of nodes,
  node parameters[number of nodes]
}
```

- The Node ID self indicates the Node ID of the node itself.
- The number of nodes parameter indicates number of nodes in the scheduling tree of this mesh BS.
- The node parameters entry shall contain the following information:
 - Node ID: The Node ID parameter indicates the node.
 - Number of children: The number of nodes parameter indicates number of children the given node.
 - Child parameters [number of children].
 - Each child parameters entry shall contain the following information:
 - child index: The child index indicates index into the list of Node IDs;
 - uplink burst profile: The uplink burst profile indicates burst profile of link to child node;
 - downlink burst profile: The downlink burst profile indicates burst profile of link from child node.

9.4 DLC management message applicability

When implementing the mesh mode, all clauses referring to the mesh mode in the standard shall apply as mandatory. Basic functionalities are mandatory for a mesh node as they are for a PMP node, except those that are stated as optional below.

For a mesh-enabled system, the messages below and the corresponding functionality are always mandatory to implement:

- MSH-NCFG.
- MSH-NENT.
- MSH-DSCH.
- MSH-CSCH.
- MSH-CSCF.
- REG-REQ.

- REG-RSP.
- PKM-REQ.
- PKM-RSP.
- SBC-REQ.
- SBC-RSP.
- TFTP-CPLT.
- TFTP-RSP.
- RES-CMD.

For a mesh enabled system, the following messages and the corresponding functionality are mandatory/optional whenever they are correspondingly optional/mandatory for a PMP system:

- ARQ-Feedback.
- AAS-FBCK-REQ.
- AAS-FBCK-RSP.

When operating in the mesh mode, the messages below and the corresponding functionality are not used:

- DL-MAP.
- DCD.
- DSC-ACK.
- DSC-REQ.
- DSC-RSP.
- DSD-RSP.
- DSX-RVD.
- UCD.
- UL-MAP.
- CLK-CMP.
- DBPC-REQ.
- DBPC-RSP.
- DREG-CMD.
- MCA-REQ.
- MCA-RSP.
- RNG-REQ.
- RNG-RSP.
- DSA-ACK.
- DSA-REQ.
- DSA-RSP.

9.5 Network synchronization

Network configuration (MSH-NCFG) and network entry (MSH-NENT) packets provide a basic level of communication between nodes in different nearby networks whether from the same or different equipment vendors or wireless operators. These packets are used to synchronize both centralized and distributed control mesh networks.

This communication is used to support basic configuration activities such as: synchronization between nearby networks used (for instance, for multiple, co-located BSs to synchronize their uplink and downlink transmission periods), communication and coordination of channel usage by nearby networks, and discovery and basic network entry of new nodes.

MSH-NCFG, MSH-NENT and MSH-DSCH can all assist a node in synchronizing to the start of frames. For these messages, the control subframe, which initiates each frame, is divided into transmit opportunities (see TS 102 177 [2]). The first transmit opportunity in a network control subframe may only contain MSH-NENT messages, while the remainder MSH_CTRL_LEN-1 may only contain MSH-NCFG messages. In scheduling control subframes, the MSH-DSCH_NUM transmit opportunities assigned for MSH-DSCH messages come last in the control subframe. The MSH-NCFG messages also contain the number of its transmit opportunity, which allows nodes to easily calculate the start time of the frame.

9.5.1 Physical neighbour list

All the basic functions like scheduling and network synchronization are based on the neighbour information all the nodes in the mesh network shall maintain. Each node (BS and SS) maintains a physical neighbourhood list with each entry containing the following fields:

- MAC Address:
 - 48-bit MAC address of the neighbour.
- Hop Count:
 - Indicates distance in hops of this neighbour from the present node. If a packet has been success-fully received from this neighbour recently (defined further below), it is considered to be 1 hop away.
- Node Identifier:
 - 16-bit Number used to identify this node in a more efficient way in MSH-NCFG messages.
- Xmt Holdoff Time:
 - The minimum number of MSH-NCFG transmit opportunities that no MSH-NCFG message transmission is expected from this node after Next Xmt Time (see for detailed definition).
- Next Xmt Time:
 - The MSH-NCFG transmit opportunity(ies) in which the next MSH-NCFG from this node is expected (see for detailed definition).
- Reported Flag:
 - Set to TRUE if this Next Xmt Time has been reported by this node in a MSH-NCFG packet. Else set to FALSE.
- Synchronization hop count:
 - This counter is used to determine superiority between nodes when synchronizing the network. Nodes can be assigned as master time keepers, which are synchronized externally (for example using GPS). These nodes transmit Synchronization hop count of 0. Nodes shall synchronize to nodes with lower synchronization hop count, or if counts are the same, to the node with the lower Node ID.

The Physical Neighbourhood List is updated as follows when a MSH-NCFG packet is received from a neighbour:

- The hop count field in the Physical Neighbourhood List for the neighbour itself is set to 1. The hop count field for other nodes listed in the MSH-NCFG message is set to Hops to Neighbour +2 (see table 57) unless they are already listed with a lower hop count.
- The Next Xmt Time and Xmt Holdoff Time of the neighbour and all nodes listed in the MSH-NCFG are updated.
- The "Reported Flag" for each entry in the Physical Neighbour table which was modified is set to FALSE.

9.5.2 MSH-NCFG/MSH-NENT transmission channel and timing

MSH-NCFG and MSH-NENT packets are scheduled for transmission during control subframes. So that all nearby nodes receive these transmissions, the channel used is cycled through the available channels in the band, with the channel selection being based on the Frame number. So, for Frame Number i , the channel is determined by the array lookup:

$$\text{NetConfigChannel} = \text{Logical channel list} \left[\left(\frac{\text{Frame Number}}{\text{Scheduling Frames} \times 4 + 1} \right)_{\text{mod Num_Channels}} \right] \quad (16)$$

where the Logical channel List and Scheduling Frames are derived from the MSH-NCFG:Network Descriptor (see table 61).

9.5.2.1 MSH-NCFG next transmission scheduling

During the current Xmt Time of a node (i.e. the time slot when a node transmits its MSH-NCFG packet), the node uses the following pseudo-code procedure to determine its Next Xmt Time:

```
Order its physical neighbour list by Next Xmt Time.
For each entry in the neighbour list:
    Entry's Earliest Subsequent Xmt Time = Entry's Next Xmt Time + Entry's Xmt Holdoff Time
Success = FALSE;
TempXmtTime = Xmt Time + Xmt Holdoff Time
While (Success == FALSE) do {
    Determine the eligible competing nodes, which is the set of all nodes in the
    physical-neighbour list for which:

TempXmtTime  $\subset$  Entry's Next Xmt Time eligibility interval (see equation 2); OR
Entry's Earliest Subsequent Xmt Time  $\leq$  TempXmtTime.
    if ( MeshElection (TempXmtTime, MyNodeID, CompetingNodeIDsList [ ] ) == FALSE)
        Set TempXmtTime equal to the next MSH-NCFG Xmt opportunity.
    else:
        Success = TRUE
        Next Xmt Time =TempXmtTime.
}
```

The Mesh Election procedure determines whether the local node is the winner for a specific TempXmtTime among all the competing nodes. It returns TRUE if the local node wins or FALSE otherwise. The algorithm works as follows:

```
boolean MeshElection (uint32 XmtTime, uint16 MyNodeID, uint16 NodeIDList [ ] ) {
    uint32 nbr_smear_val, smear_val1, smear_val2;
    smear_val1 = inline_smear(MyNodeID ^ XmtTime );
    smear_val2 = inline_smear(MyNodeID +XmtTime );
    For each Node ID nbrsNodeID in NodeIDList Do {
        nbr_smear_val = inline_smear(nbrsNodeID ^ XmtTime );
        if(nbr_smear_val >smear_val1 ) {
            return FALSE;//This node loses.
        }
    }
    else if(nbr_smear_val ==smear_val1 ) {
        //1st tie-breaker.
        nbr_smear_val = inline_smear(nbrsNodeID +XmtTime );
        if(nbr_smear_val >smear_val2 ) {
            return FALSE;//This node loses.
        }
    }
    else if(nbr_smear_val ==smear_val2 ) {
        //If we still collide at this point Break the tie based on MacAdr
        if (XmtTime is even &&(nbrsNodeID >MyNodeID))||

```

```

        (XmtTime is odd &&(nbrsNodeID <MyNodeID ))) {
        return FALSE;//This node loses.
    }
}
}
//This node won over this competing node
} //End for all competing nodes
//This node is winner, it won over all competing nodes.
return TRUE;
}

// Convert a uniform 16-bit value to an uncorrelated uniform 16-bit hash value, uses mixing.

uint32 inline smear(uint16 val) {
    val +=(val <<12);
    val ^=(val >>22);
    val +=(val <<4);
    val ^=(val >>9);
    val +=(val <<10);
    val ^=(val >>2);
    val +=(val <<7);
    val ^=(val >>12);
    return(val);
}

```

9.5.2.2 MSH-NENT next transmission scheduling

The NetEntry scheduling protocol provides the upper layer protocol an unreliable mechanism to access the NetEntry slot(s), so that new nodes, which are not yet fully-functional members of the network, can communicate with the fully-functional members of the network.

In the NetEntry slots new nodes shall transmit MSH-NENT messages using the following two step procedure:

- 1) The initial MSH-NENT packet with request IE is sent in a random, contention-based fashion in a free network entry transmission slot in the immediately following MSH-NENT transmission opportunity after the targeted sponsor sends a MSH-NCFG. with sponsored MAC Address 0x000000000000.
- 2) After the sponsor advertises the new nodes MAC Address in a MSH-NCFG message, the new node may send a MSH-NENT in the immediately following MSH-NENT transmission opportunity.

A new node uses the algorithm specified by the following pseudocode to access NetEntry transmission slots:

```

/*Variable Definitions */
Pkt *MSH-NENT_MsgQ =NULL;           //MSH-NENT Message queue
uint SponsorsState =UNAVAILABLE;   //SponsorsState and OthersState record the NetEntry
uint OthersState =BUSY;
// Address in the MSH-NCFG packet form the sponsor or other nodes,
// which can be used to determine the availability of the next NetEntry transmission opportunity
//SponsorsState can be UNAVAILABLE,AVAILABLE and POLLING.
//OthersState can be AVAILABLE and BUSY.
uint OthersMaxMacAdr =0xFFFFFFFF;
uint OthersMinMacAdr =0x00000000;

void RecvOutgoingMSH-NENT_Msg (Pkt *MSH-NENT_Msg) {
    MSH-NENT_MsgQ->enqueue (MSH-NENT_Msg);
}

void RecvIncomingMSH-NCFG_Msg (Pkt *MSH-NCFG_Msg) {
    if (MSH-NCFG_Msg->sourceMacAdr ==sponsorsMacAdr) {
        switch (MSH-NCFG_Msg->NetEntryAddress)
        {
            case 0x000000000000:    SponsorsState =AVAILABLE; break;
            case myMacAdr:         SponsorsState =POLLING; break;
            default:                break;
        }
    } else {
        switch (MSH-NCFG_Msg->NetEntryAddress)
        {
            case 0x000000000000:break;
            default:OthersState =BUSY;
                if (OthersMaxMacAdr <MSH-NCFG_Msg->NetEntryAddress)
                    OtherMaxMacAdr=MSH-NCFG_Msg->NetEntryAddress;
                if (OthersMinMacAdr >MSH-NCFG_Msg->NetEntryAddress)
                    OtherMinMacAdr =MSH-NCFG_Msg->NetEntryAddress;
        }
    }
}

```

```

    }
}

void NetworkControlSubframeStart() {
    boolean xmt =FALSE;
    if (MSH-NENT_MsgQ->qLength()) {
        if (SponsorsState ==AVAILABLE) {
            if (OthersState !=BUSY)
                xmt =TRUE;
        }
        else if (SponsorsState ==POLLING) {
            if (OthersState !=BUSY)
                xmt =TRUE;
            else if (((mayMacAdr >OthersMaxMacAdr)&&(even superframe)) ||
                    ((mayMacAdr <OthersMinMacAdr)&&(odd superframe)))
                xmt =TRUE;
        }
    }
    if (xmt) {
        Pkt*MSH-NENT_Msg =MSH-NENT_MsgQ->getHead();
        MSH-NENT_MsgQ->dequeue (MSH-NENT_Msg);
        SendOutPkt (MSH-NENT_Msg,nextNetEntrySlot);
    }
    SponsorsState =UNAVAILABLE;
    OthersState =AVAILABLE;
    OthersMaxMacAdr =0x000000000000;
    OthersMinMacAdr =0xFFFFFFFFFFFF;
}

```

The individual subroutines are triggered by the transmission of a MSH-NENT packet, the reception of a MSH-NCFG packet and the start of a NetworkControl Subframe respectively.

9.6 Network entry and synchronization

Node initialization and network entry procedures in mesh mode are in some aspects different from those in PMP mode. A new node entering the mesh network obeys the following procedures. The whole entry process to the stage when the node can start scheduled transmissions can be divided into the following phases:

- 1) Scan for active network and establish coarse synchronization with the network.
- 2) Obtain network parameters (from MSH-NCFG messages).
- 3) Open Sponsor Channel.
- 4) Node authorization.
- 5) Perform registration.
- 6) Establish IP connectivity.
- 7) Establish time of day.
- 8) Transfer operational parameters.

Each node shall contain a 48-bit universal MAC Address assigned during the manufacturing process. This is used to identify the node to the various provisioning servers during initialization and whenever performing authentication with a neighbour node.

9.6.1 DLC management message tunnelling

In Mesh networks during network entry certain DLC Message protocols take place between entities separated by multiple hops. In these cases the Sponsor Node shall relay the DLC Messages from the new node acting as the SS to the peer performing the duties of the PMP BS. The sponsor shall also relay the messages from the BS entity to the new node.

The Sponsor shall tunnel the DLC Messages received from the New Node (SS) listed in table 82 over UDP as shown in figure 9. to the entity performing the BS part of the protocol. The UDP source and destination port used for tunnelled messages shall be equal to 80216_UDP_PORT. The sponsor shall also extract the DLC messages from the UDP packets arriving from the BS entity and transmit them over the air to the New Node.

Table 82: DLC management message tunnelling over UDP

Message	Sponsor action	Direction of message
PKM-REQ: Auth Request	Tunnel	SS to BS
PKM-REQ: Auth Info	Tunnel	SS to BS
PKM-REQ: Auth Reply	Extract	BS to SS
PKM-REQ: Auth Reject	Extract	BS to SS
REG-REQ	Tunnel	SS to BS
REG-RSP	Extract	BS to SS
DSA-REQ	Tunnel	SS to BS
DSA-RSP	Extract	BS to SS
DSA-ACK	Tunnel	SS to BS

IP header(s)	UDP header	Tunnel Subheader	Message including headers
--------------	------------	------------------	---------------------------

Figure 9: DLC management message tunnelling message format

The format of the Tunnel Subheader is defined in table 83.

Table 83: Tunnel Subheader format

Syntax	Size	Notes
Tunnel Subheader() {		
Type	8 bits	0 = Reserved 1 = HiperMAN DLC header 2 to 255 = Reserved
}		

Also, DLC messages may need to be tunnelled end to end in cases when the protocol takes place between peers separated by several hops. The packet format in figure 9 shall be used in these cases with the Tunnel Subheader format defined in table 83.

9.6.2 Scanning and coarse synchronization to network

On initialization or after signal loss, the node shall search for MSH-NCFG messages to acquire coarse synchronization with the network. Upon receiving a MSH-NCFG message the node acquires the network time from the Timestamp field. The node may have non-volatile storage in which all the last operational parameters are stored and shall first try to re-acquire coarse synchronization with the network. If this fails, it shall begin to continuously scan the possible channels of the frequency band of operation until a valid network is found.

Once the PHY has achieved synchronization, the DLC Sublayer shall attempt to acquire network parameters. At the same time the node shall build a Physical Neighbour List (see clause 9.5.1).

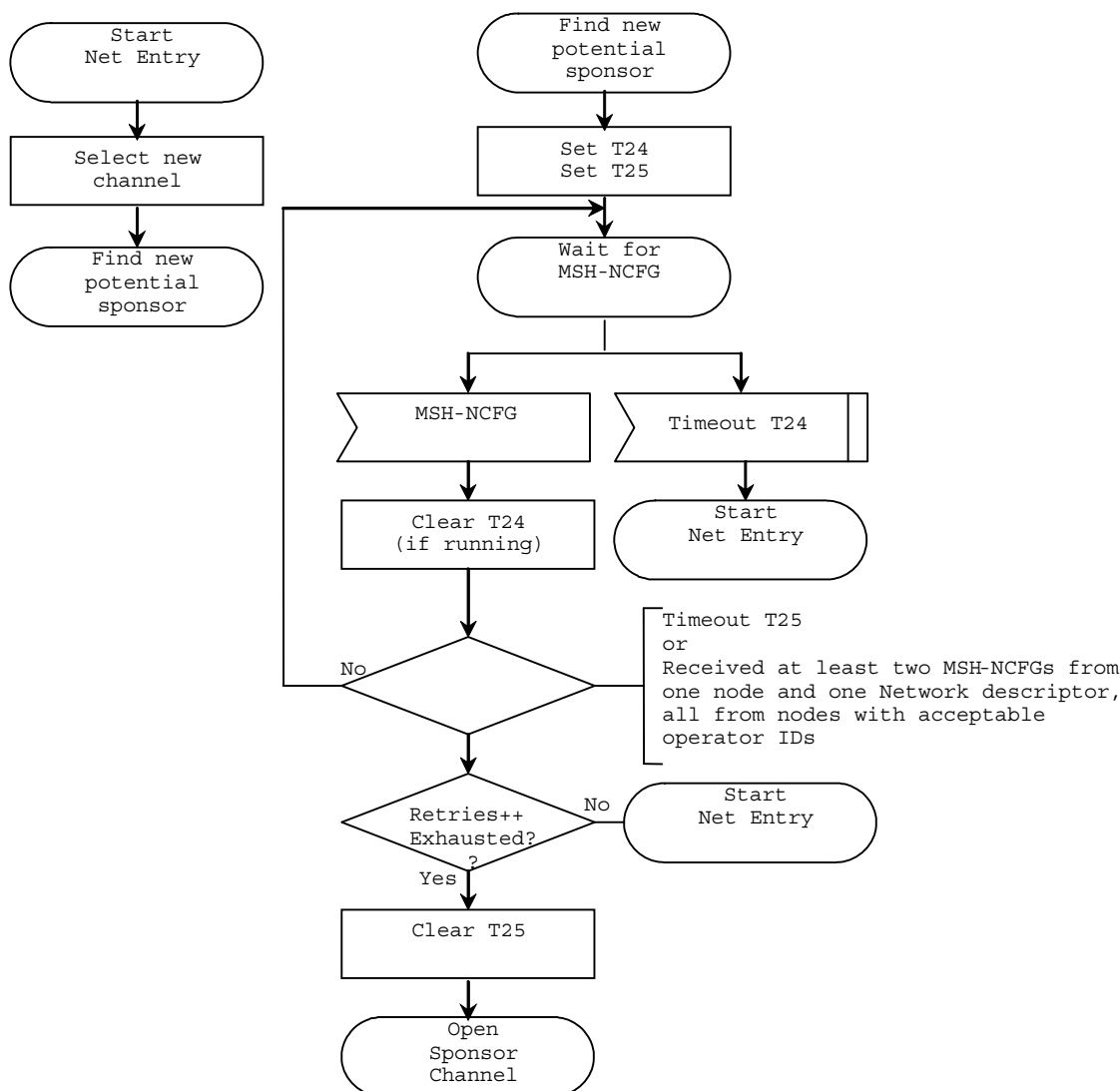

Figure 10: Synchronization and network entry - new node I

9.6.3 Obtaining network parameters

A node shall remain in synchronization as long as it receives MSH-NCFG messages. A node shall accumulate MSH-NCFG messages at least until it receives a MSH-NCFG message from the same node twice and until it has received a MSH-NCFG Network Descriptor with an operator ID matching (one of) its own if it has any. In parallel the new node shall update its Physical Neighbour List (see clause 9.5.1) from the acquired information.

From the established physical neighbour list, the new node shall select a potential Sponsoring Node out of all nodes having the Logical Network ID of the node for which it found a suitable Operator ID. The new node then shall then synchronize its time to the potential sponsor assuming 0 propagation delay after which it shall send a MSH-NENT NetEntryRequest including the Node ID of the potential sponsor. To determine a suitable transmission time, the node shall adhere to clause 9.5.2.2.

Until the node has obtained a unique Node ID, it shall use temporary Node ID (0x0000) as Transmitter's Node ID in all transmissions.

Once the Candidate Node has selected a Sponsoring Node, it shall use the Sponsoring Node to negotiate basic capabilities and to perform authorization. For that purpose the Candidate Node shall first request the Sponsoring Node to open Sponsor Channel for a more effective message exchange.

9.6.4 Opening sponsor channel

Once the new node has selected one of its neighbours as the candidate Sponsoring Node it becomes a Candidate Node. To get further in the initialization procedure the Candidate Node shall request the candidate Sponsoring Node to establish a temporary schedule which could be used for further message delivery during the Candidate Node initialization. The temporary schedule requested is termed Sponsor Channel.

The process is initiated by the Candidate Node which transmits a MSH-NENT NetEntryRequest message (a MSH-NENT message with Type set to 0x2) to the Sponsoring Node.

Upon reception of the MSH-NENT NetEntryRequest message with the Sponsor Node ID equal to Node ID of its own, the candidate Sponsoring Node shall assess the request and either opens the Sponsor Channel or rejects the request. The response is given in a MSH-NCFG message with an Embedded Data as defined in clause 7.4.28.3. If the candidate Sponsoring Node does not advertise the Candidate Node's MAC Address in the sponsor's next MSH-NCFG transmission, then the procedure is repeated MSH_SPONSOR_ATTEMPTS times using a random backoff between attempts. If these attempts all fail, then a different Candidate Sponsoring Node is selected and the procedure repeated (including re-initializing coarse network synchronization). If the selected candidate Sponsoring Node does advertise the Candidate Node's MAC Address, it shall continue to advertise this MAC Address in all its MSH-NCFG messages until the sponsorship is terminated.

Once the Candidate Node has received a positive response (a NetEntryOpen message) in from the candidate Sponsoring Node in the MSH-NCFG message, it shall acknowledge the response by transmitting a MSH-NENT NetEntryAck message (a MSH-NENT message with Type set to 0x1) to the Sponsoring Node at the first following network entry transmission opportunity. Before that the Candidate Node shall perform fine time synchronization. It makes a correction to its transmission timing by the Estimated propagation delay indicated in the embedded MSH-NCFG NetEntryOpen message.

If the Sponsoring Node accepted the request and opened a Sponsor Channel, the channel is ready for use immediately after the transmission of the acknowledgement message. At the same the candidate Sponsoring Node becomes the Sponsoring Node.

If the candidate Sponsoring Node embedded a MSH-NCFG NetEntryReject, the new node shall perform the following action based on the rejection code:

0x0: Operator Authentication Value Invalid.

The Candidate Node shall select a new candidate Sponsoring Node with a different operator ID.

0x1: Excess Propagation delay.

The Candidate Node shall repeat its MSH-NENT:NetEntryRequest in the following network entry transmission opportunity to the same candidate Sponsoring Node.

0x2: Select new sponsor.

The Candidate Node shall select a new candidate Sponsoring Node.

If the candidate Sponsoring Node embedded neither MSH-NCFG NetEntryOpen nor MSH-NCFG NetEntryReject, the Candidate Node shall wait (with timeout time T2), for the next MSH-NCFG with NetEntryOpen from the candidate Sponsoring Node and resend the MSH-NENT NetEntryRequest on timeout.

The Candidate Node and the Sponsoring Node use the schedule indicated in the NetEntryOpen message to perform message exchanges described in clauses 9.6.5 through 9.6.10. After this is completed, the Candidate Node shall terminate the entry process by sending a MSH-NENT NetEntryClose message to the Sponsoring Node in the network entry transmission immediately following a MSH-NCFG transmission from the Sponsoring Node, which shall Ack termination with MSH-NCFG NetEntryAck.

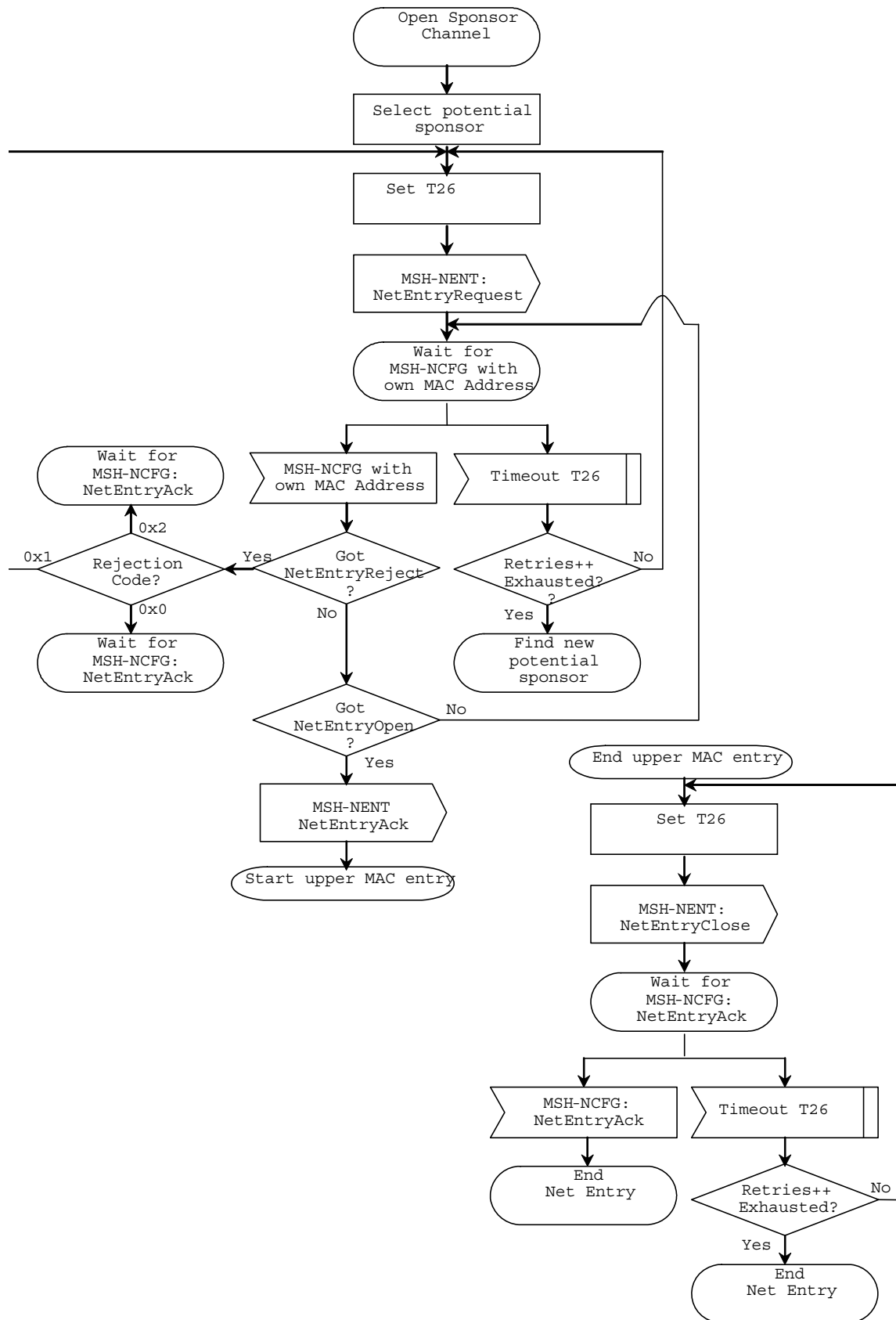

Figure 11: Synchronization and network entry - new node II

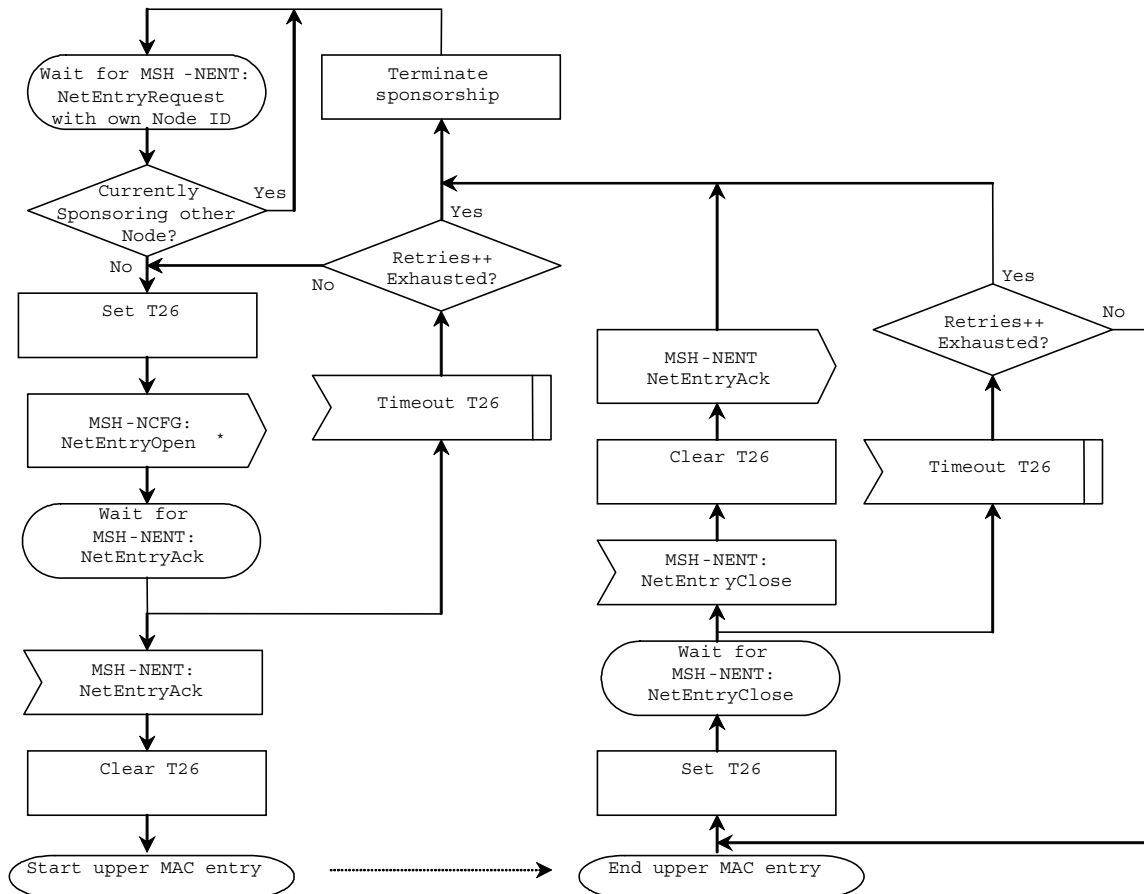
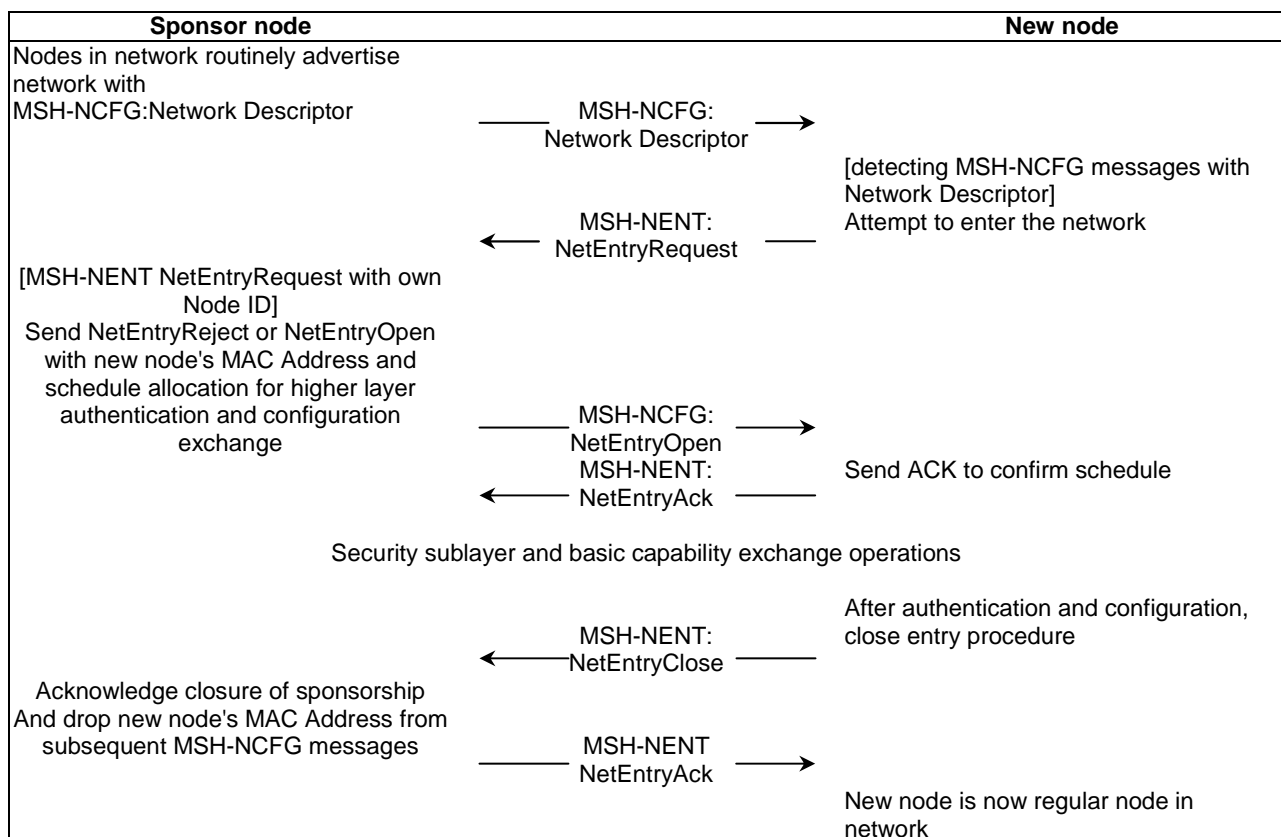

Figure 12: Synchronization and network entry - sponsor node

Table 84 displays the message transfer sequence during a successful network entry without repetitions or time-outs.

Table 84: Network entry successful message exchange



9.6.5 Negotiating basic capabilities

In Mesh Mode, basic capability negotiation is the same as for PMP systems and shall be performed after a logical link has been established. The node which requested the logical link shall act as the SS and initiate the SBC-REQ.

9.6.6 Node Authorization

The new node shall perform authorization in an identical fashion as PMP systems. The new node shall act as the SS. The sponsor node upon reception of the Authent Info and Auth Request shall tunnel the messages as described in to the Authorization Node. The Authorization Node, acting as the BS, shall verify the SS Certificate of the new node and determine whether the new node is authorized to join the Network. Upon receiving tunnelled PKM-RSP DLC Messages from the Authorization Node the Sponsor shall forward the messages to the new node.

9.6.7 Node Registration

Registration is the process by which a node is assigned its Node ID. The sponsoring node upon reception of the REG-REQ shall tunnel the message as described in clause 9.6.1 to the Registration Node. Upon receiving tunnelled REG-RSP DLC Messages from the Registration Node the Sponsor shall forward the messages to the new node. The new node shall follow the procedure in figure 13. The Registration Node shall follow the procedure in figure 14.

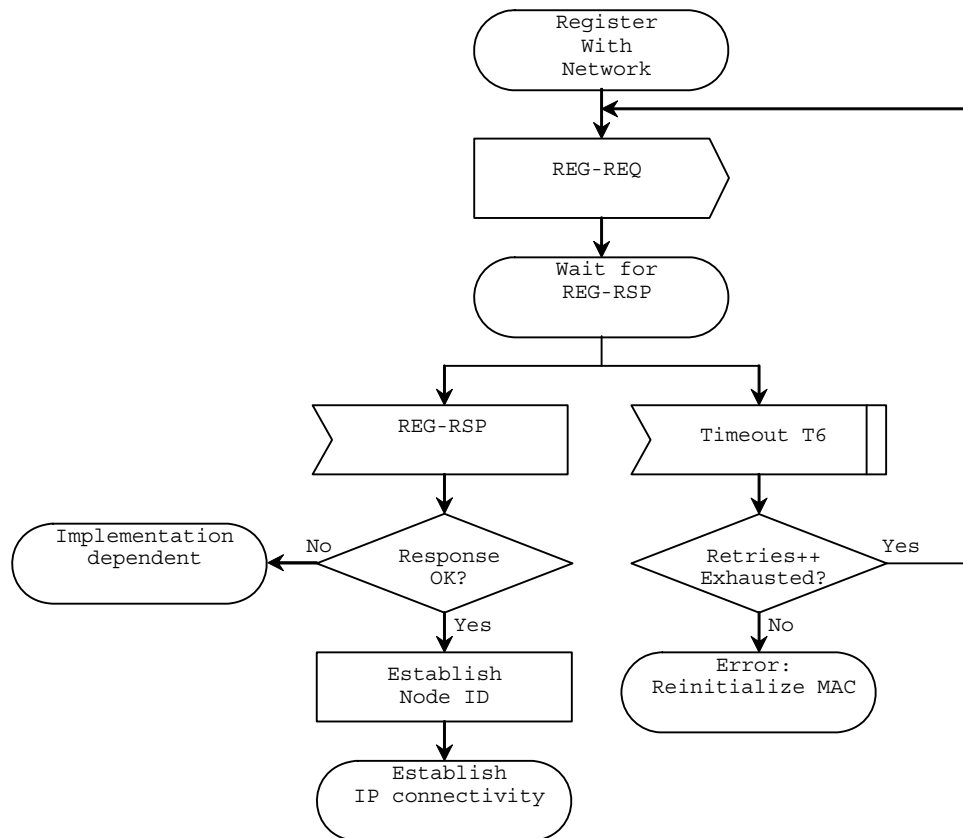

Figure 13: Registration - candidate node

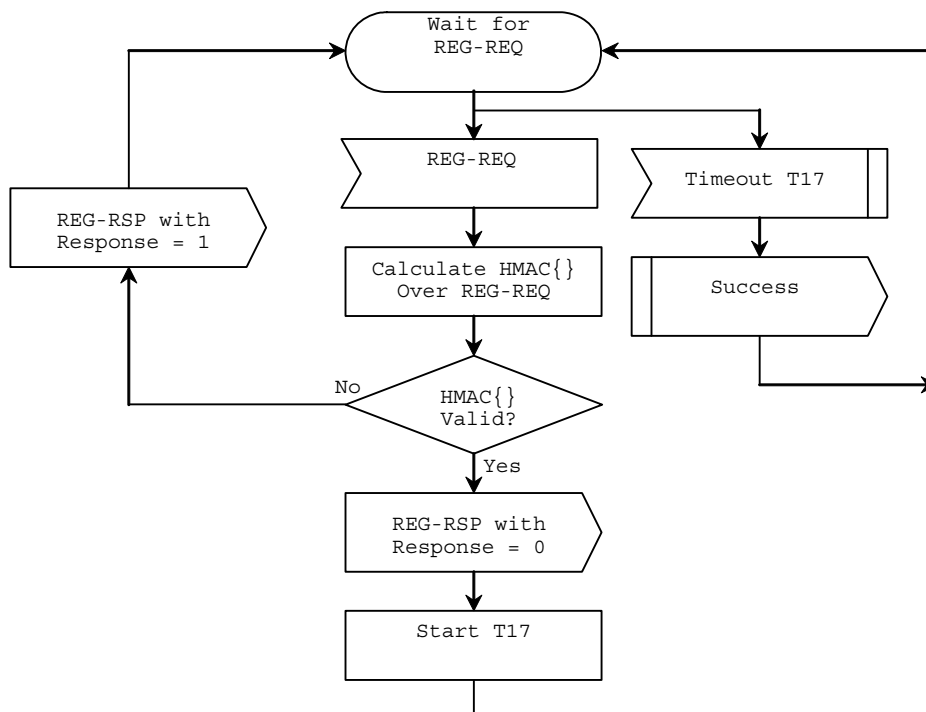

Figure 14: Registration - registration node

9.6.8 Establishing IP connectivity

The node shall acquire an IP address using DHCP in a fashion identical to PMP systems. However, the procedure shall take place over the Sponsor Channel.

9.6.9 Establishing time of day

The node shall retrieve the time of day in a fashion identical to PMP. However, the messages shall be carried over UDP in the Sponsor Channel.

9.6.10 Transfer of operational parameters

After successfully acquiring an IP address via DHCP the node shall download a parameter file using TFTP in a fashion identical to PMP systems. However, the node shall use the Sponsor Channel instead of the Secondary Management connection.

Upon receiving tunnelled REG-RSP DLC Messages from the Provisioning Node the Sponsor shall forward the messages to the Candidate Node.

The following additional configuration file encodings are available.

Name	Type	Length	Value
Authorization Node	22	4 or 16	IP Address of the Authorization Node
Registration Node	23	4 or 16	IP Address of the Registration Node
Provisioning Node	18	4 or 16	IP Address of the Provisioning Node

Using mesh, QoS is provisioned on a packet-by-packet basis using the Mesh CID. The connection-based QoS provisioning using the DSx messages are hence not used. A node obtains its AuthorizedQoSParamSet during the transfer of operational parameters.

9.7 Privacy sublayer

The privacy sublayer for Mesh mode is identical to that of PMP mode with the following exceptions.

9.7.1 TEK exchange overview

Upon achieving authorization, a Node starts for each Neighbour a separate TEK state machine for each of the SAIDs identified in the Authorization Reply message. Each TEK state machine operating within the Node is responsible for managing the keying material associated with its respective SAID. The Node is responsible for maintaining the TEKs between itself and all nodes it initiates TEK exchange with. Its TEK state machines periodically send Key Request messages to the Neighbours of the node, requesting a refresh of keying material for their respective SAIDs.

The Neighbour replies to a Key Request with a Key Reply message, containing the BS's active keying material for a specific SAID.

The Traffic Encryption Key (TEK) in the Key Reply is encrypted, using the node's public key found in the SS-Certificate attribute.

Note that at all times the node maintains two active sets of keying material per SAID per neighbour. The life-times of the two generations overlap such that each generation becomes active halfway through the life of its predecessor and expires halfway through the life of its successor. A neighbour includes in its Key Replies both of an SAID's active generations of keying material.

The Key Reply provides the requesting Node, in addition to the TEK, the remaining lifetime of each of the two sets of keying material. The receiving Node uses these remaining lifetimes to estimate when the Neighbour invalidates a particular TEK, and therefore when to schedule future Key Requests. The transmit regime between the initiating Node and the Neighbour provides for seamless key transition.

9.7.2 Node Re-Authorization

When re-authorizing with the network, the re-authorizing node shall tunnel the authorization messages as shown in figure 9 over UDP.

9.7.3 TEK usage

For each of its SAIDs, the neighbour shall transition between active TEKs according to the following rules:

- At expiration of the older TEK, the neighbour shall immediately transition to using the newer TEK for encryption.
- The neighbour that generated the TEK shall use the older of the two active TEKs for encrypting traffic towards the Node that initiated the TEK.
- The neighbour that generated the TEK shall be able to decrypt traffic from each node using either the older or newer TEK.

For each of its authorized SAIDs, the initiator node shall use the newer of its two TEKs to encrypt traffic towards its neighbours with which it initiated a TEK exchange, and shall be able to decrypt traffic from the neighbour's traffic encrypted with either of the TEKs.

9.7.4 Usage of operator shared key

Each node shall be capable of maintaining two active Operator Shared Secrets. A node shall use the Operator Shared Secret to calculate a HMAC digest for the Key Request and Key Reply messages when exchanging TEKs with its neighbouring nodes.

9.7.5 HMAC authentication keys and calculation of HMAC digests

The HMAC_KEY_S shall be derived as follows:

$$\text{HMAC_KEY_S} = \text{SHA}(\text{H_PAD_D} | \text{Operator Shared Secret}) \quad (17)$$

where H_PAD_D = 0x3A repeated 64 times.

HMAC digests calculated with the key HMAC_KEY_S shall be supported. When calculating the digest with this key the HMAC sequence Number in the HMAC tuple shall be equal to the Operator Shared Secret Sequence Number.

9.8 Data scheduling

Unlike the PMP mode, there are no clearly separate downlink and uplink subframes in the mesh mode. Each station is able to create direct communication links to a number of other stations in the network instead of communicating only with a BS. However, in typical installations, there will still be certain nodes which provide the BS function of connecting the mesh network to the backhaul links. In fact, when using mesh centralized scheduling (described below), these BS nodes perform much of the same basic functions as does the BS in PMP mode. Thus, the key difference is that in mesh mode all the SSs may have a direct links with other SSs. Further, there is no need to have direct link from a SS to the BS of the mesh network. This connection can be provided via other SSs. Communication in all these links shall be controlled by a centralized algorithm (either by the BS or "decentralized" by all nodes periodically), scheduled in a distributed manner within each node's extended neighbourhood, or scheduled using a combination of these.

9.8.1 Distributed scheduling

The stations with which a station has direct links are called neighbours and shall form a neighbourhood. A node's neighbours are considered to be "one hop" away from the node. A two-hop extended neighbourhood contains, additionally, all the neighbours of the neighbourhood. In the coordinated distributed scheduling mode, all the stations (BS and SSs) shall coordinate their transmissions in their extended two-hop neighbourhood.

The coordinated distributed scheduling mode uses some or the entire control portion of each frame to regularly transmit its own schedule and proposed schedule changes on a PMP basis to all its neighbours. Within a given channel all neighbour stations receive the same schedule transmissions. All the stations in a network shall use this same channel to transmit schedule information in a format of specific resource requests and grants.

Coordinated distributed scheduling ensures that transmissions are scheduled in a manner that does not rely on the operation of a BS, and that are not necessarily directed to or from the BS.

Within the constraints of the coordinated schedules (distributed or centralized), uncoordinated distributed scheduling can be used for fast, ad-hoc setup of schedules on a link-by-link basis. Uncoordinated distributed schedules are established by directed requests and grants between two nodes, and shall be scheduled to ensure that the resulting data transmissions (and the request and grant packets themselves) do not cause collisions with the data and control traffic scheduled by the coordinated distributed nor the centralized scheduling methods.

Both the coordinated and uncoordinated distributed scheduling employ a three-way handshake:

- 1) A MSH-DSCH:Request is made along with MSH-DSCH:Availabilities, which indicate potential slots for replies and actual schedule.
- 2) A MSH-DSCH:Grant is sent in response indicating a subset of the suggested availabilities which fits, if possible, the request. The neighbours of this node not involved in this schedule shall assume the transmission takes place as granted.
- 3) A MSH-DSCH:Grant is sent by the original requester containing a copy of the grant from the other party, to confirm the schedule to the other party. The neighbours of this node not involved in this schedule shall assume the transmission takes place as granted.

The differences between coordinated and uncoordinated distributed scheduling is, that in the coordinated case, the MSH-DSCH messages are scheduled themselves in the control subframe in a collision free manner, whereas in the uncoordinated case, MSH-DSCH messages may collide. Nodes responding to a Request should, in the uncoordinated case, wait a sufficient number of minislots of the indicated Availabilities before responding with a grant, such that nodes listed earlier in the Request have an opportunity to respond. The Grant confirmation is sent in the minislots immediately following the first successful reception of an associated Grant packet.

The relevance of the MSH-DSCH is solely defined by the message itself and entirely up to the station transmitting it.

9.8.2 Centralized scheduling

The schedule using centralized scheduling is determined in a more centralized manner than in the distributed scheduling mode.

The network connections and topology are the same as in the distributed scheduling mode described in, but some portion of the scheduled transmissions for the SSs less than or equal to HOPRANGE_THRESHOLD hops from the BS shall be either defined by the BS or computed by the SSs themselves. HOPRANGE_THRESHOLD, may be determined at the system start up phase or may be dynamic according to considerations such as network density, the proximity of other BSs, and/or the dynamic characteristics of the traffic streams.

In the basic form, the BS shall provide the schedule for all the SSs less than or equal to HOPRANGE_THRESHOLD hops from the BS. The BS determines the flow assignments from the resource requests from the SSs within the HOPRANGE_THRESHOLD hop range. Subsequently, the SSs themselves determine the actual schedule from these flow assignments by using a common algorithm that divides the frame proportionally to the assignments. Thus the BS acts just like the BS in a PMP network except that not all the SSs have to be directly connected to the BS and the assignments determined by the BS extends also to those SSs not directly connected to the BS but less than HOPRANGE_THRESHOLD hops from it. The SS resource requests and the BS assignments are both transmitted during the control portion of the frame.

Centralized scheduling ensures that transmissions are coordinated to ensure collision-free scheduling over the links in the routing tree to and from the BS, typically in a more optimal manner than the distributed scheduling method for traffic streams (or collections of traffic streams which share links) which persist over a duration that is greater than the cycle time to relay the new resource requests and distribute the updated schedule.

A simple example of the use of the centralized scheduling flow-mechanism in MSH-CSCH is provided. For the network in figure 15, the requested flows are shown. For simplicity of notation, the data rate is assumed to be the burst profile number.

The link fractions shown in figure 16 are multiplied with $2^{\text{FlowScale Exponent}+14}$ (see table 72) and with the Frame Duration, then rounded up to the nearest duration of a whole number of minislots required to transmit this fraction (including preamble).

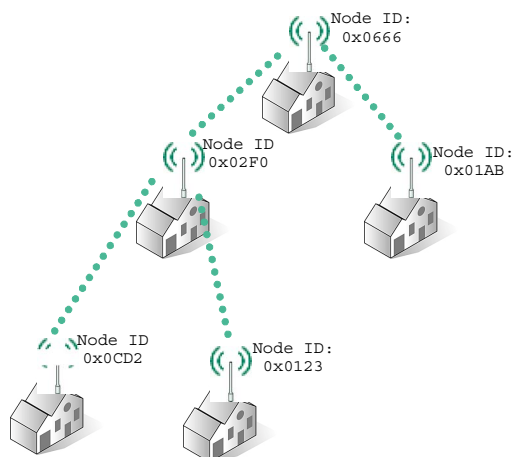

i	Node ID	Child Indexes
0	0x0666	{1:[r _{u1} ,r _{d1}], 2:[r _{u2} ,r _{d2}]}
1	0x02F0	{3:[r _{u3} ,r _{d3}], 4:[r _{u4} ,r _{d4}]}
2	0x01AB	{}
3	0x0CD2	{}
4	0x0123	{}

[r_u,r_d] is the burst profile, up and down

Figure 15: MSH-CSCF schedule example

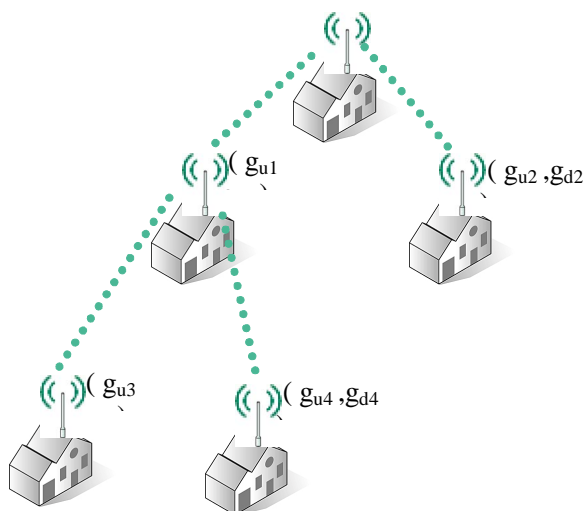

MSH-CSCF DL fraction Flowlist	UL fraction from to
(g _{u1} ,g _{d1})	(g _{u1} +g _{u3} +g _{u4})/r _{u1} (g _{d1} +g _{d3} +g _{d4})/r _{d1}
(g _{u2} ,g _{d2})	g _{u2} /r _{u2} g _{d2} /r _{d2}
(g _{u3} ,g _{d3})	g _{u3} /r _{u3} g _{d3} /r _{d3}
(g _{u4} ,g _{d4})	g _{u4} /r _{u4} g _{d4} /r _{d4}

Figure 16: MSH-CSCF flow usage example

The number of frames over which the CSCF schedule is valid is limited by the number of frames it takes to aggregate and distribute the next schedule.

Each node uses the newly received schedule to compute its retransmission time (if eligible) and the last frame when a node will be receiving this schedule, as well as the time when the mesh BS sent it. To compute this, the node uses the routing tree from the last MSH-CSCF messages as modified by the link updates of the last MSH-CSCF message (which dictates the size of MSH-CSCF messages) and the following rules:

- The mesh BS transmits first in a new frame.
- Then, the eligible children of the mesh BS (i.e. nodes with hop count equal 1), ordered by their appearance in the routing tree, transmit.
- Then, the eligible children of the nodes from step 2 (i.e. nodes with hop count equal 2), also ordered by their appearance in the routing tree, transmit.
- ...continue until all eligible nodes in the routing tree have transmitted.
- Nodes shall fragment their message if it does not fit entirely before the end of the control subframe and at least the preamble and one data symbol fit.
- All nodes are eligible to transmit the grant schedule, except those that have no children.

- If a node's order requires it to transmit immediately after receiving, a delay of $\text{MinCSForwardingDelay } \mu\text{s}$ is inserted.

Each node shall also compute the timing of the uplink requests. Uplink requests start in the last frame in which a node received the previous schedule. All nodes are eligible to transmit requests, except the mesh BS. The request transmission order is reverse in hopcount (i.e. largest hopcount first), but retains the transmission order as listed in the routing tree for nodes with the same hopcount.

The number of frames over which the CSCH schedule is valid is limited by the number of frames it takes to aggregate and distribute the next schedule. The time between the first frame in which a node sends the request schedule and the last frame in which a node receives the new grant schedule marks the validity of the previous grant schedule (see figure 17). This validity time overrides the Frame schedule flag two frame usage at the end of the validity time. Note that MSH-CSCF messages may be sent after the last request is received and before the grant schedule is transmitted by the mesh BS.

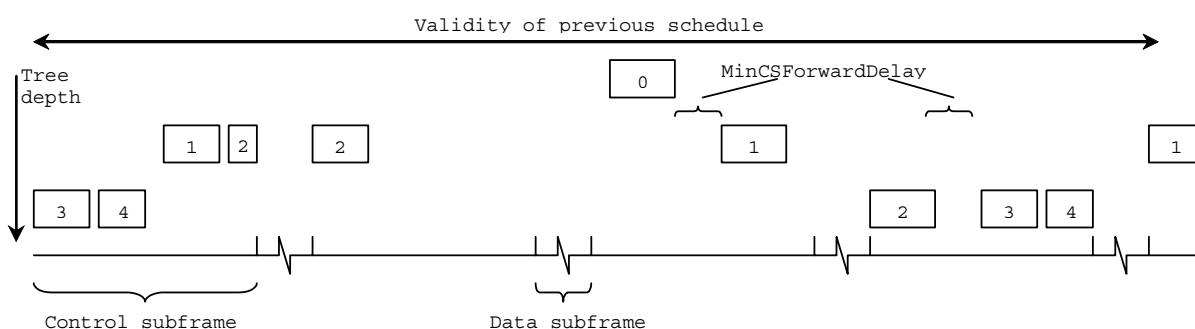

Figure 17: MSH-CSCH schedule validity

10 DLC support of PHY

A compliant device shall conform to MAC Support of PHY mechanisms as defined in IEEE 802.16 [1], clause 6.3.7 as amended by IEEE 802.16e [3] with the following exceptions nominated below. AAS optional mode is included in the referenced clause.

10.1 Uplink timing

Uplink timing is referenced from the beginning of the downlink subframe. The Allocation Start Time in the UL-MAP is referenced from the start of the downlink subframe and may be such that the UL-MAP references some point in the current or a future frame as provided in IEEE 802.16 [1], clause 6.3.7.5 as amended by IEEE 802 16e [3]. The SS shall always adjust its concept of uplink timing based upon the Timing Adjustments sent in the RNG-RSP messages.

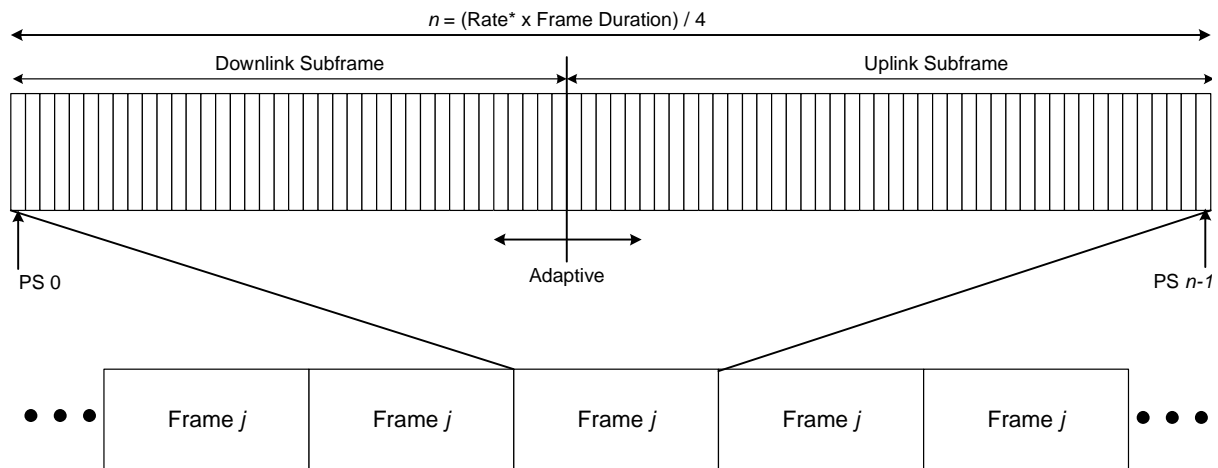

Figure 18: TDD frame structure

The Rate* is the nominal sampling frequency (F_s).

10.2 Uplink allocation

For the PHY layer, the uplink bandwidth allocation map (UL-MAP) uses units of symbols and subchannels.

11 Network Entry and Initialization

The clause 6.3.9 from IEEE 802.16 [1] as amended by IEEE 802.16e [3] shall apply to PMP systems network entry and initialization.

The following clause shall apply instead of clause 6.3.9.5 from IEEE 802.16 [1] as amended by IEEE 802.16e [3].

11.1 Initial ranging and automatic adjustments

Ranging is the process of acquiring the correct timing offset and power adjustments such that the SS's transmissions are aligned to the BS receive frame for OFDM PHY, and received within the appropriate reception thresholds. The timing delays through the PHY shall be relatively constant. Any variation in the PHY delays shall be accounted for in the guard time of the uplink PHY overhead.

11.1.1 Contention based Initial ranging and automatic adjustments

First, an SS shall synchronize to the downlink and learn the uplink channel characteristics through the UCD DLC management message. At this point, the SS shall scan the UL-MAP message to find an Initial Ranging Interval. The BS shall allocate an Initial Ranging Interval consisting of one or more transmission opportunities. For OFDM PHY, the size of each transmission opportunity shall be as specified by the UCD TLV, Ranging request opportunity size.

For OFDM PHY, the SS shall put together a RNG-REQ message to be sent in an Initial Ranging Interval. The CID field shall be set to the non initialized SS value (zero).

Ranging adjusts each SS's timing offset such that it appears to be collocated with the BS. The SS shall set its initial timing offset to the amount of internal fixed delay equivalent to collocating the SS next to the BS. This amount includes delays introduced through a particular implementation and shall include the downlink PHY interleaving latency, if any.

When the Initial Ranging transmission opportunity occurs, the SS shall send the RNG-REQ message. Thus, the SS sends the message as if it were collocated with the BS.

The SS shall calculate the maximum transmit signal strength for initial ranging, $P_{TX_IR_MAX}$, from:

$$P_{TX_IR_MAX} = EIRxP_{IR,max} + BS_EIRP - RSS \quad (18)$$

where the $EIRxP_{IR,max}$ and BS_EIRP are obtained from the DCD, and RSS is the measured RSSI, by the SS, as described in the respective PHY.

In the case that the receive and transmit gain of the SS antennae are substantially different, the SS shall use the equation:

$$P_{TX_IR_MAX} = EIRxP_{IR,max} + BS_EIRP - RSS + (G_{RX_SS} - G_{TX_SS}) \quad (19)$$

where:

- G_{RX_SS} is the SS receive antenna gain.
- G_{TX_SS} is the SS transmit antenna gain.

In the case that the $EIRxP_{IR,max}$ and/or BS_EIRP are/is not known, the SS shall start from the minimum transmit power level defined by the BS.

NOTE 1: The $EIRxP_{IR,max}$ is the maximum equivalent isotropic received power, which is computed for a simple single antenna receiver as $RSS_{IR,max} - GANT_BS_Rx$, where the $RSS_{IR,max}$ is the received signal strength at antenna output and $GANT_BS_Rx$ is the receive antenna gain. The BS_EIRP is the equivalent isotropic radiated power of the base station, which is computed for a simple single-antenna transmitter as $P_{Tx} + GANT_BS_Tx$, where P_{Tx} is the transmit power and $GANT_BS_Tx$ is the transmit antenna gain.

For OFDM PHY, the SS shall send the RNG-REQ at a power level below $P_{TX_IR_MAX}$, measured at the antenna connector. If the SS does not receive a response, the SS shall resent the RNG-REQ at the next appropriate Initial Ranging transmission opportunity at one step higher power level. If the SS receives a response containing the frame number in which the RNG-REQ was transmitted, it shall consider the transmission attempt unsuccessful but implement the corrections specified in the RNG-RSP and issue another RNG-REQ message after the appropriate backoff delay.

If the SS receives a response containing its MAC Address, it shall consider the RNG-RSP reception successful.

When BS detects a transmission in the ranging slot that it is unable to decode, it may respond by transmitting a RNG-RSP that includes transmission parameters but identifies the frame number and frame opportunity when the transmission was received instead of the MAC Address of the transmitting SS.

Once the BS has successfully received the RNG-REQ message, it shall return a RNG-RSP message using the initial ranging CID. Within the RNG-RSP message shall be the Basic and Primary Management CIDs assigned to this SS. The message shall also contain information on RF power level adjustment and offset frequency adjustment as well as any timing offset corrections. At this point the BS shall start using invited Initial Ranging Intervals addressed to the SS's Basic CID to complete the ranging process, unless the status of the RNG-RSP message is success, in which case the initial ranging procedure shall end.

If the status of the RNG-RSP message is continue, the SS shall wait for an individual Initial Ranging interval assigned to its Basic CID. Using this interval, the SS shall transmit another RNG-REQ message using the Basic CID along with any power level and timing offset corrections.

The BS shall return another RNG-RSP message to the SS with any additional fine tuning required. The ranging request/response steps shall be repeated until the response contains a Ranging Successful notification or the BS aborts ranging. Once successfully ranged (RNG-REQ is within tolerance of the BS), the SS shall join normal data traffic in the uplink. In particular, state machines and the applicability of retry counts and timer values for the ranging process are defined in table 340 from IEEE 802.16 [1].

NOTE 2: The burst profile to use for any uplink transmission is defined by the Uplink Interval Usage Code (UIUC). Each UIUC is mapped to a burst profile in the UCD message.

The message sequence chart (table 68) and flow charts from the reference define the ranging and adjustment process which shall be followed by compliant SSs and BSs.

Table 85: Ranging and automatic adjustment procedure

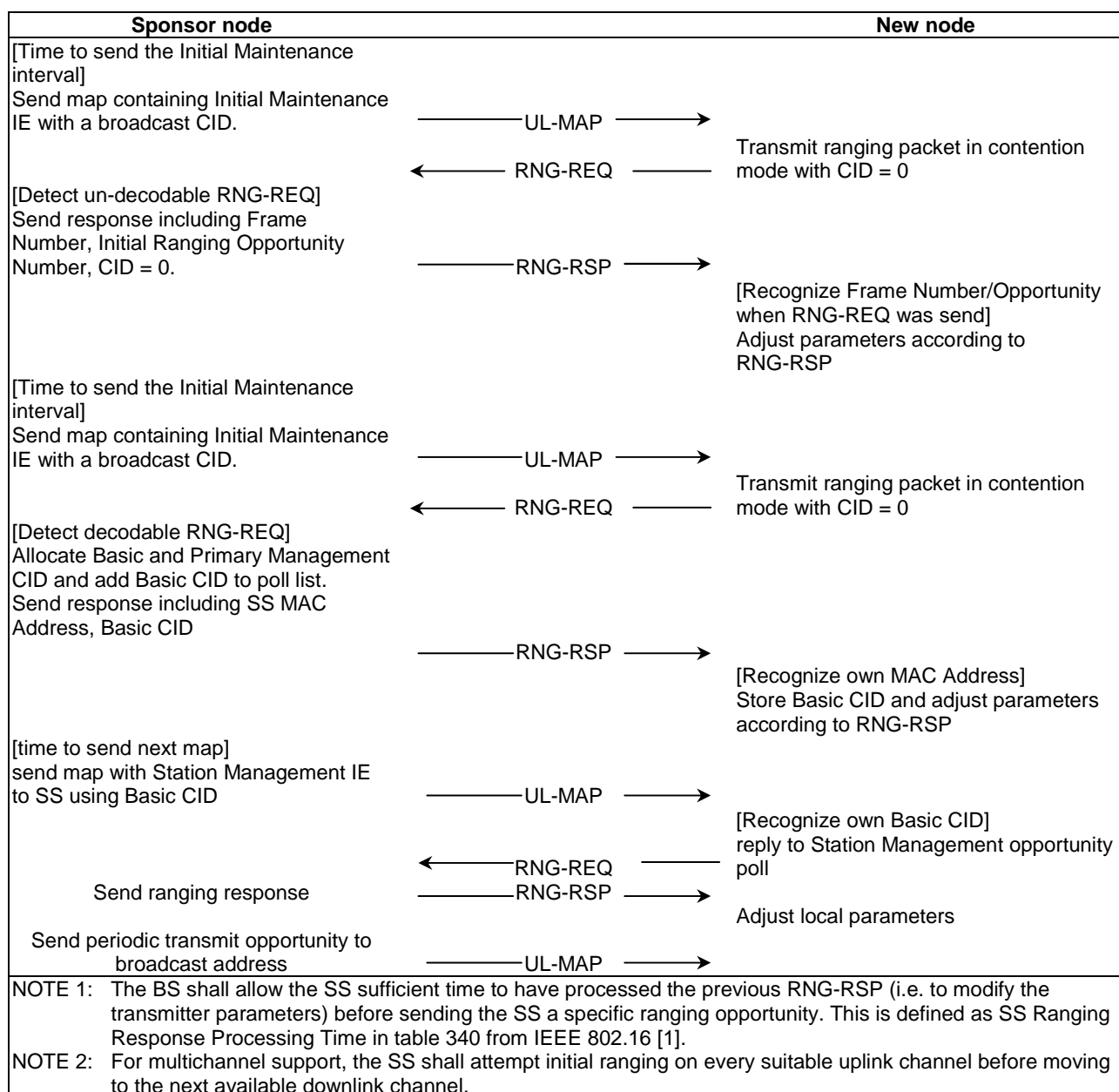

On receiving a RNG-RSP instruction to move to a new downlink frequency and/or uplink channel ID, the SS shall consider any previously assigned Basic, Primary Management, and Secondary Management CIDs to be de assigned, and shall obtain new Basic, Primary Management, and Secondary Management CIDs via initial ranging and registration.

It is possible that the RNG-RSP may be lost after transmission by the BS. The SS shall recover by timing out and reissuing its Initial RNG-REQ. Since the SS is uniquely identified by the source MAC Address in the Ranging Request, the BS may immediately reuse the Basic, Primary Management, and Secondary Management CIDs previously assigned. If the BS assigns new Basic, Primary Management, and Secondary Management CIDs, it shall make some provision for aging out the old CIDs that went unused.

12 Extended DLC Support

Compliant equipments shall implement specifications of clauses 6.1, 6.3.1, 6.3.1.1, 6.3.2, 6.3.3, 6.3.4, 6.3.5, 6.3.6, 6.3.6.1, 6.3.6.2, 6.3.6.3, 6.3.6.5, 6.3.7, 6.3.8, 6.3.9, 6.3.10, 6.3.11, 6.3.12, 6.3.13, 6.3.14, 6.3.17, 6.3.18, 6.3.19, 6.3.20, 6.3.21, 6.3.22, 6.3.23 and 6.3.24 of IEEE 802.16-2004 [1] as amended IEEE 802.16e-2005 [3] and corrected by IEEE P802.16-2004/Cor2/D4 [5].

In here, an entire listed parent clause is relevant only if the child clauses are not specifically enumerated. In the case that child clauses are enumerated, only support for those enumerated child clauses is required.

13 Extended Privacy/Security

A compliant device shall implement the clause 7, as defined in IEEE 802.16-2004 [1], amended with IEEE 802.16e-2005 [3], and corrected by IEEE P802.16-2004/Cor2/D4 [5].

14 DLC Support of OFDMA PHY

A compliant device shall implement the DLC Support for OFDMA PHY mode as specified in clause 8.4 of IEEE 802.16-2004 [1] as amended IEEE 802.16e-2005 [3] and corrected by IEEE P802.16-2004/Cor2/D4 [5].

15 Parameters and constants

A compliant device shall implement the relevant paragraphs in clauses 10.1, 10.2, 10.3.4 and 10.4 of IEEE 802.16-2004 [1] as amended IEEE 802.16e-2005 [3] and corrected by IEEE P802.16-2004/Cor2/D4 [5].

16 TLV encoding

A compliant device shall implement the relevant paragraphs in clauses 11, 11.1, 11.2, 11.3, 11.4, 11.5, 11.6, 11.7, 11.8, 11.8.1, 11.8.2, 11.8.3, 11.8.3.1, 11.8.3.2, 11.8.3.3, 11.8.3.7, 11.8.4, 11.8.5, 11.8.6, 11.8.7, 11.8.8, 11.8.9, 11.8.10, 11.9, 11.10, 11.11, 11.12, 11.13, 11.14, 11.15, 11.16, 11.17, 11.18, 11.19 and 11.20 of IEEE 802.16-2004 [1] as amended IEEE 802.16e-2005 [3] and corrected by IEEE P802.16-2004/Cor2/D4 [5].

History

Document history		
V1.1.1	November 2003	Publication
V1.2.1	January 2005	Publication
V1.3.1	February 2006	Publication
V1.3.2	March 2006	Publication
V1.4.1	November 2007	Publication