



TECHNICAL SPECIFICATION

**Speech and multimedia Transmission Quality (STQ);
QoS aspects for popular services in mobile networks;
Part 2: Definition of Quality of
Service parameters and their computation**

Reference

RTS/STQ-00206m

Keywords

3G, GSM, network, QoS, service, speech

ETSI

650 Route des Lucioles
F-06921 Sophia Antipolis Cedex - FRANCE

Tel.: +33 4 92 94 42 00 Fax: +33 4 93 65 47 16

Siret N° 348 623 562 00017 - NAF 742 C
Association à but non lucratif enregistrée à la
Sous-Préfecture de Grasse (06) N° 7803/88

Important notice

The present document can be downloaded from:
<http://www.etsi.org/standards-search>

The present document may be made available in electronic versions and/or in print. The content of any electronic and/or print versions of the present document shall not be modified without the prior written authorization of ETSI. In case of any existing or perceived difference in contents between such versions and/or in print, the only prevailing document is the print of the Portable Document Format (PDF) version kept on a specific network drive within ETSI Secretariat.

Users of the present document should be aware that the document may be subject to revision or change of status. Information on the current status of this and other ETSI documents is available at
<https://portal.etsi.org/TB/ETSIDeliverableStatus.aspx>

If you find errors in the present document, please send your comment to one of the following services:
<https://portal.etsi.org/People/CommitteeSupportStaff.aspx>

Copyright Notification

No part may be reproduced or utilized in any form or by any means, electronic or mechanical, including photocopying and microfilm except as authorized by written permission of ETSI.

The content of the PDF version shall not be modified without the written authorization of ETSI.
The copyright and the foregoing restriction extend to reproduction in all media.

© European Telecommunications Standards Institute 2016.
All rights reserved.

DECT™, **PLUGTESTS™**, **UMTS™** and the ETSI logo are Trade Marks of ETSI registered for the benefit of its Members.
3GPP™ and **LTE™** are Trade Marks of ETSI registered for the benefit of its Members and of the 3GPP Organizational Partners.
GSM® and the GSM logo are Trade Marks registered and owned by the GSM Association.

Contents

Intellectual Property Rights	20
Foreword.....	20
Modal verbs terminology.....	20
Introduction	21
1 Scope	22
2 References	22
2.1 Normative references	22
2.2 Informative references.....	24
3 Definitions and abbreviations.....	24
3.1 Definitions.....	24
3.2 Abbreviations	26
4 QoS Parameter Basics	29
4.1 General Overview.....	29
4.2 FTP, HTTP and E-Mail Issues	30
4.2.1 Performance Enhancement Proxies	31
4.3 Timeouts.....	32
4.4 Trigger points	32
4.5 Overview of technology dependent QoS parameters	32
5 Service independent QoS Parameters.....	33
5.1 Radio Network Unavailability [%].....	33
5.1.1 Abstract Definition	33
5.1.2 Abstract Equation	33
5.1.3 Trigger Points	34
5.2 Network Non-Accessibility [%]	34
5.2.1 {Manual Automatic} Network Selection and Registration Failure Ratio [%]	34
5.2.1.1 Abstract Definition.....	34
5.2.1.2 Abstract Equation.....	35
5.2.1.3 Trigger Points.....	35
5.2.2 {Manual Automatic} Network Selection and Registration Time [s]	37
5.2.2.1 Abstract Definition.....	37
5.2.2.2 Abstract Equation.....	37
5.2.2.3 Trigger Points.....	38
5.3 Attach Failure Ratio [%]	39
5.3.1 Abstract Definition	39
5.3.2 Abstract Equation	39
5.3.3 Trigger Points	39
5.4 Attach Setup Time [s].....	41
5.4.1 Abstract Definition	41
5.4.2 Abstract Equation	41
5.4.3 Trigger Points	41
5.5 PDP Context Activation Failure Ratio [%]	42
5.5.1 Abstract Definition	42
5.5.2 Abstract Equation	42
5.5.3 Trigger Points	43
5.6 PDP Context Activation Time [s].....	44
5.6.1 Abstract Definition	44
5.6.2 Abstract Equation	44
5.6.3 Trigger Points	44
5.7 PDP Context Cut-off Ratio [%].....	45
5.7.1 Abstract Definition	45
5.7.2 Abstract Equation	45
5.7.3 Trigger Points	46
5.8 Data Call Access Failure Ratio [%].....	47

5.8.1	Abstract Definition	47
5.8.2	Abstract Equation	47
5.8.3	Trigger Points	47
5.9	Data Call Access Time [s].....	47
5.9.1	Abstract Definition	47
5.9.2	Abstract Equation	47
5.9.3	Trigger Points	48
5.10	DNS Host Name Resolution Failure Ratio [%].....	48
5.10.1	Abstract Definition	48
5.10.2	Abstract Equation	48
5.10.3	Trigger Points	49
5.11	DNS Host Name Resolution Time [s].....	49
5.11.1	Abstract Definition	49
5.11.2	Abstract Equation	49
5.11.3	Trigger Points	49
5.12	Default EPS Bearer Contexts	50
5.12.1	Default EPS Bearer Context Activation Failure Ratio [%].....	50
5.12.1.1	Abstract Definition.....	50
5.12.1.2	Abstract Equation.....	50
5.12.1.3	Trigger Points.....	51
5.12.2	Default EPS Bearer Context Activation Time[s].....	51
5.12.2.1	Abstract Definition.....	51
5.12.2.2	Abstract Equation.....	51
5.12.2.3	Trigger Points.....	51
5.12.3	Default EPS Bearer Context Cut-off Ratio [%]	52
5.12.3.1	Abstract Definition.....	52
5.12.3.2	Abstract Equation.....	52
5.12.3.3	Trigger Points.....	53
5.13	Dedicated EPS Bearer Contexts	53
5.13.1	Dedicated EPS Bearer Context Activation Failure Ratio [%].....	53
5.13.1.1	Abstract Definition.....	53
5.13.1.2	Abstract Equation.....	53
5.13.1.3	Trigger Points.....	54
5.13.2	Dedicated EPS Bearer Context Activation Time [s].....	54
5.13.2.1	Abstract Definition.....	54
5.13.2.2	Abstract Equation.....	54
5.13.2.3	Trigger Points.....	55
5.13.3	Dedicated EPS Bearer Context Cut-off Ratio [%].....	55
5.13.3.1	Abstract Definition.....	55
5.13.3.2	Abstract Equation.....	55
5.13.3.3	Trigger Points.....	56
6	Direct Services QoS Parameters.....	56
6.1	File Transfer (FTP).....	56
6.1.1	FTP {Download Upload} Service Non-Accessibility [%].....	56
6.1.2	FTP {Download Upload} Setup Time [s].....	56
6.1.3	FTP {Download Upload} IP-Service Access Failure Ratio [%].....	56
6.1.3.1	Abstract Definition.....	56
6.1.3.2	Abstract Equation.....	57
6.1.3.3	Trigger Points.....	57
6.1.4	FTP {Download Upload} IP-Service Setup Time [s]	57
6.1.4.1	Abstract Definition.....	57
6.1.4.2	Abstract Equation.....	57
6.1.4.3	Trigger Points.....	58
6.1.5	FTP {Download Upload} Session Failure Ratio [%].....	58
6.1.5.1	Abstract Definition.....	58
6.1.5.2	Abstract Equation.....	58
6.1.5.3	Trigger Points.....	58
6.1.6	FTP {Download Upload} Session Time [s].....	59
6.1.6.1	Abstract Definition.....	59
6.1.6.2	Abstract Equation.....	59
6.1.6.3	Trigger Points.....	59

6.1.7	FTP {Download Upload} Mean Data Rate [kbit/s]	59
6.1.7.1	Abstract Definition.....	59
6.1.7.2	Abstract Equation.....	60
6.1.7.3	Trigger Points.....	60
6.1.8	FTP {Download Upload} Data Transfer Cut-off Ratio [%]	60
6.1.8.1	Abstract Definition.....	60
6.1.8.2	Abstract Equation.....	60
6.1.8.3	Trigger Points.....	61
6.2	Mobile Broadcast	61
6.2.1	Mobile Broadcast Network Non-Availability {Broadcast Bearer}.....	63
6.2.1.1	Abstract Definition.....	63
6.2.1.2	Abstract Equation.....	63
6.2.1.3	Trigger Points.....	63
6.2.2	Mobile Broadcast Program Menu Non-Accessibility {Bootstrapping Bearer, ESG Retrieval Bearer}.....	63
6.2.2.1	Abstract Definition.....	63
6.2.2.2	Abstract Equation.....	64
6.2.2.3	Trigger Points.....	64
6.2.3	Mobile Broadcast Program Menu Access Time {Bootstrapping Bearer, ESG Retrieval Bearer}	64
6.2.3.1	Abstract Definition.....	64
6.2.3.2	Abstract Equation.....	64
6.2.3.3	Trigger Points.....	64
6.2.4	Mobile Broadcast Channel Non-Accessibility {Broadcast Bearer}.....	65
6.2.4.1	Abstract Definition.....	65
6.2.4.2	Abstract Equation.....	65
6.2.4.3	Trigger Points.....	65
6.2.5	Mobile Broadcast Channel Access Time {Broadcast Bearer}	65
6.2.5.1	Abstract Definition.....	65
6.2.5.2	Abstract Equation.....	65
6.2.5.3	Trigger Points.....	65
6.2.6	Mobile Broadcast Interactivity Response Failure Ratio {Mobile Network Bearer} {Broadcast Bearer}.....	66
6.2.6.1	Abstract Definition.....	66
6.2.6.2	Abstract Equation.....	66
6.2.6.3	Trigger Points.....	66
6.2.7	Mobile Broadcast Interactivity Response Time {Mobile Network Bearer} {Broadcast Bearer}	67
6.2.7.1	Abstract Definition.....	67
6.2.7.2	Abstract Equation.....	67
6.2.7.3	Trigger Points.....	67
6.2.8	Mobile Broadcast Session Cut-off Ratio {Broadcast Bearer}	67
6.2.8.1	Abstract Definition.....	67
6.2.8.2	Abstract Equation.....	67
6.2.8.3	Trigger Points.....	68
6.2.9	Mobile Broadcast Service Integrity {Broadcast Bearer}	68
6.2.10	Mobile Broadcast Reproduction Soft Cut-off Ratio {Broadcast Bearer}	68
6.2.10.1	Abstract Definition.....	68
6.2.10.2	Abstract Equation.....	68
6.2.10.3	Trigger Points.....	69
6.2.11	Mobile Broadcast Reproduction Hard Cut-off Ratio {Broadcast Bearer}	69
6.2.11.1	Abstract Definition.....	69
6.2.11.2	Abstract Equation.....	69
6.2.11.3	Trigger Points.....	69
6.2.12	Mobile Broadcast Audio Quality {Broadcast Bearer}	70
6.2.12.1	Abstract Definition.....	70
6.2.12.2	Abstract Equation.....	70
6.2.12.3	Trigger Points.....	70
6.2.13	Mobile Broadcast Video Quality {Broadcast Bearer}	70
6.2.13.1	Abstract Definition.....	70
6.2.13.2	Abstract Equation.....	70
6.2.13.3	Trigger Points.....	70
6.3	Ping	71
6.3.1	Ping Round Trip Time [ms].....	71
6.3.1.1	Abstract Definition.....	71

6.3.1.2	Abstract Equation.....	71
6.3.1.3	Trigger Points.....	71
6.4	Push to Talk over Cellular (PoC)	71
6.4.1	Definitions	72
6.4.2	Generic Signal Flow	73
6.4.3	PoC Registration Failure Ratio [%]	74
6.4.3.1	Abstract Definition.....	74
6.4.3.2	Abstract Equation.....	75
6.4.3.3	Trigger Points.....	75
6.4.4	PoC Registration Time [s]	75
6.4.4.1	Abstract Definition.....	75
6.4.4.2	Abstract Equation.....	76
6.4.4.3	Trigger Points.....	76
6.4.5	PoC Publish Failure Ratio [%].....	76
6.4.5.1	Abstract Definition.....	76
6.4.5.2	Abstract Equation.....	77
6.4.5.3	Trigger Points.....	77
6.4.6	PoC Publish Time [s].....	77
6.4.6.1	Abstract Definition.....	77
6.4.6.2	Abstract Equation.....	77
6.4.6.3	Trigger Points.....	78
6.4.7	PoC Registration Failure Ratio (long) [%]	78
6.4.7.1	Abstract Definition.....	78
6.4.7.2	Abstract Equation.....	78
6.4.7.3	Trigger Points.....	78
6.4.8	PoC Registration Time (long) [s].....	79
6.4.8.1	Abstract Definition.....	79
6.4.8.2	Abstract Equation.....	79
6.4.8.3	Trigger Points.....	79
6.4.9	PoC Session Initiation Failure Ratio (on-demand) [%]	80
6.4.9.1	Abstract Definition.....	80
6.4.9.2	Abstract Equation.....	80
6.4.9.3	Trigger Points.....	80
6.4.10	PoC Session Initiation Time (on-demand) [s].....	81
6.4.10.1	Abstract Definition.....	81
6.4.10.2	Abstract Equation.....	82
6.4.10.3	Trigger Points.....	82
6.4.11	PoC Session Media Parameters Negotiation Failure Ratio (pre-established) [%]	83
6.4.11.1	Abstract Definition.....	83
6.4.11.2	Abstract Equation.....	83
6.4.11.3	Trigger Points.....	83
6.4.12	PoC Session Media Parameters Negotiation Time (pre-established) [s]	84
6.4.12.1	Abstract Definition.....	84
6.4.12.2	Abstract Equation.....	84
6.4.12.3	Trigger Points.....	84
6.4.13	PoC Session Initiation Failure Ratio (pre-established) [%]	85
6.4.13.1	Abstract Definition.....	85
6.4.13.2	Abstract Equation.....	85
6.4.13.3	Trigger Points.....	86
6.4.14	PoC Session Initiation Time (pre-established) [s]	86
6.4.14.1	Abstract Definition.....	86
6.4.14.2	Abstract Equation.....	87
6.4.14.3	Trigger Points.....	87
6.4.15	PoC Session Setup Failure Ratio (on-demand) [%]	87
6.4.15.1	Abstract Definition.....	87
6.4.15.2	Abstract Equation.....	88
6.4.15.3	Trigger Points.....	88
6.4.16	PoC Session Setup Failure Ratio (pre-established) [%].....	88
6.4.16.1	Abstract Definition.....	88
6.4.16.2	Abstract Equation.....	88
6.4.16.3	Trigger Points.....	89
6.4.17	PoC Session Setup Time [s].....	89

6.4.17.1	Abstract Definition.....	89
6.4.17.2	Abstract Equation.....	90
6.4.17.3	Trigger Points.....	90
6.4.18	PoC Push to Speak Failure Ratio [%]	90
6.4.18.1	Abstract Definition.....	90
6.4.18.2	Abstract Equation.....	90
6.4.18.3	Trigger Points.....	91
6.4.19	PoC Push to Speak Time [s]	91
6.4.19.1	Abstract Definition.....	91
6.4.19.2	Abstract Equation.....	91
6.4.19.3	Trigger Points.....	92
6.4.20	PoC Session Leaving Failure Ratio (on-demand) [%]	92
6.4.20.1	Abstract Definition.....	92
6.4.20.2	Abstract Equation.....	92
6.4.20.3	Trigger Points.....	92
6.4.21	PoC Session Leaving Time (on-demand) [s]	93
6.4.21.1	Abstract Definition.....	93
6.4.21.2	Abstract Equation.....	93
6.4.21.3	Trigger Points.....	93
6.4.22	PoC Session Leaving Failure Ratio (pre-established) [%]	93
6.4.22.1	Abstract Definition.....	93
6.4.22.2	Abstract Equation.....	94
6.4.22.3	Trigger Points.....	94
6.4.23	PoC Session Leaving Time (pre-established) [s]	94
6.4.23.1	Abstract Definition.....	94
6.4.23.2	Abstract Equation.....	94
6.4.23.3	Trigger Points.....	95
6.4.24	PoC Deregistration Failure Ratio [%]	95
6.4.24.1	Abstract Definition.....	95
6.4.24.2	Abstract Equation.....	95
6.4.24.3	Trigger Points.....	95
6.4.25	PoC Deregistration Time [s]	95
6.4.25.1	Abstract Definition.....	95
6.4.25.2	Abstract Equation.....	96
6.4.25.3	Trigger Points.....	96
6.4.26	PoC Busy Floor Response Failure Ratio [%]	96
6.4.26.1	Abstract Definition.....	96
6.4.26.2	Abstract Equation.....	96
6.4.26.3	Trigger Points.....	97
6.4.27	PoC Busy Floor Response Time [s]	97
6.4.27.1	Abstract Definition.....	97
6.4.27.2	Abstract Equation.....	97
6.4.27.3	Trigger Points.....	98
6.4.28	PoC Talk Burst Request Failure Ratio [%]	98
6.4.28.1	Abstract Definition.....	98
6.4.28.2	Abstract Equation.....	98
6.4.28.3	Trigger Points.....	98
6.4.29	PoC Talk Burst Request Time [s]	98
6.4.29.1	Abstract Definition.....	98
6.4.29.2	Abstract Equation.....	99
6.4.29.3	Trigger Points.....	99
6.4.30	PoC Talk Burst Cut-off Ratio [%]	99
6.4.30.1	Abstract Definition.....	99
6.4.30.2	Abstract Equation.....	100
6.4.30.3	Trigger Points.....	100
6.4.31	PoC Talk Burst Packet Drop Ratio [%]	100
6.4.31.1	Abstract Definition.....	100
6.4.31.2	Abstract Equation.....	101
6.4.31.3	Trigger Points.....	101
6.4.32	PoC Voice Transmission Delay (first) [s]	101
6.4.32.1	Abstract Definition.....	101
6.4.32.2	Abstract Equation.....	102

6.4.32.3	Trigger Points.....	102
6.4.33	PoC Speech Transmission Delay (others) [s].....	102
6.4.33.1	Abstract Definition.....	102
6.4.33.2	Abstract Equation.....	103
6.4.33.3	Trigger Points.....	103
6.4.34	PoC Speech Quality	103
6.4.35	Group Management QoS Parameter	103
6.4.36	Group Document related QoS Parameter.....	103
6.4.37	Instant Message QoS Parameter	103
6.5	Streaming Video.....	103
6.5.1	Definitions	103
6.5.1.1	Streaming Session or Session.....	103
6.5.2	Prerequisites.....	104
6.5.3	Streaming Scenarios	104
6.5.3.1	Generic Streaming Signalling Flow	104
6.5.3.2	Parameter Overview Chart.....	105
6.5.4	Streaming Service Non-Accessibility [%]	105
6.5.4.1	Abstract Definition.....	105
6.5.4.2	Abstract Equation.....	105
6.5.4.3	Trigger Points.....	106
6.5.5	Streaming Service Access Time [s]	106
6.5.5.1	Abstract Definition.....	106
6.5.5.2	Abstract Equation.....	106
6.5.5.3	Trigger Points.....	106
6.5.6	Streaming Reproduction Cut-off Ratio [%]	106
6.5.6.1	Abstract Definition.....	106
6.5.6.2	Abstract Equation.....	106
6.5.6.3	Trigger Points.....	107
6.5.7	Streaming Audio Quality	107
6.5.7.1	Abstract Definition.....	107
6.5.7.2	Abstract Equation.....	107
6.5.7.3	Trigger Points.....	107
6.5.8	Streaming Video Quality	107
6.5.8.1	Abstract Definition.....	107
6.5.8.2	Abstract Equation.....	107
6.5.8.3	Trigger Points.....	108
6.5.9	Streaming Audio/Video De-Synchronization	108
6.5.9.1	Abstract Definition.....	108
6.5.9.2	Abstract Equation.....	108
6.5.9.3	Trigger Points.....	108
6.5.10	Streaming Reproduction Start Failure Ratio [%]	108
6.5.10.1	Abstract Definition.....	108
6.5.10.2	Abstract Equation.....	108
6.5.10.3	Trigger Points.....	108
6.5.11	Streaming Reproduction Start Delay [s]	109
6.5.11.1	Abstract Definition.....	109
6.5.11.2	Abstract Equation.....	109
6.5.11.3	Trigger Points.....	109
6.5.12	Streaming Teardown Failure Ratio [%]	109
6.5.12.1	Abstract Definition.....	109
6.5.12.2	Abstract Equation.....	109
6.5.12.3	Trigger Points.....	109
6.5.13	Streaming Teardown Time [s]	110
6.5.13.1	Abstract Definition.....	110
6.5.13.2	Abstract Equation.....	110
6.5.13.3	Trigger Points.....	110
6.5.14	Streaming Rebuffering Failure Ratio [%].....	110
6.5.14.1	Abstract Definition.....	110
6.5.14.2	Abstract Equation.....	110
6.5.14.3	Trigger Points.....	110
6.5.15	Streaming Rebuffering Time [s]	110
6.5.15.1	Abstract Definition.....	110

6.5.15.2	Abstract Equation.....	111
6.5.15.3	Trigger Points.....	111
6.6	Telephony.....	111
6.6.1	Telephony Service Non-Accessibility [%]	111
6.6.1.1	Abstract Definition.....	111
6.6.1.2	Abstract Equation.....	111
6.6.1.3	Trigger Points.....	111
6.6.2	Telephony Setup Time [s].....	121
6.6.2.1	Abstract Definition.....	121
6.6.2.2	Abstract Equation.....	121
6.6.2.3	Trigger Points.....	121
6.6.3	Telephony Speech Quality on Call Basis.....	124
6.6.3.1	Abstract Definition.....	124
6.6.3.2	Abstract Equation.....	124
6.6.3.3	Trigger Points.....	124
6.6.4	Telephony Speech Quality on Sample Basis	124
6.6.4.1	Abstract Definition.....	124
6.6.4.2	Abstract Equation.....	125
6.6.4.3	Trigger Points.....	125
6.6.5	Telephony Cut-off Call Ratio [%]	125
6.6.5.1	Abstract Definition.....	125
6.6.5.2	Abstract Equation.....	125
6.6.5.3	Trigger Points.....	125
6.6.6	Telephony CLIP Failure Ratio [%].....	127
6.6.6.1	Abstract Definition.....	127
6.6.6.2	Abstract Equation.....	127
6.6.6.3	Trigger Points.....	127
6.7	Video Telephony.....	128
6.7.1	Network Accessibility/Availability	128
6.7.2	Parameter Overview Chart.....	128
6.7.3	VT Service Non-Accessibility [%]	130
6.7.3.1	Abstract Definition.....	130
6.7.3.2	Abstract Equation.....	130
6.7.3.3	Trigger Points.....	130
6.7.4	VT Service Access Time [s]	131
6.7.4.1	Abstract Definition.....	131
6.7.4.2	Abstract Equation.....	131
6.7.4.3	Trigger Points.....	131
6.7.5	VT Audio/Video Setup Failure Ratio [%]	132
6.7.5.1	Abstract Definition.....	132
6.7.5.2	Abstract Equation.....	132
6.7.5.3	Trigger Points.....	132
6.7.6	VT Audio/Video Setup Time [s].....	132
6.7.6.1	Abstract Definition.....	132
6.7.6.2	Abstract Equation.....	133
6.7.6.3	Trigger Points.....	133
6.7.7	VT Cut-off Call Ratio [%]	133
6.7.7.1	Abstract Definition.....	133
6.7.7.2	Abstract Equation.....	133
6.7.7.3	Trigger Points.....	134
6.7.8	VT Speech Quality on Call Basis	134
6.7.8.1	Abstract Definition.....	134
6.7.8.2	Abstract Equation.....	135
6.7.8.3	Trigger Points.....	135
6.7.9	VT Speech Quality on Sample Basis	136
6.7.9.1	Abstract Definition.....	136
6.7.9.2	Abstract Equation.....	136
6.7.9.3	Trigger Points.....	137
6.7.10	VT Video Quality	137
6.7.10.1	Abstract Definition.....	137
6.7.10.2	Abstract Equation.....	137
6.7.10.3	Trigger Points.....	138

6.7.11	VT End-To-End Mean One-Way Transmission Time [s].....	138
6.7.11.1	Abstract Definition.....	138
6.7.11.2	Abstract Equation.....	138
6.7.11.3	Trigger Points.....	139
6.7.12	VT Audio/Video Synchronization [%].....	139
6.7.12.1	Abstract Definition.....	139
6.7.12.2	Abstract Equation.....	139
6.7.12.3	Trigger Points.....	139
6.7.13	Signalling Diagrams	140
6.8	Web Browsing (HTTP).....	143
6.8.1	HTTP Service Non-Accessibility [%].....	143
6.8.2	HTTP Setup Time [s].....	143
6.8.3	HTTP IP-Service Access Failure Ratio [%]	143
6.8.3.1	Abstract Definition.....	143
6.8.3.2	Abstract Equation.....	143
6.8.3.3	Trigger Points.....	143
6.8.4	HTTP IP-Service Setup Time [s].....	143
6.8.4.1	Abstract Definition.....	143
6.8.4.2	Abstract Equation.....	144
6.8.4.3	Trigger Points.....	144
6.8.5	HTTP Session Failure Ratio [%]	144
6.8.5.1	Abstract Definition.....	144
6.8.5.2	Abstract Equation.....	144
6.8.5.3	Trigger Points.....	144
6.8.6	HTTP Session Time [s].....	144
6.8.6.1	Abstract Definition.....	144
6.8.6.2	Abstract Equation.....	145
6.8.6.3	Trigger Points.....	145
6.8.7	HTTP Mean Data Rate [kbit/s].....	145
6.8.7.1	Abstract Definition.....	145
6.8.7.2	Abstract Equation.....	145
6.8.7.3	Trigger Points.....	145
6.8.8	HTTP Data Transfer Cut-off Ratio [%]	146
6.8.8.1	Abstract Definition.....	146
6.8.8.2	Abstract Equation.....	146
6.8.8.3	Trigger Points.....	146
6.8.9	HTTP Content Compression Ratio [%]	146
6.8.9.1	Abstract Definition.....	146
6.8.9.2	Abstract Equation.....	147
6.8.9.3	Trigger Points.....	147
6.9	Web Radio.....	147
6.9.1	General.....	147
6.9.2	Preconditions	148
6.9.3	Special remarks on Internet radio audio playback and buffering.....	148
6.9.4	Transaction Definition from User's perspective.....	148
6.9.5	Result Definition.....	148
6.9.6	QoS Parameter Overview	149
6.9.7	Web Radio EPG Retrieval Failure Ratio [%]	149
6.9.7.1	Abstract Definition.....	149
6.9.7.2	Abstract Equation.....	149
6.9.7.3	Trigger Points.....	149
6.9.8	Web Radio EPG Retrieval Time [s].....	149
6.9.8.1	Abstract Definition.....	149
6.9.8.2	Abstract Equation.....	149
6.9.8.3	Trigger Points.....	149
6.9.9	Web Radio Tune-in Failure Ratio [%].....	150
6.9.9.1	Abstract Definition.....	150
6.9.9.2	Abstract Equation.....	150
6.9.9.3	Trigger Points.....	150
6.9.10	Web Radio Tune-in Time [s]	150
6.9.10.1	Abstract Definition.....	150
6.9.10.2	Abstract Equation.....	150

6.9.10.3	Trigger Points.....	150
6.9.11	Web Radio Reproduction Set-up Failure Ratio [%]	150
6.9.11.1	Abstract Definition.....	150
6.9.11.2	Abstract Equation.....	151
6.9.11.3	Trigger Points.....	151
6.9.12	Web Radio Reproduction Set-Up Time [s].....	151
6.9.12.1	Abstract Definition.....	151
6.9.12.2	Abstract Equation.....	151
6.9.12.3	Trigger Points.....	151
6.9.13	Web Radio Reproduction Cut-off Ratio [%]	152
6.9.13.1	Abstract Definition.....	152
6.9.13.2	Abstract Equation.....	152
6.9.13.3	Trigger Points.....	152
6.9.14	Web Radio Audio Quality	152
6.10	WLAN service provisioning with HTTP based authentication	153
6.10.1	Generic Signal Flow	153
6.10.2	WLAN Scan Failure Ratio [%].....	154
6.10.2.1	Abstract Definition.....	154
6.10.2.2	Abstract Equation.....	154
6.10.2.3	Trigger Points.....	154
6.10.3	WLAN Time to Scan [s].....	154
6.10.3.1	Abstract Definition.....	154
6.10.3.2	Abstract Equation.....	155
6.10.3.3	Trigger Points.....	155
6.10.4	WLAN PS Data Service Provisioning Failure Ratio [%]	155
6.10.4.1	Abstract Definition.....	155
6.10.4.2	Abstract Equation.....	155
6.10.4.3	Trigger Points.....	156
6.10.5	WLAN PS Data Service Provisioning Time [s].....	156
6.10.5.1	Abstract Definition.....	156
6.10.5.2	Abstract Equation.....	157
6.10.5.3	Trigger Points.....	157
6.10.6	WLAN Association Failure Ratio [%].....	158
6.10.6.1	Abstract Definition.....	158
6.10.6.2	Abstract Equation.....	158
6.10.6.3	Trigger Points.....	158
6.10.7	WLAN Association Time [s]	158
6.10.7.1	Abstract Definition.....	158
6.10.7.2	Abstract Equation.....	159
6.10.7.3	Trigger Points.....	159
6.10.8	WLAN IP Address Allocation Failure Ratio [%]	159
6.10.8.1	Abstract Definition.....	159
6.10.8.2	Abstract Equation.....	159
6.10.8.3	Trigger Points.....	159
6.10.9	WLAN IP Address Allocation Time [s]	160
6.10.9.1	Abstract Definition.....	160
6.10.9.2	Abstract Equation.....	160
6.10.9.3	Trigger Points.....	160
6.10.10	WLAN Landing Page Download Failure Ratio [%]	160
6.10.10.1	Abstract Definition.....	160
6.10.10.2	Abstract Equation.....	160
6.10.10.3	Trigger Points.....	160
6.10.11	WLAN Landing Page Download Time [s]	161
6.10.11.1	Abstract Definition.....	161
6.10.11.2	Abstract Equation.....	161
6.10.11.3	Trigger Points.....	161
6.10.12	WLAN Landing Page Password Retrieval Failure Ratio [%].....	161
6.10.12.1	Abstract Definition.....	161
6.10.12.2	Abstract Equation.....	161
6.10.12.3	Trigger Points.....	161
6.10.13	WLAN Landing Page Password Retrieval Time [s]	162
6.10.13.1	Abstract Definition.....	162

6.10.13.2	Abstract Equation.....	162
6.10.13.3	Trigger Points.....	162
6.10.14	WLAN Landing Page Authorization Failure Ratio [%].....	162
6.10.14.1	Abstract Definition.....	162
6.10.14.2	Abstract Equation.....	162
6.10.14.3	Trigger Points.....	162
6.10.15	WLAN Landing Page Authorization Time [s].....	163
6.10.15.1	Abstract Definition.....	163
6.10.15.2	Abstract Equation.....	163
6.10.15.3	Trigger Points.....	163
6.10.16	WLAN Re-accessibility Failure Ratio [%].....	163
6.10.16.1	Abstract Definition.....	163
6.10.16.2	Abstract Equation.....	163
6.10.16.3	Trigger Points.....	164
6.10.17	WLAN Re-accessibility Time [s]	164
6.10.17.1	Abstract Definition.....	164
6.10.17.2	Abstract Equation.....	164
6.10.17.3	Trigger Points.....	164
6.10.18	WLAN Logout Page Download Failure Ratio [%].....	164
6.10.18.1	Abstract Definition.....	164
6.10.18.2	Abstract Equation.....	165
6.10.18.3	Trigger Points.....	165
6.10.19	WLAN Logout Page Download Time [s]	165
6.10.19.1	Abstract Definition.....	165
6.10.19.2	Abstract Equation.....	165
6.10.19.3	Trigger Points.....	165
6.11	Wireless Application Protocol (WAP)	165
6.11.1	WAP Activation Failure Ratio [%] (WAP 1.x only)	166
6.11.1.1	Abstract Definition.....	166
6.11.1.2	Abstract Equation.....	166
6.11.1.3	Trigger Points.....	167
6.11.2	WAP Activation Time [s] (WAP 1.x only).....	167
6.11.2.1	Abstract Definition.....	167
6.11.2.2	Abstract Equation.....	167
6.11.2.3	Trigger Points.....	167
6.11.3	WAP {Page} IP Access Failure Ratio [%] (WAP 2.x only).....	167
6.11.3.1	Abstract Definition.....	167
6.11.3.2	Abstract Equation.....	167
6.11.3.3	Trigger Points.....	168
6.11.4	WAP {Page} IP Access Setup Time [s] (WAP 2.x only)	168
6.11.4.1	Abstract Definition.....	168
6.11.4.2	Abstract Equation.....	168
6.11.4.3	Trigger Points.....	168
6.11.5	WAP {Page} Session Failure Ratio [%]	168
6.11.5.1	Abstract Definition.....	168
6.11.5.2	Abstract Equation.....	168
6.11.5.3	Trigger Points.....	169
6.11.6	WAP {Page} Session Time [s]	169
6.11.6.1	Abstract Definition.....	169
6.11.6.2	Abstract Equation.....	169
6.11.6.3	Trigger Points.....	169
6.11.7	WAP {Page} Request Failure Ratio [%]	170
6.11.7.1	Abstract Definition.....	170
6.11.7.2	Abstract Equation.....	170
6.11.7.3	Trigger Points.....	170
6.11.8	WAP {Page} Request Time [s]	170
6.11.8.1	Abstract Definition.....	170
6.11.8.2	Abstract Equation.....	170
6.11.8.3	Trigger Points.....	170
6.11.9	WAP {Page} Mean Data Rate [kbit/s].....	171
6.11.9.1	Abstract Definition.....	171
6.11.9.2	Abstract Equation.....	171

6.11.9.3	Trigger Points.....	171
6.11.10	WAP {Page} Data Transfer Cut-off Ratio [%].....	171
6.11.10.1	Abstract Definition.....	171
6.11.10.2	Abstract Equation.....	171
6.11.10.3	Trigger Points.....	171
6.11.11	WAP {Page} Data Transfer Time [s]	172
6.11.11.1	Abstract Definition.....	172
6.11.11.2	Abstract Equation.....	172
6.11.11.3	Trigger Points.....	172
6.12	IMS Multimedia Telephony	172
6.12.1	MTSI Registration Failure Ratio [%]	173
6.12.1.1	Abstract Definition.....	173
6.12.1.2	Abstract Equation.....	173
6.12.1.3	Trigger Points.....	174
6.12.2	MTSI Registration Time [s].....	174
6.12.2.1	Abstract Definition.....	174
6.12.2.2	Abstract Equation.....	174
6.12.2.3	Trigger Points.....	174
6.12.3	MTSI Session Set-up Failure Ratio [%]	174
6.12.3.1	Abstract Definition.....	174
6.12.3.2	Abstract Equation.....	175
6.12.3.3	Trigger Points.....	175
6.12.4	MTSI Session Set-up Time [s].....	175
6.12.4.1	Abstract Definition.....	175
6.12.4.2	Abstract Equation.....	175
6.12.4.3	Trigger Points.....	176
6.12.5	MTSI Session Add Failure Ratio [%]	177
6.12.5.1	Abstract Definition.....	177
6.12.5.2	Abstract Equation.....	177
6.12.5.3	Trigger Points.....	177
6.12.6	MTSI Session Add Time [s]	177
6.12.6.1	Abstract Definition.....	177
6.12.6.2	Abstract Equation.....	178
6.12.6.3	Trigger Points.....	178
6.12.7	MTSI Session Remove Failure Ratio [%].....	179
6.12.7.1	Abstract Definition.....	179
6.12.7.2	Abstract Equation.....	179
6.12.7.3	Trigger Points.....	179
6.12.8	MTSI Session Remove Time [s].....	179
6.12.8.1	Abstract Definition.....	179
6.12.8.2	Abstract Equation.....	179
6.12.8.3	Trigger Points.....	180
6.12.9	MTSI Session Completion Failure Ratio [%]	180
6.12.9.1	Abstract Definition.....	180
6.12.9.2	Abstract Equation.....	180
6.12.9.3	Trigger Points.....	181
6.12.10	MTSI Speech Quality	181
6.12.10.1	Abstract Definition.....	181
6.12.10.2	Abstract Equation.....	181
6.12.10.3	Trigger Points.....	181
6.12.11	MTSI Speech Transmission Delay [s]	182
6.12.11.1	Abstract Definition.....	182
6.12.11.2	Abstract Equation.....	182
6.12.11.3	Trigger Points.....	182
6.12.12	MTSI Speech Path Delay [s].....	182
6.12.12.1	Abstract Definition.....	182
6.12.12.2	Abstract Equation.....	182
6.12.12.3	Trigger Points.....	183
6.12.13	MTSI Video Quality	183
6.12.13.1	Abstract Definition.....	183
6.12.13.2	Abstract Equation.....	183
6.12.13.3	Trigger Points.....	184

6.12.14	MTSI Video Transmission Delay [s]	184
6.12.14.1	Abstract Definition.....	184
6.12.14.2	Abstract Equation.....	184
6.12.14.3	Trigger Points.....	184
6.12.15	MTSI Video Path Delay [s]	185
6.12.15.1	Abstract Definition.....	185
6.12.15.2	Abstract Equation.....	185
6.12.15.3	Trigger Points.....	185
6.12.16	MTSI Audio/Video De-Synchronization [%]	185
6.12.16.1	Abstract Definition.....	185
6.12.16.2	Abstract Equation.....	186
6.12.16.3	Trigger Points.....	186
6.12.17	MTSI Real-Time Text Failure Ratio [%].....	186
6.12.17.1	Abstract Definition.....	186
6.12.17.2	Abstract Equation.....	187
6.12.17.3	Trigger Points.....	187
6.12.18	MTSI Real-Time Text Delivery Time [s]	187
6.12.18.1	Abstract Definition.....	187
6.12.18.2	Abstract Equation.....	187
6.12.18.3	Trigger Points.....	188
6.12.19	MTSI Messaging Failure Ratio [%].....	188
6.12.19.1	Abstract Definition.....	188
6.12.19.2	Abstract Equation.....	188
6.12.19.3	Trigger Points.....	189
6.12.20	MTSI Messaging Delivery Time [s]	189
6.12.20.1	Abstract Definition.....	189
6.12.20.2	Abstract Equation.....	189
6.12.20.3	Trigger Points.....	189
6.12.21	MTSI File/Media Sharing Failure Ratio [%]	190
6.12.21.1	Abstract Definition.....	190
6.12.21.2	Abstract Equation.....	190
6.12.21.3	Trigger Points.....	190
6.12.22	MTSI File/Media Sharing Mean Data Rate [kbit/s].....	190
6.12.22.1	Abstract Definition.....	190
6.12.22.2	Abstract Equation.....	191
6.12.22.3	Trigger Points.....	191
6.12.23	MTSI Media Setup Time [s]	192
6.12.23.1	Abstract Definition.....	192
6.12.23.2	Abstract Equation.....	192
6.12.23.3	Trigger Points.....	193
6.12.24	MTSI Media Add Time [s]	193
6.12.24.1	Abstract Definition.....	193
6.12.24.2	Abstract Equation.....	193
6.12.24.3	Trigger Points.....	193
6.13	E-mail	193
6.14	Group Call	194
6.14.1	Group Call Service Non-Accessibility [%].....	194
6.14.1.1	Abstract Definition.....	194
6.14.1.2	Abstract Equation.....	194
6.14.1.3	Trigger Points.....	194
6.14.2	Group Call Setup Time [s].....	195
6.14.2.1	Abstract Definition.....	195
6.14.2.2	Abstract Equation.....	195
6.14.2.3	Trigger Points.....	195
6.14.3	Group Call Speech Quality on Call Basis	196
6.14.3.1	Abstract Definition.....	196
6.14.3.2	Abstract Equation.....	196
6.14.3.3	Trigger Points.....	196
6.14.4	Group Call Speech Quality on Sample Basis.....	196
6.14.4.1	Abstract Definition.....	196
6.14.4.2	Abstract Equation.....	196
6.14.4.3	Trigger Points.....	196

6.14.5	Group Call Cut-off Call Ratio [%].....	197
6.14.5.1	Abstract Definition.....	197
6.14.5.2	Abstract Equation.....	197
6.14.5.3	Trigger Points.....	197
6.14.6	Group Call Speech Transmission Delay [s].....	197
6.14.6.1	Abstract Definition.....	197
6.14.6.2	Abstract Equation.....	198
6.14.6.3	Trigger Points.....	198
7	Store-and-forward (S&F) Services QoS Parameters	198
7.1	Generic Store-and-forward Parameters	198
7.1.1	Parameter Overview Chart.....	198
7.1.2	{Service} Message Upload Session Failure Ratio [%]	200
7.1.2.1	Abstract Definition.....	200
7.1.2.2	Abstract Equation.....	200
7.1.2.3	Trigger Points.....	200
7.1.3	{Service} Message Upload Session Time [s]	200
7.1.3.1	Abstract Definition.....	200
7.1.3.2	Abstract Equation.....	200
7.1.3.3	Trigger Points.....	200
7.1.4	{Service} Message Upload Access Failure Ratio [%]	200
7.1.4.1	Abstract Definition.....	200
7.1.4.2	Abstract Equation.....	201
7.1.4.3	Trigger Points.....	201
7.1.5	{Service} Message Upload Access Time [s]	201
7.1.5.1	Abstract Definition.....	201
7.1.5.2	Abstract Equation.....	201
7.1.5.3	Trigger Points.....	201
7.1.6	{Service} Message Upload Data Transfer Cut-off Ratio [%].....	201
7.1.6.1	Abstract Definition.....	201
7.1.6.2	Abstract Equation.....	201
7.1.6.3	Trigger Points.....	202
7.1.7	{Service} Message Upload Data Transfer Time [s]	202
7.1.7.1	Abstract Definition.....	202
7.1.7.2	Abstract Equation.....	202
7.1.7.3	Trigger Points.....	202
7.1.8	{Service} Notification Start Failure Ratio [%]	202
7.1.8.1	Abstract Definition.....	202
7.1.8.2	Abstract Equation.....	202
7.1.8.3	Trigger Points.....	202
7.1.9	{Service} Notification Start Time [s]	203
7.1.9.1	Abstract Definition.....	203
7.1.9.2	Abstract Equation.....	203
7.1.9.3	Trigger Points.....	203
7.1.10	{Service} Notification Download Session Failure Ratio [%].....	203
7.1.10.1	Abstract Definition.....	203
7.1.10.2	Abstract Equation.....	203
7.1.10.3	Trigger Points.....	203
7.1.11	{Service} Notification Download Session Time [s]	203
7.1.11.1	Abstract Definition.....	203
7.1.11.2	Abstract Equation.....	204
7.1.11.3	Trigger Points.....	204
7.1.12	{Service} Notification Download Access Failure Ratio [%].....	204
7.1.12.1	Abstract Definition.....	204
7.1.12.2	Abstract Equation.....	204
7.1.12.3	Trigger Points.....	204
7.1.13	{Service} Notification Download Access Time [s]	204
7.1.13.1	Abstract Definition.....	204
7.1.13.2	Abstract Equation.....	204
7.1.13.3	Trigger Points.....	205
7.1.14	{Service} Notification Download Data Transfer Cut-off Ratio [%].....	205
7.1.14.1	Abstract Definition.....	205

7.1.14.2	Abstract Equation.....	205
7.1.14.3	Trigger Points.....	205
7.1.15	{Service} Notification Download Data Transfer Time [s]	205
7.1.15.1	Abstract Definition.....	205
7.1.15.2	Abstract Equation.....	205
7.1.15.3	Trigger Points.....	205
7.1.16	{Service} Message Download Session Failure Ratio [%]	206
7.1.16.1	Abstract Definition.....	206
7.1.16.2	Abstract Equation.....	206
7.1.16.3	Trigger Points.....	206
7.1.17	{Service} Message Download Session Time [s]	206
7.1.17.1	Abstract Definition.....	206
7.1.17.2	Abstract Equation.....	206
7.1.17.3	Trigger Points.....	206
7.1.18	{Service} Message Download Access Failure Ratio [%]	206
7.1.18.1	Abstract Definition.....	206
7.1.18.2	Abstract Equation.....	207
7.1.18.3	Trigger Points.....	207
7.1.19	{Service} Message Download Access Time [s]	207
7.1.19.1	Abstract Definition.....	207
7.1.19.2	Abstract Equation.....	207
7.1.19.3	Trigger Points.....	207
7.1.20	{Service} Message Download Data Transfer Cut-off Ratio [%]	207
7.1.20.1	Abstract Definition.....	207
7.1.20.2	Abstract Equation.....	207
7.1.20.3	Trigger Points.....	208
7.1.21	{Service} Message Download Data Transfer Time [s].....	208
7.1.21.1	Abstract Definition.....	208
7.1.21.2	Abstract Equation.....	208
7.1.21.3	Trigger Points.....	208
7.1.22	{Service} Notification and Message Download Failure Ratio [%]	208
7.1.22.1	Abstract Definition.....	208
7.1.22.2	Abstract Equation.....	208
7.1.22.3	Trigger Points.....	208
7.1.23	{Service} Notification and Message Download Time [s].....	209
7.1.23.1	Abstract Definition.....	209
7.1.23.2	Abstract Equation.....	209
7.1.23.3	Trigger Points.....	209
7.1.24	{Service} End-to-End Failure Ratio [%]	209
7.1.24.1	Abstract Definition.....	209
7.1.24.2	Abstract Equation.....	209
7.1.24.3	Trigger Points.....	209
7.1.25	{Service} End-to-End Time [s]	209
7.1.25.1	Abstract Definition.....	209
7.1.25.2	Abstract Equation.....	210
7.1.25.3	Trigger Points.....	210
7.1.26	{Service} Login Non-Accessibility [%]	210
7.1.26.1	Abstract Definition.....	210
7.1.26.2	Abstract Equation.....	210
7.1.26.3	Trigger Points.....	210
7.1.27	{Service} Login Access Time [s]	210
7.1.27.1	Abstract Definition.....	210
7.1.27.2	Abstract Equation.....	210
7.1.27.3	Trigger Points.....	210
7.2	E-mail	211
7.2.1	Parameter Overview Chart.....	211
7.2.2	E-Mail {Download Upload} Service Non-Accessibility [%]	215
7.2.3	E-Mail {Download Upload} Setup Time [s].....	215
7.2.4	E-Mail {Download Upload} IP-Service Access Failure Ratio [%]	215
7.2.5	E-Mail {Download Upload} IP-Service Setup Time [s]	215
7.2.6	E-mail {Upload Download} Session Failure Ratio [%].....	215
7.2.6.1	Abstract Definition.....	215

7.2.6.2	Abstract Equation.....	215
7.2.6.3	Trigger Points.....	215
7.2.7	E-mail {Upload Header Download Download} Session Time [s].....	216
7.2.8	E-mail {Upload Header Download Download} Mean Data Rate [kbit/s].....	216
7.2.8.1	Abstract Definition.....	216
7.2.8.2	Abstract Equation.....	216
7.2.8.3	Trigger Points.....	217
7.2.9	E-mail {Upload Header Download Download} Data Transfer Cut-off Ratio [%].....	218
7.2.9.1	Abstract Definition.....	218
7.2.9.2	Abstract Equation.....	218
7.2.9.3	Trigger Points.....	218
7.2.10	E-mail {Upload Header Download Download} Data Transfer Time [s].....	220
7.2.10.1	Abstract Definition.....	220
7.2.10.2	Abstract Equation.....	220
7.2.10.3	Trigger Points.....	220
7.2.11	E-mail Login Non-Accessibility [%].....	221
7.2.11.1	Abstract Definition.....	221
7.2.11.2	Abstract Equation.....	221
7.2.11.3	Trigger Points.....	222
7.2.12	E-mail Login Access Time [s].....	222
7.2.12.1	Abstract Definition.....	222
7.2.12.2	Abstract Equation.....	222
7.2.12.3	Trigger Points.....	223
7.2.13	E-mail Notification Push Failure Ratio [%].....	223
7.2.13.1	Abstract Definition.....	223
7.2.13.2	Abstract Equation.....	223
7.2.13.3	Trigger Points.....	223
7.2.14	E-mail Notification Push Transfer Time [s].....	224
7.2.14.1	Abstract Definition.....	224
7.2.14.2	Abstract Equation.....	224
7.2.14.3	Trigger Points.....	224
7.2.15	E-mail End-to-End Failure Ratio [%].....	224
7.2.15.1	Abstract Definition.....	224
7.2.15.2	Abstract Equation.....	224
7.2.15.3	Trigger Points.....	225
7.2.16	Exemplary Signal Flow.....	225
7.2.16.1	SMTP E-mail Upload.....	225
7.2.16.2	IMAP4 Idle Header and E-mail Download.....	226
7.2.16.3	POP3 Header Download.....	227
7.2.16.4	POP3 E-mail Download.....	228
7.3	Multimedia Messaging Service (MMS).....	228
7.3.1	Parameter Overview Chart.....	229
7.3.2	MMS Send Failure Ratio [%].....	230
7.3.2.1	Abstract Definition.....	230
7.3.2.2	Abstract Equation.....	230
7.3.2.3	Trigger Points.....	230
7.3.3	MMS Retrieval Failure Ratio [%].....	231
7.3.3.1	Abstract Definition.....	231
7.3.3.2	Abstract Equation.....	232
7.3.3.3	Trigger Points.....	232
7.3.4	MMS Send Time [s].....	232
7.3.4.1	Abstract Definition.....	232
7.3.4.2	Abstract Equation.....	232
7.3.4.3	Trigger Points.....	233
7.3.5	MMS Retrieval Time [s].....	233
7.3.5.1	Abstract Definition.....	233
7.3.5.2	Abstract Equation.....	233
7.3.5.3	Trigger Points.....	233
7.3.6	MMS Notification Failure Ratio [%].....	234
7.3.6.1	Abstract Definition.....	234
7.3.6.2	Abstract Equation.....	234
7.3.6.3	Trigger Points.....	234

7.3.7	MMS Notification Time [s]	234
7.3.7.1	Abstract Definition.....	234
7.3.7.2	Abstract Equation.....	234
7.3.7.3	Trigger Points.....	235
7.3.8	MMS End-to-End Failure Ratio [%].....	235
7.3.8.1	Abstract Definition.....	235
7.3.8.2	Abstract Equation.....	235
7.3.8.3	Trigger Points.....	235
7.3.9	MMS End-to-End Delivery Time [s].....	236
7.3.9.1	Abstract Definition.....	236
7.3.9.2	Abstract Equation.....	236
7.3.9.3	Trigger Points.....	236
7.4	Short Message Service (SMS), Short Data Service (SDS).....	237
7.4.1	Parameter Overview Chart.....	238
7.4.2	{SMS SDS} Service Non-Accessibility [%].....	239
7.4.2.1	Abstract Definition.....	239
7.4.2.2	Abstract Equation.....	239
7.4.2.3	Trigger Points.....	239
7.4.3	{SMS SDS} Access Delay [s]	241
7.4.3.1	Abstract Definition.....	241
7.4.3.2	Abstract Equation.....	241
7.4.3.3	Trigger Points.....	242
7.4.4	{SMS SDS} Completion Failure Ratio [%].....	242
7.4.4.1	Abstract Definition.....	242
7.4.4.2	Abstract Equation.....	242
7.4.4.3	Trigger Points.....	243
7.4.5	{SMS SDS} End-to-End Delivery Time [s]	244
7.4.5.1	Abstract Definition.....	244
7.4.5.2	Abstract Equation.....	244
7.4.5.3	Trigger Points.....	245
7.4.6	{SMS SDS} Receive Confirmation Failure Ratio [%]	245
7.4.6.1	Abstract Definition.....	245
7.4.6.2	Abstract Equation.....	246
7.4.6.3	Trigger Points.....	246
7.4.7	{SMS SDS} Receive Confirmation Time [s].....	247
7.4.7.1	Abstract Definition.....	247
7.4.7.2	Abstract Equation.....	247
7.4.7.3	Trigger Points.....	248
7.4.8	{SMS SDS} Consumed Confirmation Failure Ratio [%]	248
7.4.8.1	Abstract Definition.....	248
7.4.8.2	Abstract Equation.....	248
7.4.8.3	Trigger Points.....	249
7.4.9	{SMS SDS} Consumed Confirmation Time [s]	249
7.4.9.1	Abstract Definition.....	249
7.4.9.2	Abstract Equation.....	249
7.4.9.3	Trigger Points.....	250
Annex A (informative):	Examples for measuring trigger points.....	251
Annex B (informative):	Streaming explanations	252
B.1	Streaming Hyperlink Description.....	252
Annex C (informative):	Push to Talk over Cellular Information	253
C.1	Signal Grouping	257
C.2	PoC Service Registration.....	259
C.3	PoC Publish.....	259
C.4	PoC Session Initiation, Originating Part	259
C.5	PoC Session Initiation, Terminating Part	261

C.6	Media Streaming	262
C.7	Talk Burst Request	262
C.8	Leaving PoC Session.....	263
C.9	Deregistration	264
Annex D (informative):	Bibliography.....	265
History		266

Intellectual Property Rights

IPRs essential or potentially essential to the present document may have been declared to ETSI. The information pertaining to these essential IPRs, if any, is publicly available for **ETSI members and non-members**, and can be found in ETSI SR 000 314: "*Intellectual Property Rights (IPRs); Essential, or potentially Essential, IPRs notified to ETSI in respect of ETSI standards*", which is available from the ETSI Secretariat. Latest updates are available on the ETSI Web server (<https://ipr.etsi.org>).

Pursuant to the ETSI IPR Policy, no investigation, including IPR searches, has been carried out by ETSI. No guarantee can be given as to the existence of other IPRs not referenced in ETSI SR 000 314 (or the updates on the ETSI Web server) which are, or may be, or may become, essential to the present document.

Foreword

This Technical Specification (TS) has been produced by ETSI Technical Committee Speech and multimedia Transmission Quality (STQ).

The present document is part 2 of a multi-part deliverable. Full details of the entire series can be found in part 1 [i.3].

Part 1 builds an umbrella document for this multi-part deliverable. It summarizes the basics of Quality of Service, always seen from the user's perspective. Differences to Quality of Experience (QoE) are also discussed. In extension to generic definitions, specific definitions for this multi-part deliverable are stated here. Furthermore, it gives guidance to assure that QoS assessments can be conducted in a meaningful way and proposes an according process.

The present document defines QoS parameters and their computation for popular services in mobile networks. The parameter definition is split into several parts. It contains an abstract definition which gives a generic description of the parameter, an abstract equation and the corresponding user and technical trigger points. The harmonized definitions given in part 2 are considered as prerequisites for the comparison of QoS measurements and measurement results.

Part 3 describes the measurement procedures needed to perform the measurements of QoS parameters in line with the definitions given in part 2, applying the test profiles defined in part 5.

Part 4 defines the minimum requirements of QoS measurement equipment for mobile networks in the way that the values and trigger points needed to compute the QoS parameter as defined in part 2 can be measured following the procedures defined in part 3. Test equipment fulfilling the specified minimum requirements will allow performing the proposed measurements in a reliable and reproducible way.

Part 5 specifies typical measurement profiles which are required to enable benchmarking of different mobile networks both within and outside national boundaries.

Part 6 describes procedures to be used for statistical calculations in the field of QoS measurement of mobile networks using probing systems.

Part 7 describes how Quality of Service measurements should be done inside the network without direct access to the end point terminal.

Modal verbs terminology

In the present document "**shall**", "**shall not**", "**should**", "**should not**", "**may**", "**need not**", "**will**", "**will not**", "**can**" and "**cannot**" are to be interpreted as described in clause 3.2 of the [ETSI Drafting Rules](#) (Verbal forms for the expression of provisions).

"**must**" and "**must not**" are **NOT** allowed in ETSI deliverables except when used in direct citation.

Introduction

The present document defines quality of service (QoS) parameters and their computation based on field measurements.

This means that the measurement of these QoS parameters is done from the user's point of view (full end-to-end perspective, taking into account the needs of testing).

Each parameter definition is split into several parts. It contains an abstract definition which gives a generic description of the parameter, an abstract equation and the corresponding user and technical trigger points.

1 Scope

The present document defines QoS parameters and their computation for popular services in mobile networks.

The harmonized definitions given in the present document are considered as the prerequisite for the comparison of QoS measurements and their results.

It is assumed that the end user can handle his mobile terminal and the services he wants to use (operability is not evaluated).

The computation of specific QoS parameters may vary depending on the respective mobile network, e.g. GSM or 3GPP specified 3G system. In this case a respective notification is provided.

Other standardization bodies may request an approved document containing specific QoS parameters to be used as reference in their documents. Therefore, the present document may contain incomplete QoS parameter definitions, e.g. giving a description but missing technical trigger points. Such points are marked as "tbd" (to be defined) and will be updated as soon as possible.

2 References

2.1 Normative references

References are either specific (identified by date of publication and/or edition number or version number) or non-specific. For specific references, only the cited version applies. For non-specific references, the latest version of the referenced document (including any amendments) applies.

Referenced documents which are not found to be publicly available in the expected location might be found at <http://docbox.etsi.org/Reference>.

NOTE: While any hyperlinks included in this clause were valid at the time of publication, ETSI cannot guarantee their long term validity.

The following referenced documents are necessary for the application of the present document.

- [1] Recommendation ITU-T P.862: "Perceptual evaluation of speech quality (PESQ): An objective method for end-to-end speech quality assessment of narrow-band telephone networks and speech codecs".
- [2] OMA-WAP-206-MMS-CTR-20020115-a: "Wireless Application Protocol; Multimedia Messaging Service; Client Transactions Specification".
- [3] IETF RFC 5322 (2008): "Internet Message Format".
- [4] Void.
- [5] ETSI TS 102 250-3: "Speech and multimedia Transmission Quality (STQ); QoS aspects for popular services in mobile networks; Part 3: Typical procedures for Quality of Service measurement equipment".
- [6] Recommendation ITU-R BS.1387-1: "Method for objective measurements of perceived audio quality".
- [7] IETF RFC 3550 (2003): "RTP: A Transport Protocol for Real-Time Applications".
- [8] IETF RFC 2326 (1998): "Real Time Streaming Protocol (RTSP)".
- [9] Recommendation ITU-T P.862.1: "Mapping function for transforming P.862 raw result scores to MOS-LQO".

- [10] ETSI TS 124 008: "Digital cellular telecommunications system (Phase 2+); Universal Mobile Telecommunications System (UMTS); Mobile radio interface Layer 3 specification; Core network protocols; Stage 3 (3GPP TS 24.008 Release 7)".
- [11] ETSI TS 145 008: "Digital cellular telecommunications system (Phase 2+); Radio subsystem link control (3GPP TS 45.008 Release 6)".
- [12] ETSI TS 129 002: "Digital cellular telecommunications system (Phase 2+); Universal Mobile Telecommunications System (UMTS); Mobile Application Part (MAP) specification (3GPP TS 29.002 Release 6)".
- [13] ETSI TS 123 246: "Universal Mobile Telecommunications System (UMTS); Multimedia Broadcast/Multicast Service (MBMS); Architecture and functional description (3GPP TS 23.246 Release 6)".
- [14] OMA-AD-PoC-V1-0-3-20090922-A: "Push to talk over Cellular (PoC) - Architecture" (OMA Push to talk over Cellular V1.0.3 - Status: Approved Enabler - Release date: 2009-09-22).
- [15] OMA-TS-PoC-UserPlane-V1-0-3-20090922-A: "PoC User Plane" (OMA Push to talk over Cellular V1.0.3 - Status: Approved Enabler - Release date: 2009-09-22).
- [16] OMA-TS-PoC-ControlPlane-V1-0-3-20090922-A: "OMA PoC Control Plane" (OMA Push to talk over Cellular V1.0.3 - Status: Approved Enabler - Release date: 2009-09-22).
- [17] IETF RFC 3903 (2004): "Session Initiation Protocol (SIP) Extension for Event State Publication".
- [18] Recommendation ITU-T P.862.2: "Wideband extension to Recommendation P.862 for the assessment of wideband telephone networks and speech codecs".
- [19] Recommendation ITU-T P.862.3: "Application guide for objective quality measurement based on Recommendations P.862, P.862.1 and P.862.2".
- [20] Recommendation ITU-T E.800: "Definitions of terms related to quality of service".
- [21] ETSI TS 127 007: "Digital cellular telecommunications system (Phase 2+); Universal Mobile Telecommunications System (UMTS); LTE; AT command set for User Equipment (UE) (3GPP TS 27.007)".
- [22] ETSI TS 125 304: "Universal Mobile Telecommunications System (UMTS); User Equipment (UE) procedures in idle mode and procedures for cell reselection in connected mode (3GPP TS 25.304)".
- [23] Recommendation ITU-T P.800.1: "Mean Opinion Score (MOS) terminology".
- [24] Void.
- [25] ETSI TS 123 228: "Digital cellular telecommunications system (Phase 2+); Universal Mobile Telecommunications System (UMTS); IP Multimedia Subsystem (IMS); Stage 2 (3GPP TS 23.228)".
- [26] Recommendation ITU-R BT.1359-1: "Relative timing of sound and vision for broadcasting".
- [27] ETSI EN 300 392-2: "Terrestrial Trunked Radio (TETRA); Voice plus Data (V+D); Part 2: Air Interface (AI)".
- [28] ETSI EN 300 392-5: "Terrestrial Trunked Radio (TETRA); Voice plus Data (V+D) and Direct Mode Operation (DMO); Part 5: Peripheral Equipment Interface (PEI)".
- [29] IETF RFC 5245 (2010): "Interactive Connectivity Establishment (ICE): "A Protocol for Network Address Translator (NAT) Traversal for Offer/Answer Protocols".
- [30] IETF RFC 5389: "Session Traversal Utilities for NAT (STUN)".
- [31] Recommendation ITU-T P.863: "Perceptual objective listening quality assessment".

- [32] OMA-ERELD-PoC-V1-0-4-20091203-A: "Enabler Release Definition for Push-to-Talk over Cellular" (approved Version 1.0.4, December 3rd, 2009).
- [33] ETSI TS 123 401: "LTE; General Packet Radio Service (GPRS) enhancements for Evolved Universal Terrestrial Radio Access Network (E-UTRAN) access (3GPP TS 23.401)".
- [34] ETSI TS 123 272: "Digital cellular telecommunications system (Phase 2+); Universal Mobile Telecommunications System (UMTS); LTE; Circuit Switched (CS) fallback in Evolved Packet System (EPS); Stage 2 (3GPP TS 23.272)".
- [35] ETSI TS 124 228: "Digital cellular telecommunications system (Phase 2+); Universal Mobile Telecommunications System (UMTS); Signalling flows for the IP multimedia call control based on Session Initiation Protocol (SIP) and Session Description Protocol (SDP); Stage 3 (3GPP TS 24.228)".
- [36] Recommendation ITU-T J.343.1: "Hybrid-NRe objective perceptual video quality measurement for HDTV and multimedia IP-based video services in the presence of encrypted bitstream data".
- [37] Recommendation ITU-T J.343.2: "Hybrid-NR objective perceptual video quality measurement for HDTV and multimedia IP-based video services in the presence of non-encrypted bitstream data".
- [38] Recommendation ITU-T P.1201: "Parametric non-intrusive assessment of audiovisual media streaming quality".
- [39] Recommendation ITU-T P.1202: "Parametric non-intrusive bitstream assessment of video media streaming quality".

2.2 Informative references

References are either specific (identified by date of publication and/or edition number or version number) or non-specific. For specific references, only the cited version applies. For non-specific references, the latest version of the reference document (including any amendments) applies.

NOTE: While any hyperlinks included in this clause were valid at the time of publication, ETSI cannot guarantee their long term validity.

The following referenced documents are not necessary for the application of the present document but they assist the user with regard to a particular subject area.

[i.1] ETSI TS 102 250-5: "Speech and multimedia Transmission Quality (STQ); QoS aspects for popular services in mobile networks; Part 5: Definition of typical measurement profiles".

[i.2] ETSI Directives.

NOTE: Available at <http://portal.etsi.org/Directives/home.asp>.

[i.3] ETSI TS 102 250-1: "Speech and multimedia Transmission Quality (STQ); QoS aspects for popular services in mobile networks; Part 1: Assessment of Quality of Service".

3 Definitions and abbreviations

3.1 Definitions

For the purposes of the present document, the following terms and definitions apply.

NOTE: For all QoS parameter definitions within the present document, the second column of the trigger point table - "Trigger Points" (from user's point of view) - is mandatory (if present) for all QoS parameter definitions. In the case that the measurement system is capable of tracking details presented in the third column - "Technical Description" - the specific points indicated are also mandatory.

1-1 PoC session: feature enabling a PoC user to establish a PoC session with another PoC user

ad-hoc PoC group session: PoC session for multiple PoC users that does not involve the use or definition of a pre-arranged or chat PoC group

AT interface: interface within a User Equipment (UE) between a Terminal Equipment (TE), which can be an external measurement equipment, and a Mobile Termination (MT) used for sending Attention (AT) commands from the TE to the MT and receiving responses or indications from the MT at the TE

NOTE 1: The AT interface is commonly also referred as R reference point.

NOTE 2: In TETRA, the AT interface is referred as Peripheral Equipment Interface (PEI), see ETSI EN 300 392-5 [28].

automatic answer: terminal accepts the invitation automatically if resources are available

bearer: resource in the broadcast transport system that allows the transmission of data to the terminal or from the terminal

NOTE: A distinction is made between Broadcast Bearer and Mobile Network Bearer. The latter one is synonymously referred to as Interactivity Channel.

bootstrapping: mechanism where the broadcast signal is accessed for the first time within a service usage

NOTE: Parts of this procedure are the synchronization to the signal and its decoding so that afterwards a list of available channels is accessible and presented to the user.

bootstrapping bearer: bearer on which the bootstrapping procedure is executed

broadcast bearer: bearer supporting the broadcast service (e.g. DVB-H, MBMS, etc.)

NOTE: The broadcast signal is transmitted via this bearer.

chat PoC group: persistent group in which each member individually joins the PoC session i.e. the establishment of a PoC session to a chat PoC group does not result in other members of the chat PoC group being invited

chat PoC group session: PoC session established to a chat PoC group

confirmed indication: signalling message returned by the PoC server to confirm that the PoC server, all other network elements intermediary to the PoC server and a terminating terminal are able and willing to receive media

content: in case of a FTP session content is a file, in case of a HTTP session it is a web page and the content of an e-Mail session is the text of the e-Mail

e-mail: message conforming to IETF RFC 5322 [3] consisting of a header section ("e-mail header") and a body ("e-mail body"), e-mail attachments are considered as part of the e-mail body

ESG retrieval bearer: bearer which is used to retrieve the ESG information

last data packet: packet that is needed to complete the transmission of the content on the receiving side

NOTE: For FTP download, the last data packet contains a set TCP FIN flag bit.

manual answer: PoC user accepts the invitation manually

mobile broadcast service: end-to-end system for delivery of any types of digital content and services towards a mobile terminal using IP-based mechanisms

mobile network bearer: bearer provided by a mobile network operator (e.g. GSM, GPRS, UMTS, etc.) to establish interactivity within the Mobile Broadcast Service

on-demand session: PoC session set-up mechanism in which all media parameters are negotiated at PoC session establishment

NOTE: The on-demand sessions are defined by the OMA PoC specification [32] as mandatory for PoC enabled user equipment, whereas pre-established sessions are defined as optional.

PoC session: established connection between PoC users where the users can communicate using speech one at a time

PoC user: user of the PoC service

pre-arranged PoC group session: persistent PoC session that has an associated set of PoC members

NOTE: The establishment of a PoC Session to a pre-arranged PoC group results in inviting all members of the defined group.

pre-established session: SIP session established between the terminal and the PoC server that performs the participating PoC function

NOTE: The terminal establishes the pre-established session prior to making requests for PoC sessions to other PoC users.

service provider: operating company of a PLMN

service user: end user who uses the services of a PLMN by means of a UE, e.g. a mobile phone or data card

talk burst: flow of media, e.g. some seconds of speech, from a terminal while that has the permission to send media

talk burst control: control mechanism that arbitrates requests from the terminals, for the right to send media

TBCP Talk Burst Granted: message used by the PoC server to notify the terminal that it has been granted permission to send a talk burst

NOTE: See OMA-AD-PoC-V1-0-3-20090922-A [14] for possible floor states.

TBCP Talk Burst Idle: message used by the PoC server to notify all terminals that no one has the permission to send a talk burst at the moment and that it may accept the "TBCP Talk Burst Request" message

NOTE: See OMA-AD-PoC-V1-0-3-20090922-A [14] for possible floor states.

TBCP Talk Burst Request: message used by the terminal to request permission from the PoC server to send a talk burst

NOTE: See OMA-AD-PoC-V1-0-3-20090922-A [14] for possible floor states.

PoC terminal: PoC enabled user user equipment which is a user equipment implementing a PoC client

NOTE: See ETSI TS 123 246 [13].

unconfirmed indication: indication returned by the PoC server to confirm that it is able to receive media and believes the terminal is able to accept media

NOTE: The PoC server sends the unconfirmed indication prior to determining that all egress elements are ready or even able to receive media.

3.2 Abbreviations

For the purposes of the present document, the following abbreviations apply:

3G	3 rd Generation
3GPP	Third Generation Partnership Project
ACK	Acknowledgement
API	Application Programming Interface
APN	Access Point Name
AT Command	ATtention Command
AT	Attention
ATA	ATtention Answer
ATD	ATtention Dial
ATH	ATtention Hang-up
CC	Call Control
CCCH	Common Control Channel
CLI	Calling Line Identity
CLIP	Calling Line Identity Presentation
CMCE	Circuit Mode Control Entity

CPN	Calling Party Number
CRLF	Carriage Return Line Feed
CS	Circuit Switched
CSFB	Circuit Switched Fallback
CUT	PoC Session CUT-off (PoC)
DCCH	Dedicated Control Channel
DCE	Data Circuit-terminating Equipment
DELAY	Talk Burst DELAY (PoC)
DeREG	PoC DeREGistration (PoC)
DL	DownLink
DNS	Domain Name Service
DROP	Talk Burst DROP (PoC)
DTE	Data Terminal Equipment
DVB-H	Digital Video Broadcasting - Handheld
EMM	EPS Mobility Management
EPG	Electronic Program Guide
EPS	Evolved Packet System
ESG	Electronic Service Guide
ESM	EPS Session Management
FIN	TCP FINish flag
FTP	File Transfer Protocol
GERAN	GSM EDGE Radio Access Network
GGSN	Gateway GPRS Support Node
GMM	GPRS Mobility Management
GPRS	General Packet Radio Service
GSM	Global System for Mobile communications
HLR	Home Location Register
HO	HandOver
HTML	Hypertext Markup Language
HTTP	HyperText Transfer Protocol
ICE	Interactive Connectivity Establishment
ICMP	Internet Control Message Protocol
IMAP	Internet Message Access Protocol
IMS	IP Multimedia Subsystem
INIT	PoC Session INITiation
IP	Internet Protocol
ISDN	Integrated Services for Digital Network
ITU-R	ITU Radiocommunication Sector
KPI	Key Performance Indicator
LEAVE	PoC Session LEAVing
LLC	Logical Link Control
LTE	Long Term Evolution
MAC	Media Access Control
MBMS	Multimedia Broadcast/Multicast Service
MM	Mobility Management
MME	Mobility Management Entity
MMS	Multimedia Messaging Service
MMSC	Multimedia Messaging Service Centre
MO	Mobile Originated
MOS	Mean Opinion Score
MOS-LQO	Mean Opinion Score - Listening speech Quality Objective
MS	Mobile Station
MSC	Mobile Switching Centre
MSISDN	Mobile Station International Subscriber Directory Number
MSRP	Message Session Relay Protocol
MT	Mobile Terminated
MTSI	Multimedia Telephony Service for IMS
NAT	Network Address Translation
OMA	Open Mobile Alliance
OS	Operating System
PC	Personal Computer
PDN	Packet Data Network

PDP	Packet Data Protocol
PDU	Protocol Data Unit
PEP	Performance Enhancement Proxy
PLMN	Public Land Mobile Network
PoC	Push to talk over Cellular
POP3	Post Office Protocol version 3
PS	Packet Switched
PtS	Push to Speech
PTT	Push To Talk
PUB	PoC PUBLISH
QoS	Quality of Service
RACH	Random Access Channel
RAN	Radio Access Network
RAS	Remote Access Service
REG long	PoC REGISTRATION and Publish
REG	PoC REGISTRATION
RR	Radio Resources
RRC	Radio Resource Control
RTCP	Real Time Control Protocol
RTP	Real Time Protocol
RTSP	Real Time Streaming Protocol
SASL	Simple Authentication and Security Layer
SBC	Session Border Controller
SDCCH	Stand-alone Dedicated Control Channel
SDP	Session Description Protocol
SDS	Short Data Service
SDSC	Short Data Service Centre
SDS-TL	Short Data Service-Transport Layer
SGSN	Serving GPRS Support Node
SIP	Session Initiation Protocol
SM	Session Management
SMS	Short Message Service
SMSC	Short Message Service Centre
SMTP	Simple Mail Transfer Protocol
SNDCP	SubNetwork Dependent Convergence Protocol
SpQ	Speech Quality
SRTP	Secure Real-time Transfer Protocol
SRVCC	Single Radio-Voice Call Continuity
SSID	Service Set Identifier
STUN	Session Traversal Utilities for NAT
SwMI	Switching and Management Infrastructure
SYN	TCP SYNchronize flag
TBCP	Talk Burst Control Protocol
TBF	Temporary Block Flow
TCP	Transmission Control Protocol
TCP/IP	Transmission Control Protocol/Internet Protocol
TE	Terminal Equipment
TETRA	Terrestrial Trunked Radio
TL	Transport Layer
TV	Television
TX	Transmission
UDP	User Datagram Protocol
UE	User Equipment
UMTS	Universal Mobile Telecommunications System
URL	Uniform Resource Locator
UTRAN	UMTS Terrestrial Radio Access Network
VT	Video Telephony
WAE	Wireless Application Environment
WAP™	Wireless Application Protocol
WCDMA	Wideband Code Division Multiple Access
WG	Working Group
WGR	WAP Get Request

WLAN	Wireless Local Area Network
WSL	Wireless Session Layer
WSP	Wireless Session Protocol
WTLS	Wireless Transport Layer Security
WTP	Wireless Transport Protocol
XML	Extensible Markup Language

4 QoS Parameter Basics

4.1 General Overview

Figure 1 shows a model for quality of service parameters. This model has four layers.

The first layer is the Network Availability, which defines QoS rather from the viewpoint of the service provider than the service user. The second layer is the Network Access. From the service user's point of view this is the basic requirement for all the other QoS aspects and parameters. The third layer contains the other three QoS aspects Service Access, Service Integrity and Service Retainability. The different services are located in the fourth layer. Their outcome are the QoS parameters.

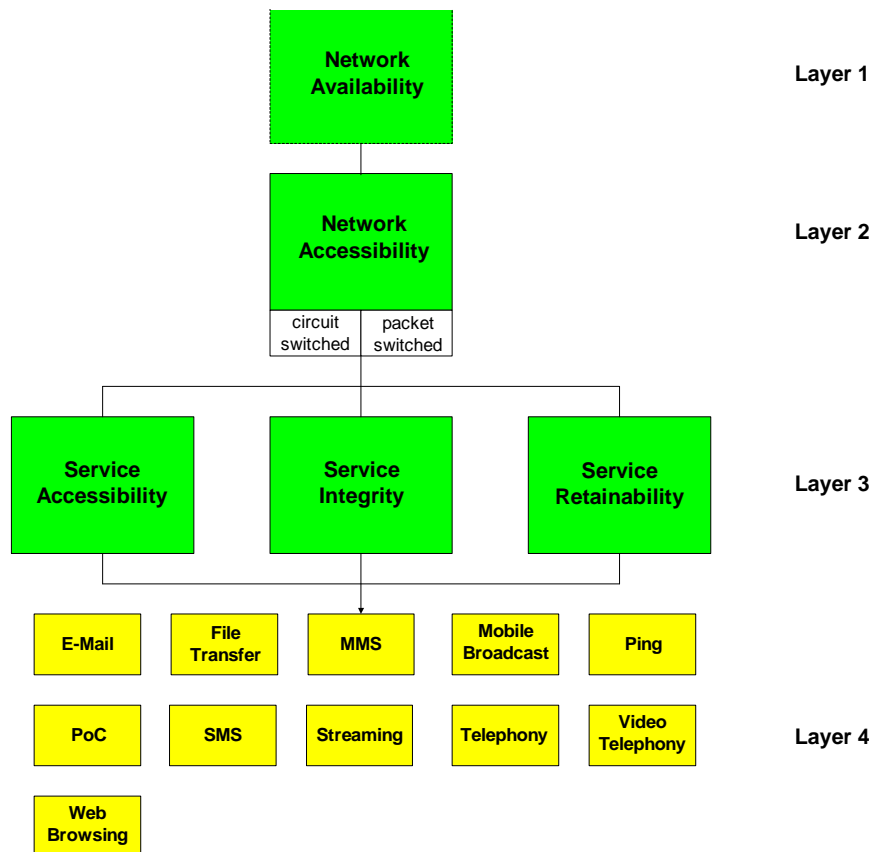

Figure 1: QoS aspects and the corresponding QoS parameters

4.2 FTP, HTTP and E-Mail Issues

Currently two main views about the best way to reflect the user's experience for these services are in place:

- One preferring the payload throughput philosophy and the other preferring the transaction throughput philosophy:
 - Method A defines trigger points which are as independent as possible from the service used, therefore representing a more generic view (payload throughput).
 - Method B defines trigger points on application layer, therefore representing a more service oriented view (transaction throughput).

An example of the different trigger points defined for each set is illustrated in Figure 2 and Figure 3. The start trigger point for the Mean Data Rate for Web browsing is either the reception of the first packet containing data content (Method A) or the sending of the HTTP GET command (Method B).

A field test system compliant to the present document shall measure both sets (Method A and B) of QoS indicators using commercial UEs.

In addition a set of technical QoS indicators is defined that covers the attach and PDP context activation procedure. Field test systems shall be able to measure these QoS indicators.

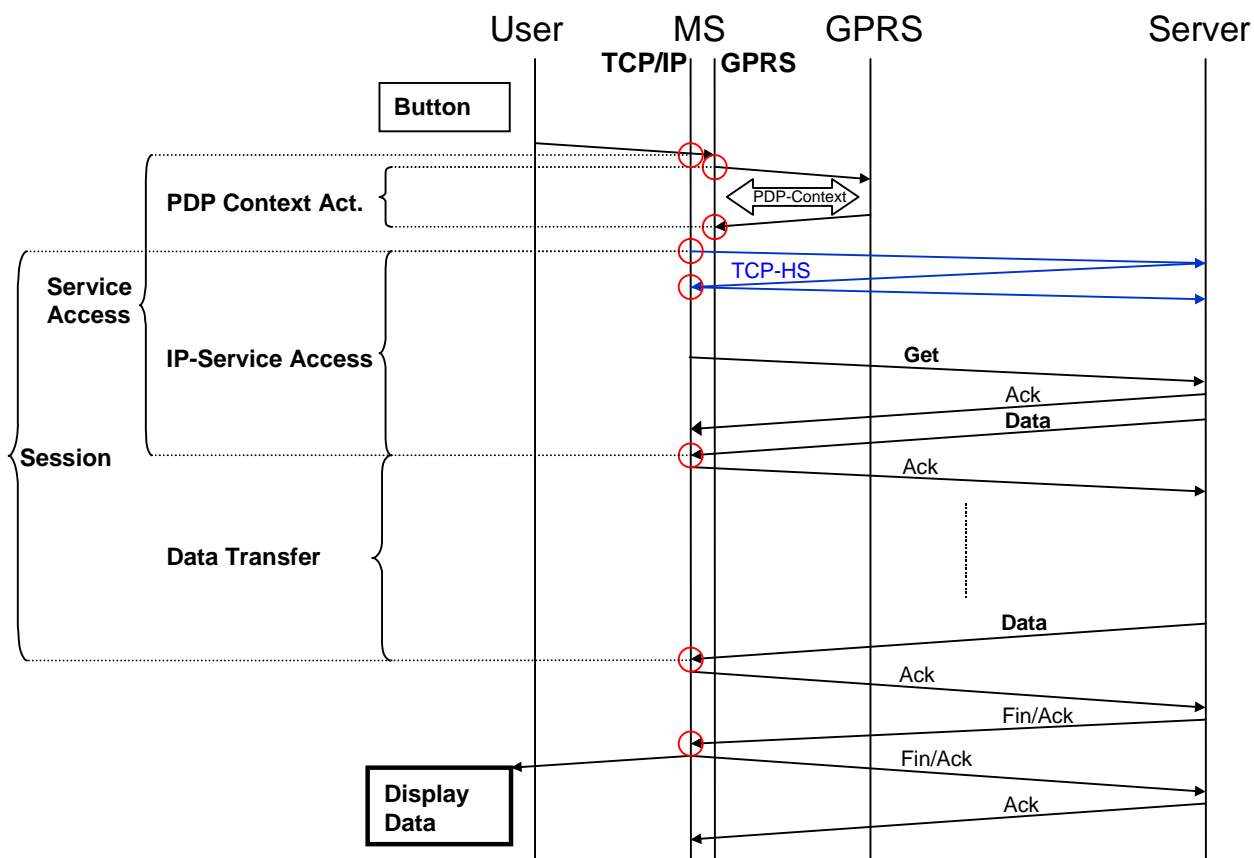

Figure 2: QoS parameters version A (example: HTTP via GPRS)

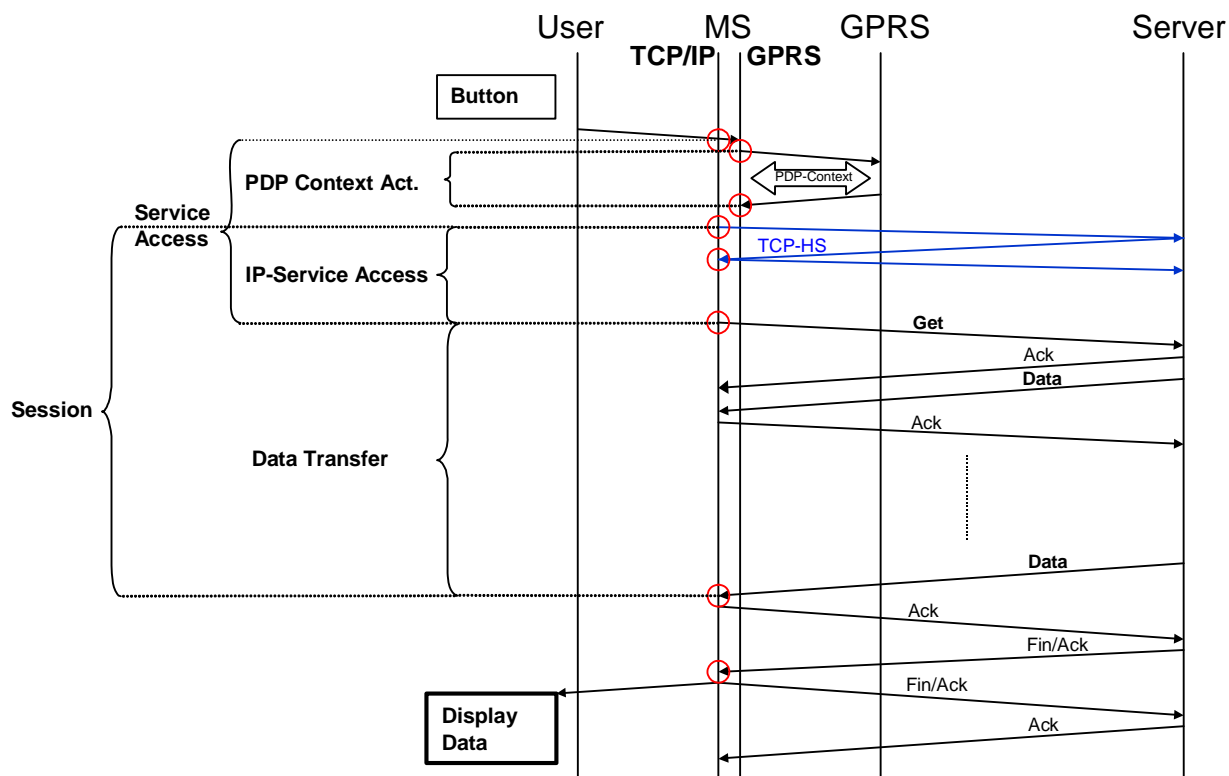

Figure 3: QoS parameters version B (Example: HTTP via GPRS)

4.2.1 Performance Enhancement Proxies

Performance Enhancement Proxies (PEP, also called accelerators) are network elements employed to improve the performance of the data services offered by the mobile operator. To achieve this goal such proxies typically employ different techniques:

- Content filtering (elimination of content of a certain type, e.g. audio files).
- Lossless content compression (e.g. compression of HTML or other text like files).
- Lossy content compression (e.g. recalculation of JPG files to a lower colour deepness or resolution of detail richness).
- Protocol optimization (e.g. for HTTP, POP3).

By these means PEPs achieve a reduction of the amount of data transferred from or to the end-user and thus a reduction of the transfer time. Some of these techniques will have an impact on content integrity and/or on the content quality as perceived by the end-user.

The following guidelines apply whenever Performance Enhancement Proxies are employed:

- When reporting mean data rates it shall be observed that the actual amount of transferred user data (rather than the original amount of hosted data) is used for calculations.
- When reporting session times it is recommended that an indication of the impact of the enhancement techniques on the content quality is given - e.g. the content compression ratio (amount of received and uncompressed content compared to the amount of originally hosted content).
- It is recommended to indicate the impact of the enhancement techniques on content integrity, e.g. eliminated or modified content.

4.3 Timeouts

In day-to-day testing it is necessary to define timeout values for specific service transactions as testing time is a limited resource. These timeouts have a direct impact on the respective QoS parameters. A small timeout value for instance will result in higher failure ratio parameters while a large timeout value will lead to lower throughput rates and higher transfer times, statistically.

With respect to the present document an expired timeout means that the stop trigger point given in the definition of the QoS parameter definition was not reached.

In case not timeout is stated in a technical description/protocol part for an expected response, this shall be understood implicitly in the sense that the response needs to be received within a predefined time. Otherwise, it is regarded as not having been received at all.

For more information on detailed timeout values for specific services please refer to ETSI TS 102 250-5 [i.1].

4.4 Trigger points

In the present document, trigger point definitions are part of each QoS parameter definition.

For each trigger point definition, information concerning the technical description/protocol part is given as part of the definition. In particular, each trigger point may contain more than one technical description/protocol part, reflecting for example different reference points and/or protocol layers.

For example, a trigger point may be defined both by 'AT commands and responses' at the AT interface and 'layer 3 messages'. In such cases and if not stated differently in the respective subsection defining the trigger point, these descriptions/protocol parts are equally valid.

Measurement data from measurements of QoS parameters being based on different technical descriptions/protocol parts for the same trigger point shall not be compared directly.

In general, for the calculation of QoS parameters, it is recommended to use related trigger points in a corresponding way, i.e. utilizing the same protocol layer and reference point for the start and stop trigger, respectively.

In case more than one technical description/protocol part is present, it is up to the reader to choose the technical description/protocol part suiting best the actual needs and/or situation. For instance, one of the related reference points might not be accessible for measurements whereas some other reference point is.

4.5 Overview of technology dependent QoS parameters

Table 1 gives an overview of the technology dependent QoS parameters defined in the present document.

In order to categorize the parameters, three different aspects have been considered:

- Radio network availability.
- Network accessibility and IP connectivity.
- Network retainability.

The aspects do not necessarily need to be the same for all network technologies. Even for a specific technology the implementation of how a service is provided to the customer may vary.

Table 1: Overview of technology dependent QoS parameters

Overview of technology dependent QoS parameters				
Aspect	2G/3G	LTE	TETRA	WLAN
Radio Network Availability	Scan for PLMN: Radio Network Unavailability	Scan for PLMN: Radio Network Unavailability	Not yet defined	Scan for WLAN (AP): WLAN Scan Failure Ratio/Time to Scan
Network Accessibility and IP Connectivity	CS and/or PS attach: Network Selection and Registration Failure Ratio/Time Attach Failure Ratio/ Setup Time	LTE attach: Network Selection and Registration Failure Ratio/Time	PDP context activation: PDP Context Activation Failure Ratio/Time	Associate to WLAN (AP): WLAN PS Data Service Provisioning Failure Ratio/Time WLAN Association Failure Ratio/Time
	PDP context activation: PDP Context Activation Failure Ratio/Time	EPS bearer setup: Default EPS Bearer Activation Failure Ratio/Time Dedicated EPS Bearer Activation Failure Ratio/Time		
Network Retainability	PDP context dropped: PDP Context Cut-off Ratio	EPS bearer dropped: Default EPS Bearer Cut-off Ratio Dedicated EPS Bearer Cut-off Ratio	PDP context dropped: PDP Context Cut-off Ratio	Association dropped: WLAN Re-accessibility Failure Ratio/Time

NOTE: The LTE attach includes the default EPS bearer setup. Additional default/dedicated EPS bearer contexts may be set up.

For 2G/3G (i.e. GSM/GPRS and UMTS) networks it is necessary to establish a data connection before it is possible to access a service. In LTE networks the concept of IP connectivity in line with the "always on" concept has been established. This allows a fast access to the services of a mobile network by state changes on request of a user or application. The impact of this new concept on the QoS parameters is that they cannot be triggered explicitly anymore as they require a specific service request. Nevertheless the QoS parameters defined in clauses 5 and 6 remain valid and can be derived from the trigger points given.

5 Service independent QoS Parameters

5.1 Radio Network Unavailability [%]

5.1.1 Abstract Definition

Probability that the mobile services are not offered to a user.

5.1.2 Abstract Equation

$$\text{Radio Network Unavailability [\%]} = \frac{\text{probing attempts with mobile services not available}}{\text{all probing attempts}} \times 100$$

5.1.3 Trigger Points

GSM:

Event from abstract equation	Trigger point from user's point of view	Technical condition
Probing attempt	Not applicable.	Check C1-Criteria.
Mobile services available	Not applicable.	C1-Criteria > 0. Any emergency camping on any other than the target networks is considered as no network.
Mobile services not available	Technical condition not met.	

GPRS:

Event from abstract equation	Trigger point from user's point of view	Technical condition
Probing attempt	Not applicable.	Check GPRS specific signalling contained within System Information 3.
Mobile service available	Not applicable.	Specific signalling contained in System Information 3 exists on cell selection.
Mobile service not available	Technical condition not met.	

UMTS (WCDMA), LTE:

Event from abstract equation	Trigger point from user's point of view	Technical condition
Probing attempt	Not applicable.	Check S-Criteria.
Mobile services available	Not applicable.	S-Criteria satisfied. Any emergency camping on any other than the target networks is considered as no network.
Mobile services not available	Technical condition not met.	

NOTE 1: For information on how C1-criteria is defined please refer to ETSI TS 145 008 [11].

NOTE 2: For information on how the S-criteria is defined please refer to ETSI TS 125 304 [22].

NOTE 3: When the test mobile operates in dual-mode (GSM/UMTS) than the judgement on Radio Network Unavailability is made with respect to the radio access technology in which the test device is at the moment of the check.

NOTE 4: The target networks could constitute of more than one network, e.g. to cover national or international roaming.

5.2 Network Non-Accessibility [%]

This parameter was replaced by the "Network Selection and Registration Failure Ratio" and "Network Selection and Registration Time" parameter specified in clauses 5.2.1 and 5.2.2.

5.2.1 {Manual | Automatic} Network Selection and Registration Failure Ratio [%]

5.2.1.1 Abstract Definition

Probability that the user cannot perform a successful selection and registration on the desired PLMN (manual selection mode, automatic selection mode with a defined desired PLMN) or on some PLMN (automatic selection mode without a defined desired PLMN).

Remarks:

- The user equipment (UE) shall be deregistered from any available PLMN and shall not be within a registration procedure.
- Some network (automatic selection mode) or the desired network (manual selection mode) to which the UE should register as well as the desired access technology shall be available and the UE shall be allowed to register to this network.
- The UE shall support the +COPS command set according to the definition in ETSI TS 127 007 [21]:
 - The optional <AcT> field of the +COPS set command as defined in ETSI TS 127 007 [21] shall be supported by the UE, if used in the respective +COPS set command.
- The execution of the +COPS set command shall not be aborted by the sending of any other commands by the Terminal Equipment (TE).
- The UE shall support the +CREG command set according to the definition in ETSI TS 127 007 [21]:
 - The network registration unsolicited result code shall be enabled in the UE.
- The UE shall support the +CGREG command set according to the definition in ETSI TS 127 007 [21]:
 - The GPRS network registration status unsolicited result code shall be enabled in the UE.
- The MT shall be in full functionality state.

5.2.1.2 Abstract Equation

$$\{ \text{Manual} | \text{Automatic} \} \text{Network Selection and Registration Failure Ratio [\%]} = \frac{\text{unsuccessful selection and registration attempts on PLMN}}{\text{all selection and registration attempts}} \times 100$$

5.2.1.3 Trigger Points

Manual Network Selection and Registration - CS case:

Event from abstract equation	Trigger point from customer's point of view	Technical description/protocol part
Manual network selection and registration attempt	Start: User initiates manual network selection and registration.	Start: The set command "+COPS=1,<format>,<oper>[,<AcT>]" for the +COPS command is sent.
Successful manual network selection and registration	Stop: Operator logo appears in the display of the UE.	Stop: Reception of "OK" for the set command "+COPS=1,<format>,<oper>[,<AcT>]" and reception of the unsolicited result code for network registration status "+CREG" by TE with the value "1" or "5" for <stat> and reception of the value "1" for <mode> and the desired values for <oper>, and optionally <AcT>, for the read command "+COPS?".
Unsuccessful manual network selection and registration	Stop trigger point not reached.	

Automatic network selection and registration - CS case:

Event from abstract equation	Trigger point from customer's point of view	Technical description/protocol part
Automatic network selection and registration attempt	Start: User initiates automatic network selection and registration.	Start: The set command "+COPS=0,0" for the +COPS command is sent.
Successful automatic network selection and registration	Stop: Operator logo appears in the display of the UE.	Stop: Reception of "OK" for the set command "+COPS=0,0" and reception of the unsolicited result code for network registration status "+CREG" by the TE with the value "1" or "5" for <stat> and in addition and only in case a certain network operator is desired, reception of the value "0" for <mode> and the desired values for <oper>, and optionally <AcT>, for the read command "+COPS?".
Unsuccessful automatic network selection and registration	Stop trigger point not reached.	

Manual Network Selection and Registration - PS case:

Event from abstract equation	Trigger point from customer's point of view	Technical description/protocol part
Manual network selection and registration attempt	Start: User initiates manual network selection and registration.	Start: The set command "+COPS=1,<format>,<oper>[,<AcT>]" for the +COPS command is sent.
Successful manual network selection and registration	Stop: PS logo appears in the display of the UE.	Stop: Reception of "OK" for the set command "+COPS=1,<format>,<oper>[,<AcT>]" and reception of the unsolicited result code for GPRS network registration status "+CGREG" by TE with the value "1" or "5" for <stat> and reception of the value "1" for <mode> and the desired values for <oper>, and optionally <AcT>, for the read command "+COPS?".
Unsuccessful manual network selection and registration	Stop trigger point not reached.	

Automatic network selection and registration - PS case:

Event from abstract equation	Trigger point from customer's point of view	Technical description/protocol part
Automatic network selection and registration attempt	Start: User initiates automatic network selection and registration.	Start: The set command "+COPS=0,0" for the +COPS command is sent.
Successful automatic network selection and registration	Stop: PS logo appears in the display of the UE.	Stop: Reception of "OK" for the set command "+COPS=0,0" and reception of the unsolicited result code for GPRS network registration status "+CGREG" by the TE with the value "1" or "5" for <stat> and in addition and only in case a certain network operator is desired, reception of the value "0" for <mode> and the desired values for <oper>, and optionally <AcT>, for the read command "+COPS?".
Unsuccessful automatic network selection and registration	Stop trigger point not reached.	

Some possible indicators for unsuccessful manual or automatic network selection and registration attempts are the following:

- In case verbose <err> values have been enabled according to ETSI TS 127 007 [21] via AT+CMEE=2: "+CMEERROR: <err>" is received for the +COPS set or read command.
- No answer is received for the +COPS set or read command within a pre-determined time.
- In case of manual network selection and registration:
The desired value(s) from the +COPS set command for <oper>, and optionally for <AcT>, are not returned by the read command.
- No unsolicited result code for network registration status "+CREG" is received within a pre-determined time.
- The unsolicited result code for network registration status "+CREG" is not received by the TE with the desired value "1" or "5" for <stat> within a pre-determined time.
- No unsolicited result code for GPRS network registration status "+CGREG" is received within a pre-determined time.
- The unsolicited result code for GPRS network registration status "+CGREG" is not received by the TE with the desired value "1" or "5" for <stat> within a pre-determined time.

5.2.2 {Manual | Automatic} Network Selection and Registration Time [s]

5.2.2.1 Abstract Definition

Time it takes the user to perform a successful selection and registration on the desired PLMN (manual selection mode, automatic selection mode with a defined desired PLMN) or on some PLMN (automatic selection mode without a defined desired PLMN).

Remarks:

- The user equipment (UE) shall be deregistered from any available PLMN and shall not be within a registration procedure.
- Some network (automatic selection mode) or the desired network (manual selection mode) to which the UE should register as well as the desired access technology shall be available and the UE shall be allowed to register to this network.
- The UE shall support the +COPS command set according to the definition in ETSI TS 127 007 [21].

- The optional <AcT> field of the +COPS set command as defined in ETSI TS 127 007 [21] shall be supported by the UE, if used in the respective +COPS set command.
- The execution of the +COPS set command shall not be aborted by the sending of any other commands by the Terminal Equipment (TE).
- The UE shall support the +CREG command set according to the definition in ETSI TS 127 007 [21].
- The network registration unsolicited result code shall be enabled in the UE.
- The UE shall support the +CGREG command set according to the definition in ETSI TS 127 007 [21].
- The GPRS network registration status unsolicited result code shall be enabled in the UE.
- The MT shall be in full functionality state.

5.2.2.2 Abstract Equation

$$\text{Network Selection and Registration Time [s]} = (t_{\text{start of network selection and registration attempt}} - t_{\text{successful network selection and registration}}) [\text{s}]$$

5.2.2.3 Trigger Points

Manual Network Selection and Registration - CS case:

Event from abstract equation	Trigger point from customer's point of view	Technical description/protocol part
Start of network selection and registration attempt	Start: User initiates manual network selection and registration.	Start: The set command "+COPS=1,<format>,<oper>[,<AcT>]" for the +COPS command is sent.
Successful network selection and registration	Stop: Operator logo appears in the display of the UE.	Stop: The point in time where the unsolicited result code for network registration status "+CREG" is received by TE with the value "1" or "5" for <stat> in case of the reception of "OK" for the set command "+COPS=1,<format>,<oper>[,<AcT>]" and reception of the value "0" for <mode> and the desired values for <oper>, and optionally <AcT>, for the read command "+COPS?".

Automatic network selection and registration - CS case:

Event from abstract equation	Trigger point from customer's point of view	Technical description/protocol part
Start of network selection and registration attempt	Start: User initiates automatic network selection and registration.	Start: The set command "+COPS=0,0" for the +COPS command is sent.
Successful network selection and registration	Stop: Operator logo appears in the display of the UE.	Stop: The point in time where the unsolicited result code for network registration status "+CREG" is received by TE with the value "1" or "5" for <stat> in case of the reception of "OK" for the set command "+COPS=0,0" and in addition and only in case a certain network operator is desired, reception of the value "0" for <mode> and the desired values for <oper>, and optionally <AcT>, for the read command "+COPS?".

Manual Network Selection and Registration - PS case:

Event from abstract equation	Trigger point from customer's point of view	Technical description/protocol part
Start of network selection and registration attempt	Start: User initiates manual network selection and registration.	Start: The set command "+COPS=1,<format>,<oper>[,<AcT>]" for the +COPS command is sent.
Successful network selection and registration	Stop: PS logo appears in the display of the UE.	Stop: The point in time where the unsolicited result code for GPRS network registration status "+CGREG" is received by TE with the value "1" or "5" for <stat> in case of the reception of "OK" for the set command "+COPS=1,<format>,<oper>[,<AcT>]" and reception of the value "0" for <mode> and the desired values for <oper>, and optionally <AcT>, for the read command "+COPS?".

Automatic network selection and registration - PS case:

Event from abstract equation	Trigger point from customer's point of view	Technical description/protocol part
Start of network selection and registration attempt	Start: User initiates automatic network selection and registration.	Start: The set command "+COPS=0,0" for the +COPS command is sent.
Successful network selection and registration	Stop: PS logo appears in the display of the UE.	Stop: The point in time where the unsolicited result code for GPRS network registration status "+CGREG" is received by TE with the value "1" or "5" for <stat> in case of the reception of "OK" for the set command "+COPS=0,0" and in addition and only in case a certain network operator is desired, reception of the value "0" for <mode> and the desired values for <oper>, and optionally <AcT>, for the read command "+COPS?".

5.3 Attach Failure Ratio [%]

5.3.1 Abstract Definition

The attach failure ratio describes the probability that a subscriber cannot attach to the PS network.

5.3.2 Abstract Equation

$$\text{Attach Failure Ratio [\%]} = \frac{\text{unsuccessful attach attempts}}{\text{all attach attempts}} \times 100$$

5.3.3 Trigger Points

GPRS/UMTS:

Event from abstract equation	Trigger point from user's point of view	Technical description/protocol part
Attach attempt	Start: User turns the UE on.	Start: Layer 3 (GMM): The "ATTACH REQUEST" message is sent by the UE. AT: "AT+CGATT=1" is sent by the TE.
Successful attach attempt	Stop: Attach logo appears in the display of the UE.	Stop: Layer 3 (GMM): The "ATTACH ACCEPT" message is received by the UE. AT: "OK" is received by the TE.
Unsuccessful attach attempt	Stop trigger point not reached.	
Remark: GPRS: Indicator will only be updated by event (a loss of S113 signalling or a coverage hole will not be detected if no attach, routing area update or TBF request is initiated).		

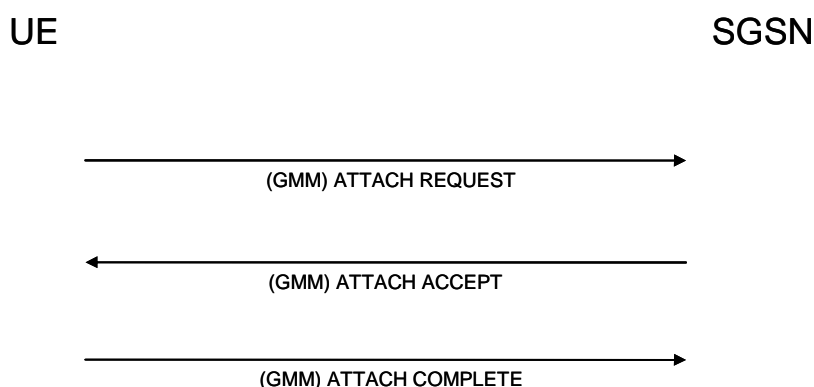

Figure 4: GPRS/UMTS attach procedure

LTE:

Within LTE the concept how to achieve IP connectivity has been changed in comparison to 2G and 3G networks. The "always on" concept necessitates the presence of a default EPS bearer context for a default APN [33] that will be always activated during the EPS attach procedure to the network.

When the UE is powered on it will perform an EPS attach which includes the registration with the network and the setup of a default EPS bearer context for the default APN. This context replaces the primary PDP context defined for 2G/3G networks.

Please refer to clause 4.5 for further details on the differences between the mobile networks technologies described in the present document.

Event from abstract equation	Trigger point from user's point of view	Technical description/protocol part
Attach attempt	Start: User turns the UE on.	Start: Layer 3 (EMM): The "ATTACH REQUEST" message is sent by the UE. AT: "AT+CGATT=1" is sent by the TE.
Successful attach attempt	Stop: Attach logo appears in the display of the UE.	Stop: Layer 3 (EMM): The "ATTACH ACCEPT" message is received by the UE. AT: "OK" is received by the TE.
Unsuccessful attach attempt	Stop trigger point not reached.	

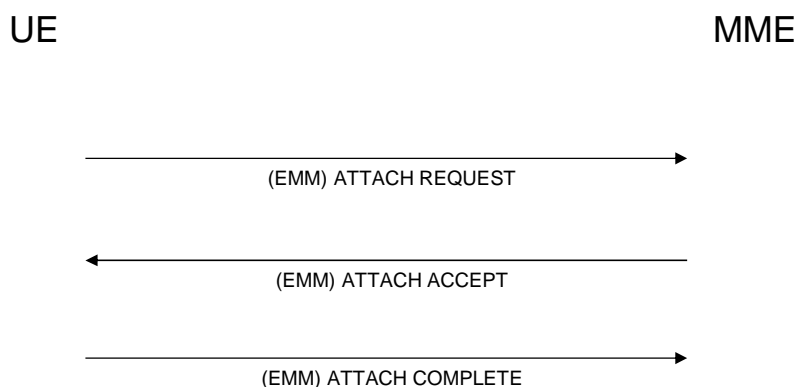

Figure 5: LTE attach procedure

Remarks:

- It might occur that the UE sends more than one attach request towards the network, since retries are necessary. A maximum of four retries are possible. These retries should not have impact on the attach failure ratio, since only one attach request message should be counted in the calculation.
- The packet bearer has to be active in the cell used by a subscriber (see clause 5.1).
- Precondition for measuring this parameter is that the UE is in detached state. Note, "AT+CGATT?" may be used to check the attach state.

5.4 Attach Setup Time [s]

5.4.1 Abstract Definition

The attach setup time describes the time period needed to attach to the PS network.

5.4.2 Abstract Equation

$$\text{AttachSetupTime}[s] = (t_{\text{attachcomplete}} - t_{\text{attachrequest}})[s]$$

5.4.3 Trigger Points

GPRS/UMTS:

Event from abstract equation	Trigger point from user's point of view	Technical description/protocol part
$t_{\text{attach request}}$: Time of attach request	Start: User turns the UE on.	Start: Layer 3 (GMM): The "ATTACH REQUEST" message is sent by the UE. AT: "AT+CGATT=1" is sent by the TE.
$T_{\text{attach complete}}$: Time when attach complete	Stop: Attach logo appears in the display of the UE.	Stop: Layer 3 (GMM): The "ATTACH ACCEPT" message is received by the UE. AT: "OK" is received by the TE.

LTE:

Within LTE the concept how to achieve IP connectivity has been changed in comparison to 2G and 3G networks. The "always on" concept necessitates the presence of a default EPS bearer context for a default APN [33] that will be always activated during the EPS attach procedure to the network.

When the UE is powered on it will perform an EPS attach which includes the registration with the network and the setup of a default EPS bearer context for the default APN. This context replaces the primary PDP context defined for 2G/3G networks.

Please refer to clause 4.5 for further details on the differences between the mobile networks technologies described in the present document.

Event from abstract equation	Trigger point from user's point of view	Technical description/protocol part
$t_{\text{attach request}}$: Time of attach request	Start: User turns the UE on.	Start: Layer 3 (EMM): The "ATTACH REQUEST" message is sent by the UE. AT: "AT+CGATT=1" is sent by the TE.
$T_{\text{attach complete}}$: Time when attach complete	Stop: Attach logo appears in the display of the UE.	Stop: Layer 3 (EMM): The "ATTACH ACCEPT" message is received by the UE. AT: "OK" is received by the TE.

Remarks:

- The difference between an attach request of a known subscriber and an unknown subscriber will be reflected in the time period indicating the attach setup time. In case of an unknown subscriber (meaning that the SGSN/MME has changed since the last detach, or if it is the very first attach of the mobile to the network), the SGSN/MME contacts the HLR in order to receive the subscriber data. The attach setup time of an unknown subscriber will be slightly longer than the one of a known subscriber.
- While determining the average attach setup time only successful attach attempts are included in the calculations.
- The PS bearer has to be active in the cell used by a subscriber (see clause 5.1).
- The UE shall be in detached state. "AT+CGATT?" may be used to check the attach state.

5.5 PDP Context Activation Failure Ratio [%]

5.5.1 Abstract Definition

The PDP context activation failure ratio denotes the probability that the PDP context cannot be activated. It is the proportion of unsuccessful PDP context activation attempts and the total number of PDP context activation attempts.

5.5.2 Abstract Equation

$$\text{PDP Context Activation Failure Ratio [\%]} = \frac{\text{unsuccessful PDP context activation attempts}}{\text{all PDP context activation attempts}} \times 100$$

5.5.3 Trigger Points

GPRS/UMTS:

Event from abstract equation	Trigger point from user's point of view	Technical description/protocol part
PDP context activation attempt	Start: User initiates the service access.	Start: Layer 3 (SM): The first "ACTIVATE PDP CONTEXT REQUEST" message is sent by the UE. AT: "AT+CGACT=1,1" is sent by the TE.
PDP context activation attempt	Stop: PDP context logo appears in the display of the UE.	Stop: Layer 3 (SM): The "ACTIVATE PDP CONTEXT ACCEPT" message is received by the UE. AT: "OK" is received by the TE.
Unsuccessful attempt	Stop trigger point not reached.	

LTE:

Within LTE, the concept how to achieve IP connectivity has been changed in comparison to 2G and 3G networks. The "always on" concept necessitates the presence of a default EPS bearer context for a default APN [33] that will be always activated during the EPS attach procedure to the network.

Being a mandatory and integral part of the EPS attach procedure, the activation of the default EPS bearer context for the default APN is already dealt with by the QoS parameters for the attach procedure (clauses 5.3 and 5.4).

If connectivity to more than one PDN gateway shall be established, additional default EPS bearer contexts may be activated by the UE (see clause 5.12 for default EPS bearer contexts). Due to the different nature of 2G/3G PDP context activation and EPS bearer context activation, and in order to distinguish between the activation of default and dedicated bearers, QoS parameters related to EPS bearer contexts have not been mapped to the PDP context activation parameters. Instead, separate QoS parameter definitions are given in clauses 5.12 and 5.13.

Please refer to clause 4.5 for further details on the differences between the mobile networks technologies described in the present document.

TETRA:

Event from abstract equation	Trigger point from user's point of view	Technical description/protocol part
PDP context activation attempt	Start: User initiates the service access.	Start: Layer 3 (SND CP): The first "SN-ACTIVATE PDP CONTEXT DEMAND" message is sent by the UE. AT: "ATD*99#" is sent by the TE.
Successful PDP context activation attempt	Stop: PDP context logo appears in the display of the UE.	Stop: Layer 3 (SND CP): The "SN-ACTIVATE PDP CONTEXT ACCEPT" message is received by the UE. AT: The "CONNECT" indication is received by the TE.
Unsuccessful attempt	Stop trigger point not reached.	

Remarks:

- In GPRS/UMTS the "AT+CGACT=1,1" shall be sent when the UE has no active context using the selected APN. "AT+CGACT?" may be used to check the state. The PDP context should be defined with the "AT+CGDCONT" command.
- In GPRS/UMTS it might occur that the UE sends more than one PDP context activation request towards the SGSN since retries are necessary. A maximum of four retries are possible. The timer T3380 expires after 30 seconds for each attempt, see ETSI TS 124 008 [10].
- In TETRA the "ATD*99#" shall be sent when the UE has no active context. The PDP context should be defined with the "AT+CTSDC" command.
- In TETRA it might occur that the UE sends more than one PDP context activation request towards the SwMI, since retries are necessary. A maximum of REPLY_ACTIVATION = 3 retries are possible.
- For GPRS/UMTS the PS bearer has to be active in the cell where the attempt is initiated (see clause 5.1) and the UE has to be attached (see clause 5.3).
- For TETRA the PS services shall be enabled at the cell where the attempt is initiated.

5.6 PDP Context Activation Time [s]

5.6.1 Abstract Definition

The PDP context activation time describes the time period needed for activating the PDP context.

5.6.2 Abstract Equation

$$\text{PDPContextActivationTime[s]} = \left(t_{\text{PDPcontextactivationaccept}} - t_{\text{PDPcontextactivationrequest}} \right) [\text{s}]$$

5.6.3 Trigger Points

GPRS/UMTS:

Event from abstract equation	Trigger point from user's point of view	Technical description/protocol part
$t_{\text{PDP context activation request}}$: Time of PDP context activation request	Start: User initiates the service access.	Start: Layer 3 (SM): The first "ACTIVATE PDP CONTEXT REQUEST" message is sent by the UE. AT: "AT+CGACT=1,1" is sent by the TE.
$t_{\text{PDP context activation accept}}$: Time when PDP context activation complete	Stop: PDP context logo appears in the display of the UE.	Stop: Point of time when the UE receives the "Activate PDP context Accept" message (Layer 3).

LTE:

Within LTE the concept how to achieve IP connectivity has been changed in comparison to 2G and 3G networks. The "always on" concept necessitates the presence of a default EPS bearer context for a default APN [33] that will be always activated during the EPS attach procedure to the network.

When the UE is powered on it will perform an EPS attach which includes the registration with the network and the setup of a default EPS bearer context for the default APN. This context replaces the primary PDP context defined for 2G/3G networks.

If connectivity to more than one PDN gateway shall be established, additional default EPS bearers contexts may be initiated by the UE (see clause 5.12 for default EPS bearer contexts).

Please refer to clause 4.5 for further details on the differences between the mobile networks technologies described in the present document.

TETRA:

Event from abstract equation	Trigger point from user's point of view	Technical description/protocol part
$t_{\text{PDP context activation request}}$: Time of PDP context activation request	Start: User initiates the service access.	Start: Layer 3 (SND CP): The first "SN-ACTIVATE PDP CONTEXT DEMAND" message is sent by the UE. AT: "ATD*99#" is sent by the TE.
$t_{\text{PDP context activation accept}}$: Time when PDP context activation complete	Stop: PDP context logo appears in the display of the UE.	Stop: Layer 3 (SND CP): The "SN-ACTIVATE PDP CONTEXT ACCEPT" message is received by the UE. AT: The "CONNECT" indication is received by the TE.

Remarks:

- While determining the average PDP context activation time only successful activation attempts are included in the calculations (see clause 5.5).
- The PDP context activation time should be determined per service, since the service might have impact on the actual activation time, e.g. different Access Point Names (APNs) for WAP.

5.7 PDP Context Cut-off Ratio [%]

5.7.1 Abstract Definition

The PDP context cut-off ratio denotes the probability that a PDP context is deactivated without being initiated intentionally by the user.

5.7.2 Abstract Equation

$$\text{PDP Context Cut - off Ratio [\%]} = \frac{\text{PDP context losses not initiated by the user}}{\text{all successfully activated PDP contexts}} \times 100$$

5.7.3 Trigger Points

GPRS/UMTS:

Event from abstract equation	Trigger point from user's point of view	Technical description/protocol part
PDP context successfully activated	Start: PDP context logo appears in the display of the UE.	Start: Layer 3 (SM): The "ACTIVATE PDP CONTEXT ACCEPT" message is received by the UE.
PDP context deactivation initiated by the user	Stop: PDP context logo disappears from the display of the UE.	Stop: Layer 3 (SM): The "DEACTIVATE PDP CONTEXT REQUEST" message is sent by the UE upon desired initiation.
PDP context loss not initiated by the user	Stop trigger point not reached.	

LTE:

Within LTE the concept how to achieve IP connectivity has been changed in comparison to 2G and 3G networks. The "always on" concept necessitates the presence of a default EPS bearer context for a default APN [33] that will be always activated during the EPS attach procedure to the network.

When the UE is powered on it will perform an EPS attach which includes the registration with the network and the setup of a default EPS bearer context for the default APN. This context replaces the primary PDP context defined for 2G/3G networks.

If connectivity to more than one PDN gateway shall be established, additional default EPS bearers contexts may be initiated by the UE (see clause 5.12 for default EPS bearer contexts).

Please refer to clause 4.5 for further details on the differences between the mobile networks technologies described in the present document.

TETRA:

Event from abstract equation	Trigger point from user's point of view	Technical description/protocol part
PDP context successfully activated	Start: PDP context logo appears in the display of the UE.	Start: Layer 3 (SNDSCP): The "SN-ACTIVATE PDP CONTEXT ACCEPT" message is received by the UE.
PDP context deactivation initiated by the user	Stop: PDP context logo disappears from the display of the UE.	Stop: Layer 3 (SNDSCP): The "SN-DEACTIVATE PDP CONTEXT DEMAND" message is sent by the UE upon desired initiation.
PDP context loss not initiated by the user	Stop trigger point not reached.	

Remarks:

- Precondition for measuring this parameter is that a PDP context was successfully established first.
- Different trigger points for a PDP context deactivation not initiated intentionally by the user are possible: SGSN failure or GGSN failure on which the PDP context will be deactivated by the SGSN or GGSN.

5.8 Data Call Access Failure Ratio [%]

5.8.1 Abstract Definition

A subscriber (A-party) wants to take advantage of a given service offering (as shown by the network ID in the display of his user equipment) and establish a data call to a B-party. The failure of the data call access from initiating the data call to alerting is covered by this parameter.

5.8.2 Abstract Equation

$$\text{Data Call Access Failure Ratio [\%]} = \frac{\text{unsuccessful data call accesses}}{\text{all data call access attempts}} \times 100$$

5.8.3 Trigger Points

GSM:

Event from abstract equation	Trigger point from user's point of view	Technical description/protocol part
Data call access attempt	Start: CONNECT button is pressed.	Start: Layer 3 (RR): The "CHANNEL REQUEST" message is sent over the RACH. AT: The "ATD <dial number>" (MSISDN) command is sent by the A-party.
Successful data call access	Stop: Alerting tone occurs/connection established.	Stop: Layer 3 (CC): The "CONNECT" message is received by the A-party. AT: The "CONNECT" indication is received by the A-party.
Unsuccessful data call access	Stop trigger point not reached.	

Remarks:

- The "ATD <dial number>" (MSISDN) should be sent when there is no ongoing call.
- "AT+CEER" can be used to read out the error cause.

5.9 Data Call Access Time [s]

5.9.1 Abstract Definition

A subscriber (A-party) wants to take advantage of a given service offering (as shown by the network ID in the display of his user equipment) and establish a data call to a B-party. The time elapsing from initiating the data call to alerting or a busy signal is covered by this parameter. This parameter is not calculated unless the call attempt is successful and not cut off beforehand.

5.9.2 Abstract Equation

$$\text{Data Call Access Time [s]} = (t_{\text{successful call access}} - t_{\text{initiation of data call}}) [\text{s}]$$

5.9.3 Trigger Points

GSM:

Event from abstract equation	Trigger point from user's point of view	Technical description/protocol part
$t_{\text{initiation of data call}}$: Time of initiation of data call	Start: Time at which CONNECT button is pressed.	Start: Layer 3 (RR): The "CHANNEL REQUEST" message is sent over the RACH. AT: The "ATD <dial number>" (MSISDN) command is sent by the A-party.
$t_{\text{successful call access}}$: Time of successful data call access	Stop: Time at which alert or busy signal occurs/connection established.	Stop: Layer 3 (CC): The "CONNECT" message is received by the A-party. AT: The "CONNECT" indication is received by the A-party.

Remarks:

- The "ATD <dial number>" (MSISDN) should be sent when there is no ongoing call.
- "AT+CEER" can be used to read out the error cause.

5.10 DNS Host Name Resolution Failure Ratio [%]

5.10.1 Abstract Definition

The DNS host name resolution failure ratio is the probability that a host name to host address translation of a DNS resolver was not successful.

Remarks:

- this QoS parameter is only relevant for packet switched services;
- resolutions of different host names shall not be compared directly, since the time to perform a search in the DNS server differs depending on the host name;
- resolutions involving different DNS name servers are not directly comparable;
- resolutions utilizing TCP cannot be directly compared to resolutions using UDP, since messages carried by UDP are restricted to 512 bytes. UDP is the recommended method for standard queries on the Internet.

5.10.2 Abstract Equation

$$\text{DNS Host Name Resolution Failure Ratio [\%]} = \frac{\text{unsuccessful DNS host name resolution requests}}{\text{DNS host name resolution requests}} \times 100$$

5.10.3 Trigger Points

Event from abstract equation	Trigger point from user's point of view	Technical description/protocol part
Host name resolution request	Start: Request to resolve a host name.	Start: Protocol: DNS. Data packet containing DNS type A (host address) "Standard query" message for the desired host name.
Successful host name resolution request	Stop: Host address resolved successfully.	Stop: Protocol: DNS. Data packet received containing a type A (host address) "Standard query response, No error" response, the respective type A "Standard query" query and an answer including the desired host name to host address translation.
Unsuccessful host name resolution request	Stop: Host address not resolved.	Stop trigger point not reached.

Precondition for measurement:

- The resolver shall not have direct access to any local DNS name server or any name server's zone.

5.11 DNS Host Name Resolution Time [s]

5.11.1 Abstract Definition

The DNS host name resolution time is the time it takes to perform a host name to host address translation.

Remarks:

- this QoS parameter is only relevant for packet switched services;
- resolutions of different host names shall not be compared directly, since the time to perform a search in the DNS server differs depending on the host name;
- resolutions involving different DNS name servers are not directly comparable;
- resolutions utilizing TCP cannot be directly compared to resolutions using UDP, since messages carried by UDP are restricted to 512 bytes. UDP is the recommended method for standard queries on the Internet.

5.11.2 Abstract Equation

$$\text{DNS Host Name Resolution Time [s]} = (t_{\text{StandardQueryResponse}} - t_{\text{StandardQuery}}) [\text{s}]$$

5.11.3 Trigger Points

Event from abstract equation	Trigger point from user's point of view	Technical description/protocol part
$t_{\text{StandardQuery}}$: Host name resolution request	Start: Request to resolve a host address from DNS server.	Start: Protocol: DNS. Data packet containing DNS type A (host address) "Standard query" query for the desired host name.
$t_{\text{StandardQueryResponse}}$: Host name resolution request answered	Stop: Host address received from DNS server.	Stop: Protocol: DNS. Data packet received containing a type A (host address) "Standard query response, No error" response, the respective type A "Standard query" query and an answer including the desired host name to host address translation.

Precondition for measurement:

- The resolver shall not have direct access to any local DNS name server or any name server's zone.
- For static measurement methodologies, as defined in ETSI TS 102 250-3 [5], the queried DNS name server shall have any data related to the host name to be resolved available as authoritative data in one of the name server's zones, so that no recursive lookups have to be performed and no use of cached information will be required.
- If the related data is not stored locally in the name server's zone, the resolution time would vary due to DNS caching strategies.

5.12 Default EPS Bearer Contexts

The activation of the initial default EPS bearer context (for the default APN; this is always the first and only default EPS bearer context needed for basic connectivity) within LTE networks will take place during the attach procedure. For this default EPS bearer context the activation failure ratio and time are regarded to be the same, respectively, as the attach failure ratio and setup time.

For any additional default EPS bearer contexts, referring to an APN different from the default APN, the QoS parameters are defined in the sub-clauses of clause 5.12.

For particular services it may be necessary to establish dedicated EPS bearer contexts referring to the same APN as the one of the already established default EPS bearer context. QoS parameters for dedicated EPS bearer contexts are defined in clause 5.13.

For the user of mobile telephony services in an LTE network the loss of the default EPS bearer context (default APN) would mean that LTE services cannot be used anymore. For a successful service usage the default EPS bearer context (default APN) has to be re-established first.

Depending on the network implementation additional default and dedicated EPS bearers contexts may be triggered and observed by activating and deactivating specific services.

5.12.1 Default EPS Bearer Context Activation Failure Ratio [%]

5.12.1.1 Abstract Definition

The default EPS bearer context activation failure ratio measures the probability that:

- In case of the default EPS bearer context for the default APN: the EPS attach procedure fails.
- In case of an additional default EPS bearer context: the additional default EPS bearer context cannot be activated.

5.12.1.2 Abstract Equation

Default EPS bearer context for the default APN: Identical with the attach failure ratio, see clause 5.3.2.

Additional default EPS bearer context:

$$\text{Additional Default EPS Bearer Context Activation Failure Ratio [\%]} = \frac{\text{additional PDN connection establishment failures}}{\text{additional PDN connection initiations}} \times 100$$

5.12.1.3 Trigger Points

Default EPS bearer context for the default APN: Identical with the attach failure ratio, see clause 5.3.3.

Additional default EPS bearer contexts:

Event from abstract equation	Trigger point from user's point of view	Technical description/protocol part
Additional PDN connection initiation	Start: User initiates the service access.	Start: Layer 3 (ESM): The "PDN CONNECTIVITY REQUEST" message is sent by the UE. AT: "+CGACT=1,<cid>" is sent by the TE, where <cid> identifies the additional PDN connection to be established.
Additional PDN connection establishment	Stop: Service access finished.	Stop: Layer 3 (ESM): The "Activate default EPS bearer context request" message is received by the UE. AT: "OK" response to the "+CGACT" command is received by the TE.
Additional PDN connection establishment failure	Stop trigger point not reached.	

Remarks:

- To activate an additional Default EPS Bearer context via the AT interface, the "AT+CGACT=1,<cid>" command should be sent when the UE has no PDN connection for the APN specified for <cid>. "AT+CGACT?" may be used to check the state. The PDN connection identified by <cid> should be defined with the "AT+CGDCONT" command before.
- The UE has to be EPS attached when starting the activation of an additional Default EPS Bearer context.

5.12.2 Default EPS Bearer Context Activation Time[s]

5.12.2.1 Abstract Definition

The default EPS bearer context activation time is the time period needed to establish the initial default EPS bearer context for the default APN or any additional PDN connection (i.e. any additional default EPS bearer context), respectively.

5.12.2.2 Abstract Equation

Default EPS bearer context for the default APN: Identical with the attach setup time, see clause 5.4.2.

Additional default EPS bearer context:

$$\text{Additional Default EPS Bearer Context Activation Time [s]} = (t_{\text{Additional PDN connection establishment}} - t_{\text{Additional PDN connection initiation}}) [\text{s}]$$

5.12.2.3 Trigger Points

Default EPS bearer context for the default APN: Identical with the attach setup time, see clause 5.4.3.

Additional default EPS bearer context:

Event from abstract equation	Trigger point from user's point of view	Technical description/protocol part
Additional PDN connection initiation	Start: User initiates service access.	Start: Layer 3 (ESM): The "PDN CONNECTIVITY REQUEST" message is sent by the UE. AT: "+CGACT=1,<cid>" is sent by the TE, where <cid> identifies the additional PDN connection to be established.
Additional PDN connection establishment	Stop: Service access finished.	Stop: Layer 3 (ESM): The "Activate default EPS bearer context request" message is received by the UE. AT: "OK" response to the "+CGACT" command is received by the TE.

Remarks:

- To activate an additional Default EPS Bearer context via the AT interface, the "AT+CGACT=1,<cid>" command should be sent when the UE has no PDN connection for the APN specified for <cid>. "AT+CGACT?" may be used to check the state. The PDN connection identified by <cid> should be defined with the "AT+CGDCONT" command before.
- The UE has to be EPS attached when starting the activation of an additional Default EPS Bearer context.

5.12.3 Default EPS Bearer Context Cut-off Ratio [%]

5.12.3.1 Abstract Definition

The default EPS bearer context cut-off ratio measures whether a default EPS bearer context (the default EPS bearer context for the default APN which is indispensable to be maintained to use any service over LTE networks or any additional default EPS bearer context) is deactivated without being initiated intentionally by the user.

5.12.3.2 Abstract Equation

$$\text{Default EPS Bearer Context Cut - off Ratio [\%]} = \frac{\text{default EPS bearer context losses not initiated by the user}}{\text{successfully activated default EPS bearer contexts}} \times 100$$

5.12.3.3 Trigger Points

LTE:

Event from abstract equation	Trigger point from user's point of view	Technical description/protocol part
Default EPS bearer context successfully activated	Start: Attach logo appears in the display of the UE or "Connection established" is shown by operation system.	Start: Layer 3 (EMM/SM): Default EPS Bearer for Default APN: The "ATTACH ACCEPT" message is received by the UE. Additional Default EPS Bearer: "ESM Activate default EPS bearer context request" received by the UE
Default EPS bearer context deactivation initiated by the user	Stop: LTE connectivity to a PDN is intentionally deactivated.	Stop: Layer 3 (EMM/SM): Last active Default EPS Bearer, or all active Default EPS Bearers: "EMM DETACH REQUEST" sent by the UE Any Default EPS Bearer but the last one: "PDN disconnect request" sent by the UE
Default EPS bearer context loss	Stop: Trigger is not reached.	

Remarks:

- There are various reasons for default EPS bearer context cut-offs that are not intended by the user (like e.g. I RAT HO, network or UE initiated detach, etc.). These default EPS bearer context cut-offs do not necessarily have a negative impact on customer experience during service usage.

5.13 Dedicated EPS Bearer Contexts

If a dedicated bearer is needed to establish a user data session, this bearer will be established by either pressing the "connect button" within a connection manager software running on a PC or automatically by the launch of an application on a mobile phone, that requires an active data connection. In this case the transition time from the "attach" status until the dedicated bearer has been established is relevant for customer experience.

5.13.1 Dedicated EPS Bearer Context Activation Failure Ratio [%]

In networks where dedicated bearers are mandatory for access to a special service, an activation failure results in service non accessibility for the user of the LTE network requesting the service.

5.13.1.1 Abstract Definition

The dedicated EPS bearer context activation failure ratio measures the probability that a dedicated bearer cannot be activated. It is the proportion of unsuccessful dedicated bearer context activation attempts and the total number of dedicated bearer activation attempts.

5.13.1.2 Abstract Equation

$$\text{Dedicated EPS Bearer Context Activation Failure Ratio [\%]} = \frac{\text{dedicated EPS bearer activation failures}}{\text{dedicated EPS bearer activation initiations}} \times 100$$

5.13.1.3 Trigger Points

Event from abstract equation	Trigger point from user's point of view	Technical description/protocol part
Dedicated EPS bearer activation initiation	Start: User initiates a service access	Start: Layer 3 message (ESM): "Bearer resource allocation request" or "Bearer resource modification request" with appropriate content sent by the UE AT: "+CGACT=1,<cid>" is sent by the TE, where <cid> identifies a traffic flow for an already existing PDN connection, defined with the "+CGDSCONT" command
Dedicated EPS bearer activation success	Stop: "Connect" logo appears in the display of the UE or is displayed by OS.	Stop: Layer 3 message (ESM): "Activate dedicated EPS bearer context request" or "Modify EPS bearer context request" received by the UE AT: "OK" response to the "+CGACT" command is received by the TE.
Dedicated EPS bearer activation failure	Stop trigger point not reached.	

Preconditions:

Successful LTE (EMM) Attach and PDN connection for the APN, for which a Dedicated EPS Bearer shall be established, already exists.

Remark:

The Ues may not support the above mentioned AT command "+CGACT=1,<cid>" for activating data transfer mode, but will use proprietary AT commands or other API functionality instead.

5.13.2 Dedicated EPS Bearer Context Activation Time [s]

If a dedicated bearer is needed to establish a user data session, this bearer will be established by either pressing the connect button within a connection manager software running on a PC or automatically by the launch of an application on a mobile phone, that requires an active data connection.

5.13.2.1 Abstract Definition

The Dedicated EPS bearer context activation time is the time that is needed to establish a dedicated bearer for user data transfer.

5.13.2.2 Abstract Equation

$$\text{DedicatedEPSBearerContextActivationTime[s]} = (t_{\text{DedicatedEPSBearercontextactivationssuccess}} - t_{\text{DedicatedEPSBearercontextactivationinitiation}}) [\text{s}]$$

5.13.2.3 Trigger Points

Event from abstract equation	Trigger point from user's point of view	Technical description/protocol part
$t_{\text{DedicatedEPSBearercontextactivationinitiation}}$ Start time of Dedicated EPS bearer context initiation	Start: User initiates a service access	Start: Layer 3 message (ESM): "Bearer resource allocation request" or "Bearer resource modification request" with appropriate content sent by the UE AT: "+CGACT=1,<cid>" is sent by the TE, where <cid> identifies a traffic flow for an already existing PDN connection, defined with the "+CGDSCONT" command
$t_{\text{DedicatedEPSBearercontextactivationsuccess}}$ End time of successful Dedicated EPS bearer context activation	Stop: "Connect" logo appears in the display of the UE or is displayed by OS.	Stop: Layer 3 message (ESM): "Activate dedicated EPS bearer context request" or "Modify EPS bearer context request" received by the UE AT: "OK" response to the "+CGACT" command is received by the TE.
Dedicated EPS Bearer activation failure	Stop trigger point not reached.	

Preconditions:

Successful LTE (EMM) Attach and PDN connection for the APN, for which a Dedicated EPS Bearer shall be established, already exists.

Remark:

The Ues may not support the above mentioned AT command "+CGACT=1,<cid>" for activating data transfer mode, but will use proprietary AT commands or other API functionality instead.

5.13.3 Dedicated EPS Bearer Context Cut-off Ratio [%]

The dedicated EPS bearer context cut-off ratio reflects the number of lost dedicated EPS radio bearers in relationship to all successful initiated service accesses with dedicated bearers non intended by the user.

Even if a dedicated bearer has been cut-off, the bearer re-establishment might be fast enough to avoid a negative influence on user experience.

5.13.3.1 Abstract Definition

The dedicated EPS bearer context cut-off ratio measures the probability that a dedicated EPS bearer context is deactivated without being initiated intentionally by the user.

5.13.3.2 Abstract Equation

$$\text{Dedicated EPS Bearer Context Cut - off Ratio [\%]} = \frac{\text{dedicated EPS bearer context losses not initiated by the user}}{\text{all successfully activated EPS dedicated bearer contexts}} \times 100$$

5.13.3.3 Trigger Points

LTE:

Event from abstract equation	Trigger point from user's point of view	Technical description/protocol part
Dedicated EPS bearer context successfully activated	Start: Start: User initiates a service access and "Connect" logo appears in the display of the UE or "Connect" logo is displayed by OS.	Start: Layer 3 message (ESM): "Activate dedicated EPS bearer context request" or "Modify EPS bearer context request" received by the UE AT: "OK" response to the "+CGACT" command is received by the TE.
Dedicated EPS bearer context deactivated intentionally	Stop: User disconnects or closes an application and the "Connect" logo disappears from the display of the UE or OS shows "not connected"	Stop: Layer 3 (ESM): UE sends " BEARER RESOURCE MODIFICATION REQUEST " message upon desired initiation with appropriate contents or "PDN Disconnect Request" sent by UE. To disconnect from the last and only PDN Gateway the "EMM Detach Request" message being sent by UE.
Dedicated EPS bearer context de-activated without user intention	Stop trigger not reached	

Remarks:

- There are various reasons for dedicated EPS bearer context cut-offs that are not intended by the user (like e.g. I RAT HO, network or UE initiated detach, etc.). These dedicated EPS bearer context cut offs do not necessarily have a negative impact on customer experience during service usage.

6 Direct Services QoS Parameters

6.1 File Transfer (FTP)

6.1.1 FTP {Download|Upload} Service Non-Accessibility [%]

This QoS parameter can be found in former versions of the present document. It is removed from the present document because the definition included a mixture of network and service access that limited its relevance and is replaced by clause 6.1.3.

In clauses 5.2, 5.3, 5.12 and 5.13 additional information with respect to Network Access are available.

6.1.2 FTP {Download|Upload} Setup Time [s]

This QoS parameter can be found in former versions of the present document. It is removed from the present document because the definition included a mixture of network and service access that limited its relevance and is replaced by clause 6.1.4.

In clauses 5.2, 5.3, 5.12 and 5.13 additional information with respect to Network Access are available.

6.1.3 FTP {Download|Upload} IP-Service Access Failure Ratio [%]

6.1.3.1 Abstract Definition

The IP-service access ratio denotes the probability that a subscriber cannot establish a TCP/IP connection to the server of a service successfully.

6.1.3.2 Abstract Equation

$$\text{FTP \{Download | Upload\} IP - Service Access Failure Ratio [\%]} = \frac{\text{unsuccessful attempts to establish an IP connection to the server}}{\text{all attempts to establish an IP connection to the server}} \times 100$$

6.1.3.3 Trigger Points

Download:

Event from abstract equation	Trigger point from user's point of view	Technical description/protocol part
IP-Service access attempt	Start: User initiates file download.	Start: First [SYN] sent on the data socket.
Successful attempt	Stop: File download starts.	Stop Method A: Reception of the first data packet containing content. Stop Method B: Reception of the [ACK] from the [SYN, ACK] for active mode connections, sending of the [ACK] for the [SYN, ACK] for passive mode connections on the data socket.
Unsuccessful attempt	Stop trigger point not reached.	

Upload:

Event from abstract equation	Trigger point from user's point of view	Technical description/protocol part
IP-Service access attempt	Start: User initiates file upload.	Start: First [SYN] sent on the data socket.
Successful attempt	Stop: File upload starts.	Stop Method A: Sending of the first data packet containing content. Stop Method B: Reception of the [ACK] from the [SYN, ACK] for active mode connections, sending of the [ACK] for the [SYN, ACK] for passive mode connections on the data socket.
Unsuccessful attempt	Stop trigger point not reached.	

Remark:

- The PS bearer has to be active in the cell used by a subscriber (see clause 5.1) and the mobile station has to be attached (see clause 5.3) as well as the respective PDP context has to be activated (see clause 5.5).

6.1.4 FTP {Download|Upload} IP-Service Setup Time [s]

6.1.4.1 Abstract Definition

The IP-service setup time is the time period needed to establish a TCP/IP connection to the server of a service, from sending the initial query to a server to the point of time when the content is sent or received.

6.1.4.2 Abstract Equation

$$\text{FTP \{Download | Upload\} IP - Service Setup Time [s]} = (t_{\text{IP-Service access successful}} - t_{\text{IP-Service access start}}) [\text{s}]$$

6.1.4.3 Trigger Points

Download:

Event from abstract equation	Trigger point from user's point of view	Technical description/protocol part
$t_{\text{IP-Service access start}}$: Time of IP-Service access attempt	Start: User initiates file download.	Start: First [SYN] sent.
$t_{\text{IP-Service access successful}}$: Time of successful IP-Service access	Stop: File download starts.	Stop Method A: Reception of the first data packet containing content. Stop Method B: Reception of the [ACK] from the [SYN, ACK] for active mode connections, sending of the [ACK] for the [SYN, ACK] for passive mode connections on the data socket.

Upload:

Event from abstract equation	Trigger point from user's point of view	Technical description/protocol part
$t_{\text{IP-Service access start}}$: Time of IP-Service access attempt	Start: User initiates file upload.	Start: First [SYN] sent.
$t_{\text{IP-Service access successful}}$: Time of successful IP-Service access	Stop: File upload starts.	Stop Method A: Sending of the first data packet containing content. Stop Method B: Reception of the [ACK] from the [SYN, ACK] for active mode connections, sending of the [ACK] for the [SYN, ACK] for passive mode connections on the data socket.

Remark:

- The PS bearer has to be active in the cell used by a subscriber (see clause 5.1) and the mobile station has to be attached (see clause 5.3) as well as the respective PDP context has to be activated (see clause 5.5).

6.1.5 FTP {Download|Upload} Session Failure Ratio [%]

6.1.5.1 Abstract Definition

The session failure ratio is the proportion of uncompleted sessions and sessions that were started successfully.

6.1.5.2 Abstract Equation

$$\text{FTP \{Download|Upload\} Session Failure Ratio [\%]} = \frac{\text{uncompleted sessions}}{\text{successfully started sessions}} \times 100$$

6.1.5.3 Trigger Points

Download:

Event from abstract equation	Trigger point from user's point of view	Technical description/protocol part
Successfully started session	Start: User initiates file download.	Start: First [SYN] sent on the control socket.
Completed session	Stop: File download successfully completed.	Stop: Reception of the last data packet containing content.
Uncompleted session	Stop trigger point not reached.	

Upload:

Event from abstract equation	Trigger point from user's point of view	Technical description/protocol part
Successfully started session	Start: User initiates file upload.	Start: First [SYN] sent on the control socket.
Completed session	Stop: File upload successfully completed.	Stop: Reception of the [FIN, ACK] for the last data packet containing content.
Uncompleted session	Stop trigger point not reached.	

Remark:

- The PS bearer has to be active in the cell used by a subscriber (see clause 5.1) and the mobile station has to be attached (see clause 5.3) as well as the respective PDP context has to be activated (see clause 5.5).

6.1.6 FTP {Download|Upload} Session Time [s]

6.1.6.1 Abstract Definition

The session time is the time period needed to successfully complete a PS data session.

6.1.6.2 Abstract Equation

$$\text{FTP}\{\text{Download|Upload}\}\text{SessionTime}[s] = (t_{\text{sessionend}} - t_{\text{sessionstart}})[s]$$

6.1.6.3 Trigger Points

Download:

Event from abstract equation	Trigger point from user's point of view	Technical description/protocol part
$t_{\text{session start}}$: Time of successfully started session	Start: User initiates file download.	Start: First [SYN] sent on the control socket.
$T_{\text{session end}}$: Time when session completed	Stop: File download successfully completed.	Stop: Reception of the last data packet containing content.

Upload:

Event from abstract equation	Trigger point from user's point of view	Technical description/protocol part
$t_{\text{session start}}$: Time of successfully started session	Start: User initiates file upload.	Start: First [SYN] sent on the control socket.
$T_{\text{session end}}$: Time when session completed	Stop: File upload successfully completed.	Stop: Reception of the [FIN, ACK] for the last data packet containing content.

Remark:

- The PS bearer has to be active in the cell used by a subscriber (see clause 5.1) and the mobile station has to be attached (see clause 5.3) as well as the respective PDP context has to be activated (see clause 5.5).

6.1.7 FTP {Download|Upload} Mean Data Rate [kbit/s]

6.1.7.1 Abstract Definition

After a data link has been successfully established, this parameter describes the average data transfer rate measured throughout the entire connect time to the service. The data transfer shall be successfully terminated. The prerequisite for this parameter is network and service access.

6.1.7.2 Abstract Equation

$$\text{FTP \{Download | Upload\} Mean Data Rate [kbit/s]} = \frac{\text{user data transferred [kbit]}}{(t_{\text{data transfer complete}} - t_{\text{data transfer start}})[\text{s}]}$$

6.1.7.3 Trigger Points

The average throughput is measured from opening the data connection to the end of the successful transfer of the content (file).

Download:

Event from abstract equation	Trigger point from user's point of view	Technical description/protocol part
$t_{\text{data transfer start}}$: Time of successfully started data transfer	Start: File download starts.	Start Method A: Reception of the first data packet containing content. Start Method B: Reception of the [ACK] from the [SYN, ACK] for active mode connections, sending of the [ACK] for the [SYN, ACK] for passive mode connections on the data socket.
$T_{\text{data transfer complete}}$: Time when data transfer complete	Stop: File download successfully completed.	Stop: Reception of the last data packet containing content.

Upload:

Event from abstract equation	Trigger point from user's point of view	Technical description/protocol part
$t_{\text{data transfer start}}$: Time of successfully started data transfer	Start: File upload starts.	Start Method A: Sending of the first data packet containing content. Start Method B: Reception of the [ACK] from the [SYN, ACK] for active mode connections; sending of the [ACK] for the [SYN, ACK] for passive mode connections on the data socket.
$T_{\text{data transfer complete}}$: Time when data transfer complete	Stop: File upload successfully completed.	Stop: Reception of the [FIN, ACK] for the last data packet containing content.

Remark:

- The mobile station is already attached (see clause 5.3), a PDP context is activated (see clause 5.5) and a service was accessed successfully (see Service Non-Accessibility).

6.1.8 FTP {Download|Upload} Data Transfer Cut-off Ratio [%]

6.1.8.1 Abstract Definition

The data transfer cut-off ratio is the proportion of incomplete data transfers and data transfers that were started successfully.

6.1.8.2 Abstract Equation

$$\text{FTP \{Download | Upload\} Data Transfer Cut - off Ratio [\%]} = \frac{\text{incomplete data transfers}}{\text{successfully started data transfers}} \times 100$$

6.1.8.3 Trigger Points

Download:

Event from abstract equation	Trigger point from user's point of view	Technical description/protocol part
Successfully started data transfer	Start: File download starts.	Start Method A: Reception of the first data packet containing content. Start Method B: Reception of the [ACK] from the [SYN, ACK] for active mode connections, sending of the [ACK] for the [SYN, ACK] for passive mode connections on the data socket.
Complete data transfer	Stop: File download successfully completed.	Stop: Reception of the last data packet containing content.
Incomplete data transfer	Stop trigger point not reached.	

Upload:

Event from abstract equation	Trigger point from user's point of view	Technical description/protocol part
Successfully started data transfer	Start: File upload starts.	Start Method A: Sending of the first data packet containing content. Start Method B: Reception of the [ACK] from the [SYN, ACK] for active mode connections, sending of the [ACK] for the [SYN, ACK] for passive mode connections on the data socket.
Complete data transfer	Stop: File upload successfully completed.	Stop: Reception of the [FIN, ACK] for the last data packet containing content.
Incomplete data transfer	Stop trigger point not reached.	

Remark:

- The mobile station is already attached (see clause 5.3), a PDP context is activated (see clause 5.5) and a service was accessed successfully (see Service Non-Accessibility).

6.2 Mobile Broadcast

Mobile Broadcast is an end-to-end broadcast system for delivery of any types of digital content and services using IP-based mechanisms. An inherent part of the Mobile Broadcast system is that it comprises of a unidirectional broadcast path (e.g. DVB-H, MBMS, and other broadcast bearers) and a bidirectional mobile/cellular interactivity path (e.g. GSM, GPRS, UMTS). The Mobile Broadcast Service is thus a platform for convergence of services from mobile/cellular and broadcast/media domains.

Figure 6 depicts the basis for a generic service concept for mobile broadcast. As being a composite service, two different bearers may be involved in mobile broadcast services. Unidirectional broadcast information is transmitted over the broadcast channel, whereas interactive procedures are related to the interactivity channel provided by a mobile network. The independent procedures at both bearers may interact with each other and build a common end-to-end procedure.

In general, this concept is not dedicated to specific bearer technologies. Different bearer technologies and their combinations are thinkable of.

Remarks:

- However, the concept depends for example on the implementation of the Electronic Service Guide (ESG). If the ESG implementation does not allow the user to recognize the reception of ESG information, the according parameters shall have to be adapted.
- Content encryption may be a central element of DVB-H implementations. This issue is not dealt with explicitly in what follows and needs further consideration.

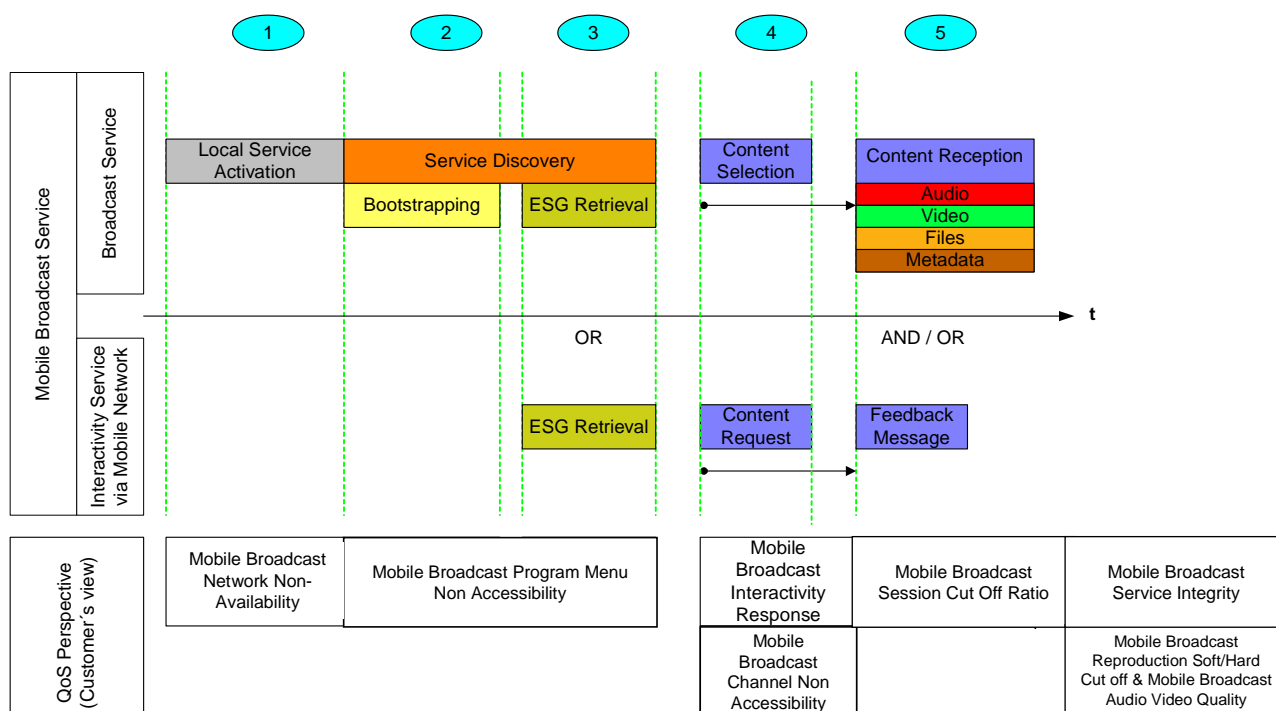

Figure 6: Service phases of mobile broadcast

From a user's point of view, the usage cycle of mobile broadcast services can be divided into:

- Terminal registration Local service activation: The broadcast receiver is switched on and the terminal registers to the broadcast bearer. This procedure includes the detection of a broadcast service signal.
- Bootstrapping: During this phase, the detected broadcast signal is decoded. At the end of this phase, a list of receivables channels is available. Each channel offers additional information via its own Electronic Service Guide (ESG).
- ESG Retrieval: At this stage, the information where to find ESG information is available. After a channel is selected, the channel related information is received, decoded and presented to the user. For example, an overview over the current and following programs can be shown on the display. The ESG information itself can be retrieved either via the broadcast bearer or via the interactivity service, for example via a WAP portal.
- Service discovery: This phase includes the bootstrapping phase and the ESG retrieval phase. Please note that manual channel selection may lead to an additional delay between both phases. During this phase, the detected broadcast signal is decoded. Afterwards, the information where to find Electronic Service Guide (ESG) information is available. The ESG information itself can be retrieved either via the broadcast bearer or via the interactivity service, for example via a WAP portal.
- Content reception: The generic term "content" comprises all kinds of content that can be transferred via the broadcast service. Examples for this kind of data are audio and video streams, file downloads and related metadata which describes the carried content.
- Interactivity based procedures: These procedures allow the interactive use of the mobile broadcast service. In general, all transmission capabilities offered by the mobile network can be used for this issue. Examples are:
 - content requests via a WAP GET request;
 - SMS voting;
 - request to receive ESG information via MMS service; or
 - voice control to request a dedicated file via the broadcast service.

The technical interpretation of this generic usage cycle leads to the phases:

- Mobile Broadcast Network Non-Accessibility.
- Mobile Broadcast Program Menu Non-Accessibility.
- Mobile Broadcast Channel Non-Accessibility.
- Mobile Broadcast Interactivity Response.
- Mobile Broadcast Session Cut Off Ratio.
- Mobile Broadcast Service Integrity.

The mentioned phases are covered by the parameters described subsequently.

6.2.1 Mobile Broadcast Network Non-Availability {Broadcast Bearer}

6.2.1.1 Abstract Definition

Probability that the Mobile Broadcast Services are not offered to an end-user by the target network indicators on the User Equipment (UE) in idle mode.

6.2.1.2 Abstract Equation

$$\text{Mobile Broadcast Network Non - Accessibility [\%]} = \frac{\text{unsuccessful Mobile Broadcast registration attempts}}{\text{all Mobile Broadcast registration attempts}} \times 100$$

6.2.1.3 Trigger Points

Event from abstract equation	Trigger point from user's point of view	Technical description/protocol part
Mobile Broadcast registration attempt	Start: Start of registration procedure performed by the UE.	Tbd.
Unsuccessful Mobile Broadcast registration attempt	Stop: "Mobile Broadcast icon", which indicates successfully registration, is not displayed on the UE.	Tbd.

Preconditions for measurement:

- The terminal shall be in an area which is intended to be covered by the broadcast service.
- The receiver responsible for the reception of Mobile Broadcast services shall be activated and initialized.

6.2.2 Mobile Broadcast Program Menu Non-Accessibility {Bootstrapping Bearer, ESG Retrieval Bearer}

6.2.2.1 Abstract Definition

This parameter describes the probability that the Mobile Broadcast Program Menu is successfully accessible by the user when requested.

Remark:

- This parameter depends on the actual implementation of the service discovery procedures (e.g. use of cached bootstrapping and/or ESG information).

6.2.2.2 Abstract Equation

$$\text{Mobile Broadcast Program Menu Non - Accessibility [\%]} = \frac{\text{unsuccessful program menu access attempts}}{\text{all program menu access attempts}} \times 100$$

6.2.2.3 Trigger Points

Event from abstract equation	Trigger point from user's point of view	Technical description/protocol part
Mobile Broadcast Program Menu access attempt	Start: Request to use the Mobile Broadcast service on the UE (push on TV button).	Start: Tbd.
Unsuccessful Mobile Broadcast Program Menu access attempt	Stop: Mobile Broadcast service is not available on the UE (no TV channel list displayed).	Stop: Tbd.

Preconditions for measurement:

- Mobile Broadcast Network Availability shall be given.

6.2.3 Mobile Broadcast Program Menu Access Time {Bootstrapping Bearer, ESG Retrieval Bearer}

6.2.3.1 Abstract Definition

The parameter Mobile Broadcast Program Menu Access Time is the time period elapsed between a session start attempt of the Mobile Broadcast service and the reception of the complete menu channels list. Hereby, the time the device requires to discover the available channels for the first time is considered.

6.2.3.2 Abstract Equation

$$\text{Mobile Broadcast Program Menu Access Time [s]} = (t_{\text{program menu reception}} - t_{\text{program menu request}}) [\text{s}]$$

6.2.3.3 Trigger Points

Event from abstract equation	Trigger point from user's point of view	Technical description/protocol part
$t_{\text{program menu request}}$: Time of Mobile Broadcast Program Menu	Start: First request of the Mobile Broadcast service on the UE.	Start: Tbd.
$T_{\text{program menu reception}}$: Time of successful Mobile Broadcast Program Menu reception	Stop: Mobile Broadcast channel list is given within a pre-determined time.	Stop: Tbd.

Preconditions for measurement:

- Mobile Broadcast Network Availability shall be given.

6.2.4 Mobile Broadcast Channel Non-Accessibility {Broadcast Bearer}

6.2.4.1 Abstract Definition

Probability that the requested Mobile Broadcast channel is not started to be delivered to the user. This parameter applies also to zapping situations in which the user changes the offered streaming content frequently in short intervals.

6.2.4.2 Abstract Equation

$$\text{Mobile Broadcast Channel Non - Accessibility [\%]} = \frac{\text{unsuccessful channel access attempts}}{\text{all channel attempts}} \times 100$$

6.2.4.3 Trigger Points

Event from abstract equation	Trigger point from user's point of view	Technical description/protocol part
Channel Access attempt	Start: Request Channel button pressed by user/request attempt from device.	Start: Tbd.
Unsuccessful Channel Access attempt	Stop: Missing indication of reception of channel content (channel displayed).	Stop: Tbd.

Preconditions for measurement:

- Mobile Broadcast Network Availability shall be given.
- Mobile Broadcast Program Menu Accessibility shall be successful.

6.2.5 Mobile Broadcast Channel Access Time {Broadcast Bearer}

6.2.5.1 Abstract Definition

The parameter Mobile Broadcast Channel Access Time is the time period elapsed between the user's request to access the channel and the Channel reception/displayed.

6.2.5.2 Abstract Equation

$$\text{Mobile Broadcast Channel Access Time [s]} = (t_{\text{channel reception}} - t_{\text{channel request}}) [\text{s}]$$

6.2.5.3 Trigger Points

Event from abstract equation	Trigger point from user's point of view	Technical description/protocol part
$t_{\text{channel request}}$: Channel request time	Start: Request channel button pressed by user.	Start: Tbd.
$T_{\text{channel reception}}$: Channel reception time	Stop: reception of channel content (channel displayed).	Stop: Tbd.

Preconditions for measurement:

- Mobile Broadcast Network Availability shall be given.
- Mobile Broadcast Program Menu Accessibility shall be successful.

6.2.6 Mobile Broadcast Interactivity Response Failure Ratio {Mobile Network Bearer} {Broadcast Bearer}

6.2.6.1 Abstract Definition

The Mobile Broadcast Interactivity Response Failure Ratio measures the probability that a service request of a Mobile Broadcast service via an interactive channel does not result in an expected reaction (i.e. changes in content updated due to user's interaction, reception of any kind of notification to the user, etc.) on either the broadcast bearer or the mobile network bearer.

6.2.6.2 Abstract Equation

<p style="text-align: center;">Mobile Broadcast Interactivity Response Failure Ratio [%] =</p> $\frac{\text{unsuccessful Mobile Broadcast service outcomes/responses}}{\text{all Mobile Broadcast service requests over interactive channel}} \times 100$

6.2.6.3 Trigger Points

Event from abstract equation	Trigger point from user's point of view	Technical description/protocol part
Mobile Broadcast service request over interactive channel	Start: Request of the Mobile Broadcast service on the UE.	Start: Tbd. Content Request on Interactivity Channel: Trigger points are chosen according to parameter definitions for SMS, MMS, GPRS and PS-UMTS in the present document.
Unsuccessful Mobile Broadcast service outcome/response	Stop: User's interactivity is not reflected in updated content or indicated at the device.	Stop: Tbd. Negative result code or timeout related to Interactivity Channel: Trigger points are chosen according to parameter definitions for SMS, MMS, GPRS and PS-UMTS in the present document.

Preconditions for measurement:

- For broadcast bearer:
 - Mobile Broadcast Network Availability shall be given.
- For mobile network bearer:
 - Mobile Network Availability shall be given.
 - Mobile Network Service Accessibility for circuit switched or packet switched data services shall be given.

6.2.7 Mobile Broadcast Interactivity Response Time {Mobile Network Bearer} {Broadcast Bearer}

6.2.7.1 Abstract Definition

The parameter Mobile Broadcast Interactivity Response Time is the time elapsed between a service request attempt of the Mobile Broadcast service via an interactive channel and the reception of a notification to the user.

6.2.7.2 Abstract Equation

$$\text{Mobile Broadcast Interactivity Response Time [s]} = (t_{\text{service response}} - t_{\text{service request}}) [\text{s}]$$

6.2.7.3 Trigger Points

Event from abstract equation	Trigger point from user's point of view	Technical description/protocol part
$t_{\text{service request}}$: Mobile Broadcast service request over interactive channel	Start: Request of the Mobile Broadcast service on the UE.	Start: Tbd. Content Request on Interactivity Channel: Trigger points are chosen according to parameter definitions for SMS, MMS, GPRS and PS-UMTS in the present document.
$T_{\text{service response}}$: Successful Mobile Broadcast service outcome/response	Stop: User's interactivity is not reflected in updated content or indicated at the device.	Stop: Tbd. Negative result code or timeout related to Interactivity Channel: Trigger points are chosen according to parameter definitions for SMS, MMS, GPRS and PS-UMTS in the present document.

Preconditions for measurement:

- For broadcast bearer:
 - Mobile Broadcast Network Availability shall be given.
- For mobile network bearer:
 - Mobile Network Availability shall be given.
 - Mobile Network Service Accessibility for circuit switched or packet switched data services shall be given.

6.2.8 Mobile Broadcast Session Cut-off Ratio {Broadcast Bearer}

6.2.8.1 Abstract Definition

Session Cut Off denotes the probability of abnormal termination of the specific service requested by the user.

6.2.8.2 Abstract Equation

$$\text{Mobile Broadcast Session Cut - off Ratio [\%]} = \frac{\text{unsuccessfully terminated sessions}}{\text{all successfully established sessions}} \times 100$$

6.2.8.3 Trigger Points

Event from abstract equation	Trigger point from user's point of view	Technical description/protocol part
Successfully established sessions	Start: Channel reproduction started.	Start: Tbd.
Unsuccessfully terminated sessions	Stop: Channel reproduction terminated abnormally (exit from service).	Stop: Tbd.

Preconditions for measurement:

- Mobile Broadcast Network Availability shall be given.
- Mobile Broadcast Program Menu Accessibility shall be successful.
- Mobile Broadcast Channel Accessibility shall be successful.

6.2.9 Mobile Broadcast Service Integrity {Broadcast Bearer}

Mobile Broadcast technology paves the way for network operators and service providers to offer a huge palette of mobile services, which can be divided in the following categories:

- Streaming services.
- Packet switched data services.
- Short Message Service (SMS).
- Multimedia Message Service (MMS).
- Wireless Application Protocol (WAP).
- Digital Video Broadcasting - Handheld (DVB-H).

According to Recommendation ITU-T E.800 [20], the Service Integrity describes the Quality of Service during service use. Since the above mentioned services are already offered in other scenarios, in the present document only a reference to the already defined QoS parameters will be made. Important to bear in mind is the fact that for Mobile Broadcast Service, only the abstract definition of the parameters applies, since the underlying protocol stack may not be the same.

6.2.10 Mobile Broadcast Reproduction Soft Cut-off Ratio {Broadcast Bearer}

6.2.10.1 Abstract Definition

Reproduction Soft Cut Off denotes the probability that the end-user cannot see normally the channel when connected to the specific service.

6.2.10.2 Abstract Equation

$$\text{Mobile Broadcast Reproduction Soft Cut - off Ratio [\%]} = \frac{\sum (t_{\text{fluid audio/video restart}} - t_{\text{signal weak}})}{t_{\text{reproduction finished}} - t_{\text{reproduction started}}} \times 100$$

6.2.10.3 Trigger Points

Event from abstract equation	Trigger point from user's point of view	Technical description/protocol part
$t_{\text{signal weak}}$	Start: Channel displays e.g. blue screen "TV signal weak search of the signal in progress".	Start: Tbd.
$T_{\text{fluid audio/video restart}}$	Stop: The service restarts normally.	Stop: Tbd.
$T_{\text{reproduction started}}$	Start: Begin of reproduction.	Start: Tbd.
$T_{\text{reproduction finished}}$	Stop: End of reproduction.	Stop: Tbd.

Preconditions for measurement:

- Mobile Broadcast Network Availability shall be given.
- Mobile Broadcast Program Menu Accessibility shall be successful.
- Mobile Broadcast Channel Accessibility shall be successful.

6.2.11 Mobile Broadcast Reproduction Hard Cut-off Ratio {Broadcast Bearer}

6.2.11.1 Abstract Definition

Reproduction Hard Cut Off denotes that the end-user cannot see normally the channel when connected to the specific service.

6.2.11.2 Abstract Equation

$$\text{Mobile Broadcast Reproduction Hard Cut - off Ratio [\%]} = \frac{\sum (t_{\text{Fluid audio/video restart}} - t_{\text{signal absent}})}{t_{\text{reproduction finished}} - t_{\text{reproduction started}}} \times 100$$

6.2.11.3 Trigger Points

Event from abstract equation	Trigger point from user's point of view	Technical description/protocol part
$t_{\text{signal absent}}$	Start: Channel displays e.g. blue screen "TV signal absent tuning in progress".	Start: Tbd.
$T_{\text{fluid audio/video restart}}$	Stop: The service restarts normally.	Stop: Tbd.
$T_{\text{reproduction started}}$	Start: Begin of reproduction.	Start: Tbd.
$T_{\text{reproduction finished}}$	Stop: End of reproduction.	Stop: Tbd.

Preconditions for measurement:

- Mobile Broadcast Network Availability shall be given.
- Mobile Broadcast Program Menu Accessibility shall be successful.
- Mobile Broadcast Channel Accessibility shall be successful.

6.2.12 Mobile Broadcast Audio Quality {Broadcast Bearer}

6.2.12.1 Abstract Definition

Mobile Broadcast Audio Quality describes the audio quality as perceived by the end-user. Since the streams can contain but not only speech information, an algorithm like Recommendation ITU-T P.862 [1] is not suitable for all scenarios and should not be used.

An audio algorithm, such as Recommendation ITU-T P.862 [1] may be used.

6.2.12.2 Abstract Equation

Tbd.

6.2.12.3 Trigger Points

Event from abstract equation	Trigger point from user's point of view	Technical description/protocol part
Tbd.	Start: Begin of audio reproduction.	Start: Tbd.
Tbd.	Stop: End of audio reproduction.	Stop: Tbd.

Preconditions for measurement:

- Mobile Broadcast Network Availability shall be given.
- Mobile Broadcast Program Menu Accessibility shall be successful.
- Mobile Broadcast Channel Accessibility shall be successful.

6.2.13 Mobile Broadcast Video Quality {Broadcast Bearer}

6.2.13.1 Abstract Definition

Mobile Broadcast Video Quality describes the video quality as perceived by the end-user.

6.2.13.2 Abstract Equation

Tbd.

6.2.13.3 Trigger Points

Event from abstract equation	Trigger point from user's point of view	Technical description/protocol part
Tbd.	Start: Begin of video reproduction.	Start: Tbd.
Tbd.	Stop: End of video reproduction.	Stop: Tbd.

Preconditions for measurement:

- Mobile Broadcast Network Availability shall be given.
- Mobile Broadcast Program Menu Accessibility shall be successful.
- Mobile Broadcast Channel Accessibility shall be successful.

For wireless application protocol services, a reference from the Open Mobile Alliance (OMA) should be added (if available).

6.3 Ping

6.3.1 Ping Round Trip Time [ms]

6.3.1.1 Abstract Definition

The round trip time is the time required for a packet to travel from a source to a destination and back. It is used to measure the delay on a network at a given time. For this measurement the service shall already be established.

6.3.1.2 Abstract Equation

$$\text{Ping Round Trip Time [ms]} = (t_{\text{packet received}} - t_{\text{packet sent}}) [\text{ms}]$$

6.3.1.3 Trigger Points

Event from abstract equation	Trigger point from user's point of view	Technical description/protocol part
$t_{\text{packet sent}}$: Time when packet is sent	Start: User starts Ping client.	Start: ICMP echo request sent.
$T_{\text{packet received}}$: Time when packet is received	Stop: Echo reply is displayed.	Stop: ICMP echo reply received by the sender.

As an alternative the measurement of the round trip time can be done by evaluating the TCP handshake:

- Start: Point of time when the [SYN] is sent.
- Stop: Point of time when the [SYN, ACK] is received.

This applies to all services that are TCP based, e.g. file transfer (FTP), web browsing (HTTP) and E-Mail (POP3, SMTP).

6.4 Push to Talk over Cellular (PoC)

The present clause describes QoS parameters for the Push to Talk over Cellular (PoC) service as described in [14], [15], [16] and [17].

To point out the development and effectiveness of these QoS parameters, a generic PoC signal flow is given. Here, some restricted information on the application layer is given. These events only show important user interactions. In this context it is important to point out that the present document does not focus on the application layer or the user plane as described in [15].

The SDP is not mentioned as an alternative to RTP in [14], [15] and [16]. Thus, trigger points defined on the SDP layer are out of scope of the present document.

NOTE: All Quality of Service parameters defined for the PoC service which do not rely on RTP in terms of trigger point definition are to be applied when measuring a PoC service utilizing SRTP.

Furthermore, some typical PoC signal flows are given in an informative annex together with some signal grouping. Here, signals have been grouped together in order to give a better insight into the signal flow details and their relation to some specific group of PoC QoS parameters.

The Push to Talk over Cellular (PoC) service is characterized by a half duplex form of communication, whereby one end-user will communicate with other end-users by pressing a button, or an equivalent function, on a PoC terminal. In the following text it will be assumed without loss of generality that the PoC terminal has a PoC button.

It is important to keep in mind that measurement equipment and techniques used can affect the data collected. The measurement equipment and techniques should be defined and their effects documented for all tests.

Remarks:

- All end trigger points defined in the present document will occur after the appropriate start trigger points. The message flow between each two trigger points is described in the text or there is a reference to a figure that visualizes the message flow.
- All SIP and RTP messages that are sent during a PoC session utilize UDP as transport layer.
- If a trigger point (technical description/protocol part) in the present document states: "First data packet sent..." then the time stamp shall be the point in time when the message is posted to the UDP transport layer.
- If a trigger point (technical description/protocol part) in the present document states: "First data packet received..." then the time stamp shall be the point in time when the message is received on the UDP transport layer.
- Trigger points for failure ratios (technical description/protocol part) may state: "No message received by the PoC terminal within a pre-determined time", which means that the PoC server timed out. Here, the exact timeout has to be specified.
- If the present document states: "active PoC talk session", then a PoC session with at least two joining parties is meant, regardless of the kind of session (1-1, ad-hoc group talk, pre-arranged group talk or chat). Furthermore, one of the participating PoC terminals shall create and send data packets containing speech data (RTP media stream).
- Unless explicitly stated differently, all PoC terminals participating in PoC sessions shall not generate notification messages. Otherwise, "SIP NOTIFY" messages might get sent to these clients leading to possible impacts on the measurement results.

6.4.1 Definitions

For PoC, there are differences between on-demand and pre-established PoC sessions which need to be taken into account. Thus, a direct comparison between these session types shall be avoided.

Another difference to be aware of is the form of indication used. If confirmed indication is used, the initiator has to wait for the "talk burst granted" indication until at least one invited user has accepted the invitation. If unconfirmed indication is used, at least one invited user has to be registered and uses automatic answer. This results in different message flows as well as in different response times (especially if media buffering is supported by the PoC server).

Particularities occur when using a pre-arranged PoC group session. In this kind of session the initiator invites a group of users. With confirmed indication at least one user has to accept the invitation but with unconfirmed indication the right-to-speak is granted at once; regardless if a user of the group is connected to the PoC service or not.

Table 2 gives an overview of the defined QoS parameters. Groups of parameters are introduced to visualize interdependencies. The reason is that certain measurements can only take place if several preconditions are fulfilled.

Table 2: QoS parameter and required preconditions

QoS Group		Description	QoS parameter in this group	Preconditions
REG		PoC Registration	6.4.3, 6.4.4	-
PUB		PoC Publish	6.4.5, 6.4.6	REG
REG long		PoC Registration + PoC Publish	6.4.6.3, 6.4.7.3	-
On demand	INIT	PoC Session Initiation	6.4.8.3, 6.4.9.3	PUB
	SETUP	PoC Session Setup	6.4.14.3, 6.4.17	-
	PtS	Push to Speech	6.4.18, 6.4.19	PUB
	LEAVE	PoC Session Leaving	6.4.20, 6.4.21	INIT or SETUP
Pre-established	NEGO	PoC Media Parameters Negotiation	6.4.10.3, 6.4.11.3	PUB
	INIT	PoC Session Initiation	6.4.12.3, 6.4.14	NEGO
	SETUP	PoC Session Setup	6.4.16, 6.4.17	-
	PtS	Push to Speech	6.4.18, 6.4.19	PUB
	LEAVE	PoC Session Leaving	6.4.22, 6.4.23	INIT or SETUP
DeREG		PoC Deregistration	6.4.24, 6.4.25	REG or SETUP
BUSY		Busy Floor Response	6.4.26, 6.4.27	SETUP or PtS
REQ		Talk Burst Request	6.4.28, 6.4.29	SETUP or PtS
CUT		PoC Session Cut-off	6.4.30	SETUP or PtS
DROP		Talk Burst Drop	6.4.31	SETUP or PtS
DELAY		Talk Burst Delay	6.4.32, 6.4.33	SETUP or PtS

6.4.2 Generic Signal Flow

This clause gives an overview of some signal flows evolving from PoC sessions. In Figure 7, a generic signal flow is given. Here, the main parts of a PoC session, also including the registration of the PoC service, are visualized. These are:

- PoC service registration (including PoC service settings publication);
- PoC session initiation, PoC talk session;
- PoC session leaving; and
- PoC service deregistration.

Most of the PoC relevant (application layer-) events generated from or receivable by the user are included in this Figure. These events are represented as dashed lines.

In the present document greyed lines are optional signals which do not have to be sent (like the "SIP NOTIFY" message which will only be sent by the PoC server if the "norefersub" option tag was included in the "SIP REFER" request (see [16]). Provisional SIP responses as described in Recommendation ITU-R BS.1387-1 [6] (e.g. "SIP 100 Trying") are greyed for clarity. These messages are provisional responses and shall be turned off during measurements.

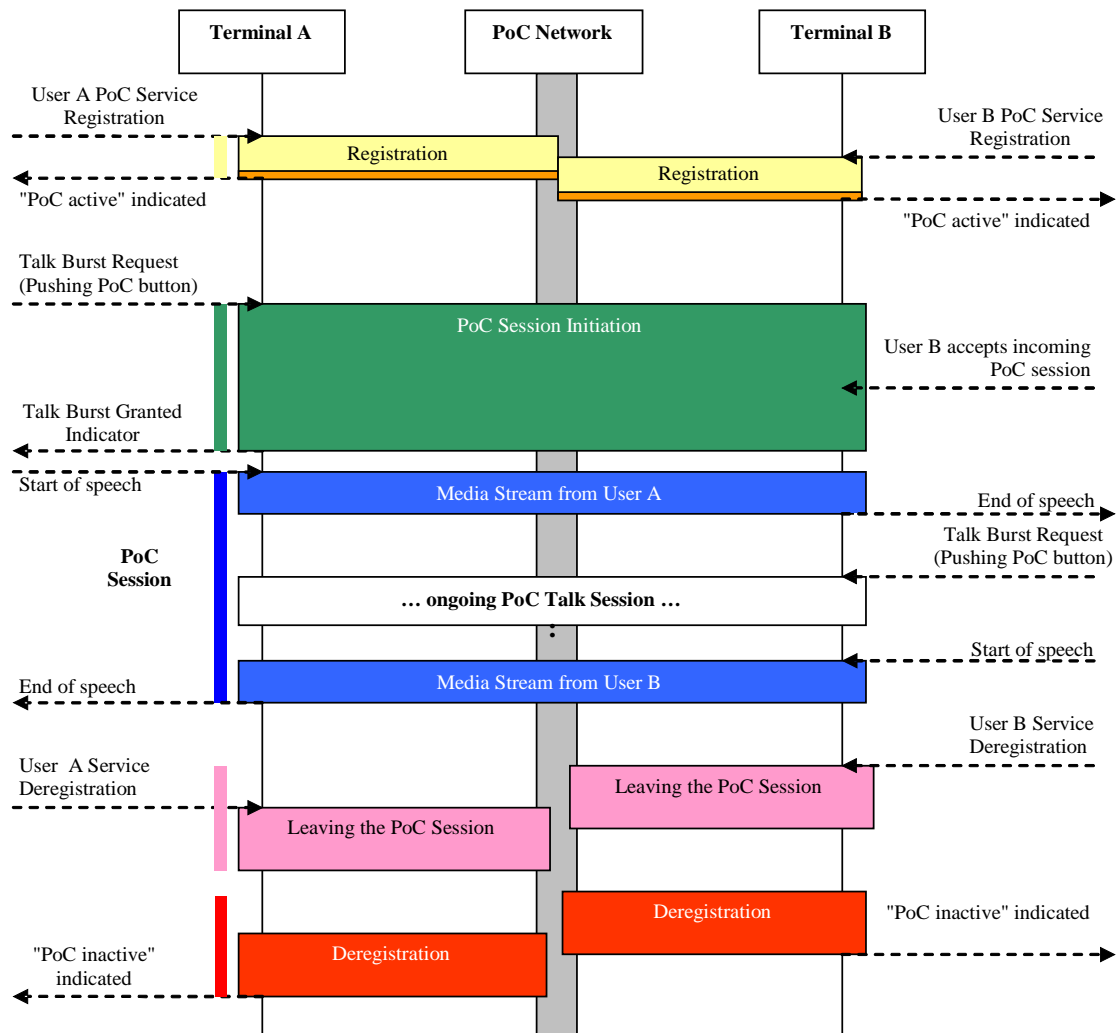

A generic PoC session:

- PoC Registration.
- PoC Session Initiation.
- PoC Talk Session.
- Leaving PoC Session.
- PoC Deregistration.

NOTE: Here, the dashed arrows indicate events generated from or receivable by the user.

Figure 7: Generic PoC session signal flow (including PoC service registration) on application layer

6.4.3 PoC Registration Failure Ratio [%]

6.4.3.1 Abstract Definition

The PoC registration failure ratio is the probability that the terminal cannot register with the Push to Talk over Cellular service when requested.

Remark:

- The terminal shall not be registered to the PoC service.

6.4.3.2 Abstract Equation

$$\text{PoC Registration Failure Ratio [\%]} = \frac{\text{unsuccessful PoC registration attempts}}{\text{all PoC registration attempts}} \times 100$$

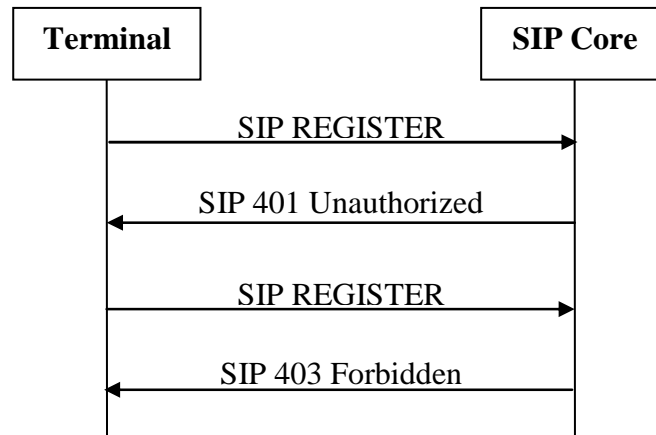

NOTE: This Figure shows an example for an unsuccessful PoC registration. After the first "SIP REGISTER" request the terminal has to answer to a WWW- authentication challenge (see [16]). If the terminal does not answer correctly to this challenge, the SIP core will send a "SIP 403 Forbidden" message.

Figure 8: Unsuccessful PoC registration example

6.4.3.3 Trigger Points

Event from abstract equation	Trigger point from user's point of view	Technical description/protocol part
PoC registration attempt	Start: Activation of the PoC service on the terminal.	Start: Protocol: SIP. First data packet sent by the terminal containing a "SIP REGISTER" message.
Successful PoC registration attempt	Stop: PoC available is indicated.	Stop: Protocol: SIP. First data packet received containing a "SIP 200 OK" message.
Unsuccessful PoC registration attempt	Stop: PoC available indication is not given within a pre-determined time.	Stop: Protocol: SIP. Case 1: Second data packet received by the terminal (after sending the "SIP REGISTER" message) containing a message different to "SIP 200 OK". This message may be implementation-dependent (see [16]). Case 2: First data packet received by the terminal (after the authentication procedure) containing a message different to "SIP 200 OK". Case 3: No message received by the terminal within a pre-determined time.

6.4.4 PoC Registration Time [s]

6.4.4.1 Abstract Definition

The PoC registration time is the time period between the registration request of the PoC service and being registered to the PoC service.

Remark:

- The terminal shall not be registered to the PoC service.

6.4.4.2 Abstract Equation

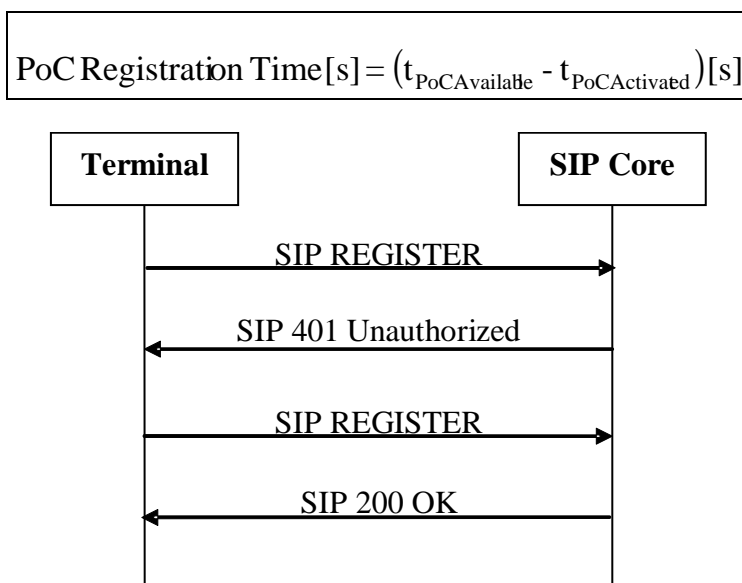

NOTE: This Figure shows an example of a successful PoC registration (see [16]). In contrast to Figure 13, the terminal answered correctly to the authentication challenge (the second "SIP REGISTER" message).

Figure 9: Successful PoC registration example

6.4.4.3 Trigger Points

Event from abstract equation	Trigger point from user's point of view	Technical description/protocol part
$t_{\text{PoCActivated}}$: Time of PoC registration attempt	Start: Activation of the PoC service on the terminal.	Start: Protocol: SIP. First data packet sent by the terminal containing a "SIP REGISTER" message.
$t_{\text{PoCAvailable}}$: Time of successful PoC registration attempt	Stop: PoC available is indicated.	Stop: Protocol: SIP. First data packet received containing a "SIP 200 OK" message.

6.4.5 PoC Publish Failure Ratio [%]

6.4.5.1 Abstract Definition

The PoC publish failure ratio is the probability that the terminal cannot successfully publish his PoC service settings to the PoC server, after the terminal is registered to the PoC service.

Remarks:

- To set, update or refresh the PoC service settings, the terminal generates a "SIP PUBLISH" request with XML MIME content according to rules and procedures of [17].
- The terminal shall be registered to the PoC service.
- PoC enabled user equipment may combine the PoC registration and the PoC publish request and may not give the user the possibility to do these actions separately.

6.4.5.2 Abstract Equation

$$\text{PoC Publish Failure Ratio [\%]} = \frac{\text{unsuccessful PoC publish attempts}}{\text{all PoC publish attempts}} \times 100$$

6.4.5.3 Trigger Points

Event from abstract equation	Trigger point from user's point of view	Technical description/protocol part
PoC publish attempt	Start: Attempt to publish the terminal's PoC service settings.	Start: Protocol: SIP. First data packet sent by the terminal containing a "SIP PUBLISH" message.
Successful PoC publish attempt	Stop: PoC service settings are published.	Stop: Protocol: SIP. First data packet received containing a "SIP 200 OK" message.
Unsuccessful PoC publish attempt	Stop: PoC service settings are not published.	Stop: Protocol: SIP Case 1: Data packet received by the terminal containing a message different to "SIP 200 OK". Case 2: No message received by the terminal within a pre-determined time.

6.4.6 PoC Publish Time [s]

6.4.6.1 Abstract Definition

The PoC publish time is the period of time that it takes to publish the terminal's PoC service settings to the PoC server.

Remarks:

- To set, update or refresh the PoC service settings, the terminal generates a "SIP PUBLISH" request with XML MIME content according to rules and procedures of [17].
- The terminal shall be registered to the PoC service.
- PoC enabled user equipment may combine the PoC registration and the PoC publish request and may not give the user the possibility to do these actions separately.

6.4.6.2 Abstract Equation

$$\text{PoC Publish Time [s]} = (t_{\text{PoCPublishEnd}} - t_{\text{PoCPublishStart}}) [\text{s}]$$

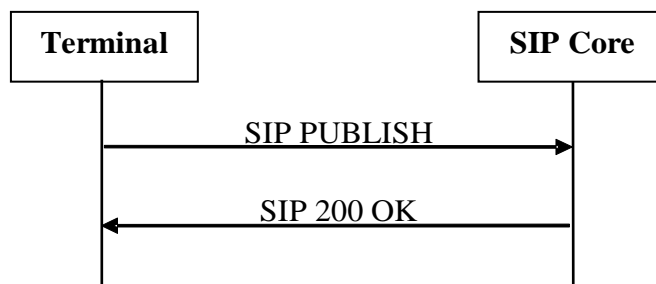

Figure 10: Example for a successful publish of PoC service settings

6.4.6.3 Trigger Points

Event from abstract equation	Trigger point from user's point of view	Technical description/protocol part
$t_{\text{PoCPublishStart}}$: Time of PoC publish attempt	Start: Attempt to publish the terminal's PoC service settings.	Start: Protocol: SIP. First data packet sent by the terminal containing a "SIP PUBLISH" message.
$t_{\text{PoCPublishEnd}}$: Time of successful PoC publish attempt	Stop: PoC service settings are published.	Stop: Protocol: SIP. First data packet received containing a "SIP 200 OK" message.

6.4.7 PoC Registration Failure Ratio (long) [%]

6.4.7.1 Abstract Definition

The PoC registration failure ratio (long) is the probability that the terminal cannot successfully be registered to the PoC service and publish his PoC service settings.

Remarks:

- This QoS parameter is a combination of the PoC registration parameter (see clause 6.4.3) and the PoC publish parameter (see clause 6.4.5). It ought to reflect the behaviour of PoC enabled user equipment that may do the PoC publish automatically after the PoC register.
- The terminal shall not be registered to the PoC service.

6.4.7.2 Abstract Equation

$$\text{PoCRegistrationFailureRatio(long)}[\%] = \frac{R + P}{\text{all PoC registration (long) attempts}} \times 100$$

6.4.7.3 Trigger Points

Event from abstract equation	Trigger point from user's point of view	Technical description/protocol part
PoC registration attempt	Start: Activation of the PoC service on the terminal.	Start: Protocol: SIP. First data packet sent by the terminal containing a "SIP REGISTER" message.
Successful PoC publish attempt	Stop: PoC service settings are published.	Stop: Protocol: SIP. First data packet received containing a "SIP 200 OK" message.
Unsuccessful PoC publish attempt	Stop: PoC service settings are not published.	Stop: Protocol: SIP Case 1: Data packet received by the terminal containing a message different to "SIP 200 OK". Case 2: No message received by the terminal within a pre-determined time.

6.4.8 PoC Registration Time (long) [s]

6.4.8.1 Abstract Definition

The PoC registration time (long) is the combined duration for a SIP registration and a SIP publish.

Remarks:

- This QoS parameter is a combination of the PoC registration parameter (see clause 6.4.3) and the PoC publish parameter (see clause 6.4.5). It ought to reflect the behaviour of PoC enabled user equipment that may do the PoC publish automatically after the PoC register.
- The terminal shall not be registered to the PoC service.

6.4.8.2 Abstract Equation

$$\text{PoC Registration Time (long) [s]} = (t_{\text{PoCPublishEnd}} - t_{\text{PoCActivated}}) [\text{s}]$$

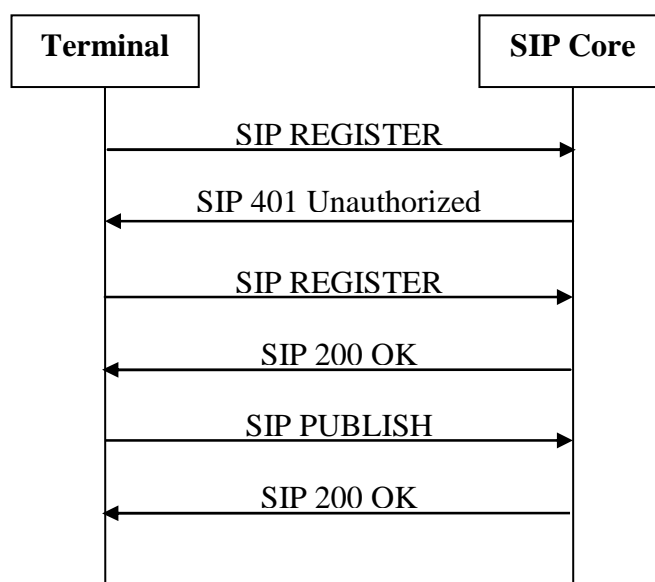

Figure 11: Example for a successful PoC Registration (long)

6.4.8.3 Trigger Points

Event from abstract equation	Trigger point from user's point of view	Technical description/protocol part
$t_{\text{PoCActivated}}$: Time of PoC registration attempt	Start: Activation of the PoC service on the terminal.	Start: Protocol: SIP. First data packet sent by the terminal containing a "SIP REGISTER" message.
$t_{\text{PoCPublishEnd}}$: Time of successful PoC publish attempt	Stop: PoC service settings are published.	Stop: Protocol: SIP. First data packet received containing a "SIP 200 OK" message.

6.4.9 PoC Session Initiation Failure Ratio (on-demand) [%]

6.4.9.1 Abstract Definition

The PoC session Initiation failure ratio (on-demand) is the probability that a PoC session cannot be successfully initiated. A PoC session is initiated when the user pushes the PoC button on the terminal (and thereby requests a talk burst) and is granted a talk burst (see Figure 12).

Remarks:

- The terminal notifies the user about the granted Talk Burst (e.g. by a "beep"-tone).
- There shall be at least one other participating terminal and the floor shall be idle. In particular, no other terminal shall create and send data packets containing speech data (RTP media stream).
- All terminals shall be registered to the PoC service and shall have successfully published their PoC service settings.
- There are different signal flows for confirmed and for unconfirmed invitations. In the confirmed case, at least one of the invited users has to accept the invitation to the PoC session in order to get the talk burst granted (see [16]). If the PoC server supports media buffering, the talk burst confirm is send after the first received auto-answer. This automatic answer mode shall be used for the measurements and media buffering shall not be supported. In both cases (confirmed and unconfirmed) the trigger points for the measurement are the same. Measurement data of confirmed and unconfirmed measurements cannot be directly compared.
- This parameter is applicable to different kinds of PoC session initiations, which has an impact on the comparability of the measurement data.
- The initial "SIP INVITE" message accepted by the PoC server is an implicit talk burst request.

6.4.9.2 Abstract Equation

$$\text{PoCSessionInitiationFailureRatio(on-demand)}[\%] = \frac{\text{unsuccessful PoC session initiations}}{\text{all PoC session initiations}} \times 100$$

6.4.9.3 Trigger Points

Event from abstract equation	Trigger point from user's point of view	Technical description/protocol part
PoC session initiation attempt	Start: PoC button is pushed.	Start: Protocol: SIP. First data packet sent by the terminal containing a "SIP INVITE" message.
Successful PoC session initiation attempt	Stop: Talk burst granted is indicated.	Stop: Protocol: RTCP:TBCP First data packet received by the terminal containing "RTCP:TBCP Talk Burst Granted".
Unsuccessful PoC session initiation attempt	Stop: Missing talk burst granted indication.	Stop: Protocol: SIP; RTCP:TBCP. Case 1: First data packet received by the terminal (after sending a "SIP INVITE" message) containing an error message or redirection message (e.g. a "403 Forbidden" or "488 Not Acceptable Here" message). Case 2: First data packet received by the terminal (after sending a "SIP INVITE" message and receiving a "SIP 200 OK" message) containing a message different to the "RTCP:TBCP Talk Burst Granted" message, e.g. "404 Not Found", "SIP 486 Busy Here" or "SIP 403 Forbidden" message. Case 3: No message received by the terminal within a pre-determined time.

6.4.10 PoC Session Initiation Time (on-demand) [s]

6.4.10.1 Abstract Definition

The PoC session initiation time (on-demand) is the time period between pushing the PoC button on the terminal in order to initiate a PoC session and being granted the talk burst, e.g. indicated by a "beep"-tone on the terminal.

Remarks:

- The terminal notifies the user about the granted talk burst (e.g. by a "beep"-tone).
- There shall be at least one other participating terminal and the floor shall be idle. In particular, no other terminal shall create and send data packets containing speech data (RTP media stream).
- All terminals shall be registered to the PoC service and shall have successfully published their PoC service settings.
- There are different signal flows for confirmed and for unconfirmed invitations. In the confirmed case, at least one of the invited users has to accept the invitation to the PoC session in order to get the talk burst granted (see [15]). If the PoC server supports media buffering, the talk burst confirm is send after the first received auto-answer. This automatic answer mode shall be used for the measurements and media buffering shall not be supported. In both cases (confirmed and unconfirmed) the trigger points for the measurement are the same. Measurement data of confirmed and unconfirmed measurements cannot be directly compared.
- This parameter is applicable to different kinds of PoC session initiations, which has an impact on the comparability of the measurement data.
- The initial "SIP INVITE" message accepted by the PoC server is an implicit talk burst request.

6.4.10.2 Abstract Equation

$$\text{PoC Session Initiation Time (on - demand) [s]} = (t_{\text{beep received}} - t_{\text{PoC button pressed}}) [\text{s}]$$

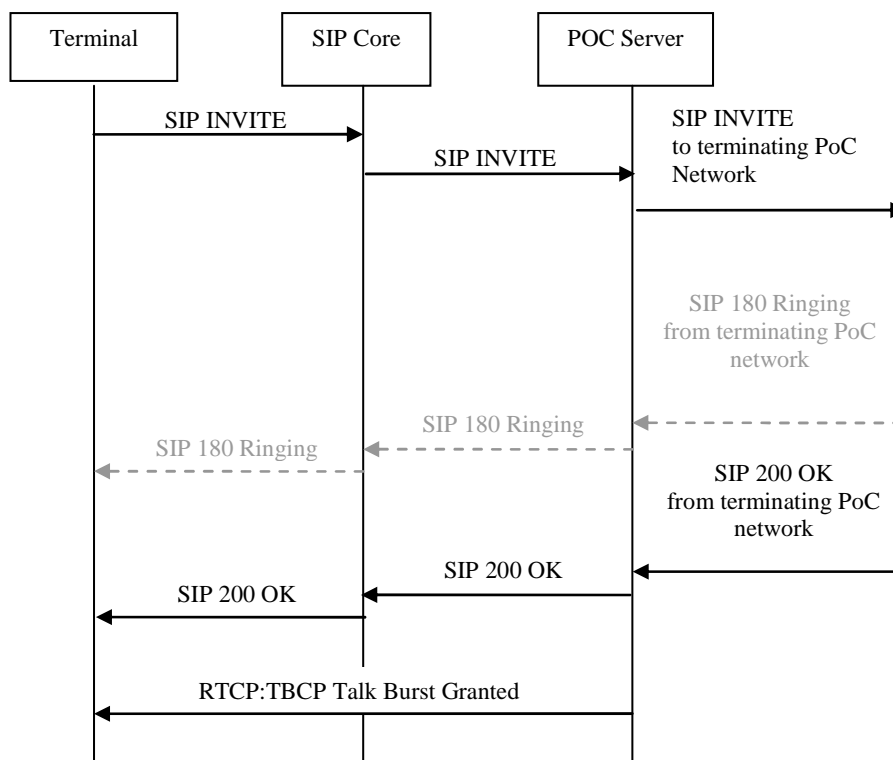

Figure 12: Implicit talk burst request procedure at the initiation of the PoC session

Remark:

- The dashed arrows in Figure 12 only occur in case of a confirmed invitation with manual answer. In this case the time that elapses between the "SIP INVITE" message and the reception of the "SIP 200 OK" message depends on how fast an invited user on the terminating side accepts the invitation.

6.4.10.3 Trigger Points

Event from abstract equation	Trigger point from user's point of view	Technical description/protocol part
$t_{\text{PoC button pressed}}$: Time of PoC session initiation attempt	Start: Push PoC button.	Start: Protocol: SIP. First data packet sent by the terminal containing a "SIP INVITE" message.
$t_{\text{beep received}}$: Time of successful PoC session initiation attempt	Stop: Talk burst granted is indicated.	Stop: Protocol: RTCP:TBCP First data packet received by the terminal containing "RTCP:TBCP Talk Burst Granted".

6.4.11 PoC Session Media Parameters Negotiation Failure Ratio (pre-established) [%]

6.4.11.1 Abstract Definition

The PoC session media parameters negotiation failure ratio (pre-established) is the probability that a negotiation procedure of media parameters for a posterior pre-established session cannot be successfully accomplished.

Remarks:

- The initial "SIP INVITE" message accepted by the PoC server is not an implicit talk burst request.
- All terminals shall be registered to the PoC service and shall have successfully published their PoC service settings.
- "The PoC server performing the controlling PoC function shall determine the codec(s) and media parameters that should be used in the PoC session. The preferred media parameters should be determined according to the lowest negotiated media parameters (e.g. bandwidth) of the terminals that have joined the PoC session (see [14], page 102)".
- "User plane adaptation may be triggered e.g. by roaming or when a new terminal with lower media parameters enters the PoC session (see [15], page 103)".

6.4.11.2 Abstract Equation

$$\text{PoC Session Media Parameters Negotiation Failure Ratio (pre - established) [\%]} = \frac{\text{unsuccessful negotiation attempts}}{\text{all negotiation attempts}} \times 100$$

6.4.11.3 Trigger Points

Event from abstract equation	Trigger point from user's point of view	Technical description/protocol part
PoC session media parameters negotiation attempt	Start: PoC terminal initiates media parameters negotiation.	Start: Protocol: SIP. First data packet sent by the terminal containing a "SIP INVITE" message with media parameters.
Successful PoC session media parameters negotiation attempt	Stop: Successful parameter negotiation indication.	Stop: Protocol: SIP. First "SIP Ack" data packet sent by the terminal after the reception of a "SIP OK" message.
Unsuccessful PoC session media parameters negotiation attempt	Stop: Media parameter negotiation is rejected or not indicated.	Stop: Protocol: SIP. Case 1: First data packet received by the terminal (after sending a "SIP INVITE" message and receiving a "SIP 100 TRYING" message) containing a message different to "SIP 200 OK"; e.g. a "SIP 403 Forbidden" or "SIP 488 Not Acceptable Here" message. Case 2: No message received by the terminal within a pre-determined time.

6.4.12 PoC Session Media Parameters Negotiation Time (pre-established) [s]

6.4.12.1 Abstract Definition

The PoC session media parameters negotiation time (pre-established) describes the time period needed to accomplish a successful negotiation of media parameters.

Remarks:

- The initial "SIP INVITE" message accepted by the PoC server is not an implicit talk burst request.
- All terminals shall be registered to the PoC service and shall have successfully published their PoC service settings.
- "The PoC server performing the controlling PoC function shall determine the codec(s) and media parameters that should be used in the PoC session. The preferred media parameters should be determined according to the lowest negotiated media parameters (e.g. bandwidth) of the terminals that have joined the PoC session (see [14], page 102)".
- "User plane adaptation may be triggered e.g. by roaming or when a new terminal with lower media parameters enters the PoC session (see [14], page 103)".

6.4.12.2 Abstract Equation

$$\text{PoCSessionMediaParametersNegotiationTime(pre-established)} [s] = (t_{\text{ok received}} - t_{\text{negotiation initiation}}) [s]$$

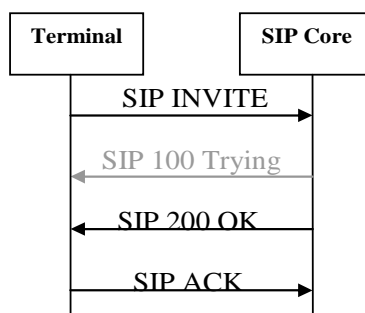

Figure 13: Media parameters negotiation for pre-established session

6.4.12.3 Trigger Points

Event from abstract equation	Trigger point from user's point of view	Technical description/protocol part
$t_{\text{negotiation initiation}}$: Time of PoC pre-established session media parameters negotiation attempt	Start: PoC terminal initiates media parameters negotiation.	Start: Protocol: SIP. First data packet sent by the terminal containing a "SIP INVITE" message with Media Parameters.
$T_{\text{ok received}}$: Time of successful PoC pre-established session media parameters negotiation attempt	Stop: Successful parameter negotiation indication.	Stop: Protocol: SIP. First "SIP Ack" data packet sent by the terminal after the reception of a "SIP OK" message.

6.4.13 PoC Session Initiation Failure Ratio (pre-established) [%]

6.4.13.1 Abstract Definition

The PoC session initiation failure ratio (pre-established) is the probability that a pre-established session cannot be successfully initiated. After the negotiation of media parameters, a pre-established session is initiated when the user pushes the PoC button on the terminal (and thereby requests the talk burst) and is granted the talk burst.

Remarks:

- The terminal notifies the user about the granted talk burst (e.g. by a "beep"-tone).
- The initial "SIP REFER" message accepted by the PoC server is an implicit talk burst request.
- There shall be at least one other participating terminal and the floor shall be idle. In particular, no other terminal shall create and send data packets containing speech data (RTP media stream).
- The terminals shall have negotiated the session media parameters with the PoC server.
- All terminals in the PoC session shall be configured to use the auto-answer mode procedure (see [16]).
- There are different signal flows for confirmed and for unconfirmed invitations. In the confirmed case, at least one of the invited users has to accept the invitation to the PoC session in order to get the talk burst granted. The terminals on the terminating side may be configured to confirm the invitation automatically. This auto-answer mode should be used for measurements. In both cases (confirmed and unconfirmed) the trigger points for the measurement are the same. Measurement data of confirmed and unconfirmed measurements cannot be directly compared.
- This parameter is applicable to different kinds of PoC session initiations, which has an impact on the comparability of the measurement data.

6.4.13.2 Abstract Equation

$$\text{PoC Session Initiation Failure Ratio (pre - established) [\%]} = \frac{\text{unsuccessful pre - established session initiation attempts}}{\text{all pre - established session initiation attempts}} \times 100$$

6.4.13.3 Trigger Points

Event from abstract equation	Trigger point from user's point of view	Technical description/protocol part
PoC session initiation attempt	Start: PoC button is pushed.	Start: Protocol: SIP. First data packet sent by the terminal containing a "SIP REFER" message with the PoC session URL.
Successful PoC session initiation attempt	Stop: Talk burst granted is indicated.	Stop: Protocol: RTCP:TBCP. First data packet received by the terminal containing "Talk Burst Granted" message.
Unsuccessful PoC session initiation attempt	Stop: Missing talk burst granted indication.	Stop: Protocol: SIP; RTCP:TBCP. Case 1: First data packet received by the terminal (after sending a "SIP REFER" message) containing a message different to the "SIP 202 Accepted" message. Case 2: Data packet received by the terminal (after sending a "SIP REFER" message and receiving a "SIP 202 Accepted" message) containing a message different to "SIP NOTIFY", "RTCP:TBCP Connect" or "RTCP:TBCP Talk Burst Granted" (e.g. "SIP 404 Not Found", "SIP 486 Busy Here" or "SIP 403 Forbidden" message). Case 3: No message received by the terminal within a pre-determined time.

6.4.14 PoC Session Initiation Time (pre-established) [s]

6.4.14.1 Abstract Definition

The PoC session initiation time (pre-established) is the time period between pushing the PoC button on the terminal in order to initiate a pre-established session and being granted the talk burst, e.g. indicated by a "beep"-tone on the terminal.

Remarks:

- The terminal notifies the user about the granted talk burst (e.g. by a "beep"-tone).
- The initial "SIP REFER" message accepted by the PoC server is an implicit talk burst request.
- There shall be at least one other participating terminal and the floor shall be idle. In particular, no other terminal shall create and send data packets containing speech data (RTP media stream).
- The terminals shall have negotiated the session media parameters with the PoC server.
- All terminals in the PoC session shall be configured to use the auto-answer mode procedure (see [16]).
- There are different signal flows for confirmed and for unconfirmed invitations. In the confirmed case, at least one of the invited users has to accept the invitation to the PoC session in order to get the talk burst granted. The terminals on the terminating side may be configured to confirm the invitation automatically. This auto-answer mode should be used for measurements. In both cases (confirmed and unconfirmed) the trigger points for the measurement are the same. Measurement data of confirmed and unconfirmed measurements cannot be directly compared.
- This parameter is applicable to different kinds of PoC session initiations, which has an impact on the comparability of the measurement data.

6.4.14.2 Abstract Equation

$$\text{PoC Session Initiation Time (pre - established) [s]} = (t_{\text{beep received}} - t_{\text{PoC button pressed}}) [\text{s}]$$

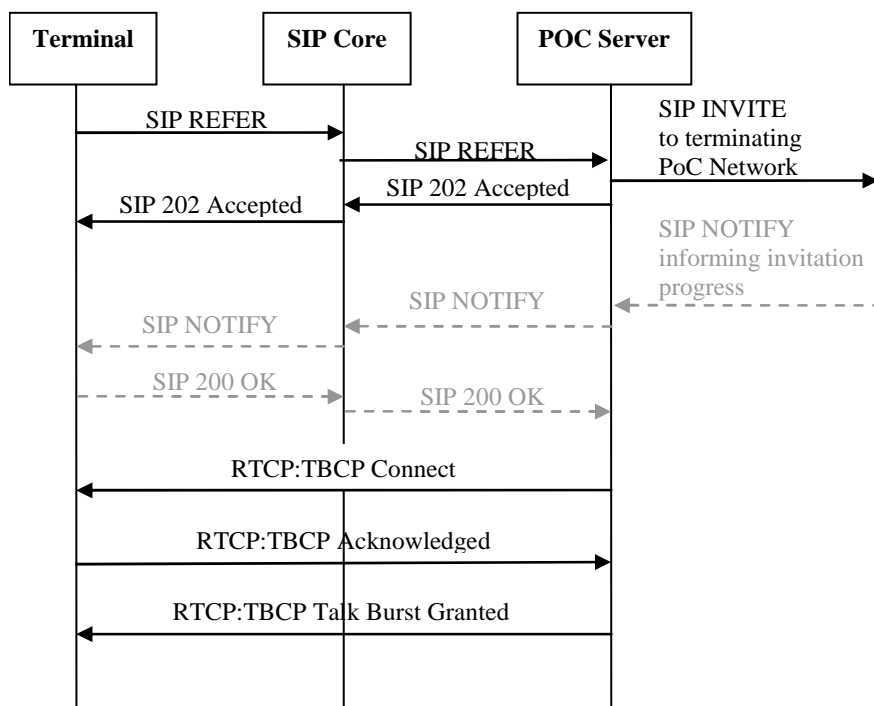

NOTE: The dashed arrows in this Figure only occur in case of a confirmed, manual answer invitation. In this case the time period between the "SIP INVITE" message and the reception of the "Talk Burst Granted" message depends on how fast an invited user on the terminating side answers to the invitation. Furthermore, the "SIP NOTIFY" message is defined as optional (see [15]) and might not be sent by the server at all. For this reason the automatic answer mode shall be used during measurements.

Figure 14: Talk burst request procedure of a pre-established PoC session

6.4.14.3 Trigger Points

Event from abstract equation	Trigger point from user's point of view	Technical description/protocol part
$t_{\text{PoC button pressed}}$: Time of PoC session initiation attempt	Start: Push PoC button.	Start: Protocol: SIP. First data packet sent by the terminal containing a "SIP REFER" message with the PoC session description.
$T_{\text{beep received}}$: Time of successful PoC session initiation attempt	Stop: Talk burst granted is indicated.	Stop: Protocol: RTCP:TBCP. First data packet received by the terminal containing "Talk Burst Granted" message.

6.4.15 PoC Session Setup Failure Ratio (on-demand) [%]

6.4.15.1 Abstract Definition

The PoC session setup failure ratio (on-demand) is the probability that a terminal cannot successfully register to the PoC service and initialize an on-demand session.

Remarks:

- This QoS parameter is a combination of the PoC registration parameter and the PoC session initiation parameter. It is ought to reflect the behaviour of PoC enabled user equipment.
- Data between confirmed and unconfirmed measurements cannot be compared directly.

6.4.15.2 Abstract Equation

Let R be the number of unsuccessful registration attempts and let S be the number of unsuccessful session initiations following a successful registration.

Then:

$$\text{PoCSessionSetupFailureRatio (on - demand) [\%]} = \frac{R + S}{\text{all PoC session setup attempts}} \times 100$$

6.4.15.3 Trigger Points

Event from abstract equation	Trigger point from user's point of view	Technical description/protocol part
PoC registration attempt	Start: Activation of the PoC service on the terminal.	Start: Protocol: SIP. First data packet sent by the terminal containing a "SIP REGISTER" message.
Successful PoC session initiation attempt	Stop: PoC available is indicated.	Stop: Protocol: RTCP:TBCP First data packet received by the terminal containing "RTCP:TBCP Talk Burst Granted".
Unsuccessful PoC session initiation attempt	Stop: Missing Talk Burst Granted indication.	Stop: Protocol: SIP; RTCP:TBCP. Case 1: First data packet received by the terminal (after sending a "SIP INVITE" message) containing an error message or redirection message (e.g. a "403 Forbidden" or "488 Not Acceptable Here" message). Case 2: First data packet received by the terminal (after sending a "SIP INVITE" message and receiving a "SIP 200 OK" message) containing a message different to the "RTCP:TBCP Talk Burst Granted" message, e.g. "404 Not Found", "SIP 486 Busy Here" or "SIP 403 Forbidden" message. Case 3: No message received by the terminal within a pre-determined time.

6.4.16 PoC Session Setup Failure Ratio (pre-established) [%]

6.4.16.1 Abstract Definition

The PoC session setup failure ratio (pre-established) is the probability that a terminal cannot successful register to the PoC service and initialize a pre-established session.

Remarks:

- This QoS parameter is a combination of the PoC registration parameter and the PoC session initiation parameter. It is ought to reflect the behaviour of PoC enabled user equipment.
- Data between confirmed and unconfirmed measurements cannot be compared directly.

6.4.16.2 Abstract Equation

Let R be the number of unsuccessful registration attempts and let S be the number of unsuccessful pre-established session media parameters negotiations following a successful registration. Let T be the number of unsuccessful session initiation attempts, which followed after a successful registration and after a successful pre-established session media parameters negotiation.

Then:

$$\text{PoC Session Setup Failure Ratio (pre - established) [\%]} = \frac{R + S + T}{\text{all PoC session setup attempts}} \times 100$$

6.4.16.3 Trigger Points

Event from abstract equation	Trigger point from user's point of view	Technical description/protocol part
PoC registration attempt	Start: Activation of the PoC service on the terminal.	Start: Protocol: SIP. First data packet sent by the terminal containing a "SIP REGISTER" message.
Successful PoC session initiation attempt	Stop: PoC available is indicated.	Stop: Protocol: RTCP:TBCP First data packet received by the terminal containing "RTCP:TBCP Talk Burst Granted".
Unsuccessful PoC session initiation attempt	Stop: Missing talk burst granted indication.	Stop: Protocol: SIP; RTCP:TBCP. Case 1: First data packet received by the terminal (after sending a "SIP REFER" message) containing a message different to the "SIP 202 Accepted" message. Case 2: Data packet received by the terminal (after sending a "SIP REFER" message and receiving a "SIP 202 Accepted" message) containing a message different to "SIP NOTIFY", "RTCP:TBCP Connect" or "RTCP:TBCP Talk Burst Granted" (e.g. "SIP 404 Not Found", "SIP 486 Busy Here" or "SIP 403 Forbidden" message). Case 3: No message received by the terminal within a pre-determined time.

6.4.17 PoC Session Setup Time [s]

6.4.17.1 Abstract Definition

The PoC session setup time is the time period for the registration to the PoC service plus the time period for the initiation of a PoC session.

Remarks:

- This QoS parameter is a combination of the PoC registration parameter and the PoC session initiation parameter. It is ought to reflect the behaviour of PoC enabled user equipment.
- Data between confirmed and unconfirmed measurements cannot be compared directly.
- Data between on-demand sessions and pre-established sessions cannot be compared directly.

6.4.17.2 Abstract Equation

$$\text{PoC Session Setup Time [s]} = (t_{\text{beep received}} - t_{\text{PoCActivated}}) [\text{s}]$$

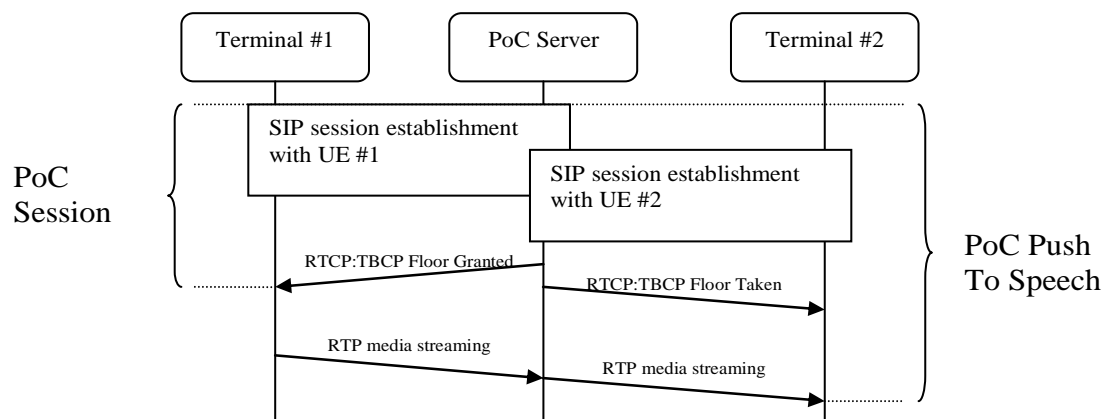

Figure 15: PoC session setup time and PoC push to speak time

6.4.17.3 Trigger Points

Event from abstract equation	Trigger point from user's point of view	Technical description/protocol part
$t_{\text{PoCActivated}}$: Time of PoC registration attempt	Start: Activation of the PoC service on the terminal.	Start: Protocol: SIP. First data packet sent by the terminal containing a "SIP REGISTER" message.
$T_{\text{beep received}}$: Time of successful PoC registration attempt	Stop: PoC available is indicated.	Stop: Protocol: RTCP:TBCP First data packet received by the terminal containing "RTCP:TBCP Talk Burst Granted".

6.4.18 PoC Push to Speak Failure Ratio [%]

6.4.18.1 Abstract Definition

The PoC Push to speak failure ratio is the probability that terminal A cannot successfully set up a PoC session and start with speech leading to no other terminal receiving speech.

Remarks:

- This QoS parameter is a combination of the PoC session setup parameter and the PoC talk burst cut-off parameter (see clause 6.4.30). It is ought to reflect the behaviour of PoC enabled user equipment.
- All terminals shall be registered to the PoC service and shall have successfully published their PoC service settings.
- Data between confirmed and unconfirmed measurements cannot be compared directly.

6.4.18.2 Abstract Equation

Let S be the number of unsuccessful PoC session setup attempts and let T be the number of talk burst cut-offs following a successful PoC session setup.

Then:

$$\text{PoC Push to Speak Failure Ratio [\%]} = \frac{S + T}{\text{all PoC push to speak attempts}} \times 100$$

6.4.18.3 Trigger Points

Event from abstract equation	Trigger point from user's point of view	Technical description/protocol part
PoC registration attempt	Start: Activation of the PoC service on the terminal.	Start: Protocol: SIP. First data packet sent by the terminal containing a "SIP REGISTER" message.
No unintended speech cut-off on terminal B	Stop: Sound received by terminal B.	Stop: Protocol: RTP. First data packet received by terminal B containing speech data.
Unintended speech cut-off on terminal B	Stop: Terminal B does not receive speech or does not receive the whole speech.	Stop: Protocol: RTP. Case 1: No packet containing speech data (RTP media stream) received by terminal B within a pre-determined time. The timeout should be chosen greater than the average speech delay (see clause 6.4.32). Case 2: The media stream is only partially received by terminal B. Some of the data packets containing speech data (RTP media stream) have not been received by terminal B.

6.4.19 PoC Push to Speak Time [s]

6.4.19.1 Abstract Definition

The PoC push to speak time is the period of time that it takes to setup a PoC session and start with speech in addition to the delay until terminal B receives the speech (as defined in clause 6.4.32).

Remarks:

- This QoS parameter is a combination of the PoC session setup time parameter and the PoC speech transmission delay parameter (see clause 6.4.32). It ought to reflect the behaviour of PoC enabled user equipment.
- All terminals shall be registered to the PoC service and shall have successfully published their PoC service settings.
- Data between confirmed and unconfirmed measurements cannot be compared directly.

6.4.19.2 Abstract Equation

$$\text{PoC Push to Speak Time [s]} = (t_{B_hears} - t_{\text{PoCActivated}})[s]$$

6.4.19.3 Trigger Points

Event from abstract equation	Trigger point from user's point of view	Technical description/protocol part
$t_{\text{PoCActivated}}$: Time of PoC registration attempt	Start: Activation of the PoC service on the terminal.	Start: Protocol: SIP. First data packet sent by the terminal containing a "SIP REGISTER" message.
$t_{\text{B_hears}}$: Time of output at terminal B	Stop: Sound received by terminal B.	Stop: Protocol: RTP. First data packet received by terminal B containing speech data.

6.4.20 PoC Session Leaving Failure Ratio (on-demand) [%]

6.4.20.1 Abstract Definition

The PoC session leaving failure ratio (on-demand) is the probability that the user cannot leave the PoC session he is participating.

Remarks:

- When a PoC session is left, the terminal is still registered to the PoC service.
- PoC enabled user equipment may not give the user the possibility to leave a PoC session explicitly. The PoC session leave request may only be sent when the terminal deregisters from the PoC service.
- The terminal shall be registered to the PoC service participating in a PoC session.

6.4.20.2 Abstract Equation

$$\text{PoC Session Leaving Failure Ratio (on - demand) [\%]} = \frac{\text{unsuccessful PoC session leaving attempts}}{\text{all PoC session leaving attempts}} \times 100$$

6.4.20.3 Trigger Points

Event from abstract equation	Trigger point from user's point of view	Technical description/protocol part
PoC session leaving attempt	Start: Leaving the participating PoC session.	Start: Protocol: SIP. First data packet sent by the terminal containing a "SIP BYE" message.
Successful PoC session leaving attempt	Stop: PoC session left is indicated.	Stop: Protocol: SIP. First data packet received by the terminal containing a "SIP 200 OK" message.
Unsuccessful PoC session leaving attempt	Stop: Terminal is still connected to the PoC session.	Stop: Protocol: SIP. Case 1: First data packet received by the terminal (after sending the "SIP BYE" message) containing a message different to "SIP 200 OK". Case 2: No message received by the terminal within a pre-determined time.

6.4.21 PoC Session Leaving Time (on-demand) [s]

6.4.21.1 Abstract Definition

The PoC session leaving time (on-demand) is the time period between sending the on-demand session leaving request and being disconnected from the on-demand session.

Remarks:

- When a PoC session is left, the terminal is still registered to the PoC service.
- PoC enabled user equipment may not give the user the possibility to leave a PoC session explicitly. The PoC session leave request may only be sent when the terminal de-registers from the PoC service.
- The terminal shall be registered to the PoC service participating in a PoC session.

6.4.21.2 Abstract Equation

$$\text{PoC Session Leaving Time (on - demand) [s]} = (t_{\text{session left}} - t_{\text{session leave request}}) [\text{s}]$$

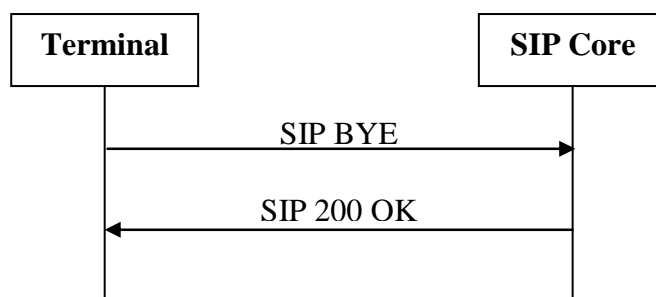

Figure 16: Successful PoC session leaving

6.4.21.3 Trigger Points

Event from abstract equation	Trigger point from user's point of view	Technical description/protocol part
$t_{\text{session leave request}}$: Time of PoC session leaving attempt	Start: Leaving the participating PoC session.	Start: Protocol: SIP. First data packet sent by the terminal containing a "SIP BYE" message.
$T_{\text{session left}}$: Time of successful PoC session leaving attempt	Stop: PoC session left is indicated.	Stop: Protocol: SIP. First data packet received by the terminal containing a "SIP 200 OK" message.

6.4.22 PoC Session Leaving Failure Ratio (pre-established) [%]

6.4.22.1 Abstract Definition

The PoC session leaving failure ratio (pre-established) is the probability that the user cannot leave the PoC pre-established session he is participating.

Remarks:

- The PoC session was established using pre-established signalling.
- The terminal may not give the user the possibility to leave a PoC session explicitly. The PoC session leave request may only be sent when the terminal deregisters from the PoC service.

6.4.22.2 Abstract Equation

$$\text{PoC Session Leaving Failure Ratio (pre - established) [\%]} = \frac{\text{unsuccessful PoC session leaving attempts}}{\text{all PoC session leaving attempts}} \times 100$$

6.4.22.3 Trigger Points

Event from abstract equation	Trigger point from user's point of view	Technical description/protocol part
PoC session leaving attempt	Start: Leaving the participating PoC session.	Start: Protocol: SIP. First data packet sent by the terminal containing a "SIP REFER BYE" message.
Successful PoC session leaving attempt	Stop: Terminal has successfully left the PoC session.	Stop: Protocol: SIP. First data packet received by the terminal containing a "SIP 202 ACCEPTED" message.
Unsuccessful PoC session leaving attempt	Stop: Terminal is still connected to the PoC session.	Stop: Protocol: SIP Case 1: First data packet received by the terminal (after sending the "SIP REFER BYE" message) containing a message different to "SIP 202 Accepted". Case 3: No message received by the terminal within a pre-determined time.

6.4.23 PoC Session Leaving Time (pre-established) [s]

6.4.23.1 Abstract Definition

The PoC session leaving time (pre-established) is the time period between sending the PoC session leaving request and being disconnected from the Pre-established session.

Remarks:

- The PoC session was established using Pre-established signalling.
- The terminal may not give the user the possibility to leave a PoC session explicitly. The PoC session leave request may only be sent when the terminal deregisters from the PoC service.

6.4.23.2 Abstract Equation

$$\text{PoC Session Leaving Time (pre - established) [s]} = (t_{\text{session left}} - t_{\text{session leave request}}) [\text{s}]$$

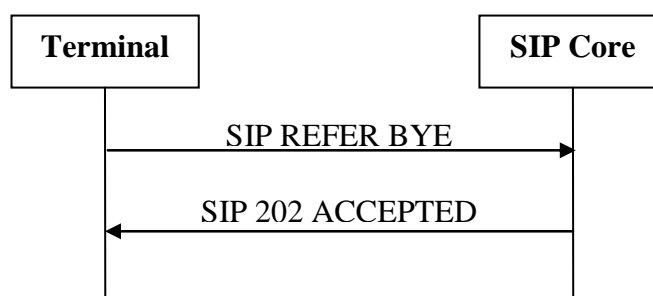

Figure 17: Successful PoC session leaving (Pre-established session)

6.4.23.3 Trigger Points

Event from abstract equation	Trigger point from user's point of view	Technical description/protocol part
$t_{\text{session leave request}}$: Time of PoC session leaving attempt	Start: Leaving the participating PoC session.	Start: Protocol: SIP. First data packet sent by the terminal containing a "SIP REFER BYE" message.
$T_{\text{session left}}$: Time of successful PoC session leaving attempt	Stop: Terminal has successfully left the PoC session.	Stop: Protocol: SIP. First data packet received by the terminal containing a "SIP 202 ACCEPTED" message.

6.4.24 PoC Deregistration Failure Ratio [%]

6.4.24.1 Abstract Definition

The PoC deregistration failure ratio is the probability that the user cannot be deregistered from the Push to Talk over Cellular service when requested.

Remark:

- The terminal shall be registered to the PoC service.

6.4.24.2 Abstract Equation

$$\text{PoC Deregistration Failure Ratio [\%]} = \frac{\text{unsuccessful PoC deregistration attempts}}{\text{all PoC deregistration attempts}} \times 100$$

6.4.24.3 Trigger Points

Event from abstract equation	Trigger point from user's point of view	Technical description/protocol part
PoC deregistration attempt	Start: Deactivation of the PoC service on the terminal.	Start: Protocol: SIP. First data packet sent by the terminal containing a "SIP Register" message, where the "Expires" header is set to 0.
Successful PoC deregistration attempt	Stop: PoC unavailable is indicated.	Stop: Protocol: SIP. First data packet received by the terminal containing a "SIP 200 OK" message.
Unsuccessful PoC deregistration attempt	Stop: PoC unavailable indication is not given within a predetermined time.	Stop: Protocol: SIP. Case 1: First data packet received by the terminal (after sending the second "SIP REGISTER" message) containing a message different to "SIP 200 OK". Case 2: No message received by the terminal within a pre-determined time.

6.4.25 PoC Deregistration Time [s]

6.4.25.1 Abstract Definition

The PoC deregistration time is the time period between the deregistration request and the successful deregistration from the PoC service.

Remark:

- The terminal shall be registered to the PoC service.

6.4.25.2 Abstract Equation

$$\text{PoC Deregistration Time [s]} = (t_{\text{PoC deregistered}} - t_{\text{deregistration request}}) [\text{s}]$$

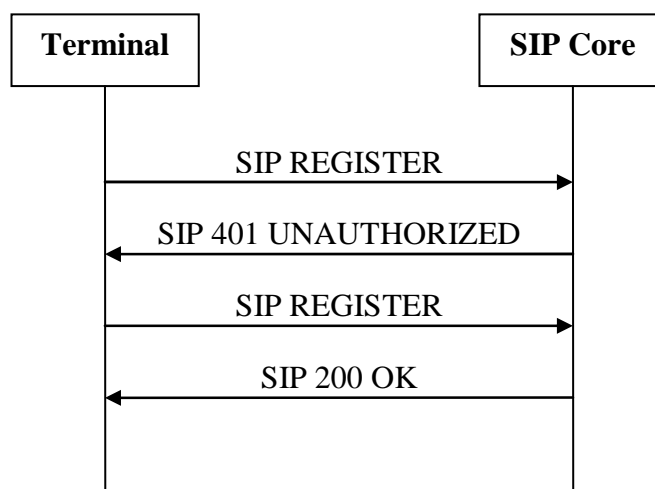

Figure 18: Successful PoC deregistration example

6.4.25.3 Trigger Points

Event from abstract equation	Trigger point from user's point of view	Technical description/protocol part
$t_{\text{deregistration request}}$: Time of PoC deregistration attempt	Start: Deactivation of the PoC service on the terminal.	Start: Protocol: SIP. First data packet sent by the terminal containing a "SIP Register" message, where the "Expires" header is set to 0.
$t_{\text{PoC deregistered}}$: Time of successful PoC deregistration attempt	Stop: PoC unavailable is indicated.	Stop: Protocol: SIP. First data packet received by the terminal containing a "SIP 200 OK" message.

6.4.26 PoC Busy Floor Response Failure Ratio [%]

6.4.26.1 Abstract Definition

The PoC busy floor response failure ratio is the probability that, once in a PoC session, the talk burst request from the terminal fails.

Remarks:

- The terminal shall be within an active PoC talk session. Thus, there shall be at least one other participating terminal.
- For the special case of requesting the idle floor, there are defined further QoS parameters (see clauses 6.4.28 and 6.4.29).

6.4.26.2 Abstract Equation

$$\text{PoC Busy Floor Response Failure Ratio [\%]} = \frac{\text{unsuccessful talk burst requests}}{\text{all talk burst requests}} \times 100$$

6.4.26.3 Trigger Points

Event from abstract equation	Trigger point from user's point of view	Technical description/protocol part
PoC talk burst request	Start: Push PoC button.	Start: Protocol: RTCP:TBCP. First data packet sent by the terminal containing a "RTCP:TBCP Talk Burst Request" message.
Successful PoC talk burst request	Stop: Current floor state is indicated.	Stop: Protocol: RTCP:TBCP. First data packet received by the terminal containing information about the floor state.
Unsuccessful PoC talk burst request	Stop: No talk burst response is indicated (e.g. grant, queued).	Stop: Protocol: RTCP:TBCP. No message received by the terminal within a pre-determined time.

6.4.27 PoC Busy Floor Response Time [s]

6.4.27.1 Abstract Definition

The PoC busy floor response time is the time period between requesting the talk burst and receiving the indication the floor is busy within an already established PoC session.

Remarks:

- The terminal shall be within an active PoC talk session. Thus, there shall be at least one other participating terminal.
- For the special case of requesting the idle floor, there are defined further QoS parameters (see clauses 6.4.28 and 6.4.29).

6.4.27.2 Abstract Equation

$$\text{PoCBusyFloorResponseTime[s]} = (t_{\text{floorresponse}} - t_{\text{floorrequest}})[\text{s}]$$

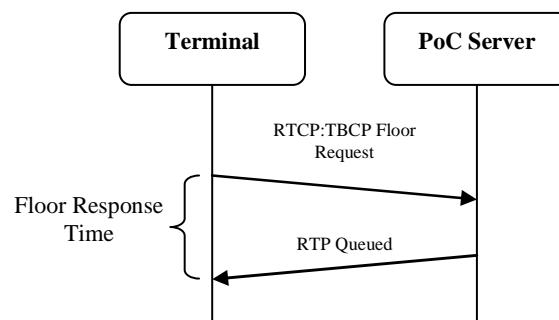

Figure 19: Example for a busy floor response

6.4.27.3 Trigger Points

Event from abstract equation	Trigger point from user's point of view	Technical description/protocol part
$t_{\text{floor request}}$: Time of PoC talk burst request	Start: Push PoC button.	Start: Protocol: RTCP:TBCP. First data packet sent by the terminal containing a "RTCP:TBCP Talk Burst Request" message.
$T_{\text{floor response}}$: Time of successful PoC talk burst request	Stop: Current floor state is indicated.	Stop: Protocol: RTCP:TBCP. First data packet received by the terminal containing information about the floor state.

6.4.28 PoC Talk Burst Request Failure Ratio [%]

6.4.28.1 Abstract Definition

The PoC talk burst request failure ratio is the probability that, once in a PoC session, the terminal's request of the idle floor fails.

Remarks:

- The terminal shall be within an active PoC session.
- There shall be at least one other participating terminal and the floor shall be idle. In particular, no other terminal shall create and send data packets containing speech data (RTP media stream).
- This parameter is defined explicitly because the server's response time and failure ratio to a request of the idle floor may be different to the response time and response failure ratio of a busy floor.

6.4.28.2 Abstract Equation

$$\text{PoC Talk Burst Request Failure Ratio [\%]} = \frac{\text{unsuccessful talk burst requests}}{\text{all talk burst requests}} \times 100$$

6.4.28.3 Trigger Points

Event from abstract equation	Trigger point from user's point of view	Technical description/protocol part
PoC talk burst request	Start: Push PoC button.	Start: Protocol: RTCP:TBCP. First data packet sent by the terminal containing a "RTCP:TBCP Talk Burst Request" message.
Successful PoC talk burst request	Stop: Talk burst granted is indicated.	Stop: Protocol: RTCP:TBCP. First data packet received by the terminal containing a "RTCP:TBCP Talk Burst Granted" message.
Unsuccessful PoC talk burst request	Stop: Talk burst granted is not indicated.	Stop: Protocol: RTCP:TBCP. Case 1: First data packet received by the terminal containing a floor state different to "RTCP:TBCP Talk Burst Granted". Possible floor states are listed in [14]. Case 2: No message received by the terminal within a predetermined time.

6.4.29 PoC Talk Burst Request Time [s]

6.4.29.1 Abstract Definition

The PoC talk burst request time is the time period between requesting the talk burst and being granted the previously idle floor within an already established PoC session.

Remarks:

- The terminal shall be within an active PoC session.
- There shall be at least one other participating terminal and the floor shall be idle. In particular, no other terminal shall create and send data packets containing speech data (RTP media stream).
- This parameter is defined explicitly because the server's response time and failure ratio to a request of the idle floor may be different to the response time and response failure ratio of a busy floor.

6.4.29.2 Abstract Equation

$$\text{PoCTalkBurstRequestTime [s]} = (t_{\text{floorgranted}} - t_{\text{floorrequest}}) [\text{s}] \quad [14]$$

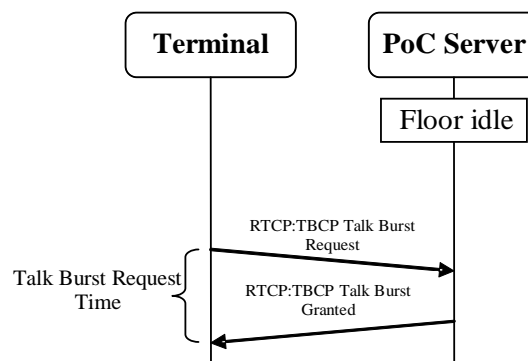

Figure 20: Example for a successful talk burst request

6.4.29.3 Trigger Points

Event from abstract equation	Trigger point from user's point of view	Technical description/protocol part
$t_{\text{floor request}}$: Time of PoC talk burst request	Start: Push PoC button.	Start: Protocol: RTCP:TBCP. First data packet sent by the terminal containing a "RTCP:TBCP Talk Burst Request" message.
$T_{\text{floor granted}}$: Time of successful PoC talk burst request	Stop: Talk burst granted is indicated.	Stop: Protocol: RTCP:TBCP. First data packet received by the terminal containing a "RTCP:TBCP Talk Burst Granted" message.

6.4.30 PoC Talk Burst Cut-off Ratio [%]

6.4.30.1 Abstract Definition

The PoC talk burst cut-off ratio is the probability that the terminal on the originating side (terminal A) has the floor and creates and sends data packets containing speech data (RTP media stream), but the stream does not arrive (or arrives only partly) at the terminating side (terminal B).

Remarks:

- There shall be at least one other active participating terminal and the floor shall be granted to terminal A. In particular, no other terminal shall create and send data packets containing speech data (RTP media stream).
- The implementation of a stop-talking timer is mandatory on the server side. When a user is granted a talk burst, the PoC server resets this stop-talking timer. When the timer expires, the PoC server revokes the talk burst from the user (see [14]). Hence this situation (talk burst revoked because of a timeout) shall not be considered for measurements.
- The time of a talk burst shall be shorter than the network-defined stop-talking timeout.

6.4.30.2 Abstract Equation

$$\text{PoCTalk Burst Cut-off Ratio}[\%] = \frac{\text{dropped talk bursts}}{\text{all talk bursts}} \times 100$$

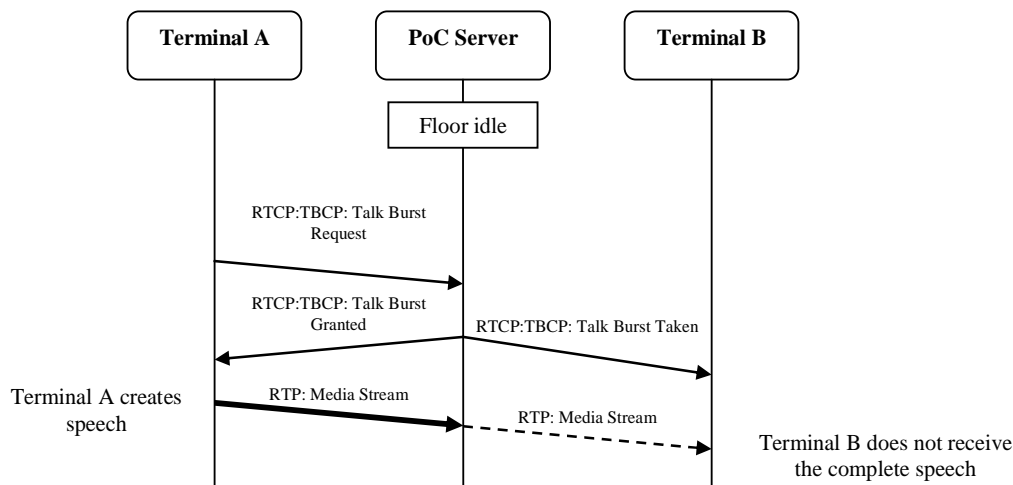

Figure 21: PoC talk burst cut-off

6.4.30.3 Trigger Points

Event from abstract equation	Trigger point from user's point of view	Technical description/protocol part
PoC talk burst granted and start of speech on terminal A	Start: Talk burst granted is indicated. Speech starts.	Start: Protocol: RTP. First data packet sent by terminal A containing speech data.
No unintended speech cut-off on terminal B	Stop: Sound received by terminal B.	Stop: Protocol: RTP. First data packet received by terminal B containing speech data.
Unintended speech cut-off on terminal B	Stop: Terminal B does not receive speech or does not receive the whole speech.	Stop: Protocol: RTP. Case 1: No packet containing speech data (RTP media stream) received by terminal B within a pre-determined time. The timeout should be chosen greater than the average speech delay (see clause 6.4.32). Case 2: The media stream is only partially received by terminal B. Some of the data packets containing speech data (RTP media stream) have not been received by terminal B.

6.4.31 PoC Talk Burst Packet Drop Ratio [%]

6.4.31.1 Abstract Definition

The PoC talk burst packet drop ratio is the ratio between the number of data packets containing speech data sent by the terminal on the originating side (terminal A) and the number of data packets containing speech data received on the terminating side (terminal B).

Remarks:

- There shall be at least one other active participating terminal and the floor shall be granted to terminal A. In particular, no other terminal shall create and send data packets containing speech data (RTP media stream).

- The implementation of a stop-talking timer is mandatory on the server side. When a user is granted a Talk Burst, the PoC server resets this stop-talking timer. When the timer expires, the PoC server revokes the talk burst from the user (see [14]). Hence this situation (talk burst revoked because of a timeout) shall not be considered for measurements.
- The time of a talk burst shall be shorter than the network-defined stop-talking timeout.

This ratio shall get calculated on a per-burst basis.

6.4.31.2 Abstract Equation

$$\text{PoC Talk Burst Packet Drop Ratio}[\%] = \frac{\text{dropped RTP speech packets}}{\text{all sent RTP speech packets}} \times 100$$

6.4.31.3 Trigger Points

Event from abstract equation	Trigger point from user's point of view	Technical description/protocol part
PoC talk burst granted and start of speech on terminal A	Start: Talk burst granted is indicated. Speech starts.	Stop: Protocol: RTP. First data packet sent by terminal A containing speech data.
End of speech on terminal B	Stop: End of speech is indicated or timeout occurred after terminal B has received speech.	Stop: Protocol: RTP. Case 1: First packet received by the terminal containing a "RTP: Last Packet" message after a data packet containing speech data has been received by terminal B. Case 2: No packet containing a "RTP: Last Packet" message received by terminal B within a pre-determined time after a data packet containing speech data has been received by terminal B.

6.4.32 PoC Voice Transmission Delay (first) [s]

6.4.32.1 Abstract Definition

The parameter PoC speech transmission delay (first) describes the period of time between a terminal sending speech data (RTP media stream) and the first terminal receiving the speech data for the first talk burst after a PoC session has been established successfully.

Remarks:

- Without loss of generality, the PoC session consists only of two active terminals (A and B) and terminal A is trying to create and send data packets containing speech data (RTP media stream). Thus, terminal B is the one who should receive the corresponding RTP media stream.
- Server side buffering has a high impact on measurement results. Depending on the configuration of the server, the PoC speech transmission delay (first) might in fact just describe the transmission delay between the server and terminal B. To avoid buffering at server side, confirmed indication shall be used.
- Terminal A shall create an RTP media stream immediately after being granted the talk burst.
- This parameter is measured on the transport layer. Thus the measured value may be smaller than the real user perceived speech delay. The perceived delay also depends on the encoding/decoding speed of the terminals.

6.4.32.2 Abstract Equation

$$\text{PoC Voice Transmission Delay}(\text{first})[\text{s}] = (t_{\text{B_hears}} - t_{\text{A_speaks}})[\text{s}]$$

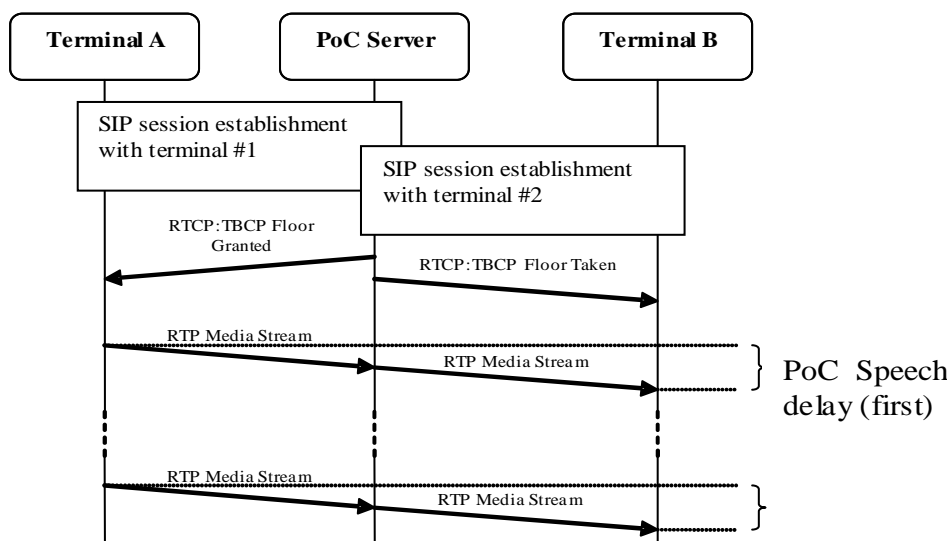

Figure 22: PoC speech transmission delay (first) and PoC speech transmission delay (others)

6.4.32.3 Trigger Points

Event from abstract equation	Trigger point from user's point of view	Technical description/protocol part
$t_{\text{A_speaks}}$: Time of input at terminal A	Start: Terminal A got the talk burst granted and creates an RTP media stream (starts talking).	Start: Protocol: RTP. First data packet sent by terminal A containing speech data.
$t_{\text{B_hears}}$: Time of output at terminal B	Stop: Sound received by terminal B.	Stop: Protocol: RTP. First data packet received by terminal B containing speech data.

6.4.33 PoC Speech Transmission Delay (others) [s]

6.4.33.1 Abstract Definition

The parameter PoC speech transmission delay (others) describes the period of time between a terminal sending speech data (RTP media stream) and the first terminal receiving the speech data (within an already established PoC session).

Remarks:

- Without loss of generality, the PoC session consists only of two active terminals (A and B) and terminal A is trying to create and send data packets containing speech data (RTP media stream). Thus, terminal B is the one who should receive the corresponding RTP media stream.
- Server side buffering has a high impact on measurement results. Depending on the configuration of the server, the PoC speech transmission delay (first) might in fact just describe the transmission delay between the server and terminal B. To avoid buffering at server side, confirmed indication shall be used.
- Terminal A shall create an RTP media stream immediately after being granted the talk burst.

- This parameter is measured on the transport layer. Thus the measured value may be smaller than the real user perceived speech delay. The perceived delay also depends on the encoding/decoding speed of the terminals.
- The speech delays on the terminating site depend on where the terminals are located (e.g. in another cell or another network).

6.4.33.2 Abstract Equation

$$\text{PoC Voice Transmission Delay (others)}[s] = (t_{B_hears} - t_{A_speaks})[s]$$

6.4.33.3 Trigger Points

Event from abstract equation	Trigger point from user's point of view	Technical description/protocol part
t_{A_speaks} : Time of input at terminal A	Start: Terminal A got the talk burst granted and creates an RTP media stream (starts talking).	Start: Protocol: RTP. First data packet sent by terminal A containing speech data.
t_{B_hears} : Time of output at terminal B	Stop: Sound received at terminal B.	Stop: Protocol: RTP. First data packet received by terminal B containing speech data.

6.4.34 PoC Speech Quality

To be defined.

6.4.35 Group Management QoS Parameter

To be defined.

6.4.36 Group Document related QoS Parameter

To be defined.

6.4.37 Instant Message QoS Parameter

To be defined.

6.5 Streaming Video

6.5.1 Definitions

6.5.1.1 Streaming Session or Session

IETF RFC 2326 [8] defines a session as "a complete RTSP "transaction", e.g. the viewing of a movie. A session typically consists of a client setting up a transport mechanism for the continuous media stream (SETUP), starting the stream with PLAY or RECORD, and closing the stream with TEARDOWN".

Referring to Figure 23 this means that the session starts at (B) and stops at (G).

6.5.2 Prerequisites

Precondition	Covered by	Reference document	Comment
Network Accessibility given	Network Accessibility Indicator		
PDP context activated			

6.5.3 Streaming Scenarios

The following two clauses describe different streaming scenarios. The first one is a generic approach in order to understand the main principles and identify the relevant protocols and communication procedures.

6.5.3.1 Generic Streaming Signalling Flow

A generic signal flow description for streaming is shown in Figure 23. The client communicates with the web server and media server entities and uses different protocols during the complete procedure, e.g. RTP, RTSP, RTCP, HTTP, etc.

The next table gives a basic description of the protocols and their usage.

Protocol	Reference in Figure 23	Description
HTTP	A	Used for the retrieval of the streaming file description data.
RTSP	B,C,F,G	RTSP is an application-level protocol. It provides different methods for the control of real-time data, e.g. audio/video (see note 1).
RTP	D	RTP is used for the transmission of real-time data, e.g. audio/video (see note 2).
RTCP	E	RTCP is the control protocol for RTP. Its main function is the provision of a quality feedback.

NOTE 1: RTSP is not responsible for the delivery of the data, this is done by RTP.
NOTE 2: RTP is only used for the delivery of the data. No control and/or QoS are included.

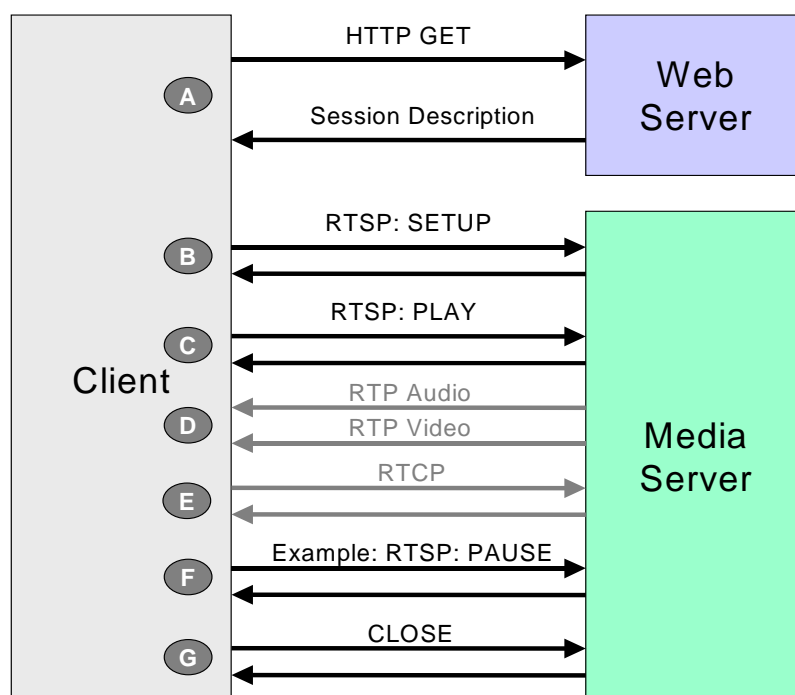

Figure 23: Generic session signalling flow, based on Schulzrinne

Referring to Figure 23 and the definition of a session in clause 6.5.1.1 it is possible to divide the communication of the client with the server side in two phases:

- In the first phase the client communicates with the web server in order to get a description of the file to be streamed. The used protocol is HTTP. Starting point is (A) and ending point is (B).
- In the second phase starts the communication with the media server which is finally delivering the stream. This means that the session starts at (B) and stops at (G). Different protocols are used in this phase (RTSP, RTP, RTCP, etc.).

6.5.3.2 Parameter Overview Chart

Figure 24 gives an overview of the defined QoS parameters with their trigger points from user's point of view.

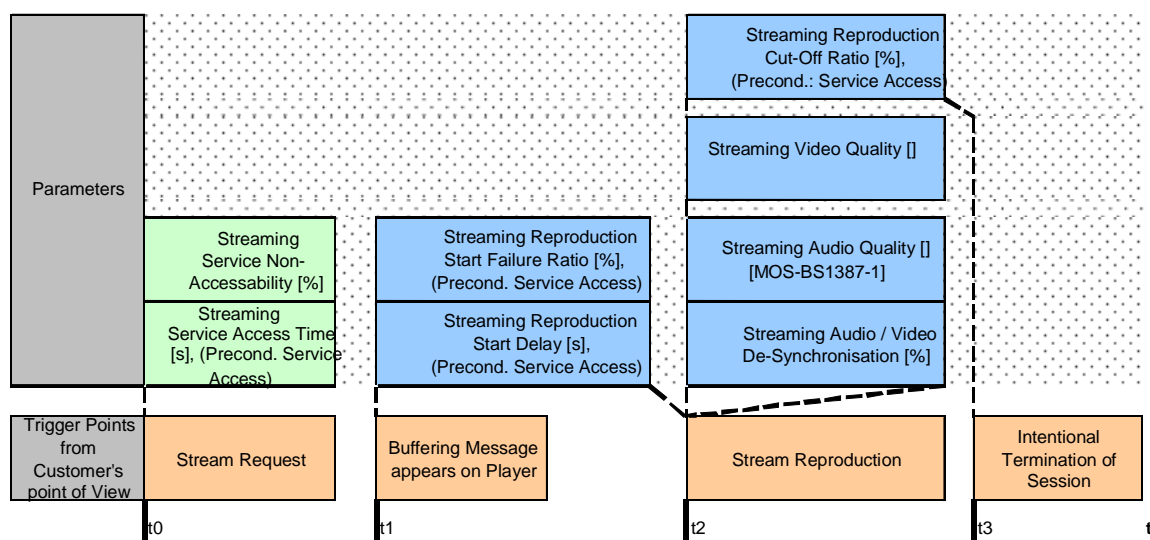

Figure 24: Parameter overview with trigger points

6.5.4 Streaming Service Non-Accessibility [%]

6.5.4.1 Abstract Definition

The parameter Streaming Service Non-Accessibility describes the probability that the first data packet of the stream cannot be received by the UE when requested by the user. The "packet reception" is completed by appearance of the "buffering" message on the player at user side.

The first data packet refers to RTP protocol.

6.5.4.2 Abstract Equation

$$\text{Streaming Service Non - Accessibility [\%]} = \frac{\text{unsuccessful stream request attempts}}{\text{all stream request attempts}} \times 100$$

6.5.4.3 Trigger Points

Event from abstract equation	Trigger point from user's point of view	Technical description/protocol part
Service access attempt	Start: Stream request.	Start: <ul style="list-style-type: none"> WAP 1.x, WAP 2.x: WSP Disconnect; WAP 2.x: TCP SYN towards streaming platform.
Successful attempt	Stop: "Buffering" message.	Stop: Reception of first data packet.
Unsuccessful attempt	Stop trigger point not reached.	

6.5.5 Streaming Service Access Time [s]

6.5.5.1 Abstract Definition

The parameter Streaming Service Access Time describes the duration of a service access from requesting the stream at the portal until the reception of the first stream data packet at the UE.

The first data packet refers to RTP protocol.

6.5.5.2 Abstract Equation

$$\text{StreamingServiceAccessTime [s]} = (t_{\text{reception of first data packet}} - t_{\text{stream request}}) [\text{s}]$$

6.5.5.3 Trigger Points

Event from abstract equation	Trigger point from user's point of view	Technical description/protocol part
$t_{\text{stream request}}$: Time when stream is requested	Start: Stream request.	Start: <ul style="list-style-type: none"> WAP 1.x, WAP 2.x: WSP Disconnect; WAP 2.x: TCP SYN towards streaming platform.
$T_{\text{reception of first data packet}}$: Time when first data packet is received	Start: "Buffering" message.	Stop: Reception of first data packet.

6.5.6 Streaming Reproduction Cut-off Ratio [%]

6.5.6.1 Abstract Definition

The parameter Streaming Reproduction Cut-off Ratio describes the probability that a successfully started stream reproduction is ended by a cause other than the intentional termination by the user.

6.5.6.2 Abstract Equation

$$\text{Streaming Reproduction Cut - off Ratio [\%]} = \frac{\text{unintentionally terminated stream reproductions}}{\text{all successfully started stream reproductions}} \times 100$$

6.5.6.3 Trigger Points

Event from abstract equation	Trigger point from user's point of view	Technical description/protocol part
Successfully started media streaming reproduction	Start: Stream reproduction starts.	Start: Streaming player signals the start of the stream reproduction.
Intentional terminated streaming reproduction	Stop: User presses the "Exit" button or end of stream is reached.	Stop: RTSP Teardown method sent by UE and reception of confirmation "RTSP 200 OK" from media server.
Unintentional terminated streaming reproduction	Stop trigger point not reached.	
NOTE: Not all players may signal the reproduction start.		

Some players do not send this TEARDOWN command at the end of the stream but a PAUSE command or in some cases nothing at all. On the server side a logic can then identify the status of the streams/clients.

Used players should send the RTSP:TEARDOWN command in order to give a stable trigger point for measurements.

6.5.7 Streaming Audio Quality

6.5.7.1 Abstract Definition

The parameter Streaming Audio Quality describes the audio quality as perceived by the end-user. Since the streams can contain and not only speech information, an algorithm like P.862 is not suitable for all scenarios.

ITU-R has defined an algorithm defined for audio information. It can be found in Recommendation ITU-R BS.1387-1 [6].

6.5.7.2 Abstract Equation

To be defined.

6.5.7.3 Trigger Points

Event from abstract equation	Trigger point from user's point of view	Technical description/protocol part
Tbd	Start: Begin of audio stream reproduction.	Start: Streaming players signal when the reproduction of the stream starts.
Tbd	Stop: End of audio stream reproduction.	Stop: RTSP: TEARDOWN.

6.5.8 Streaming Video Quality

6.5.8.1 Abstract Definition

The parameter Streaming Video Quality measures the quality of the video stream.

6.5.8.2 Abstract Equation

The validation of the visual quality is made using the mean opinion score (MOS) scales. These scales describe the opinion of users on live or on demand IP-based video reproduction and its impairment (freezing, artefacts from encoding, compression, transfer and re-scaling and changing resolutions) across all resolutions (up to HD). The measurement of visual quality should be made according to Recommendation ITU-T J.343.1 [36]. This method requires no reference signal and works for encrypted and non-encrypted streaming over TCP and RTP/UDP. Alternatively, the measurement may be made according to Recommendation ITU-T P.1201 [38]. In case of non-encrypted bit streams, Recommendation ITU-T J.343.2 [37], and Recommendation ITU-T P.1202 [39], may be used alternatively. For longer video observation times, the video quality measurement can be made in sections. An aggregation for measurement campaigns or parts of it should be made on section basis.

6.5.8.3 Trigger Points

Event from abstract equation	Trigger point from user's point of view	Technical description/protocol part
Tbd	Start: Begin of video stream reproduction.	Start: Streaming players signal when the reproduction of the stream starts.
Tbd	Stop: End of video stream reproduction.	Stop: RTSP: TEARDOWN.

6.5.9 Streaming Audio/Video De-Synchronization

6.5.9.1 Abstract Definition

The parameter Streaming Audio/Video De-Synchronization describes the percentage of times that time difference of the audio and video signal at the user side exceeds a predefined threshold.

6.5.9.2 Abstract Equation

No validated or standardized algorithm has been selected for the evaluation for video streaming content quality.

6.5.9.3 Trigger Points

Event from abstract equation	Trigger point from user's point of view	Technical description/protocol part
Tbd	Start: Begin of audio stream reproduction.	Start: Streaming players signal when the reproduction of the stream starts.
Tbd	Stop: End of audio stream reproduction.	Stop: RTSP: TEARDOWN.

6.5.10 Streaming Reproduction Start Failure Ratio [%]

6.5.10.1 Abstract Definition

The parameter Streaming Reproduction Start Failure Ratio describes the probability of unsuccessful stream reproduction.

NOTE: This parameter can be affected:

- by the player;
- by the UE performance.

6.5.10.2 Abstract Equation

$$\text{Streaming Reproduction Start Failure Ratio [\%]} = \frac{\text{reproduction failures}}{\text{all successful service accesses}} \times 100$$

6.5.10.3 Trigger Points

Event from abstract equation	Trigger point from user's point of view	Technical description/protocol part
Service access attempt	Start: "Buffering" message.	Start: Reception of first data packet.
Successful reproduction	Stop: Stream reproduction.	Stop: Streaming players signal when the reproduction of the stream starts.
Unsuccessful reproduction	Stop trigger point not reached.	

6.5.11 Streaming Reproduction Start Delay [s]

6.5.11.1 Abstract Definition

The parameter Streaming Reproduction Delay describes the duration between the reception at UE of the first stream data packet and the start of the reproduction of the stream on the UE.

NOTE: This parameter can be affected:

- by the player;
- by the UE performance.

6.5.11.2 Abstract Equation

$$\text{Streaming Reproduction Start Delay [s]} = (t_{\text{start of stream reproduction}} - t_{\text{reception of first data packet}}) [\text{s}]$$

6.5.11.3 Trigger Points

Event from abstract equation	Trigger point from user's point of view	Technical description/protocol part
$t_{\text{reception of first data packet}}$	Start: "Buffering" message.	Start: Reception of first data packet.
$T_{\text{start of stream reproduction}}$	Stop: Stream reproduction.	Stop: Streaming players signal when the reproduction of the stream starts.

6.5.12 Streaming Teardown Failure Ratio [%]

6.5.12.1 Abstract Definition

The parameter Teardown Failure Ratio describes the probability that the "Teardown" RTSP message is sent from the UE client to the server and no "200 OK" RTSP response is received from the server.

6.5.12.2 Abstract Equation

$$\text{Teardown Failure Ratio [\%]} = \frac{\text{cases without teardown server response}}{\text{all teardown attempts by UE client}} \times 100$$

6.5.12.3 Trigger Points

Event from abstract equation	Trigger point from user's point of view	Technical description/protocol part
Teardown attempt	Start: User presses the "Stop" button.	Start: RTSP: TEARDOWN.
Successful Teardown	Stop: Stream is torn down.	Stop: RTSP: 200 OK.
Unsuccessful Teardown	Stop trigger point not reached.	

Some players do not send this TEARDOWN command at the end of the stream but a PAUSE command or in some cases nothing at all. On the server side a logic can then identify the status of the streams/clients.

Used players should send the RTSP:TEARDOWN command in order to give a stable trigger point for measurements.

6.5.13 Streaming Teardown Time [s]

6.5.13.1 Abstract Definition

The parameter Teardown Failure Ratio describes the duration between the UE client sending the "Teardown" RTSP message and the "200 OK" RTSP response from the server.

6.5.13.2 Abstract Equation

$$\text{Teardown Time [s]} = (t_{\text{server response to teardown message}} - t_{\text{UE client sending teardown message}}) [\text{s}]$$

6.5.13.3 Trigger Points

Event from abstract equation	Trigger point from user's point of view	Technical description/protocol part
$t_{\text{UE client sending teardown message}}$	Start: User presses the "Stop" button.	Start: RTSP: TEARDOWN.
$T_{\text{server response to teardown message}}$	Stop: Stream is torn down.	Stop: RTSP: 200 OK.

Some players do not send this TEARDOWN command at the end of the stream but a PAUSE command or in some cases nothing at all. On the server side a logic can then identify the status of the streams/clients.

Used players should send the RTSP:TEARDOWN command in order to give a stable trigger point for measurements.

6.5.14 Streaming Rebuffering Failure Ratio [%]

6.5.14.1 Abstract Definition

The parameter Rebuffering Failure Ratio describes the probability that a stream goes into rebuffering mode and does not restart the stream reproduction, afterwards.

6.5.14.2 Abstract Equation

$$\text{Rebuffering Failure Ratio [\%]} = \frac{\text{unsuccessful rebuffering attempts}}{\text{all rebuffering attempts}} \times 100$$

6.5.14.3 Trigger Points

Event from abstract equation	Trigger point from user's point of view	Technical description/protocol part
Rebuffering attempt	Start: "Buffering" message appears.	Start: Streaming player signals the start of the stream buffering.
Successful continuation of reproduction	Stop: Stream reproduction continues.	Stop: Streaming player signals the continuation of the stream reproduction.
Unsuccessful continuation of reproduction	Stop trigger point not reached.	

6.5.15 Streaming Rebuffering Time [s]

6.5.15.1 Abstract Definition

The parameter Rebuffering Time describes the duration between a stream going into rebuffering mode and continuation of the stream, afterwards.

6.5.15.2 Abstract Equation

$$\text{Rebuffering Time [s]} = \left(t_{\text{continuation of stream}} - t_{\text{rebuffering message appears}} \right) [\text{s}]$$

6.5.15.3 Trigger Points

Event from abstract equation	Trigger point from user's point of view	Technical description/protocol part
$t_{\text{rebuffering message appears}}$	Start: "Buffering" message appears.	Start: Streaming player signals the start of the stream buffering.
$T_{\text{continuation of stream}}$	Stop: Stream reproduction continues.	Stop: Streaming player signals the continuation of the stream reproduction.

6.6 Telephony

6.6.1 Telephony Service Non-Accessibility [%]

6.6.1.1 Abstract Definition

The telephony service non-accessibility denotes the probability that the end-user cannot access the mobile telephony service when requested if it is offered by display of the network indicator on the UE.

NOTE: Due to network problems and despite B-party being not busy (see preconditions for measurement), it may even be possible for the A-party to receive a busy or not reachable signal. In this case, since no ALERTING message will be sent, the test sample will be treated as a failure.

6.6.1.2 Abstract Equation

$$\text{Telephony Service Non - Accessibility [\%]} = \frac{\text{unsuccessful call attempts}}{\text{all call attempts}} \times 100$$

6.6.1.3 Trigger Points

GSM:

Event from abstract equation	Trigger point from user's point of view	Technical description/protocol part
Call attempt	Start: Push Send button.	Start: Layer 3 (RR): The "CHANNEL REQUEST" message is sent over the RACH.
Successful call attempt	Stop: Alerting tone is heard by the A-party AND B-party rings.	Stop: Layer 3 (CC): The "ALERTING" message is passed: 1. from the B-party to the MSC (uplink) AND 2. from the MSC to the A-party (downlink) to indicate that the B-party rings.
Unsuccessful data call access	Stop trigger point not reached.	

UMTS:

Event from abstract equation	Trigger point from user's point of view	Technical description/protocol part
Call attempt	Start: Push Send button.	Start: Layer 3 (RRC): The first "RRC CONNECTION REQUEST" with Establishment Cause "Originating Conversational Call" message carried on the CCCH logical channel and mapped to the RACH transport channel is sent. (Figure 25; signalling point number 1). Comment: It is possible that the RRC connection is already established because of an e.g. Location Update, then the start trigger is not reachable. In this case, the current test sample should be deleted.
Successful call attempt	Stop: Alerting tone is heard by the A-party AND B-party rings.	Stop: Layer 3 (CC): The "ALERTING" message is passed: 1. from the B-party to the MSC (uplink) AND 2. from the MSC to the A-party (downlink) to indicate that the B-party rings. (Figure 25; signalling point number 44).
Unsuccessful call attempt	Stop trigger point not reached.	
NOTE: With automatic tools there is not a significant difference between consider the "ALERTING" or the "CONNECT" message, as the answer machine should always answer immediately.		

ISDN:

Event from abstract equation	Trigger point from user's point of view	Technical description/protocol part
Call attempt	Start: Push Dial button.	Start: Layer 3 (CC): The "SETUP" message is sent by the A-party
Successful call attempt	Stop: Alerting tone is heard by the A-party AND B-party rings.	Stop: Layer 3 (CC): The "ALERTING" message is received by the A-party.
Unsuccessful call attempt	Stop trigger point not reached.	
NOTE: With automatic tools there is not a significant difference between consider the "ALERTING" or the "CONNECT" message, as the answer machine should always answer immediately. The SETUP is assumed to use en-bloc sending.		

TETRA:

Event from abstract equation	Trigger point from user's point of view	Technical description/protocol part
Call attempt	Start: Push Send button.	Start: Layer 3 (CMCE): The "U-SETUP" message with appropriate signalling information is sent from the A-party. AT: The "ATD <dial string>" command is sent from the A-party, where <dial string> provides a unique identification of the desired B-party side. A preceding "AT+CTSDC" command is used to set the correct parameters for the dial command.
Successful call attempt	Stop: Alerting tone is heard by the A-party AND B-party rings.	Stop: Layer 3 (CMCE): <ul style="list-style-type: none"> the "U-ALERT" message is passed from the B-party to the SwMI (uplink) AND <ul style="list-style-type: none"> the "D-ALERT" message is passed from the SwMI to the A-party (downlink) to indicate that the B-party rings. AT: The "ATA" command is sent by the B-party upon reception of the ring indication and the "AT+CTOCP: <CC instance>, <call status>, ..." with <call status> = 2 (Called party paged) indication is received by the A-party to indicate that the B-party rings.
Unsuccessful call attempt	Stop trigger point not reached within desired time.	
NOTE: The described technical trigger points are valid for measurements with hook signalling enabled. In case direct signalling is used for the call establishment procedure the relevant air interface protocol messages for the stop trigger are "U-CONNECT" and "D-CONNECT" (instead of "U-ALERT" and "D-ALERT"), respectively. It shall be clearly stated which call establishment method is used for the telephony measurements.		

Preconditions for measurement:

Precondition	Covered by	Reference document
CS network available	Radio Network Unavailability	
CS attach successful		
B-party shall not be busy		

LTE CSFB:

Event from abstract equation	Trigger point from user's point of view	Technical description/protocol part
CSFB Call attempt	Start: Push Send button.	Start: "RRC Connection Request" with cause "mo_Data", if present. Otherwise: "EMM Extended Service request (CS fallback indicator)" message is sent by the A-party.
Successful CSFB Call attempt	Stop: Alerting tone is heard by the A-party AND B-party rings.	Stop: The "CC:ALERTING" message is received by the A-party.
Unsuccessful CSFB Call Setup attempt	Stop trigger point not reached.	
NOTE: With automatic tools there is not a significant difference between consider the "ALERTING" or the "CONNECT" message, as the answer machine should always answer immediately.		

LTE VoLTE:

Event from abstract equation	Trigger point from user's point of view	Technical description/protocol part
VoLTE Call attempt	Start: Push Send button.	Start: If signalling connection is established (and a default EPS bearer is activated) at this time. Protocol SIP: "INVITE" sent by the A-party. Else: LTE-RRCConnectionRequest requesting a signalling channel after the send button has been pushed or the ESM Activate dedicated EPS Bearer context request in case the signalling connection is established already.
Successful VoLTE call attempt	Stop: A-party receives a notification that the other phone accepts the invitation.	Stop: Protocol SIP: "200 OK" response to the "INVITE" is received by the A-party.
Unsuccessful VoLTE call attempt	Stop: A-party receives a notification that the session set-up is cancelled or the stop trigger point not reached.	Stop: Protocol SIP: 1. The A-party receives a 4XX error message as response to the "INVITE"); Stop trigger point not reached.
NOTE: The "200 OK" is chosen as the technical trigger for the "Successful VoLTE call attempt" since the "180 RINGING" is not a reliable indicator. The "180 RINGING" may arrive at the A-party before the call setup has been completed.		

Preconditions for measurement:

Precondition	Covered by	Reference document
IMS registered		

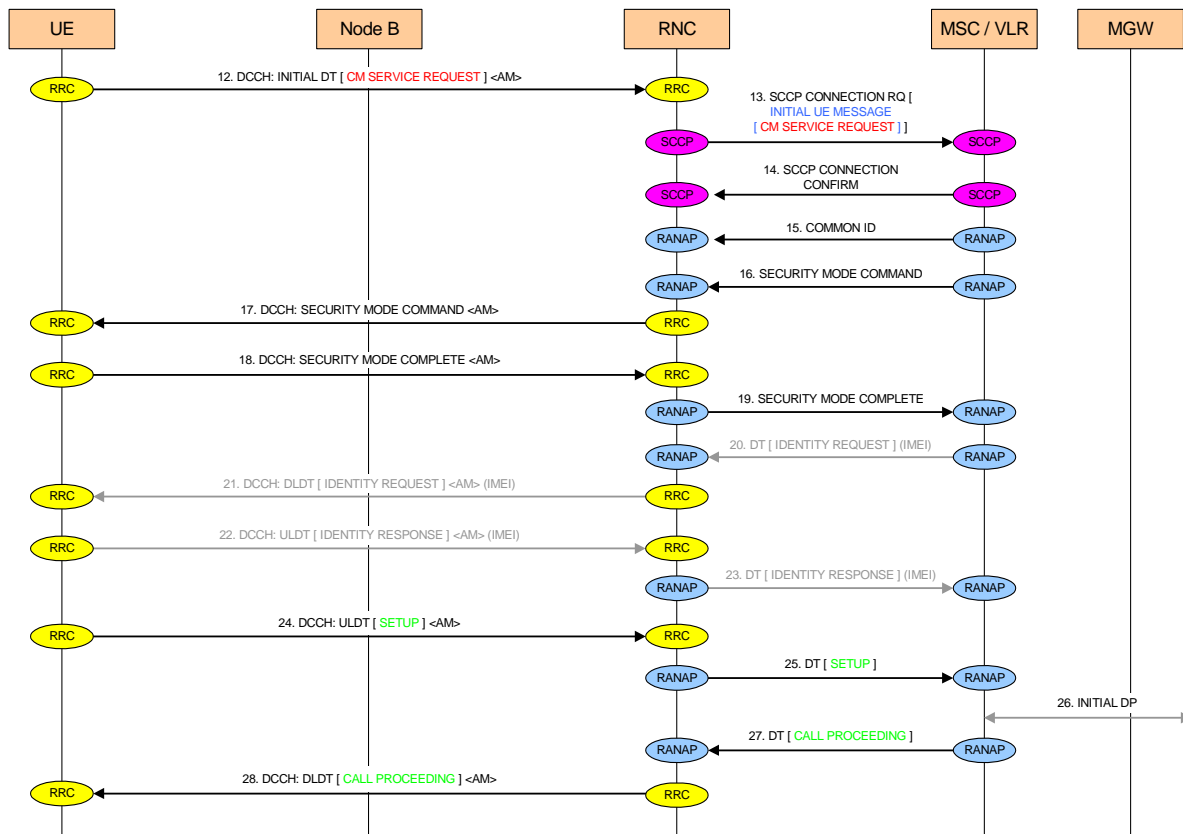
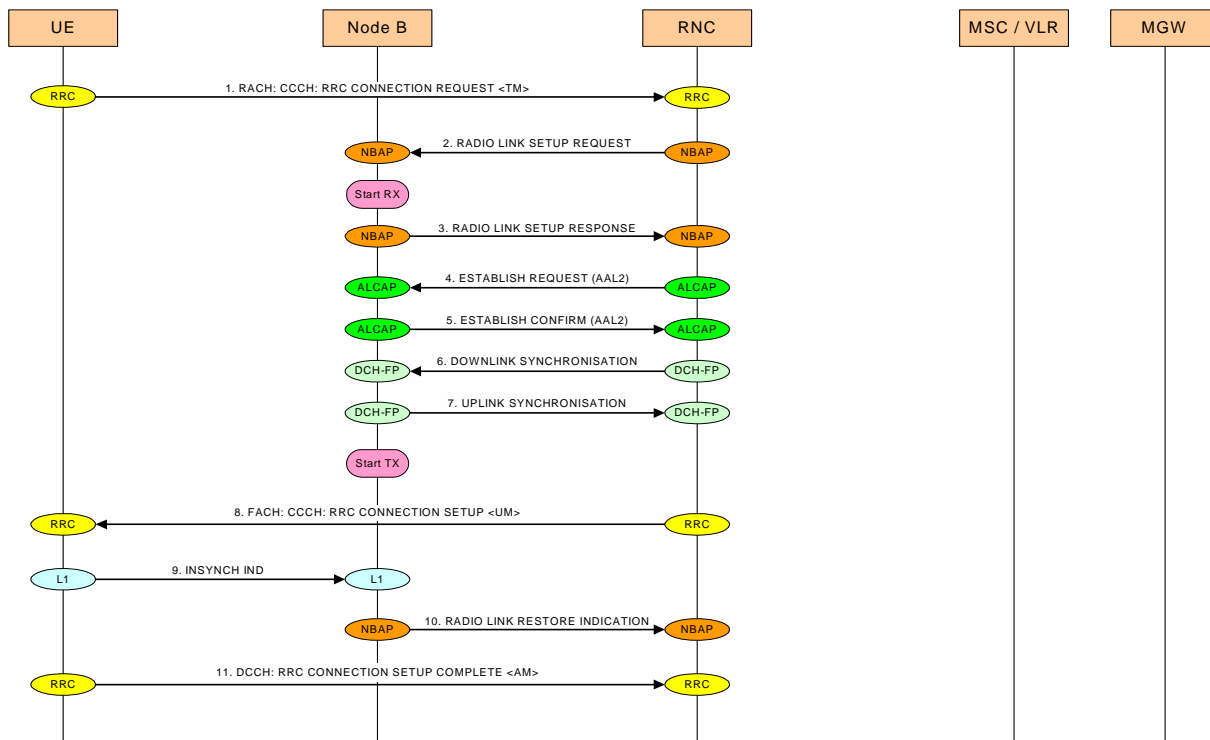

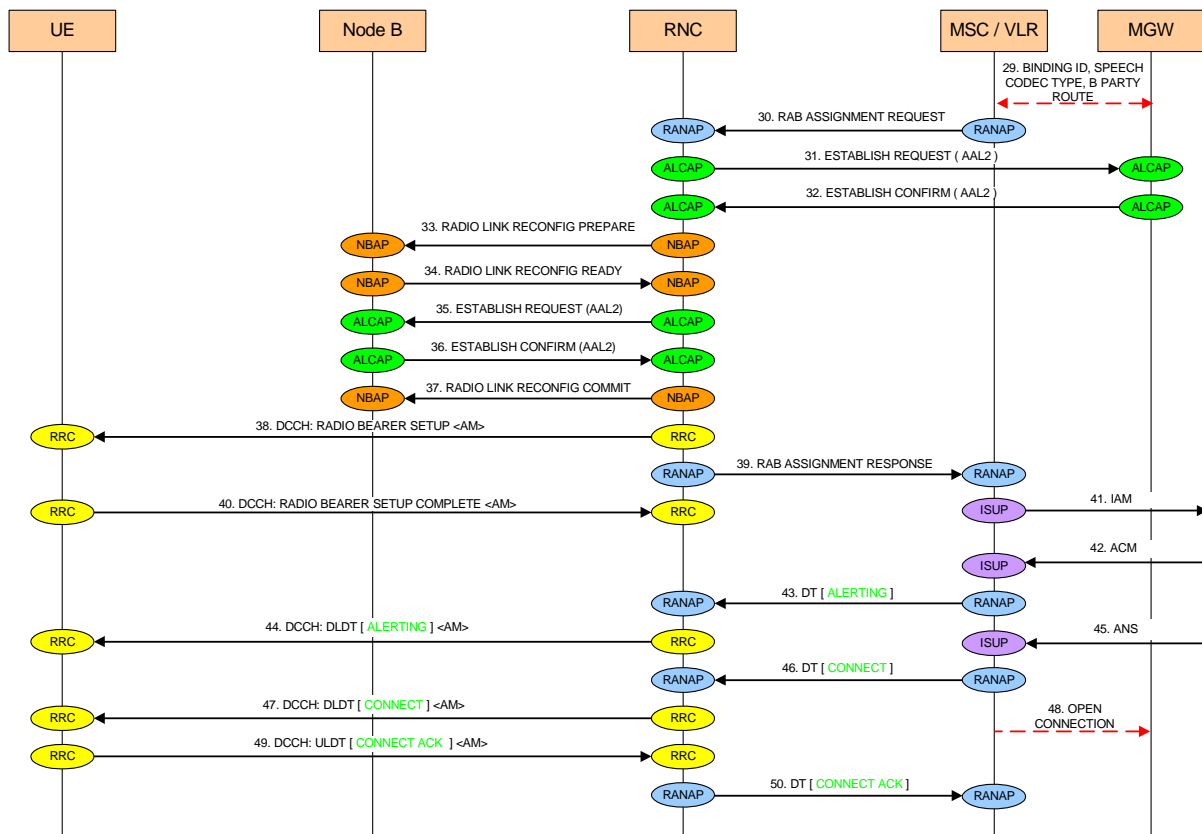

Figure 25: 3G telephony signalling flow chart: mobile originated call establishment procedure

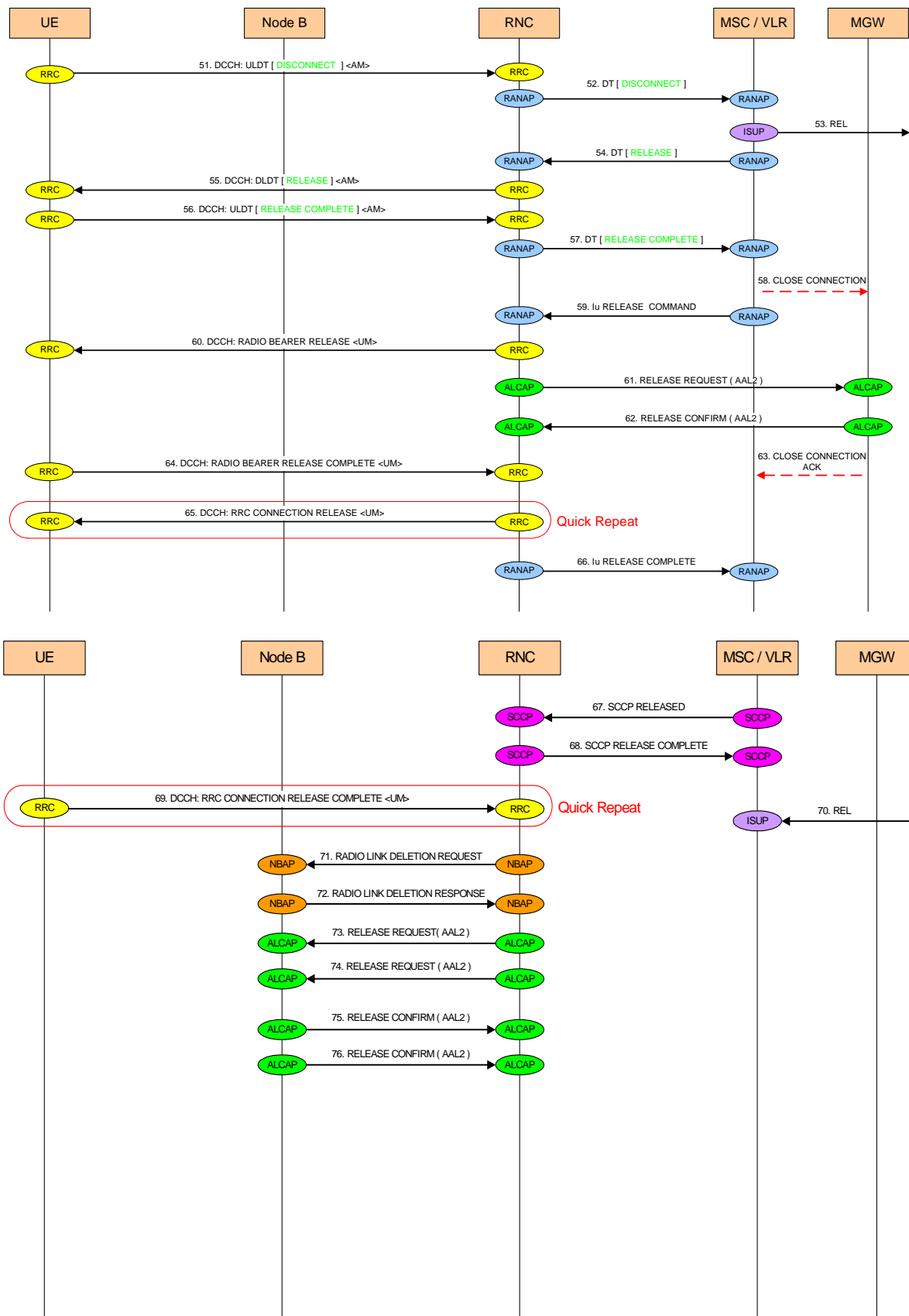

Figure 26: 3G telephony signalling flow chart: mobile initiated call disconnection procedure

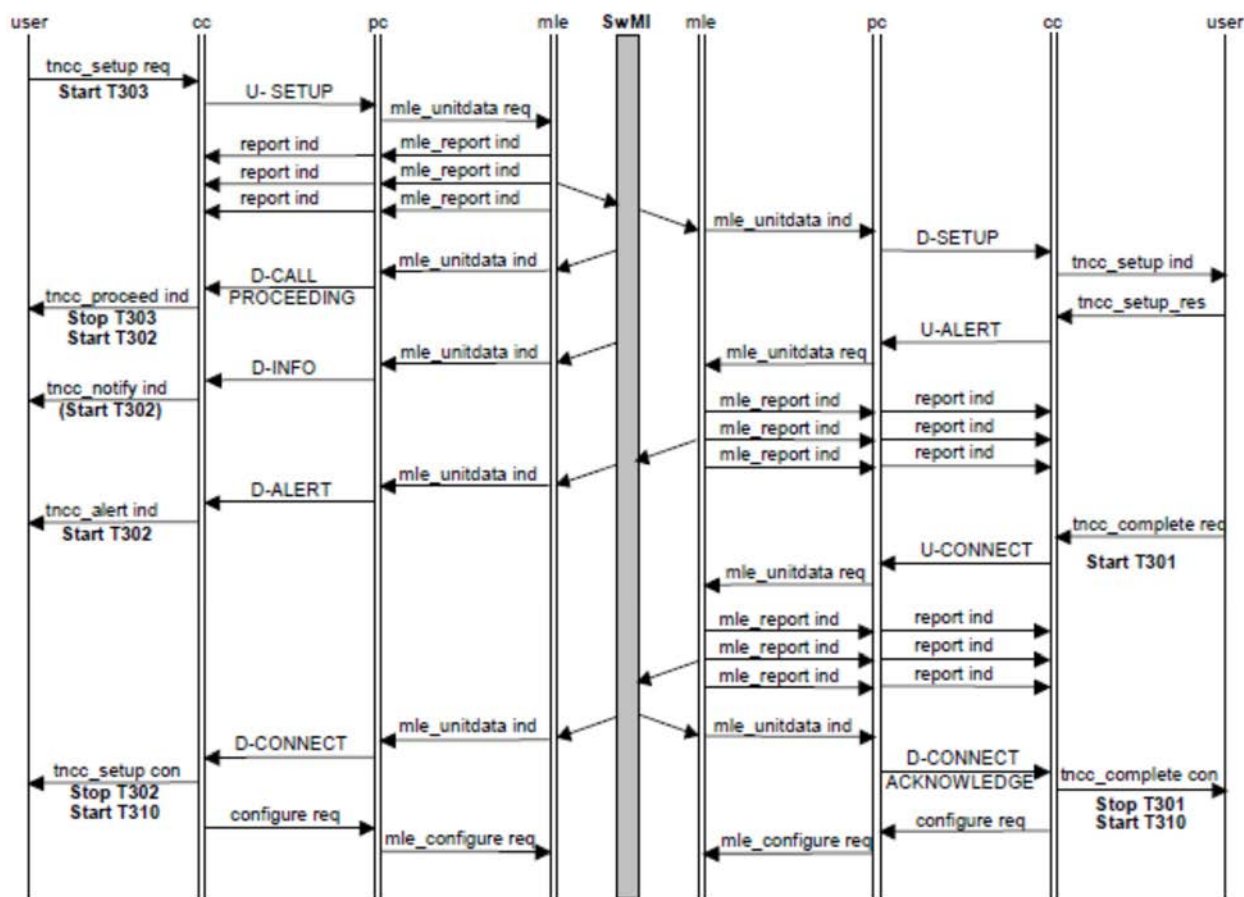

Figure 27: Individual call set-up using on/off hook signalling (ETSI EN 300 392-2 [27], clause 14.5.1)

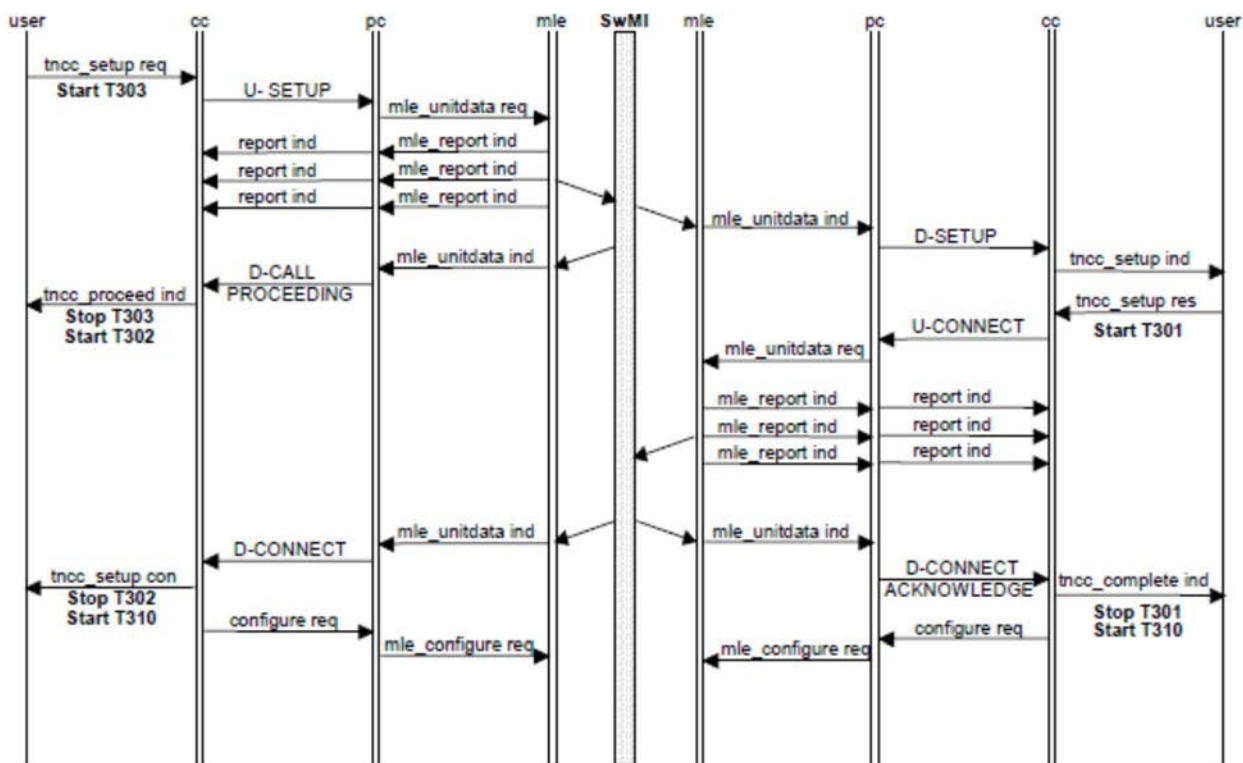
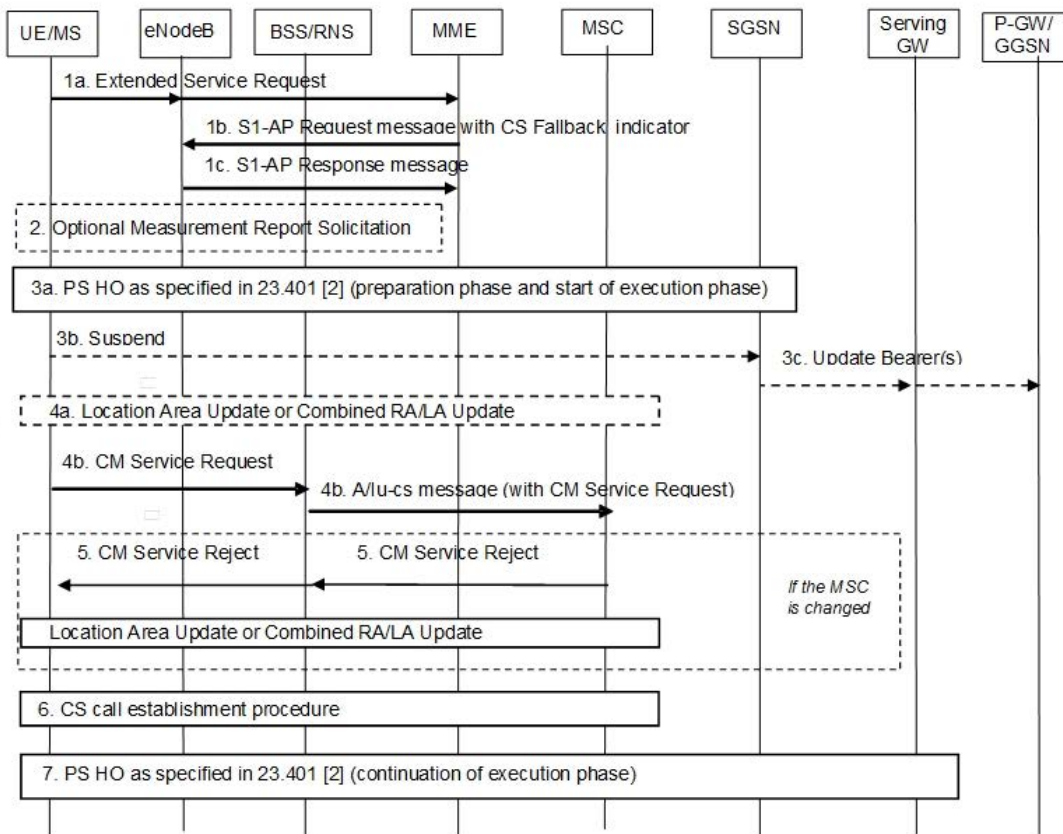

Figure 28: Individual call set-up using direct set-up signalling (ETSI EN 300 392-2 [27], clause 14.5.1)



NOTE: This figure describes the mainly procedures of CSFB, the specific procedure such as CS call establishment please refer to the call establishment procedure in 2G/3G.

Figure 29: Mobile Originating call in Active Mode - PS HO supported [34]

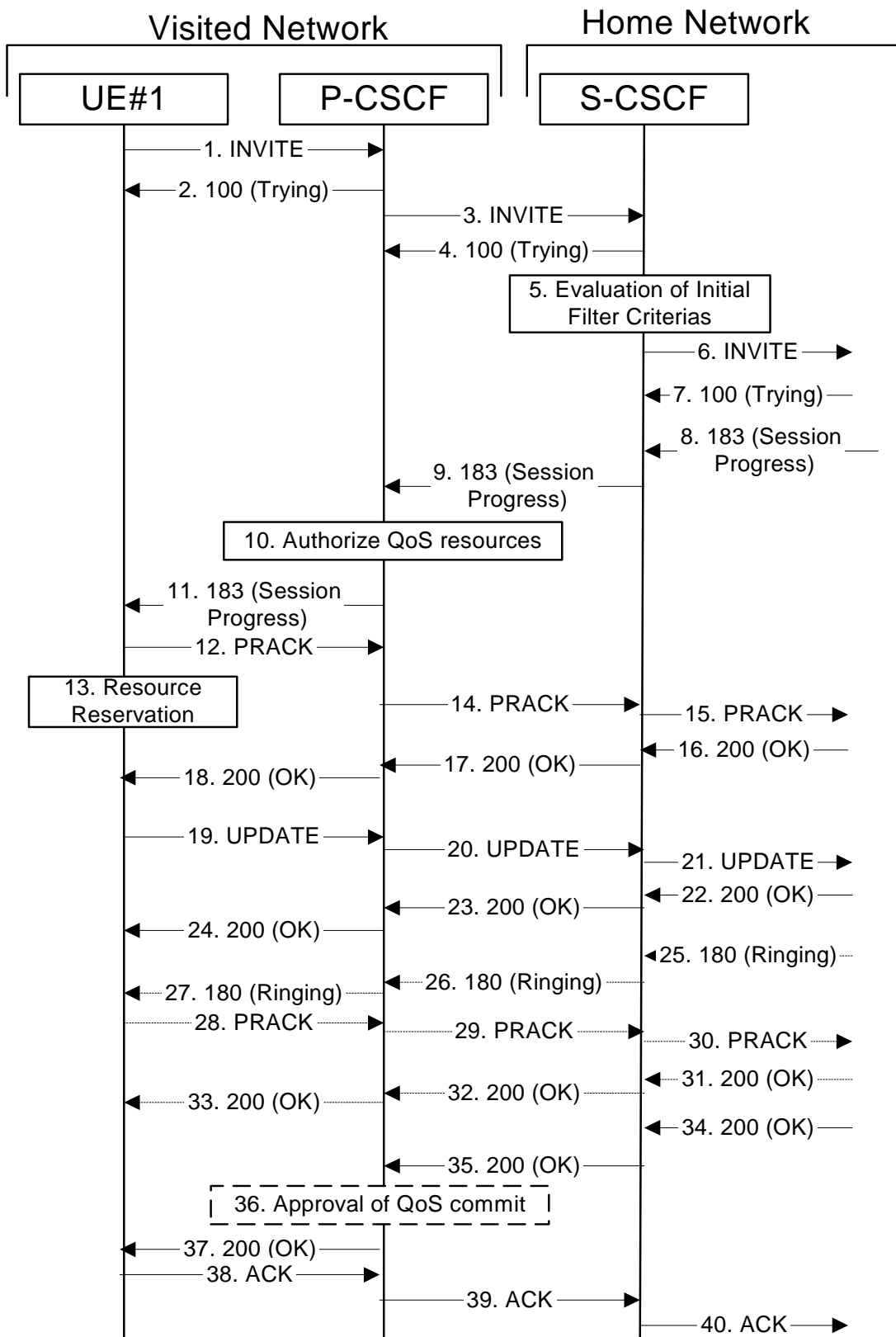

Figure 30: MO1#a [35]

6.6.2 Telephony Setup Time [s]

6.6.2.1 Abstract Definition

The telephony setup time describes the time period between sending of complete address information and receipt of call set-up notification.

6.6.2.2 Abstract Equation

$$\text{Telephony Setup Time [s]} = (t_{\text{connect established}} - t_{\text{user presses send button on UE}}) [\text{s}]$$

NOTE: This parameter is not calculated unless the telephony call setup attempt is successful. It is assumed that early traffic channel assignment is used.

6.6.2.3 Trigger Points

GSM:

Event from abstract equation	Trigger point from user's point of view	Technical description/protocol part
$t_{\text{user presses send button on UE}}$ Time of call attempt	Start: Push Send button.	Start: Layer 3 (RR): The "CHANNEL REQUEST" message is sent over the RACH.
$T_{\text{connection established}}$ Time when connection is established (successful call attempt)	Stop: Alerting tone is heard by the A-party AND B-party rings.	Stop: Layer 3 (CC): The "ALERTING" message is passed: 1. from the B-party to the MSC (uplink) AND 2. from the MSC to the A-party (downlink) to indicate that the B-party rings.

UMTS:

Event from abstract equation	Trigger point from user's point of view	Technical description/protocol part
$t_{\text{user presses send button on UE}}$ Time of call attempt	Start: Push send button.	Start: Layer 3 (RRC): The first "RRC CONNECTION REQUEST" with Establishment Cause "Originating Conversational Call" message carried on the CCCH logical channel and mapped to the RACH transport channel is sent. (Figure 25; signalling point number 1). Comment: It is possible that the RRC connection is already established because of an e.g. Location Update, then the start trigger is not reachable. In this case, the current test sample should be deleted.
$T_{\text{connection established}}$ Time when connection is established (successful call attempt)	Stop: Alerting tone is heard by the A-party AND B-party rings.	Stop: Layer 3 (CC): The "ALERTING" message is passed: 1. from the B-party to the MSC (uplink) AND 2. from the MSC to the A-party (downlink) to indicate that the B-party rings. (Figure 25; signalling point number 44).
NOTE: With automatic tools there is not a significant difference between consider the "ALERTING" or the "CONNECT" message, as the answer machine should always answer immediately.		

ISDN:

Event from abstract equation	Trigger point from users point of view	Technical description/protocol part
Call attempt	Start: Push Dial button.	Start: Layer 3 (CC): The "SETUP" message is sent by the A-party.
Successful call attempt	Stop: Alerting tone is heard by the A-party AND B-party rings.	Stop: Layer 3 (CC): The "ALERTING" message is received by the A-party.
Unsuccessful call attempt	Stop trigger point not reached.	
NOTE: With automatic tools there is not a significant difference between consider the "ALERTING" or the "CONNECT" message, as the answer machine should always answer immediately. The SETUP is assumed to use en-bloc sending.		

TETRA:

Event from abstract equation	Trigger point from user's point of view	Technical description/protocol part
$t_{\text{user presses send button on UE}}$ Time of call attempt	Start: Push Send button.	Start: Layer 3 (CMCE): The "U-SETUP" message with appropriate signalling information is sent from the A-party. AT: The "ATD <dial string>" command is sent from the A-party, where <dial string> provides a unique identification of the desired B-party side. A preceding "AT+CTSDC" command is used to set the correct parameters for the dial command.
$T_{\text{connection established}}$ Time when connection is established (successful call attempt)	Stop: Alerting tone is heard by the A-party AND B-party rings.	Stop: Layer 3 (CMCE): 1. the "U-ALERT" message is passed from the B-party to the SwMI (uplink) AND 2. the "D-ALERT" message is passed from the SwMI to the A-party (downlink) to indicate that the B-party rings. AT: The "ATA" command is sent by the B-party upon reception of the ring indication and the "AT+CTOCP: <CC instance>, <call status>, ..." with <call status> = 2 (Called party paged) indication is received by the A-party to indicate that the B-party rings.
Unsuccessful call attempt	Stop trigger point not reached.	

Preconditions for measurement:

Precondition	Covered by	Reference document
CS network available	Radio Network Unavailability	
CS attach successful		
CS service access successful	Telephony Service Non-Accessibility	

LTE CSFB:

Event from abstract equation	Trigger point from user's point of view	Technical description/protocol part
$t_{\text{user presses send button on UE}}$ Time of call attempt	Start: Push Send button.	Start: "RRC Connection Request" with cause "mo_Data", if present. Otherwise: "EMM Extended Service request (CS fallback indicator)" message is sent by the A-party.
$T_{\text{connection established}}$ Time when connection is established (successful call attempt)	Stop: Alerting tone is heard by the A-party AND B-party rings.	Stop: The "CC:ALERTING" message is received by the A-party.
Unsuccessful call attempt	Stop trigger point not reached.	

LTE VoLTE:

Event from abstract equation	Trigger point from user's point of view	Technical description/protocol part
VoLTE call attempt	Start: Push Send button.	Start: If a signalling channel is established (and a default EPS bearer activated). Protocol SIP: "INVITE" sent by the A-party. Else: LTE-RRCCoNNECTIONRequest with cause mo_Data requesting a signalling channel after the send button has been pushed or the ESM Activate dedicated EPS Bearer context request in case the signalling connection is established already.
Successful VoLTE call attempt	Stop: A-party receives a notification that the other phone accepts the invitation.	Stop: Protocol SIP: "200 OK" response to INVITE is received by the A-party.
Unsuccessful VoLTE call attempt	Stop: A-party receives a notification that the session set-up is cancelled or the stop trigger point not reached.	Stop: Protocol SIP: 1. The A-party receives a 4XX error message as response to the "INVITE"; 2. Stop trigger point not reached.
NOTE: The "200 OK" is chosen as the technical trigger for the "Successful VoLTE call attempt" since the "180 RINGING" is not a reliable indicator. The "180 RINGING" may arrive at the A-party before the call setup has been completed.		

Preconditions for measurement:

Precondition	Covered by	Reference document
IMS registered		

6.6.3 Telephony Speech Quality on Call Basis

6.6.3.1 Abstract Definition

The telephony speech quality on call basis is an indicator representing the quantification of the end-to-end speech transmission quality of the mobile telephony service. This parameter computes the speech quality on the basis of completed calls.

NOTE: The acoustic behaviour of terminals is not part of this speech quality measurement.

6.6.3.2 Abstract Equation

The validation of the end-to-end quality is made using MOS-LQO scales. These scales describe the opinion of users with speech transmission and its troubles (noise, robot voice, echo, dropouts, etc.) according to Recommendation ITU-T P.862 [1] in conjunction with Recommendation ITU-T P.862.1 [9], or according to Recommendation ITU-T P.863 [31]. The algorithm used should be reported. The speech quality measurement is taken per call. An aggregation should be made on one value for speech quality per call.

$\text{Telephony Speech Quality on Call Basis (received A - party)} = f(\text{MOS - LQO})$ $\text{Telephony Speech Quality on Call Basis (received B - party)} = f(\text{MOS - LQO})$

Optionally it might be useful to aggregate both speech quality values into one. In this case, the worst of both shall be used. This aggregated speech quality value shall be called SpQ (min).

6.6.3.3 Trigger Points

GSM/UMTS:

Event from abstract equation	Trigger point from user's point of view	Technical description/protocol part
Not applicable.	Start: Interchange speech samples between A-party and B-party.	Start: Layer 3 (CC): The "CONNECT" message on the DCCH logical channel is passed from the MSC to the UE to indicate that the called user's end has been connected. (Figure 25; signalling point number 47).
Not applicable.	Stop: Release of connection.	Stop: Layer 3 (CC): The "DISCONNECT" message on the DCCH logical channel is intentionally sent from the UE (message sent when the user ends the call). (Figure 26; signalling point number 51).

TETRA:

The applicability of a suitable speech quality evaluation method for the narrow-band speech codec within TETRA networks is for further study.

6.6.4 Telephony Speech Quality on Sample Basis

6.6.4.1 Abstract Definition

The telephony speech quality on call basis is an indicator representing the quantification of the end-to-end speech transmission quality of the mobile telephony service. This parameter computes the speech quality on a sample basis.

NOTE: The acoustic behaviour of terminals is not part of this speech quality measurement.

6.6.4.2 Abstract Equation

The validation of the end-to-end quality is made using MOS-LQO scales. These scales describe the opinion of users with speech transmission and its troubles (noise, robot voice, echo, dropouts, etc.) according to Recommendation ITU-T P.862 [1] in conjunction with Recommendation ITU-T P.862.1 [9], or according to Recommendation ITU-T P.863 [31]. The algorithm used should be reported. The speech quality measurement is taken per sample. An aggregation for measurement campaigns or parts of it should be made on speech sample basis.

$$\begin{aligned} \text{Telephony Speech Quality on Sample Basis (received A - party)} &= \text{MOS} - \text{LQO} \\ \text{Telephony Speech Quality on Sample Basis (received B - party)} &= \text{MOS} - \text{LQO} \end{aligned}$$

Optionally it might be useful to aggregate both speech quality values into one. In this case, the worst of both shall be used. This aggregated speech quality value shall be called SpQ (min).

6.6.4.3 Trigger Points

The same as for speech quality on call basis (see clause 6.6.3.3).

6.6.5 Telephony Cut-off Call Ratio [%]

6.6.5.1 Abstract Definition

The telephony cut-off call ratio denotes the probability that a successful call attempt is ended by a cause other than the intentional termination by A- or B-party.

6.6.5.2 Abstract Equation

$$\text{Telephony Cut - off Call Ratio [\%]} = \frac{\text{unintentionally terminated telephony calls}}{\text{all successful telephony call attempts}} \times 100$$

6.6.5.3 Trigger Points

GSM/UMTS:

Event from abstract equation	Trigger point from user's point of view	Technical description/protocol part
Successful telephony call attempt	Start: Alerting tone heard by the A-party coming from B-party.	Start: Layer3 (CC): The "CONNECT" message on the DCCH logical channel is passed from the MSC to the UE to indicate that the connection has been established. (Figure 25; signalling point number 47). (See note).
Intentionally terminated telephony call	Stop: Release of connection directly by A- or B-party.	Stop: Layer3 (CC): The "DISCONNECT" message on the DCCH logical channel is intentionally sent from the UE (message sent when the user ends the call). (Figure 26; signalling point number 51).
Unintentionally terminated telephony call	Stop trigger point not reached.	
NOTE 1: With automatic tools there is not a significant difference between considering the alerting or the connect message, as the answering machine should always answer immediately.		
NOTE 2: The single side condition is applicable in mobile-to-land and in mobile-to-mobile scenarios.		

ISDN:

Event from abstract equation	Trigger point from user's point of view	Technical description/protocol part
Successful telephony call attempt	Start: Alerting tone heard by the A-party coming from B-party.	Start: Layer3 (CC): The "CONNECT" message is received by the A-party
Intentionally terminated telephony call	Stop: Release of connection directly by A- or B-party.	Stop: Layer3 (CC): An intentional "DISCONNECT" message is sent or received by the A-party
Unintentionally terminated telephony call	Stop trigger point not reached.	
NOTE: With automatic tools there is not a significant difference between consider the alerting or the connect message, as the answer machine should always answer immediately.		

TETRA:

Event from abstract equation	Trigger point from user's point of view	Technical description/protocol part
Successful telephony call attempt	Start: Connect indication received at originating A-party side.	Start: Layer 3 (CMCE): The "D-CONNECT" message is received at the A-party to indicate that the called user's end has been connected. AT: The "AT+CTCC" indication is received by the A-party to indicate that the called user's end has been connected.
Intentionally terminated telephony call	Stop: Release of connection directly by A- or B-party.	Stop: Layer 3 (CMCE): The "U-DISCONNECT" message with disconnect cause "User requested disconnect" is sent from either A-party or B-party UE (message sent when the user ends the call). AT: The "ATH" command is sent by either A-party or B-party (message sent when the user ends the call).
Unintentionally terminated telephony call	Stop trigger point not reached.	

LTE VoLTE:

Event from abstract equation	Trigger point from user's point of view	Technical description/protocol part
Successful Started VoLTE telephony call	Start: A-party receives a notification that the other phone accepts the invitation.	Start: Protocol SIP: "200 OK" response to "INVITE" is received by the A-party.
Intentionally terminated telephony call	Stop: The user is notified that the call has ended.	Stop: Protocol SIP: "200 OK" response to "BYE" is received by the A-party or the B-party. In case the call ends in UTRAN or GERAN (SRVCC) the stop trigger is CC:Disconnect.
Unintentionally terminated VoLTE telephony call	Stop trigger point not reached.	
NOTE: The "200 OK" is chosen as the technical trigger for the "Successful Started VoLTE telephony call" since the "180 RINGING" is not a reliable indicator. The "180 RINGING" may arrive at the A-party before the call setup has been completed.		

Preconditions for measurement:

Precondition	Covered by	Reference document
IMS registered		
VoLTE telephony service access successful	Telephony Service Non-Accessibility	

6.6.6 Telephony CLIP Failure Ratio [%]

6.6.6.1 Abstract Definition

The telephony CLIP failure ratio denotes the percentage of call setups where a valid calling party number (CPN) parameter was sent but not received intact.

NOTE: To conform to legal request the calling line identity (CLI) may be suppressed in some (roaming) cases, taking into account that a roamed call may consist of two independent call legs.

6.6.6.2 Abstract Equation

$$\text{Telephony CLIP Failure Ratio [\%]} = \frac{\text{number of calls received by B - party with out intact CPN}}{\text{number of calls offered by A - party with valid CPN}} \times 100$$

6.6.6.3 Trigger Points

GSM:

Event from abstract equation	Trigger point from user's point of view	Technical description/protocol part
Calls offered by A-party with valid CPN	Start: Push send button at the A-party (calling party).	Start: Layer 3 (RR): The "CHANNEL REQUEST" message is sent by the UE over the RACH.
Calls received by B-party without intact CPN	Stop: No presentation or presentation of invalid calling number on the display of the B-party mobile.	Stop: Layer 3 (CC): The "SETUP" message without valid calling party (A-party) number is received by the B-party.

UMTS:

Event from abstract equation	Trigger point from user's point of view	Technical description/protocol part
Calls offered by A-party with valid CPN	Start: Push send button at the A-party (calling party).	Start: Layer 3 (RRC): The first "RRC CONNECTION REQUEST" message with establishment cause "Originating Conversational Call" message carried on the CCCH logical channel and mapped to the RACH transport channel is sent. (Figure 25: signalling point number 1). Comment: It is possible that the RRC connection is already established because of an e.g. Location Update, then the start trigger is not reachable. In this case the current test sample should be deleted.
Calls received by B-party without intact CPN	Stop: No presentation or presentation of invalid calling number on the display of the B-party mobile.	Stop: Layer 3 (CC): The "SETUP" message without valid calling party (A-party) number is received by the B-party.

TETRA:

Event from abstract equation	Trigger point from user's point of view	Technical description/protocol part
Calls offered by A-party with valid CPN	Start: Push send button at the A-party (calling party).	Start: Layer 3 (CMCE): The "U-SETUP" message with appropriate signalling information is sent from the A-party.
Calls received by B-party without intact CPN	Stop: No presentation or presentation of invalid calling number on the display of the B-party mobile.	Stop: Layer 3 (CMCE): The "D-SETUP" message without valid calling party (A-party) number (calling party identifier) is received by the B-party.

6.7 Video Telephony

6.7.1 Network Accessibility/Availability

Network availability and network accessibility are measured independently from the service, and will not be described further in this clause. Network availability and network accessibility are pre-conditions for the performance of the measurement of QoS.

6.7.2 Parameter Overview Chart

To get a better overview of the following parameters, Figure 31 shows all steps of a Video Telephony call from origin to destination, and the related QoS parameters.

Preconditions for the measurements: It should be a bi-directional Video Telephony call. Both sides should allow the transmission of both audio and video.

Explanation: The upper half considers the trigger points and parameters at the originated side and the lower half at the terminated side. The rectangles are connected to the trigger points that are relevant for analysis. For example: "t3, orig. side" (triggerpoint at originated side) and "t3, term. Side" (triggerpoint at terminated side) are points of time that describe a similar event but it could be passed at slightly different times. The preconditions are specified in brackets behind the parameter name. The technical triggers are defined for positive successful cases, if the VT works fine. For failures the triggers are the opposite, this means the non-existence of the message indicates the failure. The bold lines behind the trigger points tx are the used one and the dashed one are unused.

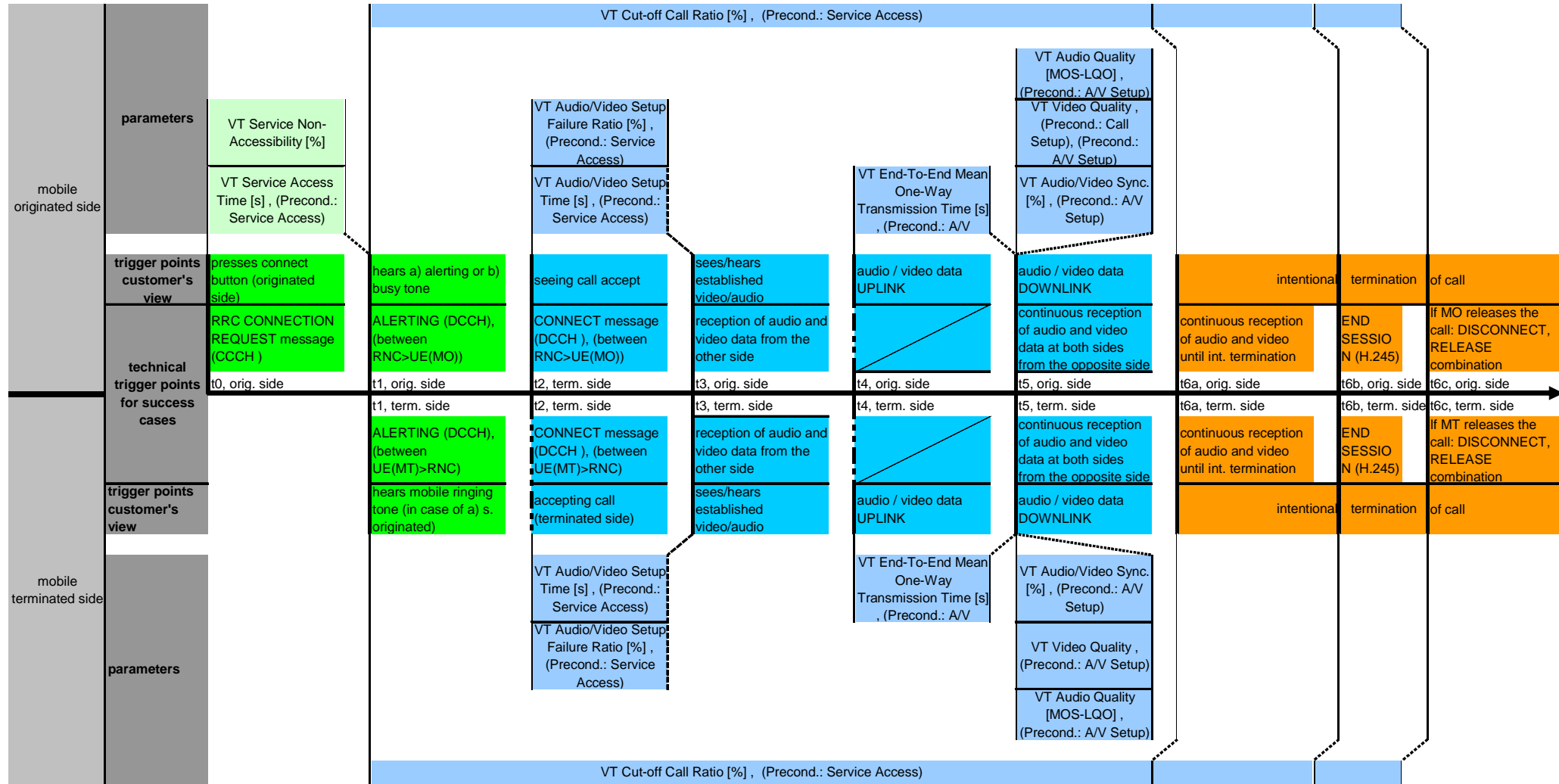

Figure 31: Parameter overview with trigger points

6.7.3 VT Service Non-Accessibility [%]

6.7.3.1 Abstract Definition

Probability that the end-user cannot access the service when requested while it is offered by network indication on the mobile equipment.

NOTE: Due to network problems and despite MO side being not busy (see preconditions for measurement), it may even be possible for the MO side to receive a busy or not reachable signal. In this case, since no ALERTING message will be sent, the test sample will be treated as a failure.

6.7.3.2 Abstract Equation

$$\text{VT Service Non - Accessibility [\%]} = \frac{\text{unsuccessful video telephony call access attempts}}{\text{all video telephony call access attempts}} \times 100$$

6.7.3.3 Trigger Points

Event from abstract equation	Trigger point from user's point of view	Technical description/protocol part
Video Telephony call attempt	Start: Push Send button.	Start: The first RRC CONNECTION REQUEST with Establishment Cause „originating conversational call message carried on the CCCH logical channel and mapped to the RACH transport channel is sent. (Figure 32, signalling point number 1). Comment: It is possible that more than one RRC CONNECTION REQUEST message per call attempt is sent. Only the first RRC CONNECTION REQUEST with Establishment Cause „Originating Conversational Call should be taken into account for the calculation. It is possible that the RRC connection is already established because of an e.g. Location Update, then the start trigger is not reachable. In this case the current test sample should be deleted.
Successful Video Telephony call attempt	Stop: Alerting tone is heard by the MO side coming from the MT side AND MT side rings.	Stop: The ALERTING message on the DCCH logical channel is passed: 1. from the UE at MT side to MSC (uplink) AND 2. from the MSC to the UE at MO side (downlink) to indicate that the MT side rings. (Figure 32, signalling point number 44).
Unsuccessful Video Telephony call attempt	Stop trigger point not reached.	Stop trigger point not reached.

Preconditions for measurement:

Precondition	Covered by	Reference document
UMTS CS available	Radio Network Unavailability	
UMTS CS attach successful		
MT side shall not be busy		

6.7.4 VT Service Access Time [s]

6.7.4.1 Abstract Definition

Time between pushing send button after input of MSISDN and receipt of alerting at MO side.

Remark:

- This parameter is not calculated unless the video telephony call access attempt is successful. At MT side the mobile shall ring.

6.7.4.2 Abstract Equation

$$\text{VT Service Access Time [s]} = (t_{\text{alerting tone}} - t_{\text{push send button}}) [\text{s}]$$

6.7.4.3 Trigger Points

Event from abstract equation	Trigger point from user's point of view	Technical description/protocol part
$t_{\text{push send button}}$: Time of Video Telephony call attempt	Start: Push Send button.	Start: The first RRC CONNECTION REQUEST with Establishment Cause „originating conversational call message carried on the CCCH logical channel and mapped to the RACH transport channel is sent. (Figure 32, signalling point number 1). Comment: It is possible that more than one RRC CONNECTION REQUEST message per call attempt is sent. Only the first RRC CONNECTION REQUEST with Establishment Cause „Originating Conversational Call should be taken into account for the calculation. It is possible that the RRC connection is already established because of an e.g. Location Update, then the start trigger is not reachable. In this case, the current test sample should be deleted.
$T_{\text{alerting tone}}$: Time of successful Video Telephony call attempt	Stop: Alerting tone is heard by the MO side coming from the MT side AND MT side rings.	Stop: The ALERTING message on the DCCH logical channel is passed: 1. from the UE at MT side to MSC (uplink) AND 2. from the MSC to the UE at MO side (downlink) to indicate that the MT side rings. (Figure 32, signalling point number 44).

Preconditions for measurement:

Precondition	Covered by	Reference document
UMTS CS available	Radio Network Unavailability	
UMTS CS attach successful		
UMTS CS service access	VT Service Access Failure Ratio	

6.7.5 VT Audio/Video Setup Failure Ratio [%]

6.7.5.1 Abstract Definition

Probability of audio/video setup failure after service access. The audio/video setup is successful if audio and video output is performed at both sides.

Remarks:

- This parameter reports a failure if the end-trigger is not reached at both sides.
- This parameter is not calculated unless the VT service access attempt is successful.
- This parameter depends on the mobile used and on the multimedia protocol stack implemented (e.g. answer fast feature).

6.7.5.2 Abstract Equation

$$\text{VT Audio/Video Setup Failure Ratio}[\%] = \frac{\text{audio/video setup failures}}{\text{all accepted calls at MT side}} \times 100$$

6.7.5.3 Trigger Points

Event from abstract equation	Trigger point from user's point of view	Technical description/protocol part
Audio/video setup attempt	Start: MO sees the call acceptance from the MT side.	Start: The CONNECT message on the DCCH logical channel is passed from the MSC to the UE at MO side to indicate that the connection has been established. (Figure 32, signalling point number 47)
Audio/Video Setup Success	Stop: Start of the audio and video output at both sides.	Stop: Start of reception of audio and video data at both sides from the opposite side. Comment: All four data streams shall be received for a success.
Audio/Video Setup Failure	Stop trigger point not reached.	Stop trigger point not reached.

Preconditions of measurement:

Precondition	Covered by	Reference document
UMTS CS available	Radio Network Unavailability	
UMTS CS attach successful		
UMTS CS service access successful	VT Service Non-Accessibility	

6.7.6 VT Audio/Video Setup Time [s]

6.7.6.1 Abstract Definition

The elapsed time from the MT call acceptance indicated at MO side until audio and video output starts at both sides.

Remarks:

- This parameter should report the worse time of both sides.
- This parameter is not calculated unless the VT audio/video setup attempt is successful.
- This parameter depends on the mobile used and on the multimedia protocol stack implemented (e.g. answer fast feature).

6.7.6.2 Abstract Equation

$$\text{VT Audio/Video Setup Time [s]} = (t_{\text{audio/video start}} - t_{\text{MT accepts call}}) [\text{s}]$$

6.7.6.3 Trigger Points

Event from abstract equation	Trigger point from user's point of view	Technical description/protocol part
$t_{\text{MT accepts call}}$: Time of beginning of audio/video setup	Start: MO sees the call acceptance from the MT side.	Start: The CONNECT message on the DCCH logical channel is passed from the MSC to the UE at MO side to indicate that the connection has been established. (Figure 32, signalling point number 47).
$T_{\text{audio/video start}}$: Time of successful audio/video setup	Stop: Start of the audio and video output at both sides.	Stop: Start of reception of audio and video data at both sides from the opposite side + constant time value for decoding. Comment: All four data streams shall be received for a success.

Preconditions for measurement:

Precondition	Covered by	Reference document
UMTS CS available	Radio Network Unavailability	
UMTS CS attach successful		
UMTS CS audio/video setup successful	VT Audio/Video Setup Failure Ratio	

6.7.7 VT Cut-off Call Ratio [%]

6.7.7.1 Abstract Definition

Probability that a successful service access is ended by a cause other than the intentional termination of the user (calling or called party).

Remark:

- This parameter is not calculated unless the VT service access attempt is successful. A VT call is considered dropped:
 - if the call acceptance fails after alerting;
 - if audio/video setup fails; or
 - if either the audio, the video or both are lost at one or both sides for an interruption timeout and before the end of "predefined call duration".

The "predefined call duration" is the difference between the indication of the call acceptance at MO side and the intentional release of the call.

6.7.7.2 Abstract Equation

$$\text{VT Cut - off Call Ratio [\%]} = \frac{\text{video telephony dropped calls}}{\text{all successful video telephony service access attempts}} \times 100$$

6.7.7.3 Trigger Points

Event from abstract equation	Trigger point from user's point of view	Technical description/protocol part
Successful Video Telephony service access attempt	Start: Alerting tone is heard by the MO side coming from MT side AND MT side rings.	Start: The ALERTING message on the DCCH logical channel is passed: 1. from the UE at MT side to MSC (uplink) AND 2. from the MSC to the UE at MO side (downlink) to indicate that the MT side rings. (Figure 32, signalling point number 1).
Video Telephony successful call	Stop: No loss of video and/or audio without any intention by MO or MT side longer than the interruption timeout within the predefined call duration.	Stop: 1. If the test system can capture audio/video information: Continuous reception of audio and video data at both sides from the opposite side without an interruption longer than the interruption timeout until intentional call release. 2. If the test system cannot capture audio/video information: The following information shall not be seen in signalling before intentional call release but they shall be seen after the intentional call release: <ul style="list-style-type: none"> H.245 EndSession command (endSessionCommand disconnect) OR the following trigger combination (all triggers on the DCCH logical channel): [M1: DISCONNECT (uplink).] AND [M2: DISCONNECT (downlink) or RELEASE (downlink)] (Figure 32, signalling point number 51). Comment: In some cases the mobiles use not the EndSession command but only the DISCONNECT or RELEASE command.
Video Telephony dropped calls	Stop trigger point not reached.	Stop trigger point not reached.

If the reception of audio and/or video is interrupted shortly before the predefined call duration, then the call duration shall be extended to check if the interruption persists for the interruption timeout or not. If the interruption is shorter than the interruption timeout the call shall be released immediately and rated as success otherwise the sample shall be rated as failure and the call will be released.

Preconditions for measurement:

Precondition	Covered by	Reference document
UMTS CS available	Radio Network Unavailability	
UMTS CS attach successful		
UMTS CS service access successful	VT Service Non-Accessibility	

6.7.8 VT Speech Quality on Call Basis

6.7.8.1 Abstract Definition

Indicator representing the quantification of the end-to-end speech transmission quality of the Video Telephony service. This parameter computes the speech quality on the basis of completed calls.

Remarks:

- This parameter is not calculated unless the VT audio/video setup attempt is successful.
- The speech quality measurement is taken per call. An aggregation for measurement campaigns or parts of it should be made on speech sample basis.
- The acoustic behaviour of terminals is not part of this audio quality measurement. The modelling of the acoustic part of the handset-terminals (e.g. frequency shaping) is incorporated in the speech quality assessment algorithm. Therefore, the test mobiles used have to be connected at their electrical interfaces and not coupled acoustically. It has to be taken into account that a detailed way for insertion and capturing of audio signals is described in Recommendation ITU-T P.862.3 [19].
- For wideband (7 kHz) applications a standardized algorithm is available in Recommendation ITU-T P.862.2 [18].
- Evaluation of a MO DL or MT DL and also for these both directions (sum) is possible by calculating the mean value of the results from all samples.
- Experience has shown a high variable delay in video calls.
- Recommendation ITU-T P.862 [1] is not approved for testing such video call applications. It has to be taken into account that further studies including auditory tests of video calls have to be conducted.

6.7.8.2 Abstract Equation

Recommendation ITU-T P.862 [1] (02-2001) together with the related mapping given in Recommendation ITU-T P.862.1 [9] (11-2003) is recommended. This algorithm describes the opinion of users related to speech transmission quality (300 Hz through 3 400 Hz) and its connected impairments (background noise, unnatural voice, temporal clipping and interruptions, etc.).

The speech quality measurement is taken per call (the evaluation algorithm is currently under study in ETSI STQ MOBILE WG) and per direction (DL at MO, DL at MT).

After mapping the raw P.862 results according to Recommendation ITU-T P.862.1 [9], the speech quality assessment is presented in a MOS-like scale between 1 and 5 called MOS Listening Quality Objective (MOS-LQO), as defined in Recommendation ITU-T P.800.1 [23].

6.7.8.3 Trigger Points

Event from abstract equation	Trigger point from user's point of view	Technical description/protocol part
Successful Audio/Video Setup Attempt	Start: Start of the audio and video output at both sides.	Start: Start of reception of audio and video data at both sides from the opposite side. Comment: All four data streams shall be received for a success.
End of call (only intentional)	Stop: End of call.	Stop: End of continuous reception of audio and video data at both sides from the opposite side because of: <ul style="list-style-type: none"> • intentional call release.

Preconditions for measurement:

Precondition	Covered by	Reference document
UMTS CS available	Radio Network Unavailability	
UMTS CS attach successful		
UMTS CS service access successful	VT Service Non-Accessibility	
UMTS CS audio/video setup successful	VT Audio/Video Setup Failure Ratio	

6.7.9 VT Speech Quality on Sample Basis

6.7.9.1 Abstract Definition

Indicator representing the quantification of the end-to-end speech transmission quality as perceived by the user. This parameter computes the speech quality on a sample basis.

Remarks:

- This parameter is not calculated unless the VT audio/video setup attempt is successful.
- Speech quality values from all video telephony calls should be taken into consideration for statistical quality analysis.
- The speech quality measurement is taken per sample. An aggregation for measurement campaigns or parts of it should be made on speech sample basis. Only complete received samples of a dropped call are evaluable.
- The acoustic behaviour of terminals is not part of this audio quality measurement. The modelling of the acoustic part of the handset-terminals (e.g. frequency shaping) is incorporated in the speech quality assessment algorithm. Therefore the test mobiles used have to be connected at their electrical interfaces and not coupled acoustically. It has to be taken into account that a detailed way for insertion and capturing of audio signals is described in the new Recommendation ITU-T P.862.3 [19].
- For wideband (7 kHz) applications a standardized algorithm is available in Recommendation ITU-T P.862.2 [18].
- Evaluation of a MO DL or MT DL and also for these both directions (sum) is possible by calculating the mean value of the results from all samples.
- Experience has shown a high variable delay in video calls.
- P.862 is not approved for testing such video call applications. It has to be taken into account that further studies including auditory tests of video calls have to be conducted.

6.7.9.2 Abstract Equation

$\text{VT Speech Quality on Sample Basis (received A - party)} = \text{MOS} - \text{LQO}$ $\text{VT Speech Quality on Sample Basis (received B - party)} = \text{MOS} - \text{LQO}$

Recommendation ITU-T P.862 [1] (02-2001) together with the related mapping given in Recommendation ITU-T P.862.1 [9] (11-2003) is recommended. This algorithm describes the opinion of users related to speech transmission quality (300 Hz through 3 400 Hz) and its connected impairments (background noise, unnatural voice, temporal clipping and interruptions, etc.).

The speech quality measurement is taken per sample and per direction (DL at MO, DL at MT).

After mapping the raw P.862 results according to Recommendation ITU-T P.862.1 [9], the speech quality assessment is presented in a MOS-like scale between 1 and 5 called MOS Listening Quality Objective (MOS-LQO), as defined in Recommendation ITU-T P.800.1 [23].

6.7.9.3 Trigger Points

Event from abstract equation	Trigger point from user's point of view	Technical description/protocol part
Successful Audio/Video Setup Attempt	Start: Start of the audio and video output at both sides.	Start: Start of reception of audio and video data at both sides from the opposite side. Comment: All four data streams shall be received for a success.
End of call (intentional or dropped)	Stop: End of call.	Stop: End of continuous reception of audio and video data at both sides from the opposite side because of: <ul style="list-style-type: none"> • an interruption for a predefined duration or longer OR <ul style="list-style-type: none"> • intentional call release.

Preconditions for measurement:

Precondition	Covered by	Reference document
UMTS CS available	Radio Network Unavailability	
UMTS CS attach successful	Attach Failure Ratio	
UMTS CS service access successful	VT Service Non-Accessibility	
UMTS CS audio/video setup successful	VT Audio/Video Setup Failure Ratio	

6.7.10 VT Video Quality

6.7.10.1 Abstract Definition

End-to-end quality of the video signal as perceived by the end user during a VT call. This parameter computes the video quality on a sample basis.

Remarks:

- This parameter is not calculated unless the VT audio/video setup attempt is successful.
- Video quality values from all video telephony calls should be taken into consideration for statistical quality analysis.
- The video quality measurement is taken per sample. An aggregation for measurement campaigns or parts of it should be made on video sample basis. Only complete received samples of a dropped call are evaluable.
- Evaluation of a MO DL or MT DL and also for these both directions (sum) is possible by calculating the mean value of the results from all samples.

6.7.10.2 Abstract Equation

To be specified.

6.7.10.3 Trigger Points

Event from abstract equation	Trigger point from user's point of view	Technical description/protocol part
Successful audio/video setup attempt	Start: Start of the audio and video output at both sides.	Start: Start of reception of audio and video data at both sides from the opposite side. Comment: All four data streams shall be received for a success.
End of call (intentional or dropped)	Stop: End of call.	Stop: End of continuous reception of audio and video data at both sides from the opposite side because of: <ul style="list-style-type: none"> an interruption for a predefined duration or longer; OR <ul style="list-style-type: none"> intentional call release.

Preconditions for measurement:

Precondition	Covered by	Reference document
UMTS CS available	Radio Network Unavailability	
UMTS CS attach successful	Attach Failure Ratio	
UMTS CS service access successful	VT Service Non-Accessibility	
UMTS CS audio/video Setup successful	VT Audio/Video Setup Failure Ratio	

6.7.11 VT End-To-End Mean One-Way Transmission Time [s]

6.7.11.1 Abstract Definition

Delay time from input of the signal at MS (MO/MT) (mic/cam) to output of the signal at MS (MT/MO) (loudspeaker/display).

Remark:

- This parameter is not calculated unless the VT audio/video setup attempt is successful.

6.7.11.2 Abstract Equation

Time from input of the signal at MS (MO/MT) to output at MS (MT/MO).

Aggregation Algorithm: $((\text{Transmission Time MO} \rightarrow \text{MT}) + (\text{Transmission Time MT} \rightarrow \text{MO}))/2$.

In case of a symmetrical channel one party could be configured as loopback device. The other one can determine the double delay by correlating transmit and receive signal. The delay should be measured after the loopback at the top of the radio bearer.

As the delay of the codec is almost constant for a specific mobile implementation, the codec delay could be considered by a mobile depending offset. In each direction, one shall add the encoder and the decoder times. For the whole loopback one shall calculate the following times:

MO>MT	Encoding of audio/video (slowest is used)	a
	Transmission of audio/video (slowest is used)	b
	Decoding of audio/video (slowest is used)	c
MT>MO	Encoding of audio/video (slowest is used)	d
	Transmission of audio/video (slowest is used)	e
	Decoding of audio/video (slowest is used)	f

$$\text{VT End - to - End Mean One - Way Transmission Time [s]} = \frac{a + b + c + d + e + f}{2} \text{ [s]}$$

6.7.11.3 Trigger Points

Event from abstract equation	Trigger point from user's point of view	Technical description/protocol part
Successful audio/video setup attempt	Start: Start of the audio and video output at both sides.	Start: Start of reception of audio and video data at both sides from the opposite side. Comment: All four data streams shall be received for a success.
End of call (intentional or dropped)	Stop: End of call.	Stop: End of continuous reception of audio and video data at both sides from the opposite side because of: <ul style="list-style-type: none"> an interruption for a predefined duration or longer; OR <ul style="list-style-type: none"> intentional call release.

Preconditions for measurement:

Precondition	Covered by	Reference document
UMTS CS available	Radio Network Unavailability	
UMTS CS attach successful	Attach Failure Ratio	
UMTS CS service access successful	VT Service Non-Accessibility	
UMTS CS audio/video Setup successful	VT Audio/Video Setup Failure Ratio	

6.7.12 VT Audio/Video Synchronization [%]

6.7.12.1 Abstract Definition

Percentage of times that the time differences of the audio and video signal at the user side exceeds a predefined threshold.

Remarks:

- This parameter is not calculated unless the VT audio/video setup attempt is successful.
- Only if audio and video use different bearers this indicator would reflect the behaviour of the network and the mobiles.

6.7.12.2 Abstract Equation

To be specified.

6.7.12.3 Trigger Points

Event from abstract equation	Trigger point from user's point of view	Technical description/protocol part
Successful audio/video setup attempt	Start: Start of the audio and video output at both sides.	Start: Start of reception of audio and video data at both sides from the opposite side. Comment: All four data streams shall be received for a success.
End of call (intentional or dropped)	Stop: End of call.	Stop: End of continuous reception of audio and video data at both sides from the opposite side because of: <ul style="list-style-type: none"> an interruption for a predefined duration or longer; OR <ul style="list-style-type: none"> intentional call release.

Preconditions for measurement:

Precondition	Covered by	Reference document
UMTS CS available	Radio Network Unavailability	
UMTS CS attach successful	Attach Failure Ratio	
UMTS CS service access successful	VT Service Non-Accessibility	
UMTS CS audio/video Setup successful	VT Audio/Video Setup Failure Ratio	

6.7.13 Signalling Diagrams

These are the flow charts of a mobile originated call until the call release. The point of view is the MO side.

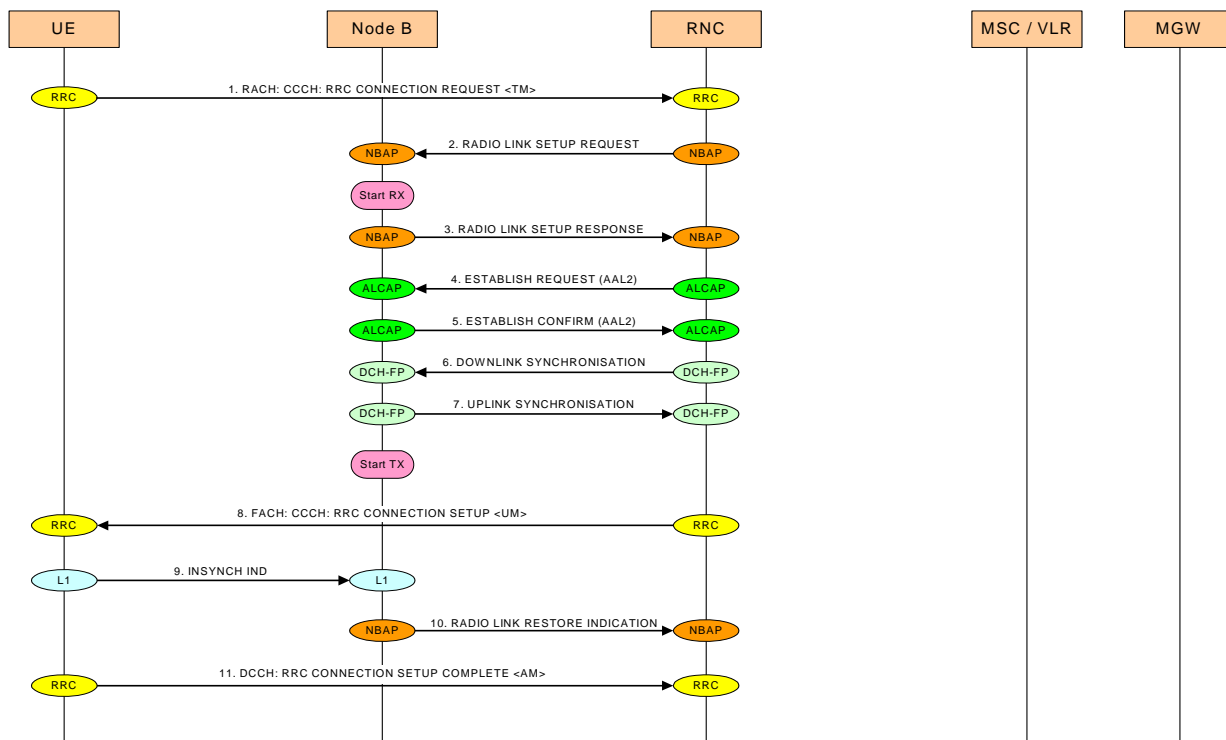

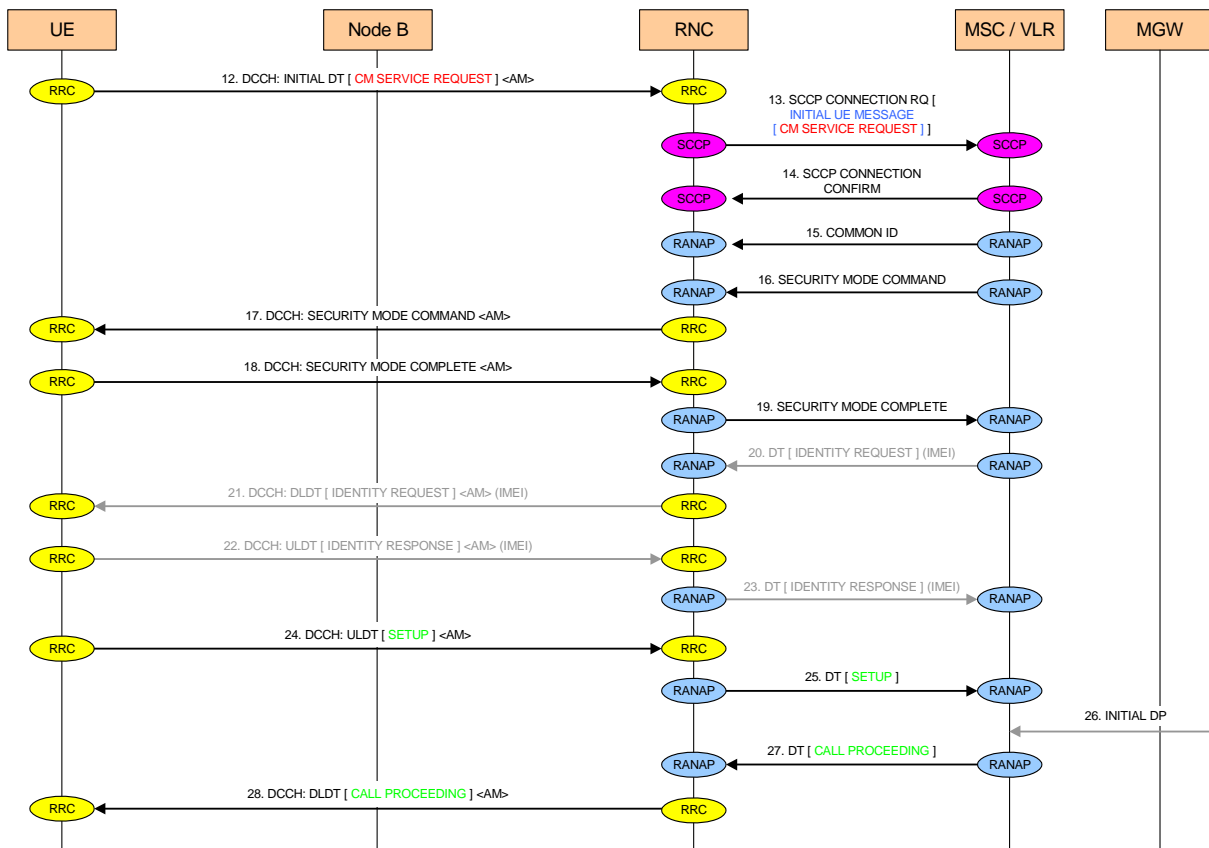
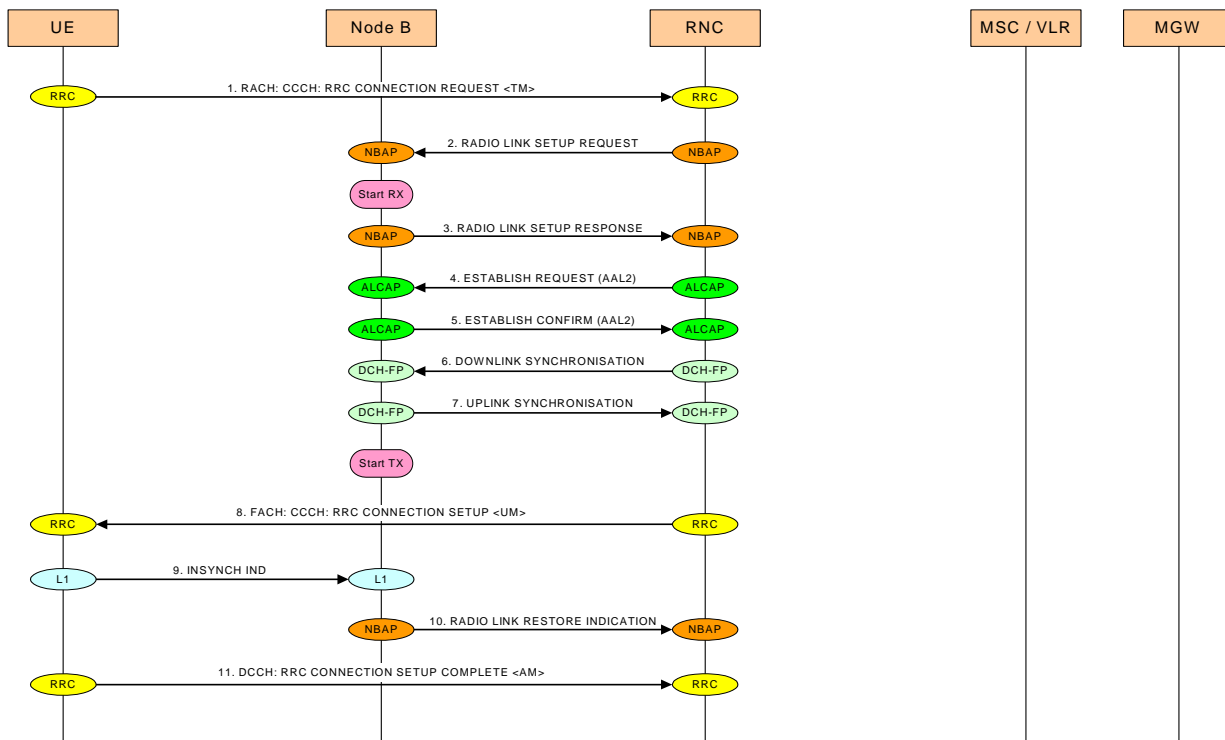

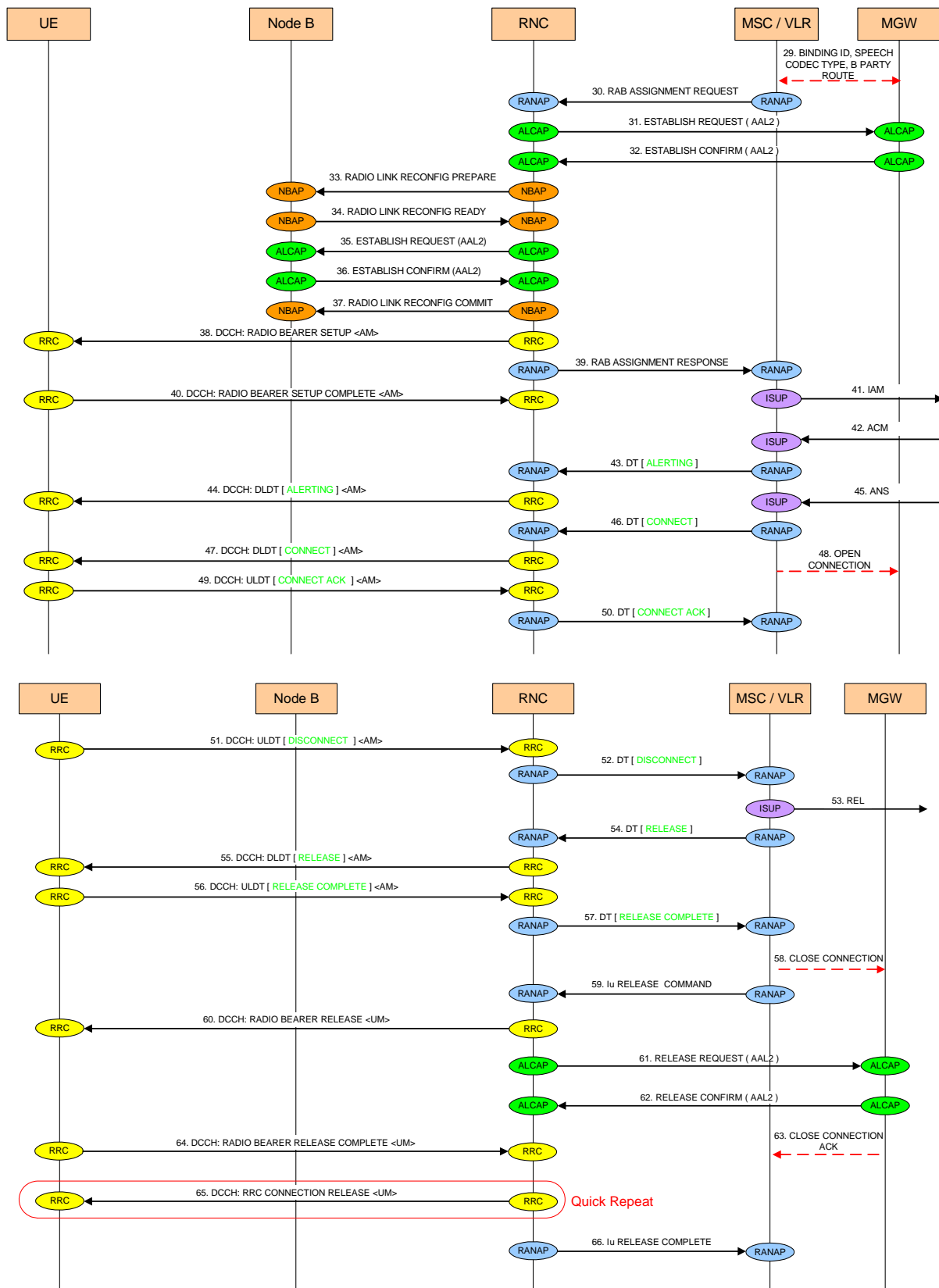

Figure 32: Video telephony signalling flow chart

6.8 Web Browsing (HTTP)

6.8.1 HTTP Service Non-Accessibility [%]

This QoS parameter can be found in former versions of the present document. It is removed from the present document because the definition included a mixture of network and service access that limited its relevance and is replaced by clause 6.8.3.

In clauses 5.2, 5.3, 5.12 and 5.13 additional information with respect to Network Access are available.

6.8.2 HTTP Setup Time [s]

This QoS parameter can be found in former versions of the present document. It is removed from the present document because the definition included a mixture of network and service access that limited its relevance and is replaced by clause 6.8.4.

In clauses 5.2, 5.3, 5.12 and 5.13 additional information with respect to Network Access are available.

6.8.3 HTTP IP-Service Access Failure Ratio [%]

6.8.3.1 Abstract Definition

The IP-service access ratio denotes the probability that a subscriber cannot establish a TCP/IP connection to the server of a service successfully.

6.8.3.2 Abstract Equation

$$\text{HTTP IP - Service Access Failure Ratio [\%]} = \frac{\text{unsuccessful attempts to establish an IP connection to the server}}{\text{all attempts to establish an IP connection to the server}} \times 100$$

6.8.3.3 Trigger Points

Event from abstract equation	Trigger point from user's point of view	Technical description/protocol part
IP-Service access attempt	Start: User enters the URL and hits "Return".	Start: First [SYN] sent.
Successful attempt	Stop: Web page download starts.	Stop Method A: Reception of the first data packet containing content. Stop Method B: Sending of the first GET command.
Unsuccessful attempt	Stop trigger point not reached.	

Remark:

- The PS bearer has to be active in the cell used by a subscriber (see clause 5.1) and the mobile station has to be attached (see clause 5.3) as well as the respective PDP context has to be activated (see clause 5.5).

6.8.4 HTTP IP-Service Setup Time [s]

6.8.4.1 Abstract Definition

The IP-service setup time is the time period needed to establish a TCP/IP connection to the server of a service, from sending the initial query to a server to the point of time when the content is sent or received.

6.8.4.2 Abstract Equation

$$\text{HTTP IP - Service Setup Time [s]} = (t_{\text{IP-Service access successful}} - t_{\text{IP-Service access start}}) [\text{s}]$$

6.8.4.3 Trigger Points

Event from abstract equation	Trigger point from user's point of view	Technical description/protocol part
$t_{\text{IP-Service access start}}$: Time of IP-Service access attempt	Start: User enters the URL and hits "Return".	Start: First [SYN] sent.
$t_{\text{IP-Service access successful}}$: Time of successful IP-Service access	Stop: Web page download starts.	Stop Method A: Reception of the first data packet containing content. Stop Method B: Sending of the first GET command.

Remark:

- The PS bearer has to be active in the cell used by a subscriber (see clause 5.1) and the mobile station has to be attached (see clause 5.3) as well as the respective PDP context has to be activated (see clause 5.5).

6.8.5 HTTP Session Failure Ratio [%]

6.8.5.1 Abstract Definition

The completed session ratio is the proportion of uncompleted sessions and sessions that were started successfully.

6.8.5.2 Abstract Equation

$$\text{HTTP Session Failure Ratio [\%]} = \frac{\text{uncompleted sessions}}{\text{successfully started sessions}} \times 100$$

6.8.5.3 Trigger Points

Event from abstract equation	Trigger point from user's point of view	Technical description/protocol part
Successfully started session	Start: User enters the URL and hits "Return".	Start: First [SYN] sent.
Completed session	Stop: The complete web page appears in the browser window.	Stop: Reception of the last data packet containing content.
Uncompleted session	Stop trigger point not reached.	
NOTE:	There are web pages that do not have a well-defined last data packet, e.g. due to dynamic content. If such pages are used for measurement, then suitable end of page indications, e.g. provided by the browser, may be used as an alternative.	

Remark:

- The PS bearer has to be active in the cell used by a subscriber (see clause 5.1) and the mobile station has to be attached (see clause 5.3) as well as the respective PDP context has to be activated (see clause 5.5).

6.8.6 HTTP Session Time [s]

6.8.6.1 Abstract Definition

The session time is the time period needed to successfully complete a PS data session.

6.8.6.2 Abstract Equation

$$\text{HTTPSession Time [s]} = (t_{\text{sessionend}} - t_{\text{sessionstart}}) [\text{s}]$$

6.8.6.3 Trigger Points

Event from abstract equation	Trigger point from user's point of view	Technical description/protocol part
$t_{\text{session start}}$: Time of successfully started session	Start: User enters the URL and hits "Return".	Start: First [SYN] sent.
$T_{\text{session end}}$: Time when session completed	Stop: The complete web page appears in the browser window.	Stop: Reception of the last data packet containing content.
NOTE: There are web pages that do not have a well-defined last data packet, e.g. due to dynamic content. If such pages are used for measurement, then suitable end of page indications, e.g. provided by the browser, may be used as an alternative.		

Remark:

- The PS bearer has to be active in the cell used by a subscriber (see clause 5.1) and the mobile station has to be attached (see clause 5.3) as well as the respective PDP context has to be activated (see clause 5.5).

6.8.7 HTTP Mean Data Rate [kbit/s]

6.8.7.1 Abstract Definition

After a data link has been successfully established, this parameter describes the average data transfer rate measured throughout the entire connect time to the service. The data transfer shall be successfully terminated. The prerequisite for this parameter is network and service access.

6.8.7.2 Abstract Equation

$$\text{HTTP Mean Data Rate [kbit/s]} = \frac{\text{user data transferred [kbit]}}{(t_{\text{data transfer complete}} - t_{\text{data transfer start}}) [\text{s}]}$$

6.8.7.3 Trigger Points

The average throughput is measured from opening the data connection to the end of the successful transfer of the content (web page).

Event from abstract equation	Trigger point from user's point of view	Technical description/protocol part
$t_{\text{data transfer start}}$: Time of successfully started data transfer	Start: Web page download starts.	Start Method A: Reception of the first data packet containing content. Start Method B: Sending of the first GET command.
$T_{\text{data transfer complete}}$: Time when data transfer complete	Stop: Web page download successfully completed.	Stop: Reception of the last data packet containing content.
NOTE: There are web pages that do not have a well-defined last data packet, e.g. due to dynamic content. If such pages are used for measurement, then suitable end of page indications, e.g. provided by the browser, may be used as an alternative.		

Remark:

- The mobile station is already attached (see clause 5.3), a PDP context is activated (see clause 5.5) and a service was accessed successfully (see Service Non-Accessibility).

6.8.8 HTTP Data Transfer Cut-off Ratio [%]

6.8.8.1 Abstract Definition

The data transfer cut-off ratio is the proportion of incomplete data transfers and data transfers that were started successfully.

6.8.8.2 Abstract Equation

$$\text{HTTP Data Transfer Cut - off Ratio [\%]} = \frac{\text{incomplete data transfers}}{\text{successfully started data transfers}} \times 100$$

6.8.8.3 Trigger Points

Event from abstract equation	Trigger point from user's point of view	Technical description/protocol part
Successfully started data transfer	Start: Web page download starts.	Start Method A: Reception of the first data packet containing content. Start Method B: Sending of the first GET command.
Complete data transfer	Stop: Web page download successfully completed.	Stop: Reception of the last data packet containing content.
Incomplete data transfer	Stop trigger point not reached.	
NOTE: There are web pages that do not have a well-defined last data packet, e.g. due to dynamic content. If such pages are used for measurement, then suitable end of page indications, e.g. provided by the browser, may be used as an alternative.		

Remark:

- The mobile station is already attached (see clause 5.3), a PDP context is activated (see clause 5.5) and a service was accessed successfully (see Service Non-Accessibility).

6.8.9 HTTP Content Compression Ratio [%]

6.8.9.1 Abstract Definition

The HTTP content compression ratio denotes the compression level of the received data accessible by the user agent (see reference point 3 in Figure 33) in relation to the data sent by the origin server (see reference point 2 in figure 1) using HTTP. It takes into account the overall effects of lossy and lossless compression and non-reversible modifications of the original stored content during transmission.

NOTE 1: Regarding the download of images the HTTP content compression ratio gives no indication on the quality of the compressed images as perceived by the user. The explanations on the influence of performance enhancement proxies given in clause 4.2.1 should be taken into account.

NOTE 2: The current definition may be applied for the transfer of HTTP content that consists of multiple objects (e.g. a web page) or content that consists of a single object.

NOTE 3: The "sent HTTP content" is an external input parameter for the calculation. It may be a constant (e.g. reference web page) or it may be measured directly at the HTTP server during the test execution, e.g. via a different network.

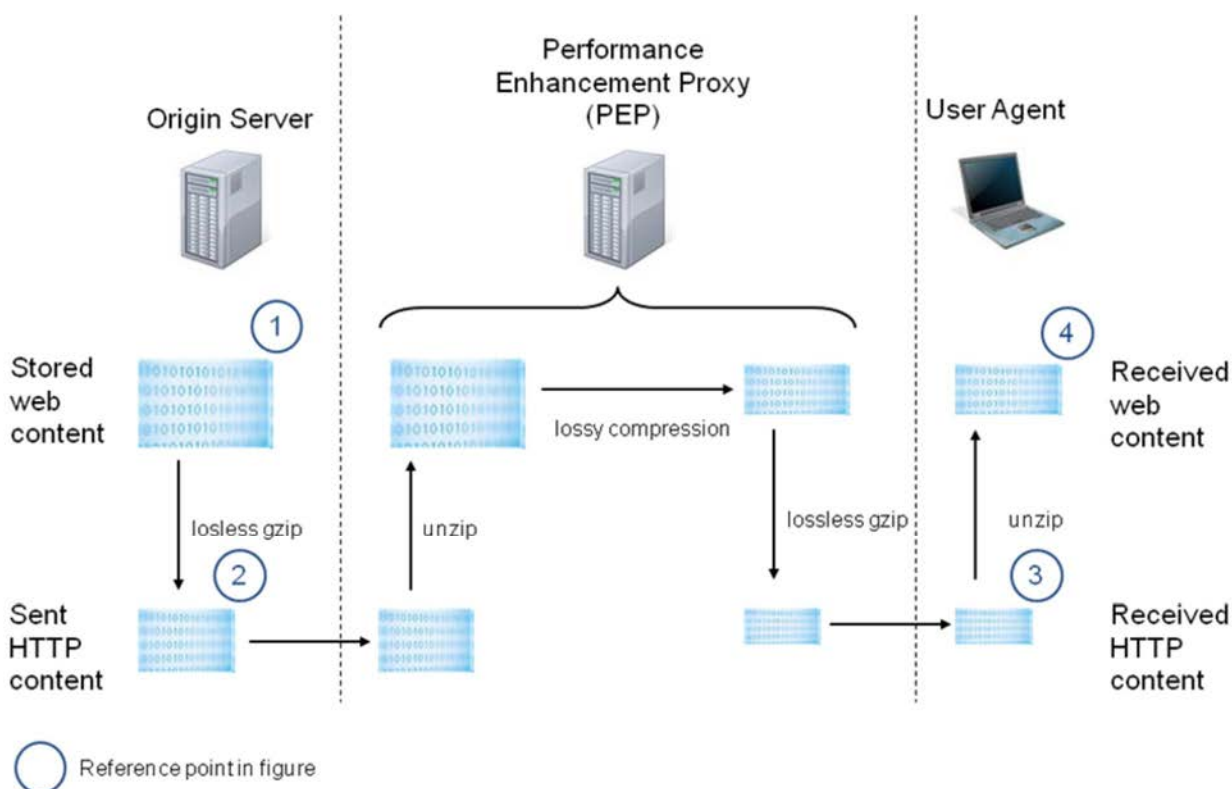

Figure 33: HTTP content download

6.8.9.2 Abstract Equation

$$\text{HTTPContentCompression Ratio}[\%] = \left(1 - \frac{\text{received HTTP content size}}{\text{sent HTTP content size}} \right) \times 100$$

6.8.9.3 Trigger Points

Precondition for the measurement of the parameter is that the HTTP data transfer was successfully completed (refer to clause 6.8.8).

6.9 Web Radio

6.9.1 General

Web Radio is a term used for different types of audio streaming. Most popular, according to current perception, is the proprietary but de-facto-standard SHOUTcast® type which is used by WinAmp® and AOL®. There is an open source variant (ICECAST). The following descriptions refer to SHOUTcast®, if not mentioned otherwise.

NOTE: SHOUTcast®, WinAmp® and AOL® are examples of suitable products available commercially. This information is given for the convenience of users of the present document and does not constitute an endorsement by ETSI of these products.

A typical Web radio basic scenario starts with starting up the respective client's Web Radio functionality.

First step is retrieval of an Electronic Program Guide (EPG), typically in the form of a station list naming station name, genre of content offered by this station, and stream rate (which gives user's a hint on expected audio quality). This EPG is typically retrieved from a fixed-URL server.

Next step is selection of a station from the list. This triggers an attempt to open the respective stream and start to receive content. Typically, before audio reproduction starts, the client will do some seconds of buffering.

6.9.2 Preconditions

With reference to the technical description above, the following KPI belong to the basic scenario only which is characterized as follows:

- EPG retrieval is not part of the scenario (because in typical listening situations this is done once for multiple-station access). It is assumed that the station ID is already known.
- EPG retrieval can be seen, however, as a kind of scenario extension.

6.9.3 Special remarks on Internet radio audio playback and buffering

Characteristic for Internet Radio audio playback is the fact that with a typical client application, no quality impairment other than gaps in reproduction occur. In other words, there is no poor MOS value or other continuous quality indicator, but simply "silence" for a period of time which cannot be estimated by the user. This fact is important when it comes to the definition of a useful KPI for audio quality.

Since the service is TCP-based and uses buffering, playback will continue until the buffer is empty. The buffer has a fixed maximum size, equalling a constant maximum playback time. If the buffer is full, the whole mechanism can be modelled by a simple differential model where new data flows in with a network-dependent data rate and flows out with a constant rate (playback stream rate).

In the stationary case with buffer completely filled, incoming throughput is equal to playback stream rate, independent of the maximum throughput the network can deliver. If the buffer is less than full due to a previous drop in incoming data rate, incoming data rate will be higher (at the maximum throughput the network/IP level chain can deliver at this time) until the buffer is full again.

6.9.4 Transaction Definition from User's perspective

A Web Radio transaction consists of a single tune-in to a selected station, followed by music playback for a given time.

- It is assumed that all servers being accessed (tune-in information server, stream server) are basically accessible and have sufficient downstream bandwidth.
- It is assumed that the length of the tune-in list is not relevant for KPI precision under given conditions (time effects caused by different lengths of tune-in list to be negligible).

6.9.5 Result Definition

With respect to the technical description, a full Web Radio transaction has one of the following results.

Result	Definition
Successful	At least one packet of content was successfully received, and no time-out condition occurred up to the end of the scheduled playback time.
Dropped	The conditions for successful transaction were not met. Examples: Unsuccessful access to the tune-in or stream server, loss of internet connection during playback, or a gap in playback longer than a pre-defined time-out value.

It shall be noted that according to this definition, a Web Radio transaction where effectively no useable audio playback was possible is still considered to be technically successful. It is assumed that the fact that the transaction was useless and probably most annoying to the user is reflected in another QoS describing subjective quality. Therefore, the situation is qualitatively equivalent to a technically stable speech telephony call with extremely poor audio MOS score.

There is no "Failed" result because it is assumed that all phases of the transaction are part of service usage, and the impact of unsuccessful phases is equally negative in the user's perception. Failure therefore is always attributed to earlier phase such as establishment of basic internet access, or DNS access. This is, however, subject to discussion with respect to the A/B method distinction.

6.9.6 QoS Parameter Overview

The following graph shows phases in web radio usage and the coverage by the defined QoS parameters.

Phase (user perspective)	Retrieve EPG	Select station	Listen to selected station	
Phase (KPI coverage)	EPG Retrieval	Tune-in	Reproduction set-up	
			Reproduction	

Please note that for the sake of "user perspective" Reproduction set-up and Reproduction are NOT seamlessly connected. Reproduction set-up QoS parameters are provided for diagnostic purposes.

6.9.7 Web Radio EPG Retrieval Failure Ratio [%]

6.9.7.1 Abstract Definition

This parameter denotes the probability that a subscriber cannot access the Web Radio EPG successfully.

6.9.7.2 Abstract Equation

$$\text{Web Radio EPG Retrieval Failure Ratio [\%]} = \frac{\text{unsuccessful attempts to access the EPG}}{\text{all attempts to access the EPG}} \times 100$$

6.9.7.3 Trigger Points

Event from abstract equation	Trigger point from user's point of view	Technical description/protocol part
EPG retrieval attempt	Start: User accesses Web Radio EPG.	Start: HTTP GET on EPG URL.
Successful attempt	Stop: EPG content successfully received.	Stop: Successful reception of EPG content (HTTP 200 OK, eventually followed by additional blocks).
Unsuccessful attempt	Stop trigger point not reached.	

6.9.8 Web Radio EPG Retrieval Time [s]

6.9.8.1 Abstract Definition

This parameter describes the time period needed to access the Web Radio EPG successfully.

6.9.8.2 Abstract Equation

$$\text{WebRadioEPGRetrievalTime[s]} = (t_{\text{Stop_ER}} - t_{\text{Start_ER}})[\text{s}]$$

6.9.8.3 Trigger Points

Event from abstract equation	Trigger point from user's point of view	Technical description/protocol part
$t_{\text{Start_ER}}$: Time of EPG retrieval attempt	Start: User accesses Web Radio EPG.	Start: Time of sending the HTTP GET on EPG URL.
$t_{\text{Stop_ER}}$: Time of successful EPG retrieval attempt	Stop: EPG content successfully received.	Stop: Time of successful reception of EPG content (HTTP 200 OK, eventually followed by additional blocks).

6.9.9 Web Radio Tune-in Failure Ratio [%]

6.9.9.1 Abstract Definition

This parameter denotes the probability that a subscriber cannot obtain the tune-in information for a Web Radio streaming server successfully.

6.9.9.2 Abstract Equation

$$\text{Web Radio Tune - in Failure Ratio [\%]} = \frac{\text{unsuccessful tune - in attempts}}{\text{all tune - in attempts}} \times 100$$

6.9.9.3 Trigger Points

Event from abstract equation	Trigger point from user's point of view	Technical description/protocol part
Tune-in attempt	Start: Attempt to retrieve tune-in information.	Start: Obtain tune-in information via a HTTP GET to a location obtained from EPG.
Successful attempt	Stop: Receive tune-in information.	Stop: Successful reception of tune-in information (HTTP 200 OK, eventually followed by additional blocks).
Unsuccessful attempt	Stop trigger point not reached.	

6.9.10 Web Radio Tune-in Time [s]

6.9.10.1 Abstract Definition

This parameter describes the time period needed to obtain the tune-in information for a Web Radio streaming server successfully.

6.9.10.2 Abstract Equation

$$\text{WebRadioTune- in Time[s]} = (t_{\text{Stop_TI}} - t_{\text{Start_TI}})[s]$$

6.9.10.3 Trigger Points

Event from abstract equation	Trigger point from user's point of view	Technical description/protocol part
$t_{\text{Start_TI}}$: Time of tune-in attempt	Start: Attempt to retrieve tune-in information.	Start: Time when HTTP GET is issued to a location obtained from EPG.
$t_{\text{Stop_TI}}$: Time of successful tune-in attempt	Stop: Receive tune-in information.	Stop: Time of successful reception of tune-in information (HTTP 200 OK, eventually followed by additional blocks).

6.9.11 Web Radio Reproduction Set-up Failure Ratio [%]

6.9.11.1 Abstract Definition

This parameter denotes the probability that a subscriber cannot successfully start listening to a given Web Radio station.

6.9.11.2 Abstract Equation

$$\text{Web Radio Reproduction Set - up Failure Ratio [\%]} = \frac{\text{unsuccessful reproduction set - up attempts}}{\text{all reproduction set - up attempts}} \times 100$$

6.9.11.3 Trigger Points

Event from abstract equation	Trigger point from user's point of view	Technical description/protocol part
Reproduction Set-up attempt	Start: Attempt to retrieve audio stream.	Start: Attempt to retrieve audio content from stream server listed in tune-in information (HTTP GET).
Successful reproduction set-up attempt	Stop: Indication that player starts buffering (may not be visible in all players).	Stop: Reception of first block of content (audio data).
Unsuccessful attempt	Stop trigger point not reached.	

6.9.12 Web Radio Reproduction Set-Up Time [s]

6.9.12.1 Abstract Definition

This parameter describes the time period from request of audio stream from Stream Server to reception of first data packet of audio content.

Remark:

- Actual start of reproduction from user's point of view will be this time plus the buffer-fill time which may be specific to a web radio client application.

6.9.12.2 Abstract Equation

$$\text{Web Radio Reproduction Set - up Time [s]} = (t_{\text{Stop_RP}} - t_{\text{Start_RP}})[\text{s}]$$

6.9.12.3 Trigger Points

Event from abstract equation	Trigger point from user's point of view	Technical description/protocol part
$t_{\text{Start_RP}}$: Time of stream reproduction attempt	Start: Indication that the audio stream is requested from server.	Start: Time when HTTP GET is issued to Stream Server.
$t_{\text{Stop_RP}}$: Time of reception of first data packet of audio content	Stop: Indication that buffering of content begins.	Stop: Receive first encoded audio data (client application is buffering).

Remark:

- Indicators listed under "user's point of view", may not be shown by actual Web Radio client applications.

6.9.13 Web Radio Reproduction Cut-off Ratio [%]

6.9.13.1 Abstract Definition

This parameter denotes the probability that a subscriber cannot successfully complete stream reproduction from a given Web Radio station for a given period of time.

Remark:

- Typically, web radio client applications use buffering; therefore actual audible reproduction will start a certain time after reception of first data packet. This parameter covers the whole reproduction time, starting from reception of the first data packet to avoid making assumptions for buffer length.

6.9.13.2 Abstract Equation

$$\text{Web Radio Reproduction Cut - off Ratio [\%]} = \frac{\text{unsuccessful listening attempts}}{\text{all listening attempts}} \times 100$$

6.9.13.3 Trigger Points

Event from abstract equation	Trigger point from user's point of view	Technical description/protocol part
Listening attempt	Start: Attempt to retrieve audio stream.	Start: Attempt to retrieve audio content from stream server listed in tune-in information (HTTP GET).
Successful listening attempt	Stop: Reach the end of intended stream playback time without break in IP connection.	Stop: Reach the end of intended stream playback time without break in IP connection.
Unsuccessful attempt	Stop trigger point not reached.	

6.9.14 Web Radio Audio Quality

Due to the nature of Web radio which is using TCP connections, expected degradation effects are audio "gaps" (silence) only, resulting in buffer-empty condition resulting from insufficient bandwidth.

At this point in time, no commonly accepted definition of perceived audio quality under these conditions exists.

Definition of such a MOS value would be outside of the scope of the STQ MOBILE group anyway. It is clear that for such a perceptual measure, all aspects of possible audio gaps need to be taken into account, namely:

- gap duration;
- frequency of gaps;
- time between gaps.

For the time being, it is recommended to report the basic data on gaps on an event basis only.

In any case, codec and stream rate (encoded bit rate) needs to be part of measurement definition since it will have decisive impact on results.

6.10 WLAN service provisioning with HTTP based authentication

6.10.1 Generic Signal Flow

KPI legend:

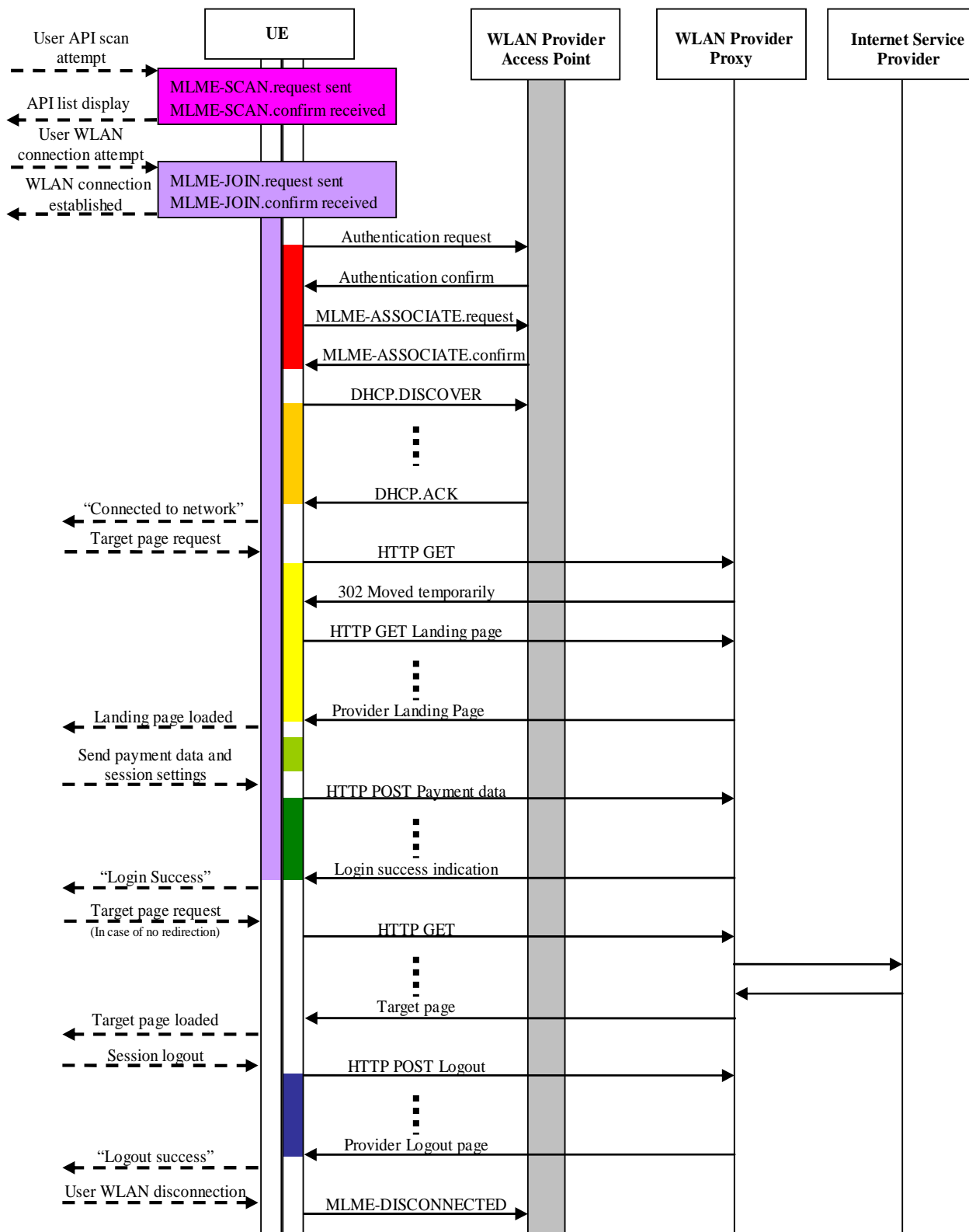

Figure 34: Generic Signal Flow

6.10.2 WLAN Scan Failure Ratio [%]

6.10.2.1 Abstract Definition

The WLAN scan failure ratio denotes the probability that no desired active Aps could be found in an area where WLAN should be present.

6.10.2.2 Abstract Equation

$$\text{WLAN Scan Failure Ratio [\%]} = \frac{\text{unsuccessful scan attempts}}{\text{total attempts to scan WLAN APs}} \times 100$$

WLAN UE

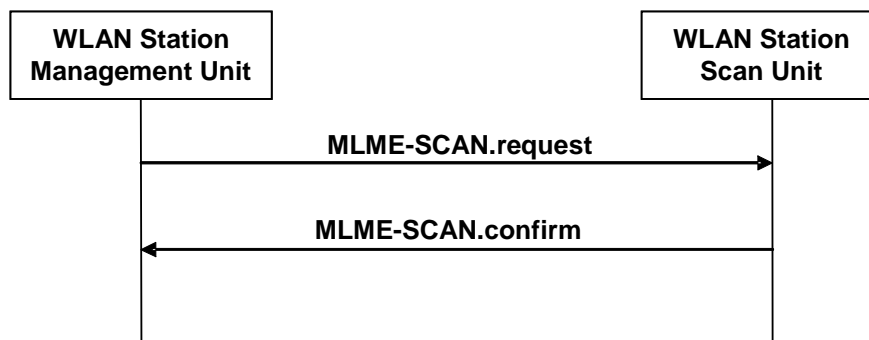

Figure 35: SCAN Signal Flow

6.10.2.3 Trigger Points

Event from abstract equation	Trigger point from user's point of view	Technical description/protocol part
Scan attempt	Start: User attempts to scan for available Aps	Start: First "MLME-SCAN.request" containing the target SSID sent
Successful scan attempt	Stop: List of available Aps is displayed including desired SSID	Stop: "MLME-SCAN.confirm" containing the target SSID received
Unsuccessful scan attempt	Stop trigger not reached	

Preconditions for measurement:

- It is possible that a scan to all access points in the area (Broadcast) is answered by an access point other than the desired one. To make sure that only the correct access point answers, the scan request shall contain the desired SSID.
- Usually, operating systems keep a list of preferred access points and sporadically scan for these access points automatically. These automated scans shall be deactivated and the list shall be kept empty.

For further study: It should be analysed if the time to scan can vary depending on the applied scan method, i.e. if an aimed scan with the target operator's SSID leads to faster/slower confirmation than a broadcast scan to all access points in the area.

6.10.3 WLAN Time to Scan [s]

6.10.3.1 Abstract Definition

WLAN time to scan denotes the time it takes to scan for available access points.

6.10.3.2 Abstract Equation

$$\text{WLANTimeToScan}[s] = (t_{\text{Scanresultreceived}} - t_{\text{Scanstarted}}) [s]$$

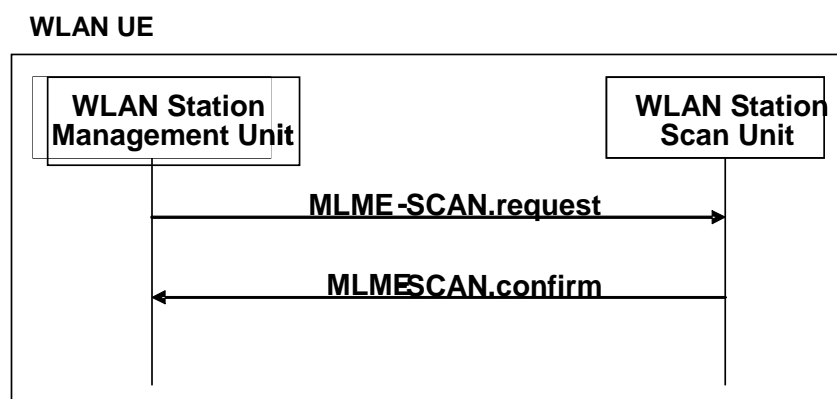

Figure 36: SCAN Signal Flow

6.10.3.3 Trigger Points

Event from abstract equation	Trigger point from user's point of view	Technical description/protocol part
$t_{\text{Scan started}}$: Time of scan attempt	Start: User attempts to scan for available Aps.	Start: First "MLME-SCAN.request" containing the target SSID sent.
$t_{\text{Scan result received}}$: Time of successful scan attempt	Stop: List of available Aps is displayed, including target SSID.	Stop: "MLME-SCAN.confirm" containing the target SSID received.

Preconditions for measurement:

- It is possible that a scan to all access points in the area (Broadcast) is answered by another access point than the desired one. To make sure that only the correct access point answers, the scan request shall contain the desired SSID.
- Usually, operating systems keep a list of preferred access points and sporadically scan for these access points automatically. These automated scans shall be deactivated and the list shall be kept empty.

NOTE: The authorization time that is consumed for entering and receiving the password has an effect on the time to scan.

For further study: It should be analysed if the time to scan can vary depending on the applied scan method, i.e. if an aimed scan with the target operator's SSID leads to faster/slower confirmation than a broadcast scan to all access points in the area.

6.10.4 WLAN PS Data Service Provisioning Failure Ratio [%]

6.10.4.1 Abstract Definition

The WLAN PS data service provisioning failure ratio denotes the probability that a user cannot get in position to access services in a WLAN area.

6.10.4.2 Abstract Equation

$$\text{WLAN PS Data Service Provisioning Failure Ratio} [\%] = \frac{\text{unsuccessful connect attempts}}{\text{all connect attempts}} \times 100$$

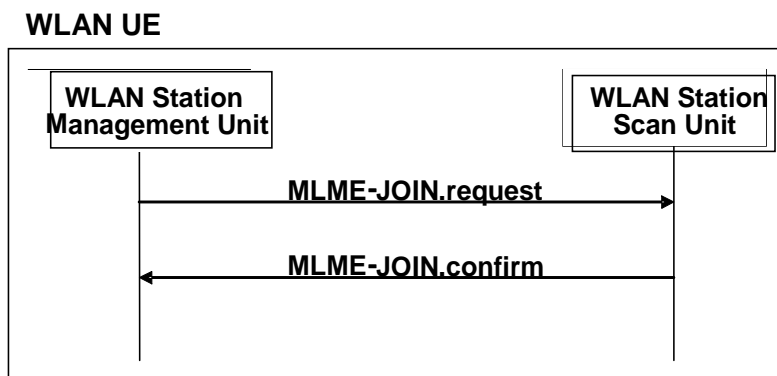

Figure 37: JOIN Signal Flow

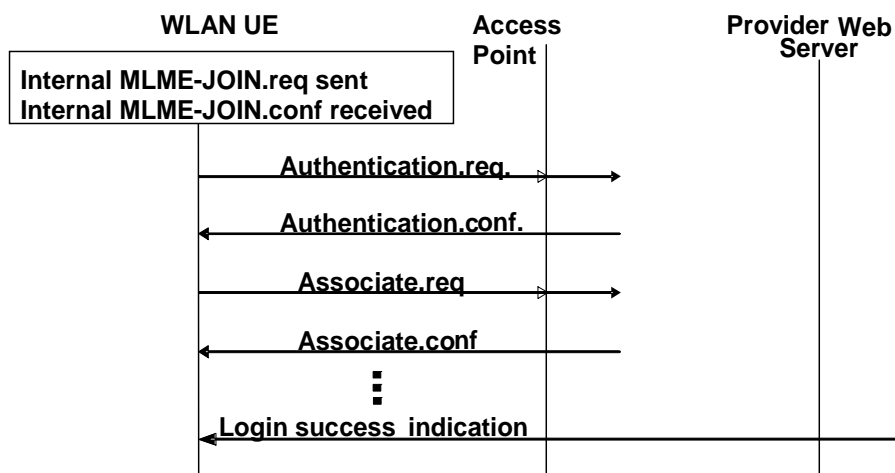

Figure 38: WLAN PS Data Service Provisioning Signal Flow

6.10.4.3 Trigger Points

Event from abstract equation	Trigger point from user's point of view	Technical description/protocol part
Connect attempt	Start: User attempts to connect to the wireless network.	Start: First "MLME-JOIN.request" sent.
Successful connect attempt	Stop: Authorization confirmed by receiving login success indication.	Stop: Reception of the first data packet of a page indicating login success.
Unsuccessful connect attempt	Stop trigger not reached.	

NOTE 1: After authorization, some operators will automatically redirect the user to the URL that was entered in the initial portal access attempt which led to the landing page redirection. Other operators display a login success page of sorts and do not redirect users to their initially entered URL.

NOTE 2: The implicit authorization failure ratio also depends on the authorization method, e.g. voucher received by SMS versus credit card. Thus, measurements based on different authorization method cannot be compared.

6.10.5 WLAN PS Data Service Provisioning Time [s]

6.10.5.1 Abstract Definition

The WLAN PS data service provisioning time denotes the time it takes until the user is authorized in WLAN and in position to access services.

6.10.5.2 Abstract Equation

$$\text{WLANPS Data Service Provisioning Time [s]} = (t_{\text{Target URL received}} - t_{\text{Connect option selected}}) [\text{s}]$$

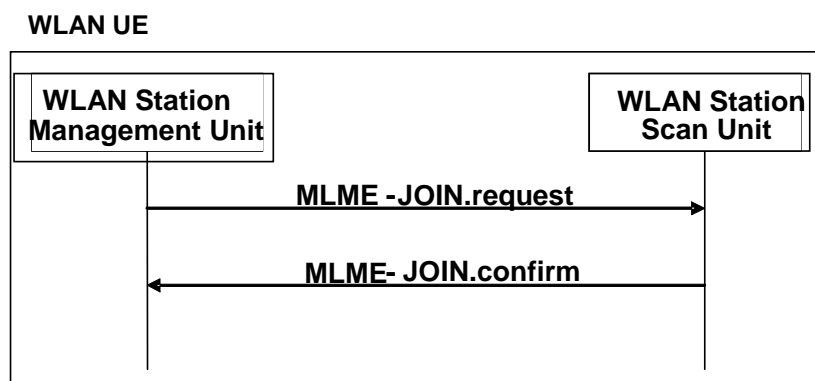

Figure 39: JOIN Signal Flow

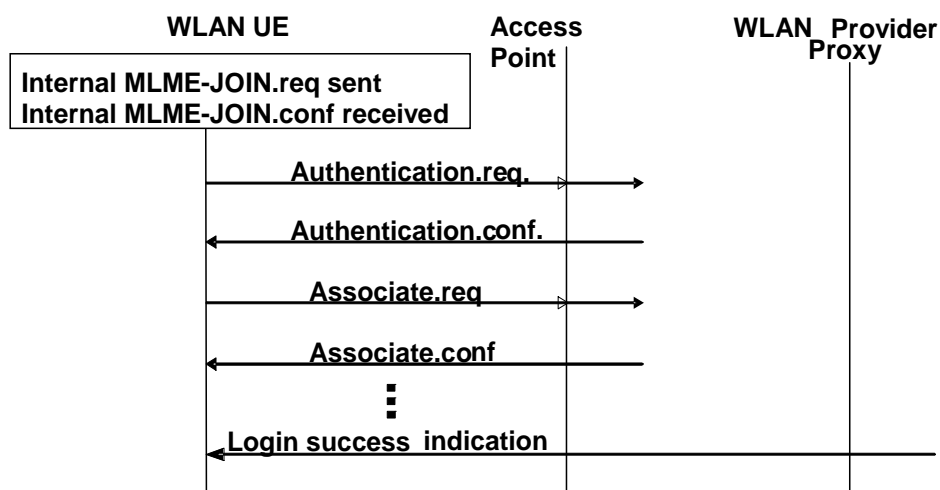

Figure 40: WLAN PS Data Service Provisioning Signal Flow

6.10.5.3 Trigger Points

Event from abstract equation	Trigger point from user's point of view	Technical description/protocol part
$t_{\text{Connect option selected}}$: Time of connect attempt	Start: User attempts to connect to wireless network.	Start: First 'MLME-JOIN.request" sent.
$t_{\text{Target URL received}}$: Time of successful connect attempt	Stop: Authorization confirmed by receiving login success indication.	Stop: Reception of the first data packet of a page indicating login success.

NOTE 1: After authorization, some operators will automatically redirect the user to the URL that was entered in the initial portal access attempt which led to the landing page redirection. Other operators display a login success page of sorts and do not redirect users to their initially entered URL.

NOTE 2: The implicit authorization time also depends on the authorization method, e.g. voucher received by SMS versus credit card. Thus, measurements based on different authorization method cannot be compared.

NOTE 3: The implicit authorization time that is consumed for entering and receiving the password has an effect on the PS data service provisioning time.

6.10.6 WLAN Association Failure Ratio [%]

6.10.6.1 Abstract Definition

The WLAN association failure ratio denotes the probability that a user cannot establish a radio link with the chosen access point.

6.10.6.2 Abstract Equation

$$\text{WLANAssociation Failure Ratio [\%]} = \frac{\text{unsuccessful association attempts}}{\text{all association attempts}} \times 100$$

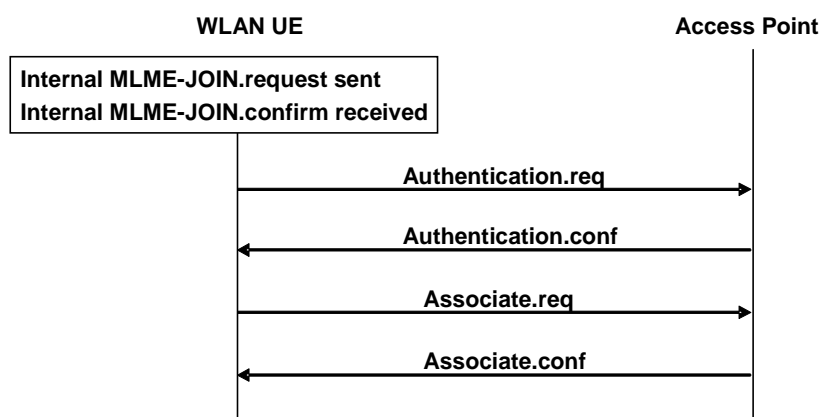

Figure 41: WLAN ASSOCIATION Signal Flow

6.10.6.3 Trigger Points

Event from abstract equation	Trigger point from user's point of view	Technical description/protocol part
Association attempt	Start: User attempts to connect to wireless network.	Start: First "MLME-JOIN.request" sent.
Successful association attempt	Stop: Connection to access point established and displayed.	Stop: "MLME-ASSOCIATE.confirm" received with status code "success".
Unsuccessful association attempt	Stop trigger not reached.	

6.10.7 WLAN Association Time [s]

6.10.7.1 Abstract Definition

The WLAN association time denotes the time it takes to associate with the chosen access point.

6.10.7.2 Abstract Equation

$$\text{WLAN Association Time [s]} = (t_{\text{Successful association}} - t_{\text{Association start}}) [\text{s}]$$

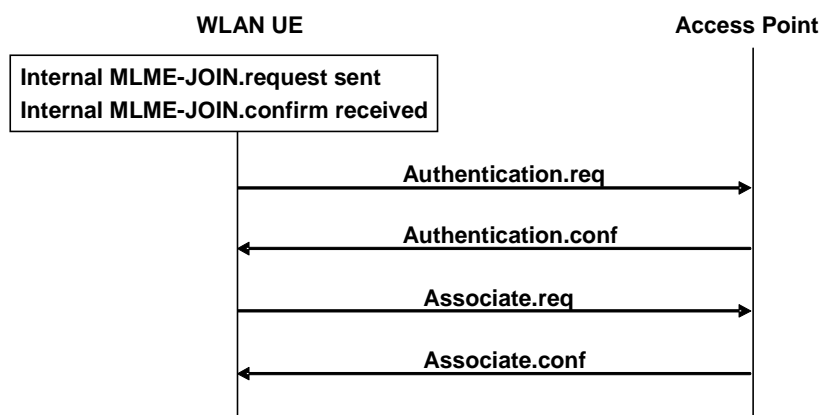

Figure 42: WLAN ASSOCIATION Signal Flow

6.10.7.3 Trigger Points

Event from abstract equation	Trigger point from user's point of view	Technical description/protocol part
$t_{\text{Association start}}$: Time of association attempt	Start: User attempts to connect to wireless network.	Start: First "MLME-JOIN.request" sent.
$t_{\text{Successful association}}$: Time of successful association attempt	Stop: Connection to access point established and displayed.	Stop: "MLME-ASSOCIATE.confirm" received with status code "success".

NOTE: The authorization time that is consumed for entering and receiving the password has an effect on the association time.

6.10.8 WLAN IP Address Allocation Failure Ratio [%]

6.10.8.1 Abstract Definition

The WLAN IP address allocation failure ratio denotes the probability that a user is not allocated an IP address by the access point.

6.10.8.2 Abstract Equation

$$\text{WLAN IP Address Allocation Failure Ratio [\%]} = \frac{\text{unsuccessful attempts to allocate IP address}}{\text{all IP address allocation requests}} \times 100$$

6.10.8.3 Trigger Points

Event from abstract equation	Trigger point from user's point of view	Technical description/protocol part
IP address allocation request	Start: Attempt to acquire network address and display of status.	Start: First "DHCP.DISCOVER" sent.
Successful attempt to allocate IP address	Stop: Connection to network established and displayed.	Stop: "DHCP.ACK" received with valid IP address.
Unsuccessful attempt to allocate IP address	Stop trigger not reached.	

6.10.9 WLAN IP Address Allocation Time [s]

6.10.9.1 Abstract Definition

The WLAN IP address allocation time denotes the time it takes the access point to allocate an IP address to the user's system.

6.10.9.2 Abstract Equation

$$\text{WLANIP Address Allocation Time [s]} = (t_{\text{IP reception}} - t_{\text{IP allocation start}}) [\text{s}]$$

6.10.9.3 Trigger Points

Event from abstract equation	Trigger point from user's point of view	Technical description/protocol part
$t_{\text{IP allocation start}}$: Time of IP address allocation request	Start: Attempt to acquire network address and display of status.	Start: First "DHCP.DISCOVER" sent.
$t_{\text{IP reception}}$: Time of successful attempt to allocate IP address	Stop: Connection to network established and displayed.	Stop: "DCHP.ACK" received with valid IP address.

NOTE: The authorization time that is consumed for entering and receiving the password has an effect on the IP address allocation time.

6.10.10 WLAN Landing Page Download Failure Ratio [%]

6.10.10.1 Abstract Definition

The WLAN landing page download failure ratio denotes the probability that the landing page to which a user will be redirected for login to the WLAN cannot be successfully downloaded after requesting the target page.

6.10.10.2 Abstract Equation

$$\text{WLAN Landing Page Download Failure Ratio [\%]} = \frac{\text{unsuccessful landing page download attempts}}{\text{all landing page download attempts}} \times 100$$

6.10.10.3 Trigger Points

Event from abstract equation	Trigger point from user's point of view	Technical description/protocol part
Landing page download attempt	Start: User enters target URL and requests the desired page.	Start: "HTTP_GET" for the target page sent.
Successful landing page download attempt	Stop: Landing page download finished.	Stop: Last HTTP data packet of the landing page received.
Unsuccessful landing page download attempt	Stop trigger not reached.	

Preconditions for measurement:

- The measurement system shall be disconnected from the WLAN prior to each measurement cycle.
- The cache shall be emptied prior to each measurement cycle and keep alive shall be deactivated/suppressed.

6.10.11 WLAN Landing Page Download Time [s]

6.10.11.1 Abstract Definition

The WLAN landing page download time denotes the time it takes for redirection and download of the landing page provided to login to the WLAN successfully, after the user has tried to access some webpage.

6.10.11.2 Abstract Equation

$$\text{WLAN Landing Page Download Time [s]} = (t_{\text{Landing page successfully downloaded}} - t_{\text{Webpage request sent}}) \text{ [s]}$$

6.10.11.3 Trigger Points

Event from abstract equation	Trigger point from user's point of view	Technical description/protocol part
$t_{\text{Webpage request sent}}$: Time of landing page download attempt	Start: User enters target URL and requests the desired page.	Start: "HTTP_GET" for the target page sent.
$t_{\text{Landing page successfully downloaded}}$: Time of successful landing page download attempt	Stop: Landing page download finished.	Stop: Last HTTP data packet of the landing page received.

Preconditions for measurement:

- The measurement system shall be disconnected from the WLAN prior to each measurement cycle.
- The cache shall be emptied prior to each measurement cycle and keep alive shall be deactivated/suppressed.

NOTE: The authorization time that is consumed for entering and receiving the password has an effect on the landing page download time.

6.10.12 WLAN Landing Page Password Retrieval Failure Ratio [%]

6.10.12.1 Abstract Definition

The WLAN landing page password retrieval failure ratio denotes the probability that the password to get submitted via the landing page is not received by the user.

6.10.12.2 Abstract Equation

$$\text{WLAN Landing Page Password Retrieval Failure Ratio [\%]} = \frac{\text{unsuccessful password retrieval attempts}}{\text{all password retrieval attempts}} \times 100$$

6.10.12.3 Trigger Points

Event from abstract equation	Trigger point from user's point of view	Technical description/protocol part
Password retrieval attempt	Start: Authorization form filled in and submitted.	Start: "TCP SYN."
Successful password retrieval attempt	Stop: Depending on used service, e.g. SMS with password received successfully.	Stop: Depending on used service, e.g. SMS with password received successfully.
Unsuccessful password retrieval attempt	Stop trigger not reached.	

NOTE: The password retrieval failure ratio can be neglected when the credit card payment method is used.

6.10.13 WLAN Landing Page Password Retrieval Time [s]

6.10.13.1 Abstract Definition

The WLAN landing page password retrieval time denotes the time it takes to request and receive a password to get submitted via the landing page.

6.10.13.2 Abstract Equation

$$\text{WLAN Landing Page Password Retrieval Time [s]} = (t_{\text{Password received}} - t_{\text{Authorisation request submitted}}) \text{ [s]}$$

6.10.13.3 Trigger Points

Event from abstract equation	Trigger point from user's point of view	Technical description/protocol part
$t_{\text{Authorization request submitted}}$: Time of password retrieval attempt	Start: Authorization form filled in and submitted.	Start: "TCP SYN".
$t_{\text{Password received}}$: Time of successful password retrieval attempt	Stop: Depending on used service, e.g. SMS with password received successfully.	Stop: Depending on used service, e.g. SMS with password received successfully.

NOTE 1: The password retrieval time can be neglected when the credit card payment method is used.

NOTE 2: The authorization time that is consumed for entering and receiving the password has an effect on the landing page password retrieval time.

6.10.14 WLAN Landing Page Authorization Failure Ratio [%]

6.10.14.1 Abstract Definition

The WLAN landing page authorization failure ratio denotes the probability that the user authorization process via the landing page is not successful.

6.10.14.2 Abstract Equation

$$\text{WLAN Landing Page Authorisation Failure Ratio [\%]} = \frac{\text{unsuccessful authorisation attempts}}{\text{all authorisation attempts}} \times 100$$

6.10.14.3 Trigger Points

Event from abstract equation	Trigger point from user's point of view	Technical description/protocol part
Authorization attempt	Start: Password or payment data is submitted.	Start: "HTTP POST" sent.
Successful authorization attempt	Stop: Authorization confirmed by receiving login success indication.	Stop: Reception of the first data packet of a page indicating login success.
Unsuccessful authorization attempt	Stop Trigger not reached.	

NOTE 1: After authorization, some operators will automatically redirect the user to the URL that was entered in the initial portal access attempt which led to the landing page redirection. Other operators will display a login success page of sorts and not redirect the user to the initially entered URL.

NOTE 2: The authorization failure ratio also depends on the authorization method, e.g. voucher received by SMS versus credit card. Thus, measurements based on different authorization method cannot be compared.

6.10.15 WLAN Landing Page Authorization Time [s]

6.10.15.1 Abstract Definition

The WLAN landing page authorization time denotes the time it takes to perform user authorization via the landing page.

6.10.15.2 Abstract Equation

$$\text{WLAN Landing Page Authorisation Time [s]} = (t_{\text{Authorisation confirmed}} - t_{\text{Password is submitted}}) [\text{s}]$$

6.10.15.3 Trigger Points

Event from abstract equation	Trigger point from user's point of view	Technical description/protocol part
$t_{\text{Password is submitted}}$: Time of authorization attempt	Start: Password or payment data is submitted.	Start: "HTTP POST" sent.
$t_{\text{Authorization confirmed}}$: Time of successful authorization attempt	Stop: Authorization confirmed by receiving login success indication.	Stop: Reception of the first data packet of a page indicating login success.

NOTE 1: After authorization, some operators will automatically redirect the user to the URL that was entered in the initial portal access attempt which led to the landing page redirection. Other operators display a login success page of sorts and do not redirect users to their initially entered URL.

NOTE 2: The authorization time also depends on the authorization method, e.g. voucher received by SMS versus credit card. Thus, measurements based on different authorization method cannot be compared.

NOTE 3: The authorization time that is consumed for entering and receiving the password has an effect on the landing page authorization time.

6.10.16 WLAN Re-accessibility Failure Ratio [%]

6.10.16.1 Abstract Definition

The WLAN re-accessibility failure ratio denotes the probability that re-accessing the access point is not successful because of a WLAN failure.

6.10.16.2 Abstract Equation

$$\text{WLAN Re - accessibility Failure Ratio [\%]} = \frac{\text{unsuccessful attempts reaccess}}{\text{all attempts to reaccess}} \times 100$$

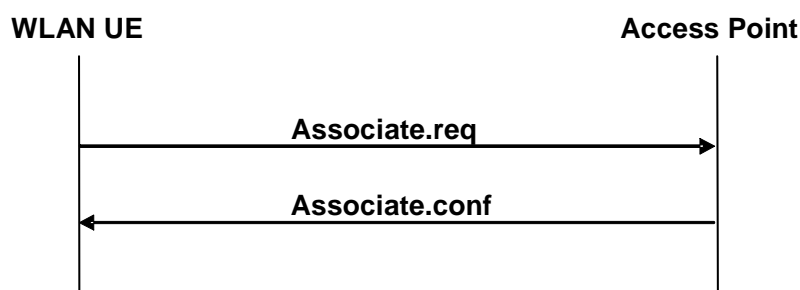

Figure 43: WLAN RE-ASSOCIATION Signal Flow

6.10.16.3 Trigger Points

Event from abstract equation	Trigger point from user's point of view	Technical description/protocol part
Attempt to reaccess	Start: Access point is displayed in the list of available access points.	Start: First "MLME-ASSOCIATE.request" sent after radio signal is sufficient again.
Successful attempt to reaccess	Stop: Message that the WLAN adapter is ready (MAC address of Access point is available).	Stop: "MLME-ASSOCIATE.confirm" has been received with status code "success".
Unsuccessful attempt to reaccess	Stop trigger point not reached.	

6.10.17 WLAN Re-accessibility Time [s]

6.10.17.1 Abstract Definition

The WLAN re-accessibility time denotes the time it takes to re-establish a lost radio link with the access point after the signal is sufficient again.

6.10.17.2 Abstract Equation

$$\text{WLAN Re - accessibility Time [s]} = (t_{\text{AP's MAC address is available}} - t_{\text{AP reappears in list}}) [\text{s}]$$

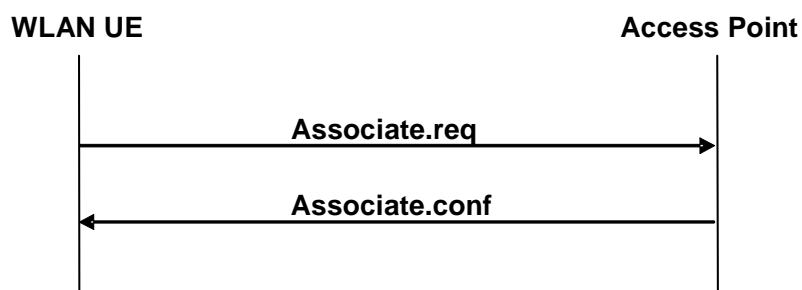

Figure 44: WLAN RE-ASSOCIATION Signal Flow

6.10.17.3 Trigger Points

Event from abstract equation	Trigger point from user's point of view	Technical description/protocol part
$t_{\text{AP reappears in list}}$: Time of attempt to reaccess	Start: access point is displayed in the list of available access points.	Start: First "MLME-ASSOCIATE.request" sent after radio signal is sufficient again.
$t_{\text{AP's MAC address is available}}$: Time of successful attempt to reaccess	Stop: message that the WLAN adapter is ready.	Stop: "MLME-ASSOCIATE.confirm" has been received with status code "success".

NOTE: The authorization time that is consumed for entering and receiving the password has an effect on the re-accessibility time.

6.10.18 WLAN Logout Page Download Failure Ratio [%]

6.10.18.1 Abstract Definition

The WLAN logout page download failure ratio denotes the probability that the logout process is not successful.

6.10.18.2 Abstract Equation

$$\text{WLAN Logout Page Download Failure Ratio [\%]} = \frac{\text{unsuccessful logout page download attempts}}{\text{all logout page download attempts}} \times 100$$

6.10.18.3 Trigger Points

Event from abstract equation	Trigger point from user's point of view	Technical description/protocol part
Logout page download attempt	Start: Decision to logout is submitted.	Start: "HTTP POST" sent.
Successful logout page download attempt	Stop: Logout confirmed by receiving logout page.	Stop: Reception of first data packet of logout page.
Unsuccessful logout page download attempt	Stop Trigger not reached.	

6.10.19 WLAN Logout Page Download Time [s]

6.10.19.1 Abstract Definition

The WLAN logout page download time denotes the time it takes to perform user logout.

6.10.19.2 Abstract Equation

$$\text{WLAN Logout Page Download Time [s]} = (t_{\text{Logout confirmed}} - t_{\text{Logout procedure start}}) [\text{s}]$$

6.10.19.3 Trigger Points

Event from abstract equation	Trigger point from user's point of view	Technical description/protocol part
$t_{\text{Logout procedure start}}$: Time of logout page download attempt	Start: Decision to logout is submitted.	Start: "HTTP POST" sent.
$t_{\text{Logout confirmed}}$: Time of successful logout page download attempt	Stop: Logout confirmed by receiving logout page.	Stop: Reception of first data packet of logout page.

NOTE: The authorization time that is consumed for entering and receiving the password has an effect on the logout page download time.

6.11 Wireless Application Protocol (WAP)

WAP (Wireless Application Protocol) is a specification for a set of communication protocols to standardize the way that wireless devices, such as cellular telephones and radio transceivers, can be used for Internet access, including e-mail, the World Wide Web, newsgroups, and instant messaging. Devices and service systems that use WAP are able to interoperate.

The WAP layers are:

- Wireless Application Environment (WAE).
- Wireless Session Layer (WSL).
- Wireless Transport Layer Security (WTLS).
- Wireless Transport Layer (WTP).

WAP is a technology designed to allow efficient transmission of optimized Internet content to cell phones.

The QoS parameters for WAP are represented in Figure 45.

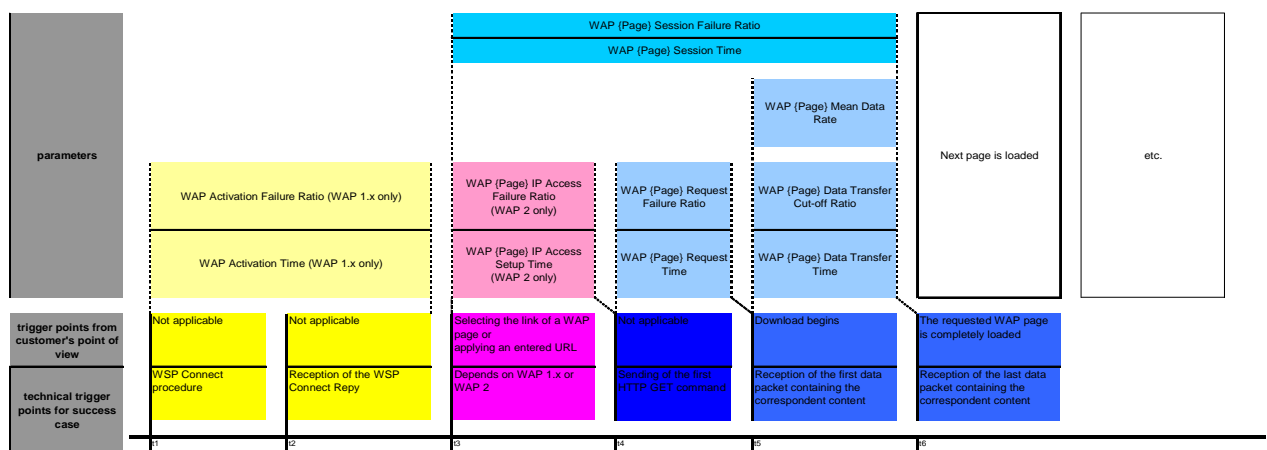

Figure 45: Parameter and service overview

The Technical description/protocol part of the Parameters of the whole clause are represented in the following "WAP Message Sequence Chart".

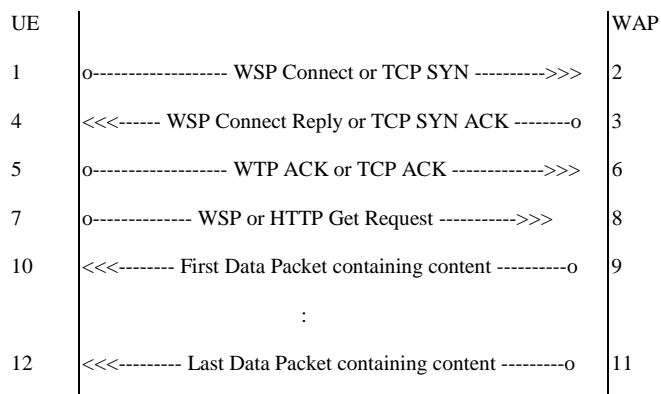

Figure 46: WAP Message Sequence Chart

NOTE: WSP Connection usually occurs once per session, TCP connection is more frequent.

6.11.1 WAP Activation Failure Ratio [%] (WAP 1.x only)

6.11.1.1 Abstract Definition

The parameter WAP Activation Failure Ratio describes the probability that the WAP session could not be activated in case of WAP 1.x connection-mode session service.

6.11.1.2 Abstract Equation

$$\text{WAP Activation Failure Ratio [\%]} = \frac{\text{unsuccessful WAP activation attempts}}{\text{all WAP activation attempts}} \times 100$$

6.11.1.3 Trigger Points

Event from abstract equation	Trigger point from user's point of view	Technical description / protocol part
WAP activation attempt	Not applicable.	Start: WSP Connect procedure.
Successful WAP activation attempt	Not applicable.	Stop: Reception of the WSP Connect Reply.
Unsuccessful WAP activation attempt	Stop trigger point not reached.	

Remark:

- The bearer has to be active in the cell used by a subscriber (see clause 5.1) and the mobile station has to be attached (see clause 5.3).

6.11.2 WAP Activation Time [s] (WAP 1.x only)

6.11.2.1 Abstract Definition

The parameter WAP Activation Time describes the time it takes to activate the WAP session in case of WAP 1.x connection-mode session service.

6.11.2.2 Abstract Equation

$$\text{WAP Activation Time [s]} = (t_{\text{WAP session established}} - t_{\text{WAP session activation request}}) [\text{s}]$$

6.11.2.3 Trigger Points

Event from abstract equation	Trigger point from user's point of view	Technical description/protocol part
$t_{\text{WAP session activation request}}$: Time of WAP session activation request.	Not applicable.	Start: WSP Connect procedure
$t_{\text{WAP session established}}$: Time when WAP session established.	Not applicable.	Stop: Reception of the WSP Connect Reply

Remark:

- The bearer has to be active in the cell used by a subscriber (see clause 5.1) and the mobile station has to be attached (see clause 5.3). Only successful measurements are taken into account to calculate the average time.

6.11.3 WAP {Page} IP Access Failure Ratio [%] (WAP 2.x only)

6.11.3.1 Abstract Definition

The parameter WAP {Page} IP Access Failure Ratio denotes the probability that a subscriber cannot establish a TCP/IP connection to the WAP server successfully.

NOTE: This parameter can only be calculated in case of follow up page, if the TCP/IP connection is not persistent.

6.11.3.2 Abstract Equation

$$\text{WAP \{Page\} IP Access Failure Ratio [\%]} = \frac{\text{unsuccessful WAP IP Access attempts}}{\text{all WAP IP Access attempts}} \times 100$$

6.11.3.3 Trigger Points

Event from abstract equation	Trigger point from user's point of view	Technical description / protocol part
WAP IP access attempt	Start: Selecting the link of a WAP page or applying an entered URL	Start: Sending of First TCP SYN
Successful WAP IP access attempt	Not applicable	Stop: Sending of the first HTTP GET command
Unsuccessful WAP IP access attempt	Stop trigger point not reached	

Remark:

- The bearer has to be active in the cell used by a subscriber (see clause 5.1) and the mobile station has to be attached (see clause 5.3) as well as the respective PDP context has to be activated (see clause 5.5).

6.11.4 WAP {Page} IP Access Setup Time [s] (WAP 2.x only)

6.11.4.1 Abstract Definition

The WAP {Page} IP Access Time is the time period needed to establish a TCP/IP connection to the WAP server, from sending the initial query to a server to the point of time when the content is demanded.

NOTE: This parameter can only be calculated in case of follow up page, if the TCP/IP connection is not persistent.

6.11.4.2 Abstract Equation

$$\text{WAP \{Page\} IP Access Time [s]} = (t_{\text{WAP IP connection established}} - t_{\text{WAP IP connection request}}) [\text{s}]$$

6.11.4.3 Trigger Points

Event from abstract equation	Trigger point from user's point of view	Technical description/protocol part
$t_{\text{WAP IP connection request}}$: Time of WAP IP connection request.	Start: Selecting the link of a WAP page or applying an entered URL.	Start: Sending of First TCP SYN.
$t_{\text{WAP IP connection established}}$: Time of WAP IP connection established.	Not applicable.	Stop: Sending of the first HTTP GET command.

Remark:

- The bearer has to be active in the cell used by a subscriber (see clause 5.1) and the mobile station has to be attached (see clause 5.3) as well as the respective PDP context has to be activated (see clause 5.5). Only successful measurements are taken into account to calculate the average time.

6.11.5 WAP {Page} Session Failure Ratio [%]

6.11.5.1 Abstract Definition

The parameter WAP {Page} Session Failure Ratio is the proportion of unsuccessful WAP page access attempts and sessions that were started successfully.

6.11.5.2 Abstract Equation

$$\text{WAP \{Page\} Session Failure Ratio [\%]} = \frac{\text{unsuccessful WAP page access attempts}}{\text{all WAP page access attempts}} \times 100$$

6.11.5.3 Trigger Points

Event from abstract equation	Trigger point from user's point of view	Technical description/protocol part
WAP page access attempt	Start: Selecting the link of a WAP page or applying an entered URL.	Start: WAP1.x: Sending of WSP Get Request WAP2.x: a) Sending of First TCP SYN (if available); or b) Sending of HTTP Get Request (only if first TCP SYN is not available).
Successful WAP page access attempt	Stop: The requested WAP page is completely loaded.	Stop: WAP1.x/WAP2.x: Reception of the last data packet containing the corresponding content.
Unsuccessful WAP page access attempt	Stop trigger point not reached.	
NOTE: In case of WAP 2.x the start trigger should be the first TCP SYN (a). If the TCP/IP connection is not re-established before the request of the new page (next page part), the start Trigger has to be the first respective HTTP Get Request (b).		

Remark:

- The bearer has to be active in the cell used by a subscriber (see clause 5.1) and the mobile station has to be attached (see clause 5.3) as well as the respective PDP context has to be activated (see clause 5.5).

6.11.6 WAP {Page} Session Time [s]

6.11.6.1 Abstract Definition

The parameter WAP {Page} Session Time provides the time in seconds between selection of a specific WAP page and the successful load of the page.

6.11.6.2 Abstract Equation

$$\text{WAP}\{\text{Page}\}\text{Session Time}[s] = (t_{\text{appearance WAP page}} - t_{\text{selection WAP page}})[s]$$

6.11.6.3 Trigger Points

Event from abstract equation	Trigger point from user's point of view	Technical description/protocol part
$t_{\text{selection WAP page}}$: Time of selection of the WAP page	Start: Selecting the link of a WAP page or applying an entered URL.	Start: WAP1.x: Sending of first WSP Get Request. WAP2.x: a) Sending of First TCP SYN (if available); or b) Sending of HTTP Get Request (only if first TCP SYN is not available).
$t_{\text{appearance WAP page}}$: Time of appearance of the WAP page	Stop: The requested WAP page is completely loaded.	Stop: WAP1.x/WAP2.x: Reception of the last data packet containing the corresponding content.
NOTE: In case of WAP 2.x the start trigger should be the first TCP SYN (a). If the TCP/IP connection is not re-established before the request of the new page (next page part), the start Trigger has to be the first respective HTTP Get Request (b).		

Remark:

- The bearer has to be active in the cell used by a subscriber (see clause 5.1) and the mobile station has to be attached (see clause 5.3) as well as the respective PDP context has to be activated (see clause 5.5). Only successful measurements are taken into account to calculate the average time.

6.11.7 WAP {Page} Request Failure Ratio [%]

6.11.7.1 Abstract Definition

The WAP {Page} Request Failure Ratio denotes the probability that a WAP page request is not successful after a timeout period.

6.11.7.2 Abstract Equation

$$\text{WAP \{Page\} Request Failure Ratio [\%]} = \frac{\text{unsuccessful WAP page request attempts}}{\text{all WAP page request attempts}} \times 100$$

6.11.7.3 Trigger Points

Event from abstract equation	Trigger point from user's point of view	Technical description/protocol part
WAP page request attempt	Start: Selecting the link of the WAP page.	Start: WAP1.x: Sending of WSP Get Request WAP2.x: Sending of HTTP Get Request.
Successful WAP page request attempt	Stop: Download begins.	Stop: WAP1.x/WAP2.x: Reception of the first data packet containing content.
Unsuccessful WAP page request attempt	Stop trigger point not reached.	

Remark:

- The bearer has to be active in the cell used by a subscriber (see clause 5.1) and the mobile station has to be attached (see clause 5.3) as well as the respective PDP context has to be activated (see clause 5.5).

6.11.8 WAP {Page} Request Time [s]

6.11.8.1 Abstract Definition

The parameter WAP {Page} Request Time describes the duration between selection of a specific WAP page and the reception of the first data packet containing WAP page content.

6.11.8.2 Abstract Equation

$$\text{WAP \{Page\} Request Time [s]} = (t_{\text{first data packet reception}} - t_{\text{selection WAP page}}) [\text{s}]$$

6.11.8.3 Trigger Points

Event from abstract equation	Trigger point from user's point of view	Technical description/protocol part
$t_{\text{selection WAP page}}$: Time of selection of the WAP site.	Start: Selecting the link of the WAP page.	Start: WAP1.x: Sending of WSP Get Request WAP2.x: Sending of HTTP Get Request.
$t_{\text{first data packet reception}}$: Time of first data packet reception.	Stop: Download begins.	Stop: WAP1.x/WAP2.x: Reception of the first data packet containing content.

Remark:

- The bearer has to be active in the cell used by a subscriber (see clause 5.1) and the mobile station has to be attached (see clause 5.3) as well as the respective PDP context has to be activated (see clause 5.5). Only successful measurements are taken into account to calculate the average time.

6.11.9 WAP {Page} Mean Data Rate [kbit/s]

6.11.9.1 Abstract Definition

The WAP {Page} Mean Data Rate denotes the average data rate (WAP throughput) in kbit/s.

6.11.9.2 Abstract Equation

$$\text{WAP}\{\text{Page}\}\text{MeanDataRate [kbit/s]} = \frac{\text{WAP}\text{pagesize[kbyte]} \times 8}{(t_{\text{last data packet reception}} - t_{\text{first data packet reception}}) [\text{s}]}$$

6.11.9.3 Trigger Points

The average throughput is measured from opening the data connection to the end of the successful transfer of the content (file, WAP page).

Event from abstract equation	Trigger point from user's point of view	Technical description/protocol part
$t_{\text{first data packet reception}}$ Time of first data packet reception	Start: Download begins.	Start: WAP1.x/WAP2.x: Reception of the first data packet containing content.
$t_{\text{last data packet reception}}$ Time of last data packet reception	Stop: Download is completed.	Stop: WAP1.x/WAP2.x: Reception of the last data packet containing the corresponding content.

Remark:

- The bearer has to be active in the cell used by a subscriber (see clause 5.1) and the mobile station has to be attached (see clause 5.3) as well as the respective PDP context has to be activated (see clause 5.5).

6.11.10 WAP {Page} Data Transfer Cut-off Ratio [%]

6.11.10.1 Abstract Definition

The WAP {Page} Data Transfer Cut off Ratio denotes the probability that a data download is incomplete after a timeout period (the download is aborted).

6.11.10.2 Abstract Equation

$$\text{WAP}\{\text{Page}\}\text{Data Transfer Cut off Ratio [\%]} = \frac{\text{incomplete WAP page transfer attempts}}{\text{all WAP page transfer attempts}} \times 100$$

6.11.10.3 Trigger Points

Event from abstract equation	Trigger point from user's point of view	Technical description/protocol part
WAP page transfer attempt	Start: Download begins.	Start: WAP1.x/WAP2.x: Reception of the first data packet containing content.
Successful WAP page transfer attempt	Stop: Download is completed.	Stop: WAP1.x/WAP2.x: Reception of the last data packet containing the corresponding content.
Incomplete WAP page transfer attempt	Stop trigger point not reached.	

Remark:

- The bearer has to be active in the cell used by a subscriber (see clause 5.1) and the mobile station has to be attached (see clause 5.3) as well as the respective PDP context has to be activated (see clause 5.5).

6.11.11 WAP {Page} Data Transfer Time [s]

6.11.11.1 Abstract Definition

The parameter WAP {Page} Data Transfer Time describes the duration between the reception of the first data packet and the last data packet containing WAP page content.

6.11.11.2 Abstract Equation

$$\text{WAP \{Page\} Data Transfer Time [s]} = (t_{\text{last data packet reception}} - t_{\text{first data packet reception}}) [\text{s}]$$

6.11.11.3 Trigger Points

Event from abstract equation	Trigger point from user's point of view	Technical description/protocol part
$t_{\text{first data packet reception}}$: Time of first data packet reception	Start: Download begins.	Start: WAP1.x/WAP2.x: Reception of the first data packet containing content.
$t_{\text{last data packet reception}}$: Time of last data packet reception	Stop: Download is completed.	Stop: WAP1.x/WAP2.x: Reception of the last data packet containing the corresponding content.

Remark:

- The bearer has to be active in the cell used by a subscriber (see clause 5.1) and the mobile station has to be attached (see clause 5.3) as well as the respective PDP context has to be activated (see clause 5.5). Only successful measurements are taken into account to calculate the average time.

6.12 IMS Multimedia Telephony

The present clause describes QoS parameters for the IMS Multimedia Telephony service (MTSI) as described in ETSI TS 123 228 [25].

The IMS Multimedia Service consists of several services, such as video, voice and text. The MTSI parameters are related to the control plane, to real-time user services or non real-time user service as in Figure 47.

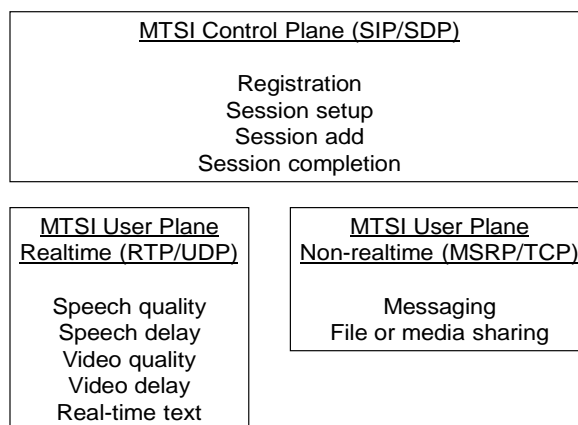

Figure 47: MTSI parameter structure

6.12.1 MTSI Registration Failure Ratio [%]

6.12.1.1 Abstract Definition

The MTSI registration failure ratio is the probability that the terminal cannot register towards IMS when requested.

Remark:

- A successful MTSI registration is required before the terminal can use any MTSI services, and before other terminals can setup MTSI sessions towards it. Even if it is technically possible to wait with the registering until the first use of any MTSI service, it is normally expected that registration is done at terminal power-on.

6.12.1.2 Abstract Equation

$$\text{MTSI Registration Failure Ratio [\%]} = \frac{\text{unsuccessful MTSI registration attempts}}{\text{all MTSI registration attempts}} \times 100$$

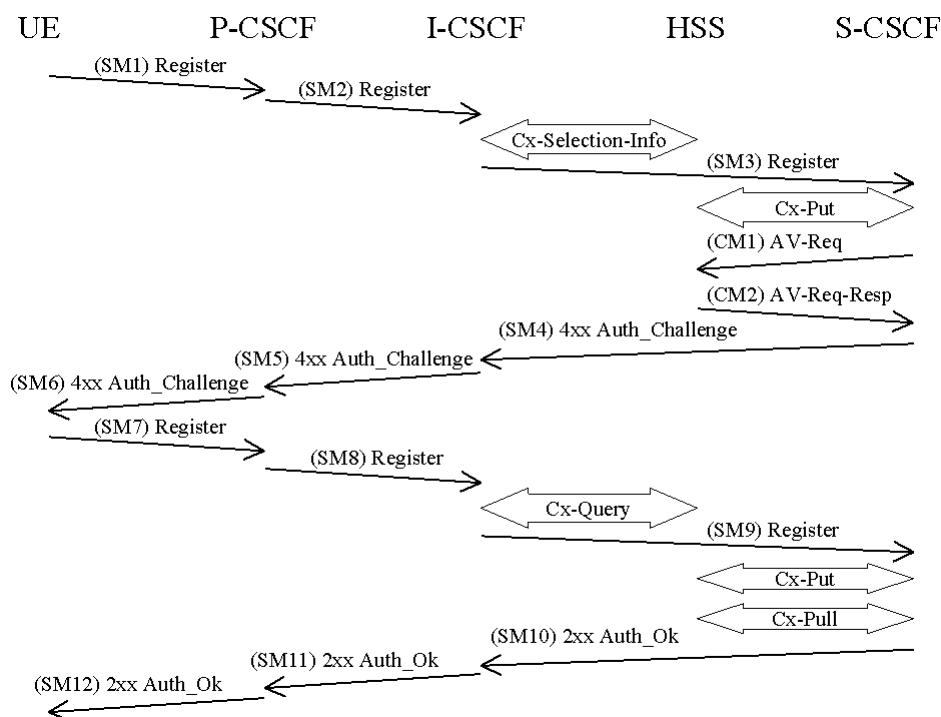

Figure 48: Successful MTSI registration example

Remark:

- The first response to the REGISTER is normally a failure response, indicating that authentication shall be done. The UE then makes a second REGISTER completed with the authentication information. After correct authentication the UE then receives the 200 OK message.

6.12.1.3 Trigger Points

Event from abstract equation	Trigger point from user's point of view	Technical description/protocol part
MTSI registration attempt	Start: Power-on or activation of any MTSI service on the terminal.	Start: Protocol: SIP. First data packet sent by the terminal containing a "SIP REGISTER" message.
Successful MTSI registration attempt	Stop: MTSI availability is indicated.	Stop: Protocol: SIP. First data packet received containing a "SIP 200 OK" message.
Unsuccessful MTSI registration attempt	Stop: MTSI availability indication is not given within a pre-determined time.	Stop: Protocol: SIP. Case 1: Second data packet received by the terminal (after sending the "SIP REGISTER" message) containing a message different to "SIP 200 OK". Case 2: First data packet received by the terminal (after the authentication procedure) containing a message different to "SIP 200 OK". Case 3: No message received by the terminal within a pre-determined time.

6.12.2 MTSI Registration Time [s]

6.12.2.1 Abstract Definition

The MTSI registration time is the time period between the IMS registration request and being registered to IMS.

6.12.2.2 Abstract Equation

$$\text{MTSI Registration Time [s]} = (t_{\text{MTSI Available}} - t_{\text{MTSI Activated}}) [\text{s}]$$

6.12.2.3 Trigger Points

Event from abstract equation	Trigger point from user's point of view	Technical description/protocol part
$t_{\text{MTSI Activated}}$: Time of MTSI registration attempt	Start: Power-on or activation of any MTSI service on the terminal.	Start: Protocol: SIP. First data packet sent by the terminal containing a "SIP REGISTER" message.
$t_{\text{MTSI Available}}$: Time of successful MTSI registration attempt	Stop: MTSI availability is indicated.	Stop: Protocol: SIP. First data packet received containing a "SIP 200 OK" message.

6.12.3 MTSI Session Set-up Failure Ratio [%]

6.12.3.1 Abstract Definition

The MTSI Session Set-up Failure Ratio is the probability that the terminal cannot setup an MTSI session. An MTSI Session is initiated when the user presses the call button and receives a notification that the callee answers within a pre-determined time.

Remarks:

- In a normal SIP call, the user first receives a callee alerted notification; a series of "beep" tones that indicates that the terminating phone is ringing, until the callee answers the phone. However, for drive testing automatic answering will be used and in that case a session set-up notification is received directly instead of the callee alerted notification. The session set-up notification indicates that the other phone accepts the communication.
- An unsuccessful attempt may either be an attempt that is explicitly acknowledged by an error message from the terminating client/network or an attempt that does not result in any responses from the terminating terminal/network at all within a pre-determined time.

6.12.3.2 Abstract Equation

$$\text{MTSISessionSetupFailureRatio}[\%] = \frac{\text{unsuccessful MTSI session setup attempts}}{\text{all MTSI session setup attempts}} \times 100$$

6.12.3.3 Trigger Points

Event from abstract equation	Trigger points from user's point of view	Technical description/protocol part
<i>MTSI session set-up attempt</i>	Start: User initiates session by pushing the call button to make the call.	Start: Protocol: SIP. The trigger from the IMS client that forces the SIP layer of the terminal to create a "SIP INVITE" and send it to the transport layers of the terminal.
<i>Successful MTSI session set-up attempt</i>	Stop: The user hears or sees an indication that the other phone accepts the invitation	Stop: Protocol: SIP. The terminal has received a data packet containing the final "SIP 200 OK (INVITE)" message.
<i>Unsuccessful MTSI session set-up attempt</i>	Stop: The user receives a notification that the session set-up is cancelled, or do not receive any notification at all within a pre-determined time.	Stop: Protocol: SIP. Example of unsuccessful case 1: The terminal informs the IMS client that the SIP session set-up is cancelled after the terminal receives an error, cancel, or redirection message (e.g. a "403 Forbidden" or "488 Not Acceptable Here" message as response to the "SIP INVITE"). Example of unsuccessful case 2: The terminal does not receive any messages to react on within a pre-determined time.

6.12.4 MTSI Session Set-up Time [s]

6.12.4.1 Abstract Definition

The MTSI Session Set-up Time is the time period between initiation of an MTSI session by e.g. pressing the call button and the reception of a notification that the session has been set-up.

6.12.4.2 Abstract Equation

$$\text{MTSI Session Setup Time [s]} = (t_{\text{user receives notification}} - t_{\text{user initiates session}})$$

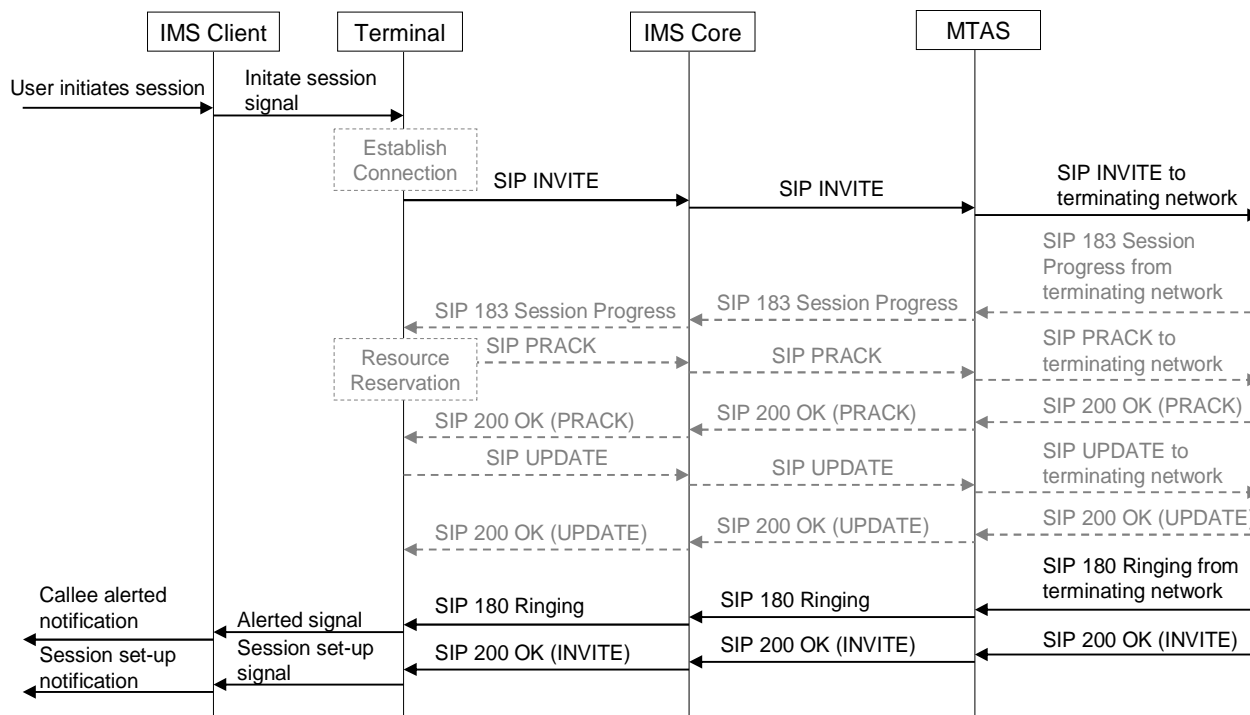

Figure 49: Implicit Initiation of the MTSI Session

Remarks:

- In a normal SIP call, the user first receives a callee alerted notification; a series of "beep" tones that indicates that the terminating phone is ringing, until the callee answers the phone. However, for drive testing automatic answering will be used and in that case a session set-up notification is received directly instead of the callee alerted notification. The session set-up notification indicates that the other phone accepts the communication.
- In most normal use-cases the originating and terminating mobile terminals are in battery saving mode and do not have any radio bearers established prior the MTSI session set-up. In these cases, the mobile terminal shall establish connection to Radio Access Network (RAN) by establishing a radio bearer. The delay contribution to the total MTSI session set-up of this procedure cannot be regarded as insignificant. This is shown in Figure 49 by a dashed box labelled "Establish Connection".
- All or a sub-set of the dashed arrows in Figure 49 occur in case that the mobile terminals involved in the call need to reserve media resources in the Radio Access Network (RAN) prior to starting the communication. Hence, the session setup time depends on the resources needed for the media and if any resources was already reserved by the mobile terminals prior to the session set-up.

6.12.4.3 Trigger Points

Event from abstract equation	Trigger point from user's point of view	Technical description/protocol part
$t_{\text{user initiates session}}$	Start: User initiates session by pushing the call button.	Start: Protocol: SIP. First data packet sent by the terminal containing a "SIP INVITE" message.
$t_{\text{user receives notification}}$	Stop: The user receives a notification that the other phone accepts the invitation.	Stop: Protocol: SIP. First data packet received by terminal containing SIP 200 OK (INVITE).

6.12.5 MTSI Session Add Failure Ratio [%]

6.12.5.1 Abstract Definition

The MTSI Session Add Failure Ratio is the probability that the terminal cannot add a media component. The change is initiated when the user starts to modify an existing MTSI session by adding a media component. The user then receives a notification that the callee is alerted about the session change within a pre-determined time. Alternatively, the terminating phone can have automatic consent to session changes configured.

Remark:

- The failure ratio can be dependent on the type of the added media component.

6.12.5.2 Abstract Equation

$$\text{MTSI Session Add Failure Ratio [\%]} = \frac{\text{unsuccessful MTSI session add attempts}}{\text{all MTSI session add attempts}} \times 100$$

6.12.5.3 Trigger Points

Event from abstract equation	Trigger point from user's point of view	Technical description/protocol part
<i>MTSI session add attempt</i>	Start: User modifies session by pushing appropriate button to add a media component to/in the session.	Start: Protocol SIP. The trigger from the IMS client that forces the SIP layer of the terminal to create a "SIP INVITE" and send it to the transport layers of the terminal.
<i>Successful MTSI session add attempt</i>	Stop: Getting notification that the session change is accepted and e.g. the new media stream starts (when using automatic consent) or appropriate notification that the other terminal accept or reject the session change.	Stop: Protocol SIP. The terminal has received a data packet containing the "SIP 180 Ringing" message or a "SIP 200 OK" message and informs the IMS client that perform a callee alerted notification or a session changed notification.
<i>Unsuccessful MTSI session add attempt</i>	Stop: The user receives a notification that the session change is cancelled, or do not receive any notification at all within a pre-determined time.	Stop: Protocol SIP. Example of unsuccessful case 1: The terminal informs the IMS client that the SIP session change is cancelled after the terminal receives an error, cancel, or redirection message (e.g. a "403 Forbidden" or "488 Not Acceptable Here" message as response to the "SIP INVITE"). Example of unsuccessful case 2: The terminal does not receive any messages to react on within a pre-determined time.

6.12.6 MTSI Session Add Time [s]

6.12.6.1 Abstract Definition

The MTSI Session Add Time is the time period from the start of changing a session (adding a media component) to the reception of a notification that the session has been changed.

Remark:

- The terminals involved shall have an MTSI session ongoing before it can be modified.

6.12.6.2 Abstract Equation

$$MTSI \text{ Session Add Time [s]} = t_{User \text{ Re ceivesChan geBotifica tion}} - t_{UserModifi esSession}$$

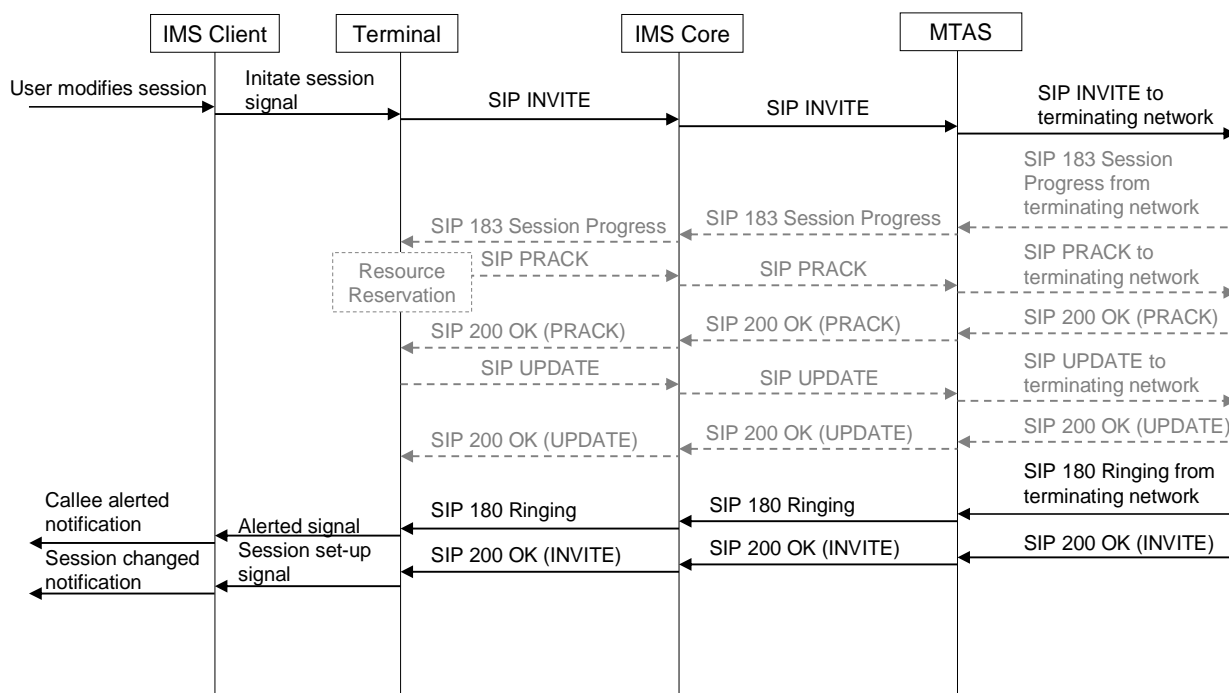

Figure 50: Modification of the MTSI Session

Remarks:

- The MTSI session change signalling to add a media component follows the same set of rules as the MTSI session set-up signalling. Therefore, the signalling diagrams in Figure 49 and Figure 50 are almost identical. The main difference is that the terminals will already have one or more radio bearers established at session change and the radio connection does not need to be established as for the initial session set-up.
- In the case of automatic consent to session changes, the terminating UE may not send any "SIP 180 Ringing" message. In that case the final session change notification (triggered by the "SIP 200 OK (INVITE)" message should be used as the final trigger point for session change latency measurements.
- The dashed arrows and box in Figure 50 are optional signals and event that may occur in the case that one or two mobile terminals are involved in the session change.
- All or a sub-set of the dashed arrows in Figure 50 occur in case that the terminals involved in the call needs to reserve resources in the Radio Access Network (RAN) when adding a new media stream to the MTSI session. Hence, the setup time depends on the resources needed for the new media stream and the resources reserved by the mobile terminals prior to the session change.

6.12.6.3 Trigger Points

Event from abstract equation	Trigger point from user's point of view	Technical description/protocol part
$t(\text{user modifies session})$	Start: User modifies session by pushing appropriate button to add a media component to/in the session.	Start: Protocol: SIP. First data packet sent by the terminal containing a "SIP INVITE" message.
$t(\text{user receives change notification})$	Stop: Getting notification that the session change is accepted.	Stop: Protocol: SIP. First data packet received by terminal containing SIP 200 OK (INVITE).

6.12.7 MTSI Session Remove Failure Ratio [%]

6.12.7.1 Abstract Definition

The MTSI Session Remove Failure Ratio is the probability that the terminal cannot remove a media component. The removal is initiated when the user starts to modify an existing MTSI session by removing a media component. The user then receives a notification that the callee is alerted about the session change within a pre-determined time. Alternatively, the terminating phone can have automatic consent to session changes configured.

6.12.7.2 Abstract Equation

$$\text{MTSI Session Remove Failure Ratio [\%]} = \frac{\text{unsuccessful MTSI session removal attempts}}{\text{all MTSI session removal attempts}} \times 100$$

6.12.7.3 Trigger Points

Event from abstract equation	Trigger point from user's point of view	Technical description/protocol part
<i>MTSI session removal attempt</i>	Start: User modifies session by pushing appropriate button to remove a media component to/in the session.	Start: Protocol SIP. The trigger from the IMS client that forces the SIP layer of the terminal to create a "SIP INVITE" and send it to the transport layers of the terminal.
<i>Successful MTSI session remove attempt</i>	Stop: Getting notification that the session change is performed.	Stop: Protocol SIP. The terminal has received a data packet containing the "SIP 180 Ringing" message or a "SIP 200 OK" message and informs the IMS client that perform a session changed notification.
<i>Unsuccessful MTSI session removal attempt</i>	Stop: The user receives a notification that the session change is cancelled, or do not receive any notification at all within a pre-determined time.	Stop: Protocol SIP. Example of unsuccessful case 1: The terminal informs the IMS client that the SIP session change is cancelled after the terminal receives an error message as a response to the "SIP INVITE"). Example of unsuccessful case 2: The terminal does not receive any messages to react on within a pre-determined time.

6.12.8 MTSI Session Remove Time [s]

6.12.8.1 Abstract Definition

The MTSI Session Remove Time is the time period from the start of changing a session (removing a media component) to the reception of a notification that the session has been changed.

Remark:

- The terminals involved shall have an MTSI session ongoing before it can be modified.

6.12.8.2 Abstract Equation

$$\text{MTSI Session Remove Time [s]} = t_{\text{User Receives Change Notification}} - t_{\text{User Modifies Session}}$$

6.12.8.3 Trigger Points

Event from abstract equation	Trigger point from user's point of view	Technical description/protocol part
<i>t(user modifies session)</i>	Start: User modifies session by pushing appropriate button to remove a media component from the session.	Start: Protocol: SIP. First data packet sent by the terminal containing a "SIP INVITE" message.
<i>t(user receives change notification)</i>	Stop: Getting notification that the session change is accepted.	Stop: Protocol: SIP. First data packet received by terminal containing SIP 200 OK (INVITE).

6.12.9 MTSI Session Completion Failure Ratio [%]

6.12.9.1 Abstract Definition

The MTSI Session Completion Failure Ratio is the probability that a successfully started MTSI call is ended by a cause other than intentional termination by A- or B-party.

6.12.9.2 Abstract Equation

$$\text{MTSI Session Completion Failure Ratio}[\%] = \frac{\text{unsuccessfully completed MTSI sessions}}{\text{all successfully started MTSI sessions}} \times 100$$

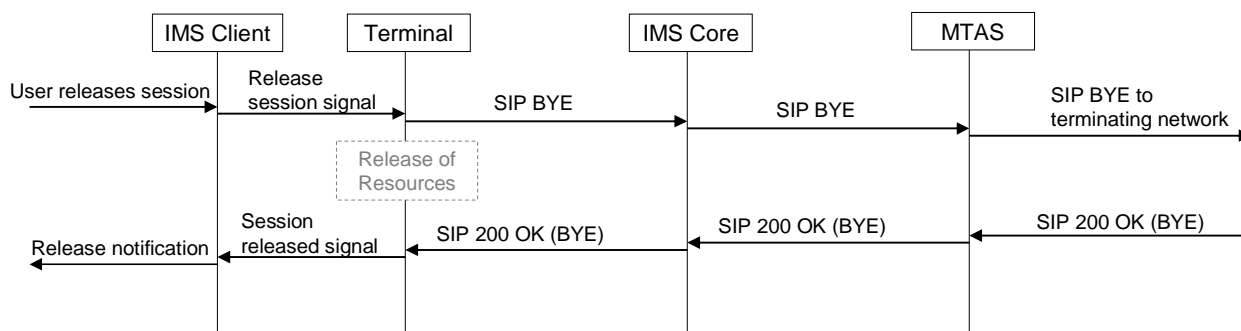

Figure 51: Signalling to end an MTSI Session

Remark:

- The dashed box is an optional event that typically occurs in the case when a mobile terminal is used. The event is the release of resources that has been reserved in the Radio Access Network.

6.12.9.3 Trigger Points

Event from abstract equation	Trigger point from user's point of view	Technical description/protocol part
<i>Successfully started MTSI sessions</i>	Start: User initiates session by pushing the call button to make the call.	Start: Protocol SIP. The terminal has sent INVITE and received a "SIP 200 OK (INVITE)" message.
<i>Successfully completed MTSI sessions</i>	Stop: The user is notified that the call has ended and that the phone is ready to initiate and receive other calls.	Stop: Protocol SIP. The terminal has received a data packet containing the "SIP 200 OK" message as a response to a "SIP BYE" request and informs the IMS client that perform a release notification.
<i>Unsuccessfully completed MTSI sessions</i>	Stop: Beside the successful release cases described above, some session may be released unexpectedly. I.e. the call is dropped.	Stop: Protocol SIP. Example of unsuccessful case: The terminal loses connectivity and no signalling and/or media can be sent or received.

6.12.10 MTSI Speech Quality

6.12.10.1 Abstract Definition

The MTSI Speech Quality represents the end-to-end speech quality of the service.

Remarks:

- The speech quality can be measured for both the caller and the callee.
- The acoustical behaviour of the terminal is not part of this speech quality measurement.
- The speech quality can be measured with a full reference model taking the original speech sample and the degraded sample as input, or with a parametric model taking transport and terminal parameters as input.

6.12.10.2 Abstract Equation

The validation of the end-to-end quality is made using MOS-LQO scales. These scales describe the opinion of users with speech transmission and its troubles (noise, robot voice, echo, dropouts, time scaling introduced by the jitter buffer, etc.) according to Recommendation ITU-T P.863 [31]. The scale used has to be reported. An aggregation for measurement campaigns or parts of it should be made on speech sample basis.

6.12.10.3 Trigger Points

Event from abstract equation	Trigger point from user's point of view	Technical description/protocol part
Not applicable.	Start: Interchange speech samples between A-party and B-party.	Start: Reception of first RTP packet containing a speech frame.
Not applicable.	Stop: Session completion or session change, where the speech service is removed from the session.	Stop case 1: The terminal has received a data packet containing the "SIP 200 OK" message as a response to a "SIP BYE" request and informs the IMS client that perform a release notification. Stop case 2: The terminal has received a data packet containing the "SIP 200 OK" message and informs the IMS client that the speech service is no longer active.

6.12.11 MTSI Speech Transmission Delay [s]

6.12.11.1 Abstract Definition

The MTSI Speech Transmission Delay is the delay between sending speech packets from terminal A to receiving speech packets at terminal B, when the speech is conveyed in the context of an MTSI call.

6.12.11.2 Abstract Equation

$$\text{MTSI Speech Transmission Delay}[s] = t(B_receives) - t(A_sends)[s]$$

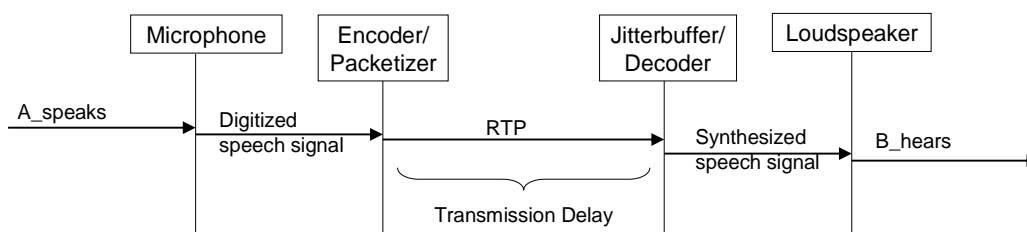

Figure 52: The Speech Transmission Delay

NOTE 1: Since the delay can vary for each packet, it is not statistically sufficient to measure the delay only for the first packet.

NOTE 2: The Speech Transmission Delay is not exactly the same as perceived by the end user. The Speech Transmission Delay does not include the delay introduced by the jitter buffer and the encoding and decoding delay.

6.12.11.3 Trigger Points

Event from abstract equation	Trigger point from user's point of view	Technical description/protocol part
$t(A_sends)$	Start: Terminal A sends speech.	Start: Protocol: RTP. Data packet sent by terminal A containing speech data.
$t(B_receives)$	Stop: Speech received by terminal B.	Stop: Protocol: RTP. Corresponding data packet received by terminal B containing speech data.

6.12.12 MTSI Speech Path Delay [s]

6.12.12.1 Abstract Definition

The MTSI Speech Path Delay is the speech delay between reception of speech by the microphone in terminal A to the loudspeaker playing out the speech at terminal B, when the speech is conveyed in the context of an MTSI call.

6.12.12.2 Abstract Equation

$$\text{MTSI Speech Path Delay}[s] = t(B_hears) - t(A_speaks)[s]$$

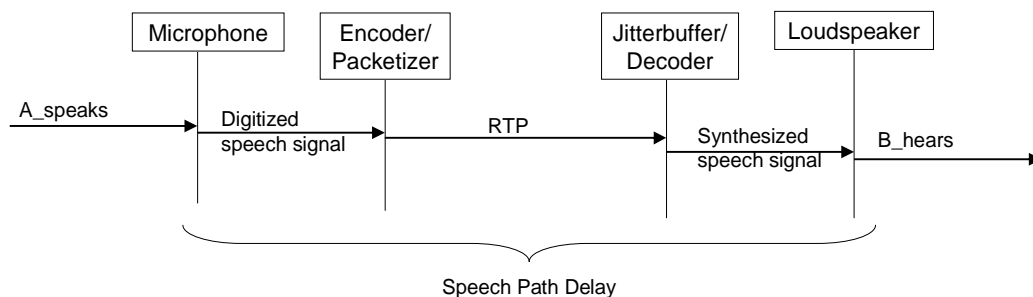

NOTE: Since the delay can vary during a call, it is not statistically sufficient to measure the delay only once.

Figure 53: The Speech Path Delay

6.12.12.3 Trigger Points

Event from abstract equation	Trigger point from user's point of view	Technical description/protocol part
$t(A_speaks)$	Start: A speaks into the microphone	Start: Electrical signal at the microphone. The speech is received at the microphone (acoustical delay not included).
$t(B_hears)$	Stop: The speaker at B plays the speech	Stop: Electrical signal at the speaker The corresponding speech is played out by the speaker (acoustical delay not included).

6.12.13 MTSI Video Quality

6.12.13.1 Abstract Definition

The MTSI Video Quality represents the end-to-end video quality of the service.

Remarks:

- The video quality can be measured for both the caller and the callee.
- The visual behaviour of the terminal's display is not part of this video quality measurement.
- The video quality can be measured with a full reference model taking the original video sample and the degraded sample as input, or with a parametric model taking transport and terminal parameters as input.

6.12.13.2 Abstract Equation

The validation of the end-to-end quality is made using the MOS scale. This scale describes the opinion of users using the video service with its degradations (blockiness, jerkiness, freezes, etc.). An aggregation for measurement campaigns or parts of it should be made on video sample basis.

Remark:

- Objective video quality models are to be defined.

6.12.13.3 Trigger Points

Event from abstract equation	Trigger point from user's point of view	Technical description/protocol part
Not applicable.	Start: Interchange video between A-party and B-party.	Start: Reception of first RTP packet containing a video frame.
Not applicable.	Stop: Session completion or session change, where the video service is removed from the session.	Stop case 1: The terminal has received a data packet containing the "SIP 200 OK" message as a response to a "SIP BYE" request and informs the IMS client that perform a release notification. Stop case 2: The terminal has received a data packet containing the "SIP 200 OK" message and informs the IMS client that the video service is no longer active.

6.12.14 MTSI Video Transmission Delay [s]

6.12.14.1 Abstract Definition

The MTSI Video Transmission Delay is the delay between sending video packets from terminal A, and reception of video packets at terminal B, where the video is transmitted in the context of an MTSI video call.

6.12.14.2 Abstract Equation

$$\text{MTSI Video Transmission Delay [s]} = t(B_receives) - t(A_sends) [s]$$

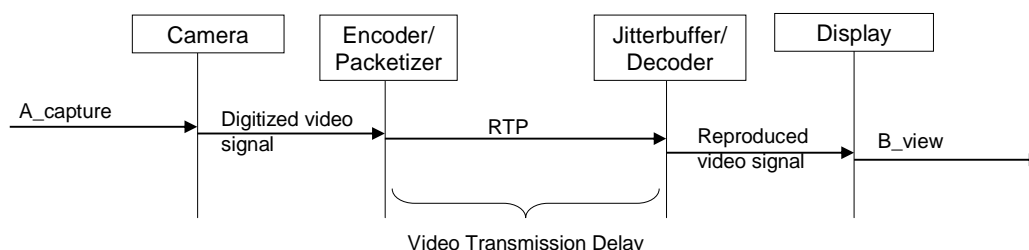

Figure 54: The Video Transmission Delay

NOTE 1: Since the delay can vary for each packet, it is not statistically enough to measure only the delay for the first packet.

NOTE 2: The Video Transmission Delay is not exactly the same as perceived by the end user. The Video Transmission Delay does not include the delay introduced by the jitter buffer and the encoding and decoding delay.

6.12.14.3 Trigger Points

Event from abstract equation	Trigger point from user's point of view	Technical description/protocol part
$t(A_sends)$	Start: Terminal A sends video.	Start: Protocol: RTP. Data packet sent by terminal A containing video data.
$t(B_receives)$	Stop: Video received at terminal B.	Stop: Protocol: RTP. Corresponding data packet received by terminal B containing video data.

6.12.15 MTSI Video Path Delay [s]

6.12.15.1 Abstract Definition

The MTSI Video Path Delay is the delay between capturing of video at terminal A and display of the video at terminal B, where the video is transmitted in the context of an MTSI video call.

6.12.15.2 Abstract Equation

$$\text{MTSIVideoPath Delay [s]} = t(B_displays) - t(A_captures)[s]$$

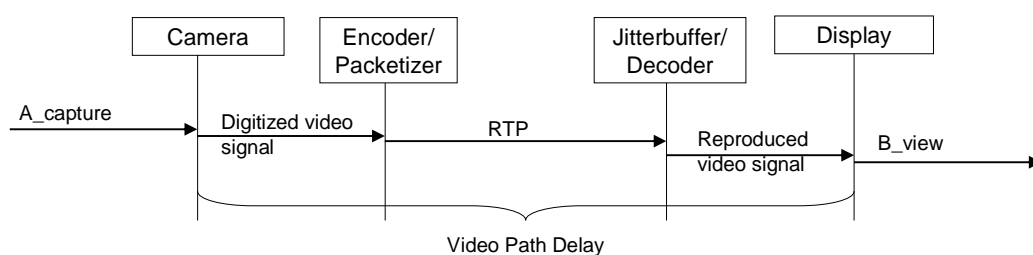

NOTE: Since the delay can vary during the session, it is not statistically sufficient to measure the delay only once.

Figure 55: The Transmission Delay

6.12.15.3 Trigger Points

Event from abstract equation	Trigger point from user's point of view	Technical description/protocol part
$t(A_captures)$	Start: Terminal A captures the video	Start: Terminal A captures a video frame
$t(B_displays)$	Stop: Terminal B displays the video	Stop: Terminal B displays the corresponding video frame

6.12.16 MTSI Audio/Video De-Synchronization [%]

6.12.16.1 Abstract Definition

The MTSI Audi/Video De-Synchronization is the percentage of time that the time differences of the audio and video signal (the "lip sync") at the receiving side is outside two thresholds, in the context of an MTSI combined audio/video call.

The de-synchronization impacts the perceived quality of the service. For broadcasting purposes Recommendation ITU-R BT.1359-1 [26] defines detectability and acceptability thresholds for lip synchronization. Figure 56 describes these thresholds. Note that the curve is not symmetrical around zero, as it is more annoying if the speech is played out too early than too late.

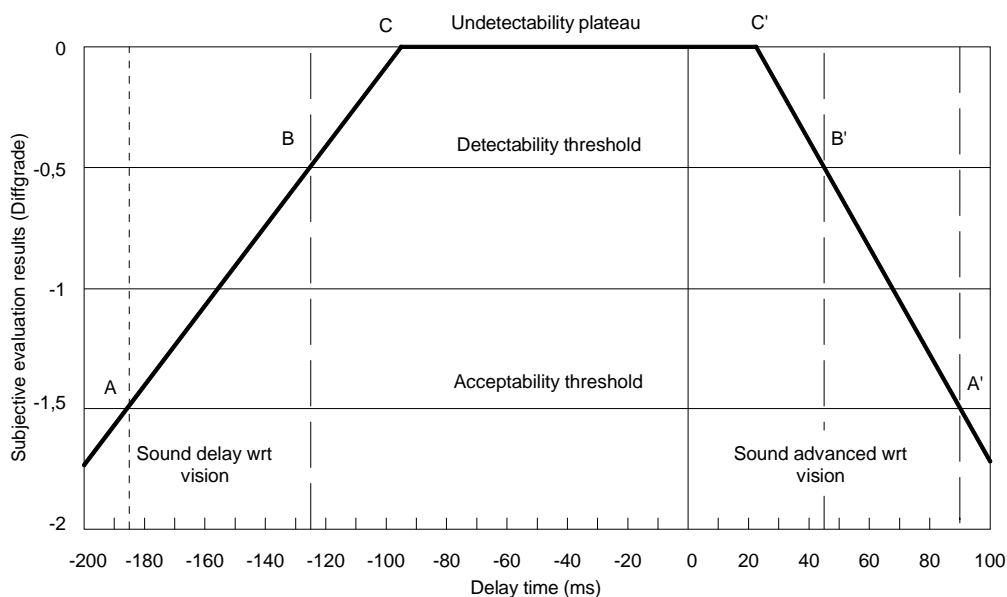

Figure 56: The impact of audio video de-synchronization on perceived quality

6.12.16.2 Abstract Equation

NOTE: The equation below only calculates the lip sync at a certain position in the video transmission. The measurement frequency it is still to be defined to get useful measurement results.

$$\text{MTSI Audio Video De - Synchronization} = \text{Video Path Delay versus Speech Path Delay [s]} = t(B_view) - t(B_hear)$$

6.12.16.3 Trigger Points

Event from abstract equation	Trigger point from user's point of view	Technical description/protocol part
$t(B_hear)$	The loudspeaker at B plays the speech	Electrical signal at the speaker playing a speech frame The speech is played out by the speaker (acoustical delay not included)
$t(B_view)$	The display at B displays the video corresponding to the speech	The rendering of a the video frame corresponding to the speech frame

6.12.17 MTSI Real-Time Text Failure Ratio [%]

6.12.17.1 Abstract Definition

The MTSI Real-Time Text Failure Ratio is the proportion of not displayed letters and total number of letters sent in a successfully started MTSI real-time text session.

Remark:

- Real-time text is a real-time communication method and it is important that the end-to-end delay is low. Therefore, when measuring the success ratio, letters that are received with a delay longer than a pre-determined time should be regarded as lost.

6.12.17.2 Abstract Equation

$$\text{MTSI Real - Time Text Failure Ratio} = \frac{\text{Number of not displayed letters in realtime text session}}{\text{Number of typed letters in realtime text session}} \times 100$$

6.12.17.3 Trigger Points

Event from abstract equation	Trigger point from user's point of view	Technical description/protocol part
<i>Started MTSI real-time text session</i>	Start: User A initiates/modifies an MTSI session with user B so it includes real-time text. This is indicated to the users, and they start to communicate using text.	Start: The first typed real-time text is captured and is sent to the transport layers of the terminal. The real-time text protocol stack may use redundancy (i.e. the letters are sent multiple times) to make the communication more robust to loss of data packets.
<i>Completed MTSI real-time text session</i>	Stop: One of the users pushes the end/modify call button to end the MTSI real-time text communication. The session ends or is modified and this is indicated to the users.	Stop: The last part of the real-time text conversation is captured and sent by the terminal. Followed by the release or modification (drop of the real-time text media) of the SIP session.
<i>Number of not displayed letters</i>	During the real-time text communication, some letters may be lost or delayed which leads to impairments of the text communication.	Example of unsuccessful case 1: data packets containing text are lost or received too late and even if redundancy was applied parts of the typed text string are lost and cannot be displayed correctly or displayed in time. Example of unsuccessful case 2: The transport of real-time text data stops unexpectedly.

6.12.18 MTSI Real-Time Text Delivery Time [s]

6.12.18.1 Abstract Definition

The MTSI Real-Time Text Delivery Time is the delay between sending a character from terminal A and reception of the same character in terminal B.

Remarks:

- The recommendation in the standard is to buffer text input 300 ms before sending the typed characters, and the maximum allowed buffering time is 500 ms. This means that normally only one or a few characters are typically transmitted to the other end in each RTP packet.
- The default redundancy scheme is to send the last two text packets together with the most recent text packet. In this way up to two consecutive RTP packets can be lost without losing any characters. However, other redundancy schemes can be used, and it is up to the terminal vendor to select an appropriate scheme depending on the current channel conditions.

6.12.18.2 Abstract Equation

NOTE: Since the delay can vary for each packet, it is not statistically enough to measure only the delay for the first packet.

$$\text{MTSI RealTime Text Delivery Time} = t_{B_receive} - t_{A_send}$$

6.12.18.3 Trigger Points

Event from abstract equation	Trigger point from user's point of view	Technical description/protocol part
$T(A_send)$	Start: User A writes a character.	Start: Protocol: RTP. Data packet sent by terminal A containing the typed character.
$t(B_receive)$	Stop: User B receives the character on his screen.	Stop: Protocol: RTP. Corresponding data packet received by terminal B containing the same character.

6.12.19 MTSI Messaging Failure Ratio [%]

6.12.19.1 Abstract Definition

The MTSI Messaging Failure Ratio is the proportion of not received messages and sent messages in an MTSI messaging session.

6.12.19.2 Abstract Equation

$$\text{MTSI Messaging Failure Ratio} = \frac{\text{Number of not received messages}}{\text{Total number of sent messages}} \times 100$$

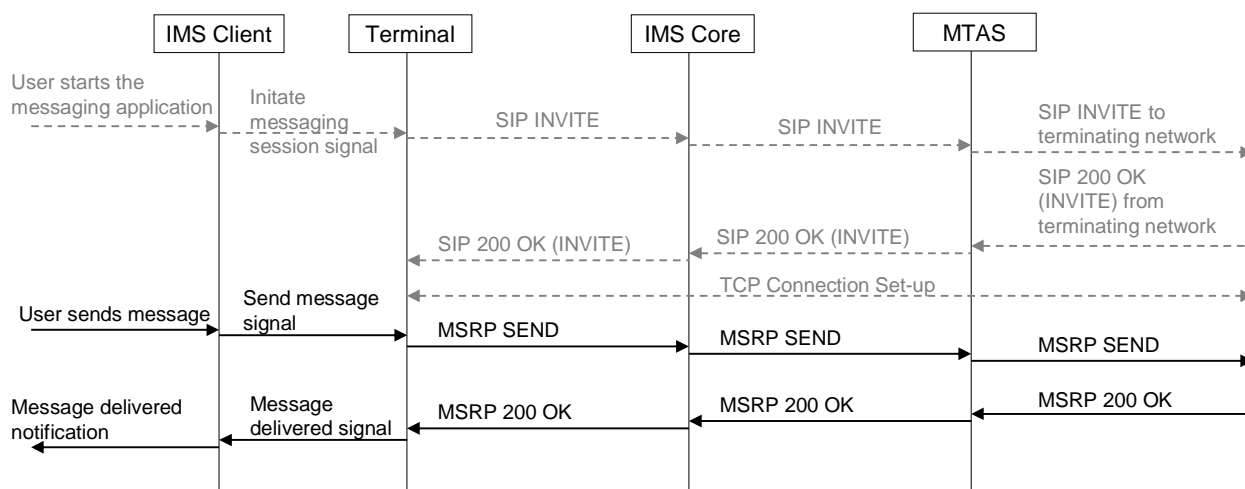

Figure 57: Messaging using MSRP

Remark:

- Before a message can be sent, an MTSI Session shall either be established or modified so it contains messaging. Further a TCP connection for MSRP transfer shall be established between the two terminals. Typically, the MTSI Session and the TCP connection is established or modified when an end user opens up the messaging application on his phone e.g. during a call. The message is sent using MSRP in a later stage, that happens when the user has typed the message using the messaging application and he/she has pressed the "send button".

6.12.19.3 Trigger Points

Event from abstract equation	Trigger point from user's point of view	Technical description/protocol part
<i>Start of MTSI Messaging session</i>	Start: User A initiates/modifies an MTSI session with user B so it includes messaging. This is indicated to the users, and they send messages.	Start: The trigger from the IMS client that starts the messaging session set-up that is followed by a number of message transmissions.
<i>Completed MTSI Messaging session</i>	Stop: One of the users pushes the end/modify call button to end the MTSI messaging exchange. The session ends or is modified and this is indicated to the users	Stop: The messaging communication ends. Followed by the release or modification (drop of the messaging service) of the SIP session.
<i>Received messages</i>	Messages are delivered to user B.	Successful case: The terminal receives the "MSRP 200 OK", in time, which acknowledges the reception of the message. This is indicated to the IMS client who notifies the user.
<i>Not received messages</i>	Messages either are not delivered to user B, or they are not delivered within a pre-determined time	Example of unsuccessful case 1: The terminal receives an error message (i.e. a "MSRP 4xx or MSRP 5xx message), which is indicated to the IMS client. Example of unsuccessful case 2: The connectivity is lost by one or both of the terminals and no MSRP messages is sent/received by the terminal within a pre-determined time.

6.12.20 MTSI Messaging Delivery Time [s]

6.12.20.1 Abstract Definition

The MTSI Messaging Delivery Time is the delay between sending a message from terminal A and reception of the same message in terminal B, where the terminals are involved in an MTSI messaging communication.

6.12.20.2 Abstract Equation

$$\text{MTSI Messaging Delivery Time} = t_{\text{Message_received}} - t_{\text{Message_sent}}$$

6.12.20.3 Trigger Points

Event from abstract equation	Trigger point from user's point of view	Technical description/protocol part
$t(\text{Message_sent})$	Start: User A sends a message.	Start: Protocol: MSRP The message is sent using MSRP SEND.
$t(\text{Message_received})$	Stop: User B receives the message.	Stop: Protocol: MSRP The corresponding MSRP SEND message is received at terminal B.

NOTE: An alternative method would be to measure the time between MSRP SEND and MSRP 200 OK, which then can be measured in the same terminal. However, the reception of MSRP 200 OK is not necessarily shown to the end user (depending on terminal implementation).

6.12.21 MTSI File/Media Sharing Failure Ratio [%]

6.12.21.1 Abstract Definition

The MTSI File/Media Sharing Failure Ratio is the proportion of uncompleted file/media sharing sessions and sessions that were started successfully.

Remark:

- The files can either be a generic file, or a file with a predetermined file and media format.

6.12.21.2 Abstract Equation

$$\text{MTSI File/Media Sharing Failure Ratio} = \frac{\text{uncompleted file/media sharing sessions}}{\text{successfully started file/media sharing sessions}} \times 100$$

6.12.21.3 Trigger Points

Event from abstract equation	Trigger point from user's point of view	Technical description/protocol part
<i>Successfully started file/media sharing session</i>	Start: User A initiates/modifies an MTSI session with user B so it includes file/media sharing. This is indicated to the users, and they send files.	Start: The trigger from the IMS client that starts the file/media sharing session set-up that is followed by the file transmission.
<i>Completed file/media sharing sessions</i>	Stop: One of the users pushes the end/modify call button to end the MTSI file/media sharing. The session ends or is modified and this is indicated to the users	Stop: The file/media sharing ends. Followed by the release or modification (removal of the file/media sharing) of the SIP session.
<i>Total number of sent files</i>	Start: User A initiates/modifies an MTSI session with user B so it includes file/media sharing. This is indicated to the users, and they send files. Stop: One of the users pushes the end/modify call button to end the MTSI file/media sharing. The session ends or is modified and this is indicated to the users	Start: The trigger from the IMS client that starts the file/media sharing session set-up that is followed by the file transmission. Stop: The file/media sharing ends. Followed by the release or modification (removal of the file/media sharing) of the SIP session.
<i>Uncompleted file/media sharing sessions</i>	Files either are not delivered to user B, or they are not delivered within a pre-determined time.	Successful case: The terminal receives the "MSRP 200 OK" that acknowledges the reception of the file. This is indicated to the IMS client who notifies the user. Example of unsuccessful case 1: The terminal receives an error message (i.e. a "MSRP 4xx or MSRP 5xx message") Example of unsuccessful case 2: The connectivity is lost by one or both of the terminals and no MSRP messages is sent/received by the terminal within a pre-determined time.

6.12.22 MTSI File/Media Sharing Mean Data Rate [kbit/s]

6.12.22.1 Abstract Definition

The Multimedia Telephony File/Media Sharing Mean Data Rate is the average data transfer rate measured of a successful transfer of a file or pre-determined media type.

6.12.22.2 Abstract Equation

$$\text{MTSI File/Media Sharing Mean Data Rate [kbps]} = \frac{\text{Amount of user data transferred [kb]}}{t(\text{ContentSent}) - t(\text{ConnectionEstablished})}$$

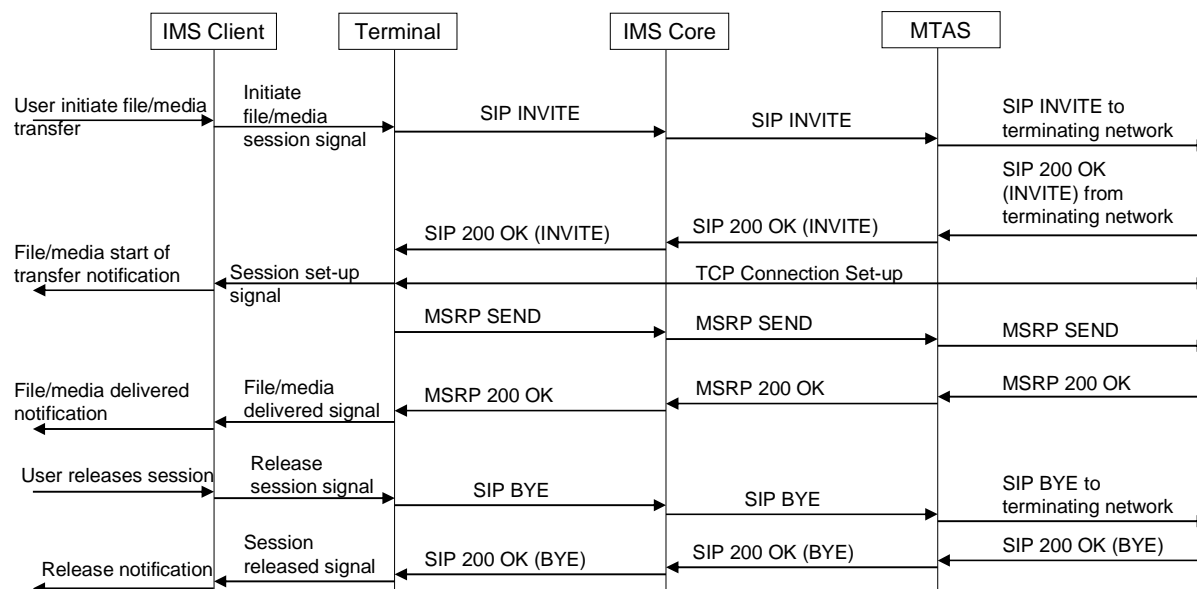

Figure 58: File/Media Sharing using MTSI

Remarks:

- MTSI File/Media Sharing uses the same user plane protocol suite as MTSI Messaging. Thus, the two methods of communication follow the same set of rules but with one exception. The exception is that for file/media sharing only one MSRP transaction is allowed per established or modified SIP session. Hence, after the file is successfully transferred the MTSI Session is either terminated or modified to not contain file/media sharing.
- The time it takes from the user initiates the file/media transfer until he receives the file/media delivered notification can be divided into two parts. The first part is the access time, which is marked in the Figure 58 as the time between "User initiate file/media transfer" until "File/media start transfer notification". The second part is the transfer time that is the time between the "File/media start transfer notification" and the "File/media delivered notification". This KPI aims to measure the average data rate during the transfer time.
- In file/media sharing the content is usually several MTUs large, therefore the MSRP SEND message that contains the payload is segmented into a number of data packets.

6.12.22.3 Trigger Points

Event from abstract equation	Trigger point from user's point of view	Technical description/protocol part
<i>Amount of user data transferred (in kbit)</i>	The users use the file/media sharing enabler to send a file with known size.	User A sends a file with known size to User B.
<i>t(connection established)</i>	Start: When the actual transmission of the file/media starts. At this moment the user is given a file/media start of transfer notification.	Start: Protocol: MSRP The MSRP SEND message containing the file data is transmitted.
<i>t(content sent)</i>	Stop: The successful reception of the file, which result in a file/media delivered notification.	Stop: Protocol: MSRP The terminal receives the "MSRP 200 OK" that acknowledges the reception of the file.

6.12.23 MTSI Media Setup Time [s]

6.12.23.1 Abstract Definition

The MTSI Media Set-up Time is the (non-negative) time period between the successful setup of the signalling part of the MTSI call setup, and the receipt of the first packet containing valid (i.e. expected) media payload.

6.12.23.2 Abstract Equation

$$\text{MTSI Media Setup Time} = \text{Max} \left[\left(t_{\text{first valid media packet received}} - t_{\text{successful signalling setup}} \right), 0 \right]$$

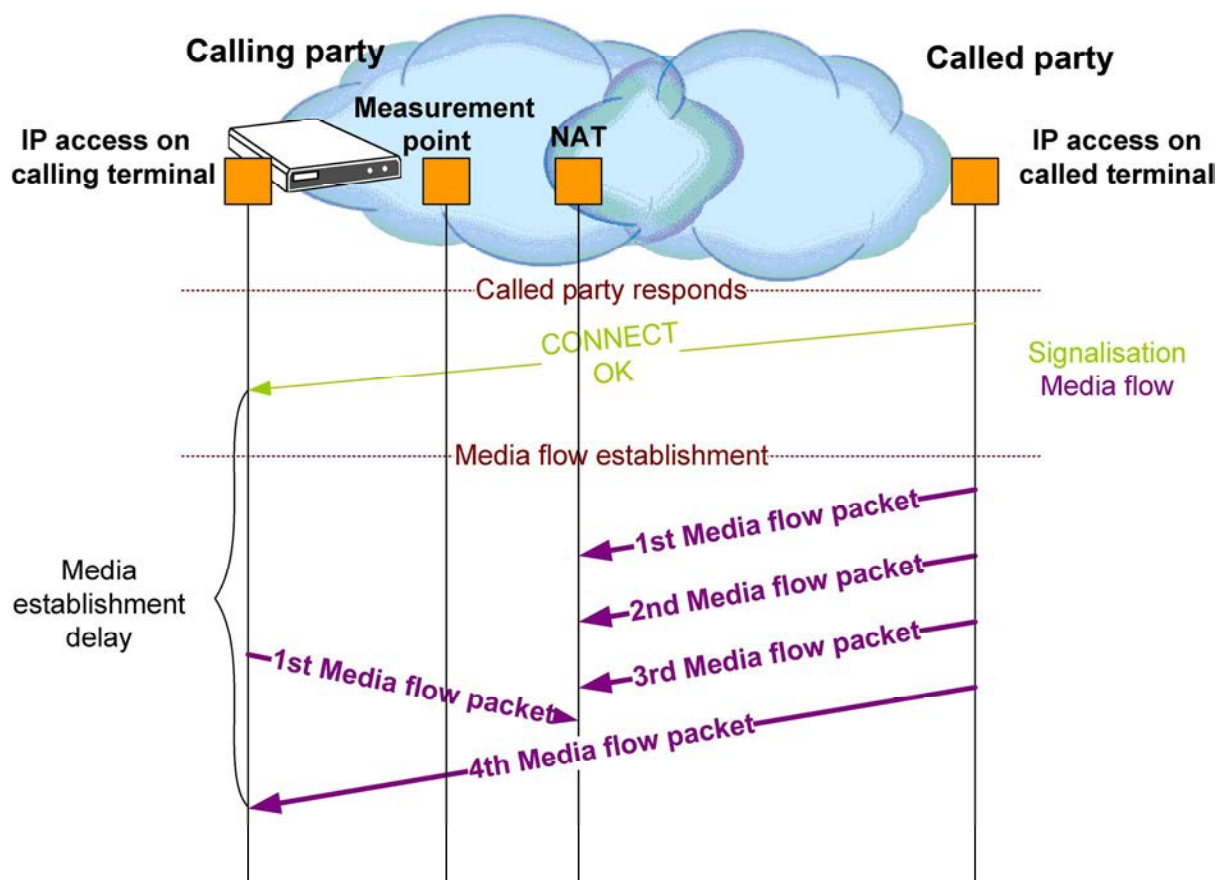

Figure 59: Media setup delayed due to NAT devices

Remarks:

- In most cases the media path will be opened at the same time as the signalling path; for instance when there are no NAT (Network Address Translator) devices in the call path, or when the NAT devices are managed by the operator (for instance the SBC, Session Border Controller) and opened up automatically during the signalling phase. In such cases the media delay might be zero, or even negative (any negative values should however be set to zero for this parameter).
- If non-managed NAT devices are present in the call path, it is the responsibility of the terminals to open these by sending media or by using protocols such as ICE [29] or STUN [30]. In such cases the media setup time might be substantially larger than zero, depending on the methods used to open the NAT pinholes.

6.12.23.3 Trigger Points

Event from abstract equation	Trigger point from user's point of view	Technical description/protocol part
$t_{\text{successful signalling setup}}$	Start: The user receives a notification that the other phone accepts the invitation.	Start: Protocol: SIP. First SIP 200 OK received after initiating a session.
$t_{\text{first valid media packet received}}$	Stop: The media is played out to the user.	Stop: Protocol: SIP. First valid media packet received.

6.12.24 MTSI Media Add Time [s]

6.12.24.1 Abstract Definition

The MTSI Media Add Time is the (non-negative) time period between the successful change of a session (adding a media component), and the receipt of the first packet containing valid (i.e. expected) payload for the new media component.

Remark:

- The terminals involved shall have an MTSI session ongoing before it can be modified.

6.12.24.2 Abstract Equation

$$\text{MTSI Media Add Time} = \text{Max} \left[\left(t_{\text{first valid media packet received}} - t_{\text{successful signalling setup}} \right), 0 \right]$$

Remark:

- The MTSI Media Add Time is similar to the MTSI Media Setup Time, except that the terminals will already have at least one media session open. Depending on the NAT structure in the call path, the time until the first media packet might be zero or even negative (when NATs are already open due to the existing media session) or significant (when NAT pinholes needs to be opened by the terminals). Any negative values should be set to zero for this parameter.

6.12.24.3 Trigger Points

Event from abstract equation	Trigger point from user's point of view	Technical description/protocol part
$t_{\text{successful signalling setup}}$	Start: The user receives a notification that the other phone accepts the added media invitation.	Start: Protocol: SIP. First SIP 200 OK received after initiating the session change.
$t_{\text{first valid media packet received}}$	Stop: The added media is played out to the user.	Stop: Protocol: SIP. First valid media packet for the added media is received.

6.13 E-mail

Please refer to clause 7.2, as the parameters described there are usable for direct service as well if notification is disabled on the e-mail server.

All QoS parameters from clause 7.2 can be used with the exception of those dealing with notification (see clauses 7.2.10 and 7.2.11).

6.14 Group Call

6.14.1 Group Call Service Non-Accessibility [%]

6.14.1.1 Abstract Definition

The group call service non-accessibility denotes the probability that the end-user cannot access the group call service when requested by pushing the Push To Talk (PTT) button.

6.14.1.2 Abstract Equation

$$\text{Group Call Service Non - Accessibility [\%]} = \frac{\text{unsuccessful group call attempts}}{\text{all group call attempts}} \times 100$$

6.14.1.3 Trigger Points

TETRA:

Event from abstract equation	Trigger point from user's point of view	Technical description/protocol part
Group call attempt	Start: Push PTT button.	Start: Layer 3 (CMCE): The "U-SETUP" message is sent from the A-party. AT: The "ATD <dial string>" command is sent from the A-party, where <dial string> provides a unique identification of the desired group. A preceding "AT+CTSDC" command is used to set the correct parameters for the dial command.
Successful group call attempt	Stop: The acoustic and/or optical indication is given to the A-party user that the group call is established.	Stop: Layer 3 (CMCE): The "D-CONNECT" message is sent from the SwMI to the A-party. AT: The "AT+CTCC" indication is received by the A-party.
Unsuccessful call attempt	Stop trigger point not reached.	
NOTE: For the group call service non-accessibility it is not necessary to check the possibly involved B-parties (other group members) for a setup indication, e.g. a "D-SETUP" message, because the group call is actually established towards the network, i.e. the SwMI – no matter if there is any B-party connected to the group call or not.		

Preconditions for measurement:

Precondition	Covered by	Reference document
CS network available	Radio Network Unavailability	
CS attach successful		
No active group call		

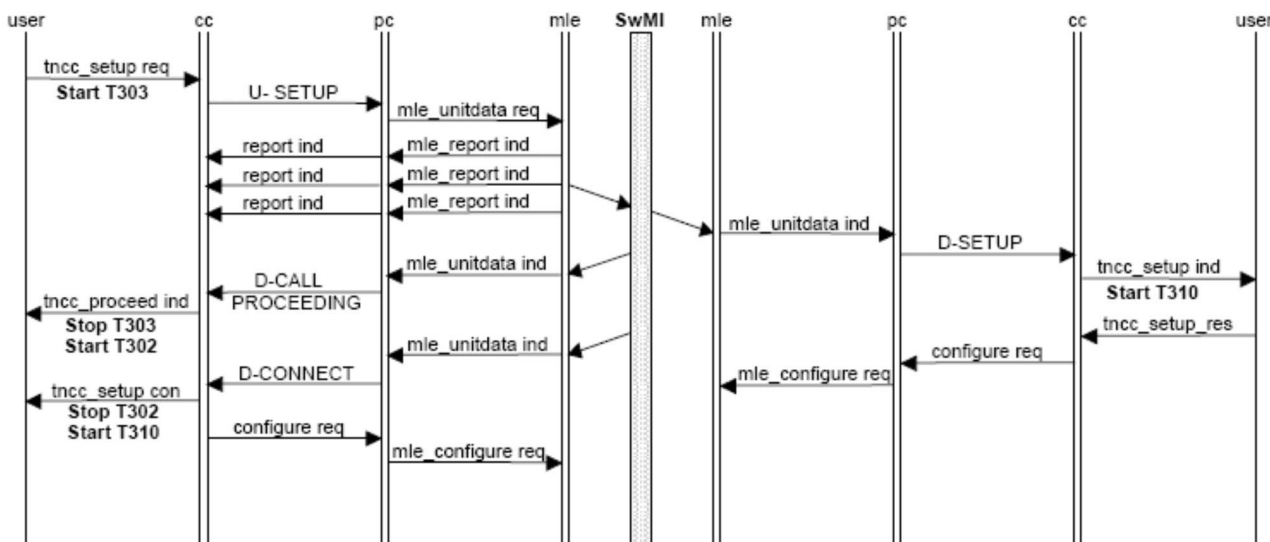

Figure 60: Group call setup procedure

6.14.2 Group Call Setup Time [s]

6.14.2.1 Abstract Definition

The group call setup time is the time period between pushing the Push To Talk (PTT) button at the UE and receipt of call set-up notification by an acoustical and/or optical indication at the UE that the group call is successfully established.

6.14.2.2 Abstract Equation

$$\text{GroupCallSetupTime[s]} = (t_{\text{connection established}} - t_{\text{user pressed button}}) [\text{s}]$$

6.14.2.3 Trigger Points

TETRA:

Event from abstract equation	Trigger point from user's point of view	Technical description/protocol part
$t_{\text{user pressed button}}$: Time of call attempt	Start: Push PTT button.	Start: Layer 3 (CMCE): The "U-SETUP" message is sent from the A-party. AT: The "ATD <dial string>" command is sent from the A-party, where <dial string> provides a unique identification of the desired group. A preceding "AT+CTSDC" command is used to set the correct parameters for the dial command.
$t_{\text{connection established}}$: Time when connection is established (successful call attempt)	Stop: The acoustic and/or optical indication is given to the A-party user that the group call is established.	Stop: Layer 3 (CMCE): The "D-CONNECT" message is sent from the SwMI to the A-party. AT: The "AT+CTCC" indication is received by the A-party.

Preconditions for measurement:

Precondition	Covered by	Reference document
CS network available	Radio Network Unavailability	
CS attach successful		
CS service access successful	Group Call Service Non-Accessibility	

6.14.3 Group Call Speech Quality on Call Basis

6.14.3.1 Abstract Definition

The group call speech quality on call basis is an indicator representing the quantification of the end-to-end speech transmission quality of the group call service. This parameter computes the speech quality on the basis of completed calls.

NOTE 1: The acoustic behaviour of terminals is not part of this speech quality measurement.

NOTE 2: The speech quality in group calls is measured at any receiving B-party, i.e. at every group member in receiving state. Thus, the overall speech quality for one group call may vary among the receiving B-party UEs. It is up to the following analysis to aggregate and evaluate the different results.

6.14.3.2 Abstract Equation

The applicability of a suitable speech quality evaluation method for the narrow-band speech codec within TETRA networks is for further study.

6.14.3.3 Trigger Points

The group call speech quality on call basis is derived from speech transmission during the duration of the entire group call. Trigger points are therefore not defined for the speech quality on call basis itself but for the group call duration according to the definitions for an intentionally terminated group call in clause 6.14.5.3.

6.14.4 Group Call Speech Quality on Sample Basis

6.14.4.1 Abstract Definition

The group call speech quality on sample basis is an indicator representing the quantification of the end-to-end speech transmission quality of the group call service. This parameter computes the speech quality on a sample basis.

NOTE 1: The acoustic behaviour of terminals is not part of this speech quality measurement.

NOTE 2: The speech quality in group calls is measured at any receiving B-party, i.e. at every group member in receiving state. Thus, speech quality for one audio sample may vary among the receiving B-party UEs. It is up to the following analysis to aggregate and evaluate the different results.

6.14.4.2 Abstract Equation

The applicability of a suitable speech quality evaluation method for the narrow-band speech codec within TETRA networks is for further study.

6.14.4.3 Trigger Points

The group call speech quality on sample basis is derived from the speech samples transmitted during the duration of the entire group call. Trigger points are therefore not defined for the speech quality on sample basis itself but for the group call duration according to the definitions for an intentionally terminated group call in clause 6.14.5.3.

6.14.5 Group Call Cut-off Call Ratio [%]

6.14.5.1 Abstract Definition

The group call cut-off ratio denotes the probability that a successful call attempt is ended by a cause other than the intentional termination by the A- or B-party.

NOTE: In TETRA a B-party may in special situations request a group call disconnection. Those instances should be excluded from the group call cut-off call ratio.

6.14.5.2 Abstract Equation

$$\text{Group Call Cut - off Call Ratio [\%]} = \frac{\text{unintentionally terminated group calls}}{\text{all successful group call attempts}} \times 100$$

6.14.5.3 Trigger Points

TETRA:

Event from abstract equation	Trigger point from customer's point of view	Technical description/protocol part
Successful group call attempt	Start: The acoustic and/or optical indication is given to the A-party user that the group call is established.	Start: Layer 3 (CMCE): The "D-CONNECT" message is sent from the SwMI to the A-party. AT: The "AT+CTCC" indication is received by the A-party.
Intentionally terminated group call	Stop: Final release of PTT button by any group member (A-party or involved B-parties).	Stop: Layer 3 (CMCE): The last "U-TX CEASED" message is sent by the latest active party. AT: The last "AT+CUTXC=1" command is sent by the latest active party.
Unintentionally terminated group call	A premature call disconnection	Stop trigger not reached.
NOTE 1: A group call may contain several phases of exchanging speech samples between A-party and B-parties. Within the speech transmission phases the roles of A-party and involved B-parties vary in terms of speech transmission originating or terminating side.		
NOTE 2: For the group call cut-off call ratio all actively involved B-parties, i.e. other group members connected to the established group call, are considered reflecting the end-to-end experience of the participating group call members, i.e. users.		

6.14.6 Group Call Speech Transmission Delay [s]

6.14.6.1 Abstract Definition

The group call speech transmission delay describes the time period between a UE sending speech data and the group member UEs receiving the speech data for a unique talk burst or speech sample within a successfully established group call.

NOTE: The speech transmission delay in group calls is measured from the initiating A-party to any receiving B-party, i.e. to every group member in receiving state. Thus, the speech transmission delay for one instance of audio may vary among the receiving B-parties. It is up to the following analysis to aggregate and evaluate the different results.

6.14.6.2 Abstract Equation

$$\text{Group Call Speech Transmission Delay [s]} = (t_{B,\text{listen}} - t_{A,\text{speak}}) [\text{s}]$$

6.14.6.3 Trigger Points

Event from abstract equation	Trigger point from customer's point of view	Technical description/protocol part
$t_{A,\text{speak}}$: Time of sending speech at the A-party	Start: A-party issues a talk burst.	Start: Audio interface: A unique audio signal is sent by the A-party.
$t_{B,\text{listen}}$: Time of receiving speech at the B-party	Stop: B-party hears the talk burst.	Stop: Audio interface: The very same audio signal is received by the B-party.
NOTE: Since every audio signal has certain duration and is therefore sent over a period of time, start and stop trigger points should both either refer to the beginning or the end of this audio signal. In case the speech transmission delay is derived from the transmission of speech samples the same applies to this particular kind of audio signal.		

7 Store-and-forward (S&F) Services QoS Parameters

The "Store-and-forward" concept can be used for every non real-time service called "Background Class", which uses the following communication concept. Two clients are assumed and one or more servers in the middle for each service.

- The A-party uploads a message to a server.
- This server forwards the message to another server (this step is optional).
- The server notifies the B-party that a new message is available (this step is optional).
- The B-party downloads the message.

The customers experience is similar for all services which follow the "Store-and-forward" approach.

At the beginning of each service-dependent clause, Figure 61 is given in an aligned version according to the respective service. The parameter names are aligned accordingly. Empty parameter boxes mean that the parameter is not yet defined.

7.1 Generic Store-and-forward Parameters

The QoS parameter concept presented in this clause should be used for all services that work as described in the introduction of clause 7 and are not defined already in a separate clause. Especially services that use proprietary or encrypted communication between the user equipment and the server of the service are predestinated to use the following generic parameter concept.

7.1.1 Parameter Overview Chart

Figure 61 gives an overview of the QoS parameters and their trigger points used in this generic parameter concept. The blue part describes the upload part of a message from the A-party to a server. The green part describes the notification part. The B-party will be informed about a new message. At the end the message will be downloaded at the B-party side from a server, described by the orange boxes.

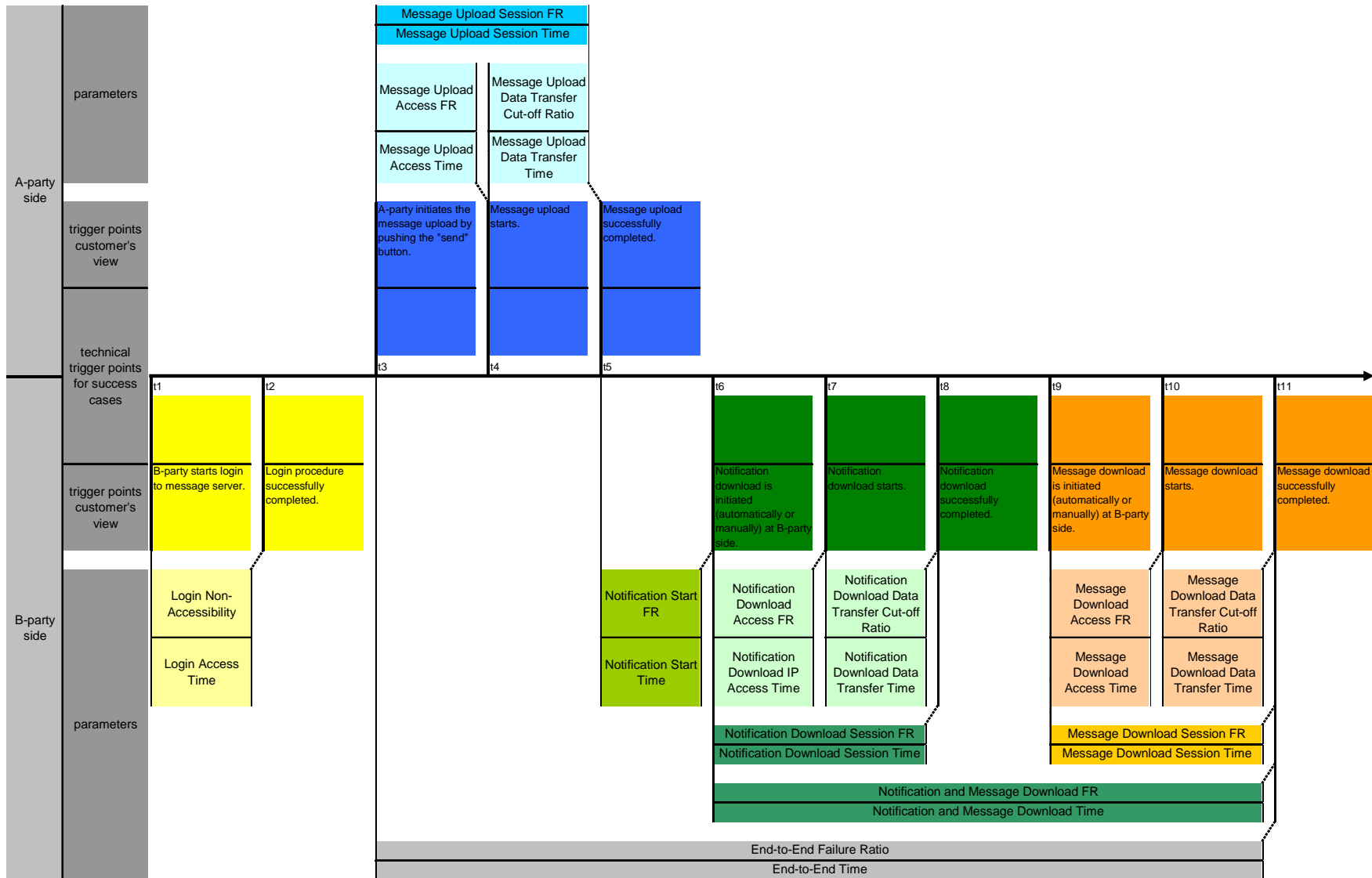

Figure 61: Generic Store-and-forward Parameter Overview

7.1.2 {Service} Message Upload Session Failure Ratio [%]

7.1.2.1 Abstract Definition

The message upload session failure ratio describes the proportion of unsuccessful message upload sessions and message upload sessions that were started successfully. The upload is successful if the message is marked as sent.

7.1.2.2 Abstract Equation

$$\text{{Service} Message Upload Session Failure Ratio [\%]} = \frac{\text{unsuccessful message upload sessions}}{\text{all message upload session start attempts}} \times 100$$

7.1.2.3 Trigger Points

Event from abstract equation	Trigger point from customer's point of view
Message upload session start attempt	A-party initiates the message upload by pushing the "send" message button.
Successful message upload session	Message upload successfully completed.
Unsuccessful message upload session	Stop trigger point not reached.

7.1.3 {Service} Message Upload Session Time [s]

7.1.3.1 Abstract Definition

The message upload session time describes the time period needed to successfully complete a message upload session.

7.1.3.2 Abstract Equation

$$\text{{Service} Message Upload Session Time [s]} = (t_{\text{successful message upload session}} - t_{\text{message upload session start attempt}}) [\text{s}]$$

7.1.3.3 Trigger Points

Event from abstract equation	Trigger point from customer's point of view
Message upload session start attempt	A-party initiates the message upload by pushing the "send" message button.
Successful message upload session	Message upload successfully completed.

Precondition for measurement: Message upload shall be successful.

7.1.4 {Service} Message Upload Access Failure Ratio [%]

7.1.4.1 Abstract Definition

The message upload access failure ratio describes the probability that the customer cannot successfully establish a data connection to the message server to upload messages.

7.1.4.2 Abstract Equation

$$\{\text{Service}\} \text{ Message Upload Access Failure Ratio [\%]} = \frac{\text{unsuccessful message upload accesses}}{\text{all message upload access attempts}} \times 100$$

7.1.4.3 Trigger Points

Event from abstract equation	Trigger point from customer's point of view
Message upload access attempt	A-party initiates the message upload by pushing the "send" message button.
Successful message upload access	Message upload starts.
Unsuccessful message upload access	Stop trigger point not reached.

7.1.5 {Service} Message Upload Access Time [s]

7.1.5.1 Abstract Definition

The message upload access time describes the time period needed to establish a data connection to the message server, from sending the initial query to the message server to the point of time when the message upload starts.

7.1.5.2 Abstract Equation

$$\{\text{Service}\} \text{ Message Upload Access Time [s]} = (t_{\text{successful message upload access}} - t_{\text{message upload access attempt}}) [\text{s}]$$

7.1.5.3 Trigger Points

Event from abstract equation	Trigger point from customer's point of view
Message upload access attempt	A-party initiates the message upload by pushing the "send" message button.
Successful message upload access	Message upload starts.

Precondition for measurement: Message upload access shall be successful.

7.1.6 {Service} Message Upload Data Transfer Cut-off Ratio [%]

7.1.6.1 Abstract Definition

The message upload data transfer cut-off ratio describes the proportion of unsuccessful message uploads and message uploads that were started successfully.

7.1.6.2 Abstract Equation

$$\{\text{Service}\} \text{ Message Upload Data Transfer Cut - off Ratio [\%]} = \frac{\text{unsuccessful message uploads}}{\text{all successfully started message uploads}} \times 100$$

7.1.6.3 Trigger Points

Event from abstract equation	Trigger point from customer's point of view
Successfully started message upload	Message upload starts at A-party side.
Successful message upload	Message upload successfully completed.
Unsuccessful message upload	Stop trigger point not reached.

7.1.7 {Service} Message Upload Data Transfer Time [s]

7.1.7.1 Abstract Definition

The message upload data transfer time describes the time period from the start to the end of the complete message upload.

7.1.7.2 Abstract Equation

$$\{\text{Service}\} \text{ Message Upload Data Transfer Time [s]} = (t_{\text{successful message upload}} - t_{\text{successfully started message upload}}) [\text{s}]$$

7.1.7.3 Trigger Points

Event from abstract equation	Trigger point from customer's point of view
Successfully started message upload	Message upload starts at A-party side.
Successful message upload	Message upload successfully completed.

Precondition for measurement: Message upload data transfer shall be successful.

7.1.8 {Service} Notification Start Failure Ratio [%]

7.1.8.1 Abstract Definition

The notification start failure ratio describes the probability that the notification download by the B-party is not successfully initiated after the successful upload of the message by the A-party.

7.1.8.2 Abstract Equation

$$\{\text{Service}\} \text{ Notification Start Failure Ratio [\%]} = \frac{\text{unsuccessful notification download attempts by B - party}}{\text{all successful message uploads by A - party}} \times 100$$

7.1.8.3 Trigger Points

Event from abstract equation	Trigger point from customer's point of view
Successful message upload by A-party	Message upload successfully completed by A-party.
Notification download attempt by B-party	Notification download is initiated (automatically or manually) at B-party side.
Unsuccessful notification download attempt by B-party	Stop trigger point not reached.

7.1.9 {Service} Notification Start Time [s]

7.1.9.1 Abstract Definition

The notification start time describes the time period from the successful message upload by the A-party to the start of the notification download attempt by the B-party.

7.1.9.2 Abstract Equation

$$\{\text{Service}\} \text{ Notification Start Time [s]} = (t_{\text{notification download attempt by B-party}} - t_{\text{successful message upload by A-party}}) [\text{s}]$$

7.1.9.3 Trigger Points

Event from abstract equation	Trigger point from customer's point of view
Successful message upload by A-party	Message upload successfully completed by A-party.
Notification download attempt by B-party	Notification download is initiated (automatically or manually) at B-party side.

Precondition for measurement: Notification download attempt shall be successful.

7.1.10 {Service} Notification Download Session Failure Ratio [%]

7.1.10.1 Abstract Definition

The notification download session failure ratio describes the proportion of unsuccessful notification downloads and notification downloads that were started successfully.

7.1.10.2 Abstract Equation

$$\{\text{Service}\} \text{ Notification Download Session Failure Ratio [\%]} = \frac{\text{unsuccessful notification download sessions}}{\text{all notification download session start attempts}} \times 100$$

7.1.10.3 Trigger Points

Event from abstract equation	Trigger point from customer's point of view
Notification download session start attempt	Notification download is initiated (automatically or manually) at B-party side.
Successful notification download session	Notification download successfully completed.
Unsuccessful notification download session	Stop trigger point not reached.

7.1.11 {Service} Notification Download Session Time [s]

7.1.11.1 Abstract Definition

The notification download session time describes the time period needed to successfully complete a notification download session.

7.1.11.2 Abstract Equation

$$\{\text{Service}\} \text{Notification Download Session Time [s]} = (t_{\text{successful notification download session}} - t_{\text{notification download session start attempt}}) [\text{s}]$$

7.1.11.3 Trigger Points

Event from abstract equation	Trigger point from customer's point of view
Notification download session start attempt	Notification download is initiated (automatically or manually) at B-party side.
Successful notification download session	Notification download successfully completed.

Precondition for measurement: Message Notification Download shall be successful.

7.1.12 {Service} Notification Download Access Failure Ratio [%]

7.1.12.1 Abstract Definition

The notification download access failure ratio describes the probability that the customer cannot successfully establish a data connection to the message server to download the notification of a new message.

7.1.12.2 Abstract Equation

$$\{\text{Service}\} \text{Notification Download Access Failure Ratio [\%]} = \frac{\text{unsuccessful notification download accesses}}{\text{all notification download access attempts}} \times 100$$

7.1.12.3 Trigger Points

Event from abstract equation	Trigger point from customer's point of view
Notification download access attempt	Notification download is initiated (automatically or manually) at B-party side.
Successful notification download access	Notification download starts.
Unsuccessful notification download access	Stop trigger point not reached.

7.1.13 {Service} Notification Download Access Time [s]

7.1.13.1 Abstract Definition

The notification download access time describes the time period needed to establish the data connection to the message server, from sending the initial query to the message server to the point of time when the notification download starts.

7.1.13.2 Abstract Equation

$$\{\text{Service}\} \text{Notification Download Access Time [s]} = (t_{\text{successful notification download access}} - t_{\text{notification download access attempt}}) [\text{s}]$$

7.1.13.3 Trigger Points

Event from abstract equation	Trigger point from customer's point of view
Notification download access attempt	Notification download is initiated (automatically or manually) at B-party side.
Successful notification download access	Notification download starts.

Precondition for measurement: Notification download access shall be successful.

7.1.14 {Service} Notification Download Data Transfer Cut-off Ratio [%]

7.1.14.1 Abstract Definition

The notification download data transfer cut-off ratio describes the proportion of unsuccessful notification downloads and notification downloads that were started successfully.

7.1.14.2 Abstract Equation

$$\{ \text{Service} \} \text{ Notification Download Data Transfer Cut - off Ratio } [\%] = \frac{\text{unsuccessful notification downloads}}{\text{all successfully started notification downloads}} \times 100$$

7.1.14.3 Trigger Points

Event from abstract equation	Trigger point from customer's point of view
Successfully started notification download	Notification download starts at B-party side.
Successful notification download	Notification download successfully completed.
Unsuccessful notification data download	Stop trigger point not reached.

7.1.15 {Service} Notification Download Data Transfer Time [s]

7.1.15.1 Abstract Definition

The notification download data transfer time describes the time period from the start to the end of the complete notification download.

7.1.15.2 Abstract Equation

$$\{ \text{Service} \} \text{ Notification Data Transfer Time } [s] = (t_{\text{successful notification download}} - t_{\text{successfully started notification download}}) [s]$$

7.1.15.3 Trigger Points

Event from abstract equation	Trigger point from customer's point of view
Successfully started notification download	Notification download starts at B-party side.
Successful notification download	Notification download successfully completed.

Precondition for measurement: Notification data transfer shall be successful.

7.1.16 {Service} Message Download Session Failure Ratio [%]

7.1.16.1 Abstract Definition

The message download session failure ratio describes the proportion of unsuccessful message download sessions and message download sessions that were started successfully.

7.1.16.2 Abstract Equation

$$\boxed{\text{\{Service\} Message Download Session Failure Ratio [\%]} = \frac{\text{unsuccessful message download sessions}}{\text{all message download session start attempts}} \times 100}$$

7.1.16.3 Trigger Points

Event from abstract equation	Trigger point from customer's point of view
Message download session start attempt	Message download is initiated (automatically or manually) at B-party side.
Successful message download session	Message download successfully completed.
Unsuccessful message download session	Stop trigger point not reached.

7.1.17 {Service} Message Download Session Time [s]

7.1.17.1 Abstract Definition

The message download session time describes the time period needed to successfully complete a message download session.

7.1.17.2 Abstract Equation

$$\boxed{\text{\{Service\} Message Download Session Time [s]} = (t_{\text{successful message download session}} - t_{\text{message download session start attempt}}) [\text{s}]}$$

7.1.17.3 Trigger Points

Event from abstract equation	Trigger point from customer's point of view
Message download session start attempt	Message download is initiated (automatically or manually) at B-party side.
Successful message download session	Message download successfully completed.

Precondition for measurement: Message download shall be successful.

7.1.18 {Service} Message Download Access Failure Ratio [%]

7.1.18.1 Abstract Definition

The message download access failure ratio describes the probability that the customer cannot successfully establish a data connection to the message server to download messages.

7.1.18.2 Abstract Equation

$$\{\text{Service}\} \text{ Message Download Access Failure Ratio } [\%] = \frac{\text{unsuccessful message download accesses}}{\text{all message download access attempts}} \times 100$$

7.1.18.3 Trigger Points

Event from abstract equation	Trigger point from customer's point of view
Message download access attempt	Message download is initiated (automatically or manually) at B-party side.
Successful message download access	Message download starts.
Unsuccessful message download access	Stop trigger point not reached.

7.1.19 {Service} Message Download Access Time [s]

7.1.19.1 Abstract Definition

The message download access time describes the time period needed to establish a data connection to the message server, from sending the initial query to the message server to the point of time when the message download starts.

7.1.19.2 Abstract Equation

$$\{\text{Service}\} \text{ Message Download Access Time } [s] = (t_{\text{successful message download access}} - t_{\text{message download access attempt}}) [s]$$

7.1.19.3 Trigger Points

Event from abstract equation	Trigger point from customer's point of view
Message download access attempt	Message download is initiated (automatically or manually) at B-party side.
Successful message download access	Message download starts.

Precondition for measurement: Message download access shall be successful.

7.1.20 {Service} Message Download Data Transfer Cut-off Ratio [%]

7.1.20.1 Abstract Definition

The message download data transfer cut-off ratio describes the proportion of unsuccessful message downloads and message downloads that were started successfully.

7.1.20.2 Abstract Equation

$$\{\text{Service}\} \text{ Message Download Data Transfer Cut - off Ratio } [\%] = \frac{\text{unsuccessful message downloads}}{\text{all successfully started message downloads}} \times 100$$

7.1.20.3 Trigger Points

Event from abstract equation	Trigger point from customer's point of view
Successfully started message download	Message download starts at B-party side.
Successful message download	Message download successfully completed.
Unsuccessful message download	Stop trigger point not reached.

7.1.21 {Service} Message Download Data Transfer Time [s]

7.1.21.1 Abstract Definition

The message download data transfer time describes the time period from the start to the end of the complete message download.

7.1.21.2 Abstract Equation

$$\{ \text{Service} \} \text{Message Download Data Transfer Time [s]} = (t_{\text{successful message download}} - t_{\text{successfully started message download}}) [\text{s}]$$

7.1.21.3 Trigger Points

Event from abstract equation	Trigger point from customer's point of view
Successfully started message download	Message download starts at B-party side.
Successful message download	Message download successfully completed.

Precondition for measurement: Message download data transfer shall be successful.

7.1.22 {Service} Notification and Message Download Failure Ratio [%]

7.1.22.1 Abstract Definition

The notification and message download failure ratio describes the probability that the customer cannot download first the notification and thereafter the complete message with the UE. User reaction times are not considered.

7.1.22.2 Abstract Equation

$$\{ \text{Service} \} \text{Notification and Message Download Failure Ratio [\%]} = \frac{\text{unsuccessful notification and message downloads}}{\text{all notification and message download attempts}} \times 100$$

7.1.22.3 Trigger Points

Event from abstract equation	Trigger point from customer's point of view
Notification and message download attempt	Notification download is initiated (automatically or manually) at B-party side.
Successful notification and message download	Message download successfully completed.
Unsuccessful notification and message download	Stop trigger point not reached.

7.1.23 {Service} Notification and Message Download Time [s]

7.1.23.1 Abstract Definition

The notification and message download time describes the time period from the start of the notification download to the end of the reception of the whole message content. User reaction times are not considered.

7.1.23.2 Abstract Equation

$$\boxed{\text{\{Service\} Notification and Message Download Time [s]} = (t_{\text{successful notification and message download}} - t_{\text{notification and message download attempt}}) [\text{s}]}$$

7.1.23.3 Trigger Points

Event from abstract equation	Trigger point from customer's point of view
Notification and message download attempt	Notification download is initiated (automatically or manually) at B-party side.
Successful notification and message download	Message download successfully completed.

Precondition for measurement: Notification and message download shall be successful.

7.1.24 {Service} End-to-End Failure Ratio [%]

7.1.24.1 Abstract Definition

The end-to-end failure ratio describes the probability that the complete service usage from the start of the message upload at the A-party to the complete message download at the B-party cannot be completed successfully. This transmission is unsuccessful if the message upload, the notification (if possible) or the message download fails.

7.1.24.2 Abstract Equation

$$\boxed{\text{\{Service\} End - to - End Failure Ratio [\%]} = \frac{\text{unsuccessful message downloads by B - party}}{\text{all message upload attempts by A - party}} \times 100}$$

7.1.24.3 Trigger Points

Event from abstract equation	Trigger point from customer's point of view
Message upload attempt	A-party initiates the message upload by pushing the "send" message button.
Successful message download	Message download successfully completed at B-party side.
Unsuccessful message download	Stop trigger point not reached.

7.1.25 {Service} End-to-End Time [s]

7.1.25.1 Abstract Definition

The end-to-end time describes the time period needed for the complete service usage, from the start of the message upload at the A-party to the complete message download at the B-party.

7.1.25.2 Abstract Equation

$$\{\text{Service}\} \text{ End - to - End Time [s]} = (t_{\text{successful message download}} - t_{\text{message upload attempt}}) [\text{s}]$$

7.1.25.3 Trigger Points

Event from abstract equation	Trigger point from customer's point of view
Message upload attempt	A-party initiates the message upload by pushing the "send" message button.
Successful message download	Message download successfully completed at B-party side.

Precondition for measurement: End-to-end service usage shall be successful.

7.1.26 {Service} Login Non-Accessibility [%]

7.1.26.1 Abstract Definition

The login non-accessibility describes the probability of a login failure between the message client and the message server. The login is needed to prepare the client of the B-party to be able to receive new notifications or messages. The parameter does not consider an actual message transfer.

7.1.26.2 Abstract Equation

$$\{\text{Service}\} \text{ Login Non - Accessibility [\%]} = \frac{\text{unsuccessful logins}}{\text{all login attempts}} \times 100$$

7.1.26.3 Trigger Points

Event from abstract equation	Trigger point from customer's point of view
Login attempt	B-party starts login to message server.
Successful login	Login procedure successfully completed.
Unsuccessful login	Stop trigger point not reached.

7.1.27 {Service} Login Access Time [s]

7.1.27.1 Abstract Definition

The login access time describes the time period from starting the login procedure to the point of time when the login procedure is successfully completed and the client can receive notifications or messages at the B-party side.

7.1.27.2 Abstract Equation

$$\{\text{Service}\} \text{ Login Access Time [s]} = (t_{\text{successful login}} - t_{\text{login attempt}}) [\text{s}]$$

7.1.27.3 Trigger Points

Event from abstract equation	Trigger point from customer's point of view
Login attempt	B-party starts login to message server.
Successful login	Login procedure successfully completed.

Precondition for measurement: Login shall be successful.

7.2 E-mail

7.2.1 Parameter Overview Chart

Figure 62 to Figure 65 give an overview of the QoS parameters used in the e-mail concept based on the SMTP, IMAP4 and POP3 protocol.

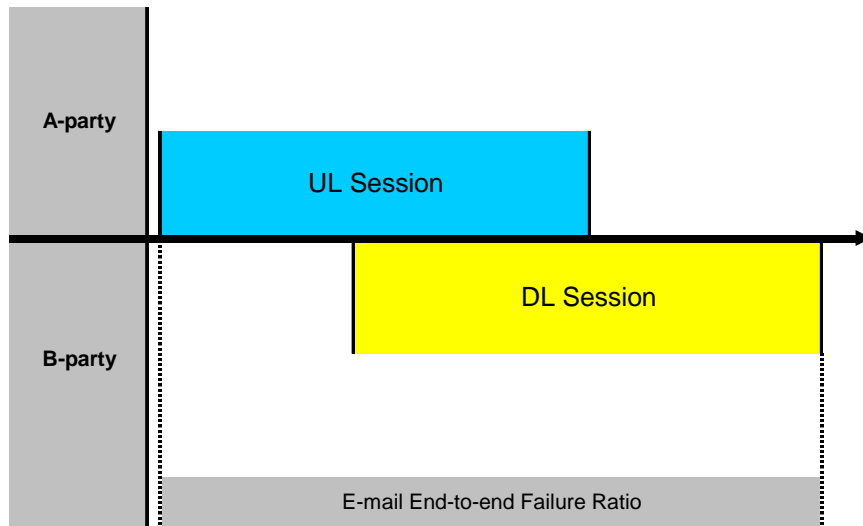

Figure 62: End-to-end Session Overview

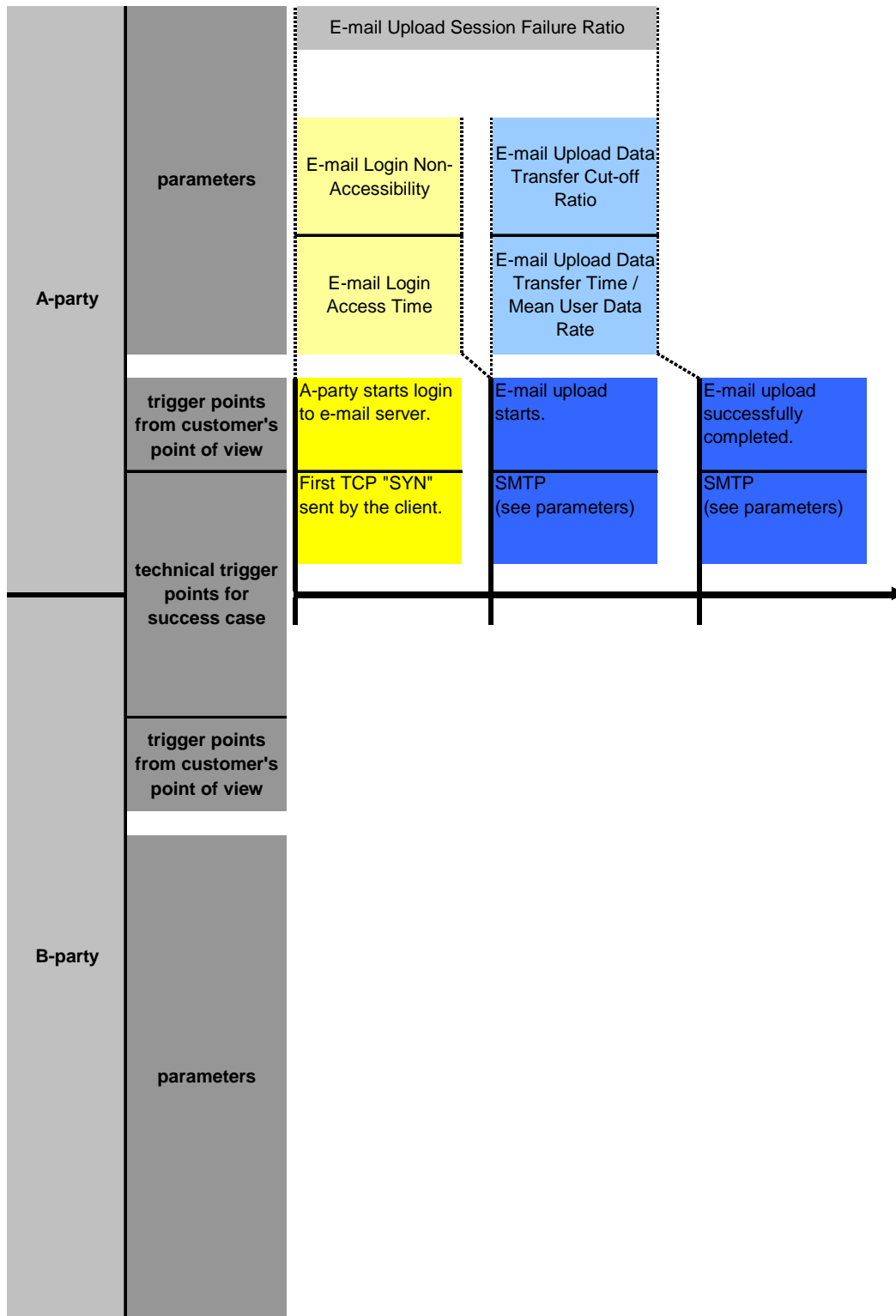

Figure 63: SMTP Overview

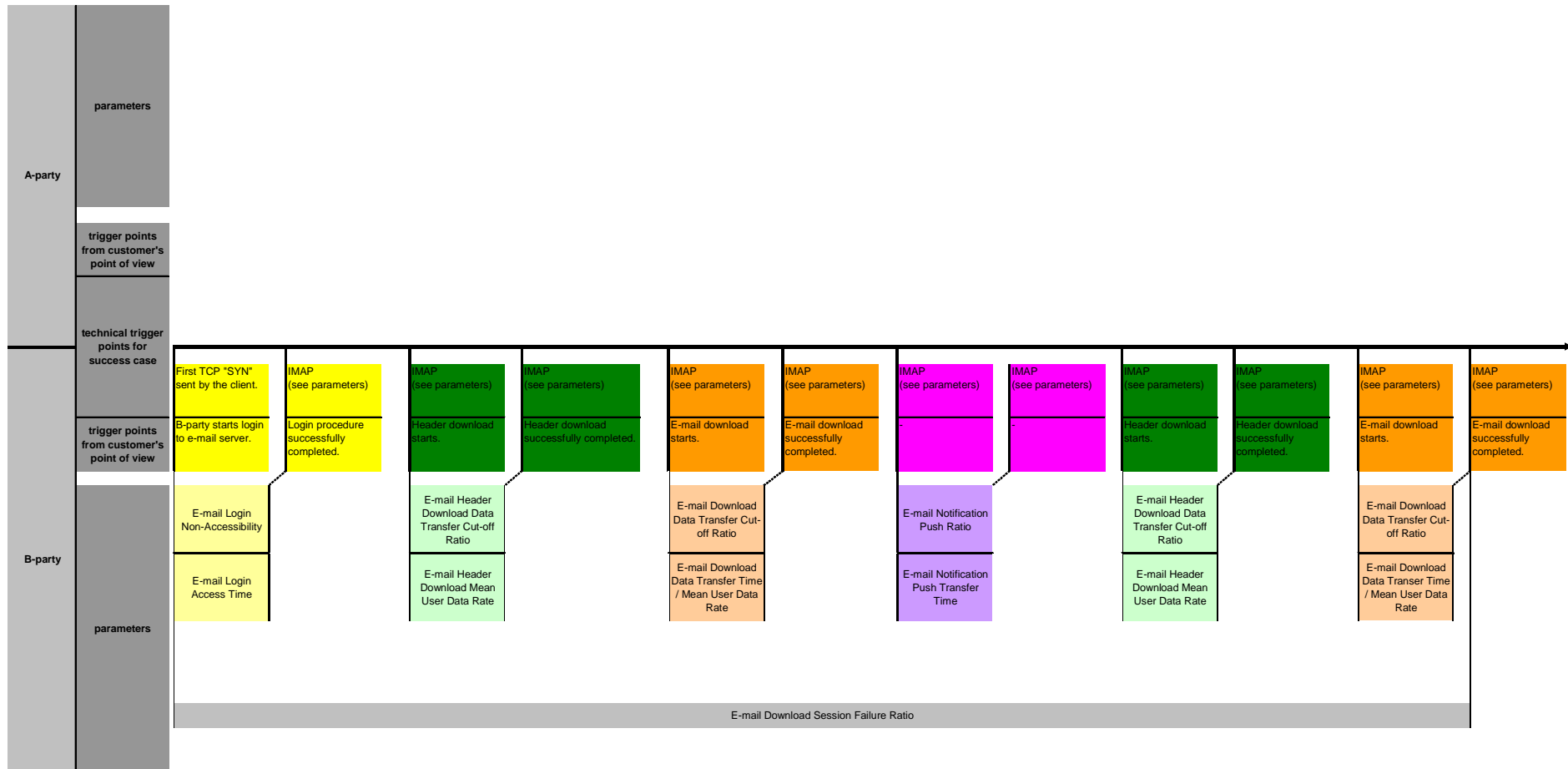

Figure 64: IMAP 4 (including idle feature) Parameter Overview

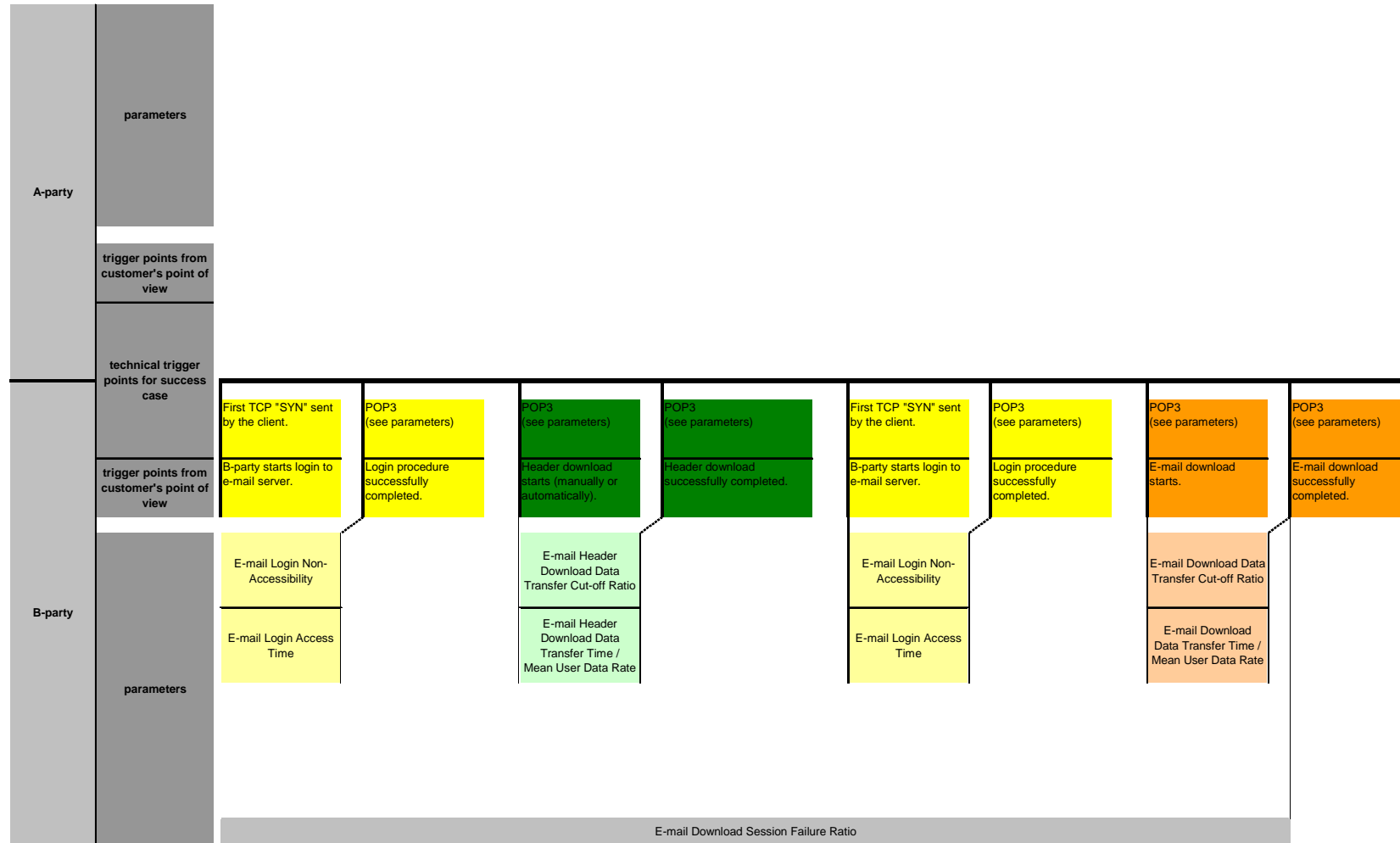

Figure 65: POP3 Parameter Overview

7.2.2 E-Mail {Download|Upload} Service Non-Accessibility [%]

This parameter was removed due to major changes in the e-mail QoS concept.

7.2.3 E-Mail {Download|Upload} Setup Time [s]

This parameter was removed due to major changes in the e-mail QoS concept.

7.2.4 E-Mail {Download|Upload} IP-Service Access Failure Ratio [%]

This parameter was replaced by the "Login Non-Accessibility" parameter specified in clause 7.2.11.

7.2.5 E-Mail {Download|Upload} IP-Service Setup Time [s]

This parameter was replaced by the "Login Non-Accessibility" parameter specified in clause 7.2.12.

7.2.6 E-mail {Upload|Download} Session Failure Ratio [%]

7.2.6.1 Abstract Definition

The e-mail session failure ratio describes the proportion of unsuccessful sessions and sessions that were started successfully.

7.2.6.2 Abstract Equation

$$\text{E-mail \{Upload|Download\} Session Failure Ratio [\%]} = \frac{\text{unsuccessful sessions}}{\text{all session start attempts}} \times 100$$

7.2.6.3 Trigger Points

Upload:

Event from abstract equation	Trigger point from customer's point of view	Technical description/protocol part
Session start attempt	Start: A-party starts login to the e-mail server.	Start: TCP: First "SYN" sent by the client.
Successful session	Stop: E-mail upload successfully completed by A-party.	Stop: SMTP: Reply code "250 message accepted" received by the client. An e-mail upload session can consist of several uploads.
Unsuccessful session	Stop trigger point not reached.	

Download:

Event from abstract equation	Trigger point from customer's point of view	Technical description/protocol part
Session start attempt	Start: B-party starts login to the e-mail server.	Start: First TCP "SYN" sent by the client.
Successful session	Stop: E-mail download successfully completed by B-party.	Stop: POP3: Termination sequence <CRLF.CRLF> received by the client as an answer to the "RETR" command. IMAP4: "OK FETCH completed" received by the client. An e-mail download session can consist of several FETCH/RETR/TOP requests (body and/or header downloads). All successful requests shall be confirmed accordingly.
Unsuccessful session	Stop trigger point not reached.	

Remark:

- The PS bearer has to be active in the cell used by a customer (see clause 5.1) and the UE has to be attached (see clause 5.3) as well as the respective PDP context has to be activated (see clause 5.5).

7.2.7 E-mail {Upload|Header Download|Download} Session Time [s]

This parameter was removed due to the fact that the significance of the parameter is weak due to the following factors:

- Different e-mail client implementations behave quite differently during a session with respect to the POP3/IMAP4 commands they send to the e-mail server.
- In certain use cases (e.g. header download first) user interaction is required to resume the session.

Both points have considerable influence on the measured results.

7.2.8 E-mail {Upload|Header Download|Download} Mean Data Rate [kbit/s]

7.2.8.1 Abstract Definition

The e-mail mean data rate describes the average data transfer rate measured throughout the entire connect time to the e-mail service. The data transfer shall be successfully terminated.

7.2.8.2 Abstract Equation

$$E - \text{mail } \{ \text{Upload} \mid \text{Download} \} \text{ Mean Data Rate [kbit/s]} = \frac{\text{user data transferred [kbit]}}{(t_{\text{successful data transfer}} - t_{\text{successfully started data transfer}}) [\text{s}]}$$

7.2.8.3 Trigger Points

Upload:

Event from abstract equation	Trigger point from customer's point of view	Technical description/protocol part
Successfully started data transfer	Start: E-mail upload starts.	Start: SMTP: "MAIL FROM" sent by the client.
Successful data transfer	Stop: E-mail upload successfully completed by A-party.	Stop: SMTP: Reply "250 message accepted" received by the client.

Header Download:

Event from abstract equation	Trigger point from customer's point of view	Technical description/protocol part
Successfully started data transfer	Start: Header download starts.	Start: POP3: "TOP" command sent by the client. IMAP4: "UID FETCH" command sent by the client to request the header.
Successful data transfer	Stop: Header download successfully completed by B-party.	Stop: POP3: Termination sequence <CRLF.CRLF> received by the client. IMAP4: "OK FETCH completed" received by the client. A header download can consist of several FETCH/TOP requests. All successful requests shall be confirmed accordingly.

Download:

Event from abstract equation	Trigger point from customer's point of view	Technical description/protocol part
Successfully started data transfer	Start: E-mail download starts.	Start: POP3: "RETR" command sent by the client. IMAP4: "UID FETCH" command sent by the client to request header and body.
Successful data transfer	Stop: E-mail download successfully completed by B-party.	Stop: POP3: Termination sequence <CRLF.CRLF> received by the client. IMAP4: "OK FETCH completed" received by the client. An e-mail download can consist of several FETCH/RETR requests. All successful requests shall be confirmed accordingly.

Preconditions for measurement: The PS bearer has to be active in the cell used by a customer (see clause 5.1), the UE has to be attached (see clause 5.3), the respective PDP context has to be activated (see clause 5.5) and the login to the e-mail server was successful (see clause 7.2.11).

7.2.9 E-mail {Upload|Header Download|Download} Data Transfer Cut-off Ratio [%]

7.2.9.1 Abstract Definition

The e-mail data transfer cut-off ratio describes the proportion of unsuccessful data transfers and data transfers that were started successfully.

7.2.9.2 Abstract Equation

$$\text{E - mail \{Upload| Header Download| Download\} Data Transfer Cut - off Ratio [\%]} = \frac{\text{unsuccessful data transfers}}{\text{all successfully started data transfers}} \times 100$$

7.2.9.3 Trigger Points

Upload:

Event from abstract equation	Trigger point from customer's point of view	Technical description/protocol part
Successfully started data transfer	Start: E-mail upload starts.	Start: SMTP: "MAIL FROM" sent by the client.
Successful data transfer	Stop: E-mail upload successfully completed by A-party.	Stop: SMTP: Reply "250 OK, message accepted" received by the client.
Unsuccessful data transfer	Stop trigger point not reached.	

Header Download:

Event from abstract equation	Trigger point from customer's point of view	Technical description/protocol part
Successfully started data transfer	Start: Header download starts.	Start: POP3: "TOP" command sent by the client. IMAP4: "UID FETCH" command sent by the client to request the header.
Successful data transfer	Stop: Header download successfully completed by B-party.	Stop: POP3: Termination sequence <CRLF.CRLF> received by the client as an answer to the "TOP" command. IMAP4: "OK Fetch complete" received by the client. A header download can consist of several FETCH/TOP requests. All successful requests shall be confirmed accordingly.
Unsuccessful data transfer	Stop trigger point not reached.	

Download:

Event from abstract equation	Trigger point from customer's point of view	Technical description/protocol part
Successfully started data transfer	Start: E-mail download starts.	Start: POP3: "RETR" command sent by the client. IMAP4: "UID FETCH" command sent by the client to request header and body.
Successful data transfer	Stop: E-mail download successfully completed by B-party.	Stop: POP3: Termination sequence <CRLF.CRLF> received by the client as an answer to the "RETR" command. IMAP4: "OK Fetch complete" received by the client. An e-mail download can consist of several fetch requests. All successful requests shall be confirmed by "OK Fetch completed". An e-mail download can consist of several FETCH/RETR requests. All successful requests shall be confirmed accordingly.
Unsuccessful data transfer	Stop trigger point not reached.	

Preconditions for measurement: The PS bearer has to be active in the cell used by a customer (see clause 5.1), the UE has to be attached (see clause 5.3), the respective PDP context has to be activated (see clause 5.5) and the login to the e-mail server was successful (see clause 7.2.11).

7.2.10 E-mail {Upload|Header Download|Download} Data Transfer Time [s]

7.2.10.1 Abstract Definition

The e-mail data transfer time describes the time period from the start to the end of the complete transfer of e-mail content.

7.2.10.2 Abstract Equation

$$\text{E - mail \{Upload | Header Download | Download\} Data Transfer Time [s] = } \\ \left(t_{\text{successful data transfer}} - t_{\text{successfully started data transfer}} \right) [\text{s}]$$

7.2.10.3 Trigger Points

Upload:

Event from abstract equation	Trigger point from customer's point of view	Technical description/protocol part
Successfully started data transfer	Start: E-mail upload starts.	Start: SMTP: "MAIL FROM" sent by the client.
Successful data transfer	Stop: E-mail upload successfully completed A-party.	Stop: SMTP: Reply "250 message accepted" received by the client.

Header Download:

Event from abstract equation	Trigger point from customer's point of view	Technical description/protocol part
Successfully started data transfer	Start: Header download starts.	Start: POP3: "TOP" command sent by the client. IMAP4: "UID FETCH" command sent by the client to request the header.
Successful data transfer	Stop: Header download successfully completed by B-party.	Stop: POP3: Termination sequence <CRLF.CRLF> received by the client. IMAP4: "OK Fetch completed" received by the client. A header download can consist of several FETCH/TOP requests. All successful requests shall be confirmed accordingly.

Download:

Event from abstract equation	Trigger point from customer's point of view	Technical description/protocol part
Successfully started data transfer	Start: E-mail download starts.	Start: POP3: "RETR" command sent by the client. IMAP4: "UID FETCH" command sent by the client to request header and body.
Successful data transfer	Stop: E-mail download successfully completed by B-party.	Stop: POP3: Termination sequence <CRLF.CRLF> received by the client as an answer to the "RETR" command. IMAP4: "OK Fetch completed" received by the client. An e-mail download can consist of several FETCH/RETR requests. All successful requests shall be confirmed accordingly.

Preconditions for measurement: The PS bearer has to be active in the cell used by a customer (see clause 5.1), the UE has to be attached (see clause 5.3), the respective PDP context has to be activated (see clause 5.5) and the login to the e-mail server was successful (see clause 7.2.11).

7.2.11 E-mail Login Non-Accessibility [%]

7.2.11.1 Abstract Definition

The e-mail login non-accessibility describes the probability that the e-mail client is not able to get access to the e-mail server.

7.2.11.2 Abstract Equation

$$\text{E - mail Login Non - Accessibility [\%]} = \frac{\text{unsuccessful logins}}{\text{all login attempts}} \times 100$$

7.2.11.3 Trigger Points

Event from abstract equation	Trigger point from customer's point of view	Technical description/protocol part
Login attempt	Start: User starts login to the e-mail server.	Start: TCP: First "SYN" sent by the client.
Successful login	Stop: Login procedure successfully completed.	Stop: SMTP: Reply "235 Authentication successful" received by the client as an answer to the authentication request. IMAP4: Reply "OK AUTHENTICATE successful" received by the client as an answer to the authentication request. POP3: "+OK" received by the client as an answer to the authentication request.
Unsuccessful login	Stop trigger point not reached.	

Preconditions for measurement: The PS bearer has to be active in the cell used by a customer (see clause 5.1) and the UE has to be attached (see clause 5.3).

7.2.12 E-mail Login Access Time [s]

7.2.12.1 Abstract Definition

The e-mail login access time describes the time period from starting the login procedure to the point of time when the client is authenticated.

7.2.12.2 Abstract Equation

$$\text{E - mail Login Access Time [s]} = (t_{\text{successful login}} - t_{\text{login attempt}}) [\text{s}]$$

7.2.12.3 Trigger Points

Event from abstract equation	Trigger point from customer's point of view	Technical description/protocol part
Login attempt	Start: User starts login to the e-mail server.	Start: TCP: First "SYN" sent by the client.
Successful login	Stop: Login procedure successfully completed.	Stop: SMTP: Reply "235 Authentication successful" received by the client as an answer to the authentication request. IMAP4: Reply "OK AUTHENTICATE successful" received by the client as an answer to the authentication request. POP3: "+OK" received by the client as an answer to the authentication request.

Preconditions for measurement: The PS bearer has to be active in the cell used by a customer (see clause 5.1) and the UE has to be attached (see clause 5.3).

7.2.13 E-mail Notification Push Failure Ratio [%]

7.2.13.1 Abstract Definition

The e-mail notification push failure ratio describes the probability that the notification announcement was not successfully conveyed to the B-party.

7.2.13.2 Abstract Equation

$$\text{E - mail Notification Push Failure Ratio [\%]} = \frac{\text{unsuccessful attempts to push the notification to the B - party}}{\text{all attempts to push the notification to the B - party}} \times 100$$

7.2.13.3 Trigger Points

Event from abstract equation	Trigger point from customer's point of view	Technical description/protocol part
Notification push attempt	Start: Not applicable.	Start: IMAP4: "EXISTS" command received by the client.
Successful idle complete	Stop: Not applicable.	Stop: IMAP4: "OK IDLE complete" received by the client.
Unsuccessful idle complete	Stop trigger point not reached.	

Preconditions for measurement: The PS bearer has to be active in the cell used by a customer (see clause 5.1), the UE has to be attached (see clause 5.3), the respective PDP context has to be activated (see clause 5.5), the login to the e-mail server was successful (see clause 7.2.11) and the e-mail upload was successful (see clause 7.2.6).

7.2.14 E-mail Notification Push Transfer Time [s]

7.2.14.1 Abstract Definition

The e-mail notification push transfer time describes the time period from starting the notification push to the successful confirmation of the e-mail server of the end of the idle period.

7.2.14.2 Abstract Equation

$$\text{E - mail Notification Push Transfer Time [s]} = (t_{\text{successful idle complete}} - t_{\text{notification push attempt}}) [\text{s}]$$

7.2.14.3 Trigger Points

Event from abstract equation	Trigger point from customer's point of view	Technical description/protocol part
Notification push attempt	Start: Not applicable.	Start: IMAP4: "EXISTS" command received by the client.
Successful idle complete	Stop: Not applicable.	Stop: IMAP4: "OK IDLE complete" received by the client.

Preconditions for measurement: The PS bearer has to be active in the cell used by a customer (see clause 5.1), the UE has to be attached (see clause 5.3), the respective PDP context has to be activated (see clause 5.5), the login to the e-mail server was successful (see clause 7.2.11) and the e-mail upload was successful (see clause 7.2.6).

7.2.15 E-mail End-to-End Failure Ratio [%]

7.2.15.1 Abstract Definition

The e-mail end-to-end failure ratio describes the probability that the complete service usage from the start of e-mail upload at the A-party to the complete e-mail download at the B-party with an e-mail client cannot be completed successfully. This transmission is unsuccessful if the e-mail upload, the header download (if applicable) or the e-mail download fails.

7.2.15.2 Abstract Equation

$$\text{E - mail End - to - End Failure Ratio [\%]} = \frac{\text{unsuccessful e - mail downloads by B - party}}{\text{all e - mail upload attempts by A - party}} \times 100$$

7.2.15.3 Trigger Points

Event from abstract equation	Trigger point from customer's point of view	Technical description/protocol part
E-mail upload attempt by A-party	Start: A-party starts login to the e-mail server.	Start: TCP: First "SYN" sent by the client.
Successful e-mail download by B-party	Stop: E-mail download successfully completed by B-party.	Stop: POP3: Termination sequence <CRLF.CRLF> received by the client. IMAP4: "OK FETCH completed" received by the client. An e-mail download can consist of several FETCH/RETR requests. All successful requests shall be confirmed accordingly.
Unsuccessful e-mail download by B-party	Stop trigger point not reached.	

Preconditions for measurement: The PS bearer has to be active in the cell used by a customer (see clause 5.1) and the UE has to be attached (see clause 5.3).

7.2.16 Exemplary Signal Flow

The following signal flows are examples. The signalling between client and server can differ. It depends on the used client and server type.

7.2.16.1 SMTP E-mail Upload

	Trigger	CLIENT	SERVER
TCP connection setup	1	SYN	
	2		SYN, ACK
	3	ACK	
Request for capabilities	4	EHLO	
	5		250 Hello [...capability list...]
Authentication	6	AUTH [...]	
	7		334
	8		<i>...authentication challenge between client and server...</i>
	8		235 Authentication successful
E-mail upload	9	MAIL FROM:<name@domain.com>	
	10		250 OK
	11	RCPT TO:<name2@domain.com>	
	12		250 OK
	13	DATA	
	14		354 Start mail input
	15	<i>... header and body data is sent from client to server...</i>	
15	<CRLF>.<CRLF>		
16		250 OK, message accepted	
Logout	17	QUIT	
	18		221 Closing connection

7.2.16.2 IMAP4 Idle Header and E-mail Download

	Trigger	Client	Server
TCP connection setup	1	SYN	
	2		SYN, ACK
	3	ACK	
	4		* OK IMAP server ready
Request for capabilities	5	001 CAPABILITY	
	6		* CAPABILITY [...capability list...]
	7		001 OK CAPABILITY complete
Authentication	8	002 AUTHENTICATE [...]	
	9		+ Go ahead
			<i>...authentication challenge between client and server...</i>
	10		002 OK AUTHENTICATE successful
Synchronization	11	003 LIST "" ""	
	12		* LIST [...]
	13		003 OK LIST completed
	14	004 SELECT "INBOX"	
	15		* 2 EXISTS
	16		* 0 RECENT
	17		* FLAGS (\Seen [..])
	18		[...]
	19		004 OK SELECT complete
Activation idle mode	20	005 IDLE	
	21		+ IDLE
			<i>...time passes; new mail arrives at server...</i>
New e-mail arrived at the server	22		* 3 EXISTS
	23	DONE	
	24		005 OK IDLE complete
Request for UID number, method differs	25	006 FETCH 3 (UID)	
	26		* 3 FETCH (UID 4711)
	27		006 OK FETCH complete
Header download	28	007 UID FETCH 4711 BODY[HEADER]	
	29		* 4711 FETCH (BODY[HEADER] {123}
	30		Date: [...] From: [...] Subject: [...] To: [...] cc: [...] Message-Id: [...]
	31		007 OK FETCH completed
E-mail Header and body download	32	008 UID FETCH 4711 (UID FLAGS BODY.PEEK[])	
	33		* 1 FETCH (UID 4711 FLAGS (\Recent) Body [] {123456}
	34		Re@domain.com
	35		<i>...header and body data is sent from server to client...</i> 008 OK FETCH completed
Delete	36	009 UID STORE 4711 +flags \deleted	
	37		* 3 FETCH (FLAGS (\Seen \Deleted))
	38		009 OK +FLAGS completed
	39	010 EXPUNGE	
	40		010 OK Expunge completed
Logout	41	011 LOGOUT	
	42		* Bye
	43		011 OK LOGOUT completed

7.2.16.3 POP3 Header Download

	Trigger	CLIENT	SERVER
TCP connection setup	1	SYN	
	2		SYN, ACK
	3	ACK	
	4		+OK POP3 server ready
Request for capabilities	5	AUTH	
	6		+OK List of supported SASL authentication methods follows: [...authentication mechanism list...]
	7	CAPA	
	8		+OK Capability list follows: [...capability list...]
Authentication	9	AUTH [...]	
			<i>...authentication challenge between client and server...</i>
	10		+OK 1 message, 1 500 octets
Synchronization	11	STAT	
	12		+OK 1 1 500
	13	LIST	
	14		+OK Scan list follows 1 1 500 <CRLF>.<CRLF>
E-mail header download	15	TOP 1 0	
	16		+OK Message top follows
			<i>...header data is sent from server to client...</i>
	17		<CRLF>.<CRLF>
Logout	18	QUIT	
	19		+OK

7.2.16.4 POP3 E-mail Download

	Trigger	CLIENT	SERVER
TCP connection setup	1	SYN	
	2		SYN, ACK
	3	ACK	
	4		+OK Server ready
Request for capabilities	5	AUTH	
	6		+OK List of supported SASL authentication methods follows: [...authentication mechanism list...]
	7	CAPA	
	8		+OK Capability list follows: [...capability list...]
Authentication	9	AUTH [...]	
		<i>...authentication challenge between client and server...</i>	
	10		+OK 1 message, 1 500 octets
Synchronization	11	STAT	
	12		+OK 1 1 500
	13	LIST	
	14		+OK Scan list follows 1 1 500 <CRLF>.<CRLF>
	15	UIDL	
	16		+OK Scan list follows 1 12 <CRLF>.<CRLF>
E-Mail header and body download	17	RETR 1	
	18		+OK 1 500 octets
		<i>...header and body data is sent from server to client...</i>	
	19		<CRLF>.<CRLF>
Delete	20	DELE 1	
	21		+OK Message deleted
Logout	22	QUIT	
	23		+OK Closing connection

7.3 Multimedia Messaging Service (MMS)

NOTE 1: It is important to keep in mind that measurement equipment and techniques used can affect the data collected. The measurement equipment and techniques should be defined and their effects documented for all tests. One example of this is the effect of Windows RAS on the setup of PDP Context (see ETSI TS 102 250-3 [5]).

NOTE 2: Please be aware that the underlying transport mechanism can either be WAP1.x or WAP2.0.

NOTE 3: The investigation of MMS functionality in LTE networks is for further study.

7.3.1 Parameter Overview Chart

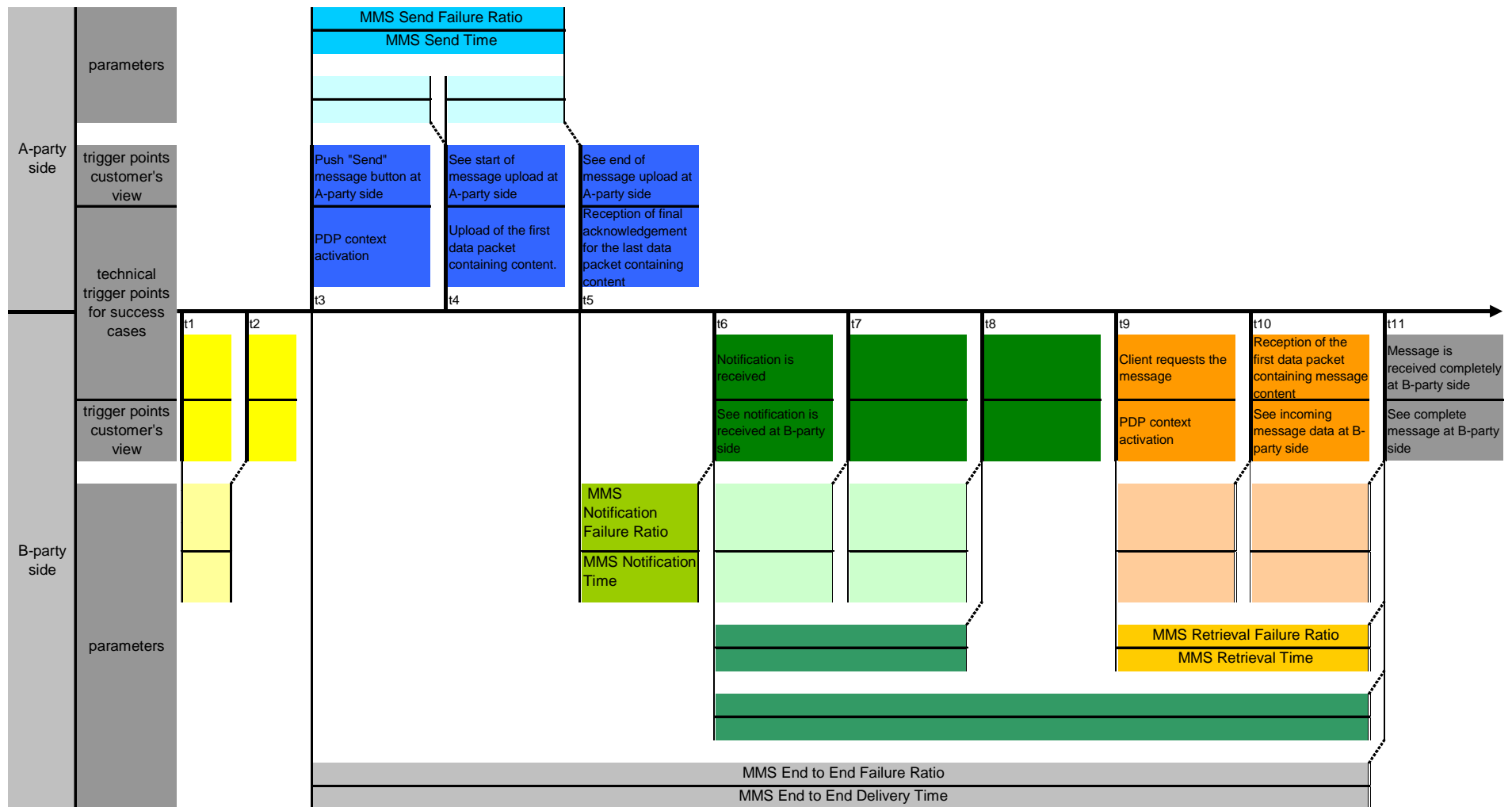

Figure 66: MMS Parameter Overview with Trigger Points

7.3.2 MMS Send Failure Ratio [%]

7.3.2.1 Abstract Definition

The parameter MMS Send Failure Ratio describes the probability that a MMS-message cannot be sent by the subscriber, although he has requested to do so by pushing the "send button".

7.3.2.2 Abstract Equation

$$\text{MMS Send Failure Ratio [\%]} = \frac{\text{unsuccessful MMS send attempts}}{\text{all MMS send attempts}} \times 100$$

7.3.2.3 Trigger Points

Event from abstract equation	Trigger point from user's point of view	Technical description/protocol part
MMS Send Attempt	Pushing of send button.	The send button initiates the <i>PDP context activation</i> of the MS (MO), followed by a connection to the WAP Gateway, and to the MMSC. (See trigger 1 in Figure 67).
Unsuccessful MMS Send Attempt	Do not see "Message sent".	The <i>m-send.conf</i> (see [2]) (where Response Status: \$80 = M_RS_OK) is not received by the MS(MO). (See trigger 18 in Figure 67). (See notes 1 to 3). "MMS unsuccessful send attempt timeout" as specified in ETSI TS 102 250-5 [i.1].
NOTE 1: The phase where the WAP session (WAP1.x) / TCP connection (WAP 2.0) will be deactivated is not covered by this indicator. Some mobiles might not support the sending/receiving of the next MMS unless the WAP session (WAP1.x) / TCP connection (WAP 2.0) is disconnected properly.		
NOTE 2: A forwarding of a MMS without reception of a positive m-send.conf (where Response Status: \$80 = M_RS_OK) shall be counted as failure.		
NOTE 3: Only MMS sent within the timeouts will be considered.		

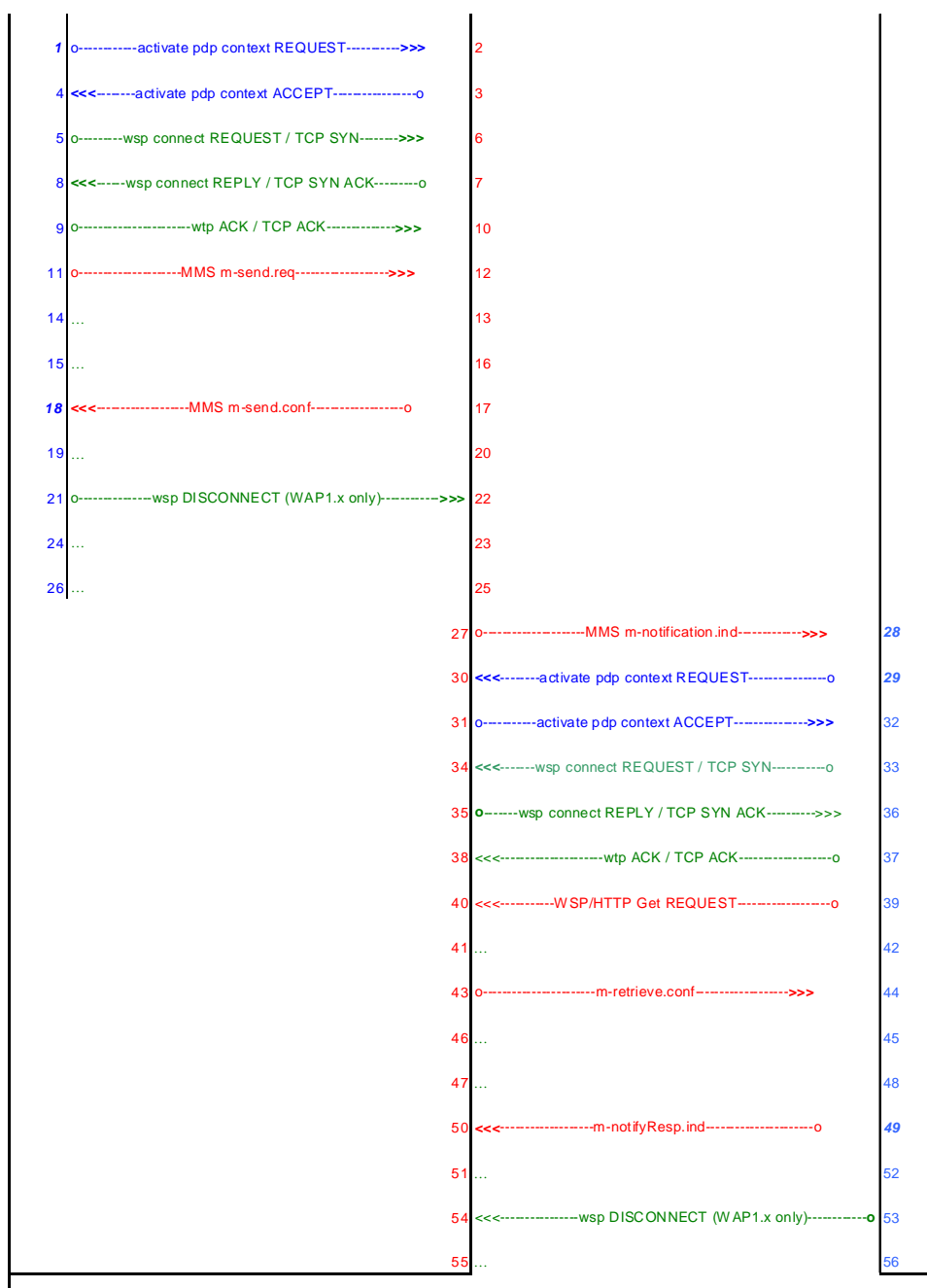

Legend: Control Plane, WAP Layers (WAP1.x / WAP2.0), MMS Layer

Figure 67: MMS Transaction flow (immediate retrieval)

NOTE: In Figure 67 only the transaction flow for immediate retrieval is shown. Please refer to Figure 5 in [2] for the delayed retrieval transaction flow.

7.3.3 MMS Retrieval Failure Ratio [%]

7.3.3.1 Abstract Definition

The parameter MMS Retrieval Failure Ratio describes the probability that the MMS-message cannot be downloaded by the MT mobile, which received a MMS notification before.

Remark:

- The MMS notification is a push-message. This message either initiates the download of the MMS content by starting a "WAP Get Request" (when the mobile is switched to automatic mode) or enables the user to manually start this "Wap Get Request" (when the mobile is switched to manual mode). The measurements will be done either using the setting "Automatic Download" (e.g. the download follows the immediate retrieval transaction flow) or following the delayed retrieval. In case of delayed retrieval the wait time between the notification response (*m-notifyResp.ind*) and the WSP/HTTP get request (WSP/HTTP Get.req) shall be set to zero. Please refer to Figure 5 in [2] for the delayed retrieval transaction flow.

7.3.3.2 Abstract Equation

$$\text{MMS Delivery Failure Ratio [\%]} = \frac{\text{unsuccessful MMS delivery attempts}}{\text{all MMS delivery attempts}} \times 100$$

7.3.3.3 Trigger Points

Event from abstract equation	Trigger point from user's point of view	Technical description/protocol part
MMS Retrieval Attempt (MT)	Start: Initiation of the Wap Get Request MT.	Start: After the <i>m-Notification.ind.</i> (see [2]) has been sent to the MS (MT), this mobile activates a PDP-context and contacts the MMSC via the WAP Gateway (see trigger 29 in Figure 67).
Unsuccessful MMS Retrieval Attempt (MT)	Stop: No MMS-message is received.	Stop (immediate retrieval): The <i>m-notifyResp.ind</i> (see [2]) is not sent by the MS (MT). (See trigger 49 in Figure 67). (See notes 1 and 2). "MMS unsuccessful Retrieval timeout" as specified in ETSI TS 102 250-5 [i.1]. Stop (deferred retrieval): The <i>m-acknowledge.ind</i> is not sent by the MS (MT).
NOTE 1: The phase where the WAP session (WAP1.x) / TCP connection (WAP 2.0) will be deactivated is not covered by this indicator. Some mobiles might not support the sending/receiving of the next MMS unless the WAP session (WAP1.x) / TCP connection (WAP 2.0) is disconnected properly.		
NOTE 2: Only MMS received within the timeouts will be considered.		

7.3.4 MMS Send Time [s]

7.3.4.1 Abstract Definition

A subscriber uses the Multimedia Messaging Service (as indicated by the network ID in his mobile phone display). The time elapsing from pushing the send button after the editing of a MMS-message to the completion of the data transfer is described by this parameter.

NOTE: Possible measurement scenarios for time indicators of MMS may vary in the number of involved MMSCs. With increasing MMS-traffic or internetwork-traffic surveillance, the number of MMSCs involved will increase also. Number of MMSCs involved is therefore a measurement condition to be discussed.

7.3.4.2 Abstract Equation

$$\text{MMS Send Time [s]} = (t_{\text{MMStoMMSCcomplete}} - t_{\text{sendButton}}) [\text{s}]$$

7.3.4.3 Trigger Points

Event from abstract equation	Trigger point from user's point of view	Technical description/protocol part
sendButton	Start: Send button is pushed.	Start: The send button initiates the <i>PDP context activation</i> of the MS(MT), followed by a connection to the WAP Gateway (See trigger 1 in Figure 67). (See notes 1 and 2). "MMS unsuccessful send transfer timeout" as specified in ETSI TS 102 250-5 [i.1].
MMSfromMMSCcomplete	Stop: MMS-message is completely transmitted to MMSC.	Stop: The <i>m-send.conf</i> (see [2]) (where Response Status: \$80 = M_RS_OK) is received by the MS(MO). (See trigger 18 in Figure 67).
NOTE 1: The phase, where the WAP session WAP session (WAP1.x) / TCP connection (WAP 2.0) will be deactivated is not covered by this indicator. Some mobiles might not support the sending/receiving of the next MMS unless the WAP session WAP session (WAP1.x) / TCP connection (WAP 2.0) is disconnected properly.		
NOTE 2: Only MMS send within the timeouts will be considered.		

7.3.5 MMS Retrieval Time [s]

7.3.5.1 Abstract Definition

The reception of a MMS-message works as follows: A push-sms is sent to the receiver's mobile. In automatic mode, the push sms initiates a WAP-connection to download the MMS from the MMSC. The initiation of the WAP connection is called the WAP GET REQUEST (WGR). The time elapsing between the WGR and the completion of the download of the MMS will be described by the parameter MMS Retrieval Time.

Possible measurement scenarios for time indicators of MMS may vary in the number of involved MMSCs. With increasing MMS-traffic or internet-traffic surveillance, the number of MMSCs involved will increase also. Number of MMSCs involved is therefore a measurement condition to be discussed.

7.3.5.2 Abstract Equation

$$\text{MMS Delivery Time [s]} = (t_{\text{MMSfromMMSCcomplete}} - t_{\text{initWGR}}) [\text{s}]$$

7.3.5.3 Trigger Points

Event from abstract equation	Trigger point from user's point of view	Technical description/protocol part
initWGR	Start: Time when WAP Get Request is initiated.	Start: The <i>m-Notification.ind</i> (see [2]) is delivered to the MS (MT). This initiates the <i>PDP context activation</i> . (See trigger 29 in Figure 67).
MMSfromMMSCcomplete	Stop: MMS-message is received completely.	Stop (immediate retrieval): The <i>m-notifyResp.ind</i> (see [2]) is sent by the MS (MT). (See trigger 49 in Figure 67). (See notes 1 and 2) "MMS successful retrieval timeout" as specified in ETSI TS 102 250-5 [i.1]. Stop (deferred retrieval): The <i>m-acknowledge.ind</i> is sent by the MS (MT).
NOTE 1: The phase, where the WAP session (WAP1.x) / TCP connection (WAP 2.0) will be deactivated is not covered by this indicator. Some mobiles might not support the sending/receiving of the next MMS unless the WAP session (WAP1.x) / TCP connection (WAP 2.0) is disconnected properly.		
NOTE 2: Only MMS received within the timeouts will be considered.		

7.3.6 MMS Notification Failure Ratio [%]

7.3.6.1 Abstract Definition

The parameter MMS Notification Failure Ratio [%] describes the probability that the Multimedia Messaging Service (MMS) is not able to deliver the Notification of a MMS-message to the b-parties mobile.

7.3.6.2 Abstract Equation

$$\text{MMS Notification Failure Ratio [\%]} = \frac{\text{failed MMS - notifications}}{\text{successfully submitted MMS}} \times 100$$

7.3.6.3 Trigger Points

Event from abstract equation	Trigger point from user's point of view	Technical description/protocol part
Successfully submitted MMS MO	Start: Reception of the acknowledgement from the MMSC MO (i.e. "Message sent").	Start: The <i>m-send.conf</i> (see [2]) (where Response Status: \$80 = M_RS_OK) is not received by the MS(MO). (See trigger 18 in Figure 67). (See notes 1 and 2)
Failed MMS-Notifications	Stop: Failure delivery (non-delivery) of the Notification-SMS.	Stop: <i>m-notification.ind</i> (see [2]) is not delivered to the MS(MT). (See trigger 28 in Figure 67). (See note 3) "MMS successful notification timeout" as specified in ETSI TS 102 250-5 [i.1].
NOTE 1: The phase where the WAP session (WAP1.x) / TCP connection (WAP 2.0) will be deactivated is not covered by this indicator. Some mobiles might not support the sending/receiving of the next MMS unless the WAP session (WAP1.x) / TCP connection (WAP 2.0) is disconnected properly.		
NOTE 2: Only the accepted MMS has to be considered (see the response status = \$80 in the sendconf) MMS with negative response but delivered can added alternatively.		
NOTE 3: Only Notifications received within the timeouts will be considered as successful.		

7.3.7 MMS Notification Time [s]

7.3.7.1 Abstract Definition

A subscriber uses the Multimedia Messaging Service. The time elapsing from the complete submission of the Multimedia-Message to the MMSC to the reception of the Notification (MT) is the *MMS Notification Delay*.

Possible measurement scenarios for time indicators of MMS may vary in the number of involved MMSCs. With increasing MMS-traffic or internetwork-traffic surveillance, the number of MMSCs involved will increase also. Number of MMSCs involved is therefore a measurement condition to be discussed.

7.3.7.2 Abstract Equation

$$\text{MMS Notification Time [s]} = (t_{\text{recNotif}} - t_{\text{MMSsubmit}}) [\text{s}]$$

7.3.7.3 Trigger Points

Event from abstract equation	Trigger point from user's point of view	Technical description/protocol part
MMSsubmit	Start: The MMS is submitted successfully.	Start: The <i>m-send.conf</i> (see [2]), (where Response Status: \$80 = M_RS_OK) is received by the MS(MO). (See trigger 18 in Figure 67). (See note 1).
recNotif	Stop: Time when the notification is received (MT).	Stop: <i>M-Notification.ind</i> (see [2]) is received by MS (MT) (See trigger 28 in Figure 67). (See note 2). "MMS successful notification timeout" as specified in ETSI TS 102 250-5 [i.1].
NOTE 1: The phase, where the WAP session (WAP1.x) / TCP connection (WAP 2.0) will be deactivated is not covered by this indicator. Some mobiles might not support the sending/receiving of the next MMS unless the WAP session (WAP1.x) / TCP connection (WAP 2.0) is disconnected properly.		
NOTE 2: Only Notifications received within the timeouts will be considered as successful.		

7.3.8 MMS End-to-End Failure Ratio [%]

7.3.8.1 Abstract Definition

The parameter MMS end-to-end failure ratio describes the probability that the Multimedia Messaging Service (MMS) is not able to deliver a MMS-message after the "send button" has been pushed or the MO party has not received an acknowledgement of the successful transmission from the MMSC.

7.3.8.2 Abstract Equation

$$\text{MMS End - to - End Failure Ratio}[\%] = \frac{\text{unsuccessfully delivered MMS - messages}}{\text{all MMS send attempts}} \times 100$$

End-to-end parameter measurement may optionally be derived by concatenating the component measurements.

7.3.8.3 Trigger Points

Event from abstract equation	Trigger point from user's point of view	Technical description/protocol part
MMS Send Attempt by MS(MO)	Start: Pushing of send button.	Start: The send button initiates the <i>PDP context activation</i> of the MS, followed by a connection to the WAP Gateway. (See trigger 1 in Figure 67). (See note 1).
Unsuccessful MMS Retrieval Attempt of MS(MT)	Stop: No MMS-message is received (MT) or no acknowledgement from the MMSC is received at MS (MO).	Stop: The <i>m-send.conf</i> (where Response Status: \$80 = M_RS_OK) is not received by the MS (MO) or the <i>m-notifyResp.ind</i> (in case of immediate retrieval) respectively the <i>m-acknowledge.ind</i> (in case of deferred retrieval, see also [2]) is not sent by the MS (MT). See trigger 18 and 49 in Figure 67 and notes 2 and 3. MMS unsuccessful end-to-end timeout as specified in ETSI TS 102 250-5 [i.1].
NOTE 1: The forwarding of a MMS by the MMSC to the MS (MT) might be possible without the reception of the <i>m-send.conf</i> MS (MO) (see [2]), (where response status is \$80 = M_RS_OK).		
NOTE 2: The phase where the WAP session (WAP1.x) / TCP connection (WAP 2.0) will be deactivated is not covered by this indicator. Some mobiles might not support the sending/receiving of the next MMS unless the WAP session (WAP1.x) / TCP connection (WAP 2.0) is disconnected properly.		
NOTE 3: Only MMS received within the timeouts will be considered.		

7.3.9 MMS End-to-End Delivery Time [s]

7.3.9.1 Abstract Definition

A subscriber uses the Multimedia Messaging Service (as indicated by the network ID in his mobile phone display). The time elapsing from pushing of the "send button" to the reception of the MMS by the b-parties mobile is the MMS End-to-end Delivery Time.

This parameter is not calculated if the MO party has not received an acknowledgement of the successful transmission from the MMSC.

The size of a MMS varies. In comparison to SMS, the size has noticeable impact on the submission time. So, a typical sized MM should be used for this measurement (see ETSI TS 102 250-5 [i.1]).

NOTE 1: Possible measurement scenarios for time indicators of MMS may vary in the number of involved MMSCs. With increasing MMS-traffic or internetwork-traffic surveillance, the number of MMSCs involved will increase also. Number of MMSCs involved is therefore a measurement condition to be discussed.

NOTE 2: End-to-end parameter measurement may optionally be derived by concatenating the component measurements.

7.3.9.2 Abstract Equation

$$\text{MMSEnd-to-EndDeliveryTime[s]} = (t_{\text{MMSrec}} - t_{\text{sendAttempt}}) [\text{s}]$$

7.3.9.3 Trigger Points

Event from abstract equation	Trigger point from user's point of view	Technical description/protocol part
sendAttempt	Start: Time when the "send button" is pushed.	Start: The send button initiates the <i>PDP context activation</i> of the MS (MO), followed by a connection to the WAP Gateway. (See trigger 1 in Figure 67). (See note 1).
MMSrec	Stop: Time when the MMS is received at the b-parties mobile.	Stop: The M-retrieve.conf (see [2]) is received completely by the MS (MT), and the MS (MT) sends the m-NotifyResp.ind (See trigger 49 in Figure 67 in case of immediate retrieval) respectively the <i>m-acknowledge.ind</i> (in case of deferred retrieval). (See notes 2 to 4). "MMS successful End-to-end timeout" as specified in ETSI TS 102 250-5 [i.1].
<p>NOTE 1: The forwarding of a MMS by the MMSC to the MS (MT) might be possible without the reception of the <i>m-send.conf</i> MS (MO).</p> <p>NOTE 2: Parameter not calculated if the m-send.conf (where Response Status: \$80 = M_RS_OK) is not received by MS (MO) (See trigger 18 in Figure 67).</p> <p>NOTE 3: The phase where the WAP session (WAP1.x) / TCP connection (WAP 2.0) will be deactivated is not covered by this indicator. Some mobiles might not support the sending/receiving of the next MMS unless the WAP session (WAP1.x) / TCP connection (WAP 2.0) is disconnected properly.</p> <p>NOTE 4: Only MMS received within the timeouts will be considered.</p>		

7.4 Short Message Service (SMS), Short Data Service (SDS)

The Short Message Service (SMS) is available in GSM/UMTS networks, whereas the Short Data Service (SDS) is available in TETRA networks. For both types of services, the actual user defined data is referred as short message in the following.

The investigation of SMS functionality in LTE networks is for further study.

NOTE: Four types of SDS are defined in ETSI EN 300 392-2 [27], SDS type 1 to SDS type 4. SDS type 1 offers 16 bit user defined data, SDS type 2 offers 32 bit user defined data, SDS type 3 offers 64 bit user defined data, and SDS type 4 offers user defined data bits up to a maximum length of 2 039 bit. SDS type 4 also offers an additional SDS Transport Layer (TL) protocol, which enhances the service provided by the layer 3 SDS protocol to provide protocol mechanisms for end-to-end acknowledgement, store and forward and to ensure that applications using this service interpret the user data in the same way.

7.4.1 Parameter Overview Chart

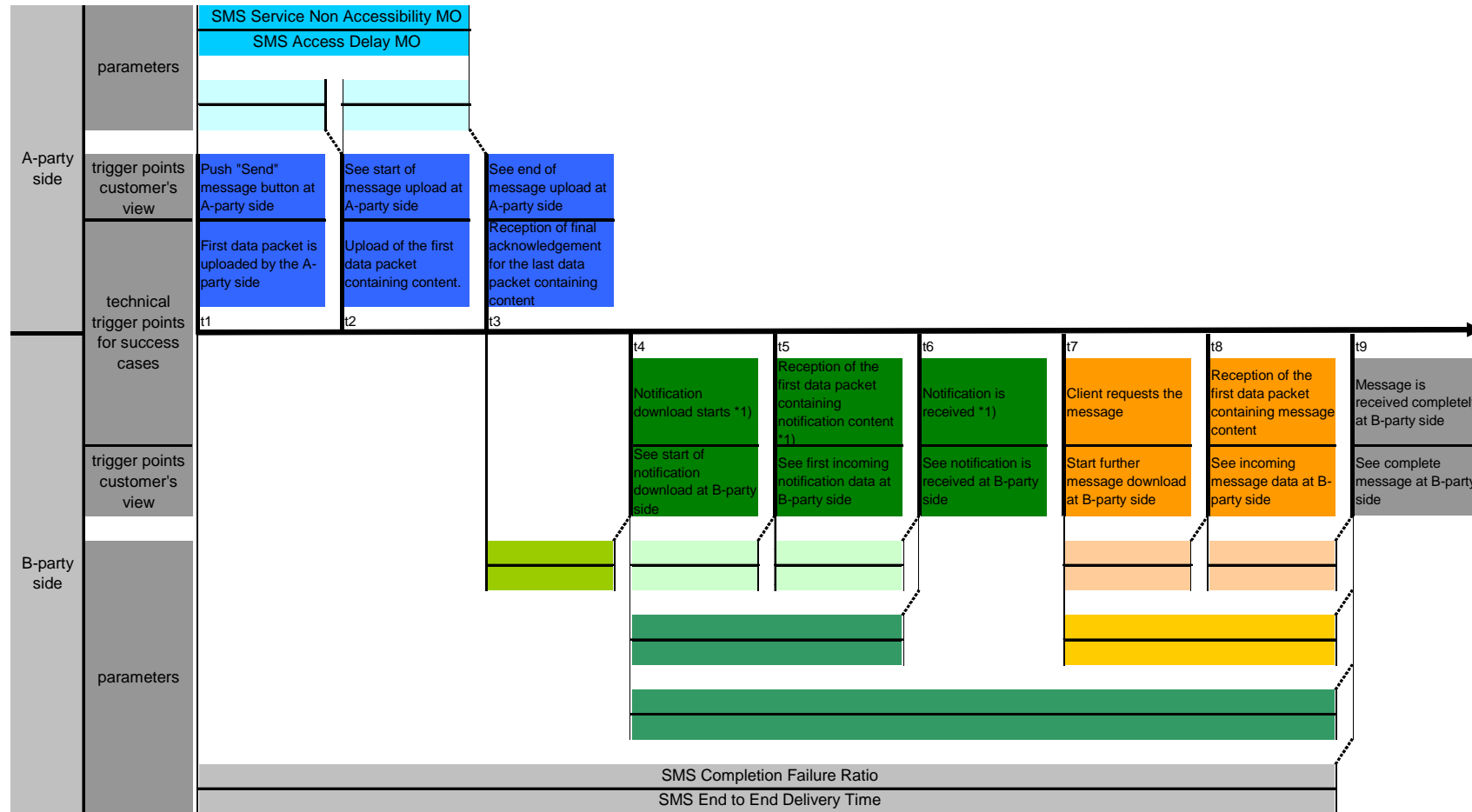

*1) For the SMS service a paging is proceed within the notification phase.

Figure 68: SMS Parameter Overview with Trigger Points

7.4.2 {SMS | SDS} Service Non-Accessibility [%]

7.4.2.1 Abstract Definition

The {SMS | SDS} service non-accessibility denotes the probability that the end-user cannot access the Short Message Service (SMS) or Short Data Service (SDS) when requested while it is offered by display of the network indicator on the UE.

7.4.2.2 Abstract Equation

$$\{ \text{SMS} | \text{SDS} \} \text{ Service Non - Accessibility} [\%] = \frac{\text{unsuccessful } \{ \text{SMS} | \text{SDS} \} \text{ service attempts}}{\text{all } \{ \text{SMS} | \text{SDS} \} \text{ service attempts}} \times 100$$

7.4.2.3 Trigger Points

GSM/UMTS:

Event from abstract equation	Trigger point from user's point of view	Technical description/protocol part
SMS service attempt	Start: Push send button (initiate sending an SMS).	Start: Layer 3 (MM): The first "Access request" is sent by the originating UE (Figure 69, most upper signalling point). Detailed: CM Service Request is sent by the originating UE. AT: The "AT+CMGS=<len>" or "AT+CMGS=<MSISDN>" (parameter depends on the "AT+CMGF" setting, PDU or text mode) command is sent by the originating TE.
Successful SMS service attempt	Stop: Receive the acknowledgement from the SMSC at the A-party.	Stop: Layer 3 (SMS): The "Delivery report" is received by the originating UE (Figure 69, signalling point number 7b). Detailed: CP_DATA (RP_ACK) is received by the originating UE. AT: "OK" is received by the originating TE.
Unsuccessful SMS service attempt	Stop trigger point not reached.	

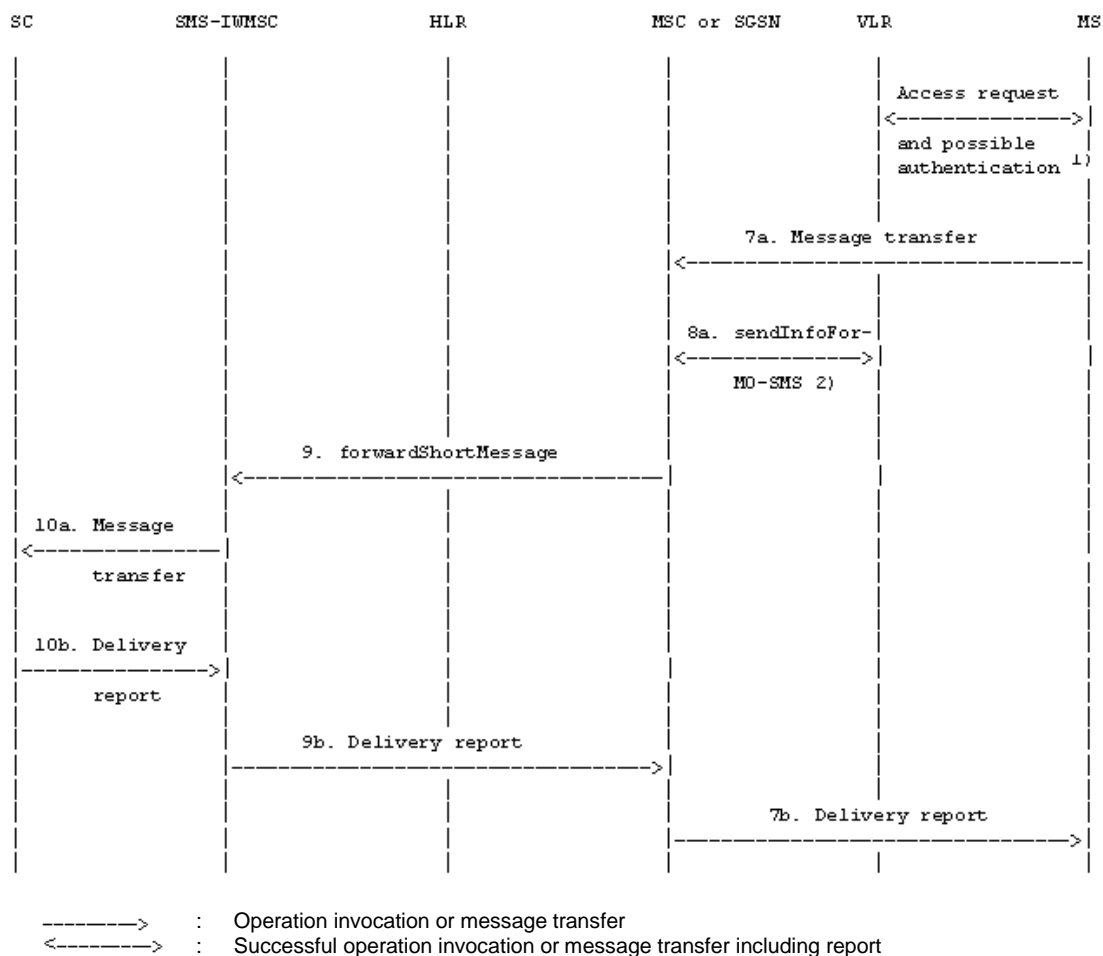

NOTE 1: Described in ETSI TS 124 008 [10] and ETSI TS 129 002 [12].

NOTE 2: This operation is not used by the SGSN.

Figure 69: SMS Transaction flow - Originating UE

TETRA:

Event from abstract equation	Trigger point from user's point of view	Technical description/protocol part
SDS service attempt	Start: Push send button (initiate sending an SDS).	Start: Layer 3 (CMCE): The first "U-SDS-DATA" message is sent by the originating UE. AT: The "AT+CMGS="<called party identity>,<length><CR> <LF><user data><CtrlZ>" command is sent by the originating TE, where <called party identity> provides a unique identification of the desired B-party and <length> is the size of the SDS in [bits].
Successful SMS service attempt	Stop: Receive the acknowledgement from the SwMI at the initiating party.	Stop: Layer 2 (LLC): The "BL-ACK" message is received at the originating UE. AT: "OK" is received by the originating TE.
Unsuccessful SMS service attempt	Stop trigger point not reached.	
NOTE: The "BL-ACK" message is related to the Logical Link Control (LLC) protocol whereas the "U-SDS-DATA" message is related to the Circuit Mode Control Entity (CMCE) protocol.		

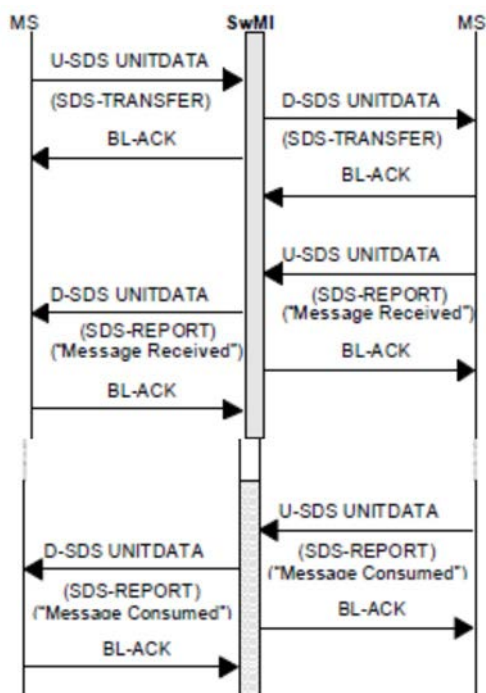

Figure 70: SDS signalling flow chart

Remark:

- In TETRA, the SDS type and parameters relating to the message are set with a previous "AT+CTSDS <AI service>, <area>, <e-to-e encryption>, <access priority>, <called party identity type>" command.

7.4.3 {SMS SDS} Access Delay [s]

7.4.3.1 Abstract Definition

The {SMS | SDS} access delay is the time period between sending a short message to the network and receiving a send confirmation from the network at the originating side.

7.4.3.2 Abstract Equation

$$\{\text{SMS | SDS}\} \text{ Access Delay [s]} = (t_{A,\text{receive}} - t_{A,\text{send}}) [\text{s}]$$

7.4.3.3 Trigger Points

GSM/UMTS:

Event from abstract equation	Trigger point from user's point of view	Technical description/protocol part
$t_{A,send}$	Start: Push send button (initiate sending an SMS).	Start: Layer 3 (MM): The first "Access request" is sent by the originating UE (Figure 69, most upper signalling point). Detailed: CM Service Request is sent from the originating UE. AT: The "AT+CMGS=<len>" or "AT+CMGS=<MSISDN>" (parameter depends on the "AT+CMGF" setting, PDU or text mode) command is sent by the originating TE.
$t_{A,receive}$	Stop: Acknowledgement from the SMSC is received at the A-party.	Stop: Layer 3 (SMS): The "Delivery report" is received by the originating UE (Figure 69, signalling point number 7b). Detailed: CP_DATA (RP_ACK) is received by the originating UE. AT: "OK" is received by the originating TE.

TETRA:

Event from abstract equation	Trigger point from user's point of view	Technical description/protocol part
$t_{A,send}$	Start: Push send button (initiate sending an SDS).	Start: Layer 3 (CMCE): The first "U-SDS-DATA" message is sent by the originating UE. AT: The "AT+CMGS="<called party identity>", <length><CR> <LF><user data><CtrlZ>" command is sent by the originating TE, where <called party identity> provides a unique identification of the desired B-party and <length> is the size of the SDS in [bits].
$t_{A,receive}$	Stop: Receive the acknowledgement from the SwMI at the initiating party.	Stop: Layer 2 (LLC): The "BL-ACK" message is received at the originating UE. AT: "OK" is received by the originating TE.
NOTE: The "BL-ACK" message is related to the Logical Link Control (LLC) protocol whereas the "U-SDS-DATA" message is related to the Circuit Mode Control Entity (CMCE) protocol.		

7.4.4 {SMS | SDS} Completion Failure Ratio [%]

7.4.4.1 Abstract Definition

The {SMS | SDS} Completion Failure Ratio is the ratio of unsuccessfully received and sent messages from one UE to another UE, excluding duplicate received and corrupted messages.

A corrupted SMS (or SDS) is an SMS (or SDS) with at least one bit error in its message part.

7.4.4.2 Abstract Equation

$$\{\text{SMS | SDS}\} \text{ Completion Failure Ratio [\%]} = \frac{\text{unsuccessfully received \{\text{SMS | SDS}\}}}{\text{all \{\text{SMS | SDS}\} service attempts}} \times 100$$

7.4.4.3 Trigger Points

GSM/UMTS:

Event from abstract equation	Trigger point from user's point of view	Technical description/protocol part
SMS service attempt	Start: Push send button (Initiate sending an SMS).	Start: Layer 3 (MM): The first "Access request" is sent by the originating UE (Figure 69, most upper signalling point). Detailed: CM Service Request is sent from the originating UE. AT: The "AT+CMGS=<len>" or "AT+CMGS=<MSISDN>" (parameter depends on the "AT+CMGF" setting, PDU or text mode) command is sent by the originating TE.
Successfully received SMS	Stop: The Short Message is received by the B-party's UE.	Stop: Layer 3: The "Message transfer" is received in the terminating UE (Figure 71, signalling point number 6). Detailed: CP_DATA (RP_ACK) is sent by the terminating UE. AT: The "CMTI" event received at the terminating TE.
Unsuccessfully received SMS	Stop trigger point not reached or SMS received is duplicated or corrupted.	

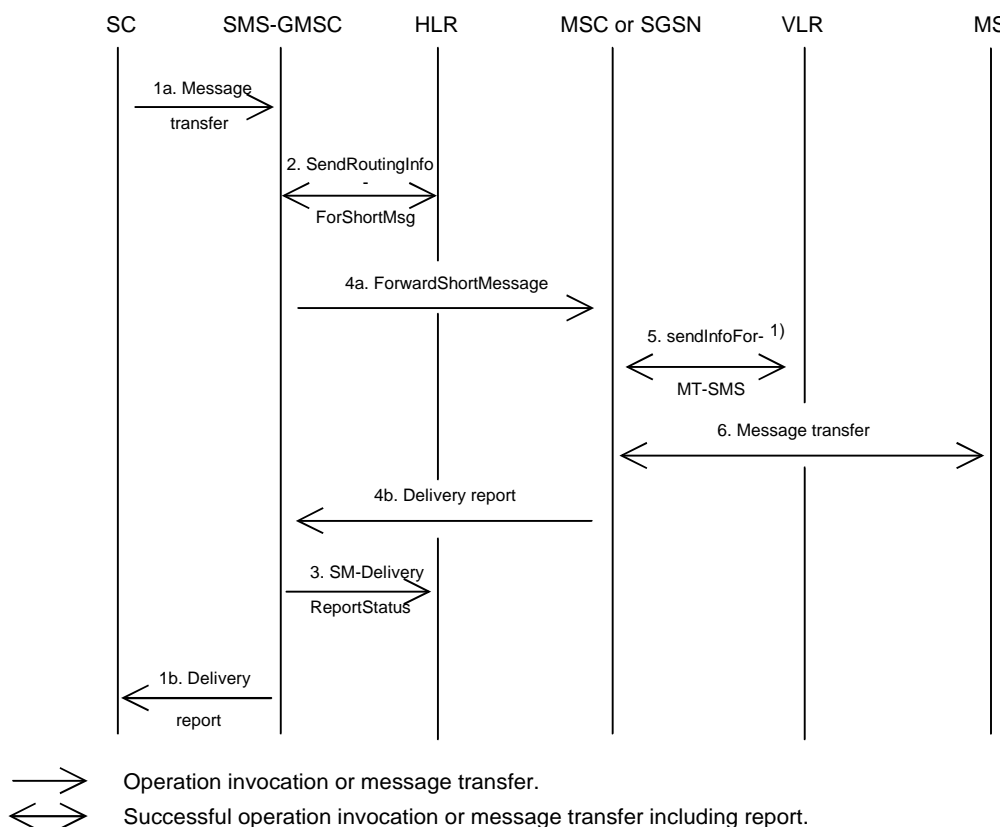

NOTE: This operation is not used by the SGSN.

Figure 71: SMS Transaction flow – Terminating UE

TETRA:

Event from abstract equation	Trigger point from user's point of view	Technical description/protocol part
SDS service attempt	Start: Push send button (initiate sending an SDS).	Start: Layer 3 (CMCE): The first "U-SDS-DATA" message is sent by the originating UE. AT: The "AT+CMGS="<called party identity>", <length><CR> <LF><user data><CtrlZ>" command is sent by the originating TE, where <called party identity> provides a unique identification of the desired B-party and <length> is the size of the SDS in [bits].
Successfully received test SDS	Stop: The Short Message is received by the terminating party.	Stop: Layer 3 (CMCE): The corresponding "D-SDS-DATA" message is received by the terminating UE. AT: The "AT+CMTI" new message indication or the "AT+CTSISR" receive notification for the corresponding message is received at the terminating TE (depending on SDS settings).
Unsuccessfully received test SDS	Stop trigger point not reached or SMS received is duplicated or corrupted.	

Remarks:

- In GSM/UMTS, "CMGR=<n>" gives back the received SMS, or "CMGL="ALL"" or "CMGL=4" all of the received ones. In order to receive CMTI events they have to be activated at the B-party with the "AT+CNMI" command.
- The detection of duplicated and corrupted received SMS or SDS is a post processing issue.
- In TETRA, the Short Data Service Centre (SDSC) might modify the content of an SDS. The unique identification of an SDS at the receiving UE is up to the following analysis.

7.4.5 {SMS | SDS} End-to-End Delivery Time [s]

7.4.5.1 Abstract Definition

The {SMS | SDS} end-to-end delivery time is the time period between sending a short message to the network and receiving the very same short message at another UE.

7.4.5.2 Abstract Equation

$$\{ \text{SMS} \mid \text{SDS} \} \text{ End - to - End Delivery Time [s]} = (t_{\text{B, receive}} - t_{\text{A, send}}) [\text{s}]$$

7.4.5.3 Trigger Points

GSM/UMTS:

Event from abstract equation	Trigger point from user's point of view	Technical description/protocol part
$t_{A,send}$	Start: Push send button (Initiate sending an SMS).	Start: Layer 3: The first "Access request" is sent by the originating UE (Figure 69, most upper signalling point). Detailed: CM Service Request is sent by the originating UE. AT: The "AT+CMGS=<len>" or "AT+CMGS=<MSISDN>" (parameter depends on the "AT+CMGF" setting, PDU or text mode) command is sent by the originating TE.
$t_{B,receive}$	Stop: The short message is received by the B-party's UE.	Stop: Layer 3: The "Message transfer" is received by the terminating UE (Figure 71, signalling point number 6). Detailed: CP_DATA (RP_ACK) is sent by the terminating UE. AT: The "CMTI" event received at the terminating TE.

TETRA:

Event from abstract equation	Trigger point from user's point of view	Technical description/protocol part
$t_{A,send}$	Start: Push send button (initiate sending an SDS).	Start: Layer 3 (CMCE): The first "U-SDS-DATA" message is sent by the originating UE. AT: The "AT+CMGS="<called party identity>", <length><CR> <LF><user data><CtrlZ>" command is sent by the originating TE, where <called party identity> provides a unique identification of the desired B-party and <length> is the size of the SDS in [bits].
$t_{B,receive}$	Stop: The short message is received by the terminating party.	Stop: Layer 3 (CMCE): The corresponding "D-SDS-DATA" message is received by the terminating UE. AT: The "AT+CMTI" new message indication or the "AT+CTSDSR" receive notification for the corresponding message is received at the terminating TE (depending on SDS settings).

7.4.6 {SMS | SDS} Receive Confirmation Failure Ratio [%]

7.4.6.1 Abstract Definition

The {SMS | SDS} receive confirmation failure ratio denotes the probability that the receive confirmation for a sent attempt is not received by the originating UE although requested.

7.4.6.2 Abstract Equation

$$\{ \text{SMS} | \text{SDS} \} \text{ Receive Confirmation Failure Ratio [\%]} = \frac{\text{non - confirmed } \{ \text{SMS} | \text{SDS} \} \text{ receptions}}{\text{all } \{ \text{SMS} | \text{SDS} \} \text{ service attempts}} \times 100$$

7.4.6.3 Trigger Points

GSM/UMTS:

Event from abstract equation	Trigger point from user's point of view	Technical description/protocol part
SMS service attempt	Start: Push send button (initiate sending an SMS).	Start: Layer 3: The first "Access request" is sent by the originating UE (Figure 69, most upper signalling point). Detailed: CM Service Request is sent by the originating UE. AT: The "AT+CMGS=<len>" or "AT+CMGS=<MSISDN>" (parameter depends on the "AT+CMGF" setting, PDU or text mode) command is sent by the originating TE.
Confirmed SMS reception	Stop: Receive the confirmation at the initiating party that the message is received at the terminating party.	Stop: To be defined.
Non-confirmed SMS reception	Stop trigger point not reached.	

TETRA:

Event from abstract equation	Trigger point from user's point of view	Technical description/protocol part
SDS service attempt	Start: Push send button (initiate sending an SDS).	Start: Layer 3 (CMCE): The first "U-SDS-DATA" message carrying the "SDS-TRANSFER" message with Delivery report request "Message received report requested" or "Message received and consumed report requested" is sent by the originating UE. AT: The "AT+CMGS="<called party identity>", <length><CR> <LF><user data><CtrlZ>" command is sent by the originating TE.
Confirmed SMS reception	Stop: Receive the confirmation at the initiating party that the message is received at the terminating party.	Stop: Layer 3 (CMCE): The "D-SDS-DATA" message carrying the "SDS-REPORT" message with Delivery Status "SDS receipt acknowledged by destination" is received by the originating UE. AT: to be defined.
Non-confirmed SMS reception	Stop trigger point not reached.	

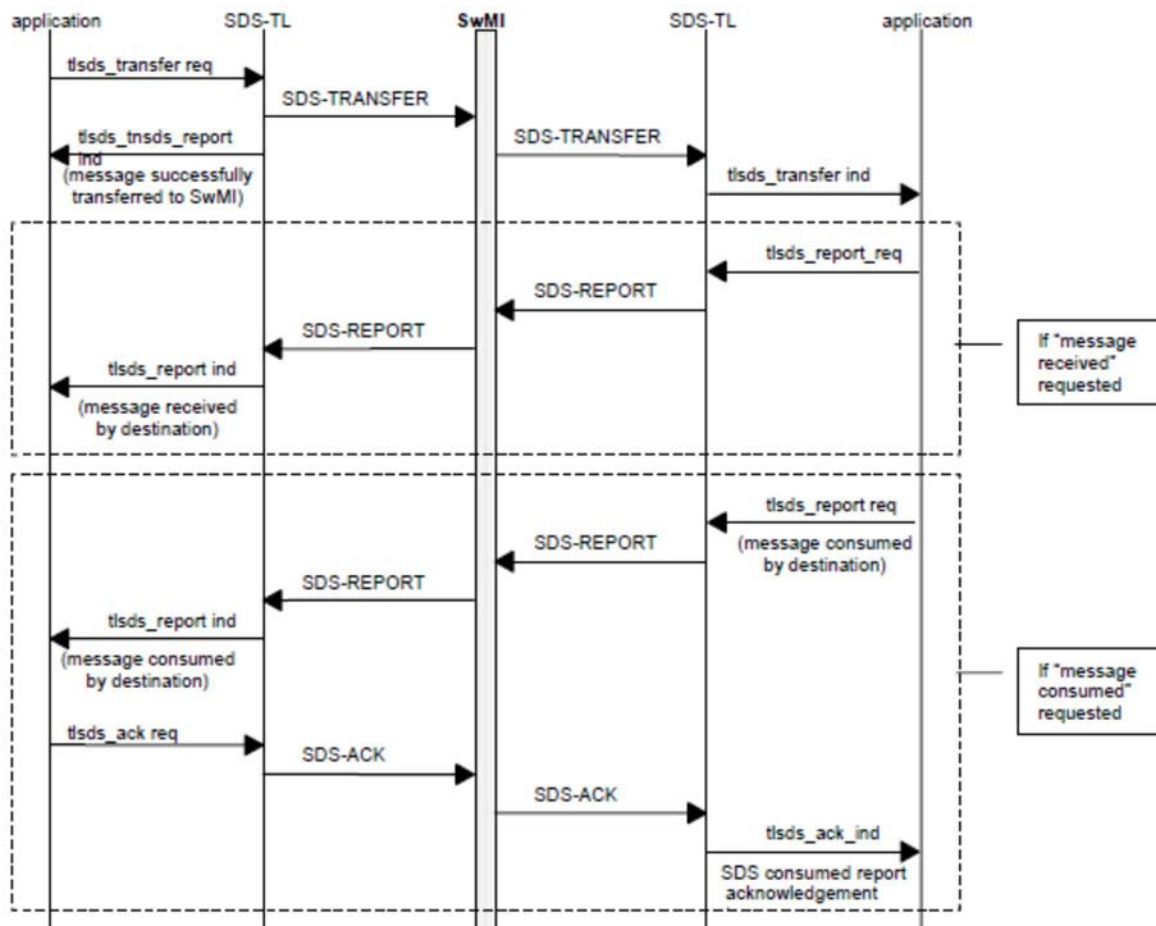

Figure 72: SDS signalling flow chart for SDS type 4 via SDS-TL protocol according to ETSI EN 300 392-2 [27], clause 29.3.3 with transparent SwMI transport (SwMI store-and-forward functionality uses additional SDS-REPORT and SDS-ACK messages)

7.4.7 {SMS | SDS} Receive Confirmation Time [s]

7.4.7.1 Abstract Definition

The {SMS | SDS} receive confirmation time is the time period between sending a short message to the network and receiving the receive confirmation for this message from the network.

7.4.7.2 Abstract Equation

$$\{ \text{SMS} \mid \text{SDS} \} \text{ Receive Confirmation Time [s]} = (t_{A, \text{receive confirmation}} - t_{A, \text{send}}) [\text{s}]$$

7.4.7.3 Trigger Points

GSM/UMTS:

Event from abstract equation	Trigger point from user's point of view	Technical description/protocol part
$t_{A,send}$	Start: Push send button (initiate sending an SMS).	Start: Layer 3: The first "Access request" is sent by the originating UE (Figure 69, most upper signalling point). Detailed: CM Service Request is sent by the originating UE. AT: The "AT+CMGS=<len>" or "AT+CMGS=<MSISDN>" (parameter depends on the "AT+CMGF" setting, PDU or text mode) command is sent by the originating TE.
$t_{A,receive\ confirmation}$	Stop: Receive the confirmation at the initiating party that the message is received at the terminating party.	Stop: To be defined.

TETRA:

Event from abstract equation	Trigger point from user's point of view	Technical description/protocol part
$t_{A,send}$	Start: Push send button (initiate sending an SDS).	Start: Layer 3 (CMCE): The first "U-SDS-DATA" message carrying the "SDS-TRANSFER" message with Delivery report request "Message received report requested" or "Message received and consumed report requested" is sent by the originating UE. AT: The "AT+CMGS="<called party identity>", <length><CR> <LF><user data><CtrlZ>" command is sent by the originating TE.
$t_{A,receive\ confirmation}$	Stop: Receive the confirmation at the initiating party that the message is received at the terminating party.	Stop: Layer 3 (CMCE): The "D-SDS-DATA" message carrying the "SDS-REPORT" message with Delivery Status "SDS receipt acknowledged by destination" is received by the originating UE. AT: to be defined.

7.4.8 {SMS | SDS} Consumed Confirmation Failure Ratio [%]

7.4.8.1 Abstract Definition

The {SMS | SDS} consumed confirmation failure ratio denotes the probability that the consumed confirmation for a sent attempt is not received by the originating UE although requested.

7.4.8.2 Abstract Equation

$$\{SMS | SDS\} \text{ Consumed Confirmation Failure Ratio } [\%] = \frac{\text{non - confirmed } \{SMS | SDS\} \text{ consumptions}}{\text{all } \{SMS | SDS\} \text{ service attempts}} \times 100$$

7.4.8.3 Trigger Points

GSM/UMTS:

Event from abstract equation	Trigger point from user's point of view	Technical description/protocol part
SMS service attempt	Start: Push send button (initiate sending an SMS).	Start: Layer 3: The first "Access request" is sent by the originating UE (Figure 69, most upper signalling point). Detailed: CM Service Request is sent by the originating UE. AT: The "AT+CMGS=<len>" or "AT+CMGS=<MSISDN>" (parameter depends on the "AT+CMGF" setting, PDU or text mode) command is sent by the originating TE.
Confirmed SMS consumption	Stop: Receive the confirmation at the initiating party that the message is received at the terminating party.	Stop: To be defined.
Non-confirmed SMS consumption	Stop trigger point not reached.	

TETRA:

Event from abstract equation	Trigger point from user's point of view	Technical description/protocol part
SMS service attempt	Start: Push send button (initiate sending an SDS).	Start: Layer 3 (CMCE): The first "U-SDS-DATA" message carrying the "SDS-TRANSFER" message with Delivery report request "Message consumed report requested" or "Message received and consumed report requested" is sent by the originating UE. AT: The "AT+CMGS="<called party identity>", <length><CR> <LF><user data><CtrlZ>" command is sent by the originating TE.
Confirmed SMS consumption	Stop: Receive the confirmation at the initiating party that the message is consumed.	Stop: Layer 3 (CMCE): The "D-SDS-DATA" message carrying the "SDS-REPORT" with Delivery status "SDS consumed by destination" is received by the originating UE. AT: To be defined.
Non-confirmed SMS consumption	Stop trigger point not reached.	

7.4.9 {SMS | SDS} Consumed Confirmation Time [s]

7.4.9.1 Abstract Definition

The {SMS | SDS} consumed confirmation time is the time period between sending a short message to the network and receiving the consumed confirmation from the network.

7.4.9.2 Abstract Equation

$$\{\text{SMS | SDS}\} \text{ Consumed Confirmation Time [s]} = (t_{A,\text{consumed confirmation}} - t_{A,\text{send}}) [\text{s}]$$

7.4.9.3 Trigger Points

GSM/UMTS:

Event from abstract equation	Trigger point from user's point of view	Technical description/protocol part
$t_{A,send}$	Start: Push send button (initiate sending an SMS).	Start: Layer 3: The first "Access request" is sent by the originating UE (Figure 69, most upper signalling point). Detailed: CM Service Request is sent by the originating UE. AT: The "AT+CMGS=<len>" or "AT+CMGS=<MSISDN>" (parameter depends on the "AT+CMGF" setting, PDU or text mode) command is sent by the originating TE.
$t_{A,consumed\ confirmation}$	Stop: Receive the confirmation at the initiating party that the message is consumed at the terminating party.	Stop: To be defined.

TETRA:

Event from abstract equation	Trigger point from user's point of view	Technical description/protocol part
$t_{A,send}$	Start: Push send button (initiate sending an SDS).	Start: Layer 3 (CMCE): The first "U-SDS-DATA" message carrying the "SDS-TRANSFER" message with Delivery report request "Message consumed report requested" or "Message received and consumed report requested" is sent by the originating UE. AT: The "AT+CMGS="<called party identity>", <length><CR> <LF><user data><CtrlZ>" command is sent by the originating TE.
$t_{A,consumed\ confirmation}$	Stop: Receive the confirmation at the initiating party that the message is consumed at the terminating party.	Stop: Layer 3 (CMCE): The "D-SDS-DATA" message carrying the "SDS-REPORT" with Delivery status "SDS consumed by destination" is received by the originating UE. AT: To be defined.

Annex A (informative): Examples for measuring trigger points

- SMS-Service:
 - Layer 3 Messages:
 - Start SMS Service Attempt: generating random access (chan_request SDCCH) at mobile equipment.
 - Successful SMS Service Attempt receiving cp_data (rp_ack) at mobile equipment.
 - Receiving SMS on Mobile Equipment 2: receiving cp_data (rp_ack) at mobile equipment.

Annex B (informative): Streaming explanations

RTP - Real Time Protocol:

The Real Time Protocol is used for the transmission of real-time data, e.g. audio, video, simulation data over multicast or unicast network services. No QoS functionality is implemented.

RTP is designed to be independent from the underlying transport and network layers. For a complete description refer to IETF RFC 3550 [7].

RTCP - Real Time Control Protocol:

The Real Time Control Protocol as control protocol for the RTP. It allows the monitoring of the data delivery and provides a minimal control and identification functionality. RTCP is designed to be independent from the underlying transport and network layers.

For a complete description of the RTCP refer to IETF RFC 3550 [7].

RTSP - Real Time Streaming Protocol:

The Real Time Streaming Protocol is used for the overall control of the streaming session.

For a complete description of the RTSP refer to IETF RFC 2326 [8].

Most important methods of RTSP:

- **DESCRIBE:** The DESCRIBE method retrieves the description of a presentation or media object identified by the request URL from a server. It may use the Accept header to specify the description formats that the client understands. The server responds with a *description* of the requested resource. The DESCRIBE reply-response pair constitutes the media initialization phase of RTSP [8].
- **SETUP:** Causes the server to allocate resources for a stream and start an RTSP session [8].
- **PLAY:** Play is send from the client to the server and informs the server to start the transmission of data as specified by the SETUP method [8].
- **PAUSE:** Send from client to server. Temporarily halts the stream transmission without freeing server resources. These resources can only be freed after a specified time [8].
- **RECORD:** This method initiates recording a range of media data according to the presentation description [8].
- **TEARDOWN:** Frees resources associated with the stream. The RTSP session ceases to exist on the server [8].

B.1 Streaming Hyperlink Description

The following syntax for the hyperlink is used in order to access streaming content on the server:

protocol://address:port/path/file

Protocol	Used protocol. E.g. rtsp://
Address	Address of the used streaming server
Port	Port used by the server for answering request
Path	Path to the file to be streamed
File	The streaming file to be reproduced and its extension

Annex C (informative): Push to Talk over Cellular Information

Figures C.1 to C.4 visualize signal flows of typical PoC Sessions. The figures include the signal flows on the transport layer as well as some restricted information on the application layer. To keep the flows concise, some signals are not pictured. So it is possible to obtain signal flows universally valid for different kinds of PoC Sessions. Figures C.1 to C.4 show particularities using Unconfirmed Indication with Media Buffering as well as differences between Pre-established and On-demand PoC Sessions.

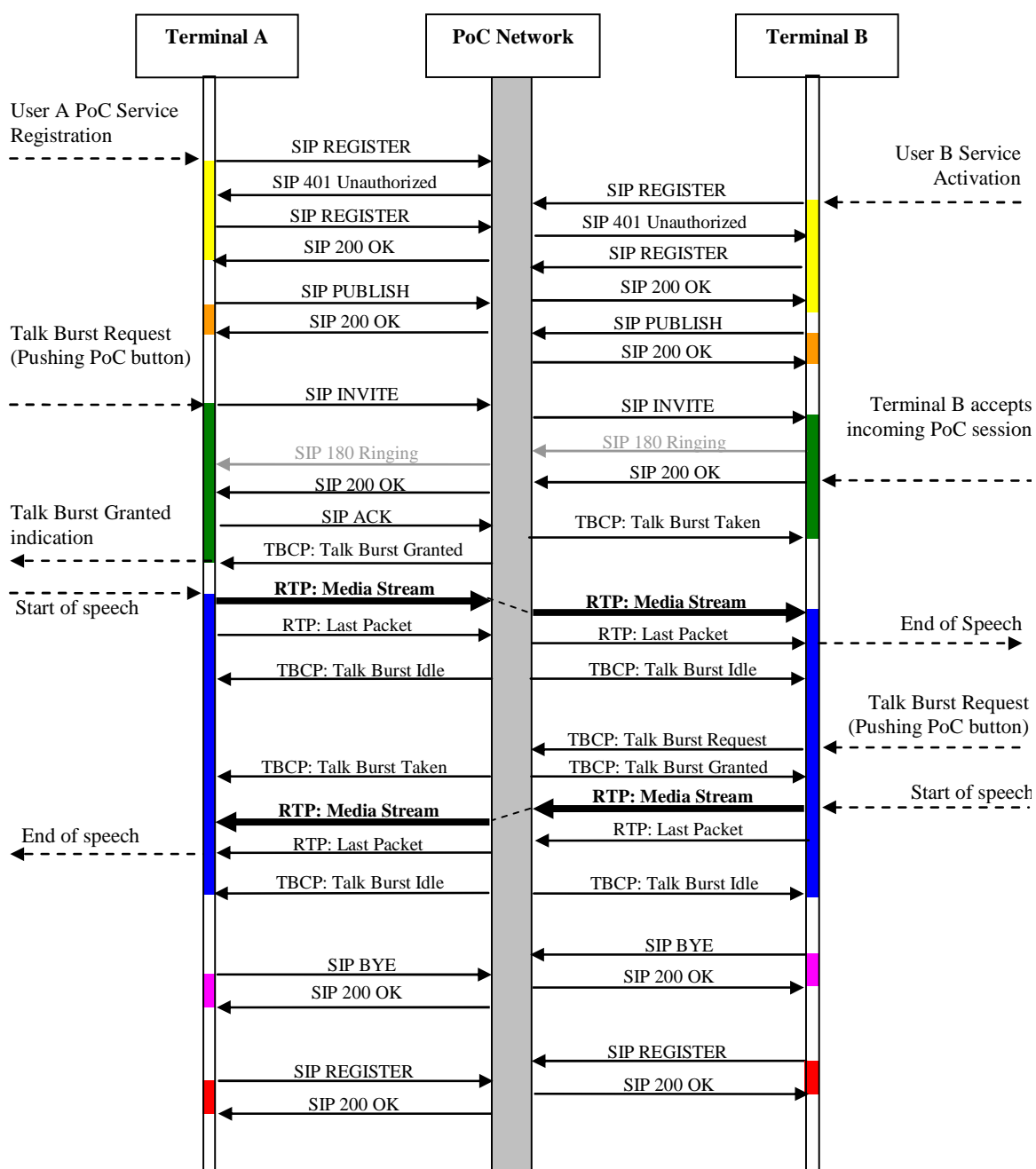
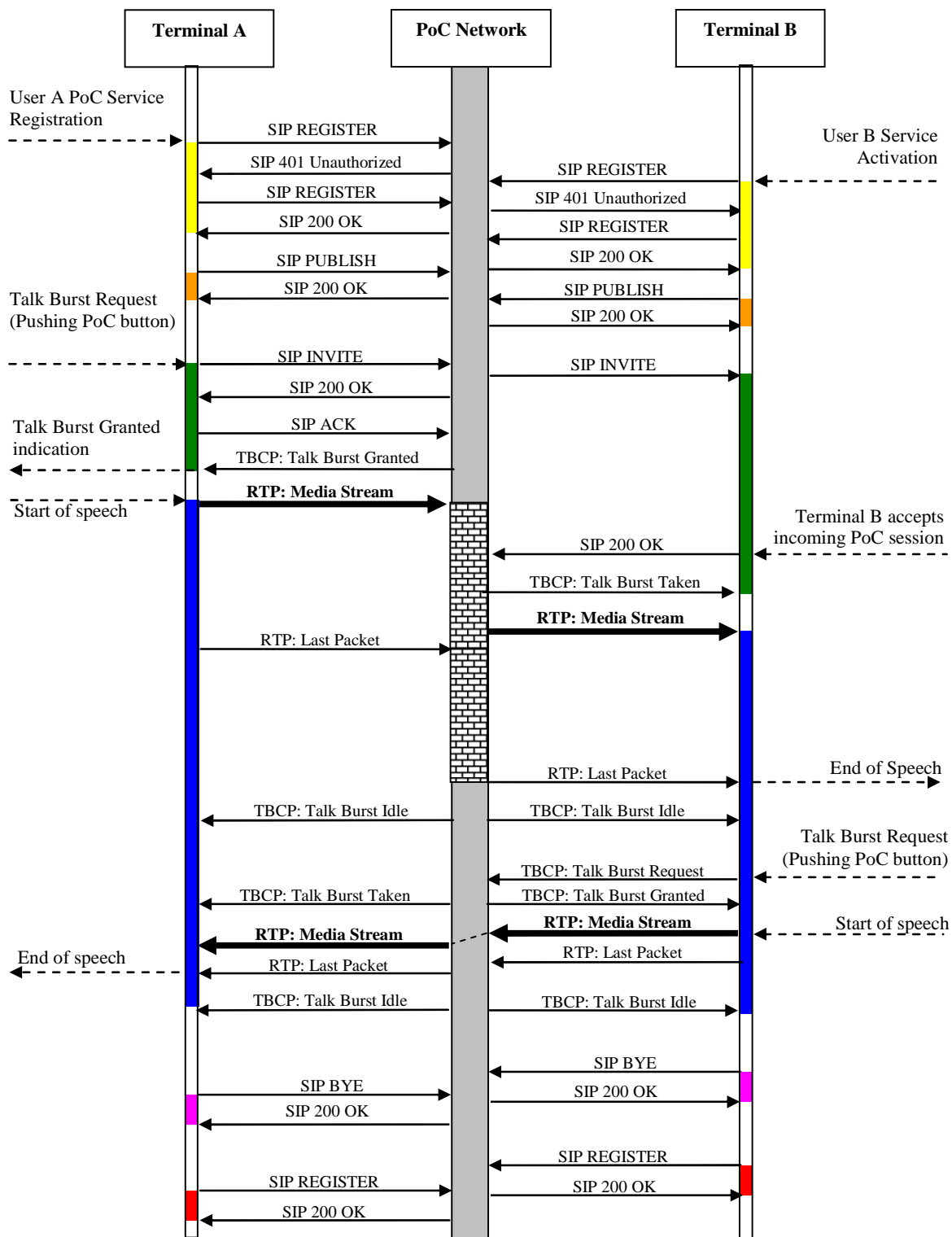

Figure C.1: On-demand PoC Session with manual-answer



NOTE: The PoC Server supports Media Buffering and sends the Talk Burst confirm message after receiving the first automatic-answer message.

Figure C.2: Unconfirmed On-demand Ad-hoc PoC Group Session with automatic-answer

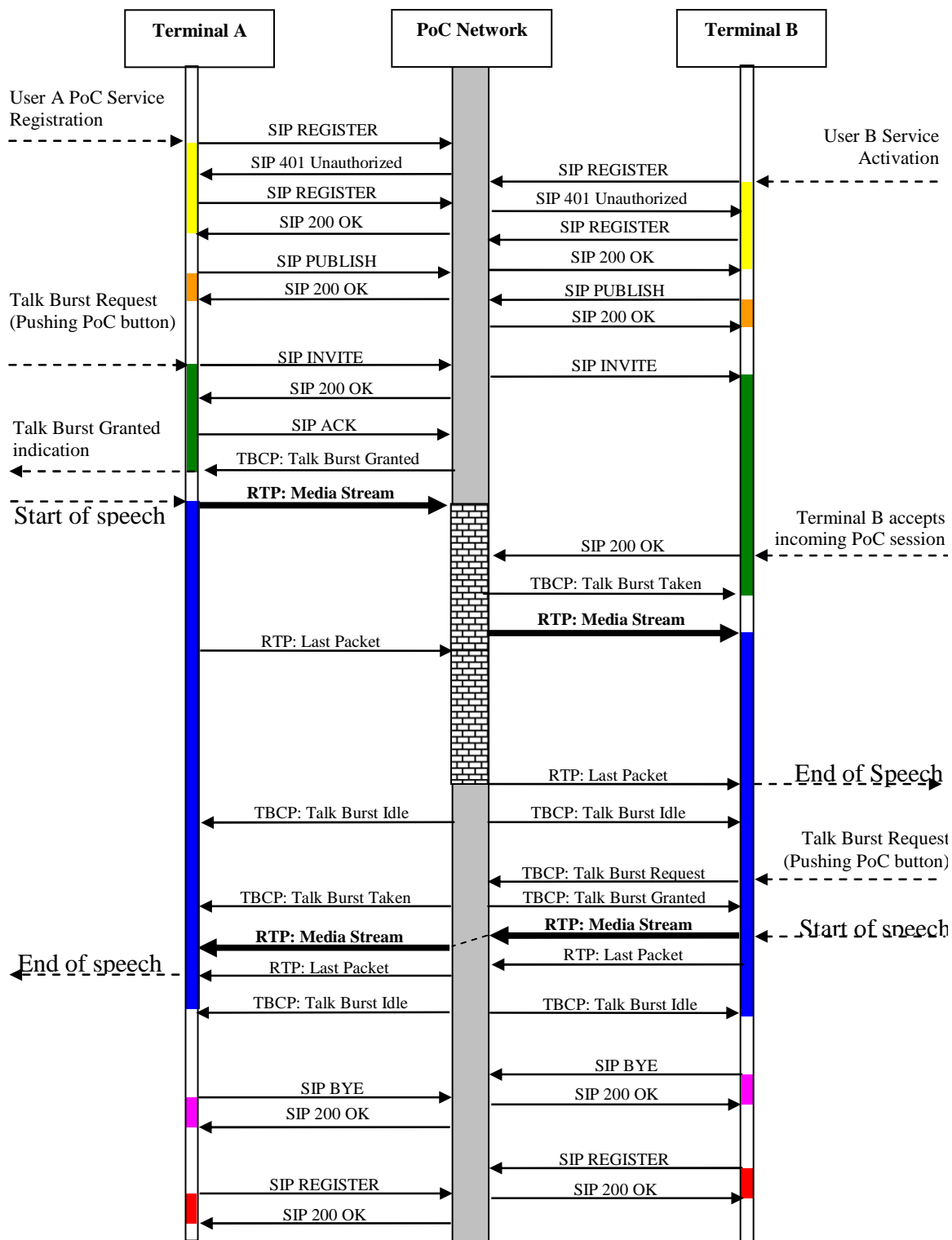

Figure C.3: Confirmed Pre-established session with manual-answer

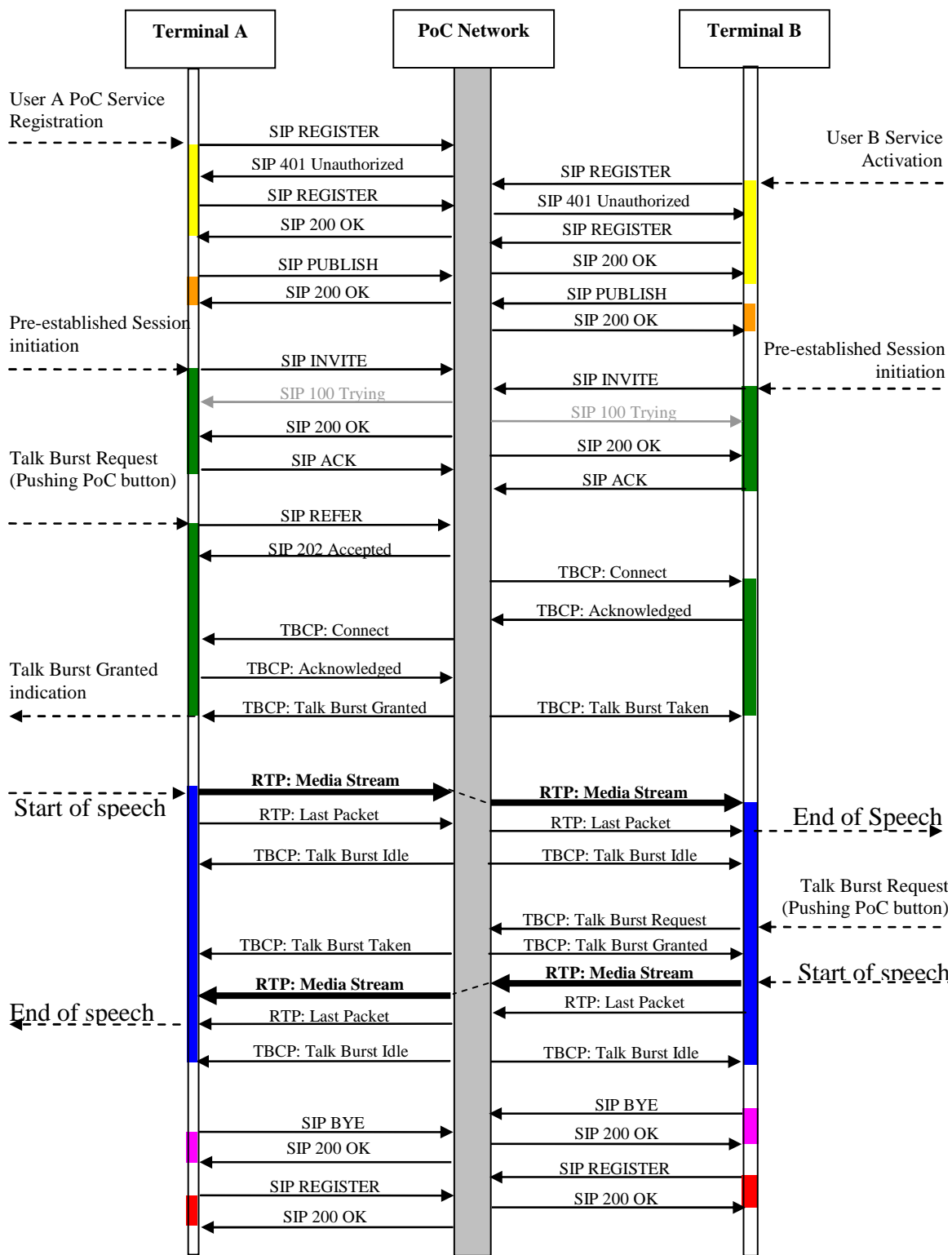

Figure C.4: Unconfirmed Pre-established session with automatic-answer

C.1 Signal Grouping

This clause defines groups of signals which will in the following be referred to as building blocks of PoC signal flows, or just building blocks. These building blocks are derived from [13], [14] and [15], representing only parts of a complete signal flow as seen in Figures C.1 to C.4. Here, different building blocks of the same kind correspond to the same QoS group. The aim of the definition of such building blocks is to give detailed information on the different signal flows.

Remark:

- In the QoS parameter defining clause of the present document, most signal flows shown are less detailed. The reason for this is that these flows are only used to visualize the relevant trigger points of the corresponding QoS parameter with respect to their occurrence over time.

The relationship between building blocks and QoS groups is pictured in the following table. In contrast to the signal flows given to illustrate QoS parameter definition, only flows leading to a positive result are given. The only exception from this is the signal flow for a queued talk burst request which was added for sufficiency.

A distinction has been made between On-demand and Pre-established PoC Sessions since here different building blocks are needed. Crosses are indicating the blocks needed for the corresponding QoS group. For simplicity some crosses are greyed. These crosses indicate that a choice between Confirmed and Unconfirmed Indication has to be made.

Further parameters for the "Session SETUP" are the following:

- Session SETUP alternative 1: confirmed with auto-answered on terminating side.
- Session SETUP alternative 2: confirmed with manual answered on terminating side.
- Session SETUP alternative 3: unconfirmed with auto-answered on terminating side.
- Session SETUP alternative 4: unconfirmed with manual answered on terminating side.

Remarks:

- Only the QoS groups relevant to the building blocks are shown in table C.1.
- Building blocks not related to any QoS group are omitted in table C.1.
- Building blocks can be identified by their number as specified in table C.1.

Table C.1: Assignment of PoC Session parts to building blocks

Building blocks (below) & QoS groups (right hand side)	REG long		REG		REG long		PUB		REG		On-demand				Pre-established				DeREG					
	REG long		REG		REG long		PUB		REG		INIT		Session SETUP		NEGO		INIT		Session SETUP		PtS		LEAVE	
	REG long		REG		REG long		PUB		REG		INIT		1 2 3 4		NEGO		INIT		1 2 3 4		PtS		LEAVE	
	REG long		REG		REG long		PUB		REG		INIT		1 2 3 4		NEGO		INIT		1 2 3 4		PtS		LEAVE	
1	PoC Service Registration	X	X	X	X	X	X	X	X	X	X	X	X	X	X	X	X	X	X	X	X	X	X	X
2	PoC Publish		X	X	X	X	X	X	X	X	X	X	X	X	X	X	X	X	X	X	X	X	X	X
3a	PoC On-demand Session Initiation, confirmed									X	X	X	X	X	X	X	X	X	X	X	X	X	X	X
3b	PoC On-demand Session Initiation, unconfirmed									X	X	X	X	X	X	X	X	X	X	X	X	X	X	X
3c	PoC Pre-established Session Media Parameters Negotiation														X	X	X	X	X	X	X	X	X	X
3d	PoC Pre-established Session Initiation, confirmed																X	X	X	X	X	X	X	X
3e	PoC Pre-established Session Initiation, unconfirmed																X	X	X	X	X	X	X	X
4a	PoC On-demand Session Initiation, User B auto-answer									X	X	X	X	X	X	X	X	X	X	X	X	X	X	X
4b	PoC On-demand Session Initiation, User B manual-answer									X	X	X	X	X	X	X	X	X	X	X	X	X	X	X
4c	PoC Pre-established Session Initiation, User B auto-answer																			X	X	X	X	X
4d	PoC Pre-established Session Initiation, User B manual-answer																			X	X	X	X	X
5a	Media Stream from User A to PoC Server																							
5b	Media Stream from PoC Server to User B, without Buffer																							
5c	Media Stream from User B to User A, without Buffer																							
6b	Talk Burst Request																							
6c	Queued Talk Burst Request																							
7a	Leaving PoC Session (On-demand)																							
7b	Leaving PoC Session (Pre-established)																							X
8	Deregistration																							X

C.2 PoC Service Registration

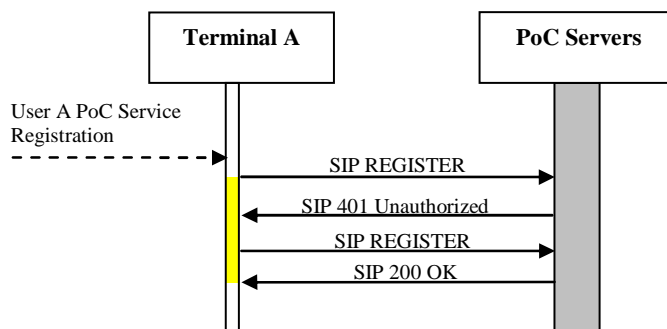

C.3 PoC Publish

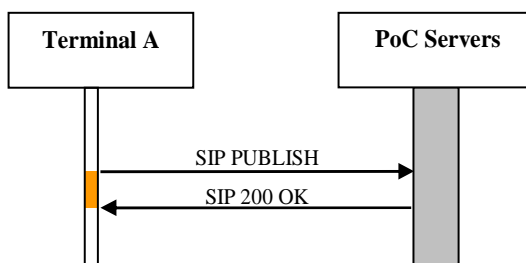

C.4 PoC Session Initiation, Originating Part

a) PoC On-demand Session Initiation, confirmed.

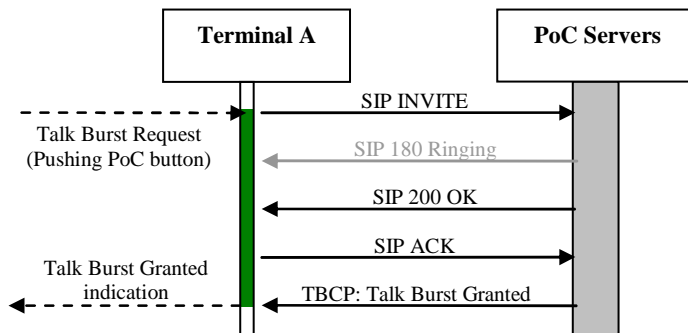

b) PoC On-demand Session Initiation, unconfirmed.

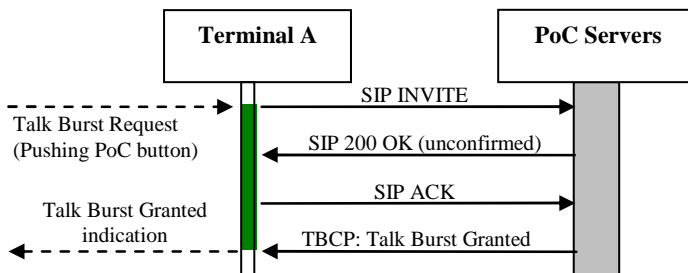

c) PoC Pre-established Session Media Parameters Negotiation.

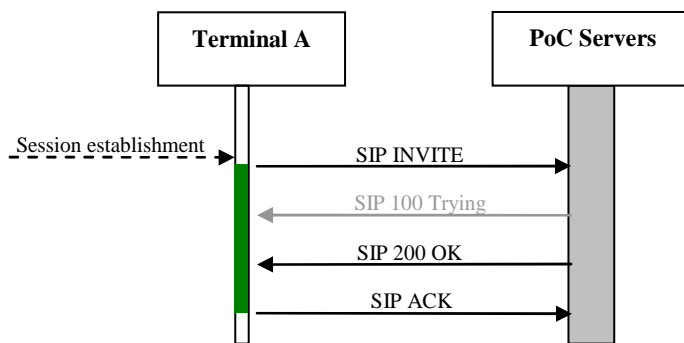

d) PoC Pre-established Session Initiation, confirmed.

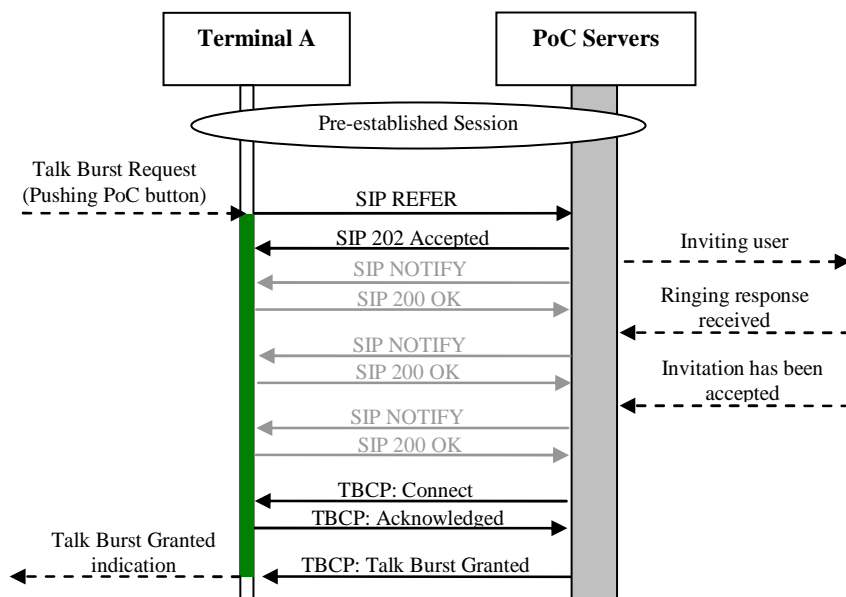

e) PoC pre-established Session Initiation, unconfirmed.

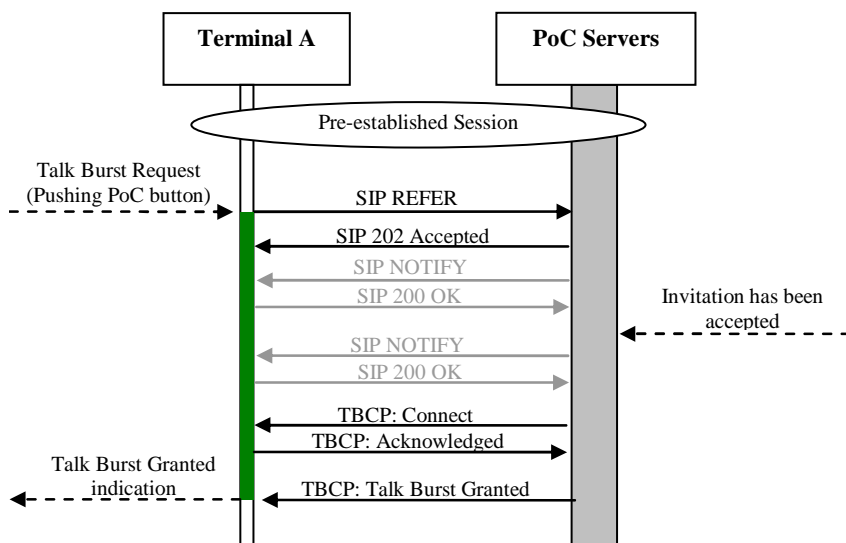

C.5 PoC Session Initiation, Terminating Part

a) PoC On-demand Session, automatic answer.

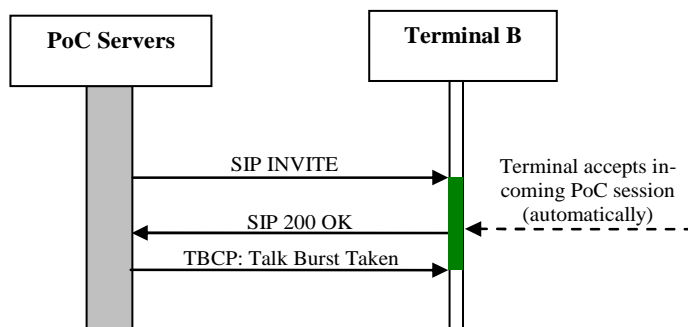

b) PoC On-demand Session, manual answer.

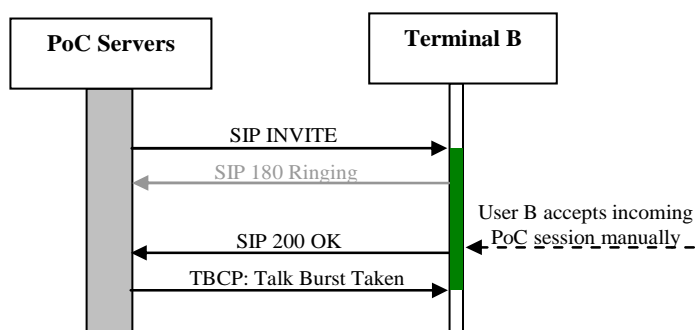

c) PoC Pre-established Session, automatic answer.

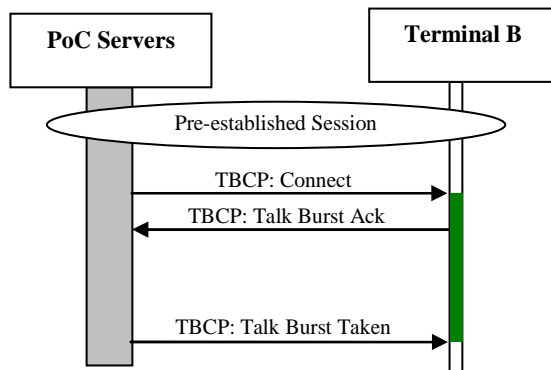

d) PoC Pre-established Session, manual answer.

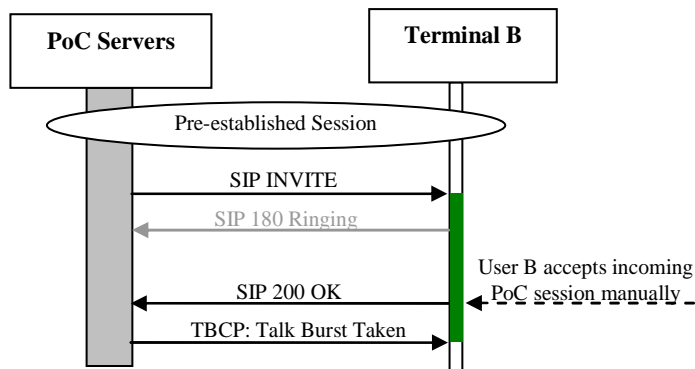

C.6 Media Streaming

a) First Media Stream from User A to PoC Server.

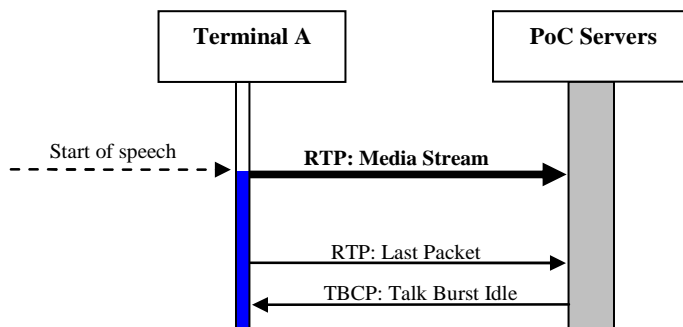

b) First Media Stream from PoC Server to User B (without Media Buffering).

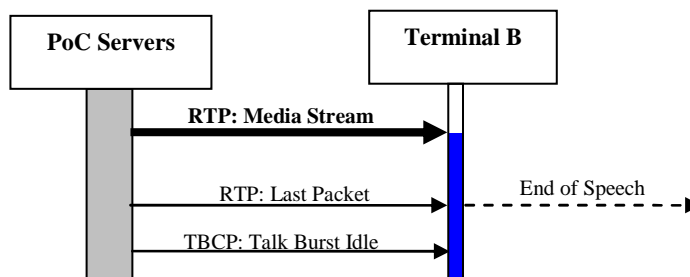

c) Last Media Stream from User B to User A via PoC Network (without Media Buffering), including Talk Burst Request of User B.

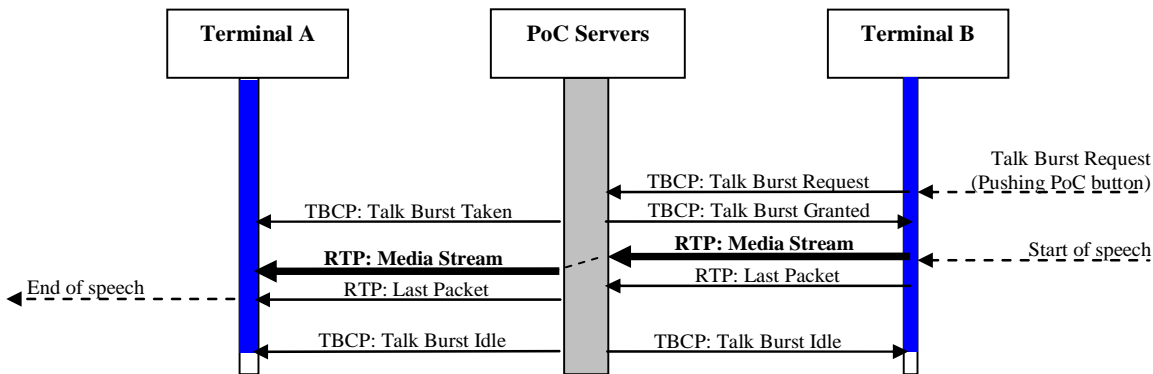

C.7 Talk Burst Request

a) Implicit Talk Burst Request (On-demand Session Initiation).

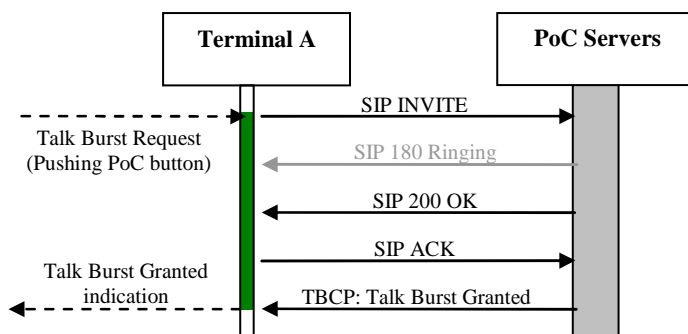

- b) Explicit Talk Burst Request.

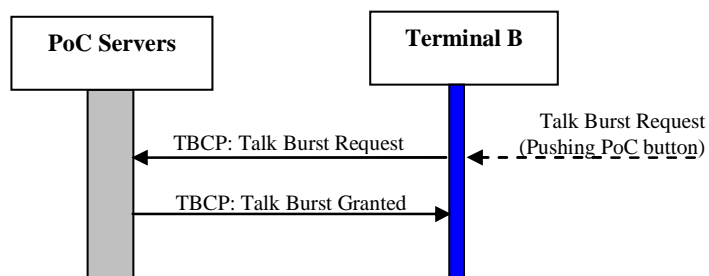

- c) Queued Talk Burst Request.

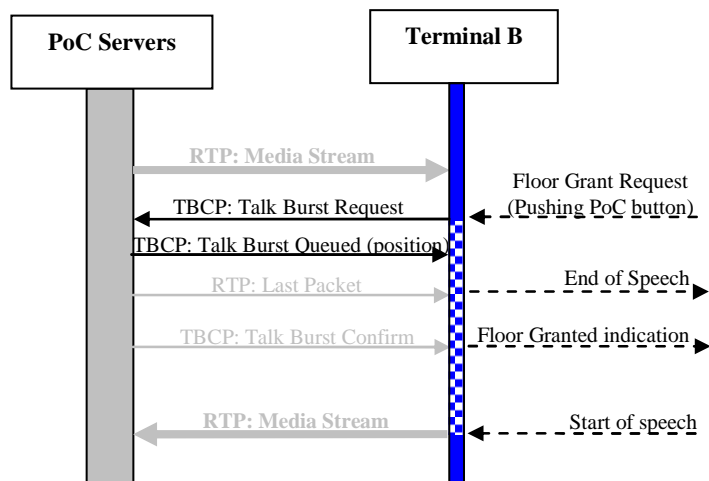

C.8 Leaving PoC Session

- a) Leaving On-demand PoC Session.

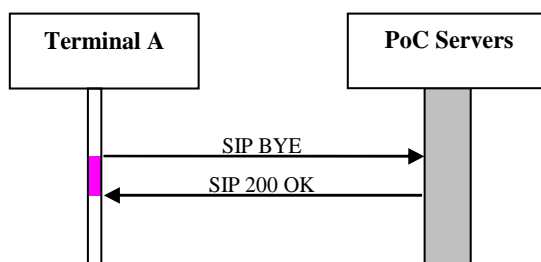

b) Leaving Pre-established PoC Session.

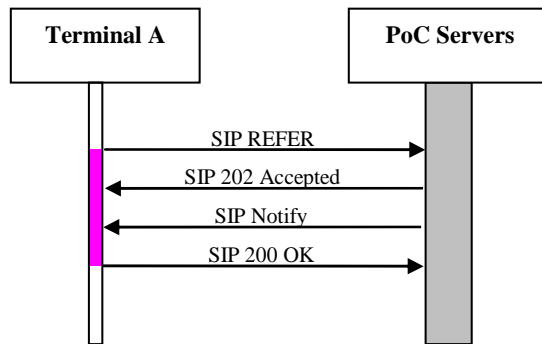

C.9 Deregistration

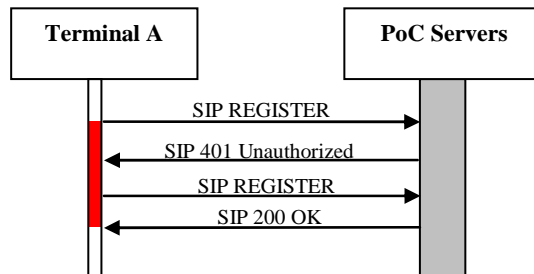

Annex D (informative): Bibliography

- Internet Media-on-Demand: "The Real-Time Streaming Protocol", Schulzrinne, Henning, 2001.
- ETSI TS 123 107: "Universal Mobile Telecommunications System (UMTS); Quality of Service (QoS) concept and architecture (3GPP TS 23.107 Release 5)".
- ETSI EN 300 911: "Digital cellular telecommunications system (Phase 2+) (GSM); Radio subsystem link control (GSM 05.08 Release 1999)".
- ETSI EN 302 304: "Digital Video Broadcasting (DVB); Transmission System for Handheld Terminals (DVB-H)".
- ETSI Draft: "Use Cases and Services for IP Datacast over DVB-H", available via DVB Forum, document tm-cbms1166.
- ETSI Draft: "IP-Datacast over DVB-H: "Electronic Service Guide (ESG)", available via DVB Forum, document tm-cbms1199.
- IETF RFC 2617: "HTTP Authentication: Basic and Digest Access Authentication".
- IETF RFC 3261: "SIP: Session Initiation Protocol".
- DVB Blue Book A100: "IP Datacast over DVB-H: Service Purchase and Protection (SPP)";

NOTE: Available at Digital Video Broadcasting Project (<http://www.dvb.org>).

- ETSI TS 127 005: "Digital cellular telecommunications system (Phase 2+); Universal Mobile Telecommunications System (UMTS); LTE; Use of Data Terminal Equipment - Data Circuit terminating Equipment (DTE-DCE) interface for Short Message Service (SMS) and Cell Broadcast Service (CBS) (3GPP TS 27.005)".

History

Document history		
V1.1.1	October 2003	Publication
V1.2.1	June 2004	Publication
V1.3.1	July 2005	Publication
V1.4.1	March 2006	Publication
V1.5.1	October 2007	Publication
V1.6.1	June 2008	Publication
V1.6.2	September 2008	Publication
V1.7.1	October 2009	Publication
V2.2.1	April 2011	Publication
V2.3.1	August 2014	Publication
V2.4.1	May 2015	Publication
V2.5.1	June 2016	Publication