

ETSI TS 102 527-3 V1.2.1 (2010-04)

Technical Specification

Digital Enhanced Cordless Telecommunications (DECT); New Generation DECT; Part 3: Extended wideband speech services



Reference

RTS/NG-DECT0257-3

Keywords7 kHz, audio, codec, DECT, GAP, IMT-2000,
interoperability, IP, profile, radio, speech**ETSI**650 Route des Lucioles
F-06921 Sophia Antipolis Cedex - FRANCE

Tel.: +33 4 92 94 42 00 Fax: +33 4 93 65 47 16

Siret N° 348 623 562 00017 - NAF 742 C
Association à but non lucratif enregistrée à la
Sous-Préfecture de Grasse (06) N° 7803/88

Important notice

Individual copies of the present document can be downloaded from:

<http://www.etsi.org>

The present document may be made available in more than one electronic version or in print. In any case of existing or perceived difference in contents between such versions, the reference version is the Portable Document Format (PDF). In case of dispute, the reference shall be the printing on ETSI printers of the PDF version kept on a specific network drive within ETSI Secretariat.

Users of the present document should be aware that the document may be subject to revision or change of status. Information on the current status of this and other ETSI documents is available at

<http://portal.etsi.org/tb/status/status.asp>

If you find errors in the present document, please send your comment to one of the following services:

http://portal.etsi.org/chaicor/ETSI_support.asp

Copyright Notification

No part may be reproduced except as authorized by written permission.
The copyright and the foregoing restriction extend to reproduction in all media.

© European Telecommunications Standards Institute 2010.
All rights reserved.

DECT™, **PLUGTESTS™**, **UMTS™**, **TIPHON™**, the TIPHON logo and the ETSI logo are Trade Marks of ETSI registered for the benefit of its Members.

3GPP™ is a Trade Mark of ETSI registered for the benefit of its Members and of the 3GPP Organizational Partners.

LTE™ is a Trade Mark of ETSI currently being registered

for the benefit of its Members and of the 3GPP Organizational Partners.

GSM® and the GSM logo are Trade Marks registered and owned by the GSM Association.

Contents

Intellectual Property Rights	11
Foreword.....	11
1 Scope	12
2 References	12
2.1 Normative references	13
2.2 Informative references.....	14
3 Definitions, symbols and abbreviations	15
3.1 Definitions.....	15
3.2 Symbols.....	16
3.3 Abbreviations	16
4 Description of Services	17
4.1 Enhanced wideband speech.....	17
4.1.1 Back-compatibility with GAP.....	17
4.1.2 Further enhancement in audio performance requirements.....	17
4.2 Wideband speech scenarios.....	18
4.3 Extended wideband speech services defined in the present document.....	18
5 Service and feature definitions	19
5.1 New Generation DECT Speech Services	19
5.2 Network (NWK) features	19
5.3 Data Link Control (DLC) service definitions.....	20
5.4 Medium Access Control (MAC) service definitions	20
5.5 Physical Layer (PHL) service definitions.....	20
5.6 Speech coding and audio feature definitions	20
5.7 Application features	20
6 Inter-operability requirements.....	20
6.1 General	20
6.2 New Generation DECT Speech Services support status	21
6.3 Services to DECT feature implementation mappings.....	21
6.4 NWK features.....	30
6.5 Data Link Control (DLC) services	31
6.6 Medium Access Control (MAC) services	32
6.7 Physical layer (PHL) services	33
6.8 Speech coding and audio features	33
6.9 Application features	34
6.10 Network (NWK) feature to procedure mapping.....	35
6.11 Data Link Control (DLC) Service to procedure mapping	41
6.12 Medium Access Control (MAC) service to procedure mapping	42
6.13 Application feature to procedure mapping	44
6.14 General requirements	44
6.14.1 Network (NWK) layer message contents.....	44
6.14.2 Transaction identifier.....	44
6.14.3 Length of a Network (NWK) layer message	44
6.14.4 Handling of error and exception conditions.....	44
6.14.5 Generic Access Profile (GAP) default setup attributes.....	44
6.14.6 Coexistence of Mobility Management (MM) and Call Control (CC) procedures	45
6.14.7 Coding rules for information elements	45
7 Procedure description.....	45
7.1 Backward compatibility with Generic Access Profile (GAP) and with New Generation DECT part 1 (wideband speech) equipment	45
7.1.1 Backward compatibility with Generic Access Profile (GAP); Requirements for NG-DECT, part 3 Fixed Parts (FPs).....	45

7.1.2	Backward compatibility with Generic Access Profile (GAP); Requirements for NG-DECT, part 3 Portable Parts (PPs) registered on GAP compliant FPs	46
7.1.3	Backward compatibility with New Generation DECT, part 1; Requirements for NG-DECT, part 3 Fixed Parts (FPs).....	46
7.1.4	Backward compatibility with New Generation DECT, part 1; Requirements for NG-DECT, part 3 Portable Parts (PPs) registered on NG-DECT Part 1 FPs	46
7.2	Generic Access Profile (GAP) procedures	46
7.3	New Generation DECT; part 1: Wideband Speech procedures.....	46
7.3.1	Implementation examples of part 1: Wideband Speech specific procedures	46
7.4	Network (NWK) layer procedures specific for part 3	46
7.4.1	Generic events notification	47
7.4.1.1	General	47
7.4.1.2	Voice Message waiting notification.....	48
7.4.1.3	Missed call notification	49
7.4.1.4	List change notification.....	51
7.4.2	Date and Time synchronization	52
7.4.2.1	FT initiated Date and Time synchronization	52
7.4.2.2	PT initiated Date and Time synchronization	53
7.4.3	Handling of parallel calls	53
7.4.3.1	Parallel call common requirements	53
7.4.3.2	Control messages	54
7.4.3.3	Codec change for parallel calls	56
7.4.3.4	Sending negative acknowledgement	56
7.4.3.5	Common parallel call procedures (external or internal)	57
7.4.3.5.1	Outgoing parallel call initiation (external or internal)	57
7.4.3.5.2	Call waiting indication (external or internal).....	61
7.4.3.5.3	Call toggle (external or internal).....	62
7.4.3.5.4	Call release and call release rejection	63
7.4.3.5.5	Void.....	66
7.4.3.5.6	Call waiting acceptance (from PP to FP)	66
7.4.3.5.7	Call waiting rejection (from PP to FP)	68
7.4.3.5.8	Putting a call on-hold.....	69
7.4.3.5.9	Resuming a call put on-hold	70
7.4.3.5.10	CLIP on call waiting.....	70
7.4.3.5.11	CNIP on call waiting indication	71
7.4.3.5.12	Active call release with replacement (from PP to FP).....	72
7.4.3.6	Call transfer.....	73
7.4.3.6.1	Announced call transfer procedure.....	74
7.4.3.6.2	Unannounced call transfer procedure	77
7.4.3.6.3	Call re-injection to the system (external or internal)	79
7.4.3.6.4	Remote party CLIP on call transfer	80
7.4.3.6.5	Remote party CNIP on call transfer.....	81
7.4.3.7	3-party conference with established external and/or internal calls.....	82
7.4.3.7.1	Unsuccessful 3-party conference call	84
7.4.3.7.2	3-party conference call release	84
7.4.3.8	Intrusion call (from PP to FP).....	86
7.4.3.8.1	Implicit intrusion call into a line in "single call" mode	86
7.4.3.8.2	Explicit intrusion call	89
7.4.3.9	Internal call codec priority	92
7.4.3.9.1	Description	92
7.4.3.9.2	Exception cases	94
7.4.3.10	Handling of lines where second calls are signalled in-band.....	94
7.4.3.10.1	General requirements.....	94
7.4.3.10.2	Basic 'double call with in-band signalling' lines.....	95
7.4.3.10.3	Off-hook CLIP enabled 'double call with in-band signalling' lines.....	96
7.4.3.10.4	Use of transparent commands on DCIBS lines (Basic or Off-hook CLIP enabled) or any other line	102
7.4.4	Handling of single call services	103
7.4.4.1	Control messages	103
7.4.4.1.1	Call deflection control messages	103
7.4.4.2	Call deflection	103
7.4.5	Line identification.....	107

7.4.5.1	Line identification general requirements.....	107
7.4.5.2	Line identification for external outgoing calls	107
7.4.5.2.1	General line identification requirements for external outgoing calls.....	107
7.4.5.2.2	Line identification for a <i>first</i> external outgoing call using <<CALL INFORMATION>>	108
7.4.5.2.3	Backward compatible line identification for a <i>first</i> external outgoing call using <<MULTI-KEYPAD >> IE.....	111
7.4.5.2.4	FP managed line selection for a <i>first</i> external outgoing call.....	112
7.4.5.3	Line identification for external incoming call.....	118
7.4.5.3.1	General line identification requirements for external incoming calls.....	118
7.4.5.3.2	Line identification for a <i>first</i> external incoming call.....	118
7.4.6	Call identification	119
7.4.6.1	Call identification general requirements	119
7.4.6.2	Call identifier assignment on first outgoing call (FP to PP).....	121
7.4.6.3	Call identifier assignment on first incoming call (FP to PP).....	122
7.4.6.4	Call status indication to the handset (FP to PP)	123
7.4.6.4.1	Call status indication general requirements.....	123
7.4.6.4.2	Call status indication as call information.....	124
7.4.6.4.3	Call status principles and values.....	125
7.4.6.4.4	Call status reasons summary and MMI mapping.....	126
7.4.6.4.5	Call statuses for a first "Outgoing external call"	128
7.4.6.4.6	Call statuses for a first "Outgoing external call" using early {CC-CONNECT} message	129
7.4.6.4.7	Call statuses for an "Outgoing external call"-user busy	130
7.4.6.4.8	Call statuses for an "Outgoing external call"-number not available	131
7.4.6.4.9	Call statuses for a first "Incoming external call"	132
7.4.7	Multiple lines handling	133
7.4.7.1	Multiple lines common requirements.....	133
7.4.7.1.1	Pre-requisites	133
7.4.7.1.2	Minimum requirements	133
7.4.7.2	Terminal attachment and line settings.....	134
7.4.7.2.1	Initial attachment	134
7.4.7.2.2	Attachment modification	134
7.4.7.2.3	Line settings	134
7.4.7.3	Incoming and outgoing external calls on a multiple line system	134
7.4.7.4	Internal calls in multiple line context.....	135
7.4.7.5	Compatibility with non multiple line PP or FP.....	135
7.4.7.5.1	Non multiple line PP in front of a multiple line FP.....	135
7.4.7.5.2	Non multiple line FP in front of a multiple line PP.....	136
7.4.8	Multiple call line handling.....	136
7.4.8.1	Multiple calls general requirements	136
7.4.8.1.1	Pre-requisites	136
7.4.8.1.2	Minimum requirements	137
7.4.8.2	Incoming and outgoing external calls on a multiple call line.....	137
7.4.8.2.1	Line set in "single call" mode.....	137
7.4.8.2.2	Line set in "multiple call" mode.....	137
7.4.8.3	Busy system or line notification.....	138
7.4.9	PP and FP capabilities indication and broadcast.....	139
7.4.9.1	Terminal capability indication	139
7.4.9.2	Higher layer information FP broadcast	140
7.4.9.2.1	Higher layer information in standard FP broadcast (Qh= 3)	141
7.4.9.2.2	Extended Higher Layer capabilities part 2	141
7.4.10	List access service.....	141
7.4.10.1	General considerations	141
7.4.10.2	List change notification.....	145
7.4.10.2.1	General rule	145
7.4.10.2.2	Mandatory notifications.....	147
7.4.10.3	List identifier codings	148
7.4.10.4	List Access Commands	148
7.4.10.4.1	Start and end session	150
7.4.10.4.2	Query supported entry fields	153
7.4.10.4.3	Read entries	154
7.4.10.4.4	Edit entry.....	156
7.4.10.4.5	Save entry.....	157

7.4.10.4.6	Delete entry	159
7.4.10.4.7	Delete list.....	160
7.4.10.4.8	Search entries	161
7.4.10.4.9	Negative Acknowledgement.....	164
7.4.10.4.10	Data packet / Data packet last.....	165
7.4.10.5	Lists and entry fields	167
7.4.10.5.1	Fields description.....	167
7.4.10.5.2	"List of supported lists" entry fields	173
7.4.10.5.3	"Missed call list" entry fields.....	174
7.4.10.5.4	"Outgoing call list" entry fields	175
7.4.10.5.5	"Incoming accepted call list" entry fields	175
7.4.10.5.6	"All call list" entry fields	175
7.4.10.5.7	"Contact list" entry fields	176
7.4.10.5.8	"Internal names list" entry fields	177
7.4.10.5.9	"DECT system settings list" entry fields	177
7.4.10.5.10	"Line settings list" entry fields	177
7.4.10.5.11	"All incoming calls list" entry fields.....	178
7.4.10.6	List access service call and interactions with voice calls	178
7.4.10.6.1	List access setup	179
7.4.10.6.2	List access with possible first voice call initiation.....	179
7.4.10.6.3	Incoming first voice call during existing list access session.....	182
7.4.10.6.4	List access during existing voice call with possible second call initiation	183
7.4.10.6.5	Switching between LiA session and voice call.....	186
7.4.10.6.6	Returning to LiA session after voice call termination	186
7.4.10.7	Generic sequence charts for list access.....	187
7.4.10.8	Use case examples for list access	187
7.4.11	DECT system and line settings	187
7.4.11.1	DECT system and line settings considerations	187
7.4.11.2	Interactions between registration, attachments of handsets and lists	190
7.4.11.3	DECT system settings list	191
7.4.11.3.1	Field 'Current PIN code'	191
7.4.11.3.2	Field 'Clock master'	192
7.4.11.3.3	Field 'Base reset'	192
7.4.11.3.4	Field 'FP IP address / type'.....	193
7.4.11.3.5	Field 'FP IP address / value'.....	194
7.4.11.3.6	Field 'FP IP address / subnet mask'.....	194
7.4.11.3.7	Field 'FP IP address / gateway'	195
7.4.11.3.8	Field 'FP IP address / DNS server'.....	195
7.4.11.3.9	Field 'FP version / Firmware version'	196
7.4.11.3.10	Field 'FP version / Eeprom version'	196
7.4.11.3.11	Field 'FP version / Hardware version' field.....	196
7.4.11.3.12	Field 'Emission mode'.....	197
7.4.11.3.13	Field 'New PIN code'	197
7.4.11.4	Line settings list	198
7.4.11.4.1	Field 'Line name'	199
7.4.11.4.2	Field 'Line id'	199
7.4.11.4.3	Field 'Attached handsets'	199
7.4.11.4.4	Field 'Dialling Prefix'.....	200
7.4.11.4.5	Field 'FP melody'.....	200
7.4.11.4.6	Field 'FP volume'	200
7.4.11.4.7	Field 'Blocked number'.....	200
7.4.11.4.8	Field 'Multiple calls mode'.....	201
7.4.11.4.9	Field 'Intrusion call'	201
7.4.11.4.10	Field 'Permanent CLIR'	201
7.4.11.4.11	Field 'Call forwarding unconditional'	202
7.4.11.4.12	Field 'Call forwarding on No Answer'	203
7.4.11.4.13	Field 'Call forwarding on Busy subscriber'.....	204
7.4.11.5	Virtual contact list and call list per line.....	204
7.4.12	Calling line identity restriction (CLIR).....	205
7.4.12.1	Considerations.....	205
7.4.12.2	Permanent CLIR mode (all calls).....	205
7.4.12.3	Temporary CLIR mode (call by call).....	206

7.4.13	Call forwarding (external calls)	206
7.4.13.1	Call forwarding common requirements.....	206
7.4.13.2	External Call Forwarding Unconditional (CFU) to external number.....	207
7.4.13.3	External Call Forwarding on No Answer (CFNA) to external number.....	208
7.4.13.4	External Call Forwarding on Busy subscriber (CFB) to external number	209
7.4.14	DTMF handling	210
7.4.14.1	Uplink DTMF transmission	210
7.4.14.1.1	Uplink DTMF transmission at call setup when FP connected to classic switching network.....	210
7.4.14.1.2	Uplink DTMF transmission when connected	211
7.4.14.2	Downlink DTMF reception.....	211
7.4.14.3	Local DTMF feedback of dialled digits	212
7.4.15	Tones provision	213
7.4.15.1	General considerations	213
7.4.15.2	Tones provision by the system	215
7.4.15.2.1	Tones provision for a NG-DECT Part 3 FP in front of a NG-DECT Part 3 PP.....	215
7.4.15.2.2	Tones provision for a NG-DECT Part 3 FP in front of a GAP or NG-DECT Part 1 PP	217
7.4.15.3	Transparency to tones provision by the network or PABX.....	222
7.4.16	Headset management	223
7.4.16.1	Headset considerations.....	223
7.4.16.2	Headset call interception	224
7.4.16.2.1	Initiation of the call	224
7.4.16.2.2	Call interception	224
7.4.16.3	Headset incoming call	228
7.4.16.4	Re-dial of last outgoing call	228
7.4.16.5	Re-dial of last incoming call	228
7.4.16.6	Switching from headset to handset (headset initiated)	229
7.4.16.7	Switching from headset to handset (handset initiated).....	229
7.4.16.8	Compatibility with other telephony features and profiles	229
7.4.16.8.1	Compatibility with other telephony features for a headset portable part (HPP).....	229
7.4.16.8.2	Compatibility of a NG-DECT Part 3 headset portable part with other profiles.....	231
7.4.17	UTF-8 CNIP	231
7.4.17.1	UTF-8 CNIP sending from the FP to PP.....	231
7.4.17.2	Display of UTF-8 characters on PP side	232
7.5	Data Link Control (DLC) layer procedures.....	232
7.5.1	DLC services	232
7.6	Medium Access Control (MAC) layer procedures.....	232
7.6.1	MAC services	232
7.6.2	Frame formats and multiplexers	232
7.6.3	Downlink broadcast	232
7.6.3.1	N _T message.....	232
7.6.3.2	Q _T - static system information.....	232
7.6.3.3	Q _T - Fixed Part capabilities	233
7.6.3.4	Q _T - Extended Fixed Part capabilities	233
7.6.3.5	Q _T - Extended Fixed Part capabilities part 2	233
7.6.3.6	Q _T - SARI list contents	234
7.6.4	Paging broadcast.....	234
7.6.5	"no-emission" mode.....	234
7.7	Physical layer (PHL) requirements.....	234
7.7.1	Modulation.....	234
7.7.2	Slot type (Physical packets)	234
7.8	Requirements regarding the speech transmission.....	234
7.8.1	General.....	234
7.8.2	Speech codecs	234
7.8.3	Audio performance requirements	234
7.9	Management procedures.....	234
7.10	Application procedures.....	234
7.10.1	Easy PIN code and easy pairing registration	235
7.10.1.1	Easy PIN code registration.....	235
7.10.1.1.1	Searching mode and PIN code requests.....	235
7.10.1.2	Easy pairing registration	236
7.10.1.2.1	Easy pairing registration description	236
7.10.1.2.2	Base station limited registration mode	236

7.10.1.2.3	Searching mode request.....	236
7.10.1.3	Common procedures to easy PIN code and easy pairing	238
7.10.1.3.1	Registration mode automatic access.....	238
7.10.1.3.2	Base station name selection.....	238
7.10.1.3.3	Registration user feedback.....	240
7.10.2	Handset locator	240
Annex A (normative): System parameters.....		243
A.1	CC timers.....	243
A.2	Application timers	243
Annex B (normative): Procedure diagrams.....		244
B.1	Events notification diagrams	244
B.1.1	Event notification when there is no existing connection	244
B.1.2	Event notification during existing connection.....	245
B.1.3	Event notification when the PP is switched on.....	245
B.1.4	Event notification using call connection	246
B.1.5	Event notification for "Missed call notification"	246
B.2	Date-time synchronization diagrams	247
B.2.1	Date-time synchronization when there is no existing connection	247
B.2.2	Date-time synchronization during existing connection	247
B.2.3	Date-time synchronization when the PP is switched on.....	248
B.2.4	Date-time synchronization using call connection	248
B.3	List access service basic sequence diagrams.....	248
B.3.1	Start/end session when PP is in idle mode	249
B.3.2	Start/end session when a call is already established to PP	250
B.3.3	Query supported entry fields	250
B.3.4	Read entries	251
B.3.5	Edit entry	252
B.3.6	Save entry	253
B.3.7	Delete entry	253
B.3.8	Delete list.....	254
B.3.9	Search entries	254
Annex C (informative): Recommended implementation of procedures.....		255
C.1	General	255
C.2	Multiple lines diagrams	255
C.2.1	Attaching a new PP to one or several lines	255
C.2.2	Outgoing first call on a line	257
C.2.2.1	PP attached to 1 line.....	257
C.2.2.2	PP attached to several lines.....	257
C.2.2.2.1	Line identification by PP using <<CALL-INFORMATION>>.....	257
C.2.2.2.2	Line identification by PP using the <<MULTI-KEYPAD>>	257
C.2.3	First incoming call on a line	258
C.2.3.1	PP attached to 1 line.....	258
C.2.3.2	PP attached to several lines.....	259
C.2.4	Missed call.....	260
C.2.5	Voice message waiting indication on a specific line	261
C.2.6	Missed call notification scenario	261
C.2.6.1	After call on line 1	262
C.2.6.2	After two almost simultaneous calls on line 2	262
C.2.6.3	After incoming internal call	262
C.2.6.4	After call on line 1	263
C.2.6.5	A PP reads one of the two 'unread' entries for line 1 in the missed call list.....	263
C.2.6.6	A PP reads the remaining 'unread' entry for line 1, and a missed call arrives on line 1 almost simultaneously	263
C.3	Multiple calls diagrams	264

C.3.1	First incoming call on the line or system.....	264
C.3.2	Second incoming call on the line or system	265
C.3.3	First outgoing call on the line or system.....	267
C.3.4	Second outgoing call on the line or system	268
C.4	Parallel calls complex or alternative diagrams	269
C.4.1	Call identification for outgoing parallel calls	269
C.4.1.1	All in one PP message - line identification by PP.....	269
C.4.1.2	All in one PP message - FP-managed line selection	270
C.4.1.3	Line pre-selection by PP - Manual dialling of called number.....	271
C.4.1.4	FP-managed line selection - Manual dialling of called number.....	272
C.4.1.5	Unsupported new outgoing parallel call	273
C.4.2	Incoming parallel calls	274
C.4.2.1	Two simultaneous incoming calls on two different lines.....	274
C.4.2.2	FP release of waiting call when remote party hangs up.....	275
C.4.2.3	Two incoming calls before user answers	275
C.4.3	Call waiting represented as first call when user hangs up	276
C.5	List access service use case examples	277
C.5.1	General	277
C.5.2	Use case: transfer number from missed call list to contact list.....	278
C.5.3	Use case: select and call internal party.....	280
C.5.4	Use case: select and call number from contact list	281
C.5.5	Use case: save entry with invalid format.....	282
C.5.6	Use case: read invalid start index	282
C.5.7	Use case: modify a PP internal name	283
C.5.8	Use case: entry distributed over two data packets	284
C.6	List access service with voice calls (additional use cases and procedure diagrams).....	285
C.6.1	General	285
C.6.2	List access when a voice call is already ongoing	285
C.6.2.1	Use case: Consult a list during a voice call.....	285
C.6.2.2	Use case: call transfer using internal names list (first call explicitly put on hold).....	286
C.6.2.3	Use case: call transfer using internal names list (first call implicitly put on hold by internal call)	287
C.6.2.4	Use case: establishing a parallel call using contact list.....	289
C.7	DECT system settings diagrams.....	289
C.7.1	General	289
C.7.2	Modifying the PIN code	290
C.7.3	Resetting the base.....	292
C.7.4	Resetting the base (PIN code protected field)	293
C.8	Line settings diagrams.....	295
C.8.1	General	295
C.8.2	Changing the settings of a line	295
C.8.3	Changing the name of a line.....	298
C.8.4	Changing the name of a line (PIN protected field).....	299
C.9	Use cases for 'Off-hook CLIP enabled DCIBS' lines	301
C.9.1	Remote party hangup 'double call with in-band signalling' line.....	301
C.9.1.1	Call waiting after 'remote party hangup'	301
C.9.1.2	Outgoing parallel call after 'remote party hangup'	303
Annex D (informative):	Guidelines for implementation of DTMF	306
D.1	Uplink DTMF transmission from FP to network	306
D.2	DTMF format	306
Annex E (informative):	Tones format in ITU-T recommendations.....	307
Annex F (informative):	Services and features defined in other specifications	308
F.1	Services and features defined in TS 102 527-1 (New Generation DECT; part 1)	308
F.1.1	New Generation DECT; part 1, Speech Services (clause 5.1 of TS 102 527-1).....	308

F.1.2	New Generation DECT; part 1, Network (NWK) features (clause 5.2 of TS 102 527-1).....	308
F.1.3	New Generation DECT; part 1, Data Link Control (DLC) services (clause 5.3 of TS 102 527-1).....	308
F.1.4	New Generation DECT; part 1, Medium Access Control (MAC) services (clause 5.4 of TS 102 527-1).....	309
F.1.5	New Generation DECT; part 1, Physical Layer (PHL) services (clause 5.5 of TS 102 527-1).....	309
F.1.6	New Generation DECT; part 1, Speech coding and audio features (clause 5.6 of TS 102 527-1).....	309
F.2	Services and features defined in EN 300 444 (GAP).....	313
F.2.1	GAP Network (NWK) features (clause 4.1 of EN 300 444).....	313
F.2.2	GAP Speech coding and audio features (clause 4.2 of EN 300 444).....	314
F.2.3	GAP Application features (clause 4.3 of EN 300 444).....	316
F.2.4	DLC service definitions (clause 5.1 of EN 300 444).....	316
F.2.5	GAP MAC service definitions (clause 5.2 of EN 300 444).....	317
F.3	GAP Feature/service to procedure mapping tables.....	317
F.3.1	GAP NWK feature to procedure mapping table (clause 6.8.1 of EN 300 444).....	318
F.3.2	GAP DLC service to procedure mapping table (clause 6.8.2 of EN 300 444).....	320
F.3.3	GAP MAC service to procedure mapping table (clause 6.8.3 of EN 300 444).....	321
F.3.4	GAP Application feature to procedure mapping table (clause 6.8.4 of EN 300 444).....	322
Annex G (informative): Bibliography.....		323
History.....		324

Intellectual Property Rights

IPRs essential or potentially essential to the present document may have been declared to ETSI. The information pertaining to these essential IPRs, if any, is publicly available for **ETSI members and non-members**, and can be found in ETSI SR 000 314: "*Intellectual Property Rights (IPRs); Essential, or potentially Essential, IPRs notified to ETSI in respect of ETSI standards*", which is available from the ETSI Secretariat. Latest updates are available on the ETSI Web server (<http://webapp.etsi.org/IPR/home.asp>).

Pursuant to the ETSI IPR Policy, no investigation, including IPR searches, has been carried out by ETSI. No guarantee can be given as to the existence of other IPRs not referenced in ETSI SR 000 314 (or the updates on the ETSI Web server) which are, or may be, or may become, essential to the present document.

Foreword

This Technical Specification (TS) has been produced by ETSI Technical Committee Digital Enhanced Cordless Telecommunications (DECT).

The present document is based on EN 300 175 parts 1 [1] to 8 [8] and EN 300 444 [12]. General attachment requirements and speech attachment requirements are based on EN 301 406 [11] (replacing TBR 006 [i.2]) and EN 300 176-2 [10] (previously covered by TBR 010 [i.3]). Further details of the DECT system may be found in TR 101 178 [i.1].

The present document has been developed in accordance to the rules of documenting a profile specification as described in ISO/IEC 9646-6 [13].

The information in the present document is believed to be correct at the time of publication. However, DECT standardization is a rapidly changing area, and it is possible that some of the information contained in the present document may become outdated or incomplete within relatively short time-scales.

The present document is part 3 of a multi-part deliverable covering the New Generation DECT as identified below:

- Part 1: "Wideband speech";
- Part 2: "Support of transparent IP packet data";
- Part 3: "Extended wideband speech services";**
- Part 4: "Light Data Services: Software Update Over The Air (SUOTA), Content Downloading and HTTP based applications ".

1 Scope

The present document specifies a set of functionalities of the New Generation DECT.

The New Generation DECT provides the following basic new functionalities:

- Wideband speech service (part 1 of this multi-part deliverable [21]).
- Packet-mode data service supporting Internet Protocol with efficient spectrum usage and high data rates (part 2 of this multi-part deliverable [i.4]).
- Extended wideband speech services (the present document).
- Light Data Services: Software Update Over The Air (SUOTA), Content Downloading and HTTP based applications (part 4 of this multi-part deliverable [i.5]).

All New Generation DECT devices will offer at least one or several of these services.

The present document describes the part 3: Extended wideband speech services:

- For the description of the wideband speech service, see TS 102 527-1 [21].
- For the description of the support of transparent IP packet data, see TS 102 527-2 [i.4].
- For the description of the Light Data Services: Software Update Over The Air (SUOTA), Content Downloading and HTTP based applications, see TS 102 527-4 [i.5].

The part 3 "Extended wideband speech services" is defined as an extension of part 1 of this multi-part deliverable "Wideband speech service" [21]. All devices compliant to part 3 specification (the present document) shall implement at least all mandatory features and may implement the optional features defined in part 1 "Wideband speech"[21]. In addition to that, the present document defines additional mandatory or optional features.

The part 1 [21], and therefore part 3, are also defined as extensions of the "Generic Access Profile (GAP)" [12]. All DECT devices offering Wideband speech services (part 1 or part 1 plus part 3) shall also be compliant with the "Generic Access Profile (GAP)" [12], and shall offer the DECT standard 32 kbit/s voice service according to GAP.

All DECT devices claiming to be compliant with this Application Profile will offer at least the basic services defined as mandatory. In addition to that, optional features can be implemented to offer additional DECT services.

The aim of the present document is to guarantee a sufficient level of interoperability and to provide an easy route for development of DECT wideband speech applications, with the features of the present document being a common fall-back option available in all compliant to this profile equipment.

2 References

References are either specific (identified by date of publication and/or edition number or version number) or non-specific.

- For a specific reference, subsequent revisions do not apply.
- Non-specific reference may be made only to a complete document or a part thereof and only in the following cases:
 - if it is accepted that it will be possible to use all future changes of the referenced document for the purposes of the referring document;
 - for informative references.

Referenced documents which are not found to be publicly available in the expected location might be found at <http://docbox.etsi.org/Reference>.

NOTE: While any hyperlinks included in this clause were valid at the time of publication ETSI cannot guarantee their long term validity.

2.1 Normative references

The following referenced documents are indispensable for the application of the present document. For dated references, only the edition cited applies. For non-specific references, the latest edition of the referenced document (including any amendments) applies.

- [1] ETSI EN 300 175-1: "Digital Enhanced Cordless Telecommunications (DECT); Common Interface (CI); Part 1: Overview".
- [2] ETSI EN 300 175-2: "Digital Enhanced Cordless Telecommunications (DECT); Common Interface (CI); Part 2: Physical layer (PHL)".
- [3] ETSI EN 300 175-3: "Digital Enhanced Cordless Telecommunications (DECT); Common Interface (CI); Part 3: Medium Access Control (MAC) layer".
- [4] ETSI EN 300 175-4: "Digital Enhanced Cordless Telecommunications (DECT); Common Interface (CI); Part 4: Data Link Control (DLC) layer".
- [5] ETSI EN 300 175-5: "Digital Enhanced Cordless Telecommunications (DECT); Common Interface (CI); Part 5: Network (NWK) layer".
- [6] ETSI EN 300 175-6: "Digital Enhanced Cordless Telecommunications (DECT); Common Interface (CI); Part 6: Identities and addressing".
- [7] ETSI EN 300 175-7: "Digital Enhanced Cordless Telecommunications (DECT); Common Interface (CI); Part 7: Security features".
- [8] ETSI EN 300 175-8: "Digital Enhanced Cordless Telecommunications (DECT); Common Interface (CI); Part 8: Speech and audio coding and transmission".
- [9] Void.
- [10] ETSI EN 300 176-2: "Digital Enhanced Cordless Telecommunications (DECT); Test specification; Part 2: Audio and speech".
- [11] ETSI EN 301 406: "Digital Enhanced Cordless Telecommunications (DECT); Harmonized EN for Digital Enhanced Cordless Telecommunications (DECT) covering the essential requirements under article 3.2 of the R&TTE Directive; Generic radio".
- [12] ETSI EN 300 444: "Digital Enhanced Cordless Telecommunications (DECT); Generic Access Profile (GAP)".
- [13] ISO/IEC 9646-6: "Information technology - Open Systems Interconnection - Conformance testing methodology and framework - Part 6: Protocol profile test specification".
- [14] ISO/IEC 9646-7: "Information technology - Open Systems Interconnection - Conformance testing methodology and framework - Part 7: Implementation Conformance Statements".
- [15] ITU-T Recommendation G.726 (1990): "40, 32, 24, 16 kbit/s Adaptive Differential Pulse Code Modulation (ADPCM) ".
- [16] ITU-T Recommendation G.711 (1988): "Pulse code modulation (PCM) of voice frequencies".
- [17] ITU-T Recommendation G.722 (1988): "7 kHz audio-coding within 64 kbit/s".
- [18] ITU-T Recommendation G.729.1 (2006): "G.729 based Embedded Variable bit-rate coder: An 8-32 kbit/s scalable wideband coder bitstream interoperable with G.729".
- [19] ISO/IEC JTC1/SC29/WG11 (MPEG): International Standard ISO/IEC 14496-3:2005/AMD 1:2007: "Coding of audio-visual objects - Part 3: Audio; AMENDMENT 1: Low Delay AAC profile".

- [20] ISO/IEC JTC1/SC29/WG11 (MPEG): International Standard ISO/IEC 14496-3:2005: "Information Technology - Coding of audio-visual objects - Part 3: Audio".
- [21] ETSI TS 102 527-1: "Digital Enhanced Cordless Telecommunications (DECT); New Generation DECT; Part 1: Wideband Speech". .
- [22] ETSI TS 122 072: "Digital cellular telecommunications system (Phase 2+); Universal Mobile Telecommunications System (UMTS); LTE; Call Deflection (CD); Stage 1 (3GPP TS 22.072 version 9.0.0 Release 9)".
- [23] ETSI TS 122 081: "Digital cellular telecommunications system (Phase 2+); Universal Mobile Telecommunications System (UMTS); LTE; Line Identification supplementary services; Stage 1 (3GPP TS 22.081)".
- [24] ETSI TS 122 082: "Digital cellular telecommunications system (Phase 2+); Universal Mobile Telecommunications System (UMTS); LTE; Call Forwarding (CF) Supplementary Services; Stage 1 (3GPP TS 22.082)".
- [25] ETSI TS 123 082: "Digital cellular telecommunications system (Phase 2+); Universal Mobile Telecommunications System (UMTS); Call Forwarding (CF) supplementary services; Stage 2 (3GPP TS 23.082)".
- [26] ETSI TS 124 082: "Digital cellular telecommunications system (Phase 2+); Universal Mobile Telecommunications System (UMTS); Call Forwarding (CF) supplementary services; Stage 3 (3GPP TS 24.082)".

2.2 Informative references

The following referenced documents are not essential to the use of the present document but they assist the user with regard to a particular subject area. For non-specific references, the latest version of the referenced document (including any amendments) applies.

- [i.1] ETSI TR 101 178: "Digital Enhanced Cordless Telecommunications (DECT); A high Level Guide to the DECT Standardization".
- [i.2] ETSI TBR 006: "Digital Enhanced Cordless Telecommunications (DECT); General terminal attachment requirements".
- [i.3] ETSI TBR 010: "Digital Enhanced Cordless Telecommunications (DECT); General terminal attachment requirements: Telephony applications".
- [i.4] ETSI TS 102 527-2: "Digital Enhanced Cordless Telecommunications (DECT); New Generation DECT; Part 2: Support of transparent IP packet data".
- [i.5] ETSI TS 102 527-4: "Digital Enhanced Cordless Telecommunications (DECT); New Generation DECT; Part 4: Light Data Services; Software Update Over The Air (SUOTA), content downloading and HTTP based applications".
- [i.6] ITU-T Recommendation P.311 (2005): "Transmission characteristics for wideband (150-7000 Hz) digital handset telephones".
- [i.7] ITU-T Recommendation G.729: "Coding of speech at 8 kbit/s using conjugate structure algebraic-code-excited linear prediction (CS-ACELP)".
- [i.8] ITU-T Recommendation Q.23 (1988): "Technical features of push-button telephone sets",.
- [i.9] ITU-T Recommendation Q.24 (1988): " Multifrequency push-button signal reception".
- [i.10] ITU-T Recommendation E.180: "Technical characteristics of tones for the telephone service".
- [i.11] ITU-T Recommendation E.180- Supplement 2: "Various tones used in national networks".
- [i.12] ITU-T Recommendation E.182: "Application of tones and recorded announcements in telephone services".

3 Definitions, symbols and abbreviations

3.1 Definitions

For the purposes of the present document, the terms and definitions given in EN 300 444 [12] and the following apply:

call status: part of the call information sent from FP to PP about the FP call state toward the peer party

double call with in-band signalling (line): legacy line on which second calls-incoming or outgoing- are handled using signalling "in-band"

FP-managed line selection: mode for an outgoing external call, in which the PP does not indicate the line to be used to the FP and the FP chooses the line where the call is placed

GAP (PP or FP) : PP or FP compliant with EN 300 444 [12].

Headset PP (HPP): wireless headset telephone using the DECT air interface

NOTE: A HPP usually has only one speaker and one microphone combined with a limited set of keys (e.g. call button, volume plus, and volume minus). Headsets provide the equivalent functionality of a PP with hands-free operation.

late release: sending of a "CS idle" call status by the FP for a call that has been released a long time before in the network

NOTE: See clause 7.4.3.10.3.1.

line: logical channel, separately accessible from the external world through a dedicated external directory entry (e.g. telephone number, uri, etc.)

NOTE: These lines may be of various types, for example: PSTN, VoIP or ISDN lines.

multiple call line: line supporting several simultaneous (external) calls

NOTE: An example of multiple call line is a VoIP line used with the SIP protocol.

multiple-call mode: configuration mode of a multiple call line from a DECT system point of view, enabling several simultaneous incoming or outgoing calls on different PPs (i.e. this possibility is not disabled by configuration)

new generation DECT: further development of the DECT standard introducing wideband speech, improved data services, new slot types and other technical enhancements

none: special line identifier value defined in clause 7.7.56 of EN 300 175 5 [5], used to indicate that the line id for the external call is not yet known.

NOTE: It is used for FP managed line selection (clauses 7.4.3.5.1 and 7.4.5.2.4) and, as a special case, for call intrusion (clause 7.4.3.8).

NG-DECT Part 1 (PP or FP) : PP or FP compliant with TS 102 527-1 [21].

NG-DECT Part 3 (PP or FP) : PP or FP compliant with the present document.

off-hook CLIP: ability of a network to send CLIP information for a waiting call (also known as "CLIP on call waiting" or "CLIP phase II")

single-call mode: configuration mode of a multiple call line from a DECT system point of view, in which the possibility of making several fully parallel call is (temporarily) disabled

NOTE: This mode may be useful for a user alone in the home. This mode does not prevent several simultaneous calls on the same PP. A line which is not "multiple call" (for instance a PSTN line only enabling double calls) is also said to be in "single call" mode.

super-wideband speech: voice service with enhanced quality compared to ADPCM G.726 and allowing the transmission of a maximum vocal frequency of at least 14 kHz

wideband speech: voice service with enhanced quality compared to ADPCM G.726 and allowing the transmission of a vocal frequency range of at least 150 Hz to 7 kHz, and fulfilling, at least, the audio performance requirements described in the ITU-T Recommendation P.311 [i.6]

3.2 Symbols

For the purposes of the present document, the following symbols apply:

M	mandatory to support (provision mandatory, process mandatory)
O	optional to support (provision optional, process mandatory)
I	out-of-scope (provision optional, process optional) not subject for testing
C	conditional to support (process mandatory)
N/A	not applicable (in the given context the specification makes it impossible to use this capability)

Provision mandatory, process mandatory means that the indicated feature service or procedure shall be implemented as described in the present document, and may be subject to testing.

Provision optional, process mandatory means that the indicated feature, service or procedure may be implemented, and if implemented, the feature, service or procedure shall be implemented as described in the present document, and may be subject to testing.

NOTE: The used notation is based on the notation proposed in ISO/IEC 9646-7 [14].

3.3 Abbreviations

For the purposes of the present document, the following abbreviations apply:

AAC	Advanced Audio Coding (MPEG)
AC	Authentication Code
ADPCM	Adaptive Differential Pulse Code Modulation
AI	Air Interface
CC	Call Control
CFB	Call Forwarding on Busy
CFNA	Call Forwarding on No Answer
CFU	Call Forwarding Unconditional
CI	Common Interface
CLIP	Calling Line Identification Presentation
CLIR	Calling Line Identity Restriction
CNIP	Calling Name Identification Presentation
DCIBS	Double Call with In-Band Signalling
DECT	Digital Enhanced Cordless Telecommunications
DLC	Data Link Control
DNS	Domain Name System
DTMF	Dual Tone Multi-Frequency
ER	Error Resilient (MPEG)
FP	Fixed Part
FT	Fixed radio Termination
GAP	Generic Access Profile
GMT	Greenwich Mean Time
HPP	Headset Portable Part
HTTP	HyperText Transfer Protocol
IA	Implementation Alternative
IE	Information Element
IP	Internet Protocol
IPUI	International Portable User Identity
ISDN	Integrated Services Digital Network
IWU	InterWorking Unit
LA	Location Area
LD	Low Delay (MPEG)
LiA	List Access
LLME	Lower Layer Management Entity

MAC	Medium Access Control
MM	Mobility Management
MMI	Man Machine Interface
NG	New Generation
NG-DECT	New Generation DECT
NWK	NetWorK
P	Public (environment)
PARK	Portable Access Rights Key
PHL	PHysical Layer
PP	Portable Part
PSTN	Public Switched Telephone Network
PT	Portable radio Termination
R/B	Residential/Business (environment)
RFP	Radio Fixed Part
S/T	ISDN S/T Interface
SARI	Secondary Access Rights Identity
TCLw	weighted Telephone Coupling Loss
TPUI	Temporary Portable User Identity
TRUP	TRansparent UnProtected service
U	ISDN U-Interface
UMT	Universal Mean Time
VoIP	Voice over IP
WB	WideBand
SUOTA	Software Update Over The Air
ISBC	???
MWI	Message Waiting Indication

4 Description of Services

4.1 Enhanced wideband speech

The present document is defined as an extension of New Generation DECT; part 1: wideband speech (TS 102 527-1 [21]). All devices compliant with the present document shall implement wideband (150 Hz to 7 kHz) audio with 16 kHz frequency sampling, and shall implement, at least, the speech coding format according to ITU-T Recommendation G.722 [17]. In addition to that, other wideband and superwideband audio codecs, providing even better audio quality, may be implemented.

See TS 102 527-1 [21], clause 4.1 for description about wideband speech.

4.1.1 Back-compatibility with GAP

The present document is backcompatible with Generic Access Profile (GAP) EN 300 444 [12]. All devices compliant with the present document shall implement ADPCM narrowband speech service according to ITU-T Recommendation G.726 [15], with automatic detection of the capabilities of the other peer.

4.1.2 Further enhancement in audio performance requirements

The present document implements a further enhancement in acoustic wideband performance compared to TS 102 527-1 [21]: the more demanding audio specifications PP types 2b and 2c (see EN 300 175-8 [8]) are mandatory for all PPs compliant with the present document. With this extra requirement, the acoustic performance of the wideband speech service will be even better than the ITU standard for wideband audio, ITU-T Recommendation P.311 [i.6].

See also TS 102 527-1 [21], clause 4.1.1.

The present document implements also a further enhancement in acoustic performance for 3,1 kHz narrowband service compared to GAP (EN 300 444 [12]) and TS 102 527-1 [21]: the more demanding audio specifications for PP types 1c and 1d (see EN 300 175-8 [8]) are mandatory for all PPs compliant with the present document. With this extra requirement, the acoustic performance of PPs compliant with the present document, when operating in 3,1 kHz narrowband service, will be even better than classic DECT/GAP specification.

All audio types used by the present document are compatible with VoIP or long delay networks.

4.2 Wideband speech scenarios

See TS 102 527-1 [21], clause 4.2.

4.3 Extended wideband speech services defined in the present document

The following additional services are provided by the present document, compared to TS 102 527-1 [21]:

- More demanding audio specifications for both; wideband and narrowband (see clause 4.1.2).
- New simplified, "easy pairing" procedures.
- New "no-emission" mode in FPs (switching down the dummy bearer when in idle mode).
- Date and time synchronization.
- CLIP and CNIP are now mandatory features.
- Internal call and wideband Internal call (mandatory features).
- CLIP and CNIP for Internal calls (mandatory features).
- Generic Event notification mechanism, providing support for:
 - Message waiting indication.
 - Missed call notification.
- List access service.
- Handling of multiple calls between the same PP and the RFP.
- CLIP and CNIP on call waiting.
- CLIP and CNIP on call transfer.
- Call deflection.
- Call identification and Line identification features.
- CLIR feature.
- Multiple calls and multiple lines features.
- Mutualised parallel calls.
- New system settings and line settings.
- Informative annexes with more examples of flowcharts, including system settings, multiple calls and parallel calls.

The new extended services, take in to account the additional scenarios possible in DECT systems connected to the network via VoIP interfaces.

5 Service and feature definitions

5.1 New Generation DECT Speech Services

For the purposes of the present document, the definitions of TS 102 527-1 [21], clause 5.1 shall apply.

5.2 Network (NWK) features

For the purposes of the present document, all definitions of TS 102 527-1 [21], clause 5.2 and EN 300 444 [12], clause 4.1, plus the following shall apply:

Missed call notification [NG1.N.3]: ability to inform a user that a call has been missed.

Voice message waiting notification [NG1.N.4]: ability to inform a user that a voice message has been left in the voice mailbox to which the user has access.

Date and time synchronization [NG1.N.5]: ability to synchronize the date and time on the DECT system. From FP to all registered PP or from one registered PP to the FP.

Parallel calls [NG1.N.6]: ability to handle in the DECT system two or more simultaneous calls originated or terminated in the same PP.

Common parallel call procedures (external or internal) [NG1.N.7]: set of common procedures for handling PSTN double calls, SIP multiple calls on a single line, as well as parallel call situations occurring in a multiple line DECT system.

Call transfer (internal or external) [NG1.N.8]: ability to create a new call while already involved in a call and connect the remote party to it (kind of parallel calls).

3-party conference call (internal or external) [NG1.N.9]: ability to connect the local party and the two remote parties of two parallel calls into a single conference (kind of parallel calls).

Intrusion call [NG1.N.10]: ability for a PP not participating to an already established call to connect to it (kind of parallel calls). Intrusion call is also known as "barging in".

Call deflection [NG1.N.11]: ability to redirect an incoming call during the call presentation to another user.

Line identification [NG1.N.12]: ability to exchange between the PP and FP a line identifier for external calls.

Call identification [NG1.N.13]: ability to exchange between the PP and FP a call identifier assigned by the FP at call setup and call statuses from FP to PP.

Multiple lines [NG1.N.14]: ability for a DECT System to handle several external lines.

Multiple calls [NG1.N.15]: ability for a DECT System to handle a line supporting several simultaneous external calls.

List access service [NG1.N.16]: ability to store information on the DECT system in a set of lists on the FP and manage these lists from the PP.

Calling Line Identity Restriction (CLIR) [NG1.N.17]: ability for the user to hide the identity of his line (i.e. Calling Line Identity Presentation) to the called party.

Call forwarding [NG1.N.18]: ability to request to the network a redirection of incoming calls.

DTMF handling [NG1.N.19]: ability to handle DTMF signalling and generation.

Tones provision [NG1.N.20]: ability to support complete call progress tones generation.

Headset management [NG1.N.21]: ability to handle calls with a headset PP in a DECT system.

Handling of lines where second calls are signalled in-band [NG1.N.22]: ability to handle second calls on PSTN lines or lines following similar rules.

5.3 Data Link Control (DLC) service definitions

For the purposes of the present document, all definitions of TS 102 527-1 [21], clause 5.3 and EN 300 444 [12], clause 5.1 shall apply.

5.4 Medium Access Control (MAC) service definitions

For the purposes of the present document, all definitions of TS 102 527-1 [21], clause 5.4 and EN 300 444 [12], clause 5.2, plus the following shall apply:

"no emission" mode [NG1.M.5]: ability to deactivate all radio transmissions in a DECT FP when it does not handle any call. Power-down is negotiated and an algorithm is provided, that guarantees a short resynchronization time, if an RF-connection is required by any of the peers.

5.5 Physical Layer (PHL) service definitions

For the purposes of the present document, all definitions of TS 102 527-1 [21], clause 5.5 shall apply.

5.6 Speech coding and audio feature definitions

For the purposes of the present document, all definitions of TS 102 527-1 [21], clause 5.6 shall apply.

5.7 Application features

For the purposes of the present document, all definitions of EN 300 444 [12], clause 4.2 plus the following shall apply.

Easy PIN code registration [NG1.A.1]: ability to invite the user to register a PP that is not registered to a FP. The access rights procedure is triggered by PIN entering.

Easy pairing registration [NG1.A.2]: ability to register a PP that is not registered to a FP by pressing a physical or logical button on the PP and on the FP.

Handset locator [NG1.A.3]: ability to locate physically handsets (have them ring) by pressing a physical or logical button on the FP.

6 Inter-operability requirements

6.1 General

The tables listed in this clause define the status of all protocol elements (i.e. features, services, and procedures) which can be: mandatory, optional, conditional under the provision of another protocol element, outside the scope of the present document, or not applicable. The status is identified by the status column designations defined in clause 3.2, and is described separately for FT and PT. In the case of FT, the status can be different for products intended for the Residential/Business (R/B) market or for the Public market segment.

All optional elements shall be process mandatory according to the procedures described in the present document.

Protocol elements defined as mandatory, optional or conditional in this clause are further defined in the referenced DECT specification, or, if needed, in clause 7 of the present document.

New Generation DECT wideband speech is defined as a backcompatible enhancement of EN 300 444 [12] (Generic Access Profile (GAP)). All procedures not specific of the New Generation DECT, are referenced to their original description in EN 300 444 [12] (GAP).

The requirements of EN 301 406 [11] and EN 300 176-2 [10] shall be met by all equipment conforming to the present document.

6.2 New Generation DECT Speech Services support status

The following end-user services shall be supported by "New Generation DECT; part 3: Extended wideband speech services" devices shall support the following end-user services.

Table 1: Speech service status

Feature supported					
Item no.	Name of Service	Reference	PT	Status	
				FT	
				R/B	P
NG1.1	Narrow band ADPCM G.726 32 kbit/s voice service	5.1 [21]	M	M	M
NG1.2	Narrow band PCM G.711 64 kbit/s voice service	5.1 [21]	O	O	O
NG1.3	Wideband G.722 64 kbit/s voice service	5.1 [21]	M	M	M
NG1.4	Wideband G.729.1 32 kbit/s voice service	5.1 [21]	O	O	O
NG1.5	MPEG-4 ER AAC-LD super wideband 64 kbit/s voice service	5.1 [21]	O	O	O
NG1.6	MPEG-4 ER AAC-LD wideband 32 kbit/s voice service	5.1 [21]	O	O	O

6.3 Services to DECT feature implementation mappings

"New Generation DECT; part 3: Extended wideband speech services" end user services shall be implemented using the DECT features and implementation alternatives defined in table 2.

Table 2: Speech service to DECT features implementation mappings

Service/DECT Feature mapping						
Service	IA	DECT feature/service	Reference	PT	Status	
					FT	
					R/B	P
NG1.1 Narrow band ADPCM G.726 32 kbit/s voice service	I		5.1 [21]	M	M	M
		NG1.P.1 2 level GFSK modulation	5.5 [21]	M	M	M
		NG1.P.2 Physical Packet P32	5.5 [21]	M	M	M
		NG1.M.1 I _N minimum delay symmetric MAC service type	5.4 [21]	M	M	M
		GAP.M.4 Basic Connections	5.2 [12]	M	M	M
		NG1.M.4 Advanced Connections	5.4 [21]	C201	C201	C201
		NG1.D.1 DLC Service LU1 TRUP Class 0/min_delay	5.3 [21]	M	M	M
		NG1.D.5 DLC frame FU1	5.3 [21]	M	M	M
		NG1.SC.1 ITU-T Recommendation G.726 [15] 32 kbit/s ADPCM codec	5.6 [21]	M	M	M
		NG1.SC.10 PP Audio type 1a (classic GAP handset)	5.6 [21]	I	N/A	N/A
		NG1.SC.11 PP Audio type 1b (improved GAP handset)	5.6 [21]	I	N/A	N/A
		NG1.SC.12 PP Audio type 1c (HATS 3,1 kHz handset)	5.6 [21]	C702	N/A	N/A
		NG1.SC.13 PP Audio type 1d (HATS 3,1 kHz improved handset)	5.6 [21]	C702	N/A	N/A
		NG1.SC.17 PP Audio type 3a (HATS 3,1 kHz handsfree)	5.6 [21]	O	N/A	N/A
		NG1.SC.18 PP Audio type 3b (HATS 3,1 kHz improved handsfree)	5.6 [21]	O	N/A	N/A
		NG1.SC.23 FP Audio type 1b (new ISDN 3,1 kHz)	5.6 [21]	N/A	C706	C706
		NG1.SC.24 PP echo canceller for FP, narrowband	5.6 [21]	N/A	C707	C707
		NG1.SC.25 PP echo spressor for FP, narrowband	5.6 [21]	N/A	C707	C707
		NG1.SC.26 FP Audio type 2 (analog PSTN 3,1 kHz)	5.6 [21]	N/A	C706	C706

Service/DECT Feature mapping						
Service	IA	DECT feature/service	Reference	PT	Status	
					FT	
					R/B	P
		NG1.SC.27 FP Audio type 3 (VoIP 3,1 kHz)	5.6 [21]	N/A	C706	C706
		NG1.SC.32 FP Audio type 6a (internal call)	5.6 [21]	N/A	M	M
		NG1.SC.33 FP Audio type 6b (internal conference)	5.6 [21]	N/A	O	O
		NG1.SC.34 Adaptive volume control for FP	5.6 [21]	N/A	O	O
NG1.2 Narrow band PCM G.711 64 kbit/s voice service	I		5.1 [21]	O	O	O
		NG1.P.1 2 level GFSK modulation	5.5 [21]	M	M	M
		NG1.P.3 Physical Packet P64	5.5 [21]	M	M	M
		NG1.M.1 I _N _minimum delay symmetric MAC service type	5.4 [21]	M	M	M
		NG1.M.4 Advanced Connections	5.4 [21]	M	M	M
		NG1.D.1 DLC Service LU1 TRUP Class 0/min_delay	5.3 [21]	M	M	M
		NG1.D.5 DLC frame FU1	5.3 [21]	M	M	M
		NG1.SC.2 ITU-T Recommendation G.711 [16] 64 kbit/s PCM codec	5.6 [21]	M	M	M
		NG1.SC.8 Detection of Fax/modem tone	5.6 [21]	O	O	O
		NG1.SC.9 Codec selection and switching	5.6 [21]	M	M	M
		NG1.SC.10 PP Audio type 1a (classic GAP handset)	5.6 [21]	I	N/A	N/A
		NG1.SC.11 PP Audio type 1b (improved GAP handset)	5.6 [21]	I	N/A	N/A
		NG1.SC.12 PP Audio type 1c (HATS 3,1 kHz handset)	5.6 [21]	C702	N/A	N/A
		NG1.SC.13 PP Audio type 1d (HATS 3,1 kHz improved handset)	5.6 [21]	C702	N/A	N/A
		NG1.SC.17 PP Audio type 3a (HATS 3,1 kHz handsfree)	5.6 [21]	O	N/A	N/A
		NG1.SC.18 PP Audio type 3b (HATS 3,1 kHz improved handsfree)	5.6 [21]	O	N/A	N/A
		NG1.SC.23 FP Audio type 1b (new ISDN 3,1 kHz)	5.6 [21]	N/A	C706	C706
		NG1.SC.24 PP echo canceller for FP, narrowband	5.6 [21]	N/A	C707	C707
		NG1.SC.25 PP echo supressor for FP, narrowband	5.6 [21]	N/A	C707	C707
		NG1.SC.26 FP Audio type 2 (analog PSTN 3,1 kHz)	5.6 [21]	N/A	C706	C706
		NG1.SC.27 FP Audio type 3 (VoIP 3,1 kHz)	5.6 [21]	N/A	C706	C706
		NG1.SC.32 FP Audio type 6a (internal call)	5.6 [21]	N/A	M	M
		NG1.SC.33 FP Audio type 6b (internal conference)	5.6 [21]	N/A	O	O
		NG1.SC.34 Adaptive volume control for FP	5.6 [21]	N/A	O	O

Service/DECT Feature mapping						
Service	IA	DECT feature/service	Reference	PT	Status	
					FT	
					R/B	P
NG1.2 Narrow band PCM G.711 64 kbit/s voice service	II		5.1 [21]	O	O	O
		NG1.P.1 2 level GFSK modulation	5.5 [21]	M	M	M
		NG1.P.4 Physical Packet P67	5.5 [21]	M	M	M
		NG1.M.3 I _{PQ} _error_detection symmetric MAC service type	5.4 [21]	M	M	M
		NG1.M.4 Advanced Connections	5.4 [21]	M	M	M
		NG1.D.1 DLC Service LU1 TRUP Class 0/min_delay	5.3 [21]	M	M	M
		NG1.D.5 DLC frame FU1	5.3 [21]	M	M	M
		NG1.SC.2 ITU-T Recommendation G.711 [16] 64 kbit/s PCM codec	5.6 [21]	M	M	M
		NG1.SC.8 Detection of Fax/modem tone	5.6 [21]	O	O	O
		NG1.SC.9 Codec selection and switching	5.6 [21]	M	M	M
		NG1.SC.10 PP Audio type 1a (classic GAP handset)	5.6 [21]	I	N/A	N/A
		NG1.SC.11 PP Audio type 1b (improved GAP handset)	5.6 [21]	I	N/A	N/A
		NG1.SC.12 PP Audio type 1c (HATS 3,1 kHz handset)	5.6 [21]	C702	N/A	N/A
		NG1.SC.13 PP Audio type 1d (HATS 3,1 kHz improved handset)	5.6 [21]	C702	N/A	N/A
		NG1.SC.17 PP Audio type 3a (HATS 3,1 kHz handsfree)	5.6 [21]	O	N/A	N/A
		NG1.SC.18 PP Audio type 3b (HATS 3,1 kHz improved handsfree)	5.6 [21]	O	N/A	N/A
		NG1.SC.23 FP Audio type 1b (new ISDN 3,1 kHz)	5.6 [21]	N/A	C706	C706
		NG1.SC.24 PP echo canceller for FP, narrowband	5.6 [21]	N/A	C707	C707
		NG1.SC.25 PP echo supressor for FP, narrowband	5.6 [21]	N/A	C707	C707
		NG1.SC.26 FP Audio type 2 (analog PSTN 3,1 kHz)	5.6 [21]	N/A	C706	C706
NG1.SC.27 FP Audio type 3 (VoIP 3,1 kHz)	5.6 [21]	N/A	C706	C706		
NG1.SC.32 FP Audio type 6a (internal call)	5.6 [21]	N/A	M	M		
NG1.SC.33 FP Audio type 6b (internal conference)	5.6 [21]	N/A	O	O		
NG1.SC.34 Adaptive volume control for FP	5.6 [21]	N/A	O	O		

Service/DECT Feature mapping						
Service	IA	DECT feature/service	Reference	PT	Status	
					FT	
					R/B	P
NG1.2 Narrow band PCM G.711 64 kbit/s voice service	III		5.1 [21]	O	O	O
		NG1.P.1 2 level GFSK modulation	5.5 [21]	M	M	M
		NG1.P.5 Physical Packet P80	5.5 [21]	M	M	M
		NG1.M.2 I _N _normal_delay symmetric MAC service type	5.4 [21]	M	M	M
		NG1.M.4 Advanced Connections	5.4 [21]	M	M	M
		NG1.D.3 DLC service LU7 64 kbit/s protected bearer service	5.3 [21]	M	M	M
		NG1.D.6 DLC frame FU7	5.3 [21]	M	M	M
		NG1.SC.2 ITU-T Recommendation G.711 [16] 64 kbit/s PCM codec	5.6 [21]	M	M	M
		NG1.SC.8 Detection of Fax/modem tone	5.6 [21]	O	O	O
		NG1.SC.9 Codec selection and switching	5.6 [21]	M	M	M
		NG1.SC.10 PP Audio type 1a (classic GAP handset)	5.6 [21]	I	N/A	N/A
		NG1.SC.11 PP Audio type 1b (improved GAP handset)	5.6 [21]	I	N/A	N/A
		NG1.SC.12 PP Audio type 1c (HATS 3,1 kHz handset)	5.6 [21]	C702	N/A	N/A
		NG1.SC.13 PP Audio type 1d (HATS 3,1 kHz improved handset)	5.6 [21]	C702	N/A	N/A
		NG1.SC.17 PP Audio type 3a (HATS 3,1 kHz handsfree)	5.6 [21]	O	N/A	N/A
		NG1.SC.18 PP Audio type 3b (HATS 3,1 kHz improved handsfree)	5.6 [21]	O	N/A	N/A
		NG1.SC.23 FP Audio type 1b (new ISDN 3,1 kHz)	5.6 [21]	N/A	C706	C706
		NG1.SC.24 PP echo canceller for FP, narrowband	5.6 [21]	N/A	C707	C707
		NG1.SC.25 PP echo supressor for FP, narrowband	5.6 [21]	N/A	C707	C707
		NG1.SC.26 FP Audio type 2 (analog PSTN 3,1 kHz)	5.6 [21]	N/A	C706	C706
		NG1.SC.27 FP Audio type 3 (VoIP 3,1 kHz)	5.6 [21]	N/A	C706	C706
		NG1.SC.32 FP Audio type 6a (internal call)	5.6 [21]	N/A	M	M
		NG1.SC.33 FP Audio type 6b (internal conference)	5.6 [21]	N/A	O	O
NG1.SC.34 Adaptive volume control for FP	5.6 [21]	N/A	O	O		

Service/DECT Feature mapping						
Service	IA	DECT feature/service	Reference	PT	Status	
					FT	
					R/B	P
NG1.3 Wideband 7 kHz G.722 64 kbit/s voice service	I		5.1 [21]	M	M	M
		NG1.P.1 2 level GFSK modulation	5.5 [21]	M	M	M
		NG1.P.3 Physical Packet P64	5.5 [21]	M	M	M
		NG1.M.1 I _N _minimum delay symmetric MAC service type	5.4 [21]	M	M	M
		NG1.M.4 Advanced Connections	5.4 [21]	M	M	M
		NG1.D.1 DLC Service LU1 TRUP Class 0/min_delay	5.3 [21]	M	M	M
		NG1.D.5 DLC frame FU1	5.3 [21]	M	M	M
		NG1.SC.3 ITU-T Recommendation G.722 [17] 64 kbit/s 7 kHz wideband codec	5.6 [21]	M	M	M
		NG1.SC.7 Packet loss Concealment (PLC) for ITU-T Recommendation G.722 [17]	5.6 [21]	O	O	O
		NG1.SC.9 Codec selection and switching	5.6 [21]	M	M	M
		NG1.SC.14 PP Audio type 2a (ITU-T Recommendation P.311 [i.6] 7 kHz handset)	5.6 [21]	I	N/A	N/A
		NG1.SC.15 PP Audio type 2b (HATS 7 kHz handset)	5.6 [21]	C703	N/A	N/A
		NG1.SC.16 PP Audio type 2c (HATS 7 kHz improved handset)	5.6 [21]	C703	N/A	N/A
		NG1.SC.19 PP Audio type 4a (HATS 7 kHz handsfree)	5.6 [21]	O	N/A	N/A
		NG1.SC.20 PP Audio type 4b (HATS 7 kHz improved handsfree)	5.6 [21]	O	N/A	N/A
		NG1.SC.28 FP Audio type 4 (ISDN wideband)	5.6 [21]	N/A	C708	C708
		NG1.SC.29 FP Audio type 5 (VoIP wideband)	5.6 [21]	N/A	C708	C708
		NG1.SC.30 NG1.SC.24 PP echo canceller for FP, wideband	5.6 [21]	N/A	C709	C709
		NG1.SC.31 NG1.SC.24 PP echo suppressor for FP, wideband	5.6 [21]	N/A	C709	C709
		NG1.SC.32 FP Audio type 6a (internal call)	5.6 [21]	N/A	M	M
NG1.SC.33 FP Audio type 6b (internal conference)	5.6 [21]	N/A	O	O		
NG1.SC.34 Adaptive volume control	5.6 [21]	N/A	O	O		

Service/DECT Feature mapping						
Service	IA	DECT feature/service	Reference	PT	Status	
					FT	
					R/B	P
NG1.3 Wideband 7 kHz G.722 64 kbit/s voice service	II		5.1 [21]	O	O	O
		NG1.P.1 2 level GFSK modulation	5.5 [21]	M	M	M
		NG1.P.3 Physical Packet P67	5.5 [21]	M	M	M
		NG1.M.3 I _{PQ} _error_detection symmetric MAC service type	5.4 [21]	M	M	M
		NG1.M.4 Advanced Connections	5.4 [21]	M	M	M
		NG1.D.1 DLC Service LU1 TRUP Class 0/min_delay	5.3 [21]	M	M	M
		NG1.D.5 DLC frame FU1	5.3 [21]	M	M	M
		NG1.SC.3 ITU-T Recommendation G.722 [17] 64 kbit/s 7 kHz wideband codec	5.6 [21]	M	M	M
		NG1.SC.7 Packet loss Concealment (PLC) for ITU-T Recommendation G.722 [17]	5.6 [21]	O	O	O
		NG1.SC.9 Codec selection and switching	5.6 [21]	M	M	M
		NG1.SC.14 PP Audio type 2a (ITU-T Recommendation P.311 [i.6] 7 kHz handset)	5.6 [21]	I	N/A	N/A
		NG1.SC.15 PP Audio type 2b (HATS 7 kHz handset)	5.6 [21]	C703	N/A	N/A
		NG1.SC.16 PP Audio type 2c (HATS 7 kHz improved handset)	5.6 [21]	C703	N/A	N/A
		NG1.SC.19 PP Audio type 4a (HATS 7 kHz handsfree)	5.6 [21]	O	N/A	N/A
		NG1.SC.20 PP Audio type 4b (HATS 7 kHz improved handsfree)	5.6 [21]	O	N/A	N/A
		NG1.SC.28 FP Audio type 4 (ISDN wideband)	5.6 [21]	N/A	C708	C708
		NG1.SC.29 FP Audio type 5 (VoIP wideband)	5.6 [21]	N/A	C708	C708
		NG1.SC.30 NG1.SC.24 PP echo canceller for FP, wideband	5.6 [21]	N/A	C709	C709
		NG1.SC.31 NG1.SC.24 PP echo supressor for FP, wideband	5.6 [21]	N/A	C709	C709
		NG1.SC.32 FP Audio type 6a (internal call)	5.6 [21]	N/A	M	M
NG1.SC.33 FP Audio type 6b (internal conference)	5.6 [21]	N/A	O	O		
NG1.SC.34 Adaptive volume control	5.6 [21]	N/A	O	O		

Service/DECT Feature mapping						
Service	IA	DECT feature/service	Reference	PT	Status	
					FT	
					R/B	P
NG1.4 Wideband 7 kHz G.729.1 32 kbit/s voice service	I		5.1 [21]	O	O	O
		NG1.P.1 2 level GFSK modulation	5.5 [21]	M	M	M
		NG1.P.3 Physical Packet P32	5.5 [21]	M	M	M
		NG1.M.2 I _N _normal_delay symmetric MAC service type	5.4 [21]	M	M	M
		NG1.M.4 Advanced Connections	5.4 [21]	M	M	M
		NG1.D.4 DLC service LU12 (UNF) Class 0	5.3 [21]	M	M	M
		NG1.D.7 DLC frame FU12 with adaptation for codec G.729.1	5.3 [21]	M	M	M
		NG1.SC.4 ITU-T Recommendation G.729.1 [18] 32 kbit/s 7 kHz wideband codec	5.6 [21]	M	M	M
		NG1.SC.9 Codec selection and switching	5.6 [21]	M	M	M
		NG1.SC.14 PP Audio type 2a (ITU-T Recommendation P.311 [i.6] 7 kHz handset)	5.6 [21]	I	N/A	N/A
		NG1.SC.15 PP Audio type 2b (HATS 7 kHz handset)	5.6 [21]	C703	N/A	N/A
		NG1.SC.16 PP Audio type 2c (HATS 7 kHz improved handset)	5.6 [21]	C703	N/A	N/A
		NG1.SC.19 PP Audio type 4a (HATS 7 kHz handsfree)	5.6 [21]	O	N/A	N/A
		NG1.SC.20 PP Audio type 4b (HATS 7 kHz improved handsfree)	5.6 [21]	O	N/A	N/A
		NG1.SC.28 FP Audio type 4 (ISDN wideband)	5.6 [21]	N/A	C708	C708
		NG1.SC.29 FP Audio type 5 (VoIP wideband)	5.6 [21]	N/A	C708	C708
		NG1.SC.30 NG1.SC.24 PP echo canceller for FP, wideband	5.6 [21]	N/A	C709	C709
		NG1.SC.31 NG1.SC.24 PP echo suppressor for FP, wideband	5.6 [21]	N/A	C709	C709
		NG1.SC.32 FP Audio type 6a (internal call)	5.6 [21]	N/A	M	M
		NG1.SC.33 FP Audio type 6b (internal conference)	5.6 [21]	N/A	O	O
NG1.SC.34 Adaptive volume control	5.6 [21]	N/A	O	O		

Service/DECT Feature mapping						
Service	IA	DECT feature/service	Reference	PT	Status	
					FT	
					R/B	P
NG1.5 Superwideband 14 kHz MPEG-4 ER AAC-LD 64 kbit/s voice service	I		5.1 [21]	O	O	O
		NG1.P.1 2 level GFSK modulation	5.5 [21]	M	M	M
		NG1.P.3 Physical Packet P64	5.5 [21]	M	M	M
		NG1.M.2 I _N _normal_delay symmetric MAC service type	5.4 [21]	M	M	M
		NG1.M.4 Advanced Connections	5.4 [21]	M	M	M
		NG1.D.2 DLC Service LU1 Class 0	5.4 [21]	M	M	M
		NG1.D.5 DLC frame FU1	5.3 [21]	M	M	M
		NG1.SC.5 MPEG4 AAC-LD 64 kbit/s 14 kHz superwideband codec	5.6 [21]	M	M	M
		NG1.SC.9 Codec selection and switching	5.6 [21]	M	M	M
		NG1.SC.21 PP Audio type 5a (Superwideband 14 KHz handset)	5.6 [21]	M	N/A	N/A
		NG1.SC.22 PP Audio type 5b (Superwideband 14 KHz handsfree)	5.6 [21]	O	N/A	N/A
		NG1.SC.28 FP Audio type 4 (ISDN wideband)	5.6 [21]	N/A	C708	C708
		NG1.SC.29 FP Audio type 5 (VoIP wideband)	5.6 [21]	N/A	C708	C708
		NG1.SC.32 FP Audio type 6a (internal call)	5.6 [21]	N/A	M	M
		NG1.SC.33 FP Audio type 6b (internal conference)	5.6 [21]	N/A	O	O
NG1.SC.34 Adaptive volume control for FP	5.6 [21]	N/A	O	O		
NG1.5 Superwideband 14 kHz MPEG-4 ER AAC-LD 64 kbit/s voice service	II		5.1 [21]	O	O	O
		NG1.P.1 2 level GFSK modulation	5.5 [21]	M	M	M
		NG1.P.3 Physical Packet P67	5.5 [21]	M	M	M
		NG1.M.3 I _{PQ} _error_detection symmetric MAC service type	5.4 [21]	M	M	M
		NG1.M.4 Advanced Connections	5.4 [21]	M	M	M
		NG1.D.2 DLC service LU1 Class 0	5.3 [21]	M	M	M
		NG1.D.5 DLC frame FU1	5.3 [21]	M	M	M
		NG1.SC.5 MPEG4 AAC-LD 64 kbit/s 14 kHz superwideband codec	5.6 [21]	M	M	M
		NG1.SC.9 Codec selection and switching	5.6 [21]	M	M	M
		NG1.SC.21 PP Audio type 5a (Superwideband 14 KHz handset)	5.6 [21]	M	N/A	N/A
		NG1.SC.22 PP Audio type 5b (Superwideband 14 KHz handsfree)	5.6 [21]	O	N/A	N/A
		NG1.SC.28 FP Audio type 4 (ISDN wideband)	5.6 [21]	N/A	C708	C708
		NG1.SC.29 FP Audio type 5 (VoIP wideband)	5.6 [21]	N/A	C708	C708
		NG1.SC.32 FP Audio type 6a (internal call)	5.6 [21]	N/A	M	M
		NG1.SC.33 FP Audio type 6b (internal conference)	5.6 [21]	N/A	O	O
NG1.SC.34 Adaptive volume control for FP	5.6 [21]	N/A	O	O		

Service/DECT Feature mapping						
Service	IA	DECT feature/service	Reference	PT	Status	
					FT	
					R/B	P
NG1.6 Wideband 11 kHz MPEG-4 ER AAC-LD 32 kbit/s voice service	I		5.1 [21]	O	O	O
		NG1.P.1 2 level GFSK modulation	5.5 [21]	M	M	M
		NG1.P.3 Physical Packet P32	5.5 [21]	M	M	M
		NG1.M.2 I _N _normal_delay symmetric MAC service type	5.4 [21]	M	M	M
		NG1.M.4 Advanced Connections	5.4 [21]	M	M	M
		NG1.D.2 DLC service LU1 Class 0	5.4 [21]	M	M	M
		NG1.D.5 DLC frame FU1	5.3 [21]	M	M	M
		NG1.SC.6 MPEG4 AAC-LD 32 kbit/s 11 kHz wideband codec	5.6 [21]	M	M	M
		NG1.SC.9 Codec selection and switching	5.6 [21]	M	M	M
		NG1.SC.14 PP Audio type 2a (ITU-T Recommendation P.311 [i.6] 7 kHz handset)	5.6 [21]	I	N/A	N/A
		NG1.SC.15 PP Audio type 2b (HATS 7 kHz handset)	5.6 [21]	C703	N/A	N/A
		NG1.SC.16 PP Audio type 2c (HATS 7 kHz improved handset)	5.6 [21]	C703	N/A	N/A
		NG1.SC.19 PP Audio type 4a (HATS 7 kHz handsfree)	5.6 [21]	O	N/A	N/A
		NG1.SC.20 PP Audio type 4b (HATS 7 kHz improved handsfree)	5.6 [21]	O	N/A	N/A
		NG1.SC.28 FP Audio type 4 (ISDN wideband)	5.6 [21]	N/A	C708	C708
		NG1.SC.29 FP Audio type 5 (VoIP wideband)	5.6 [21]	N/A	C708	C708
		NG1.SC.30 NG1.SC.24 PP echo canceller for FP, wideband	5.6 [21]	N/A	C709	C709
		NG1.SC.31 NG1.SC.24 PP echo suppressor for FP, wideband	5.6 [21]	N/A	C709	C709
		NG1.SC.32 FP Audio type 6a (internal call)	5.6 [21]	N/A	M	M
		NG1.SC.33 FP Audio type 6b (internal conference)	5.6 [21]	N/A	O	O
NG1.SC.34 Adaptive volume control	5.6 [21]	N/A	O	O		

IA = Implementation Alternative:

C201: Advanced connections for Service NG1.1 shall only be used in the case of multiple connections between the same PT-FT pair. The support of this case is optional.

C702: At least one should be provided. C703: At least one should be provided.).

C706: At least one should be provided.

C707: IF feature NG1.SC.23 (FP type 1b) OR NG1.SC.27 (FP type 3) THEN O ELSE I. Either NG1.SC.24 or NG1.SC.25 may be provided, but not both at the same time.

C708: At least one should be provided.

C709: IF feature NG1.SC.28 (FP type 4) OR NG1.SC.29 (FP type 5) THEN O ELSE I. Either NG1.SC.30 or NG1.SC.31 may be provided, but not both at the same time.

6.4 NWK features

"New Generation DECT; part 3: Extended wideband speech services" devices shall support the following Network layer features.

Table 3: NWK features status

Feature supported					
Item no.	Name of feature	Reference	PT	Status	
				R/B	P
NG1.N.1	Codec Negotiation	5.2 [21]	M	M	M
NG1.N.2	Codec Switching	5.2 [21]	M	M	M
NG1.N.3	Missed call notification	5.2	M	M	M
NG1.N.4	Voice message waiting notification	5.2	M	M	M
NG1.N.5	Date and Time synchronization	5.2	M	M	M
NG1.N.6	Parallel calls	5.2	M	M, note 7	O
NG1.N.7	Common parallel call procedures (external or internal)	5.2	M	M, note 7	O
NG1.N.8	Call transfer (external or internal)	5.2	M	M	O
NG1.N.9	3-party conference with established external and/or internal calls	5.2	O	O, note 6	O, note 6
NG1.N.10	Intrusion call	5.2	O	O, note 6	O, note 6
NG1.N.11	Call deflection (external or internal)	5.2	O	O, note 6	O, note 6
NG1.N.12	Line identification	5.2	M	M	M
NG1.N.13	Call identification	5.2	M	M	M
NG1.N.14	Multiple Lines	5.2	M	O	O
NG1.N.15	Multiple calls	5.2	M	M	O
NG1.N.16	List access service	5.2	M	M	O
NG1.N.17	Calling line identity restriction	5.2	O	O	O
NG1.N.18	Call forwarding (external calls)	5.2	M	M	I
NG1.N.19	DTMF handling	5.2	M	M	O
NG1.N.20	Tones provision	5.2	M	M	O
NG1.N.21	Headset management	5.2	C301	M	O
NG1.N.22	Handling of lines where second calls are signalled in-band	5.2	M	O, note 7	O
GAP.N.1	Outgoing call	4.1 [12]	M	M	M
GAP.N.2	Off hook	4.1 [12]	M	M	M
GAP.N.3	On hook (full release)	4.1 [12]	M	M	M
GAP.N.4	Dialled digits (basic)	4.1 [12]	M	M	M
GAP.N.5	Register recall (see notes 4 and 5)	4.1 [12]	M	O	O
GAP.N.6	Go to DTMF signalling (defined tone length) (see note 1)	4.1 [12]	M	O	M
GAP.N.7	Pause (dialling pause) (see note 3)	4.1 [12]	M	O	O
GAP.N.8	Incoming call	4.1 [12]	M	M	M
GAP.N.9	Authentication of PP	4.1 [12]	M	M	M
GAP.N.10	Authentication of user (see note 2)	4.1 [12]	M	O	O
GAP.N.11	Location registration	4.1 [12]	M	O	M
GAP.N.12	On air key allocation (see note 2)	4.1 [12]	M	M	O
GAP.N.13	Identification of PP	4.1 [12]	M	O	O
GAP.N.14	Service class indication/assignment	4.1 [12]	M	O	M
GAP.N.15	Alerting	4.1 [12]	M	M	M
GAP.N.16	ZAP (see note 2)	4.1 [12]	M	O	O
GAP.N.17	Encryption activation FT initiated	4.1 [12]	M	M	M
GAP.N.18	Subscription registration procedure on-air	4.1 [12]	M	M	M
GAP.N.19	Link control	4.1 [12]	M	M	M
GAP.N.20	Terminate access rights FT initiated (see note 2)	4.1 [12]	M	M	O
GAP.N.21	Partial release	4.1 [12]	O	O	O
GAP.N.22	Go to DTMF (infinite tone length)	4.1 [12]	O	O	O
GAP.N.23	Go to Pulse	4.1 [12]	O	O	O
GAP.N.24	Signalling of display characters	4.1 [12]	O	O	O
GAP.N.25	Display control characters	4.1 [12]	O	O	O

Feature supported					
Item no.	Name of feature	Reference	PT	Status	
				R/B	P
GAP.N.26	Authentication of FT	4.1 [12]	O	O	O
GAP.N.27	Encryption activation PT initiated	4.1 [12]	O	O	O
GAP.N.28	Encryption deactivation FT initiated	4.1 [12]	O	O	O
GAP.N.29	Encryption deactivation PT initiated	4.1 [12]	O	O	O
GAP.N.30	Calling Line Identification Presentation (CLIP)	4.1 [12]	M	M	M
GAP.N.31	Internal call	4.1 [12]	M	M	M
GAP.N.32	Service call	4.1 [12]	O	O	O
GAP.N.33	Enhanced U- plane connection	4.1 [12]	O	O	O
GAP.N.34	Calling Name Identification Presentation (CNIP)	4.1 [12]	M	M	M
GAP.N.35	Enhanced security	4.1 [12]	M	M	M
C301: IF the PT is a headset PP THEN "M" ELSE "I".					
NOTE 1: The PT is only required to be able to send the <<MULTI-KEYPAD>> information element containing the DECT standard 8-bit character (EN 300 175-5 [5], annex D) codings "Go to DTMF", defined tone length and the FT is required to be able to understand it in the public environment.					
NOTE 2: This feature is required to be supported in the PT to guarantee the same level of security among all the handsets that operates in a system. The invocation of the feature is however optional to the operator.					
NOTE 3: The PT is required to be able to send the <<MULTI-KEYPAD>> information element containing the DECT standard 8-bit character (EN 300 175-5 [5], annex D) codings "Dialling Pause". This guarantees automatic access to secondary or alternative networks.					
NOTE 4: This feature uses keypad code 15 hex.					
NOTE 5: The FT is not mandated to receive and understand the register recall DECT character. However, if a FT supports it there may be no corresponding action that the FT can take with the local network as a result of this function.					
NOTE 6: If the feature is not supported on FT side, the FT shall however implement the "sending negative acknowledgement" procedure (see clause 7.4.3.4).					
NOTE 7: All procedures of NG1.N.6 and NG1.N.7 shall apply to all FTs and for all line types (full parallel call compliant lines and DCIBS lines). For DCIBS lines, the FT shall implement in addition NG1.N.22 feature, which describes some amendments to NG1.N.6 and NG1.N.7 for such lines. A given FT shall be designed to handle both line types, or only one of them.					

6.5 Data Link Control (DLC) services

"New Generation DECT; part 3: Extended wideband speech services" devices shall support the following DLC services.

Table 4: DLC services status

Service supported					
Item no.	Name of service	Reference	PT	Status	
				R/B	P
NG1.D.1	LU1 Transparent UnProtected service (TRUP) Class 0 /minimum_delay	5.3 [21]	M	M	M
NG1.D.2	LU1 Transparent UnProtected service (TRUP) Class 0	5.3 [21]	C401	C401	C401
NG1.D.3	LU7 64 kbit/s protected bearer service	5.3 [21]	C401	C401	C401
NG1.D.4	LU 12 Unprotected Framed service (UNF) Class 0	5.3 [21]	C401	C401	C401
NG1.D.5	FU1 DLC frame	5.3 [21]	M	M	M
NG1.D.6	FU7 DLC frame	5.3 [21]	C401	C401	C401
NG1.D.7	FU12 DLC frame with adaptation for codec G.729.1	5.3 [21]	C401	C401	C401
GAP.D.1	LAPC class A service and Lc	5.1 [12]	M	M	M
GAP.D.2	Cs channel fragmentation and recombination	5.1 [12]	M	M	M
GAP.D.3	Broadcast Lb service	5.1 [12]	M	M	M
GAP.D.4	Intra-cell voluntary connection handover	5.1 [12]	M	C402	C402
GAP.D.5	Intercell voluntary connection handover (see note)	5.1 [12]	M	O	O
GAP.D.6	Encryption activation	5.1 [12]	M	C404	M
GAP.D.9	Encryption deactivation	5.1 [12]	C403	C403	C403
C401: Status defined by clause 6.3, table 2.					
C402: IF service GAP.M.9 THEN O ELSE M.					
C403: IF feature GAP.N.29 OR GAP.N.28 THEN M ELSE I.					
C404: IF feature GAP.N.17 OR GAP.N.27 THEN M ELSE I.					

Service supported					
Item no.	Name of service	Reference	PT	Status	
				FT	
				R/B	P
NOTE:	The PT is required to be able to support handover between RFPs. The invocation of the feature is however optional to the operator.				

6.6 Medium Access Control (MAC) services

"New Generation DECT; part 3: Extended wideband speech services" devices shall support the following MAC layer services.

Table 5: MAC services status

Service supported					
Item no.	Name of service	Reference	PT	Status	
				FT	
				R/B	P
NG1.M.1	I _N _minimum delay symmetric MAC service type	5.4 [21]	M	M	M
NG1.M.2	I _N _normal delay symmetric MAC service type	5.4 [21]	C501	C501	C501
NG1.M.3	I _{PQ} _error_detection symmetric MAC service type	5.4 [21]	C501	C501	C501
NG1.M.4	Advanced connections	5.4 [21]	M	M	M
NG1.M.5	"no emission" mode	5.4	O	O	O
GAP.M.1	General	5.2 [12]	M	M	M
GAP.M.2	Continuous broadcast	5.2 [12]	M	M	M
GAP.M.3	Paging broadcast	5.2 [12]	M	M	M
GAP.M.4	Basic connections	5.2 [12]	M	M	M
GAP.M.5	C _S higher layer signalling	5.2 [12]	M	M	M
GAP.M.6	Quality control	5.2 [12]	M	M	M
GAP.M.7	Encryption activation	5.2 [12]	M	M	M
GAP.M.8	Extended frequency allocation (see note)	5.2 [12]	M	O	O
GAP.M.9	Bearer Handover, intra-cell	5.2 [12]	M	C502	C502
GAP.M.10	Bearer Handover, inter-cell	5.2 [12]	M	O	O
GAP.M.11	Connection Handover, intra-cell	5.2 [12]	M	C503	C503
GAP.M.12	Connection Handover, inter-cell	5.2 [12]	M	O	O
GAP.M.13	SARI support	5.2 [12]	M	O	O
GAP.M.14	Encryption deactivation	5.2 [12]	C504	C504	C504
GAP.M.15	Re-keying	5.2 [12]	C505	C505	C505
GAP.M.16	Early encryption	5.2 [12]	C506	C506	C506
C501:	Status defined by clause 6.3, table 2.				
C502:	IF service GAP.M.11 THEN O ELSE M.				
C503:	IF service GAP.M.9 THEN O ELSE M.				
C504:	IF feature GAP.N.29 OR N.28 THEN M ELSE I.				
C505:	IF NWK layer procedure "Re-keying during a call" is implemented THEN M ELSE O.				
C506:	IF NWK layer procedure "Early encryption" is implemented THEN M ELSE O.				
NOTE:	Handsets not supporting these extra frequencies need only adapt scanning to allow continued use of the standard DECT frequencies.				

6.7 Physical layer (PHL) services

"New Generation DECT; part 3: Extended wideband speech services" devices shall support the following Physical layer (PHL) services.

Table 6: PHL services status

Service supported					
Item no.	Name of service	Reference	PT	Status	
				FT	
				R/B	P
NG1.P.1	2 level GFSK modulation	5.5 [21]	M	M	M
NG1.P.2	Physical Packet P32	5.5 [21]	M	M	M
NG1.P.3	Physical Packet P64	5.5 [21]	M	M	M
NG1.P.4	Physical Packet P67	5.5 [21]	O	O	O
NG1.P.5	Physical Packet P80	5.5 [21]	O	O	O

The requirements of EN 300 444 [12], clause 11 also apply.

6.8 Speech coding and audio features

"New Generation DECT; part 3: Extended wideband speech services" devices shall support the following Speech coding and audio related features.

Table 7: Speech Coding and audio features

Service supported					
Item no.	Name of service	Reference	PT	Status	
				FT	
				R/B	P
NG1.SC.1	G.726 32 kbit/s ADPCM codec	5.6 [21]	M	M	M
NG1.SC.2	G.711 64 kbit/s PCM codec	5.6 [21]	C701	C701	C701
NG1.SC.3	G.722 64 kbit/s 7 kHz wideband codec	5.6 [21]	M	M	M
NG1.SC.4	G.729.1 32 kbit/s 7 kHz wideband codec	5.6 [21]	C701	C701	C701
NG1.SC.5	MPEG4 AAC-LD 64 kbit/s 14 kHz superwideband codec	5.6 [21]	C701	C701	C701
NG1.SC.6	MPEG4 AAC-LD 32 kbit/s 11 kHz wideband codec	5.6 [21]	C701	C701	C701
NG1.SC.7	Packet Loss Concealment (PLC) for G.722	5.6 [21]	C701	C701	C701
NG1.SC.8	Detection of Fax/modem tone	5.6 [21]	C701	C701	C701
NG1.SC.9	Codec selection and switching	5.6 [21]	M	M	M
NG1.SC.10	PP Audio profile type 1a (classic GAP handset)	5.6 [21]	I	N/A	N/A
NG1.SC.11	PP Audio profile type 1b (improved GAP handset)	5.6 [21]	I	N/A	N/A
NG1.SC.12	PP Audio profile type 1c (HATS 3,1 kHz handset)	5.6 [21]	C702	N/A	N/A
NG1.SC.13	PP Audio profile type 1d (HATS 3,1 kHz improved handset)	5.6 [21]	C702	N/A	N/A
NG1.SC.14	PP Audio profile type 2a (ITU-T Recommendation P.311 [i.6] 7 kHz handset)	5.6 [21]	I	N/A	N/A
NG1.SC.15	PP Audio profile type 2b (HATS 7 kHz handset)	5.6 [21]	C703	N/A	N/A
NG1.SC.16	PP Audio profile type 2c (HATS 7 kHz improved handset)	5.6 [21]	C703	N/A	N/A
NG1.SC.17	PP Audio profile type 3a (HATS 3,1 kHz handsfree)	5.6 [21]	O	N/A	N/A
NG1.SC.18	PP Audio profile type 3b (HATS 3,1 kHz improved handsfree)	5.6 [21]	O	N/A	N/A
NG1.SC.19	PP Audio profile type 4a (HATS 7 kHz handsfree)	5.6 [21]	O	N/A	N/A
NG1.SC.20	PP Audio profile type 4b (HATS 7 kHz improved handsfree)	5.6 [21]	O	N/A	N/A
NG1.SC.21	PP Audio profile type 5a superwideband (14 kHz) handset	5.6 [21]	C704	N/A	N/A
NG1.SC.22	PP Audio profile type 5b superwideband (14 kHz) handsfree	5.6 [21]	C705	N/A	N/A
NG1.SC.23	FP Audio type 1b (new ISDN 3,1 kHz)	5.6 [21]	N/A	C706	C706
NG1.SC.24	PP echo canceller for FP, narrowband	5.6 [21]	N/A	C707	C707
NG1.SC.25	PP echo supressor for FP, narrowband	5.6 [21]	N/A	C707	C707
NG1.SC.26	FP Audio type 2 (analog PSTN 3,1 kHz)	5.6 [21]	N/A	C706	C706
NG1.SC.27	FP Audio type 3 (VoIP 3,1 kHz)	5.6 [21]	N/A	C706	C706
NG1.SC.28	FP Audio type 4 (ISDN wideband)	5.6 [21]	N/A	C708	C708
NG1.SC.29	FP Audio type 5 (VoIP wideband)	5.6 [21]	N/A	C708	C708
NG1.SC.30	PP echo canceller for FP, wideband	5.6 [21]	N/A	C709	C709

Service supported					
Item no.	Name of service	Reference	PT	Status	
				FT	
				R/B	P
NG1.SC.31	PP echo suppressor for FP, wideband	5.6 [21]	N/A	C709	C709
NG1.SC.32	FP Audio type 6a (internal call)	5.6 [21]	N/A	M	M
NG1.SC.33	FP Audio type 6b (internal conference)	5.6 [21]	N/A	O	O
NG1.SC.34	Adaptive volume control for FP	5.6 [21]	N/A	O	O
C701:	Status defined by clause 6.3, table 2.				
C702:	At least one should be provided. C703:At least one should be provided. C704:IF Service NG1.5 (Superwideband) THEN M ELSE I.				
C705:	IF Service NG1.5 (Superwideband) THEN O ELSE I.				
C706:	At least one should be provided.				
C707:	IF feature NG1.SC.23 (FP type 1b) OR NG1.SC.27 (FP type 3) THEN O ELSE I. Either NG1.SC.24 or NG1.SC.25 may be provided, but not both at the same time.				
C708:	At least one should be provided.				
C709:	IF feature NG1.SC.28 (FP type 4) OR NG1.SC.29 (FP type 5) THEN O ELSE I. Either NG1.SC.30 or NG1.SC.31 may be provided, but not both at the same time.				

NOTE 1: Testing specification for audio features, including handsfree, is provided in EN 300 176-2 [10].

NOTE 2: PP types 1c, 1d, 2b and 2c are based on HATS methodology. This methodology provides objective test results more consistent with subjective tests compared to artificial ear methodology.

NOTE 3: All audio types used in the present document are compatible with VoIP or long delay networks.

6.9 Application features

"New Generation DECT; part 3: Extended wideband speech services" devices shall support the following Application features.

Table 8: Application features status

Feature supported					
Item no.	Name of feature	Reference	PT	Status	
				FT	
				R/B	P
NG1.A.1	Easy PIN code registration	5.7	M	O	N/A
NG1.A.2	Easy pairing registration	5.7	M	M	N/A
NG1.A.3	Handset locator	5.7	M	O	O
GAP.A.1	AC_bitstring_mapping	4.2 [12]	M	M	M
GAP.A.2	Multiple subscription registration	4.2 [12]	M	N/A	N/A
GAP.A.3	Manual entry of the PARK	4.2 [12]	O	N/A	N/A
GAP.A.4	Terminal identity number assignment in mono cell system	4.2 [12]	M	M	N/A

6.10 Network (NWK) feature to procedure mapping

The NWK features to procedure mapping of EN 300 444 [12] (GAP), clause 6.7 with the following changes and additional features shall apply.

Table 9: NWK feature to procedure mapping

Feature/Procedure mapping					
Feature	Procedure	Reference	PT	Status	
				FT	
				R/B	P
NG1.N.1 Codec Negotiation		5.2 [21]	M	M	M
	Exchange of codec list during registration and location registration	7.3.1 [21]	M	M	M
	Basic service wideband speech and default attributes	7.3.2 [21]	M	M	M
	Codec Negotiation during call establishment	7.3.3 [21]	M	M	M
NG1.N.2 Codec Switching		5.2 [21]	M	M	M
	Codec Change	7.3.4 [21]	M	M	M
	Slot type modification	7.3.5 [21]	M	M	M
	MAC layer advanced connection slot type modification	7.6.7 [21]			
	MAC layer connection type modification: basic to/from advanced	7.6.6 [21]	M	M	M
NG1.N.3 Missed call notification		5.2	M	M	M
	Generic events notification, general	7.4.1.1	M	M	M
	Missed call notification	7.4.1.3	M	M	M
NG1.N.4 Voice message waiting notification		5.2	M	M	M
	Generic events notification, general	7.4.1.1	M	M	M
	Voice message waiting notification	7.4.1.2	M	M	M
NG1.N.5 Date and Time synchronization		5.2	M	M	M
	Date and Time synchronization	7.4.2	M	M	M
NG1.N.6 Parallel Calls		5.2	M	M, note 2	O
	Parallel call common requirements	7.4.3.1	M	M	M
	Control messages	7.4.3.2	M	M	M
	Sending Keypad information	8.10 [12]	M	M	M
	Codec change for parallel calls	7.4.3.3	M	M	M
	Sending negative acknowledgement	7.4.3.4	M	M	M
	Busy system or line notification	7.4.8.3	M	M	M
NG1.N.7 Common parallel call procedures (external or internal)		5.2	M	M, note 2	O
	Outgoing parallel call initiation (external or internal)	7.4.3.5.1	M	M	M
	Call waiting indication (external or internal)	7.4.3.5.2	M	M	M
	Call toggle (external or internal)	7.4.3.5.3	M	M	M
	Call release and call release rejection	7.4.3.5.4	M	M	M
	Call waiting acceptance (from PP to FP)	7.4.3.5.6	M	M	M
	Call waiting rejection (from PP to FP)	7.4.3.5.7	M	M	M
	Active call release with replacement (from PP to FP)	7.4.3.5.12	O	M	M
	Putting a call on-hold	7.4.3.5.8	O	M	M
	Resuming a call put on-hold	7.4.3.5.9	O	M	M
	CLIP on call waiting indication	7.4.3.5.10	M	M	M
CNIP on call waiting indication	7.4.3.5.11	M	M	M	

Feature/Procedure mapping					
Feature	Procedure	Reference	PT	Status	
				FT	
				R/B	P
NG1.N.8 Call transfer (external or internal)		5.2	M	M	O
	Announced call transfer	7.4.3.6.1	M	M	M
	Unannounced call transfer	7.4.3.6.2	M	M	M
	Call re-injection to the system (external or internal)	7.4.3.6.3	M	M	M
	Remote party CLIP on call transfer	7.4.3.6.4	M	M	M
	Remote party CNIP on call transfer	7.4.3.6.5	M	M	M
NG1.N.9 3-party conference call (external or internal)		5.2	O	O, note 1	O, note 1
	3-party Conference with established internal and external calls	7.4.3.7	M	M	M
NG1.N.10 Intrusion call		5.2	O	O, note 1	O, note 1
	Implicit intrusion call into a line in "single call" mode	7.4.3.8.1	C901	M	M
	Explicit intrusion call (from PP to FP)	7.4.3.8.2	C901	M	M
NG1.N.11 Call deflection (internal or external)		5.2	O	O, note 1	O, note 1
	Call deflection (internal)	7.4.4.2	M	M	M
	Call deflection (external)	7.4.4.2	M	M	M
	Call deflection control messages	7.4.4.1.1	M	M	M
NG1.N.12 Line identification		5.2	M	M	M
	Line identification general requirements	7.4.5.1	M	M	M
	General line identification requirements for external outgoing calls	7.4.5.2.1	M	M	M
	Line identification for a first external outgoing call using <<CALL-INFO>> IE	7.4.5.2.2	M	M	M
	Line identification for a first external outgoing call using <<MULTI-KEYPAD>> IE	7.4.5.2.3	O	M	M
	FP managed line selection for a first external outgoing call	7.4.5.2.4	M	M	M
	General line identification requirements for external incoming calls	7.4.5.3.1	M	M	M
	Line identification for a first external incoming call	7.4.5.3.2	M	M	M
NG1.N.13 Call identification		5.2	M	M	M
	Call identifier general requirements	7.4.6.1	M	M	M
	Call identifier assignment on outgoing call (FP to PP)	7.4.6.2	M	M	M
	Call identifier assignment on incoming call (FP to PP)	7.4.6.3	M	M	M
	Call status indication to the handset	7.4.6.4	M	M	M
NG1.N.14 Multiple lines		5.2	M	O	O
	Multiple lines common requirements	7.4.7.1	M	M	M
	Terminal attachment and line settings	7.4.7.2	M	M	M
	Incoming and outgoing external calls on a multiple line system	7.4.7.3	M	M	M
	Internal calls in multiple line context	7.4.7.4	M	M	M
	Compatibility with non multiple line PP or FP	7.4.7.5	M	M	M

Feature/Procedure mapping					
Feature	Procedure	Reference	PT	Status	
				FT	
				R/B	P
NG1.N.15 Multiple calls		5.2	M	M	O
	Multiple calls general requirements	7.4.8.1	M	M	M
	Incoming and outgoing external calls on a multiple call line	7.4.8.2	M	M	M
	Busy system or line notification	7.4.8.3	M	M	M
NG1.N.16 List access service		5.2	M	M	O
	General considerations	7.4.10.1	M	M	M
	List change notification	7.4.10.2	O	M	M
	Start / end session (note 4)	7.4.10.4.1	M	M	M
	Query supported entry fields (note 4)	7.4.10.4.2	O	M	M
	Read entries (note 4)	7.4.10.4.3	M	M	M
	Edit entry (note 4)	7.4.10.4.4	M	M	M
	Save entry (note 4)	7.4.10.4.5	M	M	M
	Delete entry (note 4)	7.4.10.4.6	M	M	O
	Delete list (note 4)	7.4.10.4.7	M	M	M
	Search entries (note 4)	7.4.10.4.8	M	M	M
	Negative acknowledgement	7.4.10.4.9	M	M	M
	Data packet / Data packet last	7.4.10.4.10	M	M	M
	DECT system and line settings considerations	7.4.11.1	M	M	O
	Interactions between registration, attachment of handsets and lists	7.4.11.2	M	M	O
	Fields description	7.4.10.5.1	M	M	M
	[Supported lists]				
	List of supported lists	7.4.10.5.2	O	M	M
	Missed calls list	7.4.10.5.3	M	M	M
	Outgoing calls list	7.4.10.5.4	O	O	O
	Incoming accepted calls list	7.4.10.5.5	M	M	M
	All calls list	7.4.10.5.6	O	O	O
	Contact list	7.4.10.5.7	M	M	M
	Internal names list	7.4.10.5.8	M	M	M
All incoming calls list	7.4.10.5.11	O	O	O	

Feature/Procedure mapping					
Feature	Procedure	Reference	PT	Status	
				FT	
				R/B	P
	DECT system settings list	7.4.11.3	M	M	O
	Line settings list	7.4.11.4	M	M	O
	Virtual contact list and call list per line	7.4.11.5	O	C902	O
	[Supported DECT system settings]				
	Current PIN code	7.4.11.3.1	M	M	O
	Clock master	7.4.11.3.2	M	M	O
	Base reset	7.4.11.3.3	M	M	O
	FP IP address / type	7.4.11.3.4	O	O	O
	FP IP address / value	7.4.11.3.5	O	O	O
	FP IP address / subnet mask	7.4.11.3.6	O	O	O
	FP IP address / gateway	7.4.11.3.7	O	O	O
	FP IP address / DNS server	7.4.11.3.8	O	O	O
	FP version / Firmware version	7.4.11.3.9	M	M	O
	FP version / EEprom version	7.4.11.3.10	M	M	O
	FP version / Hardware version	7.4.11.3.11	O	O	O
	Emission mode	7.4.11.3.12	C903	C903	O
	New PIN code	7.4.11.3.13	M	M	O
	[Supported line settings]				
	Line name	7.4.11.4.1	M	M	O
	Line id	7.4.11.4.2	M	M	O
	Attached handsets	7.4.11.4.3	M	M	O
	Dialling prefix	7.4.11.4.4	O	O	O
	FP melody	7.4.11.4.5	O	O	O
	FP volume	7.4.11.4.6	O	O	O
	Blocked number	7.4.11.4.7	O	O	O
	Multiple calls mode (single/multiple)	7.4.11.4.8	M	M	M
	Intrusion call	7.4.11.4.9	C904	C904	C904
	Permanent CLIR	7.4.11.4.10	C905	C905	C905
	Call forwarding Unconditional	7.4.11.4.11	M	M	I
	Call forwarding on No Answer	7.4.11.4.12	M	M	I
	Call forwarding on Busy subscriber	7.4.11.4.13	M	M	I
NG1.N.17 Calling line identity restriction		5.2	O	O	O
	Considerations	7.4.12.1	M	M	O
	Permanent CLIR mode (all calls)	7.4.12.2	M	M	O
	Temporary CLIR mode (call by call)	7.4.12.3	M	N/A	O
NG1.N.18 Call forwarding (external calls)		5.2	M	M	I
	Call Forwarding common requirements	7.4.13.1	M	M	I
	External Call Forwarding Unconditional (CFU) to external number	7.4.13.2	M	M	I
	External Call Forwarding on No Answer (CFNA) to external number	7.4.13.3	M	M	I
	External Call Forwarding on Busy subscriber (CFB) to external number	7.4.13.4	M	M	I
NG1.N.19 DTMF handling		5.2	M	M	O
	Uplink DTMF transmission at call setup when FP connected to classic switching network	7.4.14.1.1	M	C906	C906
	Uplink DTMF transmission when connected	7.4.14.1.2	M	M	O
	Downlink DTMF reception	7.4.14.2	M	M	O
	Local DTMF feedback of dialled digits	7.4.14.3	M	M	O
NG1.N.20 Tones provision		5.2	M	M	O
	General considerations	7.4.15.1	M	M	O
	Tones provision by the system	7.4.15.2	M	M	O
	Transparency to tones provision by the network or PABX	7.4.15.3	M	M	O

Feature/Procedure mapping					
Feature	Procedure	Reference	PT	Status	
				FT	
				R/B	P
NG1.N.21 Headset management		5.2	C907	M	O
	Headset considerations	7.4.16.1	C907	M	O
	Headset call interception	7.4.16.2	C907	M	O
	Headset incoming call	7.4.16.3	C907	M	O
	Re-dial of last outgoing call	7.4.16.4	C908	M	O
	Re-dial of last incoming call	7.4.16.5	C908	M	O
	Switching from headset to handset (headset initiated)	7.4.16.6	C908	M	O
	Switching from headset to handset (handset initiated)	7.4.16.7	C909	M	O
	Compatibility with other telephony features and profiles	7.4.16.8	C907	M	O
NG1.N.22 Handling of lines where second calls are signalled in-band		5.2	M	O note 2	O
	General requirements	7.4.3.10.1	I	M	M
	Basic 'double call with in-band signalling' lines	7.4.3.10.2	I	M note 3	M
	Off-hook CLIP enabled 'double call with in-band signalling' lines	7.4.3.10.3	M	M note 3	M
	Use of transparent commands on DCIBS lines (Basic or Off-hook CLIP enabled) or any other line	7.4.3.10.4	M	M	M
GAP.N.11 Location registration		4.1 [12]	M	O	M
	Location registration	8.28 [12]	M	M	M
	Location update	8.29 [12]	M	O	O
	Terminal Capability indication	7.4.9.1	M	M	M
GAP.N.14 Service class indication/assignment		4.1 [12]	M	O	M
	Obtaining access rights	8.30 [12]	M	M	M
	Terminal Capability indication	7.4.9.1	M	M	M
	Authentication of PT	8.24 [12]	M	M	M
GAP.N.16 ZAP		4.1 [12]	M	O	O
	Obtaining access rights	8.30 [12]	M	M	M
	Terminal Capability indication	8.17 [12]	M	M	M
	Incrementing the ZAP value	8.26 [12]	M	M	M
	Terminal Capability indication	7.4.9.1	M	M	M
GAP.N.18 Subscription registration user procedure on-air		4.1 [12]	M	M	M
	Obtaining access rights	8.30 [12]	M	M	M
	Terminal Capability indication	7.4.9.1	M	M	M
GAP.N.19 Link control		4.1 [12]	M	M	M
	Indirect FT initiated link establishment	7.3.8 [21]	M	M	M
	Direct PT initiated link establishment	8.36 [12]	M	M	M
	Link release "normal"	8.37 [12]	M	M	M
	Link release "abnormal"	8.38 [12]	M	M	M
	Link release "maintain"	8.39 [12]	M	M	M
GAP.N.24 Signalling of display characters		4.1 [12]	O	O	O
	Display	8.16 [12]	M	M	M
	Terminal capability indication	7.4.9.1	M	M	M
GAP.N.25 Display control characters		4.1 [12]	O	O	O
	Display	8.16 [12]	M	M	M
	Terminal capability indication	7.4.9.1	M	M	M
GAP.N.31 Internal Call		4.1 [12]	M	M	M
	Internal call setup	7.3.6 [21]	M	M	M
	Internal call keypad	8.19 [12]	M	O	O
	Internal call CLIP	8.43 [12]	M	M	M
	Internal call CNIP	8.44 [12]	M	M	M
	Internal call codec priority	7.4.3.9	M	M	M
	UTF-8 CNIP	7.4.17	M	M	M

Feature/Procedure mapping					
Feature	Procedure	Reference	PT	Status	
				FT	
				R/B	P
GAP. N.34 Calling Name Identification Presentation (CNIP)		4.1 [12]	M	M	M
	Calling Name Identification Presentation (CNIP) Indication	8.42 [12]	M	M	M
	UTF-8 CNIP	7.4.17	M	M	M
GAP.N.35 Enhanced security		4.1 [12]	M	M	M
	Encryption of all calls	8.45.1 [12]	M	M	M
	Re-keying during a call	8.45.2 [12]	O	O	O
	Early encryption	8.45.3 [12]	O	O	O
	Subscription requirements	8.45.4 [12]	M	M	M
	Behaviour against legacy devices	8.45.5 [12]	M	M	M
C901:	At least one of the two procedures 7.4.3.8.1 OR 7.4.3.8.2 shall be implemented.				
C902:	IF NG1.N.14 THEN "O" ELSE "I".				
C903:	IF NG1.M.5 THEN "M" ELSE "I".				
C904:	IF NG1.N.10 THEN "M" ELSE "I".				
C905:	IF NG1.N.17 THEN "M" ELSE "I".				
C906:	IF FP is connected to classic switching networks (PSTN for example) THEN "M" ELSE "N/A".				
C907:	IF the PT is a headset PP THEN "M" ELSE "I".				
C908:	IF the PT is a headset PP THEN "O" ELSE "I".				
C909:	IF the PT is a headset PP THEN "I" ELSE "O".				
NOTE 1:	If the corresponding feature is not supported on FT side, the FT shall however implement the "sending negative acknowledgement" procedure (see clause 7.4.3.4).				
NOTE 2:	All procedures of NG1.N.6 and NG1.N.7 shall apply to all FTs and for all line types (full parallel call compliant lines and DCIBS lines). For DCIBS lines, the FT shall implement in addition NG1.N.22 feature, which describes some amendments to NG1.N.6 and NG1.N.7 for such lines. A given FT shall be designed to handle both line types, or only one of them.				
NOTE 3:	Both procedures are M for the FP. However, for a given line, only one of the procedures 7.4.3.10.2 or 7.4.3.10.3 is used.				
NOTE 4:	See also clause 7.4.10.4 for details per list.				

6.11 Data Link Control (DLC) Service to procedure mapping

The DLC service to procedure mapping of EN 300 444 [12] (GAP), clause 6.8.1, with the following changes and additional services shall apply.

Table 10: DLC service to procedure mapping

Service/Procedure mapping					
Service	Procedure	Reference	PT	Status	
				FT	
				R/B	P
NG1.D.1 LU1 Transparent UnProtected service (TRUP) Class 0/minimum_delay		5.3 [12]	M	M	M
	LU1 Transparent UnProtected service (TRUP) operation	11.2 [4]	M	M	M
	Class 0: No Lu _x retransmission or sequencing	14.2.3.1 [4]	M	M	M
	Class 0 procedures	14.3.2 [4]	M	M	M
	Minimum delay (speech) operation	14.2.3 [4]	M	M	M
	LLME U-plane establishment	9.9.1 [12]	M	M	M
NG1.D.2 LU1 Transparent UnProtected service (TRUP) Class 0		5.3 [21]	C1001	C1001	C1001
	LU1 Transparent UnProtected service (TRUP) operation	11.2 [4]	M	M	M
	Class 0: No Lu _x retransmission or sequencing	14.2.3.1 [4]	M	M	M
	Class 0 procedures	14.3.2 [4]	M	M	M
	LLME U-plane establishment	9.9.1 [12]	M	M	M
NG1.D.3 LU7 64 kbit/s protected bearer service		5.3 [21]	C1001	C1001	C1001
	LU7 DLC layer service	11.9.4 [4]	M	M	M
NG1.D.4 LU12 LU 12 Unprotected Framed service (UNF) Class 0		5.3 [12]	C1001	C1001	C1001
	LU12 UNprotected Framed service (UNF) operation	11.14 [4]	M	M	M
	Class 0: No Lu _x retransmission or sequencing	14.2.3.1 [4]	M	M	M
	Class 0 procedures	14.3.2 [4]	M	M	M
	LLME U-plane establishment	9.9.1 [12]	M	M	M
NG1.D.5 FU1 DLC frame		5.3 [12]	M	M	M
	FU1 frame operation	8.19 [12]	M	M	M
	FU1 frame structure	12.2 [4]	M	M	M
NG1.D.6 FU7 DLC frame		5.3 [12]	C1001	C1001	C1001
	FU7 frame structure	11.9.4.2 [4]	M	M	M
NG1.D.7 FU12 DLC frame with adaptation for codec G.729.1		5.3 [12]	C1001	C1001	C1001
	FU12 frame structure	12.12 [4]	M	M	M
	Annex for codec G.729.1	E.1 [4]	M	M	M
	FU12 frame operation	7.5.2 [12]	M	M	M
C1001: Status defined by clause 6.3, table 2.					

6.12 Medium Access Control (MAC) service to procedure mapping

The MAC service to procedure mapping of EN 300 444 (GAP) [12], clause 6.8.2, with the following changes and additional services shall apply.

Table 11: MAC service to procedure mapping

Service/Procedure mapping					
Service	Procedure	Reference	PT	Status	
				FT	
				R/B	P
NG1.M.1 I _N _minimum delay symmetric MAC service type		5.4 [21]	M	M	M
	MAC layer procedures: general	7.9.1 [21]	M	M	M
	MAC Connection oriented service	5.6 [3]	M	M	M
	MAC Basic connection	5.6.1.1 [3]	M	M	M
	MAC Advanced connection	5.6.1.2 [3]	M	M	M
	I _N _minimum delay symmetric MAC service, type 1	5.6.2.1 [3]	M	M	M
NG1.M.2 I _N _normal delay symmetric MAC service type		5.4 [21]	O	O	O
	MAC layer procedures: general	7.9.1 [21]	M	M	M
	MAC Connection oriented service	5.6 [3]	M	M	M
	MAC Basic connection	5.6.1.1 [3]	M	M	M
	MAC Advanced connection	5.6.1.2 [3]	M	M	M
	I _N _normal delay symmetric MAC service type 2	5.6.2.1 [3]	M	M	M
NG1.M.3 I _{PQ} _error_detection symmetric MAC service type		5.4 [21]	O	O	O
	MAC layer procedures: general	7.9.1 [21]	M	M	M
	MAC Connection oriented service	5.6 [3]	M	M	M
	MAC Basic connection	5.6.1.1 [3]	M	M	M
	MAC Advanced connection	5.6.1.2 [3]	M	M	M
	I _P _error_detection symmetric MAC service type 3	5.6.2.1 [3]	M	M	M
	Single-subfield protected format	6.2.1.3.4 [3]	M	M	M

Service/Procedure mapping					
Service	Procedure	Reference	PT	Status	
				FT	
				R/B	P
NG1.M.4 Advanced connections		5.4 [21]	M	M	M
	Setup of advanced connection, bearer setup (A-field)	7.6.5 [21]	M	M	M
	Connection type modification: basic to/from advanced	7.6.6 [21]	M	M	M
	Slot type modification	7.6.7 [21]	M	M	M
	Service type modification	7.6.8 [21]	C1101	C1101	C1101
	ECN number modification	7.6.9 [21]	C1102	C1102	C1102
	Connection/bearer release	7.6.10 [21]	M	M	M
NG1.M.5 "no-emission" mode		5.4	O	O	O
	Tail identification for "no emission" mode	7.1.2 [3]	M	M	M
	Extended Physical and Mac layer capabilities (part 2) bit a ₂₃	7.2.3.11 [3]	M	M	M
	Bearer handover/replacement information, multiframe-countdown	7.2.4.3 [3]	M	M	M
	"no emission" mode sync information	7.3.5.3 [3]	M	M	M
	"no emission" mode procedures	9.4 [3]	M	M	M
	Management procedures for "no emission" mode	11.11 [3]	M	M	M
GAP.M.2 Continuous broadcast		5.2 [12]	M	M	M
	Downlink broadcast	7.6.3	M	M	M
	Higher Layer information FP broadcast	7.4.9.2	M	M	M
GAP.M.3 Paging broadcast		5.2 [12]	M	M	M
	Paging broadcast	7.6.4 [21]	M	M	M
GAP.M.9 Bearer handover, intra-cell		5.2 [12]	M	C1103	C1103
	Bearer handover request	7.6.11 [21]	M	M	M
GAP.M.10 Bearer handover, inter-cell		5.2 [12]	M	O	O
	Bearer handover request	7.6.11 [21]	M	M	M
GAP.M.11 Connection handover, intra-cell		5.2 [12]	M	C1104	C1104
	Connection handover request	7.6.12 [21]	M	M	M
GAP.M.12 Connection handover, inter-cell		5.2 [12]	M	O	O
	Connection handover request	7.6.12 [21]	M	M	M
GAP.M.13 SARI support		5.2 [12]	M	O	O
	Downlink broadcast	7.6.3	M	M	M
	Higher Layer information FP broadcast	7.4.9.2	M	M	M
GAP.M.15 Re-keying		5.2 [12]	C1105	C1105	C1105
	Re-keying	10.17 [12]	M	M	M
GAP.M.16 Early encryption		5.2 [12]	C1106	C1106	C1106
	Early encryption	10.18 [12]	M	M	M
C1101: IF service NG1.4 OR NG1.5 OR NG1.6 OR NG1.2 IA II OR NG1.2 IA III THEN M ELSE O.					
C1102: IF multiple connection between the same PT-FT pair THEN M ELSE O.					
C1103: IF service GAP.M.11 THEN O ELSE M.					
C1104: IF service GAP.M.9 THEN O ELSE M.					
C1105: IF NWK layer procedure "Re-keying during a call" is implemented THEN M ELSE O.					
C1106: IF NWK layer procedure "Early encryption" is implemented THEN M ELSE O.					

6.13 Application feature to procedure mapping

The Application feature to procedure mapping of EN 300 444 [12] (GAP), clause 6.8.3, with the following changes shall apply.

Table 12: Application feature to procedure mapping

Feature/Procedure mapping					
Feature	Procedure	Reference	PT	Status	
				FT	
				R/B	P
NG1.A.1 Easy PIN code registration		5.7	M	O	N/A
	Registration mode automatic access	7.10.1.3.1	M	N/A	N/A
	Searching mode and PIN code requests	7.10.1.1.1	M	N/A	N/A
	Base station name selection	7.10.1.3.2	O	O	N/A
	Registration user feedback	7.10.1.3.3	M	O	N/A
NG1.A.2 Easy pairing registration		5.7	M	M	N/A
	Easy pairing description	7.10.1.2.1	M	M	N/A
	Registration mode automatic access	7.10.1.3.1	M	N/A	N/A
	Base station limited registration mode	7.10.1.2.2	N/A	M	N/A
	Searching mode request	7.10.1.2.3	M	N/A	N/A
	Base station name selection	7.10.1.3.2	O	O	N/A
	Registration user feedback	7.10.1.3.3	M	O	N/A
NG1.A.3 Handset locator		5.7	M	O	O
	Handset locator	7.10.2	M	M	O
GAP.A.1 AC to bitstring mapping		4.2 [12]	M	C1201	M
	AC to bitstring mapping	14.2 [12]	M	M	M
GAP.A.2 Multiple subscription registration		4.2 [12]	M	N/A	N/A
	Subscription control	14.1 [12]	M	N/A	N/A
GAP.A.3 Manual entry of the PARK		4.2 [12]	O	N/A	N/A
	Manual entry of the PARK	14.3 [12]	M	N/A	N/A
GAP.A.4 Terminal identity number assignment in mono cell system		4.2 [12]	M	M	N/A
	Terminal identity number assignment	14.4 [12]	M	M	N/A
C1201: IF feature GAP.N.9 OR GAP.N.10 OR GAP.N.12 OR GAP.N.26 THEN M ELSE N/A.					

6.14 General requirements

6.14.1 Network (NWK) layer message contents

The requirements of TS 102 527-1 [21], clause 6.14.1 shall apply.

6.14.2 Transaction identifier

The requirements of TS 102 527-1 [21], clause 6.14.2 shall apply.

6.14.3 Length of a Network (NWK) layer message

The requirements of TS 102 527-1 [21], clause 6.14.3 shall apply.

6.14.4 Handling of error and exception conditions

The requirements of TS 102 527-1 [21], clause 6.14.4 shall apply.

6.14.5 Generic Access Profile (GAP) default setup attributes

The requirements of TS 102 527-1 [21], clause 6.14.5 shall apply.

6.14.6 Coexistence of Mobility Management (MM) and Call Control (CC) procedures

The requirements of TS 102 527-1 [21], clause 6.14.6 shall apply.

6.14.7 Coding rules for information elements

The requirements of TS 102 527-1 [21], clause 6.14.7 shall apply.

7 Procedure description

The following clauses define the process mandatory procedures which are in the scope of the New Generation DECT wideband speech. Each procedure (if appropriate) is divided into three parts:

- a) normal (i.e. successful) case(s). This part defines the functions and respective protocol element values in normal operation;
- b) associated procedure(s). This is an integral part of the actual procedure (if defined in the present document), i.e. if a procedure is being declared to be supported, the respective entity shall also support the associated procedures, e.g. timer management, in the clause following the description of the normal case;
- c) exceptional case(s). This is an integral part of the actual procedure (if defined in the present document), i.e. if a procedure is being declared to be supported, the respective entity shall also support the exception handling defined in the clause following the description of the normal case.

All protocol elements listed in the following clauses are process mandatory, i.e. the FT and PT depending on their role in the procedure shall send or shall receive and process the relevant protocol elements as listed in the respective tables if not explicitly stated as being optional.

The primitives used in procedure descriptions are defined only for the purpose of describing layer-to-layer interactions. The primitives are defined as an abstract list of parameters, and their concrete realization may vary between implementations. No formal testing of primitives is intended. The primitive definitions have no normative significance.

7.1 Backward compatibility with Generic Access Profile (GAP) and with New Generation DECT part 1 (wideband speech) equipment

7.1.1 Backward compatibility with Generic Access Profile (GAP); Requirements for NG-DECT, part 3 Fixed Parts (FPs)

The FP shall support the GAP (EN 300 444 [12]) standard procedures (full slot and ITU-T Recommendation G.726 [15]). In other words, it shall inter-operate with a GAP compliant PP.

NOTE 1: The FP may detect the type of PP by means of the Information Element <Terminal Capability> provided at registration.

NOTE 2: It should be noted that GAP compliant PPs may have a more relaxed requirement of TCLw than New Generation DECT part 3 devices. In some scenarios, when combining GAP terminals with poor TCLw with long delay networks (like VoIP) and insufficient echo cancellation in the network, audible echo could be perceived by the far end terminal. This problem is not specific of devices compliant with the present document. For more information refer to EN 300 175-8 [8], annex E.

7.1.2 Backward compatibility with Generic Access Profile (GAP); Requirements for NG-DECT, part 3 Portable Parts (PPs) registered on GAP compliant FPs

The PP shall use the GAP standard procedures (full slot and ITU-T Recommendation G.726 [15]) in front of GAP standard FP.

7.1.3 Backward compatibility with New Generation DECT, part 1; Requirements for NG-DECT, part 3 Fixed Parts (FPs)

The FP shall support DECT New Generation part 1 (TS 102 527-1 [21]) procedures. In other words, a DECT New Generation, part 3 Fixed part shall operate exactly as a DECT New Generation, part 1 FP for a New Generation Part 1 PP. All features and services defined in TS 102 527-1 [21] shall be provided.

NOTE 1: The FP may detect the type of PP by means of the Information Element <Terminal Capability> provided at registration.

NOTE 2: It should be noted that New Generation DECT part 1 PPs may have a more relaxed requirement of TCLw than New Generation DECT part 3 devices. Note 2 of clause 7.1.1 may be also applicable this case. For more information refer to EN 300 175-8 [8], annex E.

7.1.4 Backward compatibility with New Generation DECT, part 1; Requirements for NG-DECT, part 3 Portable Parts (PPs) registered on NG-DECT Part 1 FPs

The PP shall use the part 1 standard procedures (TS 102 527-1 [21]) in front of NG-DECT Part 1 FPs.

7.2 Generic Access Profile (GAP) procedures

Unless otherwise noted, all procedures defined in EN 300 444 [12] GAP are automatically applicable to New Generation DECT wideband speech. Therefore the present document can be considered an extension of GAP.

7.3 New Generation DECT; part 1: Wideband Speech procedures

The present document is defined as an extension of New Generation DECT; part 1: Wideband Speech [21].

Unless otherwise noted, all procedures defined in TS 102 527-1 [21] (New Generation DECT; part 1: Wideband Speech) are automatically applicable to New Generation DECT; part 3: Extended Wideband Speech Services.

The clauses 7.4 to 7.10 describe the additional procedures specific for New Generation DECT; part 3: Extended wideband speech services.

7.3.1 Implementation examples of part 1: Wideband Speech specific procedures

For detailed examples of Wideband speech specific procedures, please refer to the informative annex D of TS 102 527-1 [21].

7.4 Network (NWK) layer procedures specific for part 3

This clause specifies the additional NWK layer procedures, messages and information elements required in New Generation DECT Extended Wideband Speech Services not described in TS 102 527-1 [21] or in EN 300 444 [12] (GAP), or incorporating modifications to the description given in these specifications.

This profile does not prevent any PT or FT from transmitting or receiving and processing any other NWK layer message or information element not specified in the profile. A PT or FT receiving an unsupported NWK layer message or information element, which it does not recognize, shall ignore it, as specified in EN 300 175-5 [5], clause 17.

7.4.1 Generic events notification

7.4.1.1 General

Equipment supporting New Generation DECT wideband voice shall support the generic events notifications as described in this clause.

Generic events notifications are based on CISS {FACILITY} messages, which contain the information element <<Events Notification>>, sent in the direction FT = > PT.

For the purpose of transmitting the {FACILITY} message containing the <<Events Notification>> information element to the PT, the FT shall either:

- use any already established link used by any Connection Oriented service (such as voice, data or service call), if existing, or
- if there is no existing call at the time of sending the {FACILITY} message, use the CLSS procedure as defined in clause 10.4.2.3 of EN 300 175-5 [5].
 - The FT shall initiate indirect link establishment as defined in clause 7.3.8 of TS 102 527-1 [21] "Indirect FT initiated link establishment" procedure. The short and the full format with IPU are allowed in the paging messages. The LCE header shall be set to either; the "000" value (indicating "no U-plane") or to the "100" value (indicating "General code for voice service").
 - Full slot and long slot (j=640) are allowed as slot type. The chosen slot type (long or full) is decided by the initiating party (FT).

Whatever the {FACILITY} transport mode (CLSS procedure or re-use of already established link), the {FACILITY} message shall be used with dummy transaction identifier value 6 and the protocol discriminator CISS.

Direct FP initiated link establishment is out of the scope of the present document.

The following requirements apply for the FP and the PP:

- The FP shall send the "Event type" and "Event sub type" arguments to indicate the kind of event.
- The PP shall support the "Event multiplicity" argument which should be used to indicate how many unconsulted events of the specific type are waiting, regardless of any previous notification. The PP shall be capable of handling values up to 16 383. The PP shall ignore events of unknown types or sub-types.
- It is the responsibility of the FP to ensure that Event status information within the PP is up to date.

The <<CALL-INFORMATION>> IE may be present in a notification and is used for indicating:

- the line the notification is relating to (if any); or
- that the notification is relating to all lines (using "All lines" subtype).

For notifications relating to a set of lines (but not all), the <<CALL-INFORMATION>> IE shall contain the list of these lines.

NOTE 1: Notification relating to a set of lines (but not all) are not used in the present document and are for future use.

Optionally more than one event notification can be included by using the extension bit. In that case:

- if a <<CALL-INFORMATION>> IE is used, each of the notifications sent together shall relate to the specified line, or to 'All lines', or to a set of lines, as above;
- if no <<CALL-INFORMATION>> IE is used, each of the notifications sent together is not related to any line.

Table 13: Values used within {FACILITY} message to convey Linelid in notification

Information element	Field within the information element	Standard values within the field/IE	Normative action/comment
<<Call information>>			
	<Identifier type>	0	Line identifier
	<Identifier subtype>	'00'H, '03'H, '04'H	'Line identifier for external call', 'Relating to', or 'All lines'
	<Identifier value>	All, except 127	The line identifier value itself if present (e.g. it is absent if 'All lines' subtype is used) Value 'None' (127) cannot be used

Notification of an event shall be sent only to relevant PPs. Depending on the event nature, receiving the notification may be relevant for one or more PPs, or for one or more lines:

- If not related to a line but related to one or more PPs, the notification shall be sent by the FP to the concerned PP (or PPs) without specifying any line identifier (i.e. without any <<CALL-INFORMATION>> information element).

EXAMPLE: This is the case for the internal names list (see clause 7.4.10.2) and the DECT system settings list change notifications if implemented.

- If related to a line, the notification shall be sent by the FP to all registered PPs that are attached to this line with a line identifier in a <<CALL-INFORMATION>> to convey the line concerned by this notification (using "Line identifier for external call" or "Relating to" subtype). The FP shall use the "Attached handsets" line setting to determine these PPs.

NOTE 2: A PP may be attached to several lines.

EXAMPLE 1: This is the case for the "Voice message waiting notification" (see clause 7.4.1.2), or the "Missed calls notification" (see clause 7.4.1.3).

- If related to all lines, the notification shall be sent to all registered PPs, with a line identifier subtype set to "All lines" in a <<CALL-INFORMATION>> information element.

EXAMPLE 2: This may be the case for the contact list, if notification is implemented and the line identifier of the modified entry is "All lines" subtype.

7.4.1.2 Voice Message waiting notification

Upon reception of a voice message waiting indication (MWI) from the network on a dedicated line, the FP shall send to any PP attached to this line, a voice message waiting notification using the generic events notification.

NOTE 1: The FP is aware of the attached handsets to a line thanks to the line settings list/attached handsets field.

Voice message waiting notification shall always be sent with a line identifier using subtype 'Line identifier for external call'.

<<Events notification>> information element shall be filled with the values specified in table 14.

Table 14: Values used within {FACILITY} message for voice message waiting indication activation

Information element	Field within the information element	Standard values within the field/IE	Normative action/comment
<<Events notification>>	<Event type>	0	Message waiting
	<Event sub type>	1	Voice
	<Event multiplicity >	0..127	Number of messages, for the specified line (see note at this table and note 2 after the table)
<<Call Information>>	<Identifier type>	0	Line identifier
	<Identifier sub type>	0	Line identifier for external call
	<Identifier value>	All, except 127	The line identifier value itself Value 'None' (127) cannot be used
NOTE: 'Event multiplicity' can be extended for values up to 16 383. See note at table 39.			

Upon reception of a { FACILITY } message with a content as defined in table 14, the PP shall indicate the Voice MWI status to the receiving user.

Voice message waiting deactivation notification. As soon as the number of messages for a given line is '0', the FP shall then send a 'Voice message waiting notification' to all PPs attached to that line, with an <Event multiplicity> field set to '0'.

NOTE 2: The meaning of this number is network dependent; e.g. it may be the total number of messages in the voicemail box, or the total number of unread messages in the voicemail box only.

NOTE 3: This notification allows the PP to give a hint to the user that the voicemail box does no longer need to be consulted for the specified line. A PP attached to several lines could wait until it receives such a notification for all lines it is attached to, before it gives a hint to the user (e.g. switch off an MWI-LED)

7.4.1.3 Missed call notification

A 'missed call notification' is sent by the FP each time any event modifies the 'missed call list'. This most notably happens when an external incoming call has not been answered by any of the PPs (an entry was added to the 'missed call list').

The present procedure also specifies the sending of list change indications for the missed call list (see 'Simultaneous list change indication' subsection below).

Line identifier. An event modifying the 'missed call list' always occurs on, or concern, one of the lines of the system. The notification is sent to all PPs attached to that line, and only to them. A 'missed call notification' shall contain a line identifier, specified in a <<CALL INFORMATION>> IE, using the line id subtype 'Line identifier for external call'.

Line specific event multiplicity. The <event multiplicity> field of the 'missed call notification' shall contain the number of 'unread' missed call entries in the 'missed call list' *for the specified line*, at the time the notification is sent.

NOTE 1: An 'unread' missed call entry is an entry with 'Read status' field set. It corresponds either to a missed call that was just added to the missed call list, or to a missed call that was already in the missed call list but remained 'unread'.

NOTE 2: The 'Number of calls' field of the missed call list (see clauses 7.4.10.5.1.8 and 7.4.10.5.3) is not taken into account when computing the <event multiplicity> field: only entries are computed.

Simultaneous 'list change indication'. A 'list change indication' for the 'missed call list' shall be sent together with the 'missed call notification', in the same <<Events notification>> IE.

Conversely, a 'list change indication' for the 'missed call list' shall never be sent alone, but always along with a 'missed call notification'.

NOTE 3: Missed call subtype '02'H (see EN 300 175-5 [5], clause 7.7.55) is used to indicate that there is not actually any new missed call: in that case, the purpose of the accompanying 'missed call notification' is to possibly update the number of 'unread' missed calls on PP side.

EXAMPLE 1: In case a 'list change indication' is sent following the reading of an entry by one of the PPs (entry read status modified), the accompanying missed call notification indicates the new number of 'unread' entries.

EXAMPLE 2: In case a 'list change indication' is sent following the deletion of a 'read' entry, the accompanying missed call notification indicates the same number of 'unread' entries (i.e. serves no purpose).

The <event multiplicity> field of the 'list change indication' shall contain the total number of entries in the 'missed call list' *for the specified line*, at the time the notification is sent ('unread' plus 'read' missed calls).

Events triggering the notifications. The following event types *shall* trigger a 'missed call notification' together with a 'list change indication' from the FP. For each event type, the line to specify and the set of PPs receiving the notification (targeted PP or PPs) are indicated.

- **A new external missed call just arrived (entry added).** A 'missed call notification' shall be sent immediately after a *new external call* is missed and has been added to the 'missed call list'.
 - *Specified line:* Line where the missed call occurred.
 - *Targeted PPs:* all PPs attached to the line where the missed call occurred.
 - The *missed call subtype* used shall be '01'H ("A new external missed call just arrived").

NOTE 4: Only *external* missed incoming calls should be added to the "Missed call list" and notified by the FP.

NOTE 5: When receiving missed call subtype '01'H, the PP should give a hint to the user that the missed call list should be consulted (e.g. switching on a dedicated LED).

NOTE 6: The PP should remove the hint when it received an event multiplicity of '0' *for each of the lines* it is attached to. Additionally, the PP could also do so after having consulted the list.

- **Entry modified or deleted (especially: entry 'read').** A 'missed call notification' (see above) shall be sent as soon as an entry in the 'missed call list' is modified (especially: 'read', see clause 7.4.10.5.1.5 for the definition of a 'read' entry), or deleted.
 - *Specified line:* Line of the entry that was read or deleted.
 - *Targeted PPs:* All PPs attached to the specified line.
 - The *missed call subtype* used shall be '02'H ("No new missed call arrived, but the number of 'unread' external missed voice call has-or may have-changed").
- **Base reset.** In case the FP is reset, a 'missed call notification' shall be sent once for each line.
 - *Specified line:* Line for which the notification is sent (once for each line).
 - *Targeted PPs:* All PPs attached to the specified line.
 - The *missed call subtype* used shall be '02'H.

NOTE 7: The purpose of this notification is re-synchronise the PPs with the list state, in case the list has changed during the base reset.

NOTE 8: The 'missed call subtype' '01'H ('A new missed call just arrived') could however be used if the 'base reset' is coincidental with the arrival of a brand new missed call, to avoid sending two notifications.

- **Location registration:** A 'missed call notification' shall be sent after location registration, once for each line the PP is attached to (1 FACILITY message per line the PP is attached to).
 - *Specified line:* Line for which the notification is sent (once for each line the PP is attached to).
 - *Targeted PP:* The PP performing location registration (and only this PP).
 - The *missed call subtype* used shall be '02'H.

NOTE 9: A location registration request ({LOCATE-REQUEST} message) is sent by the PP at least when the handset is switched on. A location registration request could be sent by the PP when it goes back in range (after it got out of range) in order to inform the FP that it may have lost some notifications.

NOTE 10: The 'missed call subtype' '01'H ('A new missed call just arrived') could however be used if the 'location registration' is coincidental with the arrival of a brand new missed call, to avoid sending two notifications. But subtype '01'H cannot be used in order to inform the PP of a missed call that arrived when it was possibly out of range and that it may have lost (subtype '01'H can only be used at the time when the new missed call arrives, and the notification cannot be repeated).

Almost simultaneous events. Several events concerning the missed call list occurring almost simultaneously may be the subject of a single notification, provided the following rules are respected:

- 1) all events notified together shall occur on, or concern, the same line
- 2) the events notified together may be of the same type, or of different types (e.g. one entry added for a new missed call, another entry modified or deleted)
- 3) the common notification shall use missed call subtype '01'H if (and only if) *at least one* of the events notified together is of type 'A new external missed call just arrived (entry added)'
- 4) the notified numbers correspond to the state of the missed call list *after* all the events notified together occurred

NOTE 11: Examples of use of these rules are provided in clause C.2.6.

<< Events notification >> information element shall be filled with the values given in table 15.

Table 15: Values used within {FACILITY} message for missed call notification

Information element	Field within the information element	Standard values within the field/IE	Normative action/comment
<<Events notification>>	<Event type>	1	Missed call
	<Event sub type>	1	A new external missed voice call just arrived
	<Event multiplicity >	0...127	Number of new missed calls in the missed call list for the specified line (see note 1)
	<Event type>	3	List change indication
	<Event sub type>	1	Missed calls list
	<Event multiplicity >	All	Total number of elements in the list for the specified line (see note 2)
<<Call Information>>	<Identifier type>	0	Line identifier
	<Identifier sub type>	0	Line identifier for external call
	<Identifier value>	All	The line identifier value itself
NOTE 1: 'Event multiplicity' can be extended for values up to 16 383. See note at table 39.			
NOTE 2: The <<Call information>> Information Element is only present if the call is external.			

Upon reception of a {FACILITY} message with a content as defined in table 15, the PP shall indicate the missed call to the receiving user. The PP may use the previous calling party information provided with the last incoming call presentation.

After user intervention the PP shall access the missed call list via the list access "Read entries" command (see clause 7.4.10.4.3.1) feature.

7.4.1.4 List change notification

See "List access service", list change notification procedure (see clause 7.4.10.2) for the detailed behaviour.

7.4.2 Date and Time synchronization

Equipment supporting New Generation DECT wideband voice shall support the "Date and Time synchronization" feature as described in the present clause.

The DECT entity shall use an already established link for the purpose of transmitting the {FACILITY} message containing the <<TIME-DATE>> information element to the peer entity. It is the responsibility of the entity to ensure that time and date information within the peer entity is up to date.

If there is no existing connection when sending the {FACILITY} message, the CLSS procedure may be used as defined in clause 10.4.2.3 of EN 300 175-5 [5] with the <<TIME-DATE>> information element in the {FACILITY} message.

Whatever the {FACILITY} transport mode (CLSS procedure or re-use of already established link), the {FACILITY} message shall be used with dummy transaction identifier value 6 and the protocol discriminator CISS.

For the values used in << TIME-DATE >> information element see table 16.

Table 16: Values used within {FACILITY} message for date and time synchronization

Information element	Field within the information element	Standard values within the field/IE	Normative action/comment
<<Time-Date>>			
	<Coding>	11B	1 1 Time and Date
	<Interpretation>	0	The current time/date
	<Time/date >	All	

Additionally, the entity which is sending the {FACILITY} message should set correctly the <Time Zone> field of the <<TIME-DATE>> IE, (GMT, GMT+1h...). If this information is not available from the entity <Time Zone> field shall be set to null value. This may be the case for an FP when the information is not provided by the network.

Upon reception of a {FACILITY} message with a content as defined in table 16, the peer entity shall set its time and date information to the received one. The date and time on FP side is called "DECT system date and time" in the following text.

The FP and PP shall both support the "FT initiated Date and Time synchronization" procedure of clause 7.4.2.1, for synchronizing all PPs with the DECT system date and time.

The PP should support and the FP shall support the "PT initiated Date and Time synchronization" procedure of clause 7.4.2.2. If used by the PP, the FP should not use clause 7.4.2.1 at the same time with the same PP especially when using the date and time from the network.

The present procedure (see clause 7.4.2) shall be consistent with the "Clock master" setting (see clause 7.4.11.3.2) of the DECT system settings list (see clause 7.4.11.3), "List access service", feature [NG1.N.16].

- If the "Clock master" field is equal to "FP", PPs shall not use the "PT initiated Date and Time synchronization" procedure. The FP may set the DECT system date and time as received from the network (e.g. received upon network incoming call, or through NTP), or from a dedicated interface (e.g. local or web interface).
- If the "Clock master" field is equal to "PP": a PP shall be able to define the DECT system date and time on the FP, using procedure "PT initiated Date and Time synchronization" of clause 7.4.2.2. The FP shall ignore any date and time received by any other means (e.g. received from the network).

In both cases, the FP shall use procedure "FT initiated Date and Time synchronization" of clause 7.4.2.1 to update the date and time of all (other) registered handsets.

7.4.2.1 FT initiated Date and Time synchronization

The present procedure shall be used by the FP in order to update the PP date and time and synchronize it with the DECT system date and time. The DECT system date and time could have been provided by the network, or by one of the PPs using procedure "PT initiated Date and Time synchronization" of clause 7.4.2.2.

NOTE: When the "Clock master" setting is implemented, the DECT system date and time origin is restricted. However a PP should never ignore the FP notification, even if the "Clock master" field is set to PP, because the DECT system date and time may have been set by another PP.

If link is not available, the FP shall initiate indirect link establishment as defined in clause 7.3.8 of TS 102 527-1 [21] "Indirect FT initiated link establishment" procedure. The short format or the full format paging messages with corresponding slot types shall be used as for a regular incoming voice call. The LCE header shall be set to the "000" value (indicating "no U-plane") or to the "100" value (indicating "General code for voice service"). Full slot and long slot (j=640) are allowed as slot type. The chosen slot type (long or full) is decided by the initiating party (FT).



Figure 1: FT initiated Date and time synchronization

7.4.2.2 PT initiated Date and Time synchronization

In some cases (e.g. if the date and time are not provided by the network or erroneous), the DECT system date and time may be provided by one of the PPs, using the present procedure.

When the "Clock master" field is equal to "PP", the DECT system date and time shall only be provided by one of the PPs using the present procedure.

If link is not available, the PP shall initiate direct link establishment as defined in clause 8.36 of EN 300 444 [12] "Direct PT initiated link establishment" procedure. Full slot and long slot (j=640) are allowed as slot type. The chosen slot type (long or full) is decided by the initiating party (PT).

The FP shall check the <<Portable Identity>> IE sent by the PP in the {FACILITY} message. If the date and time is sent by an unidentified PP, the FP shall ignore the time and date. The procedure "FT initiated Date and Time synchronization" of clause 7.4.2.1 may be used subsequently, in order to transfer the updated date and time to all other registered PPs.

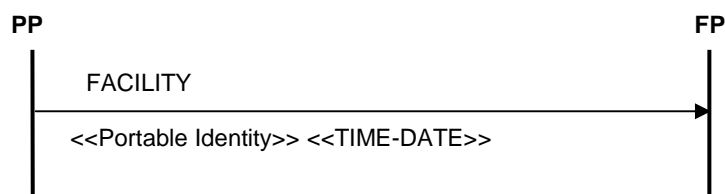

Figure 2: PT initiated Date and time synchronization

7.4.3 Handling of parallel calls

7.4.3.1 Parallel call common requirements

Procedures in clause 7.4.3 apply to DECT systems allowing to handle several simultaneous calls, and offer a common handling of them in various situations (PSTN double calls, VoIP multiple calls on a single line, as well as parallel call situations occurring in a multiple line DECT system). Clause 7.4.3 also includes related procedures (for "Call transfer", "Call intrusion" and "3-party conference with established internal and/or external calls").

The "Parallel call" feature is a prerequisite feature including high level procedures and requirements. Clauses "Common parallel call procedures", "Call transfer", "Call intrusion" and "3-party conference with established internal and/or external calls", are all handled here because they imply implementation of the "Parallel call" feature, but are however handled as separate features.

In all parallel call scenarios there shall always be only one link between FP and PP, with one U-Plane and one call control instance.

7.4.3.2 Control messages

The following control codes shall be transmitted as keypad information in {CC-INFO} (or {CC-SETUP} if explicitly noted) messages and shall trigger the corresponding actions in the FP according to table 17:

Table 17: Control messages for control of parallel calls

Procedure	Control message	Direction	PP Status	FP status
Outgoing parallel call initiation (internal)	17H + number 17H + '*' (see note 1)	PP to FP	M	M
Outgoing parallel call initiation (external)	1C15H + number (see note 2)	PP to FP	M	M
Call waiting indication (external or internal)	Call status "CS call setup" + IE <<SIGNAL = 'call waiting tone' = 07H>> + IE <<CLIP>> (see notes 3 and 8)	FP to PP	M	M
Intrusion call request indication (only internal)	Call status "CS conference connect" + IE <<SIGNAL = 'Intercept tone ON' = 02H>> (see note 8)	FP to PP	O	C1702
Call toggle request (external or internal)	1CH 31H	PP to FP	M	M
3-party conference call request (external or internal)	1CH 32H	PP to FP	O	C1703
Call release (of the indicated call)	1CH 33H	PP to FP	M	M
Call transfer request (external or internal)	1CH 34H	PP to FP	M	M
Call waiting acceptance	1CH 35H	PP to FP	M	M
Call waiting rejection	1CH 36H	PP to FP	M	M
Active call release with replacement (from PP to FP)	1CH 38H	PP to FP	O	M
Negative acknowledgement	Confirmed call status + IE <<SIGNAL, 09H = negative acknowledgement tone>> (see note 8)	FP to PP	M	M
Explicit call intrusion	1CH 40H in {CC-SETUP} + targeted terminal identifier number (handset intrusion) or targeted line id (line intrusion)	PP to FP	O	C1702
Putting a call on-hold	1CH 41H	PP to FP	O	M
Resuming a call put on-hold (see note 9)	1CH 42H	PP to FP	M	M
Call interception request from HPP (or PP) (see note 7)	1CH 50H in {CC-SETUP}	PP to FP	C1701	M
<p>C1701: If the PT is a headset PP THEN "M" ELSE "O".</p> <p>C1702: If FP implements intrusion call feature (NG1.N10) THEN "M" ELSE minimum requirement of "negative acknowledgement" with call status reason 'control code not supported' (see clause 7.4.3.4).</p> <p>C1703: If FP implements conference call feature (NG1.N9) THEN "M" ELSE minimum requirement of "negative acknowledgement" with call status reason 'control code not supported' (see clause 7.4.3.4).</p>				
<p>NOTE 1: The '*' is used to call all the registered handsets (except the initiator) and the FP when capable of; this function is also called "internal general call" as defined in Generic Access Profile (GAP) EN 300 444 [12]. It may be also used when only two PPs are registered (this allow to omit the terminal number).</p> <p>NOTE 2: This value is purposely distinct from '15H' value, although it is used here in a similar context. Use of 31H, 32H, 33H, 35H, etc., as number after 15H may have a specific meaning for the network. For backward compatibility reasons, the FP may have to interpret these codes as control messages or send them transparently to the network.</p> <p>NOTE 3: Numbering plan id field of CLIP IE is set to "private numbering plan" for internal calls, any other type for external calls (as specified in TS 102 527-1 [21]).</p> <p>NOTE 4: The definition of the new C0-control code 1C is proposed for use as described in table 17.</p> <p>NOTE 5: The new DECT codes may need a translation into network control messages on FP side. These messages are network operator dependent.</p> <p>NOTE 6: Network control messages may be sent directly by the user as keypad information. The FP should send them transparently to the network.</p> <p>NOTE 7: "Call interception" means that a PP intercepts a call initiated (i.e. being setup or in active state) by another PP. The intercepting PP is in principle a headset PP but could be any standard PP (see clause 7.4.16.2). This control code will be transmitted as keypad information in a {CC-SETUP} message.</p> <p>NOTE 8: See clause 7.4.6.4 for the definition of call statuses. Presence of <<Signal>> IE depends on the "Tones provision" feature. See clause 7.4.3.4 for more details on the negative acknowledgement.</p> <p>NOTE 9: "Resuming a call put on hold" (1C 42H) is mandatory for PPs since it may be needed by the call release procedure (see clause 7.4.3.5.4). The control code may be sent after interaction with the user, or automatically by the PP.</p>				

7.4.3.3 Codec change for parallel calls

In case the parallel calls use different codecs, the standard codec change procedure shall be used (see TS 102 527-1 [21], clause 7.3.4 and annex D).

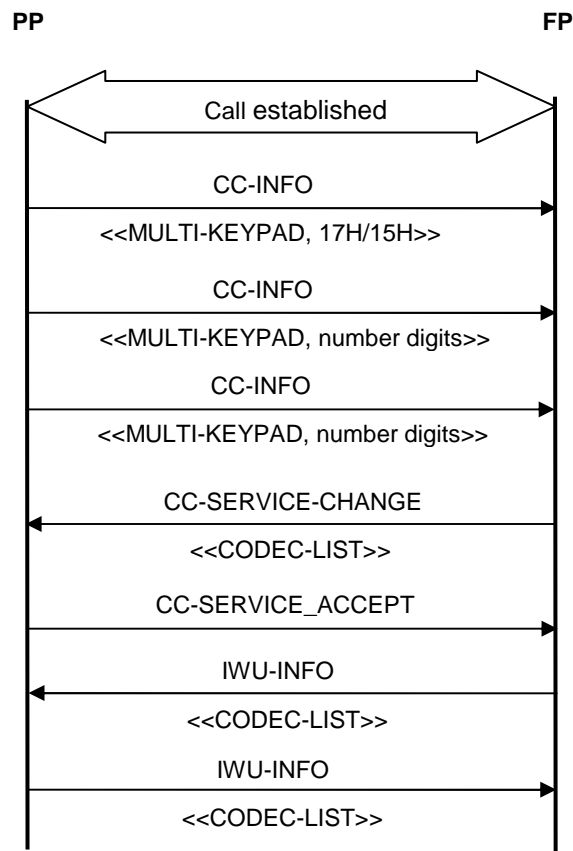

Figure 3: Codec change procedure: example for outgoing call initiation

7.4.3.4 Sending negative acknowledgement

When the FP fails to fulfil a service requested by the PP, the FP shall reply to the PP with the current call status and with an appropriate call status reason (e.g. 'control code failed'), using procedure "Call status indication to the handset (FP to PP)" of clause 7.4.6.4.

NOTE 1: The re-sending of the current call status is used to confirm that the service request was ineffective and did not result in a call status change.

NOTE 2: The call status reason to be used is indicated when the present procedure is referred to in other procedures.

The FP shall additionally send a 'negative acknowledgment tone' to the PP. The "Tones provision" feature describes the method that shall be used by the FP and PP to support the tone.

A possible cause of failure may be unsuccessful interaction of the FP with the network. In that case the FP shall use the present procedure, using the call status reason 'control code failed'.

NOTE 3: In the special case where the requested service cannot be fulfilled because it would exceed the DECT system or line capacity, the "Busy system or line notification" procedure of clause 7.4.8.3 is used instead. The main identified use case is in the context of multiple call lines (clause 7.4.8) but other parallel call use cases are relevant (e.g. in the context of a multiple lines DECT system). See also NG1.N.6 in clause 6.10.

As a special case, when the FP does not support a feature, but however receives from a PP a request for initiating that feature with the corresponding control code, the FP shall use the present procedure, using the call status reason 'control code not supported'.

NOTE 4: As stated above, use of the present procedure includes re-sending of the current call status before the PP request was sent, together with the call status reason.

EXAMPLE: The optional features 'intrusion call' (NG1.N.10), 3PTY conference call (NG1.N.9), and call deflection (NG1.N.11) are examples of features that the FP may not support.

7.4.3.5 Common parallel call procedures (external or internal)

This clause details the procedures of a feature entitled "Common parallel call procedures (external or internal)". This feature is a set of common procedures for handling PSTN double calls, VoIP multiple calls on a single line, as well as parallel call situations occurring in a multiple line DECT system (and especially for PPs attached to multiple lines in such a system).

These procedures apply to the FP and a PP already involved in at least one call on a line in a DECT system. If the "Multiple call" feature is implemented on a line, this line may be configured in "single call" mode, or in "multiple call" mode (see clause 3.1).

Implementation of the "Parallel calls" feature is a pre-requisite on PP and FP sides for implementation of the "Common parallel call procedures (external or internal)" feature.

Implementation of the "Call Identification" feature on PP side and on FP side is a prerequisite for implementation of the "Common parallel call procedures (external or internal)" feature on a DECT system.

Implementation of the "Line Identification" feature on PP side and on FP side is a prerequisite for implementation of the "Common parallel call procedures (external or internal)" feature on a DECT system.

A PP implementing the "Common parallel call procedures (external or internal)" shall be able to support at least two simultaneous call contexts.

Implementation of the "Common parallel call procedures" feature is itself a prerequisite for the implementation of the "Multiple calls" feature, or of the "Multiple lines" feature on a DECT system.

7.4.3.5.1 Outgoing parallel call initiation (external or internal)

This procedure applies to the FP and a PP already involved in a call on a DECT system implementing the feature entitled "Common parallel call procedures (external or internal)".

NOTE 1: Implementation of the "Multiple call" feature or of the "Multiple line" feature implies implementation of the "Common parallel call procedures (external or internal)" feature.

External outgoing parallel call initiation. The initiation of an external outgoing parallel call shall be done by sending the control code 1CH, followed by the *register recall* (15H) keypad information in a << MULTI-KEYPAD >> IE in a {CC-INFO} message. In the same or other {CC-INFO} message(s), one or more further keypad information containing the decimal coded digits of the external number shall follow.

Internal outgoing parallel call initiation. The initiation of an internal outgoing parallel call shall be done:

- either by sending the *internal call* ('17H) keypad information in a << MULTI-KEYPAD >> IE in a first {CC-INFO} message and the decimal coded digits of the internal number, in a << MULTI-KEYPAD >> IE in a second {CC-INFO} message; or
- by sending the *internal call* ('17H) keypad information together with the digits in a << MULTI-KEYPAD >> IE in one single {CC-INFO} message.

In case of internal parallel call, the number shall be the terminal id number of the targeted PP, or '*' in case of "internal general call". '*' may also be used when only two PPs are registered (this allows to omit the terminal number). The number of registered PPs is available from the internal names list.

An outgoing parallel call initiation (external or internal) from the PP implicitly requests that the active call be put on hold by the FP (especially if external).

NOTE 2: If the parallel call is internal, the FP does not need to actually put the first call on hold toward the remote party but could just simulate it (e.g. by playing an audio film in the FP toward the remote party).

After the PP has sent a first {CC-INFO} message, and if the PP intends to use several {CC-INFO} messages in order to complete the outgoing parallel call initiation, the PP shall wait until it receives the call id assigned by the FP before sending subsequent messages, and shall include the received call id in these messages.

If the line or the FP cannot support the additional call:

- the FP shall use the "Busy system or line notification" procedure of clause 7.4.8.3 (instead of returning a "CS call hold"), that is:
 - call status 'CS call disconnecting' sent along with the appropriate call status reason (e.g. 'line in use' or 'system busy');
 - <<CALL INFORMATION>> IE sent with call status 'CS idle' in order to free the call id.

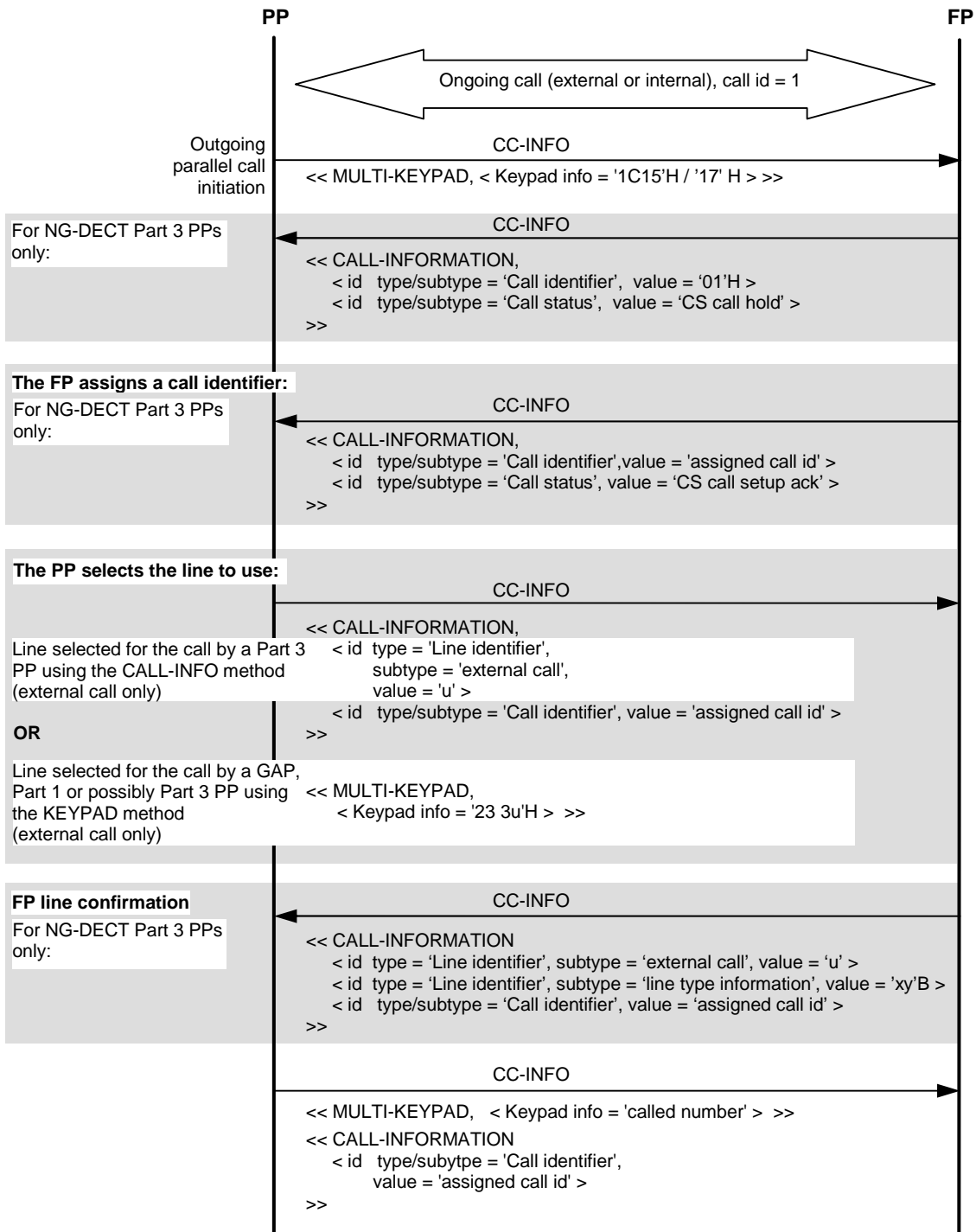

Figure 4: Outgoing parallel call initiation request with line selection by the PP

Line selection: For sending to the FP the line identifier selected for the new external call, one of the following methods shall be used:

- for Part 3 PPs only, included in a << CALL INFORMATION >> information element sent in a {CC-INFO} message; or
- for GAP and Part 1 PPs, and possibly for Part 3 PPs also, included in a << MULTI-KEYPAD >> IE sent in a {CC-INFO} message. This method shall only be used if the line identifier is in the interval 0..9. If this method is used, the line identifier information shall consist in the pound key (" # ") character ('23'H) followed by the line identifier digit, IA5-coded on a single octet.

FP line confirmation: For Part 3 PPs, the FP shall confirm the selected line in a {CC-INFO} message sent back to the PP, including the line type information for the selected line.

NOTE 3: Instead of the sequence given above, the PP might also combine '1C15'H / '17'H, line selection and called number in two or three messages. In these cases the FP will answer correspondingly in two or more messages. See clauses C.3 "Multiple calls diagrams" and C.4 "Parallel call complex or alternative diagrams", for more information.

FP-managed line selection: If the PP uses "FP-managed line selection" (see clause 7.4.5.2.4) for an external call, one of the following methods shall be used:

- for Part 3 PPs only, by using the special line id value 'None' (see clause 3.1). This value shall be sent instead of a regular line id, at any possible time and in any possible location for sending a regular line-id. The FP shall send back to the PP the line identifier value including the line type information for the selected line for the call;
- for GAP or Part 1 PPs, by having their default behavior of sending no line identifier, hence implicitly using "FP-managed line selection". In front of a GAP or Part 1 PP, a Part 3 FP shall wait for the first keypad information received from PP. If this keypad information is different from '23'H ('#' character), the FP shall infer that "FP managed line selection" is used, and shall therefore select a line on behalf of the PP. The FP may notify back the user of the PP of the used line identifier using a <<DISPLAY>> information element, but shall not use any <<CALL-INFORMATION>> element toward the PP.

See figure 5 for detailed sequence flowchart (part 3 PP case).

Internal call: In case of internal call, no line identifier shall be sent.

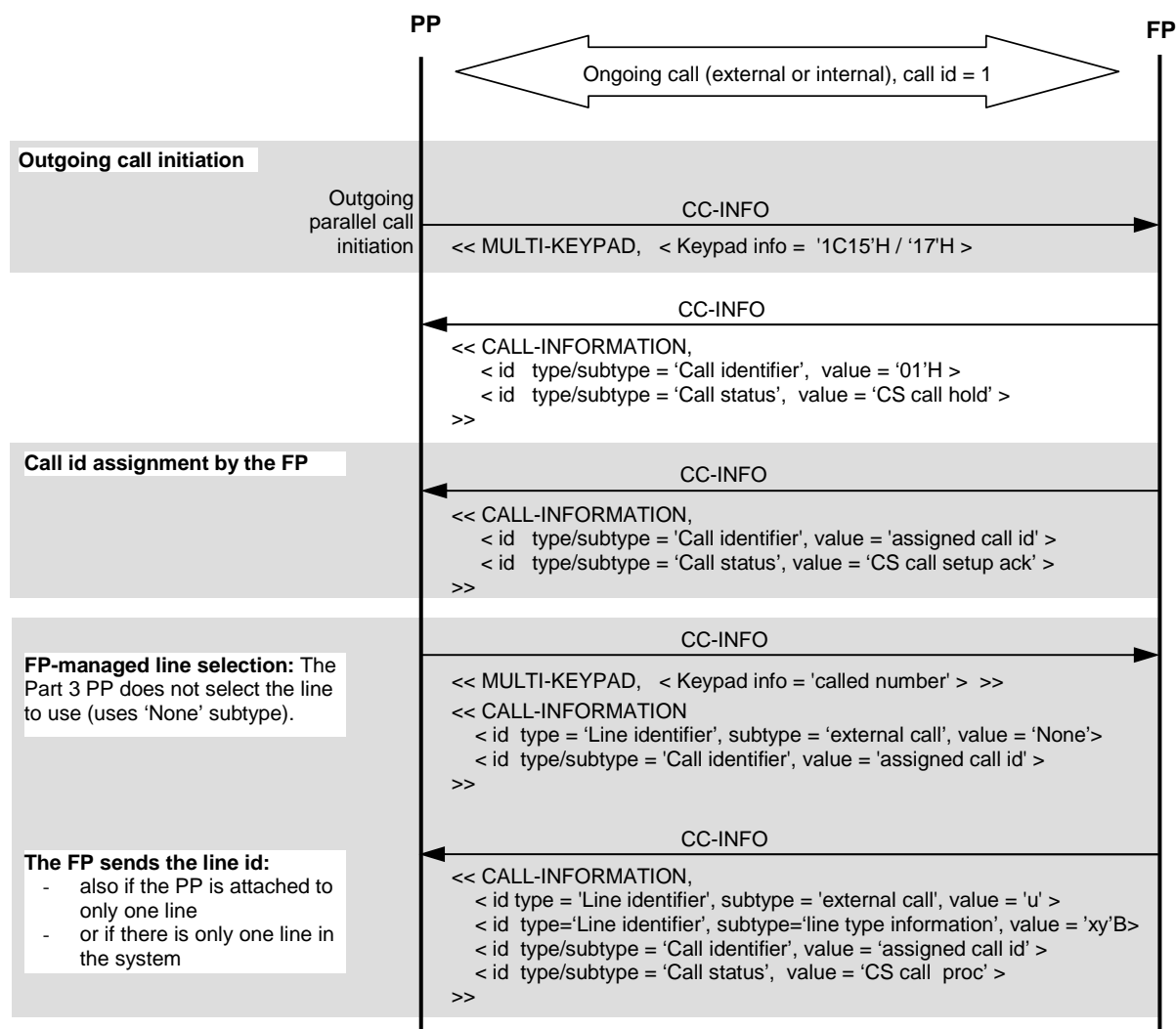

Figure 5: Outgoing parallel call initiation request with FP-managed line selection

The call statuses shall comply with clause 7.4.6.4 provisions.

The FP may change the audio codec for the parallel call by use of the service change procedure (see clause 7.4.3.3, "Codec change for parallel calls").

In case the parallel call is internal, the FP shall use the GAP "internal call CLIP" and "internal call CNIP" procedures for this parallel call (see clause 6.10).

NOTE 4: In case of internal call, the '*' character can be used as called number, meaning that an 'internal general call' is attempted.

7.4.3.5.2 Call waiting indication (external or internal)

This procedure applies to the FP and a PP already involved in a call on a DECT system implementing the feature entitled "Common parallel call procedures (external or internal)". If the "Multiple call" feature is implemented and used on a line, the line may be configured in "single call" mode, or in "multiple call" mode.

NOTE 1: Implementation of the "Multiple call" feature or of the "Multiple line" feature implies implementation of the "Common parallel call procedures (external or internal)" feature.

NOTE 2: In "single call" mode, PPs not involved in a call do not receive the call waiting indication and do not ring. In "multiple call" mode, there may be several PPs already involved in a call and all of them receive the call waiting indication; idle PPs receive an incoming call request and ring.

Call waiting shall be indicated by the FP by sending in a {CC-INFO} message the information element <<CALL-INFORMATION>> with the call status 'CS call setup'. Together with this procedure, the FP shall use the "CLIP on call waiting" procedure of clause 7.4.3.5.10.

Whenever required by the "Tones provision" feature, the FP shall additionally send the <<SIGNAL>> IE with the value '07'H indicating 'call waiting tone on'.

Whether sent in the same or in different {CC-INFO} messages, the sending of the three involved IEs shall respect the following rules:

- call status in <<Call Information>> IE shall always be sent in the first used {CC-INFO} message. If the call is external, the line identifier (including the 'line type information') shall also be sent in the first used {CC-INFO} message, together with the call status;
- whether sent in the same or different {CC-INFO} messages (including the first one above), the other two involved IEs shall always be sent in the following order: <<Signal>> (if any), <<Calling Party Number>>.

NOTE 3: These rules are consistent with the order specified in EN 300 175-5 [5], clause 6.3.2.2 for IEs within the same {CC-INFO} message.

Furthermore, as a result of the "Call identification" feature, the FP shall assign an identifier for the waiting call, and send it in a <<CALL-INFORMATION>> information element included in every {CC-INFO} message used (one or two).

If an internal call is waiting, the information element <<Calling Party Number>> shall indicate a private numbering plan.

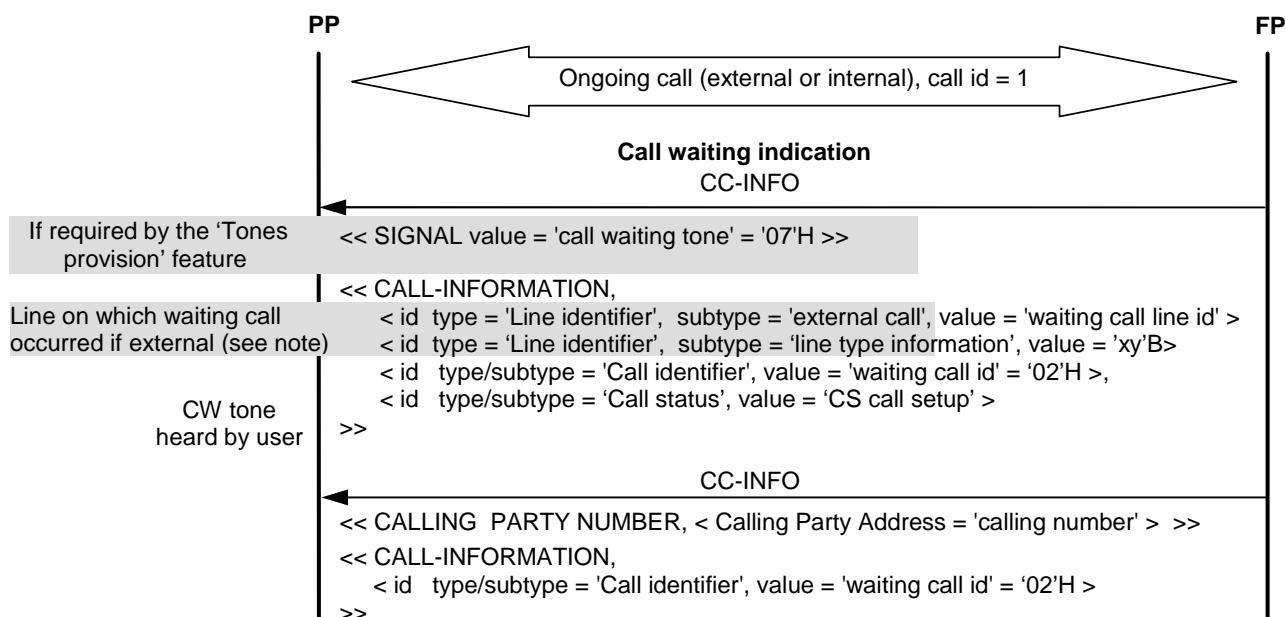

NOTE: The line identifier indicates to the PP on which line the waiting call occurred and also indicates the 'line type information' of this line (if external).

Figure 6: Call waiting indication

To accept the waiting call, the "Call waiting acceptance" procedure or the "Call waiting acceptance with active call released" procedure shall be used (see clauses 7.4.3.5.6 or 7.4.3.5.12).

To reject the waiting call, the "Call waiting rejection" procedure shall be used (see clause 7.4.3.5.7).

If the remote party hangs up before the waiting call has been accepted or rejected, the FP shall send a "CS idle" call status to the PP, with the call id of the waiting call.

7.4.3.5.3 Call toggle (external or internal)

This procedure applies to the FP and a PP already involved in a call on a DECT system implementing the feature entitled "Common parallel call procedures (external or internal)".

NOTE 1: Implementation of the "Multiple call" feature or of the "Multiple line" feature implies implementation of the "Common parallel call procedures (external or internal)" feature.

In case two parallel calls are established, in order to toggle between the calls, the PP shall send a toggle request to the FP consisting in the control code 1CH as keypad information in a {CC-INFO} message, followed by 31H. Furthermore, the PP shall send the identifier of the call targeted by the toggle in a <<CALL-INFORMATION>> information element included in the **same** {CC-INFO} message.

NOTE 2: A PP sends the call identifier of the targeted call, even if it toggles between two calls only.

The FP may change the codec using the service change procedure (see clause 7.4.3.3, "Codec change for parallel calls").

The FP shall indicate the result of the toggling by use of call status indications:

- if the toggle request is successful, the FP shall indicate first call status 'CS call hold' for the previously active call, and then 'CS call connect' for the targeted call;
- if the toggle request is unsuccessful, the FP shall send a negative acknowledgment as described in clause 7.4.3.4 (call status of the active call 'CS call connect' re-sent along with call status reason 'control code failed').

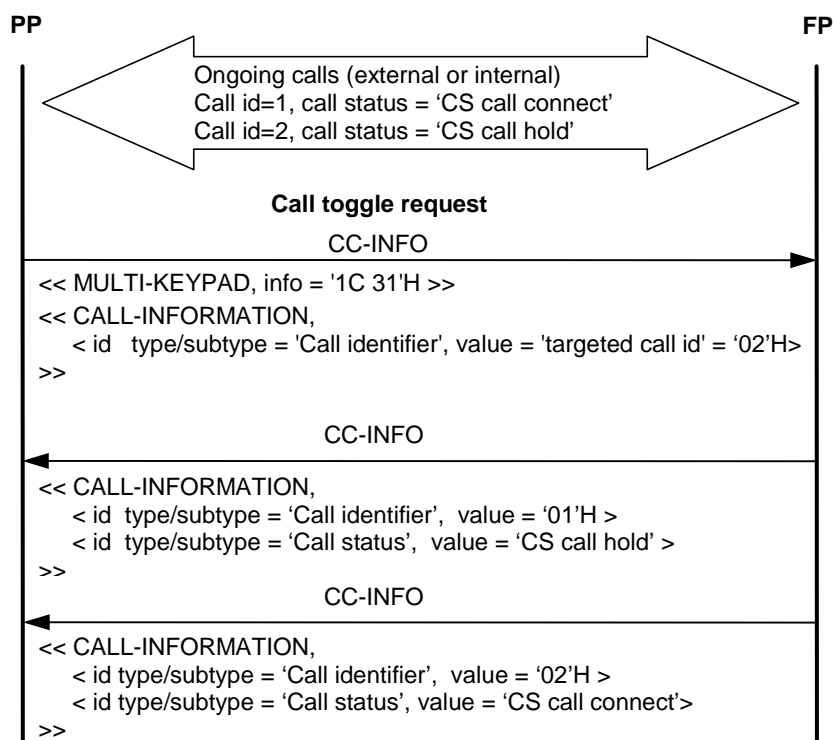

Figure 7: Call toggle request

7.4.3.5.4 Call release and call release rejection

This procedure applies to the FP and a PP already involved in at least two calls on a DECT system implementing the feature entitled "Common parallel call procedures (external or internal)", and is used by the releasing party in order to release one of these calls.

NOTE 1: Implementation of the "Multiple call" feature or of the "Multiple line" feature implies implementation of the "Common parallel call procedures (external or internal)" feature.

NOTE 2: The call may still exist in the system, if one or several other PPs are still involved in the call. See for example use case C.3.2. For the relationship between call release and the call id lifecycle, see also clause 7.4.6.1, "Call identification general requirements"

When releasing the last parallel call of the PP, the PP shall not use the current procedure. However it is allowed for the FP to use it (e.g. send a 'CS idle' before it sends a {CC-RELEASE} to the PP).

If the PP is the releasing party:

- It shall send a 'call release request' to the FP, consisting in control code 1CH as keypad information in a {CC-INFO} message, followed by 33H. Additionally, it shall send the identifier of the call to be released in a <<CALL-INFORMATION>> IE included in the same {CC-INFO} message.
- If the FP can release the call, it shall answer with the call status 'CS idle' and the call identifier of the released call.
- If the released call is the active call, the FP shall NOT automatically switch the speech path to one of the remaining parallel calls. The PP shall use the "Resuming a call put on-hold" procedure of clause 7.4.3.5.9 in order to indicate to the FP the on-hold call to be resumed. In order to use this procedure, the PP shall first:
 - either interact with the user to let him choose the on-hold call to be resumed; or
 - automatically select the on-hold call to be resumed.

NOTE 3: The only difference between the two options from protocol point of view is the delay between the 'CS idle' message from the FP, and the following resuming request from the PP. When the second option is used, the PP answer is immediate.

NOTE 4: A call release request can be sent as soon as a call identifier has been sent by the FP to the PP (e.g. in case of a waiting call release, even before the waiting call has been answered). See also clause C.4.1.5.

In some cases, when a call release request is sent by the PP, the FP might not be able to fulfil it, for instance when the call to be released is external. In that case:

- the FP shall send a negative acknowledgment as described in clause 7.4.3.4 (call status of the active call 'CS call connect' re-sent along with call status reason 'control code failed');
- the FP shall send a negative acknowledgment as described in clause 7.4.3.4: call status of the call that was to be released (e.g. 'CS call connect' if it was the active call, 'CS call hold' if it was a call on-hold) re-sent along with call status reason 'control code failed'.

If the FP is the releasing party, (i.e. as a result of a remote party hangup):

- It shall send the call status 'CS idle' together with the call identifier of the released call. This shall not be used with a newly defined call id (i.e. not yet communicated to the PP).
- If the released call is the active call, the FP shall NOT switch the speech path automatically. Instead, the user should additionally be warned (e.g. through a PP originating display) of the change in order to invite him/her to resume one of the on-hold remaining parties. The speech path can be then switched to one of the remaining parties using the procedure "Resuming a call put on-hold" of clause 7.4.3.5.9.

NOTE 5: When the speech path is switched to one remaining party, the PP should update the displayed call information to show the active telephone number.

NOTE 6: When the PP or FP releases the last parallel call, they do not use the current procedure. However, when the FP releases the last parallel call, it should still sent a 'CS idle' call status to the PP before the {CC-RELEASE} message is used. A {CC-RELEASE} message does not convey any call identifier.

The FP may change the codec using the service change procedure (see clause 7.4.3.3, "Codec change for parallel calls").

NOTE 7: To release all parallel calls, the PP may also send a single {CC-RELEASE} to the FP.

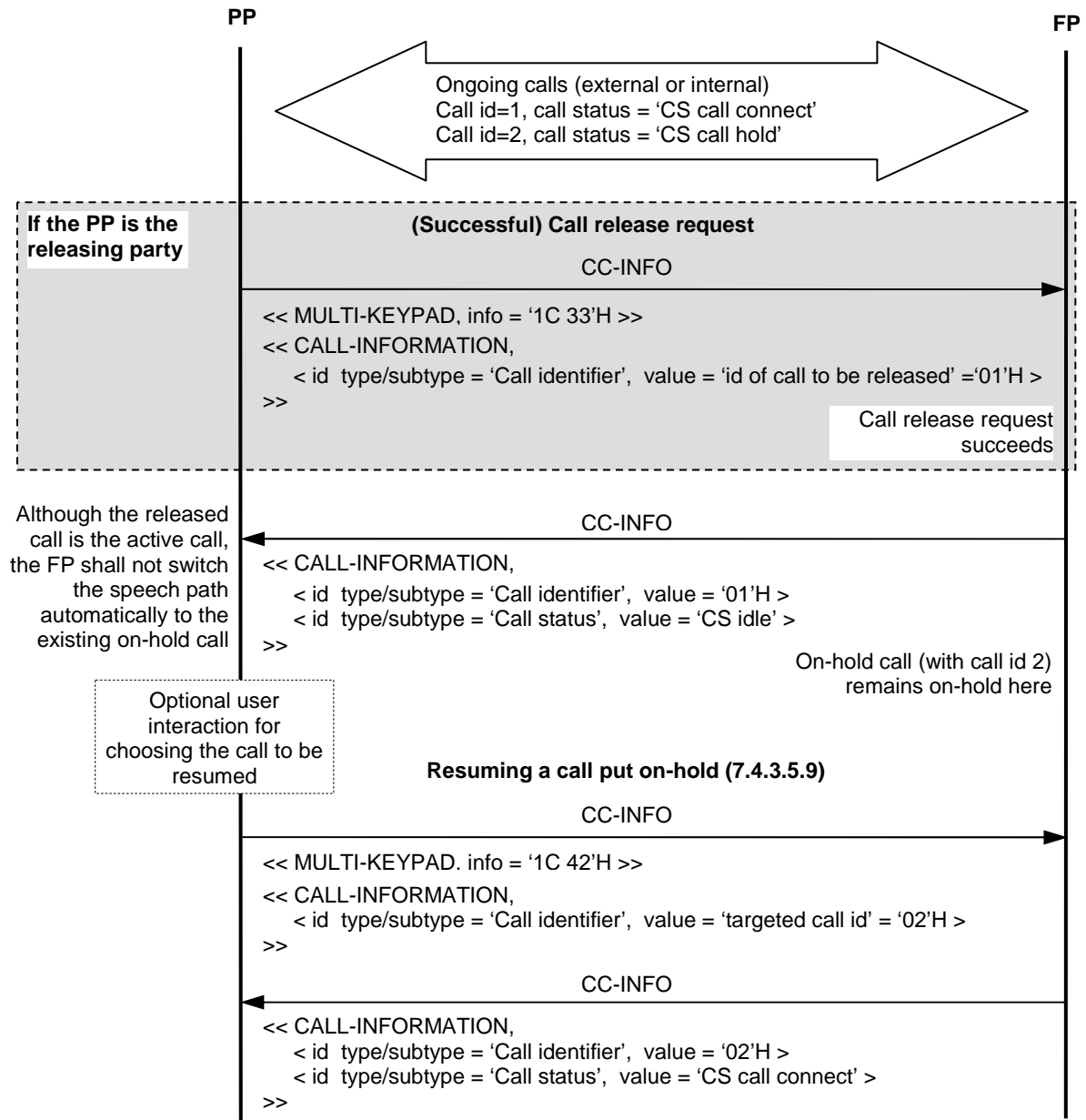

Figure 8: Successful call release of the active call (requested by the PP or not)

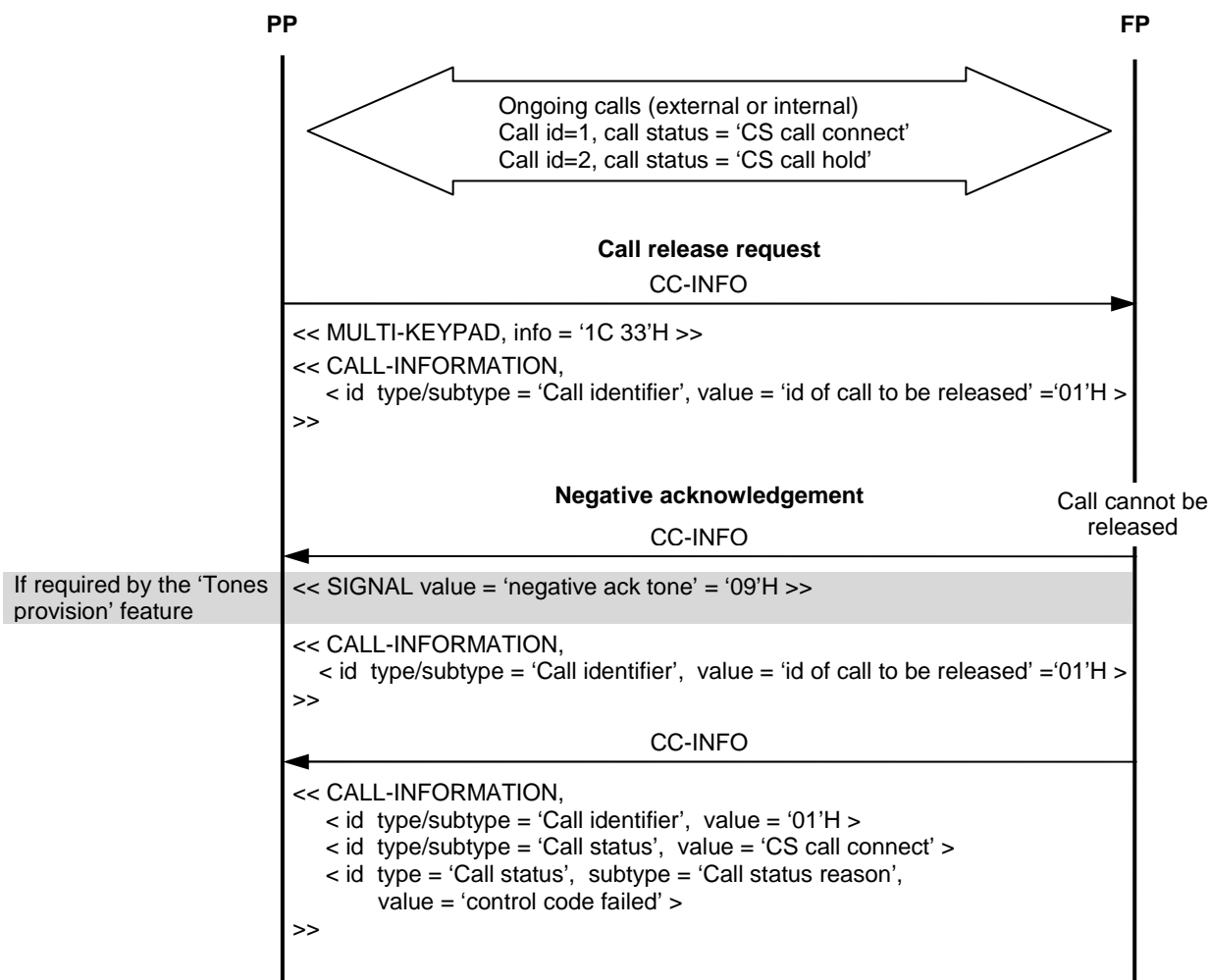

Figure 9: Failing call release request from the PP

Release of a 3-party conference call.

Additional requirements applying specifically to 3-party conference calls are described in clause 7.4.3.7 (release sub sections).

7.4.3.5.5 Void

7.4.3.5.6 Call waiting acceptance (from PP to FP)

This procedure applies to the FP and a PP already involved in a call on a DECT system implementing the feature entitled "Common parallel call procedures (external or internal)". If the "Multiple call" feature is implemented on a line, the line may be configured in "single call" mode, or in "multiple call" mode.

NOTE 1: Implementation of the "Multiple call" feature or of the "Multiple line" feature implies implementation of the "Common parallel call procedures (external or internal)" feature.

In case the PP is already involved in a call (active call) and after a call waiting has been indicated, the acceptance of the waiting call shall be done by sending the control code 1CH as keypad information in a {CC-INFO} message, followed by 35H. Furthermore, the PP shall send the call identifier of the accepted waiting call in a <<CALL-INFORMATION>> information element included in the same {CC-INFO} message.

NOTE 2: The PP sends the call identifier of the waiting call, even if there is a single call waiting.

The active call shall be automatically put on hold and the waiting call shall become active.

The FP shall indicate as a result of the call waiting acceptance : call status 'CS call connect' for the waiting call, and 'CS call hold' for the previously active call.

NOTE 3 : If any of these calls is released in the meantime by the remote party, the FP may directly send a "CS idle" (or "CS call disconnecting") on the corresponding call id instead.

In "multiple call" mode, when the PP accepts the waiting call, ongoing procedures for handling the call on other PPs (using the present clause, or EN 300 444 (GAP) [12], clause 8.12, "Incoming call request", if it is a first call for the concerned PP) shall be terminated. In particular, idle PPs shall stop ringing. If several handsets either pick-up or accept the waiting call, only the first action shall be taken into account. The other actions shall be ignored.

The FP may change the audio codec for the accepted call by use of the service change procedure.

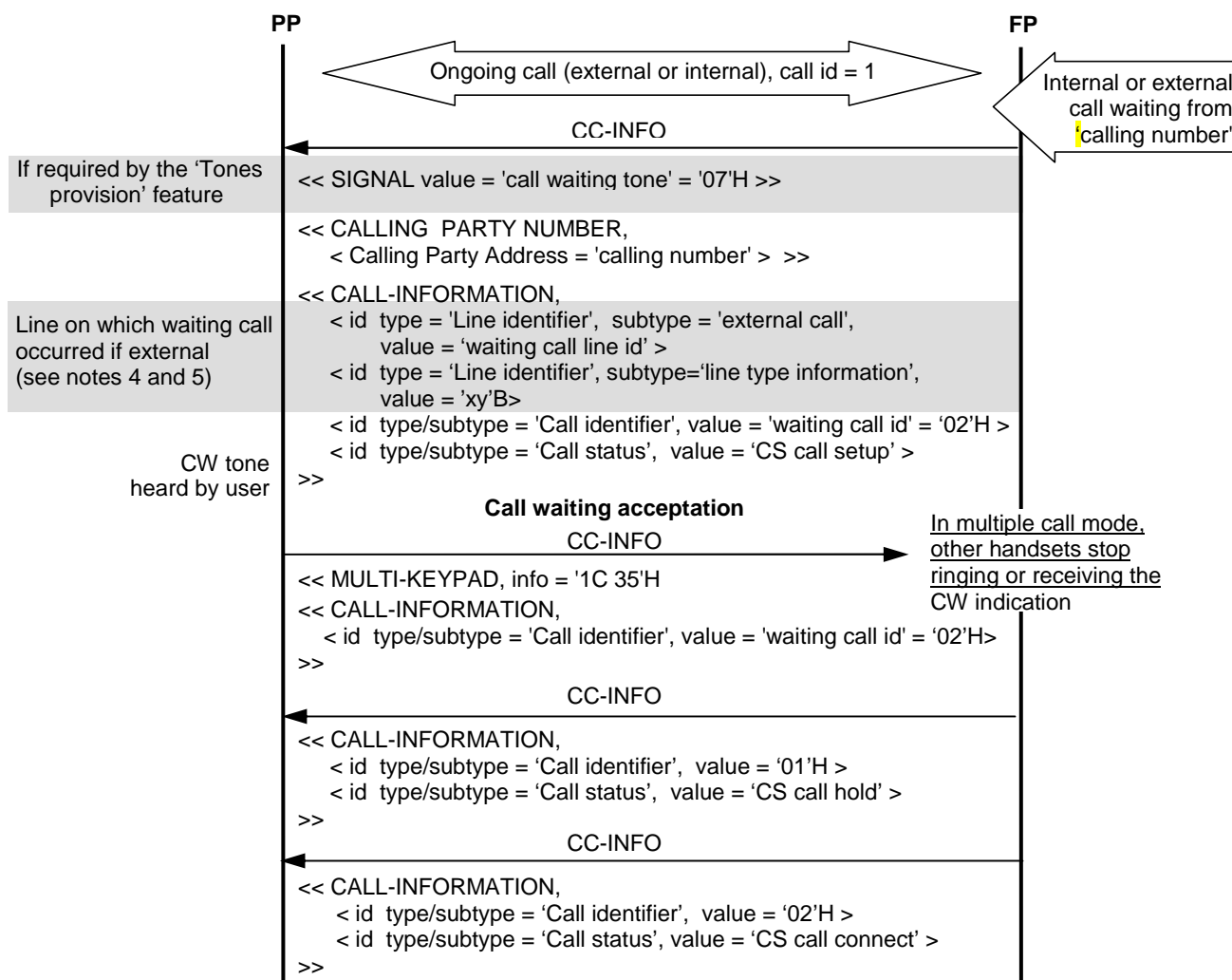

Figure 10: Call waiting acceptance

NOTE 4: The line identifier indicates to the PP on which line the waiting call occurred and also the 'line type information' of this line (if external).

NOTE 5: Although the 'network delay type' (within the 'line type information') is already sent in the first {CC_INFO} message from FP to PP, the PP may wait until the final {CC_INFO} carrying the 'CS call connect' call status before actually adapting the acoustics parameters to the announced 'network delay type'.

If the remote party hangs up before the waiting call has been accepted or rejected, the FP shall send a 'CS idle' call status to the PP, as defined in clause 7.4.3.5.4, "Call release and call release rejection".

7.4.3.5.7 Call waiting rejection (from PP to FP)

This procedure applies to the FP and a PP already involved in a call on a DECT system implementing the feature entitled "Common parallel call procedures (external or internal)". If the "Multiple call" feature is implemented on a line, the line may be configured in "single call" mode, or in "multiple call" mode.

NOTE 1: Implementation of the "Multiple call" feature or of the "Multiple line" feature implies implementation of the "Common parallel call procedures (external or internal)" feature.

In case the PP is already involved in a call (active call) and after a call waiting has been indicated, the rejection of the waiting call shall be done by sending the control code 1CH as keypad information in a {CC-INFO} message, followed by 36H. Furthermore, the PP shall send the call identifier of the rejected waiting call in a <<CALL-INFORMATION>> information element included in the same {CC-INFO} message.

NOTE 2: The PP sends the call identifier of the waiting call, even if there is a single call waiting.

The FP shall indicate the result of the call waiting rejection by use of call status indications:

- if the call waiting rejection is successful, the FP shall indicate call status 'CS idle' for the waiting call;
- if the call waiting rejection is unsuccessful, the FP shall send a negative acknowledgment as described in clause 7.4.3.4 (call status of the waiting call 'CS call setup' re-sent, along with call status reason 'control code failed').

NOTE 3: This cannot be used to avoid implementation of the procedure. In other words, there is no 'unimplemented' call status reason.

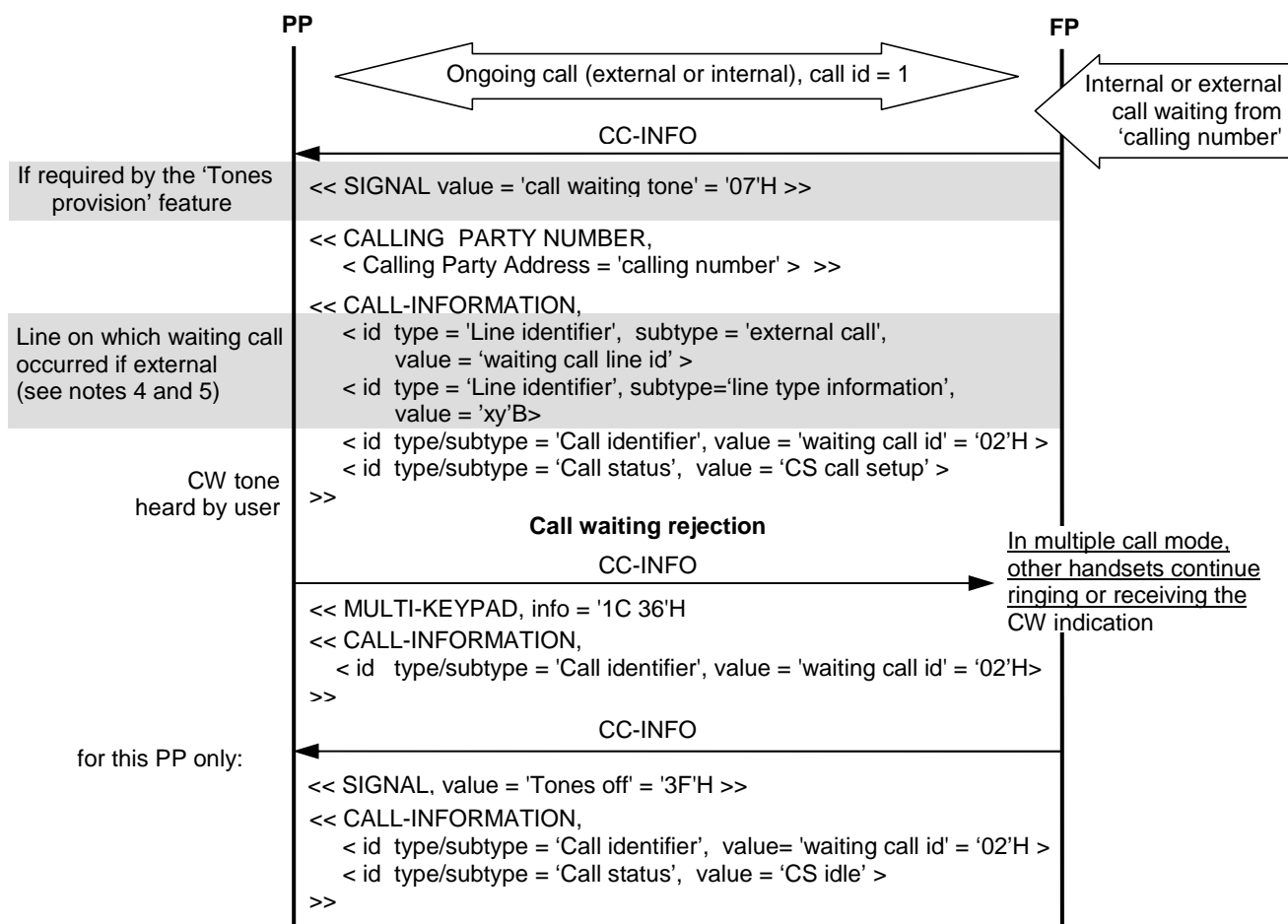

Figure 11: Call waiting rejection

NOTE 4: The line identifier indicates to the PP on which line the waiting call occurred and also the 'line type information' of this line (if external).

NOTE 5: On a multiple call line configured in "multiple call" mode, "call waiting rejection" does not necessarily imply that the call is rejected by the DECT system.

In "multiple call" mode, when the PP rejects the waiting call, the "Call waiting indication procedure" shall be terminated for this PP, but this shall not affect the handling of this call on other handsets: ongoing procedures for handling the call on other PPs (using the present clause or EN 300 444 [12] (GAP), clause 8.12, "Incoming call request" if it is a first call for the concerned PP) shall not stop. In particular, idle PPs shall not stop ringing.

NOTE 6: To reject the call for the whole DECT system, a call release may be used instead of the present procedure, using the "Call release and call release rejection" of clause 7.4.3.5.4 for the waiting call.

If the remote party hangs up before the waiting call has been accepted or rejected, the FP shall send a 'CS idle' call status to the PP, as defined in clause 7.4.3.5.4, "Call release and call release rejection".

7.4.3.5.8 Putting a call on-hold

This procedure applies to the FP and a PP already involved in a call on a DECT system implementing the feature entitled "Common parallel call procedures (external or internal)".

NOTE 1: Implementation of the "Multiple call" feature or of the "Multiple line" feature implies implementation of the "Common parallel call procedures (external or internal)" feature.

In order to put a call on-hold, the PP shall send the control code 1CH as keypad information in a {CC-INFO} message, followed by 41H. Furthermore, the PP shall send the identifier of the call to be put on-hold in a <<CALL-INFORMATION>> information element included in the same {CC-INFO} message.

NOTE 2: The PP sends the call identifier of the call to be put on hold, although it is always the active call.

The FP shall indicate the result of the "Putting a call on-hold" procedure by use of a call status indication:

- if the procedure is successful, the FP shall indicate call status 'CS call hold' for the targeted call;
- if the procedure is unsuccessful, the FP shall send a negative acknowledgment as described in clause 7.4.3.4 (call status of the targeted call 'CS call connect' re-sent, along with call status reason 'control code failed').

NOTE 3: This cannot be used to avoid implementation of the procedure. In other words, there is no 'unimplemented' call status reason.

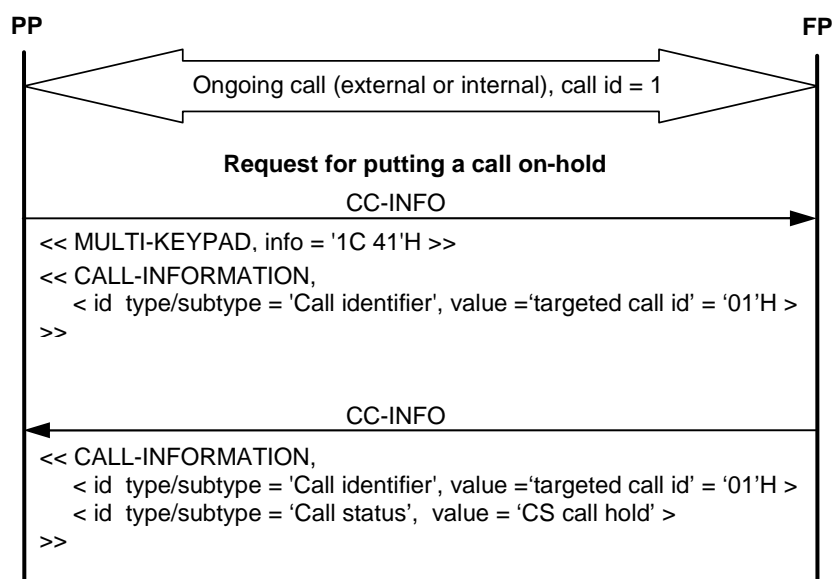

Figure 12: Putting a call on hold

NOTE 4: In the specific case where the call put on-hold is a conference call, the conference (audio path) should remain active in the FP for the two other participants.

NOTE 5: The use case when the user wants to put only one of the participant's call of a conference on hold is not described in the present document.

7.4.3.5.9 Resuming a call put on-hold

This procedure applies to the FP and a PP already involved in a call on a DECT system implementing the feature entitled "Common parallel call procedures (external or internal)".

NOTE 1: Implementation of the "Multiple call" feature or of the "Multiple line" feature implies implementation of the "Common parallel call procedures (external or internal)" feature.

In order to resume a call that was put on-hold, the PP shall send the control code 1CH as keypad information in a {CC-INFO} message, followed by 42H. Furthermore, the PP shall send the identifier of the call to be resumed in a <<CALL-INFORMATION>> information element included in the same {CC-INFO} message.

The procedure shall not be used in case of existing active call.

NOTE 2: The PP sends the call identifier of the call to be resumed, even if there is only one call on-hold.

The FP shall indicate the result of the "Resuming a call put on-hold" procedure by use of a call status indication:

- if the procedure is successful, the FP shall indicate call status 'CS call connect' for the targeted call;
- if the procedure is unsuccessful, the FP shall send a negative acknowledgment as described in 7.4.3.4 (call status of the targeted call 'CS call hold' re-sent, along with call status reason 'control code failed').

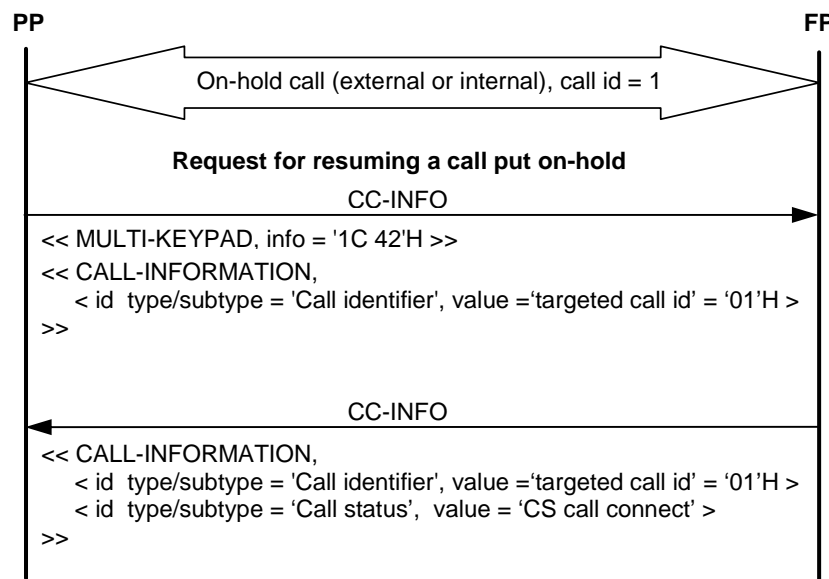

Figure 13: Resuming a call put on hold

7.4.3.5.10 CLIP on call waiting

This procedure applies to the FP and a PP already involved in a call on a DECT system implementing the feature entitled "Common parallel call procedures (external or internal)". If the "Multiple call" feature is implemented on a line, the line may be configured in "single call" mode, or in "multiple call" mode.

CLIP on call waiting shall be indicated by the FP to the PP.

This indication shall be done by sending in one of the {CC-INFO} message used, the <<Calling Party Number>> IE. More specifically, whether sent in the same or in different {CC-INFO} messages, the sending of the three involved IEs shall respect the following rules:

- call status in <<Call Information>> IE shall always be sent in the first used {CC-INFO} message. If the call is external, the line identifier (including the 'line type information') shall also be sent in the first used {CC-INFO} message, together with the call status.

- whether sent in the same or different {CC-INFO} messages (including the first one above), the other two involved IEs shall always be sent in the following order: <<Signal>> (if required by the "Tones provision" feature), <<Calling Party Number>>.

NOTE: These rules are consistent with the order specified in EN 300 175-5 [5], clause 6.3.2.2 for IEs within the same {CC-INFO} message.

If the waiting call is an internal call, the information element <<Calling Party Number>> shall indicate a private numbering plan.

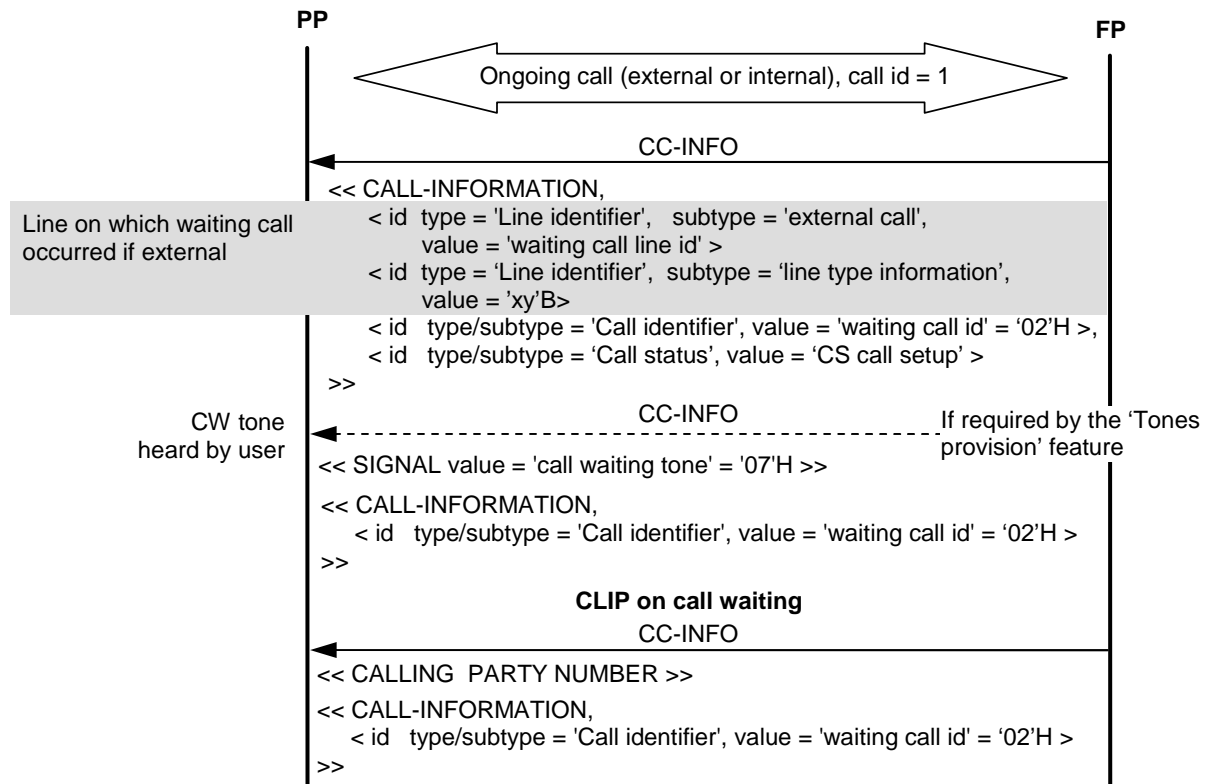

Figure 14: CLIP on call waiting

7.4.3.5.11 CNIP on call waiting indication

This procedure applies to the FP and a PP already involved in a call on a DECT system implementing the feature entitled "Common parallel call procedures (external or internal)". If the "Multiple call" feature is implemented on a line, the line may be configured in "single call" mode, or in "multiple call" mode.

CNIP on call waiting shall be indicated by the FP to the PP.

This indication shall be done by sending, in one of the {CC-INFO} messages used, the <<Calling Party Name>> IE. More specifically, whether sent in the same or in different {CC-INFO} messages, the sending of the four involved IEs shall respect the following rules:

- Call status in <<Call Information>> IE shall always be sent in the first used {CC-INFO} message. If the call is external, the line identifier (including the 'line type information') shall also be sent in the first used {CC-INFO} message, together with the call status.
- Whether sent in the same or different {CC-INFO} messages (including the first one above), the other three involved IEs shall always be sent in the following order: <<Signal>> (if required by the "Tones provision" feature), <<Calling Party Number>>, <<Calling Party Name>>.

NOTE 1: These rules are consistent with the order specified in EN 300 175-5 [5], clause 6.3.2.2 for IEs within the same {CC-INFO} message.

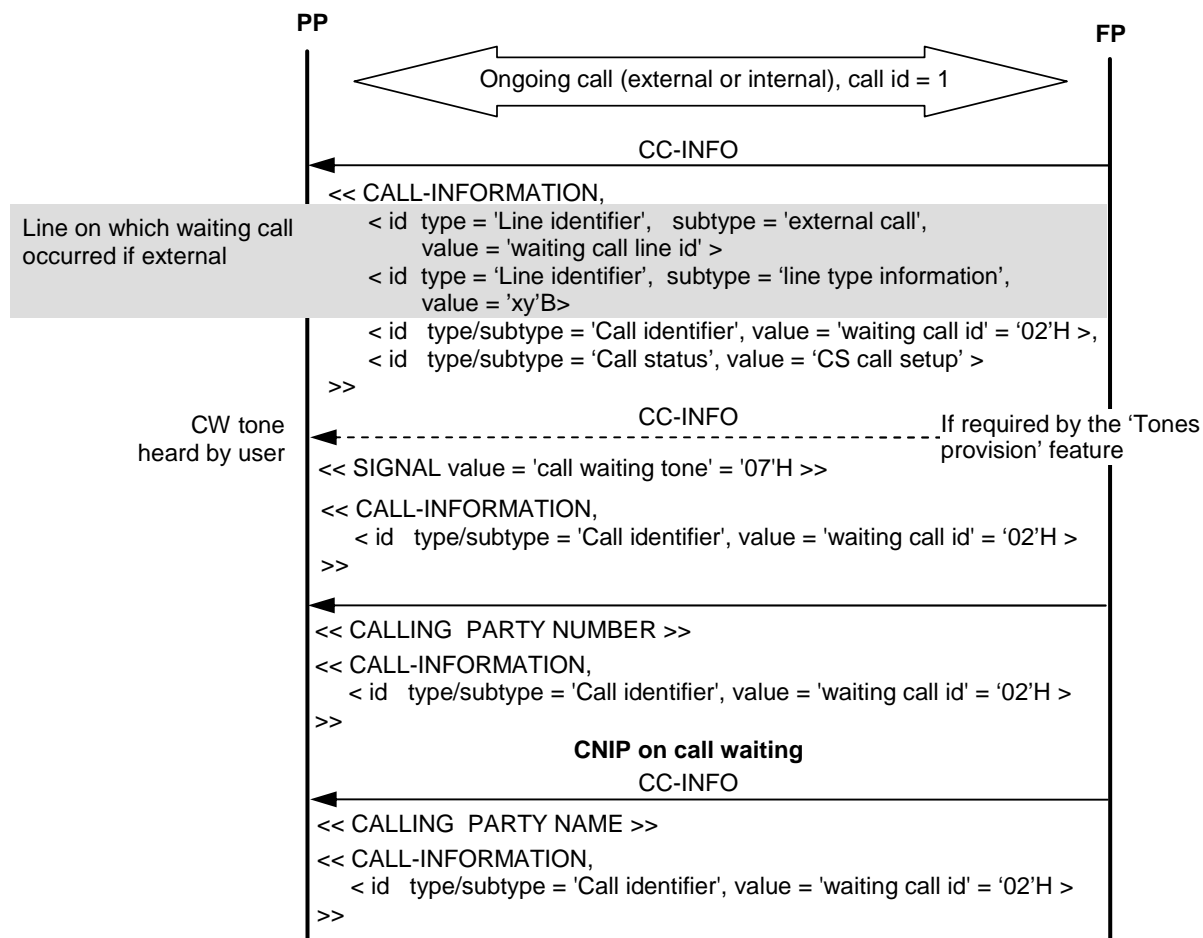

Figure 15: CNIP on call waiting

NOTE 2: In case both CLIP and CNIP are sent to the PP, it is sufficient to display one of them. It is optional to display both.

7.4.3.5.12 Active call release with replacement (from PP to FP)

The present procedure is primarily intended for backward compatibility of NG-DECT systems with PSTN lines using the 'R' key as unique control code. The release of the active call, and the replacement thereof with another call in the following two cases:

- 1) there is a waiting call, and following the 'active call release request with replacement', the current active call is released and replaced with the waiting call;
 - In case 1, all requirements of procedure "Call waiting acceptance (from PP to FP)" of clause 7.4.3.5.6 shall apply, with following modifications:
 - control code 1CH as keypad information in a {CC-INFO} message, followed by 38H (instead of 35H) shall be used;
 - when accepting the waiting call, the active call is released instead of being put on hold.
- 2) there is a call on hold, and following the 'active call release request with replacement', the current active call is released and replaced with the call on hold;
 - In case 2, all requirements of procedure "Call toggle (external or internal)" of clause 7.4.3.5.3 shall apply, with following modifications:
 - control code 1CH as keypad information in a {CC-INFO} message, followed by 38H (instead of 31H) shall be used;

- the active call is released instead of being put on hold.

In both cases, the active call that will be released may be an internal or external call.

In both cases the used call id is the call id of the call that becomes active after the request is fulfilled. In case there is both a call waiting and a call on hold, the used call id allows to disambiguate the request.

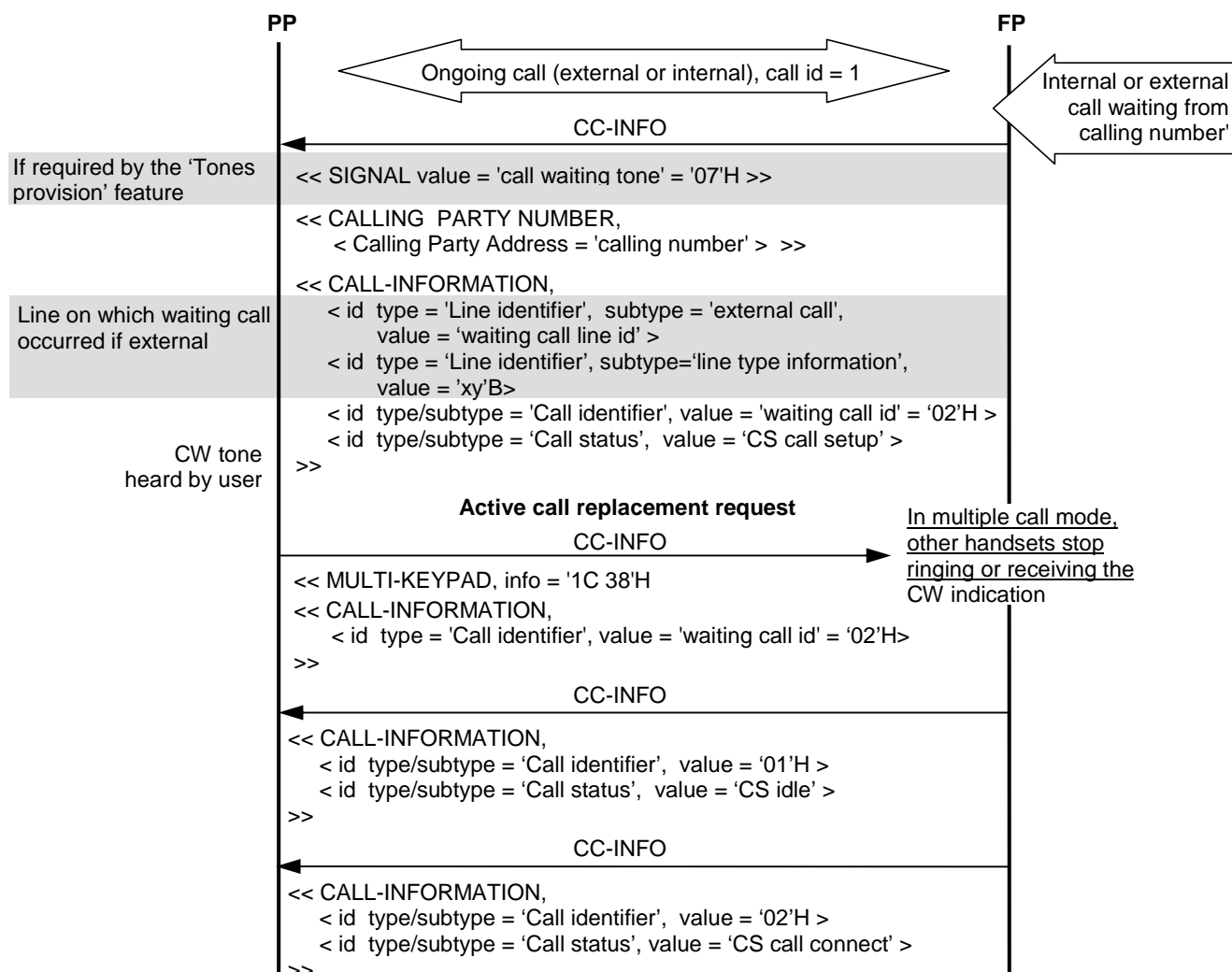

Figure 16: Active call replacement with the waiting call

7.4.3.6 Call transfer

Call transfer is used by the user of a PP involved in two parallel calls to connect the remote parties together before ending the existing calls. If one of the remote parties is a handset registered to the same FP, the transfer can be handled at FP level; otherwise, the success of the transfer is network-dependent.

Transfer target: The phrase "transfer target" refers to the internal or external party to which the call is transferred.

Implementation of the "Common parallel calls procedures" feature is a pre-requisite on PP and FP sides for implementation of the "Call transfer" feature.

The call transfer may be announced or unannounced, depending on when the call transfer control message is sent by the PP.

In order to transfer a call, the PP shall first establish a parallel call with the call transfer target, and then send the control code 1CH as keypad information in a {CC-INFO} message, followed by 34H. Furthermore, the PP shall send the identifier of the call to be transferred in a <<CALL-INFORMATION>> information element included in the **same** {CC-INFO} message.

The FP shall understand a call transfer request as a request for transferring the previously active call to the currently active call.

The call release, using a {CC-RELEASE} message shall be issued by FP. When the transfer target is internal and *only after* the {CC-RELEASE} message has been sent (i.e. when the call transfer can be considered effective on FP side), the FP shall issue a call identifier update for the PP target of the call transfer, as shown in figures 17 and 18, indicating the call identifier of the transferred call as updated call identifier.

Call transfer abort:

The PP may release the internal call before the call transfer is requested, this is handled as a regular parallel call release (see clause 7.4.3.5.4). (No later call transfer is then possible).

The PP may abort a call transfer after the call transfer request has been actually sent to the FP. To achieve the user abort, the PP shall send a call release to the FP, using "Call release and call release rejection" of clause 7.4.3.5.4 to release the parallel call initiated for the transfer. The speech path shall be then automatically switched to the waiting peer.

NOTE 1: Implementation of call transfer abort on PP side is not strictly necessary except for the announced call transfer case (see clause 7.4.3.6, "No answer from transfer target" section).

MMI independence:

The requirements and flowcharts of the call transfer procedures described below allow various user experiences. For example the following MMI implementations are compatible:

Implementation 1: A dedicated call transfer button/menu/action is offered each time the user establishes a second call (a 'call transfer request' is sent to the FP as soon as the user selects this option). Then the user separately hangs up, which triggers the sending of a {CC-RELEASE} to the FP.

Implementation 2: Establishing a second internal call and hanging up is considered as an implicit call transfer request from the user. After user hangup, the PP sends in a row a 'call transfer request' and a {CC-RELEASE} to the FP.

NOTE 2: In implementations 1 and 2, a user hangup can never be considered as a user request for call transfer abort. In particular, offering call transfer abort to the user with implementation 2 would require a dedicated MMI item (e.g. re-press the INT key).

Implementation 3: same implementation as implementation 1 except that the FP sends a {CC-RELEASE} message after reception of the call transfer request from the PP.

CLIP and CNIP. Procedures "Remote party CLIP on call transfer" (see clause 7.4.3.6.4) and "Remote party CNIP on call transfer" (see clause 7.4.3.6.5) shall be used.

7.4.3.6.1 Announced call transfer procedure

For the "Announced call transfer" procedure, all requirements of clause 7.4.3.6 apply. Additionally, if the control code is sent after establishing the connection with the transfer target, allowing for a transient call with the transfer target, the transfer is defined as announced.

Announced call transfer "failure" cases:

No answer from transfer target: when the transfer target does not answer, the FP should stop the call presentation upon timer expiry, and then provide the initiating PP with an off-hook warning tone according to "Tones provision" NG1.N.20 procedures. The initiating PP shall then abort the call transfer as described in *call transfer abort* section of clause 7.4.3.6.

NOTE 1: In other words, the present "Announced call transfer" procedure requires implementation of a *call transfer abort* in order to be able to resume the call with the initial remote party (parallel call release before the call transfer is requested).

NOTE 2: Despite the announced call transfer means that the transfer target answers the call, this sub procedure cannot be considered as out of scope of the announced call transfer procedure as it corresponds to a possible failure case.

Waiting peer premature hangup: Premature hangup occurs if the waiting peer hangs up after the FP has received the *call transfer request* but before the waiting peer and transfer target were connected. In that case the FP shall ignore the call transfer request. The initiating PP may either continue with the second call (especially if it received the waiting peer release information), or release it.

NOTE 3: If the waiting peer hangs up *before* the FP has received the call transfer request, the FP cannot assume that a call transfer was going to happen and is still in a regular double call scenario. The FP should therefore keep the second call going (whether still presented or already connected). If a subsequent call transfer request is however received, it is also ignored as it refers to an idle call id.

NOTE 4: When the initiating PP receives the release information resulting from the waiting peer hangup, it should not send the call transfer request even if already requested by the user.

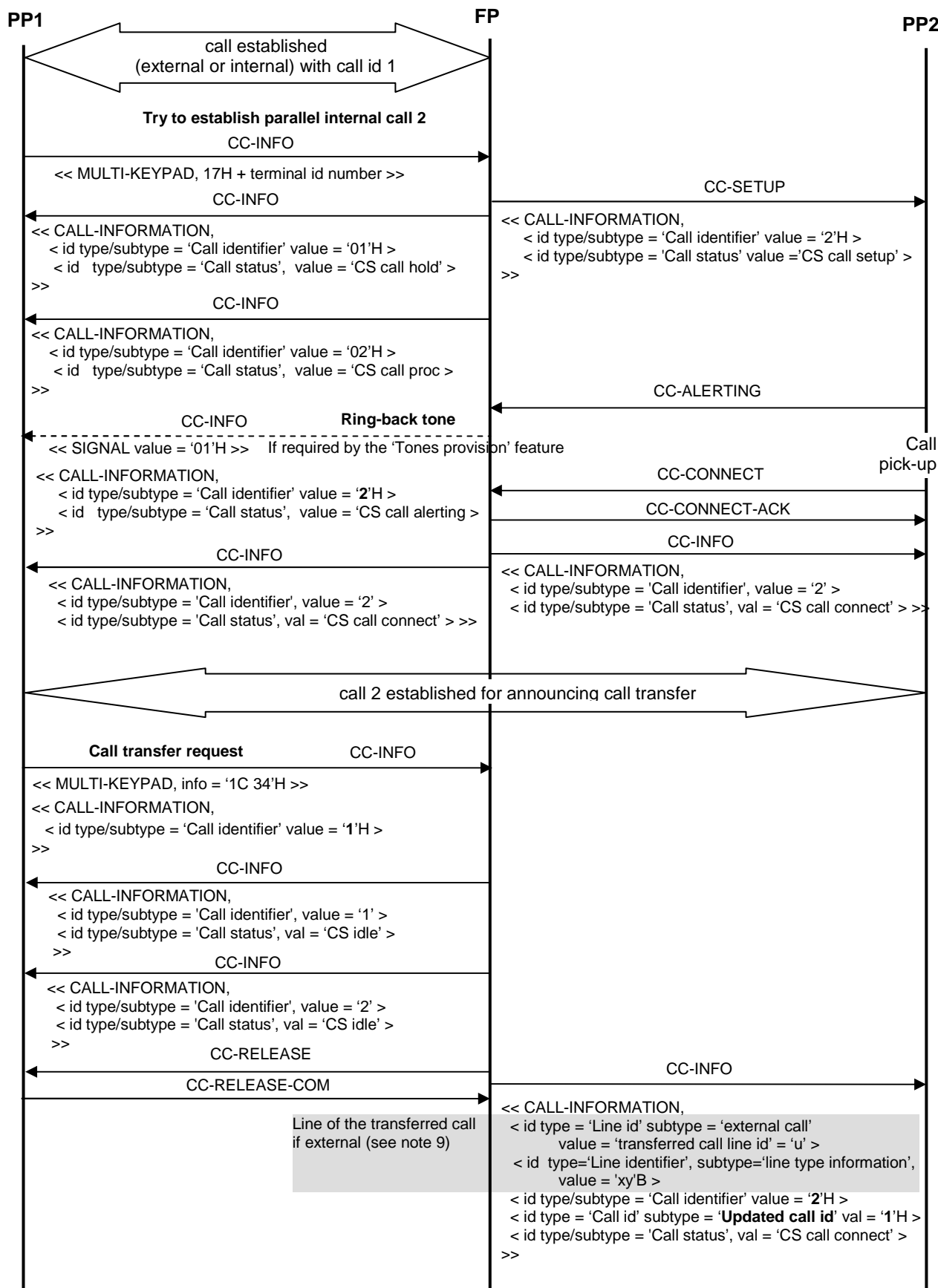

Figure 17: Announced call transfer (example with internal target PP2):
"call transfer request" after {CC-CONNECT}

NOTE 5: The Call Control message sequence in figure 17 should be understood as an example. The real sequences may also contain different Call Control messages or Call Control messages in another order or Call Control messages with other contents.

NOTE 6: PP2 may be idle or busy (involved in another call). If busy, PP2 would receive a parallel internal incoming call instead of a first internal incoming call.

NOTE 7: A multiple call line may not support the additional internal call. In that case, PP1 will receive back a busy line notification, which will terminate the procedure.

NOTE 8: In figure 17, the second call is established using the "Outgoing parallel call initiation" procedure of clause 7.4.3.5.1; however, any procedure leading to two parallel calls may precede the call transfer procedure.

NOTE 9: The call id update at the end of figure 17 contains the line id value and the 'line type information' of the transferred call, in order to inform PP2 of the line (and line type) used for this call.

7.4.3.6.2 Unannounced call transfer procedure

For the "Unannounced call transfer" procedure, all requirements of clause 7.4.3.6 apply. Additionally, if the control code is sent without knowing whether the transfer target would actually answer, the transfer is defined as unannounced.

Unannounced call transfer "failure" cases:

No answer from transfer target: When the transfer target does not answer, the FP should stop the call presentation upon timer expiry. The FP should then call back the initiating PP to re-connect the waiting peer party.

Waiting peer premature hangup: Premature hangup occurs if the waiting peer hangs up after the FP has received the *call transfer request* but before the transfer target answered. If not already done at the time the waiting peer hangs up, the FP shall release the second call toward the initiating PP in response to the received 'call transfer request', as for a successful call transfer. The FP shall then stop the presentation of the second call to the transfer target.

NOTE 1: If the waiting peer hangs up *before* the FP has received the call transfer request, the FP cannot assume that a call transfer was going to happen and is still in a regular double call scenario. The FP therefore keeps the second call going. If a subsequent call transfer request is however received, it is ignored as it refers to an idle call id.

NOTE 2: If the initiating PP receives the release information resulting from the waiting peer hangup, it should not send the call transfer request even if already requested by the user.

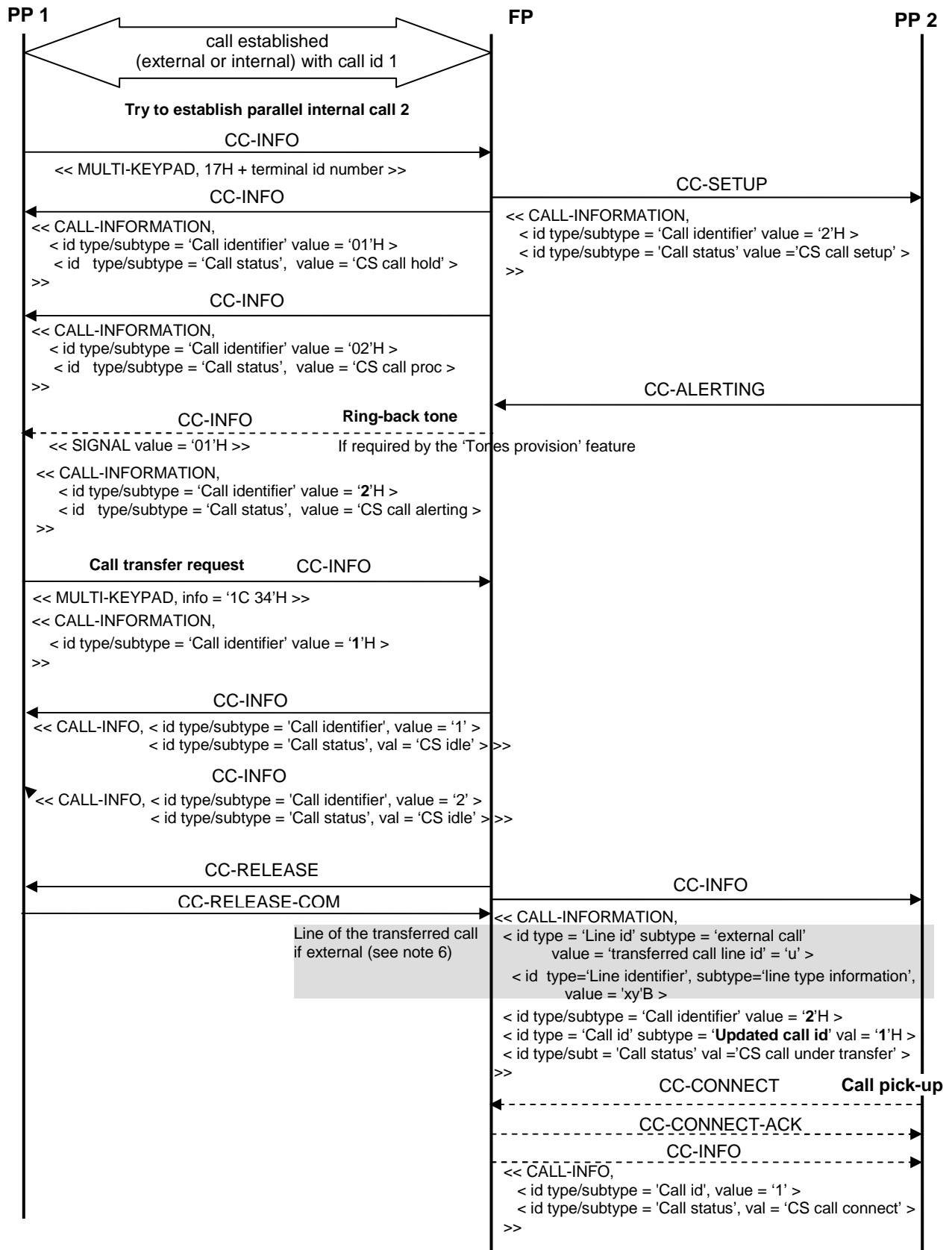

Figure 18: Unannounced call transfer (example with internal target PP2):
"call transfer request" before {CC-CONNECT}

NOTE 3: The Call Control message sequence in figure 18 should be understood as an example. The real sequences may also contain different Call Control messages or Call Control messages in another order or Call Control messages with other contents.

NOTE 4: PP2 may be idle or busy (involved in another call). If busy, PP2 would receive a parallel internal incoming call instead of a first internal incoming call.

NOTE 5: A multiple call line may not support the additional internal call. In that case, PP1 will receive back a busy line notification, which will terminate the procedure.

NOTE 6: The call id update at the end of figure 18 contains the line id value and the 'line type information' of the transferred call, in order to inform PP2 of the line (and line type) used for this call.

7.4.3.6.3 Call re-injection to the system (external or internal)

The purpose of the "Call re-injection to the system (external or internal)" procedure is to transfer a call (external or internal) –announced or unannounced- to all PPs. Both methods (announced and unannounced) shall be supported.

All requirements of clause 7.4.3.6 apply; the only difference being that the initiator requests an internal general call instead of an internal call to a targeted PP.

NOTE 1: Internal general call is defined in Generic Access Profile (GAP) EN 300 444 [12].

When the transferred call is internal (i.e. waiting peer entity is another PP), the FP shall not present the call to this PP.

Call re-injection "failure" cases :

Depending on whether the call re-injection is announced or unannounced, the provisions of clause 7.4.3.6.1 or 7.4.3.6.2 in case of call transfer failure respectively apply with the following rules :

- Provisions applying to the transfer target before picking up apply here to all PPs except the initiating PP.
- Provisions applying to the transfer target after picking up apply here to the answering PP only.

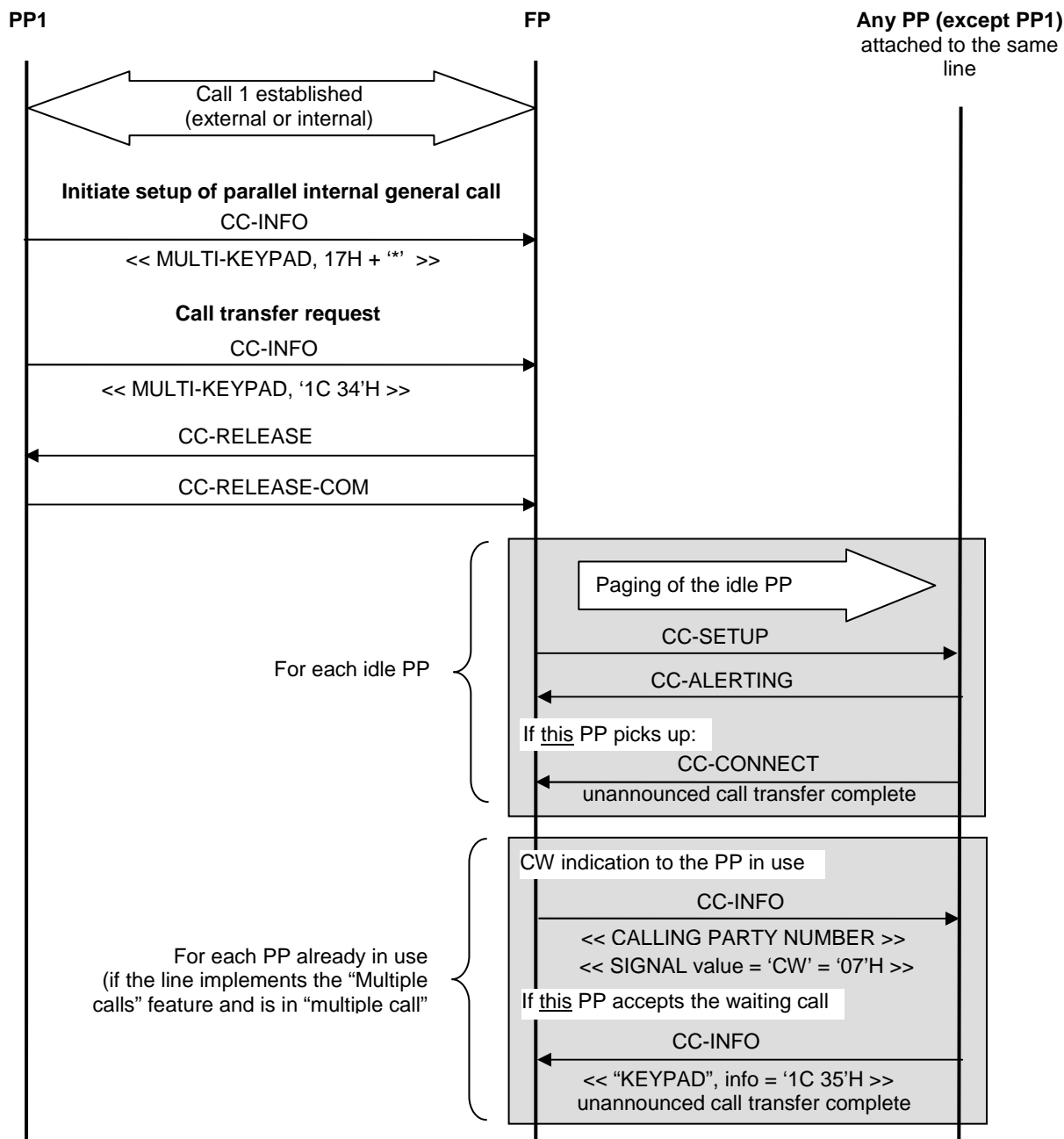

Figure 19: Use of 'unannounced call transfer' as a way to re-inject a call into the system

NOTE 2: The Call Control message sequence in figure 19 should be understood as an example. The real sequences may also contain different Call Control messages or Call Control messages in another order or Call Control messages with other contents.

NOTE 3: For the sake of simplicity in the figure 19, call information is not shown and independent timelines are used on the left and right hand sides. Implementations will follow the messages content and sequence described in clauses 7.4.3.6.1 and 7.4.3.6.2.

7.4.3.6.4 Remote party CLIP on call transfer

"Remote party CLIP on call transfer" shall be used when a call transfer occurs between the remote parties of a double call. It is defined as follows:

- A first call between a first party (A, transferring party) and a second party (B, "remote" party) is supposed to have been completely established. This first call may be external or internal.

- A second internal call between A and a third party (C, the PP target of the call transfer) is either already established (announced call transfer) or being established (unannounced call transfer). "Remote party CLIP on call transfer" shall be used on announced or unannounced call transfer.

"Remote party CLIP on call transfer" occurs in the FP after reception of the "call transfer request" from the transferring party. The remote party CLIP (of B), if available, shall be indicated by sending the <<Calling Party Number>> information element in a {CC-INFO} message.

NOTE 1: "Remote party CLIP on call transfer" is applicable when the third party C is internal (that is, registered to the same PP as the transferring party A).

NOTE 2: C successively receives the usual CLIP (of A) and the "Remote party CLIP on call transfer" (of B).

NOTE 3: The call transfer target PP will differentiate the remote party CLIP/CNIP on call transfer from the CLIP/CNIP on call waiting thanks to the associated call id.

NOTE 4: If the remote party is external and was the target of an outgoing call, the FP never received a CLIP for this party and will have to create an 'artificial' CLIP for it.

7.4.3.6.5 Remote party CNIP on call transfer

The "Remote party CLIP on call transfer" procedure applies unchanged, except that CLIP is replaced everywhere with "CNIP".

NOTE 1: In case both CLIP and CNIP are sent to the PP, it is sufficient to display one of them. It is optional to display both.

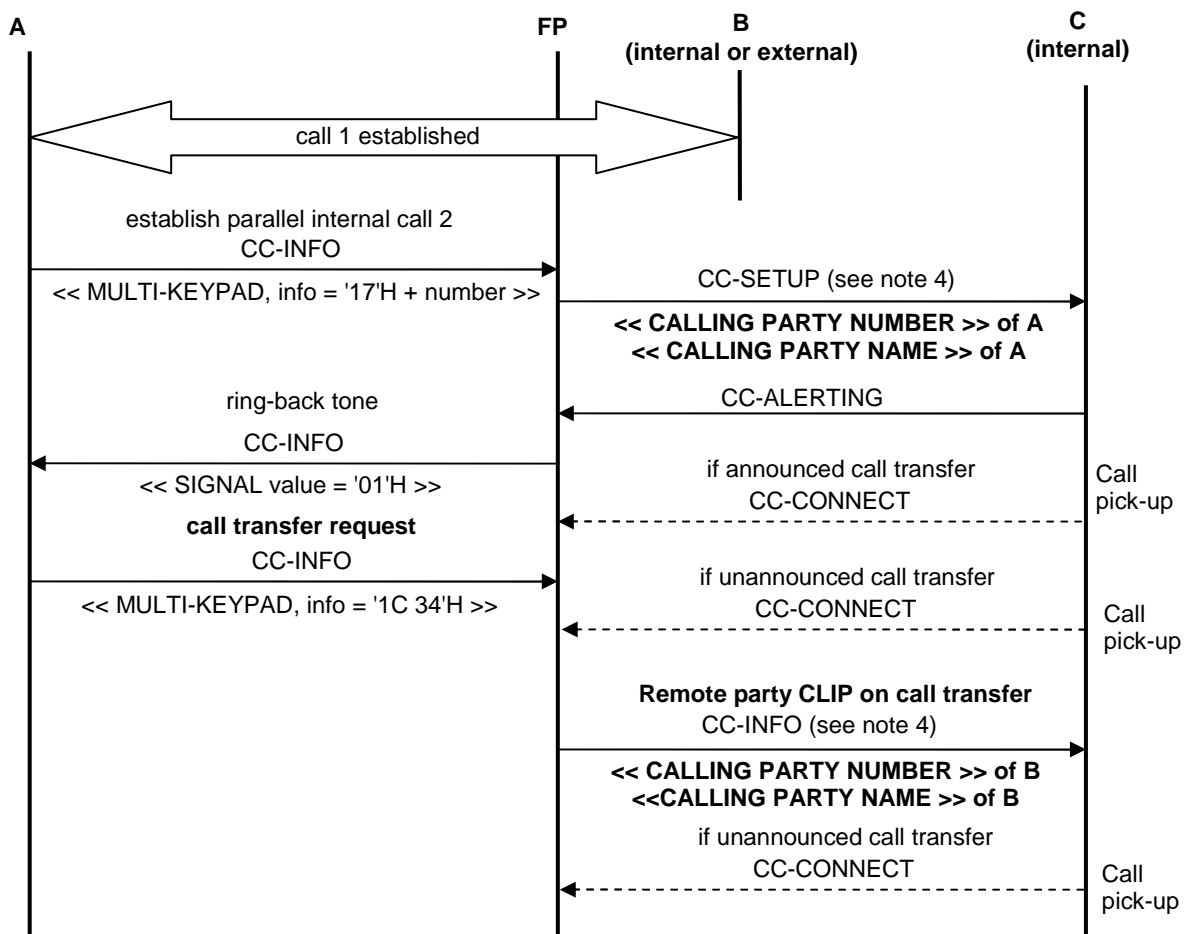

Figure 20: Remote party CLIP and CNIP on call transfer

NOTE 2: The Call Control message sequence in figure 20 should be understood as an example. The real sequences may also contain different Call Control messages or Call Control messages in another order or Call Control messages with other contents.

NOTE 3: On figure 20, three possible positions for the {CC-CONNECT} message are shown.

NOTE 4: CNIP for internal handsets is handled according to the provisions of GAP "Internal Call CNIP" procedure ((GAP)EN 300 444 [12], clause 8.44).

NOTE 5: CNIP and CLIP might not fit in a single message; in that case one or more additional {CC-INFO} message(s) are used.

7.4.3.7 3-party conference with established external and/or internal calls

The 3-party conference takes place either between 3 PPs on the same FP (based on 2 internal calls), or between 2 PPs and one remote party (based on one internal + one external calls), or between 1 PP and 2 remote parties (based on 2 external calls).

If the "Multiple lines" feature is implemented, the calls may be on two different lines.

Initiating PP. The "initiating PP" is the PP requesting the conference call.

In case two parallel calls are established, one of them being the active call, and in order to establish a conference, the initiating PP shall send:

- a 'conference call request' consisting in the control code 1CH as keypad information in a {CC-INFO} message, followed by 32H;
- the call identifier of the on-hold call to be added to the active call in order to establish the conference, in a <<CALL-INFORMATION>> IE included in the same {CC-INFO} message.

If there are several calls on hold, the PP shall select one of them (e.g. the former active call could be used) and the FP shall support all possible selections.

NOTE 1: However, a FP may not accept to create a conference call if there are more than one calls on-hold, as described in clause 7.4.3.7.1.

The call id of the conference shall be chosen by the FP among the involved call ids (either the on-hold call id selected by the PP, or the active call id).

If the conference call establishment is successful:

- the FP shall indicate 'CS idle' call status to the initiating PP, for the call whose call id was not chosen as the conference call id;
- the FP shall indicate 'CS conference connect' call status to all PPs participating in the conference call (including the initiating PP), with the chosen conference call id. The FP may send an intercept tone together with this call status to some or all of the PPs (<<SIGNAL>> information element with signal value '02'H, 'intercept tone');
- the FP shall issue a 'call identifier update' together with the 'CS conference connect' call status, to all PPs for which the call id (of the involved call) is different from the conference call id, as shown on figure 21.

NOTE 2: For a 3 party conference call as described in the present procedure, there is only one PP at most requiring a call id update. More specifically:

- if the on-hold call id is used as the conference call id, a call id update is sent to the non-initiating party involved in the active call, if internal;
- conversely, if the active call id is used as the conference call id, a call id update is sent to the non-initiating party involved in the on-hold call, if internal.

NOTE 3: In a 3-party conference call, all PPs involved in the conference share the same call identifier for the 3-party call.

The FP may change the codec using the service change procedure (see clause 7.4.3.3, "Codec change for parallel calls").

When implementing the "3-party conference" feature, the FP shall set bit a_{31} of the "Extended higher layer capabilities (part 2)" (see EN 300 175-5 [5], clause F.3).

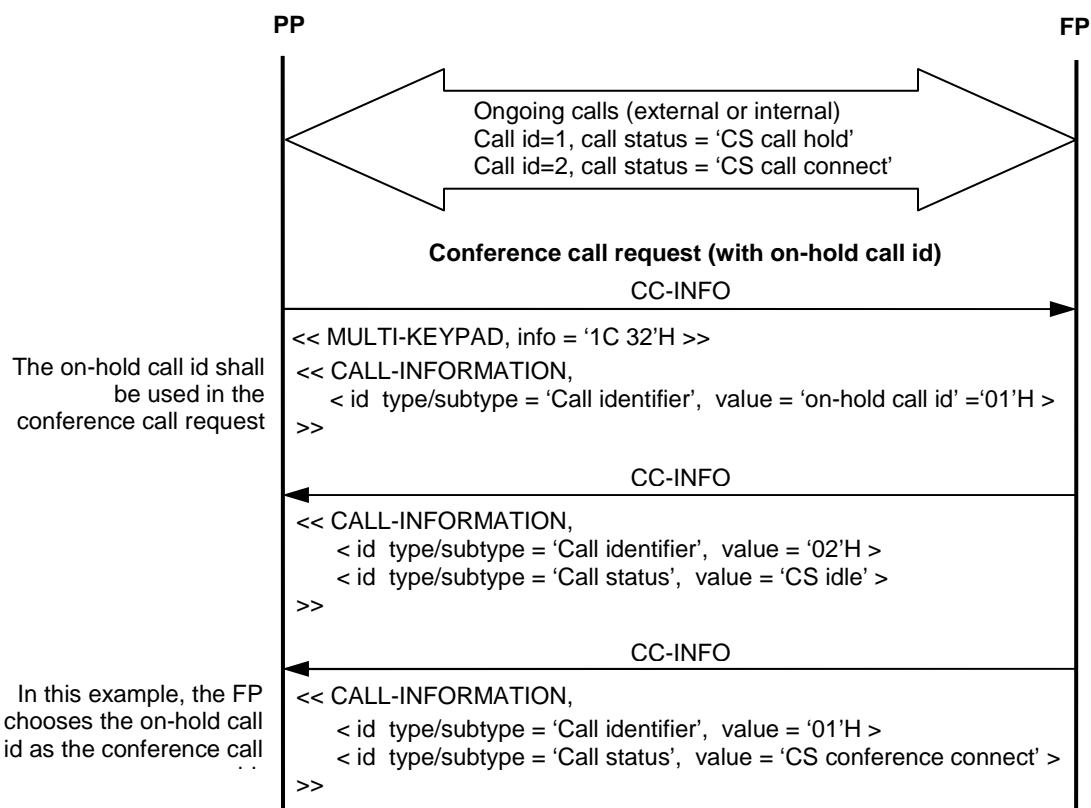

Figure 21: 3-party conference call establishment request

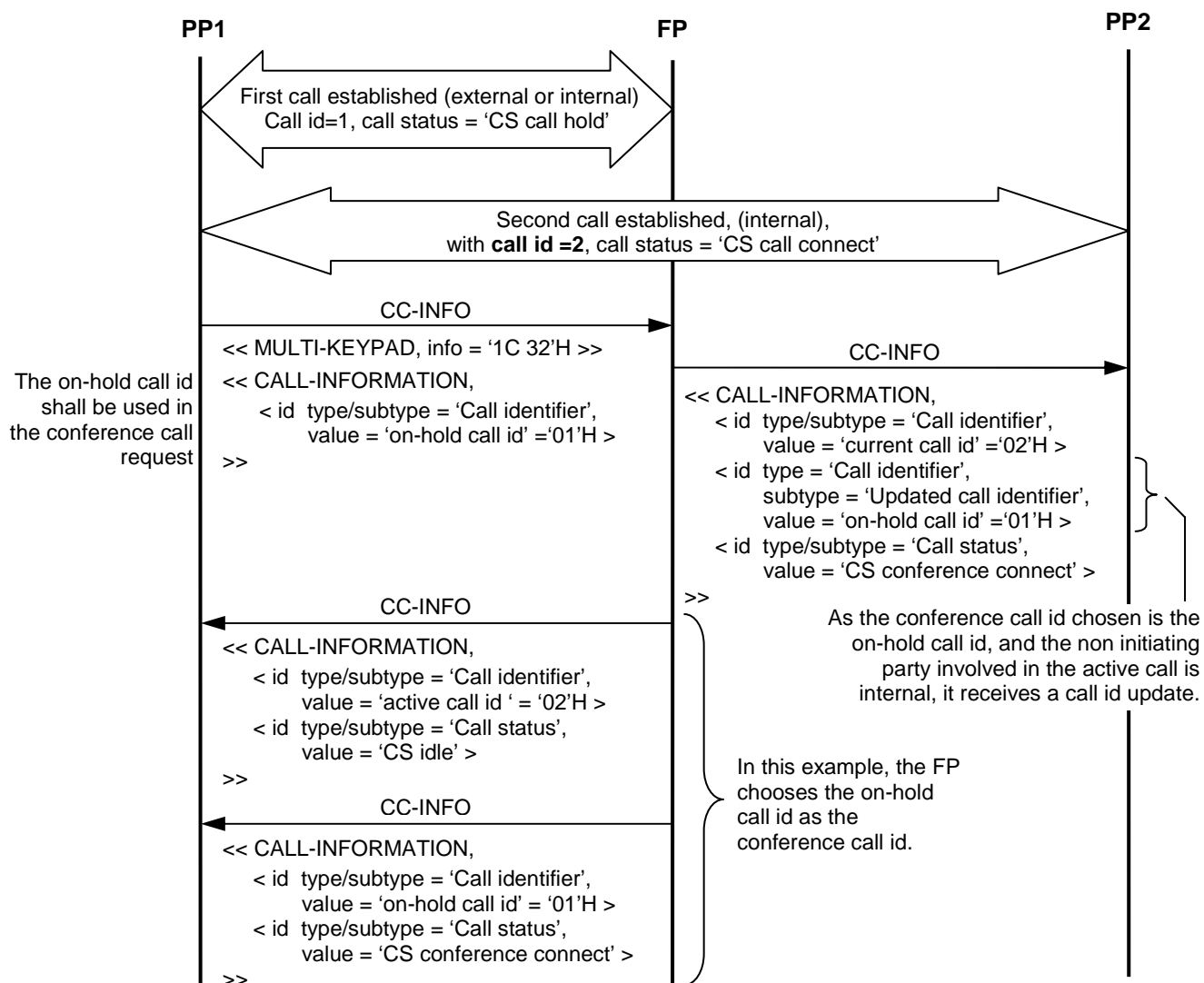

Figure 22: Call id update for the non-initiating PP

7.4.3.7.1 Unsuccessful 3-party conference call

If the conference call request is unsuccessful, e.g. because PP is involved in more than 2 calls:

- the FP shall send a negative acknowledgment as described in clause 7.4.3.4 (call status of the active call 'CS call connect' re-sent, along with call status reason 'control code failed').

7.4.3.7.2 3-party conference call release

If the conference call is later transferred from the initiating PP to a target PP (using the call transfer feature [NG1.N.8]) the target PP shall play the role of the "initiating PP" in the following sub-sections.

Release from one of the (non initiating) parties :

The procedure "Call release and call release rejection" of clause 7.4.3.5.4, can only be used if the PP is involved in a conference *and* in another call (in other words, when the conference is a parallel call) in order to terminate the PP participation in one of these calls. In particular, they cannot be used by the FP to notify the PP when one of the remote parties hangs up (otherwise, this would exclude the PP from the conference call).

When one of the (non-initiating) parties hangs up during a 3PTY conference call:

- the conference call shall become a regular two-end call;

- the FP shall send the call status 'CS call connect' to the remaining PP (or PPs) involved in the resulting regular 2-end call together with the line identifier if the remaining party is external;
- the FP shall send to the PP (or PPs) the number of the remaining other party in a <<CLIP>> IE, if this number is available;

NOTE 1: If the other party is external and was included in the conference call as a result of an outgoing call, the FP never received a CLIP for this party and will have to create an 'artificial' CLIP for it.

- the FP should issue a tone indication to the remaining parties.

The 'CS idle' call status cannot be used by the FP to notify the PP when one of the remote parties involved in the conference hangs up. Sending this call status causes the PP to be excluded from the conference call.

Release from the 3PTY conference initiating PP:

When the initiating PP of the conference hangs up during a 3PTY conference call, the conference call shall be released when the two other parties are external. If one or more of the other parties is internal, the behaviour is left free to the implementation: the conference call may be released or become a regular two-end call between the remaining parties (i.e. can be used as an alternate method to perform a simple call transfer procedure).

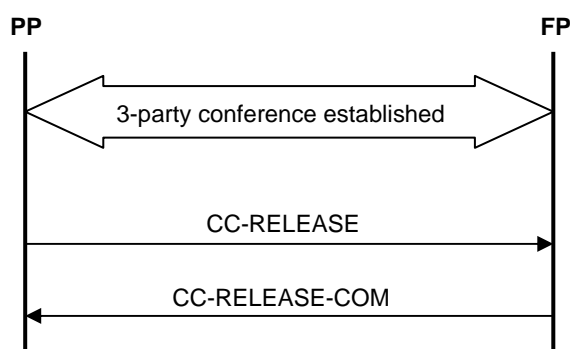

Figure 23: 3-party conference release

If the conference call becomes a regular two-end call, all provisions of the 'Release from one of the (non-initiating) parties' subsection regarding the sending of a 'CS call connect' call status, of a CLIP, and of a tone indication to the remaining PP (or PPs) apply.

Release of one of the parties from the 3PTY conference initiating PP:

Releasing a remote party from the 3PTY conference initiating PP is not systematically possible as there is only one call id assigned for the conference call. However, the following behaviour is allowed :

If the conference call was established in one of the following contexts:

- either with two external parties on two separate lines (FP using the multiple lines features [NG1.N.14]); or
- with one internal and one external parties;

then the initiating PP may release a remote party using a parallel call release command with the line identifier (no call identifier sent along). The FP shall support this type of release.

NOTE 2: In case of PSTN networks, this allows the PP to get rid of a remote party that hanged up and for which the network plays an infinite release tone.

If the conference call becomes a regular two-end call, all provisions of the 'Release from one of the (non-initiating) parties' subsection regarding the sending of a 'CS call connect' call status, of a CLIP, and of a tone indication to the remaining PP (or PPs) apply.

7.4.3.8 Intrusion call (from PP to FP)

Intrusion call is a simple way to set up a 3-party conference call, with an existing external active call on another PP. This service comes in two procedures, implicit and explicit:

- 'implicit intrusion call' mimics the usual behavior of two PSTN wired phones connected to the same physical analogue line;
- 'explicit intrusion call' can be thought of as a menu oriented service allowing intrusion into potentially any call active on the system.

NOTE: Intrusion call is also known as "barging-in".

A line setting also exists to allow or dis-allow the call intrusion. This setting applies to implicit and explicit intrusion call procedures.

When implementing the feature, the FP shall set bit a_{31} of the "Extended higher layer capabilities (part 2)" (see EN 300 175-5 [5], clause F.3).

7.4.3.8.1 Implicit intrusion call into a line in "single call" mode

This procedure applies to the FP and to an idle PP on a line configured in "single call" mode.

NOTE 1: "Implicit call intrusion" if implemented should be a configurable feature of the single call mode line.

If PP1 is involved in an active external call and PP2 wishes to participate in a 3-party conference with PP1 and the remote party:

- PP2 shall attempt to make an external call, and shall specify the external line to use (possibly 'None') using either the {CC-SETUP} or a {CC-INFO} message (see clause 7.4.5.2). Implicit call intrusion shall succeed if the following conditions are all met:
 - 1) the line to use is entirely determined, i.e. PP2 is attached to a single line or PP2 specifies the line to use (i.e. does not use 'None');

NOTE 2: If a {CC-INFO} IE is used for PP line selection, the line is however not known at {CC-SETUP} time (see figure 25).

- 2) there is already an active call on that line;
 - 3) the field 'Multiple calls mode' of the corresponding line settings (see clause 7.4.11.4.8) is set to '30'H ('Single call mode');
 - 4) the field 'Intrusion call' of the corresponding line settings (see clause 7.4.11.4.9) is set to '31'H ('allowed').
- If the PP line selection is done in the {CC-SETUP} message (see figure 24):
 - This message shall be directly acknowledged by the FP with a {CC-CONNECT} message with call status 'CS conference connect' and the call identifier of the intruded call. If the intruded call is external, the {CC-CONNECT} message shall include the line id of this call (together with the line type information).
 - If the PP line selection is done in a subsequent {CC-INFO} message (see figure 25):
 - After reception of the {CC-SETUP}, the FP shall assign a new call id as for any new outgoing first call (e.g. in a {CC-SETUP-ACK} message with call status 'CS call setup ack').
 - As soon as the PP line selection is received, the FP shall acknowledge it with a {CC-CONNECT} message, with call status 'CS conference connect' and shall update the call id in the same message to the intruded call id value. If the intruded call is external, the {CC-CONNECT} message shall include the line id of this call (together with the line type information).

- The FP shall notify PP1 with a {CC-INFO} message containing:
 - the information element <<CALL INFORMATION>> with the same call identifier and call status;
 - if required by the "Tones provision" feature, the information element <<SIGNAL>> with the value 02H indicating 'Intercept tone on'.

The FP shall generate automatically a conference call audio stream between the three parties.

Error processing. If conditions 1, 2, 3, and 4 are not all met, the FP shall handle the call as a regular outgoing call. More specifically:

- If conditions 1 is met but condition 2 is not met, the FP shall place the new outgoing call on the (idle) line.
- If conditions 1, 2 are met but condition 3 is not met, the FP shall attempt to place an additional call on the multiple call line if possible; otherwise it shall use procedure 7.4.8.3, "Busy system or line notification".
- If conditions 1, 2 and 3 are met but condition 4 is not met, the FP shall always use procedure 7.4.8.3, "Busy system or line notification".

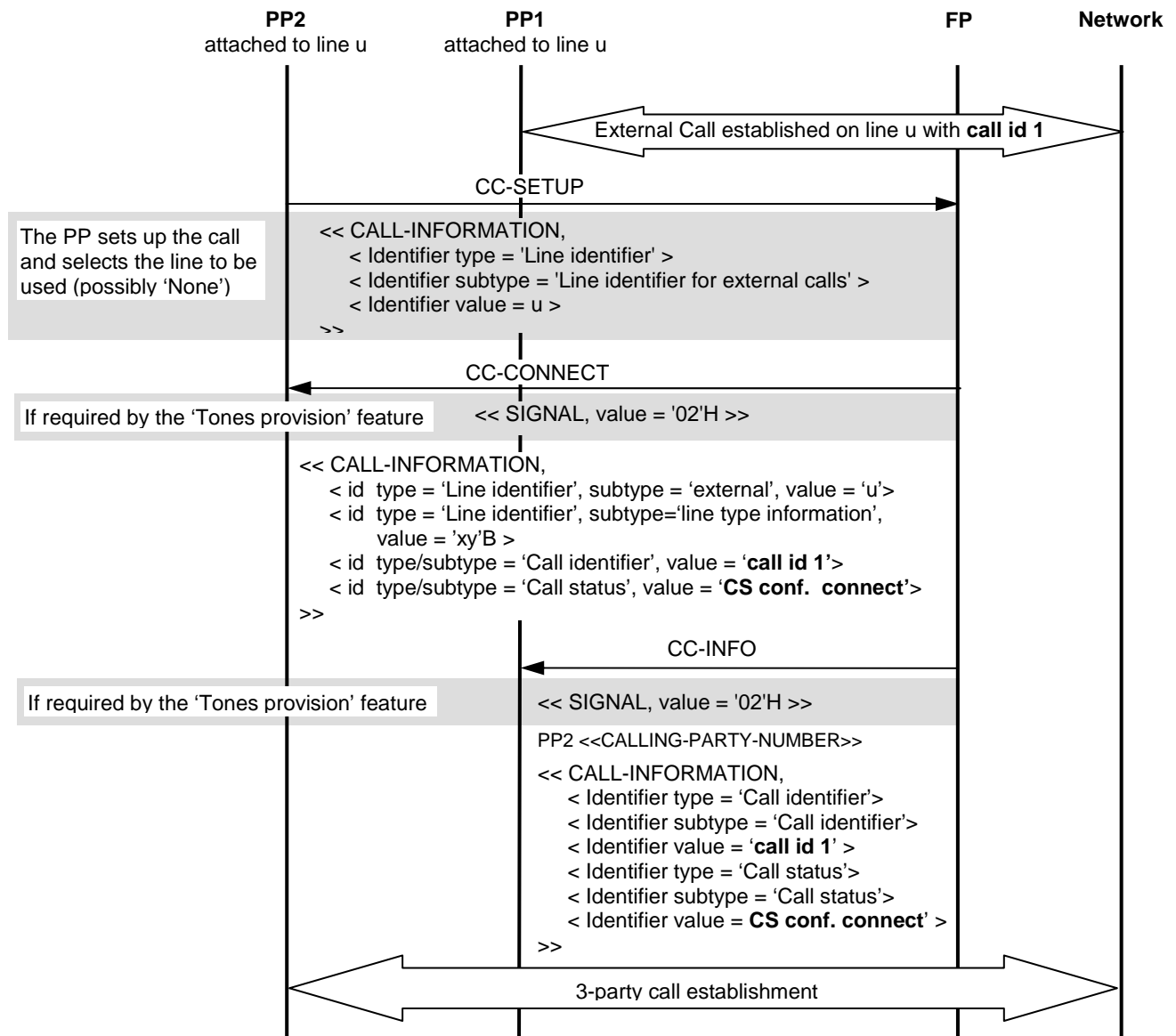

Figure 24: Implicit intrusion call with PP line selection in the {CC-SETUP}

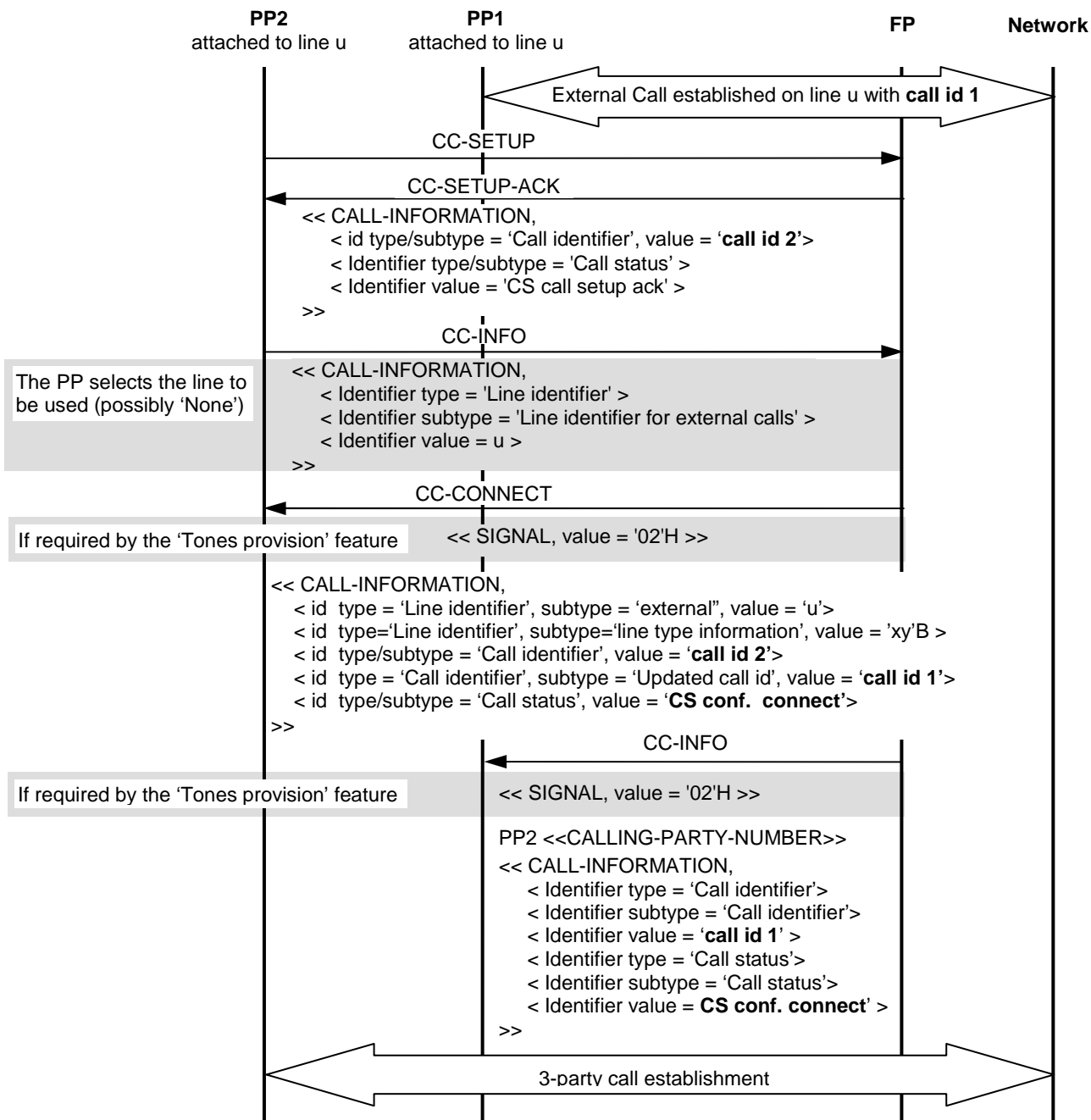

Figure 25: Implicit intrusion call with PP line selection in a {CC-INFO}

NOTE 3: The Call Control message sequence in figure 24 should be understood as an example. The real sequences may also contain different Call Control messages or Call Control messages in another order or Call Control messages with other contents.

NOTE 4: In addition to the call status 'CS conference connect', CLIP of PP2 sent together with the call id of the external call warns PP1 of a call intrusion attempt.

NOTE 5: If the selected line is not a "single-call" mode line, the DECT system will try to make an outgoing call.

When the intrusion call is established, the provisions of clause 7.4.3.7, "3-party conference with established external and/or internal calls" apply (including release related provisions).

7.4.3.8.2 Explicit intrusion call

The present procedure applies to the FP, an idle PP (the intruder), and a PP with an active call (the intruded PP). With explicit call intrusion, the PP uses a specific control code while initiating the setup of a call, in order to indicate to the FP that a call intrusion is attempted.

There are two available types of explicit call intrusion: handset intrusion and line intrusion. These two types of explicit intrusion are exclusive.

Handset intrusion. When using handset intrusion, the PP uses the terminal id number of the targeted handset to request intrusion of the call active on that handset. No line id specification is used (not even 'None').

Handset intrusion succeeds if there is an active call on the targeted handset (there can be only one). This active call may be external or internal.

NOTE 1: Only handset intrusion allows the intrusion of an internal call.

The FP may forbid handset intrusion if the intruder and intruded PPs are not attached to a common line.

Special case. It is allowed to use '*' as the target of handset intrusion. Handset intrusion with target '*' succeeds if there is one and only one active call (external or internal) in the DECT system.

Line intrusion. When using line intrusion, the PP uses the line id of the targeted line to request intrusion into an active external call on that line. No terminal id number is used (not even '*'). The PP shall not specify a line it is not attached to (see clause 7.4.5.2.1).

Line intrusion succeeds if there is a single active external call on the targeted line. The targeted line may be a single call or multiple call line. If a multiple call line, it may be configured in "multiple call" or "single call" mode.

NOTE 2: Line intrusion only intrudes external calls.

The FP could forbid a call intrusion from a PP not attached to the line of the external call to be intruded.

Special case. It is allowed to use 'None' as the target of line intrusion. Line intrusion with target 'None' succeeds if there is one and only one active *external* call in the DECT system.

PP and FP compliance with the 'Explicit call intrusion' procedure.

A PP implementing the present procedure shall implement at least one of the two types of explicit call intrusion.

A FP implementing the present procedure shall implement both types of 'explicit call intrusion'.

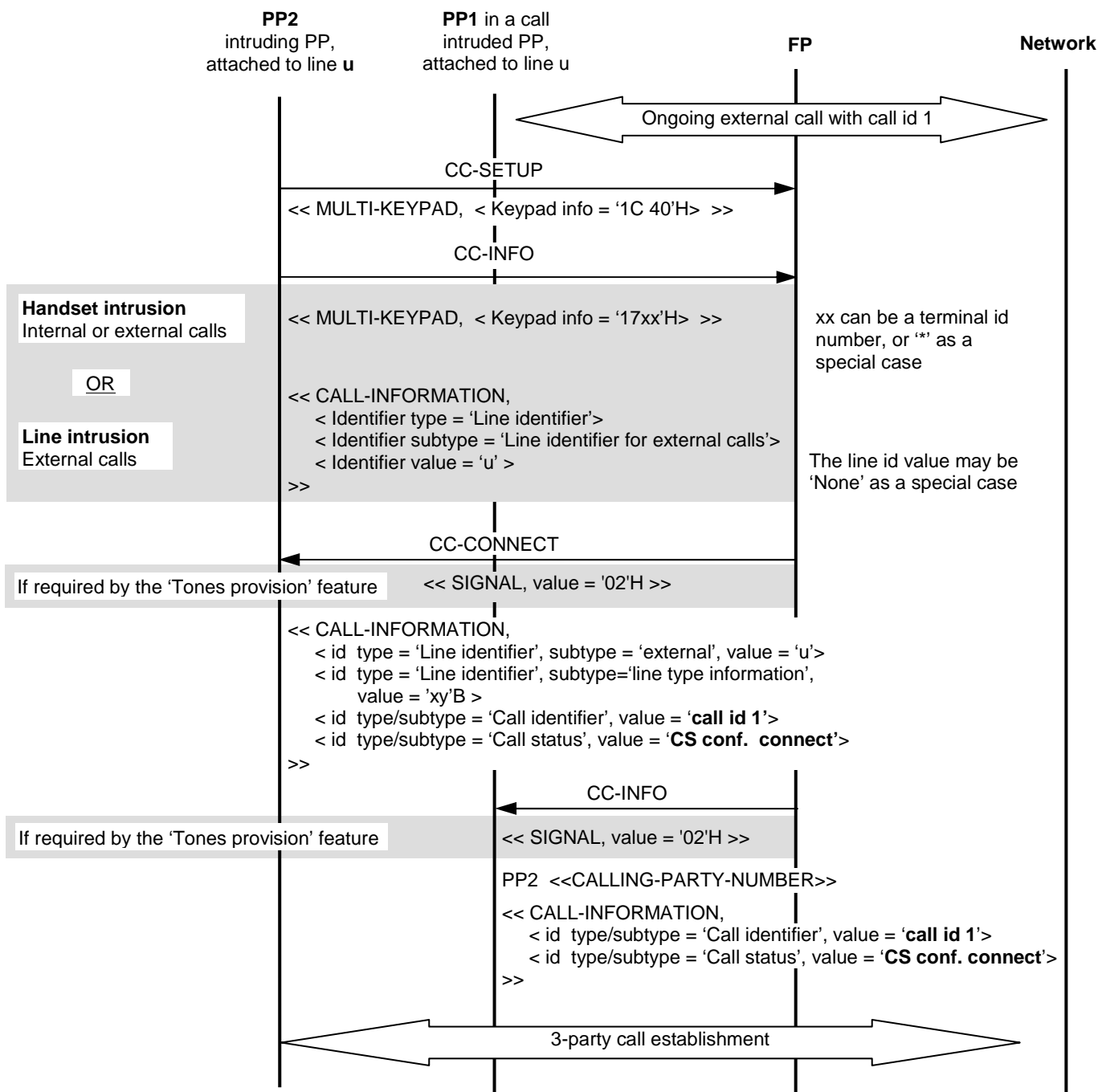

Figure 26: Successful explicit call intrusion

NOTE 3: The Call Control message sequence in figure 26 should be understood as an example. The real sequences may also contain different Call Control messages or Call Control messages in another order or Call Control messages with other contents.

If PP1 is involved in an active call and PP2 wishes to participate in a 3-party conference with PP1 and the remote party:

- PP2 shall insert a *call intrusion request*, consisting in the control code 1CH followed by 40H in the {CC-SETUP} message.
- PP2 shall then use one of two explicit intrusion use cases:
 1. **Handset intrusion.** PP2 sends the terminal id number of the handset owning the targeted call (external or internal), or '*' in order to intrude any handset, in the {CC-SETUP} or in a subsequent {CC-INFO} message. PP2 does not send any line specification (not even the 'None' value).
 - If '*' is not used and there is a call active on the specified terminal, this call (external or internal) shall be intruded.
 - If '*' is used and there is a single active call (external or internal) in the system, this only call shall be intruded.
 2. **Line intrusion.** PP2 sends the line id of the targeted external call (*without* any terminal id number) in the {CC-SETUP} or in a subsequent {CC-INFO} message.
 - If 'None' is *not* used and there is a single active *external* call on the specified line, this only call shall be intruded.
 - If 'None' is used, and there is a single active *external* call on the DECT system, this only call shall be intruded.
- The FP shall answer the intruder (PP2) with a {CC-CONNECT} message including:
 - a <<CALL INFORMATION>> IE containing:
 - the call id of the intruded call, and the call status "CS conference connect",
 - if the intruded call is external and the line id was not specified by the PP (handset intrusion, or line intrusion with 'None'), this IE shall also contain the intruded call line id.
 - if required by the "Tones provision" feature, the <<SIGNAL>> IE with the value 02H indicating 'Intercept tone on'.
- The FP shall notify the intruded PP (PP1) of the intrusion with a {CC-INFO} message containing:
 - a <<CALL INFORMATION>> IE containing the call id of the intruded call, and the call status "CS conference connect",
 - if required by the "Tones provision" feature, the <<SIGNAL>> IE with the value 02H indicating 'Intercept tone on'.

The FP shall generate automatically a conference call audio stream between the three parties.

NOTE 4: In addition to the call status 'CS conference connect', CLIP of PP2 sent together with the call id of the external call warns PP1 of a call intrusion attempt.

NOTE 5: In "multiple call" mode, simply initiating a call setup would lead to the setup of an additional call if the line can accept an additional call, or to a failure (busy tone signal received back).

When the call intrusion is established, the provisions of clause 7.4.3.7, "3-party conference with established external and/or internal calls" apply (including release related provisions).

Error processing. In all other cases, that is:

- for handset intrusion:
 - if there is no external or internal call active on the specified handset;
 - if '*' is used, if there is no external *or internal* call active (or more than one) in the system; or
 - the call to be intruded is external, and the field 'Intrusion call' of the corresponding line settings (see clause 7.4.11.4.9) is set to '30H ('not allowed)';

- for line intrusion:
 - if there is no external call or more than one external call on the specified line;
 - if 'None' is used, if there is no external active call (or more than one) in the system;
 - if the PP is not attached to the intruded line; or
 - the field 'Intrusion call' of the corresponding line settings (see clause 7.4.11.4.9) is set to '30'H ('not allowed').
- the FP shall use the "Busy system or line notification" procedure of clause 7.4.8.3, that is:
 - the FP shall send call status 'CS call disconnecting' along with call status reason 'control code failed';
 - the FP shall send a <<CALL INFORMATION>> IE with call status 'CS idle' in order to free the call id (on the intruding PP side only).

7.4.3.9 Internal call codec priority

7.4.3.9.1 Description

When performing an internal call between two wideband enabled PPs, the FP shall arrange that the call is finally established in a wideband codec rather than in a narrow band codec. Respectively in a super wideband codec rather than in a wideband or narrowband codec.

As a consequence, in the particular case where both PPs present G.722 with highest priority, the internal call shall finally be established in ITU-T Recommendation G.722 [17].

Exception cases to this procedure are listed in clause 7.4.3.9.2.

This procedure has been added to guarantee that the internal call will be established in the highest audio quality supported by both handsets involved in the internal call, at least when no other call is established at the same time in the DECT system.

Two examples of support of this procedure are given hereafter:

EXAMPLE 1: When the <<Codec List>> information element is only specified at subscription registration and location registration phases.

EXAMPLE 2: When the <<Codec List>> information element is specified at call setup phase.

Figure 27 shows an example (example 1) with an internal call sequence where no codec list is specified at call setup and both PP-s support wideband (same codec list re-used as at location registration phase).

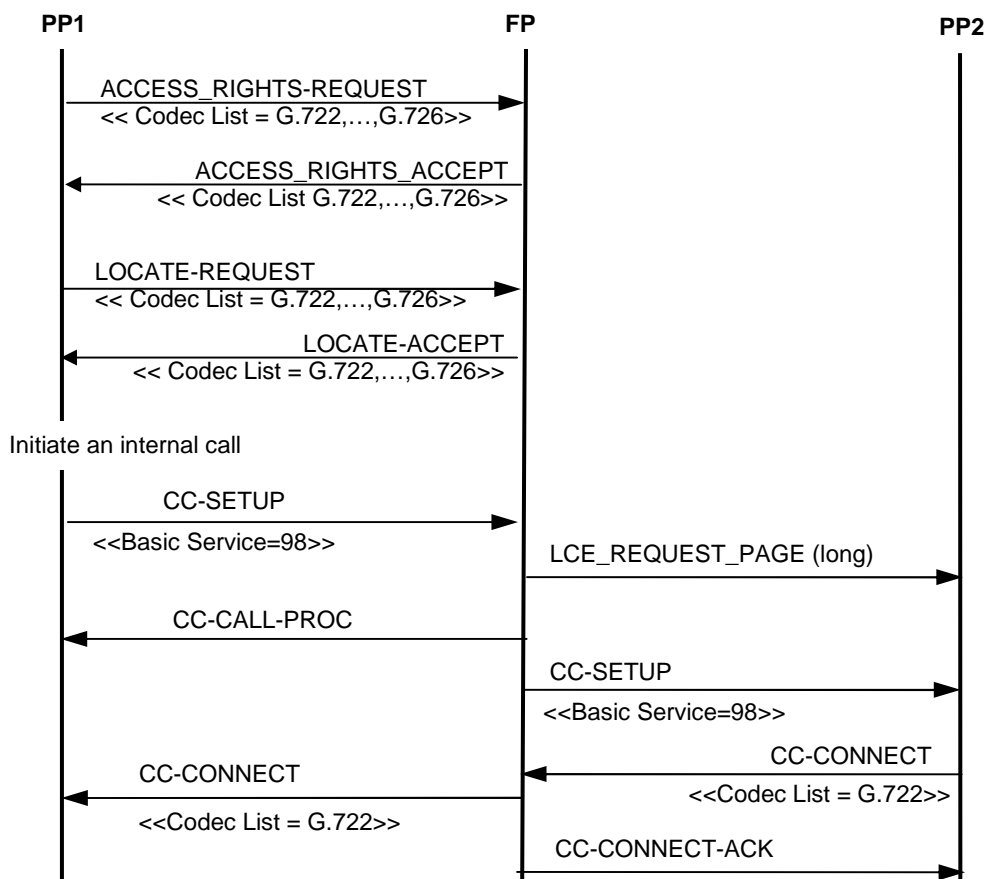

Figure 27: Internal call with no codec list at call setup

Figure 28 shows example 2 with an internal call sequence where the codec list is specified at call setup and both PPs support wideband.

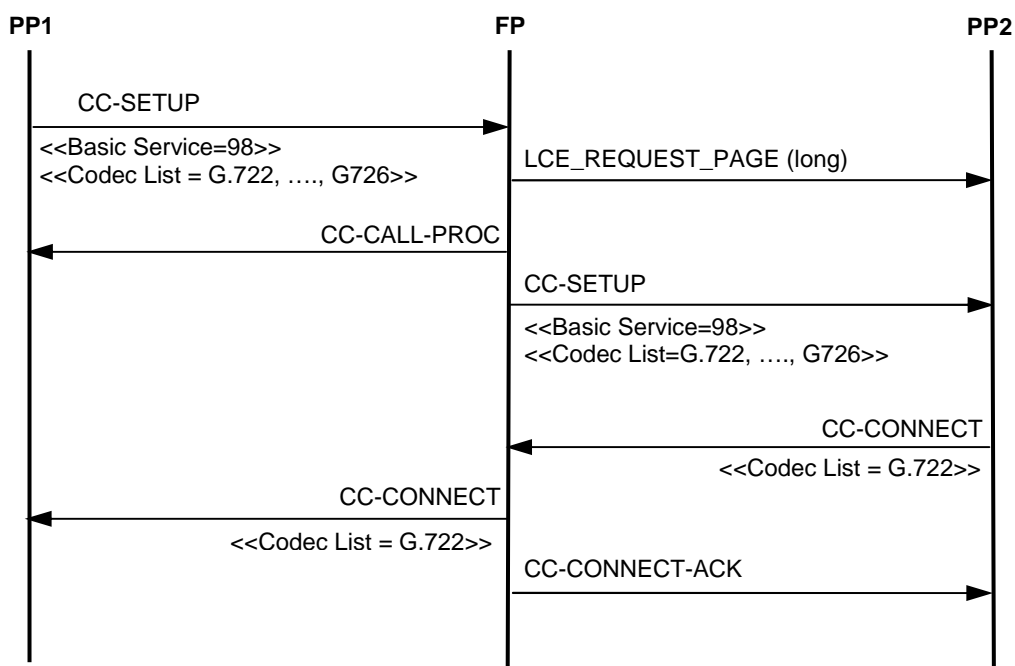

Figure 28: Internal call with codec list at call setup

NOTE: The Call Control message sequences in figures 26 and 27 should be understood as examples. The real sequences may also contain different Call Control messages or Call Control messages in another order or Call Control messages with other contents.

7.4.3.9.2 Exception cases

The following exceptions to the clause 7.4.3.9 shall apply: no requirement applies in the following cases:

- a) Case of internal call transfer. In this case, the PP requesting the transfer may specify any order for the codecs in the <<Codec List>> information element. For example, the codec used in the initial ongoing external call to be transferred may be given the highest priority in the <<Codec List>> information element sent by the PP for the parallel call. This could avoid two codec switching: one for each PP involved in the transfer.
- b) Cases of multiple calls handled by the FP at the same time, if critical for FP hardware resources.
- c) Specific implementations of PPs that have to support narrow band headsets.
- d) Specific implementations of PPs where battery autonomy is very critical.

7.4.3.10 Handling of lines where second calls are signalled in-band

The present procedure describes the 'Handling of lines where second calls are signalled in-band' feature. In other words it describes the rules specifically applicable to lines supporting 'double calls with in-band signalling' (DCIBS lines for short). Most notably, PSTN lines implementing 'PSTN double calls' are DCIBS lines, and possibly other types of lines implementing similar rules.

The present procedure describes the use by the PP and FP of a limited subset of the procedures of clause 7.4.3.5, "Common parallel call procedures", with some adjustments, so that they can be used with 'double call with in-band signalling' lines.

The PP shall support the 'Handling of lines where second calls are signalled in-band' feature *additionally* to the parallel calls relating features. However the present procedure is designed so that the PP behavior will be very close to its behavior on regular lines. The PP is informed of the type of line through the 'line type information' sent along with the line identifier.

The FP may support the feature depending on the type of lines it is designed to be connected to. A FP could be designed to support only DCIBS lines and is allowed in that case not to support all common parallel call procedures (see 7.4.3.10.3.1 for more details). However the features and procedures to be supported in that case rely heavily on the corresponding features for regular lines with as few adjustments as possible.

On the contrary, the handling of a first call on such lines does not require any modification of these procedures. This includes cases where the PP is idle when handling this first call, or already involved in a call but on another line.

7.4.3.10.1 General requirements

Double calls with in-band signalling: A 'double call with in-band signalling' (DCIBS) line is a legacy line on which second calls-incoming or outgoing- are handled using signalling 'in-band'. On such lines, the DECT FP has to send legacy network messages with limited semantics for handling second calls-incoming or outgoing. As a result:

- The Network only delivers in-band tone-based messages targeted at the user (i.e. invisible to the FP and PP).
- For some 'double call with in-band signalling lines' however, the network delivers an off-hook CLIP (see clause 3.1) in case of call waiting (or 'CLIP on call waiting') which allows the FP to be aware of the waiting call. This leads to the following two subtypes of 'double call with in-band signalling' lines, which can be distinguished by the way they handle second calls:
 - **Basic 'double call with in-band signalling' lines:** Line not supporting double calls, or supporting them but NOT delivering any off-hook CLIP for a waiting call. Such lines are considered as fully 'common parallel call' compliant lines, because the possibility of a second call on such lines is ignored from Part 3 perspective (although the use of transparent commands for handling them is still possible) and are handled in clause 7.4.3.10.2.

- **Off-hook CLIP enabled 'double call with in-band signalling' lines:** Line supporting classical 'double call' procedures and delivering an off-hook CLIP in case of call waiting. Such lines are handled in clause 7.4.3.10.3.

NOTE 1: Both subtypes of 'double call with in-band signalling' lines are 'single call mode' lines.

PP notification of the line type: The FP shall indicate whether the line is a 'double call with in-band signalling' (DCIBS) line or not, using the 'second call type' flag (bit 2) of the 'line type information'. Bit 2 set to '1' indicates a DCIBS line.

NOTE 2: The 'line type information' is a line identifier of subtype 'line type information' sent together with the line id from FP to PP. It also includes the 'network delay type' flag. See clauses 7.4.3.5.1, 7.4.3.5.2 and 7.4.5.1.

NOTE 3: Although a PSTN line is usually a DCIBS line, an enhanced FP may choose to handle a given PSTN line with the 'common parallel call procedures' if it is possible (e.g. by using a tone detector). In that case, the 'Handling of second call line' feature is not used (line type information '00'B).

Transparent network-directed commands: Transparent 'network directed' commands issued by the PP are not the main target of the present procedure, but are however dealt with in clause 7.4.3.10.4, as they can still be used to handle calls on such lines. Transparent commands generally use the 'R' key (coded as keypad information 15H) as the unique control code.

7.4.3.10.2 Basic 'double call with in-band signalling' lines

Basic 'double call with in-band signalling' lines: A basic double call with in-band signalling line (basic DCIBS line) is a DCIBS line not supporting double calls, or supporting them but NOT delivering any off-hook CLIP for a waiting call.

NOTE 1: A call waiting indication on such a line, being fully in-band, may be lost if the handset using this line is involved in a call on another line, (neither heard by the user, nor detected by the FP).

A basic DCIBS line shall be handled as a line only allowing a single call context from the 'Common parallel call procedures' point of view. More specifically:

- The 'Common parallel call' procedures shall not apply for handling second calls. In other words, the FP shall handle the line as if it was not supporting double calls. In particular:
 - In case an 'outgoing parallel call initiation' (see clause 7.4.3.5.1) is attempted on such a line, the procedure 'Busy system or line notification' of clause 7.4.8.3 shall be used by the FP.
 - The 'call waiting indication' procedure (see clause 7.4.3.5.2) shall not be used.

NOTE 2: As the FP is not aware of waiting call on such lines, incoming second calls handling cannot use the 'Common parallel call procedures'. For the overall consistency of call handling on such lines, these procedures are neither used for outgoing second calls.

- Classical 'Double call' if available on the line shall be handled by the user with transparent network directed commands from PP to network and shall not be handled through 'Common parallel call' procedures.
- The FP shall only assign a call id for the first call on that line.

NOTE 3: 'Common parallel call' procedures still apply in multiple line context for commands involving several lines (e.g. call toggle to-and-fro a basic double call with in-band signalling' line).

Line type information. A basic DCIBS line shall respect the following rule for the line type information value:

- 'Second call type' = 'SCT' = '0'B, indicating that second calls are handled in a way compliant with 'common parallel call procedures'.

NOTE 4: As only a single call context is considered on such lines, the behavior of the PP and FP is fully compliant with the 'Common parallel call' procedures (no second call is considered).

7.4.3.10.3 Off-hook CLIP enabled 'double call with in-band signalling' lines

7.4.3.10.3.1 General requirements for off-hook CLIP enabled 'double call with in-band signalling' lines

Off-hook CLIP enabled 'double call with in-band signalling' lines: A 'Off-hook CLIP enabled DCIBS line' is a DCIBS line supporting classical 'double call' procedures and delivering a off-hook CLIP in case of call waiting. For such lines:

Second call handling, call statuses and call id. For off-hook CLIP enabled DCIBS lines:

- For the handling of *second calls*, the PP shall use commands compliant with the 'Common parallel call procedures' (see clause 7.4.3.5).
- In particular, a call id shall be assigned in case of second call (incoming or outgoing).
- It is allowed for the FP to send the call statuses 'CS call hold' and 'CS call connect' at a time not exactly related to the corresponding event in the network (if any).
- Call statuses other than 'CS call hold' and 'CS call connect' may not always be available. Use of a 'tone detector' on FP side may enhance the set of call statuses the FP is able to send to the PP.

Remote party hangup in case of second call. In case a remote party hangs up one of two parallel calls, the FP may not be aware of this event occurring in the network. As a result it may maintain both call contexts and not warn the PP (although the user himself may sometimes be aware of this event through the heard tone). Consequently:

- the PP may maintain a superfluous second call context (and call id) until it hangs up itself, thus preventing the PP to accept or place a second call on the line:
 - **Issue 1:** In that case, the user of the PP could be faced either with one of the two call contexts leading to an unexisting call, or with two equivalent call contexts (both handling the same call).
- However, the FP may later on be indirectly informed of the call release in the network, when either a new call waiting occurs, or in case the user initiates an outgoing second call (both events indicating that there were no two calls any longer on the line). In that case, the FP shall release the superfluous call context (CS idle with call id sent to the PP). This behavior is called a 'late release' of the call (see clause 3.1).
- In some cases however, the FP may not be able to know which of the two existing call contexts must be deleted and shall choose one of the two contexts (e.g. the most probable one) and delete it:
 - **Issue 2:** In that case the user may be faced with a call context showing wrong data.
- The PP shall use its best endeavour to minimise the inconvenience caused by these issues for the user. Clause C.9.1 details some use cases illustrating these issues.

Translation of commands into the network. The FP shall use its best endeavour to translate the requests issued as part of the 'Common parallel call procedures' into legacy commands understandable by the network.

NOTE 1: This does not mean that the PP should forbid the use by the user of legacy commands directly targeting the network.

Line type information. An 'off-hook CLIP enabled DCIBS line' line shall respect the following rules for the line type information value:

- The 'Network delay type' ('**NDT**') should be '0'B, indicating that the line is a 'low delay' line; however the use of procedure 'Off-hook CLIP enabled double call with in-band signalling' lines' for lines with significant delay (NDT = 1) is still possible.
- 'Second call type' = '**SCT**' = '1'B, indicating that second calls are handled (mostly) with in-band signalling.

NOTE 2: On such lines, call waiting indications are not received in-band by the FP.

EXAMPLE 1: An off-hook CLIP enabled PSTN line uses line type information '10'B ('Off-hook CLIP enabled DCIBS' line with low delay).

EXAMPLE 2: A VoIP line mimicking the PSTN line behaviour including off-hook CLIP would use line type information '11'B ('Off-hook CLIP enabled DCIBS' line with significant delay).

7.4.3.10.3.2 Applicable procedures and control codes

Table 18 lists the restrictions and modifications that apply for a FP when handling an off-hook CLIP enabled DCIBS line (described in clause 7.4.3.10.3). In case a FP only supports such lines, the amended procedures only apply.

Table 18: Restrictions applying to a FP when handling an off-hook CLIP enabled DCIBS line

Feature	Procedure	Reference	Comment
Parallel Calls		NG1.N.6	
	Control messages	7.4.3.2	Amended by 7.4.3.10.3.2 (table 19)
Common parallel call procedures		NG1.N.7	
	Call release and call release rejection	clause 7.4.3.5.4	Network support unlikely in case of parallel calls on DCIBS lines. In case of two parallel calls, the FP may answer directly 'control code failed'
	Call waiting rejection	clause 7.4.3.5.7	
	Putting a call on-hold	clause 7.4.3.5.8	
Resuming a call put on-hold	clause 7.4.3.5.9		
Call transfer		NG1.N.8	Amended by clause 7.4.3.10.3.6
3-party conference call		NG1.N.9	Amended by clause 7.4.3.10.3.7
Call identification (and call statuses)		NG1.N.13	Amended by clause 7.4.3.10 and subclauses

Applicable control codes. Table 19 lists the restrictions and modifications that apply to control codes handling by a FP in case of off-hook CLIP enabled DCIBS line (described in clause 7.4.3.10.3). Other control codes apply with no change. When applicable, the FP shall translate commands into transparent network directed commands.

In case a FP only supports such lines, the amended procedures only shall apply (see also clause 6.10, table 9, note 2).

Table 19: Control messages for control of parallel calls

Procedure	Control message	Direction	Comment
Call release (of the indicated call)	1CH 33H	PP to FP	See notes 1 & 2
Call transfer request (external or internal)	1CH 34H	PP to FP	See note 3
Call waiting rejection	1CH 36H	PP to FP	See notes 1 & 2
Putting a call on-hold	1CH 41H	PP to FP	See notes 1 & 4
Resuming a call put on-hold	1CH 42H	PP to FP	See notes 1 & 4
NOTE 1: For a parallel call, the FP shall answer with a negative acknowledgement 'control code failed' if the command is not supported by the network.			
NOTE 2: The 'CS idle' control code shall be sent to the PP even if the command is not supported by the network.			
NOTE 3: In case there are two calls on the off-hook CLIP enabled DCIBS line, the FP should answer the call transfer request with a negative acknowledgement 'control code failed' (see clause 7.4.3.10.3.6).			
NOTE 4: This control code is optional for the PP.			

7.4.3.10.3.3 Parallel calls within a 'off-hook CLIP enabled DCIBS' line

There can be only two parallel calls within an 'Off-hook CLIP enabled DCIBS' line. The present procedure handles use cases with both call on the same 'Off-hook CLIP enabled DCIBS line': these use cases may require a special handling in some cases (adjustments of the 'Common parallel call procedures' of clause 7.4.3.5) and are therefore described in detail in the present clause.

NOTE: Two call use cases with two lines, and one call on each line (whatever the type of these lines) do not involve second calls and therefore do not deserve any specific handling (they are compliant with the 'Common parallel call procedures' of clause 7.4.3.5).

7.4.3.10.3.3.1 Outgoing parallel call initiation within an off-hook CLIP enabled DCIBS line

This procedure applies to a 'Off-hook CLIP enabled DCIBS' line on which a first call has already been placed, and a PP busy with another call going on on the same line.

Outgoing parallel call initiation. When the FP receives an outgoing parallel call initiation from the PP (external or internal), it shall use the 'Outgoing parallel call initiation' procedure of clause 7.4.3.5.1. In particular, the FP shall:

- assign a second call id for new outgoing call, and notify it to the PP.
- send a 'FP line confirmation' with the appropriated 'line type information' (see clause 7.4.3.10.3.1).

The FP shall use its best endeavour to translate the "outgoing parallel call initiation" into network directed commands.

7.4.3.10.3.3.2 Call waiting indication/acceptation/rejection within an off-hook CLIP enabled DCIBS line

This procedure applies to an 'Off-hook CLIP enabled DCIBS' line, a call waiting on that line, and a PP busy with the first call on the same line.

Call waiting indication. When the FP receives an off-hook CLIP from the network indicating an incoming second call, the FP shall:

- assign a new call id for the waiting call;
- send a call waiting indication to the PP as defined in clause 7.4.3.5.2 (i.e. including CLIP and/or CNIP, newly assigned call id for the second incoming call, and 'CS call setup' call status).

Call waiting acceptance. The call waiting acceptance shall always use procedure 'Call waiting acceptance (from PP to FP)' of clause 7.4.3.5.6, with the following modification:

- call statuses 'CS call hold' for the former active call, and 'CS call connect' for the newly accepted waiting call, although they shall still be sent, and sent in this order, may be sent by the FP not at the exact times when the corresponding events occurred in the network.

The FP shall use its best endeavour to translate the call waiting acceptance into network directed commands.

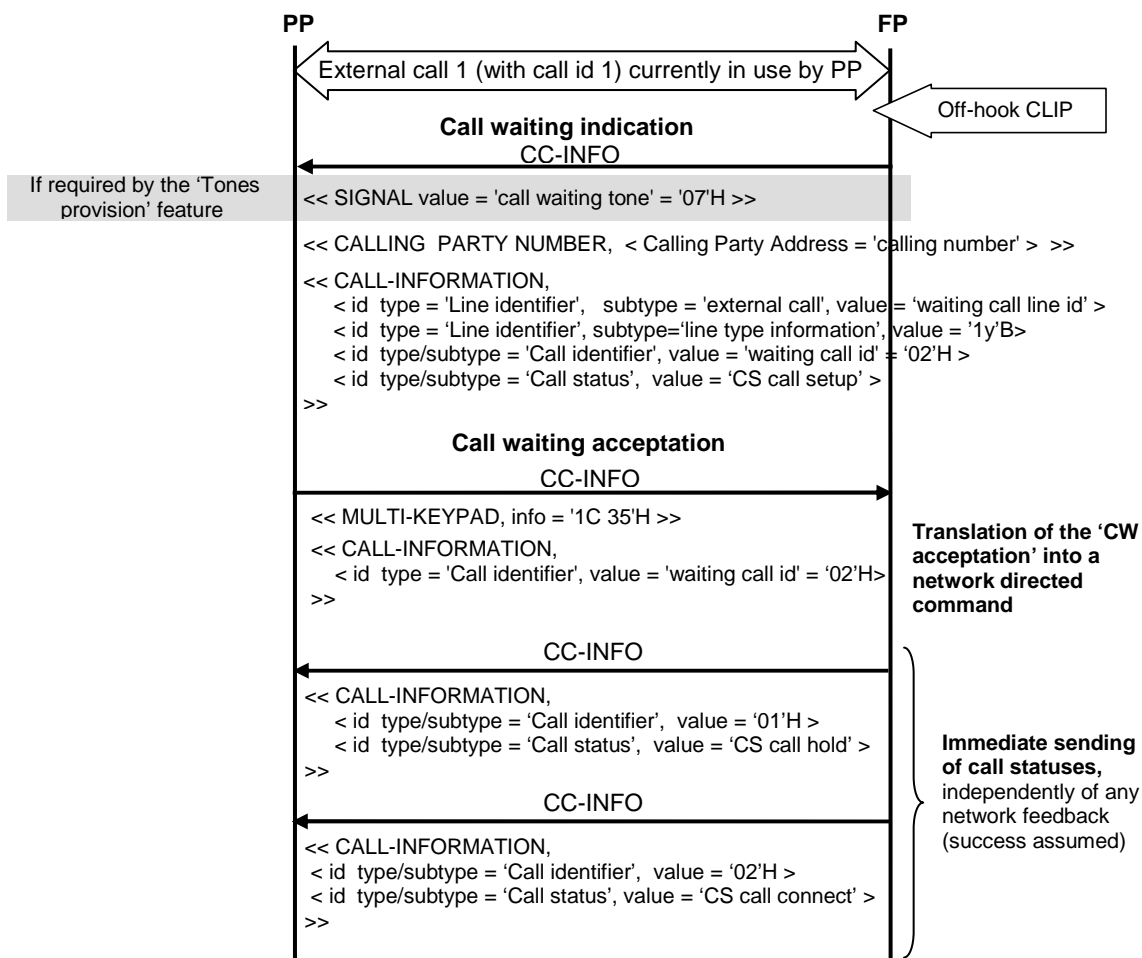

Figure 29: Call waiting acceptance within an 'off-hook CLIP enabled DCIBS' line

Call waiting rejection. The call waiting rejection shall always use procedure 'Call waiting rejection (from PP to FP)' of clause 7.4.3.5.7.

NOTE: The call status 'CS idle' to the PP indicates that the waiting call context on PP side has to be deleted, but may not be related to the time when the waiting call indication from the network terminates.

The FP shall use its best endeavour to translate the call waiting rejection into network directed commands if this is possible.

7.4.3.10.3.3.3 Call toggle within an off-hook CLIP enabled DCIBS line

This procedure applies to a 'Off-hook CLIP enabled DCIBS' line with two existing calls, and a PP busy with one of the calls on that line.

Call toggle request. The call toggle request shall always use procedure 'Call toggle (external or internal)' of clause 7.4.3.5.3, with the following modification:

- call statuses 'CS call hold' for the former active call, and 'CS call connect' for the newly active call, although they shall still be sent, and sent in this order, may be sent by the FP not at the exact times when the corresponding events occurred in the network.

The FP shall use its best endeavour to translate the call toggle request into network directed commands.

7.4.3.10.3.3.4 Active call release with replacement within an off-hook CLIP enabled DCIBS line

Active call release request with replacement. This request shall always use procedure 'Active call release with replacement (from PP to FP)' of clause 7.4.3.5.12, with the following modification:

- call statuses 'CS idle' for the former active call, and 'CS call connect' for the newly active call, although they shall still be sent, and sent in this order, may be sent by the FP not at the exact times when the call replacement occurs in the network.

The FP shall use its best endeavour to translate the "active call release with replacement" request into network directed commands.

7.4.3.10.3.4 Parallel calls away from an off-hook CLIP enabled DCIBS line

This procedure applies to a handset involved in call 'a' on line A ('Off-hook CLIP enabled DCIBS' line) and leaving this call and line in order to:

- 1) either place a new call on another line B (outgoing parallel call initiation);
- 3) connect an existing call on another line B (call toggle, call waiting acceptance); or
- 4) connect an existing call on another line B while releasing the active call (active call release with replacement).

Table 20: Call status to be sent for call a

Procedure	Clause	Message from FP to PP	
		Single call use case Call a active on line A	Two calls use cases Call a active on line A Call b on-hold on line A
Outgoing parallel call initiation (external or internal)	7.4.3.5.1	CS call hold (call a)	CS call hold (call a) (note 1)
Call toggle (external or internal)	7.4.3.5.3	CS call hold (call a)	CS call hold (call a) (note 1)
Call waiting acceptance (from PP to FP)	7.4.3.5.6	CS call hold (call a)	CS call hold (call a) (note 1)
Active call release with replacement (from PP to FP)	7.4.3.5.12	CC-RELEASE	CS idle (call a), or CS call hold (call a) (note 2)
NOTE 1: After the handset has left the line, both calls a and b shall be considered on-hold from the PP and user perspective, although call a may remain active (but not currently in use) on network side; in that case, the FP should play an on-hold music toward the network in order to inform the remote party.			
NOTE 2: The FP may not be able to perform a partial release towards the network for call a; in that case the FP shall still partially fulfil the request: 'CS call hold' shall be sent for call a with call status reason 'control code failed'. Note that the overall result of the request in that case is similar to a call toggle (but with a 'call status reason' sent for call a due to the partial failure).			

7.4.3.10.3.5 Parallel calls towards an off-hook CLIP enabled DCIBS line

This procedure applies to an 'Off-hook CLIP enabled DCIBS' line (line A), and to a handset involved in a call on another line, or in an internal call, and leaving this line or internal call in order to be connected to call a on line A.

NOTE 1: Call 'a' may be created by the handset, or be a previously existing call owned by the handset.

NOTE 2: There may be or not another call 'b' on line A.

Table 21: Call status to be sent to the handset for call a

Procedure	Clause	Message from FP to PP	
		Call a and b are both on targeted line A Call a is the call targeted by the procedure	
Procedures adding a call (new active call) to the handset		Single call use case Call a to be created	Two calls use cases Call a to be created Call b on-hold (see note 1)
Outgoing parallel call initiation (external or internal)	7.4.3.5.1	CS call connect (call a)	CS call connect (call a)
Call waiting acceptance (from PP to FP)	7.4.3.5.6	See notes 2 and 3	See notes 2 and 4
Active call release with replacement (by call waiting)	7.4.3.5.12		
Procedures changing the active call on the handset		Single call use case Call a on-hold (note 1)	Two calls use cases Call a and b on-hold (note 1)
Call toggle (external or internal)	7.4.3.5.3	CS call connect (call a)	
Active call release with replacement (by call on-hold)	7.4.3.5.12	See note 5	
NOTE 1: The indicated status is from handset point of view here. On network side, the call indicated as on-hold to the PP may remain active.			
NOTE 2: The FP may send the 'CS call connect' call status before end-to-end connection (e.g. as soon as it receives the first keypad information), as it may have no information from the network (see also clause 7.4.3.10.3.1).			
NOTE 3: Procedures of clauses 7.4.3.5.1, 7.4.3.5.6 and 7.4.3.5.12 are used here for a first call on line A (outgoing or incoming).			
NOTE 4: An appropriate translation of the request into network directed commands shall be carried out.			
NOTE 5: If call a was active on network side, the FP shall switch off the on-hold music if used, and no translation into the network shall be used. Otherwise, note 4 applies.			

7.4.3.10.3.6 Call transfer

This procedure applies to PP sending a 'call transfer request' in order to transfer an external call (announced or unannounced) on a DCIBS line to another PP.

The procedure 'Call transfer' of clause 7.4.3.6 applies, with the following modifications:

- If there are two calls on the DCIBS line, the FP should refuse the transfer of one of these calls, and send a negative acknowledgment.

NOTE: In case there are two calls on a DCIBS lines, both calls should be transferred, as they can only be handled by a single PP (single call line). However the user may not want to transfer both calls, and the transfer of two calls is not defined.

- In case of waiting call on the DCIBS line after a call transfer to a PP not attached to that line, the call waiting indication should however be sent that PP, as if it was attached to the line.

7.4.3.10.3.7 3-party conference call

This procedure applies to PP involved in two parallel calls, one of them being the active call, and one of them at least being on line A (an 'Off-hook CLIP enabled DCIBS' line), and sending a conference call request.

The procedure '3-party conference with established external and/or internal calls' of clause 7.4.3.7 applies, with the modifications described in table 22.

Table 22: Call statuses following a conference call request

Procedure	Clause	Message from FP to PP	
		The conference call is established from call a and b Call a at least is on line A	
		Call a and b on line A	Call a on line A Call b on another line, or internal
3-party Conference with established internal and external calls	7.4.3.7	CS idle (call b) and CS conf. connect (call a) (notes 1, 2, 3 and 4)	CS idle (call b) and CS conf. connect (call a) (note 2)
Unsuccessful 3-party conference call	7.4.3.7.1	CS call connect (previously active call) (note 5)	FP originating failure CS call connect (previously active call)

3-party conference call release (Conference call changed into a regular two-end call, or fully released)	7.4.3.7.2	Not applicable in case of remote party hangup. Otherwise (PP hangup): CS idle (call a) (note 2)	Applicable in case of remote party hangup at the handset initiative (see subsection 'Release of one of the parties from the 3PTY conference initiating PP')
<p>NOTE 1: Call statuses 'CS idle' for the released call, and 'CS conference connect' for the new conference, shall still be sent by the FP, and sent in this order, but may be sent not at the exact time when the conference is established in the network.</p> <p>NOTE 2: The hypothesis here is that call id of call a was reused for the conference.</p> <p>NOTE 3: An appropriate translation of the request into network directed commands shall be carried out.</p> <p>NOTE 4: As there is a single PP involved in this use case, no call id update is needed.</p> <p>NOTE 5: The conference call establishment failed in the network. The failure may not be detected by the FP. In that case no call status shall be sent back to the PP.</p>			

7.4.3.10.4 Use of transparent commands on DCIBS lines (Basic or Off-hook CLIP enabled) or any other line

This procedure applies to a PP using transparent commands as keypad information towards the FP in order to handle parallel calls on a DCIBS line or any other type of line.

NOTE 1: DCIBS lines are known to be manageable through the use of transparent commands.

NOTE 2: The feature 'Handling of lines where second calls are signalled in-band' lines discourages the use of transparent commands with off-hook CLIP enabled DCIBS lines. But transparent commands are the only way to handle double calls on *basic* DCIBS lines.

NOTE 3: Transparent commands are especially useful for GAP or Part 1 PPs, and should not be used by Part 3 PPs, unless the user directly enters these commands on the keypad (e.g. instead of using Part 3 dedicated menus). The use of transparent commands towards a line (especially a non DCIBS line) is not guaranteed to have any effect in general.

Transparent commands. Keypad information sent to the FP when no call is currently processed with the 'Common parallel call procedures'. Transparent commands consist in keypad information sent in one or several <<MULTI-KEYPAD>> information element sent in as many {CC-INFO} messages.

NOTE 4: Keypad information sent by a Part 3 PP may also be sent as part of the 'Common parallel call procedures' when a call is being processed. Such keypad information is not considered as transparent command.

EXAMPLE: The digits of the called number sent as part of the 'outgoing parallel call initiation', being part of a 'common parallel call' procedure, are not considered as a transparent commands, although they are forwarded to the network.

Transparent commands shall be sent to the FP with the call id of the currently active call (by definition, no call is currently being processed with the 'Common parallel call procedures' when a transparent command is sent).

As a result, the used {CC-INFO} messages shall always contain a <<CALL-INFORMATION>> IE.

When the currently active call is on a DCIBS line, the FP shall not translate/modify the transparent commands received from the PP when relaying them to the (ISBC) network.

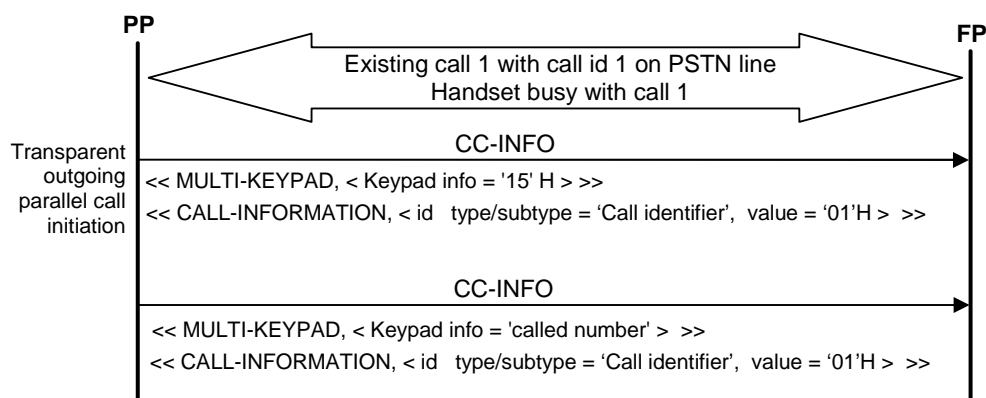

Figure 30: Example of use of transparent commands (with call id of current call)

7.4.4 Handling of single call services

7.4.4.1 Control messages

The following control codes shall be transmitted as keypad information in {CC-INFO} messages and shall trigger the corresponding actions in the FP.

7.4.4.1.1 Call deflection control messages

Table 23: Control messages for control of single call services

Procedure	Control message	Direction	PT Status	FT Status
Call deflection (to internal)	1CH 39H 17H + terminal id number	PP to FP	C2301	C2302
Call deflection (to external)	1CH 39H 15H + number	PP to FP	C2301	C2302
C2301: If PT implements call deflection feature [NG1.N.11] THEN "M" ELSE "I".				
C2302: If FT implements call deflection feature [NG1.N.11] THEN "M" ELSE minimum requirement of "negative acknowledgement" with call status reason 'control code not supported' (see clause 7.4.3.4).				

Call deflection procedure for internal and external calls is detailed in clause 7.4.4.2.

7.4.4.2 Call deflection

When implementing the feature, the FP shall set bit a_{33} of the "Extended higher layer capabilities (part 2)" (see EN 300 175-5 [5], clause F.3).

The call deflection service enables the user to respond to an incoming call (external or internal) by requesting redirection of this call to another number specified in the response. The call deflection service can only be requested before the connection is established by the user, i.e. in response to the incoming call during the period that the user is being alerted of the call (see TS 122 072 [22]).

Call deflection request. In order to deflect a call with "CS call setup" call status, the PP shall send a 'call deflection request' consisting in the control code 1CH as keypad information in a {CC-INFO} message, followed by 39H and by the deflected-to telephone number (external or internal). The deflected-to telephone number shall be preceded by 15H if external or by 17H if internal.

NOTE 1: A first incoming call, or a call waiting can be deflected.

As a result of successful call deflection to an internal number, the incoming call (external or internal) shall only be presented to the deflected-to terminal. In case of external incoming call, the deflected-to terminal may be attached to the line of the call (it continues presenting the call, but alone) or not attached to that line (it starts presenting the call).

As a result of successful call deflection to an external number, the incoming call (external or internal) shall no longer be presented to any PP.

It is recommended that the deflected-to telephone number is pre-configured (in the handset) before using this service. The PP related procedures to pre-program and display the deflected-to number is out of the scope of this procedure.

If a user sends a call deflection request, and the deflected-to telephone number is internal, the FP shall:

- present the incoming call to the "deflected-to" PP only (designated by the number in the request);
- release the call on all other PP(s) that received the incoming call.

If a user sends a call deflection request, and the deflected-to telephone number is external, the FP shall relay the service request to the network:

- if the service can be provided, the FP shall release the incoming call on all PPs that received the incoming call;
- if the service cannot be provided, the FP shall send a negative acknowledgment as described in clause 7.4.3.4 (call status of the incoming call 'CS call setup' re-sent, along with call status reason 'control code failed'). The FP shall proceed further with the incoming call.

NOTE 2: There are various mechanisms for the FP to be aware that the service can not be provided by the network. For example by getting a negative answer from the network when invoking the service or by configuration of the line. However these mechanisms are out of the scope of the present document.

On the FP side, only the first call deflection request shall be taken into account. Possible further requests concerning this call and coming from the same or other PPs shall be ignored.

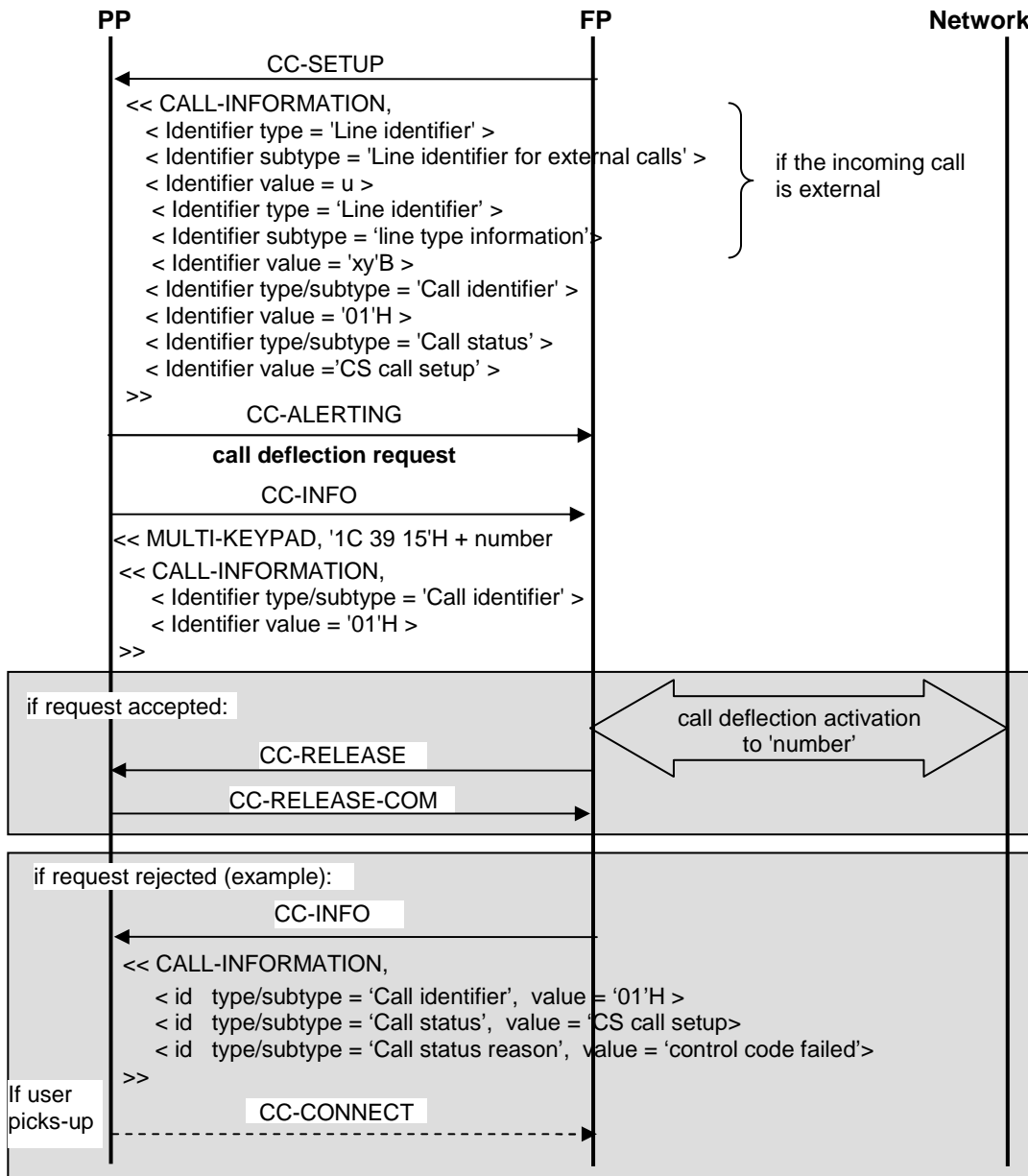

Figure 31: Call deflection invocation when the deflected-to party is external

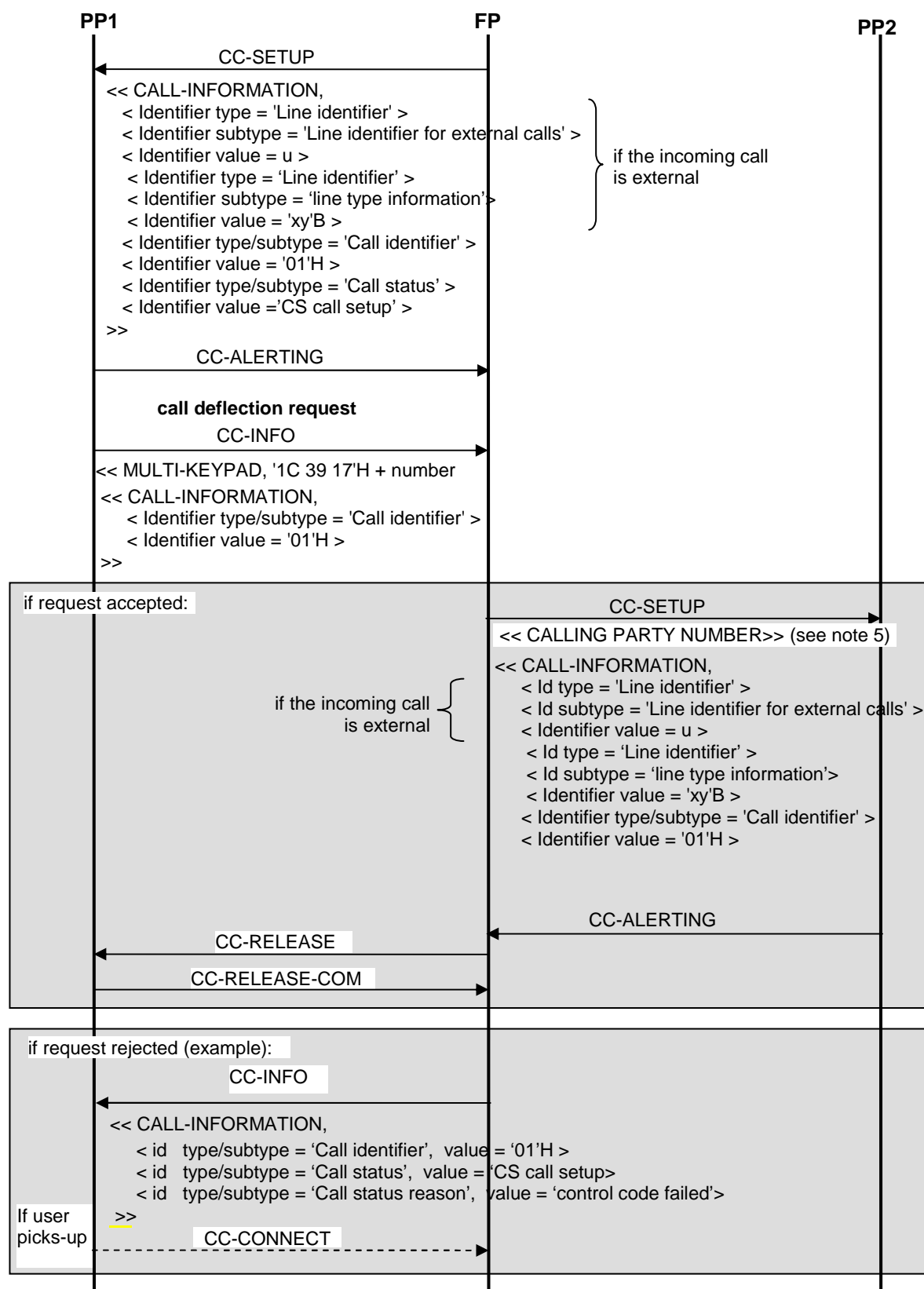

Figure 32: Call deflection invocation when the deflected-to party is internal

NOTE 3: The Call Control message sequences in figures 31 and 32 should be understood as examples. The real sequences may also contain different Call Control messages or Call Control messages in another order or Call Control messages with other contents.

NOTE 4: <<CALLING PARTY NUMBER>> is the deflected (remote) party calling party number. It could also be sent in a {CC-INFO} message.

7.4.5 Line identification

7.4.5.1 Line identification general requirements

Line identifiers are used to identify the line on which an external call (incoming or outgoing) is made. Furthermore it is used by the FP to inform the PP about the line type (i.e.: 'network delay type', 'second call type', etc.) of the selected line.

When the "Multiple line" feature is also implemented, line identifiers allow to enhance the handling of parallel calls in the "Common parallel call procedures" feature. However, when the "Line identification" feature is implemented, line identifiers shall be sent even if there is only one line in the system. Furthermore, if there are several lines in the system (meaning that the "Multiple line" feature is also implemented), the line identifiers shall be used also for PPs attached to only one line.

Typically, a FP would use line identifiers in the 0..n interval, where 'n+1' represents the number of lines it handles.

NOTE: A FP can support upto 127 lines.

For a first or parallel outgoing external call, the line identifier selected by the PP shall be sent to the FP (see clauses 7.4.5.2 and 7.4.3.5.1). However, if the PP wishes to use 'FP-managed line selection' (see clause 7.4.5.2.4), it shall send the special line id value 'None' instead (see clause 3.1). In both cases ('PP line selection' or 'FP-managed line selection') the FP shall send back the line id it selected for the call to the PP.

This line identifier sent back by the FP shall also include the line type information included in the line identifier of subtype 'Line type information', with at least the following flags:

- 'network delay type', indicating whether the delay of the network (to which the selected line is attached to) is 'significant' (e.g. VoIP based network) or 'low' (e.g. PSTN/ISDN based network);
- 'second call type', indicating whether the selected line in an 'double call with in-band signalling' line or not.

For a first or parallel incoming external call, the line identifier value and line type information of the call (with at least the same flags as above) shall be notified from FP to PP (see clauses 7.4.5.3 and 7.4.3.5.2).

The present document only specifies a single mandatory line id notification per call (either from PP to FP or from FP to PP); However, in order to ease implementation, and although it is no longer mentioned elsewhere in the present document, both parties are allowed to send the line id again in messages following this notification. But, for the sake of interoperability, the party receiving these redundant line id values should ignore them.

7.4.5.2 Line identification for external outgoing calls

7.4.5.2.1 General line identification requirements for external outgoing calls

For outgoing calls, the "Line identification" feature enables a PP to select the line on which the call has to be placed. For each outgoing call, the PP shall either :

- select a specific line to place the call; or
- select line identifier 'None' to let the FP manage the line selection for this call.

Both modes shall be available for the user on PP side.

NOTE 1: The intention is to avoid implementations where PP would send only "None" line identifier in front of a FP supporting several lines.

If the PP has selected a specific line, it shall not make a different selection in a subsequent message. The PP shall not select a line it is not attached to (in that case the FP shall disconnect the call).

If the PP uses line identifier 'None', the FP shall select a line on behalf of the PP. Whether the line is selected by the PP or by the FP, the FP shall send back to the PP the line identifier for the selected line where the call will be placed together with the line type information (see clause 7.4.5.1).

This procedure applies to all external outgoing calls (first or parallel). In the case of a parallel call, it only applies if the feature entitled "Common multiple call procedures" is also implemented. In that case, relevant procedures are described there.

Exception case: if the PP has selected a specific line in order *to place an emergency call*, the FP may consider that it has received a 'None' line identifier and use FP managed line selection instead, to process the call further. This exception shall not be used for non-emergency calls.

NOTE 2: This rule allows the FP to select a more appropriate line if the PP specified line is not suitable (e.g. busy, out of order, etc.) when an emergency number is dialled.

The line identifier information shall be sent using one of the following methods:

- For Part 3 PPs, included in a << CALL INFORMATION >> information element sent in the {CC-SETUP} message or in a {CC-INFO} message.
- For GAP PPs, Part 1 PPs, and possibly Part 3 PPs, included in a << MULTI-KEYPAD >> information element sent either in the {CC-SETUP} message, or in a {CC-INFO} message. This method shall only be used if the line identifier is in the interval 0..9. If this method is used, the line identifier information shall consist in the pound key ("#") character ('23'H) followed by the line identifier digit, IA5-coded on a single octet.

7.4.5.2.2 Line identification for a *first* external outgoing call using <<CALL INFORMATION>>

This procedure applies to the Part 3 FP and to a Part 3 PP effectively sending a line identifier for a first external outgoing call. This procedure uses the <<CALL-IDENTIFICATION>> information element.

When using the present procedure, and as an addition to procedure "Outgoing call request" of GAP [12], clause 8.2, a << CALL INFORMATION >> IE shall be used for conveying the line identifier information. This IE shall be sent:

- either included in the {CC-SETUP} message; or
- included in a subsequent {CC-INFO} message, together with the first called number digit at the latest.

If not using the present procedure for a first outgoing call, a Part 3 PP shall use procedure "FP managed line selection for a *first* external outgoing call" of clause 7.4.5.2.4 instead.

Table 24: Values used within the {CC-SETUP} message when the << CALL-IDENTIFICATION >> method is used for conveying the line identifier information

Information element	Field within the information element	Standard values within the field/information element	Normative action/comment
<<Call-identification>>	<Identifier type>	0	Code for 'Line identifier' identifier type
	<Identifier subtype>	0	Code for 'Line identifier for external calls' subtype
	<Identifier value>	All	The line identifier value itself

The FP shall confirm the line selection of the PP by sending back a <<CALL INFORMATION>> IE conveying the line identifier information with the line identifier value and the line type information. This IE shall be sent:

- for a 'non early {CC-CONNECT}' implementation of the FP:
 - either included in the {CC-SETUP-ACK} message, if sent, and if the line id value was sent in the {CC-SETUP};
 - included in the {CC-CALL-PROC} message, if sent, and sent early enough; or
 - otherwise, included in a {CC-INFO} message sent before the {CC-CONNECT}. In that case, the {CC-INFO} message contains a call id but does not bear any call status.
- for an 'early {CC-CONNECT}' implementation of the FP:
 - either included in the {CC-CONNECT} message; or

- in a {CC-INFO} message following the {CC-CONNECT}.

The FP shall not use this confirmation to change the line to be used. If the selected line cannot be used, the FP shall use procedure "Busy system or line notification" of clause 7.4.8.3 in order to disconnect the call.

Table 25: Values used within the {CC-SETUP_ACK}, {CC_CALL_PROC}, {CC_INFO} or {CC_CONNECT} message used for confirming the line selection of the PP

Information element	Field within the information element	Standard values within the field/information element	Normative action/comment
<<Call-information>>	<Identifier type>	0	Code for 'Line identifier' identifier type
	<Identifier subtype>	0	Code for 'Line identifier for external calls' subtype
	<Identifier value>	All	The line identifier value itself
	<Identifier type>	0	Code for 'Line identifier' identifier type
	<Identifier subtype>	5H	Code for 'Line type information' subtype
	<Identifier value>	'00'B '01'B '10'B '11'B	Regular line with low delay Regular line with significant delay DCIBS line with low delay DCIBS line with significant delay

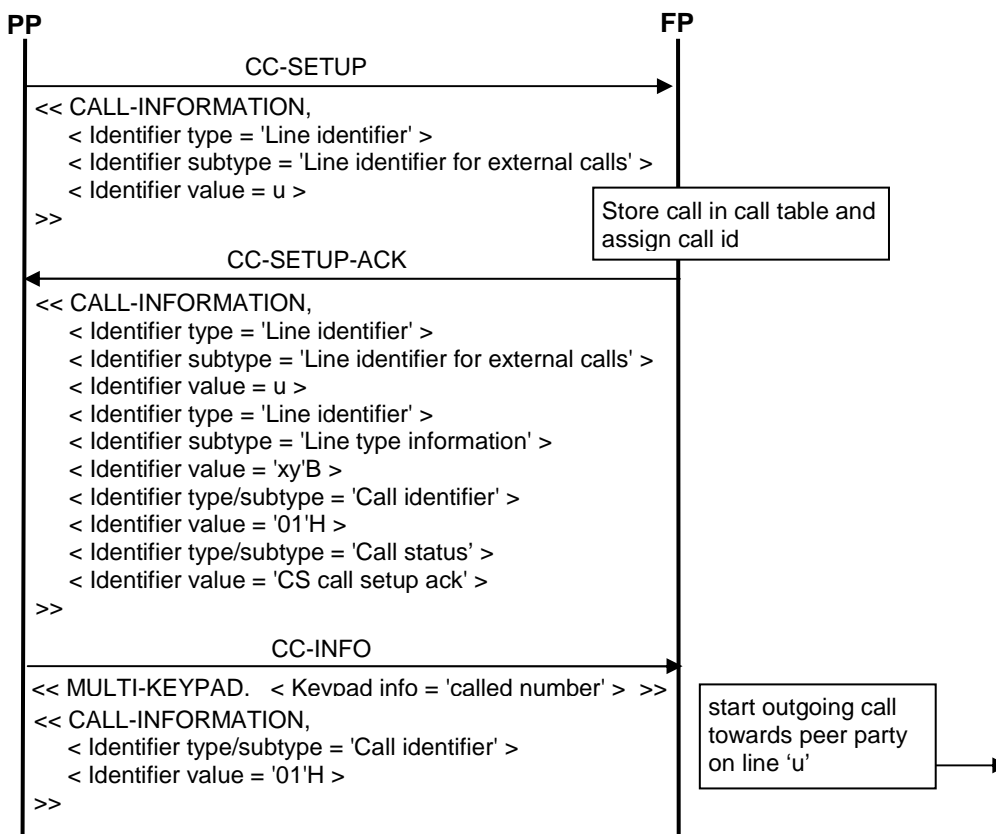

Figure 33: Line identification in {CC-SETUP}

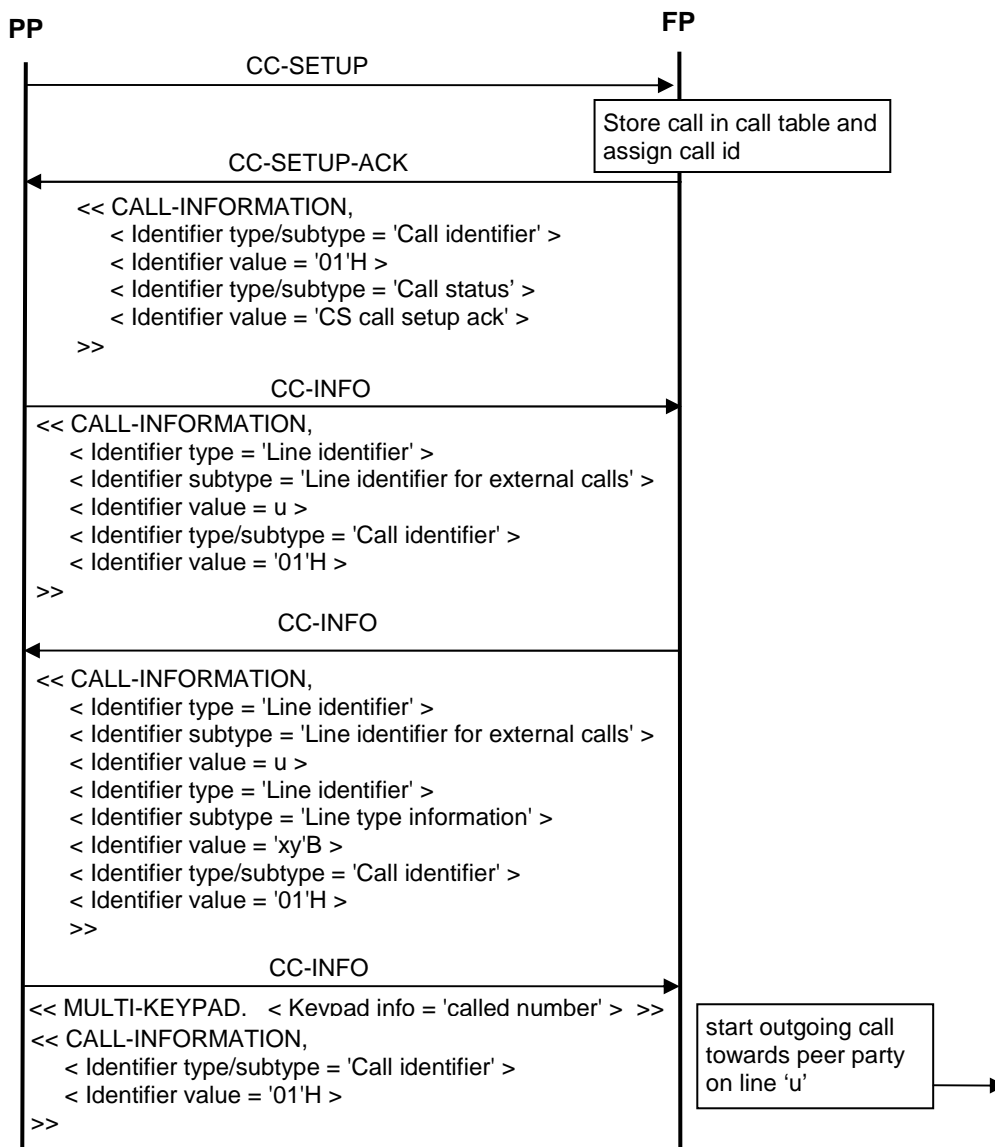

Figure 34: Line identification in {CC-INFO}

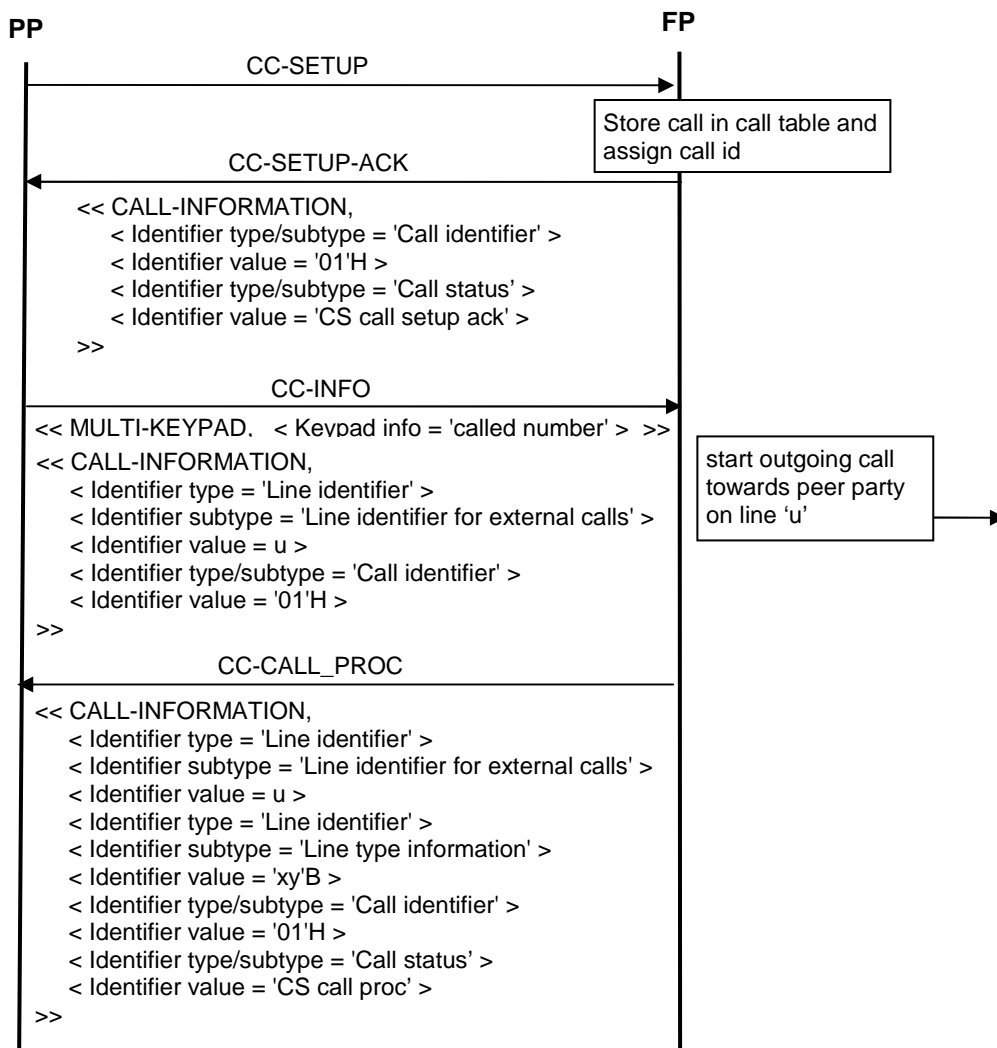

Figure 35: Line identification together with called number in {CC-INFO}

NOTE: The Call Control message sequence in figures 33, 34 and 35 should be understood as an example. The real sequences may also contain different Call Control messages, Call Control messages in different order or Call Control messages with other contents.

7.4.5.2.3 Backward compatible line identification for a *first* external outgoing call using << MULTI-KEYPAD >> IE

This procedure applies to the FP and a GAP or Part 1 PP, and possibly to a Part 3 PP, and allows the PP to send a line identifier for a first external outgoing call in a backward compatible way (i.e. using the <<MULTI-KEYPAD>> IE).

When using the present procedure, a << MULTI-KEYPAD >> information element shall be used for conveying the line identifier information. This information element shall be included in a {CC-INFO} message, as described in procedure "Sending keypad information" of GAP [12], clause 8.10.

Table 26 shall be considered.

NOTE: In the latter case, the <<MULTI-KEYPAD>> information element used may contain (partial or complete) called party number information.

Table 26: Values used within the {CC-SETUP} or a {CC-INFO} message when the <<MULTI-KEYPAD>> method is used for conveying the line identifier information

Information element	Field within the information element	Standard values within the field/information element	Normative action/comment
<<Multi-keypad>>	<Keypad info>	23H	Code for the pound key ('#') used for introducing the line identifier
		30H - 39H	The line identifier itself

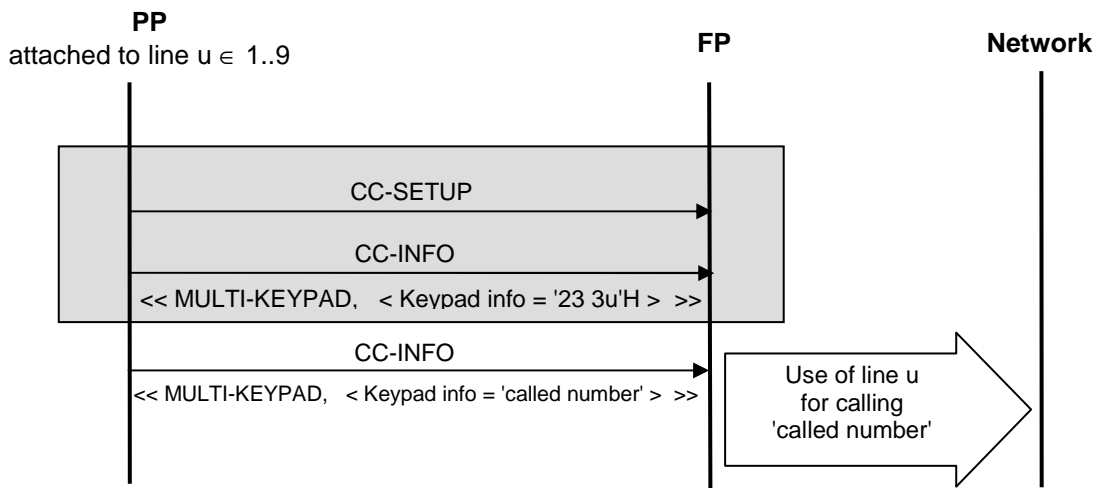

Figure 36: Line identification for a first external outgoing call, using the <<MULTI-KEYPAD >> method

7.4.5.2.4 FP managed line selection for a *first* external outgoing call

7.4.5.2.4.1 FP managed line selection for a *first* external outgoing call from a Part 3 PP

This procedure applies to the Part 3 FP and a Part 3 PP making a first external outgoing call. It allows the PP not to specify any line identifier for this new call.

In that case, the line selection is said to be "FP-managed".

When using the present procedure, and as an addition to procedure "Outgoing call request" of GAP [12], clause 8.2, a <<CALL INFORMATION >> IE shall be used for conveying the special line id value 'None' (see clause 3.1). This value shall be sent instead of a regular line id, at any possible time and in any possible location for sending a regular line-id as described in clause 7.4.5.2.2, i.e.:

- included in the {CC-SETUP} message; or
- included in a subsequent {CC-INFO} message, together with the first called number digit at the latest.

A FP implementing this procedure shall therefore always be prepared to possibly select a line on behalf of the PP.

NOTE 1: The PP can therefore allow its user not to select any line (either on a call-by-call basis, or permanently by configuration).

A PP attached to only one line (e.g. registered to a FP with only one line) may use the present procedure.

If a Part 3 PP uses the special line identifier value 'None', in order to use "FP managed line selection", it shall not select a line in a subsequent message.

When receiving 'None', the FP shall select a line on behalf of the PP. The FP shall then notify the selected line identifier value and line type information to the PP. This notification shall be sent, as described on figures 37, 38, 39 and 40:

- for a 'non early {CC-CONNECT}' implementation of the FP:
 - either included in the {CC-SETUP-ACK} message, if sent, and if the 'None' value was sent in the {CC-SETUP}; or
 - included in the {CC-CALL-PROC} message, if sent, and sent early enough;
 - otherwise, included in a {CC-INFO} message sent before the {CC-CONNECT}. In that case, the {CC-INFO} message contains a call id but does not bear any call status.
- for an 'early {CC-CONNECT}' implementation of the FP:
 - either included in the {CC-CONNECT} message; or
 - in a {CC-INFO} message following the {CC-CONNECT}.

The FP may defer line selection and notification until it has all the information needed to make the selection (in particular, in some system configurations, the selected line could depend on the dialled number).

Table 27: Values used within the {CC-SETUP_ACK}, {CC_CALL_PROC}, {CC_INFO}. or {CC_CONNECT} message used for conveying the line identifier value and line type information

Information element	Field within the information element	Standard values within the field/information element	Normative action/comment
<<Call-information>>	<Identifier type>	0	Code for 'Line identifier' identifier type
	<Identifier subtype>	0	Code for 'Line identifier for external calls' subtype
	<Identifier value>	All	The line identifier value itself
	<Identifier type>	0	Code for 'Line identifier' identifier type
	<Identifier subtype>	5H	Code for 'Line type information' subtype
	<Identifier value>	'00'B '01'B '10'B '11'B	Regular line with low delay Regular line with significant delay DCIBS line with low delay DCIBS line with significant delay

NOTE 2: Some kind of "FP managed line selection" may also be used for "Call intrusion" (see 7.4.3.8) and is used for "Headset management" (see clause 7.4.16.2.2).

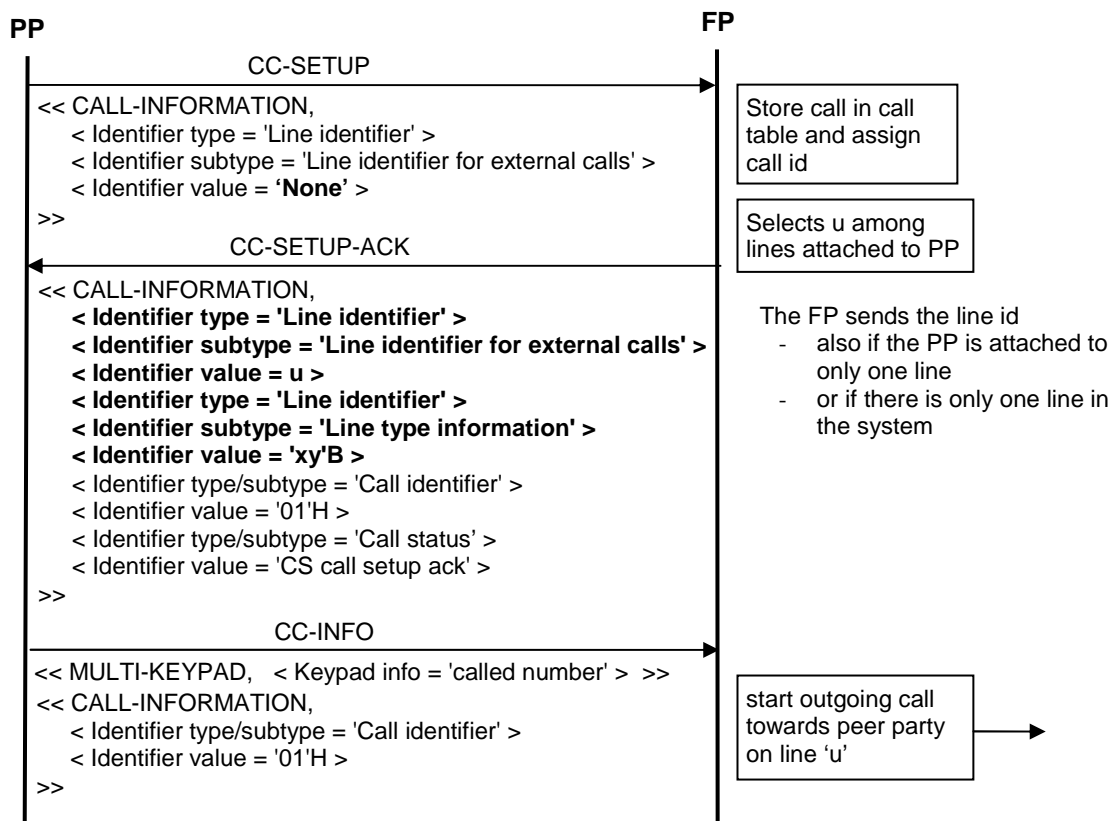

Figure 37: FP-managed line selection in {CC-SETUP-ACK} (together with call id assignment)

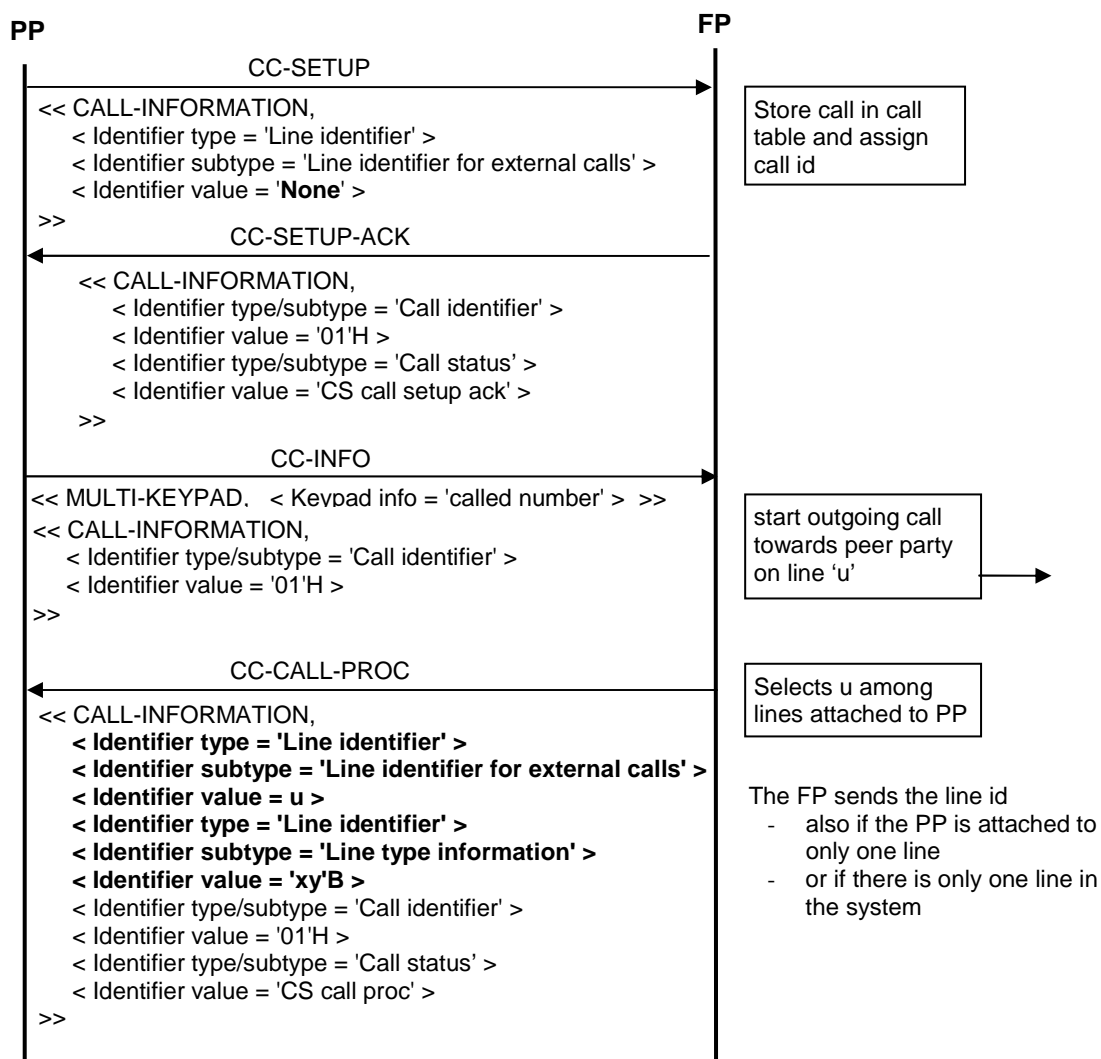

Figure 38: FP-managed line selection deferred to {CC-CALL-PROC}

NOTE 3: This can be used in case the line id selected by the FP would depend from the called number, the FP may wait until the called number is received (partly or completely) before it notifies the line id used.

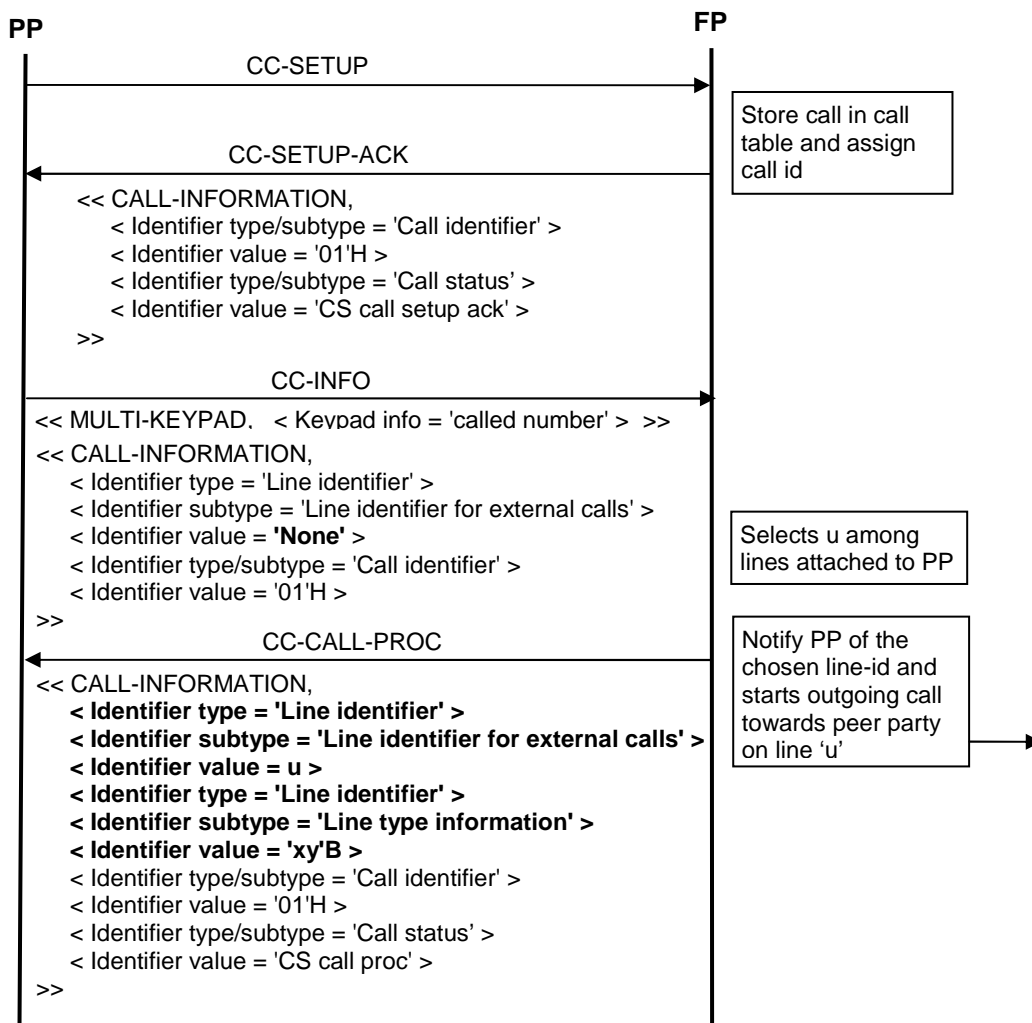

Figure 39: Deferred use of 'None', together with called number

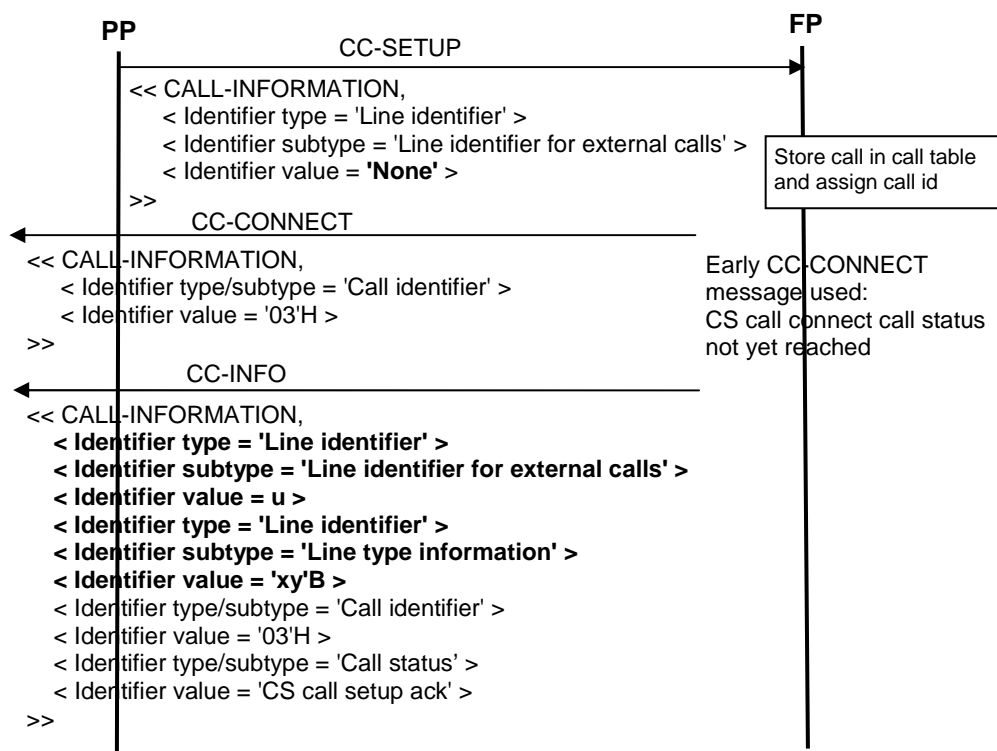

Figure 40: Example of use with an early {CC-CONNECT} implementation

7.4.5.2.4.2 Backwards compatible FP managed line selection for a *first* external outgoing call

This procedure applies to a Part 3 FP in front of a GAP or Part 1 PP making a first external outgoing call.

For a given call, the default behavior of a GAP or Part 1 PP making a first external outgoing call is to send no line identifier.

A Part 3 FP implementing this procedure shall wait for the first keypad information received from the GAP or Part 1 PP. If the keypad information is different from '23'H ('#' character), it shall infer that FP managed line selection is used, and shall therefore select a line on behalf of the PP.

NOTE: This corresponds to the classical way of using a GAP or Part 1 PP.

The FP may notify back the user of the PP of the used line identifier using a <<DISPLAY>> information element.

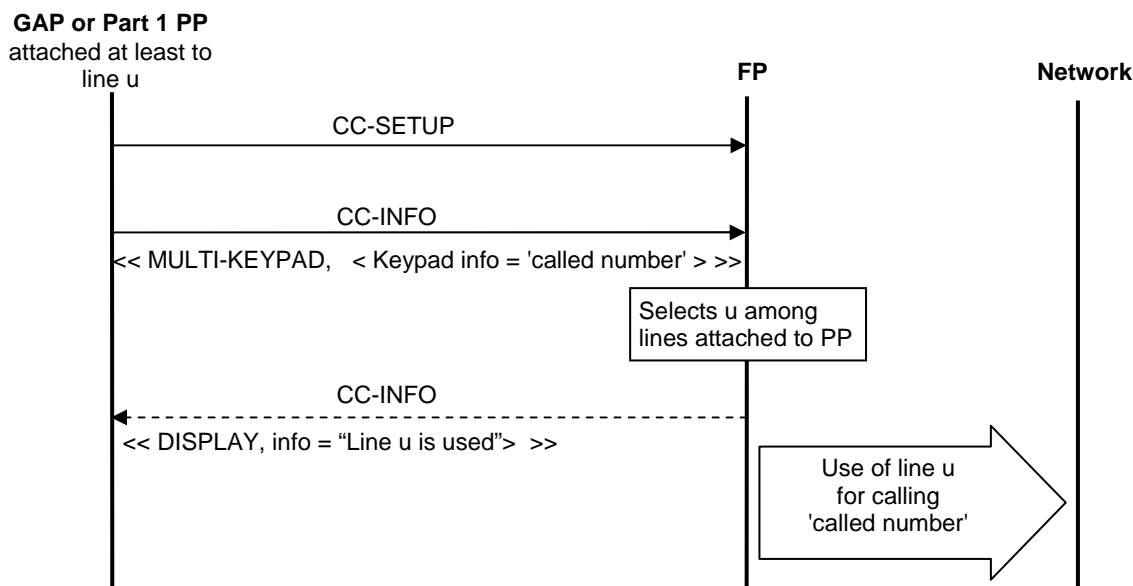

Figure 41: Backward compatible FP managed line selection

7.4.5.3 Line identification for external incoming call

7.4.5.3.1 General line identification requirements for external incoming calls

For incoming calls, the "Line identification" feature enables the FP to notify the PP of the line on which the incoming call was received.

NOTE: The current general procedure applies to all external incoming calls (first incoming call or waiting call). In the case of a waiting call, it applies conditionally to the implementation of the feature entitled "Common multiple call procedures".

For incoming calls, the line identifier information (including the 'line type information') shall always be sent included in a << CALL INFORMATION >> information element, as follows:

- For a first incoming call, it shall be sent in the {CC-SETUP} message, as described in clause 7.4.5.3.2.
- For a waiting call, it shall be sent in every {CC-INFO} message used for notifying the waiting call, as described in clause 7.4.3.5.2.

7.4.5.3.2 Line identification for a *first* external incoming call

For incoming calls, the "Line identification" feature enables the FP to notify the PP of the line identifier of the line on which the incoming call arrived. Furthermore it is used by the FP to inform the FP about the 'line type information' of the selected line.

A line identifier for an incoming call shall be sent from FP to PP in a <<CALL INFORMATION>> information element in the {CC-SETUP} message, as an addition to GAP [12], clause 8.12, "Incoming call request".

The FP shall notify the line identifier used even if there is only one line in the system, and even if the PP is attached to only one line.

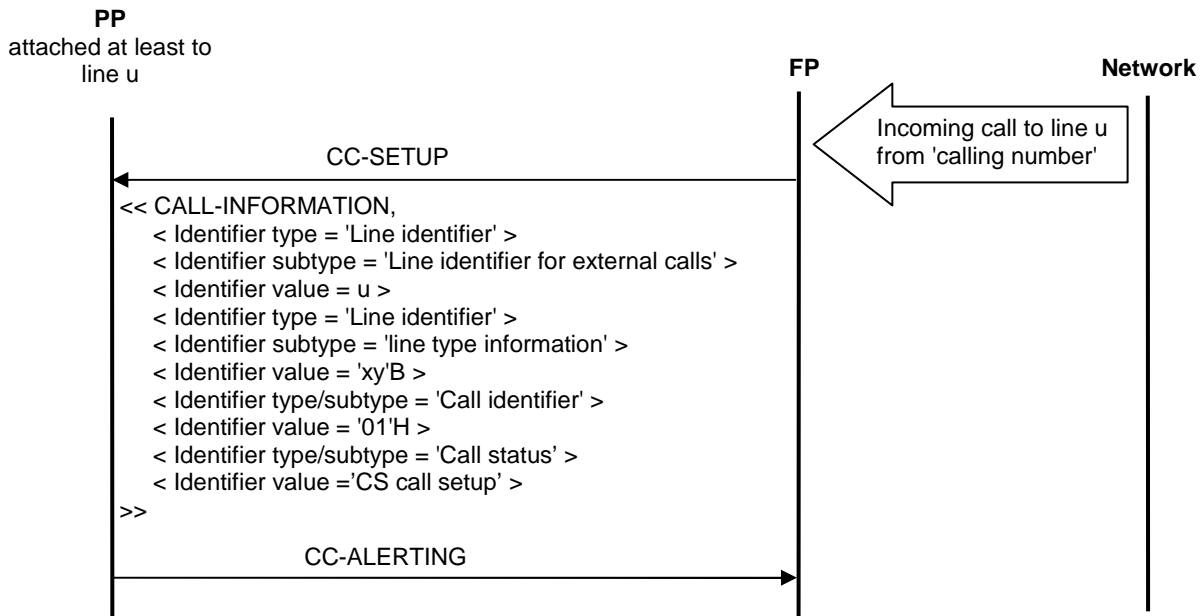

Figure 42: Line identification for a first external incoming call

7.4.6 Call identification

7.4.6.1 Call identification general requirements

The "Call identification" feature handles:

- The definition of a call identifier (or call id) by the FP for each call, and the use of this call id in both directions to identify the call a received message belongs to.
- The sending from FP to PP of a call status - at some points of the call progression- and in some cases of an associated call status reason (see clause 7.4.6.4).

Call identifiers are used to identify all ongoing calls in a DECT system, internal or external. They allow to enhance the "Parallel call" and "Multiple call" features. More specifically:

- Call identifiers allow to properly handle PPs with more than 2 call instances, especially for all double call related procedures (see clause 7.4.3.5).
- Even for PPs with only 2 call instances, call identifiers allow to properly handle asynchronous messages (for example a call toggle from the PP crossing a call release from the FP).

Call identifiers are assigned by the FP and are uniquely defined DECT system-wide. In other words, call identifiers shall NOT be PP specific (i.e. there shall never be two equal call identifiers, even for 2 different PPs), nor line specific.

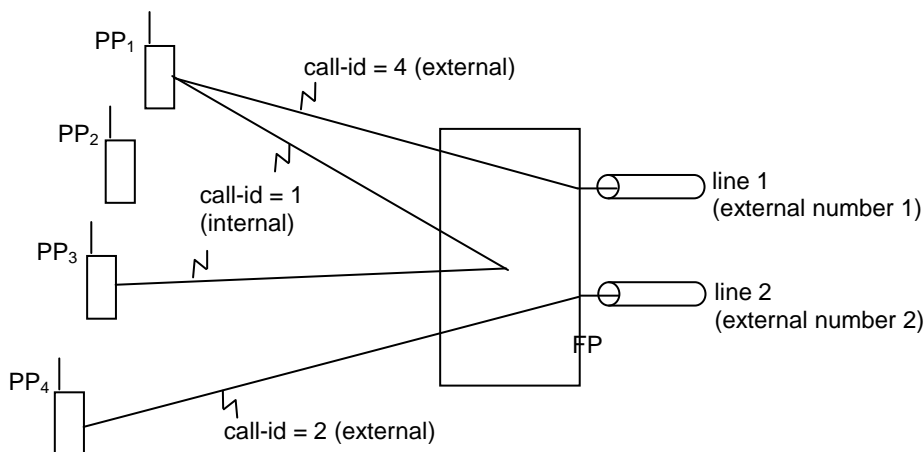

Figure 43: Calls identifiers are assigned by the FP and unique for the DECT System

A call identifier is assigned each time a call is setup. In order to be usable for parallel/multiple calls, a call identifier shall be assigned also for the first call of a PP.

The call identifier is freed on PP side at call release ('CS idle' received from the FP, or {CC-RELEASE-COM} sent or received by the PP). The PP shall no longer use the call id value except on FP's initiative.

The call identifier is freed on FP side (and available for a further new call):

- at call release if the call only involves one PP ('CS idle' sent to the PP, or {CC-RELEASE-COM} sent or received by the FP);
- if several PPs are involved in the call (e.g. in case of call transfer, multiple call line, headset call interception, etc.), when the call does no longer exist in the system, i.e. at the time the call is released for the last PP involved in the call.

The FP call identifier assignment method is left free to implementation. However, it is recommended to avoid possible conflicts of assignment when a call is being released while an other one is being setup on the same PP (avoid re-using the first free call id). The FP may implement the "no re-use method" described below, which allows this.

The "no re-use method" consists in assigning a call identifier to a new call in the interval $[0, n]$. Assignment starts or restarts at 0 each time the system comes back to idle (all registered PPs are back to idle). For further calls, the rule "Assigned id = latest assigned id in time + 1" applies. Latest assigned id may correspond to a still ongoing or an already terminated call. This method assumes that n is never reached. An easy implementation can be done by using $n=127$ (127 is the maximum call identifier length if no extension for the call identifier value is used).

The FP shall send a call identifier together with every call status sent to the PP, as specified in clause 7.4.6.4, and more generally, with all messages relating to the identified call (especially including the {CC-INFO} messages conveying the CLIP and the CNIP for a first incoming call -if a {CC-INFO} message is used- although there is no associated call status in this case). The first sending of the call identifier to the PP notifies the PP of the call id assignment for the call, as specified in clauses 7.4.6.2 (first outgoing call), 7.4.6.4.6 (first outgoing call using early CC-CONNECT implementation) and 7.4.6.3 (first incoming call), 7.4.3.5.1 (parallel outgoing call) and 7.4.3.5.2 (call waiting indication).

The FP may notify the call id assignment while the call is being disconnected (i.e. together with call status 'CS call disconnecting'), as illustrated in clause 7.4.8.3, "Busy system or line notification". However, the FP shall not notify the call id assignment while releasing the call (i.e. together with call status 'CS idle'), as specified in clause 7.4.3.5.4, "Call release and call release rejection"

The PP shall send call identifiers in {CC-INFO} messages as specified in clauses 7.4.6.4.5 (first outgoing call) and in 7.4.3.5 (parallel calls), for all messages or requests relating to the identified call. As a result, once a call identifier is assigned, all the subsequent {CC-INFO} messages shall include a call identifier (i.e. Keypad, CLIP, CNIP, Signal, Display, etc.)

Call identifiers shall be sent within the <<CALL-INFORMATION>> information element with <Identifier type> and <Identifier subtype> fields both equal to 'Call identifier'. It shall be sent in case the sending party (PP or FP) implements the "Call identification" feature. The format to be used in all messages is shown in table 28.

Table 28: Values used within any applicable CC message

Information element	Field within the information element	Standard values within the field/information element	Normative action/comment
<<Call-information>>	<Identifier type>	1	Code for 'Call identifier' identifier type
	<Identifier subtype>	0	Code for 'Call identifier' subtype
	<Identifier value>	All	The call identifier value itself

NOTE: The "Call transfer", "3-party conference with established internal and/or external calls" and "Call intrusion" features also make use of call identifiers with a different <Identifier subtype> = 'Updated call identifier', for the purpose of updating the identifier of an existing call. This subtype is not used within the "Call identification" feature itself.

When implementing the feature, the PP shall set the corresponding terminal capability bit.

Definition of 'early {CC-CONNECT} implementations'. It has been recognised that some existing implementations of GAP devices do not make use of the optional intermediate CC-States (e.g. Call Proceeding) for the first outgoing call, and rather send an early {CC-CONNECT}, thus using a simplified version of the state machine enough for the handling of PSTN calls in practice. In such implementations, the {CC-CONNECT} message from FP to PP is used as a way to require U-plane connection from the PP, even if the end to end connection with the remote party is not yet active. Such implementations avoid using the <<PROGRESS INDICATOR>> IE and minimise the number of exchanged CC messages.

Such implementations, are allowed for Part 3 FPs, and are seamlessly integrated thanks to the 'Call status indication' procedure of clause 7.4.6.4 (see there for more details).

Definition of 'Non early {CC-CONNECT} implementations'. This is used for implementation that are not 'early CC-CONNECT' ones.

7.4.6.2 Call identifier assignment on first outgoing call (FP to PP)

The purpose of this procedure is to have the FP assign a unique call identifier for a first outgoing call, external or internal, and notify it back to the calling PP.

In case of internal call, the FP shall assign a single call identifier for both PPs.

The assigned call identifier shall be notified back to the PP, by including a <<CALL-INFORMATION>> information element with <Call identifier> field value equal to the assigned call identifier in the first CC message sent back to the PP. More specifically, the call id assigned by the FP shall be sent first time to the PP as described below.

- For "*Non early {CC-CONNECT} implementations*" (see clause 7.4.6.1), the newly assigned call id for a first outgoing call shall be communicated to the PP either:
 - in a {CC-SETUP-ACK} if sent;
 - in {CC-CALL-PROC} if sent, and if sent early enough;
 - in a {CC-INFO} message sent FT to PT otherwise.
- For "*Early {CC-CONNECT} implementations*" (see clause 7.4.6.1), the newly assigned call id for a first outgoing call shall be communicated to the PP either:
 - in the {CC-CONNECT} message itself, if sent early enough;
 - in a {CC-INFO} sent FT to PT otherwise.

NOTE: As described in clause 7.4.6.1, once the call id has been assigned and communicated to the PP, it is used in all subsequent messages (both directions) related to the same call.

- The outgoing call procedure of GAP (see clauses 8.1 to 8.6 of EN 300 444 [12]) shall be used with the following modifications:
 - the Information element <<Call information>> with the content described in table 28 (see clause 7.4.6.1) shall be added to the content of the {CC-SETUP-ACK}, { CC-CALL-PROC } or {CC-CONNECT}, (depending on option) message with the rest of the content as described in EN 300 444 [12];
 - if the call identifier has not been sent in the {CC-SETUP-ACK}, { CC-CALL-PROC } or {CC-CONNECT} message, then a dedicated {CC-INFO} message, FT to PT, shall be added to the procedure carrying the Information element <<Call information>> with the content described in table 28 (see clause 7.4.6.1).

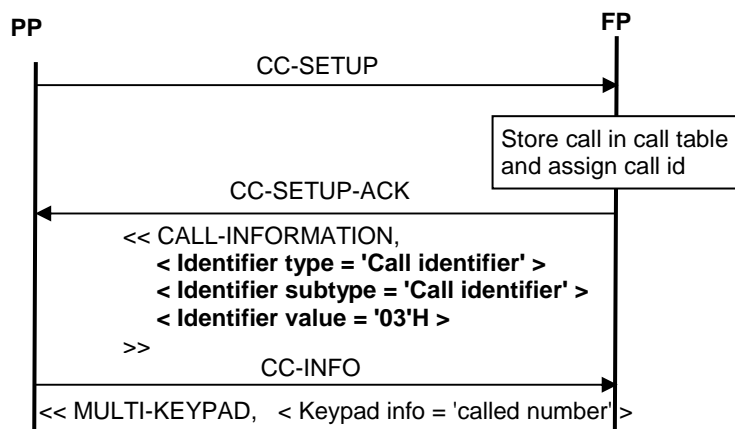

NOTE: Only the call id assignment notification by the FP is represented here. The call id is however present in the last {CC-INFO} message from PP to FP.

Figure 44: Example of call identifier assignment on outgoing call, with call-id=3

A call with basic service call class 'LiA service call setup' shall NOT be assigned any call identifier. See clause 7.4.10.6 for more details.

7.4.6.3 Call identifier assignment on first incoming call (FP to PP)

The purpose of this procedure is to have the FP, upon a first incoming call, external or internal, assign a unique call identifier and send it to the PP.

NOTE 1: The "Handset locator" feature uses a kind of incoming call to which the FP also assigns a call identifier.

In case of internal call, the FP shall assign a single call identifier for both PPs.

A Call identifier for an incoming call shall be sent from FP to PP in a <<CALL INFORMATION>> information element in the {CC-SETUP} message.

NOTE 2: The call identifier should not be displayed to the user.

The procedure shall be performed as procedure "Incoming call request" from GAP (see clause 8.12 of EN 300 444 [12]), with the following modification: the information element <<Call information>> with the content described in table 28 (see clause 7.4.6.1) shall be added to the content of the {CC-SETUP} message described in table 22 of clause 8.12 of EN 300 444 [12].

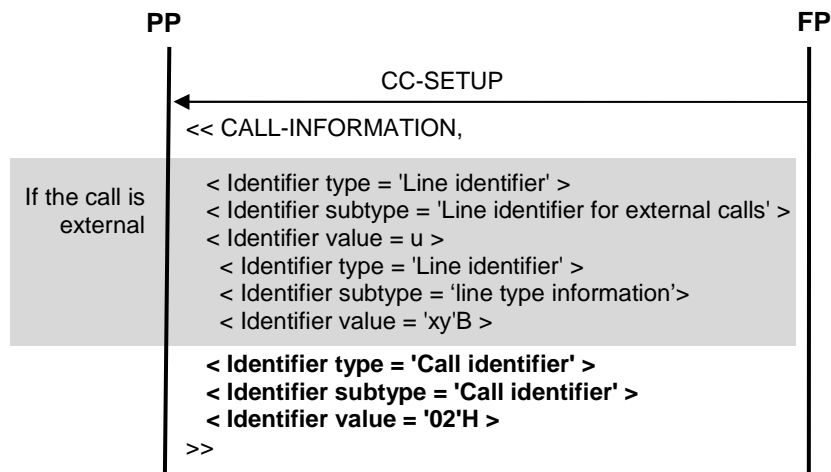

Figure 45: Example of Call identifier assignment on incoming call, with call-id = 2

7.4.6.4 Call status indication to the handset (FP to PP)

7.4.6.4.1 Call status indication general requirements

The procedure "Call status indication to the handset (FP to PP)" provides the PP with timely and accurate information about the PP current call status (or calls statuses). Call statuses are used for outgoing and incoming calls, external and internal calls, first and parallel calls.

The call status and call status reason information is primarily intended for displaying to the user accurate MMI information. (For instance a parallel call dedicated menu will only show up when the call is really connected with remote peer).

More specifically, the aim of the present procedure is to:

- enhance parallel call user experience for all Part 3 devices, by allowing the building of a state machine on PP side for every call (first and especially parallel calls);
- increase accuracy of state information exchange for Part 3 FPs that will rely on an 'Early {CC-CONNECT}' implementation, while not breaking other implementations (see '**Early {CC-CONNECT}' implementations** below for more information).

The FP shall send the call status indication to the PP (see clause 7.4.6.4.3 for details).

The PP may use this indication to inform the user of the status of the call (current procedure does not specify the way this information is displayed to the user. It could be a text string, an icon, etc.).

For example, the PP may display to the user:

- the communication duration;
- context-dependent menus;
- feedback to a user action (e.g. second call initiation, call toggle, call transfer request, conference call request, etc.);
- information about another user action (the current call becomes a conference call, is being intruded, transferred, etc.).

Information conveyed by call statuses. Information provided to the PP (and user) includes:

- real network-side normal call status ("call proceeding", "ringing", "connected", etc.). In other words, the PP is provided with the status of the call towards the peer party (between FP and peer party);

- network-side call status in case of busy/error conditions;
- **call status reason.** In addition to the indicated call status, the FP shall send the call status reason, if available in an error message from network or from the FP itself.

Link with original CC state machine (handling of radio link and first call). The present procedure does not make any change to the original CC state machine, nor to CC state transitions (as triggered by CC messages). Especially, this state machine still constrains CC message ordering in both directions. U plane opening is still based on the <<PROGRESS INDICATOR>> IE or on the {CC-CONNECT} message.

Rather, the present procedure adds a newly defined state machine (on PP side only) for each call including the first one, state transitions being triggered by the reception of call statuses (even for the first call). For 'Non-early {CC-CONNECT}' implementations, the sending of a call status for the first call generally coincides with the sending of the CC message of the same name.

NOTE: Call status names are all prefixed with 'CS' for 'Call Status', in order to avoid any confusion with existing state transitions. For convenience, call statuses have names similar to the corresponding CC messages.

Call status and external/internal calls. For external calls, call statuses originate from the FP or from the network. For internal calls, the call status always originates from the FP and is used with the same meaning. (In case of internal call, both implementations send the {CC-CONNECT} message at the same time).

'Early {CC-CONNECT}' implementations. (see definition in clause 7.4.6.1). In such implementations, the CALL ACTIVE state-defined as reached when the {CC-CONNECT} message is sent-does no longer mean end to end active call. On the contrary, the 'CS call connect' call status shall always mean end to end active call (see however the PSTN special case in clause 7.4.6.4.3).

Call statuses shall also be used for first calls, even in "Non early {CC-CONNECT} implementations", because the PP cannot guess which type of implementation the FP uses. For example, the PP shall always rely on 'CS call connect' for being informed of end to end activation of the call, and never on {CC-CONNECT} reception per se (which only means U-plane connection).

EXAMPLES: Clauses 7.4.6.4.5 to 7.4.6.4.9 provide several examples explaining the use of the call status indication procedure. It has to be noted that the sequences are only examples, it cannot be mandatory that the message flows shall always be exactly in the described way. However it is recommended to follow the examples where possible in order to ensure interoperability.

Backward compatibility.

A Part 3 FP shall not send any call status to GAP or NG Part 1 devices.

A Part 3 PP in front of a GAP FP or NG DECT Part 1 FP should behave as a GAP PP or NG DECT Part 1 PP respectively.

7.4.6.4.2 Call status indication as call information

The call status indication shall be sent in the <<CALL INFORMATION>> IE.

Table 29: Values used within CC-messages

Information element	Field within the information element	Standard values within the field/information element	Normative action/comment
<<Call-information>>	<Identifier type>	2	Code for 'Call status' identifier type
	<Identifier subtype>	1	Code for 'Call status' subtype
	<Identifier value>	All	The 'Call status' value itself
	<Identifier type>	2	Code for 'Call status' identifier type
	<Identifier subtype>	2	Code for 'Call status reason' subtype
	<Identifier value>	All	The 'Call status reason' value itself

Call identifier and call status

Each time a call status is sent from FP to PP, the call identifier for the relating call shall be sent in the same <<CALL INFORMATION>> information element.

7.4.6.4.3 Call status principles and values

General rules. The following three call statuses shall always be sent:

- '*CS call setup*' (for all incoming calls);
- '*CS idle*' (for all calls, incoming or outgoing, first or parallel). However, the use of the '*CS idle*' call status for the last released call is optional (see clause 7.4.3.5.4); and
- '*CS call connect*' (for all incoming and outgoing calls, first or parallel, but only when the call is end to end connected, and unless '*CS conference connect*' is used).

NOTE 1: Contrary to the '*CS call connect*', the {CC-CONNECT} message indicates local U-plane connection and is sometimes sent before the call is end to end connected.

The rules for using call statuses are further detailed in the 'Values summary and condition of use' clause below and especially in table 30.

Other call statuses shall also be sent by the FP if applicable or upon reception of the corresponding information from the network.

A {CC-INFO} message shall not be used to convey a call status for the first call before the {CC-CONNECT} has been sent. In this case, the standard CC message shall be used instead.

Contrary to the case of first calls, the procedure "Call status indication to the handset" introduces the concept of a state machine on PP side for the handling of parallel calls. Consequently, call statuses for a parallel call are not conveyed within specific CC messages and shall always be sent using the all-purpose {CC-INFO} message type.

Call statuses for a first outgoing call. Call statuses shall be used for a first outgoing call. The sending of a call status by the FP shall be as timely and accurate as possible with regard to the external world situation (network, other handsets).

For a 'Non early {CC-CONNECT}' implementation of the FP, the sending of a call status for a first outgoing call shall coincide with the sending of the corresponding CC message:

- the call statuses '*CS call setup ack*', '*CS call proc*', and '*CS call alerting*' are optional and shall be sent in {CC-SETUP-ACK}, {CC-CALL PROC}, {CC-ALERTING} respectively. The call status is used if and only if the corresponding message is used;
- the call status '*CS call connect*' shall always be used (if the call succeeds), and shall always be sent in the {CC-CONNECT} message.

For an 'Early {CC-CONNECT}' implementation the sending of a call status for a first outgoing call shall be done by means of a {CC-INFO} message for call statuses sent after the {CC-CONNECT}. More specifically:

- the {CC-CONNECT} message shall not bear any call status;
- the call statuses '*CS call setup ack*', '*CS call proc*', and '*CS call alerting*' are optional and-for those which are used-shall be sent in this order in separate {CC-INFO} messages following the {CC-CONNECT} message;
- the call status '*CS call connect*' shall always be used (if the call succeeds) and shall be sent after the previously mentioned call statuses in a {CC-INFO} message following the {CC-CONNECT} message.

Call statuses for a parallel outgoing call. Call statuses shall be used for a parallel outgoing call. More specifically:

- the call statuses '*CS call setup ack*', '*CS call proc*', and '*CS call alerting*' are optional and - for those which are used-shall be sent in this order in separate {CC-INFO} messages, as part of the outgoing parallel call initiation (see clause 7.4.3.5.1);
- the call status '*CS call connect*' shall always be used (if the call succeeds) and shall be sent after the previously mentioned call statuses in a {CC-INFO} message.

Call statuses for a first incoming call. Call statuses shall be used for a first incoming call. More specifically:

- The call status '*CS call setup*' shall always be used, and shall be sent within the incoming {CC-SETUP} message.

- The call status 'CS call connect' shall always be used, and shall be sent within a {CC-INFO} following the {CC-CONNECT-ACK} message. The {CC-CONNECT-ACK} message shall never be used to convey any call status.

Call statuses for a parallel incoming call. Call statuses shall be used for a parallel incoming call. More specifically:

- the call status 'CS call setup' shall always be used, and shall be sent in a {CC-INFO} message, as part of the call waiting indication (see clause 7.4.3.5.2);
- the call status 'CS call connect' shall always be used, and shall be sent in a {CC-INFO} message if (and after) the call is accepted (see clause 7.4.3.5.6).

NOTE 2: The sending of the 'CS call connect' call status by the FP for a *first* incoming call corresponds to the sending of the {CC-CONNECT-ACK} message, but is however sent in a separate {CC-INFO} message.

Special case of PSTN calls. The use of call statuses for external calls on a PSTN line is described in procedure 'Handling of lines where second calls are signalled in-band' of clause 7.4.3.10.

Values summary and condition of use. Table 30 explains use of the call status values defined in EN 300 175-5 [5], clause 7.7.56 "Call information".

Table 30: Call status value explanation

Call status	Use	Status	Explanation
CS call setup	Incoming call	Mandatory for incoming calls	Incoming call presentation to local handset The handset has not yet confirmed user alerting (e.g. CS call alerting not yet sent)
CS call setup ack	Outgoing call	If and only if the FP (or the network) is expecting to collect further dial information	
CS call proc	Outgoing call	If and only if the network provides corresponding signalling	Call is proceeding. Dial information is assumed to be complete. The FP has started outgoing call towards the network (or internal party). No final response from network or internal party has been received yet
CS call alerting	Outgoing call	If and only if the network provides corresponding signalling or for internal call	Outgoing call is signalled (ring back) at called party side. A waiting call uses a control code for the same purpose in the opposite direction
CS call connect	Both	Mandatory for all successful calls (unless CS conference connect is used)	End to end call is active; voice is available
CS call disconnecting	Both		Disconnect in progress, used from FP to differ the sending of 'CS idle' in order to signal in-band and/or Call status reason information to the handset
CS call hold	Both	If and only if applicable	connection is being held
CS call under transfer	Both	If and only if applicable	Used for unannounced call transfer in clause 7.4.3.6.2, to indicate that the incoming call is used for a call transfer
CS conference connect		If and only if applicable	3PTY conference is active If used, replaces CS call connect
CS call intercepted		If and only if applicable	Used in the "Headset management" feature (cf clause 7.4.16.2.2, Call interception)
CS idle	Both	Mandatory for all calls except the last call; Optional for the last call	Indicates that the corresponding call context must be deleted on PP side at least. For more detail, see clauses 7.4.3.5.4 and 7.4.6.1

7.4.6.4.4 Call status reasons summary and MMI mapping

The following table explains the use of the call status reason values defined in EN 300 175-5 [5], clause 7.7.56 'Call information'.

Table 31: Call status reason value explanation

Call status reason	Explanation
system busy	Call can not be proceeded due to general resource problems of the FP
line in use	Call can not be proceeded, because the choosen line (see clause 7.4.5.2 Line identification for external outgoing calls) is in use
control code not supported	Shall be sent by the FP in case the control code sent by the HS is not supported.
control code failed	Shall be sent by the FP in case execution of the control code sent by the HS was not possible or failed (for internal reasons or due to negative network response)
user busy	Called party is busy
number not available	Called number not available

Table 32 gives some examples of which user interactions are possible when existing calls are in the indicated call statuses ('CS idle' being used also for not yet existing calls), especially for double call scenarios.

Table 32: Mapping of call status (reason) to PP user interface actions

Call statuses		Reasonable display or control codes offered by the user interface of the PP in relation to the indicated call statuses
Call id 1	Call id 2	
CS call connect	CS idle	Initiating a second call external or internal / Call release / Putting a call on-hold
CS call hold	CS call setup ack / CS call proc / CS call alerting	Call release / Call transfer request
CS call hold	CS call connect	Call toggle request / 3-party conference call request / Call release / Call transfer request
CS call connect	CS call setup	Call waiting acceptance / Call waiting rejection
CS call hold	CS idle	Resuming a call put on-hold
CS call disconnecting + reason 'user busy'	CS idle	PP should present a "user busy"-display

NOTE: Table 32 does not list all possible call status combinations.

7.4.6.4.5 Call statuses for a first "Outgoing external call"

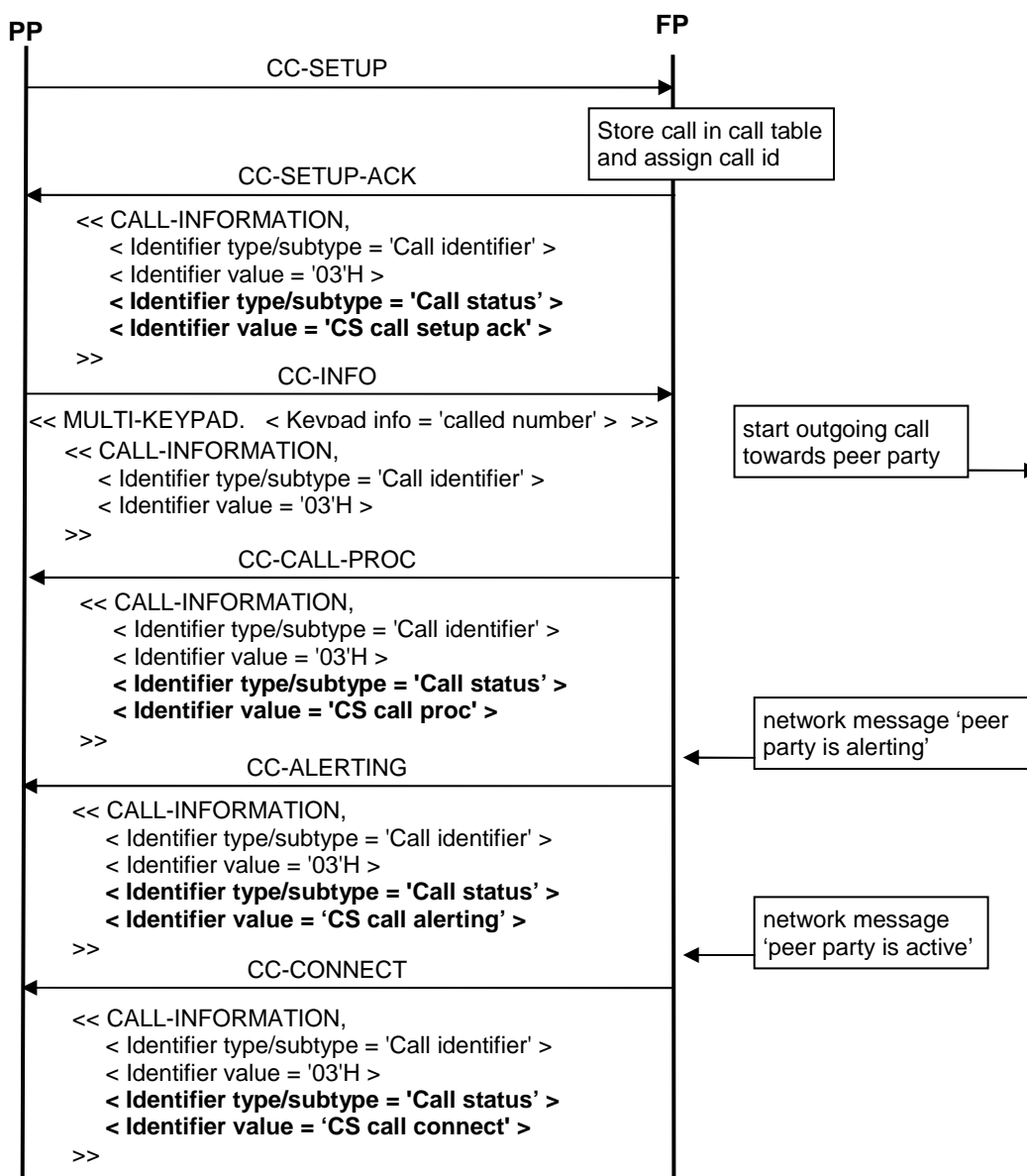

Figure 46: Example of call status indication on outgoing call

NOTE: For conciseness of the diagram, figure 46 does not show the exchange of line identifiers.

7.4.6.4.6

Call statuses for a first "Outgoing external call" using early {CC-CONNECT} message

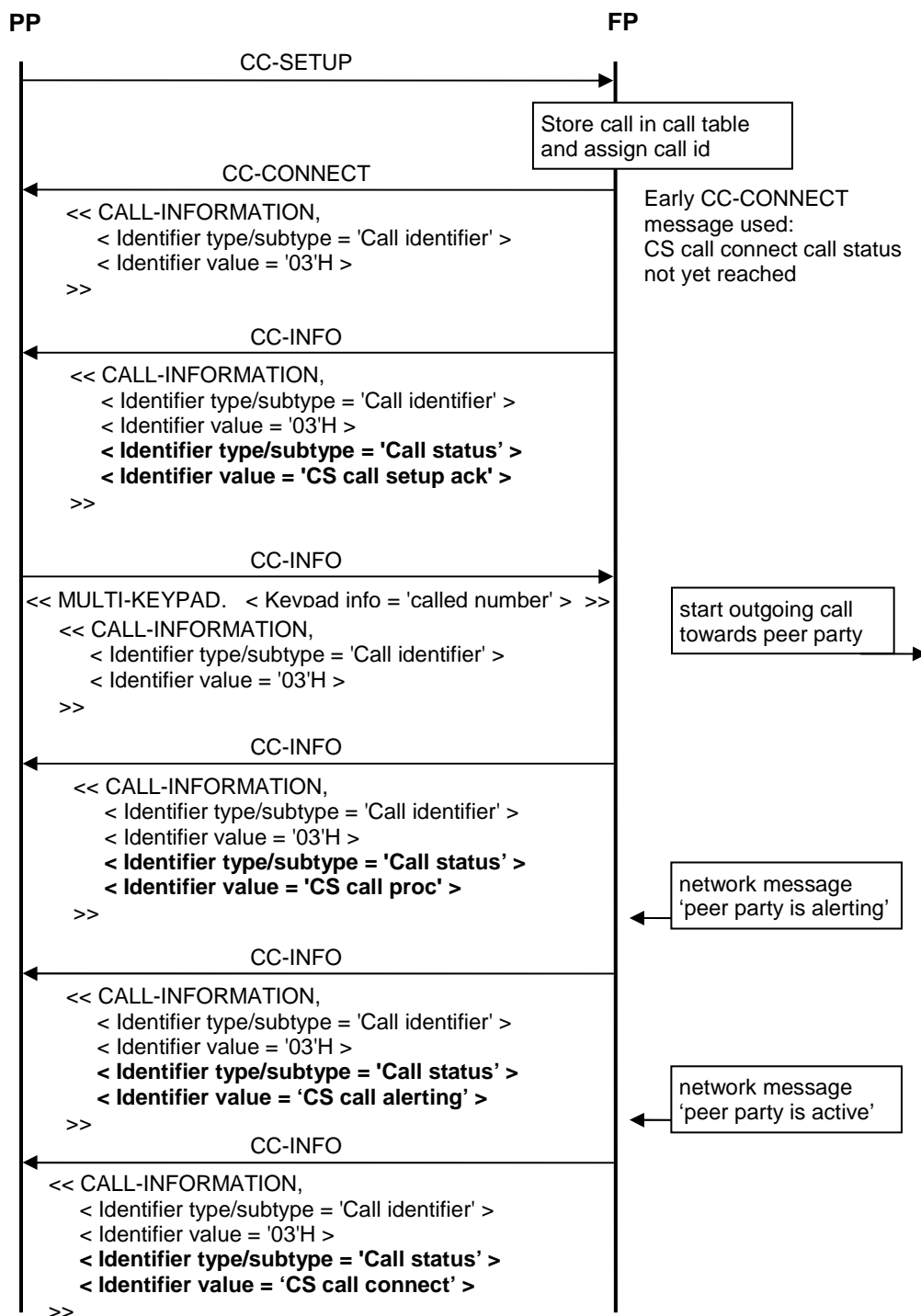

Figure 47: Example of call status indication on first outgoing call using early {CC-CONNECT}

NOTE: For conciseness of the diagram, figure 47 does not show the exchange of line identifiers.

7.4.6.4.7 Call statuses for an "Outgoing external call"-user busy

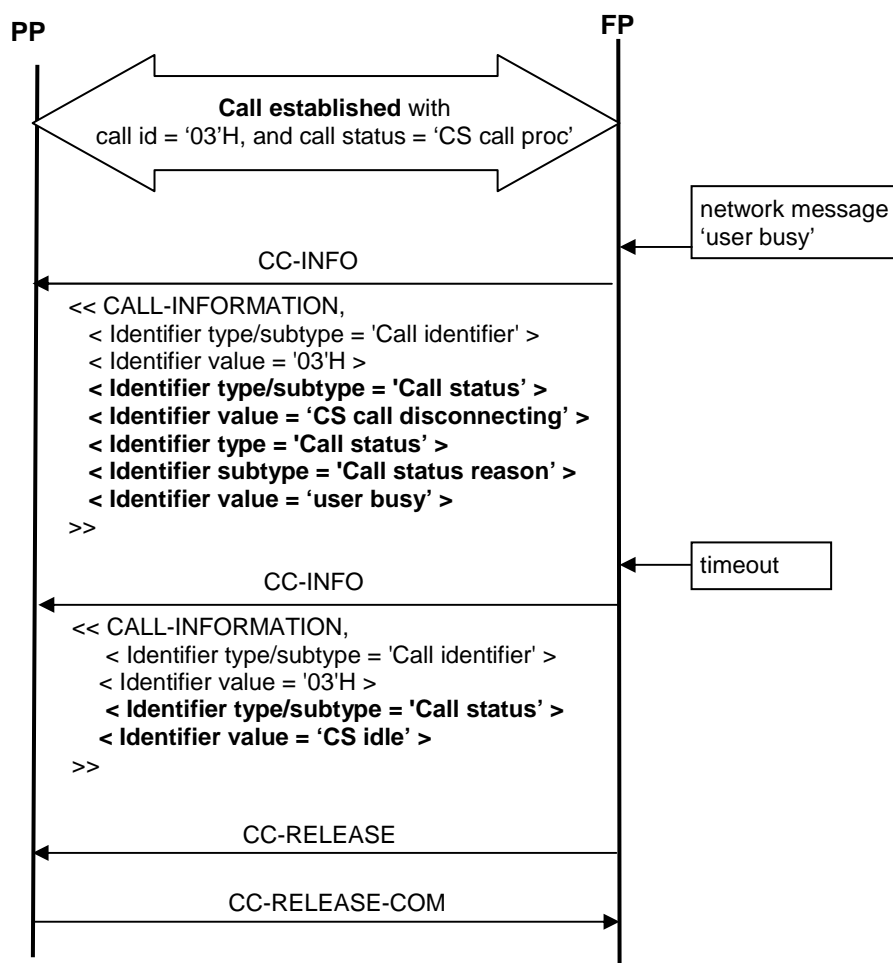

Figure 48: Example of call status indication on outgoing call, user busy

NOTE: For conciseness of the diagram, figure 48 does not show the exchange of line identifiers.

7.4.6.4.8 Call statuses for an "Outgoing external call"-number not available

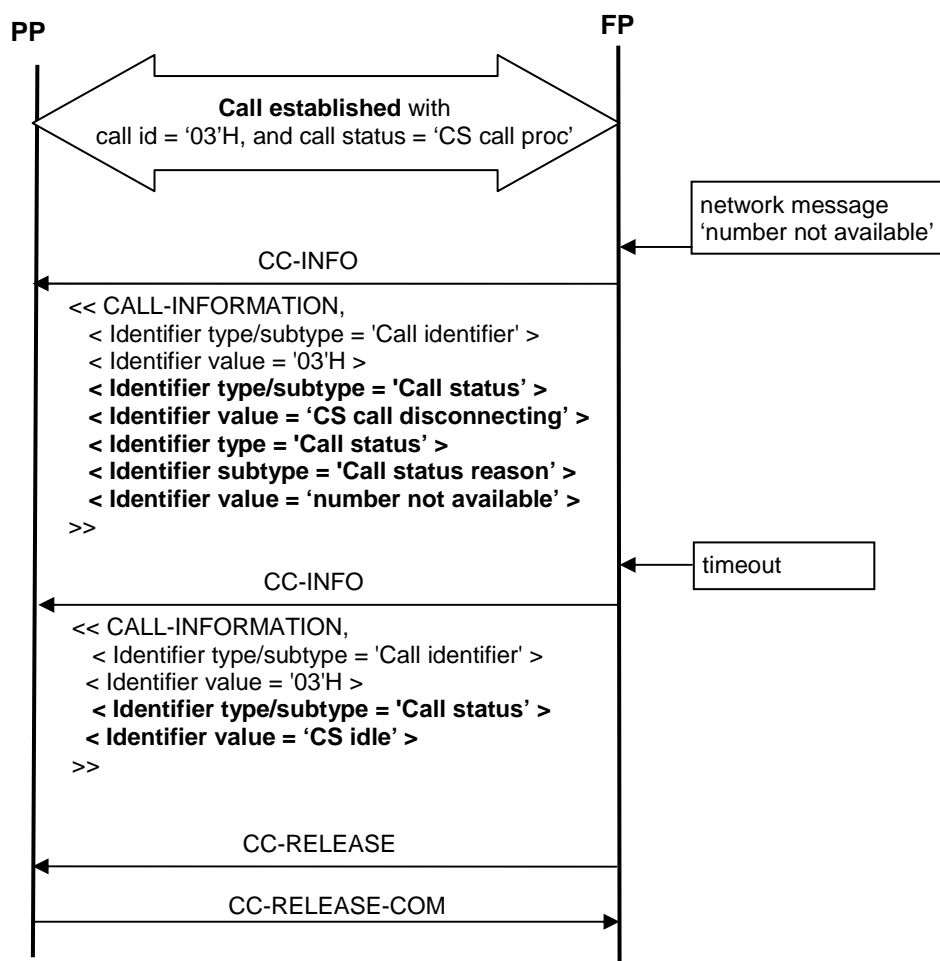

Figure 49: Example of call status indication on outgoing call, number not available

NOTE: For conciseness of the diagram, figure 49 does not show the exchange of line identifiers.

7.4.6.4.9 Call statuses for a first "Incoming external call"

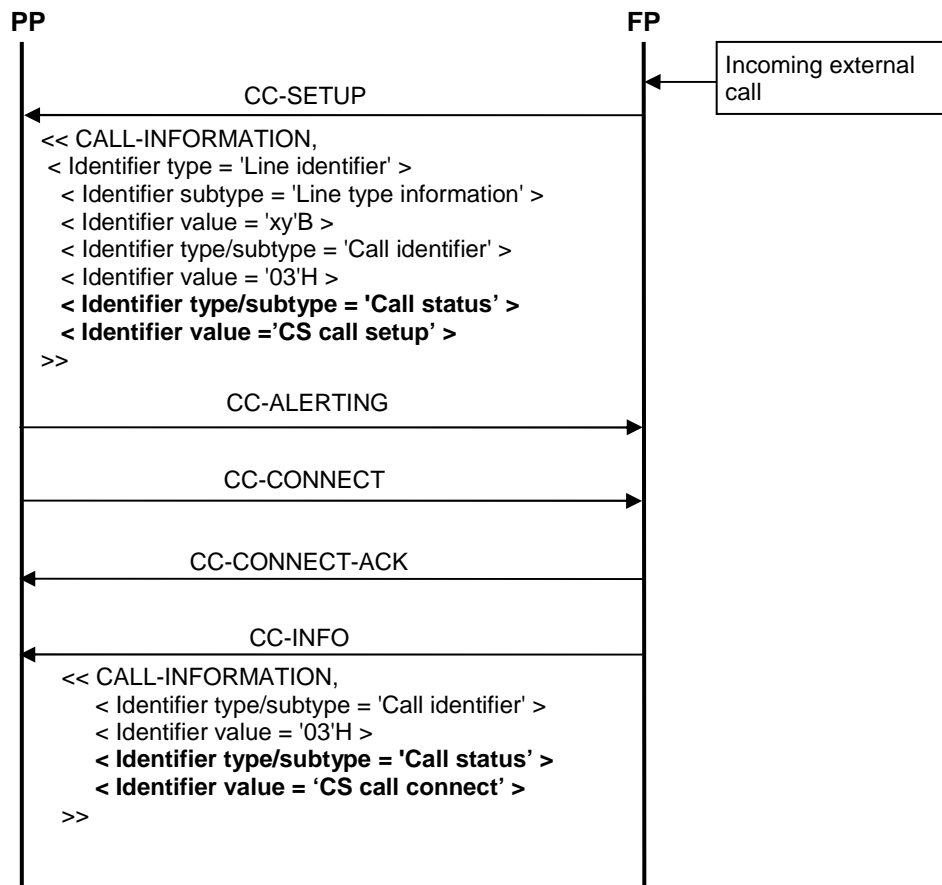

Figure 50: Call statuses for a first "Incoming external call"

7.4.7 Multiple lines handling

7.4.7.1 Multiple lines common requirements

The "Multiple lines" feature describes the behaviour of DECT systems connected to more than one network lines. A PP registered in such a DECT system may be attached to one or several of these lines.

The "Multiple line" feature is only useful if the DECT system is connected to at least two different lines.

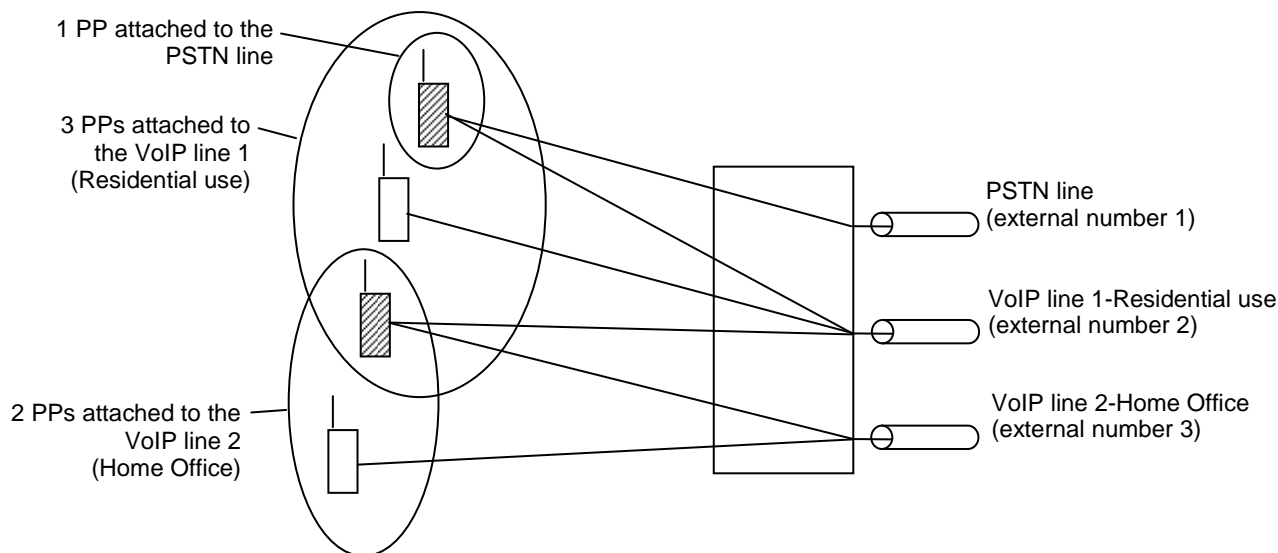

**Figure 51: Example of a multiple line configuration with 3 lines (with attachments)
PPs attached to several lines are hatched**

When implementing the "Multiple lines" feature, the PP shall set the corresponding terminal capability bit. The FP shall set bit a_{34} of the "Extended higher layer capabilities (part 2)" (see EN 300 175-5 [5], clause F.3).

7.4.7.1.1 Pre-requisites

The following pre-requisites for implementation of the "Multiple lines" feature shall be taken into account:

- A FP implementing the "Multiple lines" feature shall implement the "Line identification" feature as a pre-requisite.
- A PP implementing the "Multiple lines" feature shall implement the "Line identification" feature as well.
- A PP or FP implementing the "Multiple lines" feature shall implement the feature entitled "Common parallel call procedures" of clause 7.4.3.5 as a pre-requisite, so that a new call on a different line can be placed or received on an already in use handset.

7.4.7.1.2 Minimum requirements

An implementation of the "Multiple lines" feature on a DECT system shall comply with the following minimum requirements:

- The "Maximum number of simultaneous calls" supported by a FP implementing the "Multiple lines" feature shall be at least equal to 2. This includes support of as many simultaneous call contexts.
- As the support the "Common parallel call procedures" of clause 7.4.3.5 (see clause 7.4.8.1.1) is a prerequisite, a PP implementing the "Multiple calls" feature shall support at least two simultaneous call contexts.

NOTE: The last provision allows a multiple line PP attached to several lines to handle parallel call situations and can be seen as a consequence of the required support of the "Common parallel call procedures" of clause 7.4.3.5 (see clauses 7.4.7.1.1 and 7.4.7.2)

7.4.7.2 Terminal attachment and line settings

All registered PPs shall be attached to at least one line. A multiple line PP shall be prepared to be attached to at least two lines.

EXAMPLE 1: A PP could be attached to a PSTN line and a VoIP line at the same time.

More specifically, a multiple line PP shall provide a way for the user to select one of the available lines.

EXAMPLE 2: Line selection could be offered to the user through a menu, or by entering the keypad information #k, where k is the selected line number.

The PP should consult the line settings list in order to offer only available line choices to the user (i.e. the list of lines the PP is attached to).

7.4.7.2.1 Initial attachment

The FP shall provide at least one of the following two possible attachment modes:

FP-managed attachment: After subscription registration the PP is attached by the FP to one or several lines with no specific user intervention.

In case of FP-managed attachment, and in order to know the set of lines it is attached to, the PP may read the "Attached handsets" setting of all "Line settings" list entries via the "List access service" feature [NG1.N.16].

PP-managed attachment: Default attachment is updated by the PP during or just after subscription registration.

An initial PP-managed attachment shall be implemented as an update of the "Attached handsets" setting for every entry in the "Line settings" list corresponding to a targeted line, and performed via the "List access service" feature [NG1.N.16].

7.4.7.2.2 Attachment modification

The PP should be able to change the initial attachment (add or remove lines) during or after location registration. If supported, the PP shall initiate the procedure.

An attachment modification shall be implemented as an update of the "Attached handsets" setting for every entry in the "Line settings" list corresponding to a targeted line, and performed via the "List access service" feature [NG1.N.16].

7.4.7.2.3 Line settings

The FP shall support the "List access service" feature [NG1.N.16] and the "Line settings" list.

Apart from the "Attached handsets" setting itself, a PP shall only be able to update the settings of the lines it is attached to.

7.4.7.3 Incoming and outgoing external calls on a multiple line system

This procedure applies to the FP and to a PP attached to one or more line(s), and to one of these lines where a new call (incoming or outgoing) occurs (line A in table 33). If the PP is idle, or already in communication on that line, no specific requirement is needed. Conversely, if the PP is already in communication on another line (line B in table 33), specific requirements are needed. Table details the procedures to be used.

Table 33: Incoming and outgoing external calls on a multiple line system

	Incoming call on line A	Outgoing call on line A
All idle PPs	Usual "mono-line" requirements apply (see notes 1 and 2)	Usual "mono-line" requirements apply (see notes 1 and 2)
All PPs attached to line A and in communication on line A		
All PPs attached to line A and B in communication on line B but not A (parallel incoming or outgoing call on another line A; see note 3)	"Call waiting indication (external or internal)" (see clause 7.4.3.5.2), shall be used (see note 1)	"Outgoing parallel call initiation" (see clause 7.4.3.5.1) shall be used (see note 1)
NOTE 1: In any case, "Line identification" must be used on PP and FP side.		
NOTE 2: The new call on line A may be a first call or a parallel call. If the line A is a multiple call line, please refer to clause 7.4.8.2, "Incoming and outgoing external calls on a multiple call line"; otherwise, usual procedures defined in the present DECT standard apply.		
NOTE 3: In this case, the PP is necessarily attached to several lines (at least A and B). The PP is busy with line B but not A, which means that with regards to line A it is not involved in any call. However, as it is not idle, parallel call procedures apply (feature "Common parallel call procedures" of clause 7.4.3.5).		

7.4.7.4 Internal calls in multiple line context

This procedure applies to the FP and a PP attached to one or more line(s).

Internal calls in multiple line context shall be possible between any two PPs, even if there is no line to which both PPs are attached.

It should be possible to forbid internal calls between PPs that do not share a common line by configuration of the DECT system.

7.4.7.5 Compatibility with non multiple line PP or FP

This procedure applies to a non multiple line DECT equipment (PP or FP) in front of a NG-DECT Part 3 PP or FP implementing the "Multiple lines" feature.

Non multiple line DECT equipment include:

- NG DECT Part 3 FP, not implementing the "Multiple lines" feature;
- NG DECT Part 1 PP or FP;
- GAP PP or FP.

NOTE: GAP and NG-DECT Part 1 PPs not implementing the "Multiple lines" feature do not necessarily mean that the PP is attached to only one line. It only means that the PP is not aware of possible multiple attachments.

7.4.7.5.1 Non multiple line PP in front of a multiple line FP

Attachment: A *non* multiple line PP shall use FP-managed attachment and is not aware of the lines it is attached to (only the user is).

Outgoing calls:

- A *non* multiple line NG-DECT Part 3 PP may use FP-managed line selection (see clause 7.4.5.2.4), and should however use the line identifier notification received to notify the user of the line used.
- A *non* multiple line GAP, NG-DECT Part 1, or NG-DECT Part 3 PP may use the '#' key based line selection mechanism of clause 7.4.5.2.3 ("Backward compatible line identification for a first external outgoing call using <<MULTI-KEYPAD>> IE"). In that case, the user must manually enter the line identifier after the '#' key.

Incoming calls: A *non* multiple line PP shall receive all incoming calls arriving on one of the lines it is attached to; a Part 3 PP should however use the line identifier received to notify the user of the line used.

7.4.7.5.2 Non multiple line FP in front of a multiple line PP

In front of a "non multiple line" FP (hence connected to at most one line), a PP implementing the "Multiple lines" feature is however attached to a single line:

- In front of a Part 3 FP, it shall however send the corresponding line id for each call, as specified in clause 7.4.5.2.2 (or alternatively clause 7.4.5.2.3), or use "FP-managed line selection", as specified in clause 7.4.5.2.4.1 (sending 'None' value instead).
- In front of a GAP or Part 1 FP, it shall not send any line identifier.

7.4.8 Multiple call line handling

7.4.8.1 Multiple calls general requirements

The "Multiple calls" feature represents the ability for a FP and PP to support several fully parallel calls (outgoing or incoming) to and from a single line supporting the "Multiple call" mode.

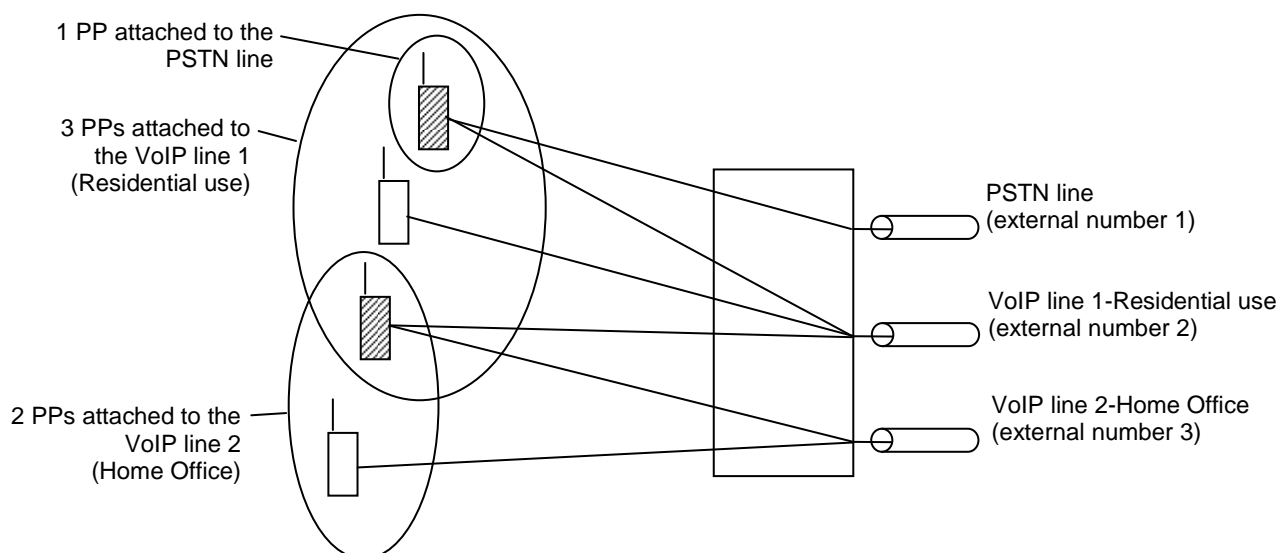

Figure 52: A multiple-call line with three simultaneous calls

This feature is especially useful when several calls are placed or received on *different* handsets at the same time. However, a multiple call enabled DECT system is compatible and can be connected to a non multiple call line like a PSTN line.

From the DECT system point of view, a multiple call line may be configured in "single call" mode. To configure a multiple call line in "single call" mode, or the other way round, the "Multiple call mode" setting of the "DECT system settings list" (see clause 7.4.11.4.8) shall be used through the "List access service" feature [NG1.N.16].

NOTE 1: PSTN double calls are also a kind of multiple calls on a single line, but always with a single handset for both calls, and only one call context active at a time.

NOTE 2: "Multiple calls" is most notably a feature brought by VoIP protocols, allowing several call contexts to be opened simultaneously on network side.

7.4.8.1.1 Pre-requisites

The following pre-requisites for implementation of the "Multiple calls" feature shall be taken into account:

- A PP or FP implementing the "Multiple calls" feature shall implement the "Call identification" feature as a pre-requisite.

- A PP or FP implementing the "Multiple calls" feature shall implement the feature entitled "Common parallel call procedures" of clause 7.4.3.5 as a pre-requisite, so that a new call can be placed or received on an already in communication PP.

NOTE: On FP side, implementation of the feature entitled "Common parallel call procedures" also implies implementation of the "Line identification" feature.

7.4.8.1.2 Minimum requirements

An implementation of the "Multiple calls" feature on a DECT system shall comply with the following minimum requirements:

- The "maximum number of simultaneous calls" supported by a FP implementing the "Multiple calls" feature shall be at least equal to 2. This includes support of as many simultaneous call contexts.
- The FP shall be able to support this maximum number of incoming or outgoing calls for idle PPs as defined in clause 7.4.6.2. This includes simultaneous ringing of all idle PPs on incoming calls and availability of all idle handsets for placing a new call when there is already a call going on on the line.
- As the support the "Common parallel call procedures" of clause 7.4.3.5 (see clause 7.4.8.1.1) is a prerequisite, a PP implementing the "Multiple calls" feature shall support at least two simultaneous call contexts.

7.4.8.2 Incoming and outgoing external calls on a multiple call line

This procedure applies to the FP and the PP at external call (incoming or outgoing) setup on a multiple call line. This line might be set in "multiple call" or "single call" mode.

7.4.8.2.1 Line set in "single call" mode

On a multiple call line configured in "single call" mode, only one call can be active at a time on the line. Other calls (second, or further) are on-hold and can only become active by replacing the existing one on the same PP.

To handle a line in "single call" mode, the DECT system shall use the usual procedures defined in the present document. In particular, the feature entitled "Common parallel call procedures" shall be used to handle the second or further call on the same PP.

If the line is busy, but implicit call intrusion is enabled by configuration, clause 7.4.3.8.1 shall be used instead of the "Busy system or line notification" procedure (see clause 7.4.8.3).

7.4.8.2.2 Line set in "multiple call" mode

On a multiple call line configured in "multiple call" mode, several calls may be active simultaneously; second and further calls are presented to all PPs (idle or busy) attached to the line. Table 34 details the procedures to be used.

Table 34: Line set in "multiple call" mode

	Incoming call setup	Outgoing call setup
On all idle PPs attached to the line	GAP 8.12 "Incoming call request" shall be used (see note 1)	GAP 8.2 "Outgoing call request" shall be used (see note 2)
On all busy PPs attached to the line	"Call waiting indication" (see clause 7.4.3.5.2), shall be used (see notes 3, 4 and 5)	"Outgoing parallel call initiation" (see clause 7.4.3.5.1) shall be used (see notes 2 and 3)
NOTE 1: Unless the DECT system is busy (see clause 7.4.8.3), although the line was not, in which case the call is not presented.		
NOTE 2: If the DECT system is busy, the "Busy system or line notification" procedure (see clause 7.4.8.3) must be used back.		
NOTE 3: All "Common parallel calls procedures", then, apply for handling the parallel calls. The fully parallel calls are in this case only alternatively active as for PSTN double calls.		
NOTE 4: On a multiple call line with VoIP interface, a call waiting procedure for already in use handsets may be used in the following two cases: a second VoIP call is received, or an in-band call waiting tone from a PSTN to VoIP gateway is received. However, the used procedures are the same.		
NOTE 5: If the call is meanwhile accepted by another PP, or if the remote party hangs up before the call is accepted by any PP, the call must be then released by the FP towards the current PP (see clauses 7.4.3.5.4).		

7.4.8.3 Busy system or line notification

This procedure applies to the FP and a PP that initiated an outgoing call (external or internal) at a point in time where the FP and/or the line cannot support the additional call. The new outgoing call may be a first call, or a parallel call.

NOTE 1: The current procedure applies within an outgoing call setup attempt. For idle PPs, a <<DISPLAY>> notification can also be used outside of any call for preventing call setup attempts, especially on a line in single-call mode.

NOTE 2: In single call mode, the line is considered busy for idle PPs, as soon as one call is going on on it.

Busy line: A busy line is a line for which no new incoming or outgoing call can be performed, because all of the available bandwidth is used. This concept is especially relevant for multiple call lines.

Busy system: A DECT system is busy if the FP is not able to support any additional call, because the maximum number of call contexts it can handle has been reached. The system may be busy without the line being busy.

NOTE 3: A call context could be used by an internal call. A system should allow as many calls (external *or* internal) as there are call contexts potentially available on the system.

On call setup attempt (first or parallel), if the system is busy or the line is busy, the FP shall send back a "busy system or line notification" back to the PP, in the form of a <<CALL_INFORMATION> IE containing:

- the call status 'CS call disconnecting' and the appropriate call status reason, (e.g. 'line in use' or 'system busy').
- the call identifier assigned for the call. This may be the first time it is communicated to the PP.

NOTE 4: On the contrary, 'CS idle' cannot be sent with a newly assigned call id.

Whenever required by the "Tones provision" feature, the FP shall additionally send a <<SIGNAL>> information element with <Signal value> field equal to 04H ('busy tone') included in a CC-INFO message.

If the PP does not hook on after a time-out has elapsed, the FP shall send a call release request to the PP to terminate the call attempt. This call release request shall take the form of a CC-RELEASE message for a first call, or of a {CC-INFO} message according to procedure "Call release and call release rejection" (see clause 7.4.3.5.4), for a parallel call.

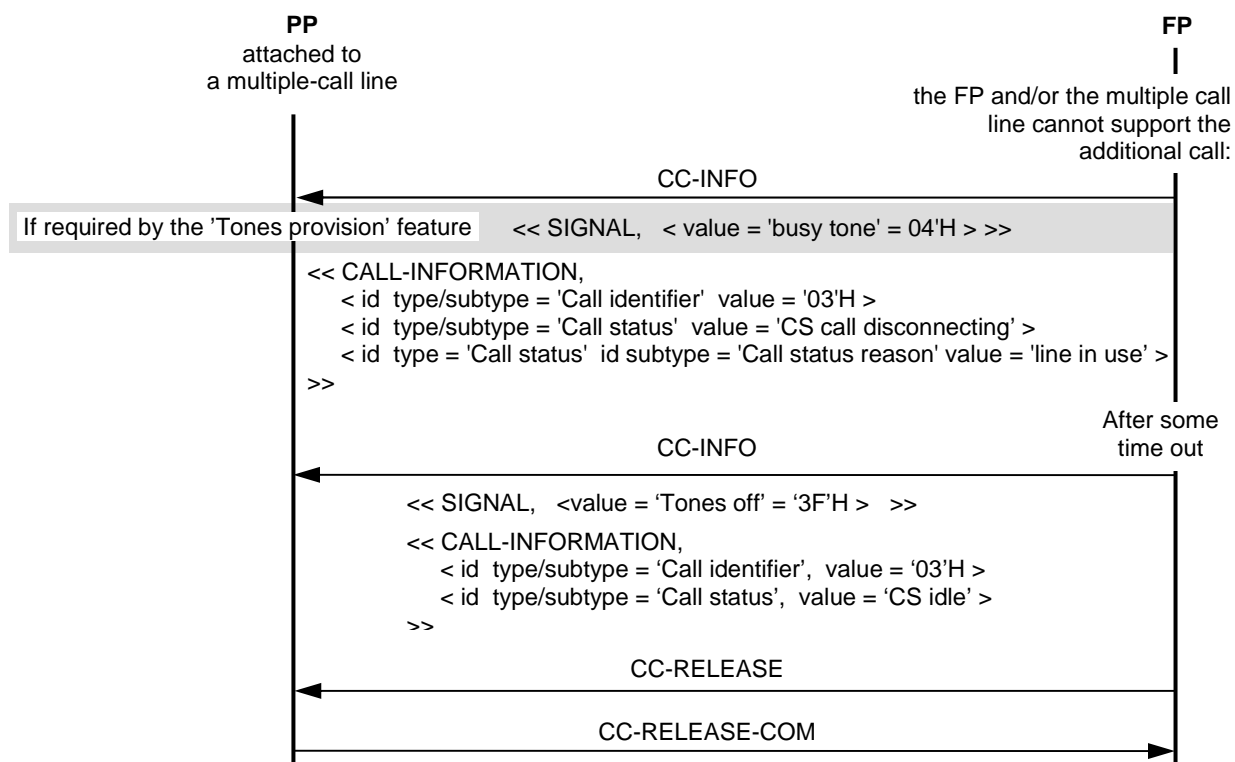

Figure 53: Busy system or line notification for call with defined call-id=3

7.4.9 PP and FP capabilities indication and broadcast

7.4.9.1 Terminal capability indication

NOTE 1: This procedure description replaces clause 8.17 of EN 300 444 (GAP) [12].

The PP shall be able to send the <<Terminal capability>> information element and the FP shall be able to receive it at least in {ACCESS-RIGHTS-REQUEST} and when location registration is supported in the {LOCATE-REQUEST}. The following text together with the associated clauses define the mandatory requirements with regard to the present document.

Table 35: Values used within the <<TERMINAL CAPABILITY>> information element

Information element	Field within the information element	Standard values within the field/information element	Normative action/comment
<<Terminal capability>>	<Display capability>	All	If PT supports feature (GAP.N.24) it shall indicate in this field value which is equal to or higher than 2
	<Tone capability>	All	
	Echo parameters	3	VoIP compatible TCLw. See note 1
	Ambient noise Rejection (N-REJ)	[1, 2]	See note 2
	Adaptive volume control (A-VOL)	[1, 2, 3]	See note 2
	Slot type capability	All	Full and long 640 slots mandatory; double and long 672 optional. See also note 2
	<Profile indicator_1>	"xxxxx1x"B	GAP and/or PAP supported
<Profile indicator_6>	"x1xxxx"B, "x0xxxx"B	Fast or slow hopping radio	

Information element	Field within the information element	Standard values within the field/information element	Normative action/comment
	<Profile indicator_6>	"1xxxxxB", "0xxxxxB"	Support (or not support) of "no-emission" mode (optional MAC service [NG1.M.5])
	<Profile indicator_7>	"xxxx11x"B	New Generation DECT part 1 (wideband speech) and part 3, (extended wideband speech services) supported
		"xxx1xxx"B or "xxx0xxx"B	Support (or not support) of the "Headset management" feature [NG1.N.21]
		"xx1xxxx"B or "xx0xxxx"B	Support (or not support) of the 'Re-keying' and 'default cipher key mechanism early encryption' (related to feature [GAP.N.35])
	<Control codes>	All	If PT supports feature (GAP.N.25) it shall indicate in this field value which is equal to or higher than 2
NOTE 1: PPs compliant with the present document shall always set the value 3 ('11'B) as result of the audio type requirements (see clause 6.8 table 7). FPs shall also understand the values 1 ('01'B) and 2 ('10'B) that may be set by PPs compliant with NG-DECT Part 1 [21] or GAP [12] when attached to FPs compliant to the present document.			
NOTE 2: This capability is assumed as the default value (see table 36) if the <<TERMINAL-CAPABILITY>> information element is omitted.			

The capabilities in table 36 shall be assumed as default if the following fields in the <<TERMINAL CAPABILITY>> information element are not present.

Table 36: Values assumed as terminal capabilities

Information element	Field within the information element	Standard values within the field/information element	Normative action/comment
<<Terminal capability>>	<Echo parameters>	3	VoIP compatible TCLw (see note 1)
	<N-REJ>	1	No noise rejection
	<A-VOL>	1	No PP adaptive volume control
	<Slot type capability>	"xxx1x1x"B	Full slot and Long slot (j=640) supported (see note 2)
NOTE 1: Value 3 (VoIP compatible TCLw) shall be assumed if the PP has declared to be a NG-DECT Part 3 PP. For GAP and NG-DECT Part 1 PPs the default values given in [12] and [21] shall be assumed.			
NOTE 2: This value shall be assumed if the PP has declared to be a NG-DECT Part 3 or part 1 PP. For GAP PPs the default values given in [12] shall be assumed.			

No echoing of characters is allowed in the FT and therefore the PT would be responsible for displaying dialled digits. All display information from the FT would be assumed to be additional information that the PT shall display in addition. The PT shall logically separate display information originating at the FT and PT. This could be achieved, for example, by one physical display and two logical displays or two physical displays and two logical displays. The key point is that display characters from the PT and FT shall not be simultaneously interleaved/mixed on the same physical display.

7.4.9.2 Higher layer information FP broadcast

The FP and PT shall support the broadcast of Higher Layer capabilities as part of Q_T MAC broadcast messages (see clauses 7.6.3, 7.6.4 and 7.6.5).

The broadcast attributes are a small set of NWK layer and DLC layer capabilities (jointly known as "higher layer capabilities") that shall be broadcast regularly as part of the MAC layer broadcast service. See EN 300 175-5 [5], annex F.

RFPs belonging to the same LA shall broadcast the same values of higher layer attributes (see EN 300 175-5 [5], annex F) at any given time.

The PP shall be capable to read and interpret at least the following broadcast attributes codings during locking procedure. In the locked state the PP may assume them as static.

FP and PT shall support the following values of "Higher Layer capabilities" information attributes.

7.4.9.2.1 Higher layer information in standard FP broadcast (Qh= 3)

The requirements of clause 7.3.9.1 of TS 102 527-1 [21] shall apply.

7.4.9.2.2 Extended Higher Layer capabilities part 2

The Extended Higher Layer capabilities, part 2, Fixed Part Information field shall be used indicating the supported set of Wideband speech Services.

Table 37: Extended Higher Layer Capabilities part 2 interpretation by the PP

BIT Number	Attribute	Value	Note
< a ₂₄ >	NG-DECT Wideband voice supported	1	See TS 102 527-1 [21] (see note)
< a ₂₉ >	NG-DECT extended wideband voice services supported	1	The present document (see note)
< a ₃₀ >	Permanent CLIR	[0, 1]	Related procedures: clause 7.4.12
< a ₃₁ >	Third party conference call (external or external)	[0, 1]	Related procedures: clause 7.4.3.7
< a ₃₂ >	Intrusion call	[0, 1]	Related procedures: clause 7.4.3.8
< a ₃₃ >	Call deflection	[0, 1]	Related procedures: clause 7.4.4.1.1, 7.4.4.2
< a ₃₄ >	Multiple lines	[0, 1]	Related procedures: clause 7.4.7
< a ₃₅ >	"no emission" mode support	[0, 1]	Related procedures: see NG1.M.5 in clause 6.12
< a ₄₂ >	Support of 'Re-keying' and 'early encryption'	[0, 1]	Support (or not support) of the 'Re-keying' and 'default cipher key mechanism early encryption' procedures (related fo feature [GAP.N.35])
NOTE:	Value refers to the value to be set by FPs complying with the present document. PPs may need to understand other values due to the compatibility with GAP and NG-DECT Part 1 FPs.		

Even if a capability bit relates to a feature which is mandatory in the present document, this bit shall be set (indicating the support of the feature). Setting only the bit a₂₉ NG-DECT "extended wideband voice services supported" is not sufficient.

7.4.10 List access service

7.4.10.1 General considerations

Equipment supporting New Generation DECT Part 3 shall support the "List access service" feature as described in the present clause. The lists managed by this feature are structured as represented in figure 54.

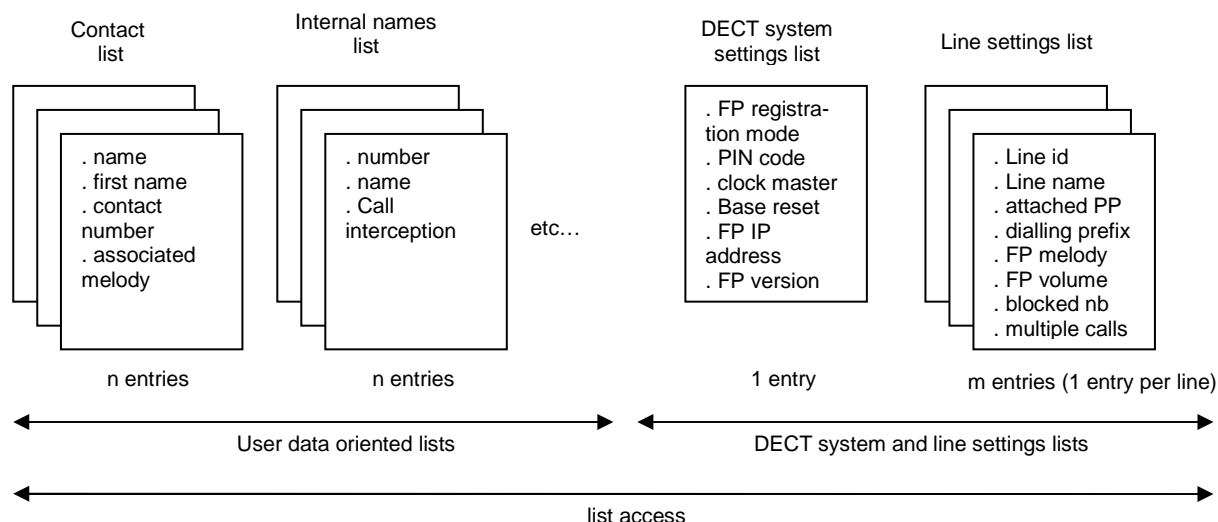

Figure 54: Structure of the lists managed by the "List access service" feature

The list access feature defines a generic way to access lists located in the FP from the PP. This access includes 'read', 'edit' and 'delete' functionalities.

The procedure is based on IWU-Info messages, which contain the information element <<IWU to IWU>>, using the dedicated protocol discriminator '03'H.

Table 38: Values used within the <<IWU to IWU>> information element

Information element	Field within the information element	Standard values within the field/IE	Normative action/comment
<<IWU to IWU>>	<Length of content>	L	Length of content
	<S/R bit>	1	Transmission of message
	<Protocol Discriminator>	03H	List access
	<Command >	1...127	List access command (see note)
	<Command specific byte 0>		
	...		
	<Command specific byte L-2>		

NOTE: Values from 128 on are reserved for proprietary list access commands.

The S/R bit shall always be set to '1'. Use of value '0', "Rejection of message", as described in EN 300 175-5 [5], clause 7.7.23, is not foreseen in the present document as dedicated commands/codes exist to handle list access error cases.

Access to a list is encapsulated in a session. Each session is linked to exactly one list access and is used:

- by the FP to grant access to a list;
- to handle accesses to multiple lists from one PP.

Typical sequences of commands between start and end of a session are the following:

- "Read entries" or "search entries", for just reading entries.
- "Read entries" or "Search entries" followed by "Edit entry" and "Save entry" for updating an existing entry, if an "Edit entry" has been issued but the list entry is left unchanged, a "Save entry" command shall still be used to unlock the entry.
- "Save entry" with entry id equal to 0, for creating a new entry in the list.

Entry identifier: Each entry in a list is unambiguously identified within the FP for a dedicated list by an entry id. This entry id has to be referenced in case of writing access and is also used by the FP to reject multiple write accesses from several PPs.

Field identifier: Each entry of a list may contain several fields. Each field has a unique identifier which is list dependent (see clause 7.4.10.5). This means the same field may be included in several list but with a different field id. This shall be taken into consideration when using field id in a command.

List index: The list index determines the position of an entry in a sorted list and is used for navigation within a list. The list index may change after modification of the list.

In order to indicate list changes to the PPs, a notification procedure is defined. This enables the PP to read list contents in advance before using them (caching), enabling the PP both to hold local copies of lists and to anticipate operations around the current entry, in order to save time and so increase interactivity (faster MMIs on PP side).

Bytes order: When characters are transported in the <<IWU to IWU>> information element, the most significant byte shall be sent first. For example, character with code point U+00A2 is coded in UTF-8 as 'C2'H 'A2'H and conveyed with 'C2'H as the most significant byte.

Guarantee of service:

When the FP supports a list, it shall manage and process all mandatory commands. See table 41 in clause 7.4.10.4 for details. Negative answers are allowed only for real faulty cases and shall not be used systematically. Especially, the FP shall not declare it supports a list and respond with negative answers to all commands.

When a PP supports a list, the PP shall provide to the user all mandatory commands described in table 40 of clause 7.4.10.4.

When the FP supports a list, the FP shall implement all fields of this list as defined in clause 7.4.10.5. For DECT system settings list and line settings list, the status of the fields are given in table 9 (see clause 6.10). The FP shall have the capability to store and retrieve these fields to the PP. The defined structure of list entries describes the way they are exchanged over the air, and it does not necessarily mean this is the way they are actually stored in the FP memory. For example, the line name does not need to be stored for each entry in the FP (because it can be retrieved from the line id), although it has to be present in each entry if the field exists for the list and is requested by the PP.

Each field has to be in each list entry at least once (a field may also be included more than once in each entry of the list). All entries of a list shall include the same fields. The PP may read, edit and save only some of the fields of entries of these lists (see each command in clause 7.4.10.4 for details).

EXAMPLE 1: A PP may request the fields of an entry in two steps. In a first step, the PP only requests a subset of the fields (but for several entries) to allow the user to browse the list. In a second step, when the user actually selects one of the entries, the PP requests all the fields, but for the selected entry only.

EXAMPLE 2: A PP may not request the linename field, as soon as it is able to display it: the PP could retrieve this field from the line settings list thanks to the line id (changes to the line settings list are notified to the PP, see clause 7.4.10.2.2).

The FP always remains the master of the entry fields that are available in a list (number of fields per entry remains always the same and statically defined by FP). These fields can not be removed nor added from the list by any PP (they can only be eventually reset by the PP). This is also valid when a field is included more than once in all entries.

When the FP supports a field of an entry, it shall support as many values as possible for the field and process this field correctly. For example: if the FP uses a name entry field it shall fill it correctly and not always leave it empty.

When the NG-DECT Part 3 system supports a list, it shall also implement the corresponding service related to this list, entry or field. The PP shall display as many fields as possible. For example: if a FP declares a contact list, the FP shall fill it correctly and support all mandatory requests from all PPs. The PP shall provide access to this contact to the user and not re-create a local copy of the list.

Of course the FP shall update automatically missed calls, outgoing call, all call list by adding locally corresponding entries in the lists.

Display and edition of string fields:

Both the PP and FP shall work in best effort mode. Meaning: do their best with their display capability, edit and storage capacities on each side independently.

If PP saves or edits a longer string than the FP is able to store, the FP shall store only the first characters of the saved string (the FP shall truncate it).

The PP will be aware of the truncation only when reading/editing the string a second time.

If the PP edits a string that is longer than its display capability:

- The PP may display to the user, edit and save the complete string by scrolling (recommended behavior).
- The PP may display, edit and save only the first characters, compatible with its display capability (fall back mechanism to be used if recommended behavior is not implemented).

Alphabet compatibility:

List entry fields with characters shall in the FP be stored in UTF-8 format.

PP shall support at least IA5 characters, and shall understand UTF-8 encoding format.

PP should not modify UTF-8 characters that it does not support, unless the character is edited by the user (e.g. replaced with a character supported by the PP).

Additionally, the PP should follow the guidelines given in clause 7.4.17.2 ("display of UTF-8 characters on PP side") for the display of UTF-8 encoded characters.

Initial values:

- First possible session identifier assigned by FP shall be "1". Value "0" is a reserved return value used by the FP when a problem occurs.
- First possible "list identifier" shall be "0" (see clause 7.4.10.3 for list identifier coding).
- First possible "entry identifier" assigned by FP shall be "1".
- First possible "field identifier" shall be "1".
- First possible "Start index" parameter value in read entries confirm/search entries confirm commands shall be "1". Start index may be equal to 0 in read entries command to point on the last entry.
- First possible "position index" parameter value in save confirm command shall be "1" (first entry).

Sessions:

FP side: The number of simultaneous sessions is left free to FP implementation. However, the FP shall fulfill the following minimum requirements:

- The FP shall be able to handle 2 started sessions initiated from a single PP at the same time on two different lists.
- Once the maximum number of sessions is reached in the FP (for different lists or the same list) the FP shall issue a dedicated error code for any further start sessions attempts (in the start confirm see clause 7.4.10.4.1.2).

NOTE 1 : A simple FP implementation could be to support only 1 started session at a time for a given list (to avoid potential collision scenarii). An other dedicated start session confirm error code exists for this. However, the list access protocol fully allows to support multiple sessions started over the same list.

PP side: The number of simultaneous sessions is left free to PP implementation.

NOTE 2: However it is recommended that the PP allows to save a number from a call list into the contact list. Depending on the PP implementation, support of 2 simultaneous sessions could be convenient for this.

All sessions between a PP and FP are ended at the latest at call release.

The number of entries allowed within a list is defined by the FP (manufacturer dependent). A dedicated error code shall be used if PP tries to save new entry in a full list.

Handling of collision scenarii when a FP allows several PPs to access the same list simultaneously :

- It is recommended that the second start session uses the same sorting criterion as the first start session. (However, FP will decide the final sorting criteria in start confirm and will probably re-use the same sorting criteria as the first started session).

- The FP shall send list change notifications upon changes in this list (see clause 7.4.10.2).
- No collision occur while both PPs perform only read entries / search entries commands.
- One PP may be marginally un-synchronised concerning the content of one entry if the other PP modifies this entry (with edit+save). However, PP will be re-synchronised at its next read entries /edit entry/search entries command.
- One PP may be temporarily un-synchronised from the list if the other PP deletes, creates (with save) an entry or deletes the list (cases where the total number of entries or position index of some entries are modified). Existing error codes for later "edit entries", "read entries" / "search entries" prevents potential problems. PP will be fully re-synchronised only when performing the next start session command. (see clause 7.4.10.2 for details).
- Edit entry command prevents severe collisions by locking an entry (relying on entry id and not position index).

7.4.10.2 List change notification

7.4.10.2.1 General rule

The present 'List change notification' procedure describes the use of the 'list change indication' type of generic events notification (see clause 7.7.55 of EN 300 175-5[5]). It is potentially usable with any of the lists described in clause 7.4.10.5, but:

- Clause 7.4.10.2.2 enumerates the lists for which the present procedure makes a 'list change indication' mandatory. Use of the procedure for other lists is optional and may not be relevant.
- The 'missed call list' does not use the list change notification procedure (see clause 7.4.10.2) for the sending of list change indications. The procedure 7.4.1.3 'Missed call notification' describes all uses of a 'list change indication' for the 'missed call list'.

Line identification used in a 'list change indication'. As a general rule:

- If the list contains a line identifier field, a 'line change indication' shall contain a line identifier, specified in a <<CALL INFORMATION>> IE. The line id to be used is described below (see 'Events triggering the notification' clause)
- If the list does not contain any line identifier, the list change indication shall NOT contain any <<CALL-INFORMATION>> IE.

Event multiplicity. The <event multiplicity> field shall contain the total number of entries in the list *for the specified line id* at the time the notification is sent. More specifically:

- If the specified line id subtype 'Line identifier for external call' or 'Relating to' is used, the entries with 'All lines' value shall not be counted.
- If the specified line id subtype is 'All lines', only entries with this subtype shall be counted.

NOTE 1: As a result, if one entry of the Line settings list is modified, a list change notification is sent with the event multiplicity value set to 1, together with a <<CALL INFORMATION>> IE set to 'Relating to' subtype and the line identifier value (see also clause 7.4.10.2.2).

Events triggering the notification. When the present 'List change notification' procedure is implemented by the FP for a list, the following event types shall trigger a 'list change indication' from the FP. For each event type, the line to specify and the set of PPs receiving the notification (targeted PP or PPs) are indicated.

- **Entry created, modified, or deleted.** If an entry in the list is created, modified or deleted, a 'list change indication' shall be sent.
 - *Specified line* (only if the list contains a line identifier field): The line id subtype used, and the value used (if any value) shall be those of the concerned entry.

NOTE 2: If the line id subtype 'All lines' is used, the line id value field is absent.

- *Targeted PPs*: All PPs attached to the specified line:
 - If the concerned entry relates to a single line (line id subtype 'Line identifier for external call' or 'Relating to'), the notification shall be sent to all PPs attached to the corresponding line.
 - If the concerned entry contains a line identifier field with 'All lines' subtype, the notification shall be sent to all registered PPs (and shall contain the 'All lines' line id subtype, as already stated above).

NOTE 3: The contact list may use both types of targeted PPs, depending on the concerned entry.

- If the list does not containing any line identifier field, the targeted PPs shall depend on the list and on the context (see clause 7.4.10.2.2).
- **Base reset**: In case the FP is reset, a 'list change indication' shall be sent once for each line.

NOTE 4: In case a list is lost (i.e. erased from memory) as a result of the base reset, a 'list change indication' is sent with <Event multiplicity> field set to '0'.

- *Specified line*: Line for which the notification is sent (once for each line).
- *Targeted PPs*: All PPs attached to the specified line.

NOTE 5: The purpose of this notification is re-synchronise the PPs with the lists state, in case the lists have changed during the base reset.

- **Location registration**: A 'list change indication' shall be sent after location registration, once for each line the PP is attached to (1 FACILITY message per line the PP is attached to).
 - *Specified line*: Line for which the notification is sent (once for each line the PP is attached to).
 - *Targeted PP*: The PP performing location registration (and only this PP).

NOTE 6: A location registration request ({LOCATE-REQUEST} message) is sent by the PP when the handset is switched on. A location registration request could be sent by the PP when it goes back in range (after it got out of range) in order to inform the FP that it may have lost some notifications.

Almost simultaneous events. Several events (i.e. list changes) occurring almost simultaneously may be the subject of a single notification, provided the following rules are respected:

- 1) all events notified together shall occur on, or concern, the same list;
- 2) all events notified together shall occur on, or concern, the same line (same line id subtype and value).

Notifications shall be sent by the FP by use of the "generic event notification" procedure. For indication of list change and values used in <<Events notification>> information element, consider table 39.

Table 39: Values used within {FACILITY} message for list change indication

Information element	Field within the information element	Standard values within the field/IE	Normative action/comment
<<Events notification>>	<Event type>	3	List change indication
	<Event sub type>	X	List identifier as indicated in clause 7.4.10.3
	<Event multiplicity >	0..127	Total number of entries in the list (see note 1)
<<Call Information>>			See note 2
	<Identifier type>	0	Line identifier
	<Identifier sub type>	'Line identifier for external call', 'Relating to', or 'All lines'	The 'None' value is excluded
	<Identifier value>	All	The line identifier value itself if present (absent if 'All lines' subtype is used)
NOTE 1: 'Event multiplicity' can be extended for values up to 16 383 by using the following extension mechanism: If the bit at bit position 8 of the first octet is set to 0 then a second octet will follow, if this bit is set to 1 then no further octet will follow. For values greater than 127 the first octet contains the 7 most significant bits and the bit at bit position 8 is set to 0 whereas the second octet contains the 7 least significant bits and the bit at bit position 8 is set to 1. For values below 128 the first octet contains the 'Event multiplicity' value and the bit at bit position 8 is set to 1 indicating that no second octet will follow. Examples: decimal value 128 is coded as 01H 80H, decimal value 17 is coded as 91H and decimal value 1 is coded as 81H.			
NOTE 2: <<Call information>> only present if list change indication is related to one or more lines.			

7.4.10.2.2 Mandatory notifications

In order to allow the display of information in idle mode on PP side, notifications shall be sent by the FP for the following lists:

- Line settings list (defined in clause 7.4.11.4). As indicated in clause 7.4.10.2.1, changes in an entry of this list shall be notified to all PPs attached to the line identified by the field 'Line id' of that entry. However for fields which are optional or which do not require the PP to update its user interface, notification is optional or irrelevant (see clause 7.4.11.4).

NOTE 1: This allows in particular the PP to immediately update the line name in other lists entries (e.g. if used instead of the line id when the list is presented to the user).

- Internal names list. A change in this list shall at least be notified when a PP modifies the name of another PP (if the FP allows it), and the list change notification shall at least be sent to that other PP concerned by the change.

For all other lists, sending of notifications is left free to the implementor. However, the possibly important extra processing on FP and PP sides necessary for sending and handling notifications (e.g. if sent for each call) shall be carefully taken into account.

NOTE 2: The present 'List change notification' procedure cannot be used for the missed call list as stated in clause 7.4.10.2.1.

7.4.10.3 List identifier codings

The following list identifier codings are defined:

Bits	8 7 6 5 4 3 2 1	Meaning
0 0 0 0 0 0 0 0		List of supported lists
0 0 0 0 0 0 0 1		Missed calls list
0 0 0 0 0 0 1 0		Outgoing calls list
0 0 0 0 0 0 1 1		Incoming accepted calls list
0 0 0 0 0 1 0 0		All calls list
0 0 0 0 0 1 0 1		Contact list
0 0 0 0 0 1 1 0		Internal names list
0 0 0 0 0 1 1 1		DECT system settings list
0 0 0 0 1 0 0 0		Line settings list
0 0 0 0 1 0 0 1		All incoming calls list
1 x x x x x x x		Reserved for proprietary lists
all other values reserved		

The lists shall be sorted on the FP, using default criteria for each of them. The default sorting criteria are the following:

- The "Missed calls", "Outgoing calls", "Incoming accepted call" lists, "All incoming calls list" and more generally all call-related lists shall be sorted by default using the "Date and time" field.
- The "Contact" list shall be sorted by default using the "Name" field (first criterion). In case the names are equal the list should be sorted using the "First name" field (criterion 2).
- The "Internal names" list shall be sorted by default using the "Number" field (terminal id number).
- The "Line settings" list shall be sorted by default using the "Line id" field.

Please refer to the "Start session" command for a definition of the sorting order used for a given field type (this definition applies independently of the position of the field in the sorting process: i.e. whether used as "first criterion", "criterion 2", etc.).

7.4.10.4 List Access Commands

The following list access commands are defined:

Bits	8 7 6 5 4 3 2 1	Meaning	PP -> FP	FP -> PP
0 0 0 0 0 0 0 0		start session	yes	-
0 0 0 0 0 0 0 1		start session confirm	-	yes
0 0 0 0 0 0 1 0		end session	yes	yes
0 0 0 0 0 0 1 1		end session confirm	yes	yes
0 0 0 0 0 1 0 0		query supported entry fields	yes	-
0 0 0 0 0 1 0 1		query supported entry fields confirm	-	yes
0 0 0 0 0 1 1 0		read entries	yes	-
0 0 0 0 0 1 1 1		read entries confirm	-	yes
0 0 0 0 1 0 0 0		edit entry	yes	-
0 0 0 0 1 0 0 1		edit entry confirm	-	yes
0 0 0 0 1 0 1 0		save entry	yes	-
0 0 0 0 1 0 1 1		save entry confirm	-	yes
0 0 0 0 1 1 0 0		delete entry	yes	-
0 0 0 0 1 1 0 1		delete entry confirm	-	yes
0 0 0 0 1 1 1 0		delete list	yes	-
0 0 0 0 1 1 1 1		delete list confirm	-	yes
0 0 0 1 0 0 0 0		search entries	yes	-
0 0 0 1 0 0 0 1		search entries confirm	-	yes
0 0 0 1 0 0 1 0		negative acknowledgement	-	yes
0 0 0 1 0 0 1 1		data packet	yes	yes
0 0 0 1 0 1 0 0		data packet last	yes	yes
1 x x x x x x x		reserved for proprietary list access commands		
all other values reserved				

Proprietary list access commands shall have list access command codings with most significant bit set to '1'.

The "read entries", "read entries confirm" and "search entries confirm" commands use a start index as these command may apply to a range of entries within a list.

The "save entry confirm" command uses a position index as this command applies to one entry.

Possible error codes are specified for each command from PP to FP. They use negative acknowledgement command, with exception of negative start session confirm.

Additionally to the general status of a given command and a given list as described in table 9 for feature [NG1.N.16], the **PP** shall follow the following more detailed requirements :

Table 40: PP commands support status per list

List (with status as given in table 9, feature [NG1.N.16])	Command (with status as given in table 9, feature [NG1.N.16])							
	Start/end session (M)	Query supported entry fields (O)	Read entries (M)	Edit entries (M)	Save entry (M)	Delete entry (M)	Delete list (M)	Search entries (M)
Lists of supported lists (O)	M	I	M	I	I	I	I	I
Missed call list (M)	M	O	M	I	I	M	M	O
Outgoing call list (O)	M	O	M	I	I	M	M	O
Incoming accepted call list (M)	M	O	M	I	I	M	M	O
All calls list (O)	M	O	M	I	I	M	M	O
Contact list (M)	M	O	M	M	M	M	O	M
Internal names list (M)	M	O	M	M	M	M	I	O
All incoming calls list (O)	M	O	M	I	I	M	M	O
DECT system settings list (M)	M	O	M	M	M	I	I	I
Line settings list (M)	M	O	M	M	M	O	I	I

EXAMPLE: If the PP implements the 'list of supported list' (optional list), PP shall then implement 'start session', 'end session' and 'read entries' commands, other commands for this list are irrelevant.

Additionally to the general status of a given command and a given list as described in table 9 for feature [NG1.N.16], the **FP** shall follow the following more details requirements :

Table 41: FP commands support status per list

List (with status as given in table 9, feature [NG1.N.16])	Command (with status as given in table 9, feature [NG1.N.16])							
	Start/end session (M)	Query supported entry fields (M)	Read entries (M)	Edit entries (M)	Save entry (M)	Delete entry (M)	Delete list (M)	Search entries (M)
Lists of supported lists (M)	M	I (note 1)	M	I (note 1)	I (note 1)	I (note 1)	I (note 1)	I (note 1)
Missed call list (M)	M	M	M	I (note 1)	I (note 1)	M	M	M
Outgoing call list (O)	M	M	M	I (note 1)	I (note 1)	M	M	M
Incoming accepted call list (M)	M	M	M	I (note 1)	I (note 1)	M	M	M
All calls list (O)	M	M	M	I (note 1)	I (note 1)	M	M	M
Contact list (M)	M	M	M	M	M	M	M	M
Internal names list (M)	M	M	M	M (note 4)	M (note 4)	M (note 4)	I (note 1)	M
All incoming calls list (O)	M	M	M	I (note 1)	I (note 1)	M	M	O
DECT system settings list (M)	M	M	M	M (note 4)	M (note 4)	I (note 1)	I (note 1)	I (note 1)
Line settings list (M)	M	M	M	M (note 4)	M (notes 3 and 4)	O (notes 2 and 4)	I (note 1)	I (note 1)

NOTE 1: FP shall answer with negative acknowledgement / 'procedure not allowed'.

NOTE 2: If not supported, FP shall answer with negative acknowledgement / 'procedure not allowed'.

NOTE 3: FP shall support the command to offer the possibility to modify a line setting. However, the 'save entry' for creating a new line may not be supported by the FP. See clause 7.4.10.4.5.2.

NOTE 4: Additional requirements apply when a PP is involved in a voice call. FP shall temporarily restrict access to the list by the until the duration of the voice call. See clause 7.4.10.6 for details.

7.4.10.4.1 Start and end session

7.4.10.4.1.1 "Start session" command

This command from PP requests to start a session to access the specified list in the FP.

Table 42: Values used within {IWU to IWU} information element to request the starting of a list change session

Information element	Field within the information element	Standard values within the field/IE	Normative action/comment
<<IWU to IWU>>	<Length of content>	L	Length of content
	<S/R bit>	1	Transmission of message
	<Protocol Discriminator>	03H	List access
	<Command =start session>	0	List access command
	<List identifier>	0..FFH	List identifier
	<Sorting fields>		List of suggested fields for sorting the list towards this PP
	<Number of sorting fields>	0..255	If 0, the default sorting of the list shall be used by the FP (see note)
	<Sorting field identifier 1>	0..255	Suggested field element type used for sorting the list (first criterion)
	... <Sorting field identifier n>	0..255	Suggested field element type used for sorting the list, to be used when field 1, ..., field n-1 of both compared entries are equal (criterion n)
NOTE: It is recommended to limit the number of requested sorting fields to two (n=2).			

The submitted sorting field identifiers suggest entry fields which should be used by the FP to sort the requested list towards this PP in the given session. This suggests to sort the list by "sorting field 1" as first criterion, and then by "sorting field 2" as second criterion, when field 1 of both compared entries are equal, and so on.

For each field type, a sorting order is defined, which applies independently of the position of the field in the sorting process: i.e. whether used as "first criterion", "criterion 2", etc. The defined sortings are as follows:

- For fields of type "Number" (including terminal id numbers), "Name", "Line name", "First name", or "Contact number", the case insensitive alphanumerical order shall be used.

NOTE: The alphanumerical order can only be defined on a subset of the UTF-8 encoded characters. This subset and the associated order depend on the locale used.

- For fields of type "Date and time", the ante-chronological order shall be used (highest index for the oldest call, lowest index for the newest call).
- For fields of type "Line id", the ascending numerical order shall be used.

If a field used for sorting is included several times in the entries, the FP shall decide which instance of the field is used for the sorting.

EXAMPLE: If the PP requests contact list to be sorted with the contact number field and the list entries include one "mobile" and one "work" contact number fields, the FP may use the "mobile" instance of the field for sorting. Entries with "mobile" numbers may appear first in the list then entries with "home" numbers. Please note that this additional "sub-sorting" performed by the FP might be unknown or a bit inconvenient to the user (on PP side). As a consequence, the PP should request such sorting only if strictly necessary.

If the <Number of sorting fields> is equal to 0, the FP shall use the default sorting of the list. No sorting field identifier is sent in this case.

7.4.10.4.1.2 "Start session confirm" command

This command from FP to PP confirms or rejects the start of the session.

Table 43: Values used within {IWU to IWU} information element to confirm or reject the starting of a list change session

Information element	Field within the information element	Standard values within the field/IE	Normative action/comment
<<IWU to IWU>>	<Length of content>	L	Length of content
	<S/R bit>	1	Transmission of message
	<Protocol Discriminator>	03H	List access
	<Command =start session confirm>	1H	List access command
	<List identifier>	0..FFH	List identifier
	<Session identifier>	0..127	Session identifier (see note 1)
	<Total number of available entries>	0..127	Number of available entries in list requested by the PP (see note 1)
	<Discriminator type>	00H, 01H	Undefined, EMC (see note 2)
	<Discriminator>	00H..FFH	EMC value high byte
	<Discriminator>	00H..FFH	EMC value low byte
	<Start session reject reason>	0..FFH	Reject reason in case of reject
	<Sorting fields>		List of fields used for the actual sorting the list towards this PP
	<Number of sorting fields>	0..255	
	<Sorting field identifier 1>	0..255	Field element type used for the actual sorting the list (first criterion)
	...		
	<Sorting field identifier n>	0..255	Field element type used for the actual sorting of the list (criterion n)

NOTE 1: 'Total number of available entries' and 'session identifier' can be extended for values up to 16 383 by using the same mechanism as for 'Event multiplicity'. See note at table 39.

NOTE 2: Discriminator type set to '1' (= EMC) indicates the support of proprietary list access commands, of proprietary lists and of proprietary list fields. For distinguishing proprietary elements from different manufacturers, the EMC is given in the following two octets. In case Discriminator type is set to '0', the following two octets are do not care. The PP shall not use proprietary elements in case either the Discriminator type is '0' (= Undefined) or the EMC is different from the own one. Proprietary elements shall have identifiers with the most significant bit set to '1'.

The session identifier shall be unique between the FP and one PP. It identifies the access to one list for the PP, which has started the session. The FP shall at least support two session at a time to one PP.

The submitted list entry field identifiers are used to indicate the entry field which is used by the FP to sort the requested list towards this PP in the given session. The FP may choose other entry fields than the ones suggested by the PP in the 'start session' command (e.g. 'name' instead of 'first name' in contact list). The sorting capabilities of the FP depend on the implementation of the FP.

For list entry field identifiers see clause 7.4.10.5.1.

If start session is confirmed the reject reason shall not be evaluated.

Even if the default sorting is required by the PP in the "Start session" command (using '0' as value for <Number of sorting fields>), the FP shall confirm the sorting fields which were actually used for sorting the list (and which shall be the ones defined as "default" sorting fields in clause 7.4.10.4.1.1).

Possible error cases:

If start session is rejected, the session identifier shall be set to 0, and the field reject reason shall indicate the appropriate reason.

If a sorting field identifier is not valid, the submitted sorting field identifier shall be ignored by the FP. Nevertheless the FP indicates the chosen sorting field identifiers in the start session confirm.

Start session reject reason:

Bits	8 7 6 5 4 3 2 1	Meaning
	0 0 0 0 0 0 0 0	not enough resources
	0 0 0 0 0 0 0 1	list already in use by another session
	0 0 0 0 0 0 1 0	list not supported
	0 0 0 0 0 0 1 1	maximum number of sessions supported by the FP reached
	all other values	reserved

If a FP allows only 1 started session *for a given list* (to avoid potential collision scenarios), the FP shall use the reject reason "list already in use by another session".

If a PP attempts to start a session and the FP has no more resources to handle this start session, the FP shall use the reject reason "maximum number of sessions supported by the FP reached".

7.4.10.4.1.3 "End session" command

This command from PP or FP ends the specified session.

Table 44: Values used within {IWU to IWU} information element to request the end of a list change session

Information element	Field within the information element	Standard values within the field/IE	Normative action/comment
<<IWU to IWU>>	<Length of content>	L	Length of content
	<S/R bit>	1	Transmission of message
	<Protocol Discriminator>	03H	List access
	<Command =end session>	2H	List access command
	<Session identifier>	1..127	Session identifier (see note)
NOTE: 'Session identifier' can be extended for values up to 16 383 by using the same mechanism as for 'Event multiplicity'. See note at table 39.			

This command is recommended to be sent by PP and FP to request end of session.

The session(s) between a PP and FP shall at latest be terminated with call release.

Remaining locked entries (see edit procedure) shall be unlocked either with the end session command or at latest with call release ({CC-RELEASE} message).

Possible error cases:

If session identifier is wrong the command should be ignored by the receiver.

7.4.10.4.1.4 "End session confirm" command

This command from PP or FP confirms the ending of the specified session.

Table 45: Values used within {IWU to IWU} information element to confirm the end of a list change session

Information element	Field within the information element	Standard values within the field/IE	Normative action/comment
<<IWU to IWU>>	<Length of content>	L	Length of content
	<S/R bit>	1	Transmission of message
	<Protocol Discriminator>	03H	List access
	<Command =end session confirm>	3H	List access command
	<Session identifier>	1..127	Session identifier (see note)
NOTE: 'Session identifier' can be extended for values up to 16 383 by using the same mechanism as for 'Event multiplicity'. See note at table 39.			

Reject of end session request shall not be possible.

7.4.10.4.2 Query supported entry fields

7.4.10.4.2.1 "Query supported entry fields" command

This command from PP queries the fields which are supported or not in the entries of a given list in the FP.

Table 46: Values used within {IWU to IWU} information element for the "Query supported entry fields" command

Information element	Field within the information element	Standard values within the field/IE	Normative action/comment
<<IWU to IWU>>	<Length of content>	L	Length of content
	<S/R bit>	1	Transmission of message
	<Protocol Discriminator>	03H	List access
	<Command = query supported entry fields>	4H	List access command
	<Session identifier>	1..127	Session identifier (see note)
NOTE: 'Session identifier' can be extended for values up to 16 383 by using the same mechanism as for 'Event multiplicity'. See note at table 39.			

Possible error cases:

If session identifier is wrong, the FP shall answer with negative acknowledgement reject reason 'invalid session number'.

7.4.10.4.2.2 "Query supported entry fields confirm" command

This command from FP confirms the query of supported fields which are supported or not in the entries of a given list in the FP.

The FP submits the supported entry field identifier and shall group them in editable and non-editable fields.

Table 47: Values used within {IWU to IWU} information element for the "Query supported entry fields confirm" command

Information element	Field within the information element	Standard values within the field/IE	Normative action/comment
<<IWU to IWU>>	<Length of content>	L	Length of content
	<S/R bit>	1	Transmission of message
	<Protocol Discriminator>	03H	List access
	<Command = query supported entry fields confirm>	5H	List access command
	<Session identifier>	1..127	Session identifier (see note)
	<number of editable entry fields>	0..255	Number of editable entry fields
	<List entry field identifier 1>	0..255	Supported field element type
	...		
	<List entry field identifier n>	0..255	Supported field element type
	<number of non-editable entry fields>	0..255	Number of non-editable entry fields
	<List entry field identifier 1>	0..255	Supported field element type
	...		
	<List entry field identifier n>	0..255	Supported field element type
NOTE: 'Session identifier' can be extended for values up to 16 383 by using the same mechanism as for 'Event multiplicity'. See note at table 39.			

When several list entry field identifiers are specified within the command, these field identifiers shall be ordered in ascending numerical order.

If a field is included more than once in the entries of the list (FP decision), all instances of this field shall appear in the "query supported entry fields confirm" (field identifier is repeated in the confirm). This allows PP to be aware how many instances of a field shall be included during a further save command.

For list entry field identifiers see clause 7.4.10.5.1.

7.4.10.4.3 Read entries

7.4.10.4.3.1 "Read entries" command

This command from PP requests to read a range of consecutive entries in the list, or only a subset of the fields of these entries. The list here shall be understood as the list resulting from the initial sorting of the list as specified by the FP in the "Start session confirm" command.

NOTE 1: Range can be limited to one entry.

In case the <mark entries request> field is used with a non-zero value, the requested subset of fields may be empty. In that case, a 'Read entries confirm' command with no data packet shall be returned by the FP (see clause 7.4.10.4.3.2).

Table 48: Values used within {IWU to IWU} information element for "Read entries" command

Information element	Field within the information element	Standard values within the field/IE	Normative action/comment
<<IWU to IWU>>	<Length of content>	L	Length of content
	<S/R bit>	1	Transmission of message
	<Protocol Discriminator>	03H	List access
	<Command =read entries>	6H	List access command
	<Session identifier>	1..127	Session identifier (see note 1)
	<Start index>	0..127	Start index (see note 1)
	<Direction (bit 8)>	0..1	Direction of the read (forward or backward)
	<Counter (bits 1 to 7)>	1..127	Number of requested entries
	<Mark entries request>	00H, 7FH, FFH	Flag for requesting resetting (or setting) of the 'Read status' field for all read entries (see note 2)
	<List entry field identifier 1>	0..255	Requested field element type
	...		
	<List entry field identifier n>	0..255	Requested field element type
NOTE 1: 'Session identifier' and 'start index' can be extended for values up to 16 383 by using the same mechanism as for 'Event multiplicity'. See note at table 39.			
NOTE 2: This field is used (with value 7FH) to indicate that the entries read by the PP are considered as read by the user, or will necessarily be read by the user. The <mark entries request> field is only considered if the list contains a 'Read status' field. Otherwise it is present but ignored on both sides. See also below subsection 'Mark entries request (octet)'.			
NOTE 3: 'List entry field identifier' values are defined for each list separately.			

Start index:

The start index is the first index of the range of requested entries.

Bits	7 6 5 4 3 2 1	Meaning
	0 0 0 0 0 0 0	last entry
	other values	list entry

Direction and Counter (octet):

Bits	8 7 6 5 4 3 2 1	Meaning
	0 x x x x x x x	forward (in ascending list index order)
	1 x x x x x x x	backward (in descending list index order)

The response contains data packets with list entries in order of ascending list index, regardless of whether counter indicated forward or backwards and always includes the entry with list index=start index.

EXAMPLE: In case 2 entries are requested 'backwards' with start index 5, the data packets shall include the entries with indices 4 and 5, with entry 4 transmitted first.

Mark entries request (octet):

This field applies to a list having a 'Read status' field, and is otherwise ignored on both sides. This field allows the PP to request from the FP that *all* read entries 'Read status' field be reset (when value '7F'H is used), or that *all* read entries be set (when value 'FF'H is used). Value '00'H indicates that the 'Read status' field for all read entries must be left unchanged.

NOTE 2: Only the 'missed call list' and the 'All incoming call list' have a 'Read status' field. For the 'All incoming call list' the mark entries request is only applied to missed call entries (incoming accepted calls have a fake 'Read status' field with a frozen value of '0').

When the value '7F'H or 'FF'H is used (mark all entries as read or as unread), the subset of requested fields may be empty. In that case the 'Read entries' command is only used by the PP to mark entries as read or as unread in the list.

Bits	8 7 6 5 4 3 2 1	Meaning
	0 0 0 0 0 0 0 0	all read entries 'Read status' field shall be left unchanged
	0 1 1 1 1 1 1 1	all read entries 'Read status' field shall be reset (i.e. marked as read)
	1 1 1 1 1 1 1 1	all read entries 'Read status' field shall be set (i.e. marked as unread)
	All other values	reserved

This field allows the PP to follow various strategies when presenting entries to the user, including the following ones:

Single-read strategy (for simple PPs): the PP always use value '7F'H so that all entries read from the FP have always their 'Read status' field reset.

Enhanced two-read strategy ('Browsing then reading'). A PP using this strategy always uses value '00'H for browsing (typically reading only part of the fields in that step). When a user selects an entry to actually read it, the PP re-reads the entry from the FP, and uses value '7F'H for resetting the 'Read status' field of that entry.

NOTE 3: The PP could also request all fields of the read entries in the browsing step, in order to speed up the second step (caching fields not shown in the first step).

List entry field identifier :

When several list entry field identifiers are specified within the command, these field identifiers shall be ordered in ascending numerical order.

Possible error cases:

If session identifier is wrong the FP shall answer with negative acknowledgement reject reason 'invalid session number'.

In case the 'start index' is invalid, the FP shall answer with negative acknowledgement, reject reason 'invalid start index'. This includes the case where the list is empty.

In case the index range given with 'counter' is invalid, the FP shall return the existing elements in the range.

In case an unknown list entry field identifier is requested, the FP shall ignore this field and continue with the next requested field.

7.4.10.4.3.2 "Read entries confirm" command

This command from FP confirms the read command with the corresponding entry/entries with one or several specified fields. Corresponding entry/entries are sent along in data packets.

Table 49: Values used within {IWU to IWU} information element for "Read entries confirm" command

Information element	Field within the information element	Standard values within the field/IE	Normative action/comment
<<IWU to IWU>>	<Length of content>	L	Length of content
	<S/R bit>	1	Transmission of message
	<Protocol Discriminator>	03H	List access
	<Command =read entries confirm>	7H	List access command
	<Session identifier>	1..127	Session identifier (see note)
	<Start index>	1..127	Start index (see note)
	<Counter>	0..127	Number of delivered entries
NOTE:	'Start index' and 'Session identifier' can be extended for values up to 16 383 by using the same mechanism as for 'Event multiplicity'. See note at table 39.		

Counter (octet):

'Counter' returns the number of returned list entries.

Bits	8 7 6 5 4 3 2 1	Meaning
	0 x x x x x x x	number of returned entries

Bit 8 shall remain unset consistently with "Read entries" command format (see clause 7.4.10.4.3.1).

If a given field is included more than once in the entries, all instances of this field shall be included in the "Read entries confirm" command.

'Start index' shall always indicate the smallest index value of the list response.

Content of list entry is transmitted in data packets.

In case the subset of fields requested in the 'Read entries' command was empty, the <Counter> field shall be set to '0' and no data packet shall be sent (see also clause 7.4.10.4.3.1).

7.4.10.4.4 Edit entry**7.4.10.4.4.1 "Edit entry" command**

This command from PP requests to read and lock only one entry.

Table 50: Values used within {IWU to IWU} information element for "Edit entry" command

Information element	Field within the information element	Standard values within the field/IE	Normative action/comment
<<IWU to IWU>>	<Length of content>	L	Length of content
	<S/R bit>	1	Transmission of message
	<Protocol Discriminator>	03H	List access
	<Command =edit entry>	8H	List access command
	<Session identifier>	1..127	Session identifier (see note)
	<Entry identifier>	1..127	Entry identifier (see note)
	<List entry field identifier 1>	0..255	Requested field element type
	...		
	<List entry field identifier n>	0..255	Requested field element type
NOTE:	'Session identifier' and 'entry identifier' can be extended for values up to 16 383 by using the same mechanism as for 'Event multiplicity'. See note at table 39.		

A PP may edit some or all the fields of an entry (independently of whether the "editable" property of the field is set or not). Whether a field element is editable or not is indicated for each field in the response message (i.e. in the "editable" property of each field).

In contrast to 'read entries', the "edit entry" list access command contains a reference to a single list entry ("entry identifier" field).

When receiving an "edit entry" command, the FP shall prevent other PPs from changing the specified list entry (negative acknowledgement with reject reason 'temporarily not possible') until the sending PP has sent the corresponding "save entry" command, or until the session is terminated. In other words, the FP shall temporarily prevent "save entry" and "delete entry" commands for the entry from being used by other PPs, as well as the "delete list" command.

'List entry field identifier' values are defined for each list separately.

When several list entry field identifiers are specified within the command, these field identifiers shall be ordered in ascending numerical order.

Possible error cases:

If session identifier is wrong the FP shall answer with negative acknowledgement reject reason 'invalid session number'.

In case an unknown entry identifier is requested, the FP shall answer with negative acknowledgement, reject reason 'entry not available'.

In case an unknown list entry field identifier is requested, the FP shall ignore this field and continue with the next requested field.

The FP may not allow editing entries on a dedicated list (especially for call lists); the FP should send negative acknowledgement with reject reason 'procedure not allowed' in this case. This also mean save will neither be allowed on those lists.

7.4.10.4.4.2 "Edit entry confirm" command

This command from FP confirms the edit command with the corresponding entry with one or several specified fields, and locks this entry against access from other PPs. Corresponding entry is sent along in data packets.

Table 51: Values used within {IWU to IWU} information element for "edit entry confirm" command

Information element	Field within the information element	Standard values within the field/IE	Normative action/comment
<<IWU to IWU>>	<Length of content>	L	Length of content
	<S/R bit>	1	Transmission of message
	<Protocol Discriminator>	03H	List access
	<Command =edit entry confirm>	9H	List access command
	<Session identifier>	1..127	Session identifier (see note)
NOTE:	'Session identifier' can be extended for values up to 16 383 by using the same mechanism as for 'Event multiplicity'. See note at table 39.		

Content of list entry is transmitted in data packets.

When a non-editable field is requested by a PP, the FP shall return it. This is not considered as an error case, the "editable" property will indicate whether this field element is editable or not.

If a field is included more than once in the entry, all instances of this field shall be included in the "edit entry confirm" command.

7.4.10.4.5 Save entry

7.4.10.4.5.1 "Save entry" command

This command from PP requests to save the entry in the list identified by the specified entry identifier, or to add a new entry to the list. Corresponding entry is sent along in data packets.

The list entries which are saved shall have been requested via 'edit' before in the same session, except for creation of a new entry.

The 'save' transaction shall contain all fields or a subset of the fields which were submitted in the 'edit' transaction. Other fields (not edited and not saved) remain unchanged in the FP.

Table 52: Values used within {IWU to IWU} information element for "Save entry" command

Information element	Field within the information element	Standard values within the field/IE	Normative action/comment
<<IWU to IWU>>	<Length of content>	L	Length of content
	<S/R bit>	1	Transmission of message
	<Protocol Discriminator>	03H	List access
	<Command = save entry>	AH	List access command
	<Session identifier>	1..127	Session identifier (see note)
	<Entry identifier>	0..127	Entry identifier (see note)
NOTE:	'Session identifier' and 'entry identifier' can be extended for values up to 16 383 by using the same mechanism as for 'Event multiplicity'. See note at table 39.		

Content of list entry is transmitted in data packets.

Entry identifier:

Bits	7	6	5	4	3	2	1	Meaning
	0	0	0	0	0	0	0	not yet assigned entry identifier (new entry proposed by the PP)
	other values							assigned entry identifier (this entry identifier shall already exist in the list)

If a new entry has to be created, the PP shall indicate this by using the entry identifier 00H. It is recommended that all fields (editable or not) of the new entry are set by the PP. If the PP omits some of the fields in the save command, the FP shall automatically assign a default value to those fields after the save command. In this case, the end FP shall assign a new entry identifier for the entry and submit it in the following 'save entry confirm'.

The new or modified entry shall be inserted in the list by the FP taking into account the sorting criteria for this list.

Content of list entry is transmitted in data packets.

If the previously started edit procedure has to be terminated without changing the list entry, PP shall perform the 'save entry' procedure with only one empty 'last data packet' following after 'save entry'.

In case several fields of the same type in one entry were received during 'edit', PP shall send with 'save' all received fields of this type.

A PP may request the reset of the field of an entry by setting the field length to 1 (only octet 3 available in entry field). The field itself is not removed from the FP list entry. It has to be noted that resetting some fields in some lists can be dangerous and should be carefully controlled by the PP.

Possible error cases:

If session identifier is wrong the FP shall answer with negative acknowledgement reject reason 'invalid session number'.

If an unknown entry identifier of the list is requested (except 0), the FP shall answer with negative acknowledgement, reject reason 'entry not available'.

If a PP attempts to save an entry with a field content which cannot be accepted, (e.g. for a field whose contents are only allowed once in the list like line-id in the "Line settings" list or when too many instances of a field are saved in the same entry), the FP shall reject the command with a negative acknowledgement, with reject reason "content not accepted".

If a PP attempts to add a new entry in a list which cannot accept an additional entry, the FP shall reject the command with a negative acknowledgement, with reject reason "list full".

7.4.10.4.5.2 "Save entry confirm" command

This command from FP confirms the save of one entry in a list and returns the position index where the entry was saved.

Table 53: Values used within {IWU to IWU} information element for "Save entry confirm" command

Information element	Field within the information element	Standard values within the field/IE	Normative action/comment
<<IWU to IWU>>	<Length of content>	L	Length of content
	<S/R bit>	1	Transmission of message
	<Protocol Discriminator>	03H	List access
	<Command = save entry confirm>	BH	List access command
	<Session identifier>	1..127	Session identifier (see note)
	<Entry identifier>	1..127	Entry identifier (see note)
	<Position index>	1..127	Position index (see note)
	<Total number of available entries>	0..127	Number of available entries in list after saving (see note)
NOTE: 'Session identifier', 'position index', 'entry identifier', and 'total number of available entries' can be extended for values up to 16 383 by using the same mechanism as for 'Event multiplicity'. See note at table 39.			

The position index indicates the (possibly new) index of the entry in the list.

The 'Total number of available entries' reflects the updated number of entries in the list after save is performed. It is useful especially when saving (creating) a new entry.

Possible error cases:

Entry fields which were not indicated as editable shall not be sent back with changes within the data packet messages belonging to the save entry procedure.

In case changes in non-editable fields or a change of a not previously requested (edit) entry, the FP shall send negative acknowledge with reject reason 'procedure not allowed'.

FP may not allow saving new entries for a dedicated list (especially for call lists), the FP should send negative acknowledge with reject reason 'procedure not allowed' in this case.

The FP may also not allow the saving of a new entry in the line settings list. Same negative acknowledgement shall be used.

NOTE: For lists that allow creation of a new entry, it is supposed that all fields are editable on FP side.

7.4.10.4.6 Delete entry

7.4.10.4.6.1 "Delete entry" command

This command from PP requests to delete one entry in a list.

Table 54: Values used within {IWU to IWU} information element for "Delete entry" command

Information element	Field within the information element	Standard values within the field/IE	Normative action/comment
<<IWU to IWU>>	<Length of content>	L	Length of content
	<S/R bit>	1	Transmission of message
	<Protocol Discriminator>	03H	List access
	<Command =delete entry>	CH	List access command
	<Session identifier>	1..127	Session identifier (see note)
	<Entry identifier>	1..127	Entry identifier (see note)
NOTE: 'Session identifier' and 'entry identifier' can be extended for values up to 16 383 by using the same mechanism as for 'Event multiplicity'. See note at table 39.			

The 'delete entry' command is not allowed for the following lists:

- 'List of supported lists', and
- 'DECT system settings list'.

The 'delete entry' command for the 'Internal names list' shall respect the following rules:

- it shall be interpreted as a request for de-registering from the system the PP listed in the entry to be deleted (see clause 7.4.11.2);
- if this PP is involved in a call, the FP shall reject the 'delete entry' command by sending a negative acknowledgement with reject reason, 'temporarily not possible' (as defined in clause 7.4.10.6).

The FP may disallow the 'delete entry' command for 'Line settings list'. See possible error case for answer.

Possible error cases:

If session identifier is wrong the FP shall answer with negative acknowledgement reject reason 'invalid session number'.

If an unknown entry identifier of the list is requested, the FP shall answer with negative acknowledgement with reject reason 'entry not available'.

If the PP sends a 'delete entry' command in a case where it is not allowed (see above), the FP shall answer with negative acknowledgement with reject reason, 'procedure not allowed'.

7.4.10.4.6.2 "Delete entry confirm" command

This command from FP confirms the deletion of an entry in a list.

Table 55: Values used within {IWU to IWU} information element for "Delete entry confirm" command

Information element	Field within the information element	Standard values within the field/IE	Normative action/comment
<<IWU to IWU>>	<Length of content>	L	Length of content
	<S/R bit>	1	Transmission of message
	<Protocol Discriminator>	03H	List access
	<Command = delete entry confirm>	DH	List access command
	<Session identifier>	1..127	Session identifier (see note)
	<Total number of available entries>	0..127	Number of available entries in list after deletion (see note)
NOTE:	'Total number of available entries' and 'session identifier' can be extended for values up to 16 383 by using the same mechanism as for 'Event multiplicity'. See note at table 39.		

7.4.10.4.7 Delete list

7.4.10.4.7.1 "Delete list" command

This command from PP requests the deletion of a complete list.

Table 56: Values used within {IWU to IWU} information element for "Delete list" command

Information element	Field within the information element	Standard values within the field/IE	Normative action/comment
<<IWU to IWU>>	<Length of content>	L	Length of content
	<S/R bit>	1	Transmission of message
	<Protocol Discriminator>	03H	List access
	<Command =delete list>	EH	List access command
	<Session identifier>	1..127	Session identifier (see note)
NOTE:	'Session identifier' can be extended for values up to 16 383 by using the same mechanism as for 'Event multiplicity'. See note at table 39.		

Delete list means deletion of all entries. The list itself is still available.

Use of the 'Delete list' command is not allowed for the following lists:

- 'List of supported lists',

- 'Internal names list',
- 'DECT system settings list', and
- 'Line settings list' (see 'possible error cases' clause).

Possible error cases:

If session identifier is wrong the FP shall answer with negative acknowledgement reject reason 'invalid session number'.

If an unknown list identifier is requested (including list of supported list), the FP shall answer with negative acknowledgement, reject reason 'procedure not allowed'.

In case the FP rejects the 'delete list' command, it shall answer with a negative acknowledgement, with reject reason = 'procedure not allowed'. This negative acknowledgement shall be used in particular if the 'delete list' command is used for one of the lists for which this command is not allowed (see above).

7.4.10.4.7.2 "Delete list confirm" command

This command from FP confirms the deletion of a complete list.

Table 57: Values used within {IWU to IWU} information element for "Delete list confirm" command

Information element	Field within the information element	Standard values within the field/IE	Normative action/comment
<<IWU to IWU>>	<Length of content>	L	Length of content
	<S/R bit>	1	Transmission of message
	<Protocol Discriminator>	03H	List access
	<Command =delete list confirm>	FH	List access command
	<Session identifier>	1..127	Session identifier (see note)
NOTE: 'Session identifier' can be extended for values up to 16 383 by using the same mechanism as for 'Event multiplicity'. See note at table 39.			

7.4.10.4.8 Search entries

7.4.10.4.8.1 "Search entries" command

This command from PP requests to read a range of consecutive entries in the list, beginning with an entry matching a search criterion. The list here shall be understood as the list resulting from the initial sorting of the list as specified by the FP in the "Start session confirm" command.

For the 'Search entries' command, the requested subset of fields should not be empty.

Table 58: Values used within {IWU to IWU} information element for "Search entries" command

Information element	Field within the information element	Standard values within the field/IE	Normative action/comment
<<IWU to IWU>>	<Length of content>	L	Length of content
	<S/R bit>	1	Transmission of message
	<Protocol Discriminator>	03H	List access
	<Command = search entries>	10H	List access command
	<Session identifier>	1..127	Session identifier (see note 1)
	<Matching option>	00H to 06H	First part of the search criterion
	<Searched value >		Second part of the search criterion; Always coded as a string
	<String length>	1..255	
	<String content 0>	...	UTF-8 coded characters
	
	<String content n>	...	UTF-8 coded characters
	<Direction (bit 8)>	0..1	Direction of the read (forward or backward)
	<Counter (bits 1 to 7)>>	1..127	Number of requested entries
	<Mark entries request>	00H, 7FH, FFH	Flag for requesting resetting (or setting) of the 'Read status' field for all read entries (see note 2)
	<List entry field identifier 1>	0..255	Requested field element type
...	...		
<List entry field identifier n>	0..255	Requested field element type	
NOTE 1: 'Session identifier' can be extended for values up to 16 383 by using the same mechanism as for 'Event multiplicity'. See note at table 39.			
NOTE 2: This field is only considered if the list contains a 'Read status' field. Otherwise it is present but ignored on both sides (see also clause 7.4.10.4.3, 'Read entries').			
NOTE 3: 'List entry field identifier' values are defined for each list separately.			

In the list access command 'search entries', the submitted searched value contents together with the matching option define the search criterion.

FP answers with list entries beginning with the first matching entry, but it does not generate a new list for the result. A matching entry shall be understood with the matching option taken into account.

The "Search entries" command shall be considered successful if at least one entry is found that matches the search criterion, and even if there are less than <counter>-1 entries after the matching entry in the list. See "Search entries confirm" command/particular cases for the case the search does not succeed (no entry found at all).

The command 'search entries' is in principle similar to 'read entries' with the exception, that instead of 'start index' the 'searched value' is used.

Matching option:

Bits	8 7 6 5 4 3 2 1	Meaning
	0 0 0 0 0 x 0 0	exact match with whole target field required
	0 0 0 0 0 x 0 1	exact match as with 00H option tried, current start index returned if exact match fails
	0 0 0 0 0 x 1 0	exact match as with 00H option tried, previous start index returned if exact match fails
	0 0 0 0 0 1 x x	case sensitive search required
	all other values reserved	

If '00H matching option is used, the FP shall only succeed if it finds an entry in the list with first sorting field value *equal* to the searched value, and shall return a "not matching" answer otherwise (see "not matching case section" in clause 7.4.10.4.8.2).

NOTE 1: This option is especially useful for the PP to retrieve a specific entry with no human intervention.

'01'H and '02'H options allow to search the "nearest" alphanumeric entry/entries in the list to the searched value (for example, option '01'H could be convenient if user/PP only enters "s" when searching for all entries starting with "s").

If '01'H matching option is used, the FP shall only succeed if either the exact match succeeds (as with option 00H), or if the end of the list was not reached when the exact match failed. The current entry index shall be returned as start index of the returned range. If the end of the list was reached when the exact match failed (there is no current entry anymore), the FP shall return a "not matching" answer (see "not matching case section" in clause 7.4.10.4.8.2).

If '02'H matching option is used, the FP shall only succeed if either the exact match succeeds (as with option 00H), or if the current entry when the exact match failed was not the first entry of the list. The "previous index" = "current entry index -1" shall be returned as start index of the returned range. If the current entry when the exact match failed was the first entry of the list, the FP shall return a "not matching" answer (see "not matching case section" in clause 7.4.10.4.8.2).

EXAMPLE 1: If "Smi" is the searched value, with matching option '01'H, and there is no entry with "Name" field equal to "Smi" in the list, exact match will fail on the first entry ranked after "Smi" in the list when using the alphanumeric order. This entry is the so-called "current entry" and may have e.g. "Smith" as "Name" field value, or any other value.

EXAMPLE 2: If "s" is the searched value, with matching option '01'H, FP will answer in search confirm with the index of the first entry starting with a "s". If there are none, FP will answer with index of the first entry starting with a "t" and so on.

In addition to the matching options ('00'H, '01'H, '02'H), the search may be case sensitive or not if bit 3 is set or not.

Searched value:

The FP shall use the 'searched value' as search criterion in the entry field which was used as first criterion by the FP for sorting the list; this sorting field is indicated to the PP in the 'Start session confirm' command.

In case a numerical value is searched, the string content fields shall contain the IA5-coded decimal representation of the value (e.g. in case of searching for Line id =12, the string content is '31'H '32'H).

NOTE 2: This particular coding of numerical values does not imply anything about the underlying sorting order of the list, which depends on the sorting fields defined for the session and on their types (see "Start session" command).

Counter (octet):

See the "Read entries" command (see clause 7.4.10.4.3), as the same definition applies here.

List entry field identifier :

When several list entry field identifiers are specified within the command, these field identifiers shall be ordered in ascending numerical order.

Possible error cases:

If session identifier is wrong the FP shall answer with negative acknowledgement reject reason 'invalid session number'.

In case an unknown list entry field identifier is requested, the FP shall ignore this field and continue with the next requested field.

7.4.10.4.8.2 "Search entries confirm" command

This command from the FP specifies the start index of the range of entries found as a result of the "Search entries" command, and the number of returned entries. Corresponding entry/entries are sent along in data packets.

Table 59: Values used within {IWU to IWU} information element for "Search entries confirm" command

Information element	Field within the information element	Standard values within the field/IE	Normative action/comment
<<IWU to IWU>>	<Length of content>	L	Length of content
	<S/R bit>	1	Transmission of message
	<Protocol Discriminator>	03H	List access
	<Command = search entries confirm>	11H	List access command
	<Session identifier>	1..127	Session identifier (see note)
	<Start index>	1..127	Start index of the range of returned entries (see note)
	<Counter>	0..127	Number of returned entries
NOTE:	'Session identifier' and 'start index' can be extended for values up to 16 383 by using the same mechanism as for 'Event multiplicity'. See note at table 39.		

Counter (octet):

'Counter' returns the number of returned list entries.

Bits	8 7 6 5 4 3 2 1	Meaning
	0 x x x x x x x	number of returned entries

Bit 8 shall remain unset consistently with "Read entries" command format (see clause 7.4.10.4.3.1).

Start index returns the index of the first returned list entry.

Content of list entry/entries is transmitted in data packets.

Not matching case:

If no entry is found that matches the search criterion, the <counter> field value shall be set to zero. No data packet shall be sent.

7.4.10.4.9 Negative Acknowledgement

This command from FP rejects the previous command with a reject reason.

Table 60: Values used within {IWU to IWU} information element for "Negative Acknowledgement" command

Information element	Field within the information element	Standard values within the field/IE	Normative action/comment
<<IWU to IWU>>	<Length of content>	L	Length of content
	<S/R bit>	1	Transmission of message
	<Protocol Discriminator>	03H	List access
	<Command=negative acknowledgement >	12H	List access command
	<Session identifier>	1..127	Session identifier (see note)
	<Reject reason>	0..255	Reject Reason
NOTE:	'Session identifier' can be extended for values up to 16 383 by using the same mechanism as for 'Event multiplicity'. See note at table 39.		

Reject reason:

Bits	8 7 6 5 4 3 2 1	Meaning
0 0 0 0 0 0 0 0		invalid range
0 0 0 0 0 0 0 1		entry not available
0 0 0 0 0 0 1 0		invalid session number
0 0 0 0 0 0 1 1		temporarily not possible
0 0 0 0 0 1 0 0		entry format incorrect
0 0 0 0 0 1 0 1		invalid start index
0 0 0 0 0 1 1 0		procedure not supported
0 0 0 0 0 1 1 1		procedure not allowed
0 0 0 0 1 0 0 0		content not accepted
0 0 0 0 1 0 0 1		list full
0 0 0 0 1 0 1 0		incorrect PIN
0 0 0 0 1 0 1 1		PIN code required
all other values reserved		

In case of 'invalid session number', the invalid session identifier of the acknowledged command is used in the negative acknowledgement.

7.4.10.4.10 Data packet / Data packet last

These packets allow to send data content along with a command.

Table 61: Values used within {IWU to IWU} information element for "Data packet" command

Information element	Field within the information element	Standard values within the field/IE	Normative action/comment
<<IWU to IWU>>	<Length of content>	L	Length of content
	<S/R bit>	1	Transmission of message
	<Protocol Discriminator>	03H	List access
	<Command =data packet / data packet last>	13H/14H	List access command
	<Session identifier>	1..127	Session identifier (see note)
	<Data content byte 0>	0.. 255	Content first byte
	...		
	<Data content byte n >	0.. 255	Content last byte

NOTE: 'Session identifier' can be extended for values up to 16 383 by using the same mechanism as for 'Event multiplicity'. See note at table 39.

'Data packet last' is used if no more data will be sent for this response.

Data content is structured as follows:

Table 62: Data content structure in the "Data packet" command

Information element	Field within the information element	Standard values within the field/IE	Normative action/comment
<<IWU to IWU>>	<Entry identifier for 1 st entry>	0..127	Identifier of the entry (see notes 1 and 2)
	<Entry length>	0..127	Length (see note 1)
	<Entry field identifier 1 >	0.. 255	
	<Entry field length>	0..127	Length (see note 1)
	<Entry field content 0>		
	...		
	<Entry field content i>		
	<Entry field identifier 2 >	0.. 255	
	...		
	<Entry field identifier n >	0..255	
	<Entry field length>	0..127	Length (see note 1)
	<Entry field content 0>		
	...		
	<Entry field content j>		
	<Entry identifier for 2 nd entry>	1..127	Identifier of the entry (see note 1)
<Entry length>	0..127	Length (see note 1)	
...			
Continues with further entries			
NOTE1: 'Entry identifier', 'entry length', and 'entry field length' can be extended for values up to 16 383 by using the same mechanism as for 'Event multiplicity'. See note at table 39.			
NOTE 2: 'Entry identifier' value 0 is used only when performing a 'save entry' command to save a new entry.			

The data content is distributed over several 'data packet' messages. One entry field might be distributed over more than one data packet.

When several entry field identifiers are specified within the data packet command, these field identifiers shall be ordered in ascending numerical order.

NOTE : This is valid for example in the 'read entries confirm', 'edit entry confirm', 'save entry' and 'search entries confirm' related data packets commands.

The maximum information length of a LAPC UI frame is 63 octets (see EN 300 175-4 [4]). As a consequence, each "Data packet" and "Data Packet last" commands can carry up to 56 octets in data content, as the header of "Data packet" message is 7 octets length.

Table 63: Header message structure of "Data packet" command

		Octet:
Transaction Identifier	Protocol Discriminator	1
Message Type = {IWU-INFO}		2
Information element = <<IWU to IWU>>		3
Length of contents; L (octets)		4
Protocol Discriminator = List Access		5
Command = data packet		6
Session identifier		7

If the data content exceeds the 56 octet limit, the data content shall be segmented into two or more data packets and these data packets shall be transmitted consequently.

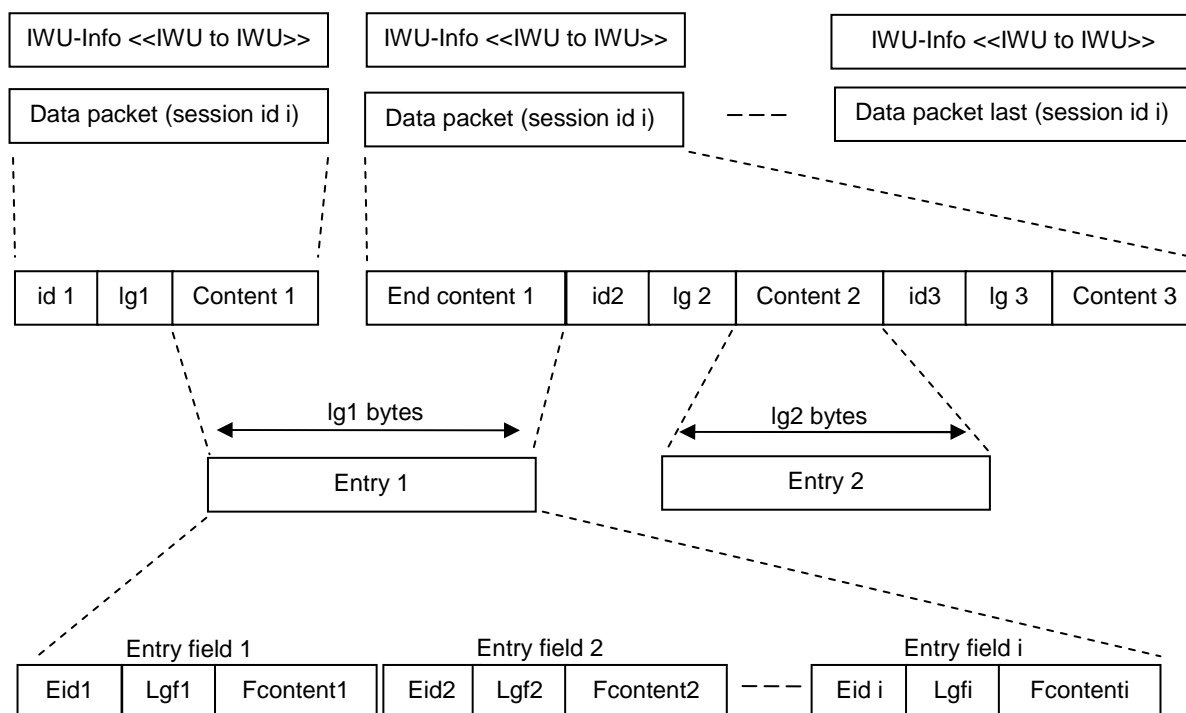

Figure 55: Example of one entry distributed over two data packets

The following notations are used in the figure 55 above:

- id1, id2, id3: entry identifier for entry 1, entry 2 and entry3.
- lg1, lg2, lg3: entry length for entry1, entry 2 and entry 3.
- Content1, Content 2, Content3: entry content for entry 1, entry 2 and entry 3.
- Eid1, Eid2, Eid3: field identifier for field 1, field 2 and field 3 of entry 1.
- Lgf1, Lgf2, Lgfi: field length for field 1, field 2,field I of entry 1.
- Fcontent1, Fcontent2, Fcontenti: field content of field 1, field content of field 2, ...field content of field I of entry1.

For entry field contents see clause 7.4.10.5.1.

7.4.10.5 Lists and entry fields

In the following, the entry field identifiers for various lists are defined.

Proprietary list fields shall have entry field identifiers with the most significant bit set to '1'.

7.4.10.5.1 Fields description

For the fields described in the following clauses:

Field identifier octet:

This field value depends on the list the field is used in, and is indicated for each list in the list definition.

Length octet and related extension bit:

The extension bit of the length octet of a field shall be set to 1 if the length is inferior to 128. If the length is equal or superior to 128, more than one byte is used for the field length, the highbyte shall be send before the lowbyte (e.g. '1' is coded as 81H, '128' is coded as 01H 80H).

The length value (bits 1 to 7 if extension bit is set) shall be the set to the number of octets in the field starting immediately after the last length octet. In particular, it shall include the properties octet defined below.

Properties octet and related extension bit:

For some fields, an "editable" property bit exists. The "editable" property bit is set to "1" by the FP to indicate to the PP if the field of this entry can be further modified by the PP during a save command. If so, the PP may modify the value (octet 4 and more) **and/or** the property bits (octet 3) of the field in a further save command.

The "editable" bit itself can not be modified by the PP (even if set to '1'). Any modification of this bit shall be disregarded by the FP. When creating a new entry (with a save command from PP to FP), the PP may set the "editable" property to any value ('0' or '1'). The FP will ignore this value and set it to the desirable value.

NOTE 1: The "editable" bit should be set to '1' by the FP only when strictly necessary. For example call-related lists entry fields should not be editable. Contact list entry fields should be editable.

The "editable" property bit does not restrict the edit command itself. Any fields (editable or not) can be edited via edit command from the PP. The "editable" property bit prevents modification on this field during the next save entry command.

The "editable" property bit does not restrict the use of the 'edit' command itself, which is provided for editing an entry as a whole. The PP should prevent edition of non-editable fields (i.e. with "editable" property reset), to avoid misleading the user. However, modifications on these fields shall be disregarded by the FP during the next save entry command anyway.

The "PIN protected" property bit allows the FP to protect the field against unauthorised modification by mandating PIN code entering before performing a save command on the field. See clause 7.4.11.1 for details.

NOTE 2: Only editable fields (with "editable" property set to 1) may need to be 'PIN protected'.

Other property bits shall be set correctly by the PP when using the 'save' command.

Error cases are described for each command in dedicated clauses (see clause 7.4.10.4).

7.4.10.5.1.1 Field 'List identifiers'

Bits	8	7	6	5	4	3	2	1	Octet
	Field identifier = List identifiers								1
	Length (L)								2
	0/1	x	x	x	x	x	x	x	3
	1 st supported list identifier								4
	2 nd supported list identifier								5
	...								

For octet 3 'x' indicates, the value is reserved for future use.

The list identifiers shall be ordered in ascending numerical order.

The list identifiers are defined in clause 7.4.10.3.

7.4.10.5.1.2 Field 'Number'

Bits	8	7	6	5	4	3	2	1	Octet
	Field identifier = Number								1
	Length (L)								2
	0/1	editable	internal	own	x	x	x	PIN protected	3
	1 st digit								4
	2 nd digit								
	...								

Each digit shall be out of 30H...39H, 23H, 2AH, 05H, 15H.

For octet 3, each bit indicates whether a property of the field is given (1) or not (0). In case of 'x', the value is reserved for future use.

'Internal' property. The 'Internal' property is used to identify internal phone numbers. It shall be set to 1 when the Number represents a Terminal identity number (see clause 7.4.10.5.1.2.1). It shall be set to 1 in all entries of the internal names list.

NOTE 1: As the call related lists do not include internal calls, this property is only set for the 'internal names list' (see clause 7.4.10.5.8).

'Own' property. The 'Own' property is used to indicate its own entry to the PP which consults the 'internal names list'. It shall be set to 1 for the PP's own entry, and to 0 for all other entries in that list. It is not used in other lists (set to 0 in other lists).

NOTE 2: The contact list does not use the 'Number' field, but the specific 'Contact number' field (see clause 7.4.10.5.1.11).

NOTE 3: 'Editable' property is set to "0" by the FP when the field is used in the 'internal names list'.

'PIN protected' property. The 'PIN protected' property shall be set to '0', unless the field 'Number' is used:

- as 'Dialling Prefix' field in the 'Line settings' list (see clause 7.4.11.4.4);
- as 'Blocked number' field in the 'Line settings' list (see clause 7.4.11.4.7);
- or as 'Terminal id number' field in the 'Internal names' list (see clauses 7.4.10.5.8 and 7.4.10.5.1.2.1 below);

in which cases, this property can be set to '0' or '1' by the FP depending on its security policy on those lists. See clause 7.4.11.1, 'PIN code' subsection, for more information.

7.4.10.5.1.2.1 Field 'number' for terminal identity numbers

This field is also used for terminal identity numbers, if needed. In that case, the digits shall correspond to the decimal representation of the terminal identity numbers coded in IA5. For example:

- For terminal 1, terminal identity number is 0000 0001B, coded value is 31H.
- For terminal 14, terminal identity number is 0000 1110B, coded value is 31H 34H.

7.4.10.5.1.3 Field 'Name'

Bits	8	7	6	5	4	3	2	1	Octet
	Field identifier = Name								1
	0/1	Length (L)							2
	0/1	editable	x	x	x	x	x	x	3
	1 st character byte								4
	2 nd character byte								
	...								

Characters shall be coded as defined for UTF-8.

NOTE: If FP supports contact list, it is recommended to use the name from the contact list (if available) for incoming calls lists (missed and accepted) instead of the CNIP provided by the network.

For octet 3, each bit indicates whether a property of the field is given (1) or not (0). In case of 'x', the value is reserved for future use.

7.4.10.5.1.4 Field 'Date and time'

Bits	8	7	6	5	4	3	2	1	Octet
	Field identifier = Date and time								1
0/1	Length (L)								2
0/1	editable	x	x	x	x	x	x	x	3
	Content as specified for IE <<Time-DATE>> octet 3								4
	Content as specified for IE <<Time-DATE>> octet 4								5
	...								

For octet 3, each bit indicates whether a property of the field is given (1) or not (0). In case of 'x', the value is reserved for future use.

Octets 4 and following are coded as specified for octets 3 and following in IE <<Time-Date>> (EN 300 175-5 [5]). Only 'interpretation' 000000 (=current time/date) is allowed. Any 'coding' is allowed (time or date or time & date).

In case of multiple calls it is recommended that date and time indicate the last call.

7.4.10.5.1.5 Field 'Read status'

Bits	8	7	6	5	4	3	2	1	Octet
	Field identifier = Read status								1
0/1	Length (L)								2
0/1	editable	unread	x	x	x	x	x	x	3

For octet 3, each bit indicates whether a property of the field is given (1) or not (0). In case of 'x', the value is reserved for future use.

Bit 6 of octet 3 ('unread' bit) may take the value 'unread' (1), or 'read' (0). When a new entry is added to the list, the 'unread' bit shall be set (to 'unread' value) by the FP.

The reset of the bit is defined by the 'read status' command, ('Mark entries request' field of the command) see clause 7.4.10.4.3.1.

7.4.10.5.1.6 Field 'Line name'

Bits	8	7	6	5	4	3	2	1	Octet
	Field identifier = Line name								1
0/1	Length (L)								2
0/1	editable	x	x	x	x	x	x	PIN protected	3
	1 st character byte								4
	2 nd character byte								5
	...								

For octet 3, each bit indicates whether a property of the field is given (1) or not (0). In case of 'x', the value is reserved for future use.

'PIN protected' property. The 'PIN protected' property shall be set to '0', unless the field 'Line name' is used in the 'Line settings' list (see clause 7.4.11.4.1), in which case, this property can be set to '0' or '1' by the FP depending on its security policy for this list. See clause 7.4.11.1, 'PIN code' subsection, for more information.

Characters shall be coded as defined for UTF-8.

7.4.10.5.1.7 Field 'Line id'

Bits	8	7	6	5	4	3	2	1	Octet
	Field identifier = Line id								1
0/1	Length (L)								2
0/1	editable	x	x	x	x	x	x	PIN protected	3
	Identifier subtype								
0/1	Identifier value								
...	...								
0/1	Identifier value								

For octet 3, each bit indicates whether a property of the field is given (1) or not (0). In case of 'x', the value is reserved for future use.

'PIN protected' property. The 'PIN protected' property shall be set to '0', unless the field 'Line id' is used in the 'Line settings' list (see clause 7.4.11.4.2), in which case, this property can be set to '0' or '1' by the FP depending on its security policy for this list. See clause 7.4.11.1, 'PIN code' subsection, for more information.

The structure of the Line id field aligns to the structure of IE <<CALL-INFORMATION>> line identifier type (see EN 300 175-5 [5], clause 7.7.56).

Identifier subtype values:

- For all call-related lists, the subtype shall be set to "Line identifier for external call" (call is external).
- For the "Contact list", subtype shall be set to "Relating to" or "All lines", depending on the contact.
- For the "Line settings" list, and for any other list, the subtype shall be set to "Relating to".

7.4.10.5.1.8 Field 'Number of calls'

Bits	8	7	6	5	4	3	2	1	Octet
	Field identifier = Number of calls								1
0/1	Length (L)								2
0/1	editable	x	x	x	x	x	x	x	3
	value								4

For octet 3, each bit indicates whether a property of the field is given (1) or not (0). In case of 'x', the value is reserved for future use.

Value shall be in the interval of 0 to 255.

7.4.10.5.1.9 Field 'Call type'

Bits	8	7	6	5	4	3	2	1	Octet
	Field identifier = Call type								1
0/1	Length (L)								2
0/1	editable	Missed call	Accepted call	Outgoing call	x	x	x		3

For octet 3, each bit indicates whether a property of the field is given (1) or not (0). In case of 'x', the value is reserved for future use.

7.4.10.5.1.10 Field 'First name'

Bits	8	7	6	5	4	3	2	1	Octet
	Field identifier = First name								1
	0/1	Length (L)							2
	0/1	editable	x	x	x	x	x	x	3
	1 st character byte								4
	2 nd character byte								
	...								

For octet 3, each bit indicates whether a property of the field is given (1) or not (0). In case of 'x', the value is reserved for future use.

Characters shall be coded as defined for UTF-8.

7.4.10.5.1.11 Field 'Contact number'

Bits	8	7	6	5	4	3	2	1	Octet
	Field identifier = Contact number								1
	0/1	Length (L)							2
	0/1	editable	default	own	Fixed	mobile	work	x	3
	1 st digit								4
	2 nd digit								
	...								

For octet 3, each bit indicates whether a property of the field is given (1) or not (0). In case of 'x', the value is reserved for future use.

Field 'contact number' can be contained several times in one entry.

A digit is out of 30H...39H, 23H, 2AH, 05H, 15H.

NOTE: 'own' property is used to identify in the contact list, contact numbers belonging to the user of the system. This can be extended to mobile or work numbers thanks to corresponding properties. Several entries in the list may have "own" property set to 1 (for example in case of several mobile numbers, multiple lines systems).

7.4.10.5.1.12 Field 'Associated melody'

Bits	8	7	6	5	4	3	2	1	Octet
	Field identifier = Associated melody								1
	0/1	Length (L)							2
	0/1	editable	x	x	x	x	x	PIN protected	3
	Value								4

For octet 3, each bit indicates whether a property of the field is given (1) or not (0). In case of 'x', the value is reserved for future use.

'PIN protected' property. The 'PIN protected' property shall be set to '0', unless the field 'Associated melody' is used as 'FP melody' in the 'Line settings' list (see clause 7.4.11.4.5), in which case, this property can be set to '0' or '1' by the FP depending on its security policy. See clause 7.4.11.1, 'PIN code' subsection, for more information.

Value shall be in the interval of 0-255. The '00'H value stands for 'melody 1', '01'H stands for 'melody 2', and so on.

The length of the field shall be set to '1' when the value of the field is not defined (default melody used).

7.4.10.5.1.13 Field 'Call interception'

Bits	8	7	6	5	4	3	2	1	Octet
	Field identifier = call interception								1
	0/1	Length (L)							2
	0/1	Editable	x	x	x	x	x	PIN protected	3
	Value								4

'PIN protected' property. The 'PIN protected' property shall be set to '0', unless the field 'Call interception' is used in the 'Internal names' list (see clause 7.4.10.5.8), in which case, this property can be set to '0' or '1' by the FP depending on its security policy for this list. See clause 7.4.11.1, 'PIN code' subsection, for more information.

Value shall be 30H or 31H. 30H stands for call interception not allowed, 31H for call interception allowed.

This field is related to the "call interception" procedure (see clause 7.4.16.2.2). When not allowed, it is forbidden for other PPs to intercept a call initiated by this PP.

By default this field is set to 31 ('allowed' value).

7.4.10.5.1.14 Proprietary fields

Field identifiers from 81H and up to FFH are reserved for proprietary fields. Proprietary fields may be used with any list identifier code. This includes both, the codes defined in clause 7.4.10.3 and the proprietary list identifiers (81H to FFH).

The format of the proprietary field shall be as follows:

Bits	8	7	6	5	4	3	2	1	Octet
	Field identifier = Proprietary Field identifier (1xxxxxx)								1
	0/1	Length (L)							2
	0/1	Editable	p	p	p	p	p	p	3
	1 st octet								4
	...								
	n th octet								

The use and meaning of bits p in octet 3 is up to the implementer.

7.4.10.5.2 "List of supported lists" entry fields-

This list contains the identifiers of the lists which are supported by the FP (as some lists are optional on FP side).

Table 64: "List of supported lists" entry fields

Field identifier	Field	Normative action/comment	Clause
01H	List identifiers	Single variable-length field with identifiers of all supported lists	7.4.10.5.1.1

The list identifiers are defined in clause 7.4.10.3.

The 'List of supported lists' refers to a list with only one entry.

NOTE: The list identifiers are ordered in ascending numerical order (see clause 7.4.10.5.1.1).

Field identifiers from 02H to 80H are reserved for further standardization and shall not be used.

Field identifiers from 81H to FFH are reserved for proprietary fields and may be freely used by implementers for coding of proprietary features.

7.4.10.5.3 "Missed call list" entry fields

This list contains all the external missed calls occurring on any line of the DECT system.

Table 65: "Missed call list" entry fields

Field identifier	Field	Normative action/comment	Clause
01H	Number	Number of the calling party	7.4.10.5.1.2
02H	Name	Name of the calling party	7.4.10.5.1.3
03H	Date and Time	Date and Time of the missed call	7.4.10.5.1.4
04H	Read status	Indicates whether entry is shown first time	7.4.10.5.1.5
05H	Line name	Name of line on which the call was received	7.4.10.5.1.6
06H	Line id	Id of line on which the call was received	7.4.10.5.1.7
07H	Number of calls	Indicates amount of missed calls from this calling party	7.4.10.5.1.8

'Line id' field. The FP shall implement the 'Line id' and 'Line name' fields in the list even if the multiple line feature [NG1.N14] is not implemented in the FP (systems with only 1 line).

'Number of calls' field. Successive unsuccessful calls from the same remote party (and on the same line), that are close enough in time to one another, may be accounted for in a single 'missed call list' entry. In that case the 'Number of calls' field shall hold the number of these calls; otherwise it shall hold the value '1'.

When a new missed call occurs from a party for which an entry already exists in the missed calls list, the FP shall implement one of the two following merging strategies concerning the 'number of calls' field:

- *Strategy 1: no merging of missed calls in the list.* When missed call occurs, a new entry shall be created by the FP with 'number of calls' field set to 1 ('ReadStatus' will be set to 'unread' as this is a new entry).
- *Strategy 2: merging of missed calls from the same party into one list entry.* When missed call occurs, the FP shall modify the existing entry and shall follow the following rules:
 - The FP shall increment the 'number of calls' field (value greater than 1).
 - The FP may update the 'Date and Time' field, for example, with the date and time of the last arrived in time call from this remote party.
 - The FP shall set the "'Read status' to 'unread' value.

In any of these cases, The FP use the appropriate notifications to PPs as defined in clauses 7.4.10.2 (List change notification clause) and 7.4.1.3 (Missed call notification).

PP shall support both strategies.

NOTE 1: In the case of merging strategy, the total number of entries in the list remains unchanged in the notification.

NOTE 2: If one of the PPs was reading the missed calls list when the incoming call arrives the PP may have to restart the session to have a missed call list status consistent with the reality. Especially when implementing some merging. Sorting of the list and read status could have changed in the FP after reading in the PP.

NOTE 3: A FP may decide to implement merging of entries with recent entries and no merging if the existing entry is very old. For example merging only with the most recent entry of the missed calls list (Mix of strategies on a call by call basis).

Field identifiers from 08H to 80H are reserved for further standardization and shall not be used.

Field identifiers from 81H to FFH are reserved for proprietary fields and may be freely used by implementers for coding of proprietary features.

7.4.10.5.4 "Outgoing call list" entry fields

This list contains all external outgoing calls occurring on any line of the DECT system.

Table 66: "Outgoing call list" entry fields

Field identifier	Field	Normative action/comment	Clause
01H	Number	Number of the called party	7.4.10.5.1.2
02H	Name	Name of called party	7.4.10.5.1.3
03H	Date and Time	Date and Time of the call	7.4.10.5.1.4
04H	Line name	Indicates name of line used for the call	7.4.10.5.1.6
05H	Line id	Id of line line used for the call	7.4.10.5.1.7

'Line id' field. The FP shall implement the 'Line id' and 'Line name' fields in the list even if the multiple line feature [NG1.N14] is not implemented in the FP (systems with only 1 line).

Field identifiers from 06H to 80H are reserved for further standardization and shall not be used.

Field identifiers from 81H to FFH are reserved for proprietary fields and may be freely used by implementers for coding of proprietary features.

7.4.10.5.5 "Incoming accepted call list" entry fields

This list contains all the accepted external incoming calls occurring on any line of the DECT system.

Table 67: "Incoming accepted call list" entry fields

Field identifier	Field	Normative action/comment	Clause
01H	Number	Number of the calling party	7.4.10.5.1.2
02H	Name	Name of calling party	7.4.10.5.1.3
03H	Date and Time	Date and Time of the call	7.4.10.5.1.4
04H	Line name	Name of line on which the call was received	7.4.10.5.1.6
05H	Line id	Id of line line used for the call	7.4.10.5.1.7

'Line id field'. The FP shall implement the 'Line id' and 'Line name' fields in the list even if the multiple line feature [NG1.N14] is not implemented in the FP (systems with only 1 line).

Field identifiers from 06H to 80H are reserved for further standardization and shall not be used.

Field identifiers from 81H to FFH are reserved for proprietary fields and may be freely used by implementers for coding of proprietary features.

7.4.10.5.6 "All call list" entry fields

This list contains all external calls (missed, outgoing, incoming accepted) occurring on any line of the DECT system.

Table 68: "All call list" entry fields

Field identifier	Field	Normative action/comment	Clause
01H	Call type	Coding of the list: missed / accepted / outgoing	7.4.10.5.1.9
02H	Number	Number of the calling/called party	7.4.10.5.1.2
03H	Name	Name of calling/called party	7.4.10.5.1.3
04H	Date and Time	Date and Time of the missed call	7.4.10.5.1.4
05H	Line name	Name of line on which the call was received/passed	7.4.10.5.1.6
06H	Line id	Id of line line used for the call	7.4.10.5.1.7

'Line id field'. The FP shall implement the 'Line id' and 'Line name' fields in the list even if the multiple line feature [NG1.N14] is not implemented in the FP (systems with only 1 line).

Field identifiers from 07H to 80H are reserved for further standardization and shall not be used.

Field identifiers from 81H to FFH are reserved for proprietary fields and may be freely used by implementers for coding of proprietary features.

7.4.10.5.7 "Contact list" entry fields

This list contains the contact list (or phone book) for the complete DECT system.

Table 69: "Contact list" entry fields

Field identifier	Field	Normative action/comment	Clause
01H	Name	Name of the contact (last name)	7.4.10.5.1.3
02H	First name	First name of the contact	7.4.10.5.1.10
03H	Contact number	Number of the contact	7.4.10.5.1.11
04H	Associated melody	Ringing melody used for the contact	7.4.10.5.1.12
05H	Line id	Id of line used for the call	7.4.10.5.1.7

'Associated melody'. The 'Associated melody' defines the melody which is used when an incoming call is received from the number in the 'Contact number' field. It allows to select the melody on FP and potentially on PP side.

The support of this field by the FP is optional. The PP may know the presence of the field via the 'query supported entry field' command. The FP may implement this field in two cases :

- Use case 1: when FP has configurable ringing capabilities.
- Use case 2: in order to personnalize the melodies used on PP side but based on the contact list in the FP. This use case may come in addition to use case 1.

When not implemented, the field is not included in any entry of the list.

The support of this field by the PP is also optional.

Use of the field by the FP: if the FP has ringing capabilities, the FP may use it to select the melody to be played on FP side. This melody overrules the 'FP melody' field in the Line settings list. In other words, the FP plays this melody instead of the default melody defined for this line. The volume to be used by the FP shall be the volume defined in the corresponding line setting list entry 'FP volume' field.

If the FP uses the field 'associated melody' to select the FP melody it should also implement 'FP melody' and 'FP volume' fields in the line settings list.

Use of the field by the PP: this field may also be used by the FP to send ring pattern in <<SIGNAL>> IE to the PP. In that case, '00'H value stands for 'Alerting on - pattern 0', '01'H stands for 'Alerting on - pattern 1', and so on. In this case, only values up to '07'H may be transmitted to the PP.

This field may also be set to 'undefined value' (see clause 7.4.10.5.1.12). In this case, the FP shall use its default melody (optionnally defined in the line settings list).

'Line id field'. The FP shall implement the 'Line id' field in the list even if the multiple line feature [NG1.N14] is not implemented in the FP (systems with only 1 line).

If the entry is related to all lines in the system, the field 'Line id/subtype' shall be set to "All lines".

'Contact number field'. The FP shall implement at least two contact number fields per entry in the contact list. The PP shall make accessible to the user at least one contact number per entry of the contact list. (However, the PP shall save the same number of 'contact number' in the 'save entry' command as received in the 'edit confirm' command (see 'save entry command' clause 7.4.10.4.5.1)). PP may know the number of 'contact number' supported by the FP via the 'query supported entry fields' command.

NOTE : From implementation point of view, three contact numbers per entry are recommended on FP side. Each contact number may be of any type (fixed, mobile or work).

Field identifiers from 06H to 80H are reserved for further standardization and shall not be used.

Field identifiers from 81H to FFH are reserved for proprietary fields and may be freely used by implementers for coding of proprietary features.

7.4.10.5.8 "Internal names list" entry fields

This list contains the names of registered PPs of the complete DECT system.

Table 70: "Internal names list" entry fields

Field identifier	Field	Normative action/comment	Clause
01H	Number	Terminal identity number	7.4.10.5.1.2 (see note 1)
02H	Name	Name of the internal party	7.4.10.5.1.3
03H	Call interception	Call interception allowed or not	7.4.10.5.1.13 (see note 2)
NOTE 1: Clause 7.4.10.5.1.2.1 specifies the coding of terminal identity numbers. NOTE 2: 'Call interception' field is relevant for each PP (especially headset PPs) (see clause 7.4.16).			

One and only one entry per terminal identity number shall exist in the "Internal names" list. A PP is not allowed to modify the "number" field using edit and save commands'. If a PP attempts to do so, the FP shall reject it after the save with negative acknowledgement and reject reason "procedure not allowed" (as defined in clause 7.4.10.4.5.2).

When a PP registers to the FP, the FP shall automatically add a corresponding entry in the internal names list (see clause 7.4.11.2) with:

- an assigned "number" (terminal identity number). Editable property bit of the field set to 0B (field not editable);
- a default name. (For example "DECT *n*" where *n* stands for the terminal identity number in decimal representation);
- the 'Call interception' field set to 'allowed' as default value.

User may later set the value of 'Call interception' field to 'Not allowed' if he wants to prevent any call on this specific PP from being intercepted.

When the PP is consulting the 'internal names list', the FP shall dynamically set to 1 the 'Own' property of the 'Number' field of the entry corresponding to this PP. This mechanism allows the PP to avoid displaying its own entry. For example, if user initiates an internal call from PP1 and PP1 displays the internal names list, PP1 has a way to display only PP2, PP3 ...PPn (display of possible remote parties which does not include PP1 itself).

Field identifiers from 04H to 80H are reserved for further standardization and shall not be used.

Field identifiers from 81H to FFH are reserved for proprietary fields and may be freely used by implementers for coding of proprietary features.

7.4.10.5.9 "DECT system settings list" entry fields

See clause 7.4.11.3.

7.4.10.5.10 "Line settings list" entry fields

See clause 7.4.11.4.

7.4.10.5.11 "All incoming calls list" entry fields

This list contains all the incoming calls, including both accepted external incoming calls and missed external calls, occurring on any line of the DECT system. "All incoming calls list" entry fields are the same as "Missed call list" entry fields, see clause 7.4.10.5.3.

For an incoming accepted call entry in the "All incoming calls list":

- the 'Read status' field value shall be set to '0';
- the 'Number of calls' field value shall be set to 1.

Field identifiers from 81H to FFH are reserved for proprietary fields and may be freely used by implementers for coding of proprietary features.

7.4.10.6 List access service call and interactions with voice calls

This section describes list access setup general considerations, and the interactions between the list access service and a voice call using the same DECT NWK layer C/O service instance (the same "call" from DECT NWK layer point of view).

A list access session can be started by a PP either in idle mode or already involved in a call. For this version of the standard, the List access service shall only use the C_S channel.

As the C_F channel shall not be used for this version of the standard, the FP capability bit a₂₆ shall be reset.

The following use cases are covered in this version of the present document:

- The PP in idle mode starts a list access session on C_S channel.
- The PP in idle mode starts a list access session on C_S channel and then places a voice call. The list access session, if not closed, continues on C_S channel.
- The PP in idle mode starts a list access session on C_S channel and then receives (and accepts) a voice call during the list access session. The list access session, if not closed, continues on C_S channel.
- The PP starts a list access session during a voice call on C_S channel.

As a consequence:

- PP and FP shall support "List access setup" as described in clause 7.4.10.6.1.
- PP and FP shall support "List access with possible first voice call initiation" as described in clause 7.4.10.6.2.
- PP and FP shall support "Incoming voice call during existing list access session" as described in clause 7.4.10.6.3.
- PP and FP shall support "List access during existing voice call with possible second call initiation" as described in clause 7.4.10.6.4.
- The PP and FP shall support procedure "Switching between LiA session and voice call" of clause 7.4.10.6.5.
- The PP and FP shall support procedure "Returning to LiA session after voice call termination" of clause 7.4.10.6.6.

In addition, the FP shall temporarily restrict access to some of the lists during a voice call (DECT system, line setting and internal names lists), in order to ensure the integrity of the system while it is used. In this case, FP shall prevent from modifying the requested list entry (negative acknowledgement with reject reason 'temporarily not possible') until the voice call is released. In other words, FP shall temporarily prevent "edit entry", "save entry" and "delete entry" commands for some entries, as well as "delete list" command. PP shall support such answers when requesting those commands on any of the 3 lists.

7.4.10.6.1 List access setup

The list access service can be used, and all lists may be accessed, whatever the call class of the underlying call. In other words, the <call class> field value of the <<basic service>> I.E. used at call setup may be 'Normal call setup', 'Internal call setup', or 'LiA service call setup' defined in EN 300 175-5 [5], clause 7.6.4.

However, the following rules shall be fulfilled:

- 1) If the PP was idle when starting a list access session, it shall use call class 'LiA service call setup', the <basic service> "wideband speech default" and the default setup attributes defined in clause E.2 of EN 300 175-5 [5] because this service call may end up into a voice call.
- 2) If the PP was already involved in a voice call (internal or external) when starting a list access session, it shall continue using the same call and call class.

In case 1 and 2, no call id shall be assigned for the LiA service call.

In case 1, the LiA service call is not connected ({CC-CALL PROC} is used, but no {CC-CONNECT} is used). {CC-CONNECT} is only used if a voice call is subsequently connected. The LiA service call shall be connected later only when a voice call is processed.

If the PP was idle when starting a list access session, it shall initiate a first call using {CC-CETUP} and call class 'LiA service call setup':

- the C_S channel shall be used;
- the FP shall immediately answer with a {CC-CALL-PROC}, without call status nor call id. No call id shall be assigned to the LiA service call;
- the 100 second timer F<CC.04> / P<CC.04> defined in EN 300 175-5 [5], clauses 9.3.1.5 and 9.3.1.6 for a {CC-CALL PROC} message shall not apply in this case on PP side, nor on FP side.

Inactivity timer:

The PP shall implement an inactivity timer mechanism intended for not leaving list access sessions opened for ever on FP side.

If the PP is not involved in a call and no activity is detected on PP side during a certain time on the list access, once list access session is started, PP shall immediately release the call by sending a {CC-RELEASE} and stop the timer.

If the PP becomes additionally involved in a voice call, the inactivity timer may be stopped. It shall be re-started after the end of the voice call if the list access is still opened.

NOTE 1: A possible implementation is that the PP re-starts the timer, each time a list access command is sent by the PP and each time user activity is ongoing in the list on PP side (for example up/down scrolling in a list without any list access command sending).

NOTE 2: Value of the timer is left free to implementation. However it is recommended that the inactivity timer value is no more than 300 seconds.

7.4.10.6.2 List access with possible first voice call initiation

The provisions of 7.4.10.6.1 shall be respected. Additionally, if the list access session is intended to establish a first voice call:

- The PP shall initiate a pseudo outgoing parallel call by using the "Outgoing parallel call initiation" procedure (see clause 7.4.3.5.1) with the following modifications:
 - The PP is using the number (external or internal) read from the list access session, sent in a single CC-INFO message ('1C15'H / '17'H + called number) along with a line identifier.
- The PP may close the list access session, by using the 'End session command' (see clause 7.4.10.4.1.3), after the CC-INFO has been sent to make sure the FP does not release the link in the meantime.

NOTE 1: Actually the PP is using the outgoing *parallel* call initiation procedure, in order to establish a *first* call, because the link was already established when starting the list access session.

NOTE 2: There is at this point an implicit change of call class, from 'LiA service call setup' to 'Normal call setup', or to 'Internal call setup'.

- The FP shall immediately answer with a CC-CONNECT, along with a default codec, in order to connect the U-plane (active audio path). This allows to handle the rest of the voice call as a pseudo outgoing parallel call. Neither call id nor call status nor line id are sent along with CC-CONNECT, as they are sent in subsequent CC-INFO as for regular outgoing parallel call.
- The FP shall then send the appropriate call status (most likely 'CS call proc') in a subsequent CC-INFO message, with the newly assigned call id.
- The codec negotiation shall be carried out as for a normal first outgoing voice call, (optional <<CODEC-LIST>> sent in {CC-SETUP}, mandatory <<CODEC-LIST>> with a single codec sent (once) by the other side with <<PROGRESS-INDICATOR>> at the latest (if used), or in {CC-CONNECT}). See TS 102 527-1 [21], clause 7.3.3). This means that a default codec is chosen by the FP at latest in CC-CONNECT.
- If the default codec is not suitable for the voice call, a codec switching may be initiated by the FP. In this case, this will very probably be performed between the outgoing parallel call initiation by the PP, and the sending of the 'CS call connect' call status by the FP.
- If the PP left the list access session open, the FP and PP shall comply with procedure "Switching between LiA session and voice call" of clause 7.4.10.6.5.
- In order to return to the LiA session at the end of the voice call if it remained open, the PP and FP shall use the procedure "Returning to LiA session after voice call termination" of clause 7.4.10.6.6.

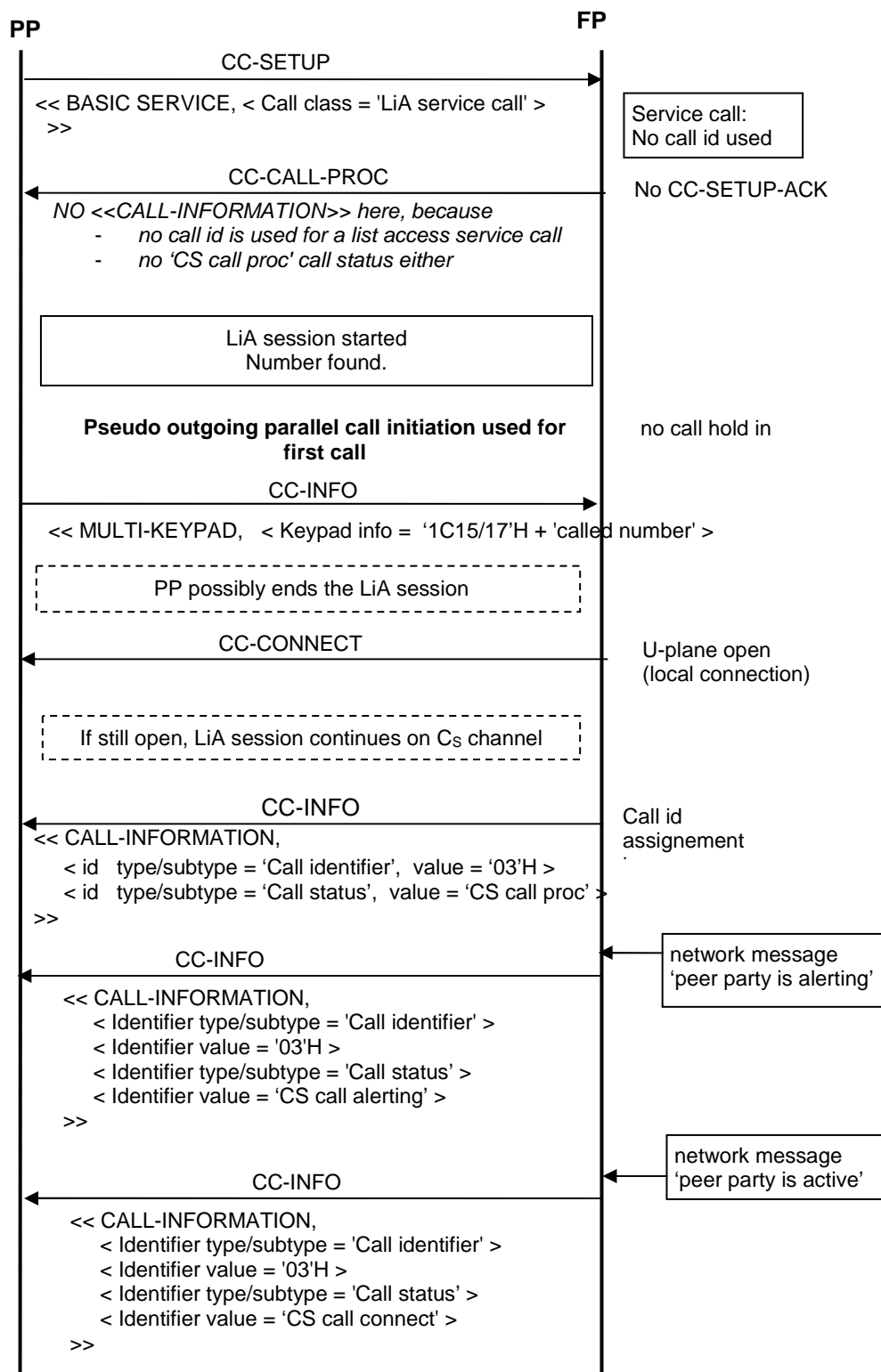

Figure 56: List access with possible first voice call initiation

NOTE 3: For conciseness of the figure, neither line identifier nor codec negotiation are represented.

7.4.10.6.3 Incoming first voice call during existing list access session

If an incoming voice call is received when the PP is involved in a list access session:

- The FP shall first answer with a CC-CONNECT along with a default codec, in order to connect the U-plane (active audio path). This allows to handle the incoming voice call as a pseudo call waiting. Neither call id nor call status nor line id are sent along with CC-CONNECT, as they are sent in subsequent CC-INFO as for regular call waiting (and actually for a first incoming call, the CC-CONNECT would be in the other direction).
- The FP shall present a pseudo call waiting to the PP by using the "Call waiting indication" procedure (see clause 7.4.3.5.2) in order to present the incoming call to the PP (including the call id for this call).

NOTE 1: The call waiting indication procedure is used here for presenting a first call, because the link was already established when starting the list access session.

- The PP shall present the incoming call to the user. For example by ringing as for an incoming first call.
- The FP shall also present the incoming call as a first call to any other idle PP.
- If the user accepts the call, the PP may close the list access session, prior to sending the call waiting acceptance, by using the 'End session command' (see clause 7.4.10.4.1.3).
- The PP and FP shall support **all** call waiting related parallel call procedures defined in clause 7.4.3.5 in order to handle the pseudo call waiting (including the handling of call id, call statuses, exception cases, etc.). More specifically:
 - If the PP wishes to answer the incoming call, it shall use the "Call waiting acceptance" procedure (see clause 7.4.3.5.6), with the following modifications:
 - The FP shall send the 'CS call connect' call status (with the call id) in a subsequent CC-INFO message.
 - As the procedure is used here for a first call, the FP shall not send back any 'CS call hold' call status to the PP (no call to be put on hold).
 - If the PP wishes to reject the incoming call, it shall use the "Call waiting rejection" procedure (see clause 7.4.3.5.7), with no modification.
 - The handling is similar to clause 7.4.6.6 "returning to LiA session after voice call termination" (case where PP hangs up the call). FP shall mute the audio.

NOTE 2: There is at this point an implicit change of the call class, from 'LiA service call setup' to 'Normal call setup', or to 'Internal call setup'.

- The codec negotiation shall be carried out as for a first outgoing voice call (although we are in an incoming voice call scenario) : optional <<CODEC-LIST>> sent in {CC-SETUP}, mandatory <<CODEC-LIST>> with a single codec sent (once) by the other side with <<PROGRESS-INDICATOR>> at the latest (if used), or in {CC-CONNECT}. See TS 102 527-1 [21], clause 7.3.3). This means that a default codec is chosen by the FP at latest in CC-CONNECT.
- If the default codec is not suitable for the voice call, a codec switching may be initiated by the FP. In this case this will very probably be performed between the call waiting acceptance by the PP and the sending of the 'CS call connect' call status by the FP.
- If the PP left the list access session open, the FP and PP shall continue using the C_s channel for the list access session.
- In order to return to the LiA session at the end of the voice call if it remained open, the PP and FP shall use procedure "Returning to LiA session after voice call termination" of clause 7.4.10.6.6.

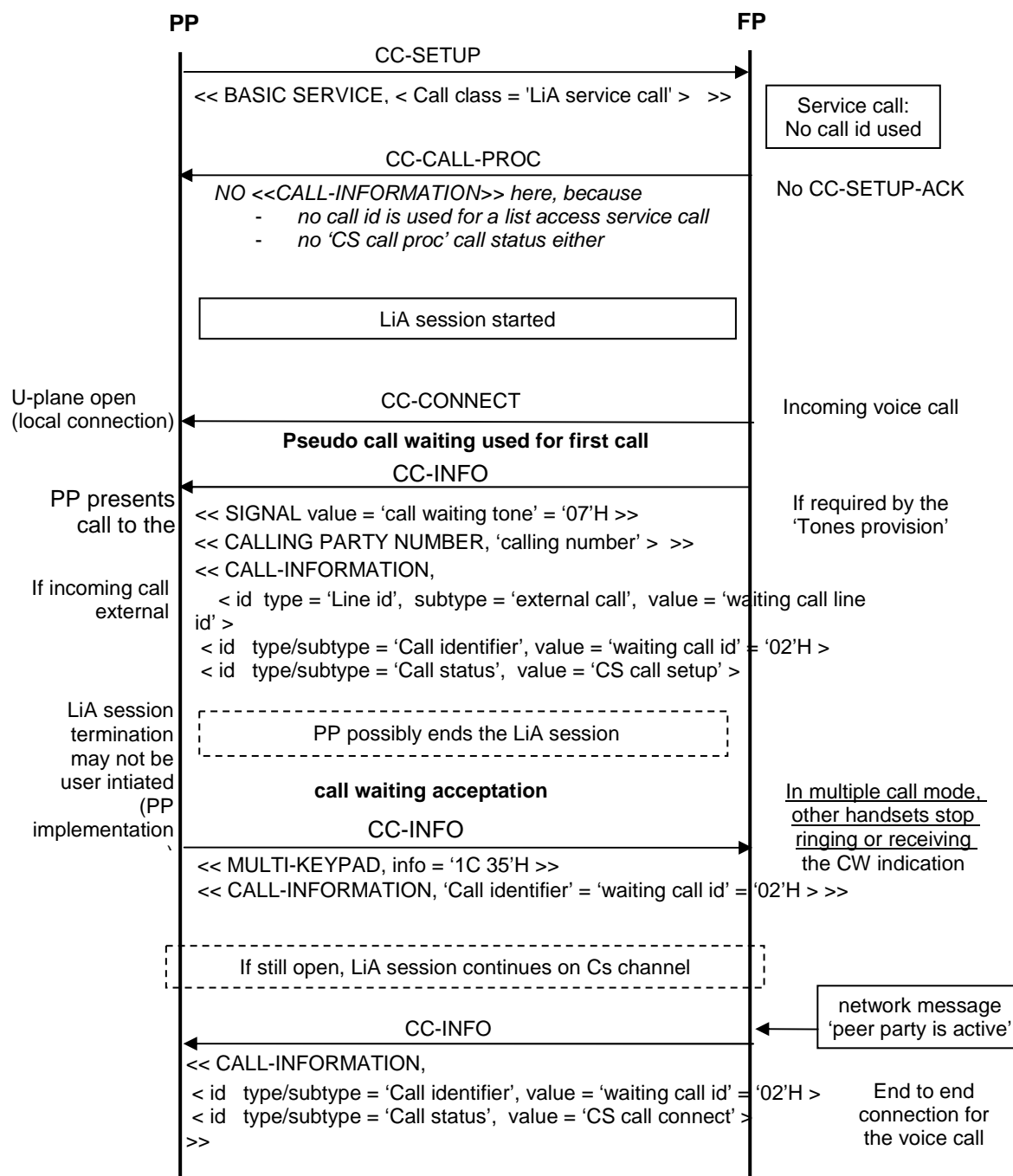

Figure 57: Incoming first voice call during existing LiA session, connected in the same call

NOTE 3: For conciseness of the figure neither line identifier nor codec negotiation are represented.

7.4.10.6.4 List access during existing voice call with possible second call initiation

This procedure illustrates the use of a regular parallel call initiation in case a second call is setup when a list access session and a voice call were already established in parallel.

NOTE: This is in contrast to clause 7.4.10.6.2 which uses a pseudo outgoing parallel call initiation.

If the PP was already involved in a voice call (internal or external) when starting a list access session (e.g. contacts list consultation for a parallel call initiation use case):

- the PP shall comply with procedure "Switching between LiA session and voice call" of clause 7.4.10.6.5 when starting the LiA session;

- the FP shall not assign any call id for the list access session.

Additionally, if the list access session is intended to establish a *parallel* voice call, and when the number to be called has been found:

- the PP shall use procedure "Switching between LiA session and voice call" of clause 7.4.10.6.5, in order to handle the switching from the LiA session to the first active voice call;
- the PP shall use the "Outgoing parallel call initiation" procedure (see clause 7.4.3.5.1) using the number (external or internal) read from the list access session;
- the PP may close the list access session, by using the 'End session command' (see clause 7.4.10.4.1.3), after the CC-INFO (initiating the parallel call) has been sent to make sure the FP does not release the link in the meantime.

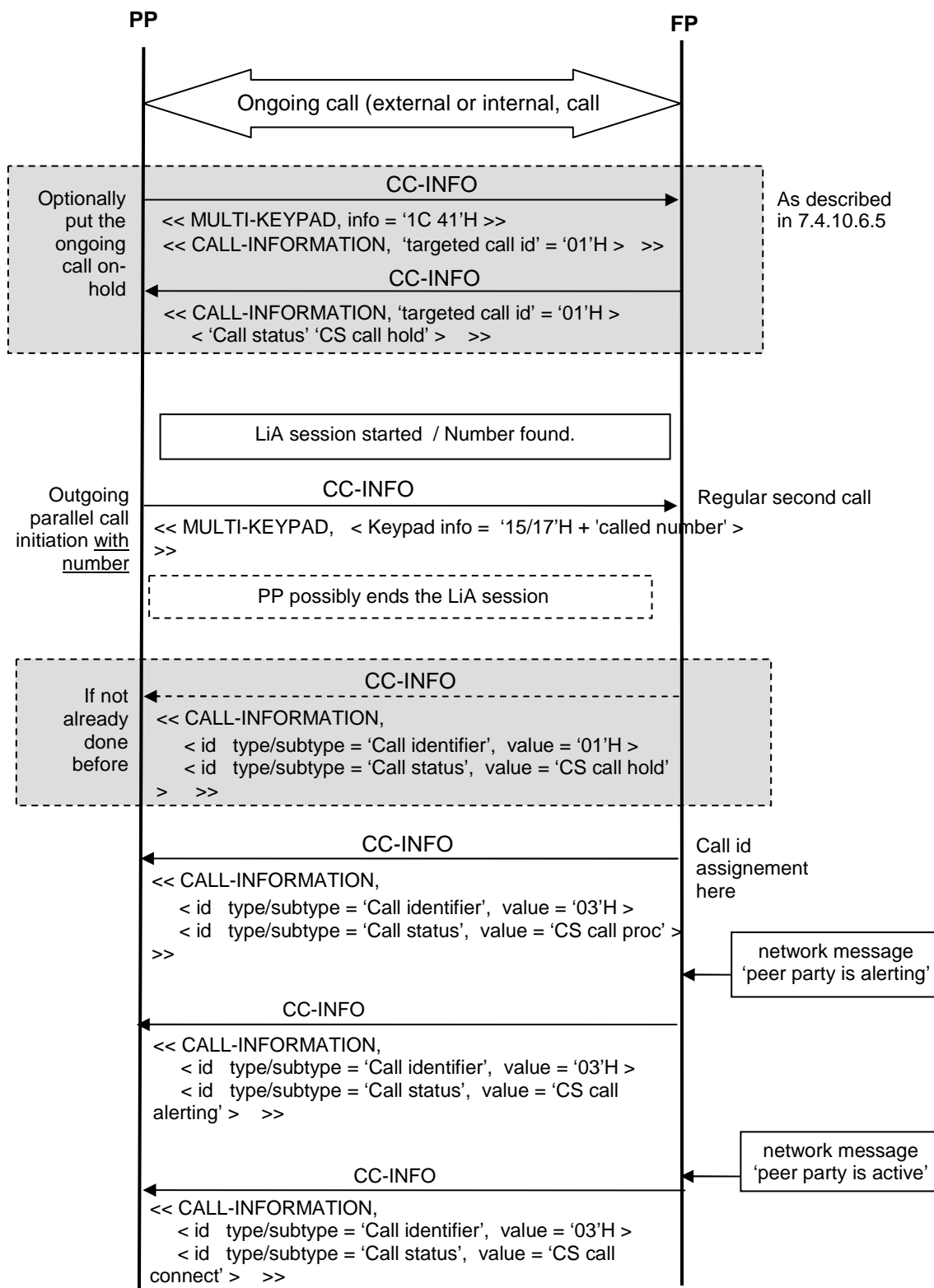

Figure 58: List access during existing voice call with second call initiation

7.4.10.6.5 Switching between LiA session and voice call

This procedure is used when a list access session is open on C_S channel and a voice call is active in parallel.

The following rules shall be applied:

- if the voice call is started while a list access session was already open, the FP and PP shall continue using the C_S channel for the list access session. The voice call initiation (incoming or outgoing) is described in other procedures;
- the list may be accessed any time during the voice call, through IWU to IWU messages;
- the U-plane always remains connected for the duration of the call;
- if a list access session is started while a voice call is active, the voice call may be put on hold; otherwise, the voice path with the remote party remains open.

NOTE: If the LiA session is open for starting a second call (contact list consultation), putting the active call on-hold only anticipates what will happen when the second call will be initiated.

7.4.10.6.6 Returning to LiA session after voice call termination

This procedure is applicable only if a LiA session is still opened at the time a voice call is terminated.

NOTE : For example this procedure is not applicable if the PP decides to close the LiA session before hanging up the voice call. A simple CC-RELEASE can be used in this case.

There are two cases of voice call termination while leaving the LiA open:

- If the remote party hangs up, the FP shall release the call using 'CS idle' as defined in clause 7.4.3.5.4, but shall not release the link.
- Additionally, the PP may terminate the voice call and leave the list access session active by using a call release request as defined in clause 7.4.3.5.4. In that case, the PP shall re-start the inactivity timer when sending the call release request.

In both cases, when the voice call is terminated:

- the FP shall maintain the link until the list access session is closed;
- the U-plane shall remain open;
- and the audio shall be muted (FP shall send mute pattern as defined in 102 527-1 [21], annex B and ignores the audio received from the PP).

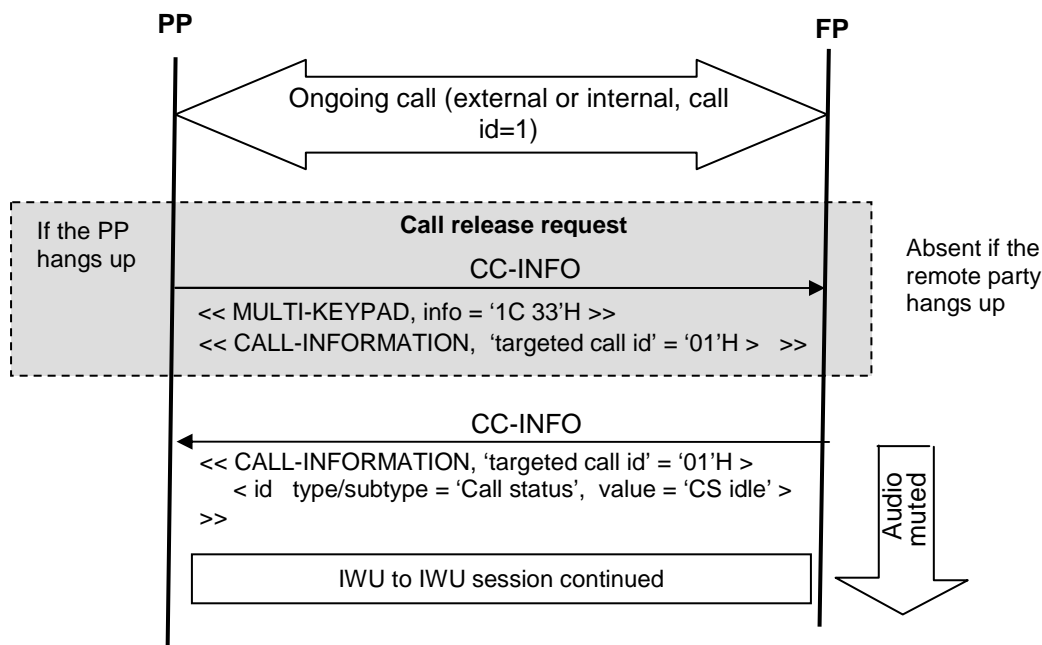

Figure 59: Returning to LiA session after voice call termination

7.4.10.7 Generic sequence charts for list access

See clause B.3 for examples of sequence charts for list access.

7.4.10.8 Use case examples for list access

See clause C.5, C.6, C.7 and C.8 for examples of use cases for list access.

7.4.11 DECT system and line settings

7.4.11.1 DECT system and line settings considerations

DECT system and line settings shall use the "List access service" procedures with the following additional requirements.

DECT system settings consist of a set of settings that are valid for the complete DECT system, i.e. valid for all registered PPs independently of line / multiple line concepts. They are stored in the FP as a unique list with only one entry in the list. Each setting is a field of this entry.

Line settings consist of a set of settings that are valid for one line of the DECT system, i.e. valid for all registered PPs attached to this line. They are stored in the FP as a unique list with one entry per line in the list. Each setting is a field of this entry. Even if the DECT system does not implement multiple line features, the FP and PP shall support line settings with only one entry: the settings for the only line supported by the system.

Sorting of the lists:

No sorting is defined for the "DECT system settings" list, as it contains only one entry.

The "Line settings" list is sorted by ascending line id number.

Commands:

All the "List access service" feature commands shall be supported for the "DECT system and line settings" feature, except for:

- The "delete entry" command is not allowed for the "DECT system settings" list.

The "delete list" command is not allowed for the "DECT system settings" list, nor for the "Line settings" list.

These commands shall not be invoked by any PP and shall be answered with negative acknowledgement from the FP with reject reason "procedure not allowed" (see clause 7.4.10.4.9).

Saving a new line setting entry or deleting a line setting entry is allowed (when creating or removing a line for the DECT system). Please refer to clause 7.4.11.2 "Interactions between registration, attachment of handsets and lists" for impacts.

Only one entry per line identifier shall exist in the "Line settings" list. In other words, two distinct entries shall never have the same line id (see clause 7.4.11.3 for details).

Settings (fields of DECT system and line settings lists):

Some DECT system or line settings are mandatory and shall be supported both by the FP and the PP. Please refer to clause 6.10, table 9 for status of each setting. When a setting is mandatory in the table, the related field is mandatory and shall be implemented in the PP and the FP.

The PP may use the "Query supported entry fields" procedure (see clause 7.4.10.4.2) to know which settings (fields) are supported by the FP. The FP shall answer with mandatory and optional settings implemented in the FP. This way, the PP will be able to give proper indication to the user (when accessing the settings menus for example).

All settings shall have default value set when product is manufactured. Some of these settings may be reset to default value with the "Base reset" setting. Please refer to tables 71 and 72 for details.

For some specific settings, a PP may request the reset of the setting/field by setting the field length to 1 (only octet 3 available in entry field). The field itself is not removed from the FP list entry. For each field this possibility is described in clause 7.4.11.4. It has to be noted that resetting some fields in some lists can be dangerous and should be carefully controlled by the PP (FP IP address for example).

EXAMPLE: If no dialling prefix is set, the length of this field shall be one.

The PP may modify 1 to n setting(s) by using an "Edit entry" command with the following parameters: (session identifier, entry identifier=1, 1 to n field identifiers).

PIN code:

For security reasons, the PIN code shall never be sent over the air on a non ciphered link. Moreover, the FP shall prevent a non-allowed PP to save a new PIN code:

The PIN code is used-among other uses-to protect the following lists against unauthorised *modifications* of some or all of their fields:

- 'DECT system settings' list (including the PIN code itself).
- 'Line settings' list.
- 'Internal names' list.

The *reading* of fields is not protected. The PIN code itself ('DECT system settings' list) is not readable, even after successful PIN authentication (an invalid value is returned in any case).

For each of the lists above, the subset of fields that require protection is left free to the implementer. If the FP requires 'PIN protection' for a field, it shall set to '1' the 'PIN protected' property of that field when sending it to the PP.

However, the FP shall always PIN protect the 'New PIN code' field of the 'DECT system settings' list.

For the PIN code value, two distinct fields are defined in the 'DECT system settings' list, which are both protected against reading:

- the 'Current PIN code' field is only used to check the PIN code entered by the user. As it is not directly modifiable, it is not considered as 'PIN protected';
- the 'New PIN code' field is used to modify the PIN code and is therefore always 'PIN protected'.

At least when accessing either the 'Current PIN code' or the 'New PIN code' setting of the "DECT system settings" list, with any command, the connection shall be ciphered; i.e.:

- for "Read entries confirm", "Search entries confirm", "Edit entry confirm", "Save entry" and "Save entry confirm" commands that includes the PIN code fields 'Current PIN code' and 'New PIN code' in data packets, the DECT link shall be ciphered prior to the command;
- if this not the case, the FP shall answer with a negative acknowledgement, with reject reason = "procedure not allowed" (see clause 7.4.10.4.9).

For the 'Current PIN code' and 'New PIN code' fields of the 'DECT system settings' list, and after any 'Edit entry' or 'Read entry' command on any of these two fields:

- the FP shall answer with the invalid value 'FFFFFFFF'H, instead of the real value of the field.

For any 'PIN protected' field of the 'DECT system setting', 'Line setting', or 'Internal names' lists (including the 'New PIN code' field of the 'DECT system settings' list):

- before saving a new value for that PIN protected field, the PP shall:
 - open a (parallel) list access session with the 'DECT system setting' list, if such a session does not already exist (i.e. if the field to protect is not from that list),
 - perform the 'Edit entry' and 'Save entry' commands on the 'Current PIN Code' field of the 'DECT system setting' list:
 - After the 'Save Entry' command, the FP shall compare the received value with the stored value of the field, but the FP shall not modify this stored value.
 - If the entered PIN code is correct (the 'Save Entry' command was successful), the FP shall allow the PP to save a new value for the PIN protected field in the same list access session via the "Save entry" command.
 - If the entered PIN code is incorrect, the FP shall answer with a negative acknowledgement with reject reason 'incorrect PIN'.
- when using a 'Save entry' command for modifying the value of that PIN protected field:
 - In case the field to be modified is the 'New PIN code' field, the new value shall be stored in both the 'Current PIN code' and 'New PIN code' fields.
 - As soon as there as been a 'DECT system settings' list access session with correct PIN authentication in the current call all subsequent modifications on any of the three lists are allowed during the same call.
 - In all cases, if the 'Save entry' command occurs at a point in time where, in the same call:
 - there has been no successful save of the 'Current PIN code' field before; or
 - there has been an unsuccessful save of that field before;
 - the FP shall answer with a negative acknowledgement with reject reason 'PIN code required'.

Access to the "DECT system settings" menu on the PP may be conditioned to prior PIN code keyboarding and may be completely in ciphered mode. This is left free to the implementer.

See clauses C.7.2, C.7.4 and C.8.4 for examples of use cases related to PIN code and PIN code protected fields.

Initial value:

The "DECT system settings" list unique entry is at position index 1 in the DECT system list.

First "Line settings" list entry is at position index 1 in the line settings list.

7.4.11.2 Interactions between registration, attachments of handsets and lists

"Internal names" list fully reflects the registered PPs. At registration of a handset, the FP shall add a new entry in the "Internal names" list with a default name. "

With a "mono-line" FP, the FP shall automatically attach the PP to the unique line, "Attached handsets" setting in the line setting list entry shall also automatically be updated by the FP with corresponding bit set.

With a "multiple lines" FP (FP connected to several lines and implementing the multiple lines feature [NG1.N.14], the FP should automatically attach the registered PP to at least one line (i.e. update "Attached handsets" setting in at least one entry of the line settings list). This default attachment may be later updated by the PP or done on FP side (e.g. through a web interface). Other implementations are allowed (i.e. attaching the PP to all lines by default).

Except during a temporary period (i.e. as result of modifications/creations/deletions of lines), a registered handset shall always be attached to at least one line: the PP shall appear at least in one "Attached handset" field of one line setting. It may appear in several line settings if it is attached to several lines.

Deleting an entry in the "Internal names" list shall result in the de-registration of the corresponding handset from the system using the "Terminating access rights FT initiated" procedure. This procedure shall be performed as defined in EN 300 444 [12], clause 8.31. The "Attached handsets" field in the line setting(s) list shall also be automatically updated by the FP. In case the corresponding handset is out of range when the 'delete entry' request is processed, the FP shall delay the "Terminating access rights FT initiated" procedure until the PP goes back in range. The PP shall be however immediately removed from the 'internal names list' and from the 'Attached handset' fields.

Deleting one entry (one line) of the line settings list shall result in the de-attachment of the corresponding handsets from the line. If, as a consequence of a "delete entry" command on the line settings list, a handset is no longer attached to any line anymore, it shall however remain registered and available in the "Internal names" list. This handset is no longer reachable from external lines. This temporary state may arise especially when removing and creating new lines.

NOTE 1: This mechanism makes it possible to register/unregister any handset to/from the DECT system, and to attach/detach it to/from a line in two separate steps.

NOTE 2: As specified in the "Multiple lines" feature NG1.N.14, attachment may be PP-managed (for example, the user chooses the line at registration) or FP-managed (for example, the handset is attached by default to a line).

A FP may decide not to implement the 'delete entry' and 'save entry' (for creating a new entry) commands for the line settings list. If the FP does not implement those commands it shall however answer those commands with negative acknowledgement reject reason 'procedure not allowed'. The PP shall support such answers.

NOTE 3: This may be the case for a FP using a web interface to configure the line settings. Or for a FP supporting some PSTN lines (as the FP is designed by default with a given number of PSTN line connectors).

NOTE 4: The 'save entry' command used for modifying an existing entry remains possible on FP side.

If the "Base reset" influences the "Internal names" list or the "Line settings" list attached handsets, the corresponding handsets de-attachments and un-registrations shall be correctly handled.

7.4.11.3 DECT system settings list

The following entry fields are defined for the (singular) DECT system list entry.

Table 71: Entry fields for the (singular) DECT system list entry

Field identifier	Field	Default value	Base reset impacted	Normative action/comment	Clause
01H	Current PIN code	YES/MD	MD	Before a PIN protected field (i.e.: a new PIN code) can be saved an edit/save of the current PIN code is required	7.4.11.3.1
02H	Clock master	MD	MD	Defines the entity which sets date and time for the DECT system (PP or FP)	7.4.11.3.2
03H	Base reset	YES	YES	Sets settings back to default factory values	7.4.11.3.3
04H	FP IP address / type	MD	MD	DHCP or static	7.4.11.3.4
05H	FP IP address / value	MD	MD	Editable only for static IP address	7.4.11.3.5
06H	FP IP address / subnet mask	MD	MD	Editable only for static IP address	7.4.11.3.6
07H	FP IP address / gateway	MD	MD	Only for static IP address	7.4.11.3.7
08H	FP IP address / DNS server	MD	MD	Only for static IP address	7.4.11.3.8
09H	FP version / Firmware version	YES/MD	NO	Software version of the FP	7.4.11.3.9
0AH	FP version / Eeprom version	YES/MD	NO	Eeprom version of the FP	7.4.11.3.10
0BH	FP version / Hardware version	YES/MD	NO	Hardware version of the FP	7.4.11.3.11
0CH	Emission mode	MD	MD	Bitmap for activating/deactivating the 'No Emission mode', etc.	7.4.11.3.12
0DH	New PIN code	YES/MD	MD	Allows modification of the PIN code	7.4.11.3.13

Field identifiers from 0EH to 80H are reserved for further standardization and shall not be used.

Field identifiers from 81H to FFH are reserved for proprietary fields and may be freely used by implementers for coding of proprietary features.

Default value: it is the value of the setting when product is manufactured:

- "YES" means that a default value is standardized. See corresponding setting clause definition.
- "MD" means that a default value shall be provided by the manufacturer (could also be empty by setting the length to 1).
- "YES/MD" means that a default value shall be provided by the manufacturer, which shall not be empty.

"Base reset" impacted: describes the impact of the "Base reset" setting on this particular setting:

- "YES" means setting is reset to default value when "Base reset" setting is activated.
- "NO" means setting is not impacted by "Base reset" setting.
- "MD" means manufacturer defines if the setting is impacted or not by the "Base reset" setting.

7.4.11.3.1 Field 'Current PIN code'

The 'PIN code' field shall be coded as follows.

Bits	8	7	6	5	4	3	2	1	Octet
	Field identifier = Current PIN code								1
	0/1	Length (L)							2
	0/1	Editable	x	x	x	x	x	x	3
	1 st byte								4
	2 nd byte								
	3 rd byte								
	4 th byte								

The 'Current PIN code' field shall respect the following rules:

- the PIN shall always have a length of 32 bits;
- each decimal digit entered by the user, is translated into one nibble (4 bits, BCD coded). The PT shall be capable to accept any PIN between 0 and 8 decimal digits (limits included);
- the resulting string of nibbles is padded with as many leading 'F'H nibbles as necessary to achieve a total of 8 nibbles;
- the result is a bitstring of 32 bits;
- on "Read Entry" or "Edit Entry" commands from the PP the FP shall always answer with the value 'FF'H 'FF'H 'FF'H 'FF'H in order not to disclose the actual value of this field;
- on a "Save Entry" command from the PP, the FP shall not overwrite the stored value of the 'Current PIN code' field. This field is only used in order to compare the value submitted by the user with the stored value. As described in clause 7.4.11.1 ('PIN code' subsection), the field value shall be changed by the FP when the field 'New PIN code' field is successfully saved.

EXAMPLE: A value of "1091" (4 decimal digits entered via keypad) is translated into a bitstring pin code of the following value:

"1111 1111 1111 1111 0001 0000 1001 0001",

MSB: PIN[31] LSB: PIN[0]

and coded as shown in figure 60:

|FFH|FFH|10H|91H|

Figure 60: Example of PIN code coding

7.4.11.3.2 Field 'Clock master'

The 'Clock master' field shall be coded as follows.

Bits	8	7	6	5	4	3	2	1	Octet
	Field identifier = clock master								1
	0/1	Length (L)							2
	0/1	Editable	x	x	x	x	x	PIN protected	3
	Value								4

'PIN protected' property (bit 1 of octet 3). The 'PIN protected' property allows the FP to protect the 'Clock master' field against unauthorised modification, depending on its security policy.

'Value' octet (octet 4). The 'Value' octet shall be 30H or 31H. 30H stands for FP, 31H stands for PP.

The behaviour of the PP and FP according to 'Clock master' field setting shall be consistent with the "Date and Time synchronization" feature described in clause 7.4.2.

Bits 2 to 6 of octet 3 are reserved for further standardization and shall be set to "0".

7.4.11.3.3 Field 'Base reset'

The 'Base reset' field shall be coded as follows.

Bits	8	7	6	5	4	3	2	1	Octet
	Field identifier = base reset								1
	0/1	Length (L)							2
	0/1	Editable	x	x	x	x	x	PIN protected	3
	Value								4

'PIN protected' property (bit 1 of octet 3). The 'PIN protected' property allows the FP to protect the 'Base reset' field against unauthorised modification, depending on its security policy.

'Value' octet (octet 4). The 'Value' octet shall be 30H or 31H. 30H stands for 'No', 31H stands for 'Yes'.

The 'Base reset' field shall respect the following rules:

- If at least one DECT system setting, or line setting, has been set to a non default value, the 'Base reset' field shall be equal to 'No' when a PP performs a read command.
- If a registered PP sets the value to 'Yes', after the save confirm command:
 - All DECT system and line settings shall be reset to their default value in the FP.
 - When the base reset is complete, the FP shall carry out the 'base reset' related requirements of clauses 7.4.1.3 ('Missed call notification') and 7.4.10.2 ('List change notification').
 - The setting shall remain set to 'Yes' until any DECT system or line setting is changed in the FP.
 - Additionally, if the FP performs a software reboot:
 - FP may send an 'end session' command on each LiA opened session;
 - FP shall release all existing LiA calls in the system by sending a {CC-RELEASE} to the concerned PPs.
 - PP shall support the possible reception of {CC-RELEASE} (for example linked to the reboot of the FP);
 - If the FP does not perform a software reboot, all LiA sessions may remain opened until terminated by the PP.
- Any attempt from a PP to set this parameter to 'No' shall result in a negative acknowledgement, with reject reason "procedure not allowed" from the FP (see clause 7.4.10.4.9).

Default value: 31H ('Yes').

Bits 2 to 6 of octet 3 are reserved for further standardization and shall be set to "0".

7.4.11.3.4 Field 'FP IP address / type'

The 'IP address type' field shall be coded as follows.

Bits	8	7	6	5	4	3	2	1	Octet
	Field identifier = IP address type								1
	Length (L)								2
	0/1	Editable	DHCP	Static	x	x	x	PIN protected	3

'PIN protected' property (bit 1 of octet 3). The 'PIN protected' property allows the FP to protect the 'FP IP address / type' field against unauthorised modification, depending on its security policy.

'DHCP' and 'Static' properties (bit 5 and 6 of octet 3). The IP address of the FP may be assigned dynamically using DHCP or manually using a static address entered by the user. The two property bits are exclusive (only one bit must be set at a time).

If the 'FP IP address / type' field is implemented in the FP, either 'DHCP' or 'Static' property shall be set to '1' (The PP can not set both properties to '0').

Bits 2 to 4 of octet 3 are reserved for further standardization and shall be set to "0".

7.4.11.3.5 Field 'FP IP address / value'

The 'IP address value' field shall be coded as follows.

Bits	8	7	6	5	4	3	2	1	Octet
	Field identifier = FP IP address / value								1
	0/1	Length (L)							2
	0/1	Editable	IPv4/6	x	x	x	x	PIN protected	3
	1 st byte								4
	2 nd byte								
	3 rd byte								
	...								

Length octet (octet 2). The length of the field shall be set to '1' when the value of the field is not defined by the user.

'PIN protected' property (bit 1 of octet 3). The 'PIN protected' property allows the FP to protect the 'FP IP address / type' field against unauthorised modification, depending on its security policy.

'IPv4/6' property (bit 6 of octet 3). If set to 0, the format is IPv4 (4 bytes long); if set to 1, the format is IPv6 (16 bytes long).

Address value (from octet 4):

An IPv4 address shall always have a length of 4 bytes.

EXAMPLE 1: A value of 192.168.213.1 is translated into an 'IP address / value' field with the following bytes: 'C0A8D501'H.

An IPv6 address shall always have a length of 16 bytes.

EXAMPLE 2: A value of fd11:2233:4455:1:a:b:c:d is translated into an 'IP address / value' field with the following bytes: 'FD11223344550001000A000B000C000D'H.

Bits 2 to 5 of octet 3 are reserved for further standardization and shall be set to "0".

7.4.11.3.6 Field 'FP IP address / subnet mask'

The 'IP address value' field shall be coded as follows.

Bits	8	7	6	5	4	3	2	1	Octet
	Field identifier = FP IP address / subnet mask								1
	0/1	Length (L)							2
	0/1	Editable	IPv4/6	x	x	x	x	PIN protected	3
	1 st byte								4
	2 nd byte								
	3 rd byte								
	...								

Length octet (octet 2). The length of the field shall be set to '1' when the value of the field is not specified by the user.

'PIN protected' property (bit 1 of octet 3). The 'PIN protected' property allows the FP to protect the 'FP IP address / subnet mask' field against unauthorised modification, depending on its security policy.

'IPv4/6' property (bit 6 of octet 3). If set to 0, the format is IPv4 (4 bytes long), if set to 1, the format is IPv6 (16 bytes long).

Subnet mask value (from octet 4):

A subnet mask for IPv4 shall always have a length of 4 bytes.

EXAMPLE 1: A value of 255.255.255.0 is translated into an 'IP address / subnet mask' field with the following bytes: 'FFFFFFF0'H.

A subnet mask for IPv6 shall always have a length of 16 bytes.

EXAMPLE 2: A subnet mask corresponding to a 59-bit prefix is translated into an 'IP address / subnet mask' field with the following bytes: 'FFFF FFFF FFFF FFE0 0000 0000 0000 0000'H.

Bits 2 to 5 of octet 3 are reserved for further standardization and shall be set to "0".

7.4.11.3.7 Field 'FP IP address / gateway'

The 'FP IP address / gateway' field shall be coded as follows.

Bits	8	7	6	5	4	3	2	1	Octet
	Field identifier = FP IP address / gateway'								1
	0/1	Length (L)							2
	0/1	Editable	IPv4/6	x	x	x	x	PIN protected	3
	1 st byte								4
	2 nd byte								
	3 rd byte								
	...								

Length octet (octet 2). The length of the field shall be set to '1' when the value of the field is not specified by the user.

'PIN protected' property (bit 1 of octet 3). The 'PIN protected' property allows the FP to protect the 'FP IP address / gateway' field against unauthorised modification, depending on its security policy.

'IPv4/6' property (bit 6 of octet 3). If set to 0, the format is IPv4 (4 bytes long), if set to 1, the format is IPv6 (16 bytes long).

'FP IP address / gateway' value (from octet 4): The 'FP IP address / gateway' value shall always have a length of 4 bytes (IPv4) or 16 bytes (IPv6). See the 'IP address / value' field for more information.

Bits 2 to 5 of octet 3 are reserved for further standardization and shall be set to "0".

7.4.11.3.8 Field 'FP IP address / DNS server'

The 'FP IP address / DNS server' field may be included several times in the entry: main server and alternate server(s).

The 'DNS server' field shall be coded as follows.

Bits	8	7	6	5	4	3	2	1	Octet
	Field identifier = FP IP address/ DNS server								1
	0/1	Length (L)							2
	0/1	Editable	IPv4/6	x	x	x	x	PIN protected	3
	1 st byte								4
	2 nd byte								
	3 rd byte								
	...								

Length octet (octet 2). The length of the field shall be set to '1' when the value of the field is not specified by the user.

'PIN protected' property (bit 1 of octet 3). The 'PIN protected' property allows the FP to protect the 'FP IP address / DNS server' field against unauthorised modification, depending on its security policy.

'IPv4/6' property (bit 6 of octet 3). If set to 0, the format is IPv4 (4 bytes long), if set to 1, the format is IPv6 (16 bytes long).

'FP IP address / DNS server' value (from octet 4). The 'FP IP address / DNS server' value shall always have a length of 4 bytes (IPv4) or 16 bytes (IPv6). See the 'IP address / value' field for more information.

Bits 2 to 5 of octet 3 are reserved for further standardization and shall be set to "0".

7.4.11.3.9 Field 'FP version / Firmware version'

The 'firmware version' field shall be coded as follows.

Bits	8	7	6	5	4	3	2	1	Octet
	Field identifier = FP version / Firmware version								1
	0/1	Length (L)							2
	0/1	x	x	x	x	x	x	PIN protected	3
	1 st character byte								4
	2 nd character byte								5
	...								

'PIN protected' property (bit 1 of octet 3). The 'PIN protected' property allows the FP to protect the 'FP version / Firmware version' field against unauthorised modification, depending on its security policy.

Characters shall be coded as defined for UTF-8 but restricted to the IA5 subset of characters (code point below or equal to 127). The length of this parameter (from octet 4) shall be of 20 octets maximum.

Bits 2 to 7 of octet 3 are reserved for further standardization and shall be set to "0".

7.4.11.3.10 Field 'FP version / Eeprom version'

The 'Eeprom version' field shall be coded as follows.

Bits	8	7	6	5	4	3	2	1	Octet
	Field identifier = FP version / Eeprom version								1
	0/1	Length (L)							2
	0/1	x	x	x	x	x	x	PIN protected	3
	1 st character byte								4
	2 nd character byte								5
	...								

'PIN protected' property (bit 1 of octet 3). The 'PIN protected' property allows the FP to protect the 'FP version / Eeprom version' field against unauthorised modification, depending on its security policy.

Characters shall be coded as defined for UTF-8 but restricted to the IA5 subset of characters (code point below or equal to 127). The length of this parameter (from octet 4) shall be of 20 octets maximum.

Bits 2 to 7 of octet 3 are reserved for further standardization and shall be set to "0".

7.4.11.3.11 Field 'FP version / Hardware version' field

The 'Hardware version' field shall be coded as follows.

Bits	8	7	6	5	4	3	2	1	Octet
	Field identifier = FP version / Hardware version								1
	0/1	Length (L)							2
	0/1	x	x	x	x	x	x	PIN protected	3
	1 st character byte								4
	2 nd character byte								5
	...								

'PIN protected' property (bit 1 of octet 3). The 'PIN protected' property allows the FP to protect the 'FP version / Hardware version' field against unauthorised modification, depending on its security policy.

Characters shall be coded as defined for UTF-8 but restricted to the IA5 subset of characters (code point below or equal to 127). The length of this parameter (from octet 4) shall be of 20 octets maximum.

Bits 2 to 7 of octet 3 are reserved for further standardization and shall be set to "0".

7.4.11.3.12 Field 'Emission mode'

The 'Emission mode' field allows to activate or deactivate the 'No emission mode' feature on the FP from on of the PPs. It shall be coded as follows.

Bits	8	7	6	5	4	3	2	1	Octet
	Field identifier = Emission mode								1
	Length (L)								2
0/1	Editable	x	x	x	x	x	x	PIN protected	3
0/1	reserved							NEM	4

'PIN protected' property (bit 1 of octet 3). The 'PIN protected' property allows the FP to protect the 'Emission mode' field against unauthorised modification, depending on its security policy.

Bits 2 to 6 of octet 3 are reserved for further standardization and shall be set to "0".

Emission mode bitmap (octet 4):

This field is a bitmap octet group.

Bits	7	6	5	4	3	2	1	Meaning
	x	x	x	x	x	x	0	'No emission mode' deactivated
	x	x	x	x	x	x	1	'No emission mode' activated

Bit 1: 'No emission' mode (NEM). If bit 1 is set, the FP shall activate the 'No emission mode' MAC service [NG1.M.5]. Otherwise the FP shall deactivate it.

Bits 2 to 7 of octet 4 are reserved for further standardization and shall be set to "0".

7.4.11.3.13 Field 'New PIN code'

The 'New PIN code' field shall be coded as follows.

Bits	8	7	6	5	4	3	2	1	Octet
	Field identifier = New PIN code								1
	Length (L)								2
0/1	Editable	x	x	x	x	x	x	PIN protected = 1	3
	1 st byte								4
	2 nd byte								
	3 rd byte								
	4 th byte								

'PIN protected' property (bit 1 of octet 3). The 'PIN protected' property allows the FP to protect the 'New PIN code' field (hence the PIN) against unauthorised modification. For the field 'New PIN code', this property shall always be set to '1'.

The 'New PIN code' field shall respect the following rules:

- the PIN shall always have a length of 32 bits;
- each decimal digit entered by the user, is translated into one nibble (4 bits, BCD coded). The PT shall be capable to accept any PIN between 0 and 8 decimal digits (limits included);
- the resulting string of nibbles is padded with as many leading 'F'H nibbles as necessary to achieve a total of 8 nibbles;
- the result is a bitstring of 32 bits;
- on "Read Entry" or "Edit Entry" commands from the PP the FP shall always answer with the value FFH FFH FFH FFH in order not to disclose the actual value of this field;

- the 'New PIN code' field shall only be modified via the "Save Entry" command if a successful "Save Entry" of the 'Current PIN code' field (see clause 7.4.11.3.1) has been executed before during the current call. See also clause 7.4.11.1 for more information. After a successful save of the 'New PIN code' field, the value of the 'Current PIN code' field shall also be changed to the same value.

EXAMPLE: See example at clause 7.4.11.3.1 and figure 60.

Bits 2 to 6 of octet 3 are reserved for further standardization and shall be set to '0'.

7.4.11.4 Line settings list

The following 'entry field identifier' for line settings list are defined.

Table 72: Entry fields for a line settings list entry

Field identifier	Field	Default value	Base reset impacted	Normative action/comment	List change notification FP status	Clause
01H	Line name	MD	MD	Name of the line	M	7.4.11.4.1
02H	Line id	MD	NO	Line identifier	M	7.4.11.4.2
03H	Attached handsets	MD	MD	List of registered handsets which are attached to the line	M	7.4.11.4.3
04H	Dialling prefix	MD	MD	If defined, adds a prefix to called party numbers for calls placed on the line	O	7.4.11.4.4
05H	FP melody	YES/MD	MD	Melody of the FP linked to this line	I	7.4.11.4.5
06H	FP volume	YES/MD	MD	Melody volume of the FP linked to this line.	I	7.4.11.4.6
07H	Blocked telephone number	MD	MD	Forbidden called party numbers on the line	O	7.4.11.4.7
08H	Multiple calls mode (single/multiple)	MD	MD	Current mode of the line: single call or multiple call	M	7.4.11.4.8
09H	Intrusion call	MD	MD	Intrusion call allowed (YES / NO)	C7201	7.4.11.4.9
0AH	Permanent CLIR	YES	MD	Restrict number for all outgoing calls on this line	M	7.4.11.4.10
0BH	Call forwarding unconditional	YES	MD	Stores the activation/deactivation codes and forwarding to number of the call forwarding	M	7.4.11.4.11
0CH	Call forwarding on No answer	YES	MD	Stores the activation/deactivation codes, forwarding to number and number of seconds of the call forwarding	M	7.4.11.4.12
0DH	Call forwarding on Busy subscriber	YES	MD	Stores the activation/deactivation codes and forwarding to number of the call forwarding	M	7.4.11.4.13
C7201 : IF intrusion call feature NG1.N.10 is implemented on FP side THEN M ELSE I.						

Field identifiers from 0EH to 80H are reserved for further standardization and shall not be used.

Field identifiers from 81H to FFH are reserved for proprietary fields and may be freely used by implementers for coding of proprietary features.

Default value: it is the value of the setting when product is manufactured:

- "MD" means that a default value, if any, shall be provided by the manufacturer (could also be empty by setting the length to 1).
- "YES/MD" means that a default value shall be provided by the manufacturer (shall not be empty).
- "YES" means that a default value is standardized. See corresponding setting clause definition.

Base reset impacted: describes the impact of the "Base reset" setting on the given setting:

- "YES" means that the setting is reset to default value when "Base reset" setting is activated.
- "NO" means that the setting is not impacted by "Base reset" setting.
- "MD" means "manufacturer defined", whether or not the setting is impacted by the "Base reset" setting.

List change notification status:

Sending a list change notification for line setting is mandatory when a setting is modified. However, for some fields that do not require the display of the PP to be aware, the notification is optional or irrelevant. See also clause 7.4.10.2.2.

The list shall be sorted by ascending numerical order of the 'Line id' field values.

Only one entry per line identifier shall exist in the line settings list. In other words, two distinct entries shall never have the same line id. If a PP attempts to add or modify an entry with an already existing line id in one entry of the list, the FP shall reject it with negative acknowledgement (see clause 7.4.10.4.9) / reject reason = 'content not accepted'.

When the line name of a specific line is modified, the FP should automatically update the other lists where line name is stored (especially call lists).

7.4.11.4.1 Field 'Line name'

See 'Line name' field in "List access service" feature, clause 7.4.10.5.1.6. This field of the 'Line settings' list may be protected against unauthorised modification by the FP by use of the 'PIN protected' property (see 7.4.10.5.1.6).

7.4.11.4.2 Field 'Line id'

See 'Line id' field in "List access service" feature, clause 7.4.10.5.1.7. This field of the 'Line settings' list may be protected against unauthorised modification by the FP by use of the 'PIN protected' property (see clause 7.4.10.5.1.7).

7.4.11.4.3 Field 'Attached handsets'

The 'Attached handsets' field shall be coded as follows.

Bits	8	7	6	5	4	3	2	1	Octet	
	0	Field identifier = Attached handsets								1
	0/1	Length (L)								2
	0/1	Editable	x	x	x	x	x	PIN protected	3	
	0/1	Number of registered handsets attached to the line								4
	0/1	Handset bitmap								5
	0/1	..								
	0/1	Handset bitmap (continued)								5n

'PIN protected' property (bit 1 of octet 3). The 'PIN protected' property allows the FP to protect the 'Attached handsets' field against unauthorised modification, depending on its security policy.

Number of registered handsets attached to the line (octet 4):

The number of handsets relates to the number of handsets attached to the line. The value shall be coded with the natural binary value, with the least significant bit in bit position "1". Allowable values are "1" to "127".

Handset bitmap (octet group 5):

This is a bitmap octet group, with the handset number 1 in bit position "1". A "1" indicates handset is attached to the line, and a "0" indicates it is not.

Handset bitmap (octet 5n):

Bits	7 6 5 4 3 2 1	Meaning
	x x x x x 1	Handset number 1 is attached
	x x x x x 1 x	Handset number 2 is attached
	x x x x 1 x x	Handset number 3 is attached
	x x x 1 x x x	Handset number 4 is attached
	x x 1 x x x x	Handset number 5 is attached
	x 1 x x x x x	Handset number 6 is attached
	1 x x x x x x	Handset number 7 is attached

NOTE 1: If the extension bit is "0" in the first octet (indicating presence of an additional octet), the least significant bit of second octet stands for handset number 8.

NOTE 2: The format of the current field is a bit mask, it is different from the format of the number field of the internal names list (terminal id number) but represents the same handset numbers.

7.4.11.4.4 Field 'Dialling Prefix'

See 'Number' field in "List access service" feature, clause 7.4.10.5.1.2. The field 'Dialling Prefix' may be protected against unauthorised modification by the FP by use of the 'PIN protected' property (see clause 7.4.10.5.1.2).

The prefix shall be added by the FP to the called party number to any external outgoing call placed on the line.

The length of the field shall be set to one when the value of the field is not defined.

7.4.11.4.5 Field 'FP melody'

See 'Associated melody' field in "List access service" feature, clause 7.4.10.5.1.12. The field 'FP melody' may be protected against unauthorised modification by the FP by use of the 'PIN protected' property (see clause 7.4.10.5.1.12).

This field defines the melody to be used to ring in the FP on an incoming call on a dedicated line.

7.4.11.4.6 Field 'FP volume'

The 'FP volume' field shall be coded as follows.

Bits	8	7	6	5	4	3	2	1	Octet
	Field identifier = volume								1
	0/1	Length (L)							2
	0/1	editable	x	x	x	x	x	PIN protected	3
	Value								4

'PIN protected' property (bit 1 of octet 3). The 'PIN protected' property allows the FP to protect the 'FP volume' field against unauthorised modification, depending on its security policy.

'Value' octet (octet 4). The 'Value' octet shall be in the interval '30'H..'39'H. The '30'H value stands for the minimum adjustment of the volume level when the FP rings, and the '39'H value is the maximum adjustment.

7.4.11.4.7 Field 'Blocked number'

See 'Number' field in "List access service" feature, clause 7.4.10.5.1.2, except that the possible value shall be in the interval '30'H..'39'H, plus the '2A'H value. The field 'Blocked number' may be protected against unauthorised modification by the FP by use of the 'PIN protected' property (see clause 7.4.10.5.1.2).

The 'blocked number' field may be composed of:

- either a single phone number value, or
- a range of phone number values. In this case, the 'Number' field shall be equal to a sequence of one or more digit(s) followed by '*'. For example: "02*" represents all numbers starting with "02" digit sequence.

When a PP attached to the line tries to place an external outgoing call on a number which is blocked, this call shall not be established by the FP. The FP shall release the call.

This field may be contained several times in line settings entry. This allows to block several numbers or ranges of numbers. The number of times the field is included shall be defined at line setting entry creation. See clause 7.4.10.4.5 list access 'Save entry' command procedure for details how to handle several fields of the same type in the same entry.

The length of the field shall be set to one when the value of the field is not defined.

7.4.11.4.8 Field 'Multiple calls mode'

The 'Multiple calls mode' field shall be coded as follows.

Bits	8	7	6	5	4	3	2	1	Octet
	Field identifier = Multiple calls mode								1
	0/1	Length (L)							2
	0/1	Editable	x	x	x	x	x	PIN protected	3
	Value								4

'PIN protected' property (bit 1 of octet 3). The 'PIN protected' property allows the FP to protect the 'Multiple calls mode' field against unauthorised modification, depending on its security policy.

'Value' octet (octet 4). The 'Value' octet shall be 30H or 31H. 30H stands for "Single call mode", 31H for "Multiple call mode".

This field is related to the "Multiple calls" feature (see clause 7.4.8) and allows to configure a multiple call line in single call mode. For non-multiple call lines, the value "Single call mode" shall always be used.

7.4.11.4.9 Field 'Intrusion call'

This field is related to the "intrusion call" feature (see clause 7.4.3.8). The 'intrusion call' field shall be coded as follows.

Bits	8	7	6	5	4	3	2	1	Octet
	Field identifier = Intrusion call								1
	0/1	Length (L)							2
	0/1	Editable	x	x	x	x	x	PIN protected	3
	Value								4

'PIN protected' property (bit 1 of octet 3). The 'PIN protected' property allows the FP to protect (or not) the 'Intrusion call' field against unauthorised modification, depending on its security policy.

'Value' octet (octet 4). The 'Value' octet shall be 30H or 31H. 30H stands for intrusion call (implicit or explicit) not allowed, 31H for intrusion call (implicit or explicit) allowed.

For "Implicit call intrusion" (see clause 7.4.3.8.1), the value also indicates the behavior of the system when a call setup is attempted on the line (real call setup, vs call intrusion if the triggering conditions described in clause 7.4.3.8.1 are met).

7.4.11.4.10 Field 'Permanent CLIR'

The 'Permanent CLIR' field shall be coded as follows.

Bits	8	7	6	5	4	3	2	1	Octet
	Field identifier =Permanent CLIR								1
	0/1	Length (L)							2
	0/1	Editable	x	x	x	x	x	PIN protected	3
	Value								4
	CLIR activation code length								5
	CLIR activation code 1 st digit								5a
	CLIR activation code 2 nd digit								
	CLIR deactivation code length								6
	CLIR deactivation code 1 st digit								6a
	CLIR deactivation code 2 nd digit								

'PIN protected' property (bit 1 of octet 3). The 'PIN protected' property allows the FP to protect (or not) the 'Permanent CLIR' field against unauthorised modification, depending on its security policy.

'Value' octet (octet 4). The 'Value' octet shall be 30H or 31H. 30H stands for CLIR de-activated for all calls, 31H for CLIR activated for all calls.

Each digit shall be in the interval 30H..39H, and values 23H, 2AH, 05H and 15H.

If a PP sets or resets the value, the FP shall activate or deactivate the CLIR service in the network using the CLIR activation or deactivation code for all outgoing calls placed on the specified line. This setting shall be consistent with the CLIR feature [NG1.N.17].

If the PP supports the field (according to table 9, feature [NG1.N.16], supported line settings), the PP shall make at least the 'Value' accessible to the user. CLIR activation and deactivation codes may not be accessible to the user on the PP side. However the PP shall handle correctly those codes in the edit and save commands. (PP shall perform the save command with the same codes received in edit confirm).

NOTE : This allows implementations where the codes can only be edited on FP side via a web interface for example.

If no code is necessary to activate or deactivate the feature on network side for a specific line, the corresponding code length shall be set to zero. When neither activation nor deactivation codes are necessary, the FP shall set the length of the field so that the field only includes the value octet.

Default value: 30H: 'de-activated'. Default CLIR codes are "manufacturer defined".

7.4.11.4.11 Field 'Call forwarding unconditional'

The 'Call forwarding' unconditional field shall be coded as follows.

Bits	8	7	6	5	4	3	2	1	Octet
	Field identifier =Call forwarding unconditional								1
	0/1	Length (L)							2
	0/1	Editable	x	x	x	x	x	PIN protected	3
	Value								4
	CFU activation code length								5
	CFU activation code 1 st digit								5a
	CFU activation code 2 nd digit								
	...								
	CFU deactivation code length								6
	CFU deactivation code 1 st digit								6a
	CFU deactivation code 2 nd digit								
	...								
	Call forwarding number length								7
	1 st digit								7a
	2 nd digit								
								

Length octet (octet 2). the length of the field shall be set to '1' (default value) when the value of the field is not specified by the user (no 'Call forwarding unconditional' defined).

'PIN protected' property (bit 1 of octet 3). The 'PIN protected' property allows the FP to protect (or not) the 'Call forwarding unconditional' field against unauthorised modification, depending on its security policy.

'Value' octet (octet 4). The 'Value' octet shall be 30H or 31H. 30H stands for CFU de-activated for all calls, 31H for CFU activated for all calls.

The digits represent the activation/deactivation codes and the call forwarding target number. Each digit shall be in the interval 30H..39H, and values 23H, 2AH, 05H and 15H.

If a PP sets or resets the field, the FP shall activate or deactivate the corresponding Call forwarding in the network for specified type of calls received and on the specified line using the CFU activation code or CFU deactivation code.

If no code is necessary to activate or deactivate the feature on network side for a specific line, the corresponding code length shall be set to zero.

The PP shall make at least the 'Value' and the 'Call forwarding number' configurable by the user. CFU activation and deactivation codes may not be accessible to the user on the PP side. However the PP shall handle correctly those codes in the edit and save commands. (PP shall perform the save command with the same codes received in edit confirm).

NOTE : This allows implementations where the codes can only be edited on FP side via a web interface for example.

7.4.11.4.12 Field 'Call forwarding on No Answer'

The 'Call forwarding on No Answer' field shall be coded as follows.

Bit:	8	7	6	5	4	3	2	1	Octet:
Field identifier =Call forwarding on No Answer									1
0/1	Length (L)								2
0/1	Editable	x	x	x	x	x	x	PIN protected	3
Value									4
Nb of seconds before call is forwarded									5
CFNA activation code length									6
CFNA activation code 1 st digit									6a
CFNA activation code 2 nd digit									
CFNA deactivation code length									7
CFNA deactivation code 1 st digit									7a
CFNA deactivation code 2 nd digit									
Call forwarding number length									8
1 st digit									8a
2 nd digit									

Length octet (octet 2). The length of the field shall be set to '1' (default value) when the value of the field is not specified by the user (no 'Call forwarding on No answer' defined).

'PIN protected' property (bit 1 of octet 3). The 'PIN protected' property allows the FP to protect (or not) the 'Call forwarding on No Answer' field against unauthorised modification, depending on its security policy.

'Value' octet (octet 4). The 'Value' octet shall be 30H or 31H. 30H stands for CFNA de-activated for all calls, 31H for CFNA activated for all calls.

The digits represent the activation/deactivation codes and the call forwarding target number. Each digit shall be in the interval 30H..39H, and values 23H, 2AH, 05H and 15H.

The number of seconds before triggering the forwarding shall be coded with the natural binary value, with the least significant bit in bit position "1". Allowable values are "0" to "64". A value of zero indicates that the choice of the number of seconds is left to the FP (use of a default or preferred value configured in the FP).

If a PP sets or resets the field, the FP shall activate or deactivate the Call forwarding on No Answer' in the network for specified type of calls received and on the specified line using the CFNA activation code or CFNA deactivation code.

If no code is necessary to activate or deactivate the feature on network side for a specific line, the corresponding code length shall be set to zero.

The PP shall make at least the 'Value' and the 'Call forwarding number' configurable by the user. Nb of seconds, CFNA activation and deactivation codes may not be accessible to the user on the PP side. However the PP shall handle correctly those codes in the edit and save commands. (PP shall perform the save command with the same codes received in edit confirm).

NOTE : This allows implementations where the codes can only be edited on FP side via a web interface for example.

7.4.11.4.13 Field 'Call forwarding on Busy subscriber'

The 'Call forwarding on Busy subscriber' field shall be coded as follows:

Bit:	8	7	6	5	4	3	2	1	Octet:
Field identifier =Call forwarding on Busy subscriber									1
0/1	Length (L)								2
0/1	Editable	x	x	x	x	x	x	PIN protected	3
Value									4
CFB activation code length									5
CFB activation code 1 st digit									5a
CFB activation code 2 nd digit									
...									
CFB deactivation code length									6
CFB deactivation code 1 st digit									6a
CFB deactivation code 2 nd digit									
...									
Call forwarding number length									7
1 st digit									7a
2 nd digit									
...									

Length octet (octet 2). The length of the field shall be set to '1' (default value) when the value of the field is not specified by the user (no 'Call forwarding on Busy subscriber' defined).

'PIN protected' property (bit 1 of octet 3). The 'PIN protected' property allows the FP to protect (or not) the 'Call forwarding on Busy subscriber' field against unauthorised modification, depending on its security policy.

'Value' octet (octet 4). The 'Value' octet shall be 30H or 31H. 30H stands for CFB de-activated for all calls, 31H for CFB activated for all calls.

The digits represent the activation/deactivation codes and the call forwarding target number. Each digit shall be in the interval 30H..39H, and values 23H, 2AH, 05H and 15H.

If a PP sets or resets the field, the FP shall activate or deactivate the Call forwarding on Busy subscriber' in the network for specified type of calls received and on the specified line using the CFB activation code or CFB deactivation code.

If no code is necessary to activate or deactivate the feature on network side for a specific line, the corresponding code length shall be set to zero.

The PP shall make at least the 'Value' and the 'Call forwarding number' configurable by the user. CFB activation and deactivation codes may not be accessible to the user on the PP side. However the PP shall handle correctly those codes in the edit and save commands. (PP shall perform the save command with the same codes received in edit confirm).

NOTE : This allows implementations where the codes can only be edited on FP side via a web interface for example.

7.4.11.5 Virtual contact list and call list per line

The default behaviour of the "List access service" feature is to share all lists between all registered PPs, independently of the line attachments of the PPs.

The current procedure allows to share virtually contact or call lists (missed calls, outgoing calls, incoming accepted calls, all incoming calls, all calls lists) only between handsets attached to the same line. For a system implementing this procedure, it shall be possible to switch back dynamically to the default behavior.

After reading or searching entries, the PP shall filter the entries that are related to a given line thanks to the line identifier field. This way, the PP has a possibility to show to the user only the calls and contacts that are related to one line (including the contacts that are attached to all lines).

7.4.12 Calling line identity restriction (CLIR)

7.4.12.1 Considerations

The "Calling line identity restriction" feature defines procedures for CLIR as defined by 3GPP Technical specifications for Line identification supplementary services (see TS 122 081 [23]).

This procedure allows a user to enable or to disable the presentation of its calling line identification when originating a call. When it is enabled, the originating network notifies the destination network that the calling party number is not allowed to be presented to the called party. If the called party subscribes to calling identification and the calling party has calling line identification restriction enabled, the called party shall receive the presentation indicator set to "presentation restricted" in the <<CALLING-PARTY-NUMBER>> IE of the {CC-SETUP}. In this case, the calling party's number will not be presented to the called party.

The CLIR service may be provisioned in a permanent (for all outgoing calls) or a temporary mode (call by call basis).

NOTE : It should be noted that this procedure allows to configure the network activation and deactivation codes from the PP. Nevertheless, these codes may be considered not being common end-user configurable but reserved for a well-informed user (and modified less often). For example call forwarding codes might be available through an advanced menu on PP side. Call forwarding activation may be available through other menus.

7.4.12.2 Permanent CLIR mode (all calls)

This procedure allows a user to enable or to disable the presentation of its calling line identification for all following outgoing calls for a specified line.

When implementing the feature, the FP shall set bit a_{30} of the "Extended higher layer capabilities (part 2)" (see EN 300 175-5 [5], clause F.3).

To enable (respectively disable) the permanent CLIR mode, the user shall set (respectively reset) the 'Permanent CLIR' field of the specified line in the "Line settings" list (see the "List access service" feature [NG1.N.16]). When this mode is enabled (respectively disabled), the FP shall invoke the permanent mode by sending the permanent CLIR activation (respectively deactivation) request to the network for the specified line.

NOTE 1: The current procedure does not state anything about the availability or not of the service on Network side.

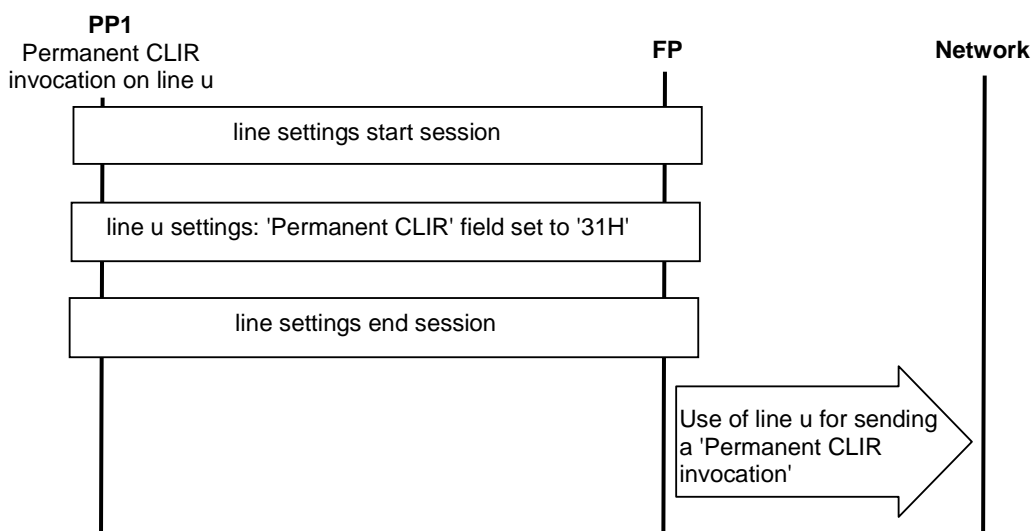

Figure 61: Permanent CLIR mode invocation

When the permanent mode is deactivated, it shall be always possible to use the temporary mode.

NOTE 2: It should be noted that the permanent mode can also be provisioned by using the temporary mode for each call.

7.4.12.3 Temporary CLIR mode (call by call)

This procedure allows a user to disable the presentation of its calling line identification at the time of the call request.

If the user requests a temporary CLIR mode when originating a call, the PP shall insert before the telephone number in the <<MULTI-KEYPAD>> IE the CLIR invocation temporary digits sequence.

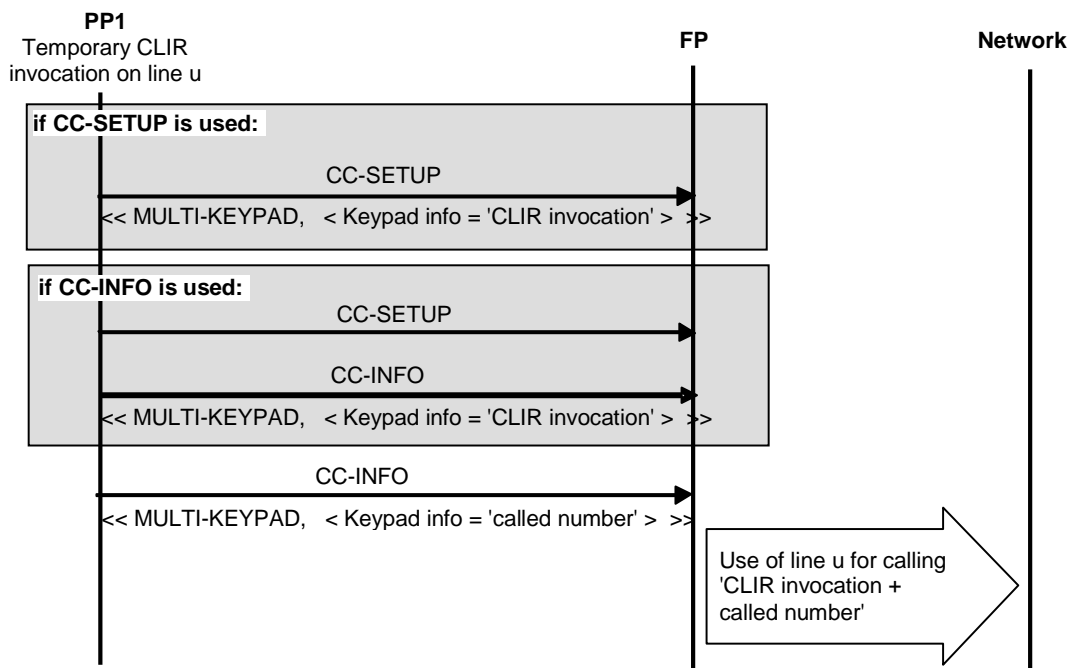

Figure 62: Temporary CLIR mode invocation

A temporary CLIR request shall override a permanent deactivated CLIR mode.

NOTE 1: It should be noted that the temporary mode can also be provisioned directly by the user by dialling the CLIR temporary digits sequence.

NOTE 2: As the network temporary CLIR invocation digits sequence is network dependent, the sequence should be configurable on PP side.

7.4.13 Call forwarding (external calls)

7.4.13.1 Call forwarding common requirements

The "Call Forwarding" feature defines procedures for Call Forwarding Unconditional (CFU), Calls Forwarding on No Answer (CFNA), and Calls Forwarding on Busy subscriber (CFB) as defined by 3GPP Technical specifications for Call Forwarding supplementary service Stage 1, 2 and 3 (see [24], [25] and [26]).

The call forwarding service enables the user to request to forward all incoming external calls to another external number when some conditions are met. The FP shall relay the procedure activation and deactivation to the network.

NOTE 1: Depending on these conditions, the call may or may not be presented to the user before the forwarding occurs.

NOTE 2: If the call is presented and the user picks up the presented call, forwarding of the call does not take place.

The "Call forwarding (external calls)" procedure uses the Call forwarding field of Line settings (see [NG1.N.16] List access service), i.e. the forwarding of calls applies to incoming calls on a specified line. When list change notification is supported by the FP, a notification shall be sent (see clause 7.4.10.2 List change notification) when 'Call forwarding' field is modified.

NOTE 3: This may allow for example to display on handsets that calls are forwarded.

NOTE 4: It should be noted that this procedure allows configuring the network activation and deactivation codes from the PP. Nevertheless, these codes may be considered not being common end-user configurable but reserved for a well-informed user. As a consequence, it is recommended not to edit them systematically on the PP side. For example these codes could be available in more "advanced" setting menu.

The current procedure does not state anything about the availability nor the implementation of the service on Network side. It is considered by default that the operation is successful on Network side.

Nevertheless, in case a network negative confirmation is received following the call forwarding service request, the FP shall notify the PP that the service cannot be provided using a negative acknowledgement tone (see "tones provision" feature in clause 7.4.15).

Call forwarding shall always be invoked for a specific line, not for all lines at the same time. Notifications shall also apply to the specified line (Value "All lines" for line identifier shall not be used in CALL INFORMATION IE).

NOTE 5: Possible implementations on Network side is not part of the current specification, please find some examples bellow just for information:

EXAMPLE 1: Call forwarding invocation may be done by performing a speech call to a call forwarding platform with sending of the code at call setup.

EXAMPLE 2: Negative confirmation, in case of wrong code, may be done by a call rejection from network side.

EXAMPLE 3: Result of the operation may be sent via audio inband information, in such a case, the list access session may end up in a speech session so that the user may hear the result of its call forwarding operation.

7.4.13.2 External Call Forwarding Unconditional (CFU) to external number

This procedure allows the user to forward all external incoming calls on a specified line to a given external number, without any triggering condition.

To activate (respectively deactivate) the Call Forwarding Unconditional (CFU) mode, the user shall set (respectively reset) the 'Call forwarding unconditional' field of the specified line in the "Line settings" list (see the "List access service" feature [NG1.N.16]) with the IA5 coded digits of the forwarded-to telephone number. Network activation and deactivation codes are also saved as part of the field (although they might not be modified on PP side very often nor in the same menu).

When this mode is activated (respectively deactivated), the FP shall invoke the call forwarding mode by sending the CFU activation (respectively deactivation) request to the network for the specified line.

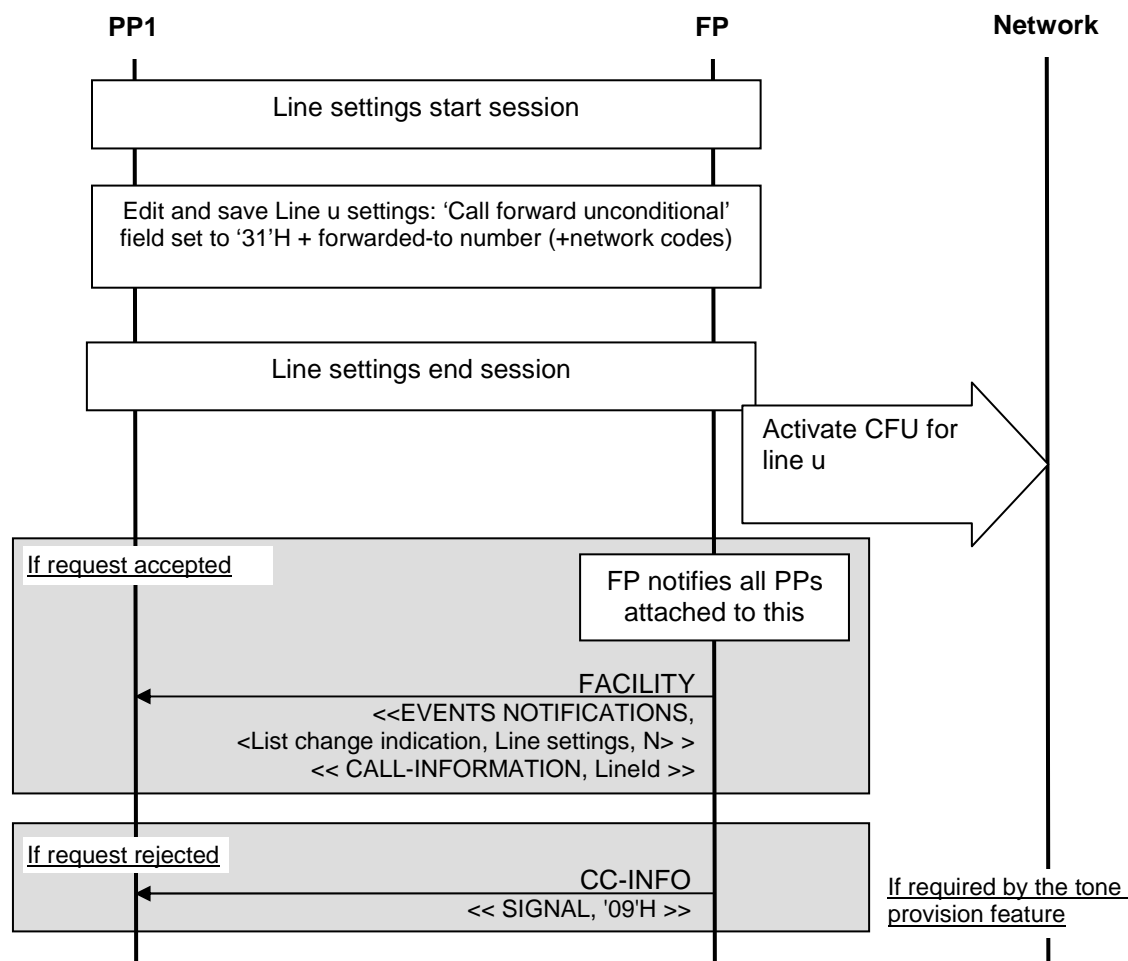

Figure 63: CFU mode invocation

7.4.13.3 External Call Forwarding on No Answer (CFNA) to external number

This procedure allows the user to forward all external incoming calls on a specified line to a given external number, when the call is presented but not answered within a specified number of seconds.

To activate (respectively deactivate) the Call Forwarding on No Answer (CFNA) mode, the user shall set (respectively reset) the 'Call forwarding on No Answer' field of the specified line in the "Line settings" list (see the "List access service" feature [NG1.N.16]) with the IA5 coded digits of the forwarded-to telephone number and the number of seconds. Network activation and deactivation codes are also saved as part of the field (although they might not be modified on PP side very often nor in the same menu).

The number of seconds before triggering the forwarding shall be coded in binary value. A value of zero indicates that the choice of the number of seconds is left to the FP (use of a default or preferred value configured in the FP).

When this mode is activated (respectively deactivated), the FP shall invoke the call forwarding mode by sending the CFNA activation (respectively deactivation) request to the network for the specified line.

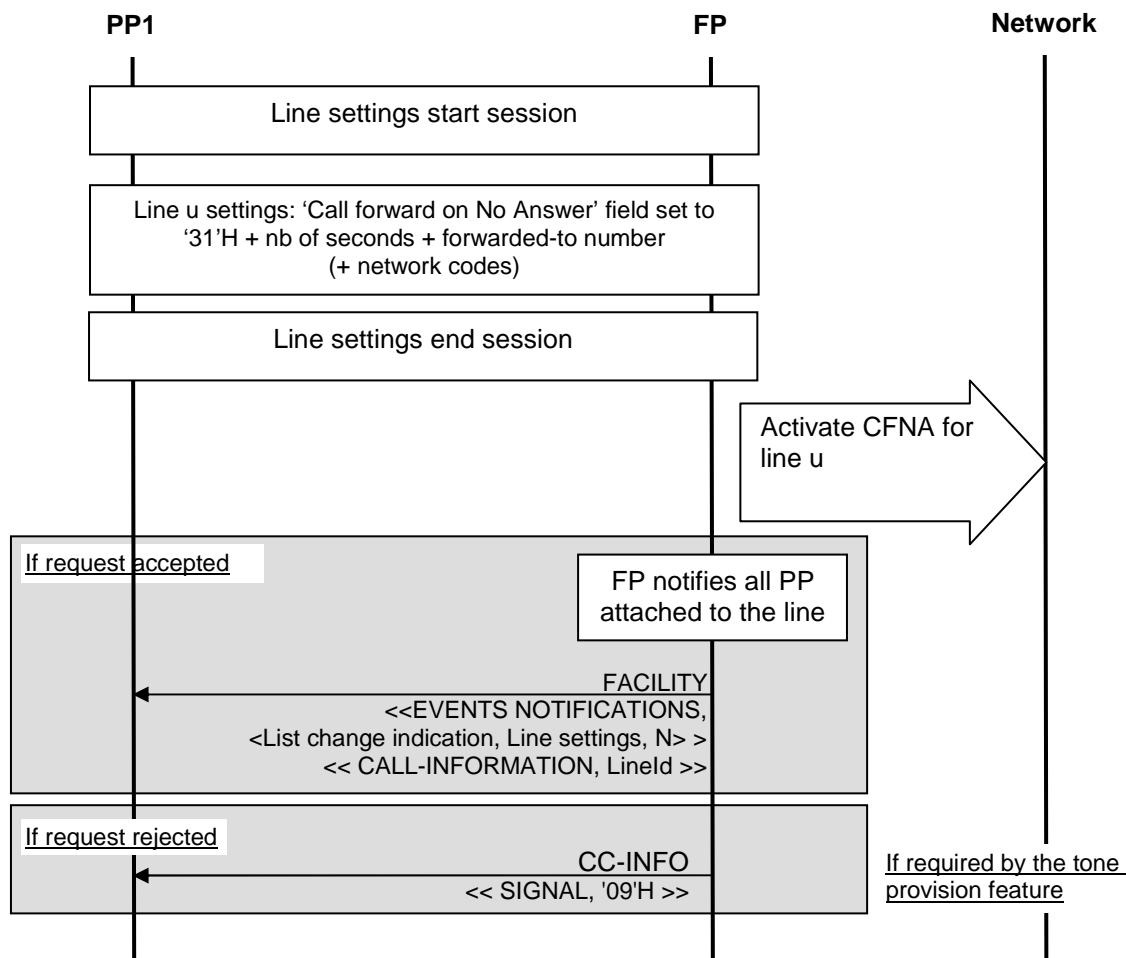

Figure 64: CFNA mode invocation

7.4.13.4 External Call Forwarding on Busy subscriber (CFB) to external number

This procedure allows the user to forward all external incoming calls on a specified line to a given external number, when the line is busy.

To activate (respectively deactivate) the Call Forwarding on Busy subscriber (CFB) mode, the user shall set (respectively reset) the 'Call forwarding on Busy subscriber' field of the specified line in the "Line settings" list (see the "List access service" feature [NG1.N.16]) with the IA5 coded digits of the forwarded-to telephone number. Network activation and deactivation codes are also saved as part of the field (although they might not be modified on PP side very often nor in the same menu).

When this mode is activated (respectively deactivated), the FP shall invoke the call forwarding mode by sending the CFB activation (respectively deactivation) request to the network for the specified line.

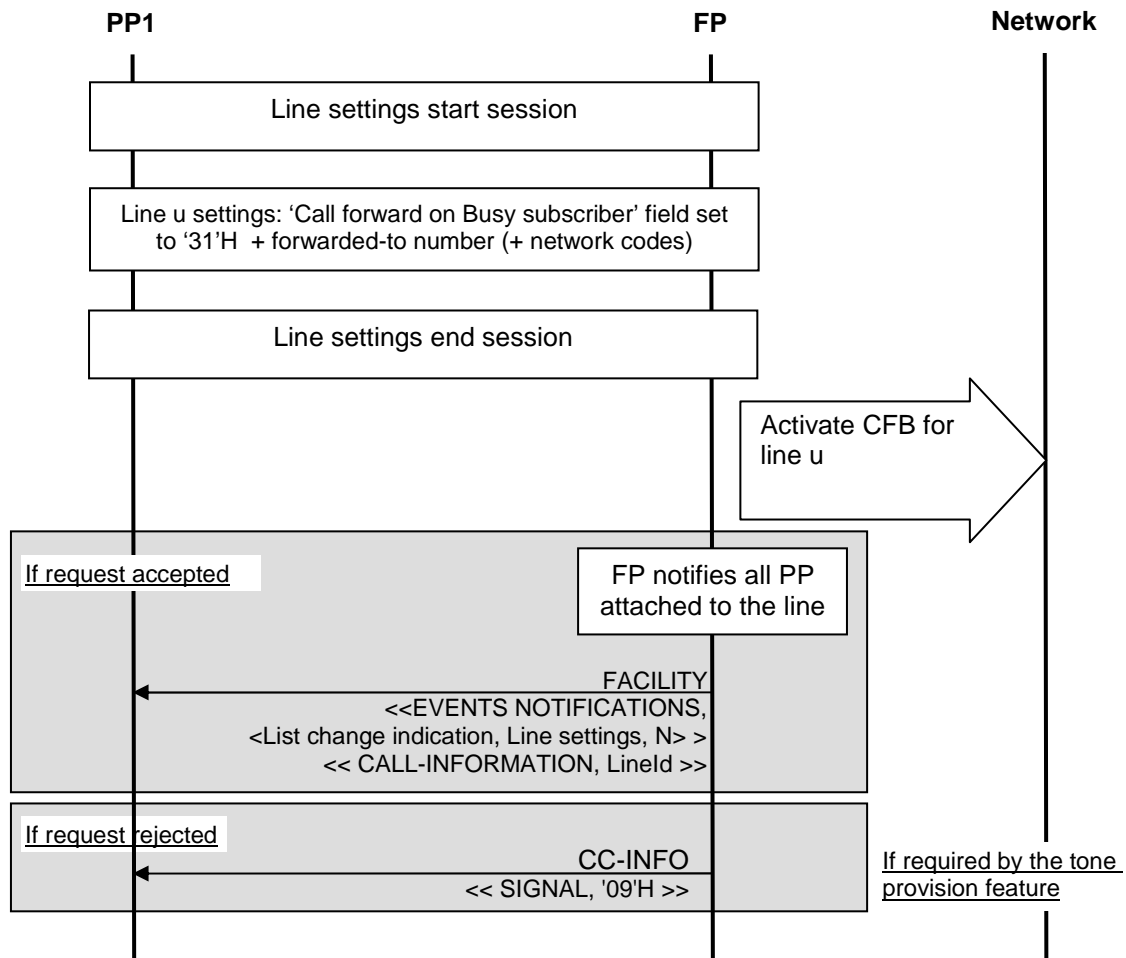

Figure 65: CFB mode invocation

7.4.14 DTMF handling

7.4.14.1 Uplink DTMF transmission

The sending of Dual-Tone Multi-Frequencies (DTMF) to the network shall correspond to the sending of dialled digits on PP side at call setup or in active state (call connected).

NOTE : For the additional support of variable length DTMF please refer to EN 300 444 (GAP) [12], clause 8.10, "Sending keypad information" and to clause D.2.2 of EN 300 175-5 [5].

7.4.14.1.1 Uplink DTMF transmission at call setup when FP connected to classic switching network

The system shall use DTMF mechanism at Network call setup, to transmit the called party number in a classic network switching circuit (use case on PSTN networks for example):

- The PP shall send a <<MULTI-KEYPAD>> or <<KEYPAD>> information element to the FP that conveys dialled digits.
- The PP shall not generate any in band audio DTMF.
- The FP shall manage this keypad information correctly to send the DTMF to the network. The behaviour of the FP towards the network is described in clause D.1.
- For PSTN calls, the FP should mute the downlink audio stream sent toward the PP (in order to avoid echo).

NOTE : The current procedure does not restrict the possible outgoing call methods. Using EN 300 444 [12], clause 8.3 "Overlap sending" procedure is one possible method among others in the present document.

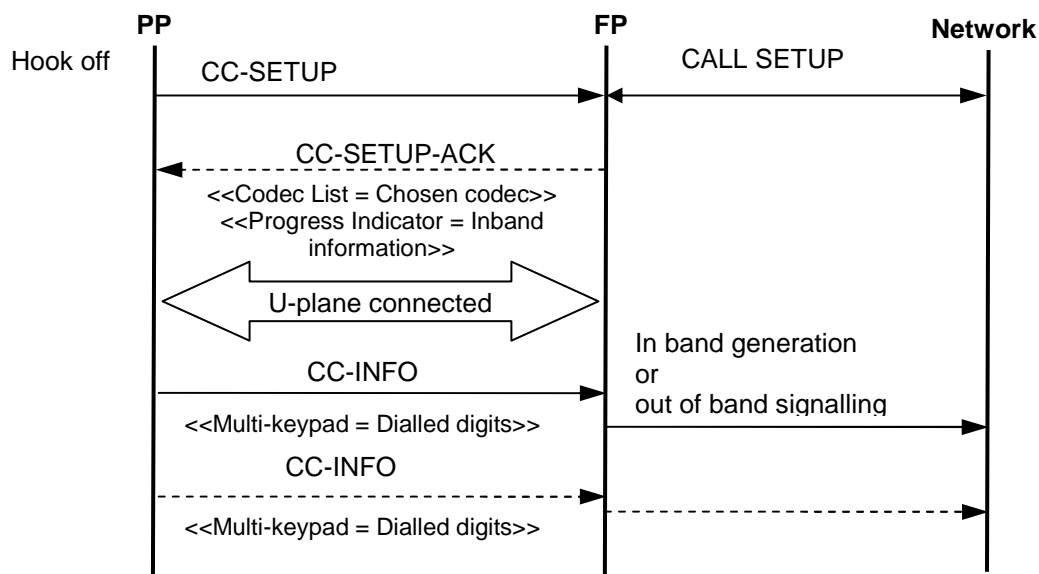

Figure 66: Using overlap sending and DTMF to establish a call

7.4.14.1.2 Uplink DTMF transmission when connected

The system shall be capable of sending DTMF to the network when call is established on network side in order to send some voice menu navigation commands

After a {CC-CONNECT} message :

- The PP shall send a <<MULTI-KEYPAD>> or <<KEYPAD>> information element to the FP that conveys dialed digits.
- The PP shall not generate any in band audio DTMF.
- The FP shall manage this keypad information correctly to send the DTMF to the network. The behaviour of the FP towards the network is described in clause D.1.

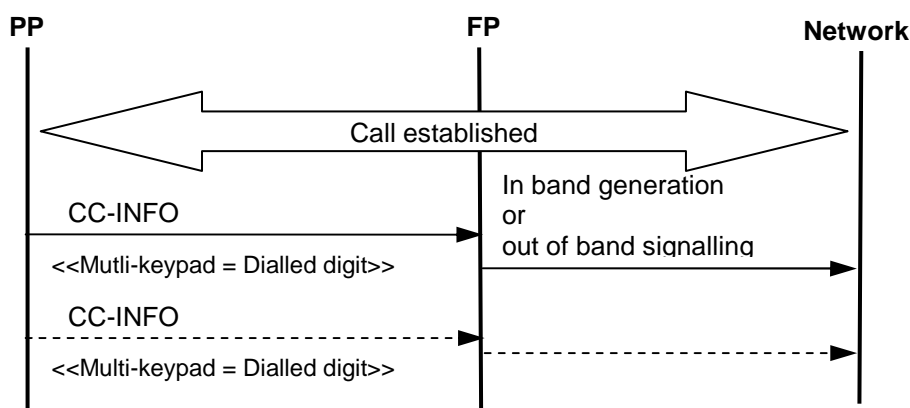

Figure 67: Sending DTMF when a call is established

7.4.14.2 Downlink DTMF reception

The system shall be capable of receiving some Dual-Tone Multi-Frequency (DTMF) from the network. These DTMF shall correspond to the sending of dialed digits from the remote party.

Upon reception of the DTMF from the network, there are two possible behaviours on FP side:

- If DTMF are received in band from the network, the FP shall play transparently the DTMF as in band audio to the PP.
- If DTMF are received out of band from the network, the FP may generate the DTMF as in-band audio in the active codec format.

When connected to PSTN networks, the in-band generation method is used by the FP.

If the FP is able to place calls on several lines from different networks that use different DTMF methods, the FP shall adapt the downlink DTMF transmission on a line by line basis.

The format of in band DTMF is given in clause D.2.

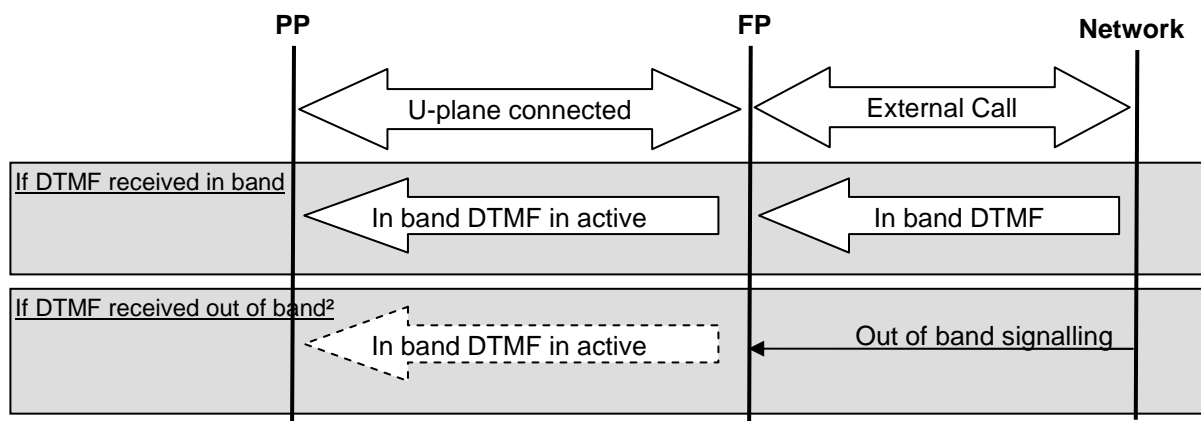

Figure 68: Downlink DTMF reception possible cases

7.4.14.3 Local DTMF feedback of dialled digits

This procedure applies to a New Generation DECT system connected to an IP packet based network (like VoIP over the Internet) or connected to a PSTN network. It clarifies and simplifies the specific case where the system implements a local DTMF feedback in order to avoid non-interoperable or more complex implementations with echo in the FP.

When a call is established on network side, when the user presses a digit key, it is recommended that the user gets a feedback to confirm that the key press was taken into account. Several implementations are allowed, this feedback may be:

- a simple "bip",
- a local DTMF generation corresponding to the dialled digit, or
- a visual indication of the digits.

Especially for PP without display capabilities, it is recommended to generate the corresponding local DTMF instead of a simple "bip" generation for ergonomic reason. If such a mechanism is implemented in the system, the DTMF shall be generated locally by the PP and not by the FP. It is recommended that this DTMF generation respects also the guidelines given in clause D.3.

This echo of the DTMF shall remain local:

- The recommended implementation is to mute temporarily the audio transmit path from the PP in order to avoid acoustic echo.
- No additional DTMF in band sending from PP to FP shall be performed as it could interfere with procedure 7.4.14.1 Uplink DTMF transmission.
- The FP shall not provide this feedback even for PSTN calls.

NOTE: Please note that some mobile phone devices do not implement any DTMF generation (only visual feedback is used).

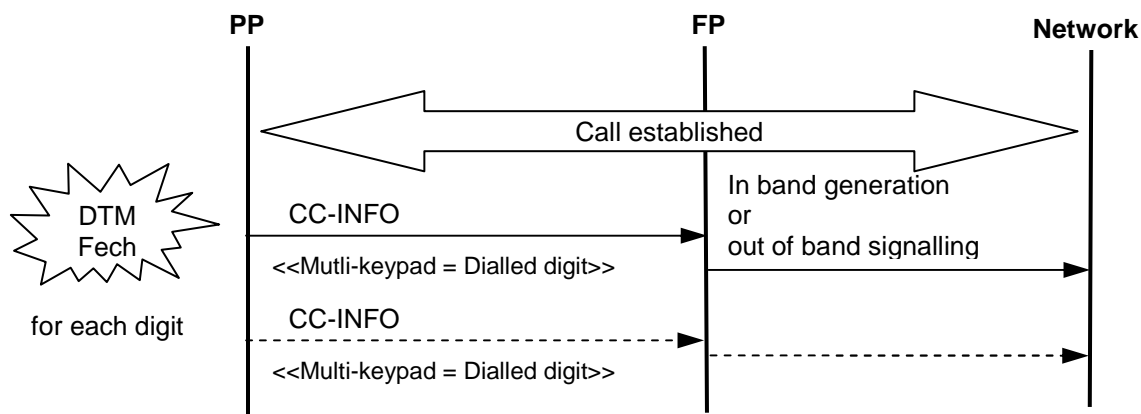

Figure 69: Local DTMF echo of dialled digits once call is established on network side

The PP may additionally use the same mechanism in the following cases :

- 1) When digit keys are pressed even if no SETUP is sent afterwards (case where you dial and then cancel the call).
- 2) When digit keys are pressed before SETUP (pre-dialling method).
- 3) When digit keys pressed after SETUP (post dialling method). See figure 66 for details.

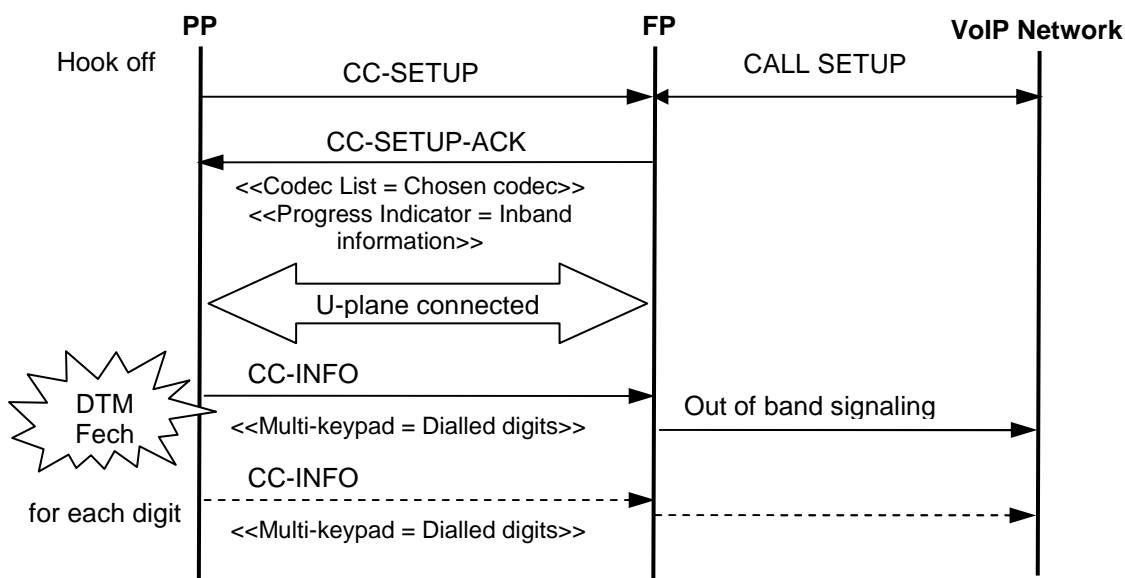

Figure 70: Local DTMF echo of dialled digits after call setup

For GAP PPs, the FP may optionally send an inband feedback of DTMF from FP to PP.

7.4.15 Tones provision

7.4.15.1 General considerations

The "Tones provision" feature describes the respective roles of the PP and the FP for tones provision to the user during an ongoing call. A tone may be related to the active call or to another call.

NOTE: The provision of "ringtones" or melodies is out of the scope of the "Tones provision" feature.

This feature is compatible with other features of the present document such as the "Multiple lines" [NG1.N.14] and "Multiple calls" [NG1.N.15] features.

Active call progress tones. It is recommended to provide tones indications while a call is in progress since silence may cause a user to believe that nothing is happening. In that respect, the "Tones provision" feature is intended to indicate to the user that the call is progressing, so as to prevent him from terminating the call prematurely.

Some information is also given in annex E about tones format.

As described in the following clauses, there are 3 exclusive methods (procedures) to provide tones on the NG-DECT system:

- Method 1- Tones provision by the system / IE <<SIGNAL>> method (NG-DECT Part 3 FP in front of NG-DECT Part 3 PP) as defined in clause 7.4.15.2.1.
- Method 2- Tones provision by the system / in band method (NG-DECT Part 3 FP in front of GAP or NG-DECT Part 1 PP) as defined in clause 7.4.15.2.2.
- Method 3- Transparency to tones provision by the network/PBX (in band tone generated by the network) as defined in clause 7.4.15.3.

NG-DECT Part 3 PP:

PP shall support all methods. The PP will receive an IE <<SIGNAL>> or an in-band tone and shall be able to play/generate the corresponding tone as far as required by table 73. From the PP point of view, method 2 and 3 are very close.

NG-DECT Part 3 FP:

For each tone, the FP shall use only one method toward a given PP to provide the tone. (For example dial tone and busy tones may be generated from the network, method 3, whereas negative acknowledgment tone is generated with method 1).

Use of method 3 for a given tone depends on the network to which the FP it is connected to and does not depend on the PP type.

Table 73 summarises the tones scenarios for a NG-DECT Part 3 FP.

Table 73: Possible scenarios for a NG-DECT Part 3 FP regarding tones

Tones	Call type	Towards a NG-DECT Part 3 PP		Towards a NG-DECT Part 1 PP or GAP PP	
		Status	Method used	Status	Method used
Ring back tone	Internal	M	1	M	2
	External	M	1 or 3	M	2 or 3
Busy tone	Internal	M	1	M	2
	External	M	1 or 3	M	2 or 3
Call Waiting	Internal	M	1 (no Tones off needed)	O	2
	External	M	1 (no Tones off needed) or 3	O	2 or 3
Intercept tone	N/A	M	1 (no Tones off needed)	O	2
Negative acknowledgment tone	N/A	M	1 (no Tones off needed)	O	2
Dial tone	Internal	O	1	O	2
	External	O	1 or 3	O	2 or 3
Off hook warning tone	Internal	O	1	O	2
	External	O	1 or 3	O	2 or 3
Network congestion tone	External	O	1 or 3	O	2 or 3

7.4.15.2 Tones provision by the system

This procedure applies to internal call and to all external calls (first or parallel) when the network does not provide tones. As a consequence, tones shall be generated by the DECT system.

However, in order to limit the complexity of the FP, a distinction is made between two cases:

- NG-DECT Part 3 systems: NG-DECT Part 3 FP in front of a NG-DECT Part 3 PP.
- Mixed systems: NG-DECT Part 3 FP in front of a GAP or NG-DECT Part 1 PP.

7.4.15.2.1 Tones provision for a NG-DECT Part 3 FP in front of a NG-DECT Part 3 PP

When an external or internal call is performed, the system shall provide the following tones to the user:

- Ring-back tone.
- Busy tone.
- Call waiting tone (see clause 7.4.3.5.2).
- Intercept tone (see clauses 7.4.16.2 and 7.4.3.8 (from FP to PP)).
- Negative acknowledgement tone (see clause 7.4.3.4).

In addition, the system may provide the following tones to the user:

- Dial tone.
- Off-hook warning tone.
- Network congestion tone (external calls only).

As a consequence to this, the PP shall support at least the following IE <<SIGNAL>> values defined in EN 300 175-5 [5], clause 7.6.8: Ring-back tone on, Busy tone on, Call waiting tone on, Intercept tone on, Negative acknowledgement tone, Tones Off.

Additionally, it is recommended that the PP supports the following values: Dial tone on, Off-hook warning tone on, Network congestion tone on. This will increase the interoperability with a FP requesting these optional tones.

The 'tone capability' field within the <<Terminal capability>> IE shall be correctly set in accordance to EN 300 175-5 [5]. However, no specific value is requested by the current procedure (as relying on the NG-DECT Part 3 capability flag of the IE <<Terminal capability>> from the PP is sufficient for the FP implementation).

For each one of the implemented tones listed above, on the basis of the signalling received from the network, the FP shall send IE <<SIGNAL>> in the correct CC messages to the PP to request a tone generation.

Upon reception of these <<SIGNAL>> IEs, the PP shall generate the corresponding tone. It shall be generated in consistency with the active codec of the ongoing call. For stopping the tone generation, the PP shall respect the following:

- For Intercept tone, negative acknowledgement tone and call waiting tone, the PP shall stop the generation by itself (as they are very short tones).
- For all other tones, the tone shall be generated by the PP until reception of another tone request (e.g. Tones off or other tone) in any Call control message

Additionally, for the call waiting tone, the FP may re-send additional IE <<SIGNAL>> with 'call waiting tone on' value in order to repeat this short tone in the PP as long as the call waiting is presented by the FP to the PP. The PP shall generate the short call waiting tone at reception of each IE <<SIGNAL>>.

Figure 71 shows an example of external call where a NG PART3 PP generates tones. In this figure, the SIP protocol exchanges between the FP and the network shall be considered as an example and not as standardised exchanges. They are given here only to provide a better understanding of the tone feature.

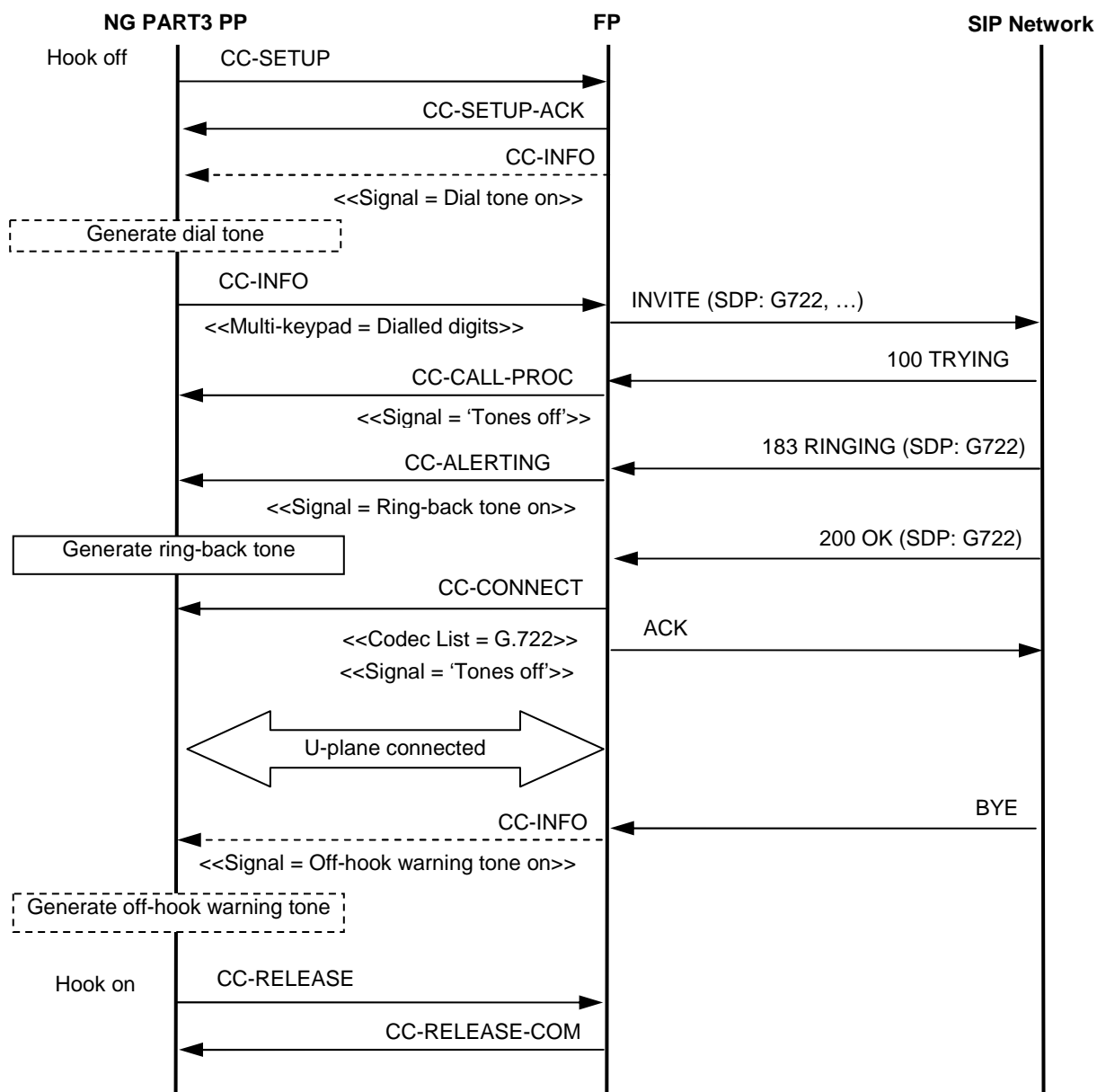

Figure 71: NG PART3 PP provides tones during SIP external call

Figure 72 shows an example of internal call where a NG PART3 PP generates tones. In this figure, the SIP protocol exchanges between the FP and the Network shall be considered as an example and not as standardised exchanges. They are given here only to provide a better understanding of the tone feature.

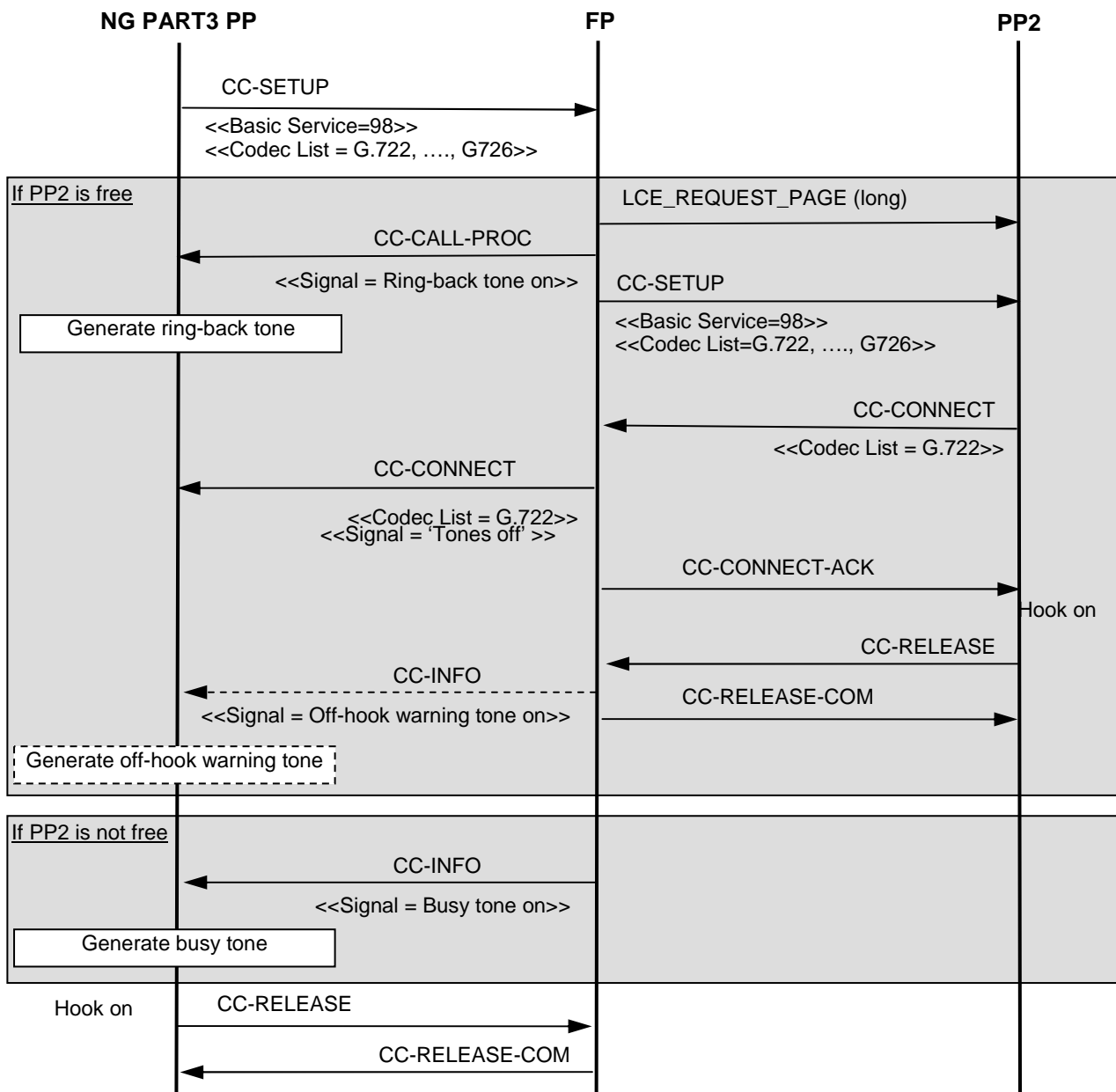

Figure 72: NG PART3 PP provides tones during Internal call

7.4.15.2.2 Tones provision for a NG-DECT Part 3 FP in front of a GAP or NG-DECT Part 1 PP

The aim of this procedure is to guarantee some minimum backward inter-operability with legacy PPs.

When an external or internal call is performed, the system shall provide the following tones to the user:

- Ring-back tone.
- Busy tone.

In addition, the system may provide the following tones to the user:

- Call waiting tone (see clause 7.4.3.5.2 "Call waiting indication").

- Intercept tone (see clause 7.4.16.2 "Headset call interception" and clause 7.4.3.8 "Call intrusion" (from FP to PP)).
- Negative acknowledgement tone (see clause 7.4.3.4 Sending negative acknowledgement).
- Dial tone.
- Off-hook warning tone.
- Network congestion tone (external calls only).

For each of the implemented tone listed above, on the basis of the signalling received from the network, the FP shall generate the correct in-band tone toward the PP.

NOTE: It is preferable that the in-band tone is generated by the FP in the current active codec of the communication. However alternative implementation is also allowed. For example, the FP may switch or choose narrow band codec in order to "fall back" into narrow band before generating the tone.

For each implemented tone, the FP shall not send any <<SIGNAL>> IE to the PP as this could lead to double generation effects (on FP plus PP sides).

7.4.15.2.2.1 Indication of availability of in-band tones

The FP shall indicate availability of in-band tones to the PP by connecting the U-plane, either:

- by transmitting the <<PROGRESS INDICATOR>> information element indicating "in-band information or appropriate pattern now available" in an appropriate message (e.g. {CC-SETUP-ACK}, {CC-ALERTING}, {CC-CALL-PROC}...);
- by sending the {CC-CONNECT} message.

NOTE 1: The selected codec will be confirmed at the latest in the same message.

NOTE 2: The FP should avoid sending the <<PROGRESS INDICATOR>> information element in a {CC-INFO}, either by opening the U-plane early in call setup stages or by using {CC-CONNECT}. In effect, the support of <<PROGRESS INDICATOR>> is not defined as mandatory for {CC-INFO} on PP side in EN 300 444 (GAP) [12] nor in TS 102 527-1 [21].

NOTE 3: The current procedure does not strictly mandate the sending of <<PROGRESS INDICATOR>> from FP as there are two methods for connecting the U plane. This is also consistent with the optional status of <<PROGRESS INDICATOR>> sending from FP in EN 300 444 (GAP) [12] and in TS 102 527-1 [21].

The PP shall accept these in-band tones in the active codec and therefore not replace them with locally generated tones (if available).

Figure 73 shows an example where the FP indicates the availability of call progress tones to the PP using the <<PROGRESS INDICATOR>> information element. In this figure, the SIP protocol exchanges between the FP and the Network shall be considered as an example and not as standardised exchanges. They are given here only to provide a better understanding of the "Tones provision" feature.

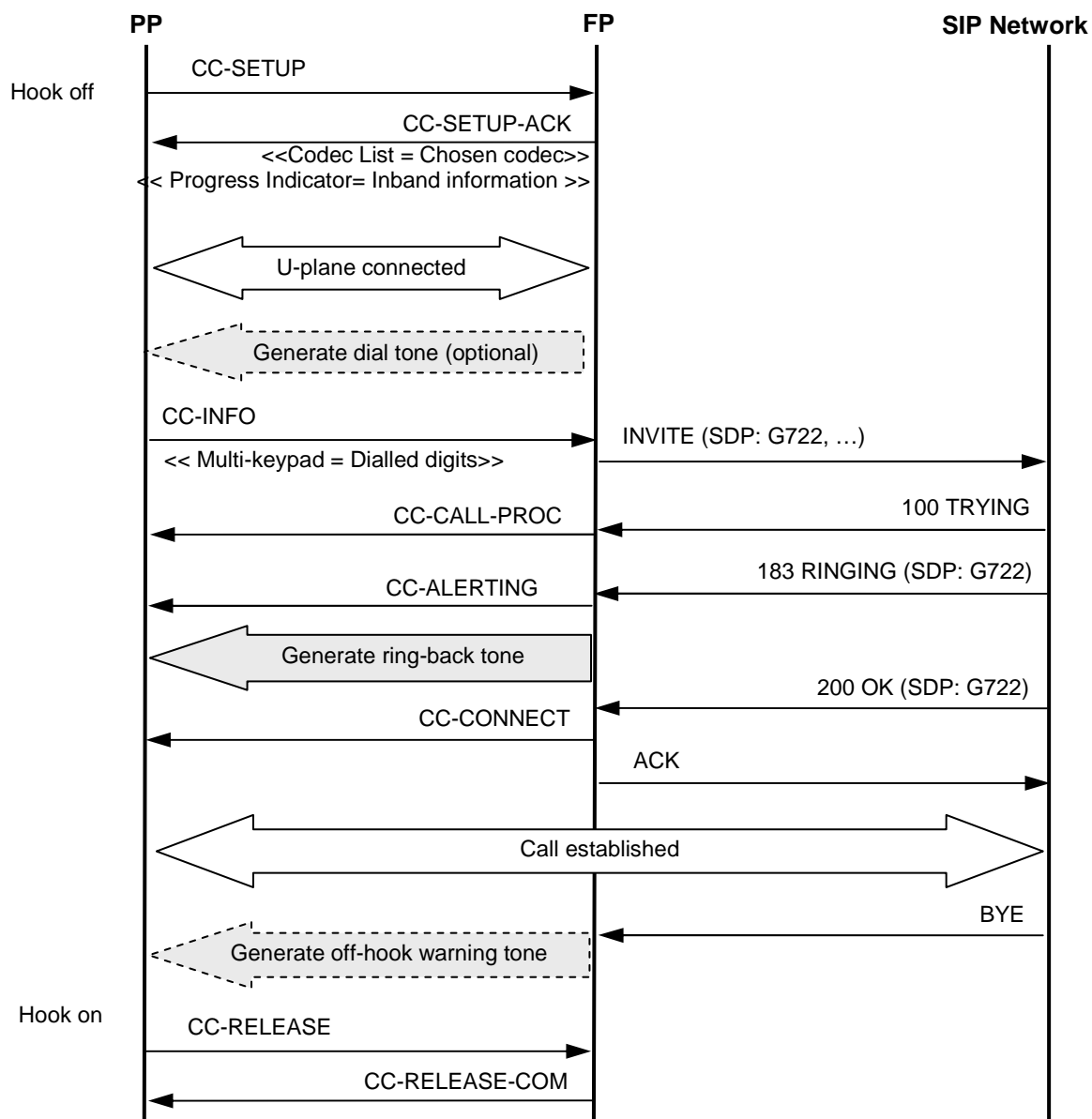

Figure 73: FP provides tones during external call using progress indicator

Figure 74 shows an example where the FP indicates the availability of call progress tones to the PP using the {CC-CONNECT} message. In this figure, the SIP protocol exchanges between the FP and the Network shall be considered as an example and not as standardised exchanges. They are given here only to provide a better understanding of the "Tones provision" feature.

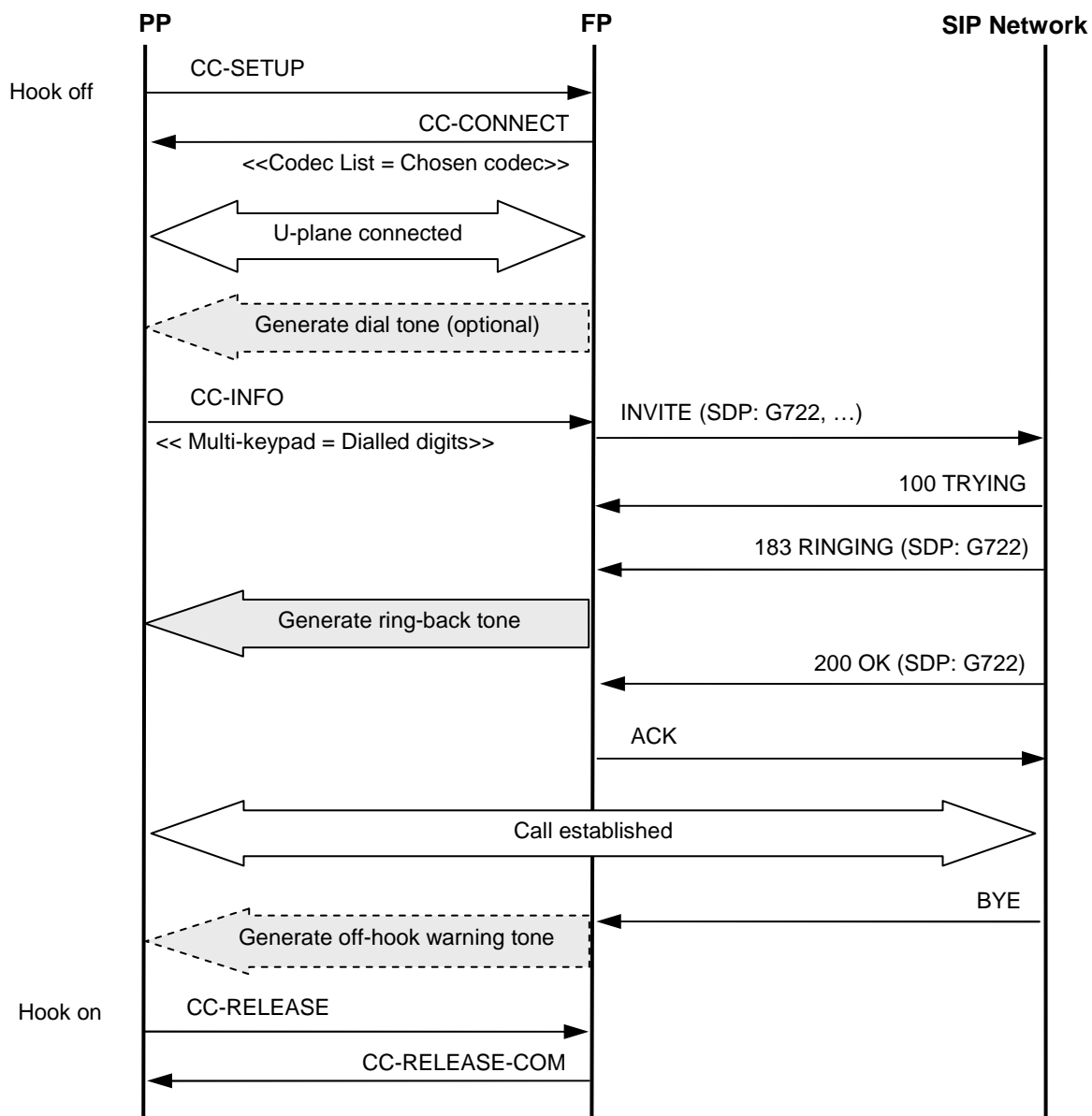

Figure 74: FP provides tones during external call using {CC-CONNECT}

Figure 75 shows an internal call example where the FP indicates the availability of call progress tones to the PP using the << PROGRESS INDICATOR>> information element. In this figure, the SIP protocol exchanges between the FP and the Network shall be considered as an example and not as standardised exchanges. They are given here only to provide a better understanding of the "Tones provision" feature.

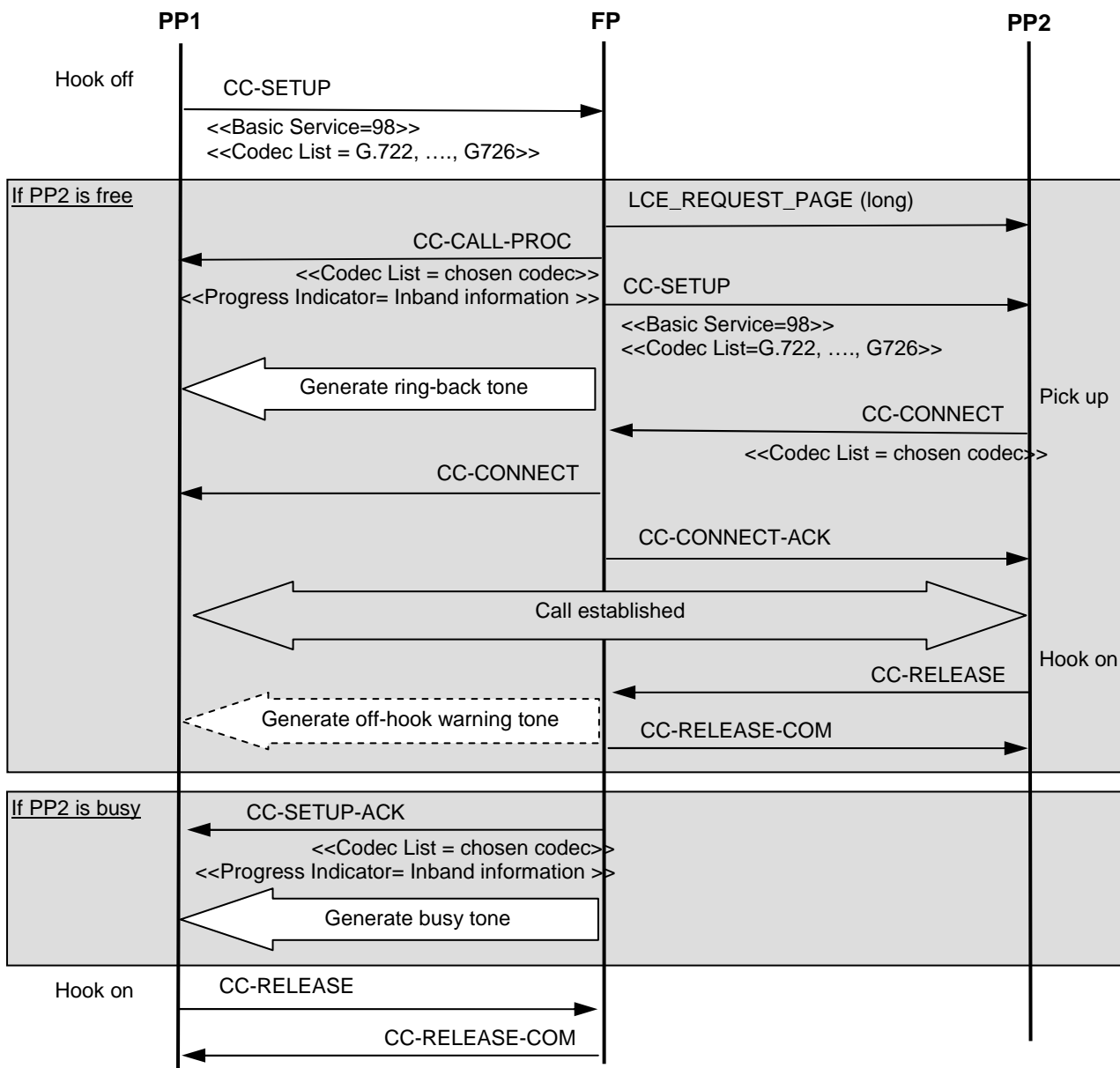

Figure 75: FP provides tones during Internal call using progress indicator

Figure 76 shows an internal call example where the FP indicates the provision of call progress tones to the PP using the {CC-CONNECT} message.

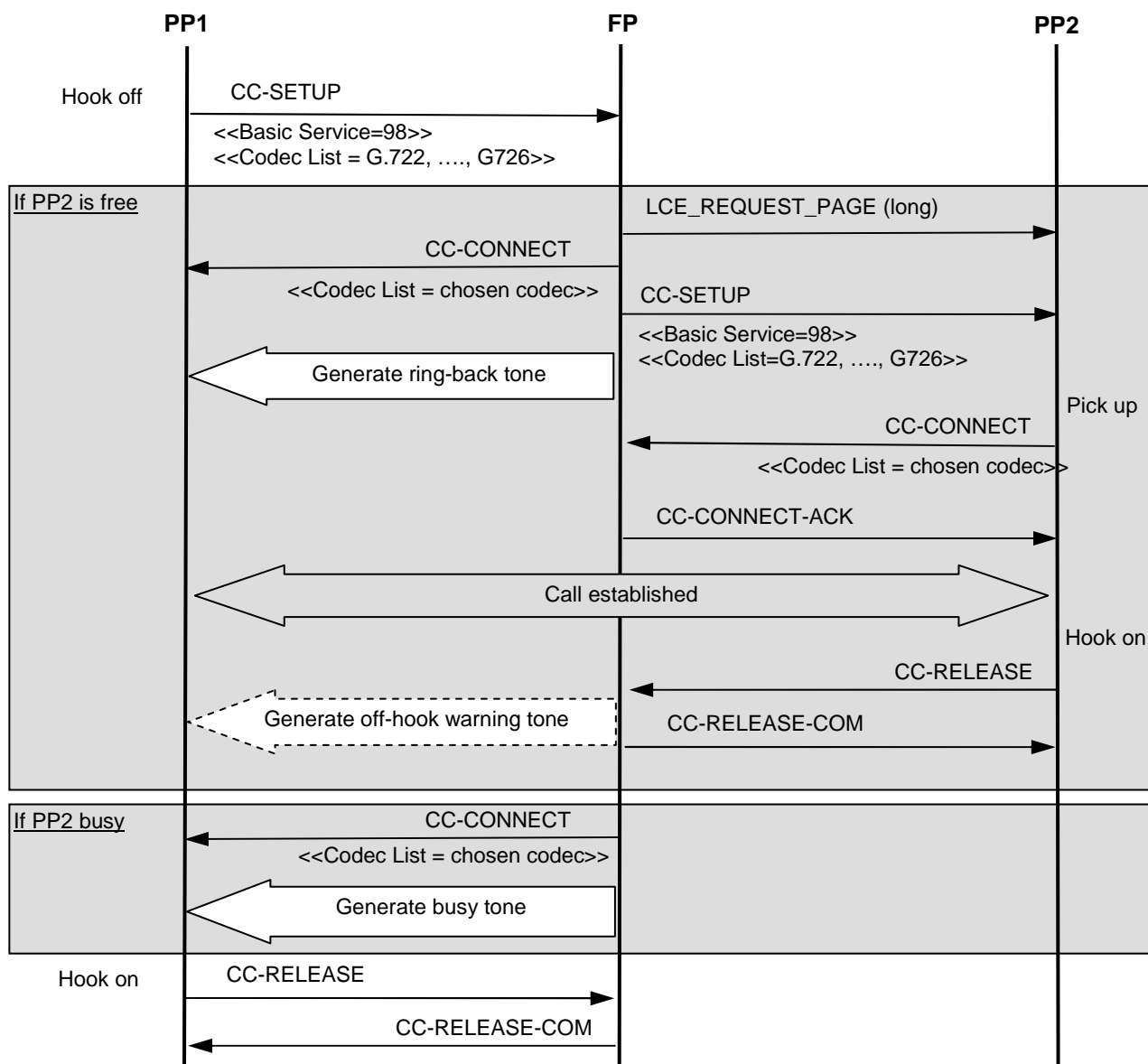

Figure 76: FP provides tones during Internal call using {CC-CONNECT}

7.4.15.3 Transparency to tones provision by the network or PABX

This procedure applies to a FP when a call is placed on a network or PABX that provides in-band tones (e.g. PSTN, private network or PABX).

When the FP recognizes the used network or PABX as a network providing in-band tones, the FP shall not generate in-band tones or request PP tone generation.

The FP shall indicate availability of in-band tones to the PP by connecting the U-plane. Connection of U-plane is described in clause 7.4.15.2.2.1.

The FP shall transparently play network or PABX originating audio in-band tones toward the PP in the U-plane.

Figure 77 shows an example where external call is placed on a Network which provides tones. In this figure, the protocol exchanges between the FP and the Network shall be considered as example and not as standardised exchanges. They are given here only to provide a better understanding of the "Tones provision" feature.

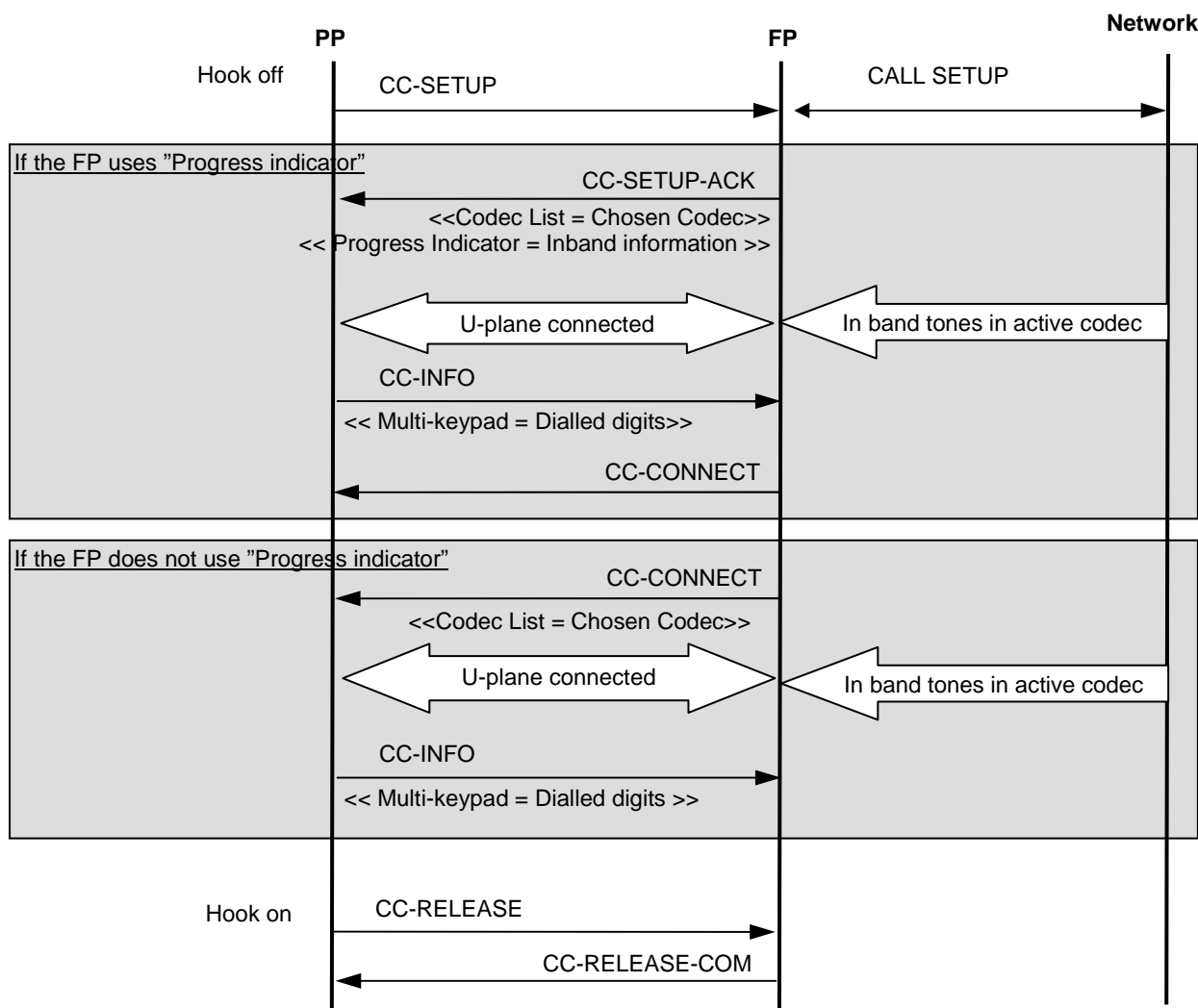

Figure 77: Network provides tones during PSTN external call

7.4.16 Headset management

7.4.16.1 Headset considerations

The "Headset management" feature defines a set of procedures that allow a better support of wideband headset PPs within an NG DECT system. This feature has been designed to guarantee a minimum of interoperability of NG DECT Part 3 systems with NG DECT Part 3 headsets without defining a complete new headset profile, while impacting only slightly the NG DECT PART3 FP implementation.

This feature simplifies the use of headsets for customers while remaining compatible with the basic and extended telephony features defined in the present document (call transfer, call intrusion, parallel calls, etc.). See clause 7.4.16.8 for compatibility details.

When implementing the "Headset management" feature, the HPP shall set the corresponding terminal capability bit: "Support of the *Headset management* feature".

For subscription registration, an HPP shall use the "0000" pin code value, as there is no numeric keypad on the HPP. The HPP should also follow as much as possible the "Registration mode automatic access" procedure (see clause 7.10.1.3.1), and also the "Searching mode request procedure" (see clause 7.10.1.2.3), with the restriction that no keypad shall be used.

NOTE: The user may change the PIN code of his/her system at any time and from any PP. But the PIN code will have to be set to default 0000 value at least temporarily for the HPP registration procedure to be successful.

For the following procedures, a headset PP may interact with any registered standard PP of the DECT system.

7.4.16.2 Headset call interception

This procedure allows to dial an outgoing call on a handset and to continue with the call on a headset. But this procedure also applies when a PP is involved in a call to switch the call to the headset PP.

7.4.16.2.1 Initiation of the call

The outgoing call shall be initiated from any of the registered PPs using the PP keypad. The HPP shall then initiate the call interception procedure, as defined in clause 7.4.16.2.2.

An HPP should always initiate outgoing calls using a 'call interception request' except in the following specific use cases:

- redial of the last outgoing call (see clause 7.4.16.4);
- redial of the last incoming call (see clause 7.4.16.5).

7.4.16.2.2 Call interception

This procedure mainly applies to an HPP willing to replace a PP involved in an existing ongoing call. The replaced PP may be attached to the same line or not.

NOTE 1: The "Call interception" procedure also applies in the following two cases:

- a standard PP tries to intercept a call of another PP;
- a standard PP tries to intercept a call of an HPP.

In these cases, it is necessary to replace the term "PP" with "HPP and/or "HPP" with "PP", as appropriate in the following text of the clause to be applicable.

NOTE 2: "Call interception" is another way to carry out a call transfer in which the transfer is triggered from the targeted PP.

The call interception shall be considered as successful if the following two conditions are met:

- **Condition 1:** There is a single active call (on one PP) in the system (this call shall already be in call setup, call proceeding or connected state).
- **Condition 2:** Call interception is allowed on this PP. In other words, the value of 'Call interception' parameter in the 'internal names' list is set to 'Allowed' value for this PP.

When a PP is involved in a call, an HPP willing to intercept this call in order to be connected with the remote party instead of the PP, shall attempt to place a call with a {CC-SETUP}:

- using the 'Normal call setup' basic service;
- together with the "Call interception request" control code '1C50 2A'H transmitted in a <<MULTI-KEYPAD>> information element in the {CC-SETUP} message (see clause 7.4.3.2).

Successful case: if the two conditions for successful call interception above are met, the DECT system behaviour shall be the following:

- The intercepted call between the HPP and the remote party is considered as a standard internal or external call. The 'call identifier' assigned by the FP for this call shall be the 'call identifier' for the intercepted call.
- As soon as the control code is received, the FP shall answer the HPP with a {CC-CALL PROC} message, including a <<CALL INFORMATION>> IE containing:
 - the call id of the intercepted call;
 - the call status "CS call proc";

- if the intercepted call is external, the line id, together with the 'line type information'.
- Standard codec negotiation mechanisms shall apply between FP and HPP. The FP shall select the codec used between FP and HPP in the {CC-CONNECT} message at the latest.
- The FP shall notify the PP of the call interception with a {CC-INFO} message containing:
 - the HPP CLIP (<<CALLING PARTY NUMBER >> IE);
 - the <<CALL INFORMATION>> IE with the call status 'CS call intercepted' and the same call identifier (call identifier of the intercepted call);
 - if required by the "Tones provision" feature (see clause 7.4.15.2), the information element <<SIGNAL>> with the value 02H indicating 'Intercept tone on'.
- The FP shall wait at least a duration of <CC.NG.01> before releasing the call between the FP and the PP with a {CC-RELEASE} message. During this period, the FP shall "ignore" the audio received from the PP.
- The FP shall connect the HPP with a {CC-CONNECT} message.

NOTE 3: Upon reception of the 'CS call intercepted' call status, the PP may warn the user that the call was intercepted (displaying a message, etc.).

- The FP shall connect the U-plane between the FP and HPP. The peer-to-peer audio path from the remote party shall be routed to HPP (instead of PP).

An example of a successful call interception is given in figure 78.

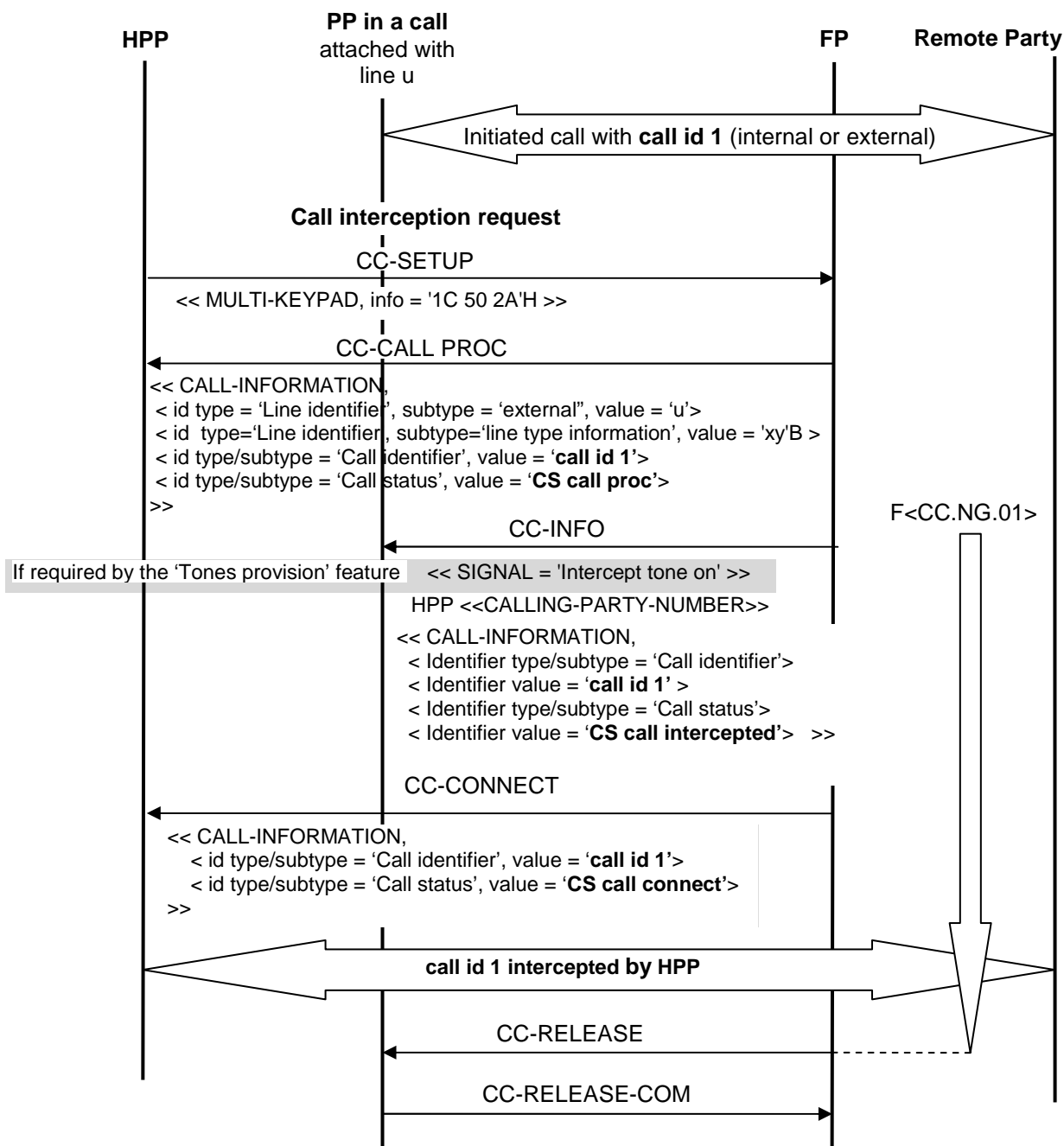

Figure 78: Successful call interception

NOTE 4: The Call Control message sequence in figure 78 should be understood as an example. The real sequence may also contain different Call Control messages or Call Control messages in another order or Call Control messages with other contents.

NOTE 5: The call interception mechanism may be considered as an automatic call transfer requested by HPP and performed by the FP.

Call interception failure cases: The following cases are distinguished and differ mainly by the tone issued in each case by the FP to properly warn the HPP user:

Case 1. If the call interception request from the HPP occurs when there is no initiated call on any PP of the DECT system:

- The FP shall consider the request as a standard outgoing call request : the FP shall issue a {CC-SETUP_ACK}. If the FP implements a dial tone as described in "Tones provision" feature (see clause 7.4.15.2) the FP may send additionally a *dial tone* (sending of the appropriate IE <<SIGNAL>> in a {CC-INFO}). This warns the user that the line is available. Please note this call has few chances to be established as the HPP is very unlikely to send the missing digits.
- The HPP shall finally release the call with {CC-RELEASE} message (For example upon user hang-up request).

Case 2. If the call interception request from the HPP occurs "too early", before all necessary digits were entered by the PP to correctly establish the call with the remote party:

- The FP, PP and HPP shall however proceed to the call interception as described in the successful case above.
- The FP should then behave toward the HPP as for a standard PP call when not enough digits are entered. (For example by issuing the dial tone nad a busy tone after a certain time). Please note this call has few chances to be established as the HPP is very unlikely to send the missing digits.
- The HPP shall finally release the call with {CC-RELEASE} message. For example upon user hang-up request.

Case 3. If the call interception request occurs and the 'Call interception' parameter is set to 'Not allowed' in the 'internal names' list:

- The FP shall use the "Busy system or line notification" procedure of clause 7.4.8.3, that is:
 - the FP shall send call status 'CS call disconnecting' along with call status reason 'control code failed';
 - the FP shall send a <<CALL INFORMATION>> IE with call status 'CS idle' in order to free the call id (on the HPP side only).
- The HPP shall finally release the call with {CC-RELEASE} message (for example upon user hang-up request).

Specific case with multiple calls or multiples lines feature.

If the FP implements multiple calls or multiples lines features and a call interception request from the HPP occurs when there is more than one active outgoing calls in the DECT system, the behaviour of the system shall be the following:

- The FP shall issue a <<DISPLAY>> message toward the PPs in communications, notifying the user that a call interception is requested by the HPP. The sending of the DISPLAY may be restricted to only the PPs attached to the same line(s) as the HPP.
- The first PP to send a "#" keypad will be considered as the intercepted party. This shall be done by the PP by sending a control code 23H in a <<MULTI-KEYPAD>> information element within a {CC-INFO} message.
- Only upon reception of this keypad, the FP shall then proceed to the call interception of the active call with this specific PP as in the successful case. (The call shall be released on PP with prior intercept tone and switched to HPP).

NOTE1: The '#' keypad sending remains compatible with GAP handsets.

NOTE2: The HPP may release the call at any time. This is also the way to terminate this specific case if none of the PP sent the "#" keypad (no need for specific timer in the FP to handle this case).

NOTE3 : The FP may additionally support alternative keypad values with equivalent behaviour to "#". (This allows an alternative implementation to prevent the very specific case where a second PP accepts the call interception after a first one already accepted, and where the "#" keypad would be transmitted over the network as standard keypad/DTMF with unexpected effect in the network).

Interception of internal calls :

The FP may support interception of internal calls additionally to interception of external calls. This shall be based on the same "#" keypad mechanisms as described in the multiple calls/multiple lines clause above. The first PP which invokes the "#" keypad will be considered as the intercepted party.

7.4.16.3 Headset incoming call

When receiving an incoming call (external or internal) in the DECT system, the HPP may answer this call using the usual incoming call procedures.

The HPP behaves as a standard PP toward the FP in the DECT system in this case.

7.4.16.4 Re-dial of last outgoing call

This procedure applies to the HPP and the FP only.

Upon user request on HPP for re-dialling the last outgoing call:

- The HPP shall attempt to place a call with a {CC-SETUP} using the 'Normal call setup' basic service. The HPP shall not invoke the "Call interception" procedure.
- The HPP shall access the last entry of the 'outgoing call' list of the FP to retrieve the number of the last outgoing call (see 'List access' feature in clause 7.4.10 and annex C for guidelines).
- **If the 'outgoing call' list is available in the FP:**
 - The HPP shall use this number to fill the <<MULTI-KEYPAD>> information element sent in a {CC-INFO} message.
 - The FP shall establish the outgoing call using this number.
- **If the 'outgoing call' list is not available in the FP:**
 - The FP shall issue a start session confirm with a <Start session reject reason> equal to 'list not supported'.
 - The HPP may play a negative acknowledgment tone.
- The HPP shall finally release the call with a {CC-RELEASE} message. For example upon user hang-up request.

NOTE: Re-dialling the last outgoing call is also possible from any registered handset. The HPP may then use the regular outgoing call procedure defined in clause 7.4.16.2 and intercept the call.

If the call can not be established with the network on the FP side for resources reasons (no line available for example) the FP shall notify the HPP with a busy tone as defined in the "Tones provision" feature (see clause 7.4.15.2)

7.4.16.5 Re-dial of last incoming call

The HPP shall store the CLIP of the last incoming external call.

Upon user request on HPP for re-dialling the last incoming call, the HPP shall re-use the number included in the CLIP of the last incoming external call.

- The HPP shall attempt to place a call with a {CC-SETUP} using the 'Normal call setup' basic service. The HPP shall not invoke the "Call interception" procedure.
- HPP shall use this number to fill a <<MULTI-KEYPAD>> information element sent in a {CC-INFO} message.
- The FP shall establish the outgoing call using this number.

If the call can not be established for resources reasons (FP or network reasons) the FP shall notify with a busy tone toward the HPP as defined in "Tones provision" feature (see clause 7.4.15.2), using the appropriate <<SIGNAL>> information element.

7.4.16.6 Switching from headset to handset (headset initiated)

This procedure applies to the FP, the HPP involved in an active call, and any registered PP. It consists in transferring the call from the HPP to the PP.

The HPP shall invoke the call transfer procedure (see clause 7.4.3.6) and more specifically the unannounced call transfer procedure (see clause 7.4.3.6.2).

FP shall support both possible unannounced call transfer requests from HPP:

- Transfer by calling all PPs: using 2AH as terminal identity number for the internal call.
- Transfer by calling one selected PP: using the corresponding terminal identity number for the internal call.

7.4.16.7 Switching from headset to handset (handset initiated)

This procedure applies to the FP, a HPP involved in an active call and any registered PP. It assumes a call interception request can be initiated from the PP via a dedicated MMI.

The switching is triggered by a user request on the PP. The PP shall invoke the call interception procedure (see clause 7.4.16.2.2).

The call initially active on HPP is "switched" to the intercepting PP.

7.4.16.8 Compatibility with other telephony features and profiles

Clause 7.4.16.8.1 clarifies the behaviour and limitations of the HPP regarding other features of the present document, taking into account that an HPP is considered as a standard PP with however a very limited set of keys.

7.4.16.8.1 Compatibility with other telephony features for a headset portable part (HPP)

When an HPP is registered on a FP, all the features of the present document apply by default for both parts with status defined in clauses 6.2 and 6.4. However, the following restrictions or clarifications also apply :

Compatibility with Easy PIN code registration [NG1.A.1]:

This feature is not applicable to HPP except if HPP has keyboard.

Compatibility with Easy pairing registration [NG1.A.2]:

This feature is not applicable to HPP except if HPP has keyboard.

Compatibility with Missed call notification [NG1.N.3]:

All procedures are applied on FP side toward the HPP as for a standard PP (sending of notifications).

The HPP may support the feature.

Compatibility with Voice message waiting notification [NG1.N.4]:

All procedures are applied on FP side toward the HPP as for a standard PP (sending of notifications).

The HPP may support the feature.

Compatibility with Date and time synchronization [NG1.N.5]:

All procedures are applied on FP side toward the HPP as for a standard PP (sending of time/date).

The HPP may support the feature but it is very unlikely.

Compatibility with Parallel calls [NG1.N.6] and Common parallel call procedures (external or internal) [NG1.N.7]:

All procedures are applied on FP side toward the HPP as for a standard PP (sending of notifications).

It is recommended that the HPP supports at least "Active call release with replacement (from PP to FP)" of clause 7.4.3.5.12. The HPP may support the other procedures but this is unlikely.

Compatibility with Call transfer (internal or external) [NG1.N.8]:

The HPP may support the feature. See also procedure "Switching headset to handset (headset initiated)", clause 7.4.16.7.

Compatibility with 3-party conference call (internal or external) [NG1.N.9]:

The HPP may participate into a conference call but support of the feature is unlikely (complex to initiate a conference from the HPP).

Compatibility with Intrusion call [NG1.N.10]:

The HPP may support implicit or explicit call intrusion.

Compatibility with Line identification [NG1.N.12]:

All procedures are applied on FP side toward the HPP as for a standard PP.

The HPP shall support the feature for performing regular calls.

EXAMPLE: When performing a "regular" external outgoing call, the HPP shall use a line identifier.

However, when performing a call interception, the HPP shall not send any line identifier value, nor the 'None' line identifier value (see clause 7.4.16.2.2).

Compatibility with Call identification [NG1.N.13]:

All procedures are applied on FP side toward the HPP as for a standard PP.

A HPP shall implement the feature.

Compatibility with Multiple lines [NG1.N.14]:

All procedures are applied on FP side toward the HPP as for a standard PP.

A HPP may implement the feature. The HPP is considered as a standard PP regarding attachment to lines in the line settings list.

Compatibility with Multiple calls [NG1.N.15]:

All procedures are applied on FP side toward the HPP as for a standard PP.

A HPP may implement the feature.

Compatibility with List access service [NG1.N.16]:

All procedures are applied on FP side toward the HPP as for a standard PP.

A HPP may implement the feature and access any of the lists available in the FP.

Compatibility with the DTMF handling feature [NG1.N.19]:

All procedures are applied on FP side toward the HPP as for a standard PP.

DTMF feature from HPP is unlikely but may be possible if HPP has keyboard.

Compatibility with Tones provision feature [NG1.N.20]:

All procedures shall be applied on FP side towards the HPP as for a standard PP.

Compatibility with Handling of lines where second calls are signalled in-band feature [NG1.N.22]:

All procedures shall be applied on FP side towards the HPP as for a standard PP (sending of notifications).

It is recommended that the HPP supports at least "Active call release with replacement (from PP to FP)" of clause 7.4.3.5.12. The HPP may support the other procedures but this is unlikely.

Compatibility with Dialed digits (basic) [GAP.N.4]:

HPP may implement the feature (e.g. shortcut key to request re-dial of last outgoing call or last incoming call).

Compatibility with internal call feature [GAP.N.31]:

All procedures are applied on FP side toward the HPP as for a standard PP.

A HPP may implement the feature and place internal calls.

7.4.16.8.2 Compatibility of a NG-DECT Part 3 headset portable part with other profiles**Behaviour of NG-DECT Part 3 headset registered on a GAP or NG-DECT Part 1 FP:**

- It shall be possible to answer HPP incoming calls as the HPP behaves as a standard PP for incoming call.
- For outgoing calls possible behaviour of the FP may be the following:
 - If the FP supports a "headset management" equivalent feature, the HPP may use it as described in the present document.
 - If the FP supports a "Call intrusion" equivalent feature, the HPP may intrude an outgoing call, if any PP is already involved in a call, FP will handle the call intrusion between PP and HPP.
 - If internal call transfer is supported by the FP, call will have to be established on PP first and then transferred to the HPP.
 - If none of the above features are supported, placing an outgoing call with HPP is not described.
- With GAP FP, established calls will only be narrow band calls.

Behaviour of NG-DECT Part 3 headset registered on a NG-DECT Part 3 FP with a GAP or NG-DECT Part 1 registered PP:

The current "headset management" feature applies with the following restrictions:

- The intercept tone shall be sent in band from FP to PP during outgoing call (instead of out band), (see the "Tones provision" procedure in clause 7.4.15.2.2).
- If the HPP intercepts the call of a GAP PP, the intercepted call (originally in G.726 with GAP PP) may be re-negotiated to an other codec between FP and HPP (G.722 for example).

7.4.17 UTF-8 CNIP**7.4.17.1 UTF-8 CNIP sending from the FP to PP**

The sending of the CNIP shall be performed as defined in EN 300 444 [12], clause 8.42 for external call and clause 8.44 for internal call. Additionally, the following requirements apply:

An NG PART3 FP shall send the <<CALLING PARTY NAME>> information element using:

- UTF-8 encoded characters when the message is sent towards a NG DECT PART3 PP;
- DECT standard characters as defined in EN 300 175-5 [5], annex D (IA5 characters) when the message is sent towards a NG DECT Part 1 or a GAP PP. This implies that the FP translates non IA5 characters it supports into more or less equivalent IA5 characters if they are received in UTF-8 format from the network.

NOTE : Use of an IA5 equivalent may be language specific (example: ö replaced with oe in german), or non-language specific (ö replaced with o).

7.4.17.2 Display of UTF-8 characters on PP side

An NG DECT Part 3 PP shall be capable of displaying at least IA5 characters and shall understand UTF-8 encoding format (PP shall not misbehave upon reception of UTF-8 encoded characters)

In addition to IA5 characters, an NG DECT Part 3 PP should be capable of displaying additional UTF-8 characters (characters with accents, and symbols for example). The set of supported characters should be in accordance with the network the PP is connected to, and may be country and/or language related. Guidelines for the display of UTF-8 encoded characters are given in annex M of EN 300 175-5 [5].

For UTF-8 characters the PP is not able to display, the PP should use a replacement character. For example, Unicode 'REPLACEMENT CHARACTER' (code point U+fffd, glyph ) could be used for this purpose. This is expected to happen when receiving a CNIP from a network in a foreign country (and for which the language is not supported by the PP).

7.5 Data Link Control (DLC) layer procedures

This clause specifies the additional DLC layer procedures, messages and information elements required in New Generation DECT Extended Wideband Speech Services not described in TS 102 527-1 [21] or in EN 300 444 [12] (GAP), or incorporating modifications to the description given in these specifications.

7.5.1 DLC services

The requirements of TS 102 527-1 [21], clause 7.5.1 shall apply.

7.6 Medium Access Control (MAC) layer procedures

This clause specifies the additional MAC layer procedures, messages and information elements required in New Generation DECT Extended Wideband Speech Services not described in TS 102 527-1 [21] or in EN 300 444 [12] (GAP), or incorporating modifications to the description given in these specifications.

7.6.1 MAC services

The requirements of TS 102 527-1 [21], clause 7.6.1 shall apply.

7.6.2 Frame formats and multiplexers

The requirements of TS 102 527-1 [21], clause 7.6.2 shall apply.

7.6.3 Downlink broadcast

7.6.3.1 N_T message

The requirements of TS 102 527-1 [21], clause 7.6.3.1 shall apply.

7.6.3.2 Q_T - static system information

The requirements of TS 102 527-1 [21], clause 7.6.3.2 shall apply.

7.6.3.3 Q_T - Fixed Part capabilities

The requirements of TS 102 527-1 [21], clause 7.6.3.3 shall apply.

Higher layer information: The management entity in the FP supplies the MAC layer with a 16-bit SDU via the Management Entity (ME) SAP. The content of that SDU is placed in bits $\langle a_{32} \rangle$ to $\langle a_{47} \rangle$ of the Q_T message. At the PT the MAC layer passes the 16 bits out through the ME SAP to the management entity.

For the setting of the higher layer information bits see clause 7.3.9.1 of TS 102 527-1 [21].

7.6.3.4 Q_T - Extended Fixed Part capabilities

The requirements of TS 102 527-1 [21], clause 7.6.3.4 shall apply.

Higher layer information: The management entity in the FP supplies the MAC layer with a 23-bit SDU via the Management Entity (ME) SAP. The content of that SDU is placed in bits $\langle a_{25} \rangle$ to $\langle a_{47} \rangle$ of the Q_T message. At the PT the MAC layer passes the 24 bits out through the ME SAP to the management entity.

No higher layer information for New Generation DECT; parts 1 or 3 is broadcasted in Q_T - Extended Fixed part capabilities.

7.6.3.5 Q_T - Extended Fixed Part capabilities part 2

The FT shall be capable of sending and the PT shall be capable of receiving and processing the Q_T message as defined in EN 300 175-3 [3], clause 7.2.3.11 with the following values.

Table 74: Values used within Extended FP capabilities part 2

MAC message	Field within the message	Standard values within the MAC message	Normative action/comment
$\langle\langle FP \text{ capabilities} \rangle\rangle$	$\langle Qh \rangle$	C	
	$\langle a_{12} \rangle$	1	Long slot $j=640$
	$\langle a_{13} \rangle$	0,1	Long slot $j=672$ (if supported)
	$\langle a_{23} \rangle$	0,1	"no emission" mode: preferred carrier number mode (CN)

Setting of bit a_{23} : "no emission mode"

$a_{23} = 1$: variable preferred CN /every CN possible.

$a_{23} = 0$: fixed preferred CN.

The preferred carrier number is selected and broadcasted by the FT (PT broadcast info).

FT:

- if ($a_{23} = 1$), then DummyPointer-wakeups on all carriers should be done after reset;
- if ($a_{23} = 0$), then DummyPointer-wakeup only on the known preferred carrier should be done after reset.

PT:

- check capability "no emission" mode: preferred carrier number mode;
- if ($a_{23} = 1$), then DummyRequest-wakeups on all carriers should be done after reset or asynchronous mode;
- if ($a_{23} = 0$), then DummyRequest-wakeup only on the known preferred carrier should be done after reset or asynchronous mode.

Higher layer information: The management entity in the FP supplies the MAC layer with a 24-bit SDU via the Management Entity (ME) SAP. The content of that SDU is placed in bits <a24> to <a47> of the Q_T message. At the PT the MAC layer passes the 24 bits out through the ME SAP to the management entity.

For the setting of the higher layer information bits see clause 7.4.9.2.2.

7.6.3.6 Q_T - SARI list contents

The requirements of TS 102 527-1 [21], clause 7.6.3.6 shall apply.

7.6.4 Paging broadcast

The requirements of TS 102 527-1 [21], clause 7.6.4 shall apply.

7.6.5 "no-emission" mode

The requirements of EN 300 175-3 [3], clauses 7.1.2, 7.2.3.11, 7.2.4.3, 7.3.5.3, 9.4 and 11.11 shall apply.

7.7 Physical layer (PHL) requirements

7.7.1 Modulation

The FT and PT shall support 2 level Gaussian Frequency Shift Keying (GFSK) modulation as defined by EN 300 175-2 [2], clause 5.

7.7.2 Slot type (Physical packets)

The requirements of TS 102 527-1 [21], clause 7.7.2 shall apply.

7.8 Requirements regarding the speech transmission

7.8.1 General

The requirements of TS 102 527-1 [21], clause 7.8.1 shall apply.

7.8.2 Speech codecs

The requirements of TS 102 527-1 [21], clause 7.8.2 shall apply.

7.8.3 Audio performance requirements

The requirements of TS 102 527-1 [21], clause 7.8.3 shall apply. The status of each feature shall be as defined by tables 8 (see clause 6.8) and 2 (see clause 6.3) of the present document.

7.9 Management procedures

All procedures described in GAP (EN 300 444 [12], clause 13) shall be supported. Higher layer capability FP broadcast shall be set as described in clause 7.4.9.2 of the present document.

7.10 Application procedures

This clause specifies the additional application layer procedures, messages and information elements required in New Generation DECT Extended Wideband Speech Services not described in TS 102 527-1 [21] or in EN 300 444 [12] (GAP), or incorporating modifications to the description given in these specifications.

7.10.1 Easy PIN code and easy pairing registration

The "Easy PIN code registration" and "Easy pairing registration" features use common procedures (see clause 7.10.1.3) and specific procedures (see clauses 7.10.1.1 and 7.10.1.2 respectively).

7.10.1.1 Easy PIN code registration

7.10.1.1.1 Searching mode and PIN code requests

The access rights procedure triggered by the user on the PP causes it to actively search for a FP broadcasting 'Access Rights requests supported' capability bit (Higher layer capabilities bit $a_{44} = 1$, see EN 300 175-5 [5], clause F.1 and EN 300 444 [12], annex A (informative): PP locking procedure for on-air subscription procedure). The searching mode shall be limited by the timer P<AP.02>.

When a FP is found in subscription mode, the PP shall prompt the user to enter the PIN code. After PIN entering, the PP shall start the access rights procedure using the PIN code value for the authentication code.

NOTE 1: When performing easy PIN code registration, it is assumed that the PP is in close proximity to the FP, and therefore the PP will receive a stronger signal from that FP. The PP can use RSSI readings to speed-up the search for the desired FP. For example:

- 1 - Measure the RSSI level on each channel.
- 2 - Synchronize on the FP with the highest RSSI value.
- 3 - Wait for the a_{44} bit to check if it is set.
- 4a - If a_{44} is set, start the access rights procedure.
- 4b - If a_{44} is not set, put the RFPI on a barred list and go to step 2 (or 1) to find other FP.

NOTE 2: It is recommended to request the PIN code entering *after* locking to a FP in subscription mode, because this procedure may be common with easy pairing search mode request procedure (see clause 7.10.4). Nevertheless it can be done before.

NOTE 3: For security purposes, it is recommended to use a PIN value different from default '0000' value. In this case it could be convenient to indicate the device PIN value with a sticker on the FP. It could also be recommended to change the PIN value in the user manual.

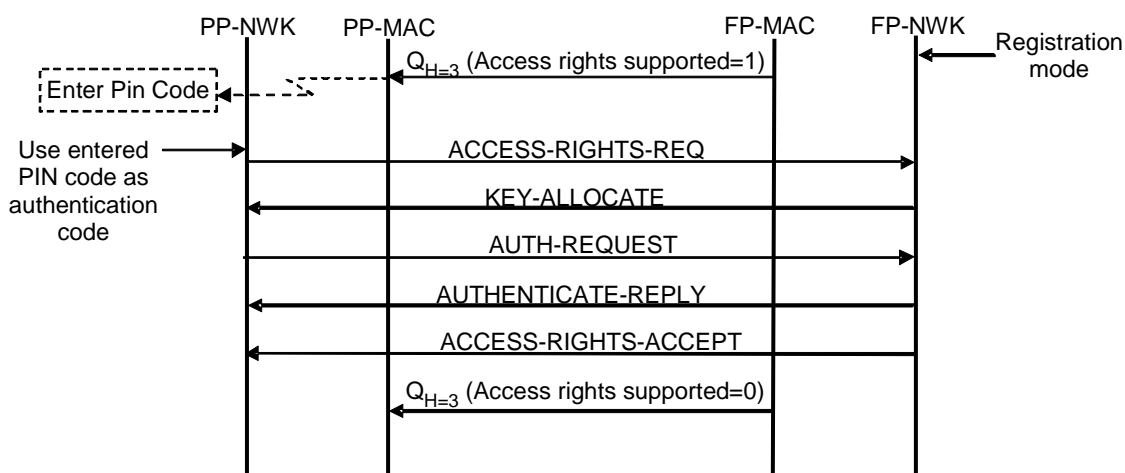

Figure 79: Easy PIN code registration mode

7.10.1.2 Easy pairing registration

7.10.1.2.1 Easy pairing registration description

Easy pairing feature simplifies the registration process by not requesting any PIN code to the user when the PIN code is set to default "0000" value.

When feature is implemented, related procedures shall be valid at first power ON of a non registered handset and at any additional further registrations.

The PP will systematically try to register with the default "0000" PIN code. In case of failure, the PP will automatically switch back to the easy PIN code registration feature process and corresponding procedures.

From security point of view, successful easy pairing is equivalent to default 0000 PIN code registration which is less secure than any non 0000 PIN code registration. As a consequence, for easy pairing registration, the user should be instructed to monitor the registration user feedback (see clause 7.10.6).

As additional security and for user convenience it is recommended to use the "Base station name selection" (see clause 7.10.7). This allows checking that registration of a PP is ongoing on the correct FP.

7.10.1.2.2 Base station limited registration mode

The FP shall have a physical or a logical button to trigger the access rights procedure.

When the button is pressed on the FP, the FP shall set its broadcasting 'Access Rights supported attributes' capability bit to enable the on air subscription (see clause 7.4.9.1 "Higher layer information in FP broadcast" and EN 300 444 [12] clause 13.6 "Broadcast attributes management"). At the same time, the FP shall set the 'Easy pairing registration supported' capability bit (see clause 7.6.3.5 "Q_T - Extended Fixed Part capabilities part 2").

These bits shall be set during timer F<AP.01>. When the access rights procedure is successfully completed, these bits shall be cleared.

For security reasons, the FP shall perform no more than one successful access rights procedure during the subscription mode.

7.10.1.2.3 Searching mode request

The access rights procedure triggering by the user on the PP causes it to actively search for a FP broadcasting 'Access Rights requests supported' capability bit (Higher layer capabilities bit a₄₄ = 1, see EN 300 175-5 [5] annex F.1 and EN 300 444 [12], annex A (informative): PP locking procedure for on-air subscription procedure). The searching mode shall be limited by the timer P<AP.02>.

When a FP is found in subscription mode, the PP shall start the access rights procedure using the '0000' value for the authentication code. If the FP rejects the access rights, the PP shall prompt the user to enter the PIN code. The PP shall then initiate a new access rights request with the same FP using the PIN entered value for the authentication code.

NOTE: When performing easy pairing registration, it is assumed that the PP is in close proximity to the FP, and therefore the PP will receive a stronger signal from that FP. The PP can use RSSI readings to speed-up the search for the desired FP. For example:

- 1 - Measure the RSSI level on each channel.
- 2 - Synchronize on the FP with the highest RSSI value.
- 3 - Wait for the a₄₄ bit to check if it is set.
- 4a - If a₄₄ is set, start the access rights procedure.
- 4b - If a₄₄ is not set, put the RFPI on a barred list and go to step 2 (or 1) to find other FP.

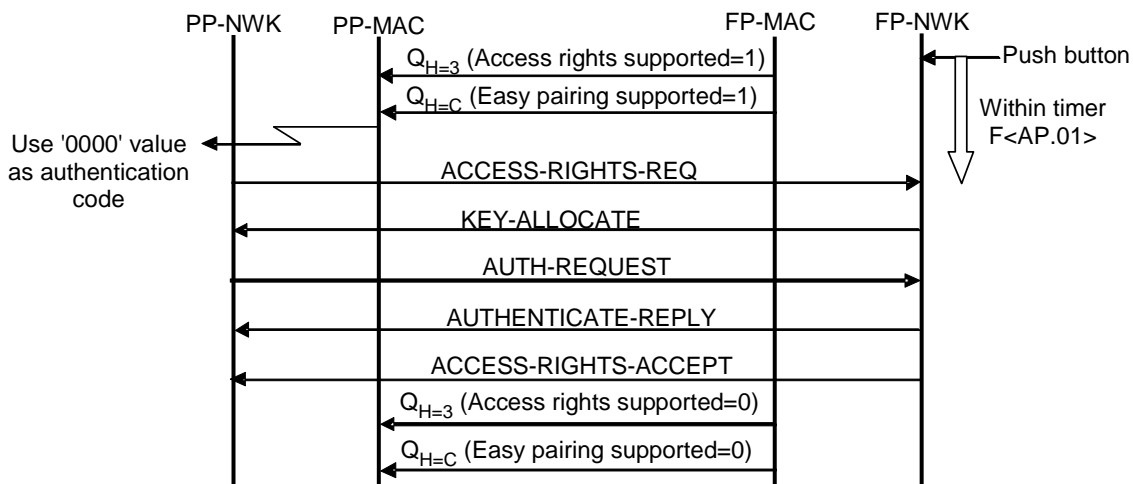

Figure 80: Easy pairing when PIN is set to default '0000' value

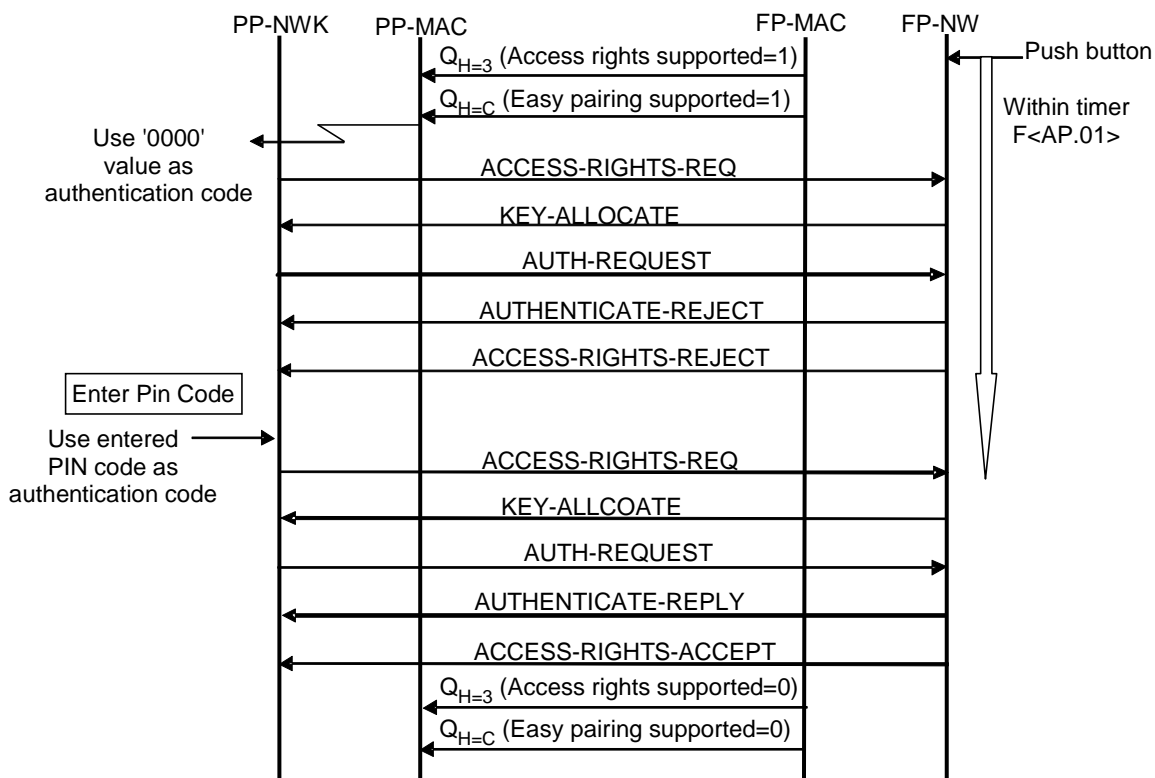

Figure 81: Easy pairing when PIN is not set to default '0000' value: switching back to PIN entry

Backward compatibility management: when a PP is in front of a FP without easy pairing capability, here are three possible behaviours of the PP (among several others and left free to implementer):

- 1) The PP uses the easy pairing feature, in case of failure, requests the PIN code, exactly as in front of a FP with easy pairing. The PP does not take into account the capability bit. This means easy pairing feature is always used on the PP independently of the FP type.
- 2) The PP uses the easy pairing feature but in case of easy pairing failure, the PP uses the capability bit to warn the user that re-triggering of the FP registration button might be necessary before using the easy PIN code registration feature. This deals with the case where the FP might not remain in registration mode in case the PP easy pairing attempt fails (could occur on some GAP FP for example).

- 3) The PP detects the absence of 'easy pairing registration supported' capability bit from the beginning and decides not to use the easy pairing feature but to use easy PIN code registration feature instead. This behaviour has the drawback not to use easy pairing. So it should be implemented only if behaviour 1 and 2 can not be implemented.

7.10.1.3 Common procedures to easy PIN code and easy pairing

7.10.1.3.1 Registration mode automatic access

When a PP that it is not registered to any FP is powered on, the PP shall start in a mode where the user is directly invited to trigger the access rights procedure. Upon user acknowledge, the access right procedure shall start.

It shall be possible for the user to leave this mode to switch back to idle mode.

For any further registrations on the PP (additional registration to the initial one), the registration mode should also be easily accessible from the user point of view.

7.10.1.3.2 Base station name selection

This clause applies only to PP with a display capability.

The FP shall broadcast its name during the subscription mode. The name shall be composed of up to 17 characters to fit in a {CLMS-FIXED} message. The name could be set to the manufacturer and model of the phone by default (see note 1) and could be changed by the user to a friendly name.

As soon as a FP with a_{44} set to 1 is found within the FP searching process based on the RSSI, the name shall be displayed by the PP.

EXAMPLE 1: The PP may display a list of FP names in subscription mode for selection by the user.

EXAMPLE 2: The PP may display only the selected FP (taking into account the best RSSI indication for example).

The PP will then start the access rights procedure with the selected FP (see clauses 7.10.2 or 7.10.5). The name shall be displayed by the PP with the result of the complete registration procedure.

The FP shall transmit its name information frequently during the subscription mode (i.e. during timer F<AP.01>). At least, the first segment of the FP name shall be transmitted within one period of F<AP.03> after the FP capabilities information transmission in order to receive it very quickly on PP side.

NOTE 1: When there are several FP of same type in range in subscription mode, this can be confusing. Therefore, it is recommended to set a unique name by default. For a DECT phone, the name could be composed of the phone model reference with the two last bytes of RFPI and indicated with a sticker on the FP. For a DECT FP integrated within a gateway/PBX, the name could be composed of the gateway/PBX model reference with additional unique identifier.

NOTE 2: The PP should take into account the FPs not supporting the base name broadcasting (e.g. GAP or NG-DECT Part 1 base stations). In that case, the PP may display a message like "Unknown" or the RFPI.

NOTE 3: With this procedure, the overall process to select a base in registration mode is a little bit longer but it really improves the security.

FP name broadcasting is initiated by including the <<NETWORK-Parameter>> information element in the {CLMS-FIXED} message. The procedure to construct a multi-section {CLMS-FIXED} message shall be performed as defined in EN 300 175-5 [5], clause 8.3.

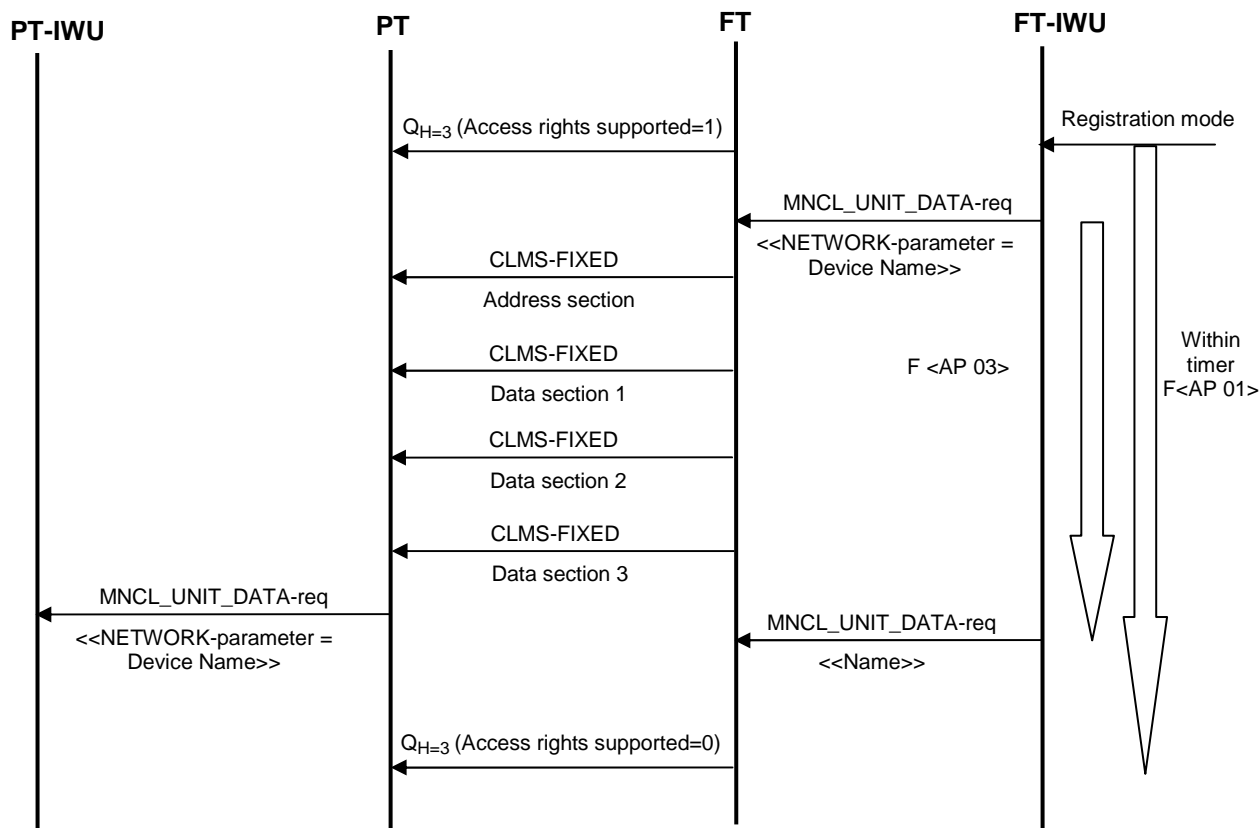

Figure 82: Base station name broadcasting

Table 75: Values used within the {CLMS-FIXED} message 1st segment

Information element	Field within the information element	Standard values within the field/IE	Normative action/comment
<<A>>		1	Address section
<<CLMS header>>		010B	Multiple sections/Standard
<<Address>>		CFFFH	Connectionless Group TPUI
<<Protocol Discriminator>>	<Second Discriminator>	000001B	DECT Information elements coding
<<Length Identifier>>		Any	Indicates implicitly the number of data sections to follow

Table 76: Values used within the {CLMS-FIXED} message 2nd segment

Information element	Field within the information element	Standard values within the field/IE	Normative action/comment
<<A>>		0	Data section
<<CLMS header>>		000B	Data section number - 0 (1st)
<<DATA/Fill>>		41H	NETWORK parameter (octet 1)
		Any < 20	Length (octet 2)
		00010000B	Discriminator: Device name (octet 3)
		Name	First character of name (octet 4)

Table 77: Values used within the {CLMS-FIXED} message k segment

Information element	Field within the information element	Standard values within the field/IE	Normative action/comment
<<A>>		0	Data section
<<CLMS header>>		K	Data segment (k+1)
<<DATA/Fill>>		Name	
		Name/Fill	
		Name/Fill	
		Name/Fill	

7.10.1.3.3 Registration user feedback

This clause applies only to FP with user signalling capability (for example a display, a LED or a buzzer). To improve the security, it is strongly recommended to support this feature both on the FP and the PP.

The FP and the PP shall give a feedback to the user of the registration process through a user interface.

The feedback given on the user interface of the PP and the FP shall be as a minimum the following status of the registration process with the following states:

- Registration in progress state:
 - Condition of entrance: the PP is looking for or is locked on a FP in subscription mode and the protocol is exchanging messages.
 - Recommended user action: wait for protocol to finish.
- Registration error state:
 - Condition of entrance: some error occurred, such as failed to find a peer device, or to complete the access rights procedure (e.g. authentication failed).
 - Recommended user action: wait then try again.
- Registration success state:
 - Condition of entrance: protocol procedure is complete and successful.
 - Recommended user action: try to make an outgoing call request.

The proposed user feedback with corresponding user interface allows user to check that registration on the correct FP was successful. This is an additional security especially in the case of the easy pairing procedure which is less secure than the PIN code registration procedure.

The user should be aware that during the registration mode unwanted PP could join the FP. The user should be instructed to monitor the user interface, especially to check the success indication on both sides for security considerations. This verification will prevent the PP from joining a FP that was not selected or to prevent an other PP from joining the selected FP.

Type of user interface is left free to implementers. For example, the user interface could be a display on the PP side and a LED on the FP side. It could also be an audio tone indication or any other richer user interface (displays on both sides for example).

7.10.2 Handset locator

On FP side, a software or hardware button shall trigger this procedure.

The FP shall present an incoming external call to all idle PPs registered to the FP. Incoming call used at NWK level is the GAP NWK feature N8 "Incoming call". The FP shall send the information element <<Calling Party Name>> with the <<Presentation indicator>> field set to 'Handset locator' value.

On PP side, the call shall be presented as an incoming call. If PP has ringing capabilities enabled, the PP shall ring.

NOTE 1: It is recommended that the FP sends a CNIP with a name related to the current procedure, for example "Handset locator".

NOTE 2: The 'Handset locator' value of <Presentation indicator> field in CNIP might be used by the PP to trigger the ringing even if it is disabled, or to increase the ringer volume in that particular case.

Table 78: Values used within the {CC-SETUP} or {CC-INFO} message for handset locator internal call CNIP

Information element	Field within the information element	Standard values within the field/information element	Normative action/comment
<<Calling party name>>	<Presentation indicator>	11	Handset locator
	<Used Alphabet>	All	
	<Screening indicator>	All	
	<Calling party name>	All	'Handset locator' for example

The procedure is stopped when incoming call is accepted by one of the PPs. In this case, the FP shall immediately release the call on this particular PP and stops incoming call presentation to other PPs.

NOTE 3: Other possible stops of the procedure are out of the scope of the present document. For example the procedure could also be stopped:

- by pressing the button again on the FP side;
- by using a timer mechanism on FP side.

NOTE 4: The way the call is accepted on the PP is out of the scope of the present document. For example only the call key could accept the incoming call.

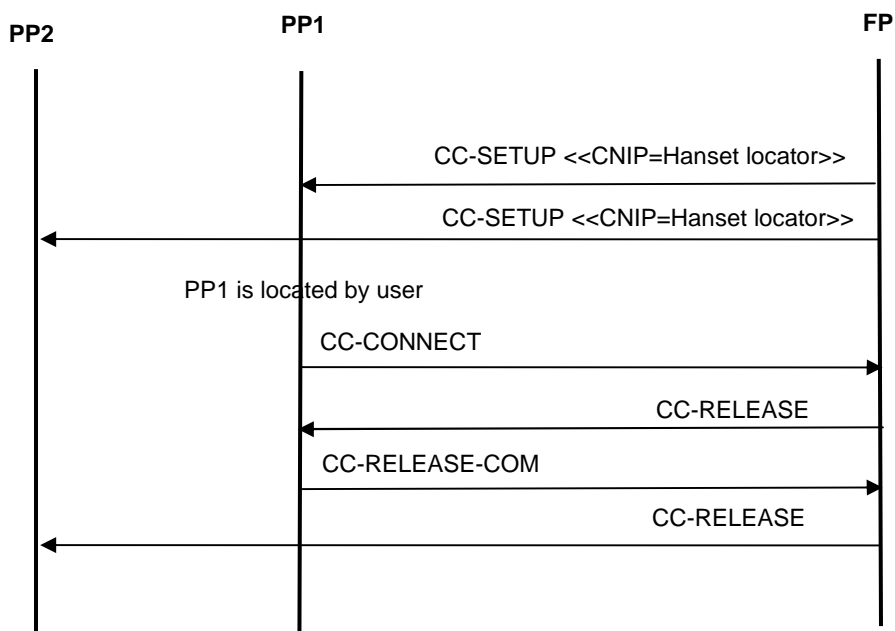

Figure 83: Handset locator example where PP1 is located

NOTE 5: The Call Control message sequence in figure 83 should be understood as an example. The real sequences may also contain different Call Control messages or Call Control messages in another order or Call Control messages with other contents.

If one of the registered PPs is already involved in a call, the FP shall either:

- Apply the current procedure to idle PPs only and leave the PP involved in its call.
- Wait for all PPs to be in idle state before applying the current procedure to all PPs.

NOTE 6: If an incoming call occurs while the handset locator procedure is already ongoing, the FP should stop the handset locator call and present the incoming call.

Annex A (normative): System parameters

A.1 CC timers

<CC.NG.01> Intercept tone provision timer.

FT value: 1 300 milliseconds.

PT value: Not used.

Start: A <<SIGNAL>> IE has been sent requesting a tone generation.

Stop: none.

NOTE : The 1 300 milliseconds value is compatible with the value defined by ITU-T Recommendation E.180 [i.10], specification for the special information tone.

A.2 Application timers

<AP.01> **Subscription mode timer.**

FT value: 120 seconds.

PT value: Not used.

Start: Subscription mode has been requested by the user and bit a₄₄ of "higher layer capabilities", "access rights supported", has been set.

Stop: As soon as on-air subscription procedure is successful and bit a₄₄ of "higher layer capabilities", "access rights supported", is cleared.

<AP.02> **Searching mode timer.**

FT value: Not used.

PT value: 120 seconds.

Start: Searching mode has been requested by the user: listen and wait for bit a₄₄ of "higher layer capabilities", "access rights supported".

Stop: As soon as a on-air subscription procedure is successful.

<AP.03> **Base station name broadcasting timer.**

FT value: 160 ms.

PT value: Not used.

Start: Base station name broadcasting occurrence (Higher layer capabilities FP broadcast sent).

Stop: The first segment of the FP name is sent.

Annex B (normative): Procedure diagrams

The following diagrams depict basic sequences that illustrate the text of present document.

The Call Control message sequences in the following diagrams shall be understood as examples. The sequences may also contain different Call Control messages or Call Control messages in another order or Call Control messages with other contents.

EXAMPLE: {CC-ALERTING} and {CC-CALL PROC} are sometimes not mentioned although they are allowed in the sequences.

B.1 Events notification diagrams

The following flowcharts are very basic sequences. See also annex C (especially clauses C.2.4 and C.2.5) for more complete examples of notifications.

For clarity of the following flowcharts, <<Call information>> IE including call identifiers and line identifiers does not appear in some of the CC messages that must convey it. Please note that they should not be omitted when implementing equivalent cases.

B.1.1 Event notification when there is no existing connection

Use case: FP wants to send an event notification and there is no existing connection: use the CLSS procedure (page the PP and setup the bearer).

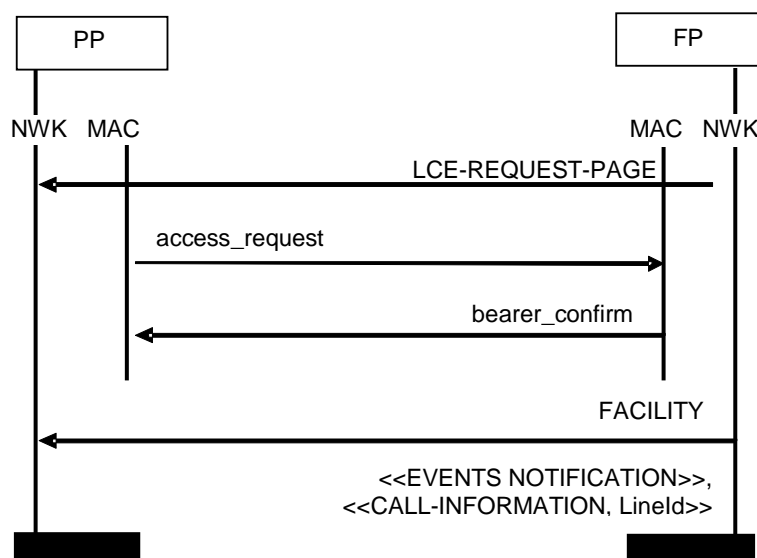

Figure B.1: Event notification when there is no existing connection

NOTE: Line identifier may be equal to 'all lines' value.

B.1.2 Event notification during existing connection

Use case: FP wants to send an event notification when the PP is on communication: use the existing connection.

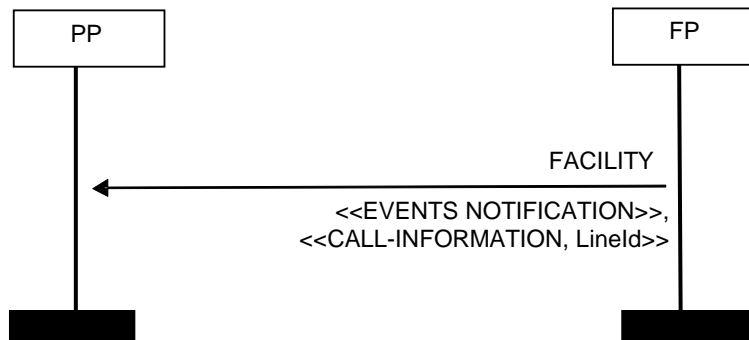

Figure B.2: Event notification during existing connection

NOTE: Line identifier may be equal to 'all lines' value.

B.1.3 Event notification when the PP is switched on

Use case: FP has wanted to send an event notification when PP was switched off, PP is switched on: use the location registration connection.

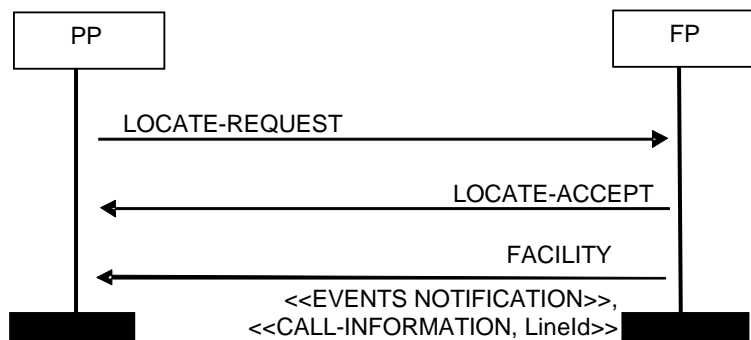

Figure B.3: Event notification when the PP is switched on

NOTE: Line identifier may be equal to 'all lines' value.

B.1.4 Event notification using call connection

Use case: FP has wanted to send an event notification when PP was not in range, PP sends a {CC-SETUP}: use the call connection.

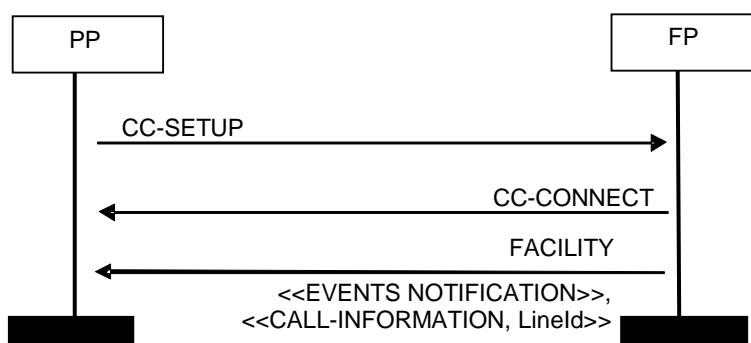

Figure B.4: Event notification using call connection

NOTE: Line identifier may be equal to 'all lines' value.

B.1.5 Event notification for "Missed call notification"

Use case: Missed call notification message sequence.

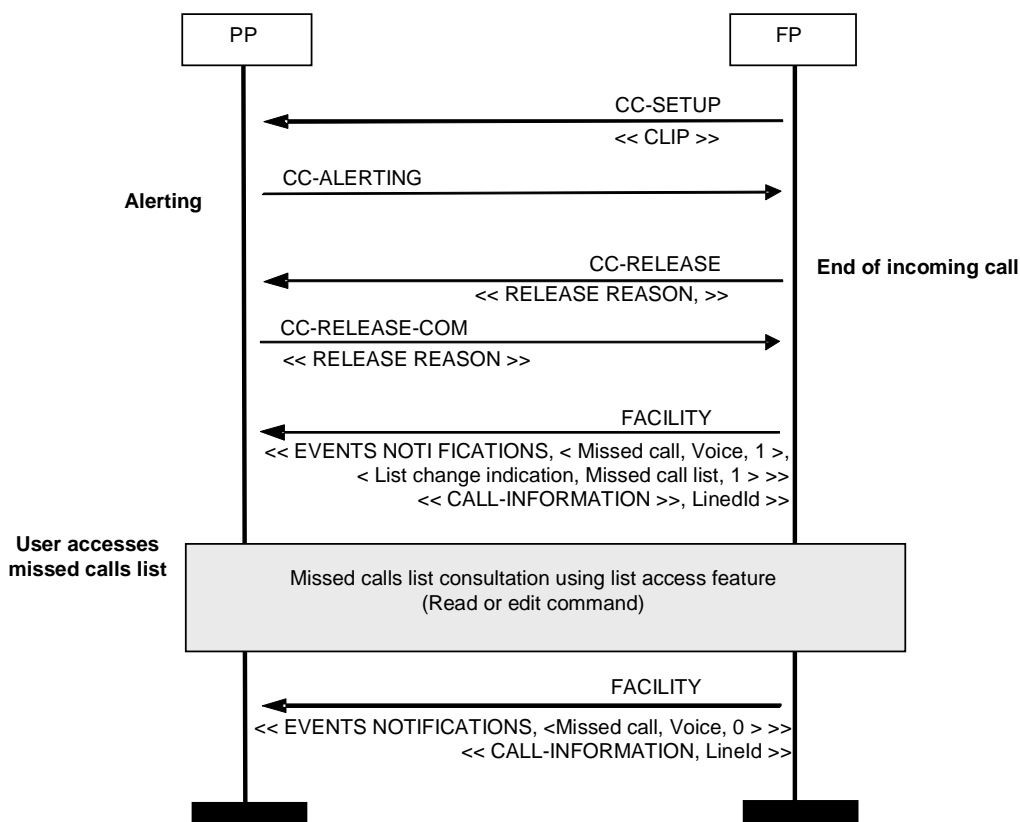

Figure B.5: Missed call notification

NOTE: See also clause C.2.4 for more detailed flowcharts including line identifiers and call identifiers.

B.2 Date-time synchronization diagrams

These flowcharts depicts the date and time synchronization feature, but only in the cases where the FP sets the date and time of the PP. When implementing this feature, the FP behaviour shall follow one of the possible use cases listed hereafter. Please note some flexibility is allowed concerning the CC messages.

For clarity of the following flowcharts the <<Call information>> IE including call identifier does not appear in the CC messages that must convey it. Please note that it should not be omitted when implementing equivalent cases.

EXAMPLE: The call identifier must be assigned by the FP after {CC-SETUP} message.

B.2.1 Date-time synchronization when there is no existing connection

Use case: FP wants to send a time and date synchronization and there is no existing connection: use the CLSS procedure (page the PP and setup the bearer).

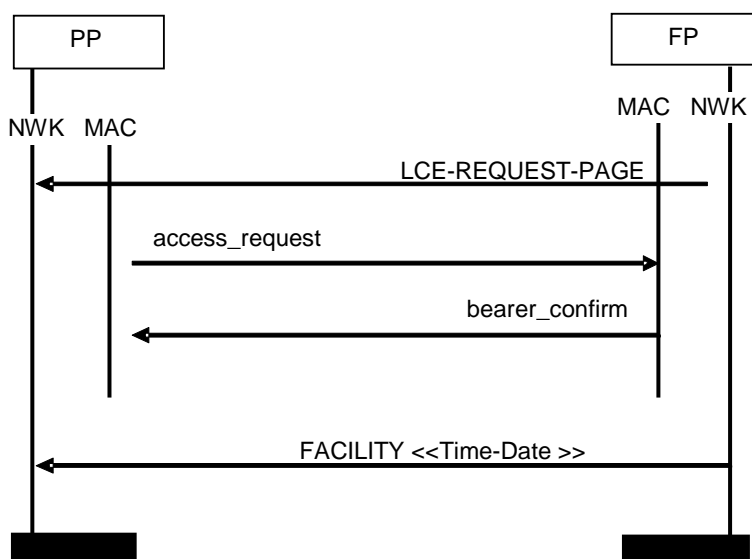

Figure B.6: Date-time synchronization when there is no existing connection

B.2.2 Date-time synchronization during existing connection

Use case: FP wants to send a time and date synchronization when the PP is on communication : use the existing connection.

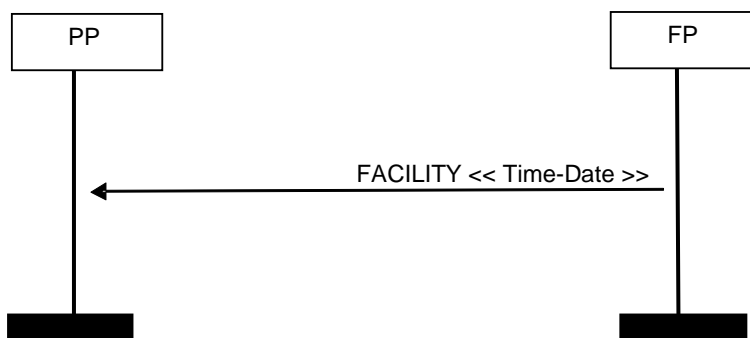

Figure B.7: Date-time synchronization during existing connection

B.2.3 Date-time synchronization when the PP is switched on

Use case: FP has wanted to send a time and date synchronization when PP was switched off, PP is switched on : use the location registration connection.

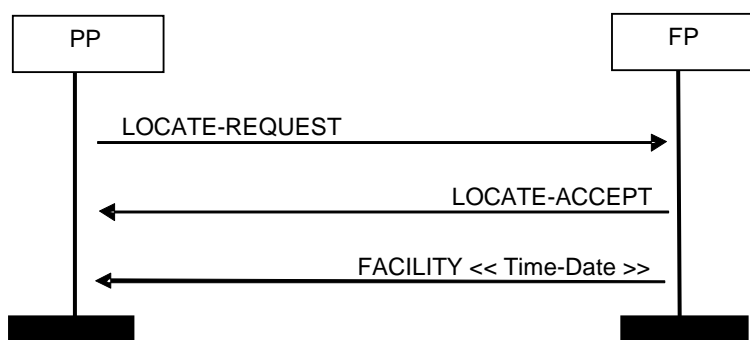

Figure B.8: Date-time synchronization when the PP is switched on

B.2.4 Date-time synchronization using call connection

Use case: FP has wanted to send a time and date synchronization when PP was not in range, PP sends a {CC-SETUP} : use the call connection.

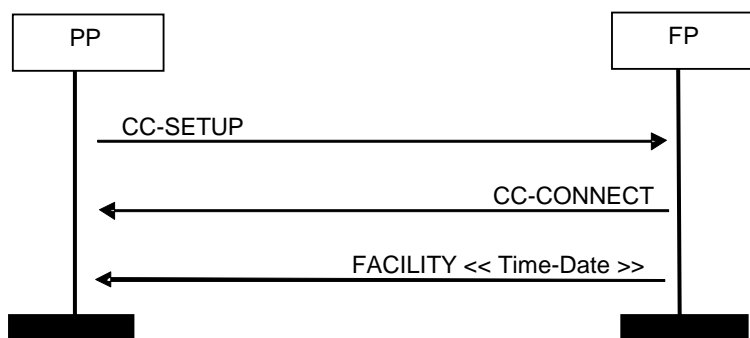

Figure B.9: Date-time synchronization using call connection

NOTE: The line identifier is not represented here. Note that it is anyway only relevant if the synchronization is done in the context of an external call.

B.3 List access service basic sequence diagrams

For clarity of the following flowcharts, <<Call information>> IE including call identifiers and line identifiers does not appear in some of the CC messages that must convey it. Please note that they should not be omitted when implementing equivalent cases.

B.3.1 Start/end session when PP is in idle mode

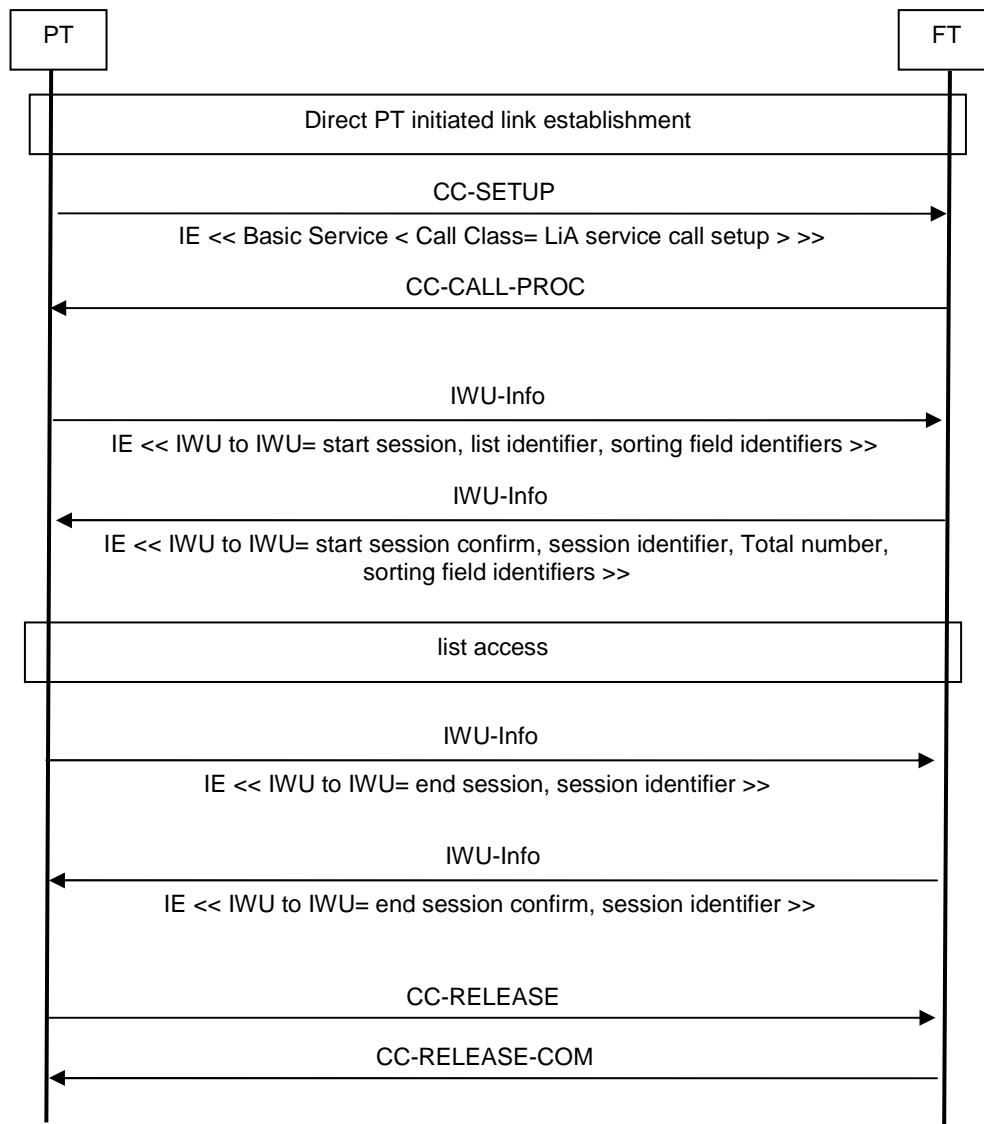

Figure B.10: List access: start/end session when PP is in idle mode

B.3.2 Start/end session when a call is already established to PP

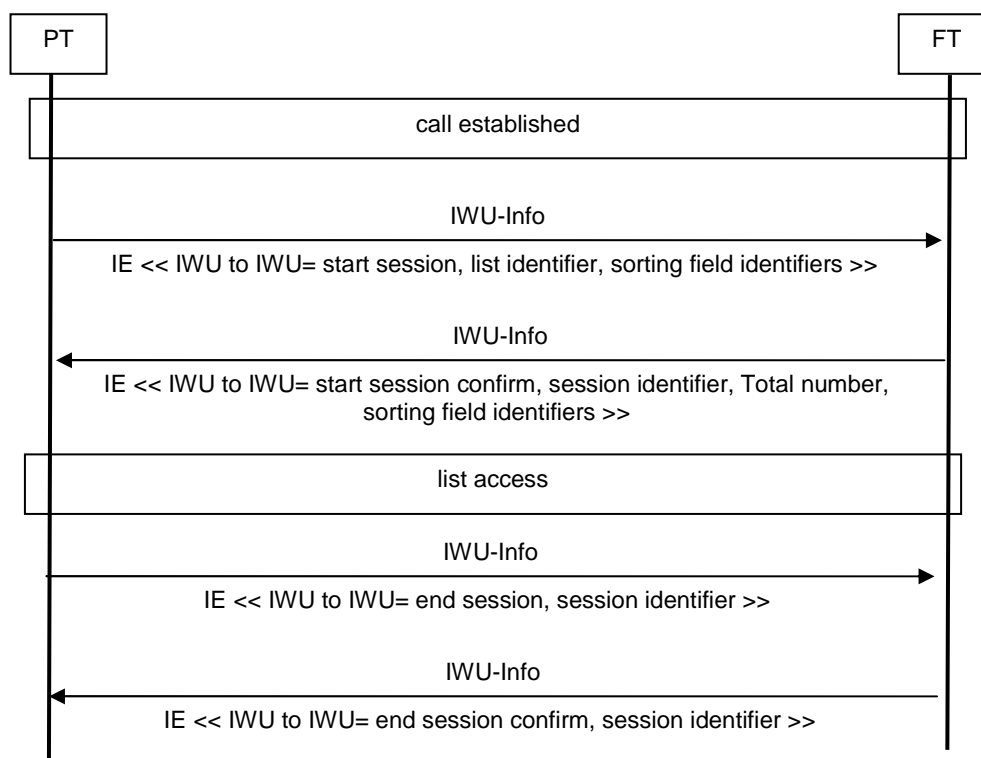

Figure B.11: List access: start/end session when a call is already established to PP

NOTE: See also diagrams in clause C.6 for examples on list access and voice calls flowcharts.

B.3.3 Query supported entry fields

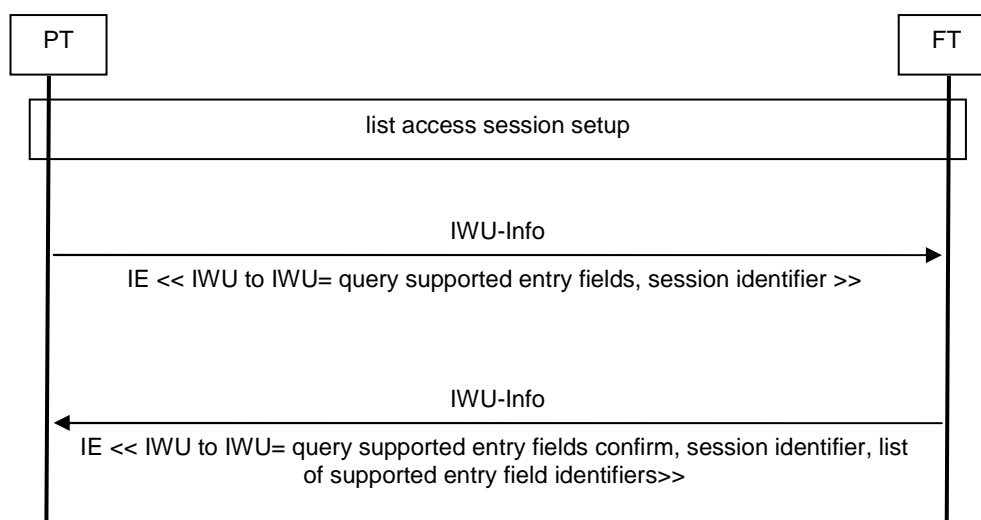

Figure B.12: List access: query supported entry fields

B.3.4 Read entries

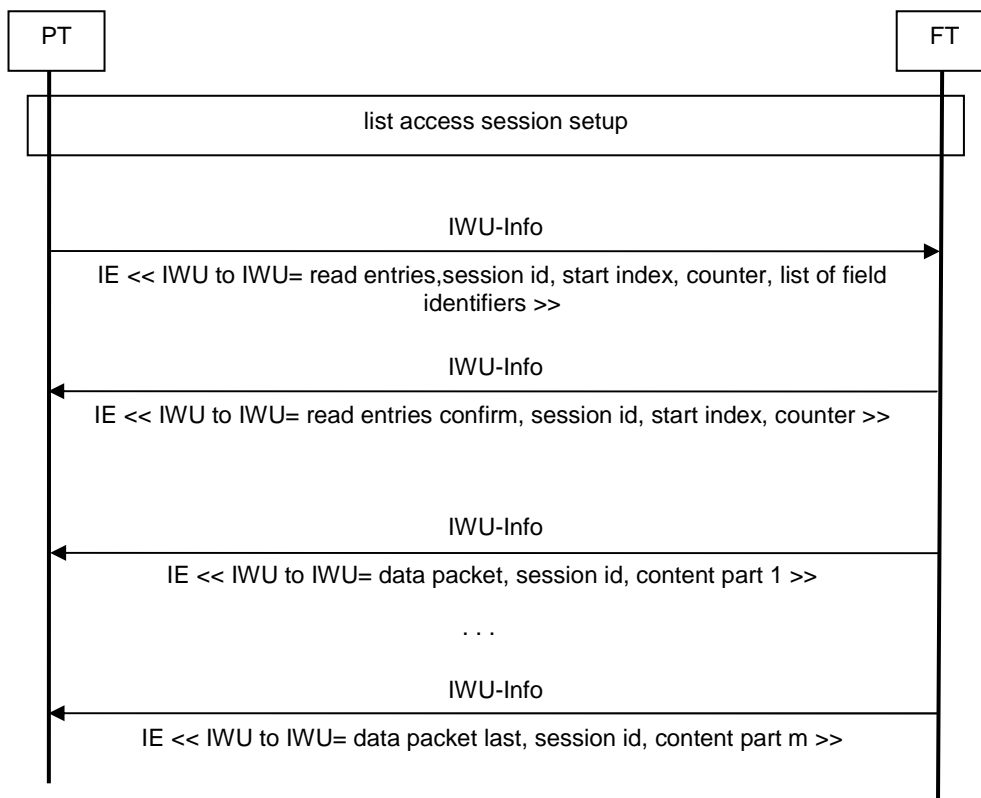

Figure B.13: List access: read entries

B.3.5 Edit entry

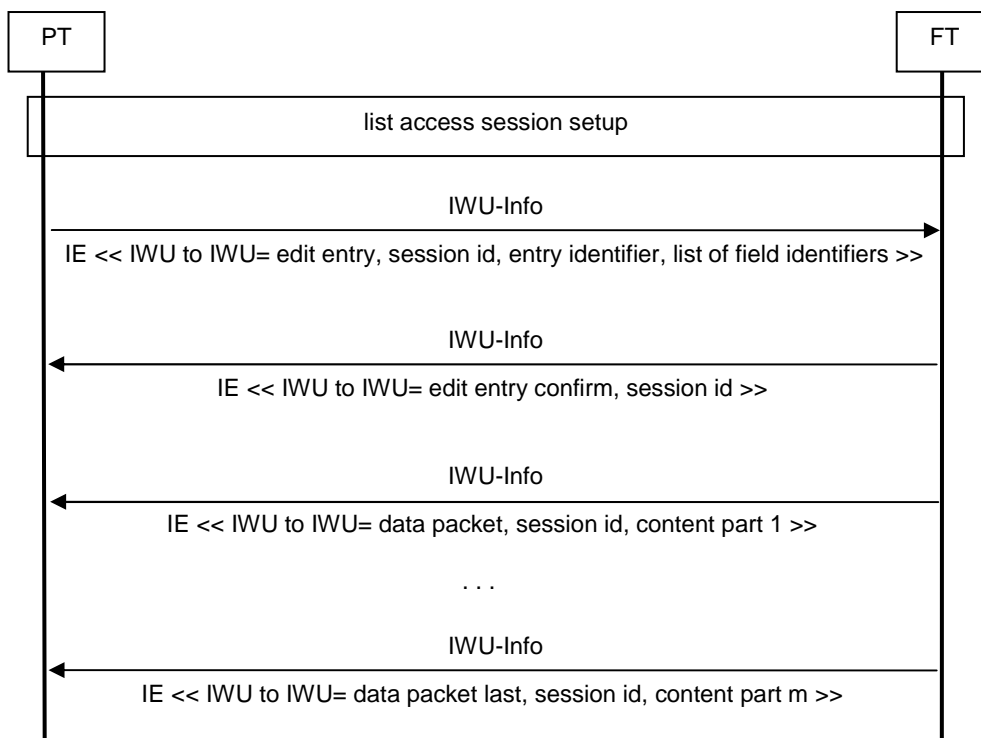

Figure B.14: List access: edit entry

B.3.6 Save entry

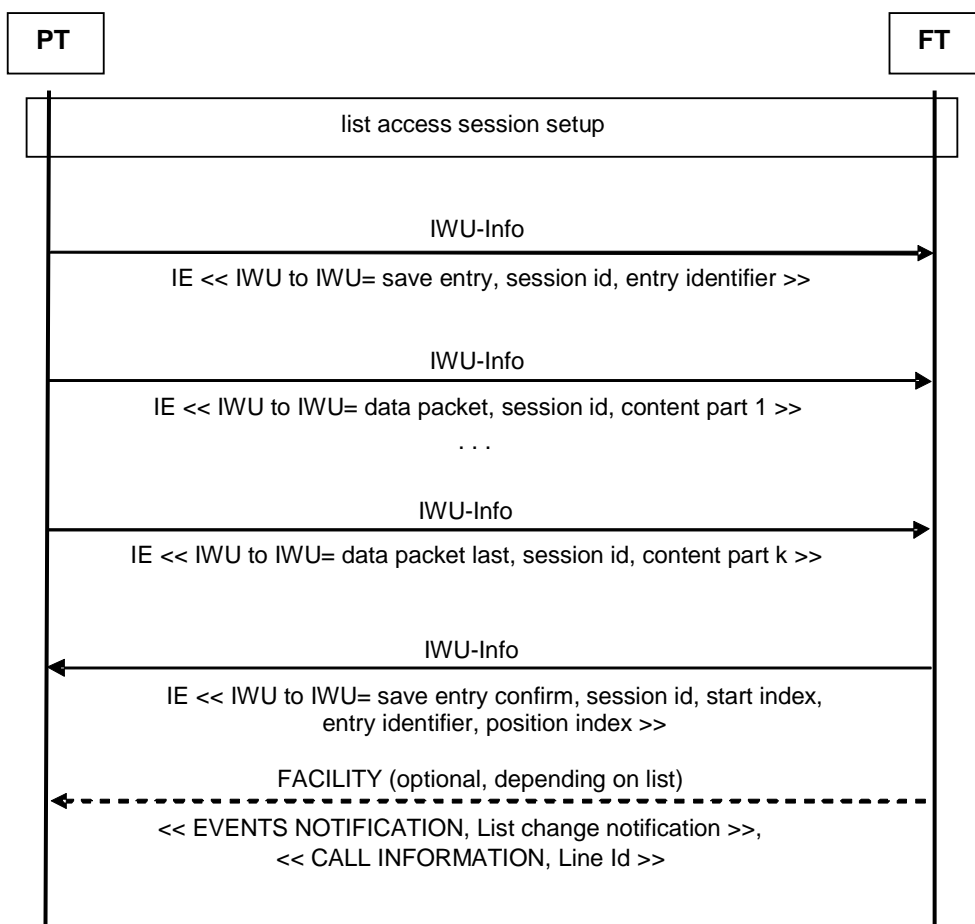

Figure B.15: List access: save entry

NOTE: Alternatively the {FACILITY} message might be sent after terminating the list access session.

B.3.7 Delete entry

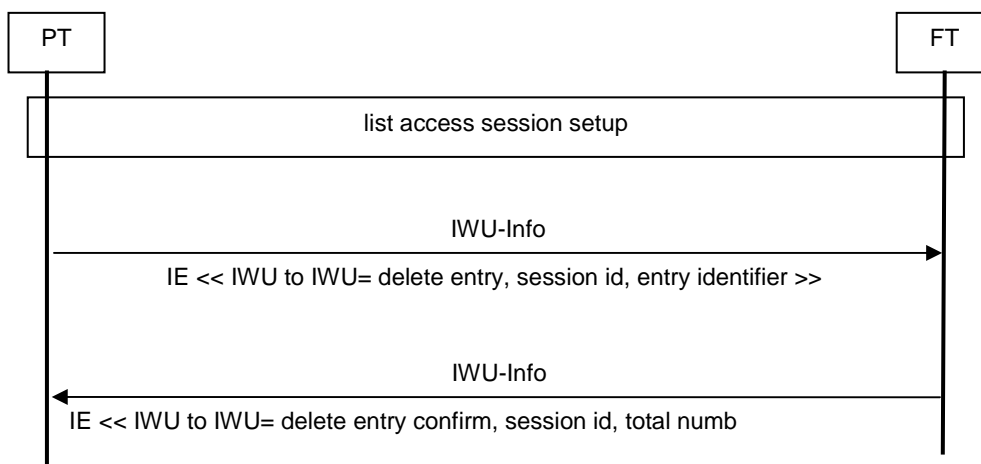

Figure B.16: List access: delete entry

NOTE: The list has changed once this procedure has been performed. PP should read list again starting from index of the first entry which was deleted.

B.3.8 Delete list

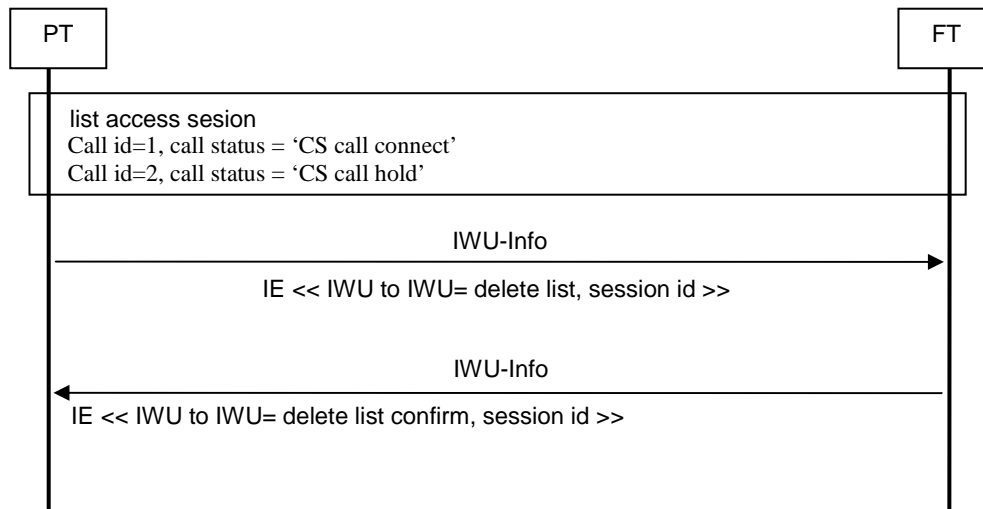

Figure B.17: List access: delete list

B.3.9 Search entries

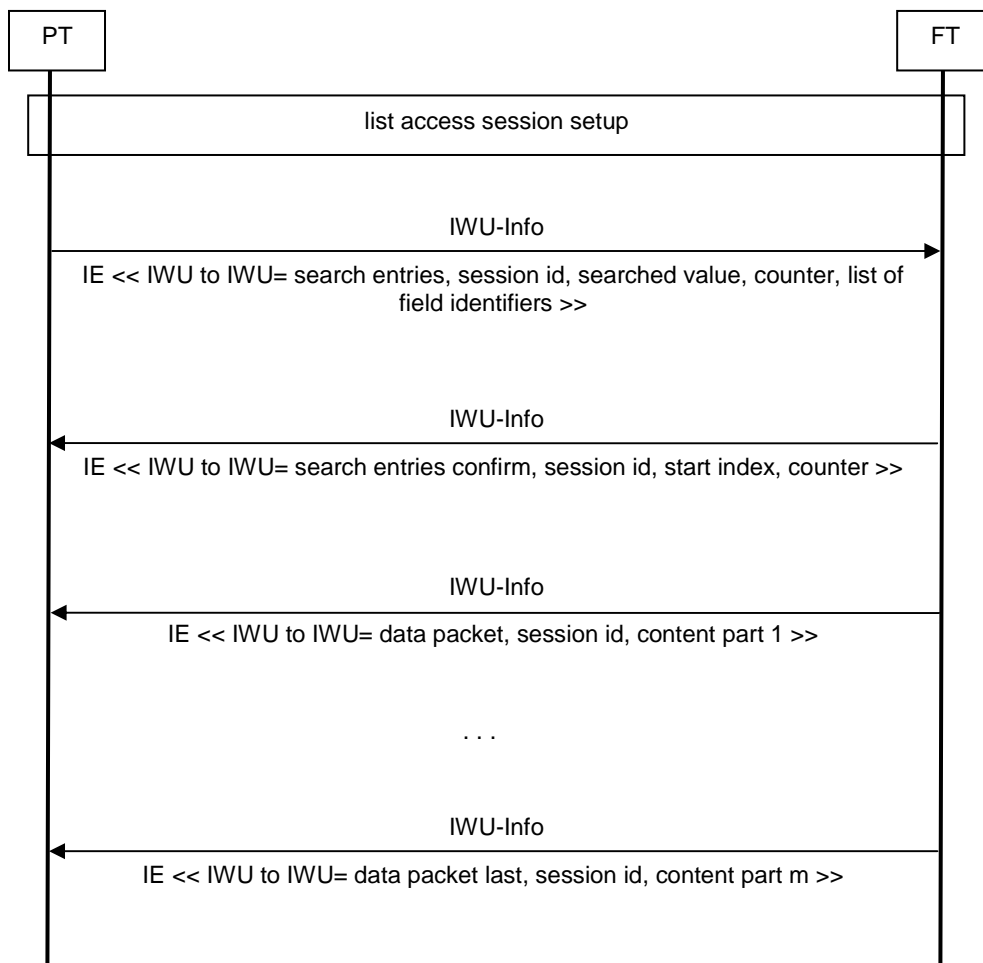

Figure B.18: List access: search entries

Annex C (informative): Recommended implementation of procedures

C.1 General

In the following clauses, several examples for generic sequence charts are depicted.

It has to be noted that the sequences are only examples, it cannot be mandatory that the message flows are always exactly in the described way. However it is recommended to follow the examples where possible in order to ensure interoperability.

C.2 Multiple lines diagrams

The diagrams of this clause document the "Multiple lines" feature. This feature can be used when at least the FP implements it. For the PP, implementing this feature means that it is aware of multiple attachments, and proposes an adapted MMI.

However a PP may be attached to several lines without being aware of it, i.e. not implementing the "Multiple lines" feature. Such a PP would use e.g. "FP-managed line selection" (see clause 7.4.5.2.4) for outgoing calls, and would receive calls from these lines at the price for the user of not knowing from which line an incoming call arrives (unless asking the calling user).

The "Line identification" feature is a pre-requisite for the 'Multiple lines' feature on PP side and on FP side. This feature allows the user to place a call on line k by keyboarding '#k' before the called number, or by introducing the 'k' value through a dedicated MMI. It also allows the user to know in advance on which line a call is received through the display. With the "Line identification" feature alone, the PP still would not be able to propose a menu with the set of attached lines presented and to choose from.

C.2.1 Attaching a new PP to one or several lines

Use case: the user has just registered a new PP, then the user is invited to select the line(s) to which the new PP is attached to (PP managed attachment). This use case can also be used later to change the handsets attachment to the lines.

We assume that the new registered PP is the terminal number 'm'.

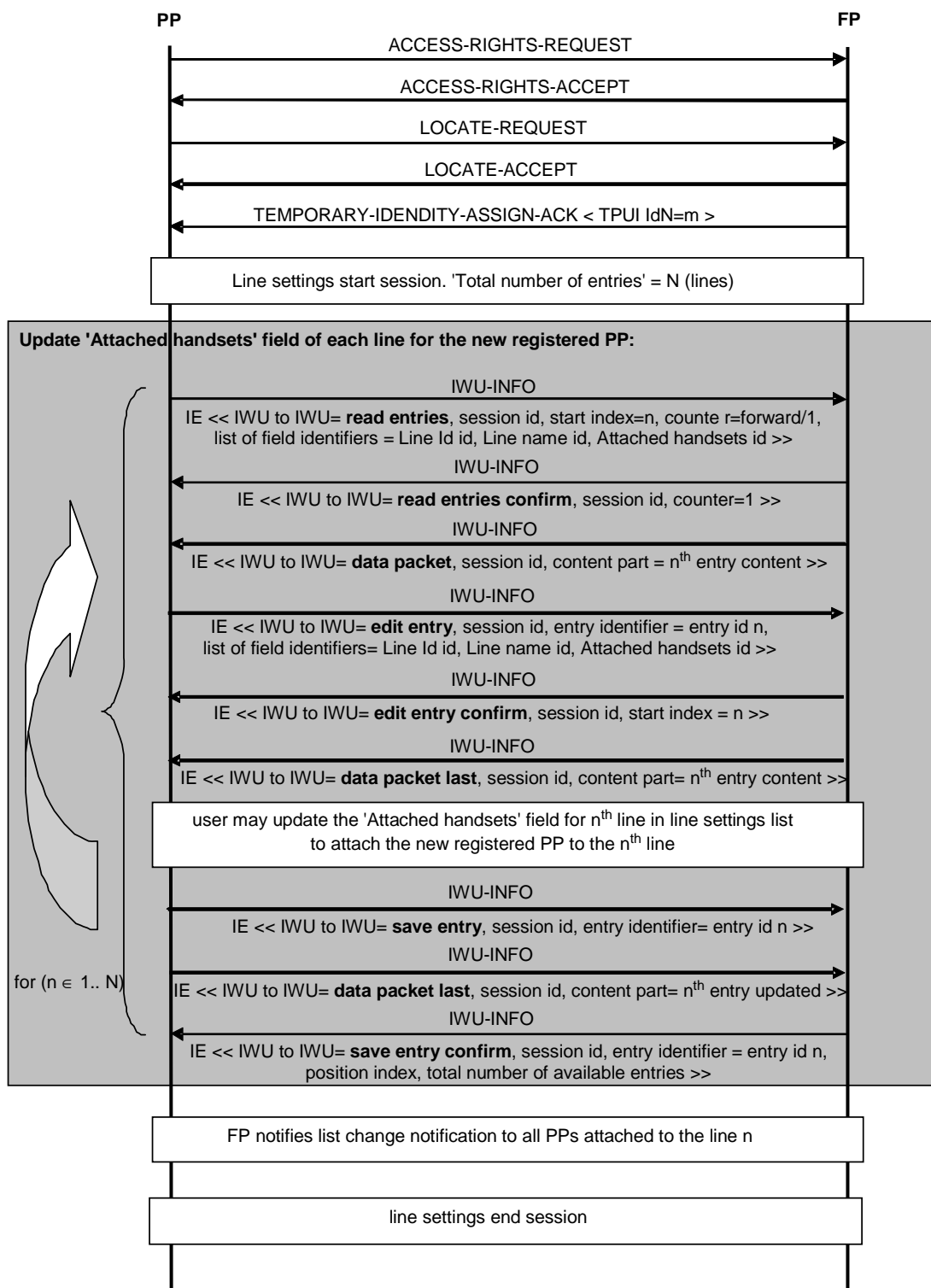

Figure C.1: Attaching a new PP to one or several lines

NOTE 1: The above diagram assumes that only one "data packet" command is necessary for reading one entry content, i.e. the 'data packet last' command is received directly.

NOTE 2: As an alternative, all entries in the "Line settings" list could be read all at once with one read entries command.

C.2.2 Outgoing first call on a line

For each use case, two sub use cases at least are handled: Line identification by PP, or FP managed line selection.

C.2.2.1 PP attached to 1 line

See below, clauses C.2.2.2.1 and C.2.2.2.2, as there is no difference from the case when a PP is attached to several lines (the only line-id still must be sent at call setup by a PP attached to only one line).

C.2.2.2 PP attached to several lines

Clauses C.2.2.2.1 and C.2.2.2.2 implement variants of the same use case: the PP implements the "Line identification" feature and sends the line-id when setting up the call.

C.2.2.2.1 Line identification by PP using <<CALL-INFORMATION>>

Use case 1: the PP selects a line on a call-by-call basis using <<CALL-INFORMATION>> IE.

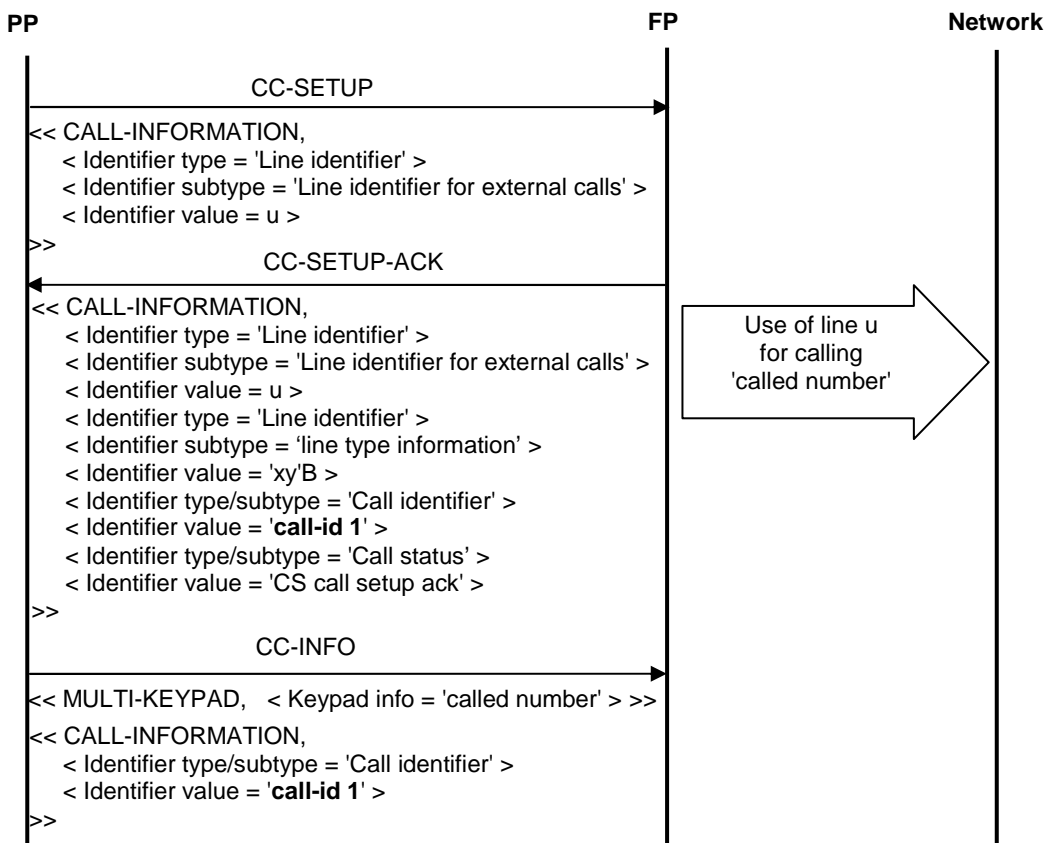

Figure C.2: Line identification by PP using <<CALL-INFORMATION>>

NOTE : As "Call identification" is mandatory for NG PART3, The call identifier notification is represented, although it is somehow independent of the "Multiple lines" feature. The line identifier value is repeated in the <<CALL INFORMATION>> IE together with the indication of the 'line type information'.

C.2.2.2.2 Line identification by PP using the <<MULTI-KEYPAD>>

Use case: the PP selects a line on a call-by-call basis using << MULTI-KEYPAD >> IE (e.g. the user used the keyboard to select the line instead of the dedicated MMI).

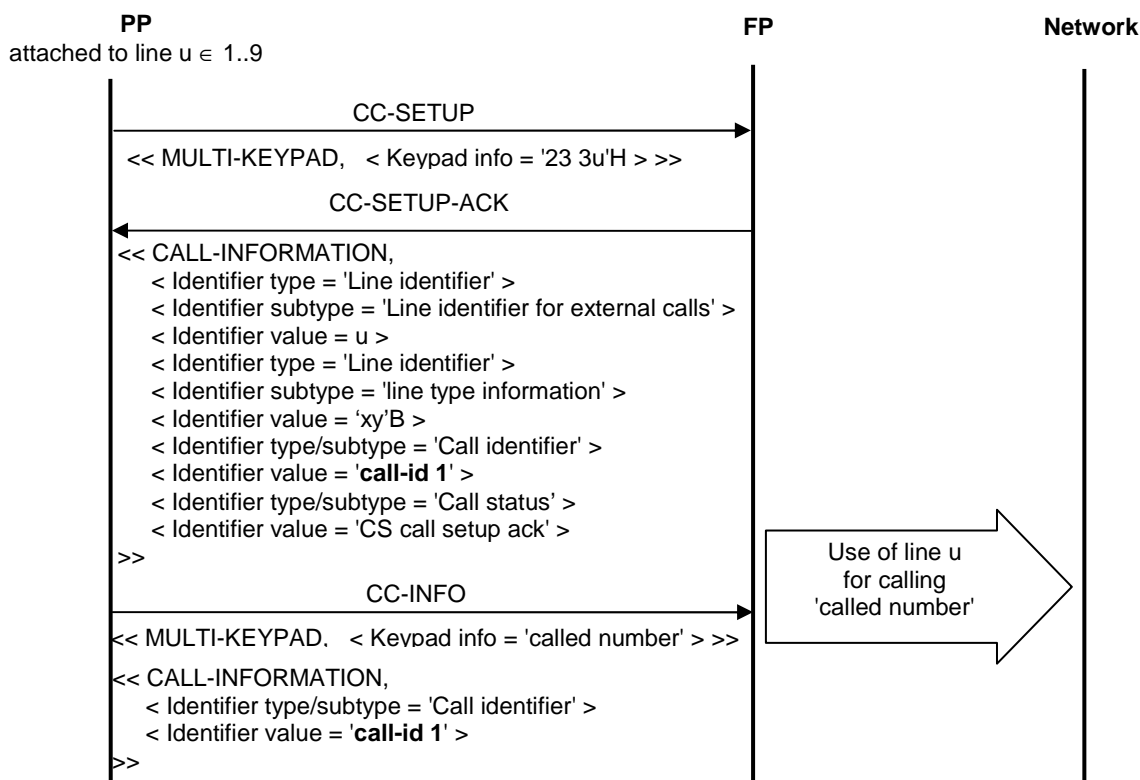

Figure C.3: Line identification by PP using <<MULTI-KEYPAD>>

NOTE 1: Restriction to [0..9] interval for the line id value is in place here because <<MULTI-KEYPAD>> is used for sending the line id.

NOTE 2: As "Call identification" is mandatory for Part 3 FPs, the call identifier notification is represented, although it is somehow independent of the "Multiple lines" feature. The line identifier value is repeated in the <<CALL INFORMATION>> IE together with the indication of the line type information.

C.2.3 First incoming call on a line

C.2.3.1 PP attached to 1 line

See below, clause C.2.3.2, PP attached to several lines, as there is no difference with the case when a PP is attached to several lines.

C.2.3.2 PP attached to several lines

Use case: the PP is attached to several lines. An incoming call on line u is presented.

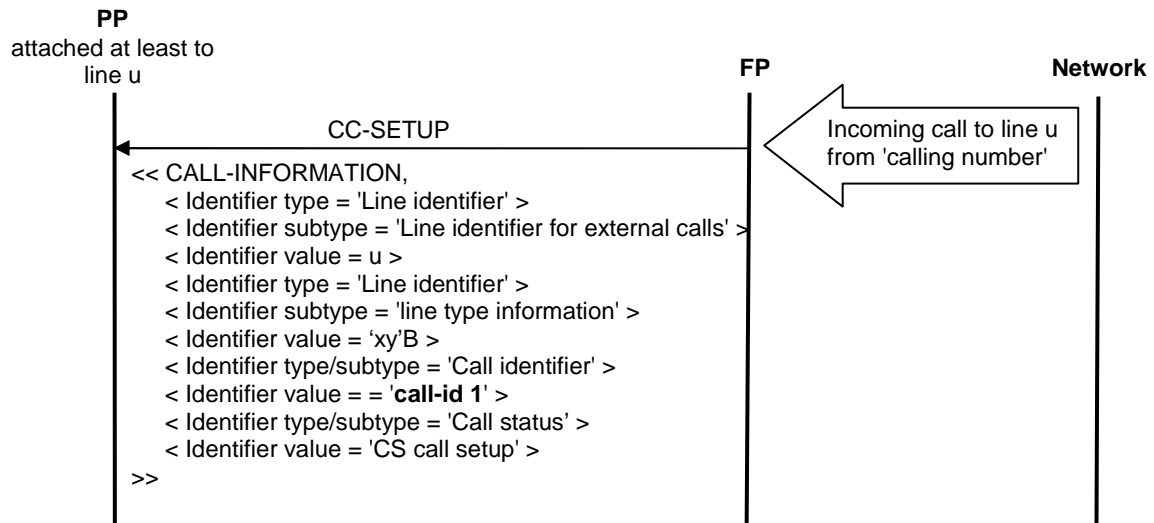

Figure C.4: First incoming call, PP attached to several lines

C.2.4 Missed call

Use case: An incoming call on line u is not answered, and there are already two 'unread' missed calls in the list. The PP is attached to one or several lines. A 'list change indication' for the 'missed call list' is sent together with the 'missed call notification' (see clause 7.4.1.3, 'simultaneous list change indication' subsection). The 'missed call notification' and related 'list change indication' are sent in this example just after the incoming call release.

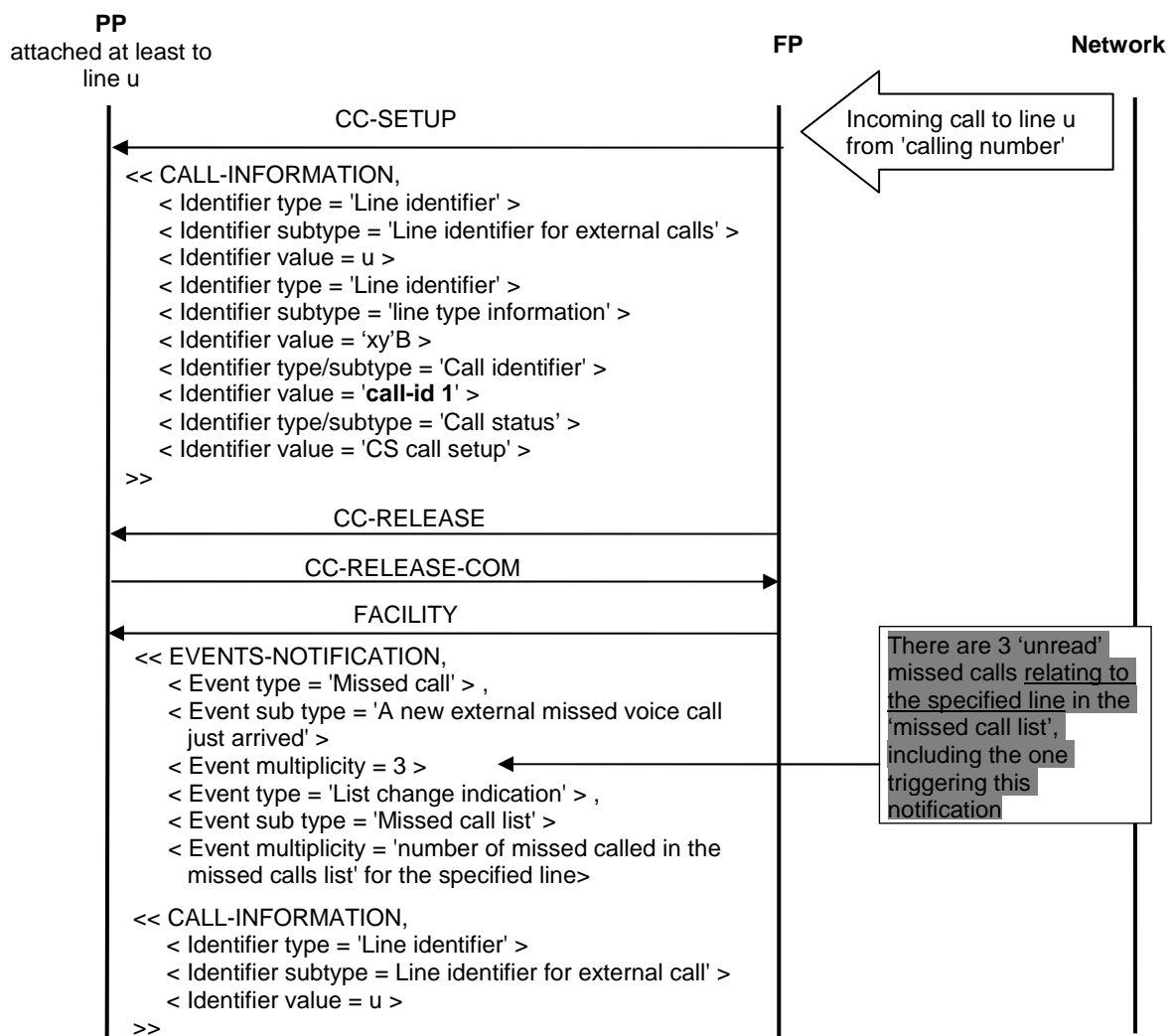

Figure C.5: Missed call

NOTE: The list change indication for the Missed call list accompanying the 'missed call notification' is mandatory.

C.2.5 Voice message waiting indication on a specific line

Use case: a voice message has been left in the voice mailbox of line 'u' which already contained one message, a voice message waiting indication is sent to each PP attached to this line. For this network, the 'number of messages' notified corresponds to the total number of messages in the voicemail box (see clause 7.4.1.2).

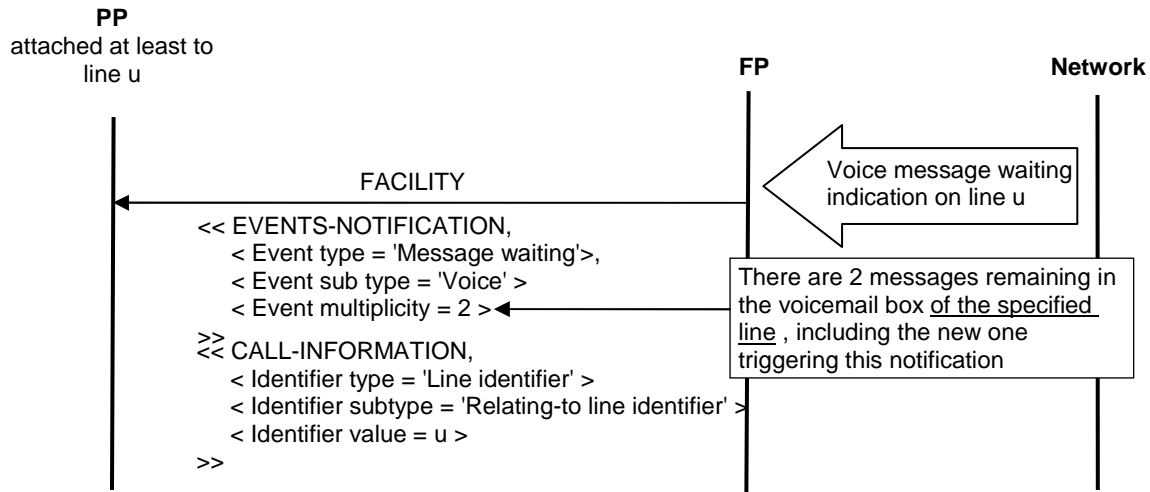

Figure C.6: Voice message waiting indication on a specific line

C.2.6 Missed call notification scenario

Use case: The following list of incoming calls and other events occurs. None of the incoming calls has been answered.

- 1) Incoming external call on line 1 (clause C.2.6.1).
- 2) Two incoming external call on line 2 almost simultaneously (clause C.2.6.2).
- 3) Incoming internal call (clause C.2.6.3).
- 4) Incoming external call on line 1 (clause C.2.6.4).
- 5) A PP reads one of the two 'unread' entries for line 1 in the missed call list (clause C.2.6.5).
- 6) A PP reads the remaining 'unread' entry for line 1, and a missed call arrives on line 1 almost simultaneously (clause C.2.6.6).

C.2.6.1 After call on line 1

Table C.1: Missed call list related notifications after event 1 (see clause C.2.6)

Information element	Field within the information element	Standard values within the field/IE	Normative action/comment
<<Events notification>>			
	<Event type>	1	Missed call
	<Event sub type>	1	A new external missed voice call just arrived
	<Event multiplicity >	1	Number of new missed call in the missed call list for the specified line.
	<Event type>	3	List change indication
	<Event sub type>	1	Missed calls list
<<Call information>>	<Event multiplicity >	1	Total number of elements in the list for the specified line
	<Identifier type>	0	Line identifier
	<Identifier subtype>	0	Line identifier for external call
	<Identifier value>	1	The line identifier value itself

The <Event multiplicity> field for the 'list change indication' gives the total number of entries in the 'missed call list', that is, the number of all ('unread' and 'read') missed calls, but for the line indicated in the <<Call information>> IE only, NOT for all lines.

C.2.6.2 After two almost simultaneous calls on line 2

Here two events of the same type occur on the same line 2 almost simultaneously, and are notified together (see clause 7.4.1.3, 'Almost simultaneous events').

Table C.2: Example Missed call list related notifications after event 2 (see clause C.2.6)

Information element	Field within the information element	Standard values within the field/IE	Normative action/comment
<<Events notification>>			
	<Event type>	1	Missed call
	<Event sub type>	1	A new external missed voice call just arrived
	<Event multiplicity >	2	Number of new missed call in the missed call list for the specified line.
	<Event type>	3	List change indication
	<Event sub type>	1	Missed calls list
<<Call information>>	<Event multiplicity >	2	Total number of elements in the list for the specified line
	<Identifier type>	0	Line identifier
	<Identifier subtype>	0	Line identifier for external call
	<Identifier value>	2	The line identifier value itself

The 'Total number of elements in the list for the specified line' only counts elements for line 2, and therefore does not take into account the first missed call (see clause C.2.6.1) which was on line 1.

C.2.6.3 After incoming internal call

Internal missed calls are not placed in the 'missed call list', and no notification is sent.

C.2.6.4 After call on line 1

Table C.3: Missed call list related notifications after event 4 (see clause C.2.6)

Information element	Field within the information element	Standard values within the field/IE	Normative action/comment
<<Events notification>>	<Event type>	1	Missed call
	<Event sub type>	1	A new external missed voice call just arrived
	<Event multiplicity >	2	Number of new missed call in the missed call list for the specified line.
	<Event type>	3	List change indication
	<Event sub type>	1	Missed calls list
	<Event multiplicity >	2	Total number of elements in the list for the specified line
<<Call information>>	<Identifier type>	0	Line identifier
	<Identifier subtype>	0	Line identifier for external call
	<Identifier value>	1	The line identifier value itself

C.2.6.5 A PP reads one of the two 'unread' entries for line 1 in the missed call list

Here there is no new missed call, but still a 'missed call notification' for updating the number of new missed calls. Absence of a new missed call is indicated through the use of subtype '02'H.

Table C.4: Missed call list related notifications after event 5 (see clause C.2.6)

Information element	Field within the information element	Standard values within the field/IE	Normative action/comment
<<Events notification>>	<Event type>	1	Missed call
	<Event sub type>	2	No new missed call arrived, but the number of 'unread' external missed voice calls has-or may have-changed
	<Event multiplicity >	1	Number of new missed call in the missed call list for the specified line.
	<Event type>	3	List change indication
	<Event sub type>	1	Missed calls list
	<Event multiplicity >	2	Total number of elements in the list for the specified line
<<Call information>>	<Identifier type>	0	Line identifier
	<Identifier subtype>	0	Line identifier for external call
	<Identifier value>	1	The line identifier value itself

C.2.6.6 A PP reads the remaining 'unread' entry for line 1, and a missed call arrives on line 1 almost simultaneously

Here two events of different types occur on the same line 1 almost simultaneously, and are notified together (see clause 7.4.1.3, 'Almost simultaneous events').

Subtype '01'H ('New external missed call') is used, as one of the events is the arrival of a new missed call (see clause 7.4.1.3, 'Almost simultaneous events', rule 3).

However, the total number of 'unread' missed calls does not change, as the other event (of type 'Entry modified') decreases the number of 'unread' entries in the missed call list by one.

NOTE: If the two events had been notified separately, the notifications would have used different 'missed call subtypes'.

Table C.5: Missed call list related notifications after event 6 (see clause C.2.6)

Information element	Field within the information element	Standard values within the field/IE	Normative action/comment
<<Events notification>>	<Event type>	1	Missed call
	<Event sub type>	1	A new external missed voice call just arrived
	<Event multiplicity >	1	Number of new missed call in the missed call list for the specified line.
	<Event type>	3	List change indication
	<Event sub type>	1	Missed calls list
	<Event multiplicity >	3	Total number of elements in the list for the specified line
<<Call information>>	<Identifier type>	0	Line identifier
	<Identifier subtype>	0	Line identifier for external call
	<Identifier value>	1	The line identifier value itself

C.3 Multiple calls diagrams

C.3.1 First incoming call on the line or system

Use case: the PP is attached to a multi-call line. An incoming call is presented to the line.

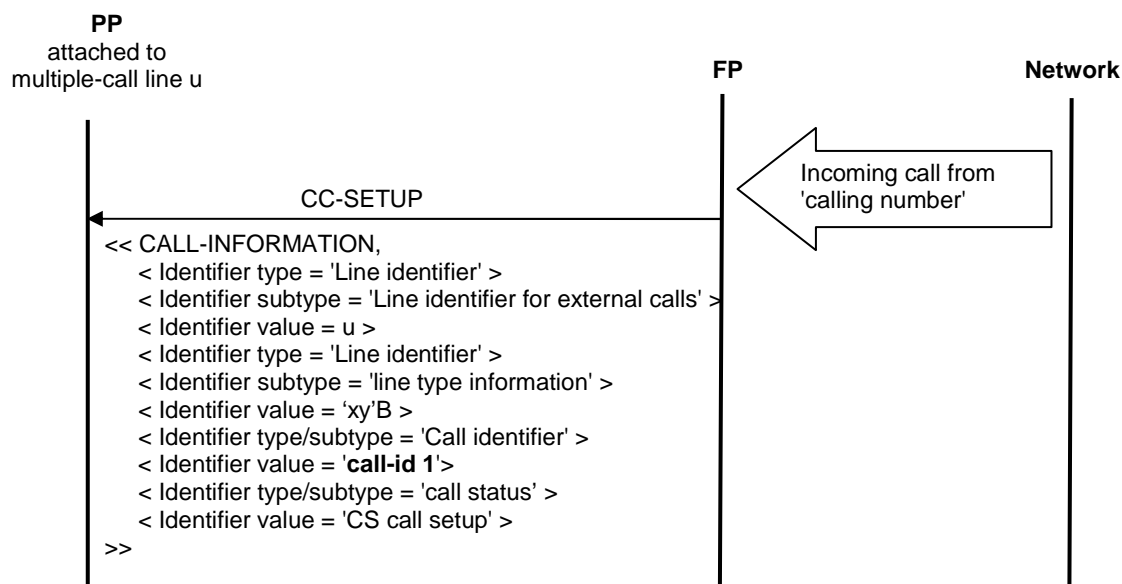

Figure C.7: First incoming call on the line or system

NOTE: Although somehow independent of the "Call identification" feature, the line identifier notification is also represented, as "Line identification" is mandatory for Part 3 FPs.

C.3.2 Second incoming call on the line or system

Use case: the PPs are attached to a multi-call line. A call is going on from PP1. An incoming call is presented to the line. For conciseness of the diagram, line identification is not represented (which corresponds to the case of an internal waiting call).

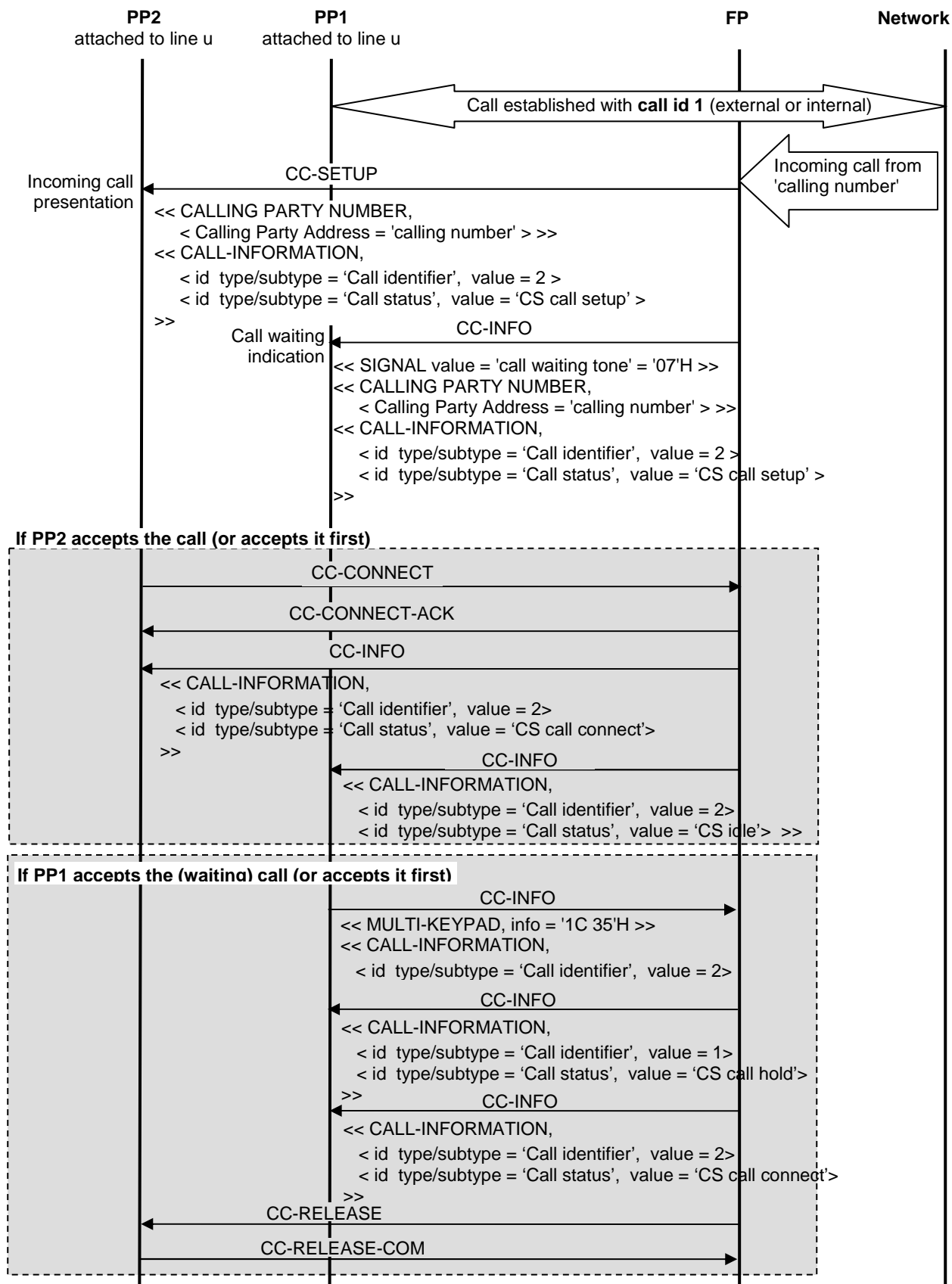

Figure C.8: Second incoming call on the line or system

C.3.3 First outgoing call on the line or system

Use case: the PP is attached to a multi-call line. An outgoing call is initiated.

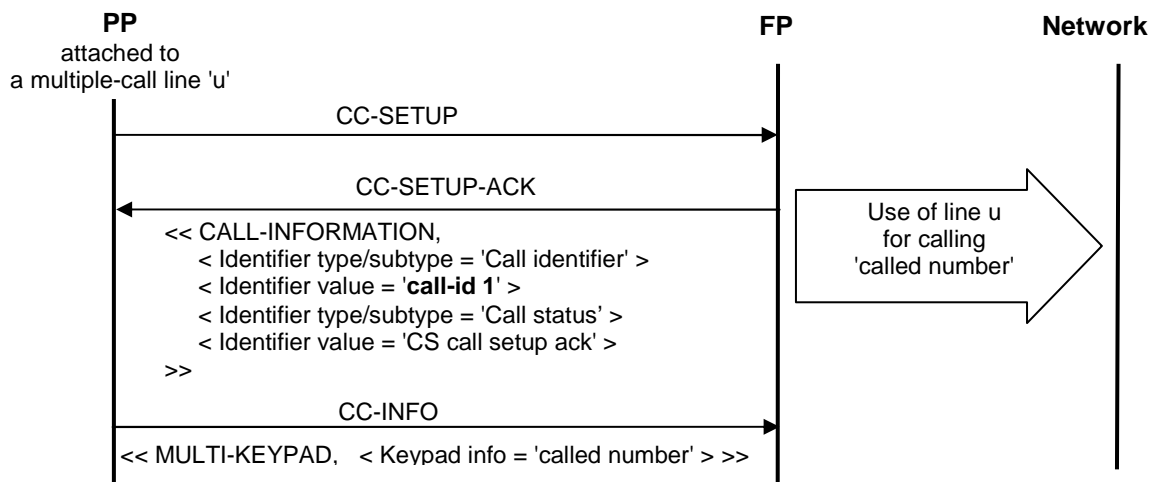

Figure C.9: First outgoing call on the line or system

NOTE: Figure C.9 does not show the exchange of line identifiers. For a complete diagram, see for example clause C.2.2.2.1.

C.3.4 Second outgoing call on the line or system

Use case: the PPs are attached to a multi-call line. A call is going on on PP1. A second external call is initiated. For conciseness of the diagram, line identification is not represented (which corresponds to the case of an internal outgoing call).

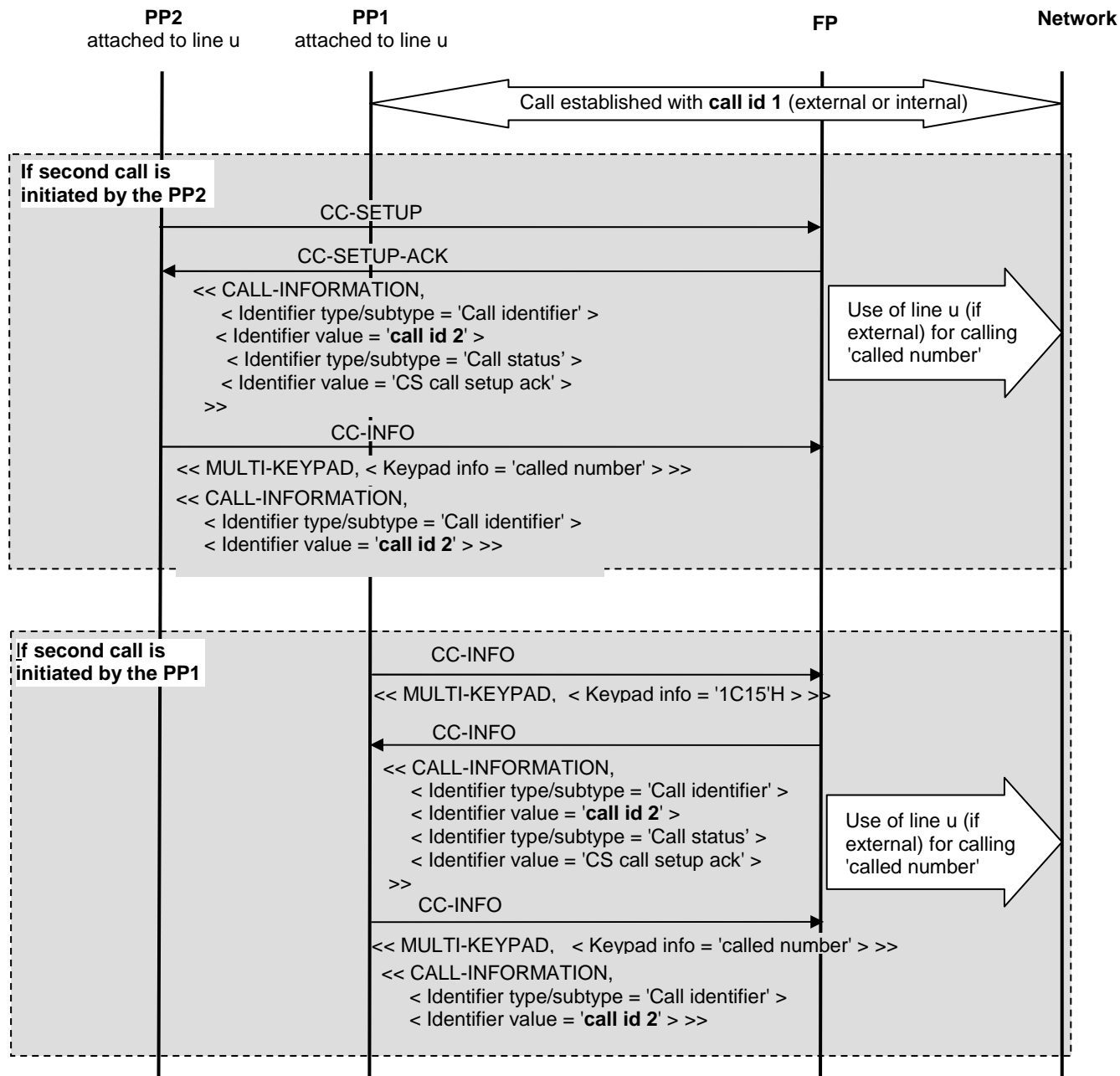

Figure C.10: Second outgoing call on the line or system

C.4 Parallel calls complex or alternative diagrams

This annex illustrates use cases of the "Common parallel call procedures" feature [NG1.N.7] that are not described in the main part of the standard (see figures of clause 7.4.3.5) but require clarification, and gives guidelines for implementation. More specifically, it includes:

- Alternative use cases.
- Limit or complex use cases that may not happen so often but illustrate the philosophy of the standardized procedures.

NOTE: Clauses C.2 and C.3 deal with "Multiple lines" and "Multiple calls" specific use cases (e.g. not applicable in the PSTN double call case).

C.4.1 Call identification for outgoing parallel calls

This clause shows variants of the "Outgoing parallel call initiation" diagrams presented in the procedure itself (see clause 7.4.3.5.1), that correspond to variant use cases. In all the diagrams presented, the call-id is sent by the FP as soon as possible, (and even if the line-id is not known at this stage) so that it can be used by the PP in all subsequent messages concerning that call (for messages that use the call id when available).

C.4.1.1 All in one PP message - line identification by PP

Use case: The PP sends all parallel call initiation information in a single {CC-INFO} message (e.g. the user used the phone book before placing a parallel call). A single message sent by the PP with '1C15'H / '17'H + line-id + called-number.

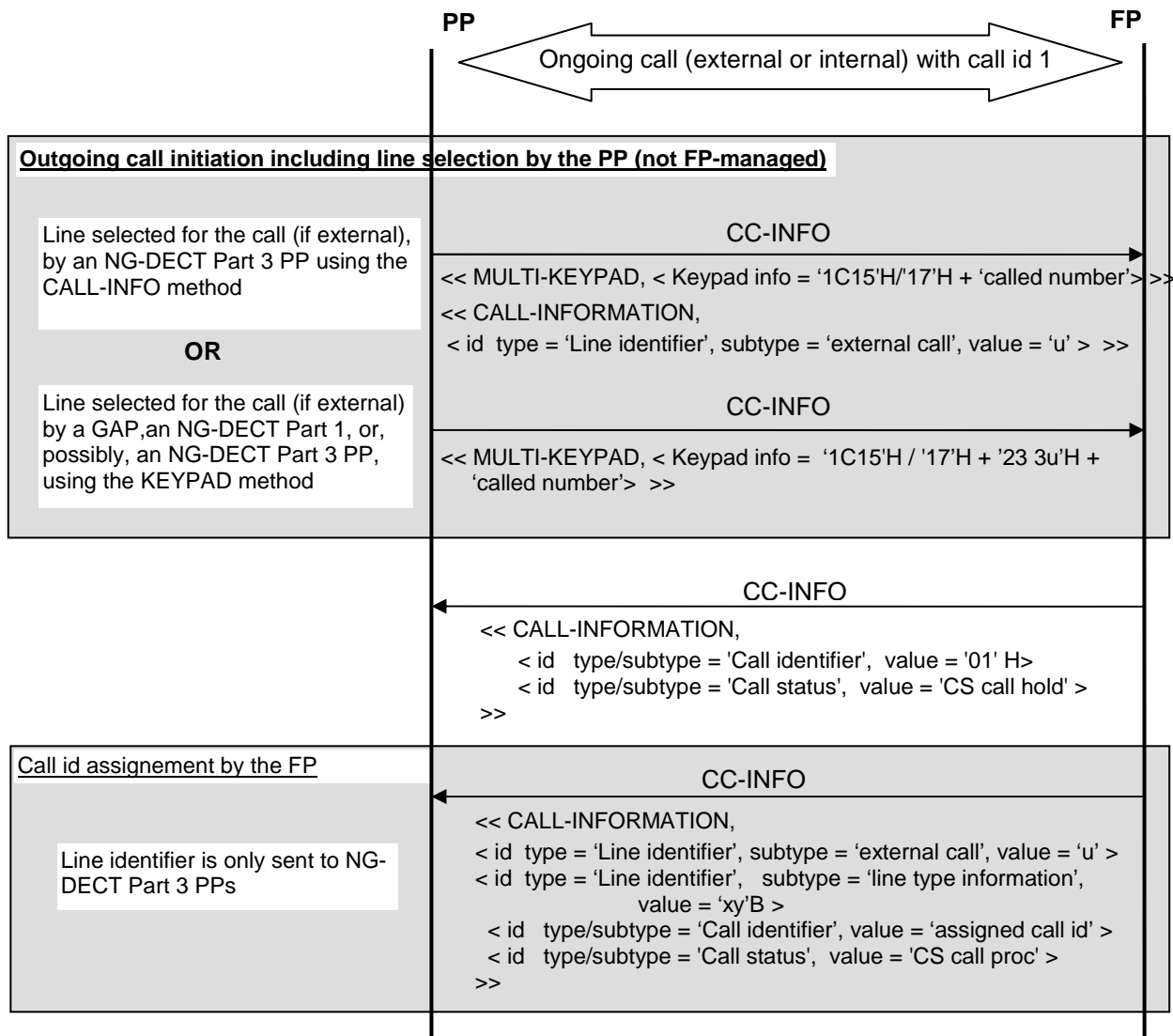

Figure C.11: Outgoing parallel calls: all in one PP message, line identification by PP

C.4.1.2 All in one PP message - FP-managed line selection

Use case: The PP sends all parallel call initiation information in a single {CC-INFO} message (e.g. the user used the phone book before placing a parallel call). However, "FP-managed line selection" (see clause 7.4.5.2.4) is used. A single message sent by the PP with '1C15'H / '17'H + called-number, but with the special line-id value 'None'.

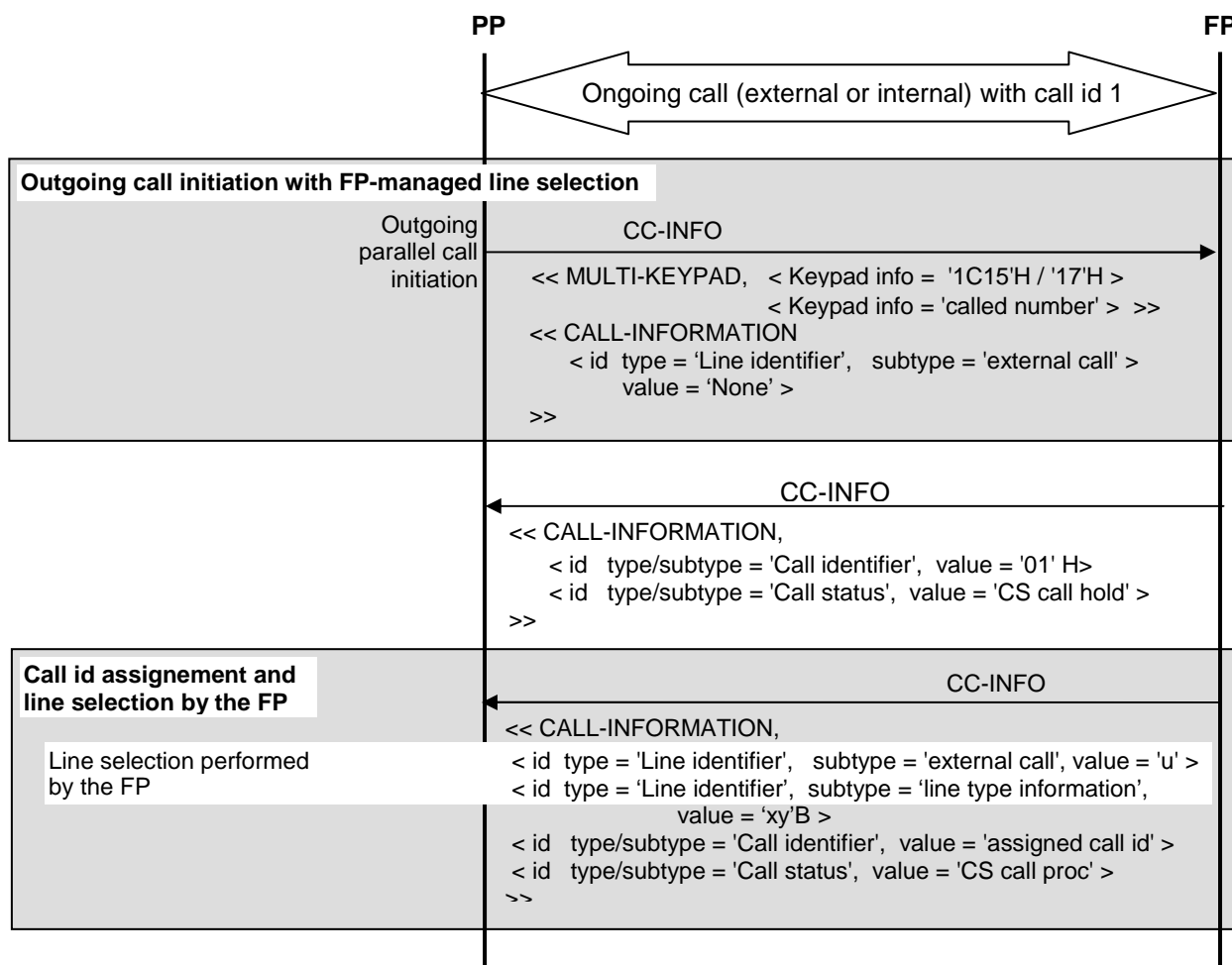

Figure C.12: Outgoing parallel calls: all in one PP message, FP managed line selection

C.4.1.3 Line pre-selection by PP - Manual dialling of called number

Use case: The PP initiates a parallel call with '1C15'H / '17'H + line-id in a single {CC-INFO} message (e.g. the user pre-selected or pre-dialled ('#k') the line to use-unless the PP is attached to only one line, in which case the user does not have to do so, but the present use case still applies-before manually dialling the called number). The FP replies with the call-id as soon as it received the first message, and before dialling of the called number.

C.4.1.5 Unsupported new outgoing parallel call

Use case: The PP initiated an outgoing parallel call (external or internal) at a point in time where the FP and/or the line cannot support the additional call. A "busy system or line notification" (see clause 7.4.8.3) is sent to the PP. If a call id was assigned to the new call (a call context was created on FP side and the call id was notified to the PP), a "call release" should also be sent.

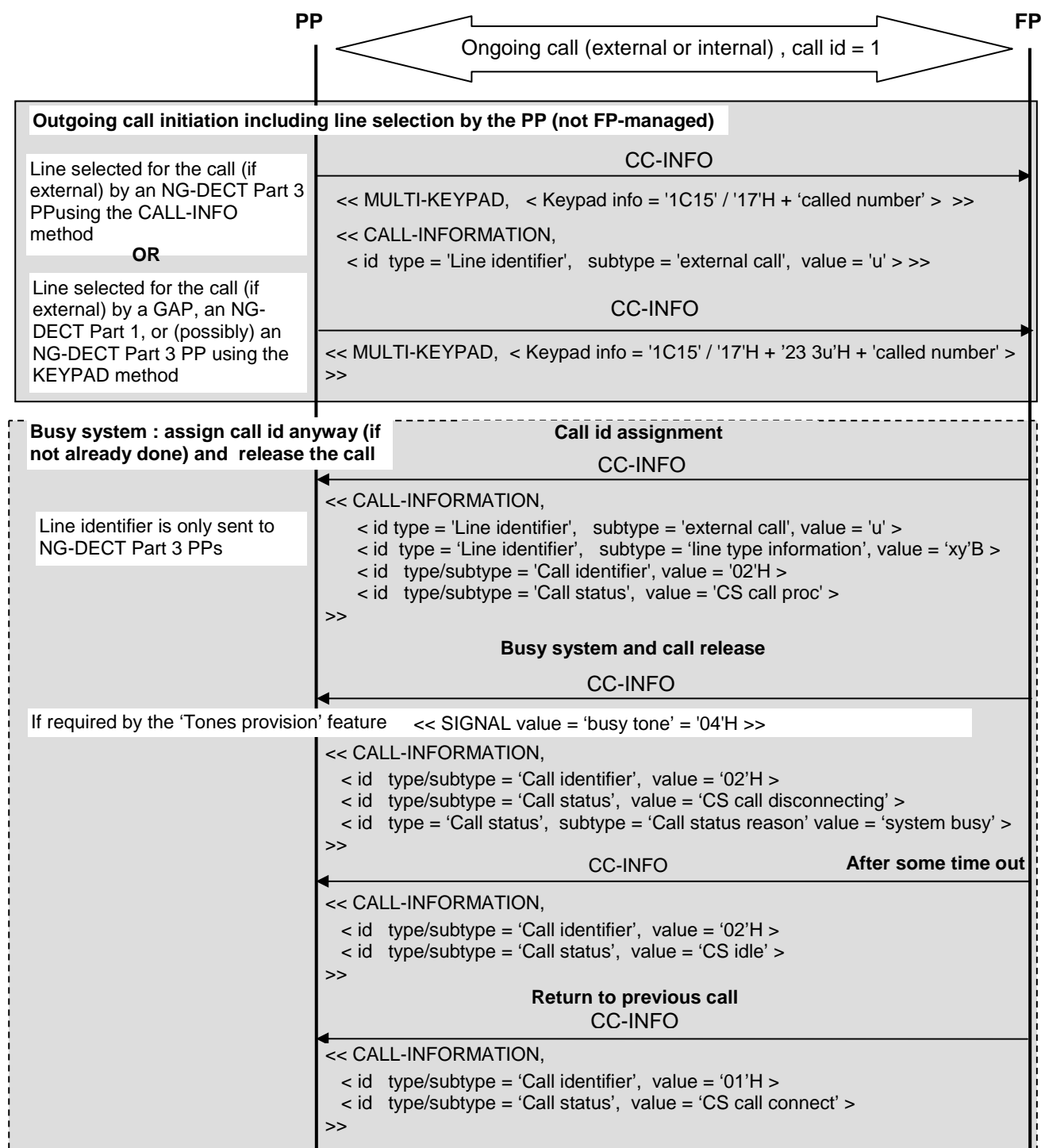

Figure C.14: Outgoing parallel calls: unsupported new outgoing parallel call

C.4.2 Incoming parallel calls

C.4.2.1 Two simultaneous incoming calls on two different lines

Use case: the PP is attached to several lines. An incoming call is received on two different lines. This use case shows that from the PP point of view, this use case does not fundamentally differ from the use case where two simultaneous calls occur on a single line.

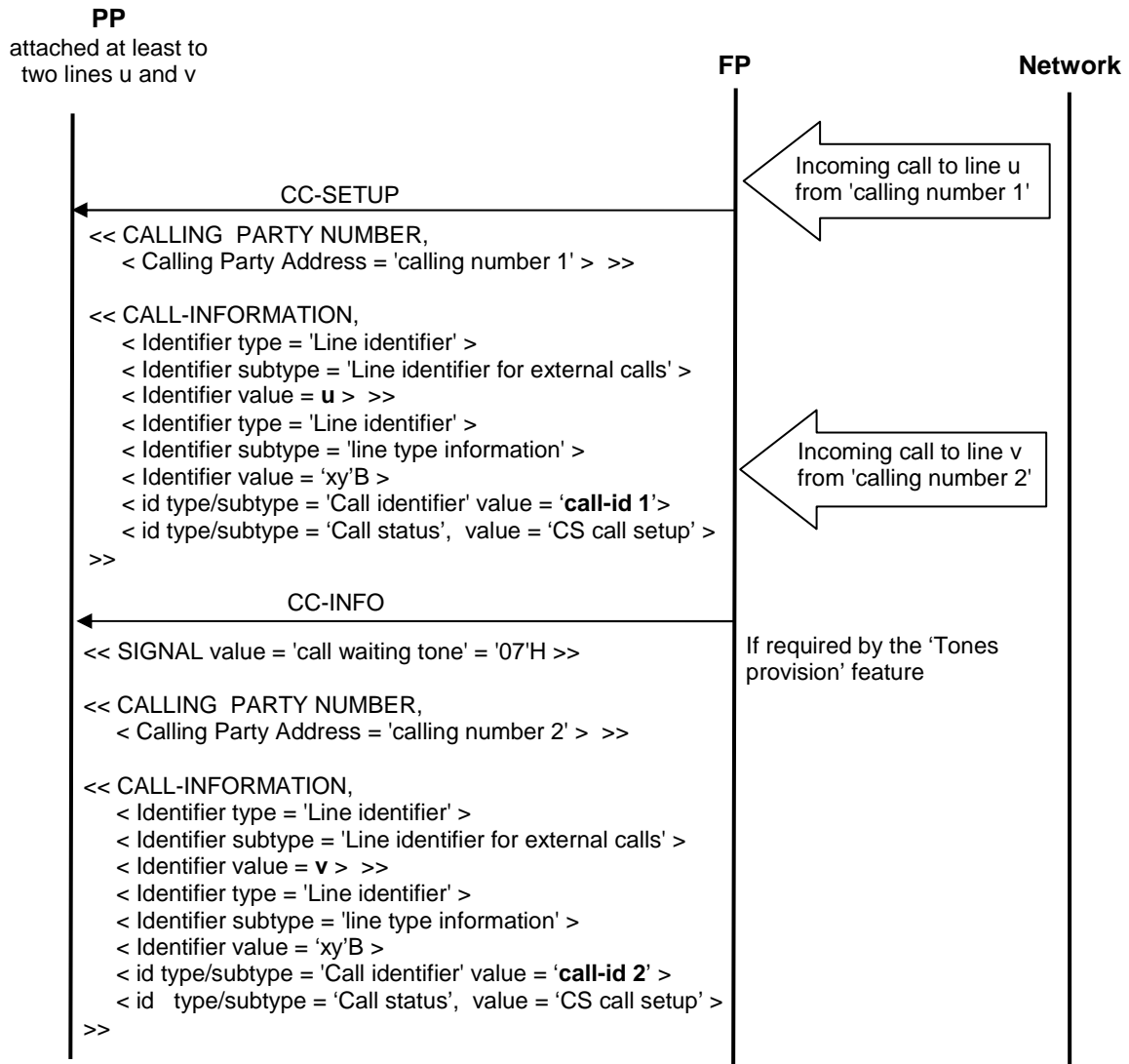

Figure C.15: Incoming parallel calls: two simultaneous incoming calls on two different lines

C.4.2.2 FP release of waiting call when remote party hangs up

Use case: use of call release from the FP when the remote party hangs up, occurring even before the PP answered the call; in that case there is no need for a 'CS call connect' call status for the first call which was not disconnected (waiting call not answered).

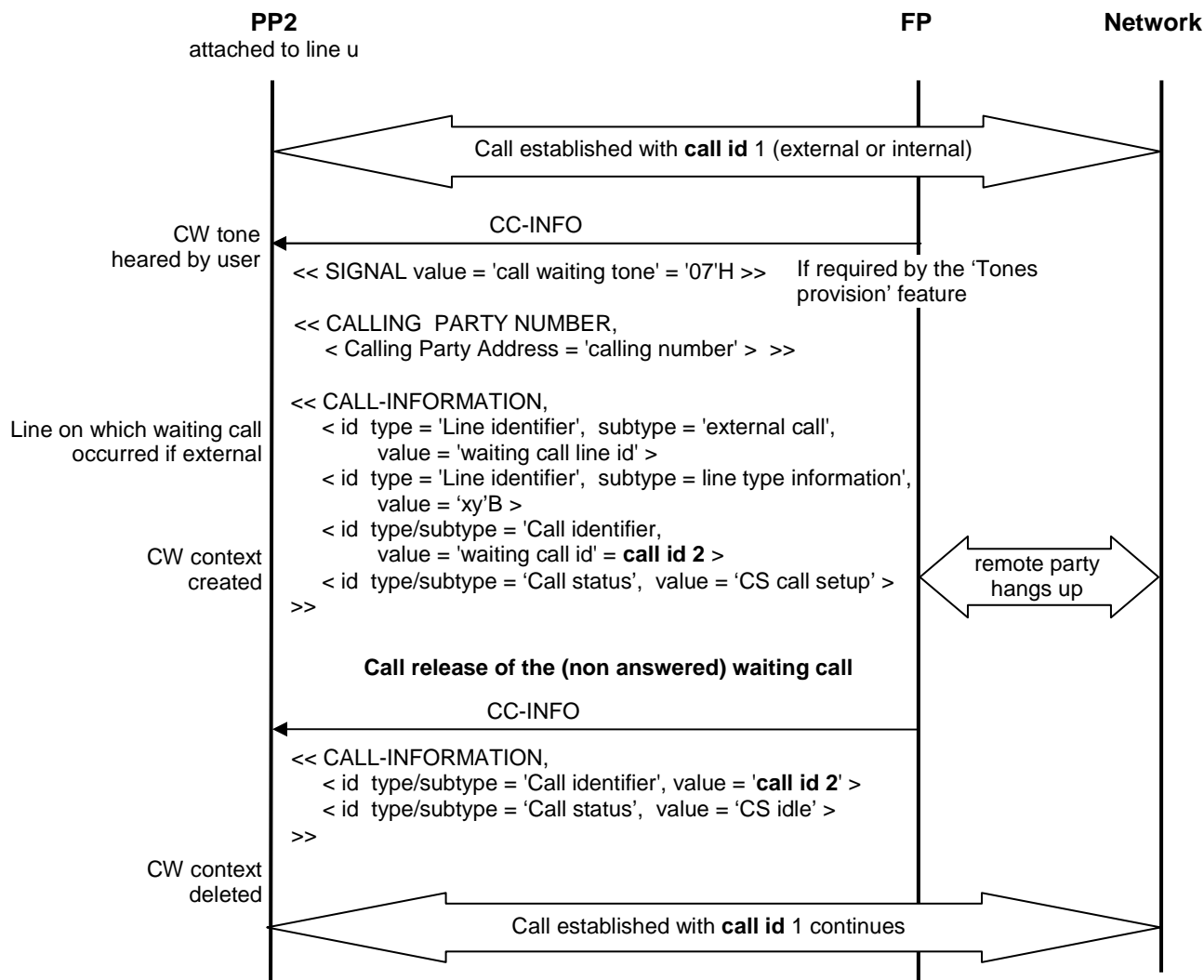

Figure C.16: Incoming parallel calls: FP release of waiting call when remote party hangs up

NOTE: There is no need here for a 'CS call connect' for the first call because the call waiting was not yet accepted).

C.4.2.3 Two incoming calls before user answers

Use case: Two calls are arriving before the user answers any of them. Both calls are presented to the user on the MMI and the user selects one of them.

For this revision of the present document, the FP blocks the second incoming call presentation until the first call presentation is terminated (i.e. until this first call is accepted or released).

NOTE: Other more advanced behaviours are left for further study.

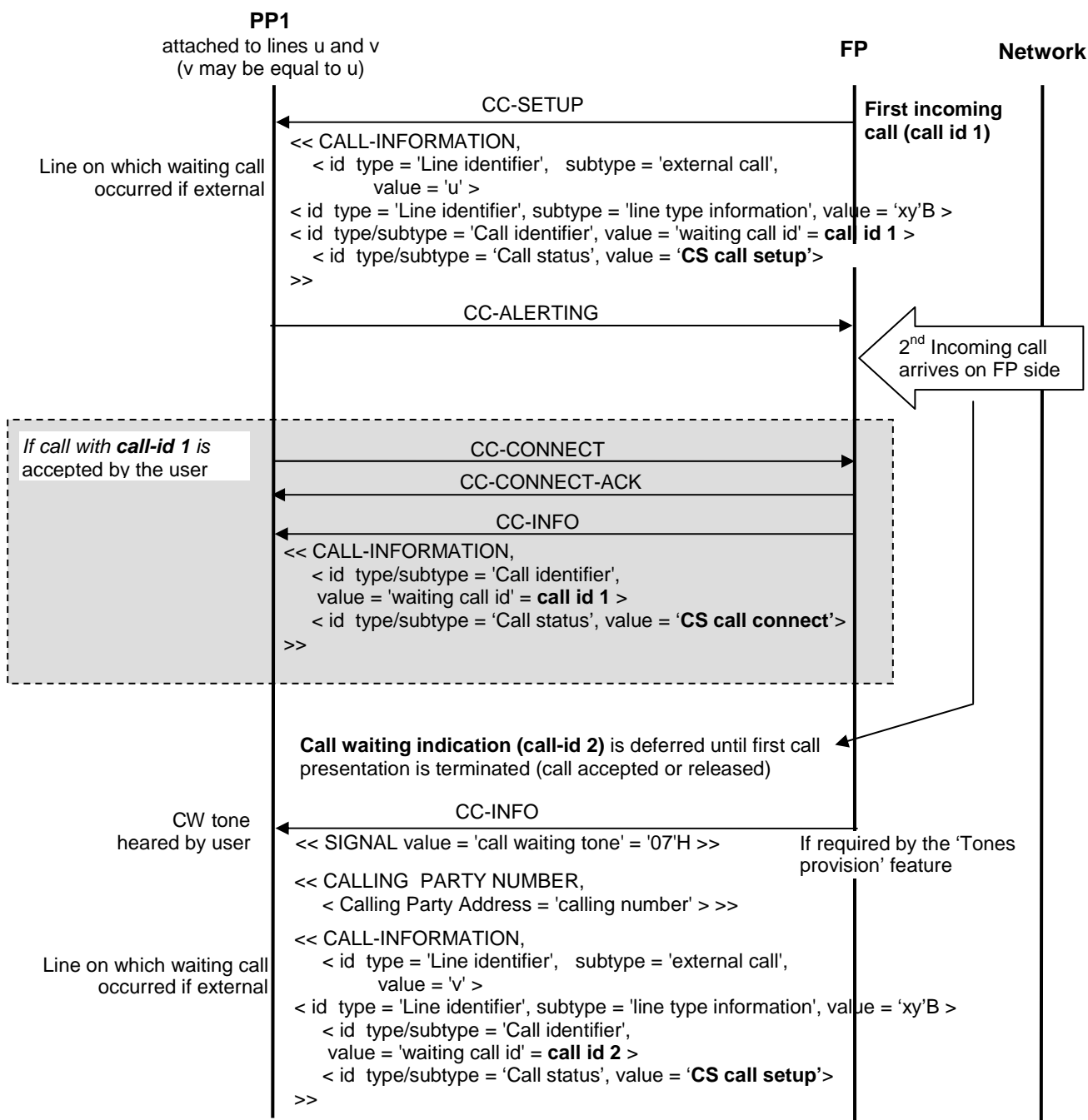
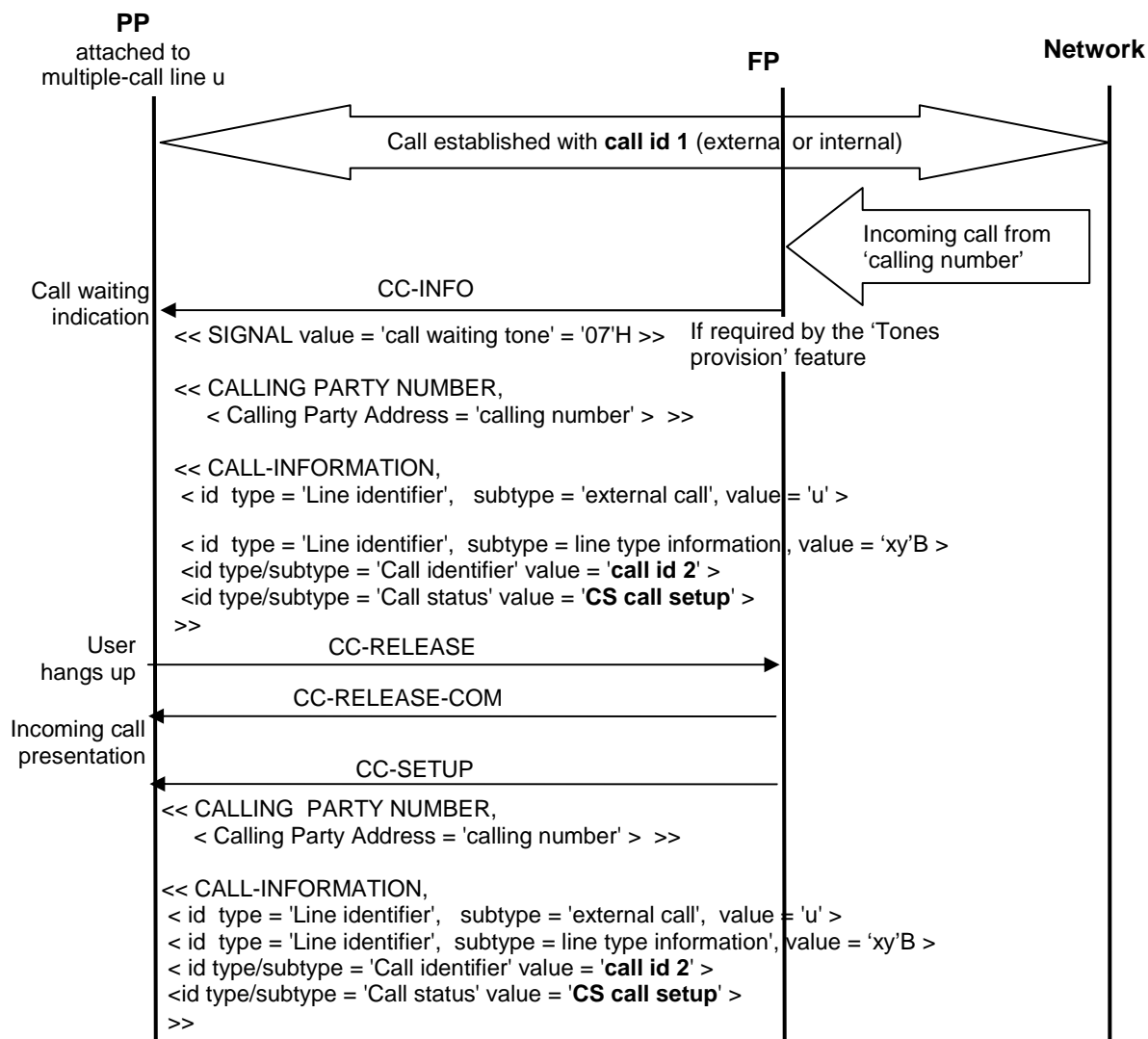

Figure C.17: Incoming parallel calls: Two incoming calls before user answers

C.4.3 Call waiting represented as first call when user hangs up

Use case: the PP is attached to a multi-call line. A call is on going from PP1. A second incoming call is presented to the line. The PP hangs up and the call is represented as a first incoming call.



NOTE: The <<CALL-INFORMATION>> information element is not sent in a CC-RELEASE or CC-RELEASE-COM message.

Figure C.18: Call waiting represented as first call when user hangs up

C.5 List access service use case examples

C.5.1 General

In the following clauses, several use case examples for list access are depicted.

It has to be noted that the sequences are only examples, it cannot be mandatory that the message flows are always exactly in the described way. However it is recommended to follow the examples where possible in order to ensure interoperability.

For clarity of the following flowcharts, <<Call information>> IE including call identifiers and line identifiers does not appear in some of the CC messages that must convey it. Please note that they should not be omitted when implementing equivalent cases.

C.5.2 Use case: transfer number from missed call list to contact list

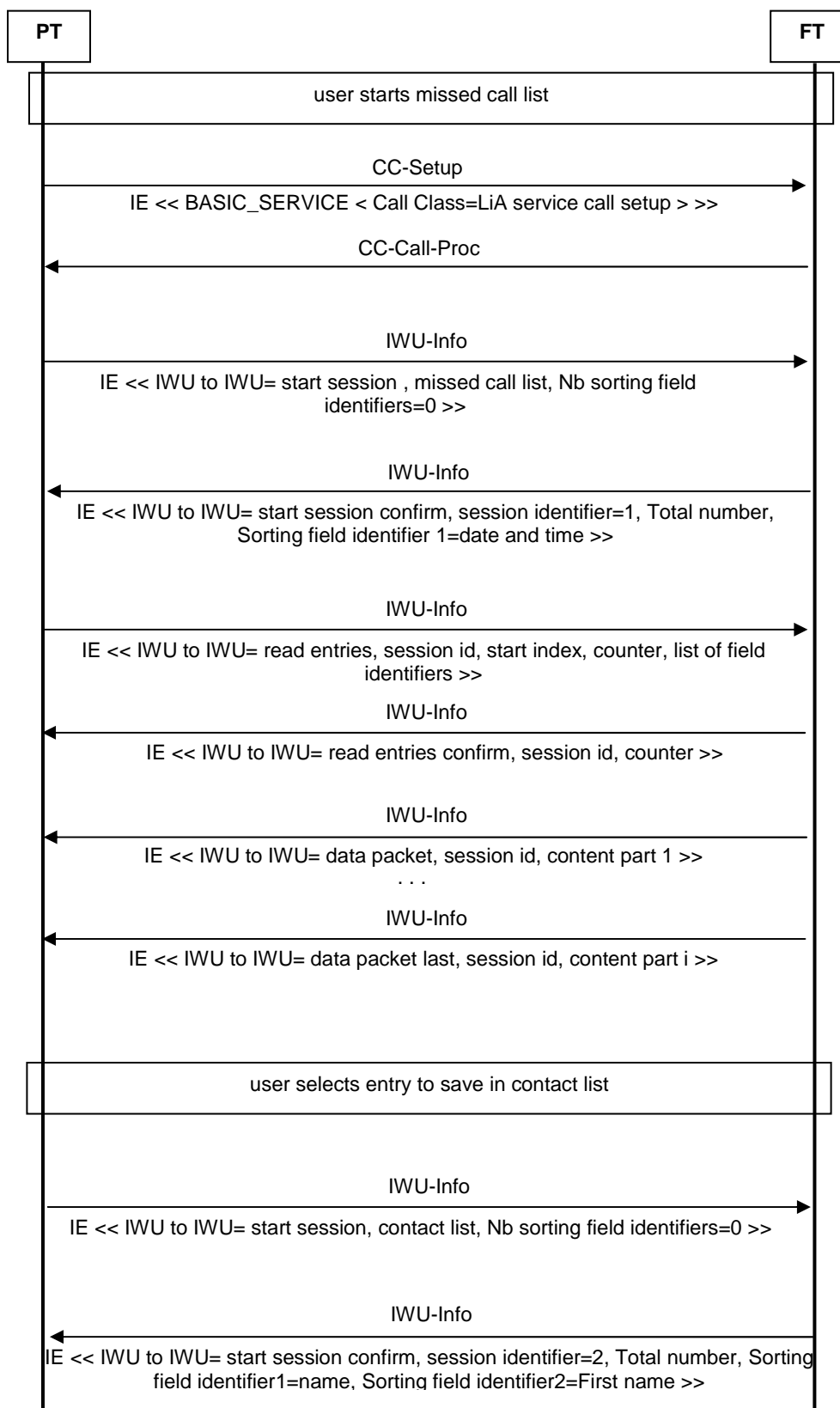

Figure C.19: List access use case: transfer number from missed call list to contact list (1/2)

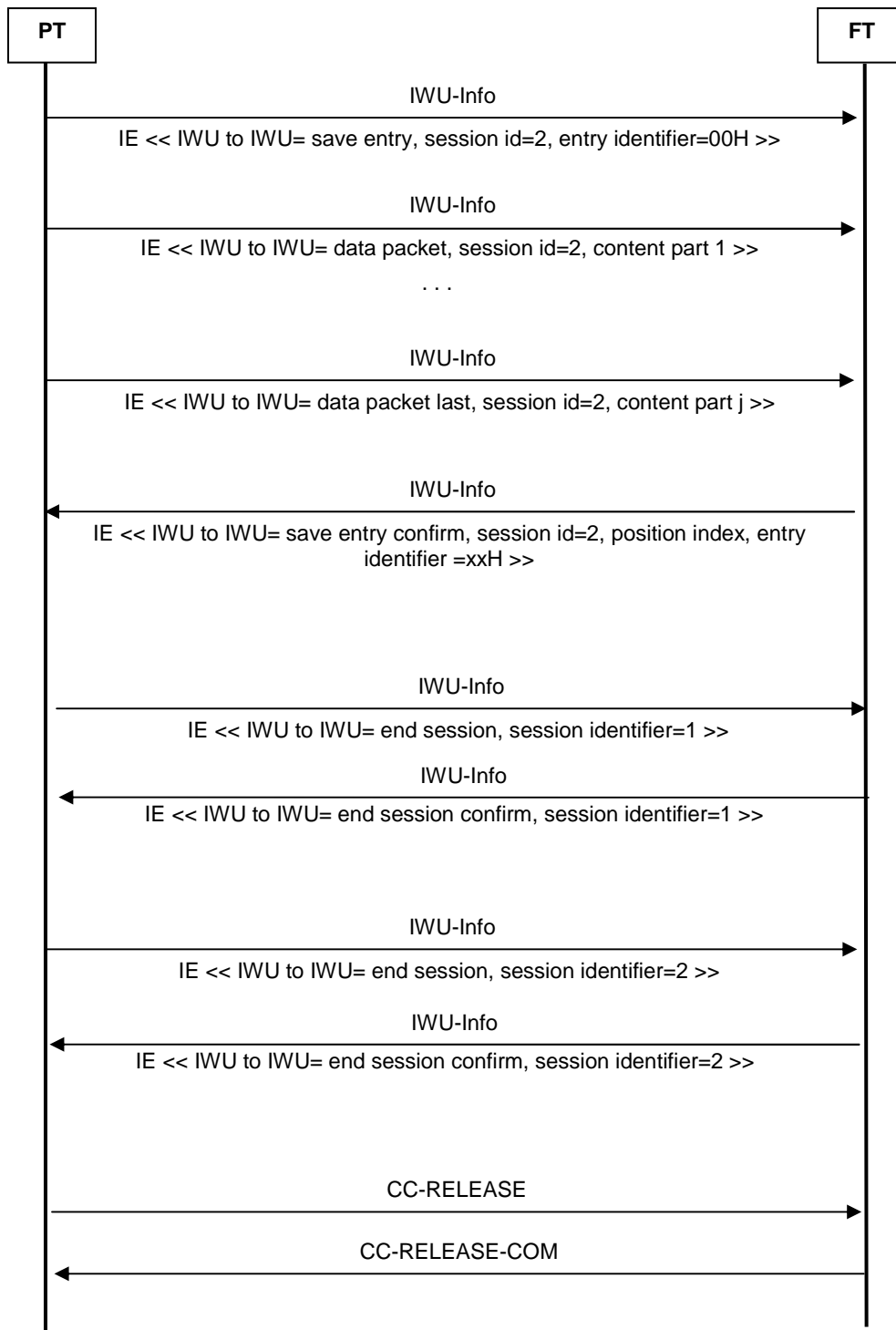

Figure C.20: List access use case: transfer number from missed call list to contact list (2/2)

The second session might also be established after release of the first session. FP shall be capable to handle at least two sessions independently.

C.5.3 Use case: select and call internal party

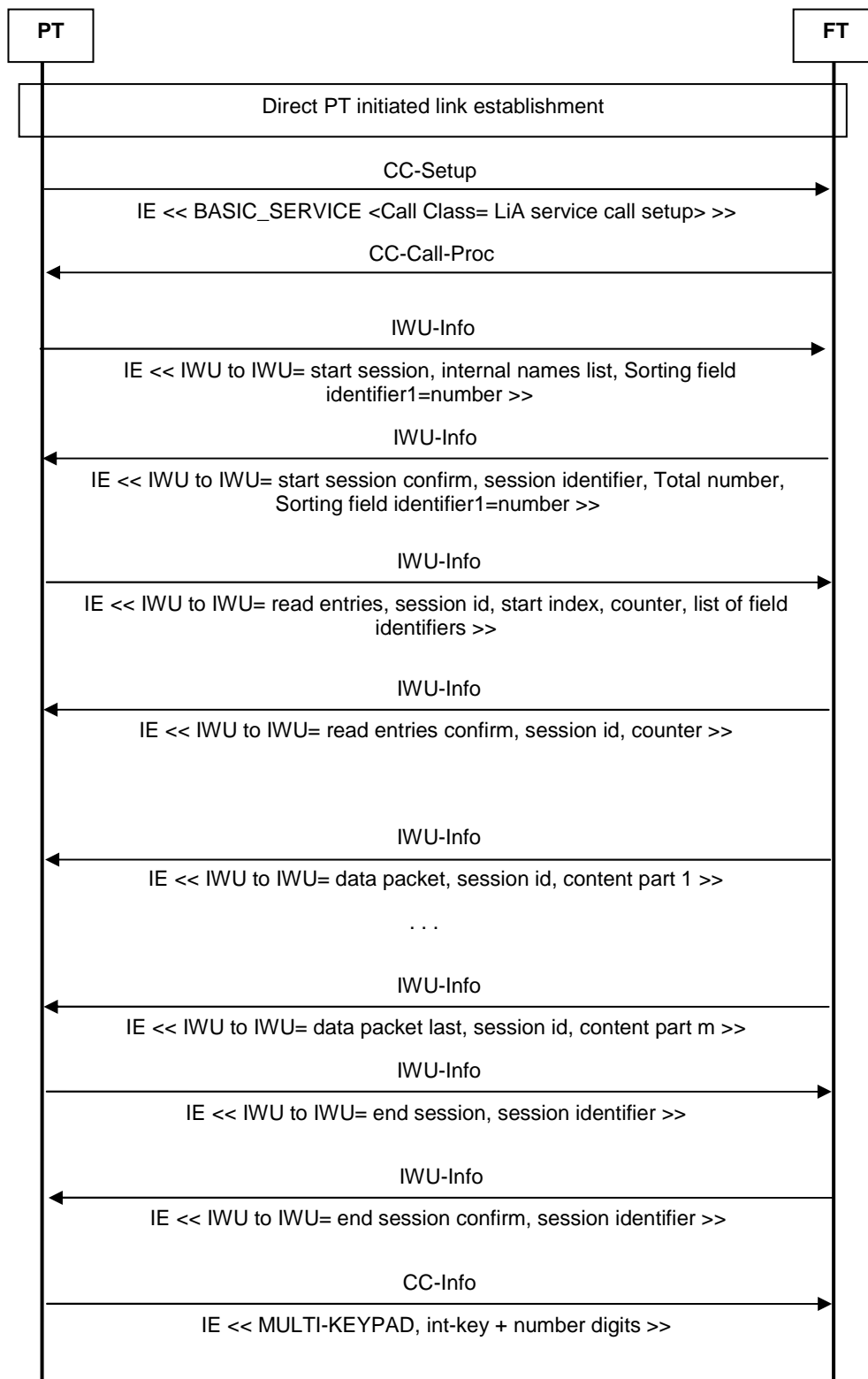

Figure C.21: List access use case: select and call internal party

The int-key is necessary at least in case basic service is not internal call.

C.5.4 Use case: select and call number from contact list

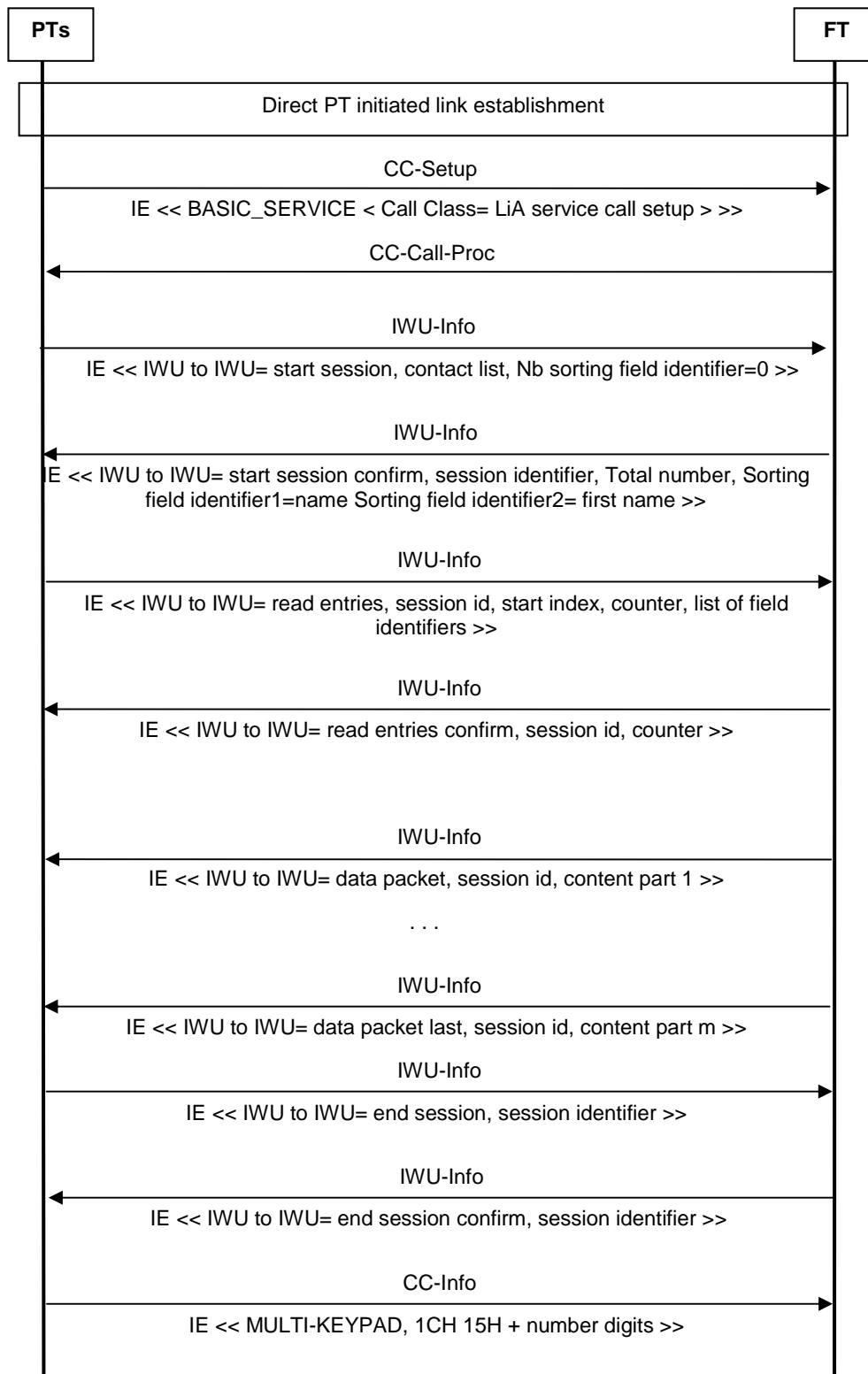

Figure C.22: List access use case: select and call number from contact list

C.5.5 Use case: save entry with invalid format

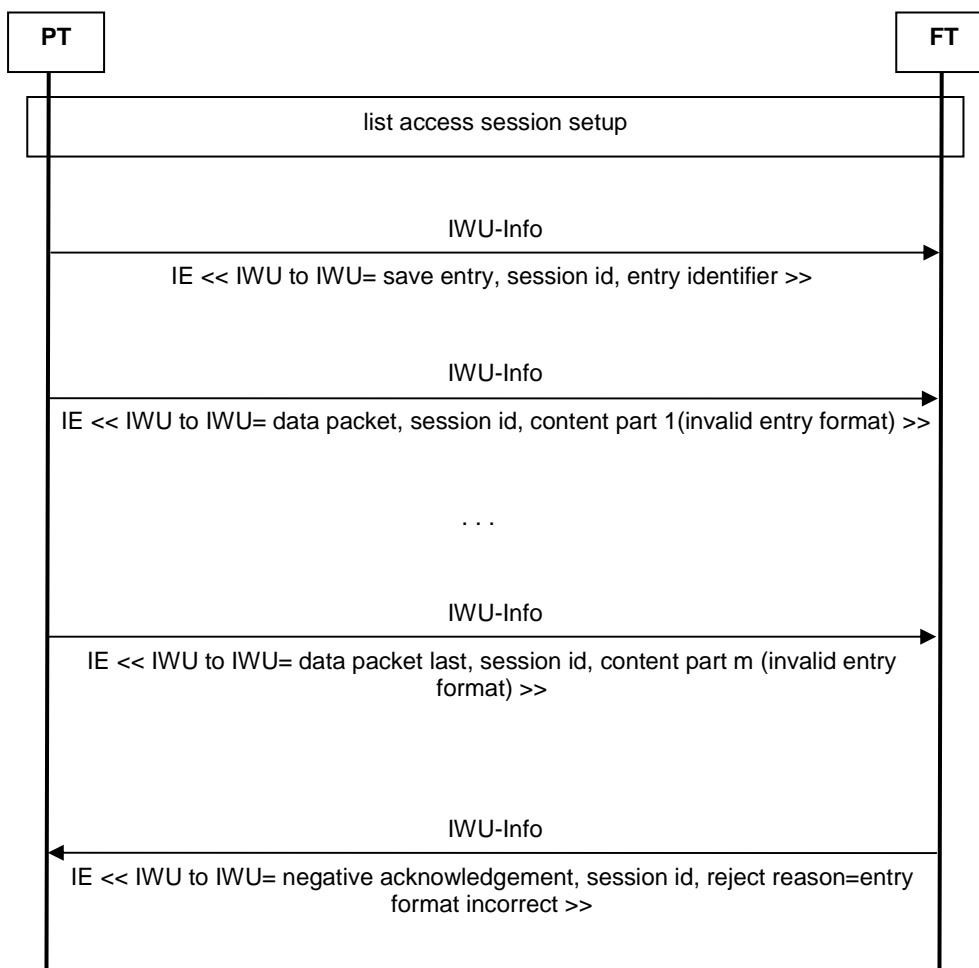

Figure C.23: List access use case: save entry with invalid format

C.5.6 Use case: read invalid start index

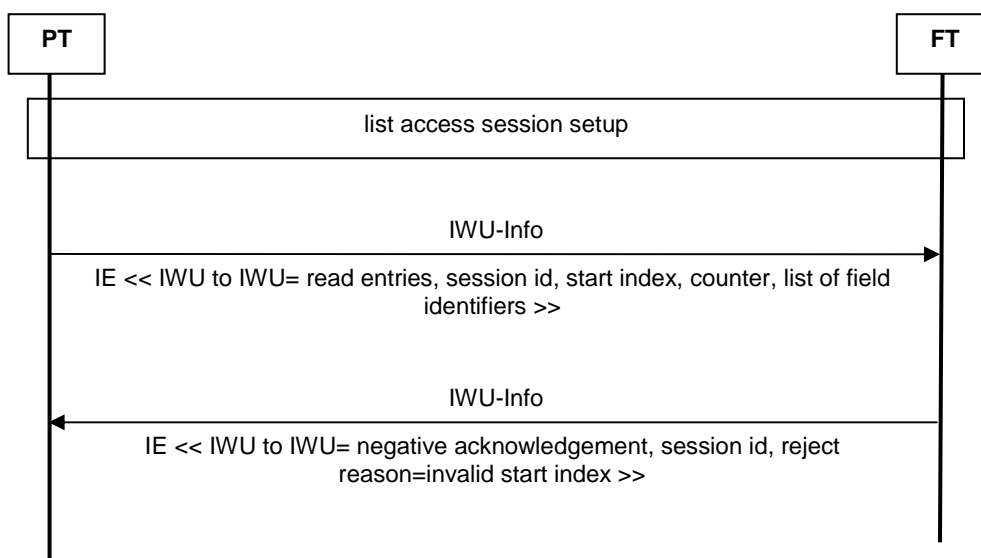

Figure C.24: List access use case: read invalid start index

C.5.7 Use case: modify a PP internal name

The user edits the internal name of the PP number '3' in the DECT system. This use case can be used just after subscription registration or later.

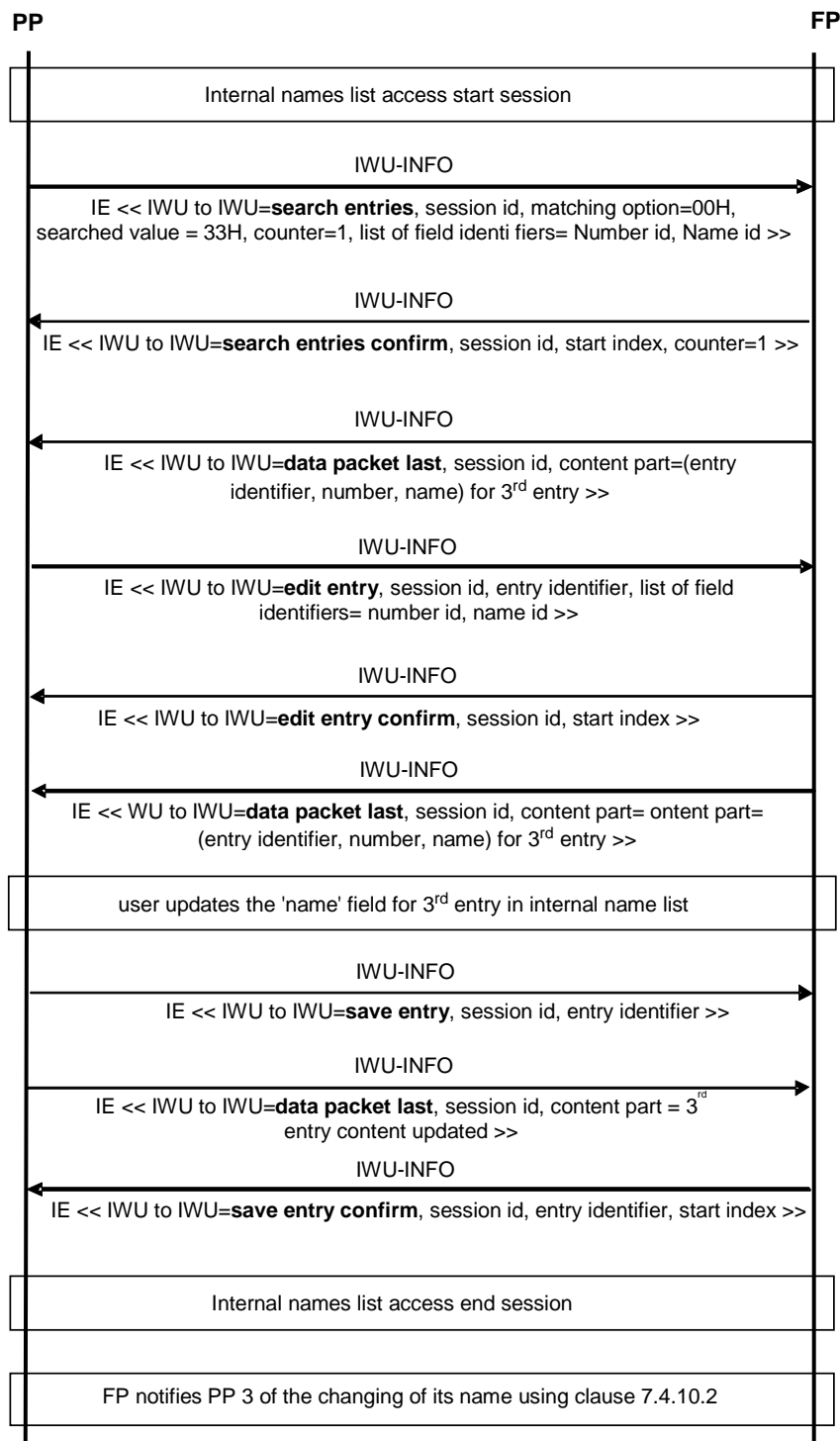

Figure C.25: List access use case: modify a PP internal name

C.5.8 Use case: entry distributed over two data packets

Read the missed call list, the number of requested entries is 1 with all possible fields. The first entry in the list is the following:

- CLIP= "0674011776"
- CNIP = "J.René BIDA"
- 8 calls received
- Last call received on 17/03/09 at 12h07mn08s

The data content of this entry exceeds the 56 octets limit, so the entry is sent over two data packets: one "data packet" command followed by one "data packet last" command. Each data packet is sent in a separate IWU-INFO <<IWU to IWU>> message as defined in tables C.6 and C.7.

Table C.6: Example of one entry sent over two 'Data packet' commands - 1st <<IWU to IWU>>

Information element	Field within the information element	Standard values within the field/IE	Normative action/comment
<<IWU to IWU>>	<Length of content>	3BH	Length of content
	<Protocol Discriminator>	03H	List access
	<Command>	13H	Data packet
	<Session identifier>	81H	Session identifier (session id=1)
	<Entry identifier for 1 st entry>	81H	Identifier of the entry (entry =01H)
	<Entry length>	BCH	Length (length=3CH)
	<Entry field identifier 1 >	01H	Field identifier = Number
	<Entry field length>	8BH	Length (length=0BH)
	<Entry field content 0>	80H	Property (editable=0, own=0, int=0)
	...	30H	Digit (1) = '0'
	...	36H	Digit (2) = '6'
	...	37H	Digit (3) = '7'
	...	34H	Digit (4) = '4'
	...	30H	Digit (5) = '0'
	...	31H	Digit (6) = '1'
	...	31H	Digit (7) = '1'
	...	37H	Digit (8) = '7'
	...	37H	Digit (9) = '7'
	<Entry field content j>	36H	Digit (10) = '6'
	<Entry field identifier 2 >	02H	Field identifier = Name
	<Entry field length>	8DH	Length (length=0DH)
	<Entry field content 0>	80H	Property (editable=0)
	...	4AH	Character (1) = 'J'
	...	2AH	Character (2) = '.'
	...	52H	Character (3) = 'R'
	...	62H	Character (4) = 'e'
	...	6EH	Character (5) = 'n'
	...	C3H	Character (6) = 'Ã'
	...	A9H	Character (7) = '©' => 'é'
	...	20H	Character (8) = ''
	...	42H	Character (9) = 'B'
	...	49H	Character (10) = 'l'
	...	44H	Character (11) = 'D'
	<Entry field content k>	41H	Character (12) = 'A'
	<Entry field identifier 3 >	03H	Field identifier = Date and Time
	<Entry field length>	88H	Length (length=08H)
	<Entry field content 0>	80H	Property (editable=0)
	...	C0H	Coding= Time and Date Interpretation = The current time/date
	...	09H	Year = 2009
	...	03H	Month = March
...	17H	Day = 17	

...	12H	Hour = 12
...	07H	Minute = 7
...	08H	Second = 8
<Entry field content l>	00H	Time Zone = +0
<Entry field identifier 4 >	04H	Field identifier = New
<Entry field length>	81H	Length (length=1)
<Entry field content 0>	A0H	Property (editable=0, new=1)
<Entry field identifier 5 >	05H	Field identifier = Line name
<Entry field length>	87H	Length
<Entry field content 0>	80H	Property (editable=0)
...	56H	Character (1) = 'V'
...	6FH	Character (2) = 'o'
...	49H	Character (3) = 'l'
...	50H	Character (4) = 'P'
...	20H	Character (5) = ''
<Entry field content m>	31H	Character (6) = '1'
<Entry field identifier 6 >	06H	Field identifier = Line id
<Entry field length>	82H	Length
<Entry field content 0>	80H	Property (editable=0)

Table C.7: Example of one entry sent over two 'Data packet' commands - 2nd <<IWU to IWU>>

Information element	Field within the information element	Standard values within the field/IE	Normative action/comment
<<IWU to IWU>>	<Length of content>	08H	Length of content
	<Protocol Discriminator>	03H	List access
	<Command>	14H	Data packet last
	<Session identifier>	81H	Session identifier (session id=1)
	<Entry field content n>	81H	Identifier value = 01H
	<Entry field identifier 7 >	07H	Field identifier = Number of calls
	<Entry field length>	82H	Length
	<Entry field content 0>	80H	Property (editable=0)
	<Entry field content p>	08H	value = 8 calls

C.6 List access service with voice calls (additional use cases and procedure diagrams)

C.6.1 General

In the following clauses, several procedure diagrams for list access service combined with voice calls are depicted. It has to be noted that the sequences are only examples, it cannot be mandatory that the message flows are always exactly in the described way. However it is recommended to follow the examples where possible in order to ensure interoperability.

C.6.2 List access when a voice call is already ongoing

Please note that for clarity of the flowcharts, the line identifier is not mentioned. However it has to be implemented and managed correctly as defined by the present document.

C.6.2.1 Use case: Consult a list during a voice call

Use case: Look for the number of a contact while you are in voice call and then come back to the voice call.

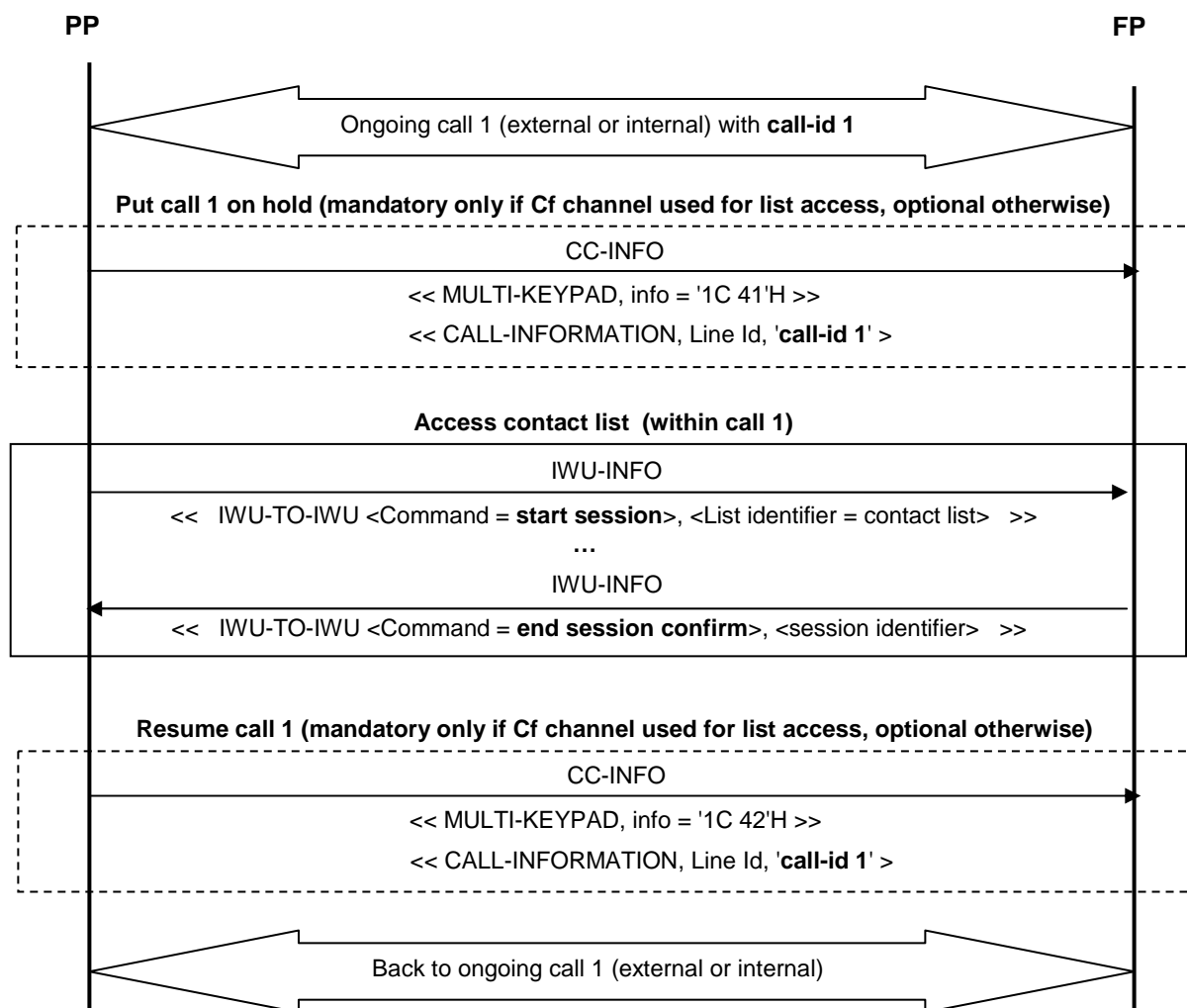

Figure C.26: List access use case: consult a list during a voice call

C.6.2.2 Use case: call transfer using internal names list (first call explicitly put on hold)

Use case: Ongoing call is put on hold before establishing a parallel internal call using the internal names list. The first call is then transferred. It shows in particular that a call can optional be put on hold before an outgoing second call is made. In this case, it is proposed that an additional call id is attached to the list access.

NOTE: The list access re-uses call id1.

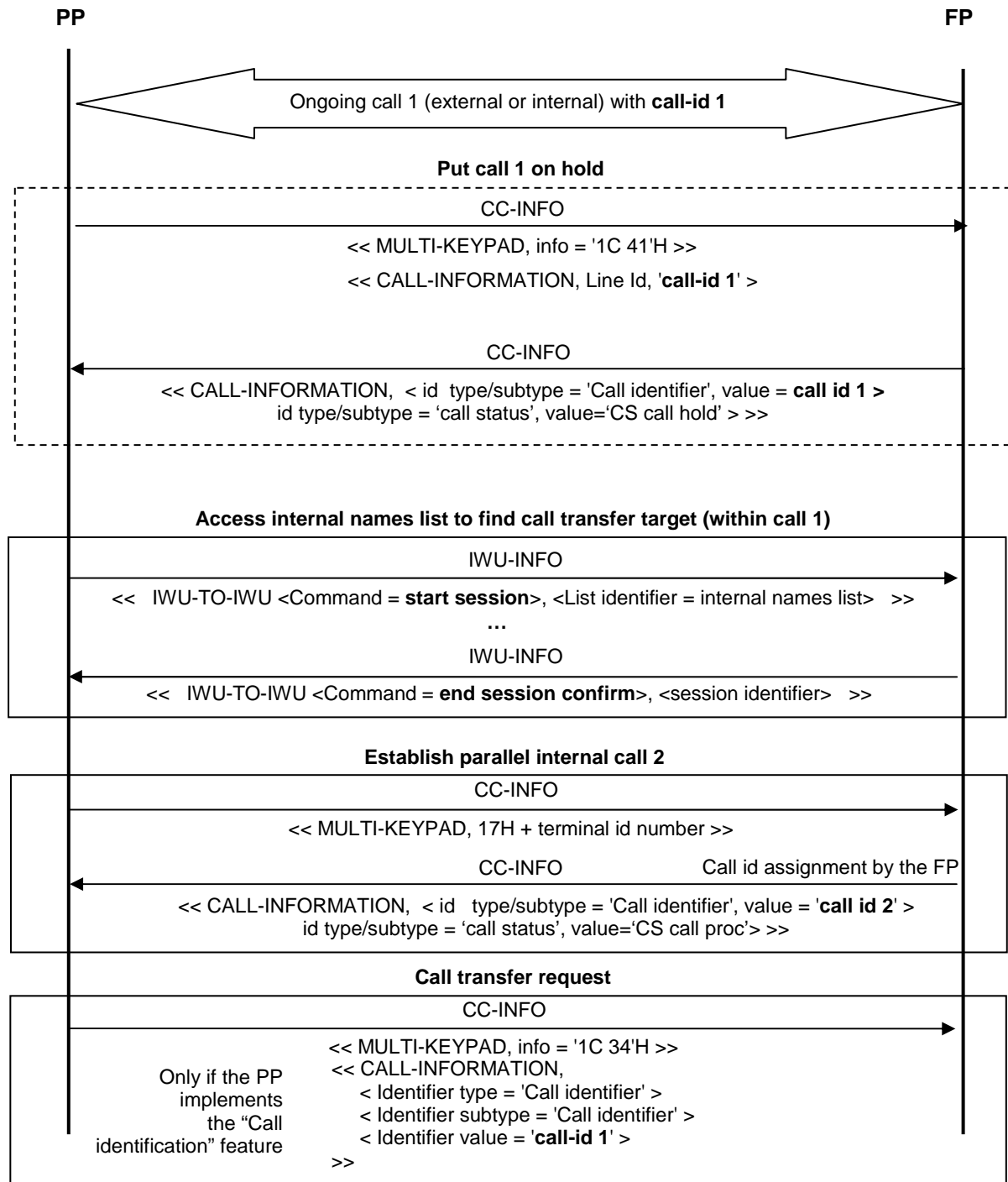

Figure C.27: List access use case: call transfer using internal names list (first call explicitly put on hold)

C.6.2.3 Use case: call transfer using internal names list (first call implicitly put on hold by internal call)

Use case: Ongoing call is implicitly put on hold before establishing a parallel internal call using the internal names list. The first call is then transferred. It shows in particular that the '17'H implicitly puts the ongoing call on hold.

NOTE: The list access re-uses call id2.

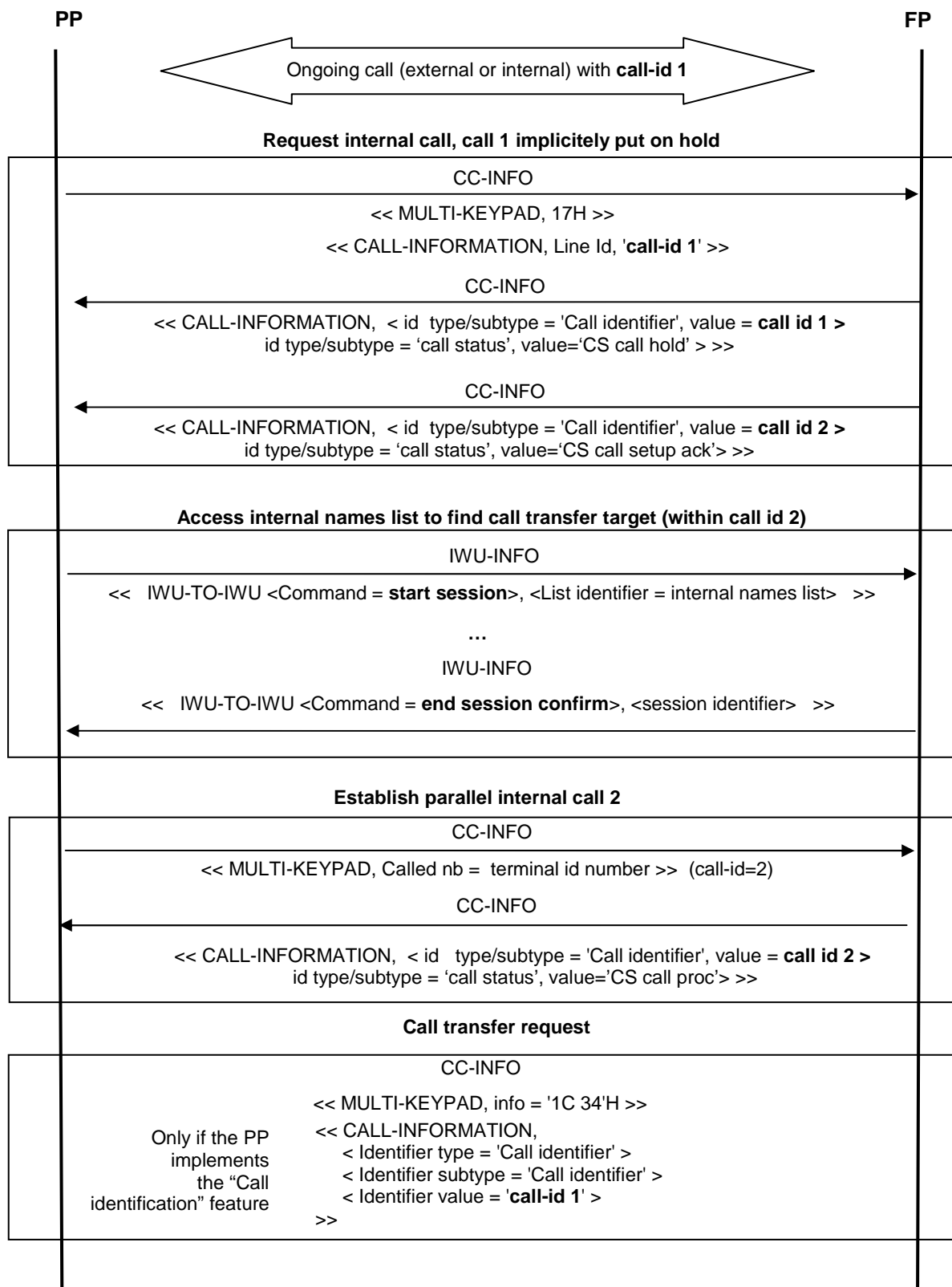

Figure C.28: List access use case: call transfer using internal names list (first call explicitly put on hold)

C.6.2.4 Use case: establishing a parallel call using contact list

Use case: During an ongoing call, the user establishes a parallel external call using the contact list. In this case, there is no need for an additional call id for the list access: it is done within existing call.

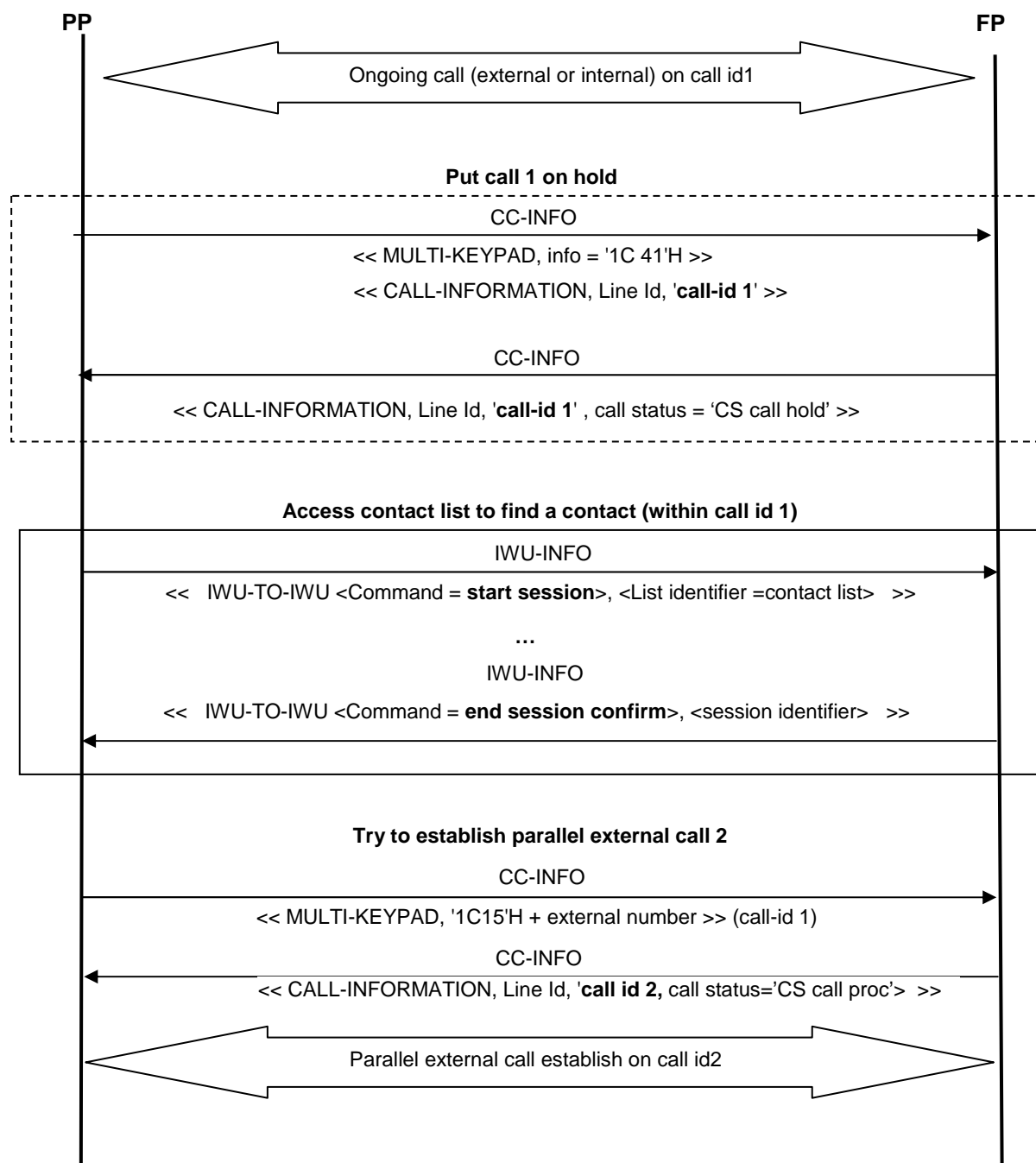

Figure C.29: List access use case: establishing a parallel call using contact list

C.7 DECT system settings diagrams

C.7.1 General

In the following flowcharts, we assume that:

- N lines are defined, i.e. 'Total number of entries' = N in line settings list before starting lines settings session.

- The total number of registered PPs is M, i.e. 'Total number of entries' = M in internal names list before starting internal names session.
- Only one data packet command is necessary to read one entry content, i.e. 'data packet last' command is received directly.
- The fields are not PIN protected (except when stated other wise).

NOTE: In the following flowcharts, the read entries or search entries might be done prior to the sequence (in a previous session for example). But this is not the most usual behaviour as the PP may probably show the current value of the setting before enabling the user to modify it.

For clarity of the following flowcharts the <<Call information>> IE including call identifier does not appear in the CC messages that convey it. Please note that it should not be omitted when implementing equivalent cases. For example the call identifier is assigned by the FP after {CC-SETUP} message.

In the following use cases, it is assumed that "Early encryption" feature [GAP.M.15] is not implemented. In the flowcharts, the encryption is started by the FP systematically after the list access call setup. However, some implementation flexibility is allowed concerning the point in time when link is encrypted as long as:

- PIN code exchange is done over an encrypted link (see clause 7.4.11.1).
- List access service call gets finally encrypted at some point in time. See [GAP.N.35] feature, encryption of all calls procedure (see clause 8.45.1 of [12]).

C.7.2 Modifying the PIN code

Use case: FP without keyboard, the user modifies the system PIN code from the PP.

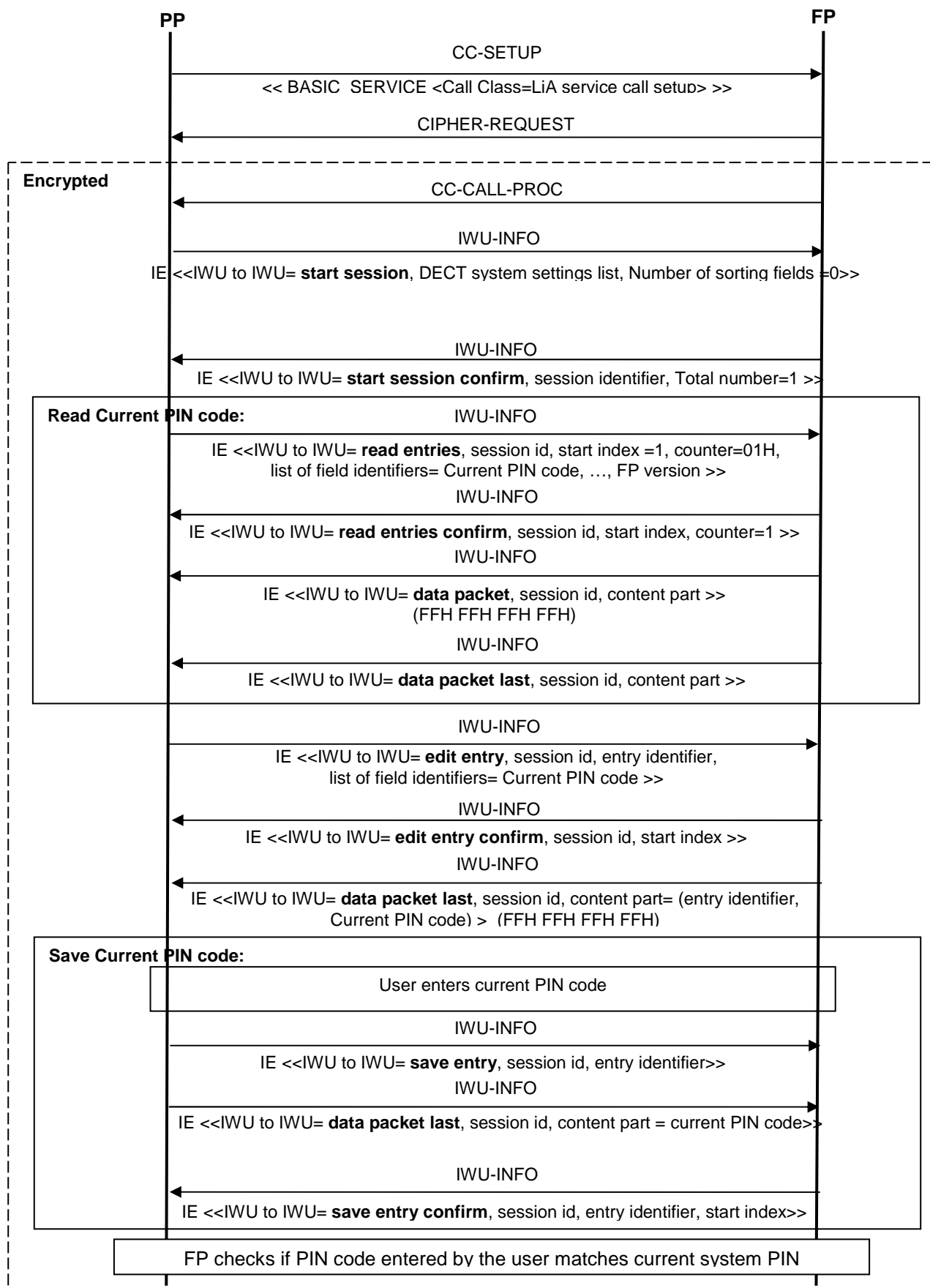

Figure C.30: Modifying the PIN code (1/2)

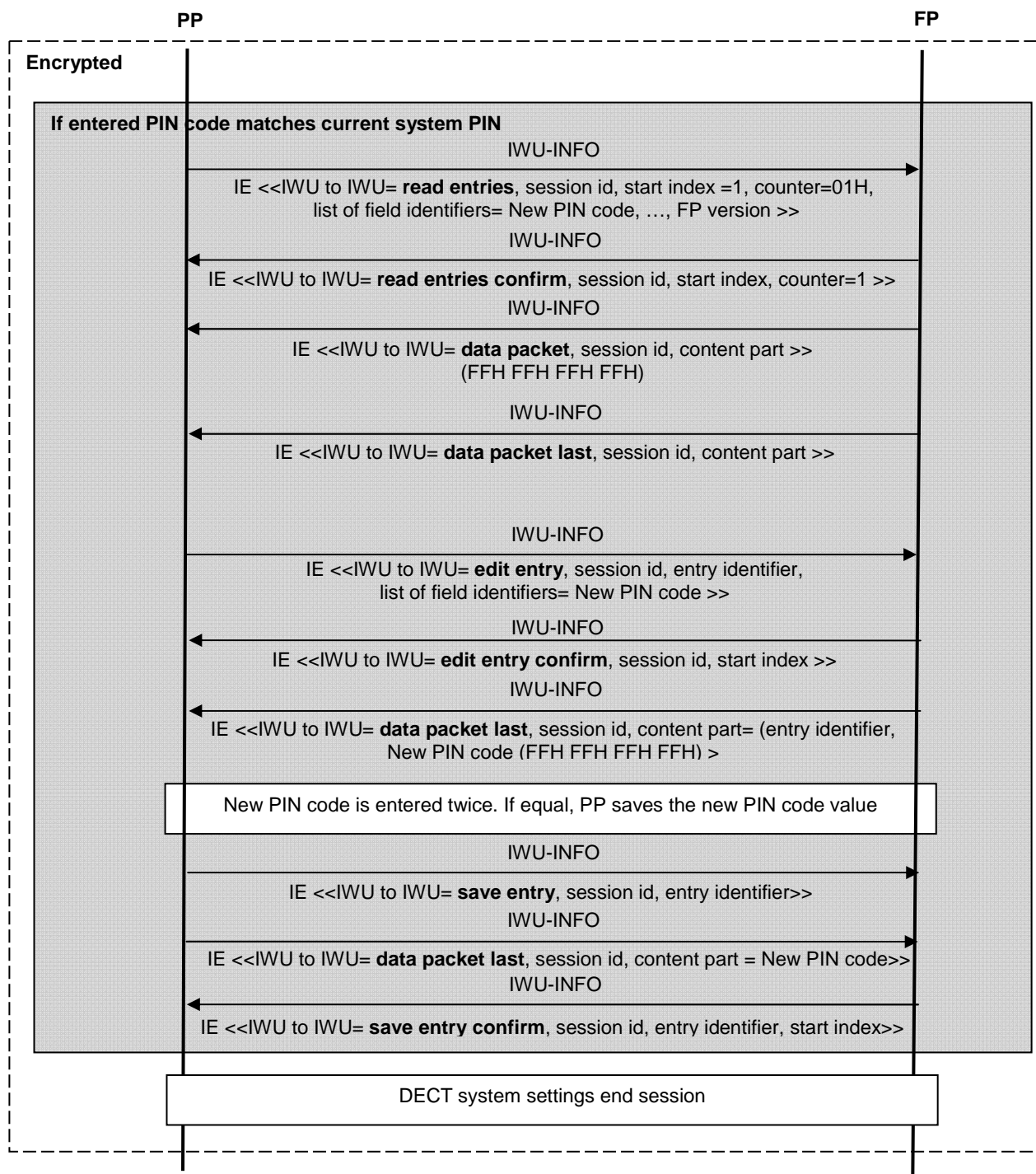

Figure C.31: Modifying the PIN code (2/2)

C.7.3 Resetting the base

Use case: Reset all DECT system and line settings to their default value.

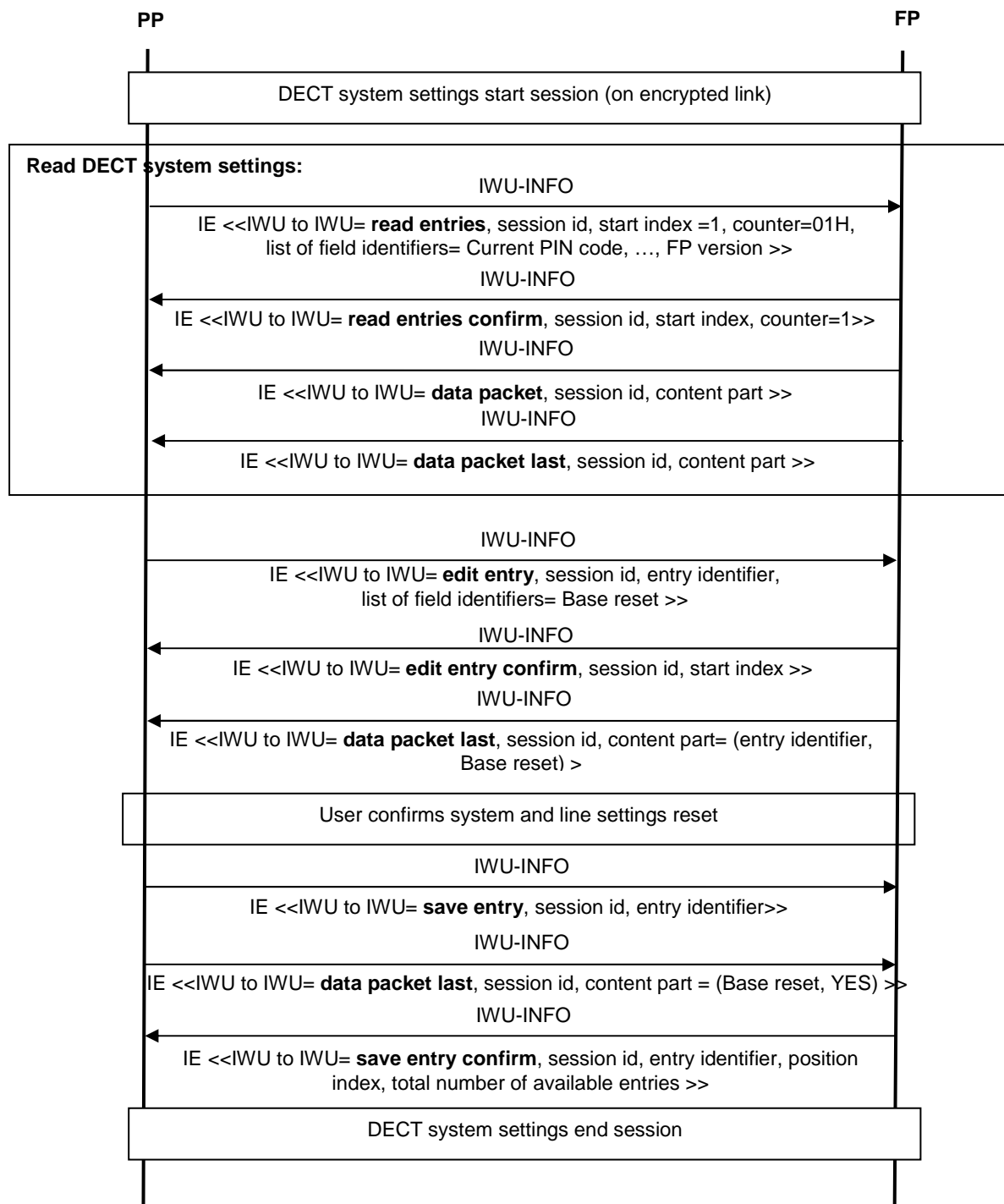

Figure C.32: Resetting the base

C.7.4 Resetting the base (PIN code protected field)

Use case: the use case is the same as the previous one except that the 'Base reset' field is PIN code protected.

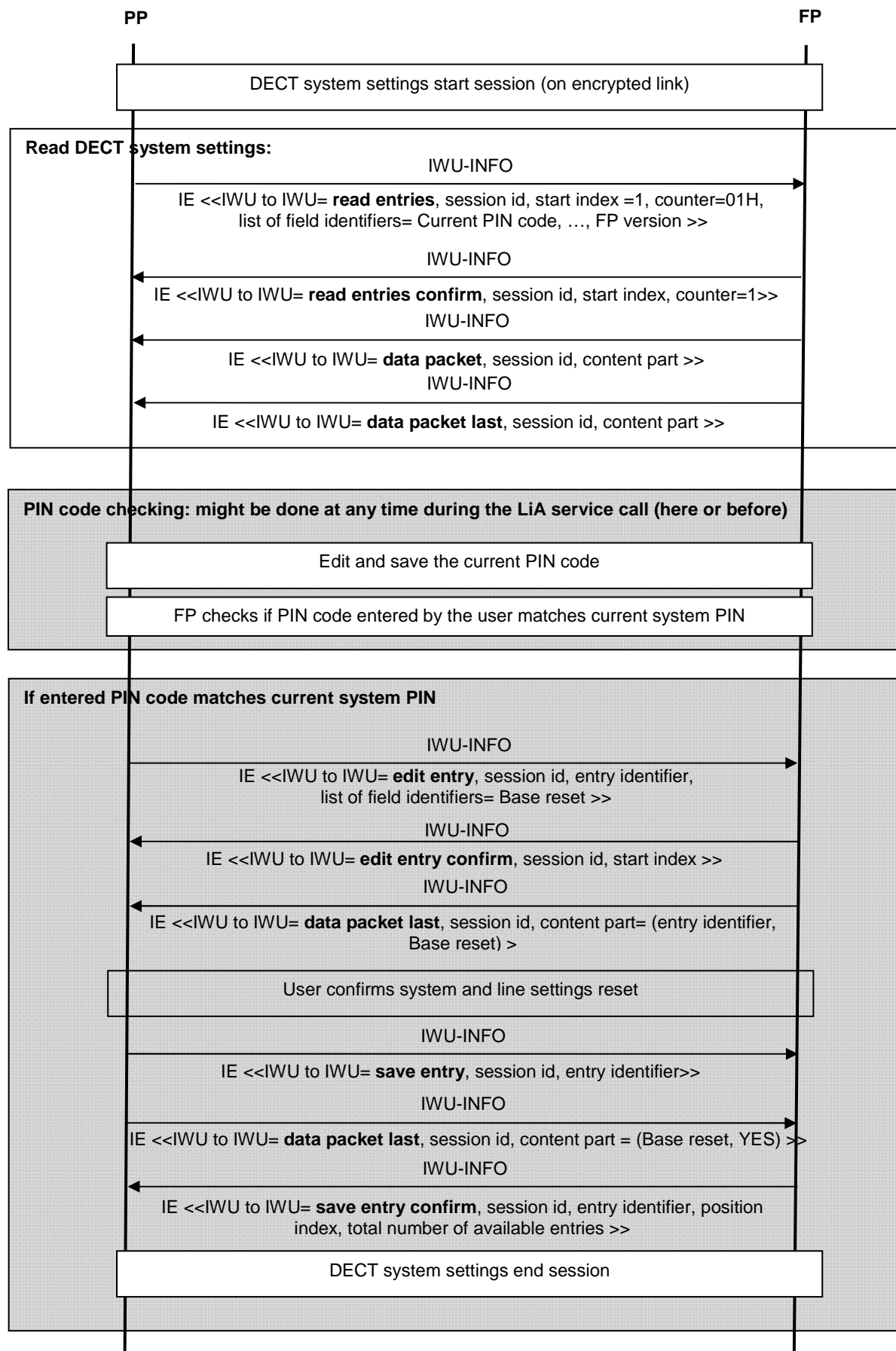

Figure C.33: Resetting the base (PIN protected field)

C.8 Line settings diagrams

C.8.1 General

In the following flowcharts, we assume that:

- N lines are defined, i.e. 'Total number of entries' = N in the line settings list before starting lines settings session.
- Only one data packet command is necessary to read one entry content, i.e. 'data packet last' command received directly.

In the following flowcharts, the read entries or search entries might be done prior to the sequence (in a previous session for example). But this is not the most usual behaviour as the PP may probably show the current value of the setting before enabling the user to modify it.

For clarity of the following flowcharts the <<Call information>> IE including call identifier does not appear in the CC messages that convey it. Please note that it should not be omitted when implementing equivalent cases. For example the call identifier is assigned by the FP after {CC-SETUP} message.

In the following use cases, it is assumed the link encryption is started by the FP at list access call setup although not always depicted in the flowcharts. As explained in clause C.7.1, some flexibility is allowed concerning this implementation choice.

C.8.2 Changing the settings of a line

Use case 1: The user edit the line settings of the line number 'i'. Read only the selected entry.

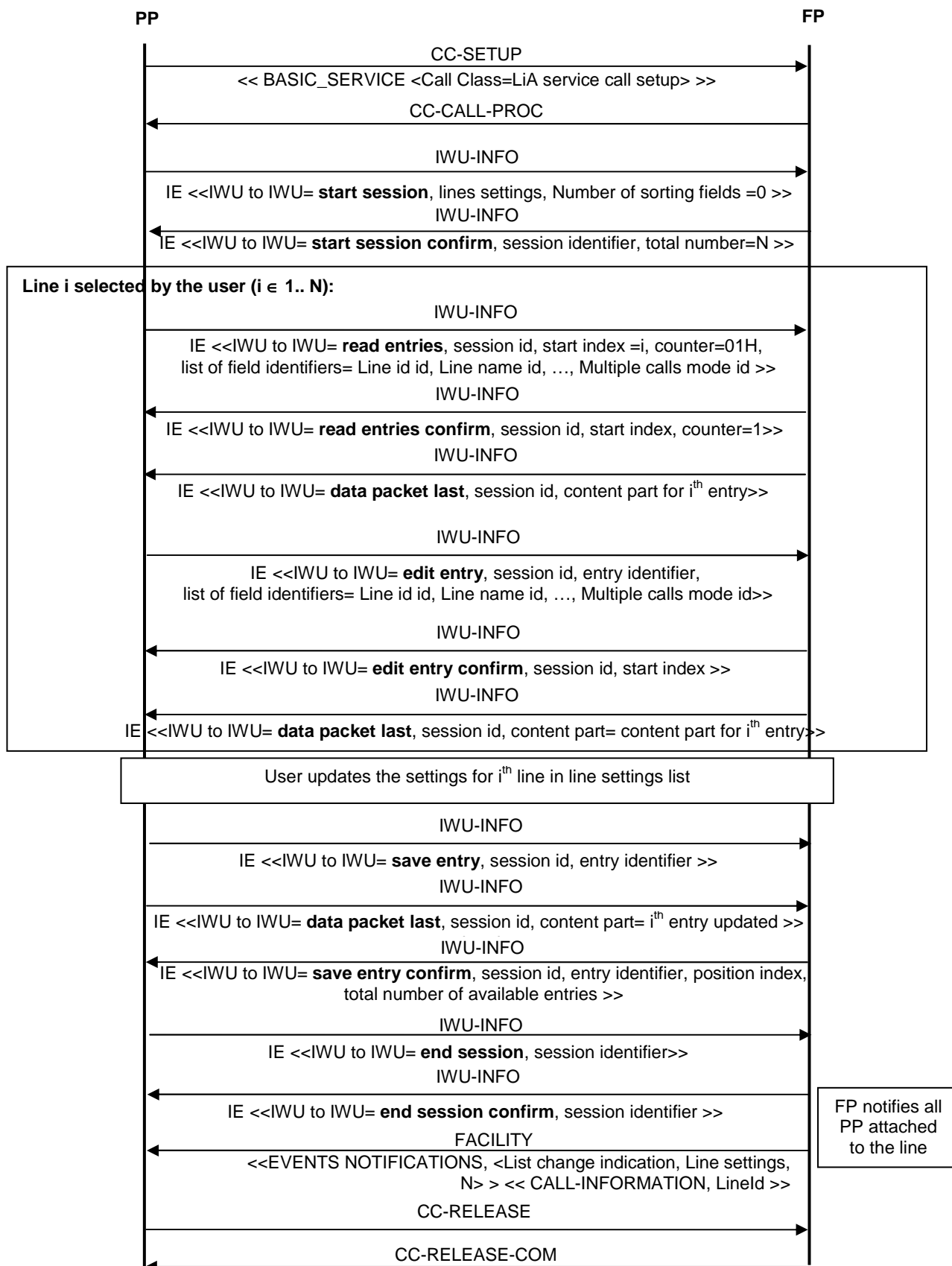

Figure C.34: Changing the settings of a line (use case 1)

Use case 2: The user edit the line settings of the line number 'i'. Read all N entries before editing the selected entry.

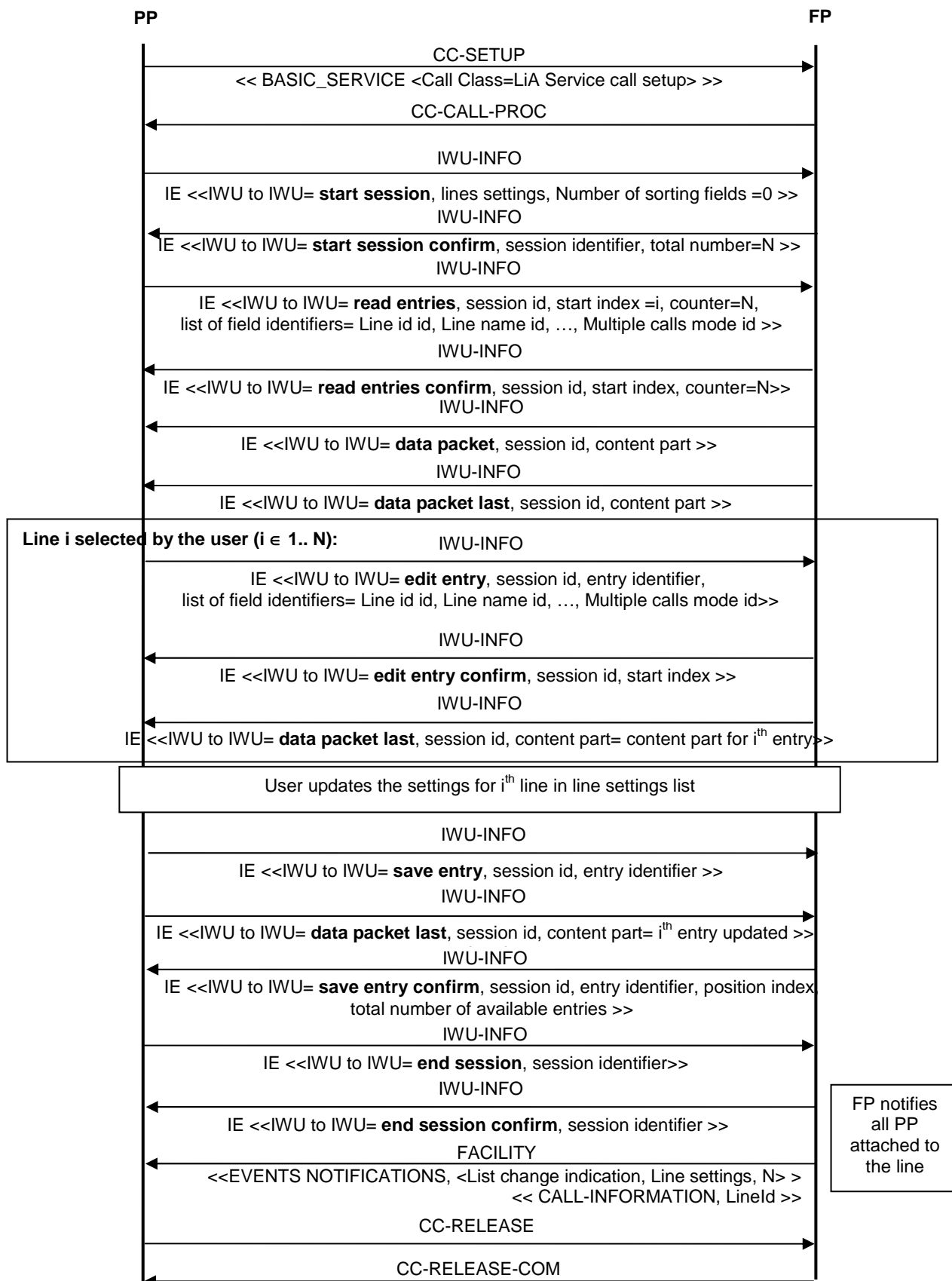

Figure C.35: Changing the settings of a line (use case 2)

C.8.3 Changing the name of a line

Use case: The user edit directly the line name of the line number '3'.

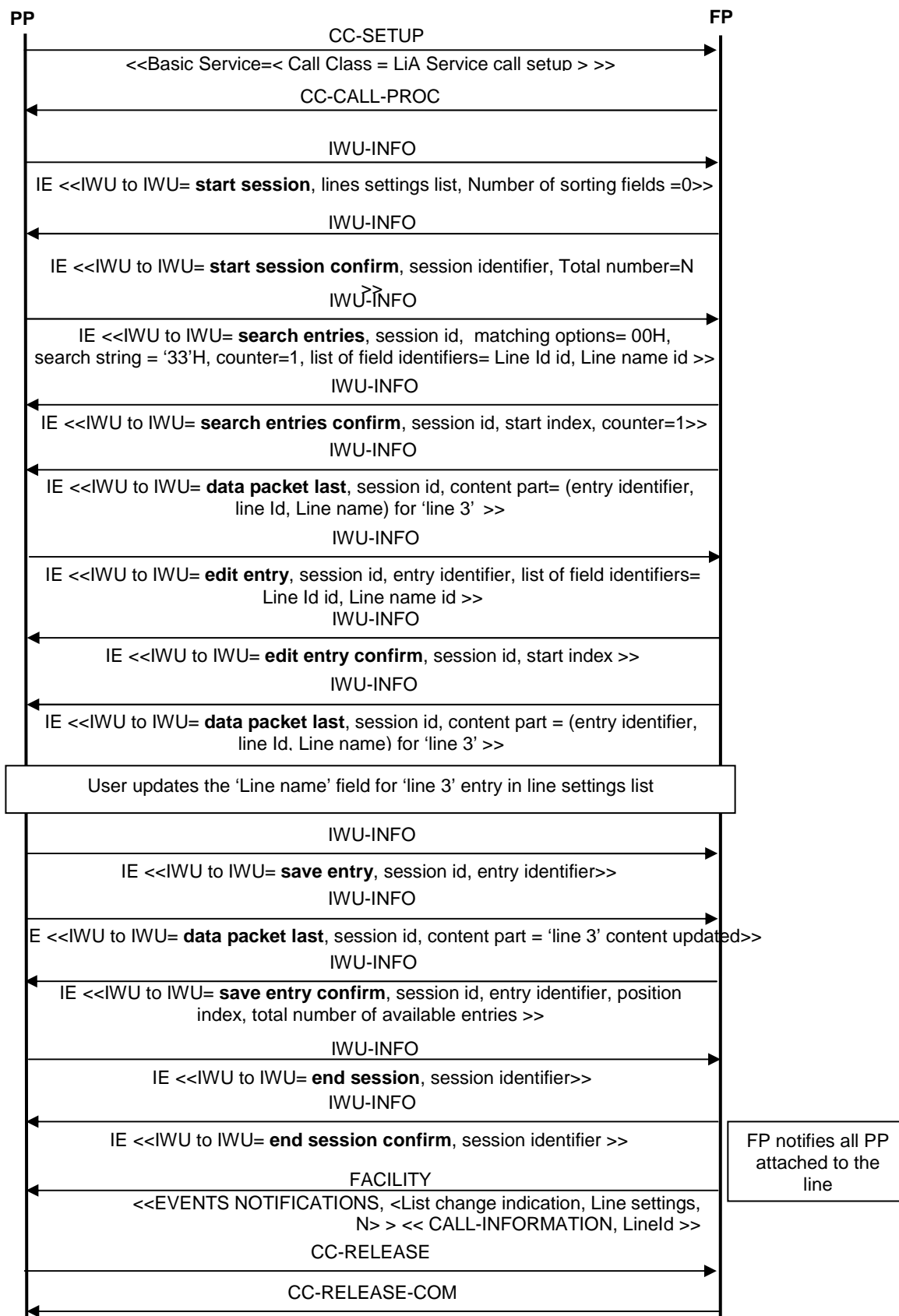

Figure C.36: Changing the name of a line

C.8.4 Changing the name of a line (PIN protected field)

Use case: the use case is the same as the previous one except that the 'linename' field is PIN code protected.

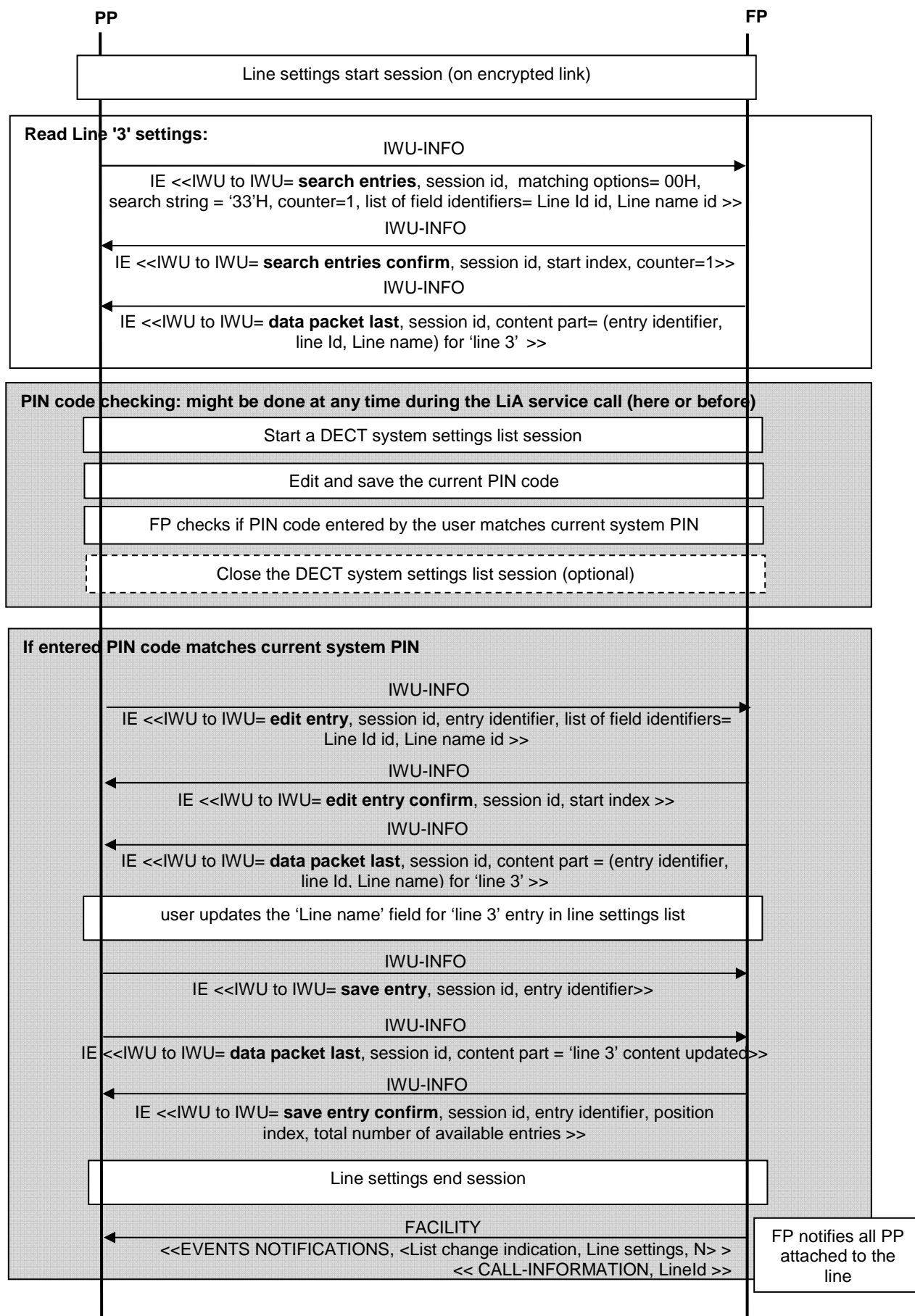

Figure C.37: Changing the name of a line (PIN protected field)

C.9 Use cases for 'Off-hook CLIP enabled DCIBS' lines

This annex studies complex use cases for the 'Handling of lines where second calls are signalled in-band' feature (see clause 7.4.3.10).

C.9.1 Remote party hangup 'double call with in-band signalling' line

This clause illustrates some of the issues possibly occurring on Off-hook CLIP enabled DCIBS lines when a remote party hangs up, but the FP is not aware of this event. See clause 7.4.3.10.3.1, subsection 'Remote party hang up in case of second call'.

C.9.1.1 Call waiting after 'remote party hangup'

In this use case, the FP becomes aware of a remote party hangup when a new call waiting is indicated by the network. As a result, the FP releases one of the two existing calls by issuing a 'CS idle' call status with the corresponding call id (late release). Two subcases are covered:

- late release (see note 1) of a former call waiting when a new call waiting occurs;

NOTE 1: The 'late release' is defined in clause 3.1.

NOTE 2: In the above subcase, the late release is not needed if the former call waiting has already been released following a timeout (never accepted waiting call).

- late release of the call on-hold when a call waiting occurs.

In both cases, the FP chooses to release the non-active call (former call waiting or call on-hold). In some case however, the FP might release the wrong call (i.e. if the remote party of the active call hanged up). In that case, the user may be faced with issue 2 described in the 'remote party hangup in case of second call' subsection of clause 7.4.10.3.1.

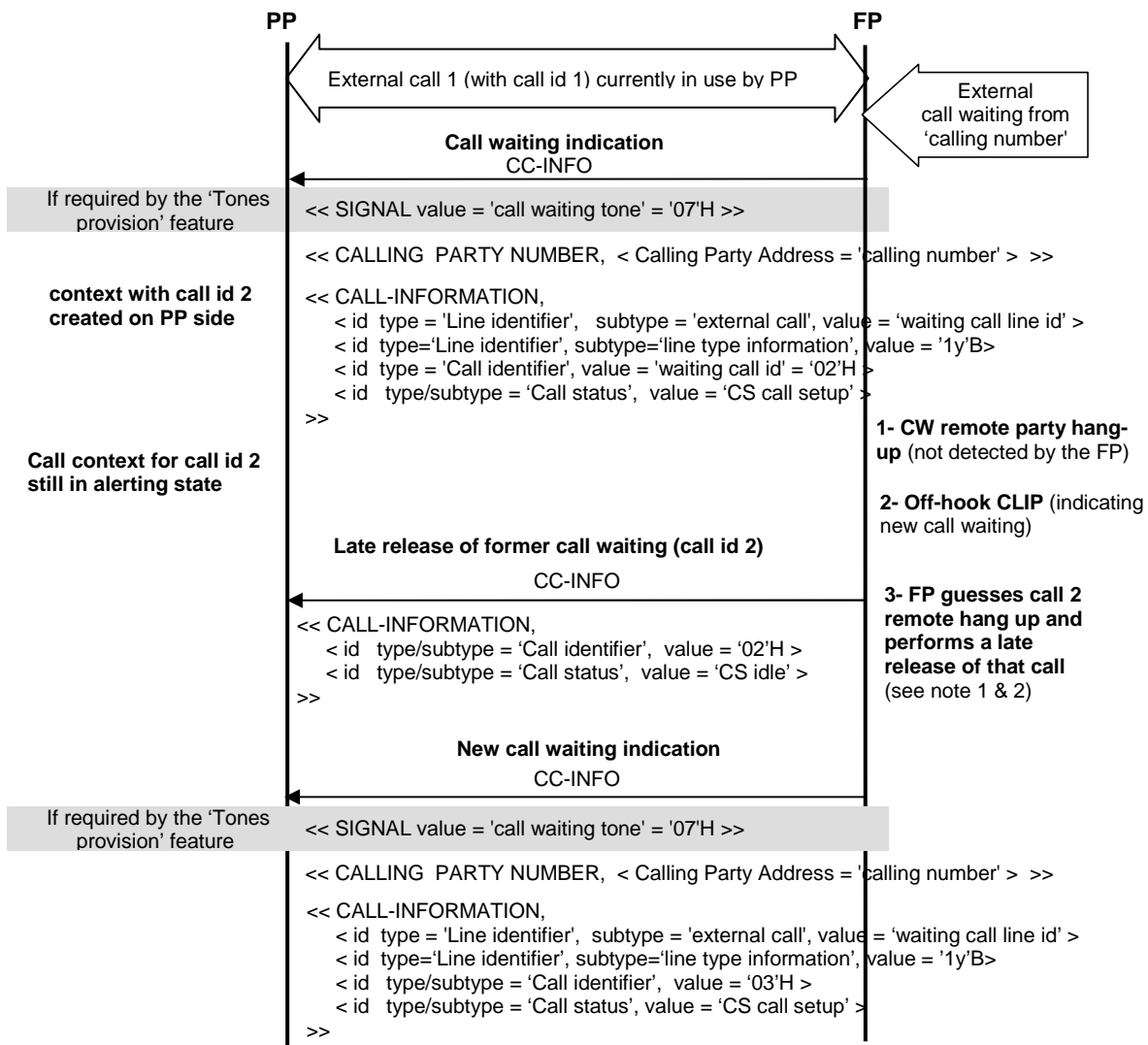

Figure C.38: Late release of former call waiting following new call waiting indication

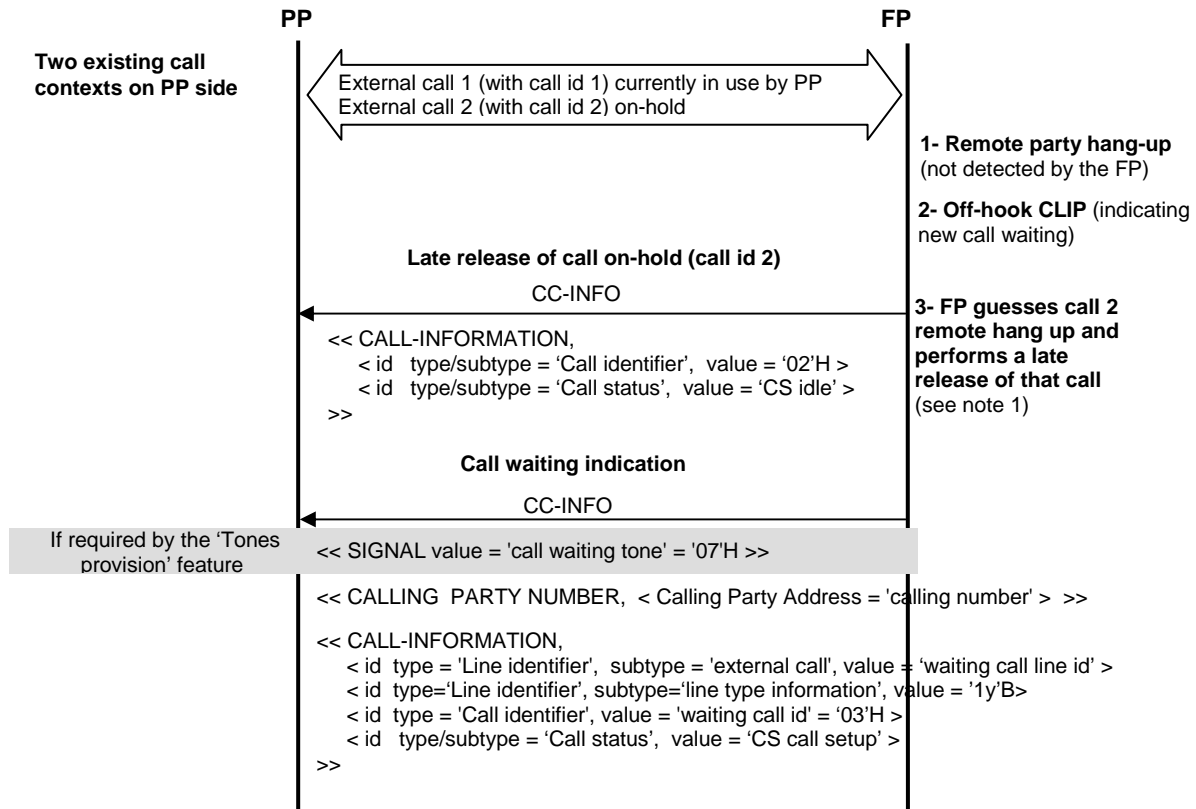

Figure C.39: Late release of call on-hold following call waiting indication

C.9.1.2 Outgoing parallel call after 'remote party hangup'

In this use case, the FP becomes aware of a remote party hangup when the user initiates an outgoing parallel call. As a result, the FP releases one of the two existing calls by issuing a 'CS idle' call status with the corresponding call id (late release). Two subcases are covered:

- late release (see note 1) of the call waiting when an outgoing parallel call occurs;

NOTE 1: The 'late release' is defined in clause 3.1.

NOTE 2: In the above subcase, the late release is not needed if the call waiting has already been released following a timeout (never accepted waiting call).

- late release of the call on-hold when an outgoing parallel call occurs.

In both cases, the FP chooses to release the non-active call (call waiting or call on-hold). In some case however, the FP might release the wrong call (i.e. if the remote party of the active call hanged up). In that case, the user may be faced with issue 2 described in the 'remote party hangup in case of second call' subsection of clause 7.4.10.3.1.

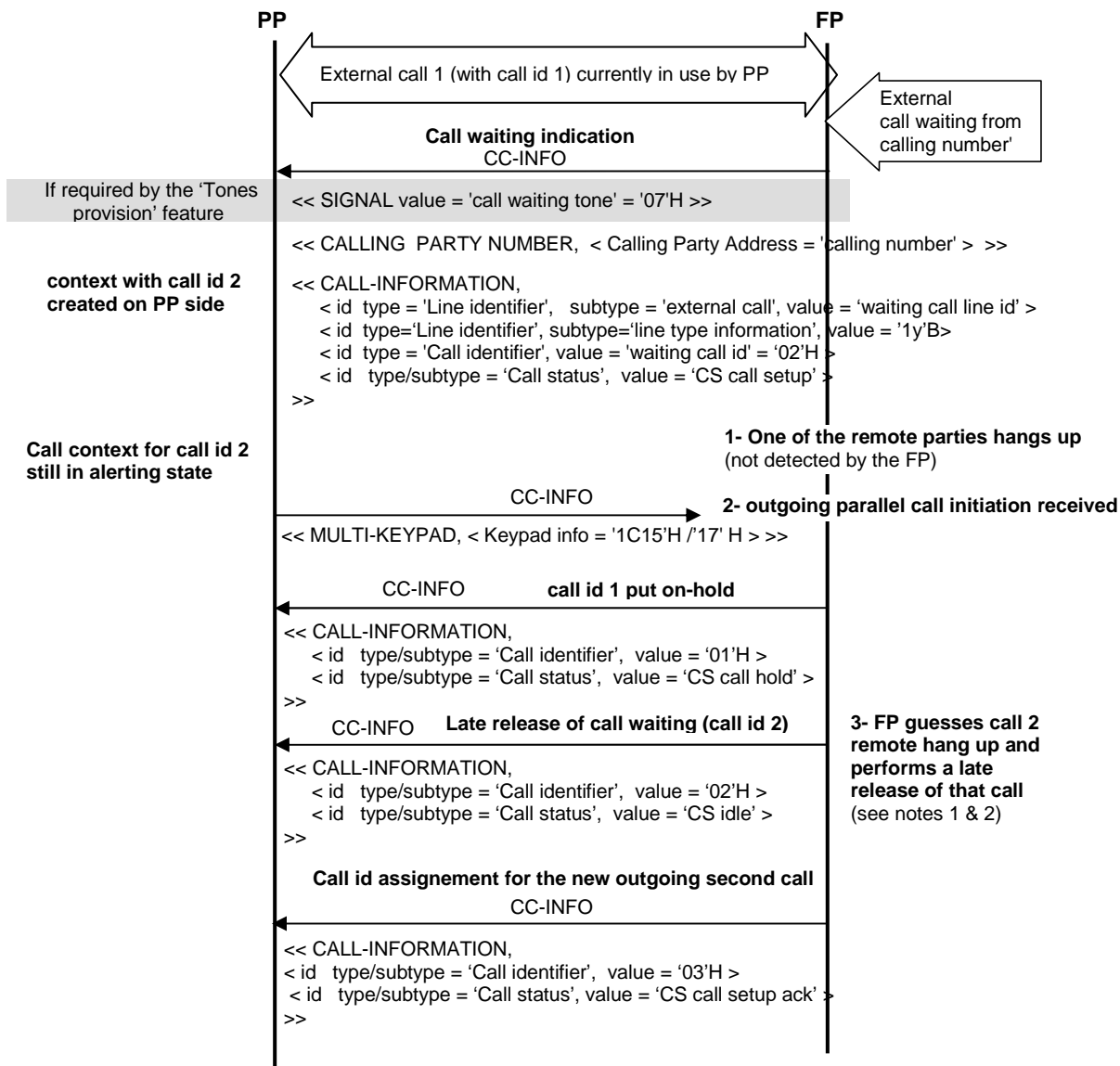

Figure C.40: Late release of call waiting following outgoing parallel call initiation

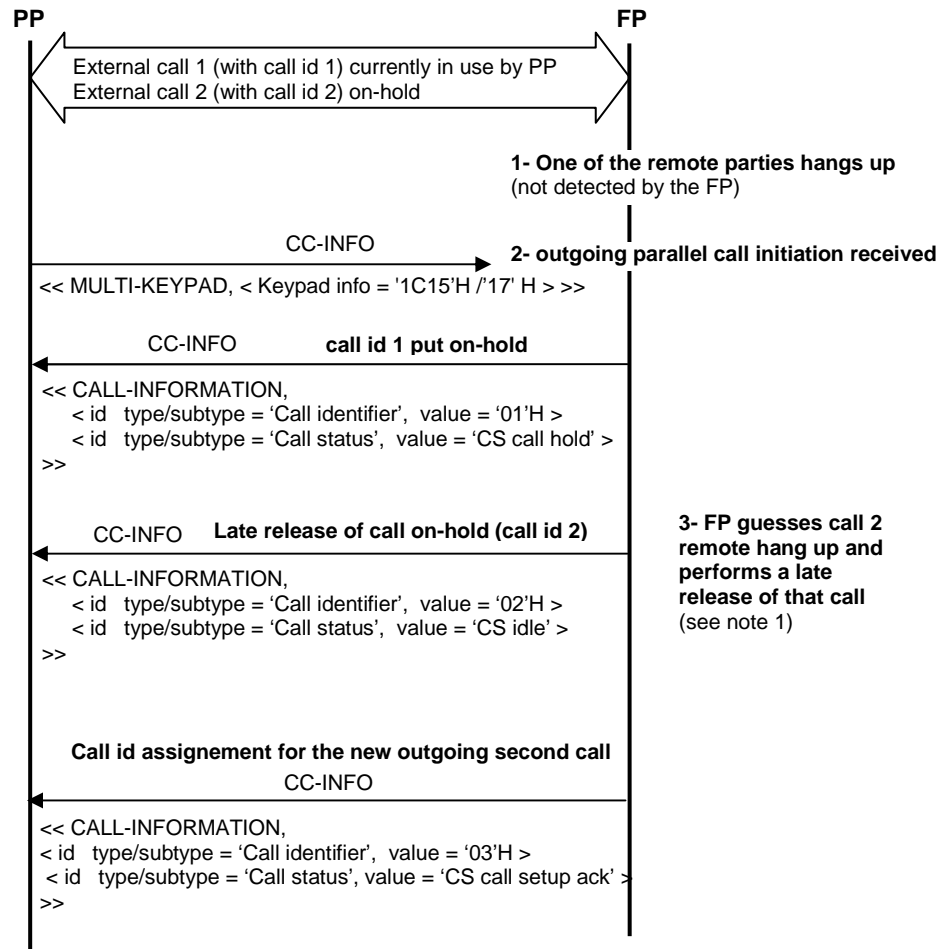

Figure C.41: Late release of call on-hold after remote party hangup

Annex D (informative): Guidelines for implementation of DTMF

D.1 Uplink DTMF transmission from FP to network

Upon reception of the keypad information element from the PP, the FP has two options according to the network capabilities:

- Digits are transmitted out of band using dedicated signalling.
- Digits are transmitted in band by inserting the corresponding audio encoded patterns in the audio bit stream in the active codec format.

When connected to PSTN networks, the in-band generation method is used by the FP.

If the FP is able to place calls on several lines from different networks that use different DTMF methods, the FP might have to adapt the uplink DTMF transmission on a line by line basis. This could be the case with the multiple lines feature. For example, one PSTN line uses the in-band method, and another VoIP line uses the out of band method.

D.2 DTMF format

The current clause is valid for:

- in-band DTMF generation from FP to PP; or
- in-band DTMF generation from FP to network when in-band method is supported on network side.

In-band DTMF shall be generated in the active codec format.

The DTMF should respect ITU-T standards Q.23 [i.8] which defines pair of frequencies to be used and ITU-T Recommendation Q.24 [i.9] which defines levels and durations.

A recommended implementation for level and duration for the DTMF is the following:

- Tone generation level: nominal - 10 dBm0 per frequency
- Tone generation time min: 80 ms
- Inter DTMF generation time min: 80 ms

Annex E (informative): Tones format in ITU-T recommendations

The generated tones should be compliant with ITU-T Recommendations: E.180 (see [i.10] and [i.11]) and E.182 (see [i.12]).

Table E.1: Tones in ITU-T recommendations

DECT Tones	ITU-T Tones
Ring-back tone	Ringing tone
Busy tone	Busy tone
Network congestion tone	Congestion tone
Call waiting tone	Call waiting tone
Intercept tone	Intercept tone (note)
Negative acknowledgment tone	Negative indication tone (note)
Dialing tone	Dialing tone
Off-hook warning tone	Special information tone

NOTE: These tones are not defined for all countries. Implementers should select one tone format among those available in ITU-T Recommendation E.182 [i.12].

Annex F (informative): Services and features defined in other specifications

F.1 Services and features defined in TS 102 527-1 (New Generation DECT; part 1)

The following informative annex shows the features and MAC/DLC services defined in TS 102 527-1 [21] (New Generation DECT; part 1), many of them are reused in the present document. This list is informative, and shows the status in TS 102 527-1 [21] (V1.2.1). In case of changes or divergences the original definitions at TS 102 527-1 [21] shall rule.

F.1.1 New Generation DECT; part 1, Speech Services (clause 5.1 of TS 102 527-1)

Narrow band ADPCM G.726 voice service [NG1.1]: ITU-T Recommendation G.726 [15] narrow band codec [NG1.SC.1] over 32 kbit/s unprotected transmission channel.

Narrow band PCM G.711 voice service [NG1.2]: ITU-T Recommendation G.711 [16] narrow band codec [NG1.SC.2] over 64 kbit/s protected or unprotected transmission channels.

Wideband 7 kHz G.722 voice service [NG1.3]: ITU-T Recommendation G.722 [17] wideband codec [NG1.SC.3] over 64 kbit/s protected or unprotected transmission channels.

Wideband 7 kHz low rate G.729.1 voice service [NG1.4]: ITU-T Recommendation G.729.1 [18] wideband codec [NG1.SC.4] over 32 kbit/s unprotected transmission channels.

Super wideband 14 kHz MPEG-4 ER AAC-LD voice service [NG1.5]: MPEG-4 ER AAC-LD super wideband codec [NG1.SC.5] over 64 kbit/s protected or unprotected transmission channels.

Wideband 11 kHz low rate MPEG-4 ER AAC-LD voice service [NG1.6]: MPEG-4 ER AAC-LD super wideband codec [NG1.SC.6] over 32 kbit/s unprotected transmission channels.

F.1.2 New Generation DECT; part 1, Network (NWK) features (clause 5.2 of TS 102 527-1)

Codec Negotiation [NG1.N.1]: capability to negotiate the speech codec to be used in a communication, based on the supported capabilities in both peers and the provisions included in the present document. This feature may require slot type change.

Codec Switching [NG1.N.2]: capability to switch between different speech codecs during a call. This feature may require slot type change.

F.1.3 New Generation DECT; part 1, Data Link Control (DLC) services (clause 5.3 of TS 102 527-1)

LU1 Transparent UnProtected service (TRUP) Class 0/minimum_delay [NG1.D.1]: transparent unprotected service introducing minimum delay, transmission Class 0/min_delay as defined by EN 300 175-4 [4], clause 11.2.

LU1 Transparent UnProtected service (TRUP) Class 0 [NG1.D.2]: transparent unprotected service introducing minimum delay, transmission Class 0 as defined by EN 300 175-4 [4], clause 11.2.

LU7 64 kbit/s protected bearer service [NG1.D.3]: protected service providing reliable 64 kbit/s transmission over packet type P80 incorporating FEC and ARQ protection mechanisms. Defined by EN 300 175-4 [4], clause 11.9.

LU12 UNProtected Framed service (UNF) Class 0 [NG1.D4]: unprotected service introducing normal delay, transmission Class 0 as defined by EN 300 175-4 [4], clause 11.14.

FU1 DLC frame [NG1.D.5]: bidirectional frame used in LU1 service. Defined in EN 300 175-4 [4], clause 12.2. Frame length depends on slot type and is defined in table 12.2.1.1 of EN 300 175-4 [4], clause 12.2.1.

FU7 DLC frame [NG1.D.6]: bidirectional frame used in LU7 service. Defined in EN 300 175-4 [4], clause 11.9.

FU12 DLC frame with adaptation for codec G.729.1 [NG1.D.7]: bidirectional frame used in LU12 service, as defined in EN 300 175-4 [4], clause 12.12, frame size specified for full slot, 2-level modulation and with the adaptation for codec G.729.1 defined in EN 300 175-4 [4], clause E.1.

F.1.4 New Generation DECT; part 1, Medium Access Control (MAC) services (clause 5.4 of TS 102 527-1)

I_N_minimum delay symmetric MAC service type [NG1.M.1]: I_N_minimum delay symmetric connection as defined in EN 300 175-3 [3], clause 5.6.2.1.

I_N_normal delay symmetric MAC service type [NG1.M.2]: I_N_normal delay symmetric connection as defined in EN 300 175-3 [3], clause 5.6.2.1.

I_{PQ}_error_detection symmetric MAC service type [NG1.M.3]: I_{PQ}_error_detection symmetric connection as defined in EN 300 175-3 [3], clause 5.6.2.1. (type 3: I_P_error_detection with single-subfield protected B-field as defined in EN 300 175-3 [3], clause 6.2.1.3.4).

Advanced Connections [NG1.M.4]: MAC Connection Oriented service providing connection between FT and PT. Advanced connections are able to support multiple bearers, bearers different of the full slot, and any MAC service. The service includes the means for setting-up and releasing the required bearer(s).

F.1.5 New Generation DECT; part 1, Physical Layer (PHL) services (clause 5.5 of TS 102 527-1)

2 level GFSK modulation [NG1.P.1]: 2 level Gaussian frequency Shift Key (GFSK) modulation as defined by EN 300 175-2 [2], clause 5.

Physical Packet P32 [NG1.P.2]: physical packet P32 (full slot) as defined by EN 300 175-2 [2], clause 4.4.2.

Physical Packet P64 [NG1.P.3]: variable capacity Physical packet P00j as defined by EN 300 175-2 [2], clause 4.4.3, with j = 640.

Physical Packet P67 [NG1.P.4]: variable capacity Physical packet P00j as defined by EN 300 175-2 [2], clause 4.4.3, with j = 672.

Physical Packet P80 [NG1.P.5]: physical packet P80 (double slot) as defined by EN 300 175-2 [2], clause 4.4.4.

F.1.6 New Generation DECT; part 1, Speech coding and audio features (clause 5.6 of TS 102 527-1)

G.726 32 kbit/s ADPCM [NG1.SC.1]: ITU-T Recommendation G.726 [15] narrow band codec as defined by EN 300 175-8 [8], clause 5.1. ITU-T Recommendation G.726 [15] codec is mandatory for New Generation DECT in order to ensure interoperability with existing DECT systems.

G.711 64 kbit/s log-PCM [NG1.SC.2]: ITU-T Recommendation G.711 narrow band codec [16] as defined by EN 300 175-8 [8], clause 5.2. ITU-T Recommendation G.711 [16] codec is optional for New Generation DECT in order to improve the quality of narrow band communications, and fax/modem transmissions. ITU-T Recommendation G.711 [16] provides a slightly higher intrinsic voice quality and no transcoding for PSTN calls. Both, A-Law and μ -Law are supported.

G.722 64 kbit/s wideband [NG1.SC.3]: ITU-T Recommendation G.722 wideband SB-ADPCM 7 kHz codec [17] as defined by EN 300 175-8 [8], clause 5.3. ITU-T Recommendation G.722 [17] is chosen as mandatory wideband codec for New Generation DECT in order to greatly increase the voice quality by extending the bandwidth from narrow band to wideband. ITU-T Recommendation G.722 [17] provides a high wideband quality at a bit rate of 64 kbit/s with low complexity and very low delay.

G.729.1 32 kbit/s wideband [NG1.SC.4]: ITU-T Recommendation G.729.1 wideband codec [18] as defined by EN 300 175-8 [8], clause 5.4. ITU-T Recommendation G.729.1 [18] codec is optional for New Generation DECT in order to provide even higher wideband quality and better robustness to packets/frames losses than ITU-T Recommendation G.722 [17] at half the bit rate of ITU-T Recommendation G.722 [17]. This allows a better transport efficiency on the network side and over the DECT air interface (one full slot). In addition, it is seamless interoperable with largely deployed ITU-T Recommendation G.729 [i.7] based VoIP networks and terminals. ITU-T Recommendation G.729.1 [18] encodes signals in frames of 20 ms. It is a scalable codec operating at bitrates of 8 kbit/s and from 12 kbit/s to 32 kbit/s per steps of 2 kbit/s, in narrow band or in wideband from 14 kbit/s. ITU-T Recommendation G.729.1 [18] already incorporates a high efficiency packet loss concealment mechanism.

MPEG-4 ER AAC-LD 64 kbit/s super wideband [NG1.SC.5]: MPEG-4 ER AAC-LD codec [19], [20] as defined by EN 300 175-8 [8] clause 5.5.1. MPEG-4 ER AAC-LD is optional for New Generation DECT in order to provide higher quality than G.722 by further extending the bandwidth to superwideband (50 Hz to 14 kHz) (and even further, up to full audio bandwidth (20 Hz to 20 kHz)). MPEG-4 ER AAC-LD is designed for high quality communication applications including all kind of audio signals e.g. speech and music and provides a high quality for music streaming or other multimedia applications mixing speech and music. It provides an audio bandwidth of 14 kHz or more at a bitrate of 64 kbit/s. MPEG 4 ER AAC-LD (Error resilient, Low Delay AAC profile) is standardized as an audio profile [19] of MPEG-4 (ISO/IEC 14496-3 [20]). The frame size is 10 ms and the algorithmic delay 20 ms.

MPEG-4 ER AAC-LD 32 kbit/s wideband [NG1.SC.6]: As [NG1.SC.5], but using the 32 kbit/s mode, as defined by EN 300 175-8 [8], clause 5.5.2. It provides a bandwidth of 11,5 kHz or more. The frame size is 20 ms and the algorithmic delay 40 ms.

PLC (Packet Loss Concealment) G.722 Appendix III & IV [NG1.SC.7]: To better cope with transmission errors, a Packet Loss Concealment algorithm (PLC) as defined by EN 300 175-8 [8], clause 5.3.2 may be optionally implemented for ITU-T Recommendation G.722 [17]. Appendices III and IV describe packet loss concealment solutions extending the ITU-T Recommendation G.722 [17] decoder. These PLC algorithms may be optionally implemented to improve voice quality in degraded transmission conditions where packets/frames may be lost (in IP network or on DECT air interface).

NOTE 1: Both appendices meet the same quality requirements but address two different quality/complexity trade offs:

- 1) Appendix III aims at maximizing the robustness at a price of additional complexity.
- 2) Appendix IV proposes an optimized complexity/quality trade off with almost no additional complexity compared with ITU-T Recommendation G.722 [17] normal decoding (0,07 WMOPS).

Since ITU-T Recommendation G.722 [17] does not incorporate any mechanism to cope with lost frames/packets, the use of a PLC algorithm is strongly recommended to avoid annoying effects in case of packet/frame losses.

NOTE 2: ITU-T Recommendation G.729.1 [18] already incorporates a packet loss concealment mechanism.

Detection of Modem/fax tone [NG1.SC.8]: Detection of the 1 100 Hz, 1 300 Hz and 2 100 Hz standard tones indicating a fax/modem transmission and answering, as defined by EN 300 175-8 [8] clause 5.2.2. The main utility of this function is the switching of codecs to transparent PCM (ITU-T Recommendation G.711 [16]) in order to facilitate modem/fax transmission. The tone detection can also be used to de-activate echo suppression if present.

Codec selection and switching [NG1.SC.9]: To handle several codecs (at least ITU-T Recommendation G.726 [15] and ITU-T Recommendation G.722 [17]), New Generation DECT will support a codec selection and switching mechanism. This may consequently allow the use of other codecs that could be specified in next releases as additional optional codecs according to future application or interoperability needs.

PP Audio type 1a ("classic GAP" handset) [NG1.SC.10]: Audio specification for a general purpose 3,1 kHz telephony handset as defined by EN 300 175-8 [8], clause 7.2.3.

PP audio type 1b ("improved GAP" handset) [NG1.SC.11]: Audio specification for a general purpose 3,1 kHz telephony handset with improved TCLw, as defined by EN 300 175-8 [8], clause 7.2.4. It is compatible with VoIP and long delay networks.

PP audio type 1c (HATS tested, 3,1 kHz handset) [NG1.SC.12]: Audio specification for a general purpose 3,1 kHz telephony handset based on the new HATS methodology, as defined by EN 300 175-8 [8], clause 7.2.5. It includes strong echo suppression (TCLw) requirements and is compatible with VoIP and long delay networks.

PP audio type 1d (HATS tested, 3,1 kHz "improved" handset) [NG1.SC.13]: Audio specification for a general purpose 3,1 kHz telephony handset based on the new HATS methodology with improved quality, as defined by EN 300 175-8 [8], clause 7.2.6. It includes strong echo suppression (TCLw) requirements and is compatible with VoIP and long delay networks. This type has a more demanding acoustic specification, providing superior subjective quality. In practice, this means better electro-acoustic components (speaker, microphone), electronics and signal processing.

PP Audio type 2a (ITU-T Recommendation P.311 [i.6] 7 kHz handset) [NG1.SC.14]: Audio specification for a wideband, 7 kHz service, handset based on the ITU-T Recommendation P.311 [i.6], as defined by EN 300 175-8 [8], clause 7.2.9.

PP Audio type 2b (HATS 7 kHz handset) [NG1.SC.15]: Handset for 7 kHz service (wideband), based on HATS methodology, as defined by EN 300 175-8 [8], clause 7.2.10. It includes strong echo suppression (TCLw) requirements and is compatible with VoIP and long delay networks.

PP Audio type 2c (HATS 7 kHz "improved" handset) [NG1.SC.16]: Handset for 7 kHz service (wideband), based on HATS methodology, with improved quality, as defined by EN 300 175-8 [8], clause 7.2.11. It includes strong echo suppression (TCLw) requirements and is compatible with VoIP and long delay networks. This type has a more demanding acoustic specification, providing superior subjective quality. In practice, this means better electro-acoustic components (speaker, microphone), electronics and signal processing.

PP audio type 3a (HATS tested, 3,1 kHz handsfree) [NG1.SC.17]: Audio specification for a Narrowband (3,1 kHz) handsfree device as defined by EN 300 175-8 [8], clause 7.2.7. This type applies to handsfree devices operating with an open loudspeaker and microphone. The type applies to either:

- 1) specific PPs designed to operate in handsfree mode;
- 2) standard handset implementing types 1a, 1b, 1c or 1d, but with the option to operate in handsfree mode; and
- 3) handsfree accessory devices connected to a handset by any wired or wireless technology.

It provides (300 Hz - 3,4 kHz) frequency range, and it is defined based on HATS methodology.

PP audio type 3b (HATS tested, 3,1 kHz "improved" handsfree) [NG1.SC.18]: Audio specification for a Narrowband (3,1 kHz) handsfree device, improved quality version, as defined by EN 300 175-8 [8], clause 7.2.8. This type applies to handsfree devices operating with an open loudspeaker and microphone. The type applies to either:

- 1) specific PPs designed to operate in handsfree mode;
- 2) standard handset implementing types 1a, 1b, 1c or 1d, but with the option to operate in handsfree mode; and
- 3) handsfree accessory devices connected to a handset by any wired or wireless technology.

It provides (300 Hz - 3,4 kHz) frequency range, and it is defined based on HATS methodology. This type has a more demanding acoustic specification, providing superior subjective quality. In practice, this means better electro-acoustic components (speaker, microphone), electronics and signal processing.

PP Audio type 4a (HATS 7 kHz handsfree) [NG1.SC.19]: Wideband (7 kHz) handsfree device, as defined by EN 300 175-8 [8], clause 7.2.12. This type applies to handsfree devices operating with an open loudspeaker and microphone. The profile applies to either:

- 1) specific PPs designed to operate in handsfree mode;
- 2) standard wideband handset implementing profiles 2a, 2b or 2c, but with the option to operate in handsfree mode; and
- 3) handsfree accessory devices connected to a handset by any wired or wireless technology.

It provides (150 Hz to 7 kHz) frequency range, and it is defined based on HATS methodology.

PP Audio type 4b (HATS 7 kHz "improved" handsfree) [NG1.SC.20]: Wideband (7 kHz) handsfree device, improved quality version, as defined by EN 300 175-8 [8], clause 7.2.13. This type applies to handsfree devices operating with an open loudspeaker and microphone. The profile applies to either:

- 1) specific PPs designed to operate in handsfree mode;
- 2) standard wideband handset implementing profiles 2a, 2b or 2c, but with the option to operate in handsfree mode; and
- 3) handsfree accessory devices connected to a handset by any wired or wireless technology.

It provides (150 Hz to 7 kHz) frequency range, and it is defined based on HATS methodology. This type has a more demanding acoustic specification, providing superior subjective quality. In practice, this means better electro-acoustic components (speaker, microphone), electronics and signal processing.

PP Audio type 5a (Super wideband 14 kHz) [NG1.SC.21]: Handset for 14 kHz service (super wideband), as defined by EN 300 175-8 [8], clause 7.2.14.

PP Audio type 5b (Super wideband 14 kHz, handsfree) [NG1.SC.22]: Handsfree device for 14 kHz service (super wideband), as defined by EN 300 175-8 [8], clause 7.2.15.

FP audio type 1b ("new ISDN" 3,1 kHz) [NG1.SC.23]: Audio specification for a DECT FP supporting narrowband service and providing a digital 64 kbit/s G.711 interface, typically (but not necessarily) an ISDN connection, new specification, as defined by EN 300 175-8 [8], clause 7.3.3.

NOTE 3: FP Audio type 1a ("classic ISDN", 3,1 kHz FP, see EN 300 175-8 [8]) is not to be used in New Generation DECT equipment. Instead of it, FP type 1b should be used in NG-DECT FPs with ISDN or digital circuit-switch interfaces.

PP echo canceller for FP, narrowband (3,1 kHz) service [NG1.SC.24]: Auxiliary feature for FPs consisting on echo canceller for handling the echo generated by PPs type 1a. As defined by EN 300 175-8 [8], clause 7.4.2. Only narrowband echo cancellation capability is required for this feature.

PP echo supressor for FP, narrowband (3,1 kHz) service [NG1.SC.25]: Auxiliary feature for FPs consisting on echo supressor for handling the echo generated by PPs type 1a. As defined by EN 300 175-8 [8], clause 7.4.3. Only narrowband capability is required for this feature.

FP audio type 2 (analog PSTN 3,1 kHz) [NG1.SC.26]: Audio specification for a DECT FP supporting narrowband service and providing an analog 2-wire PSTN interface. As defined by EN 300 175-8 [8], clause 7.3.4.

FP audio type 3 (VoIP 3,1 kHz) [NG1.SC.27]: Audio specification for a DECT FP supporting narrowband service and providing a VoIP interface, with codecs G.711 (typically) or G.726 on top of it. As defined by EN 300 175-8 [8], clause 7.3.5.

FP Audio type 4 (ISDN, wideband) [NG1.SC.28]: Audio specification for a DECT FP supporting wideband service and providing a digital 64 kbit/s interface, typically (but not necessarily) an ISDN connection, with a wideband codec such as G.722, MPEG, etc. As defined by EN 300 175-8 [8], clause 7.3.6.

FP Audio type 5 (VoIP wideband) [NG1.SC.29]: Audio specification for a DECT FP supporting wideband service and providing a VoIP interface, with a wideband codec on top such as G.722, MPEG, etc. As defined by EN 300 175-8 [8], clause 7.3.8.

PP echo canceller for FP, wideband (7 kHz) service [NG1.SC.30]: Auxiliary feature for FPs consisting on echo canceller for handling the echo generated by PPs type 2a. As defined by EN 300 175-8 [8], clause 7.4.2. Only wideband echo cancellation capability is required for this feature.

PP echo supressor for FP, wideband (7 kHz) service [NG1.SC.31]: Auxiliary feature for FPs consisting on echo supressor for handling the echo generated by PPs type 2a. As defined by EN 300 175-8 [8], clause 7.4.3. Only wideband echo cancelation capability is required for this feature.

FP audio type 6a (internal call) [NG1.SC.32]: This type of audio specification applies to the case of internal call inside a DECT FP or a DECT system without any external interface. This type applies to any service. As defined by EN 300 175-8 [8], clause 7.3.8.

FP audio type 6b (internal conference) [NG1.SC.33]: This type of audio specification applies to the case of 3-party or multi-party conference inside a DECT FP or a DECT system with or without an external interface. Applies to any service. As defined by EN 300 175-8 [8], clause 7.3.9.

Adaptive volume control for FP [NG1.SC.34]: Accessory feature for FPs consisting on an adaptive volume control depending on the level of environmental noise at the PP. The gain variation shall be symmetrical. As described in EN 300 175-8 [8], clause 7.6 and informative annex D.

F.2 Services and features defined in EN 300 444 (GAP)

The following informative annex shows the features and MAC/DLC services defined in EN 300 444 [12] (GAP), many of them are reused in the present document. This list is informative, and shows the status in EN 300 444 [12] (V2.2.1). In case of changes or divergences the original definitions at EN 300 444 [12] (GAP) shall rule.

F.2.1 GAP Network (NWK) features (clause 4.1 of EN 300 444)

outgoing call [N.1]: call initiated at a DECT PP.

off-hook [N.2]: ability to indicate the action of going off-hook, e.g. to start call setup or accept a call.

on-hook (FULL Release) [N.3]: ability to indicate the action of going on-hook (e.g. to terminate a call) and fully release the radio resource.

dialled digits (basic) [N.4]: capability to dial digits 0 to 9, *, #.

register recall [N.5]: ability of the PP to request the invocation of the supplementary service "register recall" over the DECT interface and the ability of the FP to transmit the request to the local network.
Register recall means to seize a register (with dial tone) to permit input of further digits or other action.

go to DTMF signalling (defined tone length) [N.6]: go to DTMF signalling with defined tone length.

pause (dialling pause) [N.7]: ability to generate or indicate a dialling pause, e.g. to await further dial tone.

incoming call [N.8]: call received at a DECT PP.

authentication of PP [N.9]: process by which the identity of a DECT PP is checked by the FP.

authentication of user [N.10]: process by which the identity of a user of a DECT PP is checked by the FP. The User Personal Identification (UPI), a personal identification of 0 to 8 digits, manually entered by the user, is used for user authentication.

location registration [N.11]: facility whereby a PP can be registered with a FP or a cluster of FPs such that incoming calls, radio pages or messages may be routed to it.

on-air key allocation [N.12]: capability to transform Authentication Code (AC) into User Authentication Key (UAK) using the key allocation procedure.

identification of PP [N.13]: ability for the FP to request and PP to provide specific identification parameters.

service class indication/assignment [N.14]: assignment by the FP to PP of the service class and indication to the FP by the PP of the contents of its service class.

alerting [N.15]: activates or deactivates alerting at the PP using any appropriate indication.

ZAP [N.16]: ability first to assign and then to re-program the account data held in the PP so that access rights may be suspended subject to the conditions set by the service provider being met, coupled with the ability to re-program the account data again to reinstate access rights once these conditions have been met.

One ZAP field shall be provided per account field. The PP has the right to authenticate the FP prior to the execution of ZAP suspend.

encryption activation FT initiated [N.17]: activation of the encryption process requested by FT.

subscription registration procedure on-air [N.18]: standardized procedure for loading subscription registration data into a PP in real time over the air-interface.

link control [N.19]: ability to request, accept, maintain and release a data link for the purposes of a NWK layer procedure.

terminate access rights FT initiated [N.20]: ability of the FP to delete a subscription in the PP.

partial release [N.21]: ability to release an established or in progress Call Control (CC) call whilst retaining the radio resource for the purpose of accessing further services.

go to DTMF (infinite tone length) [N.22]: go to DTMF signalling, indicating infinite DTMF tone duration.

go to pulse [N.23]: go to pulse (decadic) signalling.

signalling of display characters [N.24]: transmission to the PP of characters to be displayed on the user's PP display (if provided).

display control characters [N.25]: characters sent to the PP to control the user's display in the PP (if provided) Such characters include cursor control, clear screen, home, flash, inverse video, etc.

authentication of FT [N.26]: process by which the identity of a FP is checked by the PP.

encryption activation PT initiated [N.27]: activation of the encryption process suggested by PT. The real time start of ciphering is done in the MAC layer and is always initiated by the PT.

encryption deactivation FT initiated [N.28]: deactivation of the encryption process requested by FT. The real time stop of ciphering is done in the MAC layer and is always initiated by the PT.

encryption deactivation PT initiated [N.29]: deactivation of the encryption process suggested by PT. The real time stop of ciphering is done in the MAC layer and is always initiated by the PT.

Calling Line Identification Presentation (CLIP) [N.30]: ability to provide the calling party number to the called party before accepting the call.

internal call [N.31]: call between 2 users that does not make use of the local network resources. This is typically useful in residential environments.

service call [N.32]: call initiated by a DECT PT for entering of FT related service and adjustment procedures in a transparent way.

After having sent the service call indication, the PT behaves according to the rules of a normal call.

Enhanced U- plane connection [N.33]: ability of the FT to initiate connection of the U- plane during call establishment or release e.g. to facilitate the provision of in band tones or announcements.

Calling Name Identification Presentation (CNIP) [N.34]: ability to provide the calling party name to the called party before accepting the call.

Enhanced Security [N.35]: mechanism to enhance DECT security by introduction of early encryption and the possibility of re-keying during an ongoing call.

F.2.2 GAP Speech coding and audio features (clause 4.2 of EN 300 444)

For the purposes of the present document the following definitions shall apply:

G.726 32 kbit/s ADPCM [SC.1]: ITU-T Recommendation G.726 [15] narrow band codec as defined by EN 300 175-8 [8] clause 5.1.

PP audio type 1a ("classic GAP" handset) [SC.2]: Audio specification for a general purpose 3,1 kHz telephony handset as defined by EN 300 175-8 [8], clause 7.2.3.

PP audio type 1b ("improved GAP" handset) [SC.3]: Audio specification for a general purpose 3,1 kHz telephony handset with improved TCLw, as defined by EN 300 175-8 [8], clause 7.2.4. It is compatible with VoIP and long delay networks.

PP audio type 1c (HATS tested, 3,1 kHz handset) [SC.4]: Audio specification for a general purpose 3,1 kHz telephony handset based on the new HATS methodology, as defined by EN 300 175-8 [8], clause 7.2.5. It includes strong echo suppression (TCLw) requirements and is compatible with VoIP and long delay networks.

PP audio type 1d (HATS tested, 3,1 kHz "improved" handset) [SC.5]: Audio specification for a general purpose 3,1 kHz telephony handset based on the new HATS methodology with improved quality, as defined by EN 300 175-8 [8], clause 7.2.6. It includes strong echo suppression (TCLw) requirements and is compatible with VoIP and long delay networks. This type has a more demanding acoustic specification, providing superior subjective quality. In practice, this means better electro-acoustic components (speaker, microphone), electronics and signal processing.

PP audio type 3a (HATS tested, 3,1 kHz handsfree) [SC.6]: Audio specification for a Narrowband (3,1 kHz) handsfree device as defined by EN 300 175-8 [8], clause 7.2.7. This type applies to handsfree devices operating with an open loudspeaker and microphone. The type applies to either:

- 1) specific PPs designed to operate in handsfree mode;
- 2) standard handset implementing types 1a, 1b, 1c or 1d, but with the option to operate in handsfree mode; and
- 3) handsfree accessory devices connected to a handset by any wired or wireless technology.

It provides (300 Hz to 3,4 kHz) frequency range, and it is defined based on HATS methodology.

PP audio type 3b (HATS tested, 3,1 kHz "improved" handsfree) [SC.7]: Audio specification for a Narrowband (3,1 kHz) handsfree device, improved quality version, as defined by EN 300 175-8 [8], clause 7.2.8. This type applies to handsfree devices operating with an open loudspeaker and microphone. The type applies to either:

- 1) specific PPs designed to operate in handsfree mode;
- 2) standard handset implementing types 1a, 1b, 1c or 1d, but with the option to operate in handsfree mode; and
- 3) handsfree accessory devices connected to a handset by any wired or wireless technology.

It provides (300 Hz to 3,4 kHz) frequency range, and it is defined based on HATS methodology. This type has a more demanding acoustic specification, providing superior subjective quality. In practice, this means better electro-acoustic components (speaker, microphone), electronics and signal processing.

FP audio type 1a ("classic ISDN" 3,1 kHz) [SC.8]: Audio specification for a DECT FP supporting narrowband service and providing a digital 64 kbit/s G.711 interface, typically (but not necessarily) an ISDN connection, classic specification, as defined by EN 300 175-8 [8], clause 7.3.2. It is recommended to use FP type 1b instead of type 1a.

FP audio type 1b ("new ISDN" 3,1 kHz) [SC.9]: Audio specification for a DECT FP supporting narrowband service and providing a digital 64 kbit/s G.711 interface, typically (but not necessarily) an ISDN connection, new specification, as defined by EN 300 175-8 [8], clause 7.3.3. It is recommended to use FP type 1b instead of type 1a.

PP echo canceller for FP [SC.10]: Auxiliary feature for FPs consisting on echo canceller for handling the echo generated by PPs type 1a. As defined by EN 300 175-8 [8], clause 7.4.2. Only narrowband echo cancellation capability is required.

PP echo supressor for FP [SC.11]: Auxiliary feature for FPs consisting on echo supressor for handling the echo generated by PPs type 1a. As defined by EN 300 175-8 [8], clause 7.4.3. Only narrowband capability is required.

FP audio type 2 (analog PSTN 3,1 kHz) [SC.12]: Audio specification for a DECT FP supporting narrowband service and providing an analog 2-wire PSTN interface. As defined by EN 300 175-8 [8], clause 7.3.4.

FP audio type 3 (VoIP 3,1 kHz) [SC.13]: Audio specification for a DECT FP supporting narrowband service and providing a VoIP interface, with codecs G.711 (typically) or G.726 on top of it. As defined by EN 300 175-8 [8], clause 7.3.5.

FP audio type 5a (internal call) [SC.14]: This type of audio specification applies to the case of internal call inside a DECT FP or a DECT system without any external interface. This type applies to any service. As defined by EN 300 175-8 [8], clause 7.3.8.

FP audio type 5b (internal conference) [SC.15]: This type of audio specification applies to the case of 3-party or multi-party conference inside a DECT FP or a DECT system with or without an external interface. Applies to any service. As defined by EN 300 175-8 [8], clause 7.3.9.

Adaptive volume control for FP [SC.16]: Accessory feature for FPs consisting on an adaptive volume control depending on the level of environmental noise at the PP. The gain variation shall be symmetrical. As described in EN 300 175-8 [8], (detailed descriptions for each type of FP in clause 7.6, and examples of settings in annex D).

F.2.3 GAP Application features (clause 4.3 of EN 300 444)

AC to bitstring mapping [A.1]: Mapping of the AC into a bitstring.

multiple subscription registration [A.2]: Ability of PP to store more than one subscription.

manual entry of the Portable Access Rights Key (PARK) [A.3]: Ability of the PP to accept a manual entry of the PARK for ensuring attachment to the right FP in a physical area covered by many providers.

terminal identity number assignment in mono-cell system [A.4]: Ability to assign to each PT a terminal identity number.

F.2.4 DLC service definitions (clause 5.1 of EN 300 444)

LAPC class A service and Lc [D.1]: single frame acknowledged C-plane data link service providing a single data link between one FT and one PT.

The higher layer information is segmented (if necessary) and transmitted in numbered frames. The Lc provides frame delimiting, transparency and frame synchronization.

C_s channel fragmentation and recombination [D.2]: Lc service providing channel dependant fragmentation (by means of dividing a LAPC data unit into more than one service data units for delivery to the MAC layer C_s logical channel) and recombination (by means of joining several service units received from the MAC layer C_s logical channel into a LAPC data unit).

broadcast Lb service [D.3]: simplex point-to-multipoint transmission using simple fixed length DLC frames providing a restricted broadcast service in direction FP to PP(s).

intra-cell voluntary connection handover [D.4]: internal handover process provided and initiated by the DLC layer (e.g. as a result of continued poor quality of service from the MAC layer), whereby one set of DLC entities (C-plane and U-plane) can re-route data from one MAC connection to a second new MAC connection in the domain of the same cell, while maintaining the service provided to the NWK layer.

intercell voluntary connection handover [D.5]: internal handover process provided and initiated by the DLC layer (e.g. as a result of continued poor quality of service from the MAC layer), whereby one set of DLC entities (C-plane and U-plane) can re-route data from one MAC connection to a second new MAC connection not in the domain of the same cell, while maintaining the service provided to the NWK layer.

encryption activation [D.6]: transporting the NWK layer encryption request and the cipher key to the MAC layer, thereby enabling the encryption process in the MAC layer.

LU1 TRansparent UnProtected service (TRUP) class 0/min_delay [D.7]: transparent unprotected service introducing minimum delay between the higher layers and the MAC layer.

May be used for speech and non-speech applications. Speech transmission shall only use the class 0/min_delay operation over a single bearer MAC connection. Data integrity is not guaranteed. No error protection is applied, and octets may be lost, erroneous or duplicated. The continuous higher layer data is fragmented for delivery to the I_N logical channel in the transmission direction, and recombined from the I_N logical channel in the receiving direction.

FU1 [D.8]: offers a defined fixed length frame structure and buffering functions for transmission of U-plane data to the MAC layer (at the transmit side) or accept of data from the MAC layer (at the receiving side) on demand and with minimum delay. Used for speech but may be used for more general data purposes.

encryption deactivation [D.9]: transporting the NWK layer encryption deactivation request to the MAC layer, thereby disabling the encryption process in the MAC layer.

F.2.5 GAP MAC service definitions (clause 5.2 of EN 300 444)

general [M.1]: set of basic requirements regarding data formats, multiplexing, CRC usage, scanning and locking, which are prerequisites to communication between peer MAC entities.

continuous broadcast [M.2]: simplex service from FT to PT whereby the FT maintains at least one bearer with continuous transmissions.

The PT can use the information carried in this bearer to lock to the FT and to obtain knowledge about the FT.

paging broadcast [M.3]: service whereby the identities of specific PTs can be broadcast by the FT. This service is normally used by the FT to request a specific PT to set up a link to the FT.

basic connection [M.4]: service providing connection between FT and PT consisting of one full slot duplex bearer supporting the In_minimum_delay data service (i.e. speech).

Only one basic connection may exist between a FT and particular PT (except during connection handover). The service includes the means for setting-up and releasing the required bearer(s).

C_S higher layer signalling [M.5]: low rate connection oriented data service with ARQ using the C_S channel to transfer higher layer signalling data.

quality control [M.6]: provides means for monitoring and controlling the radio link quality.

encryption activation [M.7]: service providing means for enabling the encryption whereby on demand all higher layer data (including speech) is transferred across the AI in an encrypted form.

Always initiated by the PT.

extended frequency allocation [M.8]: service which allows a FT to support frequencies in addition to the standard DECT frequencies.

bearer handover - intra-cell [M.9]: internal MAC process whereby data transfer (C channel and I channel) is switched from one duplex bearer to another in the domain of the same cell while maintaining the service to the DLC layer.

bearer handover - inter-cell [M.10]: internal MAC process whereby data transfer (C channel and I channel) is switched from one duplex bearer to another not in the domain of the same cell while maintaining the service to the DLC layer.

connection handover - intra-cell [M.11]: in the MAC layer, it is the process enabling setting up a new basic connection in the domain of the same cell to support connection handover at the DLC layer.

connection handover - inter-cell [M.12]: in the MAC layer, it is the process enabling setting up a new basic connection not in the domain of the same cell to support connection handover at the DLC layer.

Secondary Access Rights Identity (SARI) support [M.13]: ability to support, in addition to the primary Access Rights Identity (ARI), secondary ARIs that the FT broadcasts less frequently than PARIs.

These may be used to reflect an inter-operators agreement allowing a portable to access more than one operator or services through FT.

encryption deactivation [M.14]: service providing means for disabling the encryption whereby on demand the process of transmitting higher layer data (including speech) across the AI in encrypted form is to be cancelled (a connection release automatically disables ciphering).

Re-keying [M.15]: mechanism to change the cipher key during an ongoing call.

Early encryption [M.16]: mechanism to activate encryption immediately after connection establishment.

F.3 GAP Feature/service to procedure mapping tables

The following informative annex shows the features/service to procedure mapping tables as defined in EN 300 444 [12] (GAP), that are reused in the present document (unless other specification is given). This list is informative, and shows the status in EN 300 444 [12] V2.2.1. In case of changes or divergences the original tables at EN 300 444 [12] (GAP) shall rule.

F.3.1 GAP NWK feature to procedure mapping table (clause 6.8.1 of EN 300 444)

Table F.1: NWK feature to procedure mapping (table 5 of EN 300 444)

Feature/Procedure mapping					
Feature	Procedure	Reference	PT	Status	
				R/B	P
N.1 Outgoing call		4.1	M	M	M
	Outgoing call request	8.2	M	M	M
	Overlap sending	8.3	M	O	O
	Outgoing call proceeding	8.4	M	O	O
	Outgoing call confirmation	8.5	M	O	O
	Outgoing call connection	8.6	M	M	M
	Sending keypad information	8.10	M	M	M
N.2 Off Hook		4.1	M	M	M
	Outgoing call request	8.2	M	M	M
	Incoming call connection	8.15	M	M	M
N.3 On Hook (full release)		4.1	M	M	M
	Normal call release	8.7	M	M	M
	Abnormal call release	8.8	M	M	M
N.4 Dialed digits (basic)		4.1	M	M	M
	Sending keypad information	8.10	M	M	M
N.5 Register recall		4.1	M	O	O
	Sending keypad information	8.10	M	M	M
N.6 Go to DTMF signalling (defined tone length)		4.1	M	O	M
	Sending keypad information	8.10	M	M	M
N.7 Pause (dialling pause)		4.1	M	O	O
	Sending keypad information	8.10	M	M	M
N.8 Incoming call		4.1	M	M	M
	Incoming call request	8.12	M	M	M
	Incoming call confirmation	8.13	M	M	M
	PT alerting	8.14	M	M	M
	Incoming call connection	8.15	M	M	M
N.9 Authentication of the PP		4.1	M	C501	M
	Authentication of PT	8.24	M	M	M
N.10 Authentication of the user		4.1	M	O	O
	Authentication of user	8.25	M	M	M
N.11 Location registration		4.1	M	O	M
	Location registration	8.28	M	M	M
	Location update	8.29	M	O	O
	Terminal Capability indication	8.17	O	O	O
N.12 On air key allocation		4.1	M	C501	O
	Key allocation	8.32	M	M	M
N.13 Identification of PP		4.1	M	O	O
	Identification of PT	8.22	M	M	M
N.14 Service class indication/assignment		4.1	M	O	M
	Obtaining access rights	8.30	M	M	M
	Terminal Capability indication	8.17	O	O	O
	Authentication of PT	8.24	M	M	M
N.15 Alerting		4.1	M	M	M
	PT alerting	8.14	M	M	M
N.16 ZAP		4.1	M	O	O
	Obtaining access rights	8.30	M	M	M
	Terminal Capability indication	8.17	O	O	O
	Incrementing the ZAP value	8.26	M	M	M
	Authentication of FT	8.23	O	M	M
N.17 Encryption activation FT initiated		4.1	M	C501	M
	Cipher-switching initiated by FT	8.33	M	M	M
	Storing the Derived Cipher Key (DCK)	8.27	M	M	M

Feature/Procedure mapping					
Feature	Procedure	Reference	PT	Status	
				R/B	P
N.18 Subscription registration user procedure on-air		4.1	M	M	M
	Obtaining access rights	8.30	M	M	M
	Terminal Capability indication	8.17	O	O	O
N.19 Link control		4.1	M	M	M
	Indirect FT initiated link establishment	8.35	M	M	M
	Direct PT initiated link establishment	8.36	M	M	M
	Link release "normal"	8.37	M	M	M
	Link release "abnormal"	8.38	M	M	M
	Link release "maintain"	8.39	M	M	M
N.20 Terminate access rights FT initiated		4.1	M	O	O
	FT terminating access rights	8.31	M	M	M
	Authentication of FT	8.23	O	M	M
N.21 Partial release		4.1	O	O	O
	Partial release	8.9	M	M	M
N.22 Go to DTMF (infinite tone length)		4.1	O	O	O
	Sending keypad information	8.10	M	M	M
N.23 Go to Pulse		4.1	O	O	O
	Sending keypad information	8.10	M	M	M
N.24 Signalling of display characters		4.1	O	O	O
	Display	8.16	M	M	M
	Terminal capability indication	8.17	M	M	M
N.25 Display control characters		4.1	O	O	O
	Display	8.16	M	M	M
	Terminal capability indication	8.17	M	M	M
N.26 Authentication of FT		4.1	O	O	O
	Authentication of FT	8.23	M	M	M
N.27 Encryption activation PT initiated		4.1	O	O	O
	Cipher-switching initiated by PT	8.34	M	M	M
	Storing the DCK	8.27	M	M	M
N.28 Encryption deactivation FT initiated		4.1	O	O	O
	Cipher-switching initiated by FT	8.33	M	M	M
N.29 Encryption deactivation PT initiated		4.1	O	O	O
	Cipher-switching initiated by PT	8.34	M	M	M
N.30 Calling Line Identification Presentation (CLIP)		4.1	O	O	O
	Incoming call request	8.12	M	M	M
	Calling Line Identification Presentation	8.41	M	M	M
N.31 Internal call		4.1	O	O	O
	Internal call setup	8.18	M	M	M
	Internal call keypad	8.19	M	O	O
	Internal call CLIP	8.43	O	O	O
	Internal call CNIP	8.44	O	O	O
N.32 Service call		4.1	O	O	O
	Service call setup	8.20	M	M	M
	Service call keypad	8.21	M	O	O
N.33 Enhanced U- plane connection		4.1	O	O	O
	Enhanced FT initiated U- plane connection	8.40	M	M	M
N.34 Calling Name Identification Presentation (CNIP)		4.1	O	O	O
	Calling Name Identification Presentation (CNIP) Indication	8.42	M	M	M
N.35 Enhanced security		4.1	O	O	O
	Encryption of all calls	8.45.1	M	M	M
	Re-keying during a call	8.45.2	O	O	O
	Early encryption	8.45.3	O	O	O
	Subscription requirements	8.45.4	M	M	M
	Behaviour against legacy devices	8.45.5	M	M	M
C501: IF feature N.35 THEN M ELSE O.					

F.3.2 GAP DLC service to procedure mapping table (clause 6.8.2 of EN 300 444)

Table F.2: DLC service to procedure mapping (table 6 of EN 300 444)

Service/Procedure mapping					
Service	Procedure	Reference	PT	Status	
				R/B	P
D.1 LAPC class A service and Lc		5.1	M	M	M
	Class A link establishment	9.1	M	M	M
	Class A acknowledged information transfer	9.2	M	M	M
	Class A link release	9.3	M	M	M
	Class A link re-establishment	9.4	M	M	M
D.2 C _S channel fragmentation and recombination		5.1	M	M	M
	C _S channel fragmentation and recombination	9.5	M	M	M
D.3 Broadcast Lb service		5.1	M	M	M
	Normal broadcast	9.6	M	M	M
D.4 Intra-cell voluntary connection handover		5.1	M	C601	C601
	Class A basic connection handover	9.7	M	M	M
D.5 Inter-cell voluntary connection handover		5.1	M	O	O
	Class A basic connection handover	9.7	M	M	M
D.6 Encryption activation		5.1	M	C603	M
	Encryption switching	9.8	M	M	M
D.7 LU1 TRUP Class 0/min_delay		5.1	M	M	M
	U-plane Class 0/min delay	9.9	M	M	M
D.8 FU1		5.1	M	M	M
	FU1 frame operation	9.10	M	M	M
D.9 Encryption deactivation		5.1	C602	C602	C602
	Encryption switching	9.8	M	M	M
C601: IF service M.9 THEN O ELSE M.					
C602: IF feature N.29 OR N.28 THEN M ELSE I.					
C603: IF feature N.17 OR N.27 THEN M ELSE I.					

F.3.3 GAP MAC service to procedure mapping table (clause 6.8.3 of EN 300 444)

Table F.3: MAC service to procedure mapping (table 7 of EN 300 444)

Service/Procedure mapping			Status		
Service	Procedure	Reference	PT	FT	
				R/B	P
M.1 General		5.2	M	M	M
	General	10.1	M	M	M
M.2 Continuous broadcast		5.2	M	M	M
	Downlink broadcast	10.2	M	M	M
	Higher layer information FP broadcast	13.6	M	M	M
M.3 Paging broadcast		5.2	M	M	M
	Paging broadcast	10.3	M	M	M
	Higher layer information FP broadcast	13.6	M	M	M
M.4 Basic connections		5.2	M	M	M
	Setup of basic connection, basic bearer setup (A-field)	10.4	M	M	M
	Connection/bearer release	10.5	M	M	M
M.5 C _s higher layer signalling		5.2	M	M	M
	C _s channel data	10.8	M	M	M
	Q2 bit setting	10.9	M	M	M
M.6 Quality control		5.2	M	M	M
	RFPI handshake	10.10	M	M	M
	Antenna diversity	10.11	M	O	O
	Sliding collision detection	10.12	O	M	M
M.7 Encryption activation		5.2	M	C704	M
	Encryption process - initialization and synchronization	10.13	M	M	M
	Encryption mode control	10.14	M	M	M
	Handover encryption process	10.15	M	M	M
M.8 Extended frequency allocation		5.2	M	O	O
	Extended frequency allocation	10.16	M	M	M
M.9 Bearer handover, intra-cell		5.2	M	C701	C701
	Bearer handover request	10.6	M	M	M
M.10 Bearer handover, inter-cell		5.2	M	O	O
	Bearer handover request	10.6	M	M	M
M.11 Connection handover, intra-cell		5.2	M	C702	C702
	Connection handover request	10.7	M	M	M
M.12 Connection handover, inter-cell		5.2	M	O	O
	Connection handover request	10.7	M	M	M
M.13 SARI support		5.2	M	O	O
	Downlink broadcast	10.2	M	M	M
	Higher layer information FP broadcast	13.6	M	M	M
M.14 Encryption deactivation		5.2	C703	C703	C703
	Encryption mode control	10.14	M	M	M
M.15 Re-keying		5.2	C705	C705	C705
	Re-keying	10.17	M	M	M
M.16 Early encryption		5.2	C706	C706	C706
	Early encryption	10.18	M	M	M
C701: IF service M.11 THEN O ELSE M. C702: IF service M.9 THEN O ELSE M. C703: IF feature N.29 OR N.28 THEN M ELSE I. C704: IF feature N.17 OR N.27 THEN M ELSE I. C705: IF feature N.35 and NWK layer procedure "Re-keying during a call" are implemented THEN M ELSE O. C706: IF feature N.35 and NWK layer procedure "Early encryption" are implemented THEN M ELSE O.					

F.3.4 GAP Application feature to procedure mapping table (clause 6.8.4 of EN 300 444)

Table F.4: Application feature to procedure mapping table (table 8 of EN 300 444 [12])

Feature/Procedure mapping					
Feature	Procedure	Reference	PT	Status	
				R/B	P
A.1 AC to bitstring mapping		4.3	M	C801	M
	AC to bitstring mapping	14.2	M	M	M
A.2 Multiple subscription registration		4.3	M	N/A	N/A
	Subscription control	14.1	M	N/A	N/A
A.3 Manual entry of the PARK		4.3	O	N/A	N/A
	Manual entry of the PARK	14.3	M	N/A	N/A
A.4 Terminal identity number assignment in mono cell system		4.3	O	O	N/A
	Terminal identity number assignment	14.4	O	O	N/A
C801: IF feature N.9 OR N.10 OR N.12 OR N.26 THEN M ELSE N/A.					

Annex G (informative): Bibliography

- ISO/IEC 8073 (1997): "Information technology - Open Systems Interconnection - Protocol for providing the connection-mode transport service".
- ETSI EN 301 649: "Digital Enhanced Cordless Telecommunications (DECT); DECT Packet Radio Service (DPRS)".
- ETSI EN 300 176-1: "Digital Enhanced Cordless Telecommunications (DECT); Test specification; Part 1: Radio".
- ETSI TS 124 072: "Digital cellular telecommunications system (Phase 2+); Universal Mobile Telecommunications System (UMTS); Call Deflection Supplementary Service; Stage 3".
- IETF RFC 3640: "RTP Payload Format for Transport of MPEG-4 Elementary Streams".
- IETF RFC 3016: "RTP Payload Format for MPEG-4 Audio/Visual Streams".
- IETF RFC 4749: "RTP Payload Format for the G.729.1 Audio Codec".
- IETF RFC 3261: "SIP: Session Initiation Protocol".

History

Document history		
V1.1.1	June 2008	Publication
V1.2.1	April 2010	Publication