

**Broadcast and On-line Services: Search, select, and  
rightful use of content on personal storage systems  
("TV-Anytime");  
Part 3: Metadata;  
Sub-part 1: Phase 1 - Metadata schemas**

---



---

Reference

RTS/JTC-TVA-PH1-45-03-01

---

Keywords

broadcasting, content, data, TV, video

**ETSI**

650 Route des Lucioles  
F-06921 Sophia Antipolis Cedex - FRANCE

Tel.: +33 4 92 94 42 00 Fax: +33 4 93 65 47 16

Siret N° 348 623 562 00017 - NAF 742 C  
Association à but non lucratif enregistrée à la  
Sous-Préfecture de Grasse (06) N° 7803/88

---

**Important notice**

Individual copies of the present document can be downloaded from:

<http://www.etsi.org>

The present document may be made available in more than one electronic version or in print. In any case of existing or perceived difference in contents between such versions, the reference version is the Portable Document Format (PDF). In case of dispute, the reference shall be the printing on ETSI printers of the PDF version kept on a specific network drive within ETSI Secretariat.

Users of the present document should be aware that the document may be subject to revision or change of status. Information on the current status of this and other ETSI documents is available at

<http://portal.etsi.org/tb/status/status.asp>

If you find errors in the present document, please send your comment to one of the following services:

[http://portal.etsi.org/chaicor/ETSI\\_support.asp](http://portal.etsi.org/chaicor/ETSI_support.asp)

---

**Copyright Notification**

No part may be reproduced except as authorized by written permission.  
The copyright and the foregoing restriction extend to reproduction in all media.

© European Telecommunications Standards Institute 2010.

© European Broadcasting Union 2010.

All rights reserved.

**DECT™**, **PLUGTESTS™**, **UMTS™**, **TIPHON™**, the TIPHON logo and the ETSI logo are Trade Marks of ETSI registered for the benefit of its Members.

**3GPP™** is a Trade Mark of ETSI registered for the benefit of its Members and of the 3GPP Organizational Partners.

**LTE™** is a Trade Mark of ETSI currently being registered for the benefit of its Members and of the 3GPP Organizational Partners.

**GSM®** and the GSM logo are Trade Marks registered and owned by the GSM Association.

# Contents

Intellectual Property Rights .....	6
Foreword.....	6
Introduction .....	7
1 Scope .....	8
2 References .....	9
2.1 Normative references .....	9
2.2 Informative references.....	10
3 Definitions and abbreviations.....	10
3.1 Definitions .....	10
3.2 Abbreviations .....	11
4 Introduction to metadata.....	12
5 <i>TV-Anytime</i> Metadata Data Model .....	13
5.1 <i>TV-Anytime</i> Metadata Process Model.....	13
5.2 <i>TV-Anytime</i> Metadata Structure Model .....	14
5.3 CRID and Metadata.....	15
6 Metadata definitions .....	17
6.1 Use of MPEG-7 .....	17
6.2 <i>TV-Anytime</i> Metadata Namespace.....	17
6.3 Content Description Metadata.....	17
6.3.1 Content Description Requirements .....	18
6.3.2 <i>TV-Anytime</i> Content Description model .....	18
6.3.3 Basic types .....	19
6.3.4 Description.....	22
6.3.5 Audio and video information.....	35
6.3.6 Programme information .....	40
6.3.7 Group Information .....	44
6.3.8 Media Review DS.....	47
6.3.9 Common core set of metadata.....	49
6.3.9.1 Required .....	50
6.3.9.2 Recommended.....	50
6.3.10 Optional metadata (informative).....	50
6.4 Instance description metadata.....	50
6.4.1 Programme location entities .....	50
6.4.2 Programme Location.....	52
6.4.3 Service information.....	60
6.5 Consumer metadata .....	63
6.5.1 Usage history DS .....	63
6.5.1.1 Usage history DS .....	64
6.5.1.2 UserActionHistory DS .....	65
6.5.1.3 UserActionList DS .....	66
6.5.1.4 UserAction DS .....	67
6.5.1.5 Informative examples.....	68
6.5.2 User preferences DS .....	68
6.5.2.1 Basic user preference elements .....	69
6.5.2.2 UserPreferences DS .....	70
6.5.2.3 UserIdentifier DS .....	70
6.5.2.4 FilteringAndSearchPreferences DS.....	71
6.5.2.5 CreationPreferences DS .....	72
6.5.2.6 ClassificationPreferences DS .....	73
6.5.2.7 SourcePreferences DS.....	74
6.5.2.8 PreferenceCondition DS.....	76
6.5.2.9 BrowsingPreferences DS .....	77

6.5.2.10	SummaryPreferences DS .....	78
6.6	Segmentation metadata.....	79
6.6.1	Segmentation metadata: definitions and requirements.....	79
6.6.2	Basic segment description .....	80
6.6.3	TVAMediaTime Type .....	81
6.6.4	TimeBaseReference Type.....	82
6.6.5	Segment Information .....	82
6.6.6	Segment Group Information .....	83
6.6.7	Segment information table.....	89
6.7	TV-Anytime documents.....	89
6.7.1	Information tables.....	90
6.7.2	TV-Anytime metadata document .....	94
7	The TVA metadata framework (informative) .....	98
7.1	The XML-based TV-Anytime metadata framework.....	98
7.2	Metadata security considerations .....	99
<b>Annex A (normative): TV-Anytime Classification Schemes.....</b>		<b>101</b>
A.1	Introduction .....	101
A.2	ActionType CS.....	102
A.3	HowRelated CS .....	104
A.4	TVARoleCS .....	110
A.5	RoleCS .....	114
A.6	IntentionCS.....	118
A.7	FormatCS .....	121
A.8	ContentCS .....	127
A.9	ContentCommercialCS.....	157
A.10	OriginationCS.....	160
A.11	IntendedAudienceCS.....	163
A.12	ContentAlertCS .....	166
A.13	MediaTypeCS.....	171
A.14	AtmosphereCS .....	173
A.15	AudioPurposeCS .....	176
A.16	PurchaseTypeCS .....	177
A.17	UnitTypeCS.....	177
A.18	DerivationReasonCS .....	178
A.19	CaptionCodingFormatCS .....	179
<b>Annex B (normative): Use of classification schemes for multi-dimensional content classification .....</b>		<b>180</b>
B.1	Dimensions used in TVA programme classification.....	180
B.2	Guidelines and examples.....	182
B.3	Adaptation to meet regional and other special needs .....	182
B.4	Mapping between TVA and other content classification systems.....	183
<b>Annex C (normative): TV-Anytime Description Schemes and Classification Schemes.....</b>		<b>186</b>
<b>Annex D (informative): Note on the use of UML-like diagram.....</b>		<b>187</b>

History .....191

---

# Intellectual Property Rights

IPRs essential or potentially essential to the present document may have been declared to ETSI. The information pertaining to these essential IPRs, if any, is publicly available for **ETSI members and non-members**, and can be found in ETSI SR 000 314: "*Intellectual Property Rights (IPRs); Essential, or potentially Essential, IPRs notified to ETSI in respect of ETSI standards*", which is available from the ETSI Secretariat. Latest updates are available on the ETSI Web server (<http://webapp.etsi.org/IPR/home.asp>).

Pursuant to the ETSI IPR Policy, no investigation, including IPR searches, has been carried out by ETSI. No guarantee can be given as to the existence of other IPRs not referenced in ETSI SR 000 314 (or the updates on the ETSI Web server) which are, or may be, or may become, essential to the present document.

---

## Foreword

This Technical Specification (TS) has been produced by Joint Technical Committee (JTC) Broadcast of the European Broadcasting Union (EBU), Comité Européen de Normalisation ELECTrotechnique (CENELEC) and the European Telecommunications Standards Institute (ETSI).

**NOTE:** The EBU/ETSI JTC Broadcast was established in 1990 to co-ordinate the drafting of standards in the specific field of broadcasting and related fields. Since 1995 the JTC Broadcast became a tripartite body by including in the Memorandum of Understanding also CENELEC, which is responsible for the standardization of radio and television receivers. The EBU is a professional association of broadcasting organizations whose work includes the co-ordination of its members' activities in the technical, legal, programme-making and programme-exchange domains. The EBU has active members in about 60 countries in the European broadcasting area; its headquarters is in Geneva.

European Broadcasting Union  
CH-1218 GRAND SACONNEX (Geneva)  
Switzerland  
Tel: +41 22 717 21 11  
Fax: +41 22 717 24 81

The present document is part 3, sub-part 1 of a multi-part deliverable covering Broadcast and On-line Services: Search, select and rightful use of content on personal storage systems ("*TV-Anytime*"), as identified below:

Part 1: "Benchmark Features";

Part 2: "Phase 1 - System description";

**Part 3: "Metadata":**

**Sub-part 1: "Phase 1 - Metadata schemas";**

Sub-part 2: "System aspects in a uni-directional environment";

Sub-part 3: "Phase 2 - Extended Metadata Schema";

Sub-part 4: "Phase 2 - Interstitial metadata";

Part 4: "Phase 1 - Content referencing";

Part 5: "Rights Management and Protection (RMP)";

Part 6: "Delivery of metadata over a bi-directional network";

Part 7: "Bi-directional metadata delivery protection";

Part 8: "Phase 2 - Interchange Data Format";

Part 9: "Phase 2 - Remote Programming".

---

# Introduction

The present document is based on a submission by the *TV-Anytime* forum (<http://www.tv-anytime.org>).

"*TV-Anytime*" (TVA) is a full and synchronized set of specifications established by the *TV-Anytime* Forum. TVA features enable the search, selection, acquisition and rightful use of content on local and/or remote personal storage systems from both broadcast and online services.

TS 102 822-1 [4] and TS 102 822-2 [5] set the context and system architecture in which the standards for Metadata, Content referencing, Bi-directional metadata and Metadata protection are to be implemented in the *TV-Anytime* environment. TS 102 822-1 [4] provides benchmark business models against which the *TV-Anytime* system architecture is evaluated to ensure that the specification enable key business applications. TS 102 822-2 [5] presents the *TV-Anytime* System Architecture. These two documents are placed ahead of the others for their obvious introductory value. Note that these first two documents are largely informative, while the remainder of the series is normative. The features are supported and enabled by the specifications for Metadata (TS 102 822-3-1, TS 102 822-3-2 [6], TS 102 822-3-3 [7] and TS 102 822-3-4 [8]), Content Referencing (TS 102 822-4 [9]), Rights Management (TS 102 822-5-1 [10] and TS 102 822-5-2 [11]), Bi-directional Metadata Delivery (TS 102 822-6-1 [12], TS 102 822-6-2 [13] and TS 102 822-6-3 [14]) and Protection (TS 102 822-7 [15]), Interchange Data Format (TS 102 822-8 [16]) and Remote Programming (TS 102 822-9 [17]). The present document is to be used by manufacturers, service providers and content providers for the implementation of the Phase 1 features of the *TV-Anytime* specifications.

The present document addresses more specifically Phase 1 metadata features of the *TV-Anytime* specification as identified in TS 102 822-1 [4].

---

# 1 Scope

The present document is one in a series of Technical Specifications produced by the *TV-Anytime* Forum. These documents establish the fundamental specifications for the services, systems and devices that will conform to the *TV-Anytime* standard, to a level of detail that is implementable for compliant products and services.

As is common practice in such standardization efforts, these specifications were preceded by requirements documents which define the requirements for the *TV-Anytime* services, systems and devices.

TS 102 822-1 [4] and TS 102 822-2 [5] set the context and system architecture in which the standards for Metadata, Content referencing, Bi-directional metadata and Metadata protection are to be implemented in the *TV-Anytime* environment. TS 102 822-1 [4] provides Phase 1 and Phase 2 benchmark business models against which the *TV-Anytime* system architecture is evaluated to ensure that the specification enable key business applications. TS 102 822-2 [5] presents the *TV-Anytime* System Architecture. These two documents are placed ahead of the others for their obvious introductory value. Note that these first two documents are largely informative, while the remainder of the series is normative.

Although each in the series of documents is intended to stand alone, a complete and coherent sense of the *TV-Anytime* system standard can be gathered by reading all of the specification documents in numerical order.

The present document deals with Metadata Phase 1 features of the *TV-Anytime* specification as identified in TS 102 822-1 [4].

We use the term "metadata" to mean descriptive data about content, such as programme title and synopsis. We call such metadata "attractors" because they can attract a consumer to content. Attractors allow consumers to find, navigate and manage content from various sources. In addition to attractors, metadata as defined by *TV-Anytime* also includes information about user preferences and history. User preference information, such as favourite actors or TV shows, is included within the scope of *TV-Anytime* metadata to allow software agents to select content on the consumer's behalf.

The formal definitions of metadata schemas should be read in conjunction with the system specification TS 102 822-2 [5] defining how they could be used in an end-to-end system.

*TV-Anytime* only defines the metadata format for metadata that may be exchanged between various entities such as between the content provider and consumer, among consumers, or between a third-party metadata provider and the consumer.

There are two sub-parts to TS 102 822-3 addressing Phase 1:

- In **sub-part 1**, XML is the "representation format" used to define the schemas of the *TV-Anytime* Metadata Specification (the present document). Although XML Schema is used to define how metadata is represented in XML, it can also be used to describe equivalent, non-XML representations of the same metadata.
- **Sub-part 2** of the *TV-Anytime* Metadata Specification (TS 102 822-3-2 [6]) addresses the formatting of metadata including a recommended binary format, fragmentation, encapsulation of fragments and indexing of metadata descriptions. TS 102 822-2 [5] defines how these schemas are used in an end-to-end system. Although the transport of metadata is out of scope of *TV-Anytime*, requirements have been identified. Other bodies such as DVB, ATSC and ARIB will specify the appropriate transport mechanisms for their respective systems. Furthermore, the manner in which metadata is stored, accessed and used on the PDR is also out of scope of the present document.



---

## 2 References

References are either specific (identified by date of publication and/or edition number or version number) or non-specific. For specific references, only the cited version applies. For non-specific references, the latest version of the reference document (including any amendments) applies.

Referenced documents which are not found to be publicly available in the expected location might be found at <http://docbox.etsi.org/Reference>.

NOTE: While any hyperlinks included in this clause were valid at the time of publication ETSI cannot guarantee their long term validity.

### 2.1 Normative references

The following referenced documents are necessary for the application of the present document.

[1] XML Schema, W3C Recommendations (version 20010502).

NOTE: Available at:

<http://www.w3.org/TR/2001/REC-xmlschema-0-20010502>,

<http://www.w3.org/TR/2001/REC-xmlschema-1-20010502>,

<http://www.w3.org/TR/2001/REC-xmlschema-2-20010502>.

[2] ISO/IEC 15938-5 (2003): "Information technology - Multimedia content description interface - Part 5: Multimedia description schemes".

[3] ISO/IEC 15938-2 (2002): "Information technology - Multimedia content description interface - Part 2: Description definition language".

[4] ETSI TS 102 822-1: "Broadcast and On-line Services: Search, select, and rightful use of content on personal storage systems ("TV-Anytime"); Part 1: Benchmark Features".

[5] ETSI TS 102 822-2: "Broadcast and On-line Services: Search, select, and rightful use of content on personal storage systems ("TV-Anytime"); Part 2: Phase 1 - System description".

[6] ETSI TS 102 822-3-2: "Broadcast and On-line Services: Search, select, and rightful use of content on personal storage systems ("TV-Anytime"); Part 3: Metadata; Sub-part 2: System aspects in a uni-directional environment".

[7] ETSI TS 102 822-3-3: "Broadcast and On-line Services: Search, select, and rightful use of content on personal storage systems ("TV-Anytime"); Part 3: Metadata; Sub-part 3: Phase 2 - Extended Metadata Schema".

[8] ETSI TS 102 822-3-4: "Broadcast and On-line Services: Search, select, and rightful use of content on personal storage systems ("TV-Anytime"); Part 3: Metadata; Sub-part 4: Phase 2 - Interstitial metadata".

[9] ETSI TS 102 822-4: "Broadcast and On-line Services: Search, select, and rightful use of content on personal storage systems ("TV-Anytime"); Part 4: Phase 1 - Content Referencing".

[10] ETSI TS 102 822-5-1: "Broadcast and On-line Services: Search, select, and rightful use of content on personal storage systems ("TV-Anytime"); Part 5: Rights Management and Protection (RMP) Sub-part 1: Information for Broadcast Applications".

[11] ETSI TS 102 822-5-2: "Broadcast and On-line Services: Search, select, and rightful use of content on personal storage systems ("TV-Anytime"); Part 5: Rights Management and Protection (RMP) Sub-part 2: RMPI binding".

[12] ETSI TS 102 822-6-1: "Broadcast and On-line Services: Search, select, and rightful use of content on personal storage systems ("TV-Anytime"); Part 6: Delivery of metadata over a bi-directional network; Sub-part 1: Service and transport".

- [13] ETSI TS 102 822-6-2: "Broadcast and On-line Services: Search, select, and rightful use of content on personal storage systems ("TV-Anytime"); Part 6: Delivery of metadata over a bi-directional network; Sub-part 2: Phase 1 - Service discovery".
- [14] ETSI TS 102 822-6-3: "Broadcast and On-line Services: Search, select, and rightful use of content on personal storage systems ("TV-Anytime"); Part 6: Delivery of metadata over a bi-directional network; Sub-part 3: Phase 2 - Exchange of Personal Profile".
- [15] ETSI TS 102 822-7: "Broadcast and On-line Services: Search, select, and rightful use of content on personal storage systems ("TV-Anytime Phase 1"); Part 7: Bi-directional metadata delivery protection".
- [16] ETSI TS 102 822-8: "Broadcast and On-line Services: Search, select, and rightful use of content on personal storage systems ("TV-Anytime"); Part 8: Phase 2 - Interchange data format".
- [17] ETSI TS 102 822-9: "Broadcast and On-line Services: Search, select, and rightful use of content on personal storage systems ("TV-Anytime"); Part 9: Phase 2 - Remote Programming".
- [18] ISO/IEC 639-1: "Codes for the representation of names of languages - Part 1: Alpha-2 code".

## 2.2 Informative references

The following referenced documents are not necessary for the application of the present document but they assist the user with regard to a particular subject area.

- [i.1] IETF RFC 2806: "URLs for Telephone Calls".
- [i.2] ETSI EN 300 743: "Digital Video Broadcasting (DVB); Subtitling systems".

---

## 3 Definitions and abbreviations

### 3.1 Definitions

For the purposes of the present document, the following terms and definitions apply:

**application:** specific set of functions running on the PDR

NOTE: Some applications use metadata, either automatically or under consumer control.

**ATSC-DASE:** set of application programming interfaces currently being standardized by the Advanced Television Systems Committee for the digital broadcast of multimedia and applications in North America and other regions

**attractor:** metadata element that is accessible by the consumer in order to aid in the content selection process, thus attracting the consumer

NOTE: Examples include the title and name of an actor in a television programme.

**content creator:** producer of the content

**content provider:** entity that acts as the agent for and is the prime exploiter of the content

**content reference:** pointer to a specific content item

**Content Reference Identifier (CRID):** identifier for content that is independent of its location

**description scheme:** formal definition of a metadata schema written in the MPEG-7 Description Definition Language (DDL)

NOTE: See ISO/IEC 15938-2 [3].

**descriptor:** metadata element, such as an attractor or other information about content such as the key frame index of a piece of video

**DVB-MHP:** set of application programming interfaces being standardized by Digital Video Broadcasting Project for the digital broadcast of multimedia and applications in Europe, Asia and other regions

**enhanced TV:** television that includes additional information and/or applications related to content, but does not use a return path

**interactive TV:** television that includes additional information and/or applications related to content and which takes advantage of a return path

**life cycle:** process of creation, usage, storage, and deletion of metadata

**location resolution:** process of establishing the address (location and time) of a specific content instance from its CRID

**metadata:** data about content

EXAMPLE: The title, genre and summary of a television programme.

NOTE: In the context of *TV-Anytime*, metadata also includes consumer profile and history data.

**metadata schema:** identifier associated with a set of XML schemas that globally identifies those schemas so that they can be referenced externally

NOTE: A globally unique namespace ensures that the names of types defined by schemas in that namespace do not conflict with types of the same name defined elsewhere.

**metadata system:** set of rules describing the syntax and semantics of metadata

**MPEG-7:** ongoing effort by the Motion Pictures Expert Group to specify a standard set of content-related metadata applicable to a broad range of applications

**namespace:** collection of components that allows the end-to-end operation of the *TV-Anytime* metadata solution

**programme:** editorially coherent piece of content

NOTE: Typically, a programme is acquired by the PDR as a whole.

**programme group:** one or more programmes that are grouped together

NOTE: *TV-Anytime* defines several types of programme groups such as "series" and "programme compilation".

**return path:** part of the bi-directional distribution system from the consumer to service provider

**segment:** continuous portion of a piece of content, for example a single topic in a news programme

**segmentation:** process of creating segments from a piece of content

## 3.2 Abbreviations

For the purposes of the present document, the following abbreviations apply:

ARIB	Association of Radio Industries and Businesses
ATSC	Advanced Television Systems Committee
AV	Audio-Visual
CRID	Content Reference IDentifier
CS	Classification Scheme
DDL	Description Definition Language

NOTE: The language used to define description schemes in MPEG-7 (see ISO/IEC 15938-2 [3]).

DS	Description Scheme
DVB	Digital Video Broadcasting Project
EPG	Electronic Programme Guide

NOTE: A means of presenting available content to the consumer, allowing selection of desired content.

HTML	HyperText Markup Language
------	---------------------------

IPR	Intellectual Property Rights
ISAN	International Standard Audiovisual Number
MPEG	Motion Pictures Expert Group
NID	Namespace Identifier
PDR	Personal Digital Recorder
TVA	<i>TV-Anytime</i>
UML	Unified Modelling Language
URN	Unique Resource Name
XML	Extensible Markup Language

---

## 4 Introduction to metadata

Metadata is generally defined as "data about data". Within the *TV-Anytime* environment, the most visible parts of metadata are the attractors/descriptors or hyperlinks used in electronic programme guides, or in Web pages. This is the information that the consumer or agent will use to decide whether or not to acquire a particular piece of content.

The *TV-Anytime* metadata system allows the consumer to find, navigate and manage content from a variety of internal and external sources including, for example, enhanced broadcast, interactive TV, Internet and local storage. It defines a standard way to describe consumer profiles including search preferences to facilitate automatic filtering and acquisition of content by agents on behalf of the consumer. Consumers, as used in the present document, include educators and students, who may use selected programme segments in the classroom or laboratory.

There is a need to associate metadata with content to facilitate human and automated searching for content of interest. Such metadata includes descriptive elements and attractors to aid the search process as well as elements essential to the acquisition, capture and presentation processes; content rights, formats, duration, etc. Many of these descriptive elements can be found in electronic programme guides and HTML documents.

The process of creation and evolution of metadata for an individual content item may involve many organizations during the course of creation, distribution and delivery to the consumer. Thus, there is a clear need to define a common metadata framework and a standard set of metadata elements in order to ensure a high level of interoperability within the chain from content creation to content delivery.

## 5 TV-Anytime Metadata Data Model

### 5.1 TV-Anytime Metadata Process Model

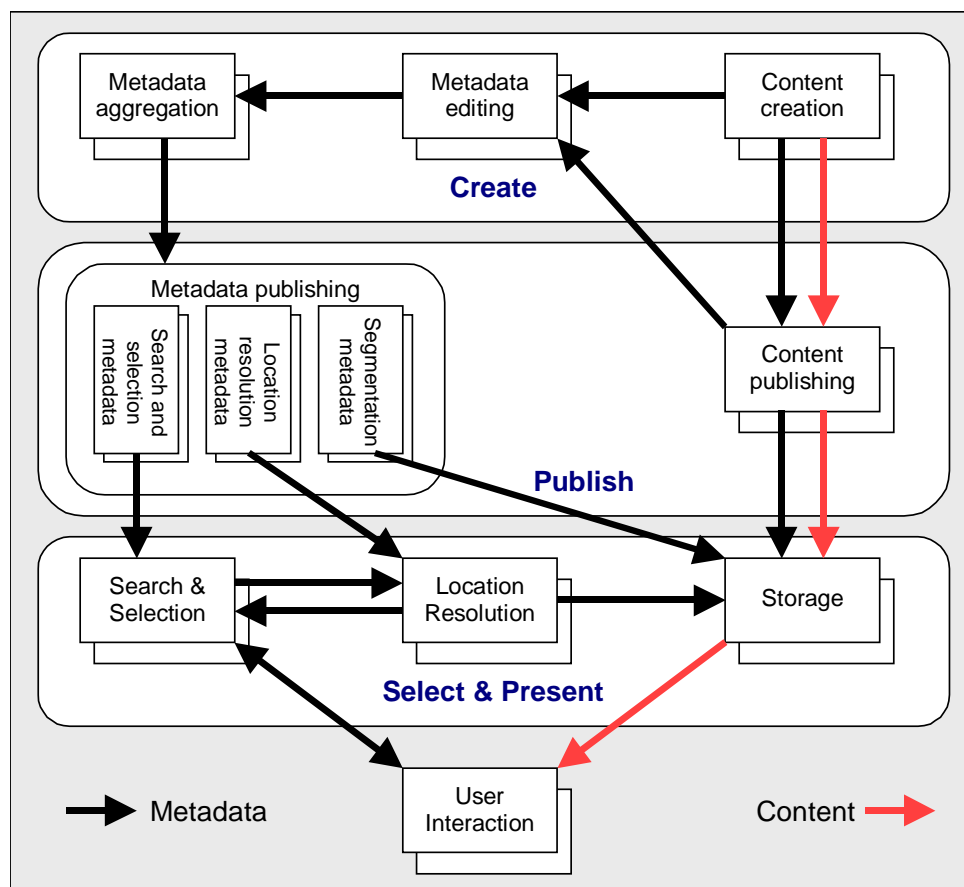

**Figure 1: Metadata and content flow**

Figure 1 shows the flow of metadata and content through various stages of creation and delivery to the end consumer.

This model clearly identifies the separation of the processing of metadata and content while at the same time illustrating the parallels between the processing of metadata and content. User profile and history metadata is generated during the selection and presentation process.

#### Content creation

The content creation process represents the production of a piece of content or a programme. During the production process, the programme content is created and information about the programme may also be captured. At this stage, however, the metadata is unlikely to be in a form that can be directly exposed to a user - some form of editing will be required before the description of the programme can be published.

## Content publishing

Once content has been created, the content is then available for publication by a content publisher. This could be, for example, as part of a broadcast service or as a publication on the Internet. The content publishing process defines instantiations of programmes - in other words, one output from the content publishing process is information about "where" the programme can be found. In the broadcast case, this means a schedule for the services that are published.

## Metadata editing

The metadata editing process takes *raw* information from the content creation and publishing processes and edits this into a form that is suitable for representing the content to the end consumer. The output of this process is edited metadata for the programmes and/or metadata describing the location of these programmes.

## Metadata aggregation

In order to support a given *TV-Anytime* system, it is likely that metadata from a number of independent content creators and publishers will need to be aggregated. It is important to recognize that the process of metadata aggregation may result in the original metadata being changed.

## Metadata publishing

Without prejudice to whether or not a *TV-Anytime* system is horizontally or vertically integrated, an aggregated metadata set will need to be published to both the content selection and location resolution processes. The content selection process will be largely concerned with the metadata describing programmes but may also involve use of the programme location metadata. The location resolution service will simply require information about the location of programmes.

## Content selection

The content selection process may occur through the direct involvement of the consumer or may be performed on the consumer's behalf by a software agent. In order for a software agent to function correctly, metadata describing the consumer and his preferences will need to be provided to the content selection process. This may be either inferred from the consumer's past history of content selection or by the explicit specification of preferences by the user (or a combination of the two). Note that the content selection process may be, in part, affected by knowledge of the programme's location.

## Location resolution

The process of location resolution is simply one of discovering where (or when) a programme can be found. Details of this discovery process can be found in the *TV-Anytime* Content Referencing Specification.

The following clauses comprise the normative specification of the *TV-Anytime* metadata system.

## 5.2 *TV-Anytime* Metadata Structure Model

Two modelling approaches are used in the following clauses.

We first introduce a simple data modelling methodology (see figure 2) that allows us to describe metadata structure at a high level in a manner independent of any particular representation. This syntax allows relationships between *TV-Anytime* entities to be clearly stated (e.g. one-to-many), as well as enabling the powerful concept of inheritance, which allows specific types of entity to be derived from generic types.

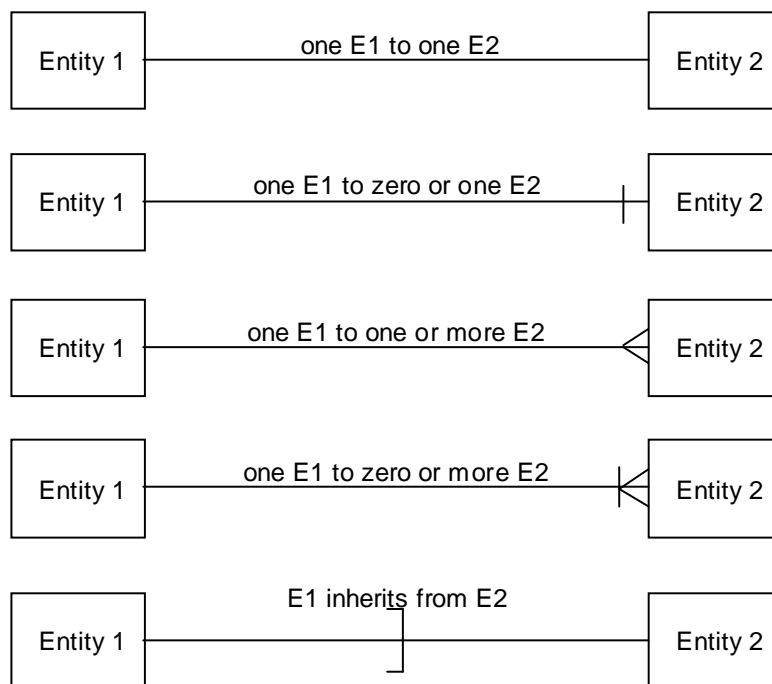

**Figure 2: Basic Entity-Relation graph syntax**

The other modelling approach followed by *TV-Anytime* is the representation of the metadata schemas using a Unified Modelling Language (UML) language defined in more details in annex D.

### 5.3 CRID and Metadata

The cornerstone of *TV-Anytime* metadata is the CRID, described in TS 102 822-4 [9]. As a content reference identifier, the CRID refers to a piece of content, though in some cases it may refer to one or more other CRIDs.

The CRID also acts as the link that connects different content-related metadata descriptions (see figure 3).

We classify content-related metadata as either **content description metadata** or **instance description metadata**.

As shown in figure 3, content description metadata is general information about a piece of content that does not change regardless of how the content is published or broadcast. It includes information such as the content's title, textual description and genre. Typically, the content creator assigns content description metadata before publication.

Instance description metadata describes a particular instance of a piece of content, including information such as the content location, usage rules (pay-per-view, etc.) and delivery parameters (e.g. video format). Instance description metadata is assigned by the content provider as a part of the publication of content. During the search and selection process, a consumer may use both general content and instance descriptions.

A third category of metadata called consumer metadata includes usage history data (logging data), annotation metadata and user preferences.

Figure 3 shows these four types of metadata and how the CRID for an individual content item (e.g. a CRID that does not resolve into further CRIDs) is used to tie them all together. This is not a complete list of all *TV-Anytime* metadata; only a few representative metadata entities are shown.

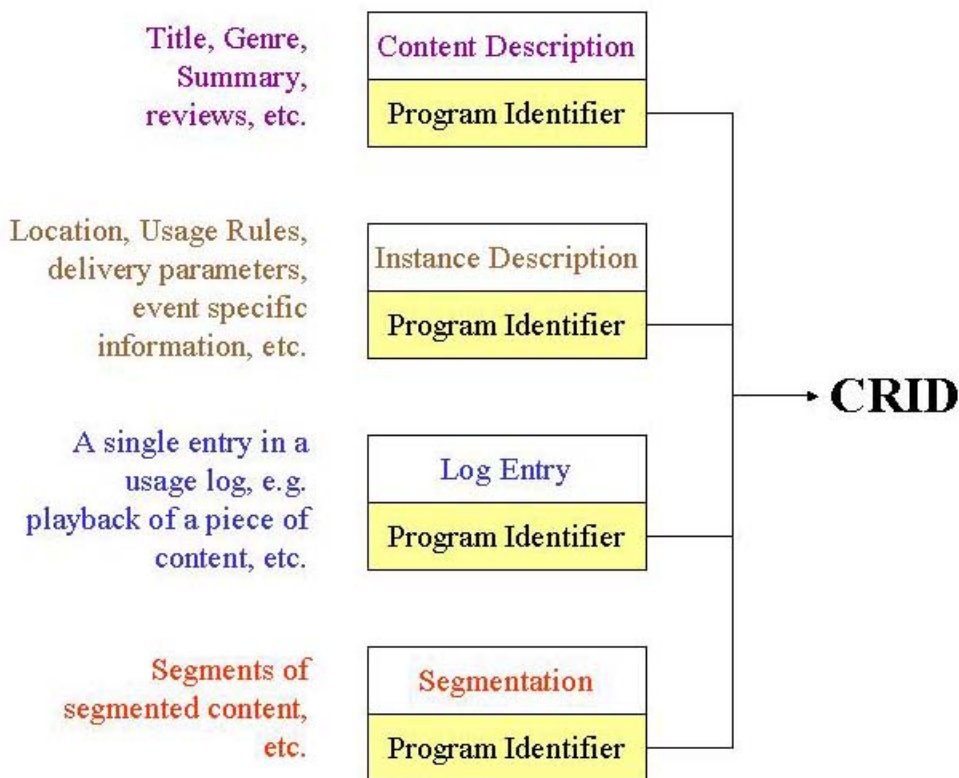
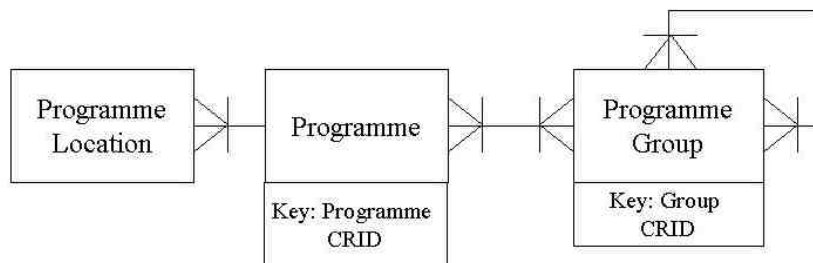

**Figure 3: Metadata that references a programme CRID**

Figure 4 shows some of the major kinds of *TV-Anytime* metadata and their relationships. Programme metadata describes information about single programmes, such as the title, genre, etc. A programme is defined to be an editorially coherent piece of content which is typically acquired as a whole. The programme is referenced via a programme CRID ("leaf CRID"), e.g. a CRID that resolves to a single programme.

The same programme may be found in any number of locations, as is defined by the location resolution process. This relationship is indicated via the one-to-many relationship link from "Programme" to "Programme Location".

Programmes can be grouped into "Programme Group" elements such that a group may contain any number of programmes and a programme can be a member of any number of groups. Furthermore, programme groups themselves can be part of other programme groups as depicted in figure 4. A programme group is uniquely identified by a group CRID. Note that as described in the TS 102 822-4 [9], the format of a CRID does not indicate by itself whether that CRID resolves to a programme or a list of CRIDs. Several types of programme groups are defined in the present document. A third party may define additional programme group types.



**Figure 4: Relationship between major kinds of *TV-Anytime* metadata**



## 6 Metadata definitions

For the purpose of interoperability, the *TV-Anytime* Forum has adopted XML as the common representation format for metadata. XML offers many advantages: it allows for extensibility, supports the separation of data from the application and is widely used. XML schema is mainly used to represent the data model. *TV-Anytime* descriptions may however be instantiated in a format other than textual. *TV-Anytime* has described some of these mechanisms such as binary encoding in TS 102 822-3-2 [6].

### 6.1 Use of MPEG-7

A metadata schema is the formal definition of the structure and type of metadata. *TV-Anytime* uses the MPEG-7 Description Definition Language (DDL) (see ISO/IEC 15938-5 [2]) to describe metadata structure as well as the XML encoding of metadata. DDL is based on XML schema as recommended by W3C in XML Schema, W3C Recommendations [1].

*TV-Anytime* uses several MPEG-7 datatypes as collected in the MPEG7 contained in archive ts\_1028220301v010601p0.zip which accompanies the present document. *TV-Anytime* also uses MPEG-7 Classification Schemes.

### 6.2 *TV-Anytime* Metadata Namespace

*TV-Anytime* metadata Description Schemes (DS) that have been developed under the auspices of the *TV-Anytime* Forum are associated with the *TV-Anytime* metadata XML namespace. The *TV-Anytime* XML schema is contained in archive ts\_1028220301v010601p0.zip which accompanies the present document. as tva\_metadata\_3-1\_v161.xsd and takes precedence over the text in the present document. The *TV-Anytime* metadata namespace is defined as:

```
xmlns:tva="urn:tva:metadata:2010"
```

The "tva" namespace identifier (NID) has been registered by IANA.

*TV-Anytime* metadata includes DSs defined by XML as included in the XML stub attached to the present document.

```
xmlns="http://www.w3.org/2001/XMLSchema"
<import namespace="http://www.w3.org/XML/1998/namespace" schemaLocation="xml.xsd"/>
```

*TV-Anytime* also includes DSs defined by MPEG-7 as included in the MPEG7 stub attached to the present document, which use the MPEG-7 namespace as described in ISO/IEC 15938-5 [2].

NOTE: The MPEG7 stub provided in the file referenced below now contains the GeographicPosition element, originally part of the MPEG7 complexType PlaceType, which was not included in the previous version of the TVA stub.

```
xmlns:mpeg7="urn:tva:mpeg7:2008"
<import namespace="urn:tva:mpeg7:2008" schemaLocation="tva_mpeg7_2008.xsd"/>
```

All TVA metadata documents must be fully namespace qualified and must declare the TVA metadata namespace.

### 6.3 Content Description Metadata

The present clause describes metadata that describes content independently of any particular instantiation of that content.

### 6.3.1 Content Description Requirements

The content description model must be able to represent the following concepts:

- 1) A simple programme.
- 2) A programme with a number of different versions (e.g. edits for sex/violence/language, director's cut, etc.).
- 3) A programme that has been divided into a number of parts for publication (e.g. a 3 h film shown in 2 parts on different days).
- 4) A programme that is a concatenation of a sequence of other programmes identified as an aggregated programme.
- 5) A series of programmes that can be ordered (e.g. episodes in a numerical order) or unordered and bounded or unbounded.
- 6) A collection of series and individual programmes that have the same programme concept - i.e. a show (e.g. all series of "Only Fools and Horses" together with the Christmas specials).
- 7) A publication of a programme that may have publication dependent attributes (e.g. a film showing as tribute to a recently deceased actor which would have a different description).

### 6.3.2 TV-Anytime Content Description model

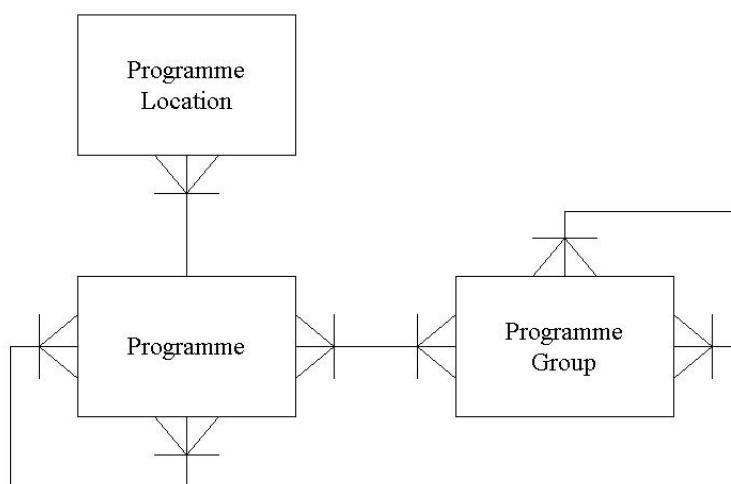

**Figure 5: TV-Anytime Content Description Model**

Entity definitions

- **"Programme"** - the programme represents an editorially coherent piece of content, which may itself aggregate other programmes.
- **"Programme group"** - the programme group entity simply represents a grouping of programmes. A number of different types of group have been identified, such as series, show and programme concept. Programme groups can also contain other programme groups.
- **"Programme location"** - a programme location contains information about one instance (or "publication event") of a programme. Multiple programme locations from the same service provider can be grouped to form a schedule.

## Relationship definitions

- 1) **"Programme to Programme" location** (zero to many) - a given programme can appear at any number of programme locations (e.g. schedule events) and a given programme location instantiates one programme.
- 2) **"Programme to Programme Group"** (many to many) - a given programme can be a member of any number of programme groups and a given programme group can contain any number of programmes.
- 3) **"Programme Group to Programme Group"** (many to many) - a given arbitrary programme group can contain any number of programme groups and a given programme group can be a member of many programme groups.
- 4) **"Programme to Programme"** (many to many) - a programme can be part of one or more aggregated programmes and aggregated programmes contain one or more than one programme.

### 6.3.3 Basic types

The simple and complex utility types defined below are used throughout the *TV-Anytime* schema specification.

```

<simpleType name="TVAIDType">
  <restriction base="string">
    </restriction>
  </simpleType>

<simpleType name="TVAIDRefType">
  <restriction base="string">
    </restriction>
  </simpleType>

<simpleType name="TVAIDRefsType">
  <list itemType="tva:TVAIDRefType"/>
</simpleType>

<simpleType name="CRIDType">
  <restriction base="anyURI">
    <pattern value="(c|C)(r|R)(i|I)(d|D)://.*/*"/>
  </restriction>
</simpleType>

<complexType name="CRIDRefType">
  <attribute name="crid" type="tva:CRIDType" use="required"/>
</complexType>

<complexType name="FlagType">
  <attribute name="value" type="boolean" use="required"/>
</complexType>

<complexType name="TVATimeType">
  <sequence>
    <element name="TimePoint" type="mpeg7:timePointType"/>
    <element name="Duration" type="mpeg7:durationType"
      minOccurs="0"/>
  </sequence>
</complexType>

<simpleType name="currencyCodeType">
  <restriction base="string">
    <pattern value="[a-zA-Z]{3}"/>
  </restriction>
</simpleType>

<complexType name="PriceType">
  <simpleContent>
    <extension base="float">
      <attribute name="currency" type="tva:currencyCodeType" use="required"/>
    </extension>
  </simpleContent>
</complexType>

```

Name	Definition
TVAIDType	A simple type used to indicate uniqueness within a metadata description.
TVAIDRefType	A simple type used to refer to an identifier of the TVAIDType.
TVAIDRefsType	A simple type used to refer to multiple identifiers of the TVAIDType.
CRIDType	A type to represent a CRID as a URI reference.
CRIDRefType	A complex type that allows a reference to be made to a CRID.
crid	The value of the CRID being referenced.
FlagType	A type that can be used to indicate simple boolean values.
value	Denotes the value of a boolean flag - can be "true" (default) or "false".
TVATimeType	Used to designate absolute time properties.
TimePoint	Used to designate a point in time.
Duration	Used to designate a period of time.
CurrencyCodeType	A type defining the national currency in which a price is expressed
PriceType	A type defining the price proposed for a particular content item. The same price can be expressed e.g. several times in different currencies.
currency	An attribute the currency in which the price is instantiated

```

<complexType name="TermNameType">
  <simpleContent>
    <extension base="mpeg7:TextualType">
      <attribute name="preferred" type="boolean" use="optional"/>
    </extension>
  </simpleContent>
</complexType>

<complexType name="ControlledTermType">
  <sequence>
    <element name="Name" type="tva:TermNameType" minOccurs="0"/>
    <element name="Definition" type="mpeg7:TextualType"
      minOccurs="0"/>
  </sequence>
  <attribute name="href" type="mpeg7:termReferenceType"
    use="required"/>
</complexType>

```

Name	Definition
TermNameType	A complex type used to represent a classification term.
preferred	An optional attribute to indicate that the given controlled term is the preferred instance e.g. in a list. Where multi-lingual names are present, the scope of "preferred" is restricted to names of the same language.
ControlledTermType	A complex type used to make a reference to a Controlled Term. In addition the "Name" and "Definition" of the term can optionally be included. If included and the referenced list of controlled terms are not available, the inline description can be used, otherwise the appropriate controlled term list should be used to obtain the definitive "Name" and "Definition".
Name	A classification term.
Definition	A definition of a classification term.
href	A URN used to point to a classification term within a classification scheme.

```
<complexType name="TVAIDRefElementType">
  <attribute name="ref" type="tva:TVAIDRefType" use="required"/>
</complexType>
```

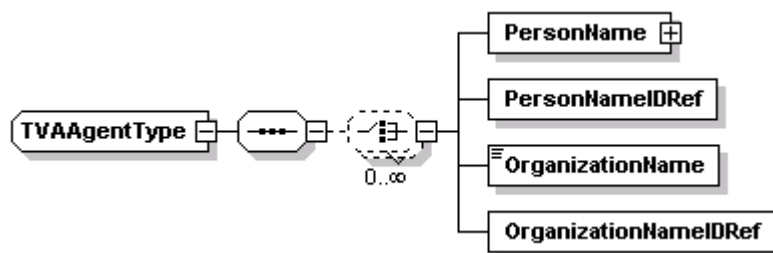

```
<complexType name="TVAAgentType">
  <sequence>
    <choice minOccurs="0" maxOccurs="unbounded">
      <element name="PersonName" type="mpeg7:PersonNameType"/>
      <element name="PersonNameIDRef" type="tva:TVAIDRefElementType"/>
      <element name="OrganizationName" type="mpeg7:TextualType"/>
      <element name="OrganizationNameIDRef" type="tva:TVAIDRefElementType"/>
    </choice>
  </sequence>
</complexType>
```

```
<attributeGroup name="fragmentIdentification">
  <attribute name="fragmentId" type="tva:TVAIDType" use="optional"/>
  <attribute name="fragmentVersion" type="unsignedLong"
    use="optional"/>
  <attribute name="fragmentExpirationDate" type="dateTime" use="optional"/>
</attributeGroup>
```

Name	Definition
TVAIDRefElementType	A complex type used to encapsulate a TVAIDref attribute.
ref	An attribute containing a TVAIDRef.
TVAAgentType	An element used to describe a person.
PersonName	Specifies the name of a person. Defined as an MPEG7 datatype, <i>PersonNameType</i> (See ISO/IEC 15938-5 [2] for a detailed description).
PersonNameIDRef	An element used to point to a PersonName held in a CreditsInformationTable.
OrganizationName	Specifies the name of an organization. Defined as an MPEG7 datatype, <i>TextualType</i> . (See ISO/IEC 15938-5 [2] for a detailed description).
OrganizationNameIDRef	An element used to point to an OrganizationName.
fragmentIdentification	An attribute group used to identify a (meta)data fragment.
fragmentId	An element used to point to a particular fragment using a TVAIDRef. The fragmentID for bi-directional shall be a superset of the fragment_id defined in Part B for unidirectional.
fragmentVersion	A version number associated to the identified fragment. A change to any item within the fragment shall cause the fragment version to be modified.
fragmentExpirationDate	The date at which this metadata becomes invalid and may be discarded. The date on which the client application should not use this data.

## 6.3.4 Description

The following simple and complex types define descriptive attributes of content.

```

<complexType name="KeywordType">
  <simpleContent>
    <extension base="mpeg7:TextualType">
      <attribute name="type" use="optional" default="main">
        <simpleType>
          <restriction base="NMTOKEN">
            <enumeration value="main"/>
            <enumeration value="secondary"/>
            <enumeration value="other"/>
          </restriction>
        </simpleType>
      </attribute>
      <attribute name="metadataOriginIDRef" type="tva:TVAIDRefType" use="optional"/>
    </extension>
  </simpleContent>
</complexType>

<complexType name="GenreType">
  <complexContent>
    <extension base="tva:ControlledTermType">
      <attribute name="type" use="optional" default="main">
        <simpleType>
          <restriction base="string">
            <enumeration value="main"/>
            <enumeration value="secondary"/>
            <enumeration value="other"/>
          </restriction>
        </simpleType>
      </attribute>
      <attribute name="metadataOriginIDRef" type="tva:TVAIDRefType" use="optional"/>
    </extension>
  </complexContent>
</complexType>

<simpleType name="SynopsisLengthType">
  <restriction base="string">
    <enumeration value="short"/>
    <enumeration value="medium"/>
    <enumeration value="long"/>
  </restriction>
</simpleType>

<complexType name="SynopsisType">
  <simpleContent>
    <extension base="mpeg7:TextualType">
      <attribute name="length" type="tva:SynopsisLengthType"
        use="optional"/>
    </extension>
  </simpleContent>
</complexType>

```

Name	Definition
KeywordType	A datatype for specifying a keyword associated to a programme.
type	Indicates the type / ranking order of importance of the keyword describing the multimedia content. The types of keywords are defined as follows: <i>main</i> - The specified keyword is the main, or primary, descriptive keyword. This is the default value. <i>secondary</i> - The specified keyword is a complementary descriptive keyword. <i>other</i> - The specified keyword is another complementary descriptive keyword.

Name	Definition
metadataOriginIDRef	A reference to an instance of MetadataOriginationInformation containing information about the provider of metadata.
GenreType type	A datatype for specifying a genre for the programme. Indicates the type of the genre of the multimedia content. The types of genres are defined as follows: <i>main</i> - The specified genre is the main, or primary. This is the default value. <i>secondary</i> - The specified genre is a secondary genre, such as a subgenre. <i>other</i> - The specified genre is an alternative genre, such as one defined or used by 3 <sup>rd</sup> parties.
metadataOriginIDRef	A reference to an instance of MetadataOriginationInformation containing information about the provider of metadata.
SynopsisLengthType	An enumeration of the possible values of the length qualifier for a synopsis. The possible values of this enumerated type are as follows: <i>short</i> - the length of the synopsis will not exceed 90 characters. <i>medium</i> - the length of the synopsis will not exceed 210 characters. <i>long</i> - the length of the synopsis will not exceed 1 200 characters.
SynopsisType length	A complex type to define a synopsis. The length of the synopsis. This attribute is optional. If no length is specified, then the synopsis may be of any length.

```

<simpleType name="segmentTypeType">
  <restriction base="string">
    <enumeration value="segment"/>
    <enumeration value="segmentgroup"/>
  </restriction>
</simpleType>

<complexType name="SegmentReferenceType">
  <attribute name="segmentType" type="tva:segmentTypeType" default="segment"/>
  <attribute name="ref" type="tva:TVAIDRefType" use="required"/>
</complexType>

```

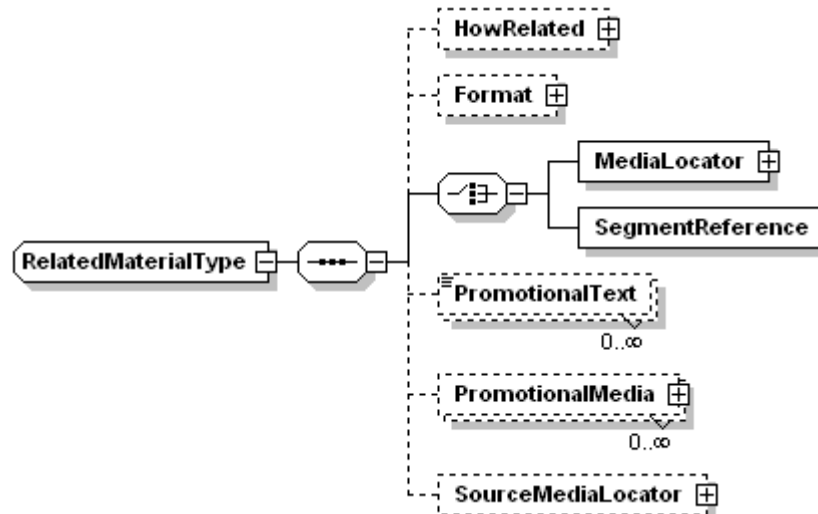

```

<complexType name="RelatedMaterialType">
  <sequence>
    <element name="HowRelated" type="tva:ControlledTermType"
      minOccurs="0"/>
    <element name="Format" type="tva:ControlledTermType"
      minOccurs="0"/>
    <choice>
      <element name="MediaLocator" type="mpeg7:MediaLocatorType"/>
      <element name="SegmentReference" type="tva:SegmentReferenceType"/>
    </choice>
    <element name="PromotionalText" type="mpeg7:TextualType"
      minOccurs="0" maxOccurs="unbounded"/>
    <element name="PromotionalMedia" type="mpeg7:TitleMediaType" minOccurs="0"
      maxOccurs="unbounded"/>
    <element name="SourceMediaLocator" type="mpeg7:MediaLocatorType"
      minOccurs="0"/>
  </sequence>
</complexType>

```

Name	Definition
segmentTypeType	A simple type which defines an enumerated list of segment reference types, with the following semantics: "segment" - The reference is to an element of type SegmentInformationType. "segmentgroup" - The reference is to an element of type SegmentGroupInformationType.
SegmentReferenceType	A complex type which describes a reference to a segment or segment group.
segmentType	Defines the type of data to which this reference points to.
ref	When segmentType is set to: "segment" - The "ref" attribute references a SegmentInformationType element with a "segmentId" value equal to that of "ref". "segmentgroup" - The "ref" attribute references a SegmentGroupInformationType element with a "groupId" value equal to that of "ref".
RelatedMaterialType	A complex type that refers to other media assets or segments that are related to the AV content (e.g. programme) that is described.
HowRelated	Specifies the nature of the relationship between the described AV content and the related media assets.
Format	Specifies the type (e.g. file format) of the media asset (optional). The format can either be specified as a free term, or chosen from the MPEG-7 "FileFormatCS" classification scheme listed in clause B.2.11 of ISO/IEC 15938-5 [2], or the MPEG-7 IPTCMimeTypeCS.
MediaLocator	Specifies the location of the media asset. Defined as an MPEG-7 datatype, MediaLocatorType (see clause 6.5.2 of ISO/IEC 15938-5 [2] for a detailed description).
SegmentReference	Specifies a segment or segment group.
PromotionalText	Provides promotional information about the link, which can be used as an additional attractor (e.g. record "Pride and Prejudice" series).
PromotionalMedia	Provide the possibility for non-text promotional information such as a logo.
SourceMediaLocator	Optionally specifies the location of the current content, to which this description is associated e.g. The trailer. Defined as an MPEG-7 datatype, MediaLocatorType (see clause 6.5.2 of ISO/IEC 15938-5 [2] for a detailed description).



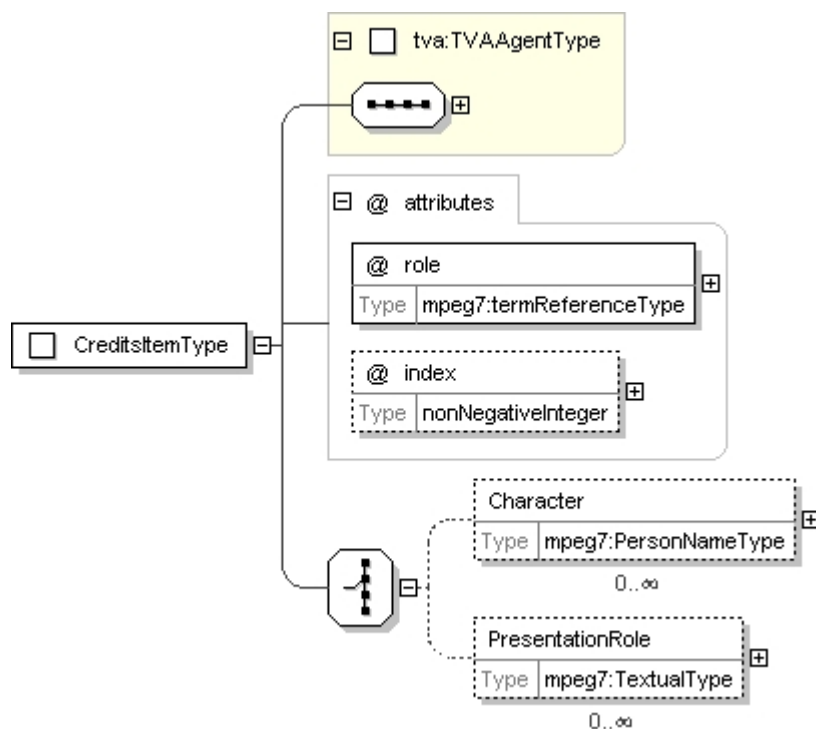

```

<complexType name="CreditsItemType">
  <complexContent>
    <extension base="tva:TVAAgentType">
      <choice>
        <element name="Character" type="mpeg7:PersonNameType"
          minOccurs="0" maxOccurs="unbounded"/>
        <element name="PresentationRole" type="mpeg7:TextualType" minOccurs="0"
          maxOccurs="unbounded"/>
      </choice>
      <attribute name="role" type="mpeg7:termReferenceType" use="required"/>
      <attribute name="index" type="nonNegativeInteger" use="optional"/>
    </extension>
  </complexContent>
</complexType>

<complexType name="CreditsListType">
  <sequence>
    <element name="CreditsItem" type="tva:CreditsItemType"
      minOccurs="0" maxOccurs="unbounded"/>
  </sequence>
</complexType>

```

Name	Definition
CreditsItemType	A tva complex type that defines one item for inclusion in a credits list for the specified programme based on an extension of the TVAAgentType.
Character	Specifies the name of a character played by an actor. Defined as an MPEG7 datatype, <i>PersonNameType</i> . (see ISO/IEC 15938-5 [2] for s detailed description).
PresentationRole	Allows the role played to be signalled explicitly as text (in addition to the controlled term signalled in the <i>role</i> attribute). The text indicates a preferred display label for the role
role	An attribute of a CreditsItem used to refer to a role classification term (e.g. actor, producer, director) using the MPEG7 termReferenceType.
index	Allows the order of the CreditsItem in a CreditsList to be specified explicitly. This enables CreditsItems from multiple different levels in the metadata hierarchy to be interleaved in a specific order.
CreditsListType	A complex type that defines a list of credits for the specified programme.
CreditsItem	An element of tva:CreditsItemType used to constitute a list of credits.

```

<complexType name="AwardType">
  <sequence>
    <element name="Category" type="mpeg7:TextualType"/>
    <choice minOccurs="0">
      <element name="Nominee" type="tva:CreditsItemType"/>
      <element name="Recipient" type="tva:CreditsItemType"/>
    </choice>
  </sequence>
</complexType>

```

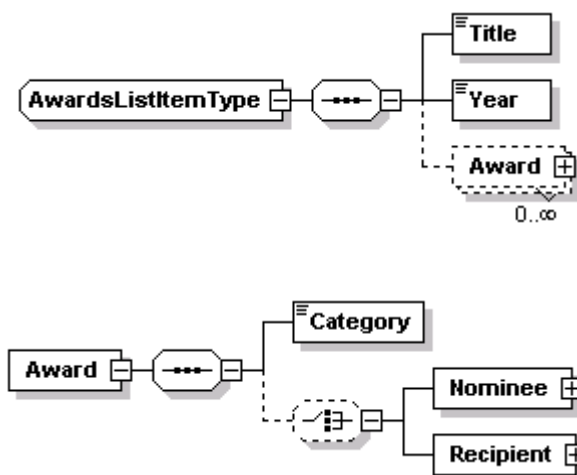

```

<complexType name="AwardsListItemType">
  <sequence>
    <element name="Title" type="mpeg7:TextualType"/>
    <element name="Year" type="gYear"/>
    <element name="Award" type="tva:AwardType" minOccurs="0" maxOccurs="unbounded"/>
  </sequence>
</complexType>

<complexType name="AwardsListType">
  <sequence>
    <element name="AwardsListItem" type="tva:AwardsListItemType"
      maxOccurs="unbounded"/>
  </sequence>
</complexType>

```

Name	Definition
AwardType	A complex type that defines an award that a programme has won, or been nominated for.
Category	Specifies the category in which the programme won the award or the nomination.
Nominee	Specifies the person(s) who won the nomination in the given category. Defined as a <i>TV-Anytime</i> datatype, <i>CreditsItemType</i> .
Recipient	Specifies the person(s) or the organization who won the award in the given category. Defined as a <i>TV-Anytime</i> datatype, <i>CreditsItemType</i> .
AwardsListItemType	A complex type that defines a list of the awards that the specified programme has won or been nominated for.
Title	Specifies the name or title of the award or the award organization (e.g. BAFTA, Oscar, etc.).
Year	Specifies the year when the programme won, or was nominated for, the award.
Award	Specifies detailed information about the particular award(s) of nomination(s) for the programme.
AwardsListType	A complex type that defines a list of awards and/or award nominations for the specified programme.
AwardsListItem	Describes the award(s) or nomination(s) from a single award organization.

```

<complexType name="ShortTitleType" >
  <simpleContent>
    <extension base="mpeg7:TitleType">
      <attribute name="length" type="unsignedShort" use="required"/>
    </extension>
  </simpleContent>
</complexType>

<complexType name="CaptionLanguageType">
  <simpleContent>
    <extension base="language">
      <attribute name="primary" type="boolean" use="optional"/>
      <attribute name="translation" type="boolean" use="optional"/>
      <attribute name="closed" type="boolean" use="optional"
        default="true"/>
      <attribute name="supplemental" type="boolean"
        use="optional" default="false"/>
    </extension>
  </simpleContent>
</complexType>

<complexType name="SignLanguageType">
  <simpleContent>
    <extension base="language">
      <attribute name="primary" type="boolean" use="optional"/>
      <attribute name="translation" type="boolean" use="optional"/>
      <attribute name="type" type="string" use="optional"/>
      <attribute name="closed" type="boolean" use="optional"/>
    </extension>
  </simpleContent>
</complexType>

<complexType name="CreationCoordinatesType">
  <sequence>
    <element name="CreationDate" type="tva:TVATimeType"
      minOccurs="0"/>
    <element name="CreationLocation" type="mpeg7:regionCode"
      minOccurs="0"/>
  </sequence>
</complexType>

```

```

<complexType name="TVAPlaceType">
  <complexContent>
    <extension base="mpeg7:PlaceType">
      <attribute name="fictional" type="boolean" use="optional" default="false"/>
    </extension>
  </complexContent>
</complexType>

<complexType name="DepictedCoordinatesType" >
  <sequence>
    <element name="DepictedDate" type="tva:TVATimeType"
      minOccurs="0"/>
    <element name="DepictedLocation" type="tva:TVAPlaceType"
      minOccurs="0"/>
  </sequence>
</complexType>

<complexType name="ReleaseDateType">
  <choice>
    <element name="DayAndYear" type="date"/>
    <element name="Year" type="gYear"/>
  </choice>
</complexType>

<complexType name="ReleaseInformationType">
  <sequence>
    <element name="ReleaseDate" type="tva:ReleaseDateType" minOccurs="0"/>
    <element name="ReleaseLocation" type="mpeg7:regionCode"
      minOccurs="0"/>
  </sequence>
</complexType>

```

Name	Definition
ShortTitleType	A complex type that defines a title with an associated length field.
length	Indicates the number of characters in the short title. The recommended maximum value of this required attribute is 80.
CaptionLanguageType	A complex type that defines the language in which the captions are presented and the type of caption. The text associated with this element indicates the language in which the captions are authored.
closed	Indicates whether the specified caption is closed. Default value of the attribute is true; if the attribute is set to false, then the provided caption description refers to open captions/subtitles.
supplemental	Indicates whether the captions provide descriptions of the scene for the benefit of hearing or visually impaired, in addition to a direct translation of the spoken words. Closed captions may include such descriptive information, such as speaker identification and non-speech sounds that would be missed.
SignLanguageType	A complex type that defines the language and type of Sign language. The text associated with this complex type indicates the natural language expressed by the sign language.
primary	Indicates if the sign language is the primary language of the content or not, i.e. if the content is produced specifically for the hearing impaired or not.
translation	Indicates if the sign language is a translation of the spoken dialogue or not.
type	Indicates the type (e.g. BSL – British Sign Language) of the specified sign language.
closed	A boolean attribute to indicate closed signing.
CreationCoordinatesType	A complex type that defines where and when the content

Name	Definition
	was created.
CreationDate	The date or period when the programme was created (optional). Defined as tva:TVATimeType.
CreationLocation	The location where the programme was created. Defined as an MPEG-7 datatype, regionCode (see clause 5.6.4 of ISO/IEC 15938-5 [2] for a detailed specification).
TVAPlaceType	A complex type defined as an extension to MPEG-7 datatype, PlaceType (see the tva_mpeg7_2008 stub and clause 7.5.2 of ISO/IEC 15938-5 [2] for a detailed specification).
fictional	A boolean attribute to specify if the place is purely fictional
DepictedCoordinatesType	A complex type that defines the location and date depicted within the content.
DepictedDate	The date or period when the programme was created (optional). Defined as tva:TVATimeType.
DepictedLocation	The location where the programme was created. Defined as a TVAPlaceType.
ReleaseDateType	A complex type that defines the date when the content was released.
DayAndYear	The day, month and year that the programme was released on.
Year	The year (only) that the programme was released in.
ReleaseInformationType	A complex type that defines the Release Information for the content.
ReleaseDate	The date when the programme was released.
ReleaseLocation	The country where the programme was released. Defined as an MPEG-7 datatype, regionCode (see clause 5.6.4 of ISO/IEC 15938-5 [2] for a detailed specification).

```

<complexType name="PurchaseType">
  <sequence>
    <element name="PurchaseType" type="tva:ControlledTermType"
      minOccurs="0"/>
    <element name="QuantityUnit" type="tva:ControlledTermType"
      minOccurs="0"/>
    <element name="QuantityRange" minOccurs="0">
      <complexType>
        <attribute name="min" type="unsignedInt" use="optional"/>
        <attribute name="max" type="unsignedInt" use="optional"/>
      </complexType>
    </element>
  </sequence>
</complexType>
<complexType name='DRMDeclarationType'>
  <sequence>
    <element name="DRM" type="anyURI" minOccurs="0"/>
    <choice>
      <element name="LicenseLocator" type="anyURI"/>
      <element name="LicenseExpression" type="string"/>
    </choice>
  </sequence>
</complexType>

```

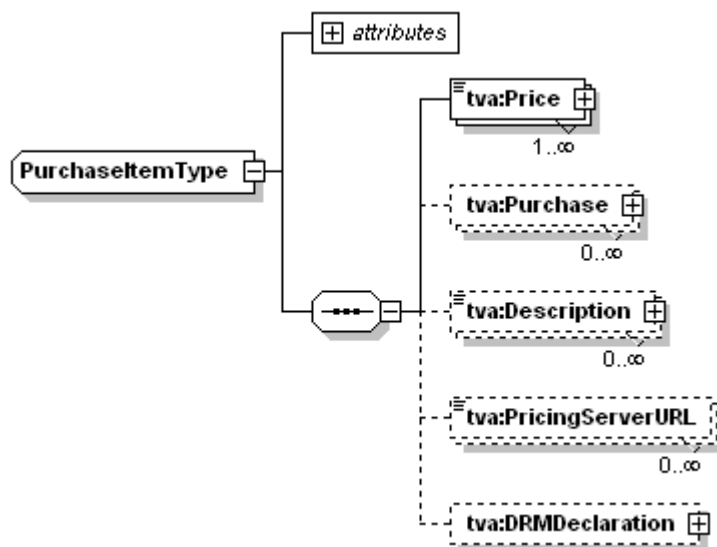

```

<complexType name="PurchaseItemType">
  <sequence>
    <element name="Price" type="tva:PriceType" maxOccurs="unbounded"/>
    <element name="Purchase" minOccurs="0" type="tva:PurchaseType"
      maxOccurs="unbounded"/>
    <element name="Description" type="mpeg7:TextualType" minOccurs="0"
      maxOccurs="unbounded"/>
    <element name="PricingServerURL" type="anyURI" minOccurs="0"
      maxOccurs="unbounded"/>
    <element name="DRMDeclaration" type="tva:DRMDeclarationType" minOccurs="0"/>
  </sequence>
  <attribute name="start" type="dateTime" use="optional"/>
  <attribute name="end" type="dateTime" use="optional"/>
</complexType>

```

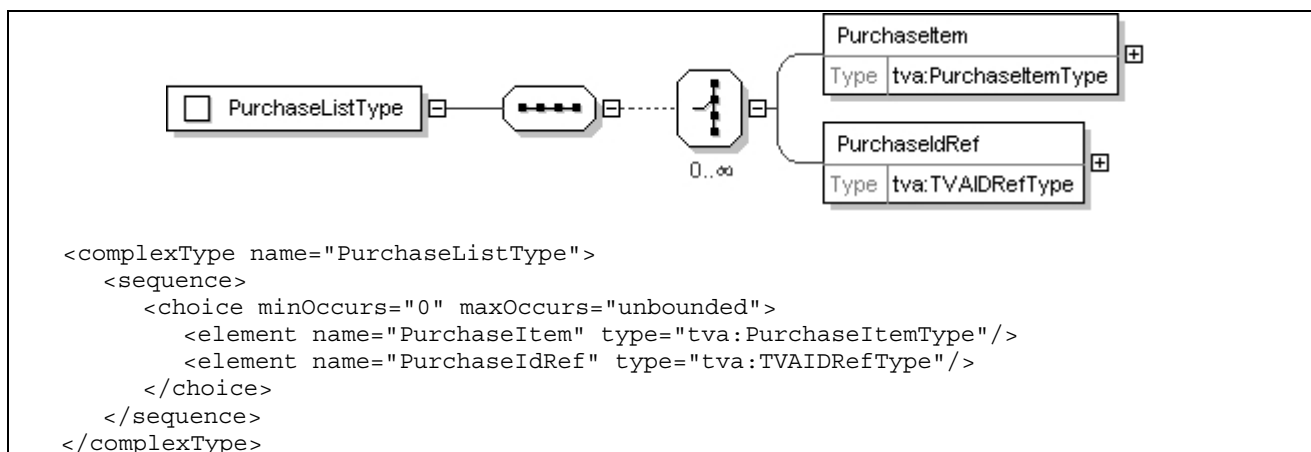

Name	Definition
PurchaseType	A complexType that describes a purchase model.
PurchaseType	Defines whether content is available forever, for a limited period of time, for a limited number of plays (see PurchaseTypeCS).
QuantityUnit	"Years, months and days" for a limited period of time and "Plays" for a limited number of plays (see UnitTypeCS).
QuantityRange	The value in years, months, days or plays.
min	Minimum value allocated.
max	Maximum value allocated.
DRMDeclarationType	A complex type to express digital rights management information.
DRM	A URL to access information on the digital rights management system in use.
LicenseLocator	A URL pointing to the licensing terms associated to content
LicenseExpression	A textual expression of the licensing terms associated to content.
PurchaseItemType	A complex type that describes an item with its associated pricing and availability information in duration of number of plays, as well as an access to a pricing server.
Price	The price proposed for this particular item. The same price can be expressed e.g. several times in different currencies.
Purchase	The conditions of availability. Multiple occurrences of the Purchase element shall be combined as a conjunction (an AND relationship).
Description	Description of the purchase item may include e.g. an explanation on the price.
PricingServerURL	A URL to access a pricing server from where more information can be retrieved on the commercial conditions content is being purchased, giving access to more complex transactional conditions, or triggering a secure transaction, which mechanisms are not defined in the TS 102 822 series of specifications.
DRMDeclaration	An element to provide additional digital rights information related to the item purchase.
start	The start time from when the purchase conditions are valid.
end	The end time after which the purchase conditions are not anymore valid.
PurchaseListType	A complex type to build a purchase list.
PurchaseItem	Description of a purchase item of PurchaseItemType.
PurchaseIDRef	Attributes an ID of TVAIDRefType to a purchase item.

```

<simpleType name="ExplanationLengthType">
  <restriction base="string">
    <enumeration value="short"/>
    <enumeration value="medium"/>
    <enumeration value="long"/>
  </restriction>
</simpleType>

<complexType name="ExplanationType">
  <simpleContent>
    <extension base="mpeg7:TextualType">
      <attribute name="length" type="tva:ExplanationLengthType" use="optional"/>
    </extension>
  </simpleContent>
</complexType>

<complexType name="TVAParentalGuidanceType">
  <complexContent>
    <extension base="mpeg7:ParentalGuidanceType">
      <sequence>
        <element name="ExplanatoryText" type="tva:ExplanationType" minOccurs="0"
          maxOccurs="unbounded"/>
      </sequence>
    </extension>
  </complexContent>
</complexType>

```

Name	Definition
ExplanationLengthType	A simple type to define three possible types of lengths for textual explanations. The possible values of this enumerated type are as follows: <i>short</i> - the length of the explanation will not exceed 90 characters. <i>medium</i> - the length of the explanation will not exceed 210 characters. <i>long</i> - the length of the explanation will not exceed 1200 characters.
ExplanationType	A complex type to define a textual explanation.
length	An attribute to specify the length of the explanation. This attribute is optional. If no length is specified, then the explanation may be of any length.
TVAParentalGuidanceType	A complexType that allows the use of parental guidance labelling from different guidance classification schemes.
ExplanatoryText	An optional editorial explanation for the Parental Guidance labelling. Multiple explanations may be provided in a variety of different languages and/or lengths.



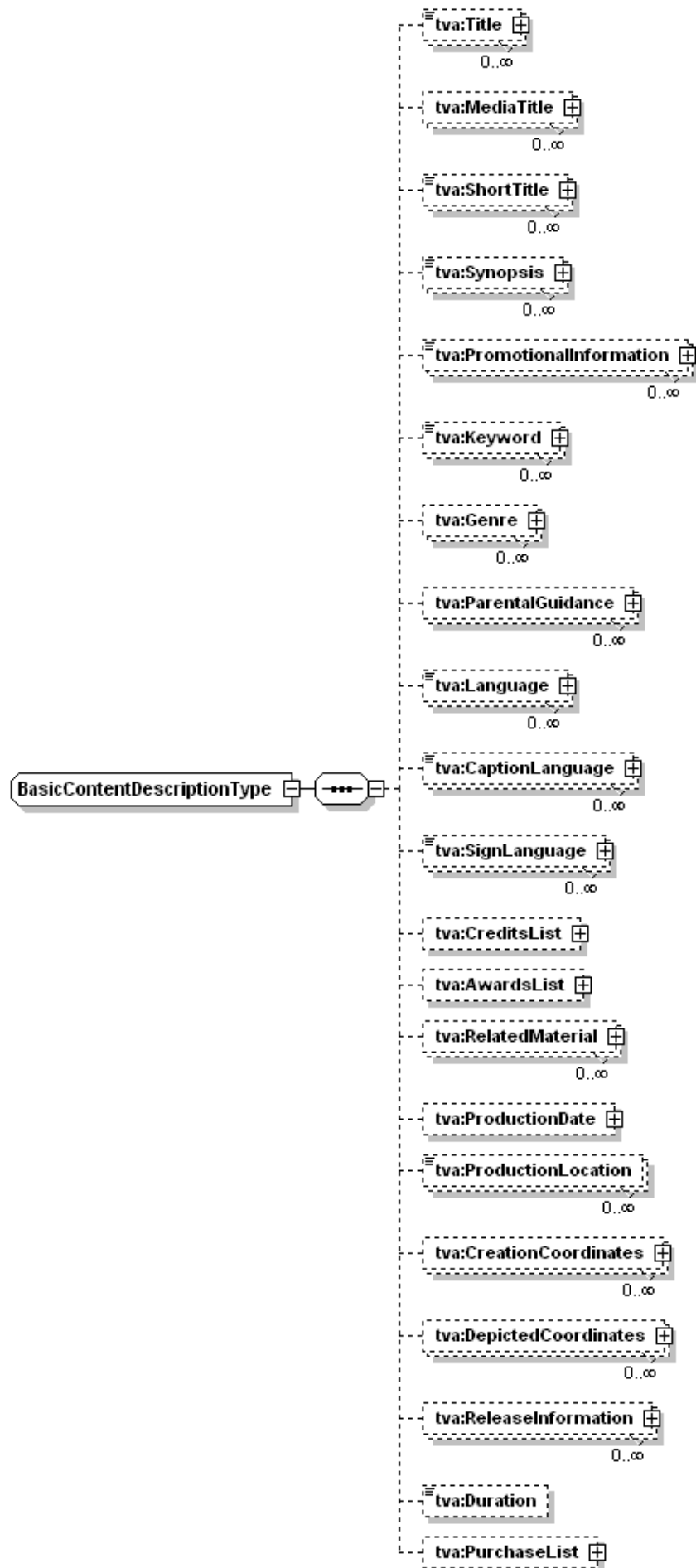

```

<complexType name="BasicContentDescriptionType">
  <sequence>
    <element name="Title" type="mpeg7:TitleType" minOccurs="0"
      maxOccurs="unbounded"/>
    <element name="MediaTitle" type="mpeg7:TitleMediaType"
      minOccurs="0" maxOccurs="unbounded"/>
    <element name="ShortTitle" type="tva:ShortTitleType" minOccurs="0"
      maxOccurs="unbounded"/>
    <element name="Synopsis" type="tva:SynopsisType" minOccurs="0"
      maxOccurs="unbounded"/>
    <element name="PromotionalInformation" type="mpeg7:TextualType"
      minOccurs="0" maxOccurs="unbounded"/>
    <element name="Keyword" type="tva:KeywordType" minOccurs="0"
      maxOccurs="unbounded"/>
    <element name="Genre" type="tva:GenreType" minOccurs="0"
      maxOccurs="unbounded"/>
    <element name="ParentalGuidance"
      type="tva:TVAParentalGuidanceType" minOccurs="0"
      maxOccurs="unbounded"/>
    <element name="Language" type="mpeg7:ExtendedLanguageType"
      minOccurs="0" maxOccurs="unbounded"/>
    <element name="CaptionLanguage" type="tva:CaptionLanguageType" minOccurs="0"
      maxOccurs="unbounded"/>
    <element name="SignLanguage" type="tva:SignLanguageType" minOccurs="0"
      maxOccurs="unbounded"/>
    <element name="CreditsList" type="tva:CreditsListType"
      minOccurs="0"/>
    <element name="AwardsList" type="tva:AwardsListType"
      minOccurs="0"/>
    <element name="RelatedMaterial" type="tva:RelatedMaterialType"
      minOccurs="0" maxOccurs="unbounded"/>
    <element name="ProductionDate" type="tva:TVATimeType"
      minOccurs="0"/>
    <element name="ProductionLocation" type="mpeg7:regionCode"
      minOccurs="0" maxOccurs="unbounded"/>
    <element name="CreationCoordinates" type="tva:CreationCoordinatesType"
      minOccurs="0"
      maxOccurs="unbounded"/>
    <element name="DepictedCoordinates" type="tva:DepictedCoordinatesType"
      minOccurs="0"
      maxOccurs="unbounded"/>
    <element name="ReleaseInformation" type="tva:ReleaseInformationType" minOccurs="0"
      maxOccurs="unbounded"/>
    <element name="Duration" type="duration" minOccurs="0"/>
    <element name="PurchaseList" type="tva:PurchaseListType" minOccurs="0"/>
  </sequence>
</complexType>

```

Name	Definition
BasicContentDescriptionType	A complex type that defines standard programme description elements.
Title	A title of the programme. A programme can have multiple titles, e.g. in different languages. Defined as an MPEG-7 datatype, TitleType (see clause 9.2.2 in ISO/IEC 15938-5 [2] for a detailed specification).
MediaTitle	A media asset (e.g. image) that can be used as a "title" for a programme. Content that is not part of the original programme can be specified and used as a (promotional) AV title. Defined as an MPEG-7 datatype, TitleMediaType (see clause 9.2.2 in ISO/IEC 15938-5 [2] for a detailed specification).
ShortTitle	A shortened version of the programme title that defines how the title should be truncated for presentation purposes.

Name	Definition
Synopsis	A textual description of the programme.
PromotionalInformation	A textual description containing promotional information.
Keyword	A list of keywords for the programme. A keyword can be a single word or an entire phrase made up of multiple words. Defined as a <i>TV-Anytime</i> datatype, <i>KeywordType</i> .
Genre	A genre for the programme. The thesaurus in annex B defines the normative <i>TV-Anytime</i> set of genres.
TVAParentalGuidance	A parental rating code for the programme. Defined as an <i>TV-Anytime</i> extension to the MPEG-7 datatype, <i>ParentalGuidanceType</i> (see clause 9.2.3 of ISO/IEC 15938-5 [2] for a detailed specification).
Language	Describes one spoken language for the programme. There may be more than one spoken language specified for a programme.
CaptionLanguage	Describes one language of the caption information included with the programme. The type of the caption information associated with the programme is denoted by the closed attribute. Closed captions can be turned on or off by the user, while open captions (or subtitles) are part of the picture itself and remain visible.
SignLanguage	Specifies the sign language provided for the multimedia content and, optionally, qualifies the use of signing as a primary language and/or as a translation of the spoken dialogue.
CreditsList	The list of credits (e.g. actors, directors, etc.) for the programme.
AwardsList	The list of awards and/or award nominations for the programme.
RelatedMaterial	A reference to any other material related to a programme.
ProductionDate	The date or time period when the programme was produced, defined as a <i>tva:TVATimeType</i> .
ProductionLocation	The country in which the programme was produced. Defined as an MPEG-7 datatype, <i>regionCode</i> (see clause 5.6.4 of ISO/IEC 15938-5 [2] for a detailed specification).
CreationCoordinates	Describes the location(s) and date(s) of creation of the programme (optional).
DepictedCoordinates	Describes the location(s) and date(s) depicted in the programme (optional).
ReleaseInformation	Information about the country and date of release of a programme.
Duration	Indicates the approximate duration of the programme.
PurchaseList	A list of purchase items.

### 6.3.5 Audio and video information

The following simple and complex types define technical attributes of audio and video.

```
<complexType name="BitRateType">
  <simpleContent>
    <extension base="nonNegativeInteger">
      <attribute name="variable" type="boolean"
        use="optional" default="false"/>
      <attribute name="minimum" type="unsignedLong"
        use="optional"/>
      <attribute name="average" type="unsignedLong"
        use="optional"/>
      <attribute name="maximum" type="unsignedLong"
        use="optional"/>
    </extension>
  </simpleContent>
</complexType>
```

```

<complexType name="AudioLanguageType">
  <simpleContent>
    <extension base="mpeg7:ExtendedLanguageType">
      <attribute name="purpose" type="mpeg7:termReferenceType" use="optional"/>
    </extension>
  </simpleContent>
</complexType>

```

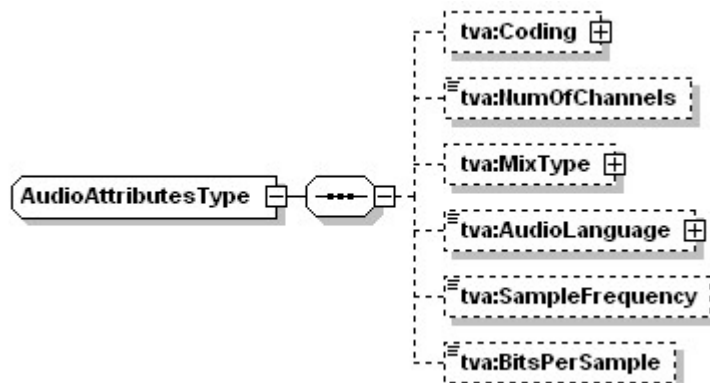

```

<complexType name="AudioAttributesType">
  <sequence>
    <element name="Coding" type="tva:ControlledTermType"
      minOccurs="0"/>
    <element name="NumOfChannels" type="unsignedShort"
      minOccurs="0"/>
    <element name="MixType" type="tva:ControlledTermType"
      minOccurs="0"/>
    <element name="AudioLanguage" type="tva:AudioLanguageType"
      minOccurs="0"/>
    <element name="SampleFrequency" type="unsignedInt"
      minOccurs="0"/>
    <element name="BitsPerSample" type="unsignedInt"
      minOccurs="0"/>
  </sequence>
</complexType>

```

```

<simpleType name="FrameRateType">
  <restriction base="string">
    <pattern value="([0-9]{1,3}([.][0-9]{1,3})?)|([0-9]{1,3}/1.001)"/>
  </restriction>
</simpleType>

```

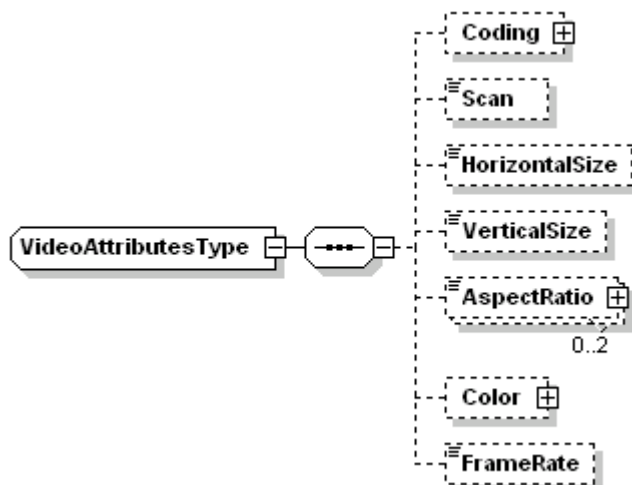

```

<complexType name="VideoAttributesType" >
  <sequence>
    <element name="Coding" type="tva:ControlledTermType"

```

```

minOccurs="0"/>
<element name="Scan" type="tva:ScanType" minOccurs="0"/>
<element name="HorizontalSize" type="unsignedShort"
minOccurs="0"/>
<element name="VerticalSize" type="unsignedShort"
minOccurs="0"/>
<element name="AspectRatio" type="tva:AspectRatioType"
minOccurs="0" maxOccurs="2"/>
<element name="Color" type="tva:ColorType" minOccurs="0"/>
<element name="FrameRate" type="tva:FrameRateType" minOccurs="0"/>
</sequence>
</complexType>

<complexType name="CaptioningAttributesType">
<sequence>
<element name="Coding" type="tva:ControlledTermType" minOccurs="0"/>
</sequence>
</complexType>

```

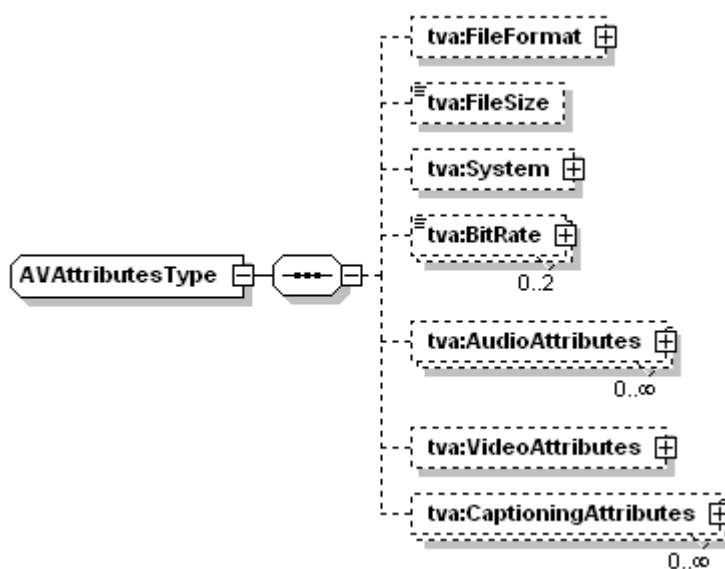

```

<complexType name="AVAttributesType">
<sequence>
<element name="FileFormat" type="tva:ControlledTermType"
minOccurs="0"/>
<element name="FileSize" type="unsignedLong" minOccurs="0"/>
<element name="System" type="tva:ControlledTermType"
minOccurs="0"/>
<element name="BitRate" type="tva:BitRateType" minOccurs="0" maxOccurs="2"/>
<element name="AudioAttributes" type="tva:AudioAttributesType" minOccurs="0"
maxOccurs="unbounded"/>
<element name="VideoAttributes" type="tva:VideoAttributesType" minOccurs="0"/>
<element name="CaptioningAttributes" type="tva:CaptioningAttributesType"
minOccurs="0" maxOccurs="unbounded"/>
</sequence>
</complexType>

<simpleType name="ScanType">
<restriction base="string">
<enumeration value="interlaced"/>
<enumeration value="progressive"/>
</restriction>
</simpleType>

<simpleType name="ColorTypeType">
<restriction base="string">
<enumeration value="color"/>

```

```

    <enumeration value="blackAndWhite"/>
    <enumeration value="blackAndWhiteAndColor"/>
    <enumeration value="colorized"/>
  </restriction>
</simpleType>

<complexType name="ColorType">
  <attribute name="type" type="tva:ColorTypeType" use="required"/>
</complexType>

<simpleType name="RatioType">
  <restriction base="string">
    <pattern value="\d+:\d+"/>
  </restriction>
</simpleType>

<complexType name="AspectRatioType">
  <simpleContent>
    <extension base="tva:RatioType">
      <attribute name="type" use="optional" default="original">
        <simpleType>
          <restriction base="string">
            <enumeration value="original"/>
            <enumeration value="publication"/>
          </restriction>
        </simpleType>
      </attribute>
    </extension>
  </simpleContent>
</complexType>

```

Name	Definition
BitRateType	A complex type that defines the bit rate for a content item. The data value associated with this type defines the average bitrate if the bitrate is variable.
variable	Indicates whether the BitRate is variable or fixed. If the BitRate is variable, three optional attributes can be used to specify the minimum, maximum and average bitrates.
minimum	Indicates the minimum numerical value for the BitRate in case of variable bit rate.
average	Indicates the average numerical value for the BitRate in case of variable bit rate.
maximum	Indicates the maximum numerical value for the BitRate in case of variable bit rate.
AudioLanguageType	A complex type that defines the spoken word of the audio and its intended purpose.
purpose	A controlled term used to define the purpose of the audio track. For example "Audio Description", Directors Commentary. By default the system shall make use of the AudioPurposeCS.
AudioAttributesType	A complex type that describe audio characteristics.
Coding	The coding format of the audio. This term should be taken from the MPEG-7 "AudioCodingFormatCS" classification scheme listed in clause B.2.3 of ISO/IEC 15938-5 [2], i.e. AC3, DTS, MP3, MPEG-1, MPEG-2 Layer III, MPEG-2 AAC, MPEG-4, AMR.
NumOfChannels	The number of channels of audio: e.g. 1 for mono, 2 for stereo or more for multi-channel audio.
MixType	The type of the audio mix. This term should be taken from the MPEG-7 "AudioPresentationCS" ClassificationScheme listed in clause B.2.6 of ISO/IEC 15938-5 [2], i.e. no sound, mono, stereo, surround, home theatre 5.1 and movie theatre.
AudioLanguage	The spoken language of the audio.
sampleFrequency	An attribute to specify the rate at which the audio material is being sampled.

Name	Definition
bitsperSample	An attribute to specify the encoding depth or the number of bits allocated to the encoding of each audio sample.
FrameRateType	A simple type that allows video frame rates to be specified. The string may be either used directly for presentation; or be converted to a numerical value for processing. In case the precise numerical value of a 30/1.001 or 60/1.001 system is intended, then it is recommended to use the form "30/1.001" resp. "60/1.001". This does not allow to signal the precise numerical value of 16 2/3 and other values. As an example, table 1 gives an indicative list of systems and frame rates used for television. FrameRateType can be used to express frame rates of other systems e.g. personal computers, personal digital assistants or mobile phones.
VideoAttributesType	A complex type defining a set of elements that describe video characteristics.
Coding	The coding format of the video. This term should be taken from the MPEG-7 "VisualCodingFormatCS" classification scheme listed in clause B.2.34 of ISO/IEC 15938-5 [2].
Scan	The scan type of the video.
HorizontalSize	The horizontal size in pixels of the video.
VerticalSize	The vertical size in pixels of the video.
AspectRatio	The aspect ratio of the video. There may be two aspect ratios associated with a programme: the original aspect ratio that the programme is available in and the aspect ratio of a particular instance of the programme.
Color	The colour format of the video (e.g. black and white).
FrameRate	An element expressing the frame rate of the video.
CaptioningAttributesType	A complex type describing captioning characteristics.
Coding	The coding format used for captioning and defined as a term extracted from a predefined list in a classification scheme (CaptionCodingFormatCS).
AVAttributesType	A complex type defining a set of elements describing audio and/or video using the AudioAttributes and VideoAttributes.
FileFormat	Describes the file format of the programme instance.
FileSize	Indicates the size, in bytes, of the file where the programme instance is stored.
System	Describes the broad media format of the programme instance. This term should be taken from the MPEG-7 "SystemCS" classification scheme listed in clause B.2.30 of ISO/IEC 15938-5 [2].
BitRate	Indicates the nominal bit rate in bits/s of the programme instance.
AudioAttributes	Describes the audio characteristics.
VideoAttributes	Describes the video characteristics.
CaptioningAttributes	An element to describe the technical attributes of subtitles.
ScanType	A simple enumerated type defining the allowable values of the ScanType element above. ScanType can take on the value interlaced or progressive.
ColorTypeType	A simple enumerated type defining the allowable values of the ColorType instantiated in the Color element above. Allowed values are: color - the content was produced using a colour video format. blackAndWhite - the content was produced using a black and white video format. blackAndWhiteAndColor - the content contains a mixture of video that was originally produced in colour and content that was produced in black and white. colorized - the content was originally produced using a black and white video format and colour was added after original production.
ColorType	A complex type, with a single attribute describing the colour format using one of the ColorTypeType values.
type	The type of colour format.

Name	Definition
RatioType	A data type that allows ratios to be specified in the form "h:v" where h and v represent horizontal and vertical dimensions, respectively.
AspectRatioType	Denotes the aspect ratio of the programme. This element can denote the aspect ratio of the original programme as well as that of its instances, through the use of type attribute.
type	Denotes whether the specified aspect ratio is associated with the original programme (original) or its published instance (publication). The default value of the attribute is original.

**Table 1: Indicative list of Television systems and frame rates**

System Nomenclature	Frame rate (Hz)
1 920 x 1 080 / 60 / P	60
1 920 x 1 080 / 59,94 / P	60 / 1,001
1 920 x 1 080 / 50 / P	50
1 920 x 1 080 / 60 / I	30
1 920 x 1 080 / 59,94 / I	30 / 1,001
1 920 x 1 080 / 50 / I	50
1 920 x 1 080 / 30 / P	30
1 920 x 1 080 / 29,97 / P	30 / 1,001
1 920 x 1 080 / 25 / P	25
1 920 x 1 080 / 24 / P	24
1 920 x 1 080 / 23,98 / P	24 / 1,001
1 280 x 720 / 24 / P	24
1 280 x 720 / 25 / P	25
1 280 / 30 / P	30
1 280 / 50 / P	50
1 280 / 59,94 / P	60 / 1,001

### 6.3.6 Programme information

```

<complexType name="AggregationOfType">
  <sequence>
    <element name="AggregatedProgram" type="tva:CRIDRefType"
      minOccurs="2" maxOccurs="unbounded"/>
  </sequence>
  <attribute name="type" use="required">
    <simpleType>
      <restriction base="string">
        <enumeration value="omnibus"/>
        <enumeration value="magazine"/>
        <enumeration value="split"/>
      </restriction>
    </simpleType>
  </attribute>
</complexType>

```



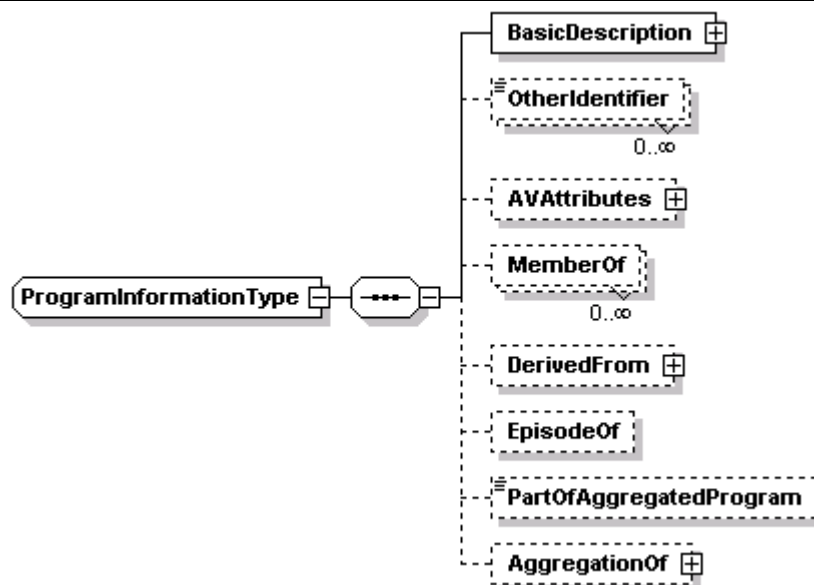

```

<complexType name="ProgramInformationType">
  <sequence>
    <element name="BasicDescription"
      type="tva:BasicContentDescriptionType"/>
    <element name="OtherIdentifier" type="mpeg7:UniqueIDType"
      minOccurs="0" maxOccurs="unbounded"/>
    <element name="AVAttributes" type="tva:AVAttributesType"
      minOccurs="0"/>
    <element name="MemberOf" type="tva:BaseMemberOfType"
      minOccurs="0" maxOccurs="unbounded"/>
    <element name="DerivedFrom" type="tva:DerivedFromType"
      minOccurs="0"/>
    <element name="EpisodeOf" type="tva:EpisodeOfType"
      minOccurs="0"/>
    <element name="PartOfAggregatedProgram" type="tva:CRIDType"
      minOccurs="0"/>
    <element name="AggregationOf" type="tva:AggregationOfType" minOccurs="0"/>
  </sequence>
  <attribute name="programId" type="tva:CRIDType" use="required"/>
  <attributeGroup ref="tva:fragmentIdentification"/>
  <attribute name="metadataOriginIDRef" type="tva:TVAIDRefType" use="optional"/>
  <attribute ref="xml:lang" use="optional"/>
</complexType>

<complexType name="EpisodeOfType">
  <complexContent>
    <extension base="tva:BaseMemberOfType"/>
  </complexContent>
</complexType>

<complexType name="BaseMemberOfType" abstract="true">
  <complexContent>
    <extension base="tva:CRIDRefType">
      <attribute name="index" type="unsignedInt" use="optional"/>
    </extension>
  </complexContent>
</complexType>

<complexType name="MemberOfType">
  <complexContent>
    <extension base="tva:BaseMemberOfType"/>
  </complexContent>
</complexType>

<complexType name="BaseDerivationReasonType" abstract="true"/>

```

```
<complexType name="DerivationReasonType">
  <complexContent>
    <extension base="tva:BaseDerivationReasonType">
      <attribute name="value" use="required">
        <simpleType>
          <restriction base="string">
            <enumeration value="violence"/>
            <enumeration value="language"/>
            <enumeration value="sex"/>
            <enumeration value="duration"/>
            <enumeration value="other"/>
          </restriction>
        </simpleType>
      </attribute>
    </extension>
  </complexContent>
</complexType>

<complexType name="GenericDerivationReasonType">
  <complexContent>
    <extension base="tva:BaseDerivationReasonType">
      <sequence>
        <element name="Classifier" type="tva:ControlledTermType" minOccurs="0"
          maxOccurs="unbounded"/>
        <element name="Description" type="mpeg7:TextualType" maxOccurs="unbounded"/>
      </sequence>
    </extension>
  </complexContent>
</complexType>

<complexType name="DerivedFromType">
  <complexContent>
    <extension base="tva:BaseMemberOfType">
      <sequence>
        <element name="DerivationReason"
          type="tva:GenericDerivationReasonType" minOccurs="0"
          maxOccurs="unbounded"/>
      </sequence>
    </extension>
  </complexContent>
</complexType>
```

Name	Definition
AggregationOfType	A complex type that describes an aggregated programme.
AggregatedProgram	An element of CRIDRefType pointing to an aggregated programme to which this programme belongs to.
type	<p>An aggregated programme can be of two distinct types:</p> <ul style="list-style-type: none"> <li>* Omnibus: an omnibus programme is defined as a single programme that contains a sequence of individual programmes that may be edited to provide a coherent single programme. It is typically used to provide a summary of a week's episodes of a daily series.</li> <li>* Magazine: a magazine programme is a programme in its own right that contains other, definite smaller programmes. One example is a children's magazine programme which contains live studio material along with cartoons or episodes of a children's drama programme.</li> <li>* Split: a single logical programme that is split into multiple parts for convenience. For example a film that is presented in two parts with a scheduled news bulletin interrupting in the middle. The individual parts of the original programme each have their own ProgramInformation with corresponding instance metadata and/or Content Referencing Information. The ProgramInformation representing the whole programme may have its own instance metadata and/or Content Referencing Information if it can also be acquired as a single, uninterrupted unit.</li> </ul>
ProgramInformationType	A complex type that describes a programme.
BasicDescription	The description of the programme.
OtherIdentifier	A code that can be used in addition to the CRID to identify a piece of content (e.g. an ISAN to identify a piece of content or an episode or a version thereof) as different CRIDs can be allocated to identical content.
AVAttributes	Audio-visual attributes that are applicable to the programme as originated.
MemberOf	Indicates group membership of a programme - for a reason other than the special cases of derivation (see DerivedFrom) or being an episode of a series (see EpisodeOf).
DerivedFrom	Indicates that a programme is derived from another programme (e.g. by reducing violent scenes) or possibly a programme concept (see ProgramGroupTypeType).
EpisodeOf	Indicates a series from which the current programme is an episode.
PartOfAggregatedProgram	An element used to specify that content is part of an aggregated programme, e.g. an Omnibus or a Magazine.
AggregationOf	An element indicating programmes aggregated by this programme
programId	The CRID for the programme.
fragmentIdentification	Used to identify the fragment of data to which this description belongs to.
metadataOriginIDRef	A reference to an instance of MetadataOriginationInformation containing information about the provider of metadata.
xml:lang	The default natural language of the description.
EpisodeOfType	A complex type used to indicate membership of a series. It instantiates BaseMemberOfType and is usually instantiated by the EpisodeOf element. In the unusual case of a programme that is a member of more than one series, EpisodeOfType may be instantiated by MemberOf (using xsi:type).
BaseMemberOfType	An abstract type, based on CRIDReferenceType, that references a group (or possibly, in the case of DerivedFrom, a programme).
index	An index for the programme within the specified group. This would be used, for example, to specify an episode number for a programme in a series.

Name	Definition
MemberOfType	A complex type used to indicate membership of a group for a reason other than the special cases of derivation (see DerivedFrom) or being an episode of a series (see EpisodeOf). MemberOfType instantiates BaseMemberOfType and is instantiated by the MemberOf element (using xsi:type). It is expected that as the specification evolves other types that can be instantiated by MemberOf will be defined.
BaseDerivationReasonType	An abstract type for defining programme derivation criteria.
DerivationReasonType	An enumerated list of the default TVA criteria for deriving a programme version from a programme concept.
value	Permitted values are violence, language, sex, duration and other.
GenericDerivationReasonType	An extension to the BaseDerivationReasonType to allow using criteria from a list of terms in a classification scheme for deriving a programme version from a programme concept.
Classifier	A URI pointing to a criteria for derivation from a classification scheme.
Description	A textual definition for the criteria for derivation.
DerivedFromType	A complex type used to indicate that a programme has been derived from a programme or a programme concept (see ProgramGroupTypeType). It instantiates BaseMemberOfType and is instantiated by DerivedFrom.
DerivationReason	The reason for the derivation of the programme version.

### 6.3.7 Group Information

```

<complexType name="BaseProgramGroupTypeType" abstract="true"/>
<complexType name="ProgramGroupTypeType">
  <complexContent>
    <extension base="tva:BaseProgramGroupTypeType">
      <attribute name="value" use="required">
        <simpleType>
          <restriction base="string">
            <enumeration value="series"/>
            <enumeration value="show"/>
            <enumeration value="programConcept"/>
            <enumeration value="programCompilation"/>
            <enumeration value="otherCollection"/>
            <enumeration value="otherChoice"/>
            <enumeration value="mini-series"/>
            <enumeration value="brand"/>
            <enumeration value="automaticAcquisitionThemed"/>
            <enumeration value="automaticAcquisitionNonThemed"/>
          </restriction>
        </simpleType>
      </attribute>
    </extension>
  </complexContent>
</complexType>

```

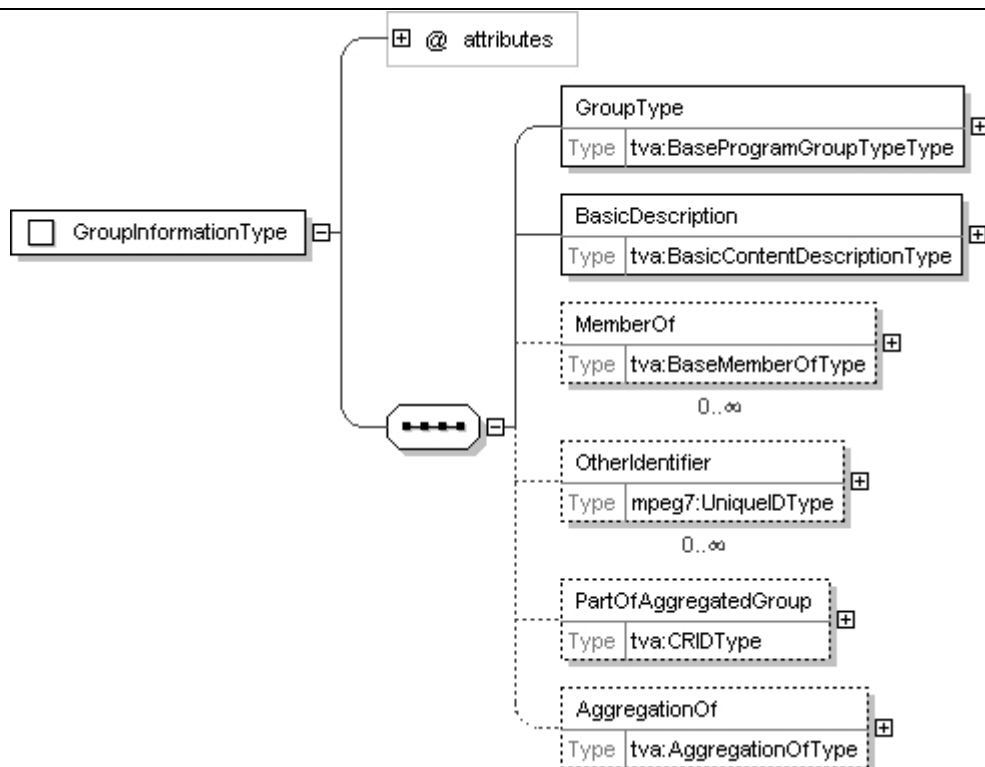

```

<complexType name="GroupInformationType">
  <sequence>
    <element name="GroupType" type="tva:BaseProgramGroupTypeType"/>
    <element name="BasicDescription"
      type="tva:BasicContentDescriptionType"/>
    <element name="MemberOf" type="tva:BaseMemberOfType" minOccurs="0"
      maxOccurs="unbounded"/>
    <element name="OtherIdentifier" type="mpeg7:UniqueIDType" minOccurs="0"
      maxOccurs="unbounded"/>
    <element name="PartOfAggregatedGroup" type="tva:CRIDType" minOccurs="0"/>
    <element name="AggregationOf" type="tva:AggregationOfType" minOccurs="0"/>
  </sequence>
  <attribute name="groupId" type="tva:CRIDType" use="required"/>
  <attribute name="ordered" type="boolean" default="false"
    use="optional"/>
  <attribute name="numOfItems" type="unsignedInt" use="optional"/>
  <attributeGroup ref="tva:fragmentIdentification"/>
  <attribute name="metadataOriginIDRef" type="tva:TVAIDRefType" use="optional"/>
  <attribute ref="xml:lang" use="optional"/>
  <attribute name="serviceIDRef" type="tva:TVAIDRefsType" use="optional"/>
</complexType>

```

Name	Definition
BaseProgramGroupTypeType	An abstract type for defining programme grouping criteria.
ProgramGroupTypeType	An enumerated list of the TVA-defined programme groups.
value	<p>The allowed values for this field are as follows:</p> <p><i>series</i> - an ordered or unordered collection of programmes that is shown in a sequence (e.g. "Friends" season 1, episodes "1 to n"). An unbounded series (e.g. an ongoing drama series) may be considered to be a serial.</p> <p><i>show</i> - a programme theme that is typically be associated with a collection of series (e.g. all episodes of Friends).</p> <p><i>programConcept</i> - the editorial concept for a programme from which specific programme versions have been derived (e.g. the concept of "Blood Runner" as opposed to "Blood Runner - The Director's Cut" as a specific version of that concept).</p> <p><i>programCompilation</i> - a collection of programmes that is used to allow segments from multiple programmes to be combined in segment groups. When used in conjunction with segmentation information, a programCompilation programme group allows, for example, several related news segments from different news programmes to be grouped for playback in sequence.</p> <p><i>otherCollection</i> - can be used for any group not defined in the preceding list where all members of the group should be acquired if the group is selected. It can also be used to define a "magazine" - a collection of individual programmes that are shown as a group because they are editorially coherent (e.g. a general sports programme with individual sub-programmes covering different events)</p> <p><i>otherChoice</i> - can be used for any other grouping of content not represented in the list above and from where only one member of the group should be acquired is the group is selected.</p> <p><i>mini-series</i> - a series consisting of a limited number of programmes (typically 2 or 3) screened over a short period of time (e.g. on consecutive days); these may be based on a literary work or have some other theme where it is important that all of the programmes be viewed and that they be viewed in sequence.</p> <p><i>brand</i> - an overarching group representing a marketing brand. Such a group may contain groups of any other type or programmes that share the same branding, for example a show and its spin-off series. All members should be acquired if the group is selected.</p> <p><i>automaticAcquisitionThemed</i> - a collection of events related by some editorial policy that shall be acquired automatically. All members of the group should be acquired.</p> <p><i>automaticAcquisitionNonThemed</i> - a collection of events that are not editorially related which shall be acquired automatically. All members of the group should be acquired.</p>
GroupInformationType	A complex type to describe a group.
GroupType	The type of the group (e.g. series) - required.
BasicDescription	The description of the group.
MemberOf	A list of other groups of which this group is a member.
OtherIdentifier	An optional additional identifier to identify the group of programmes.
PartOfAggregatedGroup	An element used to specify that the group is part of another aggregated group, such as an Omnibus or a Magazine, in particular when both groups are of type programConcept .
AggregationOf	An element indicating content aggregated by this group.
groupId	A unique CRID that identifies the group.
ordered	Optional boolean flag that indicates whether or not the

Name	Definition
	group is ordered (false by default). If ordered is "true" the index attribute of the related MemberOf element must be specified.
numOfItems	Optional indication of the total number of members in the group. This is of significance for series where an episode needs to be referred to as episode # of n.
fragmentIdentification	Used to identify the fragment of data to which this description belongs to.
metadataOriginIDRef	A reference to an instance of MetadataOriginationInformation containing information about the provider of metadata.
xml:lang	The default natural language of the description.
serviceIDRef	A reference to the service owning the group of programme (e.g. a particular programme concept or a series).

### 6.3.8 Media Review DS

The MediaReview DS provides third-party reviews of AV content, such as a critic's review of a movie. Independent programme reviews can be presented to users to aid them in programme selection.

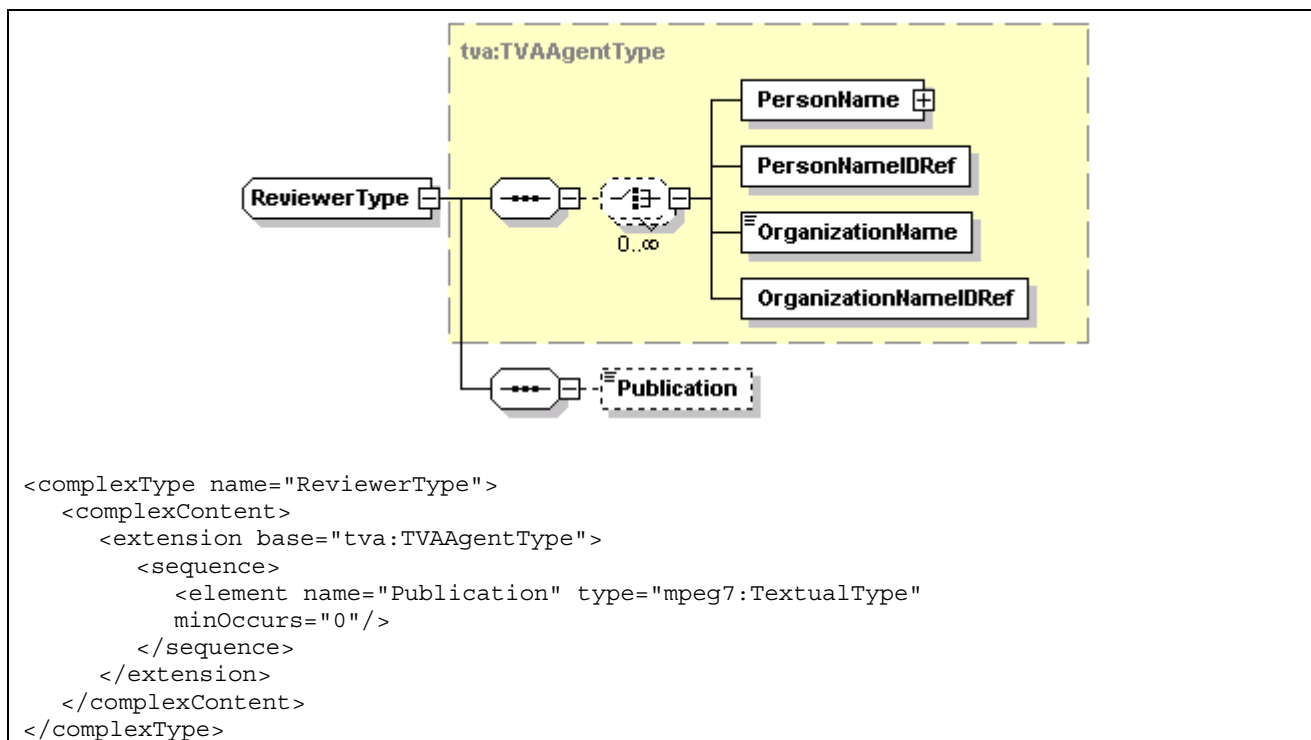

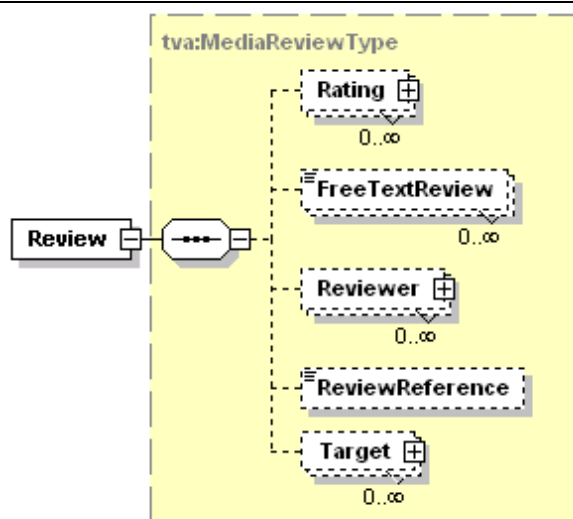

```

<complexType name="MediaReviewType">
  <sequence>
    <element name="Rating" type="mpeg7:RatingType" minOccurs="0"
      maxOccurs="unbounded"/>
    <element name="FreeTextReview" type="mpeg7:TextualType"
      minOccurs="0" maxOccurs="unbounded"/>
    <element name="Reviewer" type="tva:ReviewerType" minOccurs="0"
      maxOccurs="unbounded"/>
    <element name="ReviewReference" type="anyURI" minOccurs="0"/>
    <element name="Target" type="mpeg7:UserIdentifierType" minOccurs="0"
      maxOccurs="unbounded"/>
  </sequence>
</complexType>

```

Name	Definition
ReviewerType	A TV-Anytime complex type based on the TVAAgentType to specify a reviewer.
Publication	Specifies the name of a publication. Defined as an MPEG7 datatype, TextualType (See ISO/IEC 15938-5 [2] for a detailed description).
MediaReviewType	Describes a review for a given multimedia content.
Rating	Specifies the rating value and criterion used in the review. Defined as an MPEG-7 datatype, RatingType (see clause 8.1.6 of ISO/IEC 15938-5 [2] for a detailed description).
FreeTextReview	Describes a free-text review of the multimedia content without reference to a rating scheme. There can be multiple instances of the review, each in a different language. Defined as an MPEG-7 datatype, TextualType (see clause 7.3.1.1 of ISO/IEC 15938-5 [2] for a detailed description).
Reviewer	Describes the reviewer/critic of the multimedia content. Defined as a TV-Anytime datatype, ReviewerType.
ReviewReference	Describes the location of the material from where the review may have been extracted or quoted, e.g. the TV magazine that published the review, an interview from where the review was transcribed, etc.
Target	Identifies the individual for whom the review is provided (see clause 6.5.2.3 for a detailed specification).

Additionally, *TV-Anytime* defines the following schemas for dealing with MediaReview instances.



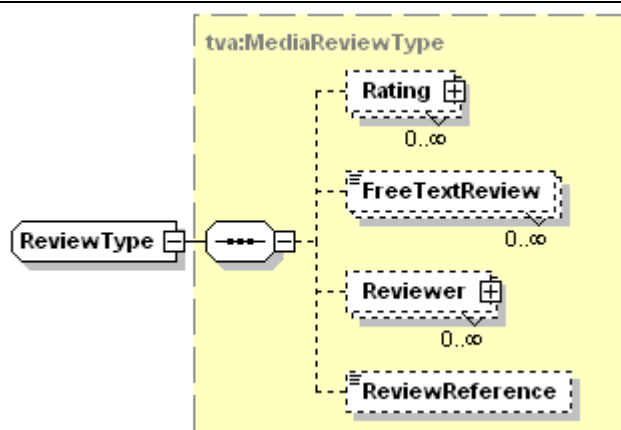

```

<complexType name="ReviewType" >
  <complexContent>
    <extension base="tva:MediaReviewType">
      <attribute name="programId" type="tva:CRIDType"
        use="required"/>
      <attributeGroup ref="tva:fragmentIdentification"/>
      <attribute name="metadataOriginIDRef" type="tva:TVAIDRefType" use="optional"/>
      <attribute ref="xml:lang" use="optional"/>
    </extension>
  </complexContent>
</complexType>

<complexType name="ProgramReviewTableType">
  <sequence>
    <element name="Review" type="tva:ReviewType" minOccurs="0" maxOccurs="unbounded"/>
  </sequence>
  <attribute name="metadataOriginIDRef" type="tva:TVAIDRefType" use="optional"/>
  <attribute ref="xml:lang" use="optional"/>
</complexType>

```

Name	Definition
ReviewType	A complex type that defines a Review.
programId	Defines a reference to the CRID of the programme for which the review(s) are provided.
fragmentIdentification	Used to identify the fragment of data to which this description belongs to.
metadataOriginIDRef	A reference to an instance of MetadataOriginationInformation containing information about the provider of metadata.
xml:lang	The default natural language of the description.
ProgramReviewTableType	A complex type that provides tabulated descriptions of reviews associated with (multiple) programmes.
Review	Describes the review associated with a single programme.
metadataOriginIDRef	A reference to an instance of MetadataOriginationInformation containing information about the provider of metadata.
xml:lang	The default natural language of the description.

### 6.3.9 Common core set of metadata

We have defined the descriptive metadata that can be associated with content above. Because *TV-Anytime* metadata will be processed on a variety of devices, including devices with extremely limited resources, we classify the above metadata into required, recommended and optional metadata elements.

### 6.3.9.1 Required

Name	Requirement
Title	All ProgramInformation and GroupInformation objects shall contain a meaningful Title field.

### 6.3.9.2 Recommended

Name	Guideline
Synopsis	It is recommended that all ProgramInformation and GroupInformation objects contain a meaningful Synopsis element.
Genre	It is recommended that all ProgramInformation and GroupInformation objects contain a meaningful set of classification elements.
Language/CaptionLanguage/ SignLanguage	It is recommended that all ProgramInformation and GroupInformation objects contain a set of meaningful language-related elements to define the spoken, subtitle and audio description properties of the content.
MemberOf	It is recommended that ProgramInformation and GroupInformation objects shall use the MemberOf element.
CreditsList	It is recommended that the following value for the role attribute of CreditsItem be provided in a CreditsList: Director, Provider, KeyTalent, KeyCharacter, Writer.

### 6.3.10 Optional metadata (informative)

All other metadata defined in the present document are optional.

## 6.4 Instance description metadata

In the previous clause, we dealt with *content description* metadata, which associates metadata with a piece of content. The key for linking content metadata to content is the CRID. In the present clause, we describe *instance description* metadata. Instance description metadata is useful in cases where there are meaningful differences between instances of the same content (that is, instances of content that share the same CRID). Instance description metadata is linked to a particular event-related instance of content.

### 6.4.1 Programme location entities

A programme location contains information about one instance (or "publication event") of a programme. Multiple programme locations from the same service provider can be grouped to form e.g. a broadcast schedule, an on-demand service or a push-download package.

A metadata provider aggregates a set of programme locations (e.g. schedules, or individual programme locations) into a ProgramLocationTable, as described in clause 6.7.1 and includes this table in a TV-Anytime metadata instance document.

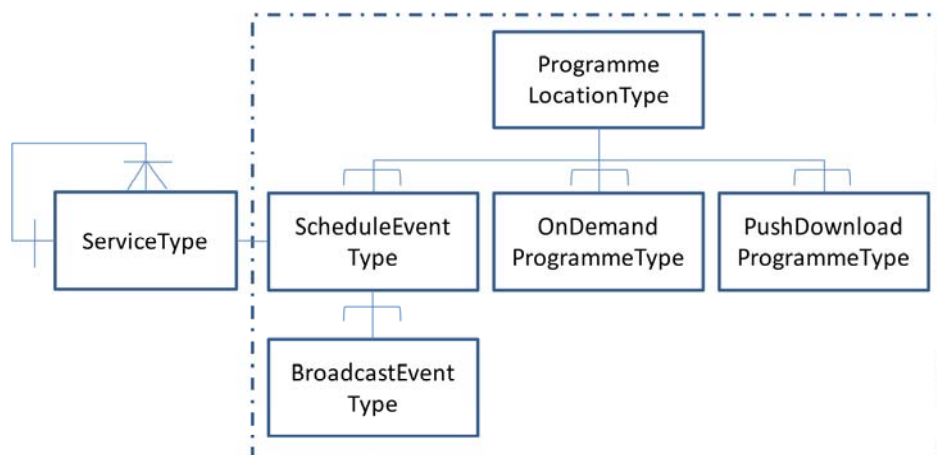

**Figure 6: Single programme location data model:**  
depicts the high-level data model for programme location

#### Entity definitions

- **Programme location** - the programme location represents a generic programme location, regardless of the nature of the medium it addresses - two obvious examples being broadcast services and the Web. The principle feature of a programme location is that it may "contain" at most one programme.
- **Schedule event** - the schedule event is a specific type of programme location that is appropriate for describing broadcast programme locations. The schedule event associates a given broadcast location (service, time and duration) with a given programme.
- **Broadcast event** - the broadcast event is a specific type of programme location that is appropriate for describing independent programme locations.
- **Service** - the service entity represents a distinct (according to content) stream of broadcast material. A service is carried in some form of physical channel but the two entities are not synonymous as a given service can be broadcast on a variety of physical channels.
- **On Demand Programme** - the on-demand programme type is a specific type of programme location appropriate for describing programme accessed on demand.
- **Push Download Programme** - the push-download programme type is a specific type of programme location that is appropriate to describe content being pushed and cached e.g. on a user device for later consumption. A Push Download is a content download autonomously performed (with out user interaction) by the terminal device on request from the service provider. Push download metadata allows to signal such push download actions in a *TV-Anytime* metadata instance document. The content that is downloaded is identified by its CRID.

For syntactic convenience, *TV-Anytime* provides a mechanism to group a series of schedule events from the same provider using the `ScheduleType`. The `ScheduleType` allows the metadata provider to specify a given service just once and then provide a list of schedule events associated with that service.

## 6.4.2 Programme Location

Figure 7 is useful in understanding how the abstract model above has been implemented in the present document.

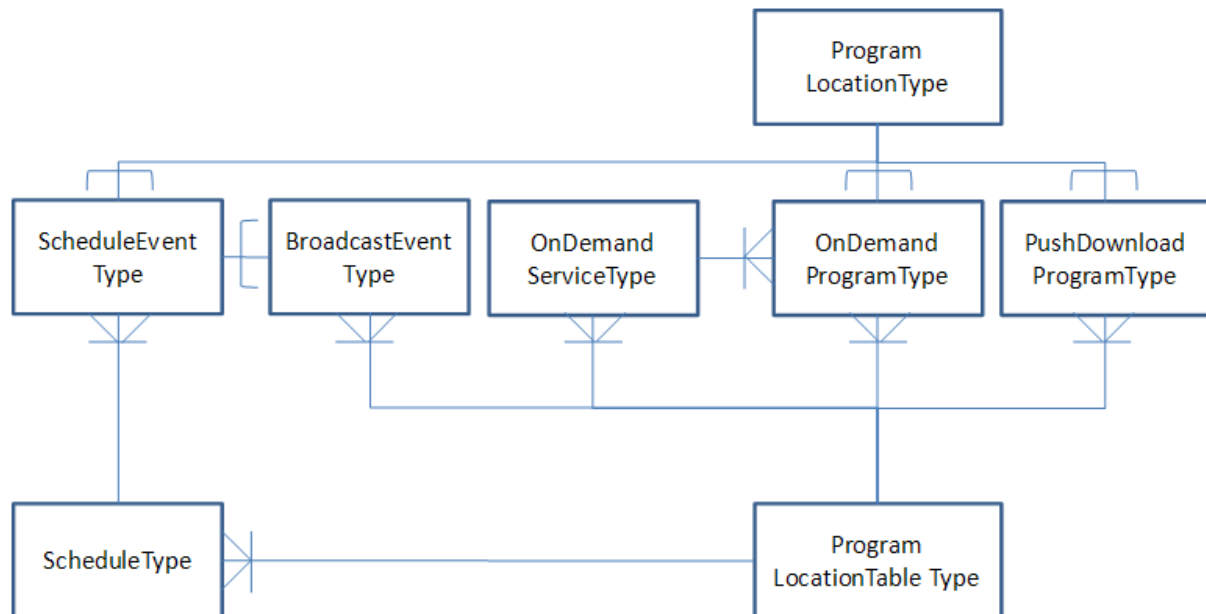

**Figure 7: ProgramLocationType and related types**

ProgramLocationType has a number of related types, some of them being used as entries in a programme location table (see clause 6.7.1).

ProgramLocationType is an abstract type that represents e.g. one EPG entry or a list of individual programme locations. Derived types are OnDemandProgramType, BroadcastEventType and PushDownloadType. The definition and semantics of each type are described below.

```

<simpleType name="InstanceMetadataIdType">
  <restriction base="anyURI">
    <pattern value="(i|I)(m|M)(i|I):(([/]+)/)?([/]+)"/>
  </restriction>
</simpleType>

```

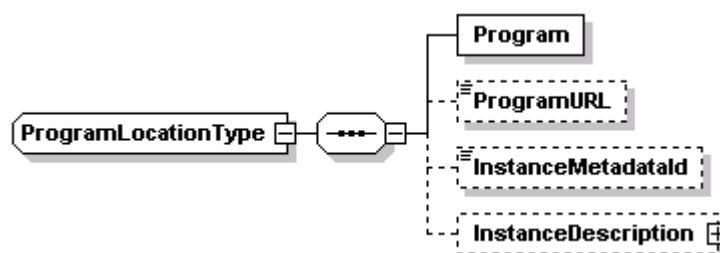

```

<complexType name="ProgramLocationType" abstract="true">
  <sequence>
    <element name="Program" type="tva:CRIDRefType"/>
    <element name="ProgramURL" type="anyURI" minOccurs="0"/>
    <element name="InstanceMetadataId"
      type="tva:InstanceMetadataIdType" minOccurs="0"/>
    <element name="InstanceDescription"
      type="tva:InstanceDescriptionType" minOccurs="0"/>
  </sequence>
</complexType>

```

```

<complexType name="ScheduleType">
  <sequence>

```

```

    <element name="ScheduleEvent" type="tva:ScheduleEventType"
      maxOccurs="unbounded"/>
  </sequence>
  <attribute name="serviceIDRef" type="tva:TVAIDRefsType"
    use="required"/>
  <attribute name="start" type="dateTime" use="optional"/>
  <attribute name="end" type="dateTime" use="optional"/>
  <attributeGroup ref="tva:fragmentIdentification"/>
  <attribute name="metadataOriginIDRef" type="tva:TVAIDRefType" use="optional"/>
  <attribute ref="xml:lang" use="optional"/>
</complexType>

```

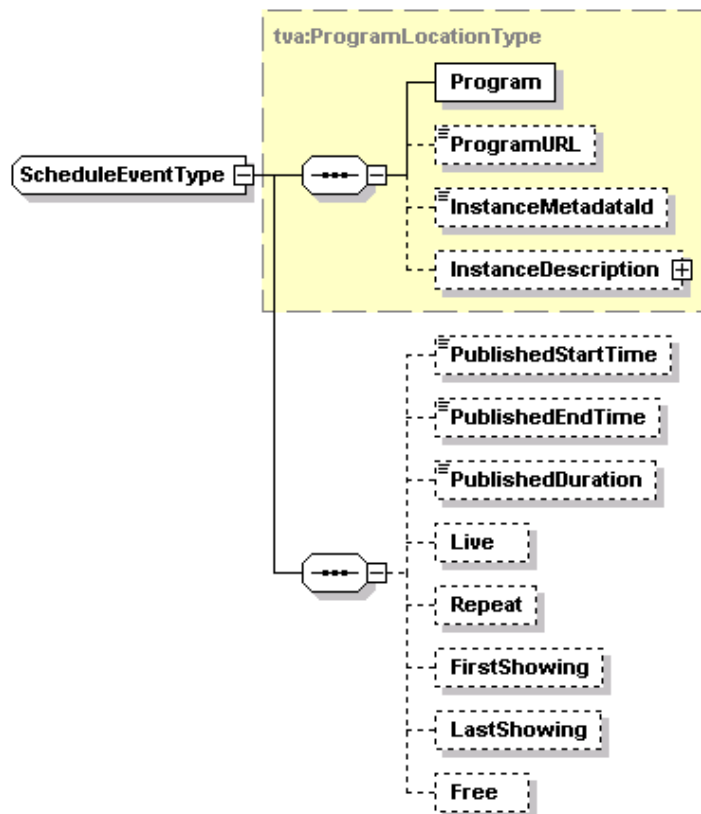

```

<complexType name="ScheduleEventType">
  <complexContent>
    <extension base="tva:ProgramLocationType">
      <sequence>
        <element name="PublishedStartTime" type="dateTime"
          minOccurs="0"/>
        <element name="PublishedEndTime" type="dateTime"
          minOccurs="0"/>
        <element name="PublishedDuration" type="duration"
          minOccurs="0"/>
        <element name="Live" type="tva:FlagType" minOccurs="0"/>
        <element name="Repeat" type="tva:FlagType" minOccurs="0"/>
        <element name="FirstShowing" type="tva:FlagType"
          minOccurs="0"/>
        <element name="LastShowing" type="tva:FlagType"
          minOccurs="0"/>
        <element name="Free" type="tva:FlagType" minOccurs="0"/>
      </sequence>
      <attribute name="metadataOriginIDRef" type="tva:TVAIDRefType" use="optional"/>
      <attribute ref="xml:lang" use="optional"/>
    </extension>
  </complexContent>
</complexType>

<complexType name="BroadcastEventType">
  <complexContent>

```

```

    <extension base="tva:ScheduleEventType">
      <attribute name="serviceIDRef" type="tva:TVAIDRefsType"
        use="optional"/>
      <attributeGroup ref="tva:fragmentIdentification"/>
    </extension>
  </complexContent>
</complexType>

<simpleType name="DeliveryModeType">
  <restriction base="string">
    <enumeration value="streaming" />
    <enumeration value="download" />
  </restriction>
</simpleType>

```

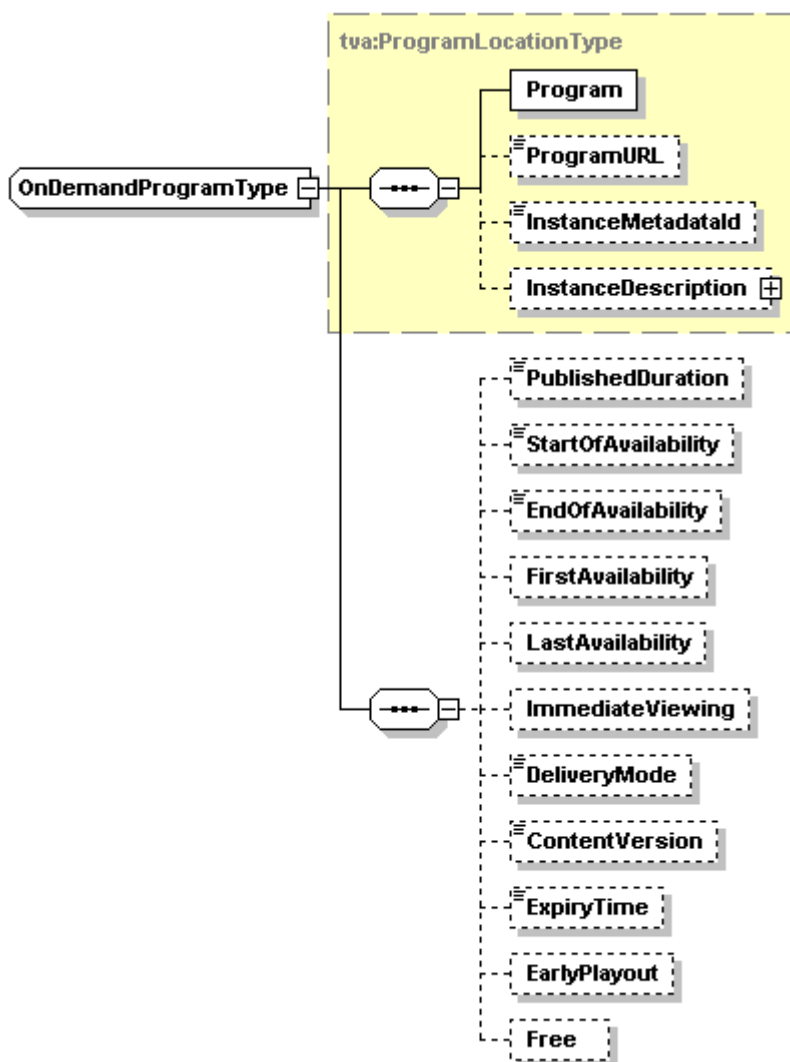

```

<complexType name="OnDemandProgramType">
  <complexContent>
    <extension base="tva:ProgramLocationType">
      <sequence>
        <element name="PublishedDuration" type="duration" minOccurs="0"/>
        <element name="StartOfAvailability" type="dateTime" minOccurs="0"/>
        <element name="EndOfAvailability" type="dateTime" minOccurs="0"/>
        <element name="FirstAvailability" type="tva:FlagType" minOccurs="0"/>
        <element name="LastAvailability" type="tva:FlagType" minOccurs="0"/>
        <element name="ImmediateViewing" type="tva:FlagType" minOccurs="0"/>
        <element name="DeliveryMode" type="tva:DeliveryModeType" minOccurs="0"
          maxOccurs="1"/>
        <element name="ContentVersion" type="unsignedByte" minOccurs="0"

```

```

    maxOccurs="1"/>
    <element name="ExpiryTime" type="dateTime" minOccurs="0" maxOccurs="1"/>
    <element name="EarlyPlayout" type="tva:FlagType" minOccurs="0" maxOccurs="1"/>
    <element name="Free" type="tva:FlagType" minOccurs="0" maxOccurs="1"/>
  </sequence>
  <attributeGroup ref="tva:fragmentIdentification"/>
  <attribute name="metadataOriginIDRef" type="tva:TVAIDRefType" use="optional"/>
  <attribute ref="xml:lang" use="optional"/>
  <attribute name="serviceIDRef" type="tva:TVAIDRefsType" use="optional"/>
</extension>
</complexContent>
</complexType>

<complexType name="OnDemandServiceType">
  <sequence>
    <element name="OnDemandProgram" type="tva:OnDemandProgramType"
      maxOccurs="unbounded"/>
  </sequence>
  <attribute name="serviceIDRef" type="tva:TVAIDRefsType" use="required"/>
  <attributeGroup ref="tva:fragmentIdentification"/>
  <attribute name="metadataOriginIDRef" type="tva:TVAIDRefType" use="optional"/>
  <attribute ref="xml:lang" use="optional"/>
</complexType>

```

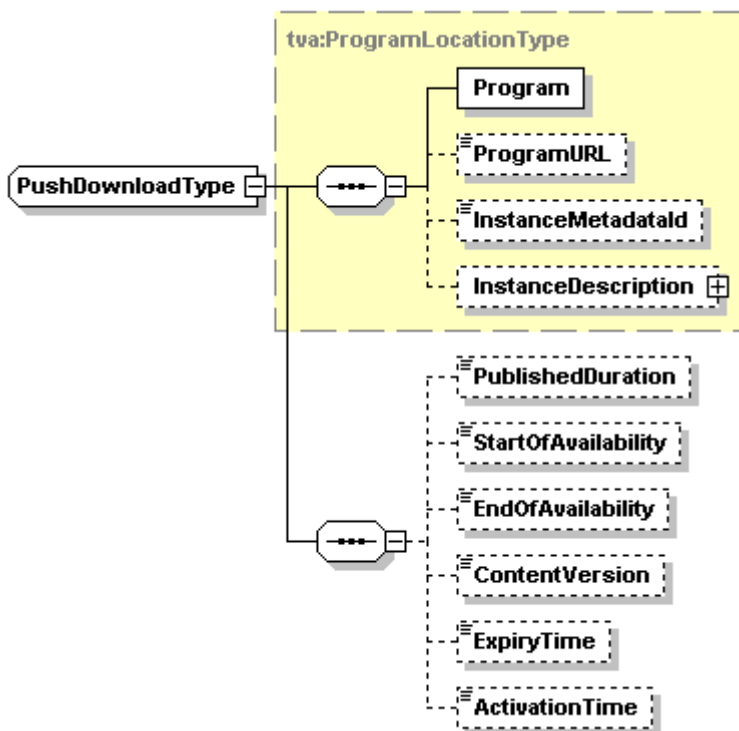

```

<complexType name="PushDownloadType">
  <complexContent mixed="false">
    <extension base="tva:ProgramLocationType">
      <sequence>
        <element name="PublishedDuration" type="duration" minOccurs="0"/>
        <element name="StartOfAvailability" type="dateTime" minOccurs="0"/>
        <element name="EndOfAvailability" type="dateTime" minOccurs="0"/>
        <element name="ContentVersion" type="unsignedByte" minOccurs="0"
          maxOccurs="1"/>
        <element name="ExpiryTime" type="dateTime" minOccurs="0" maxOccurs="1"/>
        <element name="ActivationTime" type="dateTime" minOccurs="0" maxOccurs="1"/>
      </sequence>
      <attributeGroup ref="tva:fragmentIdentification"/>
      <attribute name="metadataOriginIDRef" type="tva:TVAIDRefType" use="optional"/>
      <attribute ref="xml:lang" use="optional" />
      <attribute name="serviceIDRef" type="tva:TVAIDRefsType" use="optional"/>
    </extension>
  </complexContent>
</complexType>

```

```

</complexContent>
</complexType>

```

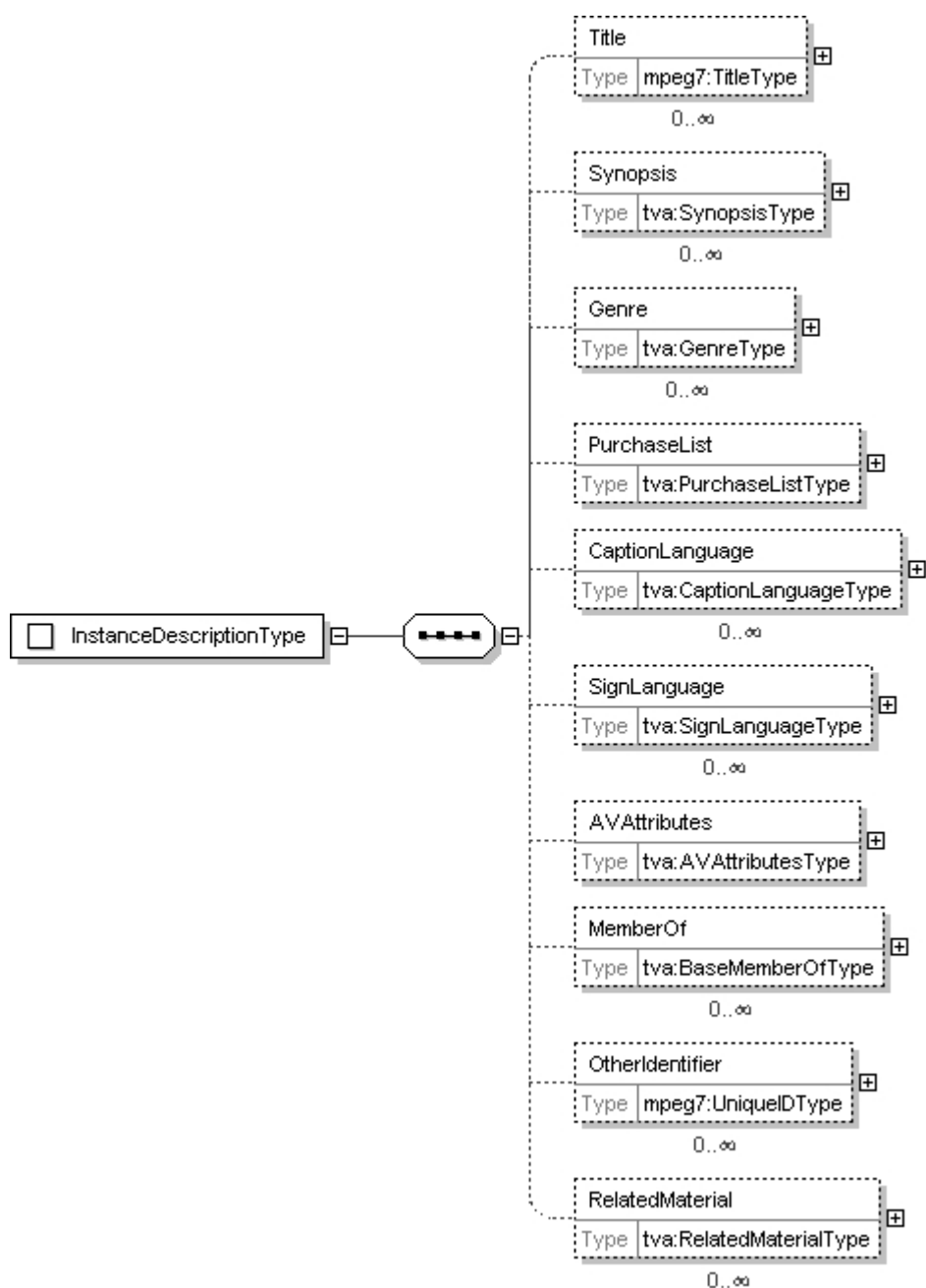

```

<complexType name="InstanceDescriptionType">
  <sequence>
    <element name="Title" type="mpeg7:TitleType" minOccurs="0" maxOccurs="unbounded"/>
    <element name="Synopsis" type="tva:SynopsisType"
      minOccurs="0" maxOccurs="unbounded"/>
    <element name="Genre" type="tva:GenreType" minOccurs="0"
      maxOccurs="unbounded"/>
    <element name="PurchaseList" type="tva:PurchaseListType" minOccurs="0"/>
    <element name="CaptionLanguage" type="tva:CaptionLanguageType" minOccurs="0"
      maxOccurs="unbounded"/>
    <element name="SignLanguage" type="tva:SignLanguageType" minOccurs="0"
      maxOccurs="unbounded"/>
    <element name="AVAttributes" type="tva:AVAttributesType"
      minOccurs="0"/>
    <element name="MemberOf" type="tva:BaseMemberOfType"
      minOccurs="0" maxOccurs="unbounded"/>
    <element name="OtherIdentifier" type="mpeg7:UniqueIDType"

```



```

minOccurs="0" maxOccurs="unbounded"/>
<element name="RelatedMaterial" type="tva:RelatedMaterialType" minOccurs="0"
maxOccurs="unbounded"/>
</sequence>
</complexType>

```

Name	Definition
InstanceMetadataIDType	A simple type used to instantiate InstanceMetadataID.
ProgramLocationType	An abstract type that represents a single programme.
Program	A reference to the CRID that this description describes.
ProgramURL	An element specifying a programme location.
InstanceMetadataId	An optional identifier that shall identify a particular location related to a CRID (i.e. a programme). This identifier shall be unique within the CRID domain and have the same life cycle as the CRID.
InstanceDescription	Descriptive metadata about this instance of content. Instance metadata is mostly comprised of technical information such as encoding formats; however, a particular instance may also include a synopsis that overrides any synopsis that might have been defined in a corresponding ProgramInformation instance.
ScheduleType	A complex type derived representing a series of schedule events that are associated with one service.
ScheduleEvent	A list of schedule events.
serviceIDRef	An attribute of Schedule used to identify the service(s) on which the scheduled events will be broadcast. Its value references one or more ServiceInformation elements.
start	Start of the period covered by the schedule.
end	End of the period covered by the schedule.
fragmentIdentification	Used to identify the fragment of data to which this description belongs to.
metadataOriginIDRef	A reference to an instance of MetadataOriginationInformation containing information about the provider of metadata.
xml:lang	The default natural language of the description.
ScheduleEventType	A complex type derived from ProgramLocationType that describes a broadcast event that is part of a schedule (i.e. where the service is already known). Note that instances of ScheduleEventType will always be included in a Schedule instance.
PublishedStartTime	The time at which the programme is advertised as starting. Note that this will typically be different from the actual exact start time. The precise start time is provided by the location resolution mechanism, as part of a locator.
PublishedEndTime	The time at which the programme is advertised as ending. Note that this will typically be different from the actual exact end time. The precise end time can be provided by the location resolution mechanism, as part of a locator.
PublishedDuration	The advertised duration of the programme. The actual duration is provided by the location resolution mechanism, in the form of a locator. When all published time parameters are provided, PublishedDuration must equal the difference between PublishedEndTime and PublishedStartTime.
Live	A flag to indicate if the programme is a live broadcast.
Repeat	A flag to indicate if the programme is a repeat.
FirstShowing	A flag to indicate if this instance is a "first showing".
LastShowing	A flag to indicate if this instance is a "last showing". Typically this will be used for film services that repeat films over a given period.
Free	A flag to indicate if access to this instance of the programme is free.

Name	Definition
metadataOriginIDRef	A reference to an instance of MetadataOriginationInformation containing information about the provider of metadata.
xml:lang	The default natural language of the description.
BroadcastEventType	A complex type derived from ScheduleEventType that allows individual events to be described outside the context of a schedule (i.e. where the service cannot be inferred).
serviceIDRef	An optional attribute of BroadcastEvent used to identify the service (s) on which this event will be broadcast. Its value references one or more ServiceInformation elements.
metadataOriginIDRef	A reference to an instance of MetadataOriginationInformation containing information about the provider of metadata.
fragmentIdentification	Used to identify the fragment of data to which this description belongs to.
xml:lang	The default natural language of the description.
DeliveryModeType	A simple type to signal the mode of content delivery: <i>Streaming</i> - content is available in a real time streaming mode either from a server or from local memory cache (if previously downloaded / pushed by the service provider). <i>Download</i> – content is available for download.
OnDemandProgramType	A complex type derived from ProgramLocationType used to describe instances that can be acquired on demand (as opposed to broadcast).
PublishedDuration	The advertised duration of the programme. The actual duration is provided by the location resolution mechanism, in the form of a locator.
StartOfAvailability	The time and date that this programme will first be available e.g. for download. If not specified, it is assumed that content is available.
EndOfAvailability	The time and date that this programme will no longer be available e.g. for download. If not specified, it is assumed that content shall be available "indefinitely".
FirstAvailability	True if this publication is the first publication of the content, false otherwise.
LastAvailability	True if this publication is the last publication of the content, false otherwise.
ImmediateViewing	A flag that when set to "true" stipulate that this content is for immediate viewing. It cannot be copied. It cannot be copied or stored temporarily in a buffer.
DeliveryMode	This attribute indicates the delivery mode. It can have the values "streaming" or "download". If the attribute is not provided "streaming" delivery is assumed by default.
ContentVersion	The attribute indicates the version of a content item available for download. The version number counts from 0 to 255 with an overflow from 255 to 0. This allows providing new versions (e.g. corrections of encoding errors) to replace already downloaded content items.
ExpiryTime	The attribute defines the date and time when the content item expires and can be removed from local storage at the user premises.
EarlyPayout	The attribute indicates if the play out of content can start while the download is still in progress. If EarlyPayout is "true" play out MAY start while the content item is being downloaded. If EarlyPayout is "false" play out SHALL NOT start before the content item is completely downloaded.
Free	The attribute defined if the content is available for free (if set to 'true') or must be paid for by the consumer (if set to 'false').
fragmentIdentification	Used to identify the fragment of data to which this description belongs to. This attribute must not be present if this OnDemandProgram is lexically contained

Name	Definition
	within an OnDemandService element.
metadataOriginIDRef	A reference to an instance of MetadataOriginationInformation containing information about the provider of metadata. This attribute must not be present if this OnDemandProgram is lexically contained within an OnDemandService element.
xml:lang	The default natural language of the description. This attribute must not be present if this OnDemandProgram is lexically contained within an OnDemandService element.
serviceIDRef	An optional attribute used to identify the on-demand service(s) of which this OnDemandProgram is part. Its value references one or more ServiceInformation elements.
OnDemandServiceType	A complex type used to describe and identify an OnDemandService.
OnDemandProgram	A list of OnDemandProgram proposed by the OnDemandService.
serviceIDRef	An identifier used to identify one or more OnDemandService(s) to which is associated the list of OnDemandProgram elements.
fragmentIdentification	Used to identify the fragment of data to which this description belongs to.
metadataOriginIDRef	A reference to an instance of MetadataOriginationInformation containing information about the provider of metadata.
xml:lang	The default natural language of the description.
PushDownloadType	
PublishedDuration	The advertised duration of the programme. The actual duration is provided by the location resolution mechanism, in the form of a locator.
StartOfAvailability	The time and date that this programme will first be available e.g. for download. If not specified, it is assumed that content is available.
EndOfAvailability	The time and date that this programme will no longer be available e.g. for download. If not specified, it is assumed that content shall be available "indefinitely".
ContentVersion	The attribute indicates the version of a content item available for download. The version number counts from 0 to 255 with an overflow from 255 to 0. This allows providing new versions (e.g. corrections of encoding errors) to replace already downloaded content items.
ExpiryTime	The attribute defines the date and time when the content item expires and can be removed from local storage at the user premises.
ActivationTime	The date and time at which the content item becomes playable by the user. If not specified, the associated content is playable immediately.
fragmentIdentification	Used to identify the fragment of data to which this description belongs to.
metadataOriginIDRef	A reference to an instance of MetadataOriginationInformation containing information about the provider of metadata.
xml:lang	The default natural language of the description.
serviceIDRef	An identifier used to identify one or more service (s) to which is associated the list of PushDownload elements.
InstanceDescriptionType	Complex type used to describe programme instances.

Name	Definition
Title	A title of the programme. An instance of a programme can have a different title. Defined as an MPEG-7 datatype, <code>TitleType</code> (see clause 9.2.2 in ISO/IEC 15938-5 [2] for a detailed specification). When this element exists, it completely overrides any <code>Title</code> with corresponding attributes that might exist for the corresponding <code>ProgramInformation</code> object.
Synopsis	A textual description of this instance. Typically, the synopsis for a programme will be described in the <code>ProgramInformation</code> type and the instance description will not contain a synopsis. However, in some cases the metadata provider may wish to supply a synopsis for a particular instance of content that includes event-specific information (for example, a showing of a film that is a tribute to a recently deceased director). When this element exists, it completely overrides any <code>Synopsis</code> with corresponding attributes that might exist for the corresponding <code>ProgramInformation</code> object.
Genre	A genre for the programme. The thesaurus in annex B defines the normative <i>TV-Anytime</i> set of genres. The genre attributes specified in the instance description update their counterparts that may have been acquired from preliminary programme information tables.
PurchaseList	A list of purchase items.
CaptionLanguage	Describes one language of the caption information included with the programme. The type of the caption information associated with the programme is denoted by the closed attribute. Closed captions can be turned on or off by the user, while open captions (or subtitles) are part of the picture itself and remain visible.
SignLanguage	Specifies the sign language provided for the multimedia content and, optionally, qualifies the use of signing as a primary language and/or as a translation of the spoken dialogue.
AVAttributes	Technical (audio-visual) attributes about this particular instance. The audio-visual attributes specified in the instance description completely override their counterparts in the programme information.
MemberOf	A list of groups of which the programme is a member. This list updates a list that may have been acquired from preliminary programme information tables.
OtherIdentifier	An additional optional identifier to identify the instance.
RelatedMaterial	A relation attribute to signal a variety of relationships between content publications, using appropriate labels from the relation classification scheme <code>HowRelatedCS</code> .

### 6.4.3 Service information

```

<simpleType name="serviceInformationNameLengthType">
  <restriction base="string">
    <enumeration value="short"/>
    <enumeration value="medium"/>
    <enumeration value="long"/>
  </restriction>
</simpleType>

<complexType name="ServiceInformationNameType">
  <complexContent>
    <extension base="mpeg7:TextualType">
      <attribute name="length" type="tva:serviceInformationNameLengthType"
        use="optional"/>
    </extension>
  </complexContent>
</complexType>

```

```

    </simpleContent>
  </complexType>

  <complexType name="ValidPeriodType" >
    <sequence>
      <element name="ValidFrom" type="dateTime" minOccurs="0"/>
      <element name="ValidTo" type="dateTime" minOccurs="0"/>
    </sequence>
  </complexType>

  <complexType name="ServiceRefType">
    <sequence>
      <element name="ValidPeriod" type="tva:ValidPeriodType" minOccurs="0"
        maxOccurs="unbounded"/>
    </sequence>
    <attribute name="serviceIDRef" type="tva:TVAIDRefType"
      use="required"/>
  </complexType>

```

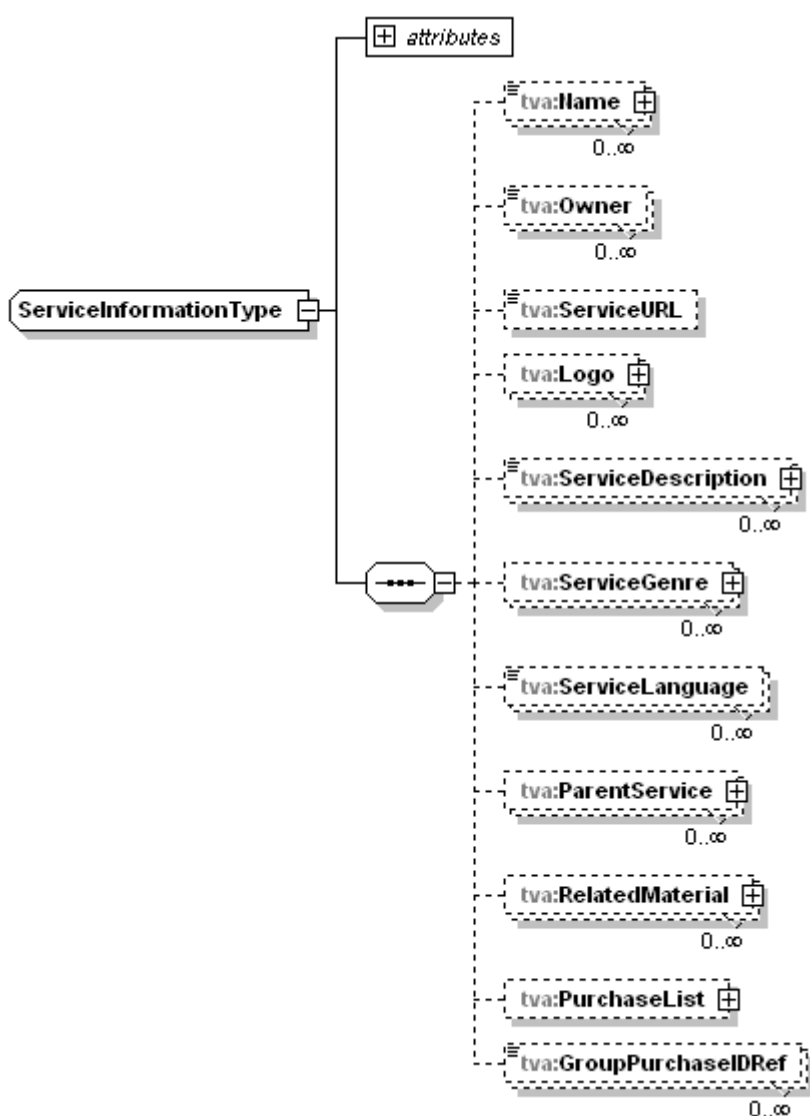

```

<complexType name="ServiceInformationType">
  <sequence>
    <element name="Name" type="tva:ServiceInformationNameType"
      minOccurs="0" maxOccurs="unbounded"/>
    <element name="Owner" type="string"
      minOccurs="0" maxOccurs="unbounded"/>

```

```

<element name="ServiceURL" type="anyURI" minOccurs="0"/>
<element name="Logo" type="mpeg7:MediaLocatorType" minOccurs="0"
maxOccurs="unbounded"/>
<element name="ServiceDescription" type="tva:SynopsisType"
minOccurs="0" maxOccurs="unbounded"/>
<element name="ServiceGenre" type="tva:GenreType" minOccurs="0"
maxOccurs="unbounded"/>
<element name="ServiceLanguage" type="language" minOccurs="0"
maxOccurs="unbounded"/>
<element name="ParentService" type="tva:ServiceRefType"
minOccurs="0" maxOccurs="unbounded"/>
<element name="RelatedMaterial" type="tva:RelatedMaterialType" minOccurs="0"
maxOccurs="unbounded"/>
<element name="PurchaseList" type="tva:PurchaseListType" minOccurs="0"/>
<element name="GroupPurchaseIDRef" type="tva:TVAIDRefType" minOccurs="0"
maxOccurs="unbounded"/>
</sequence>
<attribute name="serviceId" type="tva:TVAIDType" use="required"/>
<attributeGroup ref="tva:fragmentIdentification"/>
<attribute name="metadataOriginIDRef" type="tva:TVAIDRefType" use="optional"/>
<attribute ref="xml:lang" use="optional"/>
</complexType>

```

Name	Definition
serviceInformationNameLengthType	A simple type to define three possible types of lengths for service information names.
short	For a short service name e.g. R1.
medium	For a medium service name e.g. Radio 1.
long	For a long service name e.g. TVAF Radio One.
ServiceInformationNameType	A service name.
length	Length of the service name i.e. short, medium or long.
ValidPeriodType	A complex type that defines a period for which a service is valid.
ValidFrom	Start time and date from which the reference is valid.
ValidTo	An inclusive end time and date up to which the reference is valid.
ServiceRefType	A complex type that allows a reference to be made to a service.
ValidPeriod	An optional time window that can be applied to the reference. If only ValidFrom is specified, then the service reference is assumed to be valid any time after ValidFrom. If only ValidTo is specified, then the service reference is assumed to be valid any time up until the ValidTo time. (In some regions, the same physical channel is allocated to more than one service. Thus, multiple service "timeshare" the same channel. In such cases, ValidPeriod can be used to describe the time period during which a service is valid).
serviceIDRef	The service that is being referenced. Its value references a ServiceInformation element.
ServiceInformationType	A complex type that allows a service to be described.
Name	The name of the service.
Owner	The brand owner of the service. More than one brand owner name can be given e.g. in different languages or geographical contexts.
ServiceURL	An optional URL to access the service (e.g. a DVB URL). This URL allows the receiver to identify the associated physical service. This element should be consistent with the BroadcastURL (e.g. DVB triplet) in events that reference this ServiceInformation element, if used.
Logo	A network logo, such as an image or jingle.
ServiceDescription	An element describing the service.
ServiceGenre	A genre that characterizes the programming on the service.
ServiceLanguage	The main spoken language in which the service is available.

Name	Definition
ParentService	A reference to a parent service when the service being described inherits a part of its schedule from another service (e.g. regional variations from a national service). Note that multiple parent services may be specified on a time exclusive basis (e.g. references to different parts of the same service).
RelatedMaterial	A reference to any other material related to the service.
PurchaseList	Information on the condition of purchase of the service.
GroupPurchaseIDRef	Provides purchase information for a group of services which includes the service. Its value references a PurchaseInformation element which provides purchase information for the group.
serviceId	The unique ID for the service.
fragmentIdentification	Used to identify the fragment of data to which this description belongs.
metadataOriginIDRef	A reference to an instance of MetadataOriginationInformation containing information about the provider of metadata.
xml:lang	The default natural language of the description.

## 6.5 Consumer metadata

### 6.5.1 Usage history DS

The present clause presents a DS for describing usage history information gathered over extended periods of time. The collected usage history provides a list of the actions carried out by the user for an observation period, which can subsequently be used by automatic analysis methods to generate user preferences.

A standardized format for exchange of usage history information is important for ensuring interoperability between various devices and platforms. Collection and representation of usage history information in a standardized format are relevant to various application areas and usage scenarios identified by the *TV-Anytime* Forum, which include the following:

- Tracking and monitoring the content viewed by individual members of a household.
- Building a personalized TV guide by tracking user-viewing habits.
- Selling viewing history to advertisers.
- Tracking and monitoring content usage for more efficient content development.
- Selling of usage data by service provider.
- Compensating the user for making his/her usage history data available to content providers.

The *TV-Anytime* Forum Usage History schema is based on the UsageHistory DS as specified in ISO/IEC 15938-5 [2], clause 15.2.

A description instance contains a UserIdentifier element, which specifies the user or the group of users whose content consumption information is provided. The usage history is specified by the UserActionHistory DS, which contains multiple lists of the actions performed by the user over an observation period. Note that multiple, non-overlapping observation periods can be specified for an action list. Each action list is action-type specific; i.e. a single list contains actions of a certain type (such as "play" or "record") only. The specific types of actions that are tracked (i.e. the values allowed for the ActionType element) are defined as members of a classification scheme/thesaurus (see annex A for the default thesaurus), which enables new types of actions to be supported in the future (by augmenting). Associated with every user action are the time of the action, the CRID of the programme for which the action took place and optional referencing elements which allow related links or resources about the action to be provided. It is assumed that descriptions for the programmes cited in the action history are readily accessible through the provided content reference IDs.

The following clauses contain a specification of the syntax and semantics of the UsageHistory DS.

## 6.5.1.1 Usage history DS

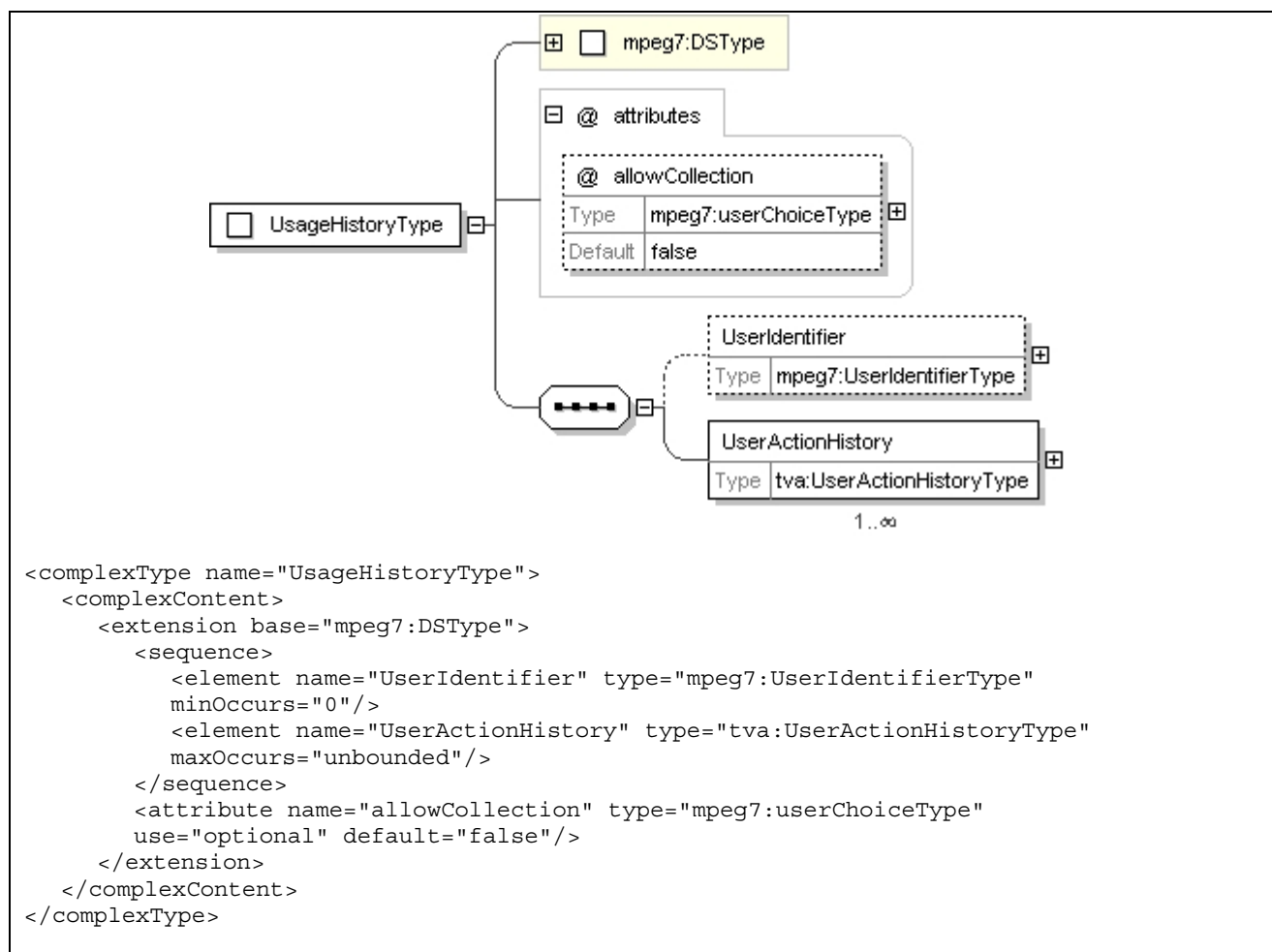

Name	Definition
UsageHistoryType	Specifies user's multimedia content consumption history.
UserIdentifier	Identifies the individual for whom the usage history is provided. This element is of type UserIdentifierType and contains the <code>protected</code> attribute. Thus the identity of the user shall not be disclosed unless this attribute is set to false. See clause 6.5.2.3
UserActionHistory	Describes a history of the actions the user has carried out during certain observation periods. See clause 6.5.1.2
allowCollection	Indicates whether the user permits usage history of his/her actions to be collected. The values allowed are defined as follows. <i>true</i> - Indicates that usage history data may be collected. <i>false</i> - Indicates that usage history data shall not be collected. <i>user</i> - Indicates that the user should be asked for permission on a case by case basis. By default, the value of <code>allowCollection</code> is false.

The UsageHistory DS describes the audiovisual content consumption history for a user, as lists of the actions performed by the user over an observation period.

The specification of the UsageHistory DS is derived from clause 15.2.1 of ISO/IEC 15938-5 [2]. Syntax of the UsageHistory DS is based on clause 15.2.1.1 in ISO/IEC 15938-5 [2]. Semantics of the Usage History DS is based on clause 15.2.1.2 in ISO/IEC 15938-5 [2].



## 6.5.1.2 UserActionHistory DS

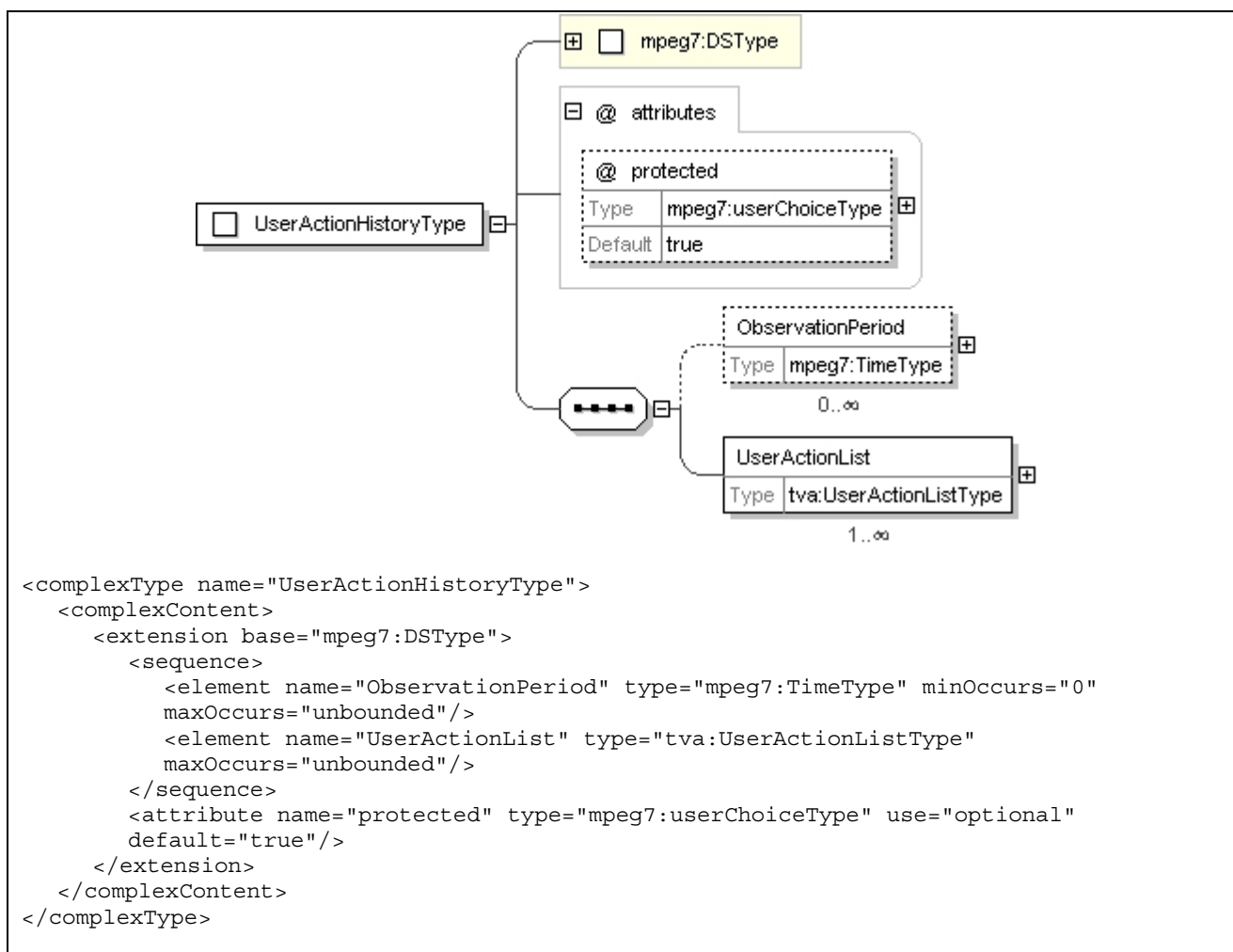

Name	Definition
UserActionHistoryType	Specifies a history of the actions carried out by the user.
ObservationPeriod	Describes the time period(s) during which the associated history items have been recorded. Multiple instance of ObservationPeriod can be used to represent discontinuous time periods.
UserActionList	Describes a list of actions of the same type, i.e. all actions in the UserActionList carry the same ActionType value. See clause 6.5.1.3.
protected	Indicates whether the user desires to keep the user action history information private. The values allowed are defined as follows. <i>true</i> - Indicates that the user action history information may only be accessed by the user and shall not be communicated to external parties. <i>false</i> - Indicates that the user action history information does not have to be kept private and may be communicated to external parties, such as service providers and trusted software agents.

The UserActionHistory DS describes multiple user action lists, each of which provides a temporally ordered log of a specific type of user action, such as "Record" or "Play," regarding audiovisual content.

The specification of the UserActionHistory DS is derived from clause 15.2.2 of ISO/IEC 15938-5 [2]. Syntax of the UserActionHistory DS is based on clause 15.2.2.1 in ISO/IEC 15938-5 [2]. Semantics of the UserActionHistory DS is based on in clause 15.2.2.2 in ISO/IEC 15938-5 [2].

## 6.5.1.3 UserActionList DS

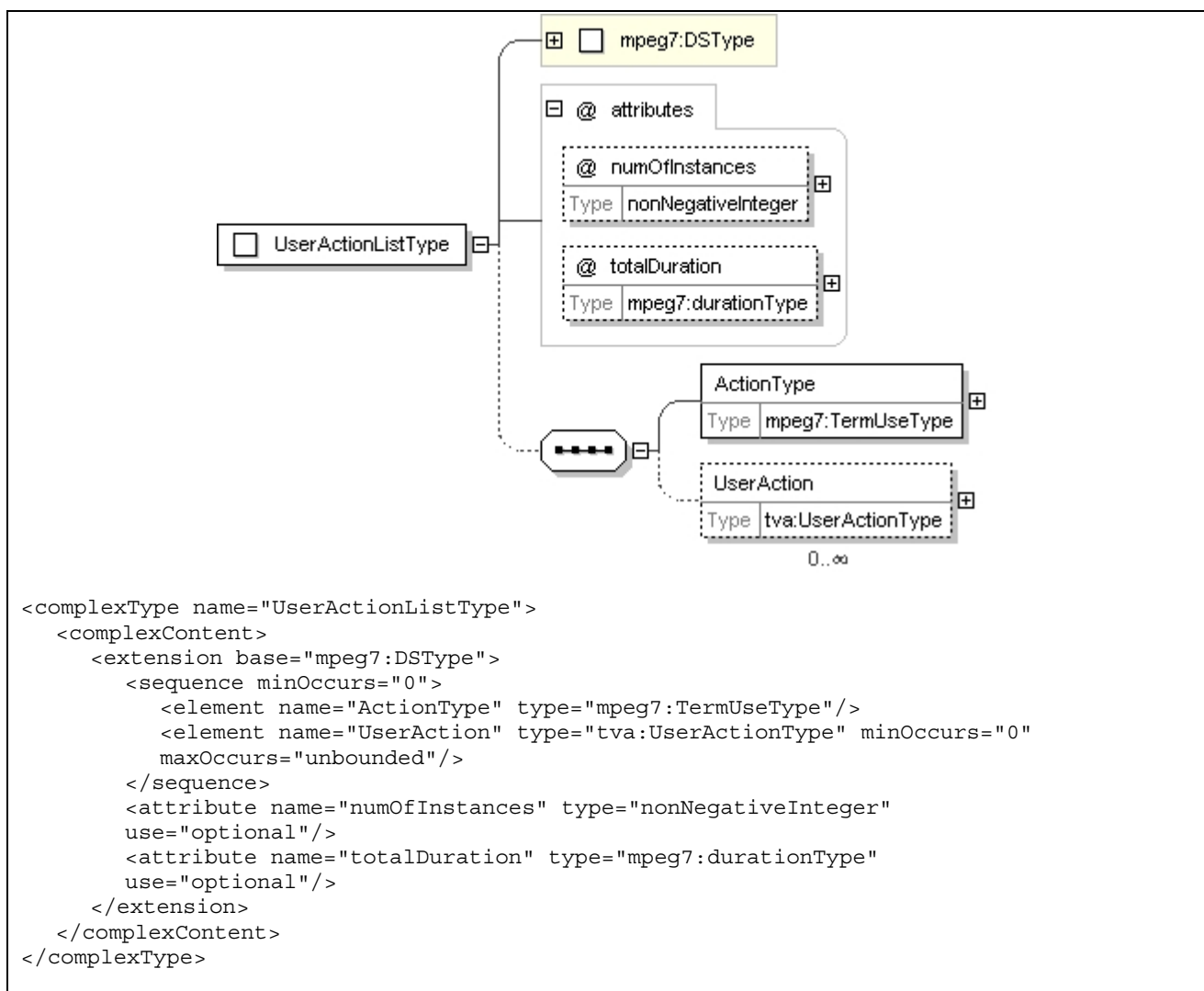

Name	Definition
UserActionListType	Describes a list of user actions, all of the same type.
ActionType	Indicates the type of action performed by the user, e.g. "View," "Pause," "Play," and so forth. All UserAction elements in an ActionList have the same ActionType. ActionType may contain a free term or a term from a classification scheme. A classification scheme that may be used (the ActionTypeCS) is defined in clause A.2.
UserAction	Describes a single user action in a list of actions. Each action is associated with a single multimedia program. See clause 6.5.1.4.
numOfInstances	Indicates the number of UserAction elements in a UserActionList (e.g. 21 "Record" actions; 5 "View" actions; and so forth).
totalDuration	Indicates the cumulative duration of the actions in the UserActionList (e.g. 32 minutes for all "Record" actions). If a UserActionList includes UserAction elements and all UserAction elements contain a MediaTime element, the value of the totalDuration attribute shall be equivalent to the sum of the time durations specified by these MediaTime elements.

The UserActionList DS specifies a structured list of user action items, organized according to action type. Every UserAction is associated with a single programme or content entity only. A default *TV-Anytime* classification scheme of valid user actions is provided in annex A.

The specification of the UserActionList DS is derived from clause 15.2.3 of ISO/IEC 15938-5 [2]. Syntax of the UserActionList DS is based on clause 15.2.3.1 in ISO/IEC 15938-5 [2]. Semantics of the UserActionList DS is based on clause 15.2.3.2 in ISO/IEC 15938-5 [2].

#### 6.5.1.4 UserAction DS

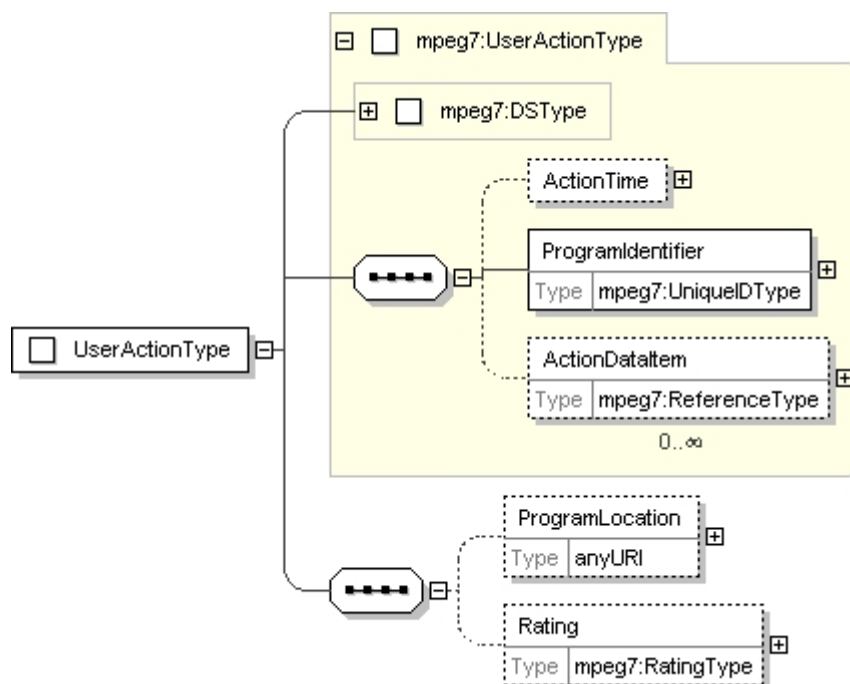

The UserAction DS provides detailed information about individual user actions, including the time of occurrence, duration, associated CRID of the programme, location of the programme and references to related content descriptions and material.

The *TV-Anytime* Forum UserAction DS is an extension of the UserAction DS specified in clause 15.2.4 of ISO/IEC 15938-5 [2], as follows.

```
<complexType name="UserActionType">
  <complexContent>
    <extension base="mpeg7:UserActionType">
      <sequence>
        <element name="ProgramLocation" type="anyURI" minOccurs="0"
          maxOccurs="1"/>
        <element name="Rating" type="mpeg7:RatingType" minOccurs="0"
          maxOccurs="1"/>
      </sequence>
    </extension>
  </complexContent>
</complexType>
```

Syntax of the base UserAction DS is specified in clause 15.2.4.1 in ISO/IEC 15938-5 [2]. Semantics of the base UserAction DS are specified in clause 15.2.4.2 in ISO/IEC 15938-5 [2]. The semantics of the additional element in the *TV-Anytime* Forum UserAction DS is as follows.

Name	Definition
ProgramLocation	An optional element describing the location of the programme associated with the user action.
Rating	An optional element which specifies the rating value and criterion of a rating action.

In order to ensure full compliance with the CRID definition as stated by the TVA Content Referencing Specification, the `ProgramIdentifier` element of the `UserAction` DS is constrained as follows:

- If the `type` attribute of `ProgramIdentifier` element is instantiated in descriptions compliant to the TVA Metadata Specification, it shall be set to the value "CRID".
- The `ProgramIdentifier` element instances in descriptions compliant to the TVA Metadata Specification shall specify a CRID that complies with the syntax defined in the TVA Content Referencing Specification.

Furthermore, in *TV-Anytime* descriptions, the `ActionDataItem` element of the base `UserAction` DS may contain an Instance Metadata ID (see clause 6.4.2).

### 6.5.1.5 Informative examples

Informative examples of the usage history DSs presented in the present clause are provided in clause 15.2 of ISO/IEC 15938-5 [2].

## 6.5.2 User preferences DS

The present clause contains DSs that facilitate description of user's preferences pertaining to consumption of multimedia material. User preference descriptions can be correlated with media descriptions to search, filter, select and consume desired content. Correspondence between user preference and media descriptions facilitates accurate and efficient personalization of content access and content consumption.

In particular, usage scenarios enabled by these schemes include the following:

- Identification of multiple users.
- Filtering according to a rich combination of user preferences on genre, time, date, channel, etc.
- Accurate and effective agent operation by featuring a well-defined mapping between user preferences and media descriptions.
- Prioritization of sources of information in combination with other preferences such as genres, titles, etc.
- Specification of preferences (e.g. for a favourite actor) for a particular time duration.
- Specification of preferred keywords in connection with other preferences, such as genre (e.g. news).
- Specification of preferred critics and critic's ratings.
- Description of consumer's desire to keep the entire, or selected parts of preference data private.
- Specification of preferences for genre and source preference combinations.
- Descriptions of preferences for particular kinds of highlights (e.g. highlights of certain duration or highlights composed of segments containing certain events).
- Exchange of personal profiles under consumer control.
- Specification of profiles for different countries.

The *TV-Anytime* Forum `UserPreferences` schema is based on the `UserPreferences` DS as defined in ISO/IEC 15938-5 [2], clause 15.

The `UserPreferences` DS is associated with a particular user (or group of users) by means of the `UserIdentifier` DS. The main entity in the diagram, the `UsagePreferences` DS, contains two main components, the `BrowsingPreferences` DS and the `FilteringAndSearchPreferences` DS. The `BrowsingPreferences` DS can be used to specify preferences on the way the content is consumed and contains `SummaryPreferences`. The `FilteringAndSearchPreferences` DS can be used to specify preferences on the type of content to be searched, filtered, selected and consumed. This DS contains the `ClassificationPreferences` DS, `CreationPreferences` DS and `SourcePreferences` DS.

The `UserPreferences` DS enables users to specify preferences that apply only in a particular context, in terms of time and place, using the `PreferenceCondition` DS. The `UserPreferences` DS allows users to specify the relative importance of their preferences with respect to each other. The DS enables users to indicate whether their preferences or parts of their preferences should be kept private or not. The DS also enables users to indicate whether the automatic update of their usage preferences description, e.g. by an agent, should be permitted or not. The `ClassificationPreferences` DS is used to specify user preferences related to classification of the content, e.g. preferred genre, preferred country of origin or preferred language. The `CreationPreferences` DS is used to specify user's preferences related to the creation description of AV content, such as preference on a particular title, or a favourite actor, or period of time within which the content was created. The `SourcePreferences` DS is used to specify preferences for the source of the media, such as its medium or its distributor or publisher.

In general, `UserPreferences` descriptions can be constructed manually or automatically. A `UserPreferences` description may be constructed based on explicit input from the audiovisual content user. Alternatively, a `UserPreferences` description may be constructed automatically based on the user's content usage history.

The following clauses contain a specification of the syntax and semantics of the `UserPreferences` DS. Some of the following clauses also contain tables that provide a mapping from individual elements (and attributes) of a user preference description to individual elements (and attributes) of programme descriptions. The first column of each table specifies the name of an element (or attribute) of a user preference description. The second column of each table specifies the name(s) of one or more elements (or attributes) of a programme description that the preference element (or attribute) maps to. Note that elements in both the first and second columns of each table may contain further children elements (or attributes) that may be including in the mapping implicitly.

NOTE: These mappings are example mappings and are not normative.

### 6.5.2.1 Basic user preference elements

The `PreferenceCondition` DS is used to specify a combination of time and/or place to be associated with a particular set of user preferences. The `userChoice` datatype is used to indicate the value of a condition set by a user, with respect to actions taken by a processor of descriptions. The `preferenceValue` datatype is used to describe the relative significance of a particular preference element.

The specifications of these basic user preference elements are given in clause 15.2.2 of ISO/IEC 15938-5 [2]. Syntax of the basic user preference elements is specified in clause 15.2.2.2 of ISO/IEC 15938-5 [2]. Semantics of the basic user preference elements are specified in clause 15.2.2.3 of ISO/IEC 15938-5 [2].

Attributes of type `preferenceValueType` should exploit the full range of values as specified by ISO/IEC 15938-5 [2], i.e. from 100 to  $\sphericalangle$ 100. The value 0 should be used as the neutral preference value, while negative values indicate a non-preference (unfavourable feature) and positive values indicate a preference (favourable feature). As specified in ISO/IEC 15938-5 [2], the value 10 should be used as the default in the absence of a preference value.

NOTE: Applications may choose to utilize only a subset of integer values between (and including)  $\sphericalangle$  100 and  $\sphericalangle$  100, while conforming to the above guidelines.

### 6.5.2.2 UserPreferences DS

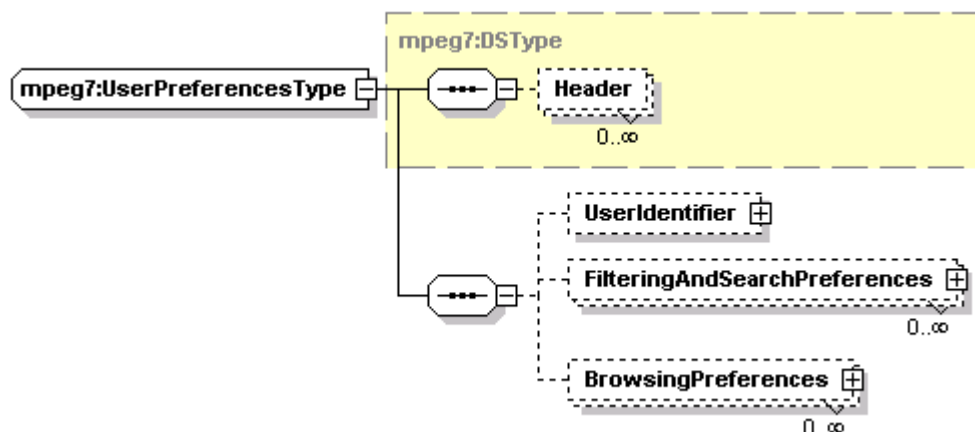

The UserPreferences DS is used to describe a user's preferences for consumption of multimedia material. Correspondence between user preference information and media descriptions allows personalization of content access and content consumption.

The specification of the UserPreferences DS is given in clause 15.2.3 of ISO/IEC 15938-5 [2]. Syntax of the UserPreferences DS is described in clause 15.2.3.2 of ISO/IEC 15938-5 [2]. Semantics of the UserPreferences DS is described in clause 15.2.3.3 of ISO/IEC 15938-5 [2].

### 6.5.2.3 UserIdentifier DS

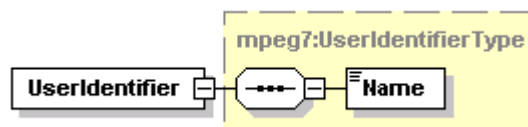

The UserIdentifier DS may be used to associate a specific user (or set of users) with a particular user preference description, or to identify a particular user preference description, or to distinguish multiple user preference descriptions.

The specification of the UserPreference DS is given in clause 15.2.4 of ISO/IEC 15938-5 [2]. Syntax of the UserIdentifier DS is specified in clause 15.2.4.2 in ISO/IEC 15938-5 [2]. Semantics of the UserIdentifier DS are specified in clause 15.2.4.3 in ISO/IEC 15938-5 [2].

The `UserIdentifier` datatype may be used to identify a particular user preference description and distinguish it from other user preference descriptions. The `Name` element may contain the user's actual name, a nickname, a user's account name or email address, or any other name. The same user may have multiple user preference descriptions, each identified by a different value of `Name`, for use under different usage conditions. Also, a group of persons can use a single set of user preferences, using a single identifier for the group.

*TV-Anytime* Forum compliant implementations should by default maintain user identification as private data. To achieve the exchange of user preference descriptions between the user(s) and a service provider while maintaining anonymity of the user(s), the following options are suggested:

- The `UserIdentifier` element is optional** within the `UserPreferences` DS; therefore, a valid user preference description can be exchanged that simply does not contain this element.
- The `Name` element of the `UserIdentifier` datatype can contain any value of string-type; therefore, this element could contain an arbitrary value, selected by the user, that does not allow identification of the user.

**NOTE:** The **protected** attribute of the `UserIdentifier` datatype can be set (under user control) to indicate whether the user identifier information should remain private or not (see clause 15.2.4.3 in ISO/IEC 15938-5 [2]). By default, the value of `protected` is true.

## 6.5.2.4 FilteringAndSearchPreferences DS

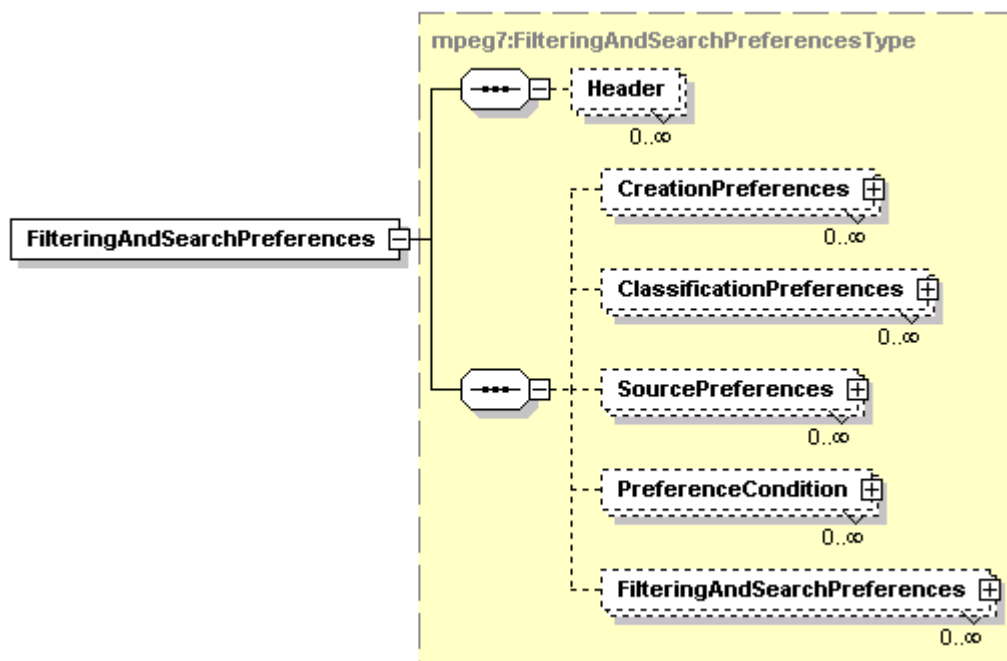

The FilteringAndSearchPreferences DS specifies a user's filtering and/or searching preferences for audio-visual content. These preferences can be specified in terms of creation-, classification- and source-related properties of the content. The FilteringAndSearchPreferences DS is a container of CreationPreferences, ClassificationPreferences and SourcePreferences.

The specification of the FilteringAndSearchPreferences DS is given in clause 15.2.5 of ISO/IEC 15938-5 [2]. Syntax of the FilteringAndSearchPreferences DS is specified in clause 15.2.5.2 in ISO/IEC 15938-5 [2]. Semantics of the FilteringAndSearchPreferences DS are specified in clause 15.2.5.3 in ISO/IEC 15938-5 [2].

**NOTE:** The **protected** attribute of the **FilteringAndSearchPreferences** DS can be set (under **user control**) to indicate whether the contained user preference information should remain private or not (see clause 15.2.4.3 in ISO/IEC 15938-5 [2]). By default, the value of **protected** is true. Because a single user preferences description can contain multiple **FilteringAndSearchPreferences** elements, it is possible to separately describe preferences that should be kept private and other preferences that do not have to be kept private.

## 6.5.2.5 CreationPreferences DS

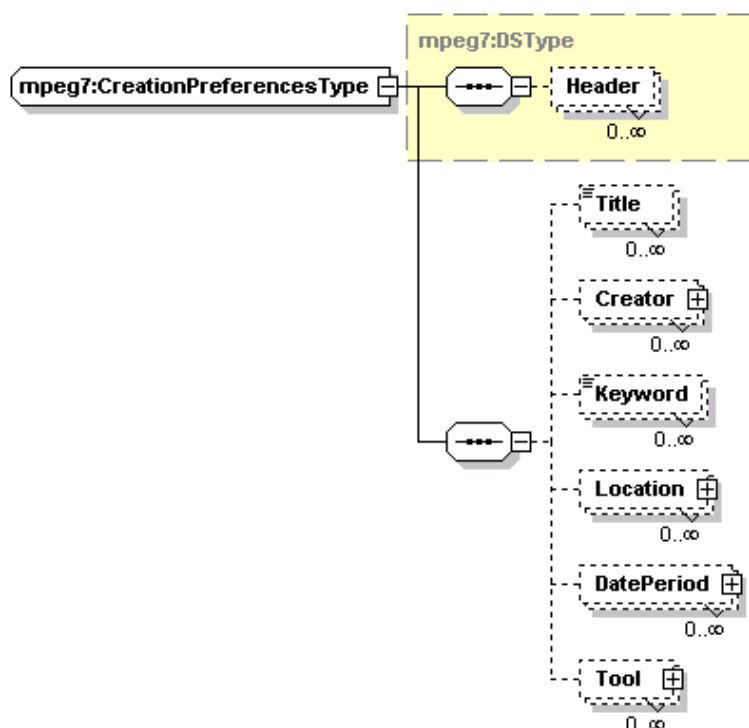

The CreationPreferences DS specifies a user's preferences about the creation-related properties of AV content, such as favourite actors etc.

The specification of the CreationPreferences DS is given in clause 15.2.6 of ISO/IEC 15938-5 [2]. Syntax of the CreationPreferences DS is specified in clause 15.2.6.2 in ISO/IEC 15938-5 [2]. Semantics of the CreationPreferences DS are specified in clause 15.2.6.3 in ISO/IEC 15938-5 [2].

The default Classification Scheme for the `Role` element of the `Creator` element of the CreationPreferences DS is specified in annex A.

The `Tool` element of the CreationPreferences DS is not used in the present document.

The following table provides an informative example mapping of elements (and attributes) from UserPreferences/FilteringAndSearchPreferences/CreationPreferences to elements (and attributes) of a programme description.

Element/attribute Name	Mapping
Title	ProgramInformationTable/ProgramInformation/BasicDescription/Title. ProgramInformationTable/ProgramInformation/BasicDescription/ShortTitle. SegmentInformationTable/SegmentInformation/Description/Title.
Creator	ProgramInformationTable/ProgramInformation/BasicDescription/CreditsList/CreditsItem.
Keyword	ProgramInformationTable/ProgramInformation/BasicDescription/Title. ProgramInformationTable/ProgramInformation/BasicDescription/ShortTitle. ProgramInformationTable/ProgramInformation/BasicDescription/Keyword. ProgramInformationTable/ProgramInformation/BasicDescription/Synopsis. SegmentInformationTable/SegmentInformation/Description/Title. SegmentInformationTable/SegmentInformation/Description/Keyword. SegmentInformationTable/SegmentInformation/Description/Synopsis.
Location	ProgramInformationTable/ProgramInformation/BasicDescription/CreationCoordinates/ CreationLocation.
DatePeriod	ProgramInformationTable/ProgramInformation/BasicDescription/CreationCoordinates/ CreationDate.
Tool	This element is not used in the present document.



## 6.5.2.6 ClassificationPreferences DS

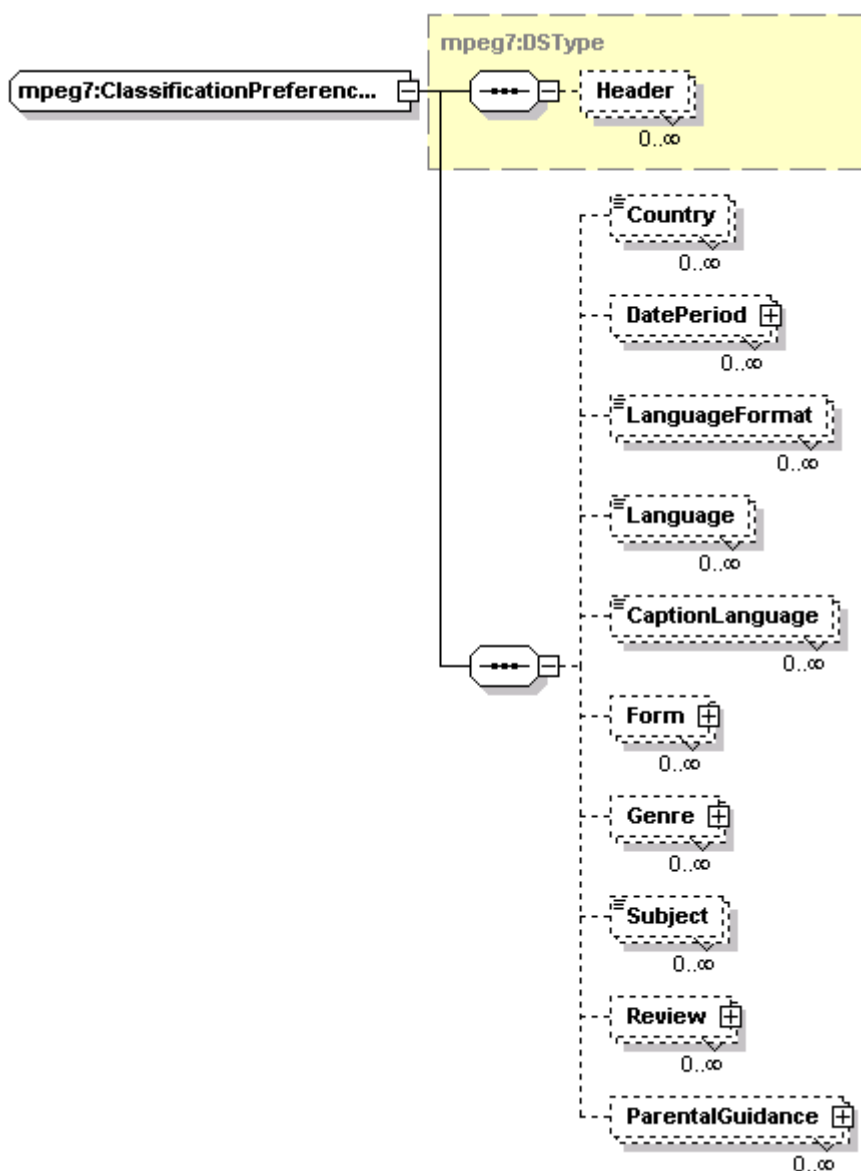

The ClassificationPreferences DS is used to convey a user's preferences about various classifications of the content, such as preferred genre or language.

The specification of the ClassificationPreferences DS is given in clause 15.2.7 of ISO/IEC 15938-5 [2]. Syntax of the ClassificationPreferences DS is specified in clause 15.2.7.2 in ISO/IEC 15938-5 [2]. Semantics of the ClassificationPreferences DS are specified in clause 15.2.7.3 in ISO/IEC 15938-5 [2].

The default Classification Scheme for the `Genre` element of the ClassificationPreferences DS is specified in annex C. Multiple `Genre` elements may be used, where each expresses a value from different parts of the multi-dimensional content classification scheme, as described in annex B.

The `Form` element of the ClassificationPreferences DS is not used in the present document.

The following table provides an informative example mapping of elements (and attributes) from UserPreferences/FilteringAndSearchPreferences/ClassificationPreferences to elements (and attributes) of a programme description.

Element/attribute Name	Mapping
Country	ProgramInformationTable/ProgramInformation/BasicDescription/ReleaseLocation.
DatePeriod	ProgramInformationTable/ProgramInformation/BasicDescription/ReleaseDate.
LanguageFormat	ProgramInformationTable/ProgramInformation/BasicDescription/Language. ProgramInformationTable/ProgramInformation/BasicDescription/CaptionLanguage. ProgramInformationTable/ProgramInformation/BasicDescription/SignLanguage.
Language	ProgramInformationTable/ProgramInformation/BasicDescription/Language.
CaptionLanguage	ProgramInformationTable/ProgramInformation/BasicDescription/CaptionLanguage.
Form	This element is not used in the present document.
Genre	ProgramInformationTable/ProgramInformation/BasicDescription/Genre.
Subject	ProgramInformationTable/ProgramInformation/BasicDescription/Title. ProgramInformationTable/ProgramInformation/BasicDescription/ShortTitle. ProgramInformationTable/ProgramInformation/BasicDescription/Keyword. ProgramInformationTable/ProgramInformation/BasicDescription/Synopsis. SegmentInformationTable/SegmentInformation/Description/Title. SegmentInformationTable/SegmentInformation/Description/Keyword. SegmentInformationTable/SegmentInformation/Description/Synopsis.
Review	ProgramReviewTable/ProgramReviews/Review.
ParentalGuidance	ProgramInformationTable/ProgramInformation/BasicDescription/ParentalGuidance.

### 6.5.2.7 SourcePreferences DS

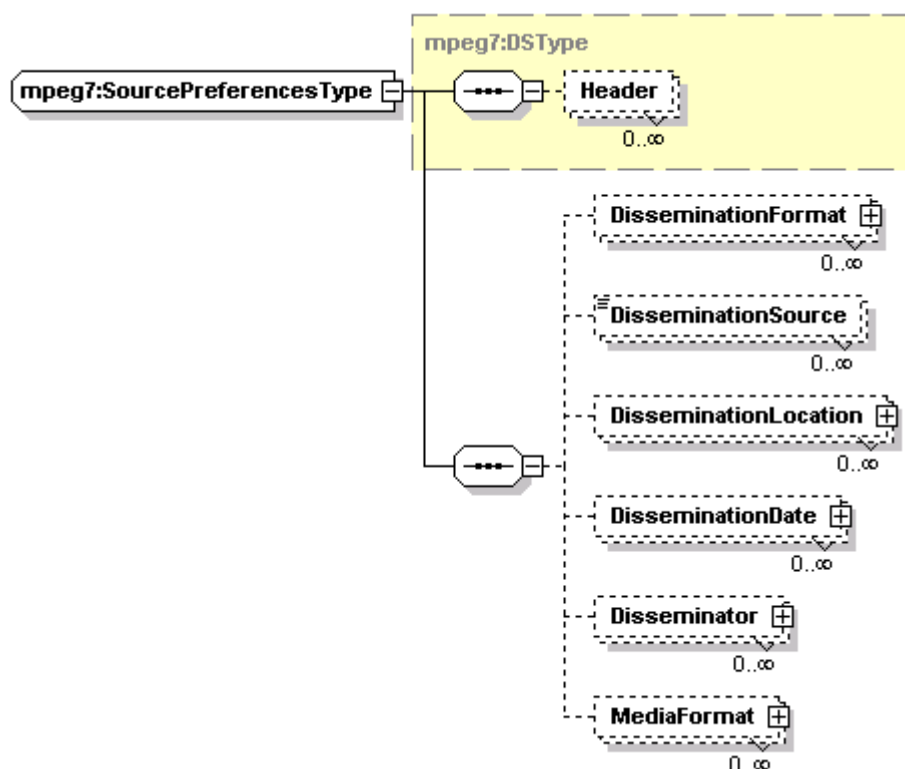

The SourcePreferences DS is used to convey preferences on the source of the AV content, such as publisher or channel of distribution. The specification of the SourcePreferences DS is given in clause 15.2.8 of ISO/IEC 15938-5 [2]. Syntax of the SourcePreferences DS is specified in clause 15.2.8.2 in ISO/IEC 15938-5 [2]. Semantics of the SourcePreferences DS are specified in clause 15.2.8.3 in ISO/IEC 15938-5 [2].

The DisseminationFormat element, the DisseminationLocation element and the noEncryption attribute of the SourcePreferences DS are not used in the present document.

The following table provides an informative example mapping of elements (and attributes) from UserPreferences/FilteringAndSearchPreferences/SourcePreferences to elements (and attributes) of a programme description.

<b>Element/attribute Name</b>	<b>Mapping</b>
DisseminationFormat	This element is not used in the present document.
DisseminationSource	ServiceInformationTable/ServiceInformation/Name.
DisseminationLocation	This element is not used in the present document.
DisseminationDate	ProgramLocationTable/BroadcastEvent/PublishedTime and PublishedDuration. ProgramLocationTable/Schedule/ScheduleEvent/PublishedTime and PublishedDuration. ProgramLocationTable/OnDemandProgram/StartOfAvailability and EndOfAvailability. ProgramLocationTable/OnDemandService/OnDemandProgram/StartOfAvailability and EndOfAvailability.
Disseminator	ServiceInformationTable/ServiceInformation/Owner.
MediaFormat	ProgramInformationTable/ProgramInformation/AVAttributes. ProgramLocationTable/BroadcastEvent/InstanceDescription/AVAttributes. ProgramLocationTable/Schedule/ScheduleEvent/InstanceDescription/AVAttributes. ProgramLocationTable/OnDemandProgram/InstanceDescription/AVAttributes. ProgramLocationTable/OnDemandService/OnDemandProgram/InstanceDescription/AVAttributes.
NoRepeat	ProgramLocationTable/BroadcastEvent/Repeat. ProgramLocationTable/Schedule/ScheduleEvent/Repeat.
NoEncryption	This attribute is not used in the present document.
NoPayPerUse	ProgramLocationTable/BroadcastEvent/Free. ProgramLocationTable/Schedule/ScheduleEvent/Free.

6.5.2.8 PreferenceCondition DS

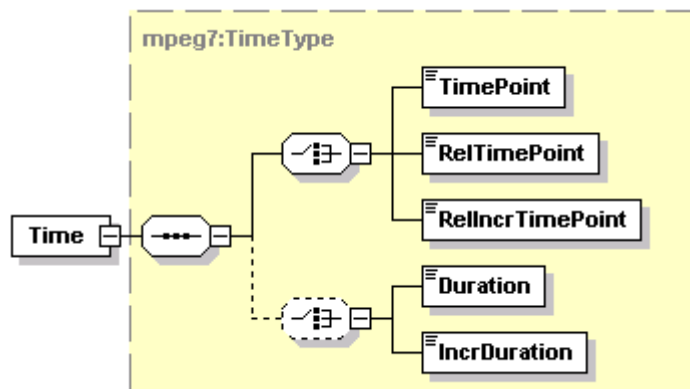
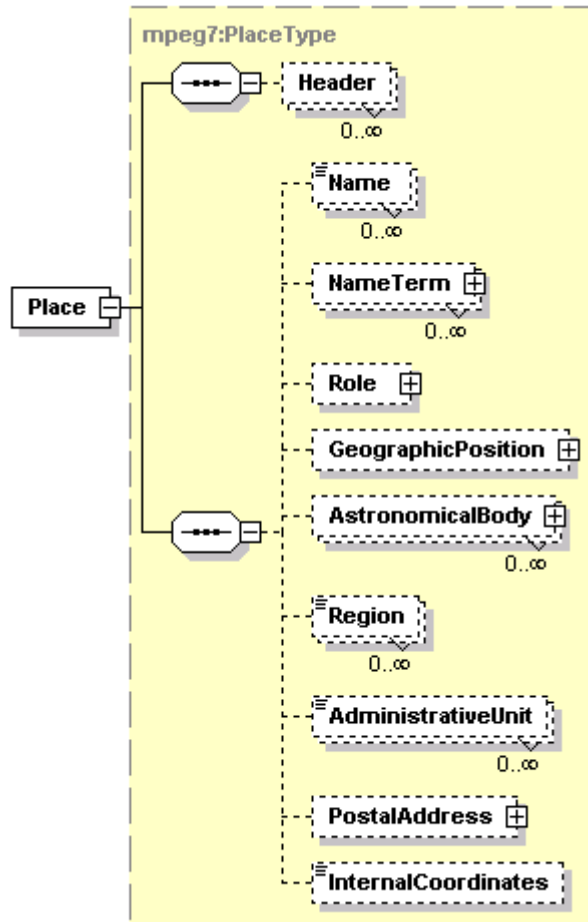
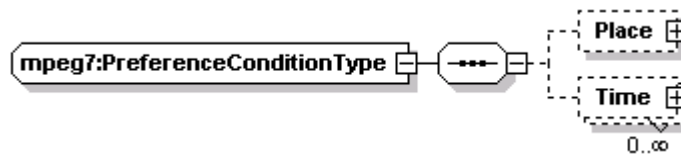

## 6.5.2.9 BrowsingPreferences DS

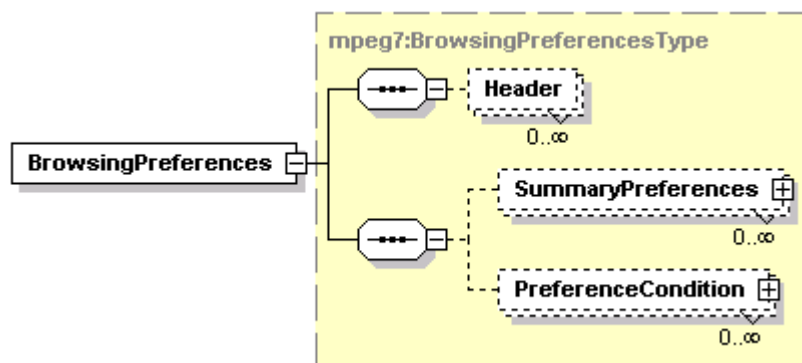

The BrowsingPreferences DS is used to specify a user's preferences for navigating and accessing multimedia content. The BrowsingPreferences DS is a container of SummaryPreferences.

The specification of the BrowsingPreferences DS is given in clause 15.2.9 of ISO/IEC 15938-5 [2]. Syntax of the BrowsingPreferences DS is specified in clause 15.2.9.2 in ISO/IEC 15938-5 [2]. Semantics of the BrowsingPreferences DS are specified in clause 15.2.9.3 in ISO/IEC 15938-5 [2].

**NOTE:** The `protected` attribute of the `BrowsingPreferences` DS can be set (under user control) to indicate whether the contained user preference information should remain private or not (see clause 15.2.4.3 in ISO/IEC 15938-5 [2]). By default, the value of `protected` is true. Because a single user preferences description can contain multiple `BrowsingPreferences` elements, it is possible to separately describe preferences that should be kept private and other preferences that do not have to be kept private.

## 6.5.2.10 SummaryPreferences DS

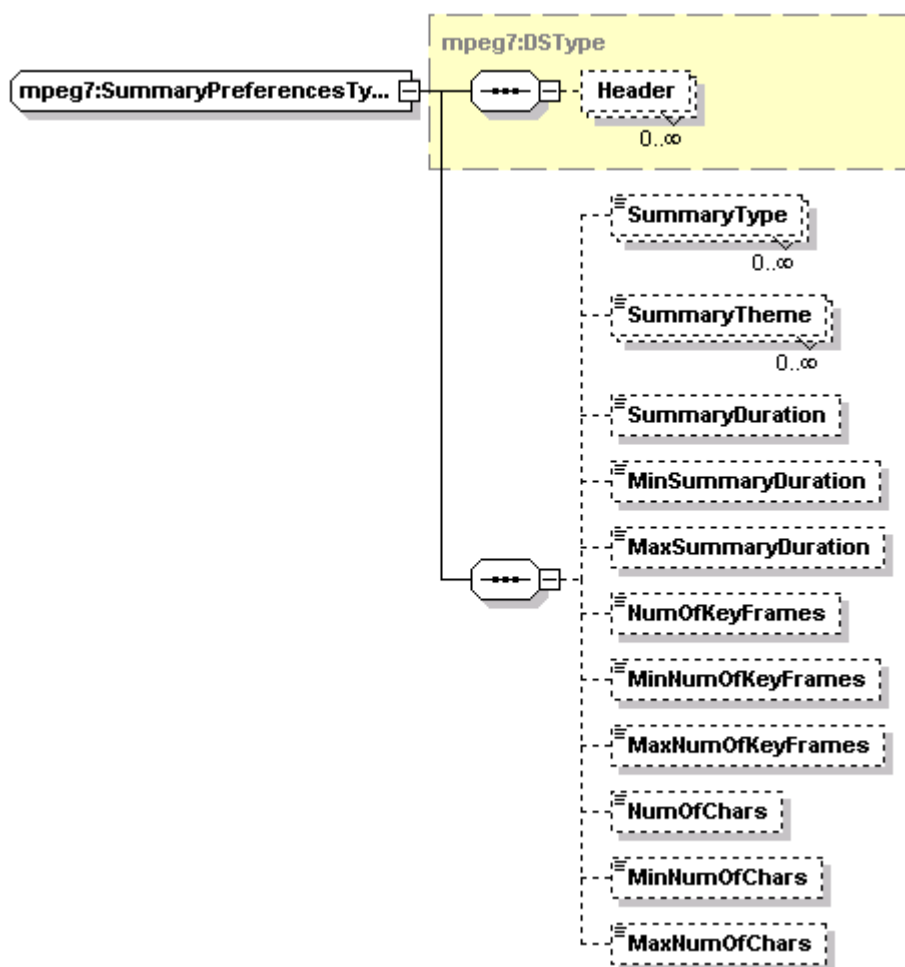

The SummaryPreferences DS describes a user's preferences for nonlinear navigation of media especially with respect to visualization and audio rendering of AV content.

The specification of the SummaryPreferences DS is given in clause 15.2.10 of ISO/IEC 15938-5 [2]. Syntax of the BrowsingPreferences DS is specified in clause 15.2.10.2 in ISO/IEC 15938-5 [2]. Semantics of the BrowsingPreferences DS are specified in clause 15.2.10.3 in ISO/IEC 15938-5 [2].

The following table provides an informative example mapping of elements (and attributes) from UserPreferences/BrowsingPreferences/SummaryPreferences to elements (and attributes) of a programme description.

Element/attribute Name	Mapping
SummaryType	SegmentInformationTable/SegmentGroupInformation/GroupType.
SummaryTheme	SegmentInformationTable/SegmentInformation/Description/Title. SegmentInformationTable/SegmentInformation/Description/Synopsis. SegmentInformationTable/SegmentInformation/Description/Keyword.
SummaryDuration	SegmentInformationTable/SegmentGroupInformation/duration.
MinSummaryDuration	SegmentInformationTable/SegmentGroupInformation/duration.
MaxSummaryDuration	SegmentInformationTable/SegmentGroupInformation/duration.
NumOfKeyFrames	SegmentInformationTable/SegmentGroupInformation/numberOfKeyFrames.
MinNumOfKeyFrames	SegmentInformationTable/SegmentGroupInformation/numberOfKeyFrames.
MaxNumOfKeyFrames	SegmentInformationTable/SegmentGroupInformation/numberOfKeyFrames.
NumOfChars	SegmentInformationTable/SegmentInformation/Description/Synopsis. SegmentInformationTable/ProgramInformation/BasicDescription/Synopsis.
MinNumOfChars	SegmentInformationTable/SegmentInformation/Description/Synopsis. ProgramInformationTable/ProgramInformation/BasicDescription/Synopsis.
MaxNumOfChars	SegmentInformationTable/SegmentInformation/Description/Synopsis. ProgramInformationTable/ProgramInformation/BasicDescription/Synopsis.

## 6.6 Segmentation metadata

Segmentation refers to the ability to define, access and manipulate temporal intervals (i.e. segments) within an AV stream. By associating metadata with segments and segment groups, it is possible to restructure and re-purpose an input AV stream to generate alternative consumption and navigation modes. Such modes could include, for example, a summary of the content with highlights, or a set of bookmarks that point to "topic headings" within the stream. Such metadata can be provided by service providers or broadcasters as a value-added feature and/or generated by viewers themselves. Applications include, for example, repurposing of content for educational purposes.

### 6.6.1 Segmentation metadata: definitions and requirements

In the present clause we present an overview of segmentation, including definitions of terminology and a list of requirements for common applications.

An entity-relationship diagram of the various components of a (segmented) programme is shown in figure 8. The properties and relationships of each entity are provided in more detail in the following clauses.

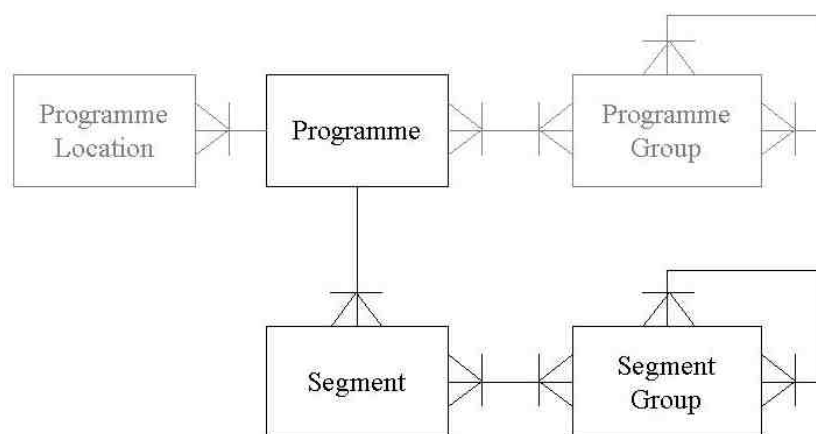

**Figure 8: Entity-relationship graph for the segmentation-related components of a TVA system**

#### Entity definitions

**Programme** - the programme represents an editorially coherent piece of content unambiguously identified by a CRID.

**Programme Group** - the programme group entity defines a grouping of programmes. Programme groups can also contain other programme groups. The relevant group type for segmentation applications is the "Programme Compilation" group type, which allows Segments from multiple programmes to be combined in Segment Groups.

**Programme Location** - Programme Location provides a physical location where the programme is available. A programme may be available at multiple programme locations; selection of a particular programme location is performed during the location resolution process. The timelines of different instances of a programme identified by a given CRID are assumed to be identical; hence it is inconsequential for the segmentation description which location is selected during the resolution process.

**Segment** - A segment is a continuous fragment of a programme. A particular segment can belong to a single programme only, but it can be a member of multiple segment groups.

**Segment Group** - denotes a collection of segments that are grouped together, for a particular purpose or due to a shared property. A segment group can contain segments or other segment groups.

## Relationship definitions

**Programme-to-Segment:** A Segment is part of a single programme, which is identified by its CRID. A Programme can contain multiple segments.

**Segment-to-Segment Group:** A Segment can belong to zero or more Segment Groups. A Segment Group can contain zero or more Segments (possibly from multiple Programmes).

**Segment Group-to-Segment Group:** A Segment Group can be a member of zero or more Segment Groups and it can contain zero or more Segment Groups. A Segment Group may contain either segments, or subgroups, but not both.

NOTE: This latter constraint is imposed by the syntax and semantics of the description schemes.

## 6.6.2 Basic segment description

The following complex type defines descriptive properties of segments.

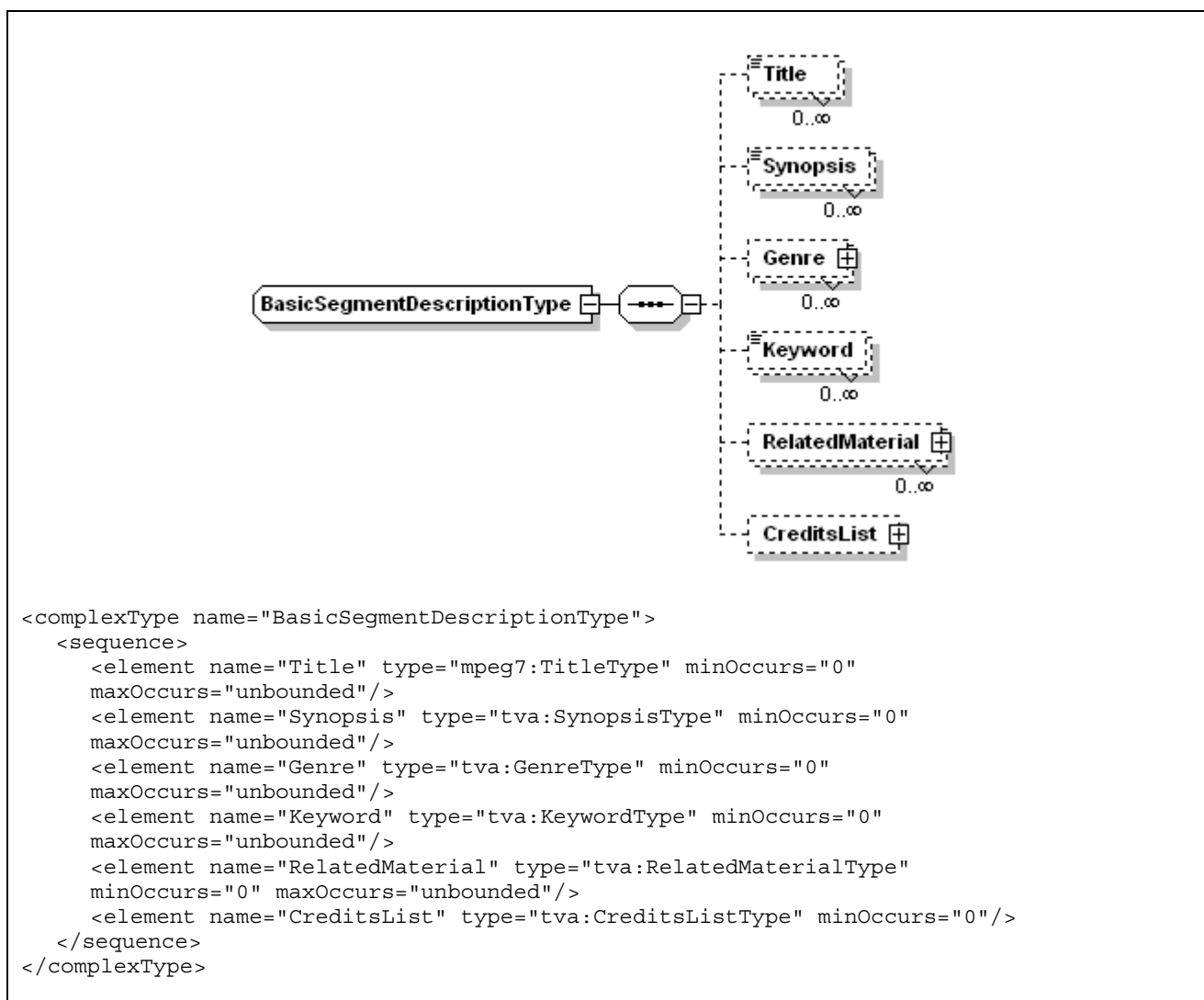

Name	Definition
BasicSegmentDescriptionType	Defines basic segment description.
Title	A title of the segment (optional). A segment can have several titles when necessary, e.g. in different languages.
Synopsis	A synopsis or textual description of the segment (optional). A segment can have several synopses when necessary, e.g. in different languages or lengths.



Name	Definition
Genre	A genre for the Segment. The thesaurus in annex B defines the normative <i>TV-Anytime</i> set of genres.
Keyword	A list of keywords associated with the segment (optional). A segment can have several keywords when necessary, e.g. in different languages.
RelatedMaterial	A link to external material related to the segment (optional). A segment can have multiple links.
CreditsList	The list of credits (e.g. actors, directors, etc.) for the segment.

### 6.6.3 TVAMediaTime Type

The TVAMediaTime Type is used to describe a time point relative to a known origin and with an optional duration. This type is used extensively by the Segmentation data types.

```

<complexType name="TVAMediaRelIncrTimePointType">
  <simpleContent>
    <restriction base="mpeg7:MediaRelIncrTimePointType" >
      <attribute name="mediaTimeUnit" type="mpeg7:mediaDurationType" use="optional"
        default="PT1N1000F"/>
    </restriction>
  </simpleContent>
</complexType>

<complexType name="TVAMediaTimeType">
  <sequence>
    <choice>
      <element name="MediaRelTimePoint" type="mpeg7:MediaRelTimePointType"/>
      <element name="MediaRelIncrTimePoint" type="tva:TVAMediaRelIncrTimePointType"/>
    </choice>
    <choice minOccurs="0">
      <element name="MediaDuration" type="mpeg7:mediaDurationType"/>
      <element name="MediaIncrDuration" type="mpeg7:MediaIncrDurationType"/>
    </choice>
  </sequence>
</complexType>

```

Name	Definition
TVAMediaRelIncrTimePointType	This complextype is used to define a time point on a timebase, using a declared set of time units.
mediaTimeUnit	An optional attribute which defines the units in which the Time point is defined. If this attribute is not declared then, the system shall use that defined in an ancestors "TimeBaseReference" element if any, or within the segments associated segment group. If no "TimeBaseReference" is defined then by default the mediaTimeUnits shall be in milliseconds.
TVAMediaTimeType	A complex type which is used to define a time point on a time line and an optional duration for the segment.
MediaRelTimePoint	This element is used to signal a relative time point using a Gregorian date and day time. When no "TimeBaseReference" is defined then the time base is assumed to be "00:00:00.000".
MediaRelIncrTimePoint	This element is used to signal a relative time point, in a user defined set of mediaTimeUnits. If mediaTimeUnits are defined within this element then they override any previously defined within a "TimeBaseReference" element. The mediaTimeBase attribute shall not be used.
MediaDuration	This element is used to signal a duration using a days, hours, minutes, seconds and fractions of seconds. See MPEG-7 MDS specification (ISO/IEC 15938-5 [2]).
MediaIncrDuration	This element is used to signal a duration using declared mediaTimeUnits.

## 6.6.4 TimeBaseReference Type

The following type is used within the Segment structures to define a time base, which segments are authored against.

```
<complexType name="TimeBaseReferenceType">
  <sequence>
    <choice>
      <element name="MediaTimePoint" type="mpeg7:mediaTimePointType"/>
      <element name="MediaRelIncrTimePoint" type="mpeg7:MediaRelIncrTimePointType"/>
    </choice>
  </sequence>
  <attribute name="timebaseId" type="string"/>
</complexType>
```

Name	Definition
TimeBaseReferenceType	This element enables the definition of a TimeBase from which all segmentLocators and KeyFrameLocators are authored relative too.
MediaTimePoint	This element enables the definition of a timebase origin using a Gregorian date and day time without specifying the TZD.
MediaRelIncrTimePoint	This element enables the definition of a timebase origin using specified time units. If no time units are given it shall be assumed that the time is defined in milliseconds i.e. "PT1N1000F". The mediaTimeBase attribute shall not be used.
timebaseId	This attribute shall be used to optionally identify a specific timebase within the content, for which the segments have been authored for. if this element is not present then the timebase shall be identified by using the CRID.

## 6.6.5 Segment Information

The following element and complex type define a segment.

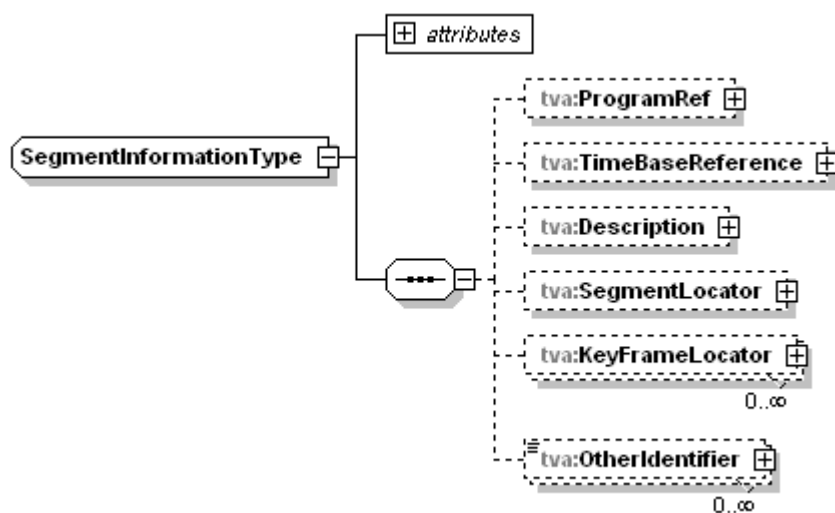

```
<complexType name="SegmentInformationType">
  <sequence>
    <element name="ProgramRef" type="tva:CRIDRefType" minOccurs="0"/>
    <element name="TimeBaseReference" type="tva:TimeBaseReferenceType" minOccurs="0"/>
    <element name="Description" type="tva:BasicSegmentDescriptionType" minOccurs="0"/>
    <element name="SegmentLocator" type="tva:TVAMediaTimeType" minOccurs="0"/>
    <element name="KeyFrameLocator" type="tva:TVAMediaTimeType" minOccurs="0" maxOccurs="unbounded"/>
  </sequence>
```

```

<element name="OtherIdentifier" type="mpeg7:UniqueIDType"
  minOccurs="0" maxOccurs="unbounded"/>
</sequence>
<attribute name="segmentId" type="tva:TVAIDType" use="required"/>
<attributeGroup ref="tva:fragmentIdentification"/>
<attribute name="metadataOriginIDRef" type="tva:TVAIDRefType" use="optional"/>
<attribute ref="xml:lang" use="optional"/>
</complexType>

```

Name	Definition
SegmentInformationType	Defines an individual segment.
ProgramRef	A reference to the programme this segment belongs to. When the ProgramRef element is not instantiated within a segment, the programme that the segment belongs to is specified by the ProgramRef element of (one of) its parent segment group(s). When the segment is a direct member of a segment group that defines a programme compilation (i.e. the ProgramRef element of the parent segment group references a CRID associated with a Programme Compilation), the ProgramRef element of the segment will reference the CRID of the particular programme that the segment belongs to. Note: When the use of a globally unique segmentId is required, the segmentId and ProgramRef should be combined to identify a segment.
TimeBaseReference	An optional element which when present signals the use of a different Timebase to that signalled within the segment Group for which this segment is a member of.
Description	A description of the content of the segment.
SegmentLocator	Locates the segment within a programme (instance) in terms of start time and duration (optional). If the duration is not specified, the segment ends at the end of the programme.
KeyFrameLocator	Locates a key frame of the segment within a programme in terms of a time point (optional). Multiple key frames may be associated with a single segment.
OtherIdentifier	An additional optional identifier to identify a segment.
segmentId	The unique identifier of the segment of TVAIDType type.
fragmentIdentification	Used to identify the fragment of data to which this description belongs to.
metadataOriginIDRef	A reference to an instance of MetadataOriginationInformation containing information about the provider of metadata.
xml:lang	The default natural language of the description.

## 6.6.6 Segment Group Information

The following element and complex types define segment grouping.

```

<complexType name="GroupIntervalType" >
  <attribute name="ref" type="tva:TVAIDRefType" use="optional"/>
</complexType>

<complexType name="SegmentsType">
  <attribute name="refList" type="tva:TVAIDRefsType"
    use="required"/>
</complexType>

<complexType name="GroupsType" >
  <attribute name="refList" type="tva:TVAIDRefsType"
    use="required"/>
</complexType>

```

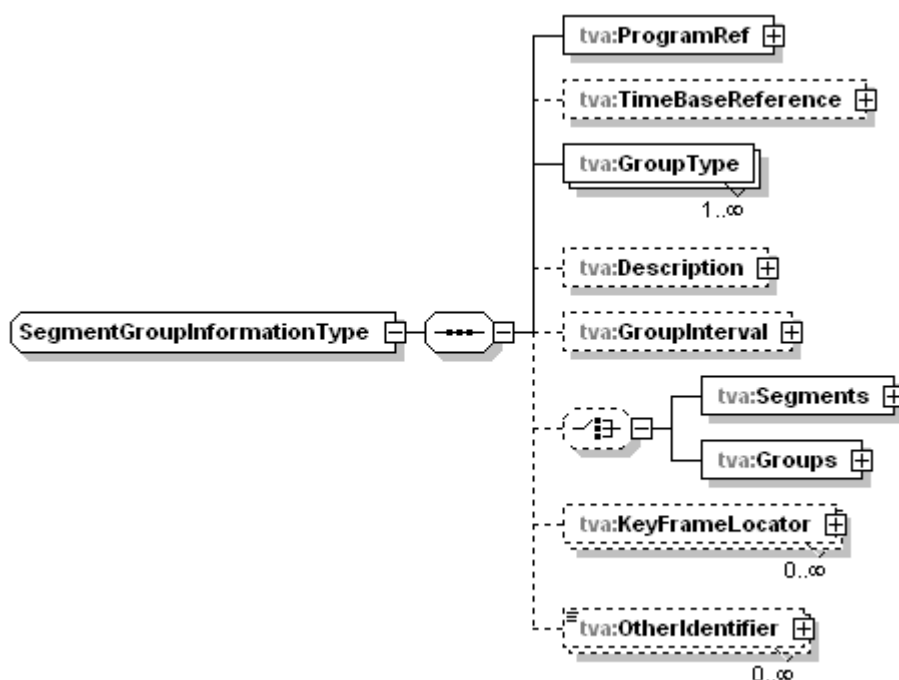

```

<complexType name="SegmentGroupInformationType">
  <sequence>
    <element name="ProgramRef" type="tva:CRIDRefType"/>
    <element name="TimeBaseReference" type="tva:TimeBaseReferenceType" minOccurs="0"/>
    <element name="GroupType" type="tva:BaseSegmentGroupTypeType"
      maxOccurs="unbounded"/>
    <element name="Description"
      type="tva:BasicSegmentDescriptionType" minOccurs="0"/>
    <element name="GroupInterval" type="tva:GroupIntervalType" minOccurs="0"/>
    <choice minOccurs="0">
      <element name="Segments" type="tva:SegmentsType"/>
      <element name="Groups" type="tva:GroupsType"/>
    </choice>
    <element name="KeyFrameLocator" type="tva:TVAMediaTimeType"
      minOccurs="0" maxOccurs="unbounded"/>
    <element name="OtherIdentifier" type="mpeg7:UniqueIDType"
      minOccurs="0" maxOccurs="unbounded"/>
  </sequence>
  <attribute name="groupId" type="tva:TVAIDType" use="required"/>
  <attribute name="ordered" type="boolean" default="true"
    use="optional"/>
  <attribute name="numberOfSegments" type="unsignedShort"
    use="optional"/>
  <attribute name="numberOfKeyFrames" type="unsignedShort"
    use="optional"/>
  <attribute name="duration" type="mpeg7:mediaDurationType"
    use="optional"/>
  <attribute name="topLevel" type="boolean" use="optional"/>
  <attributeGroup ref="tva:fragmentIdentification"/>
  <attribute name="metadataOriginIDRef" type="tva:TVAIDRefType" use="optional"/>
  <attribute ref="xml:lang" use="optional"/>
</complexType>

<complexType name="BaseSegmentGroupTypeType" abstract="true"/>

```

```

<complexType name="SegmentGroupTypeType">
  <complexContent>
    <extension base="tva:BaseSegmentGroupTypeType">
      <attribute name="value" use="required">
        <simpleType>
          <restriction base="string">
            <enumeration value="highlights"/>
            <enumeration value="highlights/objects"/>
            <enumeration value="highlights/events"/>
            <enumeration value="bookmarks"/>
            <enumeration value="bookmarks/objects"/>
            <enumeration value="bookmarks/events"/>
            <enumeration value="themeGroup"/>
            <enumeration value="preview"/>
            <enumeration value="preview/title"/>
            <enumeration value="preview/slideshow"/>
            <enumeration value="tableOfContents"/>
            <enumeration value="synopsis"/>
            <enumeration value="shots"/>
            <enumeration value="insertionPoints"/>
            <enumeration value="alternativeGroups"/>
            <enumeration value="alternativeSegments"/>
            <enumeration value="other"/>
          </restriction>
        </simpleType>
      </attribute>
    </extension>
  </complexContent>
</complexType>

```

Name	Definition
GroupIntervalType	A complex type that defines a reference to a single segment that defines the temporal range of the segment group.
ref	A reference to a segment with a segmentId attribute matching this value.
SegmentsType	A complex type that defines the segments that are part of this group.
refList	A list of references to elements of type SegmentInformationType with a matching segmentId attribute. The order of the references to segments in this list determines the temporal playback order of the segments.
GroupsType	A complex type that defines a list of segment groups.
refList	A list of references to elements of type SegmentGroupInformationType with a matching groupId attribute. The order of the references to segment groups in this list determines their ordering.
SegmentGroupInformationType	Defines an individual segment group.
ProgramRef	A reference to the programme this segment group belongs to. When the member segments/groups are collected from different programmes, the ProgramRef element references the CRID of a programme group of type "programCompilation". This CRID is resolved into the individual programmes CRIDs.
TimeBaseReference	An optional element which when present signals the use of a specific Time base for all segments of this group. When not present all segments unless specifically signalled have a timebase using timeunits of milliseconds, with an origin of "0" and the timebase identified using the CRID as declared by the ProgramRef element of this Segment Group.
GroupType	The type of the segment group.
Description	A description of the content of the segment group.

Name	Definition
GroupInterval	A reference to a single segment that defines the temporal range of the segment group. In the example of a football game, GroupInterval would be used to indicate that all the members of the segment group are available within the specified time interval, e.g. the first half.
Segments	Defines the segments that are part of this group by providing a list of references to the identifiers of elements of type SegmentInformationType (optional). The order of the references to segments in this list determines the temporal playback order of segments within this group.
Groups	Defines the segment groups that are subgroups of this group by providing a list of references to the identifiers of elements of type SegmentGroupInformationType (optional). The order of the references to segment groups in this list determines their ordering within this group.
KeyFrameLocator	Locates a key frame of the segment group within a programme in terms of a time point (optional). Multiple key frames may be associated with a single segment group.
OtherIdentifier	An additional optional identifier to identify the segment group.
groupId	The unique identifier of the segment group.
ordered	Specifies whether the given segment group presents an ordered playback list (i.e. whether order of the segment or segment groups within the given segment group is significant) (optional). The value of the attribute should match the semantics of the associated SegmentGroupType (e.g. highlights for "ordered" and bookmarks for "unordered").
numberOfSegments	The number of segments in the segment group (optional). The value of this attribute specifies only the segments that are direct members of the segment group.
numberOfKeyFrames	The number of key frames in the segment group (optional). The value of this attribute specifies only the key frames of the segments that are direct members of the segment group.
duration	The sum of the durations of the segments contained within this group (optional). This duration corresponds to the sum of the durations of the segments that are direct members of the segment group.
topLevel	Specifies whether the given segment group is a top-level group (optional).
fragmentIdentification	Used to identify the fragment of data to which this description belongs to.
metadataOriginIDRef	A reference to an instance of MetadataOriginationInformation containing information about the provider of metadata.
xml:lang	The default natural language of the description.
BaseSegmentGroupTypeType	An abstract type that specifies the valid types of segment groups.

Name	Definition
SegmentGroupTypeType	<p>An enumerated list of the TVA-defined segment group types. The allowed types are defined as follows:</p> <p><i>highlights</i> - The group of segments represents selected highlights from one or more programmes. A segment group of this type requires continuous playback.</p> <p><i>highlights/objects</i> - The group of segments represents selected highlights from a programme (or programmes) that share a common object or objects (e.g. <i>Seinfeld</i> highlights with Kramer). A segment group of this type requires continuous playback.</p> <p><i>highlights/events</i> - The group of segments represents selected highlights from a programme (or programmes) that share a common event or events (e.g. touchdowns in the Super Bowl). A segment group of this type requires continuous ordered playback.</p> <p><i>bookmarks</i> - The segment group defines a set of access points to a programme. If the member segments of a segment group of type <i>bookmarks</i> contain segment duration information, this duration information shall be ignored and the segments shall be treated as "open-ended." A segment group of this type does not require continuous playback.</p> <p><i>bookmarks/objects</i> - The segment group defines a set of access points to a programme, where the selected access points share a common object or objects. If the member segments of a segment group of type <i>bookmarks/objects</i> contain segment duration information, this duration information shall be ignored and the segments shall be treated as "open-ended." A segment group of this type does not require continuous playback.</p> <p><i>bookmarks/events</i> - The segment group defines a set of access points to a programme, where the selected access points share a common event or events. If the member segments of a segment group of type <i>bookmarks/events</i> contain segment duration information, this duration information shall be ignored and the segments shall be treated as "open-ended." A segment group of this type does not require continuous playback.</p> <p><i>themeGroup</i> - The segment group comprises segments that share a common topic or theme. The common theme can be specified in the segment group description. A theme group does not necessarily require direct continuous playback.</p> <p><i>preview</i> - The segment group defines a preview of a programme. A segment group of this type requires continuous playback.</p> <p><i>preview/title</i> - The segment group defines a preview of a programme, where the preview serves as a promotional title or trailer for the programme. A segment group of this type requires continuous playback.</p>

Name	Definition
<i>preview/slideshow</i>	The segment group defines a preview of a programme, where the preview serves as a compact slideshow of the programme content. A segment group of this type requires continuous playback.
<i>tableOfContents</i>	The segment group defines a navigable table of contents for the programme. A segment group of this type does not require continuous playback.
<i>synopsis</i>	The segment group provides a summary or synopsis of the programme. A segment group of this type requires continuous playback.
<i>shots</i>	The segment group provides a list of the shots in the programme. A segment group of this type does not require continuous playback.
<i>insertionPoints</i>	The segment group provides a list of segments which function as insertion points into the programme of interest; e.g. temporal locations of the commercials to be shown during a programme. The duration information associated with member segments in a segment group of type <i>insertionPoints</i> is ignored, since the member segments only determine the time instances in the original programme where additional content is to be inserted. A segment group of this type does not require continuous playback.
<i>alternativeGroups</i>	Each member of this type of segment group provides an alternative view or representation, with the same functionality but different durations or levels of detail. A segment group of this type does not require continuous playback.
<i>alternativeSegments</i>	The segment group contains a list of segments, each one representing an alternative source of the same logical content. This caters for cases where a content segment (e.g. a music track) is repeated at different points in the same programme, or in different programmes. Only one of the programmes referenced by the member segments needs to be acquired in order to satisfy the segment group as a whole. Only one of the alternative segments is played back when a segment group of this type is presented.
<i>other</i>	any other segment group type.

### Validity constraints

Various validity constraints are imposed on the proposed DS to ensure that (i) it fits the data model of figure 1 and (ii) the sequence and relationships of the various segments and segment groups are unambiguously defined. These constraints, which are implicit in the DSs, are outlined below also for clarity:

- A segment group may contain either segments, or subgroups, but not both.
- A segment group of type "alternativeGroups" may not contain segments and shall only contain subgroups.
- A segment group of any type other than "tableOfContents" and "alternativeGroups" may only contain segments. A group of type "tableOfContents" may contain other segment groups of type "tableOfContents".

These validity constraints reduce the complexity of the resulting descriptions by limiting the degree of nesting in the hierarchy. The navigation order of segments or segment groups is determined by the order of references to the segments in a segment group.



## 6.6.7 Segment information table

The following element and complex type define a structure for holding all segmentation-related metadata.

```
<complexType name="SegmentListType">
  <sequence>
    <element name="SegmentInformation"
      type="tva:SegmentInformationType" minOccurs="0" maxOccurs="unbounded"/>
  </sequence>
</complexType>
```

```
<complexType name="SegmentGroupListType">
  <sequence>
    <element name="SegmentGroupInformation"
      type="tva:SegmentGroupInformationType" minOccurs="0"
      maxOccurs="unbounded"/>
  </sequence>
</complexType>
```

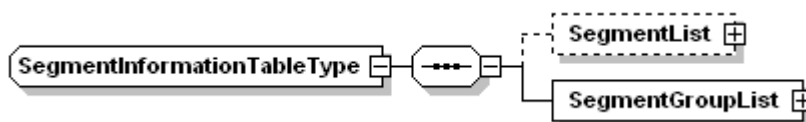

```
<complexType name="SegmentInformationTableType">
  <sequence>
    <element name="SegmentList" type="tva:SegmentListType" minOccurs="0"/>
    <element name="SegmentGroupList" type="tva:SegmentGroupListType" minOccurs="0"/>
  </sequence>
  <attribute name="metadataOriginIDRef" type="tva:TVAIDRefType" use="optional"/>
  <attribute ref="xml:lang" use="optional"/>
</complexType>
```

Name	Definition
SegmentListType	A complex type that defines a set of segments.
SegmentInformation	Information about a segment.
SegmentGroupList	A complex type that defines a list of segment groups.
SegmentGroupInformation	Information about a group of segments.
SegmentInformationTableType	Defines a structure for holding all segmentation-related metadata.
SegmentList	The list of the segments in the SegmentInformationTable.
SegmentGroupList	The list of the segment groups in the SegmentInformationTable.
metadataOriginIDRef	A reference to an instance of MetadataOriginationInformation containing information about the provider of metadata.
xml:lang	The default natural language of the description.

## 6.7 TV-Anytime documents

*TV-Anytime* metadata is structured into self-contained documents. Each document has a single top-level element that encloses all other *TV-Anytime* metadata.

## 6.7.1 Information tables

```

<complexType name="ProgramInformationTableType">
  <sequence>
    <element name="ProgramInformation"
      type="tva:ProgramInformationType" minOccurs="0"
      maxOccurs="unbounded"/>
  </sequence>
  <attribute name="metadataOriginIDRef" type="tva:TVAIDRefType" use="optional"/>
  <attribute ref="xml:lang" use="optional"/>
</complexType>

<complexType name="GroupInformationTableType">
  <sequence>
    <element name="GroupInformation" type="tva:GroupInformationType"
      minOccurs="0" maxOccurs="unbounded"/>
  </sequence>
  <attribute name="metadataOriginIDRef" type="tva:TVAIDRefType" use="optional"/>
  <attribute ref="xml:lang" use="optional"/>
</complexType>

```

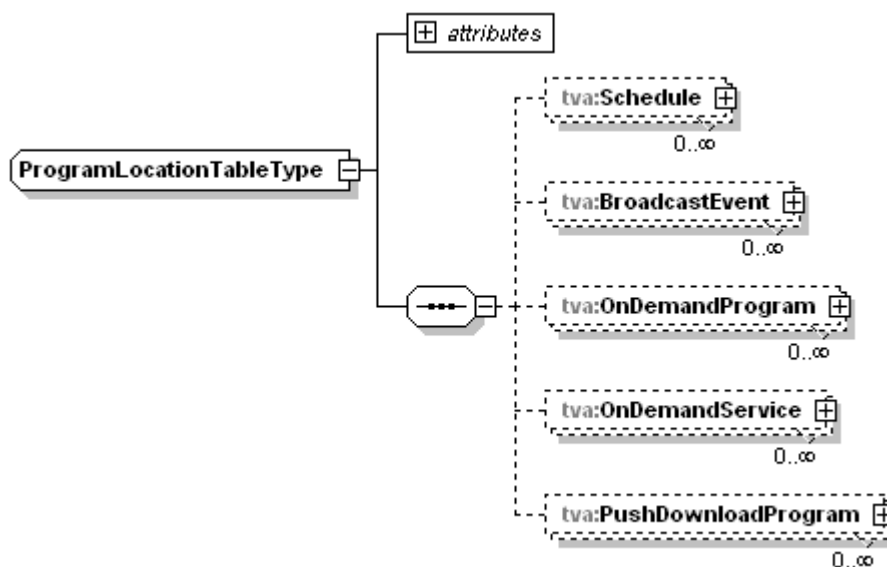

```

<complexType name="ProgramLocationTableType">
  <sequence>
    <element name="Schedule" type="tva:ScheduleType" minOccurs="0"
      maxOccurs="unbounded"/>
    <element name="BroadcastEvent" type="tva:BroadcastEventType"
      minOccurs="0" maxOccurs="unbounded"/>
    <element name="OnDemandProgram" type="tva:OnDemandProgramType"
      minOccurs="0" maxOccurs="unbounded"/>
    <element name="OnDemandService" type="tva:OnDemandServiceType"
      minOccurs="0" maxOccurs="unbounded"/>
    <element name="PushDownloadProgram" type="tva:PushDownloadType"
      minOccurs="0" maxOccurs="unbounded"/>
  </sequence>
  <attribute name="metadataOriginIDRef" type="tva:TVAIDRefType" use="optional"/>
  <attribute ref="xml:lang" use="optional"/>
</complexType>

<complexType name="ServiceInformationTableType">
  <sequence>
    <element name="ServiceInformation"
      type="tva:ServiceInformationType" minOccurs="0"
      maxOccurs="unbounded"/>
  </sequence>
  <attribute name="metadataOriginIDRef" type="tva:TVAIDRefType" use="optional"/>

```

```

    <attribute ref="xml:lang" use="optional"/>
  </complexType>

```

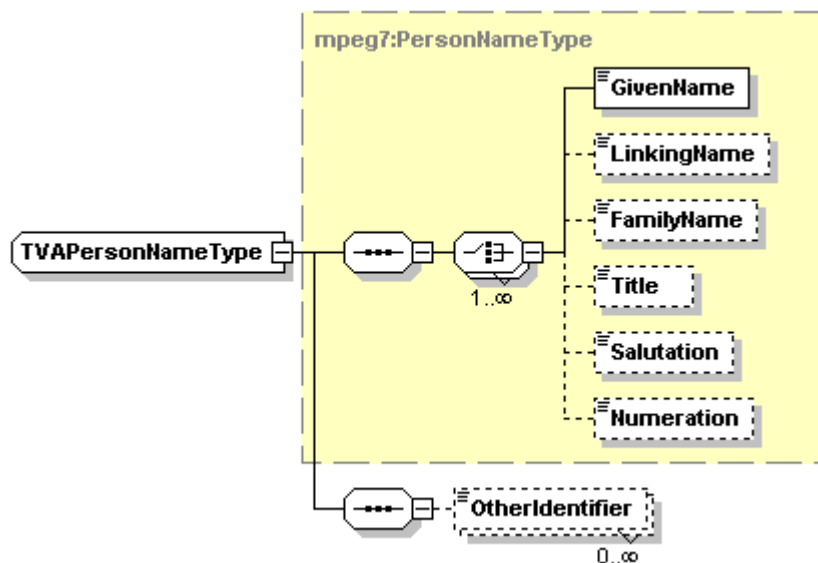

```

<complexType name="TVAPersonNameType">
  <complexContent>
    <extension base="mpeg7:PersonNameType">
      <sequence>
        <element name="OtherIdentifier" type="mpeg7:UniqueIDType" minOccurs="0"
          maxOccurs="unbounded"/>
      </sequence>
      <attribute name="personNameId" type="tva:TVAIDType"
        use="required"/>
      <attributeGroup ref="tva:fragmentIdentification"/>
      <attribute name="metadataOriginIDRef" type="tva:TVAIDRefType" use="optional"/>
    </extension>
  </complexContent>
</complexType>

```

```

<complexType name="OrganizationNameType">
  <simpleContent>
    <extension base="mpeg7:TextualType">
      <attribute name="organizationNameId"
        type="tva:TVAIDType"
        use="required"/>
      <attributeGroup ref="tva:fragmentIdentification"/>
      <attribute name="metadataOriginIDRef" type="tva:TVAIDRefType" use="optional"/>
    </extension>
  </simpleContent>
</complexType>

```

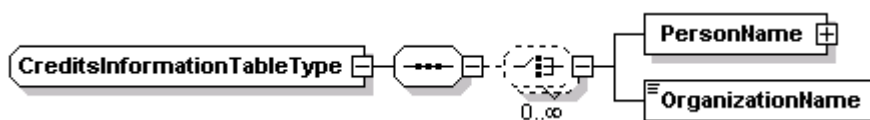

```

<complexType name="CreditsInformationTableType">
  <sequence>
    <choice minOccurs="0" maxOccurs="unbounded">
      <element name="PersonName" type="tva:TVAPersonNameType"/>
      <element name="OrganizationName" type="tva:OrganizationNameType"/>
    </choice>
  </sequence>
  <attribute name="copyrightNotice" type="string" use="optional"/>
  <attribute name="metadataOriginIDRef" type="tva:TVAIDRefType" use="optional"/>
  <attribute ref="xml:lang" use="optional"/>
</complexType>

```

Name	Definition
ProgramInformationTableType	A complex type that contains a table of programme information records.
ProgramInformation	A list of programme information records.
metadataOriginIDRef	A reference to an instance of MetadataOriginationInformation containing information about the provider of metadata.
xml:lang	The default natural language of the description.
GroupInformationTableType	A complex type that contains a table of group information records.
GroupInformation	A list of group information records.
metadataOriginIDRef	A reference to an instance of MetadataOriginationInformation containing information about the provider of metadata.
xml:lang	The default natural language of the description.
ProgramLocationTableType	A complex type that contains a table of programme location records.
Schedule	A list of Schedule records, There can be more than one schedule per serviceId. Such schedules would be temporarily exclusive. It is recommended to list schedule events by time order to facilitate timely extraction and access to the information.
BroadcastEvent	A list of BroadcastEvent records.
OnDemandProgram	A list of OnDemandProgram records.
OnDemandService	A list of OnDemandService Records.
PushDownloadProgram	A list of programmes pushed to the user device at the request and under the control of the service provider.
metadataOriginIDRef	A reference to an instance of MetadataOriginationInformation containing information about the provider of metadata.
xml:lang	The default natural language of the description.
ServiceInformationTable	A complex type that contains a table of service information records.
ServiceInformation	A list of service information records.
metadataOriginIDRef	A reference to an instance of MetadataOriginationInformation containing information about the provider of metadata.
xml:lang	The default natural language of the description.
TVAPersonNameType	A complex type that defines the name of a person.
OtherIdentifier	An attribute to enable a publisher that uses a single scheme for normalised TV-A credits (typically its own database IDs) also to supply references for the same people in alternative public or commercial identification schemes.
personNameId	A unique identifier for the name of a person referenced by the PersonNameIDRef element within a CreditsItemType.
fragmentIdentification	Used to identify the fragment of data to which this description belongs.
metadataOriginIDRef	A reference to an instance of MetadataOriginationInformation containing information about the provider of metadata for the table and associated metadata rights information.
OrganizationNameType	A complex type that defines the name of an organization.
organizationNameId	A unique identifier for the name of an organization referenced by OrganizationNameIDRef element within a CreditsItemType.
fragmentIdentification	Used to identify the fragment of data to which this description belongs to.
metadataOriginIDRef	A reference to an instance of MetadataOriginationInformation containing information about the provider of metadata for the table and associated metadata rights information.

Name	Definition
CreditsInformationTableType	A complex type that contains the credits information for the content.
PersonName	An element giving the name of a person referenced by a CreditsListItem.
OrganizationName	An element giving the name of an organization referenced in a CreditsListItem.
copyrightNotice	Specifies the copyright information for the credits information table.
metadataOriginIDRef	A reference to an instance of MetadataOriginationInformation containing information about the provider of metadata.
xml:lang	The default natural language of the description.

```

<complexType name="PurchaseInformationType">
  <complexContent>
    <extension base="tva:PurchaseItemType">
      <attribute name="purchaseId" type="tva:TVAIDType" use="required"/>
      <attributeGroup ref="tva:fragmentIdentification"/>
      <attribute name="metadataOriginIDRef" type="tva:TVAIDRefType" use="optional"/>
    </extension>
  </complexContent>
</complexType>

<complexType name="PurchaseInformationTableType">
  <sequence>
    <element name="PurchaseInformation" type="tva:PurchaseInformationType"
      minOccurs="0" maxOccurs="unbounded"/>
  </sequence>
  <attribute name="metadataOriginIDRef" type="tva:TVAIDRefType" use="optional"/>
  <attribute ref="xml:lang" use="optional"/>
</complexType>

```

Name	Definition
PurchaseInformationType	A complex type that contains all the information about a purchase item in order to group such items into a purchase information table.
purchaseId	A purchase ID of TVAIDType to allow searching of this item in the purchase information table.
fragmentIdentification	Used to identify the fragment of data that this description belongs to.
metadataOriginIDRef	A reference to an instance of MetadataOriginationInformation containing information about the provider of metadata.
PurchaseInformationTableType	A table of information gathering descriptions of purchase items.
PurchaseInformation	Contains the information on the purchase.
metadataOriginIDRef	A reference to an instance of MetadataOriginationInformation containing information about the provider of metadata.
xml:lang	The default natural language of the description.

```

<element name="TVAContentLinks">
  <complexType>
    <sequence>
      <element name="RelatedMaterial" type="tva:RelatedMaterialType"
        maxOccurs="unbounded"/>
    </sequence>
  </complexType>
</element>

```

Name	Definition
TVAContentLinks	An element to be used to establish links to related material.
RelatedMaterial	A reference to any other material related to a programme.

## 6.7.2 TV-Anytime metadata document

```
<!-- ##### -->
<!-- Definition of TVAMain DS -->
<!-- ##### -->
```

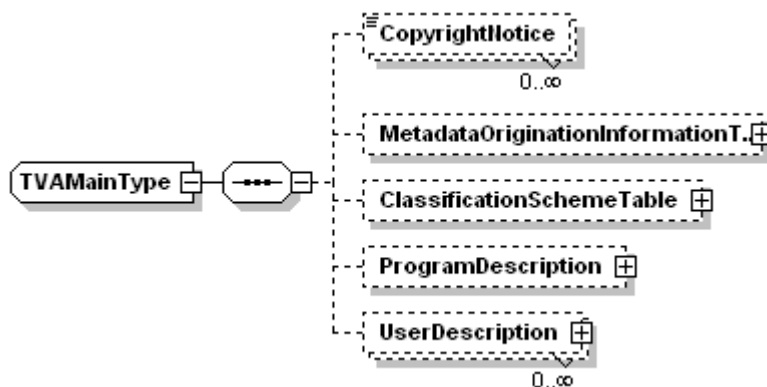

```
<element name="TVAMain" type="tva:TVAMainType"/>
<complexType name="TVAMainType">
  <sequence>
    <element name="CopyrightNotice" type="mpeg7:TextualType" minOccurs="0"
      maxOccurs="unbounded"/>
    <element name="MetadataOriginationInformationTable"
      type="tva:MetadataOriginationInformationTableType" minOccurs="0"/>
    <element name="ClassificationSchemeTable"
      type="tva:ClassificationSchemeTableType" minOccurs="0"/>
    <element name="ProgramDescription"
      type="tva:ProgramDescriptionType" minOccurs="0"/>
    <element name="UserDescription" type="tva:UserDescriptionType"
      minOccurs="0" maxOccurs="unbounded"/>
  </sequence>
  <attribute ref="xml:lang" use="required"/>
  <attribute name="publisher" type="string" use="optional"/>
  <attribute name="publicationTime" type="dateTime" use="optional"/>
  <attribute name="rightsOwner" type="string" use="optional"/>
  <attribute name="originID" type="tva:TVAIDRefType" use="optional"/>
  <attribute name="version" type="unsignedInt" use="optional"/>
</complexType>
```

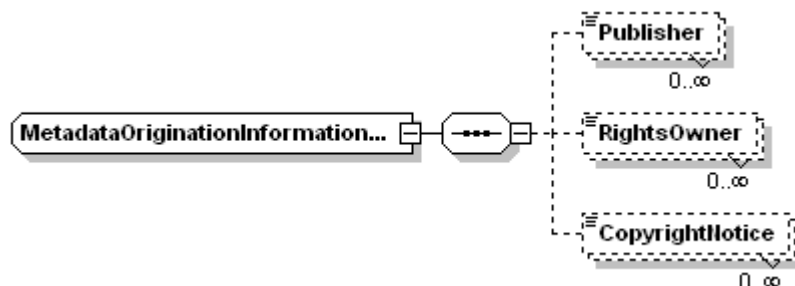

```
<complexType name="MetadataOriginationInformationType">
  <sequence>
    <element name="Publisher" type="mpeg7:TextualType" minOccurs="0"
      maxOccurs="unbounded"/>
```

```

    <element name="RightsOwner" type="mpeg7:TextualType" minOccurs="0"
    maxOccurs="unbounded"/>
    <element name="CopyrightNotice" type="mpeg7:TextualType" minOccurs="0"
    maxOccurs="unbounded"/>
  </sequence>
  <attribute name="originID" type="tva:TVAIDType" use="required"/>
  <attributeGroup ref="tva:fragmentIdentification"/>
</complexType>

<complexType name="MetadataOriginationInformationTableType">
  <sequence>
    <element name="MetadataOriginationInformation"
    type="tva:MetadataOriginationInformationType" minOccurs="0" maxOccurs="unbounded"/>
  </sequence>
  <attribute ref="xml:lang" use="optional"/>
</complexType>

```

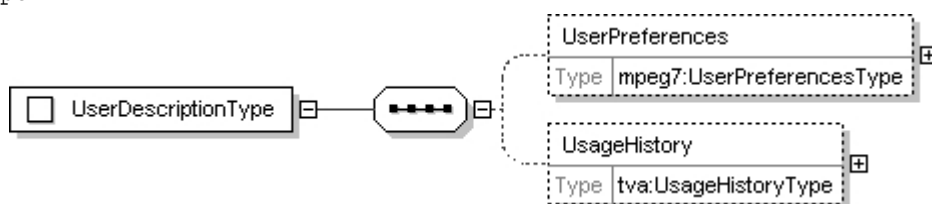

```

<complexType name="UserDescriptionType">
  <sequence>
    <element name="UserPreferences" type="mpeg7:UserPreferencesType"
    minOccurs="0"/>
    <element name="UsageHistory" type="tva:UsageHistoryType"
    minOccurs="0"/>
  </sequence>
</complexType>

<complexType name="CSAliasType" >
  <complexContent>
    <extension base="mpeg7:ClassificationSchemeAliasType">
      <attributeGroup ref="tva:fragmentIdentification"/>
      <attribute name="metadataOriginIDRef" type="tva:TVAIDRefType" use="optional"/>
    </extension>
  </complexContent>
</complexType>

<complexType name="ClassificationSchemeType">
  <complexContent>
    <extension base="mpeg7:ClassificationSchemeType">
      <attributeGroup ref="tva:fragmentIdentification"/>
      <attribute name="metadataOriginIDRef" type="tva:TVAIDRefType" use="optional"/>
      <attribute ref="xml:lang" use="optional"/>
    </extension>
  </complexContent>
</complexType>

```

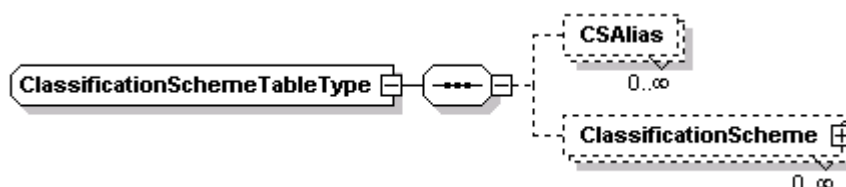

```

<complexType name="ClassificationSchemeTableType">
  <sequence>
    <element name="CSAlias" type="tva:CSAliasType" minOccurs="0"
    maxOccurs="unbounded"/>
    <element name="ClassificationScheme" type="tva:ClassificationSchemeType"
    minOccurs="0" maxOccurs="unbounded"/>
  </sequence>

```

```
<attribute ref="xml:lang" use="optional"/>
</complexType>
```

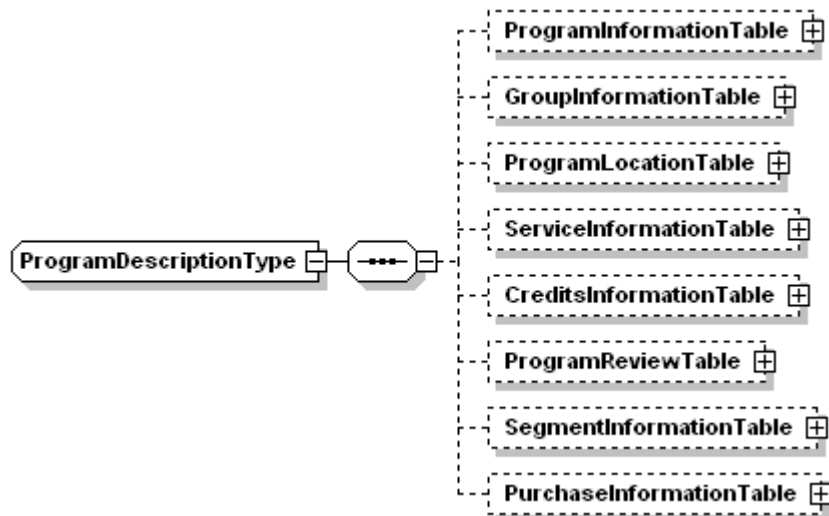

```
<complexType name="ProgramDescriptionType">
  <sequence>
    <element name="ProgramInformationTable"
      type="tva:ProgramInformationTableType" minOccurs="0"/>
    <element name="GroupInformationTable"
      type="tva:GroupInformationTableType" minOccurs="0"/>
    <element name="ProgramLocationTable"
      type="tva:ProgramLocationTableType" minOccurs="0"/>
    <element name="ServiceInformationTable"
      type="tva:ServiceInformationTableType" minOccurs="0"/>
    <element name="CreditsInformationTable"
      type="tva:CreditsInformationTableType" minOccurs="0"/>
    <element name="ProgramReviewTable"
      type="tva:ProgramReviewTableType" minOccurs="0"/>
    <element name="SegmentInformationTable"
      type="tva:SegmentInformationTableType" minOccurs="0"/>
    <element name="PurchaseInformationTable"
      type="tva:PurchaseInformationTableType" minOccurs="0"/>
  </sequence>
</complexType>
```

Name	Definition
TVAMain	The root element for a TVA schema valid instance document that provides a complete description.
TVAMainType	Specifies the root element for a TVA schema valid instance document that provides a complete description.
CopyrightNotice	Specifies the copyright information for the TVAMain document.
MetadataOriginationInformationTable	Contains information on the provider(s) of metadata in the TVA document and associated metadata rights information.
ClassificationSchemeTable	Contains the classification schemes used by the various descriptions in the TVA document and their aliases (optional).
ProgramDescription	Contains elements for description of programmes.
UserDescription	Contains elements for description of a user's preferences or content consumption history.
xml:lang	Specifies the language of the description.
publisher	Specifies the name of the publisher of the description.
publicationTime	Specifies the time the metadata description was



Name	Definition
	published.
rightsOwner	Specifies the entity that holds the rights to the description.
originID	A reference to an instance of MetadataOriginationInformation containing information about the provider of metadata for the TVA document and associated metadata rights information.
Version	Specifies the version of the description.
MetadataOriginationInformationType	A complex type that provide information on the metadata provider.
Publisher	Specifies the name of the metadata publisher.
RightsOwner	Specifies the metadata rights owner.
CopyrightNotice	Specifies copyright information.
originID	An instance of MetadataOriginationInformation containing information about a provider of metadata and associated metadata rights information.
fragmentIdentification	Used to identify the fragment of data that this description belongs to.
MetadataOriginationInformationTableType	A complex type instantiated by MetadataOriginationInformationTable.
MetadataOriginationInformation	An instance of MetadataOriginationInformationType containing information about the provider of metadata.
xml:lang	The default natural language of the description.
UserDescriptionType	A complex data type for listing user preferences and user viewing/usage history.
UserPreferences	Contains elements for description of a user's preferences.
UsageHistory	Contains elements for description of a user's usage/viewing history.
CSAliasType	A complex type that specifies an alias for a classification scheme referenced by a URI (optional). Defined as MPEG-7 type ClassificationSchemeAliasType (see clause 7.3.7 of ISO/IEC 15938-5 [2] for a detailed description).
fragmentIdentification	Used to identify the fragment of data that this description belongs to.
metadataOriginIDRef	A reference to an instance of MetadataOriginationInformation containing information about the provider of metadata.
ClassificationSchemeType	A complex type that specifies a complete classification scheme that is transmitted as part of the TVA description document (optional). Defined as MPEG-7 type ClassificationSchemeType (see clause 7.3.2 of ISO/IEC 15938-5 [2] for a detailed description).
fragmentIdentification	Used to identify the fragment of data that this description belongs to.
metadataOriginIDRef	A reference to an instance of MetadataOriginationInformation containing information about the provider of metadata.
xml:lang	The default natural language of the classification scheme.
ClassificationSchemeTableType	A complex data type for listing the classification schemes used by the various descriptions in the TVA document and their aliases.
CSAlias	Specifies an alias for a classification scheme referenced by a URI (optional).
ClassificationScheme	Specifies a complete classification scheme that is transmitted as part of the TVA description document (optional).
xml:lang	The default natural language of the classification

Name	Definition
	scheme.
ProgramDescriptionType	A complex type that aggregates the tables that contain programme description metadata.
ProgramInformationTable	The programme information table.
GroupInformationTable	The group information table.
ProgramLocationTable	The programme location table.
ServiceInformationTable	The service information table.
CreditsInformationTable	The credits information table.
ProgramReviewTable	The programme review table.
SegmentInformationTable	The segment information table.
PurchaseInformationTableType	The purchase information table.

## 7 The TVA metadata framework (informative)

### 7.1 The XML-based *TV-Anytime* metadata framework

There are different contexts where it might be preferred to continuously use XML in its textual form. Binarization allows saving bandwidth and maximizing the performance of the system (parsing at the binary level is more efficient). The transport and extraction of textual or binarized XML is out of the scope of *TV-Anytime*, which is agnostic to the delivery means. The choice of XML as a representation format is still compatible with the delivery of metadata originated in another format. TS 102 822-3-2 [6] addresses the encoding and structuring of *TV-Anytime* metadata.

Figure 9 shows how the system can be fed by different metadata descriptions encoded in different XML or non-XML formats.

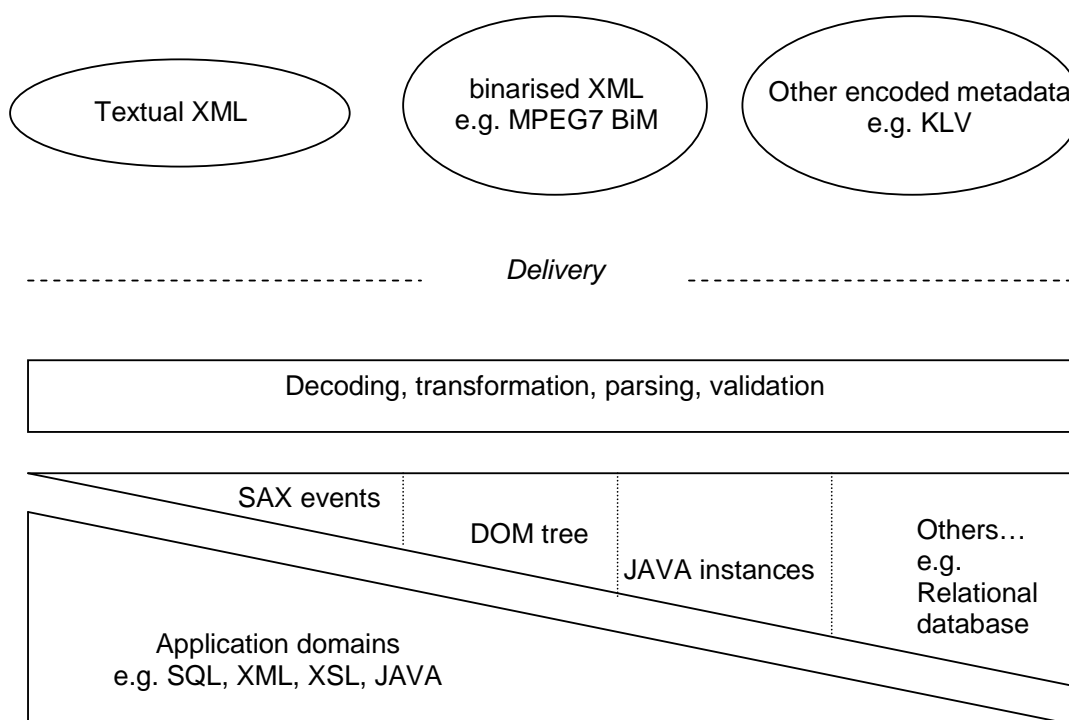

**Figure 9: The XML-based TVA metadata framework**

After delivery, metadata descriptions can be decoded, transformed, parsed and validated, as necessary. *TV-Anytime* does not specify how this should be implemented. But this is the gateway to different application domains that allows *TV-Anytime* to be platform independent.

## 7.2 Metadata security considerations

The *TV-Anytime* specification provides a rich set of metadata. This metadata can be considered as an asset requiring protection. Therefore, a protection scheme may be required to handle the usage of such data. Definition of a "proper" protection scheme depends on the nature of the metadata. For example, a critical security issue for user description information would be the protection of user privacy. On the other hand, while preventing illegal copying of programme related information is another important issue, more importantly may be the control of the usage of such data related to the value-added services based on this data.

The protection of metadata shall allow distinguishing between three different usages, i.e. copy, modify and view. These will apply differently to content or user related information.

a) Content description metadata usage rules.

It is reasonable to assume that a 3<sup>rd</sup> party, not the user him/herself, provides this information and also its usage control information to the user. In the case of content information, the usages may apply as follows:

Copy.

This refers to copying the received metadata in a local storage or copying it to another 3<sup>rd</sup> party.

Modify.

As an example, a user might want to index his favourite shots from provided segmentation data. Or the consumer may want to customize data provided by the service provider.

View (Consume).

An application is allowed "viewing", i.e. accessing and processing, metadata.

b) User description metadata usage rules. *TV-Anytime* User Description Metadata contains usage history and user preferences. By definition, it contains user private information; that needs to be protected against unauthorized access. However, it is expected that some user information will be exchanged.

Copy.

Private user data may be copied to a 3<sup>rd</sup> party by way of a bi-directional network. There could be several levels and forms of grant that the user allows to the 3<sup>rd</sup> party, i.e. will a third party be allowed to copy this data to another third party, or can it process it itself for use in targeting.

Modify.

It may or may not be desirable to allow a user to modify or delete his/her UserHistory and UserPreference Metadata. In some devices, it may be possible that agent software automatically modifies user preferences based on usage history.

View (Consume).

A typical usage is when users view and search for programmes in the usage history and then play or record the chosen programme, or an agent filters and searches for programmes according to the user preferences.

Privacy.

Private data is sensitive and conditions under which it may be accessed will vary according to different combinations of business models and legal environments. It shall be possible to monitor and control access (e.g. user control of local or remote third party access) to private data. Note that the `protected` attribute of the `UserIdentifier` datatype can be set (e.g. under user control) to indicate whether the user identifier information should remain private or not (see clause 15.2.4.3 in ISO/IEC 15938-5 [2]). By default, the value of `protected` is "true".

In addition to the respect of these usage rules, metadata security requires the following:

- The integrity of data should be maintained.
- It shall possible to protect this information either globally or at varying levels of granularity.
- It should be possible to authenticate sources of metadata.

# Annex A (normative): TV-Anytime Classification Schemes

## A.1 Introduction

The Classification Scheme DS is an MPEG-7 tool for the provision of controlled terminology for use in classification. It is defined in clause 7.3 of the ISO/IEC 15938-5 [2]. The MDS specification shows how URNs can be used to uniquely identify CSs and terms within CSs, as well as the use of CS aliasing to provide a more concise, application-specific way of referring to classification terms.

An informative set of Classification Schemes has been developed by TVA to provide a universally applicable default set of classification terms. In addition to - or as a total or partial replacement for - these default CSs, implementers may create and make use of other CSs to meet specific regional or other special requirements (see clause B.3). These default CSs are presented as well-formed XML instance documents complying with the ClassificationScheme fragment defined in clause 4.3.1.13 of TS 102 822-3-2 [6]. These are not schema valid, which would require the incorporation of the fragment into an instance of ClassificationSchemeTable in the TVAMain document.

### EXAMPLE 1:

```
<TVAMain xml:lang="en" xmlns="urn:tva:metadata:2008" xmlns:mpeg7="urn:tva:mpeg7:2008"
xmlns:xsi="http://www.w3.org/2001/XMLSchema-instance"
xsi:schemaLocation="urn:tva:metadata:2008 tva_metadata_3-1_v151.xsd">
  <ClassificationSchemeTable>
    <ClassificationScheme uri="urn:tva:metadata:cs:ActionTypeCS:2004">
      <!-- ##### -->
      <!-- ACTIONTYPE -->
      <!-- Definition: Types of user action being
      monitored to analyse viewing habits-->
      <!-- ##### -->
      <mpeg7:Term termID="1">
        <mpeg7:Name xml:lang="en">Audio-Video</mpeg7:Name>
        <mpeg7:Definition xml:lang="en">Actions Related to Audio and
        Video</mpeg7:Definition>
      </mpeg7:Term>
      <!--etc.-->
    </ClassificationScheme>
  </ClassificationSchemeTable>
</TVAMain>
```

The syntax for naming default TVA CSs is closely modelled on that used for MPEG-7 CSs and takes the form:

- "urn:tva:metadata:cs:*SchemeName*".

The first four structural components, which always take the form "urn:tva:metadata:cs:", indicate that a CS is being named within the TVA metadata CS namespace. The terminating component, *SchemeName*, uniquely names the CS within the namespace, e.g. "urn:tva:metadata:cs:IntentionCS". In addition, the *SchemeName* may, if required, include one or more version qualifiers separated from the name by a colon, e.g. "urn:tva:metadata:cs:IntentionCS:2005".

However, it is recognized that alternative forms of a URI (e.g. a URL) are equally valid to uniquely identify classification schemes other than presented in the present document.

Examples of the use of the different forms of pointers to classification schemes and associated aliases are provided in Clause 7.4.4.5.2 of the ISO/IEC 15938-5 [2]. It is to be noted that in the case of URNs, the separator to be used is the ":", while it is the "#" in the case of URLs.

EXAMPLE 2: If "S1" is the alias for "urn:tva:metadata:cs:IntentionCS:2004", then a termID will be accessed through ":S1:1.2.3.4" and the fully qualified term path is: "urn:tva:metadata:cs:IntentionCS:2004:1.2.3.4".

EXAMPLE 3: If "S2" is the alias for "<http://arib.or.jp/tv-anytime/ContentCS.xml>", then a termID will be accessed through ":S2:1.2.3.4" and the fully qualified term path is: "<http://arib.or.jp/tv-anytime/ContentCS.xml#1.2.3.4>".

If external Classification Schemes are used, it is an important implementation requirement to ensure that these resources are accessible by the metadata recipient. In the case of a URL, it must be ensured that the presence of the file is maintained at the declared location. In the case of a URN, the actual scheme location must be provided for interoperability purposes.

An informative set of Classification Schemes has been developed by TVA to provide a universally applicable default set of classification terms. In addition to - or as a total or partial replacement for - these default CSs, implementers may create and make use of other CSs to meet specific regional or other special requirements (see clause B.3).

**NOTE:** Some of the following classification schemes might have been changed to better categorize content. These modifications have been brought into the present document in a backward compatible manner. Terms that have deprecated have been removed but the original numbering has been respected. It is recommended that now missing terms defined in previous versions of the present document be replaced progressively with the new definitions provided in this annex. Missing references (keys such as e.g. CONTENT's 3.1.2.1.6) should not be used to insert private definitions. The need for customization has been covered specifically by adding keys at the root of certain classification schemes.

## A.2 ActionType CS

```
<?xml version="1.0" encoding="UTF-8"?>
<ClassificationScheme uri="urn:tva:metadata:cs:ActionTypeCS:2010">
  <!-- ##### -->
  <!-- ACTIONTYPE
-->
  <!-- Definition: Types of user action being monitored to analyse viewing habits-->
  <!-- ##### -->
  <Term termID="1">
    <Name xml:lang="en">Audio-Video</Name>
    <Definition xml:lang="en">Actions Related to Audio and Video</Definition>
    <Term termID="1.1">
      <Name xml:lang="en">PlayRecording</Name>
      <Definition xml:lang="en">Play content from a recording</Definition>
    </Term>
    <Term termID="1.2">
      <Name xml:lang="en">PlayStream</Name>
      <Definition xml:lang="en">Play content from input stream</Definition>
    </Term>
    <Term termID="1.3">
      <Name xml:lang="en">Record</Name>
      <Definition xml:lang="en">Record input stream to local storage media</Definition>
    </Term>
    <Term termID="1.4">
      <Name xml:lang="en">Preview</Name>
      <Definition xml:lang="en">View or listen to a summary of the input stream</Definition>
    </Term>
    <Term termID="1.5">
      <Name xml:lang="en">Pause</Name>
      <Definition xml:lang="en">Pause the input stream</Definition>
    </Term>
    <Term termID="1.6">
      <Name xml:lang="en">FastForward</Name>
      <Definition xml:lang="en">Fast forward the input stream</Definition>
    </Term>
    <Term termID="1.7">
      <Name xml:lang="en">Rewind</Name>
      <Definition xml:lang="en">Rewind the input stream</Definition>
    </Term>
    <Term termID="1.8">
      <Name xml:lang="en">SkipForward</Name>
      <Definition xml:lang="en">Skip forward over a portion of the input stream</Definition>
    </Term>
    <Term termID="1.9">
      <Name xml:lang="en">SkipBackward</Name>
      <Definition xml:lang="en">Skip backward over a portion of the input stream</Definition>
    </Term>
    <Term termID="1.10">
      <Name xml:lang="en">Mute</Name>
      <Definition xml:lang="en">Turn sound off</Definition>
    </Term>
    <Term termID="1.11">
      <Name xml:lang="en">VolumeUp</Name>
```

```

    <Definition xml:lang="en">Increase volume</Definition>
  </Term>
  <Term termID="1.12">
    <Name xml:lang="en">VolumeDown</Name>
    <Definition xml:lang="en">Reduce volume</Definition>
  </Term>
  <Term termID="1.13">
    <Name xml:lang="en">Loop/Repeat</Name>
    <Definition xml:lang="en">Repeat/loop (part of) the input stream</Definition>
  </Term>
  <Term termID="1.14">
    <Name xml:lang="en">Shuffle</Name>
    <Definition xml:lang="en">Randomly select next track</Definition>
  </Term>
  <Term termID="1.15">
    <Name xml:lang="en">SkipToStart</Name>
    <Definition xml:lang="en">Go to the beginning of the stream</Definition>
  </Term>
  <Term termID="1.16">
    <Name xml:lang="en">SkipToEnd</Name>
    <Definition xml:lang="en">Go to the end of the stream</Definition>
  </Term>
  <Term termID="1.17">
    <Name xml:lang="en">CopyCD</Name>
    <Definition xml:lang="en">Copy all or part of a CD</Definition>
  </Term>
  <Term termID="1.18">
    <Name xml:lang="en">RatingAction</Name>
    <Definition xml:lang="en">Express a rating.</Definition>
  </Term>
</Term>
<Term termID="2">
  <Name xml:lang="en">Video </Name>
  <Definition xml:lang="en">Actions related to video</Definition>
  <Term termID="2.1">
    <Name xml:lang="en">Zoom</Name>
    <Definition xml:lang="en">Zoom (in) to the on-screen image or sequence</Definition>
  </Term>
  <Term termID="2.2">
    <Name xml:lang="en">SlowMotion</Name>
    <Definition xml:lang="en">View input stream in slow motion</Definition>
  </Term>
  <Term termID="2.3">
    <Name xml:lang="en">CCOn</Name>
    <Definition xml:lang="en">Closed caption is on</Definition>
  </Term>
  <Term termID="2.4">
    <Name xml:lang="en">StepForward</Name>
    <Definition xml:lang="en">Advance to next frame</Definition>
  </Term>
  <Term termID="2.5">
    <Name xml:lang="en">StepBackward</Name>
    <Definition xml:lang="en">Return to previous frame</Definition>
  </Term>
</Term>
<Term termID="3">
  <Name xml:lang="en">Data</Name>
  <Definition xml:lang="en">Actions related to miscellaneous data</Definition>
  <Term termID="3.1">
    <Name xml:lang="en">ClickThrough</Name>
    <Definition xml:lang="en">Follow an available link</Definition>
  </Term>
  <Term termID="3.2">
    <Name xml:lang="en">ScrollUp</Name>
    <Definition xml:lang="en">Scroll up in a web page/composite page</Definition>
  </Term>
  <Term termID="3.3">
    <Name xml:lang="en">ScrollDown</Name>
    <Definition xml:lang="en">Scroll down in a web page/composite page</Definition>
  </Term>
  <Term termID="3.4">
    <Name xml:lang="en">ViewGuide</Name>
    <Definition xml:lang="en">View program/resource guide</Definition>
  </Term>
  <Term termID="3.5">
    <Name xml:lang="en">SavePage</Name>
    <Definition xml:lang="en">Save web page/composite page</Definition>
  </Term>

```

```

<Term termID="3.6">
  <Name xml:lang="en">PrintPage</Name>
  <Definition xml:lang="en">Print web page/composite page</Definition>
</Term>
<Term termID="3.7">
  <Name xml:lang="en">Search</Name>
  <Definition xml:lang="en">Search the web or local resources</Definition>
</Term>
<Term termID="3.8">
  <Name xml:lang="en">SubmitForm</Name>
  <Definition xml:lang="en">Submit a form with requested information</Definition>
</Term>
<Term termID="3.9">
  <Name xml:lang="en">SubmitQuery</Name>
  <Definition xml:lang="en">Submit a query</Definition>
</Term>
<Term termID="3.10">
  <Name xml:lang="en">Archive</Name>
  <Definition xml:lang="en">Archive content to persistent local storage media</Definition>
</Term>
</Term>
<Term termID="4">
  <Name xml:lang="en">Commerce</Name>
  <Definition xml:lang="en">Actions related to commerce</Definition>
<Term termID="4.1">
  <Name xml:lang="en">Buy</Name>
  <Definition xml:lang="en">Purchase a product or item</Definition>
</Term>
<Term termID="4.2">
  <Name xml:lang="en">AddToWishList</Name>
  <Definition xml:lang="en">Designate a product or item as possible future purchasing
item</Definition>
</Term>
<Term termID="4.3">
  <Name xml:lang="en">AddToCart</Name>
  <Definition xml:lang="en">Designate a product or item as potential immediate purchase
item</Definition>
</Term>
</Term>
</ClassificationScheme>

```

## A.3 HowRelated CS

```

<?xml version="1.0" encoding="UTF-8"?>
<ClassificationScheme uri="urn:tva:metadata:cs:HowRelatedCS:2010">
  <!-- ##### -->
  <!-- HOWRELATED -->
  <!--Definition: A series of definitions for possible relations between programmes-->
  <!-- ##### -->
  <Term termID="1">
    <Name xml:lang="en">Trailer</Name>
    <Definition xml:lang="en">By default, the reference points to a trailer of the currently
described resource</Definition>
    <Term termID="1.1">
      <Name xml:lang="en">HasTrailer</Name>
      <Definition xml:lang="en">The reference points to a trailer of the currently described
resource</Definition>
    </Term>
    <Term termID="1.2">
      <Name xml:lang="en">IsTrailerOf</Name>
      <Definition xml:lang="en">The reference points to a resource of which the currently
described resource is a trailer</Definition>
    </Term>
  </Term>
  <Term termID="2">
    <Name xml:lang="en">GroupTrailer</Name>
    <Definition xml:lang="en">By default, the reference points to a trailer for the group of
resources currently described.</Definition>
    <Term termID="2.1">
      <Name xml:lang="en">HasGroupTrailer</Name>
      <Definition xml:lang="en">The reference points to a trailer for the group of resources
currently described.</Definition>

```



```

</Term>
<Term termID="2.2">
  <Name xml:lang="en">IsGroupTrailerOf</Name>
  <Definition xml:lang="en">The reference points to a group of resources for which the
currently described resource is a trailer.</Definition>
</Term>
</Term>
<Term termID="3">
  <Name xml:lang="en">Sibling</Name>
  <Definition xml:lang="en">The reference points to a sibling of the current resource. Example:
Record the next episode in a series whilst watching an earlier episode</Definition>
</Term>
<Term termID="4">
  <Name xml:lang="en">Alternative</Name>
  <Definition xml:lang="en">The reference points to an alternative version of the current
resource. Example: Whilst watching a programme, or part of programme, the user is able to discover
that a high definition version is available elsewhere</Definition>
</Term>
<Term termID="5">
  <Name xml:lang="en">Parent</Name>
  <Definition xml:lang="en">The reference points to a group of resources to which belongs the
current resource. Example: "Record an entire series, whilst watching one of the
episodes"</Definition>
</Term>
<Term termID="6">
  <Name xml:lang="en">Recommendation</Name>
  <Definition xml:lang="en">The reference points to a resource recommended by the provider of
the current resource. The service provider considers there to be similarities between the
currently described resource and the referenced resource. Example: This could provide
access to previous or next episodes or to all episodes (the parent series as a whole).
Suggestion to record a programme which the broadcaster recommends because of what the user
is watching. It could also point to a Web site proposing related programmes
'recommended' by the service provider. A recommendation can be used to suggest content or
services or services bundles with a similar subject.</Definition>
</Term>
<Term termID="7">
  <Name xml:lang="en">GroupRecommendation</Name>
  <Definition xml:lang="en">The reference points to a group of resources recommended by the
provider of the current resource. The service provider considers there to be similarities between
the
currently described resource and the referenced group of resources. Example: Suggestion to
record a series which the broadcaster recommends because of what the user is watching.</Definition>
</Term>
<Term termID="8">
  <Name xml:lang="en">Commercial advert</Name>
  <Definition xml:lang="en">By default, the reference points to the advert for a product or
service featured in the current resource. Example: The user is watching a film containing a
desirable product. If the user indicates interest in that product an advert
is captured providing further information</Definition>
<Term termID="8.1">
  <Name xml:lang="en">Normal Advert</Name>
  <Definition xml:lang="en">By default, the reference points to the normal advert for a
product or service featured in the current resource</Definition>
  <Term termID="8.1.1">
    <Name xml:lang="en">HasNormalAdvert</Name>
    <Definition xml:lang="en">The reference points to the normal advert for a product or
service featured in the current resource</Definition>
  </Term>
  <Term termID="8.1.2">
    <Name xml:lang="en"> IsNormalAdvertOf</Name>
    <Definition xml:lang="en">The reference points to the resource advertised by the current
normal advert</Definition>
  </Term>
</Term>
<Term termID="8.2">
  <Name xml:lang="en">Telescoped Advert </Name>
  <Definition xml:lang="en">An extended version of an advertisement. By default, the
reference points to the telescoped advert for a product or service featured in the
current resource</Definition>
  <Term termID="8.2.1">
    <Name xml:lang="en">HasTelescopedAdvert</Name>
    <Definition xml:lang="en">The reference points to the telescoped advert for a product or
service featured in the current resource</Definition>
  </Term>
  <Term termID="8.2.2">
    <Name xml:lang="en"> IsTelescopedAdvertOf</Name>
    <Definition xml:lang="en">The reference points to the resource advertised by the
current telescoped advert</Definition>

```

```

    </Term>
  </Term>
  <Term termID="8.3">
    <Name xml:lang="en">Speedbump </Name>
    <Definition xml:lang="en">The superimposition of related or unrelated content over content
in trick play mode. By default, the reference points to the speedbump for a product or service
featured in the current resource</Definition>
    <Term termID="8.3.1">
      <Name xml:lang="en">HasSpeedbump</Name>
      <Definition xml:lang="en">The reference points to the speedbump for a product or service
featured in the current resource</Definition>
    </Term>
    <Term termID="8.3.2">
      <Name xml:lang="en"> IsSpeedbumpOf</Name>
      <Definition xml:lang="en">The reference points to the resource advertised by the
current speedbump</Definition>
    </Term>
  </Term>
</Term>
<Term termID="9">
  <Name xml:lang="en">Direct product purchase</Name>
  <Definition xml:lang="en">The reference points to a product or service directly linked to the
current resource, which can be purchased directly from this linked resource.
  Example: The user is watching a film containing a desirable product or service (The recipe
book from a cookery series for instance). If the user indicates interest in that
  product they are taken to a web page (or interactive application) which is able to fulfil
their purchasing requirement</Definition>
</Term>
<Term termID="10">
  <Name xml:lang="en">For more information</Name>
  <Definition xml:lang="en">The reference points to additional information concerning the
current resource in the form of audio/video/text/graphics/interactive app/web content.
  Example: The user watching a programme for which the content provider has made available
additional information. If the user indicates interest they are taken directly to that
additional content and then returned to the original content</Definition>
  <Term termID="10.1">
    <Name xml:lang="en">Programme E-mail Address</Name>
    <Definition xml:lang="en">The e-mail address for the resource complying with "mailto:"
URI scheme.</Definition>
  </Term>
  <Term termID="10.2">
    <Name xml:lang="en">Programme Website</Name>
    <Definition xml:lang="en">The website for the resource expressed as a URL.</Definition>
  </Term>
  <Term termID="10.3">
    <Name xml:lang="en">Telephone Number</Name>
    <Definition xml:lang="en">The telephone number for the resource complying with [IETF RFC
2806] [i.1] "tel:" URI scheme.</Definition>
  </Term>
  <Term termID="10.4">
    <Name xml:lang="en">Programme Transcript</Name>
    <Definition xml:lang="en">The transcript of the resource expressed as a
URI.</Definition>
  </Term>
  <Term termID="10.5">
    <Name xml:lang="en">Interactive Enhancement</Name>
    <Definition xml:lang="en">An interactive enhancement of the resource. The object pointed
to may be an external resource. Alternatively, it may be the CRID of a
    Programme Information or Package record. The availability of an enhancement may be
presented to the end user as a "red button" icon or similar, as defined by the
application itself.</Definition>
  </Term>
</Term>
<!-- '11. Programme Review Information' superseded by '32. Review Information'-->
<Term termID="12">
  <Name xml:lang="en">Recap</Name>
  <Definition xml:lang="en">The reference points to a text or av recap of the resource. Example:
The user can chose to read/watch a recap if they have missed a previous episode or forgotten the
thread of the series </Definition>
</Term>
<Term termID="13">
  <Name xml:lang="en">The making of</Name>
  <Definition xml:lang="en">By default, the reference points to the making-of of the current
resource. Example: "The user, if interested can view the background to how the programme was
made"</Definition>
  <Term termID="13.1">
    <Name xml:lang="en">HasMakingOf</Name>

```

```

    <Definition xml:lang="en">The reference points to the making-of of the current
resource</Definition>
  </Term>
  <Term termID="13.2">
    <Name xml:lang="en">IsMakingOfFor</Name>
    <Definition xml:lang="en">The reference points to the resource corresponding to the current
making-of</Definition>
  </Term>
</Term>
<Term termID="14">
  <Name xml:lang="en">Support</Name>
  <Definition xml:lang="en">The reference points to a resource that contains issues the user may
wish to enquire about. Example: The user can find out if there is support in the
  form of a telephone help line, postal or email address or web page that provides them with
the ability to seek advice on the subject matter of the programme</Definition>
  <Term termID="14.1">
    <Name xml:lang="en">Support E-mail Address</Name>
    <Definition xml:lang="en">A support e-mail address complying with "mailto:" URI
scheme.</Definition>
  </Term>
  <Term termID="14.2">
    <Name xml:lang="en">Support Website</Name>
    <Definition xml:lang="en">A support website expressed as a URL.</Definition>
  </Term>
  <Term termID="14.3">
    <Name xml:lang="en">Telephone Helpline</Name>
    <Definition xml:lang="en">A telephone helpline number complying with [IETF RFC 2806]
[i.1] "tel:" URI scheme.</Definition>
  </Term>
</Term>
<Term termID="15">
  <Name xml:lang="en">Segmentation</Name>
  <Definition xml:lang="en">The reference points to segmentation information</Definition>
  <Term termID="15.1">
    <Name xml:lang="en">Static Segmentation</Name>
    <Definition xml:lang="en">Relation: The content referenced by this pointer is "static"
segmentation metadata which will not change as the content progresses.</Definition>
  </Term>
  <Term termID="15.2">
    <Name xml:lang="en">Live Segmentation</Name>
    <Definition xml:lang="en">Relation: The content referenced by this pointer is "live"
segmentation metadata which will change dynamically as the content progresses. Once the content has
completed transmission the segmentation metadata will not be updated.</Definition>
  </Term>
  <Term termID="15.3">
    <Name xml:lang="en">Live & Post Segmentation</Name>
    <Definition xml:lang="en">Relation: The content referenced by this pointer is "live"
segmentation metadata which will change dynamically as the content progresses. It may also be
updated after the content has completed transmission. </Definition>
  </Term>
  <Term termID="15.4">
    <Name xml:lang="en">Post Segmentation</Name>
    <Definition xml:lang="en">Relation: The content referenced by this pointer is segmentation
metadata which will only be available after the content has completed transmission. </Definition>
  </Term>
</Term>
<Term termID="16">
  <Name xml:lang="en">Derived</Name>
  <Definition xml:lang="en"/>
</Term>
<Term termID="17">
  <Name xml:lang="en">TVA RMPI document</Name>
  <Definition xml:lang="en">The reference points to TVA-compliant rights information that the
broadcaster and/or rights holder provides, for informative purposes only. Example: "The user, during
the process of deciding whether to select a programme for acquisition, can view information in the
TVA RMPI document for that programme."</Definition>
</Term>
<Term termID="18">
  <Name xml:lang="en">Content Package</Name>
  <Definition xml:lang="en">The resource points to a content package.</Definition>
</Term>
<Term termID="19">
  <Name xml:lang="en">Promotional Still Image</Name>
  <Definition xml:lang="en">The resource points to a promotional still image for the content
programme.</Definition>
</Term>
<Term termID="20">
  <Name xml:lang="en">Broadcaster Website</Name>

```

```

    <Definition xml:lang="en">The resource points to a more general web site for the
    broadcaster.</Definition>
  </Term>
  <Term termID="21">
    <Name xml:lang="en">HasFormat</Name>
    <Definition xml:lang="en">The described resource pre-existed the referenced resource, which is
    essentially the same intellectual content presented in another format.(Dublin Core)</Definition>
  </Term>
  <Term termID="22">
    <Name xml:lang="en">IsFormatOf</Name>
    <Definition xml:lang="en">The described resource is the same intellectual content of the
    referenced resource, but presented in another format.(Dublin Core)</Definition>
  </Term>
  <Term termID="23">
    <Name xml:lang="en">HasPart</Name>
    <Definition xml:lang="en">The described resource includes the referenced resource either
    physically or logically.(Dublin Core)</Definition>
  </Term>
  <Term termID="24">
    <Name xml:lang="en">IsPartOf</Name>
    <Definition xml:lang="en">The described resource is a physical or logical part of the
    referenced resource.(Dublin Core)</Definition>
  </Term>
  <Term termID="25">
    <Name xml:lang="en">IsReferencedBy</Name>
    <Definition xml:lang="en">The described resource is referenced, cited, or otherwise pointed to
    by the referenced resource.(Dublin Core)</Definition>
  </Term>
  <Term termID="26">
    <Name xml:lang="en">IsReplacedBy</Name>
    <Definition xml:lang="en">The described resource is supplanted, displaced, or superseded by
    the referenced resource.(Dublin Core)</Definition>
  </Term>
  <Term termID="27">
    <Name xml:lang="en">IsRequiredBy</Name>
    <Definition xml:lang="en">The described resource is required by the referenced resource,
    either physically or logically.(Dublin Core)</Definition>
  </Term>
  <Term termID="28">
    <Name xml:lang="en">HasVersion</Name>
    <Definition xml:lang="en">The described resource has a version, edition, or adaptation,
    namely, the referenced resource.(Dublin Core)</Definition>
  </Term>
  <Term termID="29">
    <Name xml:lang="en">References</Name>
    <Definition xml:lang="en">The described resource references, cites, or otherwise points to the
    referenced resource.(Dublin Core)</Definition>
  </Term>
  <Term termID="30">
    <Name xml:lang="en">Replaces</Name>
    <Definition xml:lang="en">The described resource supplants, displaces, or supersedes the
    referenced resource.(Dublin Core)</Definition>
  </Term>
  <Term termID="31">
    <Name xml:lang="en">Requires</Name>
    <Definition xml:lang="en">The described resource requires the referenced resource to support
    its function, delivery, or coherence of content.(Dublin Core)</Definition>
  </Term>
  <Term termID="32">
    <Name xml:lang="en">Review Information</Name>
    <Definition xml:lang="en">By default the reference points to a review or critique of the
    resource that may be of interest to the user in deciding whether to continue to watch,
    download, etc. Example: The user can look at the additional information and use it to
    decide whether to continue watching a programme</Definition>
    <Term termID="32.1">
      <Name xml:lang="en">HasReviewInformation</Name>
      <Definition xml:lang="en">The reference points to a review or critique of the
      resource</Definition>
    </Term>
    <Term termID="32.2">
      <Name xml:lang="en">IsReviewInformationFor</Name>
      <Definition xml:lang="en">The reference points to the resource that is the subject of the
      review</Definition>
    </Term>
  </Term>
  <Term termID="33">
    <Name xml:lang="en">Preview</Name>

```

```

    <Definition xml:lang="en">By default, in complement to a Trailer, the reference points to a
    preview of the resource in a different format (e.g. longer sequences or interactive content) to
    assess e.g. previously advertised content or services.</Definition>
    <Term termID="33.1">
      <Name xml:lang="en">HasPreview</Name>
      <Definition xml:lang="en">In complement to a Trailer, the reference points to a preview of
    the resource in a different format (e.g. longer sequences or interactive content) to assess e.g.
    previously advertised content or services.</Definition>
    </Term>
    <Term termID="33.2">
      <Name xml:lang="en">IsPreviewOf</Name>
      <Definition xml:lang="en">The reference points to the resource addressed by the current
    preview.</Definition>
    </Term>
  </Term>
  <Term termID="34">
    <Name xml:lang="en">Current Broadcast</Name>
    <Definition xml:lang="en">Relation: The content referenced by this pointer is the current
    broadcast content.</Definition>
  </Term>
  <Term termID="35">
    <Name xml:lang="en">Package Main Content</Name>
    <Definition xml:lang="en">A pointer to the main content component of a Package.</Definition>
  </Term>
  <Term termID="36">
    <Name xml:lang="en">ChannelIdentification</Name>
    <Definition xml:lang="en">By default, the reference points to a channel identification or
    ident of the currently described resource.</Definition>
    <Term termID="36.1">
      <Name xml:lang="en">IsChannelIdentificationOf</Name>
      <Definition xml:lang="en">The reference points to the channel/service whose identity the
    current resource reinforces.</Definition>
    </Term>
    <Term termID="36.2">
      <Name xml:lang="en">HasChannelIdentification</Name>
      <Definition xml:lang="en">The reference points to a channel identification of the current
    resource.</Definition>
    </Term>
  </Term>
  <Term termID="37">
    <Name xml:lang="en">BestOf</Name>
    <Definition xml:lang="en">By default, the reference points to a resource collecting best-of
    selections from the currently described resource.</Definition>
    <Term termID="37.1">
      <Name xml:lang="en">IsBestOf</Name>
      <Definition xml:lang="en">The reference points to the show or brand whose best-of
    selections are collected in the current resource.</Definition>
    </Term>
    <Term termID="37.2">
      <Name xml:lang="en">HasBestOf</Name>
      <Definition xml:lang="en">The reference points to a resource collecting best-of selections
    from the current resource.</Definition>
    </Term>
  </Term>
  <Term termID="38">
    <Name xml:lang="en">AdditionalMaterial</Name>
    <Definition xml:lang="en">By default, the reference points to additional, supplementary
    material such as an extended interview or report or an additional music track.</Definition>
    <Term termID="38.1">
      <Name xml:lang="en">IsAdditionalMaterialFor</Name>
      <Definition xml:lang="en">The reference points to the programme for which the current
    resource is additional material.</Definition>
    </Term>
    <Term termID="38.2">
      <Name xml:lang="en">HasAdditionalMaterial</Name>
      <Definition xml:lang="en">The reference points to additional material for the current
    resource.</Definition>
    </Term>
  </Term>
  <Term termID="39">
    <Name xml:lang="en">Extract</Name>
    <Definition xml:lang="en">By default, the reference points to an extract of the current
    resource.</Definition>
    <Term termID="39.1">
      <Name xml:lang="en">IsExtractOf</Name>
      <Definition xml:lang="en">The reference points to the resource of which the current
    resource is an extract.</Definition>
    </Term>
  </Term>

```

```

    <Term termID="39.2">
      <Name xml:lang="en">HasExtract</Name>
      <Definition xml:lang="en">The reference points to an extract of the current
resource.</Definition>
    </Term>
  </Term>
</ClassificationScheme>

```

## A.4 TVARoleCS

```

<?xml version="1.0" encoding="UTF-8"?>
<ClassificationScheme uri="urn:tva:metadata:cs:TVARoleCS:2010">
  <!-- ##### -->
  <!-- TVAROLE -->
  <!-- Definition: Key cast roles-->
  <!-- ##### -->
  <Import href="urn:mpeg:mpeg7:cs:RoleCS:2001"/>
  <Term termID="V708">
    <Name xml:lang="en">Dubber</Name>
  </Term>
  <Term termID="V709">
    <Name xml:lang="en">Key character</Name>
  </Term>
  <Term termID="V106">
    <Name xml:lang="en">Key talent</Name>
  </Term>
  <Term termID="V43">
    <Name xml:lang="en">Participant</Name>
  </Term>
  <Term termID="V813">
    <Name xml:lang="en">Puppeteer</Name>
  </Term>
  <Term termID="V710">
    <Name xml:lang="en">Stunts</Name>
  </Term>
  <Term termID="V80">
    <Name xml:lang="en">Choreographer</Name>
  </Term>
  <Term termID="V484">
    <Name xml:lang="en">Costume designer</Name>
  </Term>
  <Term termID="V83">
    <Name xml:lang="en">Director of photography</Name>
  </Term>
  <Term termID="V714">
    <Name xml:lang="en">Fight Director</Name>
  </Term>
  <Term termID="V487">
    <Name xml:lang="en">Floor Manager</Name>
  </Term>
  <Term termID="V490">
    <Name xml:lang="en">Post-Production editor</Name>
  </Term>
  <Term termID="V715">
    <Name xml:lang="en">Script Supervisor</Name>
  </Term>
  <Term termID="V716">
    <Name xml:lang="en">Second Assistant Director</Name>
  </Term>
  <Term termID="V717">
    <Name xml:lang="en">Second Unit Director</Name>
  </Term>
  <Term termID="V718">
    <Name xml:lang="en">Sound Designer</Name>
  </Term>
  <Term termID="V76">
    <Name xml:lang="en">Adaptor</Name>
  </Term>
  <Term termID="V2">
    <Name xml:lang="en">Scenario</Name>
  </Term>
  <Term termID="V94">
    <Name xml:lang="en">Treatment/Programme Proposal</Name>
  </Term>

```

```

</Term>
<Term termID="V807">
  <Name xml:lang="en">Choir</Name>
</Term>
<Term termID="V42">
  <Name xml:lang="en">Conductor</Name>
</Term>
<Term termID="V808">
  <Name xml:lang="en">Ensemble</Name>
</Term>
<Term termID="V810">
  <Name xml:lang="en">Librettist</Name>
</Term>
<Term termID="V811">
  <Name xml:lang="en">Lyricist</Name>
</Term>
<Term termID="V719">
  <Name xml:lang="en">Music Arranger</Name>
</Term>
<Term termID="V809">
  <Name xml:lang="en">Music Group</Name>
</Term>
<Term termID="V88">
  <Name xml:lang="en">Orchestra</Name>
</Term>
<Term termID="V103">
  <Name xml:lang="en">Announcer</Name>
</Term>
<Term termID="V720">
  <Name xml:lang="en">Causeur</Name>
</Term>
<Term termID="V32">
  <Name xml:lang="en">Commentary or Commentator</Name>
</Term>
<Term termID="V483">
  <Name xml:lang="en">Correspondent</Name>
</Term>
<Term termID="V486">
  <Name xml:lang="en">Editor/Producer (News)</Name>
</Term>
<Term termID="V30">
  <Name xml:lang="en">Editor-in-chief</Name>
</Term>
<Term termID="V31">
  <Name xml:lang="en">Editor-of-the-Day</Name>
</Term>
<Term termID="V96">
  <Name xml:lang="en">Expert</Name>
</Term>
<Term termID="V97">
  <Name xml:lang="en">Interviewed Guest</Name>
</Term>
<Term termID="V721">
  <Name xml:lang="en">News Reader</Name>
</Term>
<Term termID="V117">
  <Name xml:lang="en">Witness</Name>
</Term>
<Term termID="V19">
  <Name xml:lang="en">Commissioning Broadcaster</Name>
</Term>
<Term termID="V55">
  <Name xml:lang="en">Manufacturer</Name>
</Term>
<Term termID="V20">
  <Name xml:lang="en">Production Company</Name>
</Term>
<Term termID="V22">
  <Name xml:lang="en">Production Department</Name>
</Term>
<Term termID="V724">
  <Name xml:lang="en">Assistant Chief Lighting Technician</Name>
</Term>
<Term termID="V498">
  <Name xml:lang="en">Broadcast Assistant</Name>
</Term>
<Term termID="V725">
  <Name xml:lang="en">Carpenter</Name>

```

```

</Term>
<Term termID="V727">
  <Name xml:lang="en">Dialogue Coach</Name>
</Term>
<Term termID="V728">
  <Name xml:lang="en">Draughtsman</Name>
</Term>
<Term termID="V485">
  <Name xml:lang="en">Dresser</Name>
</Term>
<Term termID="V489">
  <Name xml:lang="en">Graphic Designer</Name>
</Term>
<Term termID="V729">
  <Name xml:lang="en">Hairdresser</Name>
</Term>
<Term termID="V44">
  <Name xml:lang="en">Illustrator</Name>
</Term>
<Term termID="V730">
  <Name xml:lang="en">Leadman</Name>
</Term>
<Term termID="V496">
  <Name xml:lang="en">Scenic Operative</Name>
</Term>
<Term termID="V77">
  <Name xml:lang="en">Set Dresser</Name>
</Term>
<Term termID="V82">
  <Name xml:lang="en">Visual Editor</Name>
</Term>
<Term termID="V734">
  <Name xml:lang="en">Assistant Visual Editor</Name>
</Term>
<Term termID="V735">
  <Name xml:lang="en">Clapper Loader</Name>
</Term>
<Term termID="V736">
  <Name xml:lang="en">Focus Puller</Name>
</Term>
<Term termID="V737">
  <Name xml:lang="en">Foley Artist</Name>
</Term>
<Term termID="V738">
  <Name xml:lang="en">Foley Editor</Name>
</Term>
<Term termID="V739">
  <Name xml:lang="en">Foley Mixer</Name>
</Term>
<Term termID="V488">
  <Name xml:lang="en">Graphic Assistant</Name>
</Term>
<Term termID="V740">
  <Name xml:lang="en">Grip</Name>
</Term>
<Term termID="V741">
  <Name xml:lang="en">Key Grip</Name>
</Term>
<Term termID="V742">
  <Name xml:lang="en">Matte Artist</Name>
</Term>
<Term termID="V45">
  <Name xml:lang="en">Photographer</Name>
</Term>
<Term termID="V743">
  <Name xml:lang="en">Pyrotechnician</Name>
</Term>
<Term termID="V494">
  <Name xml:lang="en">Rigger</Name>
</Term>
<Term termID="V744">
  <Name xml:lang="en">Second Assistant Camera</Name>
</Term>
<Term termID="V745">
  <Name xml:lang="en">Sound Mixer</Name>
</Term>
<Term termID="V49">
  <Name xml:lang="en">Sound Recordist</Name>

```



```

</Term>
<Term termID="V105">
  <Name xml:lang="en">Special Effects</Name>
</Term>
<Term termID="V746">
  <Name xml:lang="en">Vision mixer</Name>
</Term>
<Term termID="V748">
  <Name xml:lang="en">Animal Trainer</Name>
</Term>
<Term termID="V749">
  <Name xml:lang="en">Armourer</Name>
</Term>
<Term termID="V812">
  <Name xml:lang="en">Computer programmer</Name>
</Term>
<Term termID="V79">
  <Name xml:lang="en">Consultant</Name>
</Term>
<Term termID="V750">
  <Name xml:lang="en">Greensman</Name>
</Term>
<Term termID="V751">
  <Name xml:lang="en">Location Manager</Name>
</Term>
<Term termID="V493">
  <Name xml:lang="en">Programme Production Researcher</Name>
</Term>
<Term termID="V495">
  <Name xml:lang="en">Runner</Name>
</Term>
<Term termID="V753">
  <Name xml:lang="en">Sign Language</Name>
</Term>
<Term termID="V754">
  <Name xml:lang="en">Subtitles</Name>
</Term>
<Term termID="V95">
  <Name xml:lang="en">Translation</Name>
</Term>
<Term termID="V755">
  <Name xml:lang="en">Transportation Manager</Name>
</Term>
<Term termID="V497">
  <Name xml:lang="en">Assistant Producer</Name>
</Term>
<Term termID="V110">
  <Name xml:lang="en">Casting</Name>
</Term>
<Term termID="V491">
  <Name xml:lang="en">Production Manager</Name>
</Term>
<Term termID="V492">
  <Name xml:lang="en">Production Secretary</Name>
</Term>
<!--Term termID="V493">
  Deprecated: termId already allocated to another term, see termID="AD9"
  <Name xml:lang="en">Caption Author</Name>
</Term-->
<Term termID="AD1">
  <Name xml:lang="en">Advertising Agency</Name>
</Term>
<Term termID="AD2">
  <Name xml:lang="en">Advertising Production Company</Name>
</Term>
<Term termID="AD3">
  <Name xml:lang="en">Advertiser</Name>
</Term>
<Term termID="AD4">
  <Name xml:lang="en">Commissioning Channel</Name>
</Term>
<Term termID="AD5">
  <Name xml:lang="en">Commissioning Brand</Name>
</Term>
<Term termID="AD6">
  <Name xml:lang="en">Presenter</Name>
</Term>
<Term termID="AD7">

```

```

    <Name xml:lang="en">Studio Manager</Name>
  </Term>
  <Term termID="AD8">
    <Name xml:lang="en">Assistant Studio Manager</Name>
  </Term>
  <Term termID="AD9">
    <Name xml:lang="en">Caption Author</Name>
  </Term>
  <Term termID="AD10">
    <Name xml:lang="en">Electrician</Name>
  </Term>
  <Term termID="AD11">
    <Name xml:lang="en">Judge</Name>
  </Term>
  <Term termID="AD12">
    <Name xml:lang="en">Series Editor</Name>
  </Term>
  <Term termID="AD13">
    <Name xml:lang="en">Series Producer</Name>
  </Term>
</ClassificationScheme>

```

## A.5 RoleCS

RoleCS is a classification scheme from MPEG-7 import by the TVARoleCS described in clause A.4. The corresponding xml file is appended to the present document with the other *TV-Anytime* classification schemes.

```

<?xml version="1.0" encoding="UTF-8"?>
<ClassificationScheme uri="urn:mpeg:mpeg7:cs:RoleCS:2010">
  <!-- ##### -->
  <!-- ROLE -->
  <!-- Definition: Key MPEG7 cast roles imported by TVAROLECS -->
  <!-- ##### -->
  <Term termID="AUTHOR">
    <Name xml:lang="en">Author</Name>
    <Definition xml:lang="en">A person who creates the content</Definition>
  </Term>
  <Term termID="ANCHOR">
    <Name xml:lang="en">Anchor</Name>
    <Name xml:lang="en">Anchorman</Name>
    <Name xml:lang="en">Anchorwoman</Name>
    <Name xml:lang="en">Anchorperson</Name>
    <Definition xml:lang="en">A television reporter who coordinates a broadcast to which several
correspondents contribute</Definition>
  </Term>
  <Term termID="REPORTER">
    <Name xml:lang="en">Reporter</Name>
    <Name xml:lang="en">Newsman</Name>
    <Name xml:lang="en">Newswoman</Name>
    <Name xml:lang="en">Newsperson</Name>
    <Definition xml:lang="en">A person who gathers news and other journalistic material and writes
or broadcasts it-the basic
job in journalism</Definition>
  </Term>
  <Term termID="INTERVIEWER">
    <Name xml:lang="en">Interviewer</Name>
    <Definition xml:lang="en">A person who conducts an interview</Definition>
  </Term>
  <Term termID="NARRATOR">
    <Name xml:lang="en">Narrator</Name>
    <Name xml:lang="en">Storyteller</Name>
    <Definition xml:lang="en">A person who tells a story</Definition>
  </Term>
  <Term termID="ACTOR">
    <Name xml:lang="en">Actor</Name>
    <Name xml:lang="en">Actress</Name>
    <Name xml:lang="en">Histrion</Name>
    <Name xml:lang="en">Player</Name>
    <Name xml:lang="en">Thespian</Name>
    <Name xml:lang="en">Role Player</Name>
    <Definition xml:lang="en">A person who plays the role of a character</Definition>
  </Term>

```

```

<Term termID="DANCER">
  <Name xml:lang="en">Dancer</Name>
  <Definition xml:lang="en">A performer who dances</Definition>
</Term>
<Term termID="MUSICIAN">
  <Name xml:lang="en">Musician</Name>
  <Name xml:lang="en">Instrumentalist</Name>
  <Name xml:lang="en">Player</Name>
  <Definition xml:lang="en">Someone who plays a musical instrument (as a
profession)</Definition>
</Term>
<Term termID="SINGER">
  <Name xml:lang="en">Singer</Name>
  <Name xml:lang="en">Vocalist</Name>
  <Definition xml:lang="en">A person who sings</Definition>
</Term>
<Term termID="PERFORMER">
  <Name xml:lang="en">Performer</Name>
  <Name xml:lang="en">Performing Artist</Name>
  <Definition xml:lang="en">An entertainer who performs a dramatic or musical work for audience.
(Other than above)</Definition>
</Term>
<Term termID="EXECUTIVE-PRODUCER">
  <Name xml:lang="en">Executive Producer</Name>
  <Name xml:lang="en">Executive in Charge of Production</Name>
  <Definition xml:lang="en">A producer who is not involved in any technical aspects of the
making process, but who is still responsible for the overall production. Typically an executive
producer handles business and legal issues</Definition>
</Term>
<Term termID="PRODUCER">
  <Name xml:lang="en">Producer</Name>
  <Definition xml:lang="en">The manager of an event, show, or other work, usually the individual
in charge of finance, personnel and other non-artistic aspects in the development of commercials,
plays, movies and other works</Definition>
</Term>
<Term termID="SCRIPTWRITER">
  <Name xml:lang="en">Scriptwriter</Name>
  <Definition xml:lang="en">A person who writes scripts for plays or movies or broadcast
dramas</Definition>
</Term>
<Term termID="DIRECTOR">
  <Name xml:lang="en">Director</Name>
  <Definition xml:lang="en">A supervisor; generally refers to the person responsible for all
audience-visible components of a program, film, or show, whereas the producer is responsible for the
financial and other behind-the-scenes aspects. A director's duties might also include casting,
script editing, shot selection, shot composition and editing</Definition>
</Term>
<Term termID="ASSISTANT-DIRECTOR">
  <Name xml:lang="en">Assistant Director</Name>
  <Name xml:lang="en">AD</Name>
  <Definition xml:lang="en">An assistant director's duties include tracking the progress of
filming versus the production schedule and preparing call sheets that is a listing of which actors
will be required for which scenes and when they will be required</Definition>
</Term>
<Term termID="PRODUCTION-ASSISTANT">
  <Name xml:lang="en">Production Assistant</Name>
  <Name xml:lang="en">PA</Name>
  <Definition xml:lang="en">A person who aids a producer, director, assistant director, or
others involved in film or TV production, such as the person who keeps passersby from waking into a
location shoot</Definition>
</Term>
<Term termID="CONTINUITY-PERSON">
  <Name xml:lang="en">Continuity Person</Name>
  <Definition xml:lang="en">A person who writes a detailed script used making a film in order to
avoid discontinuities from shot to shot</Definition>
</Term>
<Term termID="TIMEKEEPER">
  <Name xml:lang="en">Timekeeper</Name>
  <Name xml:lang="en">Production Associate</Name>
  <Definition xml:lang="en">A person who keeps track of the time elapsed in a
program</Definition>
</Term>
<Term termID="MUSIC-SUPERVISOR">
  <Name xml:lang="en">Music Supervisor</Name>
  <Definition xml:lang="en">A person who coordinates the work of the composer, the editor and
sound mixers</Definition>
</Term>
<Term termID="COMPOSER">

```

```

    <Name xml:lang="en">Composer</Name>
    <Definition xml:lang="en">A musician whose music appears in a program's score. Most movies
have at least some original music written for the score, usually after the relevant parts of the
movie have been filmed</Definition>
  </Term>
  <Term termID="PRODUCTION-DESIGNER">
    <Name xml:lang="en">Production Designer</Name>
    <Definition xml:lang="en">An artist responsible for designing the overall visual appearance of
a program</Definition>
  </Term>
  <Term termID="ART-DIRECTOR">
    <Name xml:lang="en">Art Director</Name>
    <Definition xml:lang="en">A person who oversees the artists and craftspeople who build the
sets</Definition>
  </Term>
  <Term termID="SET-DESIGNER">
    <Name xml:lang="en">Set Designer</Name>
    <Definition xml:lang="en">A person responsible for designing sets. The set designer reports to
the art director</Definition>
  </Term>
  <Term termID="SET-MAKER">
    <Name xml:lang="en">Set Maker</Name>
    <Definition xml:lang="en">A person who makes the set with the specifications dictated by the
set designer</Definition>
  </Term>
  <Term termID="PROPERTY-MASTER">
    <Name xml:lang="en">Property Master</Name>
    <Name xml:lang="en">Prop Master</Name>
    <Name xml:lang="en">Props</Name>
    <Name xml:lang="en">Property</Name>
    <Definition xml:lang="en">A person responsible for buying/acquiring any props needed for a
production</Definition>
  </Term>
  <Term termID="PROPERTY-ASSISTANT">
    <Name xml:lang="en">Property Assistant</Name>
    <Name xml:lang="en">Prop Assistant</Name>
    <Definition xml:lang="en">Responsible for the placement and maintenance of props on a
set</Definition>
  </Term>
  <Term termID="SOUND-EFFECTS-PERSON">
    <Name xml:lang="en">Sound Effects Person</Name>
    <Name xml:lang="en">Soundman</Name>
    <Name xml:lang="en">Sound Person</Name>
    <Name xml:lang="en">SE</Name>
    <Definition xml:lang="en">The sound-effects person, generally called a soundman, is
responsible for the sound effects, or sounds other than music and human voices</Definition>
  </Term>
  <Term termID="SFX-SUPERVISOR">
    <Name xml:lang="en">Special Effects Supervisor</Name>
    <Name xml:lang="en">Special Effects Co-Ordinator</Name>
    <Definition xml:lang="en">The chief of a production's special effects crew</Definition>
  </Term>
  <Term termID="SFX-ASSISTANT">
    <Name xml:lang="en">Special Effects Assistant</Name>
    <Name xml:lang="en">Special Effects Technician</Name>
    <Definition xml:lang="en">A person who makes an artificial effect used to create an illusion
in a program</Definition>
  </Term>
  <Term termID="ANIMATOR">
    <Name xml:lang="en">Animator</Name>
    <Definition xml:lang="en">An artist who produces animation drawings, or the person in charge
of an animation production</Definition>
  </Term>
  <Term termID="CG-ARTIST">
    <Name xml:lang="en">Computer Graphics Artist</Name>
    <Name xml:lang="en">CG</Name>
    <Definition xml:lang="en">An artist who produces computer graphics</Definition>
  </Term>
  <Term termID="MAKEUP-SUPERVISOR">
    <Name xml:lang="en">Makeup Supervisor</Name>
    <Definition xml:lang="en">The decorations placed directly on the skin or hair of an actor for
cosmetic or artistic effect. Practitioners are called artists or supervisors</Definition>
  </Term>
  <Term termID="MAKEUP-ARTIST">
    <Name xml:lang="en">Makeup Artist</Name>
    <Definition xml:lang="en">The decorations placed directly on the skin or hair of an actor for
cosmetic or artistic effect. Practitioners are called artists or supervisors</Definition>
  </Term>

```

```

<Term termID="COSTUME-SUPERVISOR">
  <Name xml:lang="en">Costume Supervisor</Name>
  <Definition xml:lang="en">A person responsible for handling the costumes worn by
actors</Definition>
</Term>
<Term termID="COSTUMER">
  <Name xml:lang="en">Costumer</Name>
  <Name xml:lang="en">Wardrobe</Name>
  <Name xml:lang="en">Assistant Wardrobe</Name>
  <Name xml:lang="en">Wardrobe Assistant</Name>
  <Definition xml:lang="en">A person who handles the costumes worn by actors</Definition>
</Term>
<Term termID="TECHNICAL-DIRECTOR">
  <Name xml:lang="en">Technical Director</Name>
  <Name xml:lang="en">TD</Name>
  <Definition xml:lang="en">The director of the technical facilities for a
production</Definition>
</Term>
<Term termID="SWITCHER">
  <Name xml:lang="en">Switcher</Name>
  <Definition xml:lang="en">A person (studio engineer) responsible for camera mixing or
switching. Switching is the selection process among the various audio and video sources in a
production</Definition>
</Term>
<Term termID="CAMERA-OPERATOR">
  <Name xml:lang="en">Camera Operator</Name>
  <Name xml:lang="en">Cameraperson</Name>
  <Name xml:lang="en">Cameraman</Name>
  <Definition xml:lang="en">A person who operates the camera to the specifications dictated by
the director</Definition>
</Term>
<Term termID="CAMERA-ASSISTANT">
  <Name xml:lang="en">Camera Assistant</Name>
  <Name xml:lang="en">Assistant Camera</Name>
  <Definition xml:lang="en">A member of the camera crew who assists the camera
operator</Definition>
</Term>
<Term termID="LIGHTING-SUPERVISOR">
  <Name xml:lang="en">Lighting Supervisor</Name>
  <Definition xml:lang="en">The chief of a production's lightning crew</Definition>
</Term>
<Term termID="LIGHTING-OPERATOR">
  <Name xml:lang="en">Lighting Operator</Name>
  <Name xml:lang="en">Lighting Technician</Name>
  <Definition xml:lang="en">A technician who installs, operates and maintains
lighting</Definition>
</Term>
<Term termID="SOUND-SUPERVISOR">
  <Name xml:lang="en">Sound Supervisor</Name>
  <Name xml:lang="en">Recording Supervisor</Name>
  <Definition xml:lang="en">The person responsible for the technical quality of a programme's
sound</Definition>
</Term>
<Term termID="SOUND-ENGINEER">
  <Name xml:lang="en">Sound Engineer</Name>
  <Name xml:lang="en">Audio Operator</Name>
  <Definition xml:lang="en">A person who operates sound recording devices</Definition>
</Term>
<Term termID="VISUAL-EFFECTS-SUPERVISOR">
  <Name xml:lang="en">Visual Effects Supervisor</Name>
  <Name xml:lang="en">Video Supervisor</Name>
  <Definition xml:lang="en">The chief of a production's visual effects crew</Definition>
</Term>
<Term termID="VIDEO-ENGINEER">
  <Name xml:lang="en">Video Engineer</Name>
  <Name xml:lang="en">Video Operator</Name>
  <Definition xml:lang="en">An engineer who operates the monitors and camera control units to
switch from one camera to another and maintain color, contrast and other visual
qualities</Definition>
</Term>
<Term termID="TRANSPORTATION-CAPTAIN">
  <Name xml:lang="en">Transportation Captain</Name>
  <Definition xml:lang="en">A person who drives either equipment or passenger trucks, typically
between location shootings, sets and the studio</Definition>
</Term>
<Term termID="STAFF">
  <Name xml:lang="en">Staff</Name>
  <Name xml:lang="en">Production Staff</Name>

```

```

    <Definition xml:lang="en">Personnel who carries out an assigned production task. (Other than
above)</Definition>
  </Term>
  <Term termID="DISSEMINATOR">
    <Name xml:lang="en">Disseminator</Name>
    <Definition xml:lang="en"> A person or organization who makes a creation available to
others</Definition>
  </Term>
  <Term termID="PUBLISHER">
    <Name xml:lang="en">Publisher</Name>
    <Definition>A person or organization that prepares and issues material for distribution or
sale</Definition>
  </Term>
  <Term termID="DISTRIBUTOR">
    <Name xml:lang="en">Distributor</Name>
    <Definition>A person or organization that markets merchandise</Definition>
  </Term>
  <Term termID="SYNDICATOR">
    <Name xml:lang="en">Syndicator</Name>
    <Definition>A person or organization that sells material for publication in a number of venues
simultaneously</Definition>
  </Term>
  <Term termID="AGGREGATOR">
    <Name xml:lang="en">Aggregator</Name>
    <Definition>A person or organization that gathers material into a sum or whole</Definition>
  </Term>
  <Term termID="BROADCASTER">
    <Name xml:lang="en">Broadcaster</Name>
    <Definition>A person or organization that sends out or communicates material, especially by
radio or television</Definition>
  </Term>
  <Term termID="WEBCASTER">
    <Name xml:lang="en">Webcaster</Name>
    <Definition>A person or organization that sends out or communicates material on the Internet
by audio and/or video</Definition>
  </Term>
  <Term termID="UNKNOWN">
    <Name xml:lang="en">Unknown</Name>
    <Definition>A person or organization that was involved in the creation but the role played is
unknown</Definition>
  </Term>
</ClassificationScheme>

```

## A.6 IntentionCS

```

<?xml version="1.0" encoding="UTF-8"?>
<ClassificationScheme uri="urn:tva:metadata:cs:IntentionCS:2005">
  <!-- ##### -->
  <!-- INTENTION -->
  -->
  <!--Definition: The broadcaster's primary apparent intention in transmitting the programme-->
  <!-- ##### -->
  <Term termID="1.0">
    <Name xml:lang="en">Proprietary</Name>
    <Definition xml:lang="en">For use where proprietary extensions are required, or the use of
keywords that do not fit in any classification below</Definition>
  </Term>
  <Term termID="1.1">
    <Name xml:lang="en">ENTERTAIN</Name>
    <Definition xml:lang="en">Programme intended primarily to evoke relaxation, feelings of
pleasure and/or awareness of beauty</Definition>
    <Term termID="1.1.1">
      <Name xml:lang="en">Pure entertainment</Name>
    </Term>
    <Term termID="1.1.2">
      <Name xml:lang="en">Informative entertainment</Name>
      <Definition xml:lang="en">Programmes intended primarily to entertain but with informative
elements</Definition>
    </Term>
  </Term>
  <Term termID="1.2">
    <Name xml:lang="en">INFORM</Name>

```

```

    <Definition xml:lang="en">Programme intended primarily to inform about current facts,
situations, events, theories or forecasts, or to provide explanatory background information and
advice. Information programme content has to be non-durable, that is to say that one could not
imagine that the same programme would be transmitted e.g. one year later without losing most of its
relevance. Examples: news, documentaries about current subjects, consumer information</Definition>
    <Term termID="1.2.1">
      <Name xml:lang="en">Government</Name>
      <Definition xml:lang="en">Official material broadcast on behalf of the government of the
country concerned. Examples: A short message warning of the dangers of using fireworks, AIDS
awareness campaigns etc</Definition>
    </Term>
    <Term termID="1.2.2">
      <Name xml:lang="en">Pure information</Name>
    </Term>
    <Term termID="1.2.3">
      <Name xml:lang="en">Infotainment</Name>
      <Definition xml:lang="en">Programmes intended primarily to inform but with entertaining
elements</Definition>
    </Term>
    <Term termID="1.2.4">
      <Name xml:lang="en">Advice</Name>
      <Definition xml:lang="en">Programme intended to advise about matters of personal interest
such as consumer prices and quality, financial matters, health, or, for the interest of special
groups, weather or traffic information</Definition>
    </Term>
  </Term>
  <Term termID="1.3">
    <Name xml:lang="en">EDUCATE</Name>
    <Definition xml:lang="en">Programme primarily intended to increase knowledge about non-current
subjects in a didactic or non-didactic way, or to religiously inspire</Definition>
    <Term termID="1.3.1">
      <Name xml:lang="en">School programmes</Name>
      <Term termID="1.3.1.1">
        <Name xml:lang="en">Primary</Name>
        <Definition xml:lang="en">Youth education in the first stages - between the ages of
approx 4 and 12/13</Definition>
      </Term>
      <Term termID="1.3.1.2">
        <Name xml:lang="en">Secondary</Name>
        <Definition xml:lang="en">Youth Education in the second stage - between the ages of
approx 12/13 and 18</Definition>
      </Term>
      <Term termID="1.3.1.3">
        <Name xml:lang="en">Tertiary</Name>
        <Definition xml:lang="en">University/College education</Definition>
      </Term>
    </Term>
    <Term termID="1.3.2">
      <Name xml:lang="en">Lifelong/Further education</Name>
      <Definition xml:lang="en">Adult education: Additional learning such as post graduate and
distance learning</Definition>
    </Term>
  </Term>
  <Term termID="1.4">
    <Name xml:lang="en">PROMOTE</Name>
    <Definition xml:lang="en">Intended to promote content. Produced by the broadcaster or media
owner. e.g. trailers for TV/Radio</Definition>
  </Term>
  <Term termID="1.5">
    <Name xml:lang="en">ADVERTISE</Name>
    <Definition xml:lang="en">Intended to inform consumers about commercial products and services.
Produced by/on behalf the owners/sellers of the product or service. Example: Interstitial
commercials</Definition>
  </Term>
  <Term termID="1.6">
    <Name xml:lang="en">RETAIL</Name>
    <Definition xml:lang="en">Full length programmes designed to sell a product or service to the
consumer. </Definition>
    <Term termID="1.6.1">
      <Name xml:lang="en">Gambling</Name>
      <Definition xml:lang="en">Programme that allows a consumer to participate in gambling. NB a
programme ABOUT gambling, i.e. a documentary about Las Vegas does not belong in this
category</Definition>
    </Term>
    <Term termID="1.6.2">
      <Name xml:lang="en">Home Shopping</Name>
      <Definition xml:lang="en">A programme that has the primary objective to allow consumer to
make purchases as part of the programme e.g. QVC Home Shopping channel. A programme ABOUT home

```

```

shopping does not fit in this category. Home shopping could also relate to devices outside the home
- purchases of goods and services made through the device</Definition>
</Term>
</Term>
</Term>
<Term termID="1.7">
  <Name xml:lang="en">FUND RAISE / SOCIAL ACTION</Name>
  <Definition xml:lang="en">Appeals for charities and other recognized good causes. Examples:
Telethons and disaster appeal programmes</Definition>
</Term>
  <Term termID="1.7.1">
    <Name xml:lang="en">Fund Raising</Name>
    <Definition xml:lang="en">Examples: Telethons and disaster appeal programmes</Definition>
  </Term>
  <Term termID="1.7.2">
    <Name xml:lang="en">Social Action</Name>
    <Definition xml:lang="en">Appeals by good causes for action, such as giving
blood</Definition>
  </Term>
  <Term termID="1.8">
    <Name xml:lang="en">ENRICH</Name>
    <Definition xml:lang="en">Programme primarily intended to increase knowledge about non-current
subjects in a didactic or non-didactic way, or to religiously inspire. Enrichment programme content
has to be durable, that is to say, one could very well imagine that the programme would be broadcast
one year later, without loosing its relevance. Examples: travelogues, war documentaries, educational
programmes, religious programmes</Definition>
    <Term termID="1.8.1">
      <Name xml:lang="en">General enrichment</Name>
      <Definition xml:lang="en">Programme primarily intended to increase knowledge about non
current subjects in a non-didactic way</Definition>
    </Term>
    <Term termID="1.8.2">
      <Name xml:lang="en">Inspirational enrichment</Name>
      <Definition xml:lang="en">Programme based on different forms of religious beliefs or
intended to edify the audience</Definition>
    </Term>
  </Term>
  <Term termID="1.9">
    <Name xml:lang="en">EDUCATIONAL DIFFICULTY</Name>
    <Definition xml:lang="en">The level of difficulty of an educational programme</Definition>
    <Term termID="1.9.1">
      <Name xml:lang="en">Very Easy</Name>
    </Term>
    <Term termID="1.9.2">
      <Name xml:lang="en">Easy</Name>
    </Term>
    <Term termID="1.9.3">
      <Name xml:lang="en">Medium</Name>
    </Term>
    <Term termID="1.9.4">
      <Name xml:lang="en">Difficult</Name>
    </Term>
    <Term termID="1.9.5">
      <Name xml:lang="en">Very Difficult</Name>
    </Term>
  </Term>
</ClassificationScheme>

```

## A.7 FormatCS

```

<?xml version="1.0" encoding="UTF-8"?>
<ClassificationScheme uri="urn:tva:metadata:cs:FormatCS:2010">
  <!-- ##### -->
  <!-- FORMAT
-->
  <!-- Definition: This dimension is used to classify programmes as to their formal structure, in
other words: how -->
  <!-- does the programme look, regardless of the subject with which the programme is dealing. -->
  <!-- ##### -->
  <Term termID="2.0">
    <Name xml:lang="en">Proprietary</Name>
    <Definition xml:lang="en">For use where proprietary extensions are required, or the use of
keywords that do not fit in any classification below</Definition>

```



```

</Term>
<Term termID="2.1">
  <Name xml:lang="en">STRUCTURED</Name>
  <Definition xml:lang="en">All programmes dealing with facts, situations, opinions, theories
and forecasts</Definition>
  <Term termID="2.1.1">
    <Name xml:lang="en">Bulletin</Name>
    <Definition xml:lang="en">Programme with formal desk presentation, usually interspersed
with visual material. Example: news bulletin, weather forecast</Definition>
  </Term>
  <Term termID="2.1.2">
    <Name xml:lang="en">Magazine</Name>
    <Definition xml:lang="en">Programme consisting of separate items which has at least one
common quality and presented under one main heading</Definition>
    <Term termID="2.1.2.1">
      <Name xml:lang="en">Presenter led magazine</Name>
      <Definition xml:lang="en">Presenter led programme consisting different
elements</Definition>
    </Term>
    <Term termID="2.1.2.2">
      <Name xml:lang="en">Clip led magazine</Name>
      <Definition xml:lang="en">Programme dominated or completely consisting of self
contained video clips</Definition>
    </Term>
  </Term>
  <Term termID="2.1.3">
    <Name xml:lang="en">Event</Name>
    <Definition xml:lang="en">An outside event covered by the broadcaster and with an
accompanying commentary and transmitted live or deferred (within 24 hours). Example: Soccer match,
theatre relay, parliamentary debate</Definition>
    <Term termID="2.1.3.1">
      <Name xml:lang="en">Commented event</Name>
      <Definition xml:lang="en">An outside event covered by the broadcaster and with an
accompanying commentary, and transmitted live or deferred (within 2. hours).</Definition>
    </Term>
    <Term termID="2.1.3.2">
      <Name xml:lang="en">Uncommented event</Name>
      <Definition xml:lang="en">Where the event speaks for itself. I.e. Religious
service,</Definition>
    </Term>
  </Term>
  <Term termID="2.1.4">
    <Name xml:lang="en">Documentary</Name>
    <Definition xml:lang="en">Programme concerning a single theme, involving descriptive and/or
interpretative commentaries, illustrations, I/vs., statements, photos etc</Definition>
    <Term
termID="2.1.4.1">
      <Name xml:lang="en">Archive clips documentary</Name>
      <Definition xml:lang="en">Documentary consisting mostly or completely of selected clips
of archive media</Definition>
    </Term>
  </Term>
  <Term termID="2.1.5">
    <Name xml:lang="en">Discussion/Interview/Debate/Talk show</Name>
    <Definition xml:lang="en">Mainly verbal programme in which more than one person
participates</Definition>
  </Term>
  <Term termID="2.1.6">
    <Name xml:lang="en">Lecture/Speech/Presentation</Name>
    <Definition xml:lang="en">Mainly verbal programme in which only one person
participates</Definition>
  </Term>
  <Term termID="2.1.7">
    <Name xml:lang="en">Textual (incl. relayed Teletext)</Name>
    <Definition xml:lang="en">Programme consisting only of alphanumerical
information</Definition>
  </Term>
  <Term termID="2.1.8">
    <Name xml:lang="en">Phone-in</Name>
    <Definition xml:lang="en">Programme with content primarily generated by contributions from
the general audience either on the telephone or by sending in emails/letters</Definition>
  </Term>
  <Term termID="2.1.9">
    <Name xml:lang="en">DJ with discs</Name>
    <Definition xml:lang="en">Programme (usually in audio only) in which a specialist presenter
introduces music or other pre-recorded elements</Definition>
  </Term>
  <Term termID="2.1.10">
    <Name xml:lang="en">Charitable Appeal</Name>

```

```

    <Definition xml:lang="en">Programme devoted to an appeal for donations to a particular
    charitable cause</Definition>
  </Term>
  <Term termID="2.1.11">
    <Name xml:lang="en">Party-political broadcast</Name>
    <Definition xml:lang="en">Programme promoting the views and/or policies of a political
    party, especially during an election campaign</Definition>
  </Term>
</Term>
<Term termID="2.2">
  <Name xml:lang="en">REPRESENTATION/PLAY</Name>
  <Definition xml:lang="en">Programme consisting of a prose or verse composition, one telling a
  story, written for or as if for performance by actors.Examples: soap opera, Shakespeare play,
  Monthly Python, radio play, Not: documentary or informational programme whose subject is
  drama</Definition>
  <Term termID="2.2.1">
    <Name xml:lang="en">Fictional portrayal of life</Name>
    <Definition xml:lang="en">Programme performed by live actors e.g. Performed
  drama</Definition>
  </Term>
  <Term termID="2.2.2">
    <Name xml:lang="en">Readings</Name>
    <Definition xml:lang="en">Programmes consisting of readings of poems, stories or other
  literary works</Definition>
  </Term>
  <Term termID="2.2.3">
    <Name xml:lang="en">Dramatic documentary</Name>
    <Definition xml:lang="en">Programme performed by actors. About real events e.g. Docusoap or
  docudrama</Definition>
  </Term>
</Term>
<Term termID="2.3">
  <Name xml:lang="en">CARTOON/ANIMATION/PUPPETRY</Name>
  <Definition xml:lang="en">Programme consisting of a dramatic work, constructed frame by frame
  without resource to live images</Definition>
  <Term termID="2.3.1">
    <Name xml:lang="en">Anime</Name>
    <Definition xml:lang="en">Japanese animation style</Definition>
  </Term>
  <Term termID="2.3.2">
    <Name xml:lang="en">Computer</Name>
    <Definition xml:lang="en">CGI or 3D representationExamples: Disney's Antz, Toy Story,
  etc.</Definition>
  </Term>
  <Term termID="2.3.3">
    <Name xml:lang="en">Cartoon</Name>
    <Definition xml:lang="en">Images drawn frame by frame. Example: Disney's Pinocchio, The
  Flintstones, Tom and Jerry</Definition>
  </Term>
  <Term termID="2.3.4">
    <Name xml:lang="en">Puppetry</Name>
    <Definition xml:lang="en">Programme consisting of a dramatic work, performed with
  puppet/claymation.</Definition>
  <Term termID="2.3.4.1">
    <Name xml:lang="en">Real time puppetry</Name>
    <Definition xml:lang="en">marrionettes such as Thunderbirds</Definition>
  </Term>
  <Term termID="2.3.4.2">
    <Name xml:lang="en">Physical model animation</Name>
    <Definition xml:lang="en">claymation such as Gumbi and Poky, Chicken Run, Wallace and
  Gromit</Definition>
  </Term>
</Term>
</Term>
<Term termID="2.4">
  <Name xml:lang="en">SHOW</Name>
  <Term termID="2.4.1">
    <Name xml:lang="en">Hosted show</Name>
    <Definition xml:lang="en">Programme, that can be regarded neither as non-fiction nor as
  drama or music/dance in which one or more persons fulfil the role of presenter, host, quiz or games
  master, announcer, chairperson or speaker and where the rest of the participants are generally
  members of the public</Definition>
  <Term termID="2.4.1.1">
    <Name xml:lang="en">Simple game show</Name>
    <Definition xml:lang="en">Programme in which the content is primarily contained within
  the studio and the prizes or rewards (if any) to the participant(s) may be regarded as conservative.
  Example: University Challenge</Definition>
  </Term>

```

```

    <Term termID="2.4.1.2">
      <Name xml:lang="en">Big game show</Name>
      <Definition xml:lang="en">Programme produced on a grand scale in which the prizes or
rewards are considered generous Example: Who wants to be a millionaire</Definition>
    </Term>
      <Term termID="2.4.1.3">
        <Name xml:lang="en">Telethon</Name>
        <Definition xml:lang="en">Very long programme, typically made up of many shorter
elements or items, and devoted to a single over-arching purpose, usually a
charitable appeal</Definition>
      </Term>
    </Term>
  <Term termID="2.4.2">
    <Name xml:lang="en">Panel-show</Name>
    <Definition xml:lang="en">A programme of a light entertainment nature which is presented by
a more or less fixed group of people (panel). Programme, that can be regarded neither as non-fiction
nor as drama or concert. Example: The Paul Daniels Show; Der Rudi Carrell Show</Definition>
    <Term termID="2.4.2.1">
      <Name xml:lang="en">Simple game show</Name>
      <Definition xml:lang="en">see 2.4.1.1</Definition>
    </Term>
    <Term termID="2.4.2.2">
      <Name xml:lang="en">Big game show</Name>
      <Definition xml:lang="en">see 2.4.1.2</Definition>
    </Term>
  </Term>
  <Term termID="2.4.3">
    <Name xml:lang="en">Non-hosted show</Name>
    <Definition xml:lang="en">Programme, that can be regarded neither as non-fiction nor as
drama or music/dance in which no one fulfils the role of presenter, host, quiz or games master,
announcer, chairperson or speaker</Definition>
  </Term>
  <Term termID="2.4.4">
    <Name xml:lang="en">Standup comedian(s)</Name>
    <Definition xml:lang="en">Programme performed by a single, a pair or a group of comedians
performing directly towards the audience</Definition>
  </Term>
  <Term termID="2.4.5">
    <Name xml:lang="en">Reality Show</Name>
    <Term termID="2.4.5.1">
      <Name xml:lang="en">Observational show</Name>
      <Definition xml:lang="en">where fly on the wall techniques are central to the programme
structure</Definition>
    </Term>
    <Term termID="2.4.5.2">
      <Name xml:lang="en">Controlled show</Name>
      <Definition xml:lang="en">where the flow of the programme is governed - rules
based</Definition>
    </Term>
    <Term termID="2.4.5.3">
      <Name xml:lang="en">Makeover show</Name>
      <Definition xml:lang="en">Experts collaborate to change the appearance or image of a
person or thing (e.g. a garden or house), or to modify the behaviour of a person.</Defintion>
    </Term>
  </Term>
  <Term termID="2.4.6">
    <Name xml:lang="en">Clips show</Name>
    <Definition xml:lang="en">Programme centred on clips from other material, e.g. an "out-
takes" show.</Defintion>
  </Term>
</Term>
<Term termID="2.5">
  <Name xml:lang="en">ARTISTIC PERFORMANCE</Name>
  <Definition xml:lang="en">Music, Dance, Mime etc. TV programmes (predominantly) consisting of
music, dance or ballet or theatrical performance</Definition>
  <Term termID="2.5.1">
    <Name xml:lang="en">Solo performance</Name>
    <Definition xml:lang="en">individual performance of music, dance, mime or spoken word e.g.
Nigel Kennedy solo violin performance</Definition>
  </Term>
  <Term termID="2.5.2">
    <Name xml:lang="en">Small ensemble performance</Name>
    <Definition xml:lang="en">Performance of music, dance, mime or spoken word by a small
number of people Quartet, small ensemble staged play</Definition>
  </Term>
  <Term termID="2.5.3">
    <Name xml:lang="en">Large ensemble performance</Name>

```

```

    <Definition xml:lang="en">Performance of music, dance, mime or spoken word by a large
number of people Orchestra and choirs</Definition>
  </Term>
  <Term termID="2.5.4">
    <Name xml:lang="en">Mixed</Name>
  </Term>
</Term>
<Term termID="2.6">
  <Name xml:lang="en">void</Name>
  <Definition xml:lang="en">Term not defined</Definition>
</Term>
<Term termID="2.7">
  <Name xml:lang="en">INTERACTIVE</Name>
  <Definition xml:lang="en">Formats making use of a range of features such as local application
support, return path and direct viewer interaction</Definition>
  <Term termID="2.7.1">
    <Name xml:lang="en">LOCAL INTERACTIVITY</Name>
    <Definition xml:lang="en">Formats that happen in the "box" where broadcast "data" is
processed locally giving a sense of dynamic choice</Definition>
    <Term termID="2.7.1.1">
      <Name xml:lang="en">Static informational</Name>
      <Definition xml:lang="en">Services (news or entertainment) where the information is
fixed and does not update</Definition>
    </Term>
    <Term termID="2.7.1.2">
      <Name xml:lang="en">Dynamic informational</Name>
      <Definition xml:lang="en">Services where the information is dynamic and updates
regularly from the broadcast stream</Definition>
    </Term>
    <Term termID="2.7.1.3">
      <Name xml:lang="en">Viewing chats</Name>
      <Definition xml:lang="en">The show displays chats taking place over local and remote
systems</Definition>
    </Term>
    <Term termID="2.7.1.4">
      <Name xml:lang="en">Quiz - Basic multiple choice</Name>
      <Definition xml:lang="en">Using any key number, ft, or arrows etc</Definition>
    </Term>
    <Term termID="2.7.1.5">
      <Name xml:lang="en">Quiz - Text or number entry answers</Name>
      <Definition xml:lang="en">Entering real text or numbers into a format</Definition>
    </Term>
    <Term termID="2.7.1.6">
      <Name xml:lang="en">Re-ordering</Name>
      <Definition xml:lang="en">Competitions based on moving lists into correct
orders</Definition>
    </Term>
    <Term termID="2.7.1.7">
      <Name xml:lang="en">Positional</Name>
      <Definition xml:lang="en">Challenges or games such as "Spot the Ball", clicking on
guess where something is</Definition>
    </Term>
    <Term termID="2.7.1.8">
      <Name xml:lang="en">Sync quiz</Name>
      <Definition xml:lang="en">Synchronized with audio and/or video (the
programme)</Definition>
    </Term>
    <Term termID="2.7.1.9">
      <Name xml:lang="en">Timer quiz</Name>
      <Definition xml:lang="en">Quiz synchronized with audio and/or video</Definition>
    </Term>
    <Term termID="2.7.1.10">
      <Name xml:lang="en">Elimination and timer</Name>
      <Definition xml:lang="en">Against the clock</Definition>
    </Term>
    <Term termID="2.7.1.11">
      <Name xml:lang="en">Categories</Name>
      <Definition xml:lang="en">Selecting from batches of questions</Definition>
    </Term>
    <Term termID="2.7.1.12">
      <Name xml:lang="en">Level based quiz/game</Name>
      <Definition xml:lang="en">Cannot move on without completing last level - Difficulty or
linear challenge</Definition>
    </Term>
    <Term termID="2.7.1.13">
      <Name xml:lang="en">Following a sequence</Name>
      <Definition xml:lang="en">Temporal, Simon says, red next then green etc</Definition>
    </Term>

```

```

    <Term termID="2.7.1.14">
      <Name xml:lang="en">Local multi player</Name>
      <Definition xml:lang="en">Players using the same box in the same space</Definition>
    </Term>
    <Term termID="2.7.1.15">
      <Name xml:lang="en">Multi stream audio-video</Name>
      <Definition xml:lang="en">Services where the interaction is based mostly around
alternate, parallel streamed audio or video access</Definition>
    </Term>
    <Term termID="2.7.1.16">
      <Name xml:lang="en">Enhanced advertisement</Name>
      <Definition xml:lang="en">Local interaction, more information locally etc</Definition>
    </Term>
    <Term termID="2.7.1.17">
      <Name xml:lang="en">Logic based games</Name>
    </Term>
    <Term termID="2.7.1.18">
      <Name xml:lang="en">Word games</Name>
    </Term>
    <Term termID="2.7.1.19">
      <Name xml:lang="en">Positional games</Name>
    </Term>
    <Term termID="2.7.1.20">
      <Name xml:lang="en">Board games</Name>
    </Term>
    <Term termID="2.7.1.21">
      <Name xml:lang="en">Text based gaming</Name>
    </Term>
    <Term termID="2.7.1.22">
      <Name xml:lang="en">Dynamic 2D/3D graphics</Name>
    </Term>
  </Term>
  <Term termID="2.7.2">
    <Name xml:lang="en">INTERMITTENT RESPONSE</Name>
    <Definition xml:lang="en">Formats that require an intermittent or continuous return
path</Definition>
    <Term termID="2.7.2.1">
      <Name xml:lang="en">Single impulse vote</Name>
      <Definition xml:lang="en">aka "clap-o-meter" - mass aggregation of single hit "press
red now if you think this" type votes</Definition>
    </Term>
    <Term termID="2.7.2.2">
      <Name xml:lang="en">Impulse vote from choices</Name>
      <Definition xml:lang="en">Vote from range of items - favourite act, band
etc</Definition>
    </Term>
    <Term termID="2.7.2.3">
      <Name xml:lang="en">Impulse Yes/No vote</Name>
      <Definition xml:lang="en">Impulse vote from two choices yes/no</Definition>
    </Term>
    <Term termID="2.7.2.4">
      <Name xml:lang="en">Impulse vote with a value</Name>
      <Definition xml:lang="en">Vote for something to happen with a value attached - e.g. how
many tins of baked beans should he eat</Definition>
    </Term>
    <Term termID="2.7.2.5">
      <Name xml:lang="en">Submit answers/form</Name>
      <Definition xml:lang="en">Press now to send off answers or details - quiz or
competition</Definition>
    </Term>
    <Term termID="2.7.2.6">
      <Name xml:lang="en">SMS using mobile</Name>
      <Definition xml:lang="en">Sending text from mobile into iTV or web
platforms</Definition>
    </Term>
    <Term termID="2.7.2.7">
      <Name xml:lang="en">SMS using TV remote</Name>
      <Definition xml:lang="en">Entry of messages using TV number/letter keys</Definition>
    </Term>
    <Term termID="2.7.2.8">
      <Name xml:lang="en">Impulse gambling</Name>
      <Definition xml:lang="en">Using intermittent persistently protected connection to place
real or fantasy bets</Definition>
    </Term>
    <Term termID="2.7.2.9">
      <Name xml:lang="en">Impulse transaction</Name>
      <Definition xml:lang="en">Using intermittent persistently protected connection to buy
product - T or ECommerce</Definition>

```

```

    </Term>
    <Term termID="2.7.2.10">
      <Name xml:lang="en">Multi player TS networked services/games</Name>
      <Definition xml:lang="en">Multi point networking in either time-shifted
mode</Definition>
    </Term>
    <Term termID="2.7.2.11">
      <Name xml:lang="en">Interactive advertisement</Name>
      <Definition xml:lang="en">Local interaction, request for more info, details even link
to impulse transaction etc</Definition>
    </Term>
  </Term>
  <Term termID="2.7.3">
    <Name xml:lang="en">ALWAYS ON CONNECTION</Name>
    <Definition xml:lang="en">Formats that ideally require a continuous connection to be
delivered</Definition>
    <Term termID="2.7.3.1">
      <Name xml:lang="en">Chat Forum</Name>
      <Definition xml:lang="en">Using built in platform functionality</Definition>
    </Term>
    <Term termID="2.7.3.2">
      <Name xml:lang="en">Chat Forum via web</Name>
      <Definition xml:lang="en">STB with other infrastructure layer e.g. web chat engine in
web browser on top of proprietary api</Definition>
    </Term>
    <Term termID="2.7.3.3">
      <Name xml:lang="en">Threaded mail discussions</Name>
      <Definition xml:lang="en">Listed as discussion threads such as usenet type</Definition>
    </Term>
    <Term termID="2.7.3.4">
      <Name xml:lang="en">Point to point</Name>
      <Definition xml:lang="en">Show enables/includes one to one mailing</Definition>
    </Term>
    <Term termID="2.7.3.5">
      <Name xml:lang="en">3rd party point to point</Name>
      <Definition xml:lang="en">Using 3rd party peer to peer (one to one) chat facility
layered over the show</Definition>
    </Term>
    <Term termID="2.7.3.6">
      <Name xml:lang="en">Voice chat using mic capability</Name>
      <Definition xml:lang="en">Speech to text engine enabling chat/ mailing using IP for
example</Definition>
    </Term>
    <Term termID="2.7.3.7">
      <Name xml:lang="en">Dual player networked services/games</Name>
      <Definition xml:lang="en">One to one, peer networking</Definition>
    </Term>
    <Term termID="2.7.3.8">
      <Name xml:lang="en">Multi player RT networked services/games</Name>
      <Definition xml:lang="en">Multi point networking in real time</Definition>
    </Term>
    <Term termID="2.7.3.9">
      <Name xml:lang="en">Gambling services</Name>
      <Definition xml:lang="en">Using continuous persistently protected
connection</Definition>
    </Term>
    <Term termID="2.7.3.10">
      <Name xml:lang="en">Impulse transaction</Name>
      <Definition xml:lang="en">Using intermittent persistently protected connection to buy
product - T or ECommerce</Definition>
    </Term>
    <Term termID="2.7.3.11">
      <Name xml:lang="en">Non-linear audio-video</Name>
      <Definition xml:lang="en">Services where the interaction is based mostly around
choosing alternate audio or video files - VOD and AOD, maybe combined with 2.1.1.15 (multi
stream)</Definition>
    </Term>
  </Term>
</Term>
</ClassificationScheme>

```

## A.8 ContentCS

```

<?xml version="1.0" encoding="UTF-8"?>
<ClassificationScheme uri="urn:tva:metadata:cs:ContentCS:2010">
  <!-- ##### -->
  <!--CONTENT -->
  <!-- Definition: This dimension is used to classify programmes according to their content or
subject. -->
  <!-- Unlike in the case of the form dimension, it is essential to hear the programme. -->
  <!-- ##### -->
  <Term termID="3.0">
    <Name xml:lang="en">Proprietary</Name>
    <Definition xml:lang="en">For use where proprietary extensions are required, or the use of
keywords that do not fit in any classification below</Definition>
  </Term>
  <Term termID="3.1">
    <Name xml:lang="en">NON-FICTION/INFORMATION</Name>
    <Term termID="3.1.1">
      <Name xml:lang="en">News</Name>
      <Definition xml:lang="en">Time-sensitive information</Definition>
      <Term termID="3.1.1.1">
        <Name xml:lang="en">Daily news</Name>
        <Definition xml:lang="en">regular programme carrying breaking and current news stories
e.g. News at ...</Definition>
      </Term>
      <Term termID="3.1.1.2">
        <Name xml:lang="en">Special news/edition</Name>
        <Definition xml:lang="en">one off programme to carry specific news events e.g. coverage
of breaking news such as train crash</Definition>
      </Term>
      <Term termID="3.1.1.3">
        <Name xml:lang="en">Special Report</Name>
        <Definition xml:lang="en">one off programme to carry specific news worthy events e.g.
exclusive report on specific item</Definition>
      </Term>
      <Term termID="3.1.1.4">
        <Name xml:lang="en">Commentary</Name>
      </Term>
      <Term termID="3.1.1.5">
        <Name xml:lang="en">Periodical/General</Name>
        <Definition xml:lang="en">regular timely programme covering general newsworthy
items</Definition>
      </Term>
      <Term termID="3.1.1.6">
        <Name xml:lang="en">National politics/National assembly</Name>
        <Definition xml:lang="en">new coverage of political events e.g. parliamentary
coverage</Definition>
      </Term>
      <Term termID="3.1.1.7">
        <Name xml:lang="en">Economy/Market/Financial/Business</Name>
        <Definition xml:lang="en">e.g. financial news programme from stock market</Definition>
      </Term>
      <Term termID="3.1.1.8">
        <Name xml:lang="en">Foreign/International</Name>
        <Definition xml:lang="en">news from abroad</Definition>
      </Term>
      <Term termID="3.1.1.9">
        <Name xml:lang="en">Sports</Name>
        <Definition xml:lang="en">news of sporting events NB not to be used for regular
sporting coverage</Definition>
      </Term>
      <Term termID="3.1.1.10">
        <Name xml:lang="en">Cultural</Name>
        <Definition xml:lang="en">news of cultural significance. NB only to be used when
coverage is newsworthy. Otherwise use 3.1.4 or 3.1.10</Definition>
        <Term termID="3.1.1.10.1">
          <Name xml:lang="en">Arts</Name>
        </Term>
        <Term termID="3.1.1.10.2">
          <Name xml:lang="en">Entertainment</Name>
        </Term>
        <Term termID="3.1.1.10.3">
          <Name xml:lang="en">Film</Name>
        </Term>
        <Term termID="3.1.1.10.4">
          <Name xml:lang="en">Music</Name>

```

```

    </Term>
    <Term termID="3.1.1.10.5">
      <Name xml:lang="en">Radio</Name>
    </Term>
    <Term termID="3.1.1.10.6">
      <Name xml:lang="en">TV</Name>
    </Term>
  </Term>
</Term>
<Term termID="3.1.1.11">
  <Name xml:lang="en">Local/Regional</Name>
</Term>
<Term termID="3.1.1.12">
  <Name xml:lang="en">Traffic</Name>
</Term>
<Term termID="3.1.1.13">
  <Name xml:lang="en">Weather forecasts</Name>
</Term>
<Term termID="3.1.1.14">
  <Name xml:lang="en">Service information</Name>
</Term>
<Term termID="3.1.1.15">
  <Name xml:lang="en">Public affairs</Name>
</Term>
<Term termID="3.1.1.16">
  <Name xml:lang="en">Current affairs</Name>
</Term>
<Term termID="3.1.1.17">
  <Name xml:lang="en">Consumer affairs</Name>
  <Definition xml:lang="en">e.g. Watchdog</Definition>
</Term>
</Term>
<Term termID="3.1.2">
  <Name xml:lang="en">Religion/Philosophies</Name>
  <Term termID="3.1.2.1">
    <Name xml:lang="en">Religion</Name>
    <Term termID="3.1.2.1.1">
      <Name xml:lang="en">Buddhism</Name>
    </Term>
    <Term termID="3.1.2.1.2">
      <Name xml:lang="en">Hinduism</Name>
    </Term>
    <Term termID="3.1.2.1.3">
      <Name xml:lang="en">Christianity</Name>
    </Term>
    <Term termID="3.1.2.1.4">
      <Name xml:lang="en">Islam</Name>
    </Term>
    <Term termID="3.1.2.1.5">
      <Name xml:lang="en">Judaism</Name>
    </Term>
    <Term termID="3.1.2.1.8">
      <Name xml:lang="en">Shintoism</Name>
    </Term>
    <Term termID="3.1.2.1.9">
      <Name xml:lang="en">Baha'i</Name>
    </Term>
    <Term termID="3.1.2.1.10">
      <Name xml:lang="en">Confucianism</Name>
    </Term>
    <Term termID="3.1.2.1.11">
      <Name xml:lang="en">Jainism</Name>
    </Term>
    <Term termID="3.1.2.1.12">
      <Name xml:lang="en">Sikhism</Name>
    </Term>
    <Term termID="3.1.2.1.13">
      <Name xml:lang="en">Taoism</Name>
    </Term>
    <Term termID="3.1.2.1.14">
      <Name xml:lang="en">Vodun (Voodoo)</Name>
    </Term>
    <Term termID="3.1.2.1.15">
      <Name xml:lang="en">Asatru (Nordic Paganism)</Name>
      <Definition xml:lang="en">AKA "Heathens"</Definition>
    </Term>
    <Term termID="3.1.2.1.16">
      <Name xml:lang="en">Druidism</Name>
    </Term>
  </Term>

```



```

<Term termID="3.1.2.1.17">
  <Name xml:lang="en">Goddess worship</Name>
</Term>
<Term termID="3.1.2.1.18">
  <Name xml:lang="en">Wicca</Name>
</Term>
<Term termID="3.1.2.1.19">
  <Name xml:lang="en">Witchcraft</Name>
</Term>
<Term termID="3.1.2.1.20">
  <Name xml:lang="en">Cadaism</Name>
</Term>
<Term termID="3.1.2.1.21">
  <Name xml:lang="en">Damanhur Community</Name>
</Term>
<Term termID="3.1.2.1.22">
  <Name xml:lang="en">Druse (Mowahhidoon)</Name>
</Term>
<Term termID="3.1.2.1.23">
  <Name xml:lang="en">Eckankar</Name>
</Term>
<Term termID="3.1.2.1.24">
  <Name xml:lang="en">Gnosticism</Name>
</Term>
<Term termID="3.1.2.1.25">
  <Name xml:lang="en">Roma (Gypsies)</Name>
</Term>
<Term termID="3.1.2.1.26">
  <Name xml:lang="en">Hare Krishna and ISKCON</Name>
</Term>
<Term termID="3.1.2.1.27">
  <Name xml:lang="en">Lukumi (Santeria)</Name>
</Term>
<Term termID="3.1.2.1.28">
  <Name xml:lang="en">Macumba</Name>
</Term>
<Term termID="3.1.2.1.29">
  <Name xml:lang="en">Native American spirituality</Name>
</Term>
<Term termID="3.1.2.1.30">
  <Name xml:lang="en">New Age</Name>
</Term>
<Term termID="3.1.2.1.31">
  <Name xml:lang="en">Osho</Name>
  <Definition xml:lang="en">Formerly known as Bhagwan Shree Rajneesh</Definition>
</Term>
<Term termID="3.1.2.1.32">
  <Name xml:lang="en">Satanism</Name>
</Term>
<Term termID="3.1.2.1.33">
  <Name xml:lang="en">Scientology</Name>
</Term>
<Term termID="3.1.2.1.34">
  <Name xml:lang="en">Thelema</Name>
</Term>
<Term termID="3.1.2.1.35">
  <Name xml:lang="en">Unitarian-Universalism</Name>
</Term>
<Term termID="3.1.2.1.36">
  <Name xml:lang="en">The Creativity Movement</Name>
  <Definition xml:lang="en">Formerly called World Church of the Creator</Definition>
</Term>
<Term termID="3.1.2.1.37">
  <Name xml:lang="en">Zoroastrianism</Name>
</Term>
<Term termID="3.1.2.1.38">
  <Name xml:lang="en">Quakerism</Name>
</Term>
<Term termID="3.1.2.1.39">
  <Name xml:lang="en">Rastafarianism</Name>
</Term>
</Term>
<Term termID="3.1.2.2">
  <Name xml:lang="en">Non-religious philosophies</Name>
  <Term termID="3.1.2.2.1">
    <Name xml:lang="en">Communism</Name>
  </Term>
  <Term termID="3.1.2.2.2">

```

```

    <Name xml:lang="en">Humanism</Name>
  </Term>
  <Term termID="3.1.2.2.5">
    <Name xml:lang="en">Libertarianism</Name>
  </Term>
  <Term termID="3.1.2.2.7">
    <Name xml:lang="en">Deism</Name>
  </Term>
  <Term termID="3.1.2.2.8">
    <Name xml:lang="en">Falun Gong and Falun Dafa</Name>
  </Term>
  <Term termID="3.1.2.2.9">
    <Name xml:lang="en">Objectivism</Name>
  </Term>
  <Term termID="3.1.2.2.10">
    <Name xml:lang="en">Universism</Name>
  </Term>
  <Term termID="3.1.2.2.11">
    <Name xml:lang="en">Atheism</Name>
  </Term>
  <Term termID="3.1.2.2.12">
    <Name xml:lang="en">Agnosticism</Name>
  </Term>
</Term>
</Term>
<Term termID="3.1.3">
  <Name xml:lang="en">General non-fiction</Name>
  <Term termID="3.1.3.1">
    <Name xml:lang="en">Political</Name>
    <Term termID="3.1.3.1.1">
      <Name xml:lang="en">Capitalism</Name>
    </Term>
    <Term termID="3.1.3.1.2">
      <Name xml:lang="en">Fascism</Name>
    </Term>
    <Term termID="3.1.3.1.3">
      <Name xml:lang="en">Republicanism</Name>
    </Term>
    <Term termID="3.1.3.1.4">
      <Name xml:lang="en">Socialism</Name>
    </Term>
  </Term>
  <Term termID="3.1.3.2">
    <Name xml:lang="en">Social</Name>
    <Term termID="3.1.3.2.1">
      <Name xml:lang="en">Disability Issues</Name>
    </Term>
  </Term>
  <Term termID="3.1.3.3">
    <Name xml:lang="en">Economic</Name>
  </Term>
  <Term termID="3.1.3.4">
    <Name xml:lang="en">Legal</Name>
  </Term>
  <Term termID="3.1.3.5">
    <Name xml:lang="en">Finance</Name>
  </Term>
  <Term termID="3.1.3.6">
    <Name xml:lang="en">Education</Name>
    <Term termID="3.1.3.6.1">
      <Name xml:lang="en">Pre-School</Name>
    </Term>
    <Term termID="3.1.3.6.2">
      <Name xml:lang="en">Primary</Name>
    </Term>
    <Term termID="3.1.3.6.3">
      <Name xml:lang="en">Secondary</Name>
    </Term>
    <Term termID="3.1.3.6.4">
      <Name xml:lang="en">Colleges and Universities</Name>
    </Term>
    <Term termID="3.1.3.6.5">
      <Name xml:lang="en">Adult education</Name>
    </Term>
    <Term termID="3.1.3.6.6">
      <Name xml:lang="en">Non-formal education</Name>
    </Term>
    <Term termID="3.1.3.6.7">

```

```

    <Name xml:lang="en">Homework</Name>
  </Term>
  <Term termID="3.1.3.6.8">
    <Name xml:lang="en">Reading groups</Name>
  </Term>
  <Term termID="3.1.3.6.9">
    <Name xml:lang="en">Distance learning</Name>
  </Term>
  <Term termID="3.1.3.6.10">
    <Name xml:lang="en">Religious schools</Name>
  </Term>
  <Term termID="3.1.3.6.11">
    <Name xml:lang="en">Student organizations</Name>
  </Term>
  <Term termID="3.1.3.6.12">
    <Name xml:lang="en">Testing</Name>
  </Term>
  <Term termID="3.1.3.6.13">
    <Name xml:lang="en">Theory and methods</Name>
  </Term>
  <Term termID="3.1.3.6.14">
    <Name xml:lang="en">Interdisciplinary studies</Name>
  </Term>
</Term>
<Term termID="3.1.3.7">
  <Name xml:lang="en">International affairs</Name>
</Term>
<Term termID="3.1.3.8">
  <Name xml:lang="en">Military/Defence</Name>
</Term>
<Term termID="3.1.3.9">
  <Name xml:lang="en">Industry/Manufacturing</Name>
</Term>
<Term termID="3.1.3.10">
  <Name xml:lang="en">Agriculture</Name>
</Term>
<Term termID="3.1.3.11">
  <Name xml:lang="en">Construction / Civil Engineering</Name>
</Term>
<Term termID="3.1.3.12">
  <Name xml:lang="en">Activities</Name>
  <Definition>Activities, particularly children's activities, which may or may not be
  educational.</Definition>
</Term>
</Term>
<Term termID="3.1.4">
  <Name xml:lang="en">Arts</Name>
  <Term termID="3.1.4.1">
    <Name xml:lang="en">Music</Name>
    <Definition xml:lang="en">Programme about a musical subject: NB if the content is
    predominantly the music itself this is not the category to be used - instead refer to
    3.6 Music e.g. biography of Mozart not a relay of a concert of his music</Definition>
  </Term>
  <Term termID="3.1.4.2">
    <Name xml:lang="en">Dance</Name>
    <Definition xml:lang="en">including ballet</Definition>
  </Term>
  <Term termID="3.1.4.3">
    <Name xml:lang="en">Theatre</Name>
    <Definition xml:lang="en">Programme about the theatre such as a review programme: not a
    programme consisting of the play itself</Definition>
  </Term>
  <Term termID="3.1.4.4">
    <Name xml:lang="en">Opera</Name>
  </Term>
  <Term termID="3.1.4.5">
    <Name xml:lang="en">Cinema</Name>
    <Definition xml:lang="en">Programme about subject concerning the world of the film and
    cinema not the film itself</Definition>
  </Term>
  <Term termID="3.1.4.6">
    <Name xml:lang="en">Poetry</Name>
  </Term>
  <Term termID="3.1.4.8">
    <Name xml:lang="en">Plastic arts</Name>
    <Definition xml:lang="en">Includes sculpture, carving, pottery and weaving</Definition>
  </Term>
  <Term termID="3.1.4.9">

```

```

    <Name xml:lang="en">Fine arts</Name>
  </Term>
  <Term termID="3.1.4.10">
    <Name xml:lang="en">Experimental arts</Name>
  </Term>
  <Term termID="3.1.4.11">
    <Name xml:lang="en">Architecture</Name>
  </Term>
  <Term termID="3.1.4.12">
    <Name xml:lang="en">Showbiz</Name>
  </Term>
</Term>
<Term termID="3.1.5">
  <Name xml:lang="en">Humanities</Name>
  <Definition xml:lang="en">The branches of learning regarded as having primarily a cultural
philosophy</Definition>
  <Term termID="3.1.5.1">
    <Name xml:lang="en">Literature</Name>
  </Term>
  <Term termID="3.1.5.2">
    <Name xml:lang="en">Languages</Name>
  </Term>
  <Term termID="3.1.5.3">
    <Name xml:lang="en">History</Name>
  </Term>
  <Term termID="3.1.5.4">
    <Name xml:lang="en">Culture/Tradition/Anthropology/Ethnic studies</Name>
  </Term>
  <Term termID="3.1.5.5">
    <Name xml:lang="en">War/Conflict</Name>
  </Term>
  <Term termID="3.1.5.6">
    <Name xml:lang="en">Philosophy</Name>
  </Term>
  <Term termID="3.1.5.7">
    <Name xml:lang="en">Political Science</Name>
  </Term>
</Term>
<Term termID="3.1.6">
  <Name xml:lang="en">Sciences</Name>
  <Term termID="3.1.6.1">
    <Name xml:lang="en">Applied sciences</Name>
    <Definition xml:lang="en">Sciences dealing with material phenomena or industrial
processes</Definition>
  </Term>
  <Term termID="3.1.6.2">
    <Name xml:lang="en">Nature/Natural sciences</Name>
    <Definition xml:lang="en">Biology, botany, geology and zoology</Definition>
    <Term termID="3.1.6.2.1">
      <Name xml:lang="en">Biology</Name>
    </Term>
    <Term termID="3.1.6.2.2">
      <Name xml:lang="en">Geology</Name>
    </Term>
    <Term termID="3.1.6.2.3">
      <Name xml:lang="en">Botany</Name>
    </Term>
    <Term termID="3.1.6.2.4">
      <Name xml:lang="en">Zoology</Name>
    </Term>
  </Term>
  <Term termID="3.1.6.3">
    <Name xml:lang="en">Animals/Wildlife</Name>
  </Term>
  <Term termID="3.1.6.4">
    <Name xml:lang="en">Environment/Geography</Name>
  </Term>
  <Term termID="3.1.6.5">
    <Name xml:lang="en">Space/Universe</Name>
    <Definition xml:lang="en">Astronomy, astrophysics</Definition>
  </Term>
  <Term termID="3.1.6.6">
    <Name xml:lang="en">Physical sciences</Name>
    <Definition xml:lang="en">Chemistry, electricity, mechanics, physics</Definition>
  </Term>
  <Term termID="3.1.6.6.1">
    <Name xml:lang="en">Physics</Name>
  </Term>

```

```

    </Term>
    <Term termID="3.1.6.6.2">
      <Name xml:lang="en">Chemistry</Name>
    </Term>
    <Term termID="3.1.6.6.3">
      <Name xml:lang="en">Mechanics</Name>
    </Term>
    <Term termID="3.1.6.6.4">
      <Name xml:lang="en">Engineering</Name>
    </Term>
    <Term termID="3.1.6.7">
      <Name xml:lang="en">Medicine</Name>
      <Definition xml:lang="en">Programmes about medical subjects, health etc</Definition>
      <Term termID="3.1.6.7.1">
        <Name xml:lang="en">Alternative Medicine</Name>
      </Term>
    </Term>
    <Term termID="3.1.6.8">
      <Name xml:lang="en">Technology</Name>
    </Term>
    <Term termID="3.1.6.9">
      <Name xml:lang="en">Physiology</Name>
    </Term>
    <Term termID="3.1.6.10">
      <Name xml:lang="en">Psychology</Name>
    </Term>
    <Term termID="3.1.6.11">
      <Name xml:lang="en">Social</Name>
    </Term>
    <Term termID="3.1.6.12">
      <Name xml:lang="en">Spiritual</Name>
    </Term>
    <Term termID="3.1.6.13">
      <Name xml:lang="en">Mathematics</Name>
    </Term>
    <Term termID="3.1.6.14">
      <Name xml:lang="en">Archaeology</Name>
    </Term>
    <Term termID="3.1.6.15">
      <Name xml:lang="en">Statistics</Name>
    </Term>
    <Term termID="3.1.6.16">
      <Name xml:lang="en">Liberal Arts and Science</Name>
    </Term>
  </Term>
  <Term termID="3.1.7">
    <Name xml:lang="en">Human interest</Name>
    <Term termID="3.1.7.1">
      <Name xml:lang="en">Reality</Name>
      <Definition xml:lang="en">Programme based on real life, usually by the camera observing
without changing what is happening ("fly on the wall documentary" for example)</Definition>
    </Term>
    <Term termID="3.1.7.2">
      <Name xml:lang="en">Society/Show business/Gossip</Name>
    </Term>
    <Term termID="3.1.7.3">
      <Name xml:lang="en">Biography/Notable personalities</Name>
    </Term>
    <Term termID="3.1.7.4">
      <Name xml:lang="en">Personal problems</Name>
    </Term>
    <Term termID="3.1.7.5">
      <Name xml:lang="en">Investigative journalism</Name>
    </Term>
    <Term termID="3.1.7.6">
      <Name xml:lang="en">Museums</Name>
    </Term>
    <Term termID="3.1.7.7">
      <Name xml:lang="en">Religious buildings</Name>
    </Term>
    <Term termID="3.1.7.8">
      <Name xml:lang="en">Personal stories</Name>
    </Term>
    <Term termID="3.1.7.9">
      <Name xml:lang="en">Family life</Name>
    </Term>
    <Term termID="3.1.7.10">
      <Name xml:lang="en">libraries</Name>

```

```

    </Term>
  </Term>
  <Term termID="3.1.8">
    <Name xml:lang="en">Transport and Communications</Name>
    <Term termID="3.1.8.1">
      <Name xml:lang="en">Air</Name>
      <Definition xml:lang="en">Programme consisting of elements on aviation as means of
commercial aviation. Elements concerning private pilots and general aviation should go in
leisure/Hobbies, aviation (3.3.34) Programme consisting of elements on aviation as sport should go
in (3.2.14)</Definition>
    </Term>
    <Term termID="3.1.8.2">
      <Name xml:lang="en">Land</Name>
    </Term>
    <Term termID="3.1.8.3">
      <Name xml:lang="en">Sea</Name>
    </Term>
    <Term termID="3.1.8.4">
      <Name xml:lang="en">Space</Name>
    </Term>
  </Term>
  <Term termID="3.1.9">
    <Name xml:lang="en">Events</Name>
    <Definition xml:lang="en">Coverage of events, not the event itself (see
format)</Definition>
    <Term termID="3.1.9.1">
      <Name xml:lang="en">Anniversary</Name>
    </Term>
    <Term termID="3.1.9.2">
      <Name xml:lang="en">Fair</Name>
    </Term>
    <Term termID="3.1.9.3">
      <Name xml:lang="en">Tradeshaw</Name>
    </Term>
    <Term termID="3.1.9.4">
      <Name xml:lang="en">Musical</Name>
    </Term>
    <Term termID="3.1.9.5">
      <Name xml:lang="en">Exhibition</Name>
    </Term>
    <Term termID="3.1.9.6">
      <Name xml:lang="en">Royal</Name>
    </Term>
    <Term termID="3.1.9.7">
      <Name xml:lang="en">State</Name>
    </Term>
    <Term termID="3.1.9.8">
      <Name xml:lang="en">International</Name>
    </Term>
    <Term termID="3.1.9.9">
      <Name xml:lang="en">National</Name>
    </Term>
    <Term termID="3.1.9.10">
      <Name xml:lang="en">Local/Regional</Name>
    </Term>
    <Term termID="3.1.9.11">
      <Name xml:lang="en">Seasonal</Name>
    </Term>
    <Term termID="3.1.9.12">
      <Name xml:lang="en">Sporting</Name>
    </Term>
    <Term termID="3.1.9.13">
      <Name xml:lang="en">Festival</Name>
    </Term>
    <Term termID="3.1.9.14">
      <Name xml:lang="en">Concert</Name>
    </Term>
    <Term termID="3.1.9.15">
      <Name xml:lang="en">Funeral/Memorial</Name>
    </Term>
  </Term>
  <Term termID="3.1.10">
    <Name xml:lang="en">Media</Name>
    <Term termID="3.1.10.1">
      <Name xml:lang="en">Advertising</Name>
    </Term>
    <Term termID="3.1.10.2">
      <Name xml:lang="en">Print media</Name>

```

```

</Term>
<Term termID="3.1.10.3">
  <Name xml:lang="en">Television</Name>
</Term>
<Term termID="3.1.10.4">
  <Name xml:lang="en">Radio</Name>
</Term>
<Term termID="3.1.10.5">
  <Name xml:lang="en">New media</Name>
</Term>
<Term termID="3.1.10.6">
  <Name xml:lang="en">Marketing</Name>
</Term>
</Term>
<Term termID="3.1.11">
  <Name xml:lang="en">Listings</Name>
  <Definition xml:lang="en">information about schedules to be broadcast</Definition>
</Term>
</Term>
<Term termID="3.2">
  <Name xml:lang="en">SPORTS</Name>
  <Term termID="3.2.1">
    <Name xml:lang="en">Athletics</Name>
    <Term termID="3.2.1.1">
      <Name xml:lang="en">Field</Name>
    </Term>
    <Term termID="3.2.1.2">
      <Name xml:lang="en">Track</Name>
    </Term>
    <Term termID="3.2.1.3">
      <Name xml:lang="en">Combined athletics</Name>
    </Term>
    <Term termID="3.2.1.4">
      <Name xml:lang="en">Running</Name>
    </Term>
    <Term termID="3.2.1.5">
      <Name xml:lang="en">Cross-country</Name>
    </Term>
    <Term termID="3.2.1.6">
      <Name xml:lang="en">Triathlon</Name>
    </Term>
  </Term>
  <Term termID="3.2.2">
    <Name xml:lang="en">Cycling/Bicycle</Name>
    <Term termID="3.2.2.1">
      <Name xml:lang="en">Mountain bike</Name>
    </Term>
    <Term termID="3.2.2.2">
      <Name xml:lang="en">Bicross</Name>
    </Term>
    <Term termID="3.2.2.3">
      <Name xml:lang="en">Indoor cycling</Name>
    </Term>
    <Term termID="3.2.2.4">
      <Name xml:lang="en">Road cycling</Name>
    </Term>
  </Term>
  <Term termID="3.2.3">
    <Name xml:lang="en">Team sports</Name>
    <Term termID="3.2.3.1">
      <Name xml:lang="en">Football (American)</Name>
    </Term>
    <Term termID="3.2.3.2">
      <Name xml:lang="en">Football (Australian)</Name>
    </Term>
    <Term termID="3.2.3.3">
      <Name xml:lang="en">Football (Gaelic)</Name>
    </Term>
    <Term termID="3.2.3.4">
      <Name xml:lang="en">Football (Indoor)</Name>
    </Term>
    <Term termID="3.2.3.5">
      <Name xml:lang="en">Beach soccer</Name>
    </Term>
    <Term termID="3.2.3.6">
      <Name xml:lang="en">Bandy</Name>
    </Term>
    <Term termID="3.2.3.7">

```

```

    <Name xml:lang="en">Baseball</Name>
  </Term>
  <Term termID="3.2.3.8">
    <Name xml:lang="en">Basketball</Name>
  </Term>
  <Term termID="3.2.3.9">
    <Name xml:lang="en">Cricket</Name>
  </Term>
  <Term termID="3.2.3.10">
    <Name xml:lang="en">Croquet</Name>
  </Term>
  <Term termID="3.2.3.11">
    <Name xml:lang="en">Faust ball</Name>
  </Term>
  <Term termID="3.2.3.12">
    <Name xml:lang="en">Football (Soccer)</Name>
  </Term>
  <Term termID="3.2.3.13">
    <Name xml:lang="en">Handball</Name>
  </Term>
  <Term termID="3.2.3.14">
    <Name xml:lang="en">Hockey</Name>
  </Term>
  <Term termID="3.2.3.15">
    <Name xml:lang="en">Korfball</Name>
  </Term>
  <Term termID="3.2.3.16">
    <Name xml:lang="en">Lacrosse</Name>
  </Term>
  <Term termID="3.2.3.17">
    <Name xml:lang="en">Netball</Name>
  </Term>
  <Term termID="3.2.3.18">
    <Name xml:lang="en">Roller skating</Name>
  </Term>
  <Term termID="3.2.3.19">
    <Name xml:lang="en">Rugby</Name>
  </Term>
  <Term termID="3.2.3.19.1">
    <Name xml:lang="en">Rugby union</Name>
  </Term>
  <Term termID="3.2.3.19.2">
    <Name xml:lang="en">Rugby league</Name>
  </Term>
  <Term termID="3.2.3.20">
    <Name xml:lang="en">Softball</Name>
  </Term>
  <Term termID="3.2.3.21">
    <Name xml:lang="en">Volleyball</Name>
  </Term>
  <Term termID="3.2.3.22">
    <Name xml:lang="en">Beach volley</Name>
  </Term>
  <Term termID="3.2.3.23">
    <Name xml:lang="en">Hurling</Name>
  </Term>
  <Term termID="3.2.3.24">
    <Name xml:lang="en">Flying Disc/ Frisbee</Name>
  </Term>
  <Term termID="3.2.3.25">
    <Name xml:lang="en">Kabadi</Name>
  </Term>
  <Term termID="3.2.3.26">
    <Name xml:lang="en">Camogie</Name>
    <Definition xml:lang="en">Female version of Hurling.</Definition>
  </Term>
  <Term termID="3.2.3.27">
    <Name xml:lang="en">Shinty</Name>
    <Definition xml:lang="en">Scottish game, also known as Camanachd.</Definition>
  </Term>
  <Term termID="3.2.3.28">
    <Name xml:lang="en">Street Soccer</Name>
  </Term>
</Term>
<Term termID="3.2.4">
  <Name xml:lang="en">Racket sports</Name>
  <Term termID="3.2.4.1">
    <Name xml:lang="en">Badminton</Name>
  </Term>

```



```

</Term>
<Term termID="3.2.4.2">
  <Name xml:lang="en">Racketball</Name>
</Term>
<Term termID="3.2.4.3">
  <Name xml:lang="en">Short tennis</Name>
</Term>
<Term termID="3.2.4.4">
  <Name xml:lang="en">Soft tennis</Name>
</Term>
<Term termID="3.2.4.5">
  <Name xml:lang="en">Squash</Name>
</Term>
<Term termID="3.2.4.6">
  <Name xml:lang="en">Table tennis</Name>
</Term>
<Term termID="3.2.4.7">
  <Name xml:lang="en">Tennis</Name>
</Term>
</Term>
<Term termID="3.2.5">
  <Name xml:lang="en">Martial Arts</Name>
  <Term termID="3.2.5.1">
    <Name xml:lang="en">Aikido</Name>
  </Term>
  <Term termID="3.2.5.2">
    <Name xml:lang="en">Jai-alai</Name>
  </Term>
  <Term termID="3.2.5.3">
    <Name xml:lang="en">Judo</Name>
  </Term>
  <Term termID="3.2.5.4">
    <Name xml:lang="en">Ju-jitsu</Name>
  </Term>
  <Term termID="3.2.5.5">
    <Name xml:lang="en">Karate</Name>
  </Term>
  <Term termID="3.2.5.6">
    <Name xml:lang="en">Sumo/Fighting games</Name>
  </Term>
  <Term termID="3.2.5.7">
    <Name xml:lang="en">Sambo</Name>
  </Term>
  <Term termID="3.2.5.8">
    <Name xml:lang="en">Taekwondo</Name>
  </Term>
</Term>
<Term termID="3.2.6">
  <Name xml:lang="en">Water sports</Name>
  <Term termID="3.2.6.1">
    <Name xml:lang="en">Body boarding</Name>
  </Term>
  <Term termID="3.2.6.2">
    <Name xml:lang="en">Yachting</Name>
  </Term>
  <Term termID="3.2.6.3">
    <Name xml:lang="en">Canoeing</Name>
  </Term>
  <Term termID="3.2.6.4">
    <Name xml:lang="en">Diving</Name>
  </Term>
  <Term termID="3.2.6.5">
    <Name xml:lang="en">Fishing</Name>
  </Term>
  <Term termID="3.2.6.6">
    <Name xml:lang="en">Polo</Name>
  </Term>
  <Term termID="3.2.6.7">
    <Name xml:lang="en">Rowing</Name>
  </Term>
  <Term termID="3.2.6.8">
    <Name xml:lang="en">Sailing</Name>
  </Term>
  <Term termID="3.2.6.9">
    <Name xml:lang="en">Sub-aquatics</Name>
  </Term>
  <Term termID="3.2.6.10">
    <Name xml:lang="en">Surfing</Name>

```

```

</Term>
<Term termID="3.2.6.11">
  <Name xml:lang="en">Swimming</Name>
</Term>
<Term termID="3.2.6.12">
  <Name xml:lang="en">Water polo</Name>
</Term>
<Term termID="3.2.6.13">
  <Name xml:lang="en">Water skiing</Name>
</Term>
<Term termID="3.2.6.14">
  <Name xml:lang="en">Windsurfing</Name>
  <Definition xml:lang="en">includes kite surfing</Definition>
</Term>
</Term>
<Term termID="3.2.7">
  <Name xml:lang="en">Winter sports</Name>
  <Term termID="3.2.7.1">
    <Name xml:lang="en">Bobsleigh/Tobogganing</Name>
  </Term>
  <Term termID="3.2.7.2">
    <Name xml:lang="en">Curling</Name>
  </Term>
  <Term termID="3.2.7.3">
    <Name xml:lang="en">Ice-hockey</Name>
  </Term>
  <Term termID="3.2.7.4">
    <Name xml:lang="en">Ice-skating</Name>
  </Term>
  <Term termID="3.2.7.5">
    <Name xml:lang="en">Luge</Name>
  </Term>
  <Term termID="3.2.7.6">
    <Name xml:lang="en">Skating</Name>
  </Term>
  <Term termID="3.2.7.7">
    <Name xml:lang="en">Skibob</Name>
  </Term>
  <Term termID="3.2.7.8">
    <Name xml:lang="en">Skiing</Name>
  </Term>
  <Term termID="3.2.7.9">
    <Name xml:lang="en">Sled dog</Name>
  </Term>
  <Term termID="3.2.7.10">
    <Name xml:lang="en">Snowboarding</Name>
  </Term>
  <Term termID="3.2.7.11">
    <Name xml:lang="en">Alpine skiing</Name>
  </Term>
  <Term termID="3.2.7.12">
    <Name xml:lang="en">Freestyle skiing </Name>
  </Term>
  <Term termID="3.2.7.13">
    <Name xml:lang="en">Inline skating</Name>
  </Term>
  <Term termID="3.2.7.14">
    <Name xml:lang="en">Nordic skiing</Name>
  </Term>
  <Term termID="3.2.7.15">
    <Name xml:lang="en">Ski jumping</Name>
  </Term>
  <Term termID="3.2.7.16">
    <Name xml:lang="en">Speed skating</Name>
  </Term>
  <Term termID="3.2.7.17">
    <Name xml:lang="en">Figure skating</Name>
  </Term>
  <Term termID="3.2.7.18">
    <Name xml:lang="en">Ice-dance</Name>
  </Term>
  <Term termID="3.2.7.19">
    <Name xml:lang="en">Marathon</Name>
  </Term>
  <Term termID="3.2.7.20">
    <Name xml:lang="en">Short-track</Name>
  </Term>
  <Term termID="3.2.7.21">

```

```

    <Name xml:lang="en">Biathlon</Name>
  </Term>
</Term>
<Term termID="3.2.8">
  <Name xml:lang="en">Motor sports</Name>
  <Term termID="3.2.8.1">
    <Name xml:lang="en">Auto racing</Name>
    <Definition xml:lang="en">Motor car racing not covered elsewhere - e.g. Formula Ford,
Formula .000, V8 championship, etc.</Definition>
  </Term>
  <Term termID="3.2.8.2">
    <Name xml:lang="en">Motor boating</Name>
    <Definition xml:lang="en">Motor racing on water-!</Definition>
  </Term>
  <Term termID="3.2.8.3">
    <Name xml:lang="en">Motor cycling</Name>
    <Definition xml:lang="en">Speedway, TT etc</Definition>
  </Term>
  <Term termID="3.2.8.4">
    <Name xml:lang="en">Formula 1</Name>
  </Term>
  <Term termID="3.2.8.5">
    <Name xml:lang="en">Indy car</Name>
  </Term>
  <Term termID="3.2.8.6">
    <Name xml:lang="en">Karting</Name>
  </Term>
  <Term termID="3.2.8.7">
    <Name xml:lang="en">Rally</Name>
  </Term>
  <Term termID="3.2.8.8">
    <Name xml:lang="en">Trucking</Name>
  </Term>
  <Term termID="3.2.8.9">
    <Name xml:lang="en">Tractor pulling</Name>
  </Term>
  <Term termID="3.2.8.10">
    <Name xml:lang="en">Stock car</Name>
    <Definition xml:lang="en">e.g. Nascar, demolition derby</Definition>
  </Term>
  <Term termID="3.2.8.11">
    <Name xml:lang="en">Hill Climb</Name>
    <Definition xml:lang="en">speed racing up steep hills</Definition>
  </Term>
  <Term termID="3.2.8.12">
    <Name xml:lang="en">Trials</Name>
    <Definition xml:lang="en">auto testing - skill and vehicle testing</Definition>
  </Term>
</Term>
<Term termID="3.2.9">
  <Name xml:lang="en">'Social' sports</Name>
  <Term termID="3.2.9.1">
    <Name xml:lang="en">Billiards</Name>
  </Term>
  <Term termID="3.2.9.2">
    <Name xml:lang="en">Boules</Name>
  </Term>
  <Term termID="3.2.9.3">
    <Name xml:lang="en">Bowling</Name>
  </Term>
  <Term termID="3.2.9.5">
    <Name xml:lang="en">Dance sport</Name>
  </Term>
  <Term termID="3.2.9.6">
    <Name xml:lang="en">Darts</Name>
  </Term>
  <Term termID="3.2.9.7">
    <Name xml:lang="en">Pool</Name>
  </Term>
  <Term termID="3.2.9.8">
    <Name xml:lang="en">Snooker</Name>
  </Term>
  <Term termID="3.2.9.9">
    <Name xml:lang="en">Tug-of-war</Name>
  </Term>
  <Term termID="3.2.9.10">
    <Name xml:lang="en">Balle pelote</Name>
  </Term>

```

```

<Term termID="3.2.9.11">
  <Name xml:lang="en">Basque pelote</Name>
</Term>
<Term termID="3.2.9.12">
  <Name xml:lang="en">Trickshot</Name>
</Term>
<Term termID="3.2.10">
  <Name xml:lang="en">Gymnastics</Name>
  <Term termID="3.2.10.1">
    <Name xml:lang="en">Asymmetric bars</Name>
  </Term>
  <Term termID="3.2.10.2">
    <Name xml:lang="en">Beam</Name>
  </Term>
  <Term termID="3.2.10.3">
    <Name xml:lang="en">Horse</Name>
  </Term>
  <Term termID="3.2.10.4">
    <Name xml:lang="en">Mat</Name>
  </Term>
  <Term termID="3.2.10.5">
    <Name xml:lang="en">Parallel bars</Name>
  </Term>
  <Term termID="3.2.10.6">
    <Name xml:lang="en">Rings</Name>
  </Term>
  <Term termID="3.2.10.7">
    <Name xml:lang="en">Trampoline</Name>
  </Term>
</Term>
<Term termID="3.2.11">
  <Name xml:lang="en">Equestrian</Name>
  <Term termID="3.2.11.1">
    <Name xml:lang="en">Cart</Name>
  </Term>
  <Term termID="3.2.11.2">
    <Name xml:lang="en">Dressage</Name>
  </Term>
  <Term termID="3.2.11.3">
    <Name xml:lang="en">Horse racing</Name>
  </Term>
  <Term termID="3.2.11.4">
    <Name xml:lang="en">Polo</Name>
  </Term>
  <Term termID="3.2.11.5">
    <Name xml:lang="en">Jumping</Name>
  </Term>
  <Term termID="3.2.11.6">
    <Name xml:lang="en">Crossing</Name>
  </Term>
  <Term termID="3.2.11.7">
    <Name xml:lang="en">Trotting</Name>
    <Definition xml:lang="en">Horse with two wheel cart and a jockey</Definition>
  </Term>
</Term>
<Term termID="3.2.12">
  <Name xml:lang="en">Adventure sports</Name>
  <Term termID="3.2.12.1">
    <Name xml:lang="en">Archery</Name>
  </Term>
  <Term termID="3.2.12.2">
    <Name xml:lang="en">Extreme sports</Name>
  </Term>
  <Term termID="3.2.12.3">
    <Name xml:lang="en">Mountaineering</Name>
  </Term>
  <Term termID="3.2.12.4">
    <Name xml:lang="en">Climbing</Name>
  </Term>
  <Term termID="3.2.12.5">
    <Name xml:lang="en">Orienteering</Name>
  </Term>
  <Term termID="3.2.12.6">
    <Name xml:lang="en">Shooting</Name>
  </Term>
  <Term termID="3.2.12.7">
    <Name xml:lang="en">Sport acrobatics</Name>
  </Term>

```

```

</Term>
<Term termID="3.2.12.8">
  <Name xml:lang="en">Rafting</Name>
</Term>
<Term termID="3.2.12.9">
  <Name xml:lang="en">Caving</Name>
</Term>
<Term termID="3.2.12.10">
  <Name xml:lang="en">Skateboarding</Name>
</Term>
<Term termID="3.2.12.11">
  <Name xml:lang="en">Trekking</Name>
</Term>
</Term>
<Term termID="3.2.13">
  <Name xml:lang="en">Strength-based sports</Name>
  <Term termID="3.2.13.1">
    <Name xml:lang="en">Body-building</Name>
  </Term>
  <Term termID="3.2.13.2">
    <Name xml:lang="en">Boxing</Name>
  </Term>
  <Term termID="3.2.13.3">
    <Name xml:lang="en">Combative sports</Name>
    <Definition xml:lang="en">Other than martial arts</Definition>
  </Term>
  <Term termID="3.2.13.4">
    <Name xml:lang="en">Power-lifting</Name>
  </Term>
  <Term termID="3.2.13.5">
    <Name xml:lang="en">Weight-lifting</Name>
  </Term>
  <Term termID="3.2.13.6">
    <Name xml:lang="en">Wrestling</Name>
  </Term>
</Term>
<Term termID="3.2.14">
  <Name xml:lang="en">Air sports</Name>
  <Definition xml:lang="en">Programme consisting of elements on aviation as sport. Elements
concerning commercial aviation should be categorized in Air Transport (3.1.8.1) and elements
concerning private pilots and general aviation should go in Leisure/Hobbies, aviation (3.3.34)
</Definition>
  <Term termID="3.2.14.1">
    <Name xml:lang="en">Ballooning</Name>
  </Term>
  <Term termID="3.2.14.2">
    <Name xml:lang="en">Hang gliding</Name>
  </Term>
  <Term termID="3.2.14.3">
    <Name xml:lang="en">Sky diving</Name>
  </Term>
  <Term termID="3.2.14.4">
    <Name xml:lang="en">Delta-plane</Name>
  </Term>
  <Term termID="3.2.14.5">
    <Name xml:lang="en">Parachuting</Name>
  </Term>
  <Term termID="3.2.14.6">
    <Name xml:lang="en">Kiting</Name>
  </Term>
  <Term termID="3.2.14.7">
    <Name xml:lang="en">Aeronautics</Name>
  </Term>
  <Term termID="3.2.14.8">
    <Name xml:lang="en">Gliding</Name>
    <Definition xml:lang="en">Airplane without engine </Definition>
  </Term>
  <Term termID="3.2.14.9">
    <Name xml:lang="en">Flying</Name>
    <Definition xml:lang="en">Airplane with engine(s)</Definition>
  </Term>
  <Term termID="3.2.14.10">
    <Name xml:lang="en">Aerobatics</Name>
  </Term>
</Term>
<Term termID="3.2.15">
  <Name xml:lang="en">Golf</Name>
</Term>

```

```

<Term termID="3.2.16">
  <Name xml:lang="en">Fencing</Name>
</Term>
<Term termID="3.2.17">
  <Name xml:lang="en">Dog racing</Name>
</Term>
<Term termID="3.2.18">
  <Name xml:lang="en">Casting</Name>
</Term>
<Term termID="3.2.19">
  <Name xml:lang="en">Maccabi</Name>
</Term>
<Term termID="3.2.20">
  <Name xml:lang="en">Modern Pentathlon</Name>
</Term>
<Term termID="3.2.21">
  <Name xml:lang="en">Sombo</Name>
</Term>
<Term termID="3.2.22">
  <Name xml:lang="en">Mind Games</Name>
  <Definition xml:lang="en">Competitive tests of mental acuity. This category should only be
used where the coverage relates to the competitiveness of the event. It is not intended for use
where the coverage is intended for education purposes</Definition>
  <Term termID="3.2.22.1">
    <Name xml:lang="en">Bridge</Name>
  </Term>
  <Term termID="3.2.22.2">
    <Name xml:lang="en">Chess</Name>
  </Term>
  <Term termID="3.2.22.3">
    <Name xml:lang="en">Poker</Name>
  </Term>
</Term>
<Term termID="3.2.23">
  <Name xml:lang="en">Traditional Games</Name>
  <Definition xml:lang="en">Intended for local use for specific traditional national
games</Definition>
</Term>
<Term termID="3.2.24">
  <Name xml:lang="en">Disabled Sport</Name>
  <Term termID="3.2.24.1">
    <Name xml:lang="en">Physically Challenged</Name>
  </Term>
  <Term termID="3.2.24.2">
    <Name xml:lang="en">Mentally Challenged</Name>
  </Term>
</Term>
</Term>
<Term termID="3.4">
  <Name xml:lang="en">FICTION/DRAMA</Name>
  <Definition xml:lang="en">Programme consisting of a prose or verse composition, resp. one
telling a story, written for or as if for performance by actors, puppets or animated</Definition>
  <Term termID="3.4.1">
    <Name xml:lang="en">General light drama</Name>
    <Definition xml:lang="en">Drama written after approximately 1918 and without literary or
cultural pretensions. Popular drama, e.g. Upstairs, Downstairs</Definition>
  </Term>
  <Term termID="3.4.2">
    <Name xml:lang="en">Soap</Name>
    <Definition xml:lang="en">Dramatized serial programme dealing with easy-to-grasp situations
performed by a limited cast</Definition>
    <Term termID="3.4.2.1">
      <Name xml:lang="en">Soap opera</Name>
    </Term>
    <Term termID="3.4.2.2">
      <Name xml:lang="en">Soap special</Name>
    </Term>
    <Term termID="3.4.2.3">
      <Name xml:lang="en">Soap talk</Name>
    </Term>
  </Term>
  <Term termID="3.4.3">
    <Name xml:lang="en">Romance</Name>
    <Definition xml:lang="en">e.g. Romeo and Juliet</Definition>
  </Term>
  <Term termID="3.4.4">
    <Name xml:lang="en">Legal Melodrama</Name>
  </Term>

```

```

    <Definition xml:lang="en">Drama production where the primary action takes place in law
    courts and/or law firms e.g. Philadelphia</Definition>
  </Term>
  <Term termID="3.4.5">
    <Name xml:lang="en">Medical melodrama</Name>
    <Definition xml:lang="en">Drama production situated in hospitals and/or dealing with
    medical subjects e.g. ER, Dr kildaire, Casualty</Definition>
  </Term>
  <Term termID="3.4.6">
    <Name xml:lang="en">Action</Name>
    <Term termID="3.4.6.1">
      <Name xml:lang="en">Adventure</Name>
      <Definition xml:lang="en">e.g. Tomb Raider</Definition>
    </Term>
    <Term termID="3.4.6.2">
      <Name xml:lang="en">Disaster</Name>
      <Definition xml:lang="en">e.g. Towering Inferno, Earthquake, Airport .990</Definition>
    </Term>
    <Term termID="3.4.6.3">
      <Name xml:lang="en">Mystery</Name>
    </Term>
    <Term termID="3.4.6.4">
      <Name xml:lang="en">Detective/Police</Name>
      <Definition xml:lang="en">e.g. Perry Mason, HillSt blues</Definition>
    </Term>
    <Term termID="3.4.6.5">
      <Name xml:lang="en">Historical/Epic</Name>
      <Definition xml:lang="en">e.g. Hornblower</Definition>
    </Term>
    <Term termID="3.4.6.6">
      <Name xml:lang="en">Horror</Name>
      <Definition xml:lang="en">e.g. Dracula</Definition>
    </Term>
    <Term termID="3.4.6.7">
      <Name xml:lang="en">Science fiction</Name>
      <Definition xml:lang="en">e.g. Dr Who, Star Trek</Definition>
    </Term>
    <Term termID="3.4.6.8">
      <Name xml:lang="en">War</Name>
      <Definition xml:lang="en">e.g. Band of Brothers</Definition>
    </Term>
    <Term termID="3.4.6.9">
      <Name xml:lang="en">Western</Name>
      <Definition xml:lang="en">e.g. The Virginian, The Alamo</Definition>
    </Term>
    <Term termID="3.4.6.10">
      <Name xml:lang="en">Thriller</Name>
    </Term>
    <Term termID="3.4.6.11">
      <Name xml:lang="en">Sports</Name>
      <Definition xml:lang="en">e.g. Chariots of Fire</Definition>
    </Term>
    <Term termID="3.4.6.12">
      <Name xml:lang="en">Martial arts</Name>
      <Definition xml:lang="en">e.g. Enter the Dragon</Definition>
    </Term>
    <Term termID="3.4.6.13">
      <Name xml:lang="en">Epic</Name>
      <Definition xml:lang="en">Dramatized narrative about the deeds of a traditional or
    historical hero or heroes and/or dealing with or characterized by events of historical or legendary
    importance e.g. El Cid</Definition>
    </Term>
  </Term>
  <Term termID="3.4.7">
    <Name xml:lang="en">Fantasy/Fairy tale</Name>
    <Definition xml:lang="en">EG Alice in Wonderland</Definition>
  </Term>
  <Term termID="3.4.8">
    <Name xml:lang="en">Erotica</Name>
    <Definition xml:lang="en">e.g. Emannelle</Definition>
  </Term>
  <Term termID="3.4.9">
    <Name xml:lang="en">Drama based on real events (docudrama)</Name>
    <Definition xml:lang="en">Drama based upon reality sometimes with documentary
    inserts</Definition>
  </Term>
  <Term termID="3.4.10">
    <Name xml:lang="en">Musical</Name>

```

```

    <Definition xml:lang="en">EG Mary Poppins,</Definition>
  </Term>
  <Term termID="3.4.13">
    <Name xml:lang="en">Classical drama</Name>
    <Definition xml:lang="en">Drama written before approximately 1918 e.g. Hamlet,
Othello</Definition>
  </Term>
  <Term termID="3.4.14">
    <Name xml:lang="en">Period drama</Name>
    <Definition xml:lang="en">Drama depicting events before 1918 e.g. Pride and
Prejudice</Definition>
  </Term>
  <Term termID="3.4.15">
    <Name xml:lang="en">Contemporary drama</Name>
    <Definition xml:lang="en">Drama written after approximately 1918 and with literary and/or
cultural value e.g. Waiting for Godot</Definition>
  </Term>
  <Term termID="3.4.16">
    <Name xml:lang="en">Religious</Name>
    <Definition xml:lang="en">e.g. The Red Robe,</Definition>
  </Term>
  <Term termID="3.4.17">
    <Name xml:lang="en">Poems/Stories</Name>
  </Term>
  <Term termID="3.4.18">
    <Name xml:lang="en">Biography</Name>
    <Definition xml:lang="en">e.g. Young Winston,</Definition>
  </Term>
  <Term termID="3.4.19">
    <Name xml:lang="en">Psychological drama</Name>
  </Term>
  <Term termID="3.4.20">
    <Name xml:lang="en">Political Drama</Name>
    <Definition xml:lang="en">Telling a story or recounting events in which the main characters
are politicians or where the main action takes place in political institutions.</Definition>
  </Term>
</Term>
<Term termID="3.5">
  <Name xml:lang="en">AMUSEMENT/ENTERTAINMENT</Name>
  <Term termID="3.5.2">
    <Name xml:lang="en">Quiz/Contest</Name>
    <Definition xml:lang="en">Competitions calling into play the competitors' special knowledge
and intelligence</Definition>
    <Term termID="3.5.2.1">
      <Name xml:lang="en">Quiz</Name>
      <Definition xml:lang="en">Who Wants to be a millionaire - questions and answers form
the entertainment</Definition>
    </Term>
    <Term termID="3.5.2.2">
      <Name xml:lang="en">Contest</Name>
      <Definition xml:lang="en">Participants compete directly with each other e.g. Americas
Top Model, Generation Game</Definition>
    </Term>
  </Term>
  <Term termID="3.5.3">
    <Name xml:lang="en">Variety/Talent</Name>
    <Definition xml:lang="en">Programme with various performers such as comedians, magicians,
singers etc. e.g. Paul Daniels Show, Relay from a circus</Definition>
    <Term termID="3.5.3.1">
      <Name xml:lang="en">Cabaret</Name>
      <Definition xml:lang="en">Specific instance of Variety in an intimate
environment</Definition>
    </Term>
    <Term termID="3.5.3.2">
      <Name xml:lang="en">Talent</Name>
      <Definition xml:lang="en">Spelling Bees, singing talent shows - Stars in their eyes,
American Idol</Definition>
    </Term>
  </Term>
  <Term termID="3.5.4">
    <Name xml:lang="en">Surprise</Name>
    <Definition xml:lang="en">Programme of 'dream comes true' type e.g. Jim'llFix
It</Definition>
  </Term>
  <Term termID="3.5.5">
    <Name xml:lang="en">Reality</Name>
  </Term>
  <Term termID="3.5.7">

```



```

<Name xml:lang="en">Comedy</Name>
<Term termID="3.5.7.1">
  <Name xml:lang="en">Broken comedy</Name>
  <Definition xml:lang="en">Humorous and/or satirical programme consisting of short
dramatic sequences, sketches, performed by comedians e.g. Benny Hill, Monty Python</Definition>
</Term>
<Term termID="3.5.7.2">
  <Name xml:lang="en">Romantic comedy</Name>
</Term>
<Term termID="3.5.7.3">
  <Name xml:lang="en">Sitcom</Name>
  <Definition xml:lang="en">Dramatized series in a humorous style and performed by a more
or less fixed cast e.g. Friends, The Office</Definition>
</Term>
<Term termID="3.5.7.4">
  <Name xml:lang="en">Satire</Name>
  <Definition xml:lang="en">Letterman, Dave Allen, etc.</Definition>
</Term>
<Term termID="3.5.7.5">
  <Name xml:lang="en">Candid Camera</Name>
  <Definition xml:lang="en">Programme in which the recording device is hidden so the
participants are not aware they are being recorded.</Definition>
</Term>
<Term termID="3.5.7.6">
  <Name xml:lang="en">Humour</Name>
  <Definition xml:lang="en">Programme without sketches or 'broken drama', consisting
(mainly) of verbal jokes, gags, bloopers etc.</Definition>
</Term>
<Term termID="3.5.7.7">
  <Name xml:lang="en">Spoof</Name>
  <Definition xml:lang="en">Imitating other works in order to ridicule or derive humour
from the work itself and its subject matter.</Definition>
</Term>
<Term termID="3.5.7.8">
  <Name xml:lang="en">Character</Name>
  <Definition xml:lang="en"></Definition>
</Term>
<Term termID="3.5.7.9">
  <Name xml:lang="en">Impressionists</Name>
  <Definition xml:lang="en"></Definition>
</Term>
<Term termID="3.5.7.10">
  <Name xml:lang="en">Stunt</Name>
  <Definition xml:lang="en"></Definition>
</Term>
<Term termID="3.5.7.11">
  <Name xml:lang="en">Music comedy</Name>
  <Definition xml:lang="en"></Definition>
</Term>
</Term>
<Term termID="3.5.10">
  <Name xml:lang="en">Magic/Hypnotism</Name>
</Term>
<Term termID="3.5.11">
  <Name xml:lang="en">Circus</Name>
</Term>
<Term termID="3.5.12">
  <Name xml:lang="en">Dating</Name>
</Term>
<Term termID="3.5.13">
  <Name xml:lang="en">Bullfighting</Name>
</Term>
<Term termID="3.5.14">
  <Name xml:lang="en">Rodeo</Name>
</Term>
<Term termID="3.5.16">
  <Name xml:lang="en">Chat</Name>
  <Definition xml:lang="en">Chat Show in which a presenter interviews a
celebrity</Definition>
</Term>
</Term>
<Term termID="3.6">
  <Name xml:lang="en">Music</Name>
  <Term termID="3.6.1">
    <Name xml:lang="en">Classical music</Name>
    <Definition xml:lang="en">Music including chamber, instrumental, operatic, symphonic, vocal
and choral music</Definition>
    <Term termID="3.6.1.1">

```

```

    <Name xml:lang="en">Early</Name>
    <Definition xml:lang="en">Music written before the middle of the 17th
Century</Definition>
  </Term>
  <Term termID="3.6.1.2">
    <Name xml:lang="en">Classical</Name>
    <Definition xml:lang="en">Music from the middle of the 18th until the end of the 19th
Century</Definition>
  </Term>
  <Term termID="3.6.1.3">
    <Name xml:lang="en">Romantic</Name>
    <Definition xml:lang="en">"1820-.900"</Definition>
  </Term>
  <Term termID="3.6.1.4">
    <Name xml:lang="en">Contemporary</Name>
    <Definition xml:lang="en">Music from the 20th Century onwards</Definition>
  </Term>
  <Term termID="3.6.1.5">
    <Name xml:lang="en">Light classical</Name>
    <Definition xml:lang="en">Music by Strauss, Lehar, etc.</Definition>
  </Term>
  <Term termID="3.6.1.6">
    <Name xml:lang="en">Middle Ages</Name>
  </Term>
  <Term termID="3.6.1.7">
    <Name xml:lang="en">Renaissance</Name>
    <Definition xml:lang="en">"1400-1600"</Definition>
  </Term>
  <Term termID="3.6.1.8">
    <Name xml:lang="en">Baroque</Name>
    <Definition xml:lang="en">"1600-1750"</Definition>
  </Term>
  <Term termID="3.6.1.9">
    <Name xml:lang="en">Opera</Name>
    <Definition xml:lang="en">e.g. La Bohème</Definition>
  </Term>
  <Term termID="3.6.1.10">
    <Name xml:lang="en">Solo instruments</Name>
    <Definition xml:lang="en">(e.g. Piano)</Definition>
  </Term>
  <Term termID="3.6.1.11">
    <Name xml:lang="en">Chamber</Name>
    <Definition xml:lang="en">Small group of instruments</Definition>
  </Term>
  <Term termID="3.6.1.12">
    <Name xml:lang="en">Symphonic</Name>
    <Definition xml:lang="en">Large group of instruments</Definition>
  </Term>
  <Term termID="3.6.1.13">
    <Name xml:lang="en">Vocal</Name>
    <Definition xml:lang="en">Solo or individual singing</Definition>
  </Term>
  <Term termID="3.6.1.14">
    <Name xml:lang="en">Choral</Name>
    <Definition xml:lang="en">Group of singers</Definition>
  </Term>
  <Term termID="3.6.1.15">
    <Name xml:lang="en">Song</Name>
  </Term>
  <Term termID="3.6.1.16">
    <Name xml:lang="en">Orchestral</Name>
  </Term>
  <Term termID="3.6.1.17">
    <Name xml:lang="en">Organ</Name>
  </Term>
  <Term termID="3.6.1.18">
    <Name xml:lang="en">String Quartet</Name>
  </Term>
  <Term termID="3.6.1.19">
    <Name xml:lang="en">Experimental/Avant Garde</Name>
    <Definition xml:lang="en">e.g. John Cage</Definition>
  </Term>
</Term>
<Term termID="3.6.2">
  <Name xml:lang="en">Jazz</Name>
  <Definition xml:lang="en">Indigenous American popular music, born in New Orleans of African
slaves social circumstances. The jazz idiom is characterized by certain syncopations over strongly
reiterated rhythms in which improvisation plays an important part</Definition>

```

```

<Term termID="3.6.2.1">
  <Name xml:lang="en">New Orleans/Early jazz</Name>
</Term>
<Term termID="3.6.2.2">
  <Name xml:lang="en">Big band/Swing/Dixie</Name>
  <Definition xml:lang="en">e.g. Glenn Miller, Chris Barber</Definition>
</Term>
<Term termID="3.6.2.3">
  <Name xml:lang="en">Blues/Soul jazz</Name>
  <Definition xml:lang="en">e.g. L. Armstrong</Definition>
</Term>
<Term termID="3.6.2.4">
  <Name xml:lang="en">Bop/Hard bop/Bebop/Postbop</Name>
  <Definition xml:lang="en">e.g. Sonny Rollings, Oscar Peterson, J. Coltrane, T.
Monk</Definition>
</Term>
<Term termID="3.6.2.5">
  <Name xml:lang="en">Traditional/Smooth</Name>
</Term>
<Term termID="3.6.2.6">
  <Name xml:lang="en">Cool</Name>
  <Definition xml:lang="en">e.g. Modern Jazz Quartet</Definition>
</Term>
<Term termID="3.6.2.7">
  <Name xml:lang="en">Modern/Avant-garde/Free</Name>
</Term>
<Term termID="3.6.2.8">
  <Name xml:lang="en">Latin and World jazz</Name>
  <Definition xml:lang="en">e.g. Manu Dibango</Definition>
</Term>
<Term termID="3.6.2.9">
  <Name xml:lang="en">Pop jazz/Jazz funk</Name>
</Term>
<Term termID="3.6.2.10">
  <Name xml:lang="en">Acid jazz/Fusion</Name>
  <Definition xml:lang="en">e.g. G. Benson, Miles Davis</Definition>
</Term>
</Term>
<Term termID="3.6.3">
  <Name xml:lang="en">Background music</Name>
  <Term termID="3.6.3.1">
    <Name xml:lang="en">Middle-of-the-road</Name>
    <Definition xml:lang="en">Music which, in varying circumstances, gives pleasure to the
widest possible spectrum of the music-loving audience</Definition>
  </Term>
  <Term termID="3.6.3.2">
    <Name xml:lang="en">Easy listening</Name>
  </Term>
  <Term termID="3.6.3.3">
    <Name xml:lang="en">Ambient</Name>
  </Term>
  <Term termID="3.6.3.4">
    <Name xml:lang="en">Mood music</Name>
  </Term>
  <Term termID="3.6.3.5">
    <Name xml:lang="en">Oldies</Name>
  </Term>
  <Term termID="3.6.3.6">
    <Name xml:lang="en">Love songs</Name>
  </Term>
  <Term termID="3.6.3.7">
    <Name xml:lang="en">Dance hall</Name>
  </Term>
  <Term termID="3.6.3.8">
    <Name xml:lang="en">Soundtrack</Name>
  </Term>
  <Term termID="3.6.3.9">
    <Name xml:lang="en">Trailer</Name>
  </Term>
  <Term termID="3.6.3.10">
    <Name xml:lang="en">Showtunes</Name>
  </Term>
  <Term termID="3.6.3.11">
    <Name xml:lang="en">TV</Name>
  </Term>
  <Term termID="3.6.3.12">
    <Name xml:lang="en">Cabaret</Name>
  </Term>

```

```

<Term termID="3.6.3.13">
  <Name xml:lang="en">Instrumental</Name>
</Term>
<Term termID="3.6.3.14">
  <Name xml:lang="en">Sound clip</Name>
</Term>
<Term termID="3.6.3.15">
  <Name xml:lang="en">Retro</Name>
</Term>
</Term>
<Term termID="3.6.4">
  <Name xml:lang="en">Pop-rock</Name>
  <Definition xml:lang="en">The most central and widely circulated types of popular music, in
particular rock and roll, etc.</Definition>
  <Term termID="3.6.4.1">
    <Name xml:lang="en">Pop</Name>
    <Definition xml:lang="en">e.g. early Beatles</Definition>
  </Term>
  <Term termID="3.6.4.2">
    <Name xml:lang="en">Chanson/Ballad</Name>
    <Definition xml:lang="en">e.g. Juliette Gréco, Leonard Cohen</Definition>
  </Term>
  <Term termID="3.6.4.3">
    <Name xml:lang="en">Traditional rock and roll</Name>
    <Definition xml:lang="en">e.g. Elvis Presley</Definition>
  </Term>
  <Term termID="3.6.4.5">
    <Name xml:lang="en">Classic/Dance/Pop-rock</Name>
    <Definition xml:lang="en">e.g. Michael Jackson, Spice Girls, Johnny Halliday, Rolling
Stones</Definition>
  </Term>
  <Term termID="3.6.4.6">
    <Name xml:lang="en">Folk</Name>
    <Definition xml:lang="en">e.g. Bob Dylan</Definition>
  </Term>
  <Term termID="3.6.4.8">
    <Name xml:lang="en">New Age</Name>
  </Term>
  <Term termID="3.6.4.11">
    <Name xml:lang="en">Seasonal/Holiday</Name>
    <Definition xml:lang="en">e.g. Christmas</Definition>
  </Term>
  <Term termID="3.6.4.12">
    <Name xml:lang="en">Japanese pop-rock</Name>
  </Term>
  <Term termID="3.6.4.13">
    <Name xml:lang="en">Karaoke/Singing contests</Name>
    <Definition xml:lang="en">e.g. Pizzicato Five</Definition>
  </Term>
  <Term termID="3.6.4.14">
    <Name xml:lang="en">Rock</Name>
    <Term termID="3.6.4.14.1">
      <Name xml:lang="en">AOR / Slow Rock / Soft Rock</Name>
      <Definition xml:lang="en">Adult-Orientated Rock e.g. The Eagles.</Definition>
    </Term>
    <Term termID="3.6.4.14.2">
      <Name xml:lang="en">Metal</Name>
      <Definition xml:lang="en">e.g. Iron Maiden</Definition>
    </Term>
    <Term termID="3.6.4.14.3">
      <Name xml:lang="en">Glam Rock</Name>
      <Definition xml:lang="en">e.g. T-Rex</Definition>
    </Term>
    <Term termID="3.6.4.14.4">
      <Name xml:lang="en">Punk Rock</Name>
      <Definition xml:lang="en">e.g. The Sex Pistols</Definition>
    </Term>
    <Term termID="3.6.4.14.5">
      <Name xml:lang="en">Prog / Symphonic Rock</Name>
      <Definition xml:lang="en">e.g. Yes</Definition>
    </Term>
    <Term termID="3.6.4.14.6">
      <Name xml:lang="en">Alternative / Indie</Name>
    </Term>
    <Term termID="3.6.4.14.7">
      <Name xml:lang="en">Experimental / Avant Garde</Name>
      <Definition xml:lang="en">e.g. Coil</Definition>
    </Term>
  </Term>

```

```

<Term termID="3.6.4.14.8">
  <Name xml:lang="en">Art Rock</Name>
  <Definition xml:lang="en">e.g. Talking Heads</Definition>
</Term>
<Term termID="3.6.4.14.9">
  <Name xml:lang="en">Folk Rock</Name>
  <Definition xml:lang="en">e.g. The Byrds</Definition>
</Term>
<Term termID="3.6.4.14.10">
  <Name xml:lang="en">Nu Punk</Name>
  <Definition xml:lang="en">e.g. Rancid</Definition>
</Term>
<Term termID="3.6.4.14.11">
  <Name xml:lang="en">Grunge</Name>
  <Definition xml:lang="en">e.g. Nirvana</Definition>
</Term>
<Term termID="3.6.4.14.12">
  <Name xml:lang="en">Garage Punk/Psychedelic</Name>
  <Definition xml:lang="en">1960s. e.g. The Sonics</Definition>
</Term>
<Term termID="3.6.4.14.13">
  <Name xml:lang="en">Heavy Rock</Name>
  <Definition xml:lang="en">e.g. Led Zeppelin, Cream, Hendrix</Definition>
</Term>
</Term>
<Term termID="3.6.4.15">
  <Name xml:lang="en">New Wave</Name>
  <Definition xml:lang="en">e.g. Blondie</Definition>
</Term>
<Term termID="3.6.4.16">
  <Name xml:lang="en">Easy listening / Exotica</Name>
  <Definition xml:lang="en">e.g. Yma Sumac</Definition>
</Term>
<Term termID="3.6.4.17">
  <Name xml:lang="en">Singer/Songwriter</Name>
  <Definition xml:lang="en">e.g. Paul Simon, James Taylor</Definition>
</Term>
</Term>
<Term termID="3.6.5">
  <Name xml:lang="en">Blues/Rhythm and Blues/Soul/Gospel</Name>
  <Term termID="3.6.5.1">
    <Name xml:lang="en">Blues</Name>
  </Term>
  <Term termID="3.6.5.2">
    <Name xml:lang="en">R and B</Name>
    <Definition xml:lang="en">1990s RandB (e.g. Teddy Riley) not 1960s Rhythm and Blues
(e.g. The Rolling Stones).</Definition>
    <Term termID="3.6.5.2.1">
      <Name xml:lang="en">Hip Hop Soul</Name>
    </Term>
    <Term termID="3.6.5.2.2">
      <Name xml:lang="en">Neo Soul</Name>
    </Term>
    <Term termID="3.6.5.2.3">
      <Name xml:lang="en">New Jack Swing</Name>
    </Term>
  </Term>
  <Term termID="3.6.5.3">
    <Name xml:lang="en">Soul</Name>
  </Term>
  <Term termID="3.6.5.4">
    <Name xml:lang="en">Gospel</Name>
  </Term>
  <Term termID="3.6.5.5">
    <Name xml:lang="en">Rhythm and Blues</Name>
    <Definition xml:lang="en">1960s RandB (eg. The Rolling Stones) not 1990s RandB (e.g.
Teddy Riley).</Definition>
  </Term>
  <Term termID="3.6.5.6">
    <Name xml:lang="en">Funk</Name>
    <Definition xml:lang="en">e.g. James Brown</Definition>
    <Term termID="3.6.5.6.1">
      <Name xml:lang="en">Afro Funk</Name>
    </Term>
    <Term termID="3.6.5.6.2">
      <Name xml:lang="en">Rare Groove</Name>
    </Term>
  </Term>
</Term>

```

```

</Term>
<Term termID="3.6.6">
  <Name xml:lang="en">Country and Western</Name>
</Term>
<Term termID="3.6.7">
  <Name xml:lang="en">Rap/Hip Hop/Reggae</Name>
  <Term termID="3.6.7.1">
    <Name xml:lang="en">Rap/Christian rap</Name>
    <Term termID="3.6.7.1.1">
      <Name xml:lang="en">Gangsta Rap</Name>
    </Term>
  </Term>
  <Term termID="3.6.7.2">
    <Name xml:lang="en">Hip Hop/Trip-Hop</Name>
    <Term termID="3.6.7.2.1">
      <Name xml:lang="en">Dirty South Hip Hop</Name>
    </Term>
    <Term termID="3.6.7.2.2">
      <Name xml:lang="en">East Coast Hip Hop</Name>
    </Term>
    <Term termID="3.6.7.2.4">
      <Name xml:lang="en">UK Hip Hop</Name>
    </Term>
    <Term termID="3.6.7.2.5">
      <Name xml:lang="en">West Coast Hip Hop</Name>
    </Term>
  </Term>
  <Term termID="3.6.7.3">
    <Name xml:lang="en">Reggae</Name>
    <Term termID="3.6.7.3.1">
      <Name xml:lang="en">Dancehall</Name>
      <Definition xml:lang="en">Also known as Ragga or Bashment</Definition>
    </Term>
    <Term termID="3.6.7.3.2">
      <Name xml:lang="en">Dub</Name>
    </Term>
    <Term termID="3.6.7.3.3">
      <Name xml:lang="en">Lovers Rock</Name>
    </Term>
    <Term termID="3.6.7.3.4">
      <Name xml:lang="en">Raggamuffin</Name>
    </Term>
    <Term termID="3.6.7.3.5">
      <Name xml:lang="en">Rocksteady</Name>
    </Term>
    <Term termID="3.6.7.3.6">
      <Name xml:lang="en">Ska</Name>
    </Term>
  </Term>
</Term>
<Term termID="3.6.8">
  <Name xml:lang="en">Electronic/Club/Urban/Dance</Name>
  <Term termID="3.6.8.1">
    <Name xml:lang="en">Acid/Punk/Acid Punk</Name>
  </Term>
  <Term termID="3.6.8.2">
    <Name xml:lang="en">Disco</Name>
  </Term>
  <Term termID="3.6.8.3">
    <Name xml:lang="en">Techno/Euro-Techno/Techno-Industrial/Industrial</Name>
  </Term>
  <Term termID="3.6.8.4">
    <Name xml:lang="en">House/Techno House</Name>
    <Term termID="3.6.8.4.1">
      <Name xml:lang="en">Progressive House</Name>
      <Definition xml:lang="en">e.g. Gat Decor</Definition>
    </Term>
    <Term termID="3.6.8.4.2">
      <Name xml:lang="en">Soulful Underground</Name>
    </Term>
  </Term>
  <Term termID="3.6.8.5">
    <Name xml:lang="en">Rave</Name>
  </Term>
  <Term termID="3.6.8.6">
    <Name xml:lang="en">Jungle/Tribal</Name>
  </Term>
  <Term termID="3.6.8.7">

```

```

    <Name xml:lang="en">Trance</Name>
  </Term>
  <Term termID="3.6.8.11">
    <Name xml:lang="en">Drum and Bass</Name>
  </Term>
  <Term termID="3.6.8.14">
    <Name xml:lang="en">Dance/Dance-pop</Name>
  </Term>
  <Term termID="3.6.8.15">
    <Name xml:lang="en">Garage (1990s)</Name>
    <Definition xml:lang="en">1990s US Garage not 1960s Garage Punk.</Definition>
  </Term>
  <Term termID="3.6.8.16">
    <Name xml:lang="en">UK Garage</Name>
    <Term termID="3.6.8.16.1">
      <Name xml:lang="en">2 Step</Name>
    </Term>
    <Term termID="3.6.8.16.2">
      <Name xml:lang="en">4/4 Vocal Garage</Name>
    </Term>
    <Term termID="3.6.8.16.3">
      <Name xml:lang="en">8 Bar</Name>
    </Term>
    <Term termID="3.6.8.16.4">
      <Name xml:lang="en">Dubstep</Name>
    </Term>
    <Term termID="3.6.8.16.5">
      <Name xml:lang="en">Eski-Beat</Name>
    </Term>
    <Term termID="3.6.8.16.6">
      <Name xml:lang="en">Grime</Name>
    </Term>
    <Term termID="3.6.8.16.7">
      <Name xml:lang="en">Soulful House and Garage</Name>
    </Term>
    <Term termID="3.6.8.16.8">
      <Name xml:lang="en">Speed Garage</Name>
    </Term>
    <Term termID="3.6.8.16.9">
      <Name xml:lang="en">Sublow</Name>
    </Term>
  </Term>
  <Term termID="3.6.8.17">
    <Name xml:lang="en">Breakbeat</Name>
    <Definition xml:lang="en">e.g. Fatboy Slim</Definition>
  </Term>
  <Term termID="3.6.8.18">
    <Name xml:lang="en">Broken Beat</Name>
  </Term>
  <Term termID="3.6.8.22">
    <Name xml:lang="en">Ambient Dance</Name>
    <Definition xml:lang="en">e.g. The Orb</Definition>
  </Term>
  <Term termID="3.6.8.23">
    <Name xml:lang="en">Alternative Dance</Name>
    <Definition xml:lang="en">e.g. Moby</Definition>
  </Term>
</Term>
<Term termID="3.6.9">
  <Name xml:lang="en">World/Traditional/Ethnic/Folk music</Name>
  <Definition xml:lang="en">Music that is the product of a tradition that has been evolved
through the process of oral transmission</Definition>
  <Term termID="3.6.9.1">
    <Name xml:lang="en">Africa</Name>
  </Term>
  <Term termID="3.6.9.2">
    <Name xml:lang="en">Asia</Name>
  </Term>
  <Term termID="3.6.9.3">
    <Name xml:lang="en">Australia/Oceania</Name>
  </Term>
  <Term termID="3.6.9.4">
    <Name xml:lang="en">Caribbean</Name>
    <Term termID="3.6.9.4.1">
      <Name xml:lang="en">Calypso</Name>
      <Definition xml:lang="en">e.g. Lord Kitchener</Definition>
    </Term>
  </Term>
  <Term termID="3.6.9.4.2">

```

```

        <Name xml:lang="en">SOCA</Name>
        <Definition xml:lang="en">e.g. Baha Men</Definition>
    </Term>
</Term>
<Term termID="3.6.9.5">
    <Name xml:lang="en">Europe</Name>
</Term>
<Term termID="3.6.9.6">
    <Name xml:lang="en">Latin America</Name>
</Term>
<Term termID="3.6.9.7">
    <Name xml:lang="en">Middle East</Name>
</Term>
<Term termID="3.6.9.8">
    <Name xml:lang="en">North America</Name>
</Term>
<Term termID="3.6.9.9">
    <Name xml:lang="en">Fusion</Name>
</Term>
<Term termID="3.6.9.10">
    <Name xml:lang="en">Modern</Name>
</Term>
</Term>
<Term termID="3.6.10">
    <Name xml:lang="en">Hit-Chart/Song Requests</Name>
</Term>
<Term termID="3.6.11">
    <Name xml:lang="en">Children's songs</Name>
</Term>
<Term termID="3.6.12">
    <Name xml:lang="en">Event music</Name>
    <Term termID="3.6.12.1">
        <Name xml:lang="en">Wedding</Name>
    </Term>
    <Term termID="3.6.12.2">
        <Name xml:lang="en">Sports</Name>
    </Term>
    <Term termID="3.6.12.3">
        <Name xml:lang="en">Ceremonial/Chants</Name>
    </Term>
</Term>
<Term termID="3.6.13">
    <Name xml:lang="en">Spoken</Name>
</Term>
<Term termID="3.6.14">
    <Name xml:lang="en">Dance</Name>
    <Term termID="3.6.14.1">
        <Name xml:lang="en">Ballet</Name>
    </Term>
    <Term termID="3.6.14.2">
        <Name xml:lang="en">Tap</Name>
    </Term>
    <Term termID="3.6.14.3">
        <Name xml:lang="en">Modern</Name>
    </Term>
    <Term termID="3.6.14.4">
        <Name xml:lang="en">Classical</Name>
    </Term>
    <Term termID="3.6.14.5">
        <Name xml:lang="en">Ballroom</Name>
    </Term>
</Term>
<Term termID="3.6.15">
    <Name xml:lang="en">Religious music</Name>
</Term>
<Term termID="3.6.16">
    <Name xml:lang="en">Era</Name>
    <Term termID="3.6.16.1">
        <Name xml:lang="en">Medieval (before 1400)</Name>
    </Term>
    <Term termID="3.6.16.2">
        <Name xml:lang="en">Renaissance (1400-1600)</Name>
    </Term>
    <Term termID="3.6.16.3">
        <Name xml:lang="en">Baroque (1600-1760)</Name>
    </Term>
    <Term termID="3.6.16.4">
        <Name xml:lang="en">Classical (1730-1820)</Name>
    </Term>

```



```

</Term>
<Term termID="3.6.16.5">
  <Name xml:lang="en">Romantic (1815-1910</Name>
</Term>
<Term termID="3.6.16.6">
  <Name xml:lang="en">20th Century</Name>
  <Term termID="3.6.16.6.1">
    <Name xml:lang="en">1910s</Name>
  </Term>
  <Term termID="3.6.16.6.2">
    <Name xml:lang="en">1920s</Name>
  </Term>
  <Term termID="3.6.16.6.3">
    <Name xml:lang="en">1930s</Name>
  </Term>
  <Term termID="3.6.16.6.4">
    <Name xml:lang="en">1940s</Name>
  </Term>
  <Term termID="3.6.16.6.5">
    <Name xml:lang="en">1950s</Name>
  </Term>
  <Term termID="3.6.16.6.6">
    <Name xml:lang="en">1960s</Name>
  </Term>
  <Term termID="3.6.16.6.7">
    <Name xml:lang="en">1970s</Name>
  </Term>
  <Term termID="3.6.16.6.8">
    <Name xml:lang="en">1980s</Name>
  </Term>
  <Term termID="3.6.16.6.9">
    <Name xml:lang="en">1990s</Name>
  </Term>
</Term>
<Term termID="3.6.16.7">
  <Name xml:lang="en">21st Century</Name>
  <Term termID="3.6.16.7.1">
    <Name xml:lang="en">2000s</Name>
  </Term>
  <Term termID="3.6.16.7.2">
    <Name xml:lang="en">2010s</Name>
  </Term>
  <Term termID="3.6.16.7.3">
    <Name xml:lang="en">2020s</Name>
  </Term>
  <Term termID="3.6.16.7.4">
    <Name xml:lang="en">2030s</Name>
  </Term>
  <Term termID="3.6.16.7.5">
    <Name xml:lang="en">2040s</Name>
  </Term>
  <Term termID="3.6.16.7.6">
    <Name xml:lang="en">2050s</Name>
  </Term>
  <Term termID="3.6.16.7.7">
    <Name xml:lang="en">2060s</Name>
  </Term>
  <Term termID="3.6.16.7.8">
    <Name xml:lang="en">2070s</Name>
  </Term>
  <Term termID="3.6.16.7.9">
    <Name xml:lang="en">2080s</Name>
  </Term>
  <Term termID="3.6.16.7.10">
    <Name xml:lang="en">2090s</Name>
  </Term>
</Term>
</Term>
<Term termID="3.6.17">
  <Name xml:lang="en">Desi</Name>
  <Term termID="3.6.17.1">
    <Name xml:lang="en">Asian Underground</Name>
  </Term>
  <Term termID="3.6.17.2">
    <Name xml:lang="en">Bhangra</Name>
  </Term>
  <Term termID="3.6.17.3">
    <Name xml:lang="en">Bollywood</Name>

```

```

    </Term>
  </Term>
  <Term termID="3.6.18">
    <Name xml:lang="en">Experimental</Name>
  </Term>
</Term>
<Term termID="3.7">
  <Name xml:lang="en">INTERACTIVE GAMES</Name>
  <Term termID="3.7.1">
    <Name xml:lang="en">CONTENT GAMES CATEGORIES</Name>
    <Term termID="3.7.1.1">
      <Name xml:lang="en">Action</Name>
    </Term>
    <Term termID="3.7.1.2">
      <Name xml:lang="en">Adventure</Name>
    </Term>
    <Term termID="3.7.1.3">
      <Name xml:lang="en">Fighting</Name>
    </Term>
    <Term termID="3.7.1.4">
      <Name xml:lang="en">Online</Name>
    </Term>
    <Term termID="3.7.1.5">
      <Name xml:lang="en">Platform</Name>
    </Term>
    <Term termID="3.7.1.6">
      <Name xml:lang="en">Puzzle</Name>
    </Term>
    <Term termID="3.7.1.7">
      <Name xml:lang="en">RPG/ MUDs</Name>
    </Term>
    <Term termID="3.7.1.8">
      <Name xml:lang="en">Racing</Name>
    </Term>
    <Term termID="3.7.1.9">
      <Name xml:lang="en">Simulation</Name>
    </Term>
    <Term termID="3.7.1.10">
      <Name xml:lang="en">Sports</Name>
    </Term>
    <Term termID="3.7.1.11">
      <Name xml:lang="en">Strategy</Name>
    </Term>
    <Term termID="3.7.1.12">
      <Name xml:lang="en">Wrestling</Name>
    </Term>
    <Term termID="3.7.1.13">
      <Name xml:lang="en">Classic/Retro</Name>
    </Term>
  </Term>
  <Term termID="3.7.2">
    <Name xml:lang="en">STYLE</Name>
    <Term termID="3.7.2.1">
      <Name xml:lang="en">Logic based</Name>
    </Term>
    <Term termID="3.7.2.2">
      <Name xml:lang="en">Word games</Name>
    </Term>
    <Term termID="3.7.2.3">
      <Name xml:lang="en">Positional</Name>
    </Term>
    <Term termID="3.7.2.4">
      <Name xml:lang="en">Board games</Name>
    </Term>
    <Term termID="3.7.2.5">
      <Name xml:lang="en">Text environments</Name>
    </Term>
    <Term termID="3.7.2.6">
      <Name xml:lang="en">Dynamic 2D/3D graphics</Name>
    </Term>
    <Term termID="3.7.2.7">
      <Name xml:lang="en">Non-linear video</Name>
    </Term>
  </Term>
</Term>
<Term termID="3.8">
  <Name xml:lang="en">LEISURE/HOBBY/LIFESTYLE</Name>
  <Term termID="3.8.1">

```

```

<Name xml:lang="en">General Consumer Advice</Name>
<Term termID="3.8.1.1">
  <Name xml:lang="en">Road safety</Name>
</Term>
<Term termID="3.8.1.2">
  <Name xml:lang="en">Consumer advice</Name>
</Term>
<Term termID="3.8.1.3">
  <Name xml:lang="en">Employment Advice</Name>
</Term>
<Term termID="3.8.1.4">
  <Name xml:lang="en">Self-help</Name>
</Term>
</Term>
<Term termID="3.8.2">
  <Name xml:lang="en">Computing/Technology</Name>
  <Term termID="3.8.2.1">
    <Name xml:lang="en">Technology/Computing</Name>
  </Term>
  <Term termID="3.8.2.2">
    <Name xml:lang="en">Computer Games</Name>
    <Definition xml:lang="en">Programme about games played on a computer</Definition>
  </Term>
</Term>
<Term termID="3.8.3">
  <Name xml:lang="en">Cookery, Food, Drink</Name>
  <Term termID="3.8.3.1">
    <Name xml:lang="en">Cookery</Name>
  </Term>
  <Term termID="3.8.3.2">
    <Name xml:lang="en">Food and Drink</Name>
  </Term>
</Term>
<Term termID="3.8.4">
  <Name xml:lang="en">Homes/Interior/Gardening</Name>
  <Term termID="3.8.4.1">
    <Name xml:lang="en">Do-it-yourself</Name>
    <Definition xml:lang="en">Where the consumer is given advice on how to perform home
improvements themselves</Definition>
  </Term>
  <Term termID="3.8.4.2">
    <Name xml:lang="en">Home Improvement</Name>
  </Term>
  <Term termID="3.8.4.3">
    <Name xml:lang="en">Gardening</Name>
  </Term>
  <Term termID="3.8.4.4">
    <Name xml:lang="en">Property Buying and Selling</Name>
  </Term>
</Term>
<Term termID="3.8.5">
  <Name xml:lang="en">Hobbies</Name>
  <Term termID="3.8.5.1">
    <Name xml:lang="en">Fishing</Name>
    <Definition xml:lang="en">Angling</Definition>
  </Term>
  <Term termID="3.8.5.2">
    <Name xml:lang="en">Pet</Name>
  </Term>
  <Term termID="3.8.5.3">
    <Name xml:lang="en">Craft/Handicraft</Name>
    <Definition xml:lang="en">needlework, model making, sewing, etc</Definition>
  </Term>
  <Term termID="3.8.5.4">
    <Name xml:lang="en">Art</Name>
  </Term>
  <Term termID="3.8.5.5">
    <Name xml:lang="en">Music</Name>
    <Definition xml:lang="en">teaching how to play musical instruments on learning how to
appreciate music</Definition>
  </Term>
  <Term termID="3.8.5.6">
    <Name xml:lang="en">Board Games</Name>
    <Definition xml:lang="en">Monopoly, Scrabble, Mah-jong, Draughts (checkers), Backgammon
etc</Definition>
  </Term>
  <Term termID="3.8.5.7">
    <Name xml:lang="en">Card Games</Name>

```

```

    <Definition xml:lang="en">Bridge, Poker, etc</Definition>
  </Term>
  <Term termID="3.8.5.8">
    <Name xml:lang="en">Gaming</Name>
    <Definition xml:lang="en">Non-card games such as roulette, craps, etc</Definition>
  </Term>
  <Term termID="3.8.5.9">
    <Name xml:lang="en">Shopping</Name>
    <Definition xml:lang="en">Consumer shopping advice: Not a programme designed to sell a
specific product to the consumer</Definition>
  </Term>
  <Term termID="3.8.5.10">
    <Name xml:lang="en">Collectibles/Antiques</Name>
  </Term>
  <Term termID="3.8.5.11">
    <Name xml:lang="en">Jewellery</Name>
  </Term>
  <Term termID="3.8.5.12">
    <Name xml:lang="en">Aviation</Name>
    <Definition xml:lang="en">Programme consisting of elements on aviation as a hobby, e.g.
private pilots and general aviation. Elements concerning commercial aviation should be categorized
in Air Transport (3.1.8.1) and elements concerning Aviation as a sport should be in 3.2.14 and its
sub-categories</Definition>
  </Term>
  <Term termID="3.8.5.13">
    <Name xml:lang="en">Trains</Name>
  </Term>
  <Term termID="3.8.5.14">
    <Name xml:lang="en">Boating</Name>
  </Term>
  <Term termID="3.8.5.15">
    <Name xml:lang="en">Ornithology</Name>
    <Definition xml:lang="en">Bird Watching</Definition>
  </Term>
</Term>
<Term termID="3.8.6">
  <Name xml:lang="en">Cars and Motoring</Name>
  <Term termID="3.8.6.1">
    <Name xml:lang="en">Car</Name>
  </Term>
  <Term termID="3.8.6.2">
    <Name xml:lang="en">Motorcycle</Name>
  </Term>
</Term>
<Term termID="3.8.7">
  <Name xml:lang="en">Personal/Lifestyle/Family</Name>
  <Term termID="3.8.7.1">
    <Name xml:lang="en">Fitness / Keep-fit</Name>
  </Term>
  <Term termID="3.8.7.2">
    <Name xml:lang="en">Personal health</Name>
  </Term>
  <Term termID="3.8.7.3">
    <Name xml:lang="en">Fashion</Name>
  </Term>
  <Term termID="3.8.7.4">
    <Name xml:lang="en">House Keeping</Name>
  </Term>
  <Term termID="3.8.7.5">
    <Name xml:lang="en">Parenting</Name>
  </Term>
  <Term termID="3.8.7.6">
    <Name xml:lang="en">Beauty</Name>
  </Term>
</Term>
<Term termID="3.8.9">
  <Name xml:lang="en">Travel/Tourism</Name>
  <Term termID="3.8.9.1">
    <Name xml:lang="en">Holidays</Name>
    <Definition xml:lang="en">package and self organized holidays</Definition>
  </Term>
  <Term termID="3.8.9.2">
    <Name xml:lang="en">Adventure/Expeditions</Name>
  </Term>
  <Term termID="3.8.9.3">
    <Name xml:lang="en">Outdoor pursuits</Name>
    <Definition xml:lang="en">hiking, camping, rambling</Definition>
  </Term>

```

```

    </Term>
  </Term>
  <Term termID="3.9">
    <Name xml:lang="en">ADULT</Name>
  </Term>
</ClassificationScheme>

```

## A.9 ContentCommercialCS

```

<?xml version="1.0" encoding="UTF-8"?>
<ClassificationScheme uri="urn:tva:metadata:cs:ContentCommercialCS:2005">
  <!-- ##### -->
  <!-- CONTENTCOMMERCIAL, extension for commercial products. -->
  <!-- Definition: This dimension is used to classify programmes according to their content or
subject. -->
  <!-- Unlike in the case of the form dimension, it is essential to hear the programme. -->
  <!-- ##### -->
  <Term termID="3.50">
    <Name xml:lang="en">Commercial/Products</Name>
    <Term termID="3.50.1">
      <Name xml:lang="en">Agriculture, forestry and fishery products</Name>
      <Term termID="3.50.1.1">
        <Name xml:lang="en">Products of agriculture, horticulture and market gardening</Name>
      </Term>
      <Term termID="3.50.1.2">
        <Name xml:lang="en">Live animals and animal products</Name>
      </Term>
      <Term termID="3.50.1.3">
        <Name xml:lang="en">Forestry and logging products</Name>
      </Term>
      <Term termID="3.50.1.4">
        <Name xml:lang="en">Fish and other fishing products</Name>
      </Term>
    </Term>
    <Term termID="3.50.2">
      <Name xml:lang="en">Ores and minerals; electricity, gas and water</Name>
      <Term termID="3.50.2.1">
        <Name xml:lang="en">Coal and lignite; peat</Name>
      </Term>
      <Term termID="3.50.2.2">
        <Name xml:lang="en">Crude petroleum and natural gas</Name>
      </Term>
      <Term termID="3.50.2.3">
        <Name xml:lang="en">Uranium and thorium ores</Name>
      </Term>
      <Term termID="3.50.2.4">
        <Name xml:lang="en">Metal ores</Name>
      </Term>
      <Term termID="3.50.2.5">
        <Name xml:lang="en">Stone, sand and clay</Name>
      </Term>
      <Term termID="3.50.2.6">
        <Name xml:lang="en">Other minerals</Name>
      </Term>
      <Term termID="3.50.2.7">
        <Name xml:lang="en">Electricity, town gas, steam and hot water</Name>
      </Term>
      <Term termID="3.50.2.8">
        <Name xml:lang="en">Water</Name>
      </Term>
    </Term>
    <Term termID="3.50.3">
      <Name xml:lang="en">Food products, beverages and tobacco; textiles, apparel and leather
products</Name>
      <Term termID="3.50.3.1">
        <Name xml:lang="en">Meat, fish, fruit, vegetables, oils and fats</Name>
      </Term>
      <Term termID="3.50.3.2">
        <Name xml:lang="en">Dairy products</Name>
      </Term>
      <Term termID="3.50.3.3">

```

```

    <Name xml:lang="en">Grain mill products, starches and starch products; other food
products</Name>
  </Term>
  <Term termID="3.50.3.4">
    <Name xml:lang="en">Beverages</Name>
  </Term>
  <Term termID="3.50.3.5">
    <Name xml:lang="en">Tobacco products</Name>
  </Term>
  <Term termID="3.50.3.6">
    <Name xml:lang="en">Yarn and thread; woven and tufted textile fabrics</Name>
  </Term>
  <Term termID="3.50.3.7">
    <Name xml:lang="en">Textile articles other than apparel</Name>
  </Term>
  <Term termID="3.50.3.8">
    <Name xml:lang="en">Knitted or crocheted fabrics; wearing apparel</Name>
  </Term>
  <Term termID="3.50.3.9">
    <Name xml:lang="en">Leather and leather products; footwear</Name>
  </Term>
</Term>
<Term termID="3.50.4">
  <Name xml:lang="en">Other transportable goods, except metal products, machinery and
equipment</Name>
  <Term termID="3.50.4.1">
    <Name xml:lang="en">Products of wood, cork, straw and plaiting materials</Name>
  </Term>
  <Term termID="3.50.4.2">
    <Name xml:lang="en">Pulp, paper and paper products; printed matter and related
articles</Name>
  </Term>
  <Term termID="3.50.4.3">
    <Name xml:lang="en">Coke oven products; refined petroleum products; nuclear fuel</Name>
  </Term>
  <Term termID="3.50.4.4">
    <Name xml:lang="en">Basic chemicals</Name>
  </Term>
  <Term termID="3.50.4.5">
    <Name xml:lang="en">Other chemical products; man-made fibres</Name>
  </Term>
  <Term termID="3.50.4.6">
    <Name xml:lang="en">Rubber and plastics products</Name>
  </Term>
  <Term termID="3.50.4.7">
    <Name xml:lang="en">Glass and glass products and other non-metallic products
n.e.c.</Name>
  </Term>
  <Term termID="3.50.4.8">
    <Name xml:lang="en">Furniture; other transportable goods n.e.c.</Name>
  </Term>
  <Term termID="3.50.4.9">
    <Name xml:lang="en">Wastes or scraps</Name>
  </Term>
</Term>
<Term termID="3.50.5">
  <Name xml:lang="en">Metal products, machinery and equipment</Name>
  <Term termID="3.50.5.1">
    <Name xml:lang="en">Basic metals</Name>
  </Term>
  <Term termID="3.50.5.2">
    <Name xml:lang="en">Fabricated metal products, except machinery and equipment</Name>
  </Term>
  <Term termID="3.50.5.3">
    <Name xml:lang="en">General purpose machinery</Name>
  </Term>
  <Term termID="3.50.5.4">
    <Name xml:lang="en">Special purpose machinery</Name>
  </Term>
  <Term termID="3.50.5.5">
    <Name xml:lang="en">Office, accounting and computing machinery</Name>
  </Term>
  <Term termID="3.50.5.6">
    <Name xml:lang="en">Electrical machinery and apparatus</Name>
  </Term>
  <Term termID="3.50.5.7">
    <Name xml:lang="en">Radio, television and communication equipment and apparatus</Name>
  </Term>

```

```

    <Term termID="3.50.5.8">
      <Name xml:lang="en">Medical appliances, precision and optical instruments, watches and
clocks</Name>
    </Term>
    <Term termID="3.50.5.9">
      <Name xml:lang="en">Transport equipment</Name>
    </Term>
  </Term>
<Term termID="3.50.6">
  <Name xml:lang="en">Intangible assets; land; constructions; construction services</Name>
  <Term termID="3.50.6.1">
    <Name xml:lang="en">Intangible assets</Name>
  </Term>
  <Term termID="3.50.6.2">
    <Name xml:lang="en">Land</Name>
  </Term>
  <Term termID="3.50.6.3">
    <Name xml:lang="en">Constructions</Name>
  </Term>
  <Term termID="3.50.6.4">
    <Name xml:lang="en">Construction services</Name>
  </Term>
</Term>
<Term termID="3.50.7">
  <Name xml:lang="en">Distributive trade services; lodging; food and beverage serving
services; transport services; and utilities distribution services</Name>
  <Term termID="3.50.7.1">
    <Name xml:lang="en">Wholesale trade services</Name>
  </Term>
  <Term termID="3.50.7.2">
    <Name xml:lang="en">Retail trade services</Name>
  </Term>
  <Term termID="3.50.7.3">
    <Name xml:lang="en">Lodging; food and beverage serving services</Name>
  </Term>
  <Term termID="3.50.7.4">
    <Name xml:lang="en">Land transport services</Name>
  </Term>
  <Term termID="3.50.7.5">
    <Name xml:lang="en">Water transport services</Name>
  </Term>
  <Term termID="3.50.7.6">
    <Name xml:lang="en">Air transport services</Name>
  </Term>
  <Term termID="3.50.7.7">
    <Name xml:lang="en">Supporting and auxiliary transport services</Name>
  </Term>
  <Term termID="3.50.7.8">
    <Name xml:lang="en">Postal and courier services</Name>
  </Term>
  <Term termID="3.50.7.9">
    <Name xml:lang="en">Electricity distribution services; gas and water distribution
services through mains</Name>
  </Term>
</Term>
<Term termID="3.50.8">
  <Name xml:lang="en">Financial and related services; real estate services; and rental and
leasing services</Name>
  <Term termID="3.50.8.1">
    <Name xml:lang="en">Financial intermediation, insurance and auxiliary services</Name>
  </Term>
  <Term termID="3.50.8.2">
    <Name xml:lang="en">Real estate services</Name>
  </Term>
  <Term termID="3.50.8.3">
    <Name xml:lang="en">Leasing or rental services without operator</Name>
  </Term>
</Term>
<Term termID="3.50.9">
  <Name xml:lang="en">Business and production services</Name>
  <Term termID="3.50.9.1">
    <Name xml:lang="en">Research and development services</Name>
  </Term>
  <Term termID="3.50.9.2">
    <Name xml:lang="en">Professional, scientific and technical services</Name>
  </Term>
  <Term termID="3.50.9.3">
    <Name xml:lang="en">Other professional, scientific and technical services</Name>
  </Term>

```

```

    </Term>
    <Term termID="3.50.9.4">
      <Name xml:lang="en">Telecommunications services; information retrieval and supply
services</Name>
    </Term>
    <Term termID="3.50.9.5">
      <Name xml:lang="en">Support services</Name>
    </Term>
    <Term termID="3.50.9.6">
      <Name xml:lang="en">Production services, on a fee or contract basis</Name>
    </Term>
    <Term termID="3.50.9.7">
      <Name xml:lang="en">Maintenance and repair services</Name>
    </Term>
  </Term>
  <Term termID="3.50.10">
    <Name xml:lang="en">Community, social and personal services</Name>
    <Term termID="3.50.10.1">
      <Name xml:lang="en">Public administration and other services to the community as a
whole; compulsory social security services</Name>
    </Term>
    <Term termID="3.50.10.2">
      <Name xml:lang="en">Education services</Name>
    </Term>
    <Term termID="3.50.10.3">
      <Name xml:lang="en">Health and social services</Name>
    </Term>
    <Term termID="3.50.10.4">
      <Name xml:lang="en">Sewage and refuse disposal, sanitation and other environmental
protection services</Name>
    </Term>
    <Term termID="3.50.10.5">
      <Name xml:lang="en">Services of membership organizations</Name>
    </Term>
    <Term termID="3.50.10.6">
      <Name xml:lang="en">Recreational, cultural and sporting services</Name>
    </Term>
    <Term termID="3.50.10.7">
      <Name xml:lang="en">Other services</Name>
    </Term>
    <Term termID="3.50.10.8">
      <Name xml:lang="en">Domestic services</Name>
    </Term>
    <Term termID="3.50.10.9">
      <Name xml:lang="en">Services provided by extraterritorial organizations and
bodies</Name>
    </Term>
  </Term>
</Term>
</ClassificationScheme>

```

## A.10 OriginationCS

```

<?xml version="1.0" encoding="UTF-8"?>
<ClassificationScheme uri="urn:tva:metadata:cs:OriginationCS:2005">
  <!-- ##### -->
  <!-- ORIGINATION -->
  -->
  <!-- Definition: The original distribution method or platform for the content -->
  <!-- ##### -->
  <Term termID="5.7">
    <Name xml:lang="en">Cinema</Name>
    <Definition xml:lang="en">Made originally for viewing in the cinema</Definition>
    <Term termID="5.7.1">
      <Name xml:lang="en">Made on location</Name>
      <Definition xml:lang="en">.</Definition>
    </Term>
    <Term termID="5.7.2">
      <Name xml:lang="en">Made in studio</Name>
    </Term>
    <Term termID="5.7.3">
      <Name xml:lang="en">Made by the consumer</Name>
    </Term>
  </Term>

```



```

    </Term>
  </Term>
  <Term termID="5.8">
    <Name xml:lang="en">TV</Name>
    <Definition xml:lang="en">Made originally for viewing on TV screens</Definition>
    <Term termID="5.8.1">
      <Name xml:lang="en">Made on location</Name>
      <Definition xml:lang="en">made at an event in an unstructured environment - where the
action is based</Definition>
      <Term termID="5.8.1.1">
        <Name xml:lang="en">Live</Name>
        <Definition xml:lang="en">e.g. live sporting coverage, Live concerts, Operas etc from
theatres</Definition>
      </Term>
      <Term termID="5.8.1.2">
        <Name xml:lang="en">As Live</Name>
        <Definition xml:lang="en">delayed relay of events - e.g. Olympics from different time
zone</Definition>
      </Term>
      <Term termID="5.8.1.3">
        <Name xml:lang="en">Edited</Name>
        <Definition xml:lang="en">edited highlights from event such as Match of the Day, NFL
highlights</Definition>
      </Term>
    </Term>
    <Term termID="5.8.2">
      <Name xml:lang="en">Made in studio</Name>
      <Definition xml:lang="en">made in a purpose built studio or controlled environment such as
quiz show from village hall where the action comes to the equipment required to make the
programme</Definition>
      <Term termID="5.8.2.1">
        <Name xml:lang="en">Live</Name>
        <Definition xml:lang="en">News, Weather. Lottery etc</Definition>
      </Term>
      <Term termID="5.8.2.2">
        <Name xml:lang="en">As Live</Name>
        <Definition xml:lang="en">CNN rebroadcasts, Question Time,</Definition>
      </Term>
      <Term termID="5.8.2.3">
        <Name xml:lang="en">Edited</Name>
        <Definition xml:lang="en">Sitcoms, most entertainment shows, Dramas etc</Definition>
      </Term>
    </Term>
    <Term termID="5.8.3">
      <Name xml:lang="en">Made by the consumer</Name>
      <Definition xml:lang="en">e.g. home video shared between consumer</Definition>
    </Term>
  </Term>
  <Term termID="5.9">
    <Name xml:lang="en">Radio</Name>
    <Definition xml:lang="en">Made originally for listening on Radio</Definition>
    <Term termID="5.9.1">
      <Name xml:lang="en">Made on location</Name>
      <Definition xml:lang="en">made at an event in an unstructured environment - where the
action is based</Definition>
      <Term termID="5.9.1.1">
        <Name xml:lang="en">Live</Name>
        <Definition xml:lang="en">e.g. live sporting coverage, Live concerts, Operas etc from
theatres</Definition>
      </Term>
      <Term termID="5.9.1.2">
        <Name xml:lang="en">As Live</Name>
        <Definition xml:lang="en">delayed relay of events - e.g. Olympics from different time
zone</Definition>
      </Term>
      <Term termID="5.9.1.3">
        <Name xml:lang="en">Edited</Name>
        <Definition xml:lang="en">edited highlights from events such as Down Your
Way,</Definition>
      </Term>
    </Term>
    <Term termID="5.9.2">
      <Name xml:lang="en">Made in studio</Name>
      <Definition xml:lang="en">made in a purpose built studio or controlled environment such as
quiz show from village hall where the action comes to the equipment required to make the
programme</Definition>
      <Term termID="5.9.2.1">
        <Name xml:lang="en">Live</Name>

```

```

    <Definition xml:lang="en">DJ hosted programme, live chat show</Definition>
  </Term>
  <Term termID="5.9.2.2">
    <Name xml:lang="en">As Live</Name>
    <Definition xml:lang="en">repeats of whole previous programmes, deferred relays for
rights</Definition>
  </Term>
  <Term termID="5.9.2.3">
    <Name xml:lang="en">Edited</Name>
    <Definition xml:lang="en">radio drama, documentary etc</Definition>
  </Term>
</Term>
<Term termID="5.9.3">
  <Name xml:lang="en">Made on consumer equipment (home audio)</Name>
  <Term termID="5.9.3.1">
    <Name xml:lang="en">Live</Name>
    <Definition xml:lang="en">live streaming etc</Definition>
  </Term>
  <Term termID="5.9.3.2">
    <Name xml:lang="en">As Live</Name>
    <Definition xml:lang="en">deferred live stream</Definition>
  </Term>
  <Term termID="5.9.3.3">
    <Name xml:lang="en">Edited</Name>
    <Definition xml:lang="en">home audio content</Definition>
  </Term>
</Term>
</Term>
<Term termID="5.10">
  <Name xml:lang="en">Online Distribution</Name>
  <Definition xml:lang="en">Made originally for distribution over non broadcast networks
(streaming or download)</Definition>
  <Term termID="5.10.1">
    <Name xml:lang="en">Made on location</Name>
    <Definition xml:lang="en">made at an event in an unstructured environment - where the
action is based</Definition>
    <Term termID="5.10.1.1">
      <Name xml:lang="en">Live</Name>
      <Definition xml:lang="en">e.g. live sporting coverage, Live concerts, Operas etc from
theatres</Definition>
    </Term>
    <Term termID="5.10.1.2">
      <Name xml:lang="en">As Live</Name>
      <Definition xml:lang="en">delayed relay of events - e.g. Olympics from different time
zone</Definition>
    </Term>
    <Term termID="5.10.1.3">
      <Name xml:lang="en">Edited</Name>
      <Definition xml:lang="en">edited highlights from event.</Definition>
    </Term>
  </Term>
  <Term termID="5.10.2">
    <Name xml:lang="en">Made in studio</Name>
    <Definition xml:lang="en">made in a purpose built studio or controlled
environment</Definition>
    <Term termID="5.10.2.1">
      <Name xml:lang="en">Live</Name>
      <Definition xml:lang="en">News, Weather. Lottery etc</Definition>
    </Term>
    <Term termID="5.10.2.2">
      <Name xml:lang="en">As Live</Name>
      <Definition xml:lang="en">,</Definition>
    </Term>
    <Term termID="5.10.2.3">
      <Name xml:lang="en">Edited</Name>
    </Term>
  </Term>
  <Term termID="5.10.3">
    <Name xml:lang="en">Made on consumer equipment</Name>
    <Definition xml:lang="en">e.g. home video shared between consumer</Definition>
    <Term termID="5.10.3.1">
      <Name xml:lang="en">Live</Name>
    </Term>
    <Term termID="5.10.3.2">
      <Name xml:lang="en">As Live</Name>
    </Term>
    <Term termID="5.10.3.3">
      <Name xml:lang="en">Edited</Name>
    </Term>
  </Term>

```

```

    </Term>
  </Term>
</Term>
<Term termID="5.11">
  <Name xml:lang="en">Offline Distribution</Name>
  <Definition xml:lang="en">CDs DVDs Other removable media</Definition>
</Term>
</ClassificationScheme>

```

## A.11 IntendedAudienceCS

```

<?xml version="1.0" encoding="UTF-8"?>
<ClassificationScheme uri="urn:tva:metadata:cs:IntendedAudienceCS:2010">
  <!-- ##### -->
  <!-- INTENDED AUDIENCE / TARGET GROUP -->
  <!-- Definition: Programme intended for special audiences defined by age, cultural/ethnic
background, -->
  <!-- profession etc. -->
  <!-- ##### -->
  <Term termID="4.0">
    <Name xml:lang="en">Proprietary</Name>
    <Definition xml:lang="en">For use where proprietary extensions are required, or the use of
keywords that do not fit in any classification below</Definition>
  </Term>
  <Term termID="4.1">
    <Name xml:lang="en">GENERAL AUDIENCE</Name>
    <Definition xml:lang="en">Programmes not intended for a specific target group</Definition>
  </Term>
  <Term termID="4.2">
    <Name xml:lang="en">AGE GROUPS</Name>
    <Definition xml:lang="en">The age group levels for which the programme is primarily
intended</Definition>
    <Term termID="4.2.1">
      <Name xml:lang="en">Children</Name>
      <Term termID="4.2.1.1">
        <Name xml:lang="en">Age 4-7</Name>
        <Definition xml:lang="en">Age ranges are indicative and may vary slightly in each
country</Definition>
      </Term>
      <Term termID="4.2.1.2">
        <Name xml:lang="en">Age 8-13</Name>
        <Definition xml:lang="en">Age ranges are indicative and may vary slightly in each
country</Definition>
      </Term>
      <Term termID="4.2.1.3">
        <Name xml:lang="en">Age 14-15</Name>
        <Definition xml:lang="en">Age ranges are indicative and may vary slightly in each
country</Definition>
      </Term>
      <Term termID="4.2.1.4">
        <Name xml:lang="en">age 0-3</Name>
        <Definition xml:lang="en">Age ranges are indicative and may vary slightly in each
country</Definition>
      </Term>
    </Term>
    <Term termID="4.2.2">
      <Name xml:lang="en">Adults</Name>
      <Term termID="4.2.2.1">
        <Name xml:lang="en">Age 16-17</Name>
        <Definition xml:lang="en">Age ranges are indicative and may vary slightly in each
country</Definition>
      </Term>
      <Term termID="4.2.2.2">
        <Name xml:lang="en">Age 18-24</Name>
        <Definition xml:lang="en">Age ranges are indicative and may vary slightly in each
country</Definition>
      </Term>
      <Term termID="4.2.2.3">
        <Name xml:lang="en">Age 25-34</Name>
      </Term>
      <Term termID="4.2.2.4">
        <Name xml:lang="en">age 35-44</Name>

```

```

    <Definition xml:lang="en">Age ranges are indicative and may vary slightly in each
country</Definition>
  </Term>
  <Term termID="4.2.2.5">
    <Name xml:lang="en">age 45-54</Name>
    <Definition xml:lang="en">Age ranges are indicative and may vary slightly in each
country</Definition>
  </Term>
  <Term termID="4.2.2.6">
    <Name xml:lang="en">age 55-64</Name>
    <Definition xml:lang="en">Age ranges are indicative and may vary slightly in each
country</Definition>
  </Term>
  <Term termID="4.2.2.7">
    <Name xml:lang="en">age 65+</Name>
    <Definition xml:lang="en">Age ranges are indicative and may vary slightly in each
country</Definition>
  </Term>
  <Term termID="4.2.2.8">
    <Name xml:lang="en">specific single age</Name>
    <Definition xml:lang="en">This section to be used where a programme targets one
specific age</Definition>
  </Term>
</Term>
<Term termID="4.3">
  <Name xml:lang="en">SOCIAL / REGIONAL / MINORITY GROUPS</Name>
  <Term termID="4.3.1">
    <Name xml:lang="en">Ethnic</Name>
    <Definition xml:lang="en">Programme for people differing in language and/or culture e.g.
Local key words to apply (i.e. Asian)</Definition>
  <Term termID="4.3.1.1">
    <Name xml:lang="en">Immigrant groups</Name>
    <Definition xml:lang="en">Programme for non-native born people and their immediate
descendants, differing in language and/or culture</Definition>
  </Term>
  <Term termID="4.3.1.2">
    <Name xml:lang="en">Indigenous</Name>
    <Definition xml:lang="en">Programme for native born people and their immediate
descendants, differing in language and/or culture</Definition>
  </Term>
  <Term termID="4.3.2">
    <Name xml:lang="en">Religious</Name>
    <Definition xml:lang="en">Local key words to apply (i.e. Shinto, Christian, Hindu
etc)</Definition>
  </Term>
  <Term termID="4.3.3">
    <Name xml:lang="en">Disabled</Name>
    <Definition xml:lang="en">Programme for people with one or more disabilities</Definition>
  </Term>
</Term>
<Term termID="4.4">
  <Name xml:lang="en">OCCUPATIONAL GROUPS</Name>
  <Definition xml:lang="en">The occupation of the consumer for which the programme is primarily
intended</Definition>
  <Term termID="4.4.1">
    <Name xml:lang="en">AB</Name>
    <Definition xml:lang="en"/>
  <Term termID="4.4.1.1">
    <Name xml:lang="en">A</Name>
    <Definition xml:lang="en">Opinion former, Judge, Member of the Govt etc</Definition>
  </Term>
  <Term termID="4.4.1.2">
    <Name xml:lang="en">B</Name>
    <Definition xml:lang="en">Industry leader, Senior Govt figure, Professionals (Doctors,
Lawyers, etc.), etc.</Definition>
  </Term>
  <Term termID="4.4.2">
    <Name xml:lang="en">C1C2</Name>
  <Term termID="4.4.2.1">
    <Name xml:lang="en">C1</Name>
    <Definition xml:lang="en">White collar worker</Definition>
  </Term>
  <Term termID="4.4.2.2">
    <Name xml:lang="en">C2</Name>
    <Definition xml:lang="en">Skilled manual labourer</Definition>
  </Term>

```

```

    </Term>
  </Term>
  <Term termID="4.4.3">
    <Name xml:lang="en">DE</Name>
    <Term termID="4.4.3.1">
      <Name xml:lang="en">D</Name>
      <Definition xml:lang="en">General manual labourer</Definition>
    </Term>
    <Term termID="4.4.3.2">
      <Name xml:lang="en">E</Name>
      <Definition xml:lang="en">Unemployed (+ students!)</Definition>
    </Term>
  </Term>
</Term>
<Term termID="4.5">
  <Name xml:lang="en">OTHER SPECIAL INTEREST / OCCUPATIONAL GROUPS</Name>
  <Definition xml:lang="en">Local Keywords to apply. (i.e. Farmer, Student, DIY, Angler, Gay and
lesbian)</Definition>
</Term>
<Term termID="4.6">
  <Name xml:lang="en">GENDER</Name>
  <Term termID="4.6.1">
    <Name xml:lang="en">Primarily for males</Name>
  </Term>
  <Term termID="4.6.2">
    <Name xml:lang="en">Primarily for females</Name>
  </Term>
</Term>
<Term termID="4.7">
  <Name xml:lang="en">GEOGRAPHICAL</Name>
  <Definition xml:lang="en">The territory for which the programme is primarily
intended</Definition>
  <Term termID="4.7.1">
    <Name xml:lang="en">Universal</Name>
    <Definition xml:lang="en">Intended for all audiences regardless of territory</Definition>
  </Term>
  <Term termID="4.7.2">
    <Name xml:lang="en">Continental</Name>
    <Definition xml:lang="en">Asia, European</Definition>
  </Term>
  <Term termID="4.7.3">
    <Name xml:lang="en">National</Name>
    <Definition xml:lang="en">France, S. Africa</Definition>
  </Term>
  <Term termID="4.7.4">
    <Name xml:lang="en">Regional</Name>
    <Definition xml:lang="en">Mid West, Pacific Rim</Definition>
  </Term>
  <Term termID="4.7.5">
    <Name xml:lang="en">Local</Name>
    <Definition xml:lang="en">Zip Codes, Postcodes, Towns</Definition>
  </Term>
  <Term termID="4.7.6">
    <Name xml:lang="en">Multinational</Name>
    <Definition xml:lang="en">more than one country but not continental</Definition>
  </Term>
</Term>
<Term termID="4.8">
  <Name xml:lang="en">EDUCATION STANDARD</Name>
  <Term termID="4.8.1">
    <Name xml:lang="en">Primary</Name>
  </Term>
  <Term termID="4.8.2">
    <Name xml:lang="en">Secondary</Name>
  </Term>
  <Term termID="4.8.3">
    <Name xml:lang="en">Tertiary</Name>
  </Term>
  <Term termID="4.8.4">
    <Name xml:lang="en">Post graduate/Life long learning</Name>
    <Field9/>
  </Term>
  <Term termID="4.8.5">
    <Name xml:lang="en">Pre-school</Name>
  </Term>
</Term>
<Term termID="4.9">
  <Name xml:lang="en">LIFESTYLE STAGES</Name>

```

```

<Term termID="4.9.1">
  <Name xml:lang="en">Single</Name>
  <Definition xml:lang="en">Single person with no dependants</Definition>
</Term>
<Term termID="4.9.2">
  <Name xml:lang="en">Couple</Name>
  <Definition xml:lang="en">Cohabiting adult with no dependants</Definition>
</Term>
<Term termID="4.9.3">
  <Name xml:lang="en">Family with children 0-3</Name>
  <Definition xml:lang="en">Adult with pre school children</Definition>
</Term>
<Term termID="4.9.4">
  <Name xml:lang="en">Family with children 4-7</Name>
  <Definition xml:lang="en">Adult with young children</Definition>
</Term>
<Term termID="4.9.5">
  <Name xml:lang="en">Family with children 8-15</Name>
  <Definition xml:lang="en">Adult with older children</Definition>
</Term>
<Term termID="4.9.6">
  <Name xml:lang="en">Family with children 16+</Name>
  <Definition xml:lang="en">Adult with young dependant adults</Definition>
</Term>
<Term termID="4.9.7">
  <Name xml:lang="en">Empty nester</Name>
  <Definition xml:lang="en">Adult whose dependants have left home</Definition>
</Term>
<Term termID="4.9.8">
  <Name xml:lang="en">Retired</Name>
  <Definition xml:lang="en">Single or widowed adult whose dependants have left
home</Definition>
</Term>
<Term termID="4.9.9">
  <Name xml:lang="en">Family (mixed ages)</Name>
  <Definition xml:lang="en">adult with dependent children of various ages</Definition>
</Term>
</Term>
<Term termID="4.11">
  <Name xml:lang="en">LANGUAGE OF TARGET AUDIENCE</Name>
  <Definition xml:lang="en">As used and maintained by ISO 639-1 [18]</Definition>
</Term>
</ClassificationScheme>

```

## A.12 ContentAlertCS

```

<?xml version="1.0" encoding="UTF-8"?>
<ClassificationScheme uri="urn:tva:metadata:cs:ContentAlertCS:2005">
  <!-- ##### -->
  <!-- CONTENTALERT -->
  <!-- ##### -->
  <Term termID="6.0">
    <Name xml:lang="en">ALERT NOT REQUIRED</Name>
    <Term termID="6.0.1">
      <Name xml:lang="en">No content that requires alerting in any of the categories below</Name>
    </Term>
  </Term>
  <Term termID="6.1">
    <Name xml:lang="en">SEX</Name>
    <Term termID="6.1.1">
      <Name xml:lang="en">No sex descriptors</Name>
    </Term>
    <Term termID="6.1.2">
      <Name xml:lang="en">Obscured or implied sexual activity</Name>
    </Term>
    <Term termID="6.1.3">
      <Name xml:lang="en">Frank portrayal of sex and sexuality</Name>
    </Term>
    <Term termID="6.1.4">
      <Name xml:lang="en">Scenes of explicit sexual behaviour suitable for adults only</Name>
      <Term termID="6.1.4.1">

```

```

        <Name xml:lang="en">One scene of explicit sexual behaviour suitable for adults
only</Name>
    </Term>
    <Term termID="6.1.4.2">
        <Name xml:lang="en">Occasional scenes of explicit sexual behaviour suitable for adults
only</Name>
    </Term>
    <Term termID="6.1.4.3">
        <Name xml:lang="en">Frequent scenes of explicit sexual behaviour suitable for adults
only</Name>
    </Term>
</Term>
<Term termID="6.1.5">
    <Name xml:lang="en">Sexual Violence</Name>
    <Term termID="6.1.5.1">
        <Name xml:lang="en">One scene of sexual violence</Name>
    </Term>
    <Term termID="6.1.5.2">
        <Name xml:lang="en">Occasional scenes of sexual violence</Name>
    </Term>
    <Term termID="6.1.5.3">
        <Name xml:lang="en">Frequent scenes of sexual Violence</Name>
    </Term>
</Term>
<Term termID="6.1.6">
    <Name xml:lang="en">Verbal sexual References</Name>
    <Term termID="6.1.6.1">
        <Name xml:lang="en">One verbal sexual reference</Name>
    </Term>
    <Term termID="6.1.6.2">
        <Name xml:lang="en">Occasional verbal sexual references</Name>
    </Term>
    <Term termID="6.1.6.3">
        <Name xml:lang="en">Frequent verbal sexual references</Name>
    </Term>
</Term>
</Term>
<Term termID="6.2">
    <Name xml:lang="en">Nudity</Name>
    <Term termID="6.2.1">
        <Name xml:lang="en">No nudity descriptors</Name>
    </Term>
    <Term termID="6.2.2">
        <Name xml:lang="en">Partial nudity</Name>
        <Term termID="6.2.2.1">
            <Name xml:lang="en">One scene of partial nudity</Name>
        </Term>
        <Term termID="6.2.2.2">
            <Name xml:lang="en">Occasional scenes of partial nudity</Name>
        </Term>
        <Term termID="6.2.2.3">
            <Name xml:lang="en">Frequent scenes of partial nudity</Name>
        </Term>
    </Term>
    <Term termID="6.2.3">
        <Name xml:lang="en">Full frontal nudity</Name>
        <Term termID="6.2.3.1">
            <Name xml:lang="en">One scene of full frontal nudity</Name>
        </Term>
        <Term termID="6.2.3.2">
            <Name xml:lang="en">Occasional scenes of full frontal nudity</Name>
        </Term>
        <Term termID="6.2.3.3">
            <Name xml:lang="en">Frequent scenes of full frontal nudity</Name>
        </Term>
    </Term>
</Term>
<Term termID="6.3">
    <Name xml:lang="en">VIOLENCE - HUMAN BEINGS</Name>
    <Term termID="6.3.1">
        <Name xml:lang="en">No violence descriptors human beings</Name>
    </Term>
    <Term termID="6.3.2">
        <Name xml:lang="en">Deliberate infliction of pain to human beings</Name>
        <Definition xml:lang="en">Example: Mild psychological or physical violence to human beings
(psychological pressure, punching, slapping, knocking down, etc.)</Definition>
        <Term termID="6.3.2.1">
            <Name xml:lang="en">One Scene of deliberate infliction of pain to human beings</Name>

```

```

    <Definition xml:lang="en">Mild psychological or physical violence to human beings
    (psychological pressure, punching, slapping, knocking down)</Definition>
  </Term>
  <Term termID="6.3.2.2">
    <Name xml:lang="en">Occasional deliberate infliction of pain to human beings</Name>
    <Definition xml:lang="en">Mild psychological or physical violence to human beings
    (psychological pressure, punching, slapping, knocking down)</Definition>
  </Term>
  <Term termID="6.3.2.3">
    <Name xml:lang="en">Frequent deliberate infliction of pain to human beings</Name>
    <Definition xml:lang="en">Mild psychological or physical violence to human beings
    (psychological pressure, punching, slapping, knocking down)</Definition>
  </Term>
</Term>
<Term termID="6.3.3">
  <Name xml:lang="en">Infliction of strong psychological or physical pain to human
  beings</Name>
  <Definition xml:lang="en">Example: Heavy intimidation, torture, bloody scenes, accidental
  killing of human beings</Definition>
  <Term termID="6.3.3.1">
    <Name xml:lang="en">One scene of infliction of strong psychological or physical pain to
    human beings</Name>
    <Definition xml:lang="en">(heavy intimidation, torture, bloody scenes, accidental
    killing of human beings)</Definition>
  </Term>
  <Term termID="6.3.3.2">
    <Name xml:lang="en">Occasional scenes of infliction of strong psychological or physical
    pain to human beings</Name>
    <Definition xml:lang="en">(heavy intimidation, torture, bloody scenes, accidental
    killing of human beings)</Definition>
  </Term>
  <Term termID="6.3.3.3">
    <Name xml:lang="en">Frequent scenes of infliction of strong psychological or physical
    pain to human beings</Name>
    <Definition xml:lang="en">(heavy intimidation, torture, bloody scenes, accidental
    killing of human beings)</Definition>
  </Term>
</Term>
<Term termID="6.3.4">
  <Name xml:lang="en">Deliberate killing of human beings</Name>
  <Term termID="6.3.4.1">
    <Name xml:lang="en">One scene of deliberate killing of human beings</Name>
  </Term>
  <Term termID="6.3.4.2">
    <Name xml:lang="en">Occasional deliberate killing of human beings</Name>
  </Term>
  <Term termID="6.3.4.3">
    <Name xml:lang="en">Frequent deliberate killing of human beings</Name>
  </Term>
</Term>
</Term>
<Term termID="6.4">
  <Name xml:lang="en">Violence - Animals</Name>
  <Term termID="6.4.1">
    <Name xml:lang="en">No violence descriptors animals</Name>
  </Term>
  <Term termID="6.4.2">
    <Name xml:lang="en">Deliberate infliction of pain to animals</Name>
    <Term termID="6.4.2.1">
      <Name xml:lang="en">One scene of deliberate infliction of pain to animals</Name>
    </Term>
    <Term termID="6.4.2.2">
      <Name xml:lang="en">Occasional deliberate infliction of pain to animals</Name>
    </Term>
    <Term termID="6.4.2.3">
      <Name xml:lang="en">Frequent deliberate infliction of pain to animals</Name>
    </Term>
  </Term>
  <Term termID="6.4.3">
    <Name xml:lang="en">Deliberate killing of animals</Name>
    <Term termID="6.4.3.1">
      <Name xml:lang="en">One scene of deliberate killing of animals</Name>
    </Term>
    <Term termID="6.4.3.2">
      <Name xml:lang="en">Occasional deliberate killing of animals</Name>
    </Term>
    <Term termID="6.4.3.1">
      <Name xml:lang="en">Frequent deliberate killing of animals</Name>
    </Term>
  </Term>

```



```

    </Term>
  </Term>
</Term>
<Term termID="6.5">
  <Name xml:lang="en">VIOLENCE - FANTASY CHARACTERS</Name>
  <Term termID="6.5.1">
    <Name xml:lang="en">No violence descriptors</Name>
  </Term>
  <Term termID="6.5.2">
    <Name xml:lang="en">Deliberate infliction of pain to fantasy characters (including
animation)</Name>
    <Term termID="6.5.2.1">
      <Name xml:lang="en">One scene of deliberate infliction of pain to fantasy characters
(including animation)</Name>
    </Term>
    <Term termID="6.5.2.2">
      <Name xml:lang="en">Occasional deliberate infliction of pain to fantasy characters
(including animation)</Name>
    </Term>
    <Term termID="6.5.2.3">
      <Name xml:lang="en">Frequent deliberate infliction of pain to fantasy characters
(including animation)</Name>
    </Term>
  </Term>
  <Term termID="6.5.3">
    <Name xml:lang="en">Deliberate killing of fantasy characters (including animation)</Name>
    <Term termID="6.5.3.1">
      <Name xml:lang="en">One scene of deliberate killing of fantasy characters (including
animation)</Name>
    </Term>
    <Term termID="6.5.3.2">
      <Name xml:lang="en">Occasional deliberate killing of fantasy characters (including
animation)</Name>
    </Term>
    <Term termID="6.5.3.3">
      <Name xml:lang="en">Frequent deliberate killing of fantasy characters (including
animation)</Name>
    </Term>
  </Term>
</Term>
<Term termID="6.6">
  <Name xml:lang="en">LANGUAGE</Name>
  <Term termID="6.6.1">
    <Name xml:lang="en">No language descriptors</Name>
  </Term>
  <Term termID="6.6.2">
    <Name xml:lang="en">Occasional use of mild swear words and profanities</Name>
  </Term>
  <Term termID="6.6.3">
    <Name xml:lang="en">Frequent use of mild swear words and profanities</Name>
  </Term>
  <Term termID="6.6.4">
    <Name xml:lang="en">Occasional use of very strong language</Name>
  </Term>
  <Term termID="6.6.5">
    <Name xml:lang="en">Frequent use of very strong language</Name>
  </Term>
  <Term termID="6.6.6">
    <Name xml:lang="en">One use of very strong language</Name>
  </Term>
  <Term termID="6.6.7">
    <Name xml:lang="en">Occasional use of strong language</Name>
  </Term>
  <Term termID="6.6.8">
    <Name xml:lang="en">Frequent use of strong language</Name>
  </Term>
  <Term termID="6.6.9">
    <Name xml:lang="en">One use of strong language</Name>
  </Term>
  <Term termID="6.6.10">
    <Name xml:lang="en">Occasional use of offensive language (racist, homophobic,
sexist)</Name>
  </Term>
  <Term termID="6.6.11">
    <Name xml:lang="en">Frequent use of offensive language (racist, homophobic, sexist)</Name>
  </Term>
  <Term termID="6.6.12">
    <Name xml:lang="en">One use of offensive language (racist, homophobic, sexist)</Name>
  </Term>
</Term>

```

```

    </Term>
  </Term>
  <Term termID="6.7">
    <Name xml:lang="en">DISTURBING SCENES</Name>
    <Term termID="6.7.1">
      <Name xml:lang="en">No disturbing scenes descriptors</Name>
    </Term>
    <Term termID="6.7.2">
      <Name xml:lang="en">Factual material that may cause distress, including verbal descriptions
of traumatic events and the telling of sensitive human interest stories</Name>
    </Term>
    <Term termID="6.7.3">
      <Name xml:lang="en">Mild scenes of blood and gore (including medical procedures, injuries
from accidents, terrorist attacks, murder, disaster, war)</Name>
      <Term termID="6.7.3.1">
        <Name xml:lang="en">One mild scene of blood and gore</Name>
        <Definition xml:lang="en">(including medical procedures, injuries from accidents,
terrorists attack, murder, disaster, war)</Definition>
      </Term>
      <Term termID="6.7.3.2">
        <Name xml:lang="en">Occasional mild scenes of blood and gore</Name>
        <Definition xml:lang="en">(including medical procedures, injuries from accidents,
terrorists attack, murder, disaster, war)</Definition>
      </Term>
      <Term termID="6.7.3.3">
        <Name xml:lang="en">Frequent mild scenes of blood and gore</Name>
        <Definition xml:lang="en">(including medical procedures, injuries from accidents,
terrorists attack, murder, disaster, war)</Definition>
      </Term>
    </Term>
    <Term termID="6.7.4">
      <Name xml:lang="en">Severe scenes of blood and gore (as 6.7.3 above)</Name>
      <Term termID="6.7.4.1">
        <Name xml:lang="en">One severe scene of blood and gore</Name>
      </Term>
      <Term termID="6.7.4.2">
        <Name xml:lang="en">Occasional severe scenes of blood and gore (as 6.7.3 above)</Name>
      </Term>
      <Term termID="6.7.4.3">
        <Name xml:lang="en">Frequent severe scenes of blood and gore (as 6.7.3 above)</Name>
      </Term>
    </Term>
    <Term termID="6.7.5">
      <Name xml:lang="en">Scenes with extreme horror effects</Name>
      <Term termID="6.7.5.1">
        <Name xml:lang="en">One scene with extreme horror effects</Name>
      </Term>
      <Term termID="6.7.5.2">
        <Name xml:lang="en">Occasional scenes with extreme horror effects</Name>
      </Term>
      <Term termID="6.7.5.3">
        <Name xml:lang="en">Frequent scenes with extreme horror effects</Name>
      </Term>
    </Term>
  </Term>
  <Term termID="6.8">
    <Name xml:lang="en">DISCRIMINATION</Name>
    <Term termID="6.8.1">
      <Name xml:lang="en">No discrimination descriptors</Name>
    </Term>
    <Term termID="6.8.2">
      <Name xml:lang="en">Deliberate discrimination or the portrayal of deliberate discrimination
(including discrimination on the basis of gender, sexual orientation, race, religion, colour,
nationality or ethnic background)</Name>
    </Term>
  </Term>
  <Term termID="6.9">
    <Name xml:lang="en">ILLEGAL DRUGS</Name>
    <Term termID="6.9.1">
      <Name xml:lang="en">No illegal drugs descriptors</Name>
    </Term>
    <Term termID="6.9.2">
      <Name xml:lang="en">Portrayal of illegal drug use</Name>
      <Name xml:lang="en">Portrayal of illegal drug use</Name>
      <Term termID="6.9.2.1">
        <Name xml:lang="en">One scene of illegal drug use</Name>
      </Term>
      <Term termID="6.9.2.2">

```

```

    <Name xml:lang="en">Occasional portrayal of illegal drug use</Name>
  </Term>
  <Term termID="6.9.2.3">
    <Name xml:lang="en">Frequent portrayal of illegal drug use</Name>
  </Term>
</Term>
<Term termID="6.9.3">
  <Name xml:lang="en">Portrayal of illegal drug use with instructive detail</Name>
  <Term termID="6.9.3.1">
    <Name xml:lang="en">One scene of illegal drug use with instructive detail</Name>
  </Term>
  <Term termID="6.9.3.2">
    <Name xml:lang="en">Occasional portrayal of illegal drug use with instructive
detail</Name>
  </Term>
  <Term termID="6.9.3.3">
    <Name xml:lang="en">Frequent portrayal of illegal drug use with instructive
detail</Name>
  </Term>
</Term>
<Term termID="6.10">
  <Name xml:lang="en">STROBING</Name>
  <Term termID="6.10.1">
    <Name xml:lang="en">No strobing</Name>
  </Term>
  <Term termID="6.10.2">
    <Name xml:lang="en">Strobing that could impact on those suffering from Photosensitive
epilepsy</Name>
    <Term termID="6.10.2.1">
      <Name xml:lang="en">One scene of strobing that could impact on those suffering from
photosensitive epilepsy</Name>
    </Term>
    <Term termID="6.10.2.2">
      <Name xml:lang="en">Occasional strobing that could impact on those suffering from
photosensitive epilepsy</Name>
    </Term>
    <Term termID="6.10.2.3">
      <Name xml:lang="en">Frequent strobing that could impact on those suffering from
photosensitive epilepsy</Name>
    </Term>
  </Term>
</Term>
</ClassificationScheme>

```

## A.13 MediaTypeCS

```

<?xml version="1.0" encoding="UTF-8"?>
<ClassificationScheme uri="urn:tva:metadata:cs:MediaTypeCS:2010">
  <!-- ##### -->
  <!-- MEDIATYPE
-->
  <!-- ##### -->
  <Term termID="7.0">
    <Name xml:lang="en">Proprietary</Name>
    <Definition xml:lang="en">For use where proprietary extensions are required, or the use of
keywords that do not fit in any classification below</Definition>
  </Term>
  <Term termID="7.1">
    <Name xml:lang="en">Linear</Name>
    <Term termID="7.1.1">
      <Name xml:lang="en">Audio only</Name>
      <Definition xml:lang="en">Radio programme</Definition>
    </Term>
    <Term termID="7.1.2">
      <Name xml:lang="en">Video only</Name>
    </Term>
    <Term termID="7.1.3">
      <Name xml:lang="en">Audio and video</Name>
      <Definition xml:lang="en">TV programme</Definition>
    </Term>
    <Term termID="7.1.4">

```

```

<Name xml:lang="en">Multimedia</Name>
<Term termID="7.1.4.1">
  <Name xml:lang="en">Text</Name>
  <Definition xml:lang="en">Digital text</Definition>
</Term>
<Term termID="7.1.4.2">
  <Name xml:lang="en">Graphics</Name>
  <Definition xml:lang="en">Images, Graphics</Definition>
</Term>
<Term termID="7.1.4.3">
  <Name xml:lang="en">Application</Name>
  <Definition xml:lang="en">a software application that controls the consumer
experience</Definition>
</Term>
</Term>
<Term termID="7.1.5">
  <Name xml:lang="en">Data</Name>
  <Definition xml:lang="en">e.g. a weather data service</Definition>
</Term>
</Term>
<Term termID="7.2">
  <Name xml:lang="en">Non linear</Name>
  <Definition xml:lang="en">content where the consumer can navigate within the content to alter
their experience e.g. DVD scene by scene consumption,</Definition>
<Term termID="7.2.1">
  <Name xml:lang="en">Audio only</Name>
</Term>
<Term termID="7.2.2">
  <Name xml:lang="en">Video only</Name>
</Term>
<Term termID="7.2.3">
  <Name xml:lang="en">Audio and video</Name>
</Term>
<Term termID="7.2.4">
  <Name xml:lang="en">Multimedia</Name>
  <Term termID="7.2.4.1">
    <Name xml:lang="en">Text</Name>
  </Term>
  <Term termID="7.2.4.2">
    <Name xml:lang="en">Graphics</Name>
  </Term>
  <Term termID="7.2.4.3">
    <Name xml:lang="en">Application</Name>
  </Term>
</Term>
<Term termID="7.2.5">
  <Name xml:lang="en">Data</Name>
  <Definition xml:lang="en">e.g. a weather data service</Definition>
</Term>
</Term>
<Term termID="7.3">
  <Name xml:lang="en">Audio video enhancements</Name>
  <Term termID="7.3.1">
    <Name xml:lang="en">Linear with non-sync</Name>
    <Definition xml:lang="en">Linear programme with non-synchronized, non av content. Example:
DTT Wimbledon</Definition>
  </Term>
  <Term termID="7.3.2">
    <Name xml:lang="en">Linear with sync</Name>
    <Definition xml:lang="en">Linear programme with synchronized non av content. Example:
Weakest Link Dsat Quiz, TV Nav bar</Definition>
  </Term>
  <Term termID="7.3.3">
    <Name xml:lang="en">Multi stream audio</Name>
    <Definition xml:lang="en">Multi, parallel stream linear audio programme. Example: Parallel
audio radio drama</Definition>
  </Term>
  <Term termID="7.3.4">
    <Name xml:lang="en">Multi stream video</Name>
    <Definition xml:lang="en">Multi, parallel stream linear audio/video programme. Example:
Interactive Wimbledon, Walking with Beasts</Definition>
  </Term>
  <Term termID="7.3.5">
    <Name xml:lang="en">Non-linear one stream AV show</Name>
    <Definition xml:lang="en">Non-linear single video/audio programme</Definition>
  </Term>
  <Term termID="7.3.6">
    <Name xml:lang="en">Non-linear multi stream</Name>

```

```

    <Definition xml:lang="en">Non-linear multi, parallel stream video programme</Definition>
  </Term>
  <Term termID="7.3.7">
    <Name xml:lang="en">Hybrid NVOD</Name>
    <Definition xml:lang="en">Hybrid NVOD - locally stored material linking back to scheduled
AV content. Example: Viewer can choose a movie off a PDR immediately (it has been pre-cached), watch
and then they will be linked seamlessly back into a 'live' looped channel at an appropriate
point</Definition>
  </Term>
  <Term termID="7.3.8">
    <Name xml:lang="en">Mix and match</Name>
    <Definition xml:lang="en">Video with audio programme (component) Ids e.g. BBC1 video with
BBC2 audio</Definition>
  </Term>
  <Term termID="7.3.9">
    <Name xml:lang="en">Parallel 'layer controlled' audio or video support</Name>
    <Definition xml:lang="en">Multiple decoders allow dynamic mixing of audio or
video</Definition>
  </Term>
  <Term termID="7.3.10">
    <Name xml:lang="en">Linear broadcast with online insertions</Name>
    <Definition xml:lang="en">Linear broadcast programme with dynamically inserted online
content. Example: Inserted ads into broadcast content, alternate tangents against broadcast
content</Definition>
  </Term>
  <Term termID="7.3.11">
    <Name xml:lang="en">Multimedia MashUp</Name>
    <Definition xml:lang="en">A Mash-Up / Interactive Session of linear
broadcast programme, non-linear video/audio programme, graphics, interactive
text and dynamically inserted online content</Definition>
  </Term>
</Term>
</ClassificationScheme>

```

## A.14 AtmosphereCS

```

<?xml version="1.0" encoding="UTF-8"?>
<ClassificationScheme uri="urn:tva:metadata:cs:AtmosphereCS:2005">
  <!-- ##### -->
  <!-- ATMOSPHERE -->
  >
  <!-- Definition: Definition of programme related subjective assessment-->
  <!-- ##### -->
  <Term termID="8.0">
    <Name xml:lang="en">Proprietary</Name>
  </Term>
  <Term termID="8.1">
    <Name xml:lang="en">Alternative</Name>
    <Definition xml:lang="en">Unconventional, not mainstream</Definition>
  </Term>
  <Term termID="8.2">
    <Name xml:lang="en">Analytical</Name>
    <Definition xml:lang="en">Factual, in-depth, investigative, probing</Definition>
  </Term>
  <Term termID="8.3">
    <Name xml:lang="en">Astonishing</Name>
    <Definition xml:lang="en">Amazing, surprising, breathtaking</Definition>
  </Term>
  <Term termID="8.4">
    <Name xml:lang="en">Ambitious</Name>
    <Definition xml:lang="en">Far reaching, high-aims, strongly determined</Definition>
  </Term>
  <Term termID="8.5">
    <Name xml:lang="en">Black</Name>
    <Definition xml:lang="en">Bleak, sinister, dark</Definition>
  </Term>
  <Term termID="8.6">
    <Name xml:lang="en">Breathtaking</Name>
  </Term>
  <Term termID="8.7">
    <Name xml:lang="en">Chilling</Name>
    <Definition xml:lang="en">Hair-raising, spine-tingling</Definition>

```

```

</Term>
<Term termID="8.8">
  <Name xml:lang="en">Coarse</Name>
  <Definition xml:lang="en">Crude, lacking refinement, rough, lewd</Definition>
</Term>
<Term termID="8.9">
  <Name xml:lang="en">Compelling</Name>
  <Definition xml:lang="en">Gripping, rousing strong interest, conviction or
admiration</Definition>
</Term>
<Term termID="8.10">
  <Name xml:lang="en">Confrontational</Name>
</Term>
<Term termID="8.11">
  <Name xml:lang="en">Contemporary</Name>
  <Definition xml:lang="en">Modern in style or design, up-to-date</Definition>
</Term>
<Term termID="8.12">
  <Name xml:lang="en">Crazy</Name>
  <Definition xml:lang="en">Insane, mad, foolish</Definition>
</Term>
<Term termID="8.13">
  <Name xml:lang="en">Cutting edge</Name>
  <Definition xml:lang="en">Leading the way, in the vanguard</Definition>
</Term>
<Term termID="8.14">
  <Name xml:lang="en">Eclectic</Name>
  <Definition xml:lang="en">Mixed, collection, selecting ideas & styles from various
sources</Definition>
</Term>
<Term termID="8.15">      <Name xml:lang="en">Edifying</Name>
  <Definition xml:lang="en">Morally or intellectually improving</Definition>
</Term>
<Term termID="8.16">
  <Name xml:lang="en">Exciting</Name>
  <Definition xml:lang="en">Arousing great interest or enthusiasm, thrilling.
  Example: "Buffy the Vampire Slayer", the series, could be classified as having atmospheres of
Exciting (intermediate), Fast-moving (intermediate), Stylish (very), Terrifying (slightly) and
Violent (intermediate). Selection of this programme could lead to a suggestion of "Romeo and
Juliet", the modern movie, because of a match on the classifications of Exciting, Fast-moving,
Stylish and Violent. "Romeo and Juliet" would also have classifications of Contemporary (very),
Gripping (intermediate), Innovative (very) and Romantic (very).</Definition>
</Term>
<Term termID="8.17">
  <Name xml:lang="en">Fast-moving</Name>
  <Definition xml:lang="en">Rapid action, adrenaline-charged, dynamic, energetic</Definition>
</Term>
<Term termID="8.18">
  <Name xml:lang="en">Frantic</Name>
  <Definition xml:lang="en">Frenzied, hurried</Definition>
</Term>
<Term termID="8.19">
  <Name xml:lang="en">Fun</Name>
  <Definition xml:lang="en">Lively or playful amusement, enjoyable, not for a serious
purpose</Definition>
</Term>
<Term termID="8.20">
  <Name xml:lang="en">Gripping</Name>
</Term>
<Term termID="8.21">
  <Name xml:lang="en">Gritty</Name>
  <Definition xml:lang="en">Basic, no frills</Definition>
</Term>
<Term termID="8.22">
  <Name xml:lang="en">Gutsy</Name>
  <Definition xml:lang="en">Full-on, no holds barred, courageous</Definition>
</Term>
<Term termID="8.23">
  <Name xml:lang="en">Happy</Name>
  <Definition xml:lang="en">Feeling or showing pleasure or contentment, upbeat,
uplifting</Definition>
</Term>
<Term termID="8.24">
  <Name xml:lang="en">Heart-rending</Name>
  <Definition xml:lang="en">Emotionally-charged, distressing, painful, tear-jerker</Definition>
</Term>
<Term termID="8.25">
  <Name xml:lang="en">Heart-warming</Name>

```

```

    <Definition xml:lang="en">Emotionally rewarding or uplifting, charming, delightful, enchanting
    Example: "Sleepless in Seattle", the movie, could be classified as having atmospheres of
    Heart-warming (very), Humorous (intermediate), Romantic (very) and Happy (intermediate). Selection of
    this programme could lead to a suggestion of "Friends", the series, because of a match on the
    classifications of Humorous and Happy. "Friends", itself could also have additional classifications
    of Contemporary (slightly) and Fun (intermediate).</Definition>
  </Term>
  <Term termID="8.26">
    <Name xml:lang="en">Hot</Name>
    <Definition xml:lang="en">Fresh, recent, of the moment</Definition>
  </Term>
  <Term termID="8.27">
    <Name xml:lang="en">Humorous</Name>
    <Definition xml:lang="en">Amusing, hilarious, light-hearted, witty
    Example: "Have I Got News for You", the quiz show, could be classified as having atmospheres
    of Humorous (very), Irreverent (very) and Outrageous (intermediate). Selection of this programme
    could lead to a suggestion of "Waynes World", the movie, because of a match on the classifications
    of Humorous and Outrageous. "Waynes World" would also have classifications of Fun (very) and Silly
    (very).</Definition>
  </Term>
  <Term termID="8.28">
    <Name xml:lang="en">Innovative</Name>
    <Definition xml:lang="en">Ground-breaking, landmark, new ideas and methods
    Example: Fresh.</Definition>
  </Term>
  <Term termID="8.29">
    <Name xml:lang="en">Insightful</Name>
  </Term>
  <Term termID="8.30">
    <Name xml:lang="en">Inspirational</Name>
    <Definition xml:lang="en">Uplifting, stimulating creative activity
    Example: Aspirational and enriching.</Definition>
  </Term>
  <Term termID="8.31">
    <Name xml:lang="en">Intriguing</Name>
    <Definition xml:lang="en">Arousing/inspiring curiosity</Definition>
  </Term>
  <Term termID="8.32">
    <Name xml:lang="en">Irreverent</Name>
    <Definition xml:lang="en">Anti-establishment, lacking reverence for established principles and
    ways of behaving</Definition>
  </Term>
  <Term termID="8.33">
    <Name xml:lang="en">Laid back</Name>
    <Definition xml:lang="en">Calm, relaxed, easy-going</Definition>
  </Term>
  <Term termID="8.34">
    <Name xml:lang="en">Outrageous</Name>
    <Definition xml:lang="en">Shocking, in-your-face</Definition>
  </Term>
  <Term termID="8.35">
    <Name xml:lang="en">Peaceful</Name>
    <Example xml:lang="en"> including 'calming'</Example>
  </Term>
  <Term termID="8.36">
    <Name xml:lang="en">Powerful</Name>
    <Definition xml:lang="en">Influential, emotionally-charged, strong</Definition>
  </Term>
  <Term termID="8.37">
    <Name xml:lang="en">Practical</Name>
    <Example xml:lang="en">including 'hands-on'</Example>
  </Term>
  <Term termID="8.38">
    <Name xml:lang="en">Rollercoaster</Name>
    <Definition xml:lang="en">Emotional up and downs, unpredictable, uncontrollable</Definition>
  </Term>
  <Term termID="8.39">
    <Name xml:lang="en">Romantic</Name>
    <Definition xml:lang="en">About love, being in love</Definition>
  </Term>
  <Term termID="8.40">
    <Name xml:lang="en">Rousing</Name>
    <Definition xml:lang="en">Stirring, energizing, exciting</Definition>
  </Term>
  <Term termID="8.41">
    <Name xml:lang="en">Sad</Name>
    <Definition xml:lang="en">Unhappy, causing sorrow, tragic, pitiful</Definition>
  </Term>

```

```

<Term termID="8.42">
  <Name xml:lang="en">Satirical</Name>
  <Definition xml:lang="en">Irony, used to expose folly or vice, ridicule</Definition>
</Term>
<Term termID="8.43">
  <Name xml:lang="en">Serious</Name>
  <Definition xml:lang="en">Earnest, important, demanding consideration, not
frivolous</Definition>
</Term>
<Term termID="8.44">
  <Name xml:lang="en">Sexy</Name>
  <Definition xml:lang="en">Racy, raunchy, steamy, sexually arousing, stimulating</Definition>
</Term>
<Term termID="8.45">
  <Name xml:lang="en">Shocking</Name>
  <Definition xml:lang="en">Causing shock or scandal</Definition>
</Term>
<Term termID="8.46">
  <Name xml:lang="en">Silly</Name>
  <Definition xml:lang="en">Foolish, imprudent, weak-minded</Definition>
</Term>
<Term termID="8.47">
  <Name xml:lang="en">Spooky</Name>
  <Definition xml:lang="en">Creepy, eerie, ghoulish</Definition>
</Term>
<Term termID="8.48">
  <Name xml:lang="en">Stunning</Name>
  <Definition xml:lang="en">Striking, visually impressive or attractive</Definition>
</Term>
<Term termID="8.49">
  <Name xml:lang="en">Stylish</Name>
  <Definition xml:lang="en">Fashionable, elegant</Definition>
</Term>
<Term termID="8.50">
  <Name xml:lang="en">Terrifying</Name>
  <Definition xml:lang="en">Scary, causing extreme fear</Definition>
</Term>
<Term termID="8.51">
  <Name xml:lang="en">Thriller</Name>
  <Definition xml:lang="en">Exciting or sensational story</Definition>
</Term>
<Term termID="8.52">
  <Name xml:lang="en">Violent</Name>
  <Definition xml:lang="en">Involving great physical force, violence</Definition>
</Term>
<Term termID="8.53">
  <Name xml:lang="en">Wacky</Name>
  <Definition xml:lang="en">Crazy, kooky, ridiculous, zany</Definition>
</Term>
</ClassificationScheme>

```

## A.15 AudioPurposeCS

```

<?xml version="1.0" encoding="UTF-8"?>
<ClassificationScheme uri="urn:tva:metadata:cs:AudioPurposeCS:2007">
  <!-- ##### -->
  <!-- AUDIOPURPOSE -->
  <!-- ##### -->
  <Term termID="1">
    <Name xml:lang="en">Audio description for the visually impaired</Name>
  </Term>
  <Term termID="2">
    <Name xml:lang="en">Audio description for the hard of hearing</Name>
  </Term>
  <Term termID="3">
    <Name xml:lang="en">Supplemental commentary</Name>
  </Term>
  <Term termID="4">
    <Name xml:lang="en">Director's commentary</Name>
  </Term>
  <Term termID="5">
    <Name xml:lang="en">Educational notes</Name>
  </Term>

```



```

<Term termID="6">
  <Name xml:lang="en">Main programme audio</Name>
</Term>
<Term termID="7">
  <Name xml:lang="en">Clean feed - no FX mix</Name>
</Term>
</ClassificationScheme>

```

## A.16 PurchaseTypeCS

```

<?xml version="1.0" encoding="UTF-8"?>
<ClassificationScheme uri="urn:tva:metadata:cs:PurchaseTypeCS:2004">
  <!-- ##### -->
  <!-- PURCHASETYPE -->
  <!-- ##### -->
  <Term termID="playForever">
    <Name xml:lang="en">Play forever</Name>
  </Term>
  <Term termID="playForPeriod">
    <Name xml:lang="en">Play for period</Name>
  </Term>
  <Term termID="playCounts">
    <Name xml:lang="en">Play counts</Name>
  </Term>
</ClassificationScheme>

```

## A.17 UnitTypeCS

```

<?xml version="1.0" encoding="UTF-8"?>
<ClassificationScheme uri="urn:tva:metadata:cs:UnitTypeCS:2007">
  <!-- ##### -->
  <!-- UNITTYPE -->
  <!-- ##### -->
  <Term termID="minutes">
    <Name xml:lang="en">Minutes</Name>
  </Term>
  <Term termID="hours">
    <Name xml:lang="en">Hours</Name>
  </Term>
  <Term termID="day">
    <Name xml:lang="en">Day</Name>
  </Term>
  <Term termID="month">
    <Name xml:lang="en">Month</Name>
  </Term>
  <Term termID="year">
    <Name xml:lang="en">Year</Name>
  </Term>
  <Term termID="plays">
    <Name xml:lang="en">Plays</Name>
  </Term>
</ClassificationScheme>

```

## A.18 DerivationReasonCS

```

<?xml version="1.0" encoding="UTF-8"?>
<ClassificationScheme uri="urn:tva:metadata:cs:DerivationReasonCS:2007">
  <!-- ##### -->
  <!-- DERIVATIONREASON -->
  <!-- ##### -->
  <Term termID="VIOLENCE">
    <Name xml:lang="en">Violence</Name>
    <Definition xml:lang="en">The derivative has been edited to remove violent

```

```

scenes.</Definition>
</Term>
<Term termID="LANGUAGE">
  <Name xml:lang="en">Language</Name>
  <Definition xml:lang="en">The derivative has been edited to remove bad language.</Definition>
</Term>
<Term termID="SEX">
  <Name xml:lang="en">Sex</Name>
  <Definition xml:lang="en">The derivative has been edited to remove scenes of a sexual
nature.</Definition>
</Term>
<Term termID="DURATION">
  <Name xml:lang="en">Duration</Name>
  <Definition xml:lang="en">The derivative has been edited to alter its length.</Definition>
<Term termID="DURATION.LONGER">
  <Name>Longer</Name>
  <Definition xml:lang="en">The derivative is an extended variant of the original.</Definition>
</Term>
<Term termID="DURATION.SHORTER">
  <Name>Shorter</Name>
  <Definition xml:lang="en">The derivative is a shorter variant of the original, such as edited
highlights.</Definition>
</Term>
</Term>
<Term termID="SIGNING">
  <Name xml:lang="en">Signing</Name>
  <Definition xml:lang="en">The derivative is a signed variant of the original.</Definition>
</Term>
<Term termID="CUT">
  <Name xml:lang="en">Special cut</Name>
  <Definition xml:lang="en">The derivative is a special cut of the original.</Definition>
<Term termID="CUT.DIRECTOR">
  <Name>Director's cut</Name>
  <Definition xml:lang="en">The derivative is the Director's Cut of the
original.</Definition>
</Term>
<Term termID="CUT.AIRLINE">
  <Name>Airline cut</Name>
  <Definition xml:lang="en">The derivative is a cut of the original to make it suitable for
viewing on an aeroplane.</Definition>
</Term>
</Term>
</ClassificationScheme>

```

## A.19 CaptionCodingFormatCS

```

<?xml version="1.0" encoding="UTF-8"?>
<ClassificationScheme uri="urn:tva:metadata:cs:CaptionCodingFormatCS:2007">
  <!-- ##### -->
  <!-- CAPTIONCODINGFORMAT -->
  <!-- ##### -->
  <Term termID="1">
    <Name xml:lang="en">WST Subtitles</Name>
    <Definition xml:lang="en">World System Teletext subtitles.</Definition>
  </Term>
  <Term termID="2">
    <Name xml:lang="en">DVB Subtitles</Name>
    <Definition xml:lang="en">Digital Video Broadcasting Subtitles [EN 300 743].</Definition>
    <Term termID="2.1">
      <Name>DVB Subtitles (bitmaps)</Name>
      <Definition>DVB subtitling service containing object_data_segment{}s with
object_coding_method=0x00.</Definition>
    </Term>
    <Term termID="2.2">
      <Name>DVB Subtitles (characters)</Name>
      <Definition>DVB subtitling service containing object_data_segment{}s with
object_coding_method=0x01.</Definition>
    </Term>
  </Term>
</ClassificationScheme>

```

---

## Annex B (normative): Use of classification schemes for multi-dimensional content classification

In multi-dimensional classification systems each content item is usually classified as many times as there are dimensions in the system. A multi-dimensional classification system can be understood as a way to describe a content item according to several coordinates in a multi-dimensional space.

In such a multi-dimensional classification system each content item is potentially classifiable in each of the dimensions used - i.e. each dimension is applicable to every programme or commercial.

Each dimension is used to describe content from a single viewpoint. Classification of a programme in one specific dimension may not, by itself, be meaningful. In most cases, it is only the *combination* of classification terms drawn from multiple dimensions that leads to significance.

Each dimension is structured in a hierarchical way to enable greater precision and flexibility in the description of the aspect involved.

---

### B.1 Dimensions used in TVA programme classification

*TV-Anytime* programme classification is based on these dimensions:

- Intention.
- Format.
- Content.
- Content Commercial.
- Origination.
- Intended Audience.
- Language.
- Content Alert.
- Media Type.
- Atmosphere.
- Audio Purpose.
- Purchase Type.
- Unit Type.
- DerivationReasonType.
- CaptionCodingFormat.

For each of these dimensions, a TVA at least one default hierarchical CS of up to 3 levels has been defined. It is possible to provide terms beyond the lowest level of any CS by the use of the Keyword element.

### IntentionCS

Contains terms that describe the intention of the programme at the conceptual phase, e.g. entertainment, information, education. This information can be useful for the classification of early transmitted "attractors".

uri= "urn:tva:metadata:cs:IntentionCS:2005"

### FormatCS

Contains terms that describe the format of a programme, e.g. artistic performance, a magazine show, a cartoon.

uri= "urn:tva:metadata:cs:FormatCS:2007"

### ContentCS

Contains terms that describe the nature and and/or subject of the programme or commercial, e.g. soccer.

uri= "urn:tva:metadata:cs:ContentCS:2007"

### ContentCommercialCS

Contains terms that describe the nature and and/or subject of a commercial.

uri= "urn:tva:metadata:cs:ContentCommercialCS:2005"

### OriginationCS

Contains terms that describe the origination of the programme (e.g. live from a studio, a cinema release movie, etc.).

uri= "urn:tva:metadata:cs:OriginationCS:2005"

### IntendedAudienceCS

Contains terms that describe the intended audience for the programme (e.g. by gender, age, socio-economic group or educational level).

uri= "urn:tva:metadata:cs:IntendedAudienceCS:2005"

### LanguageCS

Contains terms that describe the language of the intended audience for the programme.

uri= "urn:tva:metadata:cs:LanguageCS:2004"

### Content AlertCS

Provides a means of alerting a viewer that there are elements within the programme they may not wish to be exposed to, i.e. a "detractor". Strong language, scenes of a sexual nature, etc.

uri= "urn:tva:metadata:cs:ContentAlertCS:2005"

### Media TypeCS

Contains terms that describe the medium of the content (e.g. Video and Audio, a multimedia application, audio only, audio video enhancements, etc.).

uri= "urn:tva:metadata:cs:MediaTypeCS:2005"

### AtmosphereCS

Contains terms that convey the psychological or emotional ("soft") characteristics of a content item.

uri= "urn:tva:metadata:cs:AtmosphereCS:2005"

### AudioPurposeCS

Contains terms that describe the main purpose for the audio track to be available.

uri= "urn:tva:metadata:cs:AudioPurposeCS:2007"

### PurchaseTypeCS

Contains three basic modes of purchase: forever, for limited period of time, for a limited number of plays.

uri= "urn:tva:metadata:cs:PurchaseTypeCS:2004"

### UnitTypeCS

Defines quantity units to further qualify a purchase type in "days", "months" or "years" for a period of time and "plays" for a number of plays.

uri= "urn:tva:metadata:cs:UnitTypeCS:2007"

### DerivationReasonCS

Defines a criteria for which a content has been modified.

uri="urn:tva:metadata:cs:DerivationReasonCS:2007"

### CaptionCodingFormatCS

Defines the coding format used for subtitles.

uri="urn:tva:metadata:cs:CaptionCodingFormatCS:2007"

---

## B.2 Guidelines and examples

At least one classification term may be instantiated for each dimension. For Format, Origination and MediaType, when used, one term is preferable.

For Intention, Content and IntendedAudience multiple instantiations may sometimes be required to fully express the nature of the content. In these cases, if equal weight is not to be given to each of the terms used, this should be made explicit through the use of the **type** attribute (which can take the values: main/secondary/other).

For ContentAlert multiple instantiations may often be required (inc. to indicate unambiguously that the content item does **not** require an alert on the grounds of sex/violence etc.). Only one item should, however, be used for each of the sub-classes (such as sex, language or violence).

Table B.1 contains examples of the application of the TVA default content classification CSs to a diverse group of television programmes.

---

## B.3 Adaptation to meet regional and other special needs

Default CSs may be wholly or partially replaced by other CSs to meet regional or other special requirements. These CSs partially or wholly replace and/or extend default TVA CSs. Regional standardization bodies and other relevant bodies will be responsible for the naming of such CSs and for designating namespaces and for hosting and the designation of access URIs. Regional and other non-TVA-default CS names shall not start with the string "tva" and their URNs shall not start with the string "urn:tva:".

Regional and special-purpose CSs shall, where possible, re-use universally applicable terms from TVA default CSs and only replace or add terms to meet specific regional or other special requirements (this can, e.g. be done using the CS import feature described in clause 7.3 of the MPEG-7 MDS (W4242: Multimedia Content Description Interface - Part 5: Multimedia Description Schemes (see ISO/IEC 15938-5 [2])).

---

## B.4 Mapping between TVA and other content classification systems

TVA provides an extensive set of classification terms in the form of its set of default CSs. The schema allows for the possibility of selecting a subset of those terms and mapping them to non-TVA sets of classification terms (which do not necessarily have to be structured in a multi-dimensional or hierarchical manner). The only TVA requirement is that the selected terms be referenced using the appropriate URN.

Where complete mapping is not possible a supplementary CS (see clause B.3) may be created to cover difficult-to-map terms.

Table B.1: Examples of the multi-dimensional classification of television programmes (source: BBC)

TVIntentionCS	TVFormatCS	TVContentCS	TVIntendedAudienceCS	TVOriginationCS	TVContent AlertCS	TVMedia TypeCS
NEWS BULLETIN						
1.2 Information	2.1.1 Bulletin	3.1.1.1 Daily News	4.2.2 Age: Adult	5.8.2.1 TV Studio Live	6.0 Alert Not Required	7.1.3 Audio Video
BLUE PETER (Children's Programme)						
Main: 1.2 information Secondary: 1.1 Entertainment	2.1.2.1 Presenter led Magazine	3.8 Leisure/Hobby	4.2.1.2 Age: Children 8-13	5.8.2.2 TV Studio As live	6.0 Alert Not Required	7.1.3 Audio Video
FILM: TERMINATOR II						
1.1 Entertainment	2.2.1 Fictional portrayal of life	3.4.6.7 Science fiction	4.2.2 Age: Adult 4.6.1 Gender: Male	5.7 Cinema	6.5.2.3 Frequent Deliberate infliction of pain to fantasy characters	7.1.3 Audio Video
FILM: THE RAILWAY CHILDREN						
1.1 Entertainment	2.2.1 Fictional portrayal of life	3.4.14 Period drama	4.2.1 Age Children 4.9.5 Lifestyle Family with children: 8-15	5.7 Cinema	6.0 Alert Not Required	7.1.3 Audio Video
WALKING WITH BEASTS. (Multi stream interactive application)						
Main: 1.1 Entertainment Secondary: 1.3 Education	2.1.4 Documentary	3.1.6.2 Nature/natural sciences	4.1 General audience	5.8.1.3 TV Made on location Edited	6.0 Alert Not Required	7.3.4 Multi stream video Secondary: 7.1.3 Audio Video
THEY THINK IT'S ALL OVER (Quiz about sport)						
1.1 Entertainment	2.4.2 Panel-show	3.5.2.1 Primary Quiz 3.5.7 Secondary Comedy 3.2 Secondary Sport	4.2.2: Age Adult	5.8.2.2 TV Studio As Live	6.6.2 Occasional use of mild swear words and profanities	7.1.3 Audio Video
FA CUP LIVE (Outside Broadcast Football)						
1.1 Entertainment	2.1.3.1 Commented event	3.2.3.12 Football soccer	4.2.2 Age: Adult 4.6.1: Gender Male	5.8.1.1 TV on location Live	6.0 Alert Not Required	7.1.3 Audio Video
ANTIQUES ROADSHOW						
1.1 Entertainment	2.1.2 Magazine	3.8.5.10 Leisure/Hobby Hobbies, Collectables/antiques	4.2.2 Age: Adult 4.9.7: lifestyle Empty Nester 4.9.8: Lifestyle Retired	5.8.1.3 TV On location Edited	6.0 Alert Not Required	7.1.3 Audio Video
TOP OF THE POPS						
1.1 Entertainment	Main: 2.1.2 Magazine Secondary: 2.5 Artistic Performance	3.6.10 Hit-Chart/Song Requests	4.1 General Audience	5.8.2.3 TV Studio Edited	6.0 Alert Not Required	7.1.3 Audio Video

TVIntentionCS	TVFormatCS	TVContentCS	TVIntendedAudienceCS	TVOriginationCS	TVContent AlertCS	TVMedia TypeCS
THE SIMPSONS						
1.1 Entertainment	2.3.3 Cartoon	3.5.7 Comedy	4.2.2 Adults 4.2.1.2 Children 8-13 4.2.1.3 Children 14-15	5.8.2.3 TV Studio edited	6.5.2.2 Occasional Deliberate infliction of pain to fantasy characters including animation	7.1.3 Audio Video
SONGS OF PRAISE (religious programme with Hymns)						
1.1 ENTERTAINMENT	2.5 ARTISTIC PERFORMANCE	3.1.2.3 Religion, Christianity	4.1 General: 4.3.2 General Interest Religious: (KEYWORD Christian)	5.8.1.3 TV On location edited	6.0 Alert Not Required	7.1.3 Audio Video
PARLEZ-VOUS? (Schools programme learning French)						
1.3.1.2 Education, Schools, Secondary	2.1.4 Documentary	3.1.5.2 Languages	4.8.2 Educational Standard: Secondary 4.2.2.1 Age 16-17	5.8.2.3 TV Studio Edited	6.0 Alert Not Required	7.1.3 Audio Video



---

## Annex C (normative): *TV-Anytime* Description Schemes and Classification Schemes

The *TV-Anytime* DSs listed in the present document have been aggregated into several **xsd files identified by the Description Schemes' names**, forming the reference documentation, contained in archive ts\_1028220301v010601p0.zip which accompanies the present document.

The *TV-Anytime* CSs listed in annex A have been aggregated into several **xml files identified by the Classification Schemes' names**, forming the reference documentation, contained in archive ts\_1028220301v010601p0.zip which accompanies the present document.

The MPEG-7 RoleCS.xml file, which is imported by the TVARoleCS, is also contained in ts\_1028220301v010601p0.zip.

The MPEG7\_TVA\_2008 and XML\_2001 xml stubs which are imported by the tva\_metadata\_v16 description schema are also contained in ts\_1028220301v010601p0.zip.

## Annex D (informative): Note on the use of UML-like diagram

### Sequence

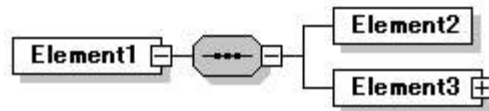

The hexagonal symbol with the horizontal "dotted" line indicates "sequence of". This diagram says the element *Element1* consists of the sequence of elements *Element2* followed by *Element3*.

The box with a "+" mark in it at there right-hand end indicates that there is more structure to them than is shown in the diagram.

### Choice

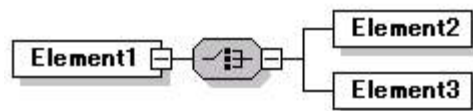

The switch-like symbol indicates a choice. In this case, a choice between the elements, *Element2* and *Element3*.

### Cardinality

#### Optional, one



The dashed line indicates that the element *Element2* is optional. The fact that there is no cardinality indicator says that there can be at most one.

#### Mandatory, one

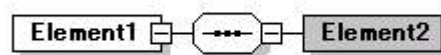

There should be exactly one of the element *Element2*.

#### Optional, repeating

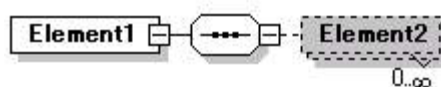

The element *Element2* is optional and may appear an indeterminate number of times. The number of times it may appear is given by the cardinality indicator meaning "zero to infinity". Other numbers may appear to indicate different cardinalities.

Mandatory, repeating

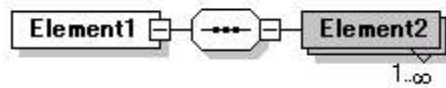

The element *Element2* should appear at least once and may appear an indefinite number of times.

Type

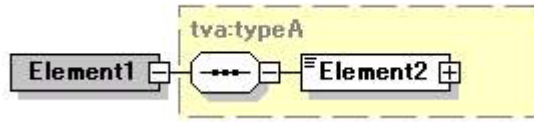

The dotted box shows that element *Element1* is of type "tva:TypeA".

---

## List of figures

Figure 1: Metadata and content flow.....	13
Figure 2: Basic Entity-Relation graph syntax.....	15
Figure 3: Metadata that references a programme CRID.....	16
Figure 4: Relationship between major kinds of <i>TV-Anytime</i> metadata.....	16
Figure 5: <i>TV-Anytime</i> Content Description Model.....	18
Figure 6: Single programme location data model: depicts the high-level data model for programme location.....	51
Figure 7: ProgramLocationType and related types.....	52
Figure 8: Entity-relationship graph for the segmentation-related components of a TVA system.....	79
Figure 9: The XML-based TVA metadata framework.....	98

---

## List of tables

Table 1: Indicative list of Television systems and frame rates.....	40
Table B.1: Examples of the multi-dimensional classification of television programmes (source: BBC) .....	184

---

## History

<b>Document history</b>		
V1.1.1	October 2003	Publication
V1.2.1	September 2004	Publication
V1.3.1	January 2006	Publication
V1.4.1	November 2007	Publication
V1.5.1	May 2009	Publication
V1.6.1	July 2010	Publication