

ETSI TS 103 021-3 V1.1.2 (2003-09)

Technical Specification

**Access and Terminals (AT);
Harmonized basic attachment requirements for Terminals for
connection to analogue interfaces of the Telephone Networks;
Update of the technical contents of TBR 021, EN 301 437,
TBR 15, TBR 17;
Part 3: Basic Interworking with the Public Telephone Network**



Reference

RTS/AT-010118

Keywords

access, PSTN, terminal, POTS

ETSI

650 Route des Lucioles
F-06921 Sophia Antipolis Cedex - FRANCE

Tel.: +33 4 92 94 42 00 Fax: +33 4 93 65 47 16

Siret N° 348 623 562 00017 - NAF 742 C
Association à but non lucratif enregistrée à la
Sous-Préfecture de Grasse (06) N° 7803/88

Important notice

Individual copies of the present document can be downloaded from:

<http://www.etsi.org>

The present document may be made available in more than one electronic version or in print. In any case of existing or perceived difference in contents between such versions, the reference version is the Portable Document Format (PDF). In case of dispute, the reference shall be the printing on ETSI printers of the PDF version kept on a specific network drive within ETSI Secretariat.

Users of the present document should be aware that the document may be subject to revision or change of status. Information on the current status of this and other ETSI documents is available at

<http://portal.etsi.org/tb/status/status.asp>

If you find errors in the present document, send your comment to:

editor@etsi.org

Copyright Notification

No part may be reproduced except as authorized by written permission.
The copyright and the foregoing restriction extend to reproduction in all media.

© European Telecommunications Standards Institute 2003.
All rights reserved.

DECT™, **PLUGTESTS™** and **UMTS™** are Trade Marks of ETSI registered for the benefit of its Members.
TIPHON™ and the **TIPHON logo** are Trade Marks currently being registered by ETSI for the benefit of its Members.
3GPP™ is a Trade Mark of ETSI registered for the benefit of its Members and of the 3GPP Organizational Partners.

Contents

Intellectual Property Rights	5
Foreword.....	5
1 Scope	6
2 References	6
3 Definitions and abbreviations.....	7
3.1 Definitions	7
3.2 Abbreviations	8
4 Requirements.....	9
4.1 Parallel connection	9
4.2 Feeding voltage	9
4.3 Requirements in all conditions: polarity.....	9
4.4 General requirements in quiescent state	9
4.4.1 DC resistance	9
4.4.2 Characteristics of TE for ringing signals	9
4.4.2.1 Impedance	9
4.4.2.2 Transient response.....	10
4.4.2.3 DC current.....	10
4.4.3 Resistance to earth	10
4.4.4 Impedance.....	10
4.5 Ringing signal detection sensitivity.....	11
4.6 Transition from quiescent to loop state	11
4.6.1 Acceptance of breaks in the loop in a call attempt.....	11
4.6.2 Loop current characteristics	12
4.6.3 On-Hook to Off-Hook transition with ringing without DC	13
4.6.4 Ring trip	14
4.7 Loop steady state characteristics	15
4.7.1 DC characteristics	15
4.7.2 Impedance.....	16
4.7.3 Resistance to earth	16
4.8 Call attempt	16
4.8.1 Automatic dialling	16
4.8.1.1 Dialling without dial tone detection	16
4.8.1.2 Dialling with dial tone detection	16
4.8.2 DTMF signalling	17
4.8.2.1 Frequency combination.....	17
4.8.2.2 Signalling levels.....	17
4.8.2.2.1 Absolute levels	17
4.8.2.2.2 Level difference.....	18
4.8.2.3 Unwanted frequency components	18
4.8.2.4 Tone duration	18
4.8.2.5 Pause duration	18
4.8.3 Loop disconnect dialling.....	18
4.8.4 Register recall	18
4.8.5 Call attempt on a low voltage line	18
4.9 Transition from loop state to quiescent state	19
Annex A (informative): Test methods.....	20
A.1 General	20
A.2 Test impedances	20
A.3 Feeding bridge.....	20
A.4 Test methods	20
A.4.1 Parallel connection	20

A.4.2	Feeding voltage	20
A.4.3	Requirements in all conditions	20
A.4.4	General requirements in quiescent state	20
A.4.4.1	DC Resistance.....	20
A.4.4.2	Characteristics of TE for ringing signals	21
A.4.4.2.1	Impedance	21
A.4.4.2.2	Transient response.....	22
A.4.4.2.3	DC current.....	23
A.4.4.3	Resistance to earth	24
A.4.4.4	Impedance.....	25
A.4.5	Ringing signal detector sensitivity	26
A.4.6	Transition from quiescent state to loop state	27
A.4.6.1	Acceptance of breaks in the loop in a call attempt.....	27
A.4.6.2	Loop current characteristics	28
A.4.6.3	On-hook to off-hook transition with ringing without DC	29
A.4.6.4	Ring trip	29
A.4.7	Loop steady state characteristics	30
A.4.7.1	DC characteristics	30
A.4.7.2	Impedance.....	31
A.4.7.3	Resistance to earth	32
A.4.8	Call attempt	33
A.4.8.1	Automatic dialling	33
A.4.8.1.1	Dialling without dial tone detection	33
A.4.8.1.2	Dialling with dial tone detection	34
A.4.8.2	DTMF signalling	35
A.4.8.2.1	Frequency combinations	35
A.4.8.2.2	Signalling levels.....	36
A.4.8.2.3	Unwanted frequency components	37
A.4.8.2.4	Tone duration	39
A.4.8.2.5	Pause duration	40
A.4.8.3	Loop disconnect dialling.....	42
A.4.8.4	Register recall	42
A.4.8.5	Call attempt on a low voltage line	42
A.4.9	Transition from loop to quiescent state	43
Annex B (informative): Requirements Table (RT).....		44
B.1	Guidance for completion of the RT.....	44
B.1.1	Condition table	44
B.1.2	Requirements table	44
Annex C (informative): Bibliography		47
History		48

Intellectual Property Rights

IPRs essential or potentially essential to the present document may have been declared to ETSI. The information pertaining to these essential IPRs, if any, is publicly available for **ETSI members and non-members**, and can be found in ETSI SR 000 314: "*Intellectual Property Rights (IPRs); Essential, or potentially Essential, IPRs notified to ETSI in respect of ETSI standards*", which is available from the ETSI Secretariat. Latest updates are available on the ETSI Web server (<http://webapp.etsi.org/IPR/home.asp>).

Pursuant to the ETSI IPR Policy, no investigation, including IPR searches, has been carried out by ETSI. No guarantee can be given as to the existence of other IPRs not referenced in ETSI SR 000 314 (or the updates on the ETSI Web server) which are, or may be, or may become, essential to the present document.

Foreword

This Technical Specification (TS) has been produced by ETSI Technical Committee Access and Terminals (AT).

The present document is a minor editorial update of the first version to include text which was omitted from tables B.1 and B.2.

The present document is part 3 of a multipart deliverable covering technical updates to the TBRs:

Part 1: "General aspects";

Part 2: "Basic transmission and protection of the network from harm".

Part 3: "Basic Interworking with the Public Telephone Network", standardizes the aspects of interworking with the network. This part 3 only applies to TE intended for switched networks".

1 Scope

The present document is a part of a multipart document. It specifies basic compatibility and interoperability aspects, including basic transmission, which are applicable to all Terminal Equipment (TE) intended to be connected to analogue interfaces of public or private, switched or non switched telephone networks. The present document is applicable to a TE which is capable of accessing an analogue telephone network line at the Network Termination Point (NTP).

The present document is intended to ensure correct interworking between network and terminal so that calls can be routed successfully through the network, but without any guarantee of terminal to terminal interoperability.

The present document is intended to ensure that no harm occurs to the network.

2 References

The following documents contain provisions which, through reference in this text, constitute provisions of the present document.

- References are either specific (identified by date of publication and/or edition number or version number) or non-specific.
- For a specific reference, subsequent revisions do not apply.
- For a non-specific reference, the latest version applies.

Referenced documents which are not found to be publicly available in the expected location might be found at <http://docbox.etsi.org/Reference>.

- | | |
|------|--|
| [1] | Void. |
| [2] | ETSI ES 201 235 (all parts): "Specification of Dual Tone Multi-Frequency (DTMF) transmitters and receivers". |
| [3] | ETSI ES 201 970 (2002): "Access and Terminals (AT); Public Switched Telephone Network (PSTN); Harmonized specification of physical and electrical characteristics at a 2-wire analogue presented Network Termination Point (NTP)". |
| [4] | ETSI ES 201 187: "2-wire analogue voice band interfaces; Loop Disconnect (LD) dialling specific requirements". |
| [5] | ETSI ES 201 729: "Public Switched Telephone Network (PSTN); 2-wire analogue voice band switched interfaces; Timed break recall (register recall); Specific requirements for terminals". |
| [6] | ETSI EG 201 120: "Public Switched Telephone Network (PSTN); Method of rating terminal equipment so that it can be connected in series and/or in parallel to a Network Termination Point (NTP)". |
| [7] | Void. |
| [8] | ITU-T Recommendation G.100: "Definitions used in Recommendations on general characteristics of international telephone connections and circuits". |
| [9] | ETSI TR 101 183: "Public Switched Telephone Network (PSTN); Analogue ringing signals". |
| [10] | ETSI TR 101 041 (all parts): "Human Factors (HF); European harmonization of network generated tones". |
| [11] | ITU-T Recommendation E.180: "Technical characteristics of tones for the telephone service". |
| [12] | ITU-T Recommendation Q.35: "Technical characteristics of tones for the telephone service". |

- [13] ETSI TS 103 021-1: "Access and Terminals (AT); Harmonized basic attachment requirements for Terminals for connection to analogue interfaces of the Telephone Networks; Update of the technical contents of TBR 021, EN 301 437, TBR 015, TBR 017; Part 1: General Aspects".
- [14] ETSI TBR 038: " Public Switched Telephone Network (PSTN); Attachment requirements for a terminal equipment incorporating an analogue handset function capable of supporting the justified case service when connected to the analogue interface of the PSTN in Europe".

3 Definitions and abbreviations

3.1 Definitions

For the purposes of the present document, the following terms and definitions apply:

automatic repeat call attempt: attempt made by the TE to the same network address as the result of the failure of the previous call attempt and not as a result of an external stimulus to the TE

call attempt: process by which the TE seizes the PSTN line and sends signalling characters of the network address with which the TE wishes to communicate

connection to earth: all the following points, as applicable are connected to the earth point during measurement:

- a point in the TE which is intended to be connected to mains earth (in practice this might be carried out by connecting to the earth of the mains source which is supplying the TE);
- connector points which are intended to be connected to earth during the normal operation of the apparatus.

dBV: absolute voltage level expressed in decibels with respect to 1 volt

loop state: state where the TE draws sufficient DC current to activate the exchange

loop steady state: loop state excluding the transitions from and to quiescent state

Network Termination Point (NTP): physical point at the boundary of the PSTN intended to accept the connection of a TE

NOTE: See figure 1.

quiescent state: state where the TE draws insufficient DC current to activate the exchange

peak to peak voltage: the difference between the maximum and minimum voltage during any 10 ms window

Public Switched Telephone Network (PSTN): term is used to describe the ordinary telephone system including subscriber lines, local exchanges and the complete system of trunks and the exchange hierarchy which makes up the network

reference impedance Z_R : complex impedance made up of 270 Ω in series with a parallel combination of 750 Ω and 150 nF

NOTE: This is shown in figure A.1 of TS 103 021-1 [13].

repeat call attempt: further call attempt to the same network address resulting from a failure to establish connection during the previous call attempt

repeat call attempt sequence: series of internally generated automatic repeat call attempts made in response to an initial call attempt

NOTE: Additional, but separate, call requests are permitted to initiate separate repeat call attempt sequences.

return loss: As defined in ITU-T Recommendation G.100 [8] clause 1.22

Telephone Network (TN): telecommunication network mainly exchanging voice band signals

NOTE: TN is a general term for PSTN, non-switched leased lines and Private telephone networks.

Terminal Connection Point (TCP): point of the TE intended to be connected to the Telephone Network.

NOTE: An adapter may be required between the terminal and the existing national network termination point in individual countries. Such an adapter is outside the scope of the present document (see figure 1).

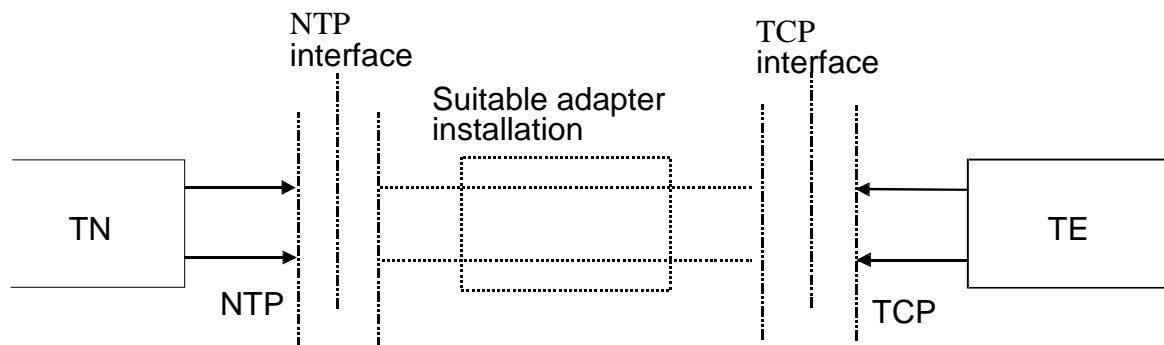

Figure 1: Terminal connection point and network termination point

Terminal Equipment (TE): equipment intended to be connected to the TN; i.e.:

- to be connected directly to the termination (NTP) of a TN; or
- to interwork with a TN being connected directly or indirectly to the NTP,

in order to send, process or receive information. The system of connection may be wire, radio, optical or other electromagnetic system

NOTE: TE intended to be connected to public networks may be subject to particular regulatory treatment, whereas TE intended to be connected to private networks are usually not subject to particular regulatory treatment.

3.2 Abbreviations

For the purposes of the present document, the following abbreviations apply:

AC	Alternating Current
DC	Direct Current
DTMF	Dual Tone Multi-Frequency
EMF	Electro Motive Force
LU	Loading Units
NTP	Network Termination Point
PSTN	Public Switched Telephone Network
rms	root mean square
SLIC	Subscriber Line Integrated Circuit
TCP	Terminal Connection Point
TE	Terminal Equipment
TN	Telephone Network

4 Requirements

4.1 Parallel connection

As stated in TS 103 021-1 [13], although up to four TE are considered for parallel connection, it is assumed that only one of them is in the loop state at any one time.

It is assumed that the network driving capability is 100 LU as defined in EG 201 120 [6].

4.2 Feeding voltage

The feeding voltage value of 50 VDC in the requirement and test parts is only a harmonized test value. It does not necessarily reflect the real TN supply voltages.

4.3 Requirements in all conditions: polarity

Justification: Interworking with the TN is assured by requiring the TE to operate with both DC polarities, since a fixed polarity is not guaranteed.

Requirement: The TE shall conform to the requirements of this document for both polarities of the DC line feeding voltage.

Test: Where tests with both polarities are needed, this is indicated in relevant clauses in annex A.

4.4 General requirements in quiescent state

4.4.1 DC resistance

Justification: Interworking with the TN is assured by requiring the TE to present a sufficiently high DC resistance in quiescent state so as not to disturb the basic call control and to prevent the malfunction of network call control equipment.

Requirement: The current drawn by the TE when connected to a source of:

- 100 VDC;
- 50 VDC;
- 25 VDC,

shall not exceed that which would be drawn by a 4 M Ω resistor replacing the TE. This requirement applies 30 s after the voltage has been applied.

For TE intended to be connected as a single terminal to an NTP the value of 1 M Ω is acceptable.

Test: The test shall be conducted according to clause A.4.4.1.

4.4.2 Characteristics of TE for ringing signals

4.4.2.1 Impedance

Justification: Interworking with the TN is assured by requiring the TE to present an impedance to ringing signals that is sufficiently high.

Requirement: The impedance of the TE at frequencies of 25 Hz and 50 Hz shall not be less than 16 k Ω when tested at 30 V rms with and without a DC component.

For TE intended to be connected as a single terminal to an NTP the value of 4 k Ω is acceptable.

Test: The test shall be conducted according to clause A.4.4.2.1.

4.4.2.2 Transient response

Justification: Interworking with the TN is assured by limiting the current transient at the beginning of a ringing signal.

Requirement: When ringing signals are applied to the terminal equipment in the quiescent state, the resulting current shall not cause the public exchange to detect a loop state. This shall be verified by DC excitation of the TE in quiescent state. The current shall be equal to or less than 25 mA, 1 ms after commencement of the excitation, and equal to or less than 10 mA, 6 ms after commencement.

Test: The test shall be conducted according to clause A.4.4.2.2.

4.4.2.3 DC current

Justification: Interworking with the TN is assured by requiring the TE to avoid creating DC current due to asymmetric load of the ringing signal (e.g. caused by the use of overvoltage arrestors). This requirement avoids false seizure of the TN.

Requirement: The resulting DC current during the ringing signal, tested with a 25 Hz and 50 Hz AC signal at a voltage of 90 V rms superimposed or not on a DC voltage of 60 V, shall be less than 0,6 mA.

Test: The test shall be conducted according to clause A.4.4.2.3.

4.4.3 Resistance to earth

Justification: Interworking with the TN is assured by requiring the TE to present a sufficiently high DC resistance to earth in the quiescent state to prevent the malfunction of network call control equipment and network test equipment.

Requirement: the DC resistance between each line terminal of the TE and earth in the quiescent state when tested at 100 V DC, shall be not less than 40 M Ω .

For TE intended to be connected as a single terminal to an NTP the value of 10 M Ω is acceptable.

Test: The test shall be conducted according to clause A.4.4.3

4.4.4 Impedance

Justification: To allow for parallel installation of TE without degrading performance.

Requirement: The quiescent state impedance of the TE shall be as specified in table 1

Table 1: Impedance

Frequency (kHz)	Impedance (k Ω)
0,2 to 4,3	≥ 40
12	≥ 5
16	≥ 5

For TE intended to be connected as a single terminal to an NTP this clause does not apply.

Test: The test shall be conducted according to clause A.4.4.4.

4.5 Ringing signal detection sensitivity

Justification: Interworking with the TN is assured by requiring the TE to detect valid ringing signals.

Requirement: If a ring detect function is provided and enabled, the TE shall be able to respond to ringing signals of 30 V rms or higher at 25 Hz and 50 Hz with a cadence of 1 s ON and 5 s OFF, superimposed or not superimposed on a 50 VDC feeding voltage.

The response shall be as stated by the supplier.

Test: The test shall be conducted according to clause A.4.5.

NOTE 1: For example, a TE might:

- generate a signal denoting an incoming call in accordance with the supplier's instructions; or
- be configured to seize the line according to clause 4.6.

NOTE 2: A TE designer should be aware that a number of different ringing voltages, frequencies, harmonic contents and cadences are in use, and more are likely to be brought into several TNs. TR 101 183 [9] gives information on common ring cadences in use. To ensure operation within all the TNs to which the TE is intended to be connected, the designer will need to choose the appropriate combination of parameters. An incorrect choice of parameters could lead to unsatisfactory operation.

NOTE 3: Some TNs generate signals as low as 24 Vrms especially in the case of some new technologies. Particularly for some electro-acoustic ringers without local power supply for the TE, it is recognized that this voltage may be insufficient to produce an acoustic output expected from some users or suitable for applications in noisy surroundings.

NOTE 4: 10 Hz signal from parallel connected pulse dialling TE, network test signals or unintended induction from power lines may cause significant signal levels (up to 16 Vrms at ringing frequencies) to appear on the line. Such conditions may cause incorrect interworking, if the TE does not provide sufficient immunity.

4.6 Transition from quiescent to loop state

4.6.1 Acceptance of breaks in the loop in a call attempt

Justification: Interworking with the TN is assured by requiring the TE to accept breaks in the loop current during establishment of loop state.

Requirement: If, during the transition from quiescent to the loop state for the purpose of making a call, the line feeding current has first reached and remained at a value greater than 12,8 mA for a duration of between 30 ms and 500 ms, the current is interrupted for a period of 400 ms. When the source of the feeding current is reconnected:

- the line current shall have reached a value greater than 12,8 mA within 20 ms of the reconnection of the feeding source;
- during the period between 20 ms and 100 ms following the reconnection of the feeding source, the current shall not drop below 12,8 mA for more than 7 ms. For the purpose of this requirement, any periods during which the current is less than 12,8 mA are aggregated and the total shall not exceed the limit stated.

This requirement applies when the line feeding current is provided by a source of 50 V DC in series with a resistance of 850 Ω .

Test: The test shall be conducted according to clause A.4.6.1.

4.6.2 Loop current characteristics

Justification: Interworking with the TN is assured by requiring the TE to be able to seize the line.

Requirement: The loop current determined by the TE shall:

- exceed the value of I_{f1} before t_1 after the seizure; and
- remain above I_{f1} for at least a further $(t_2 - t_{01})$ time; and
- remain above I_{f2} between t_2 and t_3 , for conditions of the table 3 and figure 3.

The limit values $(t_1 - t_0)$, $(t_2 - t_{01})$, $(t_3 - t_{01})$, I_{f1} and I_{f2} are given in tables 2 and 3 and shown in figures 2 and 3 and:

- « t_0 » is the reference moment of seizure, when the loop current exceeds 0,1 mA for the first time with a feeding voltage of 50 VDC and stays above this value for more than 5 ms;
- « t_{01} » is the reference moment, when the loop current exceeds the current I_{f1} for the first time with a feeding voltage of 50 VDC and stays above this value for more than 5 ms; and
- transient periods are permitted during which the loop current drops below the limits stated in this clause, as long as when aggregated, they do not exceed 7 ms.

Table 2: TE current characteristics with feeding resistors which are not used during the loop steady state

Condition		Requirements		
Feeding voltage V_f	Feeding resistance R_f	Time (ms)		Current (mA)
		t_1 to t_0	t_2 to t_{01}	I_{f1}
50 VDC	150 k Ω	400	400	0,30
50 VDC	36 k Ω	400	400	1,25
50 VDC	24 k Ω	400	400	1,86
50 VDC	8 k Ω	400	400	5,00

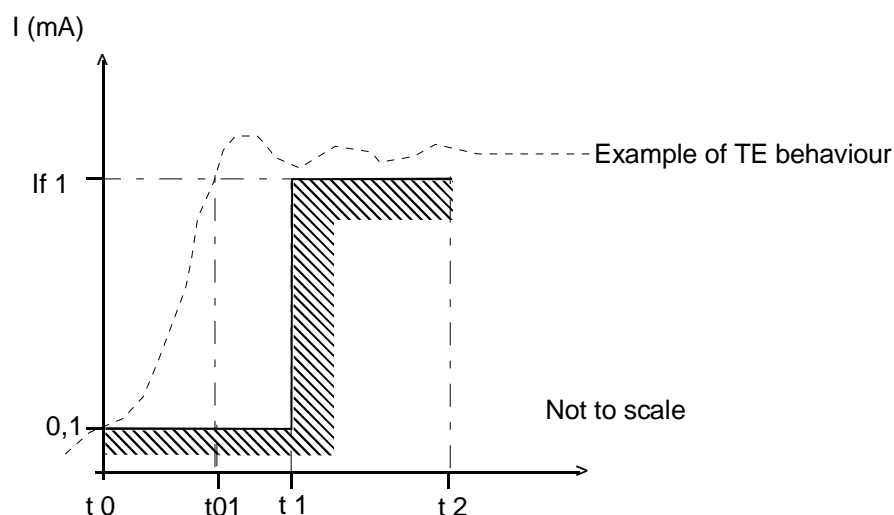

Figure 2: TE current characteristics with feeding resistors which are not used during the loop steady state

The entries in table 3 with $R_f = 2\,300\ \Omega$ are only applicable for TE, which has been declared by the manufacturer for use only on lines providing a loop current 18 mA or greater, which then are a replacement for the table entry with $R_f = 2\,800\ \Omega$.

Table 3: TE current characteristics with feeding resistors which are used during the loop steady state

Condition		Requirements				
Feeding voltage	Feeding resistance	Time (ms)			Current (mA)	
Vf	Rf	t1 to t0	t2 to t01	t3 to t01	If1	If2
50 VDC	2,8 kΩ	30	500	1200	15,0	14,6
50 VDC	2,3 kΩ	30	500	1200	18,2	17,8
50 VDC	400 Ω	20	500	1 200	47,2	47,2

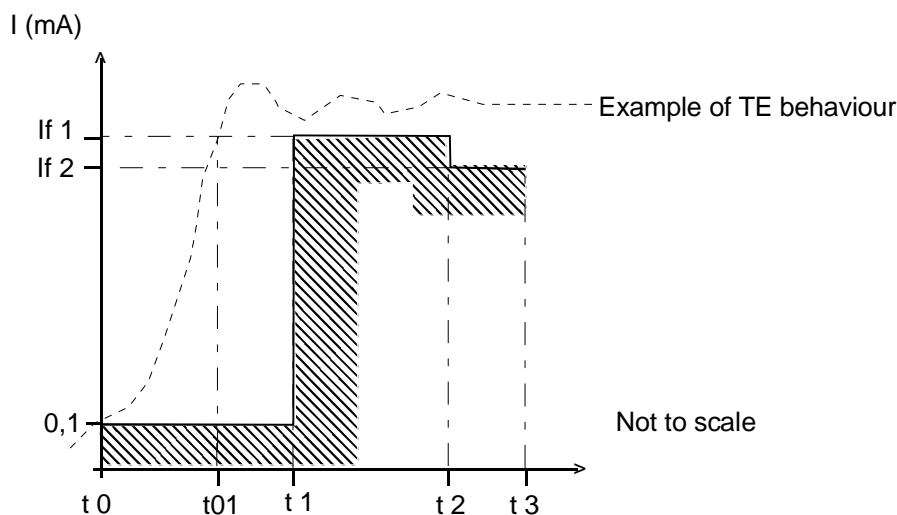

Figure 3: TE current characteristics with feeding resistors which are used during the loop steady state

Test: The test shall be conducted according to clause A.4.6.2.

4.6.3 On-Hook to Off-Hook transition with ringing without DC

Justification: Interworking with the TN if a ring without DC occurred is assured by requiring the TE to properly seize the line.

Requirement: The loop current determined by the TE shall exceed the value of I2 before t2 after the seizure according to the conditions of table 4 and figure 4.

- It is recommended that the transition is tested by measuring the AC current to the TE with measurement equipment or a test device that takes samples of the value of the AC current and stores the values in a memory e.g. for calculations.
- The sample rate should be 1 000 samples per second for 25 Hz ringing (and 2 000 samples per second for 50 Hz ringing). The transient is sampled and the samples are integrated in the time domain over a "time sliding window" of 20 ms (10 ms for 50 Hz). The result of the integration shall fall within the mask of figure 4.

NOTE: The length of the "time sliding window" is half a period of the ringing (sine) wave.

The integration is performed according to the formula:

$$I(t) = \frac{1}{20} \sum_{k=1}^{20} |I_k(t)|$$

Table 4: Test conditions and requirements for the transient test

EMF of the Ringing Source	50 Vrms
Impedance of the ringing source	800 Ω
I_1	130 % of the steady "on-hook" state AC current value
I_2	36 mA or 80 % of the steady "off-hook" (loop) state AC current value (which ever value is reached first)
$t_1 - t_0$	as short as possible
$t_2 - t_1$	40 ms
$t_0 =$	is the time when the TE goes off-hook, in general this is indicated by activating/closing of the hook switch;
$t_1 =$	the time when current $I(t)$, calculated by the equitation, passes value I_1 ;
$t_2 =$	the time when current $I(t)$, calculated by the equitation, becomes and remains above value I_2 .

To have a short ring trip, the time $t_1 - t_0$ should be as short as possible.

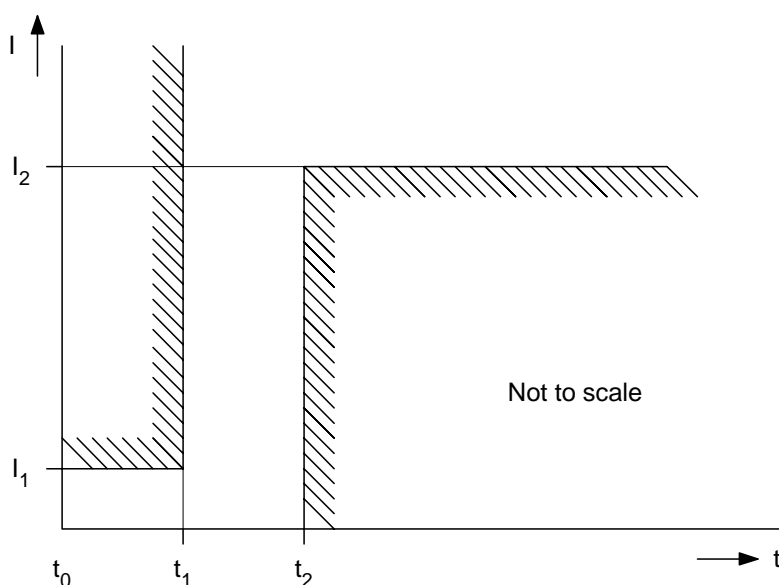

Figure 4: Mask for test of the transition of the TE from the quiescent state to the loop state during a ringing pulse

Test: The test shall be conducted according to clause A.4.6.3.

4.6.4 Ring trip

Justification: Interworking with the TN if a ring without DC occurred is assured by requiring the TE to properly seize the line.

Requirement: When the TE goes off-hook during a ringing pulse, the TE shall draw an AC current, of which the effective value (rms) is equal or more than 36 mA. This should be tested at 25 Hz as well as 50 Hz. This requirement applies for the steady state, some time after the transition of the TE to the loop state has started. The requirement for transition itself is described in clause 4.6.3.

Test: The test shall be conducted according to clause A.4.6.4.

4.7 Loop steady state characteristics

Justification: This requirement is to ensure correct seizure and interworking on a wide range of existing networks.

The requirements during the loop steady state apply when the TE has been in the loop state for a minimum of 1,2 s with a line feeding current which can be obtained when the TE is connected to a source of 50 V DC in series with a resistor within the range of 2 800 Ω to 400 Ω .

For the purpose of conducting the tests of clauses A.4.7 and A.4.8 including all applicable clauses the maximum feed resistance of 2 800 Ω shall be replaced by 2 300 Ω for TE declared to be intended for use only on lines providing a loop current of 18 mA or greater.

4.7.1 DC characteristics

Justification: Interworking with the TN is assured by requiring the TE to present a sufficiently low DC resistance in loop state.

Requirement: The DC voltage/current characteristics of the TE within the operating range as stated in clause 4.7 shall not exceed the limits given in table 5 and shown in figure 5.

Table 5: TE voltage/current characteristics

Point	Voltage (V)	Current (mA)
A	9,0	0
B	9,0	20,0
C	14,5	42,0
D	40,0	50,0

NOTE: Limits for intermediate currents can be found by drawing a straight line between the break points on a linear voltage/current scale.

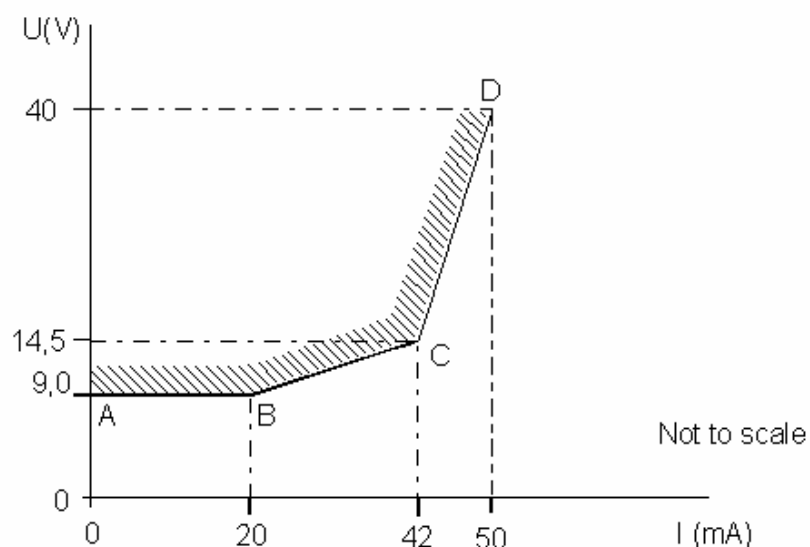

Figure 5: TE voltage/current characteristics

Test: The test shall be conducted according to clause A.4.7.1.

4.7.2 Impedance

Justification: Interworking with the TN is assured by requiring the TE to present an impedance which allows proper functioning of call control and to maintain stability.

Requirement: The return loss, with respect to the reference impedance Z_R , shall not be less than 8 dB in the frequency range 300 Hz to 4 000 Hz and not less than 6 dB in the frequency range 200 Hz to 300 Hz.

In the frequency range 200 Hz to 300 Hz, the reactive component of the impedance shall not be greater than 500 Ω inductive (+j 500).

Test: The test shall be conducted according to clause A.4.7.2.

For voice TE the echo return loss should be at least 14 dB, e.g. as specified in TBR 038 [14].

4.7.3 Resistance to earth

Justification: Interworking with the TN is assured by requiring the TE to present a sufficiently high DC resistance to earth in loop state so as not to disturb the basic call control function.

Requirement: Where the supplier's instructions state that a connection to earth is intended, the DC resistance between each line terminal of the TE and earth in loop state when tested at 100 V DC shall be not less than 1 M Ω .

Test: The test shall be conducted according to clause A.4.7.3.

4.8 Call attempt

All requirements in clause 4.7 will also apply during a call attempt.

This clause only applies for terminals intended for outgoing calls.

4.8.1 Automatic dialling

This requirement applies only to a TE with an automatic seizing and dialling function. It applies when the TE is in automatic dialling mode.

4.8.1.1 Dialling without dial tone detection

Justification: Interworking with the TN is assured by requiring a TE with automatic dialling to start sending its digits during the time period when the network is ready to receive digits under normal conditions.

Requirement: The TE shall start dialling not earlier than 2,7 s and before 8 s has elapsed after the loop state is established. Where adjustments are available to the user, resulting in a lower value, this is acceptable as long as the 2,7 s limit remains within the available range.

NOTE: It is recognized that, in some rare cases, the network may not be able to receive dialling signals within 3 s. Also, some networks will not accept addressing information after 5 s has elapsed.

Test: The test shall be conducted according to clause A.4.8.1.1.

4.8.1.2 Dialling with dial tone detection

Justification: Interworking with the TN is assured by requiring a TE with automatic dialling to start sending its digits during the time period when the network is ready to receive digits.

Requirement: If the TE is intended for automatic dialling with an automatic dial tone detection, and this facility is enabled in accordance with the supplier's instruction, it shall start dialling within 8 s of the start of the application to the TE of:

- a continuous dial tone; and
- a cadenced dial tone whose cadence comprises a repeated sequence of:
 - 200 ms ON, followed by 200 ms OFF, followed by 600 ms ON, followed by 1 000 ms OFF.

For the purposes of this requirement, the dial tone is defined as a single tone signal, delivered from a generator with a source impedance equal to Z_R , in the frequency range 300 Hz to 500 Hz, whose level is between -35,7 dBV and -0,7 dBV when measured across the reference impedance Z_R which substitutes the TE.

Test: The test shall be conducted according to clause A.4.8.1.2.

NOTE : A TE designer should be aware that a number of different dialtone levels, frequencies and cadences are in use, and more are likely to be introduced in several TNs. TR 101 041 [10] and ITU-T Recommendations. E.180 [11] and Q.35 [12] give information on dialtone parameters in use, sometimes associated with some special services. To ensure operation within all the TNs to which the TE is intended to be connected, the designer has to choose the appropriate combination of parameters. An incorrect choice of parameters could lead to unsatisfactory operation.

4.8.2 DTMF signalling

DTMF signalling is specified in detail in ES 201 235 [2].

Justification: Interworking with the TN is assured by requiring the TE to send digits that the network accepts by means of DTMF signals.

4.8.2.1 Frequency combination

Requirement: The TE shall use DTMF signalling characters (digits) according to table 6. However, the number of characters supported by the TE can be restricted, in which case only those frequencies assigned to the supported characters shall be used. The tolerances on the frequencies for the characters supported shall be $\pm 1,5\%$.

Table 6: DTMF signalling frequency combinations

Low group (Hz)	High group (Hz)			
	1 209	1 336	1 477	1 633
697	1	2	3	A
770	4	5	6	B
852	7	8	9	C
941	*	0	#	D

Test: The test shall be conducted according to clause A.4.8.2.1.

4.8.2.2 Signalling levels

4.8.2.2.1 Absolute levels

Requirement: The level of any tone in the DTMF high frequency group shall be -9,0 dBV $\pm 2,0/-2,5$ dB and the level of any tone in the low frequency group shall be -11,0 dBV $\pm 2,5/-2,0$ dB when the TE interface is terminated with the reference impedance Z_R .

Test: The test shall be conducted according to clause A.4.8.2.2.

4.8.2.2.2 Level difference

Requirement: During sending of any DTMF frequency combination, the level of the tone in the high frequency group shall be 1 dB to 4 dB higher than the level of the tone in the low frequency group.

Test: The test shall be conducted according to clause A.4.8.2.2.

4.8.2.3 Unwanted frequency components

Requirement: When transmitting any DTMF tone combination during a call attempt, the total sending level of all unwanted frequency components in the frequency range 250 Hz to 4 300 Hz shall be at least 20 dB below the low frequency group component.

Test: The test shall be conducted according to clause A.4.8.2.3.

4.8.2.4 Tone duration

This requirement applies where the DTMF signalling tone duration is controlled automatically by the TE.

Requirement: The TE shall provide a setting whereby the duration for which any individual DTMF tone combination sent is not less than 65 ms. The time shall be measured from the time when the tone reaches 90 % of its steady-state value, until it has dropped to 90 % of its steady-state value.

NOTE: For correct operation of supplementary services, DTMF tone bursts will need to be no longer than 90 ms.

Test: The test shall be conducted according to clause A.4.8.2.4.

4.8.2.5 Pause duration

This requirement applies where the DTMF signalling pause duration is controlled automatically by the TE.

Requirement: The TE shall provide a setting whereby the duration of the pause between any individual DTMF tone combination is not less than 65 ms. The time shall be measured from the time when the tone has dropped to 10 % of its steady-state value, until it has risen to 10 % of its steady-state value.

NOTE: In order to ensure correct reception of all the digits in a network address sequence, some networks may require a sufficient pause after the last DTMF digit signalled and before normal transmission starts.

Test: The test shall be conducted according to clause A.4.8.2.5.

4.8.3 Loop disconnect dialling

Loop Disconnect Dialling is specified in detail in ES 201 187 [4]

Whilst in many countries the telephone networks accept DTMF dialling everywhere, there are still several telephone networks that utilize Loop Disconnect Dialling.

It should be noted that the present document is not to encourage further use of Loop Disconnect Dialling.

4.8.4 Register recall

Register recall is specified in detail in ES 201 729 [5]

4.8.5 Call attempt on a low voltage line

Justification: Some SLIC can provide an open voltage on the line as low as 38 V. A TE should be able to handle such a low voltage.

Requirement: The TE shall be able to dial with the following line conditions: 38 V/750 Ω .

NOTE: See ES 201 970 [3] to further details

Test: The test shall be conducted according to clause A.4.8.5.

4.9 Transition from loop state to quiescent state

Justification: Interworking with the TN is assured by requiring the TE to correctly release the line.

Requirement : When the TE is connected to a source of 50 VDC in series with a resistor of 2 050 Ω and the TE initiates the transition from the loop to the quiescent state in order to release a call, the current drawn by the TE shall:

- drop to a value below 0,5 mA not later than 200 ms after the reference moment of the release; and
- in the case of automatic release and subsequent automatic reseizure for the purposes of making a new call, remain below a value of 0,5 mA for a minimum of a further 1,5 s. In this case, it is permitted for there to be transient periods during which the current exceeds 0,5 mA, as long as, when aggregated, they do not exceed 20 ms.

The reference moment of the release is defined as the moment when, for the first time, the current has dropped to a value below 10 mA and has remained at a value below 10 mA for a period or periods which, when aggregated, exceed 20 ms.

NOTE: Clause 4.4 states the requirements for the quiescent state, including the DC resistance (clause 4.4.1).

Test: The test shall be conducted according to clause A.4.9.

Annex A (informative):

Test methods

One test may cover more than one requirement. The scope of each test is defined under the heading "purpose".

A.1 General

Refer to A.1 of TS 103 021-1 [13].

A.2 Test impedances

Refer to A.2 of TS 103 021-1 [13].

A.3 Feeding bridge

Refer to A.3 of TS 103 021-1 [13].

A.4 Test methods

A.4.1 Parallel connection

No associated test.

A.4.2 Feeding voltage

No associated test.

A.4.3 Requirements in all conditions

Where test with both polarities are needed this is indicated in relevant clauses of this annex .

A.4.4 General requirements in quiescent state

A.4.4.1 DC Resistance

- **Requirement:** clause 4.4.1;
- **Purpose:** to check whether the TE presents a resistance of at least 4 M Ω (1 M Ω for a TE intended to be connected as a single terminal to an NTP) when tested at 25 VDC, 50 VDC and 100 VDC in the quiescent state.

Measurement principle:

- **Preamble:** set the TE in quiescent state;
- **Test state:** quiescent state.

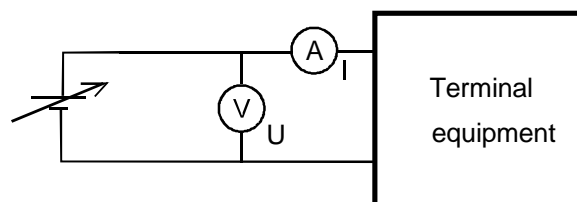
Test configuration:**Figure A.1: DC resistance configuration****Measurement points:**

- $U = 25 \text{ VDC}, 50 \text{ VDC}$ and 100 VDC .

Measurement execution:

- apply the test voltage U between the line terminals of the TE for at least 30 s before measuring DC current I . The test shall be carried out for both polarities of the applied voltage.

Formal processing:

- none.

Verdict:

- when tested at U the current I shall be less than or equal to the values of I_{\max} in table A.1:

Table A.1: Maximum current values for U

U (VDC)	I_{\max} (μA) for $4\text{M}\Omega$	I_{\max} (μA) for $1\text{M}\Omega$
25	6,25	25
50	12,5	50
100	25	100

if yes then Pass; else Fail.

Guidance:

- none.

A.4.4.2 Characteristics of TE for ringing signals**A.4.4.2.1 Impedance**

- **Requirement:** clause 4.4.2.1;
- **Purpose:** to determine whether the TE presents an impedance in the quiescent state during ringing within the specified range.

Measurement principle:

- **Preamble:** set the TE in quiescent state with any auto answering facility disabled;
- **Test state:** quiescent state.

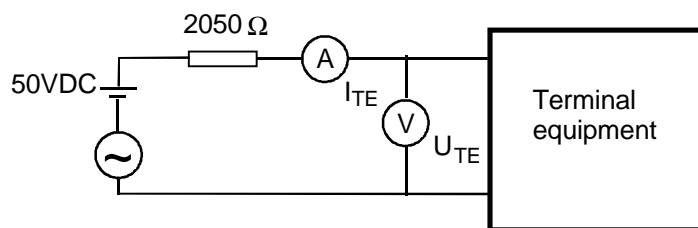
Test configuration:**Figure A.2: Impedance configuration****DC feeding arrangement:**

- feed Voltage = 50 V DC and 0 V DC.

AC feeding arrangement:

- sinusoidal source U_0 25 Hz and 50 Hz, 30 V rms U_{TE} measured across the TE.

Measurement points:

- voltage U_{TE} and current I_{TE} measured for the frequencies of 25 Hz and 50 Hz.

Safety Warning:

- this test presents the potential for a shock hazard. Ensure that satisfactory safety precautions are implemented to reduce the risk of electric shock.

Measurement execution:

- using the test configuration shown, apply the ringing signal continuously to the TE. Adjust the source voltage (U_0) to set the voltage across the TE (U_{TE}) to 30 V rms. However, if U_{TE} is less than 30 V rms for a source voltage of 90 V rms then the source voltage is not increased further and the test is deemed completed. Otherwise, measure the current (I_{TE}) flowing in the circuit.

Formal processing:

- the impedance of the TE during ringing can be calculated using the following formula:

$$|Z_{Ri}| = \frac{|U_{TE}|}{|I_{TE}|}$$

Verdict:

- if it is possible to apply 30 V rms at the TE terminals with a source voltage of less than or equal to 90 V rms and if $|Z_{Ri}|$ is equal to or greater than 16 k Ω (4 k Ω for a TE intended to be connected as a single terminal to an NTP) then Pass; else Fail.

Guidance:

- true rms reading instruments should be used because voltages and currents across the TE may not be sinusoidal.

A.4.4.2.2 Transient response

- **Requirement:** clause 4.4.2.2;
- **Purpose:** to check that the transient DC characteristics of the TE in quiescent state comply with clause 4.4.2.2.

Measurement principle:

- **Preamble:** set the TE in quiescent state with the line terminals shorted together;
- **Test state:** quiescent state. The TE shall have been in the quiescent state for not less than 1 m.

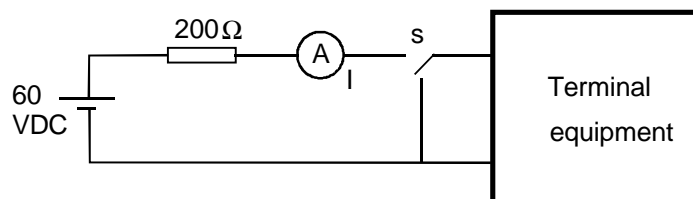
Test configuration:**Figure A.3: Transient reponse: configuration****DC feeding arrangement:**

- feed Voltage = 60 V DC.

Measurement points:

- measure current 1 ms and 6 ms after the connection of the voltage source.

Measurement execution:

- connect the voltage source to the TE with the switch S and monitor the current.

Verdict:

- if the current is less than or equal to 25 mA 1 ms after the connection and less than or equal to 10 mA 6 ms after the connection then Pass; else Fail.

Guidance:

- none.

A.4.4.2.3 DC current

- **Requirement:** clause 4.4.2.3;
- **Purpose:** to determine whether a possible DC component of the ringing current exceeds 0,6 mA.

Measurement principle:

- **Preamble:** set the TE in quiescent state with any auto answer facility disabled;
- **Test state:** quiescent state.

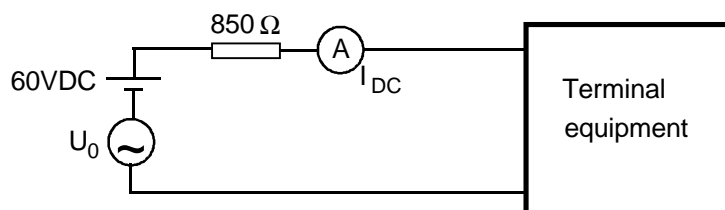
Test configuration:**Figure A.4: DC current configuration**

DC feeding arrangement:

- feed Voltage = 60V DC and 0V DC.

AC feeding arrangement:

- sinusoidal source $U_0 = 90$ V rms, 25 Hz and 50 Hz.

Safety Warning:

- this test presents the potential for a shock hazard. Ensure that satisfactory safety precautions are implemented to reduce the risk of electric shock.

Measurement execution:

- using the test configuration shown, apply the ringing signal. After 400 ms measure the current I_{DC} for one or more complete cycles of the AC voltage. The test shall be carried out for both polarities of the feeding voltage.

Formal processing:

- calculate the average value (I_{DC}).

Verdict:

- if the magnitude of I_{DC} is less than or equal to 0,6 mA then Pass; else Fail.

Guidance:

- the sampling rate should be chosen to give an even integer of samples in one cycle.

A.4.4.3 Resistance to earth

- **Requirement:** clause 4.4.3;
- **Purpose:** to check whether the TE complies with clause 4.4.3 in the quiescent state.

Measurement principle:

- **Preamble:** set the TE in quiescent state;
- **Test state:** quiescent state.

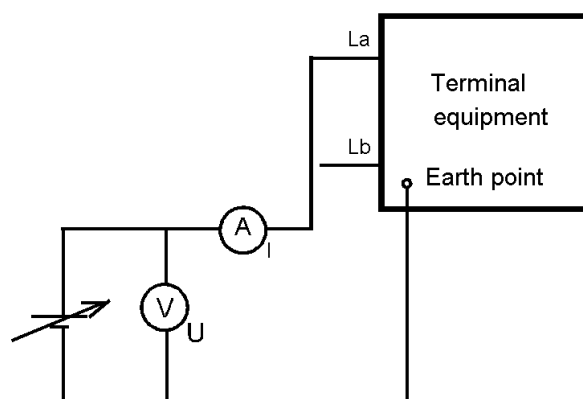
Test configuration:**Figure A.5: Resistance to earth configuration****Measurement points:**

- $U = 100$ volts DC.

Measurement execution:

- apply test voltage U between one of the line terminals and the earth connection point or points specified by the supplier's instructions for at least 30 s before measuring current I . The test shall be carried out for both line terminals and for both polarities of the applied test voltage.

Formal processing:

- resistance to earth (R) = U/I .

Verdict:

- if R is greater than or equal to 40 M Ω (10 M Ω for a TE intended to be connected as a single terminal to an NTP) then Pass; else Fail.

Guidance:

- none.

A.4.4.4 Impedance

- **Requirement:** clause 4.4.4;
- **Purpose:** to check whether the TE presents an impedance at least 40 k Ω between 200 Hz and 3 400 Hz and at least 5 k Ω at 12 kHz and 16 kHz when tested at 1 Vrms in the quiescent state.

Measurement principle:

- **Preamble:** set the TE in quiescent state;
- **Test state:** quiescent state.

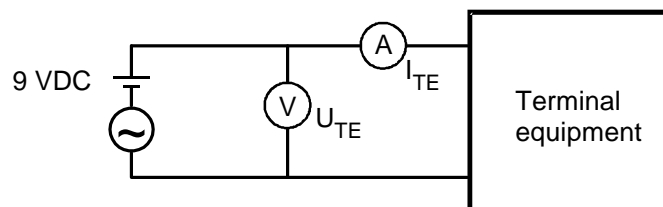
Test configuration:**Figure A.6: Impedance configuration****Measurement points:**

- $U_{TE} = 9 \text{ Vdc} + 1 \text{ Vrms}$, 200 Hz, 4300 Hz, 12 kHz and 16 kHz

Measurement execution:

- apply the test voltage U_{TE} between the line terminals of the TE for at least 5 s before measuring current I_{TE} .

Formal processing:

- the impedance modulus of the TE can be calculated using the following formula:

$$|Z_{TE}| = \frac{|U_{TE \text{ AC}}|}{|I_{TE \text{ AC}}|}$$

Verdict:

- if the impedance modulus of the TE complies with the limits stated in table 1 then Pass; else Fail.

A.4.5 Ringing signal detector sensitivity

- **Requirement:** clause 4.5;
- **Purpose:** to determine the ability of the TE to respond as stated by the supplier to ringing signals

Measurement principle:

- **Preamble:** set the TE in quiescent state with answering facility enabled;
- **Test state:** quiescent state.

Test configuration:

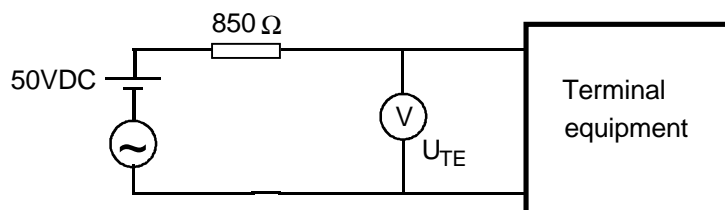

Figure A.7: Ringing signal detector sensitivity configuration

DC feeding arrangement:

- feed Voltage = 50 V DC and 0 V DC.

Measurement points:

- the ringing signal shall have a sinusoidal source of 25 Hz and 50 Hz and a cadence of 1 s ON and 5 s OFF.
- $U_{TE} = 30$ V rms

Safety Warning:

- this test presents the potential for a shock hazard. Ensure that satisfactory safety precautions are implemented to reduce the risk of electric shock.

Measurement execution:

- using the test configuration shown in figure A.7, apply, one at a time, each one of the ringing signals described in "Measurement points" to the circuit to determine whether they are detected by the TE as stated by the supplier.

Formal processing:

- none.

Verdict:

- if TE detects all the ringing signals above described in "Measurement points" then Pass; else Fail.

Guidance:

- for automatic answering TE, after the stimulation to cause the seizure, the requirement stated in clause 4.6.2 and its associated test case apply.

A.4.6 Transition from quiescent state to loop state

A.4.6.1 Acceptance of breaks in the loop in a call attempt

- **Requirement:** clause 4.6.1;
- **Purpose:** to check that the DC characteristics of the TE during the transition from quiescent to loop state complies with clause 4.6.1.

Measurement principle:

- **Preamble:** set the TE in quiescent state;
- **Test state:** in transition from quiescent to loop state.

Test configuration:

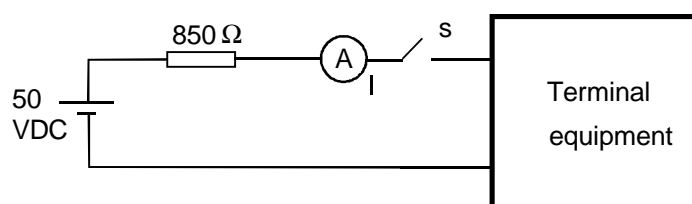

Figure A.8: Acceptance of breaks in the loop in a call attempt configuration

DC feeding arrangement:

- feed voltage: 50 VDC.

Measurement points:

- as in test configuration.

Measurement execution:

- monitor the current. Cause the TE to make a transition from the quiescent to the loop state. When the current I has first reached and remained at a value greater than 12,8 mA for:
 - test 1: 30 ms;
 - test 2: 500 ms.
- interrupt the current for a period of 400 ms. Continue to monitor the current for a period of 100 ms after restoration.

Formal processing:

- if the current drops below 12,8 mA for more than one period of time, then sum all the periods to obtain the total time for comparison with the limit.

Verdict:

- if the current I has reached a value greater than 12,8 mA within 20 ms of the restoration AND if, during the period between 20 ms and 100 ms after the restoration, the current does not drop below 12,8 mA for more than 7 ms, then Pass; else Fail.

Guidance: None.

A.4.6.2 Loop current characteristics

- **Requirement:** clause 4.6.2;
- **Purpose:** to check that the current/time characteristics of the TE during the transition from quiescent to loop state comply with clause 4.6.2.

Measurement principle:

- **Preamble:** Sset the TE in quiescent state for a time greater than 1 m;
- **Test state:** cause the TE to make a transition to loop state.

Test configuration:

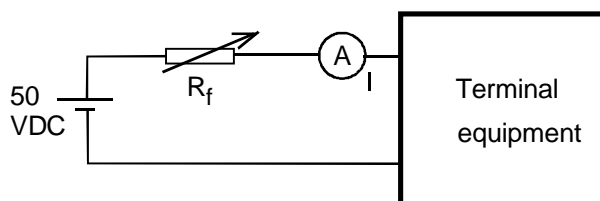

Figure A.9: Loop current characteristics configuration

DC feeding arrangement:

- feed voltage: 50 VDC. Feed resistance R_f , each of the following: 150 k Ω , 36 k Ω , 24 k Ω , 8 k Ω , 2,8 k Ω , (or 2,3 k Ω), 400 Ω .

Measurement points:

- feed resistances listed above in the DC feeding arrangement.

Measurement execution:

- before measuring for each resistance value, keep the TE in quiescent state for 1 m. In sequence, select a R_f resistance value according to the selected feeding resistance and then cause the TE to make a transition from the quiescent to the loop state.
- test 1: For R_f : 150 k Ω , 36 k Ω , 24 k Ω and 8 k Ω , monitor I for the period from t_0 to t_2 as indicated in table 2 and figure 2.
- test 2: For R_f : 2,8 k Ω (or 2,3 k Ω) and 400 Ω , monitor I for the period from t_0 to t_3 as indicated in table 3 and figure 3.

Formal processing:

- For each feeding resistance, calculate the sum of the transient periods where the current I falls under the limit of figure 2 or figure 3 as relevant.

Verdict:

- if for test 1 the TE complies with the limits stated in table 2 and in figure 2 apart from transients whose aggregated period is less than 7 ms and if for test 2 the TE complies with the limits stated in table 3 and in figure 3 apart from transients whose aggregated period is less than 7 ms then Pass; else Fail.

Guidance:

- none.

A.4.6.3 On-hook to off-hook transition with ringing without DC

Section under study.

A.4.6.4 Ring trip

- **Requirement:** clause 4.6.4;
- **Purpose:** to check that the current of the TE during the transition from quiescent to loop state comply with clause 4.6.4.

Measurement principle:

- **Preamble:** set the TE in quiescent state for a time greater than 1 m;
- **Test state:** cause the TE to make a transition to loop state during a ring without DC.

Test configuration:

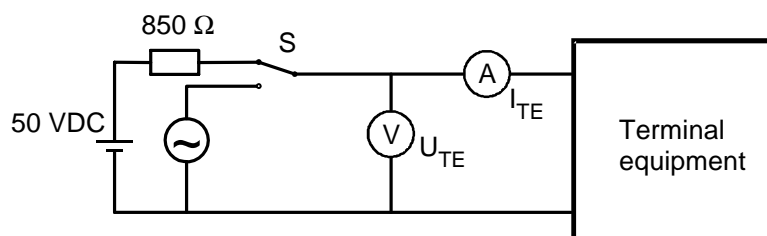

Figure A.10: Ring trip configuration

Characteristics of the ring generator:

Voltage of the Ringing Source	50 Vrms
Impedance of the ringing source	800 Ω

Measurement execution:

- before measuring, keep the TE in quiescent state for 1 m. In sequence, send the ring 50 Vrms without DC using (by switching with switch S), and then cause the TE to make a transition from the quiescent to the loop state. The AC current to the TE is measured by test-equipment, which measures the effective (rms) value of the AC current.

Verdict:

- if the current drawn is more than 36mA then Pass; else Fail.

Guidance:

- none.

A.4.7 Loop steady state characteristics

The maximum feed resistance of 2 800 Ω shall be replaced when appropriate by 2 300 Ω as stated in 4.7.

A.4.7.1 DC characteristics

- **Requirement:** clause 4.7.1;
- **Purpose:** to verify that the steady-state DC loop characteristics are within the limits given in table 5, and shown in figure 5. The test only applies to TE which are capable of reaching the loop state.

Measurement principle:

- **Preamble:** set the TE in quiescent state;
- **Test state:** loop state.

Test configuration:

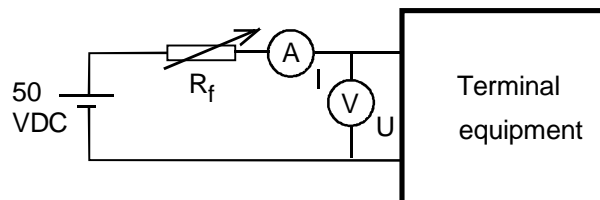

Figure A.11: DC characteristics configuration

DC feeding arrangement:

- feed voltage: 50 V. Feed resistance: each of the following: 400 Ω , 850 Ω , 2 050 Ω , and 2 800 Ω . Polarity shall be switched "off" and "on" between each feed resistance.

Measurement execution:

- in sequence, select a feed resistance value according to the DC feeding arrangement and then cause the TE to enter the loop state after making sure that the TE has been held at least 1 m in quiescent state. When the terminal has been in the loop state for at least 1,2 s, measure the DC current drawn by the TE and the DC voltage across the TE for each of the feed conditions. Allow sufficient settling time, to a maximum of 3 s, to ensure that the measured value is stable to within $\pm 0,5$ % for at least 0,2 s. Then repeat the sequence for other measurement points, repeating each time a transition from quiescent state to loop state.

Formal processing:

- none.

Verdict:

- if the DC voltage/current characteristics are within the limits given in table 5, and shown in figure 5 then Pass; else Fail.

Guidance:

- allowing "sufficient settling time" is useful to ensure test repeatability and reproducibility. Nevertheless if the stated stability cannot be found, the settling time shall be limited to 3 s. In this latter case a measurement accuracy improvement may be obtained by averaging several measurement readings made during the settling time.

A.4.7.2 Impedance

- **Requirement:** clause 4.7.2;
- **Purpose:** to verify that the return loss of the input impedance (Z_i) of the TE in relation to the reference impedance Z_R is within the limits specified below.

Measurement principle:

- **Preamble:** set the TE in loop state;
- **Test state:** loop state.

Test configuration:

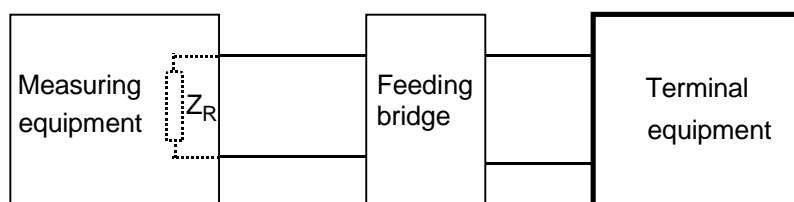

Figure A.12: Impedance configuration

DC feeding arrangement:

- feed voltage: 50 V. Feed resistance: each of the following: 400 Ω , 850 Ω , 2 050 Ω , and 2 800 Ω . Polarity shall be switched "off" and "on" between each feed resistance.

AC termination of TE:

- Z_R .

Measurement points:

- the test signal shall be sinusoidal with a constant voltage, whose level shall be pre-set to that required to achieve a level of -10 dBV at the TE line terminals;
- $f_{\min} = 200$ Hz, $f_{\max} = 4\,000$ Hz with step intervals of not more than 1/3 of an octave.

Measurement execution:

- when the TE has been in the loop state for at least 1,2 s, measure the modulus and phase of the voltage and current flowing at the measurement frequency. Calculate the complex impedance (Z_i) of the TE.

Formal processing:

- Return loss $\alpha = 20 \log_{10} \left| \frac{Z_R + Z_i}{Z_R - Z_i} \right|$ where Z_R is the reference impedance and Z_i is the impedance of the TE.

Verdict:

- if for frequencies in the range 300 Hz to 4 000 Hz, the return loss is not less than 8 dB;
- and for frequencies in the range 200 Hz to 300 Hz, the return loss is not less than 6 dB;
- and for frequencies in the range 200 Hz to 300 Hz, the reactive component of the impedance is not greater than 500 Ω inductive (+j 500 Ω), then Pass; else Fail

Guidance:

- none.

A.4.7.3 Resistance to earth

- **Requirement:** clause 4.7.3;
- **Purpose:** To check whether the TE complies with clause 4.7.3 in the loop state.

Measurement principle:

- **Preamble:** set the TE in loop state;
- **Test state:** loop state.

Test configuration:

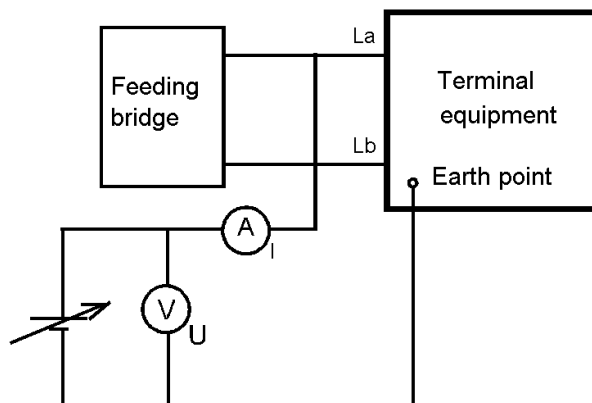

Figure A.13: Resistance to earth configuration

DC feeding arrangement:

- feed voltage: 50 V. Feed resistance: 400 Ω.

Measurement points:

- $U = 100$ VDC.

Measurement execution:

- 1) Connect the positive side of the feeding voltage to line terminal La of the TE;
Connect the positive side of the test voltage to line terminal La of the TE;
Wait for at least 30 s before measure the current I_1 .
- 2) Connect the negative side of the feeding voltage to line terminal La of the TE;
Connect the positive side of the test voltage to line terminal La of the TE;
Wait for at least 30 s before measure the current I_2 .
- 3) Connect the negative side of the feeding voltage to line terminal La of the TE;
Connect the negative side of the test voltage to line terminal La of the TE;
Wait for at least 30 s before measure the current I_3 .
- 4) Connect the positive side of the feeding voltage to line terminal La of the TE;
Connect the negative side of the test voltage to line terminal La of the TE;
Wait for at least 30 s before measure the current I_4 .

Formal processing:

- calculate the resistance to earth in branch La and Lb according to the formula: $R_p=100/(I_1+I_2)/2$ and $R_n=100/(I_3+I_4)/2$.

Verdict:

- if R_p and R_n is greater or equal to 1Mohm then Pass; else Fail.

Guidance:

- none.

A.4.8 Call attempt

The maximum feed resistance of 2 800 Ω shall be replaced when appropriate by 2 300 Ω as stated in clause 4.7.

A.4.8.1 Automatic dialling

A.4.8.1.1 Dialling without dial tone detection

- **Requirement:** clause 4.8.1.1;
- **Purpose:** to check that the TE starts dialling within the allowed period after seizure.

Measurement principle:

- **Preamble:** set the TE in quiescent state, tone-detector if any, disabled. If the pause before dialling is adjustable by the user, set it in accordance with the supplier's instructions to the closest available value to the midpoint between 3 and 8 s. If two values are equally close to the mid point, then use the lower value;
- **Test state:** automatic DTMF dialling.

Test configuration:

Figure A.14: Dialling without dial tone detection configuration

DC feeding arrangement:

- feed voltage: 50 V. Feed resistance: 850 Ω .

AC termination of TE:

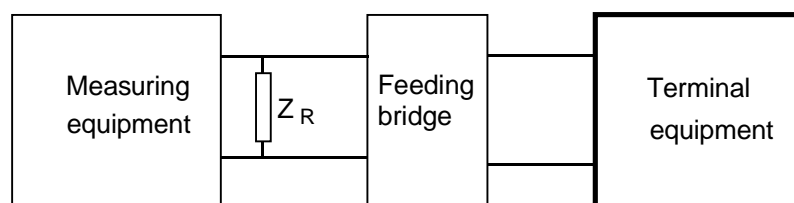
- Z_R .

Measurement execution:

- the TE is set in the loop state, transmitting signalling characters to line. The time shall be measured from seizure up to the start of the first digit.

Formal processing:

- none.

Verdict:

- if the time delay is equal to or greater than 2,7 s and dialling has started within 8 s then Pass; else Fail.

Guidance:

- none.

A.4.8.1.2 Dialling with dial tone detection

- **Requirement:** clause 4.8.1.2;
- **Purposes:** to check whether, after seizure, the TE starts dialling within the allowed period after the start of the dial tone.

Measurement principle:

- **Preamble:** set the TE in quiescent state with dial tone detector enabled;
- **Test state:** automatic DTMF dialling.

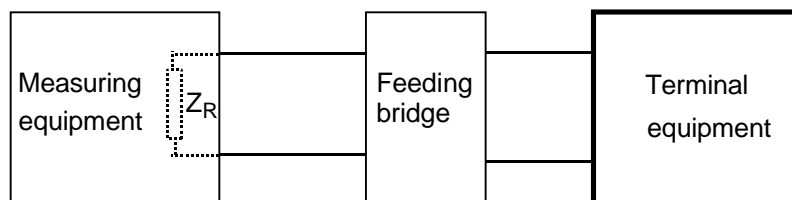
Test configuration:**Figure A.15: Dialling with dial tone detection configuration****DC feeding arrangement:**

- feed voltage: 50 V. Feed resistance: 850 Ω .

AC termination of TE:

- Z_R .

Measurement points:

- the detection range that shall be tested is limited by the frequencies and voltage levels given in the table below. The levels are defined across the reference impedance Z_R .

Detection range, frequencies:

Frequency (Hz)	Level (dBV)
300	-0,7
300	-35,7
500	-35,7
500	-0,7

Measurement execution:

- the TE is set in the loop state, ready for transmitting signalling tones to the line.
- two tests shall be performed. In both tests the dial tone is activated 3 s after having established the loop state.
 - test 1: Send continuous dial tone. Time is measured from the start of the dial tone;
 - test 2: Send a repeated sequence of cadenced dial tone whose cadence consists of a period of 200 ms ON followed by 200 ms OFF, 600 ms ON and 1 000 ms OFF. Time is measured from the start of the sequence.

Formal processing:

- none.

Verdict:

- if the TE has started dialling before 8 s in both tests 1 and 2, measured from the start of the dial tone, then Pass; else Fail.

Guidance:

- the level is supplied from a generator such that the total impedance of the generating and feeding circuitry is Z_R . The TE is replaced by a matching impedance Z_R for the purpose of level measurement. The TE is in-circuit for the purpose of timing measurement.

A.4.8.2 DTMF signalling

Guidance:

- dial tone may be necessary to activate dialling.

NOTE: The initial digit of the network address will normally be sent with dial tone present. In order for the network to recognize this digit, the signals returned to the network must be sufficiently free of unwanted frequency components. In particular when sending DTMF digits in the presence of dial tone, the frequencies produced should remain within the frequency tolerance (see Clause 4.8.2.1) and the total level of unwanted frequencies in the range 250 Hz to 4300 Hz, excluding the frequency of the dial tone itself, should be at least 20 dB below the level of the low frequency group component (see Clause 4.8.2.3). It should also be noted:

- that the frequency or frequencies provided for dial tone varies from network to network;
- that the dial tone may be a continuous tone or may be cadenced with a network dependent on to off ratio;
- that network dependent special dial tones may be provided in case of invoked supplementary services; and
- that dial tone could be present at a level as high as -0,7 dBV.

A.4.8.2.1 Frequency combinations

- **Requirement:** clause 4.8.2.1;
- **Purpose:** to check whether the TE sends appropriate DTMF signal frequency combinations. The allowed combinations are listed in the table 6.

Measurement principle:

- **Preamble:** set the TE in loop state;
- **Test state:** dialling.

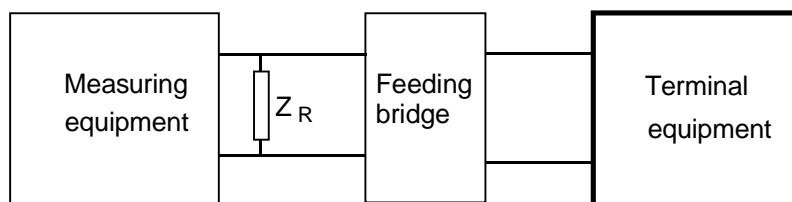
Test configuration:**Figure A.16: Frequency combinations configuration****DC feeding arrangement:**

- feed voltage: 50 V. Feed resistance: 850 Ω .

AC termination of TE:

- Z_R .

Measurement points:

- all supported characters shall be verified. The tolerances on the available frequencies shall be not more than $\pm 1,5\%$.

Measurement execution:

- the TE is set in the loop state, transmitting DTMF signals to line.
- measurement shall be made during the tone duration as defined in clause 4.8.2.4 (minimum duration 65 ms).

Formal processing:

- none.

Verdict:

- if all available frequencies are according to table 6, with a tolerance of $\pm 1,5\%$, then Pass; else Fail.

Guidance:

- none.

A.4.8.2.2 Signalling levels

- **Requirement:** clauses 4.8.2.2.1 and 4.8.2.2.2;
- **Purpose:** to check whether the TE sends appropriate DTMF signals. The level of any tone in the DTMF high frequency group shall be $-9,0\text{ dBV} +2,0/-2,5\text{ dB}$ and the level of any tone in the low frequency group shall be $-11,0\text{ dBV} +2,5/-2,0\text{ dB}$ when the TE interface is terminated with the reference impedance Z_R . The level of the tone in the high frequency group shall be 1dB to 4 dB higher than the level of the tone in the low frequency group.

Measurement principle:

- **Preamble:** set the TE in loop state. Maximum duration of tone burst setting;
- **Test state:** dialling.

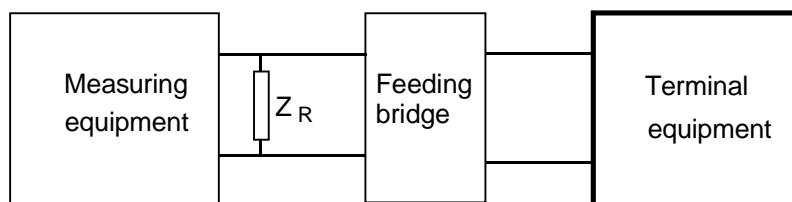
Test configuration:**Figure A.17: Signalling levels configuration****DC feeding arrangement:**

- feed voltage: 50 V. Feed resistance: each of the following: 400 Ω , and 2 800 Ω . Polarity shall be switched between each feed resistance.

AC termination of TE:

- Z_R .

Measurement points:

- all supported characters shall be verified.

Measurement execution:

- the TE is set in the loop state, transmitting DTMF signals to line.
- measurement shall be made during the tone duration as defined in clause 4.8.2.4 (minimum duration 65 ms).

Formal processing:

- none.

Verdict:

- if the tone in the high frequency group has a level between -7,0 dBV and -11,5 dBV and if the tone in the low frequency group has a level between -8,5 dBV and -13,0 dBV and if the difference between the levels is between 1 dB and 4 dB then Pass: else Fail.

Guidance: None.

A.4.8.2.3 Unwanted frequency components

- **Requirement:** clause 4.8.2.3;
- **Purpose:** to check the total sending level of all unwanted frequencies in the frequency range 250 Hz to 4 300 Hz. The level shall be at least 20 dB below the low frequency group component, when transmitting any DTMF tone combination during a call attempt.

Measurement principle:

- **Preamble:** set the TE in loop state;
- **Test state:** dialling.

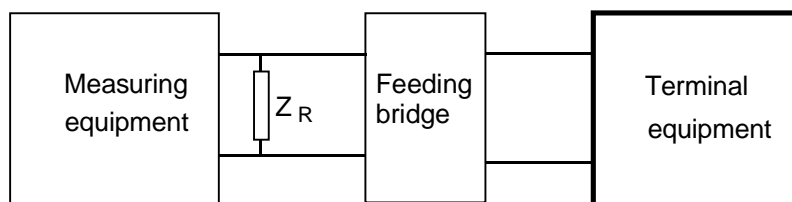
Test configuration:**Figure A.18: Unwanted frequency complaints configuration****DC feeding arrangement:**

- feed voltage: 50 V. Feed resistance: each of the following: 400 Ω , and 2 800 Ω . Polarity shall be switched "off" and "on" between each feed resistance.

AC termination of TE:

- Z_R .

Measurement points:

- where all characters of table 6 are available, select digits A, 6, 8 and *. Else if all numerals are available, select digits 3, 5, 7 and 0, else select all available digits.

Measurement execution:

- the TE is set in the loop state, transmitting DTMF characters to the line.
- measurement shall be made during the sending period as defined in clause 4.8.2.4 (minimum duration 65 ms).

Formal processing:

- integration of all signal levels is divided in 3 parts:
 - from 250 Hz up to the lower DTMF component;
 - from the lower DTMF component up to the higher DTMF component;
 - from the higher DTMF component up to 4 300 Hz.

Summation of all three parts gives the total unwanted sending level result. Frequencies up to 50 Hz on either side of the DTMF components shall be excluded from the summation. This result is compared with the level of the lower DTMF component.

Verdict:

- if the total unwanted signal level is at least 20 dB below the level of the lower DTMF component for all available digits then Pass; else Fail.

Guidance:

- the total unwanted sending level is calculated from the following formula:

$$\Sigma = \sqrt{a^2 + b^2 + c^2}$$

A.4.8.2.4 Tone duration

- **Requirement:** clause 4.8.2.4;
- **Purpose:** to check whether the TE sends DTMF signals of the appropriate duration. This requirement applies only to a TE with an automatic dialling function. It applies when the TE is in automatic dialling mode.

the TE shall provide a setting whereby the duration of any individual DTMF tone combination shall be at least 65 ms measured from the time when the tone level has reached 90 % of its steady-state value (without interruption), until it has dropped to 90 % of its steady-state value.

Measurement principle:

- **Preamble:** set the TE in loop state;
- **Test state:** automatic dialling. Tone signal duration according to supplier's instructions.

Test configuration:

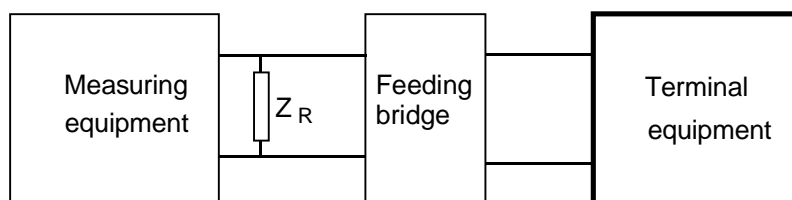

Figure A.19: Tone duration configuration

DC feeding arrangement:

- feed voltage: 50 V. Feed resistance: 850 Ω .

AC termination of TE:

- Z_R .

Measurement points:

- where all characters of table 6 are available, select digits A, 6, 8 and *. Else if all numerals are available, select digits 3, 5, 7 and 0, else select all available digits.

Measurement execution:

- set tone signalling duration according to supplier's instructions;
- the TE is set in the loop state, transmitting DTMF signals to the line. Capture the waveform of the DTMF signal.

Formal processing:

- in this formal processing, three waveforms derived from the measured waveform are used. These are referred to as waveforms A, B and C.
 - Determine waveform A such that at any time the instantaneous value of waveform A is equal to the absolute value of difference between the value of the measured waveform at that time and the mean value of the measured waveform over a period of 10 ms centred on that time;
 - Determine waveform B such that at any time its value is the greater of the linear interpolation of the maxima of waveform A, and waveform A;
 - Determine waveform C such that at any time its value is the greater of the linear interpolation of the maxima of waveform B, and waveform B;

- Determine the reference level such that it is 90% of the highest level which waveform C exceeds for 20 ms during the burst;
- The duration of the burst is the duration of the greatest period of time for which waveform C exceeds the reference level.

Verdict:

- if all bursts have a duration greater than or equal to 70 ms then Pass. If any burst has a duration of less than 60 ms then Fail;
- the test shall be repeated ten times for any burst for which the duration is between 60 and 70 ms and the mean duration calculated. If the mean duration for all such bursts is greater than or equal to 65 ms then Pass; else Fail.

Guidance:

- the repeatability of this test is intrinsically poor because the measured duration of the burst depends on the phase relationship of the tones. Therefore averaging is needed for borderline cases;
- the relationship between the measured waveform and waveforms A, B and C is shown in figure A.20.

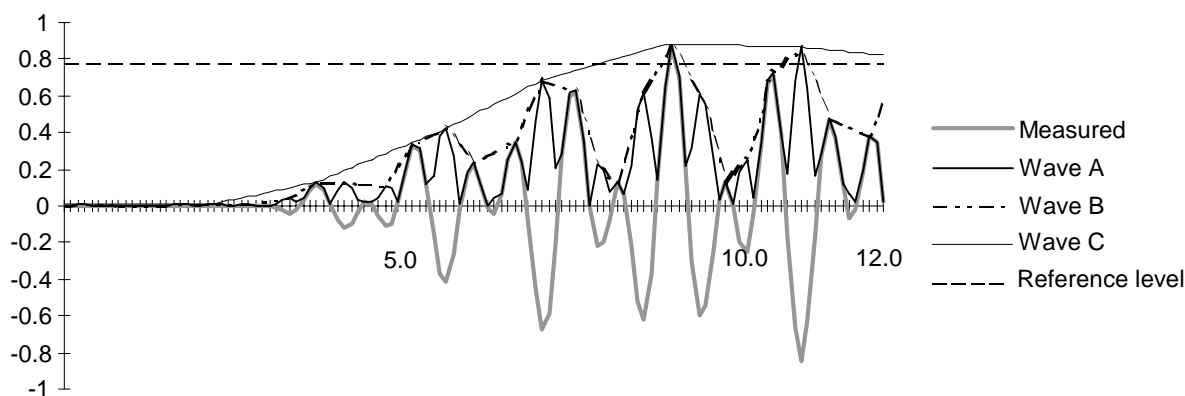

Figure A.20: Relationship between measured wavelength and waveforms A, B and C

A.4.8.2.5 Pause duration

- **Requirement:** clause 4.8.2.5;
- **Purpose:** to check whether the TE sends DTMF signals with the appropriate pauses. This requirement applies only to a TE with an automatic dialling function.

The TE shall provide a setting whereby the duration of the pause between the DTMF tone combinations shall be at least 65 ms. Time is measured from the moment when the tone has dropped to 10 % of its steady-state value, until it has risen to 10 % of its steady-state value.

Measurement principle:

- **Preamble:** set the TE in loop state;
- **Test state:** automatic dialling.

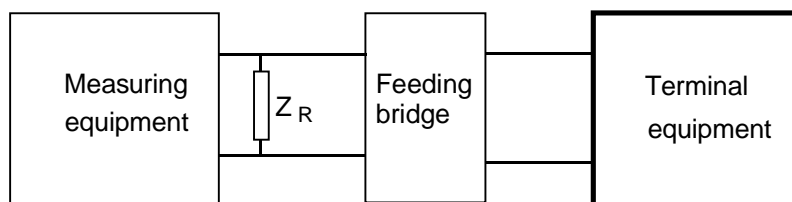
Test configuration:**Figure A.21: Pause duration configuration****DC feeding arrangement:**

- feed voltage: 50 V. Feed resistance: 850 Ω .

AC termination of TE:

- Z_R .

Measurement points:

- where all characters of table 6 are available, select digits A, 6, 8 and *. Else if all numerals are available, select digits 3, 5, 7 and 0, else select all available digits.

Measurement execution:

- the TE is set in the loop condition, transmitting DTMF signals to line. Set pause duration in accordance with the supplier's instructions. Capture the waveform of the sequence of bursts.

Formal processing:

- in this formal processing, a number of waveforms derived from the measured waveform are used. These shall be calculated independently for each burst. These are referred to as waveforms A, B, C etc.
 - determine waveform A such that at any time the instantaneous value of waveform A is equal to the absolute value of difference between the value of the measured waveform at that time and the mean value of the measured waveform over a period of 10 ms centred on that time;
 - determine waveform B such that at any time its value is the greater of the linear interpolation of the maxima of waveform A, and waveform A;
 - determine waveform C such that at any time its value is the greater of the linear interpolation of the maxima of waveform B, and waveform B;
 - determine the reference level such that it is 10% of the highest level which waveform C exceeds for 20 ms during the burst;
 - the pause between two bursts is the time between the last instant that waveform C is greater than the reference level for the first burst and the first instant that waveform C is greater than the reference level for the second burst.

Verdict:

- if all pauses have a duration greater than or equal to 70 ms then Pass;
- if any pause has a duration of less than 60 ms then Fail;
- if any pause has a duration of between 60 ms and 70 ms then the test shall be repeated 10 times, and the mean duration of the pause between each of the pairs on characters calculated. If each mean duration is greater than 65 ms then Pass; otherwise Fail.

Guidance:

- the repeatability of this test is intrinsically poor because the measured duration of the burst depends on the phase relationship of the tones. Therefore averaging is needed for borderline cases.

A.4.8.3 Loop disconnect dialling

Refer to ES 201 187 [4].

A.4.8.4 Register recall

Refer to ES 201 729 [5].

A.4.8.5 Call attempt on a low voltage line

- **Requirement:** clause 4.8.5;
- **Purpose:** to check that the TE can dial on a low voltage line.

Measurement principle:

- **Preamble:** set the TE in quiescent state, ready to dial with or without tone-detector if any;
- **Test state:** DTMF dialling.

Test configuration:

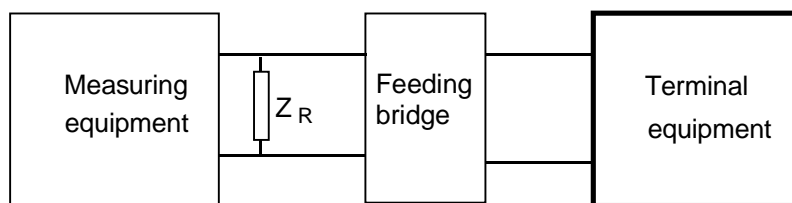

Figure A.22: Call attempt on a low voltage line configuration

DC feeding arrangement:

- feed voltage: 38 V. Feed resistance: 750 Ω .

AC termination of TE:

- Z_R .

Measurement execution:

- the TE is set in the loop state, transmitting signalling characters to line. The time shall be measured from seizure up to the start of the first digit.

Formal processing:

- none.

Verdict:

- if the TE is able to take the line and dial within 8 s then Pass; else Fail.

Guidance:

- none.

A.4.9 Transition from loop to quiescent state

- **Requirement:** clause 4.9;
- **Purpose:** to determine, whether the TE changes correctly from the loop to the quiescent state.

Measurement principle:

- **Preamble:** set the TE to loop state and in the case of automatic procedures set the period which the TE will subsequently be in the quiescent state to its minimum value and activate the automatic procedure;
- **Test state:** cause the TE to make a transition to quiescent state.

Test configuration:

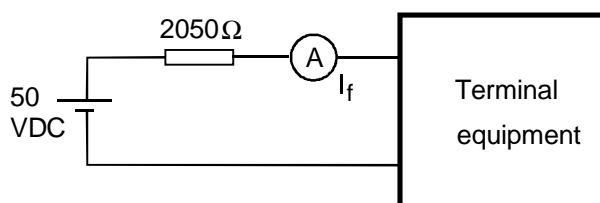

Figure A.23: Transition from loop to quiescent state configuration

DC feeding arrangement:

- feed voltage 50 VDC.

Measurement points:

- monitor the current I_f after it falls under 10 mA.

Measurement execution:

- cause the TE to make a transition from loop to quiescent state. Monitor the current drawn by the TE.

Formal Processing:

- none.

Verdict:

- if the TE complies with the limits of clause 4.9 then Pass, else Fail.

Guidance:

- none.

Annex B (informative): Requirements Table (RT)

Copyright release for RT proformas

Users of the present document may freely reproduce annex B which contains this RT proforma so that it may be used for its intended purpose. Users may further publish the completed RT.

B.1 Guidance for completion of the RT

B.1.1 Condition table

For the requirements, there is a table of condition questions.

The Reference column contains references in the form C.x where:

- C: means Condition;
- x: uniquely identifies the element of the table.

The Condition column contains a question, the answer to which determines whether the corresponding requirement(s) in the Requirements Table shall be mandatory.

The Status column identifies whether a "Yes" or "No" answer causes relevant requirements to be mandatory for the TE. The following codes are used:

- M: means that the relevant requirements are mandatory;
- N: means that the relevant requirements are not applicable.

The Support column is blank for the user to complete.

B.1.2 Requirements table

The Number column provides a unique identifier to each requirement.

The Reference column lists the clause reference in the present document where the requirement may be found.

The Requirement column gives the clause title of the relevant clause, supplemented by any additional information necessary to identify the requirement.

The Status column contains one of the following items:

- M: means that the requirement is mandatory;
- C.x: means that the requirement is mandatory if the relevant condition is met.

In some cases, two or more Conditions are included in the status column. The requirement shall be mandatory if the Boolean combination of them is true.

The Support column is blank for the user to complete.

Table B.1: Condition table

Reference	Condition	Status	Support (Y/N)	Comment
C.1.	Is the TE intended to interwork on a low voltage line?	If YES then M else N		
C.2.	Is the TE intended to have a connection to earth	If YES then M else N		
C.3.	Is the TE intended to be in loop state?	If YES then M else N		
C.4.	Is the TE intended for call answer?	If YES then M else N		
C.5.	Is the TE intended for call set-up?	If YES then M else N		
C.6.	Is the TE intended for dialling with DTMF?	If YES then M else N		
C.7.	Is the TE intended for automatic dialling without dial tone detection?	If YES then M else N		
C.8.	Is the TE intended for automatic dialling with dial tone detection?	If YES then M else N		
C.9.	Is the TE intended for automatically controlled signalling tone duration?	If YES then M else N		
C.10.	Is the TE intended for automatically controlled signalling pause duration?	If YES then M else N		
C.11.	Is the TE only intended to function on lines that provide more than 18 mA of line current?	If YES then M else N		The test resistance of 2 800 Ω shall be replaced by 2 300 Ω
C.12.	Is the TE intended for Pulse Dialing?	If YES then M else N		
C.13.	Is the TE intended for Register Recall?	If YES then M else N		
C.14.	Is the TE able to go off-hook during a ringing pulse?	If YES then M else N		

Table B.2: Requirements table

Number.	Reference	TBR Requirement	Status	Support (Y/N)
R.1.	4.3	Polarity	M	
R.2.	4.4.1	DC resistance	M	
R.3.	4.4.2.1	Impedance	M	
R.4.	4.4.2.2	Transient response	M	
R.5.	4.4.2.3	DC-current	M	
R.6.	4.4.3	Resistance to earth	C.2	
R.7.	4.4.4	Impedance	M	
R.8.	4.5	Ringling signal detector sensitivity	C.4	
R.9.	4.6.1	Acceptance of breaks in the loop in a call attempt	C.5	
R.10.	4.6.2	Loop current characteristics	C.3	
R.11.	4.6.3	On-hook to off-hook transition with ringing without DC	C.14	
R.12.	4.6.4	Ring Trip	C.14	
R.13.	4.7.1	DC characteristics	C.3	
R.14.	4.7.2	Impedance	C.3	
R.15.	4.7.3	Resistance to earth	C.3	
R.16.	4.8.1.1	Dialling without dial tone detection	C.7	
R.17.	4.8.1.2	Dialling with dial tone detection	C.8	
R.18.	4.8.2.1	Frequency combinations	C.6	
R.19.	4.8.2.2 1	Absolute levels	C.6	
R.20.	4.8.2.2.2	Level difference	C.6	
R.21.	4.8.2.3	Unwanted frequency components	C.6	
R.22.	4.8.2.4	Tone duration	C.6 and C.9	
R.23.	4.8.2.5	Pause duration	C.6 and C.10	
R.24.	4.8.3	Pulse dialling	C.12	
R.25.	4.8.4	Register recall	C.13	
R.26.	4.8.5	Call attempt on a low voltage line	C.1	
R.27.	4.9	Transition from loop state to quiescent state	C.3	

Annex C (informative): Bibliography

- ETSI TBR 021(1998): "Attachment requirements for pan-European approval for connection to the analogue Public Switched Telephone Networks (PSTNs) of TE (excluding TE supporting the voice telephony service) in which network addressing, if provided, is by means of Dual Tone Multi Frequency (DTMF) signalling"
- ETSI TR 101 959 (2002): "Access and Terminals (AT); Ringing without DC for Terminal Equipment (TE), Terminal Support Interfaces (TSI) and Local Exchange Interfaces (LEI)".

History

Document history		
V1.1.1	September 2003	Publication (Withdrawn)
V1.1.2	September 2003	Publication