

ETSI TS 103 636-5 V1.5.1 (2024-03)



TECHNICAL SPECIFICATION

**DECT-2020 New Radio (NR);
Part 5: DLC and Convergence layers;
Release 1**

Reference

RTS/DECT-00397

Keywords

CVG, DECT-2020, DLC, IMT-2020, NR

ETSI

650 Route des Lucioles
F-06921 Sophia Antipolis Cedex - FRANCE

Tel.: +33 4 92 94 42 00 Fax: +33 4 93 65 47 16

Siret N° 348 623 562 00017 - APE 7112B
Association à but non lucratif enregistrée à la
Sous-Préfecture de Grasse (06) N° w061004871

Important notice

The present document can be downloaded from:
<https://www.etsi.org/standards-search>

The present document may be made available in electronic versions and/or in print. The content of any electronic and/or print versions of the present document shall not be modified without the prior written authorization of ETSI. In case of any existing or perceived difference in contents between such versions and/or in print, the prevailing version of an ETSI deliverable is the one made publicly available in PDF format at www.etsi.org/deliver.

Users of the present document should be aware that the document may be subject to revision or change of status. Information on the current status of this and other ETSI documents is available at <https://portal.etsi.org/TB/ETSIDeliverableStatus.aspx>

If you find errors in the present document, please send your comment to one of the following services:
<https://portal.etsi.org/People/CommitteeSupportStaff.aspx>

If you find a security vulnerability in the present document, please report it through our Coordinated Vulnerability Disclosure Program:
<https://www.etsi.org/standards/coordinated-vulnerability-disclosure>

Notice of disclaimer & limitation of liability

The information provided in the present deliverable is directed solely to professionals who have the appropriate degree of experience to understand and interpret its content in accordance with generally accepted engineering or other professional standard and applicable regulations.

No recommendation as to products and services or vendors is made or should be implied.

No representation or warranty is made that this deliverable is technically accurate or sufficient or conforms to any law and/or governmental rule and/or regulation and further, no representation or warranty is made of merchantability or fitness for any particular purpose or against infringement of intellectual property rights.

In no event shall ETSI be held liable for loss of profits or any other incidental or consequential damages.

Any software contained in this deliverable is provided "AS IS" with no warranties, express or implied, including but not limited to, the warranties of merchantability, fitness for a particular purpose and non-infringement of intellectual property rights and ETSI shall not be held liable in any event for any damages whatsoever (including, without limitation, damages for loss of profits, business interruption, loss of information, or any other pecuniary loss) arising out of or related to the use of or inability to use the software.

Copyright Notification

No part may be reproduced or utilized in any form or by any means, electronic or mechanical, including photocopying and microfilm except as authorized by written permission of ETSI.

The content of the PDF version shall not be modified without the written authorization of ETSI.
The copyright and the foregoing restriction extend to reproduction in all media.

© ETSI 2024.
All rights reserved.

Contents

Intellectual Property Rights	6
Foreword.....	6
Modal verbs terminology.....	6
1 Scope	7
2 References	7
2.1 Normative references	7
2.2 Informative references.....	7
3 Definition of terms, symbols and abbreviations.....	7
3.1 Terms.....	7
3.2 Symbols.....	8
3.3 Abbreviations	8
4 General	8
4.1 Introduction	8
4.2 Architecture of the DLC and Convergence Layer	9
4.2.1 General.....	9
4.2.2 Data Link Control	11
4.2.3 Convergence Layer	12
4.3 Services	13
4.3.1 Services provided to upper layers by the DLC layer	13
4.3.1.1 General	13
4.3.1.2 DLC Service type 0: Transparent mode	13
4.3.1.3 DLC Service type 1: Segmentation mode	14
4.3.1.4 DLC Service type 2: ARQ mode.....	15
4.3.1.5 DLC Service type 3: Segmentation and ARQ mode	15
4.3.1.6 DLC Routing Service	16
4.3.2 Services provided to upper layers by the Convergence layer	16
4.3.3 Services expected from MAC layer	17
4.4 Order of transmission and figure numbering conventions.....	17
5 DLC Layer Procedures and Data Units.....	17
5.1 General	17
5.2 DLC Procedures	17
5.2.1 DLC service type 0 procedures.....	17
5.2.1.1 Transmission procedure	17
5.2.1.2 Reception procedure.....	18
5.2.2 DLC service type 1 procedures.....	18
5.2.2.1 Transmission procedure	18
5.2.2.2 Reception procedure.....	18
5.2.3 DLC service type 2 and service type 3 procedures	18
5.2.3.1 Transmission procedure	18
5.2.3.2 Reception procedure.....	19
5.2.4 Segmentation	19
5.2.5 Reassembly	20
5.2.6 DLC Retransmissions (ARQ) using implicit ACK/NACK.....	20
5.2.7 DLC SDU lifetime control.....	20
5.2.7.1 General	20
5.2.7.2 Tx side procedures	20
5.2.7.3 Rx side procedures	21
5.2.8 Routing services.....	21
5.2.8.1 General	21
5.2.8.2 Packet Routing to backend (uplink)	21
5.2.8.3 Packet Routing from backend (downlink).....	22
5.2.8.4 Packet Routing between RDs.....	23
5.2.8.4.1 Hop-limited Flooding	23
5.3 DLC Protocol Data Units	25

5.3.1	General.....	25
5.3.2	DLC Service Type 0	25
5.3.3	DLC Service Type 1, 2 and 3.....	26
5.3.3.1	Data PDU.....	26
5.3.3.2	DLC Timers configuration Control IE	26
5.3.4	Routing header.....	27
6	Convergence Layer Procedures and Data Units.....	29
6.1	General	29
6.2	CVG Procedures.....	30
6.2.1	General.....	30
6.2.2	CVG Service types.....	30
6.2.2.1	General	30
6.2.2.2	CVG Service type 0 procedures (transparent).....	30
6.2.2.3	CVG Service type 1 procedures (sequence numbering).....	30
6.2.2.4	CVG Service type 2 procedures (segmentation & reassembly)	31
6.2.2.5	CVG Service type 3 procedures (FC)	31
6.2.2.6	CVG Service type 4 procedures (FC and ARQ)	31
6.2.3	Transparent procedure	32
6.2.4	Multiplexing procedures	32
6.2.4.1	General	32
6.2.4.2	Endpoint Multiplexing procedure	33
6.2.4.3	Mux Tag multiplexing procedure.....	34
6.2.5	Duplicate Removal procedure.....	34
6.2.6	Delivery Order procedures.....	34
6.2.7	Transmission and Segmentation procedure	35
6.2.8	Reception and Reassembly procedure	36
6.2.9	Flow control procedures	36
6.2.9.1	General	36
6.2.9.2	FC transmitting procedures.....	37
6.2.9.3	FC receiving procedures	37
6.2.10	Retransmission (ARQ) procedure.....	38
6.2.11	Lifetime control procedure	38
6.2.12	Tx Services configuration procedure	38
6.2.13	Security procedures.....	39
6.2.13.1	General	39
6.2.13.2	Security Mode 1 procedures.....	39
6.2.13.2.1	General	39
6.2.13.2.2	Integrity protection	39
6.2.13.2.3	Ciphering.....	40
6.2.14	Flow Status procedures.....	41
6.3	CVG Protocol Data Units.....	42
6.3.1	General.....	42
6.3.2	CVG Header	42
6.3.3	EP Mux IE	44
6.3.4	Data IE.....	44
6.3.5	Data EP IE	45
6.3.6	Data Transparent IE.....	45
6.3.7	Security IE	46
6.3.8	Tx Services Config IE.....	46
6.3.9	ARQ Feedback IE.....	48
6.3.10	ARQ Poll IE.....	50
6.3.11	Flow Status IE.....	50
Annex A (normative):	Endpoint Multiplexing Field Value Allocation	51
A.1	General	51
Annex B (normative):	Radio Device Capabilities	52
B.1	DLC Layer.....	52
B.1.1	Introduction	52
B.1.2	DLC Service Type.....	52

B.1.3 Mesh Operation52

B.2 CVG Layer52

B.2.1 Introduction52

B.2.2 CVG service type52

B.2.3 CVG multiplexing52

B.2.4 CVG security52

Annex C (informative): Bibliography53

Annex D (informative): Change History54

History55

Intellectual Property Rights

Essential patents

IPRs essential or potentially essential to normative deliverables may have been declared to ETSI. The declarations pertaining to these essential IPRs, if any, are publicly available for **ETSI members and non-members**, and can be found in ETSI SR 000 314: "*Intellectual Property Rights (IPRs); Essential, or potentially Essential, IPRs notified to ETSI in respect of ETSI standards*", which is available from the ETSI Secretariat. Latest updates are available on the ETSI Web server (<https://ipr.etsi.org/>).

Pursuant to the ETSI Directives including the ETSI IPR Policy, no investigation regarding the essentiality of IPRs, including IPR searches, has been carried out by ETSI. No guarantee can be given as to the existence of other IPRs not referenced in ETSI SR 000 314 (or the updates on the ETSI Web server) which are, or may be, or may become, essential to the present document.

Trademarks

The present document may include trademarks and/or tradenames which are asserted and/or registered by their owners. ETSI claims no ownership of these except for any which are indicated as being the property of ETSI, and conveys no right to use or reproduce any trademark and/or tradename. Mention of those trademarks in the present document does not constitute an endorsement by ETSI of products, services or organizations associated with those trademarks.

DECT™, **PLUGTESTS™**, **UMTS™** and the ETSI logo are trademarks of ETSI registered for the benefit of its Members. **3GPP™** and **LTE™** are trademarks of ETSI registered for the benefit of its Members and of the 3GPP Organizational Partners. **oneM2M™** logo is a trademark of ETSI registered for the benefit of its Members and of the oneM2M Partners. **GSM®** and the GSM logo are trademarks registered and owned by the GSM Association.

Foreword

This Technical Specification (TS) has been produced by ETSI Technical Committee Digital Enhanced Cordless Telecommunications (DECT).

The present document is part 5 of a multi-part deliverable covering the DECT-2020 New Radio (NR) technology. Full details of the entire series can be found in part 1 [1].

DECT-2020 NR is recognized in Recommendation ITU-R M.2150 [i.1] as a component RIT fulfilling the IMT-2020 requirements of the IMT-2020 use scenarios URLLC and mMTC. The Set of Radio Interface Technology (SRIT) called "DECT 5G SRIT" is involving 3GPP NR and DECT-2020 NR.

Modal verbs terminology

In the present document "**shall**", "**shall not**", "**should**", "**should not**", "**may**", "**need not**", "**will**", "**will not**", "**can**" and "**cannot**" are to be interpreted as described in clause 3.2 of the [ETSI Drafting Rules](#) (Verbal forms for the expression of provisions).

"**must**" and "**must not**" are **NOT** allowed in ETSI deliverables except when used in direct citation.

1 Scope

The present document is one of the parts of the specification of the DECT-2020 New Radio (NR).

The present document specifies the Data Link Control (DLC) and Convergence layer (CVG) between DECT-2020 radio interface and different application protocols.

2 References

2.1 Normative references

References are either specific (identified by date of publication and/or edition number or version number) or non-specific. For specific references, only the cited version applies. For non-specific references, the latest version of the referenced document (including any amendments) applies.

Referenced documents which are not found to be publicly available in the expected location might be found at <https://docbox.etsi.org/Reference>.

NOTE: While any hyperlinks included in this clause were valid at the time of publication, ETSI cannot guarantee their long-term validity.

The following referenced documents are necessary for the application of the present document.

- [1] [ETSI TS 103 636-1](#): "DECT-2020 New Radio (NR); Part 1: Overview; Release 1".
- [2] [ETSI TS 103 636-4](#): "DECT-2020 New Radio (NR); Part 4: MAC layer; Release 1".
- [3] [FIPS PUB 197](#): "Advanced Encryption Standard (AES)".
- [4] [NIST Special Publication 800-38B](#): "Recommendation for Block Cipher Modes of Operation: The CMAC Mode for Authentication".

2.2 Informative references

References are either specific (identified by date of publication and/or edition number or version number) or non-specific. For specific references, only the cited version applies. For non-specific references, the latest version of the referenced document (including any amendments) applies.

NOTE: While any hyperlinks included in this clause were valid at the time of publication, ETSI cannot guarantee their long-term validity.

The following referenced documents are not necessary for the application of the present document, but they assist the user with regard to a particular subject area.

- [i.1] Recommendation ITU-R M.2150: "Detailed specifications of the terrestrial radio interfaces of International Mobile Telecommunications-2020 (IMT-2020)".

3 Definition of terms, symbols and abbreviations

3.1 Terms

For the purposes of the present document, the terms given in ETSI TS 103 636-1 [1] apply.

3.2 Symbols

Void.

3.3 Abbreviations

For the purposes of the present document, the abbreviations given in ETSI TS 103 636-1 [1] and the following apply:

NOTE: An abbreviation defined in the present document takes precedence over the definition of the same abbreviation, if any, in ETSI TS 103 636-1 [1].

3GPP	3 rd Generation Partnership Project
5G	5 th Generation
A/N	Acknowledgement/Negative acknowledgement
ACK	Acknowledgement
AES	Advanced Encryption Standard
ARQ	Automatic Repeat Request
CMAC	Cipher-based Message Authentication Code
CTR	Counter mode
CVG	Convergence (layer)
DECT	Digital Enhanced Cordless Telecommunications
DLC	Data Link Control (layer)
DLC-T	DLC Service type 0: Transparent mode
DLC-S	DLC Service type 1: Segmentation mode
DLC-A	DLC Service type 2: DLC-ARQ
DLC-SA	DLC Service type 3: Segmentation and ARQ mode
EP	EndPoint
F2C	Format 2 Coding
FC	Flow Control
FT	Fixed Termination point
HPC	Hyper Packet Counter
IE	Information Element
IPv6	Internet Protocol version 6
ISD	In Sequence Delivery
MAC	Medium Access Control
MIC	Message Integrity Code
MSB	Most Significant Bit
MT	Mux Tag
NACK	Negative Acknowledgement
NR	New Radio
PDU	Protocol Data Unit
PSN	Packet Sequence Number
PT	Portable Termination point
QoS	Quality of Service
RD	Radio Device
SDU	Service Data Unit
SI	Segmentation Indication
SLI	SDU Length Indicator
SN	Sequence Number

4 General

4.1 Introduction

The objective of this clause is to describe the architecture and functions of the DLC and Convergence layers, including the transfer of the application protocol layer SDU to Convergence layer PDU(s) and to DLC PDU(s) and further to the MAC layer as MAC layer SDU(s).

4.2 Architecture of the DLC and Convergence Layer

4.2.1 General

The DLC and Convergence layers support flexible system architecture, where the DLC layer provides necessary functions for the MAC layer at each radio link including, segmentation and packet routing, whereas the convergence layer provides adaptation functions between application layer protocols and the DECT-2020 NR radio interface.

Figure 4.2.1-1 illustrates an architecture overview with a point-to-point or simplified star topology for IPv6 and non-IPv6 applications. RD1 is in PT mode and RD2 in FT mode.

In an uplink example, the application at RD1 sends data to RD2. The application data is processed using the selected CVG and DLC services at RD1 and sent over the DECT-2020 radio link to RD2. The data is directed to a local application at RD2 or through a backend connection to a cloud application like in the mesh example in Figure 4.2.1-3.

In a downlink example, a local application in RD2, as in Figure 4.2.1-1, or a cloud application in RD3, as in Figure 4.2.1-3, sends data to an application at RD1. The application data is first processed using the selected CVG and DLC services and provided to the MAC layer to be sent over the DECT-2020 radio link to RD1. RD1 receives the data and passes it up to its own DLC and CVG layer and finally to the application.

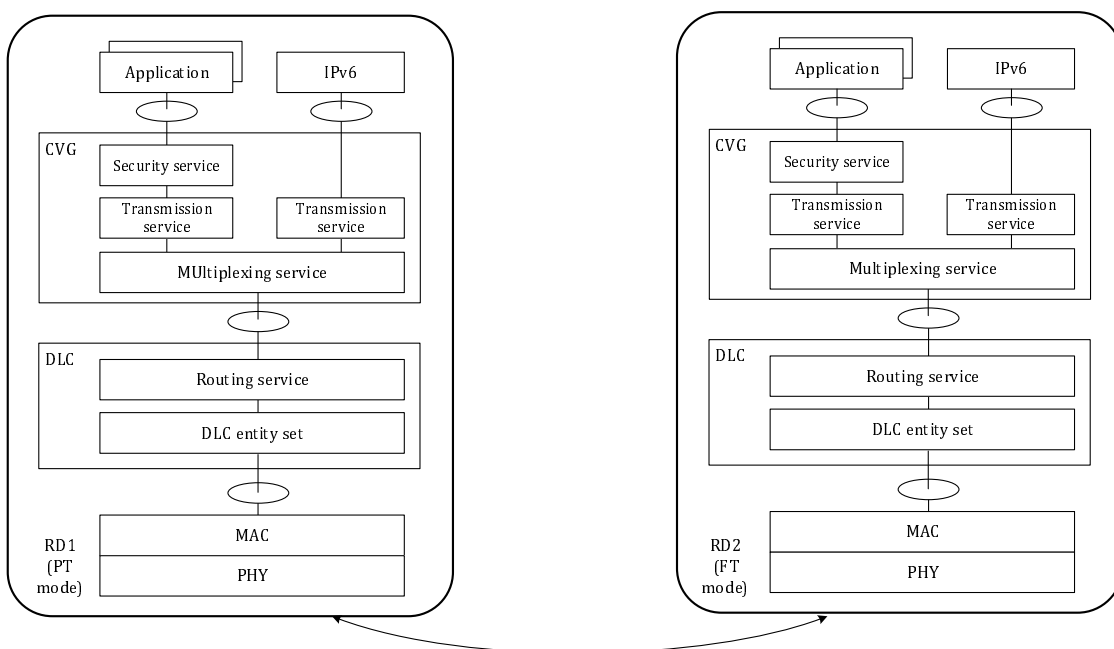

Figure 4.2.1-1: Illustration of the overall protocol architecture

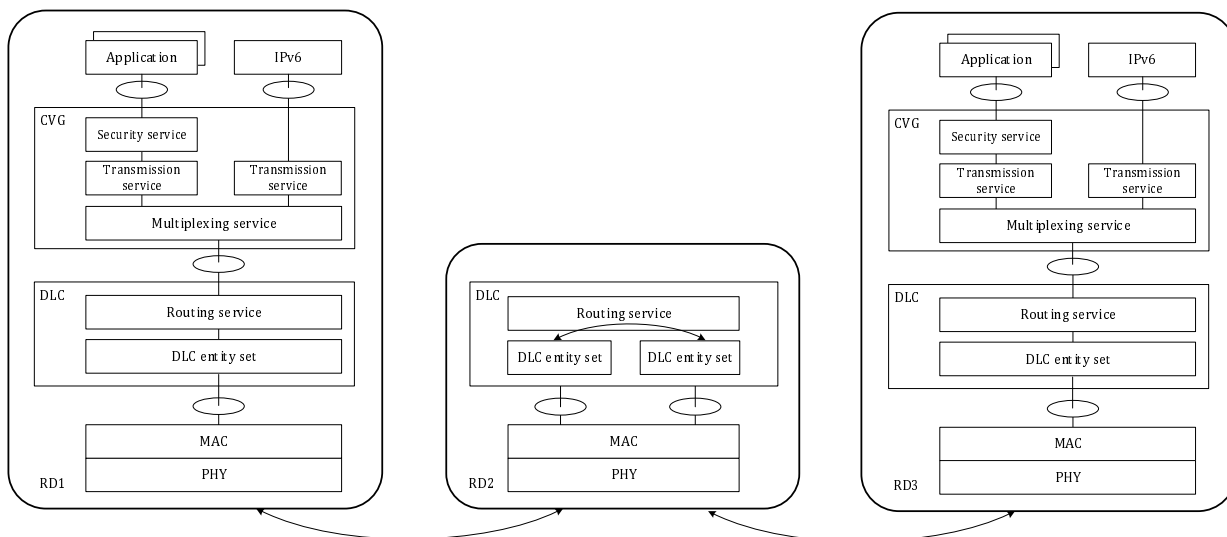

Figure 4.2.1-2: Illustration of the overall protocol architecture for mesh networking

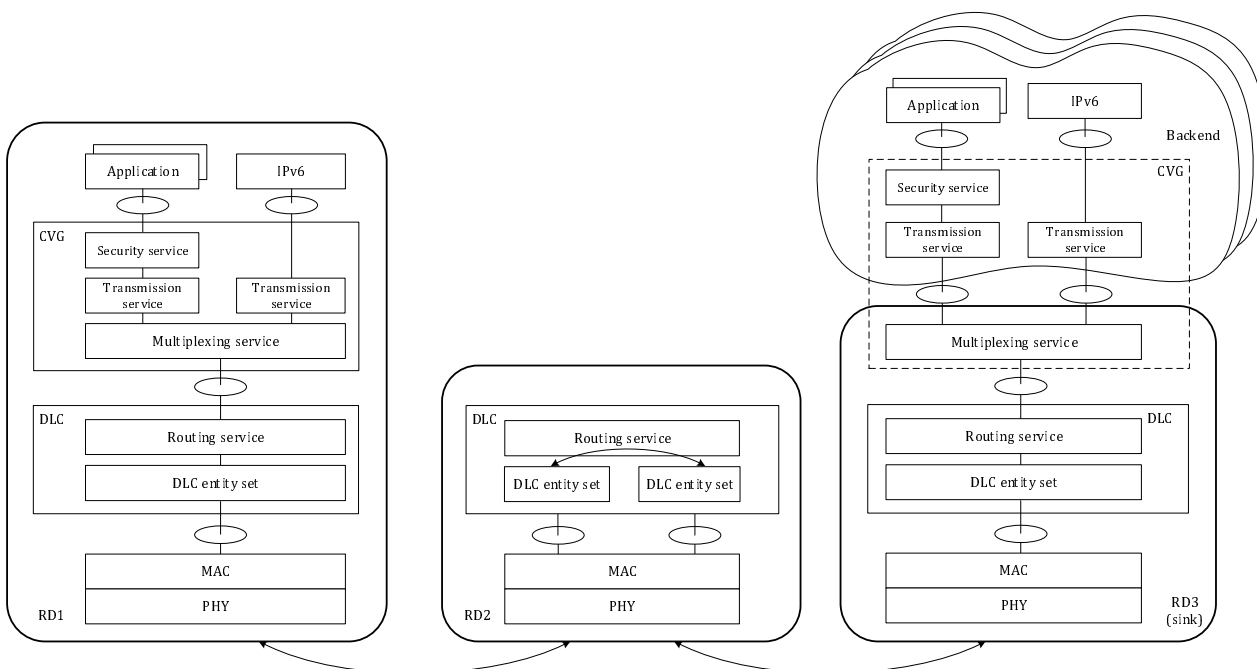

Figure 4.2.1-3: Illustration of the overall protocol architecture for mesh networking with cloud-based backend instances

Figures 4.2.1-2 and 4.2.1-3 depict examples of the protocol architecture exploiting mesh topology and routing with IPv6 and non-IPv6 applications.

In an uplink example, an application in RD1 sends data to the backend. First, the application data is processed in the selected CVG and DLC entities at RD1 and the data is sent over the DECT-2020 radio link to RD2 that operates in both FT and PT modes. RD2 routes the received data based on the routing header to RD3 using another DECT-2020 radio link. RD3 operating in FT mode passes the data to an application within RD3, as in Figure 4.2.1-2, or routes received data to a backend located in cloud as in Figure 4.2.1-3.

In a downlink example, an application in RD3, as in Figure 4.2.1-2, or a cloud application, as in Figure 4.2.1-3, sends data to an application in RD1. The application data is first processed in the selected CVG entity in the cloud and provided to the RD3 operating in FT mode. The DLC entities of the RD3 process and forward the data over the DECT-2020 radio link to RD2. RD2 routes the data based on the routing header to RD1 using the DECT-2020 radio link. RD1 receives the data, and based on routing header, forwards the data to its own convergence layer and its application.

Convergence layer services can be located separately from the DLC layer, enabling e.g. cloud CVG implementation in backend systems. In non-mesh network topologies (point-to-point, star) the set of used services can be reduced.

4.2.2 Data Link Control

The DLC architecture is depicted in Figure 4.2.2-2. There is a single routing service entity in each RD.

There is a single DLC entity set for each radio link between an RD in PT mode and an RD in FT mode. For an RD operating in both FT and PT mode in a mesh cluster tree, the RD has:

- One DLC entity set for the RD that it has performed association with as defined in ETSI TS 103 636-4 [2].
- One DLC entity set for each RD that has performed association with it as ETSI TS 103 636-4 [2], as depicted in Figure 4.2.2-1.

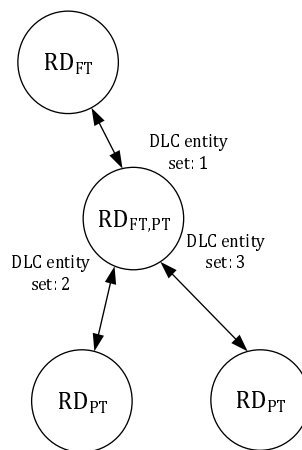

Figure 4.2.2-1: DLC entity sets for RD operating in both FT and PT mode

Additionally, an RD has a DLC entity set for Broadcast and RD-to-RD communication.

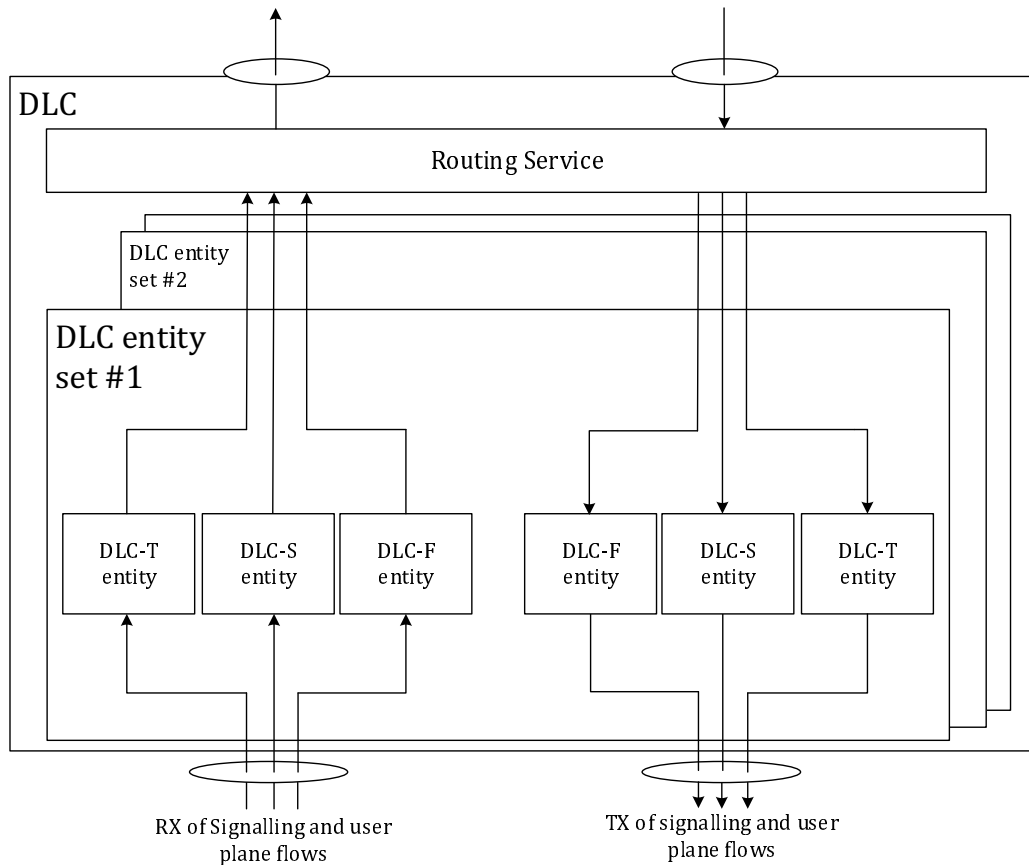

Figure 4.2.2-2: DLC architecture

A DLC entity set comprises one DLC entity for a DCH/MTCH seen by the MAC layer, as identified a MAC flow in MAC multiplexing header in clause 6.3.4 in ETSI TS 103 636-4 [2].

A DLC entity can be operating in the following service modes based on QoS and application data format requirements:

- Service type 0: Transparent mode (DLC-T).
- Service type 1: Segmentation mode (DLC-S).
- Service type 2: DLC ARQ mode (DLC-A).
- Service type 3: Segmentation and ARQ mode (DLC-SA).

NOTE 1: ETSI TS 103 636-4 [2] provides up to 4 flows for user plane data and 2 flows for higher layer signalling.

NOTE 2: Service type and configuration parameters can be selected to be appropriate for a DLC entity operating for DCH and/or MTCH.

4.2.3 Convergence Layer

The CVG architecture is depicted in Figure 4.2.3-1. The CVG comprises a set of optional services, and a transparent procedure to bypass the services as defined in clause 4.3.2.

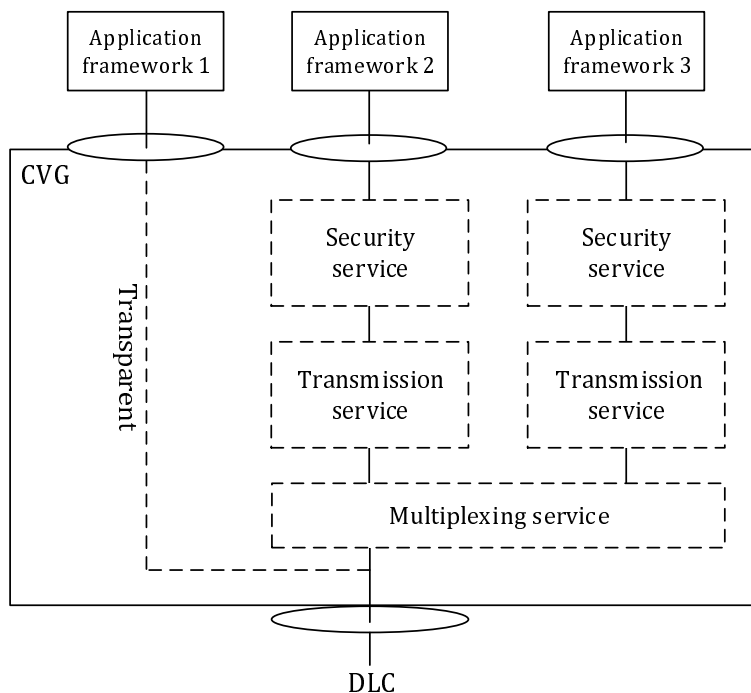

Figure 4.2.3-1: CVG architecture

4.3 Services

4.3.1 Services provided to upper layers by the DLC layer

4.3.1.1 General

The DLC layer provides the following services to the higher layers:

- DLC Service type 0: Transparent mode (DLC-T).
- DLC Service type 1: Segmentation mode (DLC-S).
- DLC Service type 2: ARQ mode (DLC-A).
- DLC Service type 3: Segmentation and ARQ mode (DLC-SA).

4.3.1.2 DLC Service type 0: Transparent mode

The DLC Service type 0 is meant for transparent transmission and reception of DLC SDUs.

In transparent mode, a DLC entity only has a transmitter buffer, and the DLC introduces a one-octet protocol header to the higher layer SDU. The transmission and reception operation are depicted in Figure 4.3.1.2-1.

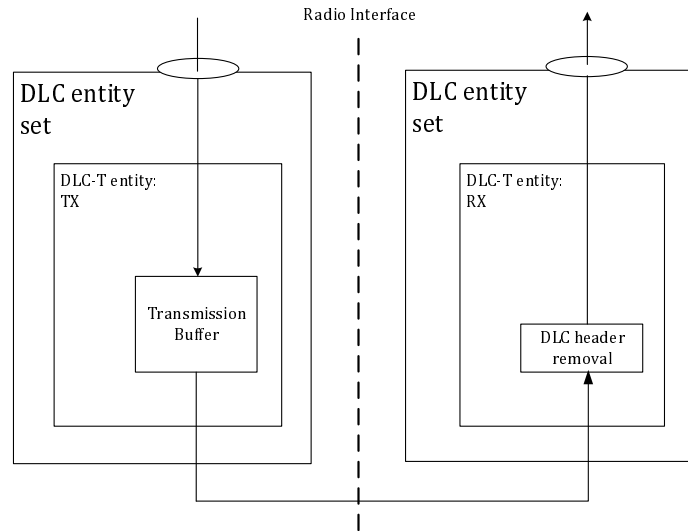

Figure 4.3.1.2-1: DLC Service Type 0 - TX and RX entities

4.3.1.3 DLC Service type 1: Segmentation mode

A DLC entity using DLC Service Type 1 provides:

- Transmission of a complete DLC SDU or a segment of a DLC SDU as defined in clause 5.2.2.
- Reception of a DLC PDU and the assembly of a DLC SDU as defined in clause 5.2.3.
- Control of the maximum lifetime of a DLC SDU in the transmitter by DLC SDU discard defined in clause 5.2.7.2.
- Control of maximum lifetime of an incomplete DLC SDU in the receiver by DLC PDU discard defined in clause 5.2.7.3.

The transmission process of the DLC entity is defined in clause 5.2.2 and shall include the DLC header as defined in clause 5.3.2 in the DLC PDU.

A receiving DLC entity constructs a complete DLC SDU from the received segments as defined in clause 5.2.3 and delivers a DLC SDU to the routing service as defined in clause 5.2.6.

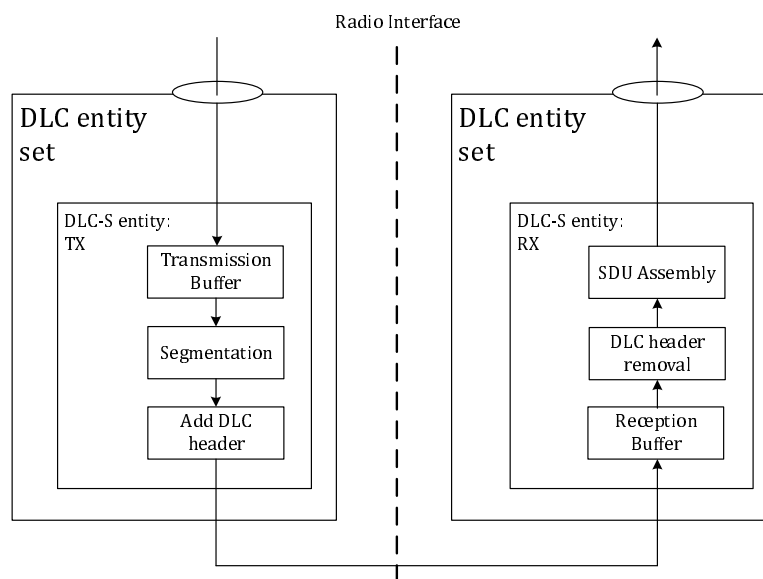

Figure 4.3.1.3-1: DLC Service Type 1 - TX and RX entities

4.3.1.4 DLC Service type 2: ARQ mode

A DLC entity using DLC Service Type 2 provides:

- Transmission of a complete DLC SDU, as defined in clause 5.2.2.
- Reception of a DLC PDU as defined in clause 5.2.3.
- Automatic Repeat Request (ARQ) with use of implicit ACK and NACK commands, by means of interaction with the MAC layer as defined in clause 5.2.6.
- Control of the maximum lifetime of a DLC SDU in the transmitter by DLC SDU discard as defined in clause 5.2.7.2.
- Control of the maximum lifetime of an incomplete DLC SDU in the receiver by DLC PDU discard defined in clause 5.2.7.3.

The transmission and reception operation in flow control mode are depicted in Figure 4.3.1.4-1.

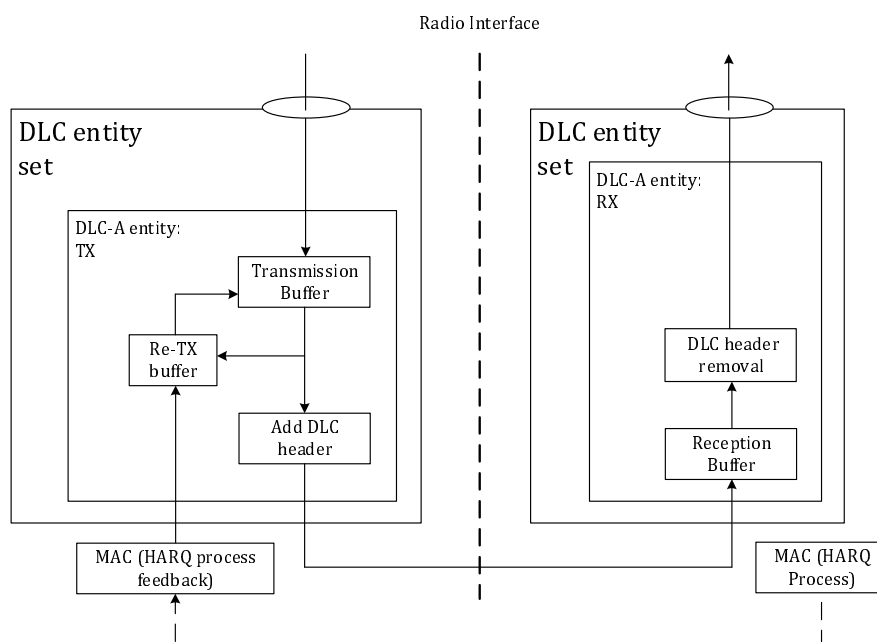

Figure 4.3.1.4-1: DLC Service Type 2 - TX and RX entities

4.3.1.5 DLC Service type 3: Segmentation and ARQ mode

A DLC entity using DLC Service Type 3 provides:

- Transmission of complete a DLC SDU or segment of a DLC SDU as defined in clause 5.2.3.1.
- Reception of a DLC PDU and assembly of a DLC SDU as defined in clause 5.2.3.2.
- Automatic Repeat Request (ARQ) with use of implicit ACK and NACK commands, by means of interaction with the MAC layer as defined in clause 5.2.6.
- Control of the maximum lifetime of a DLC SDU in the transmitter by DLC SDU discard as defined in clause 5.2.7.2.
- Control of the maximum lifetime of an non-complete DLC SDU in the receiver by DLC PDU discard defined in clause 5.2.7.3.

The transmission and reception operation in flow control modes are depicted in Figure 4.3.1.5-1.

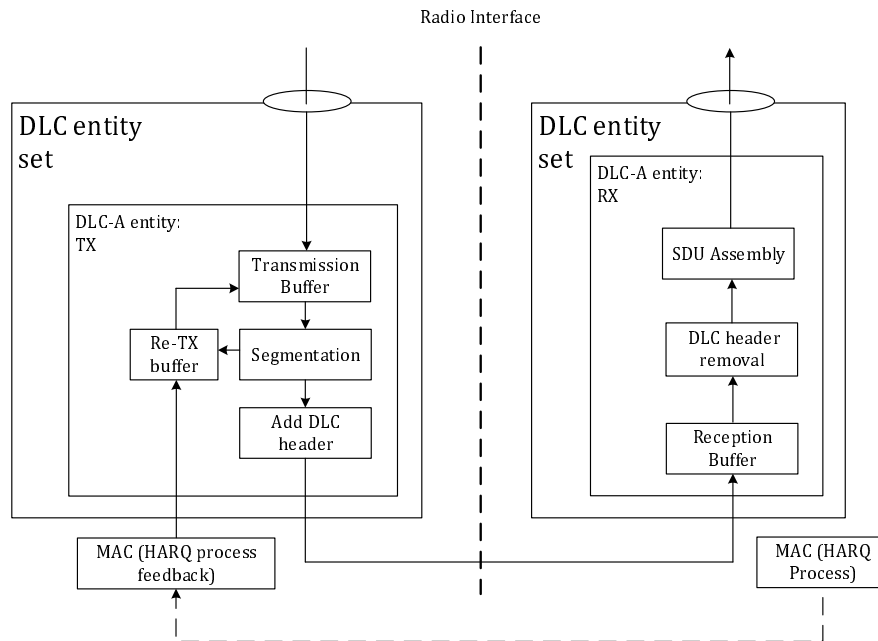

Figure 4.3.1.5-1: DLC Service Type 3 - TX and RX entities

4.3.1.6 DLC Routing Service

The DLC Routing service supports the following functions:

- Forwarding data received from the CVG layer to the correct DLC entity in a DLC entity set(s).
- Forwarding data from a DLC entity to the CVG layer.
- Routing data from one DLC entity in a DLC entity set to another DLC entity in a different DLC entity set(s).

This service is independent of other service types.

4.3.2 Services provided to upper layers by the Convergence layer

The convergence layer provides the following services to upper layer:

- Multiplexing service:
 - Identification and multiplexing of higher layer data frameworks.
- Transmission service:
 - Segmentation and reassembly, retransmission, flow control, lifetime control, duplicate removal, and delivery order of SDUs routed over the DECT-2020 network.
 - A set of Tx service types as defined in clause 6.2.2 are for implementing practical combinations of the transmission procedures.
- Security service:
 - Ciphering and integrity protection of messages.

The CVG layer operates end-to-end between the terminal entities. Intermediate nodes in a mesh network do not process the CVG layer payload.

4.3.3 Services expected from MAC layer

The DLC layer expects the following services from the MAC layer:

- Transfer of DLC PDU(s) inside MAC PDU.
- Indication of available space in MAC PDUs for transmissions.
- Indication of status (successful, not successful) of the MAC PDU transmission.

4.4 Order of transmission and figure numbering conventions

The transmission order is Big endian and left to right:

- A list of octets is transmitted 1st octet first.
- For each octet, bits are numbered 0 to 7 according to transmission order. Bit 0 is transmitted first (ascending transmission order).
- When bits are numbered in any other frame structure, they are also numbered according to the transmission order.

Whenever an octet or other container represents a numeric quantity the left most bit in the diagram and thus, the first to be transmitted, is the high order or most significant bit.

For octets, the bit labelled 0 is the most significant bit and bit 7 is the least significant bit.

When referring to the bits of a numerical value, ordinal numbers starting by 1st can be used to refer to the bits. 1st bit means the most significant bit, 2nd bit means the second MSB (note that if the value is placed in an octet the first bit is transmitted in bit 0). Last bit, 2nd last, 3rd last, etc. can be used to refer to the 3 least significant bits of the number.

5 DLC Layer Procedures and Data Units

5.1 General

DLC layer procedures for DLC service type 0, DLC service type 1, DLC service type 2, and DLC service type 3, are defined in clause 5.2 followed by DLC Protocol Data Units in clause 5.3.

5.2 DLC Procedures

5.2.1 DLC service type 0 procedures

5.2.1.1 Transmission procedure

When a DLC entity receives a DLC SDU from the routing service, the DLC entity shall:

- insert a DLC header as defined in clause 5.3.2 to the DLC SDU;
- place the created DLC PDU as the last PDU in the Tx buffer.

When the MAC layer indicates data transmission and space available in a MAC PDU the DLC entity shall:

- transmit the DLC PDU from the TX buffer to the MAC layer.

5.2.1.2 Reception procedure

When the MAC layer provides the received DLC PDU, the receiving DLC entity shall:

- remove the DLC header and provide the DLC PDU as a DLC SDU to the routing service.

5.2.2 DLC service type 1 procedures

5.2.2.1 Transmission procedure

When the DLC entity receives a DLC SDU from the routing service, the DLC entity shall:

- assign a sequence number for the SDU;
- if the SDU lifetime is configured:
 - Perform the actions defined in clause 5.2.7.2;
- Place the DLC SDU as the last SDU in Tx buffer.

When the MAC layer indicates data transmission and space is available in the MAC PDU the DLC entity shall:

- perform the actions defined in clause 5.2.4;
- transmit the DLC PDU to the MAC layer;
- remove the DLC SDU or DLC segments included in the DLC PDU from TX buffer.

5.2.2.2 Reception procedure

When the MAC layer provides a received DLC PDU, the receiving DLC entity shall:

- if the DLC PDU header indicates that the PDU carries a complete DLC SDU, the DLC entity shall:
 - remove the DLC header and provide the DLC SDU to the routing service;
- else:
 - place the DLC PDU into reception buffer;
 - perform the actions defined in clause 5.2.5.

5.2.3 DLC service type 2 and service type 3 procedures

5.2.3.1 Transmission procedure

When a DLC entity receives a DLC SDU from the routing service, the DLC entity shall:

- assign a sequence number for the SDU;
- if SDU lifetime is configured:
 - perform the action defined in clause 5.2.7.2;
- place the DLC SDU as the last SDU in the Tx buffer.

When the MAC layer indicates data transmission and space is available in the MAC PDU, the DLC entity shall:

- if operating in service type 2:
 - set the SI field to value 00, and set the assigned sequence number to DLC PDU header;
 - include the DLC SDU to the DLC PDU;

- else:
 - perform the actions defined in clause 5.2.4;
- transmit the DLC PDU to the MAC layer;
- place the DLC SDU or SDU segments included in the DLC PDU into the re-transmission buffer;
- remove the DLC SDU or DLC segments included in DLC PDU from the TX buffer.

When the DLC entity receives a MAC transmission status indication from the MAC layer, the DLC entity shall:

- perform the actions defined in clause 5.2.6.

5.2.3.2 Reception procedure

When the MAC layer provides a received DLC PDU, the receiving DLC entity shall:

- if the DLC PDU header indicates that the PDU carries a complete DLC SDU, the DLC entity shall:
 - remove the DLC header and provide the DLC SDU to the routing service;
- else if operating in DLC service type 3:
 - place the DLC PDU into the reception buffer;
 - perform the actions defined in clause 5.2.5,
- else:
 - discard the incomplete SDU.

5.2.4 Segmentation

The transmitter performs segmentation as follows:

- if the DLC SDU from the TX buffer fits completely, including the two-octet DLC header, into the MAC PDU:
 - set the SI field to value 00, and set the assigned sequence number in the DLC PDU header;
 - include the DLC SDU in the DLC PDU;
- else, if first octet of in the TX buffer contains the first octet of DLC SDU:
 - set the SI field to value 01 to indicate segmentation, and set the assigned sequence number to the DLC PDU header;
 - include the SDU segments, taking into account the two-octet DLC header that fits into the MAC PDU size, in the DLC PDU;
 - leave the remaining segments of the DLC SDU in the TX buffer waiting for the next transmission opportunity;
- else, if the DLC PDU fits the last segments of the DLC SDU:
 - set the SI field to value 10;
 - include the segmentation offset field to indicate the position of the first octet of the SDU segment in the original SDU;
 - include all the remaining SDU segments, and the four-octet DLC header to the DLC PDU;
- else, set the SI field to value 11:
 - include the segmentation offset field to indicate the position of the first octet of the SDU segment in the original SDU;

- include the SDU segments, taking into account four-octet DLC header that fits into MAC PDU size, in the DLC PDU;
- leave the remaining segments of the DLC SDU in the TX buffer waiting for the next transmission opportunity.

5.2.5 Reassembly

When the DLC PDU is placed into the reception buffer, the DLC entity shall:

- if all segments of the DLC SDU are received:
 - remove the DLC headers;
 - reassemble the DLC SDU;
 - provide the DLC SDU to the routing service;
 - remove the DLC PDU from the reception buffer;
- else, if the SDU lifetime is configured:
 - perform the actions defined in clause 5.2.7.3.

5.2.6 DLC Retransmissions (ARQ) using implicit ACK/NACK

The DLC service type 2 and DLC service type 3 retransmission procedure in the transmitter is based on MAC transmission status indications.

When the MAC layer indicates a successful transmission of the MAC PDU based on HARQ feedback a DLC entity shall:

- consider the DLC SDU or SDU segments included in MAC PDU placed in re-transmission buffer as successfully transmitted;
- remove all completely transmitted DLC SDU(s) from the re-transmission buffer.

When the MAC layer indicates unsuccessful transmission of the MAC PDU, the DLC entity shall:

- consider the DLC SDU or SDU segments included in MAC PDU placed in re-transmission buffer as unsuccessfully transmitted;
- place the DLC SDU or SDU segments from re-transmission buffer to transmission buffer:
 - a retransmitted SDU or segment shall be transmitted with priority over new SDUs or SDU segments.

5.2.7 DLC SDU lifetime control

5.2.7.1 General

Both the transmitting and receiving DLC entity may control the maximum lifetime of DLC SDUs.

5.2.7.2 Tx side procedures

When the maximum DLC SDU lifetime is configured, the transmitting DLC entity shall:

- consider the SDU lifetime value sent as defined in clause 5.3.3.2 as the initial value of the TX_SDU_discard_timer;
- when an SDU arrives from the routing service:
 - start the TX_SDU_discard_timer for the SDU;

- when the TX_SDU_discard_timer expires:
 - remove the SDU from the Tx buffer or re-transmission buffer even if it has not been completely transmitted.

NOTE: When the TX_SDU_discard timer expires the transmitter may remove the SDU from the TX buffer or re-transmission buffer when initiating transmission.

5.2.7.3 Rx side procedures

When the maximum DLC SDU lifetime is configured, the receiving DLC entity shall:

- consider the SDU lifetime value received as defined in clause 5.3.3.2 as the initial value of the RX_PDU_discard_timer;
- when a DLC PDU containing a non-complete DLC SDU is received:
 - if the RX_PDU_discard_timer is not running for the sequence number included in the DLC PDU header:
 - start the RX_PDU_discard_timer for the sequence number included in the DLC PDU header;
- when the RX_PDU_discard_timer expires for an SDU sequence number:
 - remove all DLC PDU(s) with the given SDU sequence number from the Rx buffer.

5.2.8 Routing services

5.2.8.1 General

Routing services support the following:

- Packet Routing from an RD to the backend (uplink) with a special unicast address reserved for the backend as defined in clause 5.2.8.2.
- Packet Routing from the backend (downlink) to RDs with a unicast, multicast or broadcast address as defined in clause 5.2.8.3.
- Packet Routing between RDs, with a unicast, multicast or broadcast address with hop-limited flooding as defined in clause 5.2.8.4.

5.2.8.2 Packet Routing to backend (uplink)

The packet routing to backend (uplink) is based on cluster tree routing topology. When an RD sends data to the backend it uses the backend address Long-RD ID as destination address as defined in ETSI TS 103 636-4 [2].

When data is received from the Convergence layer, the routing service shall:

- set the Dest_Add field to value 010 in the routing header, see clause 5.3.4, and omit the destination address from the routing header;
- set the routing type field to 000;
- set the source address as a Long RD-ID of the RD;
- select the DLC entity set serving the connection it has performed association with;
- select a DLC entity from the DLC entity set based on QoS requirements;
- place data to the TX buffer of the selected DLC entity.

When the routing service receives an SDU with a routing header where the destination address is the backend address, the routing service shall:

- if the RD operates in FT mode and has a connection to the backend:
 - remove the routing header;
 - provide the CVG PDU to the convergence layer at the backend interface with the source address;
- else:
 - select the DLC entity set serving the connection it has performed association with;
 - select a DLC entity from the DLC entity set based on QoS requirements;
 - place data to the TX buffer of the selected DLC entity.

5.2.8.3 Packet Routing from backend (downlink)

The packet routing from the backend (downlink) is based on selective flooding in cluster trees.

If an RD operates in FT mode and has a connection to the backend and receives a CVG PDU from the convergence layer the routing service shall:

- If the destination address is a unicast or multicast address:
 - form the routing header by setting the Dest_Add to 011 and omitting the source address.
- If the destination address is the broadcast address:
 - form the routing header by setting the Dest_Add to 100 and omitting the destination and source.
- Set routing type field to 011, see Table 5.3.4-2.

After forming a routing header or receiving an SDU with a routing header from the DLC entity, the routing type field is set to 011, the routing service shall:

- if the destination address is a unicast address:
 - if the Long RD-ID of the RD equals the destination address:
 - provide the CVG PDU to the RD's own convergence layer together with the source address;
 - else if the RD is in FT mode and has an associated RD, whose Long RD-ID equals the destination of the data:
 - select a DLC entity set serving the associated RD;
 - select a DLC entity from the DLC entity set based on QoS requirements;
 - place the data to the TX buffer of the selected DLC entity;
 - else if the RD has only associated RDs in PT mode, and none of the RDs are the destination of the data:
 - discard the SDU;
 - else:
 - select all DLC entity set(s) serving associated RDs operating in FT mode;
 - select a DLC entity from each DLC entity set based on QoS requirements;
 - place data to the TX buffer of each selected DLC entity;

- if the destination address is a multicast address:
 - if the RD is member of the multicast group provided in the destination address:
 - provide the CVG PDU to the RD's own convergence layer together with the source address;
 - if the RD is in FT mode and has associated RD(s):
 - select all DLC entity set(s) serving associated RDs;
 - select a DLC entity from each DLC entity set based on QoS requirements;
 - place data to the TX buffer of each selected DLC entity.

After forming or receiving an SDU with routing header from a DLC entity, with Dest_Add set to 001 or 100 and Routing type set to 011, the routing service shall:

- provide the CVG PDU to the RD's own convergence layer together with the source address set to the broadcast address;
- if the RD is in FT mode and has associated RD(s):
 - select all DLC entity set(s) serving the associated RDs;
 - select a DLC entity from each DLC entity set based on QoS requirements;
 - place data to the TX buffer of each selected DLC entity.

5.2.8.4 Packet Routing between RDs

5.2.8.4.1 Hop-limited Flooding

Packet routing between RDs in a cluster tree topology uses selective hop-limited flooding, where an RD transmits the data only to the destination if there is an association between the RD and the RD that is the destination of the packet. Otherwise, the data is flooded to the radio neighbourhood with a limited hop count.

When data is received from the Convergence layer, the routing service shall:

- If the destination address is a unicast or multicast address:
 - if the RD operates in FT mode and has a connection to the backend the routing service shall:
 - form the routing header by setting the Dest_Add to 011, and Routing type to 101, see Table 5.3.4-2;
 - omit the source address from the routing header;
 - else:
 - form the routing header by setting the Dest_Add to 000, and Routing type to 101 (Table 5.3.4-2);
 - indicate the presence of a hop limit and hop count and set the hop limit to a value larger than 0 and hop count to 1.
- If the destination address is the broadcast address:
 - if the RD operates in FT mode and has a connection to the backend the routing service shall:
 - form the routing header by setting the Dest_Add to 100, and Routing type to 101 (Table 5.3.4-2);
 - omit the source address from the routing header;
 - else:
 - form the routing header by setting the Dest_Add to 001, and Routing type to 101 (Table 5.3.4-2);

- omit the destination address from the routing header;
- indicate the presence of a hop limit and hop count and set the hop limit to a value larger than 0 and hop count to 1.
- Select the DLC entity set reserved for RD-to-RD communication.
- Select a DLC entity from the DLC entity set based on QoS requirements.
- Place data to the TX buffer of the selected DLC entity.

After forming a routing header or receiving an SDU with a routing header containing the Routing type set to 101 from a DLC entity, the Routing service analyses the routing header. The routing service shall:

- if the destination address is the RD's own Long RD address:
 - provide the CVG PDU to the RD's own convergence layer together with the source address, and not route the SDU further;
 - the procedure ends;
- if a packet with the same source address and sequence number has been already routed, the RD may:
 - discard the data;
 - the procedure ends.
- if the destination address is the broadcast address or a multicast address:
 - if the destination address is the broadcast address:
 - provide CVG PDU to the RD's own convergence layer together with the source address;
 - if the RD is a member of the multicast group provided in the destination address:
 - provide the CVG PDU to the RD's own convergence layer together with the source address;
 - if the hop counter value is smaller than the hop limit value, see Table 5.3.4-1:
 - increment the hop count in the routing header value by one;
 - select the DLC entity set reserved for RD-to-RD communication;
 - select a DLC entity from the DLC entity set based on QoS requirements;
 - place data to the TX buffer of the selected DLC entity;
 - else:
 - discard the data;
 - the procedure ends;
- else if the hop counter value is smaller than the hop limit value:
 - increment the hop count in the routing header value by one;
 - if the RD has an associated RD or is associated with the RD, whose Long RD-ID equals the destination address of the routing header:
 - select the DLC entity set serving the connection with that RD only;
 - select a DLC entity from DLC entity set based on QoS requirements;
 - place data to the TX buffer of the selected DLC entity;

- else:
 - select the DLC entity set reserved RD-to-RD communication;
 - select a DLC entity from DLC entity set based on QoS requirements;
 - place data to the TX buffer of the selected DLC entity;
- else:
 - discard data;
 - procedure ends.

5.3 DLC Protocol Data Units

5.3.1 General

The DLC Data PDU contains the DLC PDU header and DLC SDU. An optional routing header as defined in clause 5.3.4 is added at the beginning of each SDU when routing is used. The DLC control IE contains a DLC PDU header and control information element fields. The DLC PDU header has a variable content and size, indicated in the DLC PDU IE type field. The DLC PDU IE type is always the first four bits of the first octet of the DLC PDU header. The DLC PDU IE type also indicates whether the DLC SDU contains the routing header defined in clause 5.3.4 or directly the CVG PDU defined in clause 6.3. The coding of the DLC IE type is presented in Table 5.3.1-1.

Table 5.3.1-1: DLC IE Type coding

Value	Description
0000	Data: DLC Service type 0 with a routing header
0001	Data: DLC Service type 0 without a routing header
0010	Data: DLC Service type 1 or 2 or 3 with a routing header
0011	Data: DLC Service type 1 or 2 or 3 without a routing header
0100	DLC Timers configuration control IE
0101-1101	Reserved
1110	Escape
1111	Reserved

5.3.2 DLC Service Type 0

The PDU structure for DLC Service Type 0 is presented in Figure 5.3.2-1. When the IE Type is set to 0000 the DLC SDU contains a routing header as defined in clause 5.3.4. When the IE Type field is set to 0001 the DLC SDU directly contains a CVG protocol data unit as defined in clause 6.3.

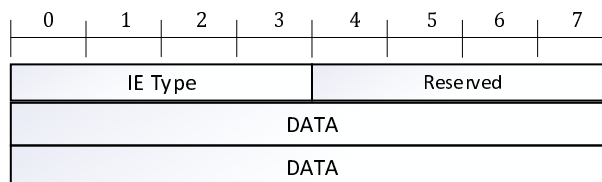

Figure 5.3.2-1: DLC Service Type 0 Data Unit

5.3.3 DLC Service Type 1, 2 and 3

5.3.3.1 Data PDU

The data PDU structure for DLC Service Type 1, 2 and 3 is presented in Figure 5.3.3.1-1 for a complete SDU. A data PDU for service type 1 and 3 with a segmentation offset field is presented in Figure 5.3.3.1-2. When the IE Type is set to 0010 the DLC SDU contains a routing header as defined in clause 5.3.4. When the IE Type field is set to 0011 the DLC SDU directly contains a CVG protocol data unit as defined in clause 6.3.

Followed by the IE type field the PDU header always contains the following two fields:

- SI: Segmentation indication as defined in Table 5.3.3.1-1.
- Sequence number that is increased every higher layer SDU.

The SI field indicates the segmentation status and presence of the segmentation offset field as defined in clause 5.2.4 for DLC service types 1 and 3.

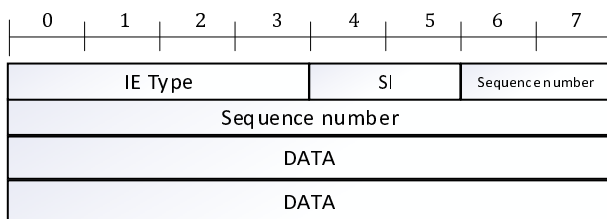

Figure 5.3.3.1-1: Segmentation PDU, for complete SDU

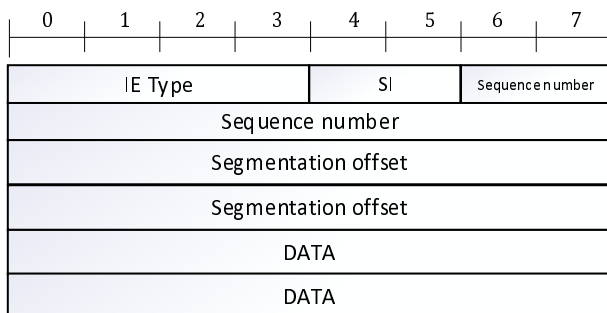

Figure 5.3.3.1-2: Segmentation PDU, for SDU Segment

Table 5.3.3.1-1: SI coding

Value	Description
00	Data field contains the complete higher layer SDU
01	Data field contains the first segment of the higher layer SDU
10	Data field contains the last segment of the higher layer SDU
11	Data field contains neither the first nor the last segment of the higher layer SDU

The Segmentation offset field indicates the position of the higher layer SDU segment in octets within the original higher layer SDU. The first octet of the original higher layer SDU is referred by the segmentation offset field value "0000000000000000", i.e. numbering starts at zero.

5.3.3.2 DLC Timers configuration Control IE

The DLC Timers configuration Control IE structure for configuring a DLC entity operating in DLC Service Types 1, 2 or 3 is presented in Figure 5.3.3.2-1. The field coding of the IE is presented in Table 5.3.3.2-2.

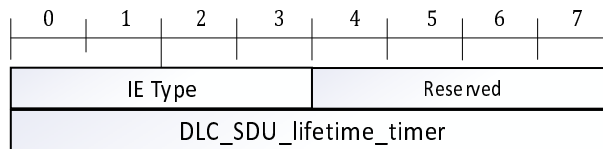

Figure 5.3.3.2-1: DLC Timer configuration PDU

Table 5.3.3.2-1: IE field coding

Parameter	Description
DLC_SDU_lifetime_timer	DLC layer lifetime timer used to control SDU discarding function in transmitter and receiver.

Table 5.3.3.2-2: TX_SDU_discard_timer and RX_PDU_discard_timer

Bit coding	Value
00000000	Reserved
00000001	0,5 ms
00000010	1 ms
00000011	5 ms
00000100	10 ms
00000101	20 ms
00000110	30 ms
00000111	40 ms
00001000	50 ms
00001001	60 ms
00001010	70 ms
00001011	80 ms
00001100	90 ms
00001101	100 ms
00001110	150 ms
00001111	200 ms
00010000	250 ms
00010001	300 ms
00010010	500 ms
00010011	750 ms
00010100	1 s
00010101	1,5 s
00010110	2 s
00010111	2,5 s
00011000	3 s
00011001	4 s
00011010	5 s
00011011	6 s
00011100	8 s
00011101	16 s
00011110	32 s
00011111	60 s
00100000 - 11111110	Reserved
11111111	Infinity

5.3.4 Routing header

An optional routing header is added at the beginning of each SDU when routing is used.

The routing header format is depicted in Figure 5.3.4-1. The first two octets is a routing bitmap field where each bit has a specific meaning as defined in Table 5.3.4-1. After the bit map field, a 32-bit source and destination address are present. For both fields Long RD IDs, defined in clause 4.2.3.1 of ETSI TS 103 636-4 [2], are used. After the address fields follow an optional hop count, Hop-limit, Delay field and sequence number. The presence of these fields is indicated in the routing bitmap field.

When setting the sequence number, the Routing service shall use one that is one higher than the previous sequence number used by the DLC entity set reserved for RD-to-RD communication.

After the routing header, the CVG layer protocol data unit as defined in clause 6.3 follows in the DLC SDU.

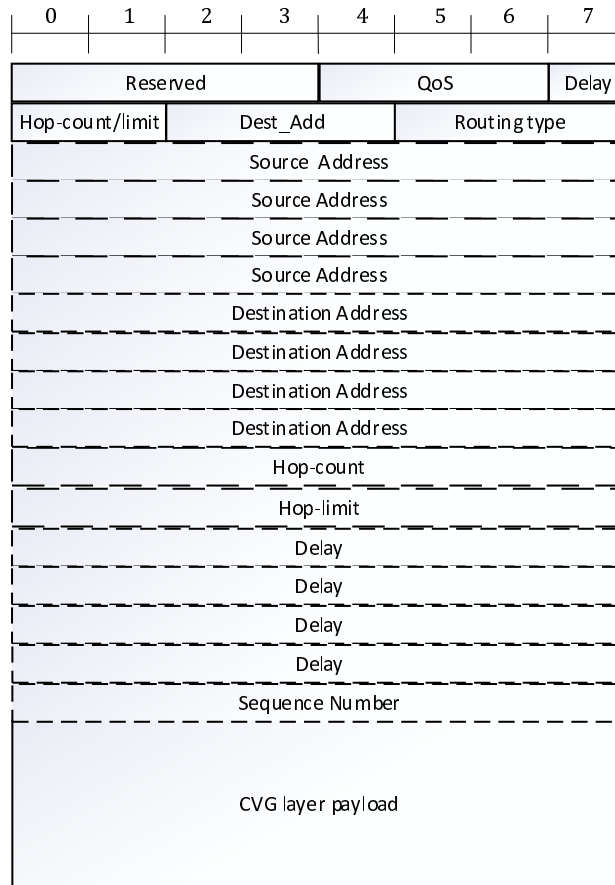

Figure 5.3.4-1: SDU structure for routing

Table 5.3.4-1: A routing bitmap field - bit definition

Bit field name	Values	Description
Reserved	Always set to 0000	Reserved for future use.
QoS	000: Low priority data 001: Reserved 010: Reserved 011: High priority data 100: Reserved 101: Reserved 110: High priority signalling 111: Reserved	Quality of Service of the packet, a higher value has a higher priority.
Delay	0: Delay field is not present 1: Delay field is present	This field indicates the presence of the Delay field in the Routing header.
Hop-count / limit	00: Hop-count and Hop-limit are not present 01: Hop-count is present and Hop-limit is not present 10: Hop-count and Hop-limit are present 11: reserved	This field indicates the presence of the Hop-count and Hop-limit fields in the Routing header.

Bit field name	Values	Description
Dest_Add	000: Destination and source addresses are present 001: Destination address is broadcast 010: Destination address is backend address 011: Source Address is backend address 100: Source Address is backend address, and target is broadcast address 101-111: Reserved	When set to 001, the destination address field is omitted, and the data is known to be sent to address 0xFFFFFFFF. When set to 010, the destination address field is omitted, and the data is known to be sent to address 0xFFFFFFFFE. When set to 011, the source address field is omitted, and the data is known to be sent from address 0xFFFFFFFFE. When set to 100, the destination and source address fields are omitted, and the data is known to be sent from address 0xFFFFFFFFE to address 0xFFFFFFFF.
Routing Type	3 bits as defined in Table 5.3.4-2	Defines the method used for packet routing.
Source Address	32 bits	Source address of the packet as Long RD IDs, defined in clause 4.2.3.1 of ETSI TS 103 636-4 [2].
Destination Address	32 bits	Destination address of the packet as Long RD IDs, defined in clause 4.2.3.1 of ETSI TS 103 636-4 [2].
Hop-count	8 bits	Provides cumulative hop count. When a packet is transmitted by the MAC layer to the next hop the value increased by 1.
Hop-limit	8 bits	Provides maximum number of hops the packet is flooded, set by the original source of the packet. If the Hop-count equals the Hop-counter the packet is no longer flooded by the RD.
Delay	32 bits	Transfer delay of the CVG PDU. Every RD processing the PDU increments the delay with the buffering time resulting to cumulative transfer time of the packet. Time resolution is 1 μ s.
Sequence number	8 bits	Sequence number of the packet at DLC layer. This field is present when the routing type is 011 or 101.

Table 5.3.4-2: Routing Type

Routing Type	Description
000	Uplink hop by hop routing for Packet Routing to backend (uplink), as defined in clause 5.2.8.2
001	Reserved
010	Reserved
011	Downlink flooding for Packet Routing from backend (downlink), as defined in clause 5.2.8.3
100	Reserved
101	Local flooding RD to RD, or RD to multicast Group, for Hop-limited flooding, as defined in clause 5.2.8.4.1
110	Reserved
111	Reserved

6 Convergence Layer Procedures and Data Units

6.1 General

A Convergence layer entity needs to be created for each peer CVG entity. Each CVG entity handles one or more parallel running flows, following the CVG procedures and using the CVG data units.

6.2 CVG Procedures

6.2.1 General

The Convergence layer specifies a Transparent procedure, see clause 6.2.3, an Endpoint multiplexing procedure, see clause 6.2.4, a set of transmission procedures, see clauses 6.2.5 to 6.2.12 and clause 6.2.14, and security procedures, see clause 6.2.13. The transmission procedures are arranged as CVG service types, see clause 6.2.2.

6.2.2 CVG Service types

6.2.2.1 General

The CVG layer's service types are related to the CVG procedures as defined in Table 6.2.2.1-1. The use of CVG Security, Multiplexing, Duplicate removal and Delivery order procedures are independent of the CVG service type.

For service type 0, the SDU is transported using the Data Transparent IE, see clause 6.3.6. For service types 1 to 4, the SDU is transported using the Data IE, see clause 6.3.4 or the Data EP IE, see clause 6.3.5.

Table 6.2.2.1-1: CVG Service types & features

	Transparent	Sequence numbering	Segmentation & reassembly	Lifetime	Flow control	ARQ
Service type 0	X	-	-	-	-	-
Service type 1	-	X	-	-	-	-
Service type 2	-	X	X	-	-	-
Service type 3	-	X	X	X	X	X(*)
Service type 4	-	X	X	X	X	X

NOTE: (*) = uses ARQ in a limited manner.

6.2.2.2 CVG Service type 0 procedures (transparent)

Service type 0 applies only the transparent procedure as defined in clause 6.2.3.

6.2.2.3 CVG Service type 1 procedures (sequence numbering)

Service type 1 applies the CVG layer sequence numbering only.

When transmitting, i.e. the CVG entity receives an SDU from a higher entity, the CVG entity shall:

- use the transmission and segmentation procedure as defined in clause 6.2.7.

NOTE: As the transmitting CVG does not use segmentation, the procedure is used only for complete SDUs, i.e. SI field is always set to value 00.

When the CVG entity receives a CVG PDU from a lower entity, the CVG entity may:

- apply the Duplicate Removal procedure as defined in clause 6.2.5;
- apply the ISD procedure as defined in clause 6.2.6.

6.2.2.4 CVG Service type 2 procedures (segmentation & reassembly)

Service type 2 applies the CVG layer segmentation and reassembly procedure.

When transmitting, i.e. the CVG entity receives an SDU from a higher entity, the CVG entity shall:

- use the transmission and segmentation procedure as defined in clause 6.2.7.

When the CVG entity receives a CVG PDU from a lower entity, the CVG entity:

- shall use the reception and reassembly procedure as defined in clause 6.2.8;
- may apply the Duplicate Removal procedure as defined in clause 6.2.5;
- may apply the ISD procedure as defined in clause 6.2.6.

6.2.2.5 CVG Service type 3 procedures (FC)

Service type 3 applies the CVG layer segmentation and reassembly, flow control and lifetime procedures. In addition, it uses the ARQ procedure in a limited manner to support the flow control.

The service type 3 is based on a transmission window with a selectable maximum window size (W_{MAX}) controlled by ACK only messages (ARQ Feedback IE) combined with a lifetime timer. It provides flow control by limiting the maximum amount of data that can exist in the buffers of the transmission chain at a given time.

The Lifetime procedure provides the automatic advance of the window and buffer clearing in case of missing ACK messages.

The provided mechanism is self-healing. In case of any error condition, the lifetime procedure will automatically lead both peers into a stable situation without the need of any reset command.

When transmitting, i.e. the CVG entity receives an SDU from a higher entity, the CVG entity shall:

- apply the Transmission and Segmentation procedure as defined in clause 6.2.7;
- apply the Flow Control procedure as defined in clause 6.2.9;
- apply the Lifetime procedure as defined in clause 6.2.11.

When the CVG entity receives a CVG PDU from a lower entity, the CVG entity:

- may apply the Duplicate Removal procedure as defined in clause 6.2.5;
- may apply the In Sequence Delivery procedure as defined in clause 6.2.6;
- shall apply the Reception and Reassembly procedure as defined in clause 6.2.8;
- shall apply the Flow Control procedure as defined in clause 6.2.9;
- shall apply the ARQ procedure as defined in clause 6.2.10, but in a limited manner:
 - the receiving CVG shall not report on missing SDUs or segments. It only sends ACK messages with "up to the SN", i.e. sets the ARQ Feedback IE field A/N to value 0 and Feedback info to value 101;
- shall apply the Lifetime procedure as defined in clause 6.2.11.

6.2.2.6 CVG Service type 4 procedures (FC and ARQ)

Service type 4 applies segmentation & reassembly, flow control, lifetime control and ARQ.

Service type 4 is based on a transmission window with a selectable maximum window size (W_{MAX}) controlled by ACK and NACK messages (ARQ Feedback IE) combined with a lifetime timer. It is able to provide reliable transmissions and effective flow control, limiting the maximum amount of data that can exist in the buffers of the transmission chain at a given time.

The window advancing is controlled by the ACK messages received from the peer. The NACK messages from the peer trigger selected re-transmissions.

The Lifetime procedure allows avoiding the unnecessary retransmission of already expired packets and also provides the automatic advance of the window and buffer clearing in case of a missing ACK or due to errors in the return channel.

The provided mechanism is self-healing. In case of any error condition, the lifetime procedure will automatically lead both peers into a stable situation without the need of any reset command.

When transmitting, i.e. the CVG entity receives an SDU from a higher entity, the CVG entity shall:

- apply the Transmission and Segmentation procedure as defined in clause 6.2.7;
- apply the Flow Control procedure as defined in clause 6.2.9;
- apply the ARQ procedure as defined in clause 6.2.10;
- apply the Lifetime procedure as defined in clause 6.2.11.

When the CVG entity receives a CVG PDU from a lower entity, the CVG entity:

- may apply the Duplicate Removal procedure as defined in clause 6.2.5;
- may apply the In Sequence Delivery procedure as defined in clause 6.2.6;
- shall apply the Reception and Reassembly procedure as defined in clause 6.2.8;
- shall apply the Flow Control procedure as defined in clause 6.2.9;
- shall apply the ARQ procedure as defined in clause 6.2.10;
- shall apply the Lifetime procedure as defined in clause 6.2.11.

6.2.3 Transparent procedure

The Transparent procedure does not apply CVG services, but only carries SDUs using the Data Transparent IE, see clause 6.3.6.

The transmitting CVG shall:

- set the CVG header fields using format 1 coding for the IEs, see clause 6.3.2:
 - set the CVG Ext field:
 - if more than one Data Transparent IEs are included within a CVG PDU, the 8 or 16-bit length field shall be used for all Data Transparent IEs;
 - set the MT (Mux Tag) field to value 0;
 - set the SDU as the Data payload field of the Data Transparent IE;
- pass the CVG PDU to the DLC.

The receiving CVG shall:

- pass the Data payload field (SDU) of the received Data Transparent IEs to the higher layer.

6.2.4 Multiplexing procedures

6.2.4.1 General

The Convergence layer provides identification and multiplexing of the flows of higher layer frameworks using different CVG level multiplexing procedures: Endpoint multiplexing and Mux tag multiplexing.

6.2.4.2 Endpoint Multiplexing procedure

Endpoint multiplexing is based on assigning values of 2-octet EP mux field, for the flows see clause A.1, and is indicated using the EP mux IE or the EP mux field of the Data EP IE.

The transmitting CVG entity shall:

- set the CVG header fields using format 1 coding for the IEs, see clause 6.3.2:
 - set the CVG Ext field:
 - if more than one Data EP IE is included within a CVG PDU, the 8 or 16-bit length field shall be used for all the Data EP IEs;
 - set the MT field to value 0;
 - set the CVG IE type;
- set the EP mux value;
- set the IE contents;
- if there are multiple IEs targeted to the same endpoint within a CVG PDU:
 - set the EP mux IE or Data EP IE directly in front of other IEs for the same endpoint;
- if there are one or more IEs for multiple endpoints within a CVG PDU:
 - set the IEs in order so that the subsequent IEs belong to the same EP mux flow;
 - set the EP mux IE or Data EP IE directly in front of the IEs targeted to the same endpoint, as in the example in Figure 6.2.4.2-1;
- pass the CVG PDU to the DLC layer.

The receiving CVG entity:

- shall pass each received IE to the corresponding EP mux flow; or
- in case the CVG does not support the EP mux indicated in the received IE, it may discard the IE and may send the Flow Status IE, see clause 6.3.11, with Reason code value 0011.

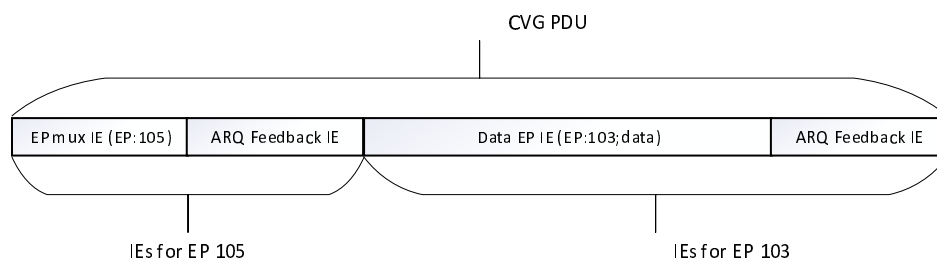

Figure 6.2.4.2-1: An example of organizing multiple IEs in a CVG PDU

6.2.4.3 Mux Tag multiplexing procedure

The Mux tag multiplexing procedure is based on the usage of a 3-bit Mux Tag field.

The transmitting CVG entity shall:

- set the CVG header fields using format 2 coding for the IEs, see clause 6.3.2:
 - set the CVG Ext field:
 - if more than one Data IE is included within a CVG PDU, the 8 or 16-bit length field shall be used for all Data IEs;
 - set the MT field into value 1;
 - set the F2C field:
 - if the F2C field value is set to 10, set the CVG IE Type field, see Figure 6.3.2-5;
 - set the Mux Tag value;
- set the IE contents;
- pass the CVG PDU to the DLC layer.

The receiving CVG entity shall:

- pass each received IE to the corresponding Mux Tag flow:
 - in case the CVG does not identify the Mux Tag indicated in the received IE, it may discard the IE.

6.2.5 Duplicate Removal procedure

The receiving CVG entity examines the Data IE, see clause 6.3.4, or Data EP IE, see clause 6.3.5, and:

- if the Sequence number of a complete SDU, or in case of a segment the Sequence number and Segmentation offset fields, indicate that it was already received within the current cycle of the sequence number, the CVG entity shall discard the SDU or the segment.

6.2.6 Delivery Order procedures

Delivery order procedures mean the arrangement of SDUs at the receiving CVG, before forwarding them to the next higher entity. In case segmentation is in use, only the completely reassembled SDUs are delivered.

Within the *default* procedure "as received delivery", the receiving CVG shall:

- deliver the complete SDUs in the order they were received from the DLC.

NOTE: The default delivery order procedure may cause passing of SDUs in non-incremental order. This needs to be taken into account by the security implementation.

Within the optional procedure "In Sequence Delivery" (ISD), the receiving CVG entity shall:

- if the SDU with the next expected sequence number is received, deliver the complete SDU to the next higher entity. Deliver also the possible buffered complete SDUs in order until the next missing or non-complete SDU;
- else if a missing SDU's lifetime expires as defined in clause 6.2.11, ignore the SDU and proceed to the next sequence number. Deliver the possible buffered complete SDUs in order until the next missing or non-complete SDU;
- else, wait for the next missing SDU.

6.2.7 Transmission and Segmentation procedure

When the CVG considers an SDU for transmission, it shall use either the Data IE or Data EP IE as following:

- if CVG security is in use:
 - follow clause 6.2.13 and the selected security mode procedure;

NOTE 1: Security mode 1 ciphering and the Transmission and Segmentation procedures use the same CVG sequence number for the SDU.

- if the SDU fits completely within a CVG PDU, the CVG entity shall:
 - set the SI value to 00;
 - set the Sequence number one higher than the previous using the same CVG flow;
 - set the SDU as the Payload field;
 - pass the IE to the next lower entity;

NOTE 2: The transmitting CVG may include two or more complete SDUs (Data IE or Data EP IE) or other IEs within a PDU, see clause 6.2.4 Multiplexing procedures.

- else if the non-transmitted octets that fit within the PDU contain the beginning of the SDU, the CVG entity shall:
 - set the SI value to 01;
 - set the Sequence number one higher than the previous using the same CVG flow;
 - include the segment, i.e. the next non-transmitted octets, taking into account what fits into DLC PDU, in the next lower entity;
 - leave the remaining octets of the SDU waiting for the next transmission opportunity;
- else if the non-transmitted octets that fit into a CVG PDU contain the last segment of the SDU, the CVG entity shall:
 - set the SI value to 10;
 - set the Sequence number the same as for the first segment of the same SDU;
 - set the Segmentation offset;
 - include the segment into the CVG PDU and pass it to the next lower entity;
- else, the CVG entity shall:
 - set the SI value to 11;
 - set the Sequence number the same as for the first segment of the same SDU;
 - set the Segmentation offset;
 - include the next set of octets that fit into the CVG PDU and pass the IE to the next lower stack entity;
 - leave the remaining segments of the SDU waiting for the next transmission opportunity.

In each case above, if the Data EP IE is used, the corresponding EP mux value shall be included in the IE.

The transmitter may set the SLI bit to value 1 and set the SDU length field in either Data IE or Data EP IE to the correct length.

6.2.8 Reception and Reassembly procedure

The receiving CVG entity shall examine the Data IE, see clause 6.3.4 or the Data EP IE, see clause 6.3.5:

- if it contains a complete SDU ($SI = 00$):
 - pass the SDU to the next higher entity;
- else if it contains a segment ($SI = 01, 10$ or 11):
 - reassemble the complete SDU or if one or more segments are still missing, store for later reassembly;
 - pass the complete SDU to the next higher entity;
- if security is in use:
 - follow clause 6.2.13 and the selected security mode procedure.

NOTE: If Security mode 1 is in use, the Sequence number within the Data IE or Data EP IE needs to be provided for the Security service for the initialization vector.

6.2.9 Flow control procedures

6.2.9.1 General

Flow Control is used for mitigating the transmission of SDUs at a CVG flow. Both the transmitting and receiving CVG maintain a Flow Control window. The maximum size (W_{MAX}) of the window is set within the Tx Services configuration, see clause 6.2.12 or as a system configuration.

The transmitter does not move the window ahead before receiving ACKs or releasing SDUs from the beginning of the window through expiration of their lifetime. Therefore, the progress of the flow is primarily controlled by the receiving CVG. The timing the receiving CVG sends the ARQ feedback is outside of the scope of the present document.

Handling of the window is described using markers A, B and C that point to the sequence numbers:

Marker A (window start pointer):

- Transmitting CVG: The last transmitted SN that has been acknowledged or has expired.
- Receiving CVG: The last received SN that has been (successfully) acknowledged or has expired.

Marker B (window end pointer):

- Transmitting CVG: The last transmitted SN.
- Receiving CVG: The last received SN.

Marker C (last sent ACK pointer):

- Receiving CVG: SN indicated in the last ACK message sent.

The window is defined to cover the SDUs from the first sequence number after marker A ($A+1$) to the sequence number indicated by marker B.

If markers A and B point to the same sequence number, the window is considered empty.

When marker A advances, all older packets including the one pointed by marker A can be removed from memory. The pointers can only move forward (advance). Marker A cannot proceed over the position of marker B. SDUs beyond marker B are pending for the first transmission. They are considered not yet in the window; however, their lifetime counter is running as defined in clause 6.2.11.

6.2.9.2 FC transmitting procedures

The transmitting CVG maintains book-keeping for the transmitted, non-expired sequence numbers of the SDUs within the Flow Control window.

When a transmitting CVG has not reached the maximum FC window size for a flow, i.e. the marker B - marker A < W_{MAX} , the Flow Control does not affect the transmissions. Marker B is advanced each time an SDU or a first segment of an SDU with new sequence number is transmitted.

When a transmitting CVG reaches the maximum FC window size for a flow (marker B - marker A = W_{MAX}):

- if no ARQ feedback is received, or lifetime did not expire for any SN, the CVG shall:
 - retain from transmitting SDUs to the flow (markers A and B remain unchanged);
- if the CVG receives a NACK for one or more non-expired complete SDUs or any segments within the window, the CVG shall:
 - retransmit the SDU(s) or segments;
 - not move with the window ahead (markers A and B remain unchanged);
- if the CVG receives an ACK for one or more non-expired complete SDUs or last missing segments of complete SDUs within the window, the CVG shall:
 - if the first N SDUs within the window are completely acknowledged, move the window ahead by N steps (both markers A and B are moved);
 - else not move the window ahead (markers A and B remain unchanged);
- if the CVG receives an ACK or NACK for one or more SDUs or segments outside of the window, the CVG shall:
 - ignore the feedback (markers A and B remain unchanged);
- if the lifetime of the SDUs within the FC window expires, the CVG shall:
 - if the first N sequence numbers (SDUs) within the window are expired, move the window ahead by N steps (both marker A and B are moved N steps);
 - else not move the window ahead (markers A and B remain unchanged);
- if the lifetime of the complete SDUs outside of the FC window expires, the CVG shall:
 - handle the SDUs as defined in clause 6.2.11 (markers A and B remain unchanged).

NOTE: An ARQ Feedback IE may contain both ACK and NACK information of the same flow. For example, ACK for SDUs with SNs 1 to 3 and a NACK for an SDU with SN 4 within the valid FC window are received. In this example the $W_{MAX} = 4$. The transmitter will retransmit the SDU with SN 4, and move the markers A and B by three SNs ahead, i.e. it is free to send SDUs with sequence numbers 5, 6 and 7.

6.2.9.3 FC receiving procedures

The receiving CVG maintains book-keeping for the non-expired complete SDUs and segments for each CVG flow that uses Flow Control to estimate the progress at the transmitting CVG. The receiving CVG sorts the received SDUs or segments in order by sequence number or by sequence number and segment offset, identifies the empty positions in the receiving buffer and applies a lifetime timer for both received packets and empty positions as described in clause 6.2.11.

When a receiving CVG has not reached the maximum FC window size for a flow, i.e. the marker B - marker A < W_{MAX} , the Flow Control does not affect the operation. However, marker B shall be advanced each time a new higher sequence number is received, counting also the possible empty positions.

When a receiving CVG reaches the maximum FC window size for a flow (marker B - marker A = W_{MAX}):

- if the CVG sends an ACK for the sequence number at position A+1, the CVG sets marker C as A+1 and moves markers A and B ahead by one step;
- if the lifetime of the SDU with sequence number at position A+1 expires, the CVG moves both markers A and B ahead by one step;
- else, the CVG does not move the window ahead, i.e. markers A, B and C remain unchanged.

NOTE: An ARQ Feedback IE may contain ACK and NACK information for multiple sequence numbers of the same flow. For example, ACK for SDUs with SNs 1 to 3 and a NACK for an SDU with SN 4 within the valid FC window are sent to the transmitting CVG. In this example the $W_{MAX} = 4$. Upon sending ARQ feedback IE, the receiving CVG moves the markers A, B and C by three SNs ahead.

6.2.10 Retransmission (ARQ) procedure

The automatic request for repetition (ARQ) function is to verify the reception of transmitted SDUs by the receiving CVG. Upon the feedback from the receiving CVG, the missing SDUs are retransmitted by the transmitting CVG.

When the ARQ Feedback IE indicates successful reception of a transmitted SDU, the transmitting CVG entity can remove the SDU from its buffers. In case of successful reception of a segment, the segment can be removed when all the segments of the SDU using the same sequence number are successfully received.

When the ARQ Feedback IE indicates unsuccessful reception of a transmitted complete SDU or a segment, the transmitting CVG shall retransmit it. The retransmissions shall be prioritized over the new transmissions.

The transmitting CVG entity may send an ARQ Poll IE to the receiver. The receiver shall respond with the ARQ Feedback IE that covers the non-expired sequence numbers.

NOTE: The usage of the ARQ Feedback IE and ARQ Poll IE should be considered carefully in DECT-2020 networks using Mesh mode, in order to mitigate extensive routing.

The ARQ configuration is included in the Tx Services configuration, see clause 6.2.12.

6.2.11 Lifetime control procedure

When a transmitting CVG entity receives a complete SDU or the first segment of an SDU from a higher entity, the CVG entity shall start the CVG_Tx_discard_timer for the SDU.

If the CVG_Tx_discard_timer expires before the SDU is removed due to successful delivery, see clause 6.2.5, the transmitting CVG entity shall remove the SDU. If the SDU is segmented, all the segments of the same SDU are removed.

When a receiving CVG entity receives a new SDU or a segment of an SDU that has a higher sequence number than those received before, the receiving CVG entity shall start the CVG_Rx_discard_timer for the SDU. If there were one or more missing sequence numbers (empty positions for SDUs) in between, the CVG_Rx_discard_timer shall be started for them as well. If the missing SDU(s) arrive later before the expiration, the timer is not restarted.

If the CVG_Rx_discard_timer expires for an SDU or a segment of an SDU, the CVG entity shall remove the SDU.

The Lifetime may be configured in the Tx Services configuration as defined in clause 6.2.12 or as a system configuration.

6.2.12 Tx Services configuration procedure

The CVG entity sends the Tx Services Config IE, see clause 6.3.8, to its peer to request the Tx services configuration, i.e. setting the Service Type, Lifetime and Max window size for a new or an existing CVG flow, or to respond to such a configuration request from a peer CVG entity.

When using the Tx Services Config IE as a request, the CVG entity shall:

- set the Rq/Rs field to value 0; and

- set the corresponding Service Type, Lifetime and Max window size fields. If using a service type that does not apply Lifetime or Max window size, they are set to value 0.

When using the Tx Services Config IE as a response to Tx Services Config IE request, the CVG entity shall:

- set the Rq/Rs field to value 1; and
- if the Service Type, Lifetime and Max window size values requested are acceptable, copy the values to the response;
- else, set acceptable values into the response.

When a CVG entity receives a response wherein any of the Service Type, Lifetime and Max Window size field values is different to the values in the corresponding request, the CVG entity shall either start using the values of the response or discard the flow.

6.2.13 Security procedures

6.2.13.1 General

The CVG layer security is defined in different Security Modes. The procedures for Security mode 1 are defined in clause 6.2.13.2.

6.2.13.2 Security Mode 1 procedures

6.2.13.2.1 General

Security Mode 1 shall use AES-128 for ciphering with integrity protection to provide confidentiality and message authentication as defined in FIPS PUB 197 [3]. One key is used for integrity protection and another key for encryption. Security is handled per CVG flow, i.e. a security entity is established for each flow and each flow shall have its own key-pair. However, the number of key-pairs and the key distribution is outside of the scope of the present document.

6.2.13.2.2 Integrity protection

The Mode 1 integrity protection of the messages is obtained by using the Message Integrity Code (MIC) that is added to the end of the SDU as shown in Figure 6.2.13.2.2-1. The MIC shall be calculated by using the CMAC (OMAC-1) message authentication algorithm as defined in NIST Special Publication 800-38B [4].

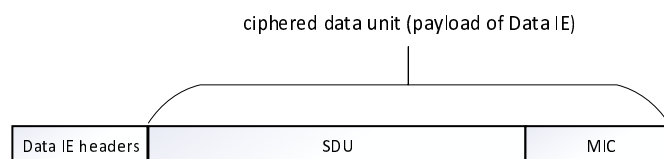

Figure 6.2.13.2.2-1: Ciphering an SDU and MIC

The transmitting CVG entity shall:

- generate a MIC from the complete SDU;
- truncate the MIC to 5 octets and attach it to the end of the SDU, see Figure 6.2.13.2.2-1;
- take actions defined in clause 6.2.13.2.3 for ciphering the SDU+5-octet MIC.

The receiving CVG entity shall:

- verify the 5-octet MIC against the de-ciphered SDU;
- if the MIC is correct:
 - pass the SDU to the above entity;

- else:
 - discard the complete SDU;
 - after consecutive MIC decoding failures indicate the lack of peer CVG's correct HPC value to its own CVG transmitter.

NOTE: The number of consecutive MIC decoding errors interpret as lack of peer CVG's correct HPC value is implementation dependent.

6.2.13.2.3 Ciphering

For Mode 1, the ciphering shall use AES-128 counter mode (CTR) for encryption as defined in FIPS PUB 197 [3]. The Initialization Vector (IV) for the counter is defined in Table 6.2.13.2.3-1. The ciphering uses the CVG sequence number carried in the Data IE or the Data EP IE, see the sequence number usage in clause 6.2.7. Respectively, either the Data IE or the Data EP IE Payload field contains the ciphered SDU, see Figure 6.2.13.2.3-1.

Table 6.2.13.2.3-1: Initialization vector

Bits	Definition
0 to 31 (octets: 0 to 3)	Long RD-ID of the transmitter.
32 to 63 (octets: 4 to 7)	Long RD-ID of the receiver.
64 to 95 (octets: 8 to 11)	Hyper Packet Counter (HPC).
96 to 107	PSN: The Sequence number included in the Data IE or the Data EP IE preceding the Security IE.
108 to 127	The ciphering engine internal octet counter. Increased by one at every 16-octet ciphered block. Set to zero for the first 16-octet block of the CVG PDU.

The transmitting CVG shall:

- if the CVG sequence number is 0:
 - increment the HPC by one;
- use the Sequence number as the PSN;
- if the CVG is providing its own HPC counter value to the peer CVG:
 - set the Sec-bit to value 0;
 - set the Security IE in front of the Data IE as in Figure 6.2.13.2.3-1;
 - set the Security IV type value to 0000;
 - increase the HPC at least by one from the previously used value;
 - cipher the SDU and MIC;
- else if the CVG is requesting to get its peer's current HPC value, it may:
 - set the Security IE in front of the Data IE as in Figure 6.2.13.2.3-1;
 - set the Security IV type value to 0001 to request the HPC;
 - increase the HPC at least by one from the previously used value;
 - cipher the SDU and MIC;

NOTE: The HPC can be sent either with the next SDU or with a Data IE or Data EP IE with a zero-length payload.

- else:
 - cipher the SDU and MIC;
- the procedure ends.

The receiving CVG shall:

- if Sequence number is 0:
 - increment HPC value by one;
- use the Sequence number as the PSN;
- if the Security IE is present as in Figure 6.2.13.2.3-1 and the Security IV Type is set to value 0000:
 - obtain the HPC value from the Security IE;
 - use the obtained HPC to receive future CVG PDUs;
 - decipher the SDU and MIC;
- else if the Security IE is present as in Figure 6.2.13.2.3-1 and the Security IV Type is set to value 0001:
 - obtain the HPC value from the Security IE;
 - use the obtained HPC to receive future CVG PDUs;
 - decipher the SDU and MIC;
 - indicate its own transmitter to send the HPC to the peer CVG (see the statement for the transmitting CVG above);
- else:
 - decipher the SDU and MIC.

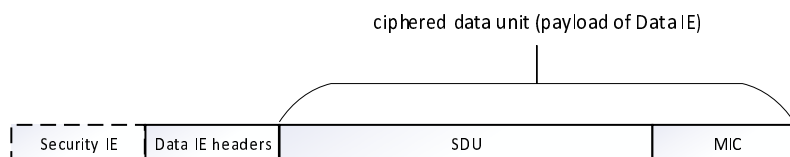

Figure 6.2.13.2.3-1: Attaching Security IE with the Data IE

6.2.14 Flow Status procedures

The receiving CVG may inform the transmitting CVG about possible issues of a flow by sending a Flow Status IE, see clause 6.3.11, the CVG entity shall:

- set the Reason field;
- pass the Flow Status IE to be transmitted.

NOTE: The Flow Status IE may be directed for a CVG flow identified by an Endpoint or Mux Tag, see clause 6.2.4. The activity following receiving the Flow Status IE is outside of the scope of the present document.

6.3 CVG Protocol Data Units

6.3.1 General

The CVG specifies a common CVG Header, see clause 6.3.2, and a set of Information Elements (IEs). Multiple IEs may be concatenated within the same CVG PDU.

6.3.2 CVG Header

The Convergence layer header, either format 1 or format 2 is always present in the beginning of each CVG Information Element (IE).

The CVG header begins with the CVG Ext and the MT (Mux Tag) field. The 2-bit CVG Ext indicates the presence of an 8 or 16-bit length field right after the CVG header octet, or no length field at all, see Figures 6.3.2-2 and 6.3.2-3. The CVG Ext coding is presented in Table 6.3.2-1. The implementation of the present document version shall discard the received information elements that contain CVG Ext field value 11 (reserved).

The 1-bit MTfield value 0 indicates the presence of the header format 1, see Figures 6.3.2-1 and 6.3.2-2. The MT field value 1 indicates the presence of header format 2, see Figures 6.3.2-3 and 6.3.2-4.

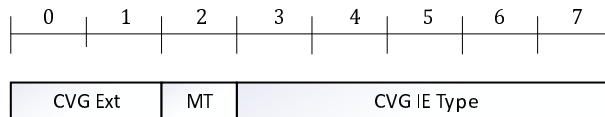

Figure 6.3.2-1: CVG Header format 1

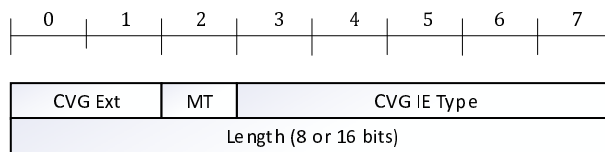

Figure 6.3.2-2: CVG Header format 1 with length field

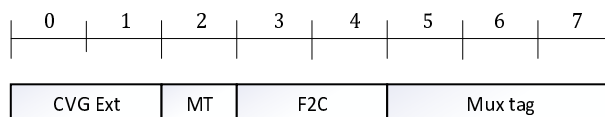

Figure 6.3.2-3: CVG Header format 2

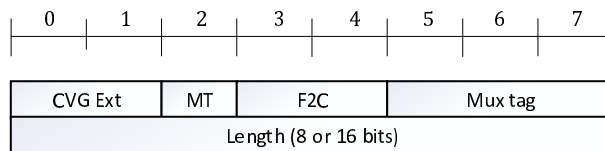

Figure 6.3.2-4: CVG Header format 2 with length field

Table 6.3.2-1: CVG Ext coding

Value	Description
00	No length field included in CVG header.
01	8-bit length included indicating the length of the IE payload.
10	16-bit length included indicating the length of the IE payload.
11	Reserved.

When header format 1 is in use (MT=0), the CVG IE Type field is applied in the first octet. The 5-bit CVG IE Type defines the context of the information element until the next CVG header or the end of the CVG PDU. The CVG IE Type coding is presented in Table 6.3.2-2.

Table 6.3.2-2: CVG IE Type coding

Value	Description
00000	EP mux IE
00001	Data IE
00010	Data EP IE
00011	Data Transparent IE
00100	Security IE
00101	Tx Services Config IE
00110	ARQ Feedback IE
00111	ARQ Poll IE
01000	Flow Status IE
01001-11101	Reserved
11110	Escape
11111	Reserved

When the CVG IE Type is set to value "Escape", as shown in Table 6.3.2-2, the definition of the octets following the CVG header are outside of the scope of the present document.

When header format 2 is in use, the F2C and Mux Tag fields are applied in the first CVG header octet. The coding of F2C is shown in Table 6.3.2-3. In case F2C is set to the value 00 or 01, the corresponding IE is attached right after the header octet or after the length field if the length is included using CVG Ext.

Table 6.3.2-3: F2C coding

Value	Description
00	Data IE
01	ARQ Feedback IE
10	IE coding with CVG IE Type field
11	Reserved

In case F2C is set to value 10, an additional octet bearing a 3-bit Reserved field and a CVG IE Type field is included as described in Figure 6.3.2-5. The optional Length field is coded using the CVG Ext field as described in Table 6.3.2-1. The IE indicated in the CVG IE Type field, as defined in Table 6.3.2-2, shall be attached right after the CVG IE Type field.

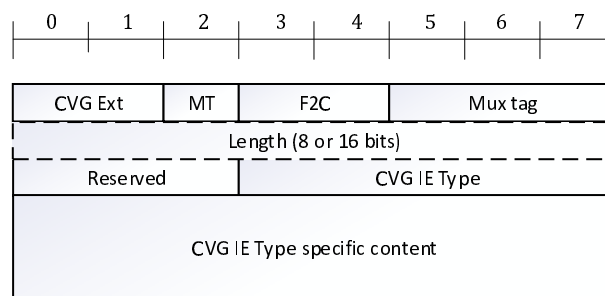

Figure 6.3.2-5: CVG Header format 2 with CVG IE Type

The 3-bit Mux Tag field identifies an instance of the CVG layer multiplexer flow.

6.3.3 EP Mux IE

The EP Mux IE is defined as in Figure 6.3.3-1.

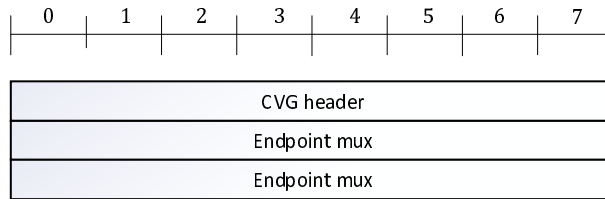

Figure 6.3.3-1: EP Mux IE

The CVG header is as defined in clause 6.3.2. The IE size is fixed and CVG header's length field is not included. The 16-bit Endpoint mux field value allocation is described in Annex A.

6.3.4 Data IE

The Data IE is defined as in Figure 6.3.4-1.

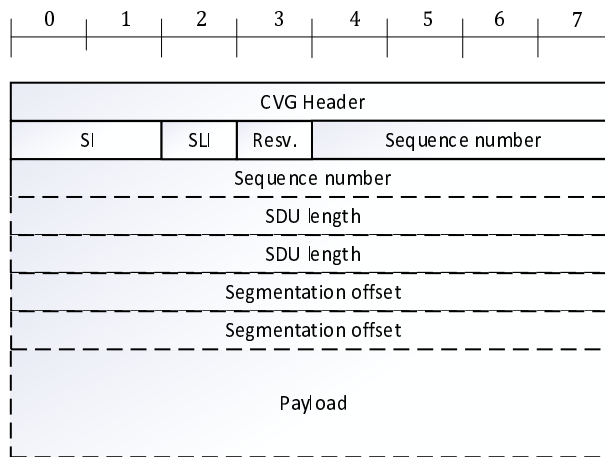

Figure 6.3.4-1: Data IE

The CVG header is as defined in clause 6.3.2. The IE size is fixed and CVG header's length field is not included. The 2-bit Segmentation Indication (SI) field encoding is defined in Table 6.3.4-1.

Table 6.3.4-1: SI coding

Value	Description
00	Payload field contains a complete SDU
01	Payload field contains the first segment of an SDU
10	Payload field contains the last segment of an SDU
11	Payload field contains neither the first nor the last segment of an SDU

The 1-bit SDU Length Indicator (SLI) field encoding is defined in Table 6.3.4-2.

Table 6.3.4-2: SLI coding

Value	Description
0	SDU length not included
1	SDU length included

The Sequence number is a 12-bit field, which value is increased for each subsequent SDU.

The SDU Length is an optional 16-bit field, which contains the length of the full SDU. The presence of the field is indicated with the SLI bit, see Table 6.3.4-2.

The Segmentation offset is a 16-bit field, which indicates the position of the segment in octets within the complete SDU. The first octet of the complete SDU is referred by the segmentation offset field value "0000000000000000", i.e. numbering starts at zero. The segmentation offset field is not present in the IE when SI field value is set to "00" or "01".

The Payload is a variable length field, which may contain an encrypted or unencrypted SDU or a segment of an SDU and it may contain a MIC.

When the CVG Ext field of the Data IE indicates a Length field, the length covers all octets starting from the octet following the length field until the end of the Payload field.

6.3.5 Data EP IE

The Data EP (EndPoint) IE is defined as in Figure 6.3.5-1.

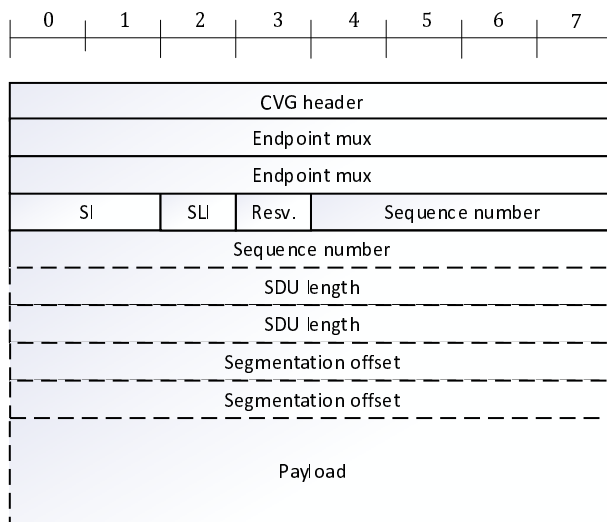

Figure 6.3.5-1: Data EP IE

The CVG header is as defined in clause 6.3.2. The Data EP IE is of variable length and the CVG header's length field may be used.

The Endpoint mux field is defined in clause 6.3.3, the SI, SLI, Sequence number, SDU Length, Segmentation offset and Payload are defined in clause 6.3.4.

6.3.6 Data Transparent IE

The Data Transparent IE is defined as in Figure 6.3.6-1.

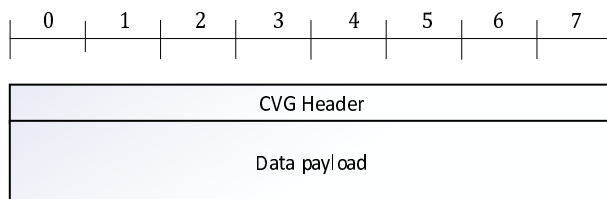

Figure 6.3.6-1: Data Transparent IE

The CVG header is as defined in clause 6.3.2. The Data Transparent IE is of variable length and the CVG header's length field may be used.

The Data payload field contains an SDU.

6.3.7 Security IE

The Security IE is defined as in Figure 6.3.7-1.

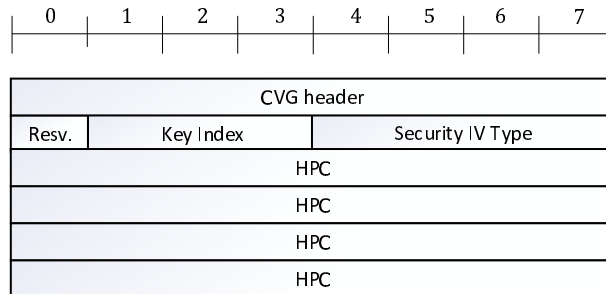

Figure 6.3.7-1: Security IE

The CVG header is as defined in clause 6.3.2. The IE size is fixed and CVG header's length field is not included.

The 3-bit Key index field indicates the key which is used for the SDUs starting from the CVG PDU the Security IE is included in. The key index refers both to the integrity and encryption key.

The 4-bit Security IV type field indicates which type of initialization vector is used, see Table 6.3.7-1.

Table 6.3.7-1: Security IV Type for Mode 1

Value	Definition
0000	Current HPC value of the transmitter is provided.
0001	Current HPC value of the transmitter is provided, and the sender requests the peer to provide its own transmitter HPC value.
0010-1111	Reserved

Hyper Packet Counter (HPC) field's four octets are used in the initialization vector, as depicted in Table 6.2.13.2.3-1.

6.3.8 Tx Services Config IE

The Tx Services Config IE is defined as in Figure 6.3.8-1.

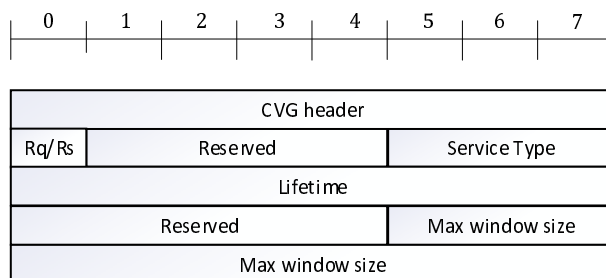

Figure 6.3.8-1: Tx Services Config IE

The CVG header is as defined in clause 6.3.2. The IE size is fixed and CVG header's length field is not included.

The 1-bit Rq/Rs (Request/Response) field encoding is defined in Table 6.3.8-1.

Table 6.3.8-1: Rq/Rw coding

Value	Description
0	This IE is a request
1	This IE is a response

The 3-bit Service Type field encoding is defined in Table 6.3.8-2.

Table 6.3.8-2: Service Type coding

Value	Description
000	Service Type 0
001	Service Type 1
010	Service Type 2
011	Service Type 3
100	Service Type 4
101-111	Reserved

The 8-bit Lifetime field defines the time duration the packets are considered valid.

Table 6.3.8-3: Lifetime coding

Bit coding	Value
00000000	Not applicable
00000001	0,5 ms
00000010	1 ms
00000011	5 ms
00000100	10 ms
00000101	20 ms
00000110	30 ms
00000111	40 ms
00001000	50 ms
00001001	60 ms
00001010	70 ms
00001011	80 ms
00001100	90 ms
00001101	100 ms
00001110	150 ms
00001111	200 ms
00010000	250 ms
00010001	300 ms
00010010	500 ms
00010011	750 ms
00010100	1 s
00010101	1,5 s
00010110	2 s
00010111	2,5 s
00011000	3 s
00011001	4 s
00011010	5 s
00011011	6 s
00011100	8 s
00011101	16 s
00011110	32 s
00011111	1 min
00100000	1,5 min
00100001	2 min
00100010	3 min
00100011	5 min
00100100	10 min
00100101	30 min
00100110	1 h
00100111	2 h

Bit coding	Value
00101000	5 h
00101001	12 h
00101010	24 h
00101011 - 11111110	Reserved
11111111	Infinity

The Max window size field is an 11-bit field and defined as the maximum number of CVG sequence numbers. Value 0 means not applicable.

6.3.9 ARQ Feedback IE

The ARQ Feedback IE has a default format as in Figure 6.3.9-1, using the CVG Ext field value 00 (no length field) as in Table 6.3.2-1. In case of the other formats, see Figure 6.3.9-2, 6.3.9-3, or 6.3.9-4, a combination of feedback elements is used and the CVG Ext field is set to the value 01, indicating the use of the 8-bit length field. Each format contains an A/N field, Feedback info, a Sequence number, and may contain Segmentation offset fields, depending on the Feedback info coding.

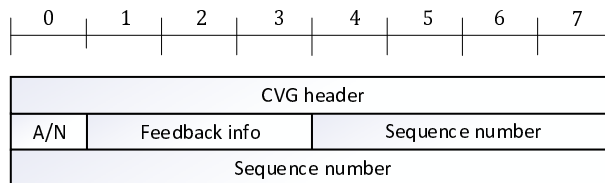

Figure 6.3.9-1: ARQ Feedback IE format 1

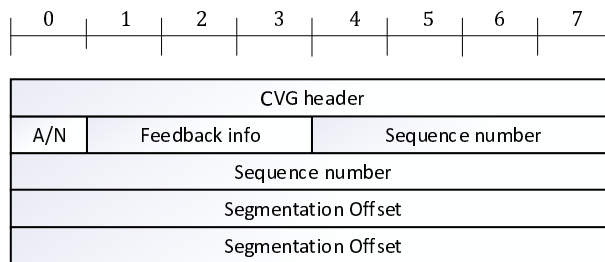

Figure 6.3.9-2: ARQ Feedback IE format 2

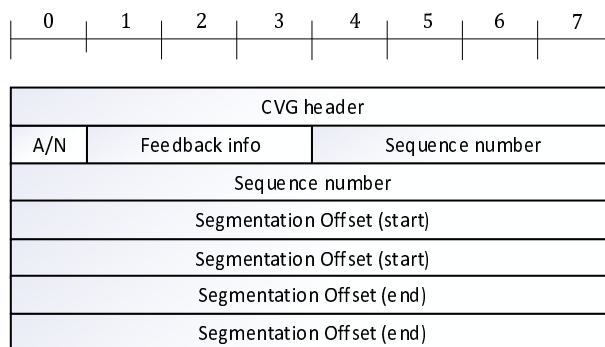

Figure 6.3.9-3: ARQ Feedback IE format 3

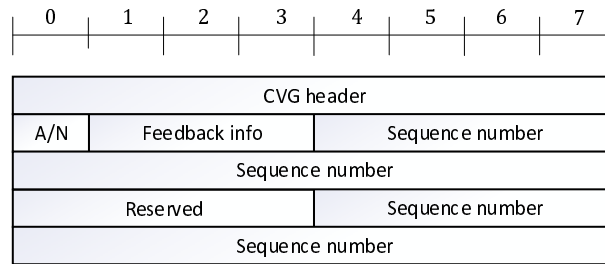

Figure 6.3.9-4: ARQ Feedback IE format 4

The CVG header is as defined in clause 6.3.2. The 1-bit A/N field indicates whether the SDU pointed to with the sequence number is received or not, as described in Table 6.3.9-1.

Table 6.3.9-1: A/N coding

Value	Description
0	The SN refers to a received SDU or segment (ACK)
1	The SN refers to a non-received SDU or segment (NACK)

The 3-bit Feedback info describes whether the Sequence number is pointing to a complete SDU, a segment, a range or the end of a sequence. In case the coding refers to a range of sequence numbers or a segment offset, additional fields follow as in Figure 6.3.9-2. The coding of the field is described in Table 6.3.9-2.

Table 6.3.9-2: Feedback info coding

Value	Description
000	A complete SDU (sequence number). Format 1 is used.
001	Start of an SDU (sequence number and offset to the last octet of the pointed segment). Format 2 is used.
010	End of an SDU (sequence number and offset to the first octet of the pointed segment). Format 2 is used.
011	Middle of an SDU (sequence number and offset to the first and last octet of the pointed segment). Format 3 is used.
100	Range of complete SDUs (first and last sequence number). Format 4 is used.
101	Complete SDUs up to this (sequence number). Format 1 is used.
110-111	Reserved

The 16-bit Segmentation Offset field is a pointer defining the position of the segment. The field is used as defined in Table 6.3.9-2.

ARQ Feedback can be constructed by concatenating the formats 1 to 4 after a common CVG header octet and a Length field. In the example in Figure 6.3.9-5 the CVG Ext field is set to value "01" to indicate the presence of the 8-bit Length field. The Length field is set to value 8 to cover the octets following the Length field. Format 1 is first used to indicate ACK up to sequence number 9. Format 1 is again used to indicate a NACK for a complete missed SDUs with sequence number 6. Format 2 is used to indicate a NACK for a segment of an SDU with sequence number 8.

NOTE: Indicating ACKs "up to" or a range of sequence numbers with the non-chronological exception of one or more NACKs within the "up to" or the range, is possible only when concatenating the information into the same ARQ Feedback IE, e.g. as in Figure 6.3.9-5.

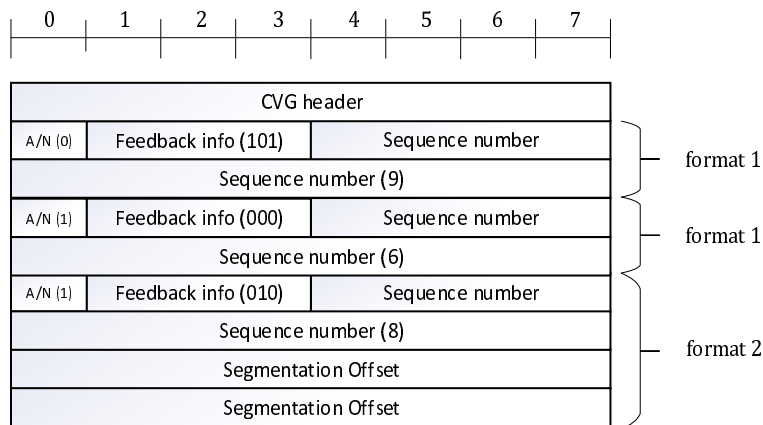

Figure 6.3.9-5: An example of constructing ARQ Feedback IE using multiple formats

6.3.10 ARQ Poll IE

The ARQ Poll IE is as in Figure 6.3.10-1.

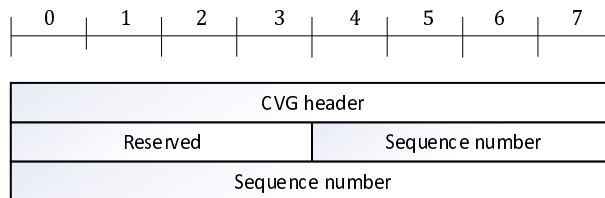

Figure 6.3.10-1: ARQ Poll IE

The CVG header is as defined in clause 6.3.2. The IE size is fixed and CVG header's length field is not included. The Sequence number points to the last sent SDU.

6.3.11 Flow Status IE

The Flow Status IE is as in Figure 6.3.11-1.

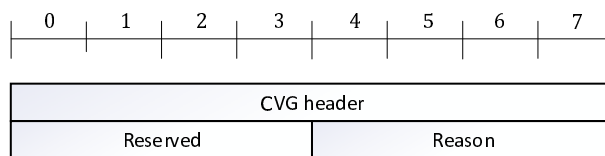

Figure 6.3.11-1: Flow Status IE

The CVG header is as defined in clause 6.3.2. The IE size is fixed and CVG header's length field is not included.

The Reason field coding is described in Table 6.3.11-1.

Table 6.3.11-1: Reason coding

Value	Description
0000	Reserved
0001	Data connection available
0010	Data connection not available
0011	Endpoint not supported
0100-1111	Reserved

Annex A (normative): Endpoint Multiplexing Field Value Allocation

A.1 General

The 2-octet Endpoint multiplexing address space is structured according to Figure A.1-1.

Reserved parts of the address space may be used with the caveat that they may be later allocated for other purposes by ETSI.

The Free use EP address space values are recommended to be used in closed systems and during development phase of any system. These values are not allocated by ETSI. The value selection within the Free use EP address space should be randomized.

The Public specifications EP address space shall only be used for application frameworks that are published. It is expected that the published specification defines the meaning of bit fields following the Endpoint field. ETSI allocates the Public specification values on request. A reference (e.g. URL) to the public specification and other related metadata to the published specification shall be provided to ETSI, see <https://portal.etsi.org/PNNS/Protocol-Specification-Allocation/DECT-2020-NR-Endpoint-Multiplexing-Addresses>.

Company specific EPs' address space shall only be used for organizations and private companies. It is expected that the organization or company to whom the value is allocated defines the meaning of bit fields following the Endpoint field, and it is up to them if the bit fields or the frameworks are published. ETSI allocates the Company specific EP values on request, based on ETSI policy, see <https://portal.etsi.org/PNNS/Protocol-Specification-Allocation/DECT-2020-NR-Endpoint-Multiplexing-Addresses>.

Reserved
Free use (0x0100 – 0x40FF)
Reserved
Public specifications (0x8000 – 0x84FF)
Reserved
Company specific EPs (0xA000 – 0xBFFF)
Reserved

Figure A.1-1: Endpoint value allocation principles

Annex B (normative): Radio Device Capabilities

B.1 DLC Layer

B.1.1 Introduction

Radio device capabilities define the set of DLC functionalities that are supported by the RD. DLC capabilities are indicated in association to the peer RD, as defined in ETSI TS 103 636-4 [2].

B.1.2 DLC Service Type

An RD shall indicate the DLC service types it supports using the DLC Service Type field in an RD Capability IE as defined in ETSI TS 103 636-4 [2].

An RD may support one of the DLC Service types, i.e. type 0, type 1, type 2, or type 3, or a combination of type 1, 2 and 3, or a combination of types 0, 1, 2 and 3.

B.1.3 Mesh Operation

An RD may indicate its support for Mesh system operation, including at least uplink and downlink packet routing using the Mesh field in an RD Capability IE as defined in ETSI TS 103 636-4 [2].

B.2 CVG Layer

B.2.1 Introduction

The CVG capabilities are exchanged using the Tx Service Config IE.

B.2.2 CVG service type

An RD may support CVG Service type 0, 1, 2, 3, 4 or multiple service types.

B.2.3 CVG multiplexing

An RD may support Endpoint multiplexing, Mux tag or both.

B.2.4 CVG security

An RD may support CVG security mode 1.

Annex C (informative): Bibliography

- ETSI TS 103 636-2: "DECT-2020 New Radio (NR); Part 2: Radio reception and transmission requirements; Release 1".
- ETSI TS 103 636-3: "DECT-2020 New Radio (NR); Part 3: Physical layer; Release 1".
- ETSI EN 300 175 (all parts): "Digital Enhanced Cordless Telecommunications (DECT); Common Interface (CI)".

Annex D (informative): Change History

Date	Version	Information about changes
December 2021	1.3.1	First publication
July 2022	1.3.2	Implementing Change Requests and maintenance update: DECT(22)000146r2 DECT-2020 DLC ARQ without segmentation DECT(22)000152 CR to ETSI TS 103 636-5 for IV simplification DECT(22)000193 ETSI TS 103 636-5 v1.3.3 DLC and Convergence layers
August 2022	1.3.3	Implementing Change Request and maintenance update: DECT(22)000148r1 DECT-2020 EP mux values for IPv6 DECT(22)000194 ETSI TS 103 636-5 v1.3.3 DLC and Convergence layers
October 2022	1.3.4	Implementing maintenance update: DECT(22)000213 ETSI TS 103 636-5 v1.3.4 DLC and Convergence layers
December 2022	1.3.5	Implementing Change Requests and maintenance update: DECT(22)000007r3 CR to ETSI TS 103 636-5 for integrating mux tag in CVG headers DECT(22)000238r3 EP mux value allocation improvements DECT(22)000259 Sequence number in routing header DECT(22)000277 Part 5 RD capabilities DECT(22)000283 Draft - Maintenance of ETSI TS 103 636-5 Release 1
January 2023	1.4.1	Publication
March 2023	1.4.2	Implementing maintenance update: DECT(23)000076r1 TS103636-5 v142 DLC&CVG layer
June 2023	1.4.3	Implementing Change Request: DECT(23)000123r2 Editorial corrections to ETSI TS 103 636-5 DLC & CVG
September 2024	1.4.4	Implementing maintenance update: DECT(24)000038 Draft - RTS/DECT-00397 v1.4.4 (ETSI TS 103 636-5) "Maintenance of ETSI TS 103 636-5 Release 1"

History

Document history		
V1.3.1	December 2021	Publication
V1.4.1	January 2023	Publication
V1.5.1	March 2024	Publication