

# ETSI TS 122 104 V18.4.0 (2024-07)



TECHNICAL SPECIFICATION

**5G;  
Service requirements  
for cyber-physical control applications in vertical domains  
(3GPP TS 22.104 version 18.4.0 Release 18)**



---

**Reference**

RTS/TSGS-0122104vi40

---

**Keywords**

5G

**ETSI**

650 Route des Lucioles  
F-06921 Sophia Antipolis Cedex - FRANCE

---

Tel.: +33 4 92 94 42 00 Fax: +33 4 93 65 47 16

Siret N° 348 623 562 00017 - APE 7112B  
Association à but non lucratif enregistrée à la  
Sous-Préfecture de Grasse (06) N° w061004871

---

**Important notice**

The present document can be downloaded from the  
ETSI [Search & Browse Standards application](#).

The present document may be made available in electronic versions and/or in print. The content of any electronic and/or print versions of the present document shall not be modified without the prior written authorization of ETSI. In case of any existing or perceived difference in contents between such versions and/or in print, the prevailing version of an ETSI deliverable is the one made publicly available in PDF format on [ETSI deliver](#).

Users should be aware that the present document may be revised or have its status changed,  
this information is available in the [Milestones listing](#).

If you find errors in the present document, please send your comments to  
the relevant service listed under [Committee Support Staff](#).

If you find a security vulnerability in the present document, please report it through our  
[Coordinated Vulnerability Disclosure \(CVD\)](#) program.

---

**Notice of disclaimer & limitation of liability**

The information provided in the present deliverable is directed solely to professionals who have the appropriate degree of experience to understand and interpret its content in accordance with generally accepted engineering or other professional standard and applicable regulations.

No recommendation as to products and services or vendors is made or should be implied.

No representation or warranty is made that this deliverable is technically accurate or sufficient or conforms to any law and/or governmental rule and/or regulation and further, no representation or warranty is made of merchantability or fitness for any particular purpose or against infringement of intellectual property rights.

In no event shall ETSI be held liable for loss of profits or any other incidental or consequential damages.

Any software contained in this deliverable is provided "AS IS" with no warranties, express or implied, including but not limited to, the warranties of merchantability, fitness for a particular purpose and non-infringement of intellectual property rights and ETSI shall not be held liable in any event for any damages whatsoever (including, without limitation, damages for loss of profits, business interruption, loss of information, or any other pecuniary loss) arising out of or related to the use of or inability to use the software.

---

**Copyright Notification**

No part may be reproduced or utilized in any form or by any means, electronic or mechanical, including photocopying and microfilm except as authorized by written permission of ETSI.

The content of the PDF version shall not be modified without the written authorization of ETSI.

The copyright and the foregoing restriction extend to reproduction in all media.

© ETSI 2024.  
All rights reserved.

---

# Intellectual Property Rights

## Essential patents

IPRs essential or potentially essential to normative deliverables may have been declared to ETSI. The declarations pertaining to these essential IPRs, if any, are publicly available for **ETSI members and non-members**, and can be found in ETSI SR 000 314: "*Intellectual Property Rights (IPRs); Essential, or potentially Essential, IPRs notified to ETSI in respect of ETSI standards*", which is available from the ETSI Secretariat. Latest updates are available on the ETSI Web server (<https://ipr.etsi.org/>).

Pursuant to the ETSI Directives including the ETSI IPR Policy, no investigation regarding the essentiality of IPRs, including IPR searches, has been carried out by ETSI. No guarantee can be given as to the existence of other IPRs not referenced in ETSI SR 000 314 (or the updates on the ETSI Web server) which are, or may be, or may become, essential to the present document.

## Trademarks

The present document may include trademarks and/or tradenames which are asserted and/or registered by their owners. ETSI claims no ownership of these except for any which are indicated as being the property of ETSI, and conveys no right to use or reproduce any trademark and/or tradename. Mention of those trademarks in the present document does not constitute an endorsement by ETSI of products, services or organizations associated with those trademarks.

**DECT™**, **PLUGTESTS™**, **UMTS™** and the ETSI logo are trademarks of ETSI registered for the benefit of its Members. **3GPP™** and **LTE™** are trademarks of ETSI registered for the benefit of its Members and of the 3GPP Organizational Partners. **oneM2M™** logo is a trademark of ETSI registered for the benefit of its Members and of the oneM2M Partners. **GSM®** and the GSM logo are trademarks registered and owned by the GSM Association.

---

# Legal Notice

This Technical Specification (TS) has been produced by ETSI 3rd Generation Partnership Project (3GPP).

The present document may refer to technical specifications or reports using their 3GPP identities. These shall be interpreted as being references to the corresponding ETSI deliverables.

The cross reference between 3GPP and ETSI identities can be found under <https://webapp.etsi.org/key/queryform.asp>.

---

# Modal verbs terminology

In the present document "**shall**", "**shall not**", "**should**", "**should not**", "**may**", "**need not**", "**will**", "**will not**", "**can**" and "**cannot**" are to be interpreted as described in clause 3.2 of the [ETSI Drafting Rules](#) (Verbal forms for the expression of provisions).

"**must**" and "**must not**" are **NOT** allowed in ETSI deliverables except when used in direct citation.

# Contents

Intellectual Property Rights .....	2
Legal Notice .....	2
Modal verbs terminology.....	2
Foreword.....	6
Introduction .....	6
1 Scope .....	7
2 References .....	7
3 Definitions, symbols and abbreviations .....	9
3.1 Definitions .....	9
3.2 Symbols.....	10
3.3 Abbreviations .....	10
4 Overview .....	10
4.1 Introduction .....	10
4.2 Activity patterns in automation .....	11
4.3 Communication attributes .....	11
4.4 Control systems and related communication patterns .....	12
4.5 Implications for 5G systems.....	12
5 Performance requirements.....	12
5.1 Overview .....	12
5.2 Periodic deterministic communication .....	14
5.3 Aperiodic deterministic communication .....	22
5.4 Non-deterministic communication .....	26
5.5 Mixed traffic.....	26
5.6 Clock synchronisation requirements .....	28
5.6.0 Description.....	28
5.6.1 Clock synchronisation service level requirements .....	28
5.6.2 Clock synchronisation service performance requirements.....	29
5.6A Time-sensitive communication requirements.....	29
5.6B 5G Timing Resiliency .....	30
5.6C Void.....	30
5.6C.1 Void .....	30
5.6C.2 Void .....	30
5.7 Positioning performance requirements.....	30
5.7.1 General requirements.....	30
5.7.2 Energy efficiency requirements for high accuracy positioning .....	31
5.8 Network operation requirements .....	31
6 Ethernet applications .....	32
6.1 Description .....	32
6.2 Requirements.....	32
7 Direct device connection for cyber-physical control applications .....	32
7.1 Description .....	32
7.2 Requirements.....	32
7.2.1 General.....	32
7.2.2 Network performance .....	33
7.2.3 Clock synchronization .....	33
7.2.3.1 Description .....	33
7.2.3.2 Clock synchronization requirements.....	33
7.2.4 Service Continuity .....	34
7.2.5 Direct device connection via UE to UE relay .....	34
8 Indirect network connection for cyber-physical control applications .....	34
8.1 Description .....	34

8.2	Requirements.....	34
8.2.1	General.....	34
8.2.2	Communication via indirect network connection .....	34
8.2.3	Clock synchronization .....	35
8.2.3.1	Description.....	35
8.2.3.2	Clock synchronization requirements.....	35
8.2.4	Service Continuity .....	35
9	Recovery of infrastructure for electrical distribution .....	36
9.1	Description .....	36
9.2	Requirements.....	36
<b>Annex A (informative): Summary of service performance requirements.....</b>		<b>37</b>
A.1	About the vertical domains addressed in this Annex .....	37
A.2	Factories of the Future.....	37
A.2.1	Overview .....	37
A.2.2	Factory automation.....	38
A.2.2.1	Motion control .....	38
A.2.2.2	Control-to-control communication .....	40
A.2.2.3	Mobile robots.....	40
A.2.2.4	Wired to wireless link replacement.....	44
A.2.2.5	Cooperative carrying.....	45
A.2.3	Process automation.....	47
A.2.3.1	Closed-loop control.....	47
A.2.3.2	Process and asset monitoring .....	47
A.2.3.3	Plant asset management .....	48
A.2.4	Human machine interfaces .....	49
A.2.4.1	Mobile control panels .....	49
A.2.4.1A	Mobile operation panels.....	51
A.2.4.2	Augmented reality .....	53
A.2.5	Monitoring and maintenance .....	53
A.2.5.1	Remote access and maintenance .....	53
A.3	(void).....	55
A.4	Electric-power distribution and Smart Grid .....	55
A.4.1	Overview .....	55
A.4.2	Primary frequency control.....	55
A.4.3	Distributed voltage control .....	56
A.4.4	Distributed energy automation .....	56
A.4.4.1	Distributed automated switching for isolation and service restoration .....	56
A.4.4.2	Distributed automation without GOOSE .....	58
A.4.4.3	Intelligent distributed feeder automation .....	59
A.4.4.4	High-speed current differential protection.....	61
A.4.5	Smart grid millisecond-level precise load control .....	62
A.4.6	Distributed energy storage.....	64
A.4.7	Advanced metering.....	65
A.4.8	Smart distribution transformer terminal .....	66
A.4.9	Distributed energy resources and micro-grids.....	68
A.4.10	Ensuring uninterrupted communication service availability during emergencies .....	70
A.5	Central power generation .....	70
A.5.1	Overview .....	70
A.5.2	Wind power plant network .....	70
A.6	Connected hospitals or medical facilities .....	71
A.6.1	Overview .....	71
A.6.2	Robotic Aided Surgery .....	71
A.6.3	Robotic Aided Diagnosis.....	74
A.7	Positioning.....	75
A.7.1	Overview of positioning in industrial use cases .....	75
A.7.2	Low Power High Accuracy Positioning .....	76

<b>Annex B (informative):</b>	<b>Communication service errors .....</b>	<b>79</b>
B.1	Introduction .....	79
B.2	Corruption .....	79
B.3	Unintended repetition.....	79
B.4	Incorrect sequence.....	79
B.5	Loss .....	80
B.6	Unacceptable deviation from target end-to-end latency.....	80
B.7	Masquerade .....	80
B.8	Insertion.....	80
B.9	Addressing.....	80
<b>Annex C (informative):</b>	<b>Characterising communication services .....</b>	<b>81</b>
C.1	Modelling of communication in automation .....	81
C.1.1	Area of consideration .....	81
C.1.2	Logical link .....	82
C.1.2.1	Nature and function .....	82
C.1.2.2	Message transformation.....	83
C.1.2.3	Communication device .....	83
C.1.2.4	Communication system.....	83
C.2	Communication service description .....	84
C.2.1	Overview .....	84
C.2.2	Characteristic parameters .....	84
C.2.3	Influence quantities .....	86
C.3	Up time and up state vs. down state and down time .....	87
C.4	Timeliness as an attribute for timing accuracy.....	88
C.4.1	Overview .....	88
C.4.2	Network latency requirement formulated by use of timeliness .....	88
C.4.3	Timeliness .....	89
C.4.4	Deviation .....	89
C.4.5	Earliness .....	90
C.4.6	Lateness.....	91
C.4.7	Conclusion.....	91
C.5	Communication service terminology w.r.t. 5G network and vertical applications .....	91
<b>Annex D (informative):</b>	<b>5G in industrial automation: different and multiple time domains for synchronization .....</b>	<b>94</b>
D.1	Description .....	94
D.2	Merging of working clock domains .....	95
D.3	Time synchronization with 5G networks .....	96
<b>Annex E (informative):</b>	<b>Audio and Video Production .....</b>	<b>97</b>
E.1	Description .....	97
E.2	Multiple source wireless studio .....	97
E.3	Timing use in AV production applications.....	98
<b>Annex F (informative):</b>	<b>Relation of reliability and communication service availability .....</b>	<b>100</b>
<b>Annex G (informative):</b>	<b>Change history .....</b>	<b>102</b>
History .....		105

---

# Foreword

This Technical Specification has been produced by the 3rd Generation Partnership Project (3GPP).

The contents of the present document are subject to continuing work within the TSG and may change following formal TSG approval. Should the TSG modify the contents of the present document, it will be re-released by the TSG with an identifying change of release date and an increase in version number as follows:

Version x.y.z

where:

- x the first digit:
  - 1 presented to TSG for information;
  - 2 presented to TSG for approval;
  - 3 or greater indicates TSG approved document under change control.
- y the second digit is incremented for all changes of substance, i.e. technical enhancements, corrections, updates, etc.
- z the third digit is incremented when editorial only changes have been incorporated in the document.

The present document implements Option 2 for decimal and thousands separator characters: "The decimal sign shall be a full-stop (period). The thousands separator shall be a comma." (TR 21.801 v16.2.0 Clause 6.6.7).

---

# Introduction

The present document addresses a challenging class of vertical applications, namely cyber-physical control applications, which require very high levels of communication service availability, and some of them also require very low end-to-end latencies.

Real-time Ethernet is one of the established wireline communication technologies for cyber-physical control applications, and this specification identifies requirements that 5G systems must meet to support real-time Ethernet.

The present document provides new Stage 1 requirements based on the input from relevant stakeholders of the respective vertical domains.

---

# 1 Scope

The present document provides Stage 1 normative service requirements for 5G systems, in particular service requirements for cyber-physical control applications in vertical domains and requirements for auxiliary applications. In the context of the present document, cyber-physical systems are to be understood as systems that include engineered, interacting networks of physical and computational components; control applications are to be understood as applications that control physical processes. Examples for auxiliary applications are distributed sensing and asset monitoring.

Communication services supporting cyber-physical control applications need to be ultra-reliable and, in some cases, the end-to-end latency must be very low. Communication for cyber-physical control applications supports operation in various vertical domains, for instance industrial automation, Smart Grid .

The aspects addressed in the present document include:

- end-to-end service performance requirements and network performance requirements related to these end-to-end service performance requirements;
- support for Ethernet services specific to industrial/high performance use cases. Related Ethernet functionalities include, for example, those in IEEE 802.1Qbv;
- direct device connection and indirect network connection for cyber-physical applications.

---

# 2 References

The following documents contain provisions which, through reference in this text, constitute provisions of the present document.

- References are either specific (identified by date of publication, edition number, version number, etc.) or non-specific.
- For a specific reference, subsequent revisions do not apply.
- For a non-specific reference, the latest version applies. In the case of a reference to a 3GPP document (including a GSM document), a non-specific reference implicitly refers to the latest version of that document *in the same Release as the present document*.

- [1] 3GPP TR 21.905: "Vocabulary for 3GPP Specifications".
- [2] 3GPP TS 22.261: "Service requirements for the 5G system".
- [3] IEC 61784-3: "Industrial communication networks – profiles – part 3: functional fieldbuses – general rules and profile definitions".
- [4] BZKI, "Aspects of dependability assessment in ZDKI", June 2017.
- [5] BZKI, "Requirement Profiles in ZDKI", 2017.
- [6] IEC 61158: "Industrial communication networks – fieldbus specification", 2014.
- [7] IEC 61907, "Communication network dependability engineering".
- [8] Richard C. Dorf and Robert H. Bishop, "Modern Control Systems", Pearson, Harlow, 13th Edition, 2017.
- [9] Ernie Hayden, Michael Assante, and Tim Conway, "An Abbreviated History of Automation & Industrial Controls Systems and Cybersecurity", SANS Institute, <https://ics.sans.org/media/An-Abbreviated-History-of-Automation-and-ICS-Cybersecurity.pdf> {accessed: 2017-05-23}, 2014.
- [10] IEC 61512 "Batch control - Part 1: Models and terminology".
- [11] RESERVE project, Deliverable D1.3, ICT Requirements, <http://www.re-serve.eu/files/reserve/Content/Deliverables/D1.3.pdf>, September 2017.



- [12] RESERVE project, Deliverable D1.2, Energy System Requirements  
<http://www.re-serve.eu/files/reserve/Content/Deliverables/D1.2.pdf>, September 2017.
- [13] G. Garner, "Designing Last Mile Communications Infrastructures for Intelligent Utility Networks (Smart Grids)", IBM Australia Limited, 2010.
- [14] B. Al-Omar, B., A. R. Al-Ali, R. Ahmed, and T. Landolsi, "Role of Information and Communication Technologies in the Smart Grid", Journal of Emerging Trends in Computing and Information Sciences, Vol. 3, pp. 707-716, 2015.
- [15] H. Kagermann, W. Wahlster, and J. Helbig, "Recommendations for implementing the strategic initiative INDUSTRIE 4.0", Final report of the Industrie 4.0 working group, acatech – National Academy of Science and Engineering, Munich, April 2013.
- [16] IEC 62443-3-2: "Security for industrial automation and control systems - Part 3-2: Security risk assessment and system design", in progress.
- [17] IEC 62657-2: "Industrial communication networks - Wireless communication networks - Part 2: Coexistence management", 2017.
- [18] IEC 62657-1: "Industrial communication networks – Wireless communication networks – Part 1: Wireless communication requirements and spectrum considerations".
- [19] IEEE Std 802.1Q: "IEEE Standard for Local and Metropolitan Area Networks---Bridges and Bridged Networks".  
  
NOTE: IEEE Std 802.1Qbv-2015 "IEEE Standard for Local and Metropolitan Area Networks--Bridges and Bridges Networks - Amendment 25: Enhancements for Scheduled Traffic" has been included into IEEE Std 802.1Q-2018.
- [20] IEEE, Use Cases IEC/IEEE 60802, 2018.
- [21] (void)
- [22] IEEE Std 802.1AS: "IEEE Standard for Local and Metropolitan Area Networks--Timing and Synchronization for Time-Sensitive Applications".
- [23] 3GPP TS 22.289: "Mobile Communication System for Railways".
- [24] IEEE P802.1CS: "IEEE Standard for Local and Metropolitan Area Networks--Link-local Registration Protocol".
- [25] IEEE P802.1Qdd: "IEEE Draft Standard for Local and Metropolitan Area Networks--Bridges and Bridged Networks -- Amendment: Resource Allocation Protocol (RAP) ".
- [26] IEC/IEEE 60802: "Time-Sensitive Networking Profile for Industrial Automation".
- [27] 3GPP TS 22.263: "Service requirements for Video, Imaging and Audio for Professional Applications (VIAPA)".
- [28] IEC TR 61850-90-1:2010, Communication Networks and Systems for Power Utility automation – Part 90-1: Use of IEC61850 for the communication between substations.
- [29] 5G DNA White Paper: "5GDN@Smart Grid White Paper: Requirements, Technologies, and Practices" <https://www.5gdna.org/>
- [30] IEC 61850-9-3-2016 – IEC/IEEE International Standard - Communication Networks and Systems for Power Utility automation – Part 9-3: Precision time protocol profile for power utility automation.
- [31] IEEE Std C37.238-2017 , IEEE Standard Profile for Use of IEEE Std 1588™ Precision Time Protocol in Power System Applications.
- [32] Void.
- [33] Void.

[34] IEEE Std 1588-2019: "IEEE Standard for a Precision Clock Synchronization Protocol for Networked Measurement and Control".

---

## 3 Definitions, symbols and abbreviations

### 3.1 Definitions

For the purposes of the present document, the terms and definitions given in 3GPP TR 21.905 [1] and the following apply. A term defined in the present document takes precedence over the definition of the same term, if any, in 3GPP TR 21.905 [1].

**characteristic parameter:** numerical value that can be used for characterising the dynamic behaviour of communication functionality from an application point of view.

**clock synchronicity:** the maximum allowed time offset within a synchronisation domain between the sync master and any sync device.

NOTE 1: Clock synchronicity (or synchronicity) is used as KPI of clock synchronisation services.

NOTE 2: Clock synchronicity is also referred to as clock (or time) synchronization precision.

**clock synchronisation service:** the service to align otherwise independent user-specific UE clocks.

**communication service availability:** as defined in TS 22.261 [2].

**communication service reliability:** ability of the communication service to perform as required for a given time interval, under given conditions.

NOTE 3: Given conditions would include aspects that affect reliability, such as: mode of operation, stress levels, and environmental conditions.

NOTE 4: Reliability may be quantified using appropriate measures such as mean time between failures, or the probability of no failure within a specified period of time.

NOTE 5: This definition is based on IEC 61907 [7].

**direct device connection:** as defined in TS 22.261 [2].

**end-to-end latency:** as defined in TS 22.261 [2].

**error:** discrepancy between a computed, observed or measured value or condition and the true, specified or theoretically correct value or condition.

NOTE 6: This definition was taken from IEC 61784-3 [3].

**factory automation:** automation application in industrial automation branches typically with discrete characteristics of the application to be automated with specific requirements for determinism, low latency, reliability, redundancy, cyber security, and functional safety.

NOTE 7: Low latency typically means below 10 ms delivery time.

NOTE 8: This definition is taken from IEC 62657-1 [18].

**global clock:** a user-specific synchronization clock set to a reference timescale such as the International Atomic Time.

**indirect network connection:** as defined in TS 22.261 [2].

**influence quantity:** quantity not essential for the performance of an item but affecting its performance.

**process automation:** automation application in industrial automation branches typically with continuous characteristics of the application to be automated with specific requirements for determinism, reliability, redundancy, cyber security, and functional safety.

NOTE 9: This definition is taken from IEC 62657-1 [18].

**service area:** as defined in TS 22.261 [2].

**survival time:** as defined in TS 22.261 [2].

**sync device:** device that synchronizes itself to the master clock of the synchronization domain.

**sync master:** device serving as the master clock of the synchronization domain.

**transfer interval:** time difference between two consecutive transfers of application data from an application via the service interface to 3GPP system.

NOTE 10: This definition is based on subclause 3.1.85 in IEC 62657-2 [17].

**user experienced data rate:** as defined in TS 22.261 [2].

**vertical domain:** an industry or group of enterprises in which similar products or services are developed, produced, and provided.

**working clock:** a user-specific synchronization clock for a localized set of UEs collaborating on a specific task or work function.

## 3.2 Symbols

For the purposes of the present document, the following symbols apply:

<symbol>      <Explanation>

## 3.3 Abbreviations

For the purposes of the present document, the abbreviations given in 3GPP TR 21.905 [1] and the following apply. An abbreviation defined in the present document takes precedence over the definition of the same abbreviation, if any, in 3GPP TR 21.905 [1].

AV	Audio-Visual
AVPROD	AV Production
CSIF	Communication Service Interface
EPON	Ethernet Passive Optical Network
FIFO	First In, First Out
GOOSE	Generic Object-Oriented Substation Event
HCL	Higher Communication Layer
HMI	Human Machine Interface
IMU	Inertial Measurement Unit
LCL	Lower Communication Layer
PMU	Phasor Measurement Unit

---

# 4 Overview

## 4.1 Introduction

For the purpose of this document, a vertical domain is a particular industry or group of enterprises in which similar products or services are developed, produced, and provided. Automation refers to the control of processes, devices, or systems in vertical domains by automatic means. The main control functions of automated control systems include taking measurements, comparing results, computing any detected or anticipated errors, and correcting the process to avoid future errors. These functions are performed by sensors, transmitters, controllers, and actuators.

In the context of this document, cyber-physical systems are referred to as systems that include engineered, interacting networks of physical and computational components. Cyber-physical control applications are to be understood as

applications that control physical processes. Cyber-physical control applications in automation follow certain activity patterns, which are open-loop control, closed-loop control, sequence control, and batch control (see Clause 4.2).

Communication services supporting cyber-physical control applications need to be ultra-reliable, dependable with a high communication service availability, and often require low or (in some cases) very low end-to-end latency.

Communication in automation in vertical domains follows certain communication patterns. The most well-known is periodic deterministic communication, others are aperiodic deterministic communication and non-deterministic communication (see Clause 4.3).

Communication for cyber-physical control applications supports operation in various vertical domains, for instance industrial automation and energy automation. This document addresses service requirements for cyber-physical control applications and supporting communication services from the vertical domains of factories of the future (smart manufacturing), electric power distribution, and central power generation. Service requirements for cyber-physical control applications and supporting communication services for rail-bound mass transit are addressed in TS 22.289 [23].

## 4.2 Activity patterns in automation

**Open-loop control:** The salient aspect of open-loop control is the lack of feedback from the output to the control; when providing commands to an actuator, it is assumed that the output of the influenced process is predetermined and within an acceptable range. This kind of control loop works if the influences of the environment on process and actuator are negligible. Also, this kind of control is applied in case unwanted output can be tolerated [8].

**Closed-loop control:** Closed-loop control enables the manipulation of processes even if the environment influences the process or the performance of the actuator changes over time. This type of control is realised by sensing the process output and by feeding these measurements back into a controller [8].

**Sequence control:** Sequence control may either step through a fixed sequence or employ logic that performs different actions based on various system states and system input [8]. Sequence control can be seen as an extension of both open-loop and closed-loop control, but instead of achieving only one output instance, an entire sequence of output instances can be produced [9].

**Batch control:** Batch processes lead to the production of finite quantities of material (batches) by subjecting input materials to a defined order of processing actions by use of one or more pieces of equipment [10].

## 4.3 Communication attributes

Communication in automation can be characterised by two main attributes: periodicity and determinism.

Periodicity means that a transmission interval is repeated. For example, a transmission occurs every 15 ms. Reasons for a periodical transmission can be the periodic update of a position or the repeated monitoring of a characteristic parameter. Most periodic intervals in communication for automation are rather short. The transmission is started once and continuous unless a stop command is provided.

An aperiodic transmission is, for example, a transmission which is triggered instantaneously by an event, i.e., events are the trigger of the transmission. Events are defined by the control system or by the user. Example events are:

- Process events: events that come from the process when thresholds are exceeded or fallen below, e.g., temperature, pressure, level, etc.
- Diagnostic events: events that indicate malfunctions of an automation device or module, e.g., power supply defective; short circuit; too high temperature; etc.
- Maintenance events: events based on information that indicates necessary maintenance work to prevent the failure of an automation device.

Most events, and especially alarms, are confirmed. In this context, alarms are messages that inform a controller or operator that an event has occurred, e.g., an equipment malfunction, process deviation, or other abnormal condition requiring a response. The receipt of the alarm is acknowledged usually within a short time period by the application that received the alarm. If no acknowledgment is received from the target application after a preset time, the so-called monitoring time, the alarm is sent again after a preset time or some failure response action is started.

Determinism refers to whether the delay between transmission of a message and receipt of the message at the destination address is stable (within bounds). Usually, communication is called deterministic if it is bounded by a given threshold for the latency/transmission time. In case of a periodic transmission, the variation of the interval is bounded.

## 4.4 Control systems and related communication patterns

There are preferences in the mapping between the type of control and the communication pattern. Open-loop control is characterised by one or many messages sent to an actuator. These can be sent in a periodic or an aperiodic pattern. However, the communication means used need to be deterministic since typically an activity response from the receiver and/or the receiving application is expected.

Closed-loop control produces both periodic and aperiodic communication patterns. Closed-loop control is often used for the control of continuous processes with tight time-control limits, e.g., the control of a printing press. In this case, one typically relies on periodic communication patterns. Note that in both the aperiodic and periodic case, the communication needs to be deterministic.

Logging of device states, measurements, etc. for maintenance purposes and such typically entails aperiodic communication patterns. In case the transmitted logging information can be time-stamped by the respective function, determinism is often not mandatory.

In practice, vertical communication networks serve a large number of applications exhibiting a wide range of communication requirements. In order to facilitate efficient modelling of the communication network during engineering and for reducing the complexity of network optimisation, traffic classes or communication patterns have been identified [6]. There are three typical traffic classes or communication patterns in industrial environments [6], i.e.,

- deterministic periodic communication: periodic communication with stringent requirements on timeliness of the transmission.
- deterministic aperiodic communication: communication without a preset sending time. Typical activity patterns for which this kind of communication is suitable are event-driven actions.
- non-deterministic communication: subsumes all other types of traffic, including periodic non-real time and aperiodic non-real time traffic. Periodicity is irrelevant in case the communication is not time-critical.

Some communication services exhibit traffic patterns that cannot be assigned to one of the above communication patterns exclusively (mixed traffic).

## 4.5 Implications for 5G systems

In order to be suitable for automation in vertical domains, 5G systems need to be dependable and flexible to meet specific KPIs to serve specific applications and use cases. They need to come with the system properties of reliability, availability, maintainability, safety, and integrity. What particular requirements each property needs to meet depends on the particularities of the domain and the use case. Annex F discusses the difference between reliability and communication service availability. The requirements in this document provide various sets of performance criteria that need to be met to satisfactorily support different use cases of cyber-physical control applications used by various vertical markets.

---

# 5 Performance requirements

## 5.1 Overview

There are two fundamental perspectives concerning dependable communication in 5G systems: the end-to-end perspective of the communication services and the network perspective (see Figure 5.1-1).

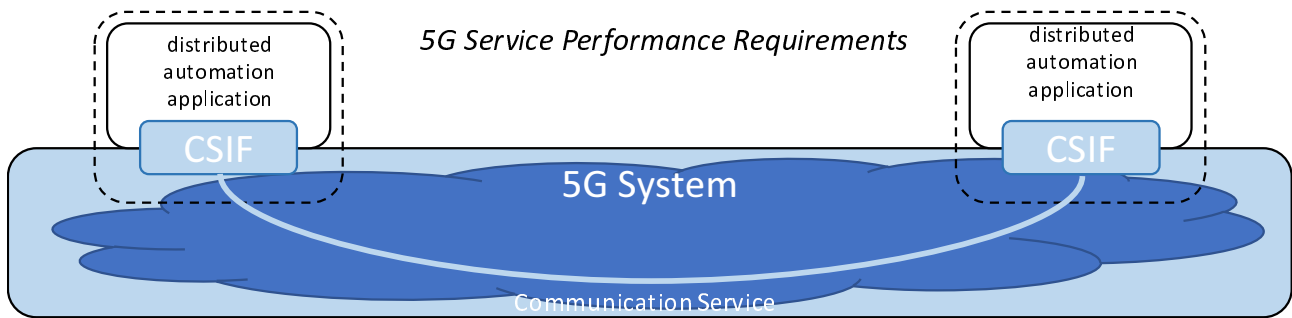

*CSIF – Communication Service Interface between distributed automation application/function and 5G system*

**Figure 5.1-1: Network perspective of 5G system**

The Communication Service in Figure 5.1-1 may be implemented as a logical communication link between a UE on one side and a network server on the other side, or between a UE on one side and a UE on the other side.

In some cases, a local approach (e.g. network edge) is preferred for the communication service on the network side in order to reduce the latency, to increase communication service availability, or to keep sensitive data in a non-public network on the factory site.

The tables in Clauses 5.2 through 5.5 below provide sets of requirements where periodicity and determinism are critical to meeting cyber-physical control application needs in various vertical scenarios. While many use cases have similar KPI values, the important distinction is that in order to meet the needs of different verticals and different uses, the 5G system will need to be sufficiently flexible to allow deployment configurations that can meet the different sets of KPIs specific to each use.

Communication service availability is considered an important service performance requirement for cyber-physical applications, especially for applications with deterministic traffic. The communication service availability depends on the latency and reliability (in the context of network layer packet transmissions, as defined in TS 22.261 [2]) of the logical communication link, as well as the survival time of the cyber-physical application (see Annex C.3 for further details on these relations).

The communication service reliability requirements also depend on the operation characteristics of the corresponding cyber-physical applications. Typically, the communication services critical for the automation application also come with stringent communication service reliability requirements. Note that the communication service reliability requirement has no direct relationship with the communication service availability requirement.

The "# of UEs" in the tables in clauses 5.2 to 5.5 is intended to give an indication of the UE density that would need to be served within a given service area.

Clock synchronisation is needed in many "vertical" use cases. The requirements and tables in Clause 5.6 provide specific criteria for managing time sensitive communications in an industrial environment.

High accuracy positioning is becoming essential for Factories of the Future. The reason for this is that tracking of mobile devices as well as mobile assets is becoming increasingly important in improving processes and increasing flexibility in industrial environments, Clause 5.7 provides positioning requirements for horizontal and vertical accuracy, availability, heading, latency and UE speed in an industrial use case scenario.

An example of the relationship between reliability (in the context of network layer packet transmissions, as defined in TS 22.261 [2]), survival time and communication service availability of a logical communication link is illustrated in the following Table 5.1-1. This is done for a special case where packet errors are uncorrelated, which in many cases is an unrealistic assumption.

**Table 5.1-1: Example of relationship between reliability (as defined in TS 22.261) and communication service availability when the survival time is equal to the transfer interval.**

<b>Communication service availability</b>	<b>Reliability ( as defined in TS 22.261) 1 - p</b>
99.999 9 %	99.9 %
99.999 999 %	99.99 %
99.999 999 99 %	99.999 %
99.999 999 999 9 %	99.999 9 %
99.999 999 999 999 %	99.999 99 %

## 5.2 Periodic deterministic communication

Periodic deterministic communication is periodic with stringent requirements on timeliness and availability of the communication service. A transmission occurs every transfer interval. A description of periodic deterministic communication can be found in Clauses 4.3 and 4.4. Additional information on the underlying use cases of the sets of requirements in Table 5.2-1 can be found in Annex A. Further information on characteristic parameters and influence quantities used in Table 5.2-1 can be found in Annex C.

The 5G system shall be able to provide periodic deterministic communication with the service performance requirements for individual logical communication links that realise the communication services reported in Table 5.2-1.

Process and asset monitoring using industrial wireless sensors is a special case of periodic deterministic communication with more relaxed requirements on timeliness and availability. These use cases put a slightly different set of requirements on the 5G system due to the specific constraints of industrial wireless sensors. These requirements for individual logical communication links are listed in Table 5.2-2 and additional information on the underlying use cases can be found in Annex A.

Smart-Grid use case information can be found in Annex A.

**Table 5.2-1: Periodic deterministic communication service performance requirements**



Characteristic parameter				Influence quantity						Remarks
Communication service availability: target value (note 1)	Communication service reliability: mean time between failures	End-to-end latency: maximum (note 2) (note 12a)	Service bit rate: user experienced data rate (note 12a)	Message size [byte] (note 12a)	Transfer interval: target value (note 12a)	Survival time (note 12a)	UE speed (note 13)	# of UEs	Service area (note 3)	
99.999 % to 99.999 99 %	~ 10 years	< transfer interval value	–	50	500 µs	500 µs	≤ 75 km/h	≤ 20	50 m x 10 m x 10 m	Motion control (A.2.2.1)
99.999 9 % to 99.999 999 %	~ 10 years	< transfer interval value	–	40	1 ms	1 ms	≤ 75 km/h	≤ 50	50 m x 10 m x 10 m	Motion control (A.2.2.1)
99.999 9 % to 99.999 999 %	~ 10 years	< transfer interval value	–	20	2 ms	2 ms	≤ 75 km/h	≤ 100	50 m x 10 m x 10 m	Motion control (A.2.2.1)
99.999 9 %	–	< 5 ms	1 kbit/s (steady state) 1.5 Mbit/s (fault case)	< 1,500	< 60 s (steady state) ≥ 1 ms (fault case)	transfer interval	stationary	20	30 km x 20 km	Electrical Distribution – Distributed automated switching for isolation and service restoration (A.4.4); (note 5)
99.999 9 % to 99.999 999 %	~ 10 years	< transfer interval value	–	1 k	≤ 10 ms	10 ms	-	5 to 10	100 m x 30 m x 10 m	Control-to-control in motion control (A.2.2.2); (note 9)
99.999 9 % to 99.999 999 %	~ 10 years	< transfer interval value (note 5)	50 Mbit/s	–	≤ 1 ms	3 x transfer interval	stationary	2 to 5	100 m x 30 m x 10 m	Wired-2-wireless 100 Mbit/s link replacement (A.2.2.4)
99.999 9 % to 99.999 999 %	~ 10 years	< transfer interval value (note 5)	250 Mbit/s	–	≤ 1 ms	3 x transfer interval	stationary	2 to 5	100 m x 30 m x 10 m	Wired-2-wireless 1 Gbit/s link replacement (A.2.2.4)
99.999 9 % to 99.999 999 %	~ 10 years	< transfer interval value	–	1 k	≤ 50 ms	50 ms	-	5 to 10	1,000 m x 30 m x 10 m	Control-to-control in motion control (A.2.2.2); (note 9)
> 99.999 9 %	~ 10 years	< transfer interval value	–	40 to 250	1 ms to 50 ms (note 6) (note 7)	transfer interval value	≤ 50 km/h	≤ 2,000	≤ 1 km <sup>2</sup>	Mobile robots (A.2.2.3)
99.999 9 % to 99.999 999 %	~ 1 month	< transfer interval value	–	40 to 250	4 ms to 8 ms (note 7)	transfer interval value	< 8 km/h (linear movement)	TBD	50 m x 10 m x 4 m	Mobile control panels – remote control of e.g. assembly robots, milling machines (A.2.4.1); (note 9)

Characteristic parameter				Influence quantity						Remarks
Communication service availability: target value (note 1)	Communication service reliability: mean time between failures	End-to-end latency: maximum (note 2) (note 12a)	Service bit rate: user experienced data rate (note 12a)	Message size [byte] (note 12a)	Transfer interval: target value (note 12a)	Survival time (note 12a)	UE speed (note 13)	# of UEs	Service area (note 3)	
99.999 999 %	1 day	< 8 ms (note 14)	250 kbit/s	40 to 250	8 ms	16 ms	quasi-static; up to 10 km/h	2 or more	30 m x 30 m	Mobile Operation Panel: Emergency stop (connectivity availability) (A.2.4.1A)
99.999 99 %	1 day	< 10 ms (note 14)	< 1 Mbit/s	< 1024	10 ms	~10 ms	quasi-static; up to 10 km/h	2 or more	30 m x 30 m	Mobile Operation Panel: Safety data stream (A.2.4.1A)
99.999 999 %	1 day	10 ms to 100 ms (note 14)	10 kbit/s	10 to 100	10 ms to 100 ms	transfer interval	stationary	2 or more	100 m <sup>2</sup> to 2,000 m <sup>2</sup>	Mobile Operation Panel: Control to visualization (A.2.4.1A)
99.999 999 %	1 day	< 1 ms (note 14)	12 Mbit/s to 16 Mbit/s	10 to 100	1 ms	~ 1 ms	stationary	2 or more	100 m <sup>2</sup>	Mobile Operation Panel: Motion control (A.2.4.1A)
99.999 999 %	1 day	< 2 ms (note 14)	16 kbit/s (UL) 2 Mbit/s (DL)	50	2 ms	~ 2 ms	stationary	2 or more	100 m <sup>2</sup>	Mobile Operation Panel: Haptic feedback data stream (A.2.4.1A)
99.999 9 % to 99.999 999 %	~ 1 year	< transfer interval	–	40 to 250	< 12 ms (note 7)	12 ms	< 8 km/h (linear movement)	TBD	typically 40 m x 60 m; maximum 200 m x 300 m	Mobile control panels - remote control of e.g. mobile cranes, mobile pumps, fixed portal cranes (A.2.4.1); (note 9)
99.999 9 % to 99.999 999 %	≥ 1 year	< transfer interval value	–	20	≥ 10 ms (note 8)	0	typically stationary	typically 10 to 20	typically ≤ 100 m x 100 m x 50 m	Process automation – closed loop control (A.2.3.1)
99.999 %	TBD	~ 50 ms	–	~ 100	~ 50 ms	TBD	stationary	≤ 100,000	several km <sup>2</sup> up to 100,000 km <sup>2</sup>	Primary frequency control (A.4.2); (note 9)
99.999 %	TBD	~ 100 ms	–	~ 100	~ 200 ms	TBD	stationary	≤ 100,000	several km <sup>2</sup> up to 100,000 km <sup>2</sup>	Distributed Voltage Control (A.4.3) (note 9)
> 99.999 9 %	~ 1 year	< transfer interval value	–	15 k to 250 k	10 ms to 100 ms (note 7)	transfer interval value	≤ 50 km/h	≤ 2,000	≤ 1 km <sup>2</sup>	Mobile robots – video-operated remote control (A.2.2.3)

Characteristic parameter				Influence quantity						Remarks
Communication service availability: target value (note 1)	Communication service reliability: mean time between failures	End-to-end latency: maximum (note 2) (note 12a)	Service bit rate: user experienced data rate (note 12a)	Message size [byte] (note 12a)	Transfer interval: target value (note 12a)	Survival time (note 12a)	UE speed (note 13)	# of UEs	Service area (note 3)	
> 99.999 9 %	~ 1 year	< transfer interval value	–	40 to 250	40 ms to 500 ms (note 7)	transfer interval value	≤ 50 km/h	≤ 2,000	≤ 1 km <sup>2</sup>	Mobile robots (A.2.2.3)
99.99 %	≥ 1 week	< transfer interval value	–	20 to 255	100 ms to 60 s (note 7)	≥ 3 x transfer interval value	typically stationary	≤ 10,000 to 100,000	≤ 10 km x 10 km x 50 m	Plant asset management (A.2.3.3)
>99.999 999 %	> 10 years	< 2 ms	2 Mbit/s to 16 Mbit/s	250 to 2,000	1 ms	transfer interval value	stationary	1	< 100 m <sup>2</sup>	Robotic Aided Surgery (A.6.2)
>99.999 9 %	> 1 year	< 20 ms	2 Mbit/s to 16 Mbit/s	250 to 2,000	1 ms	transfer interval value	stationary	2 per 1,000 km <sup>2</sup>	< 400 km (note 12)	Robotic Aided Surgery (A.6.2)
>99.999 %	>> 1 month (< 1 year)	< 20 ms	2 Mbit/s to 16 Mbit/s	80	1 ms	transfer interval value	stationary	20 per 100 km <sup>2</sup>	< 50 km (note 12)	Robotic Aided Diagnosis (A.6.3)
99.999 9 % to 99.999 999 %	~ 10 years	< 0.5 x transfer interval	2.5 Mbit/s	250 500 with localisation information	> 5 ms > 2.5 ms > 1.7 ms (note 10)	0 transfer interval 2 x transfer interval (note 10)	≤ 6 km/h (linear movement)	2 to 8	10 m x 10 m x 5 m; 50 m x 5 m x 5 m (note 11)	Cooperative carrying – fragile work pieces; (ProSe communication) (A.2.2.5)
99.999 9 % to 99.999 999 %	~ 10 years	< 0.5 x transfer interval	2.5 Mbit/s	250 500 with localisation information	> 5 ms > 2.5 ms > 1.7 ms (note 10)	0 transfer interval 2 x transfer interval (note 10)	≤ 12 km/h (linear movement)	2 to 8	10 m x 10 m x 5 m; 50 m x 5 m x 5 m (note 11)	Cooperative carrying – elastic work pieces; (ProSe communication) (A.2.2.5)

Characteristic parameter				Influence quantity						
Communication service availability: target value (note 1)	Communication service reliability: mean time between failures	End-to-end latency: maximum (note 2) (note 12a)	Service bit rate: user experienced data rate (note 12a)	Message size [byte] (note 12a)	Transfer interval: target value (note 12a)	Survival time (note 12a)	UE speed (note 13)	# of UEs	Service area (note 3)	Remarks
> 99.9 %		DL: < 10 ms UL: < 10 ms	UL: > 16 Mbit/s (urban), 640 Mbit/s (rural)  DL: > 100 kbit/s (note 15)	UL: 800 kbyte	UL: 10 ms			> 10/km <sup>2</sup> (urban), > 100/km <sup>2</sup> (rural) (note 16)		Distributed energy storage – monitoring (A.4.6)
> 99.9 %		DL: < 10 ms UL: < 1 s	UL: > 128 kbit/s (urban), 10.4 Mbit/s (rural); DL: > 100 kbit/s (note 15)	UL: 1.3 Mbyte DL: > 100 kbyte	UL: 1000 ms			> 10/km <sup>2</sup> (urban), > 100/km <sup>2</sup> (rural) (note 16)		Distributed energy storage – data collection (A.4.6)
> 99.99 %		General information data collection: < 3 s (note 17)	UL: < 2 Mbit/s DL: < 1 Mbit/s					< 10,000/km <sup>2</sup> (note 18)		Advanced metering (A.4.7)
99.999 %		< 10 ms	2 Mbit/s to 10 Mbit/s		normal: 1 s; fault: 2 ms (note 24)			54/km <sup>2</sup> (note 19), 78/km <sup>2</sup> (note 20)		Intelligent distributed feeder automation (A.4.4.3)
> 99.99 %		10 ms, 100 ms, 3 s (note 22)	> 2 Mbit/s (note 21)					500 in the service area (note 23)	Communication distance is from 100 m to 500 m, outdoor, indoor / deep indoor	Smart distribution – transformer terminal (A.4.8)
99.999 %		5 ms, 10 ms, 15 ms (note 25)	1.2 Mbit/s to 2.5 Mbit/s	< 245 byte	≤ 1 ms ≤ 2 ms (note 26)			≤ 100/km <sup>2</sup>	several km <sup>2</sup>	High speed current differential protection (note 12a) (A.4.4.4)
99.999 9 %		3 ms	5.4 Mbit/s	140 byte	≤ 1 ms		stationary			Distributed Energy Resources (DER) and micro-grids (A.4.9)

Characteristic parameter				Influence quantity						Remarks
Communication service availability: target value (note 1)	Communication service reliability: mean time between failures	End-to-end latency: maximum (note 2) (note 12a)	Service bit rate: user experienced data rate (note 12a)	Message size [byte] (note 12a)	Transfer interval: target value (note 12a)	Survival time (note 12a)	UE speed (note 13)	# of UEs	Service area (note 3)	
99.999 9 %		100 ms (note 12a and note 5)	< 1 kbit/s per DER				stationary			Ensuring uninterrupted communication service availability during emergencies (A.4.10)

- NOTE 1: One or more retransmissions of network layer packets may take place in order to satisfy the communication service availability requirement.
- NOTE 2: Unless otherwise specified, all communication includes 1 wireless link (UE to network node or network node to UE) rather than two wireless links (UE to UE).
- NOTE 3: Length x width (x height).
- NOTE 4: (void)
- NOTE 5: Communication includes two wireless links (UE to UE).
- NOTE 6: This covers different transfer intervals for different similar use cases with target values of 1 ms, 1 ms to 10 ms, and 10 ms to 50 ms.
- NOTE 7: The transfer interval deviates around its target value by  $< \pm 25\%$ .
- NOTE 8: The transfer interval deviates around its target value by  $< \pm 5\%$ .
- NOTE 9: Communication may include two wireless links (UE to UE).
- NOTE 10: The first value is the application requirement, the other values are the requirement with multiple transmission of the same information (two or three times, respectively).
- NOTE 11: Service Area for direct communication between UEs. The group of UEs with direct communication might move throughout the whole factory site (up to several km<sup>2</sup>).
- NOTE 12: Maximum straight-line distance between UEs.
- NOTE 12a: It applies to both UL and DL unless stated otherwise.
- NOTE 13: It applies to both linear movement and rotation unless stated otherwise.
- NOTE 14: The mobile operation panel is connected wirelessly to the 5G system. If the mobile robot/production line is also connected wirelessly to the 5G system, the communication includes two wireless links.
- NOTE 15: Service bit rate for one energy storage station.
- NOTE 16: Activity storage nodes/km<sup>2</sup>. This value is used for deducing the data volume in an area that features multiple energy storage stations. The data volume can be calculated with the following formula (current service bit rate per storage station) x (activity storage nodes/km<sup>2</sup>) + (video service bit rate per storage station) x (activity storage nodes/km<sup>2</sup>).
- NOTE 17: One-way delay from 5G IoT device to backend system. The distance between the two is below 40 km (city range).
- NOTE 18: Typical connection density in today's city environment. With the evolution from centralised meters to socket meters in the home, the connection density is expected to increase 5 to 10 times.
- NOTE 19: When the distributed terminals are deployed along an overhead line, there are about 54 terminals per square kilometre.
- NOTE 20: When the distributed terminals are deployed in power distribution cabinets, there are about 78 terminals per square kilometre.
- NOTE 21: Service bit rate of the smart metering application between the smart distribution transformer terminal and the energy end equipment. Once there are multiple smart grid applications, the required service bit rate will be higher.
- NOTE 22: The end-to-end latency depends on the applications supported by the smart distribution transformer terminal. The lower the end-to-end latency, the more applications can be supported.
- NOTE 23: The service area is circular with a radius between 100 m and 500 m (0.031 km<sup>2</sup> to 0.79 km<sup>2</sup>).
- NOTE 24: During the normal working phase of the feeder system, the heartbeat packet is transmitted periodically with a 1 s transfer interval. When a fault occurs, the heartbeat is sent with a 2 ms transfer interval.
- NOTE 25: The maximum allowed delay between two protection relays would be between 5 ms and 10 ms, depending on the voltage (see IEC 61850-90-1 for more details [aa]). For some legacy systems, the end-to-end latency is usually set to 15 ms.
- NOTE 26: For a sampling rate of 600 Hz, the transfer interval is 1.7 ms. For 1200 Hz, the transfer interval is 0.83 ms.

Table 5.2-2: Communication service performance requirements for industrial wireless sensors

Characteristic parameter						Influence quantity					Remarks
Communication service availability: target value	Communication service reliability: mean time between failure	End-to-end latency (note 6)	Transfer interval (note 1) (note 7)	Service bit rate: user experienced data rate (note 2) (note 7)	Battery lifetime [year] (note 3)	Message Size [byte] (note 7)	Survival time (note 7)	UE speed	UE density [UE / m <sup>2</sup> ]	Range [m] (note 4)	
99.99 %	≥ 1 week	< 100 ms	100 ms to 60 s	≤ 1 Mbit/s	≥ 5	20 (note 5)	3 x transfer interval	stationary	Up to 1	< 500	Process monitoring, e.g. temperature sensor (A.2.3.2)
99.99 %	≥ 1 week	< 100 ms	≤ 1 s	≤ 200 kbit/s	≥ 5	25 k	3 x transfer interval	stationary	Up to 0.05	< 500	Asset monitoring, e.g. vibration sensor (A.2.3.2)
99.99 %	≥ 1 week	< 100 ms	≤ 1 s	≤ 2 Mbit/s	≥ 5	250 k	3 x transfer interval	stationary	Up to 0.05	< 500	Asset monitoring, e.g. thermal camera (A.2.3.2)
<p>NOTE 1: The transfer interval deviates around its target value by &lt;math&gt;\pm 25\%&lt;/math&gt;.</p> <p>NOTE 2: The traffic is predominantly mobile originated.</p> <p>NOTE 3: Industrial sensors can use a wide variety of batteries depending on the use case, but in general they are highly constrained in terms of battery size.</p> <p>NOTE 4: Distance between the gNB and the UE.</p> <p>NOTE 5: The application-level messages in this use case are typically transferred over Ethernet. For small messages, the minimum Ethernet frame size of 64 bytes applies and dictates the minimum size of the PDU sent over the air interface.</p> <p>NOTE 6: It applies to both UL and DL unless stated otherwise.</p> <p>NOTE 7: It applies to UL.</p>											

### 5.3 Aperiodic deterministic communication

Aperiodic deterministic communication is without a pre-set sending time, but still with stringent requirements on timeliness and availability of the communication service. A description of aperiodic deterministic communication can be found in Clauses 4.3 and 4.4. Additional information on the underlying use cases of the sets of requirements in Table 5.3-1 can be found in Annex A. Further information on characteristic parameters and influence quantities used in Table 5.3-1 can be found in Annex C.

The 5G system shall be able to provide aperiodic deterministic communication with the service performance requirements for individual logical communication links that realise the communication services reported in Table 5.3-1.

**Table 5.3-1: Aperiodic deterministic communication service performance requirements**



Characteristic parameter (KPI)				Influence quantity					Remarks
Communication service availability	Communication service reliability: mean time between failures	Max Allowed End-to-end latency (note 1) (note 5)	Service bit rate: user-experienced data rate (note 5)	Message size [byte] (note 5)	Survival time	UE speed (note 6)	# of UEs	Service Area (note 3)	
> 99.999 9 %	~ 1 week	10 ms	UL: > 10 Mbit/s	–	–	≤ 50 km/h	≤ 2,000	≤ 1 km <sup>2</sup>	Mobile robots – video streaming (A.2.2.3)
99.999 9 % to 99.999 999 %	~ 1 month	< 30 ms	> 5 Mbit/s	–	–	< 8 km/h (linear movement)	TBD	TBD	Mobile control panels - parallel data transmission (A.2.4.1)
99.999 999 %	1 day	<8 ms (note 8)	250 kbit/s	40 to 250	16 ms	quasi-static; up to 10 km/h	2 or more	30 m x 30 m	Mobile Operation Panel: Emergency stop (emergency stop events) (A.2.4.1A)
99.999 9 %	–	< 50 ms	0.59 kbit/s 28 kbit/s	< 100	–	stationary	10 km <sup>2</sup> to 100 km <sup>2</sup>	TBD	Smart grid millisecond level precise load control (A.4.5)
> 99.9 %	~ 1 month	< 10 ms	–	–	–	< 8 km/h (linear movement)	≥ 3	20 m x 20 m x 4 m	Augmented reality; bi-directional transmission to image processing server (A.2.4.2)
99.999 9 % to 99.999 999 %	~ 10 years	< 1 ms (note 4)	25 Mbit/s	–	–	stationary	2 to 5	100 m x 30 m x 10 m	Wired-2-wireless 100 Mbit/s link replacement (A.2.2.4)
99.999 9 % to 99.999 999 %	~ 10 years	< 1 ms (note 4)	500 Mbit/s	–	–	stationary	2 to 5	100 m x 30 m x 10 m	Wired-2-wireless 1 Gbit/s link replacement (A.2.2.4)
> 99.9 %	–	DL: < 10 ms UL:<1 s (rural)	DL: > 100 kbit/s UL: > 5 Gbit/s (note 9)	–	–	stationary	> 100		Distributed energy storage; energy storage station video (A.4.6)
> 99.99 %	–	< 100 ms (note 10);	DL:<1 Mbit/s	–	–	–	–	–	Advanced metering (A.4.7)
> 99.999 %	–	20 ms	–	< 100 byte	–	–	–	several km <sup>2</sup>	Distributed automated switching for isolation and service restoration (A.4.4.1) (note 7)
> 99.999 9 %	–	< 3 ms	–	160 byte	–	–	–	–	Distributed Energy Resources (DERs) and micro-grids (A.4.9) (note 7)

Characteristic parameter (KPI)				Influence quantity					Remarks
Communication service availability	Communication service reliability: mean time between failures	Max Allowed End-to-end latency (note 1) (note 5)	Service bit rate: user-experienced data rate (note 5)	Message size [byte] (note 5)	Survival time	UE speed (note 6)	# of UEs	Service Area (note 3)	
> 99.999 9 %	~ 1 week	10 ms	UL: > 10 Mbit/s	–	–	≤ 50 km/h	≤ 2,000	≤ 1 km <sup>2</sup>	Mobile robots – video streaming (A.2.2.3)
99.999 9 % to 99.999 999 %	~ 1 month	< 30 ms	> 5 Mbit/s	–	–	< 8 km/h (linear movement)	TBD	TBD	Mobile control panels - parallel data transmission (A.2.4.1)
99.999 999 %	1 day	<8 ms (note 8)	250 kbit/s	40 to 250	16 ms	quasi-static; up to 10 km/h	2 or more	30 m x 30 m	Mobile Operation Panel: Emergency stop (emergency stop events) (A.2.4.1A)
99.999 9 %	–	< 50 ms	0.59 kbit/s 28 kbit/s	< 100	–	stationary	10 km <sup>2</sup> to 100 km <sup>2</sup>	TBD	Smart grid millisecond level precise load control (A.4.5)
> 99.9 %	~ 1 month	< 10 ms	–	–	–	< 8 km/h (linear movement)	≥ 3	20 m x 20 m x 4 m	Augmented reality; bi-directional transmission to image processing server (A.2.4.2)
99.999 9 % to 99.999 999 %	~ 10 years	< 1 ms (note 4)	25 Mbit/s	–	–	stationary	2 to 5	100 m x 30 m x 10 m	Wired-2-wireless 100 Mbit/s link replacement (A.2.2.4)
99.999 9 % to 99.999 999 %	~ 10 years	< 1 ms (note 4)	500 Mbit/s	–	–	stationary	2 to 5	100 m x 30 m x 10 m	Wired-2-wireless 1 Gbit/s link replacement (A.2.2.4)
<p>NOTE 1: Unless otherwise specified, all communication includes 1 wireless link (UE to network node or network node to UE) rather than two wireless links (UE to UE).</p> <p>NOTE 2: (void)</p> <p>NOTE 3: Length x width x height.</p> <p>NOTE 4: Scheduled aperiodic traffic with transfer interval (max end-to-end allowed latency &lt; transfer interval).</p> <p>NOTE 5: It applies to both UL and DL unless stated otherwise.</p> <p>NOTE 6: It applies to both linear movement and rotation unless stated otherwise.</p> <p>NOTE 7: Communication includes two wireless links (UE to UE).</p> <p>NOTE 8: The mobile operation panel is connected wirelessly to the 5G system. If the mobile robot/production line is also connected wirelessly to the 5G system, the communication includes two wireless links.</p> <p>NOTE 9: The service bit rate in one energy storage station can be calculated as follows: 12.5 Mbytes/s x 50 containers x 8 = 5 Gbit/s.</p> <p>NOTE 10: The maximum allowed end-to-end latency is for accuracy fee control. It is the delay for one-way communication between the backend system and the 5G IoT device. The distance between the two is 40 km or lower (city range).</p>									

## 5.4 Non-deterministic communication

Non-deterministic communication subsumes all other traffic types than periodic/aperiodic deterministic communication. This includes periodic/aperiodic non-real-time traffic. A description of non-deterministic communication can be found in Clauses 4.3 and 4.4. Additional information on the underlying use cases of the sets of requirements in Table 5.4-1 can be found in Annex A. Further information on characteristic parameters and influence quantities used in Table 5.4-1 can be found in Annex C.

The 5G system shall be able to provide non-deterministic communication with the service performance requirements for individual logical communication links that realise the communication services reported in Table 5.4-1.

**Table 5.4-1: Non-deterministic communication service performance requirements**

Characteristic parameter (KPI)		Influence quantity			Remarks
Communication service reliability: mean time between failures	Service bit rate: user-experienced data rate	UE speed (note 2)	# of UEs	Service area (note 1)	
~ 1 month	DL: $\geq 1$ Mbit/s	~ 0 km/h $\leq 75$ km/h	$\leq 100$	50 m x 10 m x 10 m	Motion control - software updates (A.2.2.1)
	UL: $> 10$ Mbit/s	$\leq 50$ km/h (linear movement)	$\leq 2,000$	$\leq 1$ km <sup>2</sup>	Mobile robots; real-time video stream (A.2.2.3)
NOTE 1: Length x width x height					
NOTE 2: It applies to both linear movement and rotation unless stated otherwise.					

## 5.5 Mixed traffic

Mixed traffic cannot be assigned to one of the other communication patterns exclusively. Additional information on the underlying use cases of the sets of requirements in Table 5.5-1 can be found in Annex A. Further information on characteristic parameters and influence quantities used in Table 5.5-1 can be found in Annex C.

The 5G system shall be able to provide mixed traffic communication with the service performance requirements for individual logical communication links that realise the communication services reported in Table 5.5-1.

Table 5.5-1: Mixed traffic communication service performance requirements

Characteristic parameter (KPI)				Influence quantity					Remarks
Communication service availability	Communication service reliability: mean time between failures	Max Allowed End-to-end latency (note 1) (note 3)	Service bit rate: aggregate user-experienced data rate	Message Size [byte]	Survival time	UE speed	# of UEs	Service Area	
99.999 999 9 %	~ 10 years	16 ms				stationary	< 1,000	several km <sup>2</sup>	Wind power plant – control traffic (A.5.2)
99.999 9 % to 99.999 99 %	1 day	(note 4)	12 Mbit/s	250 to 1,500		quasi-static; up to 10 km/h	2 or more	30 m x 30 m	Mobile Operation Panel: Manufacturing data stream (A.2.4.1A)
<p>NOTE 1: Unless otherwise specified, all communication includes 1 wireless link (UE to network node or network node to UE) rather than two wireless links (UE to UE).</p> <p>NOTE 2: (void)</p> <p>NOTE 3: It applies to both UL and DL unless stated otherwise.</p> <p>NOTE 4: The mobile operation panel is connected wirelessly to the 5G system. If the mobile robot/production line is also connected wirelessly to the 5G system, the communication includes two wireless links.</p>									

## 5.6 Clock synchronisation requirements

### 5.6.0 Description

Clock synchronicity, or time synchronization precision, is defined between a sync master and a sync device. The requirement on the synchronicity budget for the 5G system is the time error contribution between ingress and egress of the 5G system on the path of clock synchronization messages.

Clock synchronisation requirements specific for direct device connection and indirect network connection are captured in section 7.2.3 and 8.2.3.

### 5.6.1 Clock synchronisation service level requirements

The 5G system shall support a mechanism to process and transmit IEEE 1588v2 / Precision Time Protocol messages to support 3<sup>rd</sup>-party applications which use this protocol.

The 5G system shall support a mechanism to synchronise the user-specific time clock of UEs with a global clock.

The 5G system shall support a mechanism to synchronize the user-specific time clock of UEs with a working clock.

The 5G system shall support two types of synchronization clocks, the global time domain and the working clock domains.

The 5G system shall support networks with up to 128 working clock domains (with different synchronization domain identifiers / domain numbers), including for UEs connected through the 5G network.

NOTE 1: The domain number (synchronization domain identifier) is defined with one octet in IEEE 802.1AS [22].

The 5G system shall be able to support up to four simultaneous synchronization domains on a UE.

NOTE 1A: The four synchronization domains are used, for example, as two synchronization domains for global time and two working clock domains. One pair of global time and working clock is used as redundant synchronization domains for zero failover time.

The synchronicity budget for the 5G system within the global time domain shall not exceed 900 ns.

NOTE 2: The global time domain requires in general a precision of 1  $\mu$ s between the sync master and any device of the clock domain. Some use cases require only a precision of  $\leq 100$   $\mu$ s for the global time domain if a working clock domain with precision of  $\leq 1$   $\mu$ s is available.

NOTE 3: (void)

The synchronicity budget for the 5G system within a working clock domain shall not exceed 900 ns.

NOTE 4: The working clock domains require a precision of  $\leq 1$   $\mu$ s between the sync master and any device of the clock domain.

NOTE 5: Different working clock domains are independent and can have different precision.

NOTE 6: The synchronicity budget for the 5G system is also applicable when the flow of clock synchronization messages traverses the air interface twice.

The 5G system shall provide a media-dependent interface for one or multiple IEEE 802.1AS sync domains [22].

The 5G system shall provide an interface to the 5G sync domain which can be used by applications to derive their working clock domain or global time domain (Reference Clock Model).

The 5G system shall provide an interface at the UE to determine and to configure the precision and time scale of the working clock domain.

The 5G system shall be able to support arbitrary placement of sync master functionality and sync device functionality in integrated 5G / non-3GPP TSN networks.

The 5G system shall be able to support clock synchronization through the 5G network if the sync master and the sync devices are served by different UEs. (Flow of clock synchronization messages is in either direction, UL and DL.)

The 5G system shall provide a suitable means to support the management of the merging and separation of working clock domains, that is interoperable with the corresponding mechanisms of TSN and IEEE 802.1AS.

The 5G system shall provide a suitable means to support precise time distribution, clock synchronization functionalities specific to smart grid applications, e.g.:

- IEC 61850-9-3 [30] profile and IEEE Std C37.238-2017 [31].

## 5.6.2 Clock synchronisation service performance requirements

**Table 5.6.2-1: Clock synchronization service performance requirements for 5G System**

User-specific clock synchronicity accuracy level	Number of devices in one communication group for clock synchronisation	5GS synchronicity budget requirement (note 1)	Service area	Scenario
1	up to 300 UEs	$\leq 900$ ns	$\leq 100$ m x 100 m	- Motion control (A.2.2.1) - Control-to-control communication for industrial controller (A.2.2.2)
2	up to 300 UEs	$\leq 900$ ns	$\leq 1,000$ m x 100 m	- Control-to-control communication for industrial controller (A.2.2.2)
3	up to 10 UEs	$< 10$ $\mu$ s	$\leq 2,500$ m <sup>2</sup>	- High data rate video streaming
3a	up to 100 UEs	$< 1$ $\mu$ s	$\leq 10$ km <sup>2</sup>	- AVPROD synchronisation and packet timing
4	up to 100 UEs	$< 1$ $\mu$ s	$< 20$ km <sup>2</sup>	- Smart Grid: synchronicity between PMUs
4a	up to 100 UEs	$< 250$ ns to 1 $\mu$ s	$< 20$ km <sup>2</sup>	Smart Grid: IEC 61850-9-2 Sampled Values
4b	up to 100 UEs	$< 10$ -20 $\mu$ s	$< 20$ km <sup>2</sup>	Smart Grid: IEC 61850-9-2 Sampled Values – Power system protection in digital substation
4c	54/km <sup>2</sup> (note 2) 78/km <sup>2</sup> (note 3)	$< 10$ $\mu$ s	several km <sup>2</sup>	Smart Grid: Intelligent Distributed Feeder Automation (A.4.4.3)
4d	up to 100 UEs	$< 1$ ms	$< 20$ km <sup>2</sup>	Smart Grid: IEC 61850-9-2 Sampled Values – Event reporting and Disturbance recording
5	up to 10 UEs	$< 50$ $\mu$ s	400 km	- Telesurgery (A.6.2) and telediagnosis (A.6.3)
NOTE 1: The clock synchronicity requirement refers to the clock synchronicity budget for the 5G system, as described in Clause 5.6.1.				
NOTE 2: When the distributed terminals are deployed along overhead line, about 54 terminals will be distributed along overhead lines in one square kilometre. The resulting power load density is 20 MW/km <sup>2</sup> .				
NOTE 3: When the distributed terminals are deployed in power distribution cabinets, there are about 78 terminals in one square kilometre. The resulting power load density is 20 MW/km <sup>2</sup> ,				

## 5.6A Time-sensitive communication requirements

The 5G system shall support the fully distributed model for configuration of time-sensitive networking.

The 5G system shall support the fully distributed model for configuration of time-sensitive networking that is aligned with Multiple Stream Registration Protocol (MSRP, IEEE 802.1Q [19] clause 35.1), IEEE P802.1CS Link-local Registration Protocol (LRP) [24], and IEEE P802.1Qdd Resource Allocation Protocol (RAP) [25].

The 5G system shall support the user-network / network-network interface for the dynamic configuration of the fully distributed model for time-sensitive networking.

## 5.6B 5G Timing Resiliency

To enable support of many critical services within the 5G network, additional requirements and KPIs that enhance the 5G system with timing resiliency are specified in TS 22.261 [2] clauses 6.36 and 7.8. Those enhancements enable use of the 5G system for time critical services in collaboration with or as a backup to other timing solution such as loss or degradation of GNSS reference timing.

### 5.6C Void

#### 5.6C.1 Void

#### 5.6C.2 Void

## 5.7 Positioning performance requirements

### 5.7.1 General requirements

High accuracy positioning is becoming essential for Factories of the Future. The reason for this is that tracking of mobile devices as well as mobile assets is becoming increasingly important in improving processes and increasing flexibility in industrial environments.

The 5G system shall provide positioning information for a UE that is out of coverage of the network, with accuracy of < [1 m] relative to other UEs that are in proximity and in coverage of the network.

Table 5.7.1-1 below lists typical scenarios and the corresponding high positioning requirements for horizontal and vertical accuracy, availability, heading, latency, and UE speed.

NOTE: The column on "Corresponding Positioning Service Level in TS 22.261" maps the scenarios listed in Table 5.7.1-1 to the service levels defined in TS 22.261 [2].

Table 5.7.1-1: Positioning performance requirements

Scenario	Horizontal accuracy	Vertical accuracy	Availability	Heading	Latency for position estimation of UE	UE speed	Corresponding Positioning Service Level in TS 22.261
Mobile control panels with safety functions (non-danger zones)	< 5 m	< 3 m	90 %	n/a	< 5 s	n/a	Service Level 2
Process automation – plant asset management	< 1 m	< 3 m	90 %	n/a	< 2 s	< 30 km/h	Service Level 3
Flexible, modular assembly area in smart factories (for tracking of tools at the work-place location)	< 1 m (relative positioning)	n/a	99 %	n/a	1 s	< 30 km/h	Service Level 3
Augmented reality in smart factories	< 1 m	< 3 m	99 %	< 0.17 rad	< 15 ms	< 10 km/h	Service Level 4
Mobile control panels with safety functions in smart factories (within factory danger zones)	< 1 m	< 3 m	99.9 %	< 0.54 rad	< 1 s	n/a	Service Level 4
Flexible, modular assembly area in smart factories (for autonomous vehicles, only for monitoring purposes)	< 50 cm	< 3 m	99 %	n/a	1 s	< 30 km/h	Service Level 5
Inbound logistics for manufacturing (for driving trajectories (if supported by further sensors like camera, GNSS, IMU) of indoor autonomous driving systems))	< 30 cm (if supported by further sensors like camera, GNSS, IMU)	< 3 m	99.9 %	n/a	10 ms	< 30 km/h	Service Level 6
Inbound logistics for manufacturing (for storage of goods)	< 20 cm	< 20 cm	99 %	n/a	< 1 s	< 30 km/h	Service Level 7

## 5.7.2 Energy efficiency requirements for high accuracy positioning

The 5G system shall support low power high accuracy positioning mechanisms that allow a battery-constrained UE to sustain a long lifetime without changing battery. Some corresponding use cases and example scenarios are captured in Annex A.7.2.

## 5.8 Network operation requirements

For use by Industry 4.0, the 5G system needs to meet various operational options that are not typical in a traditional mobile operator setting. Additional system requirements that enable a 5G system to support those options are included in this clause.

5G system shall provide support for reliable communications when a UE serves as a TSN talker or listener so there is no single point of service failure.



---

## 6 Ethernet applications

### 6.1 Description

This section lists the requirements applicable to the 5G system for supporting cyber-physical applications using Ethernet.

For requirements pertaining to common, fundamental Ethernet transport requirements, and any requirements necessary to support the 5G LAN-type service, see Clause 6.24 in TS 22.261 [2].

### 6.2 Requirements

For infrastructure dedicated to high performance Ethernet applications, the 3GPP system shall support clock synchronisation defined by IEEE 802.1AS across 5G-based Ethernet links with PDU-session type Ethernet.

For infrastructure dedicated to high performance Ethernet applications, the 3GPP system shall support clock synchronisation defined by IEEE 802.1AS across 5G-based Ethernet links and other ethernet transports such as wired and optical (EPON.)

For infrastructure dedicated to high performance Ethernet applications, the accuracy of clock synchronisation should be better than 1 $\mu$ s.

For infrastructure dedicated to high performance Ethernet applications, the 3GPP system shall support enhancements for time-sensitive networking as defined by IEEE 802.1Q, e.g. time-aware scheduling with absolute cyclic time boundaries defined by IEEE 802.1Qbv [19], for 5G-based Ethernet links with PDU sessions type Ethernet.

For infrastructure dedicated to high performance Ethernet applications, absolute cyclic time boundaries shall be configurable for flows in DL direction and UL direction.

For infrastructure dedicated to high performance Ethernet applications, the 3GPP system shall support coexistence of hard-RT traffic following a time-aware schedule and lower priority traffic. The lower priority traffic cannot have a performance degrading impact on the hard-RT traffic.

The Ethernet transport service shall support routing based on information extracted from the Ethernet header information created based on IEEE 802.1Qbv.

---

## 7 Direct device connection for cyber-physical control applications

### 7.1 Description

This section lists the requirements applicable to the 5G system for supporting cyber-physical control applications using wireless direct device connection.

### 7.2 Requirements

#### 7.2.1 General

The 5G system shall allow UEs to use direct device connection when the UEs are not served by a RAN.

The 5G system shall be able to support direct device connection between UEs in close proximity using spectrum different than the spectrum being used for the 5GC-based communication.

The 5G system shall be able to support direct device connection for 5G LAN-type private communication.

The 5G system shall be able to support multicast communication between the UEs within the group of UEs using direct device connection .

## 7.2.2 Network performance

The 5G system shall be able to support direct device connection between a group of UEs for periodic deterministic communication (both unicast and multicast) with respective service performance requirements in Table 5.2-1 related to cooperative carrying.

The 5G system shall be able to support mobility of the group of UEs using direct device connections with respective service performance requirements in Table 5.2-1 related to cooperative carrying.

The 5G system shall be able to support direct device connection with respective service performance requirements in Table 5.2-1 related to cooperative carrying between UEs up to 50 m distance.

## 7.2.3 Clock synchronization

### 7.2.3.1 Description

This clause lists the service level requirements and performance requirements applicable to the 5G system for supporting clock synchronization for direct device connection, building on the description already provided in Clause 5.6.0.

### 7.2.3.2 Clock synchronization requirements

The 5G system shall be able to support clock synchronization (working clock domain) between the UEs within the group of UEs using direct device connection ProSe communication.

The 5G system shall be able to support Precision Time Protocol-based (IEEE 802.1AS [22] or another applicable IEEE Std 1588 [34] profile) or 5G sync domain-based clock synchronization among the group of UEs using direct device connection.

The 5G system shall be able to support the sync master of the working clock domain being connected to one of the UEs or being hosted at one of the UEs in the group of UEs using direct device connection.

The 5G system shall be able to support up to four simultaneous synchronization domains on a UE using direct device connection.

The 5G system using direct device connection shall support one or multiple time domains (IEEE 802.1AS [22] or another applicable IEEE Std 1588 [34] profile or 5G sync domain configuration).

The 5G system shall provide a suitable means to support the merging and separation of working clock domains at the UEs within the group of UEs connected by direct device connection, that is interoperable with the corresponding mechanisms of IEEE 802.1AS [22], IEEE Std 1588 [34], or 5G sync domain.

For direct device connection, the 5G system shall be able to support a 5GS synchronicity budget for clock synchronization according to Table 7.2.3.2-1. In this case, the sync master and sync device are located at or connected to two UEs which are connected via direct device connection.

**Table 7.2.3.2-1: Direct device connection clock synchronization service performance requirements for 5G System**

Number of devices in one communication group for clock synchronization	5GS synchronicity budget requirement (note 1)	Service area (note 2)	Scenario
2 to 16	≤ 900 ns	10 m x 10 m x 5 m; 50 m x 5 m x 5 m	Cooperative carrying – fragile work pieces; (A.2.2.5)
2 to 16	≤ 900 ns	10 m x 10 m x 5 m; 50 m x 5 m x 5 m	Cooperative carrying – elastic work pieces; (A.2.2.5)
NOTE 1: 5G synchronicity budget is the time error between ingress and egress of the 5G system on the path of clock synchronization messages (as described in Clause 5.6.0). For direct device connection, the ingress is one UE and the egress the other directly connected UE.			
NOTE 2: Service Area for direct device connections between UEs (length x width x height). The group of UEs with direct device connections might move throughout the whole factory site (up to several km <sup>2</sup> ).			

## 7.2.4 Service Continuity

The 5G system shall be able to minimize service disruption for a group of UEs using direct device connection with respective service performance requirements in Table 5.2-1 related to cooperative carrying, when the group moves between a non-public network and a PLMN (subject to operator policies and agreement between the operators and service providers).

## 7.2.5 Direct device connection via UE to UE relay

The 5G system shall be able to support direct device connection via an UE to UE relay with respective service performance requirements in Table 5.2-1 related to cooperative carrying between UEs out of transmission range of each other.

---

# 8 Indirect network connection for cyber-physical control applications

## 8.1 Description

This section lists the requirements applicable to the 5G system for supporting cyber-physical control applications using wireless indirect network connection.

## 8.2 Requirements

### 8.2.1 General

The 5G system shall be able to support multicast communication between the UEs within the group of UEs using indirect network connection.

### 8.2.2 Communication via indirect network connection

The 5G system shall be able to provide service to an out-of-coverage UE via indirect network connection using one relay UE while meeting the performance requirements specified for the process automation use cases in Table 5.2-1 (related to Annex A.2.3.1 and A.2.3.2).

## 8.2.3 Clock synchronization

### 8.2.3.1 Description

This clause lists the service level requirements and performance requirements applicable to the 5G system for supporting clock synchronization for indirect network connection, building on the description already provided in Clause 5.6.0.

### 8.2.3.2 Clock synchronization requirements

The 5G system shall be able to support clock synchronization (working clock domain) for UEs using indirect network connection.

The 5G system shall be able to support Precision Time Protocol-based (IEEE 802.1AS [22] or another applicable IEEE Std 1588 [34] profile) or 5G sync domain-based clock synchronization for UEs using indirect network connection.

The 5G system shall be able to support the sync master of the working clock domain being connected to one of the UEs or being hosted at one of the UEs using indirect network connection.

The 5G system shall be able to support up to four simultaneous synchronization domains on a UE using indirect network connection.

The 5G system shall provide a suitable means to support the merging and separation of working clock domains at the UEs connected by indirect network connection, that is interoperable with the corresponding mechanisms of IEEE 802.1AS [22] or another applicable IEEE Std 1588 [34] profile or 5G sync domain.

For indirect network connection between UEs using one UE-to-network relay, the 5G system shall be able to support a 5GS synchronicity budget for clock synchronization according to Table 8.2.3.2-1.

**Table 8.2.3.2-1: Indirect network connection clock synchronization service performance requirements for 5G System**

Number of devices in one communication group for clock synchronization	UE density [UE / m <sup>2</sup> ]	5GS synchronicity budget requirement (note 1)	Service area (note 2)	Scenario
10 to 20 UEs	-	< 1 ms	≤ 100 m x 100 m x 50 m	Process automation – closed loop control (A.2.3.1)
≤ 10,000 to 100,000	-	≤ 1 ms	≤ 10 km x 10 km x 50 m	Process and asset monitoring (A.2.3.2)
<p>NOTE 1: 5G synchronicity budget is the time error between ingress and egress of the 5G system on the path of clock synchronization messages (as described in Clause 5.6.0). For indirect network connection, 3 cases are considered:</p> <ol style="list-style-type: none"> <li>1) If the path of clock synchronization messages is between device and network side, ingress and egress of the 5G system are the remote UE and the corresponding UPF on the network side.</li> <li>2) If ingress and egress of the 5G system are at the device side, the 5G synchronicity budget is the time error between the involved remote UE and the 5G sync master.</li> <li>3) If the sync master is inside the 5G system, the 5G synchronicity budget ingress is the sync master in the 5G system and egress is the remote UE.</li> </ol> <p>NOTE 2: Service Area for indirect network connections between UEs (length x width x height).</p>				

## 8.2.4 Service Continuity

The 5G system shall be able to minimize service disruption for a UE using indirect network connection with respective service performance requirements in Table 5.2-1 related to process automation, when the UE moves between a non-public network and a PLMN (subject to operator policies and agreement between the operators and service providers).

---

## 9 Recovery of infrastructure for electrical distribution

### 9.1 Description

The robustness of the infrastructure for electrical power distribution may depend upon the possibility to operate telecommunication networks even during an energy system incident, in which electricity cannot be delivered to some network operator facilities. Through coordination between the network operator and the energy system operator, increases in the ability to recover the energy system operation can be achieved.

### 9.2 Requirements

Subject to regulatory requirements and operator policy, the 5G system shall support a mechanism by which an MNO can identify the ability of the MNO's infrastructure to continue operation despite a lack of electrical supply service, specifying which physical regions would be affected in terms of physical topology and the remaining time in which operation is possible.

NOTE1: This information can facilitate energy distribution system recovery operations.

Subject to regulatory requirements, the 5G system shall support a mechanism by which a third party can, in the event of an energy distribution system service interruption, communicate the energy distribution system recovery status in terms of location and time table to the MNO.

NOTE2: This information can facilitate MNO operations to facilitate energy system recovery.

---

# Annex A (informative): Summary of service performance requirements

## A.1 About the vertical domains addressed in this Annex

A vertical domain is an industry or group of enterprises in which similar products or services are developed, produced, and provided.

The vertical domains addressed in this Annex are

- Factories of the Future (A.2);
- electric-power distribution (A.4); and
- central power generation (A.5); and
- Connected hospitals or medical facilities (A.6).

---

## A.2 Factories of the Future

### A.2.1 Overview

The manufacturing industry is currently subject to a fundamental change, which is often referred to as the "Fourth Industrial Revolution" or simply "Industry 4.0" [15]. The main goals of Industry 4.0 are—among others—the improvement of flexibility, versatility, resource efficiency, cost efficiency, worker support, and quality of industrial production and logistics. These improvements are important for addressing the needs of increasingly volatile and globalised markets. A major enabler for all this is cyber-physical production systems based on a ubiquitous and powerful connectivity, communication, and computing infrastructure. The infrastructure interconnects people, machines, products, and all kinds of other devices in a flexible, secure and consistent manner. Several different application areas can be distinguished:

- 1) **Factory automation:** Factory automation deals with the automated control, monitoring and optimisation of processes and workflows within a factory. This includes aspects like closed-loop control applications (e.g., based on programmable logic or motion controllers) and robotics, as well as aspects of computer-integrated manufacturing. Factory automation generally represents a key enabler for industrial mass production with high quality and cost-efficiency. Corresponding applications are often characterised by highest requirements on the underlying communication infrastructure, especially in terms of communication service availability, determinism, and latency. In the Factories of the Future, static sequential production systems will be more and more replaced by novel modular production systems offering a high flexibility and versatility. This involves many increasingly mobile production assets, for which powerful wireless communication and localisation services are required.
- 2) **Process automation:** Process automation refers to the control of production and handling of substances like chemicals, food & beverage, pulp, etc. Process automation improves the efficiency of production processes, energy consumption, and safety of the facilities. Sensors measuring process values, such as pressures or temperatures, are working in closed loops via centralised and decentralised controllers. In turn, the controllers interact with actuators, e.g., valves, pumps, heaters. Also, monitoring of attributes such as the filling levels of tanks, quality of material, or environmental data are important, as well as safety warnings or plant shut downs. Workers in the plant are supported by mobile devices. A process automation facility may range from a few 100 m<sup>2</sup> to several km<sup>2</sup>, and the facility may be geographically distributed. Depending on the size, a production plant may have several 10,000 measurement points and actuators. Autarkic device power supply for years is needed in order to stay flexible and to keep the total costs of ownership low.

- 3) **HMIs and production IT:** Human-machine interfaces (HMIs) include all sorts of devices for the interaction between people and production facilities, such as panels attached to a machine or production line, but also standard IT devices, such as laptops, tablet PCs, smartphones, etc. In addition, augmented- and virtual-reality applications are expected to play an increasingly important role in future.
- 4) **Logistics and warehousing:** Organisation and control of the flow and storage of materials and goods in the context of industrial production. In this respect, intra-logistics is dealing with logistics within a certain property (e.g., within a factory), for example by ensuring the uninterrupted supply of raw materials on the shop floor level using automated guided vehicles (AGVs), fork-lifts, etc. This is to be seen in contrast to logistics between different sites. Warehousing particularly refers to the storage of materials and goods, which is also getting more and more automated, for example based on conveyors, cranes and automated storage and retrieval systems.
- 5) **Monitoring and maintenance:** Monitoring of certain processes and/or assets in the context of industrial production without an immediate impact on the processes themselves (in contrast to a typical closed-loop control system in factory automation, for example). This particularly includes applications such as condition monitoring and predictive maintenance based on sensor data, but also big data analytics for optimising future parameter sets of a certain process, for instance. For these use cases, the data acquisition process is typically not latency-critical.

For each of these application areas, a multitude of potential use cases exists, some of which are outlined in the following subclauses. These use cases can be mapped to the given application areas (see Table A.2.1-1).

**Table A.2.1-1: Mapping of the considered use cases (columns) to application areas (rows)**

	Motion control	Control-to-control	Mobile control panels with safety	Mobile robots	Remote access and maintenance	Augmented reality	Closed-loop process control	Process monitoring	Plant asset management
Factory automation	X	X		X					
Process automation				X			X	X	X
HMIs and Production IT			X			X			
Logistics and warehousing		X		X					X
Monitoring and maintenance					X				

## A.2.2 Factory automation

### A.2.2.1 Motion control

A motion control system is responsible for controlling moving and/or rotating parts of machines in a well-defined manner, for example in printing machines, machine tools or packaging machines.

A schematic representation of a motion control system is depicted in Figure A.2.2.1-1. A motion controller periodically sends desired set points to one or several actuators (e.g., a linear actuator or a drive) which thereupon perform a corresponding action on one or several processes (in this case usually a movement or rotation of a certain component). At the same time, sensors determine the current state of the process(es), e.g. the current position and/or rotation of one or multiple components, and send the actual values back to the motion controller. This is done in a strictly cyclic and deterministic manner, such that during one application cycle the motion controller sends updated set points to all actuators, and all sensors send their actual values back to the motion controller. Nowadays, typically Industrial Ethernet technologies are used for motion control systems.

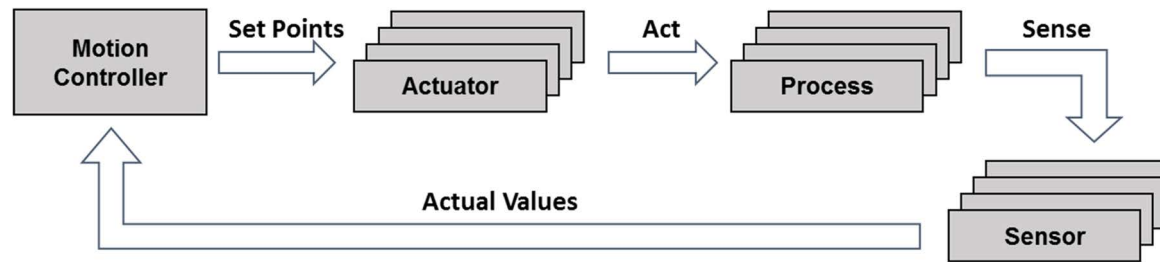

Figure A.2.2.1-1: Schematic representation of a motion control system

Table A.2.2.1-1: Service performance requirements for motion control

Use case #	Characteristic parameter				Influence quantity						
	Communication service availability: target value [%]	Communication service reliability: mean time between failures	End-to-end latency: maximum	Service bitrate: user experienced data rate	Message size [byte]	Transfer interval: lower bound	Transfer interval: upper bound	Survival time	UE speed	# of UEs	Service area (note)
1	99.999 to 99.999 99	~ 10 years	< transfer interval value	–	50	500 μs – 500 ns	500 μs + 500 ns	500 μs	≤ 72 km/h	≤ 20	50 m x 10 m x 10 m
2	99.999 9 to 99.999 999	~ 10 years	< transfer interval value	–	40	1 ms – 500 ns	1 ms + 500 ns	1 ms	≤ 72 km/h	≤ 50	50 m x 10 m x 10 m
3	99.999 9 to 99.999 999	~ 10 years	< transfer interval value	–	20	2 ms – 500 ns	2 ms + 500 ns	2 ms	≤ 72 km/h	≤ 100	50 m x 10 m x 10 m

NOTE: Length x width x height.

Use cases one to three

Characteristic parameters and influence quantities for a communication service supporting the cyclic interaction described above.



### A.2.2.2 Control-to-control communication

Control-to-control communication, i.e., the communication between different industrial controllers is already used today for different use cases, such as:

- large machines (e.g., newspaper printing machines), where several controls are used to cluster machine functions, which need to communicate with each other; these controls typically need to be synchronised and exchange real-time data;
- individual machines that are used for fulfilling a common task (e.g., machines in an assembly line) often need to communicate, for example for controlling and coordinating the handover of work pieces from one machine to another.

Typically, a control-to-control network has no fixed configuration of certain controls that need to be present. The control nodes present in the network often vary with the status of machines and the manufacturing plant. Therefore, hot-plugging support for different control nodes is important and often used.

**Table A.2.2.2-1: Service performance requirements for control-to control communication in motion control**

Use case #	Characteristic parameter			Influence quantity					
	Communication service availability: target value [%]	Communication service reliability: mean time between failures	End-to-end latency: maximum	Message size [byte]	Transfer interval	Survival time	UE speed	# of UEs	Service area (note 1)
1 (note 2)	99.999 9 to 99.999 999	~ 10 years	< transfer interval value	1 k	≤ 10 ms	10 ms	stationary	5 to 10	100 m x 30 m x 10 m
2 (note 2)	99.999 9 to 99.999 999	~ 10 years	< transfer interval value	1 k	≤ 50 ms	50 ms	stationary	5 to 10	1,000 m x 30 m x 10 m

NOTE 1: Length x width x height.  
NOTE 2: Communication may include two wireless links (UE to UE)

#### Use case one

Control-to-control communication between different motion (control) subsystems, as addressed in Subclause A.2.2.1. An exemplary application for this is large printing machines, where it is not possible or desired to control all actuators and sensors by one motion controller only.

#### Use case two

Control-to-control communication between different motion (control) subsystems. Exemplary application for this are extra-large machines or individual machines used for fulfilling a common task (e.g., machines in an assembly line).

### A.2.2.3 Mobile robots

Mobile robots and mobile platforms, such as automated guided vehicles, have numerous applications in industrial and intra-logistics environments and will play an increasingly important role in the Factory of the Future. A mobile robot essentially is a programmable machine able to execute multiple operations, following programmed paths to fulfil a large variety of tasks. This means, a mobile robot can perform activities like assistance in work steps, collaboration with other robots, e.g. for car assembly, and transport of goods, materials and other objects. Mobile robot systems are characterised by a maximum flexibility in mobility relative to the environment, with a certain level of autonomy and perception ability, i.e., they can sense and react with their environment.

Autonomous guided vehicles (AGVs) are a sub-group of mobile robots. AGVs are driverless and used for moving materials efficiently within a facility. A detailed overview of the state of the art of autonomous-guided-vehicle systems is provided elsewhere in the literature [16]. All mobile robots incorporate all functionalities needed for an AGV.

Today, the AGV's control intelligence is hosted inside the AGV. In the future, centralised fleet control will be hosted in the edge cloud, which will require reliable wireless communication between the control entity and all AGVs. Also, the current paradigm of pre-describing a route for the AGV will be replaced with target-based navigation. This paradigm change will make AGV routes more flexible.

Mobile robots are monitored and controlled from a guidance control system. Radio-controlled guidance control is necessary to get up-to-date process information, to avoid collisions between mobile robots, to assign driving jobs to the mobile robots, and to manage the traffic of mobile robots. The mobile robots are track-guided by the infrastructure with markers or wires in the floor or guided by own surround sensors, like cameras and laser scanners.

Mobile robot systems can be divided in operation in indoor, outdoor and both indoor and outdoor areas. These environmental conditions have an impact on the requirements of the communication system, e.g., the handover process, to guarantee the required cycle times.

Where this document does not explicitly refer to AGVs, the term *mobile robots* applies to AGVs as well as to mobile robots.

Table A.2.2.3-1: Service performance requirements for mobile robots

Use case #	Characteristic parameter				Influence quantity							
	Communication service availability: target value [%]	Communication service reliability: mean time between failures	End-to-end latency: maximum	Service bitrate: user experienced data rate	Message size [byte]	Transfer interval: lower bound	Transfer interval: target value (note)	Transfer interval: upper bound	Survival time	UE speed	# of UEs	Service area
1	> 99.999 9	~ 10 years	< target transfer interval value	–	40 to 250	– < 25 % of target transfer interval value	1 ms to 50 ms	+ < 25 % of target transfer interval value	target transfer interval value	≤ 50 km/h	≤ 2,000	≤ 1 km <sup>2</sup>
2	> 99.999 9	~ 1 year	< target transfer interval value	–	15 k to 250 k	– < 25 % of target transfer interval value	10 ms to 100 ms	+ < 25 % of target transfer interval value	target transfer interval value	≤ 50 km/h	≤ 2,000	≤ 1 km <sup>2</sup>
3	> 99.999 9	~ 1 year	< target transfer interval value	–	40 to 250	– < 25 % of target transfer interval value	40 ms to 500 ms	+ < 25 % of target transfer interval value	target transfer interval value	≤ 50 km/h	≤ 2,000	≤ 1 km <sup>2</sup>
4	> 99.999 9	~ 1 week	10 ms	> 10 Mbit/s	–	–	–	–	–	≤ 50 km/h	≤ 2,000	≤ 1 km <sup>2</sup>

NOTE: The transfer interval is not so strictly periodic in these use cases. The transfer interval deviates around its target value within bounds. The mean of the transfer interval is close to the target value.

*Use case one*

Periodic communication for the support of precise cooperative robotic motion control (transfer interval: 1 ms), machine control (transfer interval: 1 ms to 10 ms), co-operative driving (10 ms to 50 ms).

*Use case two*

Periodic communication for video-operated remote control.

*Use case three*

Periodic communication for standard mobile robot operation and traffic management.

*Use case four*

Real-time streaming data transmission (video data) from a mobile robot to the guidance control system.

**Additional information**

AGVs have the following needs.

- The direct-device control is time-critical since the communication involves safety-relevant functions such as emergency stop and the avoidance of obstacles.
- For the implementation of swarm intelligence, position and availability information are needed. A possible route change due to a blocked route affects the routes of all other AGVs that will follow. The communication is less time-critical than for safety-relevant functions.
- Camera-based navigation requires high data rates. Examples for camera-based navigation are the positioning of boxes/containers, detection of persons and obstacles, as well as creation and administration of a map for flexible navigation. Note that sensor-based navigation requires lower data rates than camera-based navigation.

Mobile robots have additional needs.

- The mobile robot provides an additional service during transport (for instance quality inspection, scanning of surroundings, asset identification, carrying of work pieces). In order to reduce the uplink data rate, pre-compression of data is possible directly on the device. The communication is not or at least less time-critical than the motion control of the mobile robot.
- The mobile robot needs to interact with the periphery (for instance intelligent storage racks, stationary robots, and moving machines). This communication is time-critical. Interaction with the periphery can be relevant at the start point, end point, and also at several intermediate stations (for instance the collection of parts from intelligent storage racks). The exact position and orientation can be determined by a centering station and the AGV sensors. Additional scanning by the robot with a video camera may be necessary.

### A.2.2.4 Wired to wireless link replacement

In a traditional factory, the production environment is fixed. Machines that are cooperating are connected via cable, typically using an industrial ethernet technology like PROFINET. In order to increase flexibility in the production setup, the wired links are replaced with wireless links.

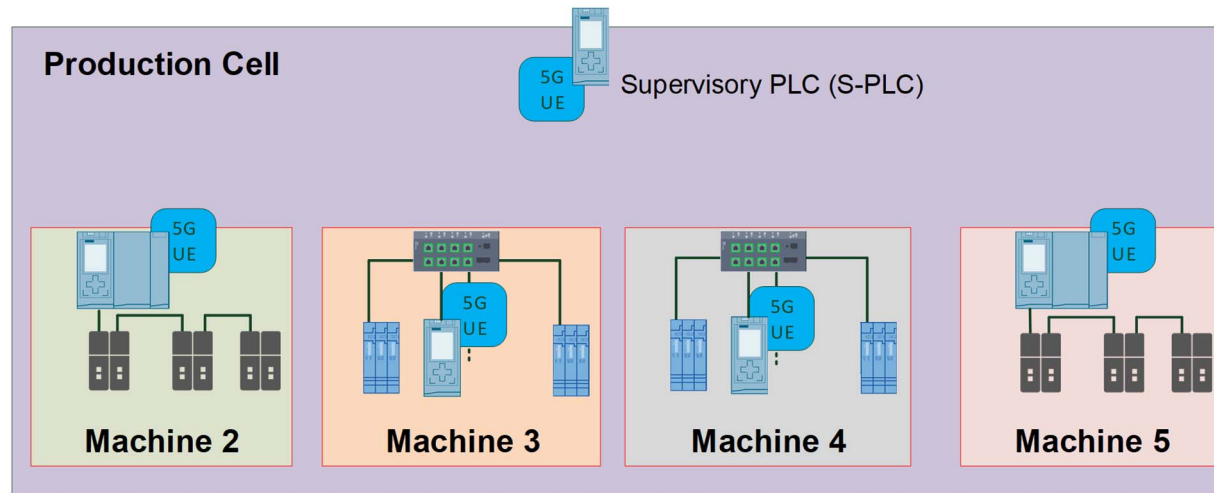

**Figure A.2.2.4-1: Example of four cooperating machines with wireless connections (based on [26])**

We assume two or more machines (typically 4 or 5) to be cooperating with each other during production. In order to replace the cables, each machine is equipped with one UE, connected to the controller (shown in Figure A.2.2.4-1). The cooperating machine's communication can be divided into two types. Periodic traffic and a-periodic traffic. Both types are scheduled, therefore the a-periodic traffic is also adhering to the transfer interval. The traffic requirements are from the point of view of the UE and give the maximum aggregate traffic of all links. Meaning, the traffic per link may change according to the number of cooperating machines but the total traffic at the UE cannot exceed the given values.

Table A.2.2.4-1: Service performance requirements for wired to wireless link replacement

Use case #	Characteristic parameter			Influence quantity					
	Communication service availability: target value [%]	Communication service reliability: mean time between failures	End-to-end latency: maximum	Data rate [Mbit/s]	Transfer interval	Survival time	UE speed	# of UEs	Service area (note 1)
1 (periodic traffic)	99.999 9 to 99.999 999	~ 10 years	< transfer interval value	50	≤ 1 ms	3 x transfer interval	stationary	2 to 5	100 m x 30 m x 10 m
1 (aperiodic traffic)	99.999 9 to 99.999 999	~ 10 years	< transfer interval value	25	≤ 1 ms (note 2)		stationary	2 to 5	100 m x 30 m x 10 m
2 (periodic traffic)	99.999 9 to 99.999 999	~ 10 years	< transfer interval value	250	≤ 1 ms	3 x transfer interval	stationary	2 to 5	100 m x 30 m x 10 m
2 (aperiodic traffic)	99.999 9 to 99.999 999	~ 10 years	< transfer interval value	500	≤ 1 ms (note 2)		stationary	2 to 5	100 m x 30 m x 10 m
NOTE 1: Length x width x height.									
NOTE 2: Transfer interval also applies for scheduled aperiodic traffic									

*Use case one*

In the case of the 100 Mbit/s link replacement, 50 % periodic traffic and 25 % a-periodic traffic are assumed.

*Use case two*

In the case of the 1 Gbit/s link replacement, 25 % periodic traffic and 50 % a-periodic traffic are assumed.

### A.2.2.5 Cooperative carrying

In a smart factory, large or heavy work pieces will be carried from one place to another by multiple mobile robots or AGVs. These mobile robots / AGVs need to work together in order to carry the large or heavy work piece safely. This cooperation is achieved with a cyber-physical control application that controls the drives and movements of the mobile robots / AGVs in a coordinated way, so that large or heavy work pieces are carried smoothly and safely from one place to another (see Figure 5.11.1-1).

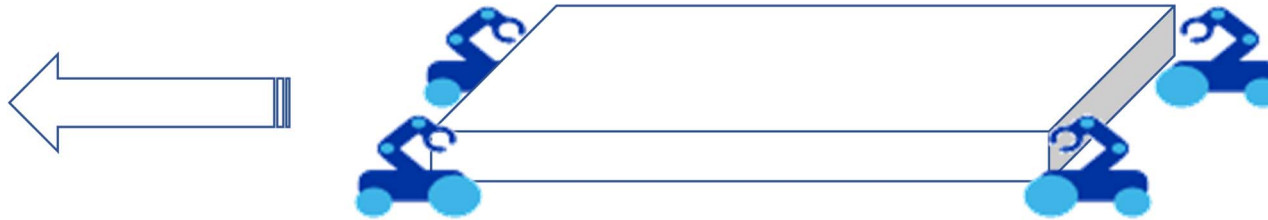

**Figure A.2.2.5-1: Mobile robots / AGVs carrying a large work piece cooperatively**

The communication between the collaborating mobile robots / AGVs requires high communication service availability and ultra-low latency. The exchange of control commands and control feedback is done with periodic deterministic communication and using time-sensitive networking.

There are two distinct use case variants of cooperative carrying: (1) carrying of rigid or fragile work pieces that require very precise coordination between the collaborating mobile robots, and (2) carrying of more flexible or elastic work pieces that allow some tolerance in the coordinated movements of the collaborative mobile robots. The higher tolerance in the coordinated movements allows for either faster movement of the work piece or longer transfer intervals (trade-off between UE speed and transfer interval).

**Table A.2.2.5-1: Service performance requirements for cooperative carrying**

Use case #	Characteristic parameter				Influence quantity					
	Communication service availability: target value [%]	Communication service reliability: mean time between failures	End-to-end latency: maximum	Service bitrate: user experienced data rate	Message size [byte]	Transfer interval: target value (note 1)	Survival time (note 1)	UE speed	# of UEs	Service area (note 2)
1	99.999 9 to 99.999 999	~ 10 years	< 0.5 x transfer interval	2.5 Mbit/s	250; 500 with localisation information	> 5 ms > 2.5 ms > 1.7 ms	0 transfer interval 2 x transfer interval	≤ 6 km/h	2 to 8	10 m x 10 m x 5 m; 50 m x 5 m x 5 m
2	99.999 9 to 99.999 999	~ 10 years	< 0.5 x transfer interval	2.5 Mbit/s	250; 500 with localisation information	> 5 ms > 2.5 ms > 1.7 ms	0 transfer interval 2 x transfer interval	≤ 12 km/h	2 to 8	10 m x 10 m x 5 m; 50 m x 5 m x 5 m

NOTE 1: The first value is the application requirement, the other values are the requirement with multiple transmission of the same information (two or three times respectively).  
 NOTE 2: Service Area for direct communication between UEs (length x width x height). The group of UEs with direct communication might move throughout the whole factory site (up to several km<sup>2</sup>)

*Use case one*

Periodic deterministic communication for cooperative carrying of fragile work pieces (UE to UE / ProSe communication).

*Use case two*

Periodic deterministic communication for cooperative carrying of elastic work pieces (UE to UE / ProSe communication).

## A.2.3 Process automation

### A.2.3.1 Closed-loop control

In the closed-loop control use case for process automation, several sensors are installed in a plant and each sensor performs continuous measurements. The measurement data are transported to a controller, which takes decision to set actuators. The latency and determinism in this use case are crucial. This use case has very stringent requirements in terms of latency and service availability. The required service area is usually bigger than for motion control use cases. Interaction with the public network (e.g., service continuity, roaming) is not required.

**Table A.2.3.1-1: Service performance requirements for closed-loop control in process automation**

Use case #	Characteristic parameter			Influence quantity							
	Communication service availability: target value [%]	Communication service reliability: mean time between failures	End-to-end latency: maximum	Message size [byte]	Transfer interval: lower bound	Transfer interval: target value	Transfer interval: upper bound	Survival time	UE speed	# of UEs	Service area (note)
1	99.999 9 to 99.999 999	≥ 1 year	< target transfer interval value	20	-5 % of target transfer interval value	≥ 10 ms	+5 % of target transfer interval value	0	typically stationary	typically 10 to 20	typically ≤ 100 m x 100 m x 50 m
NOTE: Length x width x height.											

*Use case one*

Several sensors are installed in a plant and each sensor performs continuous measurements. The measurement data are transported to a controller, which takes decision to set actuators.

### A.2.3.2 Process and asset monitoring

For process and asset monitoring in the area of process automation, a large number of industrial wireless sensors are installed in the plant to give insight into process and environmental conditions, asset health and inventory of material. The data are transported to displays for observation and/or to databases for registration and data analysis. Examples of sensors are temperature, pressure or flow rate sensors for process monitoring, vibration sensors for health monitoring of e.g. motors, or thermal cameras to detect leakages. Industrial wireless sensors are typically constrained in terms of size, complexity and/or power consumption. The operation for this use case can be in a wide service area, and interaction with the public network (e.g., service continuity, roaming) may be required.



Table A.2.3.2-1: Service performance requirements for process and asset monitoring

Use case	Characteristic parameter						Influence quantity					
	Communication service availability: target value [%]	Communication service reliability: mean time between failure	End-to-end latency	Transfer interval (note 1)	Bit rate [bits/s]	Battery lifetime [year] (note 2)	Message Size [byte]	Survival time	UE speed	UE density [UE / m <sup>2</sup> ]	Range [m] (note 4)	Service area (note 5)
1	99.99	≥ 1 week	< 100 ms	100 ms to 60 s	≤ 1 M	≥ 5	20 (note 3)	3 x transfer interval	Stationary	Up to 1	< 500	≤ 10 km x 10 km x 50 m
2	99.99	≥ 1 week	< 100 ms	≤ 1 s	≤ 200 k	≥ 5	25 k	3 x transfer interval	Stationary	Up to 0.05	< 500	≤ 10 km x 10 km x 50 m
3	99.99	≥ 1 week	< 100 ms	≤ 1 s	≤ 2 M	≥ 5	250 k	3 x transfer interval	Stationary	Up to 0.05	< 500	≤ 10 km x 10 km x 50 m
<p>NOTE 1: The transfer interval deviates around its target value by &lt;math&gt;\pm 25\%&lt;/math&gt;.</p> <p>NOTE 2: Industrial sensors can use a wide variety of batteries depending on the use case, but in general they are highly constrained in terms of battery size.</p> <p>NOTE 3: The application-level messages in this use case are typically transferred over Ethernet, in which case the minimum Ethernet frame size of 64 bytes applies and dictates the minimum size of the PDU sent over the air interface.</p> <p>NOTE 4: Distance between the gNB and the UE.</p> <p>NOTE 5: Length x width x height.</p>												

*Use case one*

Sensors generating periodic measurements of a continuous value (e.g. temperature, pressure, flow rate sensors). The traffic is predominantly mobile originated.

*Use case two*

Sensors generating waveform measurements (e.g. vibration sensors). Even though the waveform measurement is continuous, it is expected that this type of sensors will buffer and transmit the data periodically (e.g. every second) to save battery by enabling discontinuous transmission. The traffic is predominantly mobile originated.

*Use case three*

Cameras (regular or thermal) for asset monitoring (e.g. for leakage detection). Even though the video recording is continuous, it is expected that this type of sensors will buffer and transmit the data periodically (e.g. every second) to save battery by enabling discontinuous transmission. The traffic is predominantly mobile originated.

### A.2.3.3 Plant asset management

To keep a plant running, it is essential that the assets, such as pumps, valves, heaters, instruments, etc., are maintained. Timely recognition of any degradation and continuous self-diagnosis of components are used to support and plan maintenance. Remote software updates enhance and adapt the components to changing conditions and advances in technology. The operation for this use case can be in a wide service area, and interaction with the public network (e.g., service continuity, roaming) may be required. In this use case, the assets themselves are assumed to be connected to the 5G system. The use case where sensors are used to monitor assets is covered in clause A.2.3.2.

Table A.2.3.3-1: Service performance requirements for plant asset management

Use case #	Characteristic parameter			Influence quantity					
	Communication service availability: target value [%]	Communication service reliability: mean time between failures	End-to-end latency: maximum	Message size [byte]	Transfer interval	Survival time	UE speed	# of UEs	Service area (note)
1	99.99	TBD	< transfer interval value	20 to 255	several seconds	matter of convenience; typically $\geq 3 \times$ transfer interval value	typically stationary	$\leq 100,000$	typically $\leq 10 \text{ km} \times 10 \text{ km} \times 50 \text{ m}$
NOTE: Length x width x height.									

#### Use case one

To keep a plant running, it is essential that the assets, such as pumps, valves, heaters, and instruments are maintained. Timely recognition of any degradation and continuous self-diagnosis of components are used to support and plan maintenance. Remote software updates enhance and adapt the components to changing conditions and advances in technology.

## A.2.4 Human machine interfaces

### A.2.4.1 Mobile control panels

Control panels are crucial devices for the interaction between people and production machinery as well as for the interaction with moving devices. These panels are mainly used for configuring, monitoring, debugging, controlling and maintaining machines, robots, cranes or complete production lines. In addition to that, (safety) control panels are typically equipped with an emergency stop button and an enabling device, which an operator can use in case of a safety event in order to avoid damage to humans or machinery. When the emergency stop button is pushed, the controlled equipment immediately comes to a safe stationary position. Likewise, if a machine, robot, etc. is operated in the so-called special ‘enabling device mode’, the operator manually keeps the enabling device switch in a special stationary position. If the operator pushes this switch too much or releases it, the controlled equipment immediately comes to a safe stationary position as well. This way, it can be ensured that the hand(s) of the operator are on the panel (and not under a moulding press, for example), and that the operator does—for instance—not suffer from any electric shock or the like. A common use case for this ‘enabling device mode’ is the installation, testing or maintenance of a machine, during which other safety mechanisms (such as a safety fence) are deactivated.

Due to the criticality of these safety functions, safety control panels currently have mostly a wire-bound connection to the equipment they control. In consequence, there tend to be many such panels for the many machines and production units that typically can be found in a factory. With an ultra-reliable low-latency wireless link, it would be possible to connect such mobile control panels with safety functions wirelessly. This would lead to a higher usability and would allow for the flexible and easy re-use of panels for controlling different machines.

The cycle times of the control application depends on the process/machinery/equipment whose safety has to be ensured. For a fast-moving robot, for example, end-to-end latencies are lower than for slowly moving linear actuators.

Table A.2.4.1-1: Service performance requirements for mobile control panels

Use case #	Characteristic parameter				Influence quantity							
	Communication service availability: target value [%]	Communication service reliability: mean time between failures	End-to-end latency: maximum	Service bitrate: user experienced data rate	Message size [byte]	Transfer interval: lower bound	Transfer interval: target value	Transfer interval: upper bound	Survival time	UE speed	# of UEs	Service area (note 1)
1 (note 3)	99.999 9 to 99.999 999	~ 1 month	< target transfer interval value	–	40 to 250	– < 25 % of target transfer interval value	4 ms to 8 ms	+ 25 % of target transfer interval value	target transfer interval value	< 7.2 km/h	TBD	50 m x 10 m x 4 m
2 (note 3)	99.999 9 to 99.999 999	~ 1 month	< target transfer interval value	> 5 Mbit/s	–	– < 25 % of target transfer interval value	< 30 ms	+ 25 % of target transfer interval value	TBD	< 7.2 km/h	TBD	TBD
3 (note 3)	99.999 9 to 99.999 999	~ 1 year	< target transfer interval	–	40 to 250	– < 25 % of target transfer interval value	< 12 ms	+ 25 % of target transfer interval value	12 ms	< 7.2 km/h	TBD	typically 40 m x 60 m; maximum 200 m x 300 m
NOTE 1: Length x width (x height).												
NOTE 2: The transfer interval is not so strictly periodic in these use cases. The transfer interval deviates around its target value within bounds. The mean of the transfer interval is close to the target value.												
NOTE 3: Communication may include two wireless links (UE to UE)												

*Use case one*

Periodic, bi-directional communication for remote control. Examples for controlled units: assembly robots; milling machines.

*Use case two*

Aperiodic data transmission in parallel to remote control (use case one).

*Use case three*

Periodic, bi-directional communication for remote control. Examples for controlled units: mobile cranes, mobile pumps, fixed portal cranes.

### A.2.4.1A Mobile operation panels

Operation and monitoring of machines, mobile robots, or production units via a mobile operation panel provides higher flexibility and comfort for human operators. A single mobile operation panel can be used to manage more than one production system due to its mobility in the factory. The mobile operation panel provides relevant information for configuration, control of industrial machines as well as monitoring of relevant data generated during the construction of a product. The monitoring data is generally considered to be less time-critical subsequently requiring non-real-time communication. On the other hand, the mobile operation panel supports safety-critical functions such as emergency stops or enabling or changing the position of robots and other machines. These functions are generally considered to have strict ultra-low latencies and reliable transmission requirements that must follow strict safety standards making them time-critical (real-time communication).

**Table A.2.4.1A-1: Service performance requirements for mobile operation panels**

Use case #	Characteristic parameter				Influence quantity						
	Communication service availability: target value [%]	Communication service reliability: mean time between failures	End-to-end latency: maximum	Service bitrate: user experienced data rate	Direction (note 2)	Message size [byte]	Transfer interval: target value	Survival time	UE speed	# of UEs	Service area (note 1)
1	99.999 999	1 day	< 8 ms	250 kbit/s	Uplink Downlink	40 to 250	8 ms	16 ms	quasi-static; up to 10 km/h	2 or more	30 m x 30 m
2	99.999 99	1 day	< 10 ms	< 1 Mbit/s	Uplink	< 1,024	10 ms	~10 ms	quasi-static; up to 10 km/h	2 or more	30 m x 30 m
3	99.999 999	1 day	10 ms to 100 ms	10 kbit/s	Uplink Downlink	10-100	10-100 ms	transfer interval	stationary	2 or more	100 m <sup>2</sup> to 2,000 m <sup>2</sup>
4	99.999 999	1 day	< 1 ms	12 Mbit/s to 16 Mbit/s	Downlink	10-100	1 ms	~1 ms	stationary	2 or more	100 m <sup>2</sup>
5	99.999 999	1 day	< 2 ms	16 kbit/s (UL) 2 Mbit/s (DL)	Uplink Downlink	50	2 ms	~2 ms	stationary	2 or more	100 m <sup>2</sup>
6	99.999 9 to 99.999 99	1 day	up to [x]	12 Mbit/s	Uplink Downlink	250 to 1,500			quasi-static; up to 10 km/h	2 or more	30 m x 30 m

NOTE 1: Length x width.  
NOTE 2: The mobile operation panel is connected wirelessly to the 5G system. If the mobile robot/production line is also connected wirelessly to the 5G system, the communication includes two wireless links.

#### Use case one

Emergency Stop with periodic-deterministic communication for connectivity availability and aperiodic-deterministic communication for emergency stop events.

#### Use case two

Safety data stream with periodic deterministic communication.

*Use case three*

Visualization of Control with periodic deterministic communication.

*Use case four*

Motion Control with periodic deterministic communication.

*Use case five*

Haptic feedback data stream with periodic deterministic communication.

*Use case six*

Manufacturing data stream with mixed traffic.

### A.2.4.2 Augmented reality

It is envisioned that in future smart factories and production facilities, people will continue to play an important and substantial role. However, due to the envisaged high flexibility and versatility of the Factories of the Future, shop floor workers should be optimally supported in getting quickly prepared for new tasks and activities and in ensuring smooth operations in an efficient and ergonomic manner. To this end, augmented reality may play a crucial role, for example for the following applications:

- monitoring of processes and production flows;
- step-by-step instructions for specific tasks, for example in manual assembly workplaces;
- ad hoc support from a remote expert, for example for maintenance or service tasks.

In this respect, especially head-mounted augmented-reality devices with see-through display are very attractive since they allow for a maximum degree of ergonomics, flexibility and mobility and leave the hands of workers free for other tasks. However, if such augmented-reality devices are worn for a longer period (e.g., one work shift), these devices have to be lightweight and highly energy-efficient while at the same time they should not become very warm. A very promising approach is to offload complex (e.g., video) processing tasks to the network (e.g., an edge cloud) and to reduce the augmented-reality head-mounted device’s functionality. This has the additional benefit that the augmented-reality application may have easy access to different context information (e.g., information about the environment, production machinery, the current link state, etc.) if executed in the network.

**Table A.2.4.2-1: Service performance requirements for augmented reality in human-machine interfaces**

Use case #	Characteristic parameter			Influence quantity	
	Communication service availability: target value [%]	Communication service reliability: mean time between failures	End-to-end latency: maximum	UE speed	Service area (note)
1	> 99.9	~ 1 month	< 10 ms	< 8 km/h	20 m x 20 m x 4 m
NOTE: Length x width x height.					

*Use case one*

Bi-directional message transmission between an augmented-reality device and an image processing server.

## A.2.5 Monitoring and maintenance

### A.2.5.1 Remote access and maintenance

In factories of the future, there are needs to perform remote access and maintenance to devices and entities, for instance, by remote control centres. The devices and entities might be installed at geographically distributed locations. These devices typically have firmware/software which needs to be updated occasionally. Maintenance information also needs to be collected and distributed from/to these devices periodically. The devices can be both stationary and mobile. Device maintenance may happen in parallel to the actual production process and other communication services performed at the device side without any negative impact on these production communication services.

Table A.2.5.1-1: Service performance requirements for remote access and maintenance

Use case #	Characteristic parameter				Influence quantity						
	Communication service availability: target value [%]	Communication service reliability: mean time between failures	End-to-end latency: maximum	Service bitrate: user experienced data rate	Message size [byte]	Transfer interval: lower bound	Transfer interval: upper bound	Survival time	UE speed	# of UEs	Service area (note)
1	–	~ 1 month	–	≥ 1 Mbit/s	–	–	–	–	≤ 72 km/h	≤ 100	50 m x 10 m x 10 m
NOTE: Length x width x height.											

*Use case one*

Transmission of non-deterministic messages in parallel to other interactions. Example applications: software/firmware updates and exchange of maintenance information.

---

## A.3 (void)

---

## A.4 Electric-power distribution and Smart Grid

### A.4.1 Overview

The energy sector is currently subject to a fundamental change, which is caused by the evolution towards renewable energy, i.e. an increasing number of power plants based on solar and wind power. These changes lead to bi-directional electricity flows and increased dynamics of the power system. New sensors and actuators are being deployed in the power system to efficiently monitor and control the volatile conditions of the grid, requiring real-time information exchange [11][12].

The emerging electric-power distribution grid is also referred to as Smart Grid. The smartness enhances insight into both the grid as a power network and the grid as a system of systems. Enhanced insight improves controllability and predictability, both of which drive improved operation and economic performance and both of which are prerequisites for the sustainable and scalable integration of renewables into the grid and the potential transition to new grid architectures. Smart Grid benefits spread across a broad spectrum but generally include improvements in: power reliability and quality; grid resiliency; power usage optimisation; operational insights; renewable integration; insight into energy usage; and safety and security.

Overviews of (future) electric-power distribution can be found elsewhere in the literature [13][14].

### A.4.2 Primary frequency control

Primary frequency control is among the most challenging and demanding control applications in the utility sector. A primary frequency control system is responsible for controlling the energy supply injected and withheld to ensure that the frequency is not deviating more than 0.02 % from the nominal value (e.g., 50 Hz in Europe). Frequency control is based on having sensors for measuring the features in all parts of the network at all points where energy generation or storage units are connected to the grid. At these points, electronic power converters, also known as inverters, are equipped with communication units to send measurement values to other points in the grid such as a frequency control unit, or receive control commands to inject more, or less, energy into the local network.

With the widespread deployment of local generation units, i.e. solar power units, or wind turbines, hundreds of thousands of such units, and their inverters, may have to be connected in a larger power distribution network.

Primary frequency control is carried out in one of three ways:

- 1) Centralised control, all data analysis and corrective actions are determined by a central frequency control unit.
- 2) Decentralised control, the automatic routine frequency control is performed by the individual local inverter based on local frequency values. Statistics and other information is communicated to the central frequency control unit.
- 3) Distributed control, the automatic routine frequency control is performed by the individual local inverter based on local and neighbouring frequency values. Statistics and other information are communicated to the central frequency control unit.



**Table A.4.2-1: Service performance requirements for primary frequency control**

Use case #	Characteristic parameter			Influence quantity				
	Communication service availability: target value [%]	Communication service reliability: mean time between failures	End-to-end latency: maximum	Message size [byte]	Transfer interval: target value	Survival time	# of UEs	Service area
1	99.999	TBD	~ 50 ms	~ 100	~ 50 ms	TBD	≤ 100,000	several km <sup>2</sup> up to 100,000 km <sup>2</sup>

*Use case one*

Periodic communication service supporting message exchange for primary frequency control.

### A.4.3 Distributed voltage control

In the evolution towards 100 % renewable electric power production, the objective of voltage control is to balance the voltage in future low voltage distribution grids connecting local loads and prosumers, as well as energy storage facilities. The aim is to stabilise the voltage as locally as possible, so that decisions and control commands can be issued as quickly as possible. Distributed voltage control is a challenging and demanding control application. Consumer devices rely on having stable voltage levels to operate successfully. When future energy networks rely on thousands of local energy generation units relying mostly on solar and wind power, then it is crucial to stabilise the voltage levels in all segments of the distribution grid. Inverters, or electronic power converters, measure the voltage and power and change the amount of power injected into the grid, and they connect and disconnect end points from the distribution network.

Distributed control means that the automated voltage control shall be performed by the local voltage control units based on local *and neighbouring* voltage and impedance values. Statistics and other information shall be communicated to the central distribution management system, though.

**Table A.4.3-1: Service performance requirements for distributed voltage control**

Use case #	Characteristic parameter			Influence quantity				
	Communication service availability: target value [%]	Communication service reliability: mean time between failures	End-to-end latency: maximum	Message size [byte]	Transfer interval: target value	Survival time	# of UEs	Service area
1	99.999	TBD	~ 100 ms	~ 100	~ 200 ms	TBD	≤ 100,000	several km <sup>2</sup> up to 100,000 km <sup>2</sup>

*Use case one*

Periodic communication service supporting message exchange for distributed voltage control.

### A.4.4 Distributed energy automation

#### A.4.4.1 Distributed automated switching for isolation and service restoration

A power distribution grid fault is a stressful situation. There are self-healing solutions for automated switching, fault isolation, and service restoration. Furthermore, these solutions are ideally suited to handle outages that affect critical

power consumers, such as industrial plants or data centres. Supply interruptions must be fixed within less than a second for critical power consumers. Automated solutions are able to restore power supply within a few hundred milliseconds.

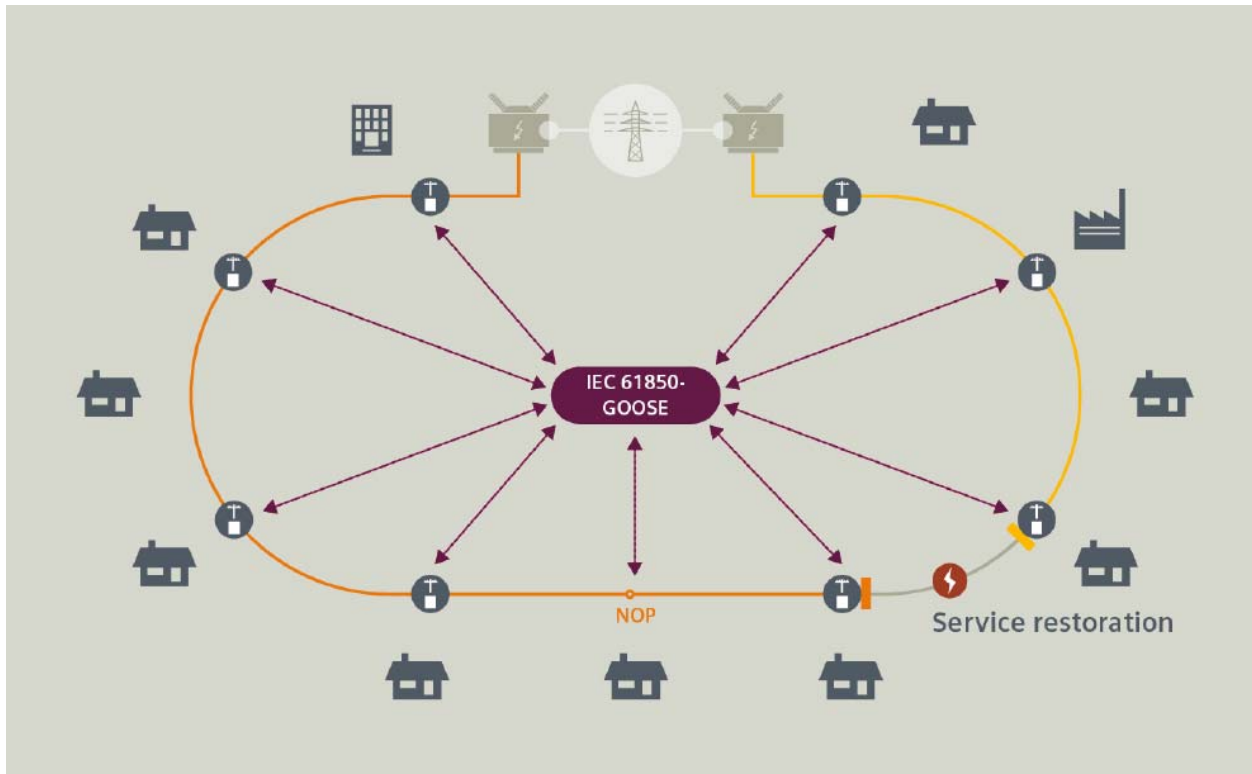

**Figure A.4.4.1-1: Depiction of a distribution ring and a failure (flash of lightning)**

The FLISR (Fault Location, Isolation & Service Restoration) solution consists of switch controller devices which are especially designed for feeder automation applications that support the self-healing of power distribution grids with overhead lines. They serve as control units for reclosers and disconnectors in overhead line distribution grids.

The system is designed for using fully distributed, independent automated devices. The logic resides in each individual feeder automation controller located at the poles in the feeder level. Each feeder section has a controller device. Using peer-to-peer communication among the controller devices, the system operates autonomously without the need of a regional controller or control centre. However, all self-healing steps carried out will be reported immediately to the control centre to keep the grid status up to date. The controllers conduct self-healing of the distribution line in typically 500 ms by isolating the faults.

Peer-to-peer communication via IEC 61850 GOOSE (Generic Object Oriented Substation Event) messages provides data as fast as possible (Layer 2 multicast message). They are sent periodically (in steady state, with changing interval time in fault case) by each controller to several or all other controllers of the same feeder and are not acknowledged.

The service bit rate per controller is low in steady state, but GOOSE bursts with high service bit rate do occur, especially during fault situations. GOOSE messages are sent by several or all controller units of the feeder nearly at the same point in time during the fault location, isolation and service restoration procedure with a low end-to-end latency.

The associated (a)periodic communication KPIs are provided in Table A4.4.1-1.

**Table A.4.4-1.1: Service performance requirements for distributed automated switching for isolation and service restoration**

Use case #	Characteristic parameter				Influence quantity					
	Communication service availability: target value [%]	Communication service reliability: mean time between failures	End-to-end latency: maximum	Service bitrate: user experienced data rate	Message size [byte]	Transfer interval: target value	Survival time	UE speed	# of UEs	Service area (note 1)
1 (note 2)	99.999 9	–	< 5 ms	1 kbit/s (steady state) 1.5 Mbit/s (fault case)	< 1,500	< 60 s (steady state) ≥ 1 ms (fault case)	transfer interval (one frame loss)	stationary	20	30 km x 20 km
2	> 99.999 %	-	20 ms (note 2)	-	< 100	-	-	stationary	≤ 100/km <sup>2</sup>	several km <sup>2</sup>
NOTE 1: Length x width										
NOTE 2: UE to UE communication (two wireless links)										

*Use case one*

GOOSE (a)periodic deterministic communication service supporting bursty message exchange for fault location, isolation, and service restoration.

*Use case two*

Typically event-driven, aperiodic deterministic communication service supporting fault detection and isolation.

#### A.4.4.2 Distributed automation without GOOSE

If the control of electrical power distribution components is performed from a central system entity, the controlled entities can be operated in a way that a controlled service restoration is possible without the use of GOOSE. Though this is not as effective as the communication has less strict requirements, this form of distribution automation is nevertheless effective, and it is also compliant with IEC standards and widely deployed in energy systems. The associated KPI is provided in Table A.4.4.2-1.

**Table A.4.4.2-1: KPI for distributed automation without use of GOOSE**

Use case #	Characteristic parameter				Influence quantity					
	Communication service availability: target value [%]	Communication service reliability: mean time between failures	End-to-end latency: maximum	Service bitrate: user experienced data rate	Message size [byte]	Transfer interval: target value	Survival time	UE speed	# of UEs	Service area
1	99.999	–	100 ms to 2 s	9.6 to100	–	–	–	–	Concentrated rural: 70.8; Dispersed rural and semi-urban: 7.6; rural support: 0.048; urban: 11.0	several km <sup>2</sup>

#### Use case one

Distributed automation without use of GOOSE using a centralized architecture.

### A.4.4.3 Intelligent distributed feeder automation

Intelligent distributed feeder automation system which supported by 5G connections is designed to realize intelligent judgment, analysis, fault location, fault isolation and non-fault area power supply restoration operations. As illustrated in the Figure A.4.4.3-1, the distributed feeder automation system is mainly composed of a distribution master station, a distribution terminal, switch stations, and the communication system (UEs in the substations, 5G network, plus the data network). The distribution master station is mainly used for information gathering and human-computer interaction, and the distributed terminals are used for the collection of feeder status information and judgment, fault location, isolation, as well as power supply restoration based on this information. Distributed terminal actions are reported to the distribution master station. The 5G communication system enables communication among the distribution terminals. The distribution master station is usually connected to the 5G system via a data network, which is out of 3GPP scope.

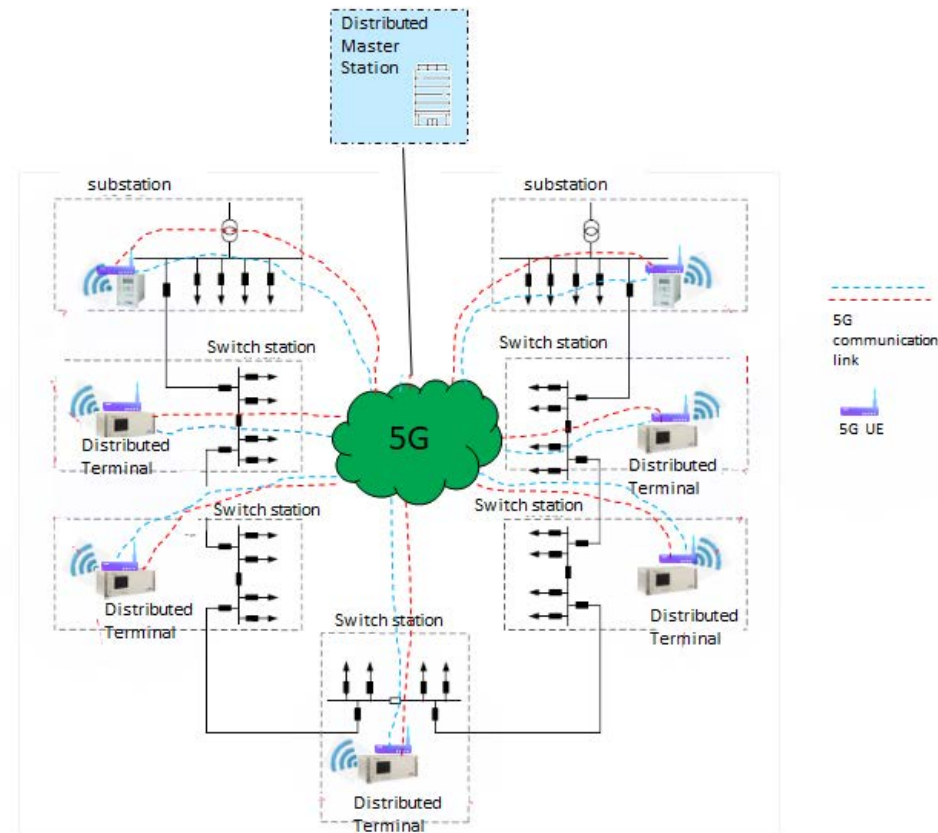

**Figure A.4.4.3-1: Example of intelligent distributed feeder automation**

The distribution master station manages multiple distributed terminals. Each distributed terminal is served by a 5G UE to exchange the collected data with other distributed terminals. From an application perspective, the communication between distributed terminals is peer-to-peer. The 5G communication service availability needs to be very high. Therefore, at least two communication links are usually deployed for hot standby or for transmitting data synchronously between two distributed terminals. The associated KPI is provided in Table A.4.4.3-1.

Table A.4.4.3-1: KPI for intelligent distributed feeder automation

Use case #	Characteristic parameter				Influence quantity					
	Communication service availability: target value [%]	Communication service reliability: mean time between failures	End-to-end latency: maximum	Service bitrate: user experienced data rate	Message size [byte]	Transfer interval: target value	Survival time	UE speed	# of UEs	Service area
1	99.999	–	Normal: 1 s; Fault: 2 ms (note 2)	2 M to 10 M (note 1)	–	Normal: 1 s; Fault: 2 ms (note 2)	–	–	54/km <sup>2</sup> (note 3) 78/km <sup>2</sup> (note 4)	several km <sup>2</sup>
NOTE 1: The KPI values are sourced from [29].										
NOTE 2: It is the one-way delay from a distributed terminal to 5G network.										
NOTE 3: When the distributed terminals are deployed along overhead line, about 54 terminals will be distributed along overhead lines in one square kilometre.										
NOTE 4: When the distributed terminals are deployed in power distribution cabinets, there are about 78 terminals in one square kilometre.										

Use cases #1: Intelligent distributed feeder automation

#### A.4.4.4 High-speed current differential protection

High-speed current differential protection, which is required for sub-millisecond fault detection, is another typical use case of power distribution automation. The approach utilises differential current measurements to significantly reduce fault detection time. The protection relays exchange the current samples via the 5G system. Each relay then compares the sent and received samples to determine if a fault has occurred in a protected area. This is done in order to identify and isolate a fault in the grid. The sampling rate varies and is dependent on the algorithms designed by the manufacturers. A protection relay collects the current samples (with the typical message size of up to 245 bytes) at a frequency of 600 Hz, 1200 Hz, 1600 Hz, or 3000 Hz. The exchange of measurement samples is done in a strictly cyclic and deterministic manner. With the sampling rate of 600 Hz, the transfer interval is 1.7 ms and the required bandwidth 1.2 Mbit/s; for 1200 Hz, the transfer interval is 0.83 ms and the required bandwidth 2.4 Mbit/s. The maximum allowed end-to-end delay between two protection relays is between 5 ms and 10 ms, depending on the voltage (see IEC 61850-90-1 for more details [28]). For some legacy systems, the latency usually is set to 15 ms. The associated KPIs are provided in Table A.4.4.4-1.

Table A.4.4.4-1: KPIs for high speed current differential protection

Use case #	Communication service availability	End-to-end latency: maximum (note)	Service bitrate: user experienced data rate	Message size [byte]	Transfer interval: target value	Survival time	UE speed	UE density [# /km <sup>2</sup> ]	Service area
1	> 99.999 %	15 ms	2.5 Mbit/s	< 245	≤ 1 ms	transfer interval (one frame loss)	stationary	≤ 100/km <sup>2</sup>	several km <sup>2</sup>
2	> 99.999 %	15 ms	1.2 Mbit/s	< 245	≤ 2 ms	transfer interval (one frame loss)	stationary	≤ 100/km <sup>2</sup>	several km <sup>2</sup>
3	> 99.999 %	10 ms	2.5 Mbit/s	< 245	≤ 1 ms	transfer interval (one frame loss)	stationary	≤ 100/km <sup>2</sup>	several km <sup>2</sup>
4	> 99.999 %	10 ms	1.2 Mbit/s	< 245	≤ 2 ms	transfer interval (one frame loss)	stationary	≤ 100/km <sup>2</sup>	several km <sup>2</sup>
5	> 99.999 %	5 ms	2.5 Mbit/s	< 245	≤ 1 ms	transfer interval (one frame loss)	stationary	≤ 100/km <sup>2</sup>	several km <sup>2</sup>
6	> 99.999 %	5 ms	1.2 Mbit/s	< 245	≤ 2 ms	transfer interval (one frame loss)	stationary	≤ 100/km <sup>2</sup>	several km <sup>2</sup>

NOTE : UE-to-UE communication.

*Use case #1:* High-speed current differential protection with a sampling rate of 1200 Hz for legacy systems.

*Use case #2:* High-speed current differential protection with a sampling rate of 600 Hz for legacy systems.

*Use case #3:* High-speed current differential protection with a sampling rate of 1200 Hz under voltage condition 1 (see IEC 61850-90-1[28] for more details).

*Use case #4:* High-speed current differential protection with a sampling rate of 600 Hz under voltage condition 1 (see IEC 61850-90-1[28] for more details).

*Use case #5:* High-speed current differential protection with a sampling rate of 1200 Hz under voltage condition 2 (see IEC 61850-90-1[28] for more details).

*Use case #6:* High-speed current differential protection with a sampling rate of 600 Hz under voltage condition 2 (see IEC 61850-90-1[28] for more details).

## A.4.5 Smart grid millisecond-level precise load control

Precise Load Control is the basic application for smart grid. When serious HVDC (high-voltage direct current) transmission fault happens, Millisecond-Level Precise Load Control is used to quickly remove interruptible less-important load, such as electric vehicle charging piles and non-continuous production power supplies in factories.

Table A.4.5-1: Service performance requirements for smart grid millisecond-level precise load control

Use case #	Characteristic parameter				Influence quantity					
	Communication service availability: target value [%]	Communication service reliability: mean time between failures	End-to-end latency: maximum	Service bitrate: user experienced data rate	Message size [byte]	Transfer interval: target value	Survival time	UE speed	# of UEs	Service area
1	99.999 9	–	< 50 ms	0.59 kbit/s 28 kbit/s	< 100	n/a (note)	–	stationary	10 km <sup>2</sup> to 100 km <sup>2</sup>	TBD
NOTE: event-triggered										

*Use case one*

A non-periodic deterministic communication service between control primary station and load control terminals for removing interruptible less-important load quickly.



## A.4.6 Distributed energy storage

Distributed power generation includes various power sources such as solar, wind, fuel cells, and gas. Distributed power generation typically comes with a low power density and entails thus typically a decentralised deployment. Decentralisation causes technical problems and challenges Smart Grid operators. When distributed power generation is connected to the electrical grid, the energy flow becomes more complicated as the user often is both an electricity consumer and producer (a so-called “prosumer”). Therefore, the current in the electricity grid can change direction at different locations of the grid and at different times of the day.

The information exchange in a distributed energy grid does not only include power-generation-related data, but also control commands for the distributed energy storage equipment. An example for such a command is “change the load characteristics to realise a flexible electricity grid” etc.

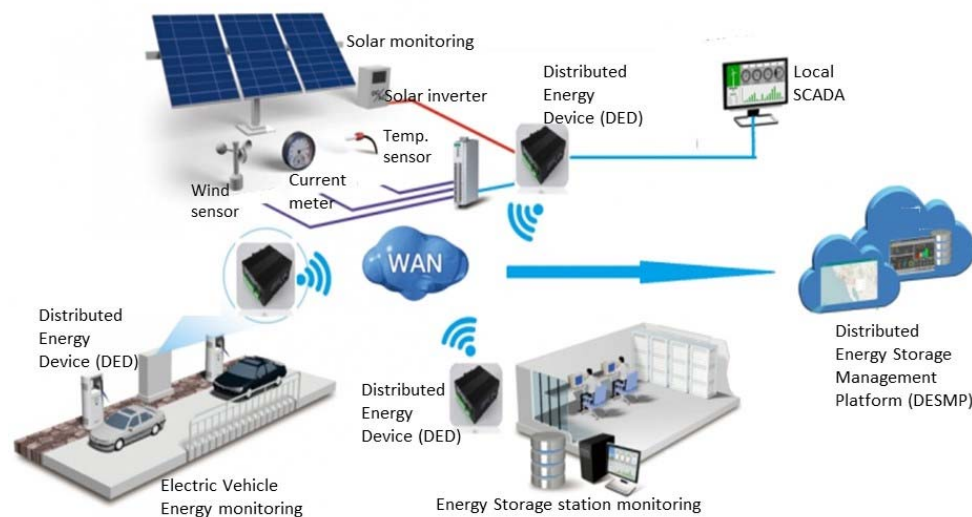

**Figure A.4.6-1 Example of a distributed-energy storage grid**

Figure A.4.6-1 shows an example of distributed-energy storage grid. The distributed-energy storage grid needs to exchange information among the distributed-energy storage management platform (DESMP) and distributed-energy devices (DEDs).

The DED is a plug-and-play device and periodically collects its energy information, such as battery energy, charge and discharge status, energy alarm information, etc. The DED then transfers this information via 5G UE to the DESMP. The DESMP regularly manages the DEDs, e.g., the DESMP monitors the DEDs working status, controls the DEDs working modes, or configures the DEDs energy parameters etc. The associated KPIs are provided in Table A.4.6-1.

Table A.4.6-1: Communication service performance requirements – data for distributed energy storage

Use case#	Characteristic parameter				Influence quantity					
	Communication service availability: target value	Communication service reliability: mean time between failures	End-to-end latency: maximum	Service bit rate: user experienced data rate	Message size [byte]	Transfer interval: target value	Survival time	UE speed	# of UEs	Service area
1	> 99.9 %		DL: < 10 ms UL: < 10 ms	UL: > 16 Mbit/s (urban); 640 Mbit/s (rural) DL: > 100 kbit/s (note 1)	UL: 800 kbyte	UL: 10 ms	–	stationary	> 10/km <sup>2</sup> (urban); > 100/km <sup>2</sup> (rural) (note 2)	several km <sup>2</sup>
2	> 99.9 %		DL: < 10 ms UL: < 1 s	UL: > 128 kbit/s (urban); 10.4 Mbit/s (rural); DL: > 100 kbit/s (note 1)	UL: 1.3 Mbyte DL: > 100 kbyte	UL: 1000 ms	–	stationary	> 10/km <sup>2</sup> (urban); > 100/km <sup>2</sup> (rural) (note 2)	several km <sup>2</sup>
3	> 99.9 %		DL: < 10 ms UL: < 1 s (rural)	DL: > 100 kbit/s UL: > 5 Gbit/s (note 3)				stationary	> 100/km <sup>2</sup>	several km <sup>2</sup>
NOTE 1: Service bit rate for one energy storage station.										
NOTE 2: Activity storage nodes/km <sup>2</sup> . This value is used for deducing the data volume in an area that features multiple energy storage stations. The data volume can be calculated with the following formula (current service bit rate per storage station) x (activity storage nodes/km <sup>2</sup> ) + (video service bit rate per storage station) x (activity storage nodes/km <sup>2</sup> ).										
NOTE 3: The downlink user experienced data rate is calculated as follows: 12.5 Mbytes/s x 50(containers) x 8 = 5 Gbit/s										

*Use case#1:* Distributed energy storage – periodic communication for monitoring

*Use case#2:* Distributed energy storage – periodic communication for data collection

*Use case#3:* Distributed energy storage – aperiodic video communication

## A.4.7 Advanced metering

Instead of recording and sending metering data from a wired electricity meter unit, electricity metering collecting can be executed by a UE-integrated smart meter unit. Smart meter units can send real-time metering data to a server in the utility through mobile networks. In this way, the power enterprise—based on the analysis of the user's power consumption behavior—gives the user power consumption suggestions, which fosters the user's power consumption and energy saving habits.

The electric smart meters monitor relevant user energy status and deliver the status data to a measurement data management system (MDMS). The MDMS sends control commands according to its policy and the status of the data collected from the smart meters. The MDMS commands include tripping, closing permission, alarm, alarm release, power protection, and power protection release. Accurate-fee control is one of the basic services of advanced metering. When the electric power user doesn't pay her electric fee on time, the MDMS can cut off the power supply. And when there is a need for temporary power supply for this user, the MDMS can recover the power supply. This operation requires real-time interaction between the electric smart meter and the MDMS. Due to massive number of electricity meters, it is estimated that in the near future, the amount of this kind of interaction will increase 5 to 10 times. The associated KPIs are provided in Table A.4.7-1.

**Table A.4.7-1: Communication KPI for advanced metering**

Use case#	Characteristic parameter				Influence quantity					
	Communication service availability: target value	Communication service reliability: mean time between failures	End-to-end latency: maximum	Service bit rate: user experienced data rate	Message size [byte]	Transfer interval: target value	Survival time	UE speed	# of UEs	Service area
1	> 99.99		Accuracy fee control: < 100 (note 1);  General information data collection: < 3000	UL: < 2 M  DL: < 1 M	–	–	–	stationary	< 10 000/km2 (note2)	–
NOTE 1: One-way delay from 5G IoT device to backend system. The distance between the two is below 40 km (city range). NOTE 2: It is the typical connection density in today city environment. With the evolution from centralised meters to socket meters in the home, the connection density is expected to increase 5 to 10 times.										

*Use case#1:* Advanced metering

## A.4.8 Smart distribution transformer terminal

A smart distribution transformer terminal is usually deployed in a distribution transformer area. The terminal can support multiple energy applications simultaneously. Multiple kinds of energy data are collected by the terminal and then delivered to a energy application platform. Figure A.4.8.1-1 illustrates a workflow example for a smart distribution transformer terminal.

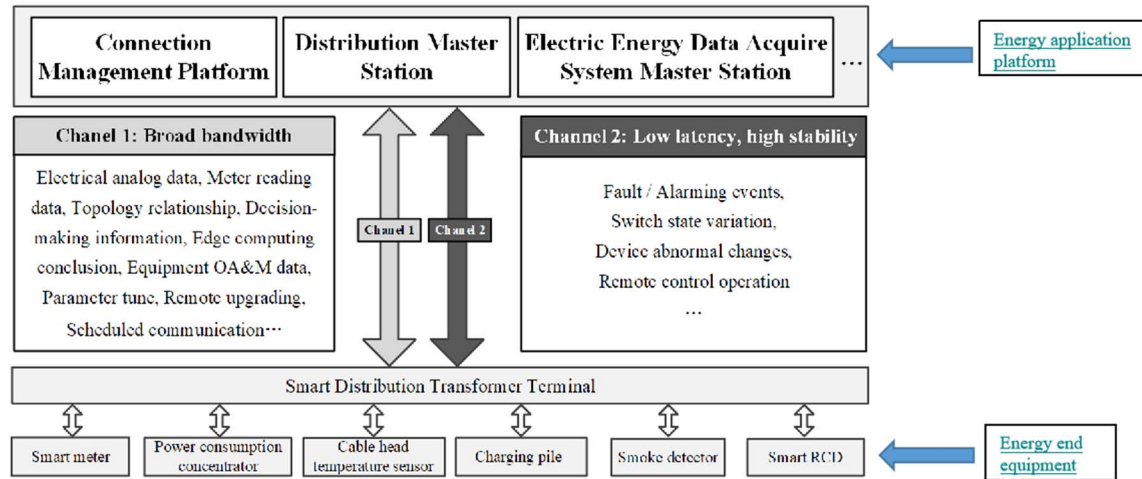

**Figure A.4.8-1: Example of a smart distribution transformer terminal workflow**

In general, the connections between the smart distribution transformer terminal and the energy application platform are provided by the 5G system. The connections between energy end equipment and smart distribution transformer terminal may be provided by 5G system. In this case, about 300 to 500 energy end devices are connected to one smart distribution transformer terminal. The average service bit rate between the smart distribution transformer terminal and an energy end device is more than 2 Mbit/s in uplink for each application. The related communication distance is between 100 m and 500 m. The associated KPI is provided in Table A.4.8-1.

**Table A.4.8-1: Key Performance for Smart Distribution Transformer Terminal**

Use case#	Characteristic parameter				Influence quantity					
	Communication service availability: target value	Communication service reliability: mean time between failures	End-to-end latency: maximum	Service bit rate: user experienced data rate	Message size [byte]	Transfer interval: target value	Survival time	UE speed	# of UEs	Service area
1	>99.99%	–	10 ms, 100 ms, 3 s (note 2)	> 2 Mbit/s (note 1)	–	–	–	–	500 in the service area (note 3)	Communication distance is from 100 m to 500 m, (outdoor, indoor, and deep indoor)
NOTE 1: It is the smart metering application data rate between the Smart Distribution Transformer Terminal and energy end equipment. Once there are multiple smart grid applications, it is required more data rate.										
NOTE 2: It depends on different applications supported by the Smart Distribution Transformer Terminal. The less the latency is, the more applications can be supported.										
NOTE 3: The distribution area can be calculated as $3.14 \times \text{range}^2$ and in general is between $0.031 \text{ km}^2$ and $0.79 \text{ km}^2$ .										

*Use case#1*: smart distribution transformer terminal

## A.4.9 Distributed energy resources and micro-grids

Distributed energy resources (DER) become increasingly important. The potentially large number of DERs will have an impact on security, stability, and operation efficiency of the energy grid.

The integration of DERs into the energy grid poses many challenges for the involved communication system. To incorporate more renewable and alternative energy sources, the communication infrastructure must have the ability to easily handle an increasing amount of data traffic or service requests and must provide a real-time monitoring and control operation for these distributed energy resources. A reliable communication between the DERs is crucial.

When it comes to communications architecture, IEC 61850 is a widely used standard for automation and equipment of power utilities and DER, specifically for defining protocols for IEDs (Intelligent electronic devices) at electrical substations. The IEC 61850 standard specifies the timing constraints for messages typically used in substations. GOOSE (Generic Object Oriented Substation Events) and SV (Sampled Values) messages are assumed as time critical messages. They have the tightest deadlines (maximum allowed transfer time) among all IEC 61850 messages, corresponding to 3 ms. While GOOSE is typically used for transferring information related to monitoring and control functions (circuit breaker status etc.), SV is used for transferring measurement samples of current and voltage signals. The SV protocol works on a periodic information transmission model, sending messages at a fixed rate. For protection purposes, the default rate is 4000 or 4800 messages per second for 50 and 60 Hz power systems, respectively. On the other hand, the GOOSE protocol operates in a sporadic information transmission model, where a continuous flow of data is maintained to increase communication reliability. The typical sizes of GOOSE and SV messages are 160 and 140 bytes, respectively. GOOSE messages are transmitted in two different modes: (1) safe

operation: 1 message per second (service bit rate = 1.28 kbit/s); (2) emergency operation: 32 messages per second (service bit rate = 41.0 kbit/s). SV messages are transmitted at much higher rate, namely 4800 messages per second (service bit rate = 5.4 Mbit/s). The associated KPIs are provided in Table A.4.9-1.

**Table A.4.9-1: Key Performance for Distributed energy resources (DER): using SV (Sampled Values) message**

Use case#	Characteristic parameter				Influence quantity			
	Communication service availability: target value	Communication service reliability: mean time between failures	End-to-end latency: maximum	Service bit rate: user experienced data rate	Message size [byte]	Transfer interval: target value	Survival time	UE speed
1	99,9999 %	–	< 3 ms	4.5 Mbit/s	140	≤ 1 ms	transfer interval	stationary
2	99,9999 %	–	< 3 ms	5.4 Mbit/s	140	≤ 1 ms	transfer interval	stationary
3	> 99.9999 %	–	< 3 ms	–	160	–	–	stationary

NOTE: UE to UE communication is assumed.

*Use case#1:* Distributed energy resources and micro-grids: using SV(sample value) message with 50Hz

*Use case#2:* Distributed energy resources and micro-grids: using SV(sample value) message with 60Hz

*Use case#3:* Distributed energy resources and micro-grids: using GOOSE message

## A.4.10 Ensuring uninterrupted communication service availability during emergencies

During emergencies, public mobile land networks (PLMNs) may restrict network access, which may lead to a prohibitively low communication service availability for machine-type communication (MTC) for Smart Grid applications. An example is communication for microgrids. Microgrids are separate parts of a power grid that can be controlled and operated individually in a so-called island mode, or together with other parts of the power grid. The idea is to prioritise Smart Grid-related communication in order to ensure reliable and available communication for selected devices during emergency conditions. Existing features of a mobile network can be used to differentiate MTC of devices in a microgrid from other kind of MTC traffic or human-to-human communication. These features can help these microgrid devices to have communication service during emergencies. The communication among the microgrid devices enables co-ordination of DERs, which help the DERs can autarkically implement recovery of an islanded microgrid.

The associated KPI is provided in Table A.4.10-1.

**Table A.4.10-1: Key Performance for uninterrupted MTC service availability**

Characteristic parameter (KPI)				Influence quantity				
Communication service availability: target value	Communication service reliability: mean time between failures	Max Allowed End-to-end latency (note 1; note 2)	Service bit rate: user-experienced data rate (note 2)	Message size [byte]	Survival time	UE speed	# of UEs	Service Area
99.999 9 %	–	100 ms	< 1 kbit/s per DER	–	–	Stationary	–	–
NOTE 1: Unless otherwise specified, all communication includes 1 wireless link (UE to network node or network node to UE) rather than two wireless links (UE to UE).								
NOTE 2: It applies to both UL and DL unless stated otherwise.								

## A.5 Central power generation

### A.5.1 Overview

This domain comprises all aspects of centralised power generation, i.e. the centralised conversion of chemical energy and other forms of energy into electrical energy. Typical electric-power outputs are 100 MW and more. Examples for pertinent systems are large gas turbines, steam turbines, combined-cycle power plants, and wind farms. The planning and installation of respective equipment and plants as well as the operation, monitoring and maintenance of these plants is encompassed by this vertical domain.

### A.5.2 Wind power plant network

**Table A.5.2-1: Service performance requirements for wind power plant network**

Use case #	Characteristic parameter				Influence quantity	
	Communication service availability: target value [%]	Communication service reliability: mean time between failures	End-to-end latency: maximum	Packet error ratio	UE speed	Service area
1	99.999 999 9	~ 10 years	16 ms	< 10 <sup>-9</sup>	stationary	several km <sup>2</sup>

*Use case one*

Communication in support of closed-loop cyber-physical control in a wind farm. The wind farm can be deployed offshore.

NOTE: This type of communication service can be provided via a wired connection.

## A.6 Connected hospitals or medical facilities

### A.6.1 Overview

The traditional value chain for the medical device industry, which historically has been driven by innovation and research and development, is currently witnessing a shift in the landscape. As governments and health insurers worldwide implement measures to control costs, public hospitals are operating on tighter budgets, while private facilities are receiving lower reimbursements. In the developed world, decisions that used to be the sole preserve of doctors are now also made by regulators, hospital administrators, and other non-clinicians. This broader set of influencers comes with different objectives, e.g. the prioritization of cost effectiveness or even just costs.

This shift in focus from volume-based healthcare to value-based healthcare has led medical devices companies to move to business models based on providing clinical value with cost efficiency.

Technological progress and better infrastructures, in particular high-quality wireless networks, have fed this business model transformation, allowing coordinated therapies, services, and health analytics and enabling efficient outcome measurement solutions.

On this matter, 5G enables shifting care location from hospitals to homes and others lower cost facilities which mechanically translates into more savings. Additionally, another example showing that 5G can enable cost savings required by the medical industry can be found inside hospitals where wireless transmission of low latency data streams improves operating room planning, enable streamlining equipment usage and simplifies operating theater implementation.

### A.6.2 Robotic Aided Surgery

Robotic aided surgery is particularly suitable to invasive surgical procedures that require delicate tissue manipulation and access to areas with difficult exposure. It is achieved through complex systems that translate the surgeon's hand movements into smaller, precise movements of tiny instruments that can generally bend and rotate far more than a human hand is capable of doing inside the patient's body. In addition, those systems are usually able to filter out hand tremor and therefore allow more consistent outcomes for existing procedures, and more importantly the development of new procedures currently made impractical by the accuracy limits of unaided manipulation.

A typical robotic setup for telesurgery can be depicted as follows.

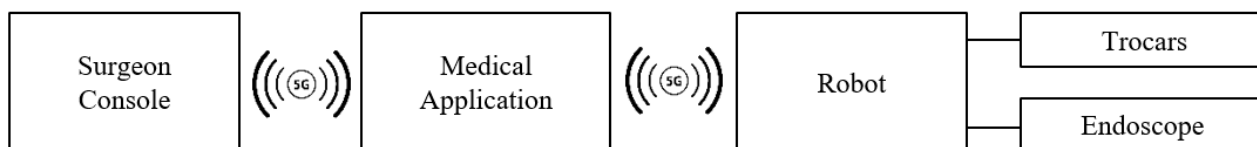

**Figure A.6.2-1: Typical Robotic Surgery System Setup**

The robot and the surgeon's console can be co-located in the same operating room in which case they communicate through a NPN, or, in another deployment option, when specialists and patients are far from each other (hundreds of kilometres) they can exchange data through communication services delivered by PLMNs. The depicted medical application can be instantiated at either side or in the Cloud. Its role consists in:

- Generating appropriate haptic feedback based on instrument location, velocity, effort measurements data and images issued by surgical instruments and 3D pre-operative patient body model. This allows to provide tactile guidance by constraining where the instruments (scalpel, etc.) can go.
- Filtering motion control commands for better closed loop stability



Typical surgery robotic systems can have around 40 actuators and the same number of sensors which allows to compute the data rate requires in each direction in order to execute a given movement.

Human sensitivity of touch is very high, tactile sensing has about 400 Hz bandwidth, where bandwidth refers to the frequency of which the stimuli can be sensed. This is why, in general, haptic feedback systems operate at frequencies around 1,000 Hz. This rate naturally applies to the update of all information used in the generation of the haptic feedback, e.g. instruments velocity, position ... Therefore, the robot control process involves:

- The surgeon console periodically sending a set of points to actuators
- Actuators executing a given process
- Sensors sampling velocity, forces, positions, ... at the very same time and returning that information to the surgeon console at the rate of 1 kHz

As opposed to machine to machine communication, robotic aided surgery implies there is a human being in the middle of the control loop, which means that the console generates new commands based on the system state collected in the previous 1 kHz cycle and also on surgeon's hand movement.

Each equipment involved in a robotic telesurgery setup (endoscopes, image processing system, displays, motion controller and haptic feedback systems) is synchronized thanks to a common clock either external or provided by the 5G system. The synchronization is often achieved through dedicated protocols such as e.g. PTP version 2 and allows to e.g. guarantee the consistency of the haptic feedback and displayed images at the master console, or enable the recording and offline replay of the whole procedure.

Table A.6.2-1: Service performance requirements for motion control and haptic feedback

Use case #	Characteristic parameter					Influence quantity					
	Communication service availability: target value [%]	Communication service reliability: Mean Time Between Failure	End-to-end latency: maximum	Bit rate	Direction	Message Size [byte]	Transfer Interval	Survival time	UE speed	# of active UEs (note1)	Service Area
1	> 99.999 999	> 10 years	< 2 ms	2 Mbit/s to 16 Mbit /s	network to UE; UE to network	250 to 2,000	1 ms	transfer interval	stationary	1	room
2	> 99.999 9	> 1 year	< 20 ms	2 Mbit/s to 16 Mbit /s	network to UE; UE to network	250 to 2,000	1 ms	transfer interval	stationary	< 2 per 1,000 km <sup>2</sup>	national

Note 1: The upper limit of UEs' density is provided for large service areas to address non-uniform distributions of UEs, while an absolute number of UEs is provided for small service areas.

*Use case one*

Periodic communication for the support of precise cooperative robotic motion control and haptic feedback in case of robotic aided surgery where the surgeon console and the robot are collocated in the same operating room

*Use case two*

Periodic communication for the support of cooperative robotic motion control and haptic feedback in case of telesurgery. In this case, the surgeon console and the robot are not collocated and communicate with each other through a connection established over a PLMN possibly spanning an entire country. Relaxed requirements imply that much less complex surgical procedures are achievable in use case 2 than in use case 1. It shall be noted that this use case also involves more experienced and trained surgeons, who can cope with longer latencies in the communication system.

### A.6.3 Robotic Aided Diagnosis

Robotic aided diagnosis involves a remote expert in a large central hospital who controls a diagnosis robotic system deployed in a local medical facility. Such robotic systems can be e.g.:

- Haptic feedback tool used for palpating and deployed in e.g. a Mobile Specialist Practise facility
- Ultrasound probe deployed in an ambulance or a medical facility

A typical robotic setup for tele diagnosis can be depicted as follows:

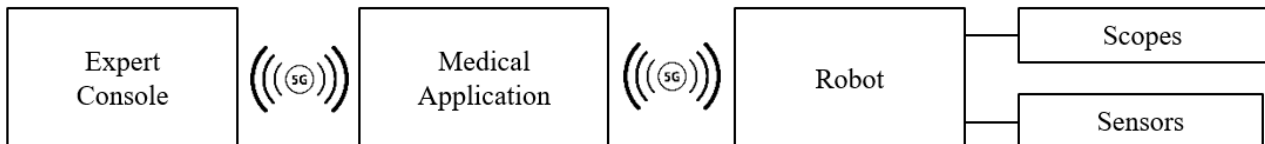

**Figure A.6.3-1: Typical Robotic Surgery System Setup**

Specialists and patients are far from each other (typically dozens of kilometres) and can exchange data through communication services delivered by PLMNs. The depicted medical application can be instantiated at either side or in the Cloud. Its role consists in:

- Generating appropriate haptic feedback based on instrument location, velocity, effort measurements data and images issued by instruments.
- Filtering motion control commands for better closed loop stability

Table A.6.3-1: Service performance requirements for motion control and haptic feedback

Use case #	Characteristic parameter					Influence quantity					
	Communication service availability: target value [%]	Communication service reliability: Mean Time Between Failure	End-to-end latency: maximum	Bit rate	Direction	Message Size [byte]	Transfer Interval	Survival time	UE speed	# of active UEs	Service Area
1	> 99.999	>> 1 month (< 1 year)	< 20 ms	2 Mbit/s to 16 Mbit/s	network to UE; UE to network	~80	< 20 ms per 100 km <sup>2</sup>	transfer interval	stationary	< 20 per 100 km <sup>2</sup>	regional

*Use case one*

Periodic communication for the support of precise cooperative robotic motion control and haptic feedback in case of robotic aided diagnosis where the expert and the patient are not collocated and communicate with each other through a connection established over a PLMN.

---

## A.7 Positioning

### A.7.1 Overview of positioning in industrial use cases

Positioning is particularly important for cyber-physical control applications in vertical domains like factories. The reason for this is that mobile devices and mobile assets are becoming increasingly common in the flexible production and subsequently the need for real-time locations data is increasing.

In this context, positioning is especially important for warehousing and logistics processes, autonomous driving systems and fleet management and flexible adaptation in production. In the best case all relevant goods and products are continuously tracked from the moment they are received to the moment they are made available. The tracking process provides the relevant context information that is needed for real-time control and optimization of the material flow and subsequent production processes. In this scenario, autonomous driving systems fetch parts from the warehouse independently and transport them to flexible assembly cells on the shop floor. As part of the flexible fleet management system, these autonomous driving systems are continuously localized and move quickly and in constant interaction with their environment. In the process, production machinery and assembly cells and their given status are monitored seamlessly while relevant objects like tools and workpieces being localized. This makes it possible to adapt quickly to changes in circumstances. The result is flexible, autonomously controlled production that is capable of adapting to new situations at any time. Wireless positioning for human machine interfaces like AR/VR should also be possible.

The requirements for positioning vary widely between different use cases.

## A.7.2 Low Power High Accuracy Positioning

Low power high accuracy positioning is an integral part of a considerable number of industrial applications. The total energy needed for a specific operation time for such a low power high accuracy positioning optimized IoT-device is a combination of energy for positioning (varies depending on the used positioning method), energy for communication/synchronization and a difficult to predict factor to take additional losses through e.g. security, power management, microcontroller, and self-discharge of batteries into account.

Examples of target applications for low power high accuracy positioning are asset tracking in process automation, tracking of vehicles, and tool tracking.

Table A.7.2-1 gives an indication of the required operation time of the 5G enabled IoT device and duty cycle of the updated position information for different use cases.

**Table A.7.2-1: Low power high accuracy positioning use cases**

Use Case #	Horizontal accuracy	Corresponding service level (22.261)	Positioning interval/ duty cycle	battery life time/ minimum operation time
1	10 m	Service Level 1	on request	24 months
2	2 m to 3 m	Service Level 2	< 4 seconds	> 6 months
3	< 1 m	Service Level 3	no indication	1 work shift - 8 hours (up to 3 days, 1 month for inventory purposes)
4	< 1 m	Service Level 3	1 second	6 - 8 years
5	< 1 m	Service Level 3	5 seconds - 15 minutes	18 months
6	< 1 m	Service Level 3	15 s to 30 s	6 - 12 months
7	30 cm	Service Level 5	250 ms	18 months
8	30 cm	Service Level 5	1 second	6 - 8 years (no strong limitation in battery size)
9	10 m	Service Level 1	20 minutes	12 years (@20mJ/position fix)

### *Use case one*

Process automation: Dolly tracking (outdoor).

### *Use case two*

Process automation: Asset tracking.

### *Use case three*

Flexible modulare assembly area: Tool tracking in flexible, modular assembly areas in smart factories.

### *Use case four*

Process automation: Sequence container (Intralogistics).

*Use case five*

Process automation: Palette tracking (e.g. in turbine construction).

*Use case six*

Flexible modulare assembly area: Tracking of workpiece (in- and outdoor) in assembly area and warehouse.

*Use case seven*

Flexible modulare assembly area: Tool assignment (assign tool to vehicles in a production line, left/right) in flexible, modular assembly area in smart factories.

*Use case eight*

Flexible modulare assembly area: Positioning of autonomous vehicles for monitoring purposes (vehicles in line, distance 1.5 meter).

*Use case nine*

(Intra-)logistics: Asset tracking



---

## Annex B (informative): Communication service errors

### B.1 Introduction

IEC 61784-3-3 describes fundamental communication errors that can be identified for applications with functional safety requirements [3]. The description of these communication errors is adjusted to field buses. These errors may however also occur in other communication systems. As explained in Annex C, some of these errors are also used for the assessment of communication services that do not support safety-critical applications.

---

### B.2 Corruption

Messages may be corrupted due to errors within an application, due to errors on the transmission medium, or due to message interference.

- NOTE 1: Message error during transfer is a normal event for any standard communication system; such events are detected with high probability at receivers by use of, for instance, hash functions.
- NOTE 2: Most communication systems include protocols for recovery from transmission errors, so these messages will not be classed as 'loss' until recovery or repetition procedures have failed or are not used.
- NOTE 3: If the recovery or repetition procedures take longer than a specified deadline, a message is classed as "unacceptable delay". See also the discussion in Clause C.3.
- NOTE 4: In the very low probability event that multiple errors result in a new message with correct message structure (for example addressing, length, hash function such as CRC, etc.), the message will be accepted and processed further. Evaluations based on a message sequence number or a time stamp can result in fault classifications such as unintended repetition, incorrect sequence, unacceptable delay, insertion [3].

---

### B.3 Unintended repetition

Due to an error, fault, or interference, not updated messages are accidentally repeated.

- NOTE 1: Repetition by the sender is a common procedure when an expected acknowledgment/response is not received from a target station, or when a receiver detects a missing message and asks for it to be resent.

In some cases, the lack of response can be detected, and the message repeated with minimal delay and no loss of sequence, in other cases the repetition occurs later and arrives out of sequence with other messages.

- NOTE 2: Some field buses use redundancy to send the same message multiple times or via multiple alternate routes to increase the probability of good reception [3].

---

### B.4 Incorrect sequence

Due to an error, fault, or interference, the predefined sequence (for example natural numbers, time references) associated with messages from a source is incorrect.

- NOTE 1: Field bus systems can contain elements that store messages (for example FIFOs in switches, bridges, routers) or use protocols that can alter the sequence (for example, by allowing messages with high priority to overtake those with lower priority).
- NOTE 2: When multiple sequences are active, such as transmission of messages from different source entities or reports relating to different object types, these sequences are monitored separately, and errors can be reported for each sequence [3].



---

## B.5 Loss

Due to an error, fault or interference, a message or acknowledgment is not received [3].

---

## B.6 Unacceptable deviation from target end-to-end latency

Messages may be delayed or advanced beyond their permitted arrival time window. Causes for this behaviour include errors in the transmission medium, congested transmission lines, interference, and applications sending messages in such a manner that communication services are delayed or denied.

Message errors can be recovered in the following ways using scheduled or cyclic scans, for instance, in field buses:

- a) immediate repetition;
- b) repetition using spare time at the end of the cycle;
- c) treating the message as lost and waiting for the next cycle to receive the next value.

In case of (a), all subsequent messages in that cycle are slightly delayed, while in case (b) only the resent message is delayed.

Cases (a) and (b) are often not classed as an unacceptable deviation from the target end-to-end latency.

Case (c) would be classed as an unacceptable delay for cyclic, distributed automation functions, unless the cycle repetition interval is short enough to ensure that delays between cycles are not significant and that the next cyclic value can be accepted as a replacement for the missed previous value before the survival time expires (see Clause C.3) [3].

---

## B.7 Masquerade

Due to a fault or interference, a message is inserted that relates to an apparently valid source entity, so a non-safety related message may be received by a safety-related participant, which then treats it as safety related.

NOTE: Communication systems used for safety-related applications can use additional checks to detect masquerade, such as authorised source identities and pass-phrases or cryptography [3].

---

## B.8 Insertion

Due to a fault or interference, a message is received that relates to an unexpected or unknown source entity.

NOTE: These messages are additional to the expected message stream, and because they do not have expected sources, they cannot be classified as correct, unintended repetition, or incorrect sequence [3].

---

## B.9 Addressing

Due to a fault or interference, a safety-related message is delivered to the incorrect safety related participant, which then treats reception as correct [3].

## Annex C (informative): Characterising communication services

### C.1 Modelling of communication in automation

#### C.1.1 Area of consideration

For our discussion of communication in automation we apply a definition of the area of consideration for industrial radio communication that is found elsewhere in the literature [4]. This definition is illustrated in Figure C.1.1-1.

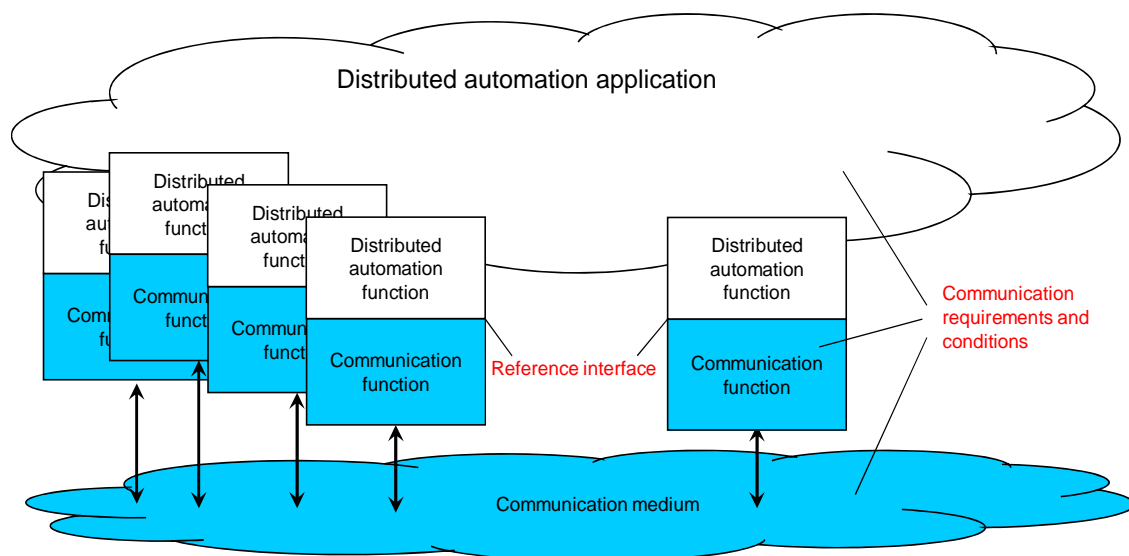

NOTE: Blue objects: communication system; other objects: automation application system.

**Figure C.1.1-1: Abstract diagram of the area of consideration for industrial radio communication**

Here, a distributed automation application system is depicted. This system includes a distributed automation application, which is the aggregation of several automation functions. These can be functions in sensors, measurement devices, drives, switches, I/O devices, encoders etc. All of these functions contribute toward the control of physical objects. Field bus systems, industrial Ethernet systems, or wireless communication systems can be used for connecting the distributed functions. The essential function of these communication systems is the distribution of messages among the distributed automation functions. For cyber-physical control applications, the dependability of the entire communication system and/or of its devices or its links is essential. Communication functions are realised by the respective hardware and software implementation.

In order for the automation application system to operate, messages need to be exchanged between spatially distributed application functions. For that process, messages are exchanged at an interface between the automation application system and the communication system. This interface is termed the reference interface. Required and guaranteed values for characteristic parameters, which describe the behavioural properties of the radio communication system, as well as some influence quantities refer to that interface.

The conditions that influence the behaviour of wireless communication are framed by the communication requirements of the application (e.g., end-to-end latency), the characteristics of the communication system (e.g., output power of a transmitter), and the transmission conditions of the media (e.g., signal fluctuations caused by multipath propagation).

General requirements from the application point of view for the time and failure behaviour of a communication system are mostly related to an end-to-end link. It is assumed in the present document that the behaviour of the link is representative of the communication system as a whole and of the entire scope of the application.

## C.1.2 Logical link

### C.1.2.1 Nature and function

Starting with the general approach mentioned in Subclause C.1.1, the logical link can be regarded as a possible asset within the area of consideration (see Figure C.1.1-1). The conditions under which its functions are to be performed are vital for the dependability of the automation application system.

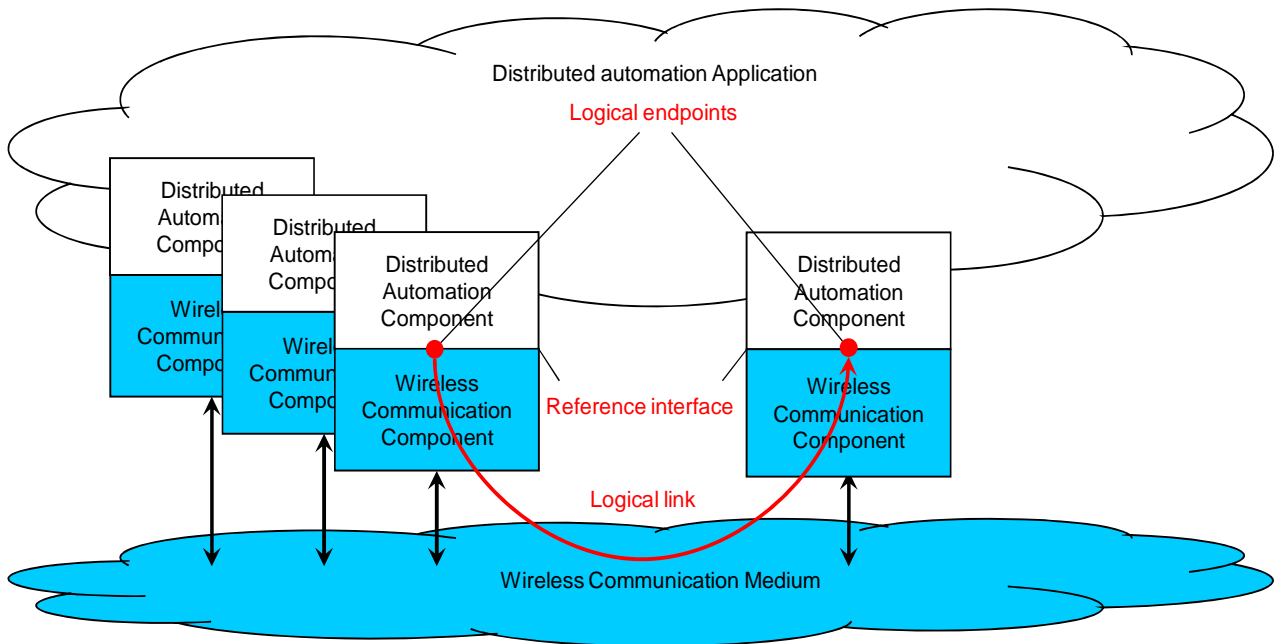
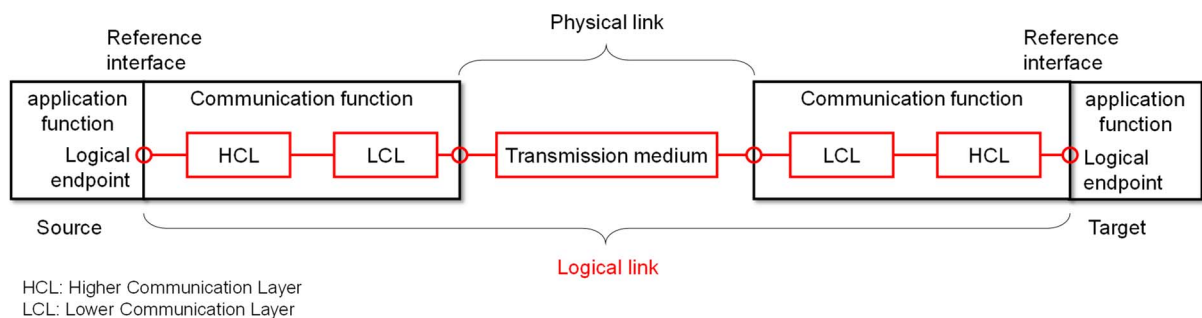

**Figure C.1.2.1-1: The concept of a logical link**

This is the link between a logical end point in a source device and the logical end point in a target device. Logical end points are elements of the reference interface, which may group several logical end points together.

The intended function of the logical link is the transmission of a sequence of messages from a logical source end point to the correct logical target end point. This is achieved by transforming each message into a form that fosters error-free transmission. The transmission process includes certain processes, for instance repetitions, in order to fulfil the intended function. After transmission, the transported package(s) is converted back into a message. The message is to be available and correct at the target within a defined time. The sequence of messages at the target is to be the same as the sequence at the source.

The functional units, which are necessary to fulfil this function are shown, in Figure C.1.2.1-1.



**Figure C.1.2.1-2: The asset "logical link"**

The required function can be impaired by various influences, which can lead to communication errors. Such errors are described elsewhere in the literature [4][5]. A summary of these errors is provided in Annex A. The occurrence of one of these errors influences the values of the relevant dependability parameters of the logical link.

### C.1.2.2 Message transformation

The present document addresses both OSI-layer-3 (IP) and OSI-layer-2 communication. The model in Figure C.1.2-1 can be used for describing both cases. The implementation of communication functions is split between a higher communication layer (HCL) and a lower communication layer (LCL). The partition of the layer for the two traffic options discussed in the present document is provided in Table C.1.2.2-1. This difference is of importance when discussing the implications of the service performance requirements in Clause 5 and Annex A for the network performance (see Clause C.5).

**Table C.1.2.2-1: Partition into higher communication layer and lower communication layer**

OSI level at which the traffic occurs	Levels comprised by the higher communication layer	Levels comprised by the lower communication layer
3	4 to 6	1 to 3
2	3 to 6 (note)	1 to 2
NOTE: In some vertical application, level 3 to 6 are not implemented.		

The messages to be transmitted for the intended function of a logical link are defined by strings of characters with a certain semantic. Such a character string is handed over as user data at the reference interface for transmission. If the number of characters in a message is too great for it to be transmitted as a unit, the message is divided for transmission into several packets (fragmentation).

### C.1.2.3 Communication device

The communication devices—together with the physical link—determine the function and thus the dependability of the logical link. The function of the communication devices is the correct sending and correct receipt of sequences of messages. The asset "communication device" is depicted in Figure C.1.2.3-1.

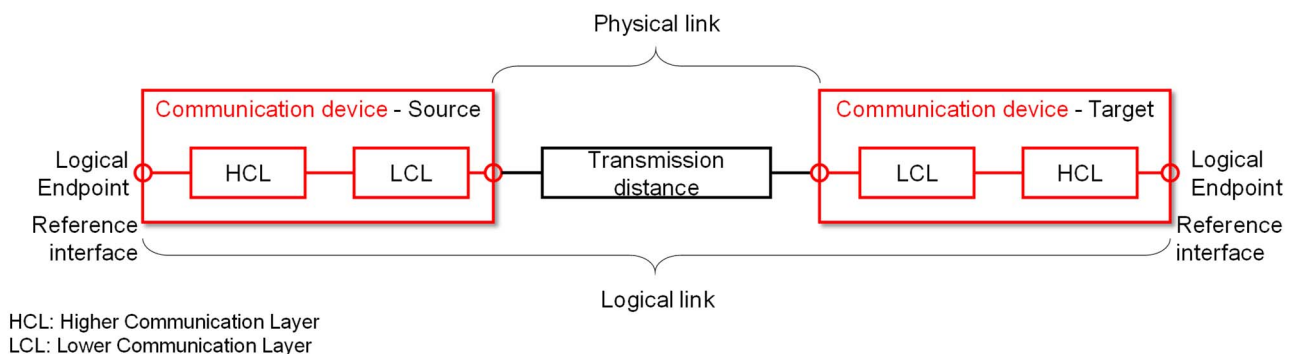

**Figure C.1.2.3-1: Asset "communication device"**

### C.1.2.4 Communication system

The communication system as an asset represents a quantity of logical links whose message transmissions are implemented by wireless devices via one or more media. The communication system function to be provided consists in transmitting messages for all the logical links in the distributed application. This function is to be performed for a defined period, the operating time of the automation application.

In an automation application system, it is paramount that requirements pertaining to logical links are fulfilled. These requirements and the conditions can be very different from one case and implementation to the other. The functions (services and protocols) for individual logical links can therefore also be different. Despite these differences, some of the logical links share communication devices and media.

## C.2 Communication service description

### C.2.1 Overview

Tables C.2.2-1, C.2.3-1 summarise candidate interface parameters for the description of the communication service performance. The lists are grouped according to whether the parameter stands for automation characteristic parameters (Table C.2.2-1) or influence quantities (Table C.2.3-1). The meaning of the columns and rows is explained after each table.

NOTE 1: Not all parameters in Table C.2.2-1 and Table C.2.3-1 would be used in a service call.

NOTE 2: Ingress and egress in this clause are in reference to the communication service interface between the source application and the communication service interface (ingress) and the communication service and the target application (egress).

### C.2.2 Characteristic parameters

**Table C.2.2-1: Candidate characteristic parameters for the dependable communication service interface**

Parameter name	Typical metric (unit)	Traffic class (note)		
		Deterministic periodic communication	Deterministic aperiodic communication	Non-deterministic communication
Communication service availability	Minimum availability (dimensionless)	X	X	X
End-to-end latency	Target value and timeliness (ms)	X	X	X
Communication service reliability	Mean time between failures (days)	X	X	X
Service bit rate	Target value (bit/s); user experienced data rate (bit/s); time window (s)	–	X	X
Update time	Target value and timeliness	X	–	–

NOTE: – application requirements (KPIs). X: applies; –: does not apply.

#### Parameter description

##### *Communication service availability*

This parameter indicates if the communication system works as contracted ("available"/"unavailable" state). The communication system is in the "available" state as long as the availability criteria for transmitted packets are met. The service is unavailable if the packets received at the target are impaired and/or untimely (e.g. update time > stipulated maximum). If the survival time (see Table C.2.3-1) is larger than zero, consecutive impairments and/or delays are ignored until the respective time has expired.

##### *End-to-end latency*

This parameter indicates the time allotted to the communication system for transmitting a message and the permitted timeliness.

##### *Communication service reliability*

Mean time between failures is one of the typical indicators for communication service reliability. This parameter states the mean value of how long the communication service is available before it becomes unavailable. For instance, a mean time between failures of one month indicates that a communication service runs error-free for one month on average before an error/errors make the communication service unavailable. Usually, an exponential distribution is assumed. This means, there will be several failures where the time between two subsequent errors is below the mean value (1 month in the example).

Communication service availability and communication service reliability (mean time between failures) give an indication on the time between failures and the length of the failures.

#### *Service bit rate*

##### *a) deterministic communication*

The target value indicates committed data rate in bit/s sought from the communication service. This is the minimum data rate the communication system guarantees to provide at any time, i.e. in this case target value = user experienced data rate.

##### *b) non-deterministic communication*

The target value indicates the target data rate in bit/s. This is the information rate the communication system aims at providing on average during a given (moving) time window (unit: s). The user experienced data rate the lower data rate threshold for any of the time windows.

#### *Update time*

Applicable only to periodic communication, the update time indicates the time interval between any two consecutive messages delivered from the egress (of the communication system) to the application.

#### **Traffic classes**

In practice, vertical communication networks serve applications exhibiting a wide range of communication requirements. In order to facilitate efficient modelling of the communication network during engineering, and for reducing the complexity of network optimisation, disjoint QoS sets have been identified. These sets are referred to as traffic classes [6]. Typically, only three traffic classes are needed in industrial environments [6], i.e.

- deterministic periodic communication;
- deterministic aperiodic communication; and
- non-deterministic communication.

Deterministic periodic communication stands for periodic communication with stringent requirements on timeliness of the transmission.

Deterministic aperiodic communication stands for communication without a pre-set sending time. Typical activity patterns for which this kind of communication is suitable are event-driven actions.

Non-deterministic communication subsumes all other types of traffic. Periodic non-real time and aperiodic non-real time traffic are subsumed by the non-deterministic traffic class, since periodicity is irrelevant in case the communication is not time-critical.

#### **Usage of the parameters in Table C.2.2-1**

Control service request and response; monitoring service response and indication.

## C.2.3 Influence quantities

**Table C.2.3-1: Candidate application influencing parameters for the dependable communication service interface**

Parameter name	Typical metric (unit)	Traffic class (note)			Usage of this parameter
		Deterministic periodic communication	Deterministic aperiodic communication	Non-deterministic communication	
Burst	Maximum user data length (byte) and line rate of the communication service interface (bit/s)	–	X	X	Service request and response; monitoring service response and indication
Message size	Maximum or current value (byte)	X	(X)	(X)	Service request and response; non-deterministic data transmission; deterministic aperiodic data transmission
Service time interval	Start (time) and end (time)	X	X	X	Service request and response
Survival time	Maximum (s)	X	X	–	Service request and response
Transfer interval	Target value and timeliness (s)	X	–	–	Service request and response

NOTE: X: applies; (X): usually does not apply; –: does not apply.

### Parameter description

#### *Burst*

The transmission of, for instance, program code and configuration data may be handed to the 3GPP system as data burst. In this case, the ingress data rate exceeds the capacity of the network, which implies that some of the data has to be stored within the ingress node of the communication system before it can be transmitted to the egress interface(s). However, the application consuming the communication service requires that the data of such a burst needs to be transmitted completely. This is in contrast to periodic data transmission, where new messages overwrite old ones.

Typical metrics for bursts: maximum user data length and line rate of the communication service interface.

#### *Message size*

The user data length indicates the (maximum) size of the user data packet delivered from the application to the ingress of the communication system and from the egress of the communication system to the application. For periodic communication this parameter can be used for calculating the requested user-experienced data rate. If this parameter is not provided, the default is the maximum value supported by the PDU type (e.g. Ethernet PDU: maximum frame length is 1,522 octets, IP PDU: maximum packet length is 65,535 octets).

#### *Service time interval*

Describes the start and end time of a communication service. Note that there are other ways to describe the service time interval numerically, for instance as the tuple [start time, service duration].

#### *Survival time*

The maximum survival time indicates the time period the communication service may not meet the application's requirement before the communication service is deemed to be in an unavailable state.

NOTE 1: The survival time indicates to the communication service the time available to recover from failure. This parameter is thus tightly related to maintainability [7].

#### *Transfer interval*

Applicable only to periodic communication, the transfer interval indicates the time elapsed between any two consecutive messages delivered by the automation application to the ingress of the communication system.

### C.3 Up time and up state vs. down state and down time

The assessment of periodic deterministic communication services is based on the assessment of successful message transmission over a logical communication link. Message transmission is either:

- *successful, if it is correctly and timely received, or*
- *unsuccessful, if it is incorrectly received, lost or untimely.*

Up time and down time can be derived from received messages. As far as timely received messages are correct, the logical communication link status is *up*. If a message loss or an incorrectly or untimely received message is detected the logical communication link status is *down*. To denote up and down states the terms “up time interval” and “down time interval”, or alternatively “available” and “unavailable” may be used. An example of the relation between logical communication link status, communication service status and application status is presented in Figure C.3-1.

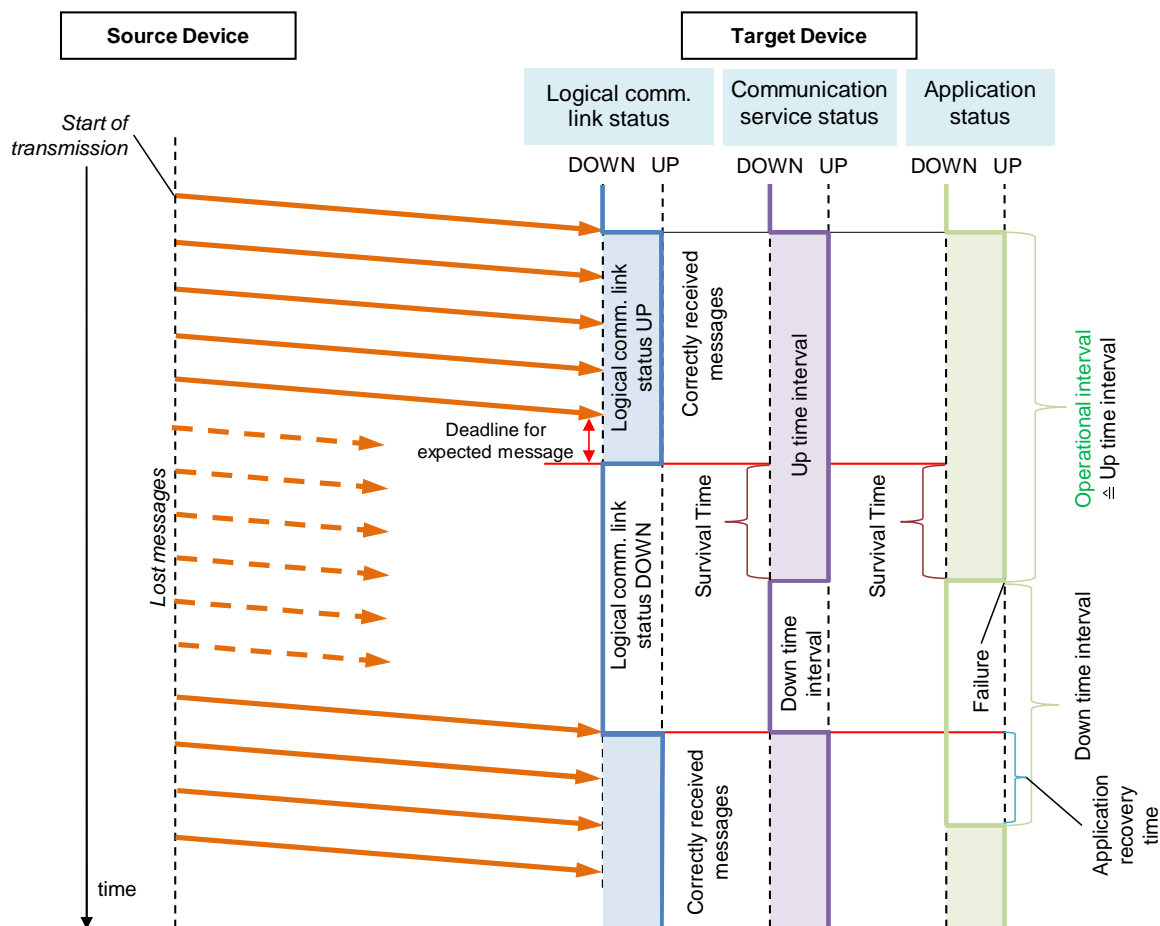

**Figure C.3-1: Relation between logical communication link, communication service and application statuses (example with lost messages)**

The flow of events in Figure C.3-1 is as follows:

- The logical communication link is up and running (blue line is UP). A source device starts sending periodic messages to a target device (orange arrows), on which an automation function (application) is running. The communication service is, from the point of view of the target application, in an up state (violet line is UP) and so is the application (green line is UP).



- b) The logical communication link status changes to down state if it no longer can support end-to-end transmission of the source device's messages to the target device in agreement with the negotiated communication requirements. Once the application on the target device senses the absence (or unsuccessful reception) of expected messages ("Deadline for expected message" in Figure C.3-1), it will wait a pre-set period before it considers the communication service to be unavailable ; this is the so-called survival time. The survival time can be expressed as
- a period or,
  - especially with cyclic traffic, as maximum number of consecutive incorrectly received or lost messages.
- c) If the survival time has been exceeded, both the communication service and the application transition into a down state (violet and green lines change to DOWN in Figure C.3-1). The application will usually take corresponding actions for handling such situations of unavailable communication services. For instance, it will commence an emergency shutdown. Note that this does not imply that the target application is "shut off"; rather it transitions into a pre-defined state, e.g. a safe state. In the safe state, the target application might still listen to incoming packets or may try to send messages to the source application.
- d) Once the logical communication link status is in the up state again (blue line in Figure C.3-1 changes to UP), the communication service state as perceived by the target application will change to the up state. The communication service is thus again perceived as available (violet line changes to UP in Figure C.3-1). The state of the application, however, depends on the counter measures taken by the application. The application might stay in down state if it is in a safe state due to an emergency shutdown. Or, the application may do a recovery and change to up state again. The time needed for the application to return to the up state after the communication service is restored is shown as "Application recovery time" in Figure C.3-1.

The availability of the communication service is calculated using the accumulated down time. For instance, in case the communication service is expected to run for a time  $T$ , the unavailability  $U$  of the communication service can be calculated as

$$U = \frac{\sum_i \Delta t_i}{T}$$

Where  $\Delta t_i$  is the length of the  $i$ -th downtime interval of the communication service within the time period  $T$ . The communication service availability  $A$  can then be calculated as

$$A = 1 - U.$$

---

## C.4 Timeliness as an attribute for timing accuracy

### C.4.1 Overview

There are several time parameters in dependability assessment. A required value is specified for every time parameter. This value can be a maximum, mean, modal, minimum etc. Typically, there is a deviation from the desired value to the actual value. Jitter is often used to characterise this variation. Since jitter generally is used for characterising the behaviour of a measured parameter, for instance the scatter of measured end-to-end latencies ("the world as it is"), it can be quite confusing to use it for formulating service performance requirements ("the world as we want it to be"). What is needed is a concept and related parameters that allow for formulating and talking about the end-to-end latency requirements in Clause 5 and Annex A.

The most important attribute is timeliness. Timeliness can be formulated a permitted interval for the actual value of the time parameter. Accuracy, earliness and lateness describe the allowed deviation from a target value. Accuracy is the magnitude of deviation. It can be negative (early) or positive (tardy).

### C.4.2 Network latency requirement formulated by use of timeliness

In 5G networks, the end-to-end latency KPI is a critical KPI in order to ensure that the network can deliver the packet within a time limit specified by an application: not too early and not too late.

In cyber-physical automation, the arrival time of a specific packet should be strictly inside a prescribed time window. In other words, a strict time boundary applies: [minimum end-to-end latency, maximum end-to-end latency]. Otherwise, the transmission is erroneous. Although most use cases that require timely delivery only specify the maximum end-to-end latency, the minimum latency is also sometimes prescribed. In the latter case, a communication error occurs if the packet is delivered earlier than the minimum end-to-end latency. An example for a related application is putting labels at a specific location on moving objects, and the arrival of a message is interpreted as a trigger for this action. In other words, the application does not keep its own time, but interprets the message arrival as clock signal. Maximum and minimum end-to-end latency alone do not disclose which value is preferred, i.e. target value. The next three subclauses introduce concepts help with relating maximum end-to-end latency, minimum end-to-end latency, and target value to each other.

### C.4.3 Timeliness

Timeliness is described by a time interval (see Figure C.4.3-1). The interval is restricted by a lower bound ( $t_{LB}$ ) and an upper bound ( $t_{UB}$ ). This interval contains all values  $t_A$  that are within an accepted "distance" to the target value  $t_R$ .

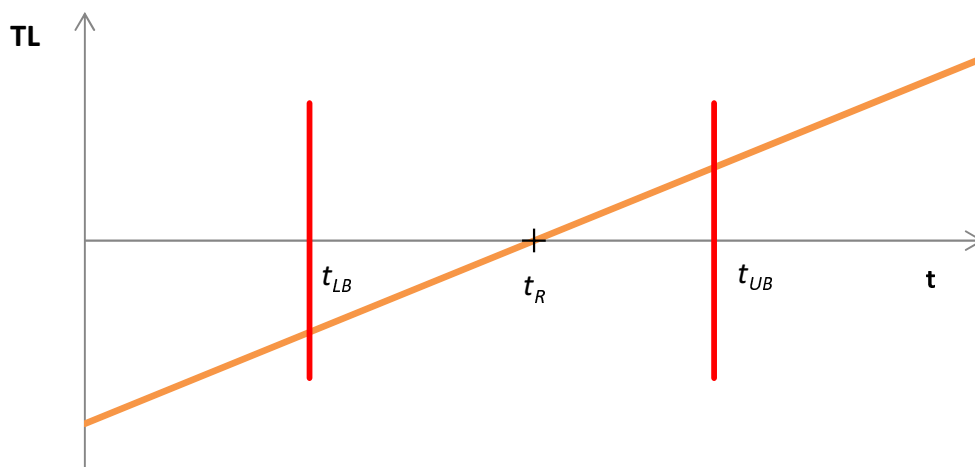

Figure C.4.3-1: Timeliness function

A message reception is considered in time, if it is received within the timeliness interval. If it is received outside the timeliness interval, the message reception is considered invalid. This is related to the communication error "unacceptable deviation from target end-to-end latency" (see Subclause B.6). In other words, maximum end-to-end latency =  $t_{UB}$  and minimum end-to-end latency =  $t_{LB}$ .

Timeliness is related to deviation (see Subclause C.4.4), the lower bound  $t_{LB}$  is related to earliness (see Subclause C.4.5), and the upper bound  $t_{UB}$  is related to lateness (see Subclause C.4.6).

### C.4.4 Deviation

The term deviation describes the discrepancy between an actual value ( $t_A$ ) and a target value ( $t_R$ ).

$$\text{Deviation}(t_A) = t_A - t_R.$$

Figure C.4.4-1 shows two examples. The target value is 10 time units ( $t_R = 10$ ) in both cases. In the first case (blue) the actual value measures 12 time units ( $t_A = 12$ ). The difference of both amounts to +2 time units, which means that the deviation is 2 time units [ $\text{Accuracy}(t_A) = 2$ ]. The second case (purple) shows the actual value as 9 time units ( $t_A = 9$ ). The difference of both amounts to -1 time unit, which means that the deviation is -1 time units [ $\text{Accuracy}(t_A) = -1$ ].



Figure C.4.4-1: Examples for accuracy values

Figure C.4.4-2 shows the deviation with respect to the target time ( $t$ ). The following applies:

$Deviation(t) < 0$  for  $t < t_R$ ; that is, the arrival is early.

$Deviation(t) = 0$  for  $t = t_R$ ; that is, the arrival is as desired, i.e. on time.

$Deviation(t) > 0$  for  $t > t_R$ ; that is, the arrival is late (see also C.4.6)

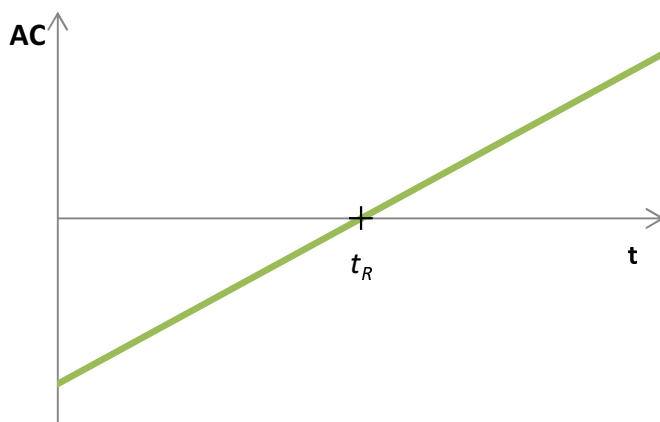

Figure C.4.4-2: Accuracy function

### C.4.5 Earliness

Earliness describes how early the actual value is: earliness is greater than 0 if the actual value is less than the target value (see Figure C.4.5-1). The following applies:

$Earliness(t_A) = t_R - t_A = -Deviation(t_A)$  for  $t_A < t_R$ ;

$Earliness(t_A) = 0$  for  $t_A \geq t_R$ .

In an example, the target value is 10 time units ( $t_R = 10$ ), and the actual value is 7 time units ( $t_A = 7$ ). The difference of both is 3 time units with respect to being early. That means that the earliness is 3 time units [ $Earliness(t_A) = 3$ ].

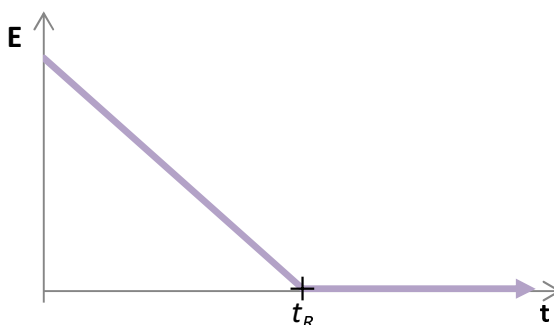

Figure C.4.5-1: Earliness function

## C.4.6 Lateness

Lateness describes how much greater the actual value is than the target value: lateness is greater than 0 if the actual value is greater than the desired value (see Figure C.4.6-1). The following applies:

$$L(t_A) = 0 \text{ for } t_A \leq t_R;$$

$$L(t_A) = t_A - t_R = \text{Deviation}(t_A) \text{ for } t_A > t_R.$$

In an example, the target value is 10 time units ( $t_R = 10$ ), and the actual value measures 14 time units ( $t_A = 14$ ). The difference of both is 4 time units with respect to being late. That means that the lateness is 4 time units [ $L(t_A) = 4$ ].

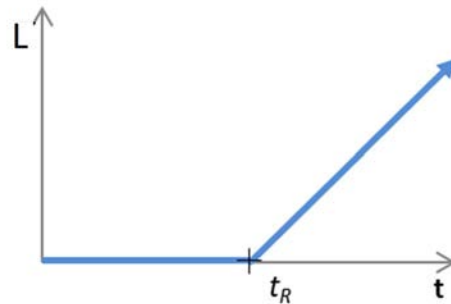

Figure C.4.6-1: Lateness function

## C.4.7 Conclusion

Using the concepts of earliness and lateness (see Subclauses C.4.5 and C.4.6, respectively), the maximum and minimum end-to-end latency can be rewritten as follows.

*Maximum end-to-end latency = target end-to-end latency + maximum lateness;*

*Minimum end-to-end latency = target end-to-end latency – maximum earliness.*

---

## C.5 Communication service terminology w.r.t. 5G network and vertical applications

This section clarifies the wording and terminology with respect to communication interfaces that are relevant for vertical applications. Because the 3GPP network does not cover the complete ISO-OSI communication stack, it is important to distinguish between

- the vertical applications' point of view, and
- the 3GPP network's point of view.

In this section, the relation between those two is clarified.

Figure C.5-1 shows a simplified version of the communication stack. The PHY layer, the MAC layer and some parts of the IP layer are part of the 3GPP network. The layers that are part of the 3GPP network are referred to as lower communication layers (LCL). The communication stack also includes an application. The OSI layers related to providing data to the application are referred to as the higher communication layers (HCL). The interface between LCL and HCL is referred to as communication service interface (CSIF).

For the assessment of the overall system performance, it is important to differentiate between the 3GPP network's performance (i.e., including only the LCL and measured at the CSIF) and the overall system performance including the application layer (i.e., including both, the LCL and the HCL). In Figure C.5-1, the orange arrow depicts the vertical application's point of view. The blue arrows indicate two options to measure the 3GPP network's performance, i.e., including and excluding the IP layer.

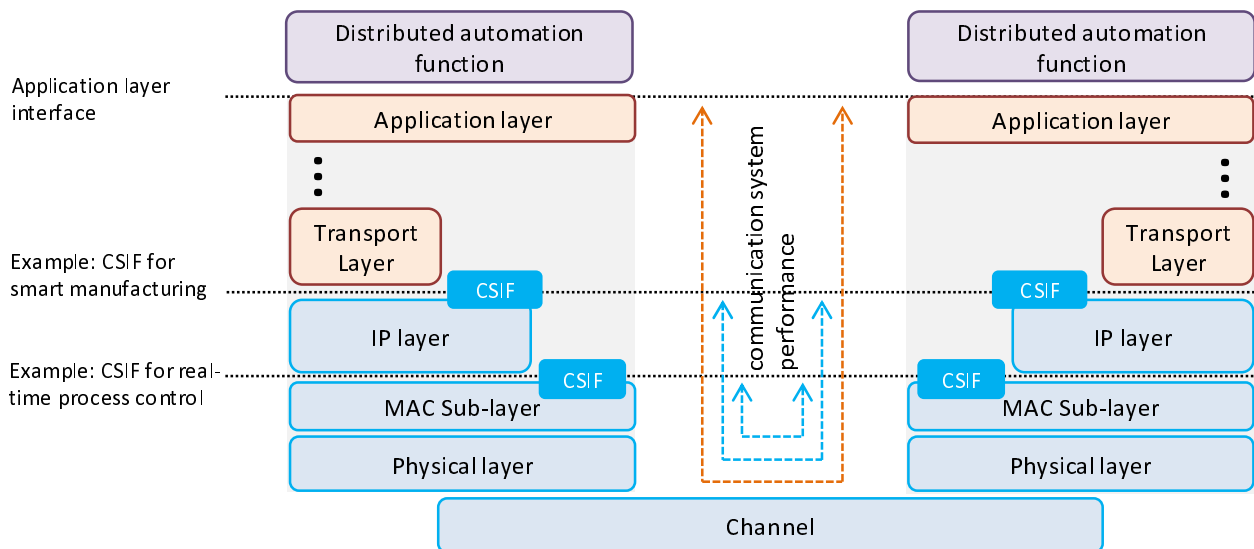

**Figure C.5-1: Network performance measurements at different communication system interfaces (CSIF)**

Figure C.5-2 illustrates how messages are transmitted from a source application device (e.g., a programmable logic controller) to a target application device (e.g. an industrial robot). The source application function (AF) is executed in the source operating system (OS) and hands over a message to the application layer interface of the source communication device. In the higher communication layers (HCL), which are not part of the 3GPP system, the data is processed. From the HCL the data is transferred to the lower communication layers (LCL), which are part of the 3GPP system. After transmission through the physical communication channel and the LCL of the target communication device, the data is passed to the HCL and lastly to the target application device. Characteristic parameters with respect to time are defined in Figure C.5-2.

From 3GPP system point of view:

- Transfer interval of 5G system: Time between the arrival of two pieces of data at the source CSIF.
- End-to-end latency: Time measured from the point when a piece of data received at the CSIF in the source communication device until the same piece of data is passed to the CSIF in the target communication device.

From vertical application point of view:

- Transfer interval of vertical application: Time between the transmission of two successive pieces of data from the source application.
- Transmission time: Time measured from the point when a piece of data is handed from the application layer interface of the source application device, until the same piece of data is received at the application layer interface of the target application device.
- Update time: Time between the reception of two consecutive pieces of data at the application layer interface to the target application device.

If not stated otherwise, the terms "end-to-end latency" and "transfer interval" refer to the 3GPP system / 5G network parameters in this document.

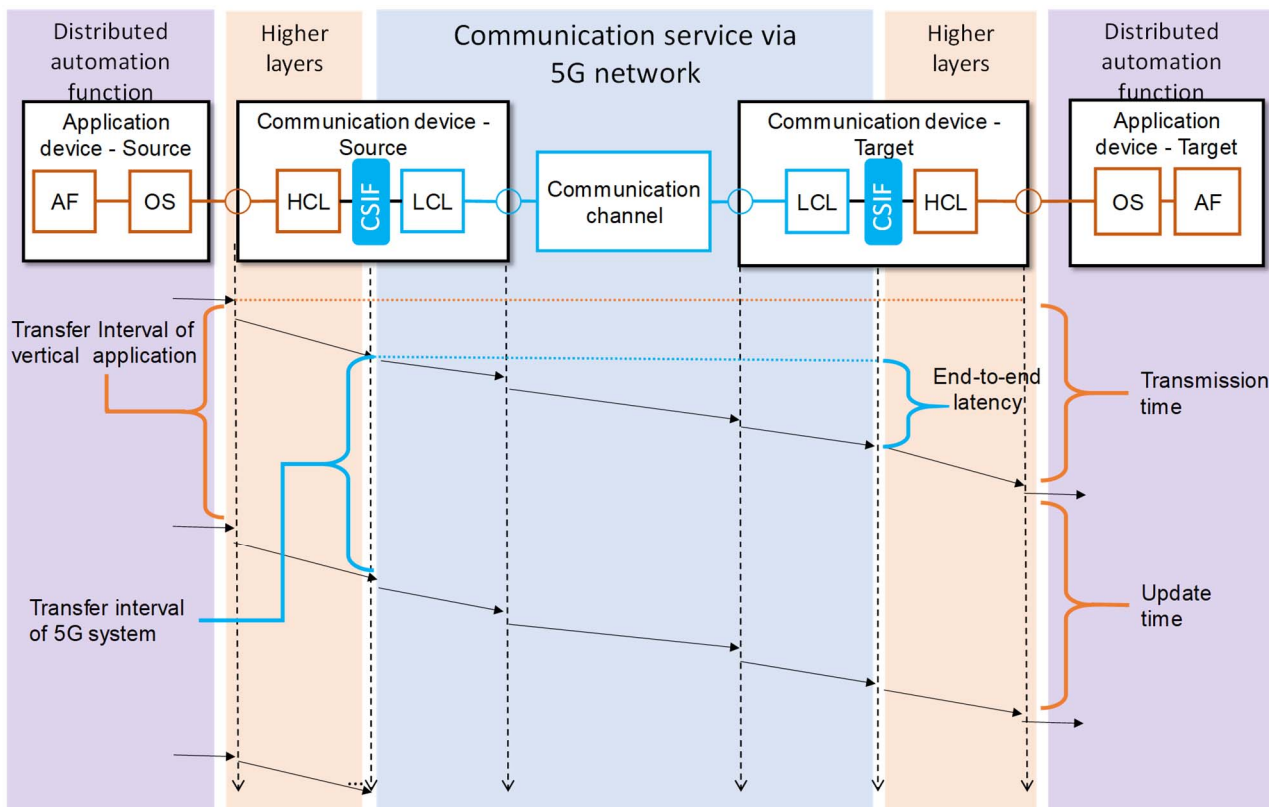

Figure C.5-2: Relation between application device and communication device (downlink example).

# Annex D (informative): 5G in industrial automation: different and multiple time domains for synchronization

## D.1 Description

The required synchronization precision is usually given as the maximum absolute value of the time difference between sync master and any device in the synchronisation domain (time domain or clock domain). A common example is a synchronisation precision of  $\leq 1 \mu\text{s}$ . This is equivalent to  $\pm$  the precision value, so  $\pm 1 \mu\text{s}$  between sync master and any device in the synchronisation domain, resulting in two times this value as maximum absolute time difference between any two devices in the synchronisation domain ( $2 \mu\text{s}$  in the example).

An industrial automation network generally consists of two distinct time domains.

First is the *global time domain*. This is the time used for overall synchronization in the system (e.g. the factory). It is used to align operations and events chronologically. Industrial automation uses the term *universal time domain* [20] for the global time domain described in this document. Global time is known as a synonym for universal time in industrial automation. Global time is called wall clock in certain areas and standards.

The synchronization precision is typically  $\leq 1 \mu\text{s}$  [20]. In some areas, a precision of  $\leq 100 \mu\text{s}$  might be sufficient for the global time domain if a working clock with precision of  $\leq 1 \mu\text{s}$  is available. The assigned timescale is usually the International Atomic Time (TAI, *temps atomique international*), based on the precision time protocol (PTP) epoch (starting from 1 January 1970 00:00:00 TAI) [22]. While there is usually only one global time, multiple global time domains are possible.

Clock synchronization in the global time domain usually applies to all UEs within the industrial facility in industrial automation. That is, a global time domain covers usually the industrial facility.

Second is the *working clock domain*. Working clock domains are constrained in size. They often consist of a single machine or a set of neighbouring machines that physically collaborate. The restricted size allows very precise time synchronization ( $\leq 1 \mu\text{s}$ ) with efficient network components. Synchronisation to a working clock is used to align e.g. production lines, production cells, or machines/functional units. In these cases, the application synchronizes locally within the working clock domains (Figure D.1-1), allowing precise synchronization with more efficient components. A global time domain usually contains multiple working clock domains. The starting point (epoch) is the start of the working clock domain.

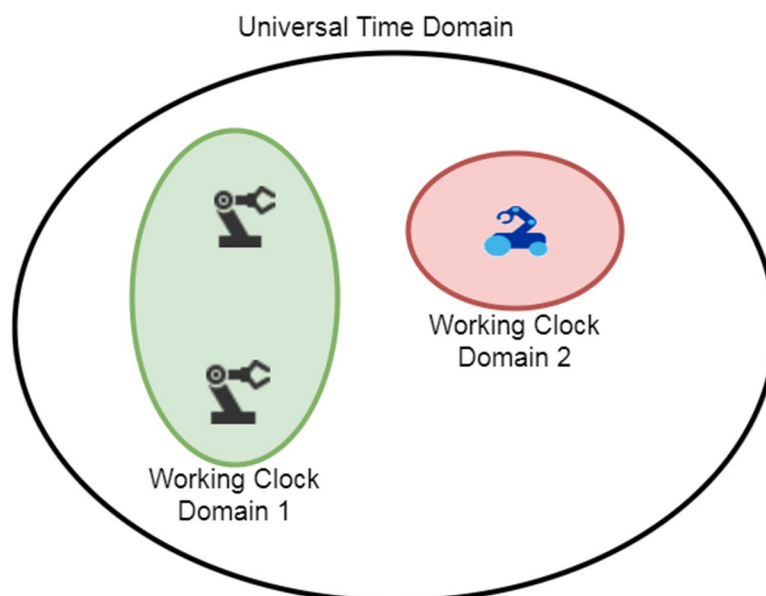

Figure D.1-1: Global time domain and working clock domains

The assigned timescale of a working clock domain is arbitrary (timescale ARB [22]). Therefore, different working clock domains may have different timescales and different synchronisation accuracy and precision. Robots, motion control applications, numeric control, and any kind of clocked / isochronous application rely on the timescale of the working clock domain to make sure that actions are precisely interwoven as needed.

Clock synchronization in the working clock domain is constraint in size. A specific working clock domain will contain only a subset of the UEs within the industrial facility. Often, the UEs of the working clock domain are connected to the same gNB. However, it is also possible that a working clock domain contains multiple neighbouring gNBs. This depends on the actual use case and its vertical application.

Devices may be part of multiple time domains leading to overlapping working clock domains.

The required precision (usually  $\leq 1 \mu\text{s}$ ) is between the sync master and any sync devices of the clock domain, both, global time domain and working clock domain.

Clock domains might be called sync domains in certain areas and standards.

## D.2 Merging of working clock domains

One key issue of the integration of TSN and 5G wireless networks that has to be handled is mobility. The integration of 5G wireless communication into the industrial communication infrastructure allows for mobility in the manufacturing process. This mobility enhances flexibility in the manufacturing process, e.g. through adding certain manufacturing capabilities on-demand by having a machine move to the respective production line. This means that machines that are synchronized to different working clock domains may need to interact with each other.

The following scenario illustrates this. After the mobile machine has arrived at the intended location and is stationary again, the two interacting working clock domains have to be synchronized with each other. Otherwise interaction might not be possible without interfering with ongoing operations. An example is an autonomous mobile handling robot adding parts to an assembly line. Without synchronization between both, correct placement of the parts would be impossible.

However, it is not feasible to schedule these interactions beforehand. Therefore, the interaction between different working clock domains requires a concept for handling the communication. TSN provides already mechanisms for this. The 5G systems and the UEs need to provide an interface in order to exchange information of the clock domain.

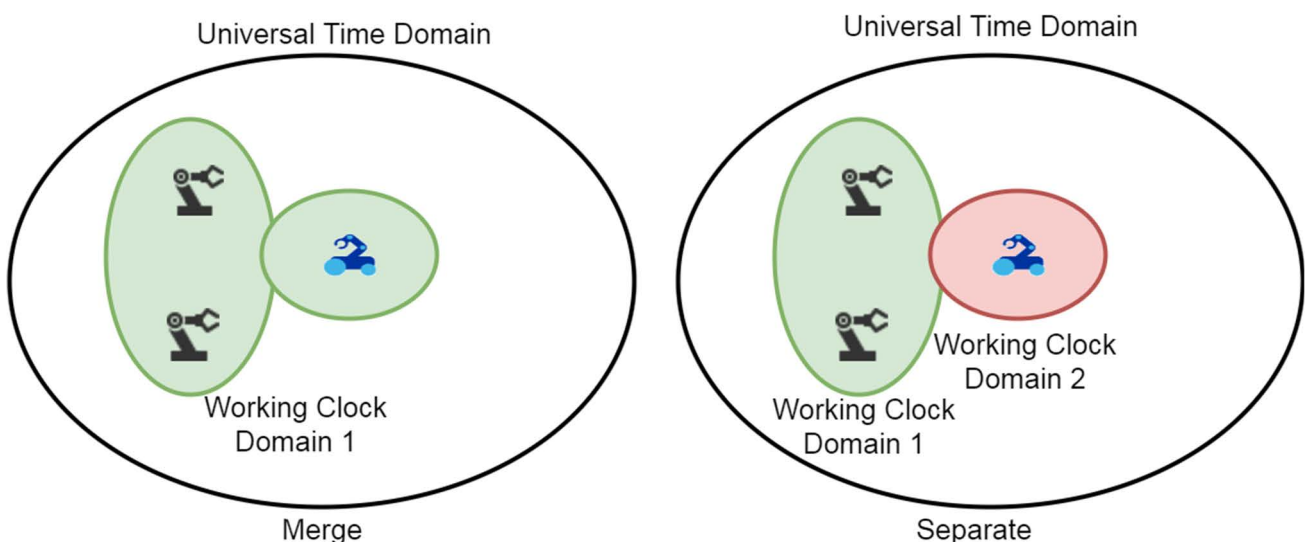

**Figure D.2-1: Working clock domain interactions "Merge" and "Separate"**

When members of different working clock domains interact, there are two possible options (Figure D.2-1). Which option is used depends on the application and its requirements.

- Merge: The working clock domains merge into one. This option can be used in applications where synchronization is critical, e.g. high precision robots interacting with each other.



- Separate: The members of the different working clock domains interact while keeping their own separate time synchronizations. This option can be used in applications where synchronization is non-critical, e.g. an AGV collecting finished products from a production line.

---

## D.3 Time synchronization with 5G networks

For the time synchronization with 5G networks, we consider two possible options.

The 5G system uses the IEEE 802.1AS sync domains [22]: In this case, the 5G system provides a media dependent interface to the IEEE 802.1AS sync domain, which the application can use to synchronize to the sync domain. In the IEEE 802.1AS standard [22], a similar concept is detailed in the MDSyncSend and MDSyncReceive structures.

The 5G system provides the working clock domains and global time domain: In this case, the 5G system has to provide an interface which the application can use to derive their working clock domain or global time domain. A device can belong to multiple working clock domains. An application can use each of these as the reference clock for synchronization (reference clock model).

NOTE: The required precision (usually  $\leq 1 \mu\text{s}$ ) is between the sync master and any sync device of the clock domain.

---

# Annex E (informative): Audio and Video Production

## E.1 Description

AV production includes television and radio studios, outside and remotely controlled broadcasts, live newsgathering, sports events, music festivals, among others. All of these applications require a high degree of reliability, since they are related to the capturing and transmission of data at the beginning of a production chain. This differs drastically when compared to other multimedia services because the communication errors will be propagated to the entire audience that is consuming that content both live and recorded for later distribution. Furthermore, the transmitted data is often post-processed with nonlinear filters which could actually amplify defects that would be otherwise not noticed by humans. Therefore, these applications call for uncompressed or only slightly compressed data, and very low probability of errors. These devices will also be used alongside existing technologies which have a high level of performance and so any new technologies will need to match or improve upon the existing workflows to drive adoption of the technology.

The performance aspects that are covered by/in TS 22.263 [27] (Service requirements for Video, Imaging and Audio for professional applications) also target the latency that these services experience.

In recent years, production facilities have moved from bespoke unidirectional highly specialised networks to IP based systems and software-based workflows. This migration is expected to continue, and wireless IP connectivity is key to a number of these workflows.

Typical set ups require multiple devices such as cameras, microphones and control surfaces that require extremely close synchronisation to maintain consistency of pictures and audio. Such clock synchronization requirements are captured in clause 5.6. Often devices need to communicate directly to each other for instance a camera to a monitor or a microphone to a PA system.

Video and audio applications also require extremely high quality of service metrics as the loss of a single packet can cause picture or sound breakup in the downstream processing or distribution. Often this is a legal, regulatory or contractual agreement to maintain a high quality, stable and clear video or audio signal.

## E.2 Multiple source wireless studio

This use case will deploy a multiple camera studio of approximately 1,000 m<sup>2</sup> (~5 cameras) where wired and wireless functionalities currently provided by traditional infrastructure technologies are likely to be deployed using a standalone non-public network. A combination of IP enabled wired and wireless cameras working at both HD and UHD resolutions will be deployed in a studio. Associated equipment such as video monitors, prompting systems, camera control will be provided over the 5G network. Camera timing and synchronisation will be provided over the 5G system. As well as video, audio will be sourced from both wired and wireless microphones incl. control/monitoring and combined with the video to produce high quality synchronised AV content. 5G will also be deployed to control lighting and camera robotics. Talkback intercom systems will be deployed using low latency multicast links.

Today's digital AV network transport is typically handled separately for wireless and wired transfers (see figure E.1.2-1). Wireless AV transmissions are implemented with application specific solutions that allow deterministic data transport of a single isolated audio or video link. Wired AV transmissions are Ethernet / IP based. Quality of service in AV IP networks is mainly achieved with IP DiffServ / DSCP based prioritization of packets in network switches. This method is sufficient for most AV use cases since jitter resulting from packet collisions is small, for example in the order of 10  $\mu$ s per concurring data stream in Gbit Ethernet.

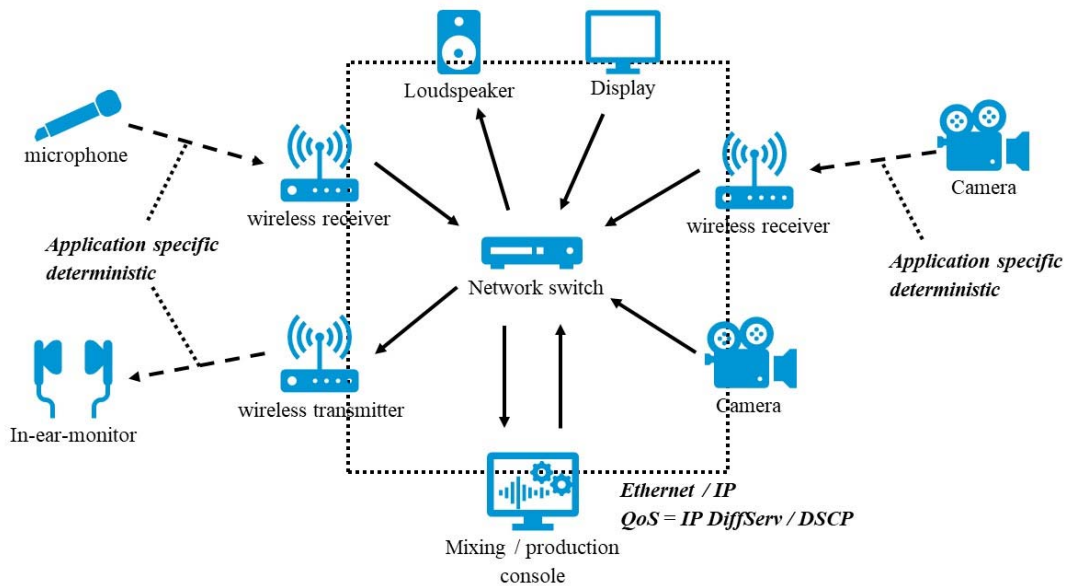

**Figure E.2-1: Typical AVPROD setup**

The microphones and cameras can be co-located in a broadcast centre in which case they would communicate through a LAN or NPN. For remote production operations the mixing and production console may be separated by some distance (existing examples are cross continental. In this instance they may communicate via a PLMN or combination of PLMN and WAN networks.

Some approaches may also deploy main (leader) equipment at the broadcast centre with secondary (follower) equipment at the location site to reduce latency.

Other aspects of this workflow may also include robotic control where both the physical position (height, direction and tilt) and the technical control (focus, zoom, iris, colour) of a device of a camera, microphone or light may be controlled remotely. In this instance round trip latency of < 20ms is required in order for an operator to see a move reflected at his control position as it is made.

It is important to note that these are a combination of automated robotics (pre-programmed moves) and manually controlled robotics (following an unpredictable event such a sport).

## E.3 Timing use in AV production applications

Timing of multiple devices such as microphones and camera is also critical. Timing signals are used in 2 separate ways.

- To maintain synchronisation between devices so that electronic shutters on cameras operate at the same time and frequency and that when cutting between any two cameras pointed at the same source no discernible jumps can be seen. This requires accuracy within the frame boundary of a given video signal. A single frame of video at 120 Hz would require a clock accurate to within 8 ms.
- To timestamp an IP packet carrying a video or audio sample. Existing standards and workflows for AVPROD rely on IEEE 1588 PTP timing with a SMPTE media profile applied. This requires a clock accurate to within 1  $\mu$ s

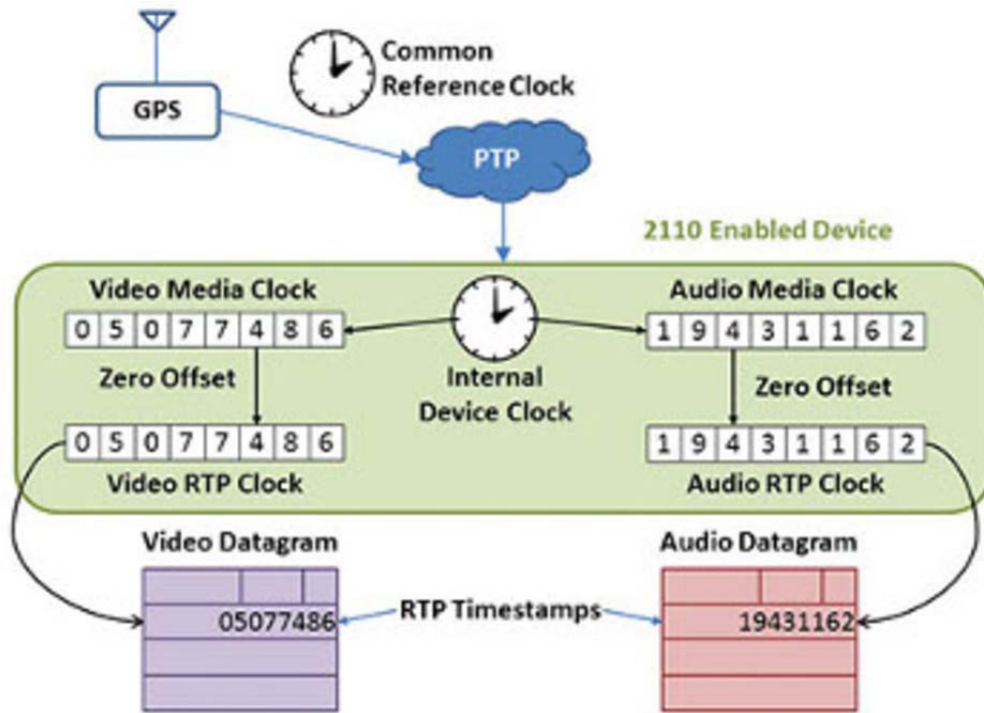
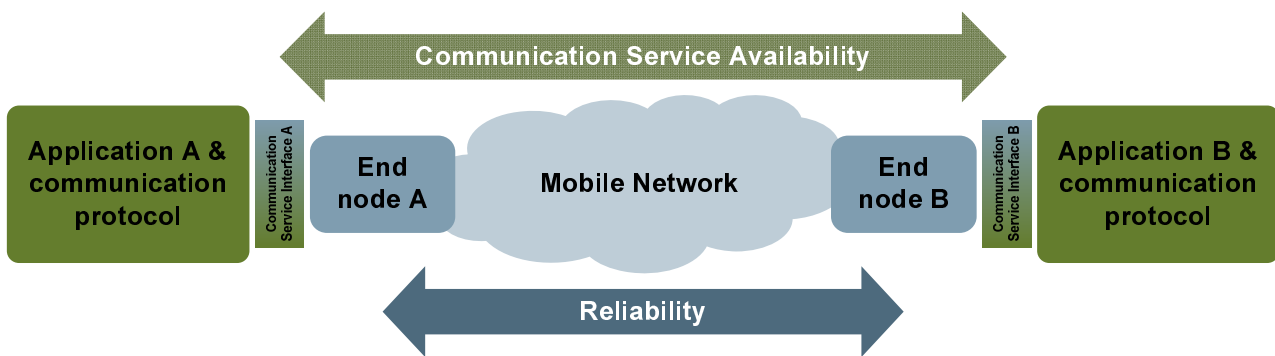

Figure E.3-1 Typical IP based timing set up for AVPROD

# Annex F (informative): Relation of reliability and communication service availability

Availability and reliability are used both in 3GPP and vertical industries, but with different meanings. Communication service availability addresses the availability of a communication service. This definition follows the vertical standard IEC 61907 [7]. On the other hand, reliability is a 3GPP term and addresses the availability of a communication network. The relation of both terms is depicted in figure F-1 for a mobile network.

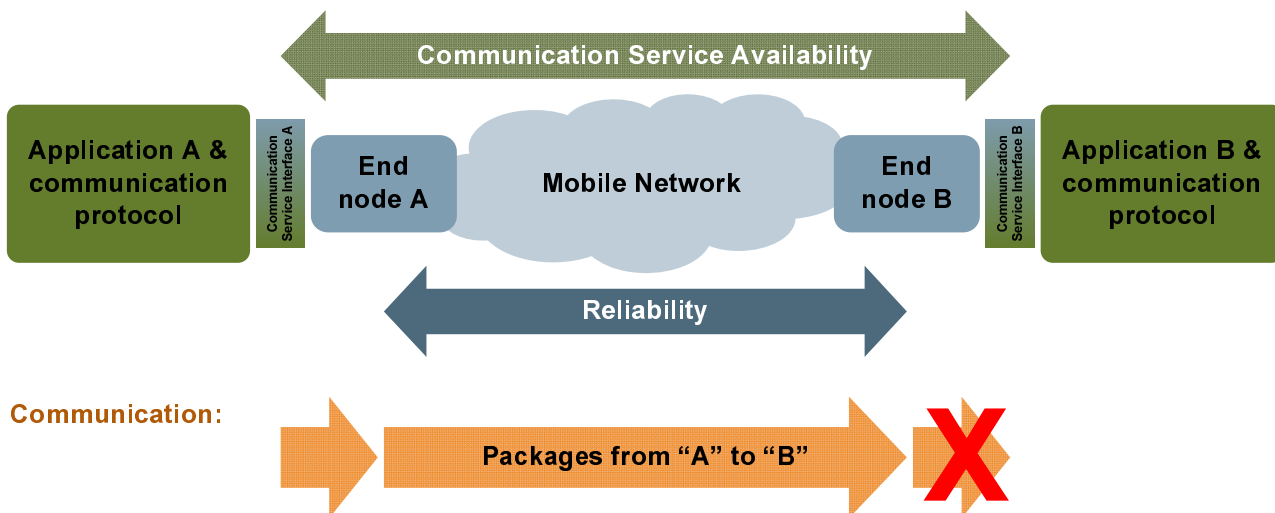

**Figure F-1: Illustration of the concepts reliability and communication service availability.**

As depicted, reliability covers the communication-related aspects between two nodes (here: end nodes), while communication service availability addresses the communication-related aspects between two communication service interfaces. This might seem to be a small difference, but this difference can lead to situations, where reliability and communication service availability have different values.

**Example: traffic gets "stuck"**

The related scenario is depicted in figure F-2.



**Figure F-2: Example in which reliability and communication service availability have different values. Packets are reliably transmitted from the communication service interface A to end node B, but they are not exposed at the communication service interface B.**

This scenario addresses unicast communication from application A to B. The packets are handed over at the communication service interface A from the application to the communication network, and the packets are then transmitted to the end node B. In this example, the packets received by end node B are not exposed at the communication service interface B. So, even if all packets that are handed over to end node A are successfully delivered

to end node B within the time constraint required by the targeted service (reliability = 100 %), the communication service availability is 0% since no packets arrive at the "end", namely the communication service interface B.

### Example: packets dropped at the communication service interface

The related scenario is depicted in figure F-3.

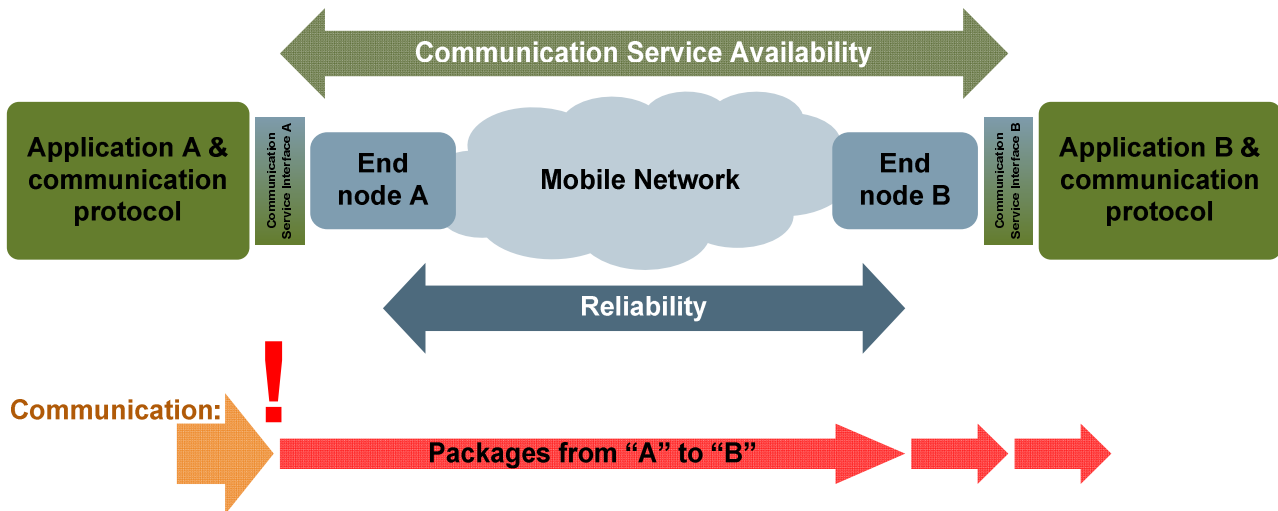

**Figure F-3: Example in which reliability and communication service availability have different values. Only half of the packets handed over to the end node A are actually transmitted to end node B and then handed over to application B at the communication service interface B.**

This scenario describes unicast communication of evenly interspersed packets from application A to B. The packets are handed over at the communication service interface A from the application to the communication network, and the packets are then transmitted to the end node B. However, only every second packet is actually successfully handed over to end node A and then transmitted to end node B. Thus, only half of the packets arrive at application B. Note though that the reliability of the mobile network is 100%, since all packets transmitted by end node A are delivered to end node B within the time constraint required by the targeted service. However, depending on the agreed QoS, the communication service availability can be of the same value as the reliability or much lower. For instance, if the agreed survival time is equal to or larger than the end-to-end latency, reliability and communication service availability are equal. However, if the survival time is smaller, the reliability is two times the communication service availability.

Note that the shortest time interval over which the communication service availability should be calculated is the sum of maximum allowed end-to-end latency and survival time.

## Annex G (informative): Change history

Change history							
Date	Meeting	TDoc	CR	Rev	Cat	Subject/Comment	New version
2018-05	SA1#82	S1-181551	-	-	-	Skeleton for TS 22.104 ("Service requirements for cyber-physical control applications in vertical domains")	0.0.0
2018-05	SA1#82	S1-181552	-	-	-	Includes agreements at SA1#82, Dubrovnik, Croatia	0.1.0
2018-08	SA1#83	S1-182344	-	-	-	Includes agreements at SA1#83, West Palm Beach, Florida	0.2.0
2018-11	SA1#84	S1-183276	-	-	-	Includes agreements at SA1#83, Spokane, WA, USA, rapporteur's clean-up	0.3.0
2018-12	SA#82	SP-181006				Presentation to SA for one-step approval	1.0.0
2018-12	SA#82	SP-181006				Raised to v.16.0.0 following SA approval	16.0.0
2019-03	SA#83	SP-190081	0003	2	F	Clarifying UE-to-UE versus UE-to-network	16.1.0
2019-03	SA#83	SP-190081	0002	1	F	Moving rail-bound mass transit requirements – shift from cyberCAV	16.1.0
2019-03	SA#83	SP-190081	0001	1	F	Clean-up and corrections of TS 22.104 cyberCAV	16.1.0
2019-06	SA#84	SP-190299	0008		F	Corrections to TS 22.104 v16.1.0	16.2.0
2019-06	SA#84	SP-190299	0006	2	F	Add missing abbreviations to TS 22.104	16.2.0
2019-06	SA#84	SP-190299	0005	2	C	Adding edge computing aspect	16.2.0
2019-06	SA#84	SP-190311	0009	1	C	Adding vertical positioning requirements to TS 22.104 v16.1.0	17.0.0
2019-09	SA#85	SP-190807	0012	1	B	Addition of a new synchronisation performance requirement	17.1.0
2019-09	SA#85	SP-190807	0011	2	B	Addition of robotic aided surgery and diagnosis performance requirements	17.1.0
2019-09	SA#85	SP-190800	0023	1	A	Correction of a figure number in Annex D.2	17.1.0
2019-09	SA#85	SP-190812	0010		B	Add one more case for control-to-control communication	17.1.0
2019-09	SA#85	SP-190812	0013	1	B	Network operation requirements	17.1.0
2019-09	SA#85	SP-190812	0015	3	B	eCAV – Further 5G service requirements for Positioning	17.1.0
2019-09	SA#85	SP-190812	0018	2	B	eCAV – Service performance requirements for Industrial Wireless Sensors	17.1.0
2019-09	SA#85	SP-190812	0016	2	B	eCAV – further 5G service requirements for wired to wireless link replacement for smart manufacturing / Industry 4.0	17.1.0
2019-09	SA#85	SP-190812	0020	3	B	eCAV – further 5G service requirements for network performance	17.1.0
2019-09	SA#85	SP-190857	0021	3	B	ECAV - further 5G service requirements for ProSe communication for CAV	17.1.0
2019-09	SA#85	SP-190856	0019	3	B	ECAV - further 5G service requirements for industrial Ethernet integration (clock synchronization, time-sensitive communication)	17.1.0
2019-12	SA#86	SP-191016	0027	5	B	Addition of informative annex for AV Prod	17.2.0
2019-12	SA#86	SP-191020	0026	1	F	Correction of CMED KPIs tables	17.2.0
2019-12	SA#86	SP-191028	0034	4	A	Clarification of clock synchronicity requirements	17.2.0
2019-12	SA#86	SP-191028	0028		F	Addition of transmission directions and movement characteristics	17.2.0
2019-12	SA#86	SP-191028	0030	1	A	Clarification on communication service reliability	17.2.0
2019-12	SA#86	SP-191028	0035	1	F	Derivation of communication service availability and reliability from network performance metrics	17.2.0
2019-12	SA#86	SP-191028	0037	1	D	Editorial and minor corrections to TR 22.104	17.2.0
2019-12	SA#86	SP-191028	0032	2	C	Network performance requirements for mobile operation panel	17.2.0
2019-12	SA#86	SP-191028	0038	2	F	TS 22104 - Annex A for cooperative carrying	17.2.0
2020-07	SA#88e	SP-200568	0050		F	Correction of service performance requirements in tables of annex A.6	17.3.0
2020-07	SA#88e	SP-200567	0049		D	22.104 Miscellaneous editorial corrections	17.3.0
2020-07	SA#88e	SP-200562	0041	2	A	Clarifications to communication service performance requirements	17.3.0
2020-07	SA#88e	SP-200567	0048	2	A	Miscellaneous values for further study	17.3.0
2020-07	SA#88e	SP-200562	0045	2	A	Correcting description of communication service status in Clause C.3	17.3.0
2020-07	SA#88e	SP-200562	0047	1	A	Clock synchronicity budget for the 5G system	17.3.0
2020-09	SA#89e	SP-200790	0055		F	Quality improvement – burst definition	17.4.0
2020-09	SA#89e	SP-200790	0058	1	D	CR 22.104 R17 - Editorial Improvements – Decimal Separator	17.4.0
2021-03	SA#91e	SP-210200	0063		D	Non-inclusive language replacement 22.104	17.5.0
2021-03	SA#91e	SP-210217	0064	1	B	Adding energy efficiency use cases for positioning to the ANNEX A	17.5.0
2021-06	SA#92e	SP-210564	0075	1	A	Quality improvement - update of definition of communication service availability	18.1.0
2021-06	SA#92e	SP-210565	0066	1	D	Quality improvement - addition of new annex (relationship between reliability and communication service availability)	18.1.0
2021-06	SA#92e	SP-210565	0068	1	D	22.104 - V18.0.0 - quality improvement - update of mobile-robots use case description	18.1.0
2021-06	SA#92e	SP-210565	0069	1	F	Correction of mobile-robot use cases (UE number)	18.1.0
2021-06	SA#92e	SP-210565	0070	1	D	Quality improvement - service duration	18.1.0
2021-06	SA#92e	SP-210517	0065	1	B	5G timing resiliency	18.1.0
2021-06	SA#92e	SP-210524	0073		D	Alignment of positioning power consumption aspects between 22.261 and 22.104	18.1.0
2021-06	SA#92e	SP-210524	0072	1	B	Adding LPHAP requirements for Industrial IoT	18.1.0
2021-09	SA#93e	SP-211038	0077	2	A	Quality improvement: update of reference to IEEE 802.1AS	18.2.0
2021-09	SA#93e	SP-211070	0078	1	B	Introduction of Smart Energy Infrastructure Requirements	18.2.0
2021-09	SA#93e	SP-211070	0080	1	B	Annex for smart grid	18.2.0
2021-09	SA#93e	SP-211070	0082	1	B	Introduction of SEI KPIs	18.2.0



2021-09	SA#93e	SP-211070	0083	1	D	Adjusting scope clause in TS 22.104 to the specification s content	18.2.0
2021-09	SA#93e	SP-211039	0084	1	F	Clarification of requirements for clock synchronization with direct device connection and indirect network connection communication	18.2.0
2021-09	SA#93e	SP-211070	0087	1	B	Inclusion of Smart Energy Infrastructure Requirements	18.2.0
2021-12	SP-94	SP-211497	0089	1	C	Correction of references for clause 2	18.3.0
2021-12	SP-94	SP-211497	0090		D	Remove editor note for Figure A.4.4.3-1	18.3.0
2021-12	SP-94	SP-211497	0091	1	F	Update to Smart Grid normative requirements	18.3.0
2024-06	SA#104	SP-240786	0099		F	Correction of reference to IEEE Std 1588-2019	18.4.0
2024-06	SA#104	SP-240786	0098	2	F	Alignment for Smart Energy Infrastructure	18.4.0

---

# History

<b>Document history</b>		
V18.3.0	May 2024	Publication
V18.4.0	July 2024	Publication