

ETSI TS 122 261 V17.11.0 (2022-10)



5G;
Service requirements for the 5G system
(3GPP TS 22.261 version 17.11.0 Release 17)



Reference

RTS/TSGS-0122261vhb0

Keywords

5G

ETSI

650 Route des Lucioles
F-06921 Sophia Antipolis Cedex - FRANCE

Tel.: +33 4 92 94 42 00 Fax: +33 4 93 65 47 16

Siret N° 348 623 562 00017 - APE 7112B
Association à but non lucratif enregistrée à la
Sous-Préfecture de Grasse (06) N° w061004871

Important notice

The present document can be downloaded from:

<http://www.etsi.org/standards-search>

The present document may be made available in electronic versions and/or in print. The content of any electronic and/or print versions of the present document shall not be modified without the prior written authorization of ETSI. In case of any existing or perceived difference in contents between such versions and/or in print, the prevailing version of an ETSI deliverable is the one made publicly available in PDF format at www.etsi.org/deliver.

Users of the present document should be aware that the document may be subject to revision or change of status.

Information on the current status of this and other ETSI documents is available at

<https://portal.etsi.org/TB/ETSIDeliverableStatus.aspx>

If you find errors in the present document, please send your comment to one of the following services:

<https://portal.etsi.org/People/CommitteeSupportStaff.aspx>

If you find a security vulnerability in the present document, please report it through our
Coordinated Vulnerability Disclosure Program:

<https://www.etsi.org/standards/coordinated-vulnerability-disclosure>

Notice of disclaimer & limitation of liability

The information provided in the present deliverable is directed solely to professionals who have the appropriate degree of experience to understand and interpret its content in accordance with generally accepted engineering or other professional standard and applicable regulations.

No recommendation as to products and services or vendors is made or should be implied.

No representation or warranty is made that this deliverable is technically accurate or sufficient or conforms to any law and/or governmental rule and/or regulation and further, no representation or warranty is made of merchantability or fitness for any particular purpose or against infringement of intellectual property rights.

In no event shall ETSI be held liable for loss of profits or any other incidental or consequential damages.

Any software contained in this deliverable is provided "AS IS" with no warranties, express or implied, including but not limited to, the warranties of merchantability, fitness for a particular purpose and non-infringement of intellectual property rights and ETSI shall not be held liable in any event for any damages whatsoever (including, without limitation, damages for loss of profits, business interruption, loss of information, or any other pecuniary loss) arising out of or related to the use of or inability to use the software.

Copyright Notification

No part may be reproduced or utilized in any form or by any means, electronic or mechanical, including photocopying and microfilm except as authorized by written permission of ETSI.

The content of the PDF version shall not be modified without the written authorization of ETSI.

The copyright and the foregoing restriction extend to reproduction in all media.

© ETSI 2022.
All rights reserved.

Intellectual Property Rights

Essential patents

IPRs essential or potentially essential to normative deliverables may have been declared to ETSI. The declarations pertaining to these essential IPRs, if any, are publicly available for **ETSI members and non-members**, and can be found in ETSI SR 000 314: "*Intellectual Property Rights (IPRs); Essential, or potentially Essential, IPRs notified to ETSI in respect of ETSI standards*", which is available from the ETSI Secretariat. Latest updates are available on the ETSI Web server (<https://ipr.etsi.org/>).

Pursuant to the ETSI Directives including the ETSI IPR Policy, no investigation regarding the essentiality of IPRs, including IPR searches, has been carried out by ETSI. No guarantee can be given as to the existence of other IPRs not referenced in ETSI SR 000 314 (or the updates on the ETSI Web server) which are, or may be, or may become, essential to the present document.

Trademarks

The present document may include trademarks and/or tradenames which are asserted and/or registered by their owners. ETSI claims no ownership of these except for any which are indicated as being the property of ETSI, and conveys no right to use or reproduce any trademark and/or tradename. Mention of those trademarks in the present document does not constitute an endorsement by ETSI of products, services or organizations associated with those trademarks.

DECT™, **PLUGTESTS™**, **UMTS™** and the ETSI logo are trademarks of ETSI registered for the benefit of its Members. **3GPP™** and **LTE™** are trademarks of ETSI registered for the benefit of its Members and of the 3GPP Organizational Partners. **oneM2M™** logo is a trademark of ETSI registered for the benefit of its Members and of the oneM2M Partners. **GSM®** and the GSM logo are trademarks registered and owned by the GSM Association.

Legal Notice

This Technical Specification (TS) has been produced by ETSI 3rd Generation Partnership Project (3GPP).

The present document may refer to technical specifications or reports using their 3GPP identities. These shall be interpreted as being references to the corresponding ETSI deliverables.

The cross reference between 3GPP and ETSI identities can be found under <http://webapp.etsi.org/key/queryform.asp>.

Modal verbs terminology

In the present document "**shall**", "**shall not**", "**should**", "**should not**", "**may**", "**need not**", "**will**", "**will not**", "**can**" and "**cannot**" are to be interpreted as described in clause 3.2 of the [ETSI Drafting Rules](#) (Verbal forms for the expression of provisions).

"**must**" and "**must not**" are **NOT** allowed in ETSI deliverables except when used in direct citation.

Contents

Intellectual Property Rights	2
Legal Notice	2
Modal verbs terminology.....	2
Foreword.....	7
Introduction	7
1 Scope	8
2 References	8
3 Definitions, symbols and abbreviations	9
3.1 Definitions	9
3.2 Abbreviations	11
4 Overview	12
5 High-level requirements	13
5.1 Migration to 5G	13
5.1.1 Description.....	13
5.1.2 Requirements	13
5.1.2.1 Interworking between 5G systems	13
5.1.2.2 Legacy service support.....	13
5.1.2.3 Interoperability with legacy 3GPP systems.....	14
6 Basic capabilities.....	14
6.1 Network slicing	14
6.1.1 Description.....	14
6.1.2 Requirements	14
6.1.2.1 General	14
6.1.2.2 Management.....	14
6.1.2.3 Network slice constraints	15
6.1.2.4 Cross-network slice coordination.....	15
6.2 Diverse mobility management.....	16
6.2.1 Description.....	16
6.2.2 General requirements.....	16
6.2.3 Service continuity requirements	16
6.2.4 Roaming related requirements	17
6.3 Multiple access technologies.....	17
6.3.1 Description.....	17
6.3.2 Requirements	17
6.3.2.1 General	17
6.3.2.2 E-UTRA access.....	18
6.3.2.3 Satellite access	18
6.3.2.4 Fixed broadband access.....	18
6.4 Resource efficiency	18
6.4.1 Description.....	18
6.4.2 Requirements	19
6.4.2.1 General	19
6.4.2.2 Efficient bulk operations for IoT.....	20
6.4.2.3 Efficient management for IoT.....	20
6.4.2.4 Efficient control plane.....	20
6.5 Efficient user plane.....	20
6.5.1 Description.....	20
6.5.2 Requirements	20
6.6 Efficient content delivery	21
6.6.1 Description.....	21
6.6.2 Requirements	22
6.7 Priority, QoS, and policy control.....	22

6.7.1	Description.....	22
6.7.2	Requirements	23
6.8	Dynamic policy control	23
6.9	Connectivity models.....	24
6.9.1	Description.....	24
6.9.2	Requirements	24
6.9.2.1	General	24
6.9.2.2	Services and Service Continuity	24
6.9.2.3	Permission and Authorization	25
6.9.2.4	Relay UE Selection	25
6.9.2.5	Satellite and Relay UEs.....	25
6.10	Network capability exposure.....	26
6.10.1	Description.....	26
6.10.2	Requirements	26
6.11	Context-aware network	27
6.11.1	Description.....	27
6.11.2	Requirements	28
6.12	Self backhaul	28
6.12.1	Description.....	28
6.12.2	Requirements	28
6.13	Flexible broadcast/multicast service.....	29
6.13.1	Description.....	29
6.13.2	Requirements	29
6.14	Subscription aspects	30
6.14.1	Description.....	30
6.14.2	Requirements	30
6.15	Energy efficiency	31
6.15.1	Description.....	31
6.15.2	Requirements	31
6.16	Markets requiring minimal service levels	31
6.16.1	Description.....	31
6.16.2	Requirements	31
6.17	Extreme long range coverage in low density areas	32
6.17.1	Description.....	32
6.17.2	Requirements	32
6.18	Multi-network connectivity and service delivery across operators	32
6.18.1	Description.....	32
6.18.2	Requirements	32
6.19	3GPP access network selection	33
6.19.1	Description.....	33
6.19.2	Requirements	33
6.20	eV2X aspects.....	33
6.20.1	Description.....	33
6.20.2	Requirements	34
6.21	NG-RAN Sharing.....	34
6.21.1	Description.....	34
6.21.2	Requirements	34
6.22	Unified access control	34
6.22.1	Description.....	34
6.22.2	Requirements	34
6.22.2.1	General	34
6.22.2.2	Access identities.....	35
6.22.2.3	Access categories	36
6.23	QoS monitoring	37
6.23.1	Description.....	37
6.23.2	Requirements	37
6.24	Ethernet transport services	38
6.24.1	Description.....	38
6.24.2	Requirements	38
6.25	Non-public networks	39
6.25.1	Description.....	39
6.25.2	Requirements	39

6.26	5G LAN-type service	40
6.26.1	Description.....	40
6.26.2	Requirements	40
6.26.2.1	General	40
6.26.2.2	5G LAN-virtual network (5G LAN-VN)	40
6.26.2.3	Creation and management.....	41
6.26.2.4	Privacy	41
6.26.2.5	Traffic types	41
6.26.2.6	Discovery	41
6.26.2.7	(void).....	41
6.26.2.8	Indirect communication mode.....	41
6.26.2.9	Service exposure	42
6.27	Positioning services.....	42
6.27.1	Description.....	42
6.27.2	Requirements	42
6.28	Cyber-physical control applications in vertical domains.....	43
6.28.1	Description.....	43
6.28.2	Requirements	44
6.29	Messaging aspects	44
6.29.1	Description.....	44
6.29.2	Requirements	44
6.30	Steering of roaming.....	44
6.30.1	Description.....	44
6.30.2	Requirements	44
6.31	Minimization of Service Interruption.....	45
6.31.1	Description.....	45
6.31.2	Requirements	45
6.31.2.1	General	45
6.31.2.2	Disaster Condition.....	45
6.31.2.3	Disaster Roaming.....	45
6.32.1	Description.....	46
6.32.2	Requirements	46
7	Performance requirements.....	47
7.1	High data rates and traffic densities	47
7.2	Low latency and high reliability	48
7.2.1	Overview	48
7.2.2	Scenarios and KPIs	48
7.2.3	Other requirements	49
7.2.3.1	(void).....	49
7.2.3.2	Wireless road-side infrastructure backhaul	49
7.3	High-accuracy positioning.....	52
7.3.1	Description.....	52
7.3.2	Requirements	52
7.3.2.1	General	52
7.3.2.2	Requirements for horizontal and vertical positioning service levels.....	52
7.3.2.3	Other performance requirements.....	54
7.4	KPIs for a 5G system with satellite access	54
7.4.1	Description.....	54
7.4.2	Requirements	54
7.5	High-availability IoT traffic	55
7.5.1	Description.....	55
7.5.2	Requirements	56
7.6	High data rate and low latency.....	57
7.6.1	AR/VR	57
7.7	KPIs for UE to network relaying in 5G system.....	58
8	Security.....	59
8.1	Description	59
8.2	General	60
8.3	Authentication	60
8.4	Authorization.....	61

8.5	Identity management	61
8.6	Regulatory	62
8.7	Fraud protection	62
8.8	Resource efficiency	62
8.9	Data security and privacy	62
9	Charging aspects	63
9.1	General	63
9.2	5G LAN.....	63
Annex A (informative):	Latency needs to support example use cases from vertical industries	64
Annex B (informative):	Positioning accuracy needs to support example use cases from vertical industries.....	65
Annex C (informative):	Relation of communication service availability and reliability	66
Annex D (informative):	Critical-communication use cases	69
D.1	Discrete automation – motion control	69
D.1.1	Service area and connection density	70
D.1.2	Security	70
D.2	Discrete automation.....	70
D.2.1	Service area and connection density	72
D.2.2	Security	72
D.3	Process automation.....	72
D.3.1	Remote control.....	73
D.3.2	Monitoring	73
D.3.3	Service area.....	73
D.4	Electricity distribution.....	73
D.4.1	Medium voltage	73
D.4.1.1	Service area and connection density	75
D.4.1.2	Security	75
D.4.2	Energy distribution – high voltage.....	75
D.4.2.1	Service area and connection density	75
D.4.2.2	Security	75
D.5	Intelligent transport systems – infrastructure backhaul	76
D.5.1	Service area and connection density	76
Annex E (informative):	(void)	77
Annex F (informative):	QoS Monitoring.....	78
F.1	QoS monitoring for assurance	78
F.2	Network Diagnostics	79
Annex G (informative):	Asset Tracking use cases	80
G.1	Asset Tracking.....	80
G.2	Battery life expectancy and message size to support example use cases for asset tracking	80
Annex H (informative):	Change history	81
History		86

Foreword

This Technical Specification has been produced by the 3rd Generation Partnership Project (3GPP).

The contents of the present document are subject to continuing work within the TSG and may change following formal TSG approval. Should the TSG modify the contents of the present document, it will be re-released by the TSG with an identifying change of release date and an increase in version number as follows:

Version x.y.z

where:

x the first digit:

- 1 presented to TSG for information;
- 2 presented to TSG for approval;
- 3 or greater indicates TSG approved document under change control.

y the second digit is incremented for all changes of substance, i.e. technical enhancements, corrections, updates, etc.

z the third digit is incremented when editorial only changes have been incorporated in the document.

Introduction

The need to support different kinds of UEs (e.g. for the Internet of Things (IoT)), services, and technologies is driving the technology revolution to a high-performance and highly efficient 3GPP system. The drivers include IoT, Virtual Reality (VR), industrial control, ubiquitous on-demand coverage, as well as the opportunity to meet customized market needs. These drivers require enhancements to the devices, services, and technologies well established by 3GPP. The key objective with the 5G system is to be able to support new deployment scenarios to address diverse market segments.

This document compiles requirements that define a 5G system.

The 5G system is characterised, for example, by:

- Support for multiple access technologies
- Scalable and customizable network
- Advanced Key Performance Indicators (KPIs) (e.g. availability, latency, reliability, user experienced data rates, area traffic capacity)
- Flexibility and programmability (e.g. network slicing, diverse mobility management, Network Function Virtualization)
- Resource efficiency (both user plane and control plane)
- Seamless mobility in densely populated and heterogeneous environment
- Support for real time and non-real time multimedia services and applications with advanced Quality of Experience (QoE)

1 Scope

The present document describes the service and operational requirements for a 5G system, including a UE, NG-RAN, and 5G Core network. Requirements for a 5G E-UTRA-NR Dual Connectivity in E-UTRAN connected to EPC are found in TS 22.278 [5].

2 References

The following documents contain provisions which, through reference in this text, constitute provisions of the present document.

- References are either specific (identified by date of publication, edition number, version number, etc.) or non-specific.
- For a specific reference, subsequent revisions do not apply.
- For a non-specific reference, the latest version applies. In the case of a reference to a 3GPP document (including a GSM document), a non-specific reference implicitly refers to the latest version of that document *in the same Release as the present document*.

- [1] 3GPP TR 21.905: "Vocabulary for 3GPP Specifications".
- [2] NGMN 5G White Paper v1.0, February 2015.
- [3] 3GPP TS 22.011: "Service accessibility".
- [4] NGMN, "Perspectives on Vertical Industries and Implications for 5G, v2.0", September 2016.
- [5] 3GPP TS 22.278: "Service requirements for the Evolved Packet System (EPS)".
- [6] 3GPP TS 22.101: "Service aspects; Service principles".
- [7] 3GPP TS 22.146: "Multimedia Broadcast/Multicast Service (MBMS)".
- [8] 3GPP TS 22.246: "Multimedia Broadcast/Multicast Service (MBMS) user services".
- [9] 3GPP TS 22.186: "Enhancement of 3GPP support for V2X scenarios".
- [10] NGMN, "Recommendations for NGMN KPIs and Requirements for 5G", June 2016
- [11] 3GPP TS 22.115: "Service aspects; Charging and billing".
- [12] Communication network dependability engineering. IEC 61907:2009.
- [13] Soriano, R., Alberto, M., Collazo, J., Gonzales, I., Kupzo, F., Moreno, L., & Lorenzo, J. OpenNode. Open Architecture for Secondary Nodes of the Electricity Smartgrid. In Proceedings CIRED 2011 21st International Conference on Electricity Distribution, CD1. June 2011.
- [14] North American Electric Reliability Council. Frequently Asked Questions (FAQs) Cyber Security Standards CIP-002-1 through CIP-009-1. Available: http://www.nerc.com/docs/standards/sar/Revised_CIP-002-009_FAQs_06Mar06.pdf. 2006.
- [15] McTaggart, Craig, et al. "Improvements in power system integrity protection schemes". Developments in Power System Protection (DPSP 2010). Managing the Change, 10th IET International Conference on. IET, 2010.
- [16] IEEE Power Engineering Society – Power System Relaying Committee – System Protection Subcommittee Working Group C-6. Wide Area Protection and Emergency Control.
- [17] Begovic, Miroslav, et al. "Wide-area protection and emergency control". Proceedings of the IEEE 93.5, pp. 876-891, 2005.

- [18] ITU-T Recommendation G.1000 "Communications quality of service: A framework and definitions".
- [19] IEC 61907, "Communication network dependability engineering".
- [20] NIST, "Framework for Cyber-Physical Systems", 2016.
- [21] 3GPP TS 22.104: "Service requirements for cyber-physical control applications in vertical domains".
- [22] 3GPP TS 22.262: "Message Service within the 5G System".
- [23] 3GPP TS 22.289: "Mobile Communication System for Railways".
- [24] 3GPP TS 22.071: " Location Services".
- [25] 3GPP TS 23.122: "Non-Access-Stratum (NAS) functions related to Mobile Station (MS) in idle mode".
- [26] 3GPP TS 22.125: "Unmanned Aerial System (UAS) support in 3GPP".
- [27] 3GPP TS 22.468: "Group Communication System Enablers (GCSE)".
- [28] 3GPP TS 22.263: "Service requirements for Video, Imaging and Audio for Professional Applications (VIAPA)".
- [29] 3GPP TS 22.263: "Service requirements for Video, Imaging and Audio for Professional Applications".
- [30] 3GPP TS 22.179: "Mission Critical Push to Talk (MCPTT)".
- [31] 3GPP TS 22.268: "Public Warning System (PWS) requirements".

3 Definitions, symbols and abbreviations

3.1 Definitions

For the purposes of the present document, the terms and definitions given in 3GPP TR 21.905 [1] and the following apply. A term defined in the present document takes precedence over the definition of the same term, if any, in 3GPP TR 21.905 [1].

5G enhanced positioning area: a subset of the 5G positioning service area that is assumed to be provided with additional infrastructure or deploy a particular set of positioning technologies to enhance positioning services.

NOTE 1: The enhanced positioning service area represents for example a factory plant, a dense urban area, an area along a road or railway track, a tunnel and covers both indoor and outdoor environments.

5G LAN-type service: a service over the 5G system offering private communication using IP and/or non-, i.e. UEs that are members of the same 5G LAN-VN IP type communications.

5G LAN-virtual network: a virtual network capable of supporting 5G LAN-type service.

5G satellite access network: 5G access network using at least one satellite.

5G positioning service area: a service area where positioning services would solely rely on infrastructures and positioning technologies that can be assumed to be present anywhere where 5G is present (e.g. a country-wide operator-supplied 5G network, GNSS, position/motion sensors).

NOTE 2: This includes both indoor and any outdoor environments.

active communication: a UE is in active communication when it has one or more connections established. A UE may have any combination of PS connections (e.g. PDP contexts, active PDN connections).

activity factor: percentage value of the amount of simultaneous active UEs to the total number of UEs where active means the UEs are exchanging data with the network.

area traffic capacity: total traffic throughput served per geographic area.

communication service availability: percentage value of the amount of time the end-to-end communication service is delivered according to a specified QoS, divided by the amount of time the system is expected to deliver the end-to-end service.

NOTE 3: The end point in "end-to-end" is the communication service interface.

NOTE 4: The communication service is considered unavailable if it does not meet the pertinent QoS requirements. For example, the communication service is unavailable if a message is not correctly received within a specified time, which is the sum of maximum allowed end-to-end latency and survival time.

direct device connection: the connection between two UEs without any network entity in the middle.

direct network connection: one mode of network connection, where there is no relay UE between a UE and the 5G network.

Disaster Condition: This is the condition that a government decides when to initiate and terminate, e.g. a natural disaster. When this condition applies, users may have the opportunity to mitigate service interruptions and failures.

Disaster Inbound Roamer: A user that (a) cannot get service from the PLMN it would normally be served by, due to failure of service during a Disaster Condition, and (b) is able to register with other PLMNs.

Disaster Roaming: This is the special roaming policy that applies during a Disaster Condition.

end-to-end latency: the time that it takes to transfer a given piece of information from a source to a destination, measured at the communication interface, from the moment it is transmitted by the source to the moment it is successfully received at the destination.

Hosted Service: a service containing the operator's own application(s) and/or trusted third-party application(s) in the Service Hosting Environment, which can be accessed by the user.

indirect network connection: one mode of network connection, where there is a relay UE between a UE and the 5G network.

IoT device: a type of UE which is dedicated for a set of specific use cases or services and which is allowed to make use of certain features restricted to this type of UEs.

NOTE 5: An IoT device may be optimized for the specific needs of services and application being executed (e.g. smart home/city, smart utilities, e-Health and smart wearables). Some IoT devices are not intended for human type communications.

network slice: a set of network functions and corresponding resources necessary to provide the required telecommunication services and network capabilities.

NG-RAN: a radio access network connecting to the 5G core network which uses NR, E-UTRA, or both.

non-public network: a network that is intended for non-public use.

NR: the new 5G radio access technology.

positioning service availability: percentage value of the amount of time the positioning service is delivering the required position-related data within the performance requirements, divided by the amount of time the system is expected to deliver the positioning service according to the specification in the targeted service area.

positioning service latency: time elapsed between the event that triggers the determination of the position-related data and the availability of the position-related data at the system interface.

priority service: a service that requires priority treatment based on regional/national or operator policies.

private communication: a communication between two or more UEs belonging to a restricted set of UEs.

private network: an isolated network deployment that does not interact with a public network.

private slice: a dedicated network slice deployment for the sole use by a specific third-party.

relative positioning: relative positioning is to estimate position relatively to other network elements or relatively to other UEs.

reliability: in the context of network layer packet transmissions, percentage value of the packets successfully delivered to a given system entity within the time constraint required by the targeted service out of all the packets transmitted.

satellite: a space-borne vehicle embarking a bent pipe payload or a regenerative payload telecommunication transmitter, placed into Low-Earth Orbit (LEO) typically at an altitude between 300 km to 2 000 km, Medium-Earth Orbit (MEO) typically at an altitude between 8 000 to 20 000 km, or Geostationary satellite Earth Orbit (GEO) at 35 786 km altitude.

satellite access: direct connectivity between the UE and the satellite.

satellite NG-RAN: a NG-RAN which uses NR in providing satellite access to UEs.

service area: geographic region where a 3GPP communication service is accessible.

NOTE 6: The service area can be indoors.

NOTE 7: For some deployments, e.g. in process industry, the vertical dimension of the service area can be considerable.

service continuity: the uninterrupted user experience of a service that is using an active communication when a UE undergoes an access change without, as far as possible, the user noticing the change.

NOTE 8: In particular service continuity encompasses the possibility that after a change the user experience is maintained by a different telecommunication service (e.g. tele- or bearer service) than before the change.

NOTE 9: Examples of access changes include the following. For EPS: CS/PS domain change. For EPS and 5G: radio access change, switching between a direct network connection and an indirect network connection.

Service Hosting Environment: the environment, located inside of 5G network and fully controlled by the operator, where Hosted Services are offered from.

survival time: the time that an application consuming a communication service may continue without an anticipated message.

Time to First Fix (TTFF): time elapsed between the event triggering for the first time the determination of the position-related data and the availability of the position-related data at the positioning system interface.

User Equipment: An equipment that allows a user access to network services via 3GPP and/or non-3GPP accesses.

user experienced data rate: the minimum data rate required to achieve a sufficient quality experience, with the exception of scenario for broadcast like services where the given value is the maximum that is needed.

wireless backhaul: a link which provides an interconnection between 5G network nodes and/or transport network using 5G radio access technology.

3.2 Abbreviations

For the purposes of the present document, the abbreviations given in 3GPP TR 21.905 [1] and the following apply. An abbreviation defined in the present document takes precedence over the definition of the same abbreviation, if any, in 3GPP TR 21.905 [1].

5G LAN-VN	5G LAN-Virtual Network
A/S	Actuator/Sensor
eFMSS	Enhancement to Flexible Mobile Service Steering
eV2X	Enhanced V2X
FMSS	Flexible Mobile Service Steering
GEO	Geostationary satellite Earth Orbit
ICP	Internet Content Provider
ID	Identification
IMU	Inertial Measurement Unit
IOPS	Isolated E-UTRAN Operation for Public Safety

LEO	Low-Earth Orbit
MCS	Mission Critical Services
MCX	Mission Critical X, with X = PTT or X = Video or X = Data
MEO	Medium-Earth Orbit
MIoT	Massive Internet of Things
MMTEL	Multimedia Telephony
MPS	Multimedia Priority Service
MSGin5G	Message Service Within the 5G System
NPN	Non-Public Network
RSTP	Rapid Spanning Tree Protocol
SEES	Service Exposure and Enablement S
SST	Slice/Service Type
TTFB	Time To First Fix
UAV	Uncrewed Aerial Vehicle

4 Overview

Unlike previous 3GPP systems that attempted to provide a 'one size fits all' system, the 5G system is expected to be able to provide optimized support for a variety of different services, different traffic loads, and different end user communities. Various industry white papers, most notably, the NGMN 5G White Paper [2], describe a multi-faceted 5G system capable of simultaneously supporting multiple combinations of reliability, latency, throughput, positioning, and availability. This technology revolution is achievable with the introduction of new technologies, both in access and the core, such as flexible, scalable assignment of network resources. In addition to increased flexibility and optimization, a 5G system needs to support stringent KPIs for latency, reliability, throughput, etc. Enhancements in the radio interface contribute to meeting these KPIs as do enhancements in the core network, such as network slicing, in-network caching and hosting services closer to the end points.

A 5G system also supports new business models such as those for IoT and enterprise managed networks. Drivers for the 5G KPIs include services such as Uncrewed Aerial Vehicle (UAV) control, Augmented Reality (AR), and factory automation. Network flexibility enhancements support self-contained enterprise networks, installed and maintained by network operators while being managed by the enterprise. Enhanced connection modes and evolved security facilitate support of massive IoT, expected to include tens of millions of UEs sending and receiving data over the 5G network.

Flexible network operations are the mainstay of the 5G system. The capabilities to provide this flexibility include network slicing, network capability exposure, scalability, and diverse mobility. Other network operations requirements address the necessary control and data plane resource efficiencies, as well as network configurations that optimize service delivery by minimizing routing between end users and application servers. Enhanced charging and security mechanisms handle new types of UEs connecting to the network in different ways.

Mobile Broadband (MBB) enhancements aim to meet a number of new KPIs. These pertain to high data rates, high user density, high user mobility, highly variable data rates, deployment, and coverage. High data rates are driven by the increasing use of data for services such as streaming (e.g. video, music, and user generated content), interactive services (e.g. AR), and IoT. These services come with stringent requirements for user experienced data rates as well as associated requirements for latency to meet service requirements. Additionally, increased coverage in densely populated areas such as sports arenas, urban areas, and transportation hubs has become essential for pedestrians and users in urban vehicles. New KPIs on traffic and connection density enable both the transport of high volumes of data traffic per area (traffic density) and transport of data for a high number of connections (e.g. UE density or connection density). Many UEs are expected to support a variety of services which exchange either a very large (e.g. streaming video) or very small (e.g. data burst) amount of data. The 5G system will handle this variability in a resource efficient manner. All of these cases introduce new deployment requirements for indoor and outdoor, local area connectivity, high user density, wide area connectivity, and UEs travelling at high speeds.

Another aspect of 5G KPIs includes requirements for various combinations of latency and reliability, as well as higher accuracy for positioning. These KPIs are driven by support for both commercial and public safety services. On the commercial side, industrial control, industrial automation, UAV control, and AR are examples of those services. Services such as UAV control will require more precise positioning information that includes altitude, speed, and direction, in addition to horizontal coordinates.

Support for Massive Internet of Things (MIoT) brings many new requirements in addition to those for the enhanced KPIs. The expansion of connected things introduces a need for significant improvements in resource efficiency in all system components (e.g. UEs, IoT devices, radio, access network, core network).

The 5G system also aims to enhance its capability to meet KPIs that emerging V2X applications require. For these advanced applications, the requirements, such as data rate, reliability, latency, communication range and speed, are made more stringent.

5 High-level requirements

5.1 Migration to 5G

5.1.1 Description

The 5G system supports most of the existing EPS services, in addition to many new services. The existing EPS services may be accessed using the new 5G access technologies even where the EPS specifications might indicate E-UTRA(N) only. Only new or changed service requirements for new or changed services are specified in this TS. The few EPS capabilities that are not supported by the 5G system are identified in clause 5.1.2.2 below.

5.1.2 Requirements

5.1.2.1 Interworking between 5G systems

The 5G system shall support a UE with a 5G subscription roaming into a 5G Visited Mobile Network which has a roaming agreement with the UE's 5G Home Mobile Network.

The 5G system shall enable a Visited Mobile Network to provide support for establishing home network provided data connectivity as well as visited network provided data connectivity.

The 5G system shall enable a Visited Mobile Network to provide support for services provided in the home network as well as provide services in the visited network. Whether a service is provided in the visited network or in the home network is determined on a service by service basis.

The 5G system shall provide a mechanism for a network operator to limit access to its services for a roaming UE, (e.g. based on roaming agreement).

The 5G system shall provide a mechanism for a network operator to direct a UE onto a partnership network for routing all or some of the UE user plane and associated control plane traffic over the partnership network, subject to an agreement between the operators.

5.1.2.2 Legacy service support

In principle, the 5G system shall support all EPS capabilities (e.g. from TSs 22.011, 22.101, 22.278, 22.185, 22.071, 22.115, 22.153, 22.173, 22.468). However,

- voice service continuity from NG-RAN to GERAN shall not be supported,
- voice service continuity from NG-RAN to UTRAN CS should be supported (see Note),
- voice service continuity from GERAN to NG-RAN shall not be supported,
- voice service continuity from UTRAN to NG-RAN shall not be supported,
- CS fallback from NG-RAN to GERAN shall not be supported,
- CS fallback from NG-RAN to UTRAN shall not be supported,
- seamless handover between NG-RAN and GERAN shall not be supported,
- seamless handover between NG-RAN and UTRAN shall not be supported,
- access to a 5G core network via GERAN or UTRAN shall not be supported,
- video service continuity between 5GS and UMTS shall not be supported,

- IP address preservation for PS service when UE moves between 5GS and GSM/UMTS shall not be supported, and
- Service continuity between 5GS and CDMA2000 shall not be supported.

NOTE: Architectural or protocol changes needed to support voice service continuity from NG-RAN to UTRAN CS are expected to have minimum impact on architecture, specifications, or the development of the 5G New Core and New Radio.

5.1.2.3 Interoperability with legacy 3GPP systems

The 5G system shall support mobility procedures between a 5G core network and an EPC with minimum impact to the user experience (e.g. QoS, QoE).

6 Basic capabilities

6.1 Network slicing

6.1.1 Description

Network slicing allows the operator to provide customised networks. For example, there can be different requirements on functionality (e.g. priority, charging, policy control, security, and mobility), differences in performance requirements (e.g. latency, mobility, availability, reliability and data rates), or they can serve only specific users (e.g. MPS users, Public Safety users, corporate customers, roamers, or hosting an MVNO).

A network slice can provide the functionality of a complete network, including radio access network functions, core network functions (e.g. potentially from different vendors) and IMS functions. One network can support one or several network slices.

6.1.2 Requirements

6.1.2.1 General

The serving 5G network shall support providing connectivity to home and roaming users in the same network slice.

In shared 5G network configuration, each operator shall be able to apply all the requirements from this clause to their allocated network resources.

The 5G system shall be able to support IMS as part of a network slice.

The 5G system shall be able to support IMS independent of network slices.

6.1.2.2 Management

The 5G system shall allow the operator to create, modify, and delete a network slice.

The 5G system shall allow the operator to define and update the set of services and capabilities supported in a network slice.

The 5G system shall allow the operator to configure the information which associates a UE to a network slice.

The 5G system shall allow the operator to configure the information which associates a service to a network slice.

The 5G system shall allow the operator to assign a UE to a network slice, to move a UE from one network slice to another, and to remove a UE from a network slice based on subscription, UE capabilities, the access technology being used by the UE, operator's policies and services provided by the network slice.

The 5G system shall support a mechanism for the VPLMN, as authorized by the HPLMN, to assign a UE to a network slice with the needed services or to a default network slice.

The 5G system shall enable a UE to be simultaneously assigned to and access services from more than one network slice of one operator.

Traffic and services in one network slice shall have no impact on traffic and services in other network slices in the same network.

Creation, modification, and deletion of a network slice shall have no or minimal impact on traffic and services in other network slices in the same network.

The 5G system shall support scaling of a network slice, i.e. adaptation of its capacity.

The 5G system shall enable the network operator to define a minimum available capacity for a network slice. Scaling of other network slices on the same network shall have no impact on the availability of the minimum capacity for that network slice.

The 5G system shall enable the network operator to define a maximum capacity (e.g., number of UEs, number of data sessions) for a network slice.

The 5G system shall enable the network operator to define a priority order between different network slices in case multiple network slices compete for resources on the same network.

The 5G system shall support means by which the operator can differentiate policy control, functionality and performance provided in different network slices.

6.1.2.3 Network slice constraints

The 5G system shall support a mechanism to prevent a UE from trying to access a radio resource dedicated to a specific private slice for any purpose other than that authorized by the associated third-party.

NOTE 1: UEs that are not authorized to access a specific private slice will not be able to access it for emergency calls if the private slice does not support emergency services.

The 5G system shall support a mechanism to configure a specific geographic area in which a network slice is accessible, i.e. a UE shall be within the geographical area in order to access the network slice.

The 5G system shall support a mechanism to limit a UE to only receiving service from an authorized slice.

The 5G system shall support a mechanism to prevent a UE from registering with a network slice when the maximum number of UEs for that slice are registered.

The 5G system shall support a mechanism to prevent a UE from establishing a new data session within a network slice when the maximum number of data sessions for that slice are established.

NOTE 2: Based on national/regional regulations and operator policy, exemptions can be provided for UEs configured for priority services (e.g., MPS) and for priority service sessions.

6.1.2.4 Cross-network slice coordination

The 5G system shall support a mechanism to provide time stamps with a common time base at the monitoring API, for services that cross multiple network slices and 5G networks.

The 5G system shall provide suitable APIs to coordinate network slices in multiple 5G networks so that the selected communication services of a non-public network can be extended through a PLMN (e.g. the service is supported by a slice in the non-public network and a slice in the PLMN).

The 5G system shall provide a mechanism to enable an MNO to operate a hosted non-public network and private slice(s) of its PLMN associated with the hosted non-public network in a combined manner.

6.2 Diverse mobility management

6.2.1 Description

A key feature of 5G is support for UEs with different mobility management needs. 5G will support UEs with a range of mobility management needs, including UEs that are

- stationary during their entire usable life (e.g. sensors embedded in infrastructure),
- stationary during active periods, but nomadic between activations (e.g. fixed access),
- mobile within a constrained and well-defined space (e.g. in a factory), and
- fully mobile.

Moreover, some applications require the network to ensure seamless mobility of a UE so that mobility is hidden from the application layer to avoid interruptions in service delivery while other applications have application specific means to ensure service continuity. But these other applications may still require the network to minimize interruption time to ensure that their application-specific means to ensure service continuity work effectively.

With the ever-increasing multimedia broadband data volumes, it is also important to enable the offloading of IP traffic from the 5G network onto traditional IP routing networks via an IP anchor node close to the network edge. As the UE moves, changing the IP anchor node may be needed in order to reduce the traffic load in the system, reduce end-to-end latency and provide a better user experience.

The flexible nature of a 5G system will support different mobility management methods that minimize signalling overhead and optimize access for these different types of UEs.

6.2.2 General requirements

The 5G network shall allow operators to optimize network behaviour (e.g. mobility management support) based on the mobility patterns (e.g. stationary, nomadic, spatially restricted mobility, full mobility) of a UE or group of UEs.

The 5G system shall enable operators to specify and modify the types of mobility support provided for a UE or group of UEs.

The 5G system shall optimize mobility management support for a UE or group of UEs that use only mobile originated communications.

The 5G system shall support inter- and/or intra- access technology mobility procedures within 5GS with minimum impact to the user experience (e.g. QoS, QoE).

6.2.3 Service continuity requirements

The 5G system shall enable packet loss to be minimized during inter- and/or intra- access technology changes for some or all connections associated with a UE.

The 5G system shall minimize interruption time during inter- and/or intra- access technology mobility for some or all connections associated with a UE.

NOTE: The interruption time includes all delays which have impact on service continuity.

For applications that require the same IP address during the lifetime of the session, the 5G system shall enable maintaining the IP address assigned to a UE when moving across different cells and access technologies for connections associated with a UE.

The 5G system shall enable minimizing impact to the user experience (e.g. minimization of interruption time) when changing the IP address and IP anchoring point for some or all connections associated with a UE.

The 5G system shall support service continuity for a remote UE, when the remote UE changes from a direct network connection to an indirect network connection and vice-versa.

The 5G system shall support service continuity for a remote UE, when the remote UE changes from one relay UE to another and both relay UEs use 3GPP access to the 5G core network.

For a 5G system with satellite access, the following requirements apply:

- The 5G system shall support service continuity between 5G terrestrial access network and 5G satellite access networks owned by the same operator or owned by different operators having an agreement.

6.2.4 Roaming related requirements

For a 5G system with satellite access, the following requirements apply:

- A 5G system with satellite access shall enable roaming of UE supporting both satellite access and terrestrial access between 5G satellite networks and 5G terrestrial networks.
- UEs supporting satellite access shall support optimized network selection and reselection to PLMNs with satellite access, based on home operator policy.

6.3 Multiple access technologies

6.3.1 Description

The 5G system will support 3GPP access technologies, including one or more NR and E-UTRA as well as non-3GPP access technologies. Interoperability among the various access technologies will be imperative. For optimization and resource efficiency, the 5G system will select the most appropriate 3GPP or non-3GPP access technology for a service, potentially allowing multiple access technologies to be used simultaneously for one or more services active on a UE. New technology such as satellite and wide area base stations will increase coverage and availability. This clause provides requirements for interworking with the various combinations of access technologies.

6.3.2 Requirements

6.3.2.1 General

Based on operator policy, the 5G system shall enable the UE to select, manage, and efficiently provision services over the 3GPP or non-3GPP access.

Based on operator policy, the 5G system shall support steering a UE to select certain 3GPP access network(s).

Based on operator policy, the 5G system shall be able to dynamically offload part of the traffic (e.g. from 3GPP RAT to non-3GPP access technology), taking into account traffic load and traffic type.

Based on operator policy, the 5G system shall be able to provide simultaneous data transmission via different access technologies (e.g. NR, E-UTRA, non-3GPP), to access one or more 3GPP services.

When a UE is using two or more access technologies simultaneously, the 5G system shall be able to optimally distribute user traffic over select between access technologies in use, taking into account e.g. service, traffic characteristics, radio characteristics, and UE's moving speed.

The 5G system shall be able to support data transmissions optimized for different access technologies (e.g. 3GPP, non-3GPP) for UEs that are simultaneously connected to the network via different accesses.

Based on operator policy, the 5G system shall be able to add or drop the various access connections for a UE during a session.

The 5G system shall be able to support mobility between the supported access networks (e.g. NG-RAN, WLAN, fixed broadband access network, 5G satellite access network).

The 5G system shall support UEs with multiple radio and single radio capabilities.

The 5G system shall support dynamic and static network address allocation of a common network address to the UE over all supported access types.

The 5G system shall support a set of identities for a single user in order to provide a consistent set of policies and a single set of services across 3GPP and non-3GPP access types.

The 5G system shall support the capability to operate in licensed and/or unlicensed bands.

6.3.2.2 E-UTRA access

The 5G system shall be able to support seamless handover between NR and E-UTRA.

The 5G system shall support UEs with dual radio capability (i.e. a UE that can transmit on NR and E-UTRA simultaneously) as well as UEs with single radio capability (i.e. a UE that cannot transmit on NR and E-UTRA simultaneously).

6.3.2.3 Satellite access

The 5G system shall be able to provide services using satellite access.

A 5G system with satellite access shall support different configurations where the radio access network is either a satellite NG-RAN or a non-3GPP satellite access network, or both.

A UE supporting satellite access shall be able to provide or assist in providing its location to the 5G network.

A 5G system with satellite access shall be able to determine a UE's location in order to provide service (e.g. route traffic, support emergency calls) in accordance with the governing national or regional regulatory requirements applicable to that UE.

The 5G system with satellite access shall be able to support low power MIoT type of communications.

6.3.2.4 Fixed broadband access

The 5G system shall be able to efficiently support connectivity using fixed broadband access.

NOTE: The specification of fixed broadband access network is outside the scope of 3GPP.

The 5G system shall support use of a relay UE that supports multiple access types (e.g. 5G RAT, WLAN access, fixed broadband access).

The 5G system shall support use of a home base station that supports multiple access types (e.g. 5G RAT, WLAN access, fixed broadband access).

6.4 Resource efficiency

6.4.1 Description

5G introduces the opportunity to design a system to be optimized for supporting diverse UEs and services. While support for IoT is provided by EPS, there is room for improvement in efficient resource utilization that can be designed into a 5G system whereas they are not easily retrofitted into an existing system. Some of the underlying principles of the potential service and network operation requirements associated with efficient configuration, deployment, and use of UEs in the 5G network include bulk provisioning, resource efficient access, optimization for UE originated data transfer, and efficiencies based on the reduced needs related to mobility management for stationary UEs and UEs with restricted range of movement.

As sensors and monitoring UEs are deployed more extensively, the need to support UEs that send data packages ranging in size from a small status update in a few bits to streaming video increases. A similar need exists for smart phones with widely varying amounts of data. Specifically, to support short data bursts, the network should be able to operate in a mode where there is no need for a lengthy and high overhead signalling procedure before and after small amounts of data are sent. The system will, as a result, avoid both a negative impact to battery life for the UE and wasting signalling resources.

For small form factor UEs it will be challenging to have more than 1 antenna due to the inability to get good isolation between multiple antennas. Thus, these UEs need to meet the expected performance in a 5G network with only one antenna.

Cloud applications like cloud robotics perform computation in the network rather than in a UE, which requires the system to have high data rate in the uplink and very low round trip latency. Supposed that high density cloud robotics will be deployed in the future, the 5G system need to optimize the resource efficiency for such scenario.

Additional resource efficiencies will contribute to meeting the various KPIs defined for 5G. Control plane resource efficiencies can be achieved by optimizing and minimizing signalling overhead, particularly for small data transmissions. Mechanisms for minimizing user plane resources utilization include in-network caching and application in a Service Hosting Environment closer to the end user. These optimization efforts contribute to achieving lower latency and higher reliability.

Diverse mobility management related resource efficiencies are covered in clause 6.2.

Security related resource efficiencies are covered in clause 8.8.

6.4.2 Requirements

6.4.2.1 General

The 5G system shall minimize control and user plane resource usage for data transfer from send only UEs.

The 5G system shall minimize control and user plane resource usage for stationary UEs (e.g. lower signalling to user data resource usage ratio).

The 5G system shall minimize control and user plane resource usage for transfer of infrequent small data units.

The 5G system shall optimize the resource use of the control plane and/or user plane for transfer of small data units.

The 5G system shall optimize the resource use of the control plane and/or user plane for transfer of continuous uplink data that requires both high data rate (e.g. 10 Mbit/s) and very low end-to-end latency (e.g. 1-10 ms).

The 5G network shall optimize the resource use of the control plane and/or user plane to support high density connections (e.g. 1 million connections per square kilometre) taking into account, for example, the following criteria:

- type of mobility support;
- communication pattern (e.g. send-only, frequent or infrequent);
- characteristics of payload (e.g. small or large size data payload);
- characteristics of application (e.g. provisioning operation, normal data transfer);
- UE location;
- timing pattern of data transfer (e.g. real time or non-delay sensitive).

The 5G system shall efficiently support service discovery mechanisms where UEs can discover, subject to access rights:

- status of other UEs (e.g. sound on/off);
- capabilities of other UEs (e.g. the UE is a relay UE) and/or;
- services provided by other UEs (e.g. the UE is a colour printer).

The 5G system shall be able to minimise the amount of wireless backhaul traffic (e.g. consolidating data transmissions to 1 larger rather than many smaller), when applicable (e.g. providing service in an area subject to power outages).

The 5G system shall support small form factor UEs with single antenna.

NOTE: Small form factor UEs are typically expected to have the diagonal less than 1/5 of the lowest supported frequency wave length.

For a 5G system with satellite access, the following requirements apply:

- The 5G system with satellite access shall support the use of satellite links between the radio access network and core network, by enhancing the 3GPP system to handle the latencies introduced by satellite backhaul.

- A 5G system with satellite access shall be able to support meshed connectivity between satellites interconnected with intersatellite links.

6.4.2.2 Efficient bulk operations for IoT

The 5G network shall optimize the resource use of the control plane and/or user plane to support bulk operation for high connection density (e.g. 1 million connections per square kilometre) of multiple UEs.

The 5G system shall support a timely, efficient, and/or reliable mechanism to transmit the same information to multiple UEs.

6.4.2.3 Efficient management for IoT

The 5G network shall optimize the resource use of the control plane and/or user plane to manage (e.g. provide service parameters, activate, deactivate) a UE.

The 5G network shall be able to provide policies for background data transfer to a UE so that the 5G system can optimally use the control plane and/or user plane resources.

6.4.2.4 Efficient control plane

The 5G system shall minimize the signalling that is required prior to user data transmission.

- NOTE: The amount of signalling overhead may vary based on the amount of data to be transmitted, even for the same UE.

6.5 Efficient user plane

6.5.1 Description

5G is designed to meet diverse services with different and enhanced performances (e.g. high throughput, low latency and massive connections) and data traffic model (e.g. IP data traffic, non-IP data traffic, short data bursts and high throughput data transmissions).

User plane should be more efficient for 5G to support differentiated requirements. On one hand, a Service Hosting Environment located inside of operator's network can offer Hosted Services closer to the end user to meet localization requirement like low latency, low bandwidth pressure. These Hosted Services contain applications provided by operators and/or trusted 3rd parties. On the other hand, user plane paths can be selected or changed to improve the user experience or reduce the bandwidth pressure, when a UE or application changes location during an active communication.

6.5.2 Requirements

Based on operator policy, application needs, or both, the 5G system shall support an efficient user plane path between UEs attached to the same network, modifying the path as needed when the UE moves during an active communication.

The 5G network shall enable a Service Hosting Environment provided by operator.

Based on operator policy, the 5G network shall be able to support routing of data traffic between a UE attached to the network and an application in a Service Hosting Environment for specific services, modifying the path as needed when the UE moves during an active communication.

Based on operator policy, application needs, or both, the 5G system shall support an efficient user plane path, modifying the path as needed when the UE moves or application changes location, between a UE in an active communication and:

- an application in a Service Hosting Environment; or
- an application server located outside the operator's network.

The 5G network shall maintain user experience (e.g. QoS, QoE) when a UE in an active communication moves from a location served by a Service Hosting Environment to:

- another location served by a different Service Hosting Environment; or
- another location served by an application server located outside the operator's network, and vice versa.

The 5G network shall maintain user experience (e.g. QoS, QoE) when an application for a UE moves as follows:

- within a Service Hosting Environment; or
- from a Service Hosting Environment to another Service Hosting Environment; or
- from a Service Hosting Environment to an application server located place outside the operator's network, and vice versa.

The 5G network shall be able to interact with applications in a Service Hosting Environment for efficient network resource utilization and offloading data traffic to the Service Hosting Environment close to the UE's point of attachment to the access network.

The 5G network shall support configurations of the Service Hosting Environment in the network (e.g. access network, core network), that provide application access close to the UE's point of attachment to the access network.

The 5G system shall support mechanisms to enable a UE to access the closest Service Hosting Environment for a specific hosted application or service.

The 5G network shall enable instantiation of applications for a UE in a Service Hosting Environment close to the UE's point of attachment to the access network.

The 5G system shall be able to suspend or stop application instances in a Service Hosting Environment.

NOTE: Not all applications will always be available in all Service Hosting Environments. Therefore, it may be needed to instantiate an application at a Service Hosting Environment nearby for serving a particular UE.

Based on operator policy, the 5G system shall provide a mechanism such that one type of traffic (from a specific application or service) to/from a UE can be offloaded close to the UE's point of attachment to the access network, while not impacting other traffic type to/from that same UE.

For a 5G system with satellite access, the following requirements apply:

- A 5G system with satellite access shall be able to select the communication link providing the UE with the connectivity that most closely fulfils the agreed QoS
- A 5G system with satellite access shall be capable of supporting simultaneous use of 5G satellite access network and 5G terrestrial access networks.
- A 5G system with satellite access shall be able to support both UEs supporting only satellite access and UEs supporting simultaneous connectivity to 5G satellite access network and 5G terrestrial access network.

The 5G System shall enable the discovery of a suitable Hosted Service.

6.6 Efficient content delivery

6.6.1 Description

Video-based services (e.g. live streaming, VR) and personal data storage applications have been instrumental for the massive growth in mobile broadband traffic. Subject to service agreement between the operator and the content provider, the information of content and content itself can be aware by operator. In-network content caching provided by the operator, a third-party or both, can improve user experience, reduce backhaul resource usage and utilize radio resource efficiently.

The operation of in-network caching includes flexible management of the location of the content cache within the network and efficient delivery of content to and from the appropriate content caching application. Examples of services are the delivery of popular video content from a content caching application via broadcast, and secure storage of a user's

personal data or files using a distributed caching application. Such a service could also provide a student with a wireless backpack, where students can resume their work through the same or a different UE at any time, with very fast response times from the network.

6.6.2 Requirements

The 5G system shall enable efficient delivery of content from a content caching application under the control of the operator (e.g. a cache located close to the UE).

The 5G system shall support a content caching application in a UE under the control of the operator.

The 5G system shall support configurations of content caching applications in the network (e.g. access network, core network), that provide content close to the UE.

Based on operator policy, the 5G system shall support an efficient mechanism for selection of a content caching application (e.g. minimize utilization of radio, backhaul resources and/or application resource) for delivery of the cached content to the UE.

The 5G system shall support a mechanism for the operator to manage content distribution across content caching applications.

The 5G system shall support delivery of cached content from a content caching application via the broadcast/multicast service.

For a 5G system with satellite access, the following requirement applies.

- A 5G system with satellite access shall be able to optimise the delivery of content from a content caching application by taking advantage of satellites in supporting ubiquitous service, as well as broadcasting/multicasting on very large to global coverages.

6.7 Priority, QoS, and policy control

6.7.1 Description

The 5G network will support many commercial services (e.g. medical) and regional or national regulatory services (e.g. MPS, Emergency, Public Safety) with requirements for priority treatment. Some of these services share common QoS characteristics such as latency and packet loss rate but may have different priority requirements. For example, UAV control and air traffic control may have stringent latency and reliability requirements but not necessarily the same priority requirements. In addition, voice-based services for MPS and Emergency share common QoS characteristics as applicable for normal public voice communications yet may have different priority requirements. The 5G network will need to support mechanisms that enable the decoupling of the priority of a particular communication from the associated QoS characteristics such as latency and reliability to allow flexibility to support different priority services (that need to be configurable to meet operator needs, consistent with operator policies and corresponding national and regional regulatory policies).

The network needs to support flexible means to make priority decisions based on the state of the network (e.g. during disaster events and network congestion) recognizing that the priority needs may change during a crisis. The priority of any service may need to be different for a user of that service based on operational needs and regional or national regulations. Therefore, the 5G system should allow a flexible means to prioritise and enforce prioritisation among the services (e.g. MPS, Emergency, medical, Public Safety) and among the users of these services. The traffic prioritisation may be enforced by adjusting resource utilization or pre-empting lower priority traffic.

The network must offer means to provide the required QoS (e.g. reliability, latency, and bandwidth) for a service and the ability to prioritize resources when necessary to meet the service requirements. Existing QoS and policy frameworks handle latency and improve reliability by traffic engineering. In order to support 5G service requirements, it is necessary for the 5G network to offer QoS and policy control for reliable communication with latency required for a service and enable the resource adaptations as necessary.

The network needs to allow multiple services to coexist, including multiple priority services (e.g. Emergency, MPS and MCS) and must provide means to prevent a single service from consuming or monopolizing all available network resources, or impacting the QoS (e.g. availability) of other services competing for resources on the same network under specific network conditions. For example, it is necessary to prevent certain services (e.g. citizen-to-authority

Emergency) sessions from monopolizing all available resources during events such as disaster, emergency, and DDoS attacks from impacting the availability of other priority services such as MPS and MCS.

Also, as 5G network is expected to operate in a heterogeneous environment with multiple access technologies, multiple types of UE, etc., it should support a harmonised QoS and policy framework that applies to multiple accesses.

Further, for QoS control in EPS only covers RAN and core network, but for 5G network E2E QoS (e.g. RAN, backhaul, core network, network to network interconnect) is needed to achieve the 5G user experience (e.g. ultra-low latency, ultra-high bandwidth).

6.7.2 Requirements

The 5G system shall allow flexible mechanisms to establish and enforce priority policies among the different services (e.g. MPS, Emergency, medical, Public Safety) and users.

NOTE 1: Priority between different services is subject to regional or national regulatory and operator policies.

The 5G system shall be able to provide the required QoS (e.g. reliability, end-to-end latency, and bandwidth) for a service and support prioritization of resources when necessary for that service.

The 5G system shall enable the network operator to define and statically configure a maximum resource assignment for a specific service that can be adjusted based on the network state (e.g. during congestion, disaster, emergency and DDoS events) subject to regional or national regulatory and operator policies.

The 5G system shall allow decoupling of the priority of a particular communication from the associated QoS characteristics such as end-to-end latency and reliability.

The 5G system shall be able to support a harmonised QoS and policy framework applicable to multiple accesses.

The 5G system shall be able to support E2E (e.g. UE to UE) QoS for a service.

NOTE 2: E2E QoS needs to consider QoS in the access networks, backhaul, core network, and network to network interconnect.

The 5G system shall be able to support QoS for applications in a Service Hosting Environment.

A 5G system with multiple access technologies shall be able to select the combination of access technologies to serve an UE on the basis of the targeted priority, pre-emption, QoS parameters and access technology availability.

6.8 Dynamic policy control

The 5G system shall support the creation and enforcement of prioritisation policy for users and traffic, during connection setup and when connected.

NOTE: Prioritisation, pre-emption, and precedence of critical traffic associated with certain priority services (e.g. MPS and Emergency) are subject to regional/national regulatory and operator policies.

The 5G system shall support optimised signalling for prioritised users and traffic where such signalling is prioritized over other signalling traffic.

Based on operator policy, the 5G system shall allow flexible means for authorized entities to create and enforce priority among the different service flows.

Based on operator policy, the 5G system shall support a real-time, dynamic, secure and efficient means for authorized entities (e.g. users, context aware network functionality) to modify the QoS and policy framework. Such modifications may have a variable duration.

Based on operator policy, the 5G system shall maintain a session when prioritization of that session changes in real time, provided that the new priority is above the threshold for maintaining the session.

6.9 Connectivity models

6.9.1 Description

The UE (remote UE) can connect to the network directly (direct network connection), connect using another UE as a relay UE (indirect network connection), or connect using both direct and indirect connections. Relay UEs can be used in many different scenarios and verticals (inHome, SmartFarming, SmartFactories, Public Safety and others). In these cases, the use of relays UEs can be used to improve the energy efficiency and coverage of the system.

Remote UEs can be anything from simple wearables, such as sensors embedded in clothing, to a more sophisticated wearable UE monitoring biometrics. They can also be non-wearable UEs that communicate in a Personal Area Network such as a set of home appliances (e.g. smart thermostat and entry key), or the electronic UEs in an office setting (e.g. smart printers), or a smart flower pot that can be remotely activated to water the plant.

When a remote UE is attempting to establish an indirect network connection, there might be several relay UEs that are available in proximity and supporting selection procedures of an appropriate relay UE among the available relay UEs is needed.

Indirect network connection covers the use of relay UEs for connecting a remote UE to the 3GPP network. There can be one or more relay UE(s) (more than one hop) between the network and the remote UE.

6.9.2 Requirements

The following set of requirements complement the requirements listed in 3GPP TS 22.278 [5], clauses 7B and 7C.

6.9.2.1 General

The 5G system shall support the relaying of traffic between a remote UE and a gNB using one or more relay UEs.

The 5G system shall support different traffic flows of a remote UE to be relayed via different indirect network connection paths.

The connection between a remote UE and a relay UE shall be able to use 3GPP RAT or non-3GPP RAT and use licensed or unlicensed band.

The connection between a remote UE and a relay UE shall be able to use fixed broadband technology.

The 5G system shall support indirect network connection mode in a VPLMN when a remote UE and a relay UE subscribe to different PLMNs and both PLMNs have a roaming agreement with the VPLMN.

The 5G system shall be able to support a UE using simultaneous indirect and direct network connection mode.

The network operator shall be able to define the maximum number of hops supported in their networks when using relay UEs.

6.9.2.2 Services and Service Continuity

A 5G system shall be able to support all types of traffic e.g. voice, data, IoT small data, multimedia, MCX for indirect network connection mode.

The 5G system shall be able to support QoS for a user traffic session between the remote UE and the network using 3GPP access technology.

The 5G system shall be able to provide indication to a remote UE (alternatively, an authorized user) on the quality of currently available indirect network connection paths.

The 5G system shall be able to maintain service continuity of indirect network connection for a remote UE when the communication path to the network changes (i.e. change of one or more of the relay UEs, change of the gNB).

6.9.2.3 Permission and Authorization

The 5G system shall enable the network operator to authorize a UE to use indirect network connection. The authorization shall be able to be restricted to using only relay UEs belonging to the same network operator. The authorization shall be able to be restricted to only relay UEs belonging to the same application layer group.

The 5G system shall enable the network operator to authorize a UE to relay traffic as relay UE. The authorization shall be able to allow relaying only for remote UEs belonging to the same network operator. The authorization shall be able to allow relaying only for remote UEs belonging to the same application layer group.

The 5G system shall support a mechanism for an end user to provide/revoke permission to an authorized UE to act as a relay UE.

The 5G system shall support a mechanism for an authorized third-party to provide/revoke permission to an authorized UE to act as a relay UE.

The 5G system shall provide a suitable API by which an authorized third-party shall be able to authorize (multiple) UEs under control of the third-party to act as a relay UE or remote UE.

The 5G system shall provide a suitable API by which an authorized third-party shall be able to enable/disable (multiple) UEs under control of the third-party to act as a relay UE or remote UE.

6.9.2.4 Relay UE Selection

The 3GPP system shall support selection and reselection of relay UEs based on a combination of different criteria e.g.

- the characteristics of the traffic that is intended to be relayed (e.g. expected message frequency and required QoS),
- the subscriptions of relay UEs and remote UE,
- the capabilities/capacity/coverage when using the relay UE,
- the QoS that is achievable by selecting the relay UE_x,
- the power consumption required by relay UE and remote UE_x,
- the pre-paired relay UE_x,
- the 3GPP or non-3GPP access the relay UE uses to connect to the network,
- the 3GPP network the relay UE connects to (either directly or indirectly),
- the overall optimization of the power consumption/performance of the 3GPP system, or
- battery capabilities and battery lifetime of the relay UE and the remote UE.

NOTE: Reselection may be triggered by any dynamic change in the selection criteria, e.g. by the battery of a relay UE getting depleted, a new relay capable UE getting in range, a remote UEs requesting additional resources or higher QoS, etc.

6.9.2.5 Satellite and Relay UEs

For a 5G system with satellite access, the following requirements apply:

- A 5G system with satellite access shall be able to support relay UE's with satellite access.

NOTE: The connection between a relay UE and a remote UE is the same regardless of whether the relay UE is using satellite access or not.

- A 5G system with satellite access shall support mobility management of relay UEs and the remote UEs connected to the relay UE between a 5G satellite access network and a 5G terrestrial network, and between 5G satellite access networks.
- A 5G system with satellite access shall support joint roaming between different 5G networks of a relay UE and the remote UEs connected to that relay UE.

6.10 Network capability exposure

6.10.1 Description

3GPP SEES and (e)FMSS features allow the operator to expose network capabilities e.g. QoS policy to third-party ISPs/ICPs. With the advent of 5G, new network capabilities need to be exposed to the third-party (e.g. to allow the third-party to customize a dedicated physical or virtual network or a dedicated network slice for diverse use cases; to allow the third-party to manage a trusted third-party application in a Service Hosting Environment to improve user experience, and efficiently utilize backhaul and application resources).

6.10.2 Requirements

The following set of requirements complement the requirements listed in 3GPP TS 22.101 [6], clause 29.

Based on operator policy, a 5G network shall provide suitable APIs to allow a trusted third-party to create, modify, and delete network slices used for the third-party.

Based on operator policy, the 5G network shall provide suitable APIs to allow a trusted third-party to monitor the network slice used for the third-party.

Based on operator policy, the 5G network shall provide suitable APIs to allow a trusted third-party to define and update the set of services and capabilities supported in a network slice used for the third-party.

Based on operator policy, the 5G network shall provide suitable APIs to allow a trusted third-party to configure the information which associates a UE to a network slice used for the third-party.

Based on operator policy, the 5G network shall provide suitable APIs to allow a trusted third-party to configure the information which associates a service to a network slice used for the third-party.

Based on operator policy, the 5G network shall provide suitable APIs to allow a trusted third-party to assign a UE to a network slice used for the third-party, to move a UE from one network slice used for the third-party to another network slice used for the third-party, and to remove a UE from a network slice used for the third-party based on subscription, UE capabilities, and services provided by the network slice.

The 3GPP network shall be able to provide suitable and secure means to enable an authorized third-party to provide the 3GPP network via encrypted connection with the expected communication behaviour of UE(s).

NOTE 1: The expected communication behaviour is, for instance, the application servers a UE is allowed to communicate with, the time a UE is allowed to communicate, or the allowed geographic area of a UE.

The 3GPP network shall be able to provide suitable and secure means to enable an authorized third-party to provide via encrypted connection the 3GPP network with the actions expected from the 3GPP network when detecting behaviour that falls outside the expected communication behaviour.

NOTE 2: Such actions can be, for instance, to terminate the UE's communication, to block the transferred data between the UE and the not allowed application.

The 5G network shall be able to provide secure means for providing communication scheduling information (i.e. the time period the UE(s) will use a communication service) to an NPN via encrypted connection. This communication scheduling information is used by the 5G network to perform network energy saving and network resource optimization.

The 5G network shall provide a mechanism to expose broadcasting capabilities to trusted third-party broadcasters' management systems.

Based on operator policy, a 5G network shall provide suitable APIs to allow a trusted third-party to manage this trusted third-party owned application(s) in the operator's Service Hosting Environment.

Based on operator policy, the 5G network shall provide suitable APIs to allow a third-party to monitor this trusted third-party owned application(s) in the operator's Service Hosting Environment.

Based on operator policy, the 5G network shall provide suitable APIs to allow a trusted third-party to scale a network slice used for the third-party, i.e. to adapt its capacity.

Based on operator policy, a 5G network shall provide suitable APIs to allow one type of traffic (from trusted third-party owned applications in the operator's Service Hosting Environment) to/from a UE to be offloaded to a Service Hosting Environment close to the UE's location.

Based on operator policy, the 5G network shall provide suitable APIs to allow a trusted third-party application to request appropriate QoE from the network.

Based on operator policy, the 5G network shall expose a suitable API to an authorized third-party to provide the information regarding the availability status of a geographic location that is associated with that third-party.

Based on operator policy, the 5G network shall expose a suitable API to allow an authorized third-party to monitor the resource utilisation of the network service (radio access point and the transport network (front, backhaul)) that are associated with the third-party.

Based on operator policy, the 5G network shall expose a suitable API to allow an authorized third-party to define and reconfigure the properties of the communication services offered to the third-party.

The 5G system shall support the means for disengagement (tear down) of communication services by an authorized third-party.

Based on operator policy, the 5G network shall expose a suitable API to provide the security logging information of UEs, for example, the active 3GPP security mechanisms (e.g. data privacy, authentication, integrity protection) to an authorized third-party.

Based on operator policy, the 5G system shall provide suitable means to allow a trusted and authorized third-party to consult security related logging information for the network slices dedicated to that third-party.

Based on operator policy, the 5G network shall be able to acknowledge within 100 ms a communication service request from an authorized third-party via a suitable API.

The 5G network shall provide suitable APIs to allow a trusted third-party to monitor the status (e.g. locations, lifecycle, registration status) of its own UEs.

NOTE 3: The number of UEs could be in the range from single digit to tens of thousands.

The 5G network shall provide suitable APIs to allow a trusted third-party to get the network status information of a private slice dedicated for the third-party, e.g. the network communication status between the slice and a specific UE.

The 5G system shall support APIs to allow the non-public network to be managed by the MNO's Operations System.

The 5G system shall provide suitable APIs to allow third-party infrastructure (i.e. physical/virtual network entities at RAN/core level) to be used in a private slice.

A 5G system shall provide suitable APIs to enable a third-party to manage its own non-public network and its private slice(s) in the PLMN in a combined manner.

The 5G system shall support suitable APIs to allow an MNO to offer automatic configuration services (for instance, interference management) to non-public networks deployed by third parties and connected to the MNO's Operations System through standardized interfaces.

6.11 Context-aware network

6.11.1 Description

A variety of sensors such as accelerometer, gyroscope, magnetometer, barometer, proximity sensor, and GPS can be integrated in a UE. Also, different applications running on the UE can have different communication needs (e.g. different traffic time). In addition, a UE can support different access technologies such as NR, E-UTRA, WLAN access technology, and fixed broadband access technology. The information gathered by sensors, the utilized access technologies, the application context, and the application traffic characteristics can provide useful information to the applications installed in the UE and can also help the 5G system utilize resources in an efficient and optimized way.

6.11.2 Requirements

The 5G system shall support network resource utilization efficiently and network optimization based on system information, including:

- network conditions, such as network load and congestion information;
- information on served UEs such as access information (e.g. 3GPP access, non-3GPP access), cell type (e.g. macro cell, small cell), user experienced data rate;
- application's characteristics (e.g. expected traffic over time);
- information on prioritized communication such as user subscription profile and priority level, priority services (e.g. MPS, Emergency, and Public Safety), application used for priority communications (e.g. voice, video, and data) and traffic associated with priority communications (signalling and media);
- subject to user consent, enhanced traffic characteristic of UE (e.g. Mobility information (e.g. no mobility, nomadic, spatially restricted mobility, full mobility), location, sensor-level information (e.g. direction, speed, power status, display status, other sensor information installed in the UE), application-level information (e.g. foreground applications, running background application, and user settings)).

The 5G system shall support mechanisms to collect system information for network optimization within an operator configured time scale.

6.12 Self backhaul

6.12.1 Description

The increased density of access nodes needed to meet future performance objectives poses considerable challenges in deployment and management (e.g. backhaul availability, backhaul capacity and scalability). The use of wireless backhaul for such access nodes helps to address some of the challenges.

Wireless self-backhauling in the radio access network can enable simpler deployment and incremental rollout by reducing reliance on the availability of wired backhaul at each access node location. Network planning and installation efforts can be reduced by leveraging plug and play type features -- self-configuration, self-organizing, and self-optimization.

6.12.2 Requirements

The 5G network shall enable operators to support wireless self-backhaul using NR and E-UTRA.

The 5G network shall support flexible and efficient wireless self-backhaul for both indoor and outdoor scenarios.

The 5G network shall support flexible partitioning of radio resources between access and backhaul functions.

The 5G network shall support autonomous configuration of access and wireless self-backhaul functions.

The 5G network shall support multi-hop wireless self-backhauling.

NOTE 1: This is to enable flexible extension of range and coverage area.

The 5G network shall support autonomous adaptation on wireless self-backhaul network topologies to minimize service disruptions.

The 5G network shall support topologically redundant connectivity on the wireless self-backhaul.

NOTE 2: This is to enhance reliability and capacity and reduce end-to-end latency.

6.13 Flexible broadcast/multicast service

6.13.1 Description

The proliferation of video services, ad-hoc multicast/broadcast streams, software delivery over wireless, group communications and broadcast/multicast IoT applications have created a need for a flexible and dynamic allocation of radio resources between unicast and multicast services within the network as well as support for a stand-alone deployment of multicast/broadcast network. Moreover, enabling such a service over a network for a wide range of inter-site distances between the radio base stations will enable a more efficient and effective delivery system for real-time and streaming multicast/broadcast content over wide geographic areas as well as in specific geographic areas spanning a limited number of base stations. A flexible multicast/broadcast service will allow the 5G system to efficiently deliver such services.

6.13.2 Requirements

The following set of requirements complement the requirements listed in 3GPP TS 22.146 [7], TS 22.246 [8] and TS 22.101 [6], clause 32.

The 5G system shall support operation of downlink only broadcast/multicast over a specific geographic area (e.g. a cell sector, a cell or a group of cells).

The 5G system shall support operation of a downlink only broadcast/multicast system over a wide geographic area in a spectrally efficient manner for stationary and mobile UEs.

The 5G system shall enable the operator to reserve 0% to 100% of radio resources of one or more radio carriers for the delivery of broadcast/multicast content.

The 5G network shall allow the UE to receive content via a broadcast/multicast radio carrier while a concurrent data session is ongoing over another radio carrier.

The 5G system shall be able to support broadcast/multicast of UHD streaming video (e.g. 4K/8K UHD).

NOTE 1: Taking into account the bandwidth needs for different streaming video resolution.

The 5G network shall allow the operator to configure and broadcast multiple quality levels (i.e. video resolutions) of broadcast/multicast content for the same user service in a stand-alone 3GPP based broadcast/multicast system.

The 5G network shall support parallel transfer of multiple quality levels (i.e. video resolutions) of broadcast/multicast content for the same user service to the same UE taking into account e.g. UE capability, radio characteristics, application information.

The 5G system shall support parallel transfer of multiple multicast/broadcast user services to a UE.

The 5G system shall support a stand-alone multicast/broadcast network comprising of multiple cells with inter-site distances of up to 200 km.

The 5G system shall support multicast/broadcast via a 5G satellite access network, or via a combination of a 5G satellite access network and other 5G access networks.

The 5G system shall be able to setup or modify a broadcast/multicast service area within [1s].

NOTE 2: For MCPTT related KPIs see 3GPP TS 22.179 [30], clause 6.15.

The 5G system shall be able to apply QoS, priority and pre-emption to a broadcast/multicast service area.

The 5G system shall support downlink parallel transfer of the same content, via broadcast/multicast and/or unicast, such that all receiver group members in a given area receive the media at the same time according to user perception.

NOTE 3: In this context user perception refers to a difference in delay of typically less than 20 ms.

The 5G system shall support a mechanism to inform a media source of relevant changes in conditions in the system (e.g. capacity, failures).

The 5G system shall provide means for a media source to provide QoS requirement requests to the broadcast/multicast service.

The 5G system shall provide means for the broadcast/multicast service to inform the media source of the available QoS, including modification of available QoS characteristics and availability of the broadcast/multicast service.

The 5G system shall be able to support broadcast/multicast of voice, data and video group communication, allowing at least 800 concurrently operating groups per geographic area.

NOTE 4: In this context "concurrently operating groups" means that the associated media streams are delivered concurrently.

6.14 Subscription aspects

6.14.1 Description

With the Internet of Things, it is expected that the diversity of IoT devices (e.g. sensors, UAVs, smart flower pots) and the usage models will largely vary. Moreover, when the IoT device is manufactured, the deployment location and specific usage may not be known. Sometimes the IoT devices will be added to existing subscriptions, other times they may be part of a new subscription for the user. Sometimes the IoT devices may be leased. During their life cycle these IoT devices go through different stages, involving the change in ownership when the IoT device is deployed and possibly afterwards, the activation of the IoT device by the preferred operator, a possible change of operators, etc. These stages need to be managed securely and efficiently. A method of dynamic subscription generation and management is needed in addition to statically provisioned subscription. Once the subscription is established, subscription management becomes necessary, for example, to modify the subscription when the ownership of the IoT device changes, to update or refresh credentials due to suspected leakage or theft of security keys or as a preventive measure.

The Internet of Things will also support various connectivity models: The IoT devices can connect with the network directly or connect with the network using another IoT device as a relay UE, or they may be capable of using both types of connections. The direct device connection between the IoT device and the relay UE can be using 3GPP or non-3GPP RAT. The relay UE can access the network also using 3GPP or non-3GPP access networks (e.g. WLAN, fixed broadband access network). In order to identify and manage the IoT devices, a subscription with the 5G network is needed, even if the access is done via non-3GPP access.

6.14.2 Requirements

An IoT device which is able to access a 5G PLMN in direct network connection mode using a 3GPP RAT shall have a 3GPP subscription.

The 5G system shall allow the operator to identify a UE as an IoT device based on UE characteristics (e.g. identified by an equipment identifier or a range of equipment identifiers) or subscription or the combination of both.

The 5G system shall be able to provide mechanisms to change the association between a subscription and address/number of an IoT device (e.g. changing the owner and subscription information associated with the IoT device) within the same operator and in between different operators in an automated or manual way.

The 5G system shall be able to support identification of subscriptions independently of identification of IoT devices. Both identities shall be secure.

An IoT device which is able to connect to a UE in direct device connection mode shall have a 3GPP subscription, if the IoT device needs to be identifiable by the core network (e.g. for IoT device management purposes or to use indirect network connection mode).

Based on operator policy, the 5G system shall support a mechanism to provision on-demand connectivity (e.g. IP connectivity for remote provisioning). This on-demand mechanism should enable means for a user to request on-the-spot network connectivity while providing operators with identification and security tools for the provided connectivity.

The 5G system shall support a secure mechanism for a home operator to remotely provision the 3GPP credentials of a uniquely identifiable and verifiably secure IoT device.

The 5G system shall support a secure mechanism for the network operator of an NPN to remotely provision the non-3GPP identities and credentials of a uniquely identifiable and verifiably secure IoT device.

Based on MNO and NPN policy, the 5G system shall support a mechanism to enable MNO to update the subscription of an authorized UE in order to allow the UE to connect to a desired NPN. This on-demand mechanism should enable means for a user to request on-the-spot network connectivity which is authorized by its MNO.

6.15 Energy efficiency

6.15.1 Description

Energy efficiency is a critical issue in 5G. The potential to deploy systems in areas without a reliable energy source requires new methods of managing energy consumption not only in the UEs but throughout all components of the 5G system.

Small form factor UEs also typically have a small battery and this not only puts constraints on general power optimization but also on how the energy is consumed. With smaller batteries it is more important to understand and follow the limitations for the both the maximum peak and continuous current drain.

6.15.2 Requirements

The 5G access network shall support an energy saving mode with the following characteristics:

- the energy saving mode can be activated/deactivated either manually or automatically;
- service can be restricted to a group of users (e.g. public safety user, emergency callers).

NOTE: When in energy saving mode the UE's and Access transmit power may be reduced or turned off (deep sleep mode), end-to-end latency and jitter may be increased with no impact on set of users or applications still allowed.

The 5G system shall support mechanisms to improve battery life for a UE over what is possible in EPS.

The 5G system shall optimize the battery consumption of a relay UE via which a UE is in indirect network connection mode.

The 5G system shall support UEs using small rechargeable and single coin cell batteries (e.g. considering impact on maximum pulse and continuous current).

6.16 Markets requiring minimal service levels

6.16.1 Description

A key aspect of 5G system flexibility is the ability to support both the very high-end markets as well as very low end markets. Some systems will be deployed in areas where there are constraints on energy resources (e.g. sporadic access to power) and lower end user expectations for availability, reliability, and data rates. In such cases, the system needs additional flexibility to adapt power consumption needs based on fluctuations in power availability. The system should be efficient in order to provide essential services in harsh environments (e.g. far remote rural areas, very large territories) while taking into account the local constraints (adapting resources consumptions to long distances, dealing with variable conditions and possibly disconnections). Content delivery should be optimized in order to reduce constraints on transport networks, on low-end UEs (e.g. small screen, limited energy consumption), variable network conditions, and client profiles.

6.16.2 Requirements

In constrained circumstances (e.g. reduced power supply), the 5G system shall be able to support a minimal user experience (e.g. user experienced data rate of [100] kbit/s, E2E latency of 50 ms, lower availability of the network of 95%).

The 5G system shall support centralized automation and management of the network in order to reduce local management tasks.

The 5G system shall support a mechanism to reduce data transfer rate at the cell edge for very large coverage area (e.g. 100 kbit/s for more than 100 km cell coverage, 1 Mbit/s for 100 km cell coverage).

The 5G system shall be able to give priority to services (e.g. e-Health) when resources are limited.

6.17 Extreme long range coverage in low density areas

6.17.1 Description

A fully connected society is expected in the near future. The network access everywhere over long distances (e.g. at remote rural areas or at sea) including both humans and machines need to be supported.

6.17.2 Requirements

The 5G system shall support the extreme long-range coverage (up to 100 km) in low density areas (up to 2 user/km²).

The 5G system shall support a minimum user throughput of 1 Mbit/s on DL and 100 kbit/s on UL at the edge of coverage.

The 5G system shall support a minimum cell throughput capacity of 10 Mbit/s/cell on DL (based on an assumption of 1 GB/month/sub).

The 5G system shall support a maximum of [400] ms E2E latency for voice services at the edge of coverage.

6.18 Multi-network connectivity and service delivery across operators

6.18.1 Description

Given the multitude of use cases for new verticals and services, each operator, based on its business model, may deploy a network serving only a subset of the vertical industries and services. However, this should not prevent an end-user from accessing all new services and capabilities that will be accessible via 5G systems. To provide a better user experience for their subscribers with UEs capable of simultaneous network access, network operators could contemplate a variety of sharing business models and partnership with other network and service providers to enable its subscribers to access all services via multiple networks simultaneously, and with minimum interruption when moving.

6.18.2 Requirements

The 5G system shall enable users to obtain services from more than one network simultaneously on an on-demand basis.

For a user with a single operator subscription, the use of multiple serving networks operated by different operators shall be under the control of the home operator.

When a service is offered by multiple operators, the 5G system shall be able to maintain service continuity with minimum service interruption when the serving network is changed to a different serving network operated by a different operator.

NOTE 1: A business agreement is required between the network operators.

In the event of the same service being offered by multiple operators, unless directed by the home operator's network, the UE shall be prioritized to receive subscribed services from the home operator's network.

NOTE 2: If the service is unavailable (e.g. due to lack of network coverage) from the home operator's network, the UE may be able to receive the service from another operator's network.

NOTE 3: QoS provided by the partner operator's network for the same service will be based on the agreement between the two operators and could be different than that provided by the home operator's network.

6.19 3GPP access network selection

6.19.1 Description

The 5G system will support the concept of "network slices" where different NG-RANs potentially are connected to network slices of different SSTs. A 5G UE can provide assistance information (e.g. SST) to enable the network to select one or more network slices. A 5G system is foreseen to support one or more SSTs, but possibly not all existing SSTs.

A 5G network operator controls and is responsible for what SSTs that should be available to a specific UE and subscription combination, based on associated subscription type, network operator policies, network capabilities and UE capabilities. The network operator can populate the Operator Controlled PLMN Selector list with associated access technology identifiers, stored in the 5G UE, with the PLMN/RAT combinations enabling access to the SSTs that are available to the 5G UE with associated subscription.

The UE uses the list of PLMN/RAT combinations for PLMN selection, if available, typically during roaming situations. In non-roaming situations, the UE and subscription combination typically matches the HPLMN/EHPLMN capabilities and policies, from a SST perspective. That is, a 5G UE accessing its HPLMN/EHPLMN should be able to access SSTs according to UE capabilities and the related subscription.

Optionally, a 5G system supports, subject to operator policies, a User Controlled PLMN Selector list that enables the 5G UE user to specify preferred PLMNs with associated access technology identifier in priority order. The user may have obtained information about suitable PLMN/RAT combination that would support services preferred by the user.

6.19.2 Requirements

The following set of requirements complement the requirements listed in 3GPP TS 22.011 [3], clause 3.2.

The 5G system shall support selection among any available PLMN/RAT combinations, identified through their respective PLMN identifier and Radio Access Technology identifier, in a prioritised order. The priority order may, subject to operator policies, be provisioned in an Operator Controlled PLMN Selector lists with associated RAT identifiers, stored in the 5G UE.

The 5G system shall support, subject to operator policies, a User Controlled PLMN Selector list stored in the 5G UE, allowing the UE user to specify preferred PLMNs with associated RAT identifier in priority order.

6.20 eV2X aspects

6.20.1 Description

The 3GPP system is expected to support various enhanced V2X scenarios.

Vehicles Platooning enables the vehicles to dynamically form a group travelling together. All the vehicles in the platoon receive periodic data from the leading vehicle, in order to carry on platoon operations. This information allows the distance between vehicles to become extremely small, i.e. the gap distance translated to time can be very low (sub second). Platooning applications may allow the vehicles following to be autonomously driven.

Advanced Driving enables semi-automated or fully-automated driving. Longer inter-vehicle distance is assumed. Each vehicle and/or RSU shares data obtained from its local sensors with vehicles in proximity, thus allowing vehicles to coordinate their trajectories or manoeuvres. In addition, each vehicle shares its driving intention with vehicles in proximity. The benefits of this use case group are safer traveling, collision avoidance, and improved traffic efficiency.

Extended Sensors enables the exchange of raw or processed data gathered through local sensors or live video data among vehicles, Road Site Units, UEs of pedestrians and V2X application servers. The vehicles can enhance the perception of their environment beyond what their own sensors can detect and have a more holistic view of the local situation.

Remote Driving enables a remote driver or a V2X application to operate a remote vehicle for those passengers who cannot drive themselves or a remote vehicle located in dangerous environments. For a case where variation is limited and routes are predictable, such as public transportation, driving based on cloud computing can be used. In addition, access to cloud-based back-end service platform can be considered for this use case group.

6.20.2 Requirements

The 3GPP system supports the transport of messages with different performance requirements to support V2X scenarios. The associated requirements are described in eV2X 3GPP TS 22.186 [9].

6.21 NG-RAN Sharing

6.21.1 Description

The increased density of access nodes needed to meet future performance objectives poses considerable challenges in deployment and acquiring spectrum and antenna locations. RAN sharing is seen as a technical solution to these issues.

6.21.2 Requirements

Requirements related to NG-RAN sharing are described in 3GPP TS 22.101 [6], clause 28.2.

A 5G satellite access network shall support NG-RAN sharing.

6.22 Unified access control

6.22.1 Description

Depending on operator's policies, deployment scenarios, subscriber profiles, and available services, different criterion will be used in determining which access attempt should be allowed or blocked when congestion occurs in the 5G System. These different criteria for access control are associated with Access Identities and Access Categories. The 5G system will provide a single unified access control where operators control accesses based on these two.

In unified access control, each access attempt is categorized into one or more of the Access Identities and one of the Access Categories. Based on the access control information applicable for the corresponding Access Identity and Access Category of the access attempt, the UE performs a test whether the actual access attempt can be made or not.

The unified access control supports extensibility to allow inclusion of additional standardized Access Identities and Access Categories and supports flexibility to allow operators to define operator-defined Access Categories using their own criterion (e.g. network slicing, application, and application server).

NOTE: Clauses 4.1 through 4.4a of TS 22.011 are obsolete and replaced by clause 6.22.2 of this specification. However, when a UE is configured for EAB according to TS 22.011, the UE is also configured for delay tolerant service for 5G system.

6.22.2 Requirements

6.22.2.1 General

Based on operator policy, the 5G system shall be able to prevent UEs from accessing the network using relevant barring parameters that vary depending on Access Identity and Access Category. Access Identities are configured at the UE as listed in Table 6.22.2.2-1. Access Categories are defined by the combination of conditions related to UE and the type of access attempt as listed in Table 6.22.2.3-1. One or more Access Identities and only one Access Category are selected and tested for an access attempt.

The 5G network shall be able to broadcast barring control information (i.e. a list of barring parameters associated with an Access Identity and an Access Category) in one or more areas of the RAN.

The UE shall be able to determine whether or not a particular new access attempt is allowed based on barring parameters that the UE receives from the broadcast barring control information and the configuration in the UE.

In the case of multiple core networks sharing the same RAN, the RAN shall be able to apply access control for the different core networks individually.

The unified access control framework shall be applicable both to UEs accessing the 5G CN using E-UTRA and to UEs accessing the 5G CN using NR.

The unified access control framework shall be applicable to UEs in RRC Idle, RRC Inactive, and RRC Connected at the time of initiating a new access attempt (e.g. new session request).

NOTE 1: "new session request" in RRC Connected refers to events, e.g. new MMTEL voice or video session, sending of SMS (SMS over IP, or SMS over NAS), sending of IMS registration related signalling, new PDU session establishment, existing PDU session modification, and service request to re-establish the user plane for an existing PDU session.

The 5G system shall support means by which the operator can define operator-defined Access Categories to be mutually exclusive.

NOTE 2: Examples of criterion of operator-defined Access Categories are network slicing, application, and application server.

The unified access control framework shall be applicable to inbound roamers to a PLMN.

The serving network should be able to provide the definition of operator-defined Access Categories to the UE.

6.22.2.2 Access identities

Table 6.22.2.2-1: Access Identities

Access Identity number	UE configuration
0	UE is not configured with any parameters from this table
1 (NOTE 1)	UE is configured for Multimedia Priority Service (MPS).
2 (NOTE 2)	UE is configured for Mission Critical Service (MCS).
3	UE for which Disaster Condition applies (note 4)
4-10	Reserved for future use
11 (NOTE 3)	Access Class 11 is configured in the UE.
12 (NOTE 3)	Access Class 12 is configured in the UE.
13 (NOTE 3)	Access Class 13 is configured in the UE.
14 (NOTE 3)	Access Class 14 is configured in the UE.
15 (NOTE 3)	Access Class 15 is configured in the UE.
<p>NOTE 1: Access Identity 1 is used by UEs configured for MPS, in the networks where the configuration is valid. The networks where the configuration is valid are NPN or HPLMN, PLMNs equivalent to HPLMN, and visited PLMNs of the home country. Access Identity 1 is also valid when the UE is explicitly authorized by the network based on specific configured NPNS or based on specific configured PLMNs inside and outside the home country.</p> <p>NOTE 2: Access Identity 2 is used by UEs configured for MCS, in the networks where the configuration is valid. The networks where the configuration is valid are NPN or HPLMN or PLMNs equivalent to HPLMN and visited PLMNs of the home country. Access Identity 2 is also valid when the UE is explicitly authorized by the network based on specific configured NPNS or based on specific configured PLMNs inside and outside the home country.</p> <p>NOTE 3: Access Identities 11 and 15 are valid in Home PLMN only if the EHPLMN list is not present or in any EHPLMN. Access Identities 12, 13 and 14 are valid in Home PLMN and visited PLMNs of home country only. For this purpose, the home country is defined as the country of the MCC part of the SUPI.</p> <p>NOTE 3a: Access Identities 11 to 15 are valid in an NPN.</p> <p>NOTE 4: The configuration is valid for PLMNs that indicate to potential Disaster Inbound Roamers that the UEs can access the PLMN. See clause 6.31.</p>	

Any number of these Access Identities may be barred at any one time.

6.22.2.3 Access categories

Table 6.22.2.3-1: Access Categories

Access Category number	Conditions related to UE	Type of access attempt
0	All	MO signalling resulting from paging
1 (NOTE 1)	UE is configured for delay tolerant service and subject to access control for Access Category 1, which is judged based on relation of UE's HPLMN and the selected PLMN or based on the UE's NPN.	All except for Emergency, or MO exception data
2	All	Emergency
3	All except for the conditions in Access Category 1.	MO signalling on NAS level resulting from other than paging
4	All except for the conditions in Access Category 1.	MMTEL voice (NOTE 3)
5	All except for the conditions in Access Category 1.	MMTEL video
6	All except for the conditions in Access Category 1.	SMS
7	All except for the conditions in Access Category 1.	MO data that do not belong to any other Access Categories (NOTE 4)
8	All except for the conditions in Access Category 1	MO signalling on RRC level resulting from other than paging
9	All except for the conditions in Access Category 1	MO IMS registration related signalling (NOTE 5)
10 (NOTE 6)	All	MO exception data
11-31		Reserved standardized Access Categories
32-63 (NOTE 2)	All	Based on operator classification
<p>NOTE 1: The barring parameter for Access Category 1 is accompanied with information that define whether Access Category applies to UEs within one of the following categories:</p> <ul style="list-style-type: none"> a) UEs that are configured for delay tolerant service; b) UEs that are configured for delay tolerant service and are neither in their HPLMN nor in a PLMN that is equivalent to it; c) UEs that are configured for delay tolerant service and are neither in the PLMN listed as most preferred PLMN of the country where the UE is roaming in the operator-defined PLMN selector list on the SIM/USIM, nor in their HPLMN nor in a PLMN that is equivalent to their HPLMN. <p>When a UE is configured for EAB, the UE is also configured for delay tolerant service. In case a UE is configured both for EAB and for EAB override, when upper layer indicates to override Access Category 1, then Access Category 1 is not applicable.</p> <p>NOTE 2: When there is an Access Category based on operator classification and a standardized Access Category to both of which an access attempt can be categorized, and the standardized Access Category is neither 0 nor 2, the UE applies the Access Category based on operator classification. When there are an Access Category based on operator classification and a standardized Access Category to both of which an access attempt can be categorized, and the standardized Access Category is 0 or 2, the UE applies the standardized Access Category.</p> <p>NOTE 3: Includes Real-Time Text (RTT).</p> <p>NOTE 4: Includes IMS Messaging.</p> <p>NOTE 5: Includes IMS registration related signalling, e.g. IMS initial registration, re-registration, and subscription refresh.</p> <p>NOTE 6: Applies to access of a NB-IoT-capable UE to a NB-IOT cell connected to 5GC when the UE is authorized to send exception data.</p>		

Access Category 0 in Table 6.22.2.3-1 shall not be barred, irrespective of Access Identities.

NOTE: The network can control the amount of access attempts relating to Access Category 0 by controlling whether to send paging or not.

6.23 QoS monitoring

6.23.1 Description

The QoS requirements specified for particular services such as URLLC services, vertical automation communication services, and V2X, mandate QoS guarantees from the network. However, the network may not be able to always guarantee the required QoS of the service. An example reason for this shortcoming is that the latency and/or packet error rate increase due to interference in a radio cell. In such cases, it is critical that the application and/or application server is notified in a timely manner. Hence, the 5G system should be able to support QoS monitoring/assurance for URLLC services, V2X and vertical automation.

For more information on QoS assurance see Annex F.

Vertical automation systems are locally distributed and are typically served by wired and wireless communication networks of different types and with different characteristics. If the operation of the system or one of its sub-processes does not work properly, there is a need for quickly finding and eliminating the related error or fault in order to avoid significant operation and thus financial losses. To that end, automation devices and applications implement diagnosis and error-analysis algorithms, as well as predictive maintenance features.

Due to their inherent challenges, wireless communication systems are usually under suspicion in case an error occurs in a distributed automation application. Therefore, diagnosis and fault analysis features for 5G systems are required. The 5G system needs to provide sufficient monitoring information as input for such diagnosis features.

QoS monitoring can be used for the following activities:

- assessing and assuring the dependability of network operation;
- assessing and assuring the dependability of the communication services;
- excluding particular communication errors;
- identifying communication errors;
- analysing the location of an error including the geographic location of the involved network component (UE; front-haul component; core node);
- activation of application-related countermeasures.

6.23.2 Requirements

The 5G system shall provide a mechanism for supporting real-time E2E QoS monitoring within a system.

NOTE 1: The end points in E2E are the termination points of the communication service within the boundary of the 5G system.

The 5G network shall provide an interface to an application for QoS monitoring (e.g. to initiate QoS monitoring, request QoS parameters, events, logging information).

The 5G system shall be able to provide real time QoS parameters and events information to an authorized application/network entity.

NOTE 2: The QoS parameters to be monitored and reported can include latency (e.g. UL/DL or round trip), jitter, and packet loss rate.

The 5G system shall be able to log the history of the communication events. This includes for examples parts of the SLA that are not met, timestamp of the events, and event position (e.g. UEs and radio access points associated with the events).

The 5G system shall support different levels of granularity for QoS monitoring (e.g. per flow or set of flows).

The 5G system shall be able to provide event notification upon detecting an error that the negotiated QoS level cannot be met/guaranteed.

The 5G system shall be able to provide information that identifies the type and the location of a communication error (e.g. cell ID).

The 5G system shall be able to provide notification of communication events to authorized entities per pre-defined patterns (e.g. every time the bandwidth drops below a pre-defined threshold for QoS parameters the authorized entity is notified, and the event is logged).

The 5G system shall be able to respond to a request from an authorized entity to provide real-time QoS monitoring information within a specified time after receiving the request (e.g. within 5 s).

The 5G system shall support an update/refresh rate for real time QoS monitoring with a specified value (e.g., at least one update per second).

The 5G system shall be able to provide statistical information of service parameters and error types while a communication service is in operation.

The 5G system shall provide information on the current availability of a specific communication service in a particular area (e.g. cell ID) upon request of an authorized entity.

6.24 Ethernet transport services

6.24.1 Description

This clause includes common, fundamental Ethernet transport requirements, and any requirements necessary to support a 5G LAN-type service. The requirements applicable to the 5G system for supporting cyber-physical applications using Ethernet are described in 3GPP TS 22.104 [21].

6.24.2 Requirements

The 3GPP system shall be able to support an Ethernet transport service.

The 5G network shall support the routing of non-IP packet (e.g. Ethernet frame) efficiently for private communication between UEs within a 5G LAN-type service.

The 5G network shall be able to provide the required QoS (e.g. reliability, latency, and bandwidth) for non-IP packet (e.g. Ethernet frame) for private communication between UEs within a 5G LAN-type service.

The Ethernet transport service shall support routing based on information extracted from Virtual LAN (VLAN) ID by the 3GPP system.

The Ethernet transport service shall support the transport of Ethernet frames between UEs that Ethernet devices are connected to.

The Ethernet transport service shall support the transport of Ethernet frames between a UE that an Ethernet device is connected to and an Ethernet network in DN (Data Network).

NOTE: If more than one Ethernet devices need to be connected to a UE, they can be connected using an Ethernet switch between the devices and the UE.

The Ethernet transport service shall support the transport of Ethernet broadcast frames.

The Ethernet transport service shall support traffic filtering and prioritization based on source and destination MAC addresses.

The Ethernet transport service shall support traffic filtering and prioritization based on Ethertype (including multiple Ethertypes in double tagging).

The Ethernet transport service shall support traffic filtering and prioritization based on 802.1Q VLAN tags (including double tagging).

The Ethernet transport service shall support routing based on information extracted by the 3GPP system from the Bridge Protocol Data Units created in the Ethernet network based on a Spanning Tree Protocol (e.g. RSTP).

6.25 Non-public networks

6.25.1 Description

Non-public networks are intended for the sole use of a private entity such as an enterprise, and may be deployed in a variety of configurations, utilising both virtual and physical elements. Specifically, they may be deployed as completely standalone networks, they may be hosted by a PLMN, or they may be offered as a slice of a PLMN.

In any of these deployment options, it is expected that unauthorized UEs, those that are not associated with the enterprise, will not attempt to access the non-public network, which could result in resources being used to reject that UE and thereby not be available for the UEs of the enterprise. It is also expected that UEs of the enterprise will not attempt to access a network they are not authorized to access. For example, some enterprise UEs may be restricted to only access the non-public network of the enterprise, even if PLMN coverage is available in the same geographic area. Other enterprise UEs may be able to access both a non-public network and a PLMN where specifically allowed.

6.25.2 Requirements

The 5G system shall support non-public networks.

The 5G system shall support non-public networks that provide coverage within a specific geographic area.

The 5G system shall support both physical and virtual non-public networks.

The 5G system shall support standalone operation of a non-public network, i.e. a non-public network may be able to operate without dependency on a PLMN.

Subject to an agreement between the operators and service providers, operator policies and the regional or national regulatory requirements, the 5G system shall support for non-public network subscribers:

- access to subscribed PLMN services via the non-public network;
- seamless service continuity for subscribed PLMN services between a non-public network and a PLMN;
- access to selected non-public network services via a PLMN;
- seamless service continuity for non-public network services between a non-public network and a PLMN.

Subject to regional or national regulatory requirements for emergency services, 5G system shall be able to support IMS emergency services for non-public networks.

Subject to regional or national regulatory requirements for PWS (see TS 22.268 [31]), the 5G system shall be able to support PWS for non-public networks.

A non-public network subscriber to access a PLMN service shall have a service subscription using 3GPP identifiers and credentials provided or accepted by a PLMN.

The 5G system shall support a mechanism for a UE to identify and select a non-public network.

NOTE: Different network selection mechanisms may be used for physical vs virtual non-public networks.

The 5G system shall support identifiers for a large number of non-public networks to minimize collision likelihood between assigned identifiers.

The 5G system shall support a mechanism to prevent a UE with a subscription to a non-public network from automatically selecting and attaching to a PLMN or non-public network it is not authorized to select.

The 5G system shall support a mechanism to prevent a UE with a subscription to a PLMN from automatically selecting and attaching to a non-public network it is not authorized to select.

The 5G system shall support a mechanism for a PLMN to control whether a user of a UE can manually select a non-public network hosted by this PLMN that the UE is not authorized to select automatically.

The 5G system may broadcast a human readable network name that a UE may display for manual selection of a non-public network.

The 5G system shall support a change of host of a non-public network from one PLMN to another PLMN without changing the network selection information stored in the UEs of the non-public network.

The 5G system shall enable an NPN to support multiple third-party service providers.

In the event of a loss of communication between RAN and core network, the 5G system shall be able to provide capability to securely re-connect an NPN network function within a short period of time (< 1s).

6.26 5G LAN-type service

6.26.1 Description

5G expands the scope and reach of 3GPP-defined technologies. There are multiple market segments in the realm of residential, office, enterprise and factory, where 5G will need to provide services with similar functionalities to Local Area Networks (LANs) and VPN's but improved with 5G capabilities (e.g. high performance, long distance access, mobility and security).

6.26.2 Requirements

6.26.2.1 General

The 5G system shall support 5G LAN-type service in a shared RAN configuration.

The 5G system shall support 5G LAN-type service over a wide area mobile network.

The 5G network shall support service continuity for 5G LAN-type service, i.e. the private communication between UEs shall not be interrupted when one or more UEs of the private communication move within the same network that provides the 5G LAN-type service.

The 5G system shall support use of unlicensed as well as licensed spectrum for 5G LAN-type services.

The 5G system shall enable the network operator to provide the same 5G LAN-type service to any 5G UE, regardless of whether it is connected via public base stations, indoor small base stations connected via fixed access, or via relay UEs connected to either of these two types of base stations.

6.26.2.2 5G LAN-virtual network (5G LAN-VN)

A UE shall be able to select a 5G LAN-VN, that the UE is a member of, for private communication.

A 5G system shall support 5G LAN-VNs with member UEs numbering between a few to tens of thousands.

The 5G LAN-VN shall support member UEs that are subscribed to different PLMNs, e.g. a 5G LAN-VN may span multiple countries and have member UEs that have a subscription to a PLMN in their home country.

The 5G system shall support on-demand establishment of UE to UE, multicast, and broadcast private communication between members UEs of the same 5G LAN-VN. Multiple types of data communication shall be supported, at least IP and Ethernet.

The 5G network shall ensure that only member UEs of the same 5G LAN-VN are able to establish or maintain private communications among each other using 5G LAN-type service.

The 5G system shall allow member UEs of a 5G LAN-VN to join an authorized multicast session over that 5G LAN-VN.

The 5G system shall be able to restrict private communications within a 5G LAN-VN based on UE's location (i.e. when the UE moves out of the area it can no longer communicate on the 5G LAN-VN).

The 5G network shall enable member UEs of a 5G LAN-VN to use multicast/broadcast over a 5G LAN-type service to communicate with required latency (e.g. 180 ms).

The 5G system shall support a mechanism to provide consistent QoE to all the member UEs of the same 5G LAN-VN.

The 5G system shall support routing based on a private addressing scheme within the 5G LAN-VN.

6.26.2.3 Creation and management

The 5G network shall enable the network operator to scale up/down a 5G LAN-VN, e.g. the coverage, capacity for efficient consumption of network resources.

The 5G network shall enable the network operator to create, manage, and remove 5G LAN-VN including their related functionality (subscription data, routing and addressing functionality).

The 5G network shall enable the network operator to add one or more authorized UEs to an existing 5G LAN-VN.

NOTE 1: A UE needs to be authorized by the MNO to use 5G LAN-type service before it can be added to any 5G LAN-VN.

NOTE 2: some use cases will require user permission for a UE to be added to a 5G LAN-VN.

The 5G system shall enable the network operator to add an authorized UE to multiple independent 5G LAN-VNs.

The 5G network shall enable the network operator to remove one or more UEs from an existing 5G LAN-VN.

NOTE 3: Removing a UE from a 5G LAN-VN does not have impact on other 5G LAN-VNs that the UE is a member of.

The 5G system shall enable the network operator to configure a 5G LAN-VN that is available only within a geographical area.

6.26.2.4 Privacy

The 5G system shall be able to prevent the sharing of a UE's identifying information (e.g. SUPI, MSISDN) on private communication among UEs using 5G LAN-type service.

6.26.2.5 Traffic types

A 5G system shall support all media types (e.g. voice, data, multimedia) for 5G LAN-type service.

The 5G system shall support traffic scenarios typically found in a home setting (from sensors to video streaming, relatively low amount of UEs per group, many devices are used only occasionally) for 5G LAN-type service.

The 5G system shall support traffic scenarios typically found in an office setting (from sensors to very high data rates e.g. for conferencing, medium amount of UEs per group) for 5G LAN-type service.

The 5G system shall support traffic scenarios typically found in an industrial setting (from sensors to remote control, large amount of UEs per group) for 5G LAN-type service.

6.26.2.6 Discovery

The 5G system shall enable a member UE to discover other member UEs within the same 5G LAN-VN.

The 5G LAN-type service shall be able to support existing non-3GPP service discovery mechanisms (e.g. mechanisms to discover printers).

6.26.2.7 (void)

6.26.2.8 Indirect communication mode

The 5G system shall support 5G LAN-type service for authorized UEs using indirect network connection or direct network connection.

The 5G network shall be able to provide a remote UE using 5G LAN-type service with same level of service as if the remote UE would be using a direct network connection (i.e. provide required QoS for the Ethernet packets transferred between remote UE and relay UE if they are using 3GPP access).

The 5G network shall be able to support service continuity for the private communication between a remote UE with other member UEs of the same 5G LAN-VN, when the remote UE changes from one relay UE to another or when the UE changes between direct and indirect network connection.

6.26.2.9 Service exposure

Based on MNO policy, the 5G network shall provide suitable APIs to allow a trusted third-party to create/remove a 5G LAN-VN.

Based on MNO policy, the 5G network shall provide suitable APIs to allow a trusted third-party to manage a 5G LAN-VN dedicated for the usage by the trusted third-party, including the address allocation.

Based on MNO policy, the 5G network shall provide suitable APIs to allow a trusted third-party to add/remove an authorized UE to/from a specific 5G LAN-VN managed by the trusted third-party.

6.27 Positioning services

6.27.1 Description

5G positioning services aims to support verticals and applications with positioning accuracies better than 10 meters, thus more accurate than the ones of TS 22.071 [24] for LCS. High accuracy positioning is characterized by ambitious system requirements for positioning accuracy in many verticals and applications, including regulatory needs.

In Location-Based-Services and eHealth, higher accuracy is instrumental to new services and applications, both outdoor and indoor.

For example, on the factory floor, it is important to locate assets and moving objects such as forklifts, or parts to be assembled. Similar needs exist in transportation and logistics, for example rail, road and use of UAVs. In some road user cases, UE's supporting V2X application(s) are also applicable to such needs. In cases such as guided vehicles (e.g. industry, UAVs) and positioning of objects involved in safety-related functions, availability needs to be very high.

Mission Critical Organizations require mission critical services to have accurate positioning such that first responders may be located at all times during normal and critical operations, indoors as well as outdoors. The level of positioning accuracy (and other KPIs) required is much more stringent than that required by local and regional regulatory requirements for commercial 5G users.

6.27.2 Requirements

The 5G system shall provide 5G positioning services in compliance with regulatory requirements.

NOTE 1: example of regulatory requirements encompasses requirements on emergency calls (e.g. e911), reliability and safety requirement (RAMS) applicable to some use cases and verticals, implementation of Priority, Precedence, Preemption (PPP) mechanisms to ensure sufficient reliability metrics are reached.

The 5G system shall provide different 5G positioning services, supported by different single and hybrid positioning methods to supply absolute and relative positioning.

NOTE 2: hybrid positioning methods include both the combination of 3GPP positioning technologies and the combination of 3GPP positioning technologies with non-3GPP positioning technologies such as, GNSS (e.g. Beidou, Galileo, GPS, Glonass), Network-based Assisted GNSS and High-Accuracy GNSS, Terrestrial Beacon Systems, dead-reckoning sensors (e.g. IMU, barometer), WLAN/Bluetooth-based positioning.

The 5G system shall enable an MCX UE to use the 5G positioning services to determine its position with the associated uncertainty/confidence of the position, on request, triggered by an event or periodically.

The 5G System shall be able to provide the 5G positioning services in case of roaming.

The 5G system shall support mechanisms to determine the UE's position-related data for period when the UE is outside the coverage of 3GPP RAT-dependent positioning technologies but within the 5G positioning service area (e.g. within the coverage of satellite access).

The 5G system shall be able to make the position-related data available to an application or to an application server existing within the 5G network, external to the 5G network, or in the User Equipment.

NOTE 3: the position service latency can be tailored to the use cases.

The 5G system shall be able to manage and log position-related data in compliance with applicable traceability, authentication and security regulatory requirements.

The 5G system shall be able to request the UE to provide its position-related-data on request, triggered by an event or periodically and to request the UE to stop providing its position-related data periodically.

NOTE 4: This requirement does not preclude whether the position is computed in the UE or elsewhere in the 5G System (e.g. core network).

The 5G system shall support mechanisms to configure dynamically the update rate of the position-related data to fulfil different performances (e.g. power consumption, position service latency) or different location modes.

NOTE 5: for example, the 5G System needs to be able to request the UE to provide its location periodically with an update rate ranging from one location every [1 s to 10 s] in location normal mode to one location every [30 s to 300 s, or more] in location power saving mode. The 5G System needs to allow UEs to sleep for extended periods (e.g. one week), without requiring the UE to update its position data.

The 5G system shall allow the UE to trigger a different update rate of the position-related data based on whether the UE is moving or not.

The 5G system shall be able to determine the position-related data of the 5G positioning services with any update rate ranging from one set of position-related data every 0,1 s to one set of position-related data every month.

NOTE 6: the position service latency can be tailored to the use cases.

The 5G System shall be able to negotiate the positioning methods according to the operator's policy or the application's requirements or the user's preferences and shall support mechanisms to allow the network or the UE to trigger this negotiation.

The 5G system shall supply a method for-the operator to configure and manage different positioning services for different users.

The 5G system shall be able to determine the reliability, and the uncertainty or confidence level, of the position-related data.

The 5G system shall be able to access to the positioning methods used for calculating the position-related data and to the associated uncertainty/confidence indicators.

6.28 Cyber-physical control applications in vertical domains

6.28.1 Description

The 5G system is expected to meet the service requirements for cyber-physical control applications in vertical domains.

A vertical domain is a particular industry or group of enterprises in which similar products or services are developed, produced, and provided. Automation refers to the control of processes, devices, or systems in vertical domains by automatic means. The main control functions of automated control systems include taking measurements, comparing results, computing any detected or anticipated errors, and correcting the process to avoid future errors. These functions are performed by sensors, transmitters, controllers, and actuators.

Cyber-physical systems are to be understood as systems that include engineered, interacting networks of physical and computational components. Cyber-physical control applications are to be understood as applications that control physical processes. Cyber-physical control applications in automation follow certain activity patterns, which are open-loop control, closed-loop control, sequence control, and batch control.

Communication services supporting cyber-physical control applications need to be ultra-reliable, dependable with a high communication service availability, and often require low or (in some cases) very low end-to-end latency.

Communication in automation in vertical domains follows certain communication patterns. The most well-known is periodic deterministic communication, others are a-periodic deterministic communication and non-deterministic communication.

Communication for cyber-physical control applications supports operation in various vertical domains, for instance industrial automation and energy automation.

6.28.2 Requirements

The 5G system supports the communication services for cyber-physical control applications in the vertical domains of factories of the future (smart manufacturing), electric power distribution, central power generation, and rail-bound mass transit. The associated requirements are described in 3GPP TS 22.104 [21].

6.29 Messaging aspects

6.29.1 Description

The 5G system is expected to support advanced capabilities and performance of messaging service especially for massive IoT communication which are introduced by the MSGin5G Service [22]. The MSGin5G Service provides one to one, group and broadcast message services for thing-to-thing and person-to-thing communication with low end-to-end latency and high reliability of message delivery, in a resource efficient manner to optimize the resource usage of the both control plane and user plane in the network, and power saving in the user devices.

6.29.2 Requirements

The 5G system supports the MSGin5G Service. The associated service level requirements of the MSGin5G Service are described in 3GPP TS 22.262 [22].

6.30 Steering of roaming

6.30.1 Description

Steering of roaming allows the HPLMN (or subscribed NPN) to steer a UE to a VPLMN or NPN on which the HPLMN (or subscribed NPN) wants the UE to register, when the UE registers on another VPLMN or NPN. This capability may be needed for reasons e.g. reselection to a higher priority PLMN, or NPNs, based on business arrangements.

6.30.2 Requirements

The following set of requirements complement the requirements listed in 3GPP TS 22.011 [3], clause 3.2.2.8.

The 5G system shall support a mechanism for the HPLMN to control the timing when a UE registered on a VPLMN, in automatic mode (see clause 3.1 of TS 23.122 [25]) and currently in CONNECTED mode, enters IDLE mode and initiates higher priority PLMN selection based on the type of ongoing communication.

NOTE 1: Changes needed to support the above requirement are expected to have minimum impact on the 5G system. UE is expected to initiate the above-mentioned PLMN selection e.g. by locally releasing the established N1 NAS signalling connection.

NOTE 1a: The requirement above applies also to the case of a UE registered to a non-subscribed (standalone) NPN, in order to select a higher priority PLMN or NPN.

The UE shall be able to delay conforming to steering of roaming control information from the HPLMN while it is engaged in priority service (e.g. emergency call, MPS session), or a service defined by HPLMN policy not to be interrupted (e.g. MMTEL voice/video call).

NOTE 2: The HPLMN policy can take into account the user's preference for the service(s) not to be interrupted. User preferences can be communicated utilizing non-standard operator-specific mechanisms, e.g. web-based.

The mechanism mentioned above in this clause shall be available to the HPLMN even if the VPLMN the UE is registered on is compliant to an earlier release of the 5G system.

The 5G system shall support mechanisms to enable a credentials holder (e.g. HPLMN or subscribed standalone NPN) to send steering of roaming information to a UE for selecting standalone NPNs (e.g. prioritized list of preferred NPNs).

6.31 Minimization of Service Interruption

6.31.1 Description

A mobile network may fail to provide service in the event of a disaster (for example a fire.) The requirements listed in this clause provide the 5GS with the capability to mitigate interruption of service. UEs may obtain service in the event of a disaster, if there are PLMN operators prepared to offer service. The minimization of service interruption is constrained to a particular time and place. To reduce the impact to the 5G System of supporting Disaster Roaming, the potential congestion resulting from an influx or outflux of Disaster Inbound Roamers is taken into account.

6.31.2 Requirements

6.31.2.1 General

Subject to regulatory requirements or operator's policy, 3GPP system shall be able to enable a UE of a given PLMN to obtain connectivity service (e.g. voice call, mobile data service) from another PLMN for the area where a Disaster Condition applies.

6.31.2.2 Disaster Condition

The 3GPP system shall enable UEs to obtain information that a Disaster Condition applies to a particular PLMN or PLMNs.

NOTE: If a UE has no coverage of its HPLMN, then obtains information that a Disaster Condition applies to the UE's HPLMN, the UE can register with a PLMN offering Disaster Roaming service.

The 3GPP system shall support means for a PLMN operator to be aware of the area where Disaster Condition applies.

The 3GPP system shall be able to support provision of service to Disaster Inbound Roamer only within the specific region where Disaster Condition applies.

The 3GPP system shall be able to provide efficient means for a network to inform Disaster Inbound roamers that a Disaster Condition is no longer applicable.

Subject to regulatory requirements or operator's policy, the 3GPP system shall support a PLMN operator to be made aware of the failure or recovery of other PLMN(s) in the same country when the Disaster Condition is applies, or when the Disaster Condition is not applicable.

6.31.2.3 Disaster Roaming

The 3GPP system shall be able to provide means to enable a UE to access PLMNs in a forbidden PLMN list if a Disaster condition applies and no other PLMN is available except for PLMNs in the forbidden PLMN list.

The 3GPP system shall provide means to enable that a Disaster Condition applies to UEs of a specific PLMN.

The 3GPP system shall be able to provide a resource efficient means for a PLMN to indicate to potential Disaster Inbound Roamers whether they can access the PLMN or not.

Disaster Inbound Roamers shall perform network reselection when a Disaster Condition has ended.

The 3GPP system shall minimize congestion caused by Disaster Roaming.

The 5G system shall support a mechanism for the HPLMN to control whether a UE, with HPLMN subscription, should apply Disaster Roaming when a Disaster Condition arises (in the HPLMN or a VPLMN).

3GPP system shall be able to collect charging information for a Disaster Inbound Roamer with information about the applied disaster condition.

6.32 UAV aspects

6.32.1 Description

The 3GPP system is expected to support various enhanced UAV scenarios, especially for a wide range of applications and scenarios by using low altitude UAVs in various commercial and government sectors.

6.32.2 Requirements

The 3GPP system supports service requirements and KPIs related to command and control (C2), payload (e.g. camera) and the operation of radio access nodes on-board of UAVs. The associated requirements are described in 3GPP TS 22.125 [26].

6.33 Video, imaging and audio for professional applications

6.33.1 Description

Audio-Visual (AV) production includes television and radio studios, live news-gathering, sports events, music festivals, among others. Typically, numerous wireless devices such as microphones, in-ear monitoring systems or cameras are used in these scenarios. In the future, the wireless communication service for such devices are expected to be provided by a 5G system. AV production applications require a high degree of confidence, since they are related to the capturing and transmission of data at the beginning of a production chain. This differs drastically when compared to other multimedia services because the communication errors will be propagated to the entire audience that is consuming that content both live and on recorded medias. Furthermore, the transmitted data is often post-processed with filters which could actually amplify defects that would be otherwise not noticed by humans. Therefore, these applications call for uncompressed or slightly compressed data, and very low probability of errors. These devices will also be used alongside existing technologies which have a high level of performance and so any new technologies will need to match or improve upon the existing workflows to drive adoption of the technology.

The 3GPP system already plays an important role in the distribution of AV media content and services. Release 14 contains substantial enhancements to deliver TV services of various kinds, from linear TV programmes for mass audiences to custom-tailored on-demand services for mobile consumption. However, it is expected that also in the domain of AV content and service production, 3GPP systems will become an important tool for a market sector with steadily growing global revenues. There are several areas in which 3GPP networks may help to produce AV content and services in an efficient and flexible manner.

6.33.2 Requirements

The 5G system supports the communication services for video, imaging and audio for professional applications. The associated requirements are described in 3GPP TS 22.263 [28].

6.34 Critical medical applications

6.34.1 Description

The 5G system is expected to meet the service requirements for critical medical applications where critical medical applications denote medical devices and applications involved in the delivery of care for patient's survival. Additionally, as the medical industry undergoes a shift to value-based healthcare, where companies and healthcare providers have to move to business models based on providing clinical value with cost efficiency, the 5G system can help to adopt new and more efficient care delivery models in order to reduce administrative and supply costs.

On this matter, 5G technology can especially have an important impact by:

- enabling superior monitoring capability means thus improving the effectiveness of preventive care,
- enabling shifting care location from hospitals to homes and other lower cost facilities,
- improving operating room planning, enabling streamlining equipment usage and simplifying operating theater implementation,
- Enhancing cooperation in critical situations between ambulance and hospital staff.

6.34.2 Requirements

The 5G system shall support the communication services for critical medical applications. The associated requirements are described:

- in 3GPP TS 22.104 [21] for the requirements related to controlling both local or remote robotic diagnosis or surgery systems,
- in 3GPP TS 22.263 [29] for the requirements related to high quality medical imaging and augmented reality systems located in hybrid operating rooms, in remote healthcare facilities or ambulances,
- in 3GPP TS 22.261 clause 7.5 for the requirements on the support of tele-diagnosis or tele-monitoring systems,
- in 3GPP TS 22.261 clauses 6.10, 8.2 and 8.9 for the requirements on the security of medical data that fulfil regulatory requirements.

7 Performance requirements

7.1 High data rates and traffic densities

Several scenarios require the support of very high data rates or traffic densities of the 5G system. The scenarios address different service areas: urban and rural areas, office and home, and special deployments (e.g. massive gatherings, broadcast, residential, and high-speed vehicles). The scenarios and their performance requirements can be found in table 7.1-1.

- Urban macro – The general wide-area scenario in urban area
- Rural macro – The general wide-area scenario in rural area
- Indoor hotspot – The scenario for offices and homes, and residential deployments.
- Broadband access in a crowd – The scenario for very dense crowds, for example, at stadiums or concerts. In addition to a very high connection density the users want to share what they see and hear, putting a higher requirement on the uplink than the downlink.
- Dense urban – The scenario for pedestrian users, and users in urban vehicles, for example, in offices, city centres, shopping centres, and residential areas. The users in vehicles can be connected either directly or via an onboard base station to the network.
- Broadcast-like services – The scenario for stationary users, pedestrian users, and users in vehicles, for example, in offices, city centres, shopping centres, residential areas, rural areas and in high speed trains. The passengers in vehicles can be connected either directly or via an onboard base station to the network.
- High-speed train – The scenario for users in trains. The users can be connected either directly or via an onboard base station to the network.
- High-speed vehicle – The scenario for users in road vehicles. The users can be connected either directly or via an onboard base station to the network.
- Airplanes connectivity – The scenario for users in airplanes. The users can be connected either directly or via an onboard base station to the network.

Table 7.1-1 Performance requirements for high data rate and traffic density scenarios.

	Scenario	Experienced data rate (DL)	Experienced data rate (UL)	Area traffic capacity (DL)	Area traffic capacity (UL)	Overall user density	Activity factor	UE speed	Coverage
1	Urban macro	50 Mbit/s	25 Mbit/s	100 Gbit/s/km ² (note 4)	50 Gbit/s/km ² (note 4)	10 000/km ²	20 %	Pedestrians and users in vehicles (up to 120 km/h)	Full network (note 1)
2	Rural macro	50 Mbit/s	25 Mbit/s	1 Gbit/s/km ² (note 4)	500 Mbit/s/km ² (note 4)	100/km ²	20 %	Pedestrians and users in vehicles (up to 120 km/h)	Full network (note 1)
3	Indoor hotspot	1 Gbit/s	500 Mbit/s	15 Tbit/s/km ²	2 Tbit/s/km ²	250 000/km ²	note 2	Pedestrians	Office and residential (note 2) (note 3)
4	Broadband access in a crowd	25 Mbit/s	50 Mbit/s	[3,75] Tbit/s/km ²	[7,5] Tbit/s/km ²	[500 000]/km ²	30 %	Pedestrians	Confined area
5	Dense urban	300 Mbit/s	50 Mbit/s	750 Gbit/s/km ² (note 4)	125 Gbit/s/km ² (note 4)	25 000/km ²	10 %	Pedestrians and users in vehicles (up to 60 km/h)	Downtown (note 1)
6	Broadcast-like services	Maximum 200 Mbit/s (per TV channel)	N/A or modest (e.g. 500 kbit/s per user)	N/A	N/A	[15] TV channels of [20 Mbit/s] on one carrier	N/A	Stationary users, pedestrians and users in vehicles (up to 500 km/h)	Full network (note 1)
7	High-speed train	50 Mbit/s	25 Mbit/s	15 Gbit/s/train	7,5 Gbit/s/train	1 000/train	30 %	Users in trains (up to 500 km/h)	Along railways (note 1)
8	High-speed vehicle	50 Mbit/s	25 Mbit/s	[100] Gbit/s/km ²	[50] Gbit/s/km ²	4 000/km ²	50 %	Users in vehicles (up to 250 km/h)	Along roads (note 1)
9	Airplanes connectivity	15 Mbit/s	7,5 Mbit/s	1,2 Gbit/s/plane	600 Mbit/s/plane	400/plane	20 %	Users in airplanes (up to 1 000 km/h)	(note 1)
<p>NOTE 1: For users in vehicles, the UE can be connected to the network directly, or via an on-board moving base station.</p> <p>NOTE 2: A certain traffic mix is assumed; only some users use services that require the highest data rates [2].</p> <p>NOTE 3: For interactive audio and video services, for example, virtual meetings, the required two-way end-to-end latency (UL and DL) is 2-4 ms while the corresponding experienced data rate needs to be up to 8K 3D video [300 Mbit/s] in uplink and downlink.</p> <p>NOTE 4: These values are derived based on overall user density. Detailed information can be found in [10].</p> <p>NOTE 5: All the values in this table are targeted values and not strict requirements.</p>									

7.2 Low latency and high reliability

7.2.1 Overview

Several scenarios require the support of very low latency and very high communications service availability. Note that this implies a very high reliability. The overall service latency depends on the delay on the radio interface, transmission within the 5G system, transmission to a server which may be outside the 5G system, and data processing. Some of these factors depend directly on the 5G system itself, whereas for others the impact can be reduced by suitable interconnections between the 5G system and services or servers outside of the 5G system, for example, to allow local hosting of the services.

7.2.2 Scenarios and KPIs

Different deployments of URLLC capabilities will depend on the 3GPP system being able to meet specific sets of KPIs with different values and ranges applicable for each attribute. A common, yet flexible, 5G approach to URLLC will

enable the 5G system to meet the specific sets of KPIs needed in a given implementation. To provide clear and precise requirements for specific types of services, the corresponding KPI requirements are included in other specifications as follows:

- Cyber-physical control applications in vertical domains can be found in 22.104 [21].
- V2X can be found in 22.186 [9].
- Rail communications can be found in 22.289 [23].

Some scenarios requiring very low latency and very high communication service availability are described below:

- Motion control – Conventional motion control is characterised by high requirements on the communications system regarding latency, reliability, and availability. Systems supporting motion control are usually deployed in geographically limited areas but may also be deployed in wider areas (e.g. city- or country-wide networks), access to them may be limited to authorized users, and they may be isolated from networks or network resources used by other cellular customers.
- Discrete automation – Discrete automation is characterised by high requirements on the communications system regarding reliability and availability. Systems supporting discrete automation are usually deployed in geographically limited areas, access to them may be limited to authorized users, and they may be isolated from networks or network resources used by other cellular customers.
- Process automation – Automation for (reactive) flows, e.g. refineries and water distribution networks. Process automation is characterized by high requirements on the communications system regarding communication service availability. Systems supporting process automation are usually deployed in geographically limited areas, access to them is usually limited to authorized users, and it will usually be served by non-public networks.
- Automation for electricity distribution (mainly medium and high voltage). Electricity distribution is characterized by high requirements on the communications service availability. In contrast to the above use cases, electricity distribution is deeply immersed into the public space. Since electricity distribution is an essential infrastructure, it will, as a rule, be served by non-public networks.
- Wireless road-side infrastructure backhaul in intelligent transport systems – Automation solutions for the infrastructure supporting street-based traffic. This use case addresses the connection of the road-side infrastructure, e.g. roadside units, with other infrastructure, e.g. a traffic guidance system. As is the case for automation electricity, the nodes are deeply immersed into the public space.
- Remote control – Remote control is characterised by a UE being operated remotely by a human or a computer. For example, Remote Driving enables a remote driver or a V2X application to operate a remote vehicle with no driver or a remote vehicle located in a dangerous environment.
- Rail communications (e.g. railway, rail-bound mass transit) have been using 3GPP based mobile communication (e.g. GSM-R) already for some time, while there is still a driver on-board of the train. The next step of the evolution will be providing fully automated train operation that requires highly reliable communication with moderate latencies but at very high speeds of up to 500 km/h.

For specific requirements, refer to the specifications noted above [21], [9], [23].

7.2.3 Other requirements

7.2.3.1 (void)

7.2.3.2 Wireless road-side infrastructure backhaul

Intelligent Transport Systems embrace a wide variety of communications-related applications that are intended to increase travel safety, minimize environmental impact, improve traffic management, and maximize the benefits of transportation to both commercial users and the general public.

Road-side infrastructure such as traffic light controllers, roadside units, traffic monitoring in urban areas and along highways and streets is wirelessly connected to traffic control centres for management and control purposes. The backhaul communication between the road-side infrastructure and the traffic control centre requires low-latency, high

communication service availability, and high-capacity connections for reliable distribution of data. Road-side infrastructure is deployed alongside streets in urban areas and alongside major roads and highways every 1-2 km.

To support wireless road-side infrastructure backhaul the 5G system shall support the performance requirements in table 7.2.3.2-1.

Table 7.2.3.2-1 Performance requirements for wireless ITS infrastructure backhaul scenario

Scenario	Max. allowed end-to-end latency (note 1)	Survival time	Communication service availability (note 2)	Reliability (note 2)	User experienced data rate	Payload size (note 3)	Traffic density (note 4)	Connection density (note 5)	Service area dimension (note 6)
wireless road-side infrastructure backhaul	30 ms	100 ms	99,9999%	99,999%	10 Mbit/s	Small to big	10 Gbit/s/km ²	1 000/km ²	2 km along a road
<p>NOTE 1: This is the maximum end-to-end latency allowed for the 5G system to deliver the service in the case the end-to-end latency is completely allocated to the 5G system from the UE to the Interface to Data Network.</p> <p>NOTE 2: Communication service availability relates to the service interfaces, and reliability relates to a given system entity. One or more retransmissions of network layer packets may take place in order to satisfy the reliability requirement.</p> <p>NOTE 3: Small: payload typically ≤ 256 bytes</p> <p>NOTE 4: Based on the assumption that all connected applications within the service volume require the user experienced data rate.</p> <p>NOTE 5: Under the assumption of 100% 5G penetration.</p> <p>NOTE 6: Estimates of maximum dimensions; the last figure is the vertical dimension.</p> <p>NOTE 7: All the values in this table are example values and not strict requirements. Deployment configurations should be taken into account when considering service offerings that meet the targets.</p>									

7.3 High-accuracy positioning

7.3.1 Description

Adaptability and flexibility are among the key features of the 5G system to serve a wide diversity of verticals and services, in different environments (e.g. rural, urban, indoor). This applies to high-accuracy positioning and translates into the ability to satisfy different levels of services and requirements, for instance on performance (e.g. accuracy, positioning service availability, positioning service latency) and on functionality (e.g. security).

7.3.2 Requirements

7.3.2.1 General

The 5G System shall provide different 5G positioning services with configurable performances working points (e.g. accuracy, positioning service availability, positioning service latency, energy consumption, update rate, TTFF) according to the needs of users, operators and third parties.

The 5G system shall support the combination of 3GPP and non-3GPP positioning technologies to achieve performances of the 5G positioning services better than those achieved using only 3GPP positioning technologies.

NOTE 1: For instance, the combination of 3GPP positioning technologies with non-3GPP positioning technologies such as GNSS (e.g. Beidou, Galileo, GLONASS, and GPS), Terrestrial Beacon Systems (TBS), sensors (e.g. barometer, IMU), WLAN/Bluetooth-based positioning, can support the improvement of accuracy, positioning service availability, reliability and/or confidence level, the reduction of positioning service latency, the increase of the update rate of the position-related data, increase the coverage (service area).

NOTE 2: The combination can vary over time to optimise the performances, and can be the combination of multiple positioning technologies at the same epoch and/or the combination of multiple positioning technologies at different epochs.

The corresponding positioning information shall be acquired in a timely fashion, be reliable, and be available (e.g. it is possible to determine the position).

UEs shall be able to share positioning information between each other e.g. to a controller if the location information cannot be processed or used locally.

7.3.2.2 Requirements for horizontal and vertical positioning service levels

The 5G system shall be able to provide positioning services with the performances requirements reported in Table 7.3.2.2-1.

NOTE: The requirements do not preclude any type of UE, including specific UE such as for example V2X, MTC.

Table 7.3.2.2-1 Performance requirements for Horizontal and Vertical positioning service levels

Positioning service level	Absolute(A) or Relative(R) positioning	Accuracy (95 % confidence level)		Positioning service availability	Positioning service latency	Coverage, environment of use and UE velocity		
		Horizontal Accuracy	Vertical Accuracy (note 1)			5G positioning service area	5G enhanced positioning service area (note 2)	
							Outdoor and tunnels	Indoor
1	A	10 m	3 m	95 %	1 s	Indoor - up to 30 km/h Outdoor (rural and urban) up to 250 km/h	NA	Indoor - up to 30 km/h
2	A	3 m	3 m	99 %	1 s	Outdoor (rural and urban) up to 500 km/h for trains and up to 250 km/h for other vehicles	Outdoor (dense urban) up to 60 km/h Along roads up to 250 km/h and along railways up to 500 km/h	Indoor - up to 30 km/h
3	A	1 m	2 m	99 %	1 s	Outdoor (rural and urban) up to 500 km/h for trains and up to 250 km/h for other vehicles	Outdoor (dense urban) up to 60 km/h Along roads up to 250 km/h and along railways up to 500 km/h	Indoor - up to 30 km/h
4	A	1 m	2 m	99,9 %	15 ms	NA	NA	Indoor - up to 30 km/h
5	A	0,3 m	2 m	99 %	1 s	Outdoor (rural) up to 250 km/h	Outdoor (dense urban) up to 60 km/h Along roads and along railways up to 250 km/h	Indoor - up to 30 km/h
6	A	0,3 m	2 m	99,9 %	10 ms	NA	Outdoor (dense urban) up to 60 km/h	Indoor - up to 30 km/h
7	R	0,2 m	0,2 m	99 %	1 s	Indoor and outdoor (rural, urban, dense urban) up to 30 km/h Relative positioning is between two UEs within 10 m of each other or between one UE and 5G positioning nodes within 10 m of each other (note 3)		
NOTE 1: The objective for the vertical positioning requirement is to determine the floor for indoor use cases and to distinguish between superposed tracks for road and rail use cases (e.g. bridges).								
NOTE 2: Indoor includes location inside buildings such as offices, hospital, industrial buildings.								
NOTE 3: 5G positioning nodes are infrastructure equipment 5G deployed in the service area to enhance positioning capabilities (e.g. beacons deployed on the perimeter of a rendezvous area or on the side of a warehouse).								

7.3.2.3 Other performance requirements

The 5G system shall be able to provide the 5G positioning services with a TTFF less than 30 s and, for some 5G positioning services, shall support mechanisms to provide a TTFF less than 10 s.

NOTE 1: In some services, a TTFF of less than 10s may only be achievable at the expense of a relaxation of some other performances (e.g. horizontal accuracy may be 1 m or 3 m after 10 s TTFF, and reach a steady state accuracy of 0,3 m after 30 s).

The 5G system shall support a mechanism to determine the UE's velocity with a positioning service availability of 99%, an accuracy better than 0,5 m/s for the speed and an accuracy better than 5 degree for the 3-Dimension direction of travel.

The 5G system shall support a mechanism to determine the UE's heading with an accuracy better than 30 degrees (0,54 rad) and a positioning service availability of 99,9 % for static users and with an accuracy better than 10 degrees (0,17 rad) and a positioning service availability of 99 % for users up to 10 km/h.

The 5G system shall support positioning technologies that allow the UE to operate at Service Level 1 for at least 12 years using less than 1800 mWh of battery capacity, assuming multiple position updates per hour.

NOTE 2: This requirement aims energy-efficient positioning technologies draining a minimal energy on the UE battery. It derives from use cases, such as asset tracking, with a small form-factor battery representative of an IoT device. This requirement may translate into an energy consumption for the UE's positioning functions in the order of 20 mJ per fix.

NOTE 3: This requirement does not preclude the use of higher energy consumption to fulfil higher position update rates than the one above, or other KPIs than those of Service Level 1 (e.g. more accurate service levels).

7.4 KPIs for a 5G system with satellite access

7.4.1 Description

Satellite access networks are based on infrastructures integrated on a minimum of satellites that can be placed in either GEO, MEO or LEO.

The propagation delay associated with these orbit ranges, for the UE to the satellite path, can be summarized in Table 7.4.1-1:

Table 7.4.1-1: UE to satellite propagation delay

	UE to satellite Delay [ms]		One-Way Max propagation delay [ms]
	Min	Max	
LEO	3	15	30
MEO	27	43	90
GEO	120	140	280

7.4.2 Requirements

A 5G system providing service with satellite access shall be able to support GEO based satellite access with up to 285 ms end-to-end latency.

NOTE 1: 5 ms network latency is assumed and added to satellite one-way delay.

A 5G system providing service with satellite access shall be able to support MEO based satellite access with up to 95 ms end-to-end latency.

NOTE 2: 5 ms network latency is assumed and added to satellite one-way delay.

A 5G system providing service with satellite access shall be able to support LEO based satellite access with up to 35 ms end-to-end latency.

NOTE 3: 5 ms network latency is assumed and added to satellite one-way delay.

A 5G system shall support negotiation on quality of service taking into account latency penalty to optimise the QoE for UE.

The 5G system with satellite access shall support high uplink data rates for 5G satellite UEs.

The 5G system with satellite access shall support high downlink data rates for 5G satellite UEs.

The 5G system with satellite access shall support communication service availabilities of at least 99,99%.

Table 7.4.2-1: Performance requirements for satellite access

Scenario	Experienced data rate (DL)	Experienced data rate (UL)	Area traffic capacity (DL) (note 1)	Area traffic capacity (UL) (note 1)	Overall user density	Activity factor	UE speed	UE type
Pedestrian (note 2)	[1] Mbit/s	[100] kbit/s	1,5 Mbit/s/km ²	150 kbit/s/km ²	[100]/km ²	[1,5] %	Pedestrian	Handheld
Public safety	[3,5] Mbit/ss	[3,5] Mbit/s	TBD	TBD	TBD	N/A	100 km/h	Handheld
Vehicular connectivity (note 3)	50 Mbit/s	25 Mbit/s	TBD	TBD	TBD	50 %	Up to 250 km/h	Vehicle mounted
Airplanes connectivity (note 4)	360 Mbit/s/ plane	180 Mbit/s/ plane	TBD	TBD	TBD	N/A	Up to 1000 km/h	Airplane mounted
Stationary	50 Mbit/s	25 Mbit/s	TBD	TBD	TBD	N/A	Stationary	Building mounted
Narrowband IoT connectivity	[2] kbit/s	[10] kbit/s	8 kbit/s/km ²	40 kbit/s/km ²	[400]/km ²	[1] %	[Up to 100 km/h]	IoT

Note 1: Area capacity is averaged over a satellite beam.
Note 2: Data rates based on Extreme long-range coverage target values in clause 6.17.2. User density based on rural area in Table 7.1-1.
Note 3: Based on Table 7.1-1
Note 4: Based on an assumption of 120 users per plane 15/7.5 Mbit/s data rate and 20 % activity factor per user
Note 5: All the values in this table are targeted values and not strict requirements.
Note 6: Performance requirements for all the values in this table should be analyzed independently for each scenario.

7.5 High-availability IoT traffic

7.5.1 Description

Several scenarios require the support of highly reliable machine type communication such as those, typically (but not restricted to) related to medical monitoring. They involve different deployment areas, different device speeds and densities and require a high-availability communication service to transfer a low data rate uplink data stream from one or several devices to an application.

Their related performance requirements can be found in table 7.5.2-1.

7.5.2 Requirements

Table 7.5.2-1: Performance requirements for highly reliable machine type communication

Profile	Characteristic parameter					Influence quantity					
	Communication service availability: target value in %	Communication service reliability (Mean Time Between Failure)	End-to-end latency: maximum	Bit rate	Direction	Message Size [byte]	Transfer Interval	Survival Time	UE speed (km/h)	# of UEs connection	Service Area
Medical monitoring (note 2)	> 99,9999	<1 year (>> 1 month)	< 100 ms	< 1 Mbit/s	Uplink	~ 1000	50 ms	Transfer Interval	< 500	10/km ² to 1000/km ²	Country wide including rural areas and deep indoor. (note 1)
<p>NOTE 1: "deep indoor" term is meant to be places like e.g. elevators, building's basement, underground parking lot, ...</p> <p>NOTE 2: These performance requirements aim energy-efficient transmissions performed using a device powered with a 3.3V battery of capacity < 1000 mAh that can last at least 1 month without recharging and whereby the peak current for transmit operations stays below 50 mA.</p>											

7.6 High data rate and low latency

7.6.1 AR/VR

Audio-visual interaction is characterised by a human being interacting with the environment or people, or controlling a UE, and relying on audio-visual feedback. In the use cases like VR and interactive conversation the latency requirements include the latencies at the application layer (e.g. codecs), which could be specified outside of 3GPP.

To support VR environments with low motion-to-photon capabilities, the 5G system shall support:

- motion-to-photon latency in the range of 7 ms to 15ms while maintaining the required resolution of up to 8k giving user data rate of up to [1Gbit/s] and
- motion-to-sound delay of [< 20 ms].

NOTE: The motion-to-photon latency is defined as the latency between the physical movement of a user's head and the updated picture in the VR headset. The motion-to-sound latency is the latency between the physical movement of a user's head and updated sound waves from a head mounted speaker reaching their ears.

To support interactive task completion during voice conversation, the 5G system shall support low-delay speech coding for interactive conversational services (100 ms, one-way mouth-to-ear).

Due to the separate handling of the audio and video component, the 5G system will have to cater for the VR audio-video synchronisation in order to avoid having a negative impact on the user experience (i.e. viewers detecting lack of synchronization). To support VR environments the 5G system shall support audio-video synchronisation thresholds:

- in the range of [125 ms to 5 ms] for audio delayed and
- in the range of [45 ms to 5 ms] for audio advanced.

When it comes to implementation of applications containing AR/VR components, the requirements on the 5G network could depend on architectural choices implementing these services. Note 3 in table 7.1-1 above gives an example on such dependences for a VR application in a 5G system. Table 7.6.1-1 below illustrates additional use cases and provides more corresponding requirements on the 5G system.

- Cloud/Edge/Split Rendering – Cloud/Edge/Split Rendering is characterised by the transition and exchange of the rendering data between the rendering server and device.
- Gaming or Training Data Exchanging – This use case is characterised by the exchange of the gaming or training service data between two 5G connected AR/VR devices.
- Consume VR content via tethered VR headset – This use case involves a tethered VR headset receiving VR content via a connected UE; this approach alleviates some of the computation complexity required at the VR headset, by allowing some or all decoding functionality to run locally at the connected UE. The requirements in the table below refer to the direct wireless link between the tethered VR headset and the corresponding connected UE.

Table 7.6.1-1 KPI Table for additional high data rate and low latency service

Use Cases	Characteristic parameter (KPI)			Influence quantity		
	Max allowed end-to-end latency	Service bit rate: user-experienced data rate	Reliability	# of UEs	UE Speed	Service Area (note 2)
Cloud/Edge/Split Rendering (note 1)	5 ms (i.e. UL+DL between UE and the interface to data network) (note 4)	0,1 to [1] Gbit/s supporting visual content (e.g. VR based or high definition video) with 4K, 8K resolution and up to 120 frames per second content.	99,99 % in uplink and 99,9 % in downlink (note 4)	-	Stationary or Pedestrian	Countrywide
Gaming or Interactive Data Exchanging (note 3)	10ms (note 4)	0,1 to [1] Gbit/s supporting visual content (e.g. VR based or high definition video) with 4K, 8K resolution and up to 120 frames per second content.	99,99 % (note 4)	≤ [10]	Stationary or Pedestrian	20 m x 10 m; in one vehicle (up to 120 km/h) and in one train (up to 500 km/h)
Consumption of VR content via tethered VR headset (note 6)	[5 to 10] ms (note 5)	0,1 to [10] Gbit/s (note 5)	[99,99 %]	-	Stationary or Pedestrian	-
<p>NOTE 1: Unless otherwise specified, all communication via wireless link is between UEs and network node (UE to network node and/or network node to UE) rather than direct wireless links (UE to UE).</p> <p>NOTE 2: Length x width (x height).</p> <p>NOTE 3: Communication includes direct wireless links (UE to UE).</p> <p>NOTE 4: Latency and reliability KPIs can vary based on specific use case/architecture, e.g. for cloud/edge/split rendering, and may be represented by a range of values.</p> <p>NOTE 5: The decoding capability in the VR headset and the encoding/decoding complexity/time of the stream will set the required bit rate and latency over the direct wireless link between the tethered VR headset and its connected UE, bit rate from 100 Mbit/s to [10] Gbit/s and latency from 5 ms to 10 ms.</p> <p>NOTE 6: The performance requirement is valid for the direct wireless link between the tethered VR headset and its connected UE.</p>						

7.7 KPIs for UE to network relaying in 5G system

In several scenarios, it can be beneficial to relay communication between one UE and the network via one or more other UEs. The functional requirements related to relaying can be found in clause 6.9.2. Performance requirements for relaying in different scenarios can be found in table 7.7-1.

Table 7.7-1: Key Performance for UE to network relaying

Scenario	Max. data rate (DL)	Max. data rate (UL)	End-to-end latency (note 7)	Area traffic capacity (DL)	Area traffic capacity (UL)	Area user density	Area	Range of a single hop (note 8)	Estimated number of hops
InHome Scenario (note 1)	1 Gbit/s	500 Mbit/s	10 ms	5 Gbit/s/home	2 Gbit/s/home	50 devices/house	10 m x 10m – 3 floors	10 m indoor	2 to 3
Factory Sensors (note 2)	100 kbit/s	5 Mbit/s	50 ms to 1 s	1 Gbit/s/factory	50 Gbit/s/factory	10000 devices/factory	100 m x 100 m	30 m indoor / metallic	2 to 3
Smart Metering (note 3)	100 bytes / 15 mins	100 bytes / 15 mins	10 s	200 x 100 bytes / 15 mins /hectare	200 x 100 bytes / 15 mins /hectare	200 devices/hectare	100 m x 100 m	> 100 m indoor / deep indoor	2 to 5
Containers (note 4)	100 bytes / 15 mins	100 bytes / 15 mins	10 s	15000 x 100 bytes / 15 mins /ship	15000 x 100 bytes / 15 mins /ship	15000 containers /ship	400 m x 60 m x 40 m	> 100 m indoor / outdoor / metallic	3 to 9
Freight Wagons	100 bytes / 15 mins	100 bytes / 15 mins	10 s	200 x 100 bytes / 15 mins /train	200 x 100 bytes / 15 mins /train	120 wagons /train	1 km	> 100 m outdoor / tunnel	10 to 15
Public Safety (note 5)	12 Mbit/s	12 Mbit/s	30 ms	20 Mbit/s/building	40 Mbit/s/building	30 devices/building	100 m x 100 m – 3 floors	> 50 m indoor (floor or stairwell)	2 to 4
Wearables (note 6)	10 Mbit/s	10 Mbit/s	10 ms	20 Mbit/s per 100 m ²	20 Mbit/s per 100 m ²	10 wearables per 100 m ²	10 m x 10 m	10 m indoor / outdoor	1 to 2
<p>NOTE 1: Area traffic capacity is determined by high bandwidth consuming devices (e.g. ultra HD TVs, VR headsets), the number of devices has been calculated assuming a family of 4 members.</p> <p>NOTE 2: Highest data rate assumes audio sensors with sampling rate of 192 kHz and 24 bits sample size.</p> <p>NOTE 3: Three meters (gas, water, electricity) per house, medium density of 50 to 70 houses per hectare.</p> <p>NOTE 4: A large containership with a mix of 20 foot and 40 foot containers is assumed.</p> <p>NOTE 5: A mix of MCPTT, MCVideo, and MCData is assumed. Average 3 devices per firefighter / police officer, of which one video device. Area traffic based on 1080 p, 60 fps is 12 Mbit/s video, with an activity factor of 30% in uplink (30% of devices transmit simultaneously at high bitrate) and 15% in downlink.</p> <p>NOTE 6: Communication for wearables is relayed via a UE. This relay UE may use a further relay UE.</p> <p>NOTE 7: End-to-end latency implies that all hops are included.</p> <p>NOTE 8: 'Metallic' implies an environment with a lot of metal obstructions (e.g. machinery, containers). 'Deep indoor' implies that there may be concrete walls / floors between the devices.</p> <p>NOTE 9: All the values in this table are example values and not strict requirements.</p>									

8 Security

8.1 Description

IoT introduces new UEs with different life cycles, including IoT devices with no user interface (e.g. embedded sensors), long life spans during which an IoT device may change ownership several times (e.g. consumer goods), and which may not be pre-provisioned (e.g. consumer goods). These drive a need for secure mechanisms to dynamically establish or refresh credentials and subscriptions. New access technologies, including licensed and unlicensed, 3GPP and non-3GPP, drive a need for access-independent security that is seamlessly available while the IoT device is active. High-end smartphones, UAVs, and factory automation drive a need for protection against theft and fraud. A high level of 5G security is essential for critical communication, e.g. in industrial automation, industrial IoT, and the Smart Grid. Expansion into enterprise, vehicular, medical, and public safety markets drive a need for increased end user privacy protection. 5G security addresses all of these new needs while continuing to provide security consistent with prior 3GPP systems.

8.2 General

The 5G system shall support a secure mechanism to store cached data.

The 5G system shall support a secure mechanism to access a content caching application.

The 5G system shall support a secure mechanism to access a service or an application in an operator's Service Hosting Environment.

The 5G system shall enable support of an access-independent security framework.

The 5G system shall support a mechanism for the operator to authorize subscribers of other PLMNs to receive temporary service (e.g. mission critical services).

The 5G system shall be able to provide temporary service for authorized users without access to their home network (e.g. IOPS, mission critical services).

The 5G system shall allow the operator to authorize a third-party to create, modify and delete network slices, subject to an agreement between the third-party and the network operator.

Based on operator policy, a 5G network shall provide suitable means to allow a trusted and authorized third-party to create and modify network slices used for the third-party with appropriate security policies (e.g. user data privacy handling, slices isolation, enhanced logging).

The 5G system shall support a secure mechanism to protect relayed data from being intercepted by a relay UE.

Subject to HPLMN policy as well as its service and operational needs, any USIM able to access EPS instead of a 5G USIM may be used to authenticate a user in a 5G system to access supported services according to the user subscription.

The 5G system shall provide integrity protection and confidentiality for communications between authorized UEs using a 5G LAN-type service.

The 5G LAN-VN shall be able to verify the identity of a UE requesting to join a specific private communication.

The 5G system shall provide suitable means to allow the use of a trusted third-party provided encryption between any UE served by a private slice and a core network entity in that private slice.

The 5G system shall provide suitable means to allow use of a trusted and authorized third-party provided integrity protection mechanism for data exchanged between an authorized UE served by a private slice and a core network entity in that private slice.

The 5G system shall provide suitable means to allow use of a trusted and authorized third-party provided integrity protection mechanism for data exchanged between an authorized UE served by a non-public network and a core network entity in that non-public network.

8.3 Authentication

The 5G system shall support an efficient means to authenticate a user to an IoT device (e.g. biometrics).

The 5G system shall be able to support authentication over a non-3GPP access technology using 3GPP credentials.

The 5G system shall support operator-controlled alternative authentication methods (i.e. alternative to AKA) with different types of credentials for network access for IoT devices in isolated deployment scenarios (e.g. for industrial automation).

The 5G system shall support a suitable framework (e.g. EAP) allowing alternative (e.g. to AKA) authentication methods with non-3GPP identities and credentials to be used for UE network access authentication in non-public networks.

NOTE: Non-public networks can use 3GPP authentication methods, identities, and credentials for a UE to access network. Non-public networks are also allowed to utilize non-AKA based authentication methods such as provided by the EAP framework, for which the credentials can be stored in the ME.

Subject to an agreement between an MNO and a 3rd party, the 5G system shall support a mechanism for the PLMN to authenticate and authorize UEs for access to both a hosted non-public network and private slice(s) of the PLMN associated with the hosted non-public network.

The 5G network shall support a 3GPP supported mechanism to authenticate legacy non-3GPP devices for 5G LAN-VN access.

The 5G system shall support a mechanism for the non-public network to authenticate and authorize UEs for access to network slices of that non-public network.

The 5G system shall enable an NPN to be able to request a third-party service provider to perform NPN access network authentication of a UE based on non-3GPP identities and credentials supplied by the third-party service provider.

The 5G system shall enable an NPN to be able to request a PLMN to perform NPN access network authentication of a UE based on 3GPP identities and credentials supplied by the PLMN.

8.4 Authorization

The 5G system shall allow the operator to authorize an IoT device to use one or more 5G system features that are restricted to IoT devices.

The 5G system shall allow the operator to authorize /de-authorize UEs for using 5G LAN-type service.

NOTE: When a UE is de-authorized from using 5G LAN-type service, it is removed from all 5G LAN-VNs.

Based on operator policy, before establishing a direct device connection using a non-3GPP access technology, IoT devices may use 3GPP credentials to determine if they are authorized to engage in direct device connection.

Based on operator policy, the 5G system shall provide a means to verify whether a UE is authorized to use prioritized network access for a specific service.

8.5 Identity management

The 5G system shall provide a mechanism for an operator to allow access from a UE using a temporary identifier that hides its subscriber identity.

The 5G system shall provide a mechanism for an operator to allow access from a UE connected in an indirect network connection using a temporary identifier that hides its subscriber identity.

The HPLMN shall be able to associate a temporary identifier to a UE's subscriber identity.

The 5G system shall be able to protect subscriber identity and other user identifying information from passive attacks.

Subject to regional or national regulatory requirements, the 5G system shall be able to protect subscriber identity and other user identifying information from active attacks.

The 5G system shall be able to allow the equipment identifier to be collected by legitimate entity regardless of UE's user interface, when required.

The 5G system shall be able to support identification of subscriptions independently of identification of equipment.

The 5G system shall support a secure mechanism to collect system information while ensuring end-user and application privacy (e.g. application level information is not to be related to an individual user identity or subscriber identity and UE information is not to be related to an individual subscriber identity).

Subject to regional or national regulatory requirements, the 5G system shall be able to provide the 5G positioning services while ensuring the protection of the privacy of the UE's user or owner, including the respect of his consent to the positioning services.

NOTE 1: this includes the ability for the 5G system to provide the positioning services on demand without having to track continuously the position of the involved UE.

NOTE 2: the respect of the user's consent to some positioning services could abide by different rules in case of emergency (for example, rules that would also receive consent from the user, but well before the emergency occurs).

For a private network using 5G technology, the 5G system shall support network access using identities, credentials, and authentication methods provided and managed by a third-party and supported by 3GPP.

8.6 Regulatory

The 5G system shall support regional or national regulatory requirements for all supported access networks.

The 5G system shall support Lawful Interception, subject to regional or national regulatory requirements.

A 5G satellite access network connected to 5G core networks in multiple countries shall be able to meet the corresponding regulatory requirements from these countries (e.g. Lawful Interception).

A 5G system shall support regulatory requirements for 5G LAN-type services.

8.7 Fraud protection

Subject to regional or national regulatory requirements, the 5G system shall support a secure mechanism for allowing an authorized entity to disable from normal operation of a UE reported as stolen.

Subject to regional or national regulatory requirements, the 5G system shall support a secure mechanism for allowing an authorized entity to re-enable a recovered stolen UE to normal operation.

The 5G system shall be able to protect user location information from passive attacks.

Subject to regional or national regulatory requirements, the 5G system shall be able to protect user location information from active attacks.

Subject to regional or national regulatory requirements, the 5G system shall support mechanisms to protect the production of the user location information and user positioning-related data against tampering and spoofing.

Subject to regional or national regulatory requirements, the 5G system shall support mechanisms to detect tampering and spoofing attempts on the production of the user location information and the user position-related data.

8.8 Resource efficiency

The 5G system shall minimize security signalling overhead without compromising the security level of the 3GPP system.

The 5G system shall support an efficient secure mechanism to transmit the same data (e.g. service provisioning multiple sensors) to multiple UEs.

8.9 Data security and privacy

The 5G system shall support data integrity protection and confidentiality methods that serve URLLC, high data rates and energy constrained devices.

The 5G system shall support a mechanism to verify the integrity of a message as well as the authenticity of the sender of the message.

The 5G system shall support encryption for URLLC services within the requested end-to-end latency.

Subject to regulatory requirements, the 5G system shall enable an MNO to provide end-to-end integrity protection, confidentiality, and protection against replay attacks between a UE and third-party application server, such that the 3GPP network is not able to intercept or modify the data transferred between a UE and third-party application server.

9 Charging aspects

9.1 General

The following set of requirements complement the requirements listed in 3GPP TS 22.115 [11]. The requirements apply for both home and roaming cases.

The 5G core network shall support collection of all charging information on either a network or a slice basis.

The 5G core network shall support collection of charging information for alternative authentication mechanisms.

The 5G core network shall support collection of charging information associated with each serving MNO when multi-network connectivity is used under the control of the home operator.

The 5G core network shall support charging for services/applications in an operator's Service Hosting Environment.

The 5G core network shall support charging for content delivered from a content caching application.

The 5G core network shall support collection of charging information based on the access type (e.g. 3GPP, non-3GPP, satellite access).

The 5G core network shall support collection of charging information based on the slice that the UE accesses.

The 5G core network shall support collection of charging information based on the capacity and performance metrics.

In a 5G system with satellite access, charging call records associated with satellite access(es) shall include the location of the associated UE(s) with satellite access

NOTE: The precision of the location of the UE can be based on the capabilities of the UE or of the network.

The 5G system shall be able to support an indirect network connection even when the UE is in E-UTRAN or NG-RAN coverage.

9.2 5G LAN

A 5G core network shall support collection of charging information for a 5G LAN-type service based on resource usage (e.g. licensed or unlicensed spectrum, QoS, applications).

The 5G core network shall support collection of charging information for a 5G LAN-type service when a UE joins or leaves a specific private communication.

The 5G core network shall support collection of charging information for a 5G LAN-type service for both home and roaming UEs based on the UE's HPLMN.

Annex A (informative): Latency needs to support example use cases from vertical industries

The latency values required to support the potential opportunities in the use cases on vertical industries are summarised in table A.1-1 based on the NGMN white paper on vertical industries [4]. Latency in this table refers to the end-to-end latency at the application layer as defined in clause 3.

Table A.1-1 Latency needs to support example use cases from vertical industries.

Services/ Use cases	Automotive use cases	Transport, logistics, IoT use cases	Health and wellness, smart cities use cases	Media and entertainment
Description	Expand detectable range beyond on board sensor capability by sharing views or detected objects among traffic participants, coordinate trajectories among vehicles, sharing coarse driving intention, real-time remote operation of vehicles	Real-time sensing, reporting, feedback, control, remote, asset tracking, monitoring; context-aware services, recommendations at shopping mall, airport	Live video feed (4K, 8K, 3D for remote healthcare (consultation, monitoring) and assisted surgery, real-time commands to control medical devices for treatment (e.g. medication, surgery); remote monitoring, surveillance and guidance for citizens and law enforcement officers.	Media production services based on aggregation of various media feeds at servers; real-time peer-to-peer or server-client sharing of data (object information) for collaborative gaming, live streaming at live events
Latency	<p>For mid/long-term environment modelling (dynamic high-definition digital map update): Not critical (100 ms end-to-end)</p> <p>For short term environment modelling (sensor sharing): <20 ms end-to-end</p> <p>For cooperation (coordinated control):</p> <ul style="list-style-type: none"> - <3 ms end-to-end for platooning , - <10 ms end-to-end for cooperative manoeuvres . - <100 ms end-to-end for coarse driving intention <p>For remote vehicle operation: 10-30 ms end-to-end</p>	<p>For massive connectivity for time-critical sensing and feedback: <30 ms end-to-end.</p> <p>For remote drone operation and cooperative farm machinery: 10-30 ms end-to-end</p> <p>Real-time control for discrete automation: ≤1 ms end-to-end</p>	<p>For real-time video/ telepresence/augmented reality for remote healthcare and assisted surgery, for monitoring and guidance (smart cities): 100 ms end-to-end</p> <p>Real-time command and control for remote medication and surgery: 10-100 ms end-to-end</p> <p>For smart grid:</p> <ul style="list-style-type: none"> - <5 ms end-to-end for transmission/grid backbone, - <50 ms end-to-end for distribution/grid backhaul, <p>Time-critical sensing and feedback for smart cities: 30 ms end-to-end</p>	<p>For live streaming in crowded areas, services for media production, augmented reality for collaborative gaming etc.: 20 ms end-to-end</p>

Annex B (informative): Positioning accuracy needs to support example use cases from vertical industries

Table B.1-1 provides a short summary of typical positioning use cases targeted in various verticals, associated with their main targets such as range of accuracy.

Information and positioning requirements associated to Factory of the Future use cases are provided in TS 22.104 [21].

Table B.1-1 Typical needs to support example use cases from vertical industries.

Use cases	Description	Main KPIs range and drivers
Commercial Handheld UE (typically pedestrian)	Mostly context aware services involving handheld UEs and pedestrian users for instance: augmented reality and wearables, advertisement push, wearables, collaborative activities such as bike sharing, guidance and flow management, etc.	Service area is both indoor and outdoor in the 5G service area. Accuracy: 1-10 m horizontal, < 3m vertical, Availability from 80 to 99% Other KPI drivers include in general: low energy and power saving modes
eHealth	Human-type or Machine-type UE involved in eHealth, for instance: patient tracking and surveillance inside or outside Hospitals (different service areas with potentially different performance requirements), location of emergency equipment outside Hospitals (public spaces, offices, etc.)	Service area is both indoor (Hospitals, housing, offices, etc.) and outdoor (5G service area). Accuracy: 3-10 m horizontal, < 3m vertical Availability from 90 to 99%
Emergency calls	Regulatory use cases related to emergency call from Human-type UE, US FCC's e911 being a typical example	Service area is both indoor and outdoor in the entire 5G service area. Accuracy: < 50 m horizontal, < 3m vertical Availability up to 95 % Other KPI drivers include: Reliability and confidence level
1st responders	Tracking and guidance of 1st responders, with requirements for high-accuracy in the horizontal domain and vertical domain, as well as accurate awareness of height variation to detect falls, combined to a high level of availability and reliability	Service area is both indoor and outdoor Accuracy: < 1m horizontal, < 2m vertical (indoor for floor detection) and < 0,3 m vertical (relative) to detect changes in height of the UE holder. Availability > 95 % (98% outdoor) Other KPI drivers include: MCX, confidence, event-triggered report
Road	Use cases involving road vehicles such as traffic monitoring, road-user charging (e.g. Road-Tolling, insurance mechanisms, etc.) which require positioning or tracking of vehicles at lane level, but also some awareness of position in the vertical domain (e.g. bridges) Service area is outdoor, but may include tunnels.	Accuracy: 1-3m horizontal (with <1m cross-track for lane detection), <2,5 m vertical, Velocity < 2m/s, Availability: 95-99% Other KPI drivers include: tampering detection and prevention (typically for Road User Charging)
UAV	Use cases involving UAV, requiring high accuracy in both the horizontal and vertical domain, as well as high level of availability and reliability – may involve absolute or relative positioning.	Service area is outdoor. Accuracy: 0,1-0,5m horizontal, 0,1 – 0,3m vertical, Velocity <0,5m/s, Availability: 99-99,9%, latency requirement may be <150 ms Other KPI drivers include: tampering detection and prevention
Railway	Use cases involving railway users (machine-type or human-type UE), such as described in FRMCS.	Service area is outdoor, but may include tunnels. Accuracy better than 1-3m horizontal. Availability better than 99 %
Asset tracking (outdoor)	Asset tracking in logistics or predictive maintenance, remote-sensing or monitoring using in-situ IoT devices, etc.	Accuracy: 1-30 m horizontal (depending on use cases and coverage area), Availability: 99% Very low energy per position fix to sustain very long lifetime without changing battery (typically 10-15 years)
NOTE 1: Vertical accuracy in the order of 2—3m aim to distinguish among floors indoor (offices, housing, etc.)		

Annex C (informative): Relation of communication service availability and reliability

Communication service availability and reliability are well known terms used not only within 3GPP but also in vertical industries (IEC 61907 [12]). Communication service availability addresses the availability of a communication service, in vertical applications usually in accordance to IEC 61907 [12]. Reliability addresses the availability of the communication network. The relation of both terms is depicted in figure C-1.

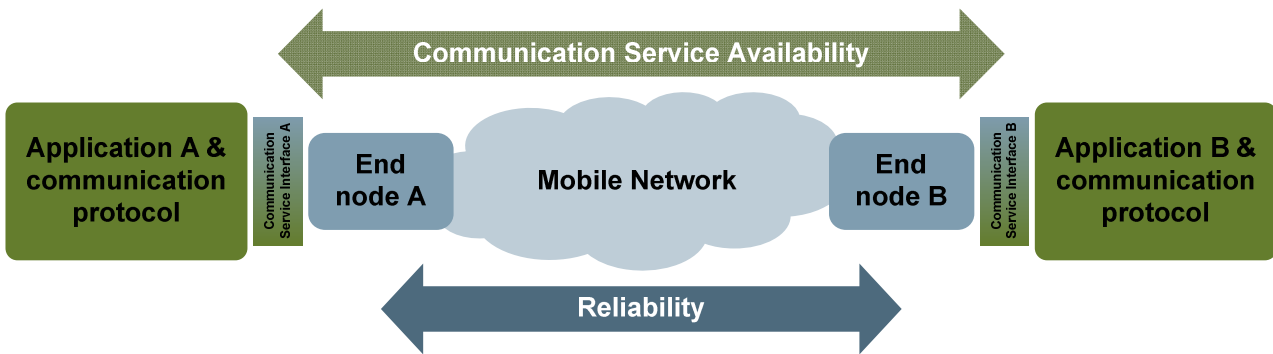

Figure C-1: Illustration of the concepts communication service availability and reliability.

As depicted, reliability covers the communication-related aspects between two nodes (here: end nodes), while communication service availability addresses the communication-related aspects between two communication service interfaces. In other words, the "gap" between both concepts is the communication interface. This might seem to be a small difference, but this difference can lead to situations, where reliability and communication service availability have different values.

Example: traffic gets "stuck"

The related scenario is depicted in figure C-2.

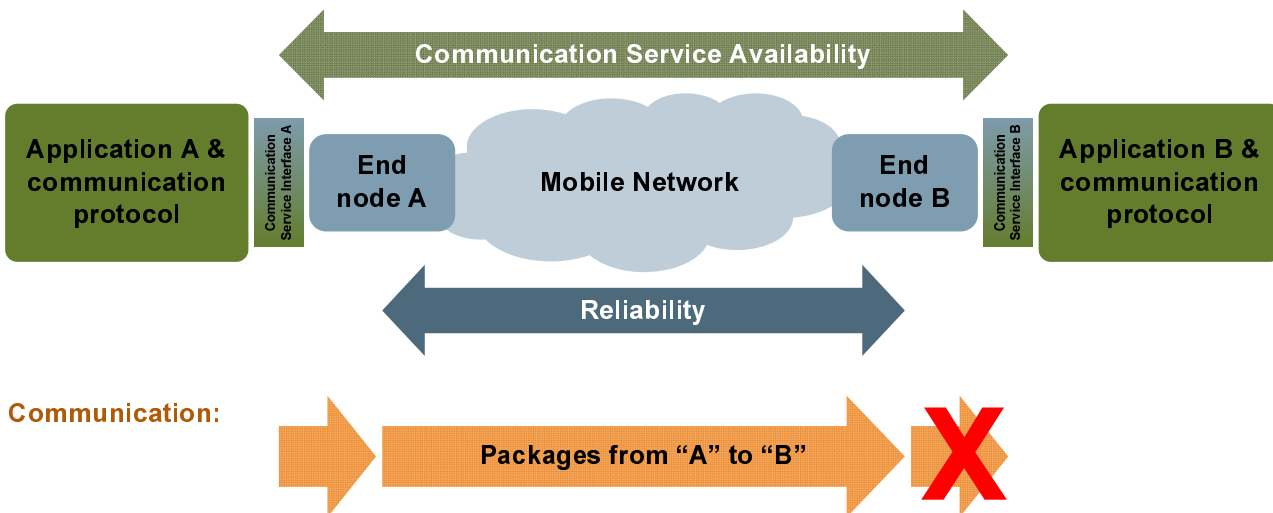

Figure C-2: Example in which communication service availability and reliability have different values. Packets are reliably transmitted from the communication service interface A to end node B, but they are not exposed at the communication service interface B.

This scenario addresses unicast communication from application A to B. The packets are handed over from the application to the communication network at the communication service interface A, and the packets are then transmitted to the end node B. In this example, the packets received by end node B are not exposed at the communication service interface B. So, even if all packets that are handed over to end node A are successfully delivered to end node B within the time constraint required by the targeted service, i.e. even if the reliability is 100%, the

communication service availability is 0% since no packets arrive at the "end", i.e. the communication service interface B.

Example: less capacity than agreed

The related scenario is depicted in figure C-3.

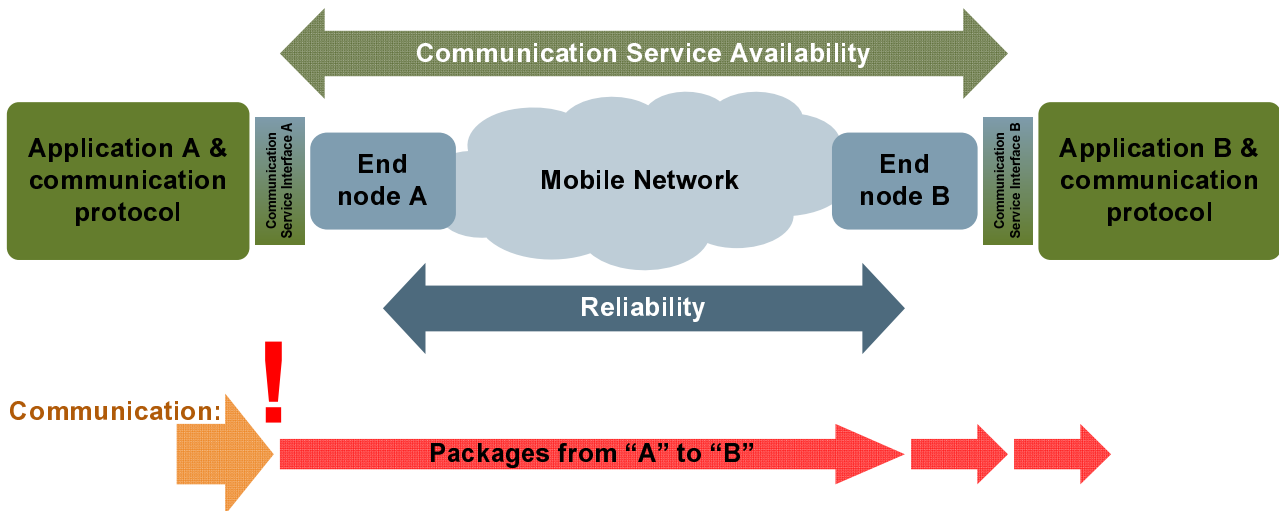

Figure C-3: Example in which communication service availability and reliability have different values. Only half of the packets handed over to the end node A are actually transmitted to end node B and handed over to application B at the communication service interface B.

This scenario describes unicast communication of evenly interspersed packets from application A to B. The packets are handed over from the application to the communication network at the communication service interface A, and the packets are then transmitted to the end node B. However, only every second packet is actually successfully handed over to end node A and then transmitted to end node B. Thus, only half of the packets arrive at application B. Note though that the reliability of the mobile network is 100%, since all packets transmitted by end node A are delivered to end node B within the time constraint required by the targeted service. However, depending on the agreed QoS, the communication service availability can be of the same value as the reliability or much lower. For instance, if the agreed survival time is larger than the time between three packets at the communication service interface A, communication service availability and reliability have the same value. However, if—due to the loss of packets at the communication service interface A—the effective bandwidth between application A and B is lower than the agreed value, the communication service availability is 0%.

Note that the shortest time interval over which the communication service availability should be calculated is the sum of maximum allowed end-to-end latency and survival time.

Example: heterogeneous network

The related scenario is depicted in figure C-4.

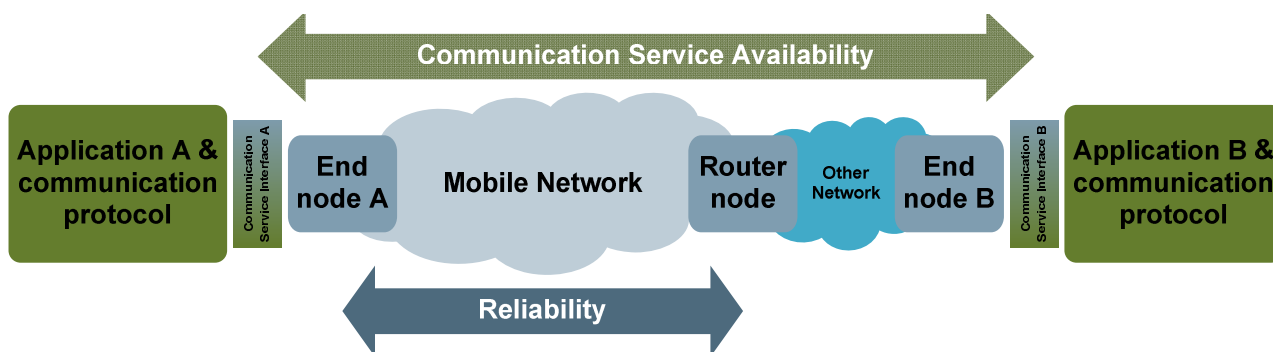

Figure C-4: Example in which communication service availability and reliability have different values. Packets are delivered over a daisy chain of a mobile network and another network (e.g. IEEE 802.11n based). Reliability is evaluated for the mobile network only, while communication service availability depends on the performance of both networks.

This scenario is not in scope for this specification, since it pertains to the particular deployment of a mobile network, but we discuss it nonetheless, as this example provides valuable insight for network operators.

This scenario describes unicast communication from application A to B. The packets are handed over from the application to the communication network at the communication service interface A, and the packets are then transmitted to the end node B. In this example, the packets are transmitted over two daisy-chained networks—one mobile network according to 3GPP specifications, and another network, e.g. a network based on IEEE 802.11n. As in the other examples above, communication service availability is measured between the two communication service interfaces, but the reliability is only measured between end node A and the router node. This has implications for, e.g. the maximum communication latency allowed for each network. In case the agreed end-to-end latency between the service interfaces is, for instance, 100 ms, and the 802.11n network has a latency of 30 ms, the maximum allowable latency for packages in the mobile network is 70 ms (NOTE). So, if the latency in the mobile network exceeds 70 ms, the communication service availability is 0%, despite the agreed QoS stipulating a larger end-to-end latency, i.e. 100 ms.

NOTE: The transit time through the router node is not considered here. It is assumed to be very small and much less than 100 ms.

Annex D (informative): Critical-communication use cases

D.1 Discrete automation – motion control

Industrial factory automation requires communications for closed-loop control applications. Examples for such applications are motion control of robots, machine tools, as well as packaging and printing machines. All other discrete-automation applications are addressed in Annex D.2.

The corresponding industrial communication solutions are referred to as fieldbuses. The pertinent standard suite is IEC 61158. Note that clock synchronization is an integral part of fieldbuses used for motion control.

In motion control applications, a controller interacts with a large number of sensors and actuators (e.g. up to 100), which are integrated in a manufacturing unit. The resulting sensor/actuator density is often very high (up to 1 m^{-3}). Many such manufacturing units may have to be supported within close proximity within a factory (e.g. up to 100 in automobile assembly line production).

In a closed-loop control application, the controller periodically submits instructions to a set of sensor/actuator devices, which return a response within a cycle time. The messages, referred to as telegrams, are typically small (≤ 56 bytes). The cycle time can be as low as 2 ms, setting stringent end-to-end latency constraints on telegram forwarding (1 ms). Additional constraints on isochronous telegram delivery add tight constraints on jitter (1 μs), and the communication service has also to be highly available (99,9999%).

Multi-robot cooperation is a case in closed-loop control where a group of robots collaborate to conduct an action, for example, symmetrical welding of a car body to minimize deformation. This requires isochronous operation between all robots. For multi-robot cooperation, the jitter (1 μs) is among the command messages of a control event to the group robots.

To meet the stringent requirements of closed-loop factory automation, the following considerations may have to be taken:

- Limitation to short-range communications.
- Use of direct device connection between the controller and actuators.
- Allocation of licensed spectrum for closed-loop control operations. Licensed spectrum may further be used as a complement to unlicensed spectrum, e.g. to enhance reliability.
- Reservation of dedicated radio interface resources for each link.
- Combination of multiple diversity techniques to approach the high reliability target within stringent end-to-end latency constraints such as frequency, antenna, and various forms of spatial diversity, e.g. via relaying
- Utilizing OTA time synchronization to satisfy jitter constraints for isochronous operation.

A typical industrial closed-loop motion control application is based on individual control events. Each closed-loop control event consists of a downlink transaction followed by a synchronous uplink transaction, both of which are executed within a cycle time. Control events within a manufacturing unit may have to occur isochronously. Factory automation considers application-layer transaction cycles between controller devices and sensor/actuator devices. Each transaction cycle consists of (1) a command sent by the controller to the sensor/actuator (downlink), (2) application-layer processing on the sensor/actuator device, and (3) a subsequent response by the sensor/actuator to the controller (uplink). Cycle time includes the entire transaction from the transmission of a command by the controller to the reception of a response by the controller. It includes all lower layer processes and latencies on the radio interface as well the application-layer processing time on the sensor/actuator.

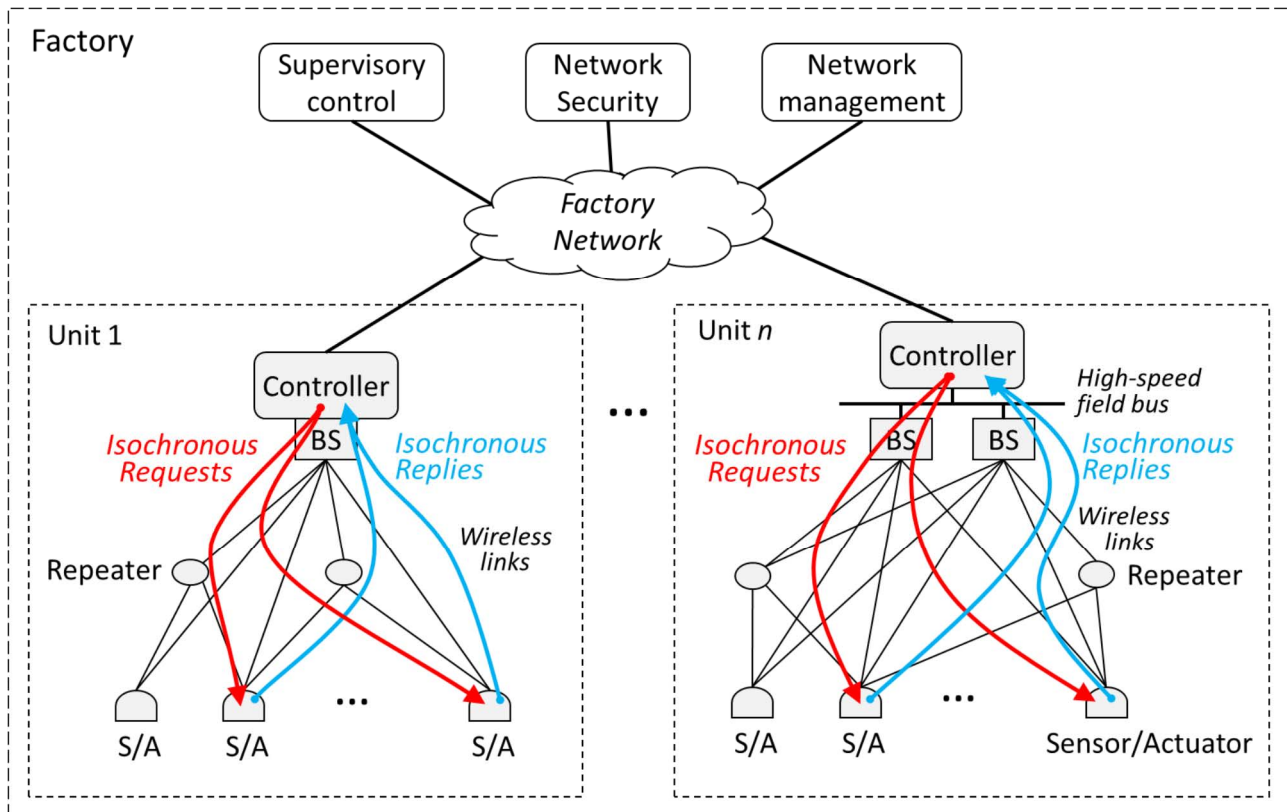

Figure D.1-1: Communication path for isochronous control cycles within factory units. Step 1 (red): controller requests sensor data (or an actuator to conduct actuation) from the sensor/actuator (S/A). Step 2 (blue): sensor sends measurement information (or acknowledges actuation) to controller.

Figure D.1-1 depicts how communication may occur in factory automation. In this use case, communication is confined to local controller-to-sensor/actuator interaction within each manufacturing unit. Repeaters may provide spatial diversity to enhance reliability.

D.1.1 Service area and connection density

The maximum service volume in motion control is currently set by hoisting solutions, i.e. cranes, and by the manipulation of large machine components, e.g. propeller blades of wind-energy generators. Cranes can be rather wide and quite high above the shop floor, even within a factory hall. In addition, they typically travel along an entire factory hall.

An approximate dimension of the service area is 100 x 100 x 30 m.

Note that production cells are commonly much smaller (< 10 x 10 x 3 m). There are typically about 10 motion-control connections in a production cell, which results in a connection density of up to 10^5 km^{-2} .

D.1.2 Security

Network access and authorization in an industrial factory deployment is typically provided and managed by the factory owner with its ID management, authentication, confidentiality and integrity.

Note that motion control telegrams usually are not encrypted due to stringent cycle time requirements.

A comprehensive security framework for factories has been described in IEC 62443.

D.2 Discrete automation

Discrete automation encompasses all types of production that result in discrete products: cars, chocolate bars, etc. Automation that addresses the control of flows and chemical reactions is referred to as process automation (see clause

D.3). Discrete automation requires communications for supervisory and open-loop control applications, as well as process monitoring and tracking operations inside an industrial plant. In these applications, a large number of sensors distributed over the plant forward measurement data to process controllers on a periodic or event-driven base. Traditionally, wireline field bus technologies have been used to interconnect sensors and control equipment. Due to the sizable extension of a plant (up to 10 km²), the large number of sensors, rotary joints, and the high deployment complexity of wired infrastructure, wireless solutions have made inroads into industrial process automation.

This use case requires support of a large number of sensor devices per plant as well as high communication service availability (99,99%). Furthermore, power consumption is relevant since some sensor devices are battery-powered with a targeted battery lifetime of several years while providing measurement updates every few seconds. Range also becomes a critical factor due to the low transmit power levels of the sensors, the large size of the plant and the high reliability requirements on transport. End-to-end latency requirements typically range between 10 ms and 1 s. User experienced data rates can be rather low since each transaction typically comprises less than 256 bytes. However, there has been a shift from field busses featuring somewhat modest data rates (~ 2 Mbit/s) to those with higher data rates (~ 10 Mbit/s) due to the increasing number of distributed applications and also "data-hungry" applications. An example for the latter is the visual control of production processes. For this application, the user experienced data rate is typically around 10 Mbit/s and the transmitted packets are much larger.

The existing wireless technologies rely on unlicensed bands. Communication is therefore vulnerable to interference caused by other technologies (e.g. WLAN). With the stringent requirements on transport reliability, such interference is detrimental to proper operation.

The use of licensed spectrum could overcome the vulnerability to same-band interference and therefore enable higher reliability. Utilization of licensed spectrum can be confined to those events where high interference bursts in unlicensed bands jeopardizes reliability and end-to-end latency constraints. This allows sharing the licensed spectrum between process automation and conventional mobile services.

Multi-hop topologies can provide range extension and mesh topologies can increase reliability through path redundancy. Clock synchronization will be highly beneficial since it enables more power-efficient sensor operation and mesh forwarding.

The corresponding industrial communication solutions are referred to as fieldbuses. The related standard suite is IEC 61158.

A typical discrete automation application supports downstream and upstream data flows between process controllers and sensors/actuators. The communication consists of individual transactions. The process controller resides in the plant network. This network interconnects via base stations to the wireless (mesh-) network which hosts the sensor/actuator devices. Typically, each transaction uses less than 256 bytes. An example of a controller-initiated transaction service flow is:

1. The process controller requests sensor data (or an actuator to conduct actuation). The request is forwarded via the plant network and the wireless network to the sensors/actuators.
2. The sensors/actuators process the request and send a replay in upstream direction to the controller. This reply may contain an acknowledgement or a measurement reading.

An example of a sensor/actuator device-initiated transaction service flow:

1. The sensor sends a measurement reading to the process controller. The request is forwarded via the wireless (mesh) network and the plant network.
2. The process controller may send an acknowledgement in opposite direction.

For both controller- and sensor/actuator-initiated service flows, upstream and downstream transactions may occur asynchronously.

Figure D.2-1 depicts how communication may occur in discrete automation. In this use case, communication runs between process controller and sensor/actuator device via the plant network and the wireless (mesh) network. The wireless (mesh) network may also support access for handheld devices for supervisory control or process monitoring purposes.

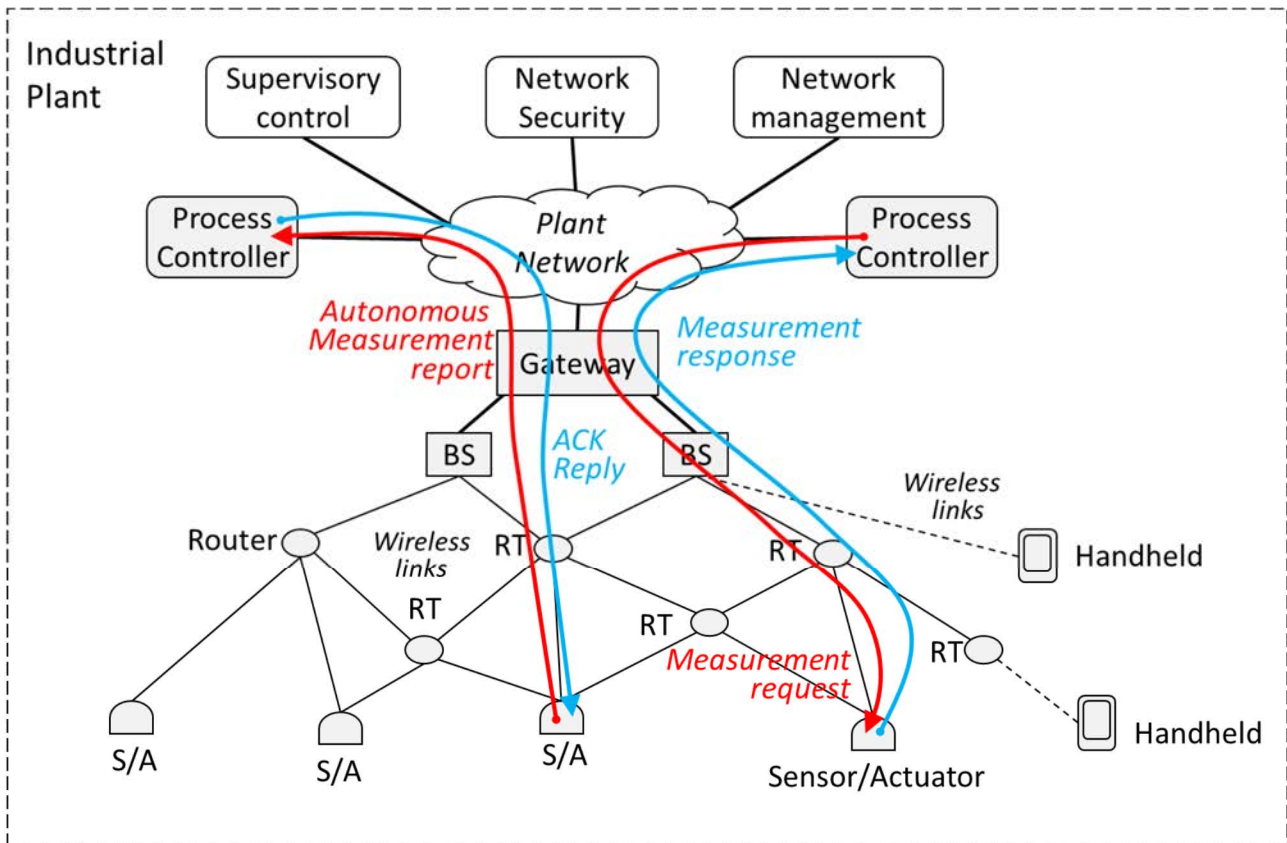

Figure D.2-1: Communication path for service flows between process controllers and sensor/actuator devices. Left-hand side: Step 1 (red) – the sensor/actuator (S/A) sends measurement report autonomously, Step 2 (blue) controller acknowledges. Right-hand side: Step 1 (red) - controller requests sensor data (or an actuator to conduct actuation), Step 2 (blue): S/A sends measurement information (or acknowledges actuation) to controller.

D.2.1 Service area and connection density

Factory halls can be rather large and even quite high. We set the upper limit at 1000 x 1000 x 30 m. Note that the connection density might vary quite a bit throughout factory halls. It is, for instance much higher along an assembly line than in an overflow buffer. Also, the density usually increases towards the factory floor. Typically, there is at least one connection per 10 m², which results in a connection density of up to 10⁵ km⁻².

D.2.2 Security

Network access and authorization in an industrial factory deployment is typically provided and managed by the factory owner with its ID management, authentication, confidentiality and integrity.

A comprehensive security framework for factories has been described in IEC 62443.

D.3 Process automation

Process automation has much in common with discrete automation (see Annex D.2). Instead of discrete products (cars, chocolate bars, etc.), process automation addresses the production of bulk products such as petrol and reactive gases. In contrast to discrete automation, motion control is of limited or no importance. Typical end-to-end latencies are 50 ms. User experienced data rates, communication service availability, and connection density vary noticeably between applications. Below we describe one emerging use case (remote control via mobile computational units, see Annex D.3.1) and a contemporary use case (monitoring, see Annex D.3.2).

Note that discrete automation fieldbuses (see Annex D.2) are also used in process automation.

D.3.1 Remote control

Some of the interactions within a plant are conducted by automated control applications similar to those described in Annex D.2. Here too, sensor output is requested in a cyclic fashion, and actuator commands are sent via the communication network between a controller and the actuator. Furthermore, there is an emerging need for the control of the plant from personnel on location. Typically, monitoring and managing of distributed control systems takes place in a dedicated control room.

Staff deployment to the plant itself occurs, for instance, during construction and commissioning of a plant and in the start-up phase of the processes. In this scenario, the locally deployed staff taps into the same real-time data as provided to the control room. These remote applications require high data rates (~ 100 Mps) since the staff on location needs to view inaccessible locations with high definition (e.g. emergency valves) and since their colleagues in the control room benefit from high-definition footage from body cameras (HD or even 4K).

For both kinds of applications, a very high communication service availability is needed (99,9999%). Typically, only a few control loops are fully automated and only handful of control personnel is deployed on location, so that the connection density is rather modest (~ 1000 km⁻²).

D.3.2 Monitoring

The monitoring of states, e.g. the level of the liquid of process reactors, is a paramount task. Due to the ever-changing states, measurement data is either pulled or pushed from the sensors in a cyclic manner. Some sensors are more conveniently accessed via wireless links, and monitoring via handheld terminals of these sensors during, e.g. maintenance is also on the rise. This kind of application entails rather modest user experienced data rates (~ 1 Mps), and since this kind of data is "only" indicator for, e.g. what process should be stopped in order to avoid an overflow, and not for automated control loops, the requirement on communication service availability is comparably low (99,9%). Note that emergency valves and such typically are operated locally and do not rely on communication networks. However, many sensors are deployed in chemical plants etc., so that connection density can readily reach 10 000 km⁻².

D.3.3 Service area

While, for instance, chemical plants and refineries readily can span over several square kilometres, the dedicated control rooms are typically only responsible for a subset of that area. Such subsets are often referred to as plant, and their typical size is 300 x 300 x 50 m.

D.4 Electricity distribution

D.4.1 Medium voltage

An energy-automation domain that hitherto has only seen very little application of mobile-network technology is the backhaul network, i.e. the part of the distribution grid between primary substations (high voltage → medium voltage) and secondary substations (medium voltage → low voltage). In figure D.4.1-1 we depict a medium-voltage ring together with energy-automation use cases that either are already deployed or are anticipated within the near future.

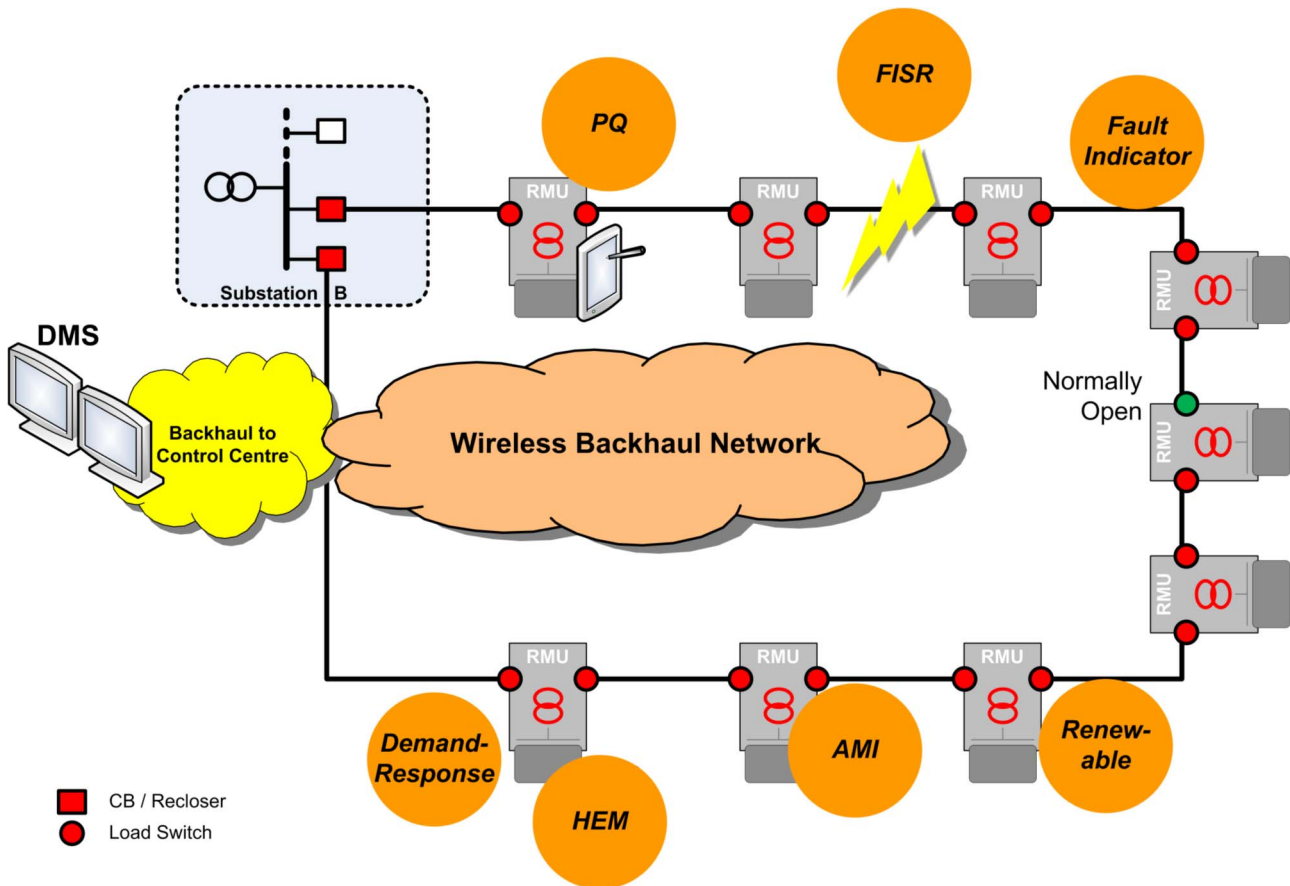

Figure D.4.1-1: Functional, topological sketch of a medium-voltage ring. AMI: advanced metering infrastructure; CB: circuit breaker; DMS: distribution management system; FISIR: fault isolation and system restoration; HEM: home energy manager; PQ: power quality; RMU: ring main unit.

The primary substation and the secondary substations are supervised and controlled by a distribution-management system (DMS). If energy-automation devices in the medium-voltage power line ring need to communicate with each other and/or the DMS, a wireless backhaul network needs to be present (orange "cloud" in Figure D.4.1-1).

A majority of applications in electricity distribution adhere to the communication standard IEC 60870-5-104, however, its modern "cousin", IEC 61850, experiences rapidly increasing popularity. The communication requirements for IEC 61850 applications can be found in IEC 61850-90-4. Communication in wide-area networks is described in IEC 61850-90-12.

Usually, power line ring structures have to be open in order to avoid a power-imbalance in the ring (green dot in the Figure). Examples for energy-automation that already is implemented in medium-voltage grids (albeit in low numbers) are power-quality measurements and the measurement of secondary-substation parameters (temperature, power load, etc.) [13]. Other use cases are demand response and the control of distributed, renewable energy resources (e.g. photovoltaics).

A use case that could also be realised in the future is fault isolation and system restoration (FISIR). FISIR automates the management of faults in the distribution grid. It supports the localization of the fault, the isolation of the fault, and the restoration of the energy delivery. For this kind of automation, the pertinent sensors and actuators broadcast telegrams about their states (e.g. "emergency closer idle") and about actions (e.g. "activating closer") into the backhaul network. This information is used by the ring main units (RMUs) as input for their decision algorithms. We illustrate this use of automation telegrams for an automated FISIR event in figure D.4.1-1. Let us assume the distribution lines are cut at the location indicated by the bolt of lightning in the Figure. In that case, the RMUs between the bolt and the green load switch (open) will be without power. The RMUs next to the "bolt" automatically open their load switches after having sensed the loss of electric connectivity between them. They both broadcast these actions into the backhaul network. Typically, these telegrams are repeated many times while the time between adjacent telegrams increases exponentially. This communication patterns leads to sudden, distributed surges in the consumed communication bandwidth. After the RMUs next to the "bolt" have open their switch, the RMU that so far has kept the power line ring open (green dot in figure D.4.1-1) close the load switch. This event too is broadcasted into the backhaul network. The typical maximum end-to-end latency for this kind of broadcast is 25 ms with a peak experienced data rate of 10 Mbit/s. Note that the

distribution system typically subscribes to telegrams from all RMUs in order to keep abreast with the happenings in the distribution grid.

Automatic fault handling in the distribution grid shortens outage time and offloads the operators in the distribution control centre for more complicated situations. Therefore, automated FISR may help to improve performance indexes like System Average Interruption Duration Index and System Average Interruption Frequency Index.

Automation telegrams are typically distributed via domain multicast. As explained above, the related communication pattern can be "bursty", i.e. only few automation telegrams are sent when the distribution network operates nominally (~ 1 kbit/s), but, for instance, a disruption in the power line triggers a short-lived avalanche of telegrams from related applications in the ring (≥ 1 Mbit/s).

D.4.1.1 Service area and connection density

Service coverage is only required along the medium-voltage line. In Europe, the line often forms a loop (see figure D.4.1-1), while deployments in other countries, e.g. the USA, tend to extend linearly over distances up to ~ 100 km. The vertical dimension of the poles in a medium voltages line is typically less than 40 m. Especially in urban areas, the number of ring main units can be rather large (> 10 km²), and the number of connections to each ring main unit is expected to increase swiftly once economical, suitable wireless connectivity becomes available. We predict connection densities of up to 1.000 km².

D.4.1.2 Security

Due to its central role in virtually every country on earth, electricity distribution is heavily regulated. Security assessment for, e.g. deployments in North America, need to adhere to the NERC CIP suite [14]. Technical implementations are described in standard suites such as IEC 62351.

D.4.2 Energy distribution – high voltage

In order to avoid region- or even nation-wide power outages, wide-area power system protection is on the rise. "When a major power system disturbance occurs, protection and control actions are required to stop the power system degradation, restore the system to a normal state and minimize the impact of the disturbance. The present control actions are not designed for a fast-developing disturbance and may be too slow. Local protection systems are not able to consider the overall system, which may be affected by the disturbance. Wide area disturbance protection is a concept of using system-wide information and sending selected local information to a remote location to counteract propagation of the major disturbances in the power system." [15]. Protection actions include, "among others, changes in demand (e.g. load shedding), changes in generation or system configuration to maintain system stability or integrity and specific actions to maintain or restore acceptable voltage levels." [16]. One specific application is phasor measurement for the stabilisation of the alternating-current phase in a transport network. For this, the voltage phase is measured locally and sent to a remote-control centre. There, this information is processed and automated actions are triggered. One can be the submission of telegrams to power plants, instructing them to either accelerate or decelerate their power generators in order to keep the voltage phase in the transport network stable. A comprehensive overview of this topic can be found elsewhere in the literature [17].

This kind of automation requires very low end-to-end latencies (5 ms) [16] and—due to its critical importance for the operation of society—a very high communication service availability (99,9999%).

D.4.2.1 Service area and connection density

As is the case for medium-voltage distribution networks (see Annex D.4.1), connectivity in high-voltage automation has to be provided mainly along the power line. The distances to be covered can be substantial (hundreds of kilometres in rural settings), while shorter links are prevalent in metropolitan areas. The number of connections in wide-area power system protection is rather low; but—due to the sliver-shaped service area—the connection density can be rather high (1000 km²).

D.4.2.2 Security

Due to its central role in virtually every country on earth, electricity distribution is heavily regulated. Security assessment for, e.g. deployments in North America, need to adhere to the NERC CIP suite [14]. Technical implementations are described in standard suites such as IEC 62351.

D.5 Intelligent transport systems – infrastructure backhaul

Intelligent Transport Systems (ITS) embrace a wide variety of communications-related applications that are intended to increase travel safety, minimize environmental impact, improve traffic management, and maximize the benefits of transportation to both commercial users and the general public. Over recent years, the emphasis in intelligent vehicle research has turned to co-operative systems in which the traffic participants (vehicles, bicycles, pedestrians, etc.) communicate with each other and/or with the infrastructure.

Cooperative ITS is the term used to describe technology that allows vehicles to become connected to each other, and to the infrastructure and other parts of the transport network. In addition to what drivers can immediately see around them, and what vehicle sensors can detect, all parts of the transport system will increasingly be able to share information to improve decision making. Thus, this technology can improve road safety through avoiding collisions, but also assist in reducing congestion and improving traffic flows, and reduce environmental impacts. Once the basic technology is in place as a platform, an array of applications can be developed.

Cooperative ITS can greatly increase the quality and reliability of information available about vehicles, their location and the road environment. In the future, cars will know the location of road works and the switching phases of traffic lights ahead, and they will be able to react accordingly. This will make for safer and more convenient travel and faster arrival at the destination. On-board driver assistance, coupled with two-way communication between vehicles and between cars and road infrastructure, can help drivers to better control their vehicle and hence have positive effects in terms of safety and traffic efficiency. An important role in this plays the so-called road-side units (RSUs). Vehicles can also function as sensors reporting weather and road conditions including incidents. In this way cars can be used as information sources for high-quality information services.

RSUs are connected to the traffic control centre for management and control purposes. They broadcast e.g. traffic light information (RSU → vehicle) and traffic information from the traffic-control centre (TCC) via the RSU to the vehicles (TCC → RSU → vehicle); and collect vehicle probe data for the traffic control centre (vehicle → RSU → TCC). For reliable distribution of data, low-latency and high-capacity connections between RSUs (e.g. traffic lights, traffic signs, etc.) and the TCC is required. This type of application comes with rather tight end-to-end latency requirements for the communication service between RSU and TCC (10 ms) since relayed data needs to be processed in the TCC and, if needed, the results need to be forwarded to neighbouring RSUs. Also, the availability of the communication service has to be very high (99,9999%) in order to compete with existing wired technology and in order to justify the costly deployment and maintenance of RSUs. Furthermore, due to considerably large aggregation areas (see Annex D.5.1), considerable amounts of data need to be backhauled to the TCC (up to 10 Mbit/s per RSU).

D.5.1 Service area and connection density

It is relatively hard to provide estimates for the service area dimension. One reason is that it depends on the placement of the base station relative to the RSUs. Also, the RSUs can, in principle, act as relay nodes for each other. The service area dimension stated in table 7.2.3.2-1 indicates the size of the typical data collection area of an RSU (2 km along a road), from which the minimum spacing of RSUs can be inferred. The connection density can be quite high in case data is relayed between RSUs, i.e. along the road (1000 km⁻²).

Annex E (informative):
(void)

Annex F (informative): QoS Monitoring

F.1 QoS monitoring for assurance

This Clause discusses how QoS monitoring information can be used for assurance purposes. For background information on assurance see [19] and appendix A.3 in [20].

Assurance consists of four major steps (see Figure F.1-1 and [18]):

- *Customer's QoS requirements*

These state the level of quality required by the customer of a service. This information is divulged to the provider.

- *Service provider's offerings of QoS (or planned/targeted QoS)*

This is a statement of the level of quality expected to be offered to the customer by the service provider.

- *QoS achieved/delivered*

This is the level of quality achieved and delivered to the customer. Monitoring information is divulged to the customer.

- *Customer rating of QoS*

The customer can compare the QoS achieved by the provider with the QoS requirements (see above) and its own experience of the QoS. This is a crucial step for establishing assurance about the fulfillment of the customer's requirements.

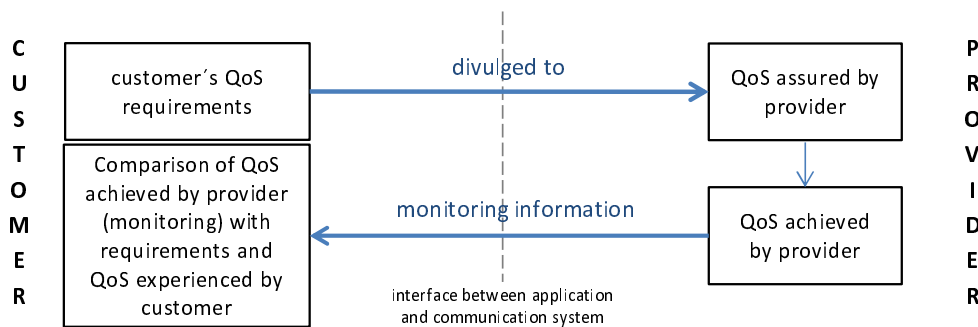

Figure F.1-1: QoS assurance by use of QoS monitoring information

NOTE: This Figure is based on the trust model in [18].

F.2 Network Diagnostics

Network diagnostics helps with scanning, diagnosing and identifying problems within a network. Diagnostics includes gathering data and continuously providing sufficient performance parameters that characterize the quality of the network connection. This includes data of the physical connection as well as of logical links and sub-networks. Exposure of relevant (and possibly aggregated) performance parameters ensures a quick reaction in case of failure as well as identifying network connectivity, performance and other related problems. Network diagnostic should be able to:

- be proactive (to early detect failures) and not only reactive (to deal with faults that have already occurred).
- accurately differentiate malfunctions/failures and evaluate their impact on the service/network.
- provide clear explanations about what happened.
- suggest corrective actions, and possibly perform them automatically.

Furthermore, specific connectivity information is also of interest as well as usage information (e.g. traffic load) of the node (e.g. RAN).

Network diagnostic information needs to be generated automatically and, in case of a hosted or virtual network deployment, be made available to the tenant of the network via a suitable API.

Annex G (informative): Asset Tracking use cases

G.1 Asset Tracking

Every organisation owns assets (e.g. machines, medical devices, containers, pallets, trolleys). These assets are often not stationary: they are transported all over the world by different kinds of vehicles; and the assets are also moved inside various kinds of buildings.

The ownership of assets may change many times during the life-cycle of the asset as different stakeholders take possession of the assets and pass them on to other stakeholders along the supply chain and value chain.

So, many stakeholders want to track their assets anytime and anywhere (indoor & outdoor) in a global and multi-modal context (e.g. sea, air, road, rail).

The asset tracking topic implies more than just knowing the location of an asset. Asset tracking includes real time and/or time-stamped monitoring of several asset-related properties depending on the asset and its content (e.g. condition of the asset and changes, environmental factors – temperature, mechanical shock).

The 5G system provides the capability to better support asset tracking in all its aspects in particular in term of coverage (need to support full coverage: e.g. indoor / urban / rural / harsh environments / metallic obstructions on land, sea) with the support of terrestrial and non-terrestrial network as well as use of relays when necessary and in term of energy efficiency (15 to 20 years' lifetime of an asset tracking device without changing the battery or the UE).

G.2 Battery life expectancy and message size to support example use cases for asset tracking

For asset tracking it is important to be able to have the asset on the field during a period corresponding to the life of the asset without changing the UE or the battery of the UE.

The battery life expectancy, message size and device density values required to support the potential opportunities in various asset tracking use cases are summarised in table G.2-1

Table G.2-1: Battery life expectancy and message size to support example use cases for asset tracking

	Scenario	Battery Life Expectancy (note 1)	Typical Message size	Maximum Message size	Typical Frequency (number of messages per day)	Typical Battery Capacity	Device density
1	Containers (note 2)	12 years	200 bytes	2500 bytes	24	21,6 Wh	1,4 devices / m ³
2	Wagons	20 years	200 bytes	2500 bytes	24	36 Wh	0,3 devices / m ²
3	Pallets	7 years	300 bytes	300 bytes	24	12 Wh	4 devices/ m ²
NOTE 1: Battery life expectancy is to be assumed in all coverage conditions and is based on typical message size value and typical frequency							
NOTE 2: A large containership with a mix of 20 ft and 40 ft containers is assumed.							
NOTE 3: All the values in this table are targeted values and not strict requirements.							

Annex H (informative): Change history

Change history							
Date	Meeting	TDoc	CR	Rev	Cat	Subject/Comment	New version
2016-12	SA#75	SP-170156	-	-	-	Skeleton	0.1.0
2017-03	SA#75	SP-170156	-	-	-	Agreements in SA1#75: S1-162342, S1-162305, S1-162480, S1-162345, S1-162481, S1-162471, S1-162313, S1-162347, S1-162486, S1-162349, S1-162546, S1-162322, S1-162323, S1-162450, S1-162547, S1-162548, S1-162549, S1-162492, S1-162550, S1-162520, S1-162485, S1-162517, S1-162551, S1-162505. And rapporteur's clean-up.	0.1.1
						Agreements in SA1#76: S1-163412, S1-163445, S1-163446, S1-163256, S1-163070, S1-163415, S1-163258, S1-163293, S1-163260, S1-163416, S1-163296, S1-163264, S1-163265, S1-163266, S1-163267, S1-163268, S1-163297, S1-163298, S1-163417, S1-163418, S1-163299, S1-163274, S1-163275, S1-163277, S1-163278, S1-163280, S1-163448, S1-163421, S1-163029, S1-163112, S1-163285, S1-163286, S1-163287, S1-163422, S1-163289, S1-163382, S1-163132, and rapporteur's clean-up.	0.2.0
2017-03	SA#75	SP-170156	-	-	-	MCC Clean-up for presentation to SA for information	1.0.0
2017-03	SA#75	SP-170156	-	-	-	Agreements in SA1#76bis: S1-170198, S1-170199, S1-170335, S1-170201, S1-170008, S1-170207, S1-170106, S1-170338, S1-170092, S1-170339, S1-170212, S1-170340, S1-170341, S1-170014, S1-170217, S1-170218, S1-170219, S1-170131, S1-170342, S1-170314, S1-170224, S1-170206, S1-170090, S1-170225, S1-170226, S1-170343, S1-170228, S1-170229, S1-170230, S1-170232, S1-170122, S1-170042, S1-170234, S1-170345, S1-170364, S1-170236, S1-170347, S1-170220, S1-170239, S1-170243, S1-170209, S1-170365, S1-170245, S1-170048, and rapporteur's clean-up.	1.1.0
2017-02	SA1#77					Agreements in SA1#77: S1-171400, S1-171401, S1-171430, S1-171141, S1-171252, S1-171253, S1-171256, S1-171257, S1-171258, S1-171143, S1-171259, S1-171431, S1-171149, S1-171261, S1-171144, S1-171263, S1-171297, S1-171290, S1-171266, S1-171154, S1-171267, S1-171268, S1-171269, S1-171073, S1-171291, S1-171150, S1-171272, S1-171151, S1-171152, S1-171273, S1-171188, S1-171153, S1-171155, S1-171283, S1-171274, S1-171277, S1-171278, S1-171393, S1-171399, S1-171156, S1-171060, S1-171069, S1-171180, S1-171284, S1-171285, S1-171140, S1-171286, S1-171288, S1-171398, S1-171292, S1-171435, and rapporteur's clean-up.	1.2.0
2017-03	SA#75	SP-170156	-	-	-	Presentation for approval	2.0.0
2017-03	SA#75	-				Raised to v.15.0.0 following SA's approval	15.0.0

Change history											
TSG SA#	SA Doc.	SA1 Doc	Spec	CR	Rev	Rel	Cat	Subject/Comment	Old	New	WI
SP-76	SP-170443	S1-172288	22.261	0017	3	Rel-15	B	Addition of requirement on charging for the tenant of the slice	15.0.0	15.1.0	SMARTER
SP-76	SP-170443	S1-172286	22.261	0016	3	Rel-15	B	Addition of requirement on maintaining user experience when UE performs handover	15.0.0	15.1.0	SMARTER
SP-76	SP-170443	S1-172270	22.261	0022	2	Rel-15	F	Alignment of network slicing requirements	15.0.0	15.1.0	SMARTER
SP-76	SP-170443	S1-172283	22.261	0011	3	Rel-15	F	Clarification on removal of network function	15.0.0	15.1.0	SMARTER
SP-76	SP-170443	S1-172279	22.261	0021	3	Rel-15	F	Clarifications on network slicing	15.0.0	15.1.0	SMARTER
SP-76	SP-170443	S1-172257	22.261	0020	1	Rel-15	F	Clean-up of requirements on network slice scaling	15.0.0	15.1.0	SMARTER
SP-76	SP-170443	S1-172262	22.261	0025	1	Rel-15	F	Correction on '8 security'	15.0.0	15.1.0	SMARTER
SP-76	SP-170443	S1-172012	22.261	0001		Rel-15	F	CR to 22.261 Correction of the references for eV2X TS	15.0.0	15.1.0	SMARTER
SP-76	SP-170443	S1-172285	22.261	0015	4	Rel-15	F	Efficient User Plane	15.0.0	15.1.0	SMARTER

SP-76	SP-170443	S1-172280	22.261	0012	3	Rel-15	C	Exposure of QoE capability	15.0.0	15.1.0	SMARTER
SP-76	SP-170443	S1-172256	22.261	0023	1	Rel-15	C	Maintaining a session whose priority changes in real time	15.0.0	15.1.0	SMARTER
SP-76	SP-170443	S1-172261	22.261	0027	1	Rel-15	B	parallel transfer of multiple multicast/broadcast user services to a UE	15.0.0	15.1.0	SMARTER
SP-76	SP-170443	S1-172277	22.261	0002	3	Rel-15	F	Replacement of 5G-RAN with NG-RAN	15.0.0	15.1.0	SMARTER
SP-76	SP-170443	S1-172278	22.261	0006	2	Rel-15	F	Update service continuity definition	15.0.0	15.1.0	SMARTER
SP-76	SP-170443	S1-172404	22.261	0007	4	Rel-15	C	Updates to network slice assignment in TS 22.261	15.0.0	15.1.0	SMARTER
SP-76	SP-170443	S1-172287						Request in CR 0031r1 to raise this spec to v.16.0.0 without CR0031r1 but with all other CRs	15.1.0	16.0.0	-
SP-77	SP-170699	S1-173544	22.261	0032	2	Rel-16	F	Requirement for audio video sync timing for audio-visual interaction.	16.0.0	16.1.0	TEI15
SP-77	SP-170692	S1-173459	22.261	0046		Rel-16	A	Correction on security requirement for relayed data protection	16.0.0	16.1.0	MONASTERY
SP-77	SP-170692	S1-173461	22.261	0048		Rel-16	A	Correction on regulatory requirement for all access technologies	16.0.0	16.1.0	MONASTERY
SP-77	SP-170692	S1-173463	22.261	0049		Rel-16	A	Update TS number of eV2X specification	16.0.0	16.1.0	MONASTERY
SP-77	SP-170692	S1-173549	22.261	0051		Rel-16	A	Clarification on access control requirement	16.0.0	16.1.0	SMARTER
SP-78	SP-170989	S1-174564	22.261	0068	1	Rel-16	F	Provide a more realistic KPI value for Virtual Reality	16.1.0	16.2.0	TEI16
SP-78	SP-170987	S1-174620	22.261	0069		Rel-16	A	Clarification of unified access control requirements	16.1.0	16.2.0	SMARTER
SP-79	SP-180129	S1-180598	22.261	0079	2	Rel-16	A	Clarification of 5GC requirements	16.2.0	16.3.0	SMARTER
SP-79	SP-180130	S1-180496	22.261	0077	1	Rel-16	A	Alignment of normative and descriptive clauses for Unified Access Control regarding operator defined Access Identities	16.2.0	16.3.0	SMARTER
SP-79	SP-180130	S1-180527	22.261	0088		Rel-16	A	Clarification of access Identity in unified access control	16.2.0	16.3.0	SMARTER
SP-79	SP-180130	S1-180529	22.261	0089		Rel-16	A	Clarification of Messaging in Unified Access Control (UAC)	16.2.0	16.3.0	SMARTER
SP-79	SP-180131	S1-180194	22.261	0085		Rel-16	A	Clarification of latency requirements	16.2.0	16.3.0	SMARTER
SP-79	SP-180213	fromS1-180611	22.261	0086	3	Rel-16	A	Support Legacy USIM in 5G	16.2.0	16.3.0	SMARTER
SP-79	SP-180224	fromS1-180503	22.261	0075	4	Rel-16	B	Support of Voice Service Continuity from 5G system to UTRAN CS	16.2.0	16.3.0	5GVSC
SP-79	SP-180140	S1-180624	22.261	0090		Rel-16	F	Release 15 alignment on the KPIs for URLLC	16.2.0	16.3.0	SMARTER_Ph2
SP-79	SP-180142	S1-180596	22.261	0081	2	Rel-16	B	5G Requirements to Prevent a Single Service (e.g. Emergency) from Monopolizing Network Resources	16.2.0	16.3.0	SMARTER
SP-80	SP-180312	S1-181389	22.261	0095	1	Rel-16	F	Positioning Part align with Rel-15 structure	16.3.0	16.4.0	SMARTER_Ph2
SP-80	SP-180312	S1-181740	22.261	0103	3	Rel-16	F	Clarifications on communication service availability and reliability	16.3.0	16.4.0	SMARTER_Ph2
SP-80	SP-180314	S1-181714	22.261	0097	3	Rel-16	B	QoS Monitoring	16.3.0	16.4.0	QoS_MON
SP-80	SP-180318	S1-181659	22.261	0253		Rel-16	B	Inter-RAT Mobility requirement for realtime service	16.3.0	16.4.0	MOBRT
SP-80	SP-180320	S1-181547	22.261	0101	3	Rel-16	B	Inclusion of ethernet transport services in TS 22.261	16.3.0	16.4.0	5GLAN
SP-80	SP-180325	S1-181671	22.261	0098	3	Rel-16	B	Policy delivery to UE for background data transfer	16.3.0	16.4.0	PDBDT
SP-80	SP-180464	S1-181719	22.261	0254	1	Rel-16	B	IMS and Network Slicing	16.3.0	16.4.0	enIMS
SP-81	SP-180752	S1-182662	22.261	0268	2	Rel-16	A	Clarification to Delay Tolerant	16.4.0	16.5.0	SMARTER

SP-81	SP-180752	S1-182674	22.261	0289	2	Rel-16	A	Clarify the method of configuring the UE to use Access Identity 1 and Access Identity 2	16.4.0	16.5.0	SMARTER
SP-81	SP-180752	S1-182758	22.261	0297	1	Rel-16	A	Support for use of licensed and unlicensed bands	16.4.0	16.5.0	SMARTER
SP-81	SP-180754	S1-182438	22.261	0283	1	Rel-16	A	Addition of new Access category for 'MO signalling on RRC level resulting from other than paging'- Mirror CR	16.4.0	16.5.0	TE115
SP-81	SP-180788	-	22.261	0280	3	Rel-16	C	Updates to QoS Monitoring Description	16.4.0	16.5.0	QoS_MON
SP-81	SP-180789	-	22.261	0292	4	Rel-16	C	Addition of Informative Annex for QoS Monitoring	16.4.0	16.5.0	QoS_MON
SP-81	SP-180763	S1-182677	22.261	0278	3	Rel-16	B	Network service exposure requirements	16.4.0	16.5.0	cyberCAV
SP-81	SP-180763	S1-182685	22.261	0295	1	Rel-16	B	Ethernet support in TS 22.261	16.4.0	16.5.0	cyberCAV
SP-81	SP-180763	S1-182756	22.261	0286	3	Rel-16	B	Non-public network requirements	16.4.0	16.5.0	cyberCAV
SP-81	SP-180764	S1-182009	22.261	0255		Rel-16	B	Performance requirements for 5G satellite access	16.4.0	16.5.0	5GSAT
SP-81	SP-180764	S1-182016	22.261	0261		Rel-16	B	NG-RAN sharing for 5G satellite access network	16.4.0	16.5.0	5GSAT
SP-81	SP-180764	S1-182385	22.261	0264	1	Rel-16	B	Satellite links between radio access network and core network	16.4.0	16.5.0	5GSAT
SP-81	SP-180764	S1-182590	22.261	0263	2	Rel-16	B	Regulatory and charging aspects related to 5G satellite access	16.4.0	16.5.0	5GSAT
SP-81	SP-180764	S1-182602	22.261	0256	1	Rel-16	B	Multiple access requirements related to 5G satellite access	16.4.0	16.5.0	5GSAT
SP-81	SP-180764	S1-182605	22.261	0259	2	Rel-16	B	Efficient user plane aspects of 5G satellite access	16.4.0	16.5.0	5GSAT
SP-81	SP-180764	S1-182606	22.261	0260	2	Rel-16	B	Mobility management related requirements for 5G satellite access	16.4.0	16.5.0	5GSAT
SP-81	SP-180764	S1-182607	22.261	0262	1	Rel-16	B	QoS control aspects of 5G satellite access	16.4.0	16.5.0	5GSAT
SP-81	SP-180764	S1-182619	22.261	0265	1	Rel-16	B	Broadcast and multicast via satellite access networks	16.4.0	16.5.0	5GSAT
SP-81	SP-180764	S1-182720	22.261	0258	2	Rel-16	B	Efficient delivery of content using 5G satellite access network	16.4.0	16.5.0	5GSAT
SP-81	SP-180764	S1-182725	22.261	0257	3	Rel-16	B	Connectivity aspects of 5G satellite access	16.4.0	16.5.0	5GSAT
SP-81	SP-180765	S1-182585	22.261	0269	2	Rel-16	B	KPIs for horizontal and vertical positioning service levels in clause 7.3.2	16.4.0	16.5.0	5G_HYPOS
SP-81	SP-180765	S1-182586	22.261	0270	2	Rel-16	B	Other KPIS for 5G positioning services	16.4.0	16.5.0	5G_HYPOS
SP-81	SP-180765	S1-182587	22.261	0271	2	Rel-16	B	Security requirements for 5G positioning services	16.4.0	16.5.0	5G_HYPOS
SP-81	SP-180765	S1-182588	22.261	0272	2	Rel-16	C	Update description (clause 7.3.1) of 5G positioning services	16.4.0	16.5.0	5G_HYPOS
SP-81	SP-180769	S1-182769	22.261	0273	3	Rel-16	F	Clarification for Inter-RAT Mobility requirement for realtime service	16.4.0	16.5.0	MOBRT
SP-81	SP-180770	S1-182395	22.261	0276	1	Rel-16	B	5GLAN Requirements	16.4.0	16.5.0	5GLAN
SP-81	SP-180770	S1-182702	22.261	0275	2	Rel-16	B	5GLAN charging requirements	16.4.0	16.5.0	5GLAN
SP-81	SP-180770	S1-182755	22.261	0274	3	Rel-16	B	5GLAN security requirements	16.4.0	16.5.0	5GLAN
SP-81	SP-180774	S1-182771	22.261	0281	2	Rel-16	B	Enhanced network slice requirements based on business role models	16.4.0	16.5.0	BRMNS

Change history							
Date	Meeting	TDoc	CR	Rev	Cat	Subject/Comment	New version
2018-12	SP-82	SP-181007	0331	2	B	Functional requirements for 5G positioning services (clause 6)	16.6.0
2018-12	SP-82	SP-181007	0309	2	F	Terminology correction for positioning-related tables in 7.3.2	16.6.0
2018-12	SP-82	SP-181007	0308	3	D	Clarification on positioning-related descriptions in 7.3.1	16.6.0
2018-12	SP-82	SP-181007	0330	2	C	Clarification of requirement on energy per fix in clause 7.3.2.3	16.6.0
2018-12	SP-82	SP-181008	0340		C	Update of 5GLAN – Indirect Communication Mode	16.6.0
2018-12	SP-82	SP-181008	0319	2	F	Clarification on Ethernet transport services	16.6.0

2018-12	SP-82	SP-181008	0334	2	C	Addition to definition on private communication	16.6.0
2018-12	SP-82	SP-181008	0335	2	C	Update of 5GLAN - General	16.6.0
2018-12	SP-82	SP-181008	0336	2	C	Update of 5G LAN - virtual network (5G LAN-VN).	16.6.0
2018-12	SP-82	SP-181008	0341	1	C	Update of 5GLAN – Service exposure	16.6.0
2018-12	SP-82	SP-181008	0337	3	C	Update of 5GLAN - Creation and management	16.6.0
2018-12	SP-82	SP-181008	0342	2	C	Update of 5GLAN – Security	16.6.0
2018-12	SP-82	SP-181008	0339	4	C	Update of 5GLAN – Discovery	16.6.0
2018-12	SP-82	SP-181008	0338	5	C	Update of 5GLAN – Privacy	16.6.0
2018-12	SP-82	SP-181008	0316	4	B	5GLAN requirements about enabling disabling UE from 5G-LAN based on location	16.6.0
2018-12	SP-82	SP-181128	0298	2	F	Corrections on requirements for SAT	16.6.0
2018-12	SP-82	SP-181011	0310	2	B	Enhanced network slice requirements based on business role models	16.6.0
2018-12	SP-82	SP-181011	0299	3	F	Correction to BRMNS requirements	16.6.0
2018-12	SP-82	SP-181005	0329		B	Introduction of cyberCAV	16.6.0
2018-12	SP-82	SP-181005	0311	2	B	Support for security requirements based on FS_CAV	16.6.0
2018-12	SP-82	SP-181005	0315	2	F	Replacing private network with non-public network	16.6.0
2018-12	SP-82	SP-181005	0333	2	B	cyberCAV - network interaction requirement for uninterrupted real-time video	16.6.0
2018-12	SP-82	SP-181129	0303	1	B	MSGin5G requirements on the 5G system	16.6.0
2018-12	SP-82	SP-181003	0343	2	C	Update to Annex F for Network Diagnostics	16.6.0
2018-12	SP-82	SP-180997	0348	1	F	Minor correction to URLLC clause	16.6.0
2018-12	SP-82	SP-181002	0313		F	Editorial correction in header	16.6.0
2018-12	SP-82	SP-181002	0312	2	F	Clause 7.2 alignment with other Rel-16 WIDs	16.6.0
2018-12	SP-82	SP-181002	0349	2	D	Move of KPIs for wireless RSU-TCC backhaul to 7.2.3	16.6.0
2019-03	SA#83	SP-190080	0354		F	Correction to the definition of communication service availability	16.7.0
2019-03	SA#83	SP-190080	0355	2	F	Clarifications of bulk authentication	16.7.0
2019-03	SA#83	SP-190082	0351	1	F	Clarification for 5GLAN requirements	16.7.0
2019-03	SA#83	SP-190080	0352	1	F	Update the Annex D in TS 22.261 to align the references	16.7.0
2019-03	SA#83	SP-190080	0353	1	D	Editorial clean-up of TS 22.261	16.7.0
2019-06	SA#84	SP-190302	0363	3	F	National or regional regulatory requirements for satellite access	16.8.0
2019-06	SA#84	SP-190298	0361		D	Editorial clean-up of TS 22.261	16.8.0
2019-06	SA#84	SP-190298	0359	2	D	Changing 'authorized user' to 'authorized entity' in requirements where an end user is not involved	16.8.0
2019-06	SA#84	SP-190298	0360	2	F	Abbreviations of TS 22.261	16.8.0
2019-06	SA#84	SP-190298	0362	2	F	Addition of selection Relay requirements to 22.261	16.8.0
2019-09	SA#85	SP-190803	0397	1	F	Modification of positioning service and high accuracy positioning	16.9.0
2019-09	SA#85	SP-190812	0392	3	C	Definition of absolute and relative positioning	16.9.0
2019-09	SA#85	SP-190798	0380		D	Editorial corrections of TS 22.261	16.9.0
2019-09	SA#85	SP-190798	0367	1	F	Clarification of dynamic policy control requirements	16.9.0
2019-09	SA#85	SP-190798	0368	2	F	Clarification of geographic constraint on a network slice	16.9.0
2019-09	SA#85	SP-190798	0383	2	F	Clarify requirements for bulk IoT operation and authentication	16.9.0
2019-09	SA#85	SP-190798	0399	3	F	Clarifications for KPIs on Low latency and high reliability scenarios	16.9.0
2019-09	SA#85	SP-190807	0371	1	B	Addition of security requirements for critical medical applications	17.0.0
2019-09	SA#85	SP-190807	0372	1	B	Addition of medical telemetry requirements	17.0.0
2019-09	SA#85	SP-190821	0381	2	B	Enhancement for the 5G Control Plane Steering of Roaming for UE in CONNECTED mode	17.0.0
2019-09	SA#85	SP-190817	0390	4	B	22.261 - Asset Tracking Description and Requirements	17.0.0
2019-09	SA#85	SP-190815	0365	2	B	Introduction of Minimization of Service Interruption (MINT)	17.0.0
2019-09	SA#85	SP-190817	0391	4	B	KPIs for Asset Tracking in 5G system	17.0.0
2019-09	SA#85	SP-190809	0382	2	B	General description for UAV aspects	17.0.0
2019-09	SA#85	SP-190812	0394	2	B	eCAV – further 5G service requirements for network operation and management	17.0.0
2019-09	SA#85	SP-190805	0377	1	B	Service hosting environment aspects of interactive service	17.0.0
2019-09	SA#85	SP-190805	0375	3	B	Performance requirements of interactive service	17.0.0
2019-09	SA#85	SP-190808	0386	1	B	Connectivity models description section updated.	17.0.0
2019-09	SA#85	SP-190808	0387	1	B	Connectivity models new functional requirements	17.0.0
2019-09	SA#85	SP-190808	0388	1	B	KPIs for UE to network relaying in 5G system	17.0.0
2019-10	-	-	-	-	-	Adding missing carriage return between the last sentence of clause 6.31.2.1 and clause 6.31.2.2, also at the end of 6.31.2.2 before 6.31.2.3	17.0.1
2019-12	SA#86	SP-191010	0418	1	A	UAC for NB-IOT	17.1.0
2019-12	SA#86	SP-191010	0432	1	A	Clarifications and updates on the description of positioning use cases in Annex B and Annex E	17.1.0
2019-12	SA#86	SP-191012	0411	1	A	Unified Access Control for IMS registration related signalling	17.1.0
2019-12	SA#86	SP-191014	0403	4	B	CR for group communication in 5G system	17.1.0
2019-12	SA#86	SP-191014	0405	2	B	Tethered VR requirement for 5G	17.1.0
2019-12	SA#86	SP-191014	0413	2	F	Update of NCIS KPI requirements	17.1.0
2019-12	SA#86	SP-191016	0420	3	B	Addition of AVProd introduction in 22.261	17.1.0
2019-12	SA#86	SP-191020	0426		C	Updating integrity protection requirement based on consolidated CMED requirements	17.1.0
2019-12	SA#86	SP-191020	0416	2	B	Addition of general section 6.x for CMED	17.1.0

2019-12	SA#86	SP-191023	0422	1	B	Establishment of an indirect network connection	17.1.0
2019-12	SA#86	SP-191023	0421	3	C	Clarification of requirements	17.1.0
2019-12	SA#86	SP-191028	0430	3	B	Operator provided end-to-end security for factory networks	17.1.0
2019-12	SA#86	SP-191032	0378	4	B	On Access control for MINT	17.1.0
2019-12	SA#86	SP-191034	0384	7	B	Broadcast / multicast requirements supporting Mission Critical Services in 5G	17.1.0
2019-12	SA#86	SP-191035	0425	2	B	Supporting IMS emergency for NPN	17.1.0
2019-12	SA#86	SP-191036	0412	1	F	Clarify requirements for bulk IoT authentication	17.1.0
2019-12	SA#86	SP-191036	0423	2	D	Editorial changes and corrections	17.1.0
2019-12	SA#86	SP-191036	0419	2	C	VR requirement for 5G	17.1.0
2020-03	SA#87	SP-200122	0436	1	A	Manual CAG selection clarification	17.2.0
2020-07	SA#88e	SP-200563	0454		A	correction to access control for NB-IoT	17.3.0
2020-07	SA#88e	SP-200565	0442	1	D	Addition of generic 5G requirements for VIAPA	17.3.0
2020-07	SA#88e	SP-200569	0428	4	B	Performance requirements for satellite access	17.3.0
2020-09	SA#89e	SP-200784	456	1	A	Addition of Human Readable Network Name	17.4.0
2020-09	SA#89e	SP-200889	462	2	D	Quality improvement of TS 22.261 (R17) – editorial modifications	17.4.0
2020-12	SA#90e	SP-201029	481	1	D	Quality improvement of TS 22.261	17.5.0
2020-12	SA#90e	SP-201029	479	1	F	Correction of Access Identities Table in clause 6.22.2.2	17.5.0
2020-12	SA#90e	SP-201025	488	1	F	Clarification of a steering of roaming requirement	17.5.0
2021-03	SA#91e	SP-210198	499	1	A	Modification of requirements for network slice constraints	17.6.0
2021-06	SA#92e	SP-210498	0527	1	F	Clarification for Congestion Avoidance for MINT	17.7.0
2021-06	SA#92e	SP-210502	0523	1	D	Editorial correction for network capability exposure and abbreviation	17.7.0
2021-06	SA#92e	SP-210564	510	1	D	Quality improvement - updating the definition of communication service availability	17.7.0
2021-06	SA#92e	SP-210564	511	1	D	Quality improvement - clarification of QoS-monitoring requirement	17.7.0
2021-09	SA#92e	SP-210586	0532	1	B	Adding support of PWS over NPN (approved at SA#92e but implemented only in v.17.8.0)	17.8.0
2021-09	SA#93e	SP-211030	0556	1	A	Correction to Reliability definition	17.8.0
2021-09	SA#93e	SP-211039	0558	1	F	Removal of user intervention on services exempted from release due to SOR	17.8.0
2021-09	SA#93e	SP-211096	0566		D	Reference correction	17.8.0
2021-09	SA#93e	SP-211096	0572		D	Correction of 'air interface' terminology	17.8.0
2021-09	SA#93e	SP-211096	0575	1	D	UAS terminology alignment	17.8.0
2021-09	SA#93e	SP-211038	0578		D	Editorial improvement of a QoS monitoring requirement	17.8.0
2021-12	SP-94	SP-211495	0581		A	Editorial corrections to clause 6.23.2 (QoS monitoring)	17.9.0
2021-12	SP-94	SP-211499	0585	1	A	Clarification of NPN in 22.261	17.9.0
2021-12	SP-94	SP-211500	0586	1	F	Clarification of NPN in 22.261	17.9.0
2021-12	SP-94	SP-211500	0592	1	A	Clarification to NPN requirements on USIM and multiple subscriptions	17.9.0
2021-12	SP-94	SP-211500	0625		F	NPN support for positioning service requirement	17.9.0
2022-03	SP#95e	SP-220081	0635		F	Clarification of SoR requirements	17.10.0
2022-09	SA#97	SP-220932	646	1	F	Add requirements on maximum capacity of network slicing	17.11.0

History

Document history		
V17.10.0	May 2022	Publication
V17.11.0	October 2022	Publication