

ETSI TS 123 002 V4.7.0 (2003-03)

Technical Specification

**Digital cellular telecommunications system (Phase 2+);
Universal Mobile Telecommunications System (UMTS);
Network architecture
(3GPP TS 23.002 version 4.7.0 Release 4)**



Reference

RTS/TSGS-0223002v470

Keywords

GSM, UMTS

ETSI

650 Route des Lucioles
F-06921 Sophia Antipolis Cedex - FRANCE

Tel.: +33 4 92 94 42 00 Fax: +33 4 93 65 47 16

Siret N° 348 623 562 00017 - NAF 742 C
Association à but non lucratif enregistrée à la
Sous-Préfecture de Grasse (06) N° 7803/88

Important notice

Individual copies of the present document can be downloaded from:

<http://www.etsi.org>

The present document may be made available in more than one electronic version or in print. In any case of existing or perceived difference in contents between such versions, the reference version is the Portable Document Format (PDF). In case of dispute, the reference shall be the printing on ETSI printers of the PDF version kept on a specific network drive within ETSI Secretariat.

Users of the present document should be aware that the document may be subject to revision or change of status. Information on the current status of this and other ETSI documents is available at

<http://portal.etsi.org/tb/status/status.asp>

If you find errors in the present document, send your comment to:

editor@etsi.org

Copyright Notification

No part may be reproduced except as authorized by written permission.
The copyright and the foregoing restriction extend to reproduction in all media.

© European Telecommunications Standards Institute 2003.
All rights reserved.

DECTTM, **PLUGTESTS**TM and **UMTS**TM are Trade Marks of ETSI registered for the benefit of its Members.
TIPHONTM and the **TIPHON logo** are Trade Marks currently being registered by ETSI for the benefit of its Members.
3GPPTM is a Trade Mark of ETSI registered for the benefit of its Members and of the 3GPP Organizational Partners.

Intellectual Property Rights

IPRs essential or potentially essential to the present document may have been declared to ETSI. The information pertaining to these essential IPRs, if any, is publicly available for **ETSI members and non-members**, and can be found in ETSI SR 000 314: "*Intellectual Property Rights (IPRs); Essential, or potentially Essential, IPRs notified to ETSI in respect of ETSI standards*", which is available from the ETSI Secretariat. Latest updates are available on the ETSI Web server (<http://webapp.etsi.org/IPR/home.asp>).

All published ETSI deliverables shall include information which directs the reader to the above source of information.

Foreword

This Technical Specification (TS) has been produced by ETSI 3rd Generation Partnership Project (3GPP).

The present document may refer to technical specifications or reports using their 3GPP identities, UMTS identities or GSM identities. These should be interpreted as being references to the corresponding ETSI deliverables.

The cross reference between GSM, UMTS, 3GPP and ETSI identities can be found under <http://webapp.etsi.org/key/queryform.asp> .

Contents

Intellectual Property Rights	2
Foreword.....	2
Foreword.....	6
Introduction	6
1 Scope	7
2 References	7
3 Definitions and abbreviations.....	9
3.1 Public Land Mobile Network (PLMN)	10
3.2 Core Network (CN) and Access Network (AN).....	10
3.3 Circuit Switched (CS) and Packet Switched (PS) Domains	10
3.3.1 CS Domain.....	10
3.3.2 PS Domain	10
3.4 Location register.....	10
3.5 Cell.....	11
3.6 Base Station Controller (BSC) area.....	11
3.7 Radio Network Controller (RNC) area.....	11
3.8 Location Area (LA)	11
3.9 Routing Area (RA)	11
3.10 MSC area.....	11
3.11 VLR area	11
3.12 SGSN area	12
3.13 Zones for Regional Subscription.....	12
3.14 Service area	12
3.15 Group call area	12
4 The basic entities of the mobile system.....	12
4.1 The Core Network (CN) entities	12
4.1.1 Entities common to the PS and CS domains.....	12
4.1.1.1 The Home Location Register (HLR).....	12
4.1.1.2 The Visitor Location Register (VLR)	13
4.1.1.3 The Authentication Centre (AuC)	14
4.1.1.4 The Equipment Identity Register (EIR)	14
4.1.1.5 SMS Gateway MSC (SMS-GMSC).....	14
4.1.1.6 SMS Interworking MSC	15
4.1.2 Entities of the CS domain	15
4.1.2.1 The Mobile-services Switching Centre (MSC)	15
4.1.2.1.1 MSC Server	15
4.1.2.1.2 Circuit Switched - Media Gateway Function (CS-MGW)	15
4.1.2.2 The Gateway MSC (GMSC).....	16
4.1.2.2.1 Gateway MSC Server (GMSC Server).....	16
4.1.2.3 The Interworking Function (IWF).....	16
4.1.3 Entities of the PS domain.....	16
4.1.3.1 Serving GPRS Support Node (SGSN)	16
4.1.3.2 Gateway GPRS Support Node (GGSN).....	17
4.1.3.3 Border Gateway (BG)	17
4.2 The Access Network (AN) entities.....	17
4.2.1 The Base Station System (BSS).....	17
4.2.1.1 Base Station Controller (BSC)	18
4.2.1.2 Base Transceiver Station (BTS).....	18
4.2.2 The Radio Network System (RNS).....	18
4.2.2.1 Radio Network Controller (RNC).....	18
4.2.2.2 Node B	18
4.3 The Mobile Station (MS)	18
4a The specific entities of the mobile system	18

4a.1	The Group Call Register (GCR) entity.....	18
4a.2	(void).....	19
4a.3	The Location Services (LCS) entities.....	19
4a.3.1	Location Services (LCS) entities in RAN.....	19
4a.3.2	Gateway Mobile Location Center (GMLC).....	20
4a.4	CAMEL entities.....	20
4a.4.1	GSM Service Control Function (gsmSCF).....	20
4a.4.2	GSM Service Switching Function (gsmSSF).....	20
4a.4.3	GSM Specialised Resource Function (gsmSRF).....	21
4a.4.4	GPRS Service Switching Function (gprsSSF).....	21
4a.5	CBS-specific entities.....	21
4a.5.1	Cell Broadcast Center (CBC).....	21
4a.6	Number Portability Specific entities.....	21
4a.6.1	IN-based solution: Number Portability Database (NPDB).....	21
4a.6.2	Signalling Relay-based solution: Mobile Number Portability/Signalling Relay function (MNP-SRF).....	21
4a.7	Signalling Gateway Function (SGW).....	22
5	Configuration of a Public Land Mobile Network.....	22
5.1	Basic configuration.....	22
5.2	Configuration of LCS entities.....	24
5.2.1	Configuration of LCS entities for GERAN.....	24
5.2.2	Configuration of LCS entities for UTRAN.....	24
5.3	Configuration of CAMEL entities.....	25
5.4	Configuration of CBS entities.....	26
5.5	Configuration of Signalling Gateway Function.....	26
6	PLMN basic interfaces and reference points.....	26
6.1	Interfaces between Mobile Station and the Fixed Infrastructure.....	27
6.1.1	Interface between Mobile Station and Base Station System (Um-interface).....	27
6.1.2	Interface between Mobile Station and Radio Network System (Uu-interface).....	27
6.2	Interface between the Core Network and the Access Network.....	27
6.2.1	Interfaces between the CS domain and the Access Network.....	27
6.2.1.1	Interface between the MSC and Base Station System (A-interface).....	27
6.2.1.2	Interface between the MSC and RNS (Iu_CS interface).....	27
6.2.2	Interfaces between the PS domain and the Access Network.....	27
6.2.2.1	Interface between SGSN and BSS (Gb-interface).....	27
6.2.2.2	Interface between SGSN and RNS (Iu_PS-interface).....	27
6.3	Interfaces internal to the Access Network.....	28
6.3.1	Interface between BSC and BTS (Abis-interface).....	28
6.3.2	Interface between RNC and Node B (Iub-interface).....	28
6.3.3	Interface between two RNCs (Iur-interface).....	28
6.4	Interfaces internal to the Core Network.....	28
6.4.1	Interfaces internal to the CS domain.....	28
6.4.1.1	Interface between the MSC server and its associated VLR (B-interface).....	28
6.4.1.2	Interface between the HLR and the MSC server (C-interface).....	28
6.4.1.3	Interface between the HLR and the VLR (D-interface).....	29
6.4.1.4	Interface between MSC servers (E-interface).....	29
6.4.1.5	Interface between MSC server and EIR (F-interface).....	29
6.4.1.6	Interface between VLRs (G-interface).....	29
6.4.1.7	Reference point (G)MSC server – CS-MGW (Mc Reference Point).....	29
6.4.1.8	Reference Point MSC Server – GMSC Server (Nc Reference Point).....	30
6.4.1.9	Reference Point CS-MGW – CS-MGW (Nb Reference Point).....	30
6.4.2	Interfaces internal to the PS domain.....	30
6.4.2.1	Interface between SGSN and HLR (Gr-interface).....	30
6.4.2.2	Interface between SGSN and GGSN (Gn- and Gp-interface).....	30
6.4.2.3	Signalling Path between GGSN and HLR (Gc-interface).....	30
6.4.2.4	Interface between SGSN and EIR (Gf-interface).....	31
6.4.3	Interfaces used by CS and PS domains.....	31
6.4.3.1	Interface between MSC/VLR and SGSN (Gs-interface).....	31
6.4.3.2	Interface between HLR and AuC (H-Interface).....	31
6a	PLMN specific interfaces.....	31
6a.1	GCR-specific interface.....	31

6a.1.1	Interface between the MSC and its associated GCR (I-interface).....	31
6a.2	(void).....	31
6a.3	LCS-specific interfaces	31
6a.3.1	LCS interfaces using MAP	31
6a.3.5	Interface between BSC and SMLC (Lb-interface).....	32
6a.3.6	Interface between Peer SMLCs (Lp-interface)	32
6a.3.7	Interface between BTS and LMU (Um-interface)	32
6a.3.8	Interface between RNS and Stand-Alone LMU, UE (Uu-interface).....	32
6a.4	CAMEL-specific interfaces.....	32
6a.4.1	GMSC - gsmSSF interface.....	32
6a.4.2	gsmSSF - gsmSCF interface	32
6a.4.3	MSC - gsmSSF interface.....	32
6a.4.4	gsmSCF - HLR interface.....	33
6a.4.5	gsmSCF - gsmSRF interface	33
6a.4.6	MSC - gsmSCF interface	33
6a.4.7	SGSN - gprsSSF interface.....	33
6a.4.8	gprsSSF - gsmSCF interface	33
6a.5	CBS-specific interfaces	33
6a.5.1	Interface between the CBC and RNS (Iu_BC Interface)	33
6a.6	Number portability specific interfaces	34
6a.6.1	IN-based solution.....	34
6a.6.1.1	NPDB to MSC interface.....	34
6a.6.2	Signalling Relay-based solution	34
6a.6.2.1	GMSC to MNP-SRF interface	34
6a.6.2.2	MNP-SRF to HLR interface.....	34
7	Interface to external networks	34
7.1	Interface between the fixed networks and the MSC.....	34
7.2	Interface between GGSN and external data networks (Gi-interface).....	34
7.3	Interface between GMLC and external LCS Client (Le-interface)	34
Annex A (informative): Description for GLR-related entities and interfaces		35
A.1	Normative references	35
A.2	Definitions related to Gateway Location Register (GLR).....	35
A.2.1	Gateway Location Register (GLR).....	35
A.2.2	Intermediate Mobile-services Switching Centre (IM-MSC)	35
A.2.3	Intermediate GPRS Serving Node (IM-GSN)	35
A.3	The entities of the mobile system.....	35
A.3.1	Gateway Location Register (GLR).....	35
A.3.2	Intermediate Mobile-services Switching Centre (IM-MSC)	36
A.3.3	Intermediate GPRS Serving Node (IM-GSN)	36
A.4	Configuration of a Public Land Mobile Network.....	36
A.4.1	Basic configuration with GLR introduction	36
A.5	PLMN interfaces	37
A.5.1	Interface between the HLR and the GLR (GLa-interface)	37
A.5.2	Interface between the VLR and the GLR (GLb-interface)	37
A.5.3	Interface between the SGSN and the GLR (GLc-interface)	37
A.5.4	Interface between the GLR and the IM_MSC (GLd-interface)	37
A.5.5	Interface between the GLR and the IM_GSN (GLe-interface)	37
A.5.6	Interface between the SMS-GMSC and the GLR (GLf-interface)	38
A.5.7	Interface between the SMS-GMSC and the IM_MSC (GLg-interface)	38
A.5.8	Interface between the MSC and the IM_MSC (GLh-interface)	38
A.5.9	Interface between the GMLC and the IM_MSC (GLi-interface)	38
A.5.10	Interface between the GGSN and the IM_GSN (GLj-interface).....	38
A.5.11	Interface between the SGSN and the IM_GSN (GLk-interface).....	38
Annex B (informative): Change history		39
History		40

Foreword

This Technical Specification (TS) has been produced by the 3rd Generation Partnership Project (3GPP).

The contents of the present document are subject to continuing work within the TSG and may change following formal TSG approval. Should the TSG modify the contents of the present document, it will be re-released by the TSG with an identifying change of release date and an increase in version number as follows:

Version x.y.z

where:

- x the first digit:
 - 1 presented to TSG for information;
 - 2 presented to TSG for approval;
 - 3 or greater indicates TSG approved document under change control.
- y the second digit is incremented for all changes of substance, i.e. technical enhancements, corrections, updates, etc.
- z the third digit is incremented when editorial only changes have been incorporated in the document.

Introduction

This document presents the possible architectures of the Universal Mobile Telecommunication System (UMTS), covering both UTRAN and GERAN radio access technologies.

Clause 3 of the document contains the definition of the PLMN entities.

Clause 4 of the document contains the description of the basic entities of the PLMN, and clause 4a contains the description of the specific entities of the PLMN.

Clause 5 of the document contains the configuration of the PLMN.

Clauses 6, 6a and 7 of the document contain the PLMN's basic and specific interfaces and reference points and the PLMN's interfaces towards other networks.

1 Scope

This document offers an overview of the PLMN and its architectures and configuration. The configuration and the functional entities of the PLMN and the interfaces between them are described on a general level in order to cope with possible implementations. These descriptions include interfaces between and within the core networks, the access networks, the user equipment, different service platforms, different domains and subsystems, and functional entities within domains and subsystems.

This document covers different architectural aspects with varying level of detail. In general, other specifications shall be referred to for further details; these specifications enable the reader to acquire the full understanding of a system or service feature.

Note that this document does not cover, or even list, all features of PLMNs.

2 References

The following documents contain provisions which, through reference in this text, constitute provisions of the present document.

- References are either specific (identified by date of publication, edition number, version number, etc.) or non-specific.
- For a specific reference, subsequent revisions do not apply.
- For a non-specific reference, the latest version applies. In the case of a reference to a 3GPP document (including a GSM document), a non-specific reference implicitly refers to the latest version of that document *in the same Release as the present document*.

- [1] GSM 01.04: "Digital cellular telecommunications system (Phase 2+); Abbreviations and acronyms".
- [1a] 3GPP TR 21.905: "3G Vocabulary".
- [2] 3GPP TS 22.016: "Digital cellular telecommunications system (Phase 2+); International Mobile station Equipment Identities (IMEI)".
- [2a] 3GPP TS 22.060: "Digital cellular telecommunications system (Phase 2+); General Packet radio Service (GPRS); Service Description; Stage 1".
- [2b] 3GPP TS 22.071: "Digital cellular telecommunications system (Phase 2+); Location Services (LCS); Service Description; Stage 1".
- [2c] 3GPP TS 22.078: "Customised Applications for Mobile network Enhanced Logic (CAMEL); Service description, Stage 1".
- [3] 3GPP TS 23.003: "Digital cellular telecommunications system (Phase 2+); Numbering, addressing and identification".
- [4] [void]
- [5] 3GPP TS 23.008: "Digital cellular telecommunications system (Phase 2+); Organisation of subscriber data".
- [6] 3GPP TS 23.009: "Digital cellular telecommunications system (Phase 2+); Handover procedures".
- [7] 3GPP TS 23.012: "Digital cellular telecommunications system (Phase 2+); Location registration procedures".
- [8] 3GPP TS 23.041: "Technical realization of Cell Broadcast Service (CBS)".

- [9] (void)
- [9a] 3GPP TS 23.060: "Digital cellular telecommunication system (Phase 2+); General Packet Radio Service (GPRS); Service Description; Stage 2".
- [10] 3GPP TS 23.068: "Digital cellular telecommunications system (Phase 2+); Voice Group Call Service (VGCS) stage 2".
- [10a] GSM 03.64: "Digital cellular telecommunication system (Phase 2+); Overall Description of the General Packet Radio Service (GPRS) Radio Interface; Stage 2".
- [10b] void
- [10c] TS 23.078: "Customised Applications for Mobile network Enhanced Logic (CAMEL) Phase 3 - Stage 2".
- [11] ITU-T Recommendation Q.1214 (05/1995): "Distributed Functional Plane for Intelligent Network CS-1"
- [11a] 3GPP TS 23.101: "General UMTS Architecture".
- [11b] 3GPP TS 23.110: "Access Stratum (AS): Services and Functions".
- [12] GSM 04.02 R98: "Digital cellular telecommunications system (Phase 2+); GSM Public Land Mobile Network (PLMN) access reference configuration".
- [13] GSM 08.01: "Digital cellular telecommunications system (Phase 2+); Base Station System - Mobile-services Switching Centre (BSS - MSC) interface General aspects".
- [14] GSM 08.02: "Digital cellular telecommunications system (Phase 2+); Base Station System - Mobile-services Switching Centre (BSS - MSC) interface Interface principles".
- [14a] 3GPP TS 25.410: "UTRAN Iu Interface: General Aspects and Principles".
- [14b] 3GPP TS 25.41x-series on definition of the Iu interface.
- [15] GSM 08.04: "Digital cellular telecommunications system (Phase 1); Base Station System - Mobile-services Switching Centre (BSS - MSC) interface Layer 1 specification".
- [16] GSM 08.06: "Digital cellular telecommunications system (Phase 2+); Signalling transport mechanism specification for the Base Station System - Mobile-services Switching Centre (BSS - MSC) interface".
- [17] GSM 08.08: "Digital cellular telecommunications system (Phase 2+); Mobile Switching Centre - Base Station System (MSC - BSS) interface - Layer 3 specification".
- [18] 3GPP TS 28.020: "Digital cellular telecommunications system (Phase 2+); Rate adaption on the Base Station System - Mobile-services Switching Centre (BSS - MSC) interface".
- [19] GSM 08.51: "Digital cellular telecommunications system (Phase 2+); Base Station Controller - Base Transceiver Station (BSC - BTS) interface - General aspects".
- [20] GSM 08.52: "Digital cellular telecommunications system (Phase 2+); Base Station Controller - Base Transceiver Station (BSC - BTS) interface - Interface principles".
- [21] GSM 08.54: "Digital cellular telecommunications system (Phase 2+); Base Station Controller (BSC) to Base Transceiver Station (BTS) interface - Layer 1 structure of physical circuits".
- [22] GSM 08.56: "Digital cellular telecommunications system (Phase 2+); Base Station Controller (BSC) to Base Transceiver Station (BTS) - Layer 2 specification".
- [23] GSM 08.58: "Digital cellular telecommunications system (Phase 2+); Base Station Controller (BSC) to Base Transceiver Station (BTS) interface - Layer 3 specification".
- [24] GSM 08.60: "Digital cellular telecommunications system (Phase 2+); Inband control of remote transcoders and rate adaptors".

- [25] GSM 08.61: "Digital cellular telecommunications system (Phase 2+); Inband control of remote transcoders and rate adaptors (half rate)".
- [26] 3GPP TS 29.002: "Digital cellular telecommunications system (Phase 2+); Mobile Application Part (MAP) specification".
- [27] GSM 09.03 R98: "Digital cellular telecommunications system (Phase 2+); Signalling requirements on interworking between the Integrated Services Digital Network (ISDN) or Public Switched Telephone Network (PSTN) and the Public Land Mobile Network (PLMN)".
- [28] 3GPP TS 29.004: "Digital cellular telecommunications system (Phase 2+); Interworking between the Public Land Mobile Network (PLMN) and the Circuit Switched Public Data Network (CSPDN)".
- [29] 3GPP TS 29.005: "Digital cellular telecommunications system (Phase 2+); Interworking between the Public Land Mobile Network (PLMN) and the Packet Switched Public Data Network (PSPDN) for Packet Assembly/Disassembly facility (PAD) access".
- [30] 3GPP TS 29.006: "Digital cellular telecommunications system (Phase 2+); Interworking between a Public Land Mobile Network (PLMN) and a Packet Switched Public Data Network/Integrated Services Digital Network (PSPDN/ISDN) for the support of packet switched data transmission services".
- [31] 3GPP TS 29.007: "Digital cellular telecommunications system (Phase 2+); General requirements on interworking between the Public Land Mobile Network (PLMN) and the Integrated Services Digital Network (ISDN) or Public Switched Telephone Network (PSTN)".
- [32] 3GPP TS 29.010: "Digital cellular telecommunications system (Phase 2+); Information element mapping between Mobile Station - Base Station System and BSS - Mobile-services Switching Centre (MS - BSS - MSC) - Signalling procedures and the Mobile Application Part (MAP)".
- [33] 3GPP TS 29.011: "Digital cellular telecommunications system (Phase 2+); Signalling interworking for supplementary services".
- [34] 3GPP TR 41.001: "GSM Release specifications".
- [35] 3GPP TS 43.051: "GERAN Overall Description, Stage 2".
- [36] 3GPP TS 25.305: "Functional Stage 2 Description of UE Positioning in UTRAN"
- [37] 3GPP TS 43.059: "Functional Stage 2 Description of Location Services in GERAN"
- [38] 3GPP TS 23.271: "Functional Stage 2 Description of Location Services"
- [39] 3GPP TS 49.031 : "Location Services (LCS);Base Station System Application Part LCS Extension (BSSAP-LE) "
- [40] 3GPP TS 48.031: "Location Services (LCS); Serving Mobile Location Centre - Serving Mobile Location Centre (SMLC - SMLC); SMLCPP specification"
- [41] 3GPP TS 44.071 : "Location Services (LCS); Mobile radio interface layer 3 Location Services (LCS) specification"

3 Definitions and abbreviations

In addition to the abbreviations given in the remainder of this clause others are listed in GSM 01.04 and in TR 21.905.

The definitions of the entities of the mobile system are given in the next subclause.

3.1 Public Land Mobile Network (PLMN)

A Public Land Mobile Network (PLMN) is established and operated by an administration or Recognized Private Operating Agency (RPOA) for the specific purpose of providing land mobile telecommunications service services to the public. A PLMN may be regarded as an extension of a network (e.g. ISDN); it is a collection of MSCs areas within a common numbering plan (e.g. same National Destination Code) and a common routing plan. The MSCs are the functional interfaces between the fixed networks and a PLMN for call set-up.

Functionally the PLMNs may be regarded as independent telecommunications entities even though different PLMNs may be interconnected through the ISDN/PSTN and PDNs for forwarding of calls or network information. A similar type of interconnection may exist for the interaction between the MSCs of one PLMN.

3.2 Core Network (CN) and Access Network (AN)

The PLMN infrastructure is logically divided into a Core Network (CN) and an Access Network (AN) infrastructures, as defined in TS 23.101 and TS 23.110. The CN is logically divided into CS domain and PS domain, as defined in next subclause. The AN is called BSS for GSM and RNS for UMTS, as defined in clause "The Access Network".

3.3 Circuit Switched (CS) and Packet Switched (PS) Domains

The CN is constituted of a Circuit Switched (CS) domain and a Packet Switched (PS) domain. These two domains differ by the way they support user traffic, as explained bellow.

These two domains are overlapping, i.e. they contain some common entities. A PLMN can implement only one domain or both domains.

3.3.1 CS Domain

The CS domain refers to the set of all the CN entities offering "CS type of connection" for user traffic as well as all the entities supporting the related signalling. A "CS type of connection" is a connection for which dedicated network resources are allocated at the connection establishment and released at the connection release.

The entities specific to the CS domain are: MSC, GMSC, VLR. All the other CN entities defined in clause "4 The basic entities of the mobile system" and not defined as PS domain specific entities (see following subclause) are common to the CS and to the PS domains.

3.3.2 PS Domain

The PS domain refers to the set of all the CN entities offering "PS type of connection" for user traffic as well as all the entities supporting the related signalling. A "PS type of connection" transports the user information using autonomous concatenation of bits called packets: each packet can be routed independently from the previous one.

The entities specific to the PS domain are the GPRS specific entities, i.e. SGSN and GGSN. All the other CN entities defined in clause "4 The basic entities of the mobile system" and not defined as CS domain specific entities (see previous subclause) are common to the CS and to the PS domains.

3.4 Location register

To enable communication to a mobile station the network must know where this mobile station is located. This information is stored in a function named location register.

The location register is handled by four different entities.

- The Home Location Register (HLR).

The Home Location Register (HLR) is the location register to which a mobile subscriber is assigned for record purposes such as subscriber information.

- The Visitor Location Register (VLR).

The Visitor Location Register (VLR) is the location register for Circuit Switched (CS) services, other than the HLR, used by an MSC to retrieve information for, e.g. handling of calls to or from a roaming mobile station currently located in its area.

- The Serving GPRS Support Node (SGSN).

The location register function in the SGSN stores subscription information and location information for Packet Switched (PS) services for each subscriber registered in the SGSN.

The SGSN is needed only in a PLMN which supports GPRS.

- The Gateway GPRS Support Node (GGSN).

The location register function in the GGSN stores subscription information and routing information (needed to tunnel packet data traffic destined for a GPRS MS to the SGSN where the MS is registered) for each subscriber for which the GGSN has at least one PDP context active.

The GGSN is needed only in a PLMN which supports GPRS.

3.5 Cell

The cell is an area of radio coverage identified by a Base station identification as defined in GSM 23.003.

3.6 Base Station Controller (BSC) area

The Base Station Controller (BSC) area is an area of radio coverage consisting of one or more cells controlled by one BSC. The boundaries of a BSC area and a location area are independent; a location area may span the boundary between BSC area and a BSC area may span the boundary between location areas.

3.7 Radio Network Controller (RNC) area

The Radio Network Controller (RNC) area is an area of radio coverage consisting of one or more cells controlled by one RNC. The boundaries of a RNC area and a location area are independent; a location area may span the boundary between RNC area and a RNC area may span the boundary between location areas.

3.8 Location Area (LA)

The Location Area (LA) is defined as an area in which a mobile station may move freely without updating the VLR. A location area may include one or several cells.

3.9 Routing Area (RA)

The Routing Area (RA) is defined as an area in which a mobile station, in certain operation modes, may move freely without updating the SGSN. A routing area may include one or several cells. A RA is always contained within a location area.

3.10 MSC area

The MSC area is the part of the network covered by an MSC. An MSC area may consist of one or several location areas. An MSC area may also consist of one or several BSC areas.

3.11 VLR area

The VLR area is the part of the network controlled by a VLR. A VLR area may consist of one or several MSC areas.

3.12 SGSN area

The SGSN area is the part of the network served by an SGSN. An SGSN area may consist of one or several routing areas. An SGSN area may also consist of one or several BSC areas. There need not be a one to one relationship between SGSN area and MSC/VLR area.

3.13 Zones for Regional Subscription

A PLMN operator may define a number of regional subscription areas, each of which is a subset of the service area for an unrestricted mobile subscriber. A regional subscription area may be contained within the service area of a single PLMN, or may lie within the service areas of two or more PLMNs. Each regional subscription area consists of one or more zones; each zone is contained within the service area of a PLMN.

The definition of a mobile subscriber's regional subscription area is stored within the HLR per National Destination Code(s) (NDC) of a PLMN and is transferred to the VLRs and/or SGSNs of that PLMN. The VLR and/or SGSN evaluates this information to extract the restricted or accessible MSC and/or SGNS areas and location areas to which the mobile subscriber is allowed to roam. The VLR and/or SGNS informs the HLR if an entire MSC and/or SGNS area is restricted.

Zones for Regional Subscription and their handling are defined in TS 23.003, TS 23.008 and TS 29.002.

3.14 Service area

The service area is defined as an area in which a mobile subscriber can be reached by another (mobile or fixed) subscriber without the subscriber's knowledge of the actual location of the mobile station within the area. A service area may consist of several PLMNs. One service area may consist of one country, be a part of a country or include several countries. The location registration system associated with each service area must thus contain a list of all mobile stations located within that service area.

3.15 Group call area

The group call area is a predefined area composed of one or a number of cells to which a particular Voice Group Call Service (VGCS) or Voice Broadcast Service (VBS) call is distributed. The composition of a group call area is predefined in the network. The group call area may include cells of more than one MSC area and cells of more than one PLMN.

4 The basic entities of the mobile system

To provide the mobile service as it is defined, it is necessary to introduce some specific functions. These functional entities can be implemented in different equipments or gathered. In any case, exchanges of data occur between these entities.

4.1 The Core Network (CN) entities

4.1.1 Entities common to the PS and CS domains

4.1.1.1 The Home Location Register (HLR)

This functional entity is a data base in charge of the management of mobile subscribers. A PLMN may contain one or several HLRs: it depends on the number of mobile subscribers, on the capacity of the equipment and on the organisation of the network. The following kinds of information are stored there:

- the subscription information;

- some location information enabling the charging and routing of calls towards the MSC where the MS is registered (e.g. the MS Roaming Number, the VLR Number, the MSC Number, the Local MS Identity);

and, if GPRS is supported, also:

- location information enabling the charging and routing of messages in the SGSN where the MS is currently registered (e.g. the SGSN Number);

and, if LCS is supported, also:

- a LCS privacy exception list, which indicates the privacy class of the MS subscriber;
- a GMLC list;
- a MO-LR list.

Different types of identity are attached to each mobile subscription and are stored in the HLR. The following identities are stored:

- the International Mobile Station Identity (IMSI);
- one or more Mobile Station International ISDN number(s) (MSISDN);

if GPRS is supported, the following identity is also stored:

- zero or more Packet Data Protocol (PDP) address(es);

and, if LCS is supported, the following identity is also stored:

- the LMU indicator.

There is always at least one identity, apart from the IMSI, attached to each mobile subscription and stored in the HLR.

The IMSI or the MSISDN may be used as a key to access the information in the database for a mobile subscription.

The data base contains other information such as:

- teleservices and bearer services subscription information;
- service restrictions (e.g. roaming limitation);
- a list of all the group IDs a service subscriber is entitled to use to establish voice group or broadcast calls;
- supplementary services; the HLR contains the parameters attached to these services;

and, if GPRS is supported, also:

- information about if a GGSN is allowed to dynamically allocate PDP addresses for a subscriber.

NOTE: Supplementary services parameters need not all be stored in the HLR. However, it seems safer to store all subscription parameters in the HLR even when some are stored in a subscriber card.

The organisation of the subscriber data is outlined in GSM 23.008.

4.1.1.2 The Visitor Location Register (VLR)

A mobile station roaming in an MSC area is controlled by the Visitor Location Register in charge of this area. When a Mobile Station (MS) enters a new location area it starts a registration procedure. The MSC in charge of that area notices this registration and transfers to the Visitor Location Register the identity of the location area where the MS is situated. If this MS is not yet registered, the VLR and the HLR exchange information to allow the proper handling of calls involving the MS.

A VLR may be in charge of one or several MSC areas.

The VLR contains also the information needed to handle the calls set-up or received by the MSs registered in its data base (for some supplementary services the VLR may have to obtain additional information from the HLR). The following elements are included:

- the International Mobile Subscriber Identity (IMSI);
- the Mobile Station International ISDN number (MSISDN);
- the Mobile Station Roaming Number (MSRN), see TS 23.003 for allocation principles;
- the Temporary Mobile Station Identity (TMSI), if applicable;
- the Local Mobile Station Identity (LMSI), if used;
- the location area where the mobile station has been registered;
- the identity of the SGSN where the MS has been registered. Only applicable to PLMNs supporting GPRS and which have a Gs interface between MSC/VLR and SGSN;
- the last known location and the initial location of the MS.

The VLR also contains supplementary service parameters attached to the mobile subscriber and received from the HLR. The organisation of the subscriber data is outlined in TS 23.008.

4.1.1.3 The Authentication Centre (AuC)

The Authentication Centre (AuC) is an entity which stores data for each mobile subscriber to allow the International Mobile Subscriber Identity (IMSI) to be authenticated and to allow communication over the radio path between the mobile station and the network to be ciphered. The AuC transmits the data needed for authentication and ciphering via the HLR to the VLR, MSC and SGSN which need to authenticate a mobile station.

The Authentication Centre (AuC) is associated with an HLR, and stores an identity key for each mobile subscriber registered with the associated HLR. This key is used to generate:

- data which are used to authenticate the International Mobile Subscriber Identity (IMSI);
- a key used to cipher communication over the radio path between the mobile station and the network.

The AuC communicates only with its associated HLR over an interface denoted the H-interface (see clause 5).

4.1.1.4 The Equipment Identity Register (EIR)

The Equipment Identity Register (EIR) in the GSM system is the logical entity which is responsible for storing in the network the International Mobile Equipment Identities (IMEIs), used in the GSM system.

The equipment is classified as "white listed", "grey listed", "black listed" or it may be unknown as specified in TS 22.016 and TS 29.002.

This functional entity contains one or several databases which store(s) the IMEIs used in the GSM system.

The mobile equipment may be classified as "white listed", "grey listed" and "black listed" and therefore may be stored in three separate lists.

An IMEI may also be unknown to the EIR.

An EIR shall as a minimum contain a "white list" (Equipment classified as "white listed").

See also TS 22.016 on IMEI.

4.1.1.5 SMS Gateway MSC (SMS-GMSC)

The SMS Gateway MSC (SMS-GMSC) acts as an interface between a Short Message Service Centre and the PLMN, to allow short messages to be delivered to mobile stations from the Service Centre (SC).

The choice of which MSCs can act as SMS Gateway MSCs is a network operator matter (e.g. all MSCs or some designated MSCs).

4.1.1.6 SMS Interworking MSC

The SMS Interworking MSC acts as an interface between the PLMN and a Short Message Service Centre (SC) to allow short messages to be submitted from Mobile Stations to the SC.

The choice of which MSCs can act as SMS Interworking MSCs is a network operator matter (e.g. all MSCs or some designated MSCs).

4.1.2 Entities of the CS domain

4.1.2.1 The Mobile-services Switching Centre (MSC)

The Mobile-services Switching Centre (MSC) constitutes the interface between the radio system and the fixed networks. The MSC performs all necessary functions in order to handle the circuit switched services to and from the mobile stations.

In order to obtain radio coverage of a given geographical area, a number of base stations are normally required; i.e. each MSC would thus have to interface several base stations. In addition several MSCs may be required to cover a country.

The Mobile-services Switching Centre is an exchange which performs all the switching and signalling functions for mobile stations located in a geographical area designated as the MSC area. The main difference between a MSC and an exchange in a fixed network is that the MSC has to take into account the impact of the allocation of radio resources and the mobile nature of the subscribers and has to perform in addition, at least the following procedures:

- procedures required for the location registration (see TS 23.012);
- procedures required for handover (see TS 23.009).

NOTE: When this improves the readability (e.g. when dealing with inter-releases handover), the term 2G-MSC can be used to refer to an MSC Release 98 or prior, and the term 3G-MSC can be used to refer to an MSC Release 99 or later.

When needed, the MSC can be implemented in two different entities: the MSC Server, handling only signalling, and the CS-MGW, handling user's data. A MSC Server and a CS-MGW make up the full functionality of a MSC.

4.1.2.1.1 MSC Server

The MSC Server mainly comprises the call control (CC) and mobility control parts of a MSC.

The MSC Server is responsible for the control of mobile originated and mobile terminated CC CS Domain calls. It terminates the user-network signalling and translates it into the relevant network – network signalling. The MSC Server also contains a VLR to hold the mobile subscriber's service data and CAMEL related data.

The MSC Server controls the parts of the call state that pertain to connection control for media channels in a CS-MGW.

4.1.2.1.2 Circuit Switched - Media Gateway Function (CS-MGW)

Note: In this document the term Media Gateway Function (MGW) is used when there is no need to differentiate between the CS domain entity and the IP Multimedia CN Subsystem entity. When referring specifically to the CS domain entity the term CS-MGW is used. When referring specifically to the IP Multimedia CN Subsystem entity, the term IM-MGW is used.

This component is PSTN/PLMN transport termination point for a defined network and interfaces UTRAN with the core network over Iu.

A CS-MGW may terminate bearer channels from a switched circuit network and media streams from a packet network (e.g., RTP streams in an IP network). Over Iu, the CS-MGW may support media conversion, bearer control and payload processing (e.g. codec, echo canceller, conference bridge) for support of different Iu options for CS services (AAL2/ATM based as well as RTP/UDP/IP based).

The CS-MGW:

- Interacts with MSC server and GMSC server for resource control.

- Owns and handles resources such as echo cancellers etc.
- May need to have codecs.

The CS-MGW will be provisioned with the necessary resources for supporting UMTS/GSM transport media. Further tailoring (i.e packages) of the H.248 may be required to support additional codecs and framing protocols, etc.

The CS-MGW bearer control and payload processing capabilities will also need to support mobile specific functions such as SRNS relocation/handover and anchoring. It is expected that current H.248 standard mechanisms can be applied to enable this.

4.1.2.2 The Gateway MSC (GMSC)

If a network delivering a call to the PLMN cannot interrogate the HLR, the call is routed to an MSC. This MSC will interrogate the appropriate HLR and then route the call to the MSC where the mobile station is located. The MSC which performs the routing function to the actual location of the MS is called the Gateway MSC (GMSC).

The acceptance of an interrogation to an HLR is the decision of the operator.

The choice of which MSCs can act as Gateway MSCs is for the operator to decide (i.e. all MSCs or some designated MSCs).

If the call is a voice group/broadcast call, it is routed directly from the GMSC to the VBS/VGCS Anchor MSC, based on information (VBS/VGCS call reference) contained in the dialled number. See also GSM 03.68 and 03.69.

When needed, the GMSC can be implemented in two different entities: the GMSC Server, handling only signalling, as defined below, and the CS-MGW, defined above. A GMSC Server and a CS-MGW make up the full functionality of a GMSC.

4.1.2.2.1 Gateway MSC Server (GMSC Server)

The GMSC server mainly comprises the call control and mobility control parts of a GMSC.

4.1.2.3 The Interworking Function (IWF)

The Interworking Function (IWF) is a functional entity associated with the MSC. The IWF provides the functionality necessary to allow interworking between a PLMN and the fixed networks (ISDN, PSTN and PDNs). The functions of the IWF depend on the services and the type of fixed network. The IWF is required to convert the protocols used in the PLMN to those used in the appropriate fixed network. The IWF may have no functionality where the service implementation in the PLMN is directly compatible with that at the fixed network. The interworking functions are described in TS Technical Specifications 29.004, 29.005, 29.007 and 09.09.

4.1.3 Entities of the PS domain

The UMTS PS-domain (or GPRS) Support Nodes (GSN) are the Gateway GSN (GGSN) and the Serving GSN (SGSN). They constitute the interface between the radio system and the fixed networks for packet switched services. The GSN performs all necessary functions in order to handle the packet transmission to and from the mobile stations.

4.1.3.1 Serving GPRS Support Node (SGSN)

The location register function in the SGSN stores two types of subscriber data needed to handle originating and terminating packet data transfer:

- subscription information:
 - the IMSI;
 - one or more temporary identities;
 - zero or more PDP addresses.
- location information:

- depending on the operating mode of the MS, the cell or the routing area where the MS is registered;
- the VLR number of the associated VLR (if the Gs interface is implemented);
- the GGSN address of each GGSN for which an active PDP context exists.

The organisation of the subscriber data in the SGSN is defined in TS 23.008 and TS 23.060.

The procedures for information transfer between the SGSN, the GGSN, the VLR and the HLR are defined in TS 23.016 and TS 23.060.

NOTE: When this improves the readability (e.g. when dealing with inter-releases handover), the term 2G-SGSN can be used to refer to an MSC Release 98 or prior, and the term 3G-SGSN can be used to refer to an MSC Release 99 or later.

4.1.3.2 Gateway GPRS Support Node (GGSN)

The location register function in the GGSN stores subscriber data received from the HLR and the SGSN. There are two types of subscriber data needed to handle originating and terminating packet data transfer:

- subscription information:
 - the IMSI;
 - zero or more PDP addresses.
- location information:
 - the SGSN address for the SGSN where the MS is registered.

The organisation of the subscriber data in the GGSN is defined in TS 23.008 and TS 23.060.

The procedures for information transfer between the GGSN, the SGSN and the HLR are defined in TS 23.016 and TS 23.060.

4.1.3.3 Border Gateway (BG)

The Border Gateway (BG) is a gateway between a PLMN supporting GPRS and an external inter-PLMN backbone network used to interconnect with other PLMNs also supporting GPRS. The role of the BG is to provide the appropriate level of security to protect the PLMN and its subscribers.

The BG is only needed in PLMNs supporting GPRS.

4.2 The Access Network (AN) entities

Two different types of access network are used by the CN: the Base Station System (BSS) and the Radio Network System (RNS). The MSC (resp. SGSN) can connect to one of these Access Network type or to both of them.

The access technologies offered by the BSS are described in the 45-series of 3GPP specifications. The access technologies offered by the RNS (FDD, TDD) are described in the 25-series of 3GPP specifications.

4.2.1 The Base Station System (BSS)

The Base Station System (BSS) is the system of base station equipments (transceivers, controllers, etc...) which is viewed by the MSC through a single A interface as being the entity responsible for communicating with Mobile Stations in a certain area. Similarly, in PLMNs supporting GPRS, the BSS is viewed by the SGSN through a single Gb interface. The functionality for the A interface is described in GSM 08.02 and for the Gb interface in TS 23.060. The functionality for the Iu-CS interface is described in TS 25.410 and for the Iu-PS interface in TS 23.060.

The radio equipment of a BSS may support one or more cells. A BSS may consist of one or more base stations. Where an Abis-interface is implemented, the BSS consists of one Base Station Controller (BSC) and one or more Base Transceiver Station (BTS).

The split of functions between BSS and CN is described in the 08-series of GSM Technical Specifications.

4.2.1.1 Base Station Controller (BSC)

A Base Station Controller (BSC) is a network component in the PLMN with the functions for control of one or more BTS.

4.2.1.2 Base Transceiver Station (BTS)

A Base Transceiver Station (BTS) is a network component which serves one cell.

4.2.2 The Radio Network System (RNS)

The Radio Network System (RNS) is the system of base station equipments (transceivers, controllers, etc...) which is viewed by the MSC through a single Iu-interface as being the entity responsible for communicating with Mobile Stations in a certain area. Similarly, in PLMNs supporting GPRS, the RNS is viewed by the SGSN through a single Iu-PS interface. The functionality for the Iu-CS interface is described in TS 25.410 and for the Iu-PS interface in TS 23.060. The radio equipment of a RNS may support one or more cells. A RNS may consist of one or more base stations. The RNS consists of one Radio Network Controller (RNC) and one or more Node B.

The split of functions between RNS and CN is described in the 25-series of UMTS Technical Specifications.

4.2.2.1 Radio Network Controller (RNC)

A Radio Network Controller (RNC) is a network component in the PLMN with the functions for control of one or more Node B.

4.2.2.2 Node B

A Node B is a network component which serves one cell.

4.3 The Mobile Station (MS)

The mobile station consists of the physical equipment used by a PLMN subscriber; it comprises the Mobile Equipment (ME) and the Subscriber Identity Module (SIM), called UMTS Subscriber Identity Module (USIM) for Release 99 and following. The ME comprises the Mobile Termination (MT) which, depending on the application and services, may support various combinations of Terminal Adapter (TA) and Terminal Equipment (TE) functional groups. These functional groups are described in GSM 04.02.

[editor's note: an input is expected to introduce the UE (User Equipment) definition and clarify the difference between MS and UE.]

4a The specific entities of the mobile system

The entities presented in this clause are dedicated to the provisioning of a given (set of) service(s). The fact that they are implemented or not in a given PLMN should have limited impact on all the other entities of the PLMN.

All the specific entities defined so far are located in the Core Network.

4a.1 The Group Call Register (GCR) entity

The Group Call Register (GCR) is a register holding information about VGCS or VBS calls, the voice group or broadcast call attributes, respectively.

Voice group or broadcast call attributes are defined for a specific voice group or broadcast call reference and include the data required to configure the conference bridge for a VGCS or VBS call and other call related attributes.

The Group Call Register (GCR) shall hold for a related MSC area for each group ID and cell from which Voice Group Call Service (VGCS) or Voice Broadcast Service (VBS) calls can be established by mobile stations the voice group call reference or voice broadcast call reference to be used for a VGCS or VBS call to be established and an indication whether the originating MSC is the MSC responsible for that call.

If the originating MSC is not responsible for that call, the GCR shall hold the routing information identifying the MSC responsible for that call.

A GCR may be in charge of one or several MSC. Each MSC involved in a voice group or broadcast call requests its proper voice group or broadcast call attributes from its related GCR by use of the voice group or broadcast call reference.

The contents of each list related to requests of the MSC responsible for a voice group or broadcast call is as follows:

- a list of cells inside the MSC area of the requesting MSC into which the call is to be sent (part of the group call area);
- a list of other MSCs into which the call is to be sent;
- a list of identities of dispatchers to which a dedicated link is to be established;
- a list of identities of dispatchers which are allowed to initiate the voice group or broadcast call;
- a list of identities of dispatchers which are allowed to terminate the voice group or broadcast call;
- the length of time over which no activity is detected before the voice group call is automatically terminated;
- the default priority level related to the voice group or broadcast call if the eMLPP supplementary service applies;
- a flag indicating if acknowledgements are required for this voice group or broadcast call.

The contents of each list related to requests of an MSC not responsible for a voice group or broadcast call is as follows:

- a list of cells inside the MSC area of the requesting MSC into which the call is to be sent (part of the group call area).

More information is provided in TS 23.068 and 23.069.

4a.2 (void)

4a.3 The Location Services (LCS) entities

This section describes the Location Services entities found in the Core Network and Radio Access Network that support positioning methods for the UE/MS.

For further details on LCS in from a system and core network point view, see 3GPP TS 23.271[38].

For further details on LCS in UTRAN, see 3GPP TS 25.305.[36].

For further details on LCS in GERAN, see 3GPP TS 43.059 [37].

4a.3.1 Location Services (LCS) entities in RAN

The RAN (UTRAN and GERAN) supports one or more UE/MS positioning methods to calculate the geographical position of the UE/MS and responds to the UE/MS location request received from the CN. The RAN may broadcast LCS assistance data to UEs/MSs under its coverage. In case this assistance data is ciphered, the ciphering key is provided by the CN to the UE/MS.

To support UE positioning methods, the RAN is made of several entities like:

BSC/SRNC: the BSC for GERAN and SRNC for UTRAN receive authenticated location requests from the CN:

- In UTRAN, the SRNC co-ordinates the positioning requests taking into account their priority and it selects the positioning method to fulfil the requested accuracy. It interfaces, when necessary, with the CRNC which mainly manages resources allocated to UE positioning operations and requests UE Positioning related measurements from its associated Node Bs and LMUs.
- In GERAN, the BSC passes the location request to the SMLC.

SMLC:

- The Serving Mobile Location Center (SMLC) function is part of the RNC for UTRAN. The SMLC function can be part of the BSC or be a separate SMLC server for GERAN.
- In UTRAN, the SMLC function provides GPS assistance data to the RNC and acts as a location calculation server if the location estimates are not to be calculated in the RNC.
- In GERAN, the SMLC function co-ordinates the positioning request, schedules resources required to perform positioning of a mobile, and calculates the final location estimate and accuracy. The SMLC may control a number of LMUs.

LMU: The Location Measurement Unit (LMU) entity makes measurements for one or more positioning methods.

Node B: Node B is a network element of UTRAN that may provide measurement results for position estimation and makes measurements of radio signals.

CBC: The Cell Broadcast Center, for GERAN, the SMLC function may interface a CBC in order to broadcast assistance data using existing cell broadcast capabilities.

For detail on Location services, entities and interfaces provided by UTRAN, see 3GPP TS 25.305 [36].

For detail on Location services, entities and interfaces provided by GERAN, see 3GPP TS 43.059 [37].

4a.3.2 Gateway Mobile Location Center (GMLC)

The Gateway Mobile Location Center (GMLC) is the first node an external Location Application accesses in the PLMN. The GMLC performs registration authorization and requests routing information from the HLR. There may be more than one GMLC in a PLMN.

4a.3.3 Void

4a.4 CAMEL entities

The entities of this subclause support the CAMEL feature (Customised Applications for Mobile network Enhanced Logic). This feature provides the mechanisms to support services consistently independently of the serving network, as described in 22.078 [2c]. The following definitions are extracted from 23.078 [10c], which completely specifies CAMEL stage 2.

4a.4.1 GSM Service Control Function (gsmSCF)

A functional entity that contains the CAMEL service logic to implement Operator Specific Service. It interfaces with the gsmSSF, the gsmSRF and the HLR.

4a.4.2 GSM Service Switching Function (gsmSSF)

A functional entity that interfaces the MSC/GMSC to the gsmSCF. The concept of the gsmSSF is derived from the IN SSF, but uses different triggering mechanisms because of the nature of the mobile network.

4a.4.3 GSM Specialised Resource Function (gsmSRF)

A functional entity which provides various specialized resources. It interfaces with the gsmSCF and with the MSC. This entity is defined in ITU-T Q.1214 [11] with variations defined in 23.078.

4a.4.4 GPRS Service Switching Function (gprsSSF)

A functional entity that interfaces the SGSN to the gsmSCF. The concept of the gprsSSF is derived from the IN SSF, but uses different triggering mechanisms because of the nature of the mobile network.

4a.5 CBS-specific entities

The cell broadcast service (CBS) is a Teleservice which enables an Information Provider to submit short messages for broadcasting to a specified area within the PLMN. The 3G Technical Specification 23.041 [8] contains the technical realization of the service.

4a.5.1 Cell Broadcast Center (CBC)

The CBC shall be responsible for the management of CBS messages and for determining the CBS delivery parameters of the RNS. The CBC may be connected to several BSCs/RNCs. In UMTS the CBC is regarded to be integrated as a node into the core network.

NOTE: Whether it should be possible that an RNC is connected to at least two CBCs at the same time (the "normal" one as in GSM and a second one for LCS) is for further study and depends on the solution taken for LCS.

4a.6 Number Portability Specific entities

Two different solutions are defined to support Number Portability. The first one is an IN based solution and is described in the next subclause. The second one is a "Signalling Relay" based solution described in next but one subclause.

For details on MNP see TS 23.066.

4a.6.1 IN-based solution: Number Portability Database (NPDB)

The Number Portability Database (NPDB) is the central element of the IN based solution for Mobile Number Portability (MNP). MNP is the ability for a mobile subscriber to change the GSM subscription network within a portability cluster (e.g. a country) whilst retaining his/her original MSISDN or MSISDNs.

The NPDB stores the table of correspondence between MSISDNs and Subscription networks. Upon request of the (gateway or visited) MSC, the NPDB retrieves from the MSISDN the Routing Number pointing out the Subscription network.

4a.6.2 Signalling Relay-based solution: Mobile Number Portability/Signalling Relay function (MNP-SRF)

The MNP-Signalling Relay Function (MNP-SRF) is the central element of the Signalling Relay based solution for Mobile Number Portability.

The MNP-SRF obtains the routing information from a NP database to identify the subscription network associated with a particular national MSISDN. Upon request from gateway MSC, the MNP-SRF may perform one of the following actions:

1. the MNP-SRF will reply back to the GMSC with the necessary routing information to route the call;
2. the message is relayed to the HLR;
3. the message is relayed to MNP-SRF in the subscription network.

For non-call related signalling (e.g. delivery of SMS), only cases 2 and 3 are applicable.

4a.7 Signalling Gateway Function (SGW)

The SGW performs the signalling conversion (both ways) at transport level between the SS7 based transport of signaling used in pre-Rel 4 networks, and the IP based transport of signalling possibly used in post-R99 networks (i.e. between Sigtran SCTP/IP and SS7 MTP). The SGW does not interpret the application layer (e.g. MAP, CAP, BICC or ISUP) messages but may have to interpret the underlying SCCP or SCTP layer to ensure proper routing of the signaling.

5 Configuration of a Public Land Mobile Network

5.1 Basic configuration

The basic configuration of a Public Land Mobile Network (PLMN) supporting GPRS and the interconnection to the PSTN/ISDN and PDN is presented in figure 1. This configuration presents signalling and user traffic interfaces which can be found in a PLMN. Implementations may be different: some particular functions may be gathered in the same equipment and then some interfaces may become internal interfaces.

In the basic configuration presented in figure 1, all the functions are considered implemented in different equipments. Therefore, all the interfaces within PLMN are external. Interfaces A and Abis are defined in the GSM 08-series of Technical Specifications. Interfaces Iu, Iur and Iub are defined in the UMTS 25.4xx-series of Technical Specifications. Interfaces B, C, D, E, F and G need the support of the Mobile Application Part of the signalling system No. 7 to exchange the data necessary to provide the mobile service. No protocols for the H-interface and for the I-interface are standardized. All the GPRS-specific interfaces (G- series) are defined in the UMTS 23-series and 24-series of Technical Specifications. Interfaces Mc, Nb, and Nc are defined in UMTS 23.205 and in the UMTS 29-series of technical specifications.

From this configuration, all the possible PLMN organisations can be deduced. In the case when some functions are contained in the same equipment, the relevant interfaces become internal to that equipment.

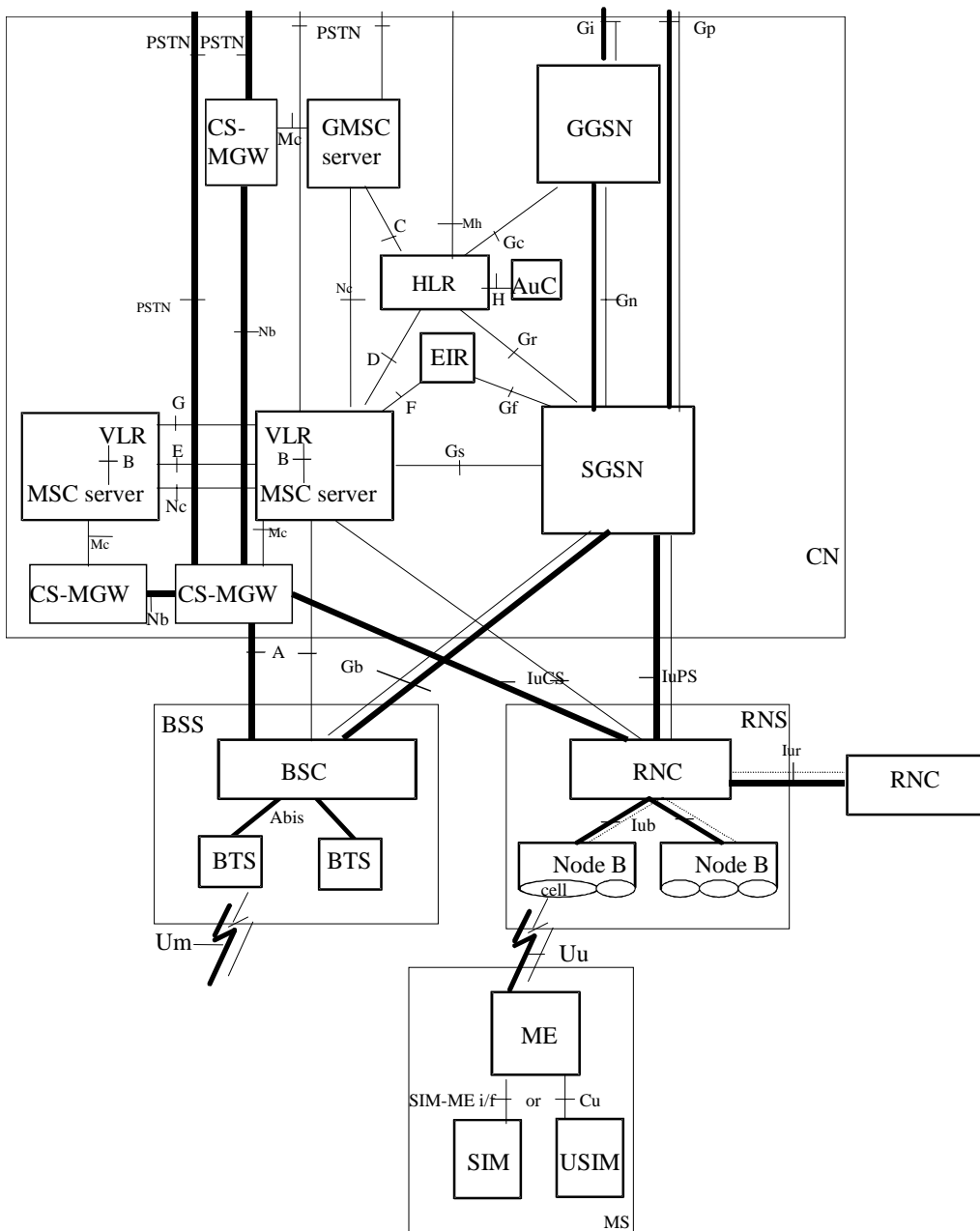

Legend:

Bold lines: interfaces supporting user traffic;

Dashed lines: interfaces supporting signalling.

NOTE 1: The figure shows direct interconnections between the entities. The actual links may be provided by an underlying network (e.g. SS7 or IP): this needs further studies.

NOTE 2: When the MSC and the SGSN are integrated in a single physical entity, this entity is called UMTS MSC (UMSC).

NOTE 3: A (G)MSC server and associated CS-MGW can be implemented as a single node: the (G)MSC.

NOTE 4: The Gn interface (between two SGSNs) is also part of the reference architecture, but is not shown for layout purposes only.

Figure 1: Basic Configuration of a PLMN supporting CS and PS services and interfaces

5.2 Configuration of LCS entities

5.2.1 Configuration of LCS entities for GERAN

The configuration of LCS entities for GERAN are presented in figure 2. In the figure, all the functions are considered implemented in different logical nodes. If two logical nodes are implemented in the same physical equipment, the relevant interfaces may become internal to that equipment.

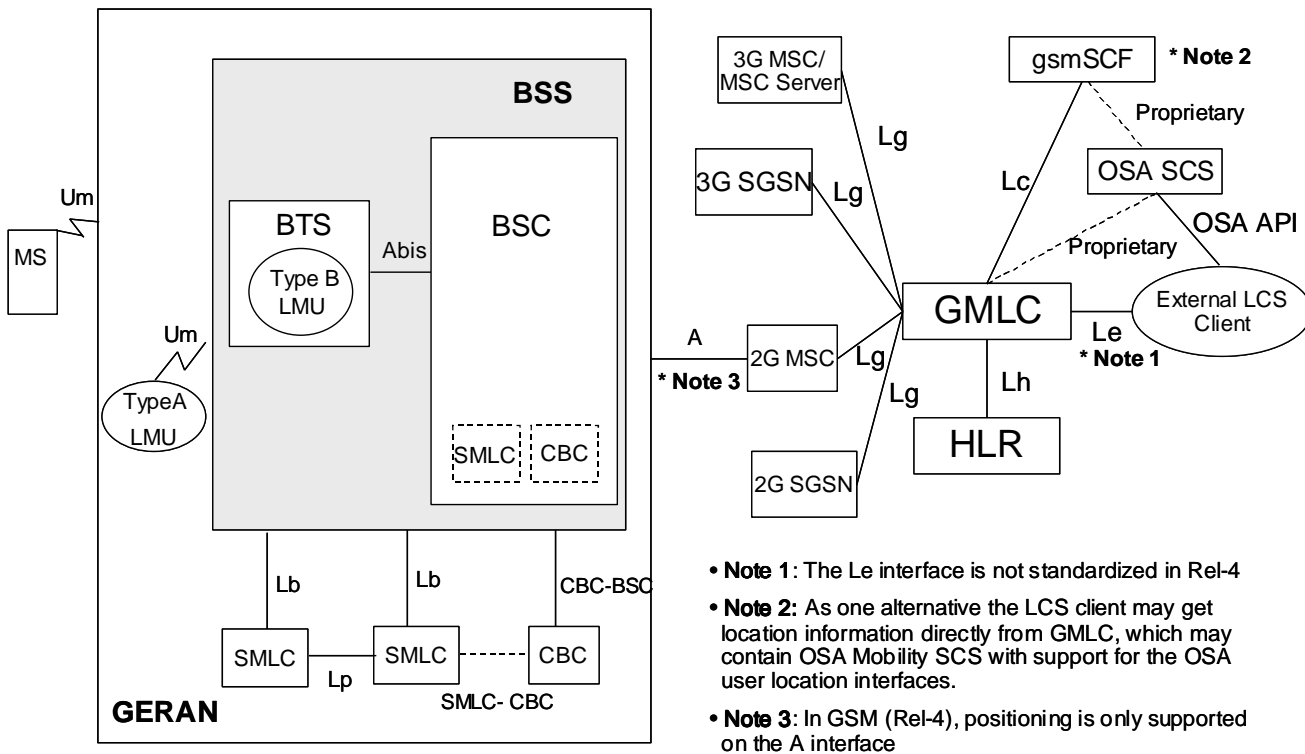

Figure 2: Configuration of LCS entities in a GERAN PLMN

5.2.2 Configuration of LCS entities for UTRAN

The basic configuration of UTRAN LCS is presented in figure 3. The SMLC functionality is integrated in SRNC.

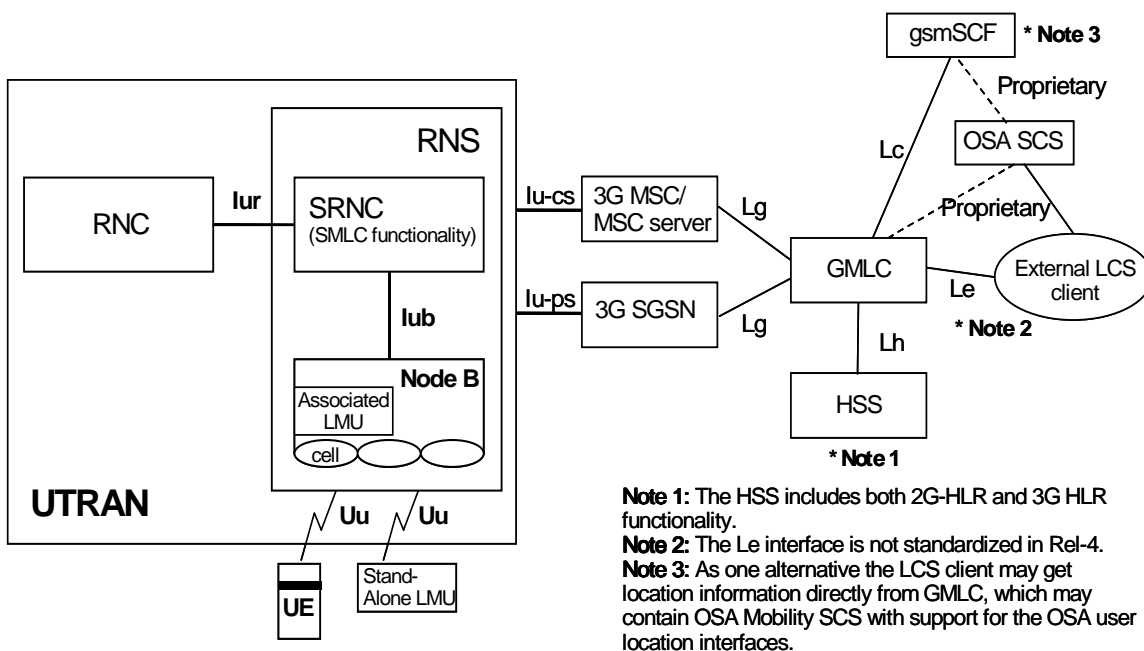

Figure 3: Configuration of LCS entities for a UTRAN PLMN

5.3 Configuration of CAMEL entities

The following figure shows the interconnection of the CAMEL-specific entities with the rest of the network. Only the interfaces specifically involved in CAMEL provisioning are shown, i.e. all the GMSC, MSC, SGSN and HLR interfaces depicted in figure 1 are still supported by these entities even if not shown.

NOTE: The CAMEL-specific interfaces have no particular name. They are designated by the name of the two entities they link together, e.g. "the gsmSSF-gsmSCF interface".

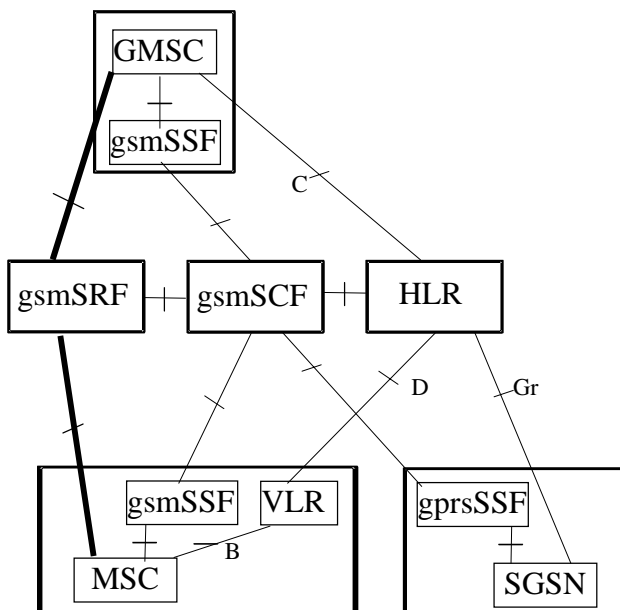

Figure 4: configuration of CAMEL entities

The bold lines are used for interfaces supporting user data only, the dashed lines are used for interfaces supporting signalling only.

5.4 Configuration of CBS entities

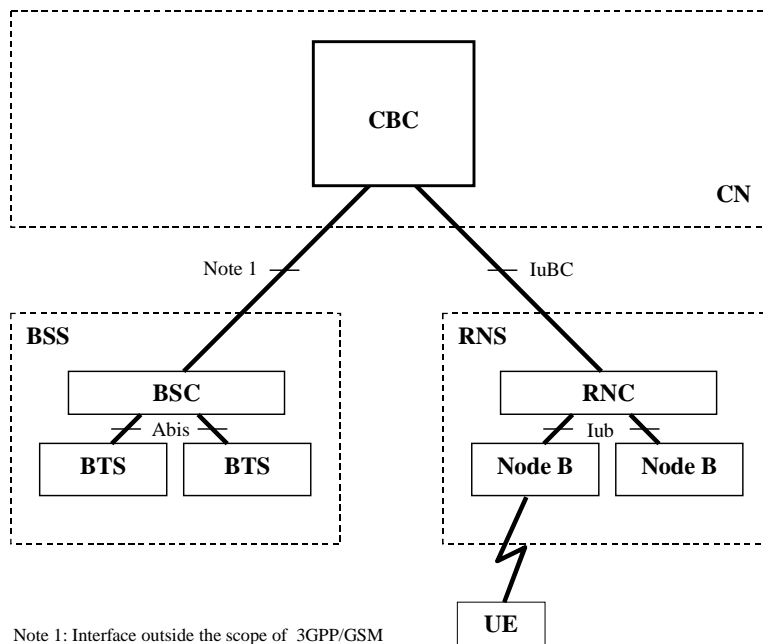

Figure 5: Configuration of a PLMN supporting Cell Broadcast Service entities

5.5 Configuration of Signalling Gateway Function

The Signalling gateway function is used to interconnect different signalling networks i.e. SCTP/IP based signalling networks and SS7 signalling networks. The application layer (e.g. ISUP, BICC, MAP or CAP) is not affected. The signalling gateway function may be implemented as a stand alone entity or inside another entity.

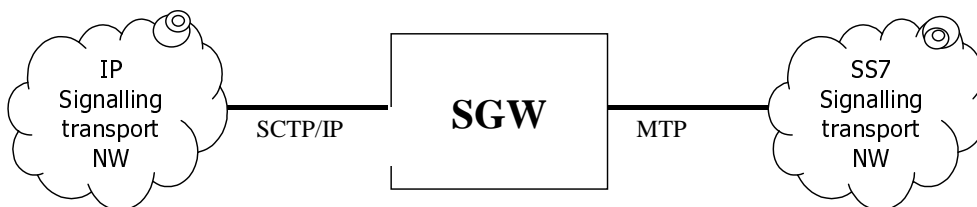

Figure 6: Configuration of a signalling gateway function

Note: SS7 application transport and SCTP/IP adaption protocols are not shown.

6 PLMN basic interfaces and reference points

The implementation of the mobile service with international roaming implies the exchange of data between the equipment involved in the service. The same No.7 signalling network should be used to transfer these data and the call-related signalling information.

[editor's note: either the difference between interface and reference point should be clearly provided, or only one of the terms should be used].

6.1 Interfaces between Mobile Station and the Fixed Infrastructure

6.1.1 Interface between Mobile Station and Base Station System (Um-interface)

The interface between the MS and the BSS is specified in the 04- and 05-series of GSM Technical Specifications.

6.1.2 Interface between Mobile Station and Radio Network System (Uu-interface)

The interface between the MS and the RNS is specified in the 24- and 25-series of UMTS Technical Specifications.

6.2 Interface between the Core Network and the Access Network

6.2.1 Interfaces between the CS domain and the Access Network

6.2.1.1 Interface between the MSC and Base Station System (A-interface)

The interface between the MSC and its BSS is specified in the 08-series of GSM Technical Specifications.

The BSS-MSC interface is used to carry information concerning:

- BSS management;
- call handling;
- mobility management.

6.2.1.2 Interface between the MSC and RNS (Iu_CS interface)

The interface between the MSC and its RNS is specified in the 25.41x-series of UMTS Technical Specifications.

The RNS-MSC interface is used to carry information concerning:

- RNS management;
- call handling;
- mobility management.

6.2.2 Interfaces between the PS domain and the Access Network

6.2.2.1 Interface between SGSN and BSS (Gb-interface)

The BSS-SGSN interface is used to carry information concerning:

- packet data transmission;
- mobility management.

The Gb interface is defined in GSM 08.14, 08.16 and 08.18.

6.2.2.2 Interface between SGSN and RNS (Iu_PS-interface)

The RNS-SGSN interface is used to carry information concerning:

- packet data transmission;
- mobility management.

The Iu_PS interface is defined in the 25.41x-series of UMTS Technical Specifications.

6.3 Interfaces internal to the Access Network

6.3.1 Interface between BSC and BTS (Abis-interface)

When the BSS consists of a Base Station Controller (BSC) and one or more Base Transceiver Stations (BTS), this interface is used between the BSC and BTS to support the services offered to the GSM users and subscribers.

The interface also allows control of the radio equipment and radio frequency allocation in the BTS.

The interface is specified in the 08.5x-series of GSM Technical Specifications.

6.3.2 Interface between RNC and Node B (Iub-interface)

When the RNS consists of a Radio Network Controller (RNC) and one or more Node B, this interface is used between the RNC and Node B to support the services offered to the UMTS users and subscribers.

The interface also allows control of the radio equipment and radio frequency allocation in the Node B.

The interface is specified in the 28.5x-series of UMTS Technical Specifications.

6.3.3 Interface between two RNCs (Iur-interface)

This interface is defined in the 25.42x series of recommendations.

6.4 Interfaces internal to the Core Network

6.4.1 Interfaces internal to the CS domain

6.4.1.1 Interface between the MSC server and its associated VLR (B-interface)

The VLR is the location and management database for the mobile subscribers roaming in the area controlled by the associated MSC server(s). Whenever the MSC server needs data related to a given mobile station currently located in its area, it interrogates the VLR. When a mobile station initiates a location updating procedure with an MSC server, the MSC server informs its VLR which stores the relevant information. This procedure occurs whenever an MS roams to another location area. Also, when a subscriber activates a specific supplementary service or modifies some data attached to a service, the MSC server informs (via the VLR) the HLR which stores these modifications and updates the VLR if required.

This interface is internal to the MSC server /VLR; signalling on it is not standardised.

6.4.1.2 Interface between the HLR and the MSC server (C-interface)

The Gateway MSC server must interrogate the HLR of the required subscriber to obtain routing information for a call or a short message directed to that subscriber.

Signalling on this interface uses the Mobile Application Part (MAP), which in turn uses the services of Transaction Capabilities. See TS 29.002.

For CAMEL purposes, this interface is used as described in 23.078. It is used e.g. at terminating calls to exchange routing information, subscriber status, location information, subscription information, etc.

6.4.1.3 Interface between the HLR and the VLR (D-interface)

This interface is used to exchange the data related to the location of the mobile station and to the management of the subscriber. The main service provided to the mobile subscriber is the capability to set up or to receive calls within the whole service area. To support this, the location registers have to exchange data. The VLR informs the HLR of the location of a mobile station managed by the latter and provides it (either at location updating or at call set-up) with the roaming number of that station. The HLR sends to the VLR all the data needed to support the service to the mobile subscriber. The HLR then instructs the previous VLR to cancel the location registration of this subscriber. Exchanges of data may occur when the mobile subscriber requires a particular service, when he wants to change some data attached to his subscription or when some parameters of the subscription are modified by administrative means.

Signalling on this interface uses the Mobile Application Part (MAP), which in turn uses the services of Transaction Capabilities. See TS 29.002.

For CAMEL purposes, this interface is used to send the CAMEL related subscriber data to the visited PLMN and for provision of MSRN. The interface is also used for the other purposes described in 23.078, e.g. to retrieve subscriber status and location information of the mobile subscriber or to indicate suppression of announcement for a CAMEL service.

6.4.1.4 Interface between MSC servers (E-interface)

When a mobile station moves from one MSC area to another during a call, a handover procedure has to be performed in order to continue the communication. For that purpose the MSC servers have to exchange data to initiate and then to realise the operation.

After the handover operation has been completed, the MSC servers will exchange information to transfer A- or Iu- interface signalling as defined in TS 23.009[6].

When a short message is to be transferred between a Mobile Station and Short Message Service Centre (SC), in either direction, this interface is used to transfer the message between the MSC server serving the Mobile Station and the MSC server which acts as the interface to the SC.

Signalling on this interface uses the Mobile Application Part (MAP), which in turn uses the services of Transaction Capabilities. See TS 29.002.

6.4.1.5 Interface between MSC server and EIR (F-interface)

This interface is used between MSC server and EIR to exchange data, in order that the EIR can verify the status of the IMEI retrieved from the Mobile Station.

Signalling on this interface uses the Mobile Application Part (MAP), which in turn uses the services of Transaction Capabilities. See TS 29.002.

6.4.1.6 Interface between VLRs (G-interface)

When a mobile subscriber moves from a VLR area to another Location Registration procedure will happen. This procedure may include the retrieval of the IMSI and authentication parameters from the old VLR.

Signalling on this interface uses the Mobile Application Part (MAP), which in turn uses the services of Transaction Capabilities. See TS 29.002.

6.4.1.7 Reference point (G)MSC server – CS-MGW (Mc Reference Point)

The Mc reference point describes the interfaces between the MSC Server and CS-MGW, and between the GMSC Server and CS-MGW. It has the following properties:

- full compliance with the H.248 standard, baseline work of which is currently carried out in ITU-T Study Group 16, in conjunction with IETF MEGACO WG.
- flexible connection handling which allows support of different call models and different media processing purposes not restricted to H.323 usage.
- open architecture where extensions/Packages definition work on the interface may be carried out.

- dynamic sharing of MGW physical node resources. A physical MGW can be partitioned into logically separate virtual MGWs/domains consisting of a set of statically allocated terminations.
- dynamic sharing of transmission resources between the domains as the MGW controls bearers and manage resources according to the H.248 protocols.

The functionality across the Mc reference point will need to support mobile specific functions such as SRNS relocation/handover and anchoring. It is expected that current H.248/IETF Megaco standard mechanisms can be applied to enable this.

6.4.1.8 Reference Point MSC Server – GMSC Server (Nc Reference Point)

Over the Nc reference point, the Network-Network based call control is performed. Examples of this are ISUP or an evolution of ISUP for bearer independent call control (BICC). In the R⁰⁰ architecture different options for signalling transport on Nc shall be possible including IP.

6.4.1.9 Reference Point CS-MGW – CS-MGW (Nb Reference Point)

Over the Nb reference point the bearer control and transport are performed. The transport may be RTP/UDP/IP or AAL2 for transport of user data. In the R⁰⁰ architecture different options for user data transport and bearer control shall be possible on Nb, for example: AAL2/Q.AAL2, STM/none, RTP/H.245.

6.4.2 Interfaces internal to the PS domain

6.4.2.1 Interface between SGSN and HLR (Gr-interface)

This interface is used to exchange the data related to the location of the mobile station and to the management of the subscriber. The main service provided to the mobile subscriber is the capability to transfer packet data within the whole service area. The SGSN informs the HLR of the location of a mobile station managed by the latter. The HLR sends to the SGSN all the data needed to support the service to the mobile subscriber. Exchanges of data may occur when the mobile subscriber requires a particular service, when he wants to change some data attached to his subscription or when some parameters of the subscription are modified by administrative means.

Signalling on this interface uses the Mobile Application Part (MAP), which in turn uses the services of Transaction Capabilities (TCAP). See TS 29.002.

6.4.2.2 Interface between SGSN and GGSN (Gn- and Gp-interface)

These interfaces are used to support mobility between the SGSN and GGSN. The Gn interface is used when GGSN and SGSN are located inside one PLMN. The Gp-interface is used if GGSN and SGSN are located in different PLMNs. The Gn/Gp interface also includes a part which allows SGSNs to communicate subscriber and user data, when changing SGSN.

Signalling on this interface uses the User Datagram Protocol, UDP/IP. The Gn/Gp interface is defined in TS 29.060.

6.4.2.3 Signalling Path between GGSN and HLR (Gc-interface)

This optional signalling path may be used by the GGSN to retrieve information about the location and supported services for the mobile subscriber, to be able to activate a packet data network address.

There are two alternative ways to implement this signalling path:

- if an SS7 interface is implemented in the GGSN, signalling between the GGSN and the HLR uses the Mobile Application Part (MAP), which in turn uses the services of Transaction Capabilities (TCAP). See TS 29.002;
- if there is *no* SS7 interface in the GGSN, any GSN in the same PLMN and which has an SS7 interface installed can be used as a GTP to MAP protocol converter, thus forming a signalling path between the GGSN and the HLR.

6.4.2.4 Interface between SGSN and EIR (Gf-interface)

This interface is used between SGSN and EIR to exchange data, in order that the EIR can verify the status of the IMEI retrieved from the Mobile Station.

Signalling on this interface uses the Mobile Application Part (MAP), which in turn uses the services of Transaction Capabilities (TCAP). See TS 29.002.

6.4.3 Interfaces used by CS and PS domains

6.4.3.1 Interface between MSC/VLR and SGSN (Gs-interface)

The SGSN may send location information to the MSC/VLR via the optional Gs interface. The SGSN may receive paging requests from the MSC/VLR via the Gs interface. The MSC/VLR may indicate to an SGSN, via the Gs interface, that an MS is engaged in a service handled by the MSC.

Signalling on this interface uses connectionless SCCP (without TCAP). SCCP Global Title (GT) is used for addressing. The Gs-interface is defined in TS 29.016 and 29.018.

6.4.3.2 Interface between HLR and AuC (H-Interface)

When an HLR receives a request for authentication and ciphering data for a Mobile Subscriber and it does not hold the requested data, the HLR requests the data from the AuC. The protocol used to transfer the data over this interface is not standardised.

6a PLMN specific interfaces

6a.1 GCR-specific interface

6a.1.1 Interface between the MSC and its associated GCR (I-interface)

The GCR is the management data base for the voice group or broadcast calls in the area controlled by the associated MSC(s). Whenever the MSC needs data related to a requested voice group or broadcast call it interrogates the GCR to obtain the respective voice group or broadcast call attributes. The protocol used to transfer the data over this interface is not standardized.

6a.2 (void)

6a.3 LCS-specific interfaces

6a.3.1 LCS interfaces using MAP

The following interfaces are based on MAP in LCS.

- **Lh interface:** interface between GMLC and HLR. This interface is used by the GMLC to request the address of the visited MSC or SGSN for a particular target UE whose location has been requested. (see TS 29.002 [26]).
- **Lg interface:** interface between GMLC - MSC and GMLC - SGSN. This interface is used by the GMLC to convey a location request to the MSC or SGSN currently serving a particular target UE whose location was requested. The interface is used by the MSC or SGSN to return location results to the GMLC. (see TS 29.002 [26]).
- **Lc interface:** between GMLC and gsmSCF, CAMEL. This interface is used to get location information for CAMEL based services. (see TS 29.002 [26]).

6a.3.2 Void

6a.3.3 Void

6a.3.4 Void

6a.3.5 Interface between BSC and SMLC (Lb-interface)

In GERAN, a SMLC supports positioning via signaling on the Lb interface to the BSC serving the target MS.

Signalling on this interface uses BSSAP-LE, which is specified in TS 49.031[39]

In UTRAN, the Lb interface is not standardized, the SMLC functionality is included in SRNC.

6a.3.6 Interface between Peer SMLCs (Lp-interface)

In GERAN, a SMLC may support the Lp interface to enable access to information and resources owned by another SMLC.

Signalling on this interface uses BSSAP-LE, which is defined in TS 49.031[39], and SMLCPP, which is specified in TS 48.031[40].

In UTRAN, the SMLC functionality is included in SRNC and the Iur interface shall include the Lp interface type of functionality.

6a.3.7 Interface between BTS and LMU (Um-interface)

The Um interface specific to LCS is defined in TS 44.071[41]

6a.3.8 Interface between RNS and Stand-Alone LMU, UE (Uu-interface)

The Uu interface is used to communicate among the UE Positioning entities associated with the SRNC, the UEs and the stand-alone LMU. The Uu interface may pass measurement requests and results to and from the UE or the stand-alone LMU. UE Positioning operations at the Uu interface are generally defined in the 24- and 25-series of 3GPP Technical Specifications. Furthermore, 25.305 describes how a stand-alone LMU may be distinguished from a normal UE.

6a.4 CAMEL-specific interfaces

The CAMEL-specific interfaces are detailed in 23.078 [10c]. These interfaces are.

6a.4.1 GMSC - gsmSSF interface

This is an internal interface. The interface is described in the specification to make it easier to understand the handling of Detection Points (arming/disarming of DPs, DP processing etc.).

6a.4.2 gsmSSF - gsmSCF interface

This interface is used by the gsmSCF to control a call in a certain gsmSSF and to request the gsmSSF to establish a connection with a gsmSRF. Relationships on this interface are opened as a result of the gsmSSF sending a request for instructions to the gsmSCF.

6a.4.3 MSC - gsmSSF interface

This is an internal interface. The interface is described in the specification to make it easier to understand the handling of DPs (arming/disarming of DPs, DP processing etc.).

6a.4.4 gsmSCF - HLR interface

This interface is used by the gsmSCF to request information from the HLR. As a network operator option the HLR may refuse to provide the information requested by the gsmSCF.

This interface is also used for USSD operations, both for gsmSCF-initiated dialogues and MS-initiated dialogues (relayed via HLR). It is a network operator option whether to support or not USSD operations on this interface.

6a.4.5 gsmSCF - gsmSRF interface

This interface is used by the gsmSCF to instruct the gsmSRF to play tones/announcements to the users.

6a.4.6 MSC - gsmSCF interface

This interface is used by the MSC to send supplementary service invocation notifications to the gsmSCF.

6a.4.7 SGSN - gprsSSF interface

This is an internal interface. The interface is described in the specification to make it easier to understand the handling of DPs (arming/disarming of DPs, DP processing etc.).

6a.4.8 gprsSSF - gsmSCF interface

This interface is used by the gsmSCF to control a GPRS session or individual PDP Context in a certain gprsSSF. Relationships between the gprsSSF and the gsmSCF (GPRS dialogues) on this interface are opened as a result of the gprsSSF sending a request for instructions to the gsmSCF.

6a.5 CBS-specific interfaces

6a.5.1 Interface between the CBC and RNS (lu_BC Interface)

The interface between the CBC and the RNS is specified in the 25.41x-series of 3G Technical Specifications.

The CBC-RNS interface is used to carry information concerning:

- the CBS messages itself; and
- CBS delivery parameter.

6a.6 Number portability specific interfaces

6a.6.1 IN-based solution

6a.6.1.1 NPDB to MSC interface

Upon receiving an ISUP IAM, the (gateway or visited) MSC send a database query to the NPDB as a result of analysis of the received MSISDN. The MSISDN is included in the query to the NPDB. The NPDB determines whether the MSISDN is ported or not. If not, it responds back to the MSC to continue the normal call setup procedure for MT calls (optionally providing the Routing Number). If it is ported, the NPDB responds back to the MSC with a Routing Number pointing out the Subscription network.

6a.6.2 Signalling Relay-based solution

6a.6.2.1 GMSC to MNP-SRF interface

Upon receiving an ISUP IAM, the gateway MSC sends a routing interrogation to the MNP-SRF, which in turn will perform one of the actions, described in subclause 4a.7, depending on the portability status of the subscriber and the network configuration. For more details see TS 23.066.

6a.6.2.2 MNP-SRF to HLR interface

When the MNP-SRF receives a routing interrogation from the GMSC or an interrogating network entity (non/call related signalling), and it determines that the subscriber is not ported or it has been ported from another network, the MNP-SRF relays the message to the HLR.

7 Interface to external networks

The interfaces with fixed networks, including dedicated networks, are described in the 09-series of GSM Technical Specifications and in the 29-series of TS Technical Specification.

7.1 Interface between the fixed networks and the MSC

The MSC is based on a normal ISDN exchange. It has, for call control, the same interface as the fixed network exchanges. The signalling interface considered in the GSM Technical Specifications is related to the signalling system No. 7 User Parts TUP and ISUP associated to the circuits used for incoming and outgoing calls.

7.2 Interface between GGSN and external data networks (Gi-interface)

This interface connects the PLMN to external public or private packet data networks.

7.3 Interface between GMLC and external LCS Client (Le-interface)

This interface connects the PLMN to the external LCS Client.

Annex A (informative): Description for GLR-related entities and interfaces

This annex describes the GLR-related entities and the interfaces. This annex is an informative annex. The 'informative' means just that the GLR is an optional functional entity to optimize signalling traffic between PLMNs. Therefore, this annex is normative to a PLMN which introduce the GLR.

A.1 Normative references

- [1] TS 23.119: "Gateway Location Register (GLR) - stage 2".

A.2 Definitions related to Gateway Location Register (GLR)

A.2.1 Gateway Location Register (GLR)

This entity handles location management of roaming subscriber in visited network without involving HLR. The location register function in the GLR stores subscription information and routing information for both CS services and PS services. This entity can be only located in a visited PLMN.

A.2.2 Intermediate Mobile-services Switching Centre (IM-MSC)

This entity is used as serving MSC towards home network and relay some messages between home network and serving MSC. This entity can be only located in a visited PLMN.

A.2.3 Intermediate GPRS Serving Node (IM-GSN)

This entity is used as serving GSN towards home network and relay some PDU notification messages between serving GSN and Gateway GSN. This entity can be only located in a visited PLMN.

A.3 The entities of the mobile system

A.3.1 Gateway Location Register (GLR)

GLR is pseudo-HLR located in visited network. The roamer's information is stored in it and handles location management of it within the network. Presence of GLR is invisible from home network therefore interface between HLR and GLR is same as one of HLR and VLR. Also, the interface between the VLR and GLR is the same as the one between the VLR and the HLR.

The GLR is a logical node and acts as a VLR for MAP signalling (e.g. PRN) from the HPLMN point of view. The GLR acts as a HLR for MAP signalling (e.g. Register SS) from the VPLMN point of view.

The GLR also acts as an SGSN for MAP signalling only (e.g. ISD) from the HPLMN point of view. This is because MAP operations such as ISD must be terminated at the GLR for the purpose of subscriber data caching.

The GLR shall terminate all TC dialogues and start new dialogues towards the HLR or the VLR. The GLR shall generate SCCP address of the HLR (i.e. E.214 MGT) from IMSI.

A.3.2 Intermediate Mobile-services Switching Centre (IM-MSC)

The Intermediate MSC (IM-MSC) is the logical node, which represent MSCs in the visited network. Some service features use the MSC Number stored in the HLR directly to deliver message from a certain node in home network (e.g. SMS-GMSC) to serving MSC in visited network. In such case, the message is firstly distributed to representative MSC (i.e., IM-MSC) and it relays it to actual serving MSC interrogating routing information to GLR.

- The Intermediate MSC (IM-MSC) is a logical node and represents the VMSC in the GLR equipped VPLMN.
- The IM-MSC acts as the VMSC for the HPLMN in the same way that the GLR acts as a VLR for HPLMN. The IM-MSC terminates MAP signalling from the HPLMN towards the VMSC and forwards the signal to the actual VMSC.
- The IM-MSC has an address interrogation function with which it is able to obtain the actual VMSC Number from the GLR.
- The IM-MSC is implemented in the same physical node as the one in which the GLR is implemented.
- The GLR alters the VMSC Number to the IM-MSC Number within an Update Location message.
- The IM-MSC Number is the E.164 Number assigned to the IM-MSC.
- The interrogation function of the IM-MSC is similar to that in the SMS-GMSC.

A.3.3 Intermediate GPRS Serving Node (IM-GSN)

The Intermediate GSN (IM-GSN) is a logical node and represents the SGSN for some GTP signalling termination in a GLR equipped VPLMN.

The IM-GSN acts as an SGSN for *only some GTP signalling messages* (i.e. PDU_Notification request/response, PDU_Notification_reject request/response) from the HPLMN point of view. The IM-GSN terminates these GTP signalling messages from the HPLMN towards SGSN and forwards the signal to the actual SGSN. The IM-GSN has an address interrogation function with which it is able to request the actual SGSN address from the GLR.

Apart from the case described above (i.e. PDU_Notification request/response, PDU_Notification_reject request/response), all other GTP signalling should be handled directly between the SGSN and the GGSN.

NOTE: *MAP signalling* towards the SGSN is *NOT* terminated at the IM-GSN. Instead it is terminated at the GLR.

A.4 Configuration of a Public Land Mobile Network

A.4.1 Basic configuration with GLR introduction

In the basic configuration with GLR introduction presented in figure A.1, all the functions related to GLR introduction are considered implemented in different equipments. Therefore, all the interfaces within PLMN are external. Interfaces GLa, GLb, GLc, GLd, GLf, GLg, GLh, and GLi need the support of the Mobile Application Part of the signalling system No. 7 to exchange the data necessary to provide the mobile service. No protocols for the GLe interface are standardized. GLj and GLk need the support of GPRS Tunneling Protocol - Control to provide the packet domain services.

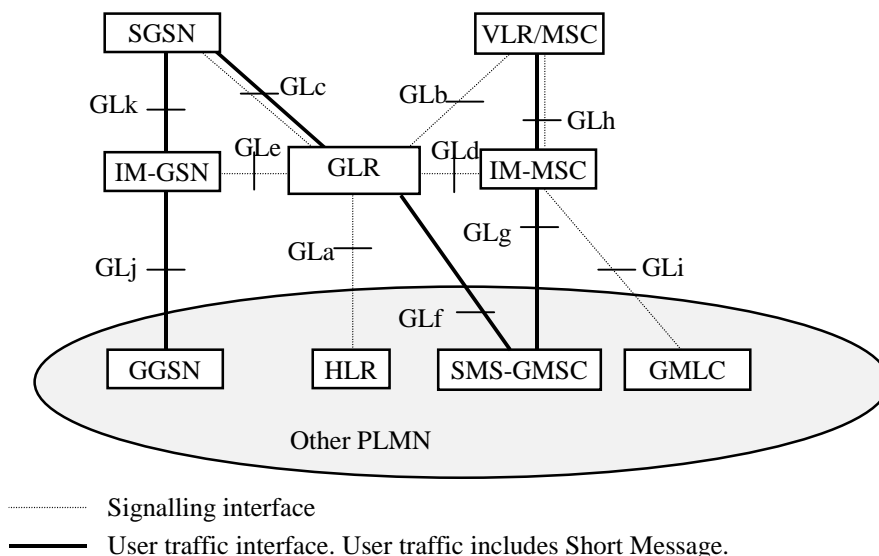

Figure A.1: Configuration of a PLMN and interfaces with GLR

A.5 PLMN interfaces

A.5.1 Interface between the HLR and the GLR (GLa-interface)

In circuit switched domain, this interface is the same as that between the VLR and the HLR (see TS 29.002). The HLR regards the GLR as the VLR via this interface. On the other hand, in packet switched domain, this interface is the same as that between the SGSN and the HLR (see TS 29.002). The HLR regards the GLR as the SGSN via this interface

A.5.2 Interface between the VLR and the GLR (GLb-interface)

This interface is the same as those between the VLR and the HLR (see TS 29.002). The VLR regards the GLR as the HLR via this interface.

A.5.3 Interface between the SGSN and the GLR (GLc-interface)

This interface is the same as those between the SGSN and the HLR (see TS 29.002). The SGSN regards the GLR as the HLR via this interface.

A.5.4 Interface between the GLR and the IM_MSC (GLd-interface)

In the network with the GLR, when the IM_MSC receives a message, it interrogates the GLR for the routing information of the MSC. However, this interface is internal because GLR and IM-MSC are implemented in the same physical node and the protocol on this interface is not specified.

A.5.5 Interface between the GLR and the IM_GSN (GLE-interface)

In the network with the GLR when the IM_GSN receiving a PDU notification from the GGSN, the IM_GSN relays the notification to the SGSN by interrogating via the interface the routing information to the GLR. The interrogation uses the same operation on the interface between the SGSN and the HLR (see TS 29.002).

A.5.6 Interface between the SMS-GMSC and the GLR (GLf-interface)

This interface is used to forward mobile-terminated short messages in the network with the GLR in case of SMS transfer over GPRS. Signalling on this interface uses the Mobile Application Part (MAP) (see TS 29.002).

The SMS-GMSC regards the GLR as the SGSN via this interface.

A.5.7 Interface between the SMS-GMSC and the IM_MSC (GLg-interface)

This interface is used to forward short messages in the network with the GLR in case of SMS transfer over non-GPRS. Signalling on this interface uses the Mobile Application Part (MAP) (see TS 29.002).

The SMS-GMSC regards the IM_MSC as the MSC via this interface.

A.5.8 Interface between the MSC and the IM_MSC (GLh-interface)

This interface is used to forward short messages in the network with the GLR in case of SMS transfer over non-GPRS. Also this interface is used to exchange data needed by the MSC to perform subscriber authorization and allocate network resources. Signalling on this interface uses the Mobile Application Part (MAP) (see TS 29.002).

A.5.9 Interface between the GMLC and the IM_MSC (GLi-interface)

Also this interface is used to exchange data needed by the MSC to perform subscriber authorization and allocate network resources. Signalling on this interface uses the Mobile Application Part (MAP) (see TS 29.002).

The GMLC regards the IM_MSC as the MSC via this interface.

A.5.10 Interface between the GGSN and the IM_GSN (GLj-interface)

In the network with the GLR when receiving a PDP PDU from the external network the GGSN sends a notification to the IM_GSN by the routing information from the HLR (see TS 29.060). The GGSN regards the IM_GSN as the SGSN via this interface.

A.5.11 Interface between the SGSN and the IM_GSN (GLk-interface)

In the network with the GLR when receiving a PDP notification from the GGSN, the IM_GSN relays the notification to the SGSN by the routing information from the GLR (see TS 29.060). The SGSN regards the IM_GSN as the GGSN via this interface.

Annex B (informative): Change history

Date	Version	Information about changes
September 1999	v.3.0.0	renumbering of the present document from 03.02 to 23.002 (23.002 v.3.0.0 identical to 03.02 v.7.0.0)
October 1999	v.3.1.0	widely modified to incorporate UMTS aspects (CR 001)
January 2000	v.3.2.0	incorporation of CR002 on GLR, update of some references
March 2000	v.3.3.0	Incorporation of the following CRs: CR #004: General improvements of the split between clause 3 (Definitions and abbreviations) and clause 4 (The entities of the mobile system). CR #005r1: Re-ordering of clause 4 (The entities of the mobile system). CR #006: Re-ordering of clause 5 (Configuration of a Public Land Mobile Network). CR #007: Re-ordering of clause 6 ("PLMN interfaces"). CR #008: Simplification of the figure 1 (configuration of a PLMN and interfaces) CR #009r1: Introduction of CAMEL aspects. CR #011r1: Introduction of CBS aspects CR #012r2: Add LCS enhancements CR #013r4: Define GSM LCS parts and add UMTS LCS "hooks" in the network architecture. CR #014r1: Incorporation of network architecture material coming from clause 4 of 29.002
October 2000	v.4.0.0	Incorporation of part of the following CRs: CR #016 on Introduction of Definitions from 23.821 into 23.002 CR #017 on Introduction of functional elements from 23.821 CR #018 on Introduction of reference model from 23.821 CR #019 on Introduction of reference points from 23.821 These CRs were, among other things, incorporating the IM subsystem in Release 4. As SA #9 decided that IM subsystem is Release 5, only the non-IM subsystem related parts of these CRs have been incorporated.
December 2000	v.4.1.0	Incorporation of: CR #023 on Camel for the PS domain CR #026r1 on Introduction of Iu-CS and Iu-S interfaces to BSS of type GERAN in the network architecture for Rel4 (with editorial changes to avoid duplication of text)
January 2001	v.4.1.1	Withdrawal of the editorial changes in incorporation of CR #026r1
April 2001	v.4.2.0	Incorporation of: CR #032r1 Clarification of the difference between MGW in BICC and IMS CR #040 Missing Nc interface in basic configuration figure CR #042 Removal of Iu for GERAN in Rel 4 CR #043 Signalling and User Traffic Interfaces CR #045 Resolution of editor's note in the MGW description CR #047 Removal of an editor's note in GMSC description
June 2001	v.4.3.0	Incorporation of: CR #052r1: Addition of Radio Access Technologies CR #061r1: Clarification of the role of the SGWs
January 2002	v.4.4.0	Incorporation of: CR #081: Deleting SIWF functionality Deletion of R-SGW and T-SGW from figure 1, as approved in CR#061r1
September 2002	v.4.5.0	Incorporation of: CR #057rev1: The usage of Iu-interface signalling is missing in the E-interface description
December 2002	v.4.6.0	Incorporation of : CR #111rev1 Scope of TS 23.002 CR #114rev1 Corrections in the LCS figures CR #107rev5 Corrections in the LCS descriptions of 23.002
March 2003	v.4.7.0	Incorporation of: CR #120 : LCS architecture in Rel4

History

Document history		
V4.2.0	April 2001	Publication
V4.3.0	June 2001	Publication
V4.4.0	January 2002	Publication
V4.5.0	September 2002	Publication
V4.6.0	December 2002	Publication
V4.7.0	March 2003	Publication