

ETSI TS 123 009 V3.5.0 (2000-12)

Technical Specification

Universal Mobile Telecommunications System (UMTS); Handover procedures (3GPP TS 23.009 version 3.5.0 Release 1999)



Reference

RTS/TSGN-0123009UR4

Keywords

UMTS

ETSI

650 Route des Lucioles
F-06921 Sophia Antipolis Cedex - FRANCE

Tel.: +33 4 92 94 42 00 Fax: +33 4 93 65 47 16

Siret N° 348 623 562 00017 - NAF 742 C
Association à but non lucratif enregistrée à la
Sous-Préfecture de Grasse (06) N° 7803/88

Important notice

Individual copies of the present document can be downloaded from:

<http://www.etsi.org>

The present document may be made available in more than one electronic version or in print. In any case of existing or perceived difference in contents between such versions, the reference version is the Portable Document Format (PDF). In case of dispute, the reference shall be the printing on ETSI printers of the PDF version kept on a specific network drive within ETSI Secretariat.

Users of the present document should be aware that the document may be subject to revision or change of status. Information on the current status of this and other ETSI documents is available at <http://www.etsi.org/tb/status/>

If you find errors in the present document, send your comment to:
editor@etsi.fr

Copyright Notification

No part may be reproduced except as authorized by written permission.
The copyright and the foregoing restriction extend to reproduction in all media.

© European Telecommunications Standards Institute 2000.

All rights reserved.

Intellectual Property Rights

IPRs essential or potentially essential to the present document may have been declared to ETSI. The information pertaining to these essential IPRs, if any, is publicly available for **ETSI members and non-members**, and can be found in ETSI SR 000 314: "*Intellectual Property Rights (IPRs); Essential, or potentially Essential, IPRs notified to ETSI in respect of ETSI standards*", which is available from the ETSI Secretariat. Latest updates are available on the ETSI Web server (<http://www.etsi.org/ipr>).

Pursuant to the ETSI IPR Policy, no investigation, including IPR searches, has been carried out by ETSI. No guarantee can be given as to the existence of other IPRs not referenced in ETSI SR 000 314 (or the updates on the ETSI Web server) which are, or may be, or may become, essential to the present document.

Foreword

This Technical Specification (TS) has been produced by the ETSI 3rd Generation Partnership Project (3GPP).

The present document may refer to technical specifications or reports using their 3GPP identities, UMTS identities or GSM identities. These should be interpreted as being references to the corresponding ETSI deliverables.

The cross reference between GSM, UMTS, 3GPP and ETSI identities can be found under www.etsi.org/key.

Contents

Foreword	6
1 Scope	7
2 References	8
3 Abbreviations	9
4 Role, functional composition of MSCs and interfaces for handover	10
4.1 MSC-A	10
4.1.1 Role of MSC-A	10
4.1.2 Functional composition of MSC-A and its interfaces for handover	10
4.2 MSC-B	12
4.2.1 Role of MSC-B	12
4.2.2 Functional composition of MSC-B and its interfaces for handover	13
4.3 3G_MSC-A	14
4.3.1 Role of 3G_MSC-A	14
4.3.2 Functional composition of 3G_MSC-A and its interfaces for handover/relocation	16
4.4 3G_MSC-B	18
4.4.1 Role of 3G_MSC-B	18
4.4.2 Functional composition of 3G_MSC-B and its interfaces for handover/relocation	19
5 Handover initiation conditions	21
6 General description of the procedures for intra - MSC handovers	21
6.1 Procedure for Intra-MSC Handovers	21
6.2 Procedure for Intra-3G_MSC Handovers	23
6.2.1 Intra-3G_MSC Handover from UMTS to GSM	23
6.2.1.1 With no bearer or one bearer	23
6.2.1.2 With multiple bearers (Optional functionality)	24
6.2.2 Intra-3G_MSC GSM to UMTS Handover	24
6.2.3 Procedure for Intra-3G_MSC SRNS Relocation	26
6.2.3.1 With no bearer or one bearer	27
6.2.3.2 With multiple bearers (Optional functionality)	27
7 General description of the procedures for inter - MSC handovers	28
7.1 Basic handover procedure requiring a circuit connection between MSC-A and MSC-B	28
7.2 Basic handover procedure not requiring the establishment of a circuit connection between MSC-A and MSC-B	30
7.3 Procedure for subsequent handover requiring a circuit connection	31
7.3.1 Description of subsequent handover procedure i): MSC-B to MSC-A	32
7.3.2 Description of the subsequent handover procedure ii): MSC-B to MSC-B'	33
7.4 Procedure for subsequent handover not requiring a circuit connection	34
7.4.1 Description of the subsequent handover procedure without circuit connection i): MSC-B to MSC-A	35
7.4.2 Description of the subsequent handover procedure without circuit connection ii): MSC-B to MSC-B'	35
8 General Description of the procedures for inter - 3G_MSC handovers	36
8.1 Handover UMTS to GSM	36
8.1.1 Basic Handover procedure requiring a circuit connection between 3G_MSC -A and MSC-B	37
8.1.1.1 With one circuit connection	37
8.1.1.2 With multiple circuit connections (Optional functionality)	39
8.1.2 Basic UMTS to GSM Handover procedure not requiring the establishment of a circuit connection between 3G_MSC-A and MSC-B	39
8.1.3 Procedure for subsequent UMTS to GSM handover requiring a circuit connection	40
8.1.3.1 Description of subsequent UMTS to GSM handover procedure i): 3G_MSC-B to MSC-A	41
8.1.3.1.1 With one circuit connection	41
8.1.3.1.2 With multiple circuit connections (Optional functionality)	42
8.1.3.2 Description of subsequent UMTS to GSM handover procedure ii): 3G_MSC-B to MSC-B'	42
8.1.3.2.1 With one circuit connection	42
8.1.3.2.2 With multiple circuit connections (Optional functionality)	42

8.1.4	Procedure for subsequent UMTS to GSM handover not requiring a circuit connection	44
8.1.4.1	Description of subsequent UMTS to GSM handover procedure i): 3G_MSC-B to MSC-A	45
8.1.4.2	Description of the subsequent UMTS to GSM handover procedure without circuit connection ii): 3G_MSC-B to MSC-B'	45
8.2	Handover GSM to UMTS	46
8.2.1	Basic Handover procedure requiring a circuit connection between MSC-A and 3G_MSC-B	47
8.2.2	Basic GSM to UMTS Handover procedure not requiring the establishment of a circuit connection between MSC-A and 3G_MSC-B	48
8.2.3	Procedure for subsequent GSM to UMTS handover requiring a circuit connection	49
8.2.3.1	Description of subsequent GSM to UMTS handover procedure i): MSC-B to 3G_MSC-A	50
8.2.3.2	Description of subsequent GSM to UMTS handover procedure ii): MSC-B to 3G_MSC-B'	50
8.2.4	Procedure for subsequent GSM to UMTS handover not requiring a circuit connection	52
8.2.4.1	Description of subsequent GSM to UMTS handover procedure without circuit connection i): MSC-B to 3G_MSC-A	53
8.2.4.2	Description of subsequent GSM to UMTS handover procedure without circuit connection ii): MSC-B to 3G_MSC-B'	53
8.3	SRNS Relocation	54
8.3.1	Basic relocation procedure requiring a circuit connection between 3G_MSC-A and 3G_MSC-B	55
8.3.1.1	With one circuit connection	55
8.3.1.2	With multiple circuit connections (Optional functionality)	57
8.3.1.2.1	3G_MSC-B does not support multiple bearers	57
8.3.1.2.2	3G_MSC-B supports multiple bearers	57
8.3.2	Basic relocation procedure not requiring the establishment of a circuit connection between 3G_MSC-A and 3G_MSC-B	58
8.3.3	Procedure for subsequent relocation requiring a circuit connection	59
8.3.3.1	Description of subsequent relocation procedure i): 3G_MSC-B to 3G_MSC-A	59
8.3.3.1.1	With one circuit connection	59
8.3.3.1.2	With multiple circuit connections (Optional functionality)	60
8.3.3.2	Description of subsequent relocation procedure ii): 3G_MSC-B to 3G_MSC-B'	60
8.3.3.2.1	With one circuit connection	60
8.3.3.2.2	With multiple circuit connections (Optional functionality)	61
8.3.4	Procedure for subsequent relocation not requiring a circuit connection	62
8.3.4.1	Description of subsequent relocation procedure i): 3G_MSC-B to 3G_MSC-A	63
8.3.4.2	Description of subsequent relocation procedure ii): 3G_MSC-B to 3G_MSC-B'	63
9	Detailed procedures in MSC-A	64
9.1	BSS/MS and MS/MS procedures in MSC-A (functional unit 1)	64
9.2	Call control procedures MSC-A (functional unit 2)	65
9.3	Handover control procedures MSC-A (functional unit 3)	66
9.4	MAP procedures in MSC-A (functional unit 4)	67
9.5	Interworking between Handover control procedures and MAP procedures in MSC-A	67
9.6	Compatibility with GSM Phase 1	67
10	Detailed procedures in MSC-B	68
10.1	BSS/MS (MS/BSS) procedures MSC-B (functional unit 1)	68
10.2	Call control procedures MSC-B (functional unit 2)	68
10.3	Handover control procedures MSC-B (functional unit 3)	69
10.4	MAP procedures MSC-B (functional unit 4)	69
10.5	Interworking between Handover control procedures and MAP procedures in MSC-B	70
10.6	Compatibility with GSM Phase 1	70
11	Detailed procedures in 3G_MSC-A	70
11.1	RNC/BSC/3G_MSC and UE/MS/3G_MSC procedures in 3G_MSC-A (functional unit 1)	70
11.2	Call control procedures 3G_MSC-A (functional unit 2)	70
11.3	Handover/Relocation control procedures 3G_MSC-A (functional unit 3)	72
11.4	MAP procedures in 3G_MSC-A (functional unit 4)	74
11.5	Interworking between Handover/Relocation control procedures and MAP procedures in 3G_MSC-A	74
11.6	Compatibility with GSM Phase 1	75
11.7	Protocol interworking	75
12	Detailed procedures in 3G_MSC-B	75
12.1	RNC/BSC/3G_MSC (UE/MS/RNC/BSC) procedures in 3G_MSC-B (functional unit 1)	75
12.2	Call control procedures 3G_MSC-B (functional unit 2)	75

12.3	Handover/Relocation control procedures in 3G_MSC-B (functional unit 3).....	76
12.4	MAP procedures in 3G_MSC-B (functional unit 4).....	78
12.5	Interworking between Handover/Relocation control procedures and MAP procedures in 3G_MSC-B	78
12.6	Compatibility with GSM Phase 1.....	78
12.7	Protocol interworking.....	78
13	Subsequent channel assignment using a circuit connection between MSC-A and MSC-B	79
13.1	GSM handover	79
13.2	UMTS to GSM handover	80
13.3	GSM to UMTS handover	81
13.4	SRNS Relocation.....	82
13.4.1	Without circuit connection.....	82
13.4.2	With circuit connection (Optional functionality).....	82
14	Directed retry handover.....	83
14.1	GSM handover	83
14.2	GSM to UMTS handover	84
14.3	UMTS to GSM handover	85
15	SDL diagrams.....	86
Annex A (informative):		
	Change history	264

Foreword

This Technical Specification (TS) has been produced by the 3rd Generation Partnership Project (3GPP).

The present document provides a mechanism giving reliable transfer of signalling messages within the 3GPP system.

The contents of the present document are subject to continuing work within the TSG and may change following formal TSG approval. Should the TSG modify the contents of the present document, it will be re-released by the TSG with an identifying change of release date and an increase in version number as follows:

Version x.y.z

where:

- x the first digit:
 - 1 presented to TSG for information;
 - 2 presented to TSG for approval;
 - 3 or greater indicates TSG approved document under change control.
- y the second digit is incremented for all changes of substance, i.e. technical enhancements, corrections, updates, etc.
- z the third digit is incremented when editorial only changes have been incorporated in the document.

1 Scope

The present document contains a detailed description of the handover procedures to be used in PLMNs. The purpose of the handover procedures, as described in the present document, are to ensure that the connection to the Mobile Station (MS) or User Equipment (UE) is maintained as it moves from one cell or radio network to another. The document defines the circuit switched handover functionality based on the service requirements in 3GPP TS 22.129 [9].

The present document considers the following four cases:

- i) handover between Base Stations connected to the same MSC, this is termed an Intra-MSC handover;
- ii) handover between Radio Network Subsystems connected to the same 3G_MSC, this is termed an Intra-3G_MSC handover/relocation. This case also includes inter-system handover between RNS and BSS if the 3G_MSC supports the A-interface;
- iii) handover between Base Stations connected to different MSCs, this is termed an Inter-MSC handover. This category can be sub-divided into three further procedures:
 - a) the Basic Inter-MSC Handover procedure, where the MS is handed over from a controlling MSC (MSC-A) to another MSC (MSC-B);
 - b) the Subsequent Inter-MSC Handover procedure, where the MS is handed over from MSC-B to a third MSC (MSC-B');
 - c) the Subsequent Inter-MSC handback, where the MS is handed back from MSC-B to MSC-A.
- iv) handover between Radio Network Subsystems connected to different 3G_MSCs, this is termed an Inter-3G_MSC handover/relocation. This category can be divided into three further sub-procedures:
 - a) the Inter-3G_MSC Handover procedure from UMTS to GSM, where the UE/MS is handed over from a controlling 3G_MSC (3G_MSC-A) to an MSC (MSC-B);
 - b) the Inter-3G_MSC Handover procedure from GSM to UMTS, where the UE/MS is handed over from a controlling MSC (MSC-A) to a 3G_MSC (3G_MSC-B);
 - c) the Inter-3G_MSC Relocation procedure, where the UE is relocated from 3G_MSC-A to 3G_MSC-B. This procedure can also be combined with a hard change of radio resources (Hard Handover with switch in the core network).

The MSC in this category can optionally be a 3G_MSC supporting the A-interface. The three sub-procedures do also cover subsequent handover/relocation to a third MSC-B' or 3G_MSC-B' and subsequent handover/relocation back to MSC-A or 3G_MSC-A.

In both cases i) and iii) the same procedures as defined in the 3GPP TS 08.08 [5] and the 3GPP TS 24.008 [10] shall be used on the A-interface and on the Radio Interface, respectively.

In case ii) the same procedures as defined in the 3GPP TS 25.413 [11] and the 3GPP TS 24.008 [10] shall be used on the Iu-interface. If the 3G_MSC in case ii) also supports the A-interface, the 3GPP TS 08.08 [5] and the 3GPP TS 24.008 [10] shall be used on the A-interface.

In case iii) the handover procedures shall transport the A-interface messages between MSC-A and MSC-B described in the Mobile Application Part (MAP), 3GPP TS 29.002 [12].

In case iv) the handover procedures shall transport the A-interface messages between 3G_MSC and MSC described in the Mobile Application Part (MAP), 3GPP TS 29.002 [12].

In case iv) the relocation procedure shall transport the Iu-interface messages between 3G_MSC-A and 3G_MSC-B described in the Mobile Application Part (MAP), 3GPP TS 29.002 [12].

The interworking between the 3GPP TS 29.002 [12] protocol and the 3GPP TS 08.08 [5] protocol is described in the 3GPP TS 29.010 [8].

Handovers, which take place on the same MSC are termed Intra-MSC handovers; this includes both Inter-BSS and Intra-BSS handovers.

Handovers, which take place on the same 3G_MSC are termed Intra-3G_MSC handovers; this includes Inter-RNS handovers and optionally RNS to BSS and BSS to RNS handovers.

The present document also covers the requirements for handover in ongoing GSM voice group calls, directed retry and handover without a circuit connection between (U)MSCs. The present document does not consider the case of handovers between radio channels on the same BSS (Intra-BSS handover) or the handover of packet radio services. The Inter-RNS handover case that results in a relocation is covered by the present document but not other Inter-RNS or Intra-RNS handover cases.

For voice broadcast calls in GSM, the speaker uses normal point-to-point handover procedures, whilst the listeners use idle mode cell reselection procedures, as for the voice group call listeners.

Voice group calls is only applicable to GSM and handover of voice group calls is therefore only possible in GSM.

Inter-MSC hand-over imposes a few limitations on the system. After inter-MSC hand-over:

- call re-establishment is not supported.

The list of 3GPP TS 08.08 [5] features supported during and after Inter-MSC handover is given in 3GPP TS 09.08 [7].

In the Inter-MSC handover case, the interworking between a Phase 1 BSSMAP protocol possibly used by one MSC and the Phase 2 BSSMAP protocol used in the Phase 2 MAP protocol on the E-interface is performed by this MSC.

NOTE: The message primitive names used in the SDL diagrams and message flows in the present document do not represent the actual messages specified in the GSM or 3GPP stage 3 technical specifications. The primitive names are only intended to be indicative of their use in the present document.

2 References

The following documents contain provisions which, through reference in this text, constitute provisions of the present document.

- References are either specific (identified by date of publication, edition number, version number, etc.) or non-specific.
- For a specific reference, subsequent revisions do not apply.
- For a non-specific reference, the latest version applies. In the case of a reference to a 3GPP document (including a GSM document), a non-specific reference implicitly refers to the latest version of that document *in the same Release as the present document*.

- [1] ITU-T Recommendation Q.118: "Special release arrangements".
- [2] 3GPP TS 01.04: "Digital cellular telecommunications system (Phase 2+); Abbreviations and acronyms".
- [2a] 3GPP TS 21.905: "3G Vocabulary".
- [3] 3GPP TS 03.68: "Digital cellular telecommunications system (Phase 2+); Voice Group Call Service (VGCS) - Stage 2".
- [4] 3GPP TS 05.08: "Digital cellular telecommunications system (Phase 2+); Radio subsystem link control".
- [5] 3GPP TS 08.08: "Digital cellular telecommunications system (Phase 2+); Mobile Switching Centre - Base Station System (MSC - BSS) interface; Layer 3 specification".
- [6] 3GPP TS 08.58: "Digital cellular telecommunications system (Phase 2+); Base Station Controller - Base Transceiver Station (BSC - BTS) interface; Layer 3 specification".
- [7] 3GPP TS 09.08: "Digital cellular telecommunications system (Phase 2+); Application of the Base Station System Application Part (BSSAP) on the E-interface".

- [8] 3GPP TS 29.010: "Information element mapping between Mobile Station - Base Station System (MS-BSS) and Base Station System - Mobile-services Switching Centre (BSS - MSC); Signalling procedures and the Mobile Application Part (MAP)".
- [9] 3GPP TS 22.129: "Handover Requirements between UMTS and GSM or other Radio Systems".
- [10] 3GPP TS 24.008: "Mobile radio interface layer 3 specification".
- [11] 3GPP TS 25.413: "UTRAN Iu interface RANAP signalling".
- [12] 3GPP TS 29.002: "Mobile Application Part (MAP) specification".
- [13] 3GPP TS 25.303: "Interlayer procedures in Connected Mode".
- [14] 3GPP TS 25.331: "RRC Protocol Specification".
- [15] 3GPP TS 29.108: "Application Part (RANAP) on the E-interface".
- [16] ITU-T Recommendation G.711: "Pulse code modulation (PCM) of voice frequencies".
- [17] 3GPP TS 23.135: "Multicall supplementary service - Stage 2"

3 Abbreviations

For the purpose of the present document, the following abbreviations apply:

3G_MSC	A third generation MSC that supports the Iu interface and optionally the A interface
3G_MSC-A	The controlling 3G_MSC on which the call was originally established
3G_MSC-B	The 3G_MSC to which the UE is handed over in a Basic Handover
3G_MSC-B'	The 3G_MSC to which the UE is handed over in a Subsequent Handover
BSC	Base Station Controller
BSS	Base Station System
BSS-A	The BSS from which the MS is being handed over
BSS-B	The BSS to which the MS is being handed over
BTS	Base Transceiver Station
ISC	International Switching Centre
MS	Mobile Station
MSC	A second generation Mobile Services Switching Centre that only supports the A interface
MSC-A	The controlling MSC on which the call was originally established
MSC-B	The MSC to which the MS is handed over in a Basic Handover
MSC-B'	The MSC to which the MS is handed over in a Subsequent Handover
RNC	Radio Network Controller
RNS	Radio Network Subsystem
UE	A User Equipment is a terminal that supports USIM and the UMTS Uu interface
UE/MS	A terminal that supports USIM, SIM, the Uu interface and the Um interface
USIM	UMTS Subscriber Identity Module

Other abbreviations used in the GSM specifications are listed in 3GPP TS 01.04 [2] and 3GPP TS 21.905[2a].

4 Role, functional composition of MSCs and interfaces for handover

4.1 MSC-A

4.1.1 Role of MSC-A

In the Intra-MSC handover case, the MSC-A (simply termed MSC) controls the call, the mobility management and the radio resources before, during and after an Intra-MSC handover. When BSSAP procedures have to be performed, they are initiated and driven by MSC-A.

In the Inter-MSC handover case, MSC-A is the MSC which controls the call and the mobility management of the Mobile during the call, before, during and after a basic or subsequent handover. When BSSAP procedures related to dedicated resources have to be performed towards the MS, they are initiated and driven by MSC-A. The MSC-A - MSC-B interface works as a MSC - BSS interface for a subset of BSSMAP procedures. These BSSMAP procedures, described in 3GPP TS 09.08 [7] are only those related to dedicated resources. The DTAP signalling is relayed transparently by MSC-B between MSC-A and the MS.

During a basic handover, MSC-A initiates and controls all the handover procedure, from its initiation (reception of Handover Required from BSS-A on A-interface) until its completion (reception of Handover Complete from MSC-B on E-interface).

During a subsequent handover back to MSC-A, MSC-A acts as a BSS towards MSC-B, which controls the handover procedure until the termination in MSC-A of the handover radio resources allocation (sending of the Handover Request Acknowledge to MSC-B from MSC-A). Then all handover related messages shall terminate at MSC-A (e.g. Handover Detect/Complete from BSS-B, Handover Failure from BSS-A).

During a subsequent handover to a third MSC, MSC-A works towards MSC-B' as described above in the basic handover paragraph and towards MSC-B as described above in subsequent handover paragraph.

In the Inter-System, inter-MSC handover case, MSC-A is the MSC which controls the call and the mobility management of the Mobile during the call, before, during and after a basic or subsequent handover. When BSSAP procedures related to dedicated resources have to be performed towards the MS, they are initiated and driven by MSC-A. The MSC-A - 3G_MSC-B interface works as a MSC - BSS interface for a subset of BSSMAP procedures. These BSSMAP procedures, described in 3GPP TS 09.08 [7] are only those related to dedicated resources. The DTAP signalling is relayed transparently by 3G_MSC-B between MSC-A and the MS.

During a basic inter-system handover, MSC-A initiates and controls all the handover procedure, from its initiation (reception of Handover Required from BSS-A on A-interface) until its completion (reception of Handover Complete from 3G_MSC-B on E-interface).

During a subsequent inter-system handover back to MSC-A, MSC-A acts as a BSS towards 3G_MSC-B, which controls the handover procedure until the termination in MSC-A of the handover radio resources allocation (sending of the Handover Request Acknowledge to 3G_MSC-B from MSC-A). Then all handover related messages shall terminate at MSC-A (e.g. Handover Detect/Complete from BSS-B, Handover Failure from BSS-A).

During a subsequent inter-system handover to a third MSC, MSC-A works towards 3G_MSC-B' as described above in the basic inter-system handover paragraph and towards 3G_MSC-B as described above in subsequent inter-system handover paragraph.

4.1.2 Functional composition of MSC-A and its interfaces for handover

In order to simplify the description of the handover procedures the controlling MSC (MSC-A) can be considered to be composed of five functional units, as shown in figure 1.

Signalling functions

- 1) BSC/MSC (MS/BSC) Procedures MSC-A. This unit is used to control the signalling between the MSC, BSC and MS. Interface A' is the connection to the old BSC and interface A'' is the connection to the new BSC, when an

Intra-MSC handover takes place. Interface x represents the interworking connection to the Handover Control Procedures MSC-A.

- 2) Call Control Procedures MSC-A. This unit is used to control the call. Interface B' is used for normal call control procedures. When a Basic handover from MSC-A to MSC-B is to be performed then interface B'' is employed to provide a signalling and call control connection to MSC-B. If a Subsequent handover to MSC-B' is to be performed then interface B''' is used. Similarly, when a Basic inter-system handover from MSC-A to 3G_MSC-B is to be performed, then interface B'' is employed to provide a signalling and call control connection to 3G_MSC-B. If a subsequent inter-system handover to 3G_MSC-B' is to be performed, then interface B''' is used.
- 3) Handover Control Procedures MSC-A. This unit provides both the overall control of the handover procedure and interworking between the internal interfaces (x, y and z).
- 4) MAP Procedures MSC-A. This unit is responsible for controlling the exchange of MAP messages between MSCs during an Inter-MSC handover, or between MSC-A and 3G_MSC-B during an Inter-system Inter-MSC handover. This unit communicates with the Handover Control Procedures MSC-A via interface z.

Switching functions

- 5) Switch and Handover Device MSC-A. For all calls, except for ongoing voice group calls (see 3GPP TS 03.68 [3] for a definition) this unit is responsible for connecting the new path into the network via interface B'. In the case of ongoing voice group calls this unit is responsible for maintaining the connection between the down link group call channels and the active uplink. In specific cases it may be unnecessary to take any explicit action in the MSC concerning the handover device. The handover device interconnections are illustrated in figure 2.

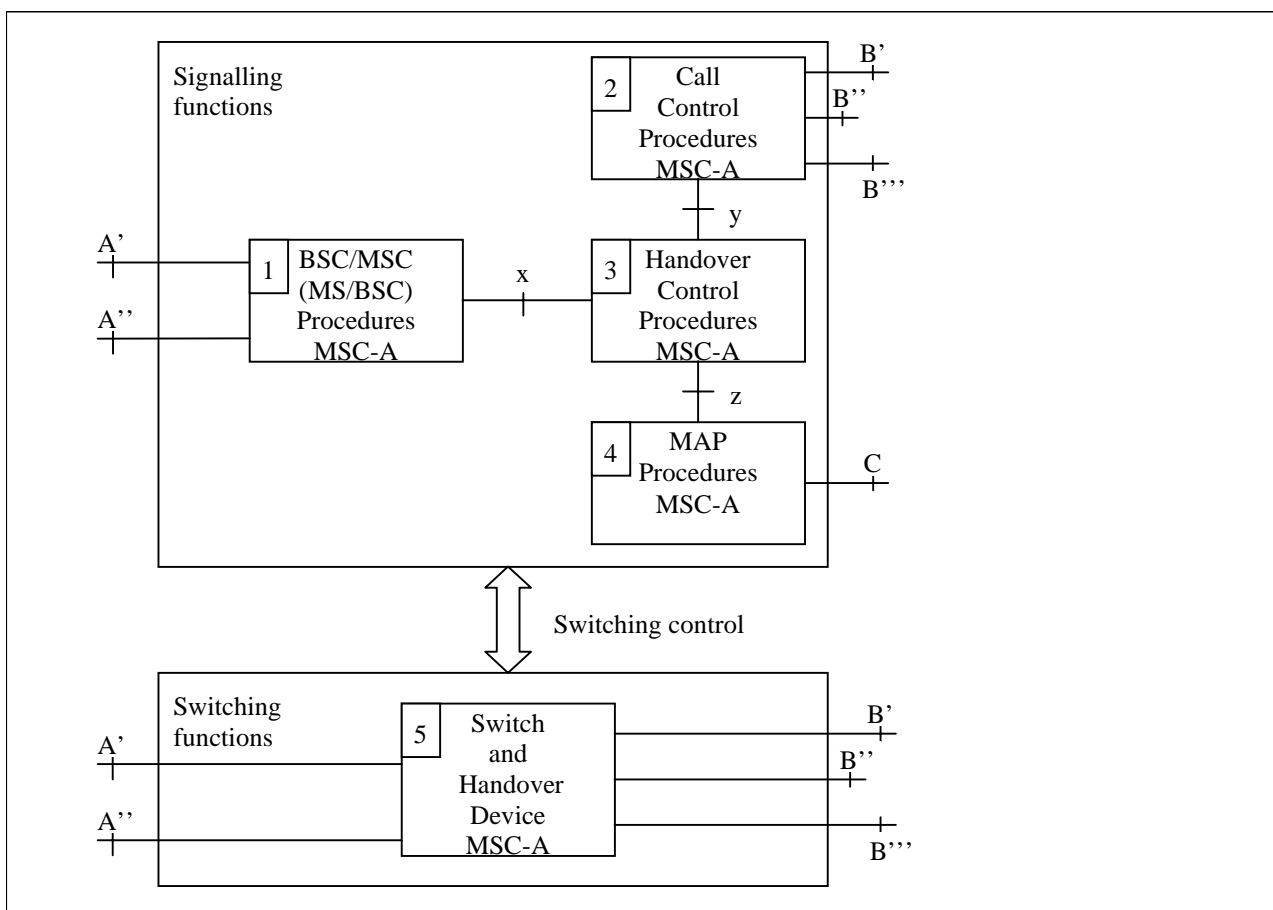

Figure 1: Functional composition of the controlling MSC (MSC-A) for supporting handover

For MS to MS calls in the same MSC the configuration in Figure 2b) applies. In this case interface B'' is internal to MSC-A and does not connect to another MSC.

The handover device can either be a three-party bridge or a switching facility without three-party connection capabilities. For a three-party bridge configuration the states of the handover device are as shown in table 1. The three-party configuration exists in the intermediate state. This type of handover device may reduce the interruption time.

However, this may require noise reduction if one of the radio channels is unterminated at some time in the intermediate state.

For a handover device consisting of a simple switch there will be no intermediate state.

Table 1: States of the handover device

Case	Initial Connection	Intermediate Connection	Resulting Connection	
			Successful Procedure	Unsuccessful Procedure
Figure 2a)	B' to A'	B' to A' and A''	B' to A''	B' to A'
Figure 2b)	B' to A'	B' to A' and B''	B' to B''	B' to A'
Figure 2c)	B' to B''	B' to B'' and B'''	B' to B'''	B' to B''

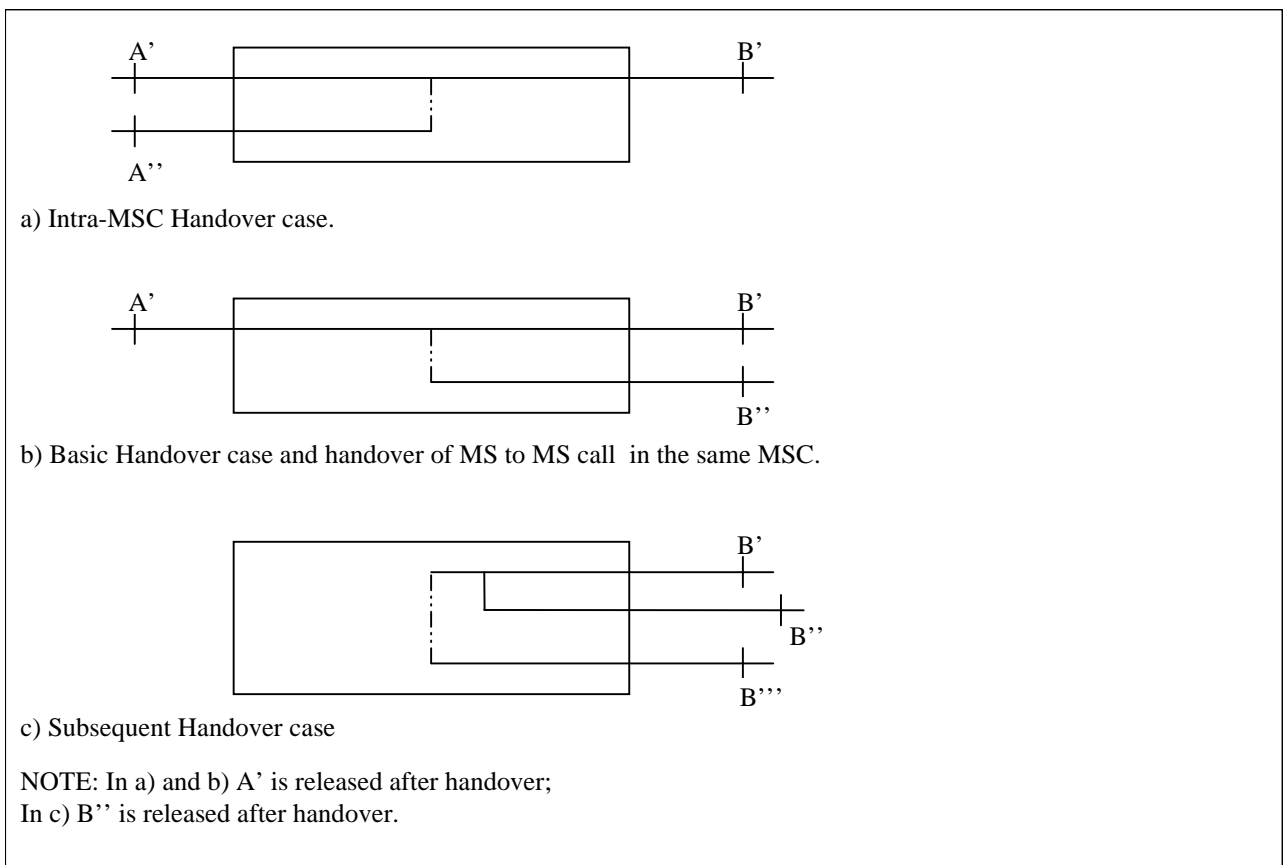

Figure 2: Connections in the handover device (Unit 5)

4.2 MSC-B

4.2.1 Role of MSC-B

In the Intra-MSC handover case, the MSC-B keeps the control of the whole Intra-MSC handover procedure.

MSC-B notifies MSC-A or 3G_MSC-A of successful intra -MSC-B handover completion by using the A_HANDOVER_PERFORMED message.

In the Inter-MSC handover case, the role of MSC-B (MSC-B') is only to provide radio resources control within its area. This means that MSC-B keeps control of the radio resources connection and release towards BSS-B. MSC-B will do some processing on the BSSMAP information received on the E-interface or A-interface whereas it will relay the DTAP

information transparently between A-interface and E-interface. MSC-A initiates and drives a subset of BSSMAP procedures towards MSC-B, while MSC-B controls them towards its BSSs to the extent that MSC-B is responsible for the connections of its BSSs. The release of the dedicated resources between MSC-B and BSS-B is under the responsibility of MSC-B and BSS-B, and is not directly controlled by MSC-A. When clearing is to be performed due to information received from BSS-B, MSC-B shall transfer this clearing indication to MSC-A, to clear its connection with BSS-B, to terminate the dialogue with MSC-A through the E-interface, and to release its circuit connection with MSC-A, if any. In the same way, the release of the connection to its BSS-B, is initiated by MSC-B, when the dialogue with MSC-A ends normally and a release is received from the circuit connection with MSC-A, if any, or when the dialogue with the MSC-A ends abnormally.

When a release is received by MSC-B for the circuit connection with MSC-A then MSC-B shall release the circuit connection.

In the Inter-system Inter-MSC handover case, the role of MSC-B (MSC-B') is only to provide radio resources control within its area. This means that MSC-B keeps control of the radio resources connection and release towards BSS-B. MSC-B will do some processing on the BSSMAP information received on the E-interface or A-interface whereas it will relay the DTAP information transparently between A-interface and E-interface. 3G_MSC-A initiates and drives a subset of BSSMAP procedures towards MSC-B, while MSC-B controls them towards its BSSs to the extent that MSC-B is responsible for the connections of its BSSs. The release of the dedicated resources between MSC-B and BSS-B is under the responsibility of MSC-B and BSS-B, and is not directly controlled by 3G_MSC-A. When clearing is to be performed due to information received from BSS-B, MSC-B shall transfer this clearing indication to 3G_MSC-A, to clear its connection with BSS-B, to terminate the dialogue with 3G_MSC-A through the E-interface, and to release its circuit connection with 3G_MSC-A, if any. In the same way, the release of the connection to its BSS-B, is initiated by MSC-B, when the dialogue with 3G_MSC-A ends normally and a release is received from the circuit connection with MSC-A, if any, or when the dialogue with the MSC-A ends abnormally.

When a release is received by MSC-B for the circuit connection with 3G_MSC-A then MSC-B shall release the circuit connection.

4.2.2 Functional composition of MSC-B and its interfaces for handover

The functional composition of an MSC acting as MSC-B is essentially the same as that of MSC-A. However, there are some differences. The functional units are as follows (see figure 3).

Signalling functions

- 1) BSC/MSC (MS/BSC) Procedures MSC-B. This unit is used to control the signalling between the MSC, BSC and MS. Interface A" is the connection to the new BSC, when an Intra-MSC handover takes place. Interface x represents the interworking connection to the Handover Control Procedures MSC-B.
- 2) Call Control Procedures MSC-B. This unit is used for normal call control and signalling to MSC-A, or 3G_MSC-A in the case of inter-system inter-MSC handover.
- 3) Handover Control Procedures MSC-B. This unit provides both the overall control of the handover procedure and interworking between the internal interfaces (x, y and z) in MSC-B.
- 4) MAP Procedures MSC-B. This unit is responsible for controlling the exchange of MAP messages between MSC-A, or 3G_MSC-A, and MSC-B and for signalling to the VLR in MSC-B.

Switching functions

- 5) Switch MSC-B. For all calls, except ongoing voice group calls (see 3GPP TS 03.68 [3] for a definition) this unit is responsible, with BSS-B, for connecting the circuit from MSC-A, or 3G_MSC-A, to BSS-B. This unit may also need to act as a handover device for Intra-MSC handovers controlled by MSC-B. In the case of ongoing voice group calls this unit is responsible for maintaining the connection between the group member currently assigned the uplink and the distribution device. In specific cases it may be unnecessary to take any explicit action in the MSC concerning the handover device.

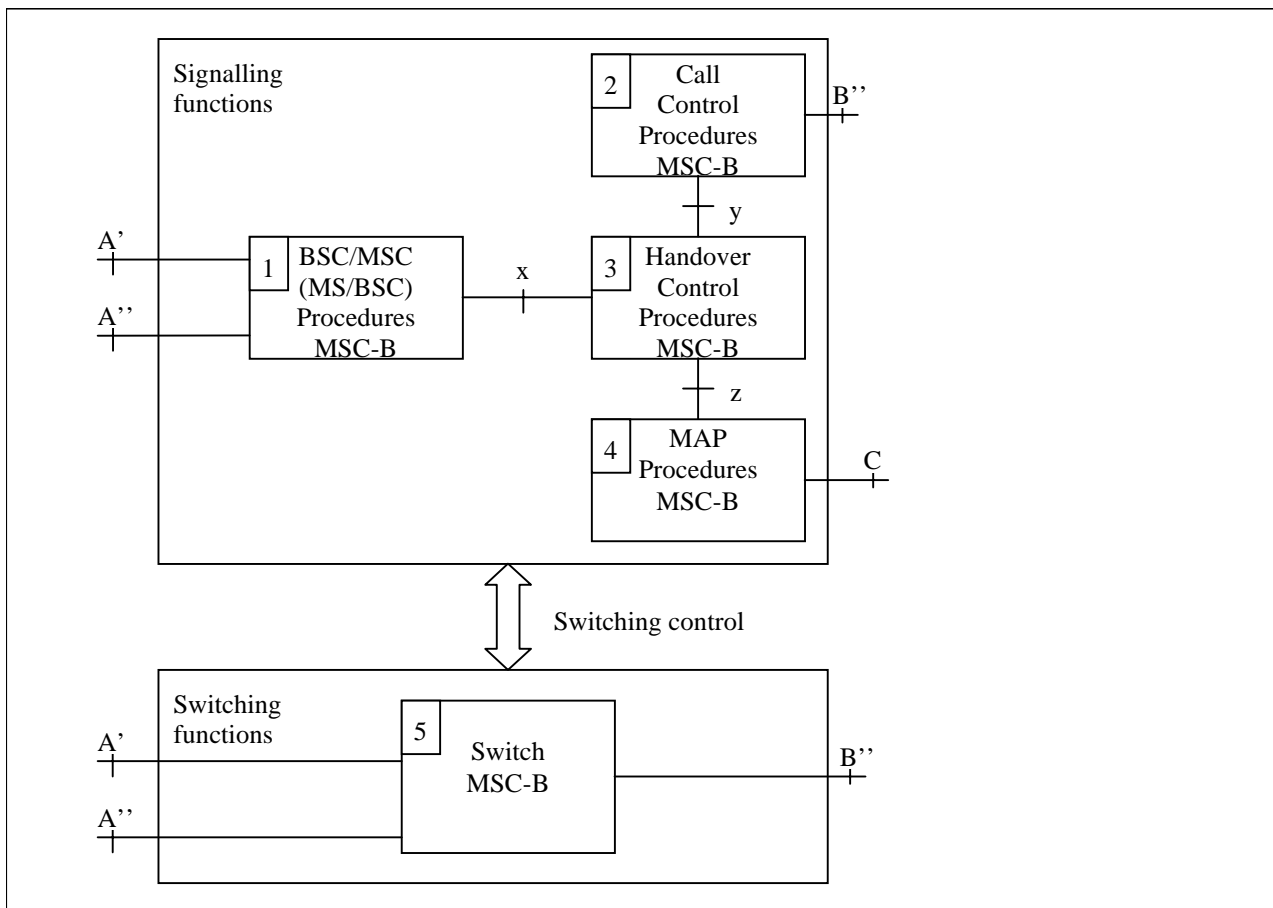

Figure 3: Functional composition of MSC-B for supporting handover

4.3 3G_MSC-A

For roles and functional composition of the 3G_MSC-A working as pure GSM MSC, please see previous clause ("MSC-A").

4.3.1 Role of 3G_MSC-A

In the Intra-3G_MSC handover/relocation case, the 3G_MSC-A (simply termed 3G_MSC) controls the call, the mobility management and the radio resources before, during and after an Intra-3G_MSC handover/relocation. When RANAP or BSSMAP procedures have to be performed, they are initiated and driven by 3G_MSC-A.

In the case of intra-MSC handover of a speech call, 3G_MSC-A controls the transcoder in the core network. The 3G_MSC-A determines if a transcoder is required to be inserted or released in the CN.

In the case of Inter-3G_MSC relocation, 3G_MSC-A links out the transcoder.

In the Inter-3G_MSC relocation case, 3G_MSC-A is the 3G_MSC that controls the call and the mobility management of the UE during the call, before, during and after a basic or subsequent relocation. When RANAP procedures related to dedicated resources have to be performed towards the UE, they are initiated and driven by 3G_MSC-A. The 3G_MSC-A - 3G_MSC-B interface works as a 3G_MSC - RNS interface for the RANAP procedures. The Direct Transfer signalling is relayed transparently by 3G_MSC-B between 3G_MSC-A and the UE.

During a basic relocation, 3G_MSC-A initiates and controls all the relocation procedure, from its initiation (reception of Relocation Required from RNS-A on Iu-interface) until its completion (reception of Relocation Complete from 3G_MSC-B on E-interface).

During a subsequent relocation back to 3G_MSC-A, 3G_MSC-A acts as an RNS towards 3G_MSC-B, which controls the relocation procedure until the termination in 3G_MSC-A of the handover radio resources allocation (sending of the

Relocation Request Acknowledge to 3G_MSC-B from 3G_MSC-A). Then all relocation related messages shall terminate at 3G_MSC-A (e.g. Relocation Detect/Complete from RNS-B, Relocation Cancel from RNS-A).

During a subsequent relocation to a third 3G_MSC, 3G_MSC-A works towards 3G_MSC-B' as described above in the basic relocation paragraph and towards 3G_MSC-B as described above in subsequent relocation paragraph.

In the Inter-System, inter-3G_MSC handover case, 3G_MSC-A is the 3G_MSC which controls the call and the mobility management of the UE/MS during the call, before, during and after a basic or subsequent inter-system handover. When BSSAP procedures related to dedicated resources have to be performed towards the UE/MS, they are initiated and driven by 3G_MSC-A. The 3G_MSC-A – MSC-B interface works as a 3G_MSC – BSS interface for a subset of BSSMAP procedures. These BSSMAP procedures described in 3GPP TS 09 08 [7] are those related to dedicated resources. The DTAP signalling is relayed transparently by MSC-B between 3G_MSC-A and the UE/MS.

During a basic inter-system UMTS to GSM handover, 3G_MSC-A initiates and controls all the handover procedure, from its initiation (reception of Relocation Required from RNS-A on Iu-interface) until its completion (reception of Handover Complete from MSC-B on E-interface).

During a subsequent inter-system UMTS to GSM handover back to 3G_MSC-A, 3G_MSC-A acts as a BSS towards 3G_MSC-B, which controls the handover procedure until the termination in 3G_MSC-A of the handover radio resources allocation (sending of the Handover Request Acknowledge to 3G_MSC-B from 3G_MSC-A). Then all handover related messages shall terminate at 3G_MSC-A (e.g. Handover Detect/Complete from BSS-B, Relocation Cancel from RNS-A).

During a subsequent inter-system UMTS to GSM handover to a third 3G_MSC, 3G_MSC-A works towards MSC-B' as described above in the basic inter-system handover paragraph and towards 3G_MSC-B as described above in subsequent inter-system handover paragraph.

During a basic inter-system GSM to UMTS handover, 3G_MSC-A initiates and controls all the handover procedure, from its initiation (reception of Handover Required from BSS-A on A-interface) until its completion (reception of Handover Complete from 3G_MSC-B on E-interface).

During a subsequent inter-system GSM to UMTS handover back to 3G_MSC-A, 3G_MSC-A acts as an RNS towards MSC-B, which controls the handover procedure until the termination in 3G_MSC-A of the handover radio resources allocation (sending of the Handover Request Acknowledge to MSC-B from 3G_MSC-A). Then all handover related messages shall terminate at 3G_MSC-A (e.g. Relocation Detect/Complete from RNS-B, Handover Failure from BSS-A).

During a subsequent inter-system GSM to UMTS handover to a third 3G_MSC, 3G_MSC-A works towards 3G_MSC-B' as described above in the basic inter-system handover paragraph and towards MSC-B as described above in subsequent inter-system handover paragraph.

If 3G_MSC-A supports the optional supplementary service Multicall (See 3GPP TS 23.135) and UE is engaged with multiple bearers the following description applies;

- In the Intra-3G_MSC relocation case, the 3G-MSC-A tries to relocate all bearers to a new RNS.
- In the basic relocation case, the 3G-MSC-A tries to relocate all bearers to 3G_MSC-B. If 3G_MSC-A receives an indication that the 3G_MSC-B does not support multiple bearers, then 3G_MSC-A shall be able to select one bearer to be handed over according to the priority level defined as RAB parameters in 3GPP TS 25.413 and tries again to relocate the selected bearer.
- In the subsequent relocation to a third 3G_MSC-B' case, the 3G-MSC-A tries to relocate all bearers to 3G_MSC-B'. If 3G_MSC-A receives an indication that the 3G_MSC-B' does not support multiple bearers, then 3G_MSC-A shall be able to select one bearer to be handed over according to the priority level defined as RAB parameters in 3GPP TS 25.413 [11] and tries again to relocate the selected bearer.
- In the Intra-3G_MSC inter-system UMTS to GSM handover case and the basic inter-system UMTS to GSM handover case, the 3G_MSC-A shall be able to select one bearer to be handed over according to the priority level defined as RAB parameters in 3GPP TS 25.413 [11] and tries to handover the selected bearer.
- In all cases described above, 3G_MSC-A shall release some calls which has been carried by the bearers failed to set up in new RNS or the bearers not to be handed over.

4.3.2 Functional composition of 3G_MSC-A and its interfaces for handover/relocation

In order to simplify the description of the handover/relocation procedures the controlling 3G_MSC (3G_MSC-A) can be considered to be composed of five functional units, as shown in figure 4.

Signalling functions

- 1) RNC/BSC/3G_MSC (UE/MS/RNC/BSC) Procedures 3G_MSC-A. This unit is used to control the signalling between the 3G_MSC, RNC or BSC and UE/MS. Interface Iu' is the connection to the old RNC and interface Iu'' is the connection to the new RNC, when an Intra-3G_MSC relocation takes place. Interface Iu' is the connection to the old RNC and interface A'' is the connection to the new BSC, when an Intra-3G_MSC UMTS to GSM handover takes place. Interface A' is the connection to the old BSC and interface Iu'' is the connection to the new RNC, when an Intra-3G_MSC GSM to UMTS handover takes place. Interface x represents the interworking connection to the Handover/Relocation Control Procedures 3G_MSC-A.
- 2) Call Control Procedures 3G_MSC-A. This unit is used to control the call. Interface B' is used for normal call control procedures. When a Basic relocation from 3G_MSC-A to 3G_MSC-B is to be performed then interface B'' is employed to provide a signalling and call control connection to 3G_MSC-B. If a Subsequent handover/relocation to 3G_MSC-B' is to be performed then interface B''' is used. Similarly, when a Basic inter-system handover from 3G_MSC-A to 3G_MSC-B is to be performed, then interface B'' is employed to provide a signalling and call control connection to 3G_MSC-B. If a Subsequent inter-system handover to 3G_MSC-B' is to be performed then interface B''' is used.
- 3) Handover/Relocation Control Procedures 3G_MSC-A. This unit provides both the overall control of the handover/relocation procedure and interworking between the internal interfaces (x, y and z).
- 4) MAP Procedures 3G_MSC-A. This unit is responsible for controlling the exchange of MAP messages between 3G_MSCs during an Inter-3G_MSC handover/relocation, or between 3G_MSC-A and MSC-B during an Inter-system Inter-3G_MSC handover. This unit communicates with the Handover/Relocation Control Procedures 3G_MSC-A via interface z.

Switching functions

- 5) Switch and Handover/Relocation Device 3G_MSC-A. For all calls this unit is responsible for connecting the new path into the network via interface B'. In specific cases it may be unnecessary to take any explicit action in the 3G_MSC concerning the handover/relocation device. The handover/relocation device interconnections are illustrated in figure 5.

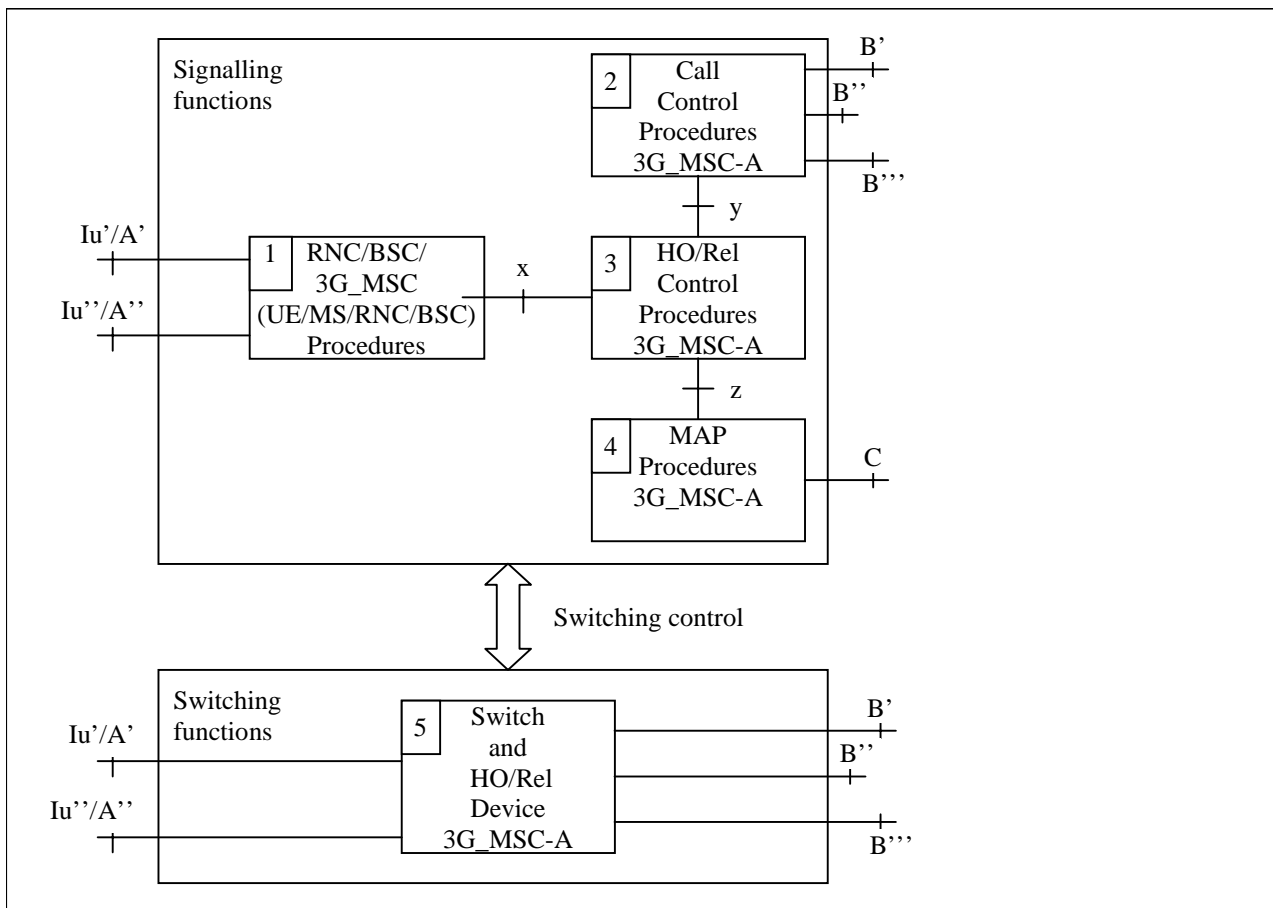

Figure 4: Functional composition of the controlling 3G_MSC (3G_MSC-A) for supporting handover/relocation

For UE/MS to UE/MS calls in the same 3G_MSC the configuration in figure 5b) applies. In this case interface B'' is internal to 3G_MSC-A and does not connect to another 3G_MSC.

The handover/relocation device can be either a three-party bridge or a switching facility without three-party connection capabilities. For a three-party bridge configuration the states of the handover/relocation device are as shown in table 2. The three-party configuration exists in the intermediate state. This type of handover/relocation device may reduce the interruption time. However, this may require noise reduction if one of the radio channels is unterminated at some time in the intermediate state.

For a handover/relocation device consisting of a simple switch there will be no intermediate state.

Table 2: States of the handover/relocation device

Case	Initial Connection	Intermediate Connection	Resulting Connection	
			Successful Procedure	Unsuccessful Procedure
Figure 5a)	B' to lu' B' to lu' B' to A'	B' to lu' and lu'' B' to lu' and A'' B' to A' and lu''	B' to lu'' B' to A'' B' to lu''	B' to lu' B' to lu' B' to A'
Figure 5b)	B' to lu'	B' to lu' and B''	B' to B''	B' to lu'
Figure 5c)	B' to B''	B' to B'' and B'''	B' to B'''	B' to B''

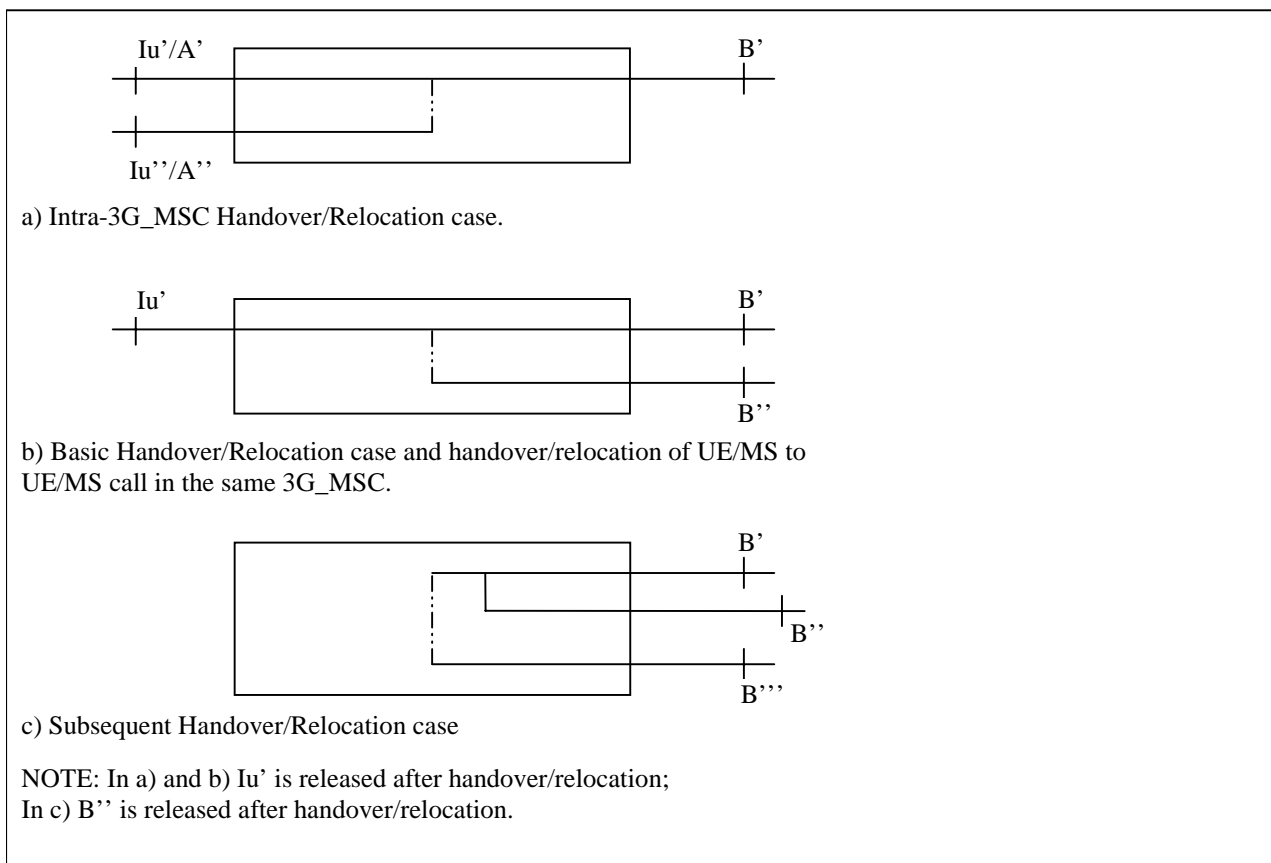

Figure 5: Connections in the handover/relocation device (Unit 5)

4.4 3G_MSC-B

For roles and functional composition of the 3G_MSC-B working as pure GSM MSC, please see previous clause ("MSC-B").

4.4.1 Role of 3G_MSC-B

In the Intra-3G_MSC handover/relocation case, the 3G_MSC-B keeps the control of the whole Intra-3G_MSC handover/relocation procedure. 3G_MSC-B notifies MSC-A or 3G_MSC-A of intra-3G_MSC-B InterSystem handover by using the A_HANOVER_PERFORMED procedure.

The role of 3G_MSC-B is also to provide transcoder resources.

In the Inter-3G_MSC relocation case, the role of 3G_MSC-B (3G_MSC-B') is only to provide radio resources control within its area. This means that 3G_MSC-B keeps control of the radio resources connection and release towards RNS-B. 3G_MSC-B will do some processing on the RANAP information received on the E-interface or the RANAP information received on the Iu-interface whereas it will relay the Direct Transfer information transparently between Iu-interface and E-interface. 3G_MSC-A initiates and drives RANAP procedures towards 3G_MSC-B, while 3G_MSC-B controls them towards its RNSs to the extent that 3G_MSC-B is responsible for the connections of its RNSs. The release of the dedicated resources between 3G_MSC-B and RNS-B is under the responsibility of 3G_MSC-B and RNS-B, and is not directly controlled by 3G_MSC-A. When clearing is to be performed due to information received from RNS-B, 3G_MSC-B shall transfer this clearing indication to 3G_MSC-A, to clear its connection with RNS-B, to terminate the dialogue with 3G_MSC-A through the E-interface, and to release its circuit connection with 3G_MSC-A, if any. In the same way, the release of the connection to its RNS-B, is initiated by 3G_MSC-B, when the dialogue with 3G_MSC-A ends normally and a release is received from the circuit connection with 3G_MSC-A, if any, or when the dialogue with the 3G_MSC-A ends abnormally.

When a release is received by 3G_MSC-B for the circuit connection with 3G_MSC-A then 3G_MSC-B shall release the circuit connection.

In the Inter-system UMTS to GSM Inter-3G_MSC handover case, the role of 3G_MSC-B (3G_MSC-B') is only to provide radio resources control within its area. This means that 3G_MSC-B keeps control of the radio resources connection and release towards BSS-B. 3G_MSC-B will do some processing on the BSSMAP information received on the E-interface or the BSSMAP information received on the A-interface whereas it will relay the DTAP information transparently between A-interface and E-interface. 3G_MSC-A initiates and drives a subset of BSSMAP procedures towards 3G_MSC-B, while 3G_MSC-B controls them towards its BSSs to the extent that 3G_MSC-B is responsible for the connections of its BSSs. The release of the dedicated resources between 3G_MSC-B and BSS-B is under the responsibility of 3G_MSC-B and BSS-B, and is not directly controlled by 3G_MSC-A. When clearing is to be performed due to information received from BSS-B, 3G_MSC-B shall transfer this clearing indication to 3G_MSC-A, to clear its connection with BSS-B, to terminate the dialogue with 3G_MSC-A through the E-interface, and to release its circuit connection with MSC-A, if any. In the same way, the release of the connection to its BSS-B, is initiated by 3G_MSC-B, when the dialogue with 3G_MSC-A ends normally and a release is received from the circuit connection with 3G_MSC-A, if any, or when the dialogue with the MSC-A ends abnormally.

When a release is received by 3G_MSC-B for the circuit connection with 3G_MSC-A then 3G_MSC-B shall release the circuit connection.

In the Inter-system GSM to UMTS Inter-3G_MSC handover case, the role of 3G_MSC-B (3G_MSC-B') is only to provide radio resources control within its area. This means that 3G_MSC-B keeps control of the radio resources connection and release towards RNS-B. 3G_MSC-B will do some processing on the BSSMAP information received on the E-interface or the RANAP information received on the Iu-interface whereas it will relay the Direct Transfer information transparently between Iu-interface and E-interface. MSC-A initiates and drives a subset of BSSMAP procedures towards 3G_MSC-B, while 3G_MSC-B controls them towards its RNSs to the extent that 3G_MSC-B is responsible for the connections of its RNSs. The release of the dedicated resources between 3G_MSC-B and RNS-B is under the responsibility of 3G_MSC-B and RNS-B, and is not directly controlled by MSC-A. When clearing is to be performed due to information received from RNS-B, 3G_MSC-B shall transfer this clearing indication to MSC-A, to clear its connection with RNS-B, to terminate the dialogue with MSC-A through the E-interface, and to release its circuit connection with MSC-A, if any. In the same way, the release of the connection to its RNS-B, is initiated by 3G_MSC-B, when the dialogue with MSC-A ends normally and a release is received from the circuit connection with MSC-A, if any, or when the dialogue with the MSC-A ends abnormally.

When a release is received by 3G_MSC-B for the circuit connection with MSC-A then 3G_MSC-B shall release the circuit connection.

If 3G_MSC-B does not support the optional supplementary service Mutlicall (See 3GPP TS 23.135) and 3G_MSC-A requests to relocate multiple bearers, 3G_MSC-B shall indicate that it does not support multiple bearers to 3G_MSC-A.

If 3G_MSC-B supports the optional supplementary service Multicall (See 3GPP TS 23.135) and UE is engaged with multiple bearers the following description applies;

- In the basic relocation case, the 3G_MSC-B shall be able to allocate an Handover Number for each bearer. The 3G-MSC-B shall also be able to select some bearers so that the number of bearers will fulfill the maximum number of bearers supported by the 3G_MSC-B.
- In the Intra-3G_MSC relocation case, the 3G-MSC-B tries to relocate all bearers to a new RNS.
- In the subsequent relocation back to the 3G_MSC-A or to a third 3G_MSC-B' case, the 3G-MSC-B tries to request to the 3G_MSC-A to relocate all bearers to the 3G_MSC-A or to the 3G_MSC-B'.
- In the Intra-3G_MSC inter-system UMTS to GSM handover case and the subsequent inter-system UMTS to GSM handover back to the 3G_MSC-A or to a third MSC-B' case, the 3G_MSC-B shall be able to select one bearer to be handed over according to the priority level defined as RAB parameters in 3GPP TS 25.413 [11] and tries to handover the selected bearer.

4.4.2 Functional composition of 3G_MSC-B and its interfaces for handover/relocation

The functional composition of a 3G_MSC acting as 3G_MSC-B is essentially the same as that of 3G_MSC-A. However, there are some differences. The functional units are as follows (see figure 6).

Signalling functions

- 1) RNC/BSC/3G_MSC (UE/MS/RNC/BSC) Procedures 3G_MSC-B. This unit is used to control the signalling between the 3G_MSC, RNC, BSC and UE/MS. Interface Iu' is the connection to the old RNC and interface Iu'' is the connection to the new RNC, when an Intra-3G_MSC relocation takes place. Interface Iu' is the connection to the old RNC and interface A' is the connection to the new BSC, when an Intra-3G_MSC UMTS to GSM handover takes place. Interface A' is the connection to the old BSC and interface Iu'' is the connection to the new RNC, when an Intra-3G_MSC GSM to UMTS handover takes place. Interface x represents the interworking connection to the Handover/Relocation Control Procedures 3G_MSC-B.
- 2) Call Control Procedures 3G_MSC-B. This unit is used for normal call control and signalling to 3G_MSC-A or MSC-A in the case of inter-system inter-3G_MSC handover.
- 3) Handover/Relocation Control Procedures 3G_MSC-B. This unit provides both the overall control of the handover/relocation procedure and interworking between the internal interfaces (x, y and z) in 3G_MSC-B.
- 4) MAP Procedures 3G_MSC-B. This unit is responsible for controlling the exchange of MAP messages between 3G_MSC-A, or MSC-A, and 3G_MSC-B and for signalling to the VLR in 3G_MSC-B.

Switching functions

- 5) Switch 3G_MSC-B. For all calls this unit is responsible, with RNS-B, for connecting the circuit from 3G_MSC-A, or MSC-A, to RNS-B. This unit may also need to act as a handover/relocation device for Intra-3G_MSC handovers/relocation controlled by 3G_MSC-B. In specific cases it may be unnecessary to take any explicit action in the 3G_MSC concerning the handover/relocation device.

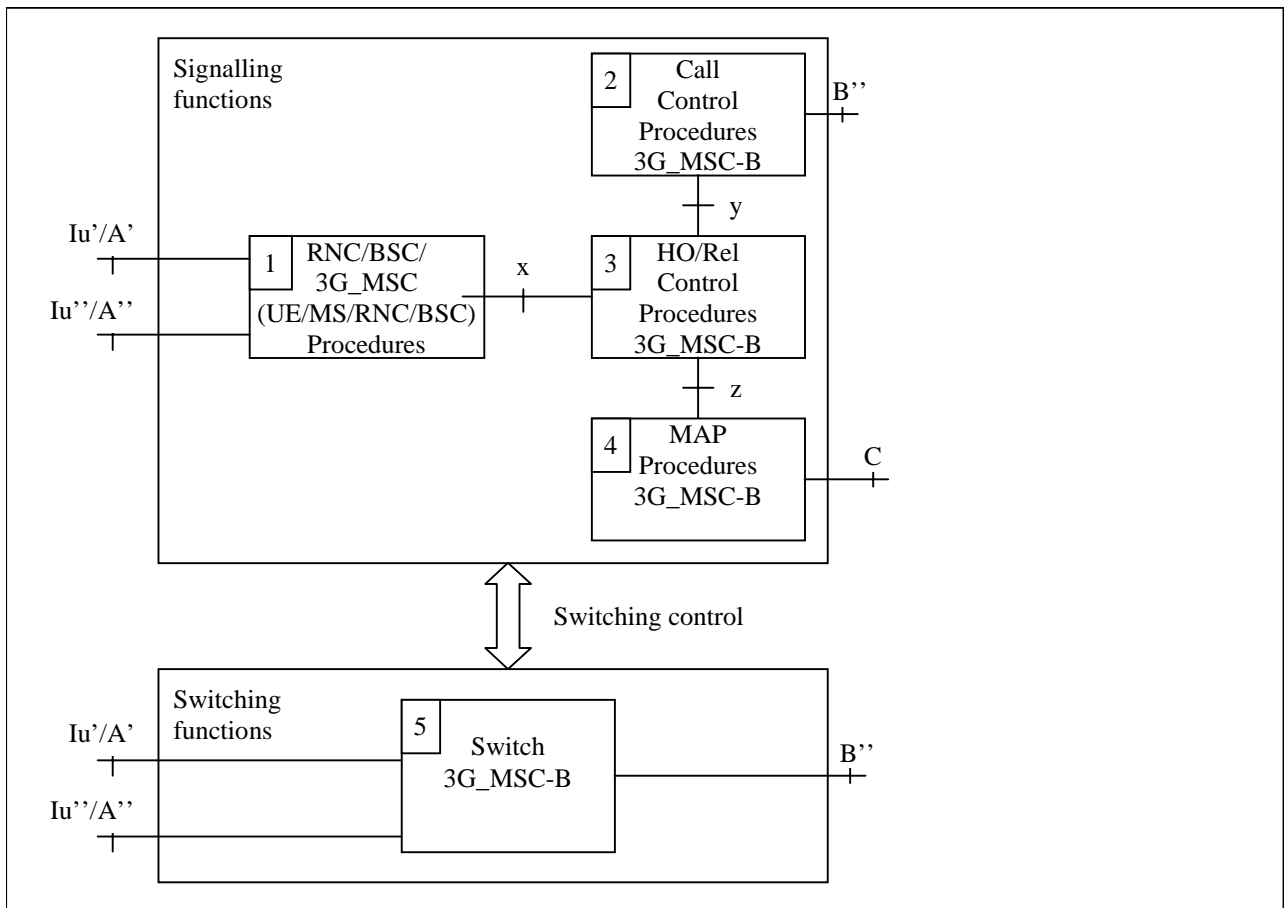

Figure 6: Functional composition of 3G_MSC-B for supporting handover/relocation

5 Handover initiation conditions

Handover may be initiated by the network based on RF criteria as measured by the MS or the Network (signal level, Connection quality, power level propagation delay) as well as traffic criteria (e.g. current traffic loading per cell, interference levels, maintenance requests, etc.).

In order to determine if a handover is required, due to RF criteria, it is typically the MS that shall take radio measurements from neighbouring cells. These measurements are reported to the serving cell on an event driven or regular basis. When a network determines a need for executing a handover the procedures given in 3GPP TS 08.08 [5], 3GPP TS 25.303 [13], 3GPP TS 25.331 [14] are followed.

The decision process used to determine when to perform soft handover or hard handover will typically differ. Depending on the support for soft or hard handover the Intra-MSC and Inter-MSC handover may differ.

In the case of an ongoing GSM voice group call (see 3GPP TS 03.68 [3]) the criteria described above shall only apply to the mobile station currently assigned the uplink and other users with a dedicated connection, no actions shall be taken for the listening users.

6 General description of the procedures for intra - MSC handovers

This clause gives a brief overview of the procedures that shall be followed when performing Intra-MSC handovers. Detailed explanation of these procedures can be found in 3GPP TS 08.08 [5] and 3GPP TS 24.008 [10].

There are two types of handover that can be considered which involve a BSS and single MSC. These are Internal Handover and External Handover. An Internal Handover is a handover which takes place between channels on a cell or cells controlled by a single BSS, without reference to the MSC, although the MSC maybe informed of its occurrence. This case is not considered in the present document.

Handovers between channels on the same cell or between cells on the same BSS which are controlled by the MSC are termed External Handovers and use identical procedures to those for Intra-MSC handovers. Only the Intra-MSC handover case will be considered in the present document.

Handovers from a BSS to an RNS controlled by the same 3G_MSC are intra-3G_MSC GSM to UMTS handovers. Handovers from an RNS to a BSS controlled by the same 3G_MSC are intra-3G_MSC UMTS to GSM handovers.

There are two types of handover in UMTS: soft handover and hard handover. The first one is fully performed within UTRAN, without involving the core network. The second one may be also performed within UTRAN, or the core network may be involved if the Iur interface between RNSs does not exist. This case of hard handover involving the core network is the only one that is covered in the present document, together with SRNS relocation with Iur interface.

6.1 Procedure for Intra-MSC Handovers

The procedure for a successful External Intra-MSC handover is shown in figure 7. It is assumed that selection of a candidate MS has already taken place within the BSS based upon the criteria presented in clause 5. The exact algorithm, in the BSS, for determining a candidate MS is not addressed in the present document. The procedures discussed do not make use of the Mobile Application Part (MAP), represented by signalling function 4 in figure 2 and figure 3. The procedure described in this subclause covers case i).

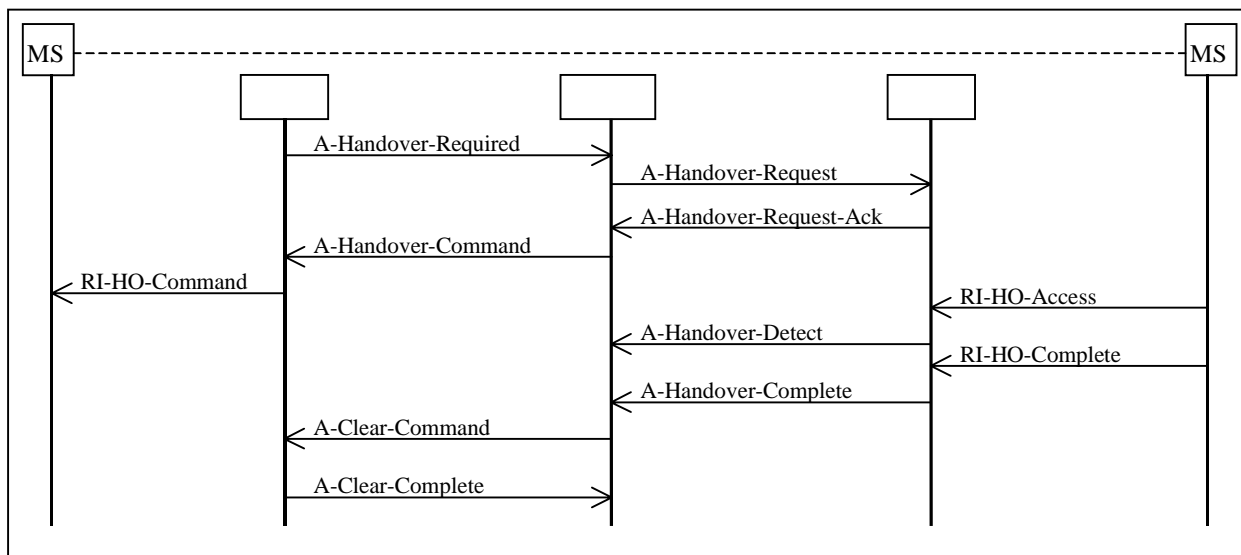

Figure 7: Basic External Intra-MSC Handover Procedure

The successful operation of the procedure is as follows. When the BSS (BSS-A), currently supporting the MS, determines that the MS requires to be handed over it will send an A-HANDOVER-REQUIRED message to the MSC (MSC-A). The A-HANDOVER-REQUIRED message shall contain a list of cells, or a single cell, to which the MS can be handed over. The list of cells shall be given in order of preference based upon operator determined criteria (These criteria are not addressed within the present document and are operator dependent). When the MSC-A receives the A-HANDOVER-REQUIRED message it shall begin the process of handing over the MS to a new BSS (BSS-B). (NOTE: BSS-A and BSS-B maybe the same BSS). The MSC-A shall generate an A-HANDOVER-REQUEST message to the selected BSS (BSS-B). When BSS-B receives the A-HANDOVER-REQUEST message it shall take the necessary action to allow the MS to access the radio resource of BSS-B, this is detailed in 3GPP TS 08.58 [6] and in 3GPP TS 05.08 [4]. The switching of the radio resource through the necessary terrestrial resources is detailed in 3GPP TS 24.008 [10] and 3GPP TS 08.08 [5].

Once resource allocation has been completed by BSS-B it shall return an A-HANDOVER-REQUEST-ACK. to MSC-A. When this message is received by MSC-A it shall begin the process of instructing the MS to tune to a new dedicated radio resource. An A-HANDOVER-COMMAND will be sent by the MSC-A to BSS-A. On receipt of the A-HANDOVER-COMMAND message BSS-A will send the radio interface message RI-HANDOVER-COMMAND, containing a Handover Reference number previously allocated by BSS-B, to the MS. The MS will then access the new radio resource using the Handover Reference number contained in the RI-HANDOVER-ACCESS message. The number will be checked by BSS-B to ensure it is as expected and the correct MS has been captured. If this is the correct MS then the BSS-B shall send an A-HANDOVER-DETECT to MSC-A. When the MS is successfully communicating with the BSS-B a RI-HANDOVER-COMplete message will be sent by the MS to BSS-B. The BSS-B will then send an A-HANDOVER-COMplete message to MSC-A.

NOTE: The A-HANDOVER-REQUEST-ACK from BSS-B contains the complete Radio Interface message that shall be sent by BSS-A to the MS in the RI-HANDOVER-COMMAND, MSC-A transparently passes this radio interface message onto BSS-A.

After MSC-A has received the A-HANDOVER-COMplete message from BSS-B it shall begin to release the resources allocated on BSS-A. In figure 7 the resource is released by using the A-CLEAR-COMMAND sequence.

In the case of ongoing GSM voice group calls the clearing of resources on BSS-A shall not be used if the resources are still be used on the down link.

If a failure occurs during the handover attempt, for example A-HANDOVER-FAILURE returned from BSS-A or BSS-B, then MSC-A will terminate the handover to BSS-B. Under these conditions MSC-A may optionally take one of a number of actions:

- i) retry the handover to the same cell;
- ii) select the next cell from the list contained in the A-HANDOVER-REQUIRED message and attempt a handover to the new cell;

- iii) await the next A-HANDOVER-REQUIRED message;
- iv) send an A-HANDOVER-REQUIRED-REJECT to BSS-A, if an A-HANDOVER-COMMAND has not already been sent.

The exact action taken is dependent on whether the failure occurs before or after the A-HANDOVER-COMMAND has been sent.

In all cases the existing connection to the MS shall not be cleared.

During the period that the MS is not in communication with the network MSC-A shall queue all appropriate messages. All messages shall be delivered to the MS once communication is resumed. In the case of an Intra-MS handover on MSC-B then the messages shall be queued by MSC-B.

In the case of ongoing GSM voice group calls if a failure occurs when handing over a user on a dedicated channel then the procedures described above may optionally be applied.

6.2 Procedure for Intra-3G_MSC Handovers

6.2.1 Intra-3G_MSC Handover from UMTS to GSM

The procedure for a successful Intra-3G_MSC handover from UMTS to GSM is shown in figure 8. It is assumed that selection of a candidate UE/MS has already taken place within the RNS based upon the criteria presented in clause 5. The exact algorithm, in the RNS, for determining a candidate UE/MS is not addressed in the present document. The procedures discussed do not make use of the Mobile Application Part (MAP), represented by signalling function 4 in figures 4 and 6. The procedure described in this subclause covers case ii).

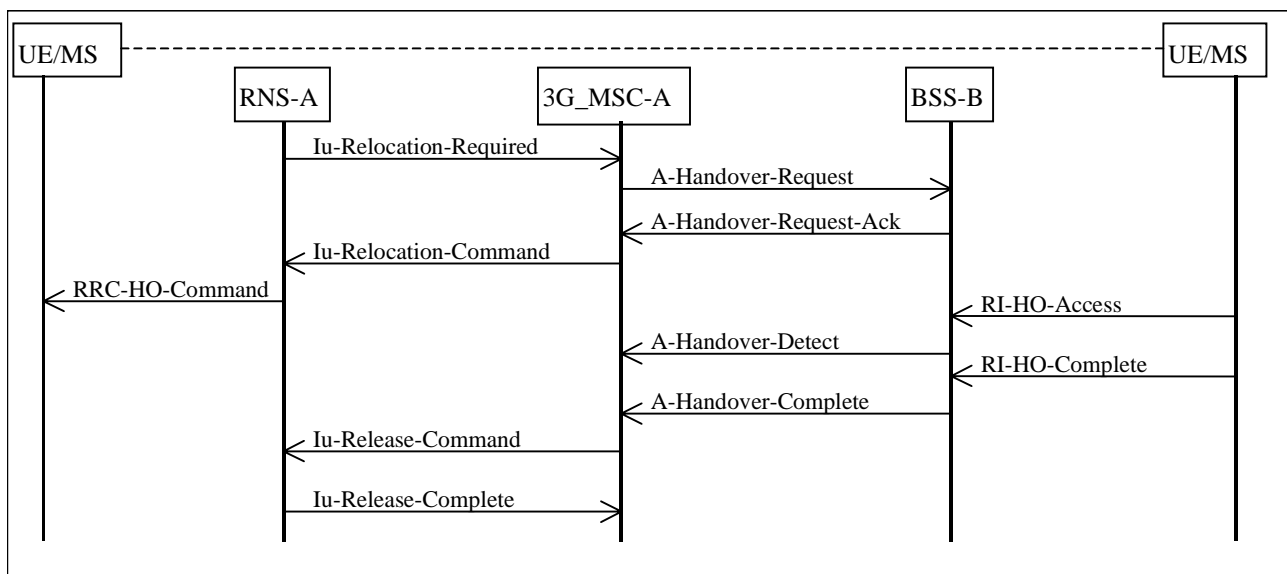

Figure 8: Basic Intra-3G_MSC Handover from UMTS to GSM Procedure

6.2.1.1 With no bearer or one bearer

The successful operation of the procedure is as follows. When the RNS (RNS-A), currently supporting the UE/MS, determines that the UE/MS requires to be handed over to GSM it will send an IU-RELOCATION-REQUIRED message to the 3G_MSC (3G_MSC-A). The IU-RELOCATION-REQUIRED message shall contain a single cell, to which the UE/MS can be handed over. When the 3G_MSC-A receives the IU-RELOCATION-REQUIRED message it shall begin the process of handing over the UE/MS to a BSS (BSS-B). The 3G_MSC-A shall generate an A-HANDOVER-REQUEST message to the selected BSS (BSS-B). When BSS-B receives the A-HANDOVER-REQUEST message it shall take the necessary action to allow the UE/MS to access the radio resource of BSS-B, this is detailed in 3GPP TS 08.58 [6] and in 3GPP TS 05.08 [4]. The switching of the radio resource through the necessary terrestrial resources is detailed in 3GPP TS 24.008 [10] and 3GPP TS 08.08 [5].

Once resource allocation has been completed by BSS-B it shall return an A-HANDOVER-REQUEST-ACK. to 3G_MSC-A. When this message is received by 3G_MSC-A it shall begin the process of instructing the UE/MS to tune to a new dedicated radio resource. An IU-RELOCATION-COMMAND will be sent by the 3G_MSC-A to RNS-A. On receipt of the IU-RELOCATION-COMMAND message RNS-A will send the radio resource control message RRC-HANDOVER-COMMAND, containing a Handover Reference number previously allocated by BSS-B, to the UE/MS. The UE/MS will then access the new radio resource using the Handover Reference number contained in the RI-HANDOVER-ACCESS message. The number will be checked by BSS-B to ensure it is as expected and the correct UE/MS has been captured. If this is the correct UE/MS then the BSS-B shall send an A-HANDOVER-DETECT to 3G_MSC-A. When the UE/MS is successfully communicating with the BSS-B a RI-HANDOVER-COMplete message will be sent by the UE/MS to BSS-B. The BSS-B will then send an A-HANDOVER-COMplete message to 3G_MSC-A.

NOTE: The A-HANDOVER-REQUEST-ACK from BSS-B contains the complete radio resource control message that shall be sent by RNS-A to the UE/MS in the RRC-HANDOVER-COMMAND, 3G_MSC-A transparently passes this radio interface message onto RNS-A.

After 3G_MSC-A has received the A-HANDOVER-COMplete message from BSS-B it shall begin to release the resources allocated on RNS-A. In figure 8 the resource is released by using the IU-RELEASE-COMMAND sequence.

If a failure occurs during the handover attempt, for example A-HANDOVER-FAILURE returned from BSS-B, then 3G_MSC-A will terminate the handover to BSS-B and send an IU-RELOCATION-PREPARATION-FAILURE message to RNS-A.

If RNS-A has decided to cancel the handover, it sends IU-RELOCATION-CANCEL message to 3G_MSC-A. The 3G_MSC-A will then terminate the handover towards BSS-B (if initiated) and send IU-RELOCATION-CANCEL-ACKNOWLEDGE message to RNS-A.

In all cases the existing connection to the UE/MS shall not be cleared except in the case of expiry of the timer for receipt of A-HANDOVER-COMplete.

During the period that the UE/MS is not in communication with the network 3G_MSC-A shall queue all appropriate messages. All messages shall be delivered to the UE/MS once communication is resumed. In the case of an Intra-3G_MSC handover from UMTS to GSM on 3G_MSC-B then the messages shall be queued by 3G_MSC-B.

6.2.1.2 With multiple bearers (Optional functionality)

If 3G_MSC-A supports the optional supplementary service Multicall (See 3GPP TS 23.135), 3G_MSC-A shall have the following functionality additionally to the description in section 6.2.1.1.

Upon receipt of the IU-RELOCATION-REQUIRED from RNS-A 3G_MSC-A shall select one bearer to be handed over if the UE is engaged with multiple bearers. After that, 3G_MSC-A generates an A-HO-REQUEST message for the selected bearer to BSS-B.

When an A-HO-REQUEST-ACK is received from BSS-B, 3G_MSC-A sends IU-RELOCATION-COMMAND, which indicates the bearers not to be handed over as bearers to be released, to RNS-A.

After 3G_MSC-A receives A-HO-COMplete message from BSS-B, 3G_MSC-A shall release calls via BSS-B, which has been carried by the bearers not to be handed over, and then sends IU-RELEASE-COMMAND to RNS-A.

6.2.2 Intra-3G_MSC GSM to UMTS Handover

The procedure for a successful Intra-3G_MSC handover is shown in figure 9. It is assumed that selection of a candidate UE/MS has already taken place within the BSC based upon the criteria presented in clause 5. The exact algorithm, in the BSC, for determining a candidate UE/MS is not addressed in the present document. The procedures discussed do not make use of the Mobile Application Part (MAP), represented by signalling function 4 in figures 4 and 6. The procedure described in this subclause covers case ii).

In case of subsequent handover the following applies. If 3G_MSC-B supports Location Reporting Control, 3G_MSC-B shall always initiate the Location Reporting Control procedure towards the target RNS since no request for Location Reporting is received from MSC-A. If supported by the 3G_MSC-B, the Location Reporting Control procedure shall be initiated after the Relocation Resource Allocation procedure has been executed successfully.

In the case of ongoing voice group calls, the handover does not take place since voice group calls are not supported in UMTS.

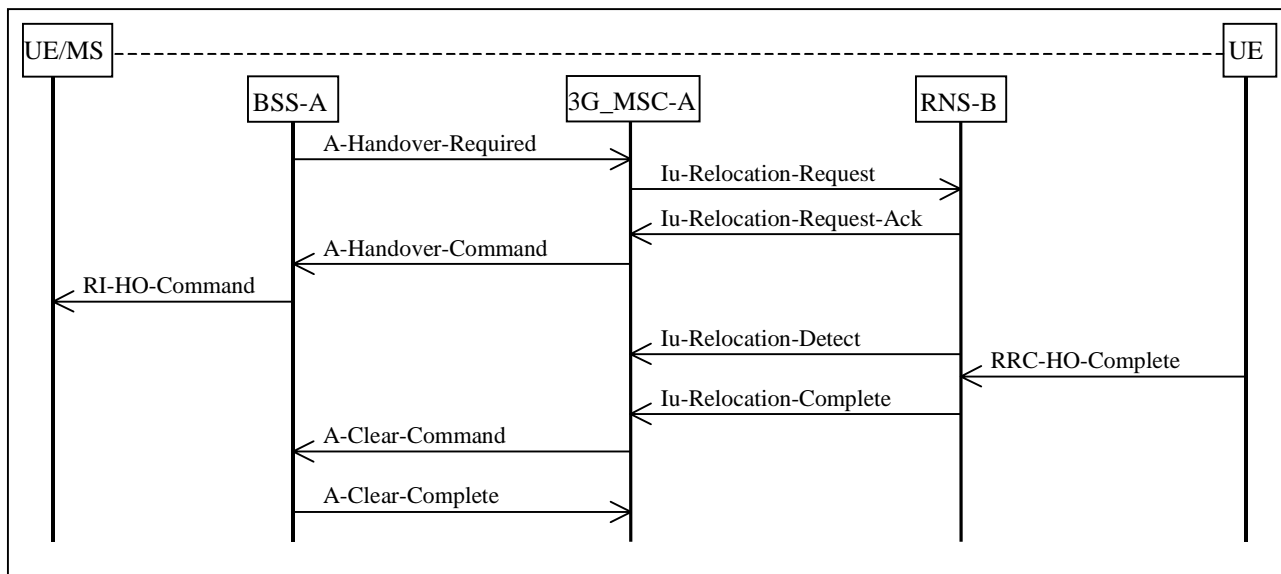

Figure 9: Basic External Intra-3G_MSC GSM to UMTS Handover Procedure

The successful operation of the procedure is as follows. When the BSS (BSS-A), currently supporting the UE, determines that the UE requires to be handed over to UMTS it will send an A-HANDOVER-REQUIRED message to the 3G_MSC (3G_MSC-A). The A-HANDOVER-REQUIRED message shall contain a single cell, to which the UE can be handed over. When the 3G_MSC-A receives the A-HANDOVER-REQUIRED message it shall begin the process of handing over the UE to a new RNS (RNS-B). The 3G_MSC-A shall generate an Iu-RELOCATION-REQUEST message to the selected RNS (RNS-B). When RNS-B receives the Iu-RELOCATION-REQUEST message it shall take the necessary action to allow the UE to access the radio resource of RNS-B, this is detailed in the 3GPP TS 25.300 series and the 3GPP TS 25.200 series of Technical Specifications. The switching of the radio resource through the necessary terrestrial resources is detailed in the 3GPP TS 25.430 series and 3GPP TS 25.413 [11].

Once resource allocation has been completed by RNS-B, it shall return an Iu-RELOCATION-REQUEST-ACK. to 3G_MSC-A. When this message is received by 3G_MSC-A it shall begin the process of instructing the UE to tune to a new dedicated radio resource. An A-HANDOVER-COMMAND will be sent by the 3G_MSC-A to BSS-A. On receipt of the A-HANDOVER-COMMAND message BSS-A will send the radio interface message RI-HANDOVER-COMMAND. The UE will then access the new radio resource. On detection of the UE, the RNS-B shall send an Iu-RELOCATION-DETECT to 3G_MSC-A. When the UE is successfully communicating with the RNS-B an RRC-HANDOVER-COMplete message will be sent by the UE to RNS-B. The RNS-B will then send an Iu-RELOCATION-COMplete message to 3G_MSC-A.

NOTE: The Iu-RELOCATION-REQUEST-ACK from RNS-B contains the complete RRC message that shall be sent by BSS-A to the MS in the RI-HANDOVER-COMMAND, 3G_MSC-A transparently passes this radio interface message onto BSS-A.

After 3G_MSC-A has received the Iu-RELOCATION-COMplete message from RNS-B, it shall begin to release the resources allocated on BSS-A. In figure 9 the resource is released by using the A-CLEAR-COMMAND sequence.

If a failure occurs during the handover attempt, for example, A-HANDOVER-FAILURE returned from BSS-A or Iu-RELOCATION FAILURE returned from RNS-B, then 3G_MSC-A will terminate the handover to RNS-B. Under these conditions 3G_MSC-A may optionally take one of a number of actions:

- i) await the next A-HANDOVER-REQUIRED message;
- ii) send an A-HANDOVER-REQUIRED-REJECT to BSS-A, if an A-HANDOVER-COMMAND has not already been sent.

The exact action taken is dependent on whether the failure occurs before or after the A-HANDOVER-COMMAND has been sent.

In all cases the existing connection to the UE shall not be cleared.

During the period that the UE is not in communication with the network 3G_MSC-A shall queue all appropriate messages. All messages shall be delivered to the UE once communication is resumed. In the case of an Intra-3G_MSC GSM to UMTS handover on 3G_MSC-B then the messages shall be queued by 3G_MSC-B.

6.2.3 Procedure for Intra-3G_MSC SRNS Relocation

The procedure for a successful Intra-3G_MSC SRNS Relocation is shown in figures 10 and 11. SRNS Relocation is used to relocate the serving RNS functionality from one RNS to another. The procedure may or may not involve change of the radio resources assigned for the corresponding UE. Whether or not the Relocation includes change of radio resources assigned for the UE does not affect the SRNS Relocation procedure in the Core Network.

It is assumed that selection of a candidate UE has already taken place within RNS based upon the criteria presenting in clause 5. The exact algorithm, in RNS, for determining a candidate UE is not addressed in the present document. The procedure discussed does not make use of the Mobile Application Part (MAP), represented by signalling function 4 in figures 4 and 6. The procedure described in this subclause covers case ii).

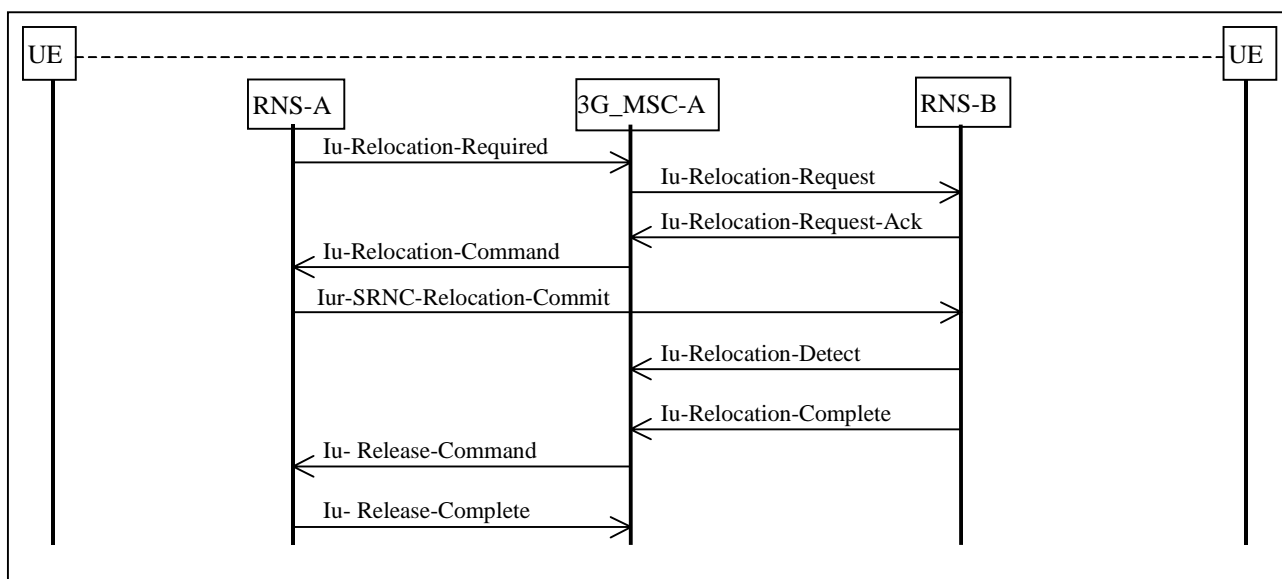

Figure 10 Basic intra-3G_MSC SRNS Relocation Procedure

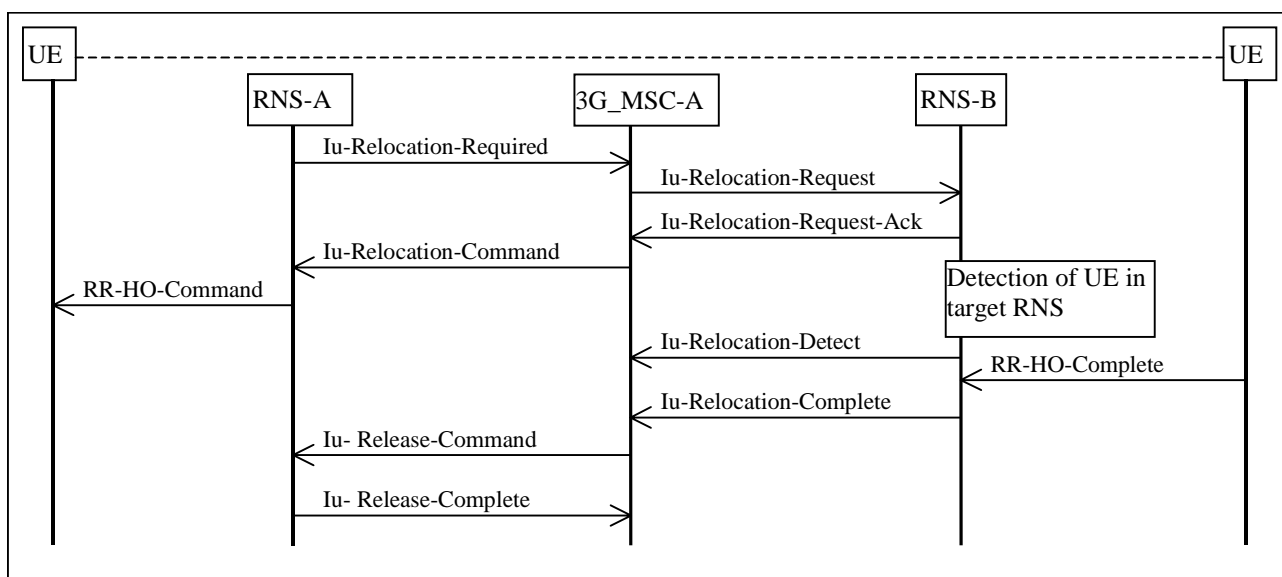

Figure 11 Basic intra-3G_MSC SRNS Relocation Procedure combined with hard change of radio resources (Hard Handover with switch in the Core Network)

6.2.3.1 With no bearer or one bearer

The successful operation of the procedure is as follows. When the Serving RNS (RNS-A) makes the decision to perform the SRNS Relocation procedure it will send an IU-RELOCATION-REQUIRED message to the 3G_MSC (3G_MSC-A). The IU-RELOCATION-REQUIRED message shall contain the identifier of the target RNS to which the Relocation is to be performed. When the 3G_MSC-A receives the IU-RELOCATION-REQUIRED message it shall begin the process of relocating the serving RNS functionality to the new RNS (RNS-B). The 3G_MSC-A shall generate an IU-RELOCATION-REQUEST message to the selected RNS (RNS-B). When RNS-B receives the IU-RELOCATION-REQUEST message it shall take the necessary action to establish the new Iu transport bearers for each Radio Access Bearer related to 3G_MSC-A for the UE in question, this is detailed in the 3GPP TS 25.430 series and 3GPP TS 25.413 [11].

Once resource allocation has been completed by RNS-B it shall return an IU-RELOCATION-REQUEST-ACKNOWLEDGE to 3G_MSC-A. When this message is received by 3G_MSC-A, and 3G_MSC-A is ready for the move in Serving RNS functionality, it shall indicate the completion of the preparation phase on the core network side for the SRNS Relocation. An IU-RELOCATION-COMMAND message is sent by 3G_MSC-A to RNS-A. RNS-A acts as follows:

- i) if the procedure is a SRNS Relocation without change of radio resources, which means that the Iur interface between RNS-A and RNS-B can be used for the procedure, the RNS-A shall send IUR-SRNS-RELOCATION-COMMIT message to the RNS-B to trigger the Relocation execution. See figure 10.
- ii) if the procedure is a SRNS Relocation with change of radio resources, which means that the Iur interface between RNS-A and RNS-B is not used for the procedure, the RNS-A shall trigger the handover procedure on the air interface by sending the RRC-HANDOVER-COMMAND to the UE. The UE will then access the new radio resources. See figure 11.

NOTE: The IU-RELOCATION-REQUEST-ACKNOWLEDGE from RNS-B may optionally contain a transparent container, which is transferred by 3G_MSC-A to the RNS-A using the IU-RELOCATION-COMMAND message.

When the relocation execution trigger is received, RNS-B shall then take the necessary action to assume the role of Serving RNS and shall send an IU-RELOCATION-DETECT message to 3G_MSC-A. When the UE is successfully in communication with the RNS-B, then RNS-B shall send an IU-RELOCATION-COMplete message to 3G_MSC-A.

After 3G_MSC-A has received the IU-RELOCATION-COMplete message from RNS-B, it shall begin to release the resources associated to the RNS-A. In figures 10 and 11, the resources are released by using the IU-RELEASE-COMMAND sequence.

If a failure occurs during the SRNS Relocation attempt, then 3G_MSC-A will terminate the relocation to RNS-B. For example, if IU-RELOCATION-FAILURE is returned from RNS-B then 3G_MSC-A will terminate the relocation to RNS-B and send IU-RELOCATION-PREPARATION-FAILURE to RNS-A. If IU-RELOCATION-CANCEL is returned from RNS-A, then 3G_MSC-A will terminate the relocation to RNS-B and send IU-RELOCATION-CANCEL-ACKNOWLEDGE to RNS-A.

In all cases the existing connection to the UE shall not be cleared.

During the period that the UE is not in communication with the network, 3G_MSC-A shall queue all appropriate messages. All messages shall be delivered to the UE once communication is resumed. In the case of an Intra-3G_MSC SRNS Relocation (with or without change of radio resources) on 3G_MSC-B, then the messages shall be queued by 3G_MSC-B.

6.2.3.2 With multiple bearers (Optional functionality)

If 3G_MSC-A supports the optional supplementary service Multicall (See 3GPP TS 23.135), 3G_MSC-A shall have the following functionality additionally to the description in section 6.2.3.1.

Upon receipt of the IU-RELOCATION-REQUIRED from RNS-A, 3G_MSC-A generates an IU-RELOCATION-REQUEST message, which may include multiple bearers, to RNS-B.

When an IU-RELOCATION-REQUEST-ACK is received from RNS-B, 3G_MSC-A sends IU-RELOCATION-COMMAND, which indicates the bearers failed to set up in RNS-B as bearers to be released, to RNS-A.

After 3G_MSC-A receives IU-RELOCATION-COMPLETE message from RNS-B, 3G_MSC-A shall release calls via RNS-B, which has been carried by the bearers failed to set up in RNS-B, and then sends IU-RELEASE-COMMAND to RNS-A.

7 General description of the procedures for inter - MSC handovers

The following subclauses describe two options for the Basic and Subsequent Handover procedures. The first, as described in subclauses 7.1 and 7.3 respectively, provides for a circuit connection between MSC-A and MSC-B. The second, as described in subclauses 7.2 and 7.4 respectively, provides for a Basic and Subsequent Handover without the provision of a circuit connection between MSC-A and MSC-B.

In all the above mentioned subclauses, the following principles apply:

- during the handover resource allocation, only the handover related messages that are part of the applicable BSSAP subset - as defined in 3GPP TS 09.08 [7] - shall be transferred on the E-interface;
- the trace related messages that are part of the applicable BSSAP subset - as defined in 3GPP TS 09.08 [7] - can be sent by the MSC-A on the E-interface after successful handover resource allocation. In the subclauses 7.1 and 7.2, it is however allowed at basic handover initiation on the E-Interface to transfer one trace related message that is part of the applicable BSSAP subset - as defined in 3GPP TS 09.08 [7] - together with the applicable handover related message. The applicable handover related message shall always appear as the first message;
- during the handover execution, ie while the MS is not in communication with the network, the MSC-A shall queue all outgoing BSSAP messages until the communication with the MS is resumed;
- finally, during supervision, ie while the MS is not in the area of MSC-A after a successful Inter-MSC handover, the subset of BSSAP procedures and their related messages - as defined in 3GPP TS 09.08 [7] - shall apply on the E-Interface;
- during the intra-MSC-B handover execution, if any, the MSC-B shall queue all outgoing BSSAP messages until the communication with the MS is resumed.

7.1 Basic handover procedure requiring a circuit connection between MSC-A and MSC-B

The procedure used for successful Inter-MSC Handover is shown in figure 12. Initiation of the handover procedure is described in clause 5. The procedure described in this subclause makes use of messages from the 3GPP TS 08.08 [5] and of the transport mechanism from the Mobile Application Part (MAP) (3GPP TS 29.002 [12]). After an Inter-MSC handover further Intra-MSC handovers may occur on MSC-B, these handovers will follow the procedures specified in the previous clause.

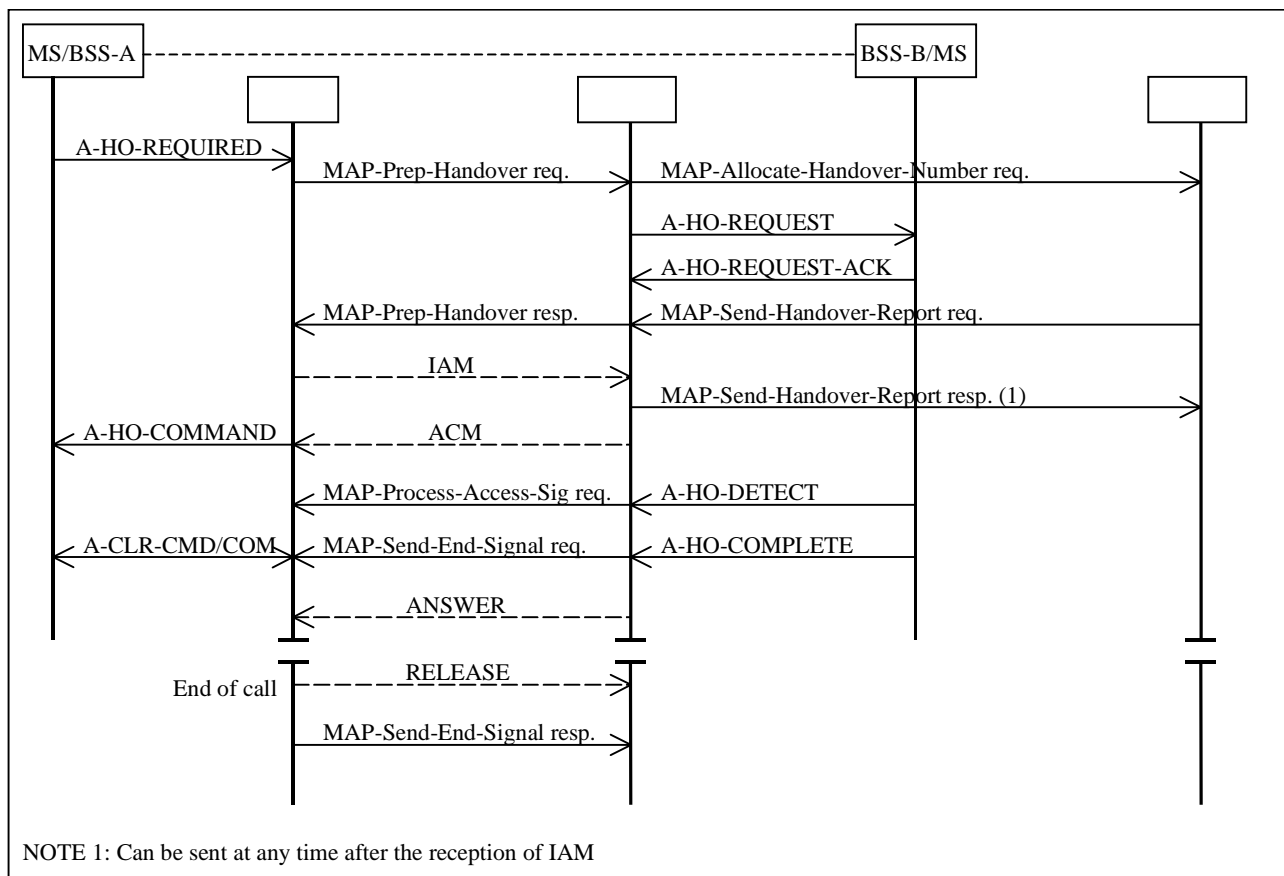

Figure 12: Basic Handover Procedure requiring a circuit connection

The handover is initiated as described in subclause 6.1. (This is represented by A-HO-REQUIRED in figure 12. Upon receipt of the A-HO-REQUIRED from BSS-A, MSC-A shall send a MAP-PREPARE-HANDOVER request to MSC-B including a complete A-HO-REQUEST message.

NOTE: MSC-A shall not send further MAP-PREPARE-HANDOVER requests while a MAP-PREPARE-HANDOVER response is pending or before any timeouts.

The MAP-PREPARE-HANDOVER request shall carry in the A-HO-REQUEST all information needed by MSC-B for allocating a radio channel, see 3GPP TS 08.08 [5]. For compatibility reasons, the MAP-PREPARE-HANDOVER request will also identify the cell to which the call is to be handed over. MSC-B will return the MAP-PREPARE-HANDOVER response after having retrieved a Handover Number from its associated VLR (exchange of the messages MAP-allocate-handover-number request and MAP-send-handover-report request). The Handover Number shall be used for routing the connection of the call from MSC-A to MSC-B. If a traffic channel is available in MSC-B the MAP-PREPARE-HANDOVER response, sent to MSC-A will contain the complete A-HO-REQUEST-ACKNOWLEDGE message received from BSS-B, containing the radio resources definition to be sent by BSS-A to the MS and possible extra BSSMAP information, amended by MSC-B due to the possible interworking between the BSSMAP protocol carried on the E-interface and the BSSMAP protocol used on the A-interface. If the traffic channel allocation is queued by BSS-B, the A-QUEUING-INDICATION may optionally be sent back to MSC-A. The further traffic channel allocation result (A-HO-REQUEST-ACK or A-HO-FAILURE) will be transferred to MSC-A using the MAP-PROCESS-ACCESS-SIGNALLING request. If the traffic channel allocation is not possible, the MAP-PREPARE-HANDOVER response containing an A-HO-FAILURE will be sent to MSC-A. MSC-B will do the same if a fault is detected on the identity of the cell where the call has to be handed over. MSC-B simply reports the events related to the dialogue. It is up to MSC-A to decide the action to perform if it receives negative responses or the operation fails due to the expiry of the MAP-PREPARE-HANDOVER timer.

If an error related to the TCAP dialogue or to the MAP-PREPARE-HANDOVER request is returned from MSC-B, this will be indicated to MSC-A and MSC-A will terminate the handover attempt. MSC-A may retry the handover attempt using the cell identity list, if provided, or may reject the handover attempt towards BSS-A. The existing connection to the MS shall not be cleared.

When the A-HO-REQUEST-ACKNOWLEDGE has been received, MSC-A shall establish a circuit between MSC-A and MSC-B by signalling procedures supported by the network. In figure 12 this is illustrated by the messages IAM (Initial Address Message) and ACM (Address Complete Message) of Signalling System no 7. MSC-B awaits the capturing of the MS (subclause 6.1) on the radio path when the ACM is sent and MSC-A initiates the handover execution when ACM is received (illustrated by the A-HO-COMMAND and described in the subclause 6.1).

MSC-B transfers to MSC-A the acknowledgement received from the correct MS (A-HO-DETECT/A-HO-COMplete). The A-HO-DETECT, if received, is transferred to MSC-A using the MAP-PROCESS-ACCESS-SIGNALLING request. The A-HO-COMplete, when received from the correct MS, is included in the MAP-SEND-END-SIGNAL request and sent back to MSC-A. The circuit is through-connected in MSC-A when the A-HO-DETECT or the A-HO-COMplete is received from MSC-B. The old radio channel is released when the A-HO-COMplete message is received from MSC-B. The sending of the MAP-SEND-END-SIGNAL request starts the MAP supervision timer for the MAP dialogue between MSC-A and MSC-B. When the MAP-SEND-END-SIGNAL request including the A-HO-COMplete message is received in MSC-A the resources in BSS-A shall be cleared.

In order not to conflict with the PSTN/ISDN signalling system(s) used between MSC-A and MSC-B, MSC-B must generate an answer signal when A-HO-DETECT/COMplete is received.

MSC-B shall release the Handover Number when the circuit between MSC-A and MSC-B has been established.

If the circuit between MSC-A and MSC-B cannot be established (e.g. an unsuccessful backward message is received instead of ACM). MSC-A terminates the inter-MSC handover attempt by sending an appropriate MAP message, for example an ABORT. MSC-A may retry the handover at this point, see subclause 6.1.

MSC-A shall retain overall call control until the call is cleared by the fixed subscriber or the MS and there is no further call control functions to be performed (e.g. servicing waiting calls, echo cancellers).

When MSC-A clears the call to the MS it also clears the call control functions in MSC-A and sends the MAP-SEND-END-SIGNAL response to release the MAP resources in MSC-B.

MSC-A may terminate the procedure at any time by sending an appropriate MAP message to MSC-B. If establishment of the circuit between MSC-A and MSC-B has been initiated, the circuit must also be cleared.

The handover will be aborted by MSC-A if it detects clearing or interruption of the radio path before the call has been established on MSC-B.

7.2 Basic handover procedure not requiring the establishment of a circuit connection between MSC-A and MSC-B

The basic handover procedures to be used when no circuit connection is required by MSC-A are similar to those described in subclause 7.1 for circuit switched calls. The main differences to the procedures described in subclause 7.1 relate to the establishment of circuits between the network entities and the Handover Number allocation.

In the case of ongoing GSM voice group calls the circuit connections are already established therefore the procedures described in this subclause are also applicable. When applied to ongoing voice group calls the clearing of resources on BSS-A shall not be used if the resources are still be used on the down link. Consequently the A-CLEAR-COMMAND message shall not be sent, but an HANDOVER-SUCCEDED message shall be sent.

In the case of basic handover, MSC-A shall specify to MSC-B that no Handover Number is required in the MAP-PREPARE-HANDOVER request (see 3GPP TS 29.002 [12]). As for the basic handover using a circuit connection, the A-HO-REQUEST is transmitted at the same time. Any subsequent Handover Number allocation procedure will not be invoked until the completion of the basic handover procedure (see clause: Subsequent Channel Assignment using a circuit connection). MSC-B shall then perform the radio resources allocation as described in subclause 7.1. The MAP-PREPARE-HANDOVER response shall be returned to MSC-A including either the response of the radio resources allocation request received from BSS-B (A-HO-REQUEST-ACKNOWLEDGE/A-HO-FAILURE with possible extra BSSMAP information. These extra information are amended by MSC-B due to the possible interworking between the BSSMAP protocol carried on the E-interface and the BSSMAP protocol used on the A-interface) or potentially the A-QUEUING-INDICATION. The basic handover procedure will continue as described in subclause 7.1 except that no circuit connection will be established towards MSC-B.

The relevant case for the basic handover without circuit connection is shown in figure 13. As can be seen the major differences to the equivalent figure 12 is the omission of any circuit establishment messaging and the omission of handover number allocation signalling.

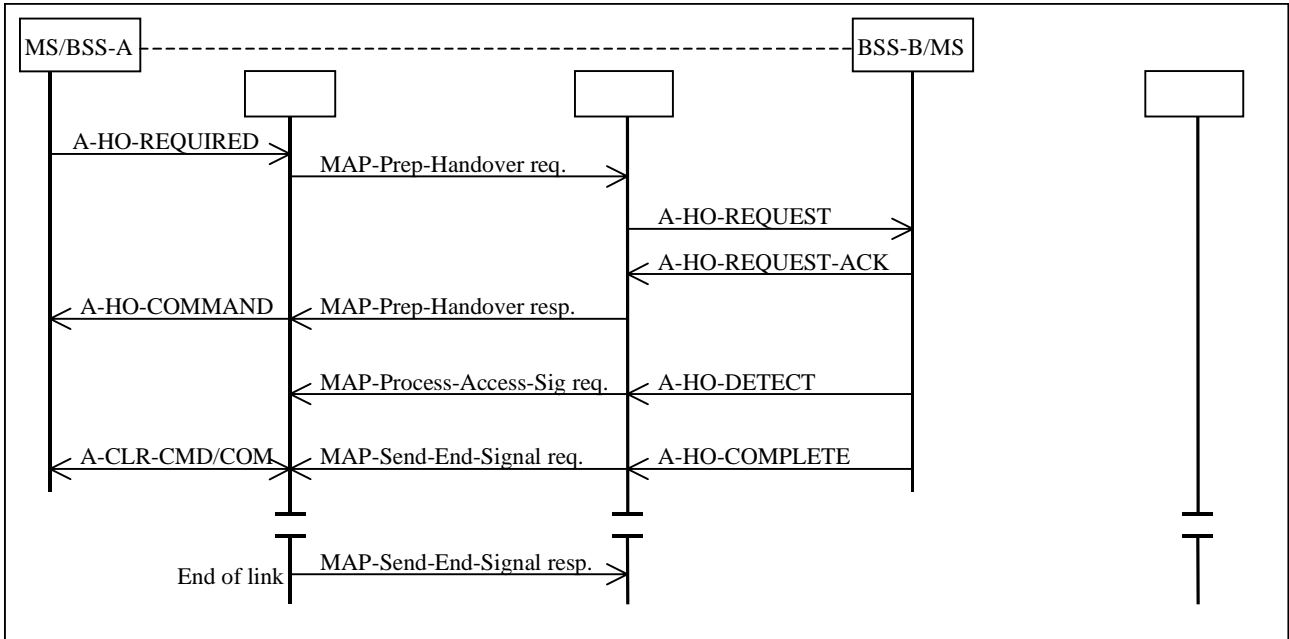

Figure 13: Basic Handover Procedure without circuit connection

7.3 Procedure for subsequent handover requiring a circuit connection

After the call has been handed over to MSC-B, if the MS leaves the area of MSC-B during the same call, subsequent handover is necessary in order to continue the connection.

The following cases apply:

- i) the MS moves back to the area of MSC-A;
- ii) the MS moves into the area of a third MSC (MSC-B').

In both cases the call is switched in MSC-A; the circuit between MSC-A and MSC-B shall be released after a successful subsequent handover has been performed.

7.3.1 Description of subsequent handover procedure i): MSC-B to MSC-A

The procedure for successful handover from MSC-B back to MSC-A is shown in figure 14.

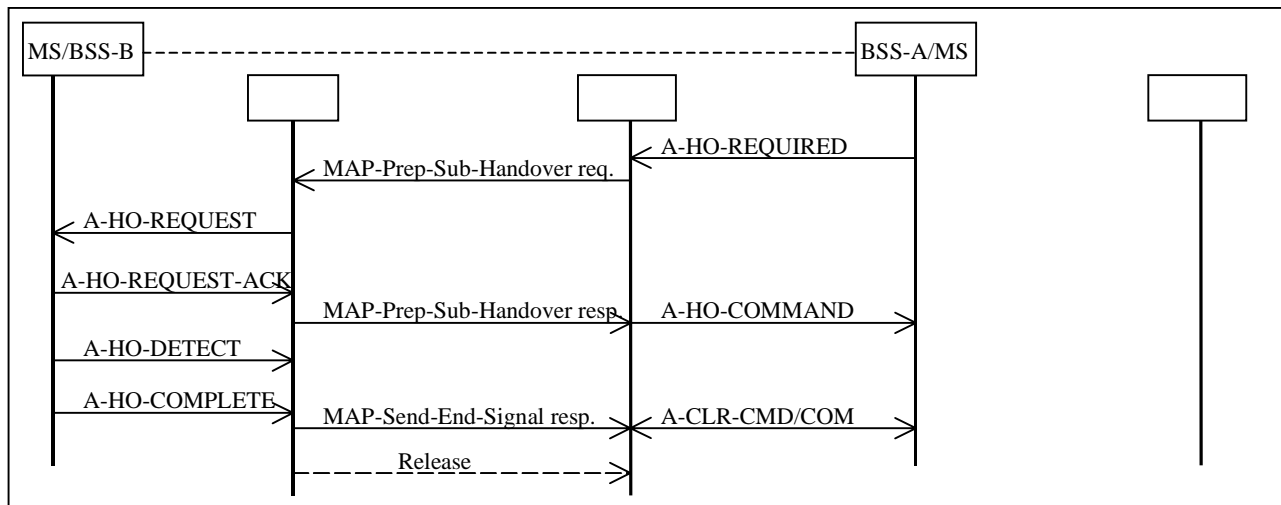

Figure 14: Subsequent handover procedure i):successful handover from MSC-B to MSC-A using a circuit connection

The procedure is as follows.

MSC-B sends the MAP-PREPARE-SUBSEQUENT-HANDOVER request to MSC-A indicating the new MSC number(MSC-A number), indicating also the identity of the cell where the call has to be handed over and including a complete A-HO-REQUEST message. (NOTE: MSC-B shall not send further MAP-PREPARE-SUBSEQUENT-HANDOVER requests while a handover attempt is pending or before any timeouts). Since MSC-A is the call controlling MSC, this MSC needs no Handover Number for routing purposes; MSC-A can immediately initiate the search for a free radio channel.

When a radio channel can be assigned, MSC-A shall return in the MAP-PREPARE-SUBSEQUENT-HANDOVER response the complete A-HO-REQUEST-ACKNOWLEDGE message received from the BSS-B and possible extra BSSMAP information, amended by MSC-A due to the possible interworking between the BSSMAP protocol carried on the E-interface and the BSSMAP protocol used on the A-interface. If the traffic channel allocation is queued by BSS-B, the A-QUEUING-INDICATION may optionally be sent back to MSC-B. The further traffic channel allocation result (A-HO-REQUEST-ACK or A-HO-FAILURE) will be transferred to MSC-B using the MAP-FORWARD-ACCESS-SIGNALING request.If a radio channel cannot be assigned or if a fault is detected on the target cell identity, or the target cell identity in the A-HO-REQUEST is not consistent with the target MSC number, the MAP-PREPARE-SUBSEQUENT-HANDOVER response containing an A-HO-FAILURE message shall be given to MSC-B, in addition MSC-B shall maintain the connection with the MS.

If the procedure in MSC-A is successful then MSC-B can request the MS to retune to the new BSS-B on MSC-A. This is illustrated in figure 14 by the A-HO-COMMAND message. The operation is successfully completed when MSC-A receives the A-HO-COMPLETE message.

After handover MSC-A shall release the circuit to MSC-B.

MSC-A must also terminate the MAP procedure for the basic handover between MSC-A and MSC-B by sending an appropriate MAP message. MSC-B will clear the resources in BSS-A when the MAP-SEND-END-SIGNAL response is received.

7.3.2 Description of the subsequent handover procedure ii): MSC-B to MSC-B'

The procedure for successful handover from MSC-B to MSC-B' is shown in figure 15.

The procedure consists of two parts:

- a subsequent handover from MSC-B back to MSC-A as described in subclause 7.3.1 (the same procedures apply if MSC-A is replaced by 3G_MSC-A); and
- a basic handover from MSC-A to MSC-B' as described in subclause 7.1.

MSC-B sends the MAP-PREPARE-SUBSEQUENT-HANDOVER request to MSC-A indicating a new MSC number (which is the identity of MSC-B'), indicating also the target cell identity and including a complete A-HO-REQUEST, MSC-A then starts a basic handover procedure towards MSC-B'.

When MSC-A receives the ACM from MSC-B', MSC-A informs MSC-B that MSC-B' has successfully allocated the radio resources on BSS-B' side by sending the MAP-PREPARE-SUBSEQUENT-HANDOVER response containing the complete A-HO-REQUEST-ACKNOWLEDGE received from BSS-B' and possible extra BSSMAP information, amended by MSC-A due to the possible interworking between the BSSMAP protocol carried on the E-interface between MSC-A and MSC-B' and the BSSMAP protocol carried on the E-interface between MSC-A and MSC-B. Now MSC-B can start the procedure on the radio path.

For MSC-A the handover is completed when it has received the MAP-SEND-END-SIGNAL REQUEST from MSC-B' containing the A-HO-COMPLETE received from the BSS-B'. The circuit between MSC-A and MSC-B is released. MSC-A also sends the MAP-SEND-END-SIGNAL response to MSC-B in order to terminate the original MAP dialogue between MSC-A and MSC-B. MSC-B releases the radio resources when it receives this message.

If the traffic channel allocation is queued by the BSS-B', the A-QUEUING-INDICATION may optionally be sent back to MSC-B. If no radio channel can be allocated by MSC-B' or no circuit between MSC-A and MSC-B' can be established or a fault is detected on the target cell identity or the target cell identity in the A-HO-REQUEST is not consistent with the target MSC number, MSC-A informs MSC-B by using the A-HO-FAILURE message included in the MAP-PREPARE-SUBSEQUENT-HANDOVER response. MSC-B shall maintain the existing connection with the MS.

When the subsequent handover is completed, MSC-B' is considered as MSC-B. Any further inter-MSC handover is handled as described above for a subsequent handover.

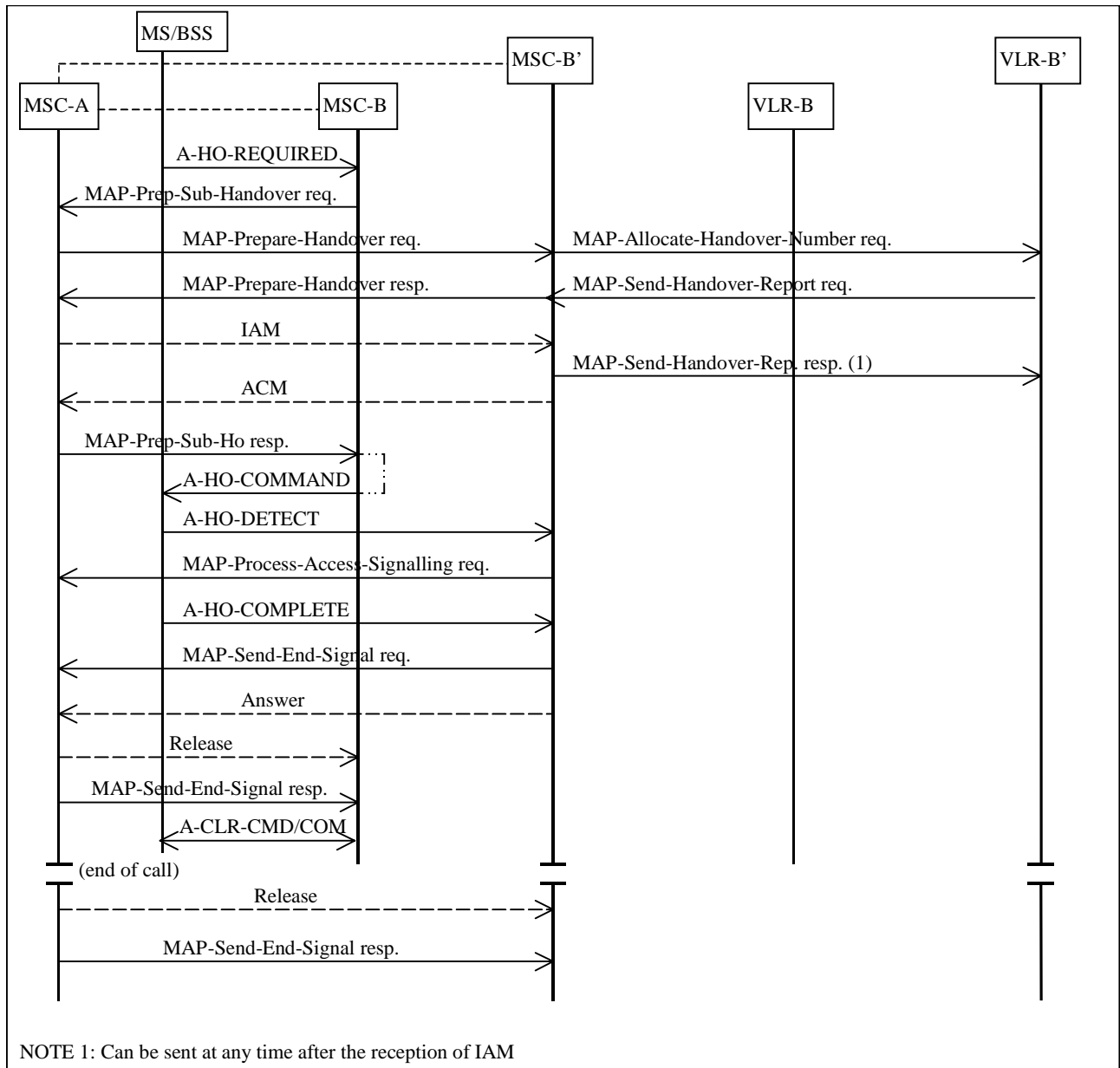

Figure 15: Subsequent handover procedure ii): Successful handover from MSC-B to MSC-B' requiring a circuit connection

7.4 Procedure for subsequent handover not requiring a circuit connection

As for the subsequent handover with a circuit connection, the same two cases of subsequent handover apply:

- i) the MS moves back to the area of MSC-A;
- ii) the MS moves into the area of a third MSC (MSC-B').

7.4.1 Description of the subsequent handover procedure without circuit connection i): MSC-B to MSC-A

The procedure for successful handover from MSC-B back to MSC-A without circuit connection is shown in figure 16. The only difference with the figure 14, is that no circuit release is needed between MSC-A and MSC-B.

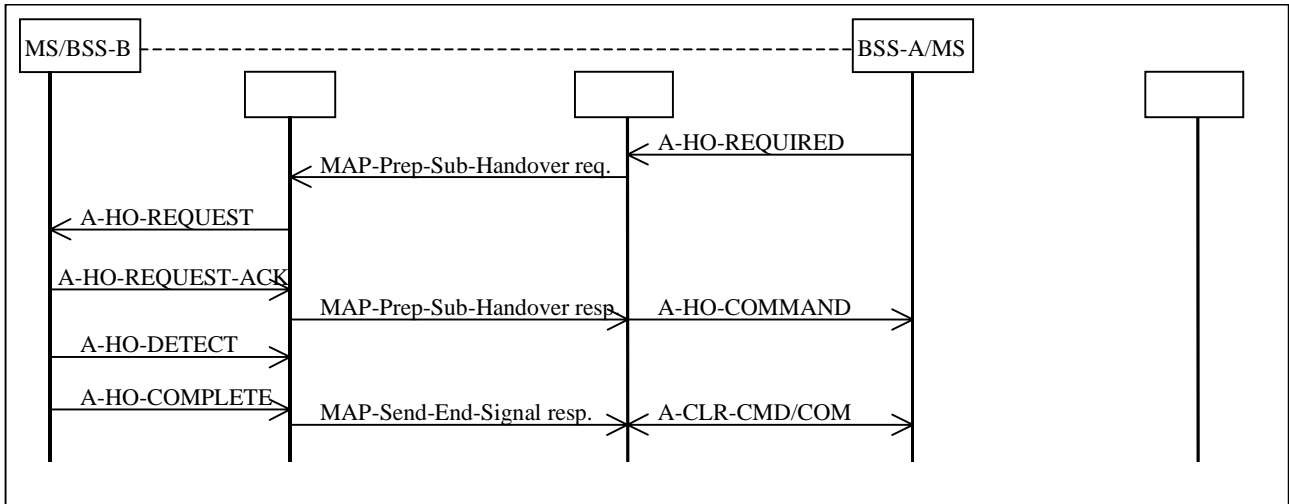

Figure 16: Subsequent handover procedure i): Successful handover from MSC-B to MSC-A not requiring a circuit connection

7.4.2 Description of the subsequent handover procedure without circuit connection ii): MSC-B to MSC-B'

The procedure for successful handover from MSC-B to MSC-B' is shown in figure 17.

The procedure consists of two parts:

- a subsequent handover from MSC-B back to MSC-A as described in subclause 7.4.1 (the same procedures apply if MSC-A is replaced by 3G_MSC-A); and
- a basic handover from MSC-A to MSC-B' as described in subclause 7.2.

The only difference to the equivalent figure 15 is the omission of the circuit and handover number allocation signalling.

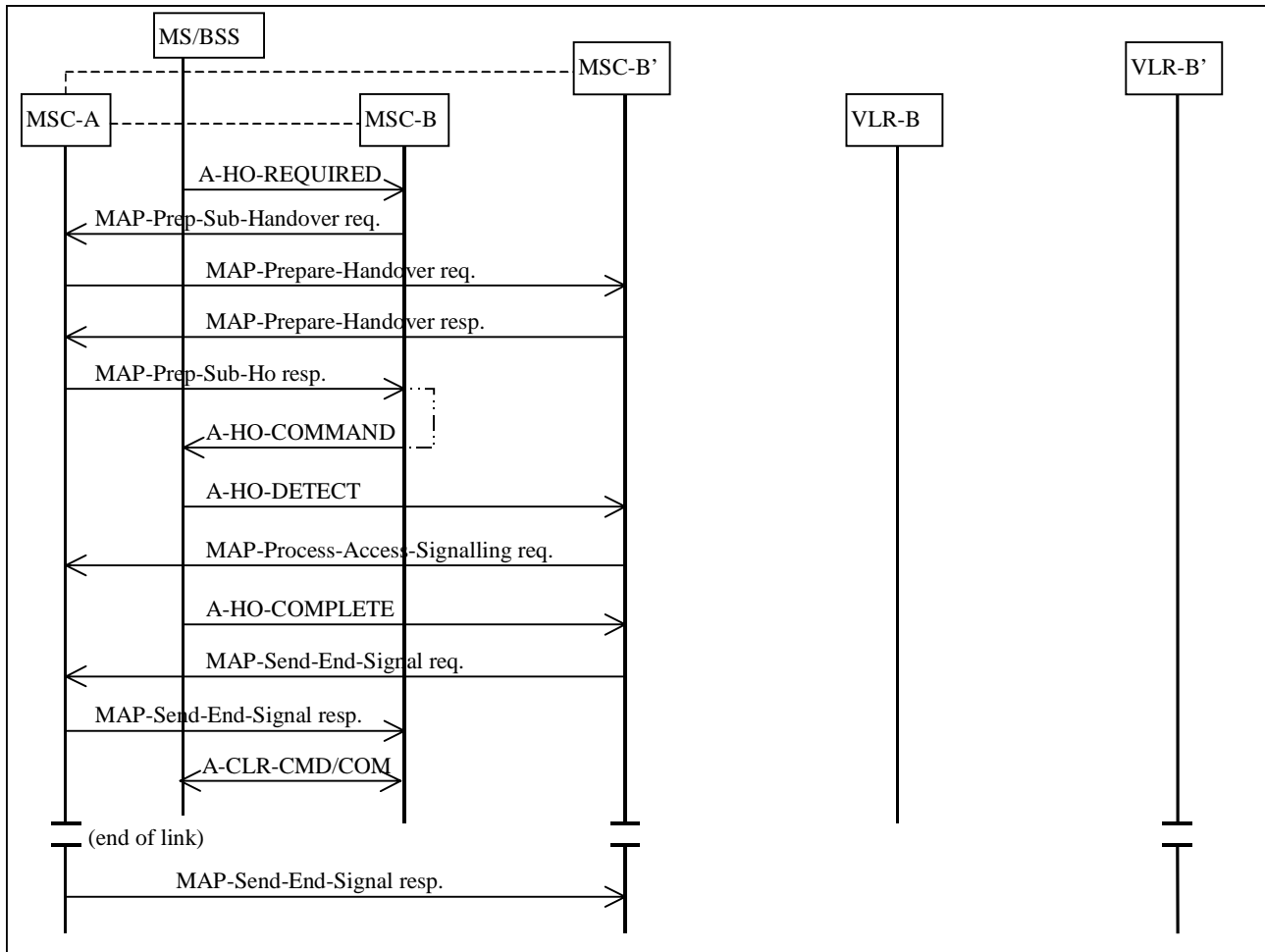

Figure 17: Subsequent handover procedure ii): Successful handover from MSC-B to MSC-B' without circuit connection

8 General Description of the procedures for inter - 3G_MSC handovers

8.1 Handover UMTS to GSM

The following subclauses describe two options for the Basic and Subsequent UMTS to GSM Handover procedures. The first, as described in subclauses 8.1.1 and 8.1.3 respectively, provides for a circuit connection between 3G_MSC-A and 3G_MSC-B. The second, as described in subclauses 8.1.2 and 8.1.4 respectively, provides for a Basic and Subsequent Handover without the provision of a circuit connection between 3G_MSC-A and 3G_MSC-B. 3G_MSC can also be a pure GSM MSC.

In all the above mentioned subclauses, the following principles apply:

- during the handover resource allocation, only the handover related messages that are part of the applicable BSSAP subset - as defined in 3GPP TS 09.08 [7] - shall be transferred on the E-interface;
- the trace related messages that are part of the applicable BSSAP subset - as defined in 3GPP TS 09.08 - can be sent by the 3G_MSC-A on the E-interface after successful handover resource allocation. In the subclauses 8.1.1 and 8.1.2, it is however allowed at basic handover initiation on the E-Interface to transfer one trace related message that is part of the applicable BSSAP subset - as defined in 3GPP TS 09.08 [7] - together with the applicable handover related message. The applicable handover related message shall always appear as the first message;

- during the handover execution, i.e. while the UE/MS is not in communication with the network, the 3G_MSC-A shall queue all outgoing BSSAP/Direct Transfer messages until the communication with the UE/MS is resumed;
- finally, during supervision, i.e. while the UE/MS is not in the area of 3G_MSC-A after a successful Inter-3G_MSC handover, the subset of BSSAP procedures and their related messages - as defined in 3GPP TS 09.08 [7] - shall apply on the E-Interface;
- during the intra-3G_MSC -B handover execution, if any, the 3G_MSC -B shall queue all outgoing BSSAP messages until the communication with the UE/MS is resumed.

8.1.1 Basic Handover procedure requiring a circuit connection between 3G_MSC -A and MSC-B

The procedure used for successful Inter-3G_MSC UMTS to GSM Handover is shown in figure 18. Initiation of the UMTS to GSM handover procedure is described in clause 5. The procedure described in this subclause makes use of messages from the 3GPP TS 08.08 and of the transport mechanism from the Mobile Application Part (MAP) (3GPP TS 29.002 [12]). After an Inter-3G_MSC relocation/handover, Intra-3G_MSC UMTS to GSM handover may occur on 3G_MSC -B, this handover will follow the procedures specified in a previous subclause.

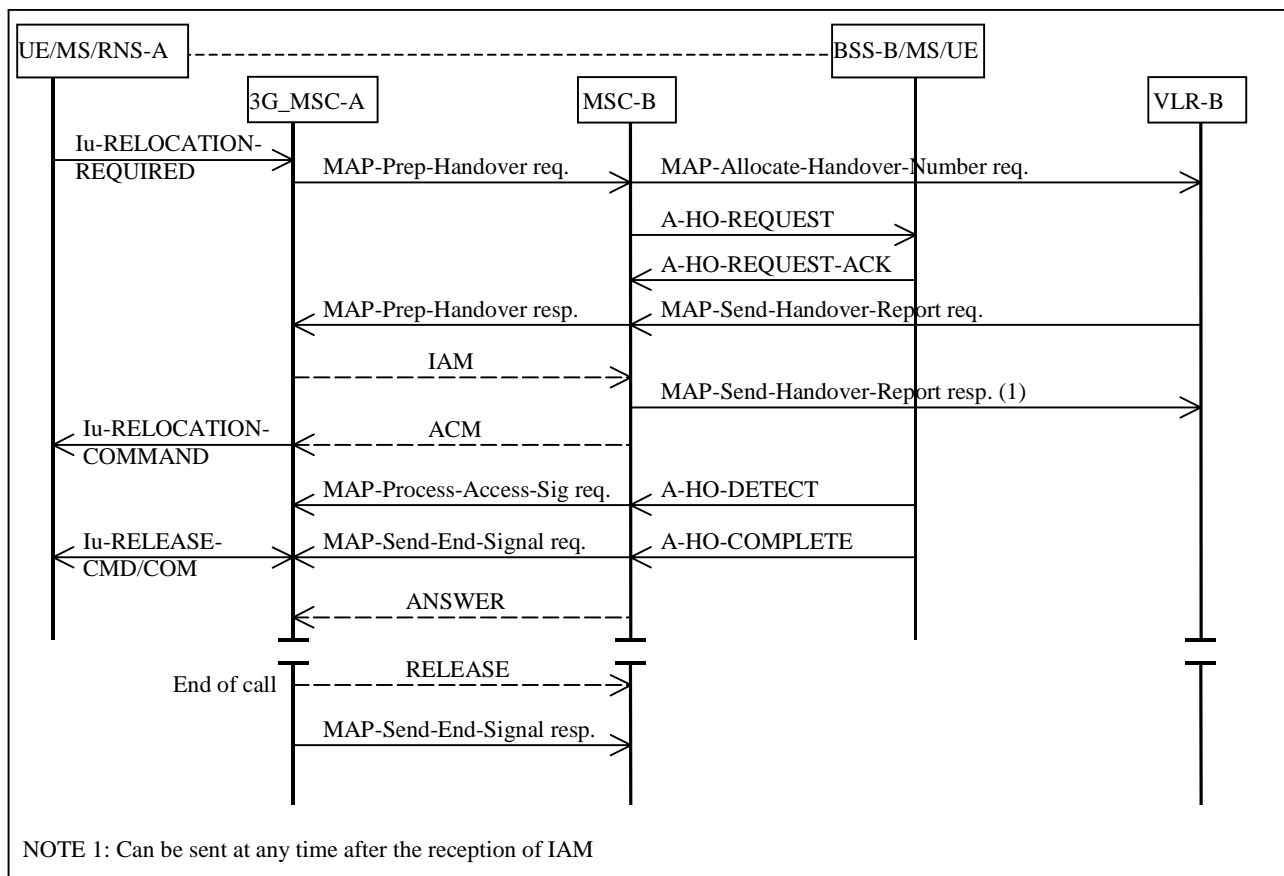

Figure 18: Basic UMTS to GSM Handover Procedure requiring a circuit connection

8.1.1.1 With one circuit connection

The UMTS to GSM handover is initiated as described in subclause 6.2.1. (This is represented by Iu-RELOCATION-REQUIRED in figure 18). Upon receipt of the Iu-RELOCATION-REQUIRED from RNS-A, 3G_MSC-A shall send a MAP-PREPARE-HANDOVER request to MSC-B including a complete A-HO-REQUEST message.

NOTE: 3G_MSC-A shall not send further MAP-PREPARE-HANDOVER requests while a MAP-PREPARE-HANDOVER response is pending or before any timeouts.

The MAP-PREPARE-HANDOVER request shall carry in the A-HO-REQUEST all information needed by MSC-B for allocating a radio channel, see 3GPP TS 08.08. For compatibility reasons, the MAP-PREPARE-HANDOVER request will also identify the cell to which the call is to be handed over. MSC-B will return the MAP-PREPARE-HANDOVER response after having retrieved a Handover Number from its associated VLR (exchange of the messages MAP-allocate-handover-number request and MAP-send-handover-report request). The Handover Number shall be used for routing the connection of the call from 3G_MSC-A to MSC-B. If a traffic channel is available in MSC-B the MAP-PREPARE-HANDOVER response, sent to 3G_MSC-A will contain the complete A-HO-REQUEST-ACKNOWLEDGE message received from BSS-B, containing the radio resources definition to be sent by RNS-A to the UE/MS and possible extra BSSMAP information, amended by MSC-B due to the possible interworking between the BSSMAP protocol carried on the E-interface and the BSSMAP protocol used on the A-interface. If the traffic channel allocation is queued by BSS-B, the A-QUEUING-INDICATION may optionally be sent back to 3G_MSC-A. The further traffic channel allocation result (A-HO-REQUEST-ACK or A-HO-FAILURE) will be transferred to 3G_MSC-A using the MAP-PROCESS-ACCESS-SIGNALLING request. If the traffic channel allocation is not possible, the MAP-PREPARE-HANDOVER response containing an A-HO-FAILURE will be sent to 3G_MSC-A. MSC-B will do the same if a fault is detected on the identity of the cell where the call has to be handed over. MSC-B simply reports the events related to the dialogue. It is up to 3G_MSC-A to decide the action to perform if it receives negative responses or the operation fails due to the expiry of the MAP-PREPARE-HANDOVER timer.

If an error related to the TCAP dialogue or to the MAP-PREPARE-HANDOVER request is returned from MSC-B, this will be indicated to 3G_MSC-A and 3G_MSC-A will terminate the handover attempt. 3G_MSC-A rejects the handover attempt towards RNS-A. The existing connection to the UE/MS shall not be cleared.

When the A-HO-REQUEST-ACKNOWLEDGE has been received, 3G_MSC-A shall establish a circuit between 3G_MSC-A and MSC-B by signalling procedures supported by the network. In figure 18 this is illustrated by the messages IAM (Initial Address Message) and ACM (Address Complete Message) of Signalling System no 7. MSC-B awaits the capturing of the UE/MS (subclause 6.2.1) on the radio path when the ACM is sent and 3G_MSC-A initiates the UMTS to GSM handover execution when ACM is received (illustrated by the Iu-RELOCATION-COMMAND and described in the subclause 6.2.1). 3G_MSC-A removes the transcoder from the path to the other party. As handover to GSM means that a transcoder is inserted in the BSS-B then G.711 [16] is assumed on the E-interface.

MSC-B transfers to 3G_MSC-A the acknowledgement received from the correct UE/MS (A-HO-DETECT/A-HO-COMplete). The A-HO-DETECT, if received, is transferred to 3G_MSC-A using the MAP-PROCESS-ACCESS-SIGNALLING request. The A-HO-COMplete, when received from the correct UE/MS, is included in the MAP-SEND-END-SIGNAL request and sent back to 3G_MSC-A. The circuit is through connected in 3G_MSC-A when the A-HO-DETECT or the A-HO-COMplete is received from MSC-B. The old radio channel is released when the A-HO-COMplete message is received from MSC-B. The sending of the MAP-SEND-END-SIGNAL request starts the MAP supervision timer for the MAP dialogue between 3G_MSC-A and MSC-B. When the MAP-SEND-END-SIGNAL request including the A-HO-COMplete message is received in 3G_MSC-A, the resources in RNS-A shall be cleared.

In order not to conflict with the PSTN/ISDN signalling system(s) used between 3G_MSC-A and MSC-B, MSC-B must generate an answer signal when A-HO-DETECT/COMPLETE is received.

MSC-B shall release the Handover Number when the circuit between 3G_MSC-A and MSC-B has been established.

If the circuit between 3G_MSC-A and MSC-B cannot be established, (e.g. an unsuccessful backward message is received instead of ACM), 3G_MSC-A terminates the inter-3G_MSC UMTS to GSM handover attempt by sending an appropriate MAP message, for example an ABORT.

3G_MSC-A shall retain overall call control until the call is cleared by the fixed subscriber or the UE/MS and there is no further call control functions to be performed (e.g. servicing waiting calls, echo cancellers).

When 3G_MSC-A clears the call to the UE/MS it also clears the call control functions in 3G_MSC-A and sends the MAP-SEND-END-SIGNAL response to release the MAP resources in MSC-B.

3G_MSC-A may terminate the procedure at any time by sending an appropriate MAP message to MSC-B. If establishment of the circuit between 3G_MSC-A and MSC-B has been initiated, the circuit must also be cleared.

The UMTS to GSM handover will be aborted by 3G_MSC-A if it detects clearing or interruption of the radio path before the call has been established on MSC-B.

8.1.1.2 With multiple circuit connections (Optional functionality)

If 3G_MSC-A supports the optional supplementary service Multicall (See 3GPP TS 23.135), 3G_MSC-A shall have the following functionality additionally to the description in section 8.1.1.1.

Upon receipt of the IU-RELOCATION-REQUIRED from RNS-A 3G_MSC-A shall select one bearer to be handed over if the UE is engaged with multiple bearers. After that, the 3G_MSC-A generates an A-HO-REQUEST message for the selected bearer and sends it to MSC-B over MAP-PREPARE-HANDOVER request.

When MAP-PREPARE-HANDOVER response including an A-HO-REQUEST-ACK is received from MSC-B, 3G_MSC-A sends IU-RELOCATION-COMMAND, which indicates the bearers not to be handed over as bearers to be released, to RNS-A.

After 3G_MSC-A receives MAP-SEND-END-SIGNAL request from MSC-B, 3G_MSC-A shall release calls via MSC-B, which has been carried by the bearers not to be handed over, and then 3G_MSC-A sends IU-RELEASE-COMMAND to RNS-A.

8.1.2 Basic UMTS to GSM Handover procedure not requiring the establishment of a circuit connection between 3G_MSC-A and MSC-B

The basic UMTS to GSM handover procedures to be used when no circuit connection is required by 3G_MSC-A are similar to those described in subclause 8.1.1 for circuit switched calls. The main differences to the procedures described in subclause 8.1.1 relate to the establishment of circuits between the network entities and the Handover Number allocation.

In the case of basic UMTS to GSM handover, 3G_MSC-A shall specify to MSC-B that no Handover Number is required in the MAP-PREPARE-HANDOVER request (see 3GPP TS 29.002 [12]). As for the basic UMTS to GSM handover using a circuit connection, the A-HO-REQUEST is transmitted at the same time. Any subsequent Handover Number allocation procedure will not be invoked until the completion of the basic UMTS to GSM handover procedure (see clause: Subsequent Channel Assignment using a circuit connection). MSC-B shall then perform the radio resources allocation as described in subclause 8.1.1. The MAP-PREPARE-HANDOVER response shall be returned to 3G_MSC-A including either the response of the radio resources allocation request received from BSS-B (A-HO-REQUEST-ACKNOWLEDGE/A-HO-FAILURE with possible extra BSSMAP information. These extra information are amended by MSC-B due to the possible interworking between the BSSMAP protocol carried on the E-interface and the BSSMAP protocol used on the A-interface) or potentially the A-QUEUING-INDICATION. The basic UMTS to GSM handover procedure will continue as described in subclause 8.1.1 except that no circuit connection will be established towards MSC-B.

The relevant case for the basic UMTS to GSM handover without circuit connection is shown in figure 19. As can be seen the major differences to the equivalent figure 18 is the omission of any circuit establishment messaging and the omission of handover number allocation signalling.

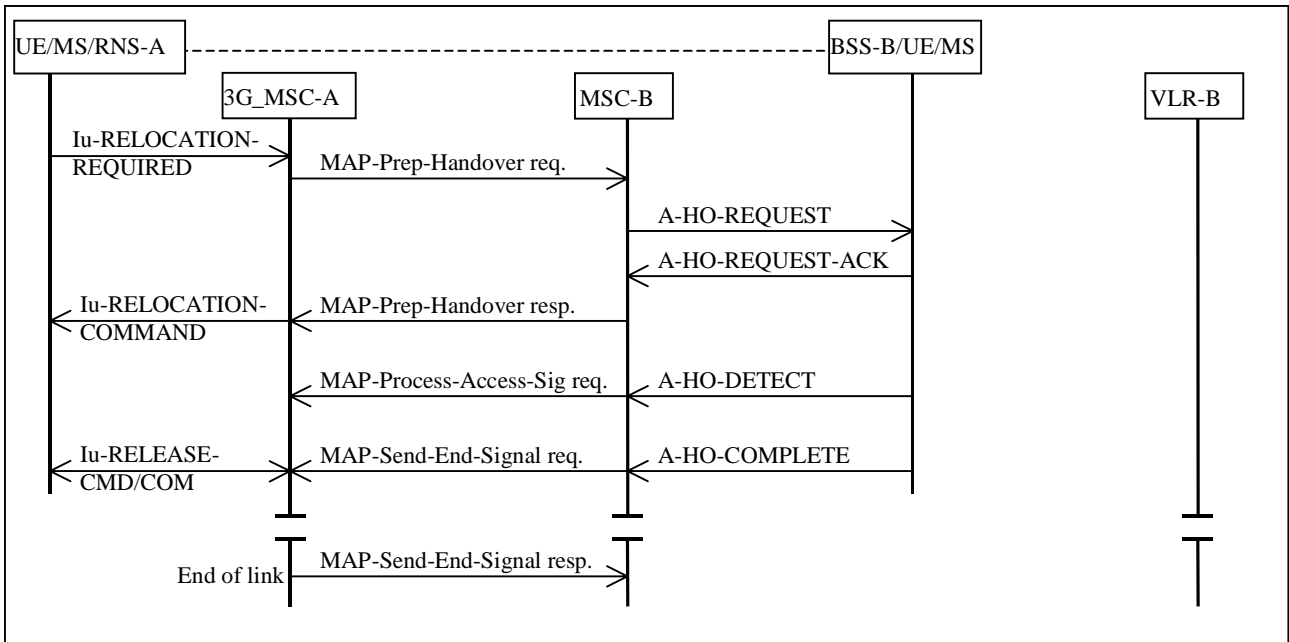

Figure 19: Basic UMTS to GSM Handover Procedure without circuit connection

8.1.3 Procedure for subsequent UMTS to GSM handover requiring a circuit connection

After the call has been handed over to 3G_MSC-B, if the UE/MS leaves the area of 3G_MSC-B during the same call and enters a GSM area, subsequent UMTS to GSM handover is necessary in order to continue the connection.

The following cases apply:

- i) the UE/MS moves back to the area of MSC-A;
- ii) the UE/MS moves into the area of a third MSC (MSC-B').

In both cases the call is switched in 3G_MSC-A; the circuit between 3G_MSC-A and MSC-B shall be released after a successful subsequent handover has been performed the same procedures apply if 3G_MSC-A is replaced by MSC-A.

8.1.3.1 Description of subsequent UMTS to GSM handover procedure i): 3G_MSC-B to MSC-A

The procedure for successful UMTS to GSM handover from MSC-B back to 3G_MSC-A is shown in figure 20.

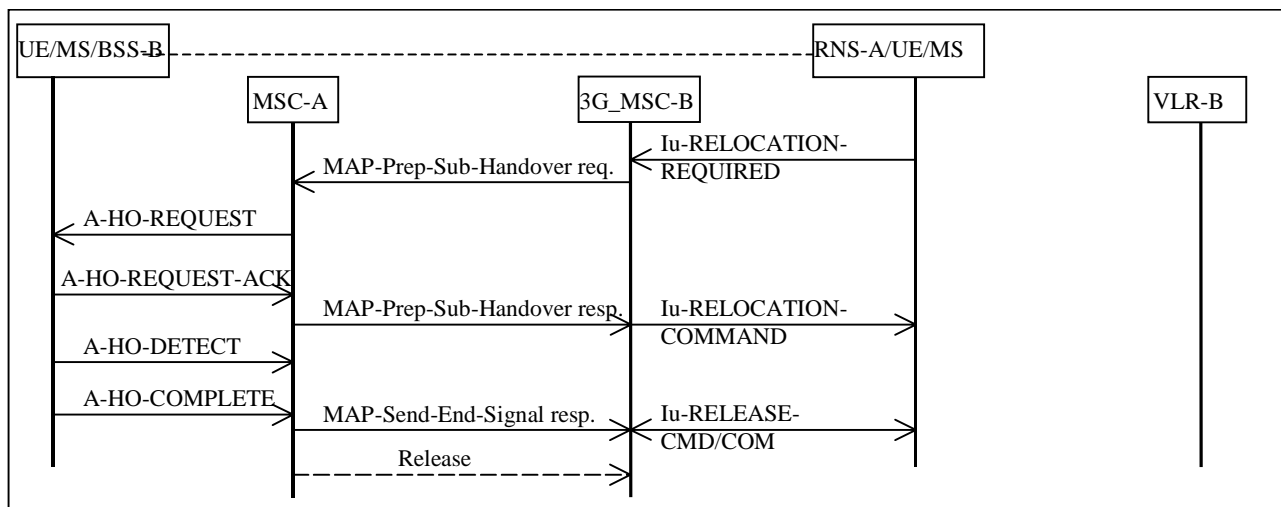

Figure 20: Subsequent UMTS to GSM handover procedure i): successful UMTS to GSM handover from 3G_MSC-B to MSC-A using a circuit connection

8.1.3.1.1 With one circuit connection

The procedure is as follows.

3G_MSC-B sends the MAP-PREPARE-SUBSEQUENT-HANDOVER request to MSC-A indicating the new MSC number (MSC-A number), indicating also the identity of the cell where the call has to be handed over and including a complete A-HO-REQUEST message. (NOTE: 3G_MSC-B shall not send further MAP-PREPARE-SUBSEQUENT-HANDOVER requests while a handover attempt is pending or before any timeouts). Since MSC-A is the call controlling MSC, this MSC needs no Handover Number for routing purposes; MSC-A can immediately initiate the search for a free radio channel.

When a radio channel can be assigned, MSC-A shall return in the MAP-PREPARE-SUBSEQUENT-HANDOVER response the complete A-HO-REQUEST-ACKNOWLEDGE message received from the BSS-B and possible extra BSSMAP information, amended by MSC-A due to the possible interworking between the BSSMAP protocol carried on the E-interface and the BSSMAP protocol used on the A-interface. If the traffic channel allocation is queued by BSS-B, the A-QUEUING-INDICATION may optionally be sent back to 3G_MSC-B. The further traffic channel allocation result (A-HO-REQUEST-ACK or A-HO-FAILURE) will be transferred to 3G_MSC-B using the MAP-FORWARD-ACCESS-SIGNALLING request. If a radio channel cannot be assigned or if a fault is detected on the target cell identity, or the target cell identity in the A-HO-REQUEST is not consistent with the target MSC number, the MAP-PREPARE-SUBSEQUENT-HANDOVER response containing an A-HO-FAILURE message shall be given to 3G_MSC-B, in addition 3G_MSC-B shall maintain the connection with the UE/MS.

If the procedure in MSC-A is successful then 3G_MSC-B can request the UE/MS to retune to the new BSS-B on MSC-A. This is illustrated in figure 20 by the Iu-RELOCATION-COMMAND message. The operation is successfully completed when MSC-A receives the A-HO-COMPLETE message.

After UMTS to GSM handover MSC-A shall release the circuit to 3G_MSC-B.

MSC-A must also terminate the MAP procedure for the basic UMTS to GSM handover between MSC-A and 3G_MSC-B by sending an appropriate MAP message. 3G_MSC-B will clear the resources in RNS-A when the MAP-SEND-END-SIGNAL response is received.

8.1.3.1.2 With multiple circuit connections (Optional functionality)

If 3G_MSC-B supports the optional supplementary service Multicall (See 3GPP TS 23.135), 3G_MSC-B shall have the following functionality additionally to the description in section 8.1.3.1.1.

Upon receipt of the IU-RELOCATION-REQUIRED from RNS-A which indicates the target is BSS, 3G_MSC-B shall select one bearer to be handed over if the UE is engaged with multiple bearers. After that, the 3G_MSC-B generates an A-HO-REQUEST message for the selected bearer and sends it to 3G_MSC-A over MAP-PREPARE-SUBSEQUENT-HANDOVER request with indication of RAB ID of the selected bearer.

When MAP-PREPARE-SUBSEQUENT-HANDOVER response including an A-HO-REQUEST-ACK is received from the 3G_MSC-A, 3G_MSC-B sends IU-RELOCATION-COMMAND, which indicates the bearers not to be handed over as bearers to be released, to RNS-A.

After 3G_MSC-A receives A-HO-COMplete message from BSS-B, 3G_MSC-A shall release calls via BSS-B, which has been carried by the bearers not to be handed over, and then 3G_MSC-A sends MAP-SEND-END-SIGNAL response to 3G_MSC-B.

8.1.3.2 Description of subsequent UMTS to GSM handover procedure ii): 3G_MSC-B to MSC-B'

The procedure for successful UMTS to GSM handover from 3G_MSC-B to MSC-B' is shown in figure 21.

The procedure consists of two parts:

- a subsequent UMTS to GSM handover from 3G_MSC-B back to 3G_MSC-A as described in subclause 8.1.3.1 (the same procedures apply if 3G_MSC-A is replaced by MSC-A); and
- a basic handover from 3G_MSC-A to MSC-B' as described in subclause 7.1.

8.1.3.2.1 With one circuit connection

3G_MSC-B sends the MAP-PREPARE-SUBSEQUENT-HANDOVER request to 3G_MSC-A indicating a new MSC number (which is the identity of MSC-B'), indicating also the target cell identity and including a complete A-HO-REQUEST, 3G_MSC-A then starts a basic handover procedure towards MSC-B'.

When 3G_MSC-A receives the ACM from MSC-B', 3G_MSC-A informs 3G_MSC-B that MSC-B' has successfully allocated the radio resources on BSS-B' side by sending the MAP-PREPARE-SUBSEQUENT-HANDOVER response containing the complete A-HO-REQUEST-ACKNOWLEDGE received from BSS-B' and possible extra BSSMAP information, amended by 3G_MSC-A due to the possible interworking between the BSSMAP protocol carried on the E-interface between 3G_MSC-A and MSC-B' and the BSSMAP protocol carried on the E-interface between 3G_MSC-A and 3G_MSC-B. Now 3G_MSC-B can start the procedure on the radio path.

For 3G_MSC-A the UMTS to GSM handover is completed when it has received the MAP-SEND-END-SIGNAL REQUEST from MSC-B' containing the A-HO-COMplete received from the BSS-B'. The circuit between 3G_MSC-A and 3G_MSC-B is released. 3G_MSC-A also sends the MAP-SEND-END-SIGNAL response to 3G_MSC-B in order to terminate the original MAP dialogue between 3G_MSC-A and 3G_MSC-B. 3G_MSC-B releases the radio resources when it receives this message.

If the traffic channel allocation is queued by the BSS-B', the A-QUEUING-INDICATION may optionally be sent back to 3G_MSC-B. If no radio channel can be allocated by MSC-B' or no circuit between 3G_MSC-A and MSC-B' can be established or a fault is detected on the target cell identity or the target cell identity in the A-HO-REQUEST is not consistent with the target MSC number, 3G_MSC-A informs 3G_MSC-B by using the A-HO-FAILURE message included in the MAP-PREPARE-SUBSEQUENT-HANDOVER response. 3G_MSC-B shall maintain the existing connection with the UE/MS.

When the subsequent UMTS to GSM handover is completed, MSC-B' is considered as MSC-B. Any further inter-MSC handover is handled as described earlier for a subsequent handover.

8.1.3.2.2 With multiple circuit connections (Optional functionality)

If 3G_MSC-B supports the optional supplementary service Multicall (See 3GPP TS 23.135), 3G_MSC-B shall have the following functionality additionally to the description in section 8.1.3.2.1.

Upon receipt of the IU-RELOCATION-REQUIRED from RNS-B 3G_MSC-B shall select one bearer to be handed over if the UE is engaged with multiple bearers. After that, the 3G_MSC-B generates an A-HO-REQUEST message for the selected bearer and sends it to 3G_MSC-A over MAP-PREPARE-SUBSEQUENT-HANDOVER request with indication of RAB ID of the selected bearer.

Upon receipt of the MAP-PREPARE-SUBSEQUENT-HANDOVER request from 3G_MSC-B, 3G_MSC-A starts a basic handover procedure towards MSC-B'.

When 3G_MSC-A receives the ACM from MSC-B', 3G_MSC-A informs 3G_MSC-B that MSC-B' has successfully allocated the radio resources on BSS-B' side by sending the MAP-PREPARE-SUBSEQUENT-HANDOVER response containing the complete A-HO-REQUEST-ACK received from BSS-B' and possible extra BSSAP information, amended by 3G_MSC-A due to the possible interworking between the BSSMAP protocol carried on the E-interface between 3G_MSC-A and MSC-B' and the BSSMAP protocol carried on the E-interface between 3G_MSC-A and 3G_MSC-B.

When MAP-PREPARE-SUBSEQUENT-HANDOVER response including an A-HO-REQUEST-ACK is received from 3G_MSC-A, 3G_MSC-B sends IU-RELOCATION-COMMAND, which indicates the bearers not to be handed over as bearers to be released, to RNS-A.

After 3G_MSC-A receives MAP-SEND-END-SIGNAL request from MSC-B', 3G_MSC-A shall release calls via MSC-B', which has been carried by the bearers not to be handed over, and then 3G_MSC-A sends MAP-SEND-END-SIGNAL response to 3G_MSC-B.

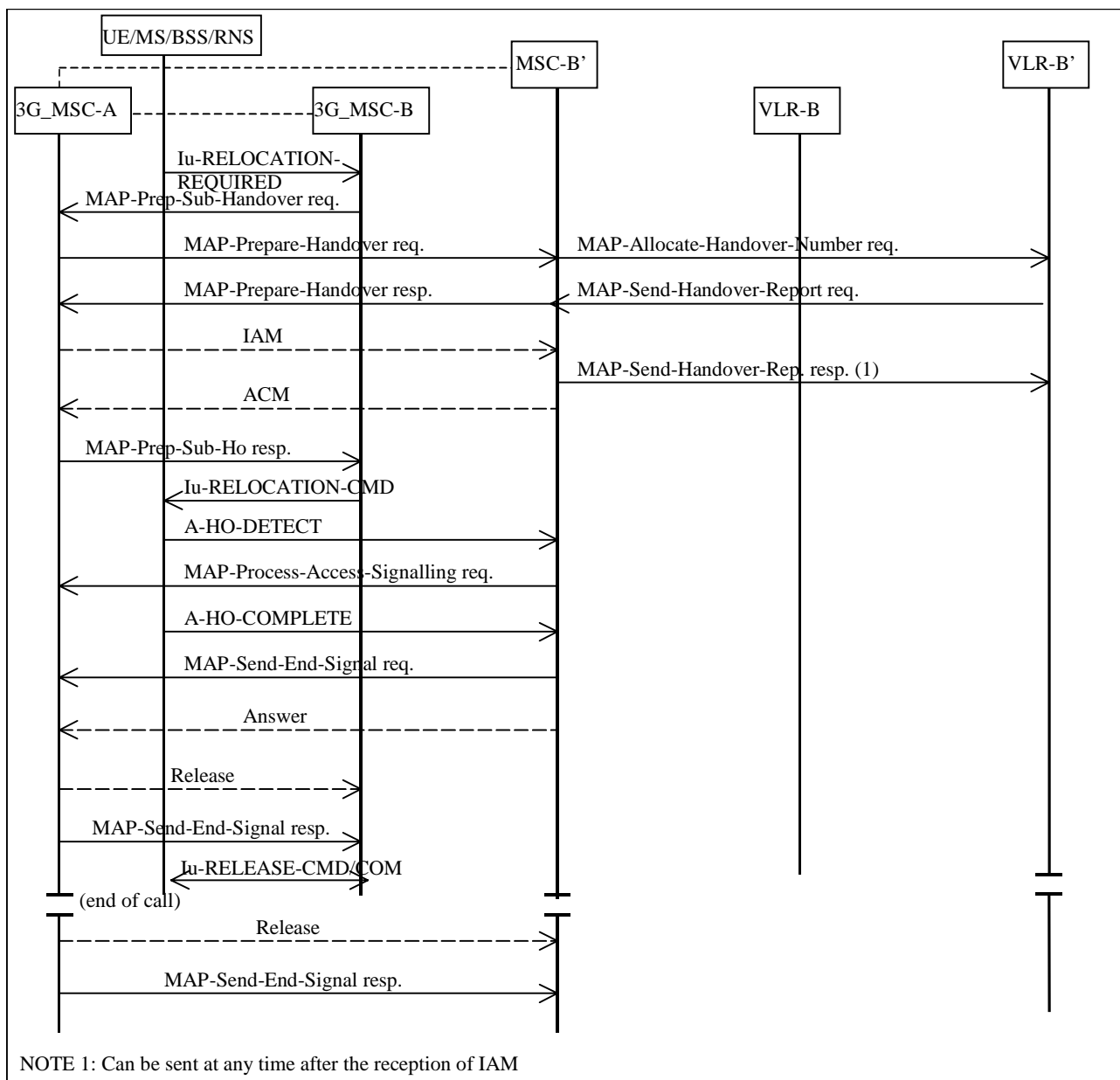

Figure 21: Subsequent handover procedure ii): Successful UMTS to GSM handover from 3G_MSC-B to MSC-B' requiring a circuit connection

8.1.4 Procedure for subsequent UMTS to GSM handover not requiring a circuit connection

As for the subsequent UMTS to GSM handover with a circuit connection, the same two cases of subsequent handover apply:

- i) the UE/MS moves back to the area of MSC-A;
- ii) the UE/MS moves into the area of a third MSC (MSC-B').

8.1.4.1 Description of subsequent UMTS to GSM handover procedure i): 3G_MSC-B to MSC-A

The procedure for successful UMTS to GSM handover from 3G_MSC-B back to MSC-A without circuit connection is shown in figure 22. The only difference with the figure 20, is that no circuit release is needed between MSC-A and 3G_MSC-B.

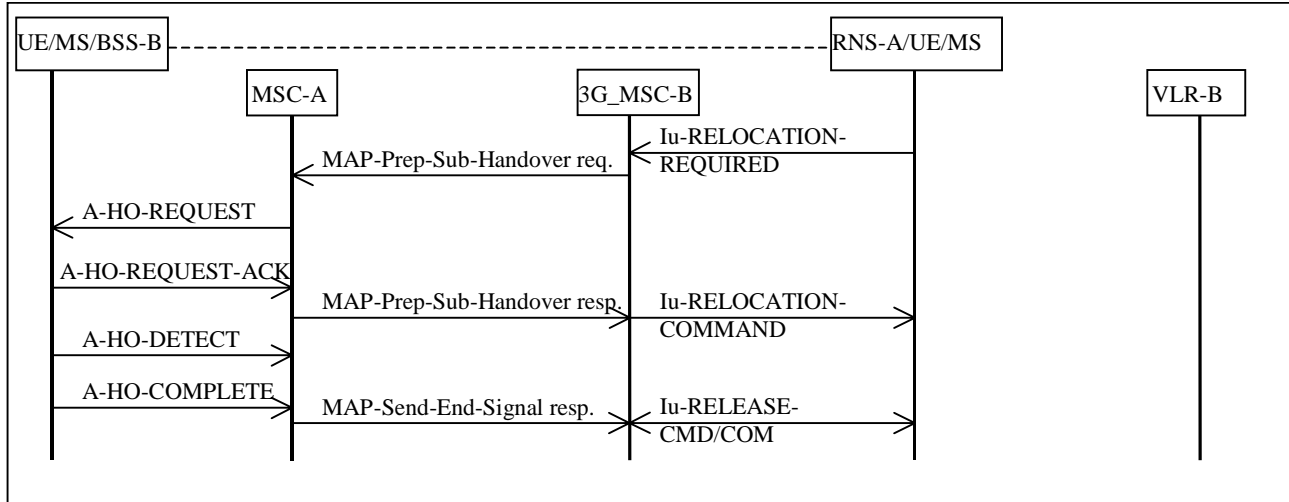

Figure 22: Subsequent UMTS to GSM handover procedure i): Successful UMTS to GSM handover from 3G_MSC-B to MSC-A not requiring a circuit connection

8.1.4.2 Description of the subsequent UMTS to GSM handover procedure without circuit connection ii): 3G_MSC-B to MSC-B'

The procedure for successful UMTS to GSM handover from 3G_MSC-B to MSC-B' is shown in figure 23.

The procedure consists of two parts:

- a subsequent UMTS to GSM handover from 3G_MSC-B back to 3G_MSC-A as described in subclause 8.1.4.1 (the same procedures apply if 3G_MSC-A is replaced by MSC-A); and
- a basic handover from 3G_MSC-A to MSC-B' as described in subclause 7.2.

The only difference to the equivalent figure 21 is the omission of the circuit and handover number allocation signalling.

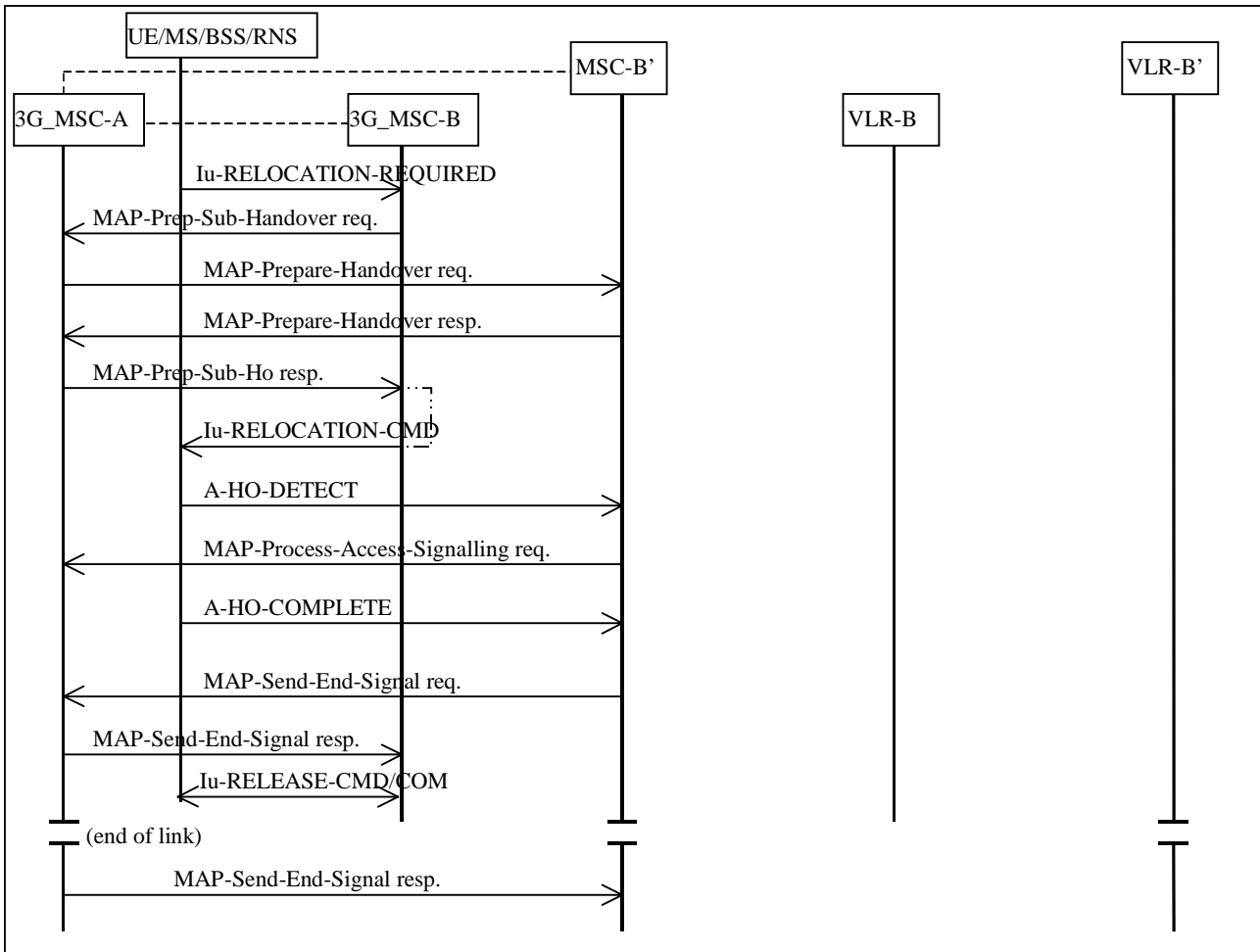

Figure 23: Subsequent UMTS to GSM handover procedure ii): Successful UMTS to GSM handover from 3G_MSC-B to MSC-B' without circuit connection

8.2 Handover GSM to UMTS

The following subclauses describe two options for the Basic and Subsequent GSM to UMTS Handover procedures. The first, as described in subclauses 8.2.1 and 8.2.3 respectively, provides for a circuit connection between (3G_)MSC-A and (3G_)MSC-B. The second, as described in subclauses 8.2.2 and 8.2.4 respectively, provides for a Basic and Subsequent Handover without the provision of a circuit connection between (3G_)MSC-A and (3G_)MSC-B. In all the above mentioned subclauses, the following principles apply:

- during the handover resource allocation, only the handover related messages that are part of the applicable BSSAP subset - as defined in 3GPP TS 09.08 [7] - shall be transferred on the E-interface;
- the trace related messages that are part of the applicable BSSAP subset - as defined in 3GPP TS 09.08 [7] - can be sent by the MSC-A on the E-interface after successful handover resource allocation. In the subclauses 8.2.1 and 8.2.2, it is however allowed at basic handover initiation on the E-Interface to transfer one trace related message that is part of the applicable BSSAP subset - as defined in 3GPP TS 09.08 [7] - together with the applicable handover related message. The applicable handover related message shall always appear as the first message;
- If 3G_MSC-B or 3G-MSC-B' supports Location Reporting Control, 3G_MSC-B or 3G_MSC-B' shall always initiate the Location Reporting Control procedure towards the target RNS since no request for Location Reporting is received from MSC-A. If 3G-MSC-B or 3G-MSC-B' supports the Location Reporting Control, the Location Reporting Control procedure shall be initiated after the Relocation Resource Allocation procedure has been executed successfully.
- during the handover execution, i.e. while the UE/MS is not in communication with the network, the MSC-A shall queue all outgoing BSSAP messages until the communication with the UE/MS is resumed;

- finally, during supervision, i.e. while the UE/MS is not in the area of MSC-A after a successful Inter-3G_MSC GSM to UMTS handover, the subset of BSSAP procedures and their related messages - as defined in 3GPP TS 09.08 [7] - shall apply on the E-Interface;
- during the intra-3G_MSC-B GSM to UMTS handover execution, if any, the 3G_MSC-B shall queue all outgoing Direct Transfer messages until the communication with the UE/MS is resumed.

8.2.1 Basic Handover procedure requiring a circuit connection between MSC-A and 3G_MSC-B

The procedure used for successful Inter-3G_MSC Handover from GSM to UMTS is shown in figure 24. Initiation of the GSM to UMTS handover procedure is described in clause 5. The procedure described in this subclause makes use of messages from the 3GPP TS 08.08 [5], 3GPP TS 25.413 [11] and of the transport mechanism from the Mobile Application Part (MAP) (3GPP TS 29.002 [12]). After an Inter-3G_MSC handover further Intra-3G_MSC handovers may occur on 3G_MSC-B, these handovers will follow the procedures specified in the previous subclauses.

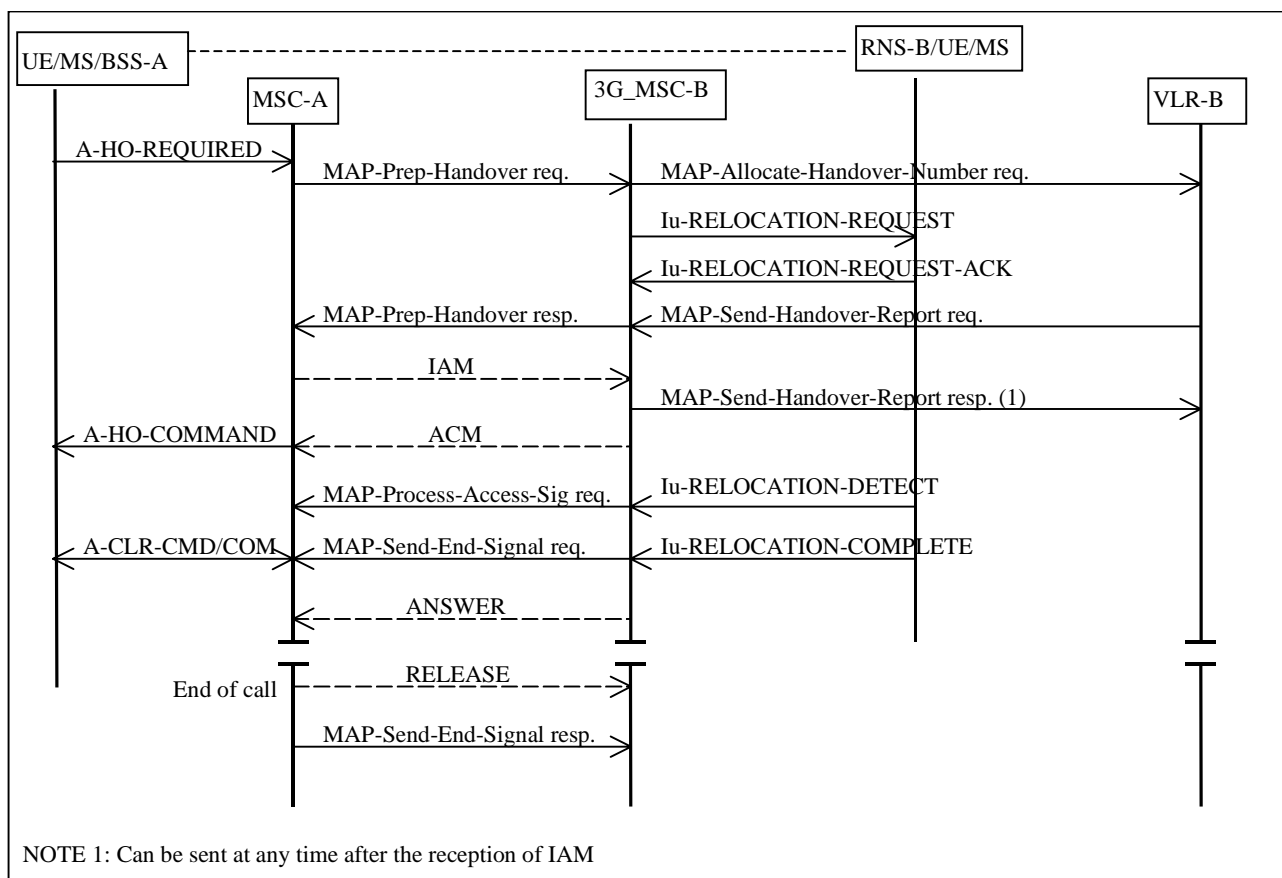

Figure 24: Basic GSM to UMTS Handover Procedure requiring a circuit connection

The GSM to UMTS handover is initiated as described in subclause 6.2.2. (This is represented by A-HO-REQUIRED in figure 24). Upon receipt of the A-HO-REQUIRED from BSS-A, MSC-A shall send a MAP-PREPARE-HANDOVER request to 3G_MSC-B including a complete A-HO-REQUEST message.

NOTE: MSC-A shall not send further MAP-PREPARE-HANDOVER requests while a MAP-PREPARE-HANDOVER response is pending or before any timeouts.

The MAP-PREPARE-HANDOVER request shall carry in the A-HO-REQUEST all information needed by 3G_MSC-B for allocating radio resources in RNS-B, see 3GPP TS 08.08 [5].

3G_MSC-B will return the MAP-PREPARE-HANDOVER response after having retrieved a Handover Number from its associated VLR (exchange of the messages MAP-allocate-handover-number request and MAP-send-handover-report request). The Handover Number shall be used for routing the connection of the call from MSC-A to 3G_MSC-B. 3G_MSC-B inserts a transcoder as G711 is assumed between 2G MSC and 3G_MSC-B. If radio resources are available in RNS-B the MAP-PREPARE-HANDOVER response, sent to MSC-A from 3G_MSC-B will contain the complete A-HO-REQUEST-ACK message generated from the Iu-RELOCATION-REQUEST-ACK received from RNS-B, containing the radio resources definition to be sent by BSS-A to the UE/MS. If the radio resource allocation is not possible, the MAP-PREPARE-HANDOVER response containing an A-HO-FAILURE will be sent to MSC-A. 3G_MSC-B will do the same if a fault is detected on the identity of the cell where the call has to be handed over. 3G_MSC-B simply reports the events related to the dialogue. It is up to MSC-A to decide the action to perform if it receives negative responses or the operation fails due to the expiry of the MAP-PREPARE-HANDOVER timer.

If an error related to the TCAP dialogue or to the MAP-PREPARE-HANDOVER request is returned from 3G_MSC-B, this will be indicated to MSC-A and MSC-A will terminate the handover attempt. MSC-A shall reject the handover attempt towards BSS-A. The existing connection to the UE/MS shall not be cleared.

When the A-HO-REQUEST-ACK has been received, MSC-A shall establish a circuit between MSC-A and 3G_MSC-B by signalling procedures supported by the network. In figure 24 this is illustrated by the messages IAM (Initial Address Message) and ACM (Address Complete Message) of Signalling System no 7. 3G_MSC-B awaits the capturing of the UE/MS (subclause 6.2.2) on the radio path when the ACM is sent and MSC-A initiates the handover execution when ACM is received (illustrated by the A-HO-COMMAND and described in the subclause 6.2.2).

3G_MSC-B transfers to MSC-A the acknowledgement received from the correct UE/MS (A-HO-DETECT/A-HO-COMplete). The Iu-RELOCATION-DETECT, if received, is converted to A-HO-DETECT and transferred to MSC-A using the MAP-PROCESS-ACCESS-SIGNALLING request. The Iu-RELOCATION-COMplete, when received from the correct UE/MS, is converted to A-HO-COMplete and included in the MAP-SEND-END-SIGNAL request and sent back to MSC-A. The circuit is through-connected in MSC-A when the A-HO-DETECT or the A-HO-COMplete is received from 3G_MSC-B. The old radio channel is released when the A-HO-COMplete message is received from 3G_MSC-B. The sending of the MAP-SEND-END-SIGNAL request starts the MAP supervision timer for the MAP dialogue between MSC-A and 3G_MSC-B. When the MAP-SEND-END-SIGNAL request including the A-HO-COMplete message is received in MSC-A the resources in BSS-A shall be cleared.

In order not to conflict with the PSTN/ISDN signalling system(s) used between MSC-A and 3G_MSC-B, 3G_MSC-B must generate an answer signal when Iu-RELOCATION-DETECT/COMplete is received.

3G_MSC-B shall release the Handover Number when the circuit between MSC-A and 3G_MSC-B has been established.

If the circuit between MSC-A and 3G_MSC-B cannot be established (e.g. an unsuccessful backward message is received instead of ACM). MSC-A terminates the inter3G_MSC handover attempt by sending an appropriate MAP message, for example an ABORT.

MSC-A shall retain overall call control until the call is cleared by the fixed subscriber or the UE/MS and there is no further call control functions to be performed (e.g. servicing waiting calls, echo cancellers).

When MSC-A clears the call to the UE/MS it also clears the call control functions in MSC-A and sends the MAP-SEND-END-SIGNAL response to release the MAP resources in 3G_MSC-B.

MSC-A may terminate the procedure at any time by sending an appropriate MAP message to 3G_MSC-B. If establishment of the circuit between MSC-A and 3G_MSC-B has been initiated, the circuit must also be cleared.

The GSM to UMTS handover will be aborted by MSC-A if it detects clearing or interruption of the radio path before the call has been established on 3G_MSC-B.

8.2.2 Basic GSM to UMTS Handover procedure not requiring the establishment of a circuit connection between MSC-A and 3G_MSC-B

The basic GSM to UMTS handover procedures to be used when no circuit connection is required by MSC-A are similar to those described in subclause 8.2.1 for circuit switched calls. The main differences to the procedures described in subclause 8.2.1 relate to the establishment of circuits between the network entities and the Handover Number allocation.

In the case of basic GSM to UMTS handover, MSC-A shall specify to 3G_MSC-B that no Handover Number is required in the MAP-PREPARE-HANDOVER request (see 3GPP TS 29.002 [12]). As for the basic GSM to UMTS handover using a circuit connection, the A-HO-REQUEST is transmitted at the same time. Any subsequent Handover Number allocation procedure will not be invoked until the completion of the basic GSM to UMTS handover procedure (see subclause: Subsequent Channel Assignment using a circuit connection). 3G_MSC-B shall then perform the radio resources allocation as described in subclause 8.2.1. The MAP-PREPARE-HANDOVER response shall be returned to MSC-A including either the translated response of the radio resources allocation request received from RNS-B (A-HO-REQUEST-ACK/A-HO-FAILURE). The basic GSM to UMTS handover procedure will continue as described in subclause 8.2.1 except that no circuit connection will be established towards 3G_MSC-B.

The relevant case for the basic GSM to UMTS handover without circuit connection is shown in figure 25. As can be seen the major differences to the equivalent figure 24 are the omission of any circuit establishment messaging and the omission of handover number allocation signalling.

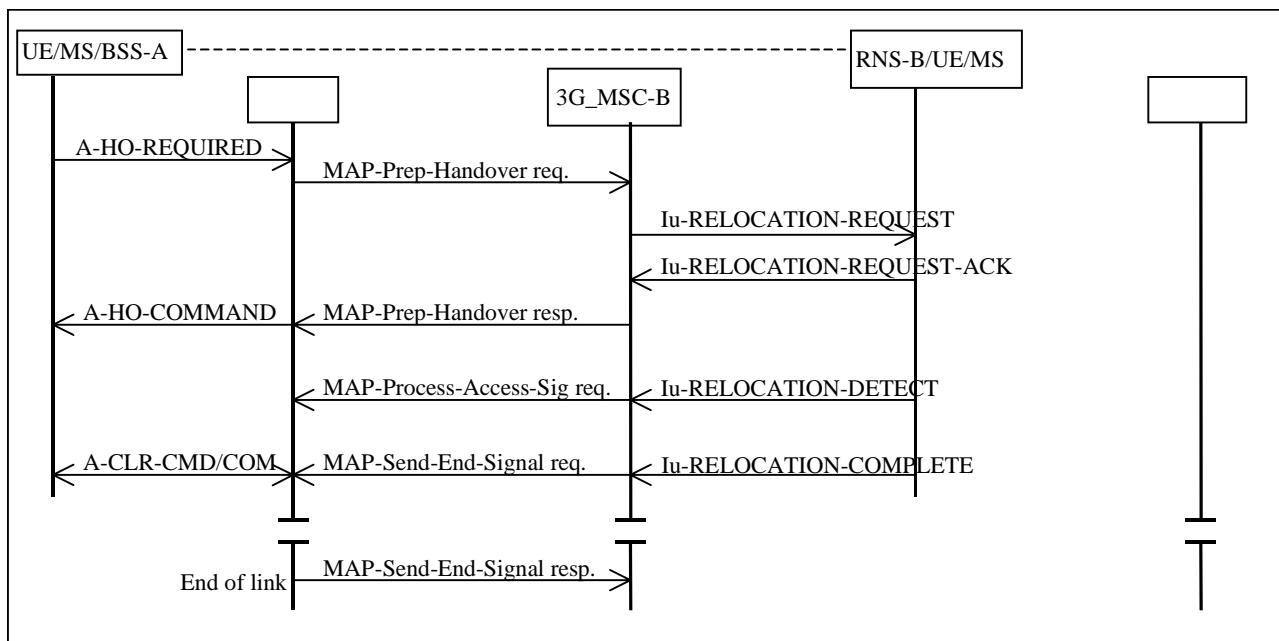

Figure 25: Basic GSM to UMTS Handover Procedure without circuit connection

8.2.3 Procedure for subsequent GSM to UMTS handover requiring a circuit connection

After the call has been handed over to MSC-B, if the UE/MS leaves the GSM area of MSC-B during the same call and enters a UTRAN area, subsequent GSM to UMTS handover is necessary in order to continue the connection.

The following cases apply:

- i) the UE/MS moves back to the area of 3G_MSC-A;
- ii) the UE/MS moves into the area of a third 3G_MSC (3G_MSC-B').

In both cases the call is switched in 3G_MSC-A; the circuit between 3G_MSC-A and MSC-B shall be released after a successful subsequent handover has been performed.

8.2.3.1 Description of subsequent GSM to UMTS handover procedure i): MSC-B to 3G_MSC-A

The procedure for successful GSM to UMTS handover from MSC-B back to 3G_MSC-A is shown in figure 26.

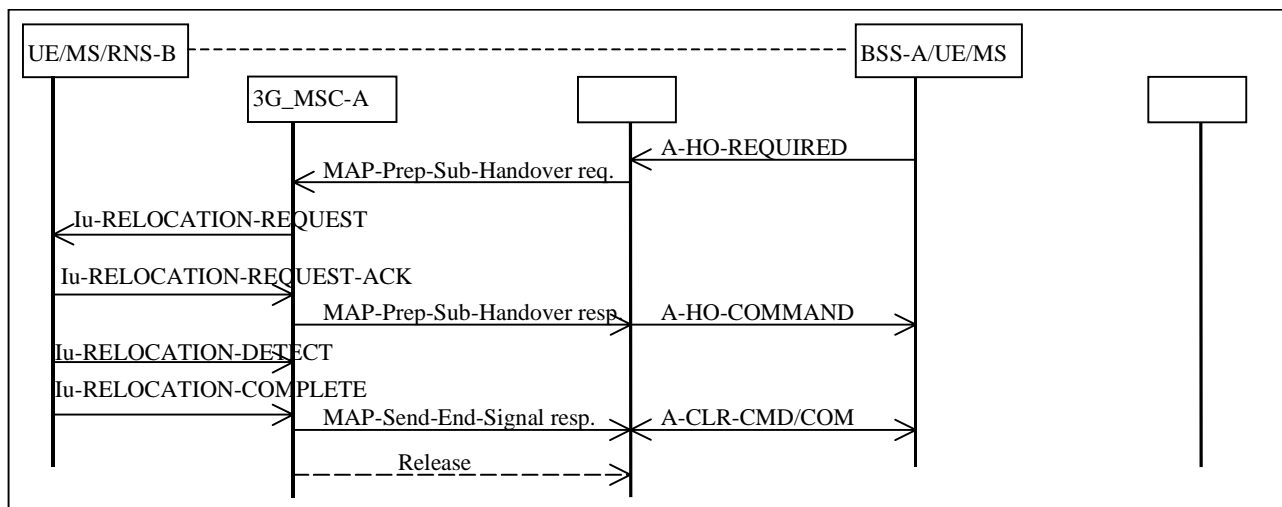

Figure 26: Subsequent GSM to UMTS handover procedure i): successful handover from MSC-B to 3G_MSC-A using a circuit connection

The procedure is as follows.

MSC-B sends the MAP-PREPARE-SUBSEQUENT-HANDOVER request to 3G_MSC-A indicating the new MSC number (3G_MSC-A number) and including a complete A-HO-REQUEST message. (NOTE: MSC-B shall not send further MAP-PREPARE-SUBSEQUENT-HANDOVER requests while a handover attempt is pending or before any timeouts). Since 3G_MSC-A is the call controlling MSC, this MSC needs no Handover Number for routing purposes; 3G_MSC-A can immediately initiate the search for free radio resources. 3G_MSC-A then inserts a transcoder between it's RNS and the connection to the other party.

When radio resources can be assigned, 3G_MSC-A shall return in the MAP-PREPARE-SUBSEQUENT-HANDOVER response the complete A-HO-REQUEST-ACK message generated from the Iu-RELOCATION-REQUEST-ACK received from the RNS-B and possible extra BSSMAP information, amended by 3G_MSC-A due to the possible interworking between the BSSMAP protocol carried on the E-interface and the RANAP protocol used on the Iu-interface. If radio resources cannot be assigned or if a fault is detected on the target cell identity, or the target cell identity in the A-HO-REQUEST is not consistent with the target MSC number, the MAP-PREPARE-SUBSEQUENT-HANDOVER response containing an A-HO-FAILURE message shall be given to MSC-B, in addition MSC-B shall maintain the connection with the UE/MS.

If the procedure in 3G_MSC-A is successful then MSC-B can request the UE/MS to retune to the new RNS-B on 3G_MSC-A. This is illustrated in figure 26 by the A-HO-COMMAND message. The operation is successfully completed when 3G_MSC-A receives the Iu-RELOCATION-COMPLETE message.

After GSM to UMTS handover 3G_MSC-A shall release the circuit to MSC-B.

3G_MSC-A must also terminate the MAP procedure for the basic handover between 3G_MSC-A and MSC-B by sending an appropriate MAP message. MSC-B will clear the resources in BSS-A when the MAP-SEND-END-SIGNAL response is received.

8.2.3.2 Description of subsequent GSM to UMTS handover procedure ii): MSC-B to 3G_MSC-B'

The procedure for successful GSM to UMTS handover from MSC-B to 3G_MSC-B' is shown in figure 27.

The procedure consists of two parts:

- a subsequent handover from MSC-B back to MSC-A as described in subclause 7.3.1 (the same procedures apply if MSC-A is replaced by 3G_MSC-A); and
- a basic GSM to UMTS handover from MSC-A to 3G_MSC-B' as described in subclause 8.2.1.

MSC-B sends the MAP-PREPARE-SUBSEQUENT-HANDOVER request to MSC-A indicating a new MSC number (which is the identity of 3G_MSC-B') and including a complete A-HO-REQUEST, MSC-A then starts a basic handover procedure towards 3G_MSC-B'.

When MSC-A receives the ACM from 3G_MSC-B', MSC-A informs MSC-B that 3G_MSC-B' has successfully allocated the radio resources on RNS-B' side by sending the MAP-PREPARE-SUBSEQUENT-HANDOVER response containing the complete A-HO-REQUEST-ACK generated from the RELOCATION-REQUEST-ACK received from RNS-B' and possible extra BSSMAP information, amended by MSC-A due to the possible interworking between the BSSMAP protocol carried on the E-interface between MSC-A and 3G_MSC-B' and the BSSMAP protocol carried on the E-interface between MSC-A and MSC-B. Now MSC-B can start the procedure on the radio path.

For MSC-A the handover is completed when it has received the MAP-SEND-END-SIGNAL REQUEST from 3G_MSC-B' containing the A-HO-COMPLETE generated from Iu-RELOCATION COMPLETE received from the RNS-B'. The circuit between MSC-A and MSC-B is released. MSC-A also sends the MAP-SEND-END-SIGNAL response to MSC-B in order to terminate the original MAP dialogue between MSC-A and MSC-B. MSC-B releases the radio resources when it receives this message.

If no radio resources can be allocated by 3G_MSC-B' or no circuit between MSC-A and 3G_MSC-B' can be established or a fault is detected on the target cell identity or the target cell identity in the A-HO-REQUEST is not consistent with the target MSC number, MSC-A informs MSC-B by using the A-HO-FAILURE message included in the MAP-PREPARE-SUBSEQUENT-HANDOVER response. MSC-B shall maintain the existing connection with the UE/MS.

When the subsequent GSM to UMTS handover is completed, 3G_MSC-B' is considered as 3G_MSC-B. Any further inter-MSC handover is handled as described above for a subsequent handover.

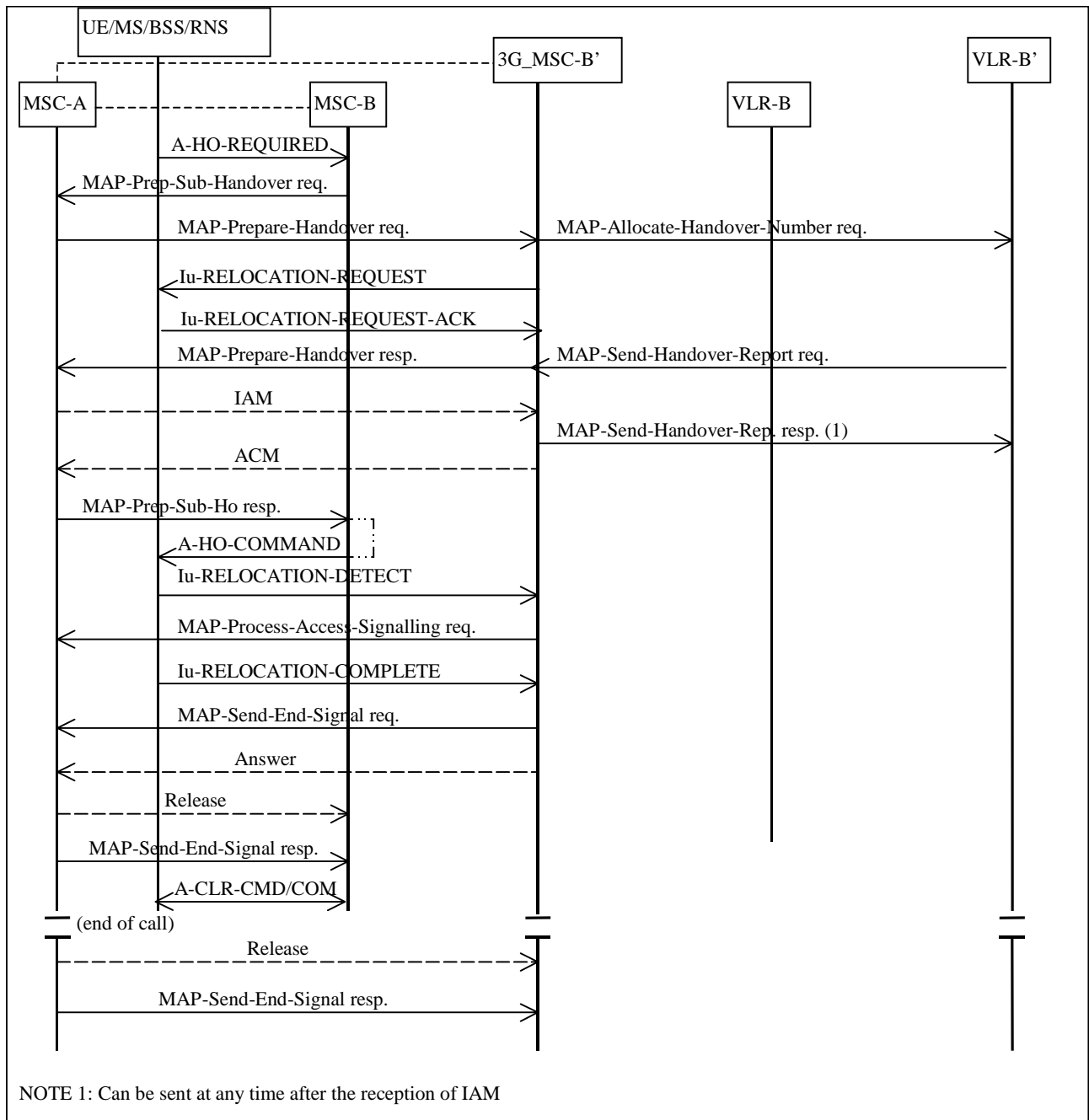

Figure 27: Subsequent GSM to UMTS handover procedure ii): Successful handover from MSC-B to 3G_MSC-B' requiring a circuit connection

8.2.4 Procedure for subsequent GSM to UMTS handover not requiring a circuit connection

As for the subsequent GSM to UMTS handover with a circuit connection, the same two cases of subsequent handover apply:

- i) the UE/MS moves back to the area of 3G_MSC-A;
- ii) the UE/MS moves into the area of a third 3G_MSC (3G_MSC-B').

8.2.4.1 Description of subsequent GSM to UMTS handover procedure without circuit connection i): MSC-B to 3G_MSC-A

The procedure for successful GSM to UMTS handover from MSC-B back to 3G_MSC-A without circuit connection is shown in figure 28. The only difference with the figure 26, is that no circuit release is needed between 3G_MSC-A and MSC-B.

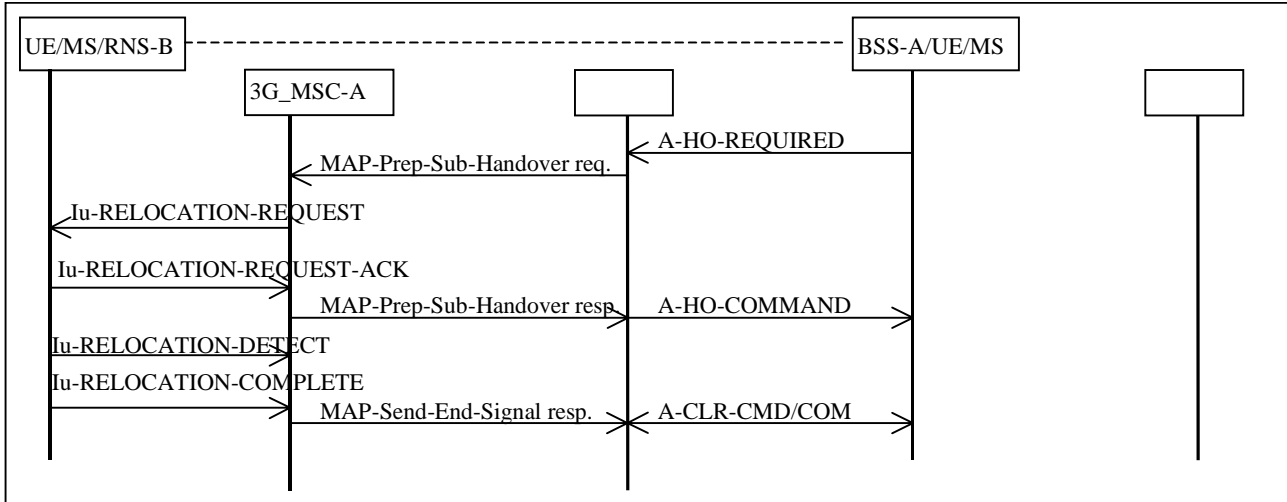

Figure 28: Subsequent GSM to UMTS handover procedure i): Successful handover from MSC-B to 3G_MSC-A not requiring a circuit connection

8.2.4.2 Description of subsequent GSM to UMTS handover procedure without circuit connection ii): MSC-B to 3G_MSC-B'

The procedure for successful GSM to UMTS handover from MSC-B to 3G_MSC-B' is shown in figure 29.

The procedure consists of two parts:

- a subsequent handover from MSC-B back to MSC-A as described in subclause 7.4.1 (the same procedures apply if MSC-A is replaced by 3G_MSC-A); and
- a basic GSM to UMTS handover from MSC-A to 3G_MSC-B' as described in subclause 8.2.2.

The only difference to the equivalent figure 27 is the omission of the circuit and handover number allocation signalling.

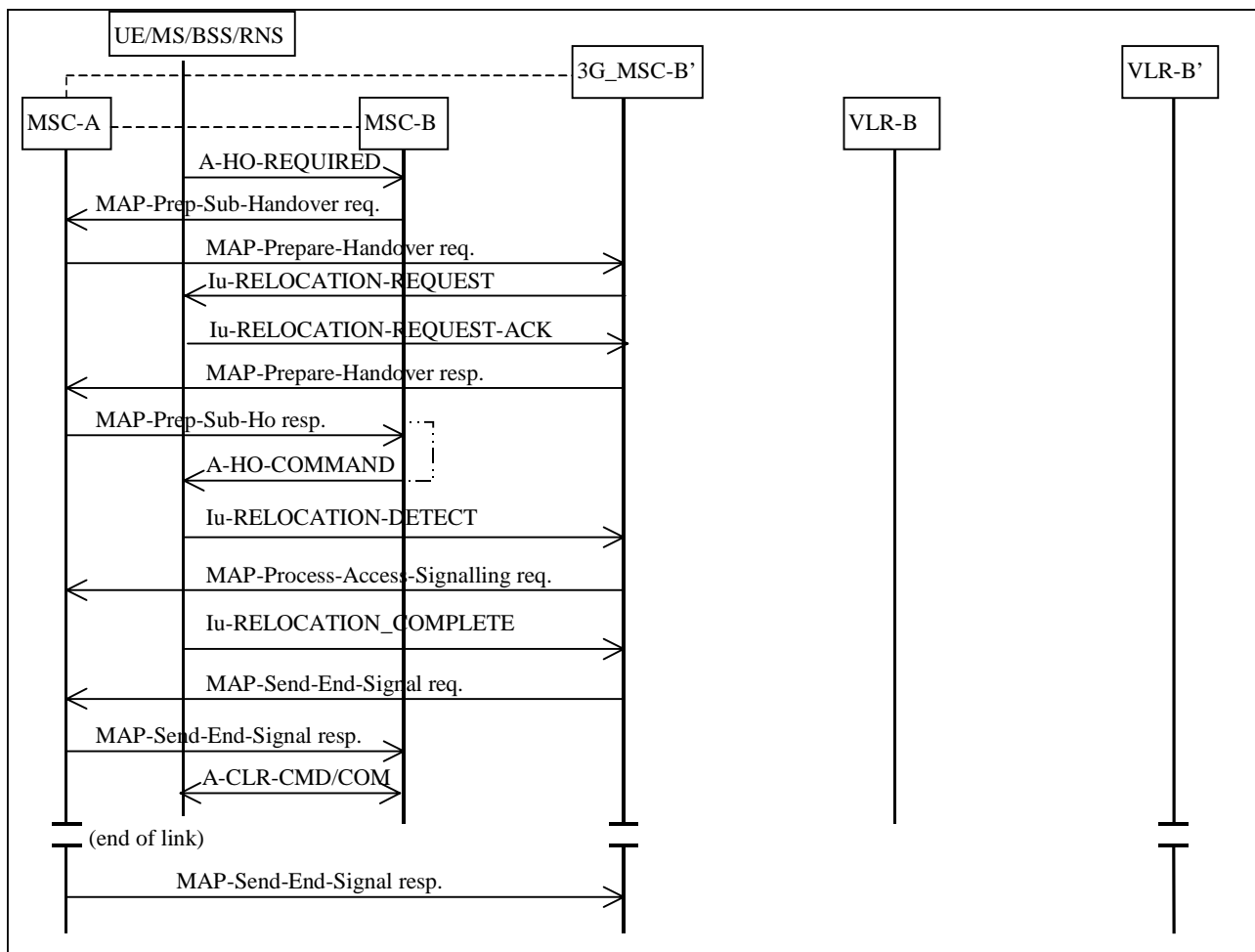

Figure 29: Subsequent GSM to UMTS handover procedure ii): Successful handover from MSC-B to 3G_MSC-B' without circuit connection

8.3 SRNS Relocation

The following subclauses describe two options for the Basic and Subsequent Relocation procedures. The first, as described in subclauses 8.3.1 and 8.3.3 respectively, provides for a circuit connection between 3G_MSC-A and 3G_MSC-B. The second, as described in subclauses 8.3.2 and 8.3.4 respectively, provides for a Basic and Subsequent Relocation without the provision of a circuit connection between 3G_MSC-A and 3G_MSC-B.

In all the above mentioned subclauses, the following principles apply:

- during the relocation resource allocation, only the handover related messages that are part of the applicable RANAP subset - as defined in 3GPP TS 29.108 [15] - shall be transferred on the E-interface;
- the trace related messages that are part of the applicable RANAP subset - as defined in 3GPP TS 29.108 [15] - can be sent by the 3G_MSC-A on the E-interface after successful relocation resource allocation. In the subclauses 8.3.1 and 8.3.2, it is however allowed at basic relocation initiation on the E-Interface to transfer one trace related message that is part of the applicable RANAP subset - as defined in 3GPP TS 29.108 [15] - together with the applicable relocation related message. The applicable relocation related message shall always appear as the first message;
- during the relocation execution, i.e. while the UE is not in communication with the network, the 3G_MSC-A shall queue all outgoing RANAP messages until the communication with the UE is resumed;
- finally, during supervision, i.e. while the UE is not in the area of 3G_MSC-A after a successful Inter-3G_MSC relocation, the subset of RANAP procedures and their related messages - as defined in 3GPP TS 29.108 [15] - shall apply on the E-Interface;

- during the intra-3G_MSC-B relocation execution, if any, the 3G_MSC-B shall queue all outgoing RANAP messages until the communication with the UE is resumed.

8.3.1 Basic relocation procedure requiring a circuit connection between 3G_MSC-A and 3G_MSC-B

The procedure used for successful Inter-3G_MSC SRNS relocation is shown in figure 30. Initiation of the relocation procedure is described in clause 5. The procedure described in this subclause makes use of messages from the 3GPP TS 25.413 [11] and of the transport mechanism from the Mobile Application Part (MAP) (3GPP TS 29.002 [12]). After an Inter-3G_MSC SRNS relocation further Intra-3G_MSC relocations may occur on 3G_MSC-B, these relocations will follow the procedures specified in a previous clause.

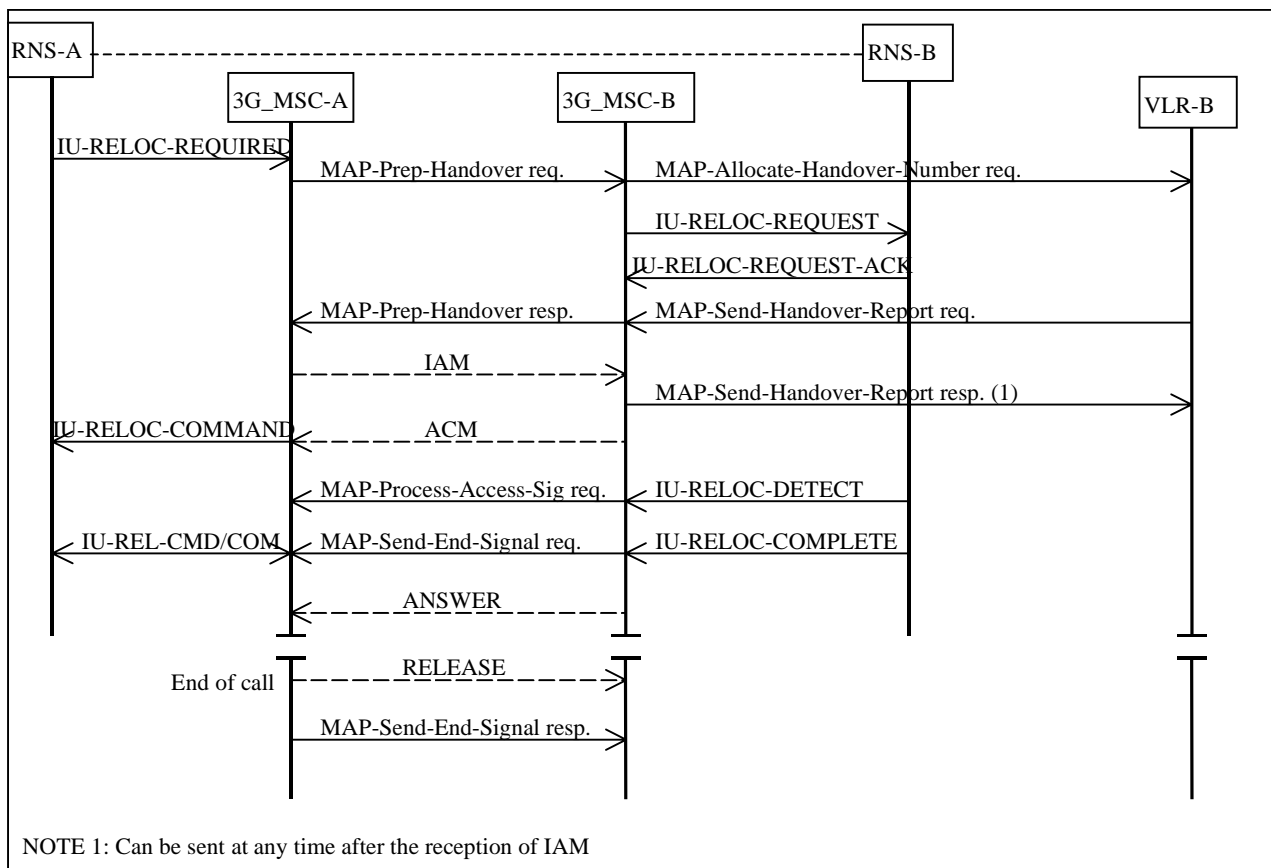

Figure 30: Basic SRNS Relocation Procedure requiring a circuit connection

8.3.1.1 With one circuit connection

The relocation is initiated as described in subclause 6.2.3. (This is represented by IU-RELOC-REQUIRED in figure 30). Upon receipt of the IU-RELOC-REQUIRED from RNS-A, 3G_MSC-A shall send a MAP-PREPARE-HANDOVER request to 3G_MSC-B including a complete IU-RELOC-REQUEST message. (NOTE: 3G_MSC-A shall not send further MAP-PREPARE-HANDOVER requests while a MAP-PREPARE-HANDOVER response is pending or before any timeouts). The MAP-PREPARE-HANDOVER request shall carry in the IU-RELOC-REQUEST all information needed by 3G_MSC-B for allocating radio resources in the case of SRNS relocation without Iur interface, see 3GPP TS 25.413 [11].

3G_MSC-A shall configure the RANAP RAB parameters according to the current selected codec.

MAP-PREPARE-HANDOVER request shall also carry the identity of the target RNS to which the call is to be relocated, see 3GPP TS 29.002. 3G_MSC-B will return the MAP-PREPARE-HANDOVER response after having retrieved one or several Handover Numbers from its associated VLR (exchange of the messages MAP-allocate-handover-number request and MAP-send-handover-report request), 3G_MSC-B shall connect a transcoder. The Handover Numbers shall be used for routing the connections of the calls from 3G_MSC-A to 3G_MSC-B. If radio resources are available in 3G_MSC-B, the MAP-PREPARE-HANDOVER response sent to 3G_MSC-A will contain the complete IU-RELOC-REQUEST-ACKNOWLEDGE message received from RNS-B, containing the radio resources definition to be sent by RNS-A to the UE (in case of relocation without Iur interface) and possible extra RANAP information, amended by 3G_MSC-B due to the possible interworking between the RANAP protocol carried on the E-interface and the RANAP protocol used on the Iu-interface. If the radio resource allocation is not possible, the MAP-PREPARE-HANDOVER response containing an IU-RELOCATION-FAILURE will be sent to 3G_MSC-A. 3G_MSC-B will do the same if a fault is detected on the identity of the RNS where the call has to be relocated. 3G_MSC-B simply reports the events related to the dialogue. It is up to 3G_MSC-A to decide the action to perform if it receives negative responses or the operation fails due to the expiry of the MAP-PREPARE-HANDOVER timer.

If an error related to the TCAP dialogue or to the MAP-PREPARE-HANDOVER request is returned from 3G_MSC-B, this will be indicated to 3G_MSC-A and 3G_MSC-A will terminate the relocation attempt. The existing connection to the UE shall not be cleared.

When the IU-RELOC-REQUEST-ACKNOWLEDGE has been received, 3G_MSC-A shall establish a circuit between 3G_MSC-A and 3G_MSC-B by signalling procedures supported by the network. In figure 30 this is illustrated by the messages IAM (Initial Address Message) and ACM (Address Complete Message) of Signalling System no 7. 3G_MSC-B awaits the capturing of the UE (subclause 6.2.3) on the radio path when the ACM is sent and 3G_MSC-A initiates the relocation execution when ACM is received (illustrated by the IU-RELOC-COMMAND and described in the subclause 6.2.3). 3G_MSC-A shall remove the transcoder between the MSC and other party.

3G_MSC-B transfers to 3G_MSC-A the acknowledgement received from the correct UE (IU-RELOC-DETECT/IU-RELOC-COMplete). The IU-RELOC-DETECT, if received, is transferred to 3G_MSC-A using the MAP-PROCESS-ACCESS-SIGNALLING request. The IU-RELOC-COMplete, when received from the correct UE, is included in the MAP-SEND-END-SIGNAL request and sent back to 3G_MSC-A. The circuit is through connected in 3G_MSC-A when the IU-RELOC-DETECT or the IU-RELOC-COMplete is received from 3G_MSC-B. The old radio resources are released when the IU-RELOC-COMplete message is received from 3G_MSC-B. The sending of the MAP-SEND-END-SIGNAL request starts the MAP supervision timer for the MAP dialogue between 3G_MSC-A and 3G_MSC-B. When the MAP-SEND-END-SIGNAL request including the IU-RELOC-COMplete message is received in 3G_MSC-A, the resources in RNS-A shall be released.

In order not to conflict with the PSTN/ISDN signalling system(s) used between 3G_MSC-A and 3G_MSC-B, 3G_MSC-B must generate an answer signal when IU-RELOC-DETECT/COMplete is received.

3G_MSC-B shall release the Handover Number when the circuit between 3G_MSC-A and 3G_MSC-B has been established.

If the circuit between 3G_MSC-A and 3G_MSC-B cannot be established, (e.g. an unsuccessful backward message is received instead of ACM) 3G_MSC-A terminates the inter-3G_MSC relocation attempt by sending an appropriate MAP message, for example an ABORT.

3G_MSC-A shall retain overall call control until the call is cleared by the fixed subscriber or the UE and there is no further call control functions to be performed (e.g. servicing waiting calls, echo cancellers).

When 3G_MSC-A clears the call to the UE it also clears the call control functions in 3G_MSC-A and sends the MAP-SEND-END-SIGNAL response to release the MAP resources in 3G_MSC-B.

3G_MSC-A may terminate the procedure at any time by sending an appropriate MAP message to 3G_MSC-B. If establishment of the circuit between 3G_MSC-A and 3G_MSC-B has been initiated, the circuit must also be cleared.

The relocation will be aborted by 3G_MSC-A if it detects release or interruption of the radio path before the call has been established on 3G_MSC-B.

8.3.1.2 With multiple circuit connections (Optional functionality)

8.3.1.2.1 3G_MSC-B does not support multiple bearers

If 3G_MSC-A supports the optional supplementary service Multicall (See 3GPP TS 23.135), 3G_MSC-A shall have the following functionality additionally to the description in section 8.3.1.1.

Upon receipt of the IU-RELOCATION-REQUIRED from RNS-A, 3G_MSC-A generates IU-RELOCATION-REQUEST and sends a MAP-PREPARE-HANDOVER request to 3G_MSC-B including the IU-RELOCATION-REQUEST message, which may include multiple bearers. If 3G_MSC-A receives an indication that 3G_MSC-B does not support multiple bearers, 3G_MSC-A shall select one bearer to be handed over if the UE is engaged with multiple bearers. 3G_MSC-A reconstructs IU-RELOCATION-REQUEST and sends again a MAP-PREPARE-HANDOVER request to 3G_MSC-B including the IU-RELOCATION-REQUEST message, which includes only the selected bearer.

When MAP-PREPARE-HANDOVER response including an IU-RELOCATION-REQUEST-ACK is received from 3G_MSC-B, 3G_MSC-A sends IU-RELOCATION-COMMAND, which indicates the bearers not to be handed over as bearers to be released, to RNS-A.

After 3G_MSC-A receives MAP-SEND-END-SIGNAL request from 3G_MSC-B, 3G_MSC-A shall release calls via 3G_MSC-B, which has been carried by the bearers not to be handed over, and then 3G_MSC-A sends IU-RELEASE-COMMAND to RNS-A.

8.3.1.2.2 3G_MSC-B supports multiple bearers

If 3G_MSC-A and 3G_MSC-B support the optional supplementary service Multicall (See 3GPP TS 23.135), 3G_MSC-A and 3G_MSC-B shall have the following functionality additionally to the description in section 8.3.1.1.

Upon receipt of the IU-RELOCATION-REQUIRED from RNS-A, 3G_MSC-A generates IU-RELOCATION-REQUEST and sends a MAP-PREPARE-HANDOVER request to 3G_MSC-B including the IU-RELOCATION-REQUEST message, which may include multiple bearers.

When MAP-PREPARE-HANDOVER request including an IU-RELOCATION-REQUEST message is received by the 3G_MSC-B and the number of bearers included in the IU-RELOCATION-REQUEST message has exceeded the maximum number of bearers supported by 3G_MSC-B, the 3G_MSC-B shall select several bearers so that the number of bearers will fulfil the range of 3G_MSC-B capability. In this case 3G_MSC-B shall reconstruct IU-RELOCATION-REQUEST message to cope with the capability of 3G_MSC-B. The 3G_MSC-B shall retrieve multiple Handover Numbers from its associated VLR (exchange of the messages MAP-allocate-handover-number request and MAP-send-handover-report request several times). The number of Handover Numbers depends on the number of RAB IDs in the reconstructed IU-RELOCATION-REQUEST.

After the completion of Handover Number allocation 3G_MSC-B may select several bearers and reconstruct IU-RELOCATION-REQUEST again if the number of successfully allocated Handover Numbers is less than the number of required bearers, and sends IU-RELOCATION-REQUEST to RNS-B.

After the reception of IU-RELOCATION-REQUEST-ACK from RNS-B, the 3G_MSC-B shall generate Relocation Number List, which includes couples of RAB ID (See 3GPP TS 25.413 [11]) and Handover Number successfully allocated. Then the 3G_MSC-B sends MAP-PREPARE-HANDOVER response including Relocation Number List back to the 3G_MSC-A.

Upon receipt of the MAP-PREPARE-HANDOVER response 3G_MSC-A shall establish circuits between 3G_MSC-A and 3G_MSC-B by signalling procedures supported by the network according to the Relocation Number List. When 3G_MSC-A receives all the results from attempted circuits (the results may be successful ACM message or unsuccessful backward message for each attempt) and if at least one circuit has been successfully established, 3G_MSC-A sends IU-RELOCATION-COMMAND, which indicates the bearers failed to set up in RNS-B and the bearers associated with circuits which has failed to set up as bearers to be released, to RNS-A.

After 3G_MSC-A receives MAP-SEND-END-SIGNAL request from 3G_MSC-B, 3G_MSC-A shall release calls via 3G_MSC-B, which has been carried by the bearers failed to set up in RNS-B and the bearers associated with circuits which has failed to set up, and then 3G_MSC-A sends IU-RELEASE-COMMAND to RNS-A.

If no circuit connection has been successfully established 3G_MSC-A terminates the inter-3G_MSC relocation attempt by sending an appropriate MAP message, for example ABORT.

8.3.2 Basic relocation procedure not requiring the establishment of a circuit connection between 3G_MSC-A and 3G_MSC-B

The basic SRNS relocation procedures to be used when no circuit connection is required by 3G_MSC-A are similar to those described in subclause 8.3.1 for circuit switched calls. The main differences to the procedures described in subclause 8.3.1 relate to the establishment of circuits between the network entities and the Handover Number allocation.

In the case of basic relocation, 3G_MSC-A shall specify to 3G_MSC-B that no Handover Number is required in the MAP-PREPARE-HANDOVER request (see 3GPP TS 29.002 [12]). As for the basic relocation using a circuit connection, the IU-RELOC-REQUEST is transmitted at the same time together with the identity of the target RNS to which the call is to be relocated. Any subsequent Handover Number allocation procedure will not be invoked until the completion of the basic relocation procedure (see clause: Subsequent Channel Assignment using a circuit connection). 3G_MSC-B shall then perform the radio resources allocation as described in subclause 8.3.1 if applicable. The MAP-PREPARE-HANDOVER response shall be returned to 3G_MSC-A including either the response of the radio resources allocation request received from RNS-B (IU-RELOC-REQUEST-ACKNOWLEDGE/IU-RELOC-FAILURE with possible extra RANAP information. This extra information is amended by 3G_MSC-B due to the possible interworking between the RANMAP protocol carried on the E-interface and the RANAP protocol used on the Iu-interface). The basic relocation procedure will continue as described in subclause 8.3.1 except that no circuit connection will be established towards 3G_MSC-B.

The relevant case for the basic relocation without circuit connection is shown in figure 31. As can be seen the major differences to the equivalent figure 30 are the omission of any circuit establishment messaging and the omission of handover number allocation signalling.

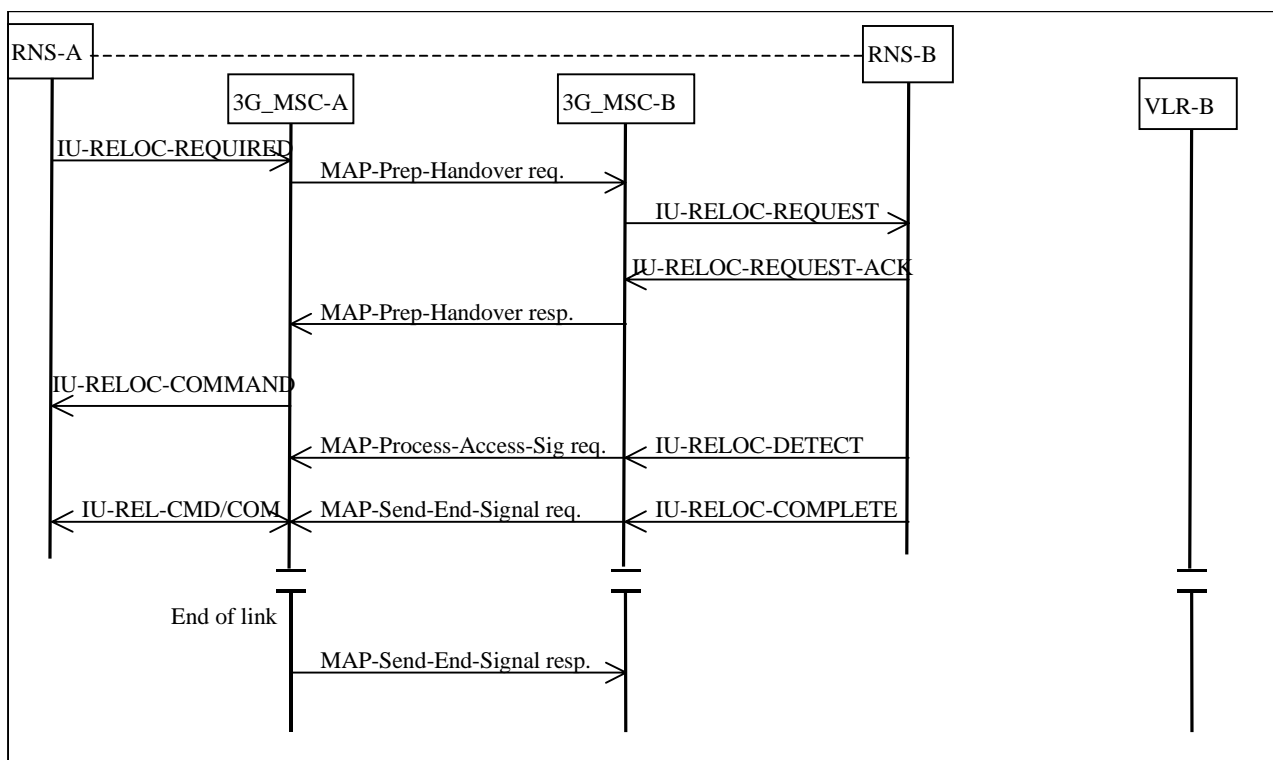

Figure 31: Basic SRNS relocation procedure without a circuit connection

8.3.3 Procedure for subsequent relocation requiring a circuit connection

After the call has been relocated to 3G_MSC-B, if the UE leaves the area of 3G_MSC-B during the same call, subsequent relocation is necessary in order to continue the connection when no Iur interface exists between the involved RNSs, or to optimise the transmission path when the Iur interface is used.

The following cases apply:

- i) the UE moves back to the area of 3G_MSC-A;
- ii) the UE moves into the area of a third 3G_MSC (3G_MSC-B').

In both cases the call is switched in 3G_MSC-A; the circuit between 3G_MSC-A and 3G_MSC-B shall be released after a successful subsequent relocation has been performed.

If 3G_MSC-A is replaced by MSC-A in the procedures, then a subsequent relocation from 3G_MSC-B to 3G_MSC-B' shall not be possible since MSC-A does not support the RANAP protocol.

8.3.3.1 Description of subsequent relocation procedure i): 3G_MSC-B to 3G_MSC-A

The procedure for successful relocation from 3G_MSC-B back to 3G_MSC-A is shown in figure 32.

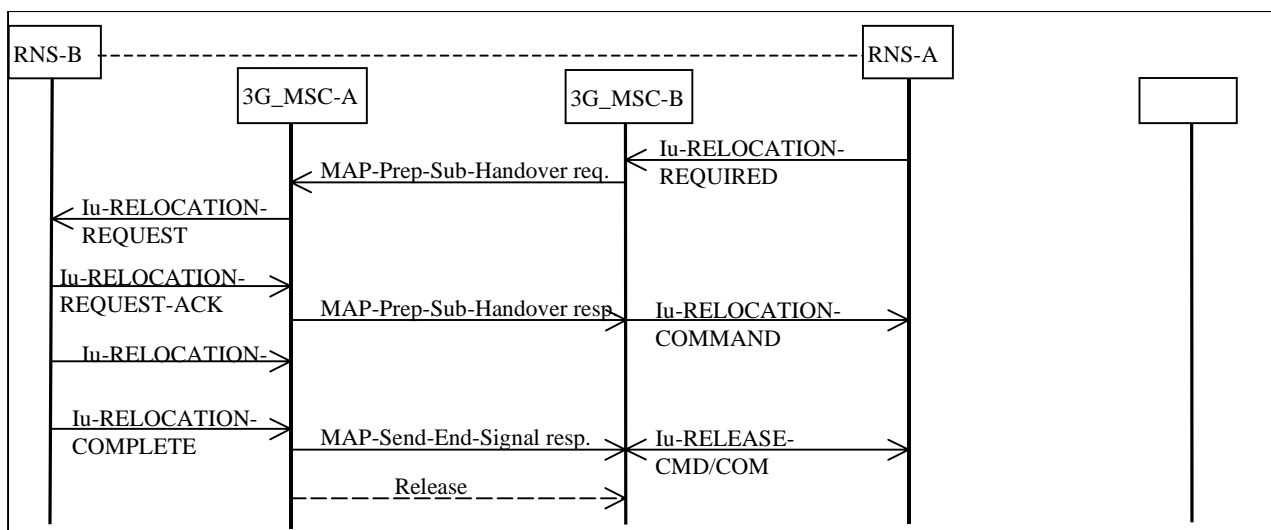

Figure 32: Subsequent relocation procedure i) successful relocation from 3G_MSC-B to 3G_MSC-A using a circuit connection

8.3.3.1.1 With one circuit connection

The procedure is as follows.

3G_MSC-B sends the MAP-PREPARE-SUBSEQUENT-HANDOVER request to 3G_MSC-A indicating the new 3G_MSC number (3G_MSC-A number), indicating also the identity of the target RNS where the call has to be relocated and including a complete IU-RELOC-REQUEST message.

NOTE: 3G_MSC-B shall not send further MAP-PREPARE-SUBSEQUENT-HANDOVER requests while a relocation attempt is pending or before any timeouts.

Since 3G_MSC-A is the call controlling 3G_MSC, this 3G_MSC needs no Handover Number for routing purposes; 3G_MSC-A can immediately initiate the relocation towards the target RNS.

When relocation can be initiated, 3G_MSC-A shall return in the MAP-PREPARE-SUBSEQUENT-HANDOVER response the complete IU-RELOC-REQUEST-ACKNOWLEDGE message received from the RNS-B and possible extra RANAP information, amended by 3G_MSC-A due to the possible interworking between the RANAP protocol carried on the E-interface and the RANAP protocol used on the Iu-interface. If a radio resource cannot be assigned or if a fault is detected on the target RNS identity, or the target RNS identity in the IU-RELOC-REQUEST is not consistent with the target 3G_MSC number, the MAP-PREPARE-SUBSEQUENT-HANDOVER response containing an IU-

RELOC-FAILURE message shall be given to 3G_MSC-B, in addition 3G_MSC-B shall maintain the connection with the UE.

If the procedure in 3G_MSC-A is successful then 3G_MSC-B can request the UE to retune to the new RNS-B on 3G_MSC-A in the case of relocation without Iur interface, or request RNS-B to become serving RNS in the case of relocation with Iur interface. This is illustrated in figure 32 by the IU-RELOC-COMMAND message. The operation is successfully completed when 3G_MSC-A receives the IU-RELOC-COMplete message.

3G_MSC-A shall insert a transcoder at successful subsequent relocation back to 3G_MSC-A.

After relocation 3G_MSC-A shall release the circuit to 3G_MSC-B.

3G_MSC-A must also terminate the MAP procedure for the basic relocation between 3G_MSC-A and 3G_MSC-B by sending an appropriate MAP message. 3G_MSC-B will release the resources in RNS-A when the MAP-SEND-END-SIGNAL response is received.

8.3.3.1.2 With multiple circuit connections (Optional functionality)

If 3G_MSC-A and 3G_MSC-B support the optional supplementary service Multicall (See 3GPP TS 23.135), 3G_MSC-A and 3G_MSC-B shall have the following functionality additionally to the description in section 8.3.3.1.1.

Upon receipt of the IU-RELOCATION-REQUIRED from RNS-A, 3G_MSC-B generates IU-RELOCATION-REQUEST which may include several bearers and sends it to 3G_MSC-A over MAP-PREPARE-SUBSEQUENT-HANDOVER request.

3G_MSC-A sends IU-RELOCATION-REQUEST to RNS-B and receives IU-RELOCATION-REQUEST-ACK.

When MAP-PREPARE-SUBSEQUENT-HANDOVER response is received from 3G_MSC-A, 3G_MSC-B sends IU-RELOCATION-COMMAND, which indicates the bearers failed to set up in RNS-B as bearers to be released, to RNS-A.

After 3G_MSC-A receives IU-RELOCATION-COMplete message from RNS-B, 3G_MSC-A shall release calls via RNS-B, which has been carried by the bearers failed to set up in RNS-B, and then 3G_MSC-A sends MAP-SEND-END-SIGNAL response to 3G_MSC-B.

8.3.3.2 Description of subsequent relocation procedure ii): 3G_MSC-B to 3G_MSC-B'

The procedure for successful relocation from 3G_MSC-B to 3G_MSC-B' is shown in figure 33.

The procedure consists of two parts:

- a subsequent relocation from 3G_MSC-B back to 3G_MSC-A as described in subclause 8.3.3.1; and
- a basic relocation from 3G_MSC-A to 3G_MSC-B' as described in subclause 8.3.1.

8.3.3.2.1 With one circuit connection

3G_MSC-B sends the MAP-PREPARE-SUBSEQUENT-HANDOVER request to 3G_MSC-A indicating a new 3G_MSC number (which is the identity of 3G_MSC-B'), indicating also the target RNS identity and including a complete IU-RELOC-REQUEST, 3G_MSC-A then starts a basic relocation procedure towards 3G_MSC-B'.

When 3G_MSC-A receives the ACM from 3G_MSC-B', 3G_MSC-A informs 3G_MSC-B that 3G_MSC-B' has successfully allocated the radio resources on RNS-B' side by sending the MAP-PREPARE-SUBSEQUENT-HANDOVER response containing the complete IU-RELOC-REQUEST-ACKNOWLEDGE received from RNS-B' and possible extra RANAP information, amended by 3G_MSC-A due to the possible interworking between the RANAP protocol carried on the E-interface between 3G_MSC-A and 3G_MSC-B' and the RANAP protocol carried on the E-interface between 3G_MSC-A and 3G_MSC-B. Now 3G_MSC-B can start the procedure on the radio path if needed.

For 3G_MSC-A the relocation is completed when it has received the MAP-SEND-END-SIGNAL REQUEST from 3G_MSC-B' containing the IU-RELOC-COMplete received from the RNS-B'. The circuit between 3G_MSC-A and 3G_MSC-B is released. 3G_MSC-A also sends the MAP-SEND-END-SIGNAL response to 3G_MSC-B in order to terminate the original MAP dialogue between 3G_MSC-A and 3G_MSC-B. 3G_MSC-B releases the radio resources when it receives this message.

If no radio resource can be allocated by 3G_MSC-B' or no circuit between 3G_MSC-A and 3G_MSC-B' can be established or a fault is detected on the target RNS identity or the target RNS identity in the IU-RELOC-REQUEST is not consistent with the target 3G_MSC number, 3G_MSC-A informs 3G_MSC-B by using the IU-RELOC-FAILURE message included in the MAP-PREPARE-SUBSEQUENT-HANDOVER response. 3G_MSC-B shall maintain the existing connection with the UE.

When the subsequent relocation is completed, 3G_MSC-B' is considered as 3G_MSC-B. Any further inter-3G_MSC relocation is handled as described above for a subsequent relocation.

8.3.3.2.2 With multiple circuit connections (Optional functionality)

If 3G_MSC-A and 3G_MSC-B support the optional supplementary service Multicall (See 3GPP TS 23.135), 3G_MSC-A and 3G_MSC-B shall have the following functionality additionally to the description in section 8.3.3.2.1.

Upon receipt of the IU-RELOCATION-REQUIRED from RNS-B 3G_MSC-B generates an IU-RELOCATION-REQUEST message which may include multiple bearer and sends it to 3G_MSC-A over MAP-PREPARE-SUBSEQUENT-HANDOVER request.

Upon receipt of the MAP-PREPARE-SUBSEQUENT-HANDOVER request from 3G_MSC-B, 3G_MSC-A starts a basic relocation procedure towards 3G_MSC-B'.

8.3.3.2.2.1 3G_MSC-B' does not support multiple bearers

If 3G_MSC-A receives an indication that 3G_MSC-B' does not support multiple bearers, 3G_MSC-A shall select one bearer to be handed over. 3G_MSC-A reconstructs IU-RELOCATION-REQUEST and sends again a MAP-PREPARE-HANDOVER request to 3G_MSC-B' including the IU-RELOCATION-REQUEST message, which includes only the selected bearer. Upon receipt of MAP-PREPARE-HANDOVER response from 3G_MSC-B', 3G_MSC-A shall reconstruct IU-RELOCATION-REQUEST-ACK to indicate the bearers not to be handed over as the bearers failed to set up in IU-RELOCATION-REQUEST-ACK and send it over MAP-PREPARE-SUBSEQUENT-HANDOVER response to 3G_MSC-B.

When MAP-PREPARE-SUBSEQUENT-HANDOVER response is received from 3G_MSC-A 3G_MSC-B sends IU-RELOCATION-COMMAND, which indicates the bearers failed to set up as bearers to be released, to RNS-A.

After 3G_MSC-A receives MAP-SEND-END-SIGNAL request from 3G_MSC-B', 3G_MSC-A shall release calls via 3G_MSC-B', which has been carried by the bearers failed to set up, and then 3G_MSC-A sends MAP-SEND-END-SIGNAL response to 3G_MSC-B.

8.3.3.2.2.2 3G_MSC-B' supports multiple bearers

If some of circuit connections failed to set up between 3G_MSC-A and 3G_MSC-B', 3G_MSC-A shall reconstruct IU-RELOCATION-REQUEST-ACK message so that the IU-RELOCATION-REQUEST-ACK includes only the bearers which have successfully established circuit connection and sends it to 3G_MSC-B over MAP-PREPARE-SUBSEQUENT-HANDOVER response.

When MAP-PREPARE-SUBSEQUENT-HANDOVER response is received from 3G_MSC-A 3G_MSC-B sends IU-RELOCATION-COMMAND, which indicates the bearers failed to set up as bearers to be released, to RNS-A.

After 3G_MSC-A receives MAP-SEND-END-SIGNAL request from 3G_MSC-B', 3G_MSC-A shall release calls via 3G_MSC-B', which has been carried by the bearers failed to set up, and then 3G_MSC-A sends MAP-SEND-END-SIGNAL response to 3G_MSC-B.

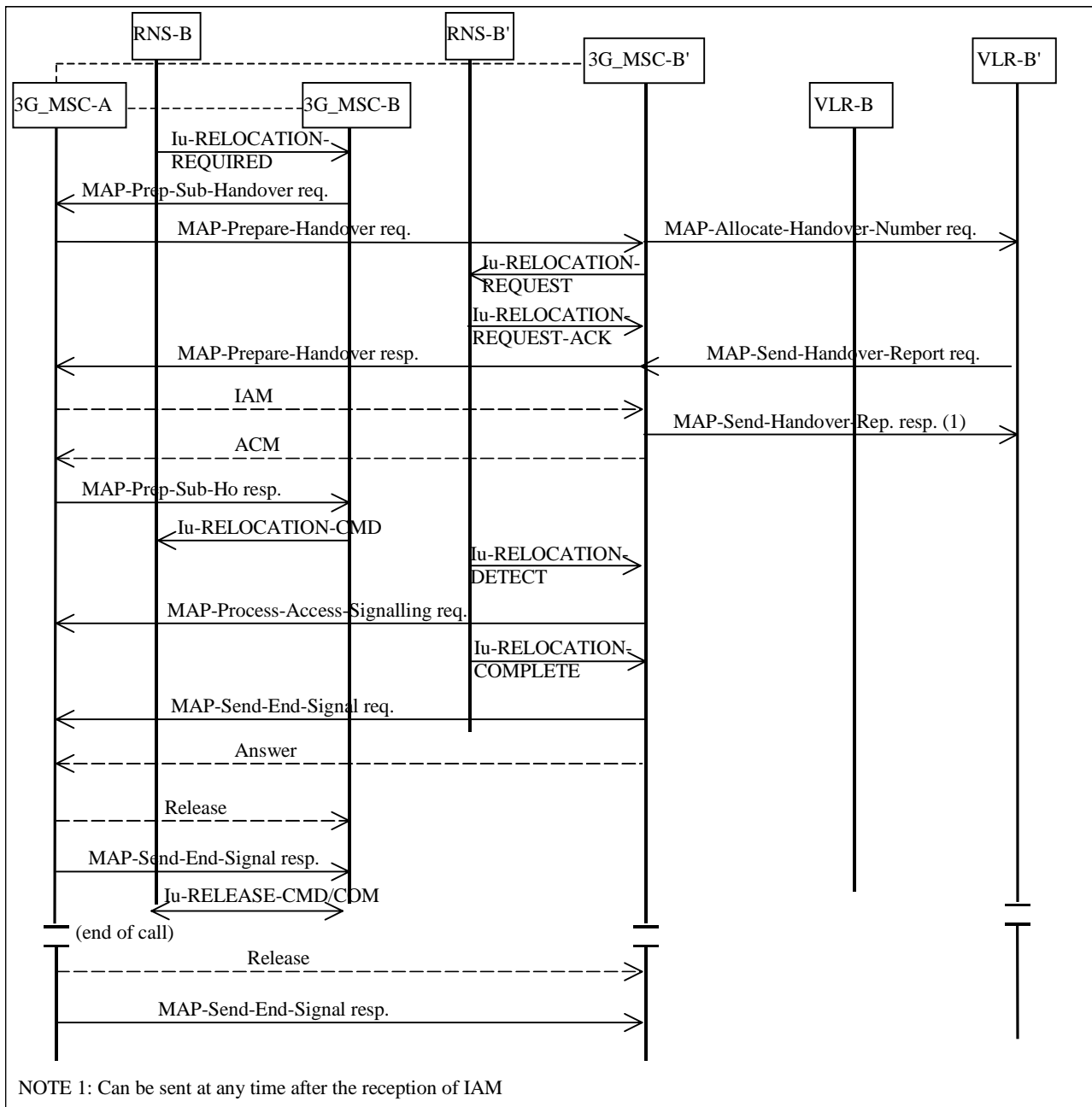

Figure 33: Subsequent relocation procedure ii) Successful SRNS relocation from 3G_MSC-B to 3G_MSC-B' requiring a circuit connection

8.3.4 Procedure for subsequent relocation not requiring a circuit connection

As for the subsequent relocation with a circuit connection between 3G_MSC-A and 3G_MSC-B, the same two cases of subsequent relocation apply:

- i) the UE moves back to the area of 3G_MSC-A;
- ii) the UE moves into the area of a third 3G_MSC (3G_MSC-B').

If 3G_MSC-A is replaced by MSC-A in the procedures, then a subsequent relocation from 3G_MSC-B to 3G_MSC-B' shall not be possible since MSC-A does not support the RANAP protocol.

8.3.4.1 Description of subsequent relocation procedure i): 3G_MSC-B to 3G_MSC-A

The procedure for successful relocation from 3G_MSC-B back to 3G_MSC-A without circuit connection is shown in figure 34. The only difference with the figure 32 is that no circuit release is needed between 3G_MSC-A and 3G_MSC-B.

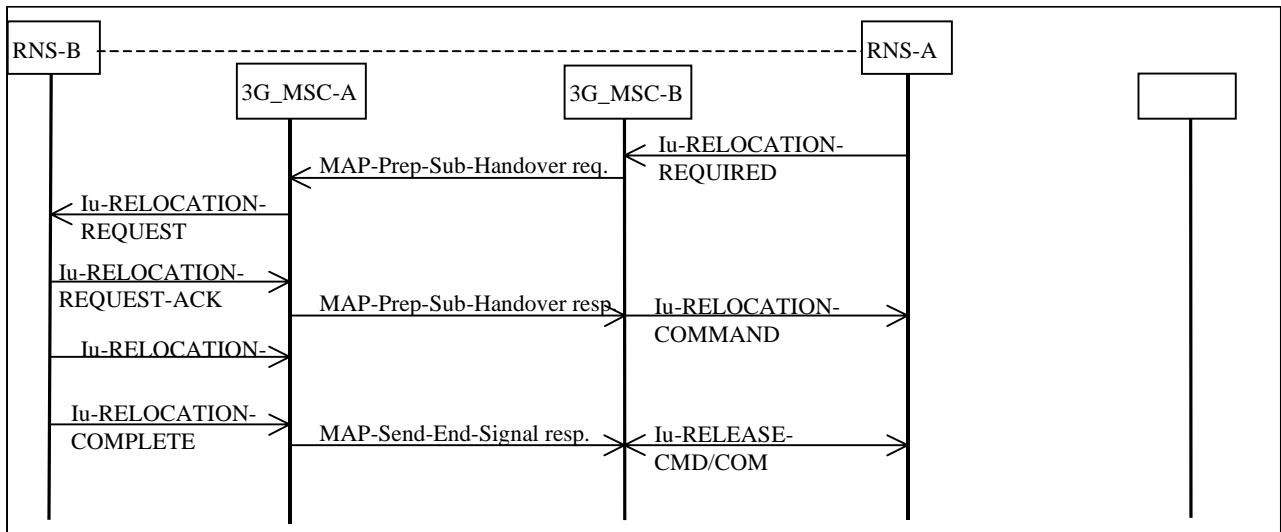

Figure 34: Subsequent relocation procedure i) successful relocation from 3G_MSC-B to 3G_MSC-B not requiring a circuit connection

8.3.4.2 Description of subsequent relocation procedure ii): 3G_MSC-B to 3G_MSC-B'

The procedure for successful relocation from 3G_MSC-B to 3G_MSC-B' is shown in figure 35.

The procedure consists of two parts:

- a subsequent relocation from 3G_MSC-B back to 3G_MSC-A as described in subclause 8.3.4.1; and
- a basic relocation from 3G_MSC-A to 3G_MSC-B' as described in subclause 8.3.2.

The only difference to the equivalent figure 33 is the omission of the circuit and handover number allocation signalling.

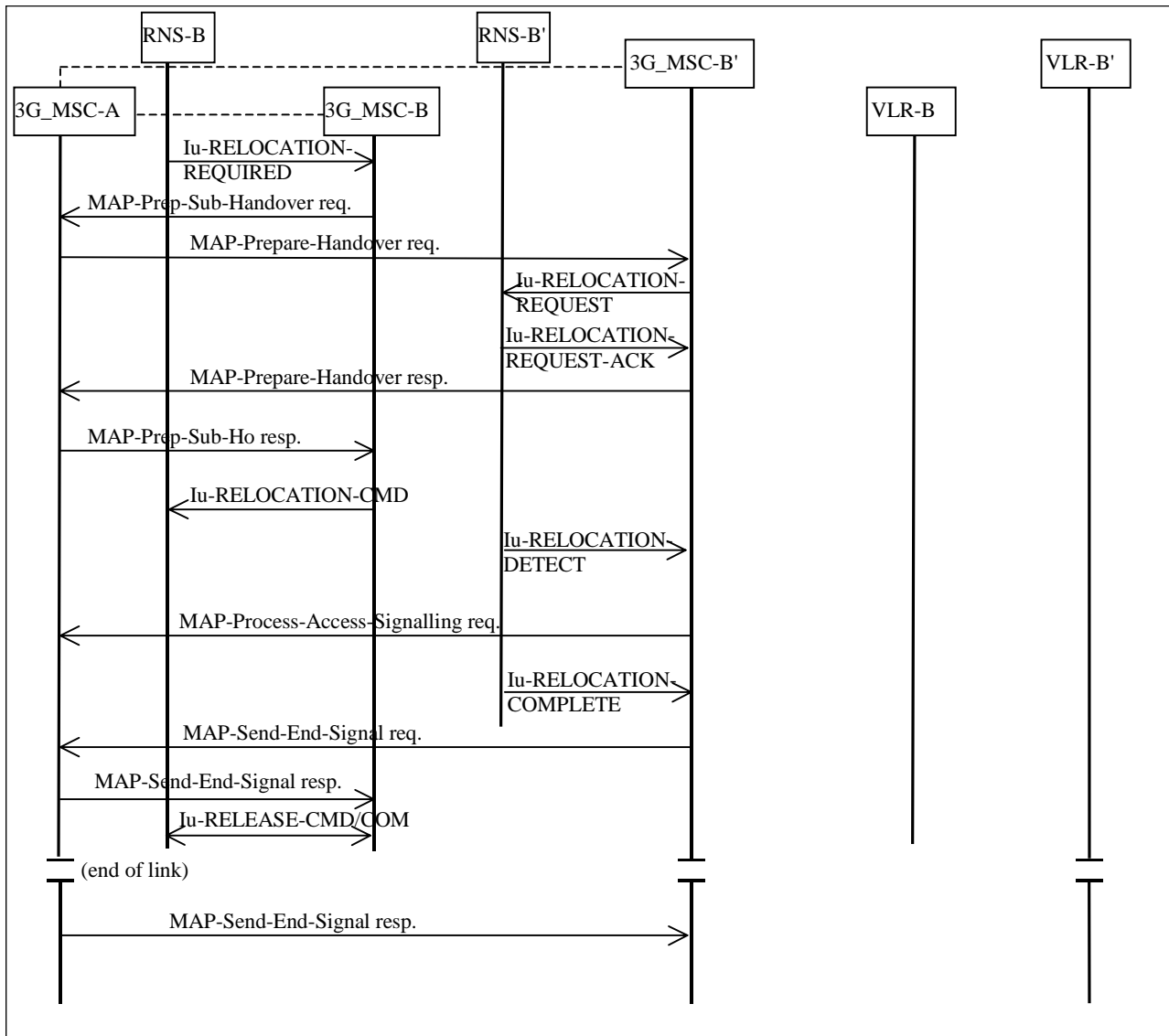

Figure 35: Subsequent relocation procedure ii) Successful SRNS relocation from 3G_MSC-B to 3G_MSC-B' not requiring a circuit connection

9 Detailed procedures in MSC-A

9.1 BSS/MSC and MS/MSC procedures in MSC-A (functional unit 1)

The handover procedures in this functional unit consist of:

- i) signalling between the MS and the MSC;
- ii) signalling between the BSS and the MSC for access management.

9.2 Call control procedures MSC-A (functional unit 2)

The call control procedures related to handover in MSC-A can be divided into two functional entities:

- the first entity is the call control procedure as part of the normal interworking between the PSTN/ISDN and the PLMN; for an MS originating call MSC-A is the originating exchange, for an MS terminating call MSC-A is the destination exchange;
- the second entity is the call control procedure for the connection between MSC-A and MSC-B in case of a handover from MSC-A to MSC-B. For this call control procedure the following applies.

Call set-up

- the connection to MSC-B is set up by procedures relevant to the signalling system used in the PSTN/ISDN to which MSC-A is connected. The call is set up by using the MS Handover Number received from MSC-B as part of the MAP procedure;
- the call set-up direction will always be from MSC-A to MSC-B, even when the call was originally established by the MS. Functional unit 2 (see figure 2) should therefore keep information on call set-up direction in order to be able to interpret correctly any clearing signals (see below);
- the unit should indicate the address complete condition to functional unit 3 and through-connect without awaiting the answer signal from MSC-B. This applies also to signalling systems where address complete signals are not supported. In such cases an artificial address complete is established by functional unit 2.

Call clearing

- call clearing consists of two parts: after inter-MSC handover, clearing of the MS-BSS connection and clearing of the inter-MSC connection. If a request to release the call is generated by the network while the MS is re-tuning from one BSS to another BSS, then MSC-A shall begin clearing the call to the network and queue the call release to the MS until the MS has resumed communication. This includes the case when MSC-B and/or MSC-B' are involved;
- the MAP procedures are used to transfer information between MSC-B and MSC-A in order to maintain full call control within MSC-A. MSC-A determines, based on information received from MSC-B, the appropriate signals (according to 3GPP TS 24.008 [10]) to be sent to the MS, and sends this information to MSC-B;
- when MSC-A clears the call to the MS it also clears the call control functions in MSC-B and sends the MAP-SEND-END-SIGNAL response to release the MAP resources in MSC-B. The clearing of the connection is by procedures relevant to the signalling system in the PSTN/ISDN to which MSC-A is connected;
- when the Signalling System no 7 ISDN User Part is used, the normal symmetric release procedures apply on both the connection to the fixed network and to MSC-B;
- when a signalling system is used without a symmetric release possibility, some notice should be given to the clear-forward and clear-back procedures;
- for MS terminating calls the following conditions apply on clear-forward and clear-back:
 - when a clear-forward signal is received on interface B' (see figure 1), MSC-A clears the circuit to MSC-B by normal clear-forward procedures;
 - when a clear-back signal is received from MSC-B, MSC-A starts normal clear-back procedures towards the fixed network (interface B') and sends the clear-forward signal on interface B'' in order to clear the connection with MSC-B.

NOTE 1: This case corresponds to a fault situation.

- for MS originated calls the following applies:
 - when MSC-A receives a clear-back signal from MSC-B, this signal must be interpreted as indicating a clear-forward condition. MSC-A then clears both the connection on interface B' (see figure 1) and to MSC-B by normal clear-forward procedures.

NOTE 2: This case corresponds to a fault situation.

- when MSC-A receives a clear-back signal on interface B', MSC-A should distinguish between national and international connections:
 - for international connections where the Q.118 [1] supervision is done in the ISC, MSC-A sends a clear-forward signal on both interface B' to the fixed network and interface B'' to MSC-B;
 - for national connections or for international connections where the Q.118 [1] supervision is not done in the ISC, a timer is started according to national practice for clear-back supervision and MSC-A proceeds as follows:
 - i) if a clear-back signal is received from MSC-B, MSC-A interprets this as indicating a clear-forward condition and proceeds by clearing the connections on interface B' and to MSC-B by normal clear-forward procedures;
 - ii) if the timer expires, MSC-A proceeds by normal clear-forward of the connections on interface B' and to MSC-B.

9.3 Handover control procedures MSC-A (functional unit 3)

The procedures of functional unit 3 are given in terms of SDL diagrams in figure 41. To easily distinguish the interface concerned the messages received or sent from this unit are prefixed with either 'MAP' for a MAP message, 'A' for an A-Interface message or 'I' for an ISDN/PSTN message.

The procedures of functional unit 3 include:

- i) initiation. The initiation condition is shown by the signal A-HANDOVER-REQUIRED.

The diagram also includes queuing when there is no channel available. Calls for which handover has been initiated should be queued with priority higher than normal calls. They should have lower priority than emergency calls.

- ii) handover of calls within the area of MSC-A, i.e. handover case i). In this case MSC-A controls the procedures on both the previous and the new radio channel, using signals A-HANDOVER-REQUEST and A-HANDOVER-COMMAND. The handover procedure is completed when A-HANDOVER-COMplete is received. If this signal is not received, the radio path and the connection on interface B' are either released or the original connection is maintained.

In the case of ongoing GSM voice group calls for subsequent users of the VGCS channel uplink the original connection shall always be maintained.

For handover devices with three-party capabilities the handover device is first set up so that all interfaces A', A'' and B' are connected (illustrated by the signal 'set up handover device'). This is done when the Handover Command is sent to the MS. The device is connected in its final position (i.e. A'' to B' for case ii)) (illustrated by the signal 'connect handover device') when A-HANDOVER-COMplete is received.

- iii) handover to MSC-B. This procedure is the one described in subclauses 7.1. and 7.2. For handover devices with three-party capabilities the handover device is set-up when MSC-A sends the Handover Command to the MS, i.e. the interfaces A', B' and B'' are then connected. The device is connected in its final position (i.e. B' to B'') when the successful procedure indication is received from functional unit 4.
- iv) subsequent handover to MSC-A. The procedure is described in subclauses 7.3. and 7.4. When a handover to MSC-A indication is received from functional unit 4, the handover device is set up so that interfaces B', B'' and A' are connected (for handover devices with three-party capabilities). When A-HANDOVER-COMplete is received, the device is connected in its final position (i.e. B' to A').

If A-HANDOVER-COMplete is not received (expiry of timer T104), the handover device releases interface A' and returns to a position where B' and B'' are connected.

- v) subsequent handover to a third MSC (MSC-B') . The procedure is described in subclauses 7.3. and 7.4. The handover device is set up in its initial position, (i.e. interconnection of interfaces B', B'' and B''') when the connection to MSC-B' has been established. MSC-B is informed via functional unit 4 that the connection has been established and that the procedure on the radio path can be initiated. The device is connected in its final position (i.e. B' to B''') when a successful procedure indication is received from functional unit 4. MSC-B is informed that all procedures in MSC-B can be terminated (illustrated by the MAP-SEND-END-SIGNAL response). The device returns to the state where B' and B'' are connected if the subsequent handover procedure fails.

Timers in MSC-A.

The procedures are supervised by timers in order to avoid a deadlock when responses are not received or the procedures fail. The following timers are defined:

- T101: this timer supervises the queuing time for a free channel. If T101 expires, a no channel indication is generated, a retry procedure could be applied as described in subclause 6.1. T101 is set by O&M,
- T102: this timer supervises the time for handover completion for handover between BSSs in MSC-A. T102 is set by O&M,
- T103: this timer supervises the time between issuing an A-HANDOVER-COMMAND from MSC-A and receiving a successful procedure indication from MSC-B. This timer also supervises the time between sending an A-HO-REQUEST-ACKNOWLEDGE to MSC-B and receiving a successful procedure indication from MSC-B'. If T103 expires, the handover procedure is terminated. T103 is set by O&M,
- T104: this timer supervises the time between sending of an A-HO-REQUEST-ACKNOWLEDGE to MSC-B and receiving the A-HANDOVER-COMplete from BSS-B on MSC-A. If the timer expires, the new radio channel is released and the existing handover device connection to MSC-B is maintained. T104 is set by O&M.

9.4 MAP procedures in MSC-A (functional unit 4)

The MAP procedures for handover are defined in 3GPP TS 29.002 [12]. They include:

- procedures for basic handover;
- procedures for subsequent handover.

These procedures are as outlined in clause 7.

9.5 Interworking between Handover control procedures and MAP procedures in MSC-A

The interworking between the Handover control procedures and the MAP procedures for handover is defined in 3GPP TS 29.010 [8]. It includes:

- interworking at basic handover initiation;
- interworking at subsequent handover completion.

This interworking is not described in the present document.

9.6 Compatibility with GSM Phase 1

If the MSC-A initiates an Inter-MSC handover procedure according to Phase 2 MAP and BSSMAP protocols while using a Phase 1 BSSMAP protocol towards BSS-A, MSC-A has to perform the protocol interworking.

The same holds if a Phase 2 BSSMAP protocol is used between MSC-A and BSS-A and the E-interface supports only Phase 1 protocol.

10 Detailed procedures in MSC-B

10.1 BSS/MS (MS/BSS) procedures MSC-B (functional unit 1)

The handover procedures in this functional unit consist of:

- i) signalling between the MS and the MSC;
- ii) signalling between the BS and the MSC for access management.

Signals exchanged with functional unit 3 are indicated in subclause 10.3.

10.2 Call control procedures MSC-B (functional unit 2)

These procedures relate to the call control in MSC-B of the "handover" connection with MSC-A. For these procedures the following apply:

Call set-up:

- the connection is set up by MSC-A. MSC-B should provide, if possible, the following backward signals:
 - signals indicating unsuccessful call set-up and, if possible, the cause of call failure;
 - address complete signal;
 - answer signal (see note).

NOTE: The answer signal is not related to answering by the MS and it has no meaning in the handover procedure between MSC-A and MSC-B. But after successful handover or successful subsequent channel assignment using a circuit connection between MSC-A and MSC-B this signal is needed for bringing the connection in the answered state in the intermediate PSTN/ISDN exchanges.

- there will be no indication that the call applies to a handover. This information has to be derived from the MS Handover Number received during call set-up in relation to the earlier MAP-PREPARE-HANDOVER request/MAP-PREPARE-HANDOVER response procedure between MSC-A and MSC-B.

Call clearing:

- call clearing consists of two parts after inter-MSC handover: clearing of the BSS-MS connection and clearing of the inter-MSC connection, this case is only applicable to calls successfully handed over. If a request to release the call is generated by the network while the MS is re-tuning from one BSS to another BSS, then MSC-B shall begin clearing the call to the network and queue the call release to the MS until the MS has resumed communication;
- the MAP is used to transfer information between MSC-A and MSC-B in order to make it possible for MSC-B to send the appropriate signals to the MS, specified in 3GPP TS 24.008 [10], and still leave the call control to MSC-A. MSC-A normally initiates release of the connection between MSC-A and MSC-B. Exceptionally MSC-B is allowed to release the connection if no MAP-SEND-END-SIGNAL response is received, or if the Handover is to be aborted.
- when the Signalling System no 7 ISDN User Part is used, the normal symmetric release procedures apply. When a signalling system is used without a symmetric release possibility or a fault condition occurs, the following may apply:
 - when MSC-B receives a clear-forward signal from MSC-A, it shall release the radio resources;
 - in fault situation eg. machine malfunction or loss of the connection on interface A, MSC-B may send a clear-back signal to MSC-A.

10.3 Handover control procedures MSC-B (functional unit 3)

The procedures of functional unit 3 are given in form of SDL diagrams in figure 42. To easily distinguish the interface concerned the messages received or sent from this unit are prefixed with either 'MAP' for a MAP message, 'A' for an A-Interface message or 'I' for an ISDN/PSTN message. The procedure in functional unit 3 include:

i) handover from MSC-A.

This case is initiated by MSC-A, and includes allocation and establishment of the new radio channel. The procedure is outlined in subclauses 7.1. and 7.2.

ii) intra-MSC handovers within the area controlled by MSC-B.

This procedure is the same as that of i) in subclause 9.3, except that the A-HANDOVER-REQUIRED is received by MSC-B.

iii) subsequent handover to another MSC (MSC-A or MSC-B').

The initiation procedure is essentially the same as that of i) of subclause 9.3. The Handover Command to the MS is now generated by MSC-B after the A-HO-REQUEST-ACKNOWLEDGE is received from MSC-A (via functional unit 4). The procedure is terminated in MSC-B when MSC-B receives a terminate procedure indication from functional unit 4.

Timers in MSC-B.

The following procedures are supervised by timers in order to avoid a deadlock when responses are not received or the procedures fail.

The following timers are defined:

- T201: this timer supervises the queuing time for a free channel. T201 is set by O&M;
- T202: this timer supervises the time for handover completion for handover between BSSs in MSC-B. If T202 expires, the radio path and the connection on interface B' are released. T202 is set by O&M;
- T204: this timer supervises the time between sending of address complete message to MSC-A and receiving the A-HANDOVER-COMPLETE from BSS-B on MSC-B. This timer also supervises the time between issuing the handover command to the MS and receiving the MAP-SEND-END-SIGNAL response from MSC-A, for a subsequent handover. In the case of a handover without circuit connection between MSC-A and MSC-B this timer supervises the time between issuing the A-HO-REQUEST-ACKNOWLEDGE to the MSC-A and receiving the A-HANDOVER-COMPLETE from BSS-B on MSC-B. If the timer expires, then any new radio channel is released. T204 is set by O&M;
- T210: this timer is used to supervise the time for establishing a circuit connection from MSC-A to MSC-B. When T210 expires, the allocated channel in MSC-B is released. T210 is set by O&M. This timer is not started when MSC-A explicitly indicates that no handover number is needed;
- T211: this timer is used to control the time between requesting a subsequent handover (A-HO-REQUEST to the MSC-A) and receiving the response from MSC-A (A-REQUEST-ACKNOWLEDGE/A-HO-FAILURE). If T211 expires, the existing connection with the MS is maintained. T211 is set by O&M.

10.4 MAP procedures MSC-B (functional unit 4)

The MAP procedures for handover are defined in 3GPP TS 29.002 [12]. They include:

- procedures for basic handover;
- procedures for subsequent handover;
- procedures for obtaining the handover number from the VLR.

These procedures are outlined in clause 7.

10.5 Interworking between Handover control procedures and MAP procedures in MSC-B

The interworking between the Handover control procedures and the MAP procedures for handover is defined in 3GPP TS 29.010 [8]. It includes:

- interworking at basic handover completion;
- interworking at subsequent handover initiation.

This interworking is not described in the present document.

10.6 Compatibility with GSM Phase 1

If the MSC-B accepts an Inter-MSC handover procedure according to Phase 2 MAP and BSSMAP protocols while using a Phase 1 BSSMAP protocol towards BSS-B, MSC-B has to perform the protocol interworking.

The same holds if a Phase 1 MAP protocol is requested on the E-interface and MSC-B uses a Phase 2 BSSMAP protocol towards BSS-B.

11 Detailed procedures in 3G_MSC-A

For detailed procedures in MSC-A at handover within the GSM network, please see clause 9 "Detailed procedures in MSC-A".

11.1 RNC/BSC/3G_MSC and UE/MS/3G_MSC procedures in 3G_MSC-A (functional unit 1)

The handover/relocation procedures in this functional unit consist of:

- i) signalling between the UE/MS and the 3G_MSC;
- ii) signalling between the RNS/BSS and the 3G_MSC for access management.

11.2 Call control procedures 3G_MSC-A (functional unit 2)

The call control procedures related to handover/relocation in 3G_MSC-A can be divided into two functional entities:

- the first entity is the call control procedure as part of the normal interworking between the PSTN/ISDN and the PLMN/UTRAN; for an UE/MS originating call 3G_MSC-A is the originating exchange, for an UE/MS terminating call 3G_MSC-A is the destination exchange;
- the second entity is the call control procedure for the connection between 3G_MSC-A and 3G_MSC-B in case of a handover/relocation from 3G_MSC-A to 3G_MSC-B. For this call control procedure the following applies.

Call set-up:

- the connection to 3G_MSC-B is set up by procedures relevant to the signalling system used in the PSTN/ISDN to which 3G_MSC-A is connected. The call is set up by using the Handover Number received from 3G_MSC-B as part of the MAP procedure;
- the call set-up direction will always be from 3G_MSC-A to 3G_MSC-B, even when the call was originally established by the UE/MS. Functional unit 2 (see figure 5) should therefore keep information on call set-up direction in order to be able to interpret correctly any clearing signals (see below);
- the unit should indicate the address complete condition to functional unit 3 and through-connect without awaiting the answer signal from 3G_MSC-B. This applies also to signalling systems where address complete signals are not supported. In such cases an artificial address complete is established by functional unit 2.

Call clearing:

- call clearing consists of two parts: after handover/relocation, clearing of the RNS-UE/MS or BSS-UE/MS connection and clearing of the inter-3G_MSC connection. If a request to release the call is generated by the network while the UE/MS is re-tuning from one RNS/BSS to another RNS/BSS, then 3G_MSC-A shall begin clearing the call to the network and queue the call release to the UE/MS until the UE/MS has resumed communication. This includes the case when 3G_MSC-B and/or 3G_MSC-B' are involved;
- the MAP procedures are used to transfer information between 3G_MSC-B and 3G_MSC-A in order to maintain full call control within 3G_MSC-A. 3G_MSC-A determines, based on information received from 3G_MSC-B, the appropriate signals (according to 3GPP TS 24.008 [10]) to be sent to the UE/MS, and sends this information to 3G_MSC-B;
- when 3G_MSC-A clears the call to the UE/MS it also clears the call control functions in 3G_MSC-B and sends the MAP-SEND-END-SIGNAL response to release the MAP resources in 3G_MSC-B. The clearing of the connection is by procedures relevant to the signalling system in the PSTN/ISDN to which 3G_MSC-A is connected;
- when the Signalling System no 7 ISDN User Part is used, the normal symmetric release procedures apply on both the connection to the fixed network and to 3G_MSC-B;
- when a signalling system is used without a symmetric release possibility, some notice should be given to the clear-forward and clear-back procedures;
- for UE/MS terminating calls the following conditions apply on clear-forward and clear-back:
 - when a clear-forward signal is received on interface B' (see figure 4), 3G_MSC-A clears the circuit to 3G_MSC-B by normal clear-forward procedures;
 - when a clear-back signal is received from 3G_MSC-B, 3G_MSC-A starts normal clear-back procedures towards the fixed network (interface B') and sends the clear-forward signal on interface B'' in order to clear the connection with 3G_MSC-B.

NOTE 1: This case corresponds to a fault situation.

- for UE/MS originated calls the following applies:
 - when 3G_MSC-A receives a clear-back signal from 3G_MSC-B, this signal must be interpreted as indicating a clear-forward condition. 3G_MSC-A then clears both the connection on interface B' (see figure 4) and to 3G_MSC-B by normal clear-forward procedures;

NOTE 2: This case corresponds to a fault situation.

- when 3G_MSC-A receives a clear-back signal on interface B', 3G_MSC-A should distinguish between national and international connections:
 - for international connections where the Q.118 [1] supervision is done in the ISC, 3G_MSC-A sends a clear-forward signal on both interface B' to the fixed network and interface B'' to 3G_MSC-B;
 - for national connections or for international connections where the Q.118 [1] supervision is not done in the ISC, a timer is started according to national practice for clear-back supervision and MSC-A proceeds as follows:
 - i) if a clear-back signal is received from 3G_MSC-B, 3G_MSC-A interprets this as indicating a clear-forward condition and proceeds by clearing the connections on interface B' and to 3G_MSC-B by normal clear-forward procedures;
 - ii) if the timer expires, 3G_MSC-A proceeds by normal clear-forward of the connections on interface B' and to 3G_MSC-B.

11.3 Handover/Relocation control procedures 3G_MSC-A (functional unit 3)

The procedures of functional unit 3 are given in terms of SDL diagrams in figure 43. To easily distinguish the interface concerned the messages received or sent from this unit are prefixed with either 'MAP' for a MAP message, 'A' for an A-Interface message, 'I' for an ISDN/PSTN message or 'Iu' for an Iu-message.

The procedures of functional unit 3 include:

- i) initiation. The initiation condition is shown by the signal Iu-RELOCATION-REQUIRED or A-HANDOVER-REQUIRED;

The diagram also includes queuing when there is no channel available. Calls for which handover/relocation has been initiated should be queued with priority higher than normal calls. They should have lower priority than emergency calls.

- ii) handover/relocation of calls within the area of 3G_MSC-A, i.e. handover/relocation case i);

In the handover/relocation from RNS-A/BSS-A to RNS-B/BSS-B 3G_MSC-A controls the procedures on both the previous and the new radio channel, using signals Iu-RELOCATION-REQUEST/A-HANDOVER-REQUEST and Iu-RELOCATION-COMMAND/A-HANDOVER-COMMAND. The handover/relocation procedure is completed when Iu-RELOCATION-COMplete/A-HANDOVER-COMplete is received. If this signal is not received, the radio path and the connection on interface B' are either released or the original connection is maintained.

For handover/relocation devices with three-party capabilities the device is first set up so that all interfaces Iu'/A', Iu"/A" and B' are connected (illustrated by the signal 'set up handover device'). This is done when the Relocation Command is sent to serving RNS or Handover Command is sent to the serving BSS. The device is connected in its final position (i.e. Iu"/A" to B' for case ii)) (illustrated by the signal 'connect handover device') when Iu-RELOCATION-COMplete/A-HANDOVER-COMplete is received.

- iii) relocation to 3G_MSC-B. This procedure is the one described in subclauses 8.3.1 and 8.3.2. For handover/relocation devices with three-party capabilities the device is set-up when 3G_MSC-A sends the Relocation Command to the UE, i.e. the interfaces Iu', B' and B" are then connected. The device is connected in its final position (i.e. B' to B") when the successful procedure indication is received from functional unit 4;
- iv) UMTS to GSM handover to MSC-B. This procedure is the one described in subclauses 8.1.1 and 8.1.2. For handover/relocation devices with three-party capabilities the device is set-up when 3G_MSC-A sends the Relocation Command to the serving RNS, i.e. the interfaces Iu', B' and B" are then connected. The device is connected in its final position (i.e. B' to B") when the successful procedure indication is received from functional unit 4;
- v) GSM to UMTS handover to 3G_MSC-B. This procedure is the one described in subclauses 8.2.1 and 8.2.2. For handover/relocation devices with three-party capabilities the device is set-up when MSC-A sends the Handover Command to the serving BSS, i.e. the interfaces A', B' and B" are then connected. The device is connected in its final position (i.e. B' to B") when the successful procedure indication is received from functional unit 4;
- vi) subsequent relocation from 3G_MSC-B to 3G_MSC-A. The procedure is described in subclauses 8.3.3.1 and 8.3.4.1. When a relocation to 3G_MSC-A indication is received from functional unit 4, the handover/relocation device is set up so that interfaces B', B" and Iu' are connected (for devices with three-party capabilities). When Iu-RELOCATION-COMplete is received, the device is connected in its final position (i.e. B' to Iu');

If Iu-RELOCATION-COMplete is not received (expiry of timer T704), the handover/relocation device releases interface Iu' and returns to a position where B' and B" are connected.
- vii) subsequent GSM to UMTS handover from MSC-B to 3G_MSC-A. The procedure is described in subclauses 8.2.3.1 and 8.2.4.1. When a handover to 3G_MSC-A indication is received from functional unit 4, the handover device is set up so that interfaces B', B" and A' are connected (for handover devices with three-party capabilities). When A-RELOCATION-COMplete is received, the device is connected in its final position (i.e. B' to Iu');

If A-RELOCATION-COMplete is not received (expiry of timer T504), the device releases interface Iu' and returns to a position where B' and B" are connected.

viii) subsequent UMTS to GSM handover from 3G_MSC-B to MSC-A. The procedure is described in subclauses 8.1.3.1 and 8.1.4.1. When a handover to MSC-A indication is received from functional unit 4, the handover device is set up so that interfaces B', B'' and Iu' are connected (for handover devices with three-party capabilities). When A-HANDOVER-COMPLETE is received, the device is connected in its final position (i.e. B' to A');

If A-HANDOVER-COMPLETE is not received (expiry of timer T304), the device releases interface A' and returns to a position where B' and B'' are connected.

- ix) subsequent relocation from 3G_MSC-B to a third 3G_MSC (3G_MSC-B'). The procedure is described in subclauses 8.3.4.2 and 8.3.5.2. The handover/relocation device is set up in its initial position, (i.e. interconnection of interfaces B', B'' and B''') when the connection to 3G_MSC-B' has been established. 3G_MSC-B is informed via functional unit 4 that the connection has been established and that the procedure on the radio path can be initiated. The device is connected in its final position (i.e. B' to B''') when a successful procedure indication is received from functional unit 4. 3G_MSC-B is informed that all procedures in 3G_MSC-B can be terminated (illustrated by the MAP-SEND-END-SIGNAL response). The device returns to the state where B' and B'' are connected if the subsequent relocation procedure fails;
- x) subsequent UMTS to GSM handover from 3G_MSC-B to a third MSC (MSC-B'). The procedure is described in subclauses 8.1.3.2 and 8.1.4.2. The handover/relocation device is set up in its initial position, (i.e. interconnection of interfaces B', B'' and B''') when the connection to MSC-B' has been established. 3G_MSC-B is informed via functional unit 4 that the connection has been established and that the procedure on the radio path can be initiated. The device is connected in its final position (i.e. B' to B''') when a successful procedure indication is received from functional unit 4. 3G_MSC-B is informed that all procedures in 3G_MSC-B can be terminated (illustrated by the MAP-SEND-END-SIGNAL response). The device returns to the state where B' and B'' are connected if the subsequent UMTS to GSM handover procedure fails;
- xi) subsequent GSM to UMTS handover from MSC-B to a third MSC (3G_MSC-B'). The procedure is described in subclauses 8.2.3.2 and 8.2.4.2. The handover/relocation device is set up in its initial position, (i.e. interconnection of interfaces B', B'' and B''') when the connection to 3G_MSC-B' has been established. MSC-B is informed via functional unit 4 that the connection has been established and that the procedure on the radio path can be initiated. The device is connected in its final position (i.e. B' to B''') when a successful procedure indication is received from functional unit 4. MSC-B is informed that all procedures in MSC-B can be terminated (illustrated by the MAP-SEND-END-SIGNAL response). The device returns to the state where B' and B'' are connected if the subsequent GSM to UMTS handover procedure fails.

Timers in 3G_MSC-A.

The procedures are supervised by timers in order to avoid a deadlock when responses are not received or the procedures fail.

The following timers are defined for SRNS Relocation:

- T701: this timer supervises the queuing time for a free channel for the relocation inside UMTS. If T701 expires, a no channel indication is generated and 3G_MSC-A will terminate the relocation as described in subclause 6.2.3. T701 is set by O&M;
- T702: this timer supervises the time for relocation completion for relocation between RNSs in 3G_MSC-A. T702 is set by O&M;
- T703: this timer supervises the time between issuing an Iu-RELOCATION-COMMAND from 3G_MSC-A and receiving a successful procedure indication from 3G_MSC-B. This timer also supervises the time between sending an IU-RELOCATION-REQUEST-ACKNOWLEDGE to 3G_MSC-B and receiving a successful procedure indication from 3G_MSC-B'. If T703 expires, the relocation procedure is terminated. T703 is set by O&M;
- T704: this timer supervises the time between sending of an IU-RELOCATION-REQUEST-ACKNOWLEDGE to 3G_MSC-B and receiving the Iu-RELOCATION-COMPLETE from RNS-B on 3G_MSC-A. If the timer expires, the new radio channel is released and the existing handover/relocation device connection to 3G_MSC-B is maintained. T704 is set by O&M.

The following timers are defined for UMTS to GSM handover:

- T301: this timer supervises the queuing time for a free channel for the UMTS to GSM handover. If T301 expires, a no channel indication is generated and 3G_MSC-A will terminate the handover as described in subclause 6.2.3. T301 is set by O&M;
- T302: this timer supervises the time for UMTS to GSM handover completion for handover from RNS to BSS in 3G_MSC-A. T302 is set by O&M;
- T303: this timer supervises the time between issuing an Iu-RELOCATION-COMMAND from 3G_MSC-A and receiving a successful procedure indication from MSC-B. This timer also supervises the time between sending an A-HO-REQUEST-ACKNOWLEDGE to MSC-B and receiving a successful procedure indication from MSC-B'. If T303 expires, the UMTS to GSM handover procedure is terminated. T303 is set by O&M;
- T304: this timer supervises the time between sending of an A-HO-REQUEST-ACKNOWLEDGE to MSC-B and receiving the A-HANDOVER-COMPLETE from BSS-B on 3G_MSC-A. If the timer expires, the new radio channel is released and the existing handover device connection to MSC-B is maintained. T304 is set by O&M.

The following timers are defined for GSM to UMTS handover:

- T501: this timer supervises the queuing time for a free channel for the GSM to UMTS handover. If T501 expires, a no channel indication is generated and 3G_MSC-A will terminate the handover as described in subclause 6.2.3. T501 is set by O&M;
- T502: this timer supervises the time for GSM to UMTS handover completion for handover from BSS to RNS in 3G_MSC-A. T502 is set by O&M;
- T503: this timer supervises the time between issuing an A-HANDOVER-COMMAND from MSC-A and receiving a successful procedure indication from 3G_MSC-B. This timer also supervises the time between sending an A-HANDOVER-REQUEST-ACKNOWLEDGE to 3G_MSC-B and receiving a successful procedure indication from 3G_MSC-B'. If T503 expires, the GSM to UMTS handover procedure is terminated. T503 is set by O&M;
- T504: this timer supervises the time between sending of an A-HANDOVER-REQUEST-ACKNOWLEDGE to 3G_MSC-B and receiving the Iu-RELOCATION-COMPLETE from RNS-B on 3G_MSC-A. If the timer expires, the new radio channel is released and the existing handover device connection to MSC-B is maintained. T504 is set by O&M.

11.4 MAP procedures in 3G_MSC-A (functional unit 4)

The MAP procedures for handover/relocation are defined in 3GPP TS 29.002 [12]. They include:

- procedures for basic handover/relocation;
- procedures for subsequent handover/relocation.

These procedures are as outlined in clause 8.

11.5 Interworking between Handover/Relocation control procedures and MAP procedures in 3G_MSC-A

The interworking between the Handover/Relocation control procedures and the MAP procedures for handover/relocation is defined in 3GPP TS 29.010 [8]. It includes:

- interworking at basic handover/relocation initiation;
- interworking at subsequent handover/relocation completion.

This interworking is not described in the present document.

11.6 Compatibility with GSM Phase 1

Interworking with the GSM Phase 1 is not supported.

11.7 Protocol interworking

If the 3G_MSC-A initiates an Inter UMTS to GSM handover procedure according to MAP and BSSMAP protocols while using a RANAP protocol towards RNS-A, 3G_MSC-A has to perform the protocol interworking.

The same holds if 3G_MSC-A accepts a subsequent GSM to UMTS handover while using a RANAP protocol towards RNS-B.

12 Detailed procedures in 3G_MSC-B

For detailed procedures in 3G_MSC-B at handover within the GSM network, please see clause 10 'Detailed procedures in MSC-B'.

12.1 RNC/BSC/3G_MSC (UE/MS/RNC/BSC) procedures in 3G_MSC-B (functional unit 1)

The Intra and Inter-3G_MSC handover/relocation procedures in this functional unit consist of:

- i) signalling between the UE/MS and the 3G_MSC;
- ii) signalling between the RNS/BSS and the 3G_MSC for access management.

Signals exchanged with functional unit 3 are indicated in subclause 12.3.

12.2 Call control procedures 3G_MSC-B (functional unit 2)

These procedures relate to the call control in 3G_MSC-B of the "3G_MSC handover/relocation" connection with 3G_MSC-A. For these procedures the following apply:

Call set-up:

- the connection is set up by 3G_MSC-A. 3G_MSC-B should provide, if possible, the following backward signals:
 - signals indicating unsuccessful call set-up and, if possible, the cause of call failure;
 - address complete signal;
 - answer signal (see note).

NOTE: The answer signal is not related to answering by the UE/MS and it has no meaning in the 3G_MSC handover/relocation procedure between 3G_MSC-A and 3G_MSC-B. But after successful handover/relocation or successful subsequent channel assignment using a circuit connection between 3G_MSC-A and 3G_MSC-B this signal is needed for bringing the connection in the answered state in the intermediate PSTN/ISDN exchanges.

- there will be no indication that the call applies to a 3G_MSC handover/relocation. This information has to be derived from the UE/MS Handover Number received during call set-up in relation to the earlier MAP-PREPARE-HANDOVER request/MAP-PREPARE-HANDOVER response procedure between 3G_MSC-A and 3G_MSC-B.

Call clearing:

- call clearing consists of two parts after inter-3G_MSC handover/relocation: clearing of the RNS-UE/MS or the BSS-UE/MS connection and clearing of the inter-3G_MSC connection, these cases are only applicable to calls successfully handed over or relocated. If a request to release the call is generated by the network while the UE/MS is re-tuning from one RNS/BSS to another RNS/BSS, then 3G_MSC-B shall begin clearing the call to the network and queue the call release to the UE/MS until the UE/MS has resumed communication;
- the MAP is used to transfer information between 3G_MSC-A and 3G_MSC-B in order to make it possible for 3G_MSC-B to send the appropriate signals to the UE/MS, specified in 3GPP TS 24.008 [10], and still leave the call control to 3G_MSC-A. 3G_MSC-A normally initiates release of the connection between 3G_MSC-A and 3G_MSC-B. Exceptionally 3G_MSC-B is allowed to release the connection if no MAP-SEND-END-SIGNAL response is received, or if the 3G_MSC Handover/Relocation is to be aborted;
- when the Signalling System no 7 ISDN User Part is used, the normal symmetric release procedures apply. When a signalling system is used without a symmetric release possibility or a fault condition occurs, the following may apply:
 - when 3G_MSC-B receives a clear-forward signal from 3G_MSC-A, it shall release the radio resources;
 - in fault situation e.g. machine malfunction or loss of the connection on interface Iu or interface A, 3G_MSC-B may send a clear-back signal to 3G_MSC-A.

12.3 Handover/Relocation control procedures in 3G_MSC-B (functional unit 3)

The procedures of functional unit 3 are given in form of SDL diagrams in figure 44. To easily distinguish the interface concerned the messages received or sent from this unit are prefixed with either 'MAP' for a MAP message, 'A' for an A-Interface message, 'Iu' for an Iu-Interface message or 'I' for an ISDN/PSTN message. The procedure in functional unit 3 include:

- i) inter 3G_MSC handover/relocation from 3G_MSC-A;

This case is initiated by 3G_MSC-A, and includes allocation and establishment of the new radio resources. The procedure is outlined in subclauses 8.1.1 and 8.1.2. for UMTS to GSM handover, subclauses 8.2.1 and 8.2.2 for GSM to UMTS handover and subclauses 8.3.1 and 8.3.2 for relocation.

- ii) intra-3G_MSC UMTS to GSM handovers within the area controlled by 3G_MSC-B;

This procedure is the same as that of ii) in subclause 11.3, except that the Iu-RELOCATION-REQUIRED is received by 3G_MSC-B.

- iii) intra-3G_MSC GSM to UMTS handovers within the area controlled by 3G_MSC-B;

This procedure is the same as that of ii) in subclause 11.3, except that the A-HANDOVER-REQUIRED is received by 3G_MSC-B.

- iv) intra-3G_MSC SRNS Relocation within the area controlled by 3G_MSC-B;

This procedure is the same as that of ii) in subclause 11.3, except that the Iu-RELOCATION-REQUIRED is received by 3G_MSC-B.

- v) subsequent handover/relocation to another 3G_MSC (3G_MSC-A or 3G_MSC-B');

The initiation procedure is essentially the same as that of i) of subclause 11.3. The Handover Command to the BSS or the Relocation Command to the RNS is now generated by 3G_MSC-B after the A-HO-REQUEST-ACKNOWLEDGE or Iu-RELOCATION-REQUEST-ACKNOWLEDGE is received from 3G_MSC-A (via functional unit 4). The procedure is terminated in 3G_MSC-B when 3G_MSC-B receives a terminate procedure indication from functional unit 4.

Timers in 3G_MSC-B.

The following procedures are supervised by timers in order to avoid a deadlock when responses are not received or the procedures fail.

The following timers are defined for UMTS to GSM handover:

- T401: this timer supervises the queuing time for a free channel. T401 is set by O&M;
- T402: this timer supervises the time for handover completion for UMTS to GSM handover from RNS to BSS in 3G_MSC-B. If T402 expires, the radio path and the connection on interface B' are released. T402 is set by O&M;
- T404: this timer supervises the time between sending of address complete message to 3G_MSC-A and receiving the A-HANDOVER-COMPLETE from BSS-B on 3G_MSC-B. This timer also supervises the time between issuing the handover command to the UE/MS and receiving the MAP-SEND-END-SIGNAL response from 3G_MSC-A, for a subsequent handover from UMTS to GSM. In the case of a UMTS to GSM handover without circuit connection between 3G_MSC-A and 3G_MSC-B this timer supervises the time between issuing the A-HO-REQUEST-ACKNOWLEDGE to the 3G_MSC-A and receiving the A-HANDOVER-COMPLETE from BSS-B on 3G_MSC-B. If the timer expires, then any new radio channel is released. T404 is set by O&M;
- T410: this timer is used to supervise the time for establishing a circuit connection from 3G_MSC-A to 3G_MSC-B. When T410 expires, the allocated channel in 3G_MSC-B is released. T410 is set by O&M. This timer is not started when 3G_MSC-A explicitly indicates that no handover number is needed;
- T411: this timer is used to control the time between requesting a subsequent UMTS to GSM handover (A-HO-REQUEST to the 3G_MSC-A) and receiving the response from 3G_MSC-A (A-HO-REQUEST-ACKNOWLEDGE/A-HO-FAILURE). If T411 expires, the existing connection with the UE/MS is maintained. T411 is set by O&M.

The following timers are defined for GSM to UMTS handover:

- T601: this timer supervises the queuing time for a free radio resource. T601 is set by O&M;
- T602: this timer supervises the time for handover completion for GSM to UMTS handover from BSS to RNS in 3G_MSC-B. If T602 expires, the radio path and the connection on interface B' are released. T602 is set by O&M;
- T604: this timer supervises the time between sending of address complete message to 3G_MSC-A and receiving the Iu-RELOCATION-COMPLETE from RNS-B on 3G_MSC-B. This timer also supervises the time between issuing the handover command to the UE/MS and receiving the MAP-SEND-END-SIGNAL response from 3G_MSC-A, for a subsequent handover from GSM to UMTS. In the case of a GSM to UMTS handover without circuit connection between 3G_MSC-A and 3G_MSC-B this timer supervises the time between issuing the A-HO-REQUEST-ACKNOWLEDGE to the 3G_MSC-A and receiving the Iu-RELOCATION-COMPLETE from RNS-B on 3G_MSC-B. If the timer expires, then any new radio resource is released. T604 is set by O&M;
- T610: this timer is used to supervise the time for establishing a circuit connection from 3G_MSC-A to 3G_MSC-B. When T610 expires, the allocated radio resource in 3G_MSC-B is released. T610 is set by O&M. This timer is not started when 3G_MSC-A explicitly indicates that no handover number is needed;
- T611: this timer is used to control the time between requesting a subsequent GSM to UMTS handover (A-HO-REQUEST to the 3G_MSC-A) and receiving the response from 3G_MSC-A (A-HO-REQUEST-ACKNOWLEDGE/A-HO-FAILURE). If T611 expires, the existing connection with the UE/MS is maintained. T611 is set by O&M.

The following timers are defined for SRNS Relocation:

- T801: this timer supervises the queuing time for a free radio resource. T801 is set by O&M;
- T802: this timer supervises the time for relocation completion for relocation between RNSs in 3G_MSC-B. If T802 expires, the radio path and the connection on interface B' are released. T802 is set by O&M;

- T804: this timer supervises the time between sending of address complete message to 3G_MSC-A and receiving the Iu-RELOCATION-COMPLETE from RNS-B on 3G_MSC-B. This timer also supervises the time between issuing the handover command to the UE and receiving the MAP-SEND-END-SIGNAL response from 3G_MSC-A, for a subsequent relocation. In the case of a relocation without circuit connection between 3G_MSC-A and 3G_MSC-B this timer supervises the time between issuing the Iu-RELOCATION-REQUEST-ACKNOWLEDGE to the 3G_MSC-A and receiving the Iu-RELOCATION-COMPLETE from RNS-B on 3G_MSC-B. If the timer expires, then any new radio resource is released. T804 is set by O&M;
- T810: this timer is used to supervise the time for establishing a circuit connection from 3G_MSC-A to 3G_MSC-B. When T810 expires, the allocated channel in 3G_MSC-B is released. T810 is set by O&M. This timer is not started when 3G_MSC-A explicitly indicates that no handover number is needed;
- T811: this timer is used to control the time between requesting a subsequent relocation (Iu-RELOCATION-REQUEST to the 3G_MSC-A) and receiving the response from 3G_MSC-A (Iu-RELOCATION-REQUEST-ACKNOWLEDGE/ Iu-RELOCATION-FAILURE). If T811 expires, the existing connection with the UE is maintained. T811 is set by O&M.

12.4 MAP procedures in 3G_MSC-B (functional unit 4)

The MAP procedures for handover/relocation are defined in 3GPP TS 29.002 [12]. They include:

- procedures for basic handover/relocation;
- procedures for subsequent handover/relocation;
- procedures for obtaining the handover number from the VLR.

These procedures are outlined in clause 8.

12.5 Interworking between Handover/Relocation control procedures and MAP procedures in 3G_MSC-B

The interworking between the Handover/Relocation control procedures and the MAP procedures for handover/relocation is defined in 3GPP TS 29.010 [8]. It includes:

- interworking at basic handover/relocation completion;
- interworking at subsequent handover/relocation initiation.

This interworking is not described in the present document.

12.6 Compatibility with GSM Phase 1

GSM phase 1 is not supported.

12.7 Protocol interworking

If the 3G_MSC-B accepts an Inter-3G_MSC GSM to UMTS handover procedure according to MAP and BSSMAP protocols while using a RANAP protocol towards RNS-B, 3G_MSC-B has to perform the protocol interworking.

The same holds if 3G_MSC-B initiates a subsequent UMTS to GSM handover while using a RANAP protocol towards RNS-A.

13 Subsequent channel assignment using a circuit connection between MSC-A and MSC-B

13.1 GSM handover

If a circuit connection has to be set up (for example for a Mobile Originated or Mobile Terminated Call Establishment) after an Inter-MSC handover without circuit connection, MSC-A shall request a Handover Number using a MAP-PREPARE-HANDOVER request, containing the A-ASSIGNMENT-REQUEST, on the established MAP connection. If MSC-B indicates to MSC-B and to MSC-A that at least one of two procedures assignment or Handover Number allocation can not be completed, then MSC-A shall terminate the circuit establishment attempt. The existing connection to the MS shall be maintained, if possible.

Upon receipt of the MAP-PREPARE-HANDOVER request MSC-B shall perform the requested assignment operation towards the BSS. In addition it shall retrieve a Handover Number from VLR-B. If a failure occurs in the assignment or Handover Number allocation then it shall be reflected in the MAP-PREPARE-HANDOVER response that at least one of these two procedures has not been completed (i.e. either by a MAP-PREPARE-HANDOVER result with the assignment procedure outcome and the Handover Number allocation outcome or by a MAP-PREPARE-HANDOVER error).

When MSC-A receives a successful MAP-PREPARE-HANDOVER response it shall establish a circuit connection to MSC-B by using the appropriate network supported procedures. In figure 36 this is indicated by the IAM (Initial Address Message) and ACM (Address Complete Message). MSC-B shall also send the Answer message if appropriate to the signalling system. Upon receipt of the Answer MSC-A shall consider the circuit connection establishment phase complete. If a failure occurs during the circuit establishment phase then the existing connection to the MS shall be maintained, if possible.

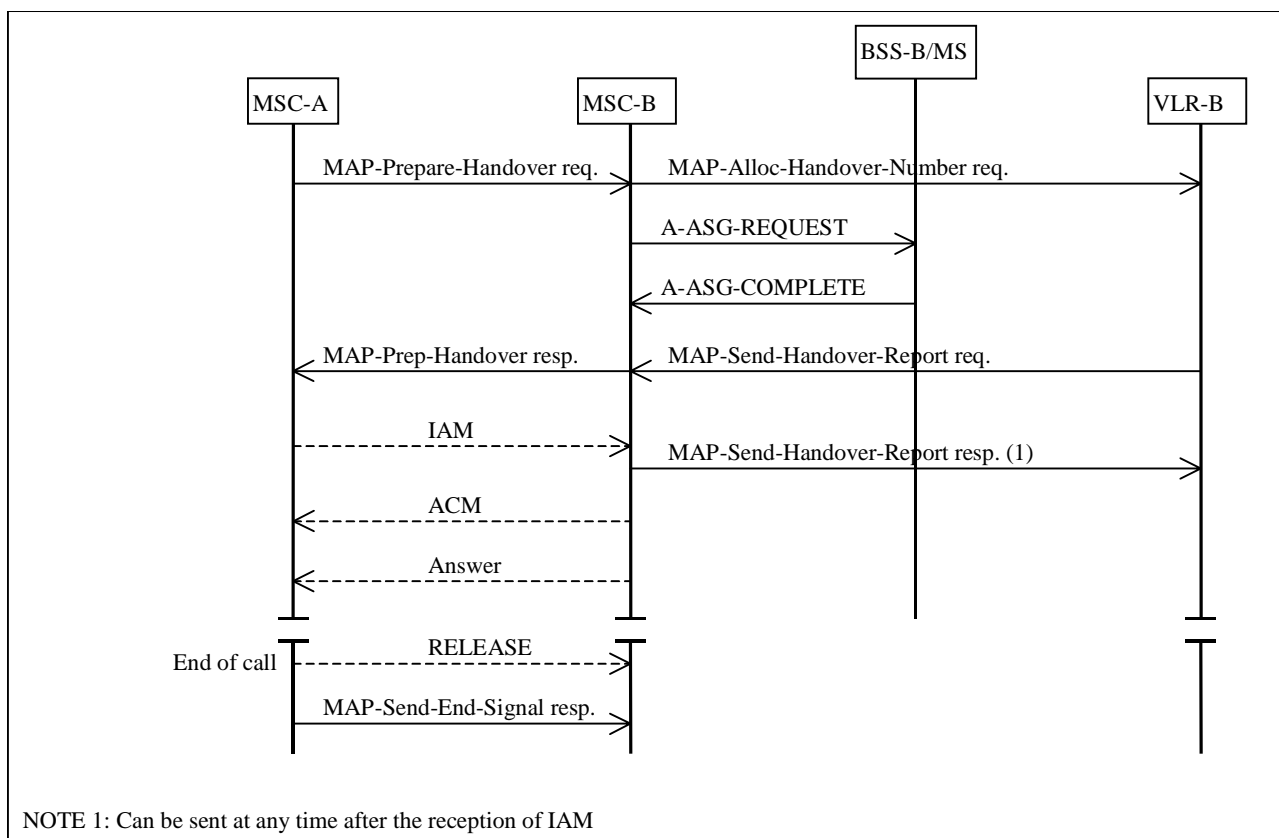

Figure 36: Successful circuit-switched call establishment after a Basic Handover without circuit connection

13.2 UMTS to GSM handover

If a circuit connection has to be set up (for example for a Mobile Originated or Mobile Terminated Call Establishment) after an Inter-3G_MSC UMTS to GSM handover without circuit connection, 3G_MSC-A shall request a Handover Number using a MAP-PREPARE-HANDOVER request, containing the A-ASSIGNMENT-REQUEST, on the established MAP connection. If MSC-B indicates to MSC-B and to 3G_MSC-A that at least one of two procedures assignment or Handover Number allocation can not be completed, then 3G_MSC-A shall terminate the circuit establishment attempt. The existing connection to the UE/MS shall be maintained, if possible.

Upon receipt of the MAP-PREPARE-HANDOVER request MSC-B shall perform the requested assignment operation towards the BSS. In addition it shall retrieve a Handover Number from VLR-B. If a failure occurs in the assignment or Handover Number allocation then it shall be reflected in the MAP-PREPARE-HANDOVER response that at least one of these two procedures has not been completed (i.e. either by a MAP-PREPARE-HANDOVER result with the assignment procedure outcome and the Handover Number allocation outcome or by a MAP-PREPARE-HANDOVER error).

When 3G_MSC-A receives a successful MAP-PREPARE-HANDOVER response, it shall establish a circuit connection to MSC-B by using the appropriate network supported procedures. In figure 37 this is indicated by the IAM (Initial Address Message) and ACM (Address Complete Message). MSC-B shall also send the Answer message if appropriate to the signalling system. Upon receipt of the Answer 3G_MSC-A shall consider the circuit connection establishment phase complete. If a failure occurs during the circuit establishment phase then the existing connection to the UE/MS shall be maintained, if possible.

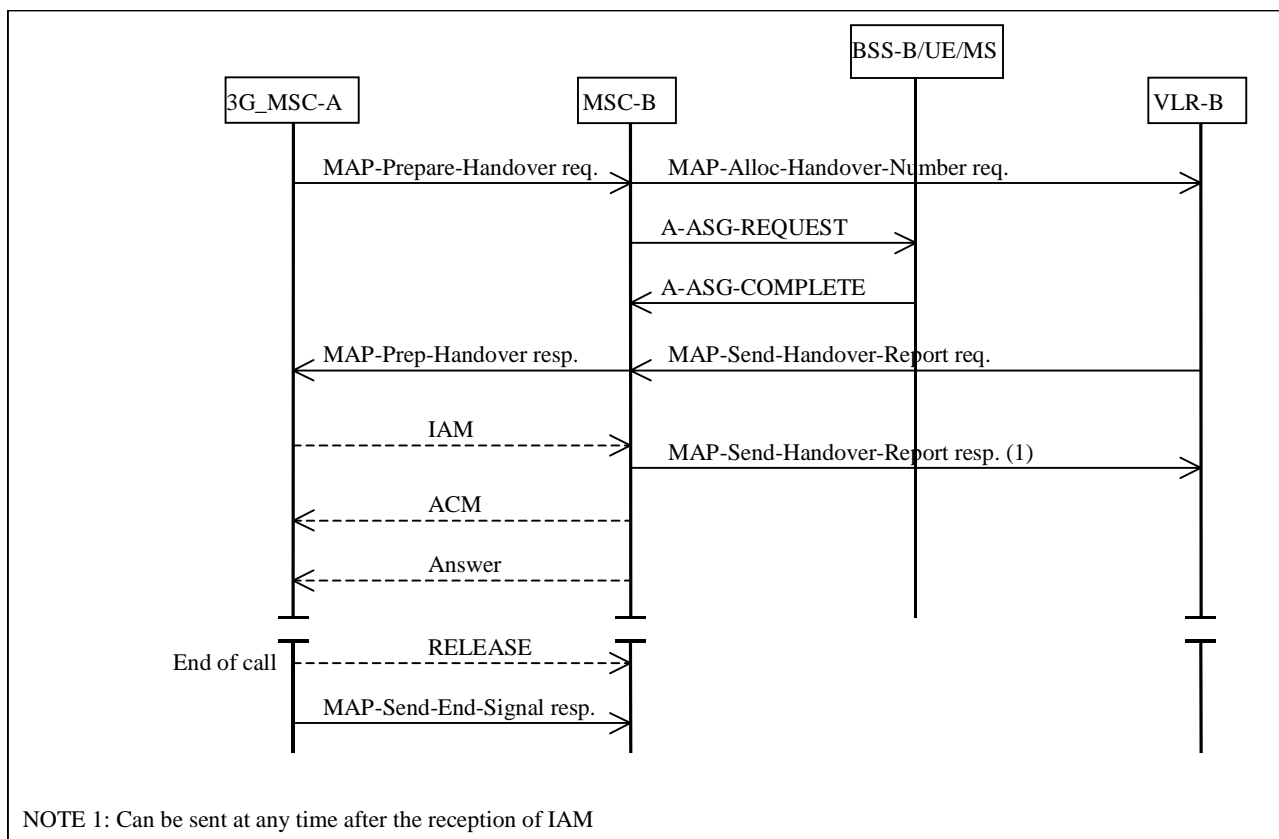

Figure 37: Successful circuit-switched call establishment after a Basic UMTS to GSM Handover without circuit connection

13.3 GSM to UMTS handover

If a circuit connection has to be set up (for example for a Mobile Originated or Mobile Terminated Call Establishment) after an Inter-3G_MSC GSM to UMTS handover without circuit connection, MSC-A shall request a Handover Number using a MAP-PREPARE-HANDOVER request, containing the A-ASSIGNMENT-REQUEST, on the established MAP connection. If 3G_MSC-B indicates to 3G_MSC-B and to MSC-A that at least one of two procedures assignment or Handover Number allocation can not be completed, then MSC-A shall terminate the circuit establishment attempt. The existing connection to the UE/MS shall be maintained, if possible.

Upon receipt of the MAP-PREPARE-HANDOVER request 3G_MSC-B shall perform the requested assignment operation towards the RNS. In addition it shall retrieve a Handover Number from VLR-B. If a failure occurs in the assignment or Handover Number allocation then it shall be reflected in the MAP-PREPARE-HANDOVER response that at least one of these two procedures has not been completed (i.e. either by a MAP-PREPARE-HANDOVER result with the assignment procedure outcome and the Handover Number allocation outcome or by a MAP-PREPARE-HANDOVER error). 3G_MSC-B inserts the transcoder according to the information received from MSC-A.

When MSC-A receives a successful MAP-PREPARE-HANDOVER response, it shall establish a circuit connection to 3G_MSC-B by using the appropriate network supported procedures. In figure 38 this is indicated by the IAM (Initial Address Message) and ACM (Address Complete Message). 3G_MSC-B shall also send the Answer message if appropriate to the signalling system. Upon receipt of the Answer MSC-A shall consider the circuit connection establishment phase complete. If a failure occurs during the circuit establishment phase then the existing connection to the UE/MS shall be maintained, if possible.

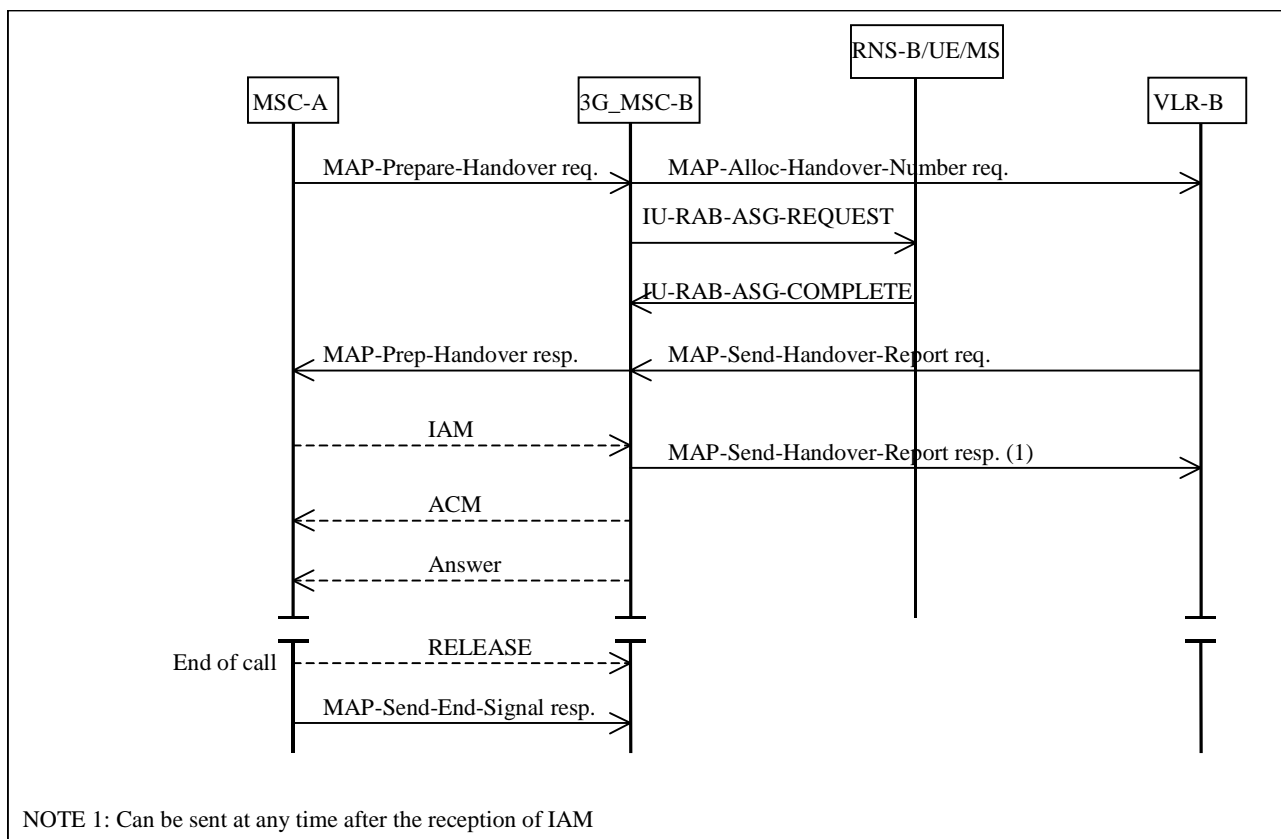

Figure 38: Successful circuit-switched call establishment after a Basic GSM to UMTS Handover without circuit connection

13.4 SRNS Relocation

13.4.1 Without circuit connection

If a circuit connection has to be set up (for example for a Mobile Originated or Mobile Terminated Call Establishment) after an Inter-3G_MSC relocation without circuit connection, 3G_MSC-A shall request a Handover Number using a MAP-PREPARE-HANDOVER request, containing the IU-RAB-ASSIGNMENT-REQUEST, on the established MAP connection. If 3G_MSC-B indicates to 3G_MSC-B and to 3G_MSC-A that at least one of two procedures (RAB) assignment or Handover Number allocation can not be completed, then 3G_MSC-A shall terminate the circuit establishment attempt. The existing connection to the UE shall be maintained, if possible.

Upon receipt of the MAP-PREPARE-HANDOVER request, 3G_MSC-B shall perform the requested RAB assignment operation towards the RNS. In addition it shall retrieve a Handover Number from VLR-B. and connect a transcoder in case of TDM networks. If a failure occurs in the RAB assignment or Handover Number allocation then it shall be reflected in the MAP-PREPARE-HANDOVER response that at least one of these two procedures has not been completed (i.e. either by a MAP-PREPARE-HANDOVER result with the RAB assignment procedure outcome and the Handover Number allocation outcome or by a MAP-PREPARE-HANDOVER error).

When 3G_MSC-A receives a successful MAP-PREPARE-HANDOVER response, it shall establish a circuit connection to 3G_MSC-B by using the appropriate network supported procedures. In figure 39 this is indicated by the IAM (Initial Address Message) and ACM (Address Complete Message). 3G_MSC-B shall also send the Answer message if appropriate to the signalling system. Upon receipt of the Answer 3G_MSC-A shall consider the circuit connection establishment phase complete. If a failure occurs during the circuit establishment phase then the existing connection to the UE shall be maintained, if possible.

13.4.2 With circuit connection (Optional functionality)

If 3G_MSC-A and 3G_MSC-B support the optional supplementary service Multicall (See 3GPP TS 23.135), 3G_MSC-A and 3G_MSC-B shall have the following functionality additionally to the description in section 13.4.1.

A new circuit connection shall be able to set up (for example for a new Mobile Originated or a new Mobile Terminated Call Establishment) after an Inter-3G_MSC relocation with one or several circuit connections. The procedures for the establishment of the additional circuit connection in 3G_MSC-A and 3G_MSC-B are the same as that described in section 13.4.1.

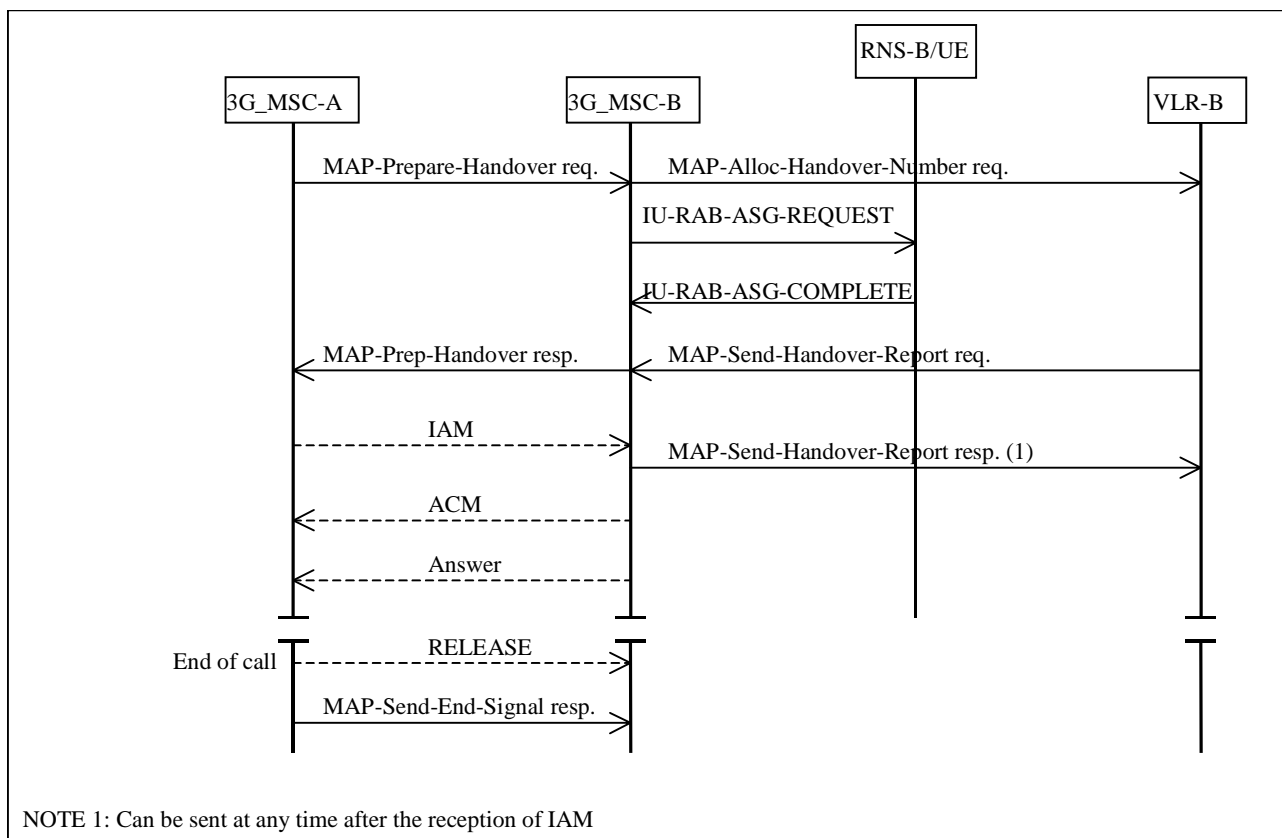

Figure 39: Successful circuit-switched call establishment after a Basic Relocation without circuit connection

14 Directed retry handover

Editor's Note: [Directed retry in the cases of SRNS relocation is FFS]

14.1 GSM handover

The directed retry procedure allows the network to select the optimum cell for the Mobile Station. The process of directed retry involves the assignment of a Mobile Station to a radio channel on a cell other than the serving cell. This process is triggered by the assignment procedures, as described in 3GPP TS 08.08 [5], and employs internal or external handover procedures as described in clauses 6 and 7. The successful procedure for a directed retry is as shown in figure 40 and as described below.

If during the assignment phase, as represented by the A-ASSIGNMENT-REQUEST message, a handover becomes necessary, due to either radio conditions or congestion, then the Mobile Station may be handed over to a different cell. When the decision has been made to handover the MS the BSS-A may send an A-ASSIGNMENT-FAILURE message, indicating 'directed retry', before sending the A-HANDOVER-REQUIRED message to MSC-A, indicating 'directed retry'. However BSS-A may alternatively send the A-HANDOVER-REQUIRED message, indicating 'directed retry', without sending the A-ASSIGNMENT-FAILURE message. Other cause values may be used instead of "Directed Retry" in the A-HANDOVER-REQUIRED message, this will allow the MSC to take different actions dependent on the received cause. Upon receipt of the A-HANDOVER-REQUIRED message from BSS-A, then MSC-A shall initiate the handover as described in clauses 6 and 7. No resources shall be cleared in the MSC-A or BSS-A for this connection.

After receipt of the A-HANDOVER-COMPLETE message from BSS-B the assignment procedure shall be considered to be complete and the resources on BSS-A shall be cleared.

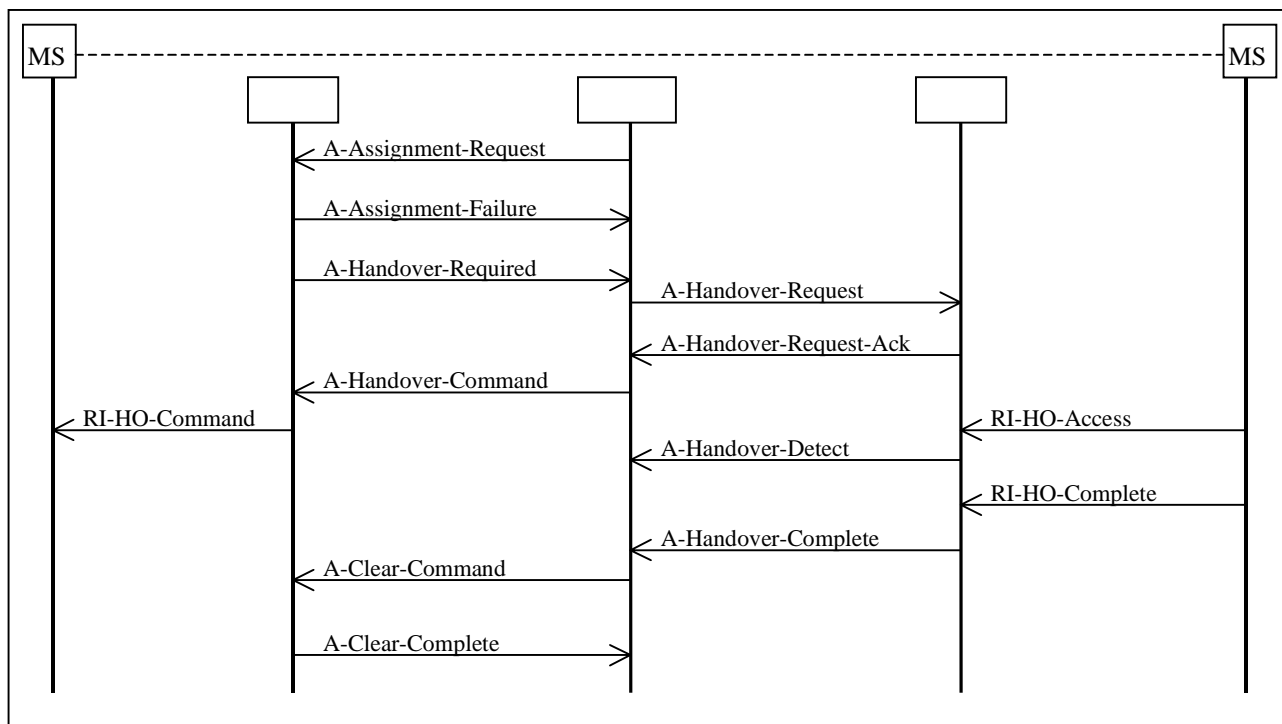

Figure 40: Example of a Directed Retry Intra-MS Handover Procedure

If a failure occurs during the handover attempt, for example A-HANDOVER-FAILURE returned from BSS-A or BSS-B, then MSC-A will terminate the handover to BSS-B. Under these conditions MSC-A may optionally take one of a number of actions:

- i) retry the handover to the same cell;
- ii) select the next cell from the list contained in the A-HANDOVER-REQUIRED message and attempt a handover to the new cell;
- iii) send an A-HANDOVER-REQUIRED-REJECT to BSS-A, if an A-HANDOVER-COMMAND has not already been sent;
- iv) retry the assignment procedure to BSS-A, if the failure message was returned from BSS-A. This option is additional to those for normal handover;
- v) Clear the complete call.

The procedures for Inter-MS handover are also applicable to the directed retry process. If an Inter-MS handover is necessary then the assignment process should be considered to have completed successfully upon receipt of the A-HO-COMplete included in the MAP-SEND-END-SIGNAL request.

14.2 GSM to UMTS handover

The directed retry procedure allows the network to select the optimum cell for the UE/MS. The process of directed retry involves the assignment of a UE/MS to a radio channel on a cell other than the serving cell. This process is triggered by the assignment procedures, as described in 3GPP TS 08.08 [5], and employs internal or external GSM to UMTS handover procedures as described in clauses 6.2.2 and 8.2. The successful procedure for a directed retry in case of an intra-3G_MSC GSM to UMTS handover is as shown in figure 40a and as described below.

If during the assignment phase, as represented by the A-ASSIGNMENT-REQUEST message, a GSM to UMTS handover becomes necessary, due to either radio conditions or congestion, then the UE/MS may be handed over to a UMTS cell. When the decision has been made to handover the UE/MS the BSS-A may send an A-ASSIGNMENT-FAILURE message, indicating 'directed retry', before sending the A-HANDOVER-REQUIRED message to 3G_MSC-A, indicating 'directed retry'. However BSS-A may alternatively send the A-HANDOVER-REQUIRED message, indicating 'directed retry', without sending the A-ASSIGNMENT-FAILURE message. Other cause values may be used instead of "Directed Retry" in the A-HANDOVER-REQUIRED message, this will allow the 3G_MSC to

take different actions dependent on the received cause. Upon receipt of the A-HANDOVER-REQUIRED message from BSS-A, then 3G_MSC-A shall initiate the GSM to UMTS handover as described in clauses 6.2.2 and 8.2. No resources shall be cleared in the 3G_MSC-A or BSS-A for this connection.

After receipt of the Iu-RELOCATION-COMPLETE message from RNS-B the assignment procedure shall be considered to be complete and the resources on BSS-A shall be cleared.

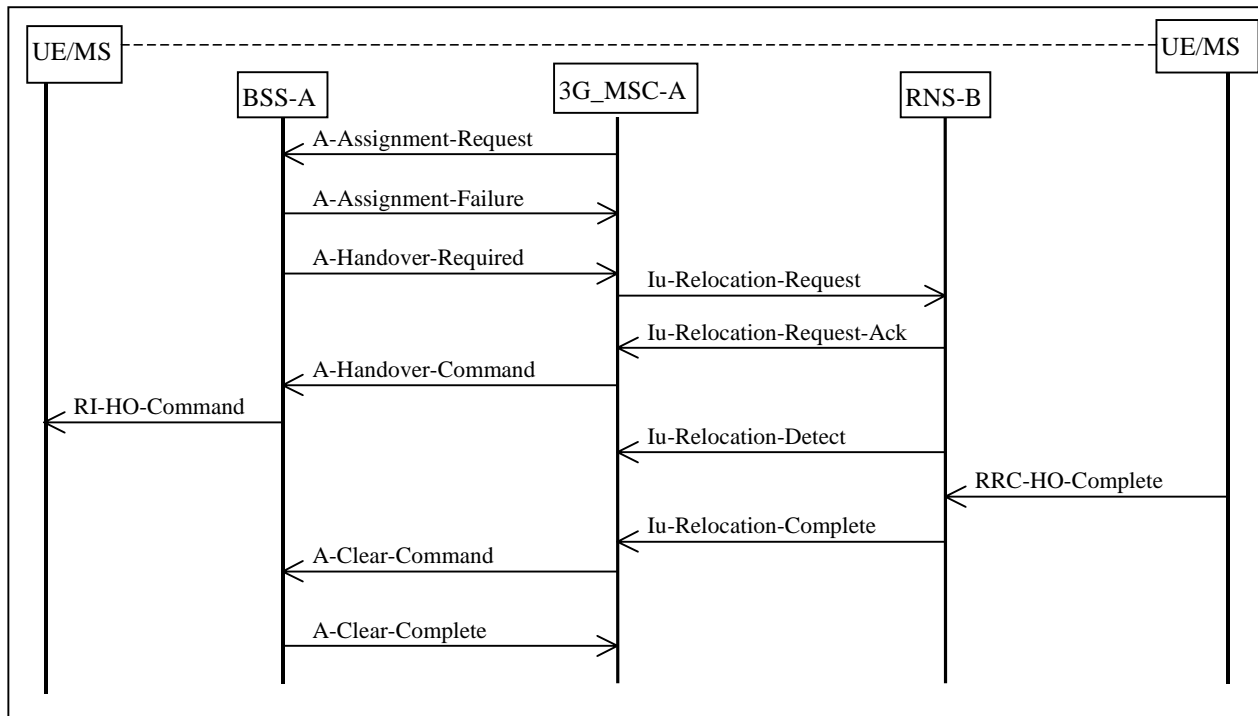

Figure 40a: Example of a Directed Retry Intra-3G_MSC GSM to UMTS Handover Procedure

If a failure occurs during the handover attempt, for example A-HANDOVER-FAILURE returned from BSS-A or Iu-RELOCATION FAILURE from RNS-B then 3G_MSC-A will terminate the GSM to UMTS handover to RNS-B. Under these conditions 3G_MSC-A may optionally take one of a number of actions:

- i) send an A-HANDOVER-REQUIRED-REJECT to BSS-A, if an A-HANDOVER-COMMAND has not already been sent;
- ii) retry the assignment procedure to BSS-A, if the failure message was returned from BSS-A. This option is additional to those for normal handover;
- iii) Clear the complete call.

The procedures for Inter-3G_MSC GSM to UMTS handover are also applicable to the directed retry process. If an Inter-3G_MSC GSM to UMTS handover is necessary then the assignment process should be considered to have completed successfully upon receipt of the A-HO-COMPLETE included in the MAP-SEND-END-SIGNAL request.

14.3 UMTS to GSM handover

The directed retry procedure allows the network to select the optimum cell for the UE/MS. The process of directed retry involves the assignment of a UE/MS to a radio channel on a cell other than the serving cell. This process is triggered by the assignment procedures, as described in 3GPP TS 25.413 [1], and employs UMTS to GSM handover procedures as described in clauses 6.2.1 and 8.1. The successful procedure for a directed retry in case of an intra-3G_MSC UMTS to GSM handover is as shown in figure 40b and as described below.

If during the assignment phase, as represented by the Iu-RAB-ASSIGNMENT-REQUEST message, a UMTS to GSM handover becomes necessary, due to either radio conditions or congestion, then the UE/MS may be handed over to a GSM cell. When the decision has been made to handover the UE/MS the RNS-A may send an Iu-RAB-ASSIGNMENT-RESPONSE message, indicating 'directed retry', before sending the Iu-RELOCATION-REQUIRED message to 3G_MSC-A, indicating 'directed retry'. However RNS-A may alternatively send the Iu-RELOCATION-

REQUIRED message, indicating 'directed retry', without sending the Iu-RAB-ASSIGNMENT-RESPONSE message. Other cause values may be used instead of "Directed Retry" in the Iu-RELOCATION-REQUIRED message, this will allow the 3G_MSC to take different actions dependent on the received cause. Upon receipt of the Iu-RELOCATION-REQUIRED message from RNS-A, then 3G_MSC-A shall initiate the UMTS to GSM handover as described in clauses 6.2.1 and 8.1. No resources shall be cleared in the 3G_MSC-A or RNS-A for this connection.

After receipt of the A-HANDOVER-COMPLETE message from BSS-B the assignment procedure shall be considered to be complete and the resources on RNS-A shall be cleared.

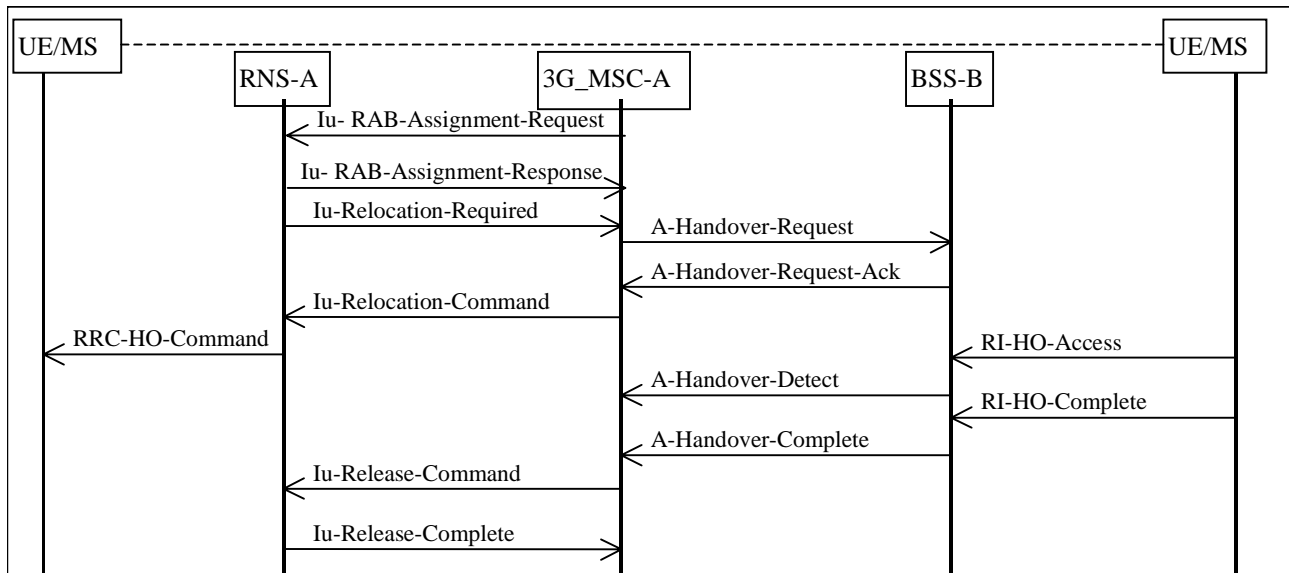

Figure 40b: Example of a Directed Retry Intra-3G_MSC UMTS to GSM Handover Procedure

If a failure occurs during the handover attempt, for example Iu-RELOCATION FAILURE returned from RNS-A or A-HANDOVER-FAILURE from BSS-B then 3G_MSC-A will terminate the UMTS to GSM handover to BSS-B. Under these conditions 3G_MSC-A may optionally take one of a number of actions:

- i) send an Iu-RELOCATION-PREPARATION FAILURE to RNS-A, if an Iu-RELOCATION-COMMAND has not already been sent;
- ii) retry the assignment procedure to RNS-A, if the failure message was returned from RNS-A. This option is additional to those for normal handover;
- iii) Clear the complete call.

The procedures for Inter-3G_MSC UMTS to GSM handover are also applicable to the directed retry process. If an Inter-3G_MSC UMTS to GSM handover is necessary then the assignment process should be considered to have completed successfully upon receipt of the A-HO-COMPLETE included in the MAP-SEND-END-SIGNAL request.

15 SDL diagrams

NOTE 1: The message primitive names used in the SDL diagrams and message flows in the present document do not represent the actual messages specified in the GSM or 3GPP stage 3 technical specifications. The primitive names are only intended to be indicative of their use in the present document.

SDL Annotation.

The following conventions and abbreviations have been used in the SDLs. Text included in '['] is used to indicate either, the BSSMAP message (as defined in 3GPP TS 09.08 [7]) included in the message, or the transport of a Handover Number.

When traversing the following SDLs it may be possible that resources appear to be released repeatedly, however these operations are only executed once on their first occurrence. Furthermore it maybe that certain messages cannot, in practice, be received in particular states, after specific events have taken place. In general both of the above cases are

obvious. This approach has been adopted (in line with other GSM Technical Specifications) in order to reduce the complexity of the SDLs and improve clarity, without reducing the quality of the functional description.

The following abbreviations have been used in the SDLs:

A-HO-REQUEST	A-HANDOVER-REQUEST
A-HO-REQUEST-ACK	A-HANDOVER-REQUEST-ACK.
A-HO-COMPLETE	A-HANDOVER-COMPLETE
A-HO-DETECT	A-HANDOVER-DETECT
A-HO-PERFORMED	A-HANDOVER-PERFORMED
A-ASG-REQUEST	A-ASSIGNMENT-REQUEST
A-ASG-COMPLETE	A-ASSIGNMENT-COMPLETE
A-ASG-FAILURE	A-ASSIGNMENT-FAILURE
MAP-PAS req	MAP-PROCESS-ACCESS-SIGNALLING req.
MAP-FAS req	MAP-FORWARD-ACCESS-SIGNALLING req.
IU-RLC-REQUEST	IU-RELOCATION-REQUEST
IU-RLC-REQUEST-ACK	IU-RELOCATION-REQUEST-ACK
IU-RLC-COMPLETE	IU-RELOCATION-COMPLETE
IU-RLC-DETECT	IU-RELOCATION-DETECT
IU-IREL-REQUEST	IU-IU-RELEASE-REQUEST
IU-RREL-REQUEST	IU-RAB-RELEASE-REQUEST
IU-RASG-REQUEST	IU-RAB-ASSIGNMENT-REQUEST
IU-RASG-RESPONSE	IU-RAB-ASSIGNMENT-RESPONSE

NOTE 2: The SDL diagrams have been checked for consistency with the allocation of the A interface circuits by the BSC. The conclusion was that SDLs are expressed in general terms, and offer a sufficient latitude of interpretation to be consistent with the allocation of A interface circuits by the BSC.

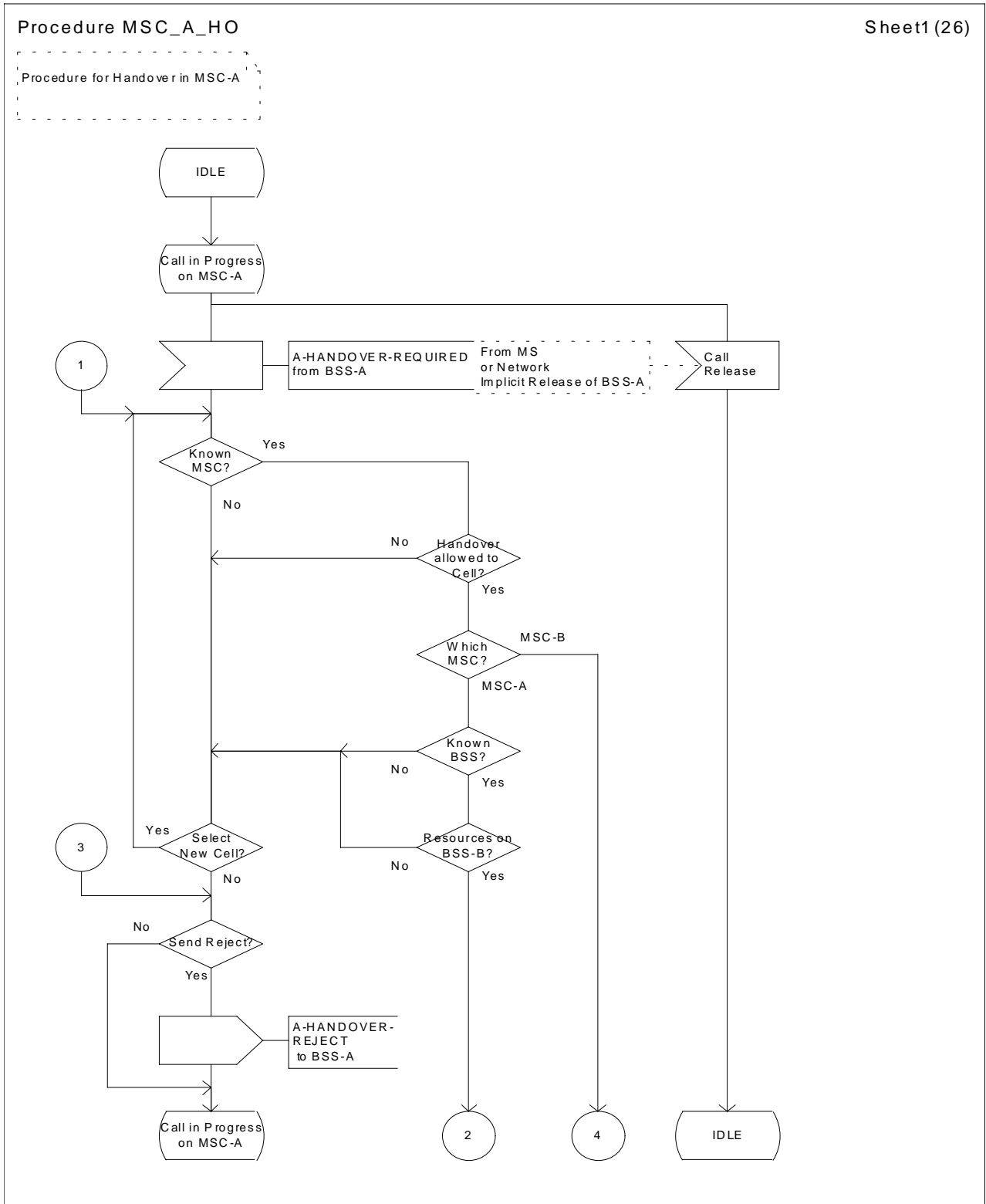

Figure 41 (Sheet 1 of 26): Handover control procedure in MSC-A

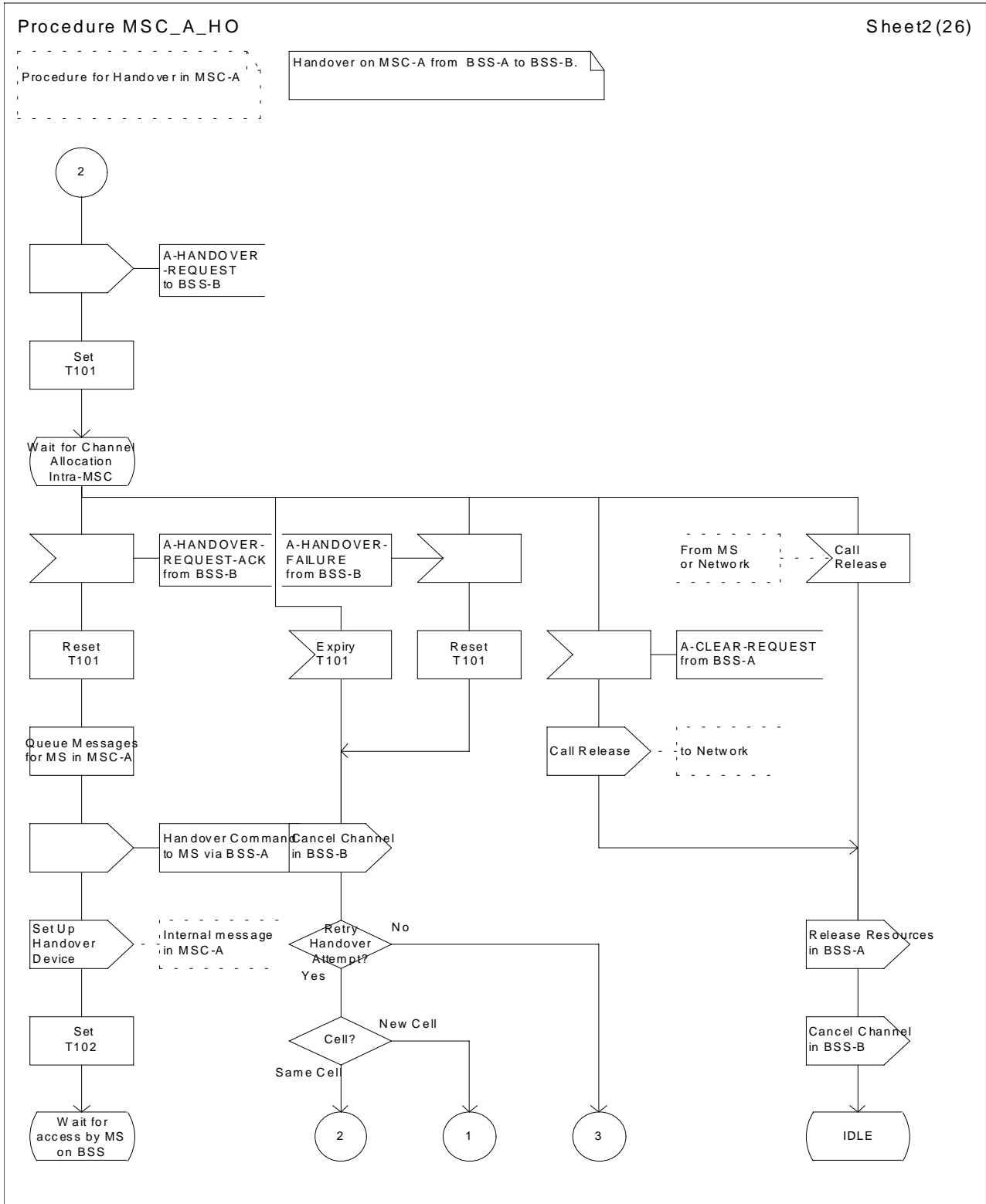

Figure 41 (Sheet 2 of 26): Handover control procedure in MSC-A

Procedure MSC_A_HO

Sheet3(26)

Procedure for Handover in MSC-A

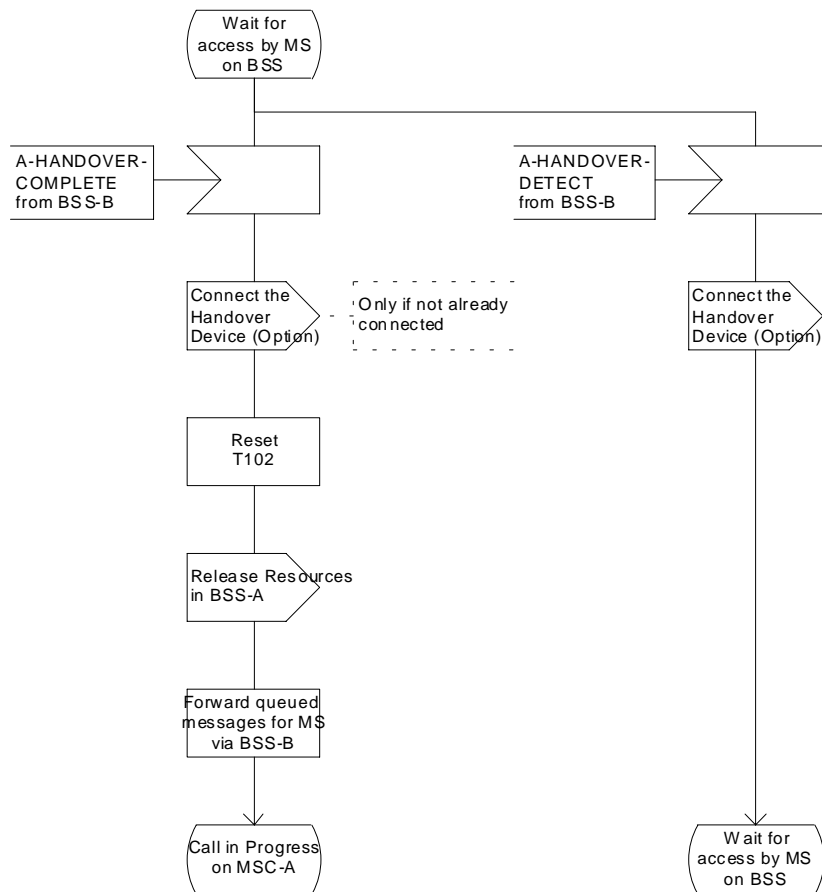

Figure 41 (Sheet 3 of 26): Handover control procedure in MSC-A

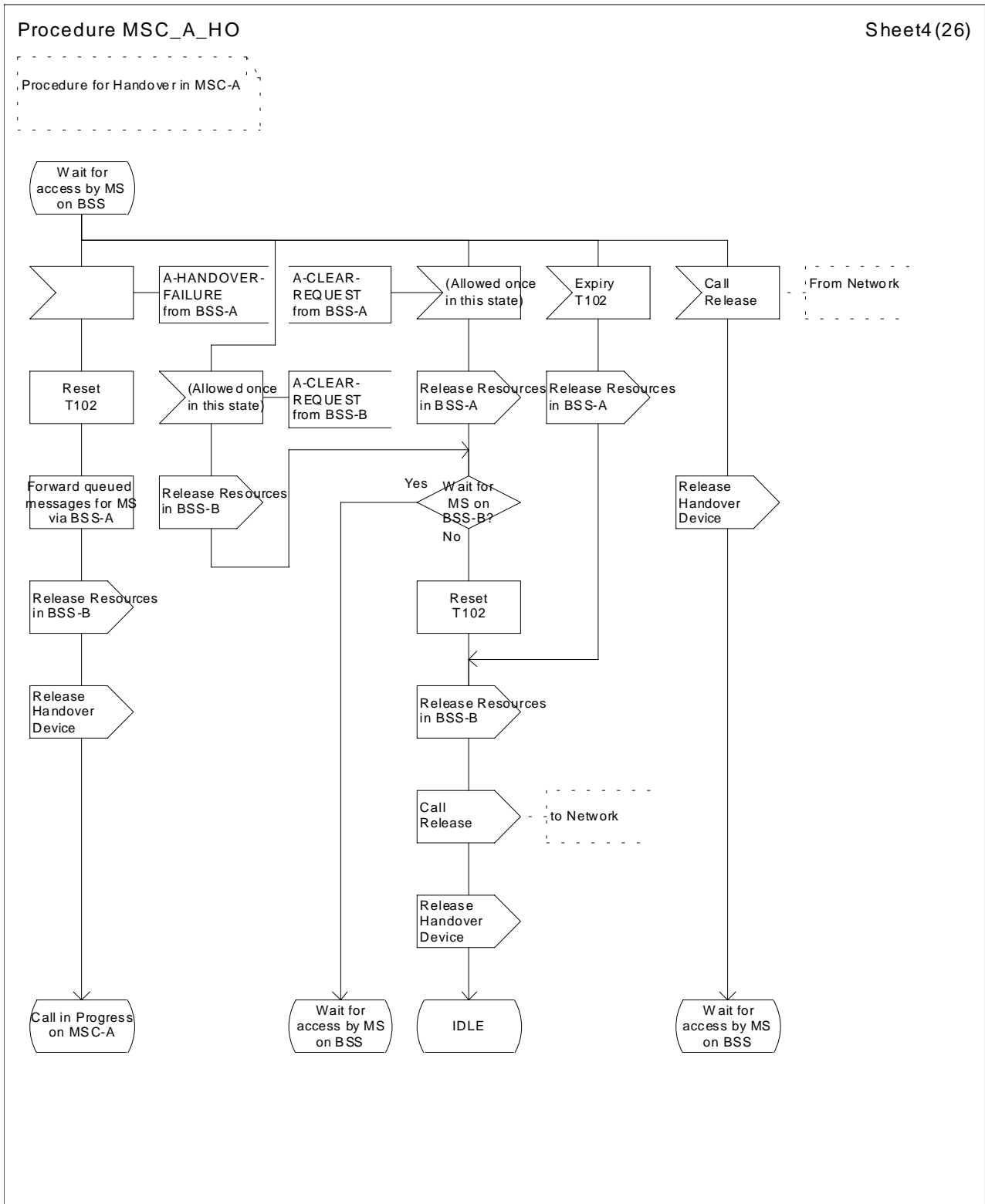

Figure 41 (Sheet 4 of 26): Handover control procedure in MSC-A

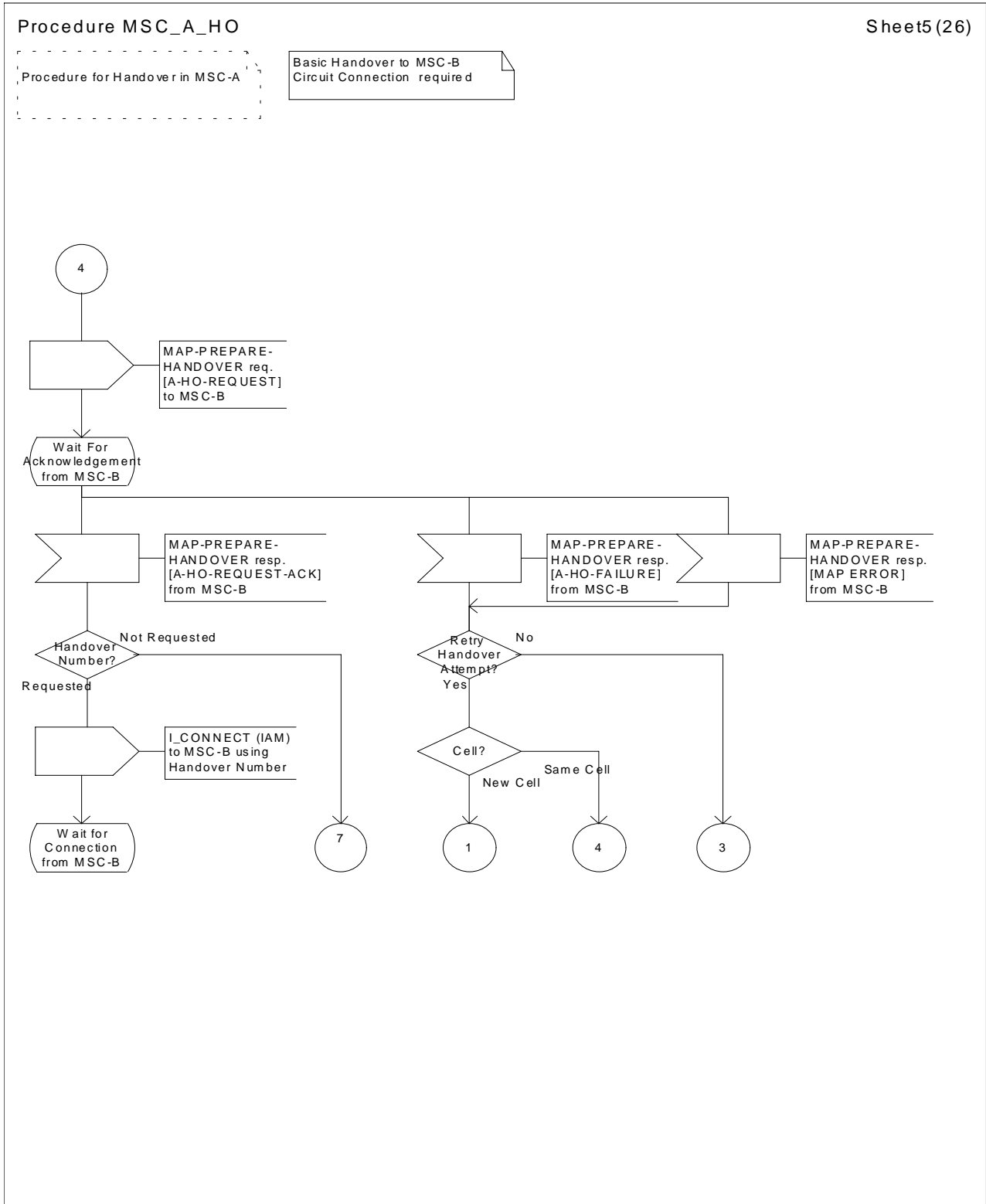

Figure 41 (Sheet 5 of 26): Handover control procedure in MSC-A

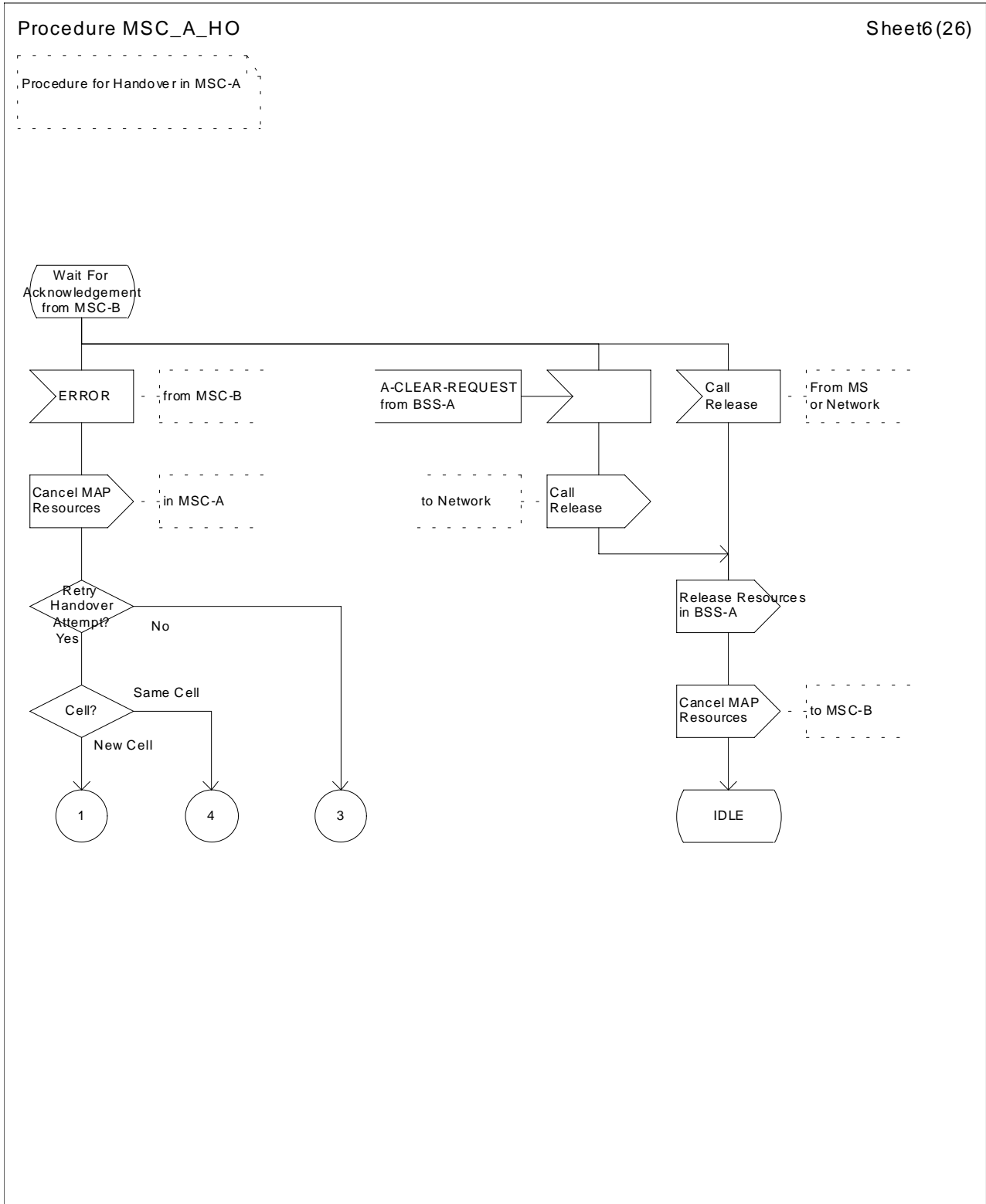

Figure 41 (Sheet 6 of 26): Handover control procedure in MSC-A

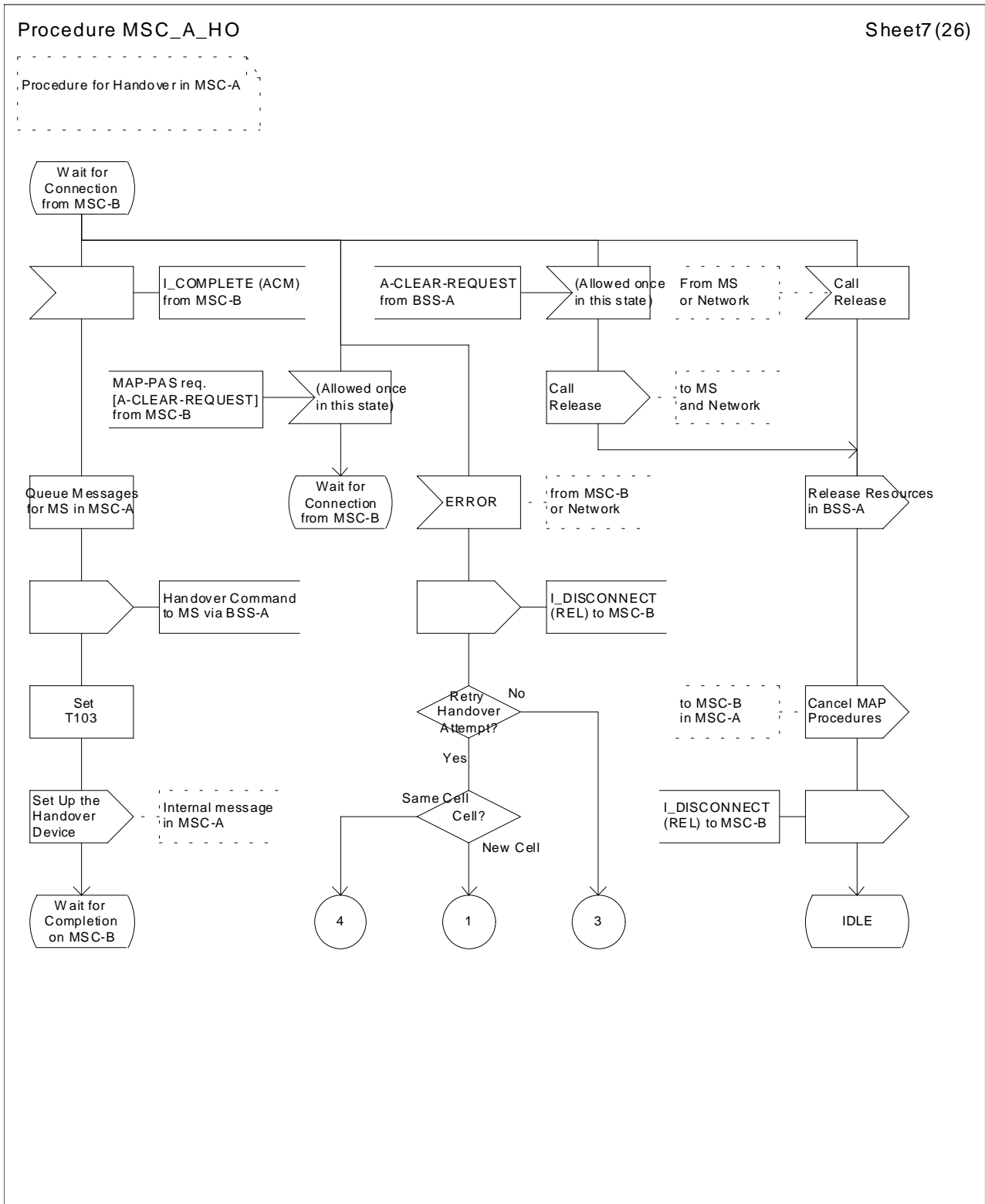

Figure 41 (Sheet 7 of 26): Handover control procedure in MSC-A

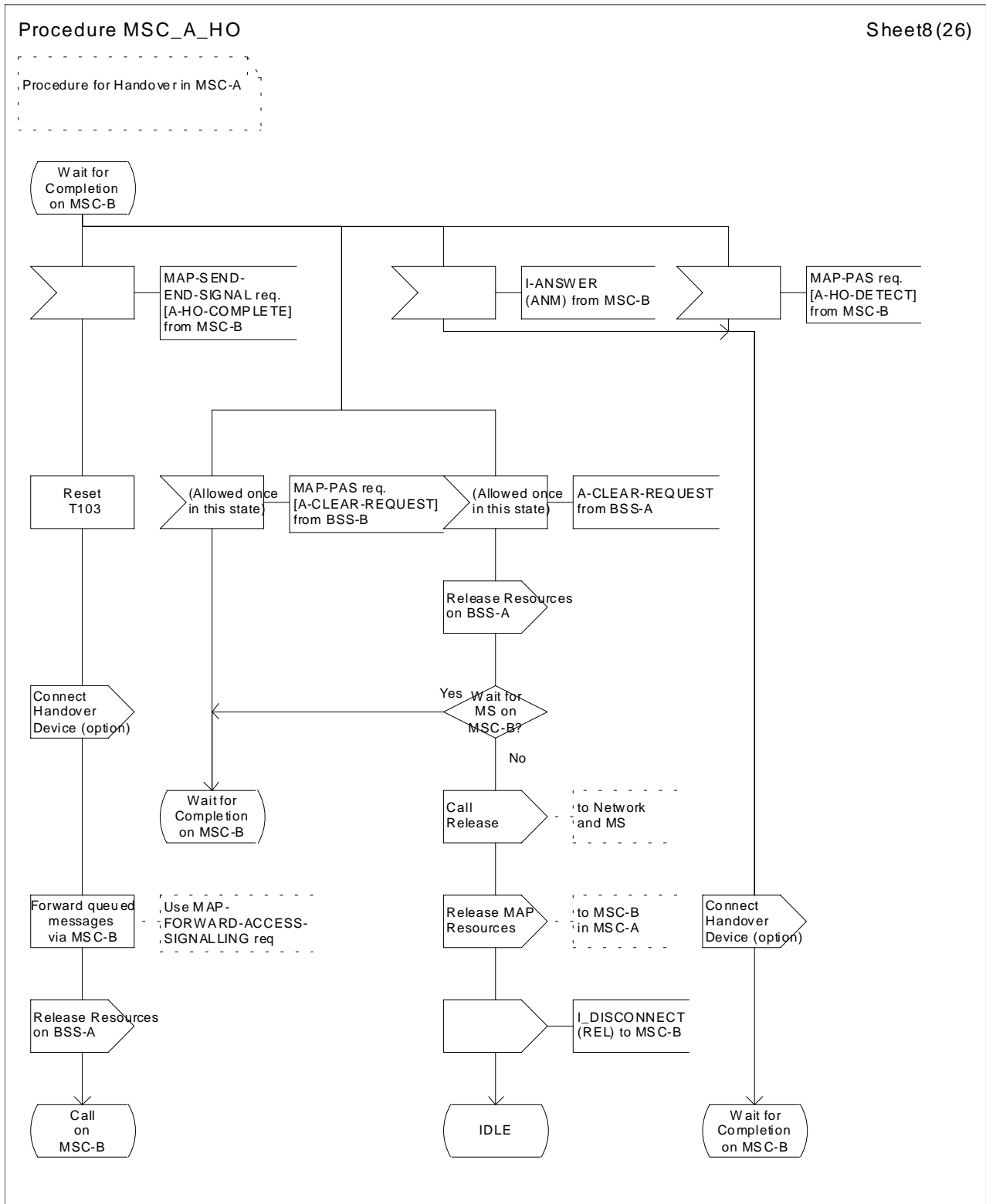

Figure 41 (Sheet 8 of 26): Handover control procedure in MSC-A

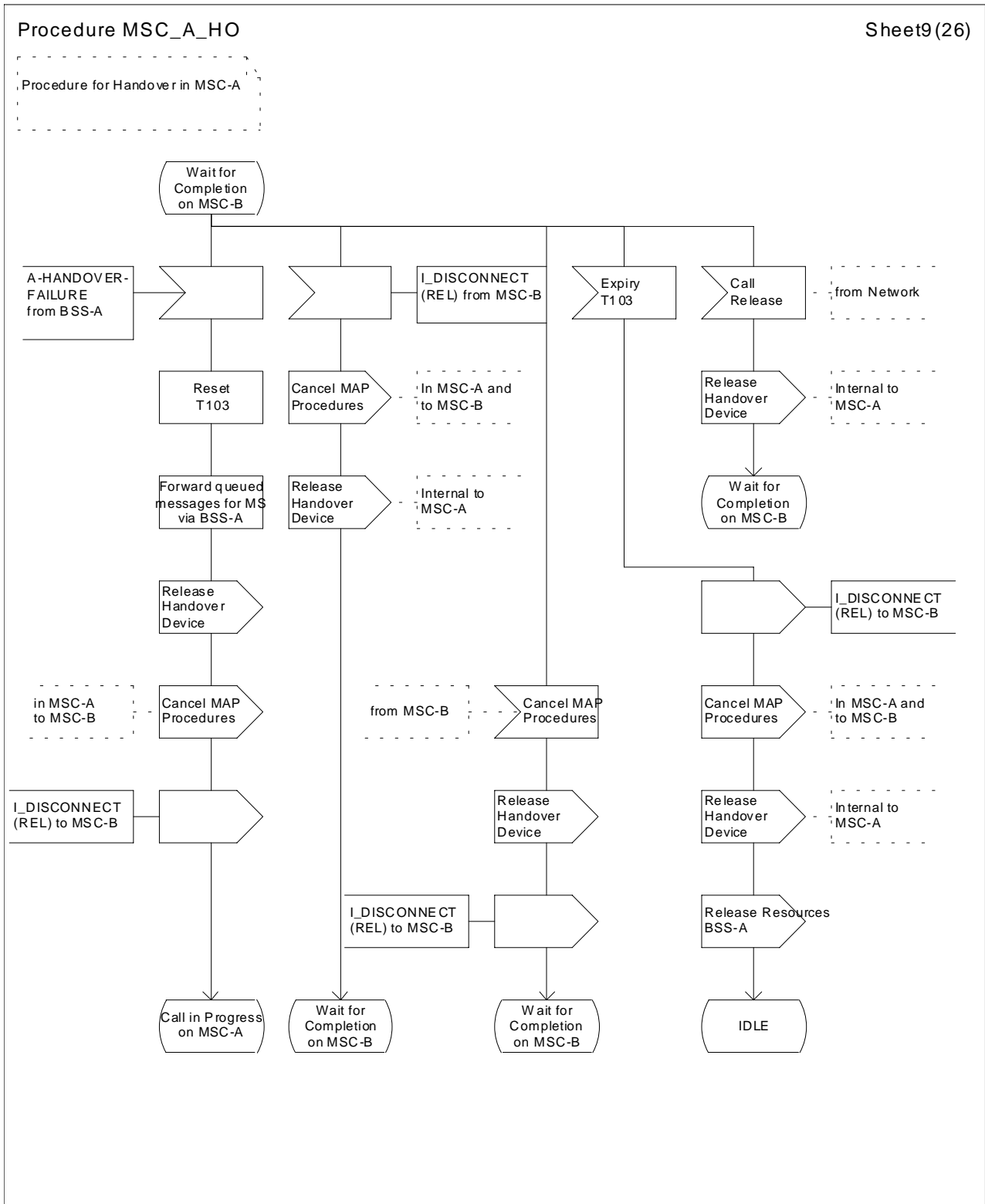

Figure 41 (Sheet 9 of 26): Handover control procedure in MSC-A

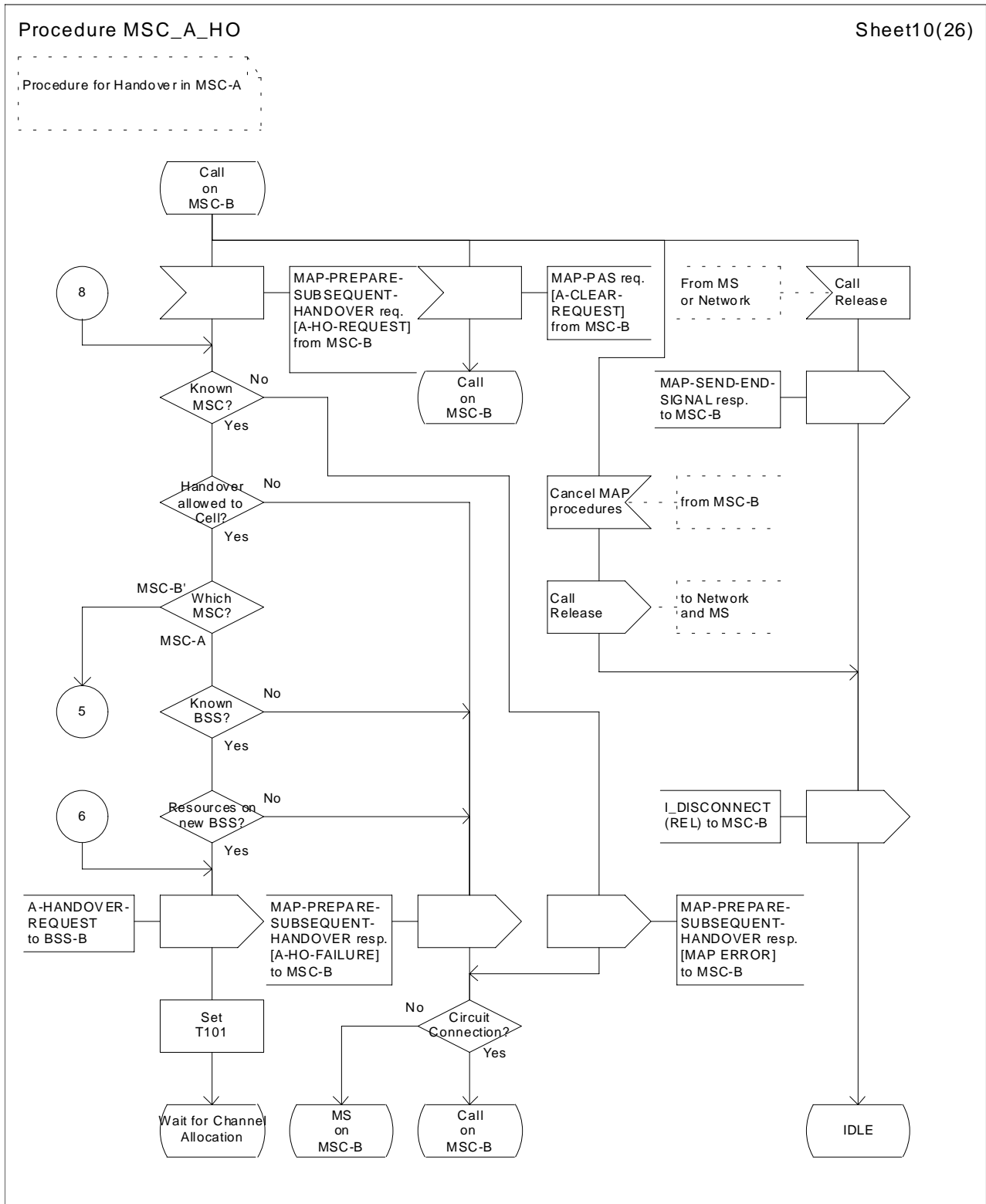

Figure 41 (Sheet 10 of 26): Handover control procedure in MSC-A

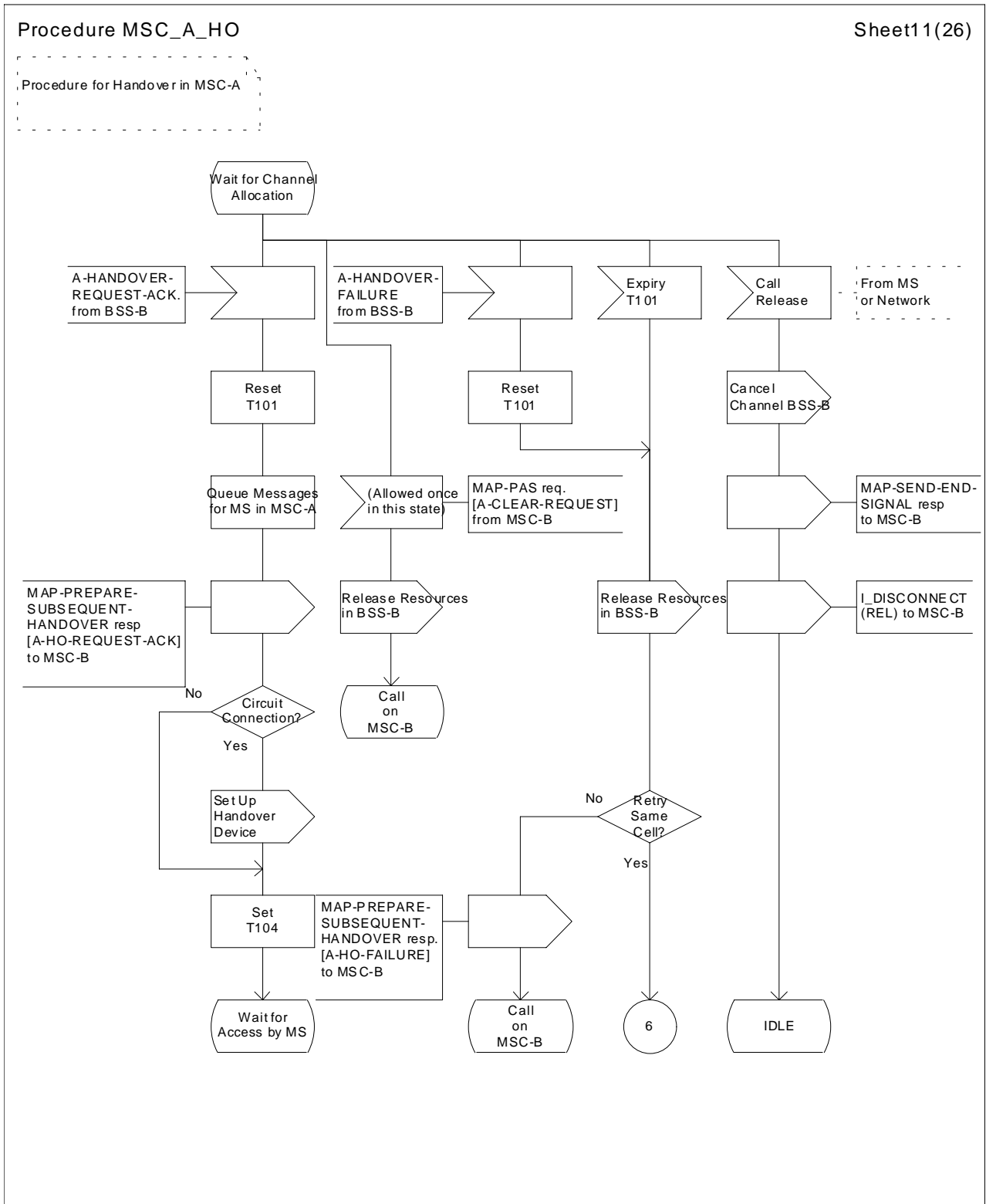

Figure 41 (Sheet 11 of 26): Handover control procedure in MSC-A

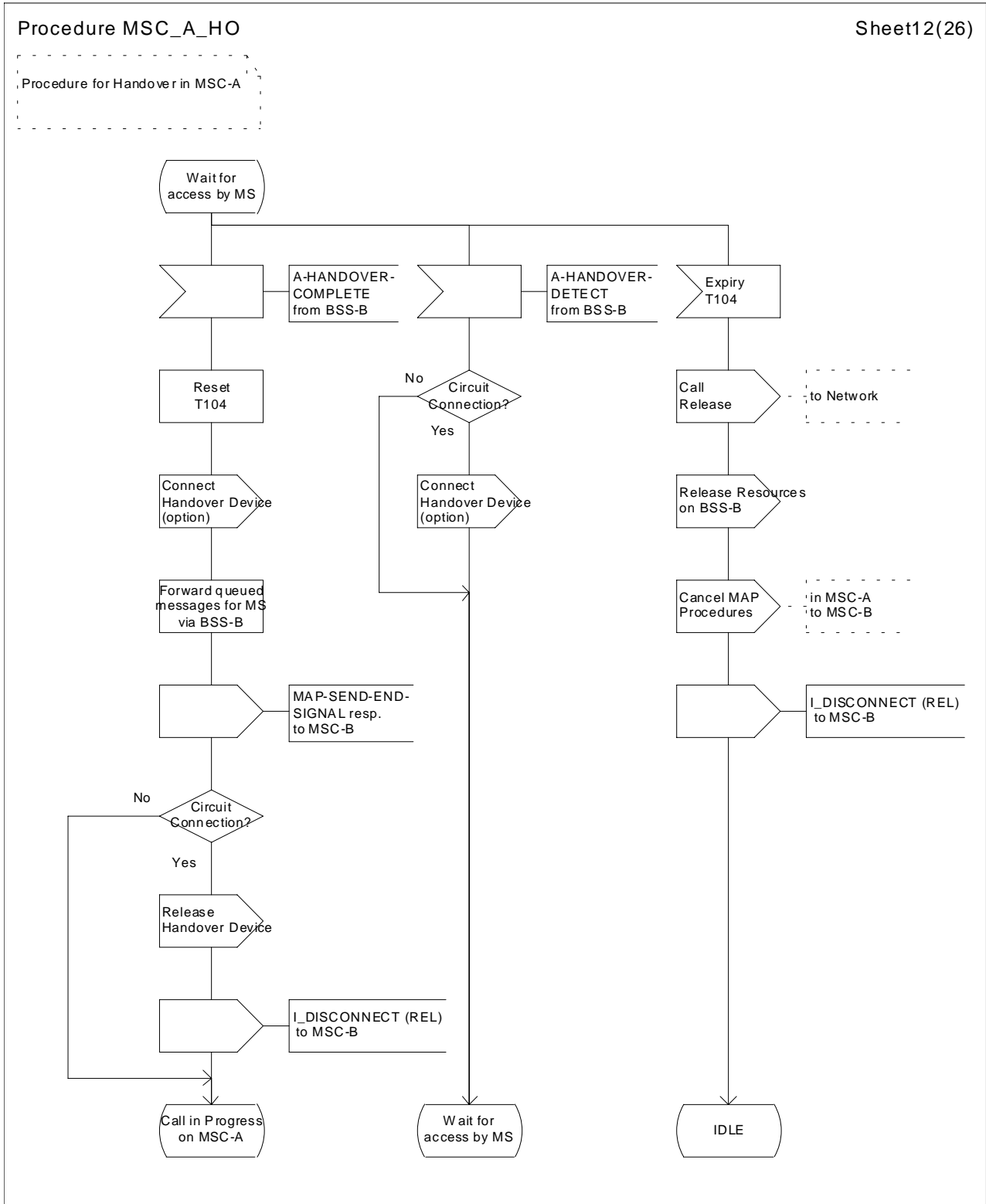

Figure 41 (Sheet 12 of 26): Handover control procedure in MSC-A

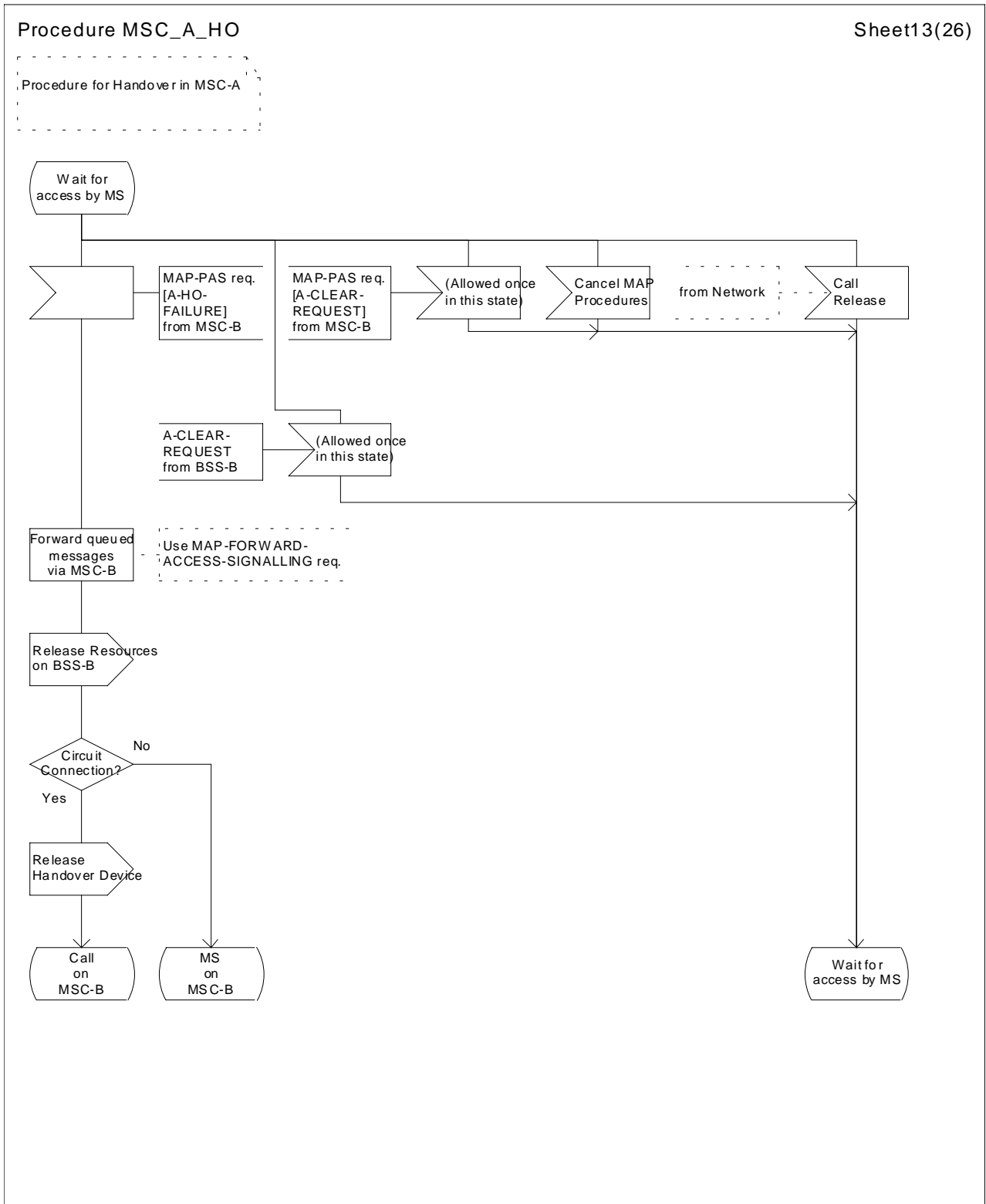

Figure 41 (Sheet 13 of 26): Handover control procedure in MSC-A

Procedure MSC_A_HO

Sheet14(26)

Procedure for Handover in MSC-A

Subsequent Handover from MSC-B to MSC-B'
Circuit Connection required

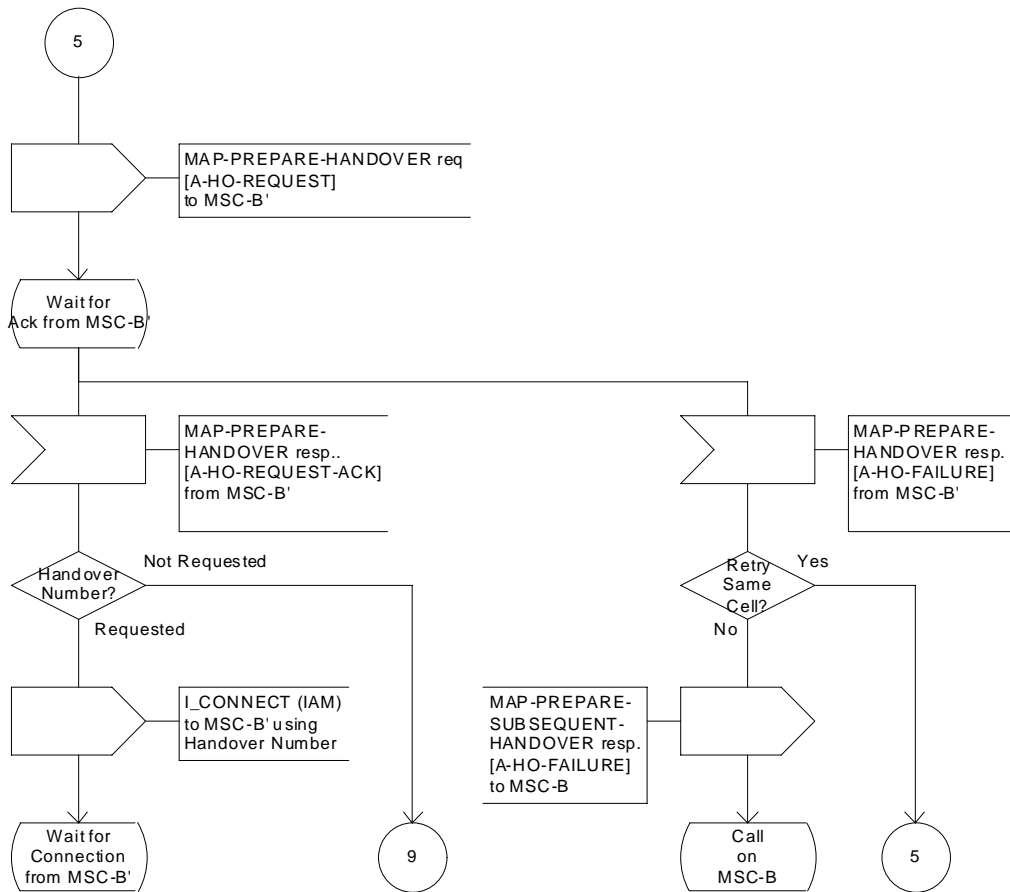

Figure 41 (Sheet 14 of 26): Handover control procedure in MSC-A

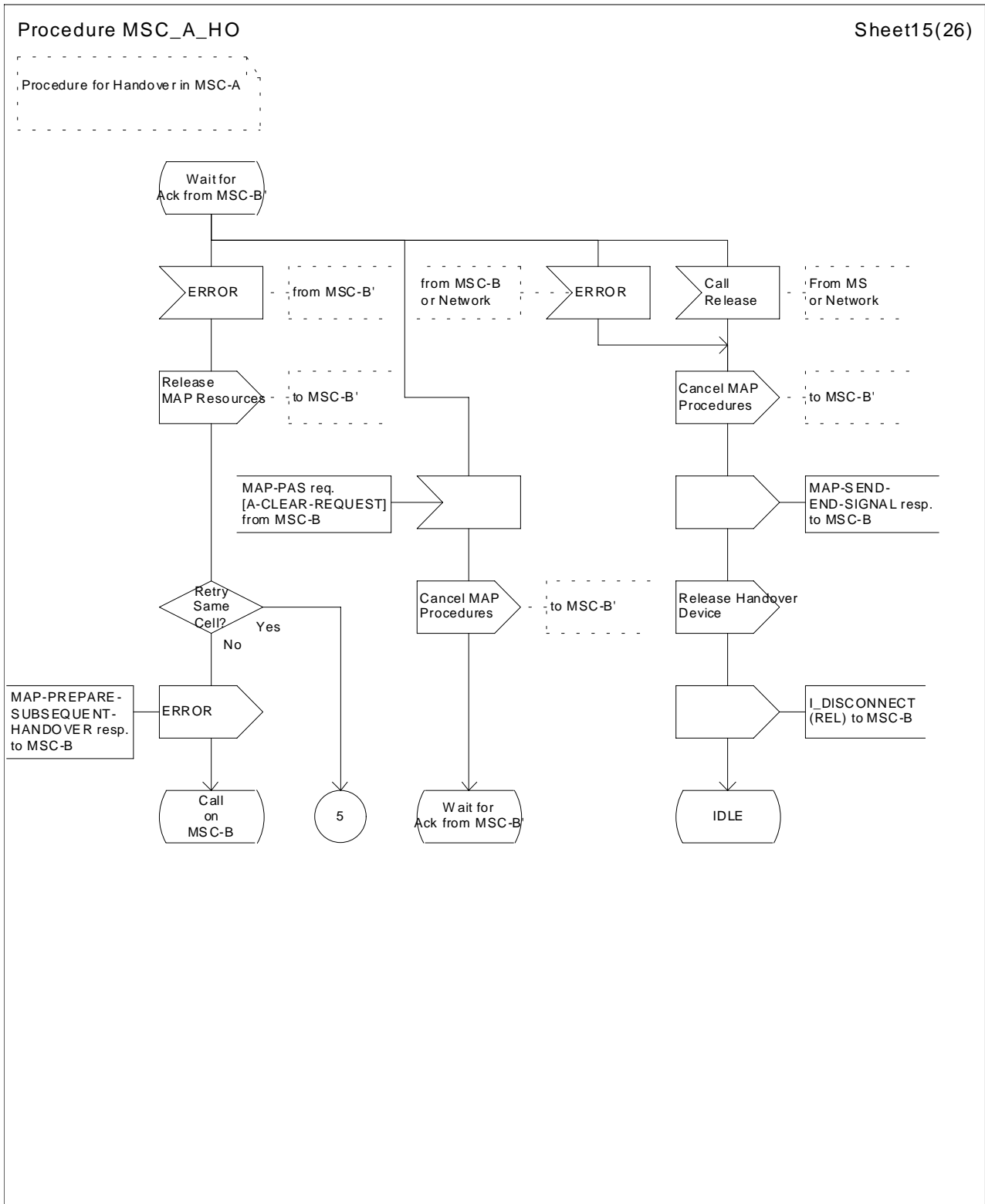

Figure 41 (Sheet 15 of 26): Handover control procedure in MSC-A

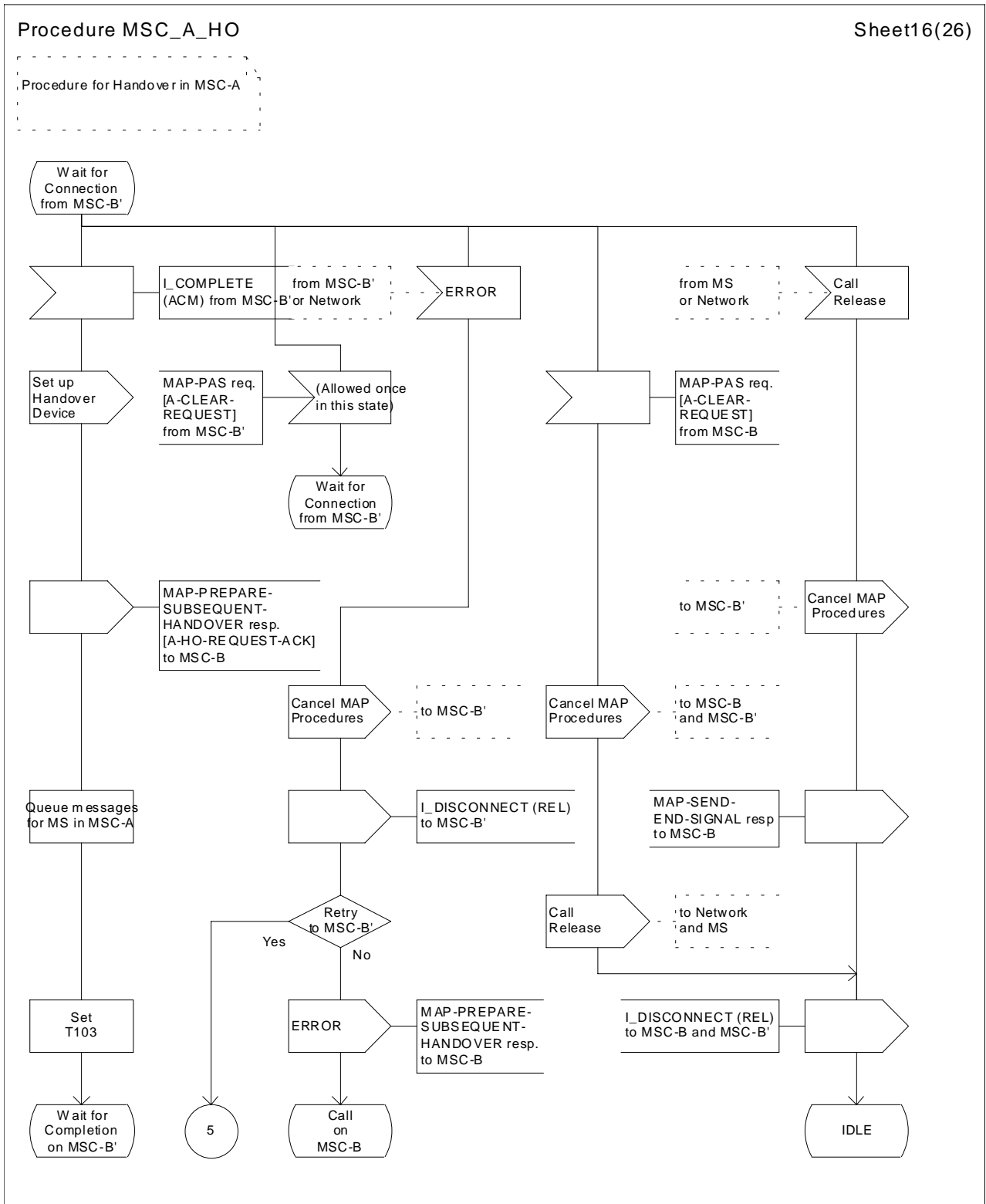

Figure 41 (Sheet 16 of 26): Handover control procedure in MSC-A

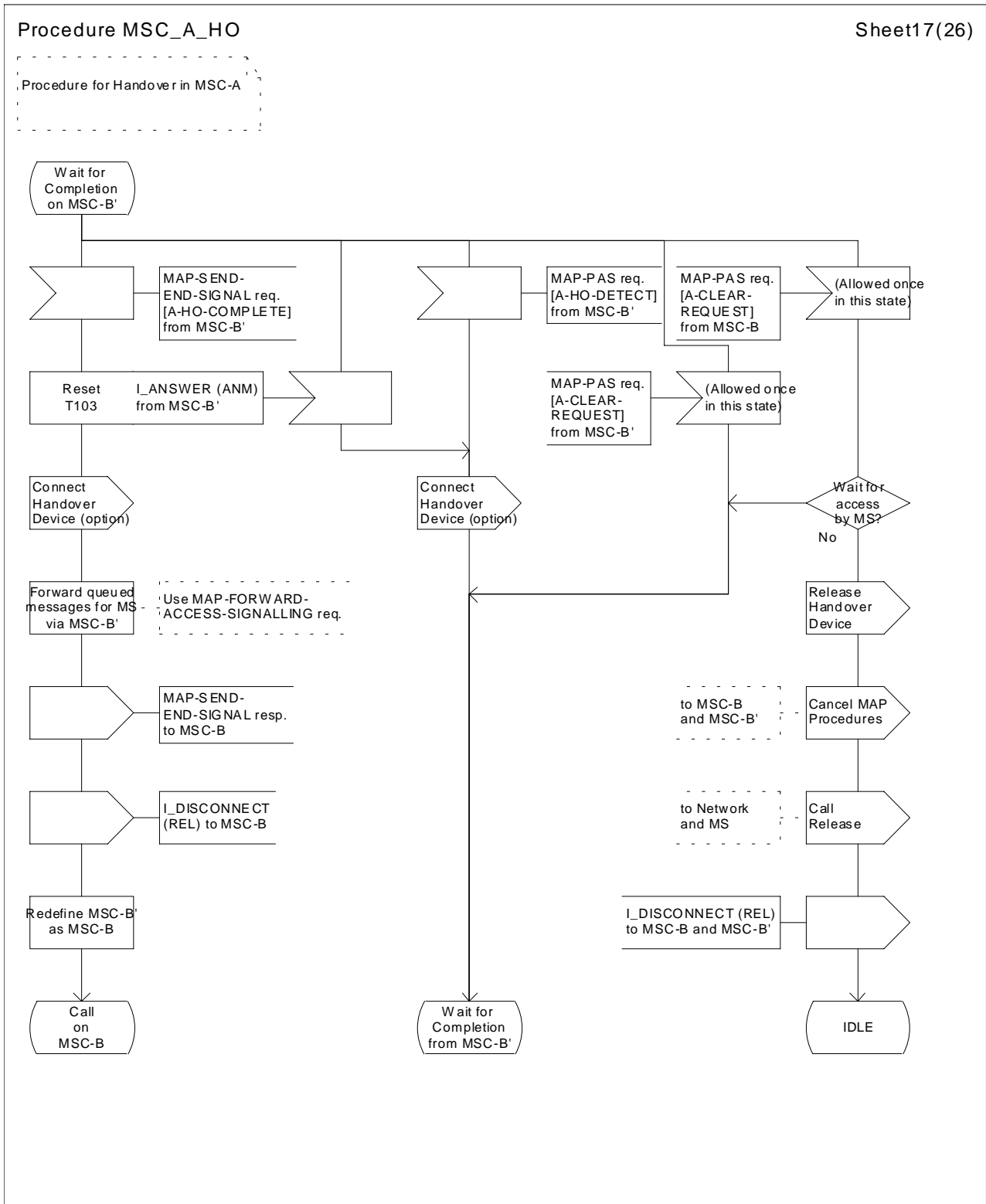

Figure 41 (Sheet 17 of 26): Handover control procedure in MSC-A

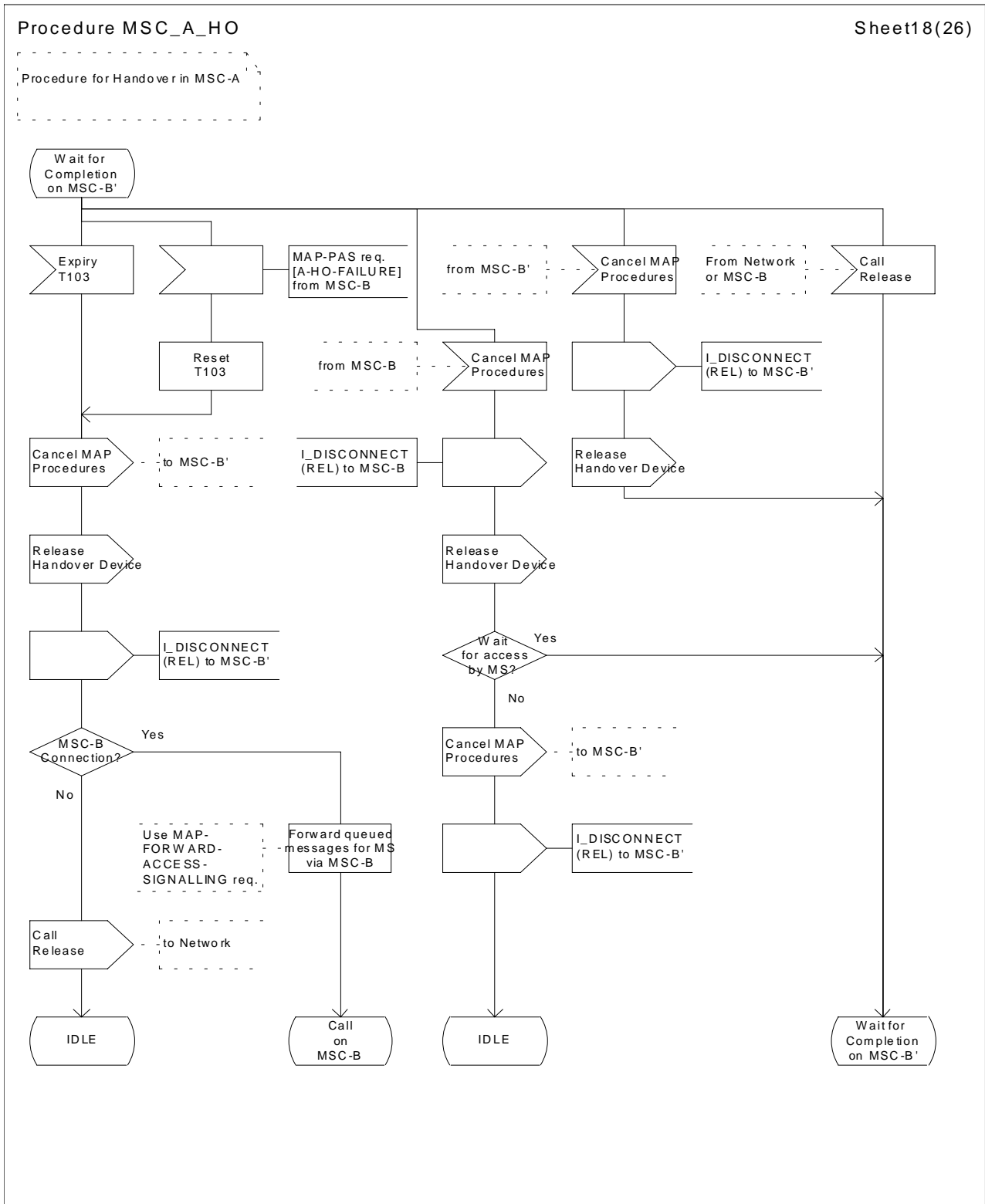

Figure 41 (Sheet 18 of 26): Handover control procedure in MSC-A

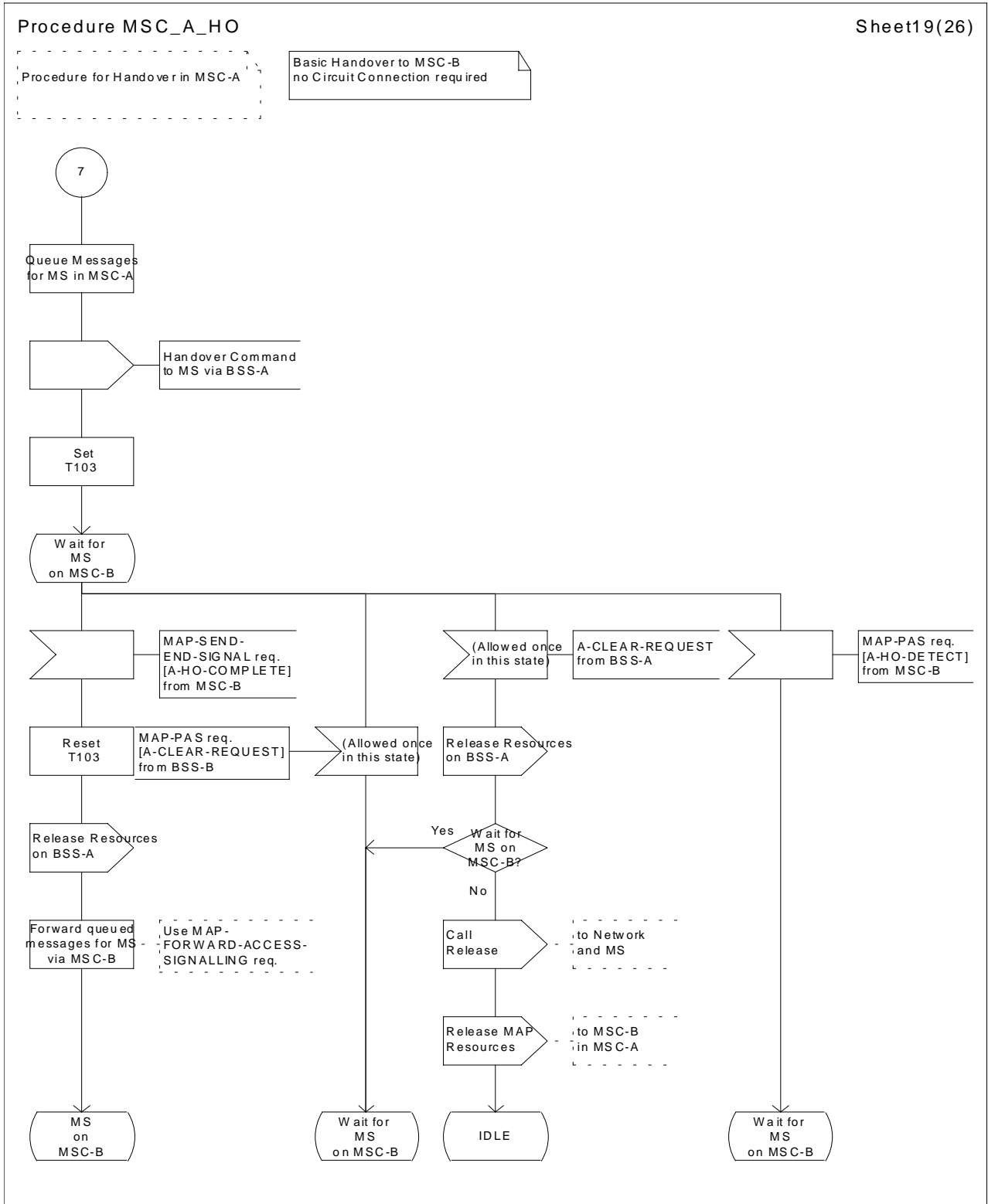

Figure 41 (Sheet 19 of 26): Handover control procedure in MSC-A

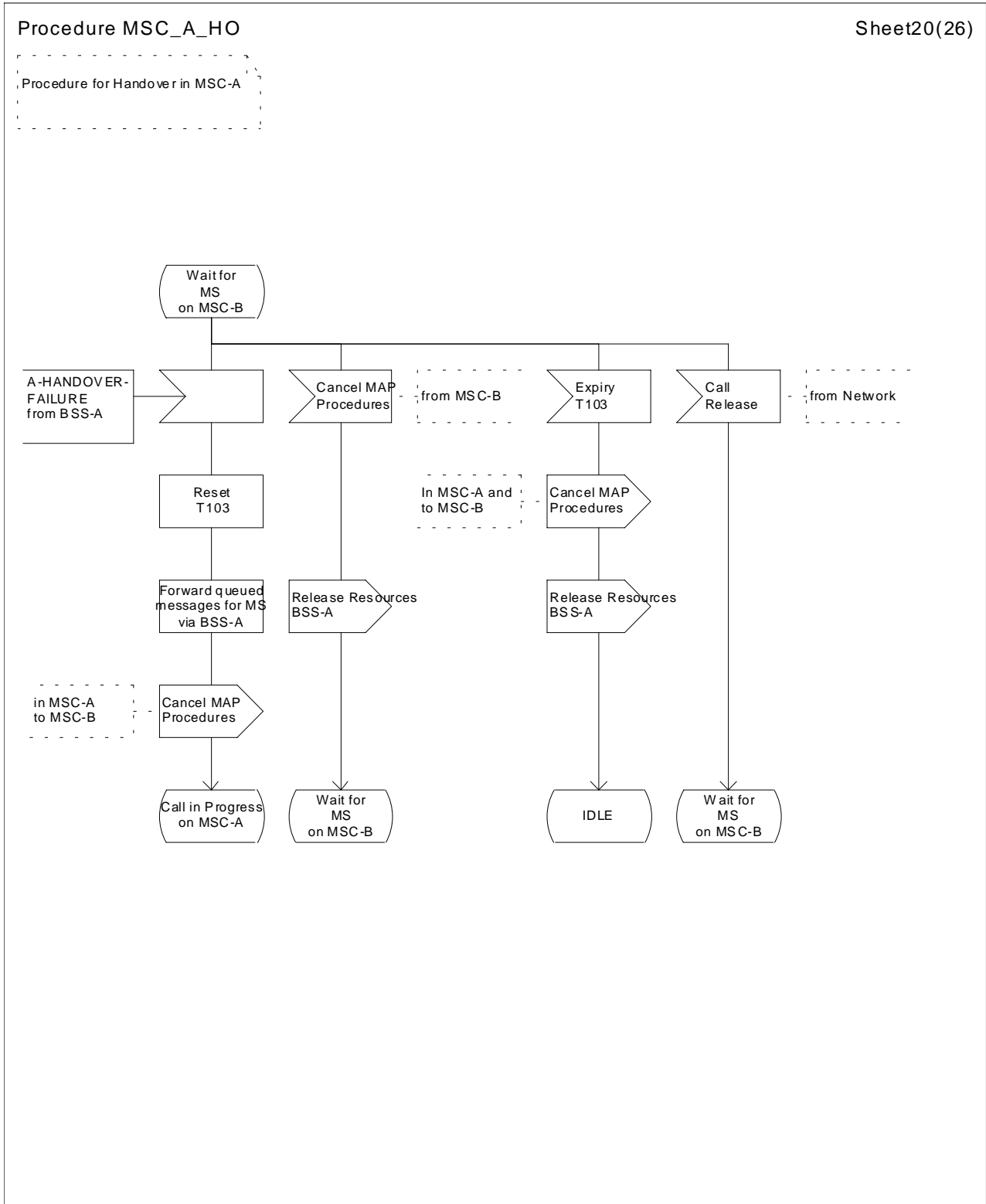

Figure 41 (Sheet 20 of 26): Handover control procedure in MSC-A

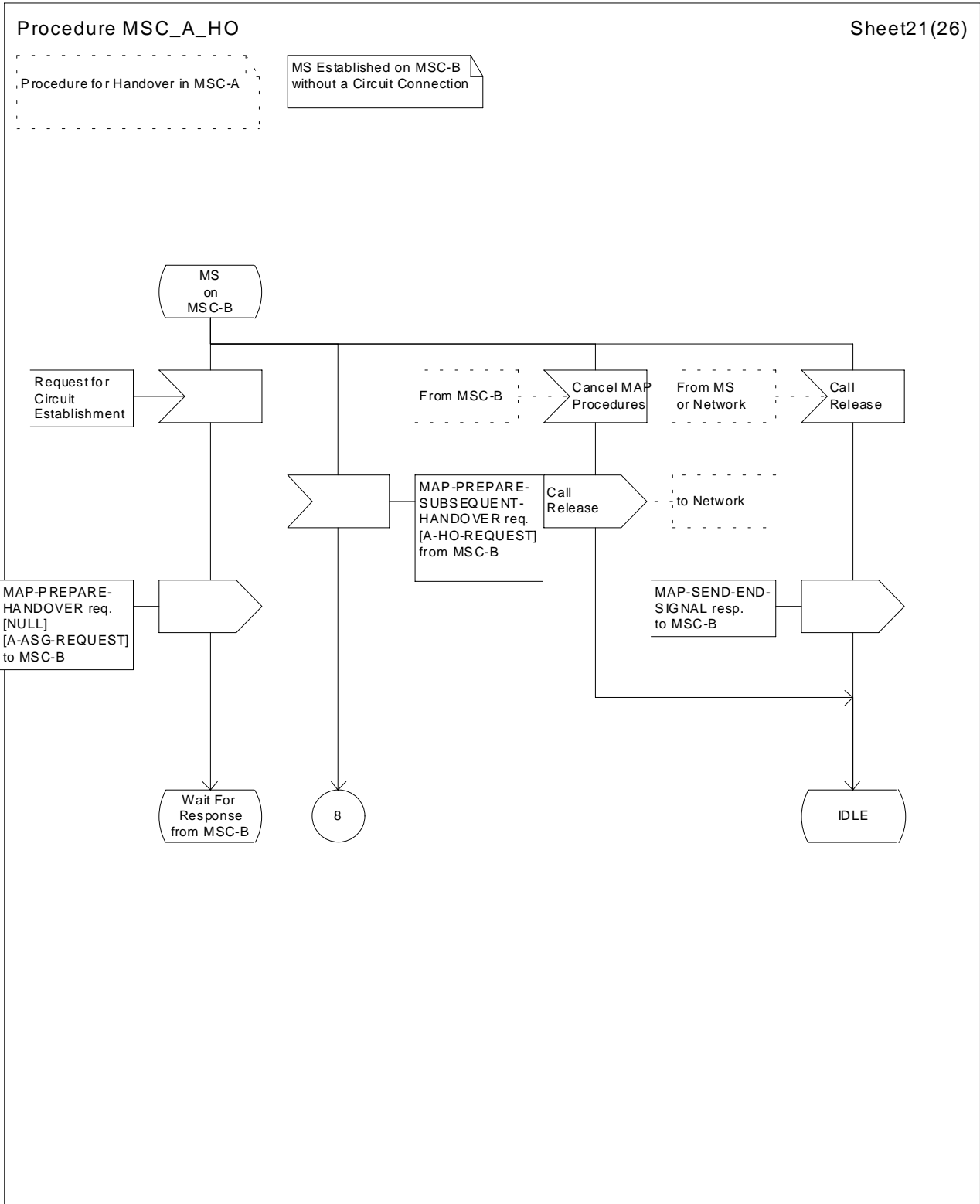

Figure 41 (Sheet 21 of 26): Handover control procedure in MSC-A

Procedure MSC_A_HO

Sheet22(26)

Procedure for Handover in MSC-A

Circuit Connection Establishment to MSC-B

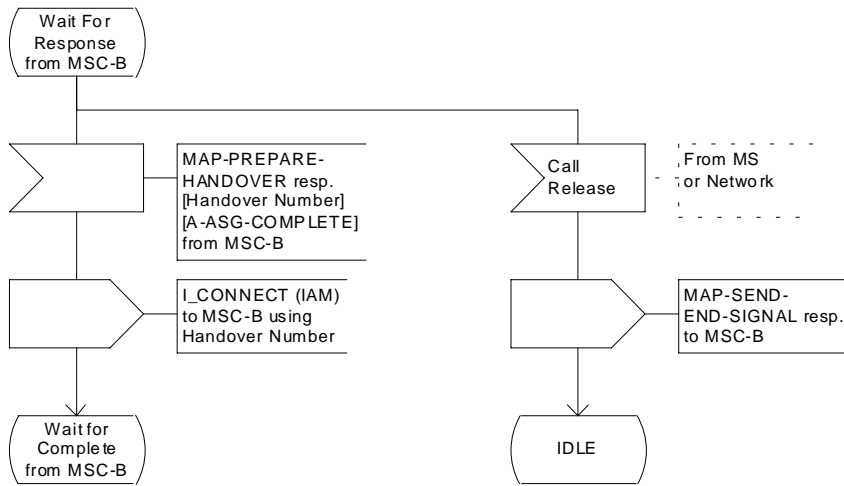

Figure 41 (Sheet 22 of 26): Handover control procedure in MSC-A

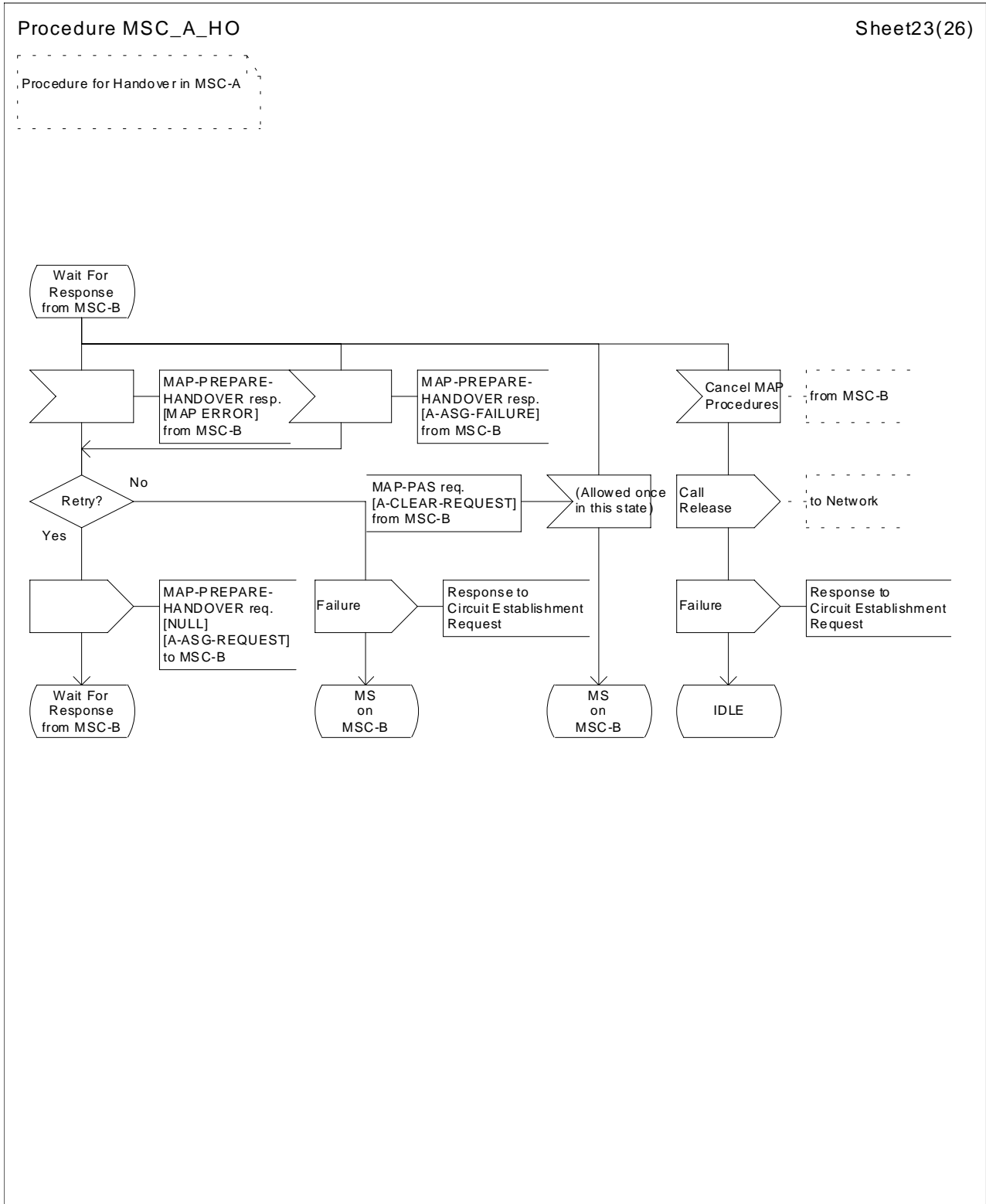

Figure 41 (Sheet 23 of 26): Handover control procedure in MSC-A

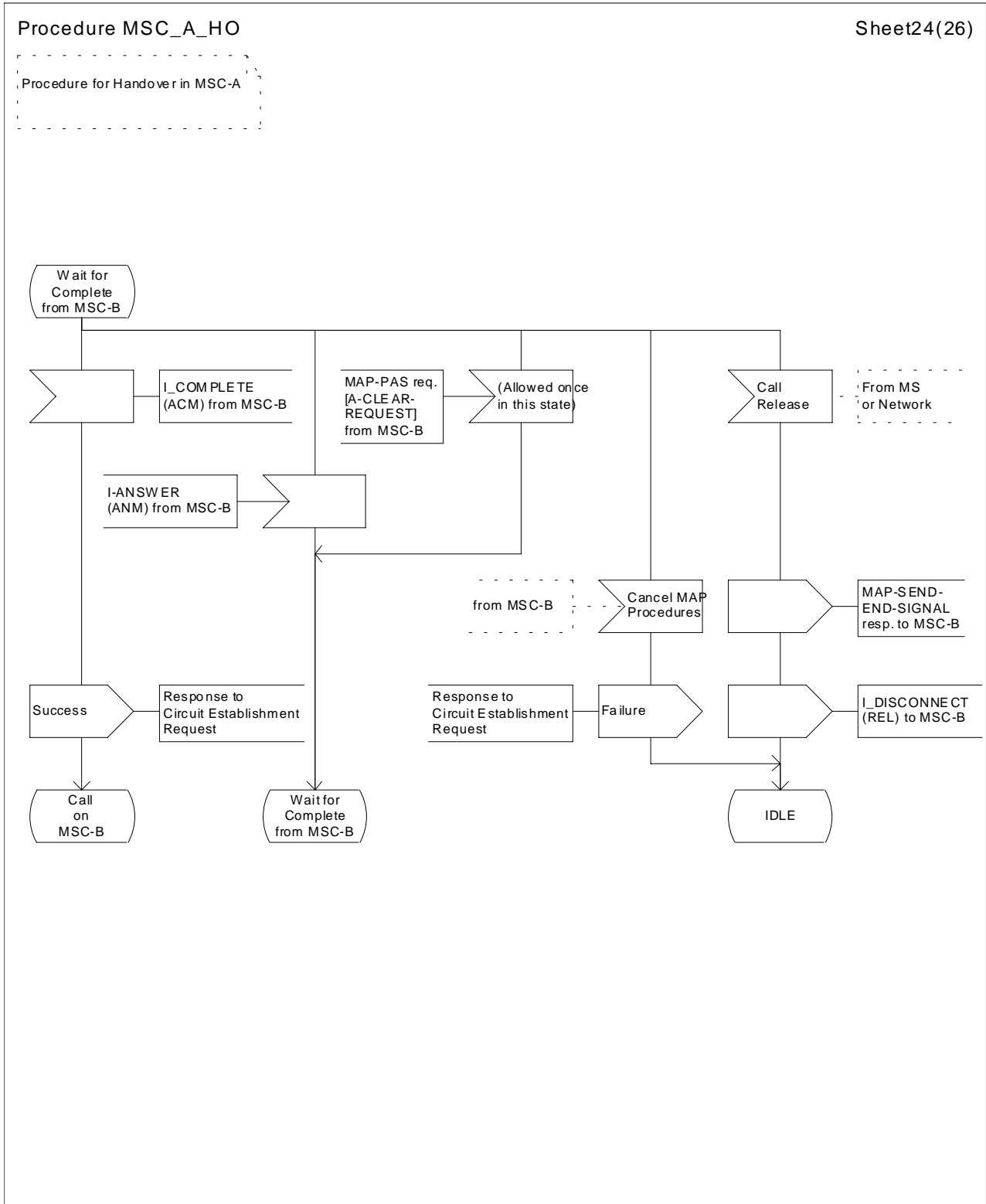

Figure 41 (Sheet 24 of 26): Handover control procedure in MSC-A

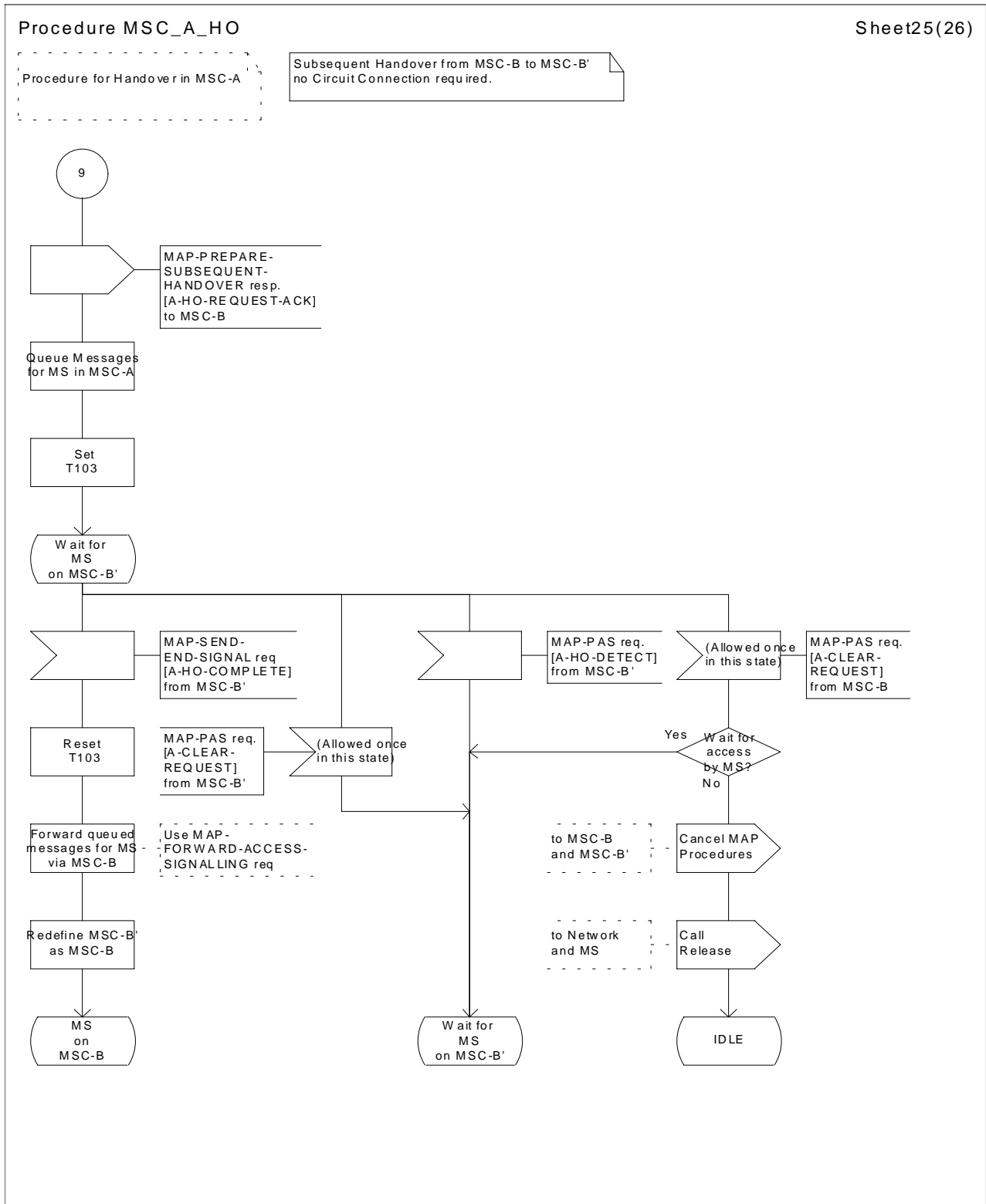

Figure 41 (Sheet 25 of 26): Handover control procedure in MSC-A

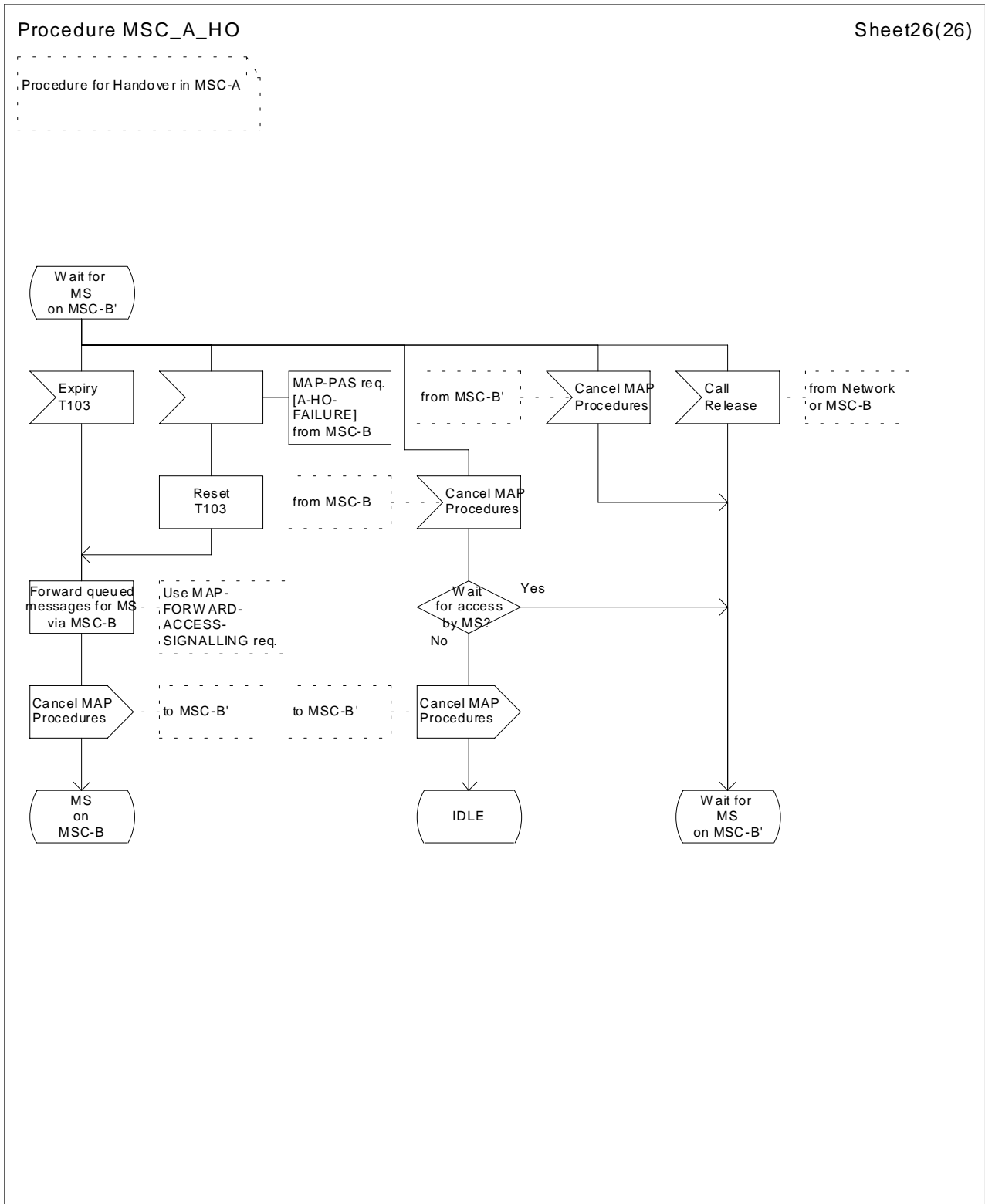

Figure 41 (Sheet 26 of 26): Handover control procedure in MSC-A

Procedure MSC_B_HO

Sheet1 (18)

Procedures for Handover in MSC-B

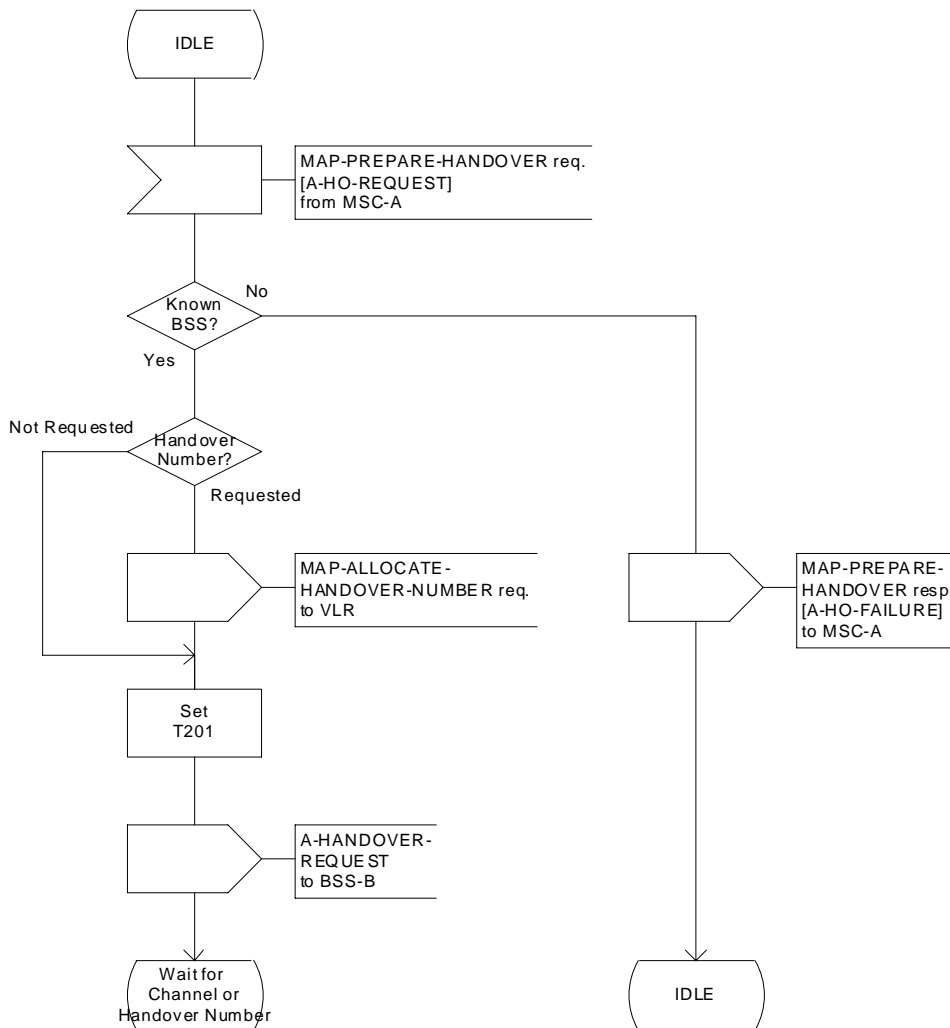

Figure 42 (Sheet 1 of 18): Handover control procedure in MSC-B

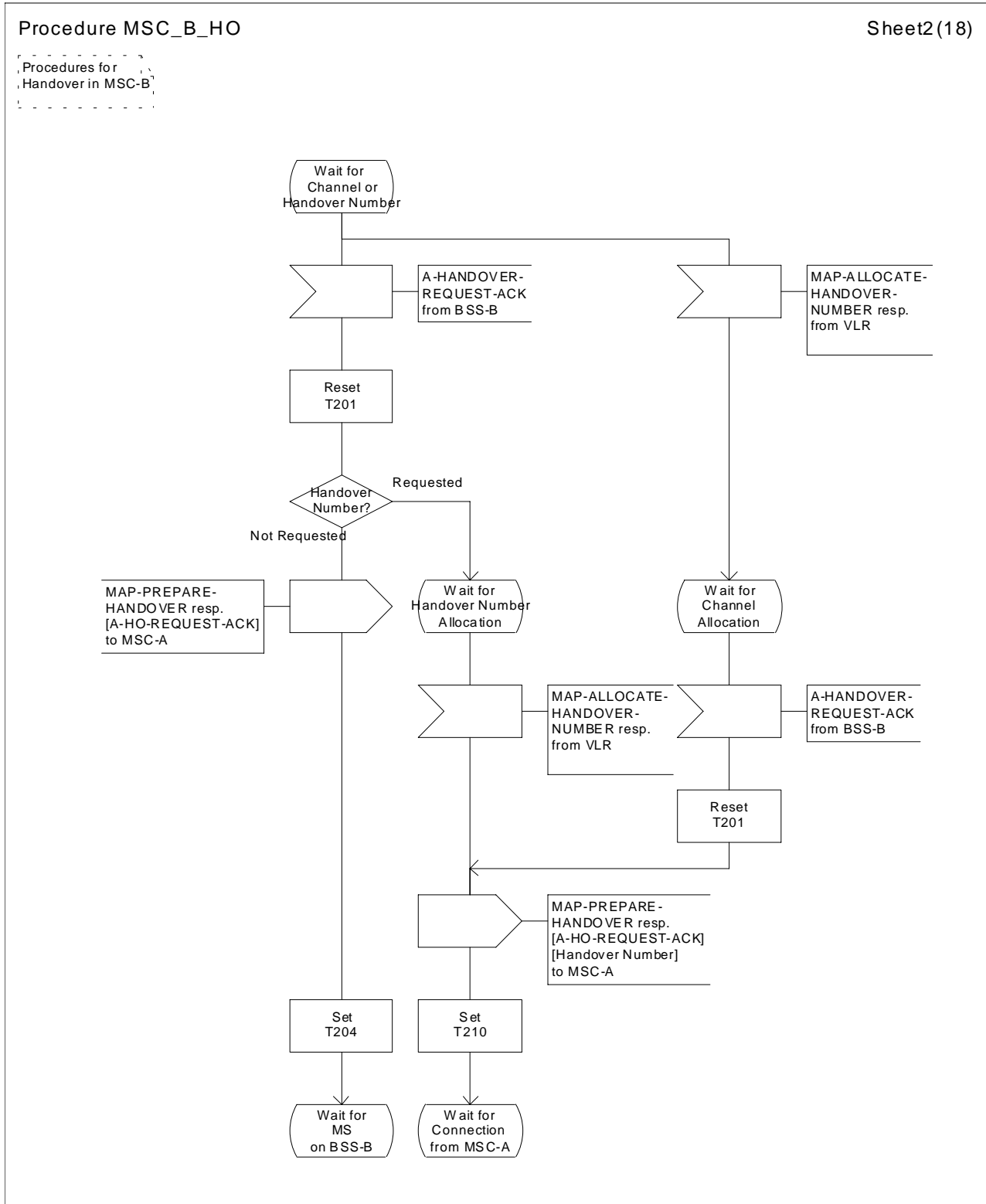

Figure 42 (Sheet 2 of 18): Handover control procedure in MSC-B

Procedure MSC_B_HO

Sheet3(18)

Procedures for Handover in MSC-B

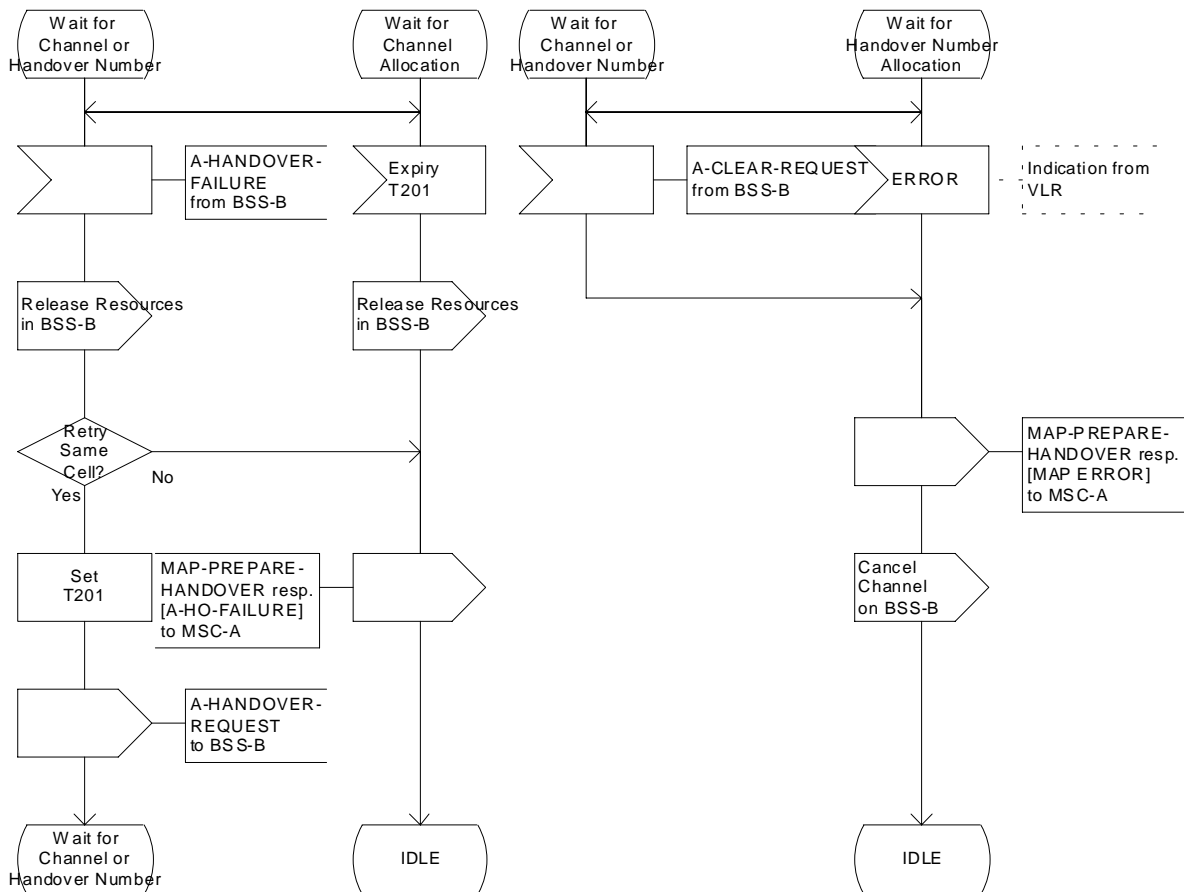

Figure 42 (Sheet 3 of 18): Handover control procedure in MSC-B

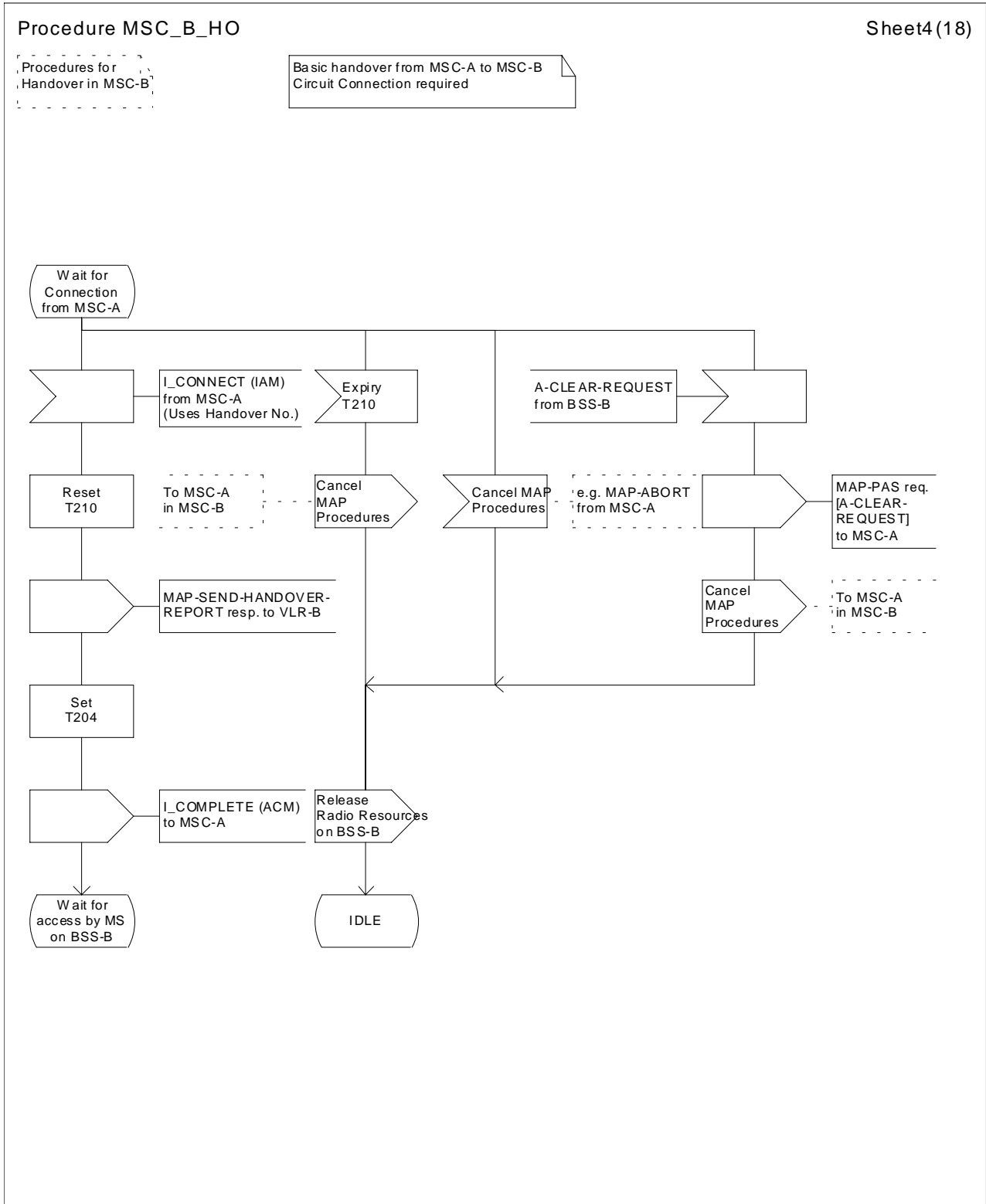

Figure 42 (Sheet 4 of 18): Handover control procedure in MSC-B

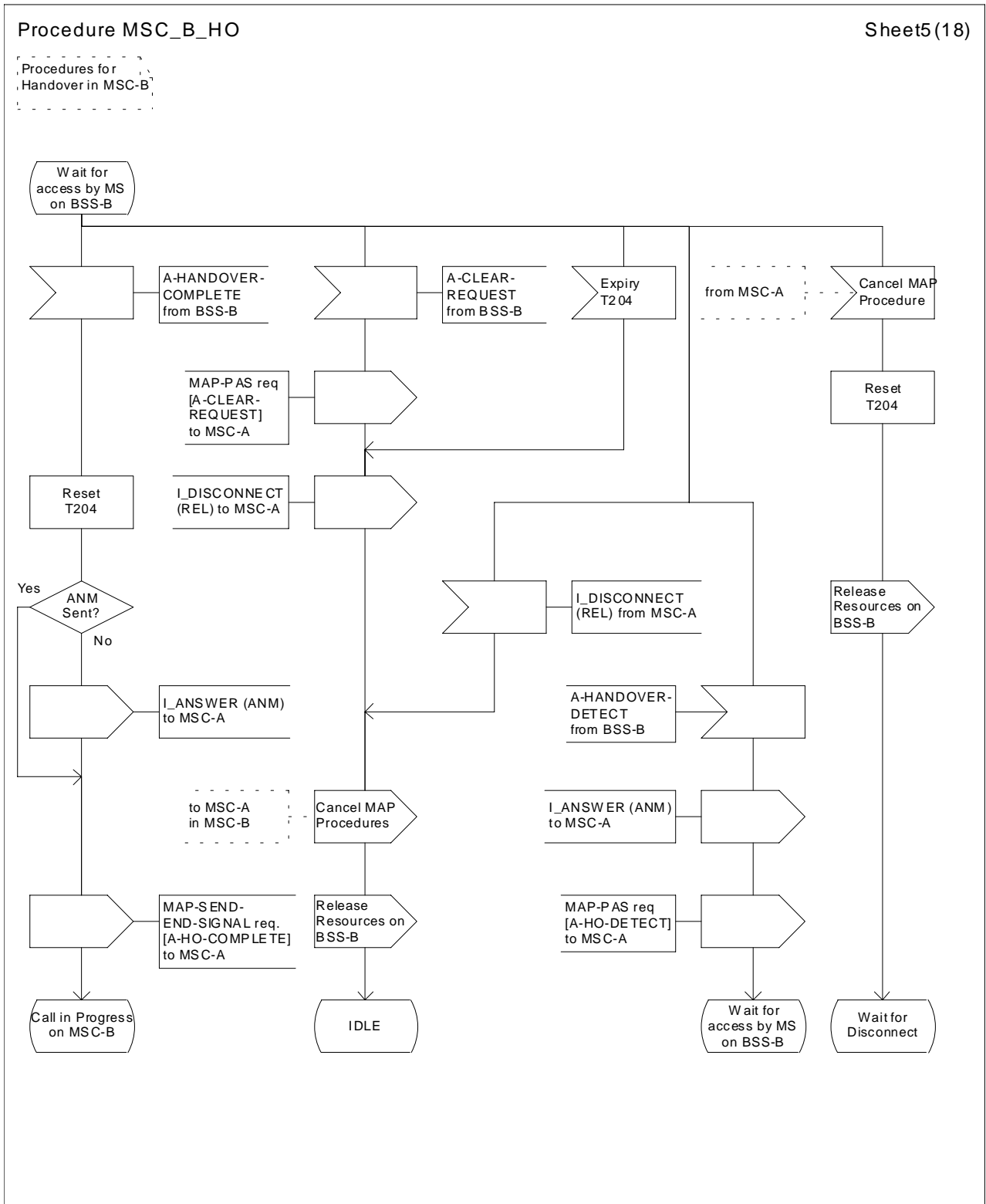

Figure 42 (Sheet 5 of 18): Handover control procedure in MSC-B

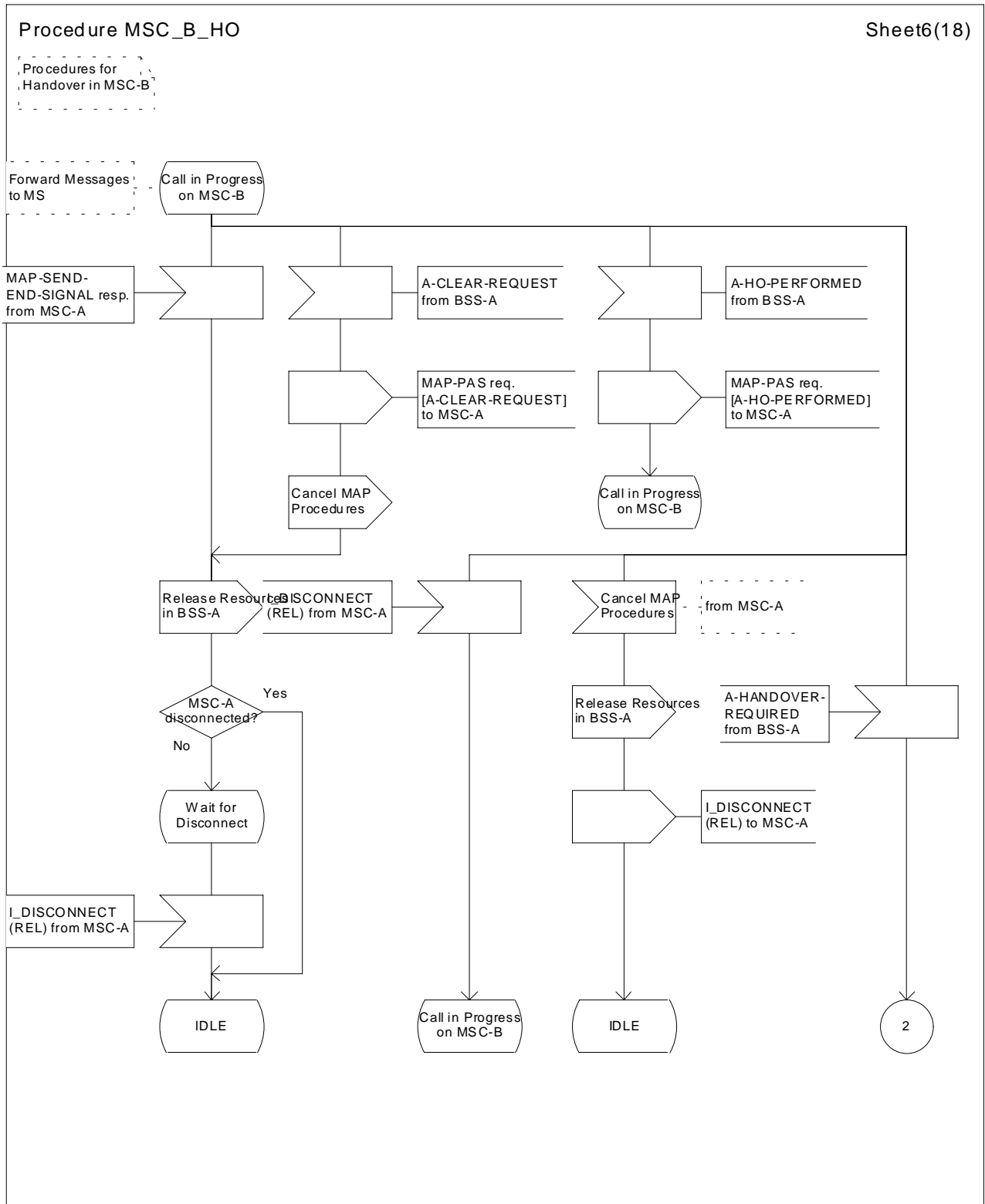

Figure 42 (Sheet 6 of 18): Handover control procedure in MSC-B

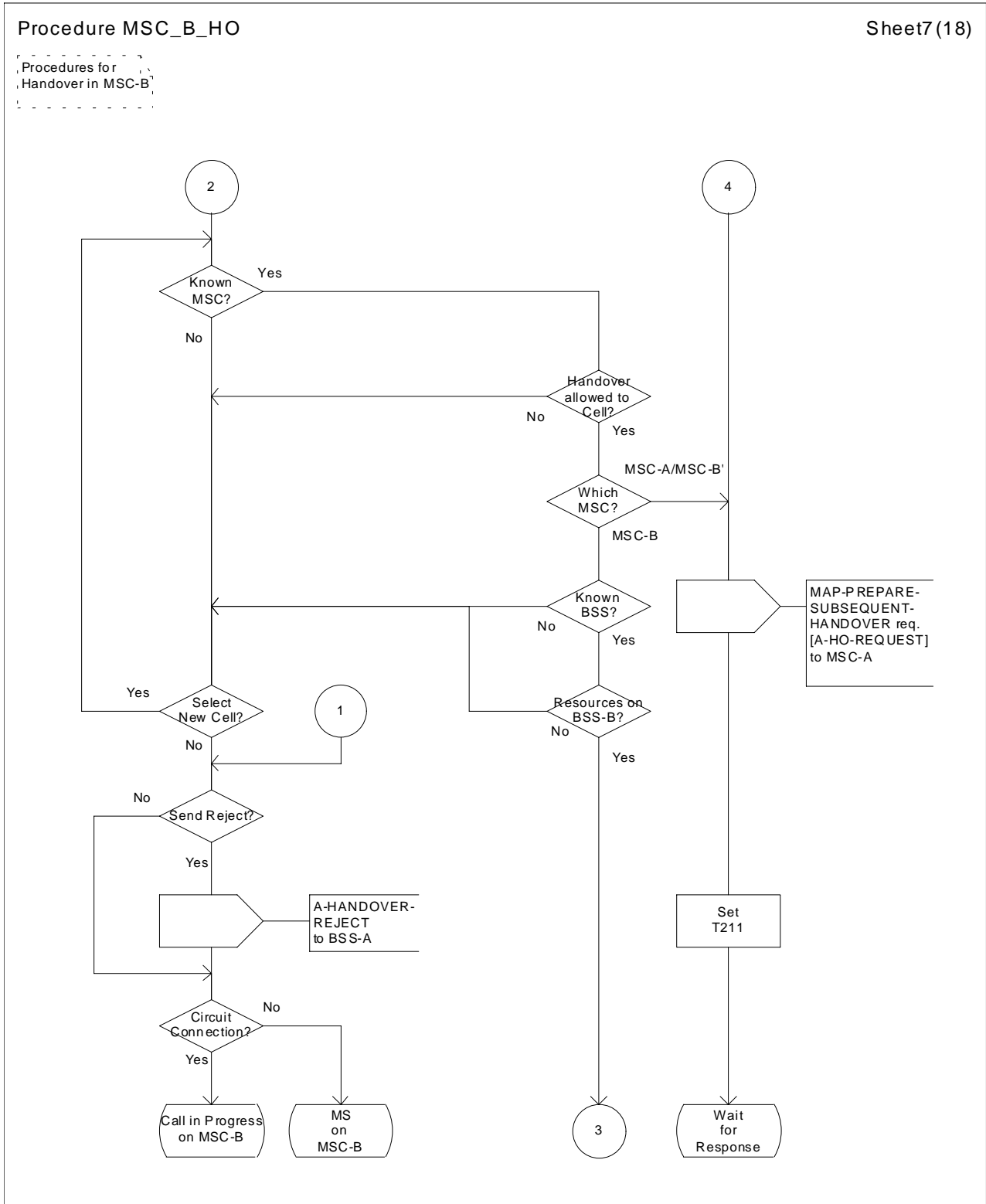

Figure 42 (Sheet 7 of 18): Handover control procedure in MSC-B

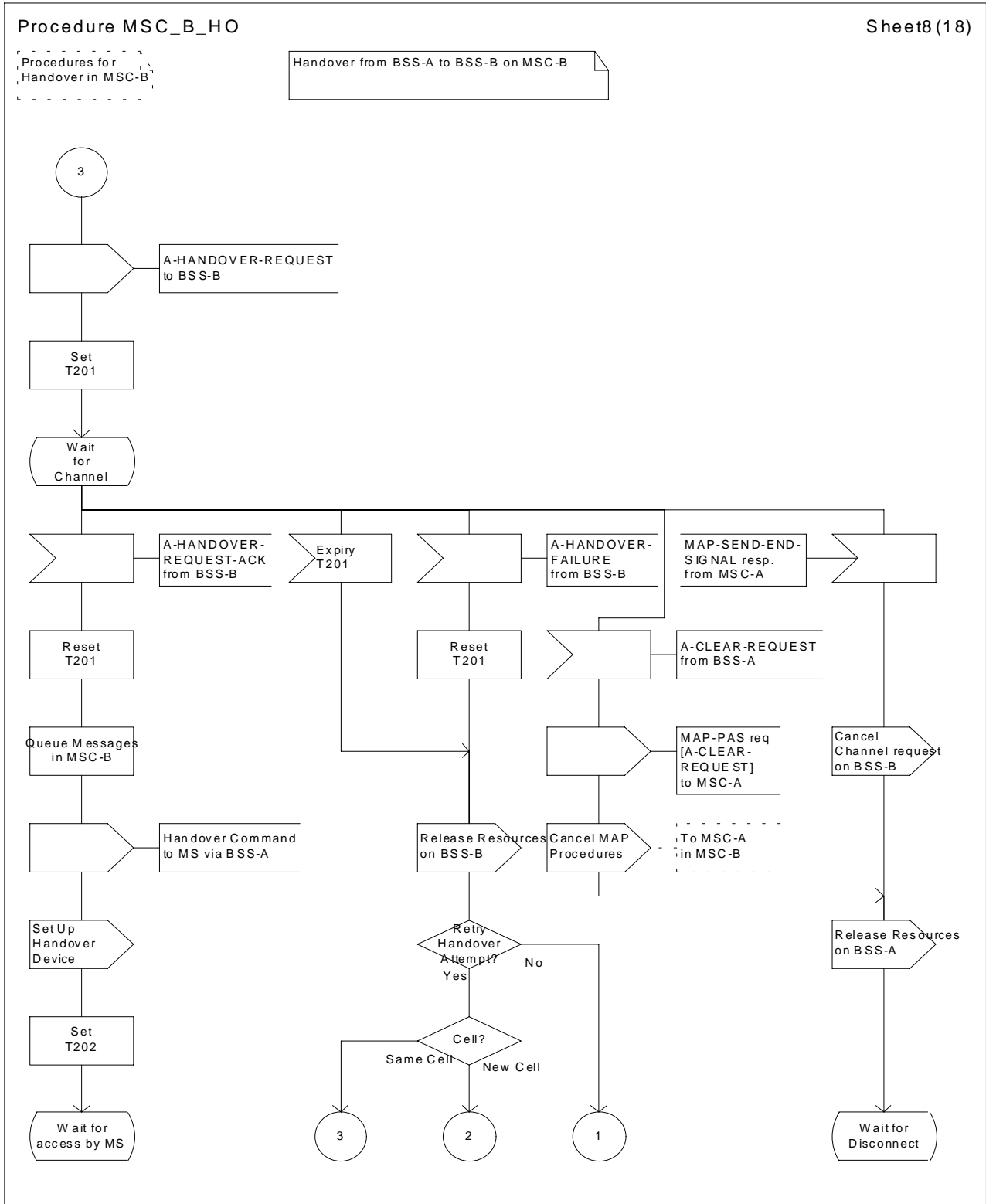

Figure 42 (Sheet 8 of 18): Handover control procedure in MSC-B

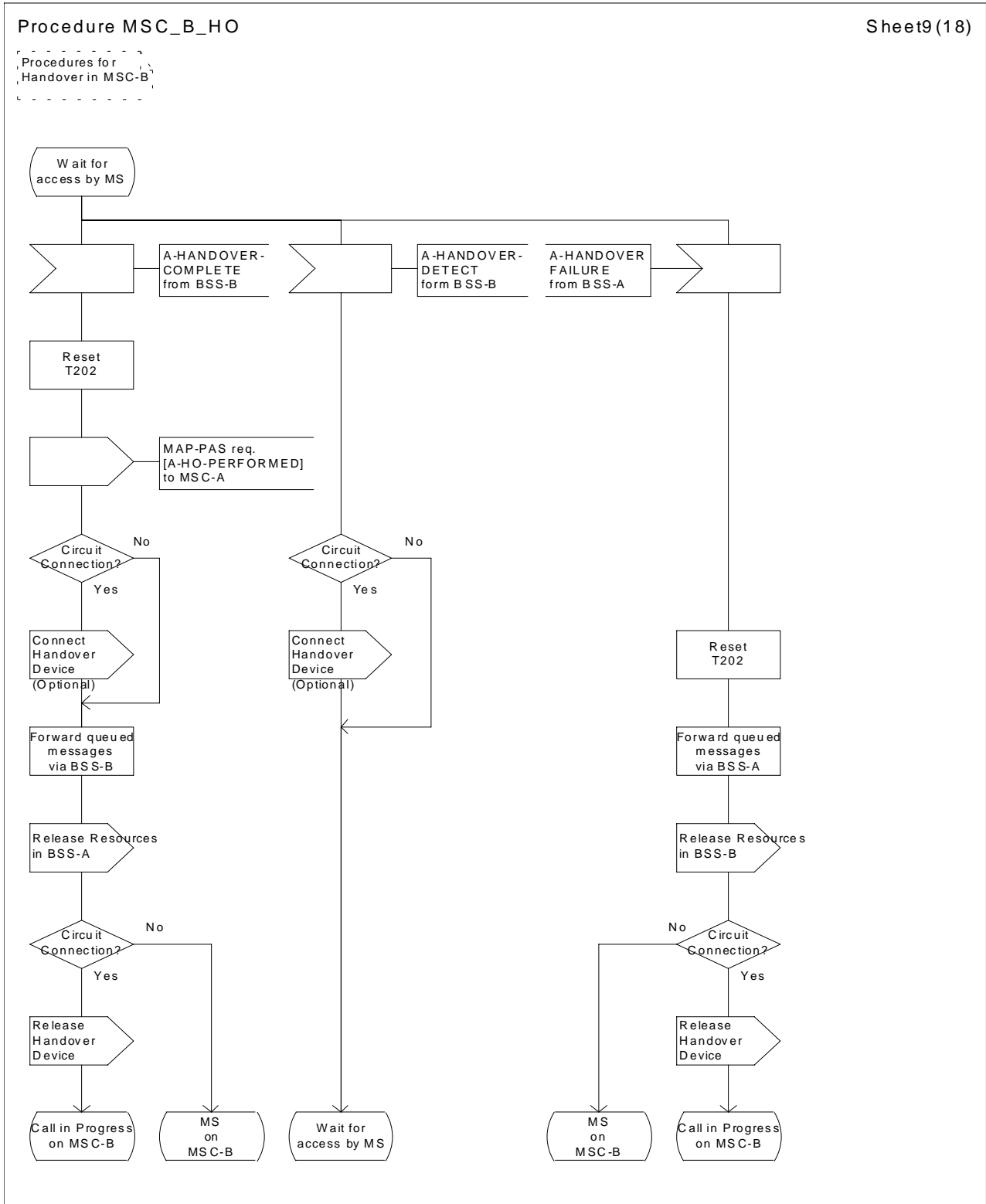

Figure 42 (Sheet 9 of 18): Handover control procedure in MSC-B

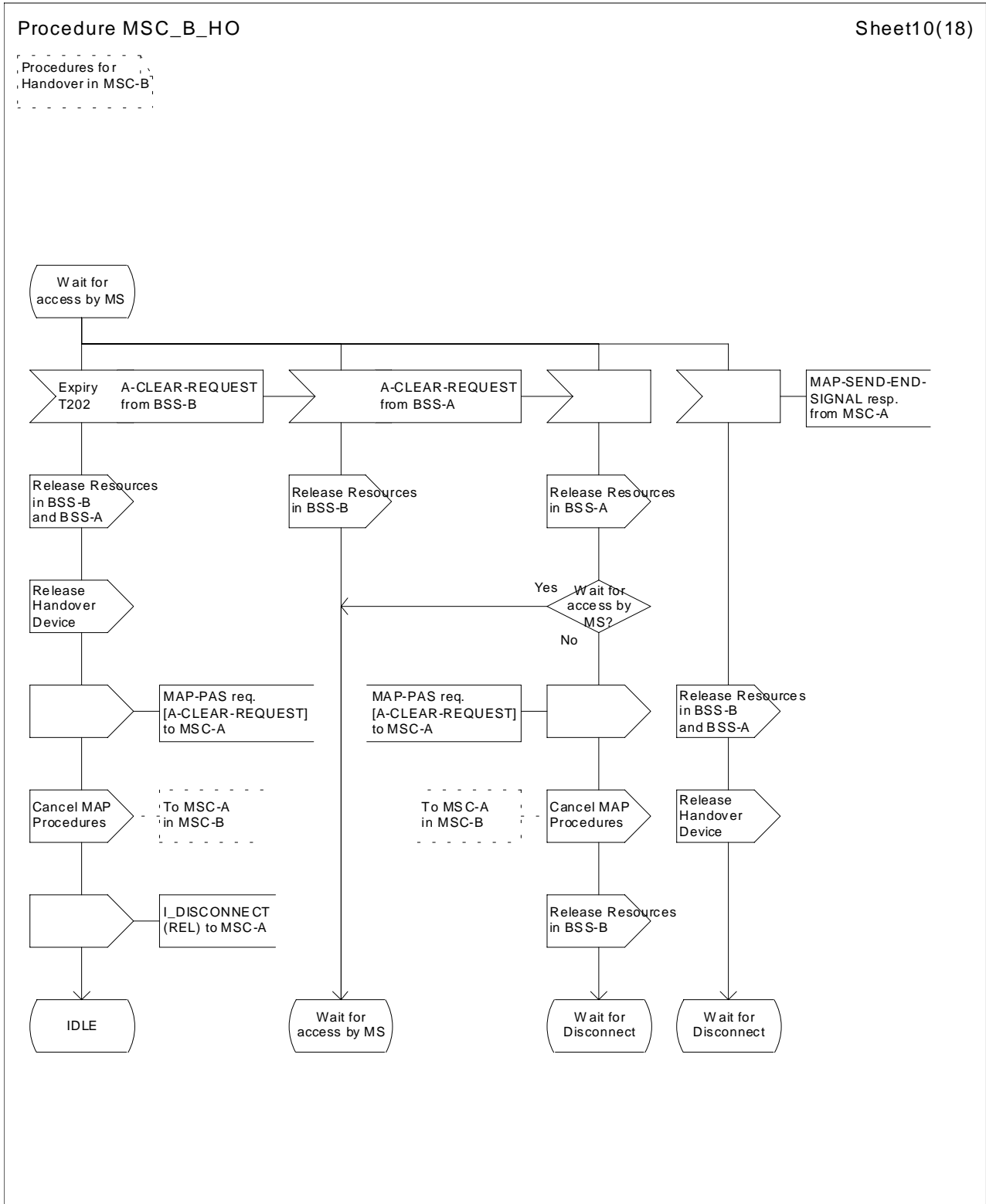

Figure 42 (Sheet 10 of 18): Handover control procedure in MSC-B

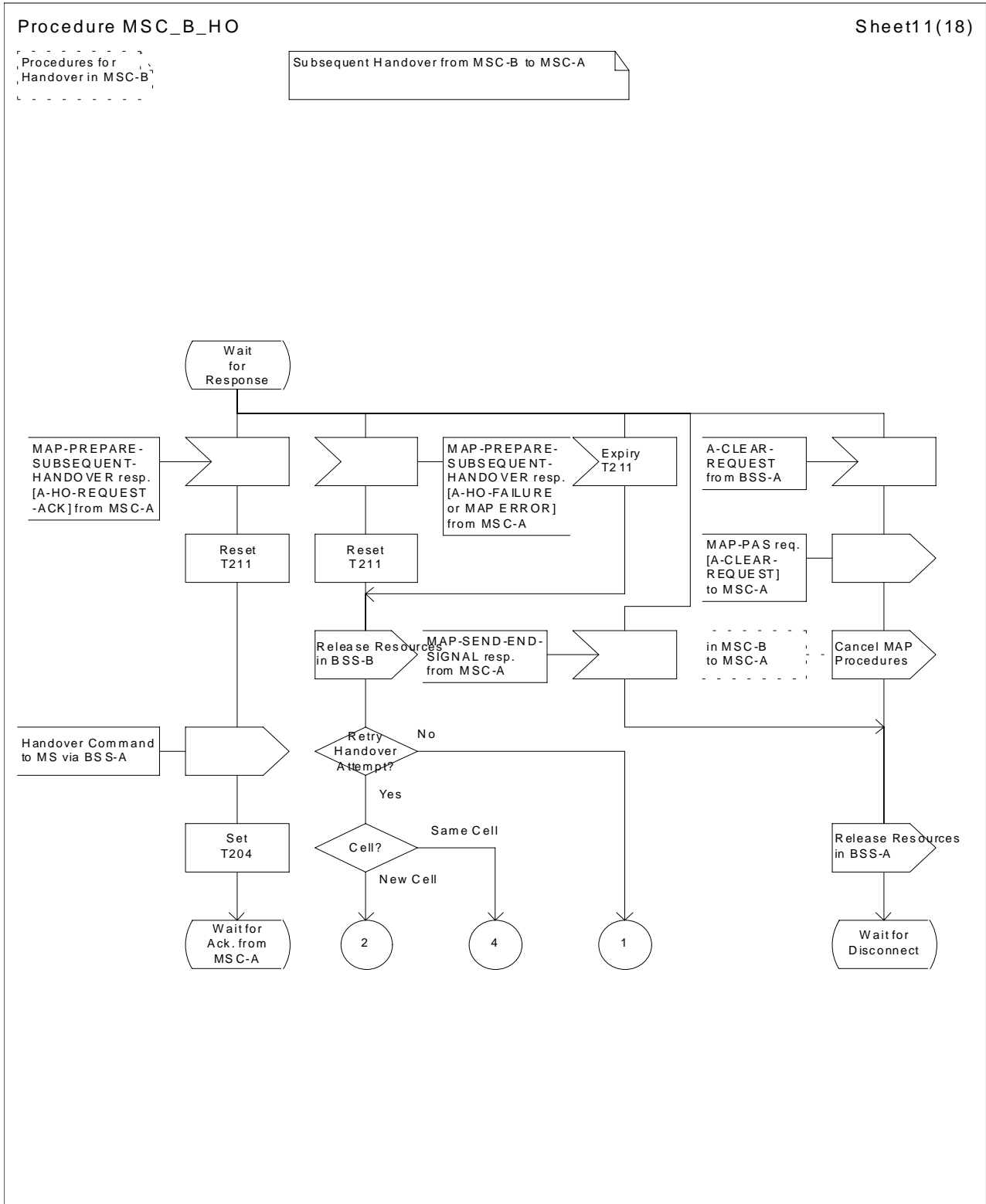

Figure 42 (Sheet 11 of 18): Handover control procedure in MSC-B

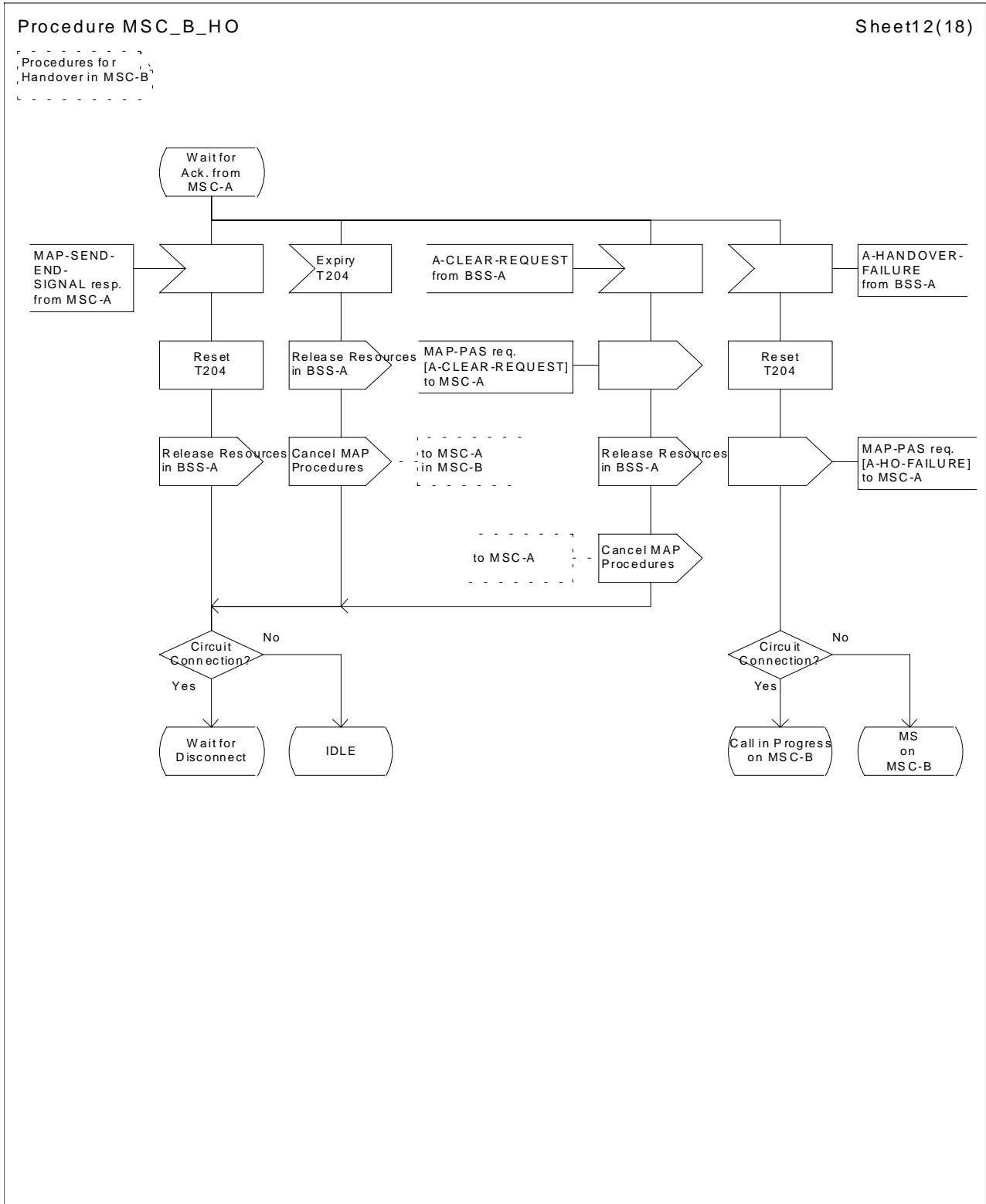

Figure 42 (Sheet 12 of 18): Handover control procedure in MSC-B

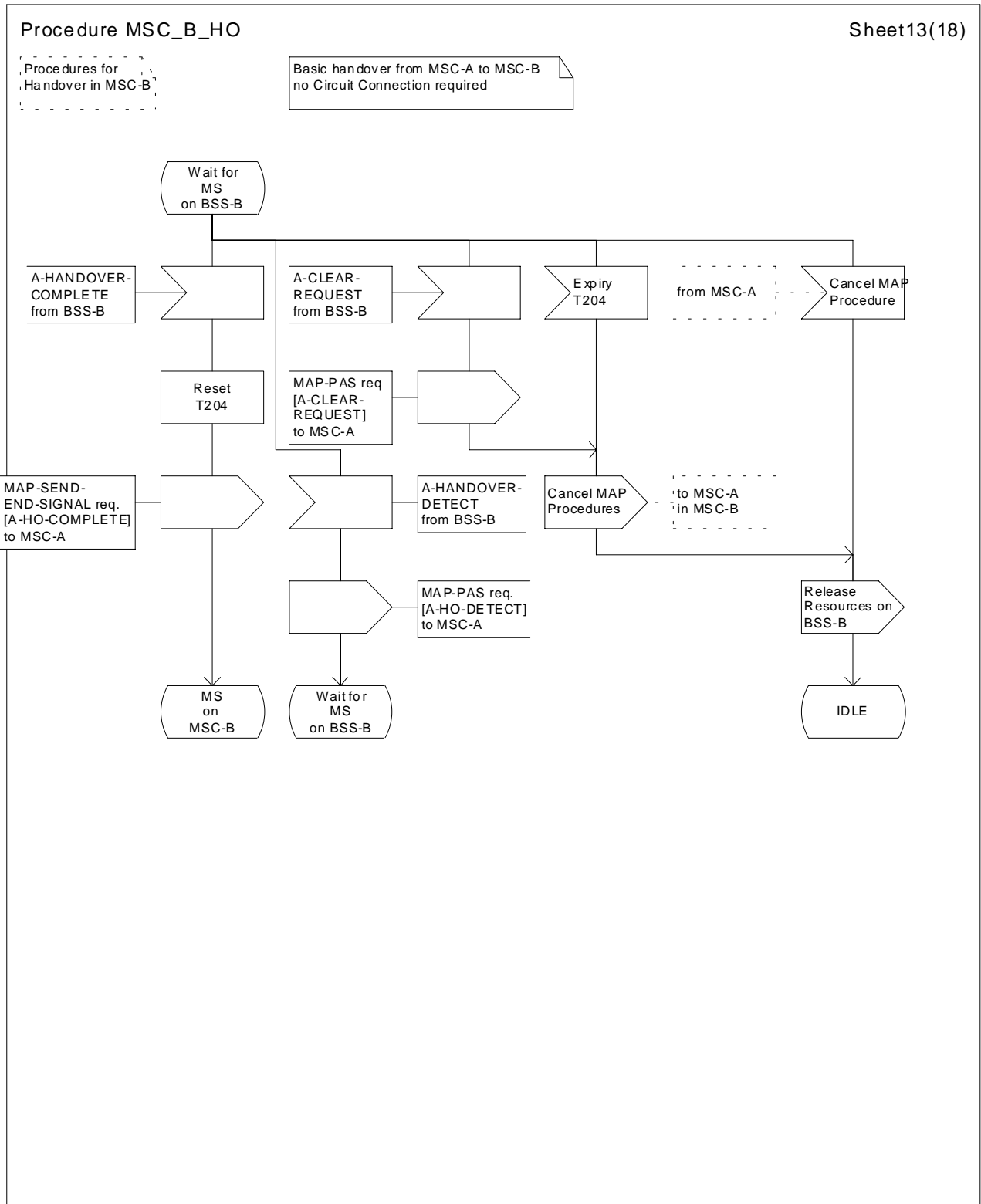

Figure 42 (Sheet 13 of 18): Handover control procedure in MSC-B

Procedure MSC_B_HO

Sheet14(18)

Procedures for Handover in MSC-B

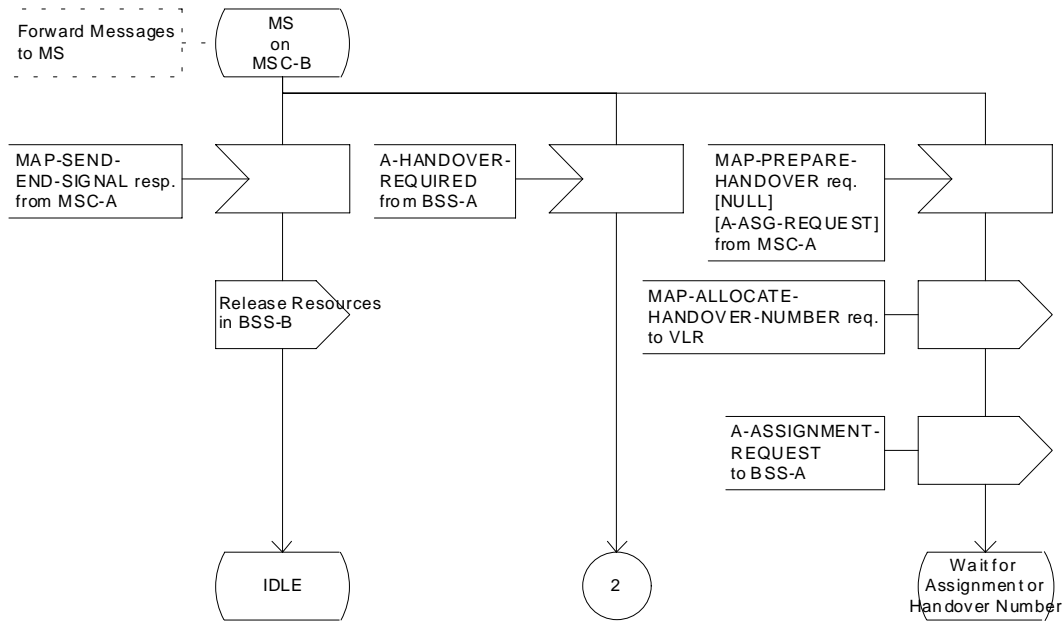

Figure 42 (Sheet 14 of 18): Handover control procedure in MSC-B

Procedure MSC_B_HO

Sheet15(18)

Procedures for Handover in MSC-B

Circuit Connection Establishment on MSC-B

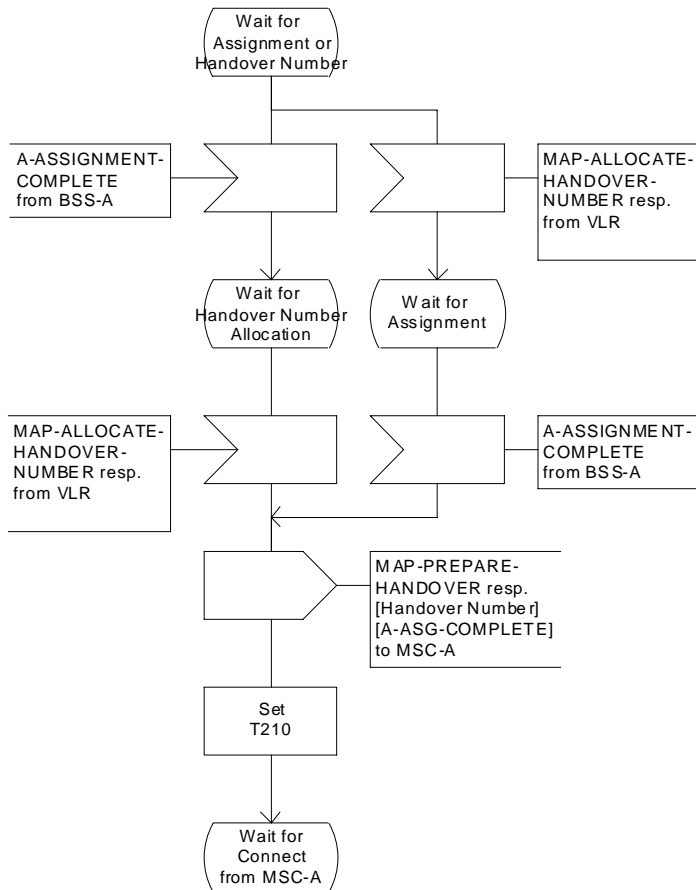

Figure 42 (Sheet 15 of 18): Handover control procedure in MSC-B

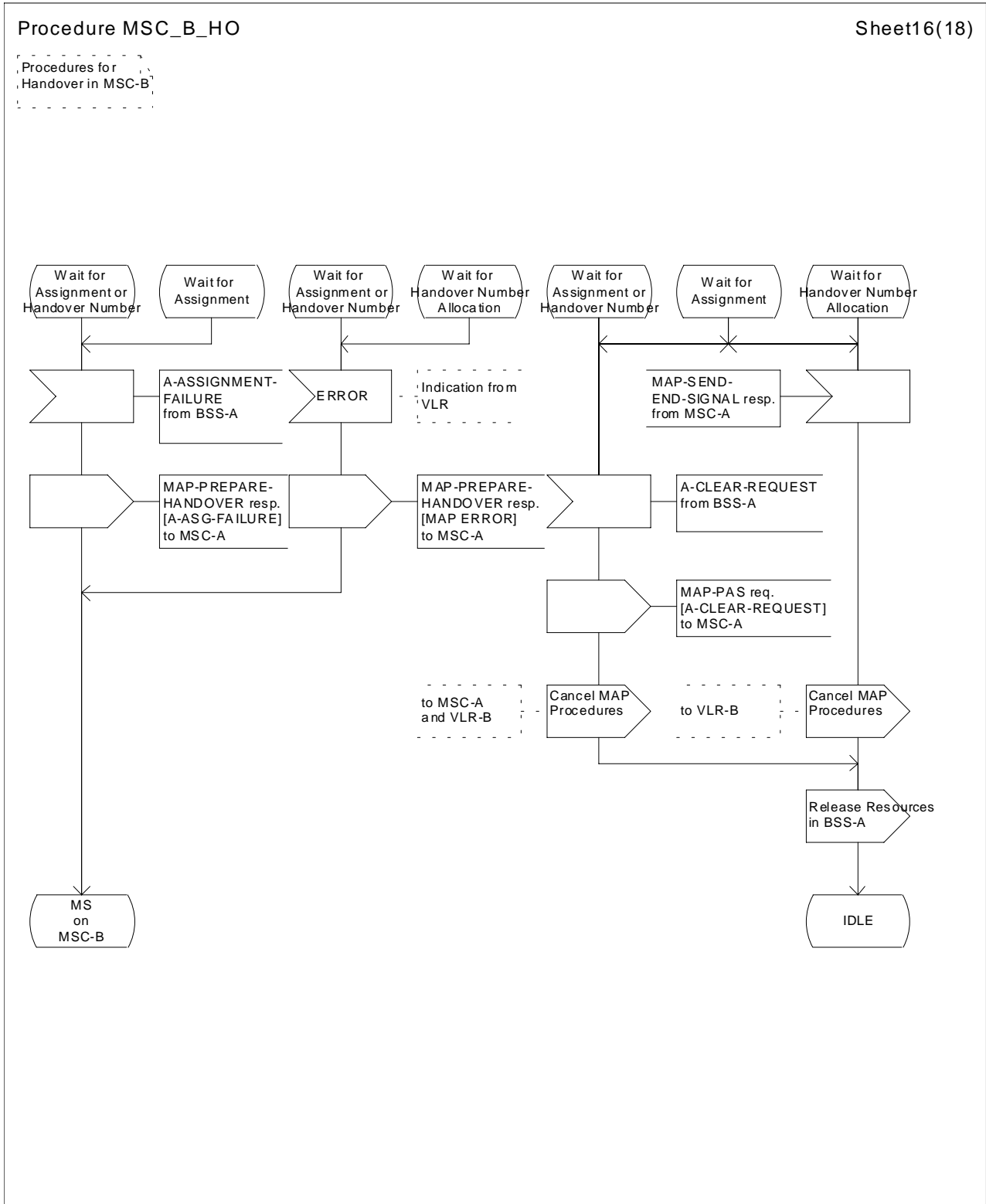

Figure 42 (Sheet 16 of 18): Handover control procedure in MSC-B

Procedure MSC_B_HO

Sheet17(18)

Procedures for Handover in MSC-B

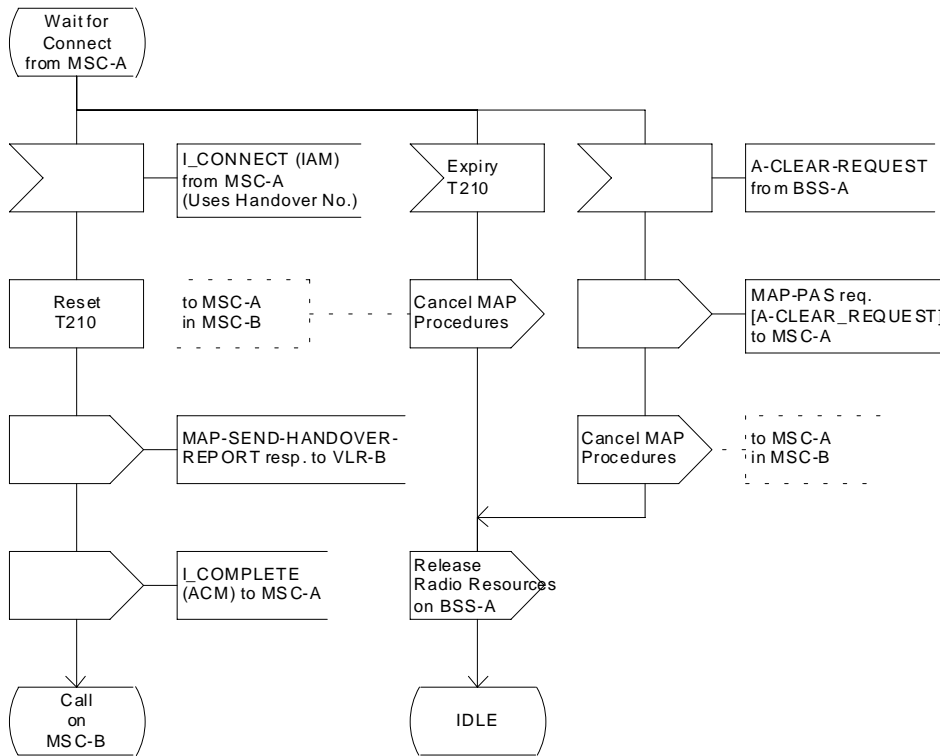

Figure 42 (Sheet 17 of 18): Handover control procedure in MSC-B

Procedure MSC_B_HO

Sheet18(18)

Procedures for Handover in MSC-B

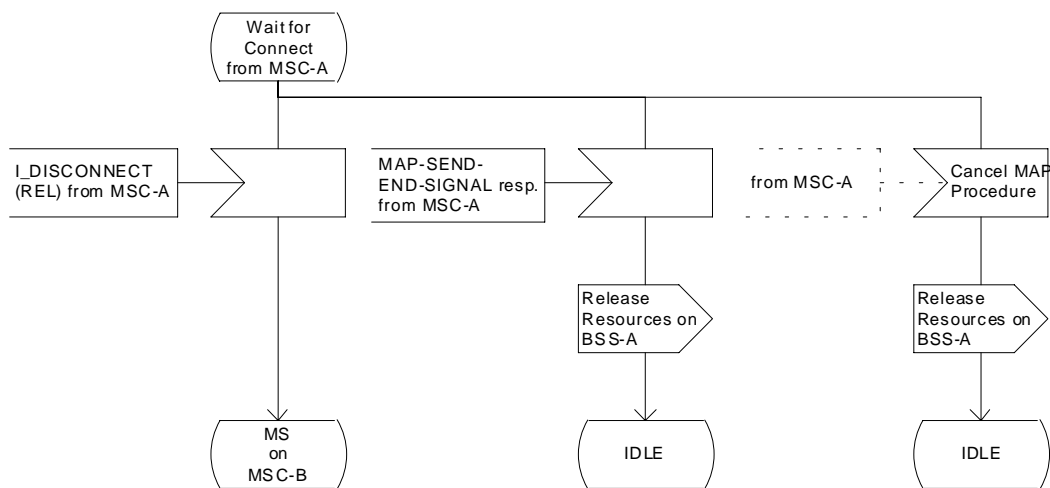

Figure 42 (Sheet 18 of 18): Handover control procedure in MSC-B

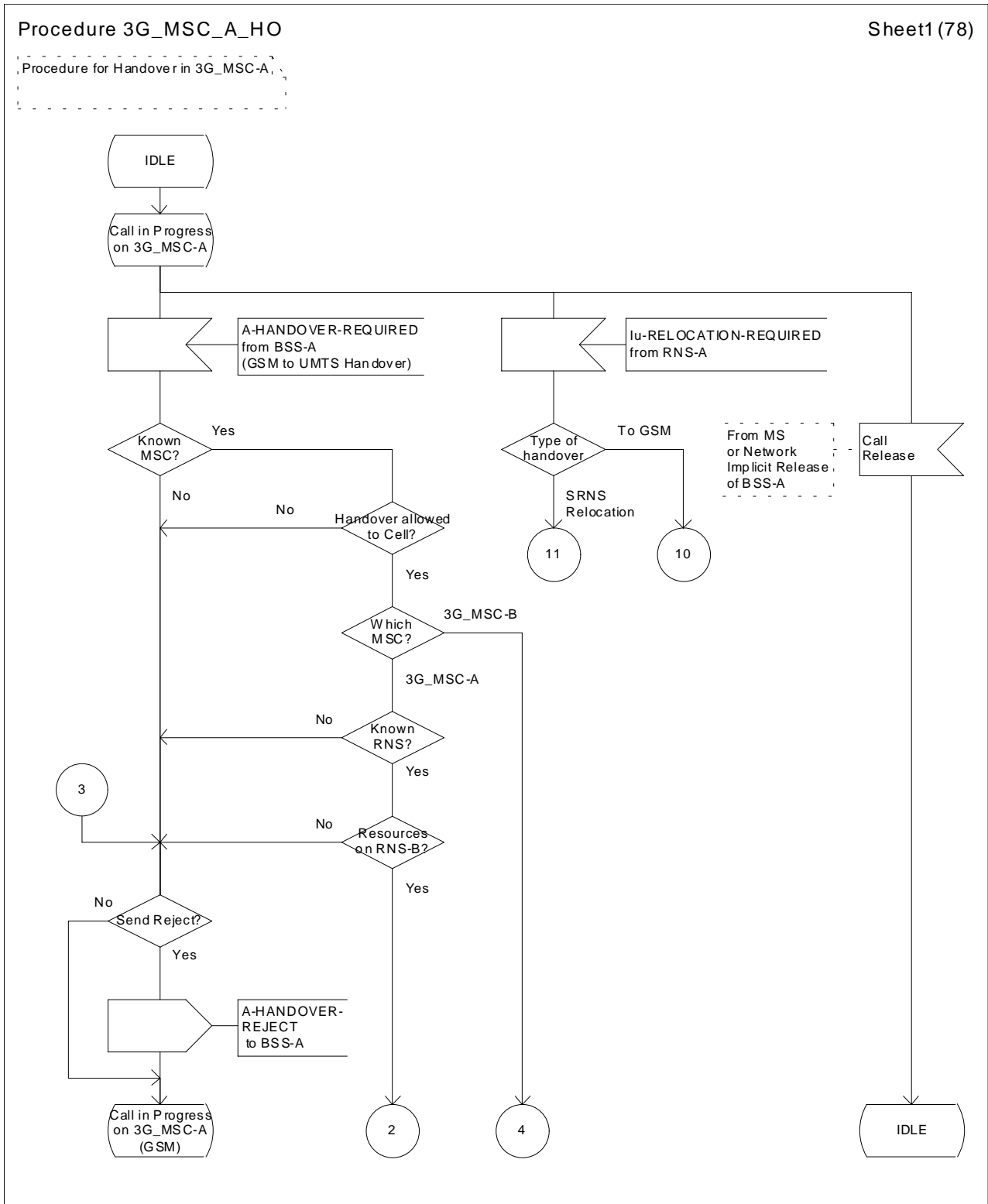

Figure 43 (sheet 1 of 78): Handover control procedure in 3G_MSC-A

Procedure 3G_MSC_A_HO

Sheet2(78)

Procedure for Handover in 3G_MSC-A

Handover on 3G_MSC-A from BSS-A to RNS-B.

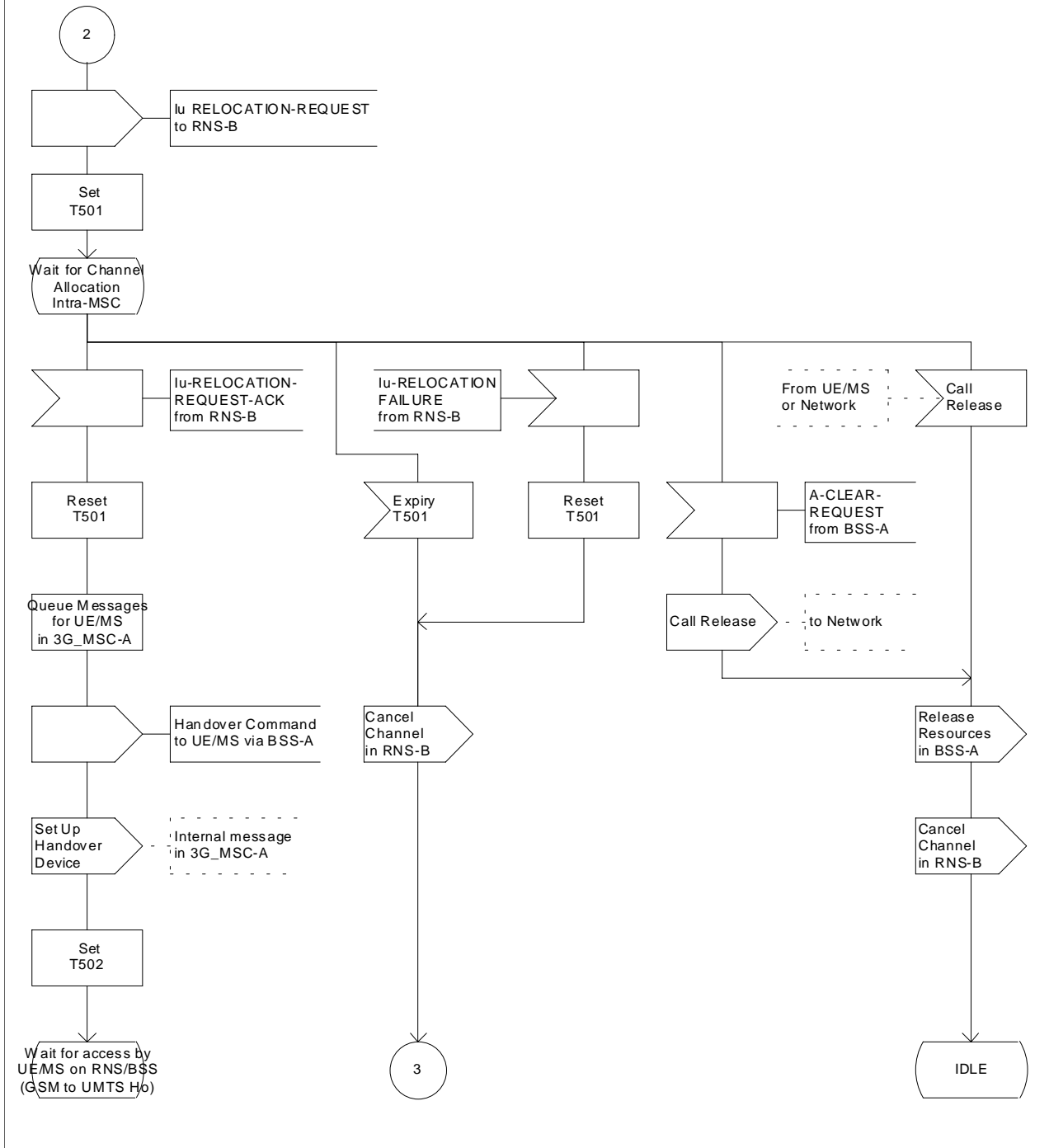

Figure 43 (sheet 2 of 78): Handover control procedure in 3G_MSC-A

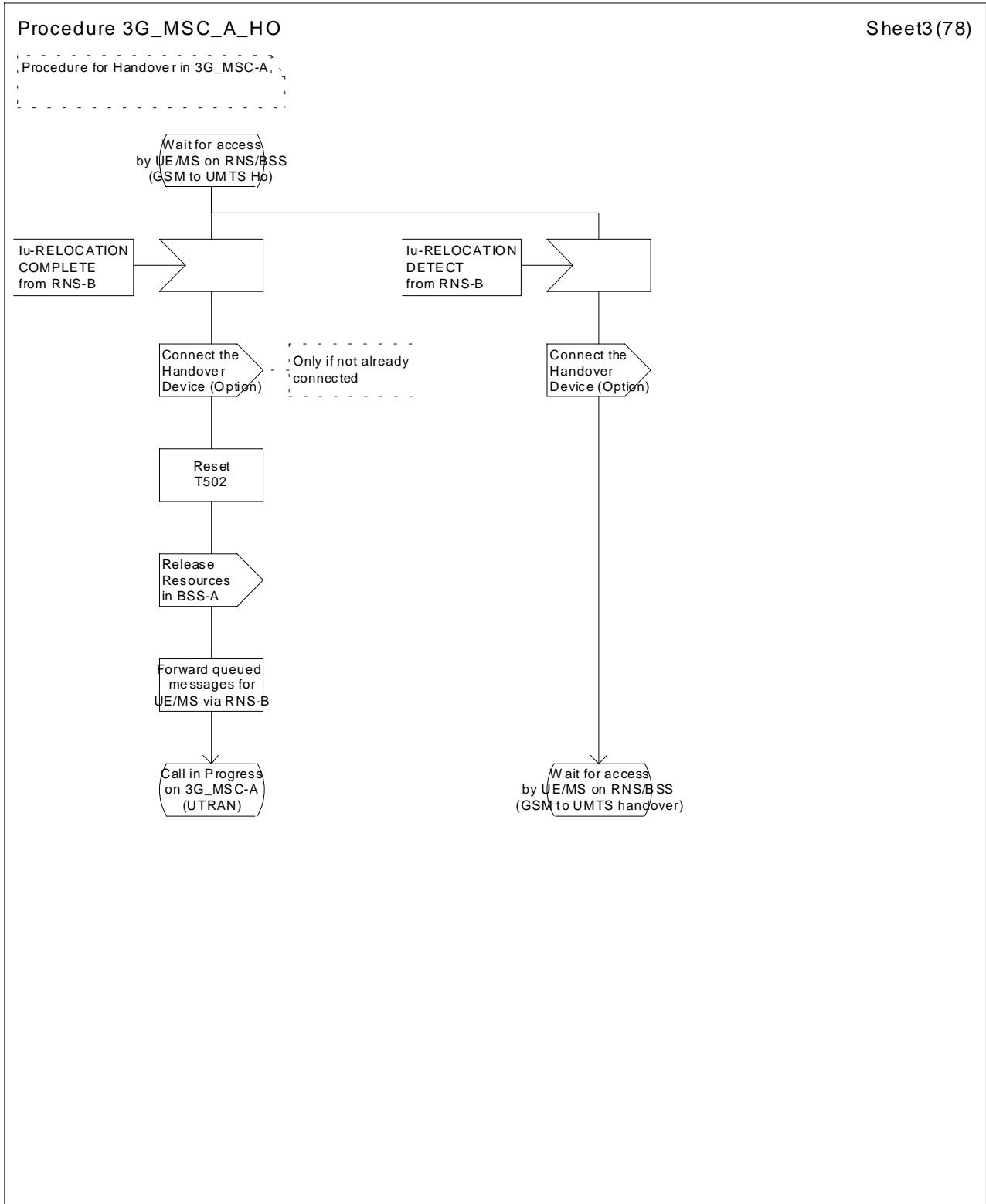

Figure 43 (sheet 3 of 78): Handover control procedure in 3G_MSC-A

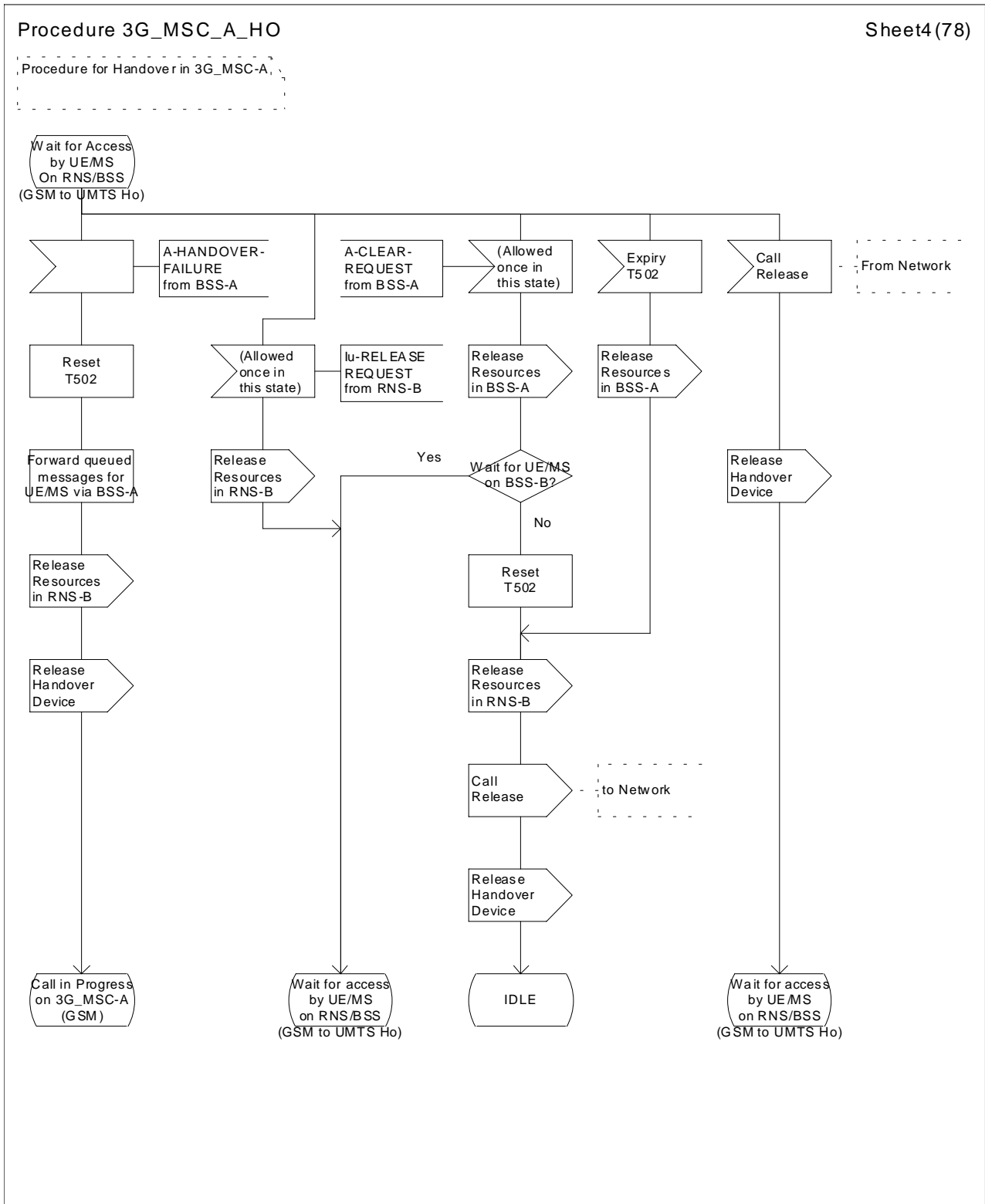

Figure 43 (sheet 4 of 78): Handover control procedure in 3G_MSC-A

Procedure 3G_MSC_A_HO

Sheet5(78)

Procedure for Handover in 3G_MSC-A

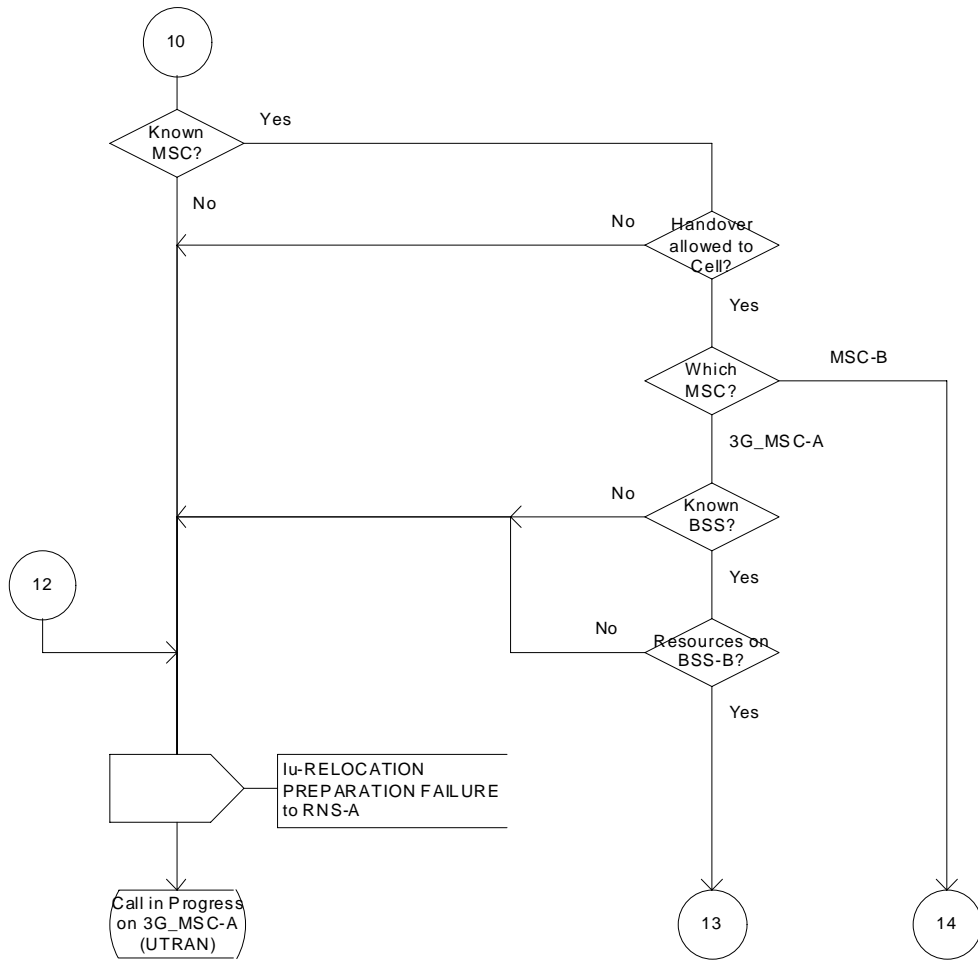

Figure 43 (sheet 5 of 78): Handover control procedure in 3G_MSC-A

Procedure 3G_MSC_A_HO

Sheet6(78)

Procedure for Handover in 3G_MSC-A

Handover on 3G_MSC-A from RNS-A to BSS-B.

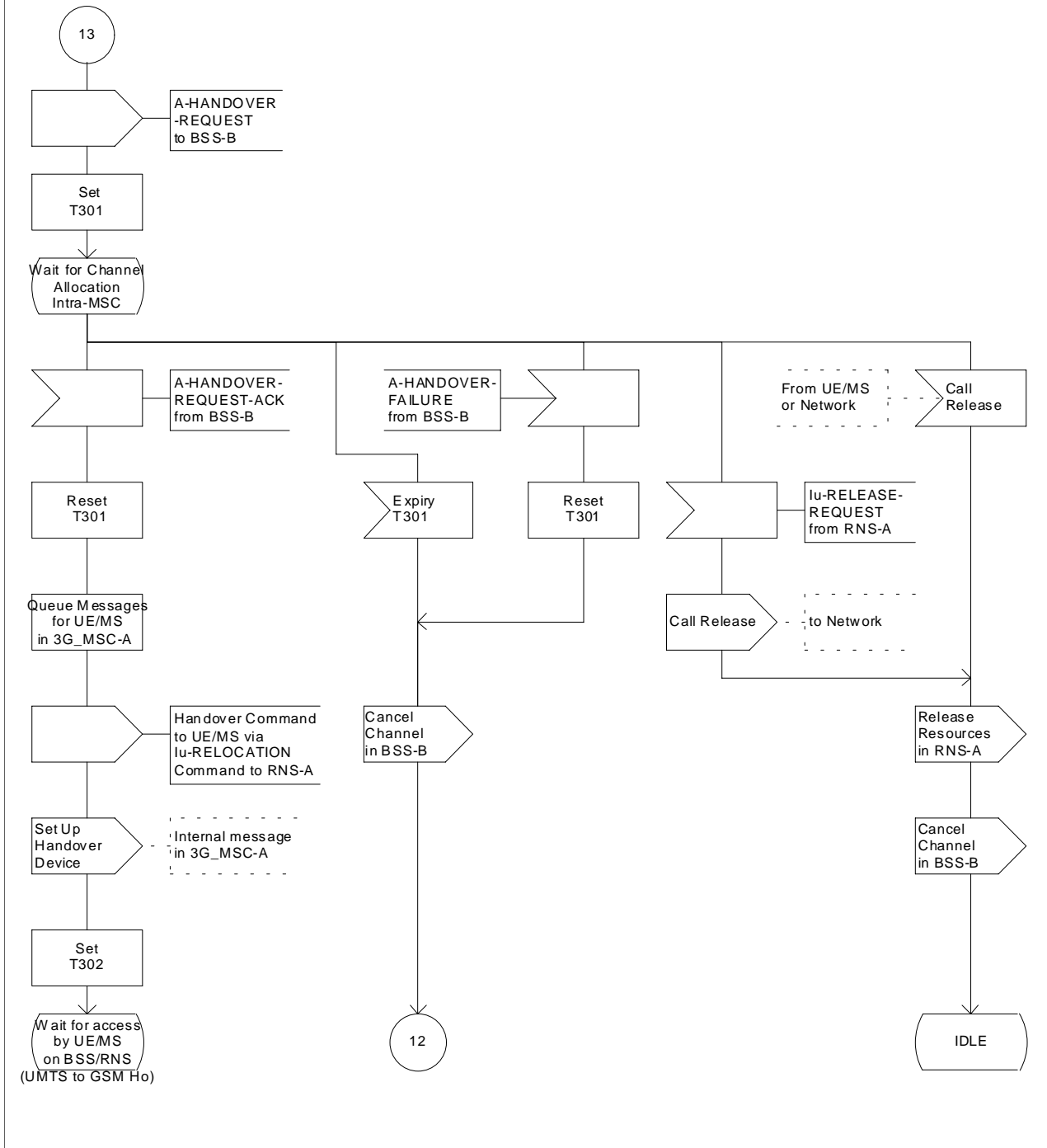

Figure 43 (sheet 6 of 78): Handover control procedure in 3G_MSC-A

Procedure 3G_MSC_A_HO

Sheet7 (78)

Procedure for Handover in 3G_MSC-A

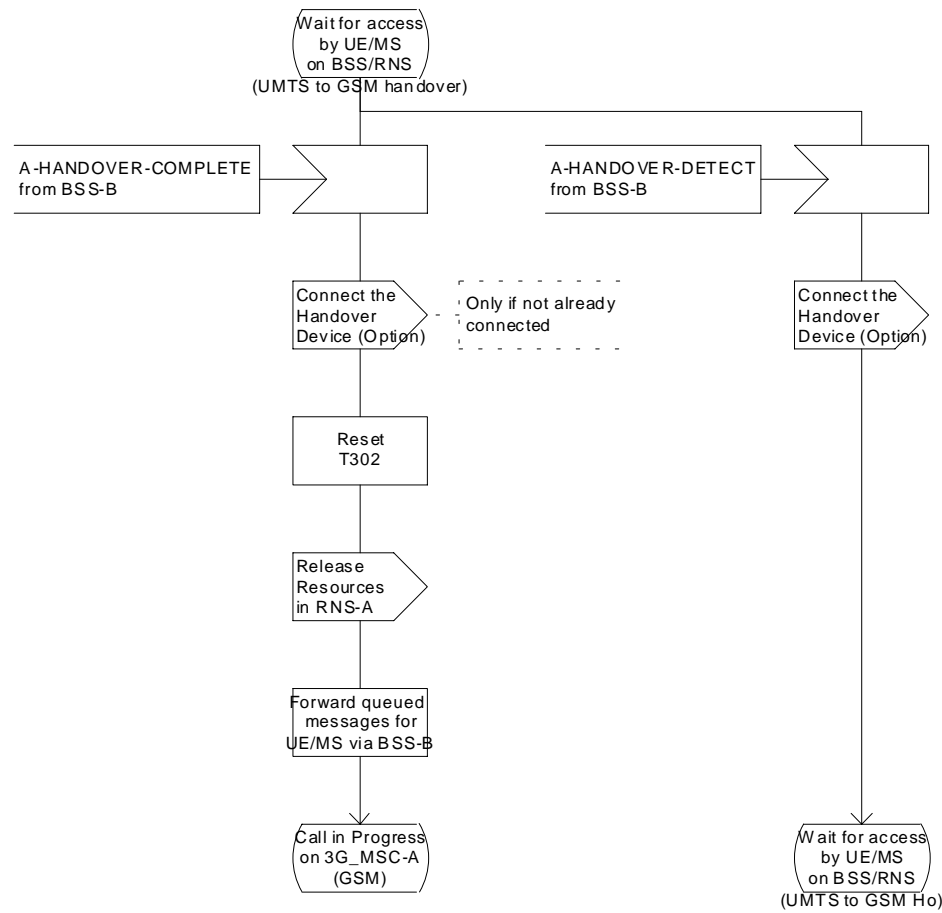

Figure 43 (sheet 7 of 78): Handover control procedure in 3G_MSC-A

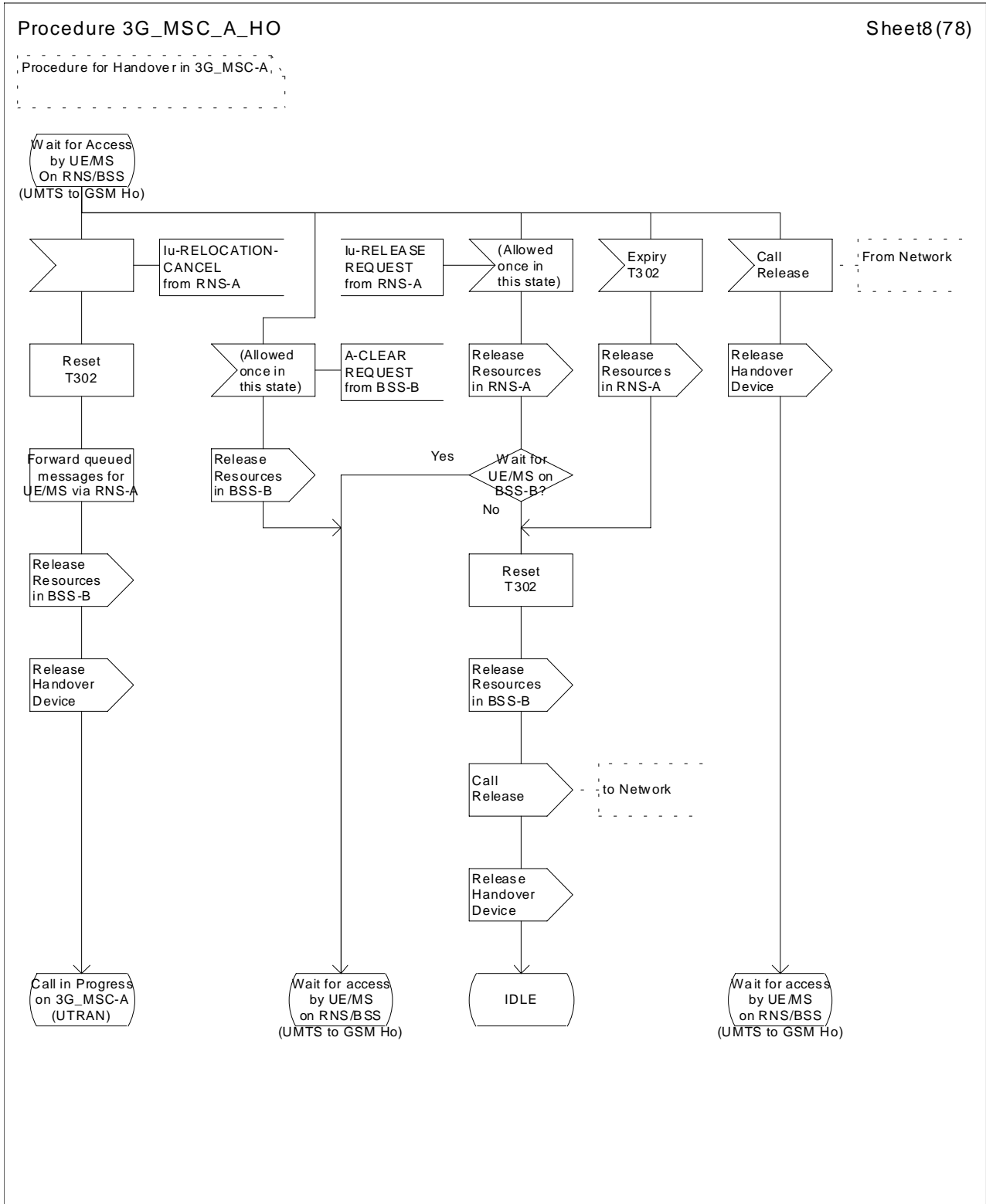

Figure 43 (sheet 8 of 78): Handover control procedure in 3G_MSC-A

Procedure 3G_MSC_A_HO

Sheet9(78)

Procedure for Handover in 3G_MSC-A

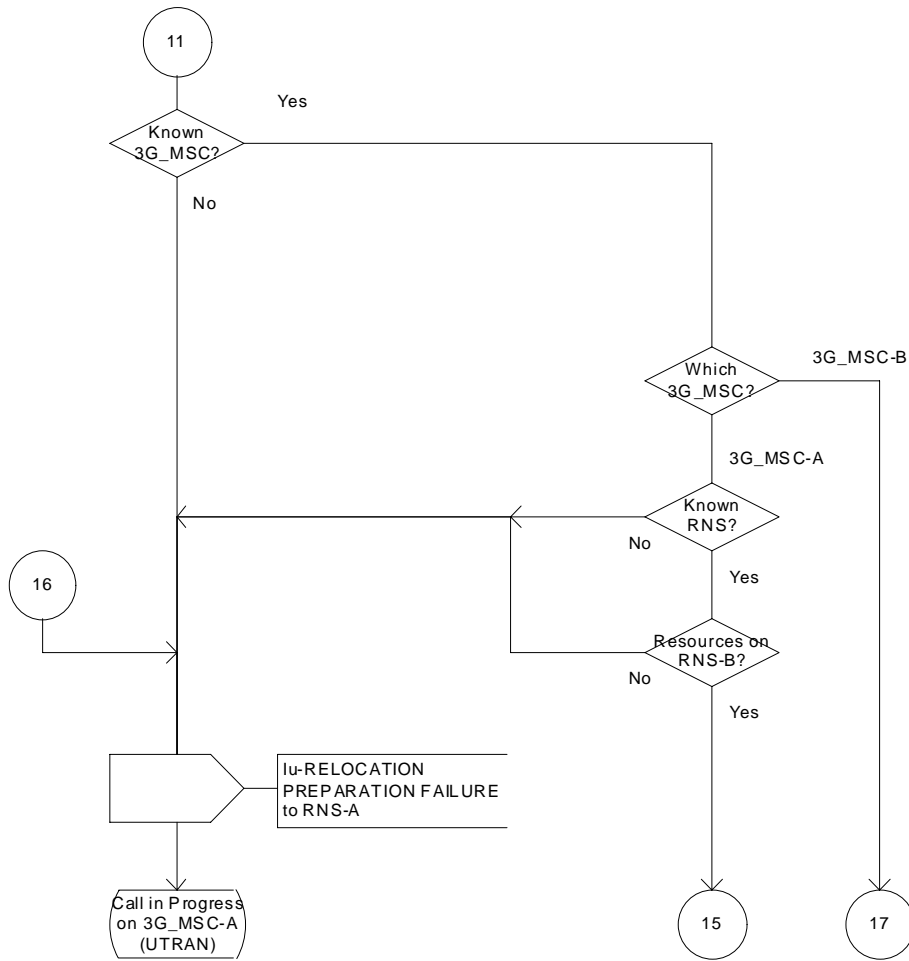

Figure 43 (sheet 9 of 78): Handover control procedure in 3G_MSC-A

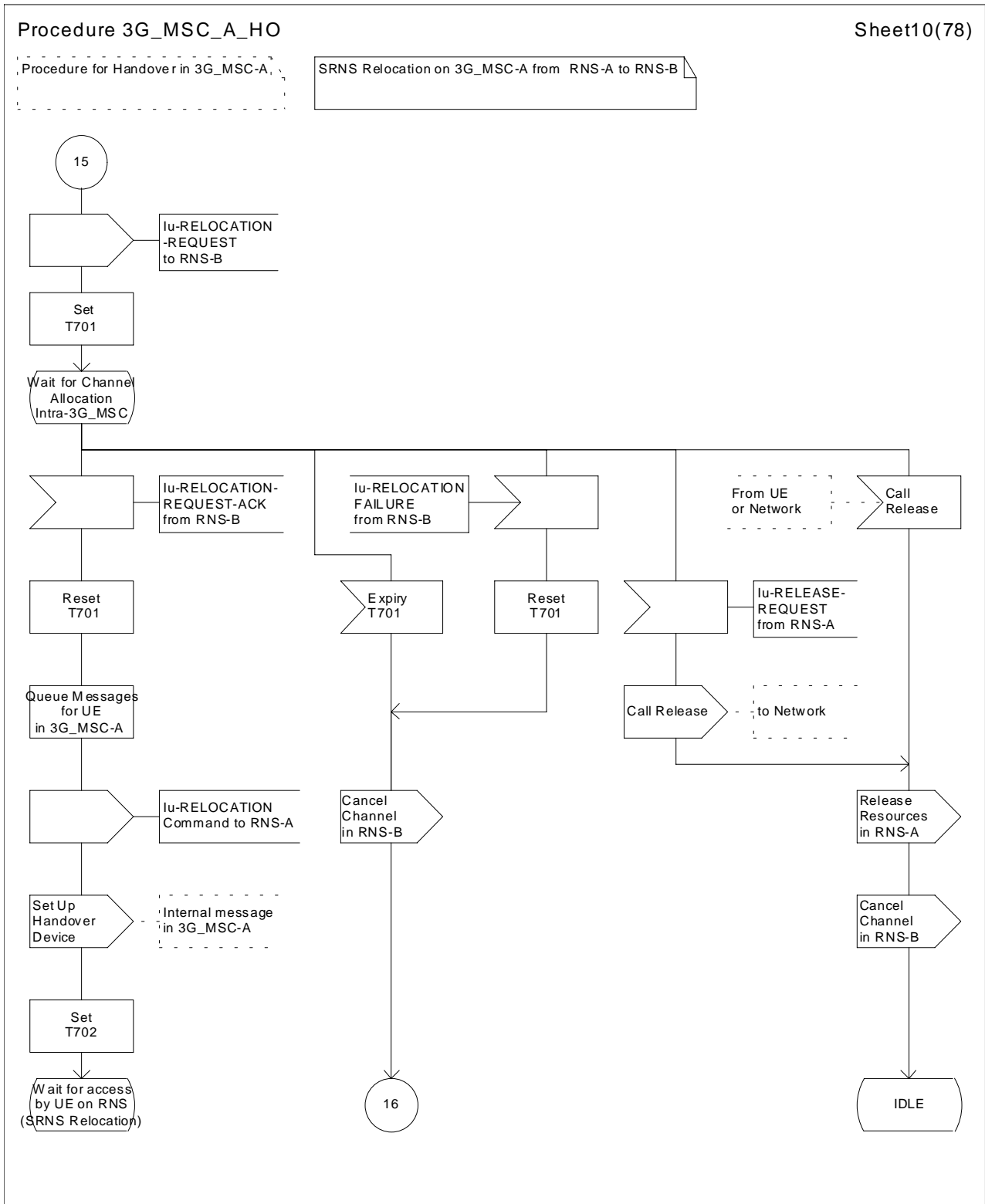

Figure 43 (sheet 10 of 78): Handover control procedure in 3G_MSC-A

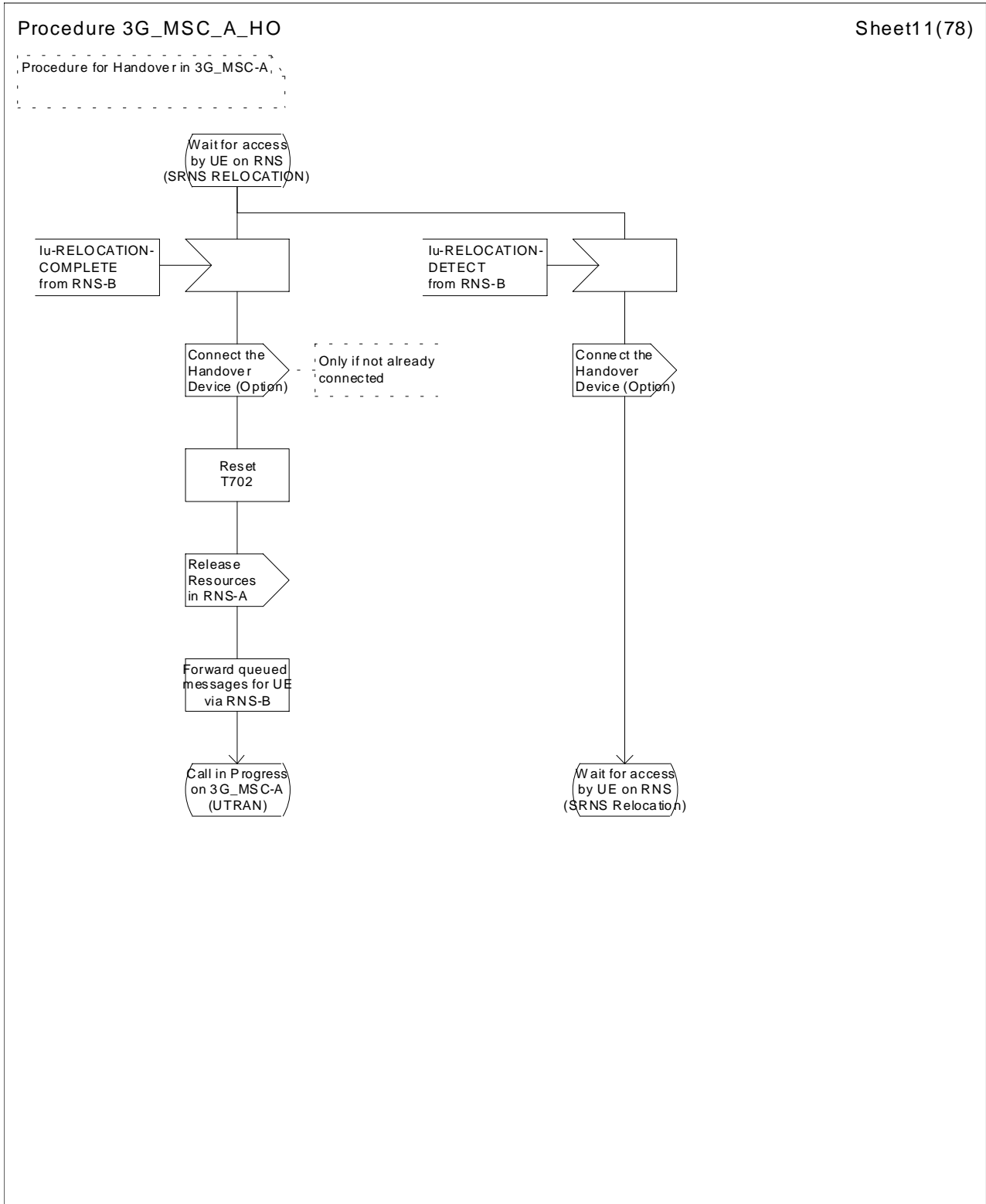

Figure 43 (sheet 11 of 78): Handover control procedure in 3G_MSC-A

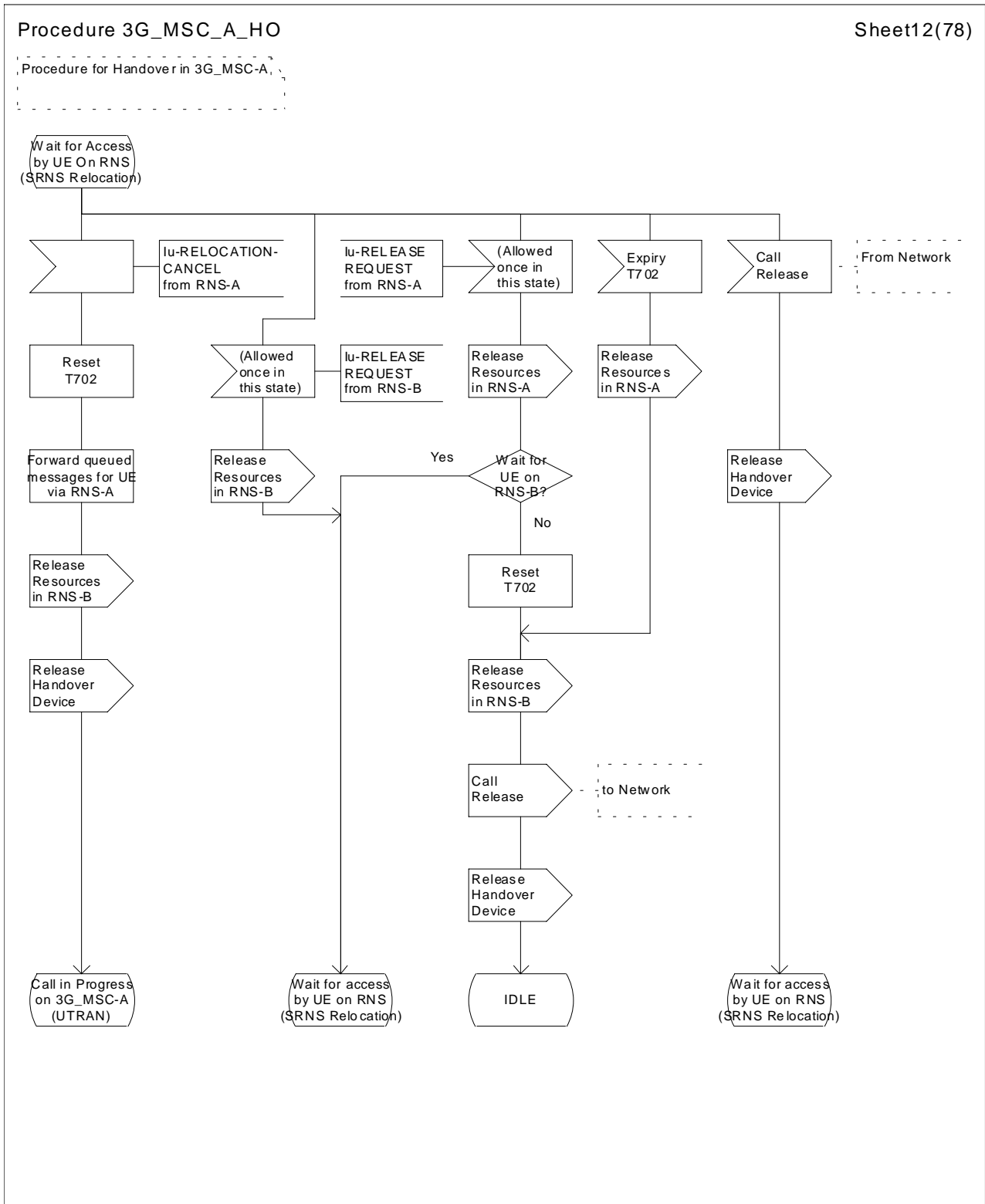

Figure 43 (sheet 12 of 78): Handover control procedure in 3G_MSC-A

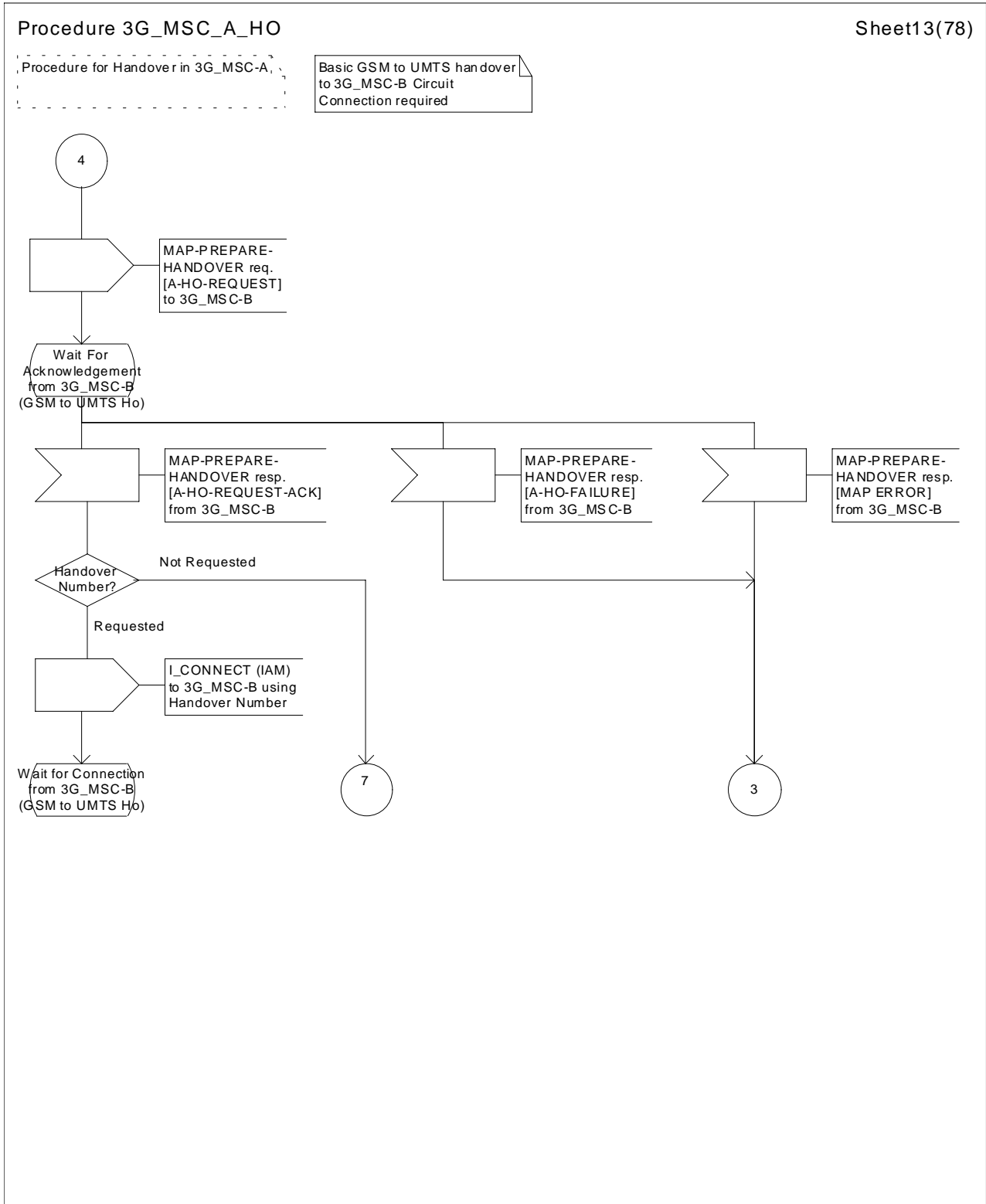

Figure 43 (sheet 13 of 78): Handover control procedure in 3G_MSC-A

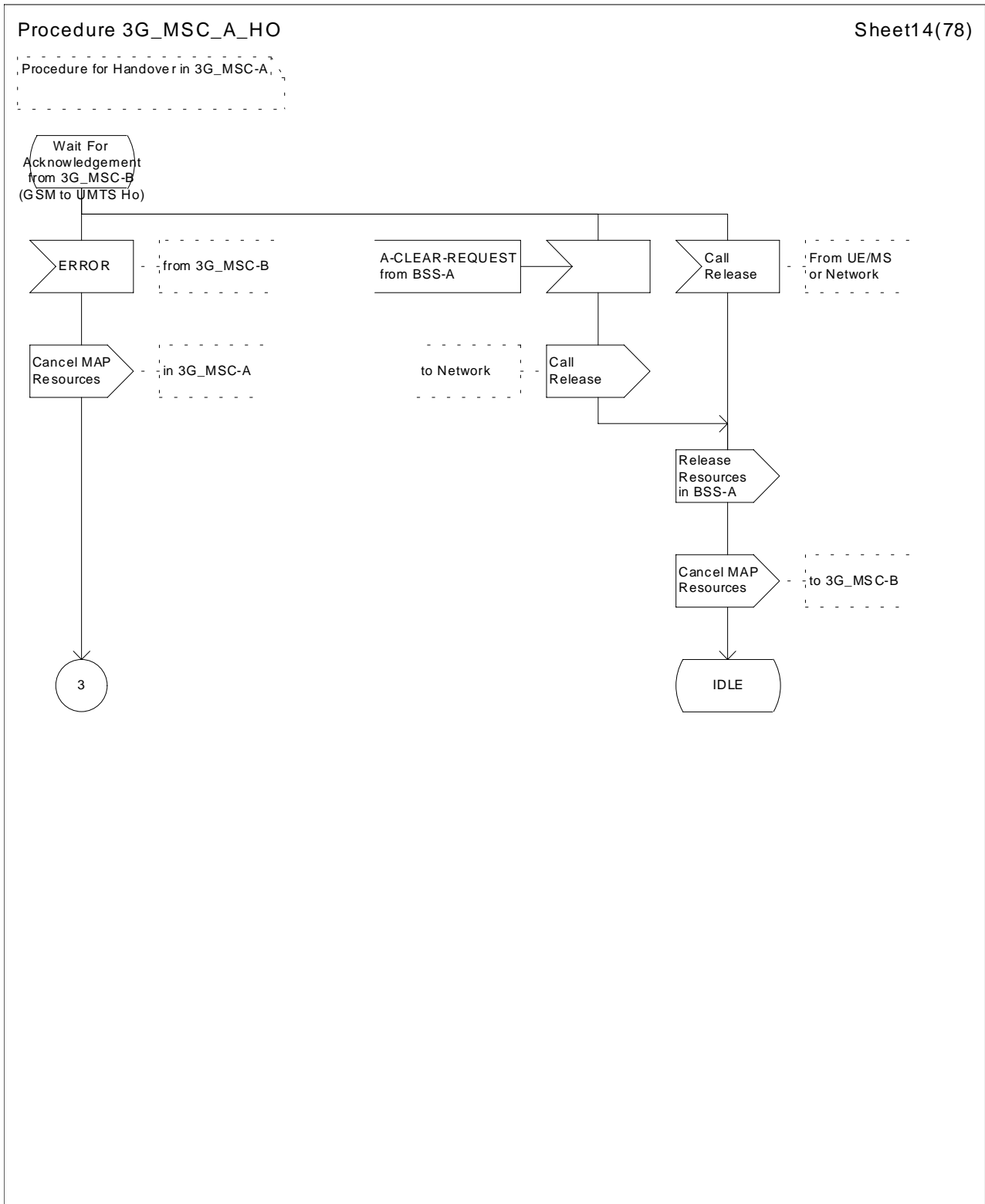

Figure 43 (sheet 14 of 78): Handover control procedure in 3G_MSC-A

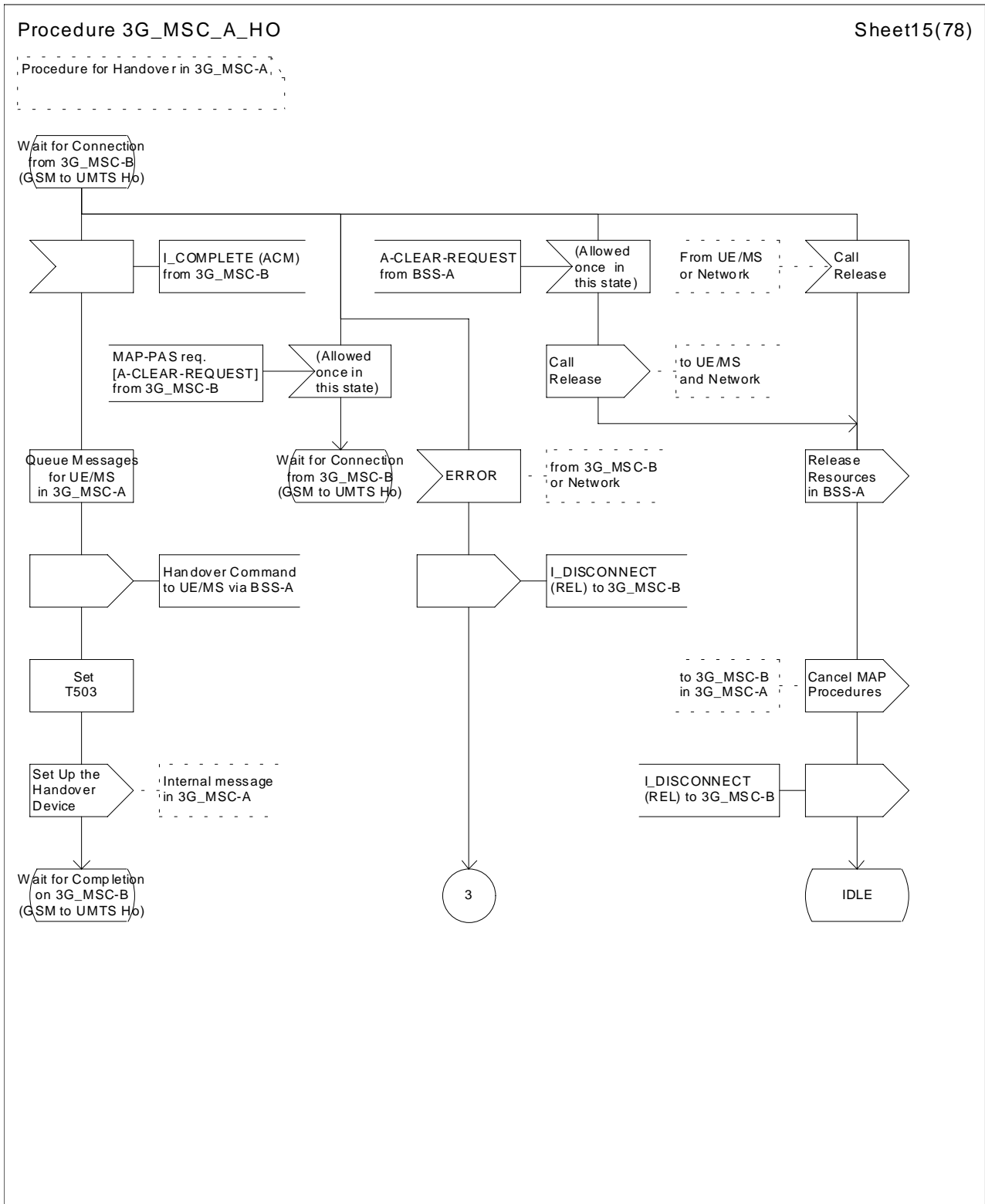

Figure 43 (sheet 15 of 78): Handover control procedure in 3G_MSC-A

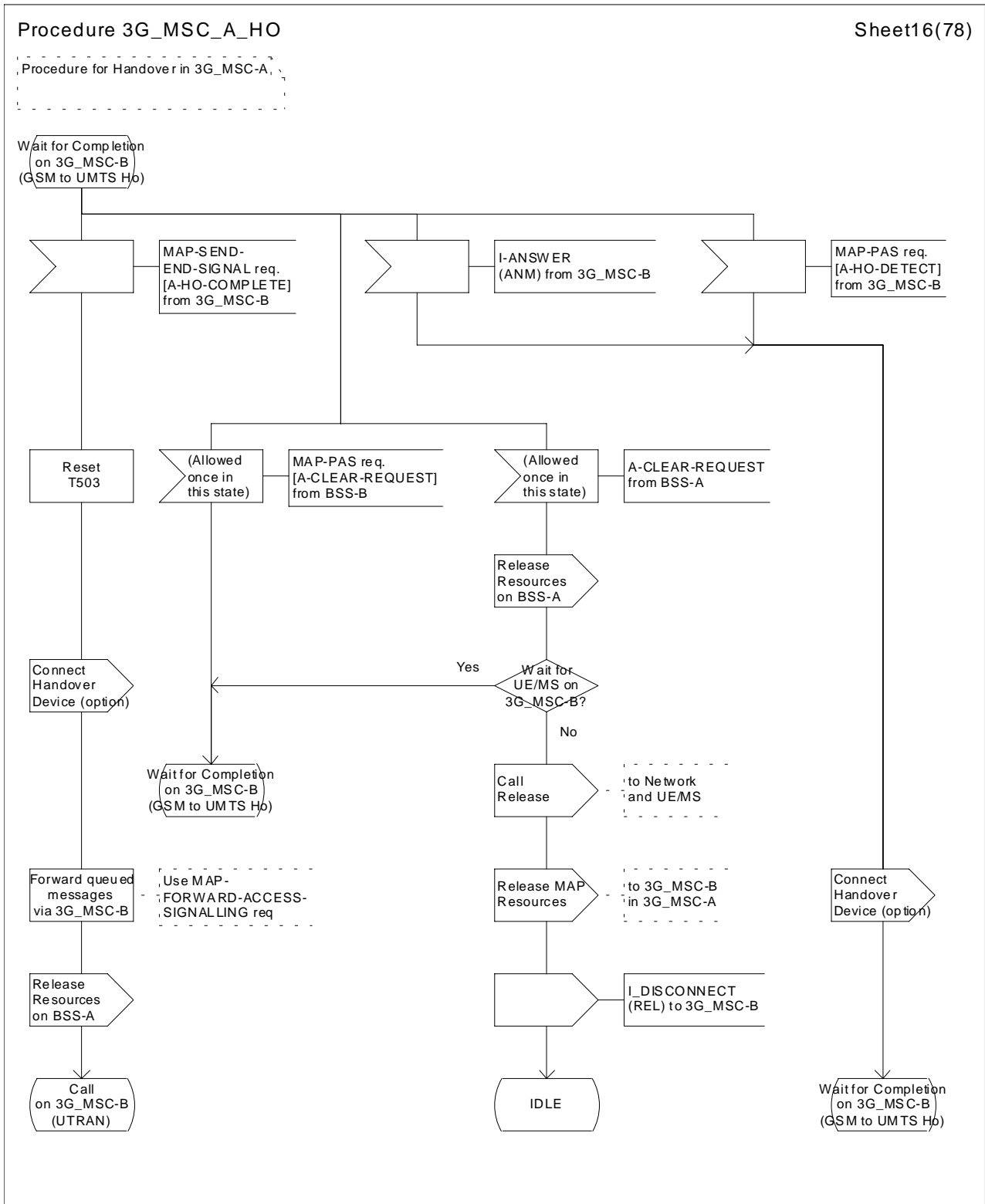

Figure 43 (sheet 16 of 78): Handover control procedure in 3G_MSC-A

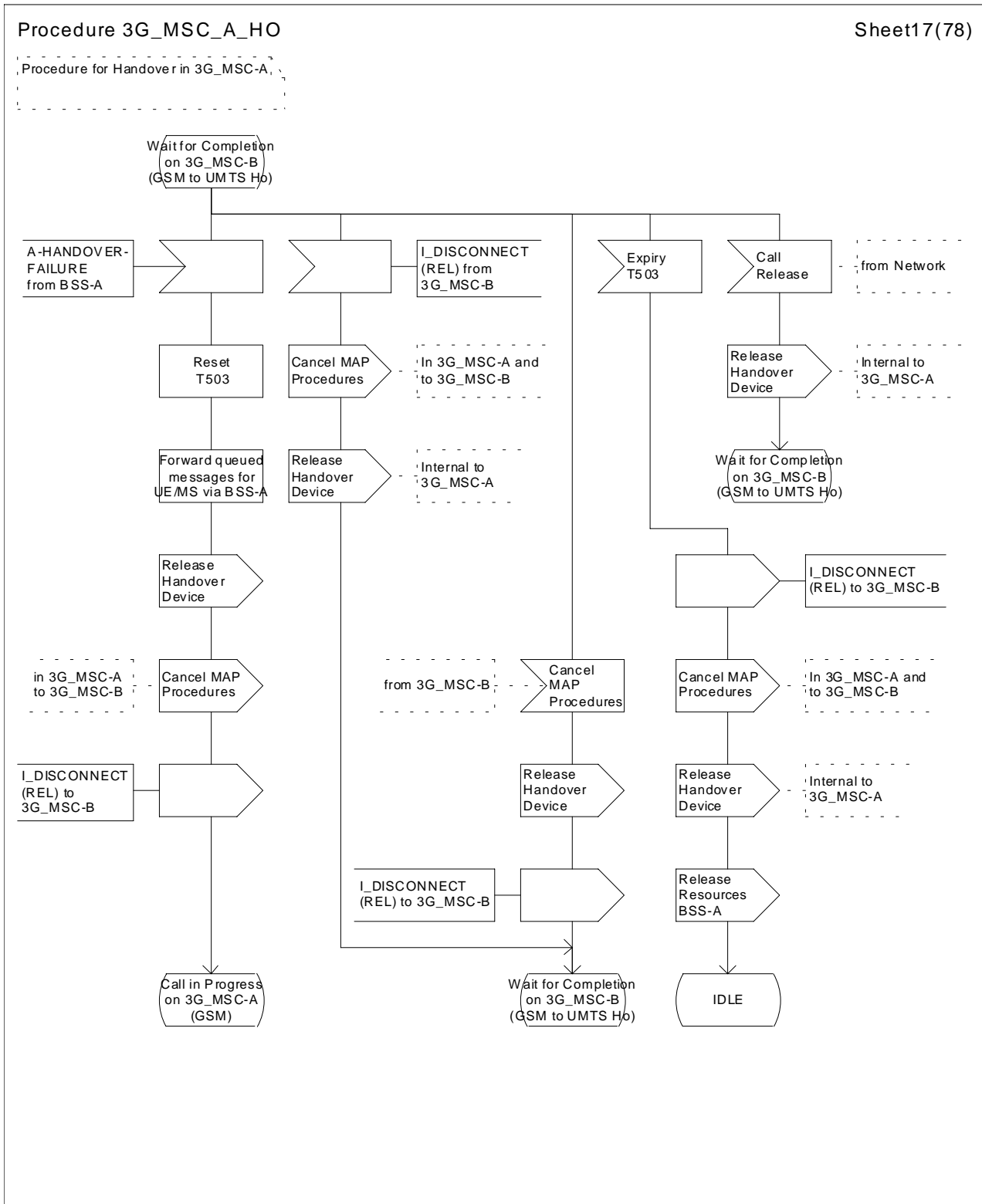

Figure 43 (sheet 17 of 78): Handover control procedure in 3G_MSC-A

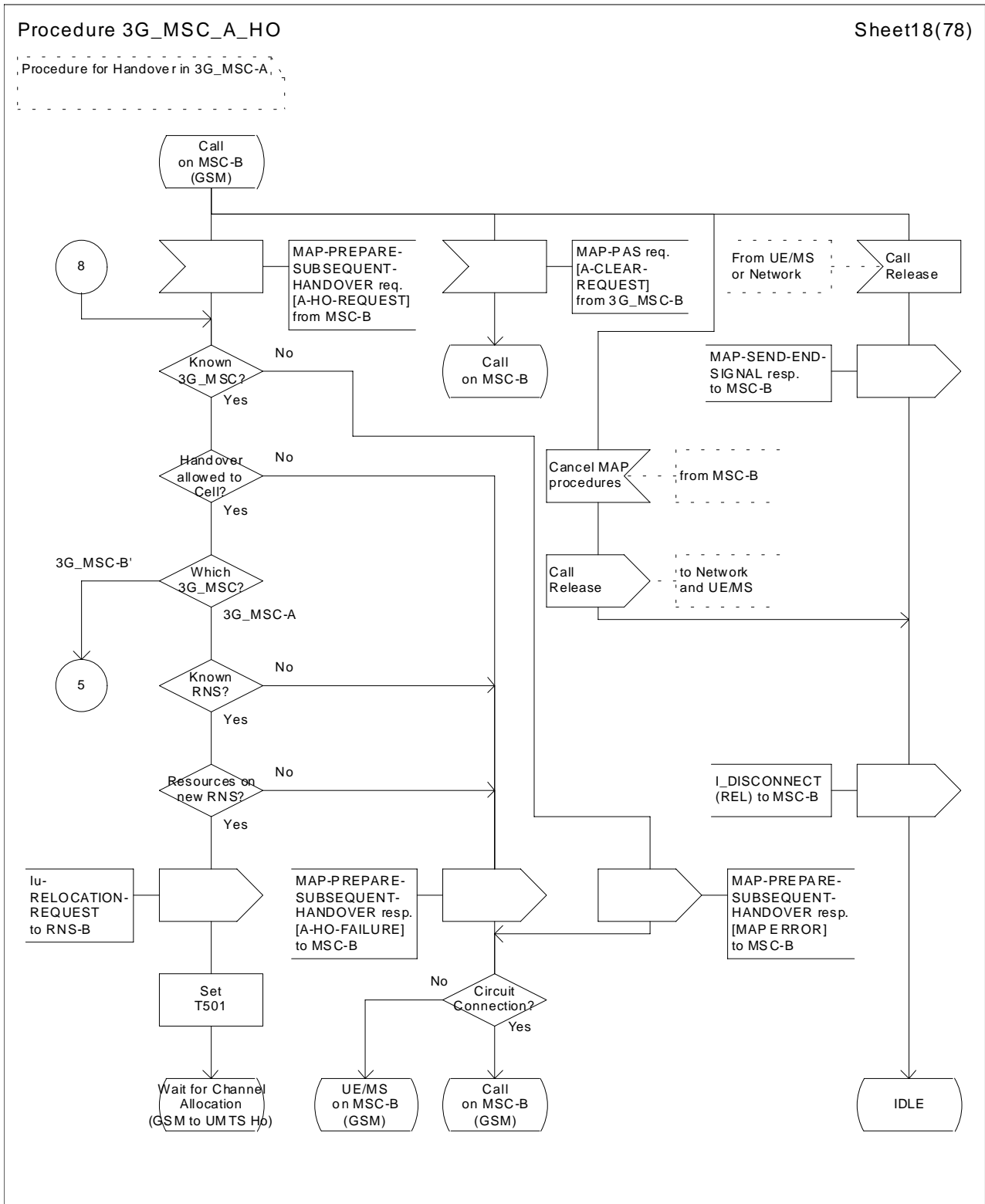

Figure 43 (sheet 18 of 78): Handover control procedure in 3G_MSC-A

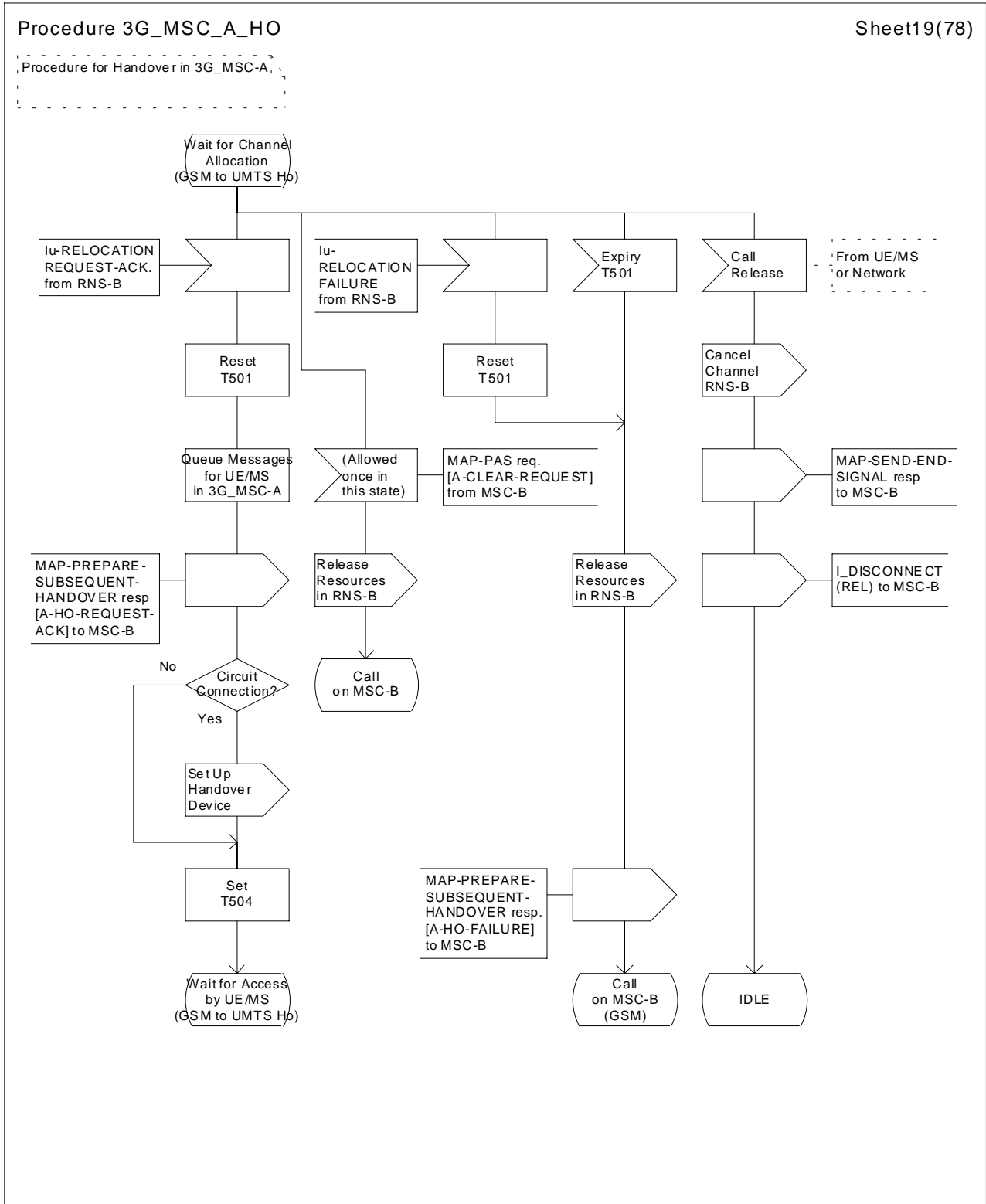

Figure 43 (sheet 19 of 78): Handover control procedure in 3G_MSC-A

Procedure 3G_MSC_A_HO

Sheet20(78)

Procedure for Handover in 3G_MSC-A

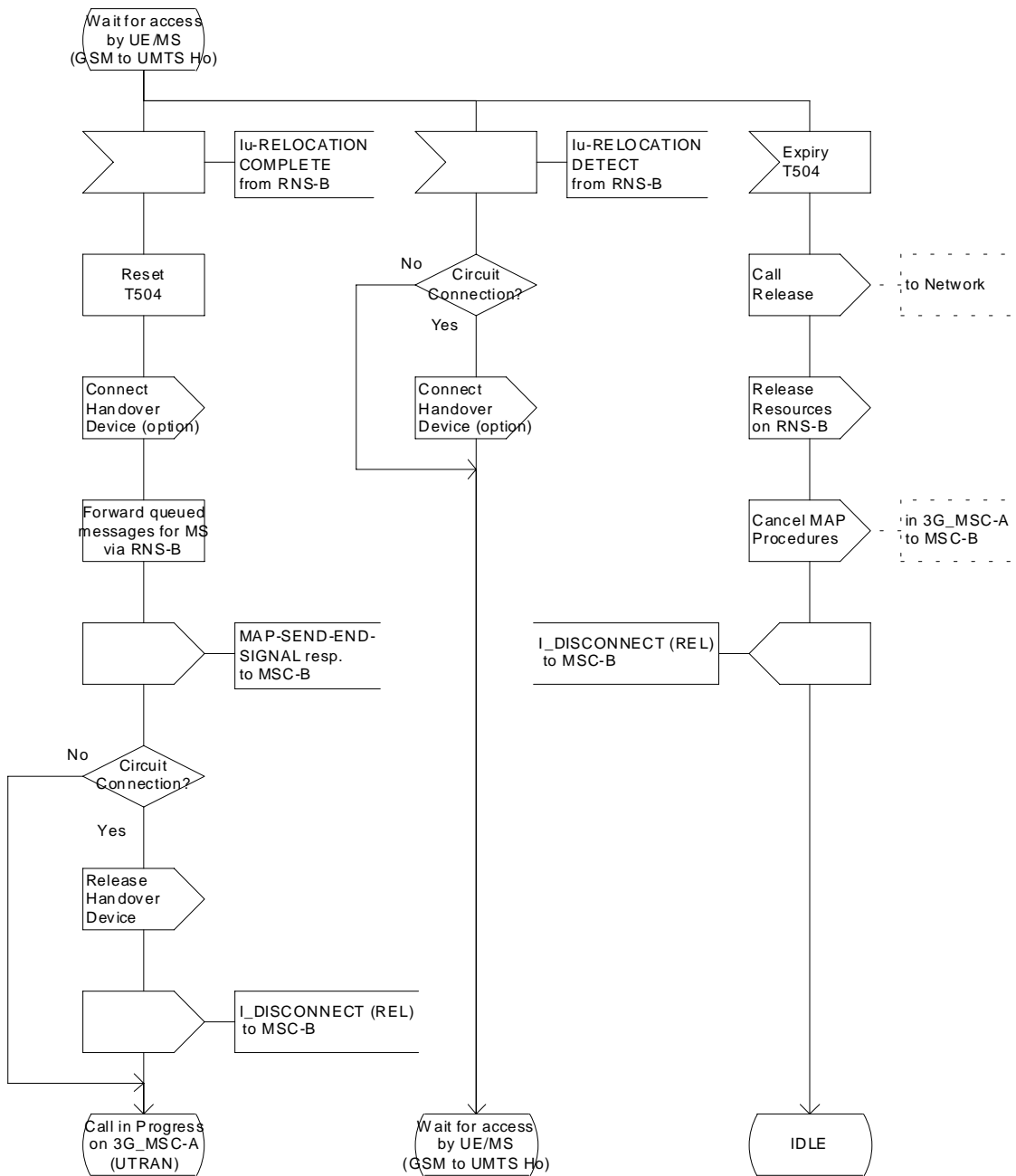

Figure 43 (sheet 20 of 78): Handover control procedure in 3G_MSC-A

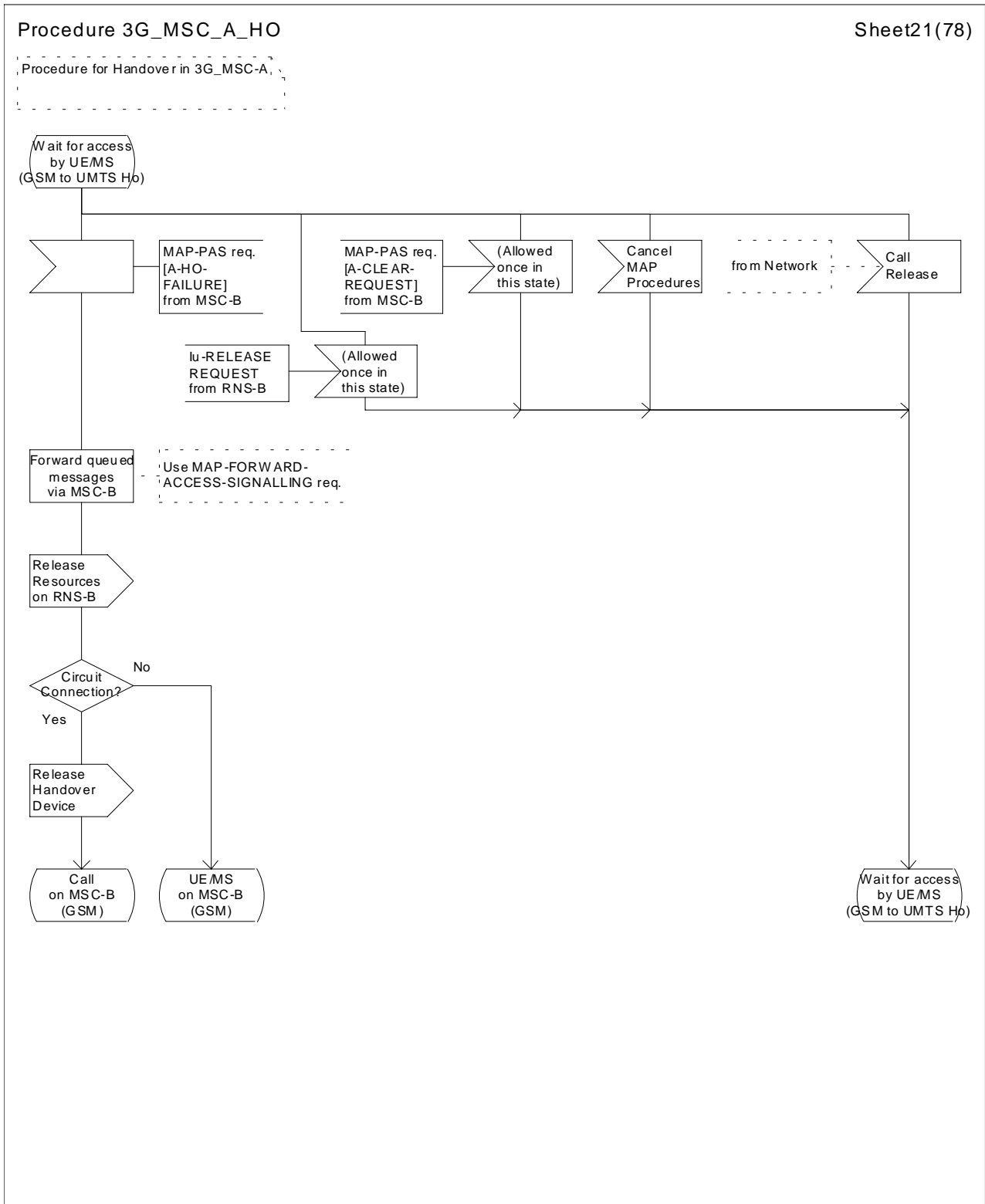

Figure 43 (sheet 21 of 78): Handover control procedure in 3G_MSC-A

Procedure 3G_MSC_A_HO

Sheet22(78)

Procedure for Handover in 3G_MSC-A

Subsequent GSM to UMTS Handover from MSC-B to 3G_MSC-B
Circuit Connection required

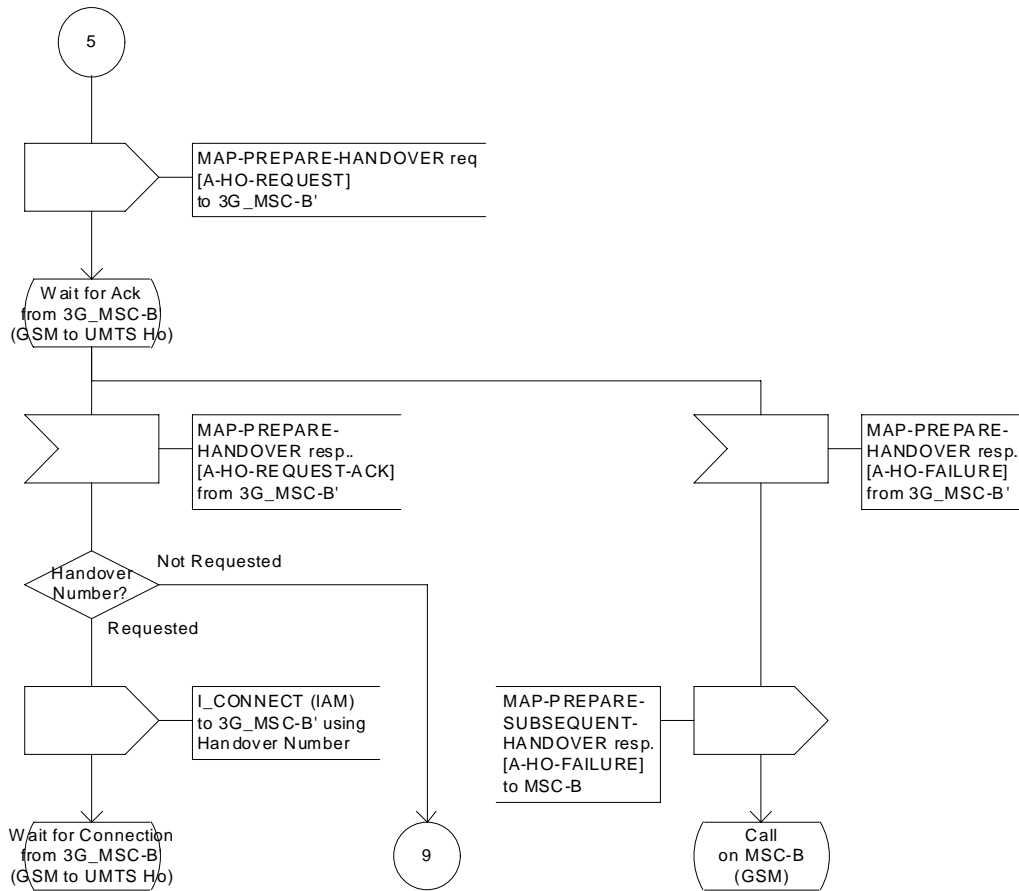

Figure 43 (sheet 22 of 78): Handover control procedure in 3G_MSC-A

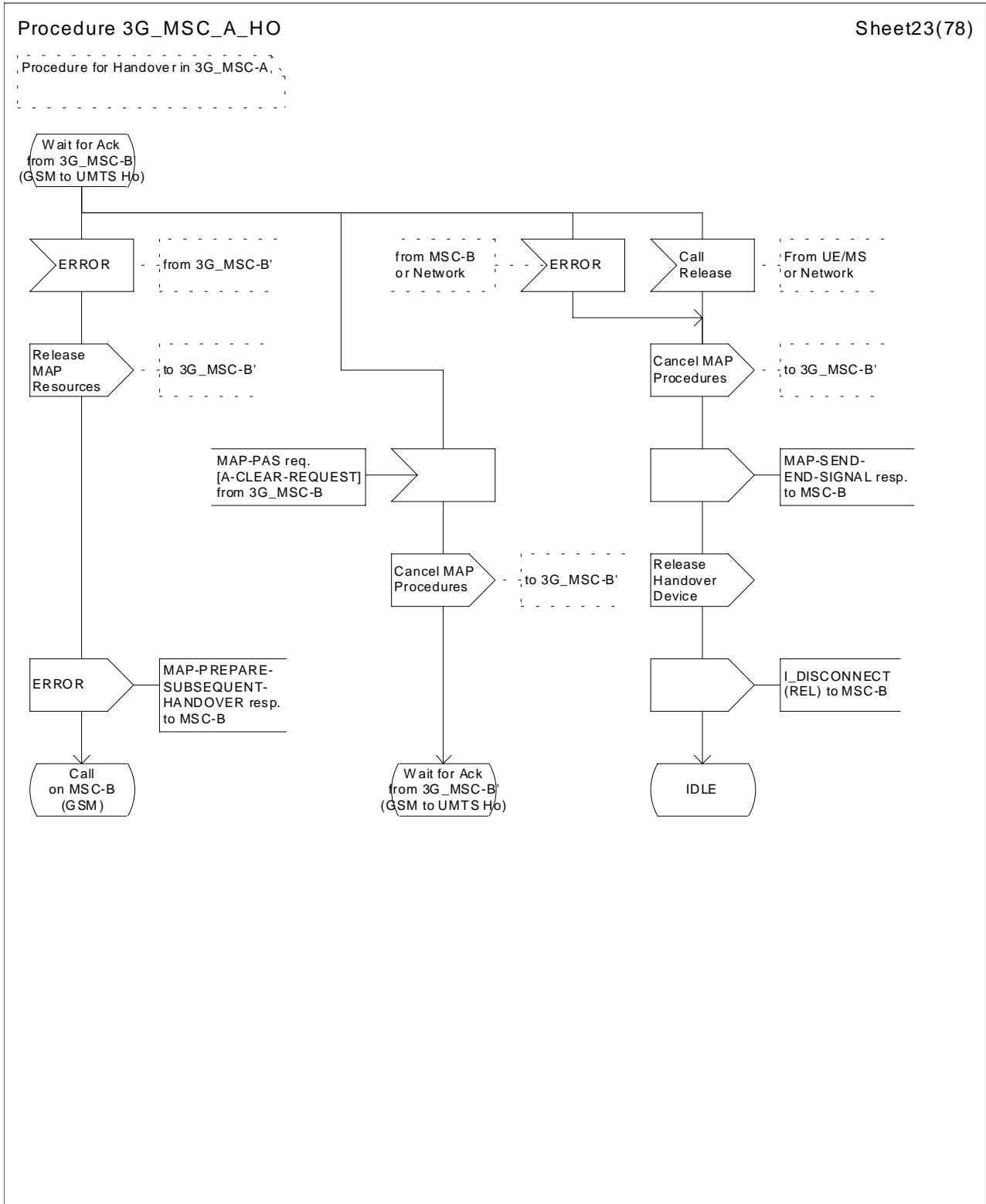

Figure 43 (sheet 23 of 78): Handover control procedure in 3G_MSC-A

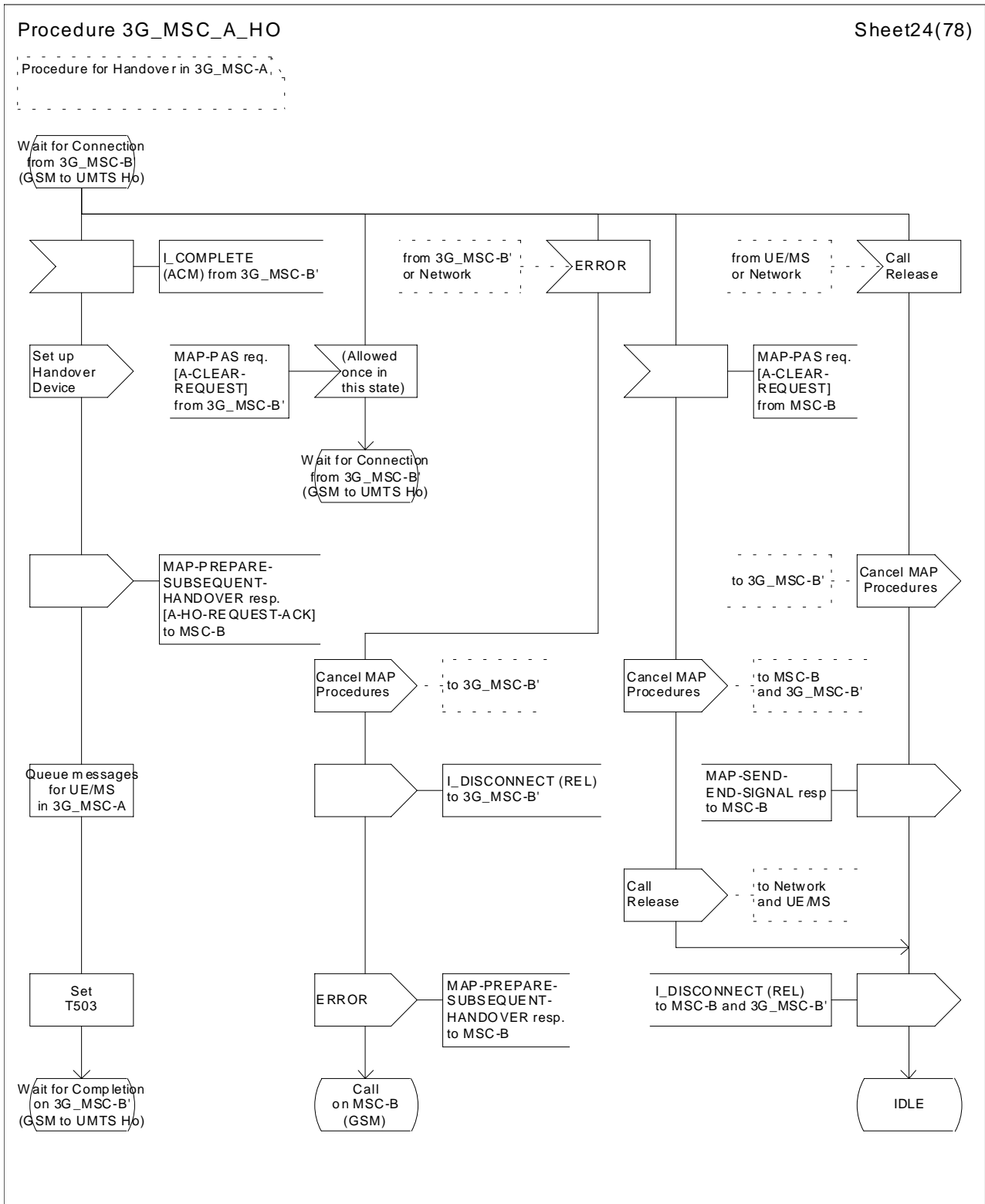

Figure 43 (sheet 24 of 78): Handover control procedure in 3G_MSC-A

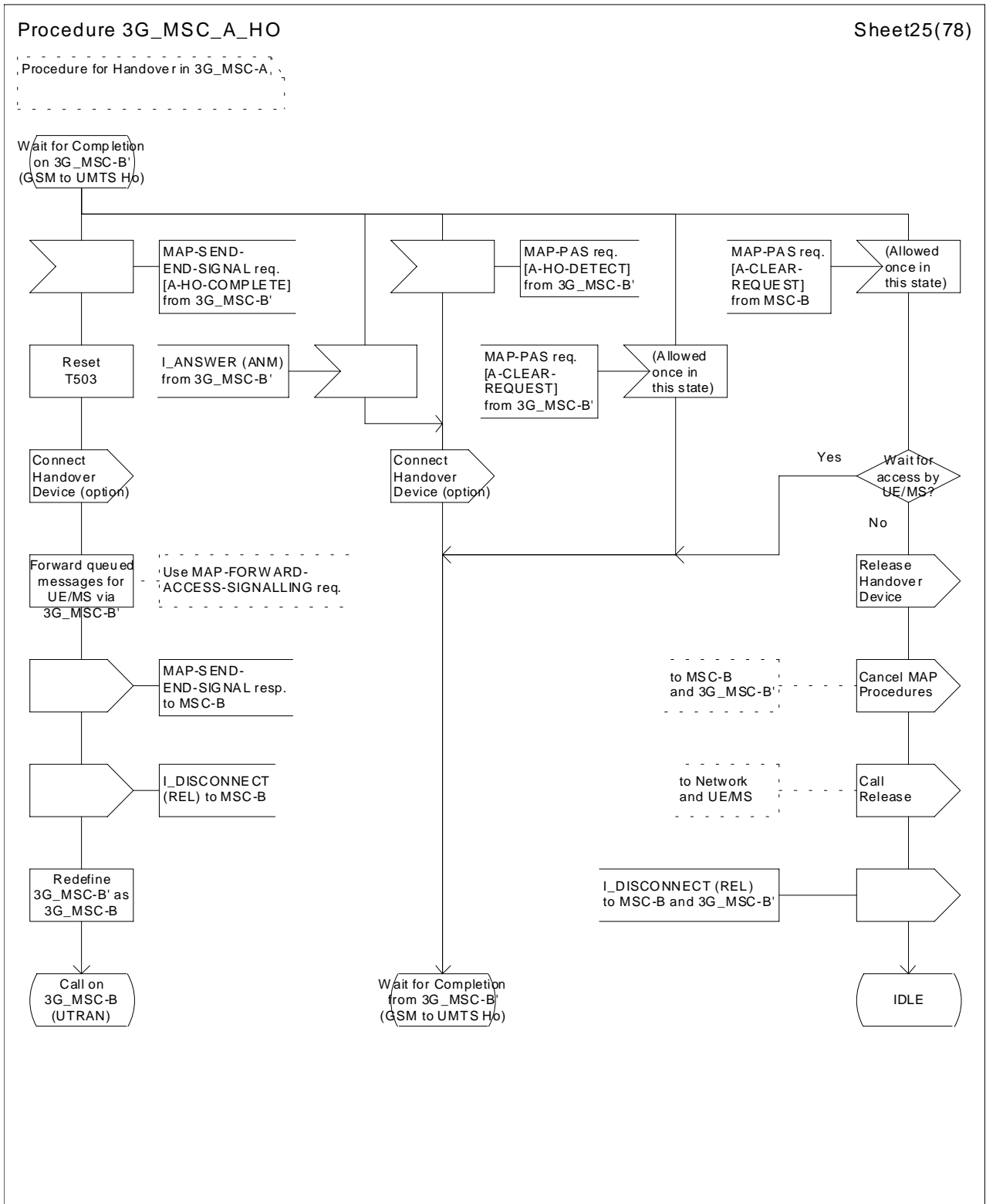

Figure 43 (sheet 25 of 78): Handover control procedure in 3G_MSC-A

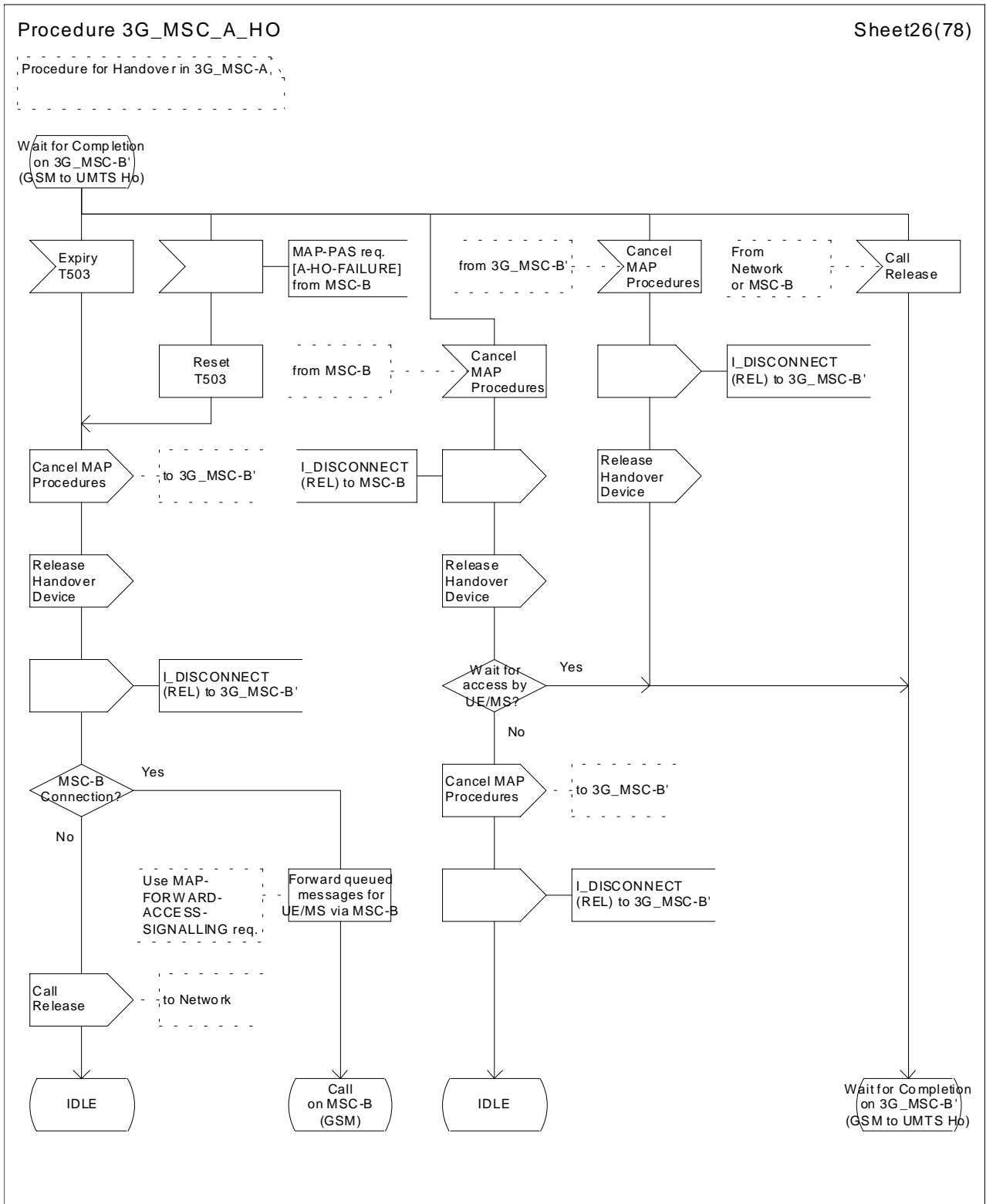

Figure 43 (sheet 26 of 78): Handover control procedure in 3G_MSC-A

Procedure 3G_MSC_A_HO

Sheet27(78)

Procedure for Handover in 3G_MSC-A

Basic GSM to UMTS Handover to 3G_MSC-B
no Circuit Connection required

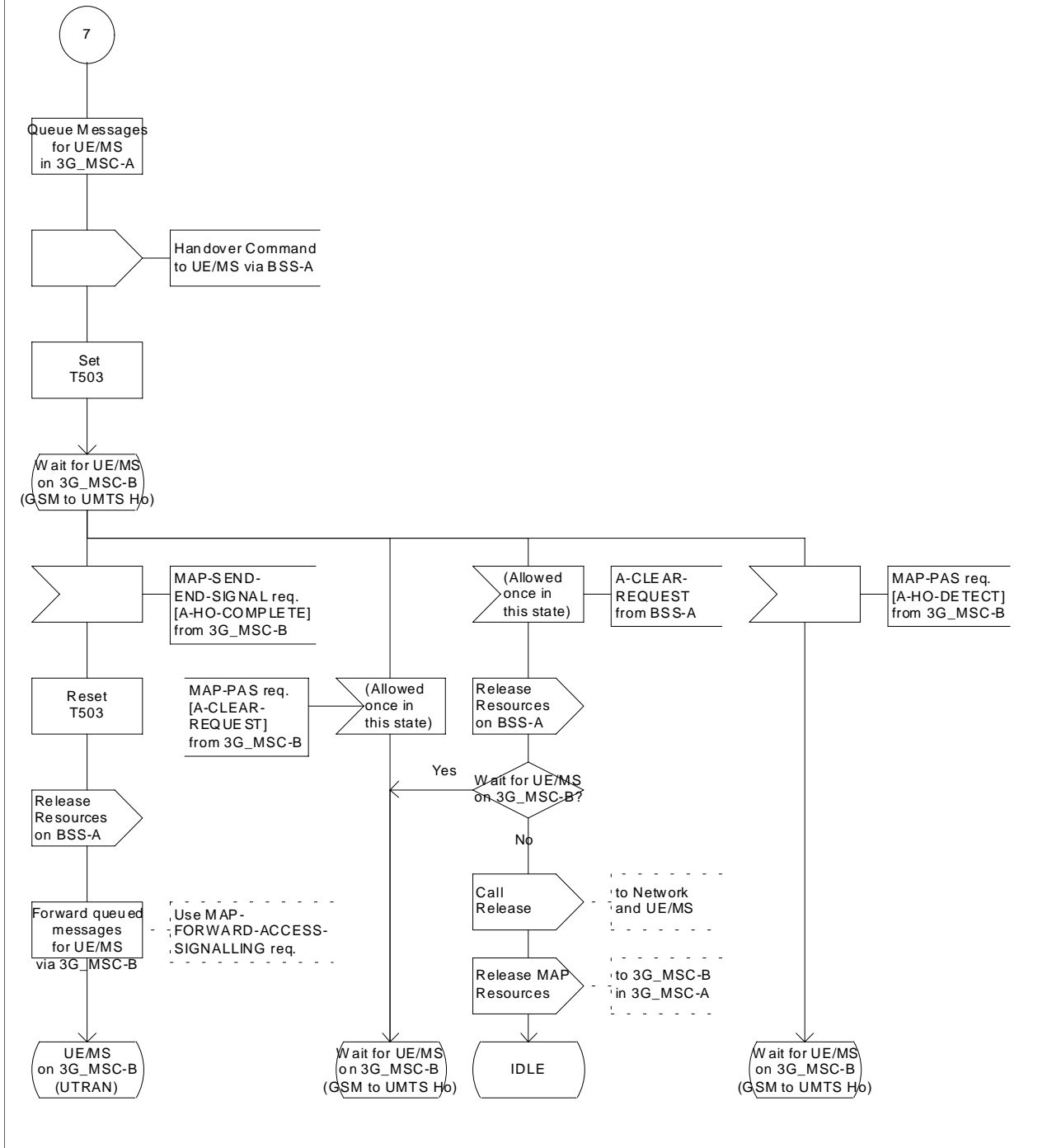

Figure 43 (sheet 27 of 78): Handover control procedure in 3G_MSC-A

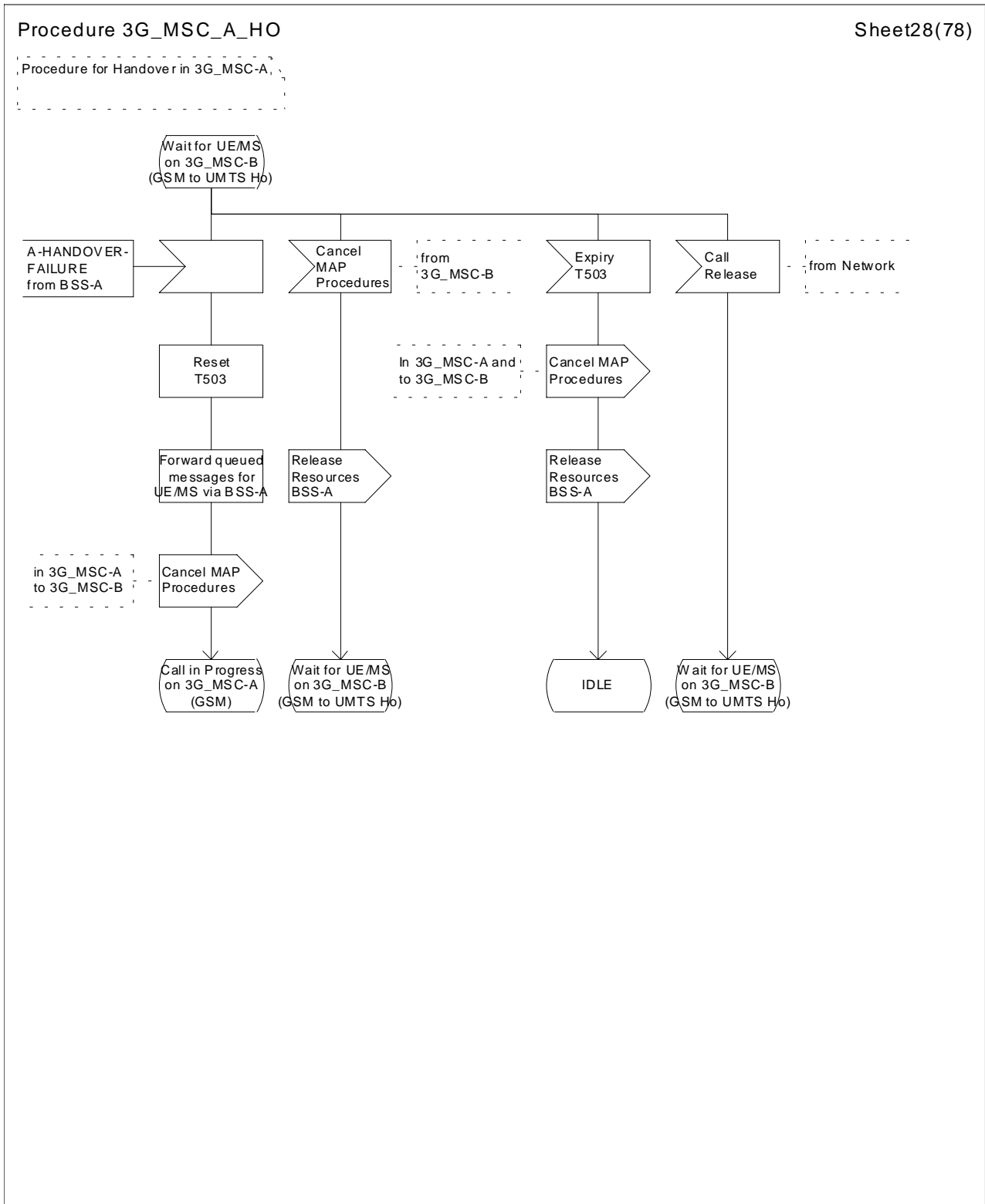

Figure 43 (sheet 28 of 78): Handover control procedure in 3G_MSC-A

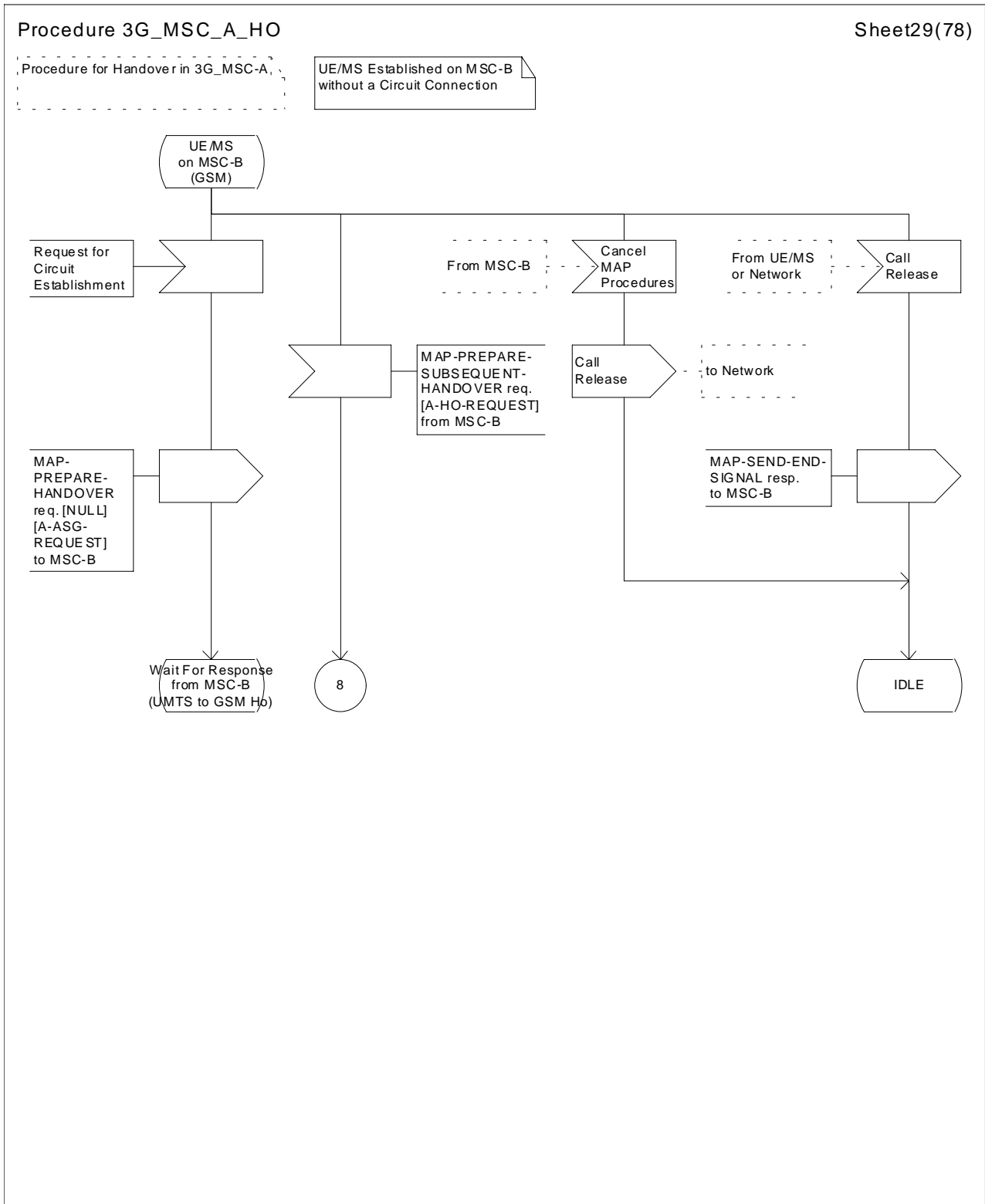

Figure 43 (sheet 29 of 78): Handover control procedure in 3G_MSC-A

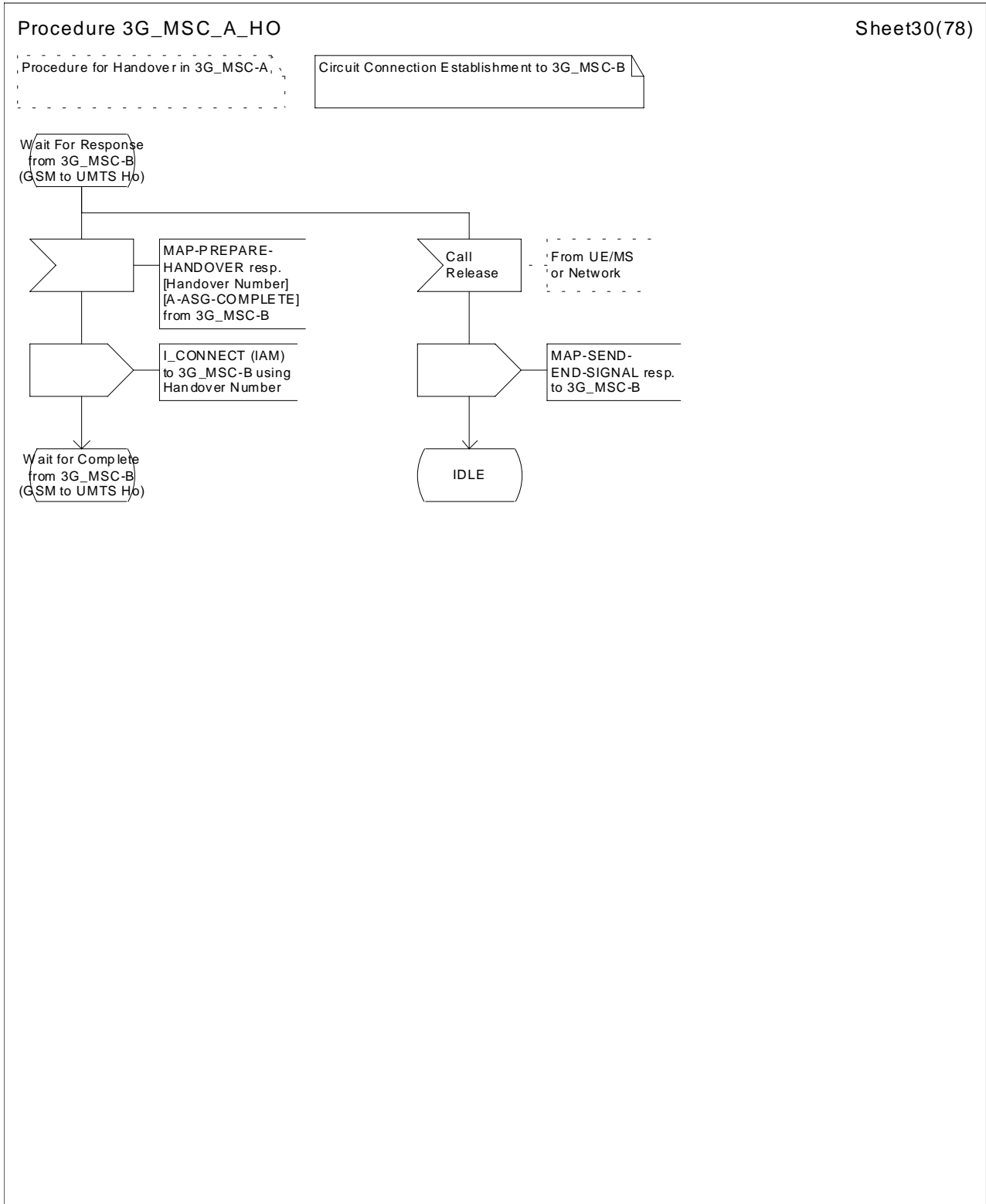

Figure 43 (sheet 30 of 78): Handover control procedure in 3G_MSC-A

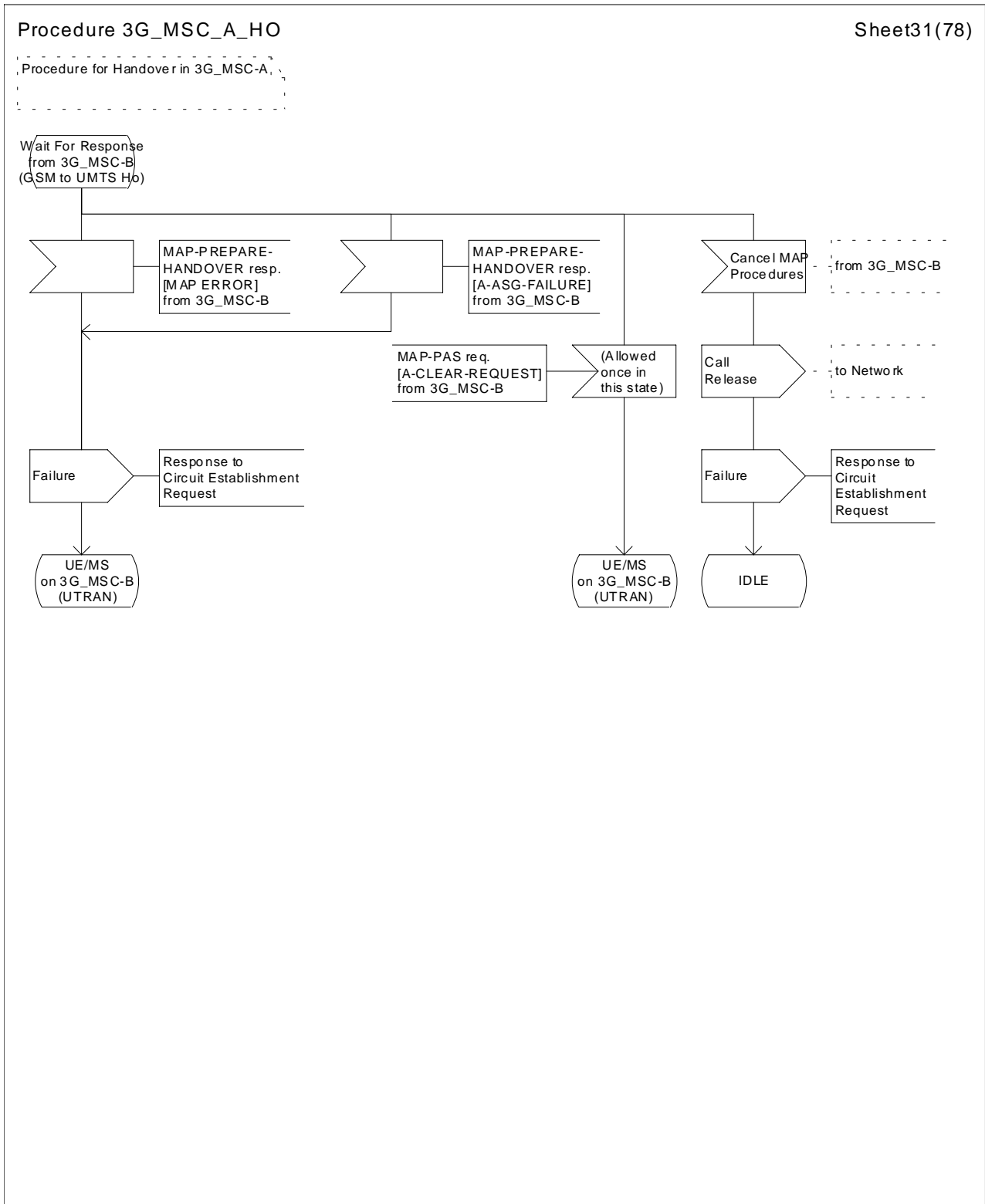

Figure 43 (sheet 31 of 78): Handover control procedure in 3G_MSC-A

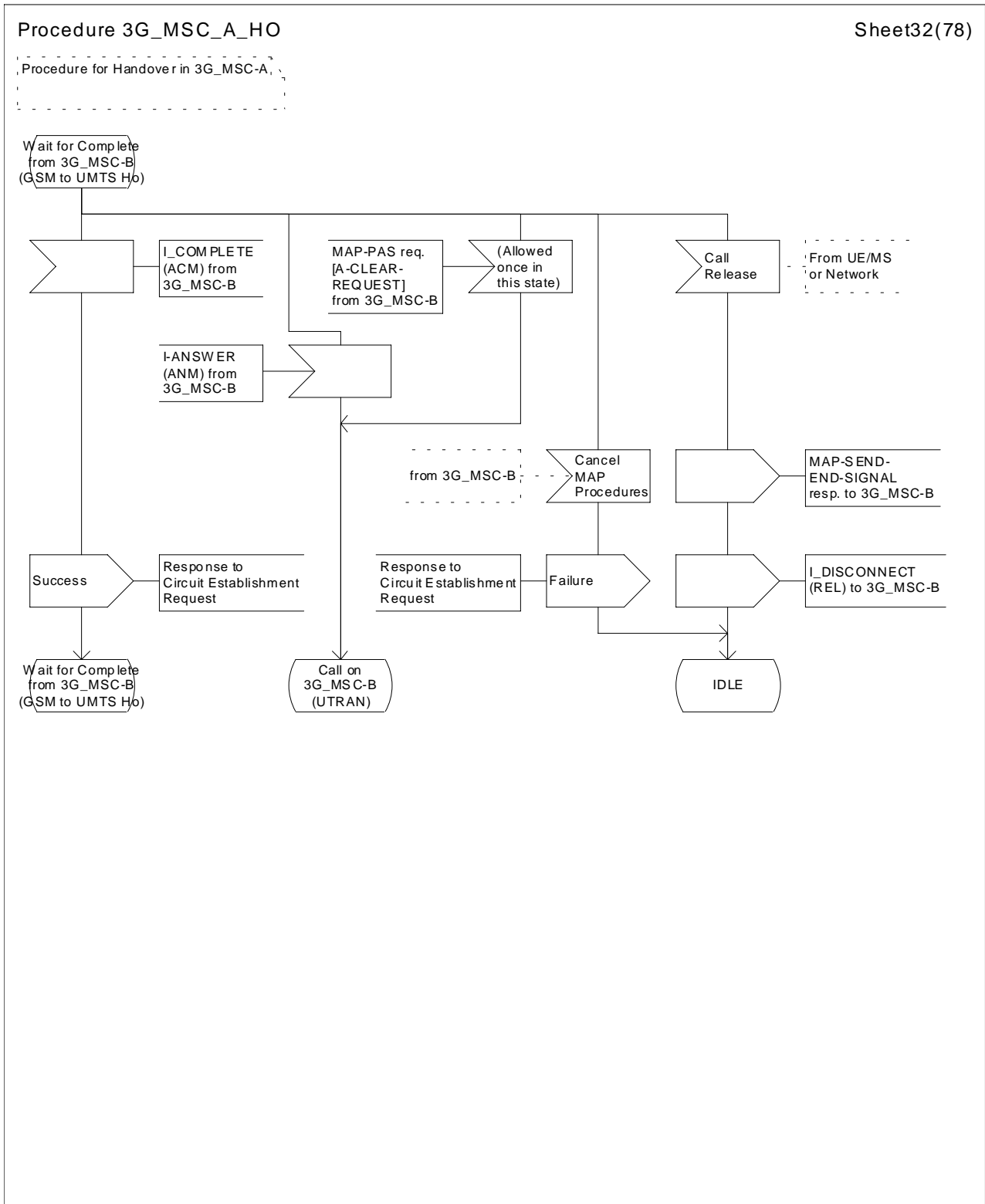

Figure 43 (sheet 32 of 78): Handover control procedure in 3G_MSC-A

Procedure 3G_MSC_A_HO

Sheet33(78)

Procedure for Handover in 3G_MSC-A

Subsequent GSM to UMTS Handover from MSC-B to 3G_MSC-B' no Circuit Connection required.

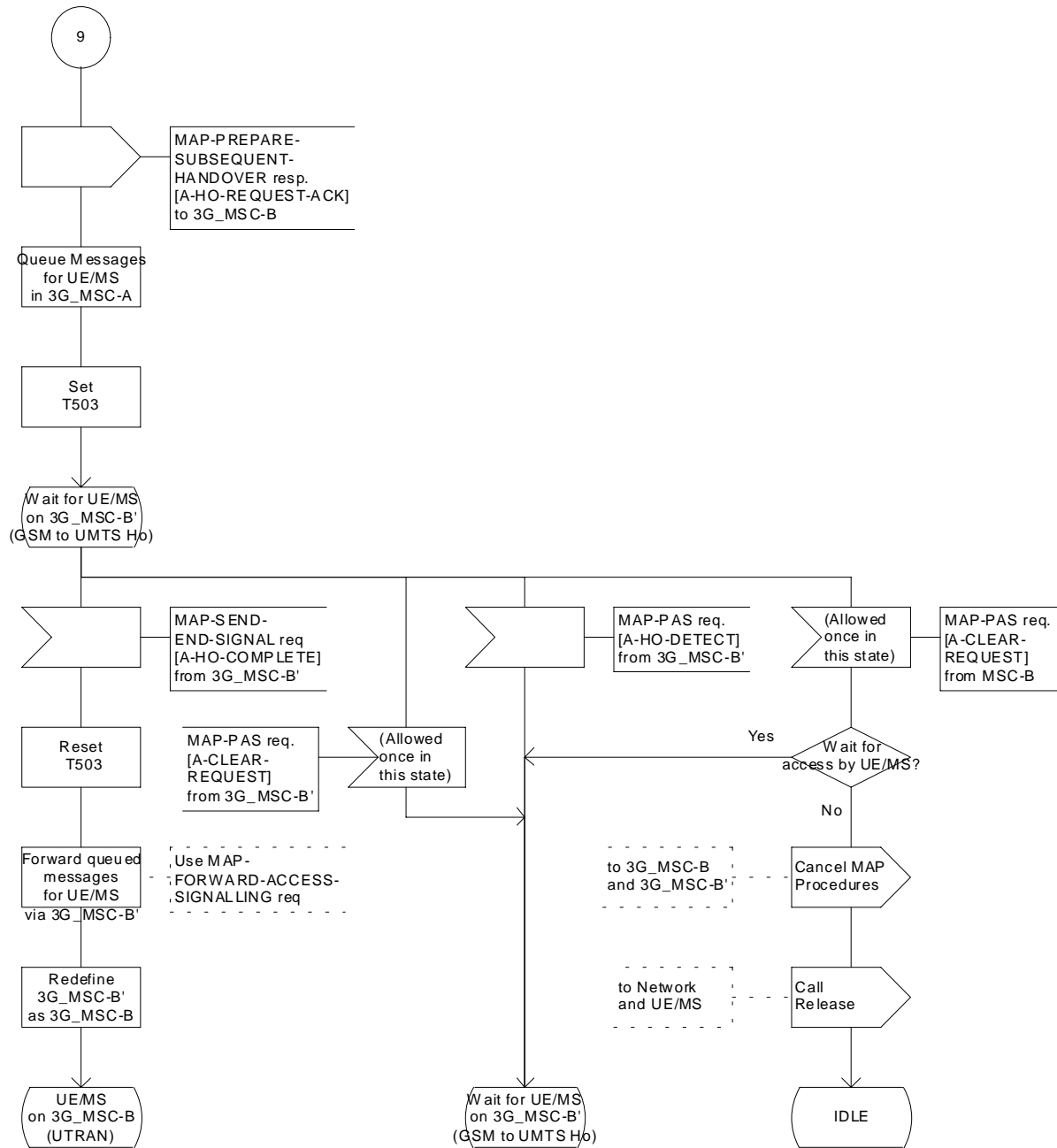

Figure 43 (sheet 33 of 78): Handover control procedure in 3G_MSC-A

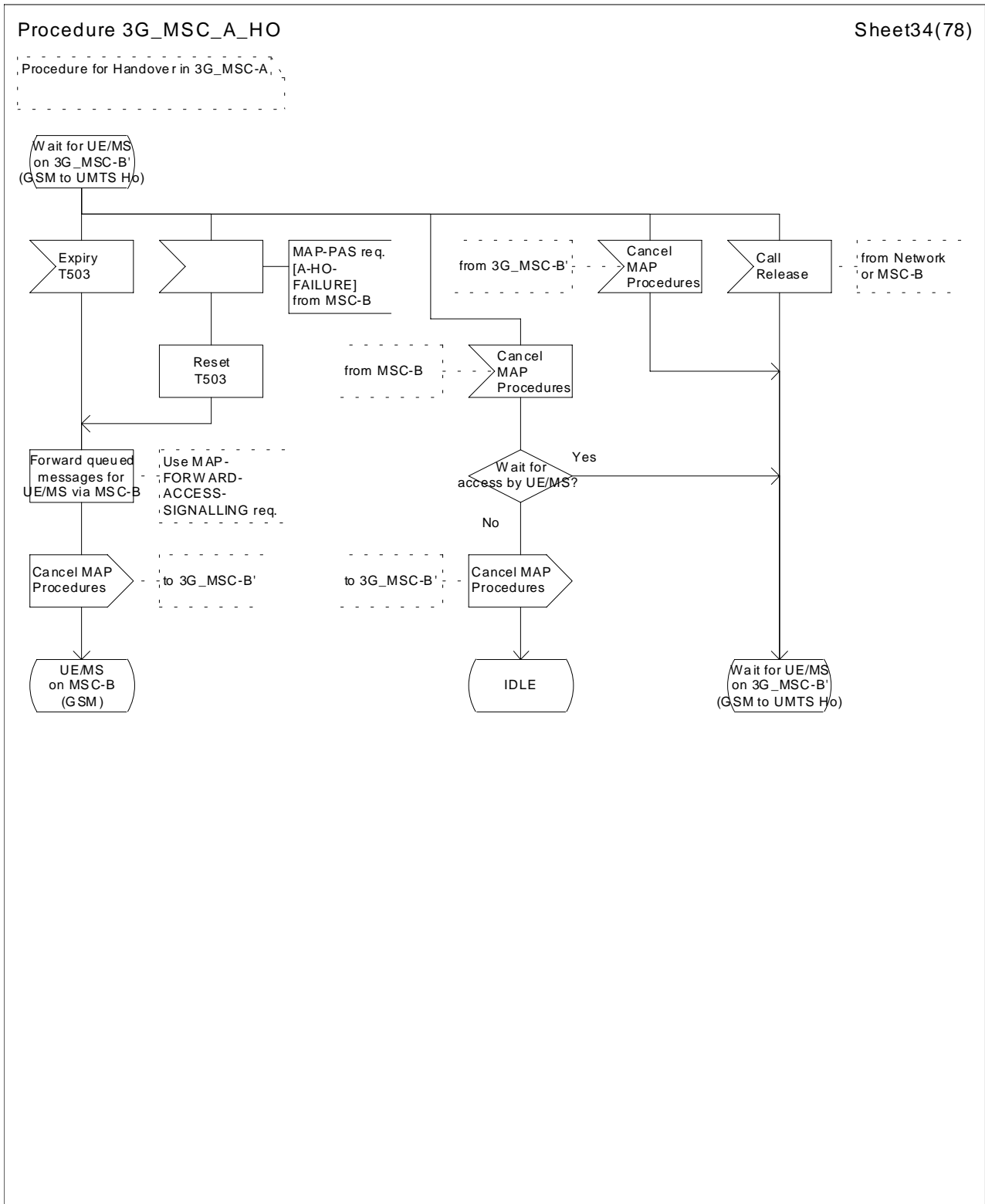

Figure 43 (sheet 34 of 78): Handover control procedure in 3G_MSC-A

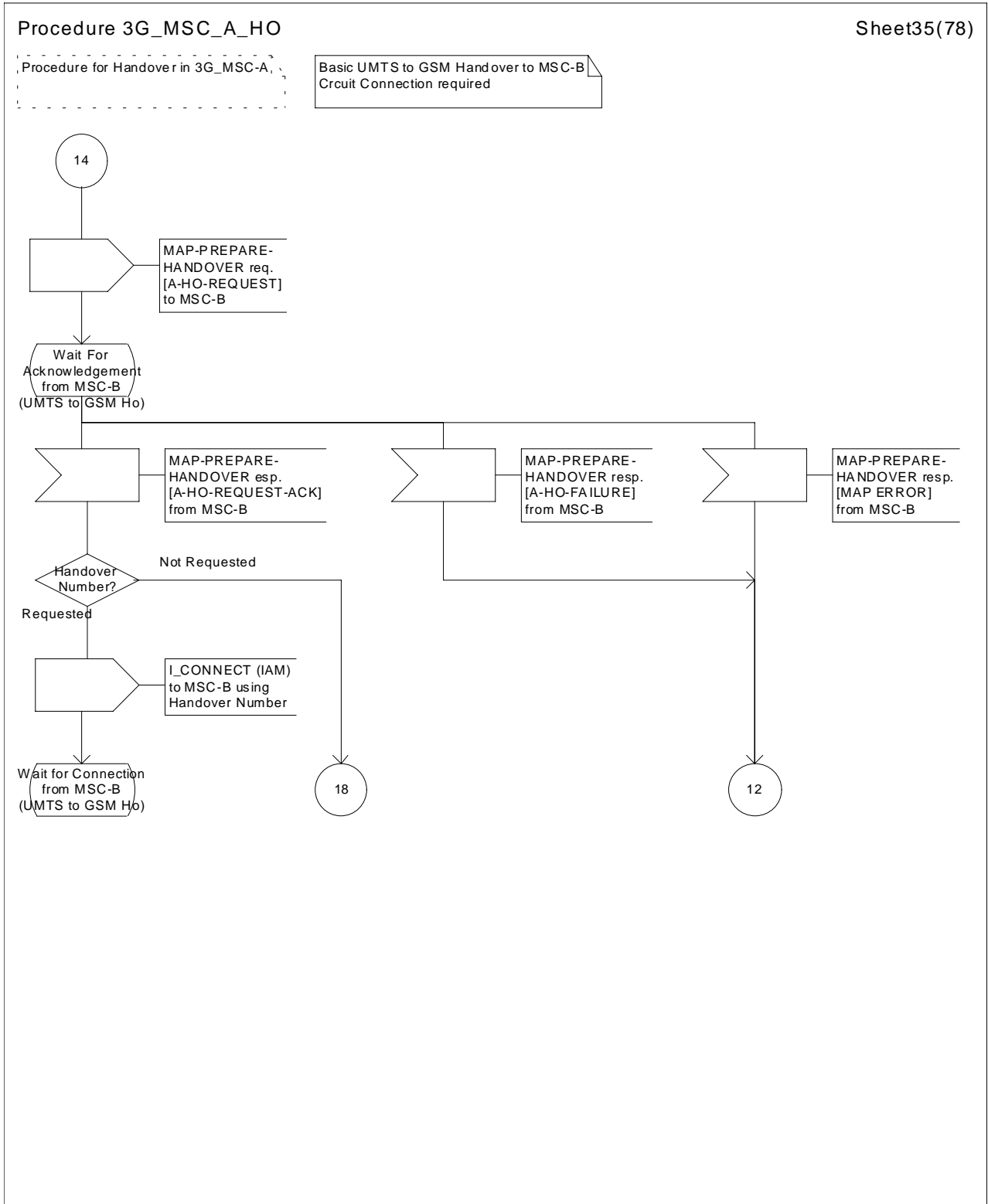

Figure 43 (sheet 35 of 78): Handover control procedure in 3G_MSC-A

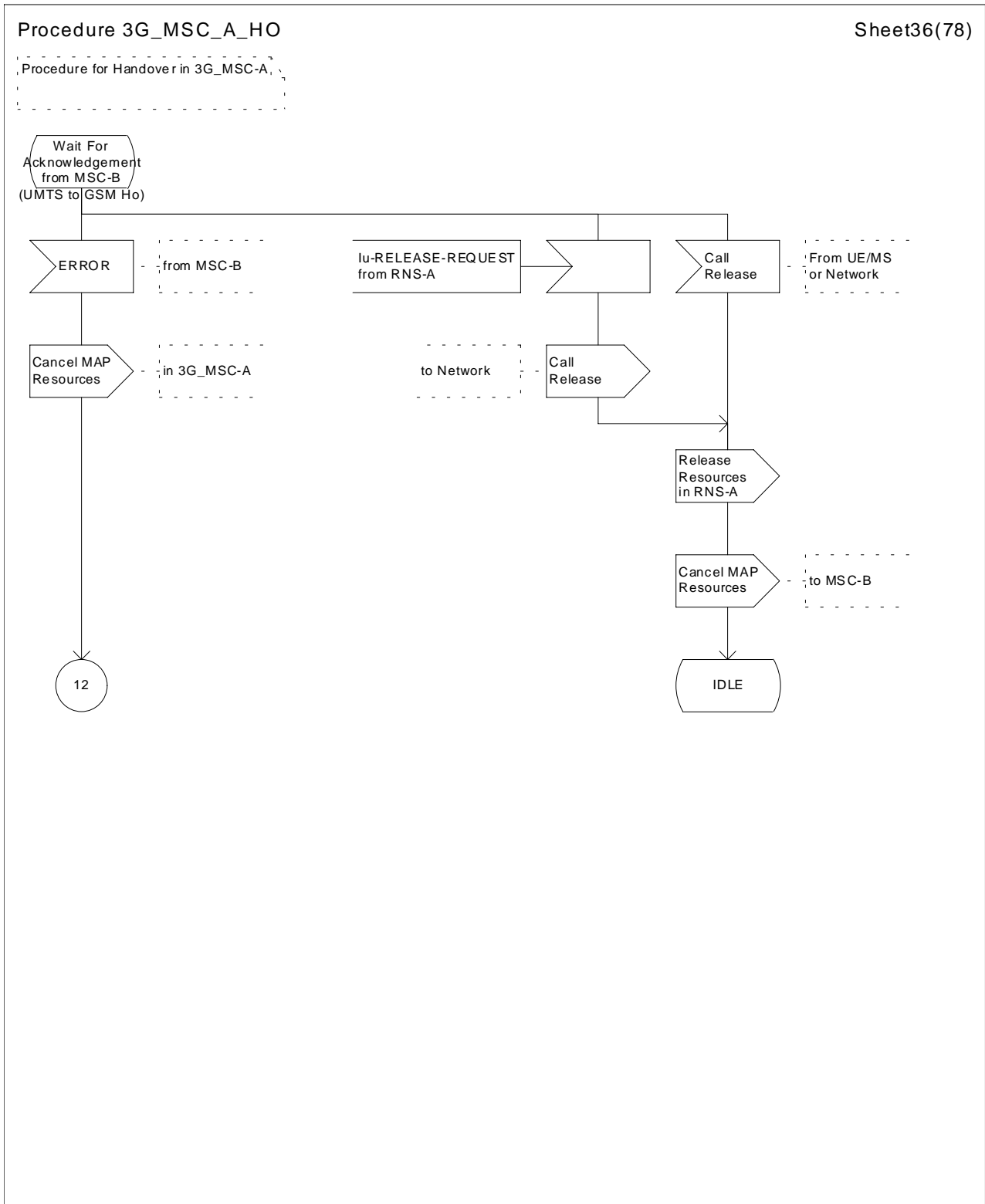

Figure 43 (sheet 36 of 78): Handover control procedure in 3G_MSC-A

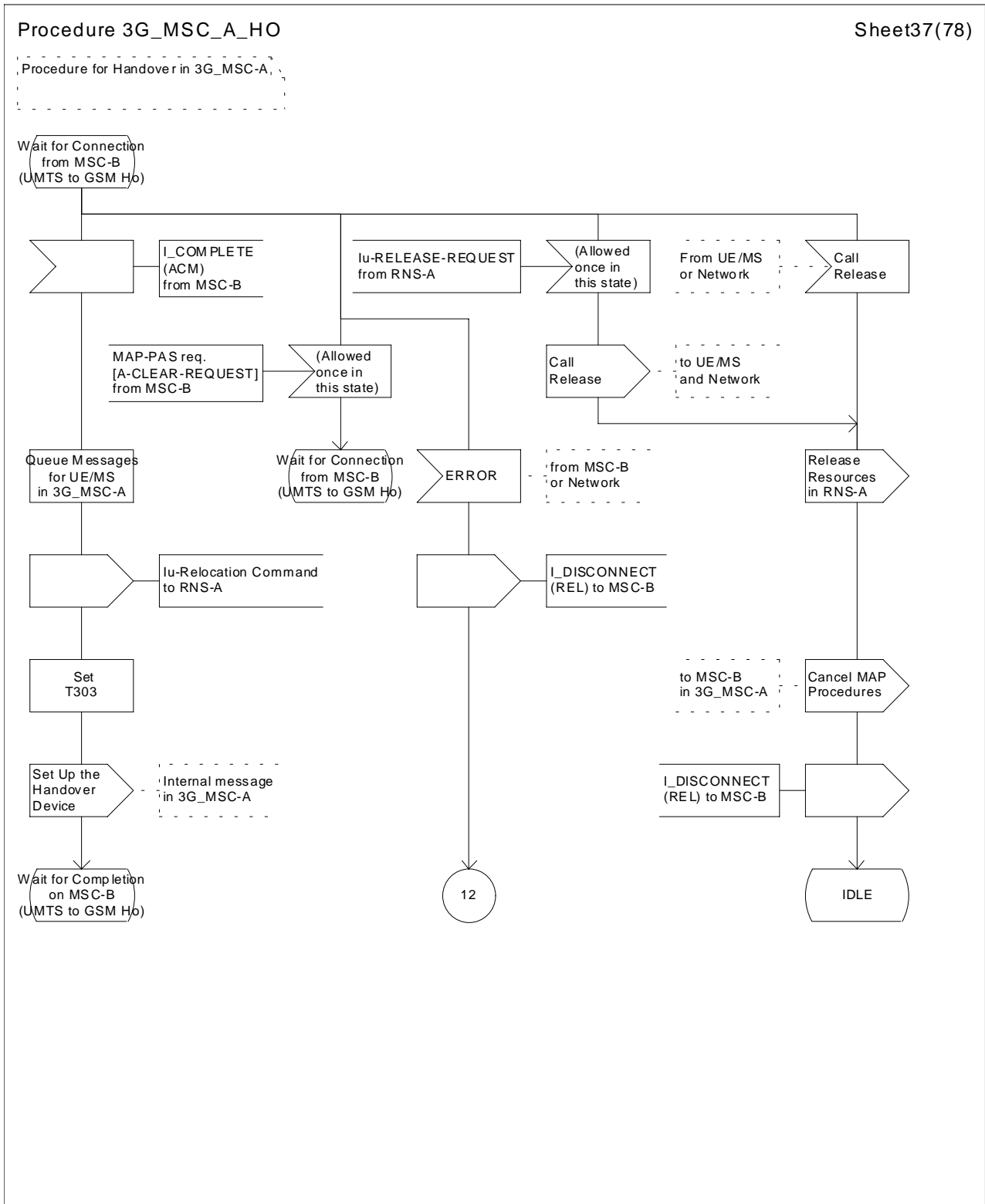
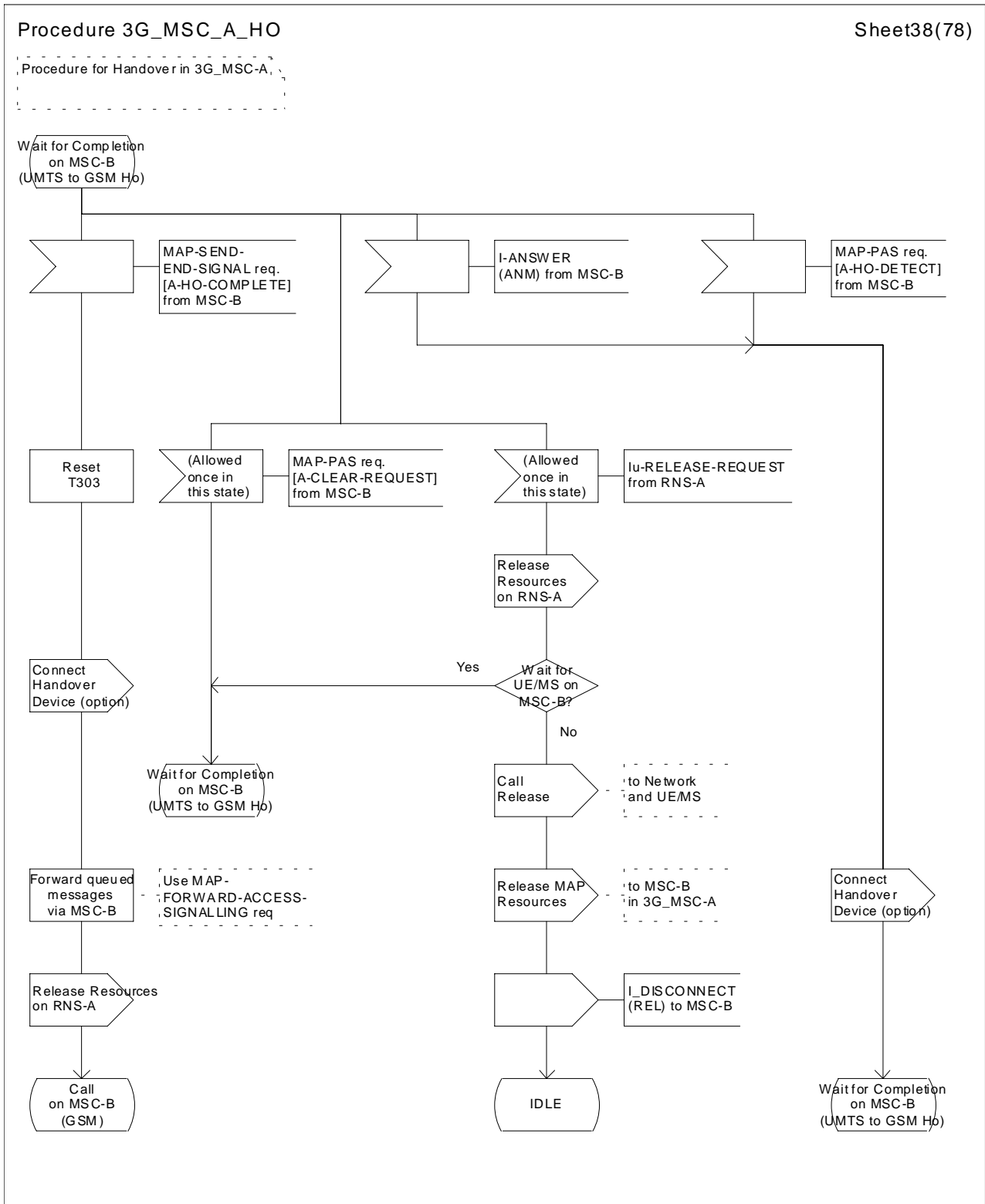

Figure 43 (sheet 37 of 78): Handover control procedure in 3G_MSC-A



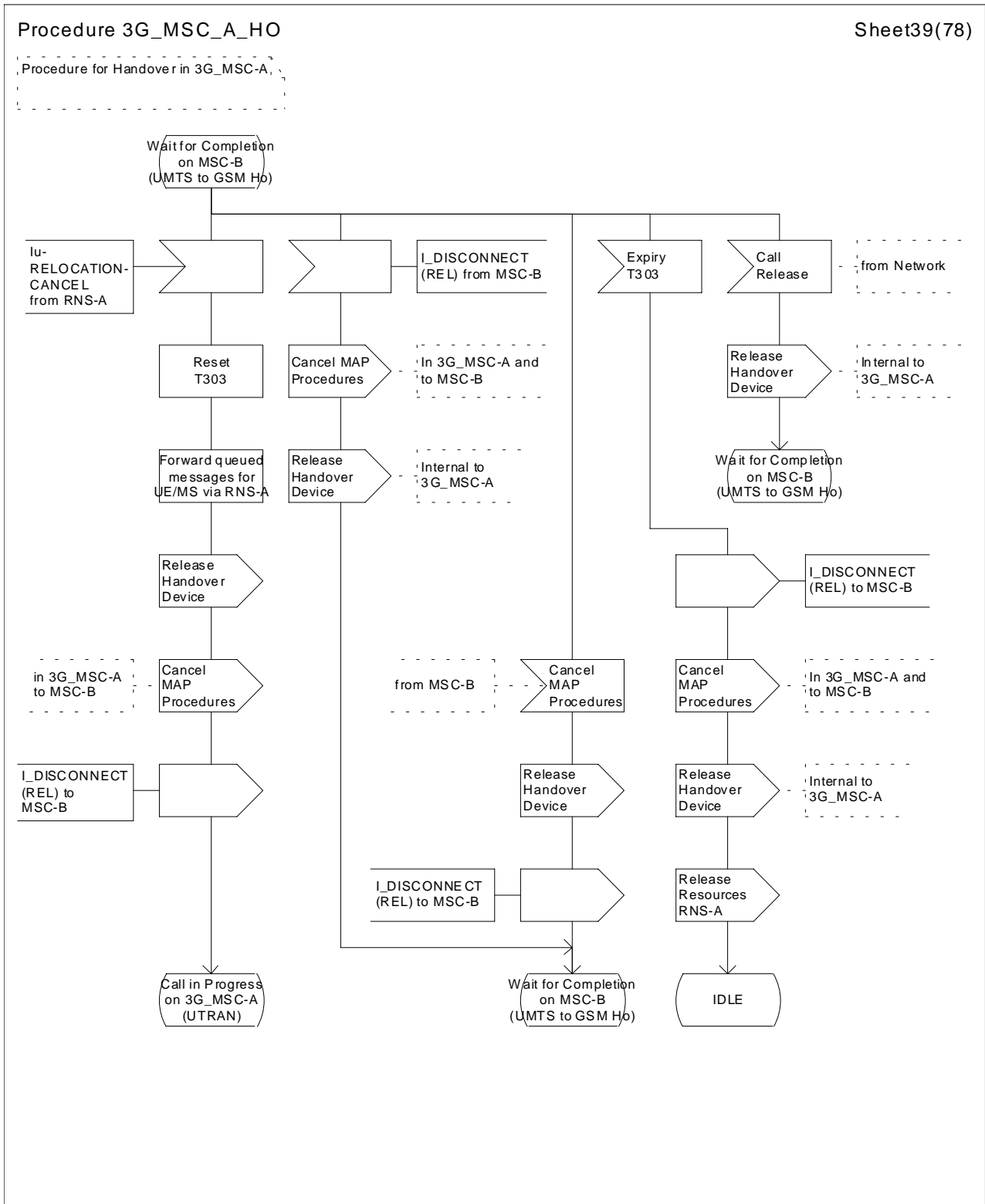

Figure 43 (sheet 39 of 78): Handover control procedure in 3G_MSC-A

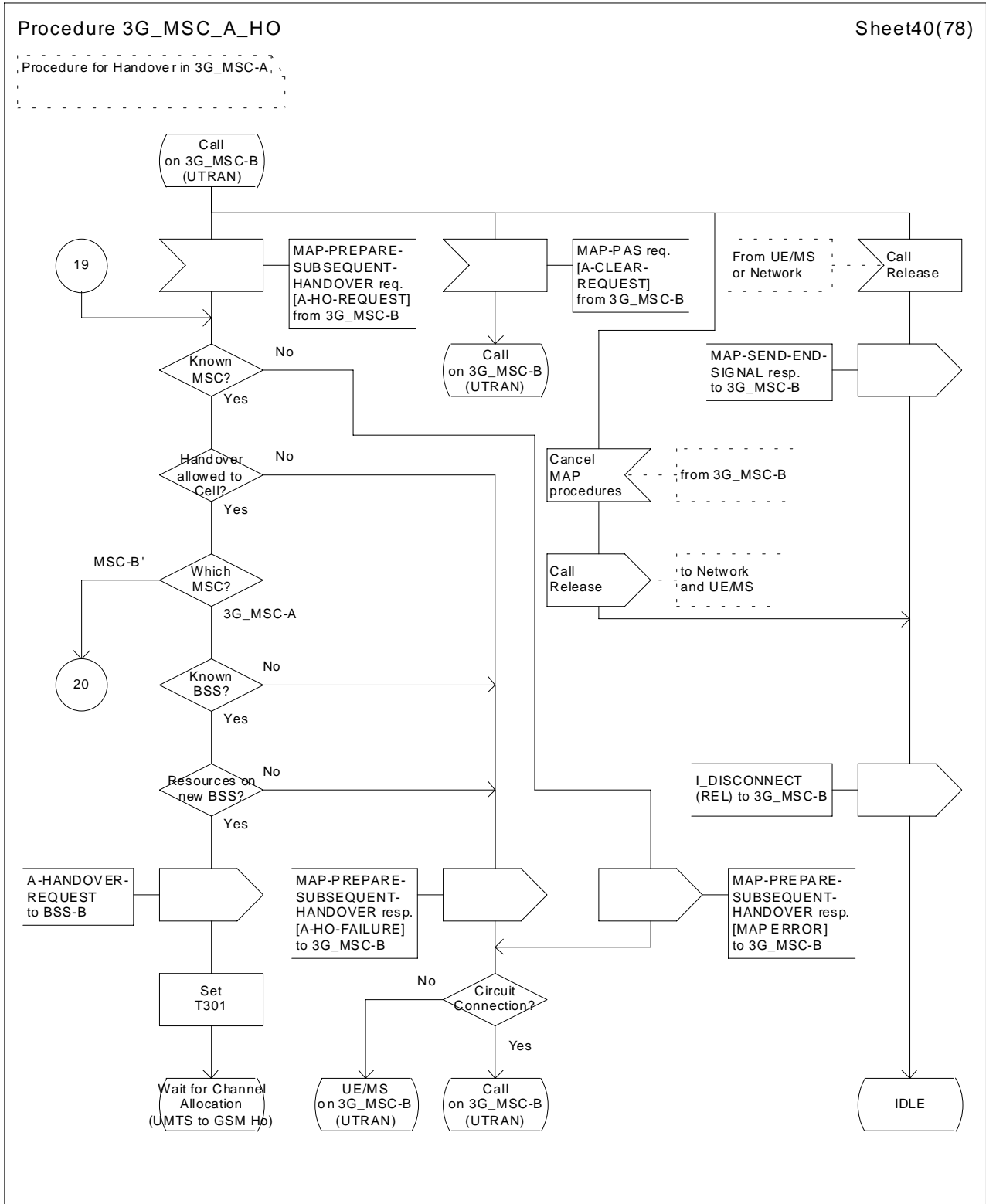

Figure 43 (sheet 40 of 78): Handover control procedure in 3G_MSC-A

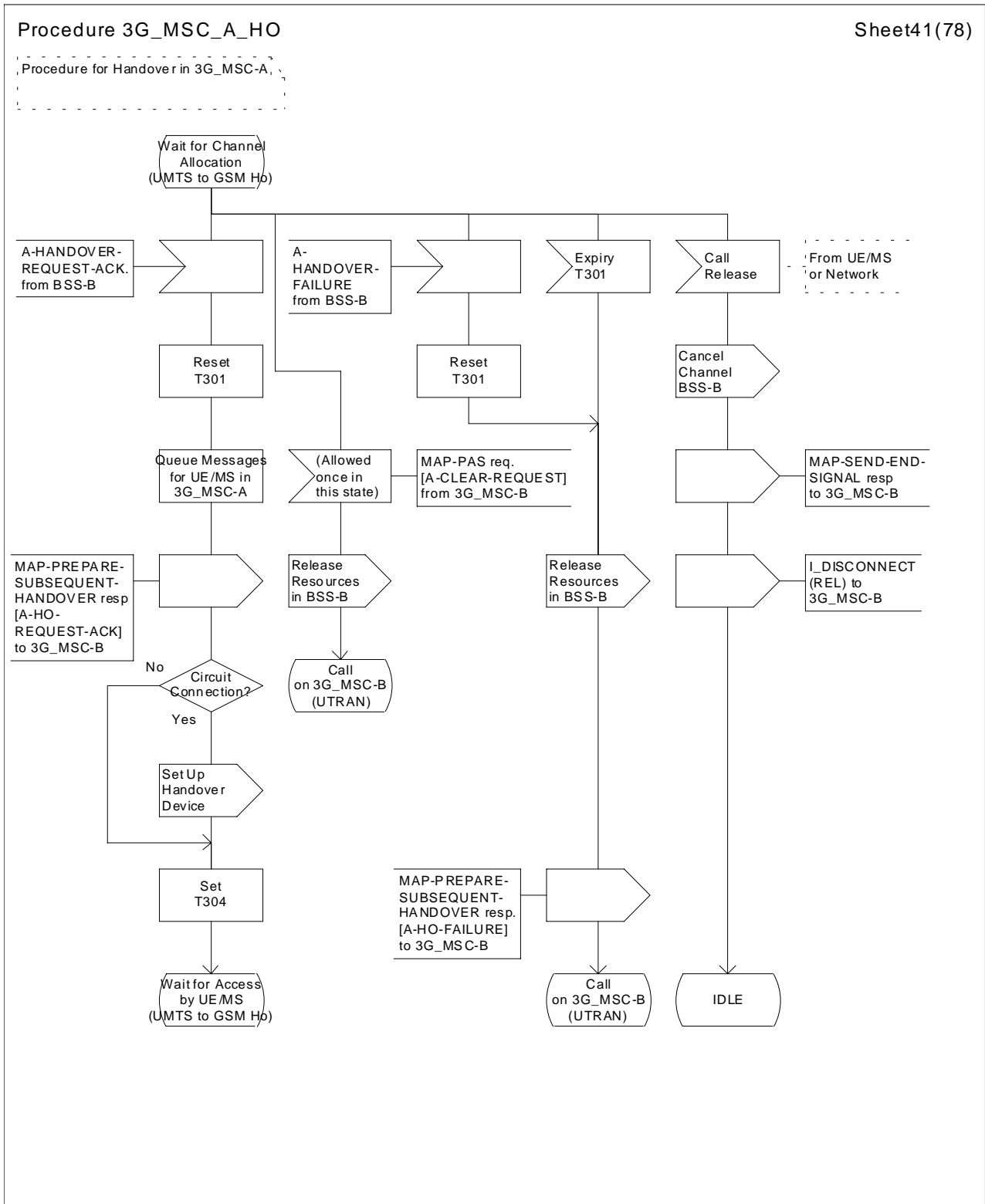

Figure 43 (sheet 41 of 78): Handover control procedure in 3G_MSC-A

Procedure 3G_MSC_A_HO

Sheet42(78)

Procedure for Handover in 3G_MSC-A

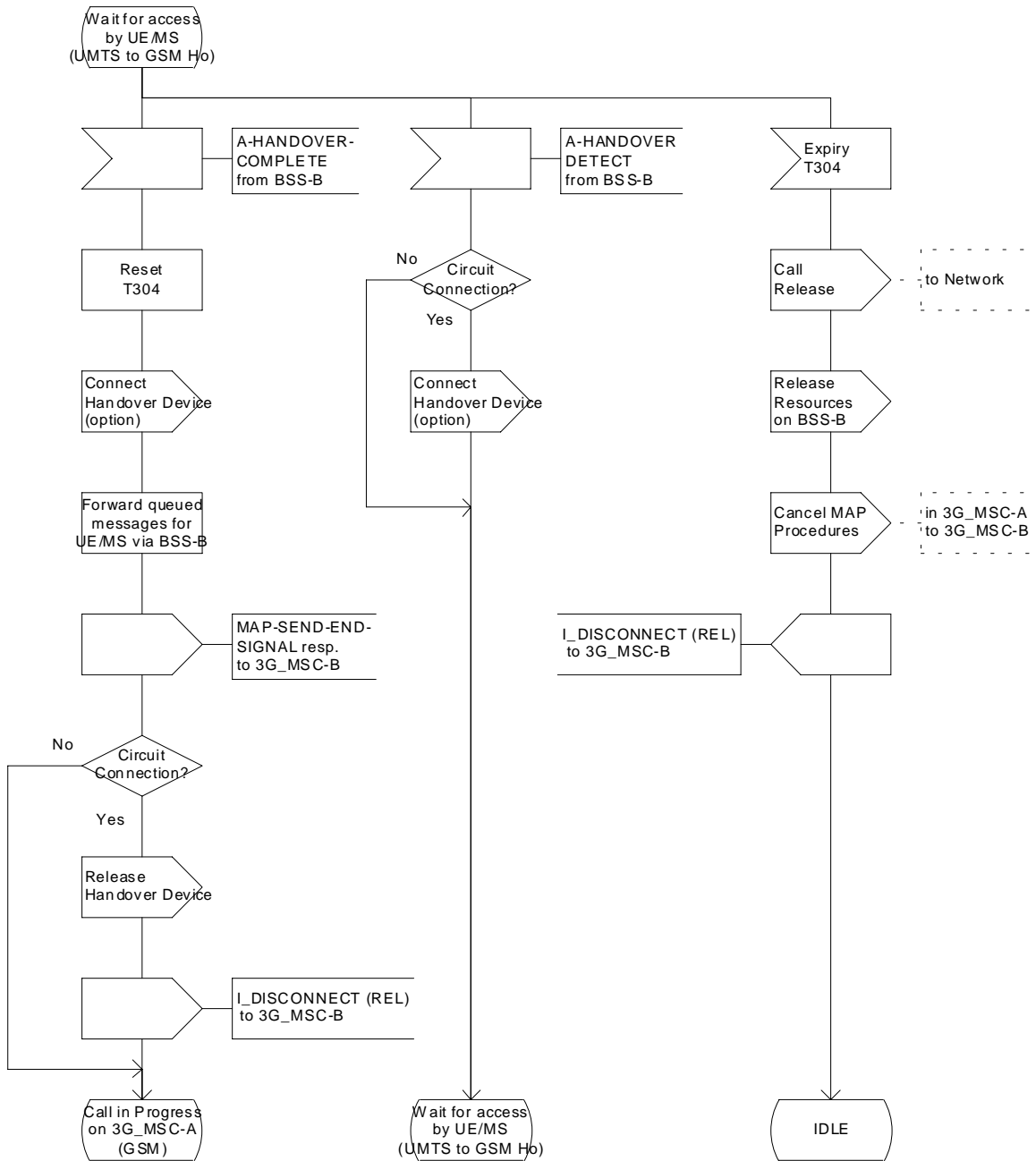

Figure 43 (sheet 42 of 78): Handover control procedure in 3G_MSC-A

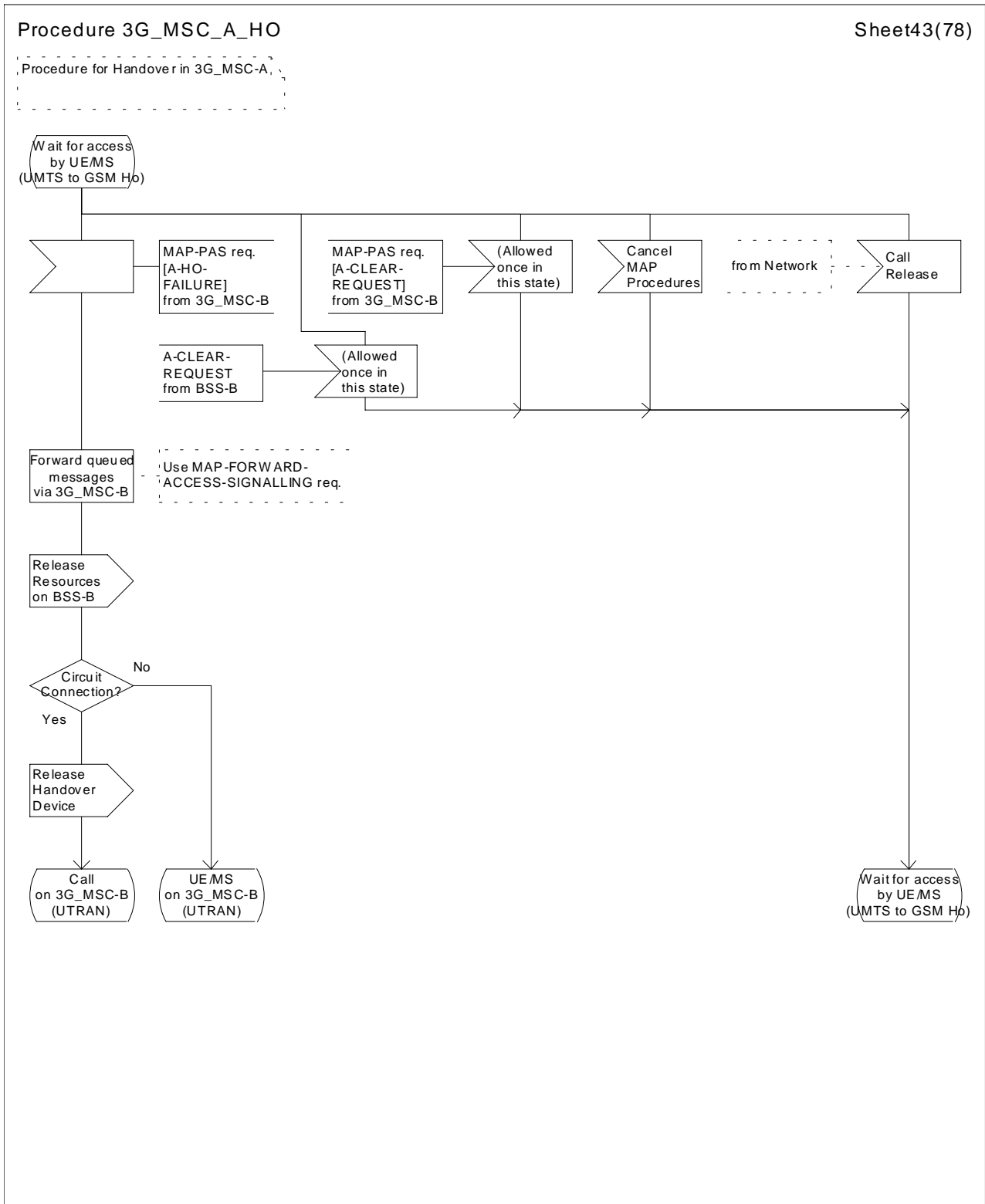

Figure 43 (sheet 43 of 78): Handover control procedure in 3G_MSC-A

Procedure 3G_MSC_A_HO

Sheet44(78)

Procedure for Handover in 3G_MSC-A

Subsequent UMTS to GSM Handover from 3G_MSC-B to MSC-B' Circuit Connection required

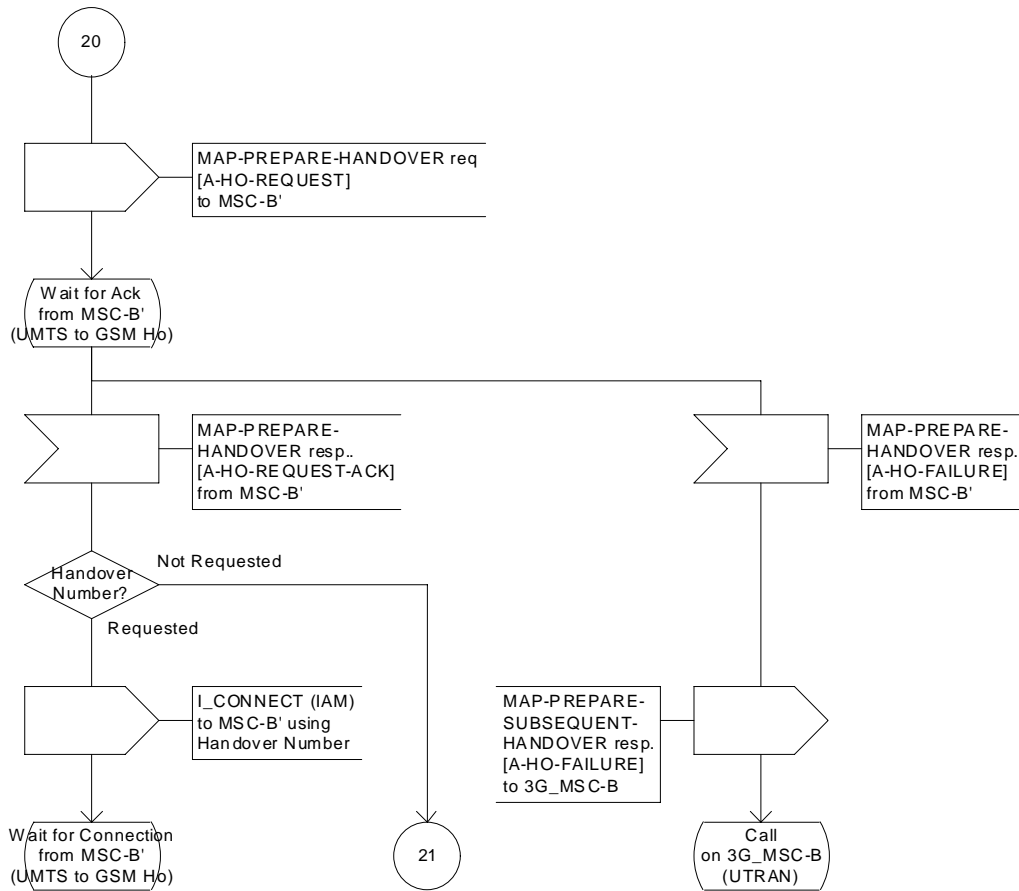

Figure 43 (sheet 44 of 78): Handover control procedure in 3G_MSC-A

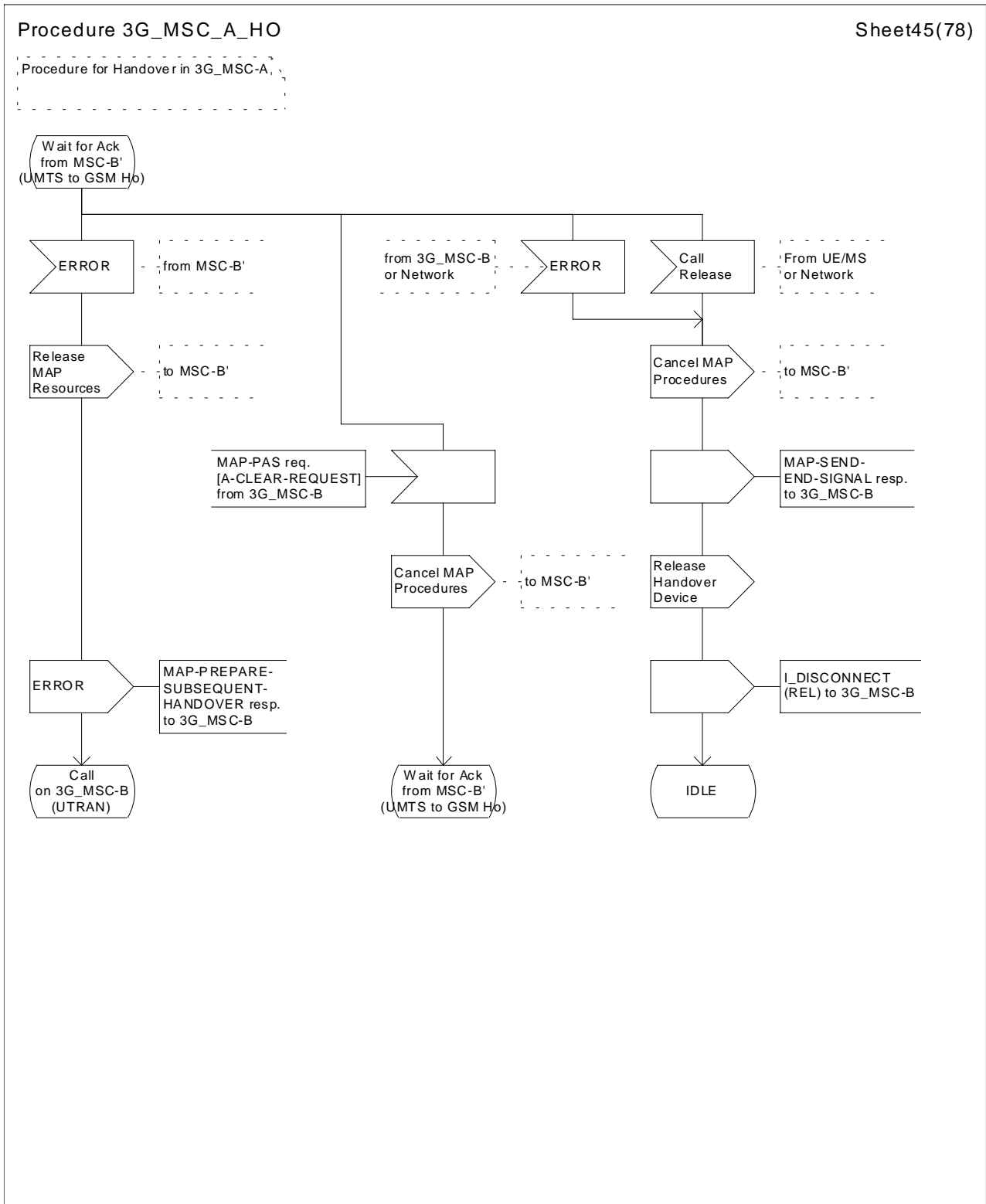

Figure 43 (sheet 45 of 78): Handover control procedure in 3G_MSC-A

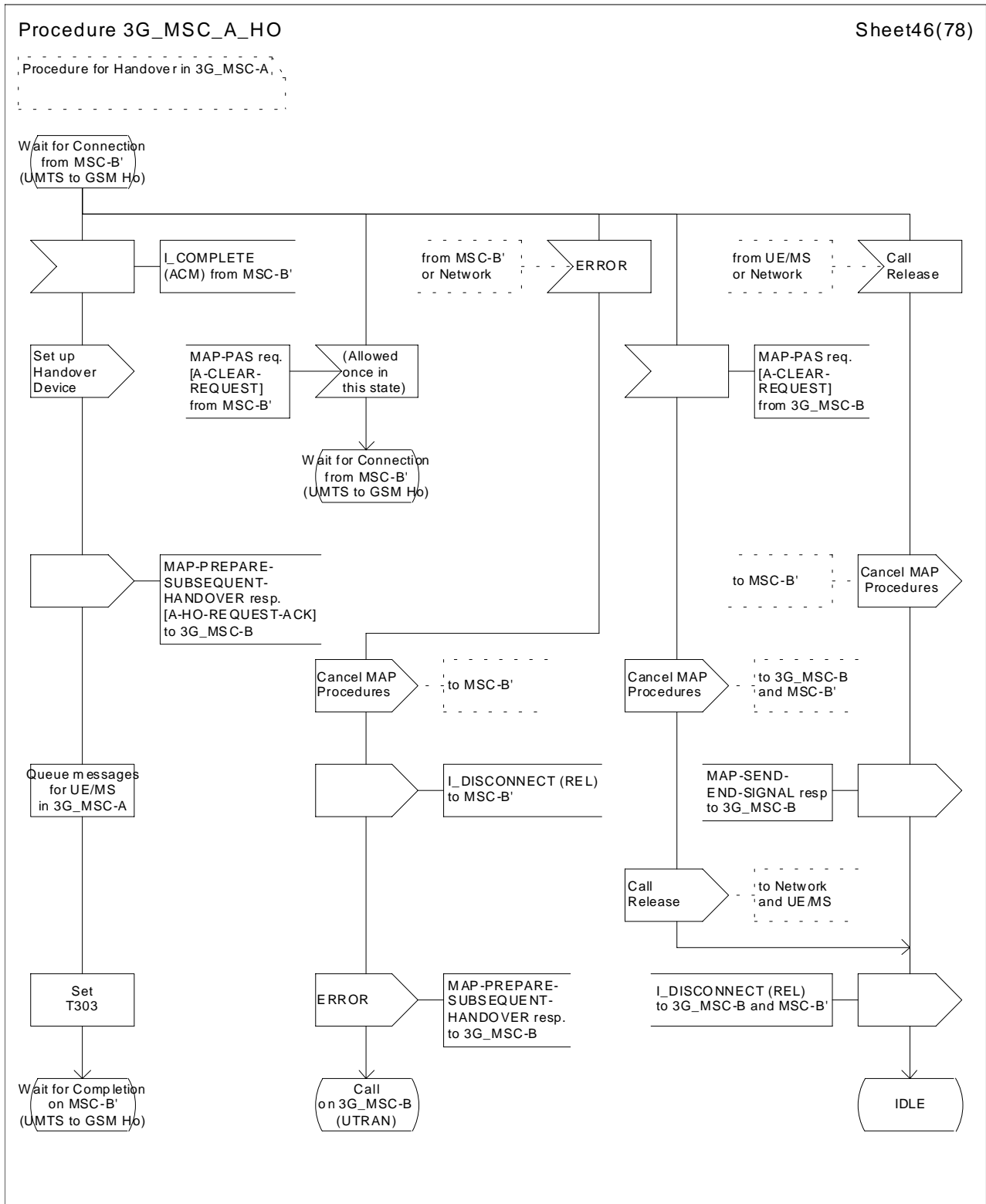

Figure 43 (sheet 46 of 78): Handover control procedure in 3G_MSC-A

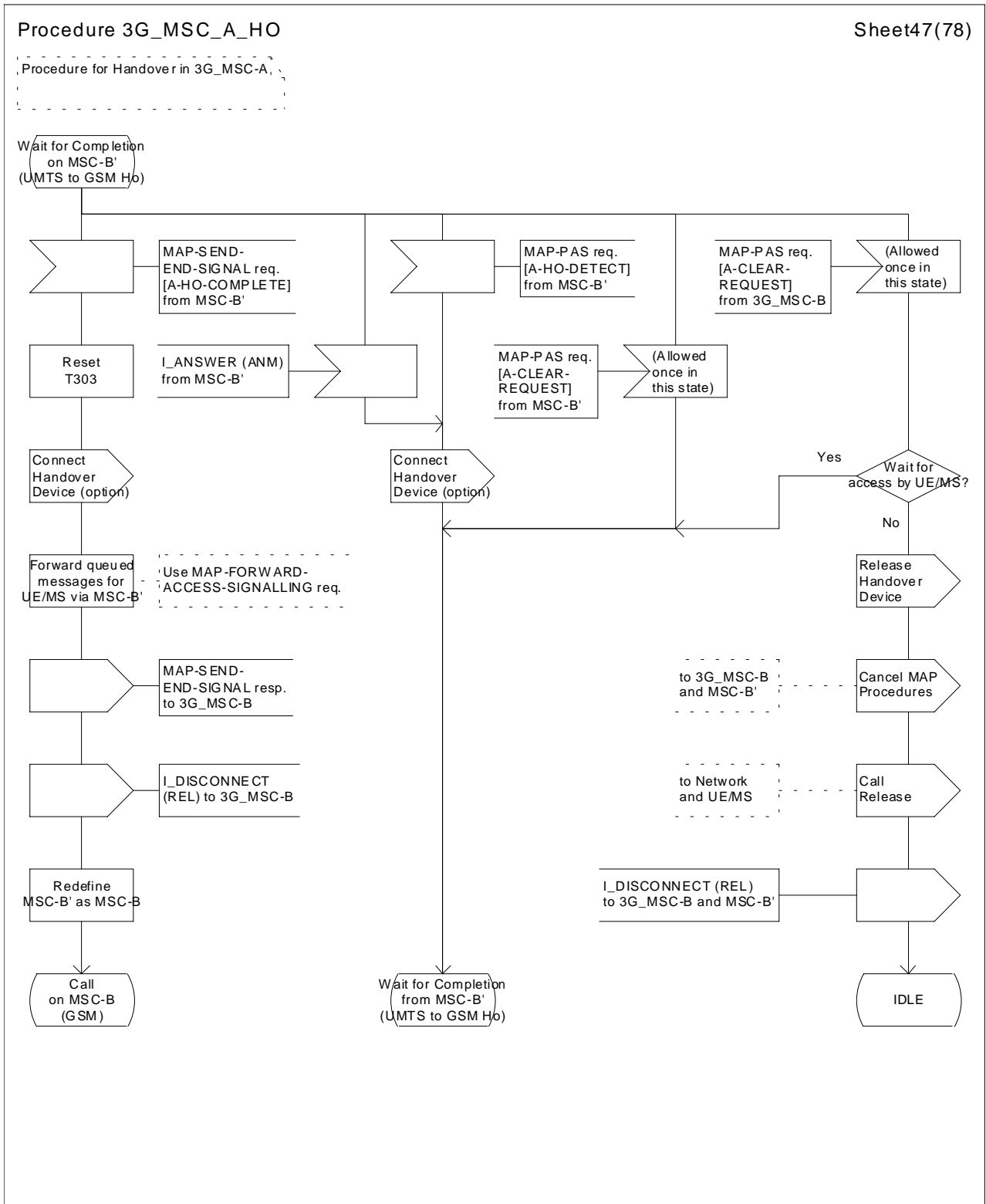

Figure 43 (sheet 47 of 78): Handover control procedure in 3G_MSC-A

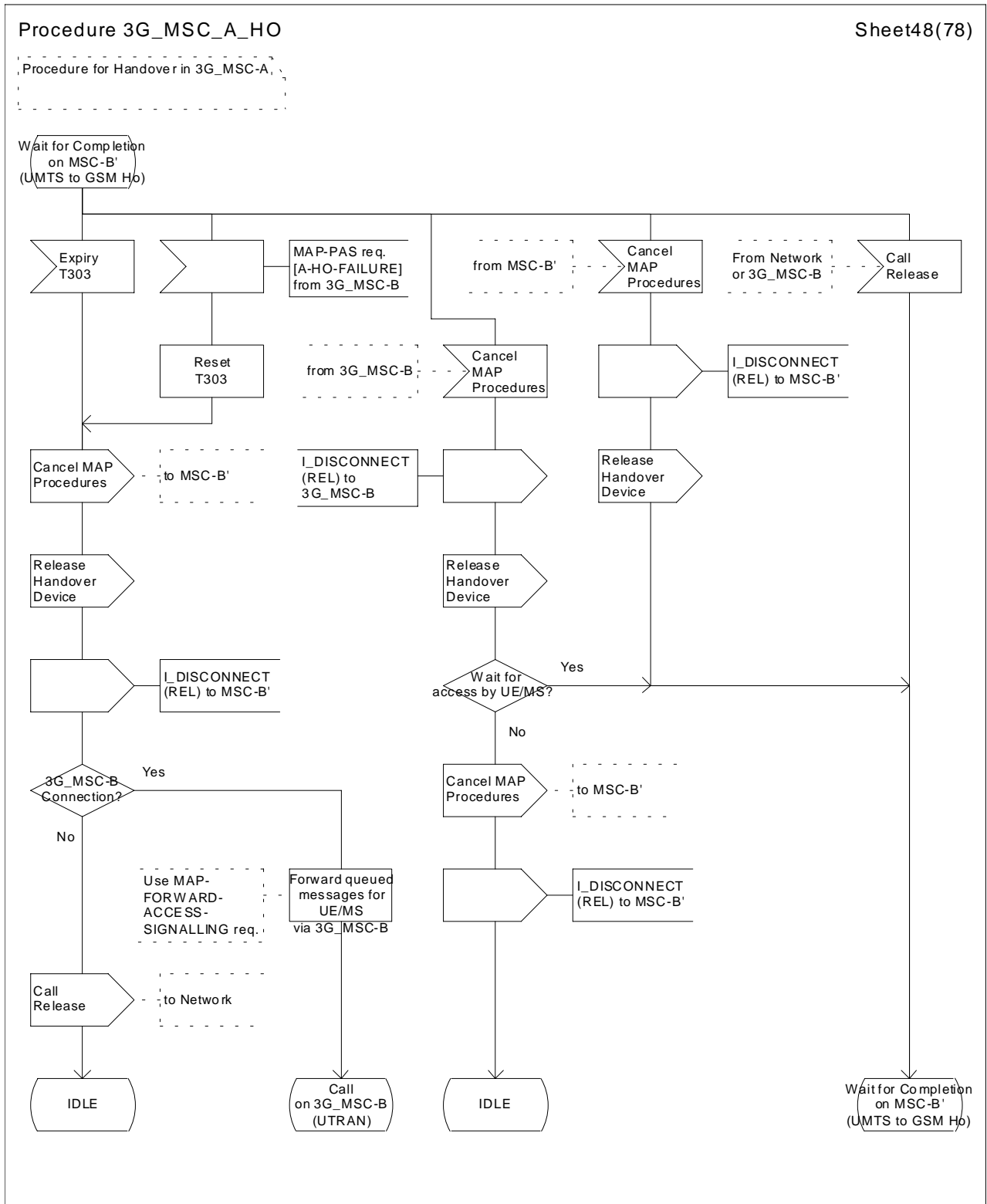

Figure 43 (sheet 48 of 78): Handover control procedure in 3G_MSC-A

Procedure 3G_MSC_A_HO

Sheet49(78)

Procedure for Handover in 3G_MSC-A

Basic UMTS to GSM Handover to MSC-B
no Circuit Connection required

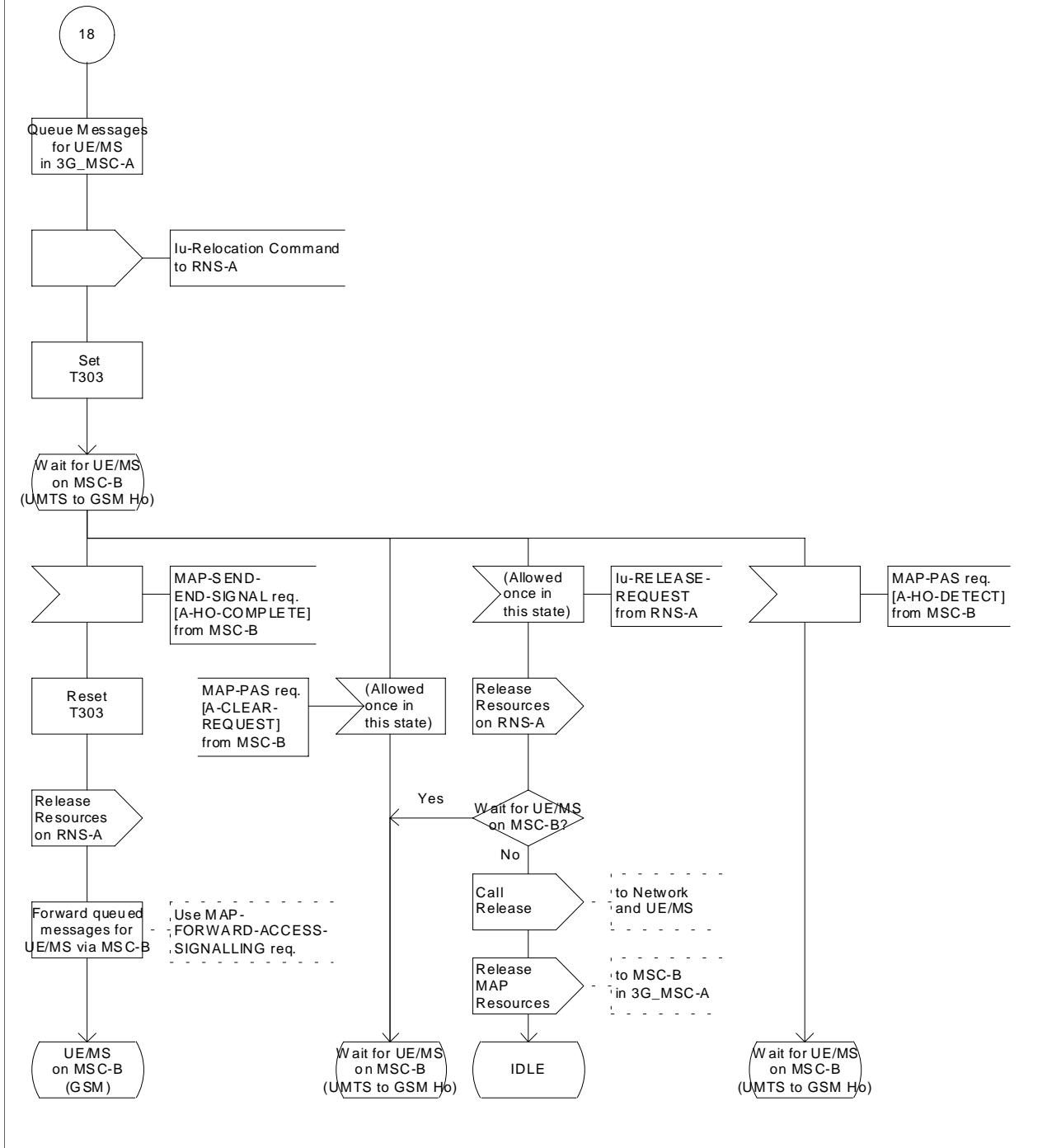

Figure 43 (sheet 49 of 78): Handover control procedure in 3G_MSC-A

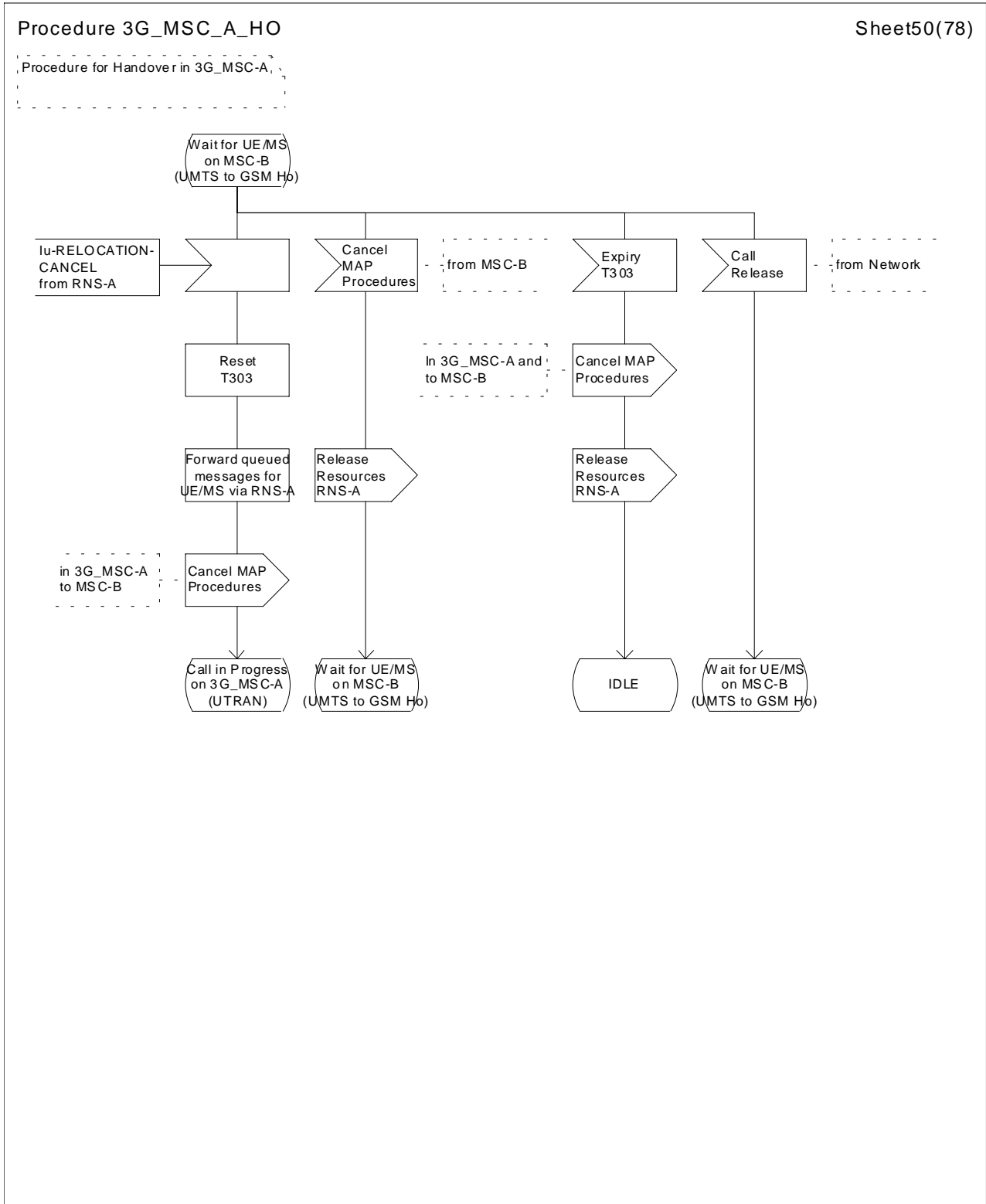

Figure 43 (sheet 50 of 78): Handover control procedure in 3G_MSC-A

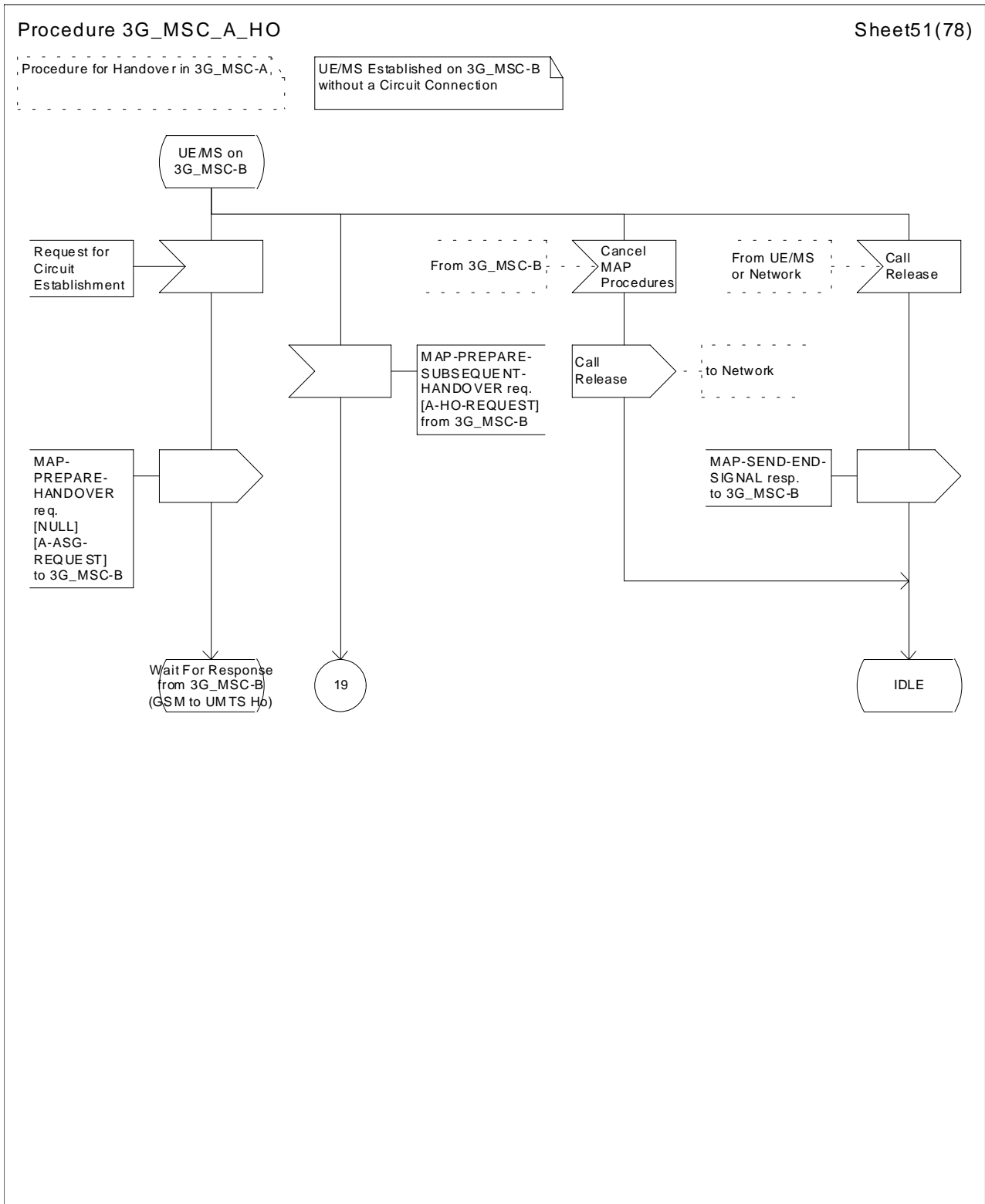

Figure 43 (sheet 51 of 78): Handover control procedure in 3G_MSC-A

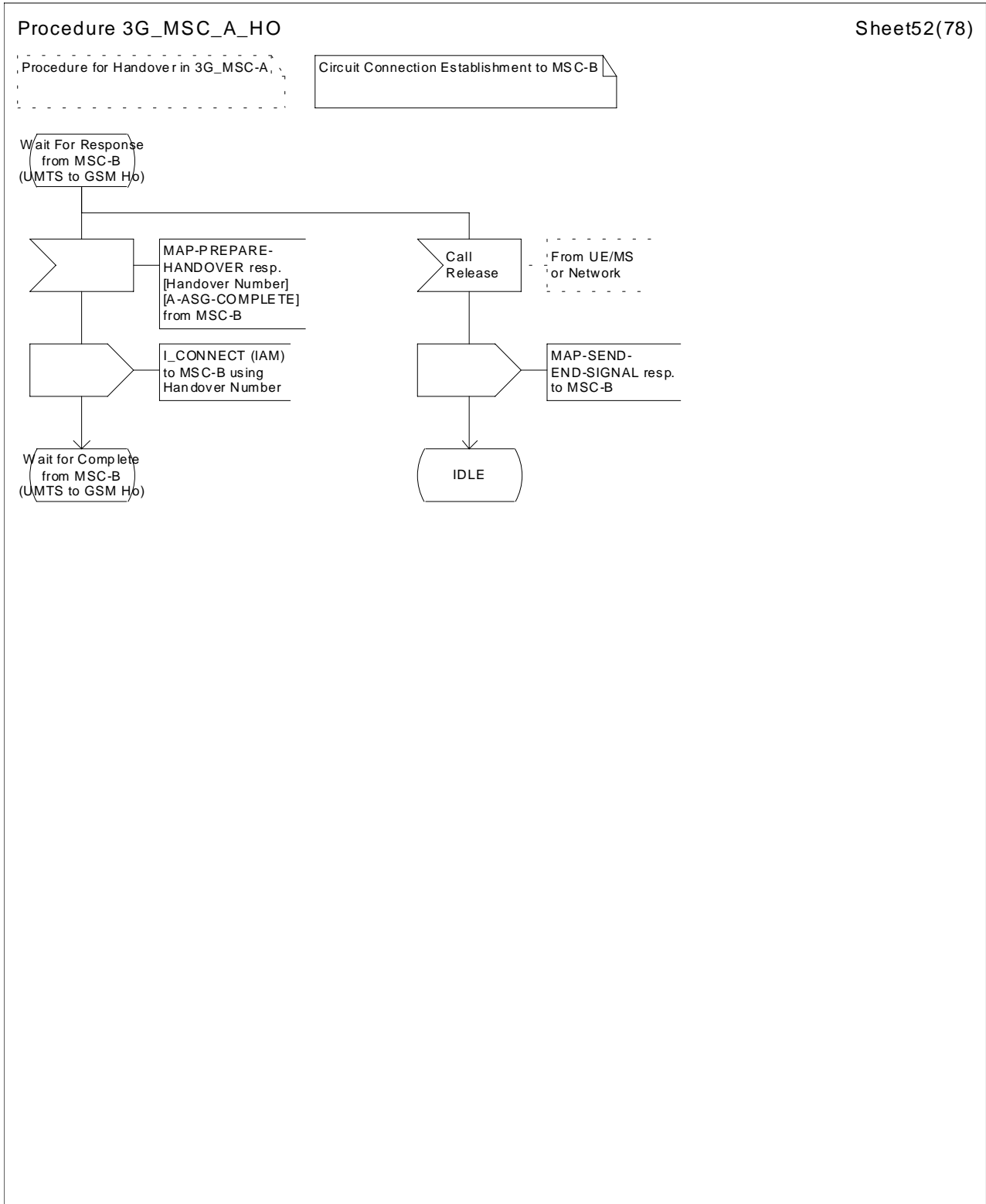

Figure 43 (sheet 52 of 78): Handover control procedure in 3G_MSC-A

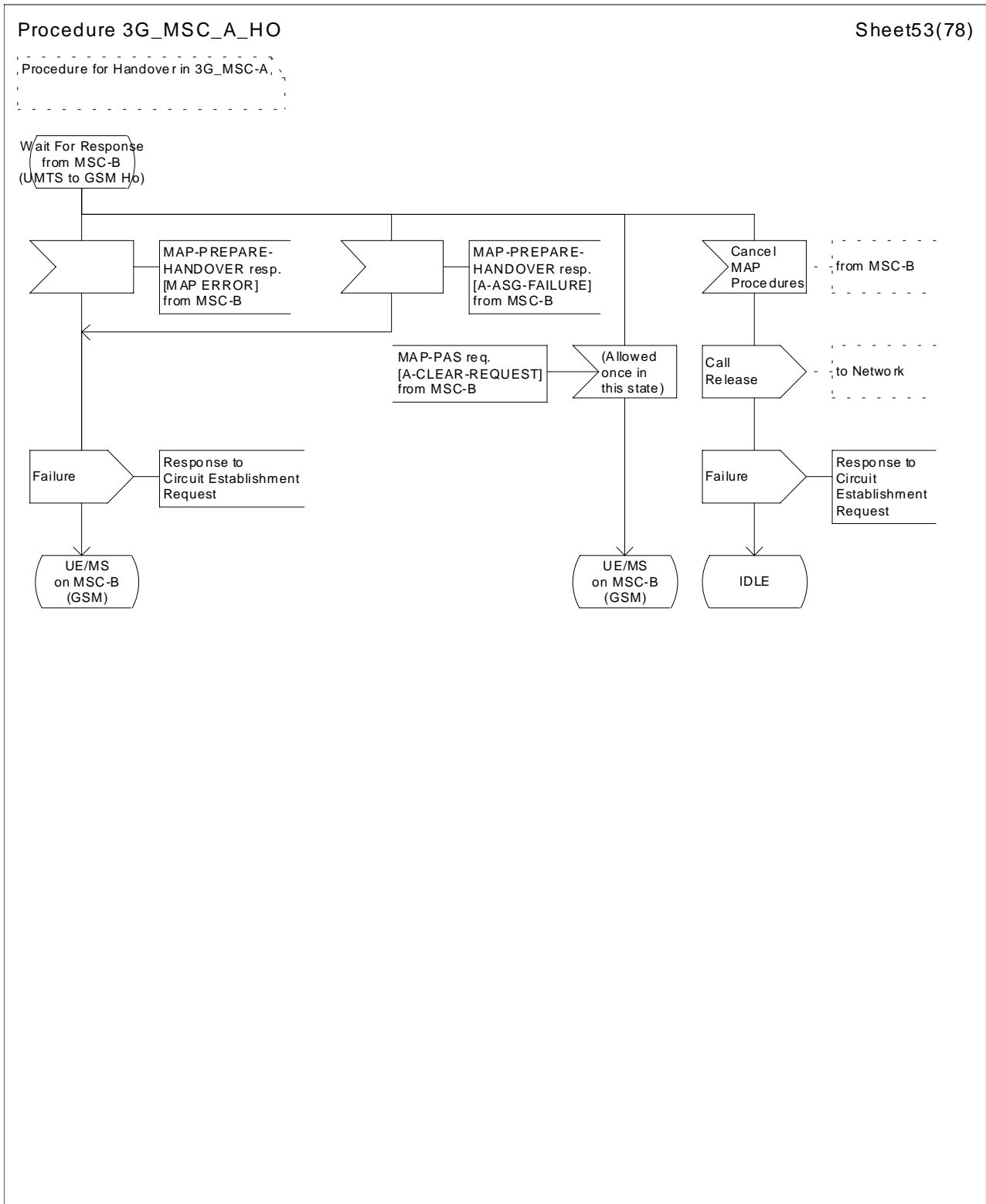

Figure 43 (sheet 53 of 78): Handover control procedure in 3G_MSC-A

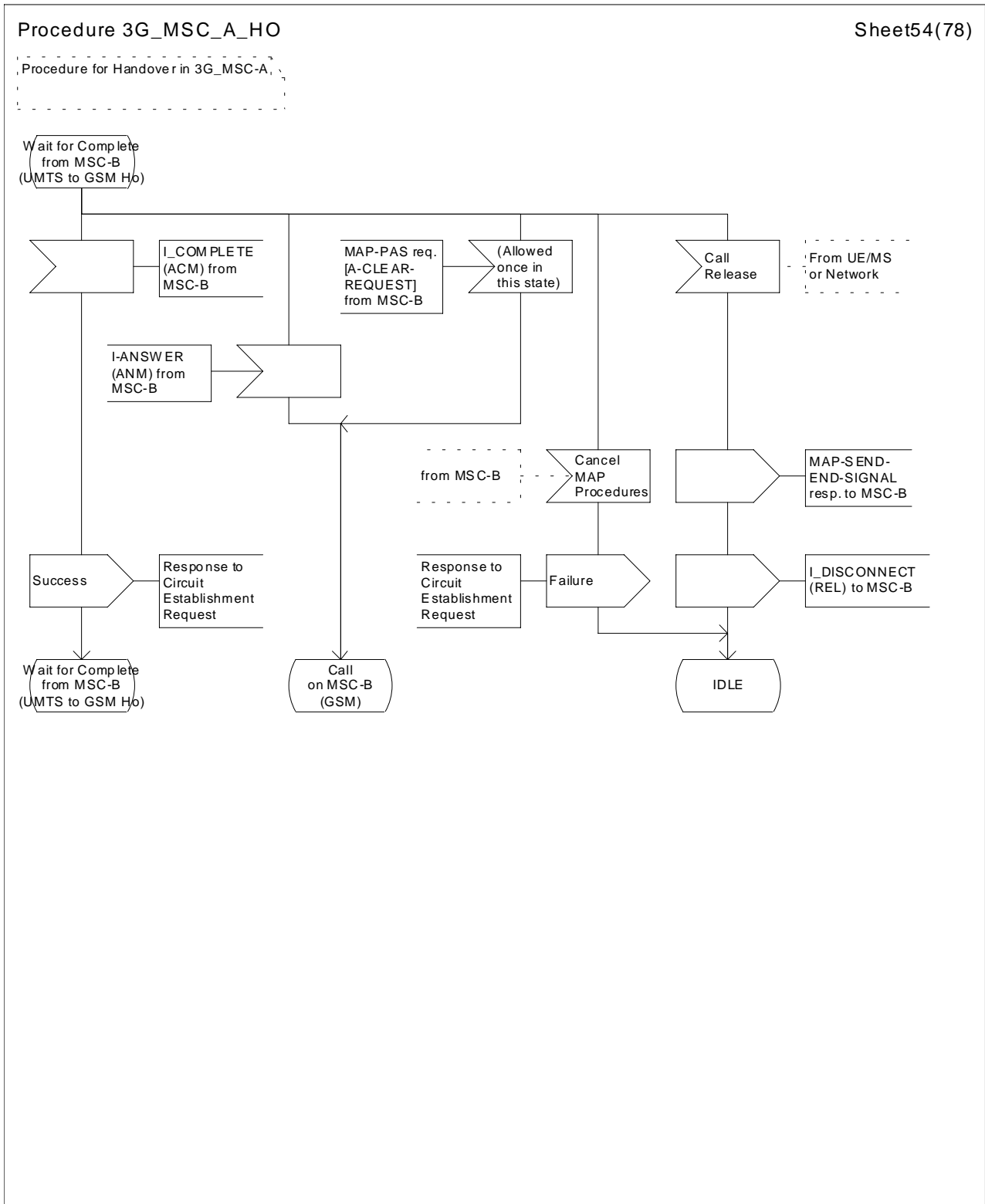

Figure 43 (sheet 54 of 78): Handover control procedure in 3G_MSC-A

Procedure 3G_MSC_A_HO

Sheet55(78)

Procedure for Handover in 3G_MSC-A

Subsequent UMTS to GSM Handover from 3G_MSC-B to MSC-B' no Circuit Connection required.

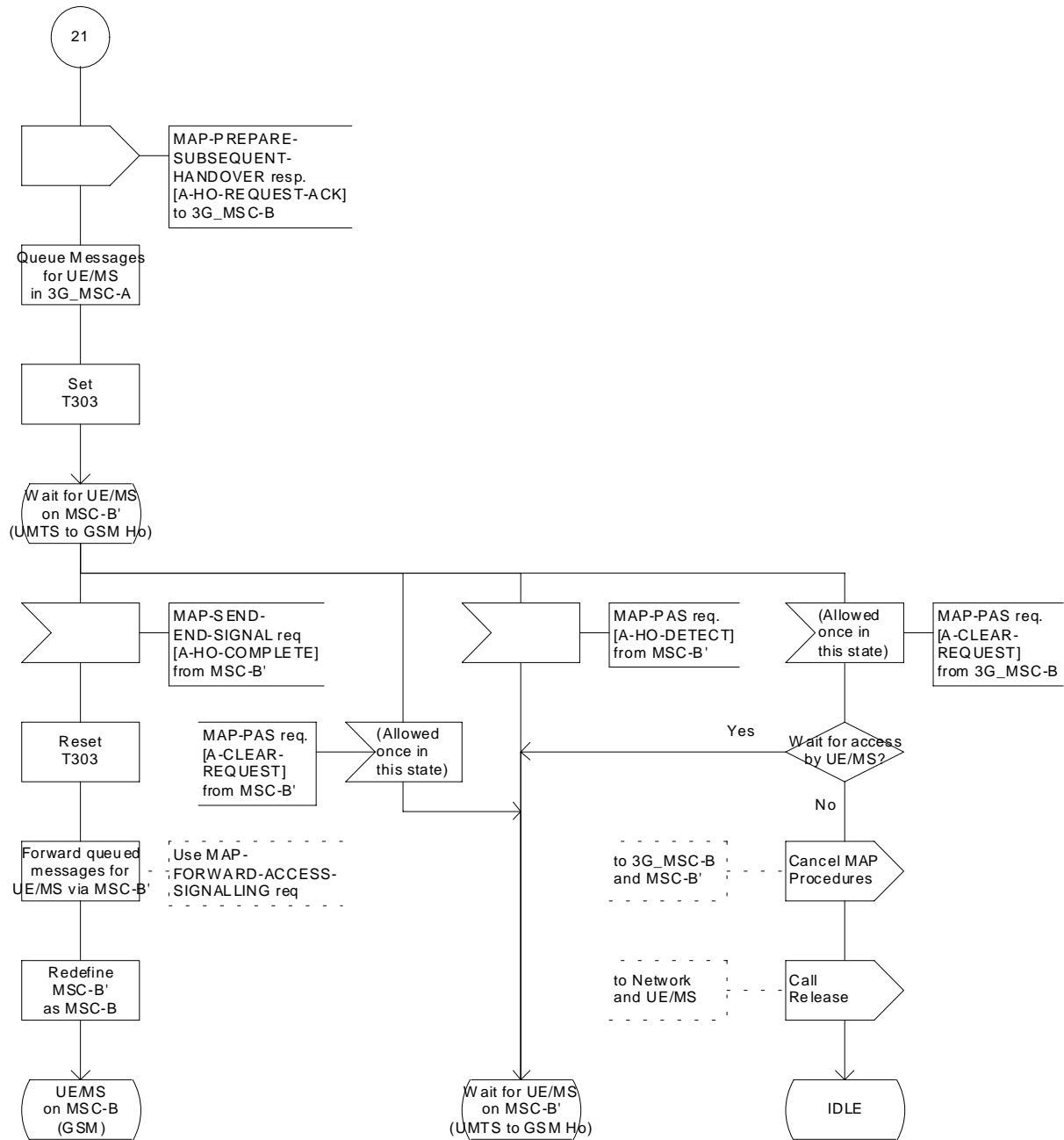

Figure 43 (sheet 55 of 78): Handover control procedure in 3G_MSC-A

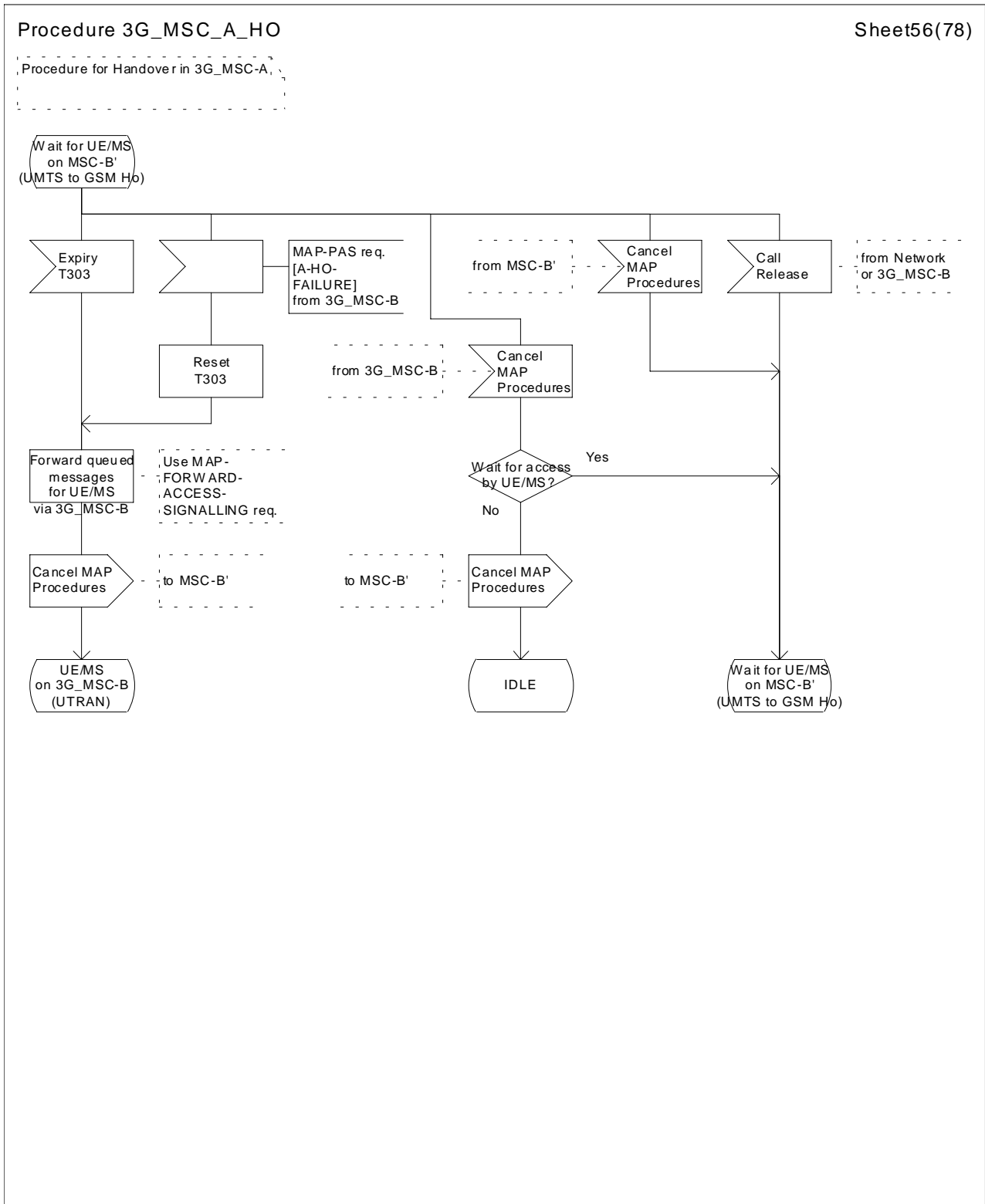

Figure 43 (sheet 56 of 78): Handover control procedure in 3G_MSC-A

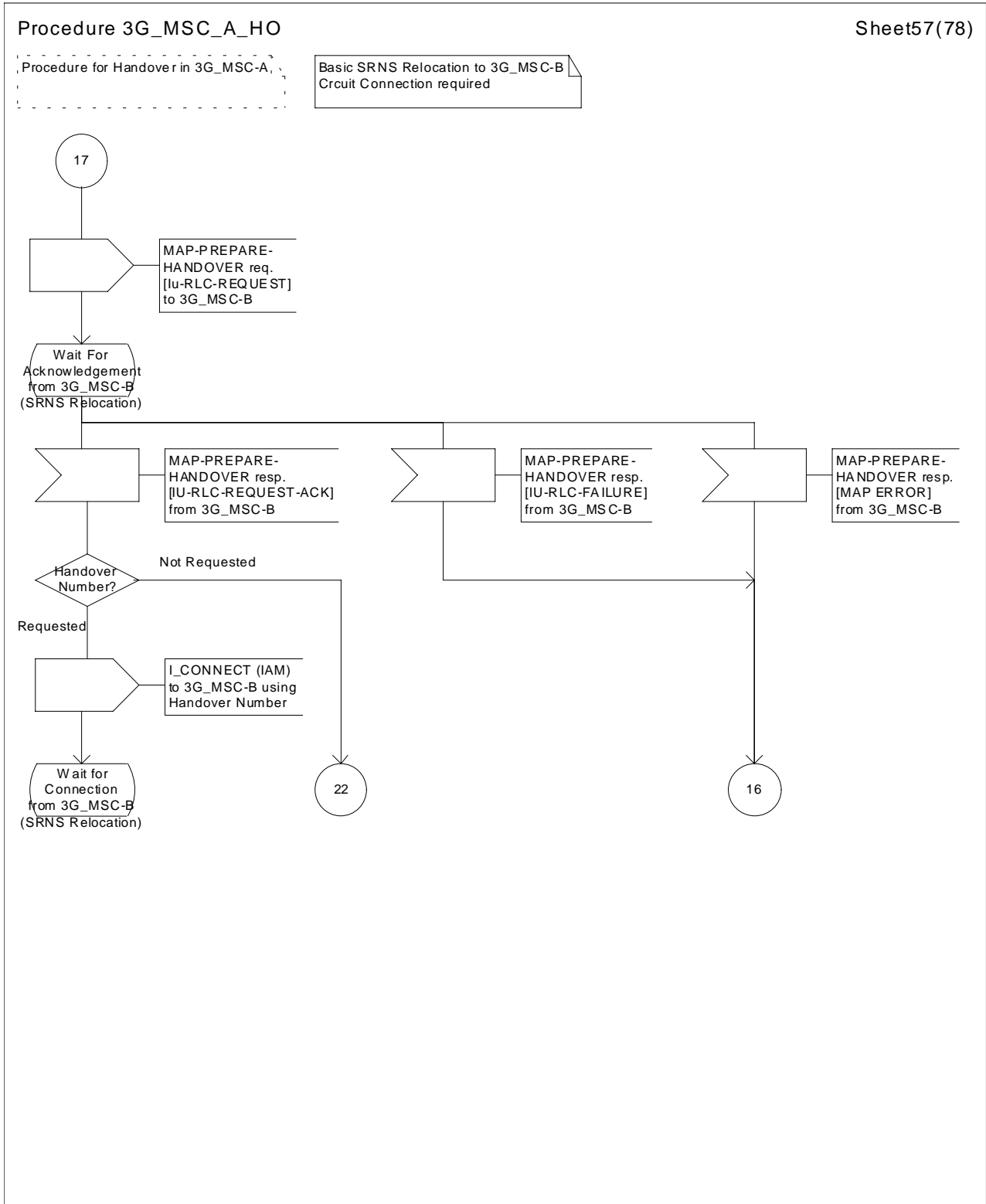

Figure 43 (sheet 57 of 78): Handover control procedure in 3G_MSC-A

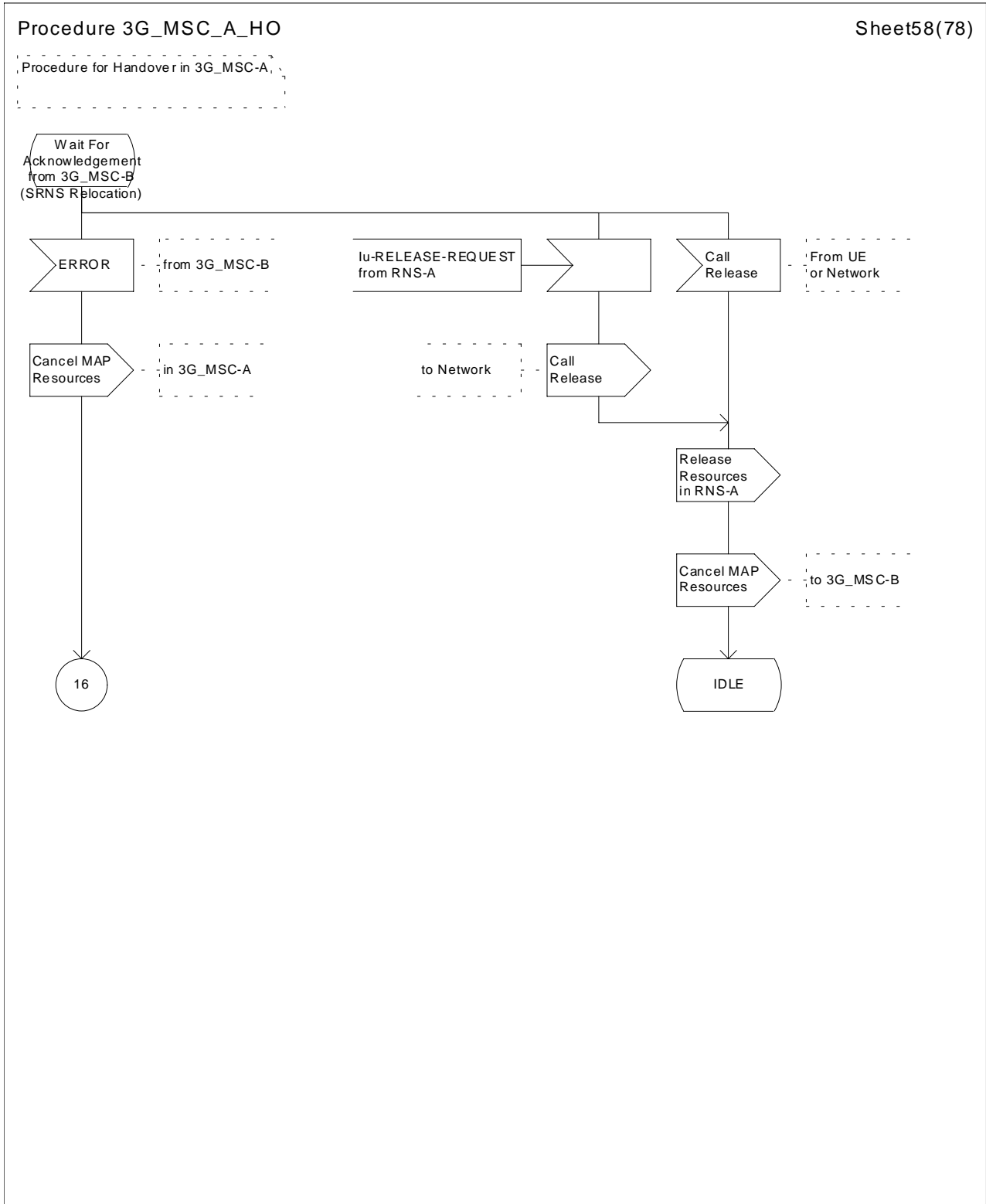

Figure 43 (sheet 58 of 78): Handover control procedure in 3G_MSC-A

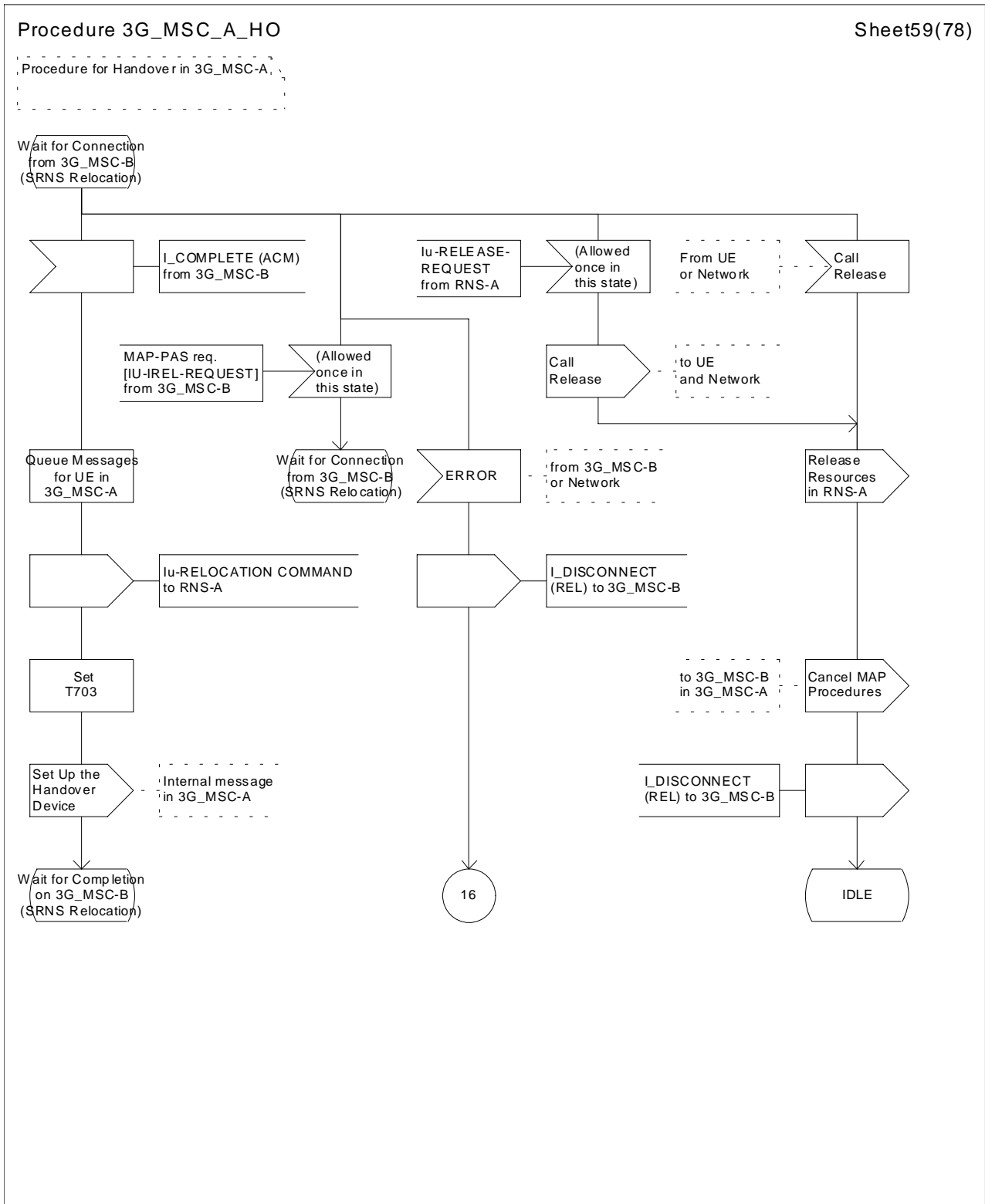
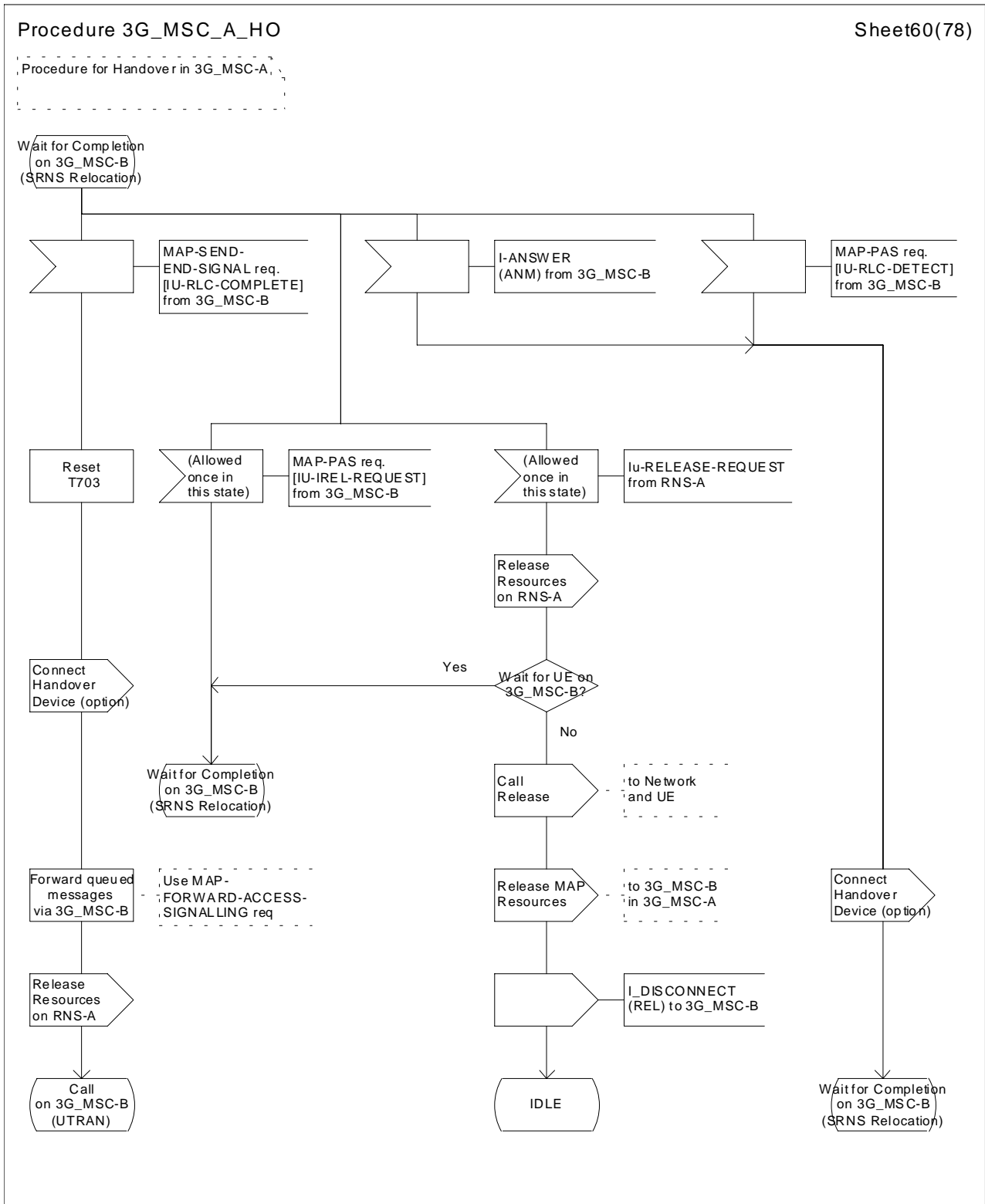

Figure 43 (sheet 59 of 78): Handover control procedure in 3G_MSC-A



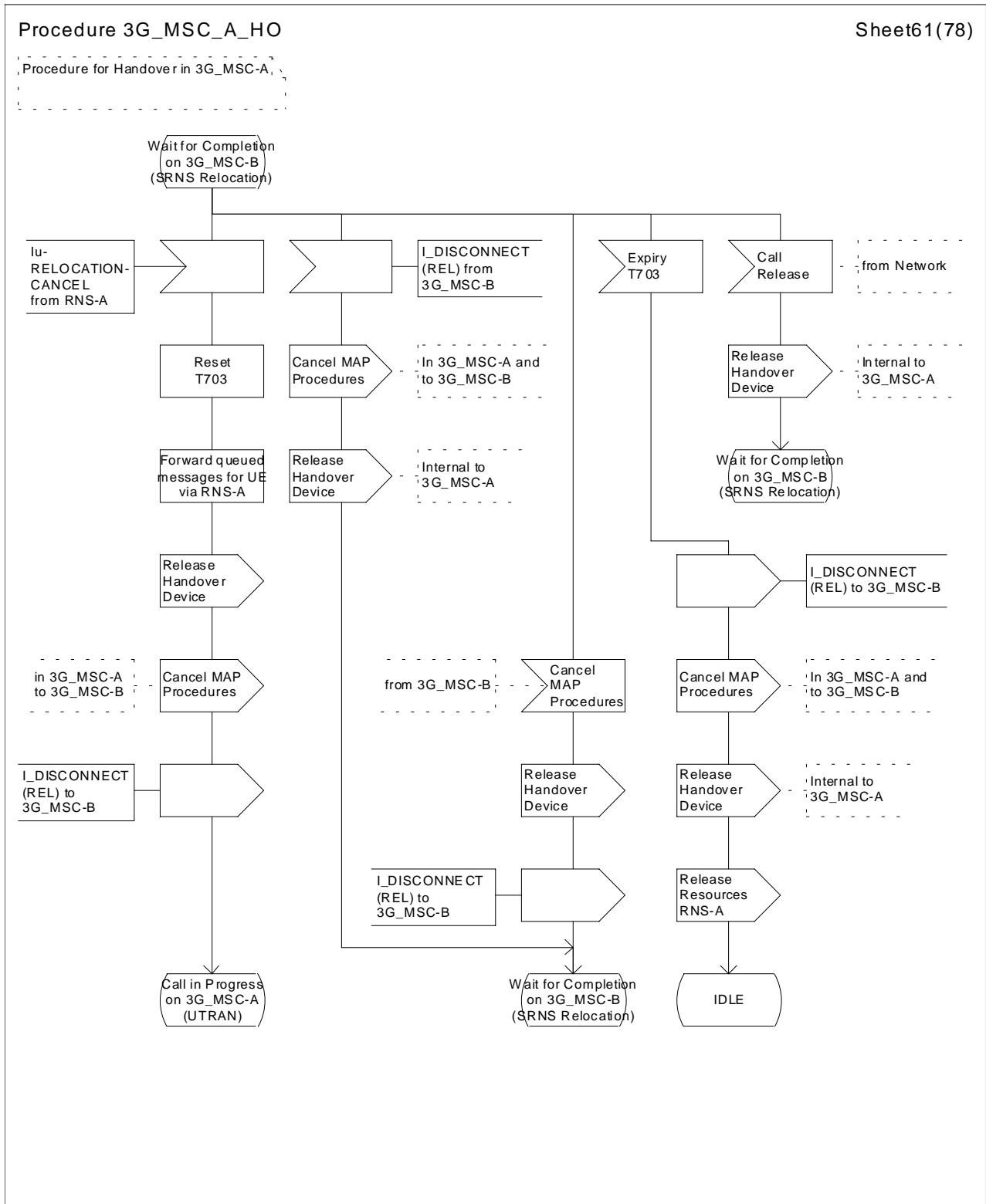

Figure 43 (sheet 61 of 78): Handover control procedure in 3G_MSC-A

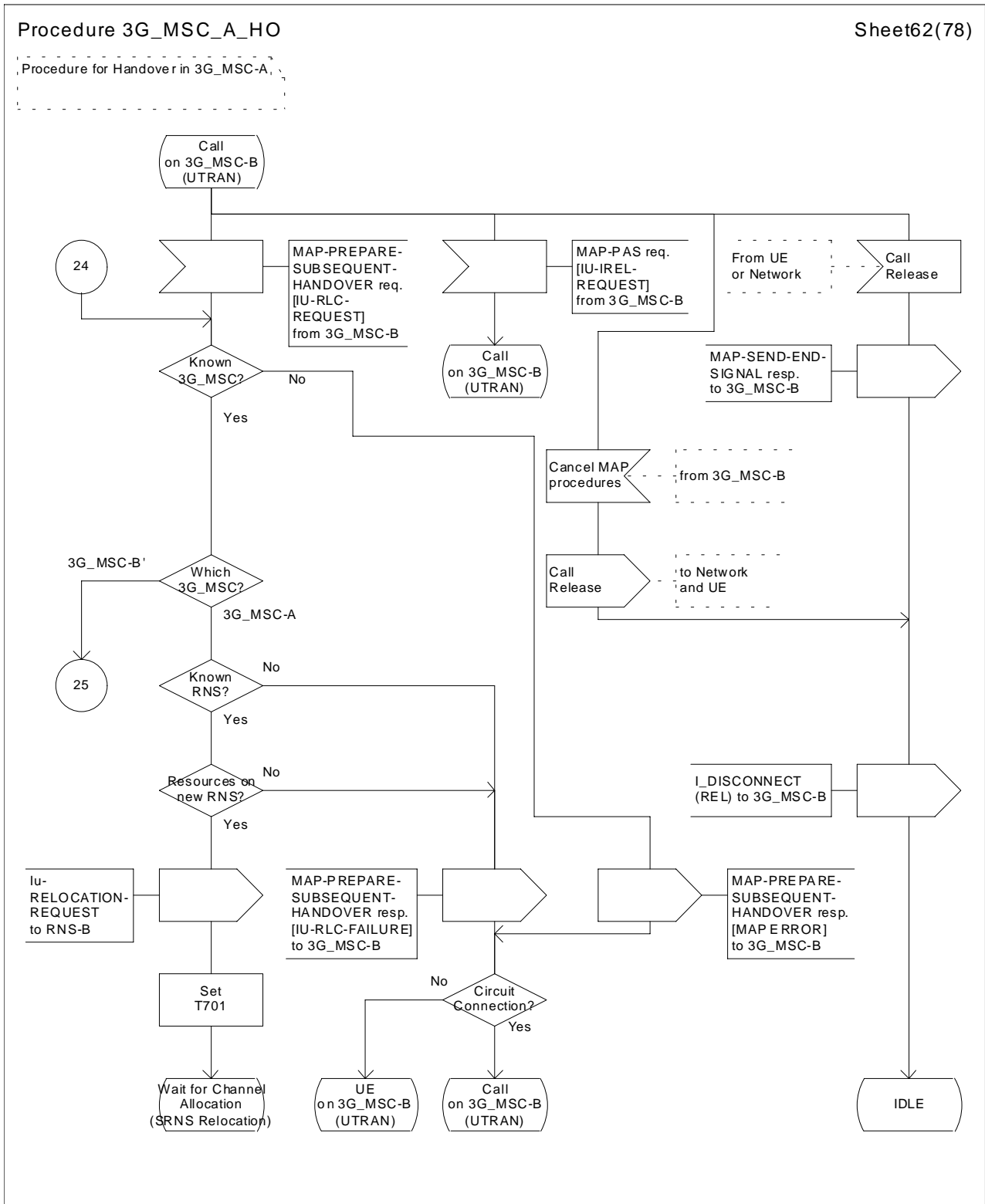

Figure 43 (sheet 62 of 78): Handover control procedure in 3G_MSC-A

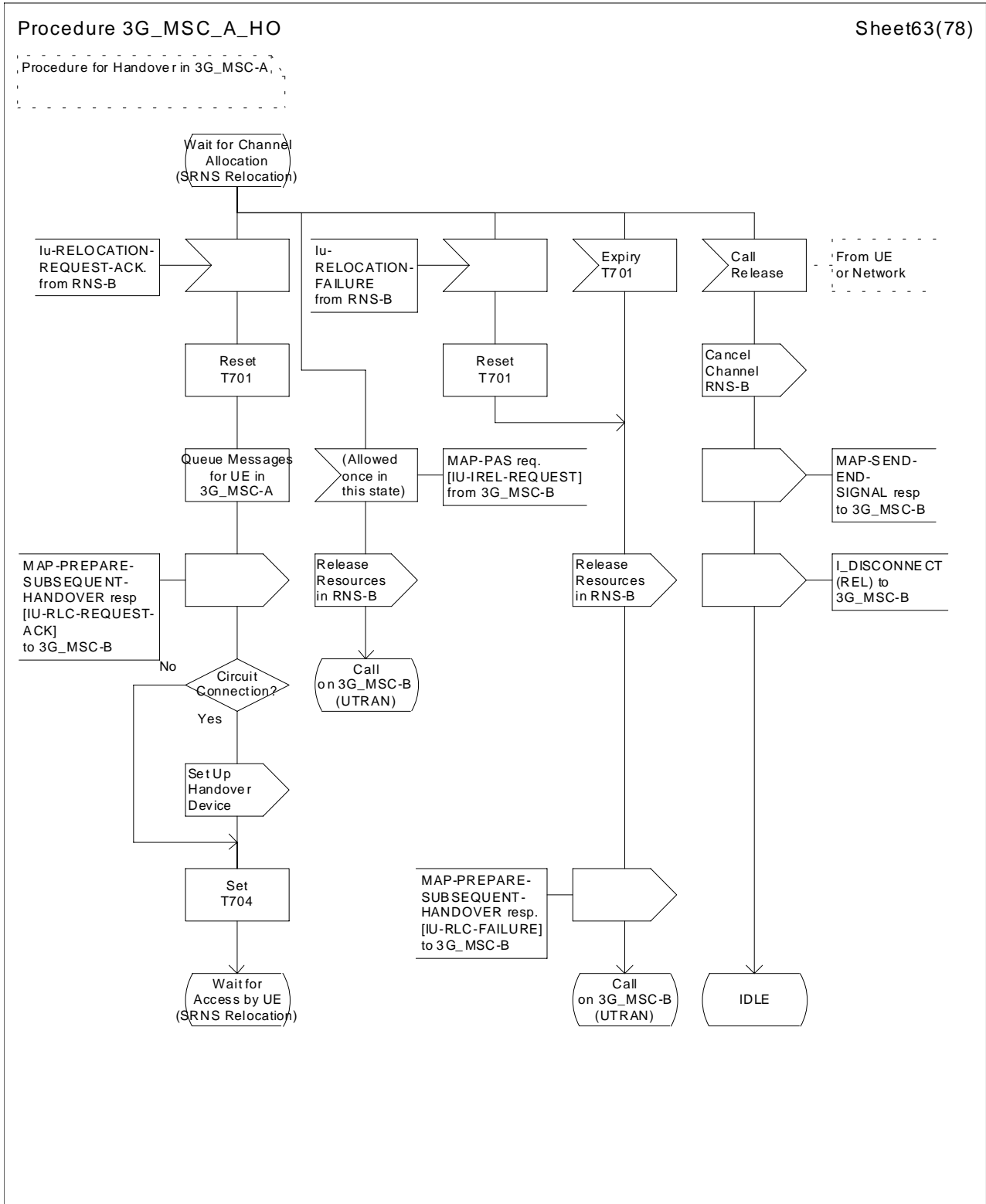

Figure 43 (sheet 63 of 78): Handover control procedure in 3G_MSC-A

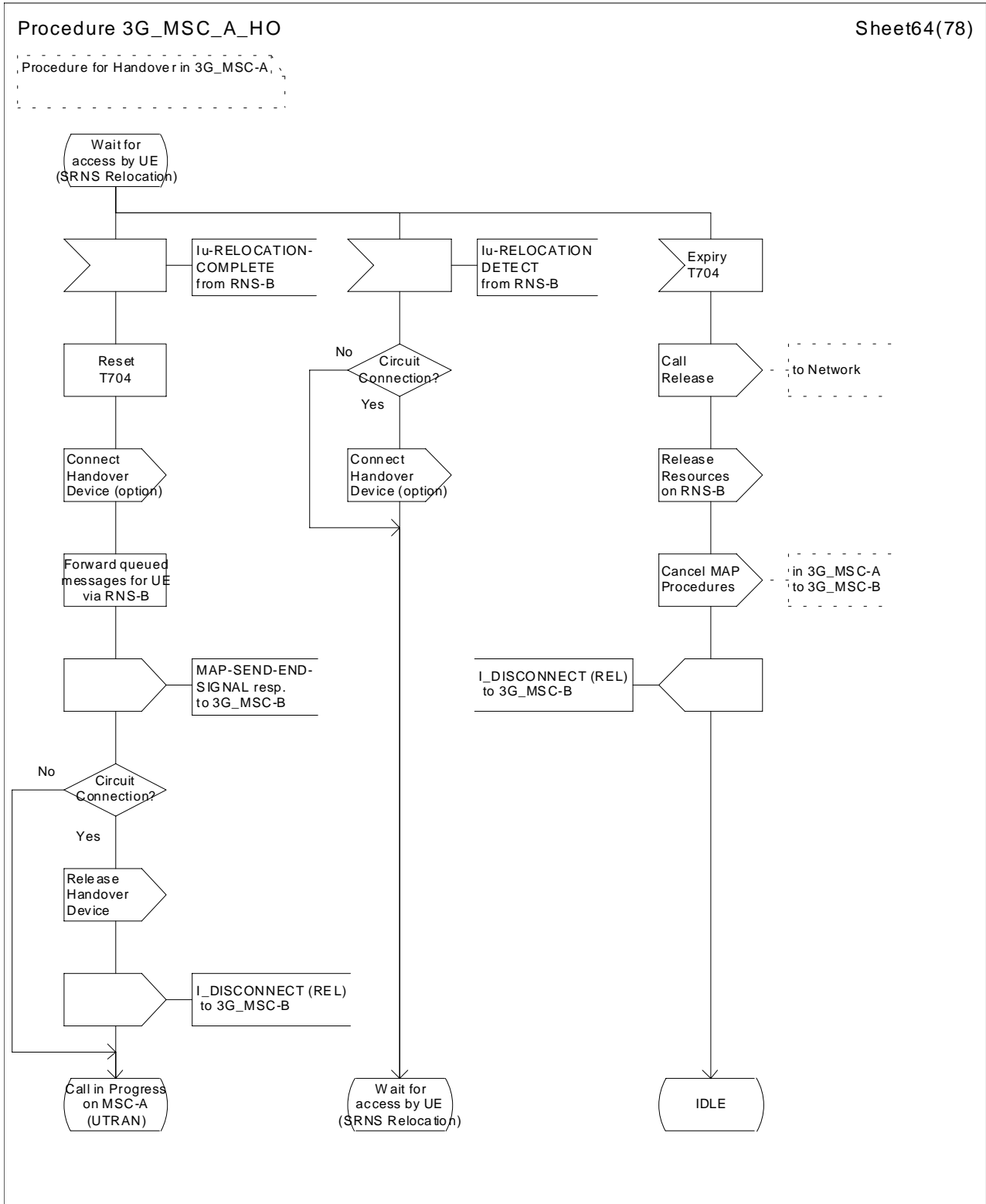

Figure 43 (sheet 64 of 78): Handover control procedure in 3G_MSC-A

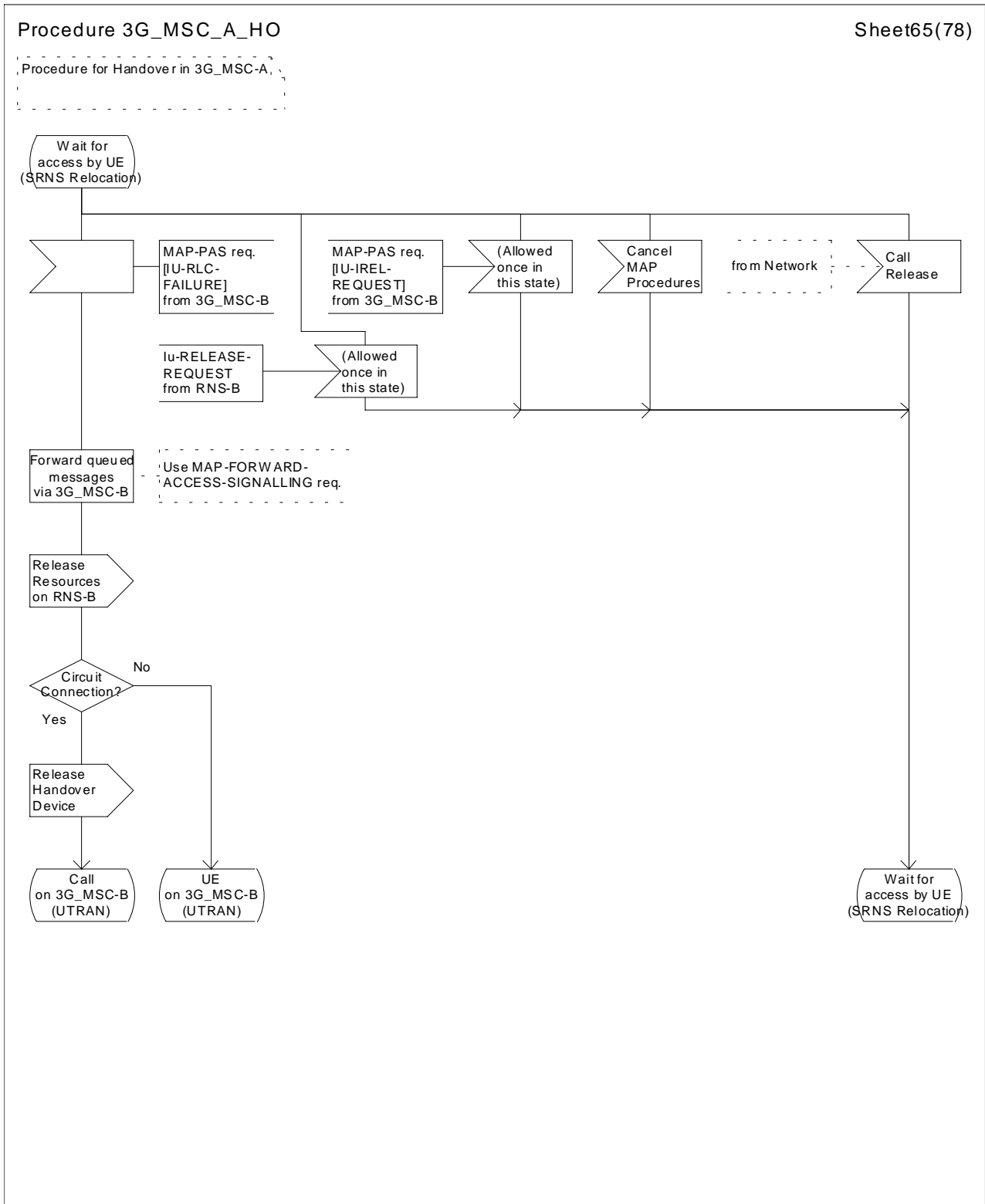
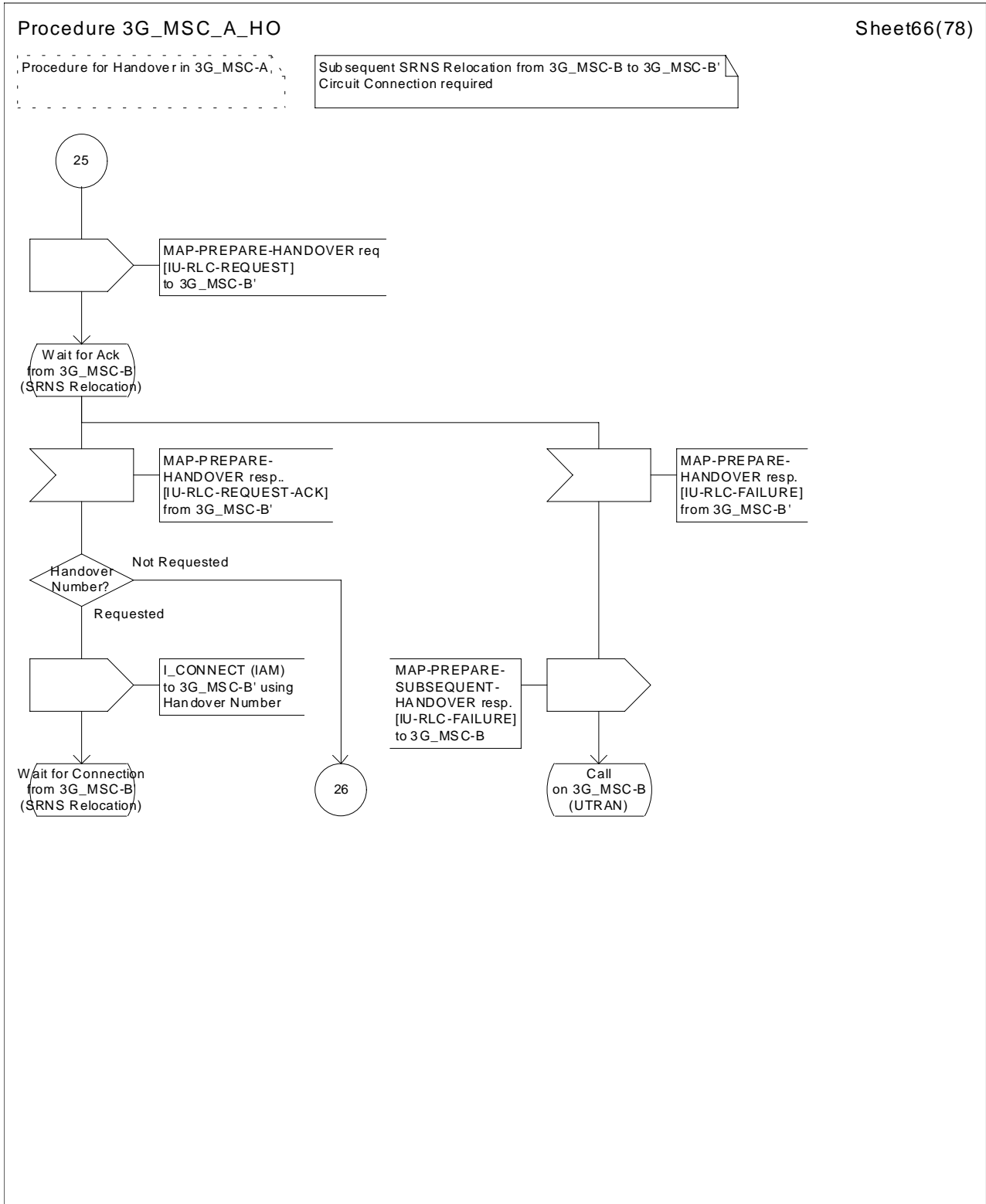

Figure 43 (sheet 65 of 78): Handover control procedure in 3G_MSC-A



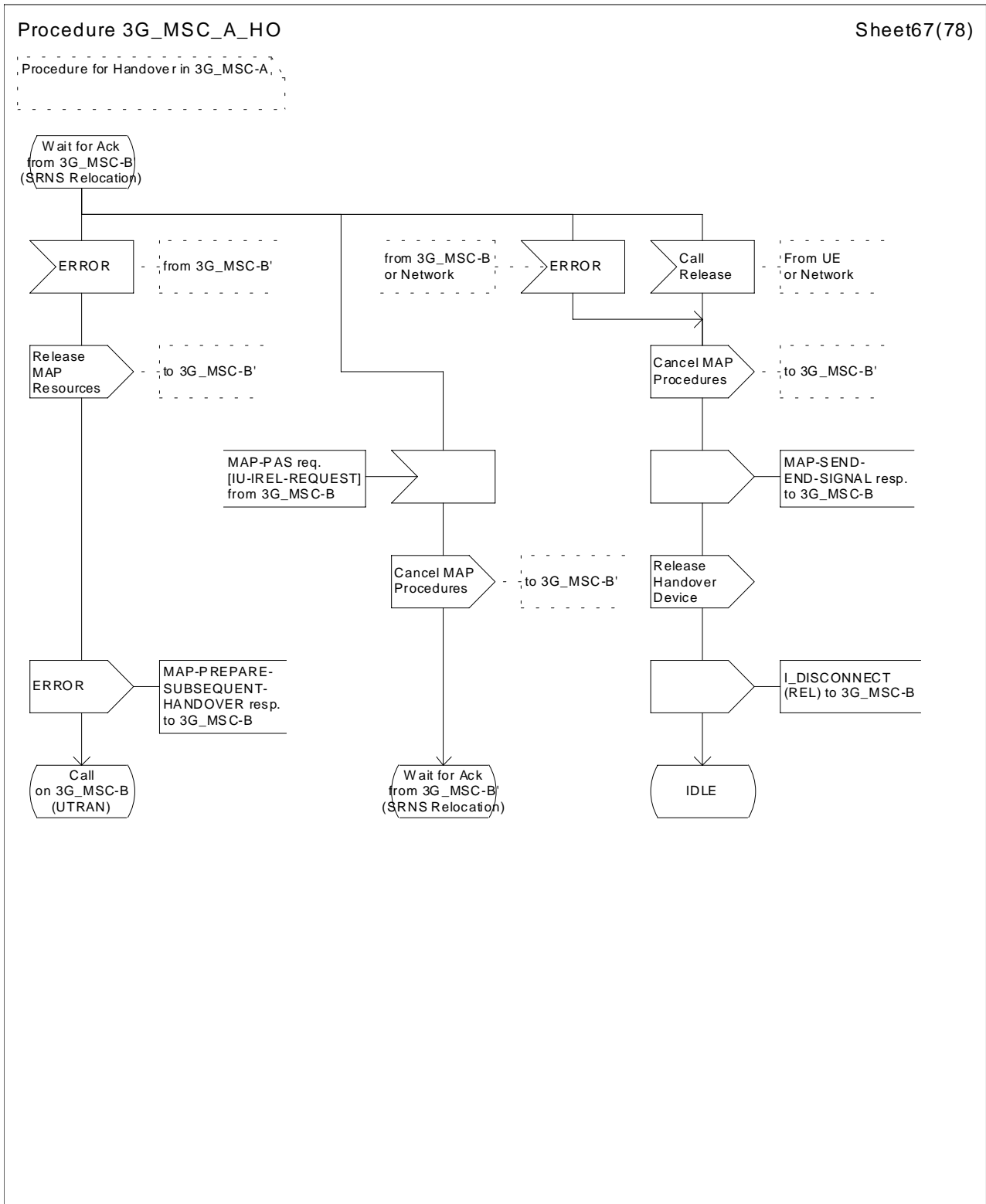

Figure 43 (sheet 67 of 78): Handover control procedure in 3G_MSC-A

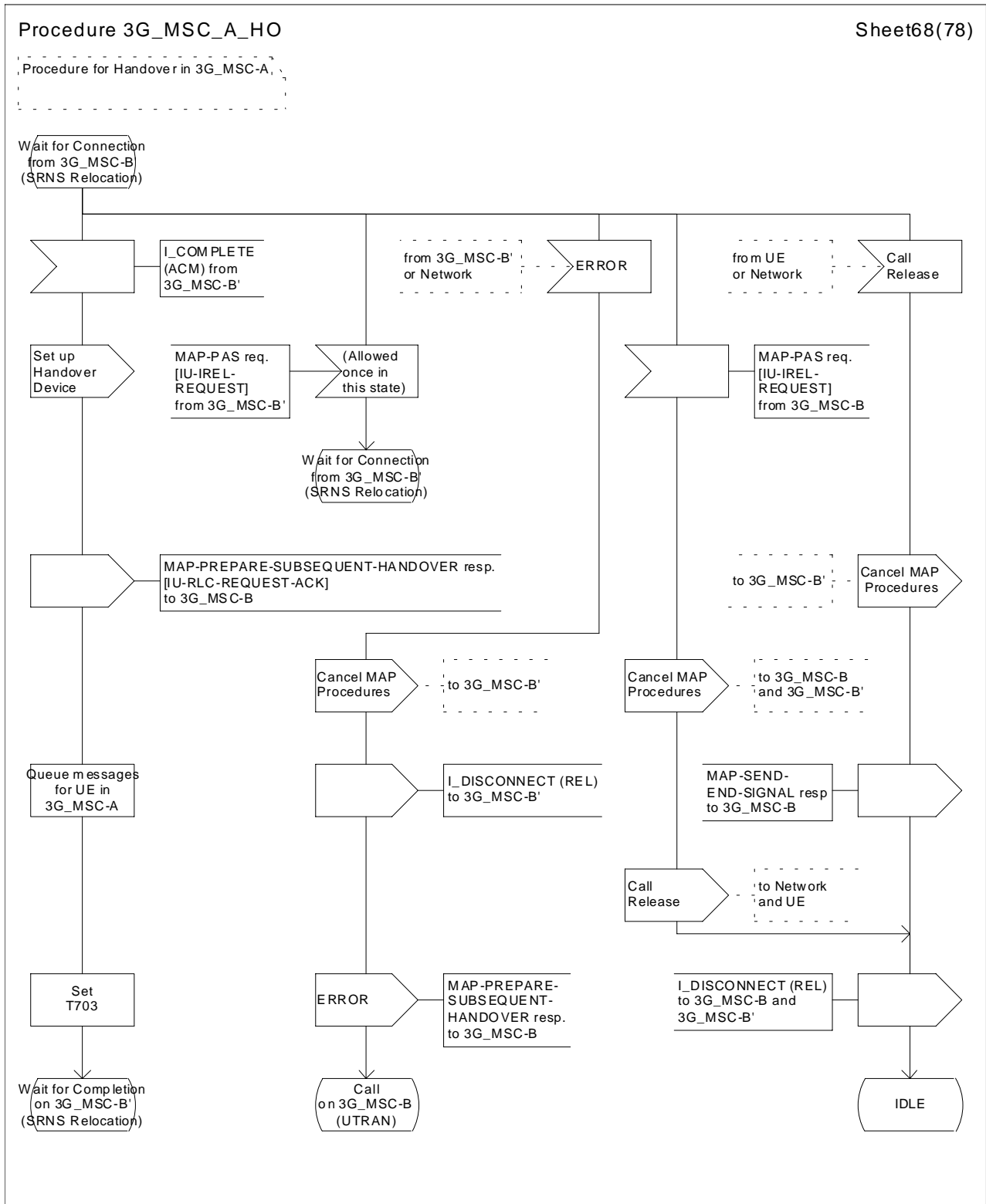

Figure 43 (sheet 68 of 78): Handover control procedure in 3G_MSC-A

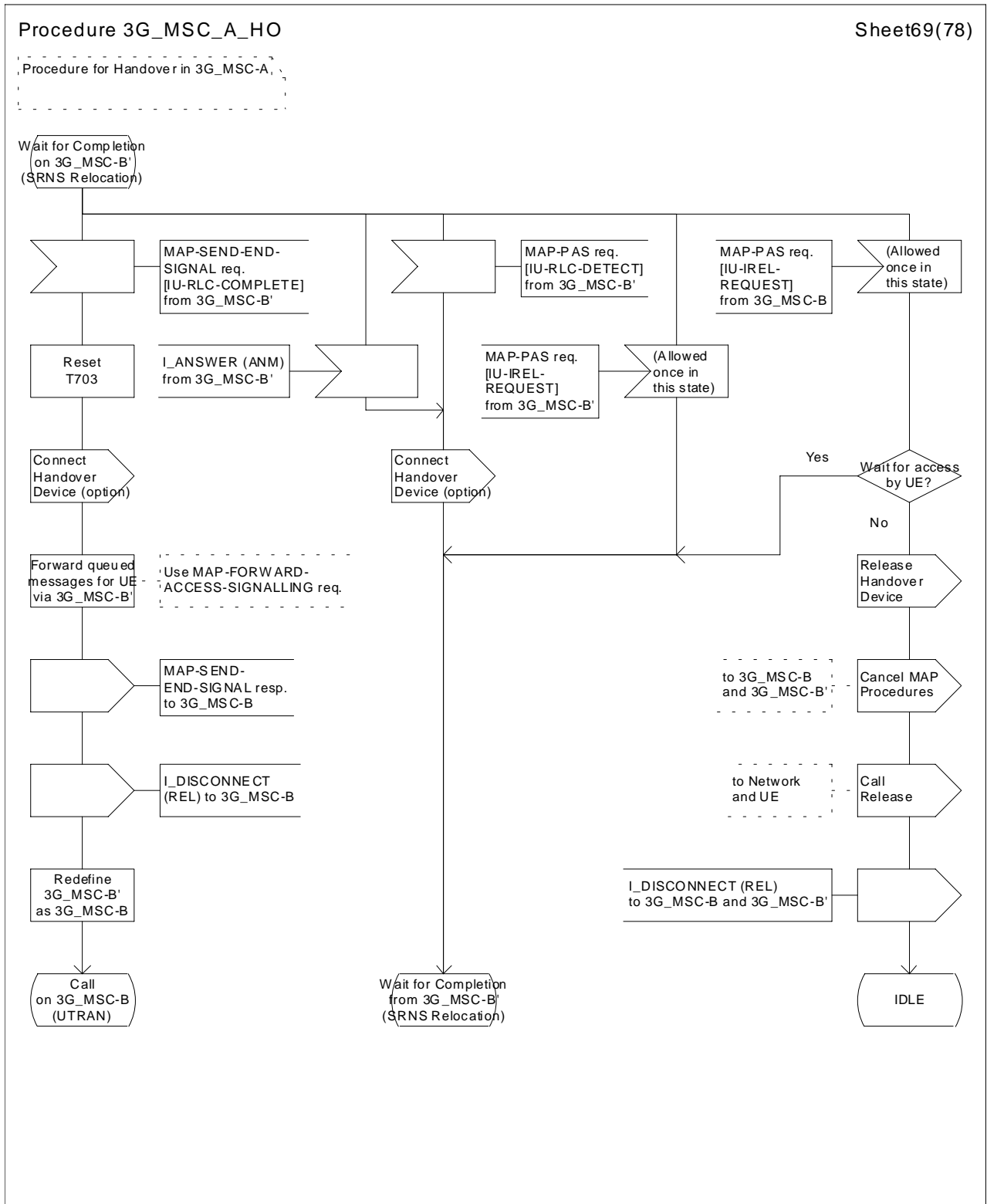

Figure 43 (sheet 69 of 78): Handover control procedure in 3G_MSC-A

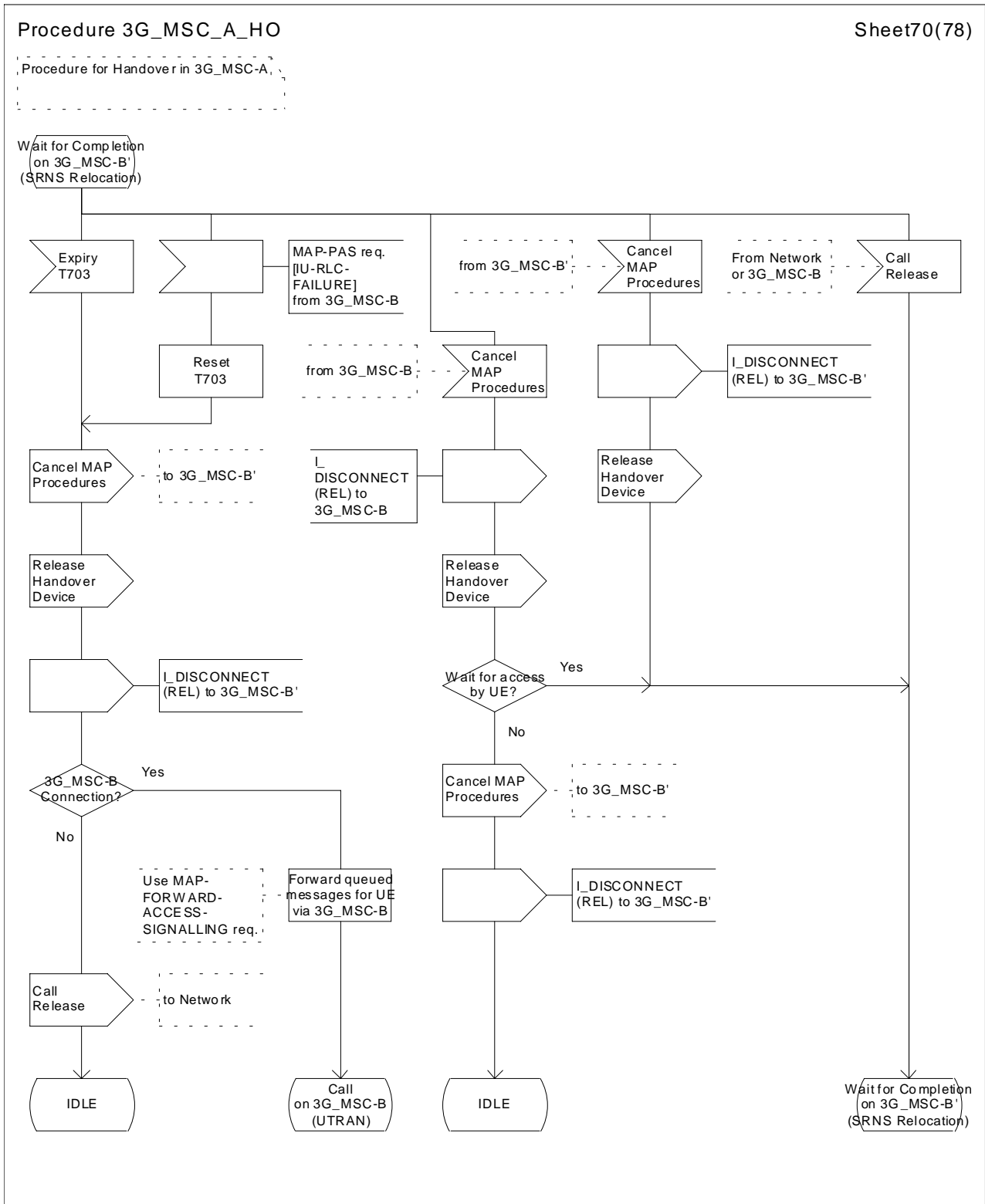

Figure 43 (sheet 70 of 78): Handover control procedure in 3G_MSC-A

Procedure 3G_MSC_A_HO

Sheet71(78)

Procedure for Handover in 3G_MSC-A

Basic SRNS Relocation to 3G_MSC-B
no Circuit Connection required

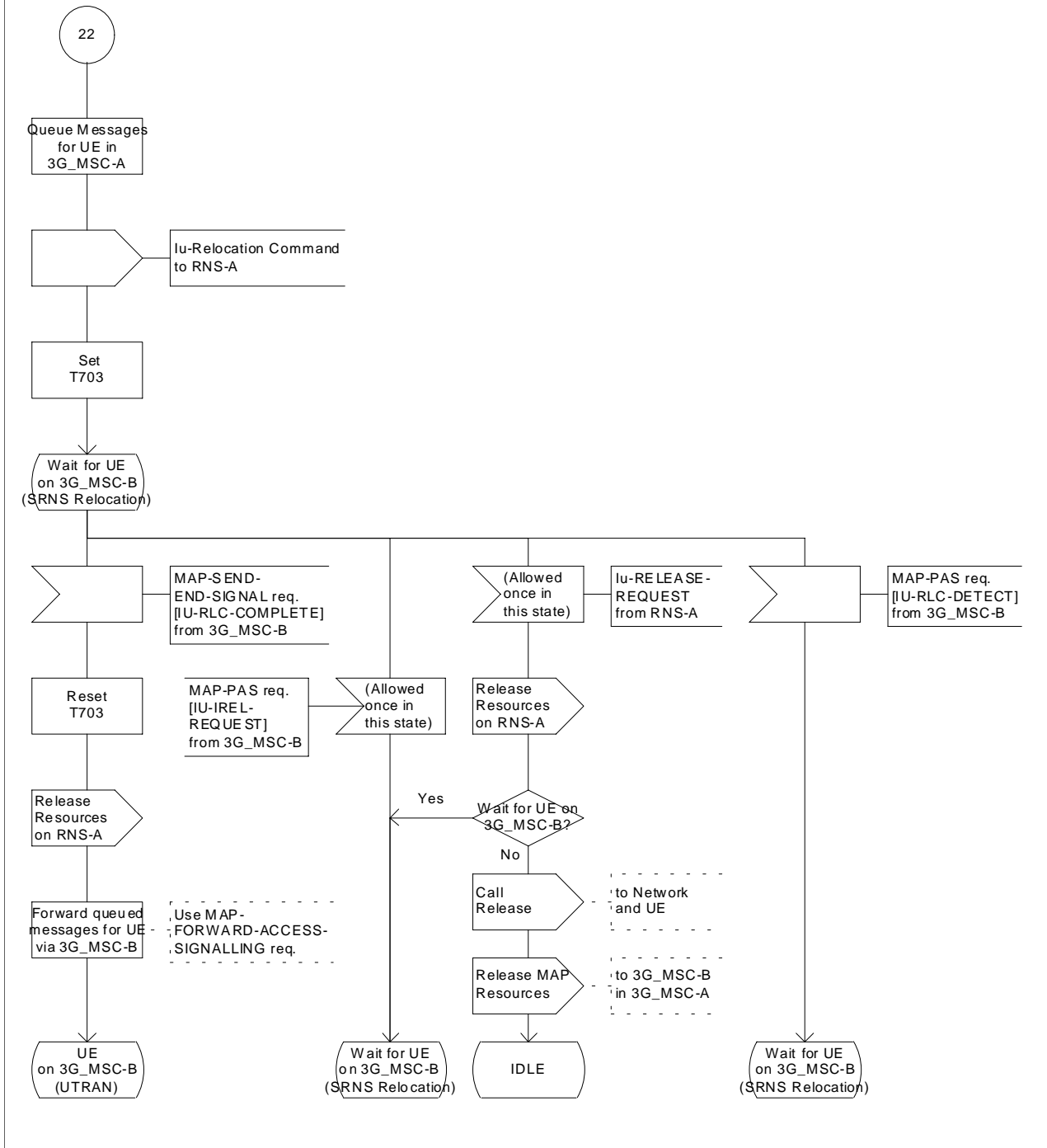

Figure 43 (sheet 71 of 78): Handover control procedure in 3G_MSC-A

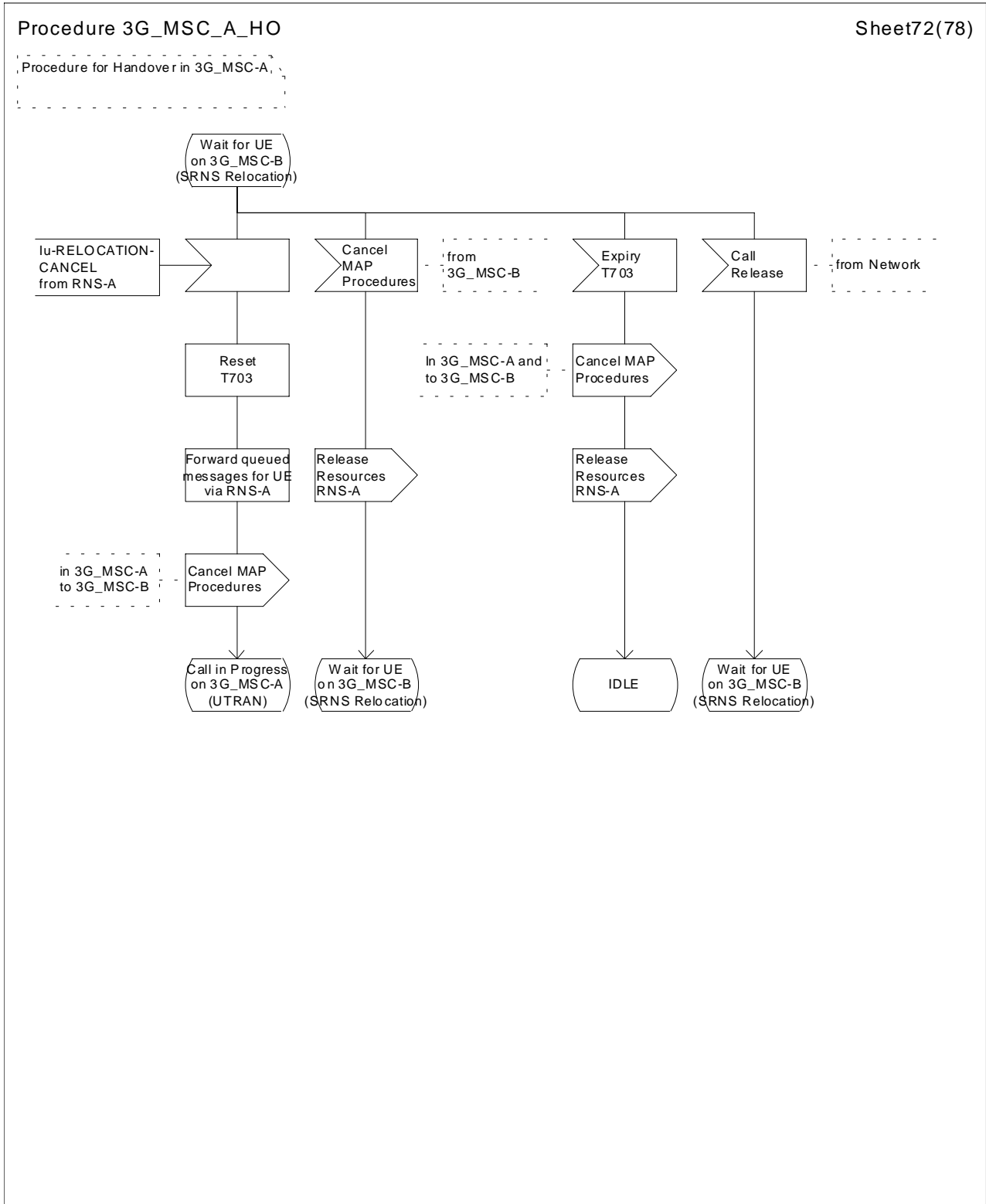

Figure 43 (sheet 72 of 78): Handover control procedure in 3G_MSC-A

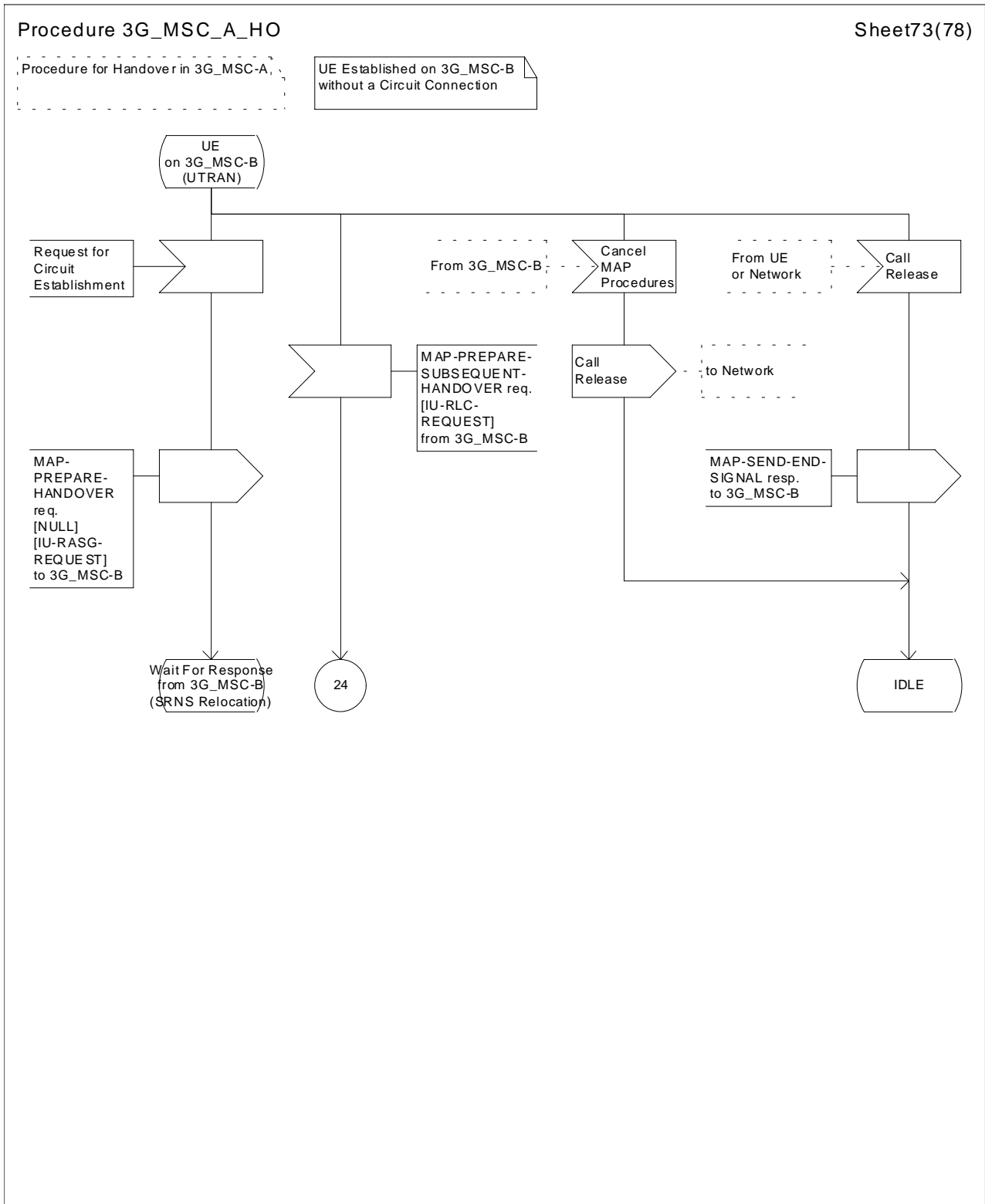

Figure 43 (sheet 73 of 78): Handover control procedure in 3G_MSC-A

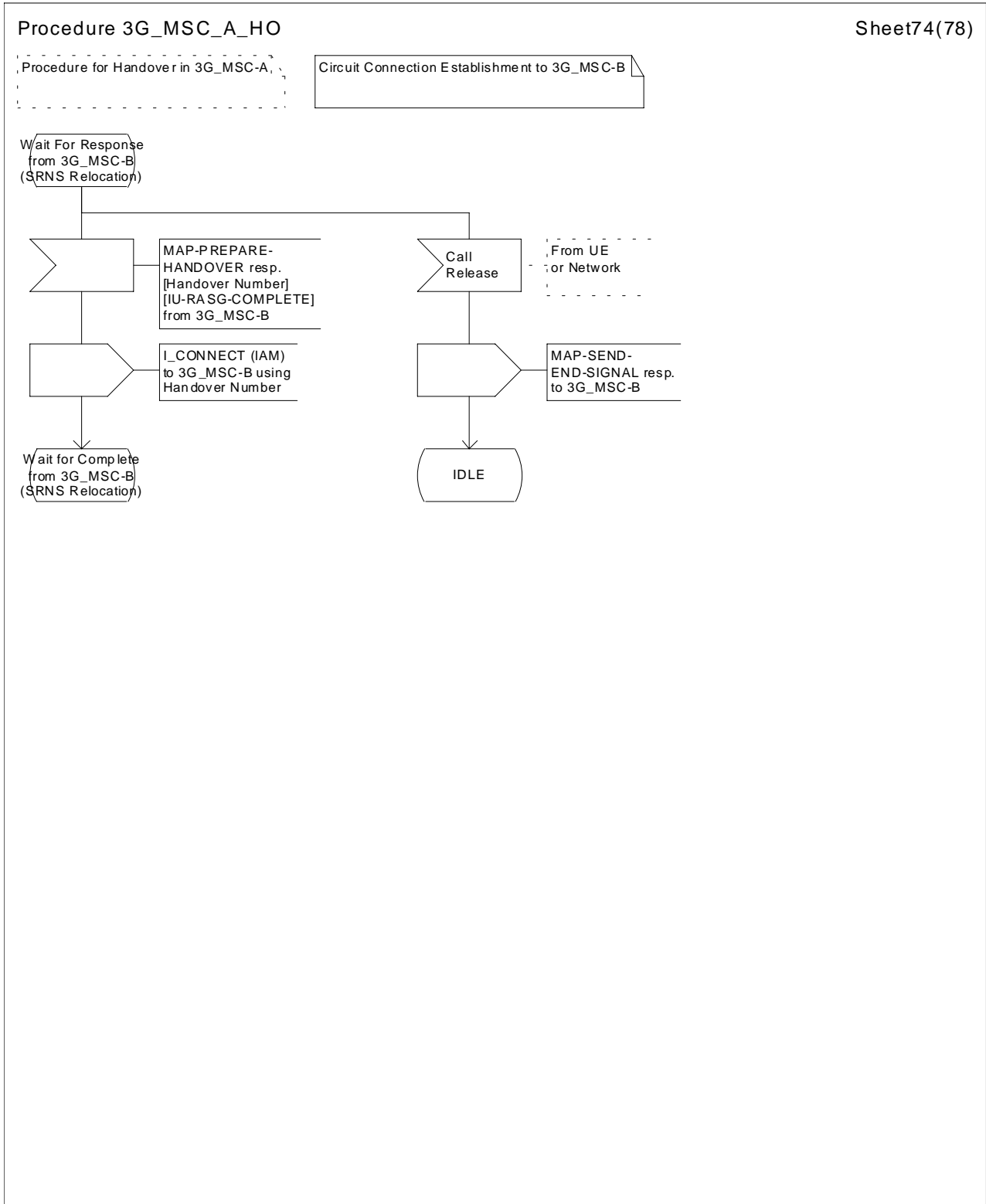

Figure 43 (sheet 74 of 78): Handover control procedure in 3G_MSC-A

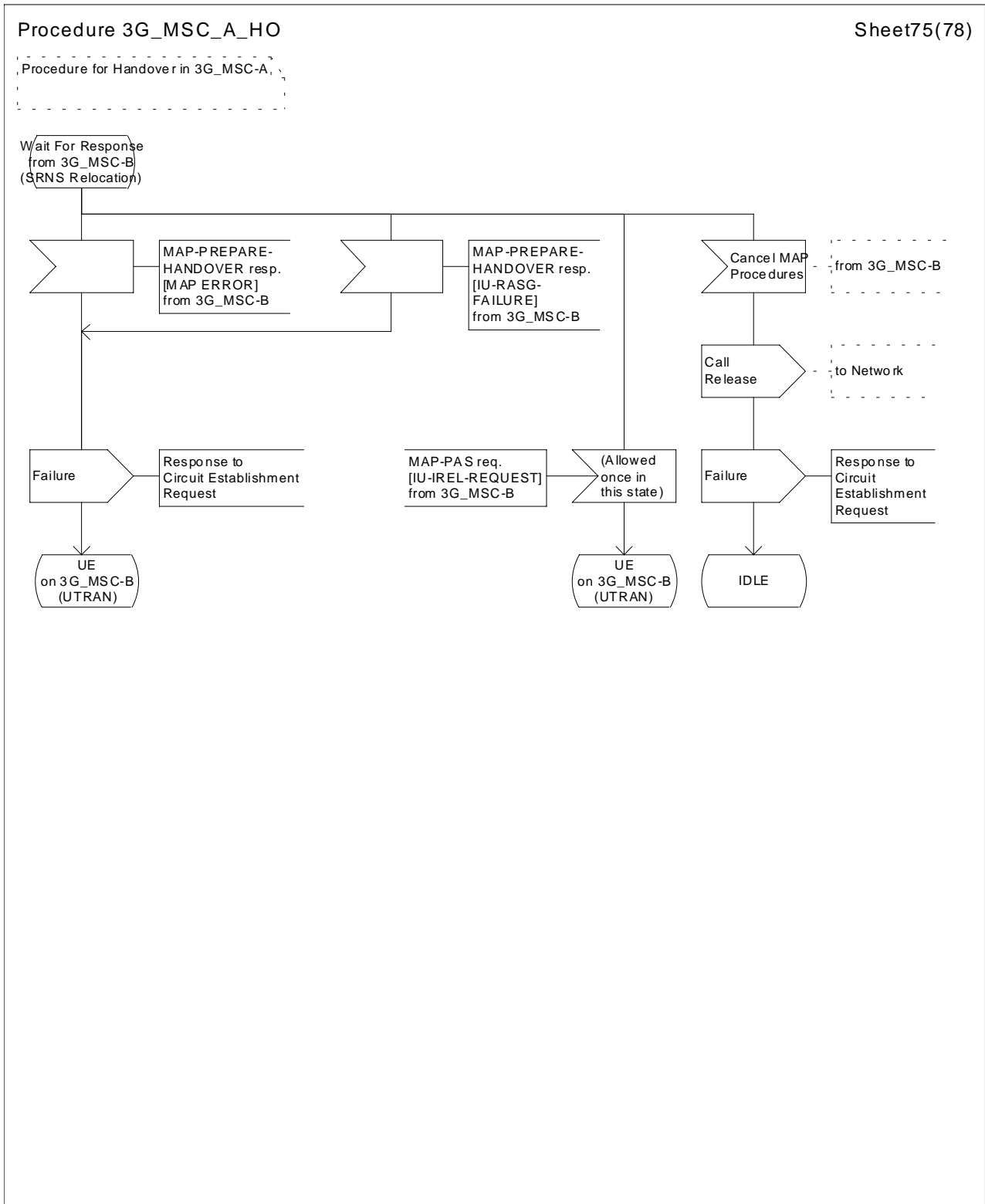

Figure 43 (sheet 75 of 78): Handover control procedure in 3G_MSC-A

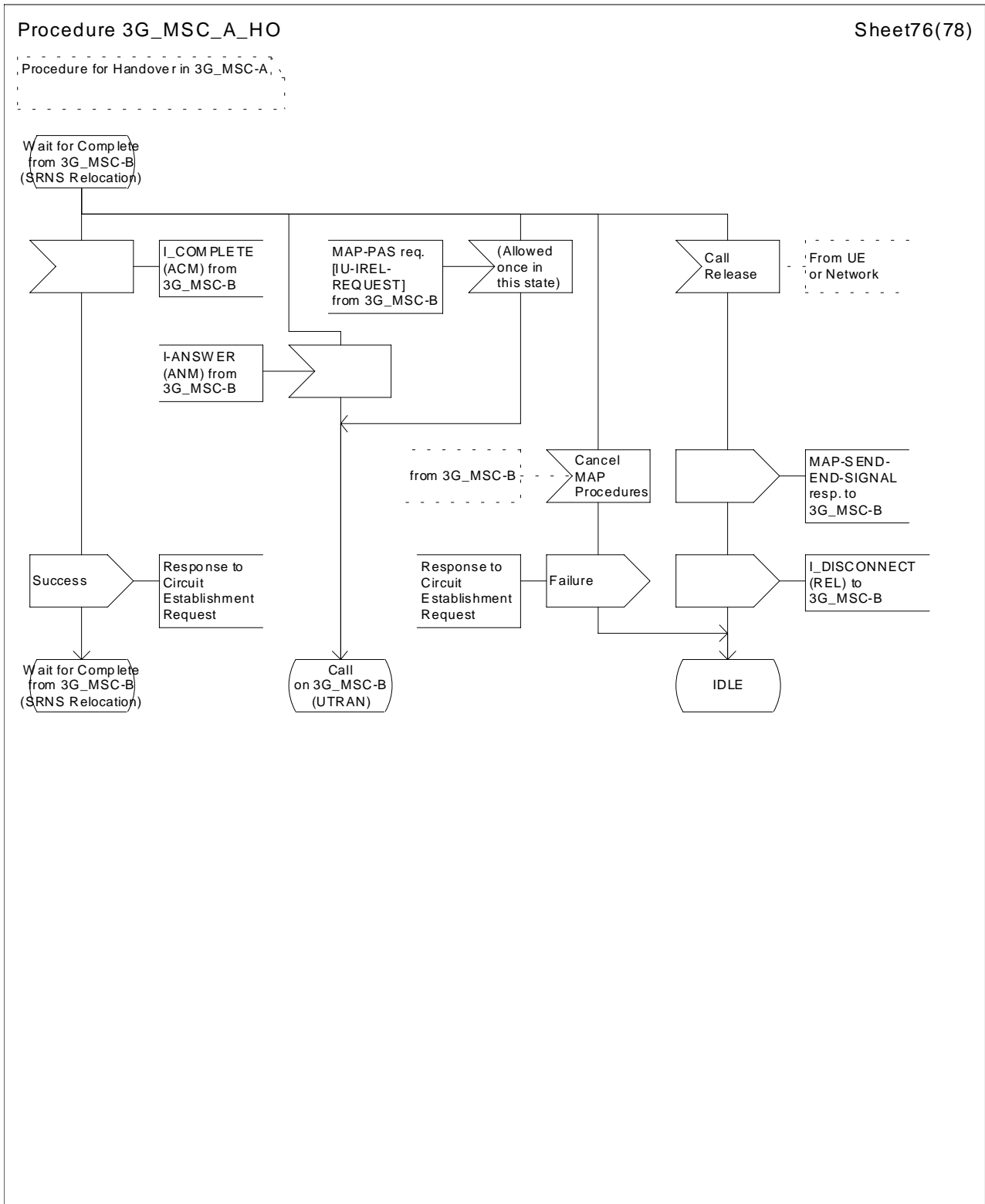

Figure 43 (sheet 76 of 78): Handover control procedure in 3G_MSC-A

Procedure 3G_MSC_A_HO

Sheet77(78)

Procedure for Handover in 3G_MSC-A

Subsequent SRNS Relocation from 3G_MSC-B to 3G_MSC-B' no Circuit Connection required.

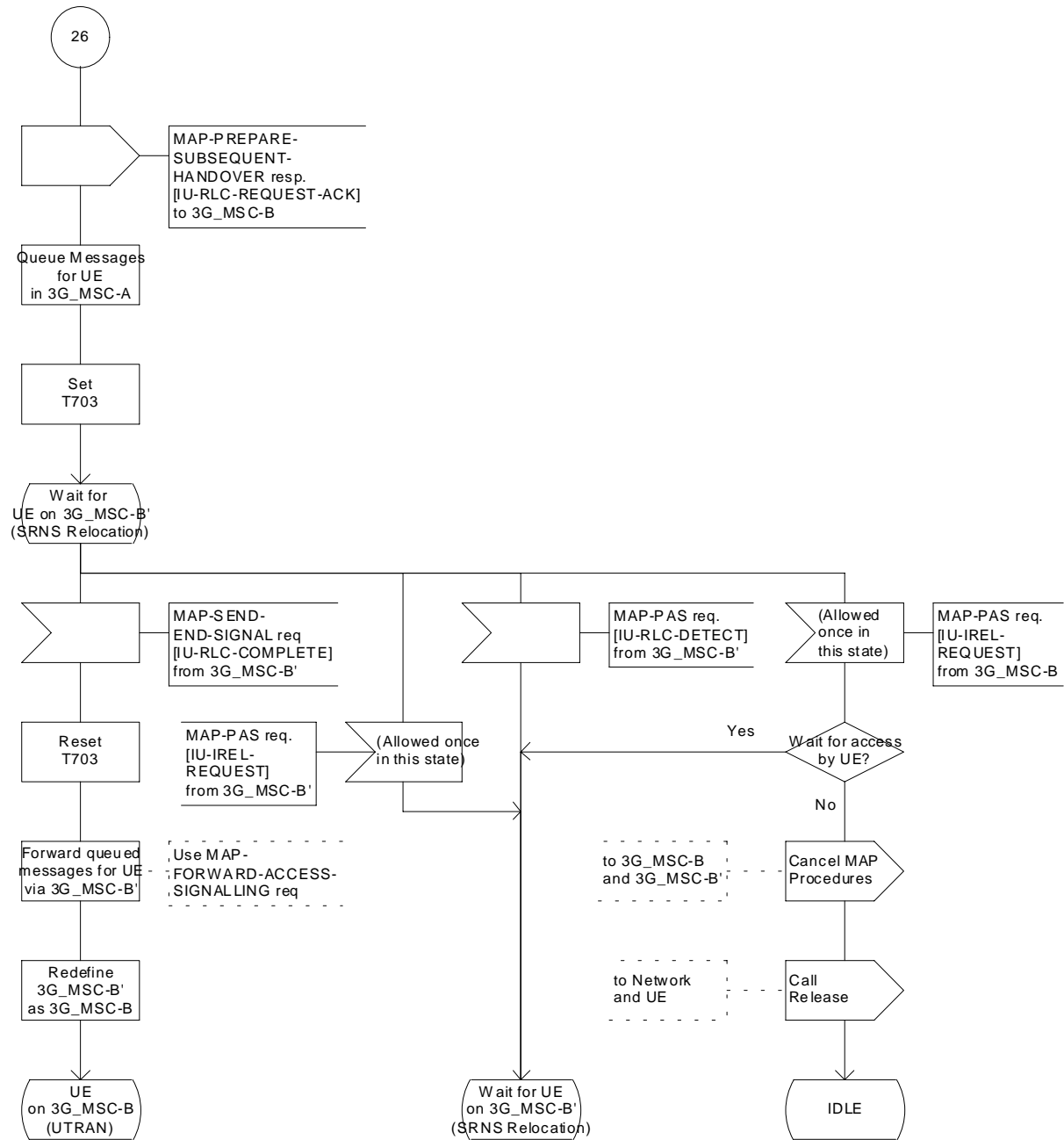

Figure 43 (sheet 77 of 78): Handover control procedure in 3G_MSC-A

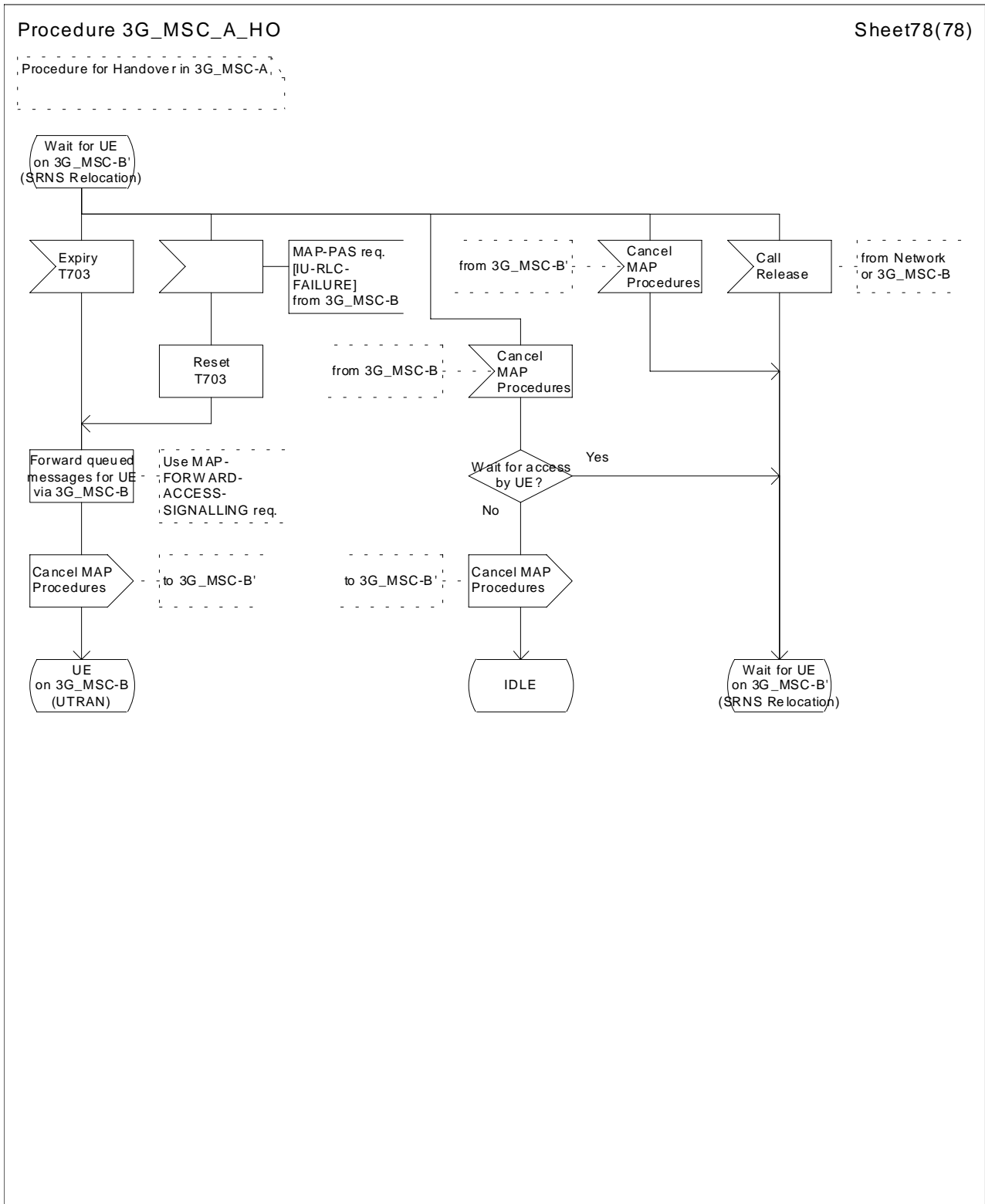

Figure 43 (sheet 78 of 78): Handover control procedure in 3G_MSC-A

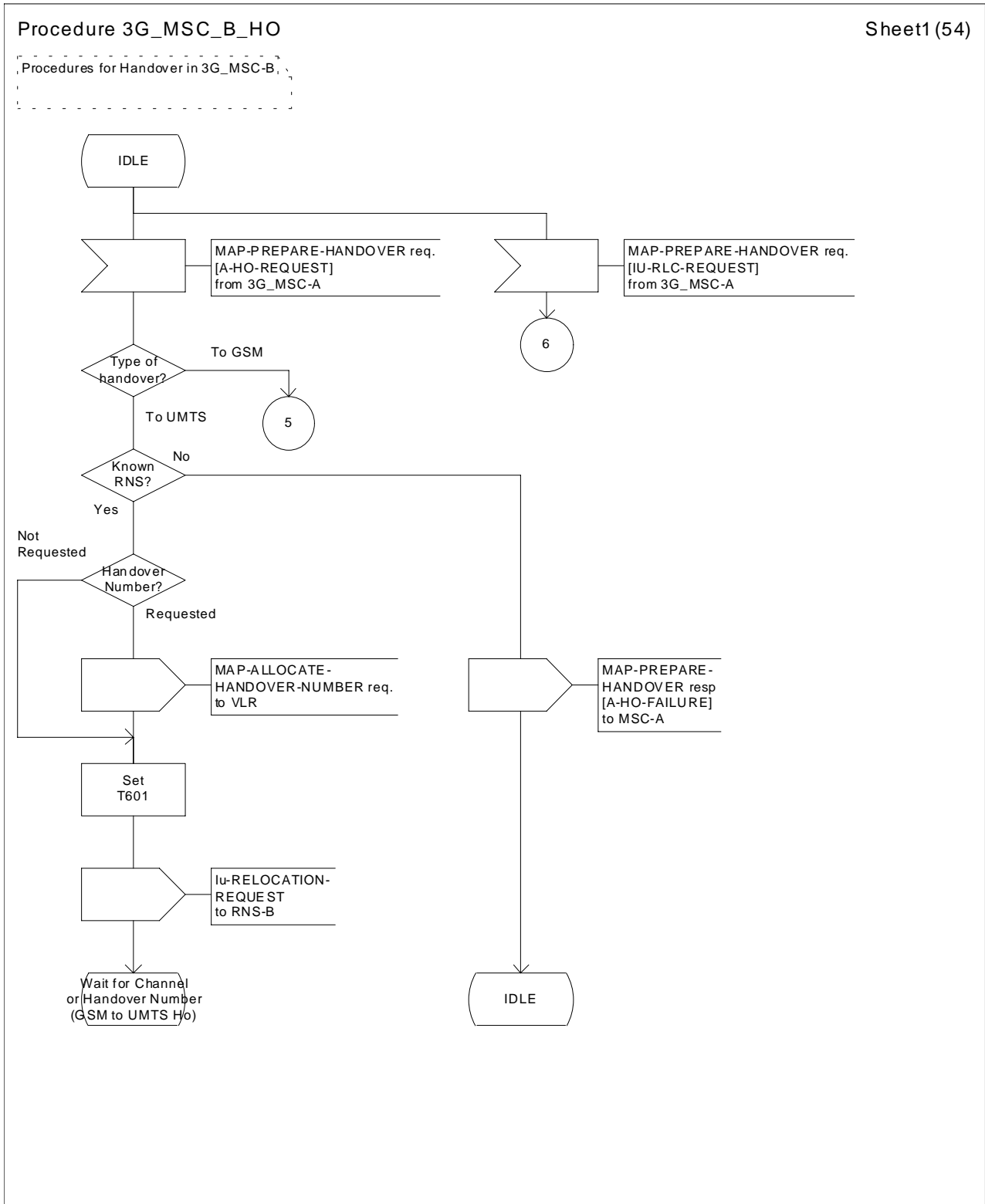

Figure 44 (sheet 1 of 54): Handover control procedure in 3G_MSC-B

Procedure 3G_MSC_B_HO

Sheet2 (54)

Procedures for Handover in 3G_MSC-B

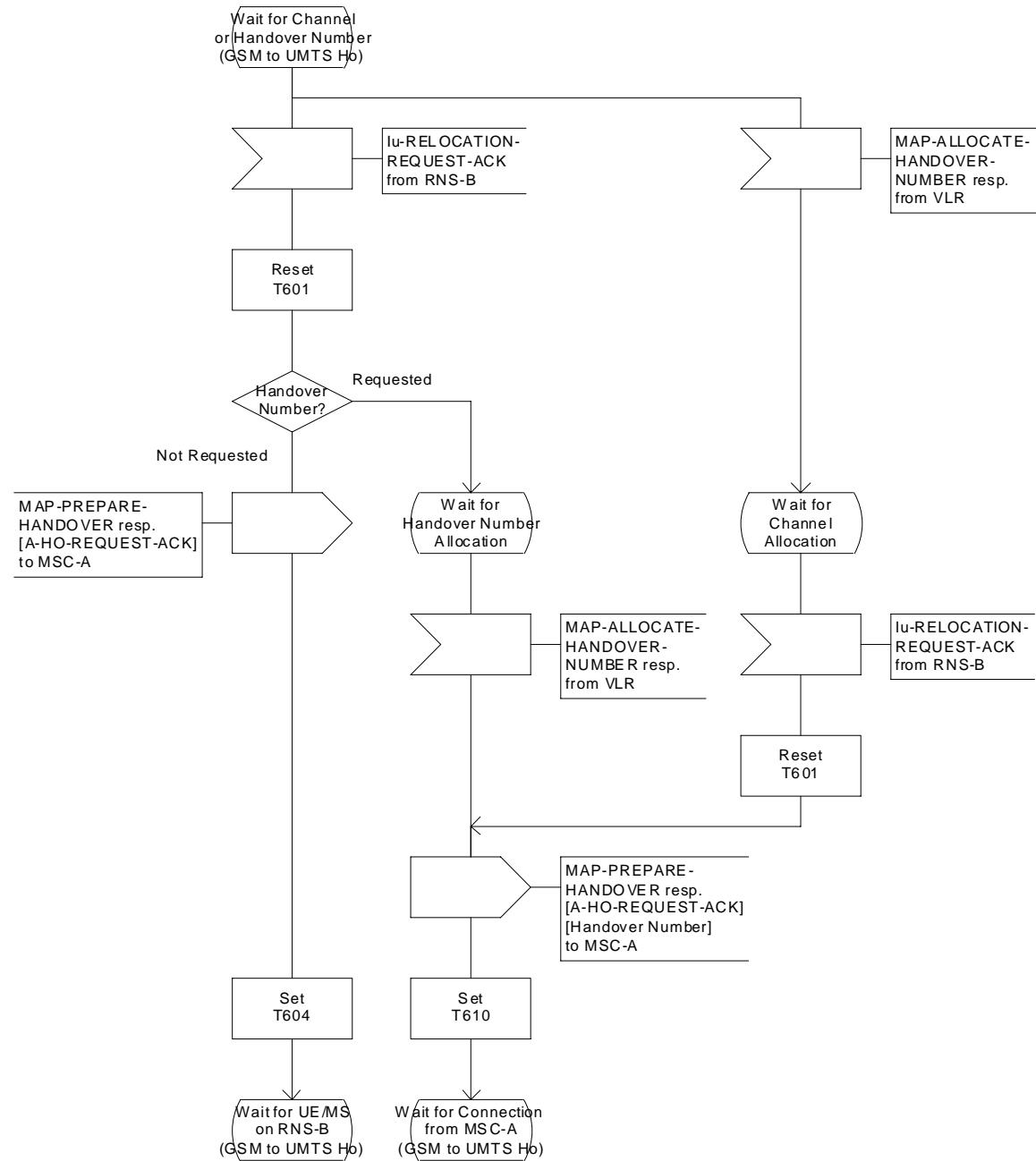

Figure 44 (sheet 2 of 54): Handover control procedure in 3G_MSC-B

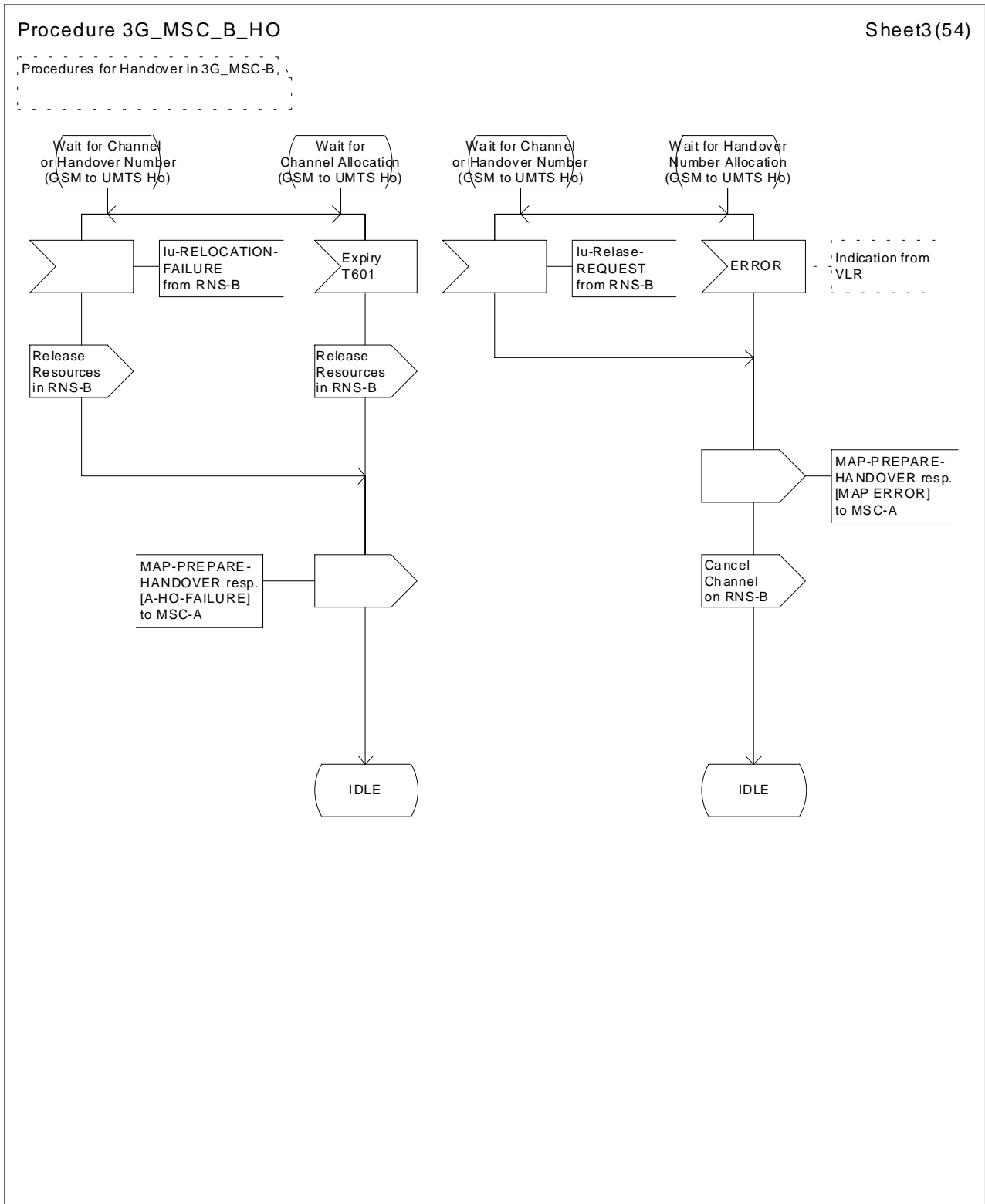

Figure 44 (sheet 3 of 54): Handover control procedure in 3G_MSC-B

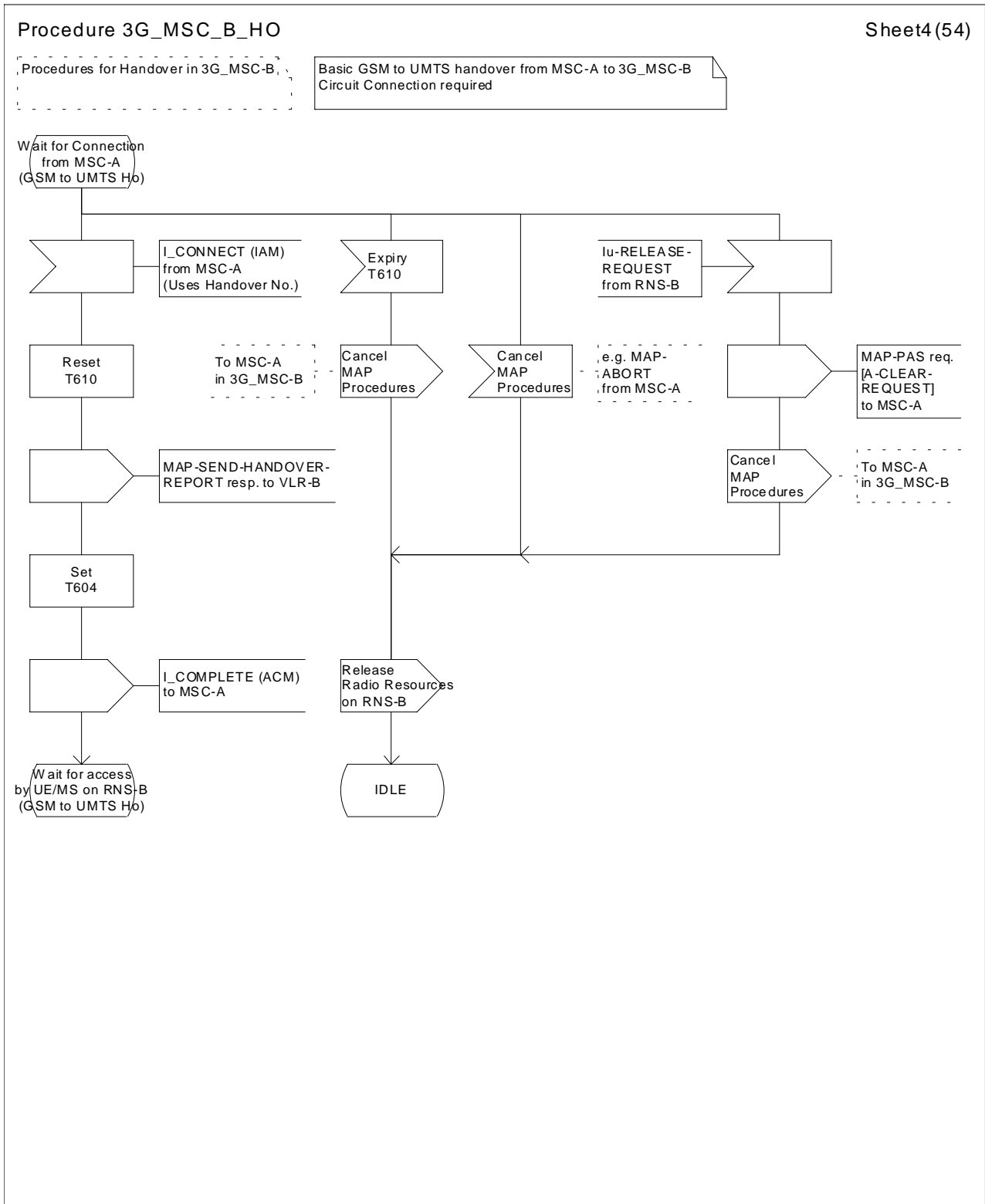

Figure 44 (sheet 4 of 54): Handover control procedure in 3G_MSC-B

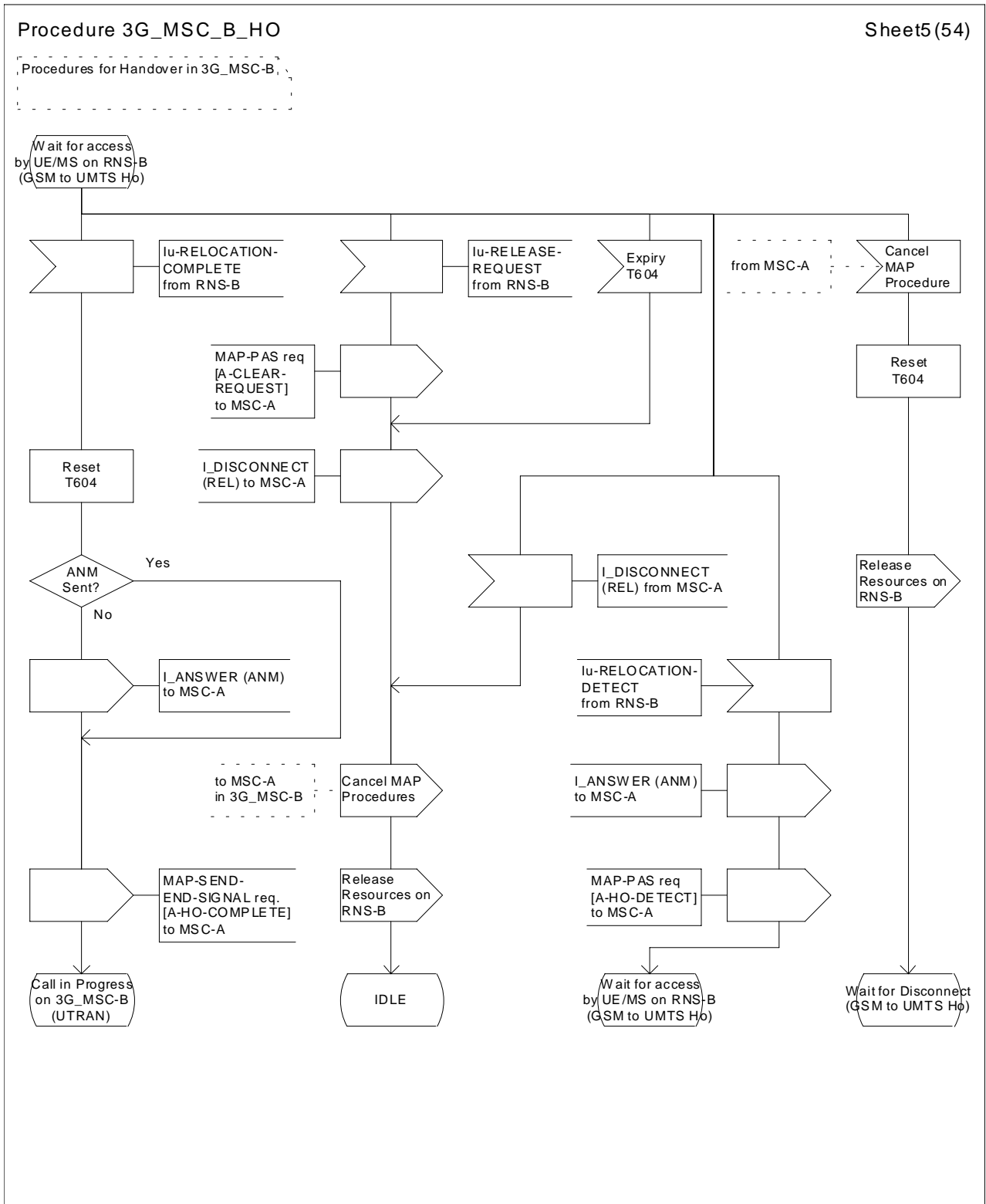

Figure 44 (sheet 5 of 54): Handover control procedure in 3G_MSC-B

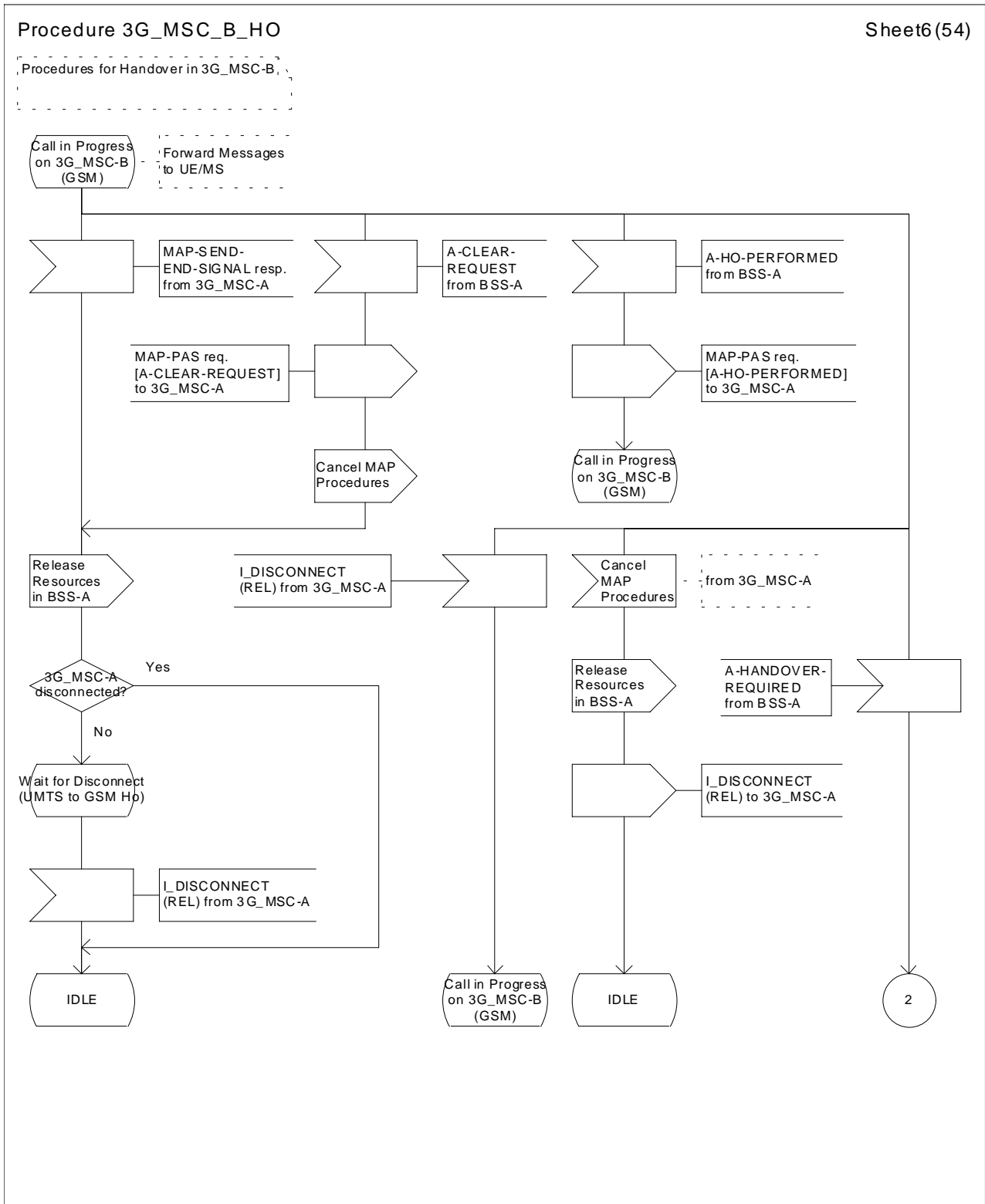

Figure 44 (sheet 6 of 54): Handover control procedure in 3G_MSC-B

Procedure 3G_MSC_B_HO

Sheet7 (54)

Procedures for Handover in 3G_MSC-B

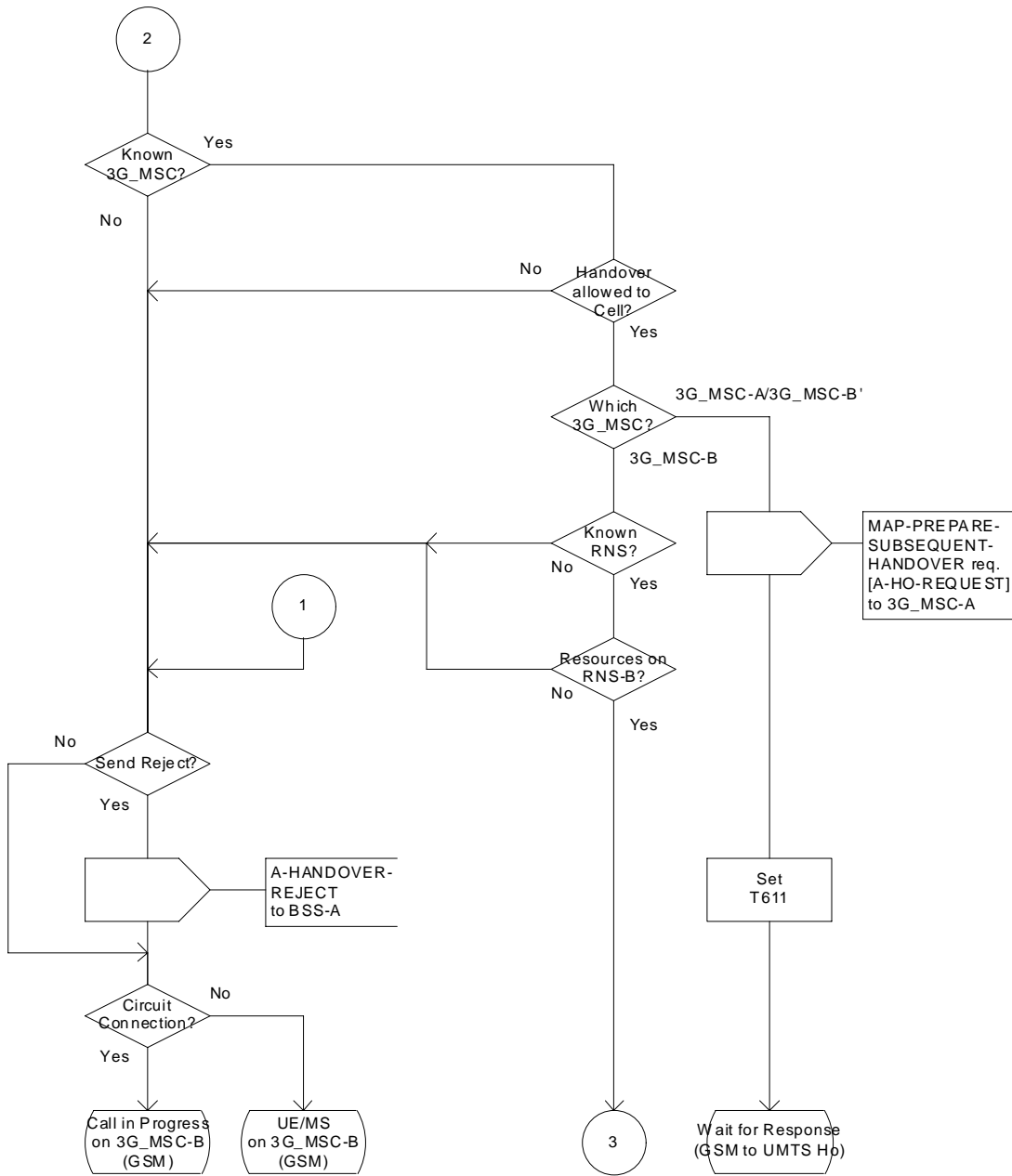

Figure 44 (sheet 7 of 54): Handover control procedure in 3G_MSC-B

Procedure 3G_MSC_B_HO

Sheet8 (54)

Procedures for Handover in 3G_MSC-B

Handover from BSS-A to RNS-B on 3G_MSC-B

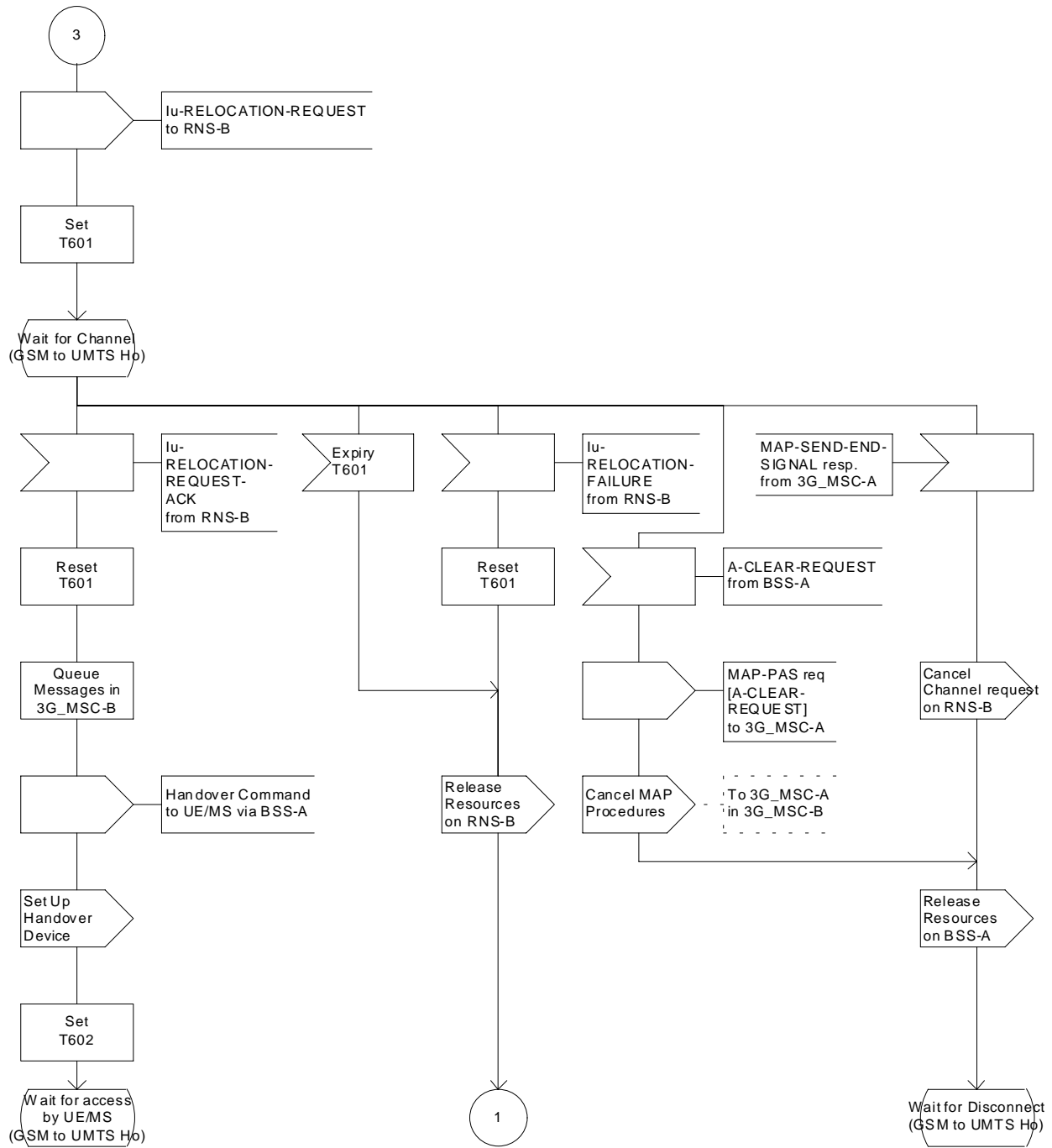

Figure 44 (sheet 8 of 54): Handover control procedure in 3G_MSC-B

Procedure 3G_MSC_B_HO

Sheet9 (54)

Procedures for Handover in 3G_MSC-B

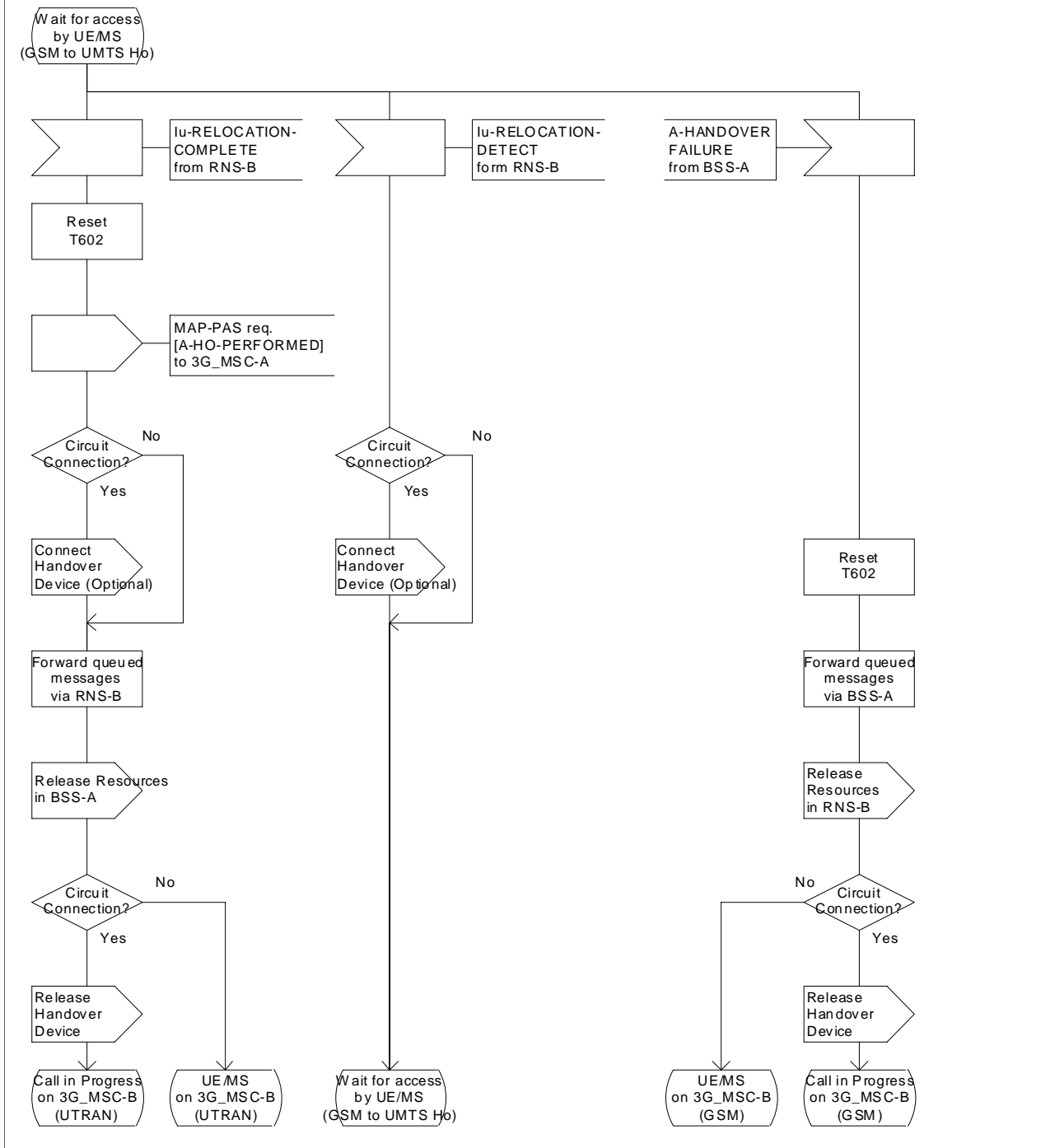

Figure 44 (sheet 9 of 54): Handover control procedure in 3G_MSC-B

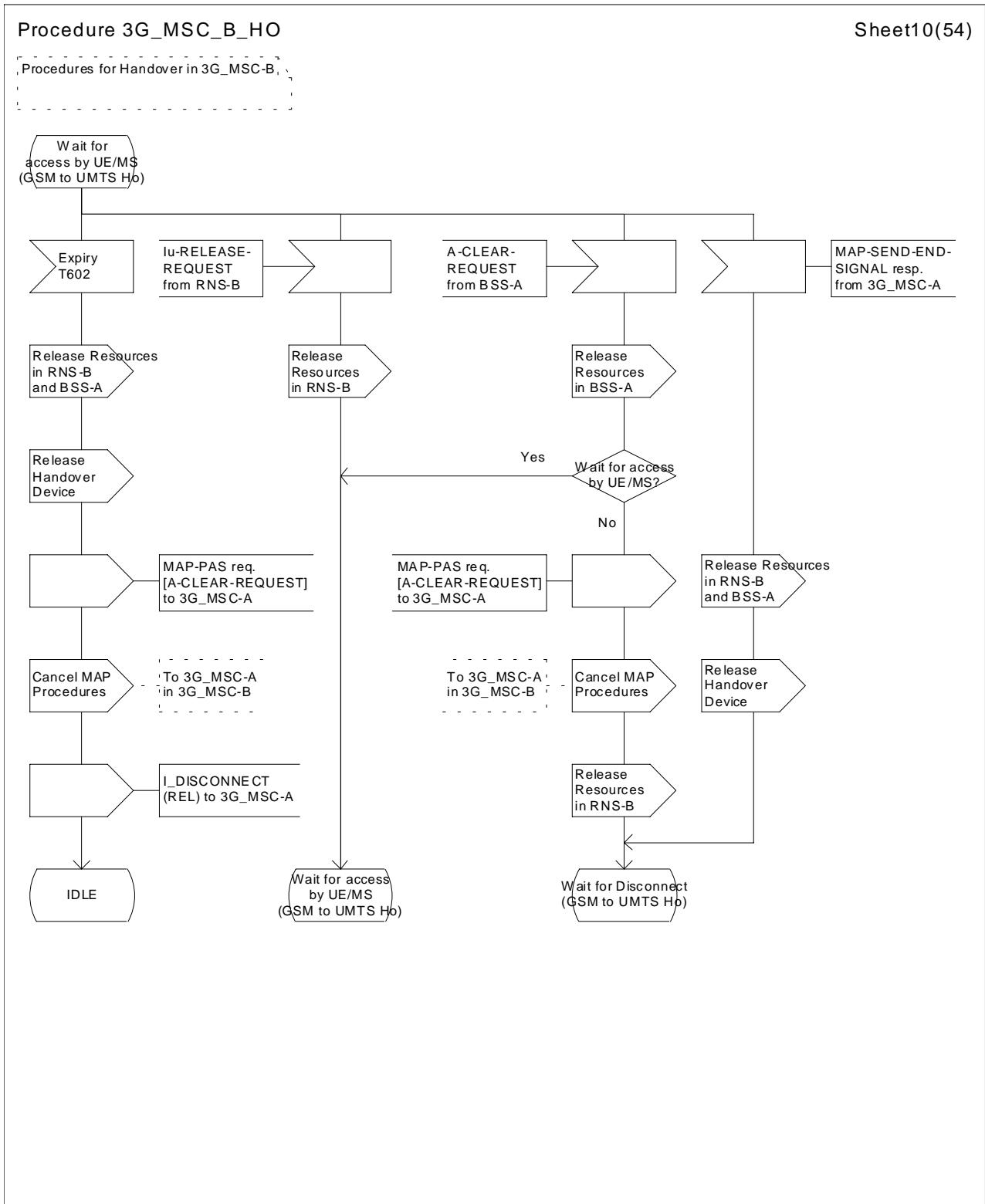

Figure 44 (sheet 10 of 54): Handover control procedure in 3G_MSC-B

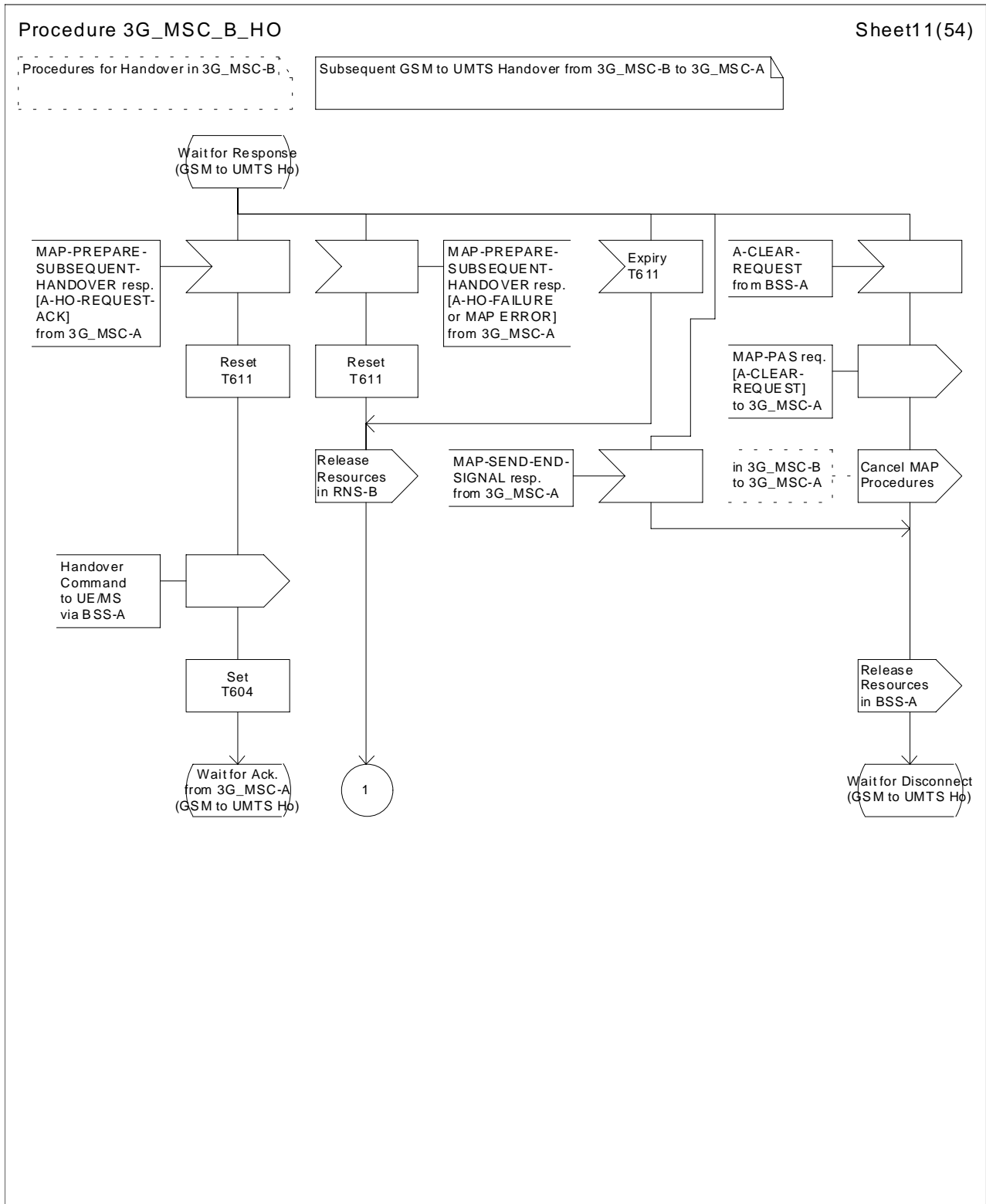

Figure 44 (sheet 11 of 54): Handover control procedure in 3G_MSC-B

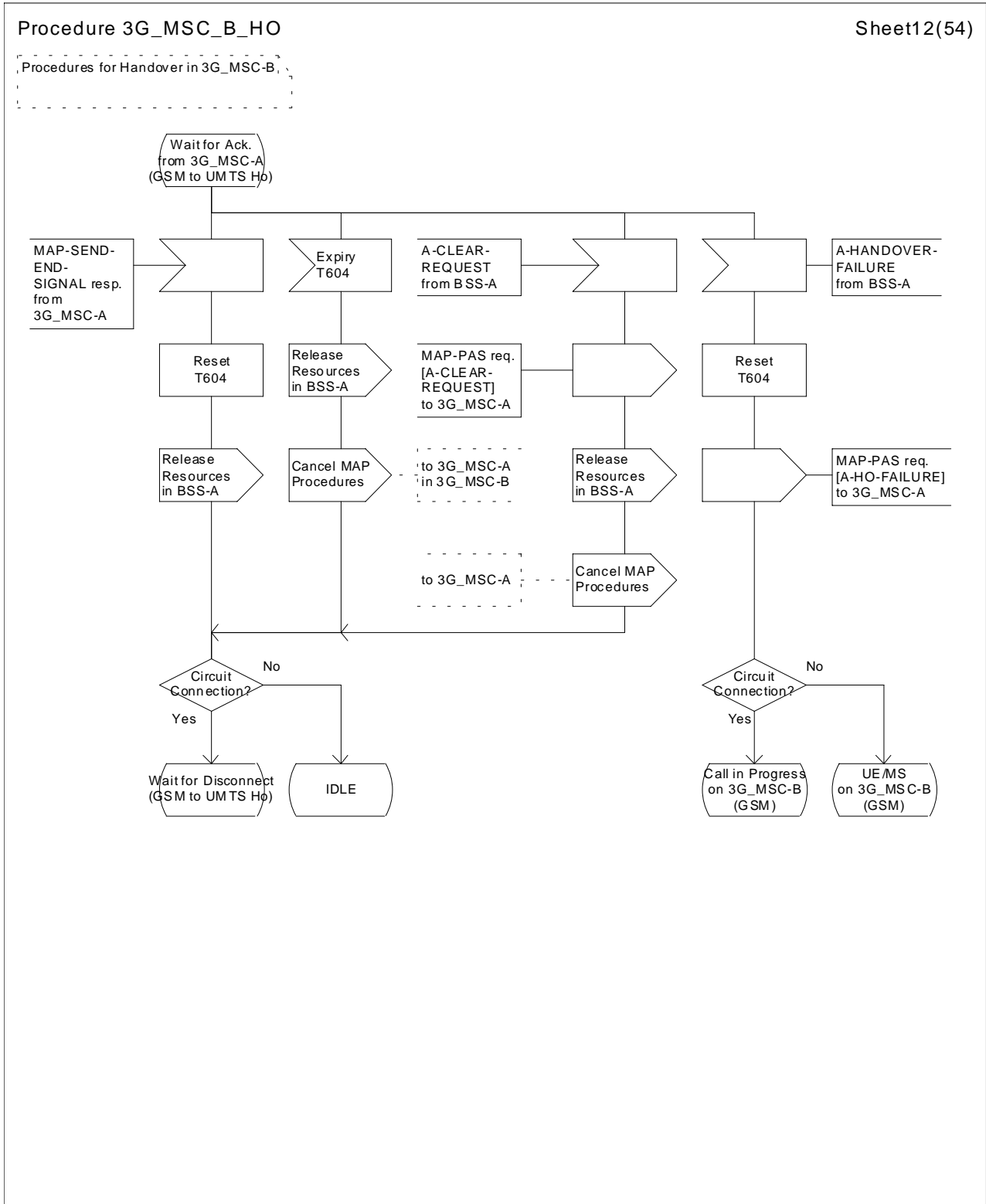

Figure 44 (sheet 12 of 54): Handover control procedure in 3G_MSC-B

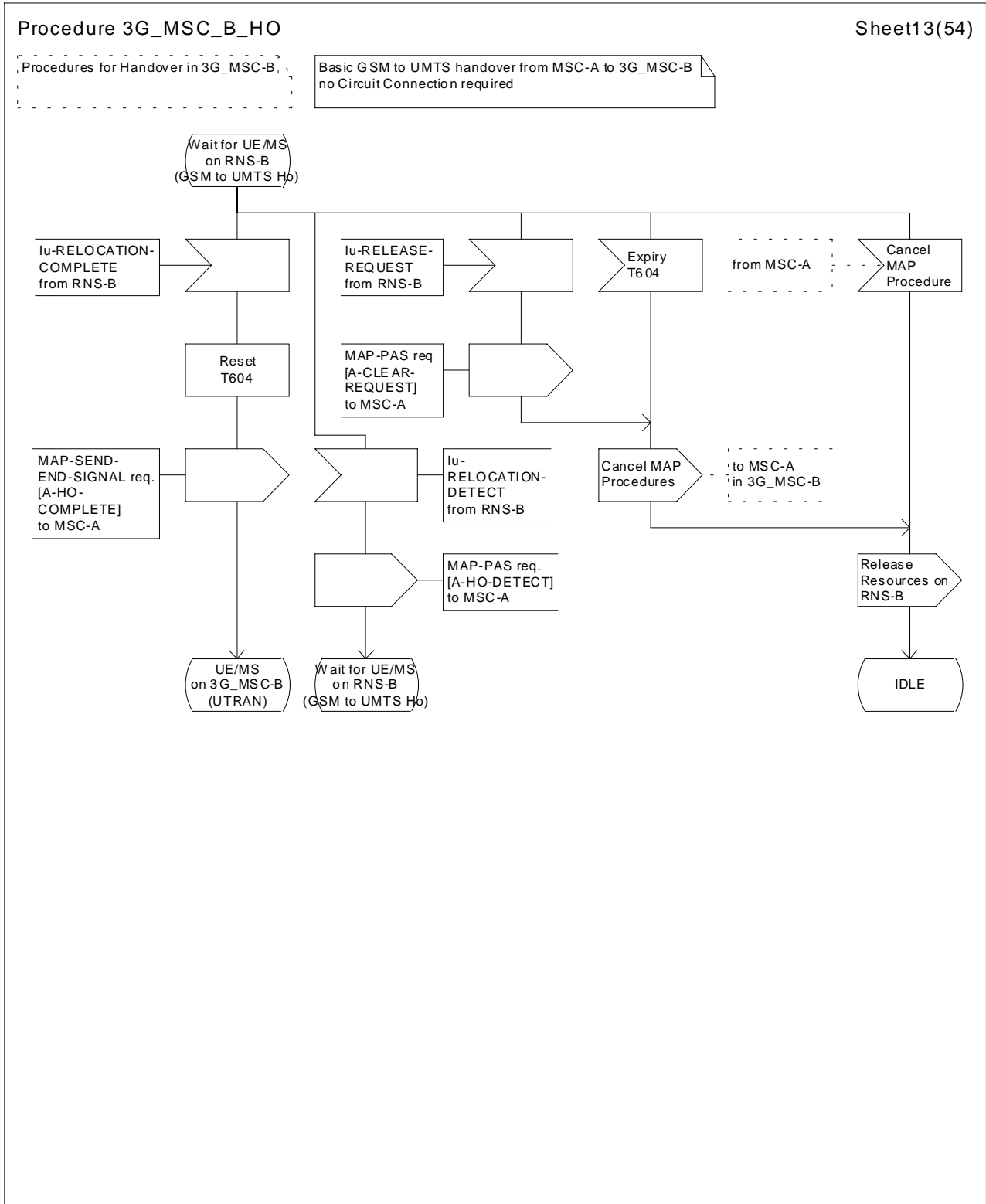

Figure 44 (sheet 13 of 54): Handover control procedure in 3G_MSC-B

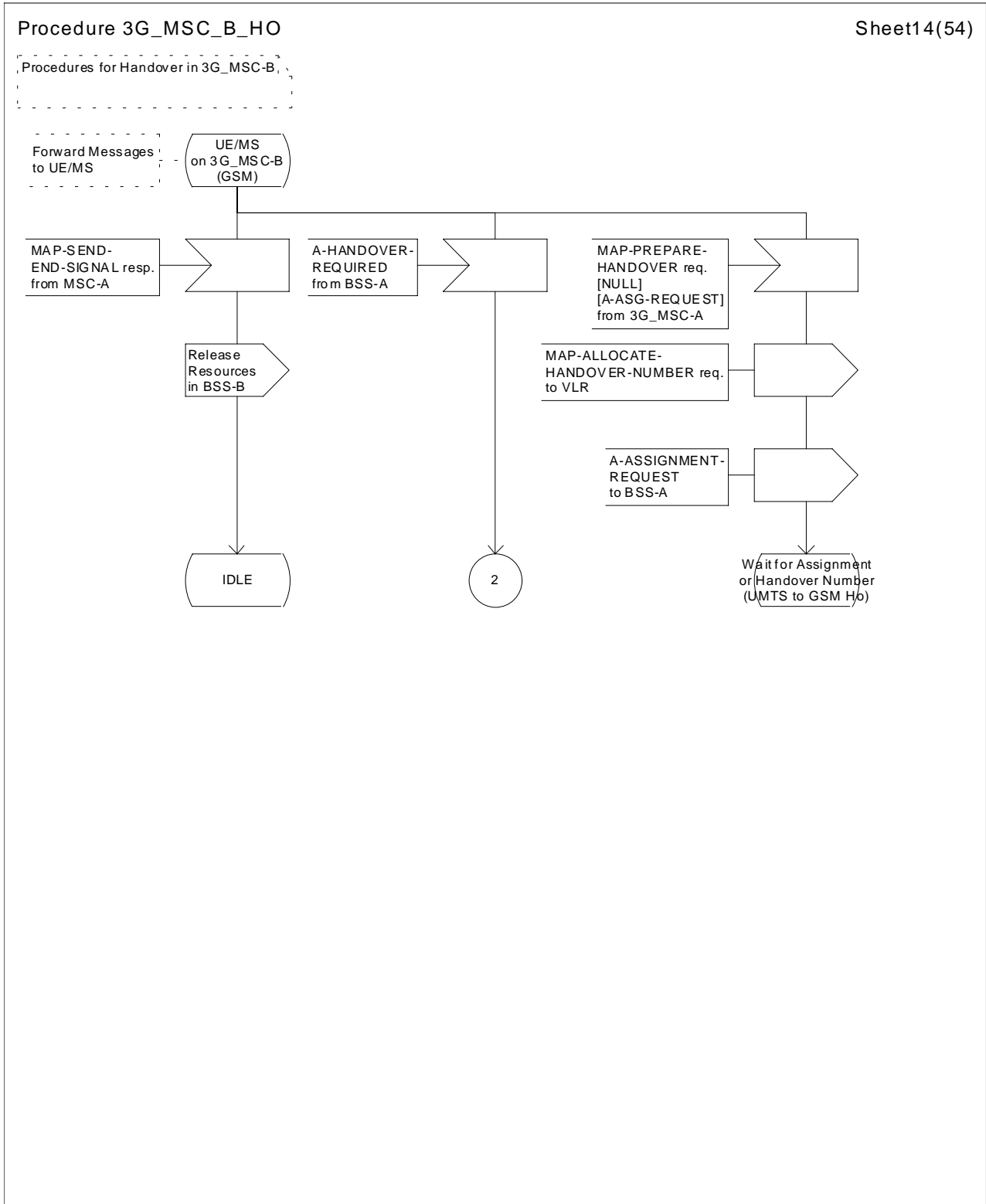

Figure 44 (sheet 14 of 54): Handover control procedure in 3G_MSC-B

Procedure 3G_MSC_B_HO

Sheet15(54)

Procedures for Handover in 3G_MSC-B

Circuit Connection Establishment on 3G_MSC-B

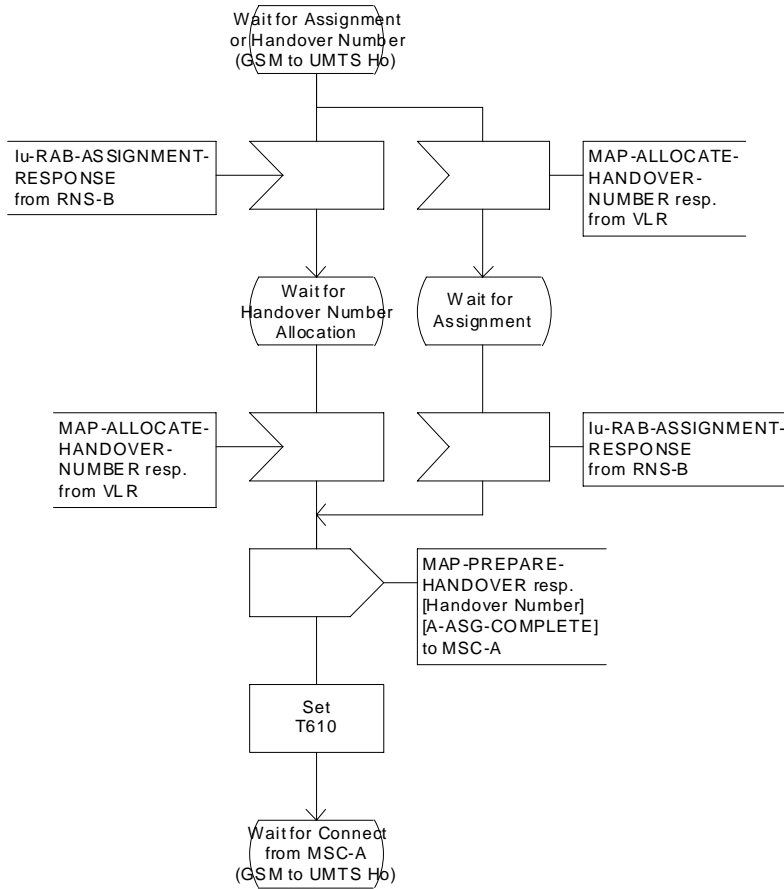

Figure 44 (sheet 15 of 54): Handover control procedure in 3G_MSC-B

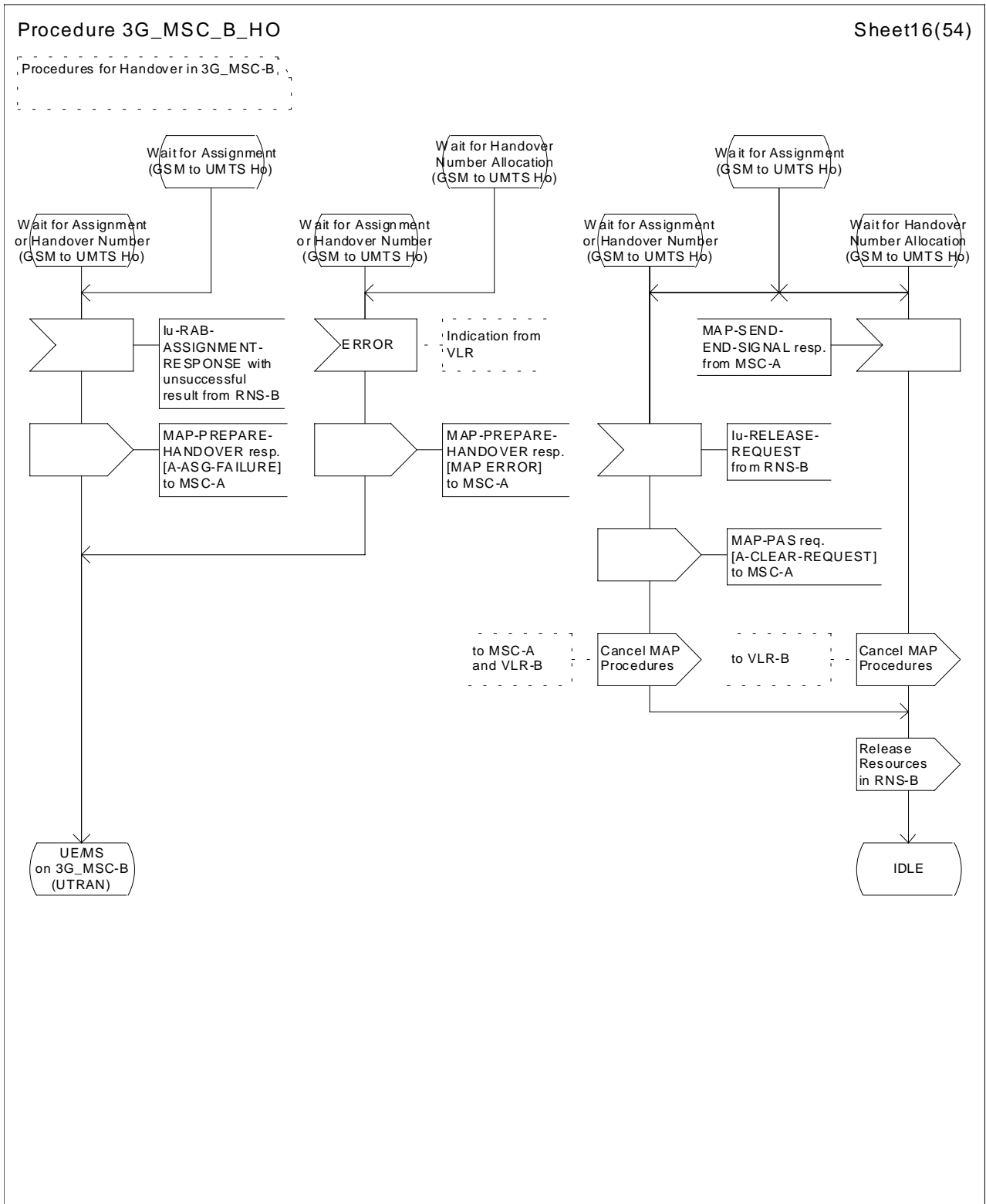

Figure 44 (sheet 16 of 54): Handover control procedure in 3G_MSC-B

Procedure 3G_MSC_B_HO

Sheet17(54)

Procedures for Handover in 3G_MSC-B

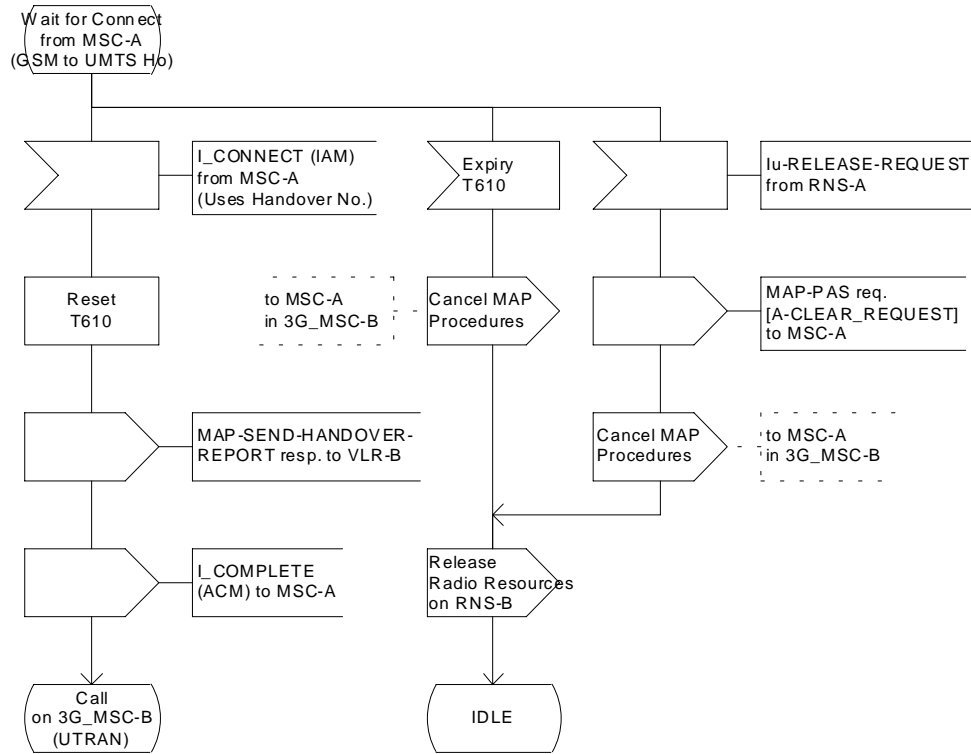

Figure 44 (sheet 17 of 54): Handover control procedure in 3G_MSC-B

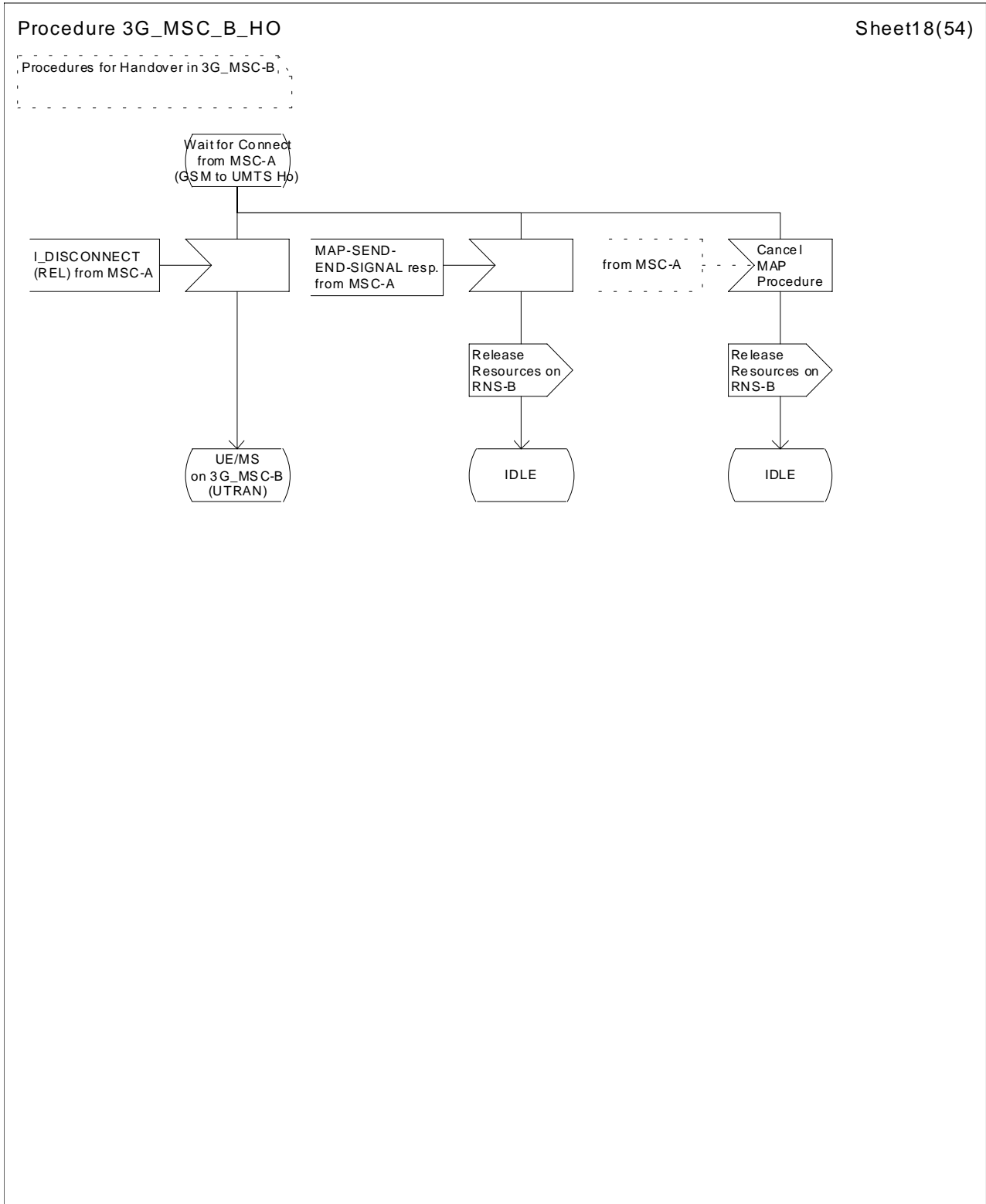

Figure 44 (sheet 18 of 54): Handover control procedure in 3G_MSC-B

Procedure 3G_MSC_B_HO

Sheet19(54)

Procedures for Handover in 3G_MSC-B

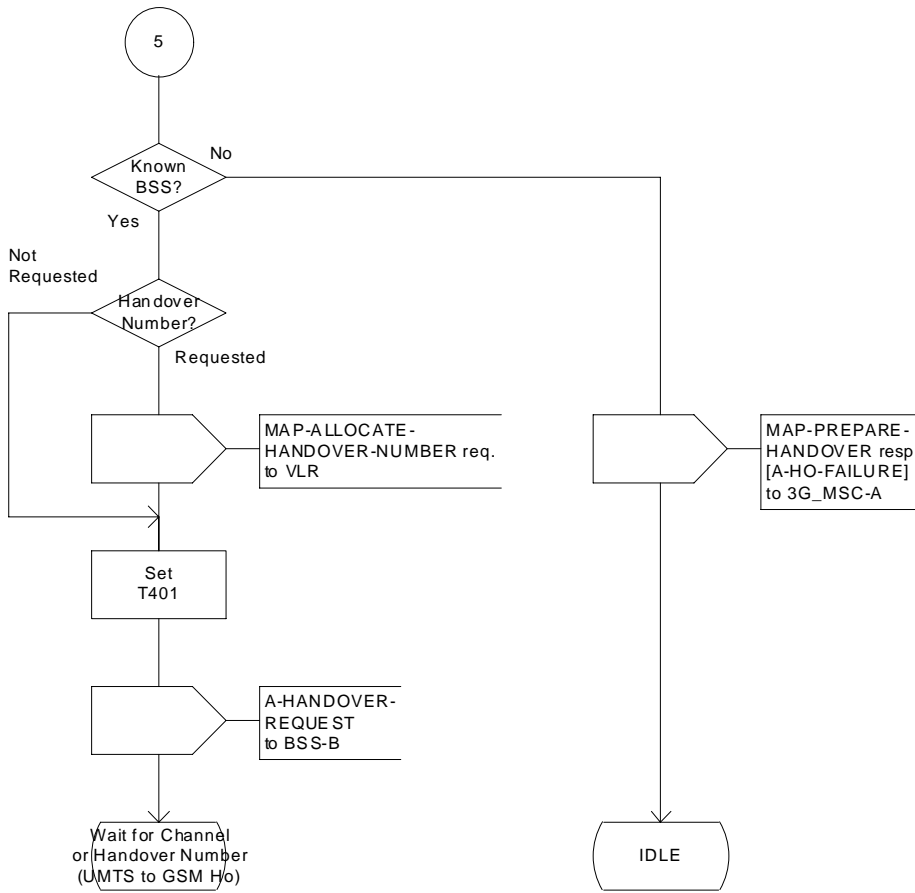

Figure 44 (sheet 19 of 54): Handover control procedure in 3G_MSC-B

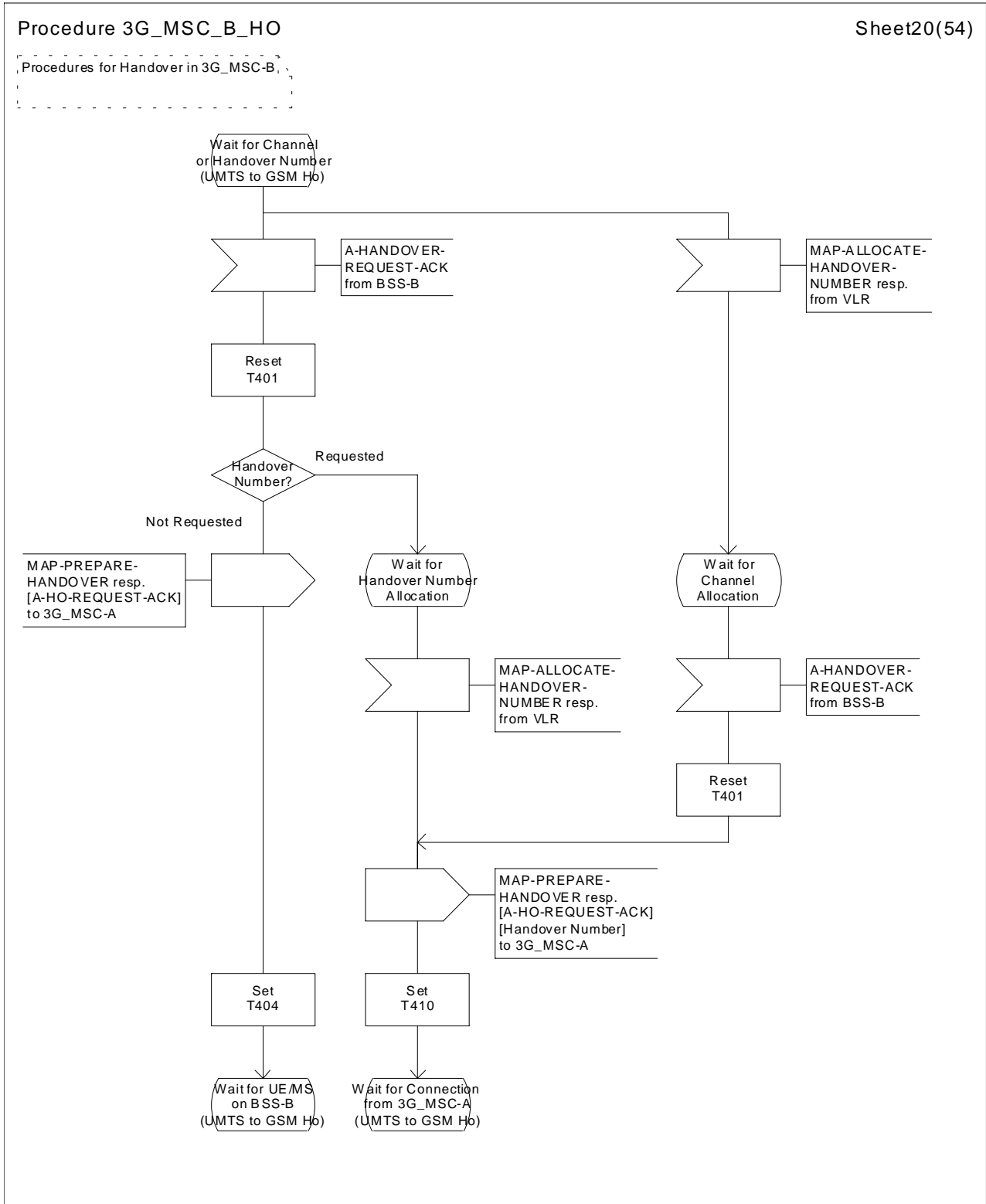

Figure 44 (sheet 20 of 54): Handover control procedure in 3G_MSC-B

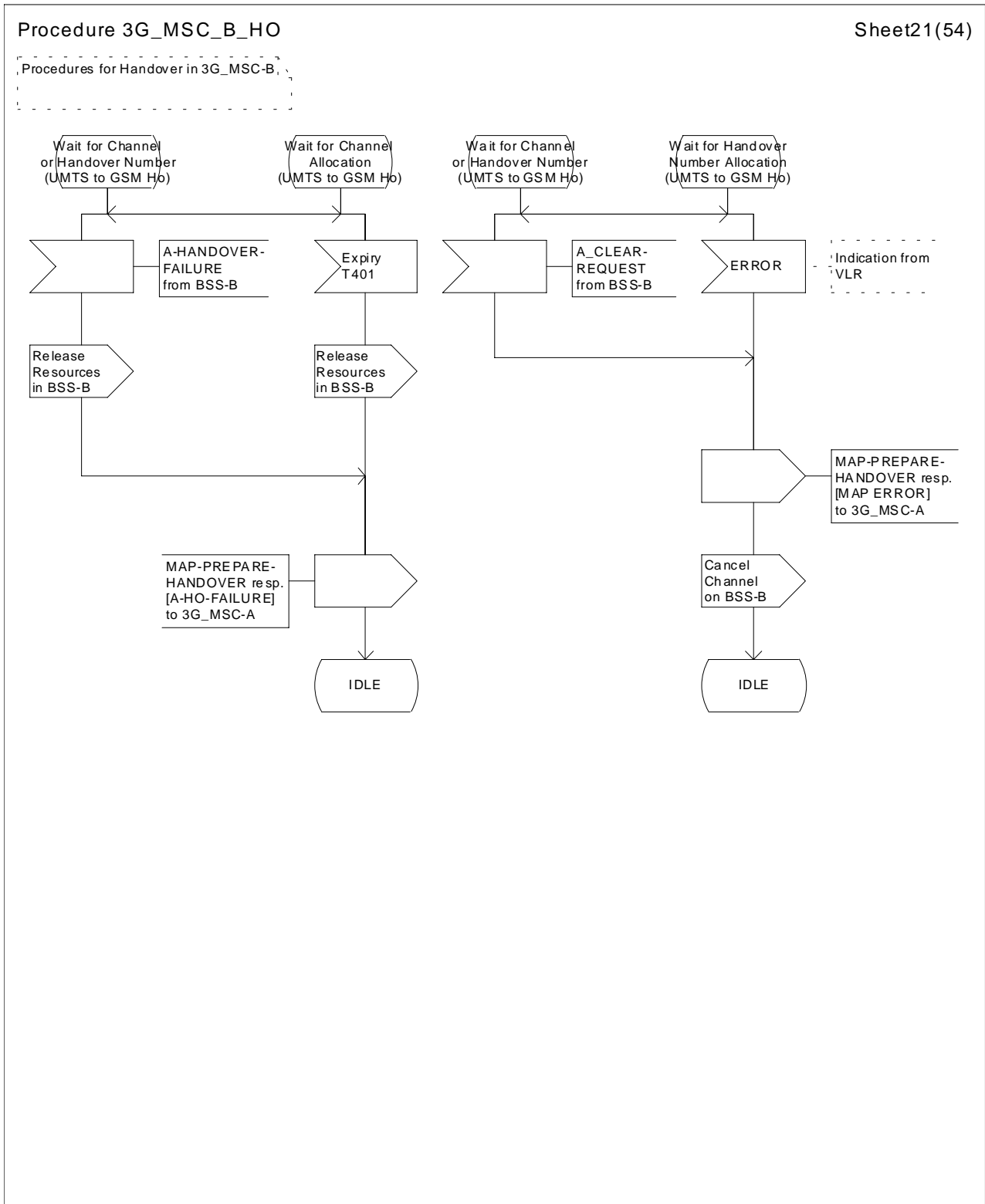

Figure 44 (sheet 21 of 54): Handover control procedure in 3G_MSC-B

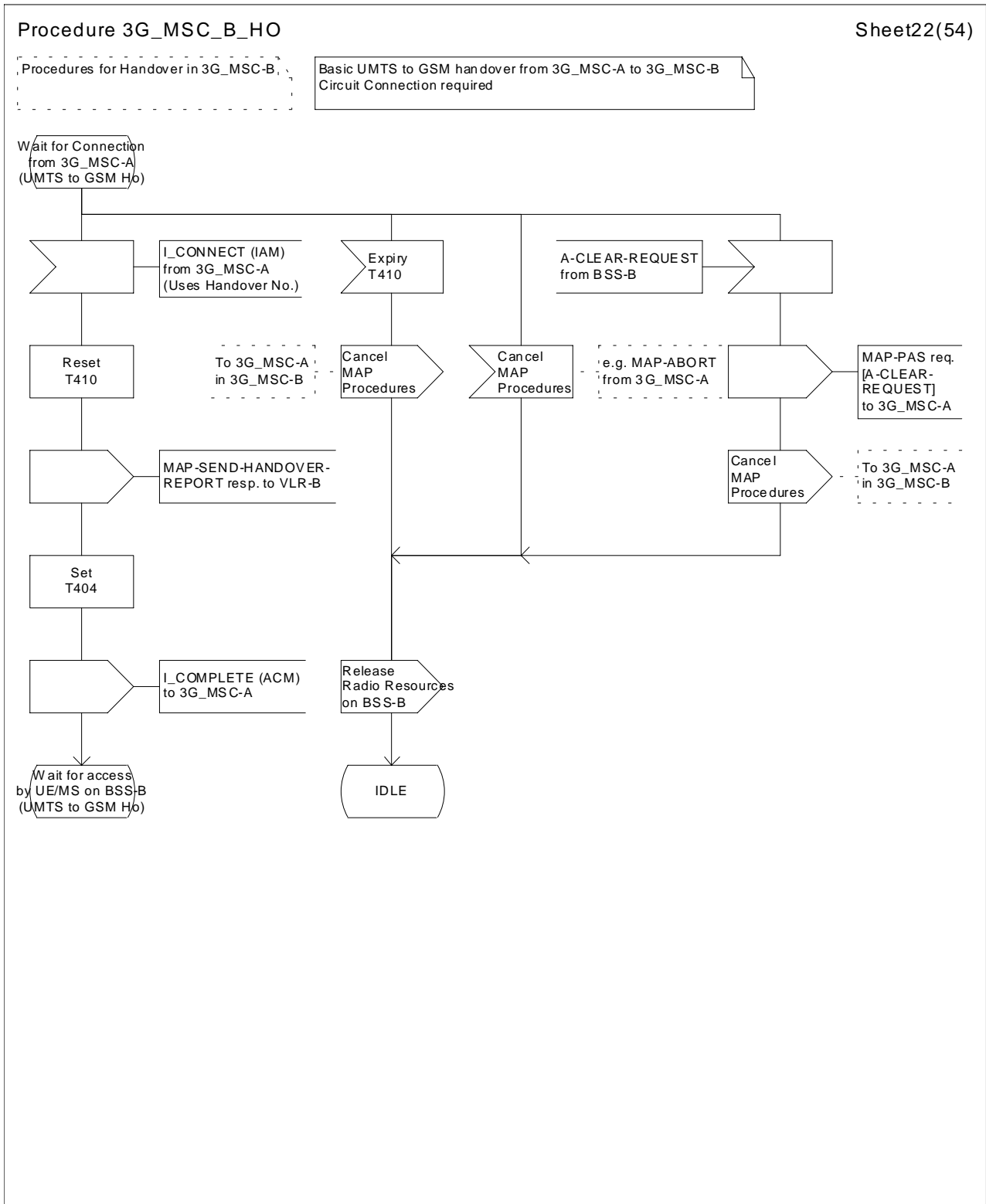

Figure 44 (sheet 22 of 54): Handover control procedure in 3G_MSC-B

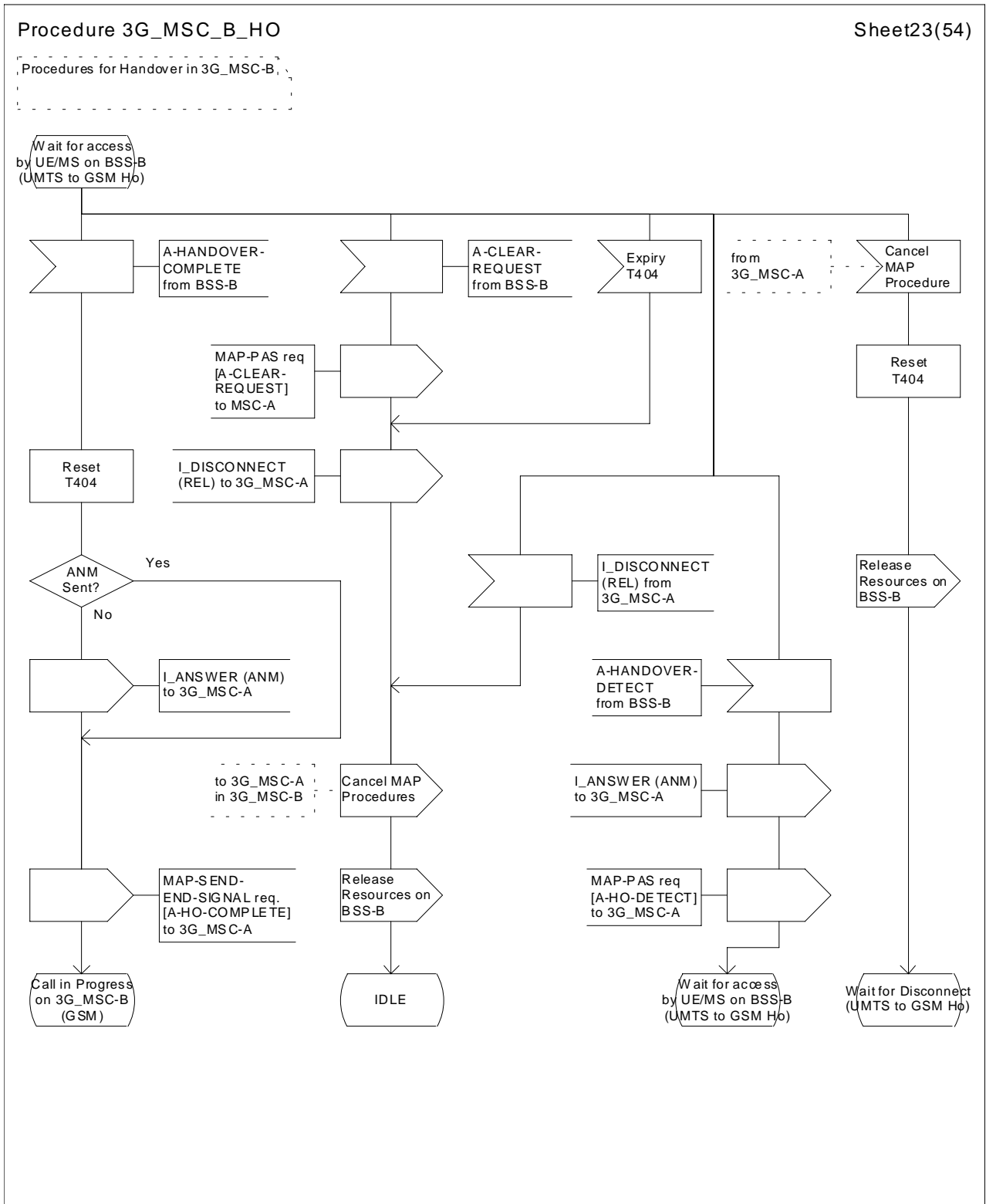

Figure 44 (sheet 23 of 54): Handover control procedure in 3G_MSC-B

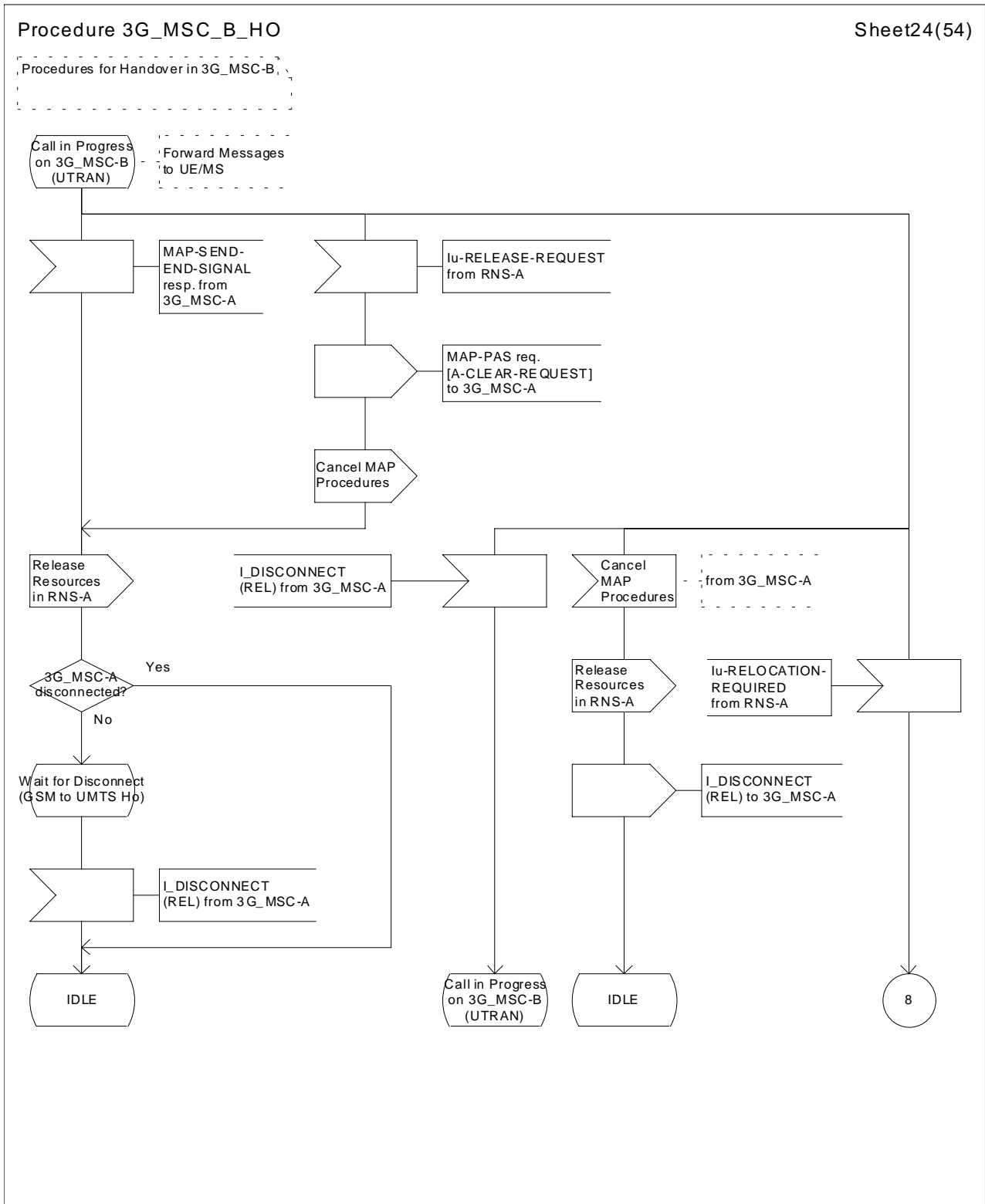

Figure 44 (sheet 24 of 54): Handover control procedure in 3G_MSC-B

Procedure 3G_MSC_B_HO

Sheet25(54)

Procedures for Handover in 3G_MSC-B

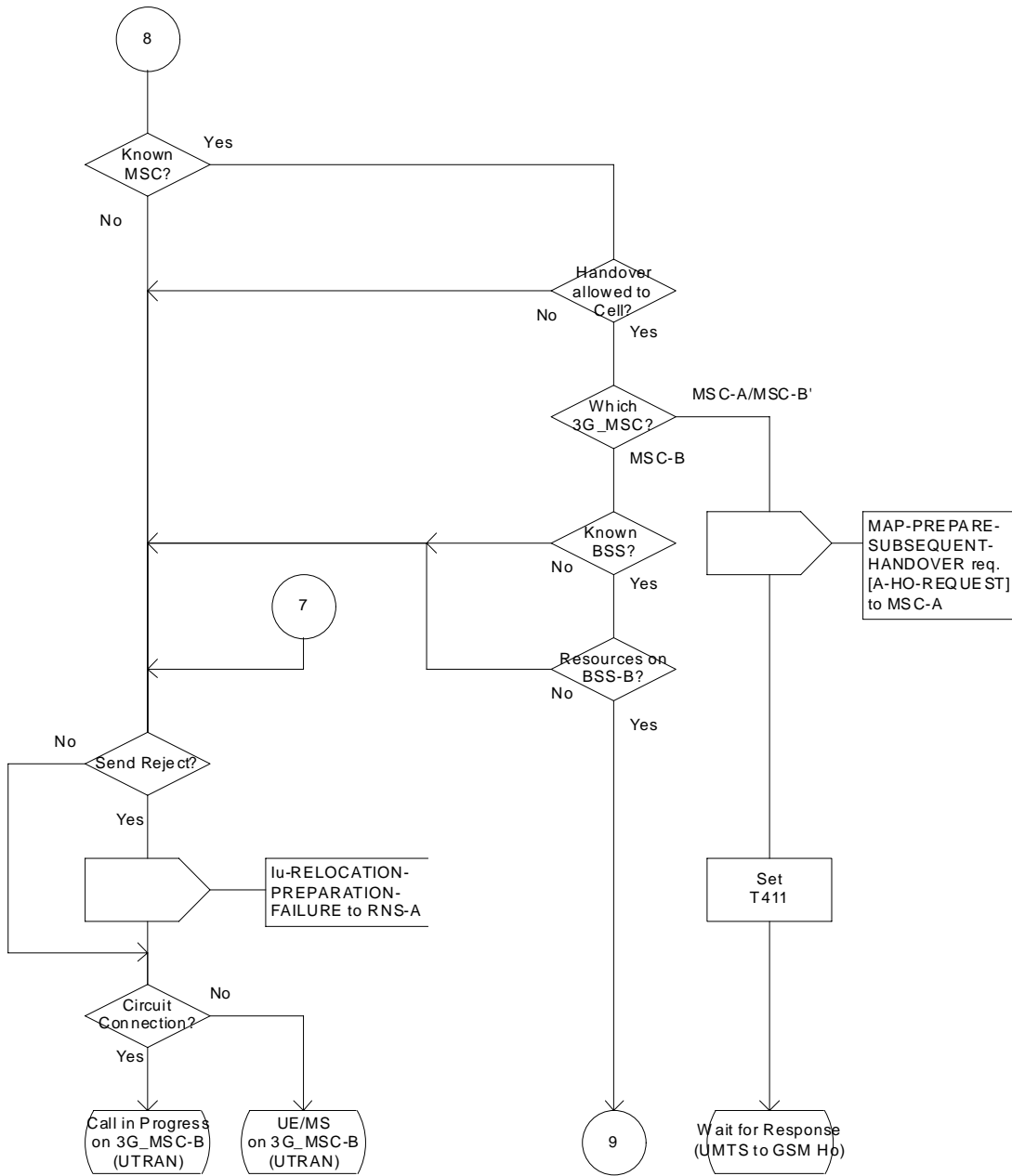

Figure 44 (sheet 25 of 54): Handover control procedure in 3G_MSC-B

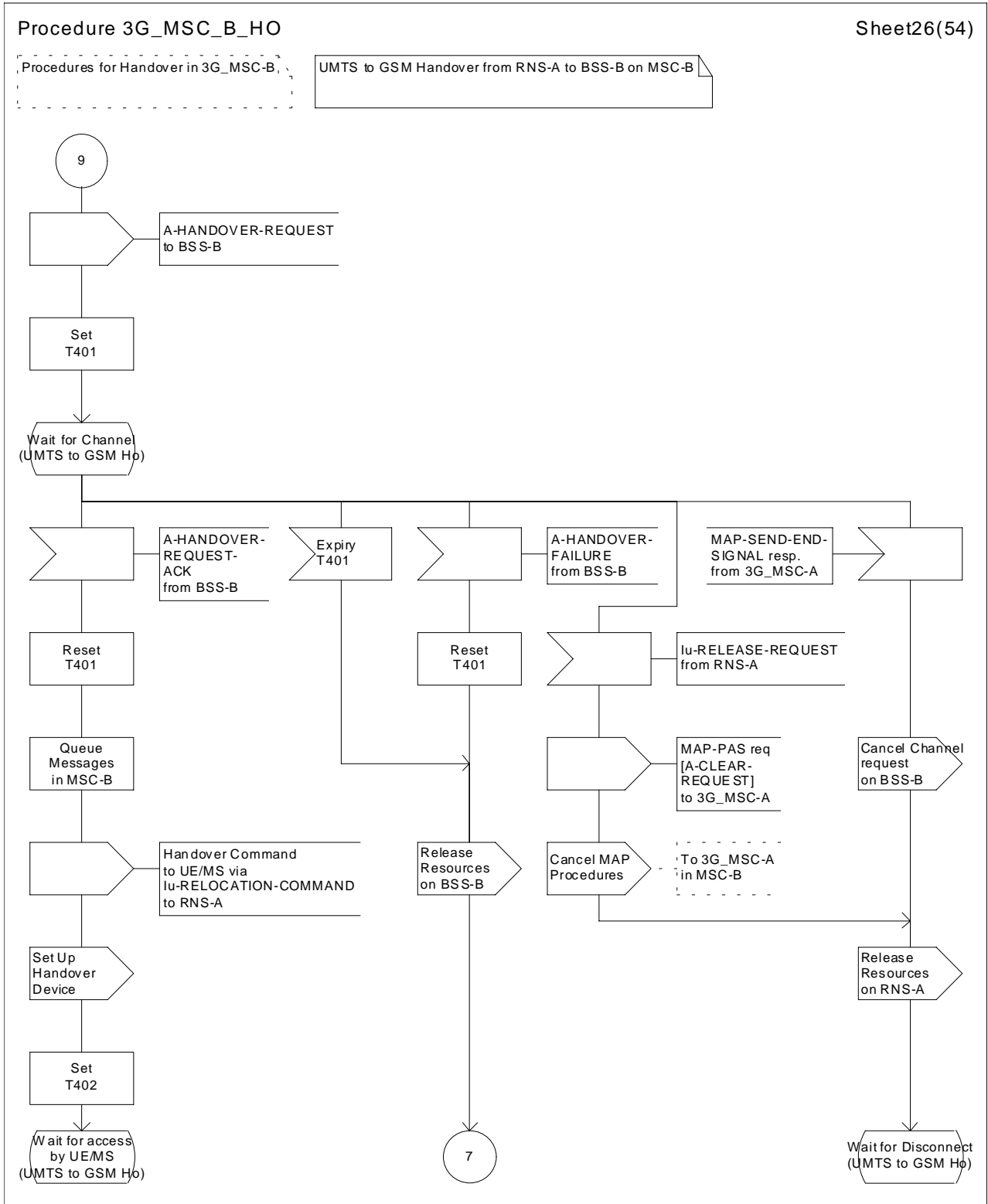

Figure 44 (sheet 26 of 54): Handover control procedure in 3G_MSC-B

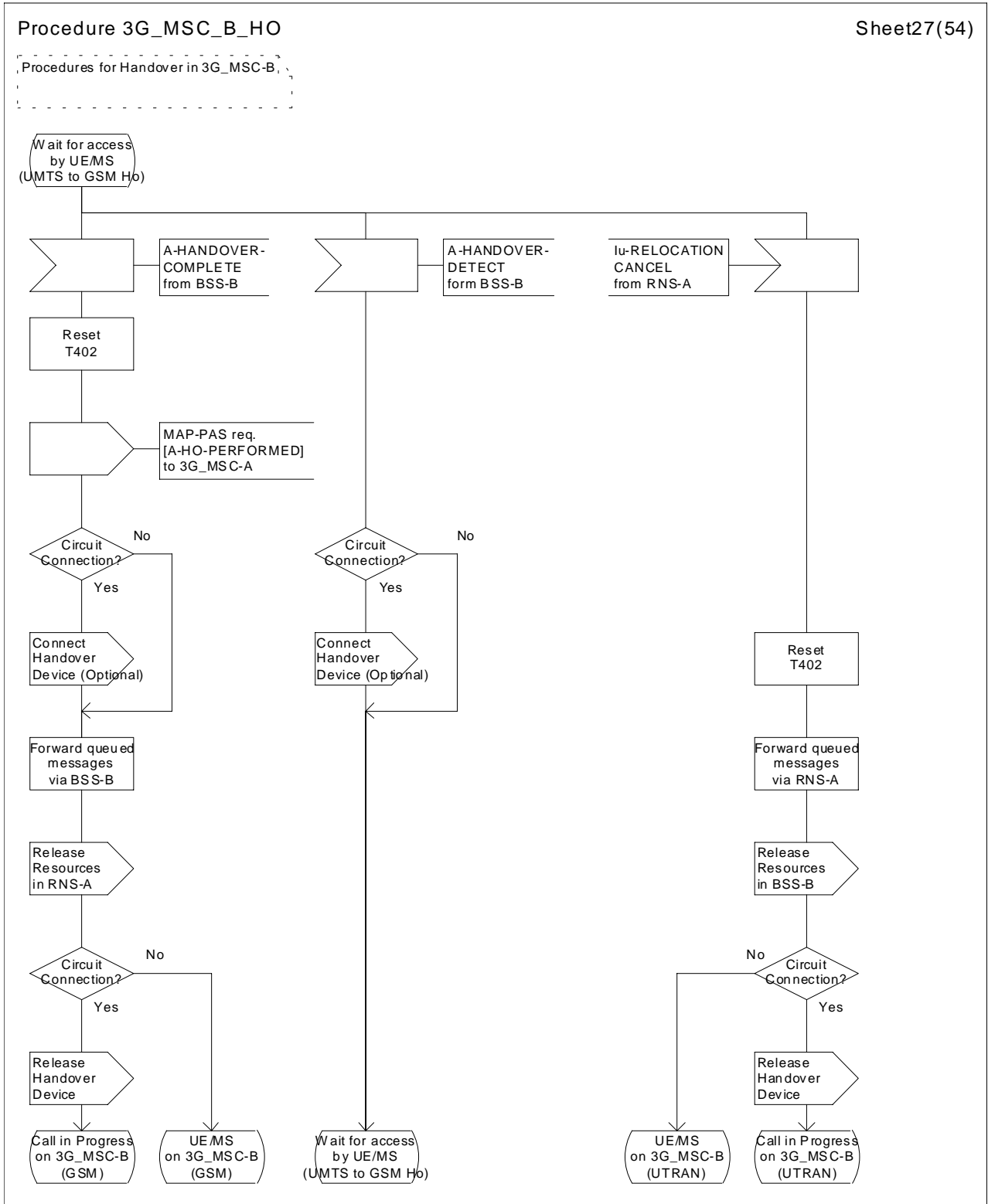

Figure 44 (sheet 27 of 54): Handover control procedure in 3G_MSC-B

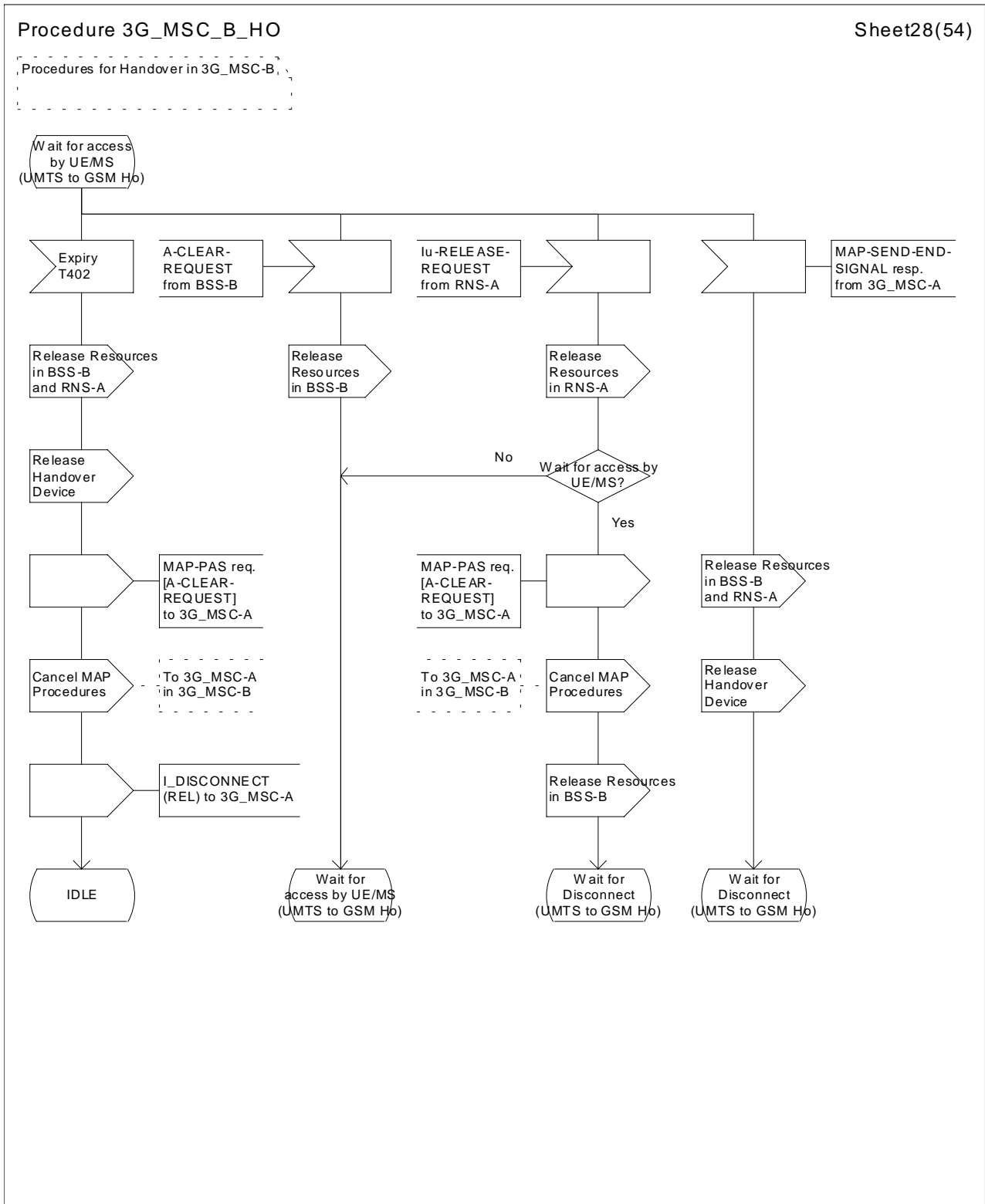

Figure 44 (sheet 28 of 54): Handover control procedure in 3G_MSC-B

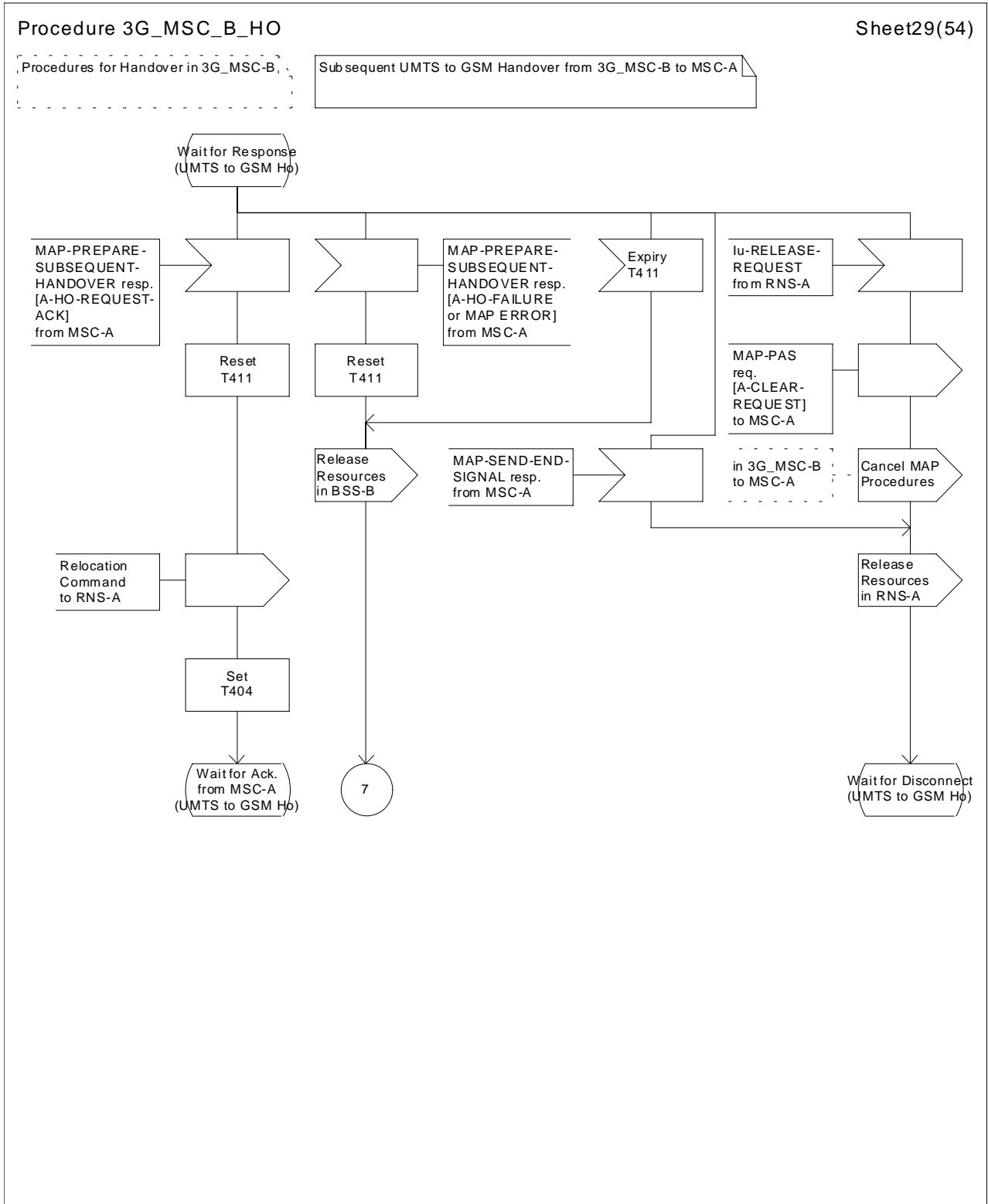

Figure 44 (sheet 29 of 54): Handover control procedure in 3G_MSC-B

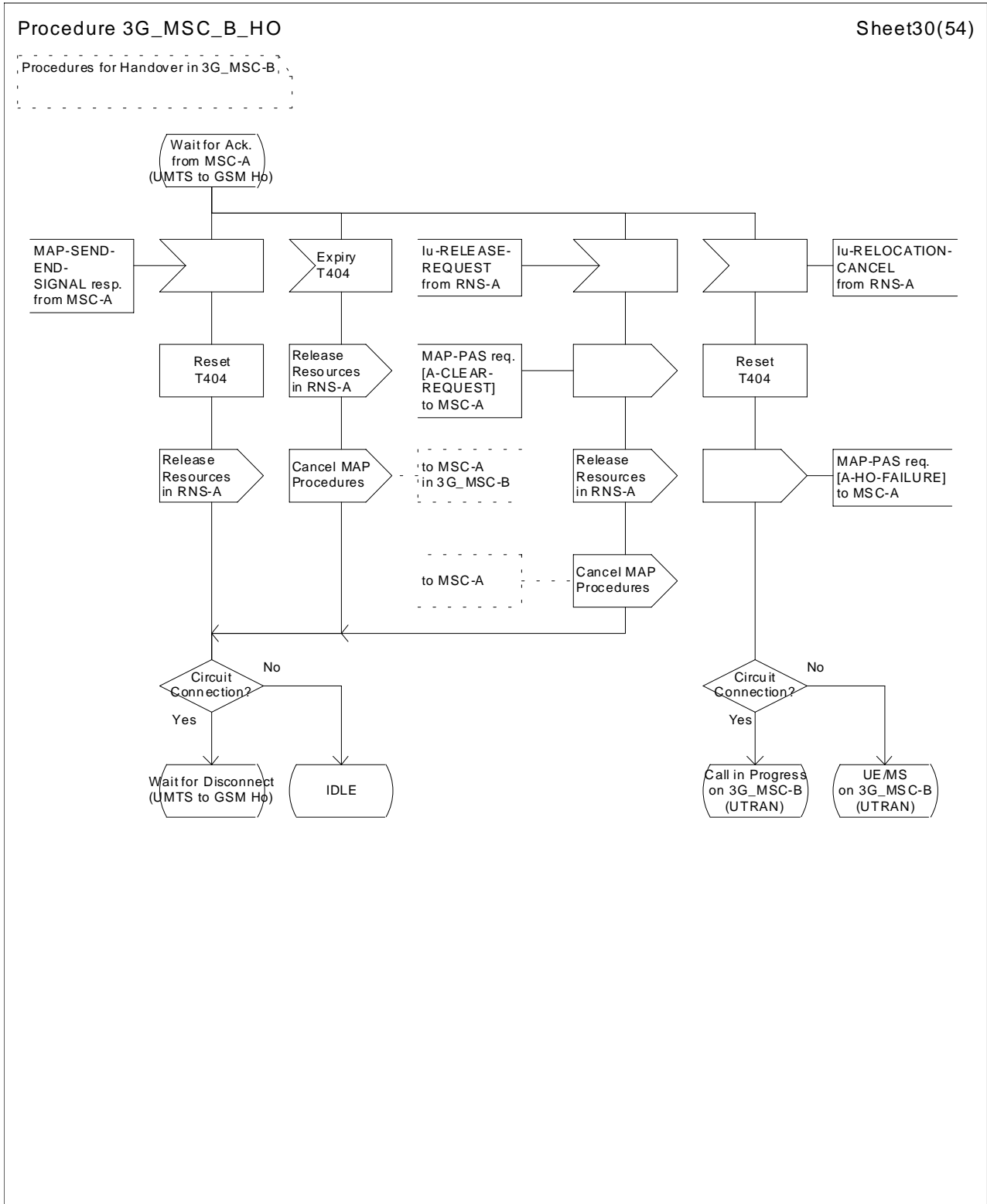

Figure 44 (sheet 30 of 54): Handover control procedure in 3G_MSC-B

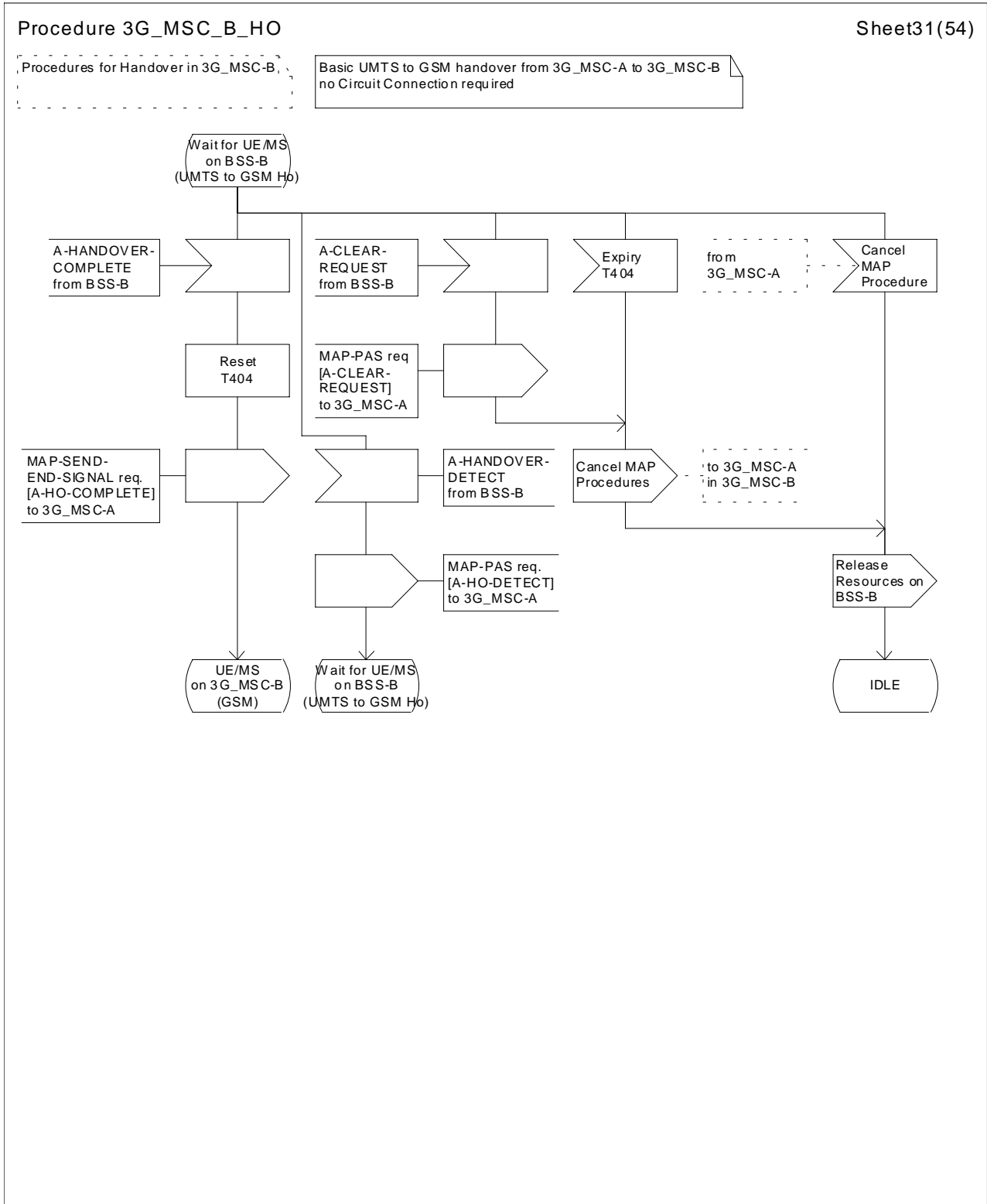

Figure 44 (sheet 31 of 54): Handover control procedure in 3G_MSC-B

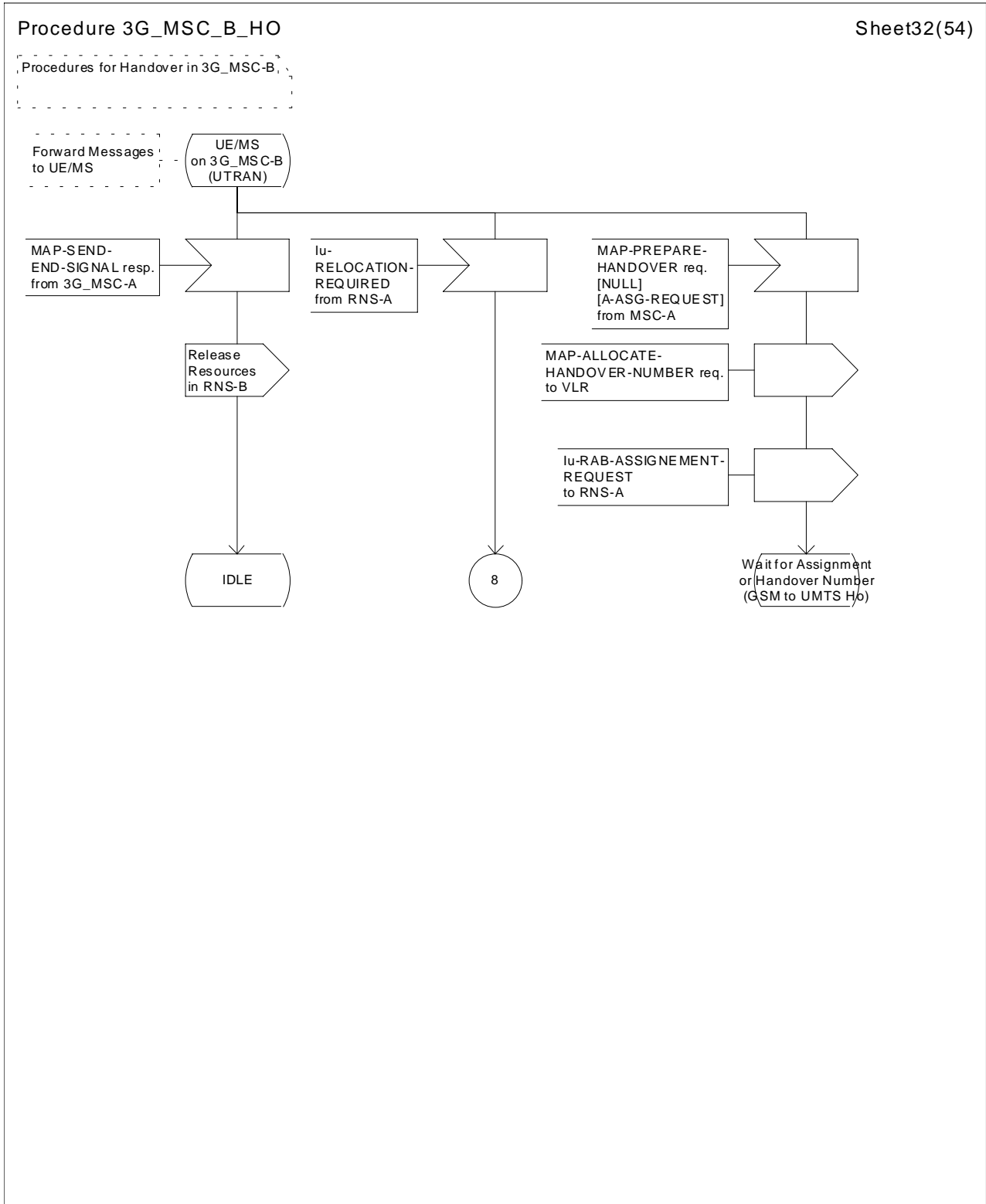

Figure 44 (sheet 32 of 54): Handover control procedure in 3G_MSC-B

Procedure 3G_MSC_B_HO

Sheet33(54)

Procedures for Handover in 3G_MSC-B, Circuit Connection Establishment on 3G_MSC-B

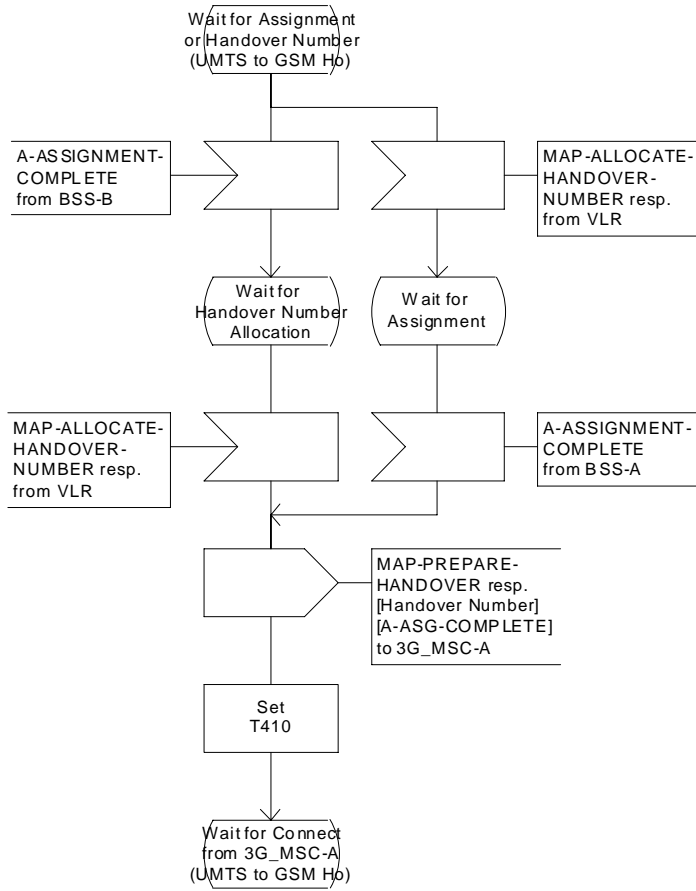

Figure 44 (sheet 33 of 54): Handover control procedure in 3G_MSC-B

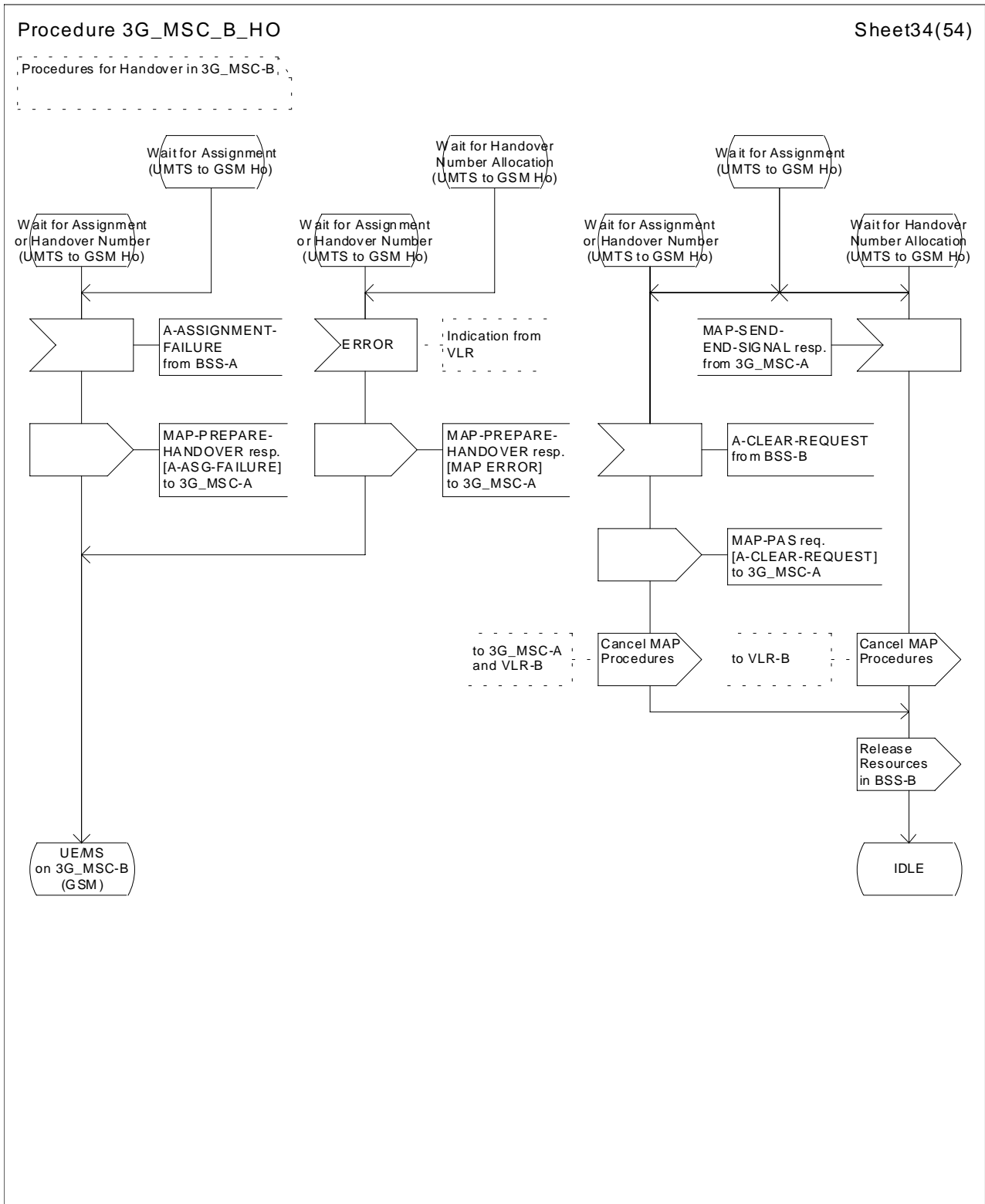

Figure 44 (sheet 34 of 54): Handover control procedure in 3G_MSC-B

Procedure 3G_MSC_B_HO

Sheet35(54)

Procedures for Handover in 3G_MSC-B

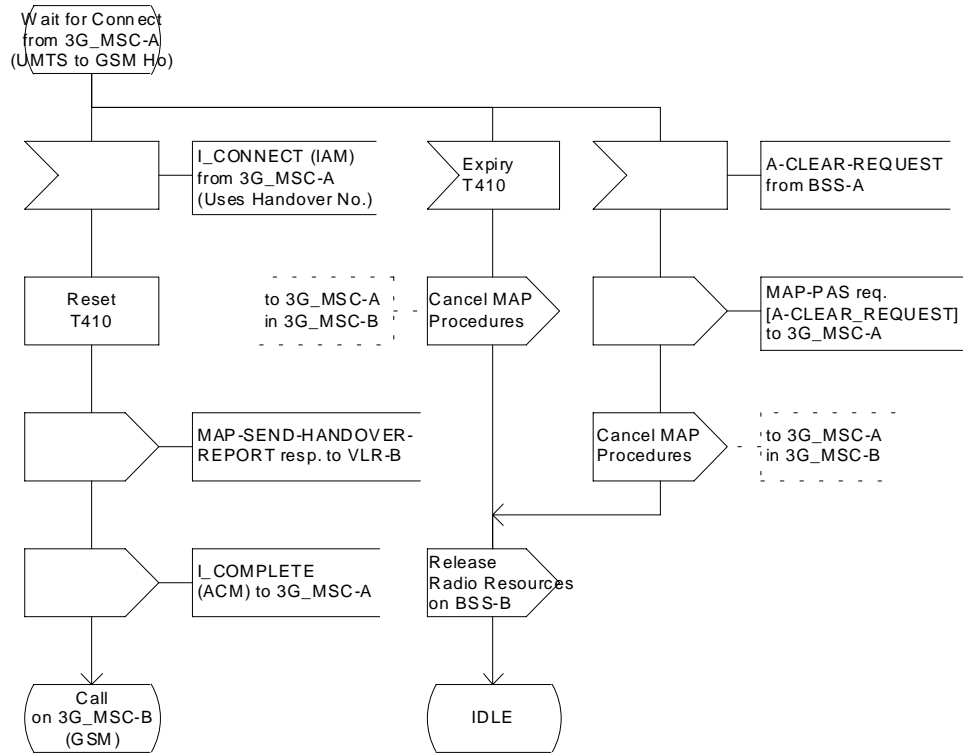

Figure 44 (sheet 35 of 54): Handover control procedure in 3G_MSC-B

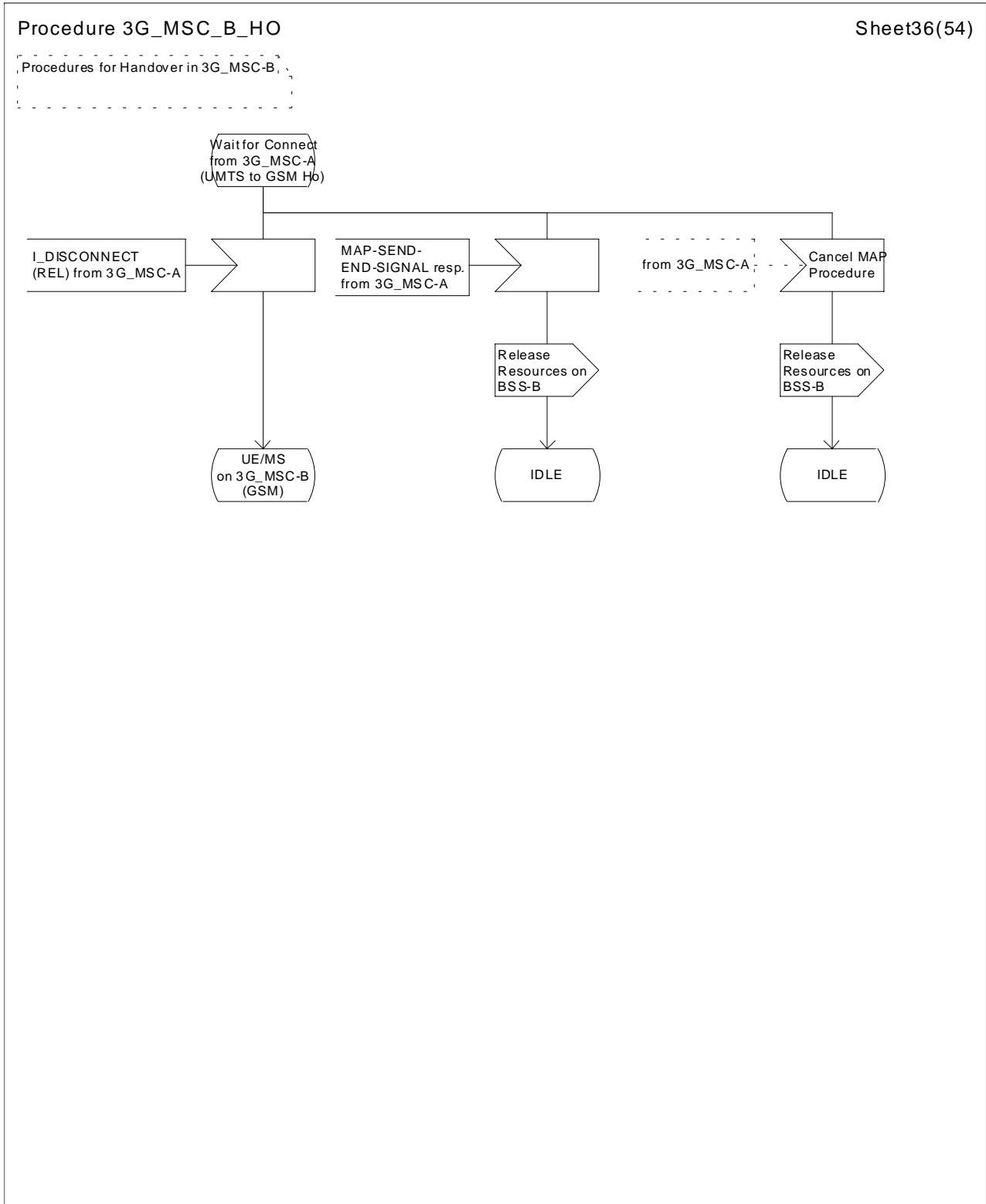

Figure 44 (sheet 36 of 54): Handover control procedure in 3G_MSC-B

Procedure 3G_MSC_B_HO

Sheet37(54)

Procedures for Handover in 3G_MSC-B

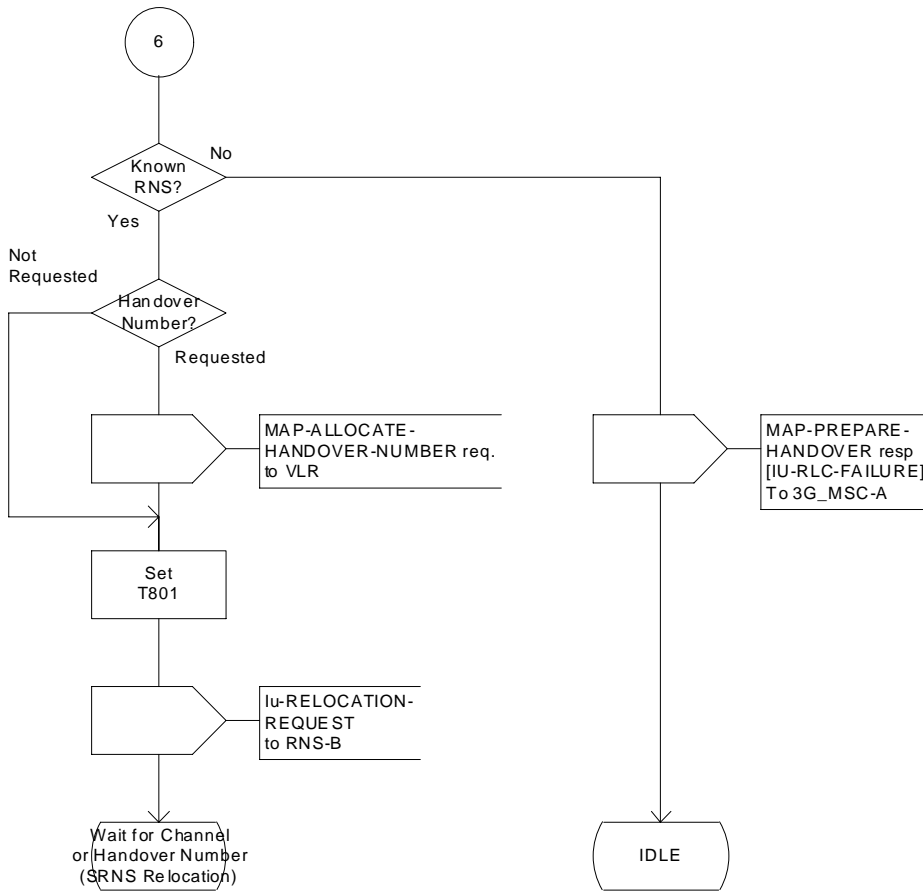

Figure 44 (sheet 37 of 54): Handover control procedure in 3G_MSC-B

Procedure 3G_MSC_B_HO

Sheet38(54)

Procedures for Handover in 3G_MSC-B

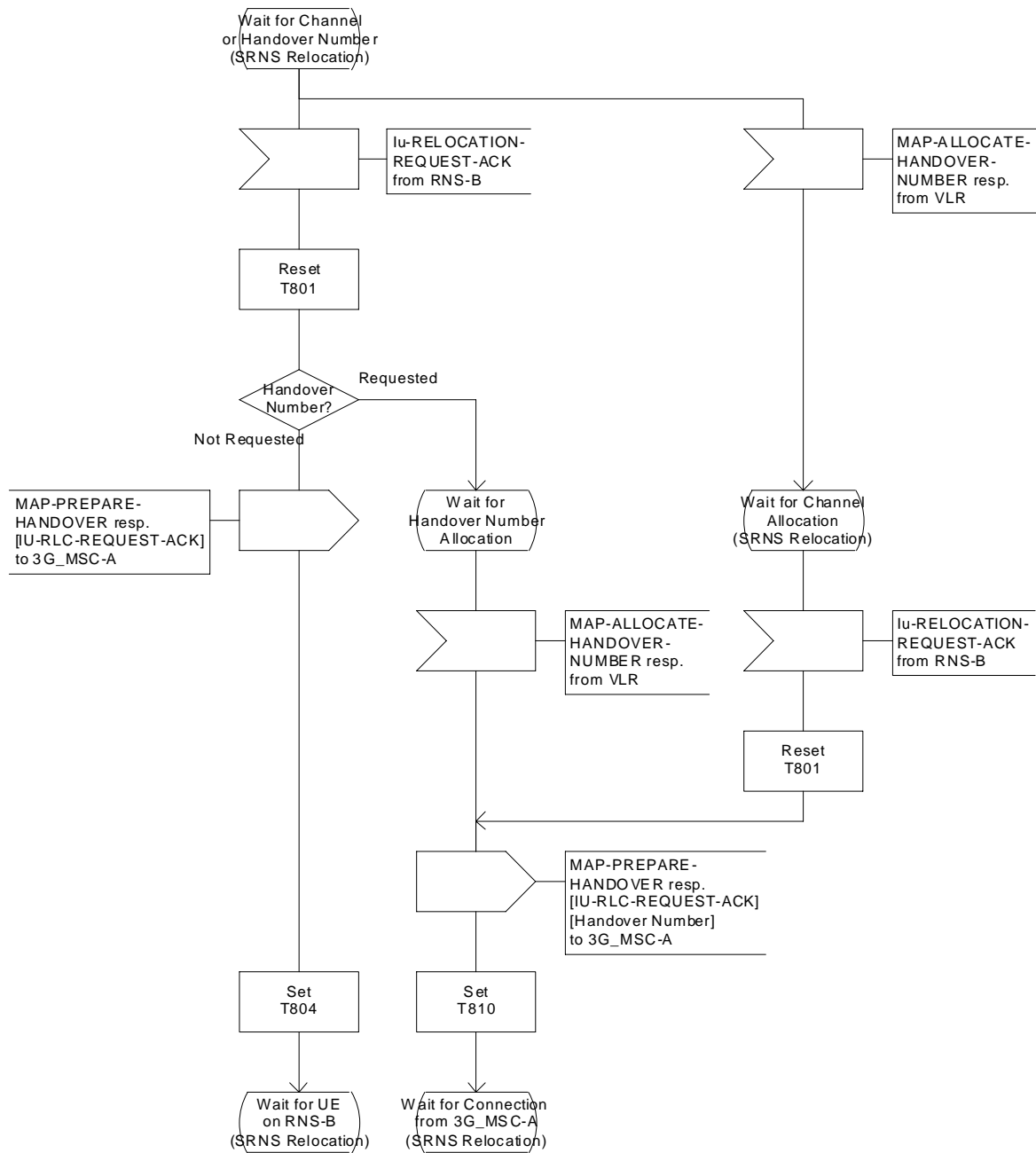

Figure 44 (sheet 38 of 54): Handover control procedure in 3G_MSC-B

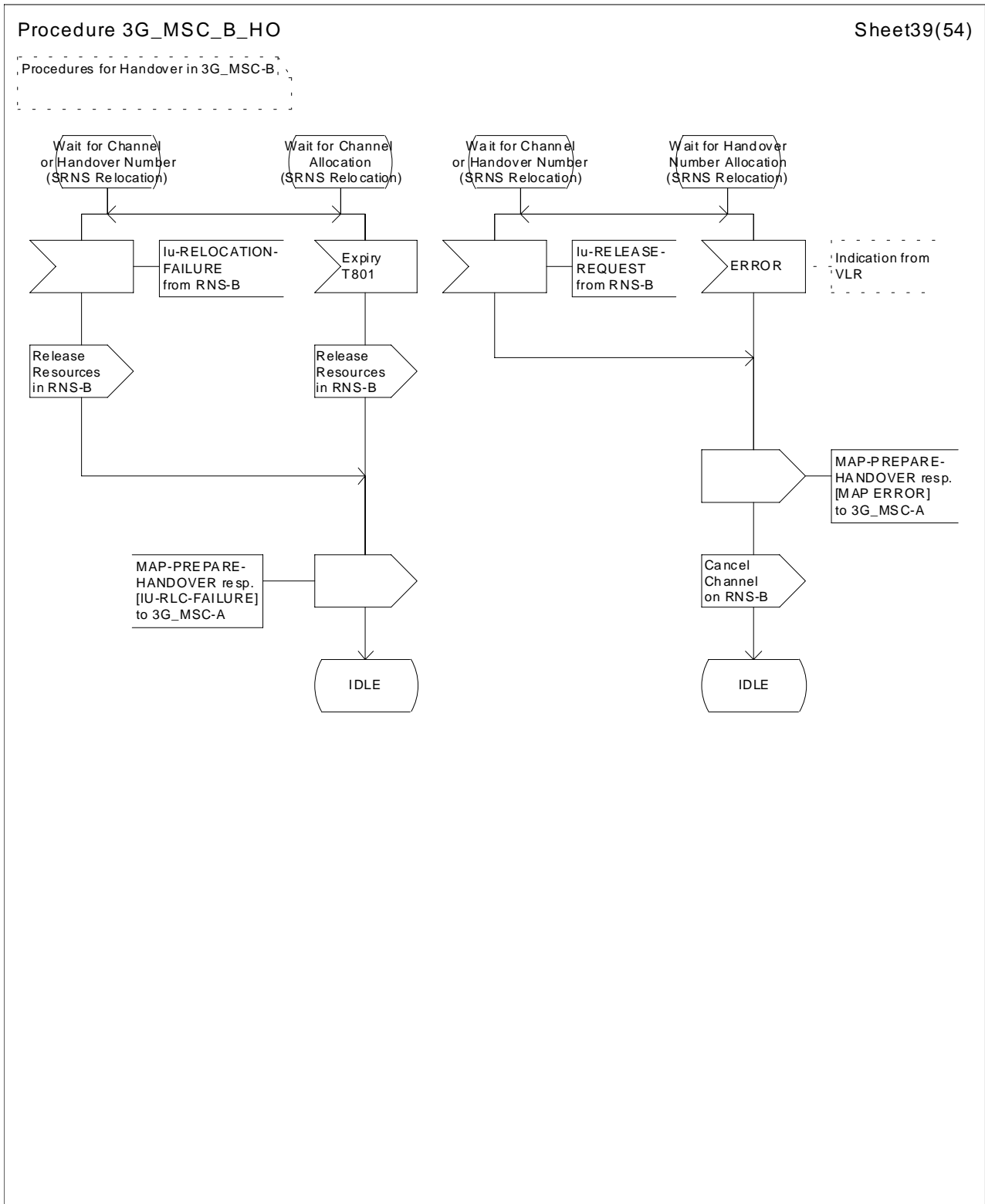

Figure 44 (sheet 39 of 54): Handover control procedure in 3G_MSC-B

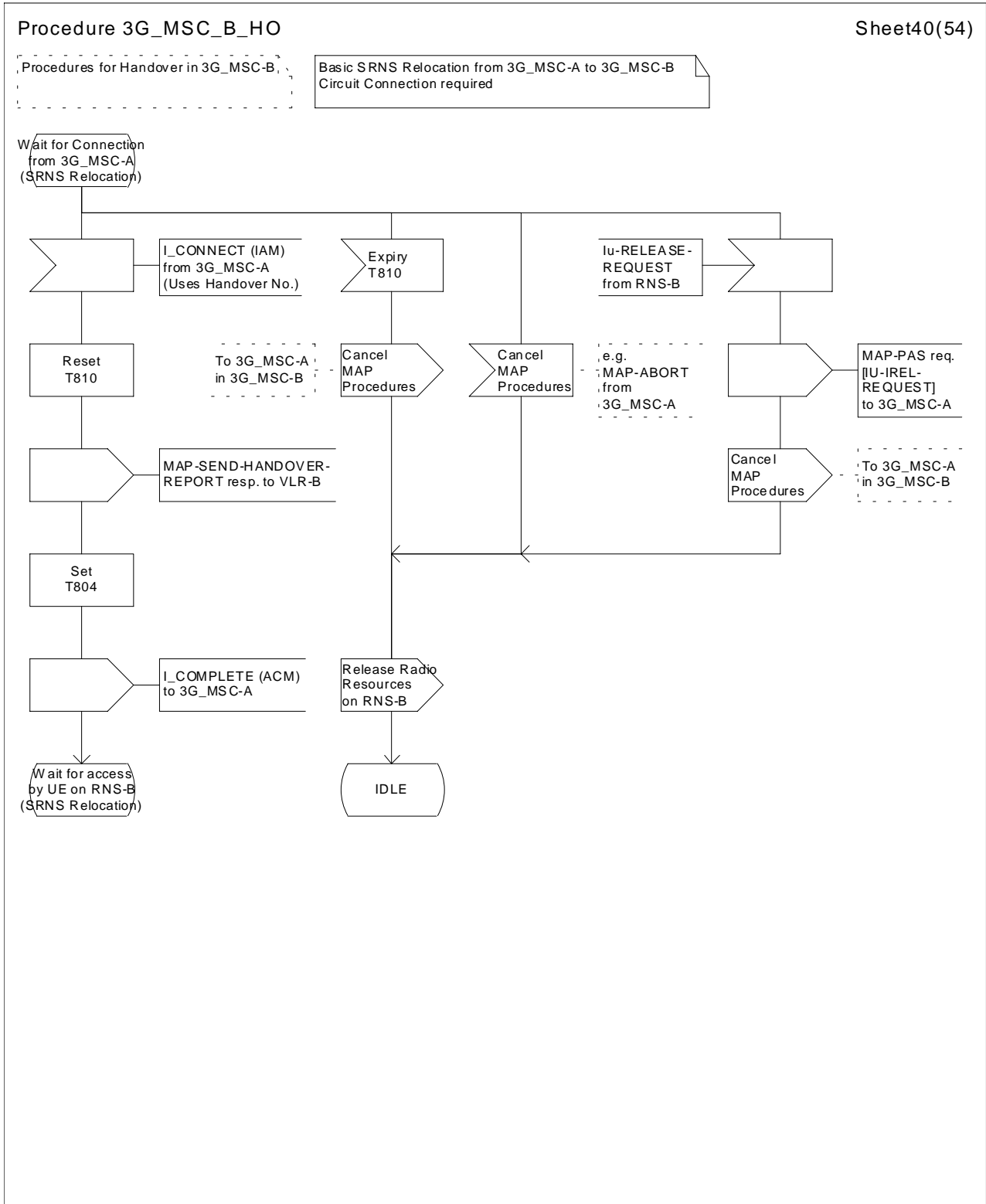

Figure 44 (sheet 40 of 54): Handover control procedure in 3G_MSC-B

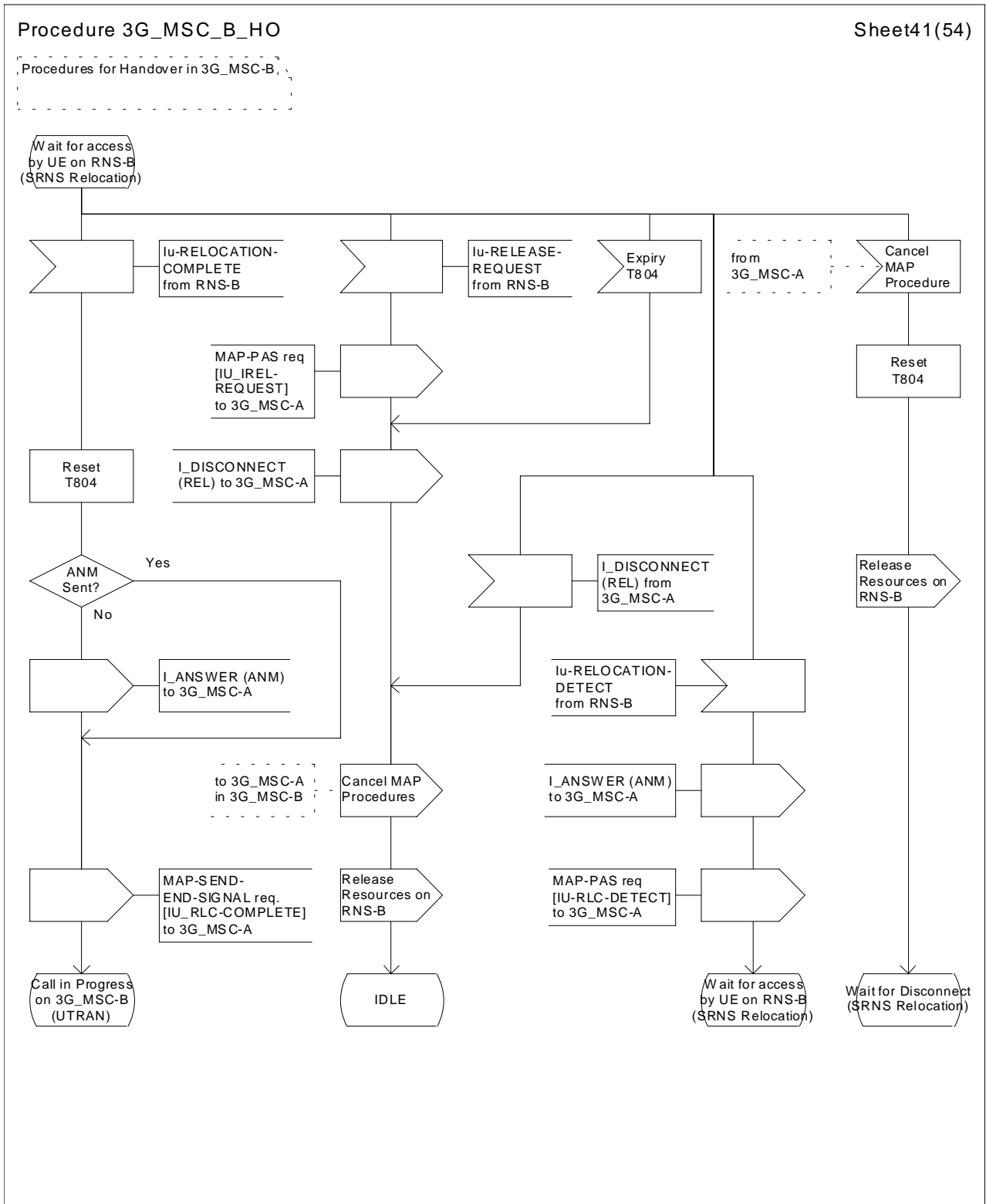

Figure 44 (sheet 41 of 54): Handover control procedure in 3G_MSC-B

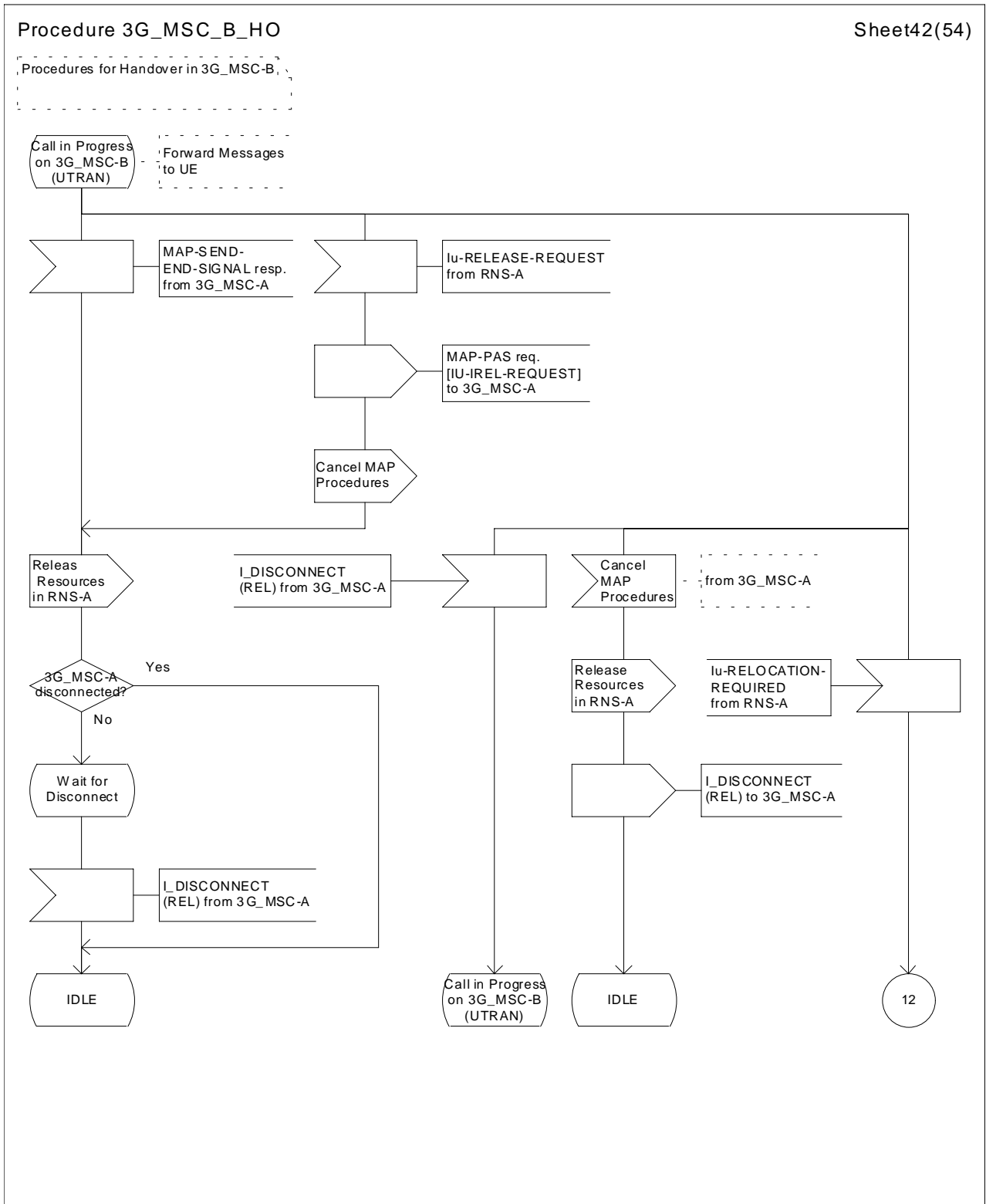

Figure 44 (sheet 42 of 54): Handover control procedure in 3G_MSC-B

Procedure 3G_MSC_B_HO

Sheet43(54)

Procedures for Handover in 3G_MSC-B

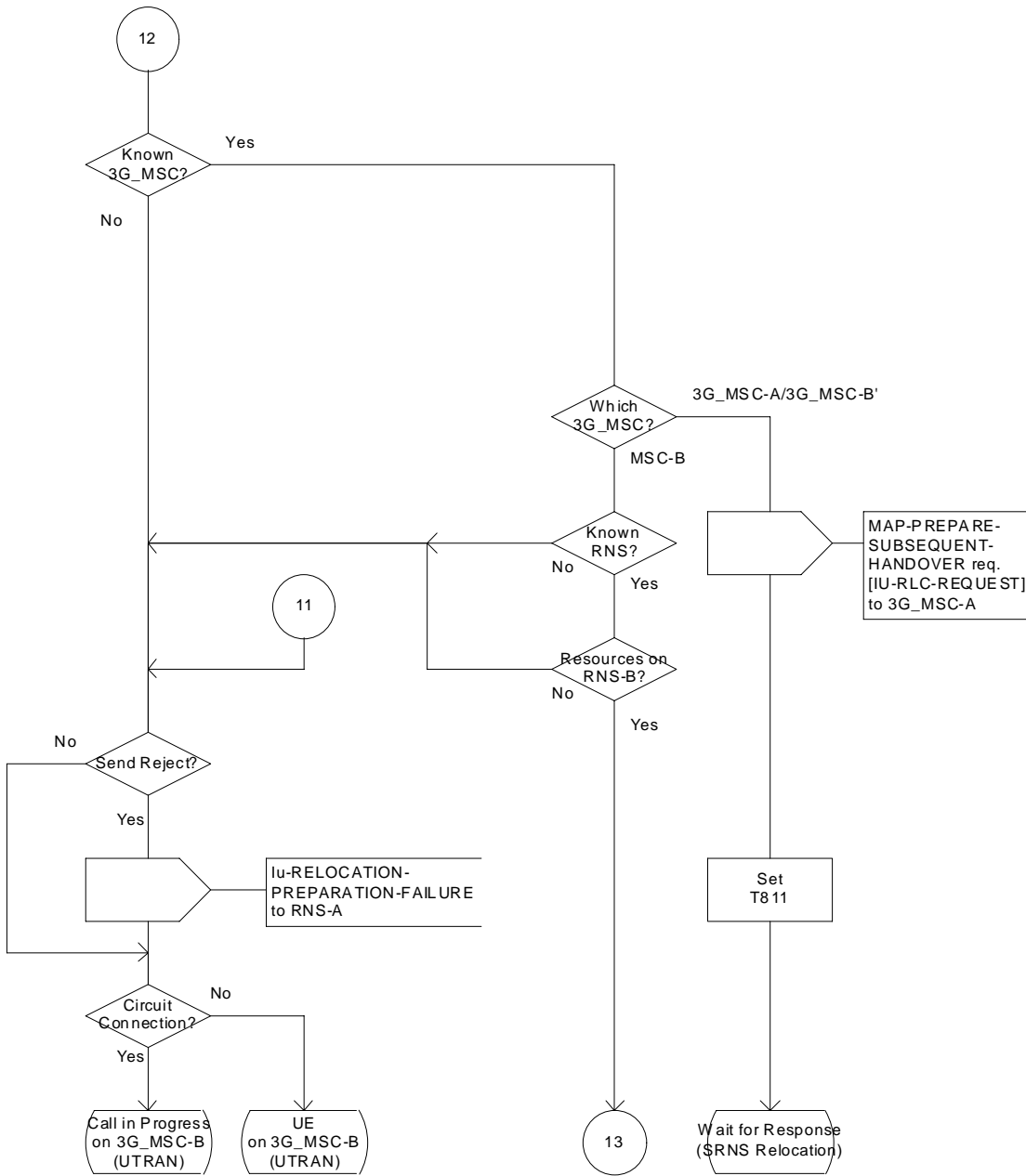

Figure 44 (sheet 43 of 54): Handover control procedure in 3G_MSC-B

Procedure 3G_MSC_B_HO

Sheet44(54)

Procedures for Handover in 3G_MSC-B

SRNS Relocation from RNS-A to RNS-B on 3G_MSC-B

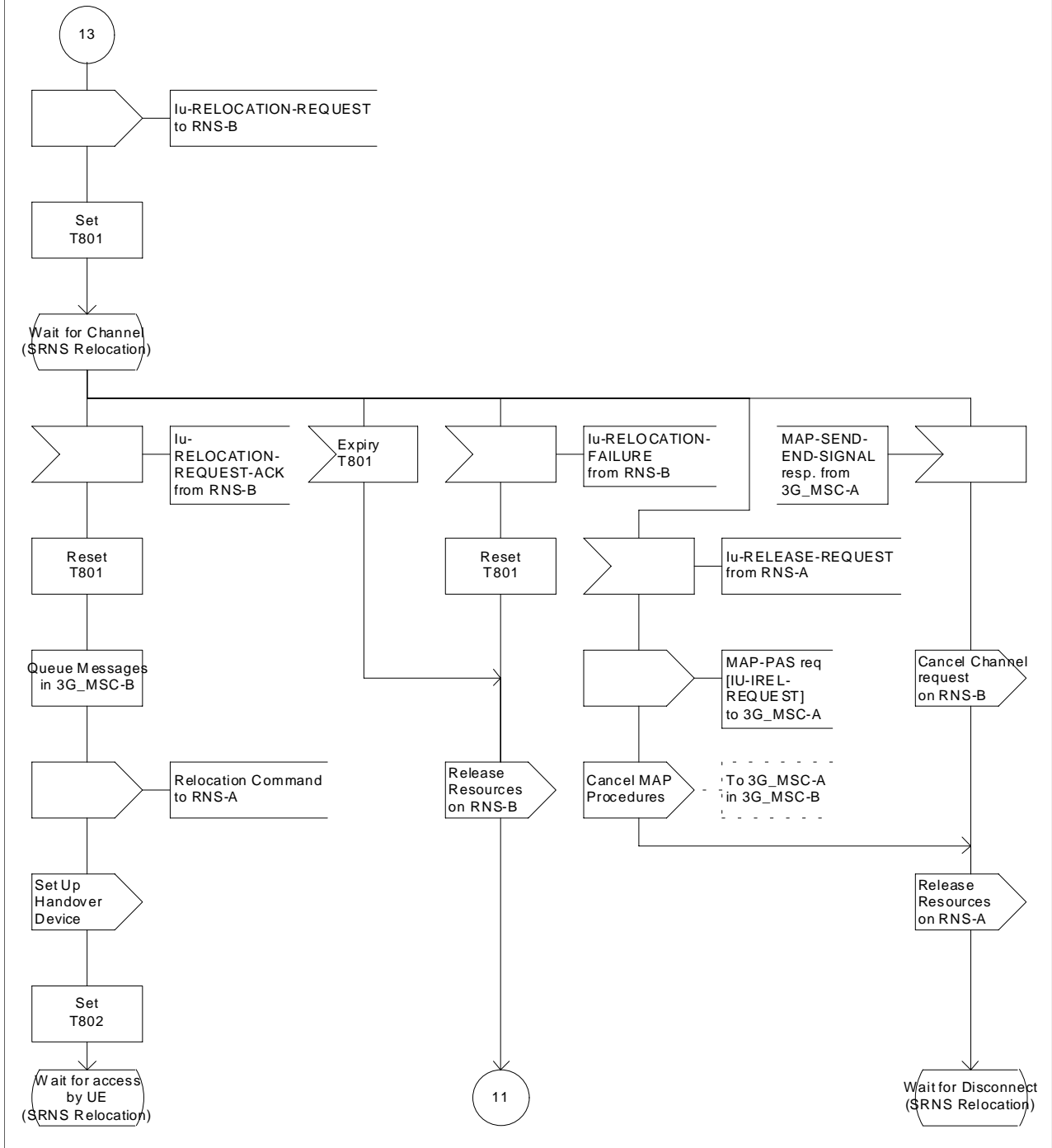

Figure 44 (sheet 44 of 54): Handover control procedure in 3G_MSC-B

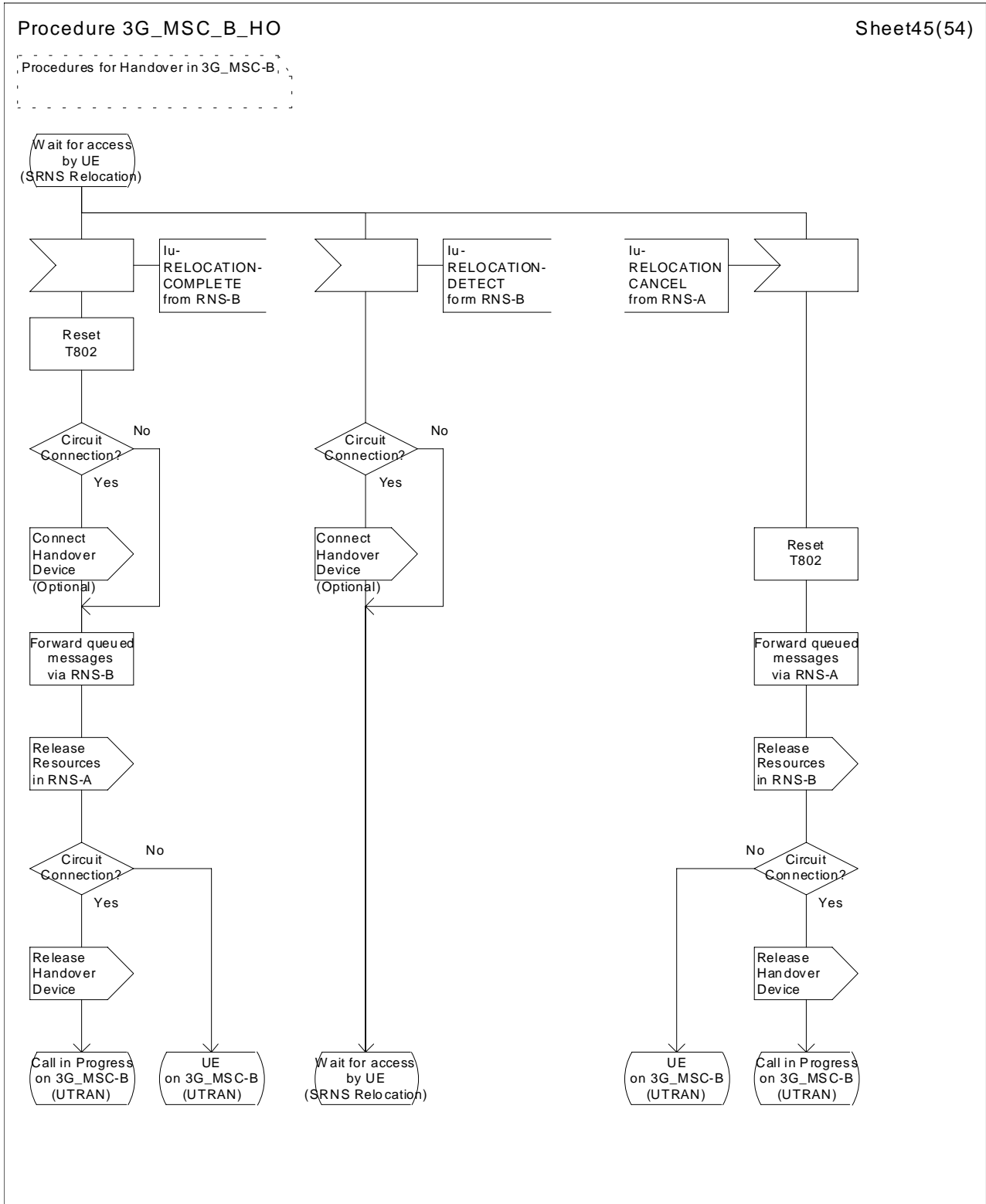

Figure 44 (sheet 45 of 54): Handover control procedure in 3G_MSC-B

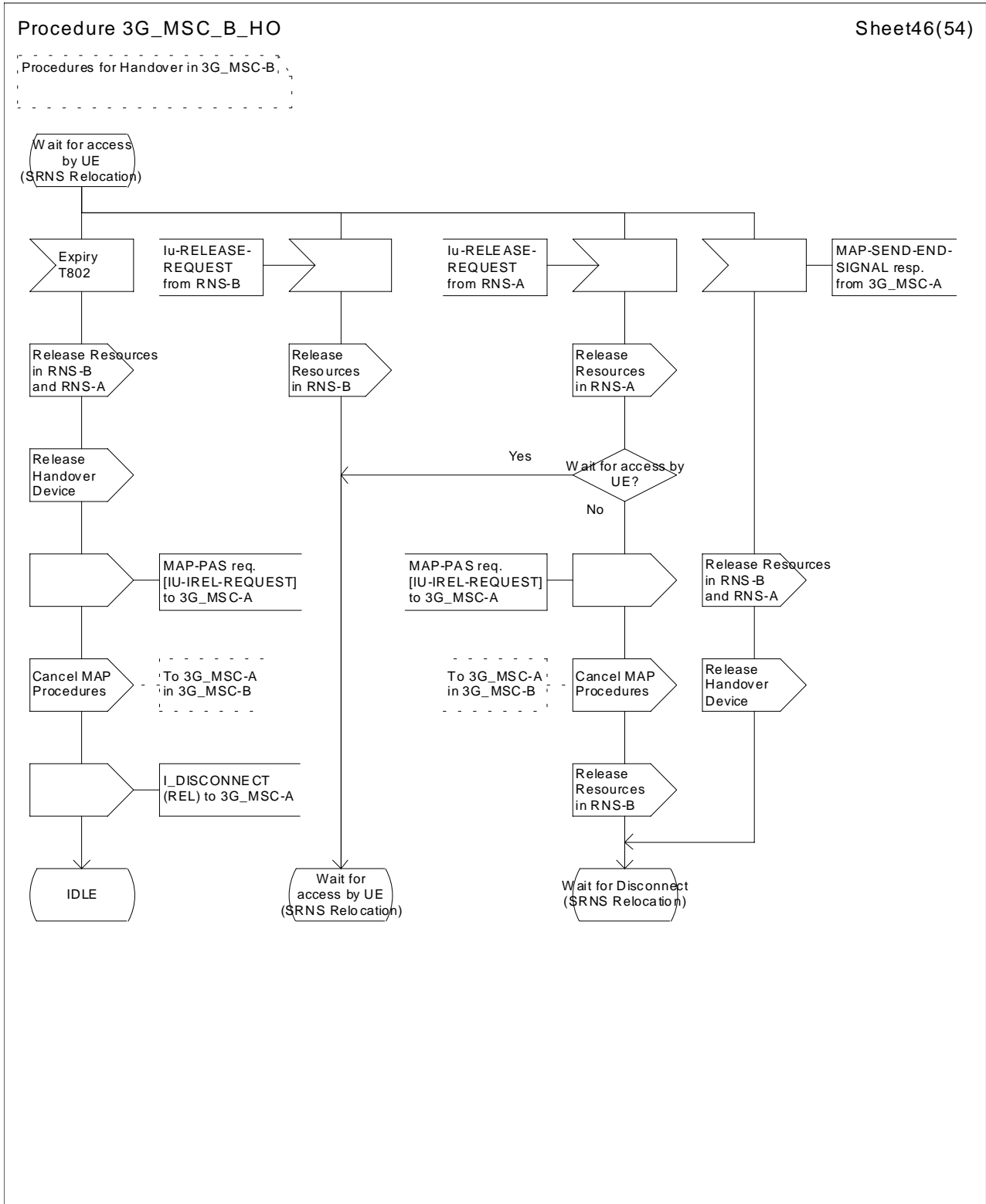

Figure 44 (sheet 46 of 54): Handover control procedure in 3G_MSC-B

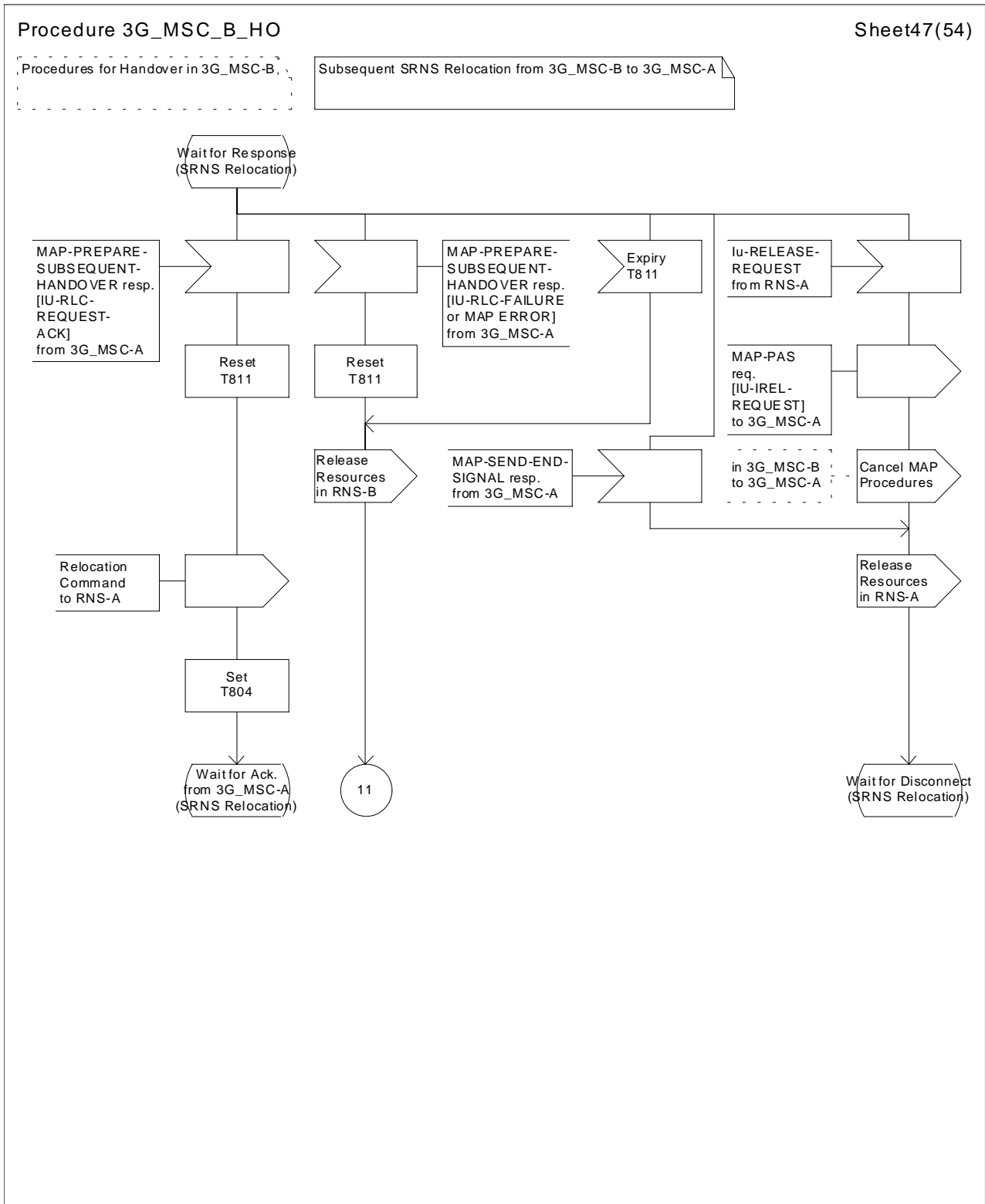

Figure 44 (sheet 47 of 54): Handover control procedure in 3G_MSC-B

Procedure 3G_MSC_B_HO

Sheet48(54)

Procedures for Handover in 3G_MSC-B

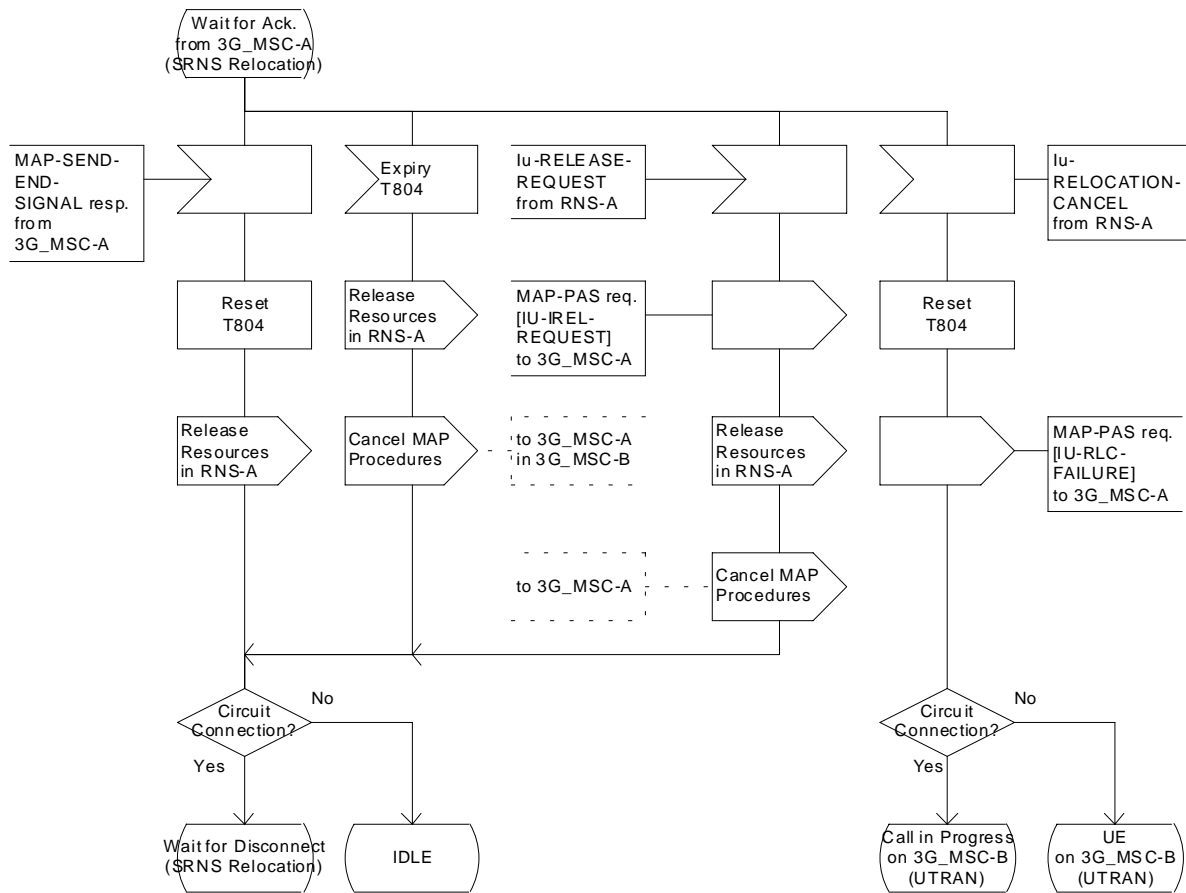

Figure 44 (sheet 48 of 54): Handover control procedure in 3G_MSC-B

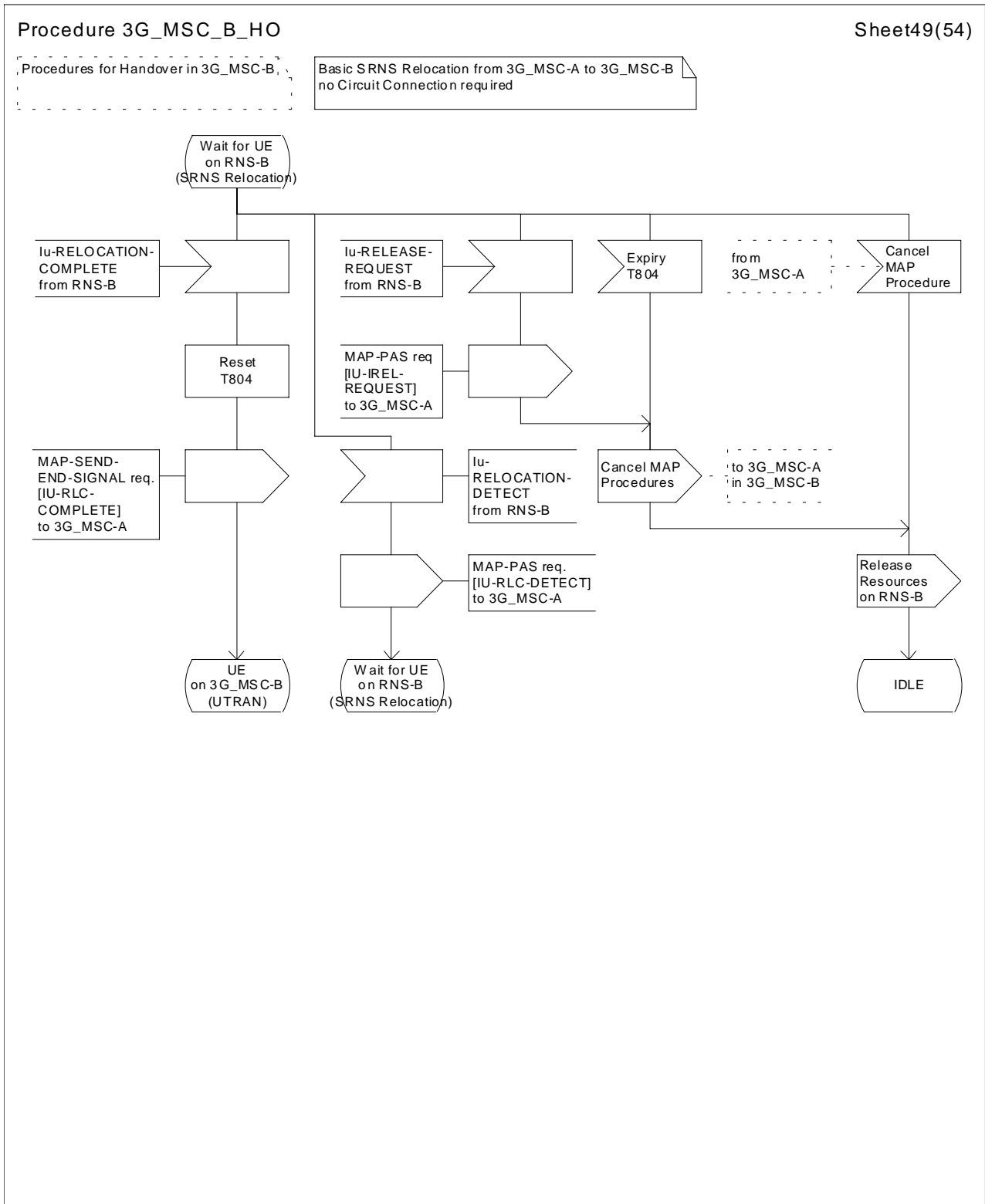

Figure 44 (sheet 49 of 54): Handover control procedure in 3G_MSC-B

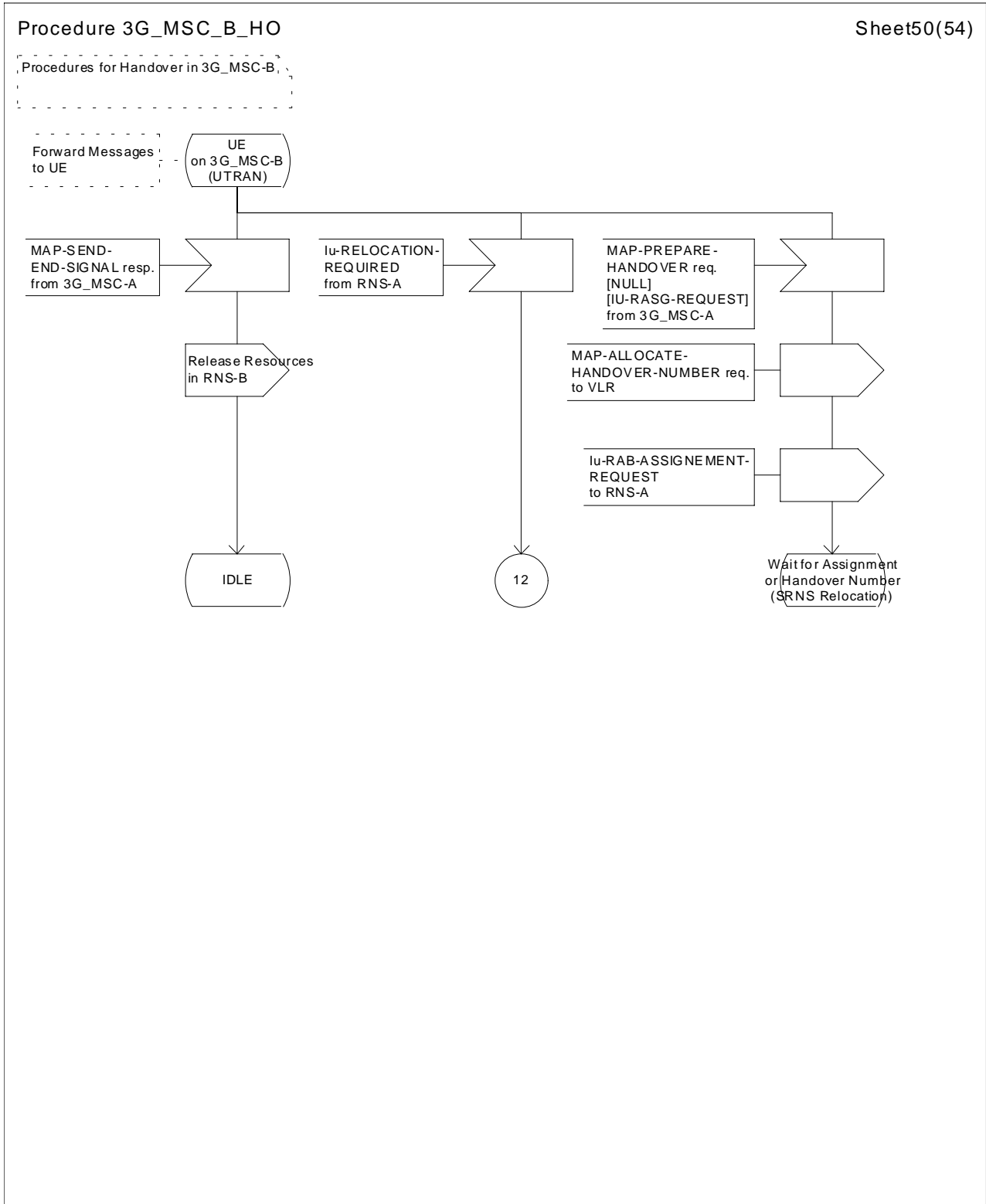

Figure 44 (sheet 50 of 54): Handover control procedure in 3G_MSC-B

Procedure 3G_MSC_B_HO

Sheet51(54)

Procedures for Handover in 3G_MSC-B, Circuit Connection Establishment on 3G_MSC-B

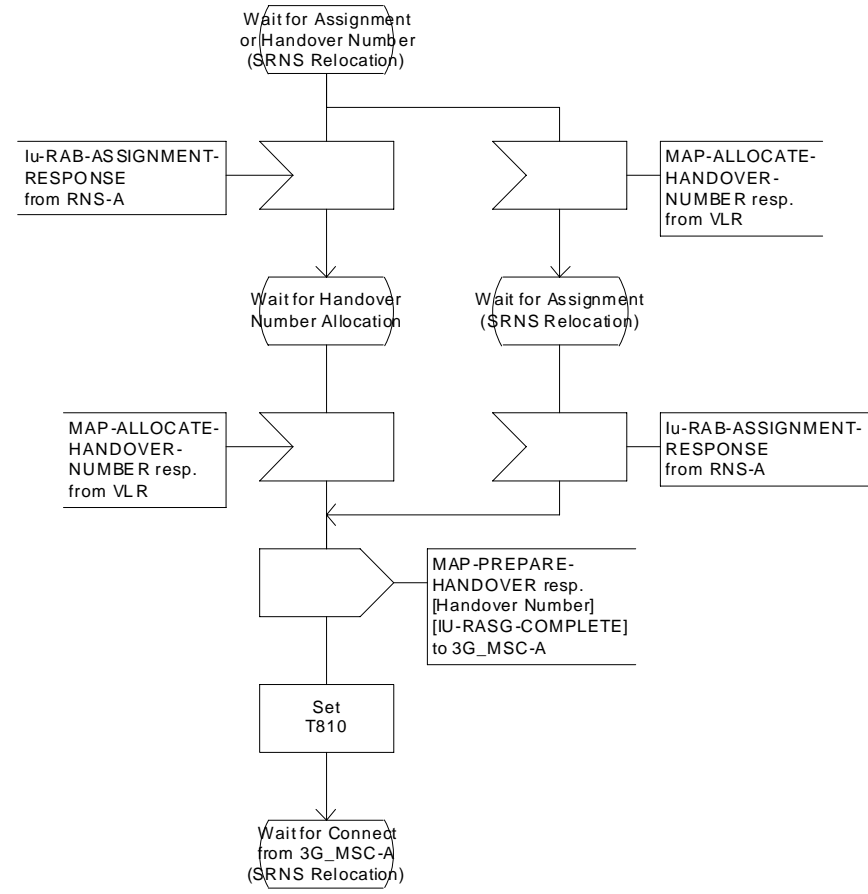

Figure 44 (sheet 51 of 54): Handover control procedure in 3G_MSC-B

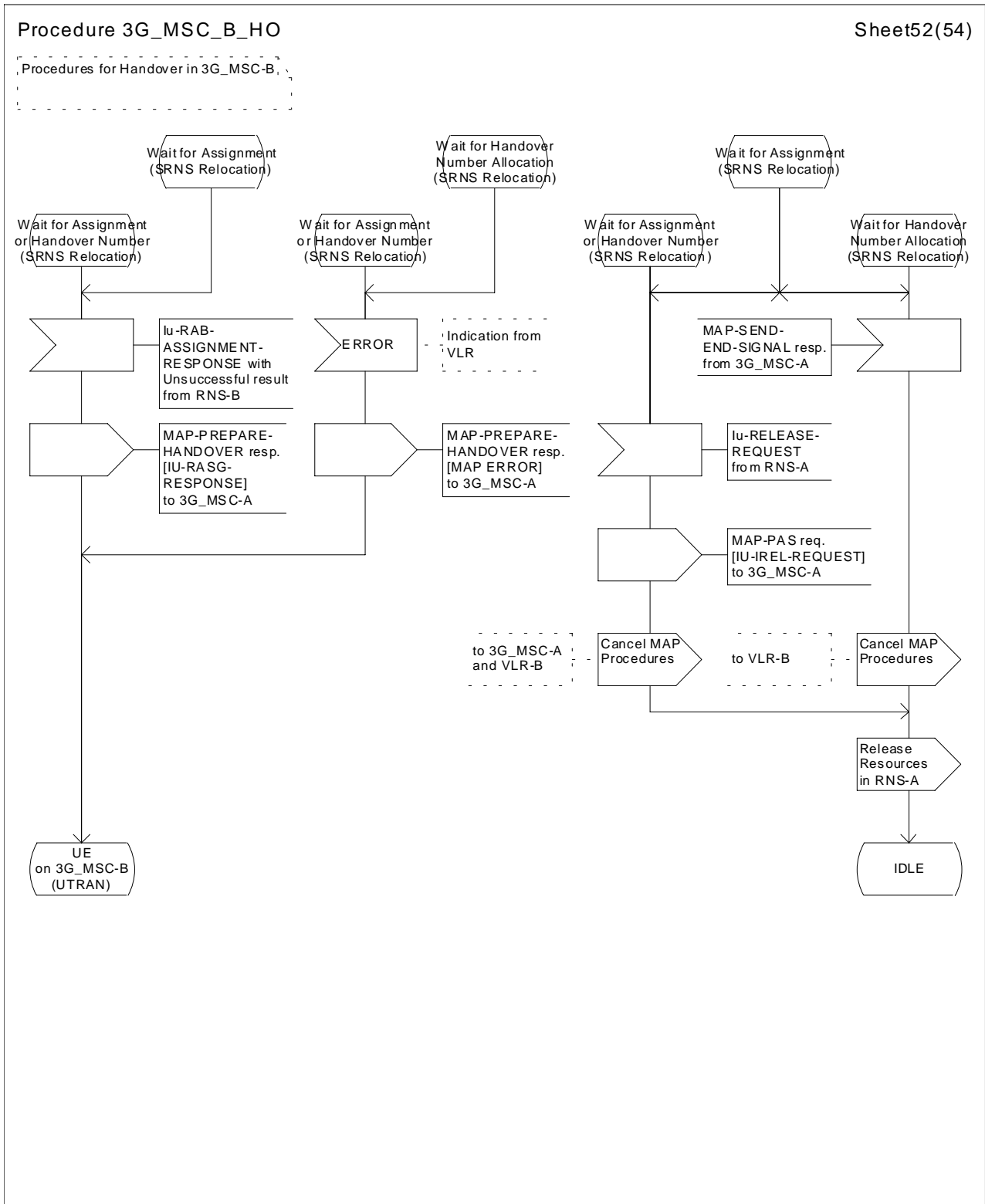

Figure 44 (sheet 52 of 54): Handover control procedure in 3G_MSC-B

Procedure 3G_MSC_B_HO

Sheet53(54)

Procedures for Handover in 3G_MSC-B

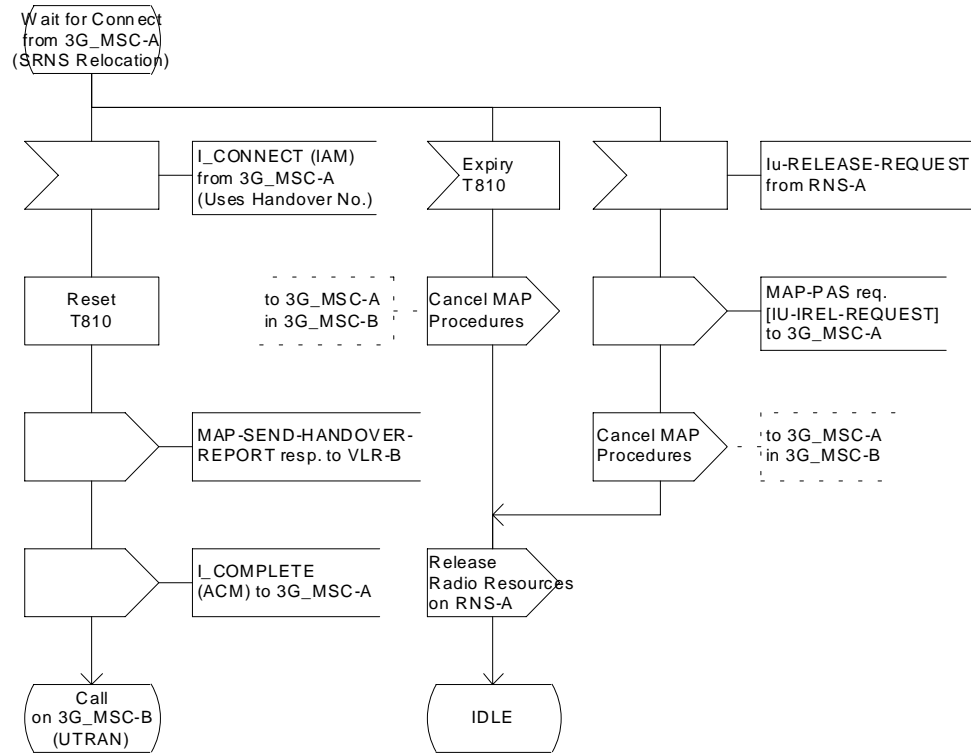

Figure 44 (sheet 53 of 54): Handover control procedure in 3G_MSC-B

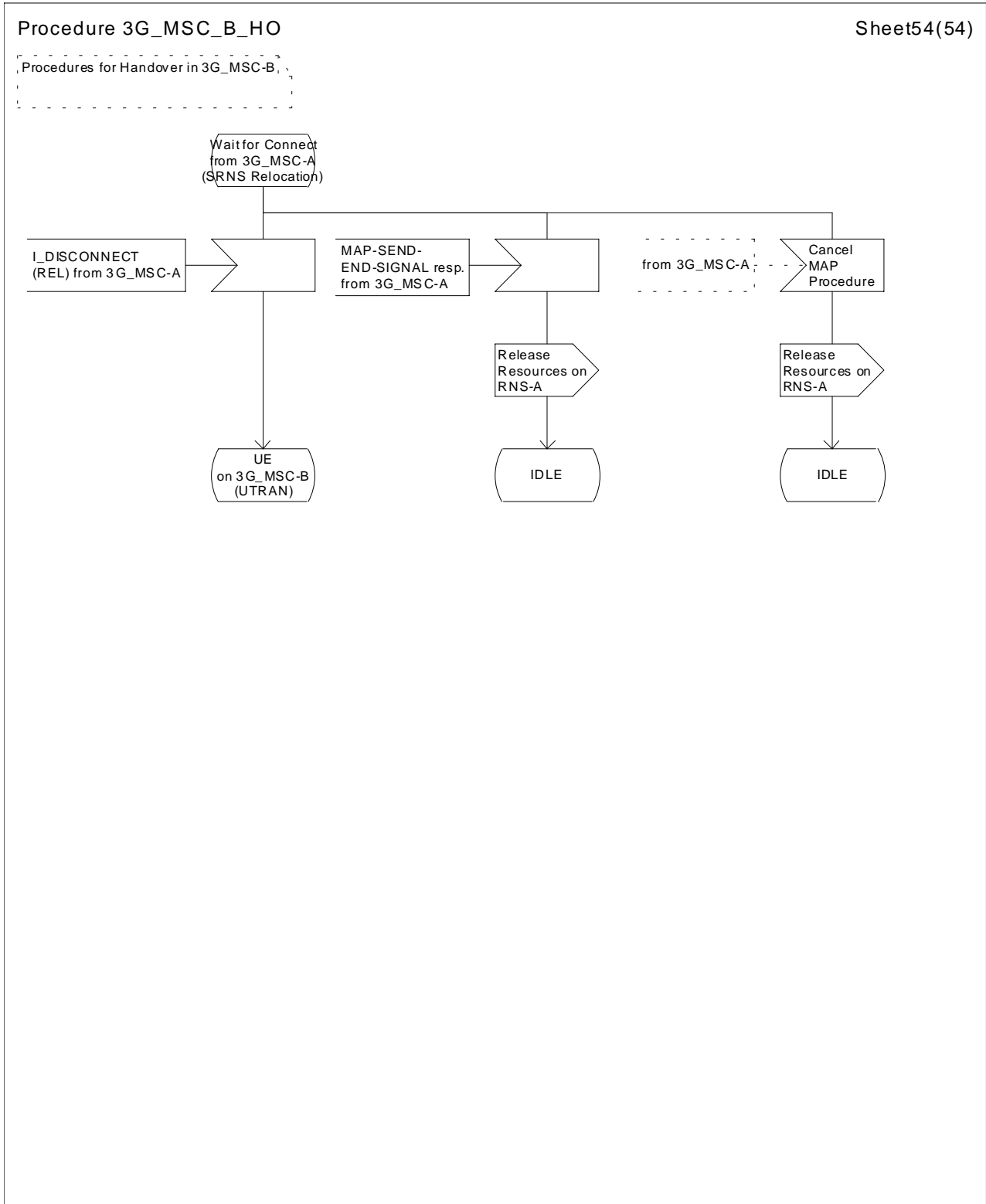

Figure 44 (sheet 54 of 54): Handover control procedure in 3G_MSC-B

Annex A (informative): Change history

Change history							
TSG CN#	Spec	Version	CR	Rel	New Version	Subject	Comment
Apr 1999	GSM 03.09	6.0.0					Transferred to 3GPP CN1
CN#03	23.009				3.0.0		Approved at CN#03
CN#06	23.009	3.0.0	CR001r2	R99	3.1.0	Introduction of UMTS functionalities in 23.009	
CN#7	23.009	3.1.0	CR003	R99	3.2.0	Functional requirements for the use of RANAP over the E i/f	
CN#7	23.009	3.1.0	CR004	R99	3.2.0		SDLs
CN#7	23.009	3.1.0	CR005	R99	3.2.0		SDLs
CN#7	23.009	3.1.0	CR006	R99	3.2.0	Introduction of RANAP for intra-UMTS inter-MSC relocation	
CN#7	23.009	3.1.0	CR007	R99	3.2.0	Clarifications of 3G_MSC-A and 3G_MSC-B roles	
CN#7	23.009	3.1.0	CR008r2	R99	3.2.0	Transcoder handling in the CN at inter-system handover and relocation	
15/05/00	23.009	3.2.0	-	R99	3.2.1	Missing SDLs re-inserted by MCC for Figures 41 - 42 (GSM Handover control procedure in MSC-A and MSC-B)	SDLs

TSGN	TSGN-number	WG Number	Spec	CR	Rev	Rel	Cat	Old vers	New ver	Title	WI	Notes
NP-08	NP-000278	N1-000638	23.009	002	4	R99	B	3.2.1	3.3.0	CR to 23.009 on Handover scenario for Multicall	Multicall	
NP-08	NP-000270	N1-000607	23.009	009		R99	C	3.2.1	3.3.0	Clean-up of 3G_MSC-A_HO SDLs	GSM/UMTS Interworking	
NP-08	NP-000270	N1-000608	23.009	010		R99	C	3.2.1	3.3.0	Clean-up of 3G_MSC-B_HO SDLs	GSM/UMTS Interworking	
NP-09	NP-000444	N1-000922	23.009	012	1	R99	F	3.3.0	3.4.0	Correction to transcoder handling for R99	TrFo/Oo BTC	
NP-10	NP-000671	N1-001174	23.009	013		R99	F	3.4.0	3.5.0	GSM to UMTS Handover: Directed Retry	GSM/UMTS Interworking	
NP-10	NP-000671	N1-001175	23.009	014		R99	F	3.4.0	3.5.0	GSM to UMTS Handover: MAP parameter Target Cell ID	GSM/UMTS Interworking	
NP-10	NP-000724	N1-001412	23.009	015	2	R99	F	3.4.0	3.5.0	GSM to UMTS Handover: Location Reporting in 3G MSC B	GSM/UMTS Interworking	Accompanying CR 18 r? is the SDLs which will be provided to the next TSG-CN
NP-10	NP-000671	N1-001347	23.009	016	1	R99	F	3.4.0	3.5.0	Subsequent Handover procedure corrections	GSM/UMTS Interworking	
NP-10	NP-000671	N1-001408	23.009	017	3	R99	F	3.4.0	3.5.0	Missing Subsequent Handover scenarios	GSM/UMTS Interworking	
NP-10	NP-000673	N1-001304	23.009	019		R99	F	3.4.0	3.5.0	Reference clean-up	TEI	
NP-10	NP-000671	N1-001372	23.009	020	1	R99	F	3.4.0	3.5.0	Indication of Intra-MSC Intersystem handover from 3G_MSC-B to MSC-A/3G_MSC-A	GSM/UMTS Interworking	
NP-10	NP-000671	N1-001403	23.009	021	1	R99	F	3.4.0	3.5.0	UMTS to GSM handover: Directed Retry	GSM/UMTS Interworking	

History

Document history		
V3.1.0	January 2000	Publication
V3.2.0	March 2000	Publication
V3.3.0	June 2000	Publication
V3.4.0	September 2000	Publication
V3.5.0	December 2000	Publication