

ETSI TS 123 012 V9.0.0 (2010-02)

Technical Specification

**Digital cellular telecommunications system (Phase 2+);
Universal Mobile Telecommunications System (UMTS);
Location management procedures
(3GPP TS 23.012 version 9.0.0 Release 9)**



Reference

RTS/TSGC-0423012v900

Keywords

GSM, UMTS

ETSI

650 Route des Lucioles
F-06921 Sophia Antipolis Cedex - FRANCE

Tel.: +33 4 92 94 42 00 Fax: +33 4 93 65 47 16

Siret N° 348 623 562 00017 - NAF 742 C
Association à but non lucratif enregistrée à la
Sous-Préfecture de Grasse (06) N° 7803/88

Important notice

Individual copies of the present document can be downloaded from:

<http://www.etsi.org>

The present document may be made available in more than one electronic version or in print. In any case of existing or perceived difference in contents between such versions, the reference version is the Portable Document Format (PDF). In case of dispute, the reference shall be the printing on ETSI printers of the PDF version kept on a specific network drive within ETSI Secretariat.

Users of the present document should be aware that the document may be subject to revision or change of status. Information on the current status of this and other ETSI documents is available at

<http://portal.etsi.org/tb/status/status.asp>

If you find errors in the present document, please send your comment to one of the following services:

http://portal.etsi.org/chaicor/ETSI_support.asp

Copyright Notification

No part may be reproduced except as authorized by written permission.
The copyright and the foregoing restriction extend to reproduction in all media.

© European Telecommunications Standards Institute 2010.
All rights reserved.

DECT™, **PLUGTESTS™**, **UMTS™**, **TIPHON™**, the TIPHON logo and the ETSI logo are Trade Marks of ETSI registered for the benefit of its Members.

3GPP™ is a Trade Mark of ETSI registered for the benefit of its Members and of the 3GPP Organizational Partners.

LTE™ is a Trade Mark of ETSI currently being registered

for the benefit of its Members and of the 3GPP Organizational Partners.

GSM® and the GSM logo are Trade Marks registered and owned by the GSM Association.

Intellectual Property Rights

IPRs essential or potentially essential to the present document may have been declared to ETSI. The information pertaining to these essential IPRs, if any, is publicly available for **ETSI members and non-members**, and can be found in ETSI SR 000 314: "*Intellectual Property Rights (IPRs); Essential, or potentially Essential, IPRs notified to ETSI in respect of ETSI standards*", which is available from the ETSI Secretariat. Latest updates are available on the ETSI Web server (<http://webapp.etsi.org/IPR/home.asp>).

Pursuant to the ETSI IPR Policy, no investigation, including IPR searches, has been carried out by ETSI. No guarantee can be given as to the existence of other IPRs not referenced in ETSI SR 000 314 (or the updates on the ETSI Web server) which are, or may be, or may become, essential to the present document.

Foreword

This Technical Specification (TS) has been produced by ETSI 3rd Generation Partnership Project (3GPP).

The present document may refer to technical specifications or reports using their 3GPP identities, UMTS identities or GSM identities. These should be interpreted as being references to the corresponding ETSI deliverables.

The cross reference between GSM, UMTS, 3GPP and ETSI identities can be found under <http://webapp.etsi.org/key/queryform.asp>.

Contents

Intellectual Property Rights	2
Foreword.....	2
Foreword.....	5
1 Scope	6
1.1 References	6
1.2 Abbreviations	7
2 Definitions	7
2.1 Location management	7
2.2 Location area and MSC area	7
2.3 Location area identification	8
2.4 IMSI detach/attach operation	8
2.4.1 Explicit IMSI detach/attach	8
2.4.2 Implicit IMSI detach	8
2.5 Use of the term mobile station (MS) in the present document	8
2.6 Paging area	8
3 General procedures in the network related to Location Management.....	8
3.1 Procedures in the MSC related to Location Updating	8
3.2 Procedures in the VLR related to Location Updating	8
3.3 Procedures in the HLR related to Location Updating	9
3.4 Normal Location Updating and IMSI detach/attach operation.....	9
3.5 IMSI enquiry procedure	9
3.6 Information transfer between Visitor and Home Location Registers	9
3.6.1 Procedures for location management.....	9
3.6.1.1 Location updating procedure.....	9
3.6.1.2 Downloading of subscriber parameters to the VLR.....	9
3.6.1.3 Location cancellation procedure	10
3.6.1.4 Mobile subscriber purging procedure.....	10
4 Detailed Procedures in the network related to Location Management.....	10
4.1 Location Updating.....	10
4.1.1 Detailed procedure in the MSC.....	10
4.1.1.1 Process Update_Location_Area_MSC.....	10
4.1.1.2 Procedure Authenticate_MSC.....	14
4.1.2 Detailed procedure in the VLR.....	15
4.1.2.1 Process Update_Location_Area_VLR	15
4.1.2.1a Procedure Retrieve_IMEISV_If_Required	19
4.1.2.2 Procedure Authenticate_VLR	20
4.1.2.3 Procedure Location_Update_Completion_VLR	22
4.1.2.4 Procedure Update_HLR_VLR	25
4.1.2.5 Procedure Insert_Subscriber_Data_VLR	26
4.1.2.6 Procedure Activate_Tracing_VLR.....	28
4.1.2.7 Process Send_Identification_PVLR.....	28
4.1.2.8 Process Trace_Subscriber_Activity_VLR	31
4.1.2.9 Procedure Perform Relaying	31
4.1.3 Detailed procedure in the HLR.....	32
4.1.3.1 Process Update_Location_HLR.....	32
4.1.3.2 Procedure Insert_Subscriber_Data_HLR	37
4.1.3.3 Process Subscriber_Present_HLR.....	39
4.1.3.4 Procedure Control_Tracing_HLR	40
4.2 Location Cancellation.....	41
4.2.1 Detailed procedure in the VLR.....	41
4.2.1.1 Process Cancel_Location_VLR	41
4.2.2 Detailed procedure in the HLR.....	44
4.2.2.1 Process Cancel_Location_HLR	44

4.3	Detach IMSI	45
4.3.1	Detailed procedure in the MSC.....	45
4.3.1.1	Process Detach_IMSI_MSC	45
4.3.2	Detailed procedure in the VLR.....	46
4.3.2.1	Process Detach_IMSI_VLR.....	46
4.4	Purge MS.....	48
4.4.1	Detailed procedure in the VLR.....	48
4.4.1.1	Procedure Purge_MS_VLR	48
4.4.2	Detailed procedure in the HLR.....	50
4.4.2.1	Process Purge_MS_HLR	50
Annex A (informative): Change history		52
History		53

Foreword

This Technical Specification (TS) has been produced by the 3rd Generation Partnership Project (3GPP).

The present document defines the location management procedures within the 3GPP system.

The contents of the present document are subject to continuing work within the TSG and may change following formal TSG approval. Should the TSG modify the contents of the present document, it will be re-released by the TSG with an identifying change of release date and an increase in version number as follows:

Version x.y.z

where:

- x the first digit:
 - 1 presented to TSG for information;
 - 2 presented to TSG for approval;
 - 3 or greater indicates TSG approved document under change control.
- y the second digit is incremented for all changes of substance, i.e. technical enhancements, corrections, updates, etc.
- z the third digit is incremented when editorial only changes have been incorporated in the document.

1 Scope

The present document describes the location management procedures for the circuit switched domain, with respect to the application level functional behaviour. This is to be distinguished from the corresponding protocol handling behaviour, which is specified in 3G TS 29.002. The following location management procedures are included:

- location updating;
- location cancellation;
- MS purging;
- IMSI attach/detach.

The procedures in the Mobile Station (MS) are described in GSM 03.22. The procedures between MSC, VLR and HLR utilise the Mobile Application Part (MAP) and details concerning the protocol handling are contained in 3G TS 29.002.

The present document excludes location management procedures for the packet switched domain, which are covered in 3G TS 23.060.

The descriptions herein depict a logical separation between the MSC and VLR. This logical separation, as well as the messages transferred between the two logical entities are the basis of a model used to define the externally visible behaviour of the MSC/VLR, which may be a single physical entity. They do not impose any requirement except the definition of the externally visible behaviour.

1.1 References

The following documents contain provisions which, through reference in this text, constitute provisions of the present document.

- References are either specific (identified by date of publication, edition number, version number, etc.) or non-specific.
- For a specific reference, subsequent revisions do not apply.
- For a non-specific reference, the latest version applies. In the case of a reference to a 3GPP document (including a GSM document), a non-specific reference implicitly refers to the latest version of that document *in the same Release as the present document*.

- [1] 3GPP TR 21.905: "3G Vocabulary".
- [2] 3GPP TS 23.002: "Network architecture".
- [3] 3GPP TS 23.003: "Numbering, addressing and identification".
- [4] 3GPP TS 23.007: "Restoration procedures".
- [5] 3GPP TS 23.008: "Organization of subscriber data".
- [5a] 3GPP TS 23.018: "Basic call handling; Technical realization".
- [6] 3GPP TS 23.022: "Functions related to Mobile Station (MS) in idle mode".
- [7] 3GPP TS 23.116: "Super-Charger Technical Realisation; Stage 2".
- [8] 3GPP TS 29.002: "Mobile Application Part (MAP) specification".
- [9] 3GPP TS 29.007: "General requirements on interworking between the Public Land Mobile Network (PLMN) and the Integrated Services Digital Network (ISDN) or Public Switched Telephone Network (PSTN)".
- [10] 3GPP TS 43.020: "Security related network functions".

- [11] 3GPP TS 23.078: " Customised Applications for Mobile network Enhanced Logic (CAMEL) Phase 4 – stage2 "
- [11a] 3GPP TS 23.195: "Provision of UE Specific Behaviour Information to Network Entities".
- [12] 3GPP TS 23.236: "Intra Domain Connection of RAN Nodes to Multiple CN Nodes"
- [13] 3GPP TS 24.008: "Mobile Radio Interface Layer 3 specification; Core Network Protocols - Stage 3".
- [14] 3GPP TS 29.010: "Information element mapping between Mobile Station - Base Station System and BSS - Mobile-services Switching Centre (MS - BSS - MSC) Signalling procedures and the Mobile Application Part (MAP)".
- [15] 3GPP TS 32.422: "Subscriber and equipment trace: Trace control and configuration management"
- [16] 3GPP TS 32.421: "Subscriber and equipment trace: Trace concepts and requirements"
- [17] 3GPP TS 25.413: "UTRAN Iu interface RANAP signalling"
- [18] 3GPP TR 29.994: "Recommended infrastructure measures to overcome specific Mobile Station (MS) faults"

1.2 Abbreviations

Abbreviations are listed in 3GPP TR 21.905 [1].

In addition, for the purposes of the present document, the following abbreviations apply:

ADD	Automatic Device Detection
PUESBINE	Provision of User Equipment Specific Behaviour Information to Network Entities
UESBI-Iu	User Equipment Specific Behaviour Information over the Iu interface

2 Definitions

2.1 Location management

Location management means that the PLMNs keep track of where the MSs are located in the system area. The location information for each MS is stored in functional units called location registers. Functionally, there are two types of location registers:

- the Home Location Register where all subscriber parameters of an MS are permanently stored, and where the current location may be stored;
- the Visitor Location Register where all relevant data concerning an MS are stored as long as the station is within the area controlled by that visitor location register.

See also GSM 03.02 where the network architecture is described, and GSM 03.08 where the data stored in the location registers are described.

The action taken by a MS in order to provide location information to the PLMN will be referred to as location updating.

2.2 Location area and MSC area

The MSC area is composed of the area covered by all base stations controlled by the MSC. An MSC area may consist of several location areas. A location area is an area in which, after having performed a location update once, MSs may roam without being required to perform subsequent location updates for reason of location change. A location area consists of one or more cells.

For further details of the network architecture, see GSM 03.02.

2.3 Location area identification

The Location Area Identification (LAI) plan is part of the base station identification plan. The base stations are identified uniquely (see GSM 03.03).

2.4 IMSI detach/attach operation

The support of IMSI detach/attach operation is mandatory in MSs. The facility is optional in the fixed infrastructure of the PLMN.

2.4.1 Explicit IMSI detach/attach

Explicit IMSI detach operation is the action taken by an MS to indicate to the PLMN that the station has entered an inactive state (e.g. the station is powered down). Explicit IMSI attach operation is the action taken by an MS to indicate that the station has re-entered an active state (e.g. the station is powered up).

2.4.2 Implicit IMSI detach

Implicit IMSI detach operation is the action taken by the VLR to mark an MS as detached when there has been no successful contact between the MS and the network for a time determined by the implicit detach timer. The value of the implicit detach timer is derived from the periodic location updating timer. During an established radio contact, the implicit detach timer shall be prevented from triggering implicit detach. At the release of the radio connection, the implicit detach timer shall be reset and restarted. Implicit IMSI detach shall also be performed in the case of a negative response to an IMEI check.

2.5 Use of the term mobile station (MS) in the present document

In order to simplify the text the term Mobile Station (MS) as used in relation to location management refers to the entity where the IMSI is stored, i.e., in card operated MSs the term Mobile Station (MS) refers to the card.

2.6 Paging area

As an option, and for paging optimization purpose, the VLR may control Paging Areas. A Paging Area (PgA) is composed of up to 5 Location Areas, and the MSC area is composed of several Paging Areas. Paging areas may overlap each other. The Paging Area is stored in the HLR and updated at each paging area change. The Paging Area is sent by the HLR to the VLR at roaming number request and may be used by the MSC/VLR for paging (e.g. when LAI is not known, after MSC/VLR restart) (see 3GPP TS 23.018 [5a]).

3 General procedures in the network related to Location Management

3.1 Procedures in the MSC related to Location Updating

The MSC shall pass messages related to location updating between the MS and the VLR.

3.2 Procedures in the VLR related to Location Updating

FFS

3.3 Procedures in the HLR related to Location Updating

FFS

3.4 Normal Location Updating and IMSI detach/attach operation

When receiving a Location Updating Request or an IMSI detach/attach message from an MS, the MSC shall convey the message to its associated Visitor Location Register. Any response from the location register shall similarly be conveyed to the MS.

3.5 IMSI enquiry procedure

The MS shall identify itself by either the IMSI or the TMSI plus Location Area Identification of the previous VLR. In the latter case the new VLR shall attempt to request the IMSI and authentication parameters from the previous VLR by the methods defined in GSM 09.02.

If this procedure fails, or if the TMSI is not allocated, the VLR shall request that the MS identifies itself by use of the IMSI.

3.6 Information transfer between Visitor and Home Location Registers

3.6.1 Procedures for location management

Detailed procedures for exchange of and location updating information between visitor and home location registers are given in GSM 09.02. Below follows an overview of these procedures.

3.6.1.1 Location updating procedure

This procedure is used when an MS registers with a Visitor Location Register.

The VLR provides its address to the HLR.

The VLR may also allocate an optional identity for the MS at location updating: the Local Mobile Station Identity (see GSM 03.03).

3.6.1.2 Downloading of subscriber parameters to the VLR

As a part of the location updating procedure, the Home Location Register will convey the subscriber parameters of the MS which need to be known by the visitor location register for proper call handling. This procedure is also used whenever there is a change in the subscriber parameters that need to be conveyed to the VLR (e.g. change in subscription, a change in supplementary services activation status).

If the HPLMN applies the multinumbring option, different MSISDNs are allocated for different Basic Services (see GSM 09.07) and stored in the HLR. Among these MSISDNs, the Basic MSISDN Indicator as part of the HLR subscriber data (see GSM 03.08) marks the 'Basic MSISDN' to be sent to the VLR at location update. It is used in the VLR for call handling as calling party and as line identity.

If the HPLMN applies the Administrative Restriction of Subscribers" Access feature, the HLR shall convey the subscriber access restriction parameter (AccessRestrictionData) to the VLR. The VLR shall check this subscription parameter against the radio access technology that supports the LA/RA in which the UE is roaming to decide whether the location update should be allowed or rejected.

For further information of the Subscriber access restriction see 3GPP TS 23.008[5].

3.6.1.3 Location cancellation procedure

The procedure is used by the home location register to remove a MS from a visitor location register. The procedure will normally be used when the MS has moved to an area controlled by a different location register. The procedure can also be used in other cases, e.g. an MS ceases to be a subscriber of the Home PLMN.

3.6.1.4 Mobile subscriber purging procedure

A VLR may purge the subscriber data for an MS which has not established radio contact for a period determined by the network operator. Purging means to delete the subscriber data and to "freeze" the TMSI that has been allocated to the purged MS in order to avoid double TMSI allocation. The VLR shall inform the HLR of the purging.

When the HLR is informed of the purging, it shall set the flag "MS purged" in the IMSI record of the MS concerned. Presence of the "MS purged" flag will cause any request for routing information for a call or short message to the MS to be treated as if the MS were not reachable.

In the VLR, the "frozen" TMSI is freed for usage in the TMSI allocation procedure by location updating for the purged MS in the same VLR, location cancellation for the purged MS or, in exceptional cases, by O&M.

In the HLR, the "MS purged" flag is reset by the location updating procedure and after reload of data from the non-volatile back-up that is performed when the HLR restarts after a failure.

4 Detailed Procedures in the network related to Location Management

The text in this clause is a supplement to the definition in the SDL diagrams; it does not duplicate the information in the SDL diagrams.

This specification shows the location management application processes interworking with the MAP protocol handler, which is specified in 3G TS 29.002. The MAP protocol defines supervision timers. If a supervision timer expires before a distant entity responds to a signal, the handling is as defined in 3G TS 29.002. In general, the protocol handler reports timer expiry to the application as an error condition or negative response. Where a timer is shown in this specification, therefore, it is an **application timer** rather than a **protocol** timer. Interworking with the protocol handlers uses functional signal names which do not necessarily have a one-to-one correspondence with the names of messages used in the MAP protocols.

4.1 Location Updating

4.1.1 Detailed procedure in the MSC

4.1.1.1 Process Update_Location_Area_MSC

Sheet 1: Location Update corresponds to a Location_Registration_Request indicating any of the following:

- Normal location update;
- Periodic location update;
- IMSI attach.

Sheet 1: The procedures Check_IMEI_MSC, Obtain_IMEI_MSC and Obtain_IMSI_MSC are specified in 3GPP TS 23.018 [5a].

Sheet 1: The input signal "Send UESBI-Iu to Access Network" carries the IMEISV.

Sheet 1: The task "Convert IMEISV to UESBI" is defined in 3GPP TS 23.195 [11a].

Sheet 2: The procedure Check_IMEI_MSC is specified in 3GPP TS 23.018 [5a].

Sheet 2: When the MSC receives a Set Ciphering Mode request from the VLR, it sends a Start ciphering request towards the MS. After that, the Forward new TMSI and Update Location Area ack may be received in any order.

Sheet 2: The Forward new TMSI may also be received prior to Update Location Area negative response if the option "TMSI reallocation in case of Location Update reject with cause #13 (roaming not allowed in Location Area) or #15 (no suitable cells in Location Area)" is applicable (see §4.1.2.3). The new TMSI is forwarded together with the new LAI. They are kept in the UE/SIM on receipt of the Location Update reject with cause #13 or #15 (see 3GPP TS 24.008 [13]).

Sheet 2: IMEISV trace list shall be made available to the MSC. The list may contain IMEISV entries if Management Based Trace Activation is supported in RAN and MSC has received the trace list in the Uplink Information Transfer message (See 3GPP TS 32.422 [15] and 25.413 [17]). The test "Current IMEISV included in IMEISV trace list?" will follow the "no" case when no entries exist.

Sheet 2: For Trace Invocation in RAN concepts and procedures see 3GPP TSs 32.421 [16], 32.422[15] and 25.413[17].

Sheet 2: IMEISV trace list

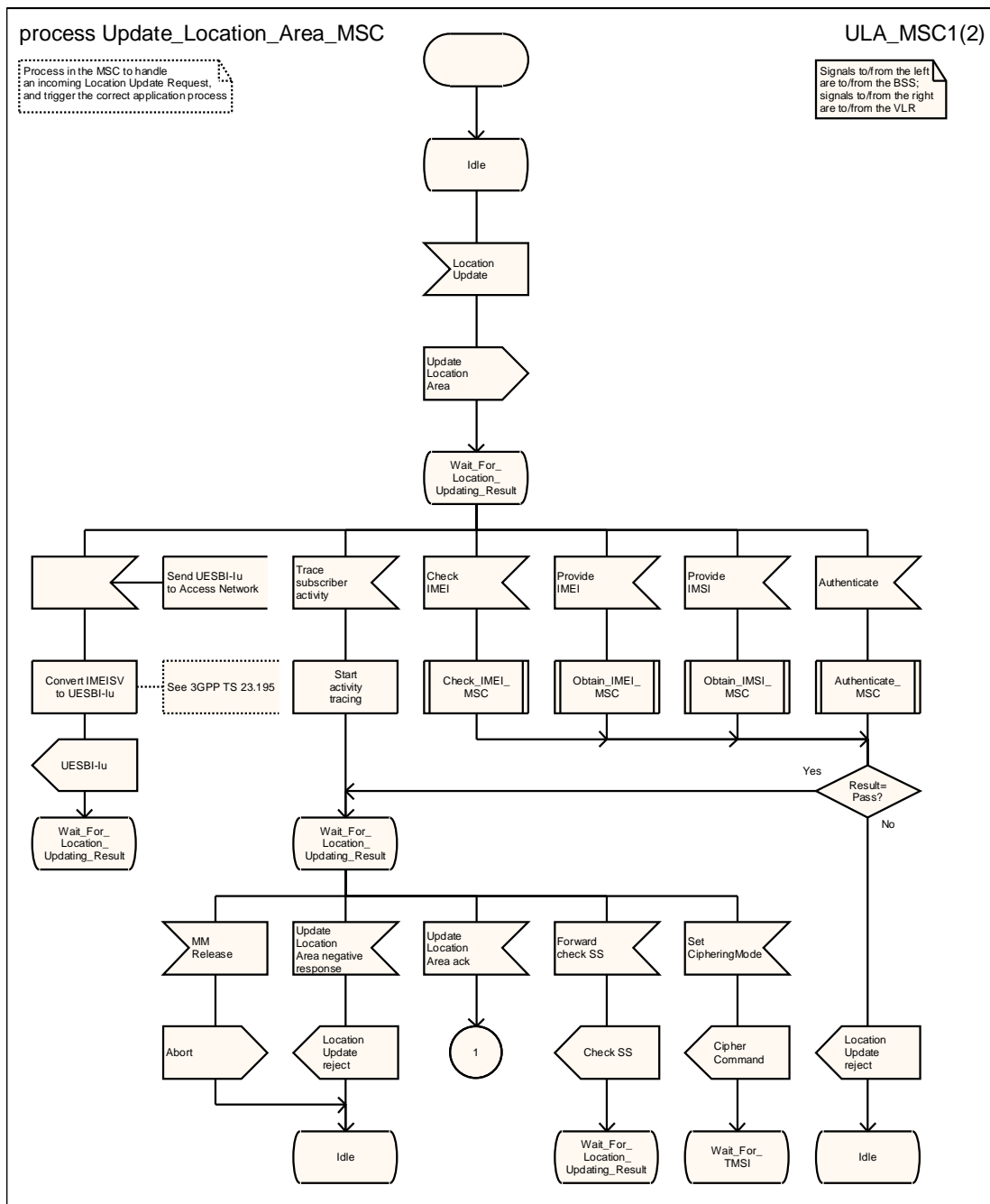

Figure 4.1.1.1 (sheet 1 of 2): Process Update_Location_Area_MSC

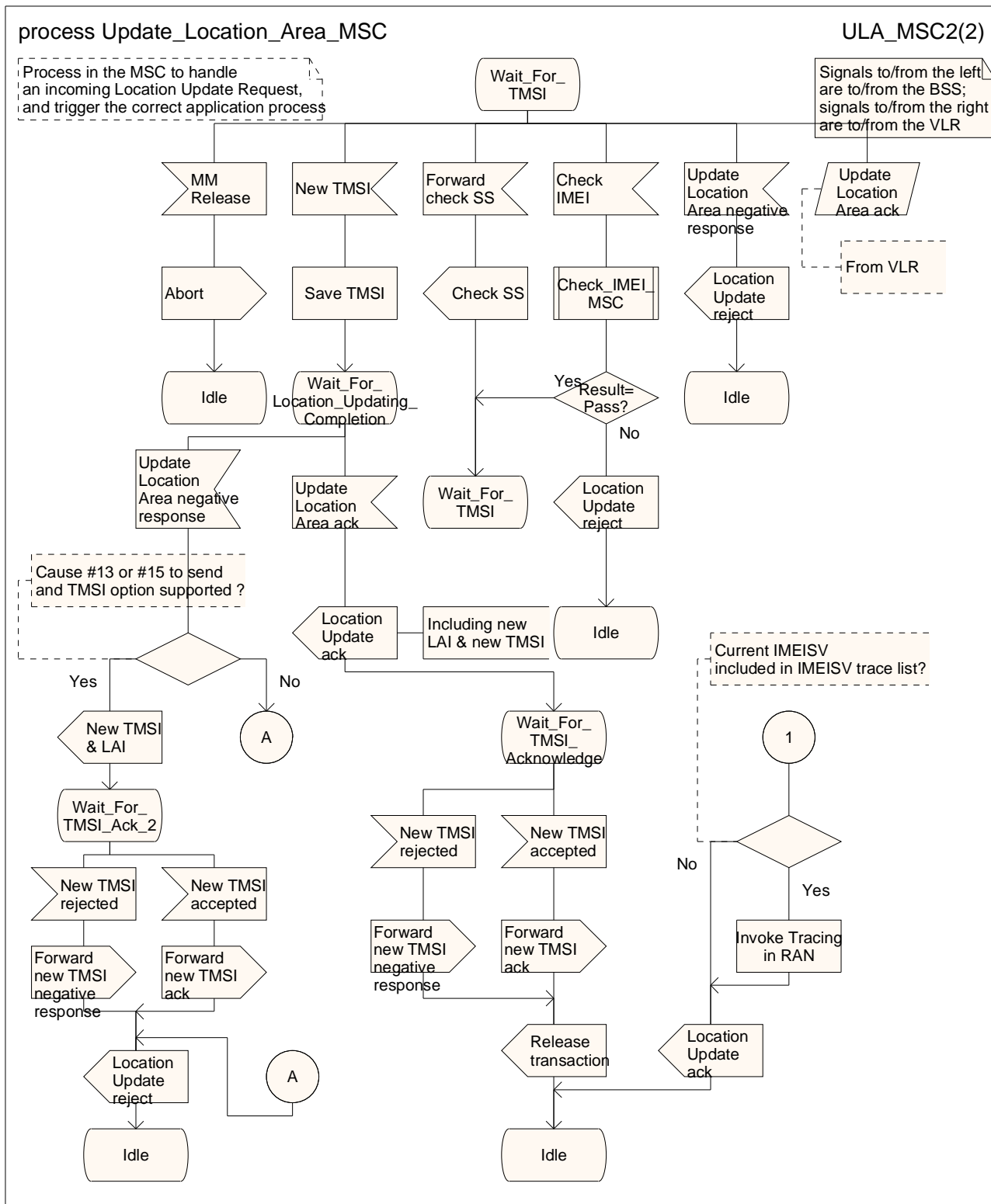

Figure 4.1.1.1 (sheet 2 of 2): Process Update_Location_Area_MSC

4.1.1.2 Procedure Authenticate_MSC

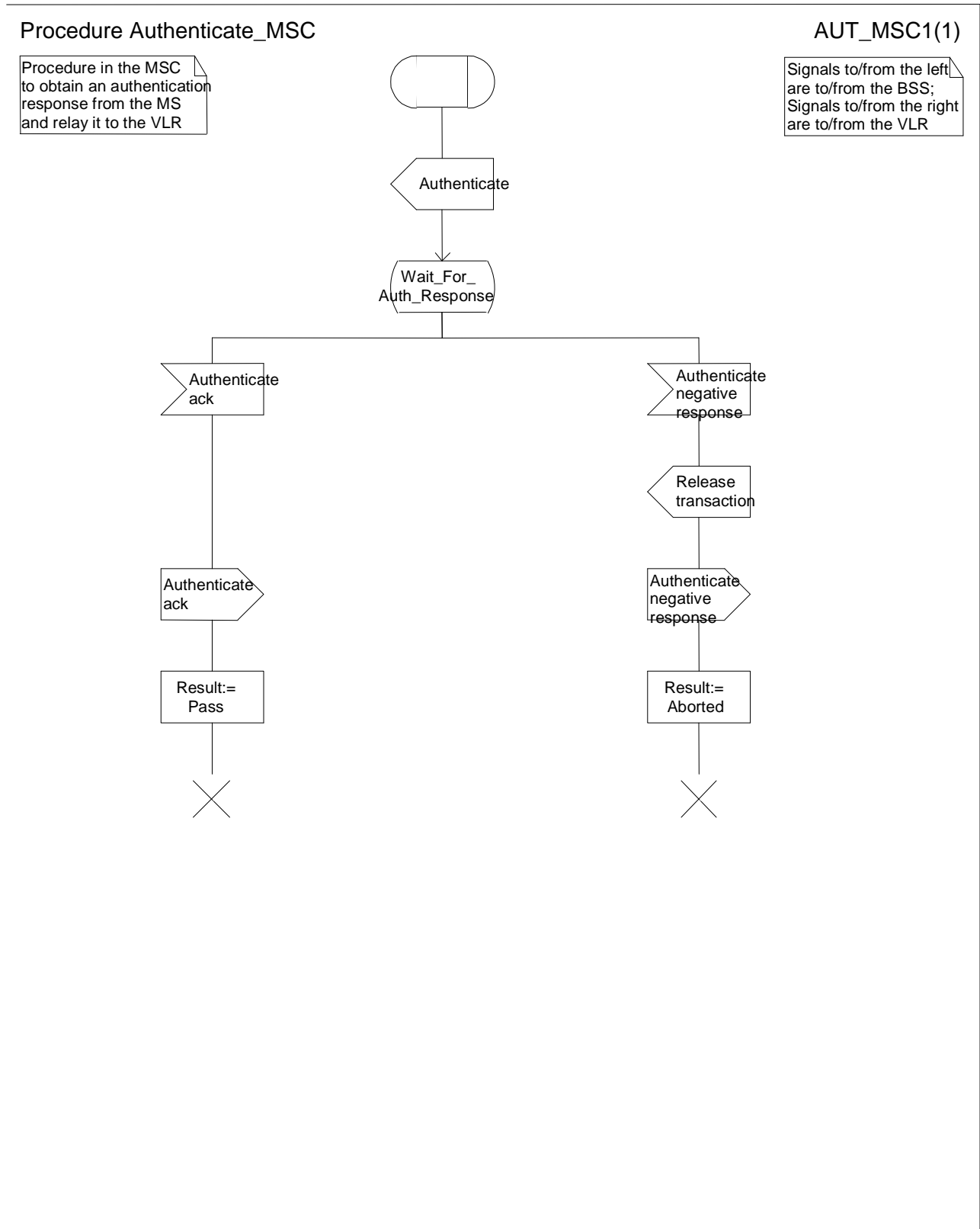

Figure 4.1.1.2 (sheet 1 of 1): Procedure Authenticate_MSC

4.1.2 Detailed procedure in the VLR

4.1.2.1 Process Update_Location_Area_VLR

General comment: at any stage in the location updating process the MSC may receive an indication from the BSS that the MM transaction has been released. The MSC then sends an Abort signal to the VLR. Upon receipt of this message, the VLR shall follow one of two possible courses of action.

The two possible courses of action and the conditions determining which course shall be taken are as follows:

1. If a successfully authenticated radio connection is already established before the Abort message is received, the VLR shall ignore the message.
2. If a successfully authenticated radio connection has not been established before the Abort message is received, the VLR shall abort the Update Location Area process and return to the idle state.

Sheet 1: the location area updating process will be activated by receiving an Update Location Area indication from the MSC. If there are parameter errors in the indication, the process is terminated with the appropriate error sent in the Update Location Area response to the MSC. Else, the behaviour will depend on the subscriber identity received, either an IMSI or a TMSI.

The Automatic Device Detection (ADD) function is an optional feature that allows the HLR to be updated with the current User Equipment (IMEISV) and thus enables the network to configure the subscriber's equipment based on a predefined profile. The mechanism for the IMEISV retrieval by device management system (either from HLR or VLR) is outside the scope of this specification. As an optimisation, the VLR may optionally store whether or not the HLR supports the ADD feature and use this information to decide whether or not to send an update to the HLR.

The Paging Area function is an optional feature that allows the HLR to be updated with the current Paging Area (PgA) (see subclause 2.6). If supported, whenever the paging area changes, the VLR shall send a MAP Update Location request with the Paging Area parameter set to the location areas belonging to the new paging area. The Paging Area is then sent by the HLR (if available) to the VLR in the MAP Provide Roaming Number and may be used for paging optimisation after a MSC/VLR restart (see 3GPP TS 23.018 [5a]).

Sheet 1: The usage of a Hop Counter is an optional optimization.

Sheet 2: at the decision "HLR updating required?" the "True" branch shall be taken if and only if one or more of the following conditions is true:

- (1) Location Info Confirmed in HLR is false.
- (2) Data Confirmed by HLR is false.

Sheet 2: : The execution of the test "HLR supports ADD?" and the action "set: skip subscriber data update" is an optional optimisation and depends on the presence of the relevant indication from the HLR that ADD functionality is supported. If this optimisation is not supported on the VLR or no indication is received, both are bypassed in which case processing continues at connector 4.

Sheet 2: The execution of the test "HLR supports PgA?" and the action "set: skip subscriber data update" depends on the presence of the relevant indication from the HLR that PgA functionality is supported.

Sheet 2: The "Subscriber data dormant" flag is an optional parameter that shall at least be supported by VLR implementing the Mobile Terminating Roaming Retry feature (see 3GPP TS 23.018 [5a]). A VLR not supporting this flag shall behave as if the flag is set to false.

Sheet 3: the procedure Obtain_IMSI_VLR is specified in 3GPP TS 23.018 [5a].

The type of Location Update is retrieved in 3G TS 23.078 procedure "Set_Notification_Type" and is returned into the "Notify" variable; this information is necessary for the CAMEL Mobility Management event notification procedure 3G TS 23.078 "Notify_gsmSCF".

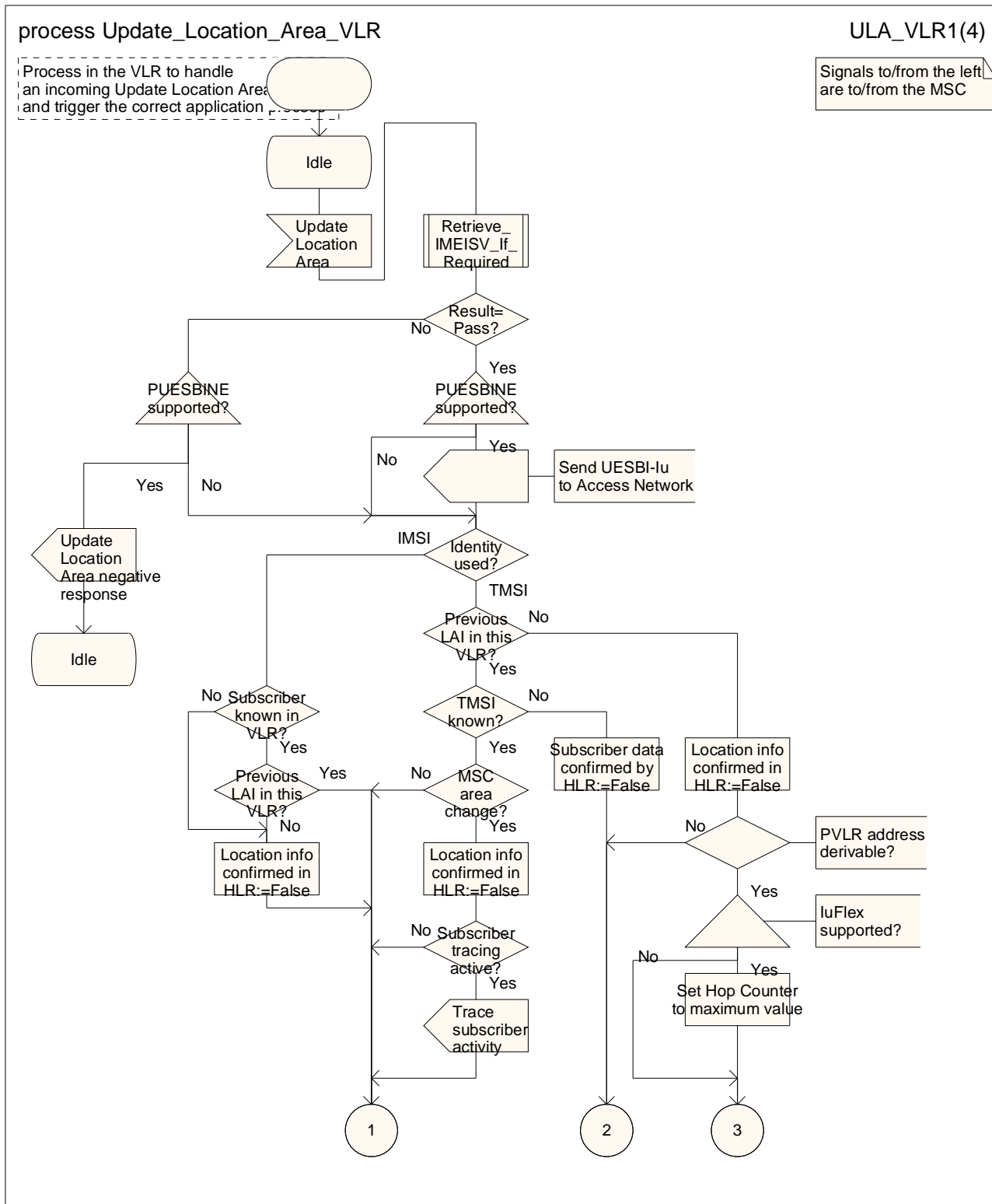

Figure 4.1.2.1 (sheet 1 of 3): Process Update_Location_Area_VLR

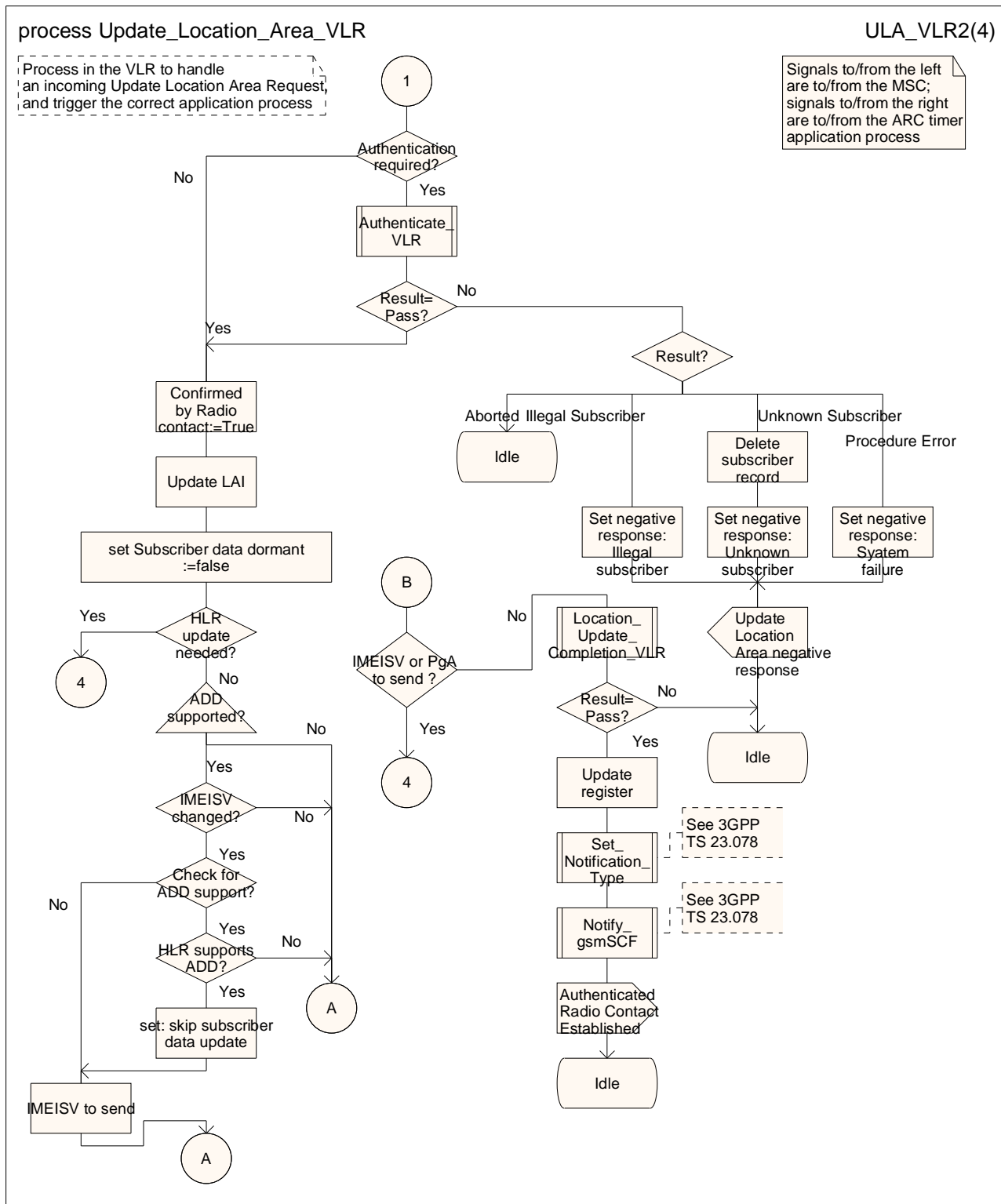

Figure 4.1.2.1 (sheet 2 of 3): Process Update_Location_Area_VLR

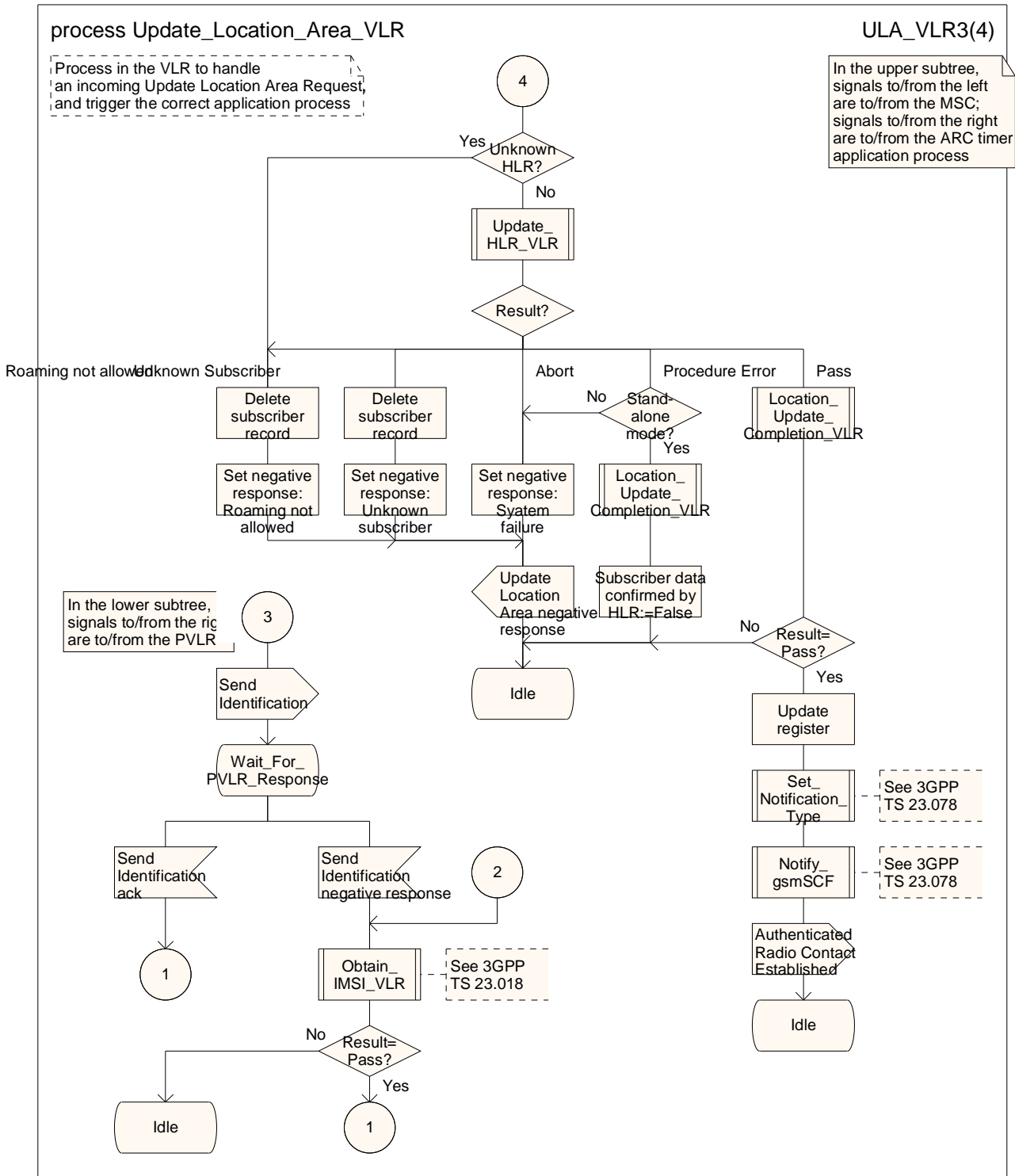

Figure 4.1.2.1 (sheet 3 of 3): Process Update_Location_Area_VLR

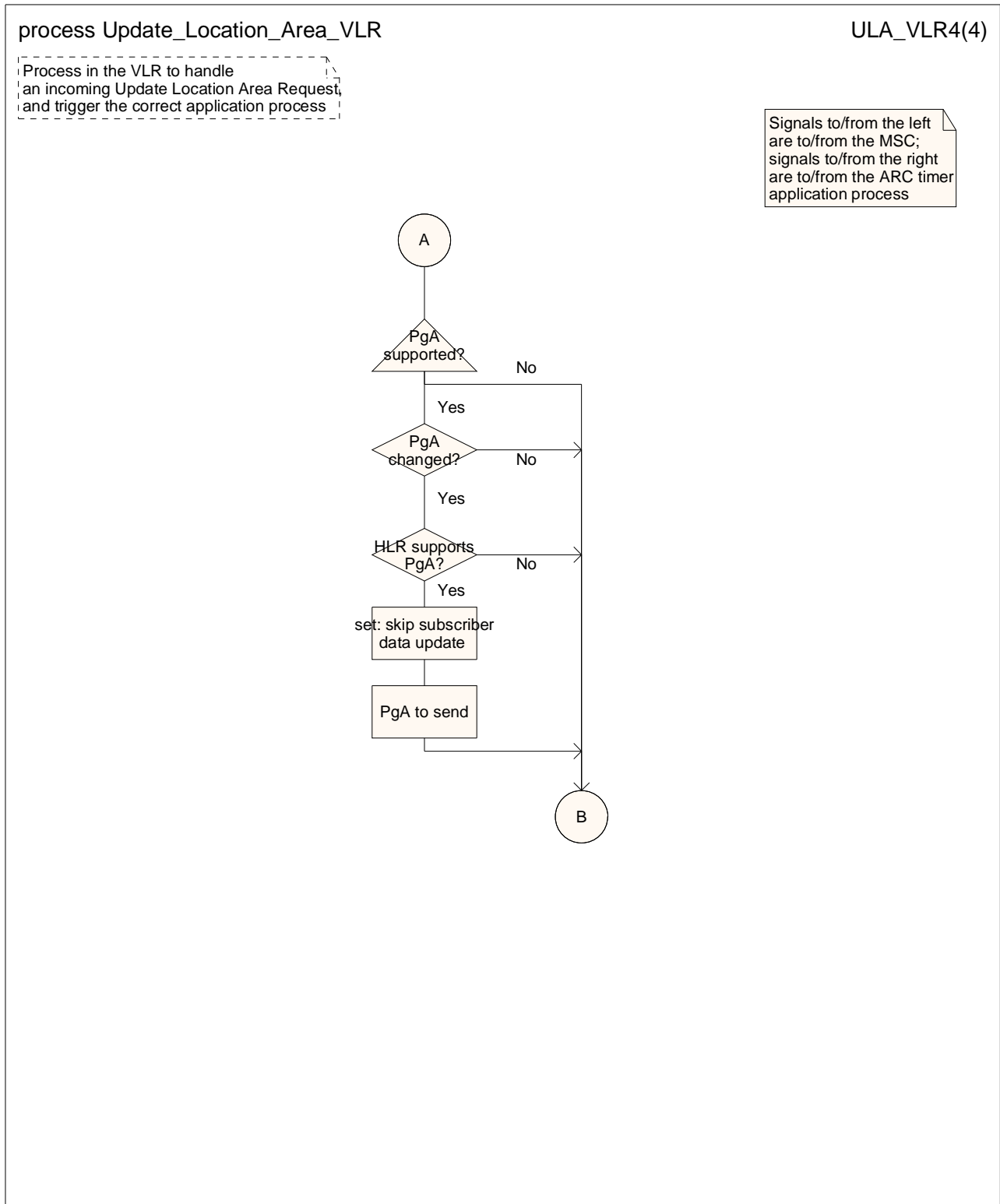

Figure 4.1.2.1 (sheet 4 of 4): Process Update_Location_Area_VLR

4.1.2.1a Procedure Retrieve_IMEISV_If_Required

The decision box "received IMEISV = stored IMEISV" takes the "No" exit if no IMEISV is stored.

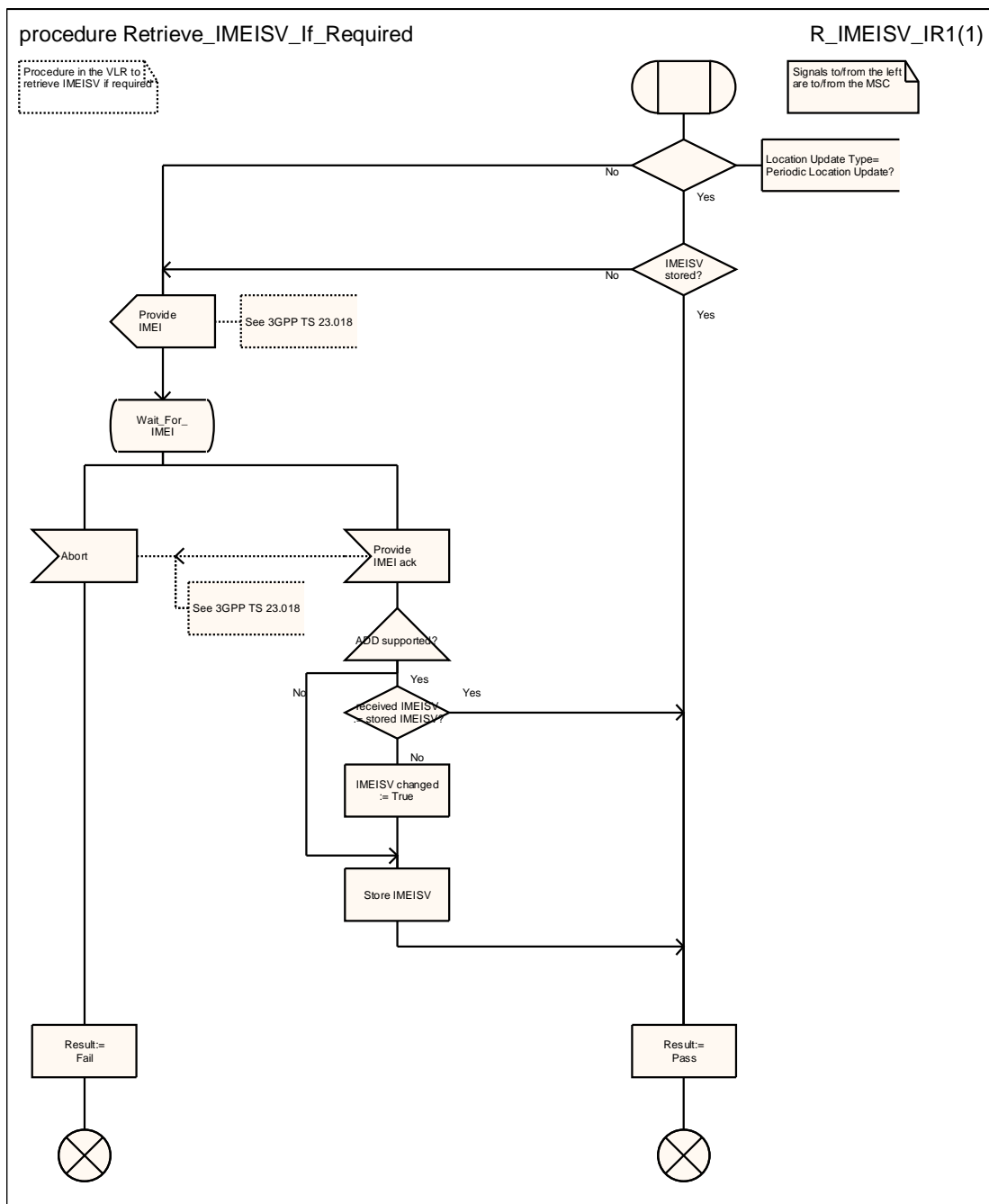

Figure 4.1.2.1A: Procedure Retrieve_IMEISV_If_Required

4.1.2.2 Procedure Authenticate_VLR

Sheet 2: The procedure Obtain_IMSI_VLR is specified in 3GPP TS 23.018 [5a].

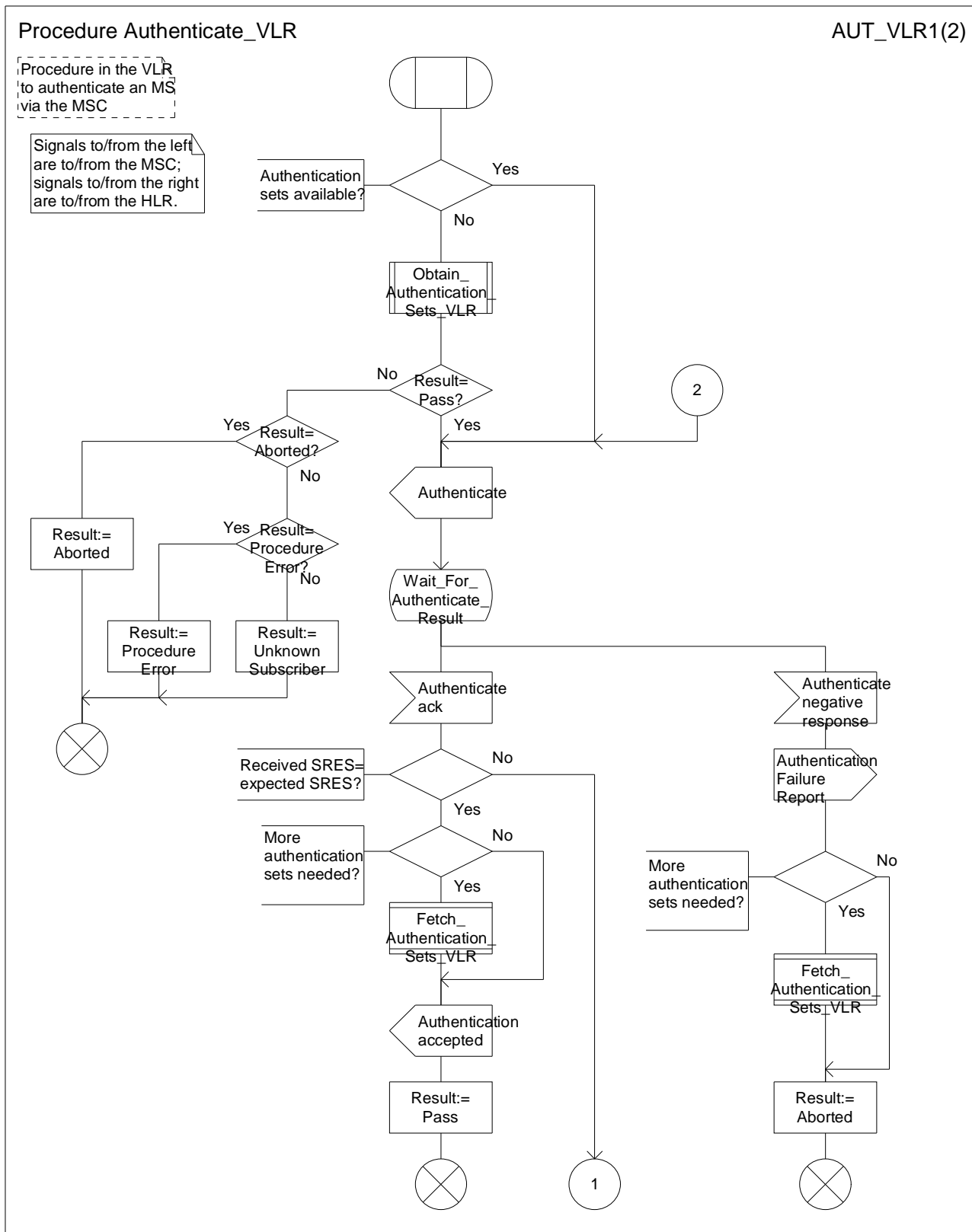

Figure 4.1.2.2 (sheet 1 of 2): Procedure Authenticate_VLR

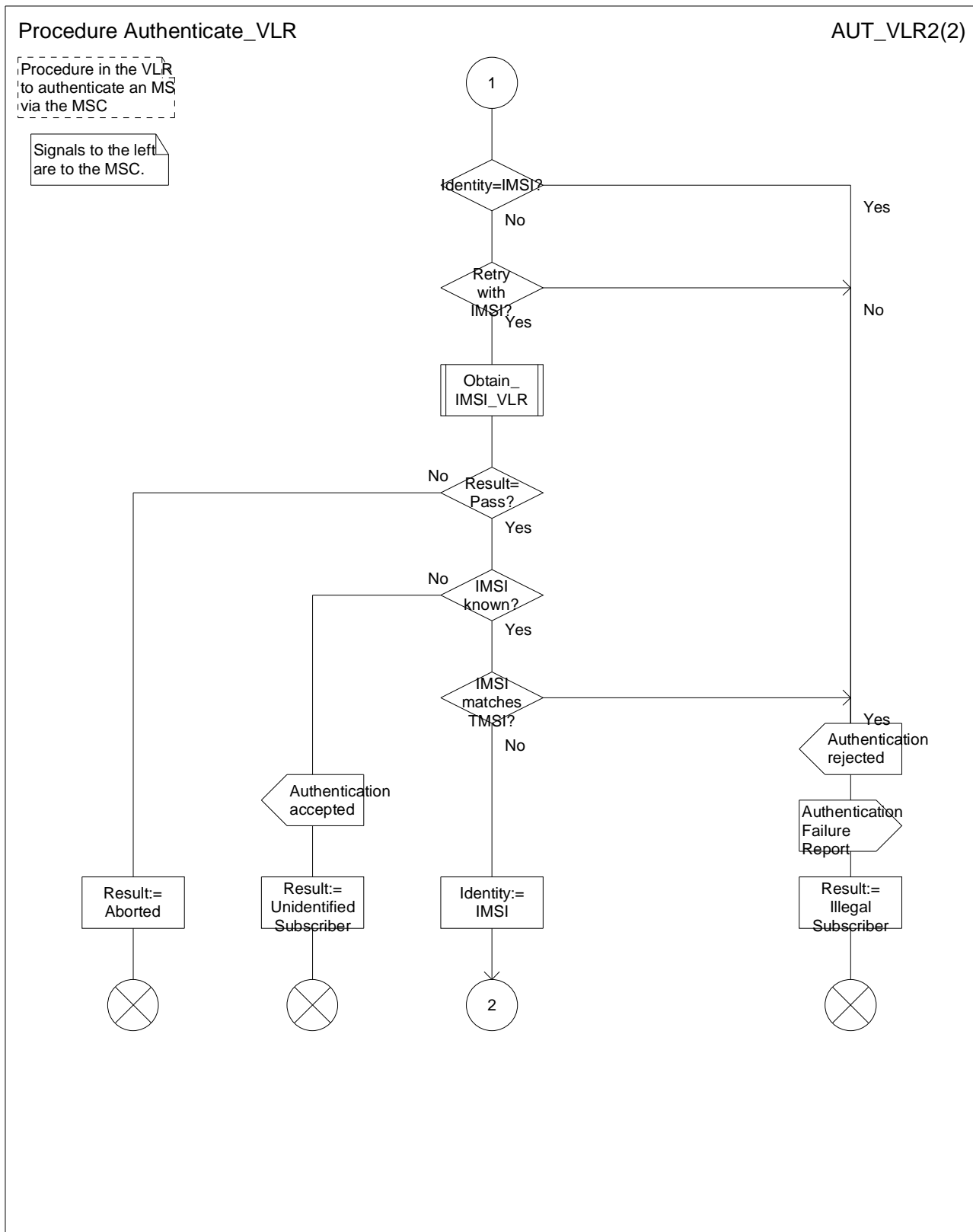

Figure 4.1.2.2 (sheet 2 of 2): Procedure Authenticate_VLR

4.1.2.3 Procedure Location_Update_Completion_VLR

Sheet 1: Decision "National Roaming Restrictions Exist?" distinguishes whether or not the subscriber is allowed service in the target LA, based on the current location of the MS and the VLR's knowledge of other networks. The "Yes" branch results in the sending of "Update Location Area Negative Response" toward the MSC (and the MS), with cause

"National Roaming Not Allowed." However, subscriber data shall not be deleted from the VLR. This is to avoid unnecessary HLR updating should the subscriber be allowed subsequently to roam in other LAs of the same MSC.

Sheet 1: Decision "Access-Restriction-Data permits current RAT?" performs a check on the subscriber's AccessRestrictionData information received from the HLR and either allows the operation to continue or rejects the Location Update. The decision is taken according to the following:

-If AccessRestrictionData value includes "GERAN not allowed" and the LA/RA, where the MS accesses the network, is served by GERAN, then the subscriber's access is not permitted.

-If AccessRestrictionData value includes "UTRAN not allowed" and the LA/RA, where the MS accesses the network is served by UTRAN, then the subscriber's access is not permitted.

Sheet 1: When the Location Update is not allowed because the subscriber access is restricted due to Administrative Restriction of Subscribers" Access feature, the flow results in the sending of "Update Location Area Negative Response" toward the MSC (and the MS). The recommended cause code is "RAT not allowed", but cause codes "PLMN not allowed" or "National Roaming Not allowed" may also be used based on operator configuration and the required MS behaviour.

Note: For the mapping of MAP Process cause code values to values on the MM protocol interface see 3GPP TS 29.010 [14].

For the MS behaviour determined on the received cause code see 3GPP TS 24.008[13].

Sheet 1: Decision "Roaming restriction due to Unsupported Feature received in subscriber data?" distinguishes whether or not the subscriber data received from the HLR indicates "roaming restriction due to unsupported feature." The "Yes" branch results in the sending of "Update Location Area Negative Response" toward the MSC (and the MS), with cause "National Roaming Not Allowed." However, subscriber data shall not be deleted from the VLR. This is to avoid unnecessary HLR updating should the subscriber be allowed subsequently to roam in other LAs of the same MSC.

Sheet 1: Decision "Regional subscription restriction" distinguishes whether or not the subscriber is allowed service in the target LA, which the VLR deduces based on regional subscription information received from the HLR. The "Yes" branch results in the sending of "Update Location Area Negative Response" toward the MSC (and the MS), with cause "location area not allowed." However, subscriber data shall not be deleted from the VLR. This is to avoid unnecessary HLR updating should the subscriber be allowed subsequently to roam in other LAs of the same MSC.

Sheet 1: Causes "National Roaming Not Allowed" and "RAT not allowed" lead to sending of cause #13 (roaming not allowed in the Location Area) and #15 (no suitable cells in Location Area) respectively to the MS (see 3GPP TS 29.010 [14]). On receipt of cause #13 or #15 the TMSI and LAI currently stored in the MS are not deleted (see 3GPP TS 24.008 [13]). As an option (referred-to as "TMSI option"), for these two reject causes, the VLR may forward a new TMSI (with the new LAI) together with the sending of "Update Location Area Negative Response" toward the MSC. The Location Updating Reject is sent to the MS after forwarding of the new TMSI (and new LAI) (see subclause 4.1.1.1).

This optional TMSI allocation (with new LAI) ensures that:

- a pre-Rel-8 MS will initiate a location updating if it roams back to the previous Location Area (allowed), i.e. to the location area whose identity is already stored in the MS, after having received the reject cause #13 or #15; otherwise the location updating may not be initiated and mobile terminated calls may not be delivered until the next mobile originated activity or periodic location update (see 3GPP TR 29.994 [18]).
- the next location update enables the new VLR to address the correct previous VLR (which controls the not allowed Location Area) and to obtain the right IMSI and security context; otherwise a wrong VLR is addressed (corresponding to the TMSI/LAI of the VLR that controlled the previous allowed LA) and a wrong IMSI / security context would be obtained if the TMSI was reallocated.

Sheet 2: The procedure Check_IMEI_VLR is specified in 3GPP TS 23.018 [5a].

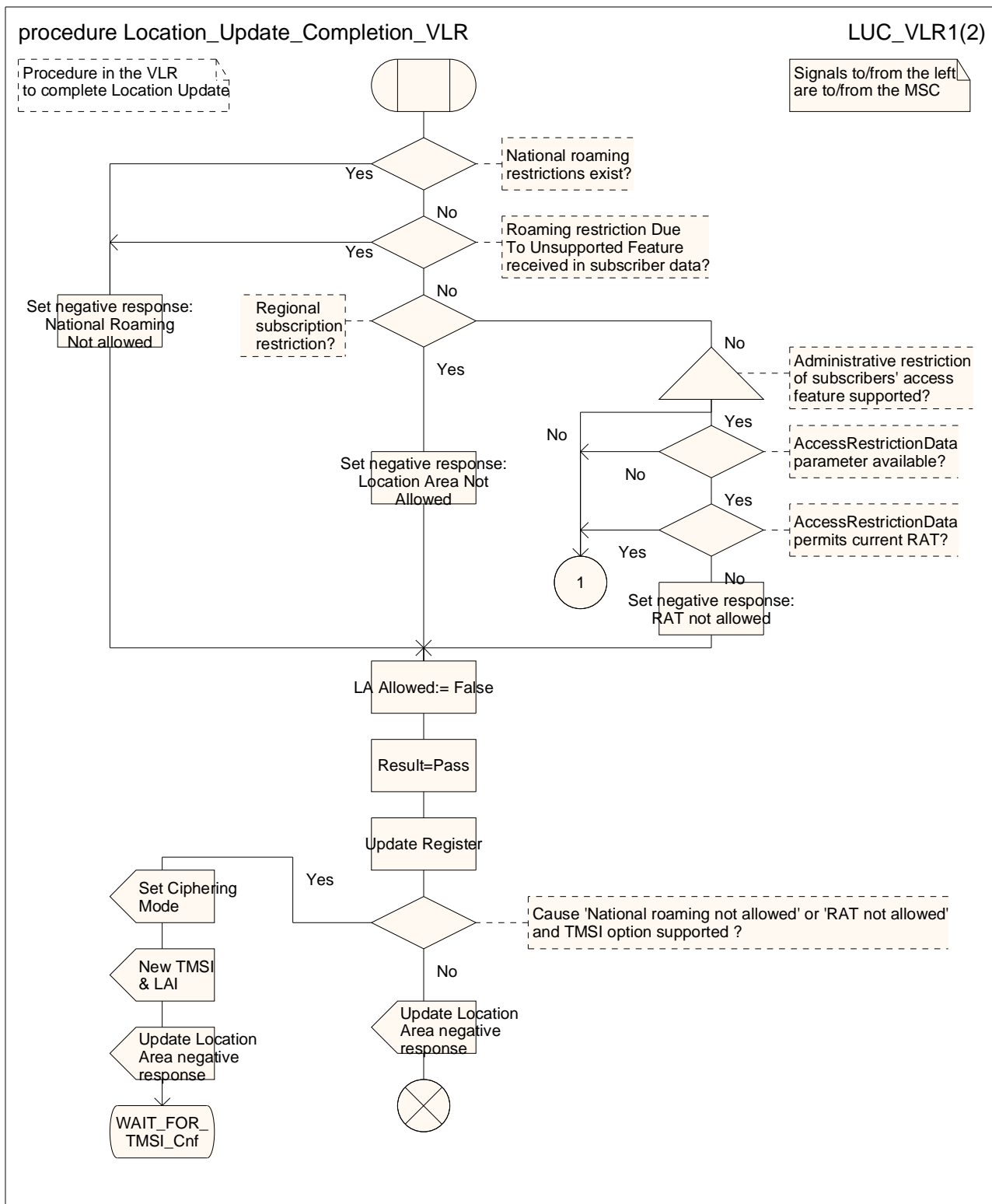

Figure 4.1.2.3 (sheet 1 of 2): Procedure Location_Update_Completion_VLR

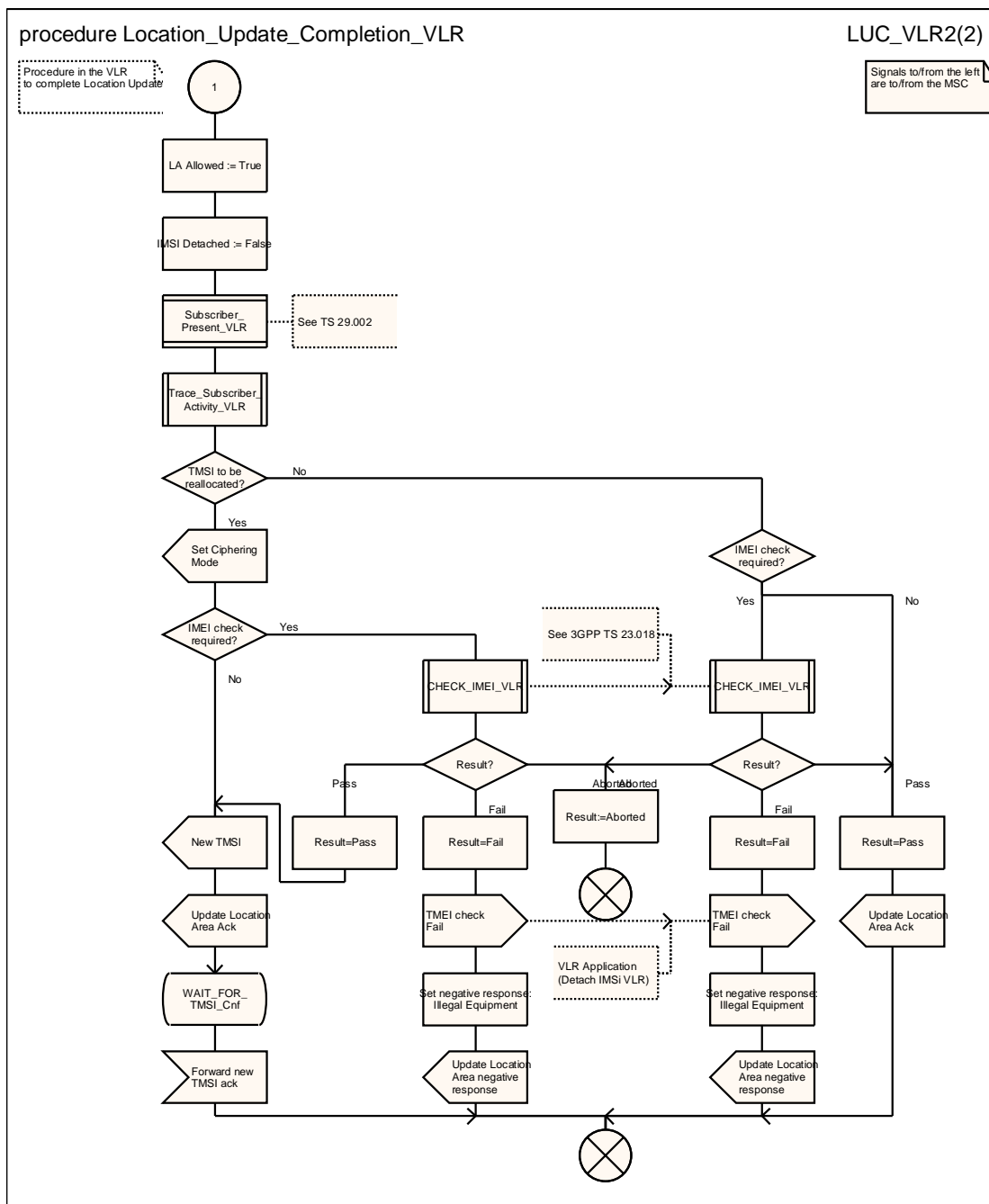

Figure 4.1.2.3 (sheet 2 of 2): Procedure Location_Update_Completion_VLR

4.1.2.4 Procedure Update_HLR_VLR

Sheet 1: The procedure Check_User_Error_In_Serving_Network_Entity is specific to Super-Charger; it is specified in 3G TS 23.116 [7].

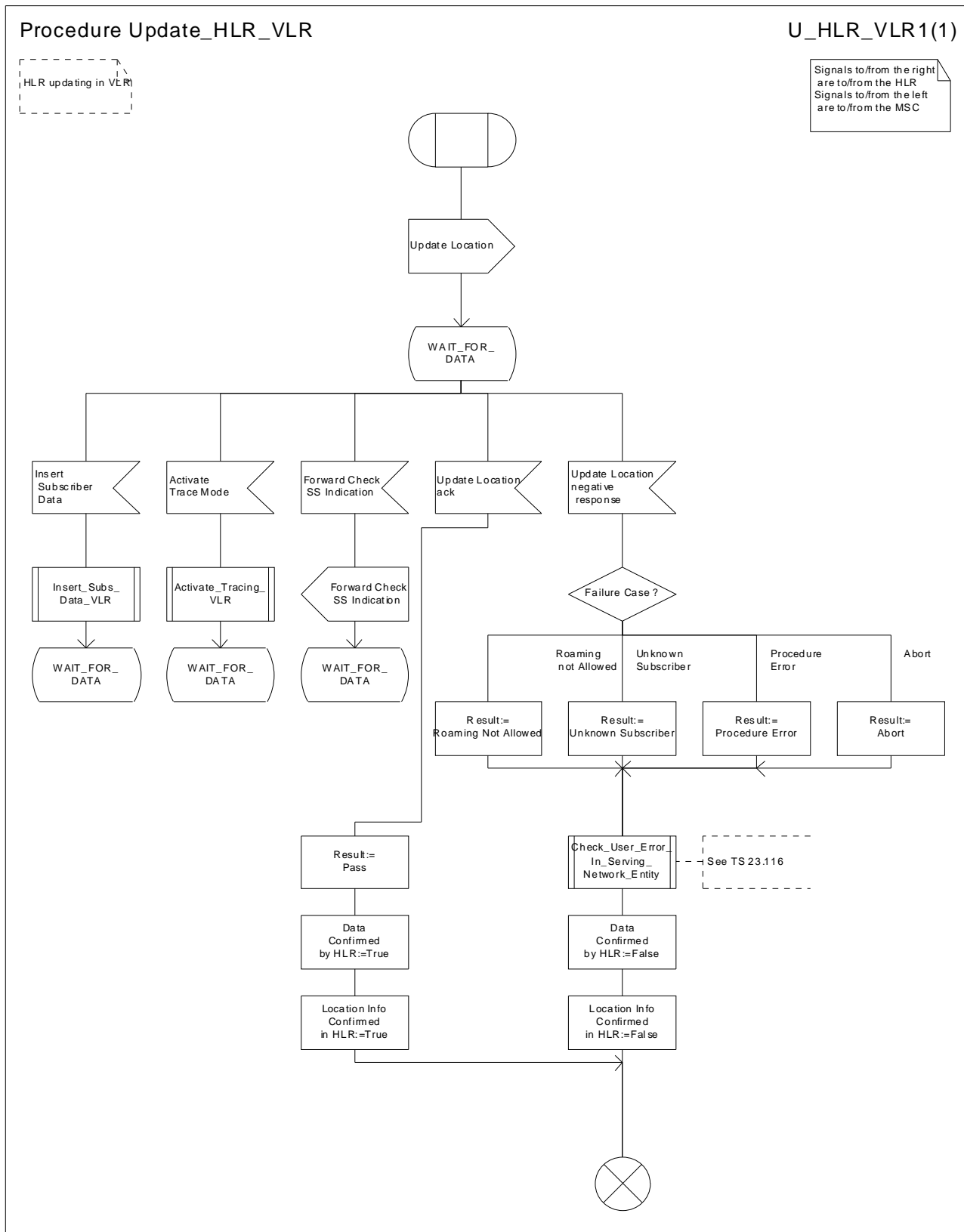

Figure 4.1.2.4 (sheet 1 of 1): Procedure Update_HLR_VLR

4.1.2.5 Procedure Insert_Sub_Data_VLR

The procedure Check_Parameters is specified in 3GPP TS 23.018 [5a].

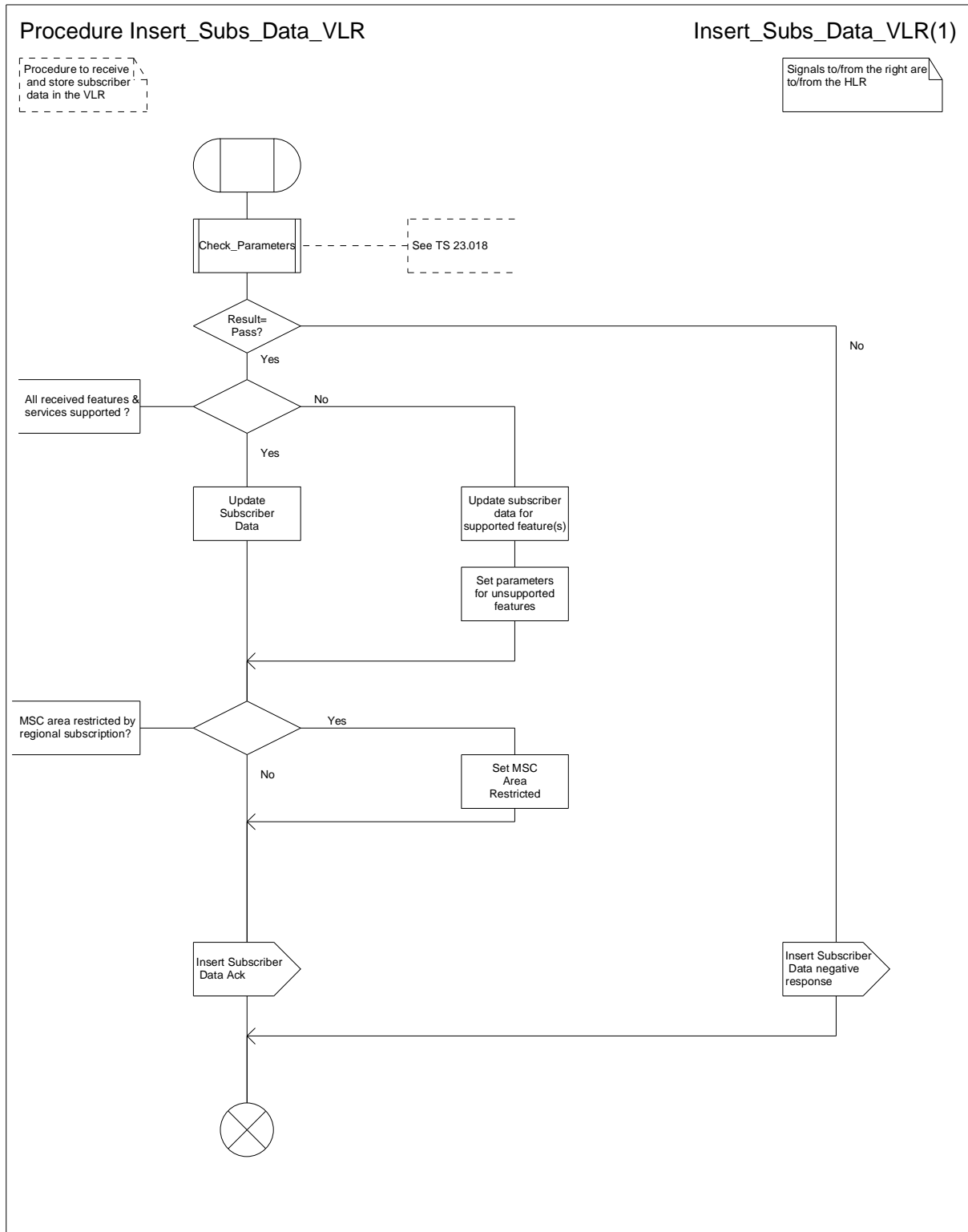

Figure 4.1.2.5 (sheet 1 of 1): Procedure Insert_Subs_Data_VLR

4.1.2.6 Procedure Activate_Tracing_VLR

The procedure Check_Parameters is specified in 3GPP TS 23.018 [5a].

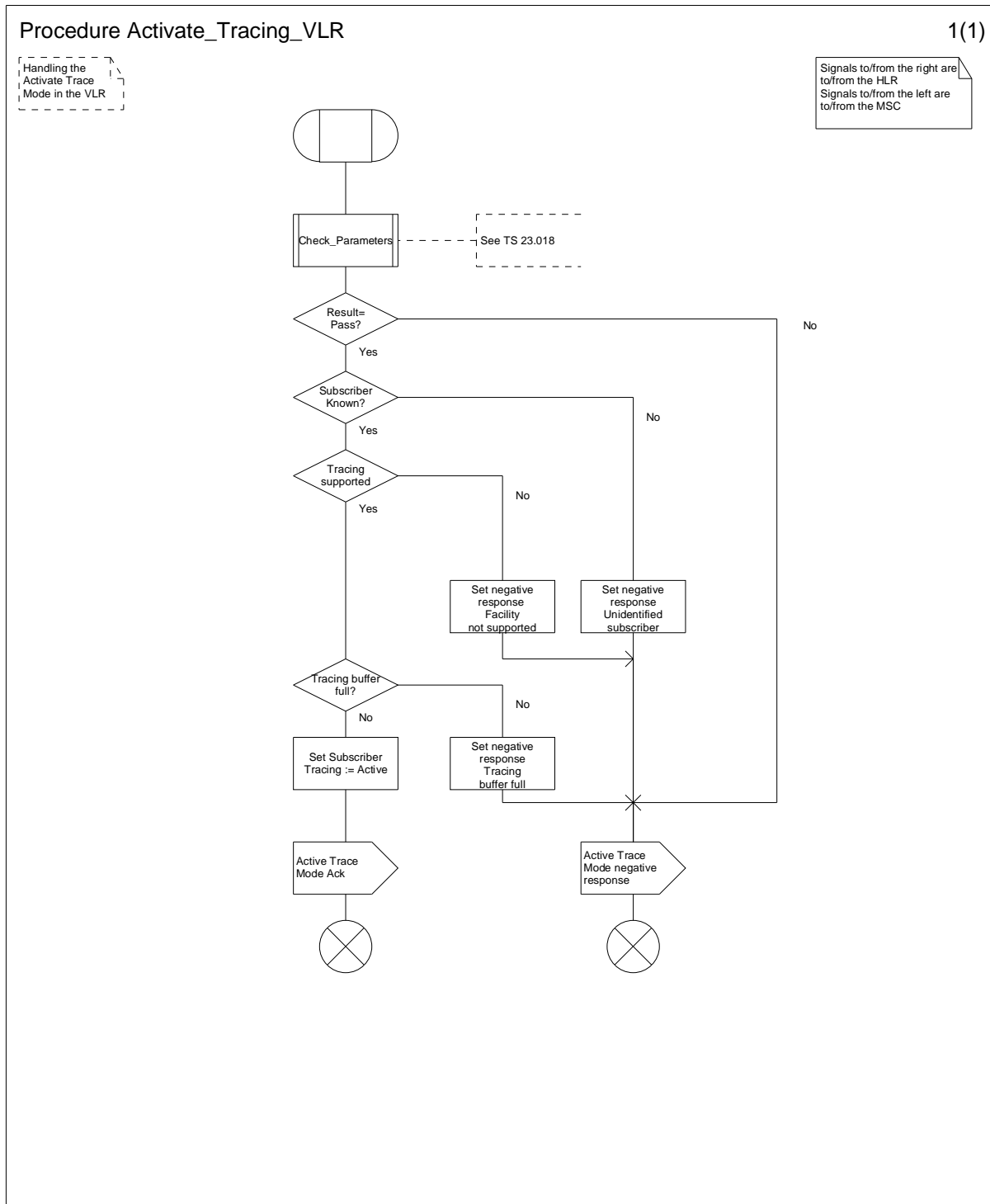

Figure 4.1.2.6 (sheet 1 of 1): Procedure Activate_Tracing_VLR

4.1.2.7 Process Send_Identification_PVLR

Sheet 1: The procedure Check_Parameters is specified in 3GPP TS 23.018 [5a].

Sheet 1: Decision "IuFlex applied?" distinguishes whether or not the PVLR applies "Intra Domain Connection of RAN Nodes to Multiple CN Nodes" as described in 3GPP TS 23.236. If this feature is applied, the VLR shall extract the NRI

from the TMSI and attempt to derive the VLR address of the VLR where the subscriber was previously registered, denoted in the following as the "real PVLR".

Sheet 1: Decision "Result = success?" distinguishes whether the NRI could be successfully converted into the "real PVLR" address. In case of successful conversion, the PVLR shall relay the received Send_Identification message to the "real PVLR" as specified in 3GPP TS 23.236. The new VLR and the "real PVLR" shall not perceive that relaying is being performed, i.e. they shall not notice the presence of the relaying node. The actual mechanism used to perform the relay is an implementation choice. A possible mechanism is described in section 4.1.2.9.

Sheet 1: If supported by the VLR, the "Subscriber data dormant" flag shall be set to true to reflect that the MS has moved outside the VLR area. This is necessary for MSC/VLR to trigger mobile terminating roaming retry feature for a super-charged subscriber. Since the Cancel Location may not be received, upon receiving Send Identification message, the VLR may send a Cancel Location to MSC for super-charger subscribers. A VLR not supporting this flag shall behave as if the flag is set to false.

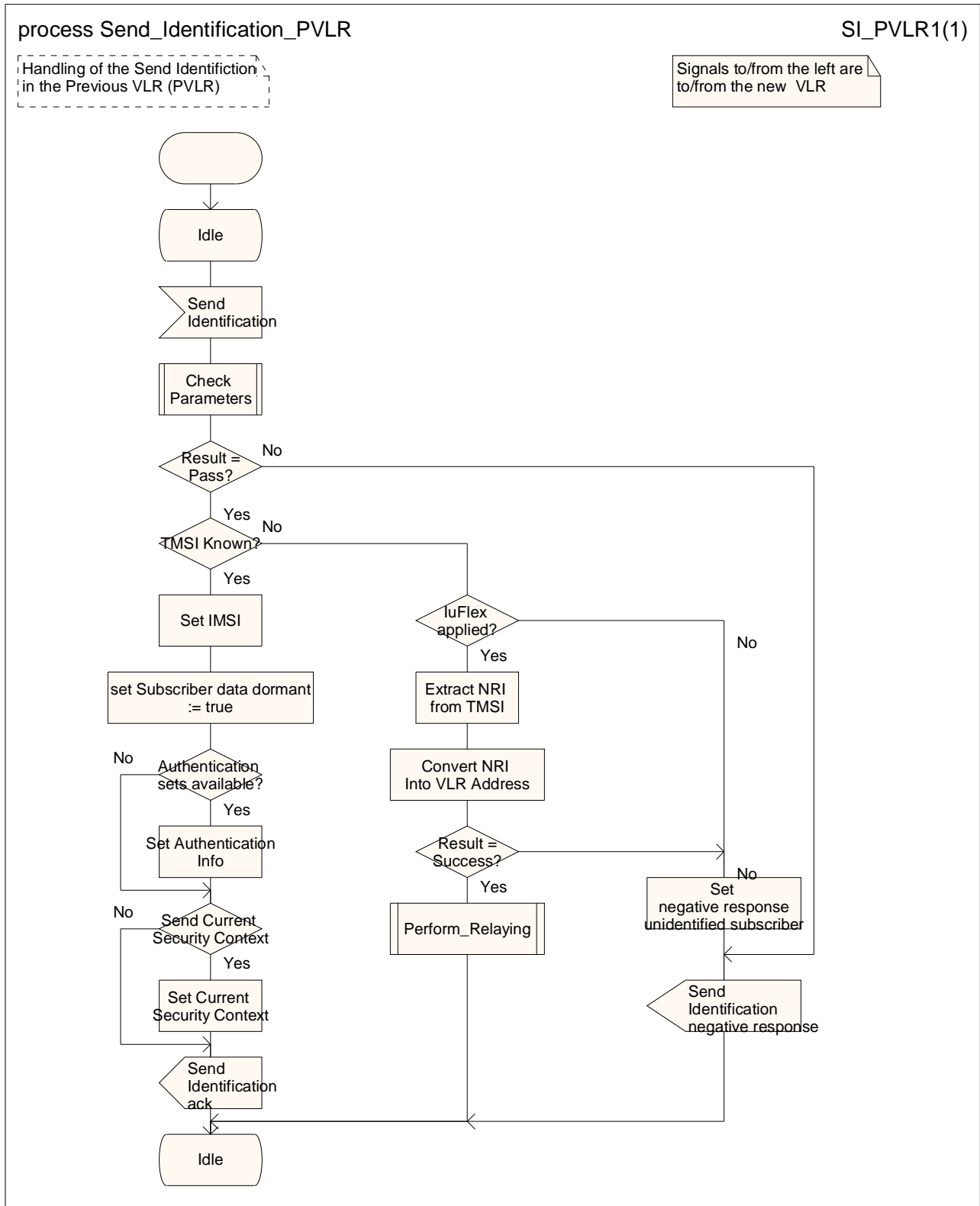

Figure 4.1.2.7 (sheet 1 of 1): Process Send_Identification_PVLR

4.1.2.8 Process Trace_Subscriber_Activity_VLR

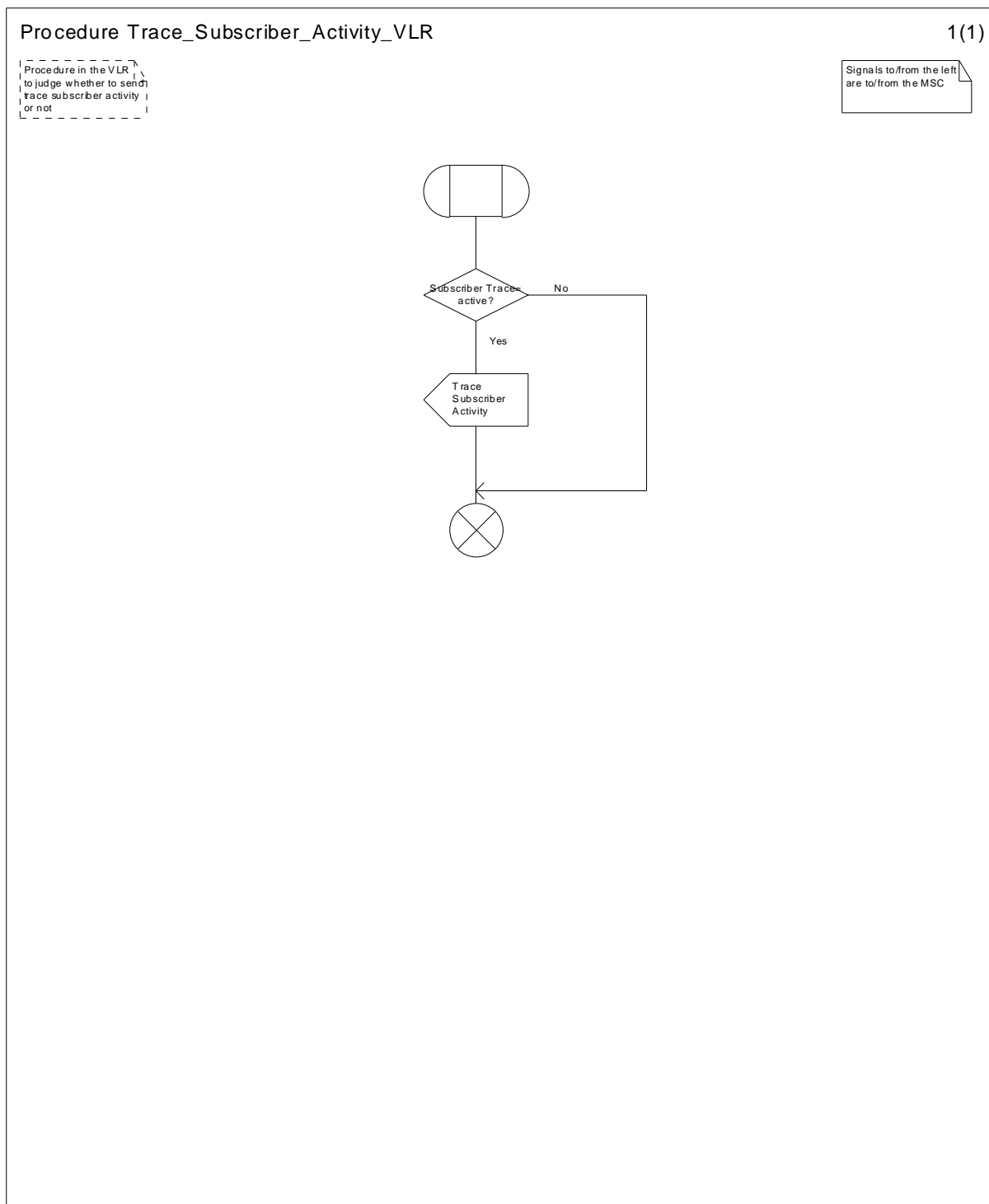

Figure 4.1.2.8 (sheet 1 of 1): Process Trace_Subscriber_Activity_VLR

4.1.2.9 Procedure Perform Relaying

The relay may be performed by opening a new MAP dialogue to the "real PVLR" and keeping it linked to the existing MAP dialogue between the new VLR and the PVLR. Every message received for one of these dialogues shall be relayed to the other one, until the two dialogues are closed. This mechanism is described in figure 4.1.2.9.

In order to improve the signalling efficiency of the relaying function, alternative mechanisms may be implemented as long as no difference shall be perceived by the new VLR and the "real PVLR".

The usage of a Hop Counter is an optional optimization.

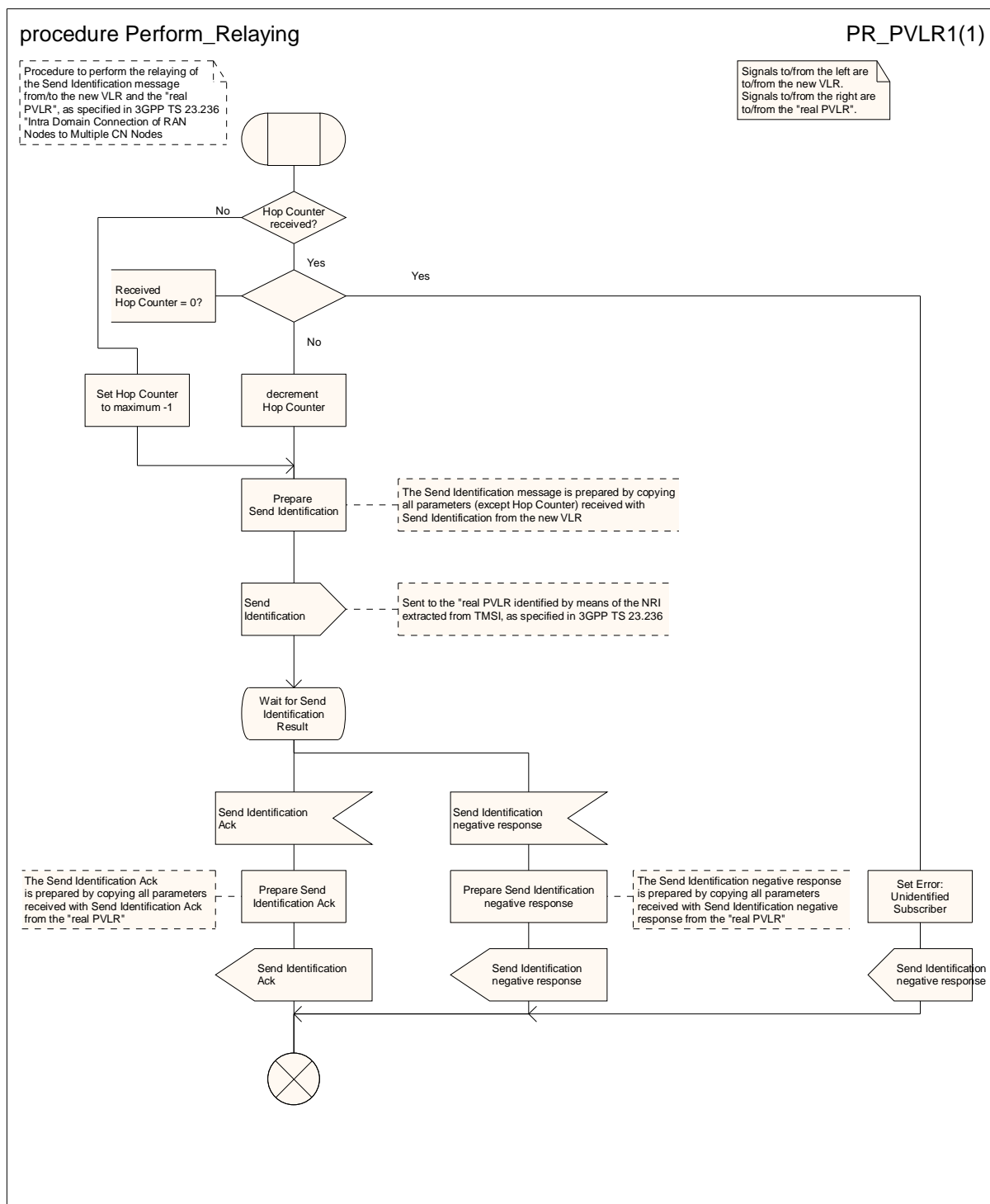

Figure 4.1.2.9 (sheet 1 of 1): Procedure Perform Relaying

4.1.3 Detailed procedure in the HLR

4.1.3.1 Process Update_Location_HLR

The Paging Area function is an optional feature that allows the HLR to be updated with the current Paging Area (PgA) (see subclause 2.6). If supported, the HLR shall store the Paging Area received from the VLR in MAP Update Location requests. If the Paging Area parameter is not included in a MAP Update Location request and the VLR has not changed,

the HLR shall keep the stored Paging Area. If the Paging Area parameter is not included in a MAP Update Location request and the VLR has changed, the HLR shall delete the stored Paging Area.

Sheet 1: The procedure Check_Parameters is specified in 3GPP TS 23.018 [5a].

Sheet 1: The procedure Super_Charged_Cancel_Location_HLR is specific to Super-Charger; it is specified in TS 23.116 [7]. If the previous VLR and the originating HLR support the Super-Charger functionality, processing continues from the "Yes" exit of the test "Result=Pass?".

Sheet 2: The procedure Super_Charged_Location_Updating_HLR is specific to Super-Charger; it is specified in TS 23.116 [7]. If subscription data needs to be sent to the VLR, processing continues from the "No" exit of the test "Result=Pass?".

Sheet 2: The execution of the test "skip subscriber data update?" is optional and depends on the presence of the relevant indication from the VLR. If no indication is received, then the result of the test is "No". The HLR may additionally skip the procedures Update_Routing_Info and Control_Tracing_HLR if this indication is received from the VLR.

Sheet 2: If the HLR supports the Administrative Restriction of Subscribers Access feature and roaming is allowed in the VPLMN then the HLR may check the "Supported RAT Types" received from the VLR against the access restriction parameters. If this check fails then the decision box "Roaming allowed in this PLMN" shall take the exit "No".

Process Update_Location_HLR

1(3)

Process in the HLR Application to handle Location Updating

Signals to/from the left are to/from the VLR

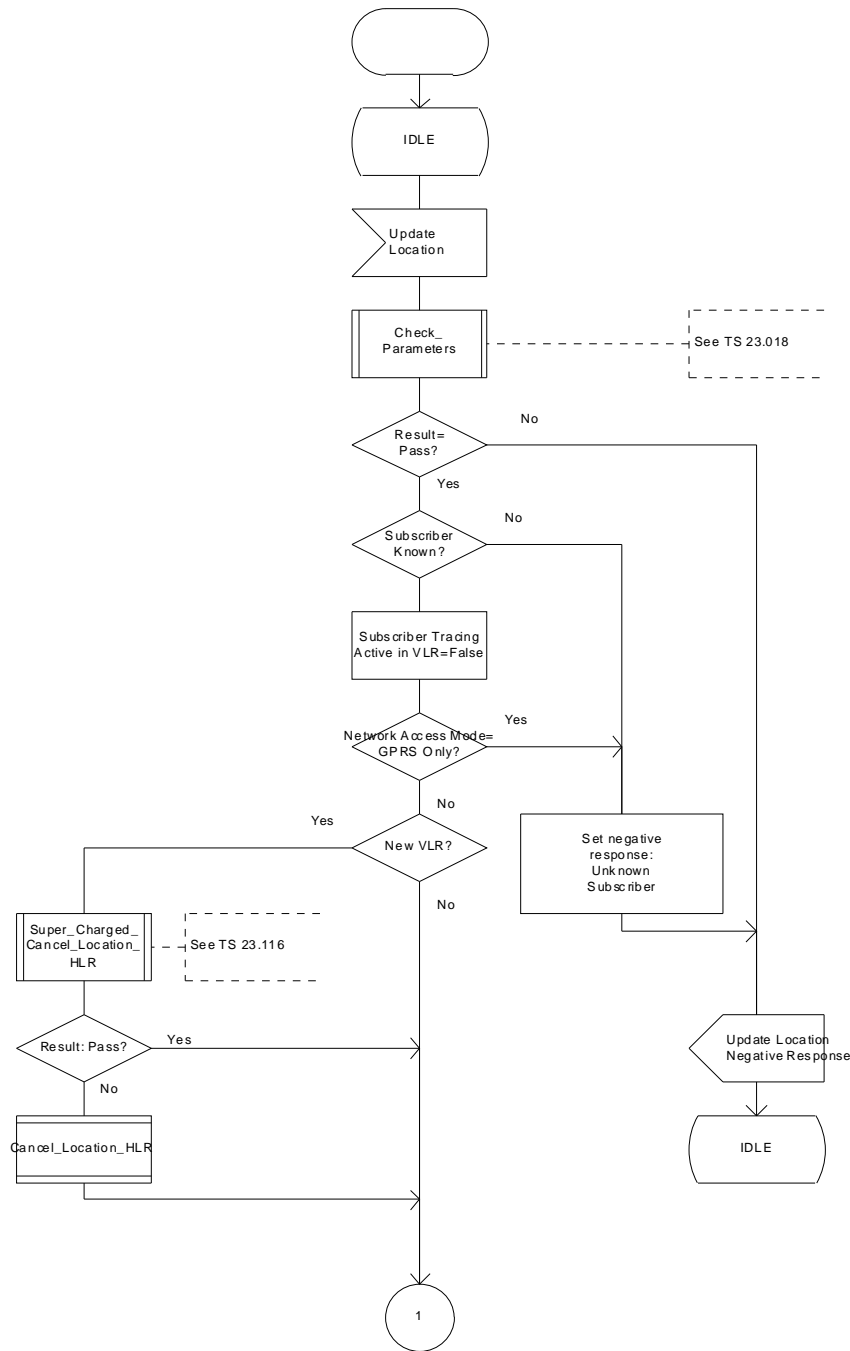

Figure 4.1.3.1 (sheet 1 of 3): Process Update_Location_HLR

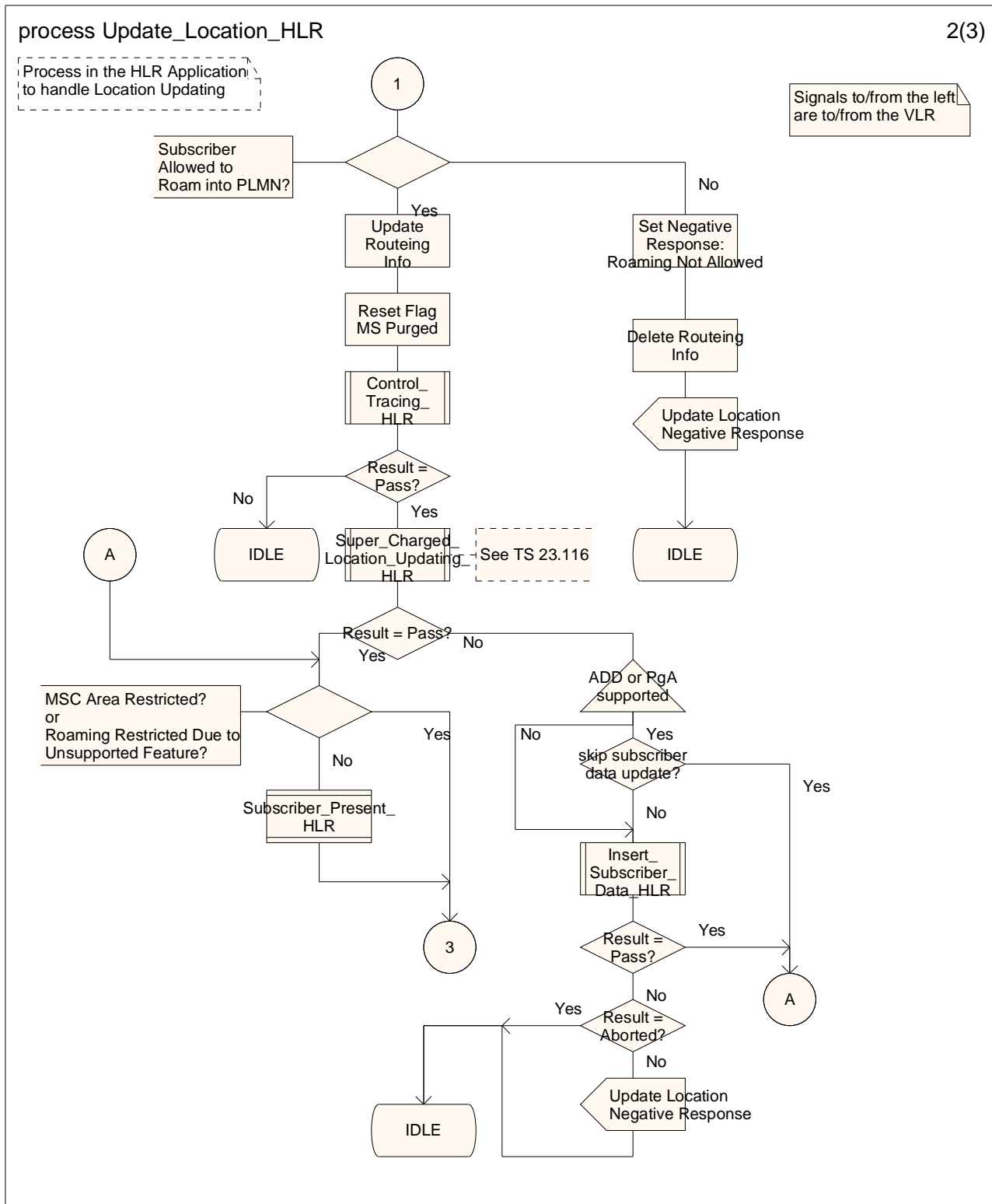

Figure 4.1.3.1 (sheet 2 of 3): Process Update_Location_HLR

Process Update_Location_HLR

3(3)

Process in the HLR Application to handle Location Updating

Signals to/from the left are to/from the VLR

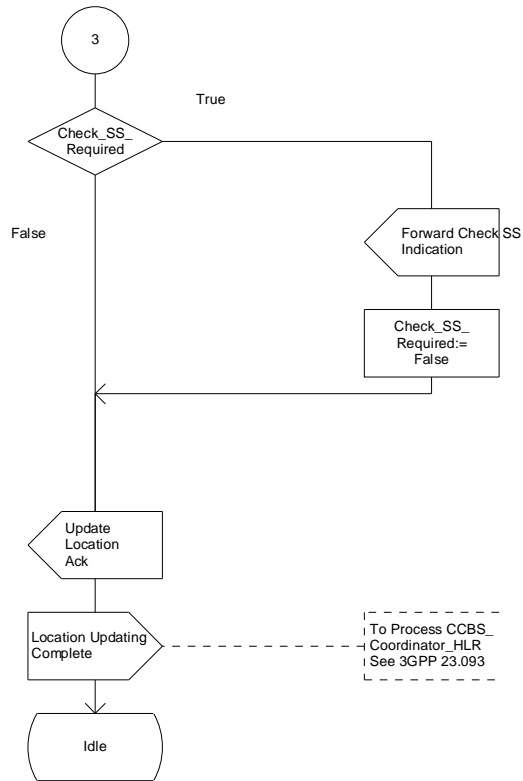

Figure 4.1.3.1 (sheet 3 of 3): Process Update_Location_HLR

4.1.3.2 Procedure Insert_Subscriber_Data_HLR

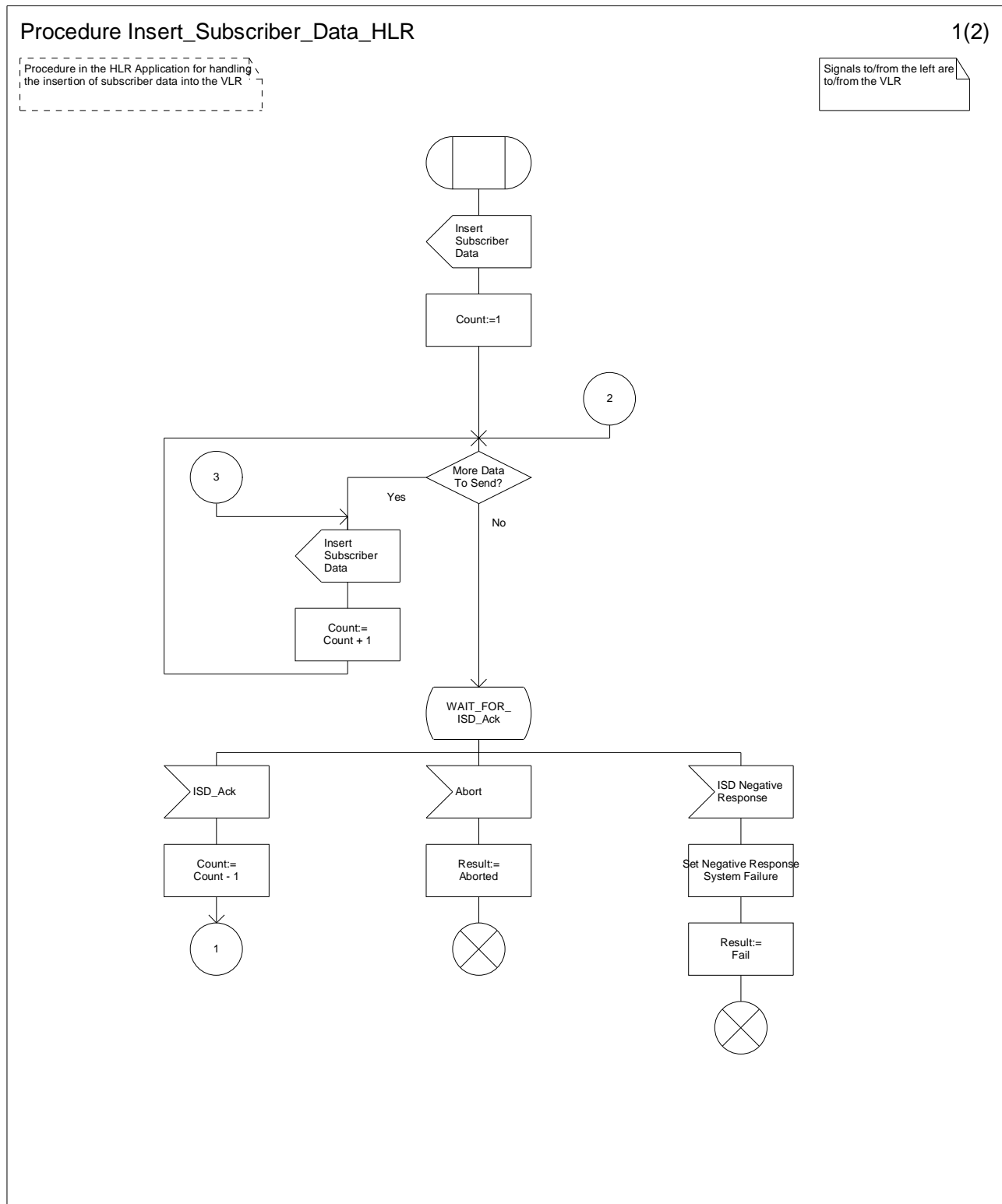

Figure 4.1.3.2 (sheet 1 of 2): Procedure Insert_Subscriber_Data_HLR

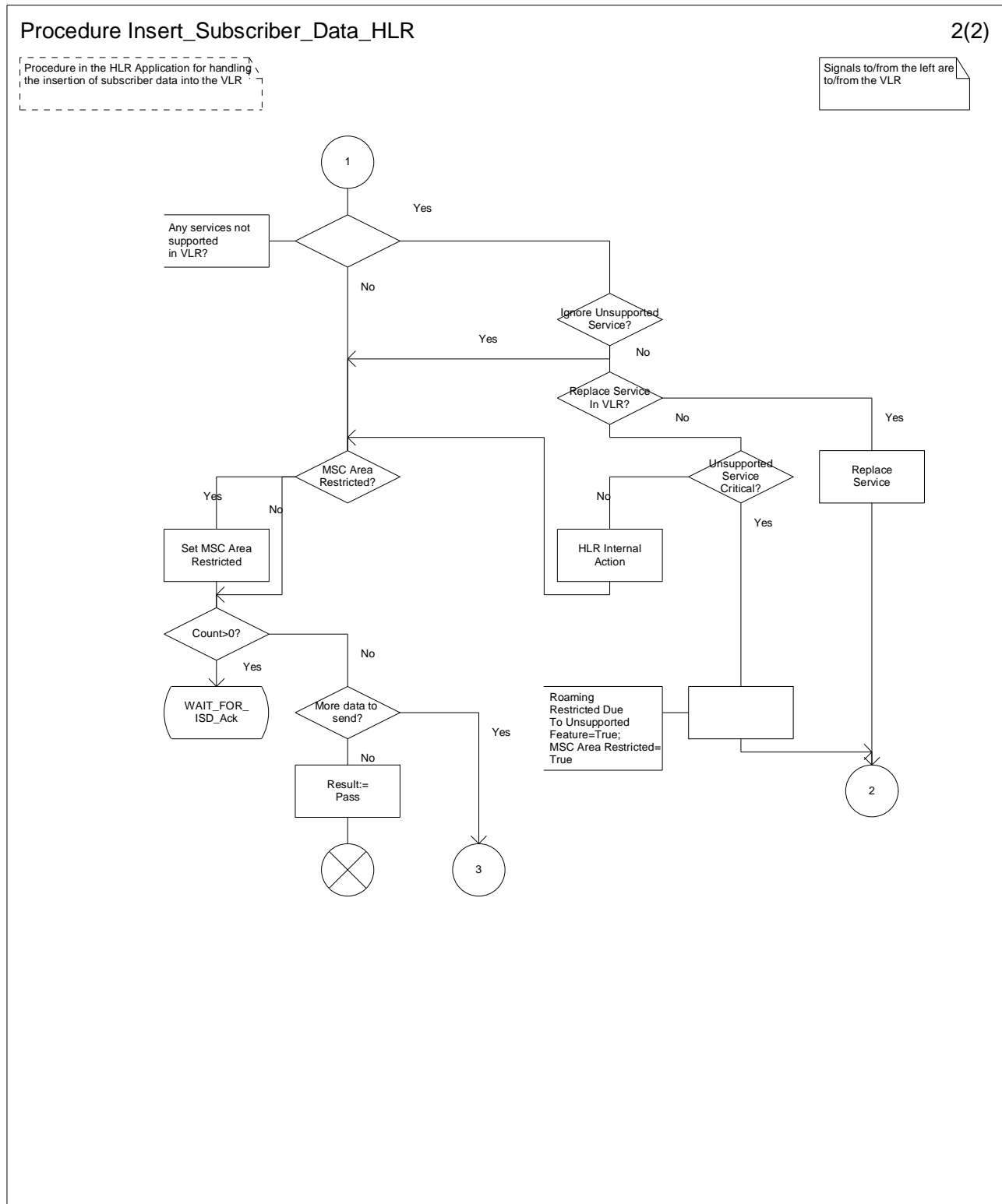

Figure 4.1.3.2 (sheet 2 of 2): Procedure Insert_Subscriber_Data_HLR

4.1.3.3 Process Subscriber_Present_HLR

The macro Alert_Service_Centre_HLR is specified in 3GPP TS 29.002 [8].

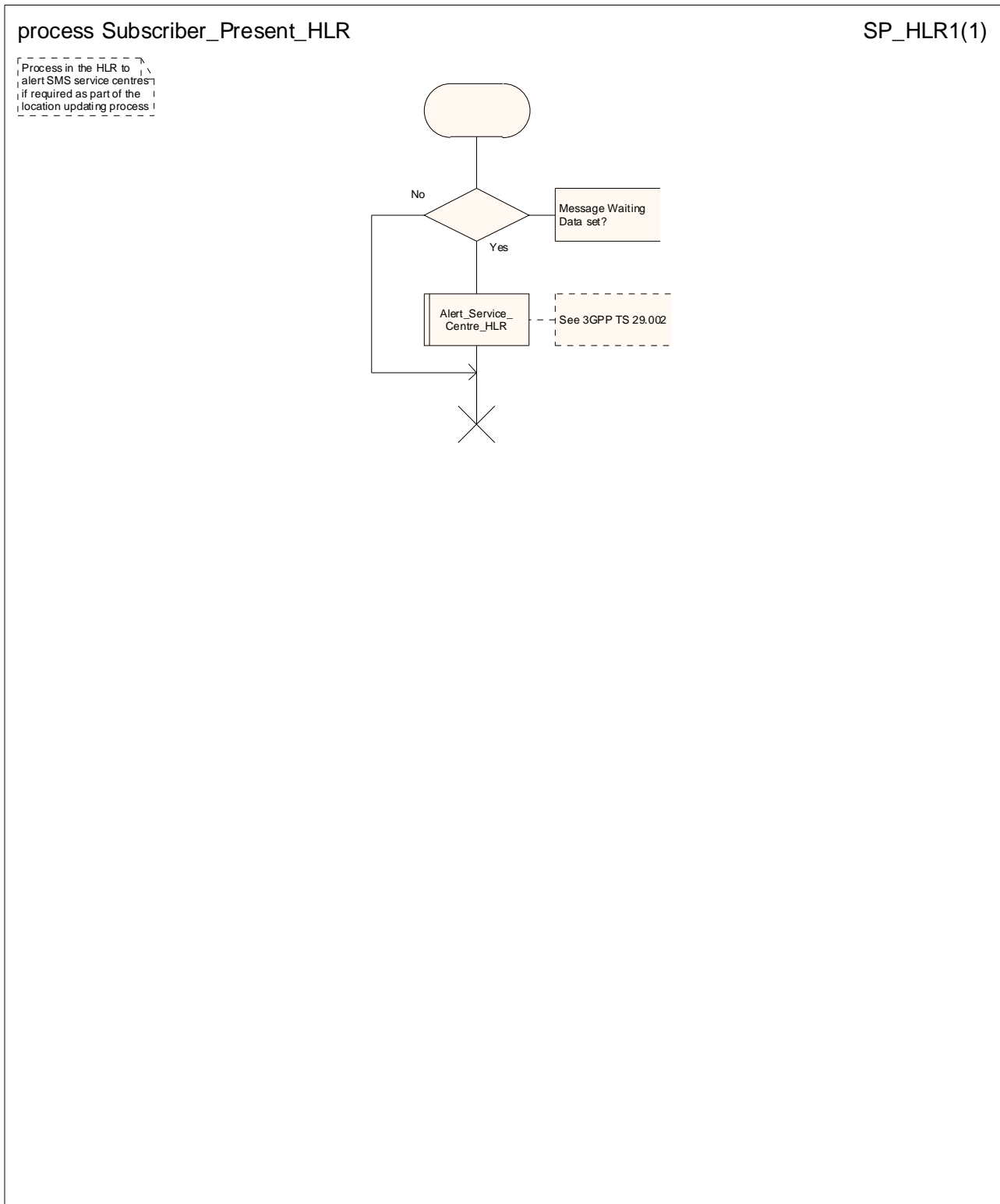

Figure 4.1.3.3: Process Subscriber_Present_HLR

4.1.3.4 Procedure Control_Tracing_HLR

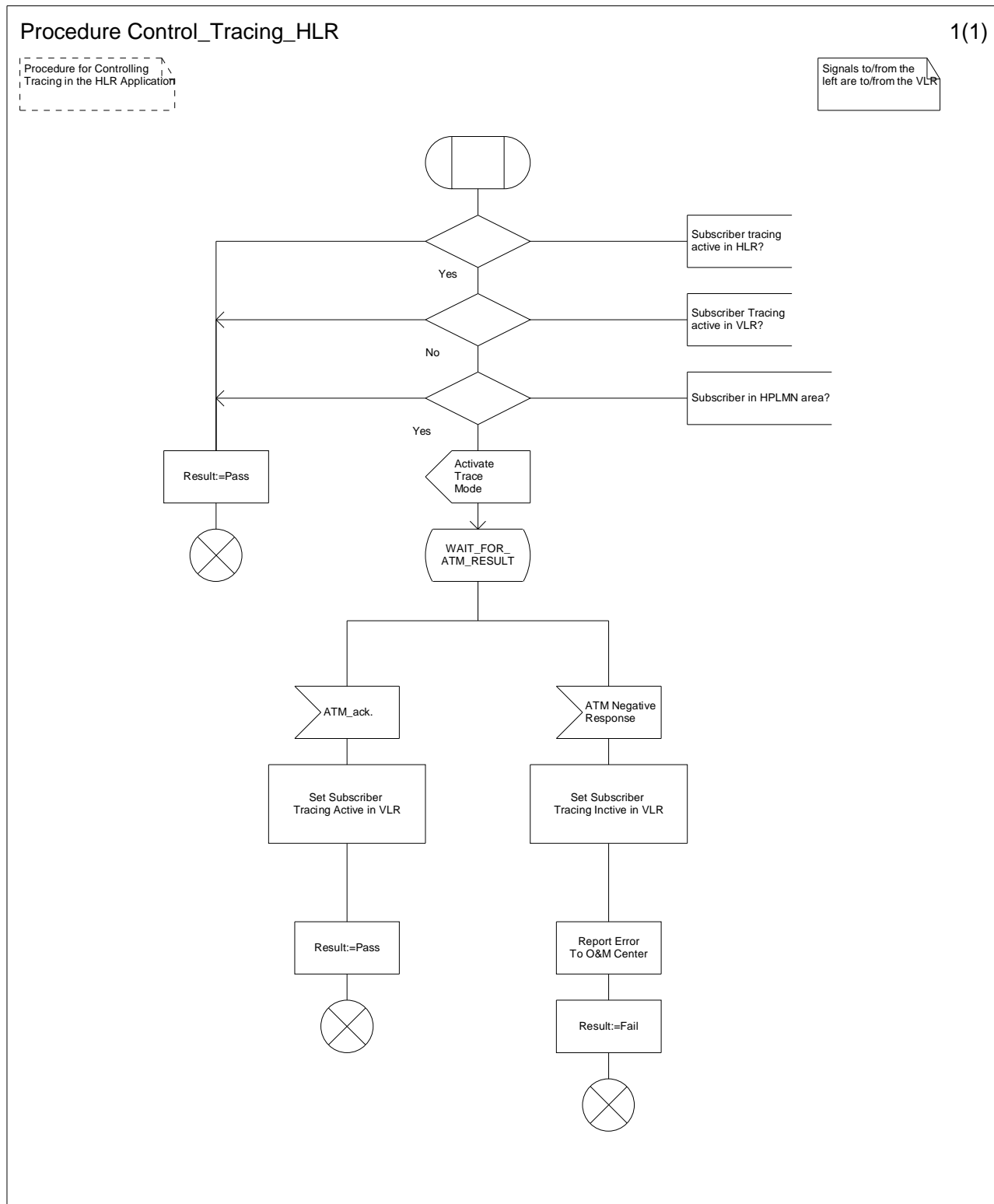

Figure 4.1.3.4 (sheet 1 of 1): Procedure Control_Tracing_HLR

4.2 Location Cancellation

4.2.1 Detailed procedure in the VLR

4.2.1.1 Process Cancel_Location_VLR

The procedure Check_Parameters is specified in 3GPP TS 23.018 [5a].

Sheet 1: If supported by the VLR, the "Subscriber data dormant" flag shall be set to true to allow triggering Mobile Terminating Roaming Retry. A VLR not supporting this flag shall behave as if the flag is set to false.

Sheet 1: A VLR not supporting the Mobile Terminating Roaming Retry feature (see 3GPP TS 23.018 [5a]) may not send Cancel Location to MSC.

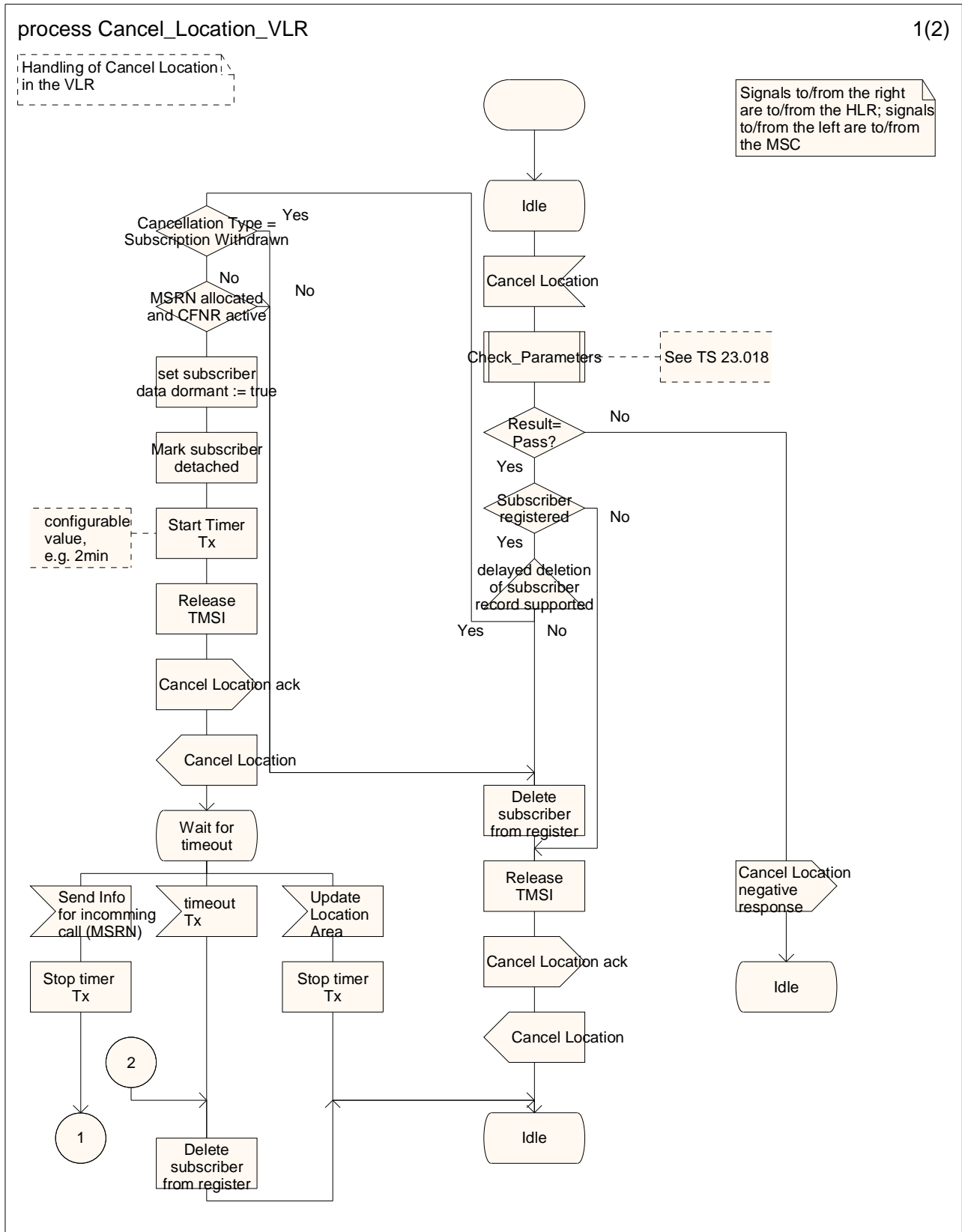

Figure 4.2.1.1 (Sheet 1 of 2): Process Cancel_Location_VLR

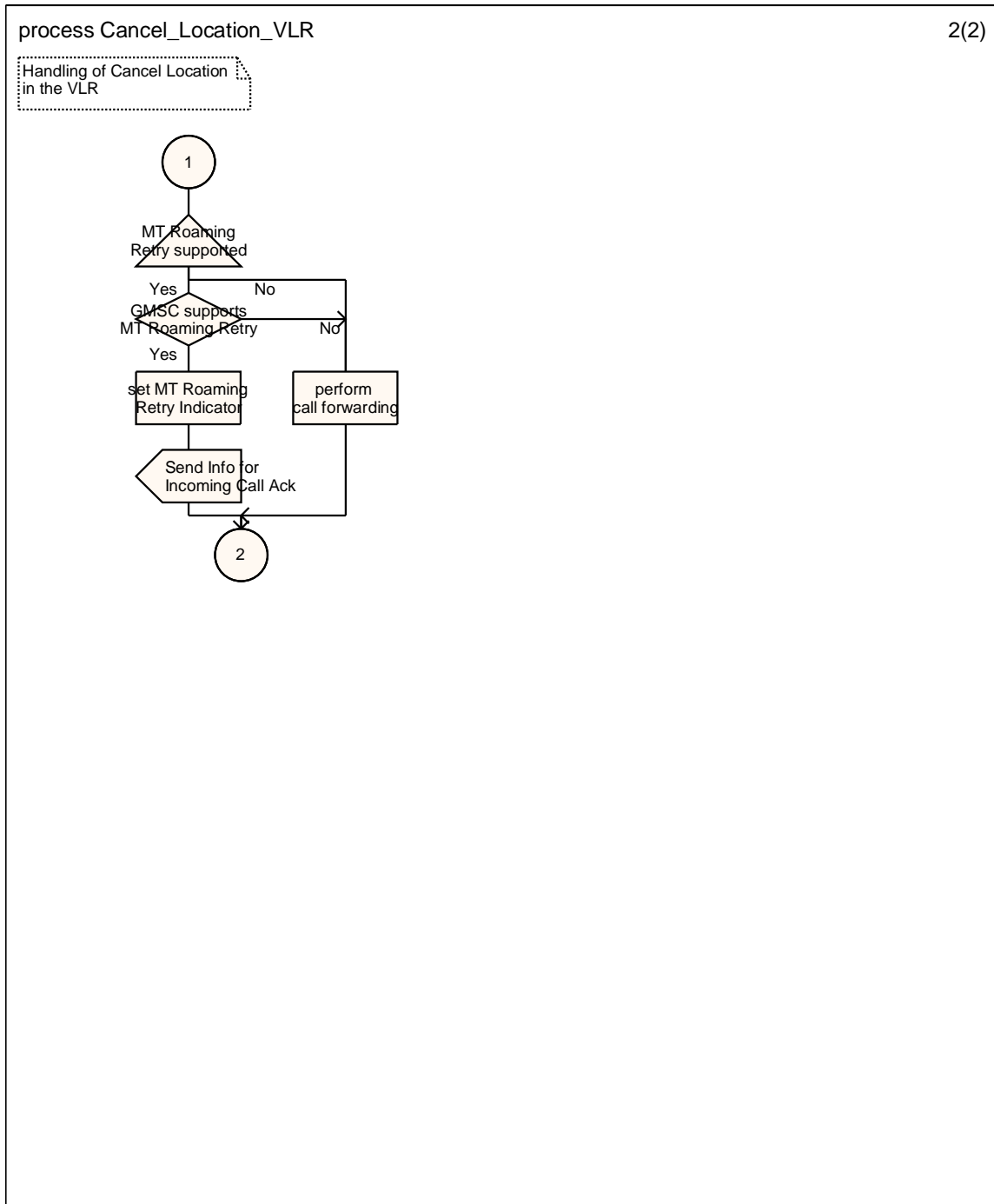

Figure 4.2.1.1 (Sheet 2 of 2): Process Cancel_Location_VLR

4.2.2 Detailed procedure in the HLR

4.2.2.1 Process Cancel_Location_HLR

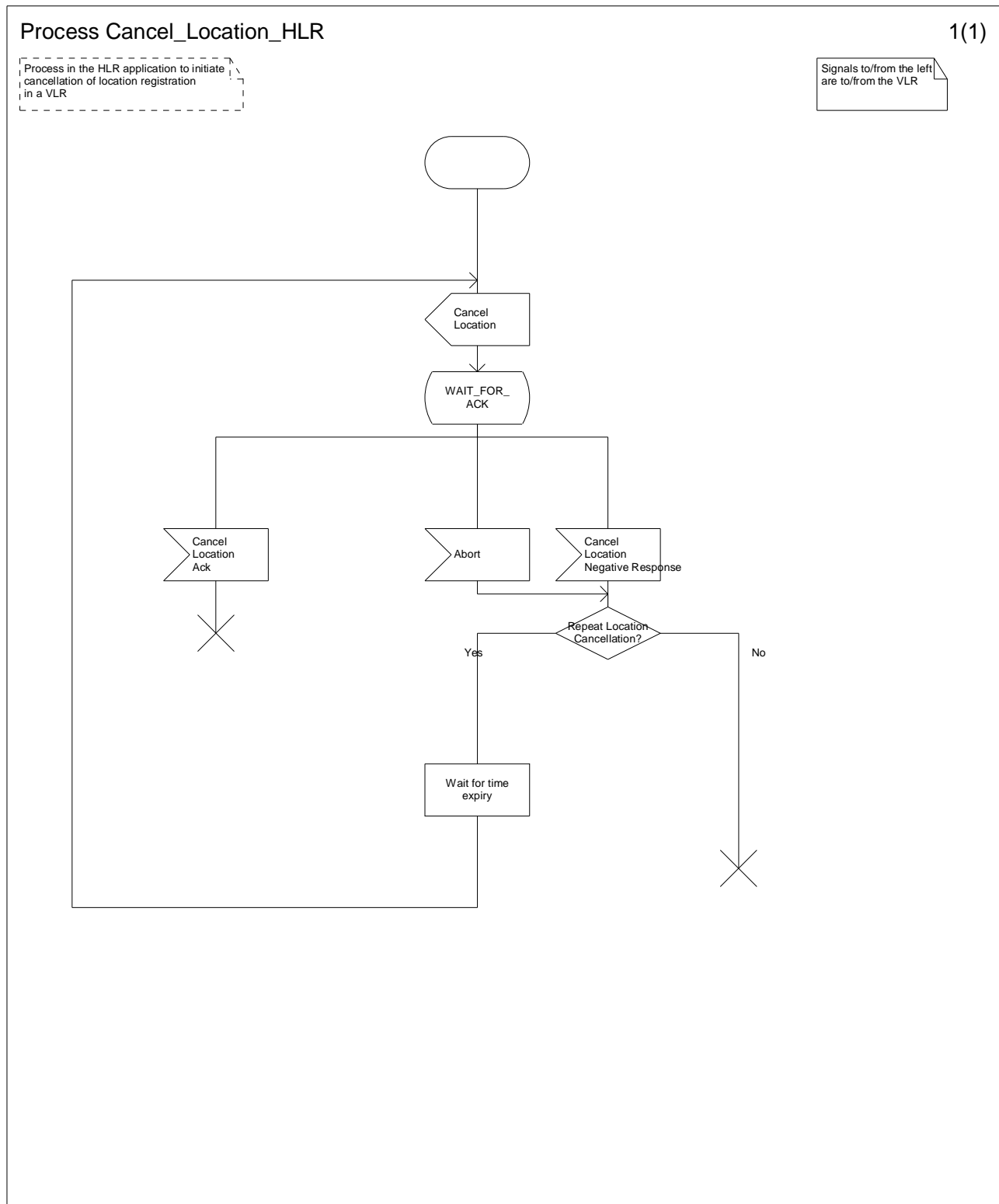

Figure 4.2.2.1: Process Cancel_Location_HLR

4.3 Detach IMSI

4.3.1 Detailed procedure in the MSC

4.3.1.1 Process Detach_IMSI_MSC

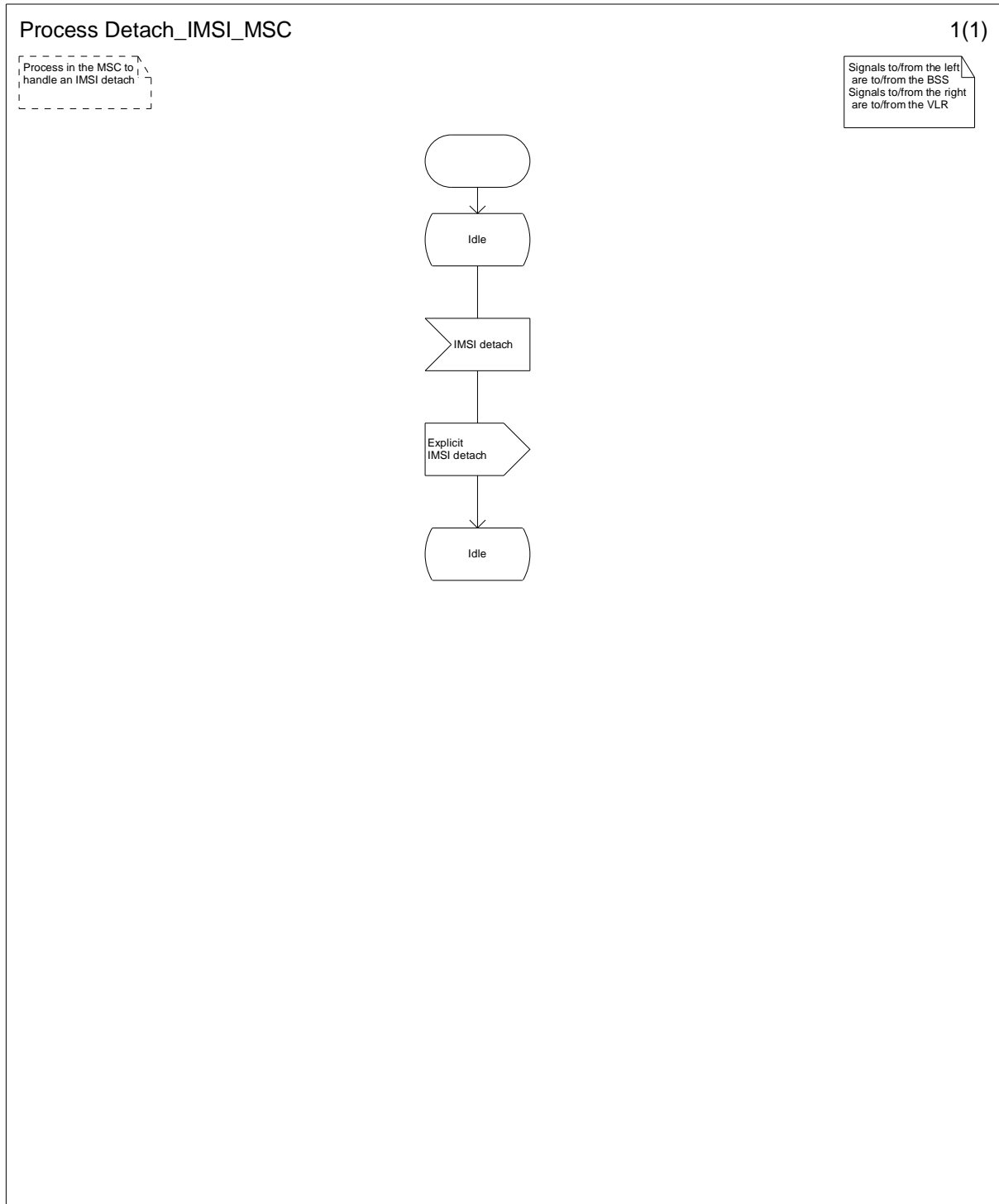

Figure 4.3.1.1 (Sheet 1 of 1): Process Detach_IMSI_MSC

4.3.2 Detailed procedure in the VLR

4.3.2.1 Process Detach_IMSI_VLR

The signal "Authenticated Radio Contact Terminated" is sent to Process Detach_IMSI_VLR from RR handling in the MSC whenever authenticated radio contact is terminated, e.g. at the release of a call.

The procedure "Notify_gsmSCF" is specified in 3GPP TS 23.078 [11]. The "Notify" parameter indicates whether the IMSI detach was explicit or implicit.

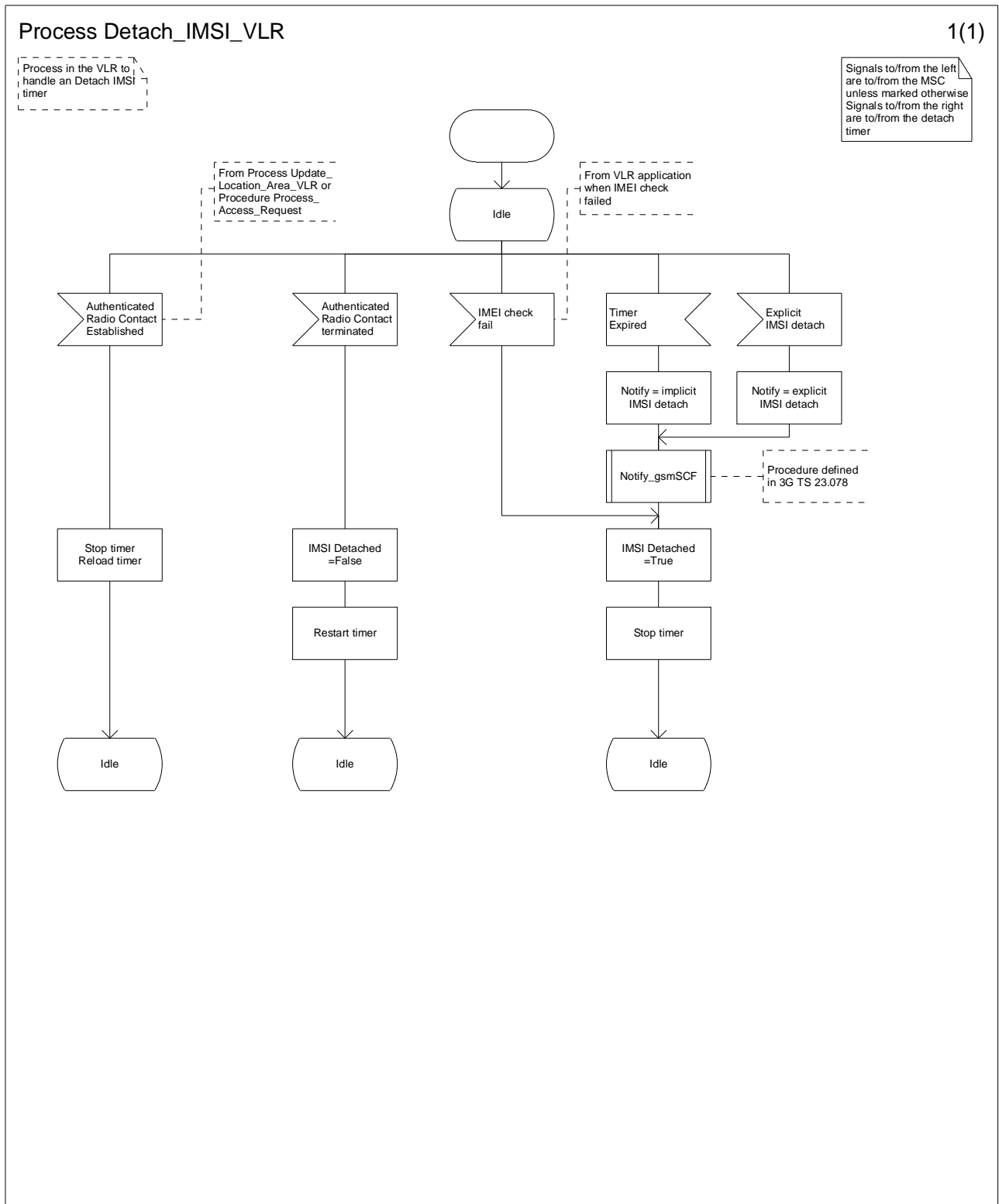

Figure 4.3.1.1 (Sheet 1 of 1): Process Detach_IMSI_VLR

4.4 Purge MS

4.4.1 Detailed procedure in the VLR

4.4.1.1 Procedure Purge_MS_VLR

Sheet 1: The procedure Purge_MS_In_Serving_Network_Entity is specific to Super-Charger; it is specified in TS 23.116 [7]. If the VLR and the originating HLR support the Super-Charger functionality, processing continues from the "Yes" exit of the test "Result=Pass?".

Process Purge_MS_VLR

1(1)

Process in the VLR to purge MS.

Signals to/from the right are to/from the HLR
Signals to/from the left are to/from the Operation & Maintenance Centre

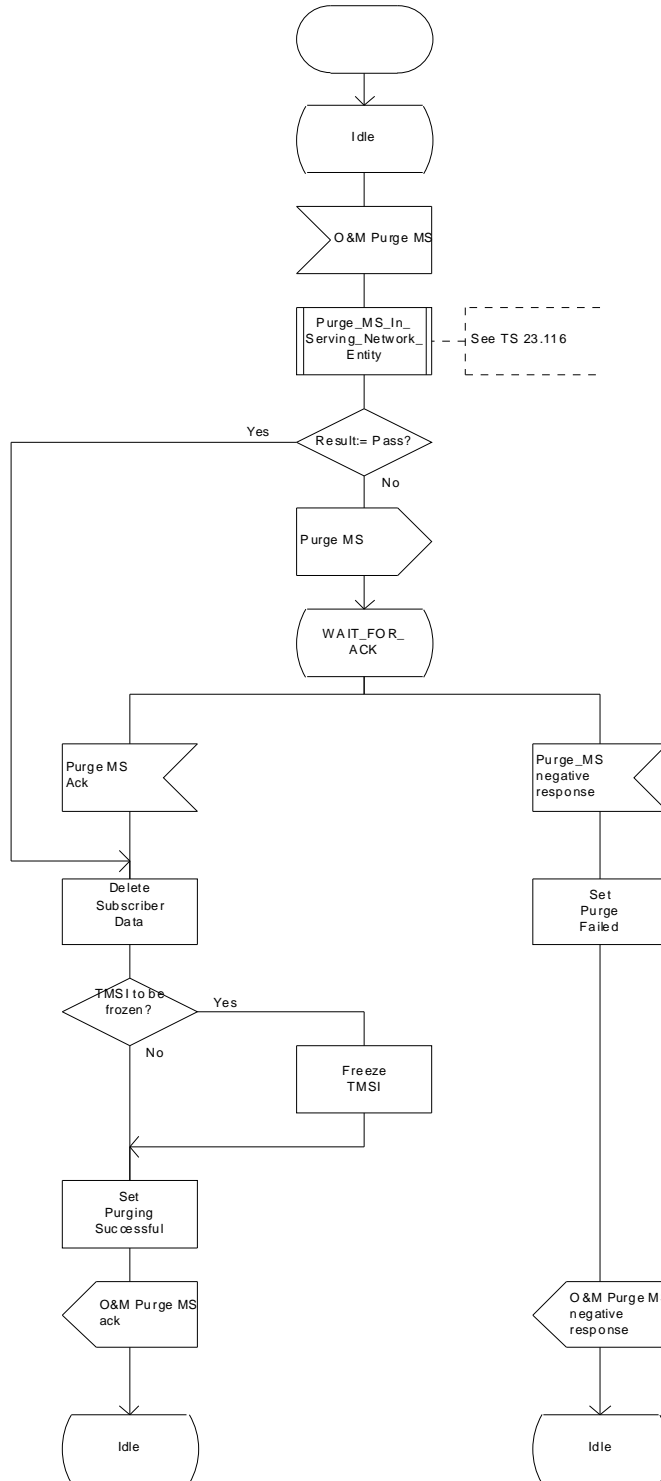

Figure 4.4.1.1 (Sheet 1 of 1): Procedure Purge_MS_VLR

4.4.2 Detailed procedure in the HLR

4.4.2.1 Process Purge_MS_HLR

The procedure Check_Parameters is specified in 3GPP TS 23.018 [5a].

If the received VLR number and the stored VLR number do not match, the HLR sends Purge MS ack containing an empty result to indicate successful outcome. Since the MS is known by the HLR to be in a different VLR area, it is not appropriate to block mobile terminated calls or short messages to the MS, but the VLR which initiated the purging procedure can safely purge its record for the MS without freezing the TMSI.

If the received SGSN number and the stored SGSN number do not match, the HLR sends a Purge MS ack containing an empty result to indicate successful outcome. Since the MS is known by the HLR to be in a different SGSN area, it is not appropriate to block short messages to the MS, but the SGSN which initiated the purging procedure can safely purge its record for the MS without freezing the P-TMSI.

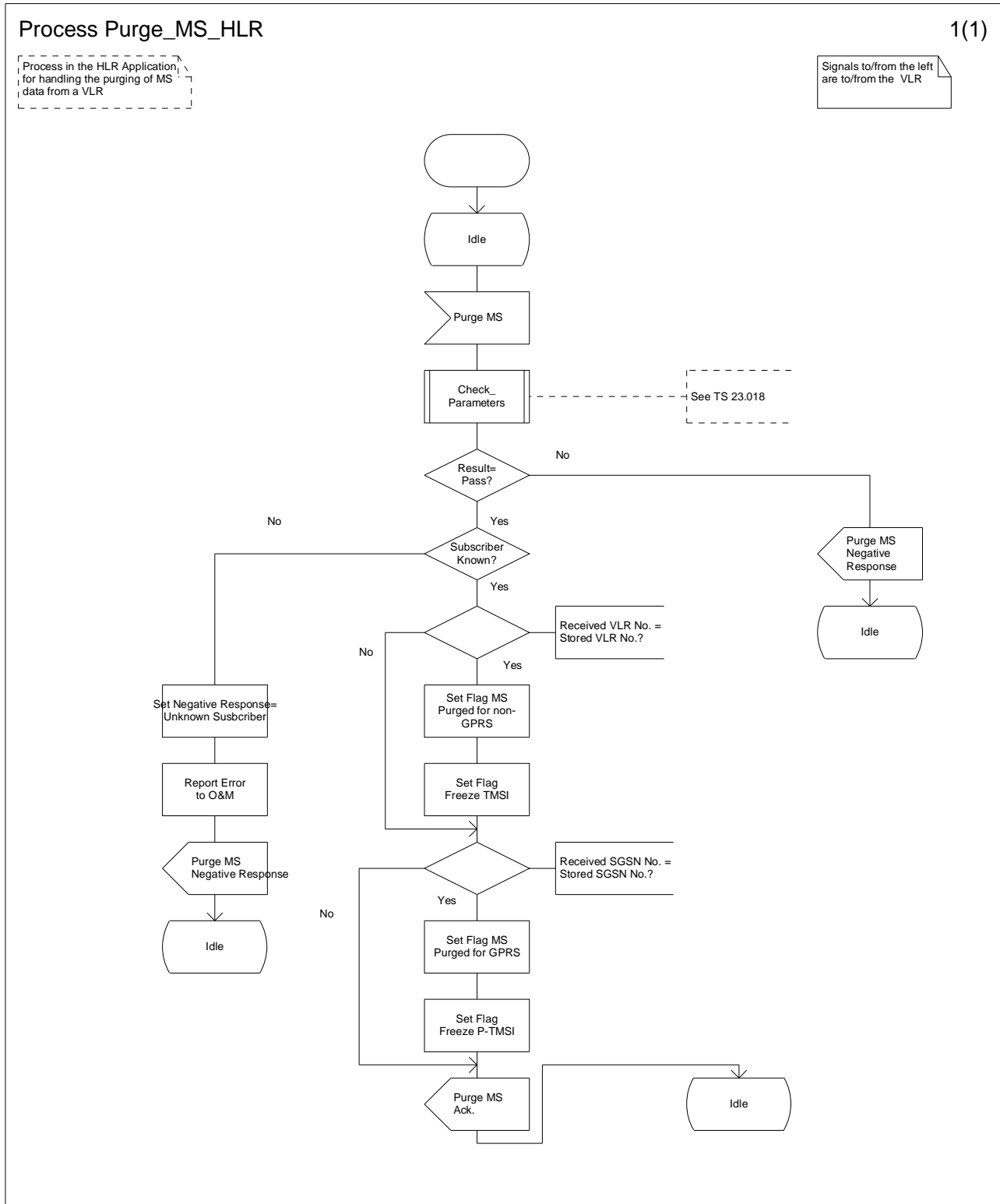

Figure 4.4.2.1 (Sheet 1 of 1): Procedure Purge_MS_HLR

Annex A (informative): Change history

Change history						
TSG CN#	Spec	Version	CR	<Phase>	New Version	Subject/Comment
Apr 1999	GSM 03.12	6.0.0				Transferred to 3GPP CN1
CN#03	23.012				3.0.0	Approved at CN#03
CN#06	23.012	3.0.0	001r1	R99	3.1.0	Restructuring of MAP Location Management Procedures, Stage 2
CN#06	23.012	3.0.0	002	R99	3.1.0	Introduction of Super-Charger into TS 23.012
CN#07	23.012	3.1.0	003r3	R99	3.2.0	Introduction of Enhanced User Identity Confidentiality
CN#07	23.012	3.1.0	004	R99	3.2.0	Addition of Current Security Context Data to Send_Identification_PVLR
CN#07	23.012	3.1.0	005	R99	3.2.0	Introduction of Authentication Failure Report
	23.012	3.2.0		R99	3.2.1	CR 23.012-003r3 removed because implemented in error
CN#08	23.012	3.2.1	006	R99	3.3.0	Introduction of Mobility Management event notification into 23.012 procedures
CN#11	23.012	3.3.0		Rel-4	4.0.0	Release 4 after CN#11
CN#11	23.012	4.0.0	008r1	Rel-5	5.0.0	Relaying of SendIdentification when luFlex is applied
CN#20	23.012	5.0.0	010r1	Rel-5	5.1.0	Addition of procedure to retrieve UE-specific behaviour data
CN#21	23.012	5.1.0	012	Rel-5	5.2.0	Correction of misaligned signal names between VLR and PVLR
CN#21	23.012	5.1.0	013r1	Rel-5	5.2.0	Corrections to "Early UE" handling
CN#23	23.012	5.2.0	014r1	Rel-6	6.0.0	Include administrative restriction subscription parameter
CN#24	23.012	6.0.0	015r6	Rel-6	6.1.0	Addition of ADD feature
CN#25	23.012	6.2.0	016r1	Rel-6	6.2.0	Clarification of the Automatic Device Detection feature
CN#27	23.012	6.2.0	018r2	Rel-6	6.3.0	Introduction of Hop Counter for Send Identification
CN#27	23.012	6.2.0	018r2	Rel-6	6.3.0	Management Based Activation Impacts
CT#31	23.012	6.3.0	0020	Rel-7	7.0.0	Enhancement of the administrative restriction of subscribers" access feature
CT#32	23.012	7.0.0	0022	Rel-7	7.1.0	Use of cause #12 in VPLMNs
CT#32	23.012	7.0.0	0021	Rel-7	7.1.0	Skipping Update Location and Control Tracing for SkipSubscriberData
CT#34	23.012	7.1.0	0024r1	Rel-7	7.2.0	Change to CANCEL_LOCATION procedure in VLR
CT#36	23.012	7.2.0	0026r2	Rel-7	7.3.0	Mobile Termination whilst the MS is moving to another MSC
CT#40	23.012	7.3.0	0027r1	Rel-8	8.0.0	Paging optimization with A/lu flex
CT#42	23.012	8.0.0	0029	Rel-8	8.1.0	TMSI re-allocation during Location Updating Reject with cause #13 or #15
CT#44	23.012	8.1.0	0030r1	Rel-8	8.2.0	MAP Update Location w/o the PgA parameter
Ct#46	-	8.2.0	-		9.0.0	Update to Rel-9 version (MCC)

History

Document history		
V9.0.0	February 2010	Publication