

# ETSI TS 123 083 V5.1.0 (2002-09)

*Technical Specification*

**Digital cellular telecommunications system (Phase 2+);  
Universal Mobile Telecommunications System (UMTS);  
Call Waiting (CW) and Call Hold (HOLD)  
Supplementary Service;  
Stage 2  
(3GPP TS 23.083 version 5.1.0 Release 5)**



---

Reference

RTS/TSGN-0423083v510

---

Keywords

GSM, UMTS

**ETSI**

650 Route des Lucioles  
F-06921 Sophia Antipolis Cedex - FRANCE

Tel.: +33 4 92 94 42 00 Fax: +33 4 93 65 47 16

Siret N° 348 623 562 00017 - NAF 742 C  
Association à but non lucratif enregistrée à la  
Sous-Préfecture de Grasse (06) N° 7803/88

---

**Important notice**

Individual copies of the present document can be downloaded from:

<http://www.etsi.org>

The present document may be made available in more than one electronic version or in print. In any case of existing or perceived difference in contents between such versions, the reference version is the Portable Document Format (PDF). In case of dispute, the reference shall be the printing on ETSI printers of the PDF version kept on a specific network drive within ETSI Secretariat.

Users of the present document should be aware that the document may be subject to revision or change of status. Information on the current status of this and other ETSI documents is available at

<http://portal.etsi.org/tb/status/status.asp>

If you find errors in the present document, send your comment to:

[editor@etsi.org](mailto:editor@etsi.org)

---

**Copyright Notification**

No part may be reproduced except as authorized by written permission.  
The copyright and the foregoing restriction extend to reproduction in all media.

© European Telecommunications Standards Institute 2002.  
All rights reserved.

**DECT**<sup>TM</sup>, **PLUGTESTS**<sup>TM</sup> and **UMTS**<sup>TM</sup> are Trade Marks of ETSI registered for the benefit of its Members.  
**TIPHON**<sup>TM</sup> and the **TIPHON logo** are Trade Marks currently being registered by ETSI for the benefit of its Members.  
**3GPP**<sup>TM</sup> is a Trade Mark of ETSI registered for the benefit of its Members and of the 3GPP Organizational Partners.

---

## Intellectual Property Rights

IPRs essential or potentially essential to the present document may have been declared to ETSI. The information pertaining to these essential IPRs, if any, is publicly available for **ETSI members and non-members**, and can be found in ETSI SR 000 314: "*Intellectual Property Rights (IPRs); Essential, or potentially Essential, IPRs notified to ETSI in respect of ETSI standards*", which is available from the ETSI Secretariat. Latest updates are available on the ETSI Web server (<http://webapp.etsi.org/IPR/home.asp>).

Pursuant to the ETSI IPR Policy, no investigation, including IPR searches, has been carried out by ETSI. No guarantee can be given as to the existence of other IPRs not referenced in ETSI SR 000 314 (or the updates on the ETSI Web server) which are, or may be, or may become, essential to the present document.

---

## Foreword

This Technical Specification (TS) has been produced by ETSI 3rd Generation Partnership Project (3GPP).

The present document may refer to technical specifications or reports using their 3GPP identities, UMTS identities or GSM identities. These should be interpreted as being references to the corresponding ETSI deliverables.

The cross reference between GSM, UMTS, 3GPP and ETSI identities can be found under [www.etsi.org/key](http://www.etsi.org/key).

---

# Contents

Intellectual Property Rights .....	2
Foreword.....	2
Foreword.....	4
0 Scope .....	5
0.1 References .....	5
0.2 Abbreviations .....	5
1 Call waiting (CW) .....	6
1.1 Handling of call waiting .....	6
1.1.1 Activation .....	6
1.1.2 Deactivation.....	6
1.1.3 Interrogation .....	7
1.2 Functions and information flows.....	7
1.3 Information stored in the HLR .....	26
1.4 State transition model.....	26
1.5 Transfer of information from HLR to VLR.....	27
1.6 Information stored in the VLR .....	27
1.7 Handover .....	27
2 Call hold (HOLD) .....	27
2.1 Functions and information flows.....	27
2.2 Information stored in the HLR .....	36
2.3 State transition model.....	37
2.4 Transfer of information from HLR to VLR.....	37
2.5 Information stored in the VLR .....	37
2.6 Handover .....	37
<b>Annex A: Change history .....</b>	<b>38</b>
History .....	39

---

## Foreword

This Technical Specification has been produced by the 3<sup>rd</sup> Generation Partnership Project (3GPP).

The contents of the present document are subject to continuing work within the TSG and may change following formal TSG approval. Should the TSG modify the contents of the present document, it will be re-released by the TSG with an identifying change of release date and an increase in version number as follows:

Version x.y.z

where:

- x the first digit:
  - 1 presented to TSG for information;
  - 2 presented to TSG for approval;
  - 3 or greater indicates TSG approved document under change control.
- y the second digit is incremented for all changes of substance, i.e. technical enhancements, corrections, updates, etc.
- z the third digit is incremented when editorial only changes have been incorporated in the document.

---

## 0 Scope

The present document gives the stage 2 description of the call completion supplementary services.

The group of call completion supplementary services is divided into the following two supplementary services:

- Call waiting (CW) (clause 1);
- Call hold (HOLD) (clause 2).

## 0.1 References

The following documents contain provisions which, through reference in this text, constitute provisions of the present document.

- References are either specific (identified by date of publication, edition number, version number, etc.) or non-specific.
- For a specific reference, subsequent revisions do not apply.
- For a non-specific reference, the latest version applies. In the case of a reference to a 3GPP document (including a GSM document), a non-specific reference implicitly refers to the latest version of that document *in the same Release as the present document*.

- [1] 3GPP TR 21.905: "3G Vocabulary".
- [2] 3GPP TS 22.082: "Call Forwarding (CF) Supplementary Services - Stage 1".
- [3] 3GPP TS 23.011: "Technical realization of supplementary services - General Aspects".
- [4] 3GPP TS 24.008: "Mobile radio interface layer 3 specification; Core Network Protocols - Stage3".
- [5] 3GPP TS 23.018: "Basic call handling".
- [6] 3GPP TS 23.078: "Customized Applications for Mobile network Enhanced Logic (CAMEL) - Phase 3; Stage 2".
- [7] 3GPP TS 23.135: "Multicall supplementary service; Technical Realisation; Stage 2".
- [8] 3GPP TS 23.087: "User-to-User Signalling (UUS) - Stage 2".
- [9] 3GPP TS 23.093: "Technical realisation of Completion of Calls to Busy Subscriber (CCBS) - Stage 2".
- [10] 3GPP TS 23.072: "Call Deflection (CD) supplementary service - Stage2".
- [11] 3GPP TS 29.007: "General requirements on interworking between the Public Land Mobile Network (PLMN) and the Integrated Services Digital Network (ISDN) or Public Switched Telephone Network (PSTN)".

## 0.2 Abbreviations

In addition to those below, abbreviations used in the present document are listed in 3GPP TR 21.905.

HTI: HoldTreatment Indicator

# 1 Call waiting (CW)

## 1.1 Handling of call waiting

### 1.1.1 Activation

The call waiting supplementary service is activated at the request of the user. The activation request indicates the basic services to which the activation request refers.

The information flow for activation of call waiting is shown in figure 1.1.

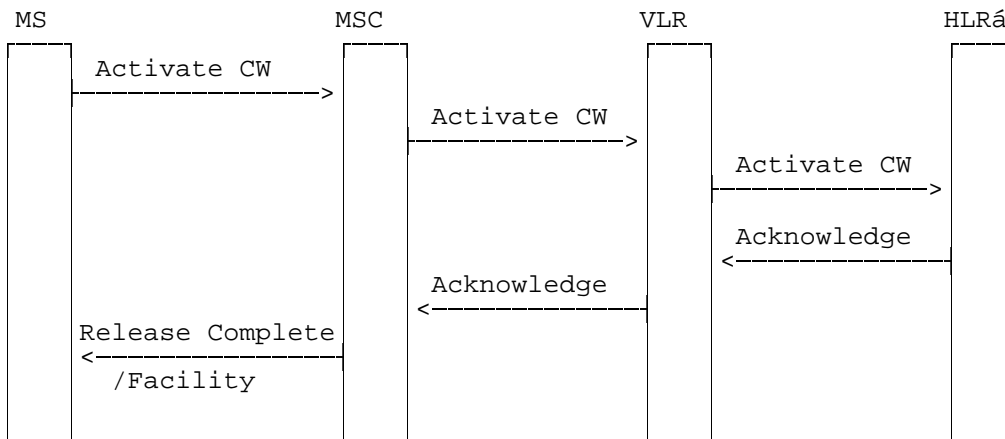

Figure 1.1: Activation of call waiting

### 1.1.2 Deactivation

The call waiting supplementary service is deactivated at the request of the user. The deactivation request indicates the basic services to which the deactivation request refers.

The information flow for deactivation of call waiting is shown in figure 1.2.

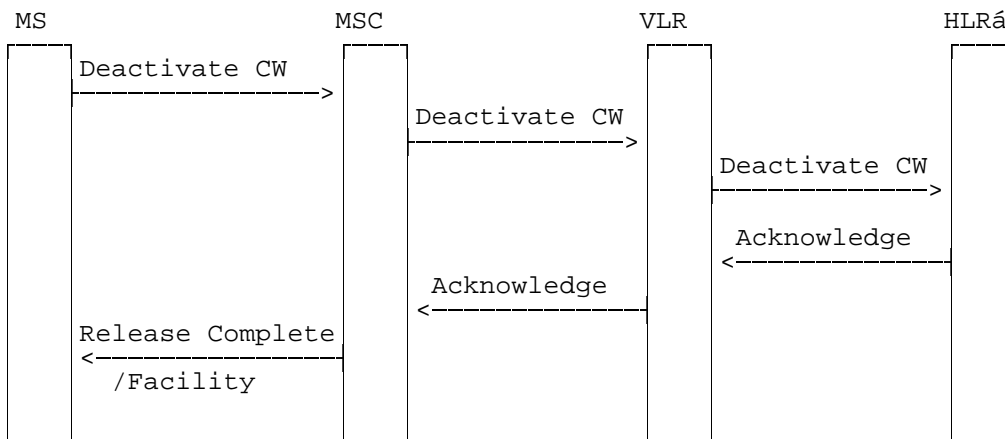

Figure 1.2: Deactivation of call waiting

### 1.1.3 Interrogation

#### Status check

The status check procedure enables the mobile subscriber to obtain information about the status of the call waiting supplementary service with respect to subscribed basic service groups.

The interrogation of call waiting is for all applicable basic services.

The information flow for interrogation of call waiting is shown in figure 1.3.

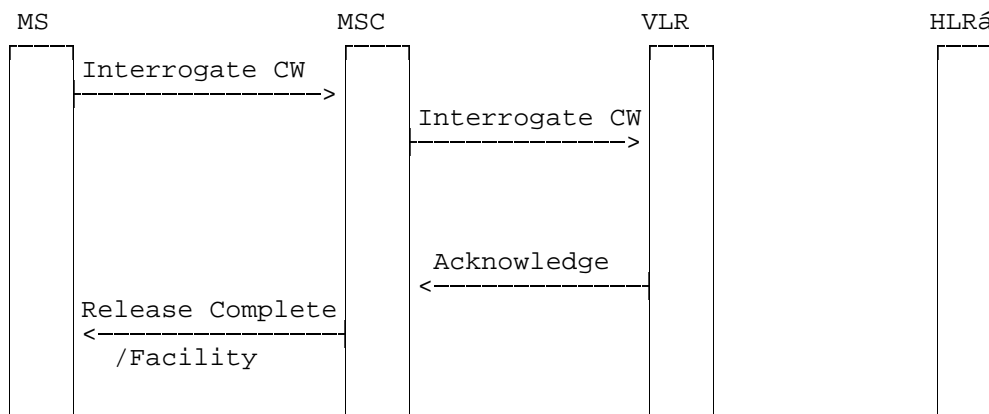

**Figure 1.3: Interrogation of call waiting**

## 1.2 Functions and information flows

TS 24.008 specifies the procedures for call control. These shall also be used for waiting calls when applicable.

The following Mobile Additional Function has been identified for the call waiting service:

#### MAF013

Call waiting related authorizations examination

The ability of a PLMN component to determine the authorizations relating to call waiting. See figure 1.4.

Location: VLR

Definitions:

Subscriber B:

The subscriber who is provided by the network with the call waiting supplementary service. The subscriber B is always a mobile subscriber.

User B:

The user who reacts to call waiting at subscriber B. The user B is always a mobile user.

User C:

The user who has originated a call to subscriber B which causes the call waiting supplementary service to be invoked. The user C may be a mobile user.

User A:

The user who is engaged in a call with user B. The user A may be a mobile user.

Timer T1:

This timer corresponds to T303 + T310 (as defined in TS 24.008).



Timer T2:

Call Waiting Timer. This shall limit the duration of the call in the waiting condition.

Timer T3:

No Reply Condition Timer (see TS 22.082).

CFNRc:

Call Forwarding on Not Reachable (see TS 22.082).

CFNRy:

Call Forwarding on No Reply (see TS 22.082).

CW:

Call Waiting.

The procedure Process\_Call\_Waiting is shown in figure 1.5.

Sheet 1: the procedure Set\_CLIP\_Info\_MSC is specific to CLIP; it is specified in 3GPP TS 23.018 [5].

Sheet 1: the VMSC derives the PLMN bearer capability required for the call according to the rules defined in 3GPP TS 29.007 [11].

Sheet 1: the VMSC and the MS may negotiate the bearer capability to be used for the call by the exchange of information in the Set-up and Call Confirmed messages.

Sheet 1: the Call Confirmed message indicates "busy" for the successful case.

Sheet 1: the procedure Establish\_Terminating\_TCH\_Multicall1 is specific to Multicall; it is specified in 3GPP TS 23.135 [7]. If the VMSC does not support Multicall, processing continues from the "Yes" exit of the test "Result=Pass?".

Sheet 1: the procedure UUS\_ICH\_UUS1\_Implicit\_Active is specific to UUS; it is specified in 3GPP TS 23.087 [8].

Sheet 1: the procedure CCBS\_Report\_Not\_Idle is specific to CCBS; it is specified in 3GPP TS 23.093 [9].

Sheet 2, sheet 3, sheet 5: the procedure UUS\_ICH\_Check\_Support is specific to UUS; it is specified in 3GPP TS 23.087 [8]. If the VMSC does not support UUS, processing continues from the "Yes" exit of the test "Result=Pass?" where the test follows the procedure call.

Sheet 2: the procedure CCBS\_ICH\_MSC\_Report\_Success is specific to CCBS; it is specified in 3GPP TS 23.093 [9].

Sheet 2: the task "UTU2Cnt:=0" is executed only if the VMSC supports UUS.

Sheet 2: the procedure CAMEL\_Start\_TNRy is called if the VMSC supports CAMEL phase 3 or later; it is specified in 3GPP TS 23.078 [6].

Sheet 2: the procedure Send\_ACM\_If\_Required is specified in 3GPP TS 23.018 [5].

Sheet 2: The procedure CAMEL\_MT\_MSC\_ALERTING is specific to CAMEL phase 4 or later; it is specified in 3GPP TS 23.078 [6]. If the VMSC does not support CAMEL phase 4 or later, processing continues from the "Pass" exit of the test "Result?".

Sheet 2, sheet 8: the processing in the branch starting with the input "CD Request" is specific to Call Deflection; if the VMSC does not support Call Deflection the input is discarded.

Sheet 2, sheet 8: the procedure Handling\_CD\_MSC is specific to Call Deflection; it is specified in 3GPP TS 23.072 [10].

Sheet 2, sheet 3, sheet 6, sheet 7: the procedure CAMEL\_MT\_GMSC\_DISC4 is called if the VMSC supports CAMEL phase 3 or later; it is specified in 3GPP TS 23.078 [6]. If the VMSC does not support CAMEL phase 3 or later, processing continues from the "No" exit of the test "Result=Reconnect?".

Sheet 2, sheet 3, sheet 4, sheet 8: the procedure CCBS\_ICH\_MSC\_Report\_Failure is specific to CCBS; it is specified in 3GPP TS 23.093 [9].

Sheet 3, sheet 7: the Release transaction (reject) message covers all unsuccessful cases not otherwise indicated.

Sheet 4, sheet 7: the procedure UUS\_MSC\_Check\_UUS1\_UI is specific to UUS; it is specified in 3GPP TS 23.087 [8].

Sheet 4, sheet 8: the procedure CAMEL\_MT\_GMSC\_DISC6 is called if the VMSC supports CAMEL phase 3 or later; it is specified in 3GPP TS 23.078 [6].

Sheet 5: the procedure CAMEL\_Stop\_TNRy is called if the VMSC supports CAMEL phase 3 or later; it is specified in 3GPP TS 23.078 [6].

Sheet 5: the procedure Establish\_Terminating\_TCH\_If\_Required is specified in 3GPP TS 23.018 [5].

Sheet 5: the procedure Establish\_Terminating\_TCH\_Multicall is specific to Multicall; it is specified in 3GPP TS 23.135 [7].

Sheet 6: the procedure Handle\_AoC\_MT\_MSC is specific to AoC; it is specified in 3GPP TS 23.018 [5]. If the VMSC does not support AoC, processing continues from the "Yes" exit of the test "Result=Pass?".

Sheet 6: the procedure CAMEL\_MT\_GMSC\_ANSWER is called if the VMSC supports CAMEL phase 3 or later; it is specified in 3GPP TS 23.078 [6]. If the VMSC does not support CAMEL phase 3 or later, processing continues from the "Pass" exit of the test "Result?" on sheet 6.

Sheet 6: the procedure Set\_COL\_Presentation\_Indicator\_MSC is specific to COLP; it is specified in 3GPP TS 23.018 [5].

Sheet 6: the procedure Send\_Answer\_If\_Required is specified in 3GPP TS 23.018 [5]

Sheet 7: the input signal "CAMEL TNRy expired" will be received only if the VMSC supports CAMEL phase 3 or later.

Sheet 7: the procedure CAMEL\_MT\_GMSC\_DISC5 is called if the VMSC supports CAMEL phase 3 or later; it is specified in 3GPP TS 23.078 [6]. If the VMSC does not support CAMEL phase 3 or later, processing continues from the "No" exit of the test "Result=Reconnect?".

Sheet 7, sheet 8: the procedure UUS\_ICH\_Check\_Forwarding is specific to UUS; it is specified in 3GPP TS 23.087 [8]. If the VMSC does not support UUS, processing continues from the "Yes" exit of the test "Result=Pass?".

Sheet 7, sheet 8, sheet 9: the procedure UUS\_MSC\_Check\_UUS1\_UI is specific to UUS; it is specified in 3GPP TS 23.087 [8].

Sheet 8: the procedures UUS\_MSC\_Check\_UUS2\_UI\_to\_MS and UUS\_MSC\_Check\_UUS2\_UI\_to\_NW are specific to UUS; they are specified in 3GPP TS 23.087 [8].

Sheet 8: the procedure CD\_UUS\_Interaction is specific to Call Deflection; it is specified in GSM 23.072 [10].

Sheet 9: the procedure CCBS\_ICH\_MSC\_Report\_Failure is specific to CCBS; it is specified in 23.093 [9].

Sheet 9: the procedure CAMEL\_MT\_GMSC\_DISC6 is specific to CAMEL; it is specified in 23.078 [6].

The information flows are shown in figure 1.6. In these flows it is assumed that user A and user C are fixed users and that user B is a mobile user. Functions to be performed by the fixed ISDN are not shown in the information flows. Only the functions to be performed by the PLMN are shown.

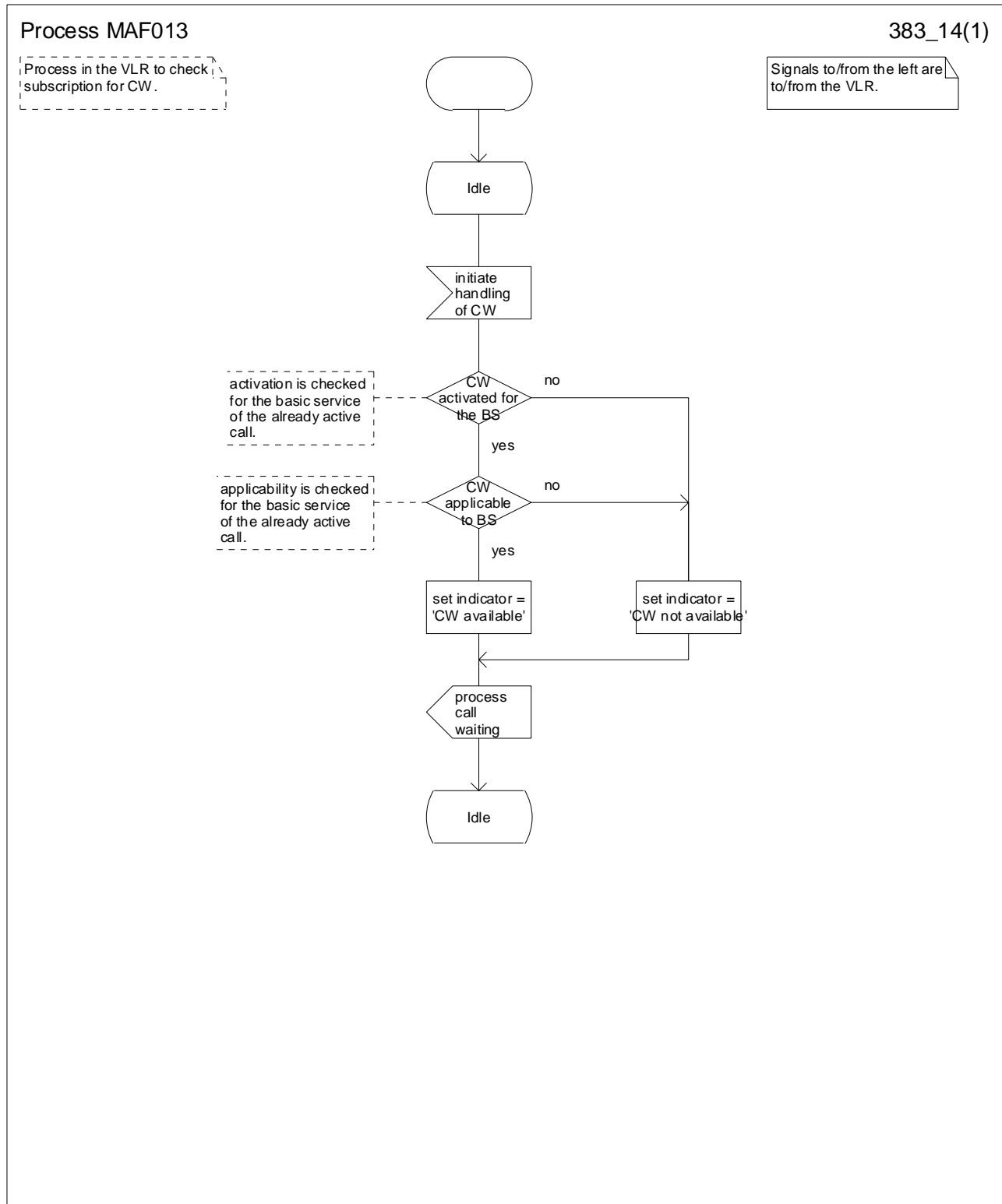

Figure 1.4: MAF013 Call waiting related authorisations examination (VLR)

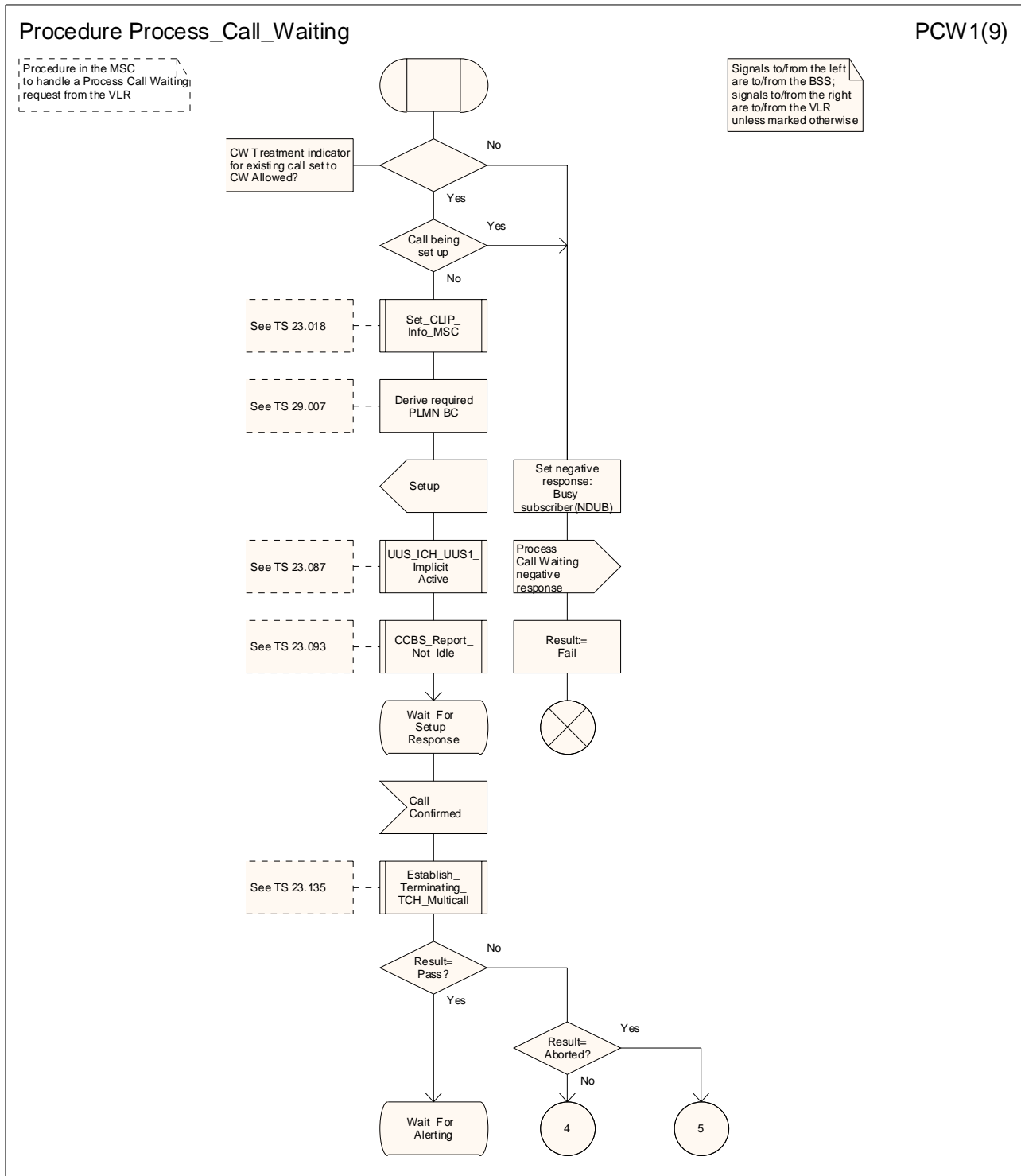

Figure 1.5 (sheet 1 of 9): Procedure Process\_Call\_Waiting

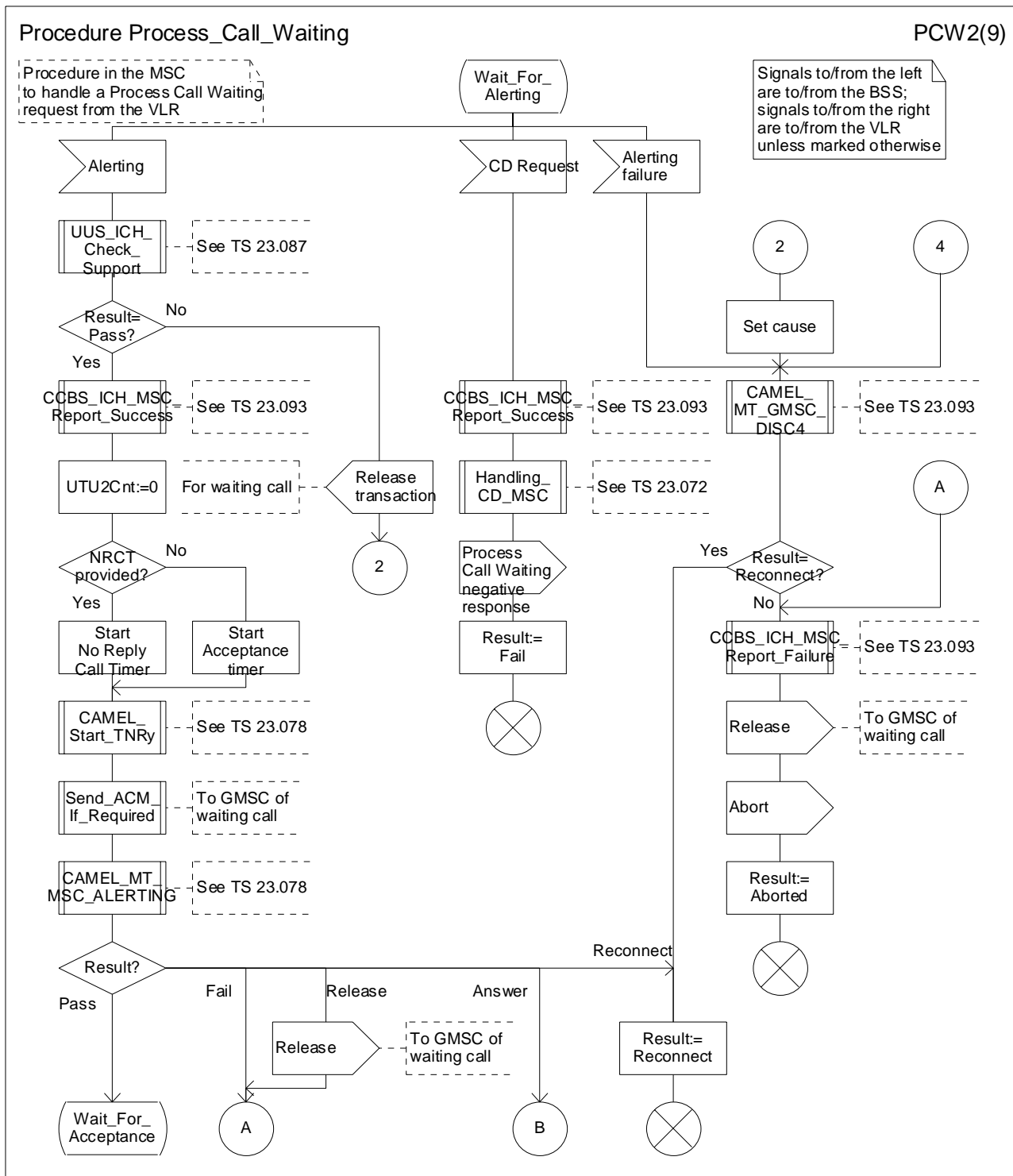

Figure 1.5 (sheet 2 of 9): Procedure Process\_Call\_Waiting

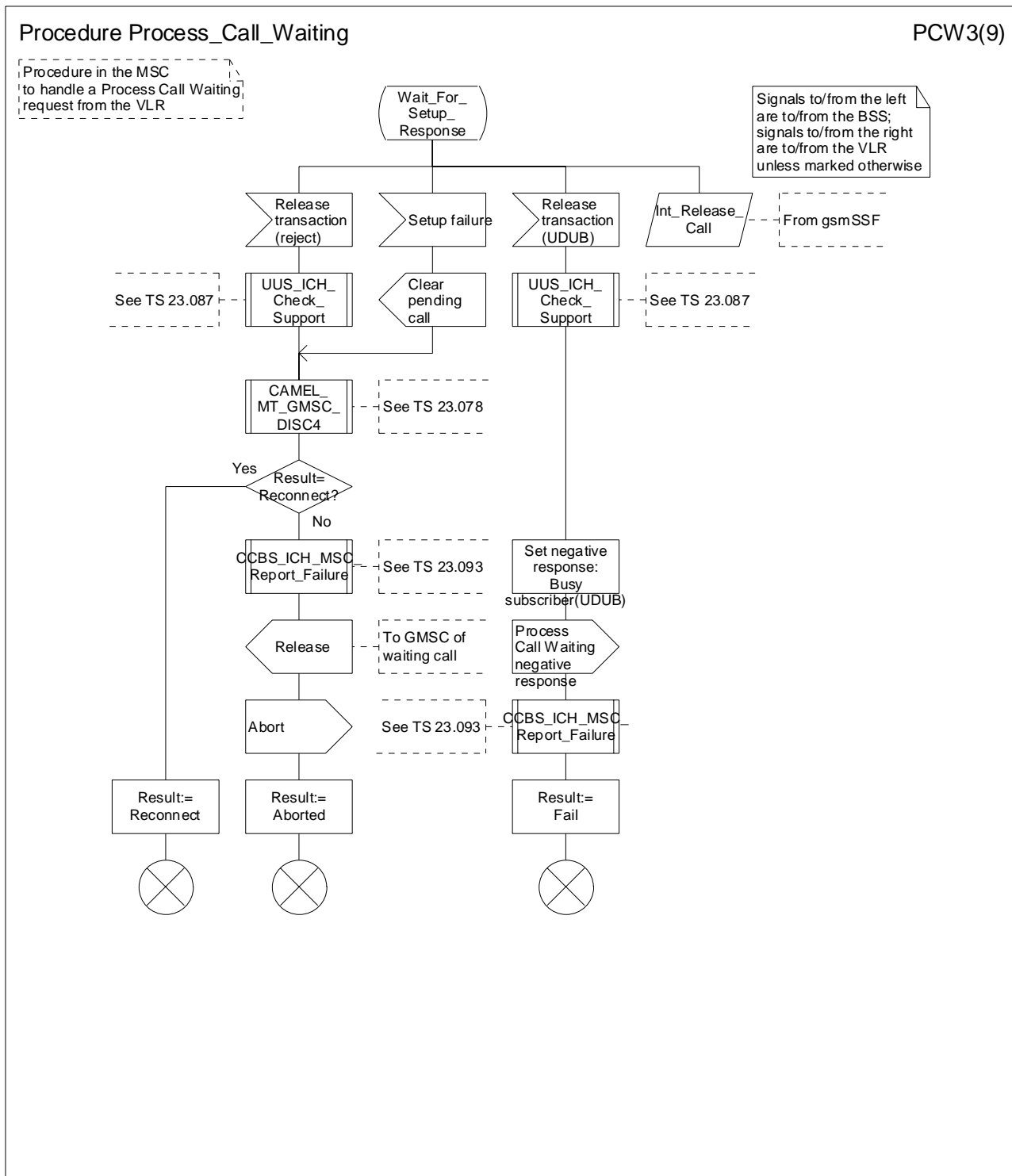

Figure 1.5 (sheet 3 of 9): Procedure Process\_Call\_Waiting

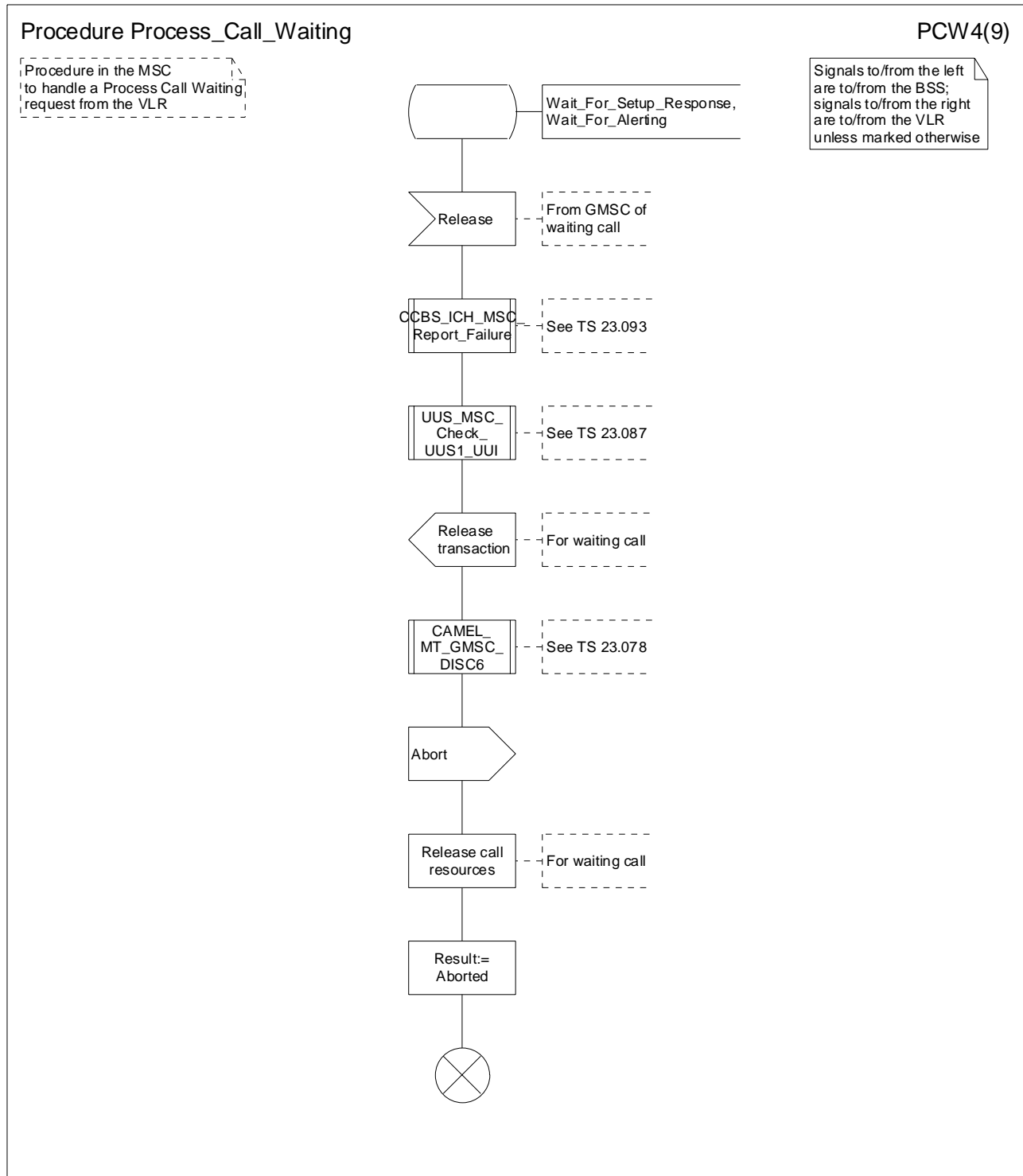

Figure 1.5 (sheet 4 of 9): Procedure Process\_Call\_Waiting

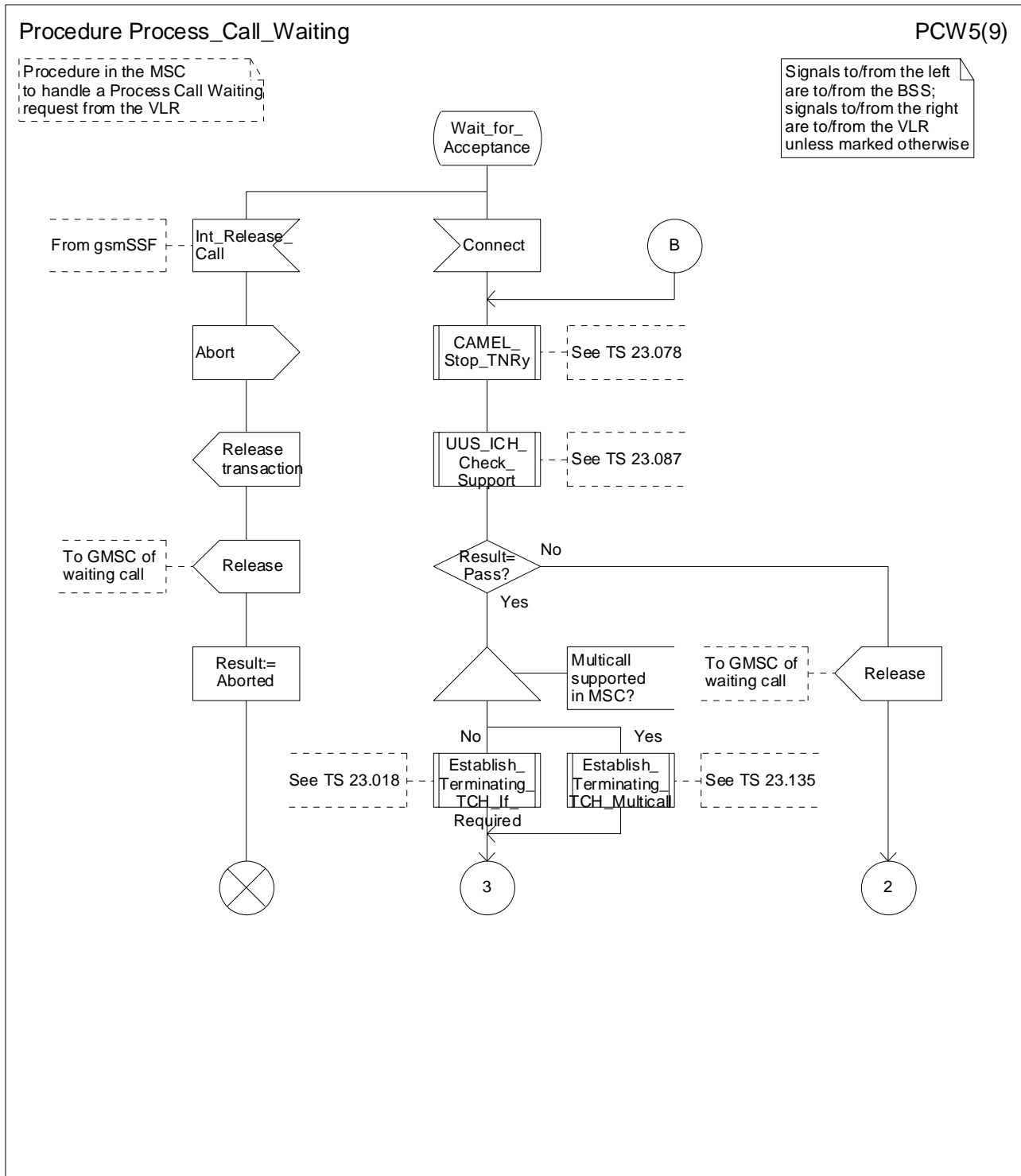

Figure 1.5 (sheet 5 of 9): Procedure Process\_Call\_Waiting



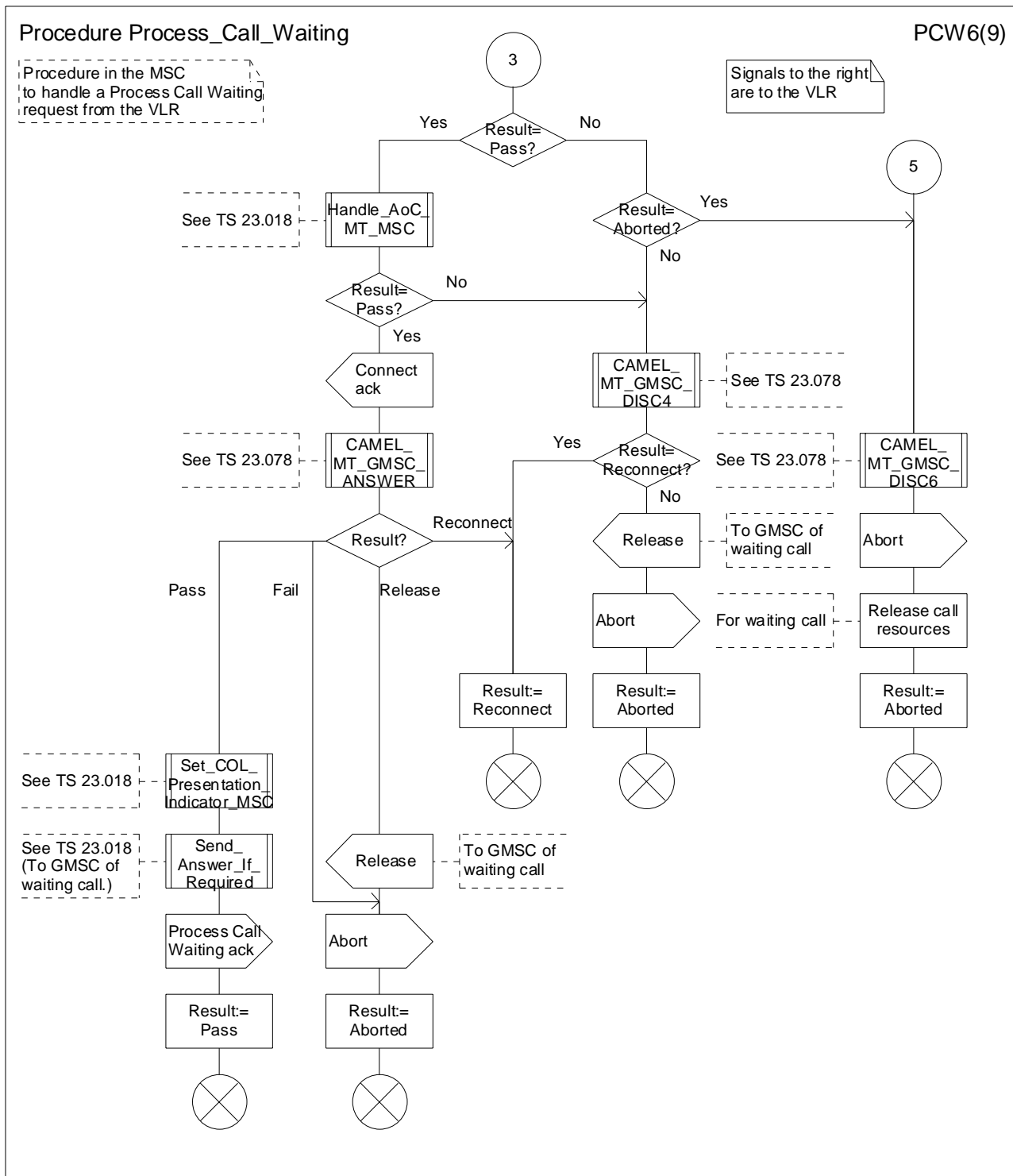

Figure 1.5 (sheet 6 of 9): Procedure Process\_Call\_Waiting

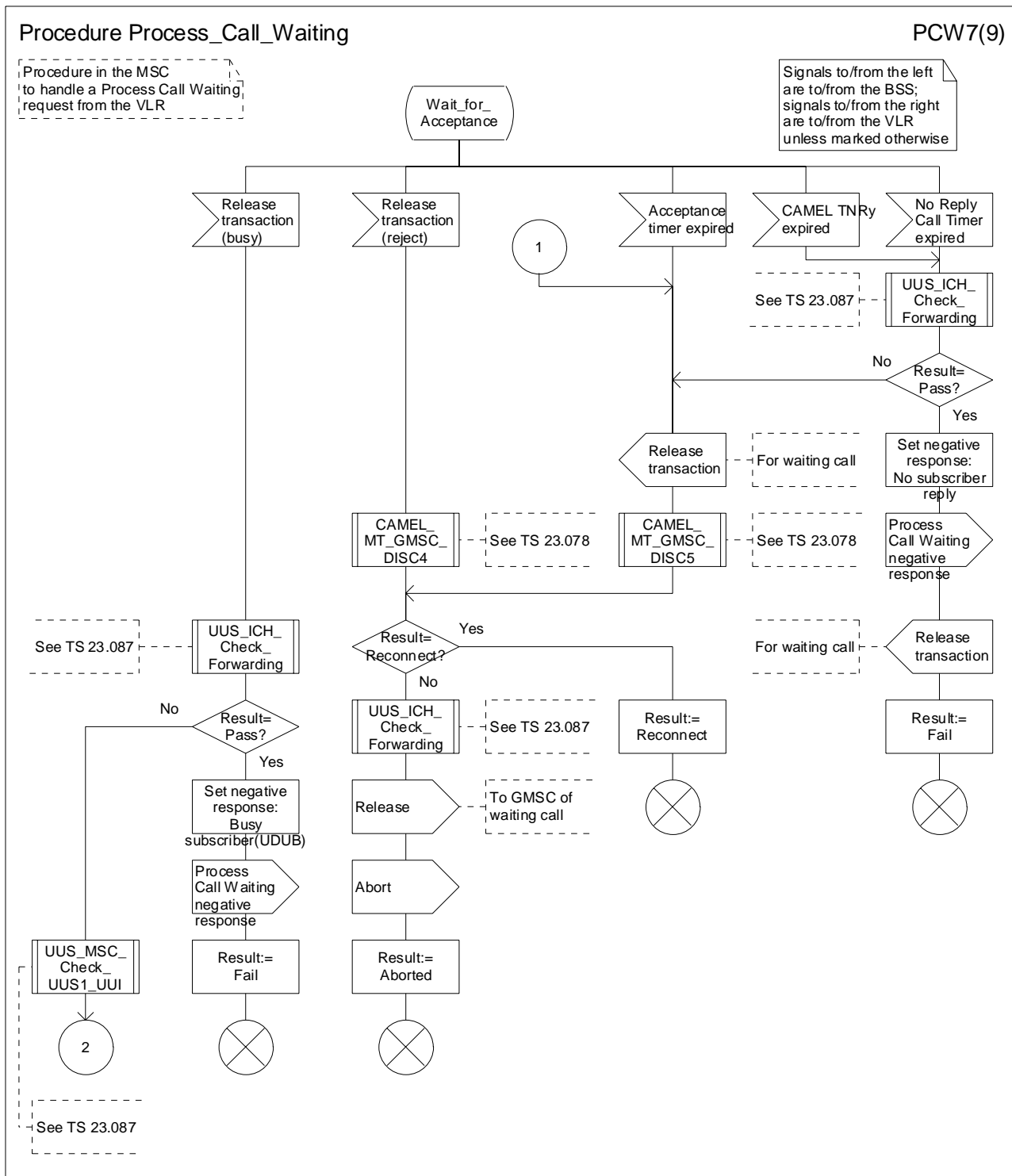

Figure 1.5 (sheet 7 of 9): Procedure Process\_Call\_Waiting

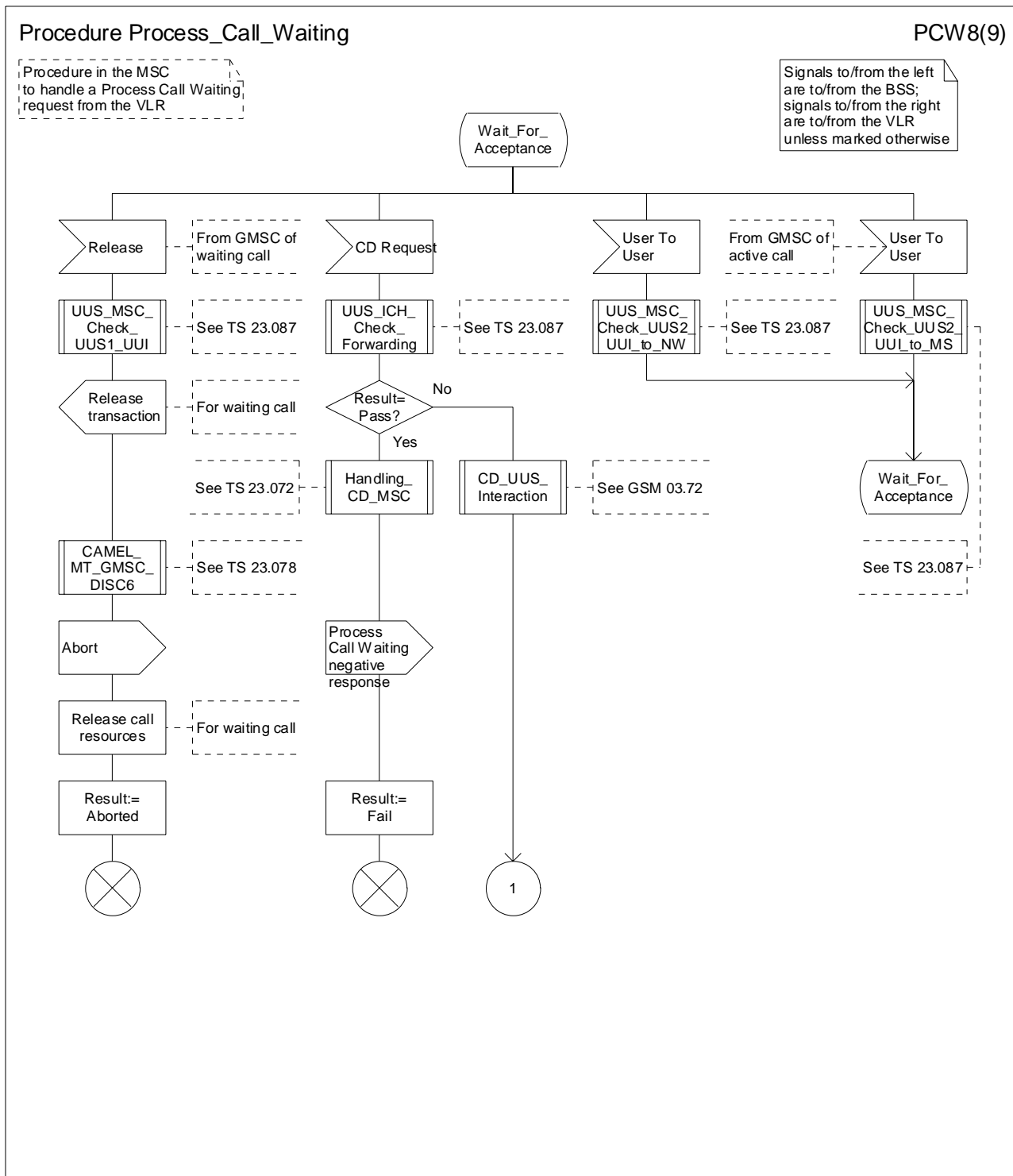

Figure 1.5 (sheet 8 of 9): Procedure Process\_Call\_Waiting

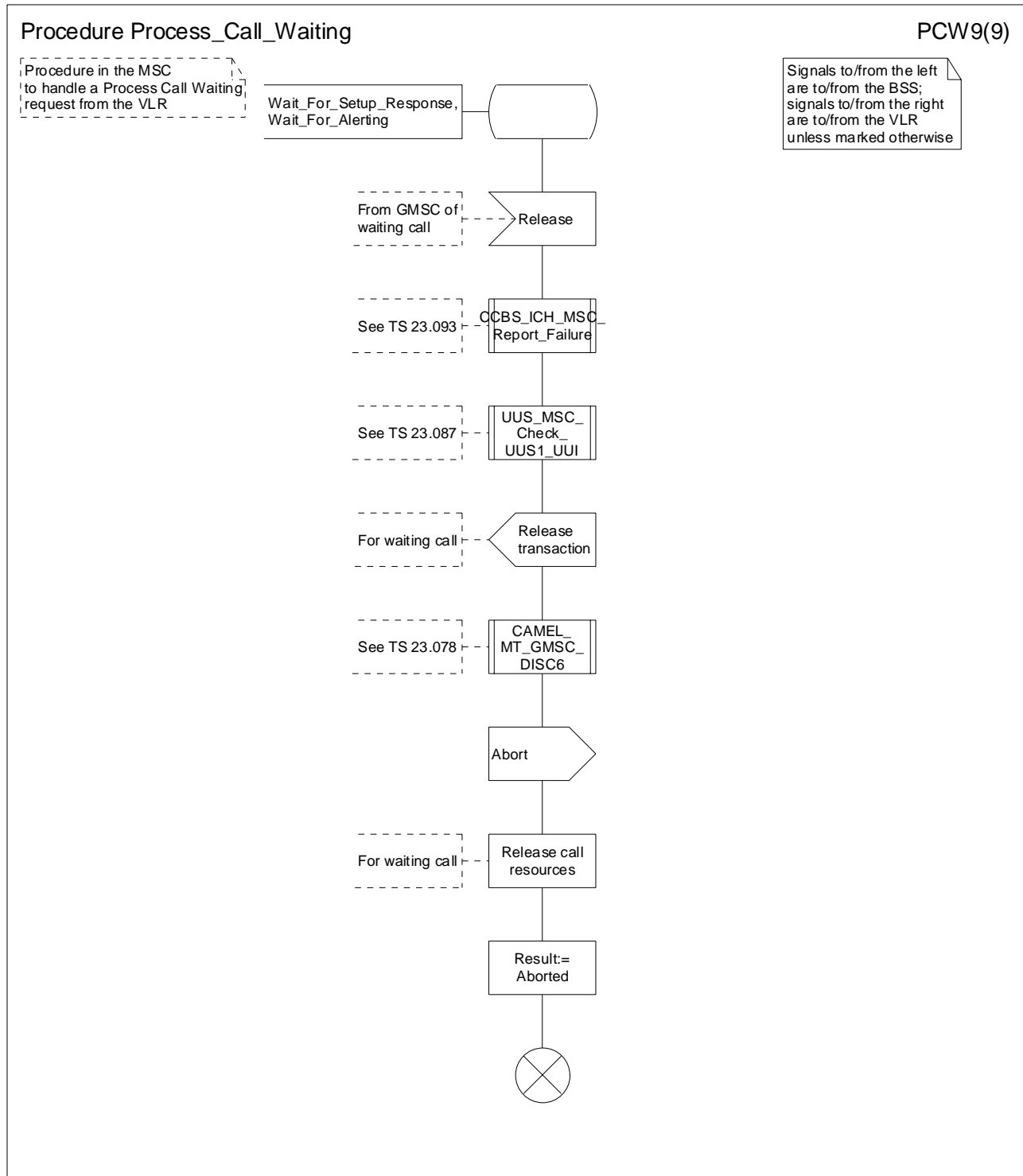
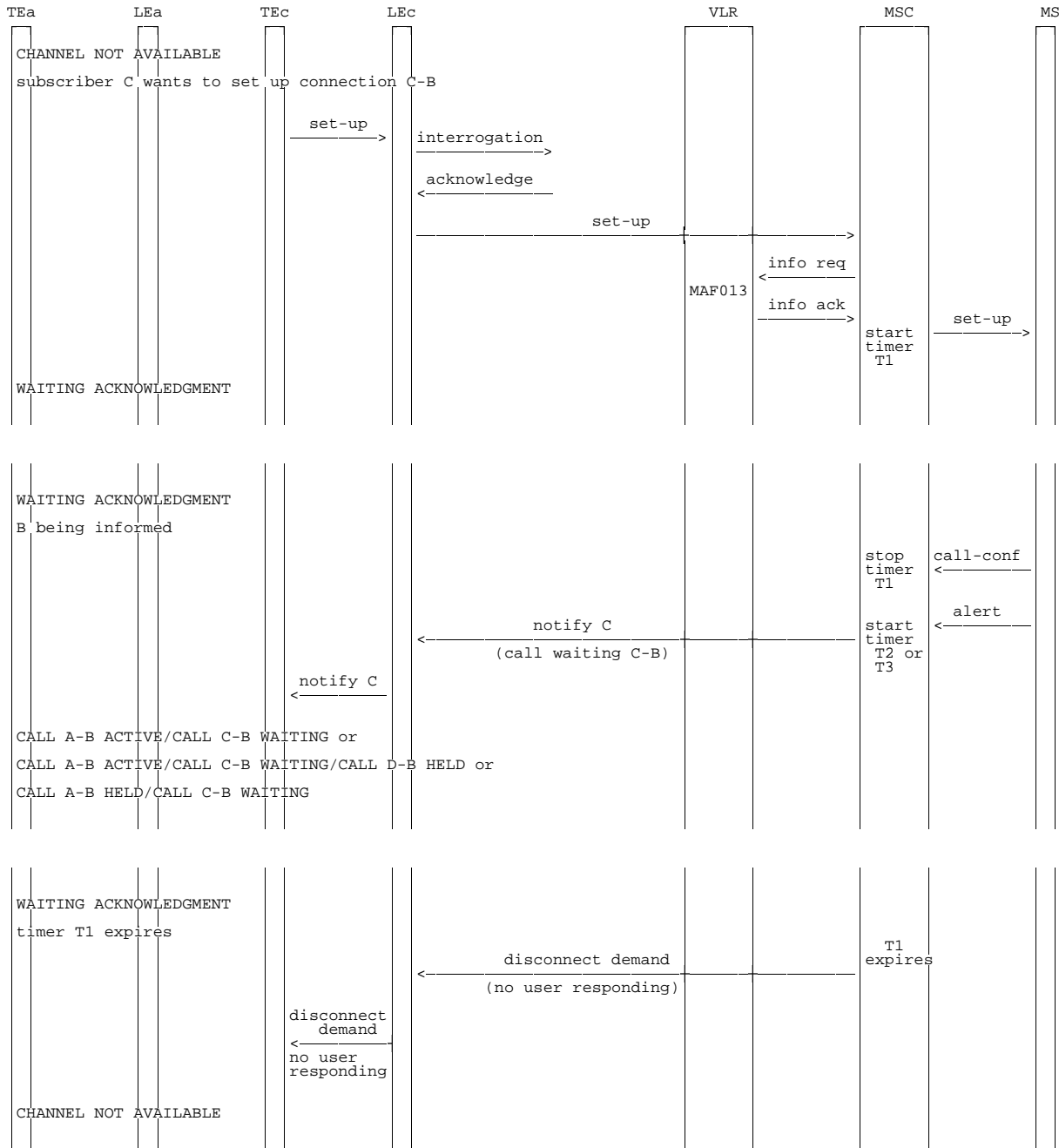
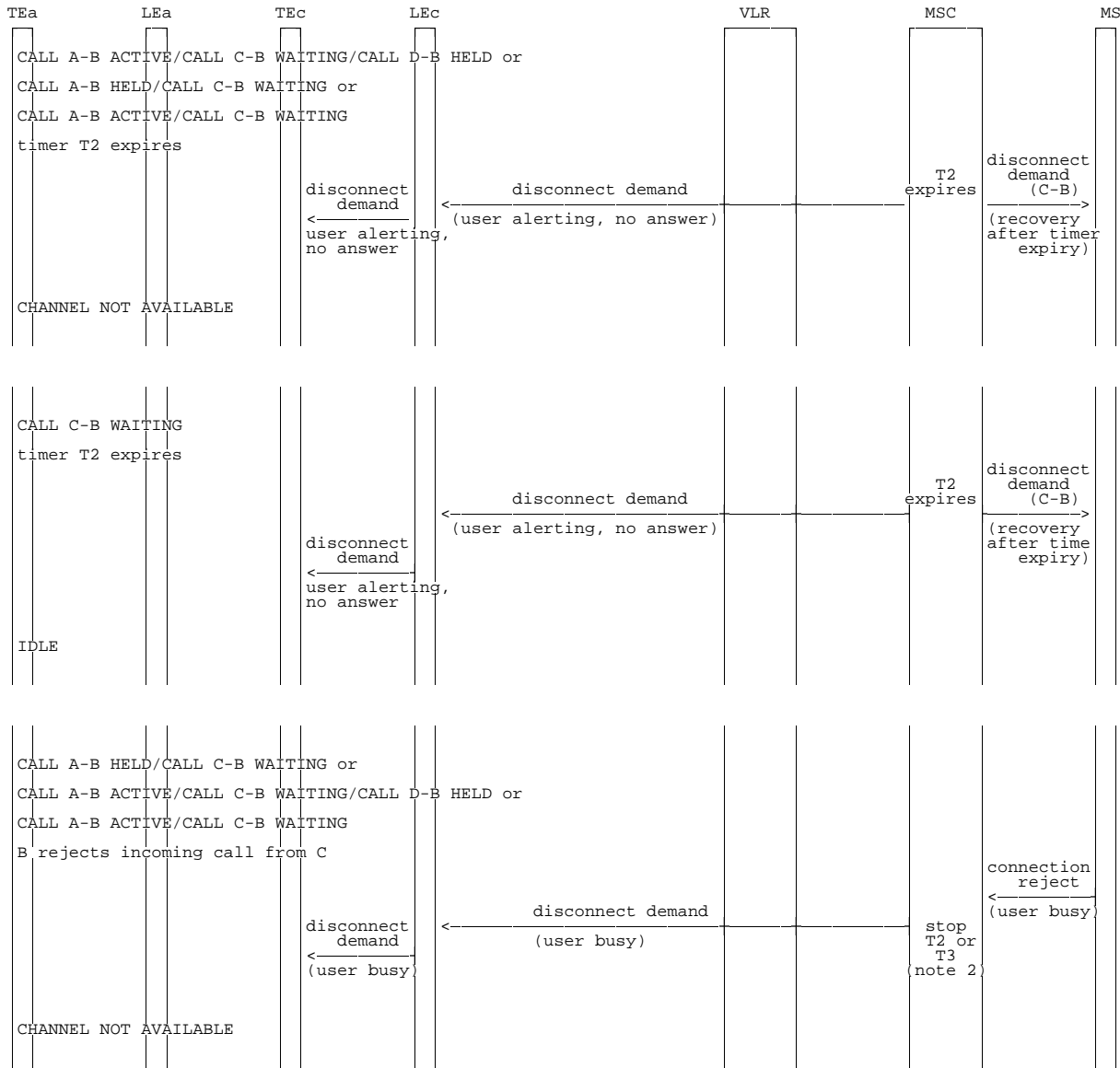

Figure 1.5 (sheet 9 of 9): Procedure Process\_Call\_Waiting



NOTE 1: info req: information request  
info ack: information acknowledge

Figure 1.6 (sheet 1 of 7): Information flow for call waiting



NOTE 2: The call shall be forwarded on mobile subscriber busy at this stage if activated.

Figure 1.6 (sheet 2 of 7): Information flow for call waiting

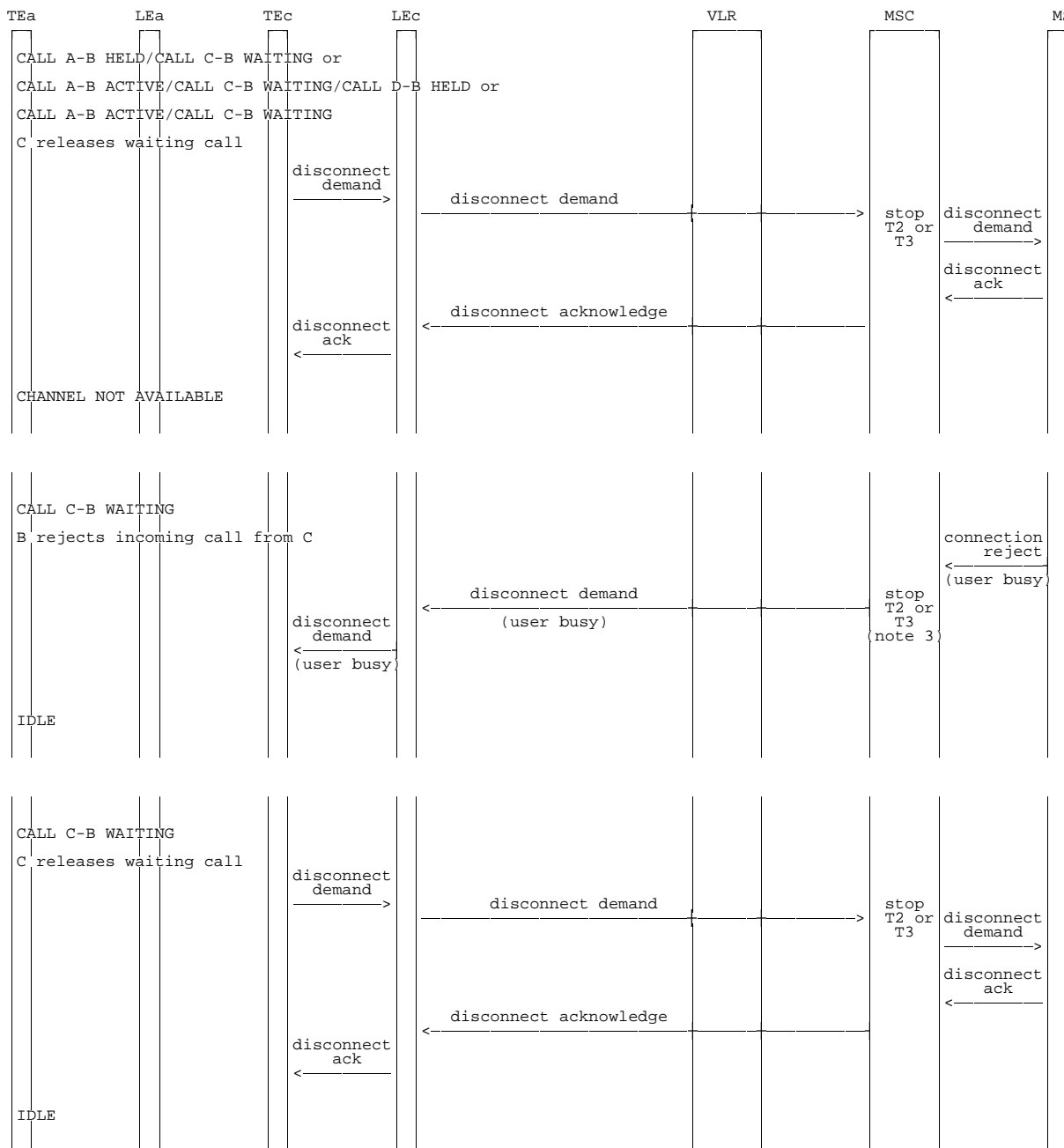

NOTE 3: The call shall be forwarded on mobile subscriber busy at this stage if activated.

Figure 1.6 (sheet 3 of 7): Information flow for call waiting

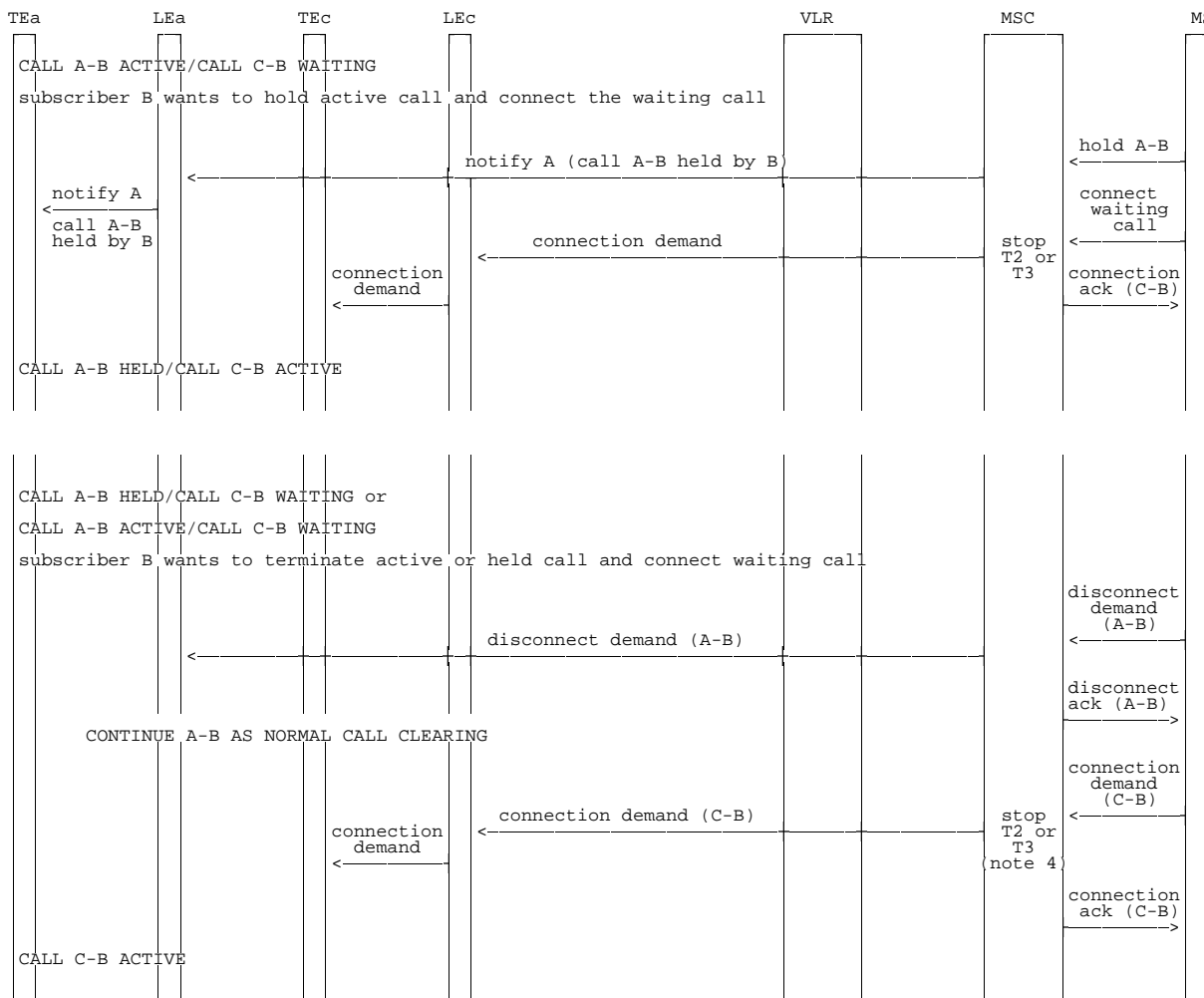

NOTE 4: If T2 or if applicable T3 expires before reception of connection demand in the MSC then call c-b shall be released with cause no reply and if it was T3 which expired the waiting call from C shall be forwarded on no reply.

Figure 1.6 (sheet 4 of 7): Information flow for call waiting



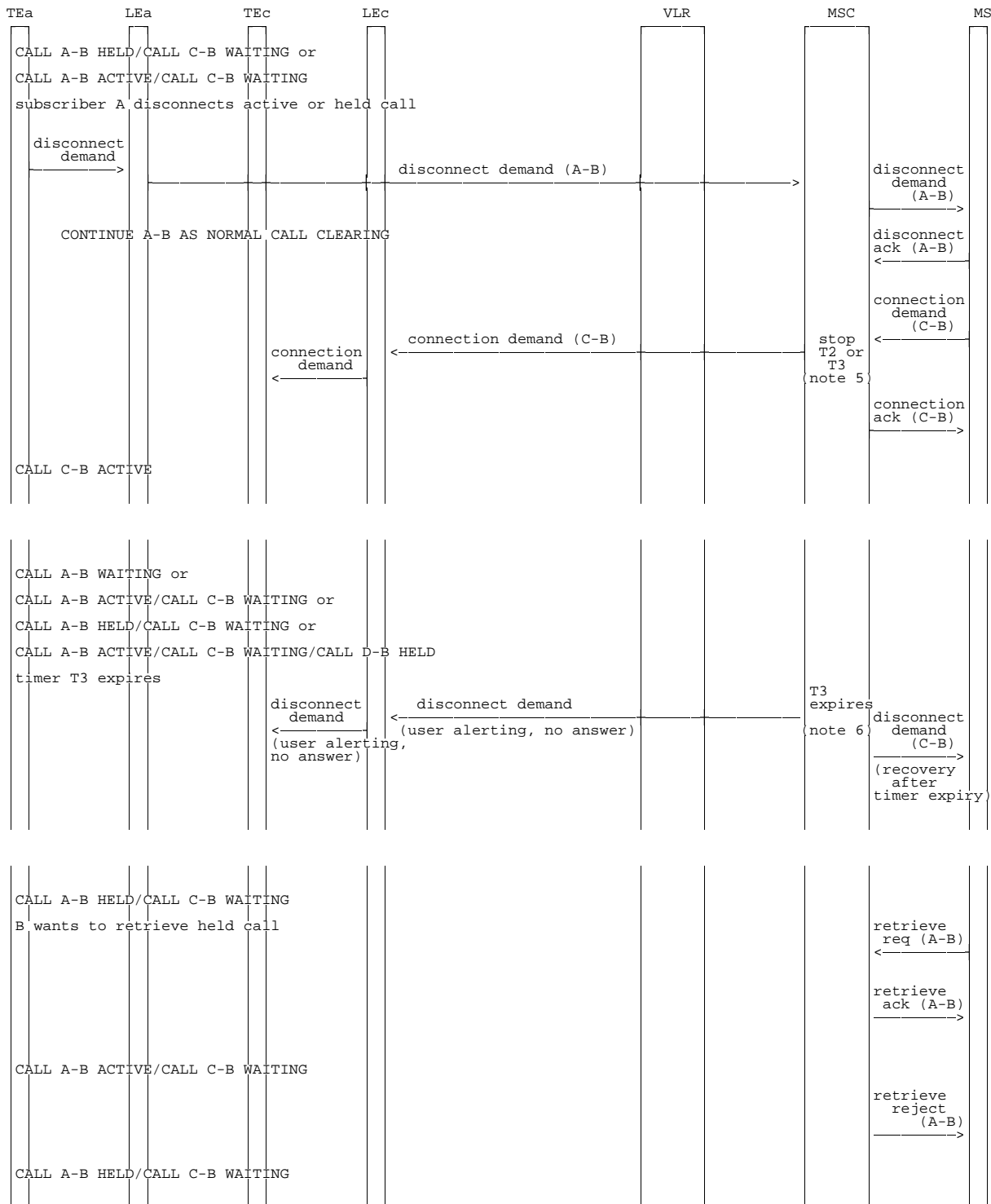

NOTE 5: The call shall be forwarded on mobile subscriber busy at this stage if activated.

NOTE 6: The call shall be forwarded on no reply.

Figure 1.6 (sheet 5 of 7): Information flow for call waiting

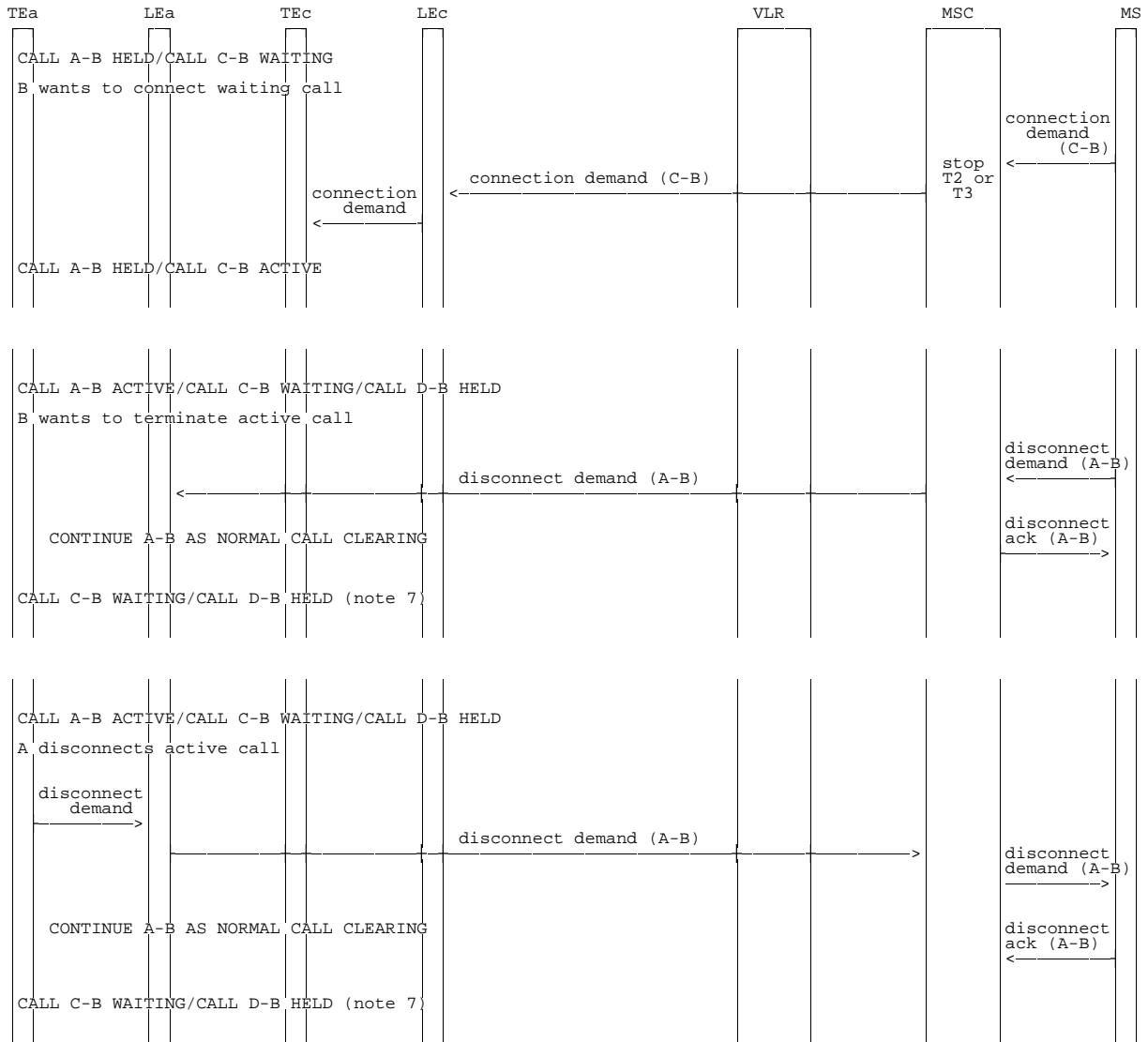

NOTE 7: This state can be treated as CALL C-B WAITING/CALL A-B HELD.

Figure 1.6 (sheet 6 of 7): Information flow for call waiting

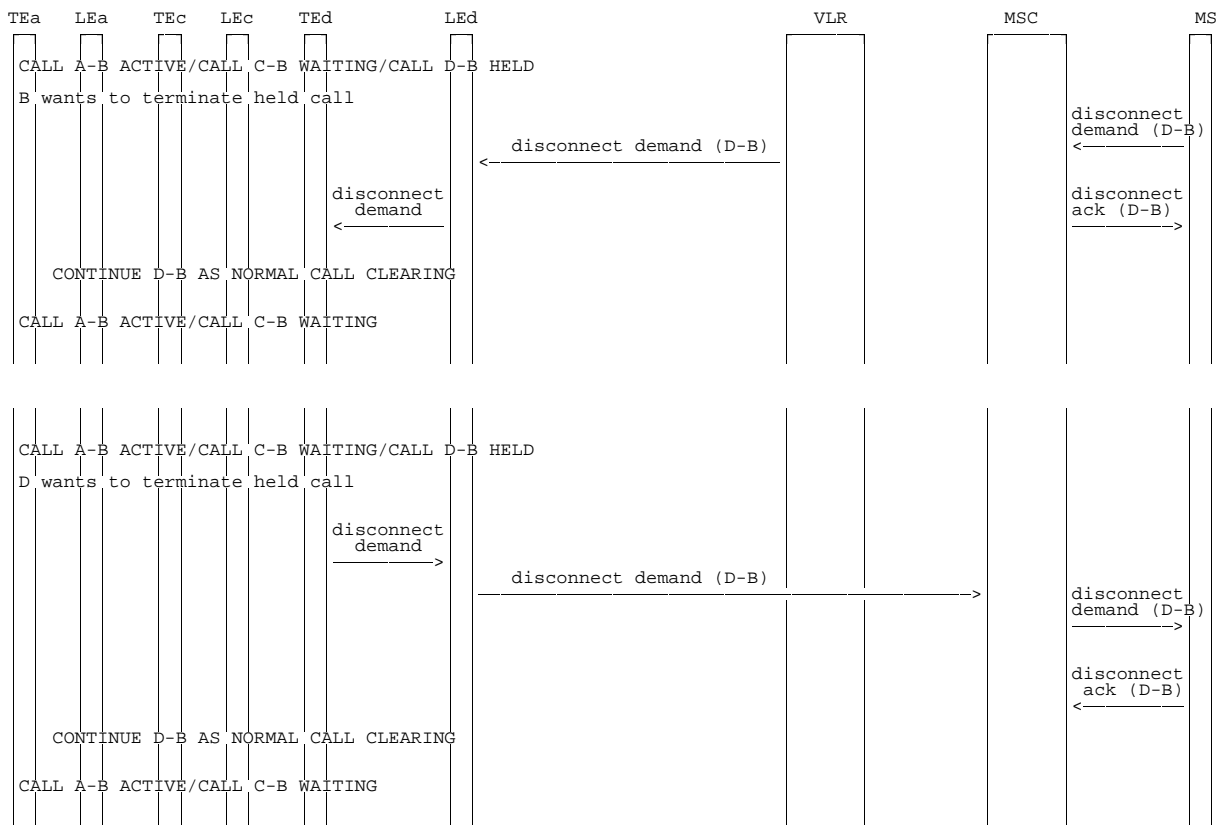

Figure 1.6 (sheet 7 of 7): Information flow for call waiting

### 1.3 Information stored in the HLR

Call waiting may have the following logical states (refer to TS 23.011 for an explanation of the notation):

Provisioning State	Registration State	Activation State	HLR Induction State
(Not Provisioned,	Not Applicable,	Not Active,	Not Induced)
(Provisioned,	Not Applicable,	Not Active,	Not Induced)
(Provisioned,	Not Applicable,	Active and Operative,	Not Induced)

The activation state may be different for each applicable elementary basic service group.

The provisioning state shall be on a per subscriber basis, and hence the same for all basic service groups.

The HLR shall store the logical state of the call waiting service (which shall be one of the valid states listed above) on a per elementary basic service group.

### 1.4 State transition model

The following figure shows the successful cases of transition between the applicable logical states of call waiting. The state changes are either caused by actions of the service provider or the mobile user.

Note that error cases are not shown in the diagram as they normally do not cause a state change. Additionally, some successful requests may not cause a state change. Hence they are not shown in the diagram.

The diagram only shows operations on elementary basic service groups.

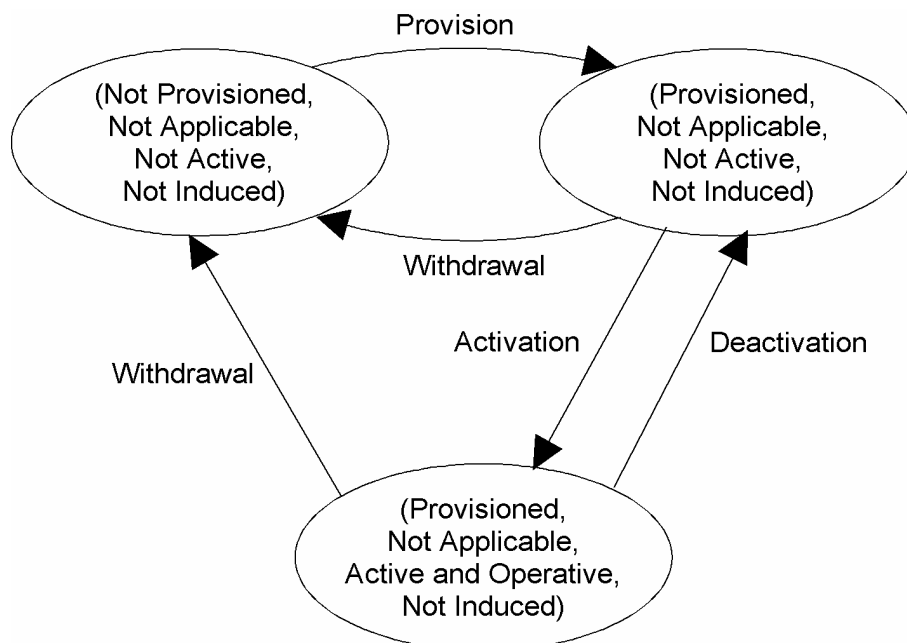

Figure 1.7: State transition model for call waiting

## 1.5 Transfer of information from HLR to VLR

If the provisioning state for call waiting is "Provisioned" then, when the subscriber registers on a VLR, the HLR shall send that VLR information about the logical state of call waiting.

If the logical state of call waiting is changed while a subscriber is registered on a VLR, then the HLR shall inform the VLR of the new logical state of call waiting.

## 1.6 Information stored in the VLR

For call waiting, the VLR shall store the service state information received from the HLR.

## 1.7 Handover

Handover will have no impact on the control procedures and the operation of the service.

---

# 2 Call hold (HOLD)

## 2.1 Functions and information flows

The following Mobile Additional Function has been identified for the call hold service:

### MAF024

Call hold related authorizations examination

The ability of a PLMN component to determine the authorizations relating to call hold. See figure 2.1.

Location: VLR

The Indicator are shown in figures 2.2 a, 2.2b and 2.2c, respectively.

Procedure Process\_Retrieve\_Request: the process Subs\_FSM is defined in 3GPP TS 23.018 [5].

Procedure Process\_Hold\_Request, procedure Process\_Retrieve\_Request: the variable On\_Hold is set in the process OCH\_MSC or the process ICH\_MSC.

Procedure Handle\_Timed\_Call\_Swap: the macro Decrement\_Call\_Counter is defined in 3GPP TS 23.018 [5].

All procedures: to avoid having two calls on hold at the same time (except as a transient effect during the handling of retrieve), the reception of the retrieve request is supervised by a retrieve timer T ( $T = 5$  s).

All procedures: the network may receive hold and retrieve requests not included in this overall SDL. These requests will be rejected by the network.

All procedures: the handling of requests other than hold and retrieve requests is defined in the appropriate supplementary service specification.

The information flows are shown in figure 2.3. In these flows it is assumed that the served user is a mobile user and that other users are fixed network users.

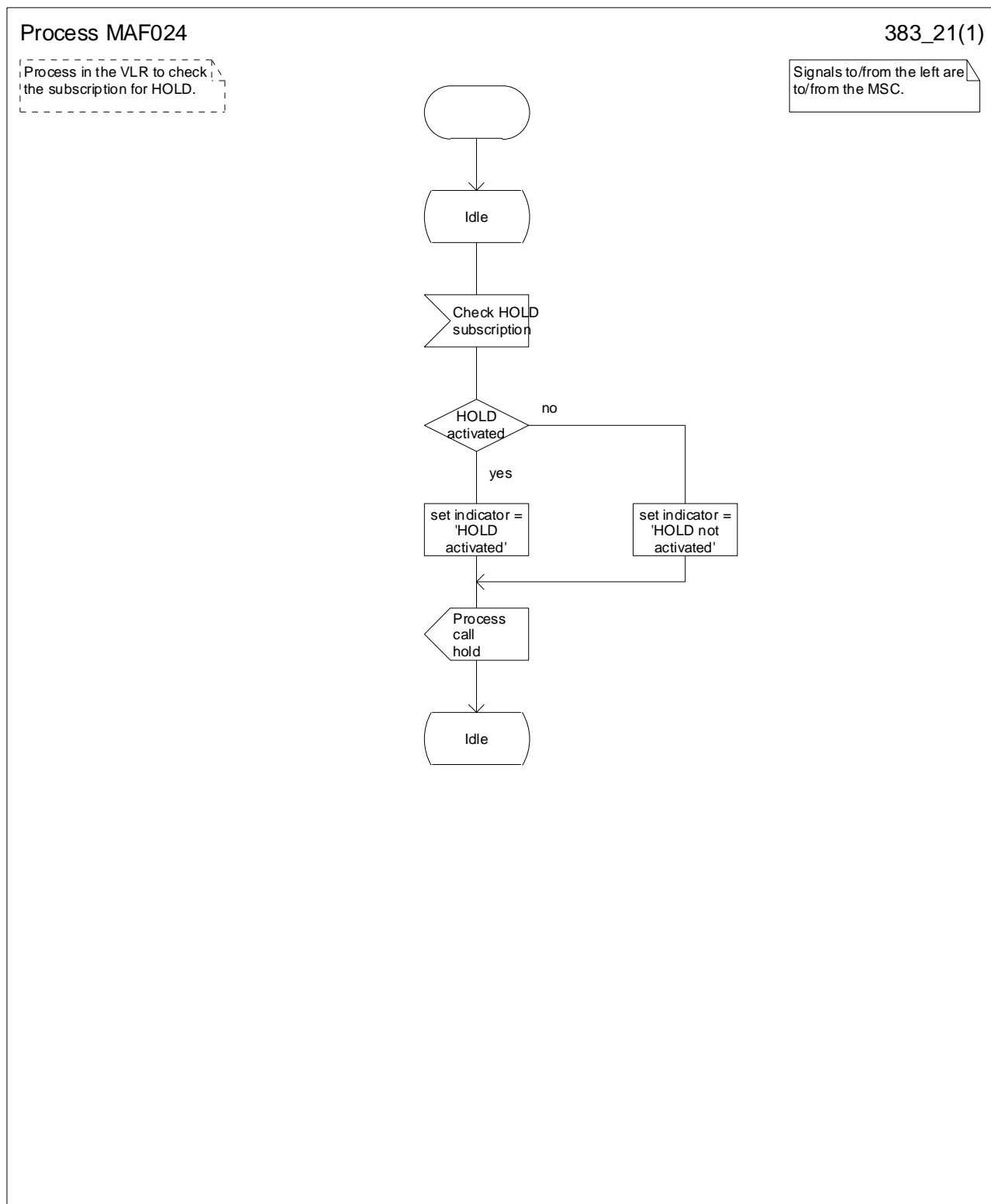

Figure 2.1: MAF024 Call hold related authorisations examination (VLR)

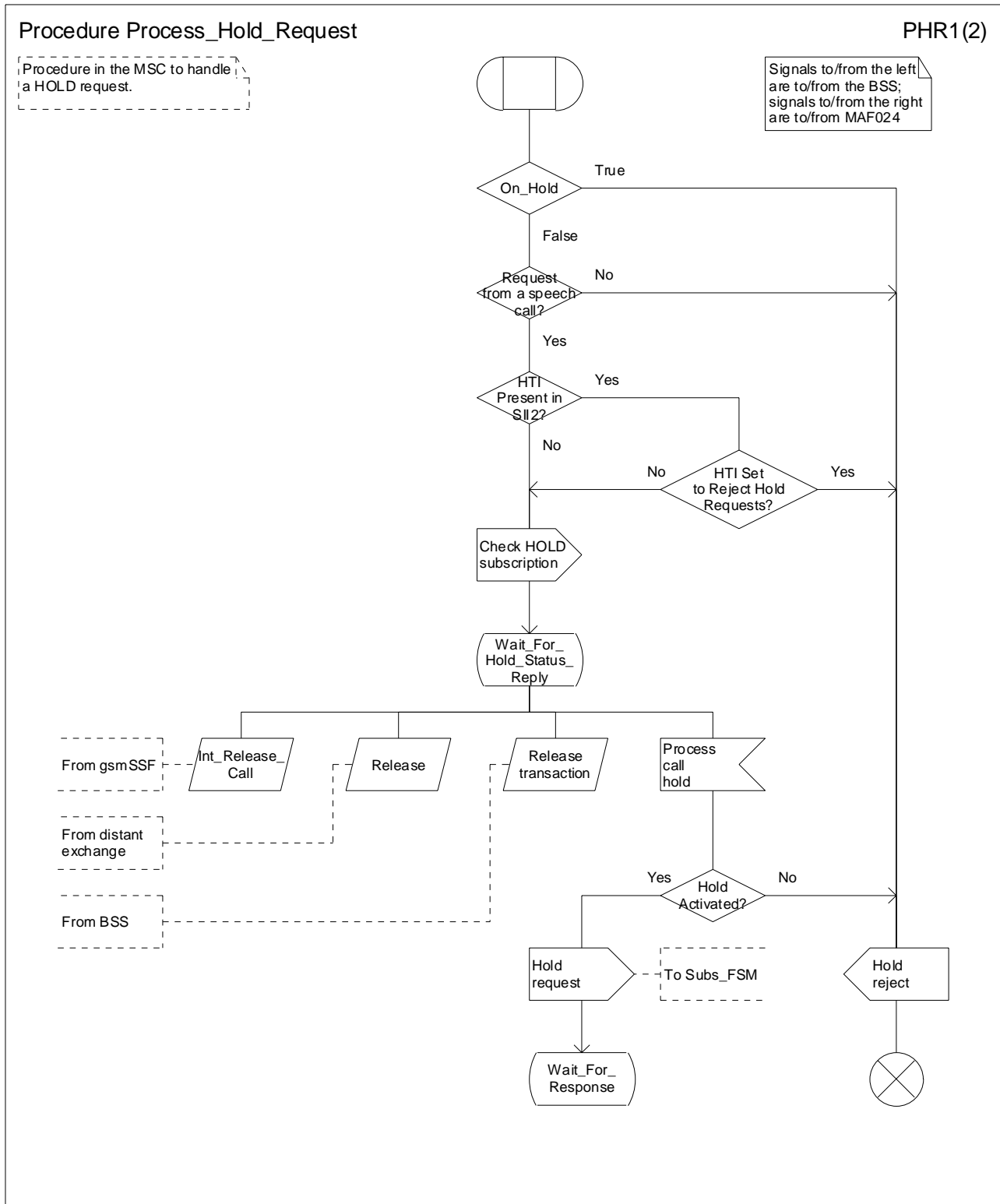

Figure 2.2a (sheet 1 of 2): Procedure Process\_Hold\_Request

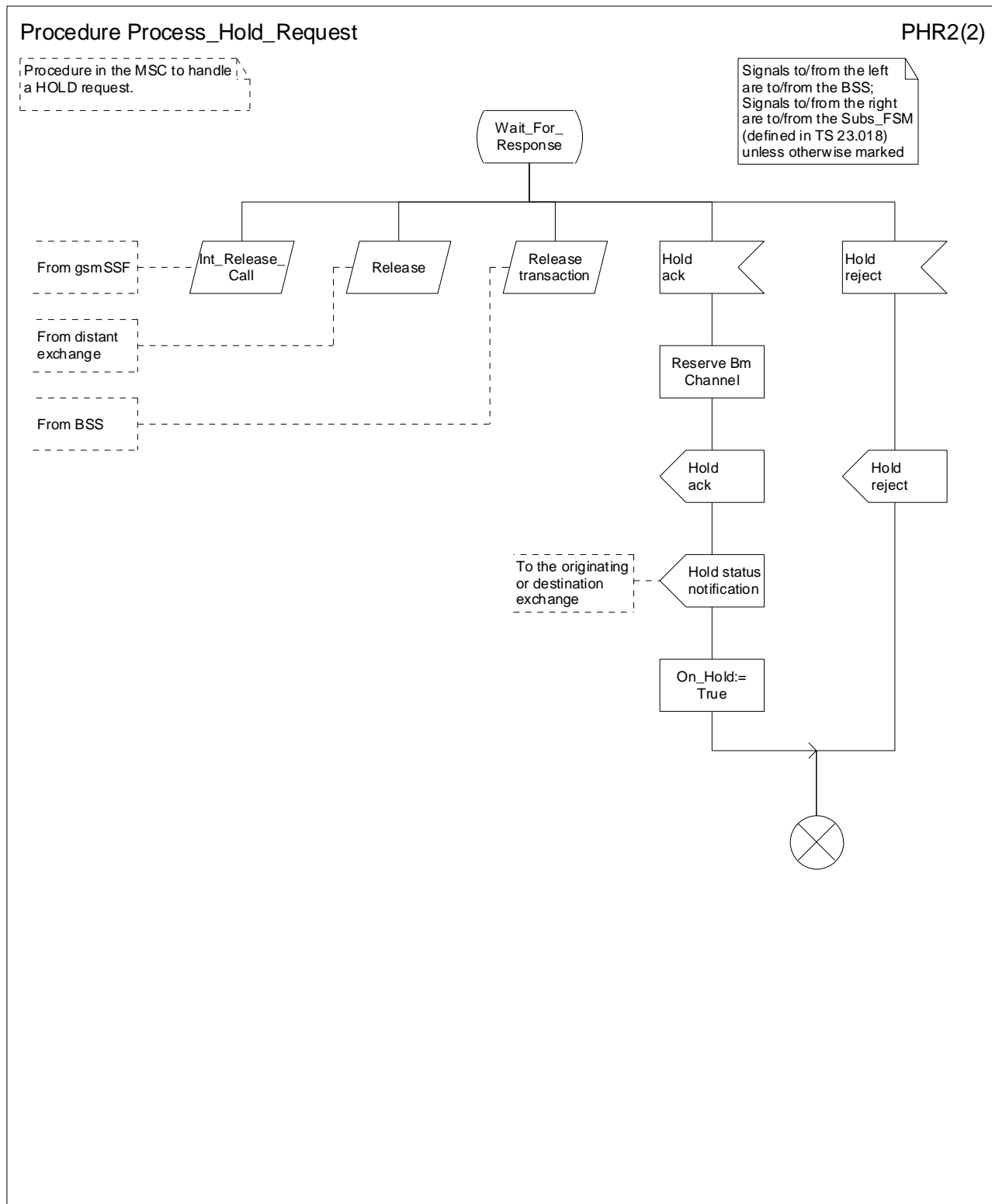

Figure 2.2a (sheet 2 of 2): Procedure Process\_Hold\_Request



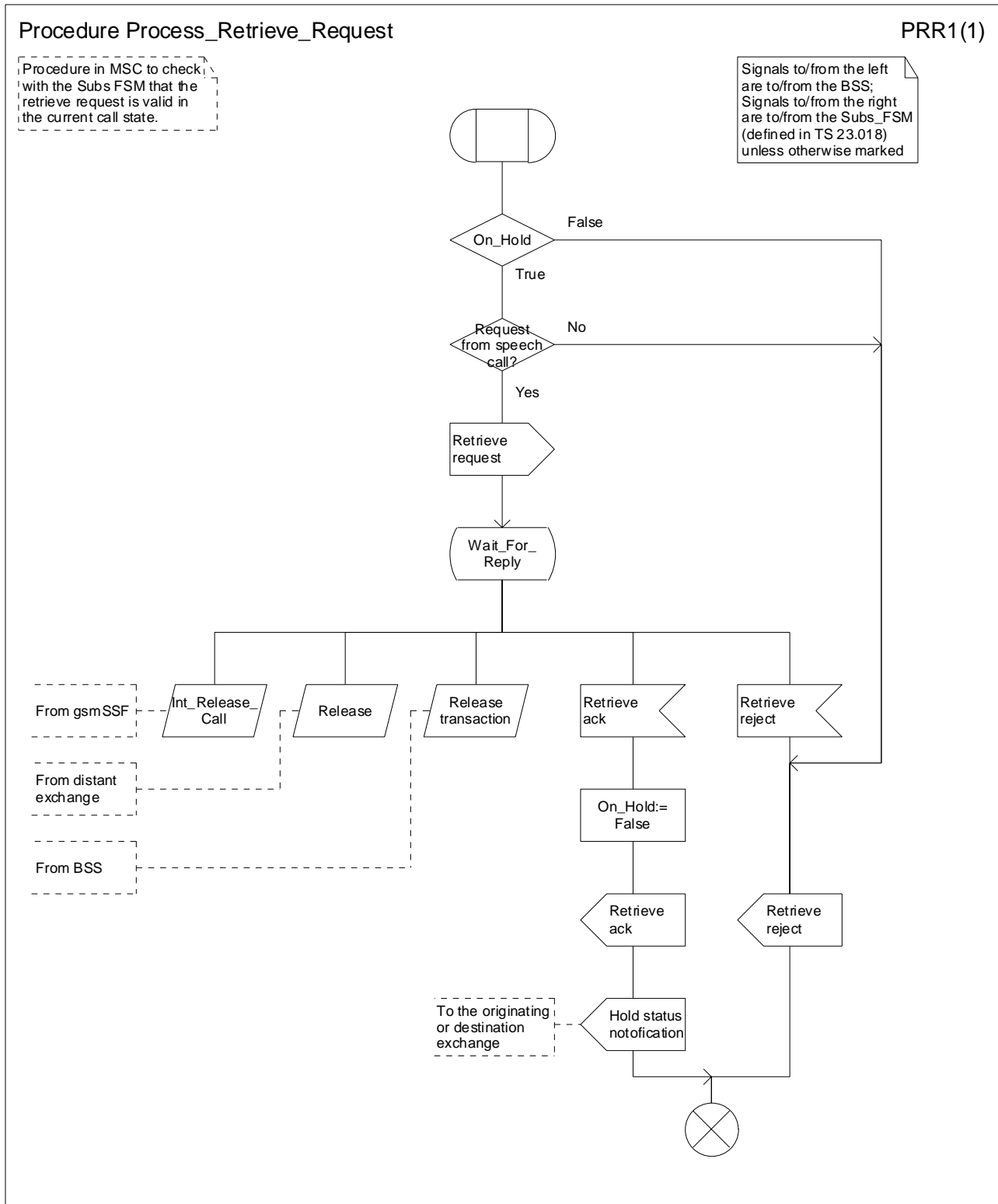

Figure 2.2b: Procedure Process\_Retrieve\_Request

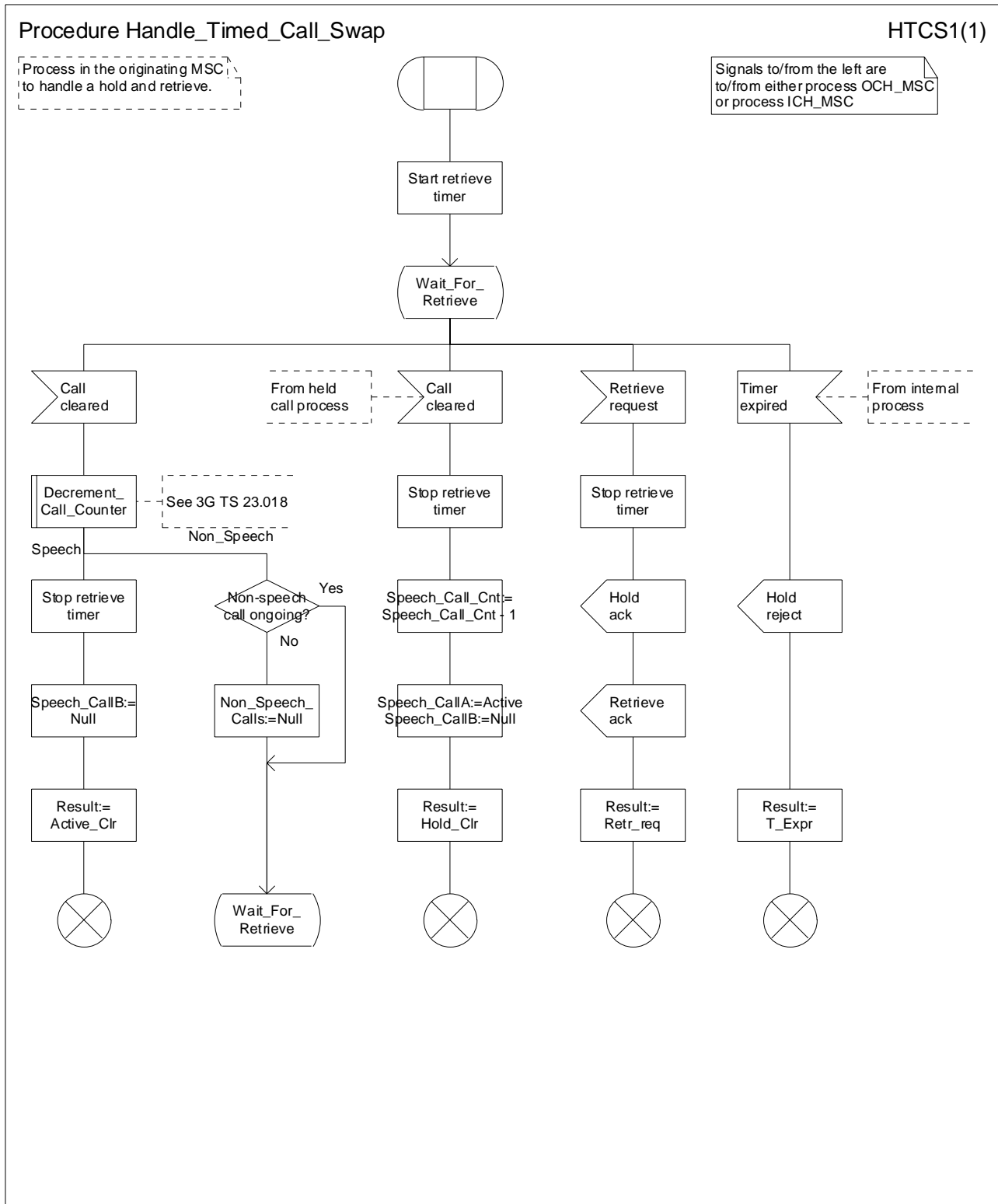
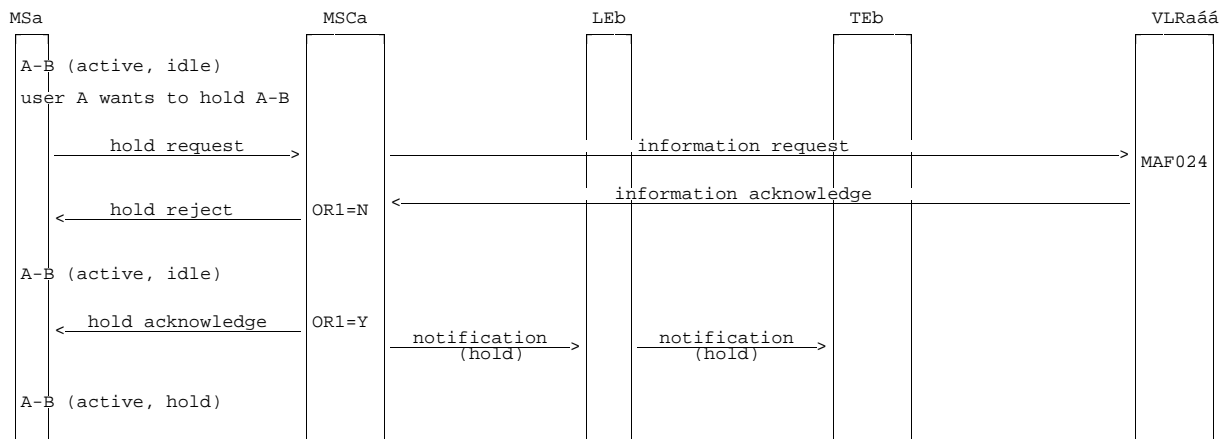

Figure 2.2c: Procedure Handle\_Timed\_Call\_Swap



NOTE: OR1: call hold (Y: yes N: no)

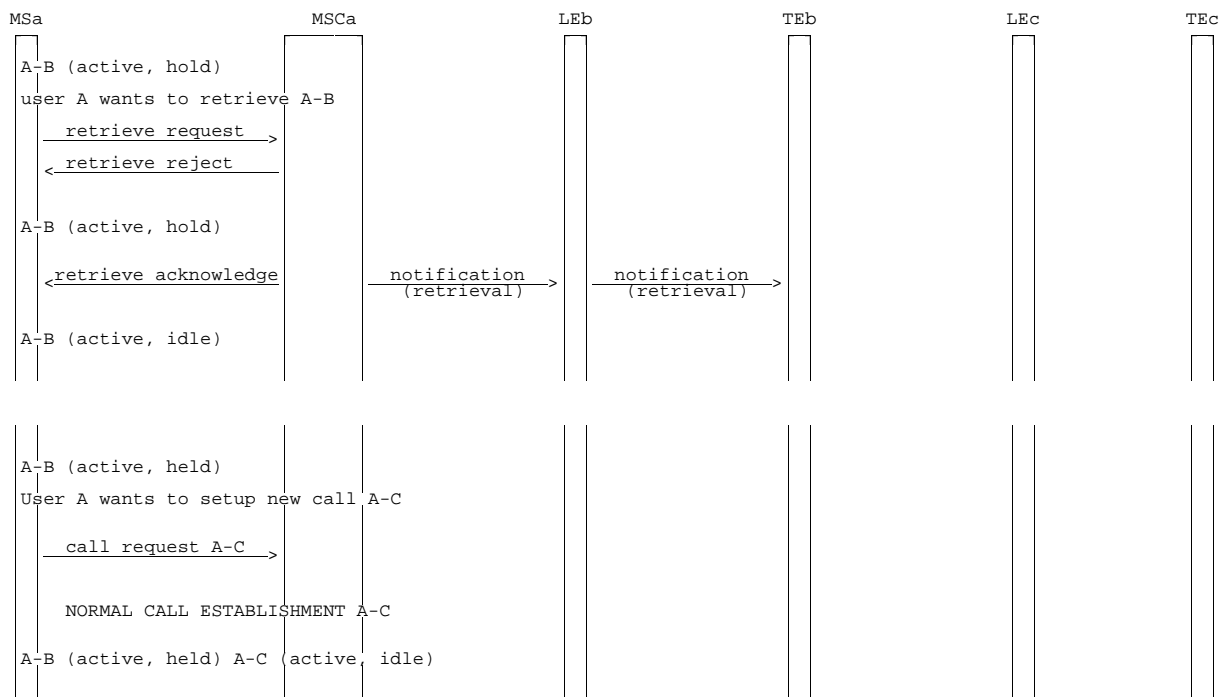

Figure 2.3 (sheet 1 of 3): Information flow for call hold

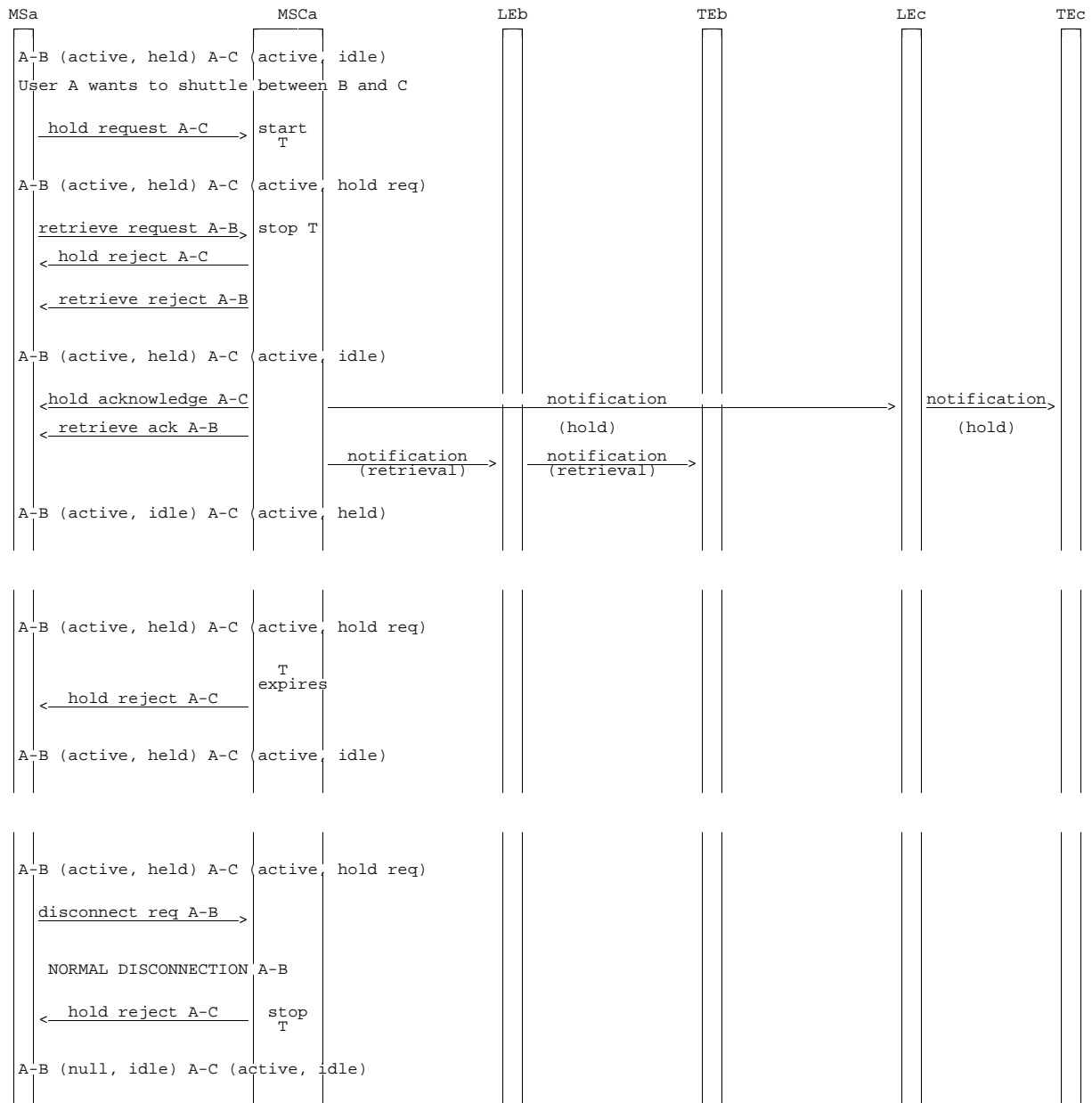

Figure 2.3 (sheet 2 of 3): Information flow for call hold

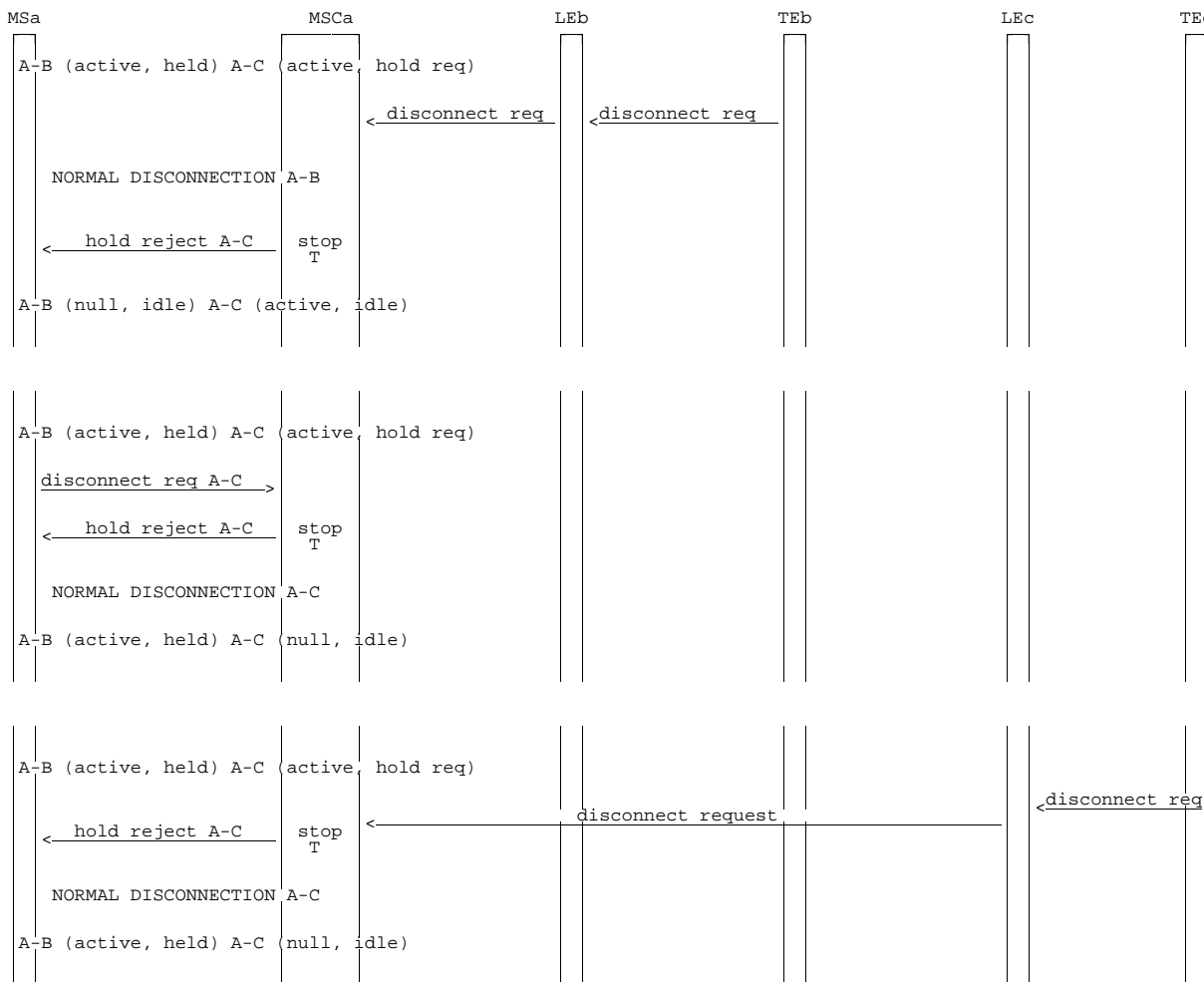

Figure 2.3 (sheet 3 of 3): Information flow for call hold

## 2.2 Information stored in the HLR

Call hold may have the following logical states (refer to TS 23.011 for an explanation of the notation):

Provisioning State	Registration State	Activation State	HLR Induction State
(Not Provisioned,	Not Applicable,	Not Active,	Not Induced)
(Provisioned,	Not Applicable,	Active and Operative,	Not Induced)

The HLR shall store the logical state of the call hold service (which shall be one of the valid states listed above) on a per subscriber basis.

## 2.3 State transition model

The following figure shows the successful cases of transition between the applicable logical states of call hold. The state changes are caused by actions of the service provider.

Note that error cases are not shown in the diagram as they normally do not cause a state change. Additionally, some successful requests may not cause a state change. Hence they are not shown in the diagram.

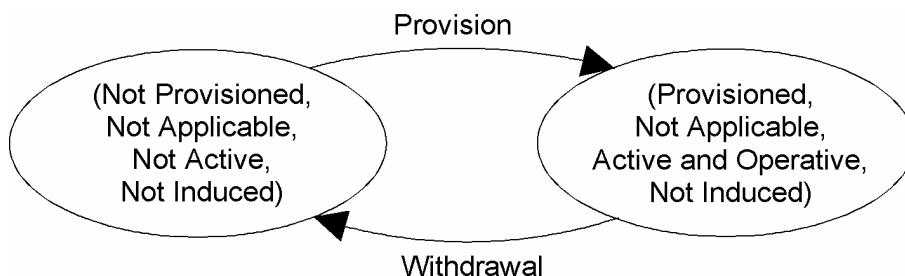

**Figure 2.4: State transition model for call hold**

## 2.4 Transfer of information from HLR to VLR

If the provisioning state for call hold is "Provisioned" then, when the subscriber registers on a VLR, the HLR shall send that VLR information about the logical state of call hold.

If the logical state of call hold is changed while a subscriber is registered on a VLR, then the HLR shall inform the VLR of the new logical state of call hold.

## 2.5 Information stored in the VLR

For call hold, the VLR shall store the service state information received from the HLR.

## 2.6 Handover

Handover will have no impact on the control procedures and the operation of the service.

## Annex A: Change history

Change history								
TSG CN#	Spec	Old Ver	CR	Rev	Phase	Cat	New Ver	Subject/Comment
CN#09	23.083	3.1.0	004	1	R99	F	3.2.0	SDL refresh
CN#09	23.083	3.2.0	005	1	Rel-4	D	4.0.0	Inclusion of call hold in basic call handling
CN#11	23.083	4.0.0	006	3	Rel-4	C	4.1.0	Enhancement of procedures for Call Hold
CN#11	23.083	4.1.0	007	1	Rel-4	C	4.2.0	Enhancement of CW procedures (Missed CR added; TSG agreed 007r1 at CN#11 -> v.4.2.0)
CN#14	23.083	4.2.0	008		Rel-4	F	4.3.0	Missing connector in procedure Process_Call_Waiting
CN#15	23.083	4.3.0	009	1	Rel-5	B	5.0.0	Introduction of CAMEL Phase 4
CN#17	23.083	5.0.0	010		Rel-5	F	5.1.0	Determining the basic service for MT calls

---

## History

<b>Document history</b>		
V5.0.0	March 2002	Publication
V5.1.0	September 2002	Publication