

ETSI TS 123 083 V16.0.0 (2020-07)



**Digital cellular telecommunications system (Phase 2+) (GSM);
Universal Mobile Telecommunications System (UMTS);
Call Waiting (CW) and Call Hold (HOLD) supplementary
services;
Stage 2
(3GPP TS 23.083 version 16.0.0 Release 16)**



Reference

RTS/TSGC-0423083vg00

Keywords

GSM,UMTS

ETSI

650 Route des Lucioles
F-06921 Sophia Antipolis Cedex - FRANCE

Tel.: +33 4 92 94 42 00 Fax: +33 4 93 65 47 16

Siret N° 348 623 562 00017 - NAF 742 C
Association à but non lucratif enregistrée à la
Sous-Préfecture de Grasse (06) N° 7803/88

Important notice

The present document can be downloaded from:

<http://www.etsi.org/standards-search>

The present document may be made available in electronic versions and/or in print. The content of any electronic and/or print versions of the present document shall not be modified without the prior written authorization of ETSI. In case of any existing or perceived difference in contents between such versions and/or in print, the prevailing version of an ETSI deliverable is the one made publicly available in PDF format at www.etsi.org/deliver.

Users of the present document should be aware that the document may be subject to revision or change of status.

Information on the current status of this and other ETSI documents is available at

<https://portal.etsi.org/TB/ETSIDeliverableStatus.aspx>

If you find errors in the present document, please send your comment to one of the following services:

<https://portal.etsi.org/People/CommiteeSupportStaff.aspx>

Copyright Notification

No part may be reproduced or utilized in any form or by any means, electronic or mechanical, including photocopying and microfilm except as authorized by written permission of ETSI.

The content of the PDF version shall not be modified without the written authorization of ETSI.

The copyright and the foregoing restriction extend to reproduction in all media.

© ETSI 2020.

All rights reserved.

DECT™, **PLUGTESTS™**, **UMTS™** and the ETSI logo are trademarks of ETSI registered for the benefit of its Members.

3GPP™ and **LTE™** are trademarks of ETSI registered for the benefit of its Members and of the 3GPP Organizational Partners.

oneM2M™ logo is a trademark of ETSI registered for the benefit of its Members and of the oneM2M Partners.

GSM® and the GSM logo are trademarks registered and owned by the GSM Association.

Intellectual Property Rights

Essential patents

IPRs essential or potentially essential to normative deliverables may have been declared to ETSI. The information pertaining to these essential IPRs, if any, is publicly available for **ETSI members and non-members**, and can be found in ETSI SR 000 314: "*Intellectual Property Rights (IPRs); Essential, or potentially Essential, IPRs notified to ETSI in respect of ETSI standards*", which is available from the ETSI Secretariat. Latest updates are available on the ETSI Web server (<https://ipr.etsi.org/>).

Pursuant to the ETSI IPR Policy, no investigation, including IPR searches, has been carried out by ETSI. No guarantee can be given as to the existence of other IPRs not referenced in ETSI SR 000 314 (or the updates on the ETSI Web server) which are, or may be, or may become, essential to the present document.

Trademarks

The present document may include trademarks and/or tradenames which are asserted and/or registered by their owners. ETSI claims no ownership of these except for any which are indicated as being the property of ETSI, and conveys no right to use or reproduce any trademark and/or tradename. Mention of those trademarks in the present document does not constitute an endorsement by ETSI of products, services or organizations associated with those trademarks.

Legal Notice

This Technical Specification (TS) has been produced by ETSI 3rd Generation Partnership Project (3GPP).

The present document may refer to technical specifications or reports using their 3GPP identities. These shall be interpreted as being references to the corresponding ETSI deliverables.

The cross reference between 3GPP and ETSI identities can be found under <http://webapp.etsi.org/key/queryform.asp>.

Modal verbs terminology

In the present document "**shall**", "**shall not**", "**should**", "**should not**", "**may**", "**need not**", "**will**", "**will not**", "**can**" and "**cannot**" are to be interpreted as described in clause 3.2 of the [ETSI Drafting Rules](#) (Verbal forms for the expression of provisions).

"**must**" and "**must not**" are **NOT** allowed in ETSI deliverables except when used in direct citation.

Contents

Intellectual Property Rights	2
Legal Notice	2
Modal verbs terminology.....	2
Foreword.....	4
0 Scope	5
0.1 References	5
0.2 Abbreviations	5
1 Call waiting (CW)	6
1.1 Handling of call waiting	6
1.1.1 Activation	6
1.1.2 Deactivation.....	6
1.1.3 Interrogation	7
1.2 Functions and information flows.....	7
1.3 Information stored in the HLR	26
1.4 State transition model.....	26
1.5 Transfer of information from HLR to VLR.....	27
1.6 Information stored in the VLR	27
1.7 Handover	27
2 Call hold (HOLD)	27
2.1 Functions and information flows.....	27
2.2 Information stored in the HLR	36
2.3 State transition model.....	37
2.4 Transfer of information from HLR to VLR.....	37
2.5 Information stored in the VLR	37
2.6 Handover	37
Annex A: Change history	38
History	39

Foreword

This Technical Specification has been produced by the 3rd Generation Partnership Project (3GPP).

The contents of the present document are subject to continuing work within the TSG and may change following formal TSG approval. Should the TSG modify the contents of the present document, it will be re-released by the TSG with an identifying change of release date and an increase in version number as follows:

Version x.y.z

where:

- x the first digit:
 - 1 presented to TSG for information;
 - 2 presented to TSG for approval;
 - 3 or greater indicates TSG approved document under change control.
- y the second digit is incremented for all changes of substance, i.e. technical enhancements, corrections, updates, etc.
- z the third digit is incremented when editorial only changes have been incorporated in the document.

0 Scope

The present document gives the stage 2 description of the call completion supplementary services.

The group of call completion supplementary services is divided into the following two supplementary services:

- Call waiting (CW) (clause 1);
- Call hold (HOLD) (clause 2).

0.1 References

The following documents contain provisions which, through reference in this text, constitute provisions of the present document.

- References are either specific (identified by date of publication, edition number, version number, etc.) or non-specific.
- For a specific reference, subsequent revisions do not apply.
- For a non-specific reference, the latest version applies. In the case of a reference to a 3GPP document (including a GSM document), a non-specific reference implicitly refers to the latest version of that document *in the same Release as the present document*.

- [1] 3GPP TR 21.905: "3G Vocabulary".
- [2] 3GPP TS 22.082: "Call Forwarding (CF) Supplementary Services - Stage 1".
- [3] 3GPP TS 23.011: "Technical realization of supplementary services - General Aspects".
- [4] 3GPP TS 24.008: "Mobile radio interface layer 3 specification; Core Network Protocols - Stage3".
- [5] 3GPP TS 23.018: "Basic call handling".
- [6] 3GPP TS 23.078: "Customized Applications for Mobile network Enhanced Logic (CAMEL) - Phase 3; Stage 2".
- [7] 3GPP TS 23.135: "Multicall supplementary service; Technical Realisation; Stage 2".
- [8] 3GPP TS 23.087: "User-to-User Signalling (UUS) - Stage 2".
- [9] 3GPP TS 23.093: "Technical realisation of Completion of Calls to Busy Subscriber (CCBS) - Stage 2".
- [10] 3GPP TS 23.072: "Call Deflection (CD) supplementary service - Stage2".
- [11] 3GPP TS 29.007: "General requirements on interworking between the Public Land Mobile Network (PLMN) and the Integrated Services Digital Network (ISDN) or Public Switched Telephone Network (PSTN)".

0.2 Abbreviations

In addition to those below, abbreviations used in the present document are listed in 3GPP TR 21.905.

HTI: HoldTreatment Indicator

1 Call waiting (CW)

1.1 Handling of call waiting

1.1.1 Activation

The call waiting supplementary service is activated at the request of the user. The activation request indicates the basic services to which the activation request refers.

The information flow for activation of call waiting is shown in figure 1.1.

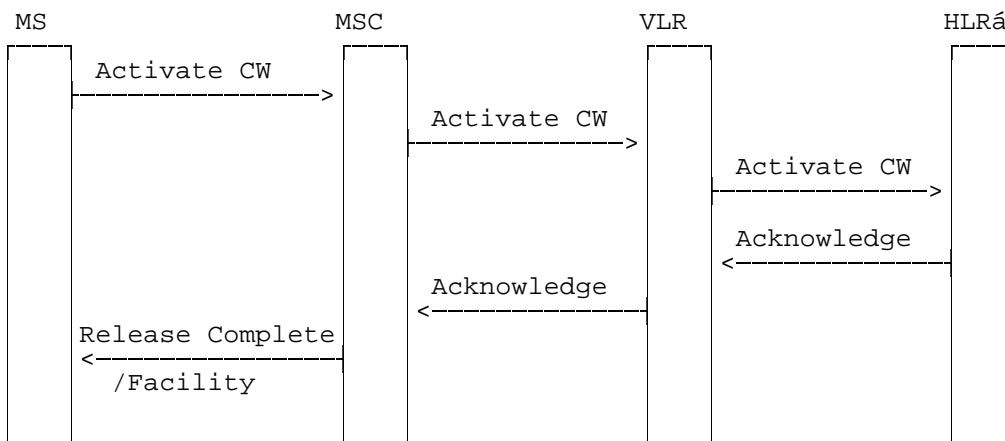

Figure 1.1: Activation of call waiting

1.1.2 Deactivation

The call waiting supplementary service is deactivated at the request of the user. The deactivation request indicates the basic services to which the deactivation request refers.

The information flow for deactivation of call waiting is shown in figure 1.2.

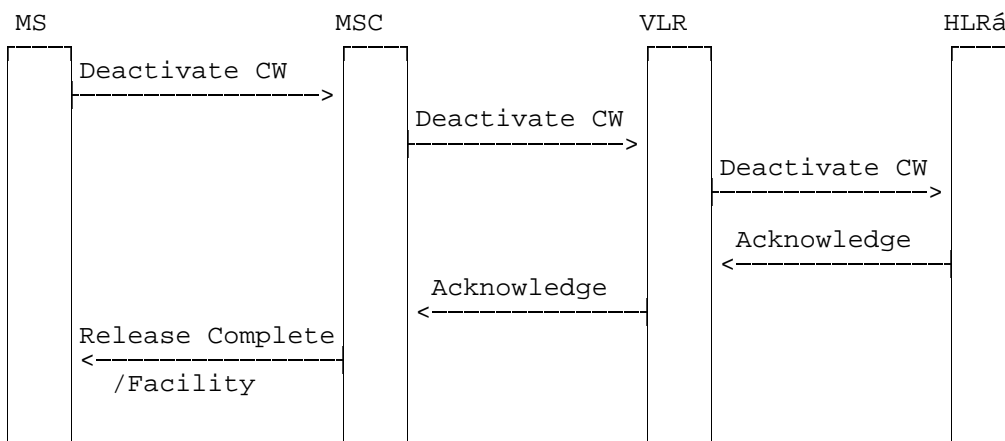

Figure 1.2: Deactivation of call waiting

1.1.3 Interrogation

Status check

The status check procedure enables the mobile subscriber to obtain information about the status of the call waiting supplementary service with respect to subscribed basic service groups.

The interrogation of call waiting is for all applicable basic services.

The information flow for interrogation of call waiting is shown in figure 1.3.

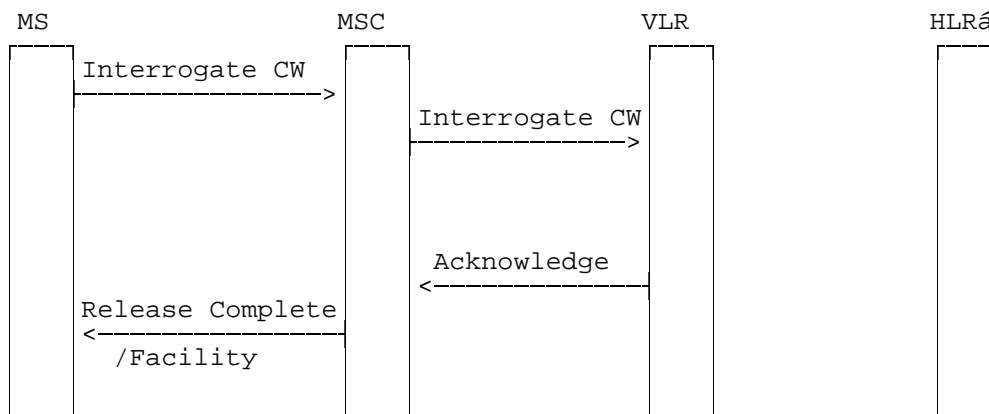

Figure 1.3: Interrogation of call waiting

1.2 Functions and information flows

TS 24.008 specifies the procedures for call control. These shall also be used for waiting calls when applicable.

The following Mobile Additional Function has been identified for the call waiting service:

MAF013

Call waiting related authorizations examination

The ability of a PLMN component to determine the authorizations relating to call waiting. See figure 1.4.

Location: VLR

Definitions:

Subscriber B:

The subscriber who is provided by the network with the call waiting supplementary service. The subscriber B is always a mobile subscriber.

User B:

The user who reacts to call waiting at subscriber B. The user B is always a mobile user.

User C:

The user who has originated a call to subscriber B which causes the call waiting supplementary service to be invoked. The user C may be a mobile user.

User A:

The user who is engaged in a call with user B. The user A may be a mobile user.

Timer T1:

This timer corresponds to T303 + T310 (as defined in TS 24.008).

Timer T2:

Call Waiting Timer. This shall limit the duration of the call in the waiting condition.

Timer T3:

No Reply Condition Timer (see TS 22.082).

CFNRc:

Call Forwarding on Not Reachable (see TS 22.082).

CFNRy:

Call Forwarding on No Reply (see TS 22.082).

CW:

Call Waiting.

The procedure Process_Call_Waiting is shown in figure 1.5.

Sheet 1: the procedure Set_CLIP_Info_MSC is specific to CLIP; it is specified in 3GPP TS 23.018 [5].

Sheet 1: the VMSC derives the PLMN bearer capability required for the call according to the rules defined in 3GPP TS 29.007 [11].

Sheet 1: the VMSC and the MS may negotiate the bearer capability to be used for the call by the exchange of information in the Set-up and Call Confirmed messages.

Sheet 1: the Call Confirmed message indicates "busy" for the successful case.

Sheet 1: the procedure Establish_Terminating_TCH_Multicall1 is specific to Multicall; it is specified in 3GPP TS 23.135 [7]. If the VMSC does not support Multicall, processing continues from the "Yes" exit of the test "Result=Pass?".

Sheet 1: the procedure UUS_ICH_UUS1_Implicit_Active is specific to UUS; it is specified in 3GPP TS 23.087 [8].

Sheet 1: the procedure CCBS_Report_Not_Idle is specific to CCBS; it is specified in 3GPP TS 23.093 [9].

Sheet 2, sheet 3, sheet 5: the procedure UUS_ICH_Check_Support is specific to UUS; it is specified in 3GPP TS 23.087 [8]. If the VMSC does not support UUS, processing continues from the "Yes" exit of the test "Result=Pass?" where the test follows the procedure call.

Sheet 2: the procedure CCBS_ICH_MSC_Report_Success is specific to CCBS; it is specified in 3GPP TS 23.093 [9].

Sheet 2: the task "UTU2Cnt:=0" is executed only if the VMSC supports UUS.

Sheet 2: the procedure CAMEL_Start_TNRy is called if the VMSC supports CAMEL phase 3 or later; it is specified in 3GPP TS 23.078 [6].

Sheet 2: the procedure Send_ACM_If_Required is specified in 3GPP TS 23.018 [5].

Sheet 2: The procedure CAMEL_MT_MSC_ALERTING is specific to CAMEL phase 4 or later; it is specified in 3GPP TS 23.078 [6]. If the VMSC does not support CAMEL phase 4 or later, processing continues from the "Pass" exit of the test "Result?".

Sheet 2, sheet 8: the processing in the branch starting with the input "CD Request" is specific to Call Deflection; if the VMSC does not support Call Deflection the input is discarded.

Sheet 2, sheet 8: the procedure Handling_CD_MSC is specific to Call Deflection; it is specified in 3GPP TS 23.072 [10].

Sheet 2, sheet 3, sheet 6, sheet 7: the procedure CAMEL_MT_GMSC_DISC4 is called if the VMSC supports CAMEL phase 3 or later; it is specified in 3GPP TS 23.078 [6]. If the VMSC does not support CAMEL phase 3 or later, processing continues from the "No" exit of the test "Result=Reconnect?".

Sheet 2, sheet 3, sheet 4, sheet 8: the procedure CCBS_ICH_MSC_Report_Failure is specific to CCBS; it is specified in 3GPP TS 23.093 [9].

Sheet 3, sheet 7: the Release transaction (reject) message covers all unsuccessful cases not otherwise indicated.

Sheet 4, sheet 7: the procedure UUS_MSC_Check_UUS1_UI is specific to UUS; it is specified in 3GPP TS 23.087 [8].

Sheet 4, sheet 8: the procedure CAMEL_MT_GMSC_DISC6 is called if the VMSC supports CAMEL phase 3 or later; it is specified in 3GPP TS 23.078 [6].

Sheet 5: the procedure CAMEL_Stop_TNRy is called if the VMSC supports CAMEL phase 3 or later; it is specified in 3GPP TS 23.078 [6].

Sheet 5: the procedure Establish_Terminating_TCH_If_Required is specified in 3GPP TS 23.018 [5].

Sheet 5: the procedure Establish_Terminating_TCH_Multicall is specific to Multicall; it is specified in 3GPP TS 23.135 [7].

Sheet 6: the procedure Handle_AoC_MT_MSC is specific to AoC; it is specified in 3GPP TS 23.018 [5]. If the VMSC does not support AoC, processing continues from the "Yes" exit of the test "Result=Pass?".

Sheet 6: the procedure CAMEL_MT_GMSC_ANSWER is called if the VMSC supports CAMEL phase 3 or later; it is specified in 3GPP TS 23.078 [6]. If the VMSC does not support CAMEL phase 3 or later, processing continues from the "Pass" exit of the test "Result?" on sheet 6.

Sheet 6: the procedure Set_COL_Presentation_Indicator_MSC is specific to COLP; it is specified in 3GPP TS 23.018 [5].

Sheet 6: the procedure Send_Answer_If_Required is specified in 3GPP TS 23.018 [5]

Sheet 7: the input signal "CAMEL TNRY expired" will be received only if the VMSC supports CAMEL phase 3 or later.

Sheet 7: the procedure CAMEL_MT_GMSC_DISC5 is called if the VMSC supports CAMEL phase 3 or later; it is specified in 3GPP TS 23.078 [6]. If the VMSC does not support CAMEL phase 3 or later, processing continues from the "No" exit of the test "Result=Reconnect?".

Sheet 7, sheet 8: the procedure UUS_ICH_Check_Forwarding is specific to UUS; it is specified in 3GPP TS 23.087 [8]. If the VMSC does not support UUS, processing continues from the "Yes" exit of the test "Result=Pass?".

Sheet 7, sheet 8, sheet 9: the procedure UUS_MSC_Check_UUS1_UI is specific to UUS; it is specified in 3GPP TS 23.087 [8].

Sheet 8: the procedures UUS_MSC_Check_UUS2_UI_to_MS and UUS_MSC_Check_UUS2_UI_to_NW are specific to UUS; they are specified in 3GPP TS 23.087 [8].

Sheet 8: the procedure CD_UUS_Interaction is specific to Call Deflection; it is specified in GSM 23.072 [10].

Sheet 9: the procedure CCBS_ICH_MSC_Report_Failure is specific to CCBS; it is specified in 23.093 [9].

Sheet 9: the procedure CAMEL_MT_GMSC_DISC6 is specific to CAMEL; it is specified in 23.078 [6].

The information flows are shown in figure 1.6. In these flows it is assumed that user A and user C are fixed users and that user B is a mobile user. Functions to be performed by the fixed ISDN are not shown in the information flows. Only the functions to be performed by the PLMN are shown.

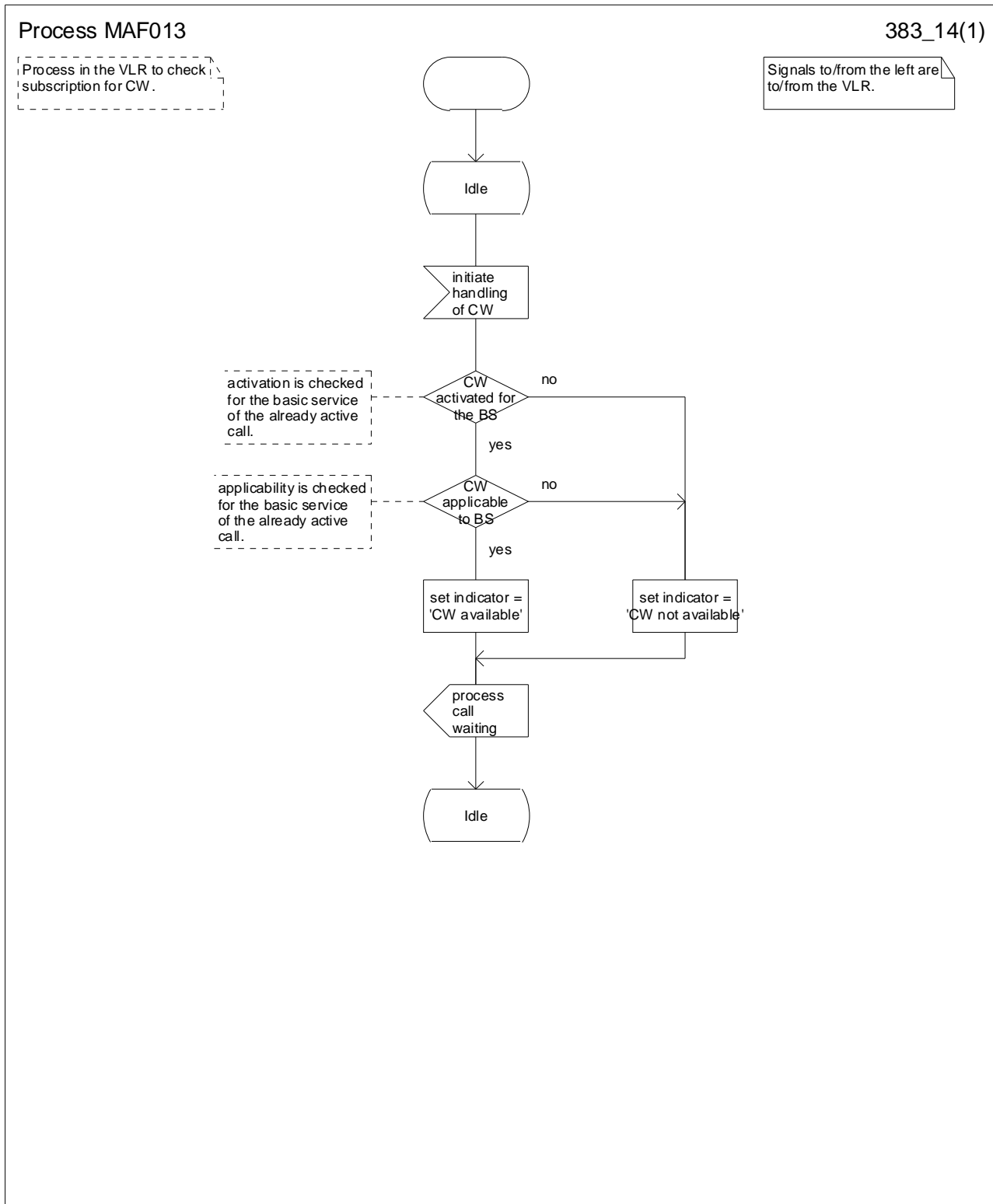

Figure 1.4: MAF013 Call waiting related authorisations examination (VLR)

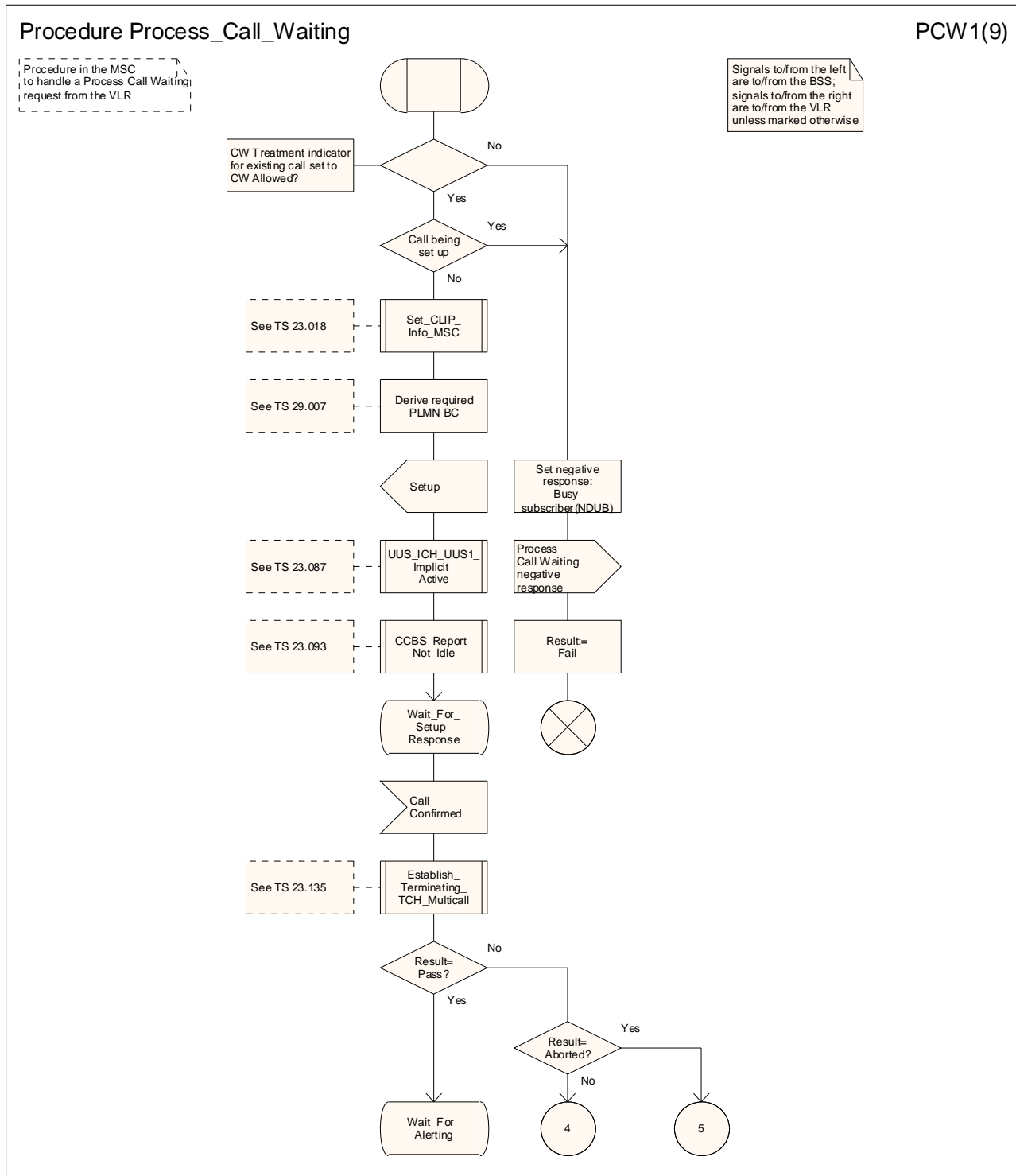

Figure 1.5 (sheet 1 of 9): Procedure Process_Call_Waiting

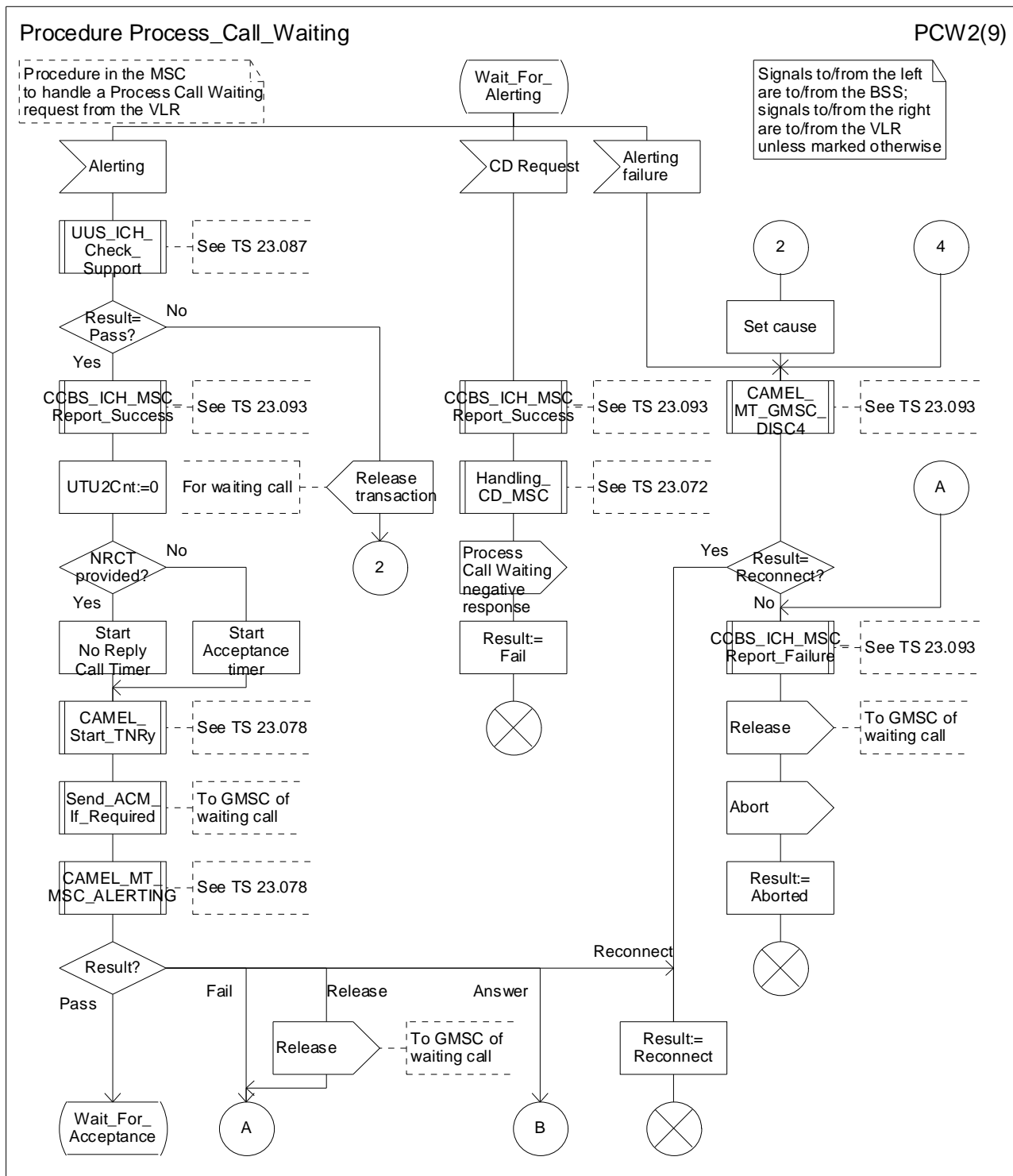

Figure 1.5 (sheet 2 of 9): Procedure Process_Call_Waiting

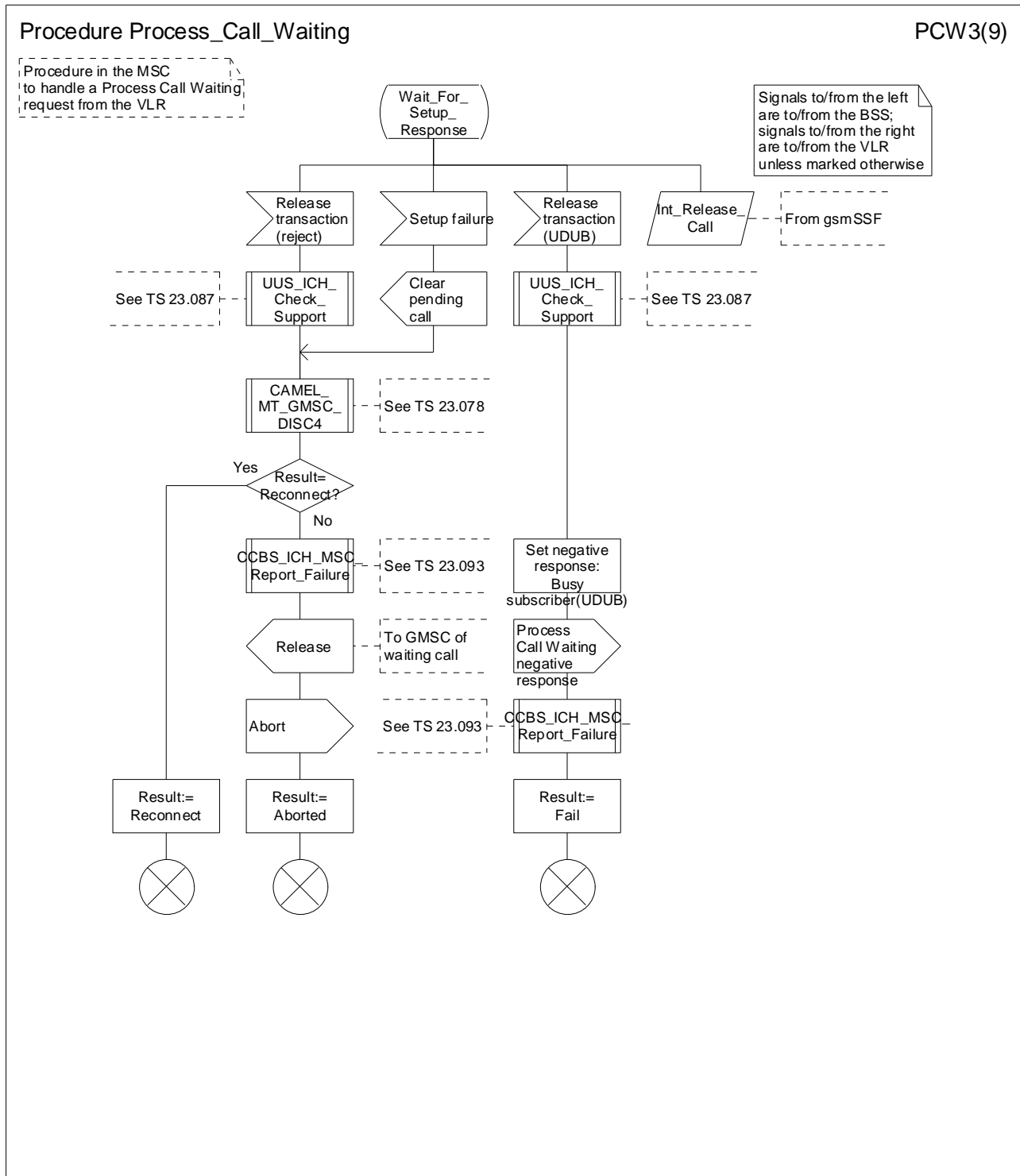

Figure 1.5 (sheet 3 of 9): Procedure Process_Call_Waiting

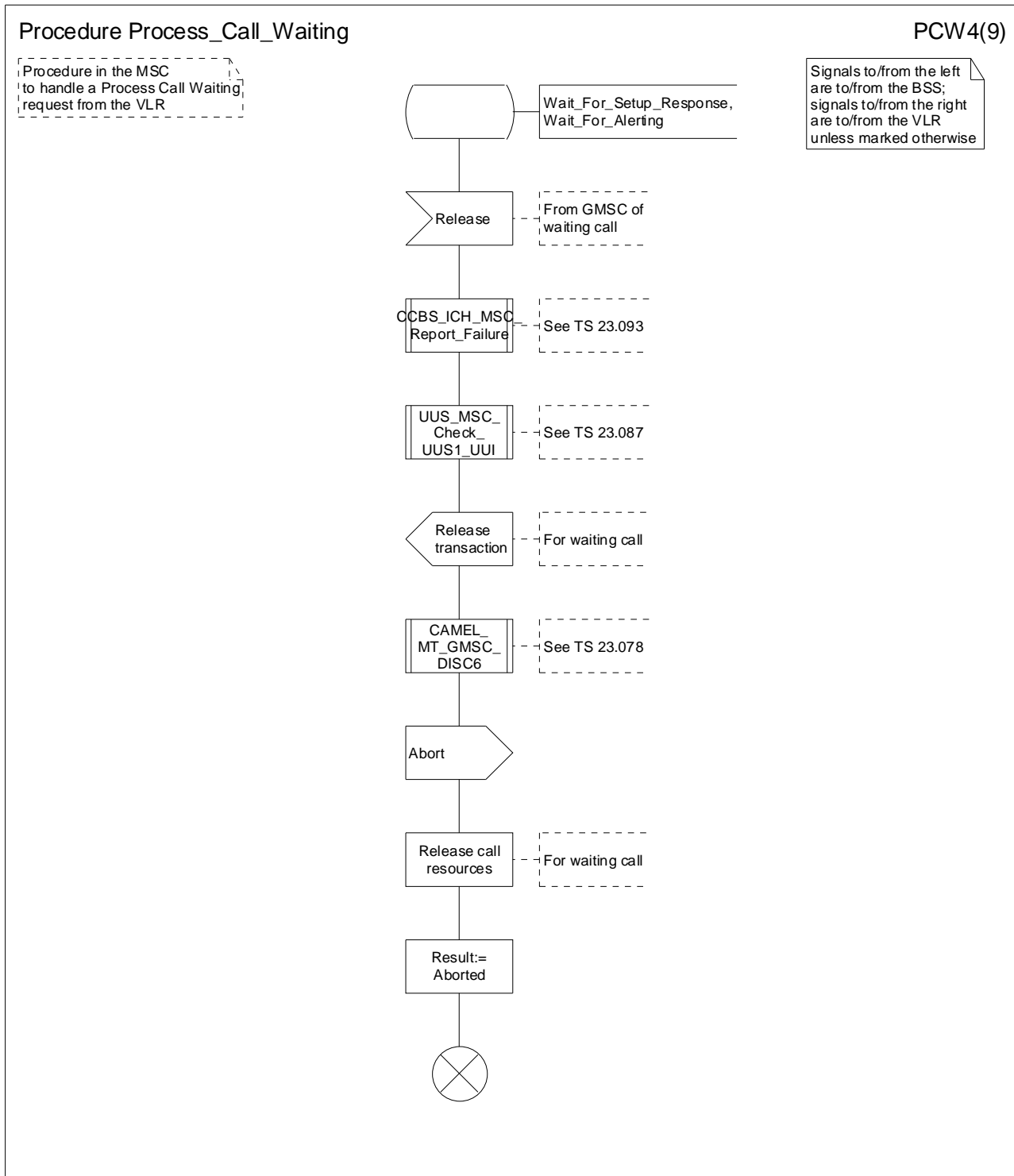

Figure 1.5 (sheet 4 of 9): Procedure Process_Call_Waiting

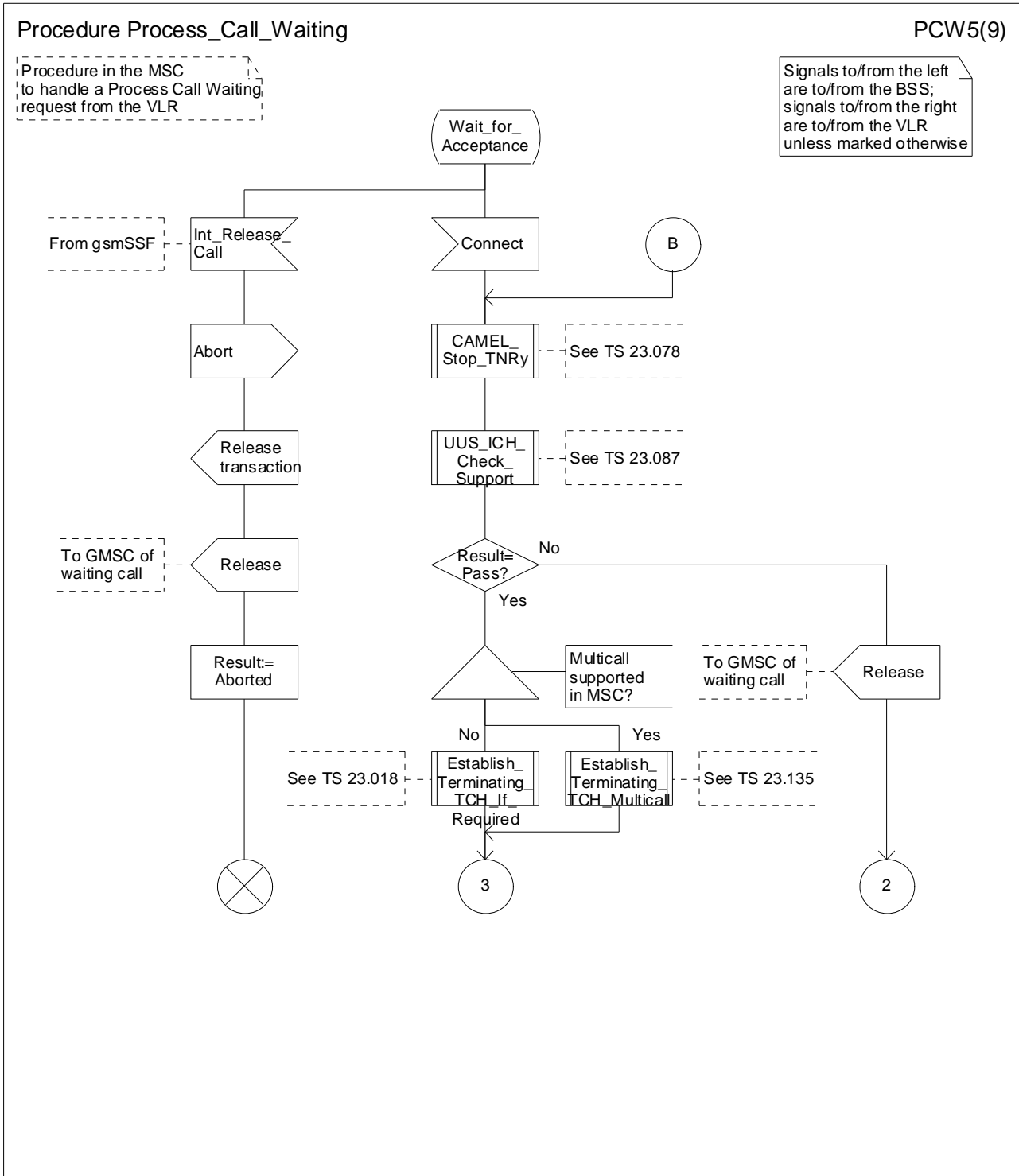

Figure 1.5 (sheet 5 of 9): Procedure Process_Call_Waiting

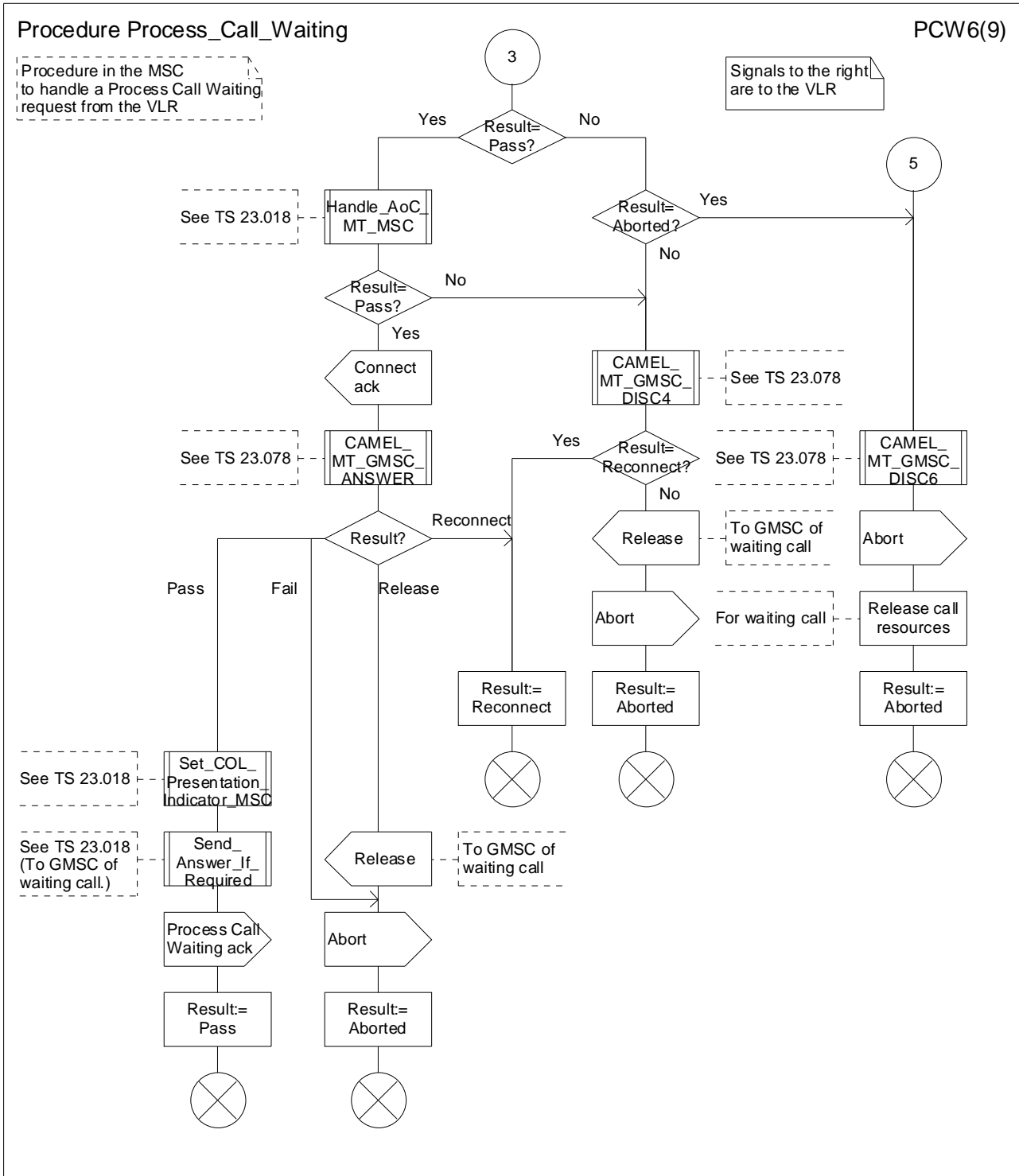

Figure 1.5 (sheet 6 of 9): Procedure Process_Call_Waiting

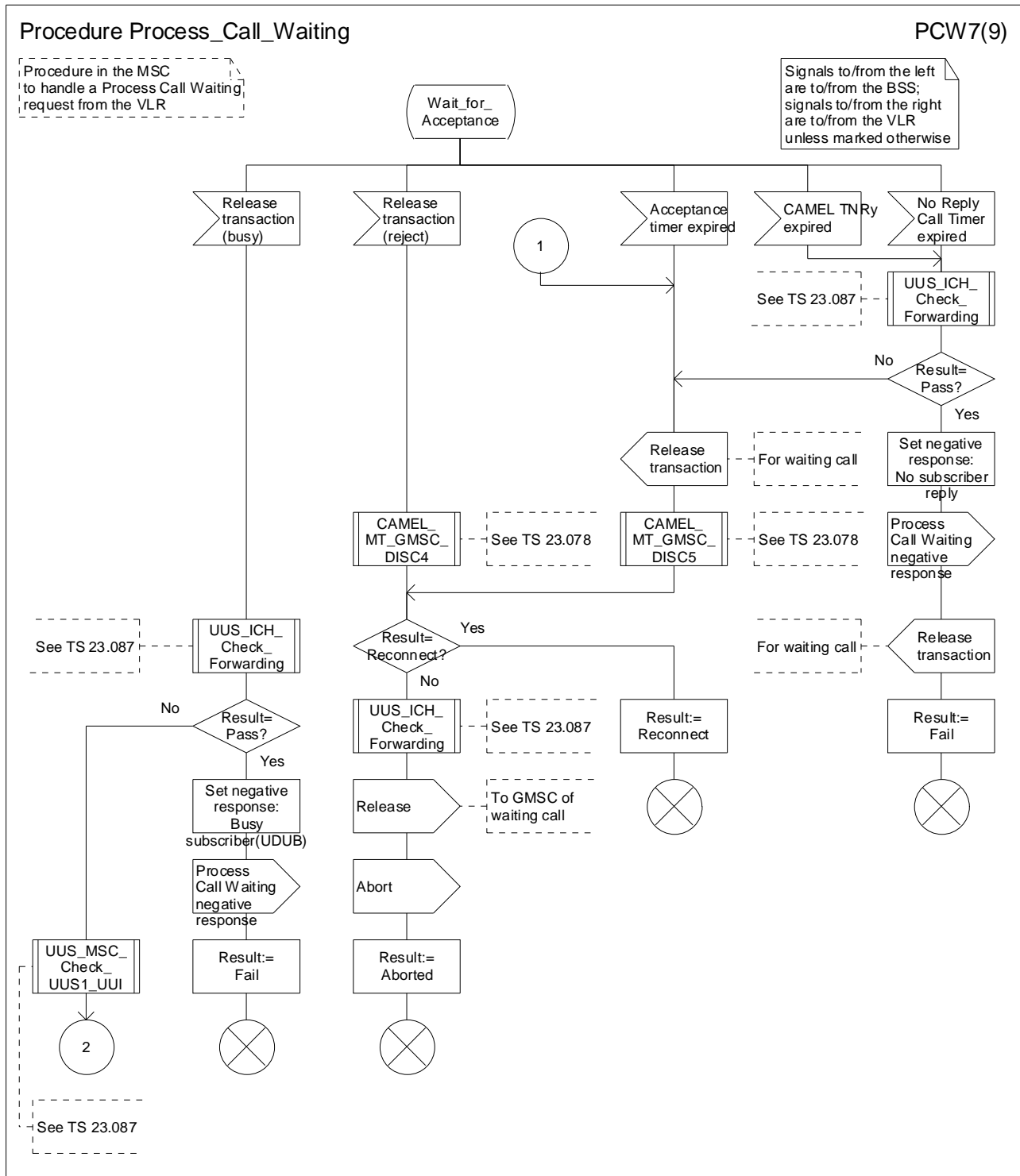

Figure 1.5 (sheet 7 of 9): Procedure Process_Call_Waiting

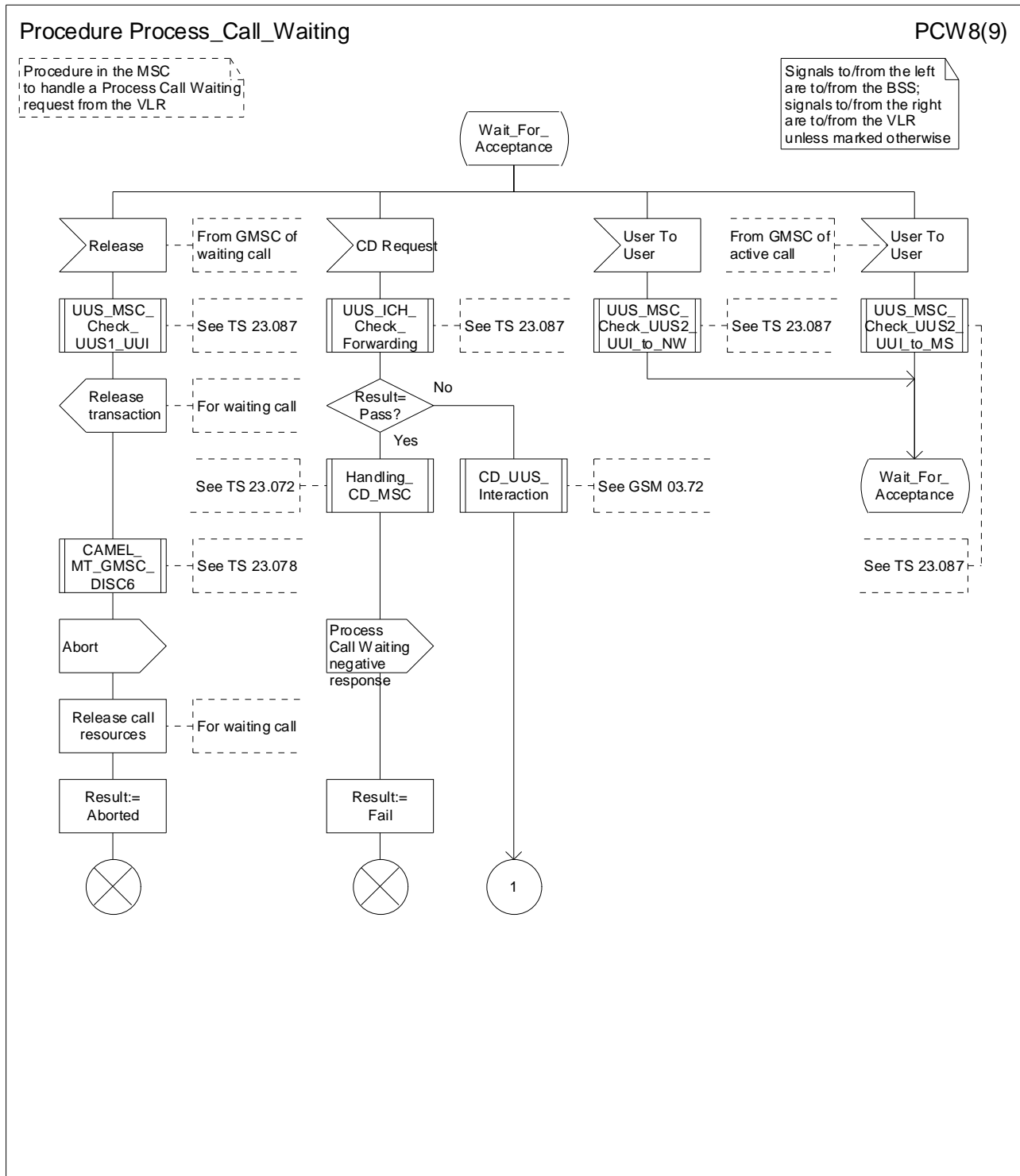

Figure 1.5 (sheet 8 of 9): Procedure Process_Call_Waiting

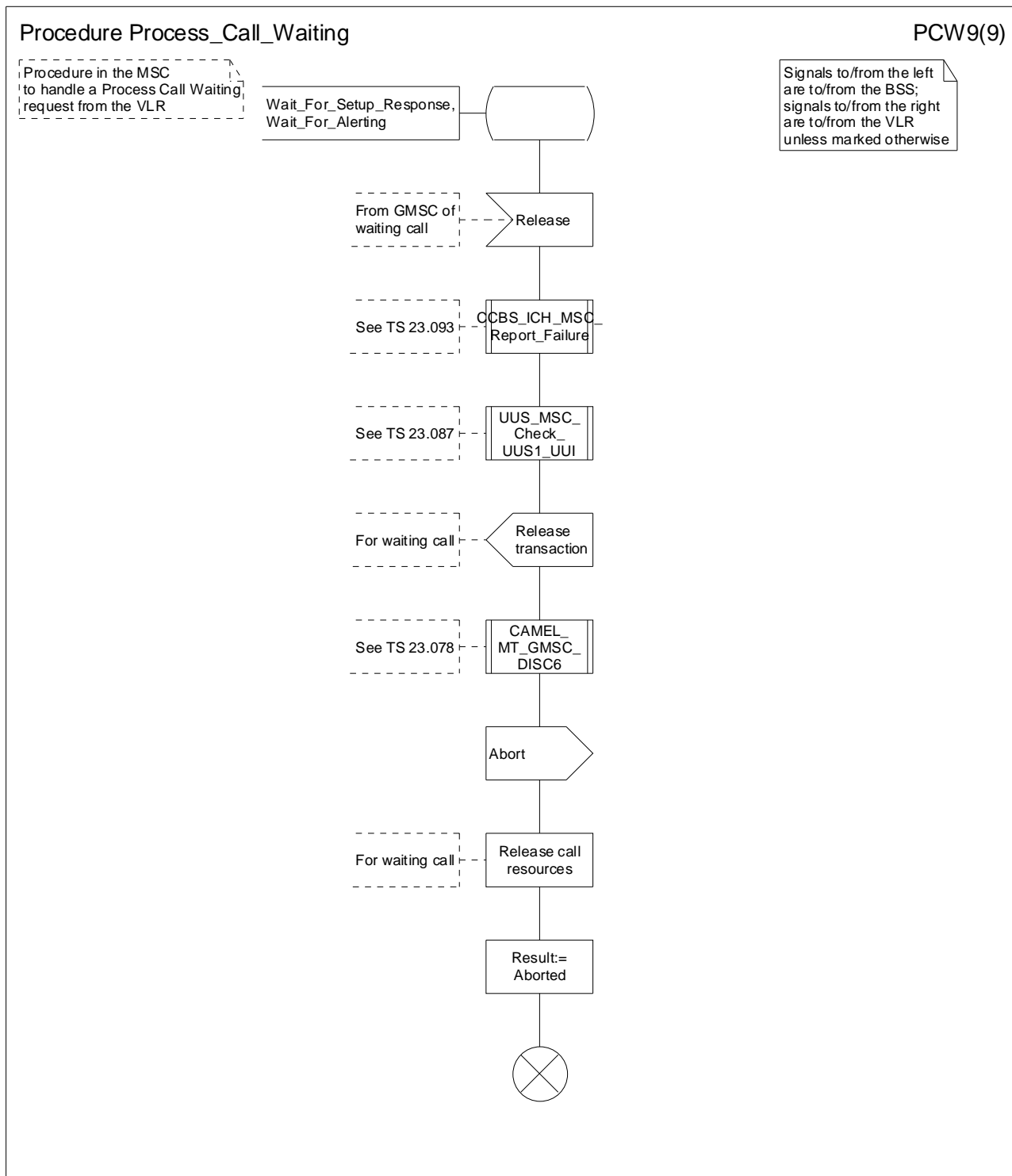
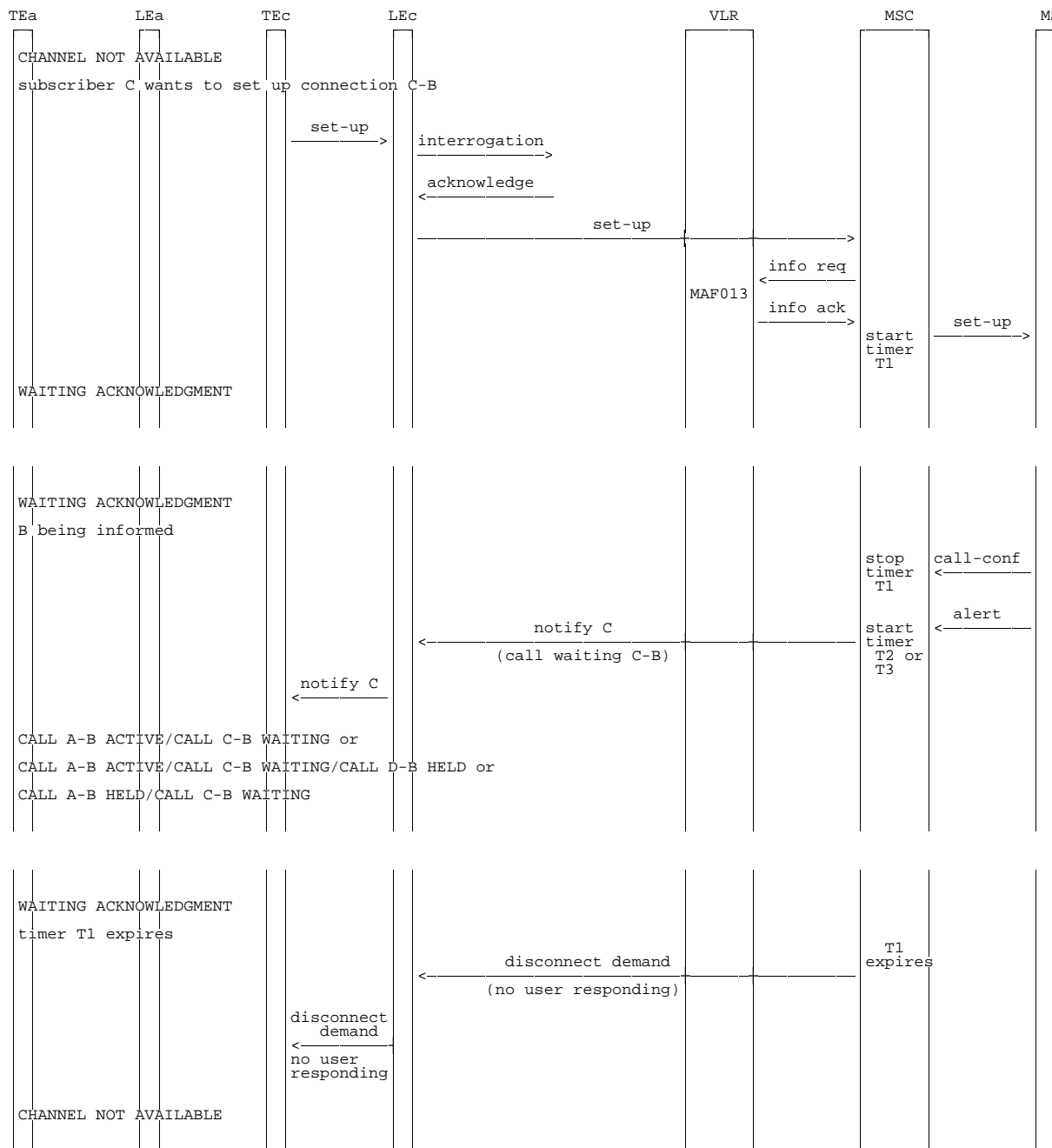
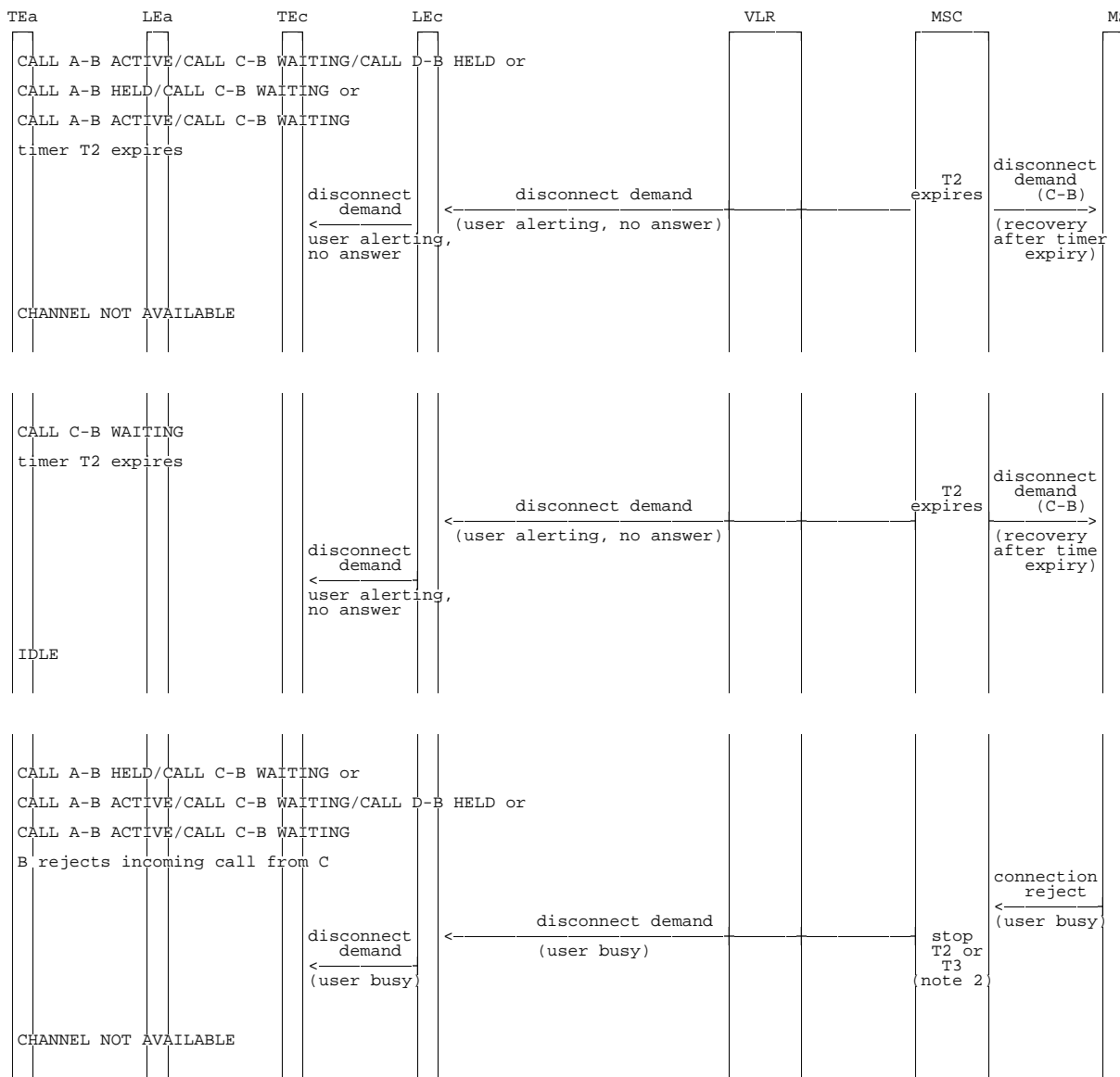

Figure 1.5 (sheet 9 of 9): Procedure Process_Call_Waiting



NOTE 1: info req: information request
info ack: information acknowledge

Figure 1.6 (sheet 1 of 7): Information flow for call waiting



NOTE 2: The call shall be forwarded on mobile subscriber busy at this stage if activated.

Figure 1.6 (sheet 2 of 7): Information flow for call waiting

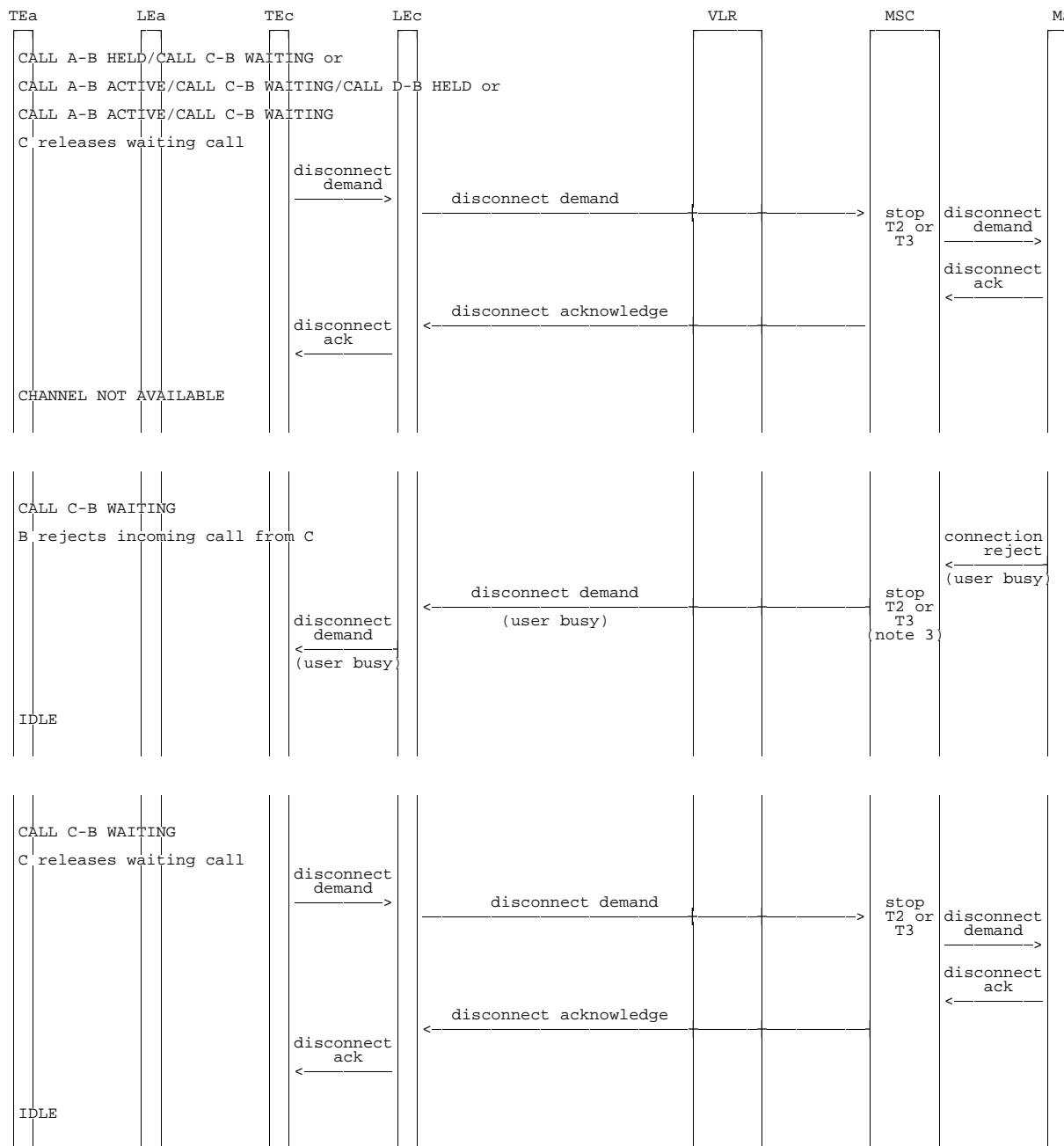

NOTE 3: The call shall be forwarded on mobile subscriber busy at this stage if activated.

Figure 1.6 (sheet 3 of 7): Information flow for call waiting

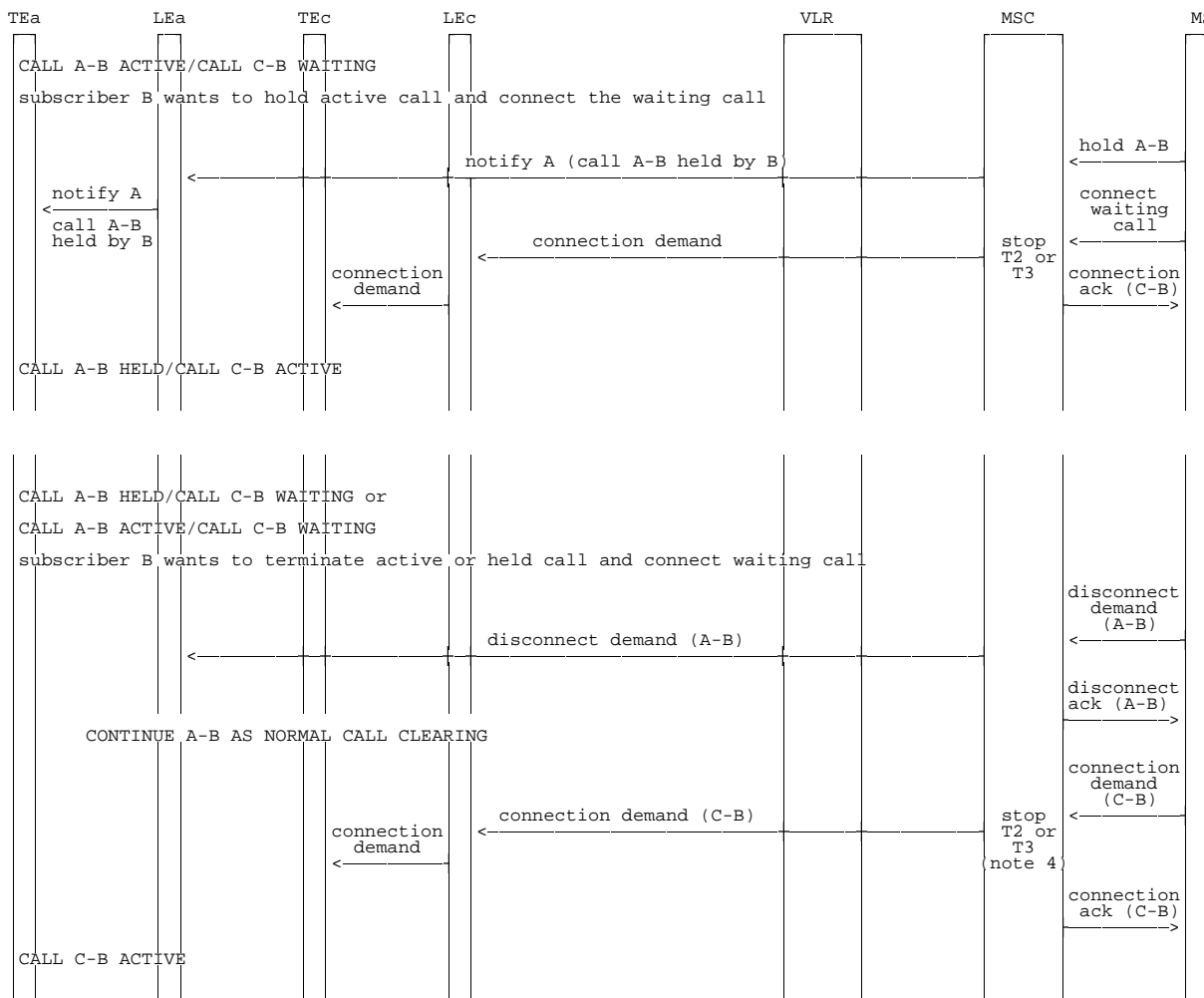

NOTE 4: If T2 or if applicable T3 expires before reception of connection demand in the MSC then call c-b shall be released with cause no reply and if it was T3 which expired the waiting call from C shall be forwarded on no reply.

Figure 1.6 (sheet 4 of 7): Information flow for call waiting

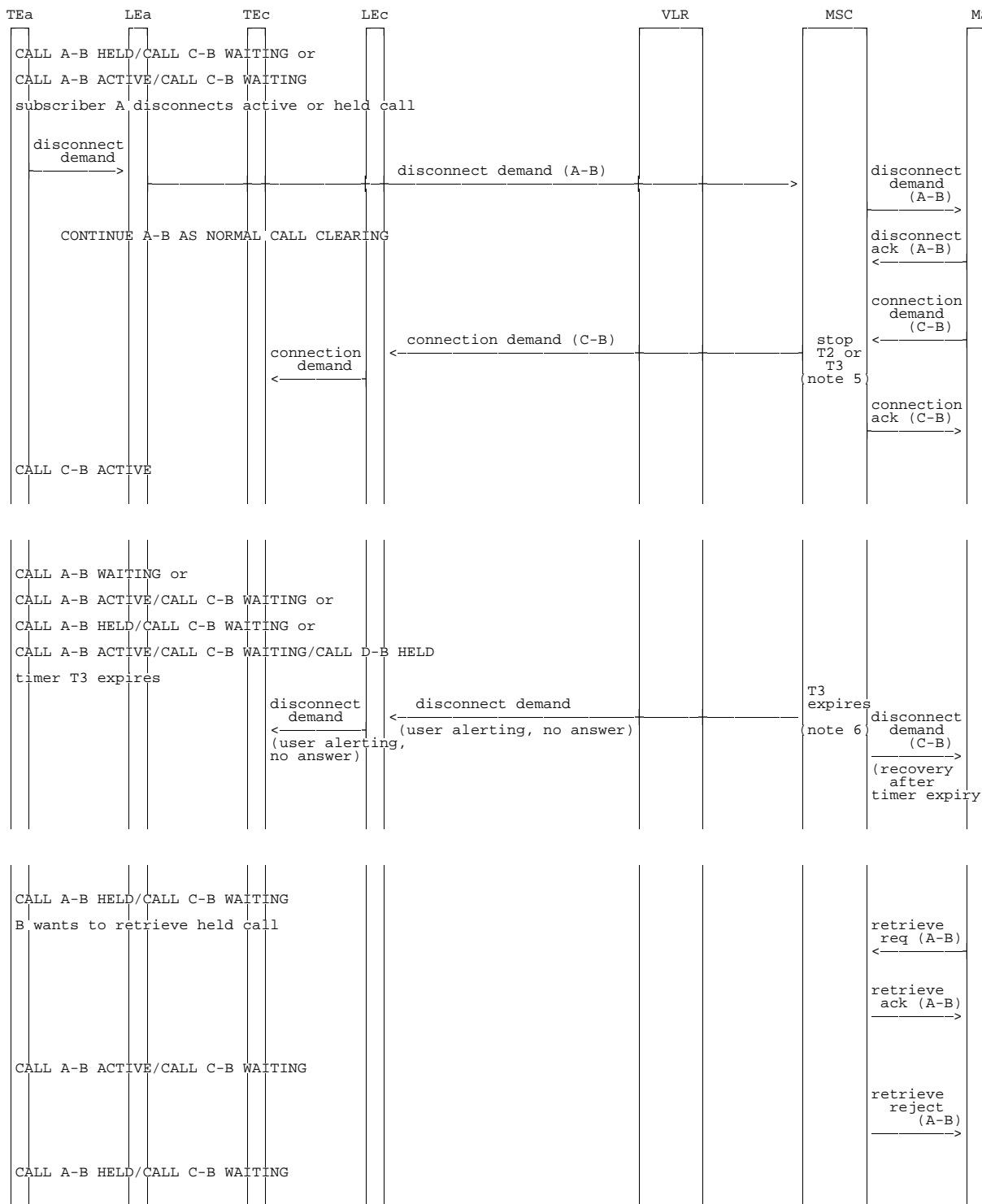

NOTE 5: The call shall be forwarded on mobile subscriber busy at this stage if activated.

NOTE 6: The call shall be forwarded on no reply.

Figure 1.6 (sheet 5 of 7): Information flow for call waiting

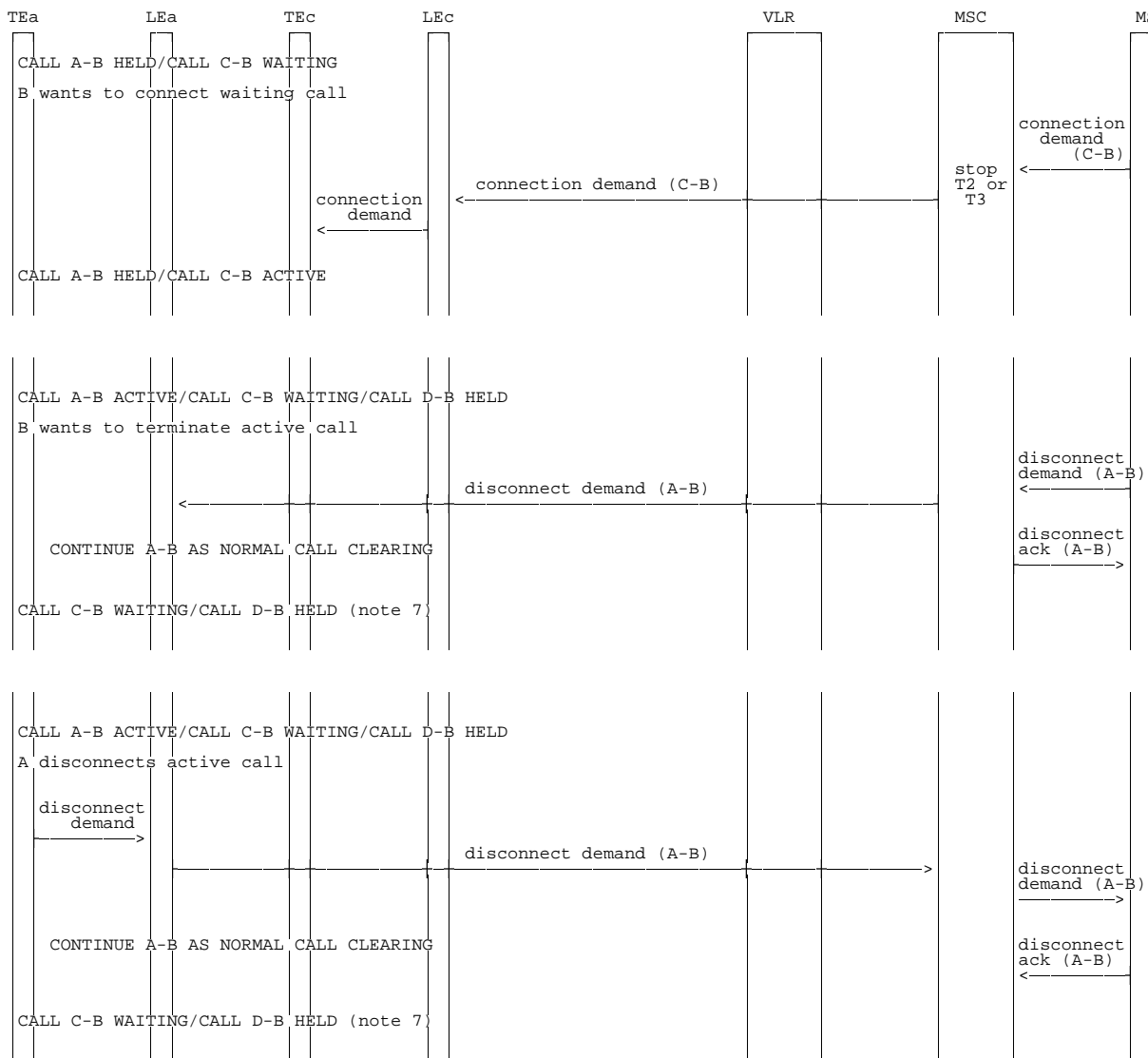

NOTE 7: This state can be treated as CALL C-B WAITING / CALL A-B HELD.

Figure 1.6 (sheet 6 of 7): Information flow for call waiting

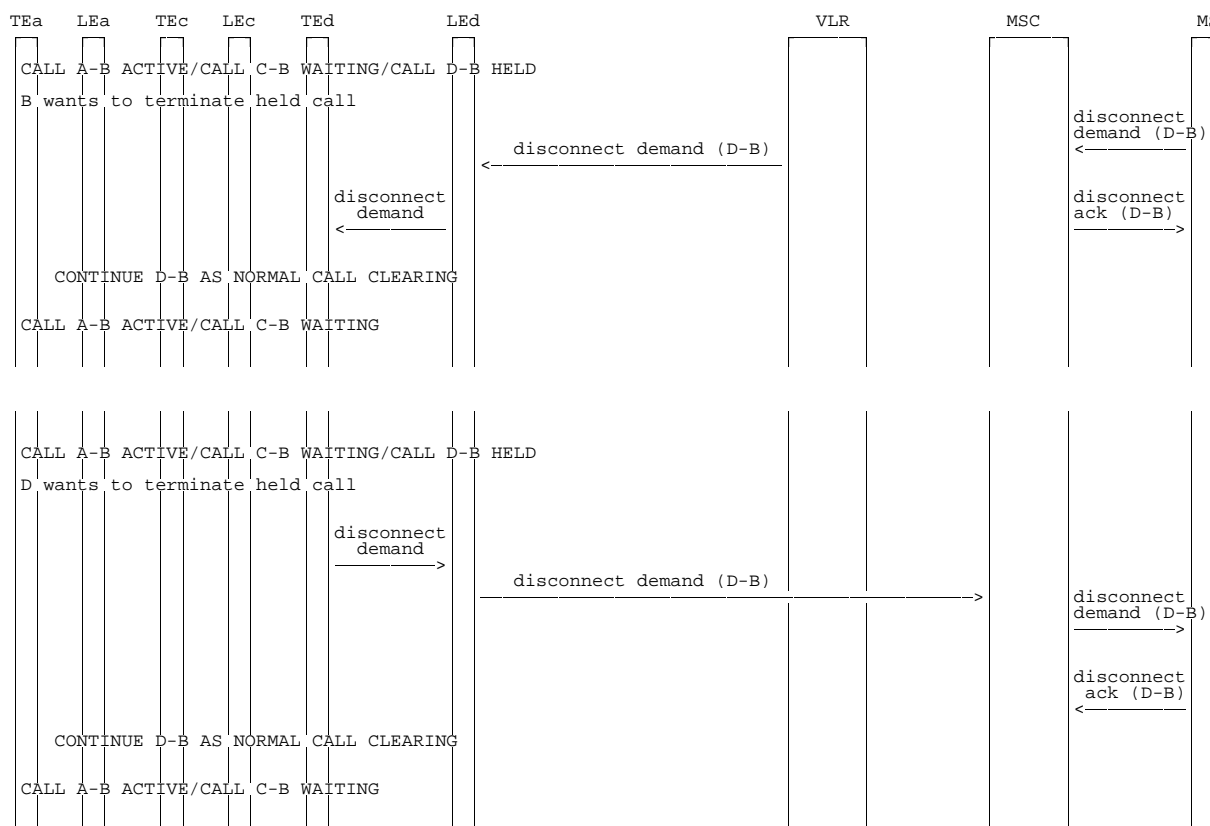

Figure 1.6 (sheet 7 of 7): Information flow for call waiting

1.3 Information stored in the HLR

Call waiting may have the following logical states (refer to TS 23.011 for an explanation of the notation):

Provisioning State	Registration State	Activation State	HLR Induction State
(Not Provisioned,	Not Applicable,	Not Active,	Not Induced)
(Provisioned,	Not Applicable,	Not Active,	Not Induced)
(Provisioned,	Not Applicable,	Active and Operative,	Not Induced)

The activation state may be different for each applicable elementary basic service group.

The provisioning state shall be on a per subscriber basis, and hence the same for all basic service groups.

The HLR shall store the logical state of the call waiting service (which shall be one of the valid states listed above) on a per elementary basic service group.

1.4 State transition model

The following figure shows the successful cases of transition between the applicable logical states of call waiting. The state changes are either caused by actions of the service provider or the mobile user.

Note that error cases are not shown in the diagram as they normally do not cause a state change. Additionally, some successful requests may not cause a state change. Hence they are not shown in the diagram.

The diagram only shows operations on elementary basic service groups.

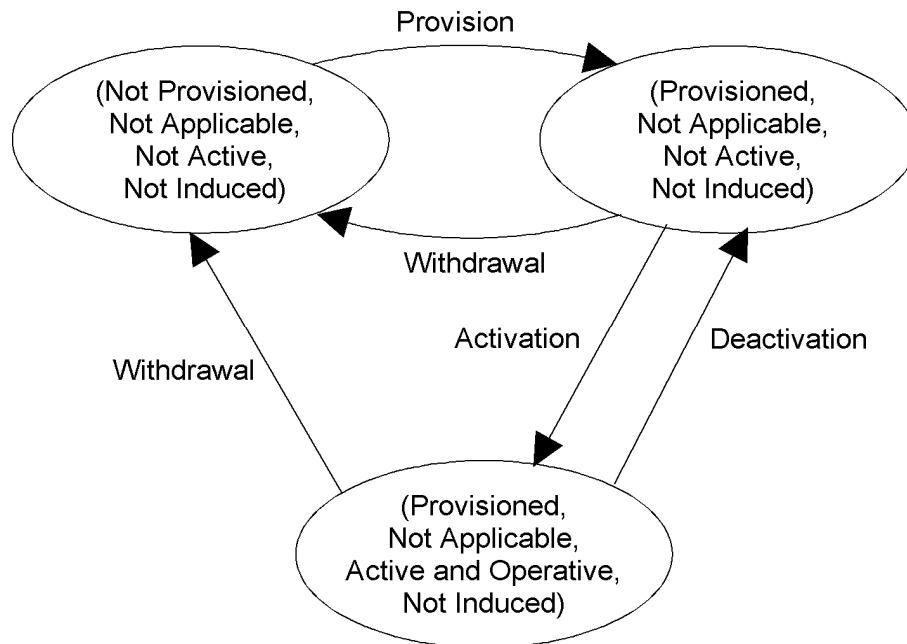

Figure 1.7: State transition model for call waiting

1.5 Transfer of information from HLR to VLR

If the provisioning state for call waiting is "Provisioned" then, when the subscriber registers on a VLR, the HLR shall send that VLR information about the logical state of call waiting.

If the logical state of call waiting is changed while a subscriber is registered on a VLR, then the HLR shall inform the VLR of the new logical state of call waiting.

1.6 Information stored in the VLR

For call waiting, the VLR shall store the service state information received from the HLR.

1.7 Handover

Handover will have no impact on the control procedures and the operation of the service.

2 Call hold (HOLD)

2.1 Functions and information flows

The following Mobile Additional Function has been identified for the call hold service:

MAF024

Call hold related authorizations examination

The ability of a PLMN component to determine the authorizations relating to call hold. See figure 2.1.

Location: VLR

The Indicator are shown in figures 2.2 a, 2.2b and 2.2c, respectively.

Procedure Process_Retrieve_Request: the process Subs_FSM is defined in 3GPP TS 23.018 [5].

Procedure Process_Hold_Request, procedure Process_Retrieve_Request: the variable On_Hold is set in the process OCH_MSC or the process ICH_MSC.

Procedure Handle_Timed_Call_Swap: the macro Decrement_Call_Counter is defined in 3GPP TS 23.018 [5].

All procedures: to avoid having two calls on hold at the same time (except as a transient effect during the handling of retrieve), the reception of the retrieve request is supervised by a retrieve timer T ($T = 5$ s).

All procedures: the network may receive hold and retrieve requests not included in this overall SDL. These requests will be rejected by the network.

All procedures: the handling of requests other than hold and retrieve requests is defined in the appropriate supplementary service specification.

The information flows are shown in figure 2.3. In these flows it is assumed that the served user is a mobile user and that other users are fixed network users.

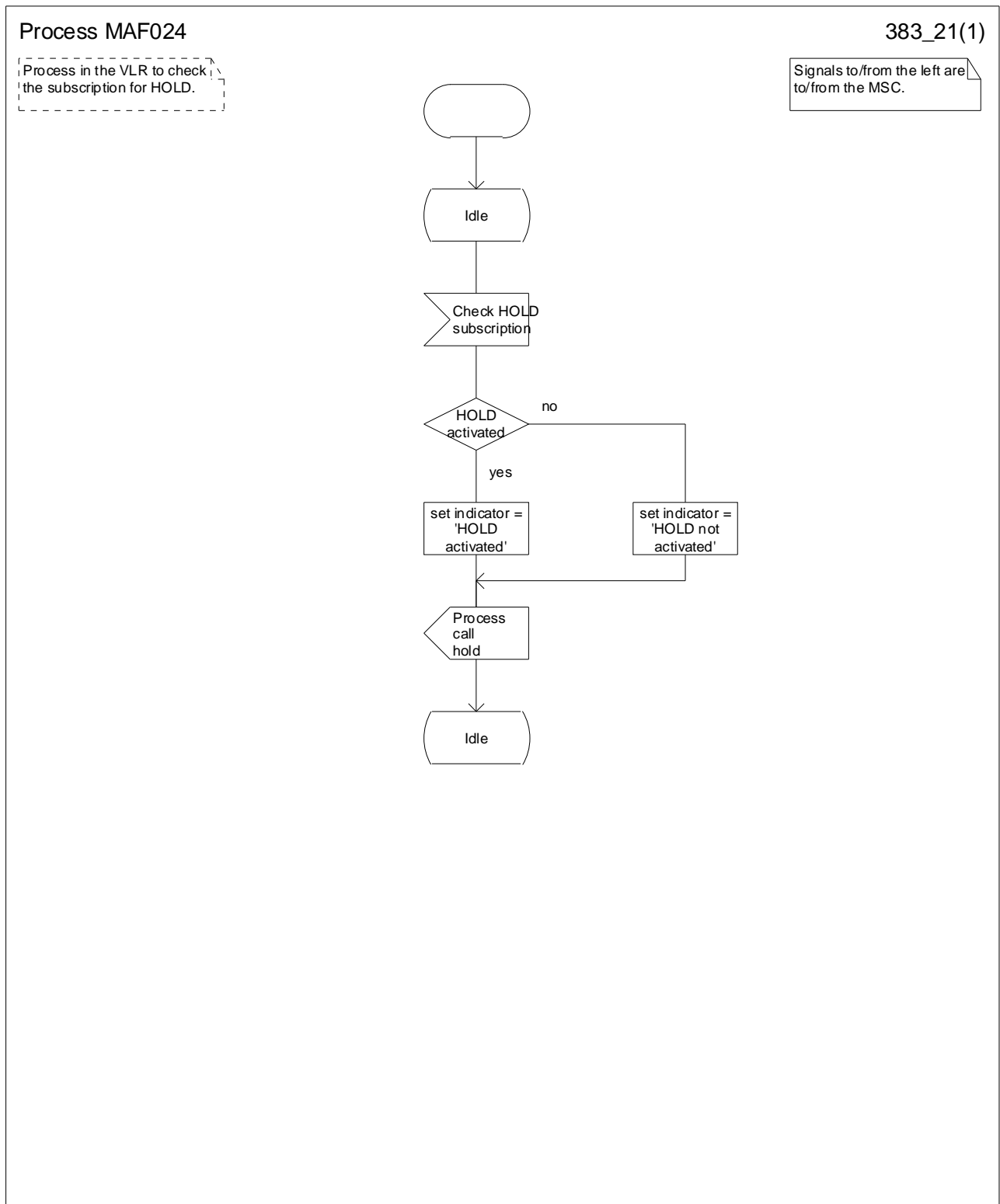

Figure 2.1: MAF024 Call hold related authorisations examination (VLR)

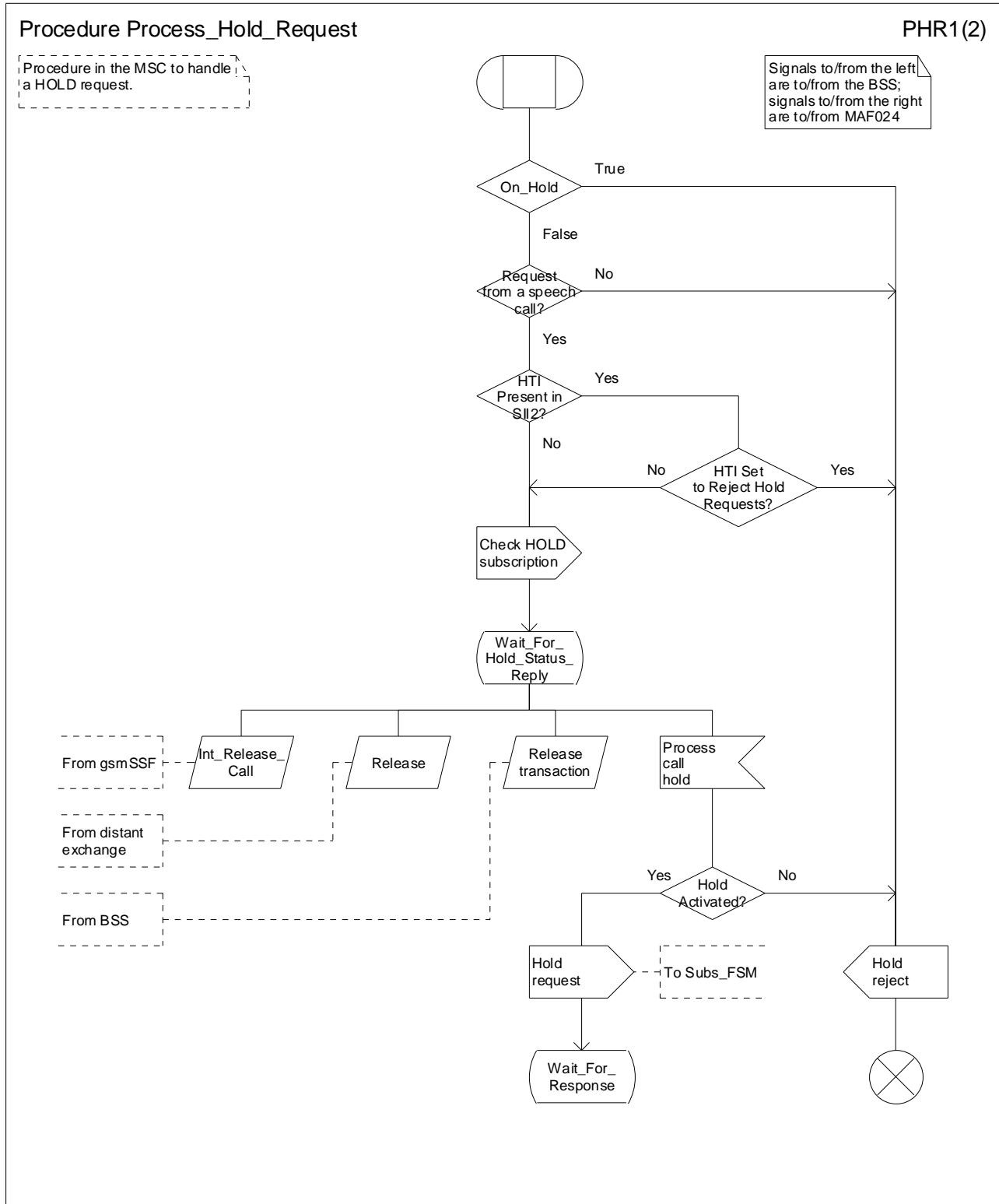

Figure 2.2a (sheet 1 of 2): Procedure Process_Hold_Request

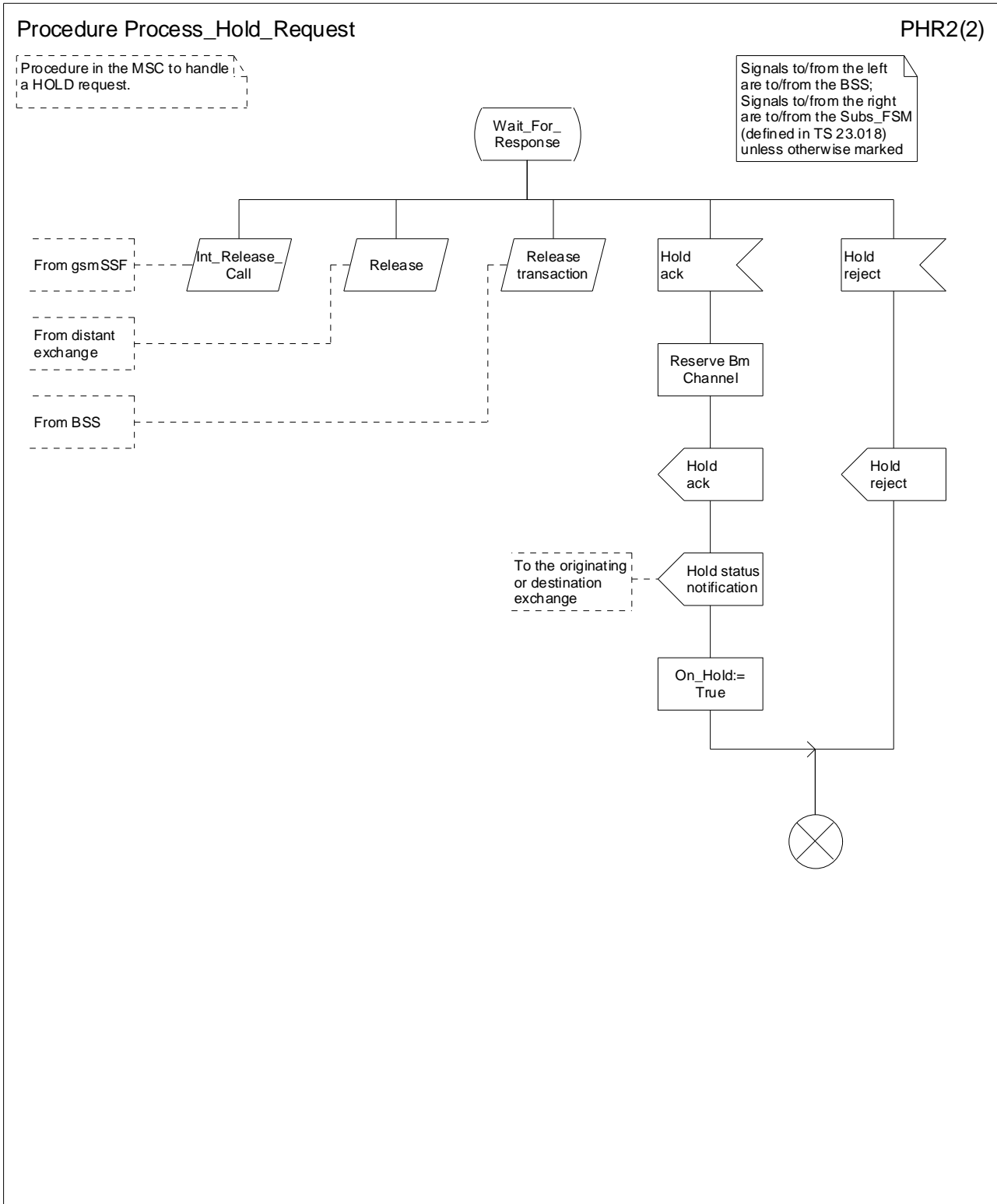

Figure 2.2a (sheet 2 of 2): Procedure Process_Hold_Request

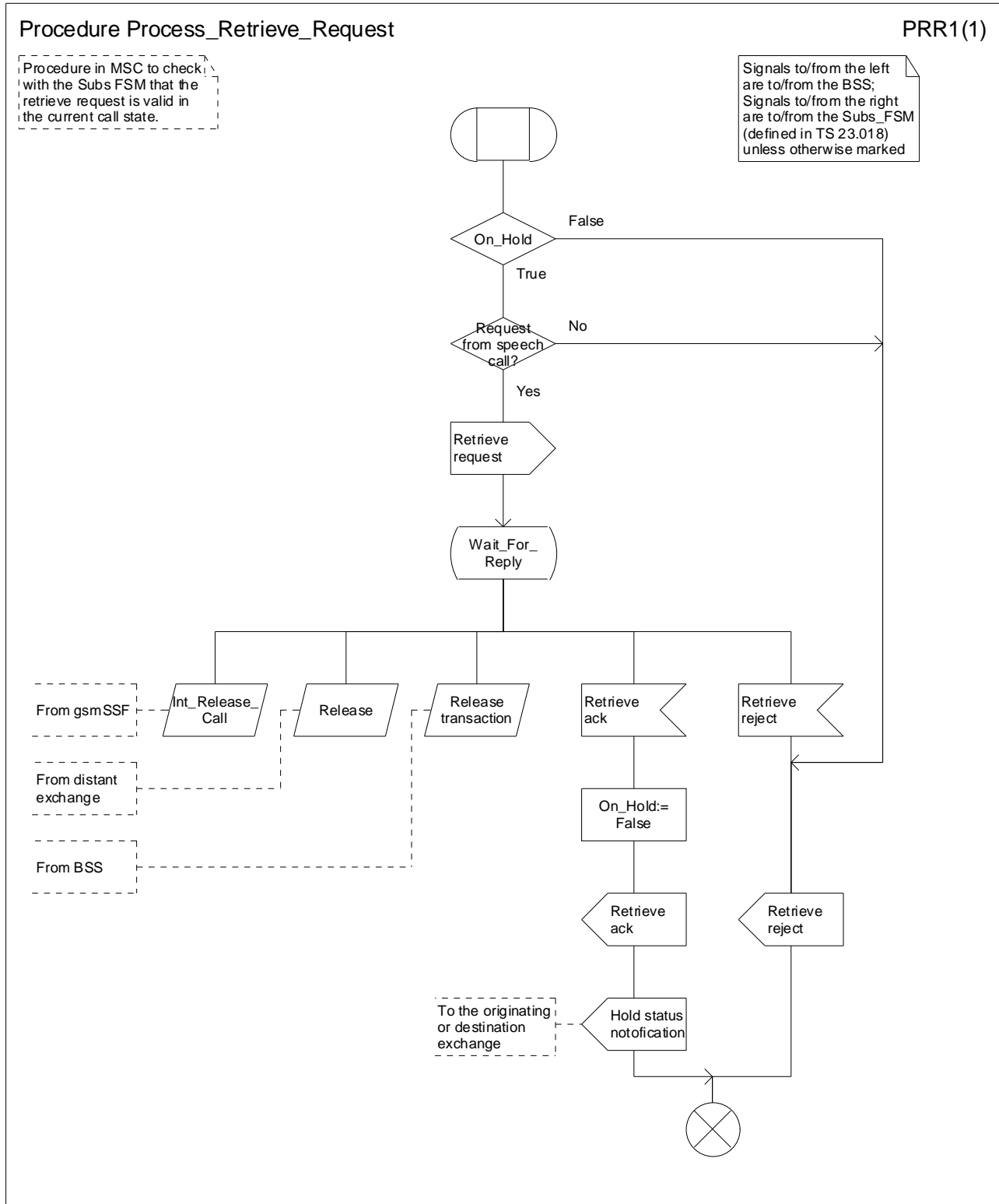

Figure 2.2b: Procedure Process_Retrieve_Request

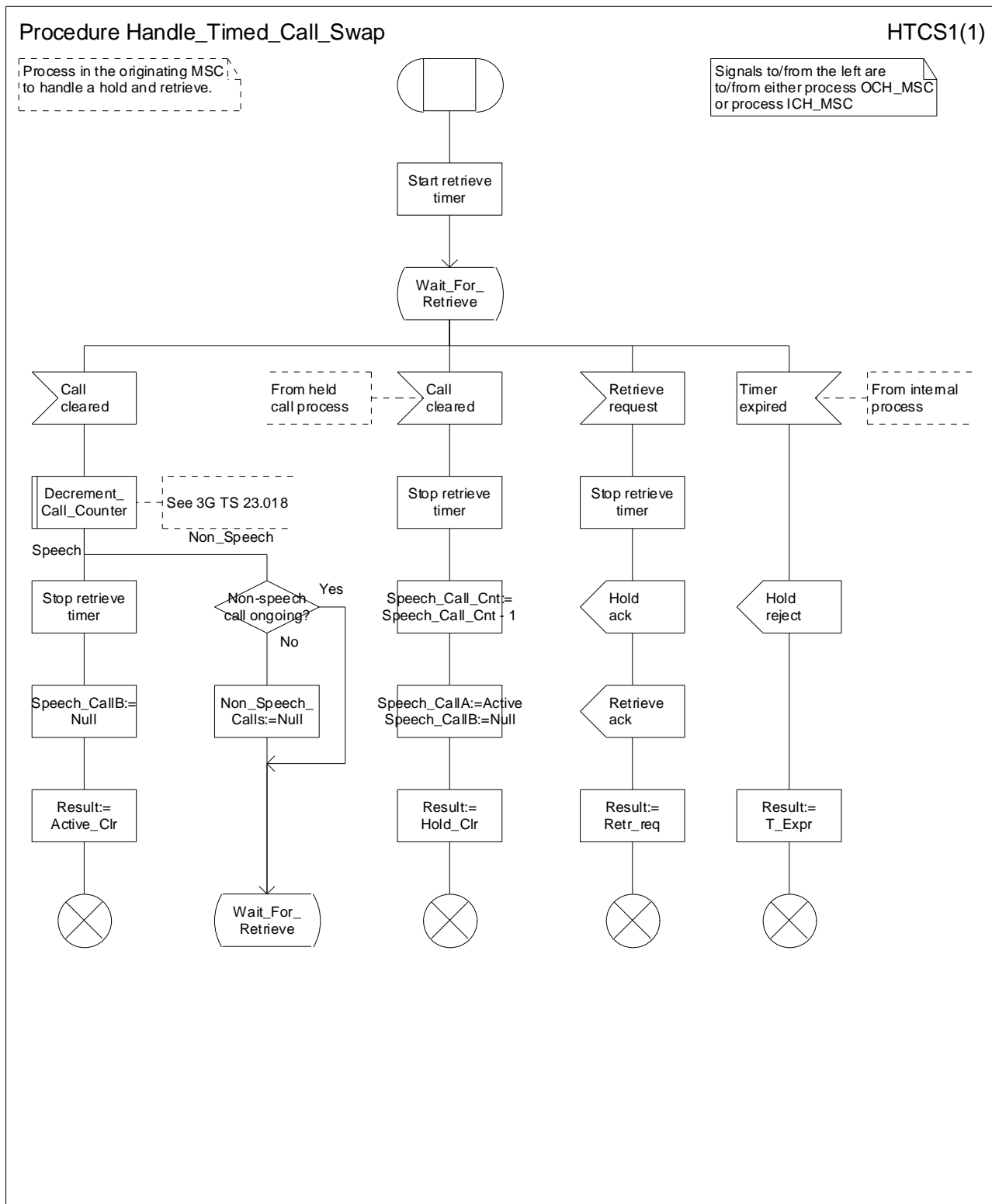
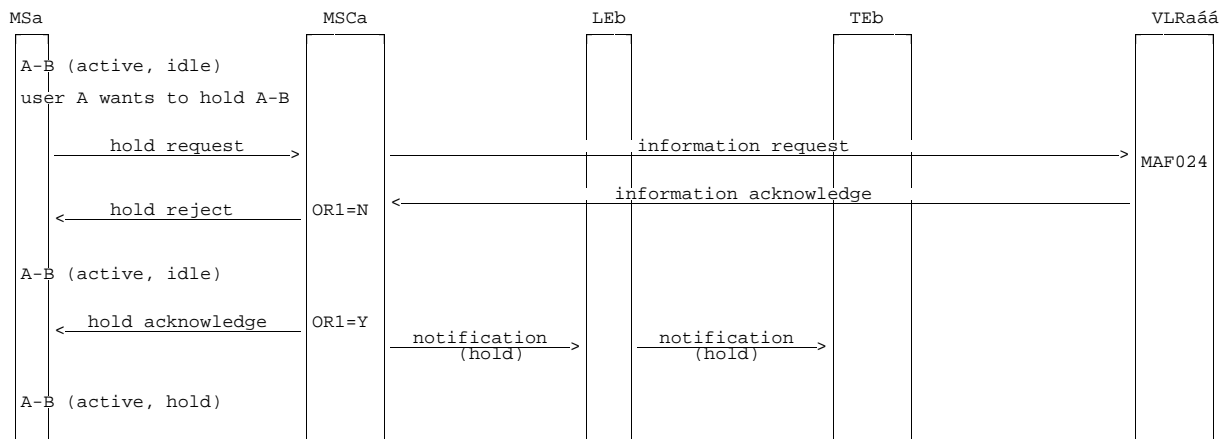

Figure 2.2c: Procedure Handle_Timed_Call_Swap



NOTE: OR1: call hold (Y: yes N: no)

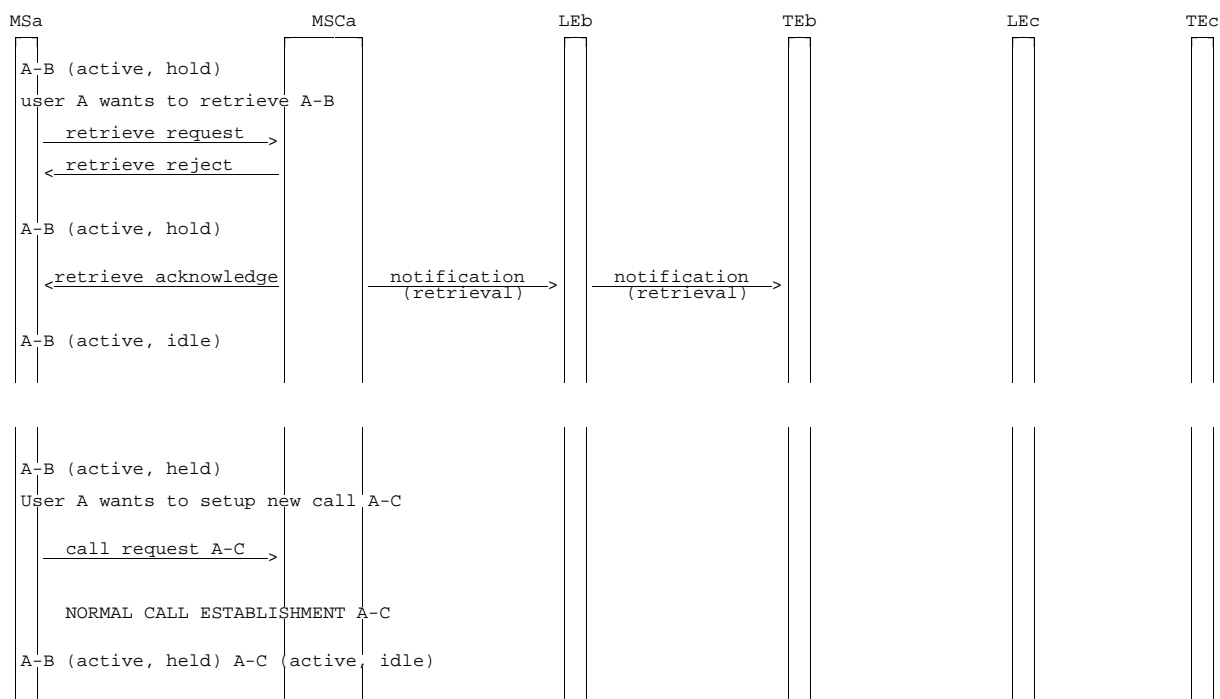

Figure 2.3 (sheet 1 of 3): Information flow for call hold

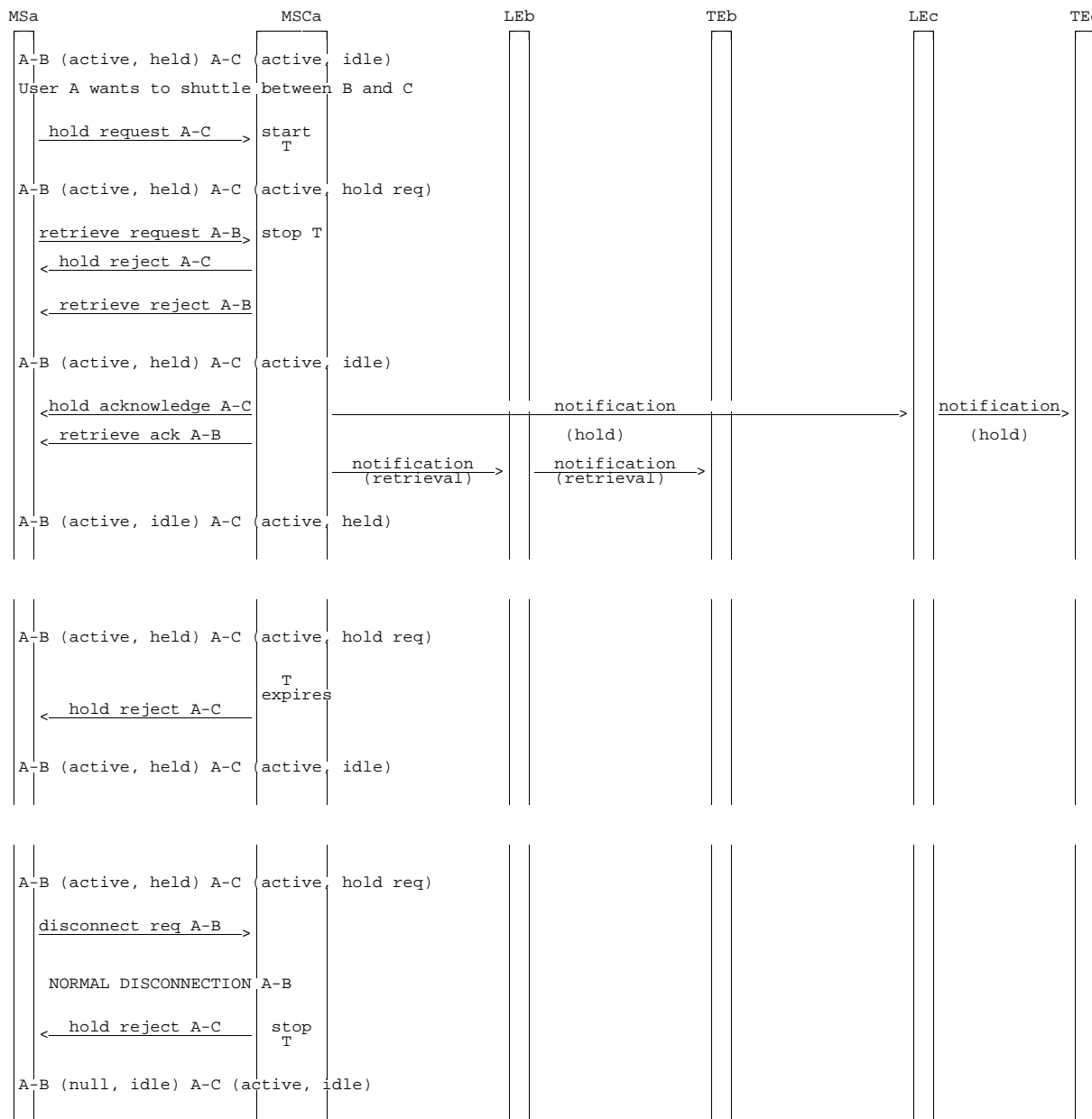

Figure 2.3 (sheet 2 of 3): Information flow for call hold

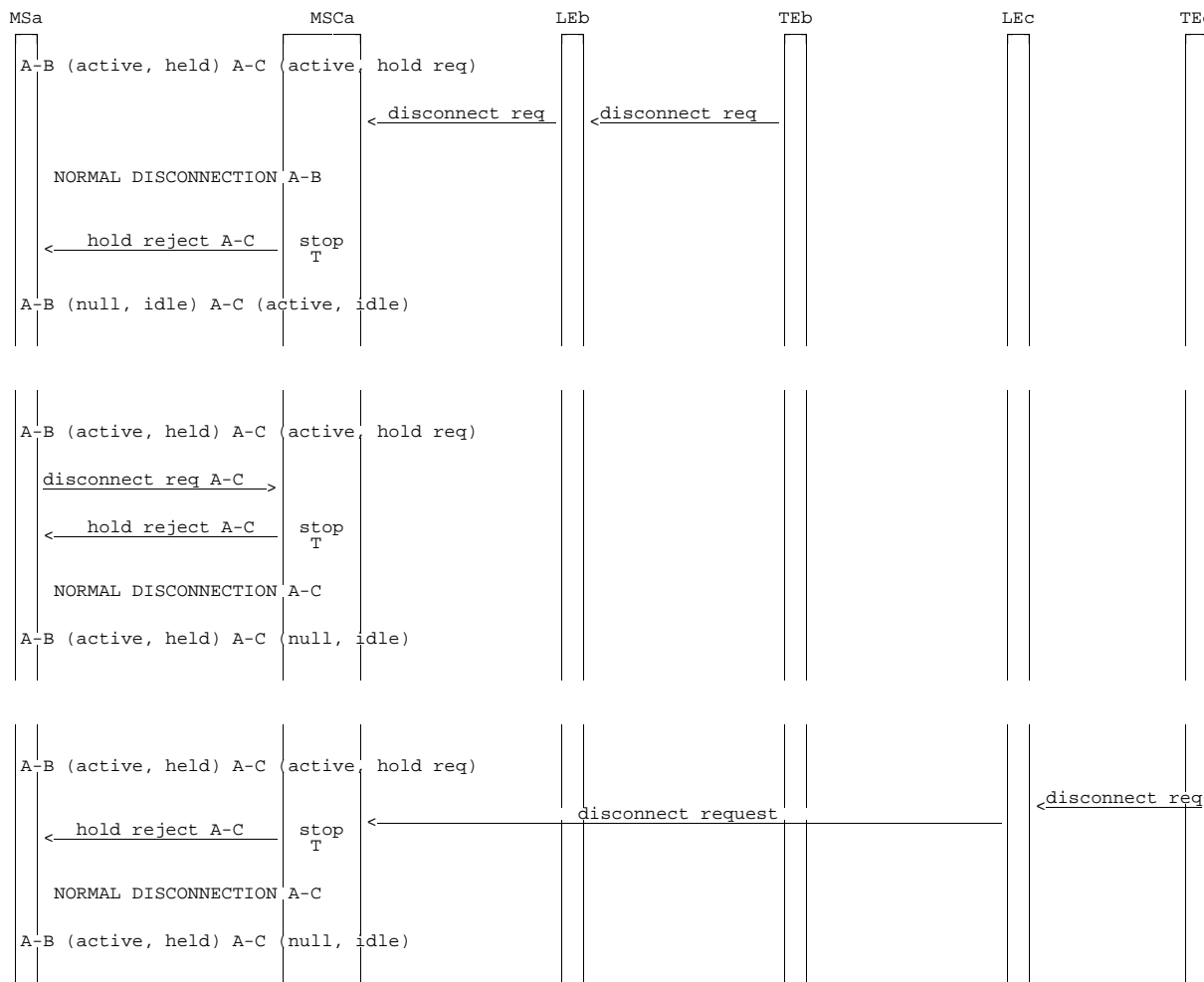

Figure 2.3 (sheet 3 of 3): Information flow for call hold

2.2 Information stored in the HLR

Call hold may have the following logical states (refer to TS 23.011 for an explanation of the notation):

Provisioning State	Registration State	Activation State	HLR Induction State
(Not Provisioned,	Not Applicable,	Not Active,	Not Induced)
(Provisioned,	Not Applicable,	Active and Operative,	Not Induced)

The HLR shall store the logical state of the call hold service (which shall be one of the valid states listed above) on a per subscriber basis.

2.3 State transition model

The following figure shows the successful cases of transition between the applicable logical states of call hold. The state changes are caused by actions of the service provider.

Note that error cases are not shown in the diagram as they normally do not cause a state change. Additionally, some successful requests may not cause a state change. Hence they are not shown in the diagram.

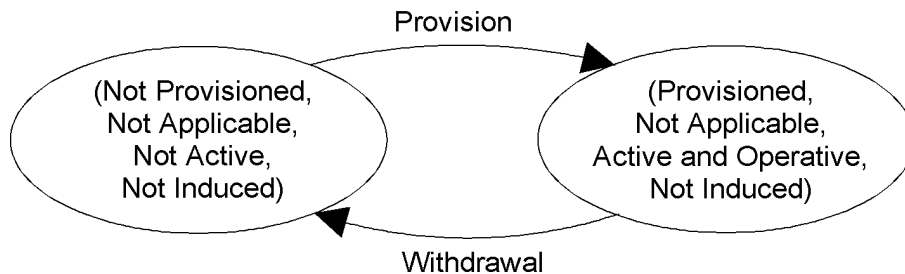

Figure 2.4: State transition model for call hold

2.4 Transfer of information from HLR to VLR

If the provisioning state for call hold is "Provisioned" then, when the subscriber registers on a VLR, the HLR shall send that VLR information about the logical state of call hold.

If the logical state of call hold is changed while a subscriber is registered on a VLR, then the HLR shall inform the VLR of the new logical state of call hold.

2.5 Information stored in the VLR

For call hold, the VLR shall store the service state information received from the HLR.

2.6 Handover

Handover will have no impact on the control procedures and the operation of the service.

Annex A: Change history

TSG CN#	Spec	CR	Rev	Phase	Cat	New Ver	Subject/Comment
CN#09	23.083	004	1	R99	F	3.2.0	SDL refresh
CN#09	23.083	005	1	Rel-4	D	4.0.0	Inclusion of call hold in basic call handling
CN#11	23.083	006	3	Rel-4	C	4.1.0	Enhancement of procedures for Call Hold
CN#11	23.083	007	1	Rel-4	C	4.2.0	Enhancement of CW procedures (Missed CR added; TSG agreed 007r1 at CN#11 -> v.4.2.0)
CN#14	23.083	008		Rel-4	F	4.3.0	Missing connector in procedure Process_Call_Waiting
CN#15	23.083	009	1	Rel-5	B	5.0.0	Introduction of CAMEL Phase 4
CN#17	23.083	010		Rel-5	F	5.1.0	Determining the basic service for MT calls
CN#26	23.083			Rel-6		6.0.0	Release 6 after CN#26
CT#36	23.083			Rel-7		7.0.0	Upgraded unchanged from Rel-6
CT#42	23.083			Rel-8		8.0.0	Upgraded unchanged from Rel-7
CT#46	23.083	-	-	Rel-9		9.0.0	Update to Rel-9 version (MCC)
2011-03	23.083	-	-	Rel-10		10.0.0	Update to Rel-10 version (MCC)
2012-09	23.083	-	-	Rel-11		11.0.0	Update to Rel-11 version (MCC)
2014-09	23.083	-	-	Rel-12		12.0.0	Update to Rel-12 version (MCC)
2015-12	23.083	-	-	Rel-13		13.0.0	Update to Rel-13 version (MCC)
2017-03	23.083	-	-	Rel-14		14.0.0	Update to Rel-14 version (MCC)
2018-06	23.083	-	-	Rel-15	-	15.0.0	Update to Rel-15 version (MCC)
2020-07	23.083	-	-	Rel-16	-	16.0.0	Update to Rel-16 version (MCC)

History

Document history		
V16.0.0	July 2020	Publication