

ETSI TS 123 172 V13.0.0 (2016-01)



TECHNICAL SPECIFICATION

**Universal Mobile Telecommunications System (UMTS);
Technical realization of Circuit Switched (CS)
multimedia service UDI/RDI fallback and service modification;
Stage 2
(3GPP TS 23.172 version 13.0.0 Release 13)**



Reference

RTS/TSGC-0323172vd00

Keywords

UMTS

ETSI

650 Route des Lucioles
F-06921 Sophia Antipolis Cedex - FRANCE

Tel.: +33 4 92 94 42 00 Fax: +33 4 93 65 47 16

Siret N° 348 623 562 00017 - NAF 742 C
Association à but non lucratif enregistrée à la
Sous-Préfecture de Grasse (06) N° 7803/88

Important notice

The present document can be downloaded from:
<http://www.etsi.org/standards-search>

The present document may be made available in electronic versions and/or in print. The content of any electronic and/or print versions of the present document shall not be modified without the prior written authorization of ETSI. In case of any existing or perceived difference in contents between such versions and/or in print, the only prevailing document is the print of the Portable Document Format (PDF) version kept on a specific network drive within ETSI Secretariat.

Users of the present document should be aware that the document may be subject to revision or change of status. Information on the current status of this and other ETSI documents is available at
<http://portal.etsi.org/tb/status/status.asp>

If you find errors in the present document, please send your comment to one of the following services:
<https://portal.etsi.org/People/CommiteeSupportStaff.aspx>

Copyright Notification

No part may be reproduced or utilized in any form or by any means, electronic or mechanical, including photocopying and microfilm except as authorized by written permission of ETSI.

The content of the PDF version shall not be modified without the written authorization of ETSI.
The copyright and the foregoing restriction extend to reproduction in all media.

© European Telecommunications Standards Institute 2016.
All rights reserved.

DECT™, **PLUGTESTS™**, **UMTS™** and the ETSI logo are Trade Marks of ETSI registered for the benefit of its Members.
3GPP™ and **LTE™** are Trade Marks of ETSI registered for the benefit of its Members and of the 3GPP Organizational Partners.
GSM® and the GSM logo are Trade Marks registered and owned by the GSM Association.

Intellectual Property Rights

IPRs essential or potentially essential to the present document may have been declared to ETSI. The information pertaining to these essential IPRs, if any, is publicly available for **ETSI members and non-members**, and can be found in ETSI SR 000 314: *"Intellectual Property Rights (IPRs); Essential, or potentially Essential, IPRs notified to ETSI in respect of ETSI standards"*, which is available from the ETSI Secretariat. Latest updates are available on the ETSI Web server (<https://ipr.etsi.org/>).

Pursuant to the ETSI IPR Policy, no investigation, including IPR searches, has been carried out by ETSI. No guarantee can be given as to the existence of other IPRs not referenced in ETSI SR 000 314 (or the updates on the ETSI Web server) which are, or may be, or may become, essential to the present document.

Foreword

This Technical Specification (TS) has been produced by ETSI 3rd Generation Partnership Project (3GPP).

The present document may refer to technical specifications or reports using their 3GPP identities, UMTS identities or GSM identities. These should be interpreted as being references to the corresponding ETSI deliverables.

The cross reference between GSM, UMTS, 3GPP and ETSI identities can be found under <http://webapp.etsi.org/key/queryform.asp>.

Modal verbs terminology

In the present document "**shall**", "**shall not**", "**should**", "**should not**", "**may**", "**need not**", "**will**", "**will not**", "**can**" and "**cannot**" are to be interpreted as described in clause 3.2 of the [ETSI Drafting Rules](#) (Verbal forms for the expression of provisions).

"**must**" and "**must not**" are **NOT** allowed in ETSI deliverables except when used in direct citation.

Contents

Intellectual Property Rights	2
Foreword.....	2
Modal verbs terminology.....	2
Foreword.....	5
1 Scope	6
2 References	6
3 Definitions and abbreviations.....	7
3.1 Definitions	7
3.2 Abbreviations	7
4 Service change and fallback for UDI/RDI multimedia	7
4.1 General Requirements	7
4.2 Access Call Control Signalling	8
4.2.1 Mobile originating side - initiation of call setup	8
4.2.1.1 Subscription checking	9
4.2.1.1.1 Send Info For Outgoing Call	9
4.2.1.1.2 Complete Call.....	10
4.2.2 Mobile terminating side	10
4.2.2.1 Subscription checking	11
4.2.2.1.1 Send Info For Incoming Call	11
4.2.2.1.2 Complete Call.....	11
4.2.3 Mobile originating side - completion of call setup	11
4.2.4 User-initiated Service change in the active state.....	13
4.2.5 Network-initiated Service change in the active state	14
4.2.5.1 Network-initiated Service change in the active state starting with multimedia in Iu mode	16
4.2.5.2 Network-initiated Service change in the active state starting with speech in Iu mode.....	17
4.3 Core Network procedures.....	22
4.3.1 Multimedia codec	23
4.3.2 Originating side - initiation of call setup	23
4.3.2.1 Originating MSC Handling	23
4.3.2.2 VMSC Handling at Originating Side	24
4.3.3 Terminating side	24
4.3.3.1 HLR Interrogation.....	24
4.3.3.1.1 Send Routing Info.....	25
4.3.3.1.2 Send Routing Info Ack.....	25
4.3.3.1.3 Handling of mobile terminating calls in the HLR	26
4.3.3.1.4 Handling of mobile terminating calls in the GMSC	33
4.3.3.1a GMSC Handling at Terminating Side	36
4.3.3.2 Terminating MSC Handling.....	36
4.3.4 Originating side - completion of call setup.....	39
4.3.5 Service change during the active state	40
4.3.5.1 Mid-Call Codec Modification Procedure For Service Change	41
4.3.5.2 Unsuccessful Service Change	51
4.3.6 Interaction with supplementary services.....	55
4.3.6.1 Call forwarding and Call deflection	55
4.3.6.2 Closed User Group (CUG).....	56
4.3.6.3 Call barring	56
4.3.7 Interactions with CAMEL	56
4.3.7.1 Interaction at call setup	56
4.3.7.2 Interaction at call answer	56
4.3.7.3 Interaction with Call Party Handling.....	56
4.3.7.4 Interaction with CAMEL in-band information and user interaction	57
4.3.7.5 Interaction during service change	57
4.3.8 Interworking with external networks	57

4.3.9 User interaction and in-band information57

5 Lawful Interception58

Annex A (informative): Change history59

History60

Foreword

This Technical Specification has been produced by the 3rd Generation Partnership Project (3GPP).

The contents of the present document are subject to continuing work within the TSG and may change following formal TSG approval. Should the TSG modify the contents of the present document, it will be re-released by the TSG with an identifying change of release date and an increase in version number as follows:

Version x.y.z

where:

- x the first digit:
 - 1 presented to TSG for information;
 - 2 presented to TSG for approval;
 - 3 or greater indicates TSG approved document under change control.
- y the second digit is incremented for all changes of substance, i.e. technical enhancements, corrections, updates, etc.
- z the third digit is incremented when editorial only changes have been incorporated in the document.

1 Scope

The present document describes the Service Change and UDI Fallback (SCUDIF) feature. This service is available to UDI/RDI multimedia calls and allows users to achieve successful call establishment when end to end circuit-switched (CS) multimedia is not possible (fallback to speech) or when signalling of the feature is not possible in the network (fallback to preferred service or speech). Furthermore, it allows the users to swap between a multimedia service and basic speech during an established call.

NOTE: In the present document, the term "multimedia" refers to UDI/RDI multimedia unless specifically stated.

2 References

The following documents contain provisions, which, through reference in this text, constitute provisions of the present document.

- References are either specific (identified by date of publication and/or edition number or version number) or non-specific.
- For a specific reference, subsequent revisions do not apply.
- For a non-specific reference, the latest version applies. In the case of a reference to a 3GPP document (including a GSM document), a non-specific reference implicitly refers to the latest version of that document *in the same Release as the present document*.

- [1] 3GPP TR 21.905: "Vocabulary for 3GPP Specifications".
- [2] 3GPP TS 23.153: "Out of Band Transcoder Control; Stage 2".
- [3] 3GPP TS 24.008: "Mobile Radio Interface Layer 3 specification; Core network protocols; Stage 3".
- [4] 3GPP TS 26.103: "Speech Codec List for GSM and UMTS".
- [5] 3GPP TS 27.001: "General on Terminal Adaptation Functions (TAF) for Mobile Stations (MS)".
- [6] 3GPP TS 29.007: "General requirements on interworking between the Public Land Mobile Network (PLMN) and the Integrated Services Digital Network (ISDN) or Public Switched Telephone Network (PSTN)".
- [7] 3GPP TS 29.205: "Application of Q.1900 series to bearer-independent circuit-switched core network architecture; Stage 3".
- [8] 3GPP TS 22.101: "Service aspects; Service principles".
- [9] 3GPP TS 33.106: "3GPP Security; Lawful Interception Requirements".
- [10] 3GPP TS 23.018: "Basic Call Handling; Technical realization".
- [11] 3GPP TS 23.003: "Numbering, addressing and identification".
- [12] 3GPP TS 29.232: "Media Gateway Controller (MGC) – Media Gateway (MGW) Interface; Stage 3".
- [13] 3GPP TS 26.102: "Mandatory Speech Codec; AMR Speech Codec; Interface to Iu, Uu, Nb".
- [14] 3GPP TS 23.078: "Customised Applications for Mobile network Enhanced Logic (CAMEL) ; Stage 2".
- [15] 3GPP TS 23.082: "Call Forwarding (CF) supplementary services, Stage 2".
- [16] 3GPP TS 22.078: "Customised Applications for Mobile network Enhanced Logic (CAMEL); Service description, Stage 1".

- [17] 3GPP TS 25.413: "UTRAN Iu interface RANAP signalling".
- [18] IETF RFC 4040: "RTP Payload Format for a 64 kbit/s Transparent Call"

3 Definitions and abbreviations

3.1 Definitions

For the purposes of the present document, the terms and definitions given in 3GPP TR 21.905 [1] and the following apply:

fallback: when two services (multimedia and speech) are proposed but only one of them is available or wanted, only the service available (preferred or less preferred) is selected, and the other one is discarded

service change: when two services (multimedia and speech) are available during the active state of a call, users may request a service change to switch between the two services

3.2 Abbreviations

For the purposes of the present document, the abbreviations given in 3GPP TR 21.905 [1] and the following apply:

BC	Bearer Capability
BC1	First Bearer Capability in a message (preferred service)
BC2	Second Bearer Capability in a message (less preferred service)
BCa	Bearer Capability of the currently selected service
BCb	Bearer Capability of the service to switch to
BCmm	Bearer Capability multimedia
BCSM	Basic Call State Model
BCsp	Bearer Capability speech
CAMEL	Customised Applications for Mobile network Enhanced Logic
DP	Detection Point
IE	Information Element
MMI	Man-Machine Interface
O-MSC	Originating MSC
OoBTC	Out-of-Band Transcoder Control
O-UE	Originating UE
RI	Repeat Indicator
SCUDIF	Service Change and UDI/RDI Fallback
T-MSC	Terminating MSC
T-UE	Terminating UE

4 Service change and fallback for UDI/RDI multimedia

4.1 General Requirements

The Service Change and UDI Fallback (SCUDIF) is a function which applies to UDI/RDI multimedia calls (see 3GPP TS 22.101 [8], clause 7.2.1), and shall support the following:

- Fallback to speech during call setup: allow a user to attempt to set up a multimedia call, and try a speech connection if the former doesn't succeed;
- Fallback to the less preferred service (speech or multimedia) during call setup: allow the terminating side via specific settings for this service in the terminal to accept or reject a multimedia call, without interrupting the call setup;
- Fallback to the preferred service (speech or multimedia) or speech during call setup: allow the call setup to proceed with a single service if the transit network does not support the signalling of this functionality;

- d) BC negotiation at the terminating side: allow the terminating side via specific settings for this service in the terminal to turn a speech call (with service change) into a multimedia call and vice-versa;
- e) Service change: allow a speech call to be turned to multimedia by either of parties, and back to speech, through a successful in call modification procedure;
- f) Allow any of the users to reject a multimedia request from the other party while in speech mode.
- g) Network-initiated service change: The network shall initiate a service-change from multimedia to speech during the active call if a multimedia call can no longer be supported. If a multimedia call can again be supported at a later point in time, the network may initiate a service change from speech to multimedia.

To fulfil:

- service request signalling between the UE and the MSC;
- service request signalling across the Core Network.

This functionality is not supported for multimedia with Fixed Network User Rate set to 32 kbit/s. In this case, the MSC shall revert to a multimedia only call.

4.2 Access Call Control Signalling

Using the repeat indicator value "support of service change and fallback", as described in 3GPP TS 24.008 [3], clause 5.3.6, together with two BC-IEs, a multimedia and a speech, it is possible to request a service change and fallback functionality, while still maintaining the backwards compatibility with non-supporting terminals.

4.2.1 Mobile originating side - initiation of call setup

By sending a SETUP message with a Repeat Indicator set to "support of service change and fallback", a multimedia BC-IE, and a speech BC-IE (see figure 4.1), a terminal may request a call to be set with the capability to fallback to either a speech only, a multimedia only call or to use service change later during the active state of the call (the first BC-IE indicates the preferred service). If the terminal supports Network-initiated service upgrade to multimedia, then it shall also indicate this in the SETUP message with the "Enhanced Network-initiated ICM" (ENICM) Capability (see 3GPP TS 24.008[3]).

After checking the provisioning (see subclause 4.2.1.1), and verifying that the functionality is supported, the MSC replies in the CALL PROCEEDING message with either the two BCs in the same order (to indicate that it accepts the proposed settings - see figure 4.2), or with a single BC (multimedia or speech - see figure 4.3) unless the CALL PROCEEDING is delayed until the response from the terminating user and then it may also be sent with the BCs in reverse order (see clause 4.2.3).

In the case the MSC ignores the SETUP message if the presence of a reserved value for the Repeat Indicator is set, it sends a STATUS message back to the UE (see figure 4.4), with the Cause Value set to #100, "Conditional IE error" (see 3GPP TS 24.008 [3], clause 8.7.2). The UE then reacts as described in 3GPP TS 24.008 [3], clause 5.5.3.2.2, and may resend a new SETUP message with a single BC, or perform any appropriate action according to its implementation. This also applies in case the MSC returns instead a RELEASE COMPLETE message.

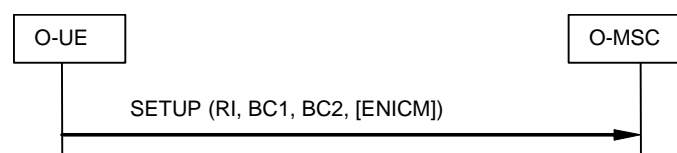

Figure 4.1: SETUP message towards the originating MSC

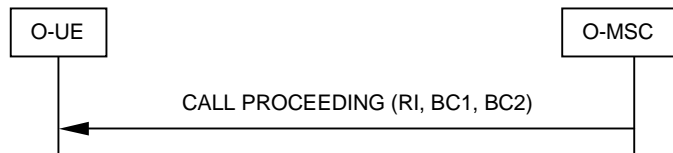
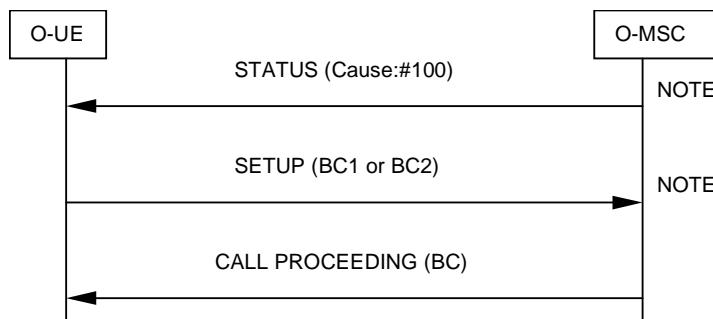

Figure 4.2: Normal case



Figure 4.3: Fallback case



NOTE: The sending of the STATUS message from the MSC and the second SETUP message from the UE are implementation dependent.

Figure 4.4: MSC not supporting the RI value

4.2.1.1 Subscription checking

The functional behaviour of the originating MSC and VLR is specified in 3GPP TS 23.018 [10]. The procedure specific to SCUDIF is specified in this subclause:

For mobile originated SCUDIF calls, the MSC shall convert both PLMN bearer capability 1 and PLMN bearer capability 2 to two individual Basic Service codes and send them in Send Info For Outgoing Call. The VLR shall check the subscription for those basic services, then indicates the availability of each basic service to the MSC by Complete Call. If both services are not provisioned, the VLR shall send Send Info For Outgoing Call negative response to the MSC. The MSC shall fall back to the allowed service if the availability of only one service is indicated. The MSC shall continue as a SCUDIF call if the availability of both services is indicated.

4.2.1.1.1 Send Info For Outgoing Call

Send Info For Outgoing Call contains the following SCUDIF specific information elements:

Information element name	Status	Description
Bearer service2	C	Bearer service 2 required for the MO call, derived from the PLMN bearer capability 2 information received in the set-up request from the MS. For a SCUDIF call, one of bearer service 2 or teleservice 2 shall be present.
Teleservice2	C	Teleservice 2 required for the MO call, derived from the PLMN bearer capability 2 information received in the set-up request from the MS. For a SCUDIF call, one of bearer service 2 or teleservice 2 shall be present.

4.2.1.1.2 Complete Call

Complete Call contains the following SCUDIF specific information elements:

Information element name	Status	Description
First service availability	C	Shall be present for a MO SCUDIF call if the Bearer service or Teleservice is allowed; otherwise shall be absent.
Second service availability	C	Shall be present for a MO SCUDIF call if the Bearer service 2 or Teleservice 2 is allowed; otherwise shall be absent.

4.2.2 Mobile terminating side

When the terminating MSC receives a request for a multimedia call, it shall check if the called user is provisioned for the service (see subclause 4.2.2.1).

The terminating MSC shall include in the SETUP message towards the UE both BC-IEs in the same order as indicated by the incoming request together with the Repeat Indicator set to "service change and fallback in order to invoke the SCUDIF functionality in the called terminal (see figure 4.5).

The terminating UE, based on its capabilities and internal settings, may return the two BC-IEs in the same order (to indicate that it accepts the proposed settings - see figure 4.6), reversed order (see figure 4.7), or just one BC-IE (either speech or multimedia - see figure 4.8) to the terminating MSC in the CALL CONFIRMED message. If the terminal supports Network-initiated service upgrade to multimedia, then it shall also indicate this in the CALL CONFIRMED message with the "Enhanced Network-initiated ICM" (ENICM) Capability (see 3GPP TS 24.008[3]).

In the case the UE ignores the SETUP message due to the presence of a reserved value for the Repeat Indicator, it sends a STATUS message back to the terminating MSC (see figure 4.9), with the Cause Value set to #100, "Conditional IE error" (see 3GPP TS 24.008 [3], clause 8.7.2). The terminating MSC shall then react according to 3GPP TS 24.008 [3], clause 5.5.3.2.2 and it shall send a new SETUP message with a single BC, either the preferred service BC-IE or the speech BC-IE (fallback to speech), depending on configuration. The call setup then proceeds accordingly.

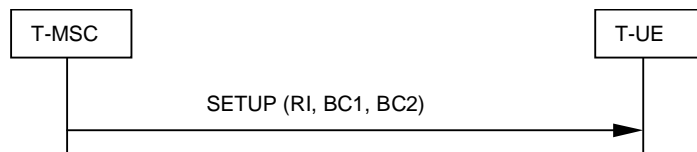

Figure 4.5: SETUP message towards the terminating UE

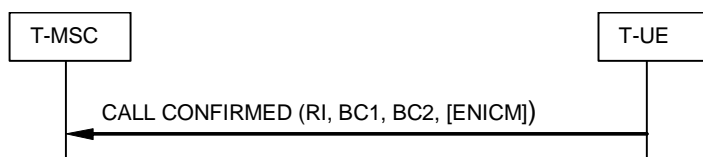

Figure 4.6: Normal case



Figure 4.7: Reversed call setup

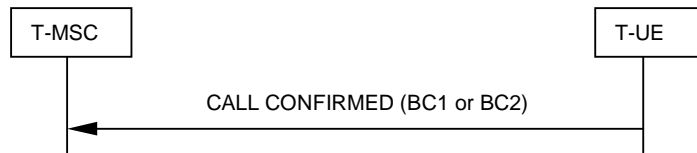

Figure 4.8: Fallback case

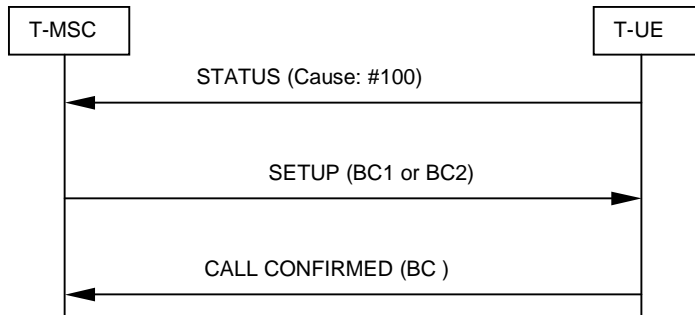

Figure 4.9: UE not supporting the RI value

4.2.2.1 Subscription checking

The functional behaviour of the terminating MSC and VLR is specified in 3GPP TS 23.018 [10]. The procedure specific to SCUDIF calls is specified in this subclause.

For mobile terminating SCUDIF calls, the MSC shall convert the services received in the incoming request to two individual Basic Service codes, and include them in Send Info For Incoming Call. The VLR shall check the subscription for those basic services, then indicate the availability of each basic service to the MSC by Complete Call. If both services are not provisioned, the VLR shall send Send Info for Incoming Call negative response to the MSC. The MSC shall fall back to the allowed service if the availability of only one service is indicated. The MSC shall continue as a SCUDIF call if the availability of both services is indicated.

4.2.2.1.1 Send Info For Incoming Call

Send Info For Incoming Call contains the following SCUDIF specific information elements:

Information element name	Required	Description
Bearer Service 2	C	Bearer Service 2 required for the MT call, derived from the less preferred service indicated in the incoming IAM of a SCUDIF call. For a SCUDIF call, one of Bearer service 2 or Teleservice 2 shall be present.
Teleservice 2	C	Teleservice 2 required for the MT call, derived from the less preferred service indicated in the incoming IAM of a SCUDIF call. For a SCUDIF call, one of Bearer service 2 or Teleservice 2 shall be present.

4.2.2.1.2 Complete Call

The parameters described in subclause 4.2.1.1.2 "Complete Call" for the mobile originating MSC are also applicable to the mobile terminating MSC.

4.2.3 Mobile originating side - completion of call setup

If the preferred mode, that is the first BC-IE indicated by the originating UE, was selected as the result of negotiations, the call shall be set up normally towards the originating UE.

If the negotiation resulted in a change of the selected mode, i.e. the call was set up as "multimedia first" and changed during the negotiation to a speech call, or vice-versa, because of either fallback or change of selected mode and the Call Proceeding message has been sent then an In-Call Modification procedure (see 3GPP TS 24.008 [3], clause 5.3.4.3) shall be initiated towards the originating UE after the call control entity has entered the active state, i.e. the CONNECT message has been sent.

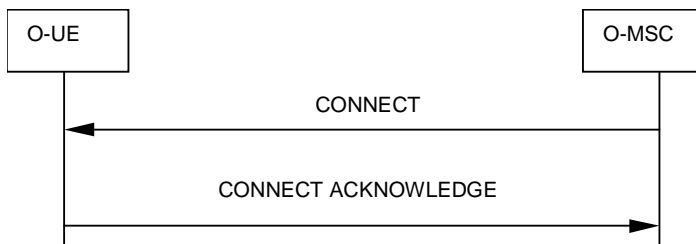

Figure 4.10: Preferred mode selected

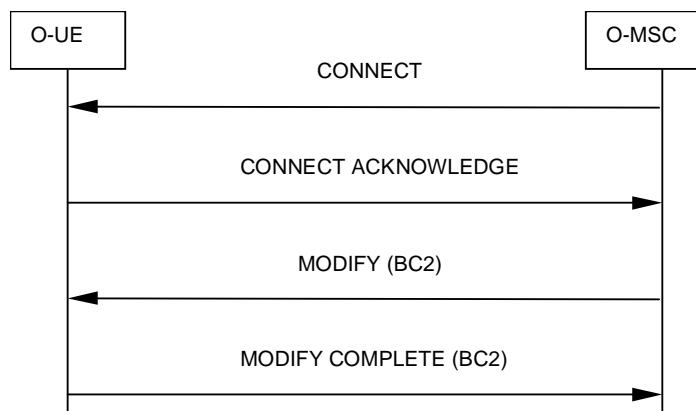

Figure 4.11: Less preferred mode selected, accepted

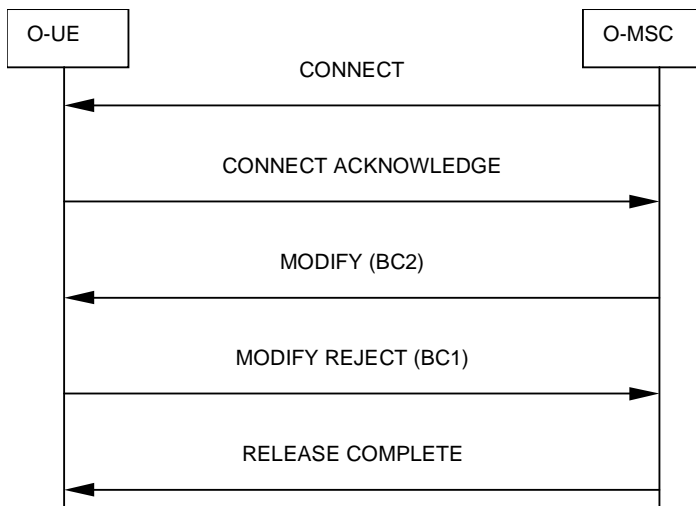

Figure 4.12: Less preferred mode selected, rejected

If the Call Proceeding message is delayed until response from the terminating side then it may include one or both BCs either in the order requested from the Originating UE or the order of the BCs may be reversed, depending on the result from the negotiation or (single BC) due to fallback. See Figure 4.12a.

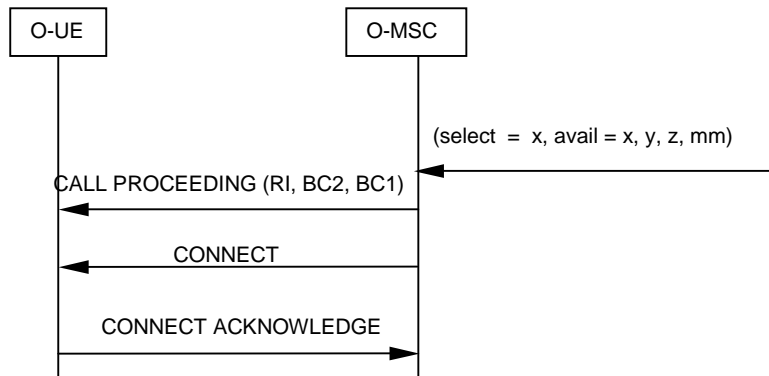

Figure 4.12a: Call Proceeding Delayed

4.2.4 User-initiated Service change in the active state

At any given time, if either of the call parties wants to change from the current active mode to the other mode via MMI, the terminal shall activate an In-Call Modification procedure. Using this procedure, described in 3GPP TS 24.008 [3], clause 5.3.4.3, the UE shall send a MODIFY message containing the BC-IE to change to. This BC-IE shall be one of those already negotiated at call setup.

As a result, the MSC shall then invoke the service change procedure (see clause 4.3.5). If the request is accepted, the originating MSC sends a MODIFY COMPLETE message to the UE including the BC-IE of the mode to switch to (see figure 4.13). If the request is rejected, the MSC sends a MODIFY REJECT message to the UE including the BC-IE from the current active mode (see figure 4.14).

In the case the MSC has determined that the other mode is unavailable (e.g. a fallback to either mode has occurred), it shall reject the MODIFY request at once by replying with a MODIFY REJECT message.

On the remote side, the MSC shall initiate an In-Call Modification procedure towards the terminal using the MODIFY message. For a service change from speech to multimedia, the terminal shall request confirmation from the user unless configured differently. For a service change from multimedia to speech, the terminal shall accept the request without requesting confirmation from the user. If the change is accepted, the UE shall reply to the MSC with a MODIFY COMPLETE message, whereas a MODIFY REJECT message shall be sent if the change is rejected.

NOTE: Privacy concerns strongly advise that any change to multimedia mode, unless explicitly allowed by the user in the terminal configuration settings, triggers a question to the user in order to confirm or decline the change. The details on how to provide the user interaction are left for implementation.

When receiving a MODIFY message, a terminal shall not interrupt the data traffic and shall continue to send and receive data in the old mode, even after the terminal accepts the modification with a MODIFY COMPLETE message. The radio bearer will then be reconfigured by the network. After the radio bearer has been reconfigured, the terminal shall send and receive data in the new mode.

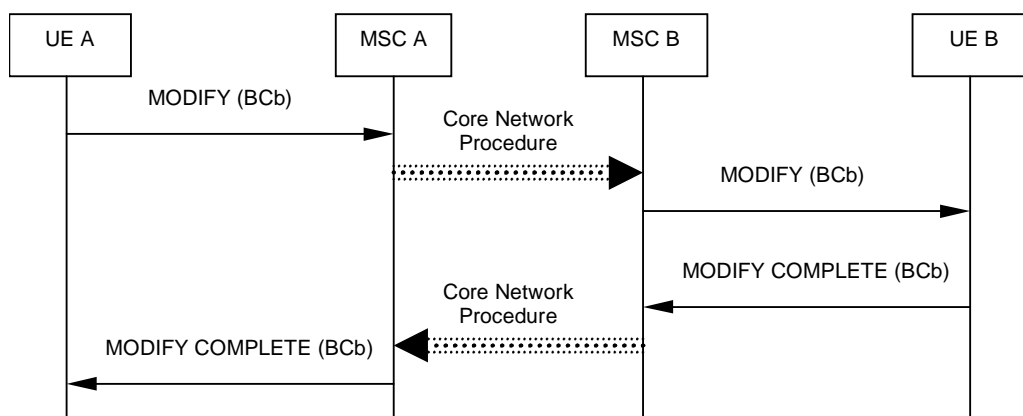

Figure 4.13: Service change requested, accepted

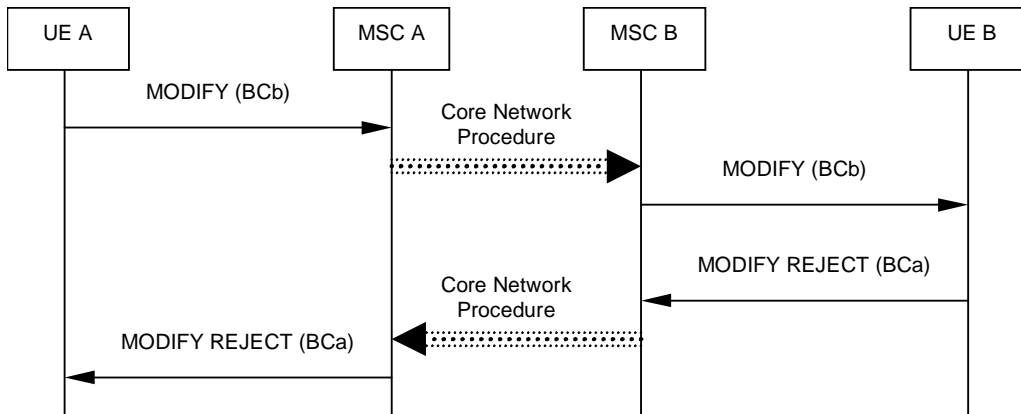

Figure 4.14: Service change requested, rejected

4.2.5 Network-initiated Service change in the active state

When the visited MSC of either party can no longer support an ongoing multimedia call, for example due to degraded coverage conditions (including UTRAN to GERAN only transitions), the visited MSC of this party shall initiate a service-change from multimedia to speech, following the procedures described below.

If the visited MSC is again able to support the multimedia at a later point in time while the speech call is still ongoing, the same visited MSC may initiate a service change from speech to multimedia as stated in TS 22.101 [8]. The details for the service change from speech to multimedia are described in section 4.2.5.2.

For a downgrade from multimedia to speech the visited MSC shall initiate an In-Call Modification procedure towards the terminal it serves using the MODIFY message. The visited MSC shall also invoke the service change procedure (see clause 4.3.5) towards the remote side. The terminals on both sides will react as described in Clause 4.2.4.

The Visited MSC shall only initiate a Network Initiated Service Upgrade from speech to multimedia if the terminal has indicated support for Network Initiated Service Upgrade Capability during the call establishment phase, as detailed in 3GPP TS 24.008 [3]. When sending the Modify request to the local terminal the MSC shall include the Network-initiated Service Upgrade indicator. A visited MSC receiving an incoming Network Initiated Service Upgrade procedure from the core network shall also include the Network-initiated Service Upgrade indicator within the MODIFY request to the local terminal.

NOTE: If the visited MSC initiating the Network Initiated Service Upgrade uses the 3G-324.M codec in the core network signalling due to operator’s policy, the visited MSC receiving the incoming Service Upgrade procedure from the core network will not recognise that this procedure is network-initiated and thus will not include the Network-initiated Service Upgrade indicator within the MODIFY request to the local terminal.

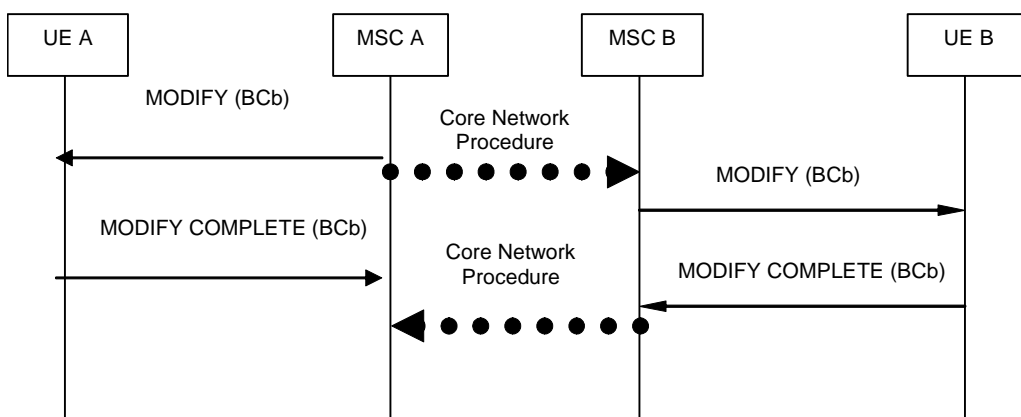

Figure 4.14a: Network-Initiated Service change from multimedia to speech requested, accepted

Figure 4.14b: void

Figure 4.14c: void

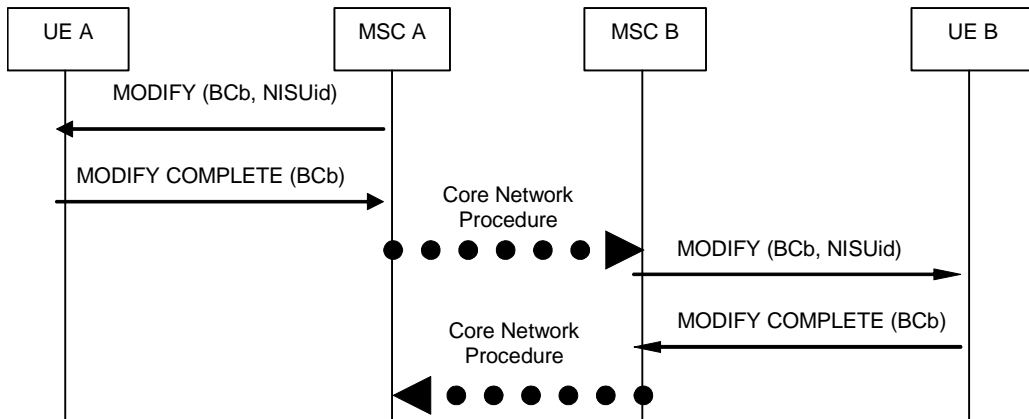

Figure 4.14c1: Network-Initiated Service change from speech to multimedia requested, accepted

If the served terminal rejects the service change from speech to multimedia, the initiating MSC shall maintain the original service. If the remote side rejects the service change from speech to multimedia, the initiating MSC shall initiate a service change procedure towards the served terminal to revert to the original service.

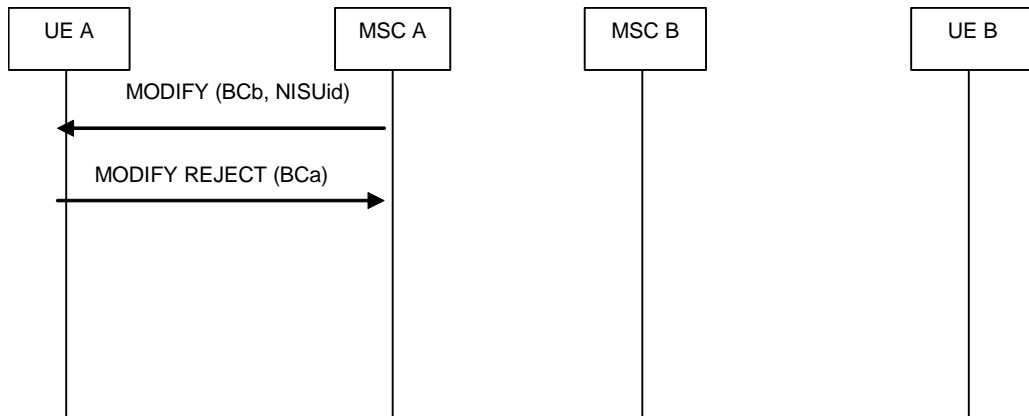

Figure 4.14c2: Network-Initiated Service change from speech to multimedia requested, rejected by user A

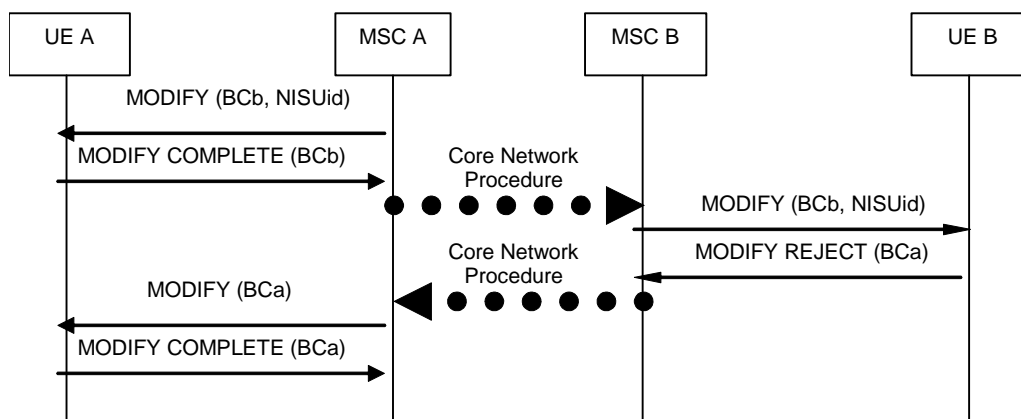

Figure 4.14c3: Network-Initiated Service change from speech to multimedia requested, rejected by user B

4.2.5.1 Network-initiated Service change in the active state starting with multimedia in Iu mode

For a network initiated service change from multimedia in Iu mode to speech, the visited MSC shall use the following procedure.

In order to request a notification from the RNC when it detects a lack of sufficient resources or radio signal degradation, the visited MSC shall include an Alternative RAB Parameters IE in the RANAP RAB Assignment Request or RANAP Relocation Request message indicating the RAB configuration for speech in addition to the RAB configuration for multimedia, when it establishes or modifies the radio access bearer for multimedia at the Iu interface.

When the radio access network detects a lack of sufficient resources to sustain the multimedia RAB configuration, it shall inform the visited MSC by sending a RANAP Modify Request message (see 3GPP TS 25.413 [17]) to the visited MSC. The visited MSC shall then:

- initiate an In-Call Modification procedure to speech towards the terminal it serves using the MODIFY message; and
- invoke the service change procedure (see clause 4.3.5) towards the remote side,
- trigger the RAB modification by sending a RANAP RAB Assignment with the RAB requested to be Modified to the RNC.

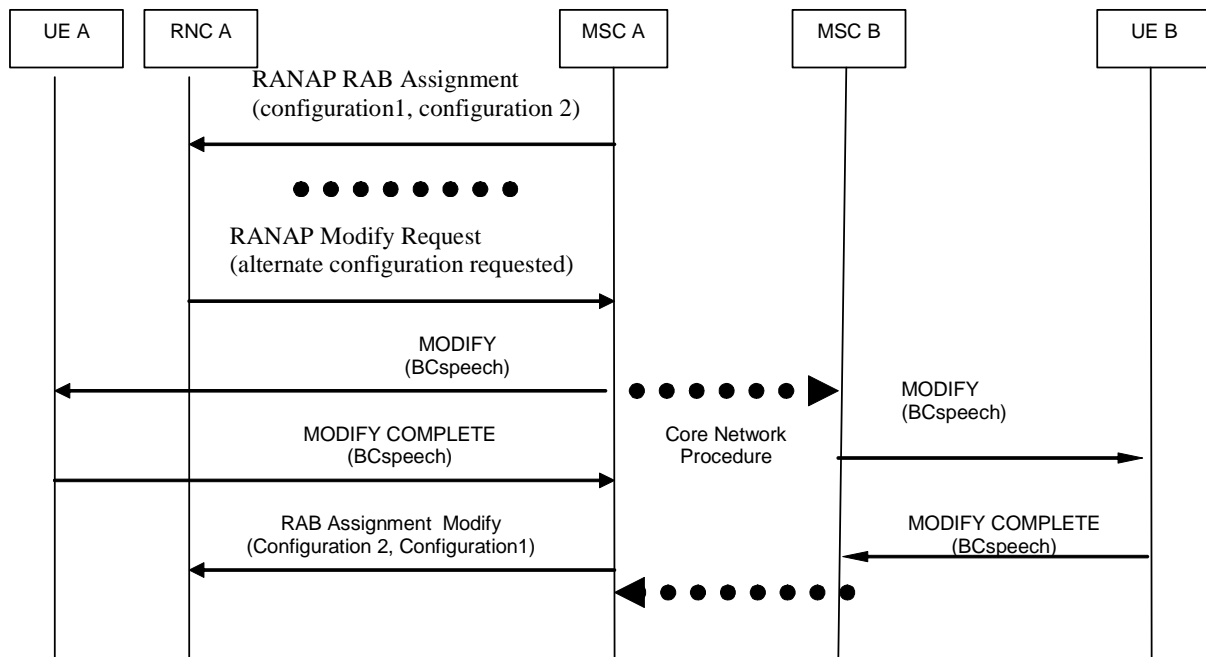

Figure 4.14d: Network-Initiated Service change from UTRAN multimedia to speech requested, accepted

4.2.5.2 Network-initiated Service change in the active state starting with speech in Iu mode

The network initiated service change from speech to multimedia in Iu mode is an optional feature. If supported the MSC initiating the service upgrade to multimedia shall use the following procedure. However a service change from speech to multimedia should not be initiated unless a network initiated service change from multimedia to speech had previously taken place during the same user session. Furthermore a network initiated service upgrade to multimedia shall not be performed unless the terminal has indicated that it supports it by including the Enhanced Network-initiated ICM (ENICM) Capability at call establishment. If the 3G-324.M2 was not received in the available codec list, depending on operator policy, the visited MSC may or may not perform a Network-initiated Service change procedure from speech to multimedia.

NOTE: The 3G-324.M2 codec in the available codec list indicates that all nodes in the call support incoming request for the network initiated service change from speech to multimedia and thus collect charging information indicating that a network-initiated service change was performed. An operator could choose to perform a network-initiated service change even if the 3G-324.M2 codec was not received in the available codec list, for example if the operator applies a billing scheme where the initiator of the multimedia call pays for the call and mutual agreements with the peer's operator allow this policy.

In order to request a notification about sufficient resources to sustain again the multimedia RAB configuration from the radio access network, the visited MSC shall include an Alternative RAB Parameters IE in the RANAP RAB Assignment Request or RANAP Relocation Request message indicating the RAB configuration for multimedia in addition to the RAB configuration for speech, when it establishes or modifies the radio access bearer for speech at the Iu interface during or after a network-initiated service change from multimedia to speech. In order to request a notification about sufficient resources from a target RNC after a subsequent relocation, the MSC shall pass the Alternative RAB Parameters IE in the RELOCATION REQUEST message to the target RNC.

NOTE: If the non-anchor RNC is a pre-Release 6 node then no notification about sufficient resources can be received and therefore the MSC cannot assume that it will receive the notification for upgrade if it did not receive a previous notification for downgrade from that RNC.

When the radio access network later detects that there are sufficient resources to sustain again the multimedia RAB configuration, it shall indicate the possibility of a service change to the alternative multimedia RAB configuration by sending a RANAP Modify Request message (see 3GPP TS 25.413 [17]) to the MSC. The MSC may then:

- initiate an In-Call Modification procedure to multimedia towards the terminal it serves using the MODIFY message. The visited MSC shall include the NISUId information element in the MODIFY message. The MSC

initiating the service change shall not interrupt the user plane until the terminal accepts the modification with a MODIFY COMPLETE message. When the MODIFY COMPLETE message is received from the served terminal, the initiating MSC shall then:

- invoke the service change procedure (see clause 4.3.5) towards the remote side. The initiating MSC shall then;
- reconfigure the RAB to the multimedia bearer at the latest when receiving a confirmation about the successful service change procedure from the remote side.

When receiving a MODIFY message, a terminal shall not interrupt the data traffic and shall continue to send and receive data in the old mode, even after the terminal accepts the modification with a MODIFY COMPLETE message. After the radio bearer has been reconfigured by the network, the terminal shall send and receive data in the new mode.

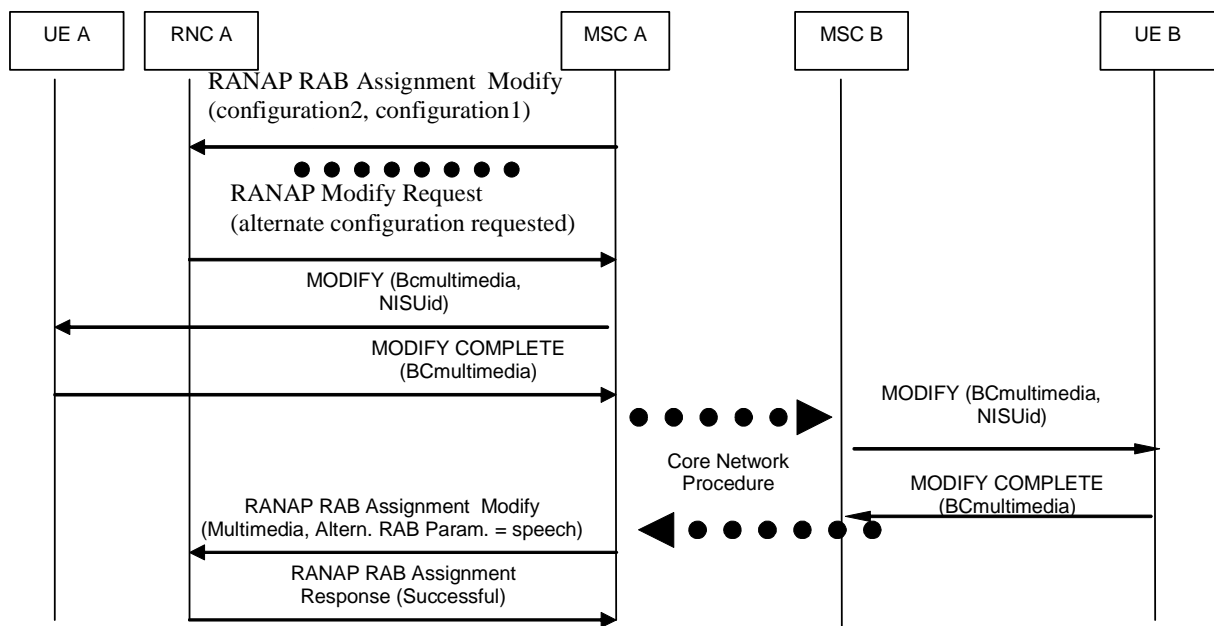

Figure 4.2.5.2/1: Network-Initiated Service change from UTRAN speech to multimedia requested, accepted in case the RAB is modified on the initiating side after receiving the response to the service change request from the remote side

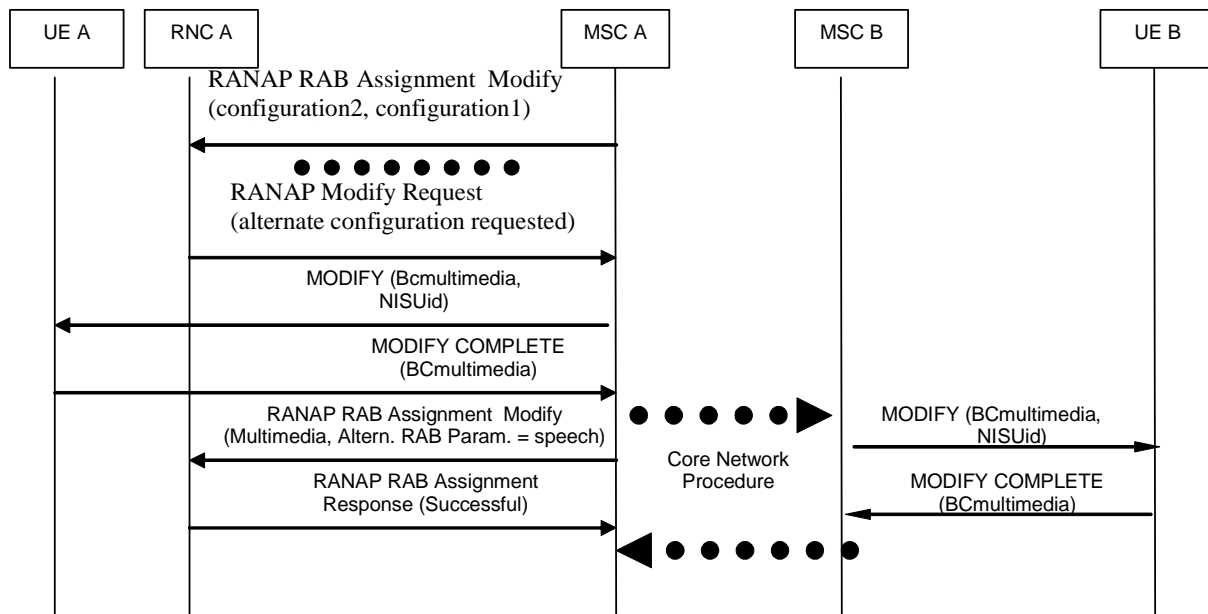

Figure 4.2.5.2/2: Network-Initiated Service change from UTRAN speech to multimedia requested, accepted in case the RAB is modified on the initiating side before receiving the response to the service change request from the remote side

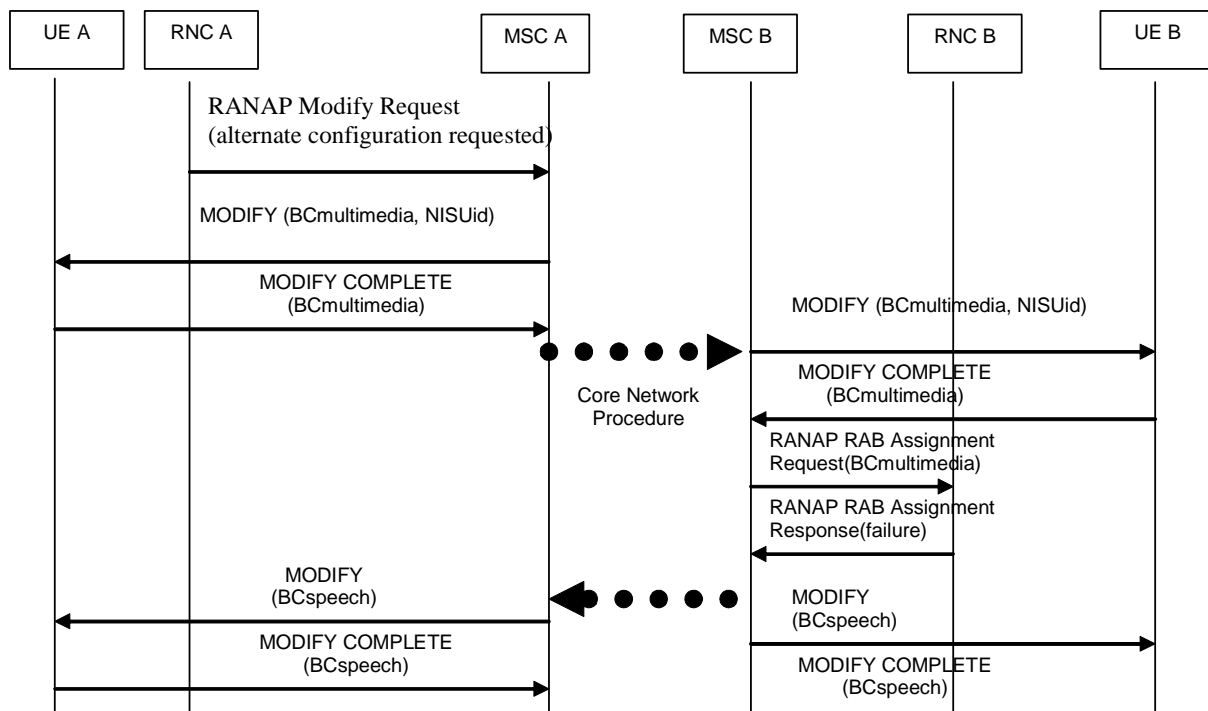

Figure 4.2.5.2/3: Network-Initiated Service change from UTRAN speech to multimedia, RNC B failure in case the RAB on the initiating side is not modified before receiving the response to the service change request from the remote side

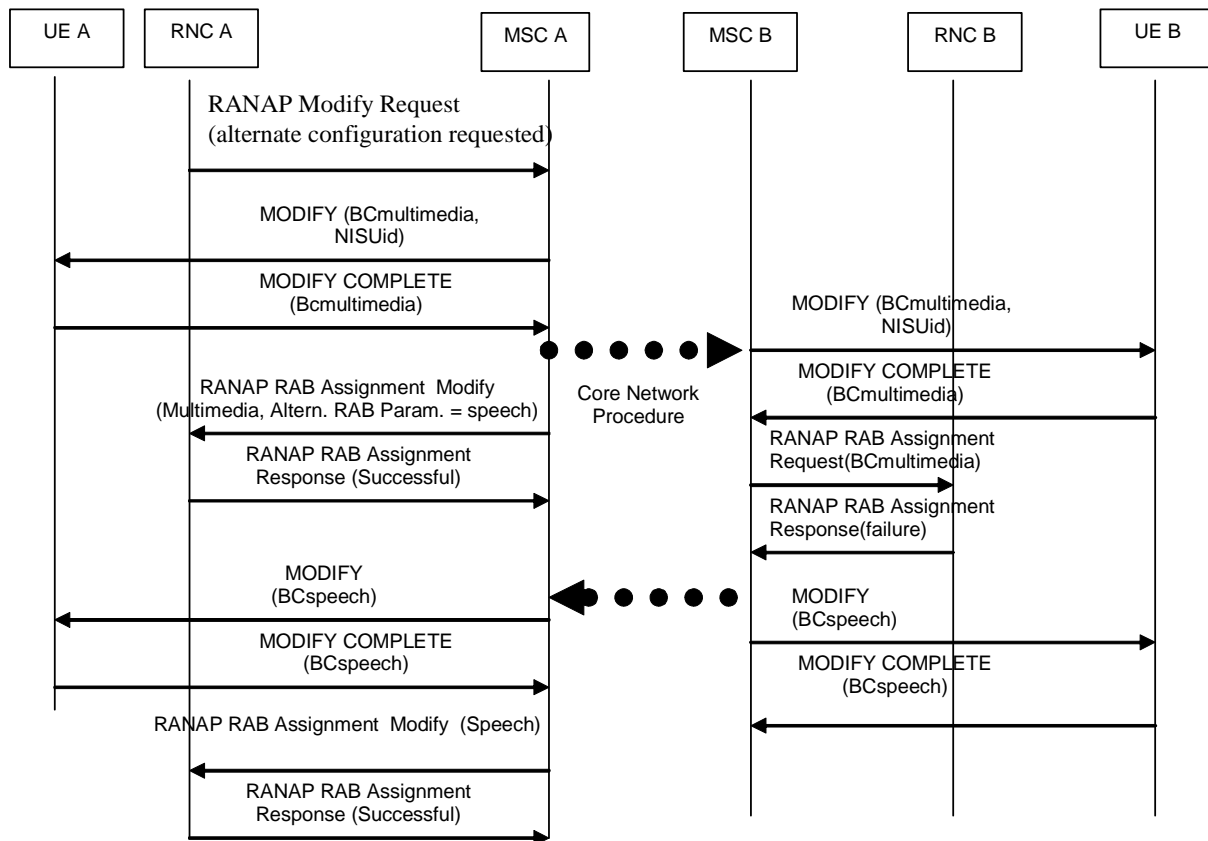

Figure 4.2.5.2/4: Network-Initiated Service change from UTRAN speech to multimedia, RNC B failure in case the RAB is modified on the initiating side before receiving the response to the service change request from the remote side

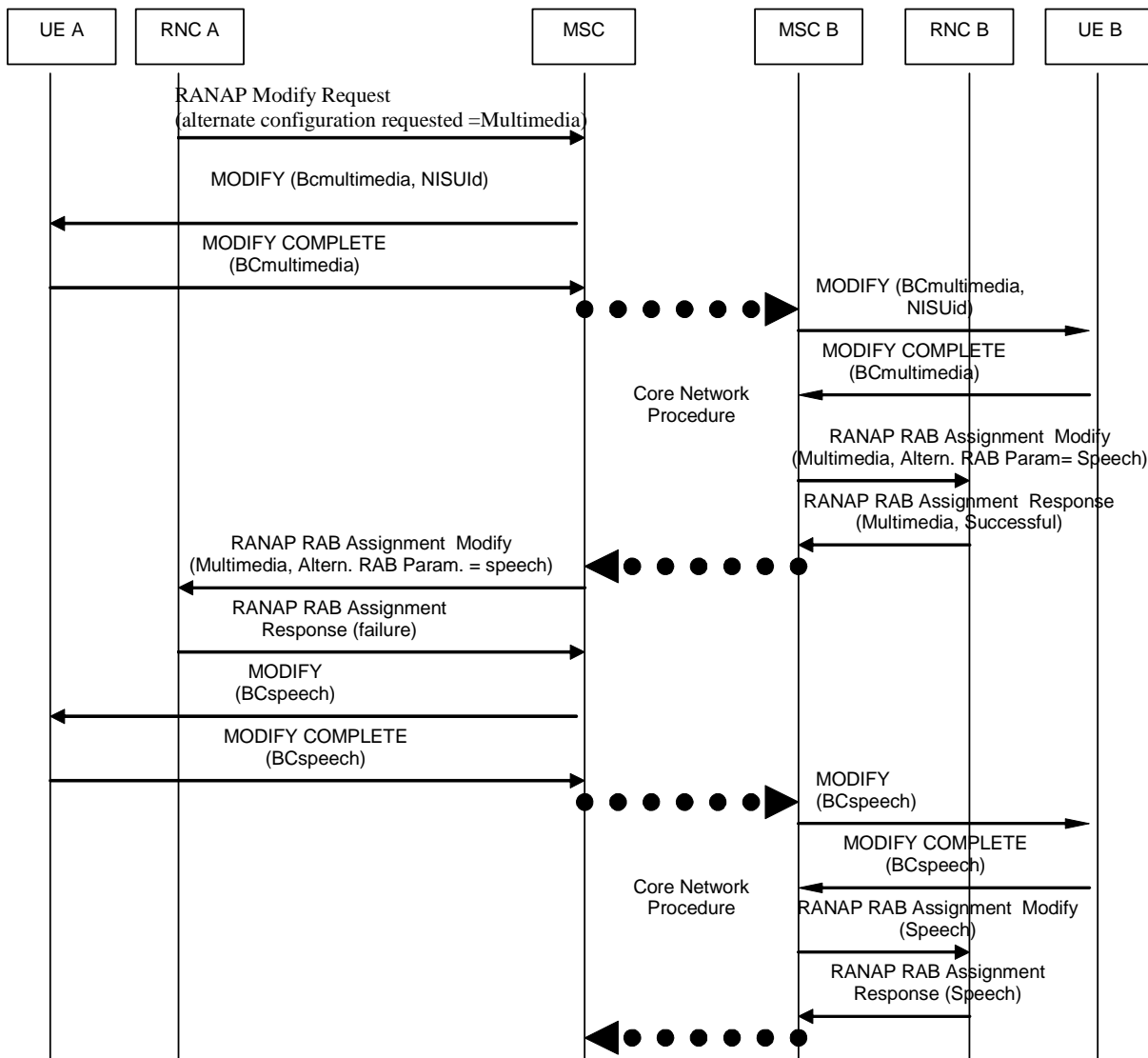

Figure 4.2.5.2/5: Network-Initiated Service change from UTRAN speech to multimedia requested, RNC A failure in case the RAB is modified on the initiating side after receiving the response to the service change request from the remote side

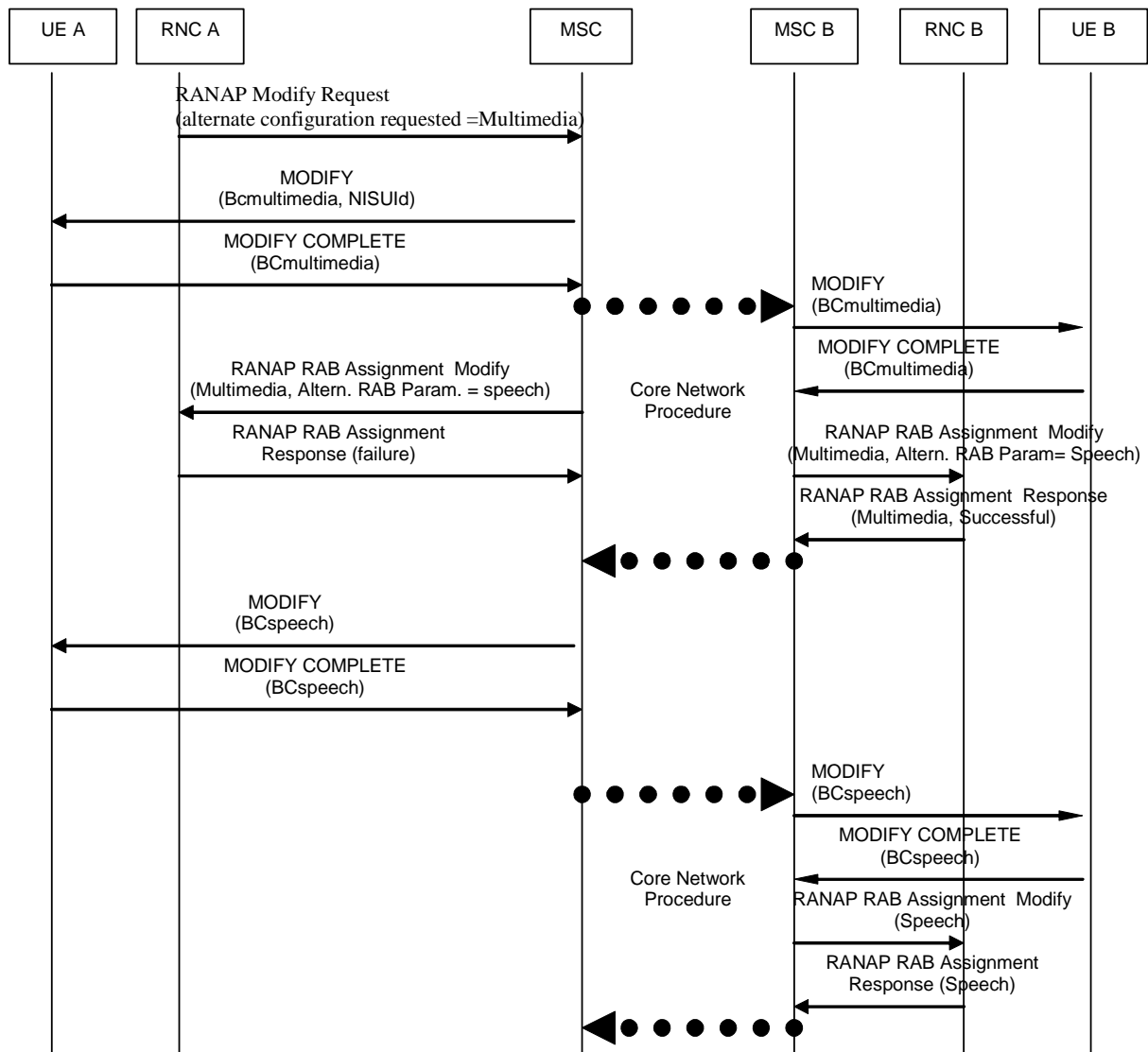

Figure 4.2.5.2/6: Network-Initiated Service change from UTRAN speech to multimedia requested, RNC A failure in case the RAB is modified on the initiating side before receiving the response to the service change request from the remote side

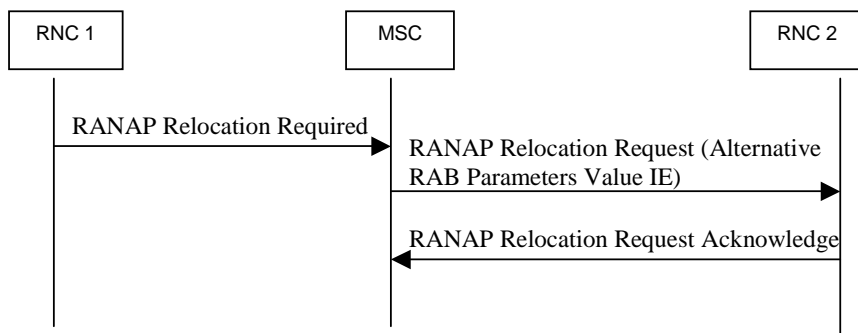

Figure 4.2.5.2/7: Alternative RAB Parameters delivery during the relocation

4.3 Core Network procedures

In order to provide the capability in the network to transmit the request for service change (upgrade to multi-media and fallback to speech) both at call setup and during the active state of a call, the normal Out-of-Band Transcoder Control procedures, described in 3GPP TS 23.153 [2] shall be used. The following text describes the codec type to be used, the

mapping between the terminal interface described above, and the different IEs to be used for the codec negotiation procedures at both the originating and the terminating MSC.

4.3.1 Multimedia codec

The codec negotiation procedures transmit an ordered list of preferred codecs from the originating to the terminating MSC. A node that requires interaction with the user plane will remove the codecs it does not support. The terminating MSC shall select the codec to use ("selected codec") from the list of available codecs for the call. This selection shall be based on the received list of codecs and on the information given by the terminating UE in the CALL CONFIRMED message.

A dummy codec (defined in 3GPP TS 26.103 [4] for a BICC based CS core network and in 3GPP TS 29.007 [6] as dedicated RTP payload types for a SIP-I based CS core network) is included in the codec list to indicate that a multimedia call is requested. Two dummy codecs are defined:

- Dummy codec 1 shall be used for a terminal-initiated service change from speech to multimedia. Based on the operator policy the dummy codec 1 may be used for the network-initiated service change from speech to multimedia, if one of the MSCs has not included the dummy codec 2 to the available codec list during the call setup phase. This dummy codec 1 is in the present document referred to as the 3G-324.M codec. It shall be supported by any SCUDIF compliant MSC.
- Dummy codec 2 shall be used for a network-initiated service change from speech to multimedia, if all the MSCs in the call have indicated the dummy codec 2 in the available codec list during the call setup phase. This codec is in the present document referred to as the 3G-324.M2 codec. The 3G-324.M2 codec is identical to the 3G-324.M codec except for the CoID. It shall be supported by any SCUDIF compliant MSC that supports a network-initiated service change from speech to multimedia.

NOTE: An Rel-5 MSC does not support the 3G-324.M2 codec. A Rel-6 MSC not supporting the optional network-initiated service change procedures could also not support the 3G-324.M2 codec.

These codec are in the present document referred to as the 3G-324.M codec.

This codec is only used by the Core Network and shall not be sent from the terminal in the Supported Codec List IE.

For a BICC based CS core network, the 3G-324.M codec shall be indicated to the MGW as codec media stream property in accordance with the 3GPP TS 29.232 [12]. The 3G-324.M codec shall be indicated to the MGW also if the 3G-324.M2 codec is selected in Out-of-Band Transcoder Control procedures. The MGW shall treat the User Plane configuration (SDU Format) of the 3G-324.M codec as for PCM, as defined in 3GPP TS 26.102 [13].

For a SIP-I based CS core network, instead of the 3G-324.M or 3G-324.M2 codecs, the CLEARMODE RTP payload type (see IETF RFC 4040 [18]) shall be indicated to the MGW as media type in accordance with the 3GPP TS 29.232 [12]. The MGW will treat the user plane for the Clearmode RTP payload type as defined in 3GPP TS 29.007 [6].

4.3.2 Originating side - initiation of call setup

4.3.2.1 Originating MSC Handling

The originating MSC has a list of supported codec types, listed in order of preference.

If the SETUP message received from the UE contains a Repeat Indicator with a value of "service change and fallback", in addition to a multimedia BC-IE and a speech BC-IE, the MSC shall include a 3G-324.M codec in the list of supported codec types according to the following rule:

- If the multimedia BC-IE is listed first, then the 3G-324.M codec shall be the first codec in the list (see figure 4.15) If the originating MSC supports a network-initiated service change from speech to multimedia, it shall include the 3G-324.M2 codec as second codec in the list.
- If the speech BC-IE is listed first, then the 3G-324.M codec shall be the last codec in the list (see figure 4.16) sent by a originating MSC not supporting a network-initiated service change from speech to multimedia. If the originating MSC supports a network-initiated service change from speech to multimedia, the 3G-324.M codec shall be the last but one codec in the list and the 3G-324.M2 codec shall be the last codec in the list.. In the case that the maximum number of codecs is already reached before insertion of the 3G-324M and possibly 3G-324.M2 codec(s), the optional speech codec(s) with the least preference shall be replaced by those codec(s).

The list shall then be sent according to the Out-of-Band Transcoder Control codec negotiation procedures. The TMR field, although mandatory BICC/ISUP parameter, has no meaning when using OoBTC/BICC codec negotiation (the link characteristics and QoS are determined from the codec type and signalled to any intermediate switches via the bearer control protocol) and thus shall be set arbitrarily to "speech". A transit node that requires interaction with the user plane will remove from the list the codecs it does not support. If the 3G-324.M codec is not supported, and thus removed, the call shall be turned into a normal speech call (fallback to speech) and follow the normal call setup procedures.

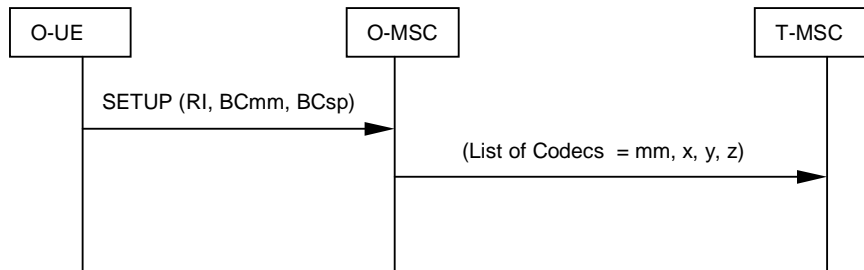

x, y, z: speech codecs.
mm: dummy multimedia codec 3G-324.M.

NOTE: If the originating MSC supports incoming requests for a network-initiated service change from speech to multimedia, it shall include the 3G-324.M2 codec as second codec in the list after 3G-324.M. This is not depicted in the figure.

Figure 4.15: Multimedia BC as first BC

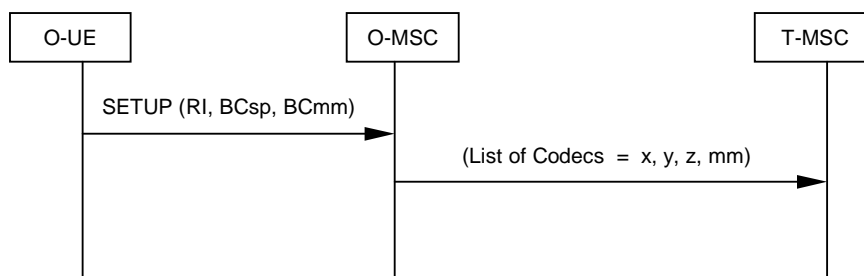

NOTE: If the originating MSC supports incoming requests for a network-initiated service change from speech to multimedia, it shall include the 3G-324.M2 codec as last codec in the list after 3G-324.M. This is not depicted in the figure.

Figure 4.16: Speech BC as first BC

4.3.2.2 VMSC Handling at Originating Side

Depending on operator policy, the VMSC may remove the 3G-324.M2 codec from the list of supported codec types if the call is routed to selected other PLMNs.

NOTE: This enables the operator to block a network initiated upgrade if inter-operator accounting agreements do not allow this functionality, e.g. because billing schemes are not compatible for the network-initiated upgrade.

4.3.3 Terminating side

4.3.3.1 HLR Interrogation

The GMSC sends the Send Routing Information request with both the Network Signal Information and Network Signal Information 2 parameters. The Network Signal Information shall include the ISDN BC IE for the preferred service, and the Network Signal Information 2 includes the ISDN BC IE for the less preferred service.

The functional behaviour of the HLR is described in 3GPP TS 23.018 [10]. The procedures specific to SCUDIF calls are specified in the subclause 4.3.3.1.3 for the HLR and 4.3.3.1.4 for the GMSC. The information elements specific to SCUDIF between the GMSC and the HLR are specified in subclauses 4.3.3.1.1 and 4.3.3.1.2.

4.3.3.1.1 Send Routing Info

The following element specific to SCUDIF calls is defined for Send Routing Info:

Information element name	Required	Description
ISDN BC 2	C	ISDN bearer capability 2. Shall be present for a SCUDIF call to indicate the less preferred service.
ISDN LLC 2	C	ISDN lower layer compatibility 2. Shall be present for a SCUDIF call if necessary for the less preferred service, otherwise shall be absent.
ISDN HLC 2	C	ISDN higher layer compatibility 2. Shall be present for a SCUDIF call if necessary for the less preferred service, otherwise shall be absent.

4.3.3.1.2 Send Routing Info Ack

The following elements specific to SCUDIF calls are defined for Send Routing Info Ack:

Information element name	Required	Description
Roaming number 2	C	E.164 number required to route the call to VMSCB (see 3GPP TS 23.003 [11]) for the less preferred service of a SCUDIF call. Shall be present for a SCUDIF call if the preferred service is not forwarded (<i>i.e.</i> either Roaming Number is present or the preferred service is not allowed) and the less preferred service is allowed and not forwarded, otherwise shall be absent.
Forwarded-to number 2	C	E.164 number of the C subscriber for the less preferred service of a SCUDIF call. Shall be present if the HLR has determined that the less preferred service of a SCUDIF call is to be forwarded, otherwise shall be absent.
Long forwarded-to number 2	C	Number of the C subscriber (see 3GPP TS 23.082 [15]) for the less preferred service of a SCUDIF call. Shall be present if the HLR has determined that the less preferred service of a SCUDIF call is to be forwarded, and GMSC and HLR support Long Forwarded-to Numbers, otherwise shall be absent.
Forwarded-to subaddress 2	C	Subaddress of the C subscriber (see 3GPP TS 23.003 [11]) for the less preferred service of a SCUDIF call. Shall be present if the HLR has determined that the less preferred service of a SCUDIF call is to be forwarded and a forwarded-to subaddress is stored in the HLR in association with the forwarded-to number 2, otherwise shall be absent.
Notification to calling party 2	C	Indication of whether the calling party is to be notified that the call has been forwarded if the less preferred service of a SCUDIF call is kept. Shall be present if the HLR has determined that the less preferred service of a SCUDIF call is to be forwarded, otherwise shall be absent.
Forwarding reason 2	C	Indication of why the call has been forwarded (unconditionally or on mobile subscriber not reachable) for the less preferred service of a SCUDIF call. Shall be present if the HLR has determined that the less preferred service of a SCUDIF call is to be forwarded, otherwise shall be absent.
SS-List 2	C	List of SS-codes for the less preferred service of a SCUDIF call. Shall be present if the HLR has determined that the less preferred service of a SCUDIF call is allowed, otherwise shall be absent.
Basic Service Code 2	C	Indicates the type of the basic service for the less preferred service, <i>i.e.</i> teleservice or bearer service.
Allowed Services	C	Shall be present for SCUDIF calls. Indicates which services are available for that call.
Unavailability Cause	C	Indicates the reason for which one of the services of a SCUDIF call is not available. Shall be present for SCUDIF calls if one service is not available.

4.3.3.1.3 Handling of mobile terminating calls in the HLR

The procedures specific to SCUDIF calls in the HLR are specified within this subclause:

- Procedure SCUDIF_Subscription_Check_HLR
- Procedure SCUDIF_CAMEL_CSI_Check_HLR
- Procedure SCUDIF_Set_Second_Service_when_Forwarded
- Procedure SCUDIF_Set_Correct_PLMN_BC
- Procedure SCUDIF_Check_Second_Service_before_Negative_Response
- Procedure SCUDIF_Check_Second_Service_after_PRN
- Procedure SCUDIF_Check_Second_Service_when_Forwarded

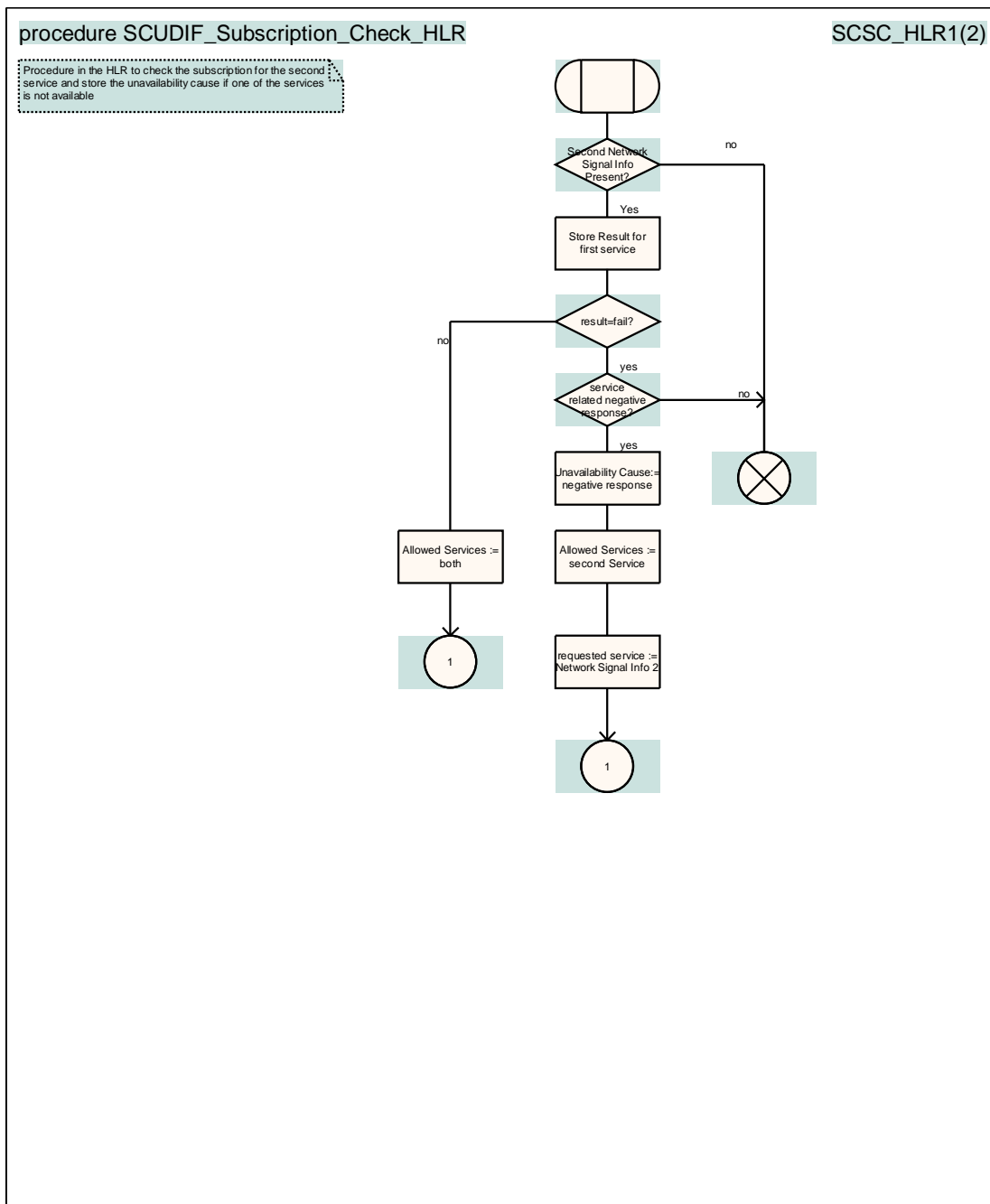

Figure 4.16A: Procedure SCUDIF_Subscription_Check_HLR (sheet 1)

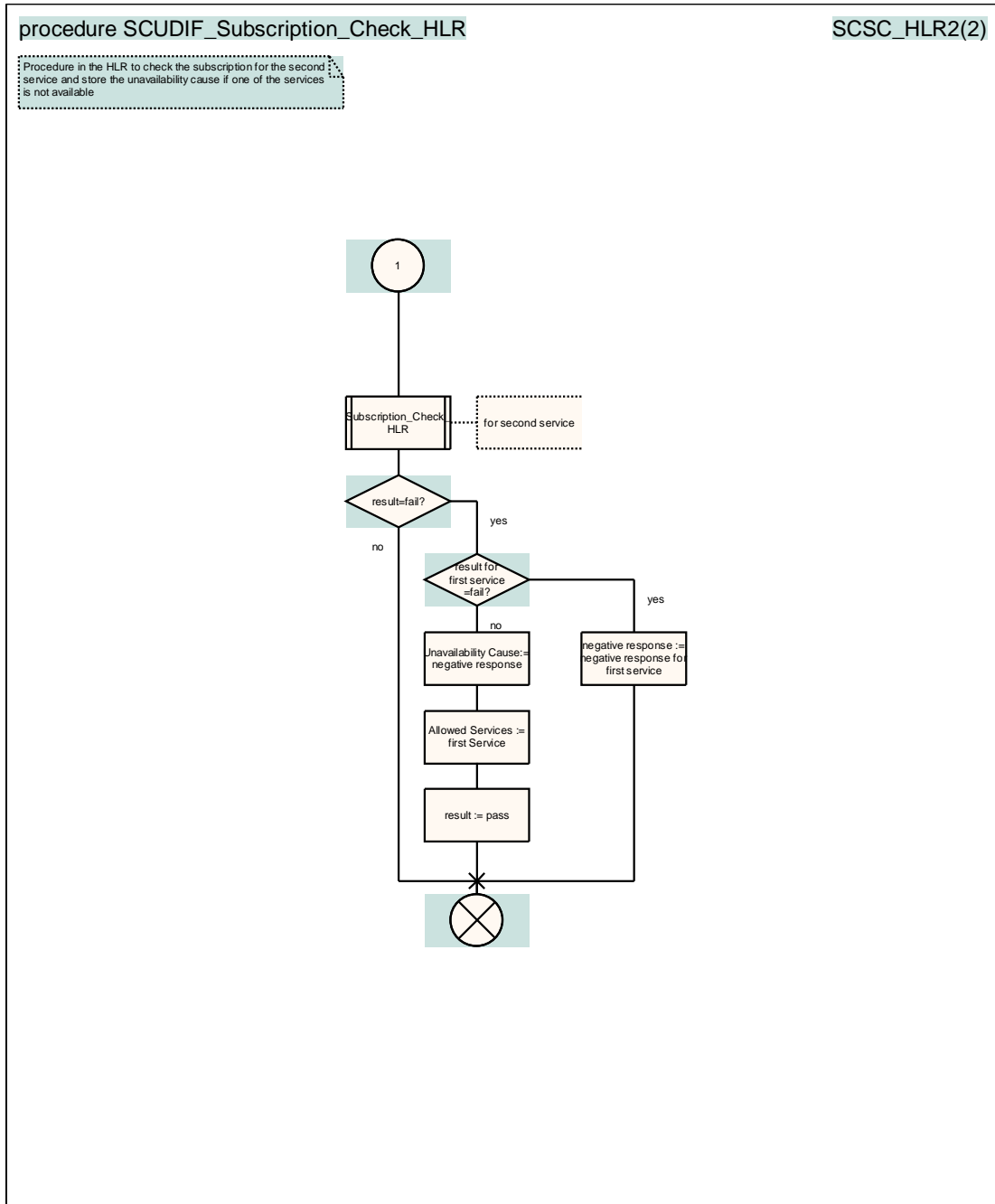

Figure 4.16B: Procedure SCUDIF_Subscription_Check_HLR (sheet 2)

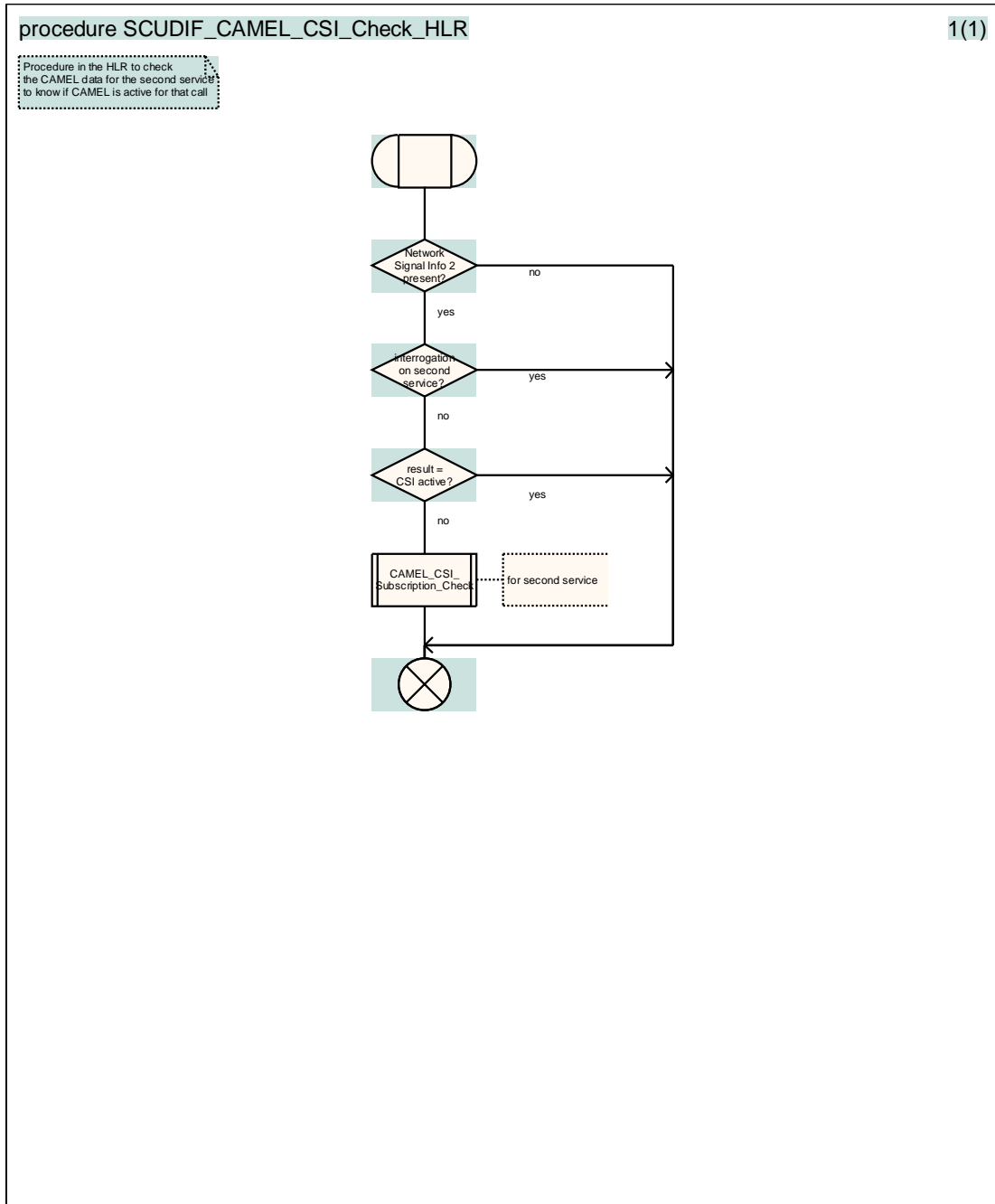

Figure 4.16C: Procedure SCUDIF_CAMEL_CSI_Check_HLR

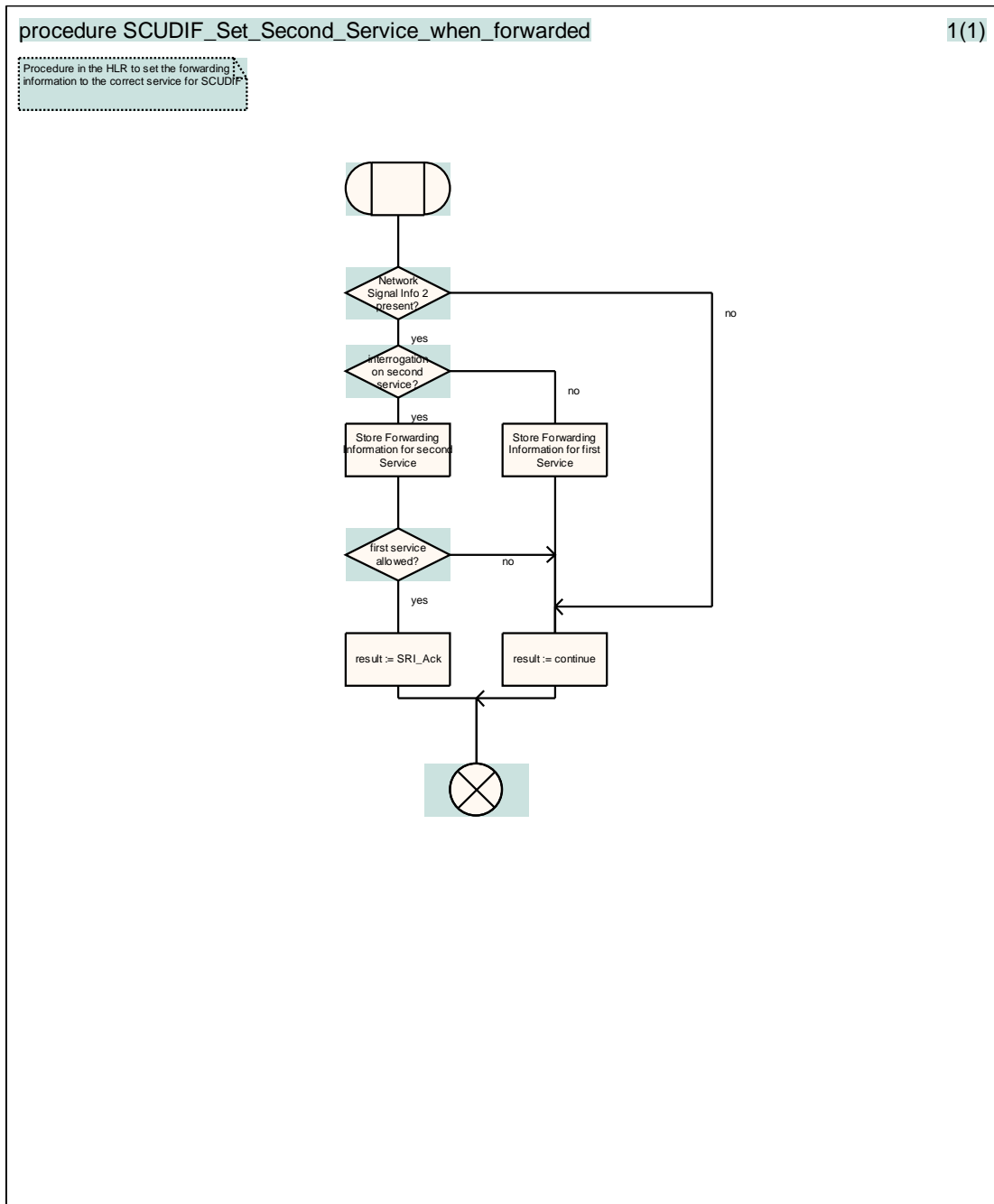

Figure 4.16D: Procedure SCUDIF_Set_Second_Service_when_Forwarded

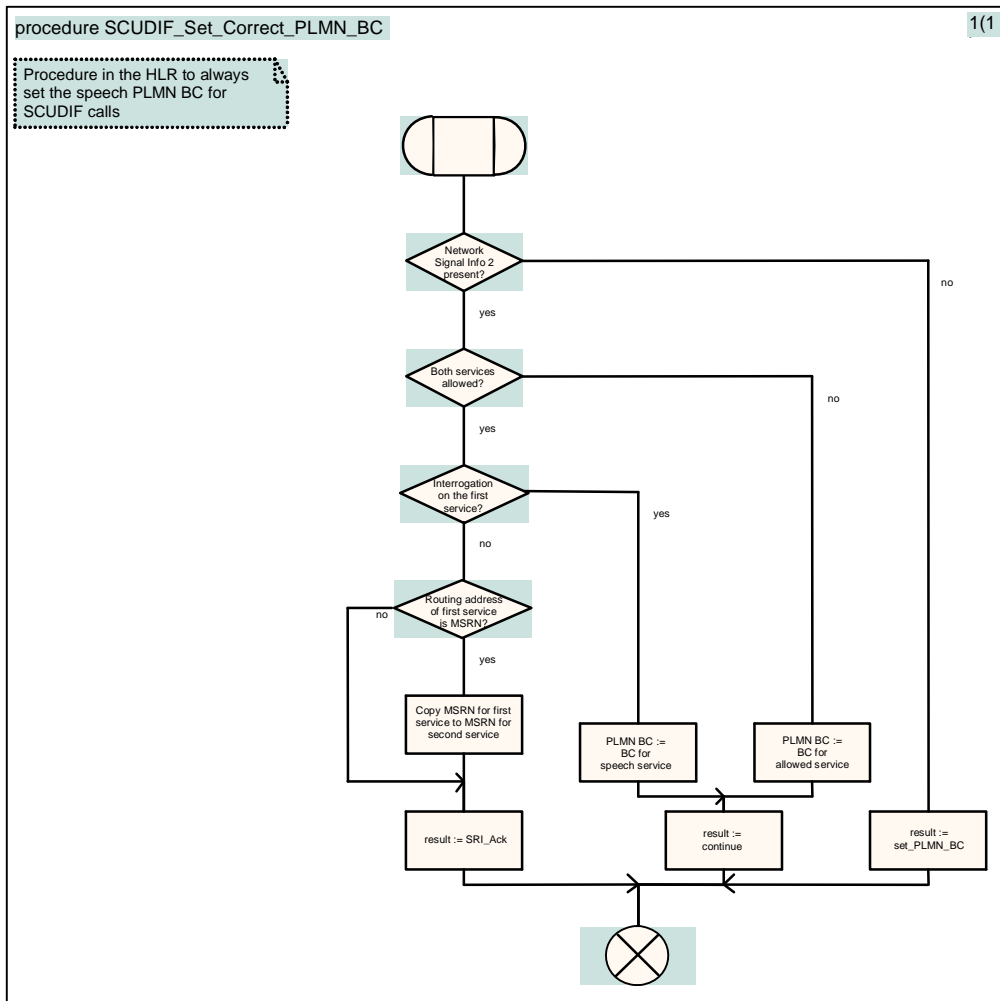

Figure 4.16E: Procedure SCUDIF_Set_Correct_PLMN_BC

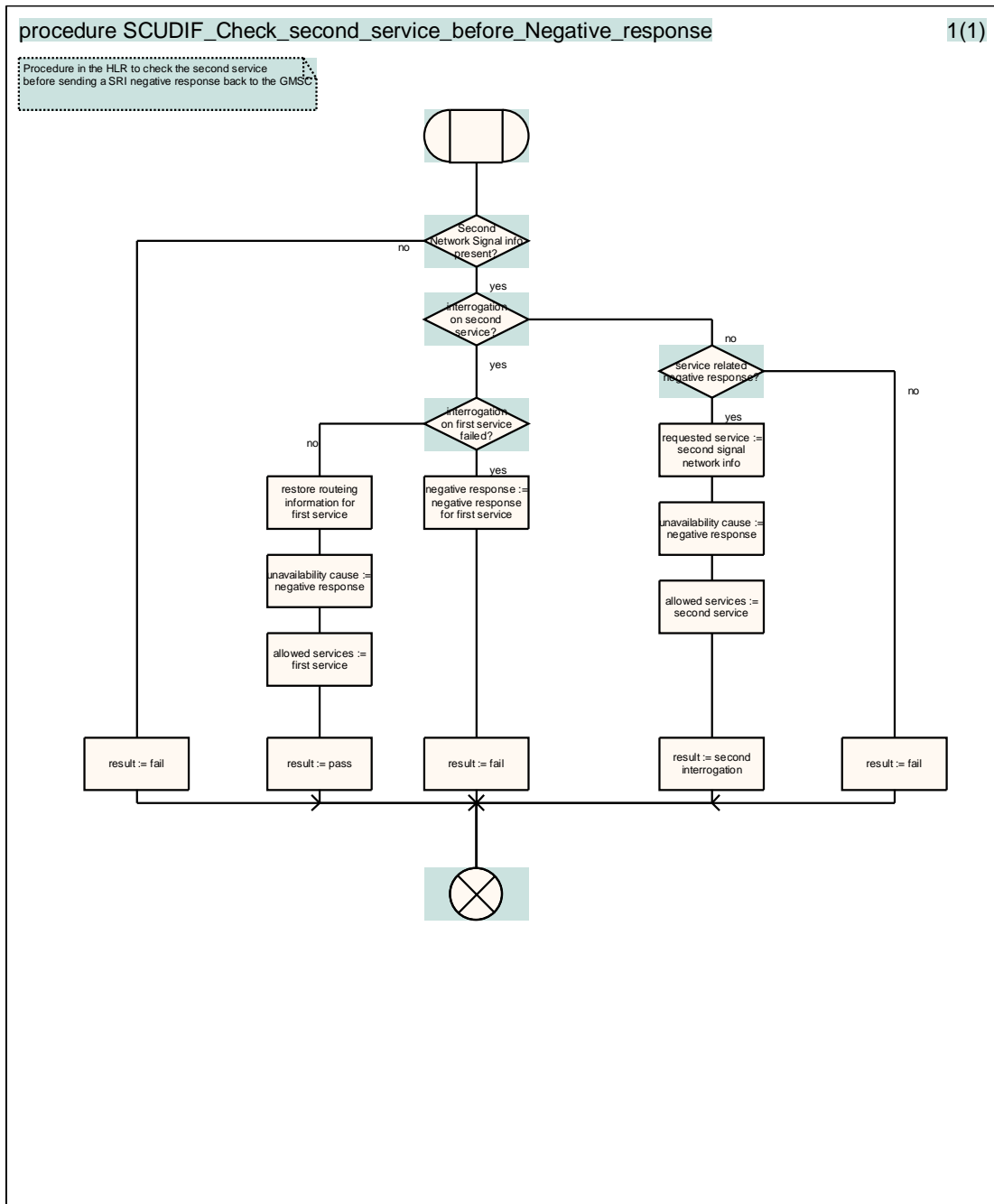

Figure 4.16F: Procedure SCUDIF_Check_Second_Service_before_Negative_Response

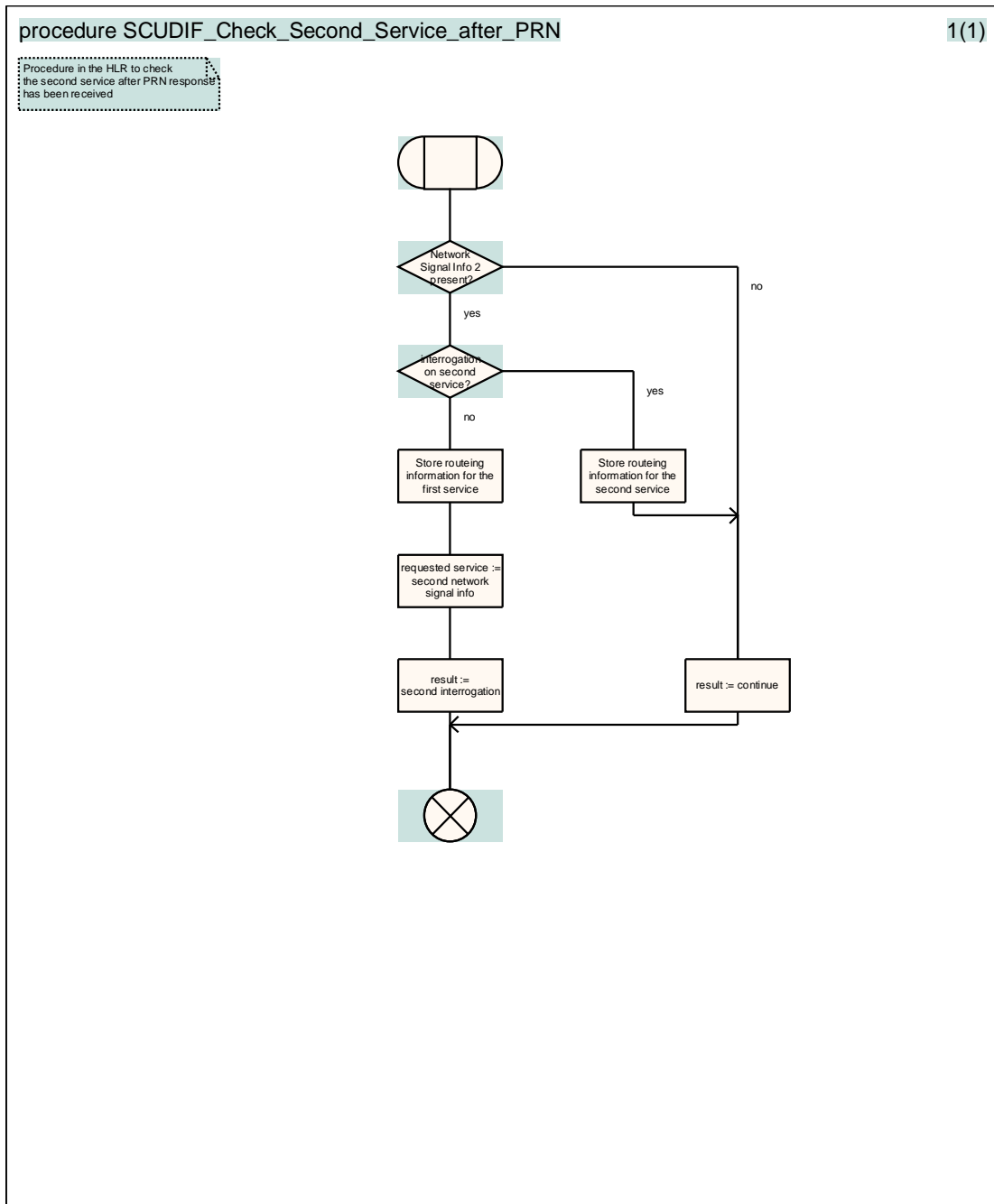

Figure 4.16G: Procedure SCUDIF_Check_Second_Service_after_PRN

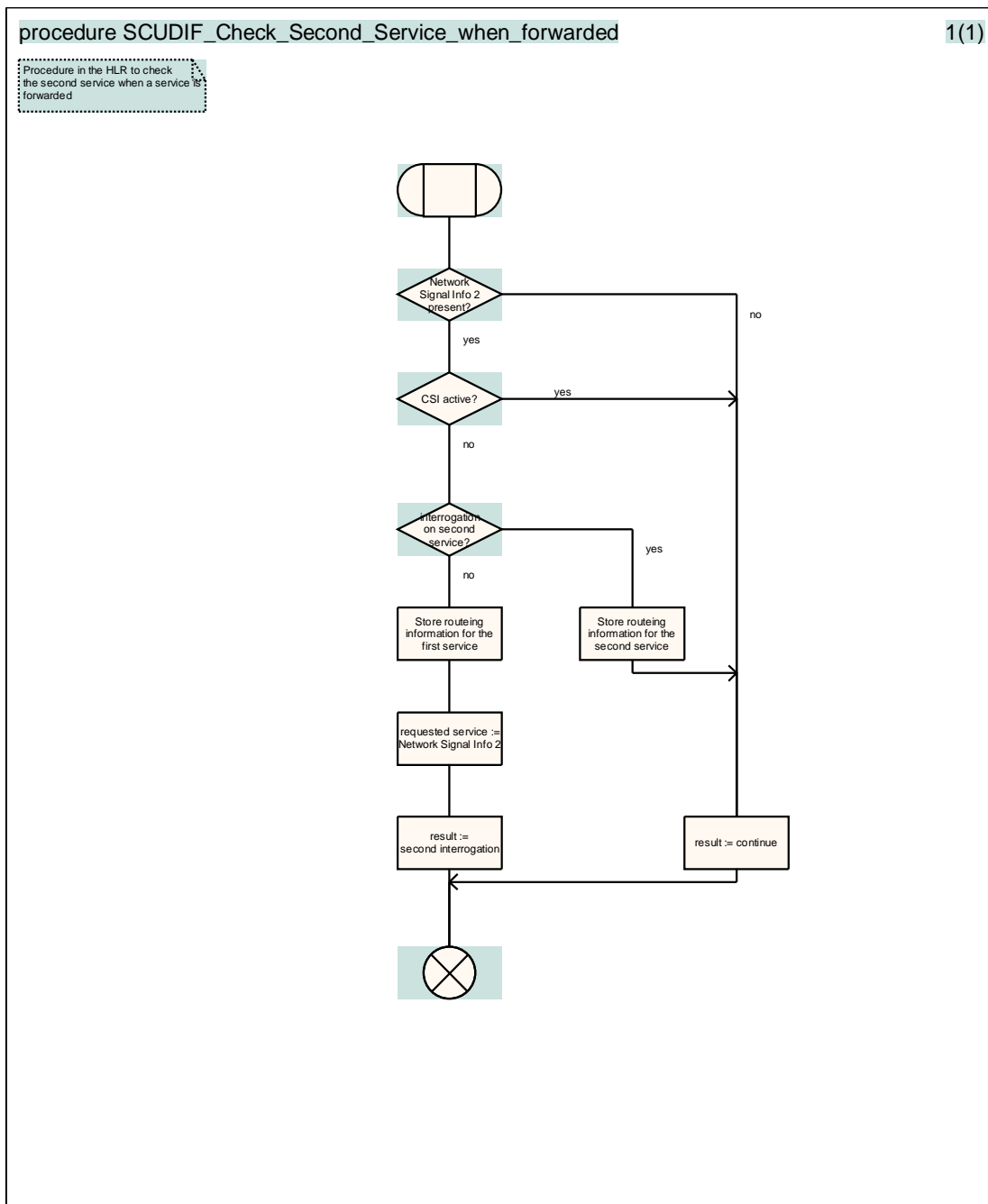

Figure 4.16H: Procedure SCUDIF_Check_Second_Service_when_Forwarded

4.3.3.1.4 Handling of mobile terminating calls in the GMSC

The procedures specific to SCUDIF calls in the GMSC are specified within this subclause:

- Procedure SCUDIF_Negative_SRI_Response_Handling
- Procedure SCUDIF_Check_Service_Availability
- Procedure SCUDIF_Check_Service_Compatibility

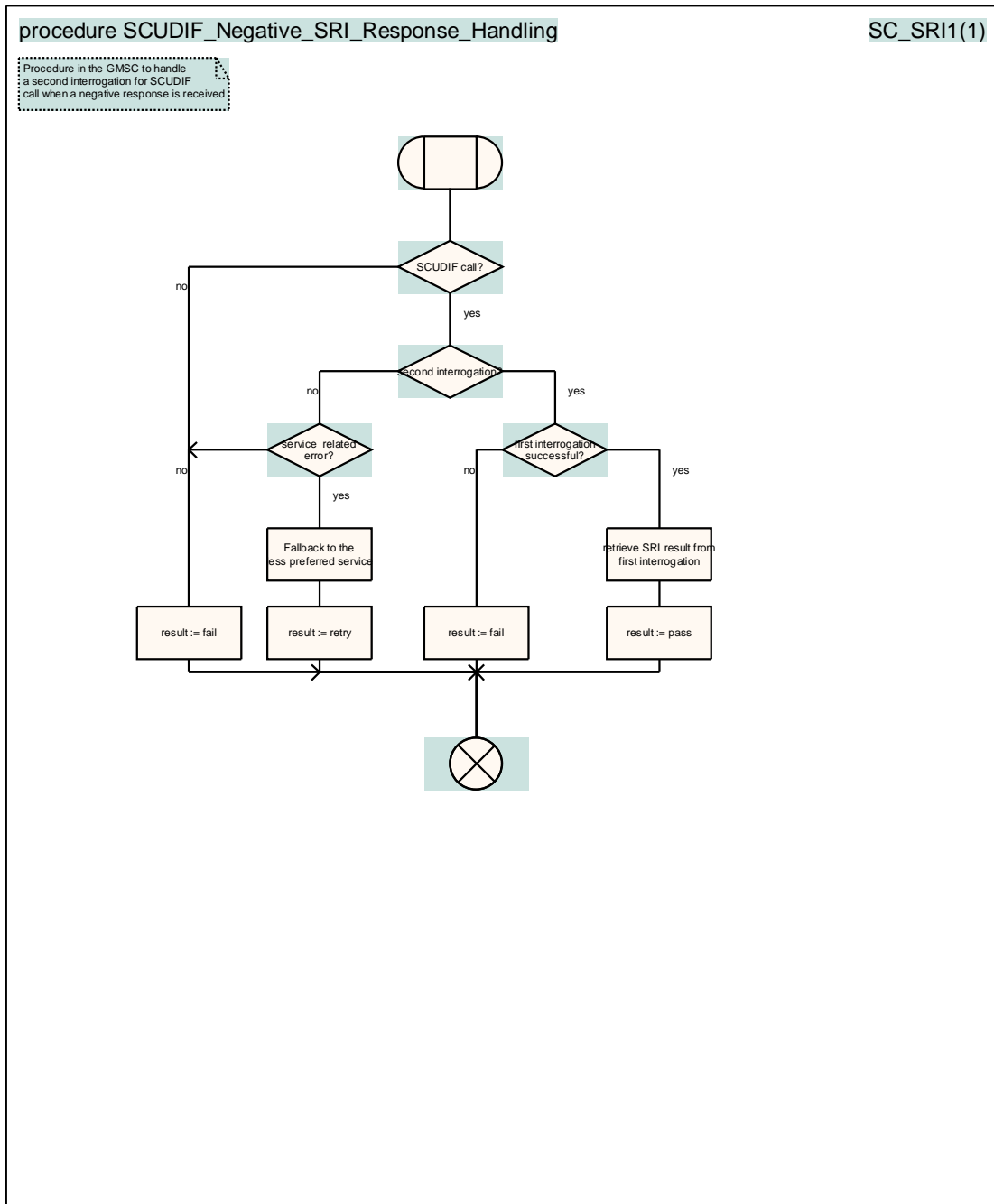

Figure 4.16l: Procedure SCUDIF_Negative_SRI_Response_Handling

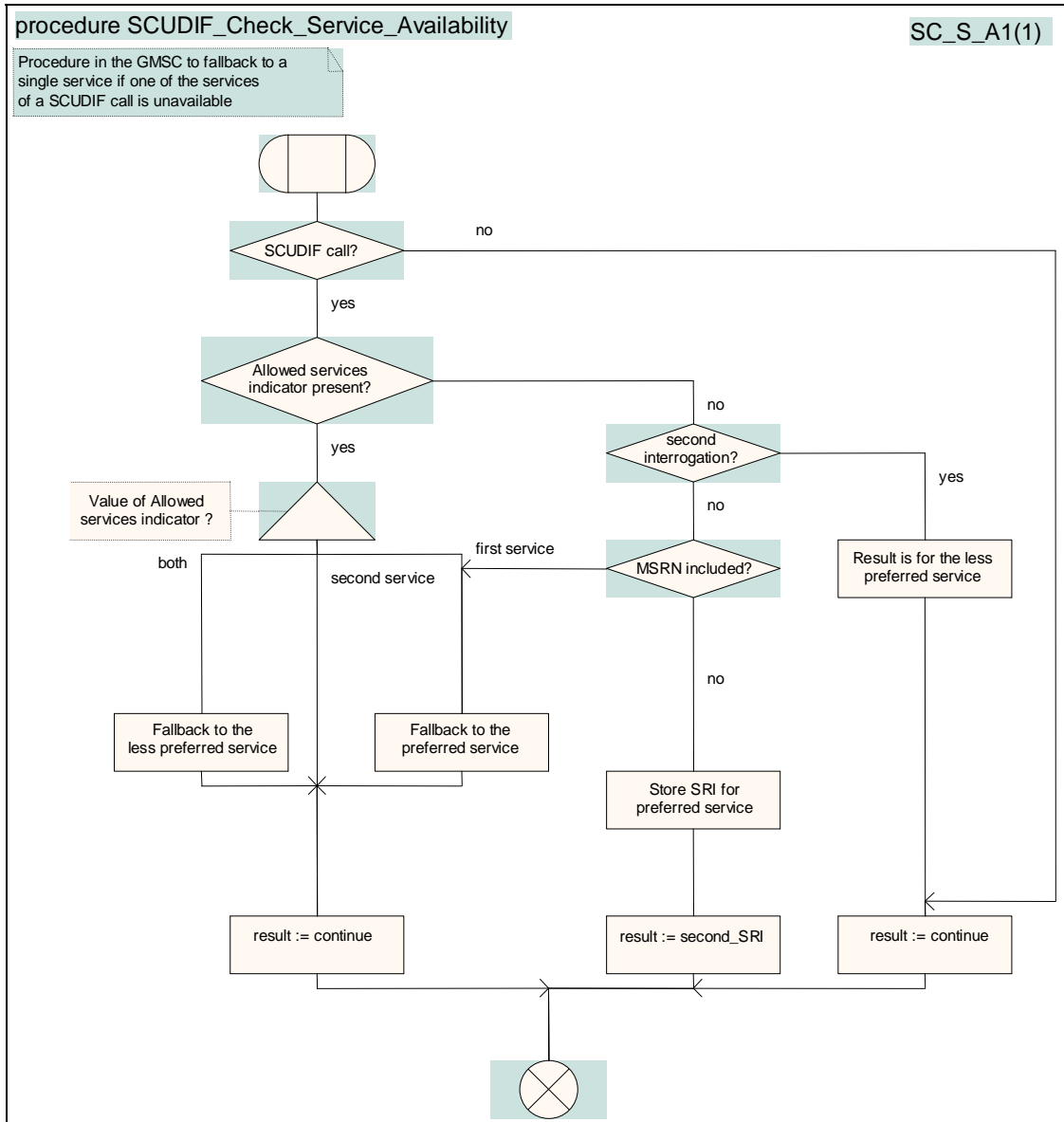

Figure 4.16J: Procedure SCUDIF_Check_Service_Availability

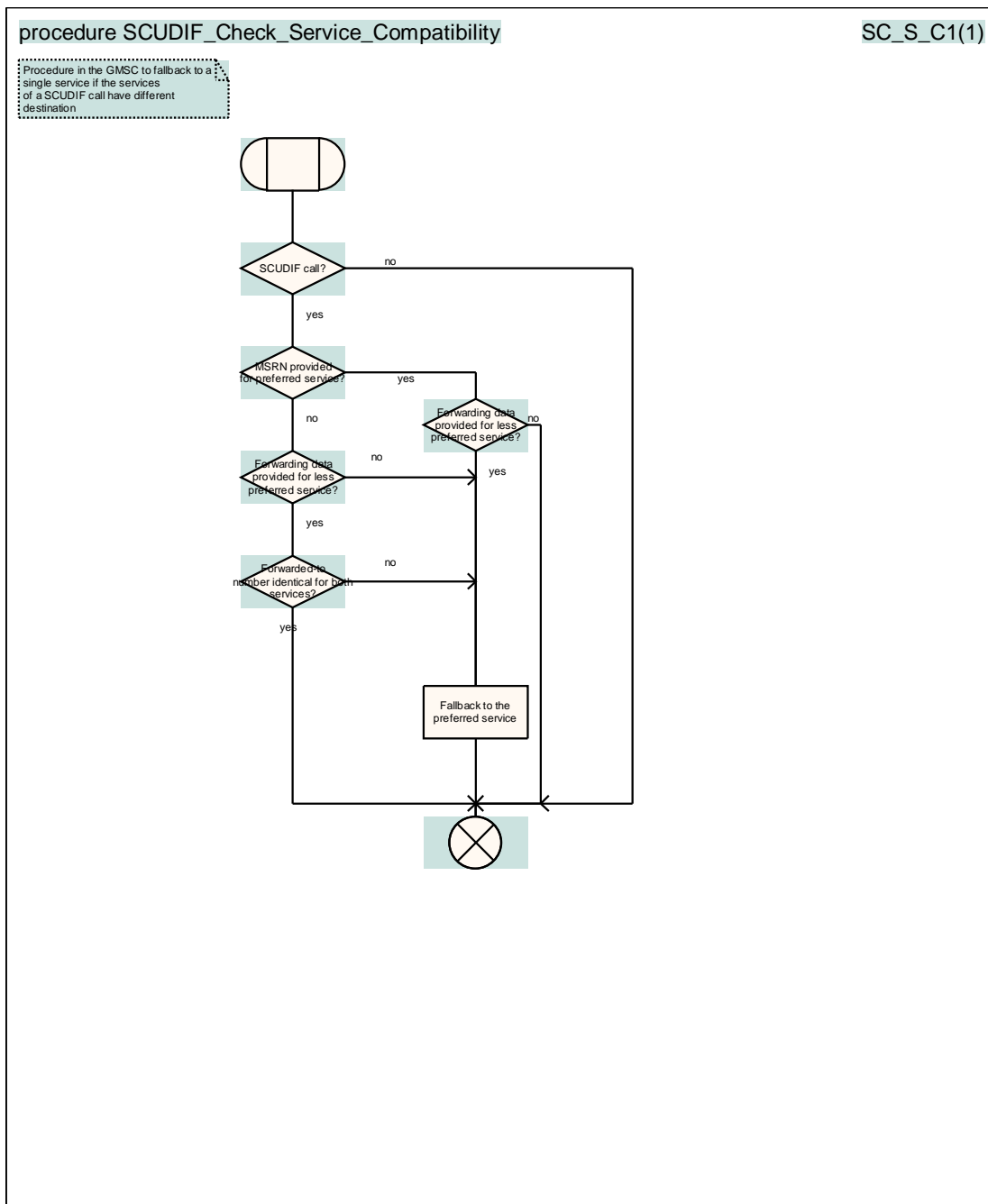

Figure 4.16K: Procedure SCUDIF_Check_Service_Compatibility

4.3.3.1a GMSC Handling at Terminating Side

Depending on operator policy, the GMSC may remove the 3G-324.M2 codec from the list of supported codec types if the call is received from selected other PLMNs.

NOTE: This enables the operator to block a network initiated upgrade if inter-operator accounting agreements do not allow this functionality, e.g. because billing schemes are not compatible for the network-initiated upgrade.

4.3.3.2 Terminating MSC Handling

The terminating MSC receives the list of supported codec types, including the 3G-324.M codec and possibly the 3G-324.M2 codec. It shall then send a SETUP message towards the terminating UE including a Repeat Indicator with the value "service change and fallback" and two BC-IEs, according to the following rule:

- if the 3G-324.M codec is the first (preferred) codec in the list of supported codecs, then the first BC-IE in the SETUP message is the multimedia BC-IE, and the second BC-IE is the speech BC-IE (see figure 4.17);
- if the 3G-324.M codec is in the list of supported codec types, but not in the first position, then the first BC-IE in the SETUP message is the speech BC-IE, and the second BC-IE is the multimedia BC-IE (see figure 4.18).

The terminating UE answers according to its capabilities in the CALL CONFIRMED message. The terminating MSC shall determine the Selected Codec and construct the list of available codecs according to the following rules:

- If no Repeat Indicator is included, and only a speech BC-IE is received, the MSC shall choose a speech codec as the Selected Codec according to the normal mechanism, and no 3G-324.M codec shall be inserted in the list of available codecs (see figure 4.19).
- If no Repeat Indicator is included, and only a multimedia BC-IE is received, the MSC shall choose the 3G-324.M codec as the Selected Codec, and only the 3G-324.M codec shall be inserted in the list of available codecs (see figure 4.20).
- If the Repeat Indicator is included, and the speech BC-IE is the first BC-IE and the multimedia BC-IE is the second BC-IE, the MSC shall choose a speech codec as the Selected Codec according to the normal mechanism, and both the 3G-324.M codec and speech codecs shall be inserted in the list of available codecs (see figure 4.21) If the terminating MSC supports incoming requests for a network-initiated service change from speech to multimedia and was offered the 3G-324.M2 codec and the terminal had indicated in the CALL CONFIRMED message with the "Enhanced Network-initiated ICM" (ENICM) Capability for the support of Network-initiated service upgrade to multimedia, the 3G-324.M codec shall be the last but one codec in the list and the 3G-324.M2 codec shall be the last codec in the list.
- If the Repeat Indicator is included, and the multimedia BC-IE is the first BC-IE and the speech BC-IE is the second BC-IE, the Selected Codec shall be the 3G-324.M codec, and both the 3G-324.M codec and speech codecs shall be inserted in the list of available codecs (see figure 4.22). If the terminating MSC supports incoming requests for a network-initiated service change from speech to multimedia and was offered the 3G-324.M2 codec and the terminal had indicated in the CALL CONFIRMED message with the "Enhanced Network-initiated ICM" (ENICM) Capability for the support of Network-initiated service upgrade to multimedia, the terminating MSC it shall include the 3G-324.M2 codec as second codec in the list of available codecs.

The Selected Codec and the list of available codecs shall be sent back to the originating MSC according to the normal codec negotiation procedure.

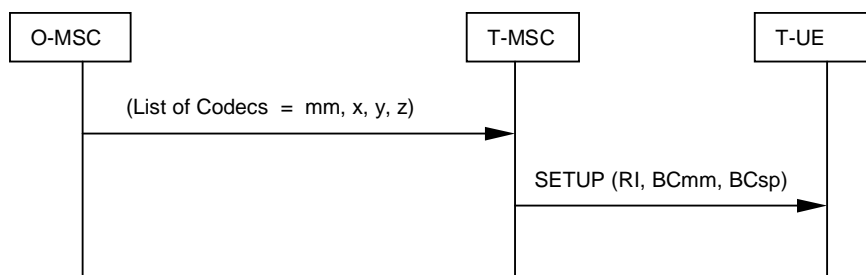

NOTE: The 3G-324.M2 codec may be included the list in addition to 3G-324.M. This is not depicted in the figure.

Figure 4.17: 3G-324M codec first

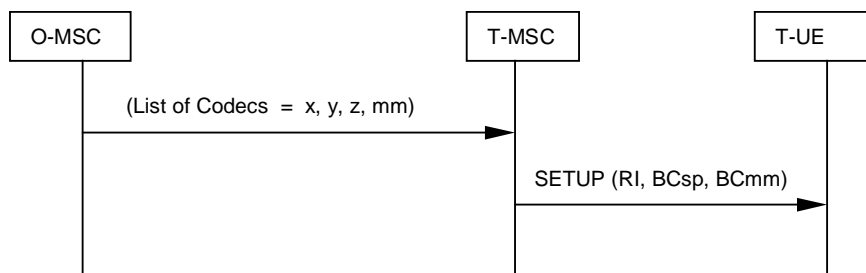

NOTE: The 3G-324.M2 codec may be included the list in addition to 3G-324.M. This is not depicted in the figure.

Figure 4.18: Speech codec first

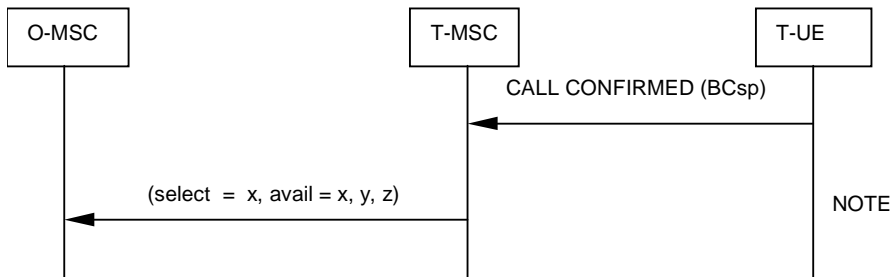

NOTE: The actual speech codec is selected according to OoBTC procedures.

Figure 4.19: Speech only

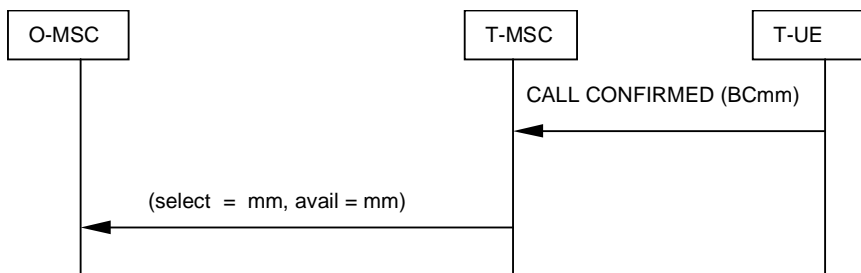

NOTE: The 3G-324.M2 codec may be included in the list of available codecs after the 3G-324.M codec. This is not depicted in the figure.

Figure 4.20: Multimedia only

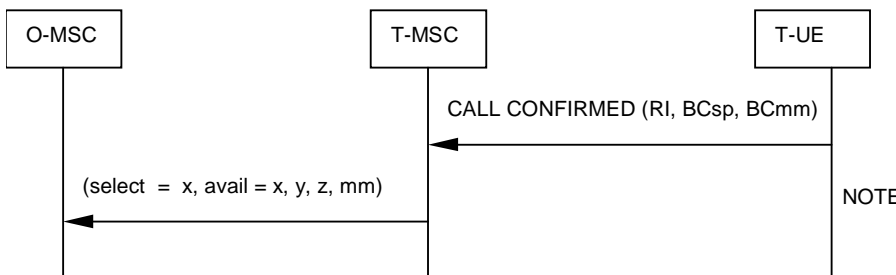

NOTE 1: The actual speech codec is selected according to OoBTC procedures.

NOTE 2: If the terminating MSC supports incoming requests for a network-initiated service change from speech to multimedia and was offered the 3G-324.M2 codec and the terminal had indicated in the CALL CONFIRMED message with the "Enhanced Network-initiated ICM" (ENICM) Capability for the support of Network-initiated service upgrade to multimedia, the terminating MSC shall include the 3G-324.M2 codec as last codec in the list of available codecs after 3G-324.M. This is not depicted in the figure.

Figure 4.21: Speech preferred

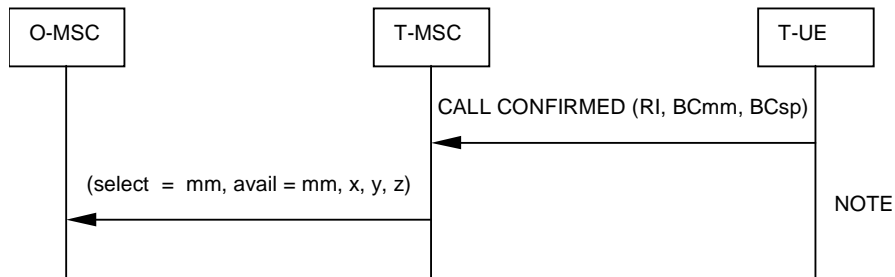

NOTE 1: The actual list of speech codecs is built according to OoBTC procedures.

NOTE 2: If the terminating MSC supports incoming requests for a network-initiated service change from speech to multimedia and was offered the 3G-324.M2 codec and the terminal had indicated in the CALL CONFIRMED message with the "Enhanced Network-initiated ICM" (ENICM) Capability for the support of Network-initiated service upgrade to multimedia, the terminating MSC shall include the 3G-324.M2 codec as second codec in the list of available codecs after 3G-324.M. This is not depicted in the figure.

Figure 4.22: Multimedia preferred

4.3.4 Originating side - completion of call setup

The originating MSC receives the Selected Codec and the list of available codecs, and, depending on the active mode, shall do the following:

The call was set up with a multimedia BC-IE first:

- if the Selected Codec is the 3G-324.M codec, no In-Call Modification procedure is necessary (see figure 4.23). If no speech codecs are included in the list of available codecs, all In-Call Modification procedures initiated by the UE using the speech BC-IE shall be rejected with a MODIFY REJECT message;
- if the Selected Codec is a speech codec, an In-Call Modification procedure to change to speech mode shall take place (see figure 4.24). If the 3G-324.M codec is not included in the list of available codecs, all In-Call Modification procedures initiated by the UE using the multimedia BC-IE shall be rejected with a MODIFY REJECT message.

The call was set up with a speech BC-IE first:

- if the Selected Codec is the 3G-324.M codec, an In-Call Modification procedure to change to multimedia mode shall take place (see figure 4.25). If no speech codecs are included in the list of available codecs, all In-Call Modification procedures initiated by the UE using the speech BC-IE shall be rejected with a MODIFY REJECT message;
- if the Selected Codec is a speech codec, no In-Call Modification procedure is necessary (see figure 4.26). If the 3G-324.M codec is not included in the list of available codecs, all In-Call Modification procedures initiated by the UE using the multimedia BC-IE shall be rejected with a MODIFY REJECT message.

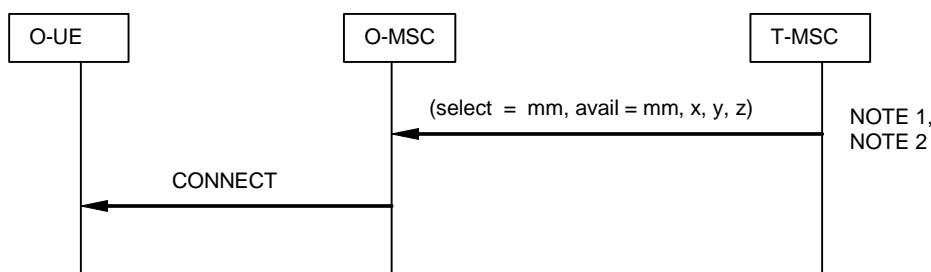

NOTE 1: Speech codecs (x, y, z) may or may not be present. If they are not present, subsequent MODIFY requests from the UE are rejected.

NOTE 2: The 3G-324.M2 codec may be included in the list of available codecs after the 3G-324.M codec. This is not depicted in the figure.

Figure 4.23: Multimedia preferred, selected

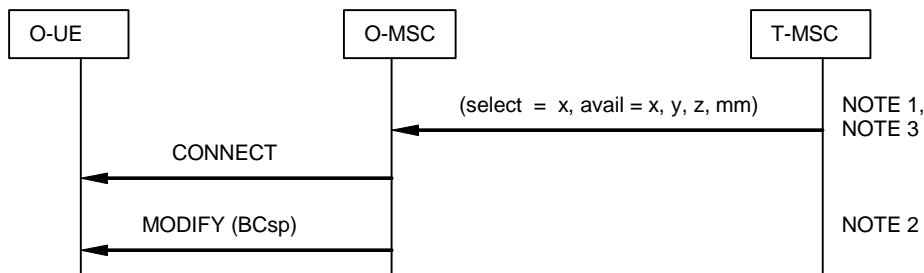

NOTE 1: The multimedia codec (mm) may or may not be present. If it is not present, subsequent MODIFY requests from the UE are rejected.

NOTE 2: see clause 4.2.3 for the In-Call Modification signalling.

NOTE 3: The 3G-324.M2 codec may be included in the list of available codecs after the 3G-324.M codec. This is not depicted in the figure.

Figure 4.24: Multimedia preferred, speech selected

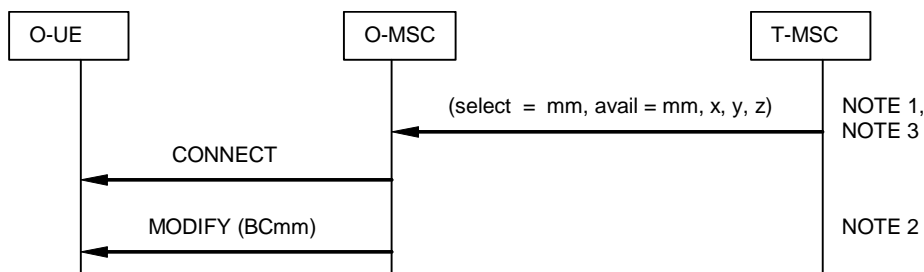

NOTE 1: Speech codecs (x, y, z) may or may not be present. If they are not present, subsequent MODIFY requests from the UE are rejected.

NOTE 2: see clause 4.2.3 for the In-Call Modification signalling.

NOTE 3: The 3G-324.M2 codec may be included in the list of available codecs after the 3G-324.M codec. This is not depicted in the figure.

Figure 4.25: Speech preferred, multimedia selected

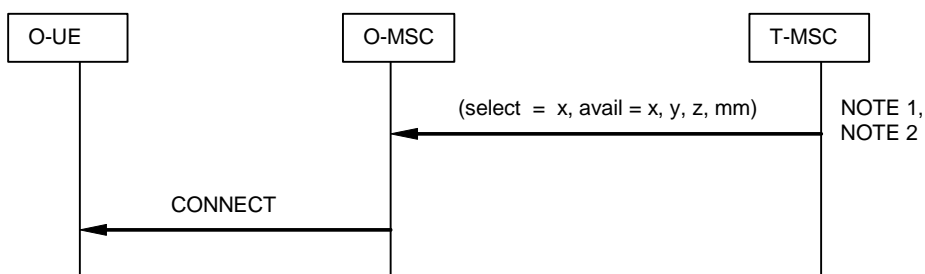

NOTE 1: The multimedia codec (mm) may or may not be present. If it is not present, subsequent MODIFY requests from the UE are rejected.

NOTE 2: The 3G-324.M2 codec may be included in the list of available codecs after the 3G-324.M codec. This is not depicted in the figure.

Figure 4.26: Speech preferred, selected

4.3.5 Service change during the active state

Whenever an In-Call Modification procedure is invoked by a terminal, unless it is not allowed as determined at call setup, the following shall take place:

- if the current mode is the speech mode and the MODIFY message contains a multimedia BC-IE, the normal Out-of-Band Transcoder Control procedures shall be invoked in order to change the Selected Codec to the 3G-324.M/3G-324.M2 codec;

- if the current mode is the multimedia mode and the MODIFY message contains a speech BC-IE, the normal Out-of-Band Transcoder Control procedures shall be invoked in order to change the Selected Codec to the preferred speech codec.

When a visited MSC invokes Network-initiated Service change in the active state (see Clause 4.2.5), this visited MSC shall also invoke the normal Out-of-Band Transcoder Control procedures in order to change the Selected Codec to speech or to the 3G-324.M/3G-324.M2 codec, respectively.

For a User-initiated service change from speech to multimedia, the visited MSC shall use the 3G-324.M codec as Selected Codec.

If the visited MSC received the 3G-324.M2 codec in the available codec list, the visited MSC shall use the 3G-324.M2 codec as Selected Codec for a Network-initiated Service change procedure from speech to multimedia.

If the visited MSC did not receive the 3G-324.M2 codec in the available codec list, depending on operator policy, the visited MSC may either use the 3G-324.M codec as Selected Codec for a Network-initiated Service change procedure from speech to multimedia, or the visited MSC may not perform a Network-initiated Service change procedure from speech to multimedia.

NOTE: The the 3G-324.M2 codec in the available codec list indicates that all nodes in the call support collecting appropriate charging records for the network initiated service change from speech to multimedia.

If the 3G-324.M2 codec is used as Selected Codec in BICC signalling, the 3G-324.M codec shall be signalled instead to the MGW.

NOTE: This avoids that MGWs need to support the 3G-324.M2 codec.

The Codec Modification procedure shall be supported for service change. The use of mid-call codec negotiation procedure is optional for service change.

When a MSC detects through an Out-of-Band Transcoder Control procedure that the selected codec has changed from a speech codec to the 3G-324.M codec, or vice-versa, it shall initiate an In-Call Modification procedure towards the UE with a MODIFY message containing the multimedia BC-IE (or the speech BC-IE), unless the new mode has been denied at call setup (see clause 4.2.4).

4.3.5.1 Mid-Call Codec Modification Procedure For Service Change

The Codec Modification procedures as defined in 3GPP TS 23.153 [2] shall be applied with the following specific additional rules for the Service Change procedure.

In order to prevent the MGW generating an error or seizing resources during the interim period, when its terminations are being altered and it may have a speech codec on one side of the context and the 3G-324M codec on the other side the Server shall modify the Stream-mode of the affected terminations to inactive during the Service change and shall restore the stream mode to active – (send/receive – bothway) on completion of the service change procedure. In order to restore the stream mode to active, the MSC servers shall use the 'Modify Bearer Characteristics' procedure for Iu terminations and for Nb terminations towards the succeeding node with respect to the 'Modify Codec' message. The MSC servers shall use the 'Confirm Bearer Characteristics' procedure for Nb terminations towards the preceding node with respect to the 'Modify Codec' message.

If the affected termination's stream mode is inactive a MGW shall not reject a 'Modify Bearer Characteristics' or a 'Reserve Bearer Characteristics' procedure because the multimedia codec and a speech codec are interconnected simultaneously in the same context.

For a service change where the CN shall initiate the IuUP on the Nb interface, the MSC server terminating the service change shall trigger the IuUP initialisation towards the core network by setting the IuUP initialisation direction to 'out' in the 'Confirm Bearer Characteristics' procedure for the corresponding termination towards the core network.

Example call flows are shown in Figure 4.3.5.1/1 to 4.3.5.1/10.

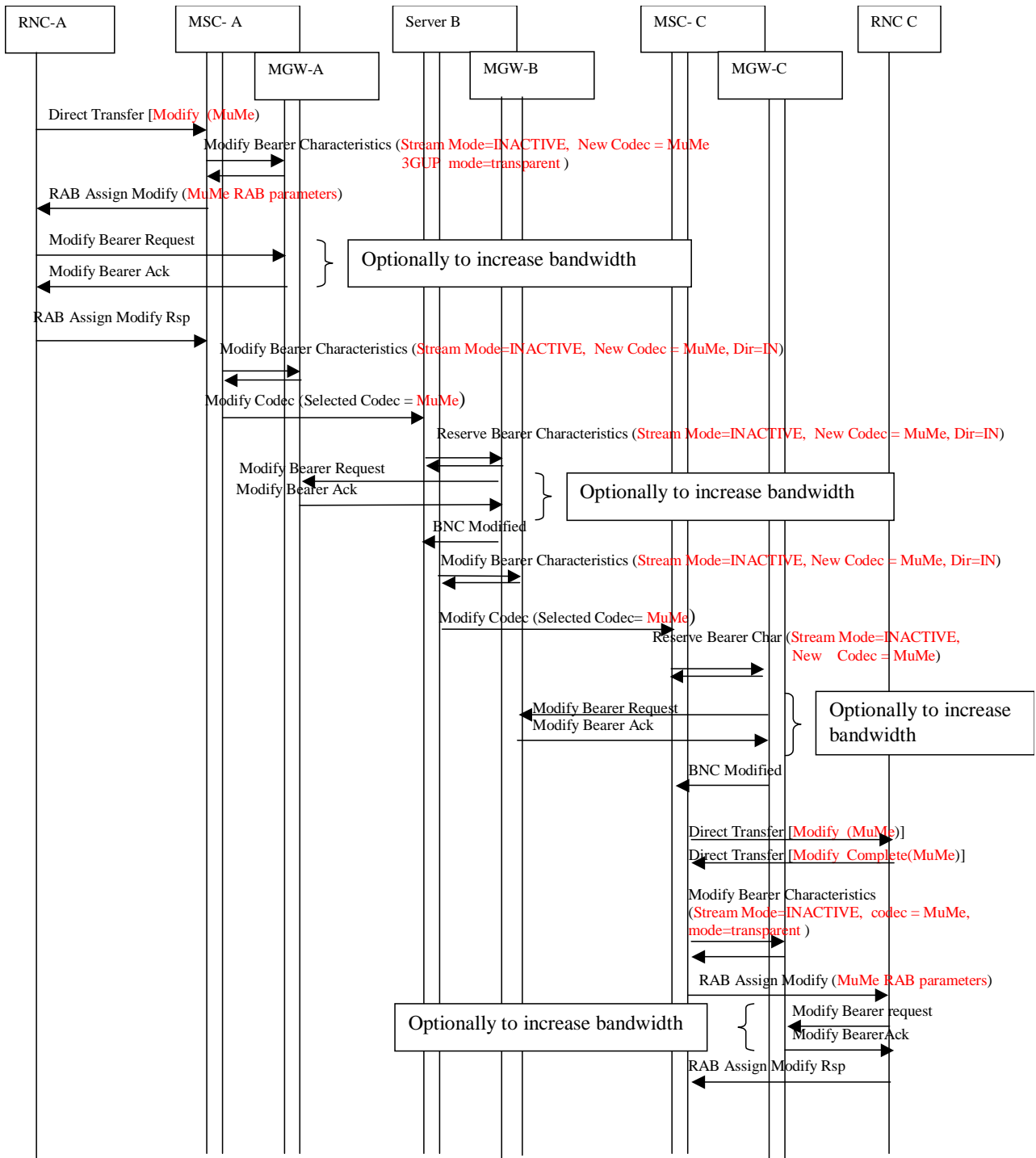

Figure 4.3.5.1/1: Service change speech to MuMe

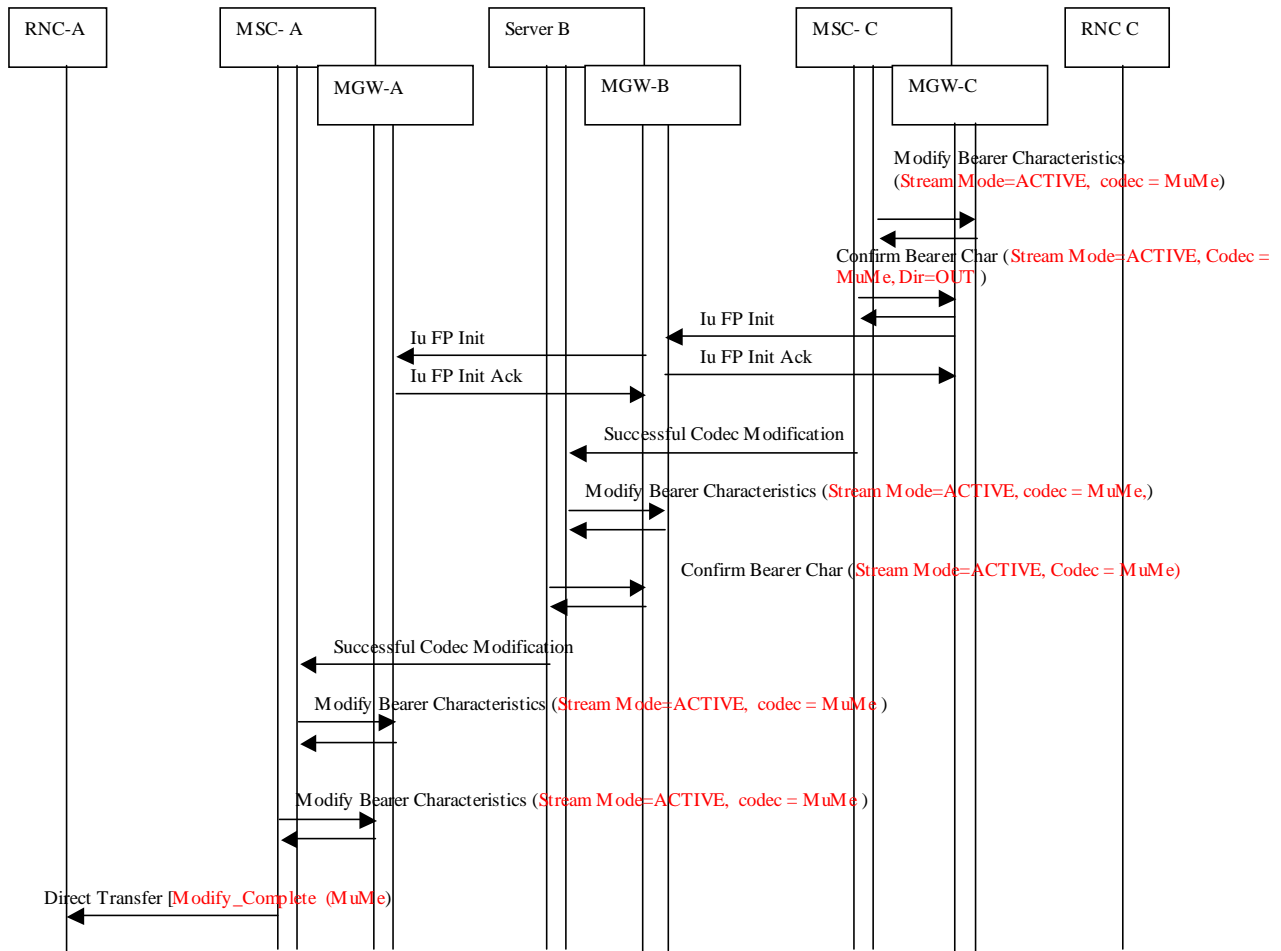

Figure 4.3.5.1/2: Service change speech to MuMe (continued)

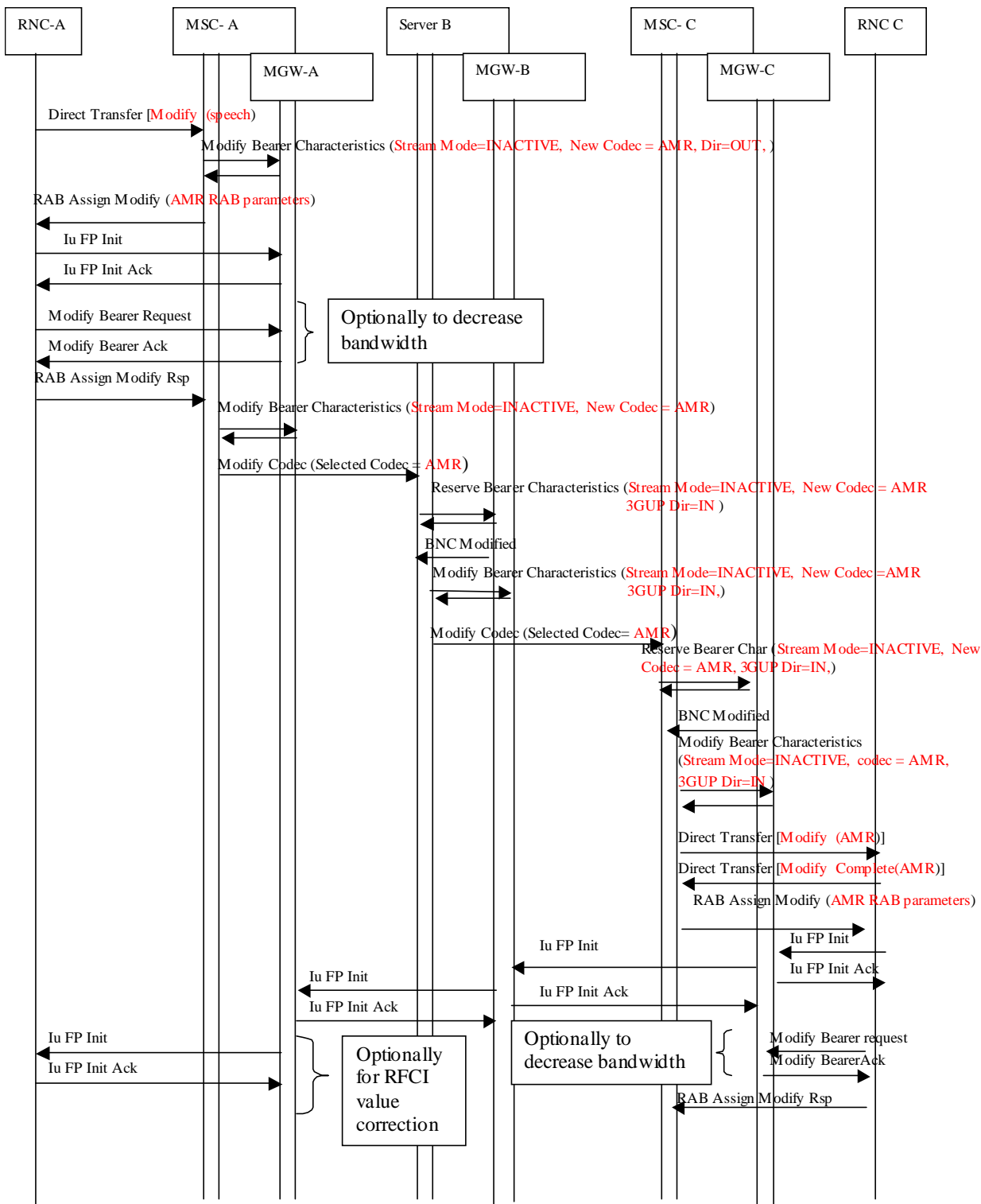

Figure 4.3.5.1/3: Service change MuMe to AMR

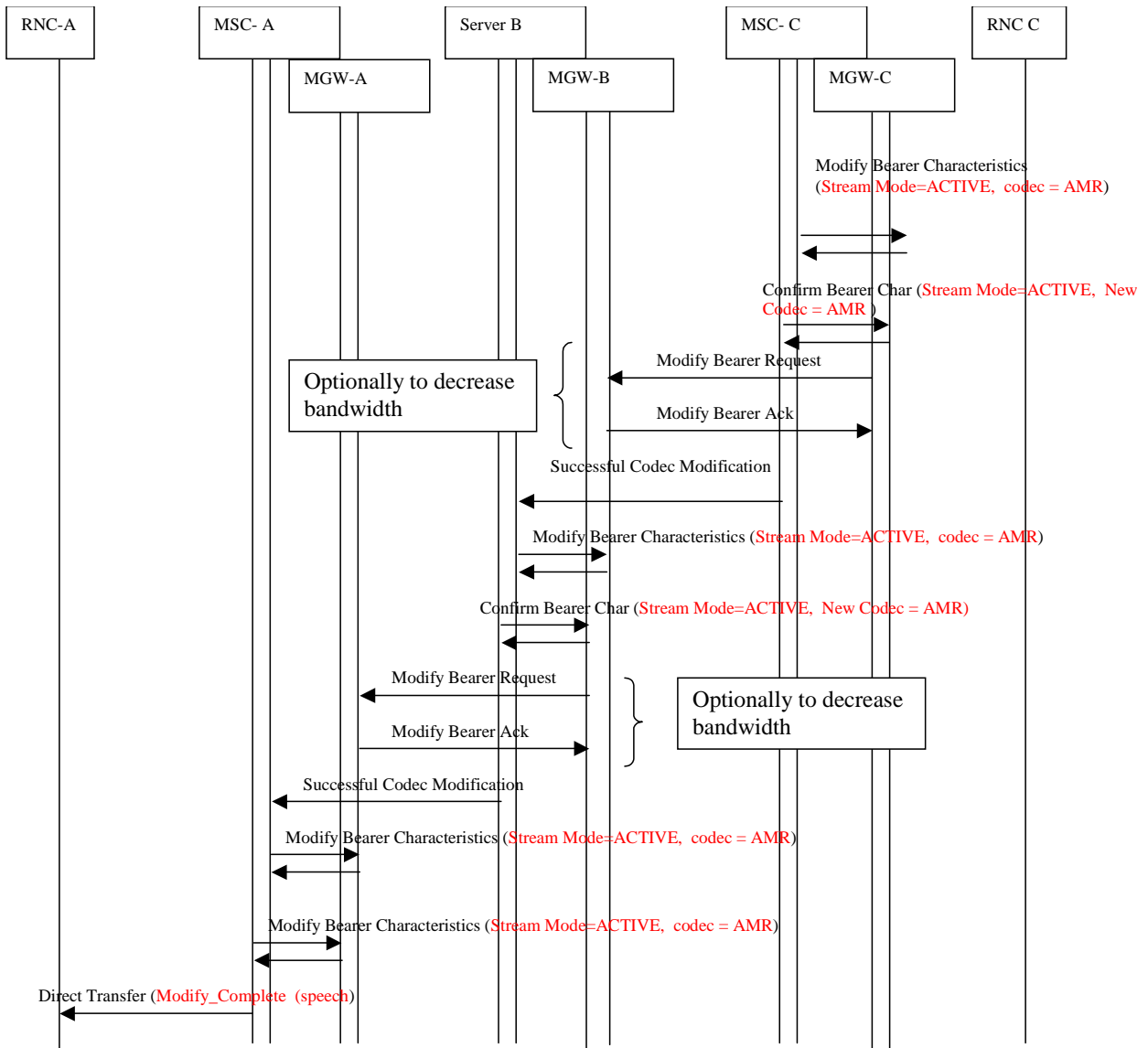

Figure 4.3.5.1/4: Service change MuMe to AMR (continued)

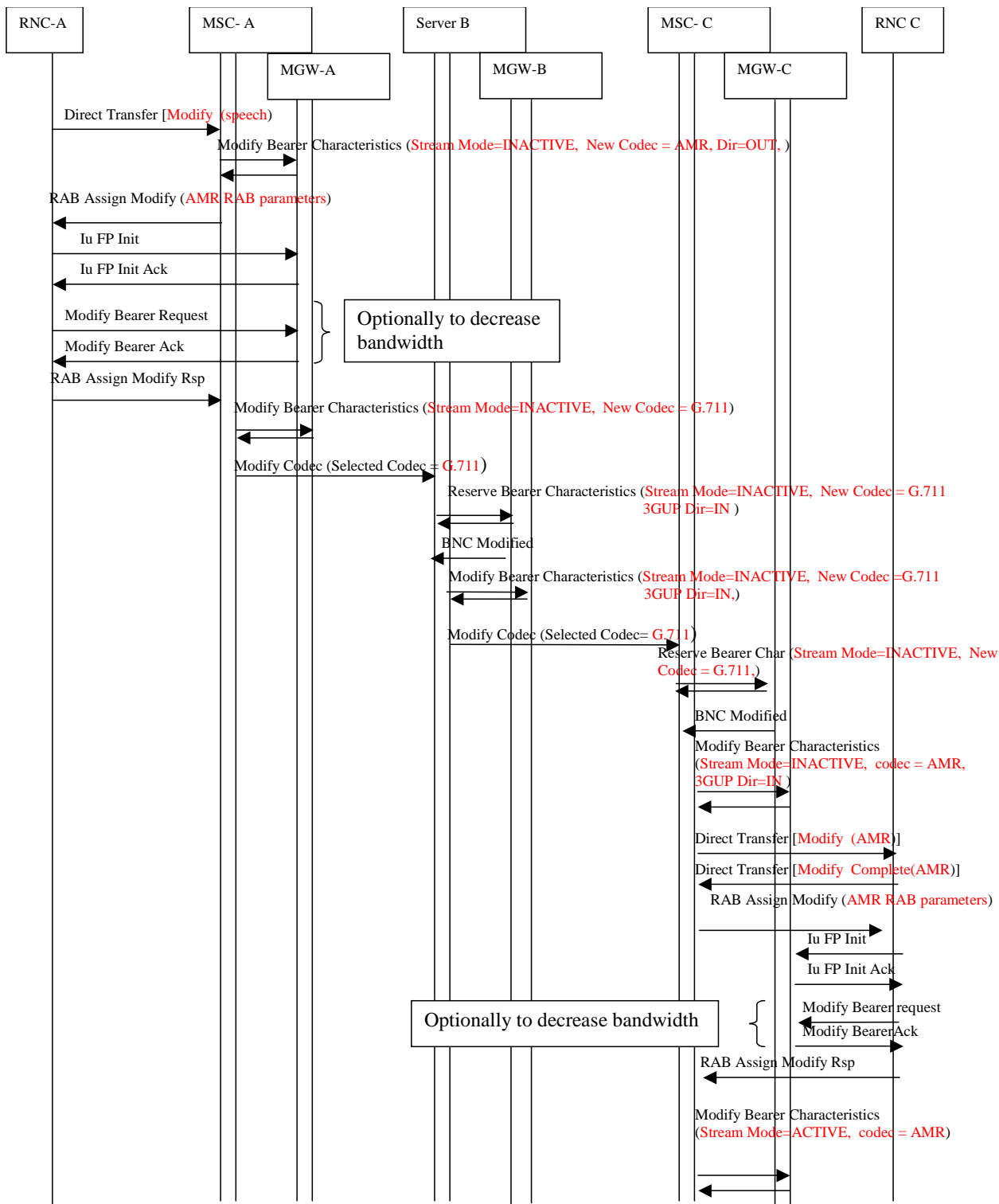

Figure 4.3.5.1/5: Service change MuMe to PCM(G.711)

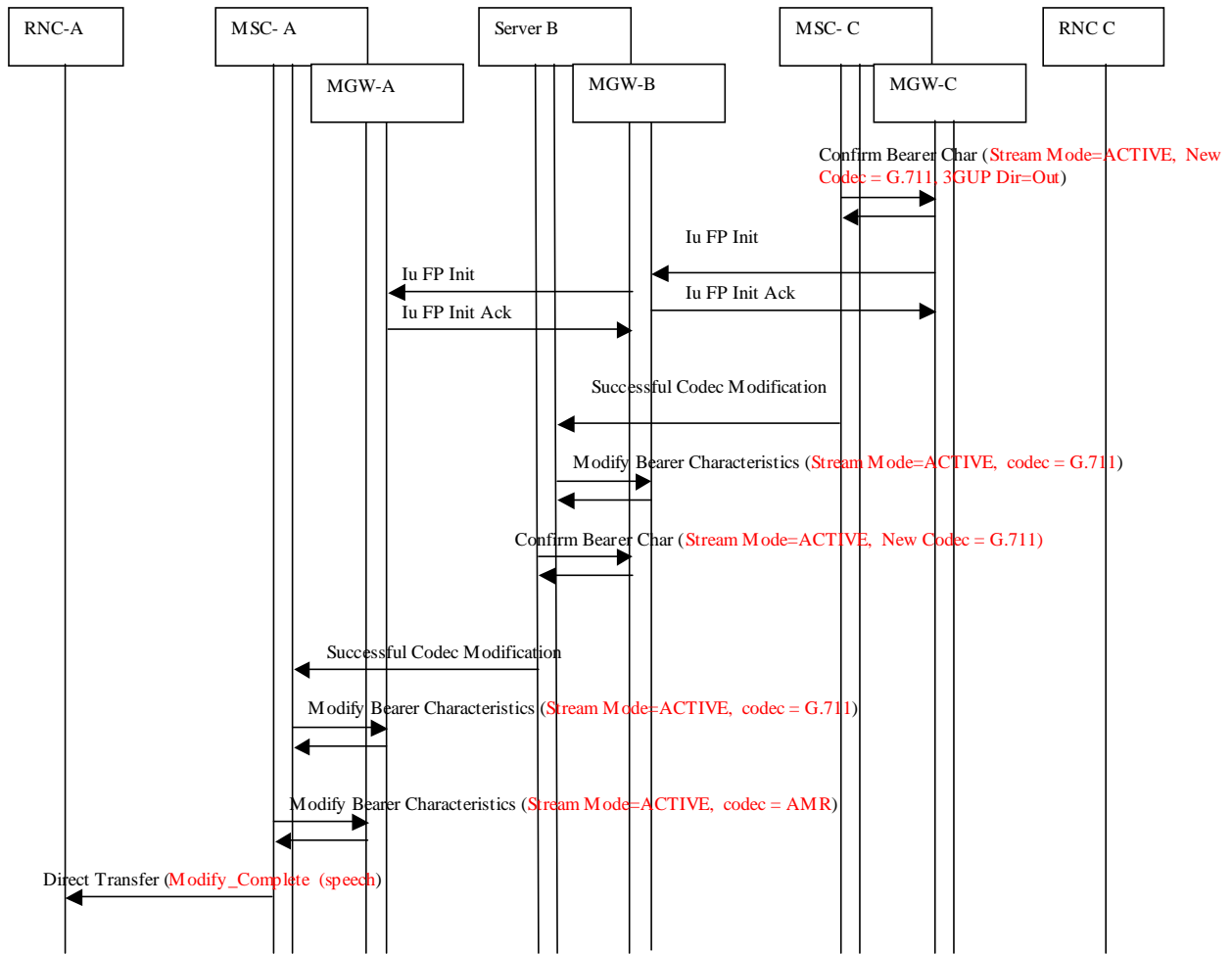

Figure 4.3.5.1/6: Service change MuMe to PCM(G.711) (continued)

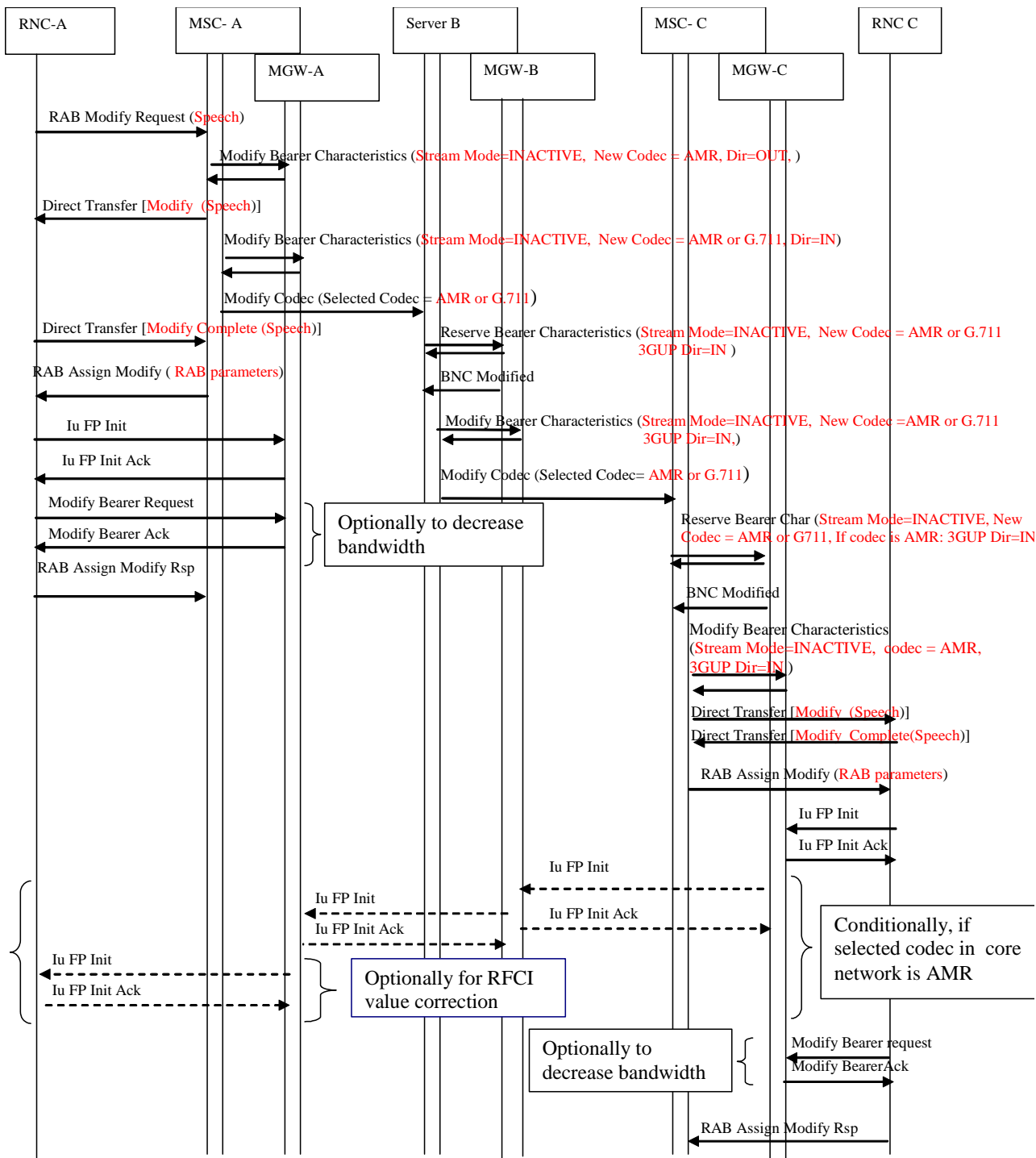

Figure 4.3.5.1/7: Network-initiated service change from MuMe to speech

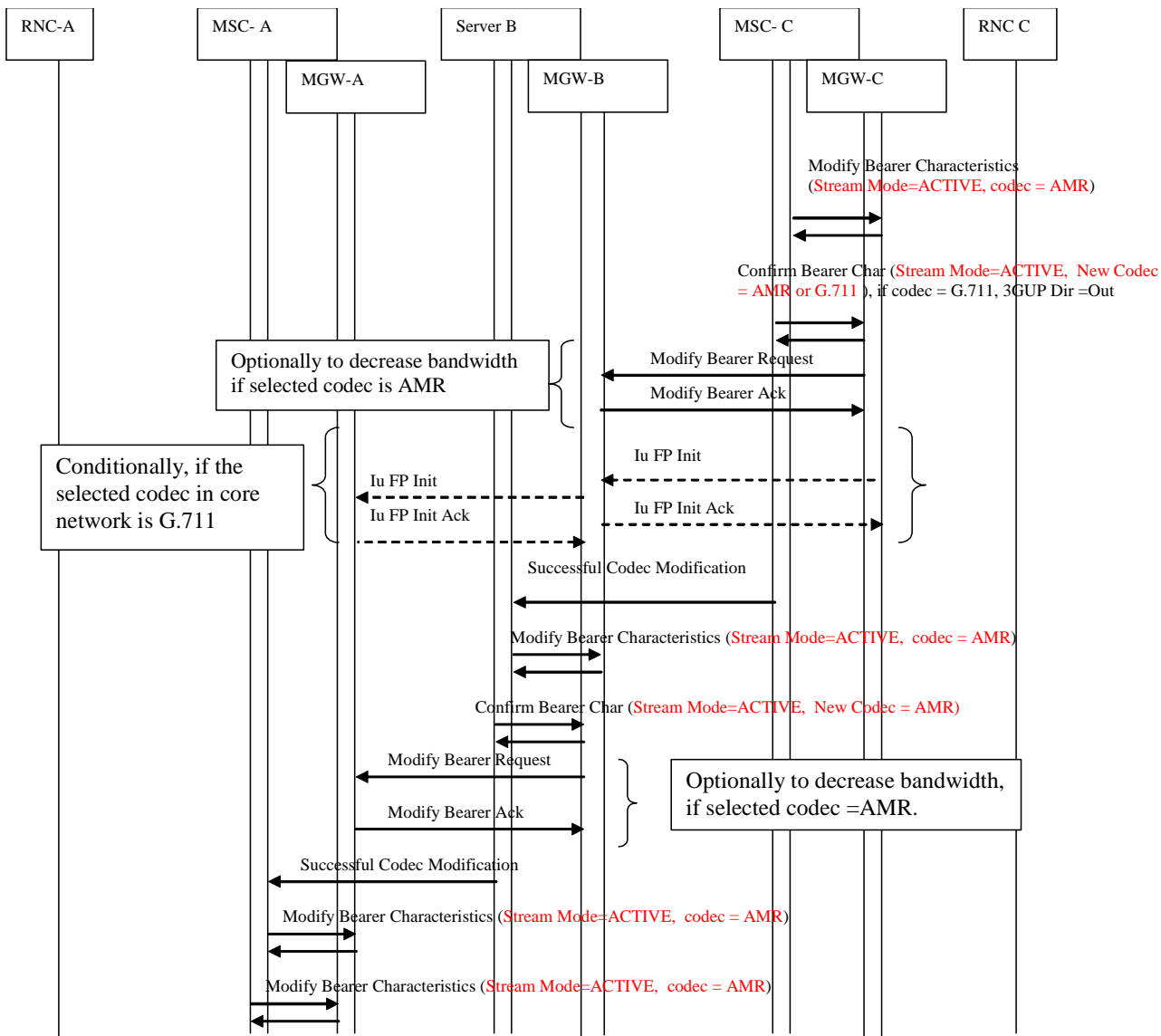

Figure 4.3.5.1/8: Network-initiated service change from MuMe to speech (continue)

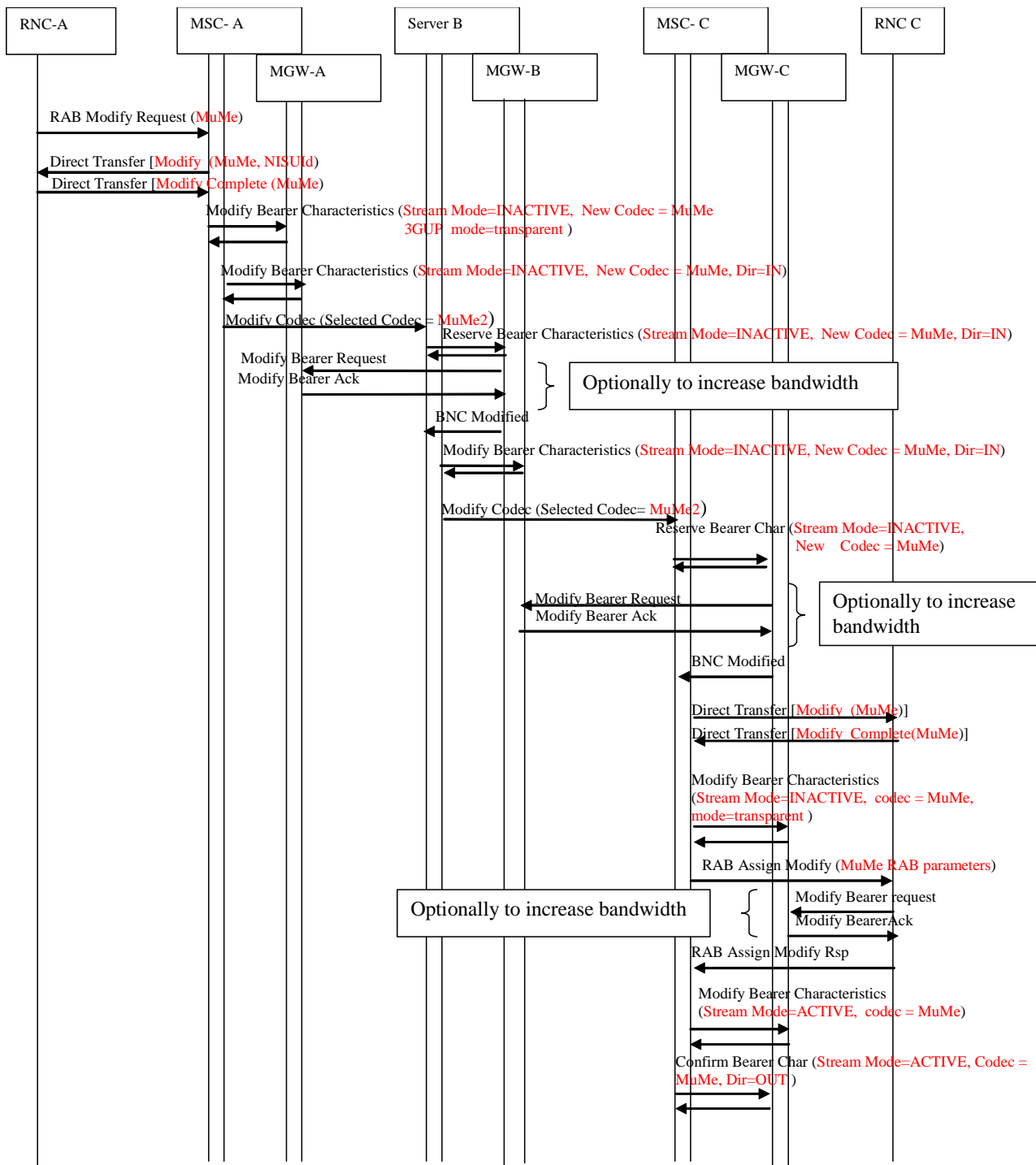
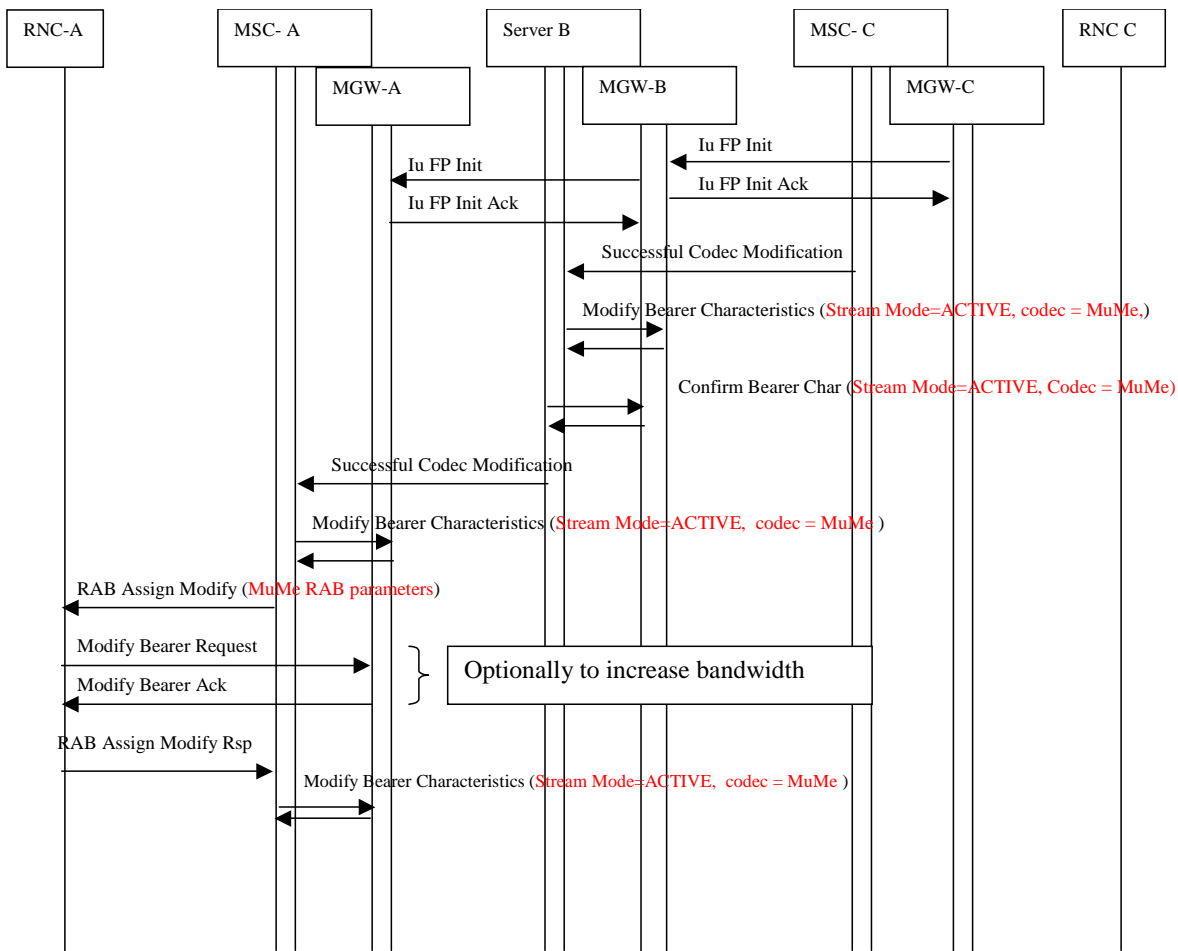

Figure 4.3.5.1/9: Network-initiated service change speech to MuMe



NOTE: The RAB Assign Modify sent towards RNC-A may also be sent by MSC-A before receiving the Successful Codec Modification Message.

Figure 4.3.5.1/10: Network-initiated service change speech to MuMe (continued)

4.3.5.2 Unsuccessful Service Change

In the case the service change is denied by the UE at the terminating side, the procedures for the unsuccessful Codec Modification as defined in [2] shall be applied to revert to the old medium (speech or multimedia).

The through-connection of terminations shall be performed as described in Subclause 4.3.5.1. The "Codec Modification Failure" message shall interact with the "Modify Bearer Characteristics" procedure and the "Confirm Bearer Characteristics" procedure in the same way as the 'Successful Codec Modification' message.

An example sequence is shown in Figure 4.3.5.2/1 to 4.3.5.2/5.

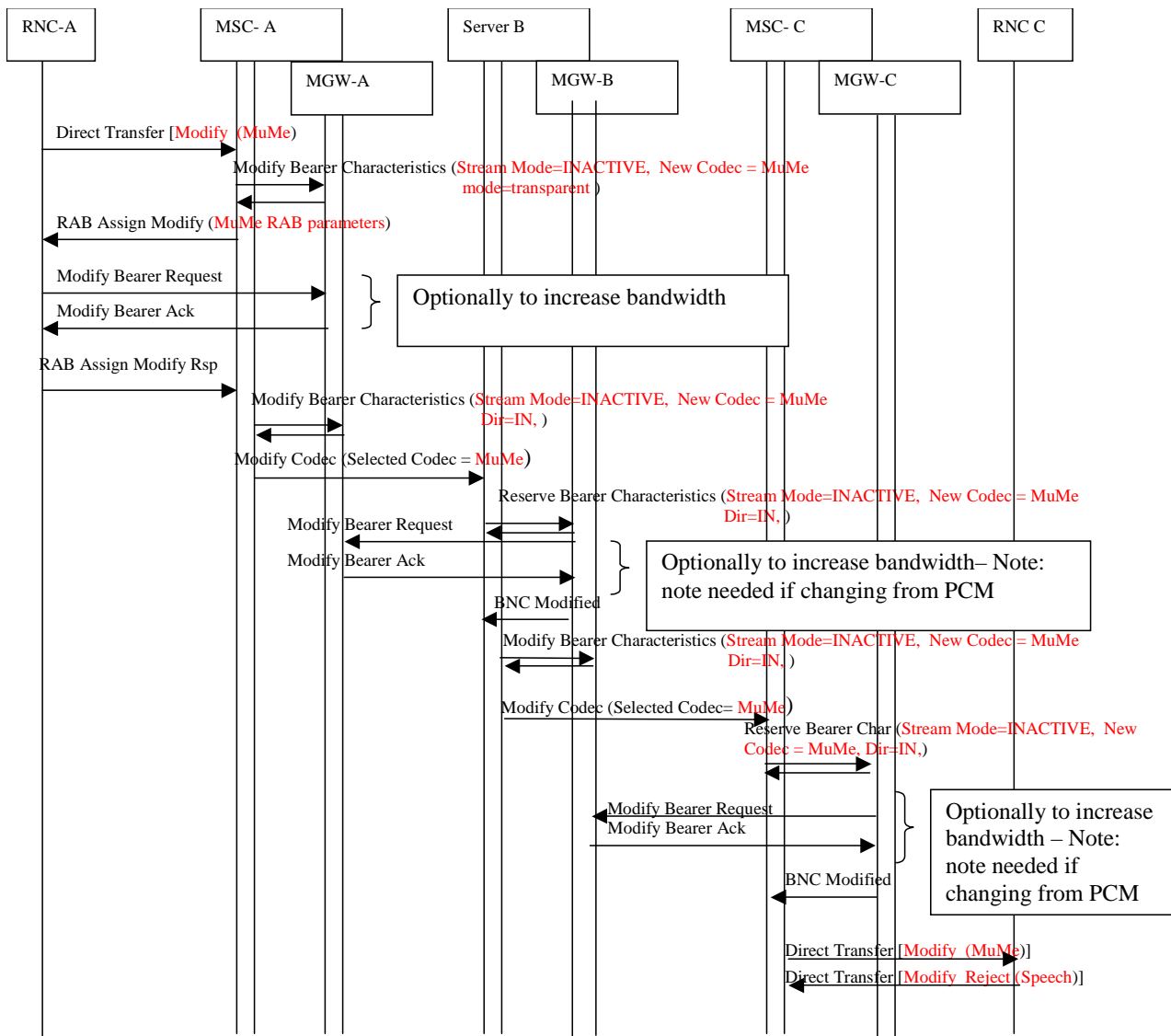

Figure 4.3.5.2/1: Service Change Rejected

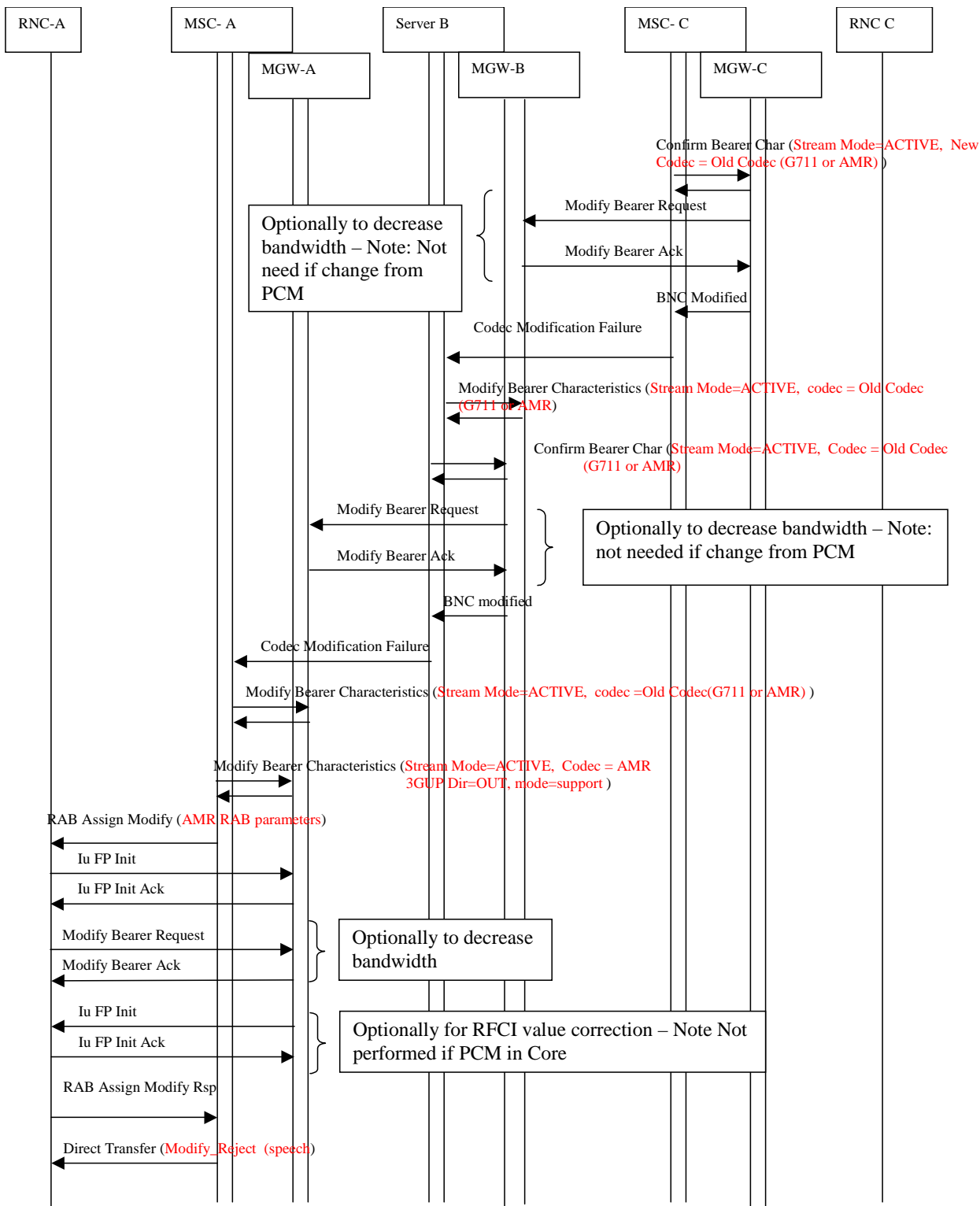

Figure 4.3.5.2/2: Service Change Rejected (Continued)

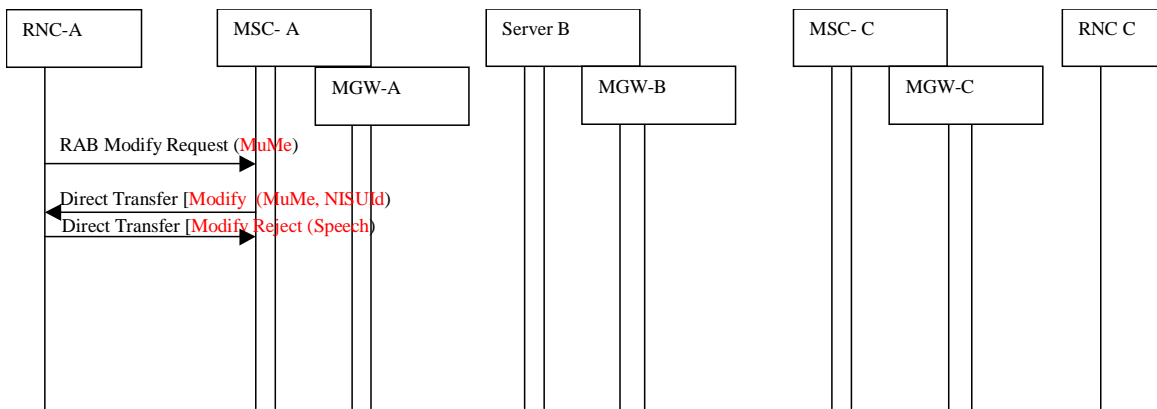

Figure 4.3.5.2/3: Network-initiated service change from speech to MuMe initiated by MSS A, rejected by user A

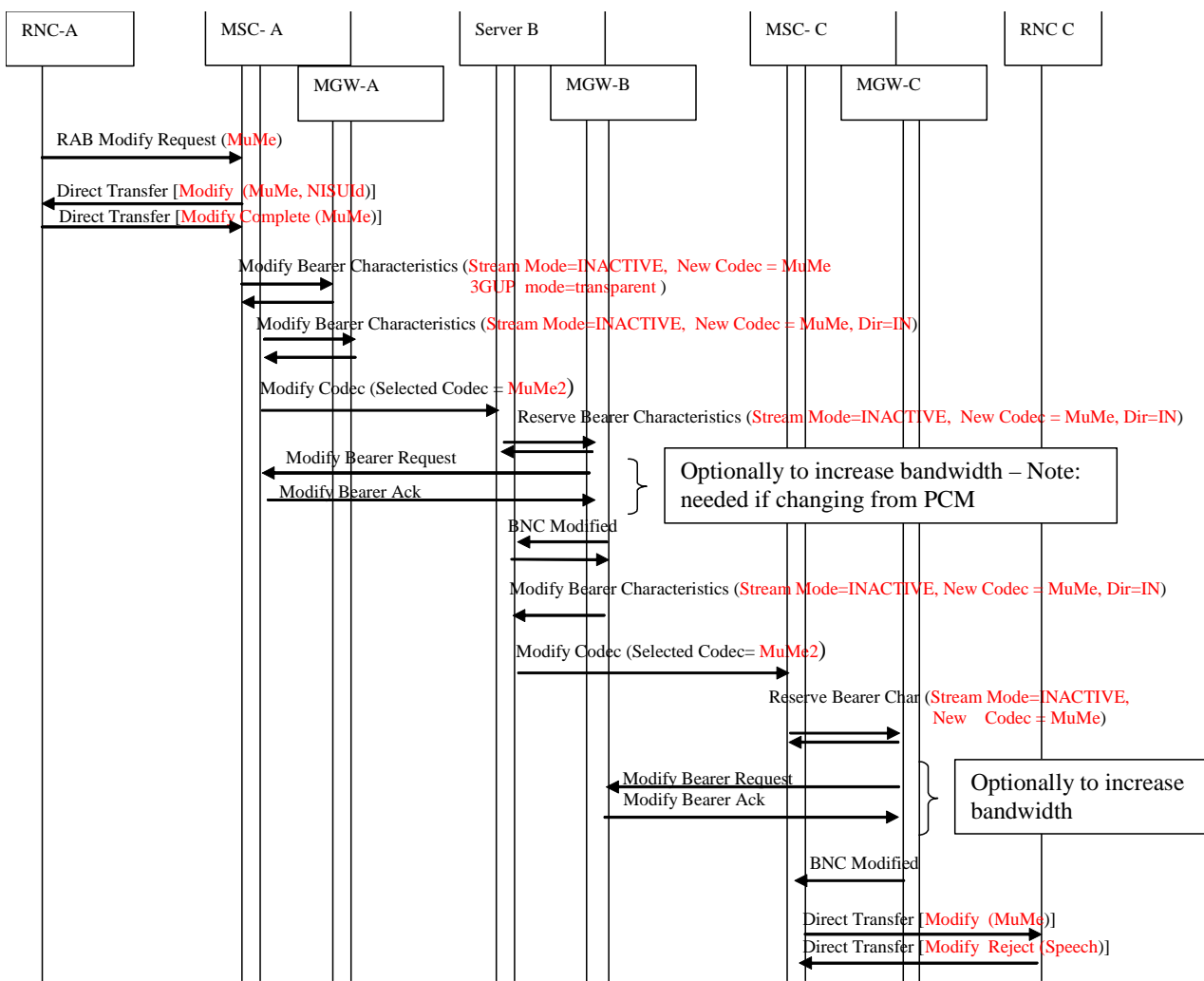

Figure 4.3.5.2/4: Network-initiated service change from speech to MuMe initiated by MSS A, rejected by user B

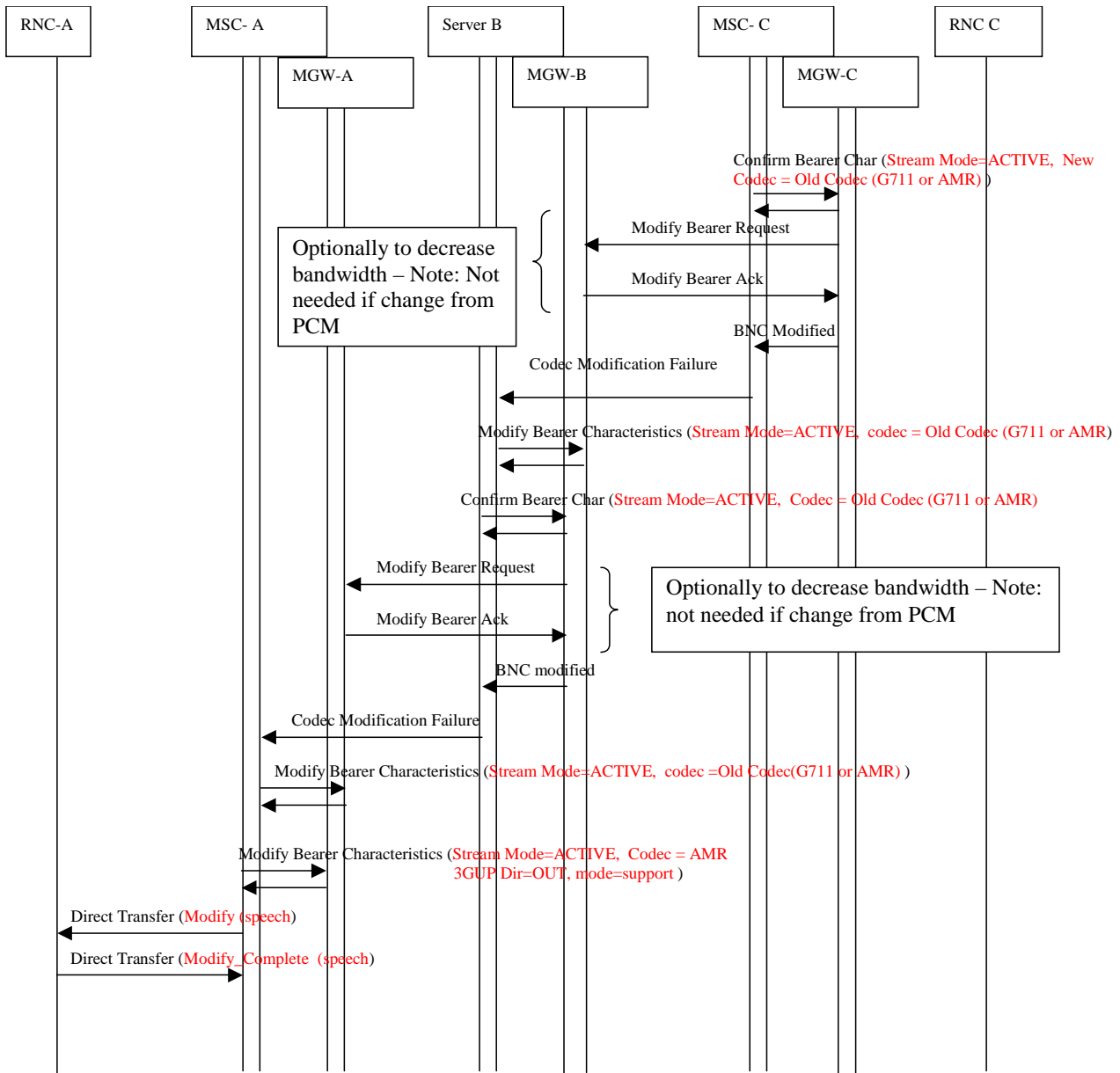

Figure 4.3.5.2/5: Network-initiated service change from speech to MuMe initiated by MSS A, rejected by user B (continued)

4.3.6 Interaction with supplementary services

4.3.6.1 Call forwarding and Call deflection

If CFB(UDUB), CFNRy, or Call Deflection is invoked in a SCUDIF call, and both basic services are provisioned, the HLR (for early call forwarding) or VLR (for late call forwarding) shall check the handling of the call should continue with the active service negotiated between the called UE and the network.

If call forwarding except CFB(UDUB) and CFNRy is invoked in a SCUDIF call, and both basic services are provisioned, the HLR (for early call forwarding) or VLR (for late call forwarding) shall check the service for both the preferred service and the less preferred service.

Then, the SCUDIF call interacting with call forwarding shall be handled according to the following rules:

- If the call forwarding is active only for the less preferred service, the preferred service shall be selected and the call setup shall continue with a single service without invoking call forwarding.

- If the call forwarding is active only for the preferred service, the preferred service shall be selected and call forwarding shall continue with a single service to the destination indicated by the forwarded to number.
- If the call forwarding is active for both services and the forwarded to number for the preferred service is same as for the less preferred service, the call shall continue as a SCUDIF call to the destination indicated by the forwarded to number.
- If the call forwarding is active for both services and the forwarded to number for the preferred service is different from that for the less preferred service, the preferred service shall be selected and call forwarding shall continue with a single service to the destination indicated by the forwarded to number for the preferred service.
- If the call forwarding is active for both services and CF type for the preferred service is different from that of less preferred service, the call shall continue as a SCUDIF call to the destination indicated by the forwarded to number, and the forwarding reason for the preferred service shall be indicated.

NOTE: For Late call forwarding or Call Deflection with Optimal Routing, the second basic service group code shall be generated in VMSC and sent in Resume Call Handling and may be sent in the following Send Routing Information. The preferred service is set as basic service group IE, and the less preferred service is set as basic service group 2 IE.

4.3.6.2 Closed User Group (CUG)

If a SCUDIF call interacts with CUG and both basic services are provisioned, the service state shall be checked for both the preferred service and the less preferred service. If one service is not allowed, then the call shall fall back to the allowed service.

4.3.6.3 Call barring

If a SCUDIF call interacts with call barring and both basic services are provisioned, the service state shall be checked for both the preferred service and the less preferred service. If one service is barred, then the call shall fall back to the allowed service.

4.3.7 Interactions with CAMEL

4.3.7.1 Interaction at call setup

When a SCUDIF call activates a CAMEL dialogue for the originating or the terminating subscriber, both basic services shall be indicated to the gsmSCF in the InitialDP message (see 3GPP TS 23.078 [14]) :

- the bearer capability IE and the ext-basic service code IE shall indicate the preferred service (*i.e.* 3G-324.M if the 3G-324.M codec is the first codec in the list of supported codecs ; speech otherwise),
- the bearer capability 2 IE and the ext-basic service code 2 IE shall indicate the other, less preferred service (*i.e.* resp. speech or 3G-324.M).

4.3.7.2 Interaction at call answer

When the Answer DP is triggered according to the BCSM (see 3GPP TS 23.078 [14]), the event report sent to the gsmSCF shall indicate the result from the OoBTC codec negotiation procedure according to the following :

- the ext-basic service code IE is included, and represents the selected service (indicated by the selected codec) ;
- the ext-basic service code 2 IE is included if the list of available codecs contains codecs both for speech and 3G-324.M, and represents the other service (*i.e.* speech if the selected service is 3G-324.M, and vice-versa).

4.3.7.3 Interaction with Call Party Handling

Interaction with Call Party Handling is allowed, when the call is a speech call and it cannot become a multimedia call.

See 3GPP TS 22.078 [16] clause 21.

4.3.7.4 Interaction with CAMEL in-band information and user interaction

Interaction with Camel in-band information and user interaction is allowed, when the call is a speech call and it cannot become a multimedia call.

See 3GPP TS 22.078 [16] clause 21.

4.3.7.5 Interaction during service change

When a service change is successfully completed (*i.e.* the codec modification or mid-call codec negotiation reply message indicates a successful codec modification), and the O_Service_Change DP or the T_Service_Change DP is armed, then the relevant detection point is triggered (see 3GPP TS 23.078 [14]).

When a service change is rejected (*i.e.* the codec modification or mid-call codec negotiation reply message indicates a failure), then the previously selected service is kept, and no event report shall be sent to the gsmSCF for the O_Service_Change DP and the T_Service_Change DP.

4.3.8 Interworking with external networks

If the 3G-324.M codec is included in the list of supported codec types received by a Gateway MSC, and the external network does not support BICC or does not support Codec Negotiation, the Gateway MSC shall terminate the codec negotiation and fallback to a single service.

NOTE 1: If the route is known not to support the SCUDIF functionality, the Gateway MSC may decide by configuration to terminate the codec negotiation and follow the procedure described in this clause.

In the case where the 3G-324.M codec is the first in the list, the network decides by configuration to fallback either to a UDI multimedia-only call or to speech. In the case where the 3G-324.M codec is not the first on the list, the call shall fallback to speech only.

If fallback to multimedia occurs, the call control parameters sent towards the external network shall be set according to the setting for multimedia calls, and TMR is set to "64 kbit/s unrestricted". The 3G-324.M codec shall be returned to the originating MSC server as the selected codec and be the only member of the available codec list.

NOTE 2: For multimedia calls, 3GPP TS 27.001 [5], annex B, and 3GPP TS 29.007 [6], table 7A, describe the setting and validity of the PLMN BC-IE as well as the comparable settings of parameters in the PLMN and ISDN BC-IEs. As the ISDN BC-IE parameter values used for UDI/RDI multimedia calls are identical to the BICC USI IE parameter values (see 3GPP TS 29.205 [7]), the setting of call control parameters sent towards the external network in case of fallback to multimedia can be derived straightforward.

If fallback to speech occurs, the call control parameters shall be set according to the setting for speech calls, and TMR is set to "speech". The 3G-324.M codec shall be removed from the available codec list. Speech codec selection shall be made according to normal OoBTC procedures for interworking to external networks, and the selected codec and available codec list returned to the originating MSC server.

4.3.9 User interaction and in-band information

The MSC provided announcements and tones do not work, if the negotiated BC is a multimedia BC. Most often the in-band information is connected to the originating UE but the same rules apply for the terminating UE. The following rules apply:

- 1) Before sending the CONNECT message the originating MSC may insert in-band information if CALL PROCEEDING message indicates speech as the selected or preferred service. When fallback to multimedia occurs after CALL PROCEEDING but before CONNECT, the MSC may insert in-band information.
- 2) Before sending the CONNECT message the originating MSC shall not insert in-band information, if CALL PROCEEDING message indicates multimedia as the selected or preferred service. When fallback to speech occurs after CALL PROCEEDING but before CONNECT, the MSC shall not insert in-band information.
- 3) After the CONNECT message to/from the UE the originating/terminating MSC may insert in-band information, if the selected service is speech. Otherwise, the MSC shall not insert any in-band information. As an option, if the call is to be cleared, the MSC may perform an in-call modification to speech prior to the insertion of the in-band information.

- 4) During the call setup phase the terminating MSC, transit MSC and GMSC may insert in-band information, if the selected/preferred service received from the originating switch is speech. Otherwise the terminating MSC, transit MSC and GMSC shall not insert any in-band information during the call setup phase.
- 5) In the active phase of the call the terminating MSC, transit MSC and GMSC may insert in-band information, if the selected service is speech. Otherwise the terminating MSC, transit MSC and GMSC shall not insert any in-band information. As an option, if the call is to be cleared, the terminating MSC, transit MSC or GMSC may perform an in-call modification to speech prior to insertion of the in-band information.

5 Lawful Interception

SCUDIF calls shall be monitored as for normal Circuit Switched data calls, for detailed requirements see 3GPP TS 33.106 [9].

Annex A (informative): Change history

Change history							
Date	TSG #	TSG Doc.	CR	Rev	Subject/Comment	Old	New
2004-03	NP#23	NP-040147	025	3	Network-Initiated Service Change	5.4.0	6.0.0
2004-09	NP#25	NP-040366	027	-	Interaction of CAMEL with Service Change	6.0.0	6.1.0
2005-03	NP#27	NP-050100	031	-	Inclusion of Missing HLR Interrogation Parameter for SCUDIF	6.1.0	6.2.0
2005-03	NP#27	NP-050101	029	-	Correction to Network-initiated SCUDIF	6.1.0	6.2.0
2005-06	CP#28	CP-050033	036	1	Correction to figure 4.3.5.2/1, wrong Bearer Capability in MODIFY REJECT-message	6.2.0	6.3.0
2005-06	CP#28	CP-050035	038	1	Network-initiated downgrade, signaling flows	6.2.0	6.3.0
2005-06	CP#28	CP-050036	040	4	Network-Initiated upgrade procedure for SCUDIF	6.2.0	6.3.0
2006-03	CP#31	CP-060050	043	1	Indication of Network-Initiated Service Change	6.3.0	6.4.0
2007-06	CT#36				Upgraded to v7.0.0	6.4.0	7.0.0
2008-12	CT#42	CP-080754	045	1	Multimedia Dummy Codec for SIP-I	7.0.0	8.0.0
2009-12	CT#46				Automatic upgrade from previous Release	8.0.0	9.0.0
2011-03	CT#51				Automatic upgrade from previous Release version 9.0.0	9.0.0	10.0.0
2011-03	CT#51				Correction of heading and numbering made by MCC	10.0.0	10.0.1
2012-09	CT#57				Automatic upgrade from previous Release version 10.0.1	10.0.1	11.0.0
10-2014					Automatic upgrade from previous Release	11.0.0	12.0.0
12-2015					Automatic upgrade from previous Release	12.0.0	13.0.0

History

Document history		
V13.0.0	January 2016	Publication