

ETSI TS 123 214 V15.3.0 (2018-07)



**Universal Mobile Telecommunications System (UMTS);
LTE;
Architecture enhancements for control and user plane
separation of EPC nodes
(3GPP TS 23.214 version 15.3.0 Release 15)**



Reference

RTS/TSGS-0223214vf30

Keywords

LTE,UMTS

ETSI

650 Route des Lucioles
F-06921 Sophia Antipolis Cedex - FRANCE

Tel.: +33 4 92 94 42 00 Fax: +33 4 93 65 47 16

Siret N° 348 623 562 00017 - NAF 742 C
Association à but non lucratif enregistrée à la
Sous-Préfecture de Grasse (06) N° 7803/88

Important notice

The present document can be downloaded from:

<http://www.etsi.org/standards-search>

The present document may be made available in electronic versions and/or in print. The content of any electronic and/or print versions of the present document shall not be modified without the prior written authorization of ETSI. In case of any existing or perceived difference in contents between such versions and/or in print, the only prevailing document is the print of the Portable Document Format (PDF) version kept on a specific network drive within ETSI Secretariat.

Users of the present document should be aware that the document may be subject to revision or change of status.

Information on the current status of this and other ETSI documents is available at

<https://portal.etsi.org/TB/ETSIDeliverableStatus.aspx>

If you find errors in the present document, please send your comment to one of the following services:

<https://portal.etsi.org/People/CommiteeSupportStaff.aspx>

Copyright Notification

No part may be reproduced or utilized in any form or by any means, electronic or mechanical, including photocopying and microfilm except as authorized by written permission of ETSI.

The content of the PDF version shall not be modified without the written authorization of ETSI.

The copyright and the foregoing restriction extend to reproduction in all media.

© ETSI 2018.

All rights reserved.

DECT™, **PLUGTESTS™**, **UMTS™** and the ETSI logo are trademarks of ETSI registered for the benefit of its Members.

3GPP™ and **LTE™** are trademarks of ETSI registered for the benefit of its Members and of the 3GPP Organizational Partners.

oneM2M logo is protected for the benefit of its Members.

GSM® and the GSM logo are trademarks registered and owned by the GSM Association.

Intellectual Property Rights

Essential patents

IPRs essential or potentially essential to normative deliverables may have been declared to ETSI. The information pertaining to these essential IPRs, if any, is publicly available for **ETSI members and non-members**, and can be found in ETSI SR 000 314: "*Intellectual Property Rights (IPRs); Essential, or potentially Essential, IPRs notified to ETSI in respect of ETSI standards*", which is available from the ETSI Secretariat. Latest updates are available on the ETSI Web server (<https://ipr.etsi.org/>).

Pursuant to the ETSI IPR Policy, no investigation, including IPR searches, has been carried out by ETSI. No guarantee can be given as to the existence of other IPRs not referenced in ETSI SR 000 314 (or the updates on the ETSI Web server) which are, or may be, or may become, essential to the present document.

Trademarks

The present document may include trademarks and/or tradenames which are asserted and/or registered by their owners. ETSI claims no ownership of these except for any which are indicated as being the property of ETSI, and conveys no right to use or reproduce any trademark and/or tradename. Mention of those trademarks in the present document does not constitute an endorsement by ETSI of products, services or organizations associated with those trademarks.

Foreword

This Technical Specification (TS) has been produced by ETSI 3rd Generation Partnership Project (3GPP).

The present document may refer to technical specifications or reports using their 3GPP identities, UMTS identities or GSM identities. These should be interpreted as being references to the corresponding ETSI deliverables.

The cross reference between GSM, UMTS, 3GPP and ETSI identities can be found under <http://webapp.etsi.org/key/queryform.asp>.

Modal verbs terminology

In the present document "**shall**", "**shall not**", "**should**", "**should not**", "**may**", "**need not**", "**will**", "**will not**", "**can**" and "**cannot**" are to be interpreted as described in clause 3.2 of the [ETSI Drafting Rules](#) (Verbal forms for the expression of provisions).

"**must**" and "**must not**" are **NOT** allowed in ETSI deliverables except when used in direct citation.

Contents

Intellectual Property Rights	2
Foreword.....	2
Modal verbs terminology.....	2
Foreword.....	6
1 Scope	7
2 References	7
3 Definitions and abbreviations.....	7
3.1 Definitions	7
3.2 Abbreviations	8
4 Architecture model and concepts	8
4.1 General concepts	8
4.2 Architecture reference model	8
4.2.1 Non-roaming and roaming architectures.....	8
4.2.2 Combined SGW/PGW architecture	9
4.2.3 Reference points	10
4.3 High level functions	10
4.3.1 General.....	10
4.3.2 Functional split of SGW, PGW and TDF	13
4.3.2.1 Functional split of SGW.....	13
4.3.2.2 Functional split of PGW.....	15
4.3.2.3 Functional split of TDF.....	18
4.3.3 User Plane Function selection.....	20
4.3.4 SGW-C Partitioning.....	20
4.4 Network elements.....	21
4.4.1 General.....	21
4.4.2 SGW control plane function	21
4.4.3 SGW user plane function	21
4.4.4 PGW control plane function	21
4.4.5 PGW user plane function.....	21
4.4.6 TDF control plane function.....	22
4.4.7 TDF user plane function	22
5 Functional description	22
5.1 General	22
5.2 Traffic detection	22
5.2.1 General.....	22
5.2.2 Traffic detection information.....	22
5.3 Charging and usage monitoring handling.....	23
5.3.1 General.....	23
5.3.2 Activation of usage reporting in UP function	24
5.3.3 Reporting of usage information towards CP function.....	24
5.3.4 PGW Pause of Charging	25
5.4 GTP-U IP address and TEIDu allocation	25
5.4.1 General.....	25
5.4.2 F-TEIDu allocation / release in the CP function.....	25
5.4.3 F-TEIDu allocation / release in the UP function.....	25
5.5 UE IP address management (allocation, renewal and release)	26
5.6 Control of user plane forwarding	27
5.6.1 General.....	27
5.6.2 Control of user plane forwarding.....	27
5.6.3 Format of forwarded user plane data	27
5.7 UE's permanent identifier usage.....	28
5.8 Functionality of sending of "end marker"	28
5.8.1 UP function constructing the "end marker" packets	28
5.8.2 CP function constructing the "end marker" packets.....	28

5.9	Idle state packet SGW buffering function	28
5.9.1	General.....	28
5.9.2	Buffering in CP function.....	29
5.9.3	Buffering in UP function	29
5.9.3.1	General	29
5.9.3.2	Delay Downlink Packet Notification	29
5.9.3.3	Extended buffering.....	30
5.9.3.4	Throttling	30
5.10	Bearer and APN policing	30
5.11	PCC/ADC related functions	31
5.11.1	Activation/Deactivation of predefined PCC/ADC rules	31
5.11.2	Enforcement of dynamic PCC/ADC rules	31
5.11.3	Redirection.....	32
5.11.4	Support of SDCI	32
5.12	User Plane function selection	32
5.12.1	General.....	32
5.12.2	Selection of PGW-U	32
5.12.3	Selection of SGW-U	33
5.12.4	Selection of a combined SGW/PGW-U.....	33
5.12.5	Selection of TDF-U	34
5.12.5.1	Solicited application reporting mode	34
5.12.5.2	Unsolicited application reporting mode	34
6	Information flows	34
6.1	General	34
6.2	Sx Session Management Procedures	34
6.2.1	General.....	34
6.2.2	Sx Session Establishment Procedure	35
6.2.3	Sx Session Modification Procedure	35
6.2.4	Sx Session Termination Procedure	36
6.3	Updates to procedures in other specifications	37
6.3.1	Updates to procedures specified in TS 23.401	37
6.3.1.2	Procedures with SGW change.....	40
6.3.1.2.1	General	40
6.3.1.2.2	Type 1.....	40
6.3.1.2.3	Type 2.....	42
6.3.1.3	Procedures with eNB F-TEIDu update	44
6.3.1.4	Procedures with release of eNB F-TEIDu.....	45
6.3.1.5	Procedures when downlink data is buffered in the UP function	46
6.3.1.6	Procedures with release of PDN connection	47
6.3.1.7	Procedures with modification of bearer	49
6.3.2	Updates to procedures specified in TS 23.203.....	51
6.3.2.1	IP-CAN session establishment.....	51
6.3.2.2	IP-CAN session termination.....	52
6.3.2.3	IP-CAN session modification.....	52
6.3.2.4	Management of PFDs.....	53
6.3.3	Updates to procedures specified in TS 23.402.....	54
6.3.3.1	Procedures with GTP based S2b establishment	54
6.3.3.2	Procedures with GTP based S2a establishment.....	55
6.3.3.3	Procedures with GTP based S2b release	56
6.3.3.4	Procedures with GTP based S2a release	56
6.3.3.5	Procedures with dedicated bearer activation by PGW	57
6.3.3.6	Procedures with bearer deactivation by PGW	58
6.3.3.7	Procedures with bearer modification.....	58
6.3.3.8	Procedures with handover from non-3GPP access.....	59
6.3.3.9	Procedures with handover from 3GPP access	61
6.3.4	Updates to procedures specified in TS 23.060.....	62
6.3.4.1	Procedures with PDN connection deactivation	62
6.3.4.1.1	Procedures with SGSN terminating S4 interface.....	62
6.3.4.1.2	Procedures with SGSN terminating Gn/Gp interface	65
6.3.4.2	Procedures with PDN connection modification	67
6.3.4.2.1	Procedures with SGSN terminating S4 interface.....	67

6.3.4.2.2	Procedures with SGSN terminating Gn/Gp interface	75
6.3.4.3	Procedures with PDN connection establishment.....	78
6.4	Sx Reporting Procedures	80
6.4.1	General.....	80
6.4.2	Sx Session Level Reporting Procedure.....	80
6.5	Sx Management Procedures	81
6.5.1	General.....	81
6.5.2	Sx PFD management Procedure	81
6.5.3	Sx Association Setup Procedure	81
6.5.4	Sx Association Update Procedure.....	82
6.5.5	Sx Association Release Procedure.....	82
7	Parameters	82
7.1	Parameters for Sx session management.....	82
7.2	Session context.....	82
7.3	Packet Detection Rule	83
7.4	Usage Reporting Rule	86
7.5	Forwarding Action Rule.....	87
7.6	QoS Enforcement Rule.....	88
7.7	Usage Report generated by UP function	89
7.8	Functional description	90
7.8.1	General.....	90
7.8.2	PDN connection and TDF session level context.....	91
7.8.3	Bearer related context	91
7.8.4	Measurement key related context	91
7.9	Parameters for Sx management	92
7.9.1	Parameters for PFD management	92
Annex A (informative):	Change history	93
History		94

Foreword

This Technical Specification has been produced by the 3rd Generation Partnership Project (3GPP).

The contents of the present document are subject to continuing work within the TSG and may change following formal TSG approval. Should the TSG modify the contents of the present document, it will be re-released by the TSG with an identifying change of release date and an increase in version number as follows:

Version x.y.z

where:

- x the first digit:
 - 1 presented to TSG for information;
 - 2 presented to TSG for approval;
 - 3 or greater indicates TSG approved document under change control.
- y the second digit is incremented for all changes of substance, i.e. technical enhancements, corrections, updates, etc.
- z the third digit is incremented when editorial only changes have been incorporated in the document.

1 Scope

The present document specifies the overall stage 2 level functionality for control and user plane separation of EPC's SGW, PGW and TDF. This enables a flexible placement of the separated control plane and user plane functions for supporting diverse deployment scenarios (e.g. central or distributed user plane function) without affecting the overall functionality provided by these EPC entities.

2 References

The following documents contain provisions which, through reference in this text, constitute provisions of the present document.

- References are either specific (identified by date of publication, edition number, version number, etc.) or non-specific.
- For a specific reference, subsequent revisions do not apply.
- For a non-specific reference, the latest version applies. In the case of a reference to a 3GPP document (including a GSM document), a non-specific reference implicitly refers to the latest version of that document *in the same Release as the present document*.

- [1] 3GPP TR 21.905: "Vocabulary for 3GPP Specifications".
- [2] 3GPP TS 23.401: "General Packet Radio Service (GPRS) enhancements for Evolved Universal Terrestrial Radio Access Network (E-UTRAN) access".
- [3] 3GPP TS 23.203: "Policy and charging control architecture".
- [4] 3GPP TS 23.402: "Architecture enhancements for non-3GPP accesses".
- [5] 3GPP TS 23.060: "General Packet Radio Service (GPRS); Service description; Stage 2".
- [6] 3GPP TS 29.060: "GPRS Tunnelling Protocol (GTP) across the Gn and Gp interface".
- [7] 3GPP TS 29.274: "3GPP Evolved Packet System (EPS); Evolved General Packet Radio Service (GPRS) Tunnelling Protocol for Control plane (GTPv2-C); Stage 3".
- [8] 3GPP TS 32.251: "Telecommunication management; Charging management; Packet Switched (PS) domain charging".
- [9] 3GPP TS 32.240: "Charging architecture and principles".
- [10] 3GPP TS 33.107: "3G security; Lawful interception architecture and functions".
- [11] 3GPP TS 29.212: "Policy and Charging Control (PCC); Reference points".
- [12] 3GPP TS 29.244: "Interface between the Control Plane and the User Plane of EPC Nodes; Stage 3".

3 Definitions and abbreviations

3.1 Definitions

For the purposes of the present document, the terms and definitions given in TR 21.905 [1], TS 23.401 [2], TS 23.203 [3] and the following apply. A term defined in the present document takes precedence over the definition of the same term, if any, in TR 21.905 [1].

F-TEID: as defined in clause 8.22 of TS 29.274 [7].

F-TEIDu: The F-TEID of a GTP-u tunnel.

3.2 Abbreviations

For the purposes of the present document, the abbreviations given in TR 21.905 [1], TS 23.401 [2], TS 23.203 [3] and the following apply. An abbreviation defined in the present document takes precedence over the definition of the same abbreviation, if any, in TR 21.905 [1].

CP function	Control Plane function
PGW	PDN Gateway
PGW-C	PDN Gateway Control plane function
PGW-U	PDN Gateway User plane function
SGW	Serving Gateway
SGW-C	Serving Gateway Control plane function
SGW-U	Serving Gateway User plane function
TDF	Traffic Detection Function
TDF-C	Traffic Detection Function Control plane function
TDF-U	Traffic Detection Function User plane function
UP function	User Plane function

4 Architecture model and concepts

4.1 General concepts

The architecture and functionality for control and user plane separation of SGW, PGW and TDF is based on the following concepts:

- Interworking with networks not applying control and user plane separation is possible (i.e. in case of roaming scenarios);
- Split network entities can interwork with network entities that are not split within the same network;
- Split network entities have no requirement to update UE, and Radio Access Network;
- The SGW/PGW selection function of the MME/ePDG/TWAN described in TS 23.401 [2] and TS 23.402 [4] is used for the selection of the respective CP function;
- The configuration based mechanism (in PGW or PCRF) described in TS 23.203 [3] is used for the selection of the CP function of the TDF;
- A CP function can interface with one or more UP functions (e.g. to enable independent scalability of CP functions and UP functions).

4.2 Architecture reference model

4.2.1 Non-roaming and roaming architectures

This clause defines the complementary aspects of the architecture reference models specified in TS 23.401 [2] clause 4.2 and TS 23.402 [4] clauses 4.2.2 and 4.2.3 for GTP-based interfaces when SGW, PGW and TDF control and user planes are separated.

For S2a, S2b, S5 and S8 reference points, this architecture reference model is only supported with GTP-based interfaces. PMIP-based interfaces and S2c interface are not supported.

Figure 4.2.1-1 shows the architecture reference model in the case of separation between control plane and user plane. This architecture reference model covers non-roaming as well as home routed and local breakout roaming scenarios.

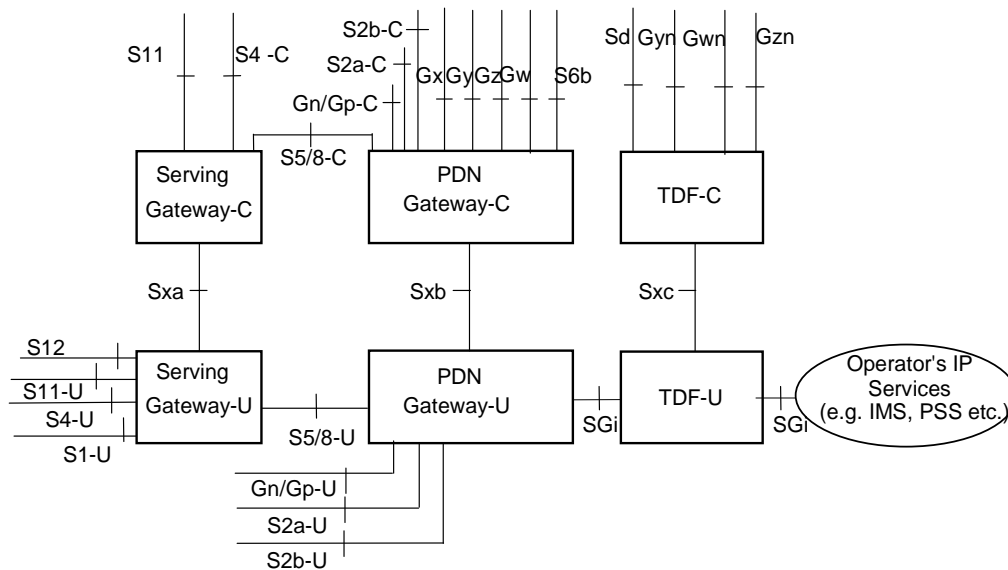

Figure 4.2.1-1: Architecture reference model with separation of user plane and control plane for non-roaming and roaming scenarios

NOTE 1: The -C or -U suffix appended to S2a, S2b, S5 and S8 existing reference points only indicate the control plane and user plane components of those interfaces.

NOTE 2: The architecture in figure 4.2.1-1 only depicts the case when the CP and UP functions of all SGW, PGW and TDF nodes are split. However, the other cases when the CP and UP function of only one of these nodes is split while the CP and UP function of the other interfacing node is not split, e.g. PGW's control plane and user plane is split while SGW's control plane and user plane is not split, are also supported. The split architecture of a node does not put any architectural requirements on the peer nodes with which it interfaces.

NOTE 3: TDF is an optional functional entity.

NOTE 4: Additional interfaces/reference points are documented in TS 23.401 [2], TS 23.402 [4], TS 23.060 [5] and TS 23.203 [3].

NOTE 5: For a roaming architecture with local breakout, the Gx interface is defined between the PGW-C and PCRF in the visited network.

NOTE 6: S11-U is the interface between MME and SGW-U, supporting CP CIoT EPS Optimisation (see TS 23.401 [2]).

4.2.2 Combined SGW/PGW architecture

The usage of a combined SGW/PGW documented in TS 23.401 [2] remains possible in a deployment with separated control and user planes. This is enabled by supporting an Sx interface with a common parameter structure for non-combined and combined cases. Figure 4.2.2-1 shows the architecture reference model for a combined SGW/PGW in the case of separation between control plane and user plane.

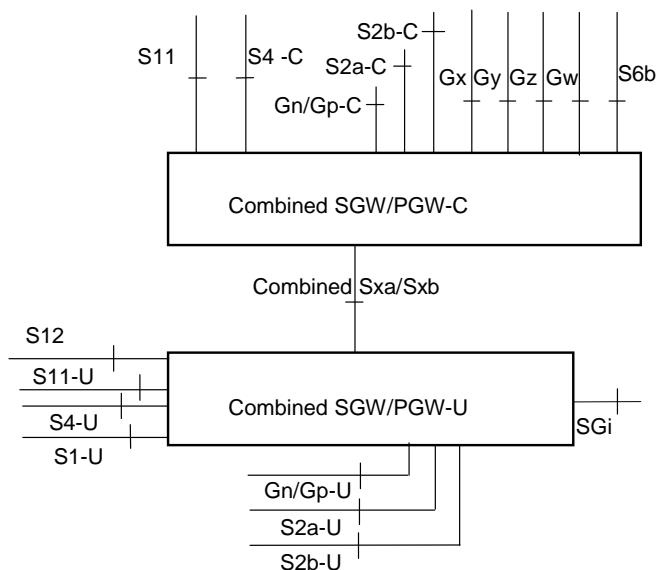

Figure 4.2.2-1: Architecture reference model with separation of user plane and control plane for a combined SGW/PGW

NOTE 1: The combined Sxa/Sxb shown in figure 4.2.2-1 only covers the functionality of Sxa and Sxb.

NOTE 2: S11-U is the interface between MME and combined SGW/PGW-U, supporting CP CIoT EPS Optimisation (see TS 23.401 [2]).

4.2.3 Reference points

This clause defines the complementary reference points of the architecture reference models specified in TS 23.401 [2] clause 4.2 and TS 23.402 [4] clauses 4.2.2 and 4.2.3 for GTP-based interfaces when SGW, PGW and TDF control and user planes are separated.

The reference points added to the reference points defined in TS 23.401 [2], TS 23.402 [4] and TS 23.203 [3] are the following ones:

Sxa: Reference point between SGW-C and SGW-U.

Sxb: Reference point between PGW-C and PGW-U.

Sxc: Reference point between TDF-C and TDF-U.

4.3 High level functions

4.3.1 General

This clause documents the existing functionality of SGW, PGW and TDF as described in TS 23.401 [2], TS 23.402 [4] and TS 23.203 [3].

Table 4.3.1-1: Existing functionality of SGW, PGW and TDF

Main functionality	Sub-functionality	SGW	PGW	TDF
A. Session management (default & dedicated bearer establishment, bearer modification, bearer deactivation)	1. Resource management for bearer resources	X	X	
	2. IP address and TEID assignment for GTP-U	X	X	
	3. Packet forwarding	X	X	
	4. Transport level packet marking	X	X	
B. UE IP address management	1. IP address allocation from local pool		X	
	2. DHCPv4 / DHCPv6 client		X	
	3. DHCPv4 / DHCPv6 server		X	
	4. Router advertisement, router solicitation, neighbour advertisement, neighbour solicitation (as in RFC 4861)		X	
C. Support for UE mobility	1. Forwarding of "end marker" (as long as user plane to source eNB exists)	X		
	2. Sending of "end marker" after switching the path to target node	X	X	
	3. Forwarding of buffered packet	X		
	4. Change of target GTP-U endpoint within 3GPP accesses	X	X	
	5. Change of target GTP-U endpoint between 3GPP and non-3GPP access		X	
D. S1-Release / Buffering / Downlink Data Notification	1. ECM-IDLE mode DL packet buffering; Triggering of Downlink Data Notification message generation per bearer (multiple, if DL packet received on higher ARP than previous DDN); Inclusion of DSCP of packet in DDN message for Paging Policy Differentiation	X		
	2. Delay Downlink Data Notification Request (if terminating side replies to uplink data after UE service request before SGW gets updated)	X		
	3. Extended buffering of downlink data when the UE is in a power saving state and not reachable (high latency communication); dropping of downlink data (if MME has requested SGW to throttle downlink low priority traffic and if the downlink data packet is received on such a bearer (see clause 4.3.7.4.1a)).	X		
	4. PGW pause of charging procedure based on operator policy/configuration the SGW (failed paging, abnormal radio link release, number/fraction of packets/bytes dropped at SGW)	X	X	
E. Bearer/APN policing	1. UL/DL APN-AMBR enforcement		X	X
	2. UL/DL bearer MBR enforcement (for GBR bearer)		X	
	3. UL/DL bearer MBR enforcement (for nonGBR bearer on Gn/Gp interface)		X	
F. PCC related functions	1. Service detection (DPI, IP-5-tuple)		X	X
	2. Bearer binding (bearer QoS & TFT)		X	
	3. UL bearer binding verification and mapping of DL traffic to bearers		X	
	4. UL and DL service level gating		X	X
	5. UL and DL service level MBR enforcement		X	X
	6. UL and DL service level charging (online & offline, per charging key)		X	X

	7. Usage monitoring		X	X
	8. Event reporting (including application detection)		X	X
	9. Request for forwarding of event reporting			X
	10. Redirection		X	X
	11. FMSS handling		X	X
	12. PCC support for NBIFOM		X	
	13. DL DSCP marking for application indication			X
	14. Predefined PCC/ADC rules activation and deactivation		X	X
	15. PCC support for SDCI		X	X
G. NBIFOM	Non-PCC aspects of NBIFOM	X	X	
H. Inter-operator accounting (counting of volume and time)	1. Accounting per UE and bearer	X	X	
	2. Interfacing OFCS through reference points specified in TS 32.240 [9]	X	X	X
I. Load/overload control functions	Exchange of load/overload control information and actions during peer node overload	X	X	
J. Lawful interception	Interfacing LI functions through reference points specified in TS 33.107 [10] and performing LI functionality	X	X	
K. Packet screening function			X	
L. Restoration and recovery		X	X	X
M. RADIUS / Diameter on SGi			X	
N. OAM interfaces		X	X	X
O. GTP bearer and path management	Generation of echo request, handling of echo response, echo request timeout and Error Indication message	X	X	

4.3.2 Functional split of SGW, PGW and TDF

4.3.2.1 Functional split of SGW

The following table describes the functionality of the SGW-C and the SGW-U.

All functionality performed by the SGW-U is controlled from the SGW-C and thus even if it is marked below as a SGW-U functionality only, there will be corresponding control functionality in the SGW-C.

NOTE: Functionality not marked for SGW-U is either only provided by SGW-C or does not require any specific SGW-U behaviour.

For interfaces not listed in the table below, Figure 4.2.1-1 describes whether they are terminated in SGW- C or SGW-U.

Table 4.3.2-1: Functional split of SGW

Main functionality	Sub-functionality	SGW-C	SGW-U	Comments
A. Session management (default & dedicated bearer establishment, bearer modification, bearer deactivation)	1. Resource management for bearer resources	X	X	See clause 5.10
	2. IP address and TEID assignment for GTP-U	X	X	See clause 5.4
	3. Packet forwarding		X	
	4. Transport level packet marking		X	
C. Support for UE mobility	1. Forwarding of "end marker" (as long as user plane to source eNB exists)		X	
	2. Sending of "end marker" after switching the path to target node	X	X	See clause 5.8
	3. Forwarding of buffered packet	X	X	See clause 5.9
	4. Change of target GTP-U endpoint within 3GPP accesses	X		
	5. Change of target GTP-U endpoint between 3GPP and non-3GPP access			N/A
D. S1-Release / Buffering / Downlink Data Notification	1. ECM-IDLE mode DL packet buffering; Triggering of Downlink Data Notification message generation per bearer (multiple, if DL packet received on higher ARP than previous DDN); Inclusion of DSCP of packet in DDN message for Paging Policy Differentiation	X	X	See clause 5.9
	2. Delay Downlink Data Notification Request (if terminating side replies to uplink data after UE service request before SGW gets updated)	X		
	3. Extended buffering of downlink data when the UE is in a power saving state and not reachable (high latency communication); dropping of downlink data (if MME has requested SGW to throttle downlink low priority traffic and if the downlink data packet is received on such a bearer (see clause 4.3.7.4.1a).	X	X	See clause 5.9
	4. PGW pause of charging procedure based on operator policy/configuration the SGW (failed paging, abnormal radio link release, number/fraction of packets/bytes dropped at SGW)	X		See clause 5.3.4
G. NBIFOM	Non-PCC aspects of NBIFOM	X		
H. Inter-operator accounting (counting of volume and time)	1. Accounting per UE and bearer		X	See clause 5.3
	2. Interfacing OFCS through reference points specified in TS 32.240 [9]	X		See clause 5.3
I. Load/overload control functions	Exchange of load/overload control information and actions during peer node overload			As defined in CT WG4 TS 29.244 [12]
J. Lawful interception	Interfacing LI functions through reference points specified in TS 33.107 [10] and performing LI functionality	X	X	As defined in SA WG3-LI TS 33.107 [10]
L. Restoration and recovery				As defined in CT WG4 TS 29.244 [12]
N. OAM interfaces				As defined in SA WG5 TS xx.xxx
O. GTP bearer and path management	Generation of echo request, handling of echo response, echo request timeout and Error Indication message			As defined in CT WG4 TS 29.244 [12]

4.3.2.2 Functional split of PGW

The following table describes the functionality of the PGW-C and the PGW-U.

All functionality performed by the PGW-U is controlled from the PGW-C and thus even if it is marked below as a PGW-U functionality only there will be corresponding control functionality in the PGW-C.

NOTE: Functionality not marked for PGW-U is either only provided by PGW-C or does not require any specific PGW-U behaviour.

For interfaces not listed in the table below, Figure 4.2.1-1 describes whether they are terminated in the PGW-C or the PGW-U.

Table 4.3.2-2: Functional split of PGW

Main functionality	Sub-functionality	PGW-C	PGW-U	Comments
A. Session management (default & dedicated bearer establishment, bearer modification, bearer deactivation)	1. Resource management for bearer resources	X	X	See clause 5.10
	2. IP address and TEID assignment for GTP-U	X	X	See clause 5.4
	3. Packet forwarding		X	
	4. Transport level packet marking		X	
B. UE IP address management	1. IP address allocation from local pool	X		See clause 5.5
	2. DHCPv4 / DHCPv6 client	X		See clause 5.5
	3. DHCPv4 / DHCPv6 server	X		See clause 5.5
	4. Router advertisement, router solicitation, neighbour advertisement, neighbour solicitation (as in RFC 4861)	X		See clause 5.5
C. Support for UE mobility	<i>1. Forwarding of "end marker" (as long as user plane to source eNB exists)</i>			N/A
	2. Sending of "end marker" after switching the path to target node	X	X	See clause 5.8
	<i>3. Forwarding of buffered packet</i>			N/A
	4. Change of target GTP-U endpoint within 3GPP accesses	X		
	5. Change of target GTP-U endpoint between 3GPP and non-3GPP access	X		
D. S1-Release / Buffering / Downlink Data Notification	<i>1. ECM-IDLE mode DL packet buffering; Triggering of Downlink Data Notification message generation per bearer (multiple, if DL packet received on higher ARP than previous DDN); Inclusion of DSCP of packet in DDN message for Paging Policy Differentiation</i>			N/A
	<i>2. Delay Downlink Data Notification Request (if terminating side replies to uplink data after UE service request before SGW gets updated)</i>			N/A
	<i>3. Extended buffering of downlink data when the UE is in a power saving state and not reachable (high latency communication); dropping of downlink data (if MME has requested SGW to throttle downlink low priority traffic and if the downlink data packet is received on such a bearer (see 4.3.7.4.1a)).</i>			N/A
	4. PGW pause of charging procedure based on operator policy/configuration the SGW (failed paging, abnormal radio link release, number/fraction of packets/bytes dropped at SGW)	X		See clause 5.3.4
E. Bearer/APN policing	1. UL/DL APN-AMBR enforcement		X	
	2. UL/DL bearer MBR enforcement (for GBR bearer)		X	
	3. UL/DL bearer MBR enforcement (for nonGBR bearer on Gn/Gp interface)		X	
F. PCC related functions	1. Service detection (DPI, IP-5-tuple)		X	
	2. Bearer binding (bearer QoS & TFT)	X		
	3. UL bearer binding verification and mapping of DL traffic to bearers		X	See clause 5.2
	4. UL and DL service level gating		X	
	5. UL and DL service level MBR enforcement		X	
	6. UL and DL service level charging (online & offline, per charging key)	X	X	See clause 5.3

	7. Usage monitoring	X	X	See clause 5.3
	8. Event reporting (including application detection)	X	X	Note: User-plane related events such as application detection reporting supported in UP function, while control-plane related events such as RAT change etc. supported only in CP function.
	9. Request for forwarding of event reporting			N/A
	10. Redirection	X	X	See clause 5.11.3
	11. FMSS handling		X	
	12. PCC support for NBIFOM	X		
	13. DL DSCP marking for application indication			N/A
	14. Predefined PCC/ADC rules activation and deactivation	X	X	See clause 5.11.1
	15. PCC support for SDCI	X	X	See clause 5.11.4
G. NBIFOM	Non-PCC aspects of NBIFOM	X		
H. Inter-operator accounting (counting of volume and time)	1. Accounting per UE and bearer		X	See clause 5.3
	2. Interfacing OFCS through reference points specified in TS 32.240 [9]	X		See clause 5.3
I. Load/overload control functions	Exchange of load/overload control information and actions during peer node overload			As defined in CT WG4 TS 29.244 [12]
J. Lawful interception	Interfacing LI functions through reference points specified in TS 33.107 [10] and performing LI functionality	X	X	As defined in SA WG3-LI TS 33.107 [10]
K. Packet screening function			X	
L. Restoration and recovery				As defined in CT WG4 TS 29.244 [12]
M. RADIUS / Diameter on SGi		X	X	See clause 5.5
N. OAM interfaces				As defined in SA WG5 TS xx.xxx
O. GTP bearer and path management	Generation of echo request, handling of echo response, echo request timeout and Error Indication message			As defined in CT WG4 TS 29.244 [12]

4.3.2.3 Functional split of TDF

The following table describes the functionality of the TDF-C and the TDF-U.

All functionality performed by the TDF-U is controlled from the TDF-C and thus even if it is marked below as a TDF-U functionality only there will be corresponding control functionality in the TDF-C.

For interfaces not listed in the table below, Figure 4.2.1-1 describes whether they are terminated in the TDF-C or TDF-U.

Table 4.3.2-3: Functional split of TDF

Main functionality	Sub-functionality	TDF-C	TDF-U	Comments
E. Bearer/APN policing	1. UL/DL APN-AMBR enforcement		X	Not identical to APN-AMBR enforcement as it a) covers every flow in TDF session and b) does not cover other TDF sessions of the UE to the same APN
	2. UL/DL bearer MBR enforcement (for GBR bearer)			N/A
	3. UL/DL bearer MBR enforcement (for nonGBR bearer on Gn/Gp interface)			N/A
F. PCC related functions	1. Service detection (DPI, IP-5-tuple)		X	
	2. Bearer binding (bearer QoS & TFT)			N/A
	3. UL bearer binding verification and mapping of DL traffic to bearers			N/A
	4. UL and DL service level gating		X	
	5. UL and DL service level MBR enforcement		X	
	6. UL and DL service level charging (online & offline, per charging key)	X	X	See clause 5.3
	7. Usage monitoring	X	X	See clause 5.3
	8. Event reporting (including application detection)	X	X	Note: User-plane related events such as application detection reporting supported in UP function, while control-plane related events such as RAT change etc. supported only in CP function.
	9. Request for forwarding of event reporting	X		
	10. Redirection	X	X	See clause 5.11.3
	11. FMSS handling		X	
	12. PCC support for NBIFOM			N/A
	13. DL DSCP marking for application indication		X	
	14. Predefined PCC/ADC rules activation and deactivation	X	X	See clause 5.11.1
	15. PCC support for SDCI	X	X	See clause 5.11.4
H. Inter-operator accounting (counting of volume and time)	1. Accounting per UE and bearer			N/A
	2. Interfacing OFCS through reference points specified in TS 32.240 [9]	X		See clause 5.3
I. Load/overload control functions	Exchange of load/overload control information and actions during peer node overload			As defined in CT WG4 TS 29.244 [12]
L. Restoration and recovery				As defined in CT WG4 TS 29.244 [12]
N. OAM interfaces				As defined in SA WG5 TS xx.xxx

4.3.3 User Plane Function selection

The CP function of a functional entity performs selection of its respective UP function considering parameters such as UE's location information, capability of the UP function and features required for an UE. Additionally, the selection of UP function shall consider UP function deployment scenarios such as centrally located UP function and distributed UP functions located close to or at the RAN site. The selection of UP function shall also allow deployment of UP functions with different capabilities, e.g. UP functions supporting no or a subset of optional functionalities.

For standalone CP functions:

- SGW's CP function shall select SGW's UP function;
- PGW's CP function shall select PGW's UP function;
- TDF's CP function shall select TDF's UP function.

Combined SGW/PGW's CP function should select either combined SGW/PGW UP function or standalone SGW UP and PGW UP functions.

For details, refer to clause 5.12.

4.3.4 SGW-C Partitioning

If the SGW-U service area is smaller than the SGW-C service area, the SGW-C can be partitioned into multiple SGW-C partitions. Each of the SGW-C partition is aligned with the corresponding SGW-U service area. The MME treats the SGW-C partition as legacy SGW.

NOTE 1: There is only one Sxa reference point between one SGW-C and one SGW-U.

NOTE 2: This ensures that the TAI List allocated by the MME will only contain TAs that have connectivity to the SGW-U function serving the UE in case the MME uses the service area of the SGW-C partition when constructing the TAI List (and it cannot be assured that there is "full mesh" IP connectivity between the eNBs and the SGW-U function outside the SGW-U Service Area).

NOTE 3: If more than one SGW-U is selected to serve a given UE, these SGW-U's need to cover an area including at least the service area of the SGW-C.

4.4 Network elements

4.4.1 General

SGW-C and SGW-U jointly provide functionality equivalent to the functionality provided by SGW as defined by the TS 23.401 [2].

PGW-C and PGW-U jointly provide functionality equivalent to the functionality provided by PGW as defined by the TS 23.401 [2] and TS 23.402 [4], and the PCEF as defined by the TS 23.203 [3].

TDF-C and TDF-U jointly provide functionality equivalent to the functionality provided by TDF as defined by the TS 23.203 [3].

The clause 4.3.2 defines how the functional control and user plane split is done and which functionality SGW-C, SGW-U, PGW-C, PGW-U, TDF-C, TDF-U correspondingly support.

4.4.2 SGW control plane function

The SGW control plane function (SGW-C) provides the functionality of the SGW as defined by TS 23.401 [2] except for the functions that are performed by the SGW-U as described in table 4.3.2-1.

In addition, the SGW-C is responsible for selecting the SGW-U (as described in clause 4.3.3) and for controlling the SGW-U with respect to the functions described in table 4.3.2-1.

4.4.3 SGW user plane function

The SGW user plane function (SGW-U) provides the functionality described in this TS. The functions that are performed by the SGW-U are listed in table 4.3.2-1 together with a reference to a detailed functional description in clause 5 for some of them. The control parameters relevant for the SGW-U are described in clause 7.

NOTE: The standard allows certain functionalities to be supported in both SGW-C and SGW-U. For details refer to clause 5.

4.4.4 PGW control plane function

The PGW control plane function (PGW-C) provides the functionality of the PGW as defined by TS 23.401 [2] and TS 23.402 [4], and the PCEF as defined by the TS 23.203 [3] except for the functions that are performed by the PGW-U as described in table 4.3.2-2.

In addition, the PGW-C is responsible for selecting the PGW-U (as described in clause 4.3.3) and for controlling the PGW-U with respect to the functions described in table 4.3.2-2.

4.4.5 PGW user plane function

The PGW user plane function (PGW-U) provides the functionality described in this TS. The functions that are performed by the PGW-U are listed in table 4.3.2-2 together with a reference to a detailed functional description in clause 5 for some of them. The control parameters relevant for the PGW-U are described in clause 7.

NOTE: The standard allows certain functionalities to be supported in both PGW-C and PGW-U. For details refer to clause 5.

4.4.6 TDF control plane function

The TDF control plane function (TDF -C) provides the functionality of the TDF as defined by TS 23.203 [3] except for the functions that are performed by the TDF -U as described in table 4.3.2-3.

In addition, the TDF -C is responsible for selecting the TDF -U (as described in clause 4.3.3) and for controlling the TDF -U with respect to the functions described in table 4.3.2-3.

4.4.7 TDF user plane function

The TDF user plane function (TDF -U) provides the functionality described in this TS. The functions that are performed by the TDF -U are listed in table 4.3.2-3 together with a reference to a detailed functional description in clause 5 for some of them. The control parameters relevant for the TDF-U are described in clause 7.

NOTE: The standard allows certain functionalities to be supported in both TDF-C and TDF-U. For details refer to clause 5.

5 Functional description

5.1 General

This clause contains detailed functional descriptions for some of the functions provided by the UP function of SGW, PGW and TDF (whether a function has to be supported by a functional entity is defined in clause 4.3.2). It is documented how the respective CP function instructs it's corresponding UP function and which control parameters are used.

5.2 Traffic detection

5.2.1 General

This clause describes the detection process at the UP function that identifies the packets belonging to a bearer, service data flow or IP-CAN/TDF session.

The CP function is responsible for instructing the UP function about how to detect user data traffic belonging to a Packet Detection Rule (PDR). The other parameters provided within a PDR describe how the UP function shall treat a packet that matches the detection information.

5.2.2 Traffic detection information

The CP function controls the traffic detection at the UP function by providing detection information for every PDR. Detection information is a combination of:

- UE IP address;
- F-TEIDu;
- SDF filters as defined in TS 23.203 [3];
- Application ID (referring to an application detection filter) as defined in TS 23.203 [3].

The following Table 5.2.2-1 lists the possible combinations of the traffic detection information for the different UP functions and usage scenarios.

Table 5.2.2-1: Detection information for the different UP functions and usage scenarios

Usage scenario	UP function	Detection information for UL	Detection information for DL	Description
1	SGW-U	Local F-TEIDu (access side)	Local F-TEIDu (core side)	Detection of traffic belonging to a bearer
2	PGW-U	Local F-TEIDu (access side) + uplink SDF filter(s)/application ID (NOTE 2)	UE IP address as destination + downlink SDF filter(s)/application ID	Detection of traffic belonging to a service data flow + UL bearer binding verification (based on F-TEIDu in UL filter)
3	PGW-U	Local F-TEID (access side) + UE IP address as source + uplink SDF filter(s)/application ID (NOTE 2)	UE IP address as destination + downlink SDF filter(s)/application ID	Usage scenario 2 + Packet screening (based on UE IP as source in UL filter)
4	PGW-U	Local F-TEID (access side) (NOTE 1)	-	Detection of remaining traffic, e.g. with wrong UE IP address or on wrong bearer, for measurement and discarding.
5	PGW-U	-	UE IP address as destination (NOTE 1)	Detection of remaining traffic, e.g. not matching any other detection information, for discarding.
6	PGW-U	-	Downlink SDF filter(s)/application ID (NOTE 2)	Detection of RADIUS, Diameter and DHCP signalling traffic on SGi.
7	TDF-U	UE IP address as source + uplink SDF filter(s)/application ID	UE IP address as destination + downlink SDF filter(s)/application ID	Detection of traffic belonging to a service data flow
8	TDF-U	UE IP address as source (NOTE 1)	UE IP address as destination (NOTE 1)	Detecting of remaining traffic (i.e. not matching any other PDR) belonging to a TDF session
NOTE 1: A PDR with such detection information should have the lowest precedence amongst all the PDRs installed for this Sx session.				
NOTE 2: The detection of traffic related to UE IP address allocation as well as RADIUS, Diameter and DHCP signalling traffic on SGi can be accomplished using SDF filter(s) or an application ID (referring to an application detection filter).				

5.3 Charging and usage monitoring handling

5.3.1 General

If functional split of SGW into SGW-C and SGW-U is supported, the overall functionality of offline charging support as defined by TS 23.401 [2] and TS 32.251 [8] shall be preserved.

If functional split of PGW into PGW-C and PGW-U is supported, the overall functionality of online and offline charging as defined by TS 32.251 [8], and of usage monitoring control as defined by TS 23.401 [2], TS 23.203 [3] shall be preserved.

If functional split of TDF into TDF-C and TDF-U is supported, the overall functionality of online and offline charging as defined by TS 32.251 [8], and of usage monitoring control as defined by TS 23.203 [3] shall be preserved.

The following principles shall apply in case of a functional split:

- The Gx, Sd, Gy, Gyn, Gz, Gzn interfaces as well as the interface between SGW and OFCS shall be terminated in the CP function (SGW-C/PGW-C/TDF-C). This implies that the CP function shall support those interfaces towards OCS/OFCS and PCRF, based on information received at the corresponding CP function as well as gathered user-plane related information received from the UP function as further described below.
- There is no impact on PCRF, OCS and OFCS compared to non-split architecture.
- All bearer/traffic flow level, session level and subscriber related information remains at the CP function, and only usage information is requested from UP function.

5.3.2 Activation of usage reporting in UP function

Triggered by the PCC/ADC rules received from the PCRF or preconfigured information available at PGW-C/TDF-C/SGW-C, as well as from the OCS for online charging via Credit-Control session mechanisms, the CP function (PGW-C/TDF-C/SGW-C) shall provide Usage Reporting Rules to the UP function (PGW-U/TDF-U/SGW-U) for controlling how usage reporting is performed.

The CP function shall request the report of the relevant usage information for Usage Monitoring, based on Monitoring Keys and triggers which are specified in TS 23.203 [3] and TS 29.212 [11]. Each Usage Reporting Rule requested for usage monitoring control contains a list of "traffic flows" for PGW-U and TDF-U whose traffic is to be accounted under this rule. The CP function shall use Monitoring-key either preconfigured or received from the PCRF within the PCC/ADC Rule in order to generate this list and also shall keep the mapping between them. This list may overlap across multiple Usage-Report-Rules, i.e. multiple different Usage Reporting Rules may contain the same "traffic flows".

The CP function shall request the report of the relevant usage information for offline and online charging, based on Rating Groups and triggers which are specified in TS 32.251 [8]. Each Usage Reporting Rule requested for offline or online charging contains a list of "traffic flows" for PGW-U and TDF-U whose traffic is to be accounted under this rule. The CP function shall use Rating Group or Sponsor Identity either preconfigured or provided by PCRF and/or OCS as defined in TS 32.251 [8] and the PCC/ADC rule in order to generate this list and also shall keep the mapping between them. This list may overlap across multiple Usage-Report-Rules, i.e. multiple different Usage Reporting Rules may contain the same "traffic flows".

The CP function shall also provide reporting trigger events to the UP function for when to report usage information. The reporting trigger events (e.g. triggers, threshold information etc.) shall be supported for the session (IP-CAN/TDF) level reporting as well as on Rule level basis as determined by the CP function. The triggers may be provided as a volume, time or event to cater for the different charging/usage monitoring models supported by the TS 23.203 [3] for usage monitoring and by TS 32.251 [8] for offline and online charging. The CP function shall decide on the thresholds value(s) based on allowance received from PCRF, OCS or based on local configuration.

In some cases, the same Usage Reporting Rule can be used for different purposes (for both usage monitoring and charging), e.g. in case the same set of traffic flows, measurement method, trigger event, threshold, etc. apply. Similarly a reported measurement can be used for different purposes by the CP function.

5.3.3 Reporting of usage information towards CP function

The UP function shall support reporting of usage information to the CP function. The UP function shall be capable to support reporting based on different triggers, including:

- Periodic reporting with period defined by the CP function.
- Usage thresholds provided by the CP function.
- Report on demand received from the CP function.

The CP function shall make sure that the multiple granularity levels required by the reporting keys in the Usage Reporting rules satisfy the following aggregation levels without requiring a knowledge of the granularity levels by the UP function:

- Session level reporting (IP-CAN/TDF session);
- Bearer (for charging)/traffic flow (for both charging and usage monitoring) level reporting as defined by the reporting keys in the Usage Reporting Rule (see the description above).

Based on the mapping between Monitoring-key and PCC/ADC rule stored at the CP function, the CP function shall combine the reported information with session and subscriber related information which is available at the CP function, for Usage Monitoring reporting over the corresponding Gx, Sd interfaces.

Based on the mapping between Rating Group or Sponsor Identity and PCC/ADC rule stored at the CP function, the CP function shall combine the reported information with session and subscriber related information which is available at the CP function, for offline and online charging reporting over the corresponding Gy, Gyn, Gz, Gzn interfaces.

This functionality is specified in TS 32.240 [9].

The usage information shall be collected in the UP function and reported to the CP function as defined in 5.3.3, based on Monitoring Keys and triggers which are specified in TS 23.203 [3] and TS 29.212 [11].

5.3.4 PGW Pause of Charging

When the UE moves to ECM-IDLE state and the SGW-C decides to activate buffering in SGW-U for the session, it shall also instruct the SGW-U to measure the number of packets/bytes that are buffered or discarded in SGW-U and the criteria for reporting within the Usage Reporting Rule.

Once the trigger of reporting is met, the SGW-U shall inform the SGW-C by reporting usage information.

The SGW-C can then inform the PGW-C as described in TS 23.401 [2].

When the PGW-C determines to stop the charging and usage monitoring actions for the PDN connection, it shall indicate the PGW-U to stop collecting the usage information.

PGW-C sends an Sx session modification request message to the PGW-U and modifies all the Usage Reporting Rules within the PDN connection to indicate the usage collection shall be stopped. When PGW-C determines to continue the charging action for the PDN connection, it sends an Sx session modification request message to the PGW-U and modifies all the Usage Reporting Rules within the PDN connection to indicate the usage collection shall be resumed.

NOTE: The support for PGW pause of charging is optional as described in TS 23.401 [2], and used only if both the SGW-C and the PGW-C support this feature.

5.4 GTP-U IP address and TEIDu allocation

5.4.1 General

Allocation and release of F-TEIDu is performed by SGW and PGW when a bearer needs to be established or released. If functional split into SGW-C/PGW-C and SGW-U/PGW-U is supported, F-TEIDu allocation and release can either be done in the CP function or in the UP function, as described in clauses 5.4.2 and 5.4.3 below.

The support of F-TEIDu allocation by the CP function is mandatory, and the support of F-TEIDu allocation by the UP function is optional. The UP function shall support F-TEIDu allocation by the CP function. The CP function optionally supports F-TEIDu allocation by the UP function.

Whether F-TEIDu allocation/release is performed by CP function or UP function is determined by network configuration of the CP functions. When both F-TEIDu allocation in CP function and F-TEIDu allocation in UP function coexist in the same network, the same F-TEIDu allocation option shall be used by all the CP functions controlling a particular UP function.

5.4.2 F-TEIDu allocation / release in the CP function

If the network is configured to perform allocation/release of F-TEIDu in the SGW-C, the SGW-C shall manage the SGW F-TEIDu space, including ensuring that the allocated F-TEIDu(s) are unique as described in TS 29.060 [6]. The SGW-C shall allocate F-TEIDu(s) for the applicable SGW-U reference points when a bearer is activated and release the F-TEIDu(s) when a bearer is deactivated. In case of bearer activation, the SGW-C shall provide the allocated F-TEIDu(s) to SGW-U. The SGW-C shall also provide the F-TEIDu(s) to other network entities as described in TS 23.401 [2] in order to complete the bearer establishment. In case of bearer deactivation, the SGW-C shall notify the SGW-U about the release of the F-TEIDu(s).

If network is configured to perform allocation/release of F-TEIDu in the PGW-C, the PGW-C shall manage the PGW F-TEIDu space, including ensuring that the allocated F-TEIDu(s) are unique as described in TS 29.060 [6]. The PGW-C shall allocate F-TEIDu(s) for the applicable PGW-U reference points when a bearer is activated and release the F-TEIDu(s) when a bearer is deactivated. In case of bearer activation, the PGW-C shall provide the allocated F-TEIDu(s) to PGW-U. The PGW-C shall also provide the F-TEIDu(s) to other network entities as described in TS 23.401 [2] and TS 23.402 [4] in order to complete the bearer establishment. In case of bearer deactivation, the PGW-C shall notify the PGW-U about the release of the F-TEIDu(s).

5.4.3 F-TEIDu allocation / release in the UP function

If the network is configured to perform allocation/release of F-TEIDu in the SGW-U, the SGW-U shall manage the SGW F-TEIDu space, including ensuring that the allocated F-TEIDu(s) are unique as described in TS 29.060 [6]. In case of bearer activation, the SGW-C shall request SGW-U to allocate F-TEIDu(s) for the applicable SGW-U reference points and provide them to the SGW-C. The SGW-C shall provide the F-TEIDu(s) to other network entities as

described in TS 23.401 [2] in order to complete the bearer establishment. In case of bearer deactivation, the SGW-C shall request SGW-U to release F-TEIDu(s) for the bearer.

If the network is configured to perform allocation/release of F-TEIDu in the PGW-U, the PGW-U shall manage the PGW F-TEIDu space, including ensuring that the allocated F-TEIDu(s) are unique as described in TS 29.060 [6]. In case of bearer activation, the PGW-C shall request PGW-U to allocate F-TEIDu(s) for the applicable PGW-U reference points and provide them to the PGW-C. The PGW-C shall provide the F-TEIDu(s) to other network entities as described in TS 23.401 [2] and TS 23.402 [4] in order to complete the bearer establishment. In case of bearer deactivation, the PGW-C shall request PGW-U to release F-TEIDu(s) for the bearer.

5.5 UE IP address management (allocation, renewal and release)

The UE IP address management includes allocation and release of the UE IP address as well as renewal of the allocated IP address, where applicable.

The UE IP address management shall be performed by the PGW-C. As part of this functionality, various UE IP address management mechanisms as defined in 3GPP TS 23.401 [2] clause 5.3.1 are supported by the PGW-C. The PGW-C shall process the UE IP address management related messages, maintain the corresponding state information and provide the response messages to the UE. In case the UE IP address is obtained from the external PDN, additionally, the PGW-C shall also send the allocation, renewal and release related request messages to the external PDN and maintain the corresponding state information. The PGW-U shall support forwarding of the UE IP address management related messages to the PGW-C, when they are received via the user plane signalling from the UE or from the external PDN.

When PGW-C performs IPv4 address allocation via default bearer activation and release via PDN connection release (3GPP TS 23.401 [2] clause 5.3.1.2.1), no special functionality is required from the PGW-U.

For the other UE IP address management mechanisms, the UE sends the IP address management related request messages via the user plane signalling. Hence the PGW-U is required to forward these request messages to the PGW-C for processing. Once these request messages are processed by the PGW-C, the PGW-C sends response messages to the UE via the user plane signalling. Hence the PGW-C is required to forward these response messages to the PGW-U so that it can be relayed it to the UE. Correspondingly, following functionality is required to be supported by the PGW-C and PGW-U:

- For IPv6 default prefix management via IPv6 stateless address autoconfiguration (3GPP TS 23.401 [2] clause 5.3.1.2.2): PGW-C shall configure PGW-U to forward Router Solicitation and Neighbor Solicitation messages from the UE to the PGW-C. The PGW-C shall forward Router Advertisement and Neighbor Advertisement messages to the PGW-U for relaying them to the UE.
- For IPv6 parameter configuration via stateless DHCPv6 (3GPP TS 23.401 [2] clause 5.3.1.2.3): PGW-C shall configure PGW-U to forward all the DHCPv6 messages from the UE to the PGW-C. The PGW-C shall forward the DHCPv6 response messages to the PGW-U for relaying them to the UE.
- For IPv4 address management and parameter configuration DHCPv4 (3GPP TS 23.401 [2] clause 5.3.1.2.4): PGW-C shall configure PGW-U to forward all the DHCPv4 messages from the UE to the PGW-C. The PGW-C shall forward the DHCPv4 response messages to PGW-U for relaying them to the UE.
- For IPv6 prefix management via IPv6 prefix delegation (3GPP TS 23.401 [2] clause 5.3.1.2.6): PGW-C shall configure PGW-U to forward all the DHCPv6 messages from the UE to the PGW-C. The PGW-C shall forward the DHCPv6 response messages to PGW-U for relaying them to the UE.

In addition to the above, when the UE IP address is obtained from the external PDN, following functionality is required to be supported by the PGW-C and PGW-U:

- For UE IP address from AAA server in the external PDN: If the AAA server in the external PDN is reachable only via the PGW-U the PGW-C shall configure the PGW-U to forward all the Diameter or RADIUS messages from the AAA server in the external PDN to the PGW-C. And the PGW-C shall forward the Diameter or RADIUS messages to the PGW-U for relaying them to the AAA server in the external PDN.
- For UE IP address from DHCPv4/v6 server in the external PDN: If the DHCPv4/v6 server in the external PDN is reachable only via the PGW-U the PGW-C shall configure the PGW-U to forward all the DHCPv4/v6 messages from the DHCPv4/v6 server in the external PDN to the PGW-C. And the PGW-C shall forward the DHCPv4/v6 messages to the PGW-U for relaying them to the DHCPv4/v6 server in the external PDN.

NOTE: If the AAA server or the DHCPv4/v6 server in the external PDN is reachable directly, then the PGW-C communicates with it directly, without involving the PGW-U.

5.6 Control of user plane forwarding

5.6.1 General

One of the main tasks of the Sx interface is to enable the CP function to instruct the UP function about how to forward user data traffic. There are several different user plane forwarding scenarios supported. Some scenarios are applicable to SGW only or PGW only, while other scenarios are applicable to SGW and PGW or PGW and TDF. A non-exhaustive list of forwarding scenarios is provided in Table 5.6.2-1 below.

The CP function shall be able to provide the UP with instructions for at least the following behaviors: forward, forward with end marker. The CP function shall also be able to request multiple sets of forwarding instructions to be performed in sequence, e.g. forward to the DL side and forward to the CP function for the purpose of duplication.

5.6.2 Control of user plane forwarding

The CP function controls user-plane packet forwarding for traffic detected by a PDR by providing FAR(s) with instructions to the UP function, including:

- Forwarding operation information;
- Forwarding target information.

The details of the forwarding target and operation will depend on the scenario and is described in Table 5.6.2-1 below. The following forwarding functionality is required by the UP function (more than one forwarding scenario can be active for the same traffic):

- Apply GTP-U bearer related handling, i.e. encapsulation, de-capsulation or both. (This covers scenario 1 in the table below).
- Forward the traffic to the CP function (This covers scenario 2, 3, 4 in the table below).
- Apply locally configured policy for traffic steering. (This covers scenario 5 in the table below).

Further details on the forwarding related information are provided in clause 7.5.

Table 5.6.2-1: Forwarding information for different scenarios

	Scenario description	Forwarding target and operation	Applicable to
1	Forwarding of user-plane between UE and PDN, including mapping onto GTP-U tunnels and mapping between GTP-U tunnels	GTP-U encapsulation information (F-TEID)	SGW, PGW
2	Forwarding of user-plane packets from UE and CP function (e.g. RS/RA, DHCPv4/v6, traffic subject to HTTP redirect etc)	Information that the CP function is source/target (CP function IP address)	PGW
3	Forwarding of packets from the external PDN / SGi and the CP function (e.g. for RADIUS, Diameter and DHCP signalling, traffic subject to HTTP redirect etc)	Information that the CP function is source/target (CP function IP address)	PGW
4	Forwarding of packets subject to buffering in CP function	Information that the CP function is source/target (CP function IP address)	SGW
5	Forwarding of packets between the UP function and the SGi-LAN for Flexible Mobile Service Chaining	Reference to a predefined traffic steering configuration (e.g. Traffic-Steering Policy identifier)	PGW, TDF

5.6.3 Format of forwarded user plane data

For forwarding between the CP function and UP function the user plane packet is forwarded via an Sx-u tunnel by encapsulating the user-plane packet using GTP-U protocol that allows the receiving entity to identify which PDN Connection and which bearer the traffic belongs to. In the direction from the CP function to UP function for forwarding towards the UE or PDN, the UP encapsulation protocol also shall contain information that allows the UP function to identify whether the UE or PDN is targeted.

NOTE: The Sx-u tunnel may be established per bearer of a PDN connection, or per PDN or per UP function. The details of Sx-u tunnel are defined in TS 29.244 [12].

5.7 UE's permanent identifier usage

For the scenarios requiring UE's permanent identity at the UP function, e.g. UP function performing http header enrichment in a trusted environment, the UE's permanent identity may be provided from the CP function to the UP function in a container, instead of in an Sx parameter.

NOTE: In an untrusted environment in which the UE's permanent identity cannot be provided, due to e.g. to fulfil the privacy requirements, the session identifier is used between the CP function and UP function for correlating UE's session related events.

5.8 Functionality of sending of "end marker"

Sending of "end marker" is a functionality which involve SGW-C and SGW-U, and PGW-C and PGW-U. As part of the functionality, constructing of end marker packets can either be done in the CP function or in the UP function, as described in clauses 5.8.1 and 5.8.2. Whether constructing of end marker packets is performed by CP function or UP function is determined by network configuration.

5.8.1 UP function constructing the "end marker" packets

In case of eNodeB relocation during handover procedure without SGW-U change, SGW-C shall indicate the SGW-U to switch the S1 path(s) by sending an Sx session modification request message with the new F-TEID-u of eNodeB and in addition, provide an indication to the SGW-U to send the end marker packet(s) on the old path.

On receiving this indication, the SGW-U shall construct end marker packet(s) and send it for each S1 GTP-U tunnel towards the source eNodeB after sending the last PDU on the old path.

In case of SGW-U relocation during handover procedure, PGW-C shall indicate the PGW-U to switch the S5/S8 path(s) by sending an Sx session modification request message (bearer ID, new F-TEID of SGW-U) and in addition, provide an indication to the PGW-U to send the end marker packet(s) on the old path.

On receiving this indication, the PGW-U shall construct end marker packet(s) and send it for each S5/S8 GTP-U tunnel towards the source SGW-U after sending the last PDU on the old path.

On receiving the end marker packet(s) on S5/S8 GTP-U tunnel, SGW-U shall forward the end marker packet(s) and send it for each S1 GTP-U tunnel towards the source eNodeB.

5.8.2 CP function constructing the "end marker" packets

In case of eNodeB relocation during handover procedure without SGW-U change, SGW-C shall indicate the SGW-U to switch the S1 path(s) by sending an Sx session modification request message (bearer ID, new F-TEID of eNodeB). After sending the last PDU on the old path, SGW-U shall replace the old F-TEID with the new one and responds with an Sx session modification response message to acknowledge the success of path switch.

When the path switch is finished, SGW-C constructs the end marker packet(s) and sends it to the SGW-U. SGW-U then forwards the packet(s) to the source eNodeB.

In case of SGW-U relocation during handover procedure, PGW-C shall indicate the PGW-U to switch the S5/S8 path(s) by sending an Sx session modification request message (bearer ID, new F-TEID of SGW-U). After sending the last PDU on the old S5/S8 path, PGW-U shall replace the old F-TEID with the new one and responds with an Sx session modification response message to acknowledge the success of path switch.

When the path switch is finished, PGW-C constructs the end marker packet(s) and sends it to PGW-U. PGW-U then forwards the packet(s) to the source SGW-U.

5.9 Idle state packet SGW buffering function

5.9.1 General

Buffering of the UE's data packets for the UE in idle or power saving mode can be performed in SGW-U or SGW-C.

The support of buffering in the SGW-U is mandatory and the SGW-C shall support buffering by the SGW-U.

The support of buffering in the SGW-C is optional and the SGW-U optionally supports buffering by the SGW-C. An exception is that in a dedicated core network serving UEs which may enter power saving mode or apply eDRX, e.g. NB-IoT UEs, the SGW-C shall support buffering capability.

When buffering is supported in both SGW-C and SGW-U, the SGW-C decides on a per UE session basis (e.g. based on local configuration and other information such as UE capability) to perform buffering in either the SGW-C or the SGW-U.

5.9.2 Buffering in CP function

When the UE moves to ECM-IDLE state, if the SGW-C supports buffering capability and decides to activate buffering, the SGW-C shall inform the SGW-U to stop sending data packets to eNodeB and start forwarding the downlink data packets towards the SGW-C.

When the UE transition to the ECM-CONNECTED state, the SGW-C shall update the SGW-U via Sxa interface with the F-TEIDu of the eNodeB. If there are buffered packets available and their buffering duration has not expired, the SGW-C shall forward those packets to the SGW-U outside of the control plane signalling (see clause 5.6.3 "Format of forwarded user plane data") to relay them to the UE. These packets are then forwarded by the SGW-U to the eNodeB.

5.9.3 Buffering in UP function

5.9.3.1 General

The SGW-C shall be able to provide the SGW-U with instructions for at least the following behaviors: buffer without reporting the arrival of first downlink packet, buffer with reporting the arrival of first downlink packet, drop packets.

When the UE moves to ECM-IDLE state, if the SGW-C does not support buffering capability, or if the SGW-C supports buffering capability and decides to activate buffering in SGW-U for the session, the SGW-C shall inform the SGW-U, via an Sx session modification. The SGW-C decides whether buffering timers are handled by the SGW-U or by the SGW-C. The activation of buffering implicitly stops sending data to the eNodeB/RNC/SGSN.

After starting the buffering, when the first downlink packet arrives on any bearer, SGW-U shall inform the SGW-C. SGW-U sends an Sx reporting message to the SGW-C unless specified otherwise and identifies the S5/S8 bearer on which the downlink packet was received.

On receiving this reporting message, the SGW-C decides whether to send a Downlink Data Notification message to the MME as defined in TS 23.401 [2].

At the UE transition to ECM-CONNECTED state, the SGW-C shall update the SGW-U via Sxa interface with the F-TEIDu of the eNodeB/RNC/SGSN. The buffered data packets, if any, are then forwarded to the eNodeB/RNC/SGSN by the SGW-U.

In case of SGW-U relocation, buffered data packets are transferred from the old SGW-U to the new SGW-U.

5.9.3.2 Delay Downlink Packet Notification

According to clause 5.3.4.2 of TS 23.401 [2], the MME/SGSN may inform the SGW that for all UEs served by the MME/SGSN, the Downlink Packet Data Notification shall be delayed for a period D.

If the parameter D is handled by the SGW-U, the SGW-C shall include the parameter D in the Sx session establishment for new Sx sessions, in the Sx session modification for Sx sessions which are not in buffering state (when transitioning these sessions to the buffering state), and in the next Sx report ack message for Sx sessions already in buffering state. The SGW-U shall then delay the sending of subsequent Sx reporting upon next DL data arrival.

If the parameter D is handled by the SGW-C, there is no special handling compared to clause 5.9.3.1. When the SGW-U reports the arrival of a DL data packet, the SGW-C shall delay the sending of the Downlink Data Notification to the MME by parameter D delay.

5.9.3.3 Extended buffering

According to clauses 5.3.4.3 and 5.7.3 of TS 23.401 [2], the MME/SGSN invoking extended buffering indicates it to the Serving GW in the Downlink Data Notification Ack message, includes a DL Buffering Duration time and optionally a DL Buffering Suggested Packet Count.

If the MME/SGSN included the DL Suggested Packet Count, the SGW-C shall include the DL Suggested Packet Count in the Sx reporting Ack message.

If the DL Data Buffer Expiration Time is handled by the SGW-U, the SGW-C includes it in the Sx reporting Ack message and requests the SGW-U to buffer DL data packets. When the SGW-U receives the DL Data Buffer Expiration Time, the SGW-U buffers the DL data packets without reporting the arrival of the first DL data packet until the DL Data Buffer Expiration Time expires. When the DL Data Buffer Expiration Time expires, the SGW-U shall discard the buffered DL packets and shall restart buffering DL data packets with reporting the arrival of the first DL data packet.

If the DL Data Buffer Expiration Time is handled by the SGW-C, the SGW-C requests the SGW-U to buffer the DL data packets without reporting the arrival of the first DL data packet. When the DL Data Buffer Expiration Time expires, the SGW-C requests the SGW-U to drop the buffered data packets and to start buffering the DL data packets with reporting of the arrival of the first DL data packet, via an Sx Session Modification.

If the DL Suggested Packet Count was included in the request from the SGW-C, the SGW-U buffers the DL data packets up to the number of packets indicated by the DL Suggested Packet Count.

5.9.3.4 Throttling

According to clause 4.3.7.4.1a of TS 23.401 [2], the MME/SGSN can request the SGWs to selectively reduce the number of Downlink Data Notification requests it sends for downlink non-priority traffic received for UEs in idle mode according to a throttling factor and for a throttling delay specified in the Downlink Data Notification Ack message.

Throttling mechanism by which the MME uses Downlink Data Notification Acknowledgement messages DL low priority traffic Throttling parameters, is handled by the SGW-C as follows:

- On receiving Downlink Data Notification Acknowledgement from the MME/SGSN, the SGW-C determines which bearers are subject to the throttling of Downlink Data Notification requests on the basis of the bearer's ARP priority level and the operator policy.
- Upon receipt of an Sx report notifying the arrival of DL data packets on those bearers, the SGW-C decides whether or not to send a DDN to MME based on the requested throttling factor. The SGW-C may indicate in the Sx Report Ack whether SGW-U shall discard the buffered packet and may also indicate whether SGW-U shall notify when additional DL packets arrive.
- The throttling delay timer and throttling factor are handled by the SGW-C and not provided to SGW-U.

5.10 Bearer and APN policing

ARP is used for admission control (i.e. retention and pre-emption of the bearer). The value of ARP is not required to be provided to the UP function.

For every bearer, SGW-C/PGW-C shall use the QCI and optionally, the ARP priority level, to determine the transport level packet marking and provide the transport level packet marking to the SGW-U/PGW-U.

PGW-C shall provide the APN-AMBR value together with a QoS Enforcement Rule correlation ID (as described in clause 7.6) to PGW-U so that the PGW-U can enforce the APN-AMBR across all IP-CAN sessions of the UE to the same APN at the PGW-U.

SGW-C/PGW-C shall provide the GBR and MBR value for each GBR bearer of the PDN connection to the SGW-U/PGW-U. When the Gn/Gp interface is used by the PGW-U, PGW-C shall also provide the MBR value to the PGW-U for each non-GBR bearer of the PDN connection on the Gn/Gp interface.

TDF-C shall provide the TDF session MBR value to TDF-U to be applied to the TDF session of the UE.

5.11 PCC/ADC related functions

5.11.1 Activation/Deactivation of predefined PCC/ADC rules

A predefined PCC/ADC rule is configured in the CP function.

The traffic detection filters required in the UP function can be configured either in the CP function and provided to the UP function, as service data flow filter(s), or be configured in the UP function, as the application detection filter identified by an application identifier. For the latter case, the application identifier has to be configured in the CP function and the UP function.

The traffic steering policy information can be only configured in the UP function, together with traffic steering policy identifier(s), while the CP function has to be configured with the traffic steering policy identifier(s).

Policies for traffic handling in the UP function, which are referred by some identifiers corresponding to the parameters of a PCC/ADC rule, can be configured in the UP function. These traffic handling policies are configured as predefined QER(s), FAR(s) and URR(s).

When a predefined PCC/ADC rule is activated/deactivated by the PCRF, PGW-C/TDF-C shall decide what information has to be provided to the PGW-U/TDF-U to enforce the rule based on where the traffic detection filters (i.e. service data flow filter(s) or application detection filter), traffic steering policy information and the policies used for the traffic handling in the UP function are configured and where they are enforced:

- If the predefined PCC/ADC rule contains an application identifier for which corresponding application detection filters are configured in the UP function, the PGW-C/TDF-C shall provide a corresponding application identifier to the UP function;
- If the predefined PCC/ADC rule contains traffic steering policy identifier(s), the PGW-C/TDF-C shall provide a corresponding traffic steering policy identifier(s) to the UP function;
- If the predefined PCC/ADC rule contains service data flow filter(s), the PGW-C/TDF-C shall provide them to the PGW-U/TDF-U;
- If the predefined PCC/ADC rule contains some parameters for which corresponding policies for traffic handling in the UP function are configured in the UP function, the PGW-C/TDF-C shall activate those traffic handling policies via their rule ID(s).

The CP function shall maintain the mapping between a PCC/ADC rule received over Gx/Sd and the flow level PDR rule(s) used on Sx.

5.11.2 Enforcement of dynamic PCC/ADC rules

The application detection filters required in the UP function can be configured either in the CP function and provided to the UP function as the service data flow filter, or be configured in the UP function identified by an application identifier.

When receiving a dynamic PCC/ADC rule from the PCRF which contains an application identifier and/or parameters for traffic handling in the UP function:

- if the application detection filter is configured in the PGW-C/TDF-C, the PGW-C/TDF-C shall provide it in the service data flow filter to the UP function, as well as parameters for traffic handling in the UP function received from the dynamic PCC/ADC rule;
- otherwise, the application detection filters is configured in UP function, the PGW-C/TDF-C shall provide to PGW-U/TDF-U with the application identifier and the parameters for traffic handling in the UP function as required based on the dynamic PCC/ADC rule.

The CP function shall maintain the mapping between a PCC/ADC rule received over Gx/Sd and the flow level PDR(s) used on Sx.

5.11.3 Redirection

The uplink application's traffic redirection may be enforced either in the PGW-C/TDF-C (as specified in 5.4.2 Control of user plane forwarding) or directly in the UP function. The redirect destination may be provided in the dynamic PCC/ADC rule or be preconfigured, either in the CP function or in the UP function.

When receiving redirect information (redirection enabled/disabled and redirect destination) within a dynamic PCC/ADC rule or being activated/deactivated by the PCRF for the predefined redirection policies, PGW-C/TDF-C shall decide whether to provide and what information to be provided to the UP function based on where the redirection is enforced and where the redirect destination is acquired/preconfigured. When redirection is enforced in the UP function and the redirect destination is acquired from the dynamic PCC/ADC rule or is configured in the CP function, CP function shall provide the redirect destination to the UP function. When redirection is enforced in the CP function, CP function shall instruct the UP function to forward applicable user plane traffic to the CP function.

5.11.4 Support of SDCI

PFDF shall provide PFD(s) to the PGW-C/TDF-C on the request of PGW-C/TDF-C (pull mode) or on the request of PFD management from SCEF (push mode), as described in TS 23.203 [3]. The PGW-C/TDF-C shall provide the PFD(s) to the PGW-U/TDF-U, on which the Application ID corresponding to the PFD(s) is active.

The PGW-C/TDF-C supports the procedures for Gw/Gwn as specified in TS 23.203 [3], for management of PFDs. PFD(s) is cached in the PGW-C/TDF-C, and the PGW-C/TDF-C maintains a caching timer associated to the PFD(s). When the caching timer expires and there's no active PCC/ADC rule that refers to the corresponding application identifier, the PGW-C/TDF-C informs the PGW-U/TDF-U to remove the PFD(s) identified by the application identifier using the PFD management message.

When a PDR is provided for an Application ID corresponding to the PFD(s) that are not already provided to the PGW-U/TDF-U, the PGW-C/TDF-C shall provide the PFD(s) to the PGW-U/TDF-U (if there are no PFD(s) cached, the PGW-C/TDF-C retrieves them from the PFDF as specified in TS 23.203 [3]). When any update of the PFD(s) is received from PFDF by PGW-C/TDF-C (using "push" or "pull" mode), and there are still active PDRs in PGW-U/TDF-U for the Application ID, the PGW-C/TDF-C shall provision the updated PFD set corresponding to the Application ID to the PGW-U/TDF-U using the PFD management message.

NOTE 1: PGW-C/TDF-C should assure not to overload Sx signalling while managing PFD(s) to the UP function, e.g. forwarding the PFD(s) to the right UP function where the PFD(s) is enforced.

When the PGW-U/TDF-U receives the updated PFD(s) from either the same or different PGW-C/TDF-C for the same application identifier, the latest received PFD(s) shall overwrite any existing PFD(s) stored in the UP function.

NOTE 2: For the case a single UP function is controlled by multiple CP functions, the conflict of PFD(s) corresponding to the same application identifier provided by different CP functions should be avoided by operator enforcing a well-planned PFDF and CP/UP function deployment.

5.12 User Plane function selection

5.12.1 General

The selection of the UP function (SGW-U, PGW-U, TDF-U, combined SGW/PGW-U) is performed by its respective CP function (SGW-C, PGW-C, TDF-C, combined SGW/PGW-C).

The UP function's capabilities shall be signalled during the initial connection establishment between the CP function and the UP function.

The CP function shall be made dynamically aware on the UP function load and relative static capacity for which it has an established Sx session as specified in the clauses below.

The exact set of parameters used for the selection mechanism is deployment specific and controlled by the operator configuration, e.g. UE capabilities such as the UE support for dual connectivity with NR, and, the UE's location information may be used for selecting UP function in some deployments while may not be used in other deployments.

5.12.2 Selection of PGW-U

For PGW-U selection, the PGW-C shall be able to consider the following parameters:

- the PGW-U's dynamic load, at the node level (the PGW-C may then derive the load at the APN level);
- the PGW-U's relative static capacity (among PGW-U's supporting the same APN);
- the PGW-U location configured in the PGW-C and the UE location information provided by the MME/SGSN in order to select the appropriate PGW-U, e.g. for SIPTO above RAN service;
- the capability of the UP function and the functionality required for the particular UE session: An appropriate UP function can be selected by matching the functionality and features required for an UE (which can be derived from the information received over S11/S4/S5/S8 (e.g. APN, mapped UE Usage Type, UE location information, UE capabilities (e.g. UE support for dual connectivity with NR)) or from the PCRF (e.g. need to perform DPI)) with the capabilities of the UP function so as to fulfil the service for the UE, e.g. if L7 based traffic detection is needed then an UP function supporting corresponding functionality needs to be selected.
- to enable APN-AMBR enforcement, whether a PDN connection already exists for the same UE and APN, in which case the same PGW-U shall be selected;

The criteria for PGW-U selection may include load balancing between PGW-U's.

The PGW-C may support the Sx Load Control feature.

In order to allow the PGW-C to select a PGW-U according to above parameters:

- the SGW-C shall provide the relevant UE's capabilities when available (e.g. UE support for dual connectivity with NR) over the S5/S8 interface.
- the SGW-C may provide the mapped UE Usage Type over the S5 interface.

5.12.3 Selection of SGW-U

For SGW-U selection, the SGW-C shall be able to consider the following parameters:

- the SGW-U location (e.g. SGW Service Area) and the UE location information, provided by the MME/SGSN in order to select a UP function close to the UE's point of attachment;
- the SGW-U's dynamic load;
- the SGW-U's relative static capacity (versus other SGW-U's);
- the capability of the UP function and the functionality required for the particular UE session: An appropriate UP function can be selected by matching the functionalities and features required for an UE (which can be derived from the information received over S11/S4 (e.g. individual CIoT capabilities, UE Usage Type, the APN (for selection of combined SGW/PGW), UE capabilities (e.g. UE support for dual connectivity with NR)) with the capabilities of the UP function so as to fulfil the service requirement for the UE then a UP function supporting corresponding functionality needs to be selected.

The criteria for SGW-U selection may include load balancing between SGW-U's.

The SGW-C may support the Sx Load Control feature.

In order to allow the SGW-C to select a SGW-U according to the above parameters:

- the MME/SGSN shall provide the location of the UE (i.e. ECGI, eNB or TAI for E-UTRAN, and RAI or RNC-ID for UTRAN), the APN (for selection of a combined SGW/PGW), relevant UE capabilities when available (e.g. UE support for dual connectivity with NR) and may provide the mapped UE Usage Type in the Create Session Request over the S11/S4 interface;

NOTE: MME sets the UE support for dual connectivity with NR indication when the UE indicates support for NR and there is no Access Restriction for NR for the UE (see TS 23.401 [2] clause 4.3.2a).

5.12.4 Selection of a combined SGW/PGW-U

A combined SGW/PGW-C selects the SGW-U and PGW-U as defined respectively in clauses 5.12.3 and 5.12.4, with the following addition:

- The SGW-C determines that it is a combined SGW/PGW-C entity the same way as in the non-split case;

- The combined SGW/PGW-C may optimize UP function selection by selecting the best couple of SGW-U and PGW-U for the requested APN, among all candidate couples of (SGW-U, PGW-U), instead of selecting independently the SGW-U first and then the PGW-U (which may result in selecting non-co-located SGW-U and PGW-U).

5.12.5 Selection of TDF-U

5.12.5.1 Solicited application reporting mode

TDF-C shall select TDF-U at PDN connection establishment (TDF session establishment).

The selection may be based on the following parameters:

- the TDF-U's dynamic load;
- the TDF-U's relative static capacity;
- the capability of the UP function and the functionalities and the capabilities required for the particular UE session: An appropriate UP function can be selected by matching the functionalities and features required for the UE from the PCRF.

The criteria for TDF-U selection includes load balancing between TDF-U's.

The TDF-C may support the Sx Load Control feature.

5.12.5.2 Unsolicited application reporting mode

The selection of TDF-U for the unsolicited application reporting is performed by TDF-C during the Sx management procedure, using the information configured in TDF-C.

NOTE: TDF-C provides the instructions for application detection and reporting to the TDF-U during the Sx session management procedure. TDF-U shall communicate with the TDF-C (using the same Sx session) when application reporting is necessary, based on instructions provided by TDF-C.

6 Information flows

Editor's note: This clause will document the Sx information flows and their usage for the various existing procedures.

6.1 General

This clause defines the procedures that are used for the interaction between SGW-C and SGW-U, PGW-C and PGW-U, TDF-C and TDF-U, and documents how these procedures shall be embedded into existing procedures of TS 23.401 [2], TS 23.402 [4], TS 23.060 [5] and TS 23.203 [3].

NOTE: TS 23.401 [2], TS 23.402 [4], TS 23.060 [5] and TS 23.203 [3] do not reflect control and user plane separation of SGW, PGW or TDF and thus the procedures in these specifications do not show the interaction between the respective CP function and UP function. In case of any discrepancies, the procedures defined in TS 23.401 [2], TS 23.402 [4], TS 23.060 [5] and TS 23.203 [3] apply.

6.2 Sx Session Management Procedures

6.2.1 General

Sx session management procedures are used to control the functionality of the UP function, which involve SGW, PGW or TDF. The CP function can create, update and remove the Sx session context (i.e. the parameters related to a PDN connection, IP-CAN session, TDF session or TDF in unsolicited reporting mode) in the UP function.

The following Sx session management procedures exist: Sx session establishment procedure, Sx session modification procedure and Sx session termination procedure. All of them are initiated by the CP function.

6.2.2 Sx Session Establishment Procedure

The Sx session establishment procedure is used to create the initial Sx session context for a PDN connection, IP-CAN session, TDF session or TDF in unsolicited reporting mode at the UP function. The CP function assigns a new Session ID and provides it to the UP function. The Session ID is stored by both entities and used to identify the Sx session context during their interaction. The CP function stores also the relation between the Session ID and PDN connection, IP-CAN session, TDF session or TDF in unsolicited reporting mode and can then correlate events reported by the UP function to them.

During PDN connection establishment, the Sx session establishment procedure is executed between SGW-C and SGW-U as well as PGW-C and PGW-U. The Sx session context comprises the parameters for the default as well as every dedicated bearer of the PDN connection. In addition, the Sx session context for the PGW-U comprises IP-CAN session related parameters.

During SGW-U relocation, the Sx session establishment procedure is executed between SGW-C and the target SGW-U. The Sx session context comprises the parameters for the default as well as every dedicated bearer of the PDN connection.

During TDF session establishment, the Sx session establishment procedure is executed between TDF-C and TDF-U. The Sx session context comprises TDF session related parameters.

For a TDF in unsolicited reporting mode, the Sx session establishment procedure is executed between TDF-C and the TDF-U selected during Sx management procedure. The Sx session context comprises the instructions for application detection and reporting in unsolicited reporting mode.

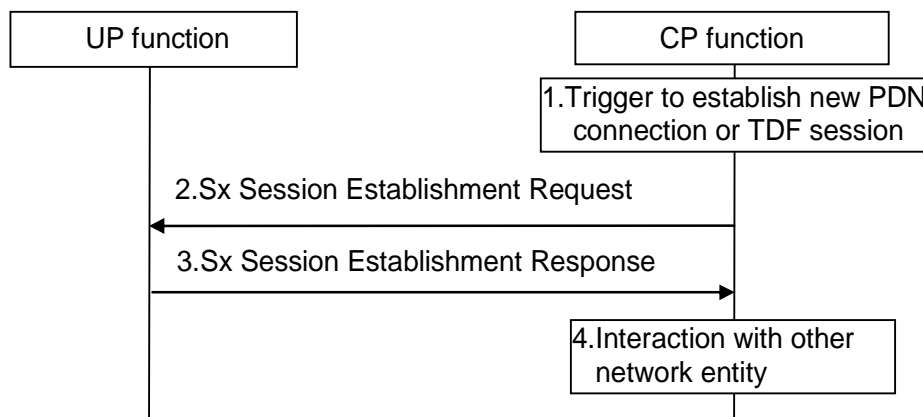

Figure 6.2.2-1 Sx session establishment procedure

NOTE: In case of a TDF in unsolicited reporting mode, the procedure is triggered by TDF configuration and step 1 and 4 do not apply.

1. CP function receives the trigger to establish a new PDN connection or TDF session from a peer CP function, an MME or a PCRF.
2. The CP function sends an Sx session establishment request message to the UP function that contains the structured control information which defines how the UP function needs to behave.
3. The UP function responds with an Sx session establishment response message containing any information that the UP function has to provide to the CP function in response to the control information received.
4. The CP function interacts with the network entity which triggered this procedure (e.g. a peer CP function, an MME or a PCRF).

6.2.3 Sx Session Modification Procedure

The Sx session modification procedure is used to update the Sx session context of an existing PDN connection, IP-CAN session, TDF session or TDF in unsolicited reporting mode at the UP function.

The Sx session modification procedure is executed between SGW-C and SGW-U whenever PDN connection related parameters have to be modified, as well as between PGW-C and PGW-U whenever PDN connection or IP-CAN session related parameters have to be modified.

The Sx session modification procedure is executed between TDF-C and TDF-U whenever TDF session related parameters have to be modified.

For a TDF in unsolicited reporting mode, the Sx session modification procedure is executed between TDF-C and TDF-U whenever instructions for application detection and reporting have to be modified.

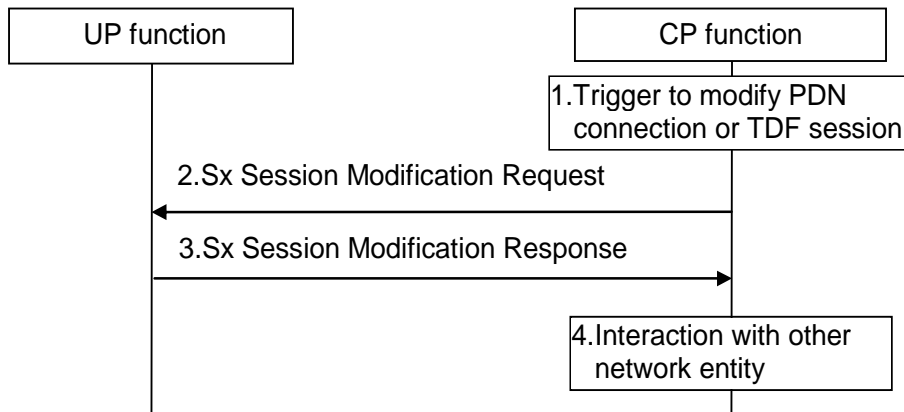

Figure 6.2.3-1 Sx session modification procedure

NOTE: In case of a TDF in unsolicited reporting mode, the procedure is triggered by TDF configuration and step 1 and 4 do not apply.

1. CP function receives the trigger to modify the existing PDN connection or TDF session from a peer CP function, an MME or a PCRF.
2. The CP function sends an Sx session modification request message to the UP function that contains the update for the structured control information which defines how the UP function needs to behave.
3. The UP function identifies the Sx session context to be modified by the Session ID. Then, the UP function updates the parameters of this Sx session context according to the list of parameters sent by the CP function. The UP function responds with an Sx session modification response message containing any information that the UP function has to provide to the CP function in response to the control information received.
4. The CP function interacts with the network entity which triggered this procedure (e.g. a peer CP function, an MME or a PCRF).

6.2.4 Sx Session Termination Procedure

The Sx session termination procedure is used to remove the Sx session context of an existing PDN connection, IP-CAN session, TDF session or TDF in unsolicited reporting mode at the UP function.

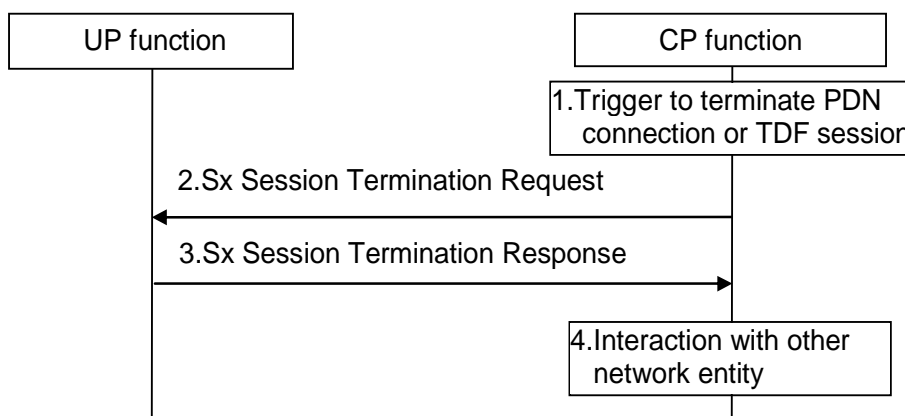

Figure 6.2.4-1 Sx session termination procedure

NOTE: In case of a TDF in unsolicited reporting mode, the procedure is triggered by TDF configuration and step 1 and 4 do not apply.

1. CP function receives the trigger to terminate the existing PDN connection or TDF session from a peer CP function, an MME or a PCRF.
2. The CP function sends an Sx session termination request message to the UP function.
3. The UP function identifies the Sx session context to be terminated by the Session ID and removes the whole session context. The UP function responds with an Sx session termination response message containing any information that the UP function has to provide to the CP function.
4. The CP function interacts with the network entity which triggered this procedure (e.g. a peer CP function, an MME or a PCRF).

6.3 Updates to procedures in other specifications

6.3.1 Updates to procedures specified in TS 23.401

6.3.1.1 Procedures with PDN connection establishment

This clause defines interactions between the CP and UP function during the following procedures:

- E-UTRAN initial attach (TS 23.401 [2] clause 5.3.2.1)
- UE requested PDN connectivity (TS 23.401 [2] clause 5.10.2)

During the above procedures following is the nature of interactions between the CP and UP function:

- The new SGW-C selects a new SGW-U and creates an Sx session.
- The new PGW-C selects a new PGW-U and creates an Sx session.
- The old SGW-C releases the existing Sx session from the old SGW-U.
- The old PGW-C releases the existing Sx session from the old PGW-U.
- The SGW-C modifies the SGW-U to update with the F-TEIDu of the eNodeB and the PGW-U.

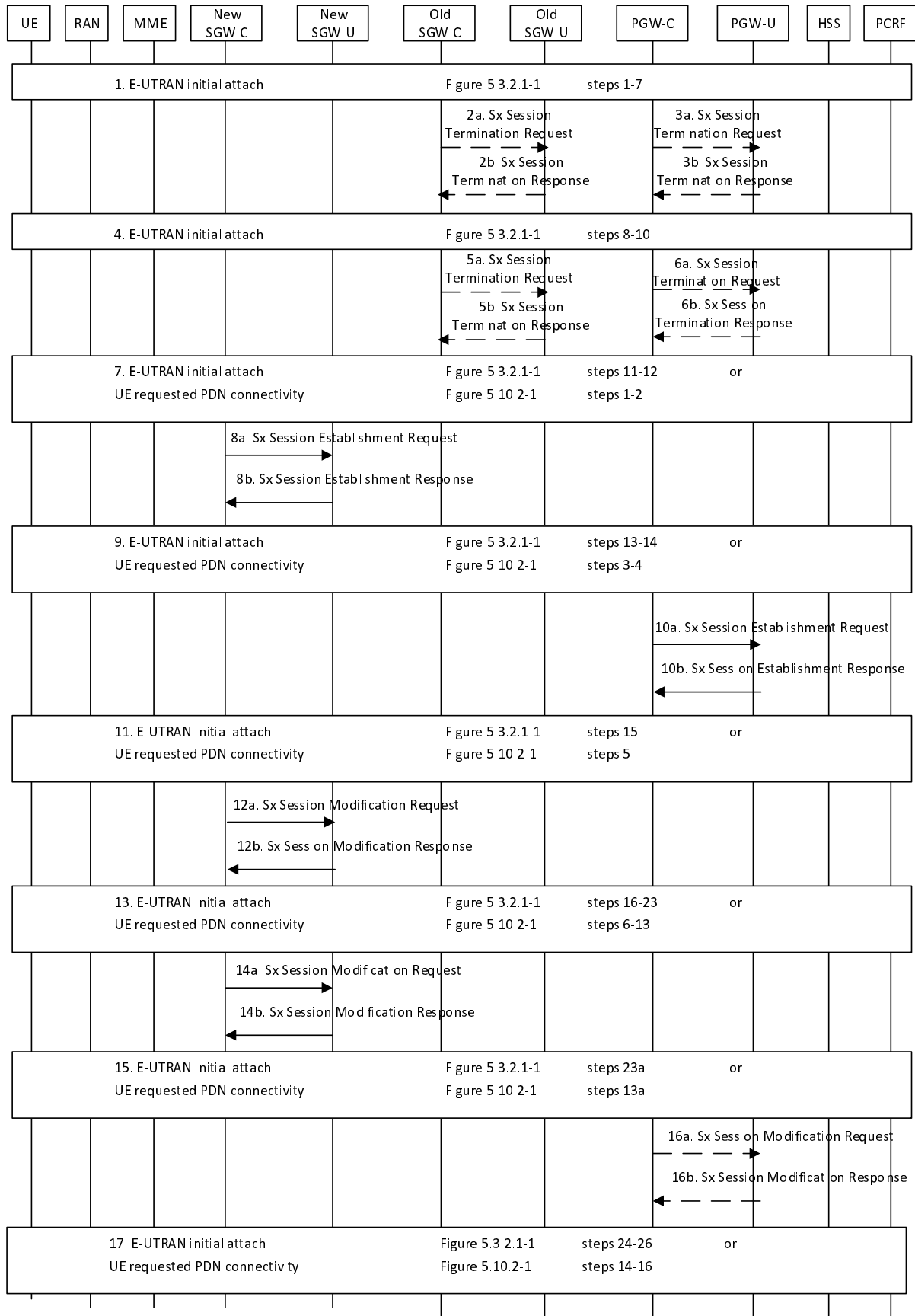

Figure 6.3.1.1-1: Interaction between CP and UP function during PDN connection establishment

1. Procedure as listed in this step is initiated as specified in the relevant clauses of this specification. The relevant steps of the procedure as specified in the figure above are executed.
- 2a. The SGW-C may send an Sx Session Termination Request to the SGW-U to release the Sx session.
- 2b. The SGW-U sends an Sx Session Termination Response to the SGW-C confirming the release of the Sx session.
- 3a. The PGW-C may send an Sx Session Termination Request to the PGW-U to release the Sx session.
- 3b. The PGW-U sends an Sx Session Termination Response to the PGW-C confirming the release of the Sx session.
4. The relevant steps of the procedure as specified in the figure above are executed.
- 5a. The SGW-C may send an Sx Session Termination Request to the SGW-U to release the Sx session.
- 5b. The SGW-U sends an Sx Session Termination Response to the SGW-C confirming the release of the Sx session.
- 6a. The PGW-C may send an Sx Session Termination Request to the PGW-U to release the Sx session.
- 6b. The PGW-U sends an Sx Session Termination Response to the PGW-C confirming the release of the Sx session.
7. The relevant steps of the procedure as specified in the figure above are executed.
- 8a. The SGW-C shall select new SGW-U as specified in clause 5.12. If the network is configured to perform F-TEIDu allocation in the CP function then SGW-C allocates F-TEIDu for the default bearer. Then the SGW-C sends an Sx Session Establishment Request to the selected SGW-U for creating an Sx session for the UE. The F-TEIDu for the default bearer shall be included if the SGW-C has allocated the same.
- 8b. If the network is configured to perform F-TEIDu allocation in the UP function, the SGW-U allocates F-TEIDu for the bearer. The SGW-U sends an Sx Session Establishment Response to the SGW-C confirming the successful creation of the Sx session. It shall include the F-TEIDu for the bearer if it has allocated the same.
9. The relevant steps of the procedure as specified in the figure above are executed.
- 10a. The PGW-C shall select new PGW-U as specified in clause 5.12. If the network is configured to perform F-TEIDu allocation in the CP function then PGW-C allocates F-TEIDu for the default bearer. Then the PGW-C sends an Sx Session Establishment Request to the selected PGW-U for creating an Sx session for the UE. The PGW-C shall include the F-TEIDu of the default bearer received from the SGW. The F-TEIDu for the default bearer shall be included if the PGW-C has allocated the same.
- 10b. If the network is configured to perform F-TEIDu allocation in the UP function, the PGW-U allocates F-TEIDu for the bearer. The PGW-U sends an Sx Session Establishment Response to the PGW-C confirming the successful creation of the Sx session. It shall include the F-TEIDu for the bearer if it has allocated the same.
11. The relevant steps of the procedure as specified in the figure above are executed.
- 12a. The SGW-C sends Session Modification Request to the SGW-U. The SGW-C shall include the F-TEIDu of the default bearer received from the PGW.
- 12b. The SGW-U sends an Sx Session Modification Response to the SGW-C confirming the success of the Sx session modification.
13. The relevant steps of the procedure as specified in the figure above are executed.
- 14a. The SGW-C sends an Sx Session Modification Request to the SGW-U. The SGW-C shall include the F-TEIDu of the default bearer received from the eNodeB.
- 14b. The SGW-U sends an Sx Session Modification Response to the SGW-C confirming the success of the Sx session modification.
15. The relevant steps of the procedure as specified in the figure above are executed.
- 16a. If the Handover Indication is included in step 15, the PGW-C updates the old PGW-U session corresponding to the non-3GPP access by sending "Sx session modification request" message to the PGW-U (session ID) and instructs the PGW-U to start routing the downlink packets to the SGW/SGW-U.
- 16b. The PGW-U sends "Sx session modification response" message to the PGW-C.

17. The relevant steps of the procedure as specified in the figure above are executed.

6.3.1.2 Procedures with SGW change

6.3.1.2.1 General

This clause covers the following two types of procedures involving SGW change:

- Type 1: Procedures in which only Create Session Request message is sent from MME/SGSN to SGW-C during SGW change.
- Type 2: Procedures in which Create Session Request message followed by Modify Bearer Request message are sent from MME/SGSN to SGW-C during SGW change.

6.3.1.2.2 Type 1

This clause defines interactions between the CP and UP function during the following procedures:

- Tracking Area Update procedure with Serving GW change (TS 23.401 [2] clause 5.3.3.1)
- Routing Area Update with MME interaction and with SGW change (TS 23.401 [2] clause 5.3.3.6)
- X2-based handover with Serving GW relocation (TS 23.401 [2] clause 5.5.1.1.3)
- MME triggered Serving GW relocation (TS 23.401 [2] clause 5.10.4)

Editor's Note: "Tracking Area Update procedure with Serving GW change and data forwarding" (TS 23.401 [2] clause 5.3.3.1A) is FFS.

During the above procedures following is the nature of interactions between the CP and UP function:

- The new SGW-C selects a new SGW-U and creates an Sx session
- The PGW-C modifies the PGW-U to update with the F-TEIDu(s) of the new SGW-U
- The old SGW-C releases the existing Sx session from the old SGW-U

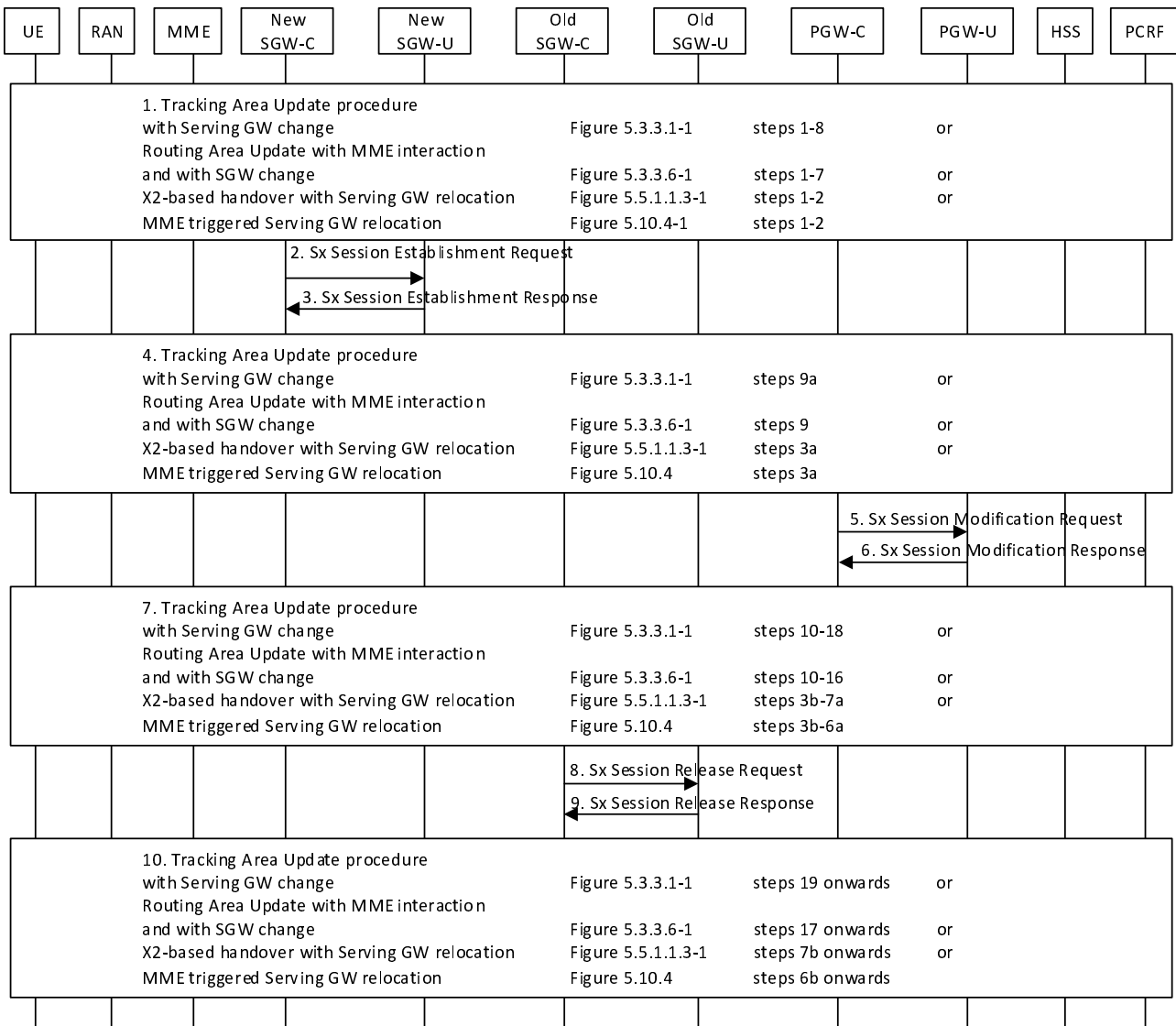

Figure 6.3.1.2.2-1: Interaction between CP and UP function during procedures with SGW change (Type 1)

1. Procedure as listed in this step is initiated as specified in the relevant clauses of this specification. The relevant steps of the procedure as specified in the figure above are executed.
2. The new SGW-C shall select new SGW-U as specified in clause 5.12. If the network is configured to perform F-TEIDu allocation in the CP function then SGW-C allocates an F-TEIDu for each and every bearer. Then the new SGW-C sends Sx Session Establishment Request to the selected SGW-U for creating an Sx session for the UE. Additionally, an F-TEIDu for each and every bearer shall be included if the SGW-C has allocated the same.
3. If the network is configured to perform F-TEIDu allocation in the UP function, the SGW-U allocates an F-TEIDu for each and every bearer received. The new SGW-U sends Sx Session Establishment Response to the new SGW-C confirming the successful creation of the Sx session. It shall include the F-TEIDu for each and every bearer if it has allocated the same.
4. The relevant steps of the procedure as specified in the figure above are executed.
5. The PGW-C sends an Sx Session Modification Request to the PGW-U. The PGW-C shall include the F-TEIDu(s) of the new SGW-U. Additionally, based on the interaction with the PCRF, the PGW-C may also update other Sx parameters for the PDN connection.
6. The PGW-U sends Sx Session Modification Response to the PGW-C confirming the success of the Sx session modification.

7. The relevant steps of the procedure as specified in the figure above are executed.
8. The old SGW-C sends Sx Session Release Request to the old SGW-U to release the Sx session.
9. The old SGW-U sends Sx Session Release Response to the old SGW-C confirming the release of the Sx session.
10. The relevant steps of the procedure as specified in the figure above are executed.

6.3.1.2.3 Type 2

This clause defines interactions between the CP and UP function during the following procedures:

- S1-based handover, normal (TS 23.401 [2] clause 5.5.1.2.2)
- E-UTRAN to UTRAN Iu mode Inter RAT handover (TS 23.401 [2] clause 5.5.2.1)
- UTRAN Iu mode to E-UTRAN Inter RAT handover (TS 23.401 [2] clause 5.5.2.2)
- E-UTRAN to GERAN A/Gb mode Inter RAT handover (TS 23.401 [2] clause 5.5.2.3)
- GERAN A/Gb mode to E-UTRAN Inter RAT handover (TS 23.401 [2] clause 5.5.2.4)

Editor's Note: Most of the above procedures involve establishment and release of indirect data forwarding tunnel at the source and the target SGW. It is FFS if this needs to be supported in the CP and UP split architecture.

During the above procedures following is the nature of interactions between the CP and UP function:

- The new SGW-C selects a new SGW-U and creates an Sx session.
- The SGW-C modifies the Sx session at SGW-U to update the F-TEIDu(s) of the eNB.
- The PGW-C modifies the PGW-U to update with the F-TEIDu(s) of the new SGW-U.
- The old SGW-C releases the existing Sx session from the old SGW-U.

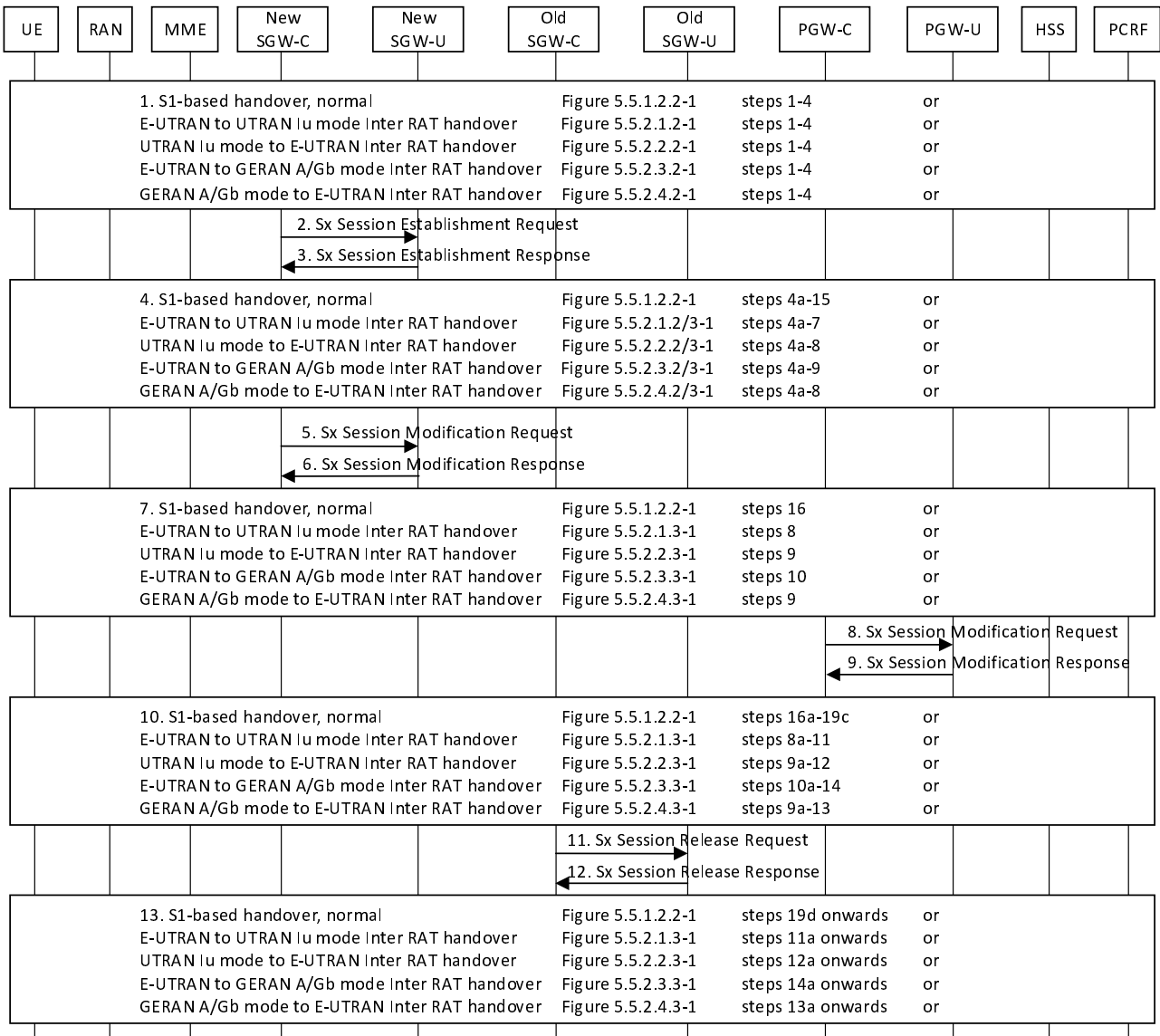

Figure 6.3.1.2.3-1: Interaction between CP and UP function during procedures with SGW change (Type 2)

1. Procedure as listed in this step is initiated as specified in the relevant clauses of this specification. The relevant steps of the procedure as specified in the figure above are executed.
2. The new SGW-C shall select new SGW-U as specified in clause 5.12. If the network is configured to perform F-TEIDu allocation in the CP function then SGW-C allocates F-TEIDu for each and every bearer. Then the new SGW-C sends an Sx Session Establishment Request to the selected SGW-U for creating an Sx session for the UE. Additionally, F-TEIDu for each and every bearer shall be included if the SGW-C has allocated the same. The Usage Monitoring Rules may also be included in case of home-routed roaming scenario and if the inter-operator charging is required.
3. If the network is configured to perform F-TEIDu allocation in the UP function, the SGW-U allocates F-TEIDu for each and every bearer received. The new SGW-U sends an Sx Session Establishment Response to the new SGW-C confirming the successful creation of the Sx session. It shall include the F-TEIDu for each and every bearer if it has allocated the same.
4. The relevant steps of the procedure as specified in the figure above are executed.
5. The SGW-C sends an Sx Session Modification Request to the SGW-U. It shall include the F-TEIDu of the eNB.
6. The SGW-U sends an Sx Session Modification Response to the SGW-C confirming the successful modification of the Sx session.

1. Procedure as listed in this step is initiated as specified in the relevant clauses of this specification. The relevant steps of the procedure as specified in the figure above are executed.
2. The SGW-C sends an Sx Session Modification Request to the SGW-U. It shall include the new F-TEIDu of the eNB. Additionally, for the following procedures extra steps may apply:
 - UE triggered Service Request: If the buffering of the data packets in the idle mode is performed in the SGW-C and if those buffered packets are still valid (e.g. data packets for which the buffering duration hasn't expired yet), then SGW-C shall also provide those data packets to the SGW-U (as specified in clause 5.12) so that it can be sent to the eNB.
3. The SGW-U sends an Sx Session Modification Response to the SGW-C confirming the successful modification of the Sx session.
4. The relevant steps of the procedure as specified in the figure above are executed.
5. Based on the interaction with the PCRF, the PGW-C may update other Sx parameters for the PDN connection. Correspondingly, the PGW-C sends an Sx Session Modification Request to the PGW-U.
6. The PGW-U sends an Sx Session Modification Response to the PGW-C confirming the success of the Sx session modification.
7. The relevant steps of the procedure as specified in the figure above are executed.

6.3.1.4 Procedures with release of eNB F-TEIDu

This clause defines interactions between the CP and UP function during the following procedures:

- Connection Suspend procedure (TS 23.401 [2] clause 5.3.4A)
- S1 release procedure (TS 23.401 [2] clause 5.3.5)

During the above procedures following is the nature of interactions between the CP and UP function:

- The SGW-C modifies the SGW-U to release the eNB F-TEIDu. Additionally, the SGW-C configures the SGW-U so that the downlink data packets can be buffered either in the SGW-C or in the SGW-U.

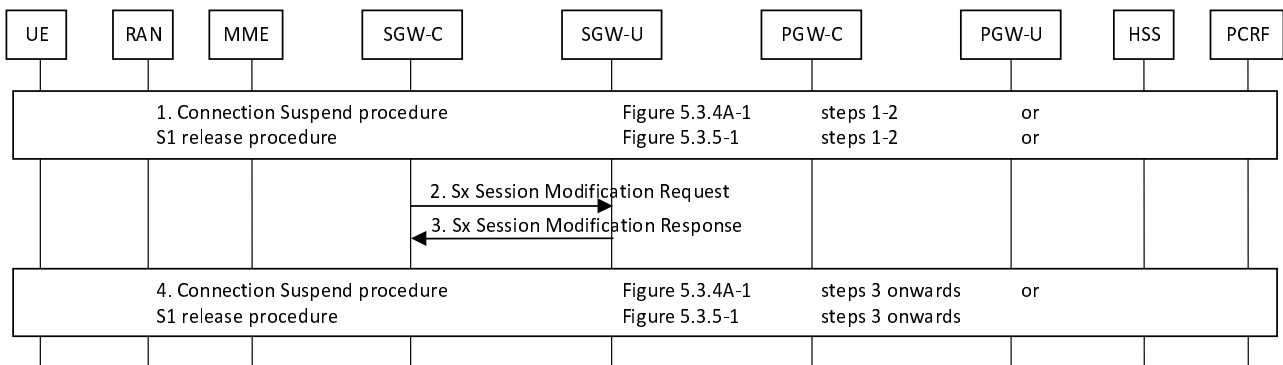

Figure 6.3.1.4-1: Interaction between CP and UP function during procedures with release of eNB F-TEIDu

1. Procedure as listed in this step is initiated as specified in the relevant clauses of this specification. The relevant steps of the procedure as specified in the figure above are executed.
2. The SGW-C sends an Sx Session Modification Request to the SGW-U. It shall indicate the SGW-U to release the eNB F-TEIDu. Additionally, the SGW-C decides if the buffering of the downlink data packets shall be done in CP or the UP function, as specified in clause 5.9) and correspondingly informs the SGW-U for as follows:
 - If the downlink data packets are to be buffered in the SGW-C, the SGW-C shall configure the SGW-U to forward the downlink data packets for all the bearers of the UE to the SGW-C, as specified in clause 5.6.
 - If the downlink data packets are to be buffered in the SGW-U, the SGW-C shall indicate the same to SGW-U. Additionally, the following applies:

- if the Paging Policy Differentiation feature (as specified in 3GPP TS 23.401 [2] clause 4.9) is supported by the SGW-C and SGW-U and based on operator's policy if it is required to be activated for this UE, the SGW-C shall include an indication to provide the DSCP in TOS (IPv4) / TC (IPv6) value from the IP header of the first downlink data packet of each bearer.
 - if the PDN GW Pause Charging procedure (as specified in 3GPP TS 23.401 [2] clause 5.3.6A) is supported by the SGW-C and SGW-U and based on operator's policy if it is required to be activated for this UE, the SGW-C may provide the number/fraction of packets/bytes drop threshold value. When this threshold is reached, the SGW-U is required to provide an indication to the SGW-C.
3. The SGW-U sends an Sx Session Modification Response to the SGW-C confirming the successful modification of the Sx session.
 4. The relevant steps of the procedure as specified in the figure above are executed.

6.3.1.5 Procedures when downlink data is buffered in the UP function

This clause defines interactions between the CP and UP function when the UE is in idle mode and buffering of the downlink data is performed in the UP function, during the following procedures:

- Network Triggered Service Request (TS 23.401 [2] clause 5.3.4.3)
- PDN GW Pause of Charging procedure (TS 23.401 [2] clause 5.3.6A)

During the above procedures following is the nature of interactions between the CP and UP function:

- The SGW-U notifies the SGW-C that the first downlink data packet was received for a bearer.

NOTE: A bearer is identified in the SGW-U as a combination of PDR(s) and FAR(s).

- The SGW-U notifies the SGW-C that the drop threshold was reached.

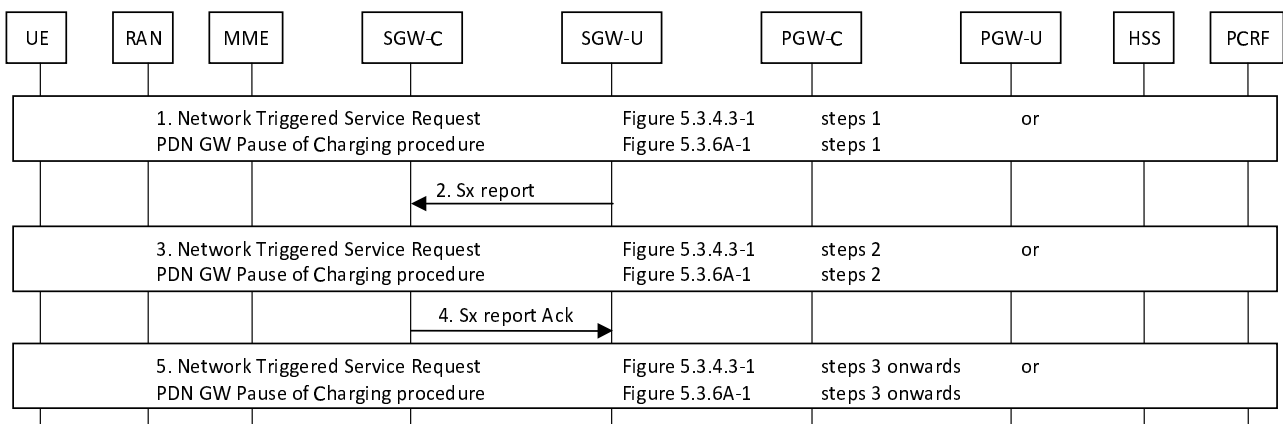

Figure 6.3.1.5-1: Interaction between CP and UP when downlink data is buffered in the UP function

1. Procedure as listed in this step is initiated as specified in the relevant clauses of this specification. The relevant steps of the procedure as specified in the figure above are executed.
2. When the downlink data is received, the SGW-U starts buffering it.

On arrival of the first downlink data packet for a bearer, the SGW-U shall send an Sx report message (first packet indication) to the SGW-C. If the Paging Policy Differentiation feature (as specified in 3GPP TS 23.401 [2] clause 4.9) is supported by the SGW-U and if it is activated by the SGW-C for this Sx session, the SGW-U shall also include the DSCP in TOS (IPv4) / TC (IPv6) value from the IP header of the downlink data packet.

If the SGW-C has provided the number/fraction of packets/bytes drop threshold value during the procedure with release of eNB F-TEIDu (clause 6.3.1.4), the SGW-U shall monitor that threshold. Once the threshold is reached the SGW-U shall send an Sx report message (drop threshold reached) to the SGW-C.

3. The relevant steps of the procedure as specified in the figure above are executed.

4. The SGW-C sends an Sx report Ack message to the SGW-U. Additionally, for the following procedures the following applies:
 - Network Triggered Service Request: If DL Buffering Duration time and DL Buffering Suggested Packet Counts were received from the MME/SGSN (refer to step no. 2 of TS 23.401 [2] clause 5.3.4.3) by the SGW-C then SGW-C shall include the same in the Sx report Ack message.
5. The relevant steps of the procedure as specified in the figure above are executed.

6.3.1.6 Procedures with release of PDN connection

This clause defines interactions between the CP and UP function during the following procedures:

- UE-initiated Detach procedure for E-UTRAN (TS 23.401 [2] clause 5.3.8.2.1)
- UE-initiated Detach procedure for GERAN/UTRAN with ISR activated (TS 23.401 [2] clause 5.3.8.2.2)
- MME-initiated Detach procedure (TS 23.401 [2] clause 5.3.8.3)
- SGSN-initiated Detach procedure with ISR activated (TS 23.401 [2] clause 5.3.8.3A)
- HSS-initiated Detach procedure (TS 23.401 [2] clause 5.3.8.4)
- UE or MME requested PDN disconnection (TS 23.401 [2] clause 5.10.3)

During the above procedures following is the nature of interactions between the CP and UP function:

- The SGW-C terminates the Sx session at the SGW-U.
- The PGW-C terminates the Sx session at the PGW-U.

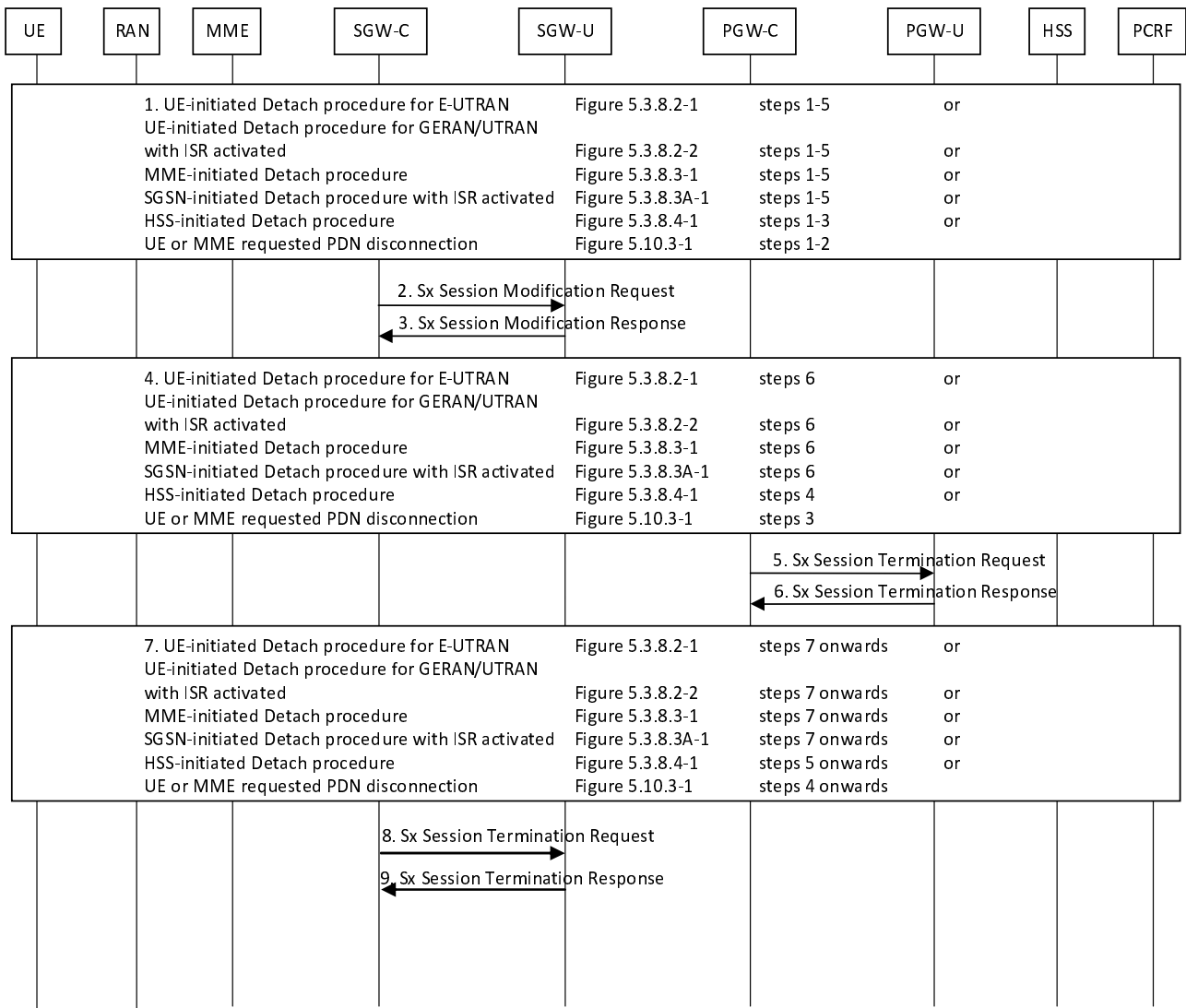

Figure 6.3.1.6-1: Interaction between CP and UP function during release of PDN connection

1. Procedure as listed in this step is initiated as specified in the relevant clauses of this specification. The relevant steps of the procedure as specified in the figure above are executed.
2. The SGW-C sends an Sx Session Modification Request to the SGW-U. SGW-C shall indicate SGW-U to stop counting for the affected bearers. SGW-C shall also indicate the SGW-U to discard downlink packets received from PGW-U for the affected bearers, and discard uplink packets received from eNodeB for the affected bearers.
3. The SGW-U sends an Sx Session Modification Response to the SGW-C.
4. The relevant steps of the procedure as specified in the figure above are executed.
5. The PGW-C sends an Sx Session Termination Request to the PGW-U.
6. The PGW-U sends an Sx Session Termination Response to the PGW-C confirming the successful termination of the Sx session. Additionally, if the usage reporting is configured by the PGW-C (as specified in clause 5.3.2) the PGW-U shall provide the usage report(s) for the PDN connection (as specified in clause 5.3.3) to the PGW-C.
7. The relevant steps of the procedure as specified in the figure above are executed.
8. The SGW-C sends an Sx Session Termination Request to the SGW-U.
9. The SGW-U sends an Sx Session Termination Response to the SGW-C confirming the successful termination of the Sx session. Additionally, if the usage reporting is configured by the SGW-C (as specified in clause 5.3.2) the SGW-U shall provide the usage report(s) for the PDN connection (as specified in clause 5.3.3) to the SGW-C.

6.3.1.7 Procedures with modification of bearer

This clause defines interactions between the CP and UP function during the following procedures:

- Dedicated bearer activation (TS 23.401 [2] clause 5.4.1)
- PDN GW initiated bearer modification with bearer QoS update (TS 23.401 [2] clause 5.4.2.1)
- PDN GW initiated bearer modification without bearer QoS update (TS 23.401 [2] clause 5.4.3)
- PDN GW initiated bearer deactivation (TS 23.401 [2] clause 5.4.4.1)
- HSS Initiated Subscribed QoS Modification (TS 23.401 [2] clause 5.4.2.2)
- MME Initiated Dedicated Bearer Deactivation (TS 23.401 [2] clause 5.4.4.2)

During the above procedures following is the nature of interactions between the CP and UP function:

- The PGW-C modifies the Sx session at the PGW-U.
- The SGW-C modifies the Sx session at the SGW-U.

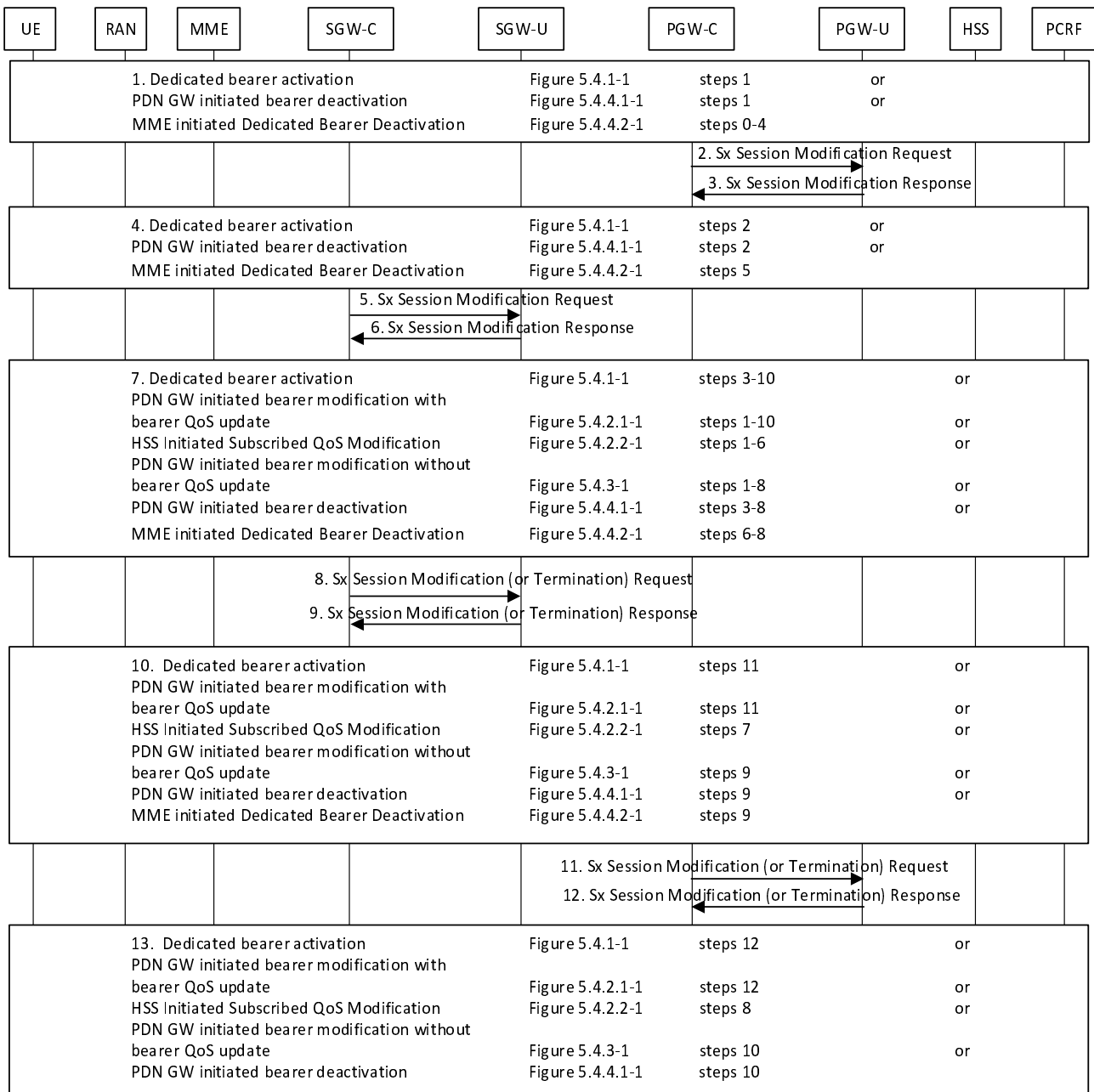

Figure 6.3.1.7-1: Interaction between CP and UP function during modification of bearer

1. Procedure as listed in this step is initiated as specified in the relevant clauses of this specification. The relevant steps of the procedure as specified in the figure above are executed.
2. The PGW-C sends an Sx Session Modification Request to the PGW-U. For "Dedicated bearer activation", PGW-C may indicate PGW-U to allocate F-TEID for the dedicate bearer. For "PGW/MME initiated bearer deactivation procedure", PGW-C shall indicate PGW-U to stop counting and stop forwarding packets for the affected bearers.
3. The PGW-U sends an Sx Session Modification Response to the PGW-C confirming the successful modification of the Sx session.
4. The relevant steps of the procedure as specified in the figure above are executed.
5. The SGW-C sends an Sx Session Modification Request to the SGW-U. For "Dedicated bearer activation", SGW-C may indicate SGW-U to allocate F-TEID for the dedicate bearer. For "PGW/MME initiated bearer deactivation procedure", SGW-C shall indicate SGW-U to stop counting and stop forwarding packets for the affected bearers.

6. The SGW-U sends an Sx Session Modification Response to the SGW-C confirming the successful modification of the Sx session.
7. The relevant steps of the procedure as specified in the figure above are executed.
8. The SGW-C sends an Sx Session Modification Request to the SGW-U. For dedicated bearer activation procedure, the SGW-C shall include the F-TEIDu of the activated bearer received from the eNodeB. For PDN GW/HSS initiated bearer modification with bearer QoS update procedure, SGW-C provides updated QoS parameters to SGW-U. For PDN GW/MME initiated bearer deactivation procedure, SGW-C shall indicate SGW-U to remove the PDR for the affected bearers.

If the default bearer belonging to a PDN connection is deactivated, the SGW-C sends an Sx Session Termination Request to the SGW-U.

9. The SGW-U sends an Sx Session Modification Response or an Sx Session Termination Response to the SGW-C confirming the successful modification or termination of the Sx session.
10. The relevant steps of the procedure as specified in the figure above are executed.
11. The PGW-C sends an Sx Session Modification Request to the PGW-U. For dedicated bearer activation procedure, the PGW-C shall include the F-TEIDu of the activated bearer received from the SGW. For PDN GW/HSS initiated bearer modification with bearer QoS update procedure, PGW-C provides updated QoS parameters to PGW-U. For "PDN GW initiated bearer modification without bearer QoS update" procedure, PGW-C provides updated TFT to PGW-U. For PDN GW/MME initiated bearer deactivation procedure, PGW-C shall indicate PGW-U to remove the PDR for the affected bearers.

If the default bearer belonging to a PDN connection is deactivated, the PGW-C sends an Sx Session Termination Request to the PGW-U.

12. The PGW-U sends an Sx Session Modification Response or an Sx Session Termination Response to the PGW-C confirming the successful modification or termination of the Sx session.
13. The relevant steps of the procedure as specified in the figure above are executed.

6.3.2 Updates to procedures specified in TS 23.203

6.3.2.1 IP-CAN session establishment

This clause defines interactions between the CP and UP function during the following procedures:

- IP-CAN session establishment (TS 23.203 [3] clause 7.2)

During the above procedures following is the nature of interactions between the CP and UP function:

- The new TDF-C selects a new TDF-U and creates Sx session.
- The TDF-C modifies the TDF-U to update Sx parameters.

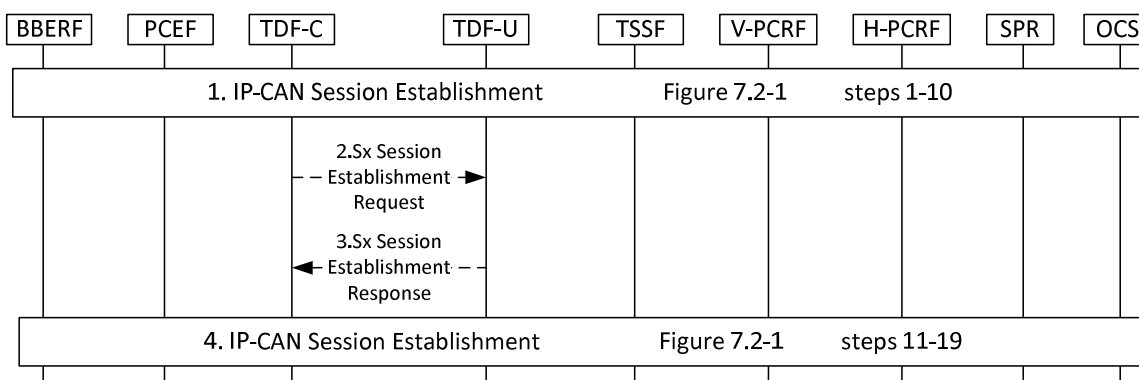

Figure 6.3.2.1-1: Interaction between CP and UP function with IP-CAN session establishment

1. Procedure as listed in this step is initiated as specified in the relevant clauses of this specification. The relevant steps of the procedure as specified in the figure above are executed.
2. For the solicited application reporting, the PCRF requests the TDF to establish the relevant session towards PCRF and provides ADC Rules to the TDF. The TDF-C selects a new TDF-U as specified in clause 5.12 and sends an Sx Session Establishment Request to the TDF-U to establish the Sx session.
3. The TDF-U sends an Sx Session Establishment Response to the TDF-C confirming the successful creation of the Sx session.
4. The relevant steps of the procedure as specified in the figure above are executed.

6.3.2.2 IP-CAN session termination

This clause defines interactions between the CP and UP function during the following procedures:

- IP-CAN session termination (TS 23.203 [3] clause 7.3).

During the above procedures following is the nature of interactions between the CP and UP function:

- The TDF-C releases the existing Sx session from the TDF-U

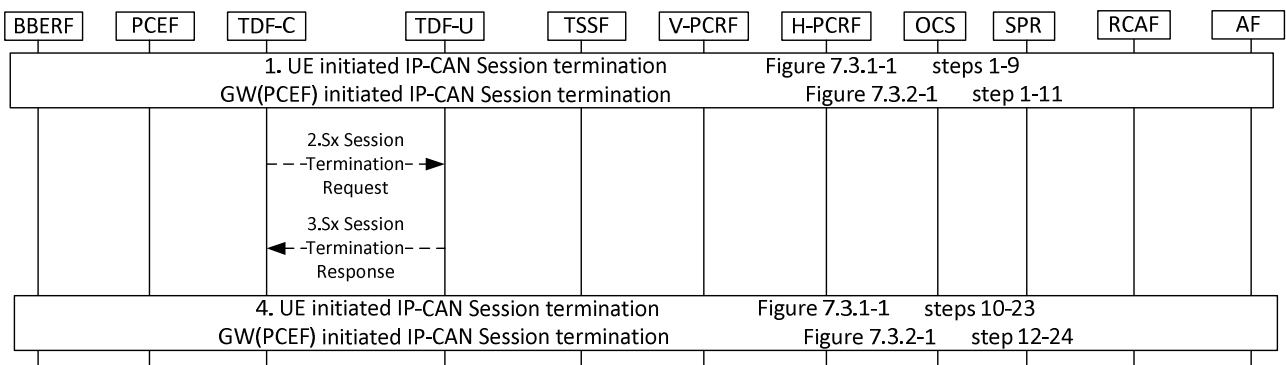

Figure 6.3.2.2-1: Interaction between CP and UP function with IP-CAN session termination

1. Procedure as listed in this step is initiated as specified in the relevant clauses of this specification. The relevant steps of the procedure as specified in the figure above are executed.
2. If there is an active Sd session between TDF and PCRF, TDF-C sends an Sx Session Termination Request to the TDF-U to release the Sx session.
3. The TDF-U sends an Sx Session Termination Response to the TDF-C confirming the release of the Sx session
4. The relevant steps of the procedure as specified in the figure above are executed.

6.3.2.3 IP-CAN session modification

This clause defines interactions between the CP and UP function during the following procedures:

- IP-CAN session modification (3GPP TS 23.203 [3] clause 7.4)

During the above procedures following is the nature of interactions between the CP and UP function:

- The TDF-C modifies the TDF-U to update Sx parameters.
- The PGW-C modifies the PGW-U to update Sx parameters.

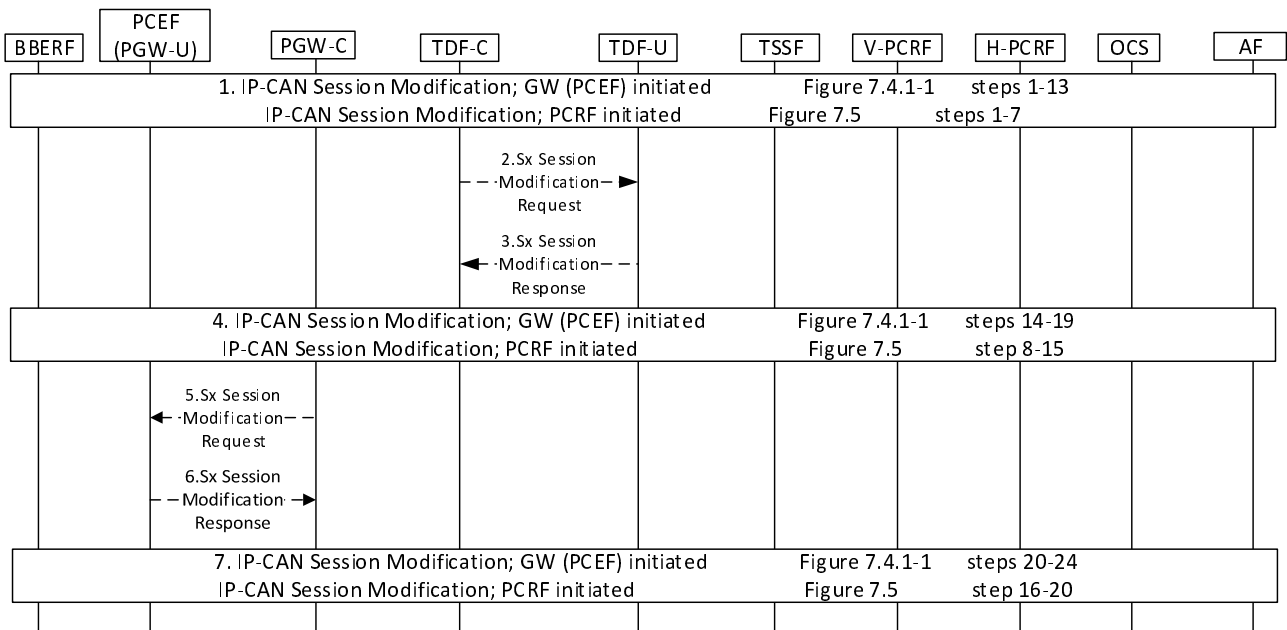

Figure 6.3.2.3: Interaction between CP and UP function with IP-CAN session modification

1. Procedure as listed in this step is initiated as specified in the relevant clauses of this specification. The relevant steps of the procedure as specified in the figure above are executed.
2. For the TDF solicited application reporting, and PCRF provides new ADC decisions to the TDF, TDF-C sends an Sx Session Modification Request to the TDF-U to update Sx parameters.
3. The TDF-U sends an Sx Session Modification Response to the TDF-C confirming update of Sx session
4. The relevant steps of the procedure as specified in the figure above are executed.
5. PCRF provides the updated PCC rules, and PGW-C may send an Sx Session Modification Request to the PGW-U to update Sx parameters.
6. The PGW-U sends an Sx Session Modification Response to the PGW-C confirming the update of Sx session.
7. The relevant steps of the procedure as specified in the figure above are executed.

NOTE: If PCEF determines to trigger the procedures defined in TS 23.401 [2], e.g. modify bearer request, steps 5 and 6 are combined with the Sx Session Modification in the corresponding call flows described in clause 6.3.1.7.

6.3.2.4 Management of PFDs

This clause defines interactions between the CP and UP function during the following procedures:

- Procedures for management of PFDs (TS 23.203 [3] clause 7.12).

During the above procedures following is the nature of interactions between the CP and UP function:

- The PGW-C/TDF-C provision/update/remove the PFD (s) to the PGW-U/TDF-U.

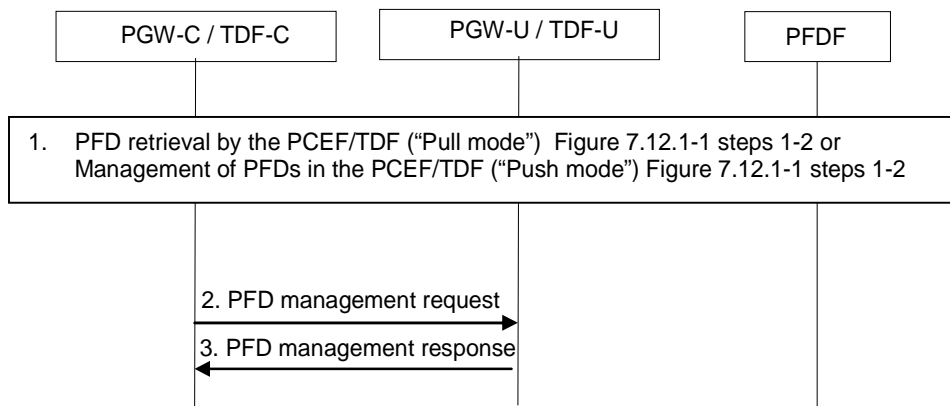

Figure 6.3.2.4-1: Interaction between CP and UP function with PFD management

1. Procedure as listed in this step is initiated as specified in the relevant clauses of this specification. The relevant steps of the procedure as specified in the figure above are executed.
2. When there's any change to the PFD (s) due to pull mode or push mode procedure, the PGW-C/TDF-C sends PFD management request to the PGW-U/TDF-U to provision/update/remove the PFD (s).
3. PGW-U/TDF-U acknowledges by responding with PFD management response message.

6.3.3 Updates to procedures specified in TS 23.402

6.3.3.1 Procedures with GTP based S2b establishment

This clause defines interactions between the CP and UP function during the following procedures:

- GTP based S2b for roaming, non-roaming and LBO (3GPP TS 23.402 [4] clause 7.2.4).
- Emergency services over GTP based S2b (3GPP TS 23.402 [4] clause 7.2.5).
- UE-initiated connectivity to additional PDN from Un-trusted Non-3GPP IP Access with GTP (3GPP TS 23.402 [4] clause 7.6.3).

During the above procedures following is the nature of interactions between the CP and UP function:

- The new PGW-C selects a new PGW-U and creates an Sx session.

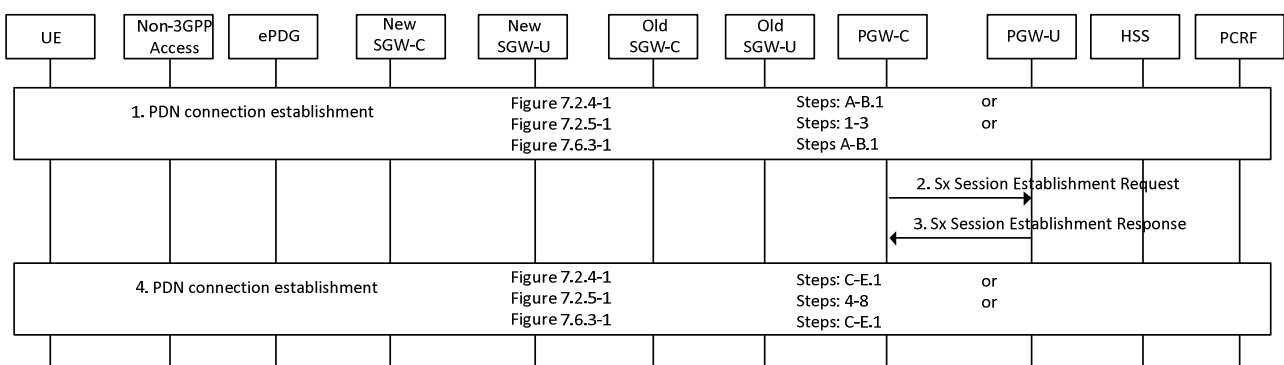

Figure 6.3.3.1-1: Interaction between CP and UP function with GTP based S2b establishment

1. Procedure as listed in this step is initiated as specified in the relevant clauses of this specification. The relevant steps of the procedure as specified in the figure above are executed.
2. The PGW-C shall select new PGW-U as specified in clause 5.12. If the network is configured to perform F-TEIDu allocation in the CP function then PGW-C allocates F-TEIDu for the default bearer. Then the PGW-C sends an Sx Session Establishment Request to the selected PGW-U for creating an Sx session for the UE. The F-TEIDu for the default bearer shall be included if the PGW-C has allocated the same.

3. If the network is configured to perform F-TEIDu allocation in the UP function, the PGW-U allocates F-TEIDu for the bearer. The PGW-U sends an Sx Session Establishment Response to the PGW-C confirming the successful creation of the Sx session. It shall include the F-TEIDu for the bearer if it has allocated the same.
4. The relevant steps of the procedure as specified in the figure above are executed.

6.3.3.2 Procedures with GTP based S2a establishment

This clause defines interactions between the CP and UP function during the following procedures:

- UE-Initiated Connectivity to PDN in WLAN on GTP S2a (TS 23.402 [4] clause 16.8.1)
- WLAN on GTP S2a for roaming, LBO and non-roaming scenarios (TS 23.402 [4] clause 16.2.1)

During the above procedures following is the nature of interactions between the CP and UP function:

- The new PGW-C selects a new PGW-U and creates an Sx session.

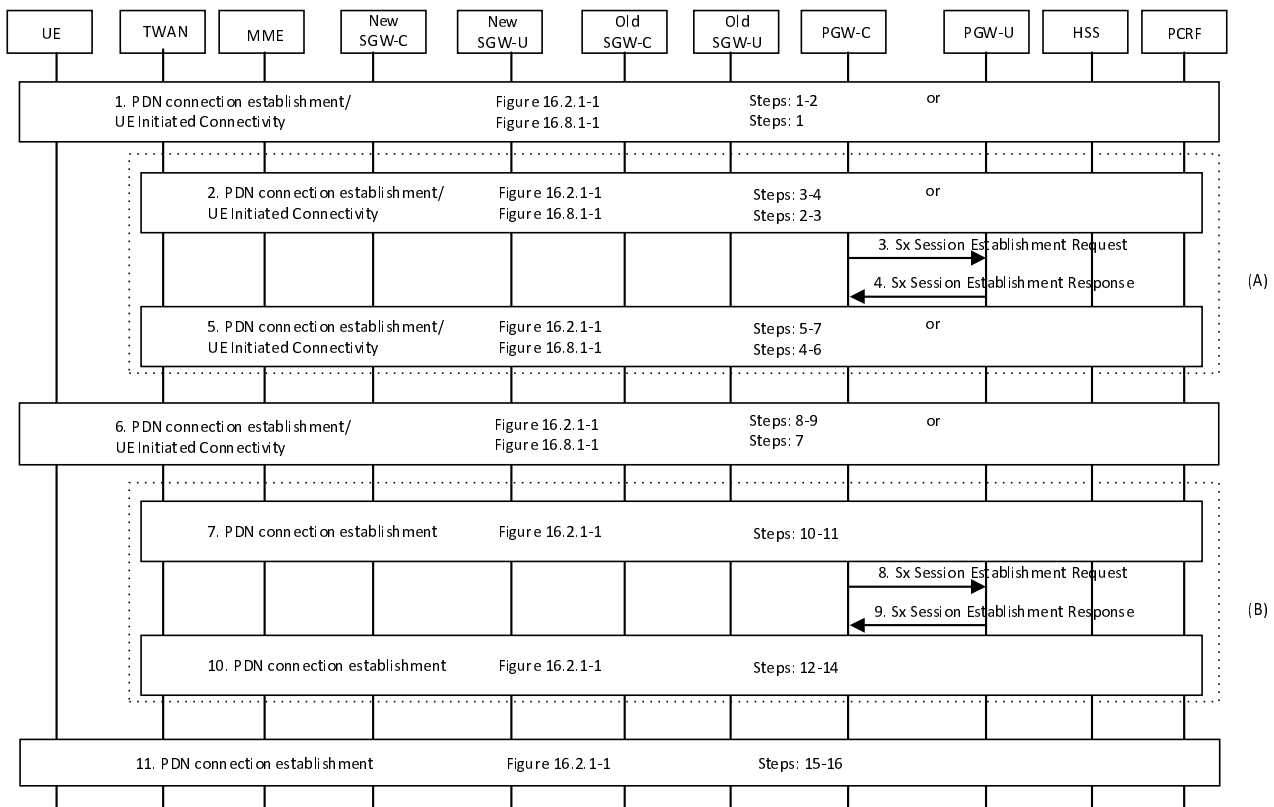

Figure 6.3.3.2-1: Interaction between CP and UP function with GTP based S2a establishment

- 1-2. Procedure as listed in this step is initiated as specified in the relevant clauses of this specification. The relevant steps of the procedure as specified in the figure above are executed.
3. The PGW-C shall select new PGW-U as specified in clause 5.12. If the network is configured to perform F-TEIDu allocation in the CP function then PGW-C allocates F-TEIDu for the default bearer. Then the PGW-C sends an Sx Session Establishment Request to the selected PGW-U for creating Sx session for the UE. The F-TEIDu for the default bearer shall be included if the PGW-C has allocated the same.
4. If the network is configured to perform F-TEIDu allocation in the UP function, the PGW-U allocates F-TEIDu for the bearer. The PGW-U sends an Sx Session Establishment Response to the PGW-C confirming the successful creation of the Sx session. It shall include the F-TEIDu for the bearer if it has allocated the same.
- 5-7. The HSS/AAA is also made aware of the PGW-C identity at this time. The relevant steps of the procedure as specified in the figure above are then executed.

The following steps are relevant only for "WLAN on GTP S2a for roaming, LBO and non-roaming scenarios" where TWAG using the layer 3 attach request (i.e. a DHCPv4 message) is sent by the UE as the attach trigger.

These steps are executed only if steps 3-7 shown in figure 16.2.1-1 are omitted where TWAP sends the layer 2 attach trigger to the TWAG.

- 8. The PGW-C shall select new PGW-U as specified in clause 5.12. If the network is configured to perform F-TEIDu allocation in the CP function then PGW-C allocates F-TEIDu for the default bearer. Then the PGW-C sends an Sx Session Establishment Request to the selected PGW-U for creating Sx session for the UE. The F-TEIDu for the default bearer shall be included if the PGW-C has allocated the same.
 - 9. If the network is configured to perform F-TEIDu allocation in the UP function, the PGW-U allocates F-TEIDu for the bearer. The PGW-U sends an Sx Session Establishment Response to the PGW-C confirming the successful creation of the Sx session. It shall include the F-TEIDu for the bearer if it has allocated the same.
- 10-11. The relevant steps of the procedure as specified in the figure above are executed.

6.3.3.3 Procedures with GTP based S2b release

This clause defines interactions between the CP and UP function during the following procedures:

- UE/ePDG-initiated detach procedure with GTP on S2b (TS 23.402 [4] clause 7.4.3.1)
- HSS/AAA-initiated detach procedure with GTP on S2b (TS 23.402 [4] clause 7.4.4.1)

During the above procedures following is the nature of interactions between the CP and UP function:

- The PGW-C releases the existing Sx session from the PGW-U.

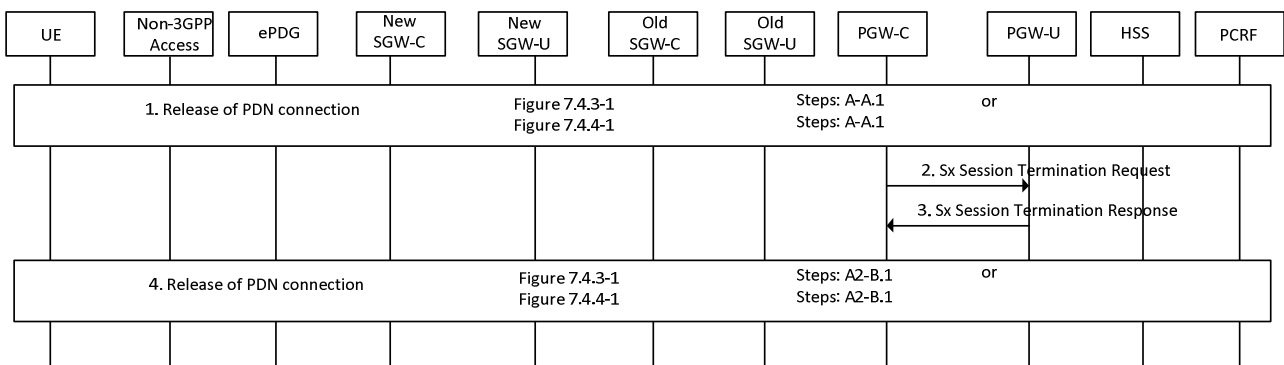

Figure 6.3.3.3-1: Interaction between CP and UP function with release of GTP based S2b

1. Procedure as listed in this step is initiated as specified in the relevant clauses of this specification. The relevant steps of the procedure as specified in the figure above are executed.
2. The PGW-C sends an Sx Session Termination Request to the PGW-U to release the Sx session.
3. The PGW-U sends an Sx Session Termination Response to the PGW-C confirming the release of the Sx session.
4. The relevant steps of the procedure as specified in the figure above are executed.

6.3.3.4 Procedures with GTP based S2a release

This clause defines interactions between the CP and UP function during the following procedures:

- UE/TWAN Initiated Detach and UE/TWAN requested PDN Disconnection on GTP S2a (TS 23.402 [4] clause 16.3.1.1)
- UE/TWAN-Initiated Detach in WLAN on GTP S2a (TS 23.402 [4] clause 16.7.1.1)

During the above procedures following is the nature of interactions between the CP and UP function:

- The PGW-C releases the existing Sx session from the PGW-U.

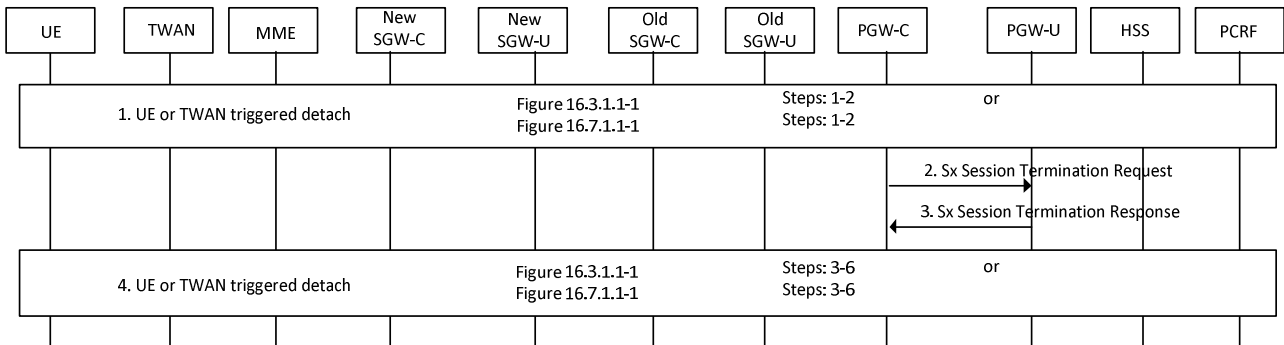

Figure 6.3.3.4-1: Interaction between CP and UP function with release of GTP based S2a

1. Procedure as listed in this step is initiated as specified in the relevant clauses of this specification. The relevant steps of the procedure as specified in the figure above are executed.
2. The PGW-C sends an Sx Session Termination Request to the PGW-U to release the Sx session.
3. The PGW-U sends an Sx Session Termination Response to the PGW-C confirming the release of the Sx session.
4. The relevant steps of the procedure as specified in the figure above are executed.

6.3.3.5 Procedures with dedicated bearer activation by PGW

This clause defines interactions between the CP and UP function during the following procedures:

- Dedicated S2b Bearer Activation Procedure with GTP on S2b (TS 23.402 [4] clause 7.10)
- Dedicated S2a Bearer Activation Procedure with GTP on S2a (TS 23.402 [4] clause 16.5)

During the above procedures following is the nature of interactions between the CP and UP function:

- The PGW-C modifies the existing Sx session for activating new dedicated bearer.

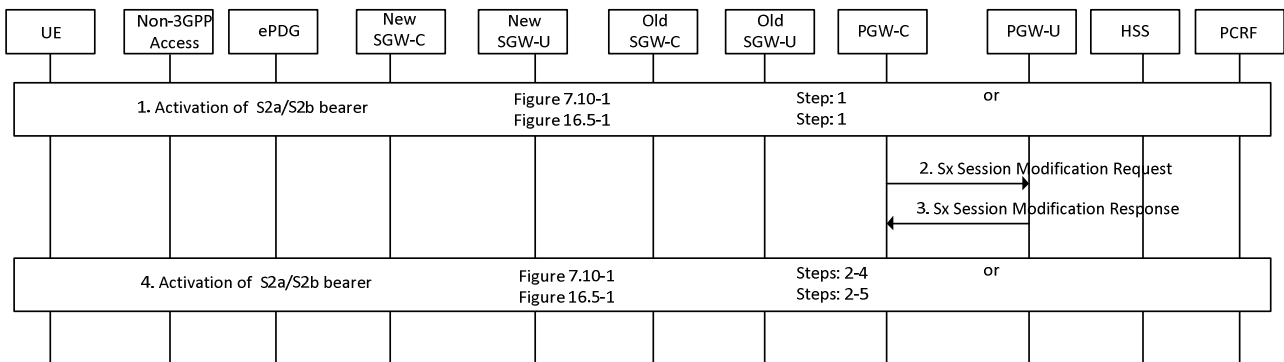

Figure 6.3.3.5-1: Interaction between CP and UP function with dedicated bearer activation by PGW

1. Procedure as listed in this step is initiated as specified in the relevant clauses of this specification. The relevant steps of the procedure as specified in the figure above are executed.
2. The PGW-C initiates dedicated bearer activation procedure based on the PCC decision provision (QoS policy) message received from the PCRF. It uses received QoS policy to assign the EPS Bearer QoS, i.e., it assigns the values to the bearer level QoS parameters QCI, ARP, GBR and MBR. The PGW-C sends an Sx Session Modification Request to the existing PGW-U for activating new dedicated bearer for the UE. If the TEIDs allocation is done in the CP function then PGW-C shall allocate TEIDs for the new bearer(s) and sends them to the PGW-U.
3. If the F-TEIDu allocation is done in the UP function, the PGW-U shall allocate TEIDs for the new bearer(s). The PGW-U sends an Sx Session Modification Response to the PGW-C confirming the successful modification of the Sx session. It shall include the TEIDs for the new bearer(s) if it has allocated the same.

4. The relevant steps of the procedure as specified in the figure above are executed.

6.3.3.6 Procedures with bearer deactivation by PGW

This clause defines interactions between the CP and UP function during the following procedures:

- PDN GW Initiated Bearer Deactivation with GTP on S2b (TS 23.402 [4] clause 7.9.2)
- PDN GW Initiated Bearer Deactivation with GTP on S2a (TS 23.402 [4] clause 16.4.1)

During the above procedures following is the nature of interactions between the CP and UP function:

- The PGW-C modifies the existing Sx session for deactivating the dedicated bearer.

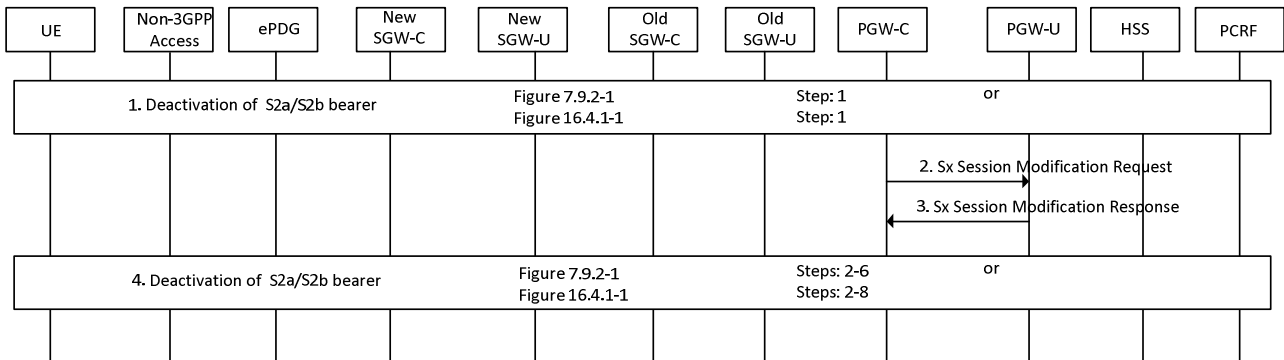

Figure 6.3.3.6-1: Interaction between CP and UP function with bearer deactivation by PGW-C

1. Procedure as listed in this step is initiated as specified in the relevant clauses of this specification. The relevant steps of the procedure as specified in the figure above are executed.
2. The PGW-C initiates bearer deactivation procedure based on IP-CAN modifications encountered by the PCRF when the dynamic PCC is deployed. The PGW-C sends an Sx Session Modification Request to the existing PGW-U for deactivating the dedicated bearer for the UE. If the TEIDs allocation was done in the CP function then PGW-C shall de-allocate these TEIDs.
3. If the TEIDs allocation was done in the UP function then PGW-U shall de-allocate these TEIDs once it receives Sx Session Modification Request from the PGW-C. The PGW-U sends an Sx Session Modification Response to the PGW-C confirming the successful modification of the Sx session.
4. The relevant steps of the procedure as specified in the figure above are executed.

6.3.3.7 Procedures with bearer modification

This clause defines interactions between the CP and UP function during the following procedures:

- S2b Bearer Modification Procedure with GTP on S2b (TS 23.402 [4] clause 7.11.1)
- HSS Initiated Subscribed QoS Modification (TS 23.402 [4] clause 7.11.2)
- PDN GW-initiated S2a Bearer Modification Procedure with GTP on S2a (TS 23.402 [4] clause 16.6.1)
- HSS Initiated Subscribed QoS Modification (TS 23.402 [4] clause 16.6.2)

During the above procedures following is the nature of interactions between the CP and UP function:

- The PGW-C modifies the existing Sx session for modification of the existing bearer.

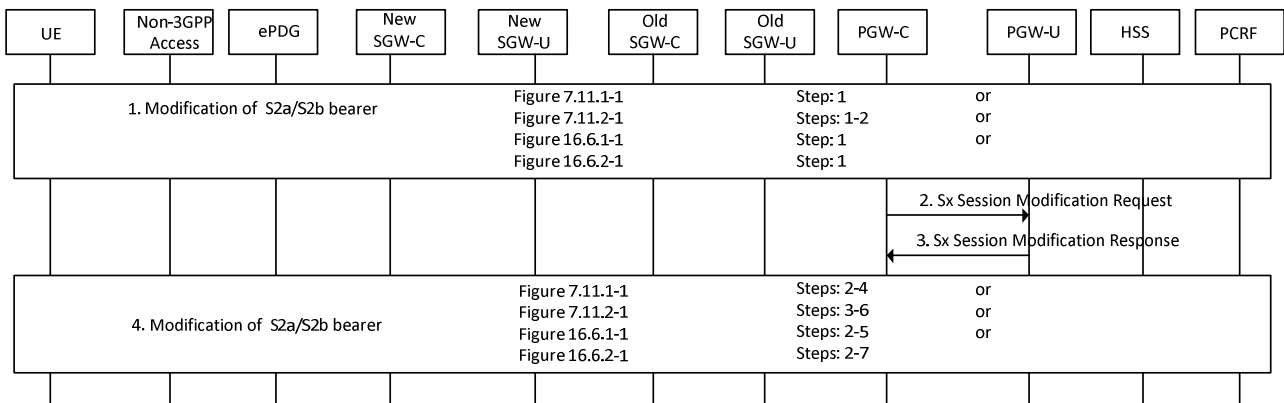

Figure 6.3.3.7-1: Interaction between CP and UP function with bearer modification

1. Procedure as listed in this step is initiated as specified in the relevant clauses of this specification. The relevant steps of the procedure as specified in the figure above are executed.
2. The PGW-C initiates dedicated bearer modification procedure based on the PCC decision provision (QoS policy) message received from the PCRF. It uses this QoS policy to determine that a service data flow shall be aggregated to or removed from an active bearer or that the authorized QoS of a service data flow has changed. The PGW-C sends an Sx Session Modification Request to the existing PGW-U for modification of the existing bearer for the UE.
3. The PGW-U updates the Sx parameters and sends an Sx Session Modification Response to the PGW-C confirming the successful modification of the Sx session.
4. The relevant steps of the procedure as specified in the figure above are executed.

6.3.3.8 Procedures with handover from non-3GPP access

This clause defines interactions between the CP and UP function during the following procedures:

- Handover from Trusted Non-3GPP IP Access to E-UTRAN with GTP on S2a or S2b and GTP on S5/S8 interfaces (TS 23.402 [4] clause 8.2.1.1 and clause 16.11).
- Handover from Trusted Non-3GPP IP Access to UTRAN/GERAN with GTP on S2a and GTP based S5/S8 (TS 23.402 [4] clause 8.2.1.3 and clause 16.11).
- Handover from Untrusted Non-3GPP IP Access to E-UTRAN with GTP on S2b and GTP on S5/S8 interfaces (TS 23.402 [4] clause 8.6.1.1).
- Handover from Untrusted Non-3GPP IP Access to UTRAN/GERAN with GTP on S2b and GTP on S5/S8 interfaces (TS 23.402 [4] clause 8.6.1.2).

During the above procedures following is the nature of interactions between the CP and UP function:

- The SGW-C selects a SGW-U and creates an Sx session.
- The SGW-C modifies the existing Sx session for modification of the bearer.
- The PGW-C selects a PGW-U and creates an Sx session.
- The PGW-C modifies the existing Sx session for modification of the bearer.

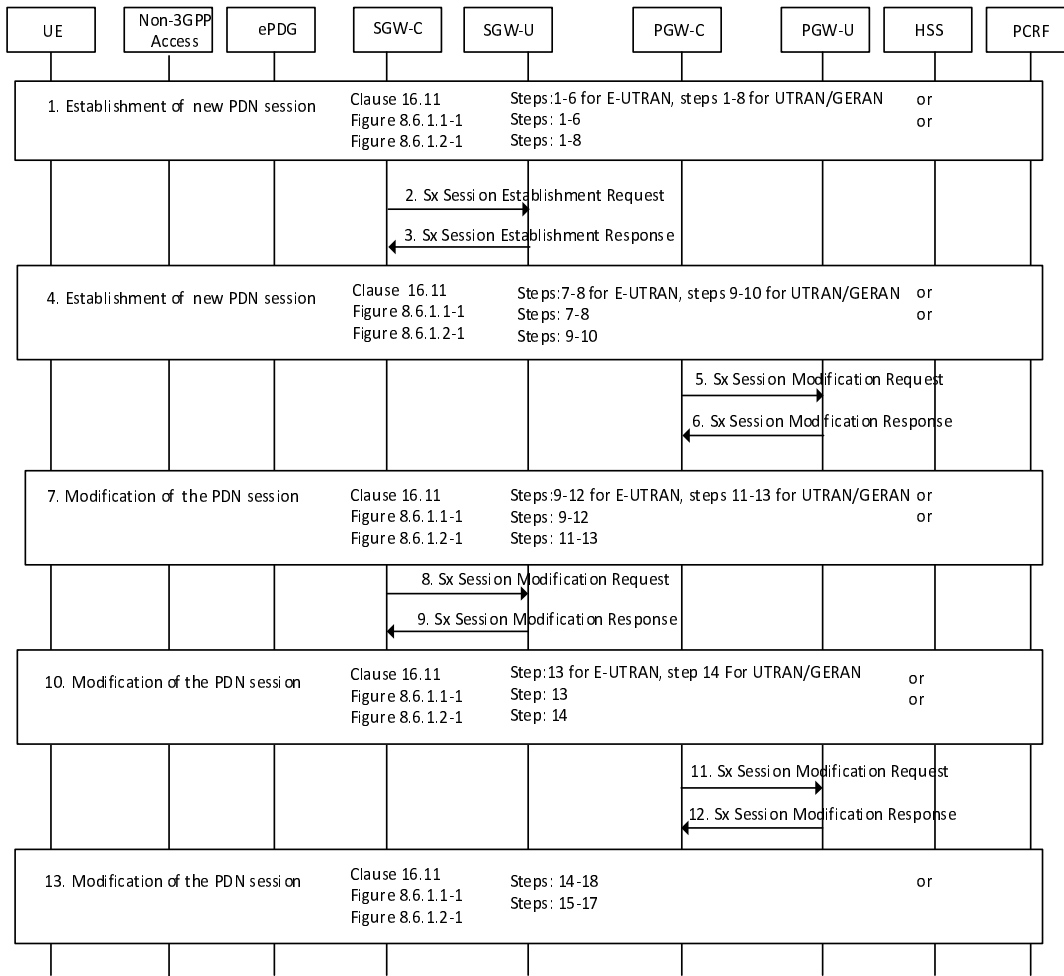

Figure 6.3.3.8-1: Interaction between CP and UP function with handover from non-3GPP access

1. Procedure as listed in this step is initiated as specified in the relevant clauses of this specification. The relevant steps of the procedure as specified in the figure above are executed.
2. The SGW-C shall select SGW-U as specified in clause 5.12 when the request with a Handover Indication information. If the network is configured to perform F-TEIDu allocation in the CP function then SGW-C allocates F-TEIDu for each and every bearer. Then the SGW-C sends Sx Session Establishment Request to the selected SGW-U for creating Sx session for the UE. The F-TEIDu for each and every bearer shall be included if the SGW-C has allocated the same.
3. If the network is configured to perform F-TEIDu allocation in the UP function, the SGW-U allocates F-TEIDu for all received bearers. The SGW-U sends Sx Session Establishment Response to the SGW-C confirming the successful creation of the Sx session. It shall include the F-TEIDu for each and every bearer if it has allocated the same.
4. The relevant steps of the procedure as specified in the figure above are executed. Since Handover Indication is included, the PGW-C may execute a PCEF-Initiated IP-CAN Session Modification Procedure with the PCRF.
5. If the network is configured to perform F-TEIDu allocation in the CP function then PGW-C allocates F-TEIDu for each and every bearer. Then the PGW-C sends an Sx Session Modification Request to the PGW-U for modifying the Sx session for the UE. The F-TEIDu for each and every bearer shall be included if the PGW-C has allocated the same.
6. If the network is configured to perform F-TEIDu allocation in the UP function, the PGW-U allocates F-TEIDu for all received bearers. The PGW-U sends an Sx Session Modification Response to the PGW-C confirming the

successful modification of the Sx session. It shall include the F-TEIDu for each and every bearer if it has allocated the same.

7. The relevant steps of the procedure as specified in the figure above are executed.
8. The SGW-C sends an Sx Session Modification Request after Radio and Access bearers are established at the SGW-C.
9. The SGW-U sends an Sx Session Modification Response to the SGW-C confirming the successful modification of the Sx session.
10. The relevant steps of the procedure as specified in the figure above are executed.
11. The PGW-C sends an Sx Session Modification Request to prompt the PGW-U to tunnel packets from non 3GPP IP access to 3GPP access system and immediately start routing packets to the SGW-U for the default and any dedicated EPS bearers established.
12. The PGW-U sends an Sx Session Modification Response to the PGW-C.
13. The relevant steps of the procedure as specified in the figure above are executed.

6.3.3.9 Procedures with handover from 3GPP access

This clause defines interactions between the CP and UP function during the following procedures:

- Handover from 3GPP Access to Untrusted Non-3GPP IP Access with GTP on S2b (TS 23.402 [4] clause 8.6.2.1)
- Handover in single-connection mode from 3GPP access to Trusted WLAN on GTP S2a for roaming and non-roaming scenarios (TS 23.402 [4] clause 16.10.1.1)

During the above procedures following is the nature of interactions between the CP and UP function:

- The new PGW-C selects a new PGW-U and creates an Sx session.

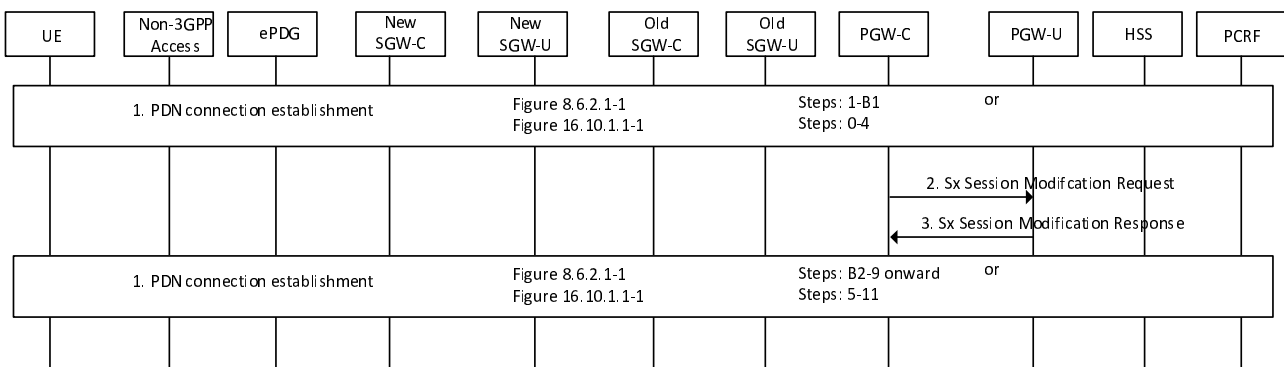

Figure 6.3.3.9-1: Interaction between CP and UP function with handover from 3GPP access

1. Procedure as listed in this step is initiated as specified in the relevant clauses of this specification. The relevant steps of the procedure as specified in the figure above are executed.
2. If the network is configured to perform F-TEIDu allocation in the CP function then PGW-C allocates F-TEIDu for each and every bearer. Then the PGW-C sends an Sx Session Establishment Request to the selected PGW-U for modifying the Sx session for the UE. The F-TEIDu for each and every bearer shall be included if the PGW-C has allocated the same.
3. If the network is configured to perform F-TEIDu allocation in the UP function, the PGW-U allocates F-TEIDu for all received bearers. The PGW-U sends an Sx Session Establishment Response to the PGW-C confirming the successful modification of the Sx session. It shall include the F-TEIDu for each and every bearer if it has allocated the same.
4. The relevant steps of the procedure as specified in the figure above are executed.

6.3.4 Updates to procedures specified in TS 23.060

6.3.4.1 Procedures with PDN connection deactivation

6.3.4.1.1 Procedures with SGSN terminating S4 interface

This clause defines interactions between the CP and UP function during the following procedures related to the deactivation of a PDN connection:

Group 1:

- Combined GPRS / IMSI Attach procedure:
 - Including steps specific for S4 SGSN: Combined GPRS / IMSI Attach procedure, Delete Bearer by the new SGSN, using S4, and Combined GPRS / IMSI Attach procedure, Delete Bearer by the old SGSN, using S4.
- MS-Initiated Combined GPRS / IMSI Detach Procedure.
- SGSN-Initiated GPRS Detach Procedure.
- HLR-Initiated GPRS Detach Procedure:
 - Including steps specific for S4 SGSN: SGSN interaction during Detach Procedure when using S4.
- MS Initiated Bearer Deactivation Procedure for A/Gb mode (with Teardown Ind).
- MS Initiated Bearer Deactivation Procedure for Iu mode (with Teardown Ind).
- SGSN-initiated Bearer Deactivation Procedure (with Teardown Ind):
 - Including steps specific for S4 SGSN: MS-and SGSN Initiated PDN connection Deactivation Procedure using S4.

Group 2:

- GGSN-initiated PDP Context Deactivation Procedure (with Teardown Ind):
 - Including steps specific for S4 SGSN: PDN GW-initiated Bearer Deactivation Procedure using S4, part 1 and part 2.

During the above procedures, following is the nature of interactions between the CP and UP function:

- The SGW-C releases the existing Sx session from SGW-U.
- The PGW-C releases the existing Sx session from PGW-U.
- The SGW-C modifies the existing Sx session for SGW-U.
- The PGW-C modifies the existing Sx session for PGW-U.

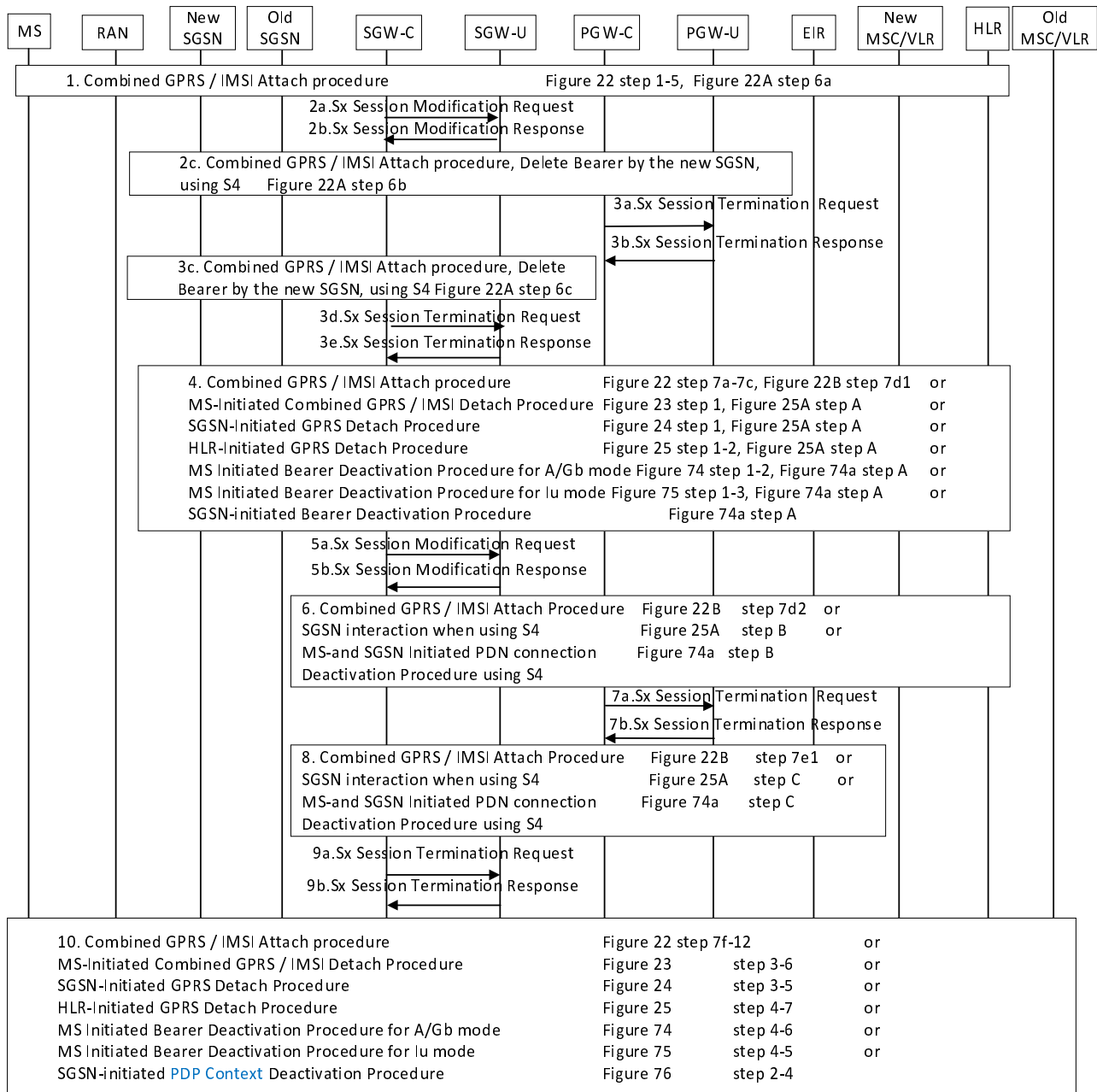

Figure 6.3.4.1-1-1: Interaction between CP and UP function with PDN connection deactivation Group 1

1

1. Procedure as listed in this step is initiated as specified in the relevant clauses of this specification. The relevant steps of the procedure as specified in the figure above are executed.
- 2a. The SGW-C sends an Sx Session Modification Request to the SGW-U to modify the Sx session. SGW-C shall request SGW-U to stop counting for the affected bearers. SGW-C shall also request the SGW-U to discard downlink packets received from PGW-U for the affected bearers, and discard uplink packets received from eNodeB for the affected bearers.
- 2b. The SGW-U sends an Sx Session Modification Response to the SGW-C confirming the modification of the Sx session.
- 2c. The relevant steps of the procedure as specified in the figure above are executed.
- 3a. The PGW-C may send an Sx Session Termination Request to the PGW-U to release the Sx session.
- 3b. The PGW-U sends an Sx Session Termination Response to the PGW-C confirming the release of the Sx session.

- 3c. The relevant steps of the procedure as specified in the figure above are executed.
- 3d. The SGW-C may send an Sx Session Termination Request to the SGW-U to release the Sx session.
- 3e. The SGW-U sends an Sx Session Termination Response to the SGW-C confirming the release of the Sx session.
- 4. The relevant steps of the procedure as specified in the figure above are executed.
- 5a. The SGW-C may send an Sx Session Modification Request to the SGW-U in detach and Bearer Deactivation procedures. SGW-C shall indicate SGW-U to stop counting for the affected bearers. SGW-C shall also indicate the SGW-U to discard downlink packets received from PGW-U for the affected bearers, and discard uplink packets received from eNodeB for the affected bearers..
- 5b. The SGW-U sends an Sx Session Modification Response to the SGW-C.
- 6. The relevant steps of the procedure as specified in the figure above are executed.
- 7a. The PGW-C may send an Sx Session Termination Request to the PGW-U to release the Sx session.
- 7b. The PGW-U sends an Sx Session Termination Response to the PGW-C confirming the release of the Sx session.
- 8. The relevant steps of the procedure as specified in the figure above are executed.
- 9a. The SGW-C may send an Sx Session Termination Request to the SGW-U to release the Sx session.
- 9b. The SGW-U sends an Sx Session Termination Response to the SGW-C confirming the release of the Sx session.
- 10. The relevant steps of the procedure as specified in the figure above are executed.

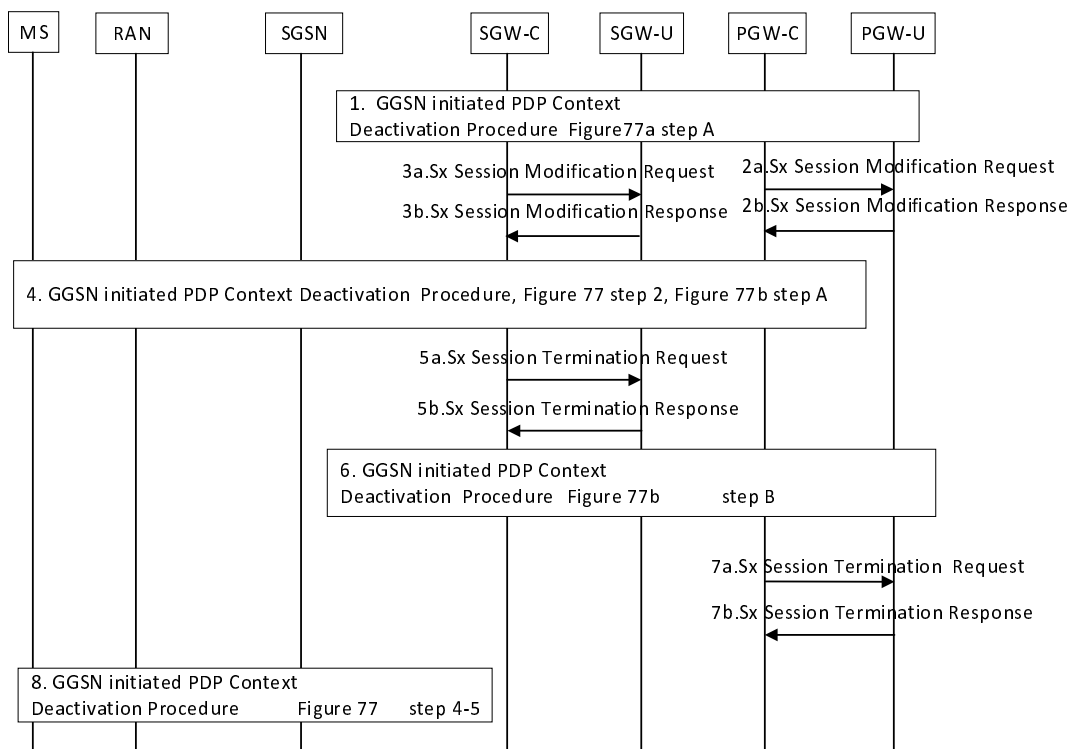

Figure 6.3.4.1.1-2: Interaction between CP and UP function with PDN connection deactivation Group 2

- 1. Procedure as listed in this step is initiated as specified in the relevant clauses of this specification. The relevant steps of the procedure as specified in the figure above are executed.
- 2a. The PGW-C sends an Sx Session Modification Request to the PGW-U when it initiates bearer deactivation procedure. PGW-C shall indicate PGW-U to stop counting for the affected bearers. PGW-C shall also indicate the PGW-U to discard packets received for the affected bearers.

- 2b. The PGW-U sends an Sx Session Modification Response to the PGW-C.
- 3a. The SGW-C sends an Sx Session Modification Request to the SGW-U. SGW-C shall indicate SGW-U to stop counting for the affected bearers. SGW-C shall also indicate the SGW-U to discard packets received for the affected bearers.
- 3b. The SGW-U sends an Sx Session Modification Response to the SGW-C.
4. The relevant steps of the procedure as specified in the figure above are executed.
- 5a. The SGW-C sends an Sx Session Termination Request to the SGW-U to release the Sx session.
- 5b. The SGW-U sends an Sx Session Termination Response to the SGW-C confirming the release of the Sx session.
6. The relevant steps of the procedure as specified in the figure above are executed.
- 7a. The PGW-C sends an Sx Session Termination Request to the PGW-U to release the Sx session.
- 7b. The PGW-U sends an Sx Session Termination Response to the PGW-C confirming the release of the Sx session.
8. The relevant steps of the procedure as specified in the figure above are executed.

6.3.4.1.2 Procedures with SGSN terminating Gn/Gp interface

This clause defines interactions between the CP and UP function during the following procedures related to the deactivation of a PDN connection:

Group 1:

- Combined GPRS / IMSI Attach procedure.
- MS-Initiated Combined GPRS / IMSI Detach Procedure.
- SGSN-Initiated GPRS Detach Procedure.
- HLR-Initiated GPRS Detach Procedure.
- MS Initiated PDP Context Deactivation Procedure for A/Gb mode (with Teardown Ind).
- MS Initiated PDP Context Deactivation Procedure for Iu mode (with Teardown Ind).
- SGSN-initiated PDP Context Deactivation Procedure (with Teardown Ind).

Group 2:

- GGSN-initiated PDP Context Deactivation Procedure (with Teardown Ind).

During the above procedures, following is the nature of interactions between the CP and UP function:

- The PGW-C releases the existing Sx session from PGW-U.

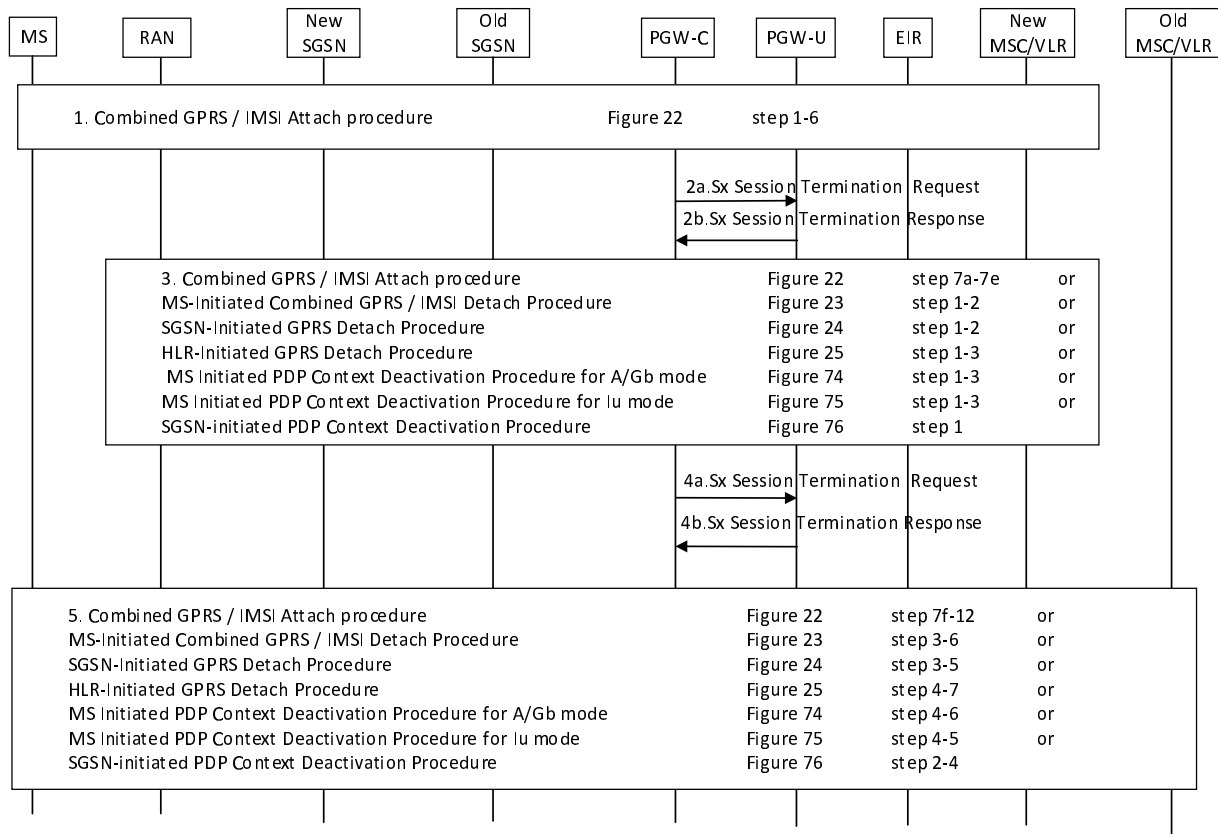

Figure 6.3.4.1.2-1: Interaction between CP and UP function with PDN connection deactivation Group 1

1. Procedure as listed in this step is initiated as specified in the relevant clauses of this specification. The relevant steps of the procedure as specified in the figure above are executed.
- 2a. The PGW-C may send an Sx Session Termination Request to the PGW-U to release the Sx session.
- 2b. The PGW-U sends an Sx Session Termination Response to the PGW-C confirming the release of the Sx session.
3. The relevant steps of the procedure as specified in the figure above are executed.
- 4a. The PGW-C may send an Sx Session Termination Request to the PGW-U to release the Sx session.
- 4b. The PGW-U sends an Sx Session Termination Response to the PGW-C confirming the release of the Sx session.
5. The relevant steps of the procedure as specified in the figure above are executed.

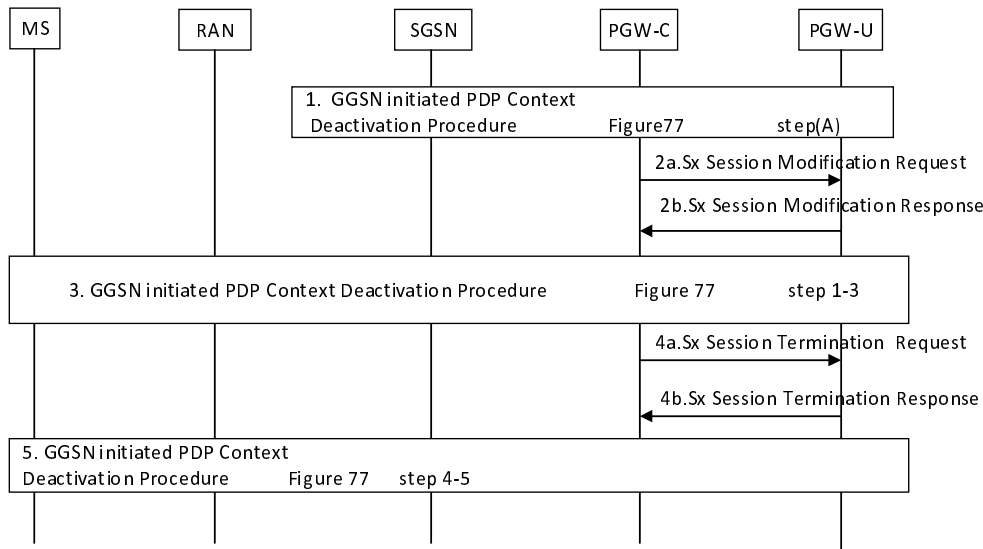

Figure 6.3.4.1.2-2: Interaction between CP and UP function with PDN connection deactivation Group 2

1. Procedure as listed in this step is initiated as specified in the relevant clauses of this specification. The relevant steps of the procedure as specified in the figure above are executed.
- 2a. The PGW-C sends an Sx Session Modification Request to the PGW-U when it initiates bearer deactivation procedure. PGW-C shall indicate PGW-U to stop counting for the affected bearers. PGW-C shall also indicate the PGW-U to discard packets received for the affected bearers.
- 2b. The PGW-U sends an Sx Session Modification Response to the PGW-C.
3. The relevant steps of the procedure as specified in the figure above are executed.
- 4a. The PGW-C sends an Sx Session Termination Request to the PGW-U to release the Sx session.
- 4b. The PGW-U sends an Sx Session Termination Response to the PGW-C confirming the release of the Sx session.
5. The relevant steps of the procedure as specified in the figure above are executed.

6.3.4.2 Procedures with PDN connection modification

6.3.4.2.1 Procedures with SGSN terminating S4 interface

This clause defines interactions between the CP and UP function during the following procedures related to the modification of a PDN connection.

Group 1 Procedures for Location Management, Handover, Service Request and Inter-System Change:

- Inter SGSN Routing Area Update Procedure:
 - Including steps specific for S4 SGSN: Inter SGSN Routing Area Update and Combined Inter SGSN RA / LA Update using S4.
- Combined RA / LA Update in the Case of Inter SGSN RA Update Procedure:
 - Including steps specific for S4 SGSN: Inter SGSN Routing Area Update and Combined Inter SGSN RA / LA Update using S4.
- Iu mode RA Update Procedure:
 - Including steps specific for S4 SGSN: Routing Area Update Procedure using S4.
- SRNS Relocation Procedure.

- Combined Hard Handover and SRNS Relocation Procedure.
- Combined Cell / URA Update and SRNS Relocation Procedure:
 - Including steps specific for S4 SGSN: Serving RNS Relocation Procedure, Combined Hard Handover and SRNS Relocation Procedure, and Combined Cell / URA Update and SRNS Relocation Procedure Using S4.
- Enhanced Serving RNS Relocation:
 - Including steps specific for S4 SGSN: Enhanced Serving RNS Relocation Procedure using S4.
- MS Initiated Service Request Procedure.
- Network Initiated Service Request Procedure:
 - Including steps specific for S4 SGSN: UE Initiated Service Request Procedure Using S4.
- Iu mode to A/Gb mode Intra SGSN Change:
 - Including steps specific for S4 SGSN: Iu mode to A/Gb mode Intra SGSN Change using S4.
- A/Gb mode to Iu mode Intra SGSN Change:
 - Including steps specific for S4 SGSN: A/Gb mode to Iu mode Intra-SGSN Change using S4.
- Iu mode to A/Gb mode Inter-SGSN Change:
 - Including steps specific for S4 SGSN: Iu mode to A/Gb mode Inter-SGSN Change using S4.
- A/Gb mode to Iu mode Inter SGSN Change:
 - Including steps specific for S4 SGSN: A/Gb mode to Iu mode Inter-SGSN Change using S4.
- GPRS Paging Procedure (A/Gb mode):
 - S4 specific handling in Paging response for GPRS Downlink Transfer with no established user plane on S4.

Group 2 UE/SGSN initiated PDN connection modification:

- Secondary PDP Context Activation Procedure for A/Gb mode.
- Secondary PDP Context Activation Procedure for Iu mode:
 - Including steps specific for S4 SGSN: Secondary PDP Context Activation Procedure, PDP Creation part, using S4.
- MS-Initiated PDP Context Modification Procedure, A/Gb mode.
- MS-Initiated PDP Context Modification Procedure, Iu mode.
- SGSN-Initiated PDP Context Modification Procedure, A/Gb mode.
- SGSN-Initiated PDP Context Modification Procedure, Iu mode:
 - Including steps specific for S4 SGSN: Request part of SGSN-Initiated EPS Bearer Modification Procedure using S4, and Update part of SGSN-Initiated EPS Bearer Modification Procedure using S4.
- MS Initiated PDP Context Deactivation Procedure for A/Gb mode (without Teardown Ind).
- MS Initiated PDP Context Deactivation Procedure for Iu mode (without Teardown Ind).
- SGSN-initiated PDP Context Deactivation Procedure (without Teardown Ind):
 - Steps specific for S4 SGSN: MS-and SGSN Initiated Bearer Deactivation Procedure.

Group 3 PGW initiated PDN connection modification:

- Network Requested Secondary PDP Context Activation Procedure using S4.

- GGSN-Initiated PDP Context Modification Procedure:
 - Including steps specific for S4 SGSN: PGW-Initiated Bearer Modification Procedure, A/Gb mode.
- GGSN-Initiated PDP Context Modification Procedure:
 - Including steps specific for S4 SGSN: PGW-Initiated Bearer Modification Procedure, Iu mode.
- GGSN-initiated PDP Context Deactivation Procedure (without Teardown Ind):
 - Including steps specific for S4 SGSN: PGW-initiated Bearer Deactivation Procedure

During the above procedures, following is the nature of interactions between the CP and UP function:

- The SGW-C informs the SGW-U to modify the Sx session.
- The PGW-C informs the PGW-U to modify the Sx session.

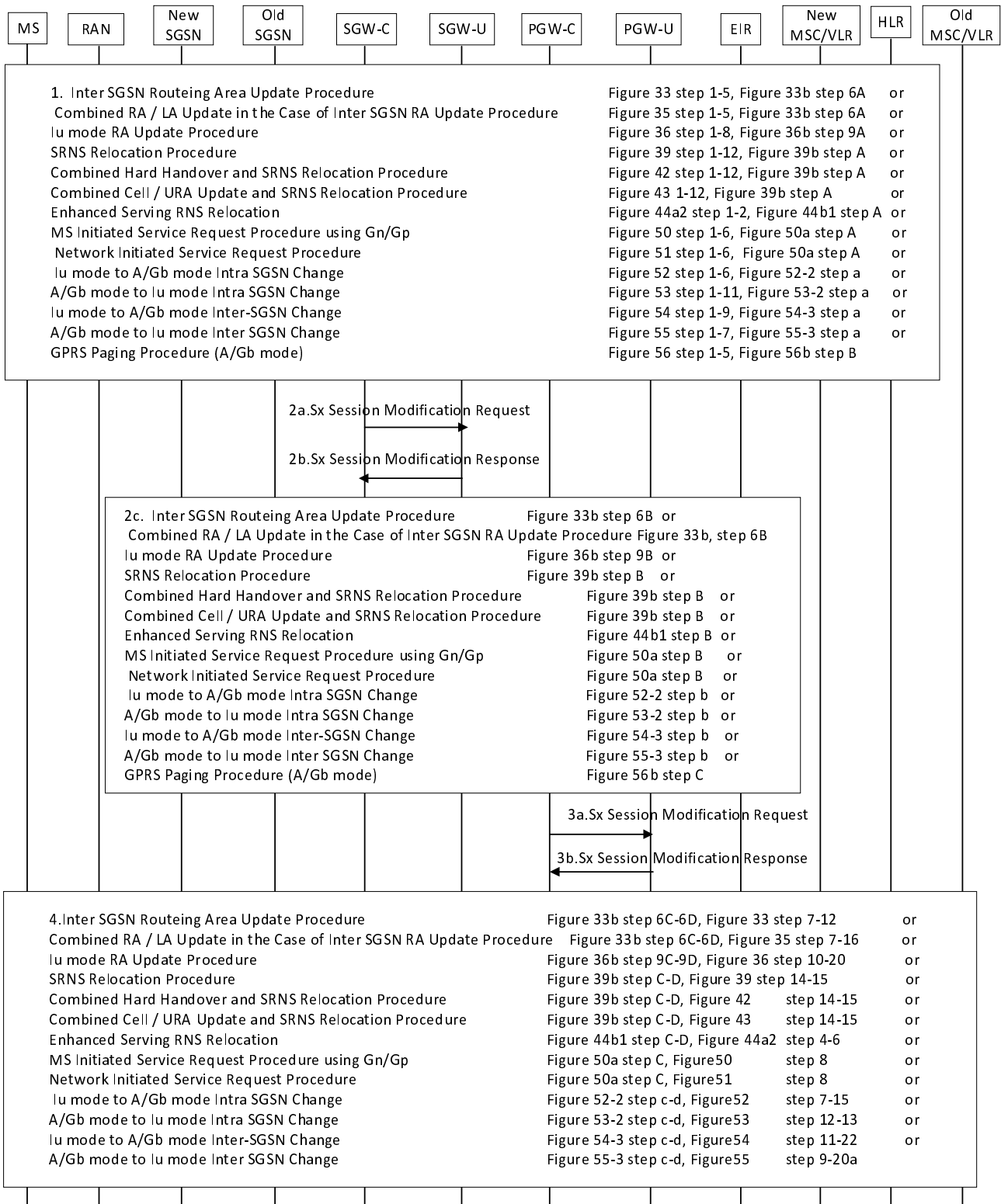

Figure 6.3.4.2.1-1: Interaction between CP and UP function with PDN connection modification, Group 1

1. Procedure as listed in this step is initiated as specified in the relevant clauses of this specification. The relevant steps of the procedure as specified in the figure above are executed.
- 2a. The SGW-C may send an Sx Session Modification Request to the SGW-U to update the Sx session.
- 2b. The SGW-U sends an Sx Session Modification Response to the SGW-C confirming the update the Sx session.
- 2c. The relevant steps of the procedure as specified in the figure above are executed.

- 3a. The PGW-C may send an Sx Session Modification Request to the PGW-U to update the Sx session.
- 3b. The PGW-U sends an Sx Session Modification Response to the PGW-C confirming the update the Sx session.
4. The relevant steps of the procedure as specified in the figure above are executed.

NOTE 1: Step 2a/2b happens when SGW-C receives request message from S4 SGSN, and step 3a/3b happens when PGW-C receives request message from SGW-C.

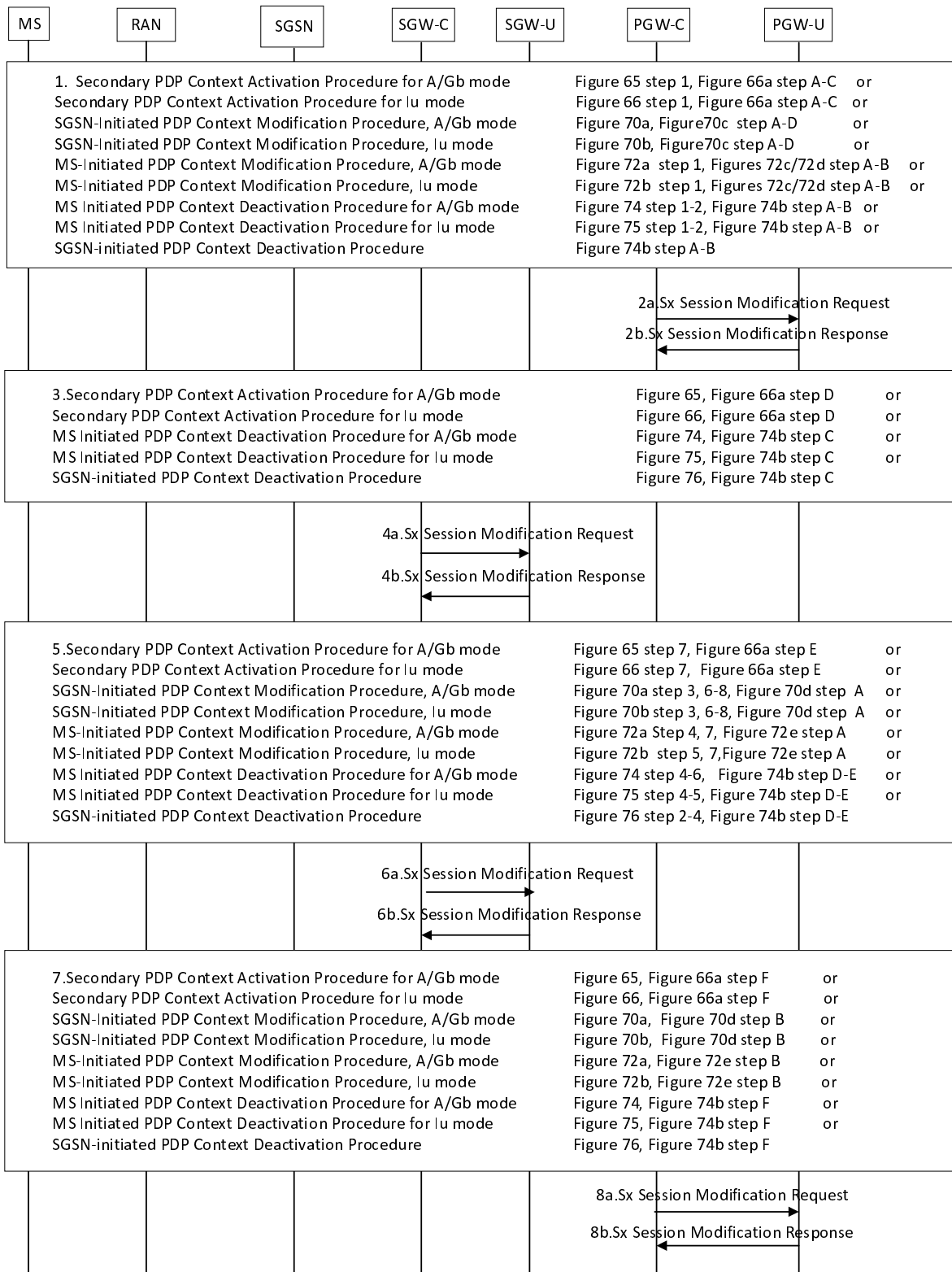

Figure 6.3.4.2.1-2: Interaction between CP and UP function with PDN connection modification, Group 2

1. Procedure as listed in this step is initiated as specified in the relevant clauses of this specification. The relevant steps of the procedure as specified in the figure above are executed.
- 2a. The PGW-C may send an Sx Session Modification Request to the PGW-U to update the Sx session. For "Secondary PDP Context Activation Procedure", PGW-C may request PGW-U to allocate F-TEID for the dedicated bearer. For "MS- or SGSN- Initiated PDP Context Deactivation Procedure", PGW-C shall request PGW-U to stop counting and stop forwarding packets for the affected bearers.

- 2b. The PGW-U sends an Sx Session Modification Response to the PGW-C confirming the update the Sx session.
3. The relevant steps of the procedure as specified in the figure above are executed.
- 4a. The SGW-C may send an Sx Session Modification Request to the SGW-U to update the Sx session. For "Secondary PDP Context Activation Procedure", SGW-C may request SGW-U to allocate F-TEID for the dedicate bearer. For "MS- or SGSN Initiated PDP Context Deactivation Procedure", SGW-C shall request SGW-U to stop counting and stop forwarding packets for the affected bearers.
- 4b. The SGW-U sends an Sx Session Modification Response to the SGW-C confirming the update the Sx session.
5. The relevant steps of the procedure as specified in the figure above are executed.
- 6a. The SGW-C may send an Sx Session Modification Request to the SGW-U to update the Sx session. For "Secondary PDP Context Activation Procedure", the SGW-C shall include the F-TEIDu of the activated bearer received from the S4 SGSN or RNC. For "MS- or SGSN- initiated PDP Context Modification" with bearer QoS update procedure, SGW-C provides updated QoS parameters to SGW-U. For "MS- or SGSN Initiated PDP Context Deactivation Procedure", SGW-C shall request SGW-U to remove the PDR for the affected bearers.
- 6b. The SGW-U sends an Sx Session Modification Response to the SGW-C confirming the update the Sx session.
7. The relevant steps of the procedure as specified in the figure above are executed.
- 8a. The PGW-C may send an Sx Session Modification Request to the PGW-U to update the Sx session. For "Secondary PDP Context Activation Procedure", the PGW-C shall include the F-TEIDu of the activated bearer received from the SGW. For "MS- or SGSN- Initiated PDP Context Deactivation Procedure, the PGW-C shall request PGW-U to remove the PDR for the affected bearers.
- 8b. The PGW-U sends an Sx Session Modification Response to the PGW-C confirming the update the Sx session.

NOTE 2: Step 2a/2b happens before PGW-C sends request message to SGW-C, and step 8a/8b happens when PGW-C receives response message from SGW-C.

NOTE 3: Step 4a/4b happens when SGW-C receives request message from PGW-C, and step 6a/6b happens when SGW-C receives response message from S4 SGSN.

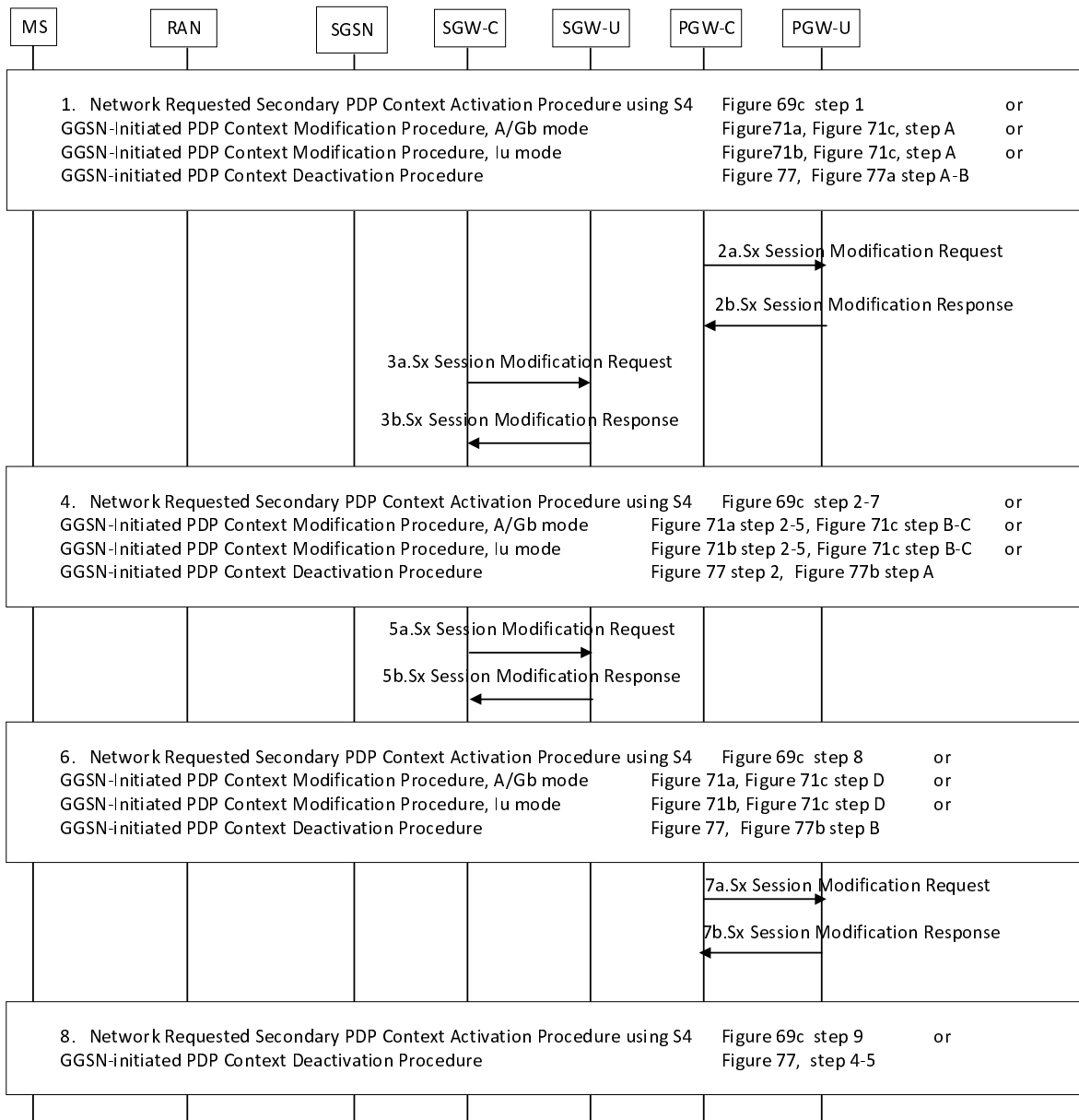

Figure 6.3.4.2.1-3: Interaction between CP and UP function with PDN connection modification, Group 3

1. Procedure as listed in this step is initiated as specified in the relevant clauses of this specification. The relevant steps of the procedure as specified in the figure above are executed.
- 2a. The PGW-C may send an Sx Session Modification Request to the PGW-U to update the Sx session. For "Network Requested Secondary PDP Context Activation Procedure", PGW-C may request PGW-U to allocate F-TEID for the dedicated bearer. For "GGSN Initiated PDP Context Deactivation Procedure", PGW-C shall request PGW-U to stop counting and stop forwarding packets for the affected bearers.
- 2b. The PGW-U sends an Sx Session Modification Response to the PGW-C confirming the update the Sx session.
- 3a. The SGW-C may send an Sx Session Modification Request to the SGW-U to update the Sx session. For "Network Requested Secondary PDP Context Activation Procedure", SGW-C may request SGW-U to allocate F-TEID for the dedicate bearer. For "GGSN Initiated PDP Context Deactivation Procedure", SGW-C shall request SGW-U to stop counting and stop forwarding packets for the affected bearers.
- 3b. The SGW-U sends an Sx Session Modification Response to the SGW-C confirming the update the Sx session.
4. The relevant steps of the procedure as specified in the figure above are executed.

- 5a. The SGW-C may send an Sx Session Modification Request to the SGW-U to update the Sx session. For "Network Requested Secondary PDP Context Activation Procedure", the SGW-C shall include the F-TEIDu of the activated bearer received from the S4 SGSN or RNC. For "GGSN initiated PDP Context Modification" with bearer QoS update, SGW-C provides updated QoS parameters to SGW-U. For "GGSN Initiated PDP Context Deactivation Procedure", SGW-C shall request SGW-U to remove the PDR for the affected bearers.
- 5b. The SGW-U sends an Sx Session Modification Response to the SGW-C confirming the update the Sx session.
6. The relevant steps of the procedure as specified in the figure above are executed.
- 7a. The PGW-C may send an Sx Session Modification Request to the PGW-U to update the Sx session. For "Network Requested Secondary PDP Context Activation Procedure", the PGW-C shall include the F-TEIDu of the activated bearer received from the SGW. For "GGSN initiated PDP Context Modification" with bearer QoS update, PGW-C provides updated QoS parameters to PGW-U. For "GGSN Initiated PDP Context Deactivation Procedure", the PGW-C shall request PGW-U to remove the PDR for the affected bearers.
- 7b. The PGW-U sends an Sx Session Modification Response to the PGW-C confirming the update the Sx session.

NOTE 4: Step 2a/2b happens before PGW-C sends request message to SGW-C, and step 7a/7b happens when PGW-C receives response message from SGW-C.

NOTE 5: Step 3a/3b happens when SGW-C receives request message from PGW-C, and step 5a/5b happens when SGW-C receives response message from S4 SGSN.

6.3.4.2.2 Procedures with SGSN terminating Gn/Gp interface

This clause defines interactions between the CP and UP function during the following procedures related to the modification of a PDN connection.

Group 1 Procedures for Location Management, Handover, Service Request and Inter-System Change:

- Inter SGSN Routing Area Update Procedure.
- Combined RA / LA Update in the Case of Inter SGSN RA Update Procedure.
- Iu mode RA Update Procedure.
- SRNS Relocation Procedure.
- Combined Hard Handover and SRNS Relocation Procedure.
- Combined Cell / URA Update and SRNS Relocation Procedure.
- Enhanced Serving RNS Relocation.
- MS Initiated Service Request Procedure.
- Network Initiated Service Request Procedure.
- Iu mode to A/Gb mode Intra SGSN Change.
- A/Gb mode to Iu mode Intra SGSN Change.
- Iu mode to A/Gb mode Inter-SGSN Change.
- A/Gb mode to Iu mode Inter SGSN Change.
- GPRS Paging Procedure (A/Gb mode).

Group 2 UE/SGSN initiated PDN connection modification:

- Secondary PDP Context Activation Procedure for A/Gb mode.
- Secondary PDP Context Activation Procedure for Iu mode.
- SGSN-Initiated PDP Context Modification Procedure, A/Gb mode.
- SGSN-Initiated PDP Context Modification Procedure, Iu mode.

1. Procedure as listed in this step is initiated as specified in the relevant clauses of this specification. The relevant steps of the procedure as specified in the figure above are executed.
- 2a. The PGW-C may send an Sx Session Modification Request to the PGW-U to update the Sx session.
- 2b. The PGW-U sends an Sx Session Modification Response to the PGW-C confirming the update the Sx session.
3. The relevant steps of the procedure as specified in the figure above are executed.

NOTE 1: Step 2a/2b happens when PGW-C receives request message from GnSGSN.

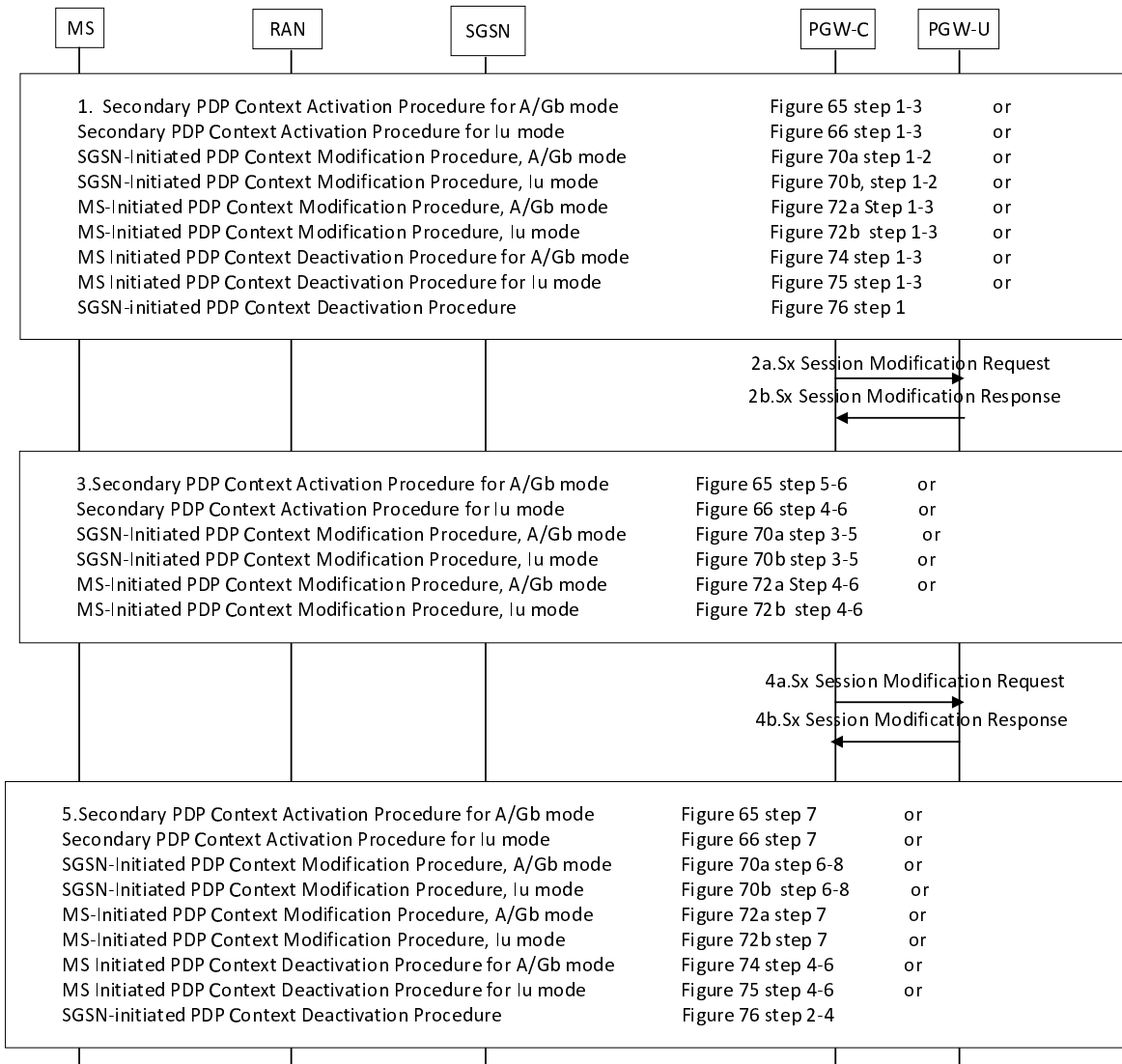

Figure 6.3.4.2.2-2: Interaction between CP and UP function with PDN connection modification, Group 2

1. Procedure as listed in this step is initiated as specified in the relevant clauses of this specification. The relevant steps of the procedure as specified in the figure above are executed.
- 2a. The PGW-C may send an Sx Session Modification Request to the PGW-U to update the Sx session. For "Secondary PDP Context Activation Procedure", PGW-C may request PGW-U to allocate F-TEID for the dedicated bearer. For "MS- and SGSN- Initiated PDP Context Deactivation Procedure", the PGW-C shall request PGW-U to remove the PDR for the affected bearers.
- 2b. The PGW-U sends an Sx Session Modification Response to the PGW-C confirming the update the Sx session.
3. The relevant steps of the procedure as specified in the figure above are executed.

- 4a. The PGW-C may send an Sx Session Modification Request to the PGW-U to update the Sx session.
- 4b. The PGW-U sends an Sx Session Modification Response to the PGW-C confirming the update the Sx session.
5. The relevant steps of the procedure as specified in the figure above are executed.

NOTE 2: Step 2a/2b and step 4a/4b happen when PGW-C receives request message from GnSGSN.

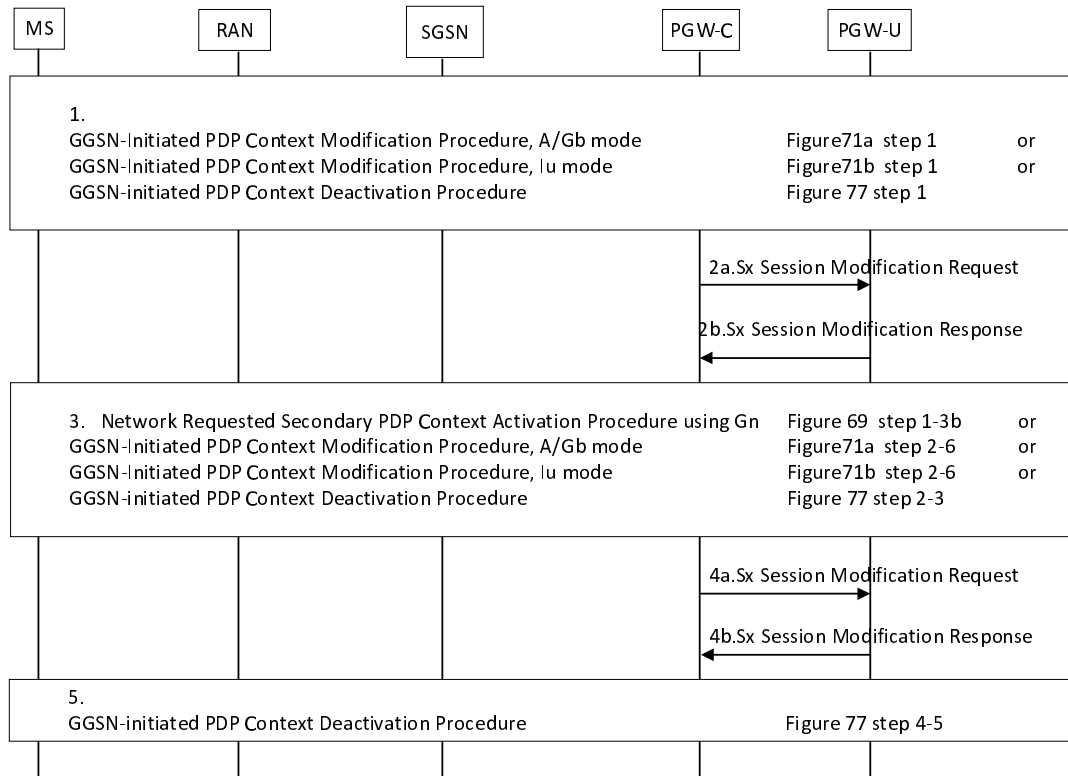

Figure 6.3.4.2.2-3: Interaction between CP and UP function with PDN connection modification, Group 3

1. Procedure as listed in this step is initiated as specified in the relevant clauses of this specification. The relevant steps of the procedure as specified in the figure above are executed.
- 2a. The PGW-C may send an Sx Session Modification Request to the PGW-U to update the Sx session. For "GGSN Initiated PDP Context Deactivation Procedure", PGW-C shall request PGW-U to stop counting and stop forwarding packets for the affected bearers.
- 2b. The PGW-U sends an Sx Session Modification Response to the PGW-C confirming the update the Sx session.
3. The relevant steps of the procedure as specified in the figure above are executed.
- 4a. The PGW-C may send an Sx Session Modification Request to the PGW-U to update the Sx session. For "Network Requested Secondary PDP Context Activation Procedure", the PGW-C shall include the F-TEIDu of the activated bearer received from the GnSGSN. For "GGSN Initiated PDP Context Deactivation Procedure", the PGW-C shall request PGW-U to remove the PDR for the affected bearers.
- 4b. The PGW-U sends an Sx Session Modification Response to the PGW-C confirming the update the Sx session.
5. The relevant steps of the procedure as specified in the figure above are executed.

NOTE 3: Step 2a/2b happens when PGW-C sends request message to GnSGSN, and step 4a/4b happens when PGW-C receives response message from GnSGSN for GGSN initiated PDP Context Modification/Deactivation Procedure, or request message for Network Requested Secondary PDP Context Activation.

6.3.4.3 Procedures with PDN connection establishment

This clause defines interactions between the CP and UP function during the following procedures related to the establishment of a PDN connection:

- IPv6 Stateless Address Autoconfiguration Procedure.
- PDP Context Activation Procedure for A/Gb mode.
- PDP Context Activation Procedure for Iu mode.

During the procedures involving S4 listed above, following is the nature of interactions between the CP and UP function:

- The SGW-C informs the SGW-U to create the Sx session.
- The PGW-C informs the PGW-U to create the Sx session.
- The SGW-C informs the SGW-U to modify the Sx session.
- The PGW-C informs the PGW-U to modify the Sx session.

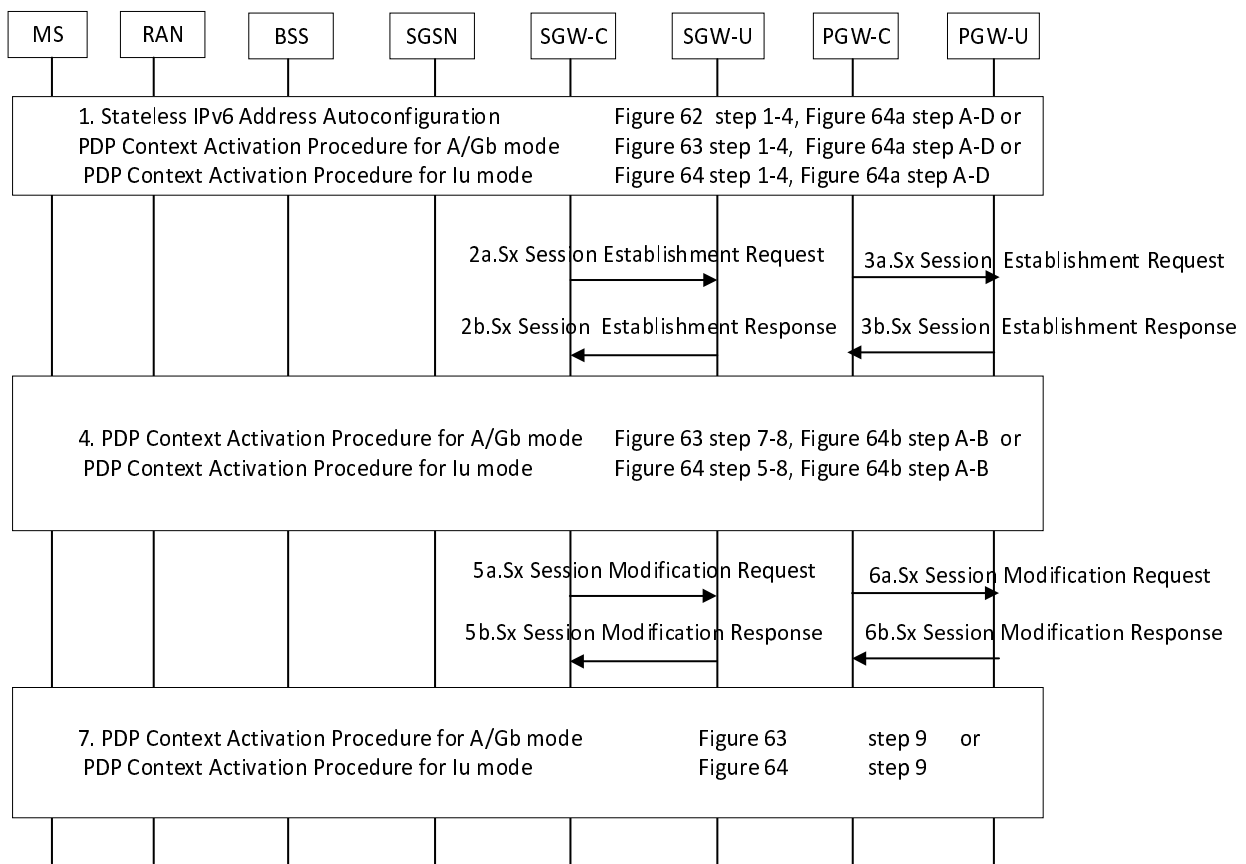

Figure 6.3.4.3-1: Interaction between CP and UP function with PDN connection establishment

1. Procedure as listed in this step is initiated as specified in the relevant clauses of this specification. The relevant steps of the procedure as specified in the figure above are executed. Steps in Figure 64a are specific for S4 SGSN.

For the case that Gn/Gp SGSN interconnects with PGW-C, steps 2a/2b or 5a/5b are skipped.

- 2a. The SGW-C sends an Sx Session Establishment Request to the SGW-U to create the Sx session.
- 2b. The SGW-U sends an Sx Session Modification Response to the SGW-C confirming the Sx session creation.
- 3a. The PGW-C sends an Sx Session Establishment Request to the PGW-U to create the Sx session.

- 3b. The PGW-U sends an Sx Session Establishment Response to the PGW-C confirming the Sx session creation.
4. The relevant steps of the procedure as specified in the figure above are executed. Steps in Figure 64b are specific for S4 SGSN.
- 5a. The SGW-C may send an Sx Session Modification Request to the SGW-U to update the Sx session.
- 5b. The SGW-U sends an Sx Session Modification Response to the SGW-C confirming the Sx session update.
- 6a. The PGW-C may send an Sx Session Modification Request to the PGW-U to update the Sx session.
- 6b. The PGW-U sends an Sx Session Modification Response to the PGW-C confirming the Sx session update.
7. The relevant steps of the procedure as specified in the figure above are executed.

NOTE 1: For the case that SGSN interconnects with SGW via S4 reference point, steps 2a/2b or 5a/5b happens when SGW-C receives request message from SGSN, and steps 3a/3b or 6a/6b happens when PGW-C receives request message from SGW.

NOTE 2: For the case that Gn/Gp SGSN interconnects with PGW-C, steps 3a/3b or 6a/6b happens when PGW-C receives request message from Gn/Gp SGSN.

6.4 Sx Reporting Procedures

6.4.1 General

The Sx reporting procedure is used by the UP function of SGW, PGW or TDF to report events to the CP function.

The following Sx reporting procedures exist: Sx session level reporting and Sx node level reporting. Both are initiated by the CP function.

6.4.2 Sx Session Level Reporting Procedure

This procedure is used by the UP function to report events related to an Sx session for an individual PDN connection IP-CAN session, TDF session or TDF in unsolicited reporting mode. The triggers for event reporting were configured on the UP function during Sx session management procedures by the CP function (excluding the Sx session termination procedure).

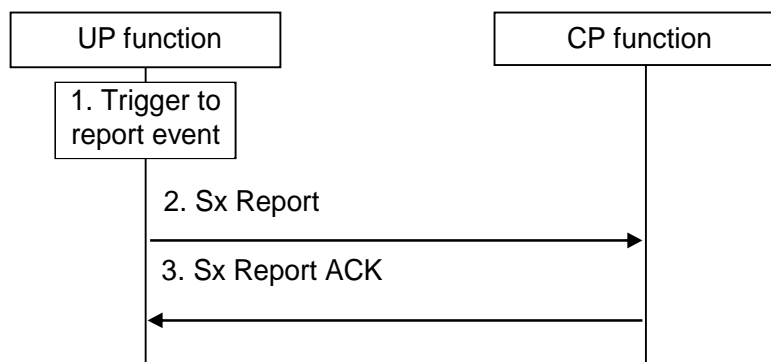

Figure 6.4.2-1: Sx Session Level Reporting procedure

1. The UP function detects that an event has to be reported. The reporting triggers involve the following cases:

- (1) Usage report (by SGW-U, PGW-U and TDF-U).

Usage information shall be collected in the UP function and reported to the CP function as defined in clause 5.3 and clause 7.4.

- (2) Start of traffic detection (by PGW-U and TDF-U).

When traffic detection is requested by PGW-C/TDF-C, and the start of traffic is detected for a PDR, the PGW-U/TDF-U shall report the start of traffic detection to the PGW-C/TDF-C and indicate the PDR rule ID.

(3) Stop of traffic detection (by PGW-U and TDF-U).

When traffic detection is requested by PGW-C/TDF-C, and the end of traffic is detected for a PDR, the PGW-U/TDF-U shall report the stop of traffic detection to the PGW-C/TDF-C and indicate the PDR rule ID.

(4) Detection of 1st Downlink Data for Idle-Mode UE (by SGW-U)

When SGW-U receives the downlink packet but no S1-bearer for transmission and the buffering is performed by SGW-U, it shall report the detection of 1st downlink data to SGW-C, for the purpose of paging the UE. SGW-U shall also report the DSCP of the packet when instructed by SGW-C (e.g. in case the Paging Policy Differentiation function as described in TS 23.401 [2] is enabled at the SGW-C).

2. The UP function sends an Sx report message (Session ID, list of [Reporting trigger, Measurement information]) to the CP function.

The Reporting trigger parameter contains the name of the event which triggered the report and the Measurement information parameter contains the actual information the CP function requested to be informed about.

3. The CP function identifies the Sx session context based on the received Session ID and applies the reported information for the corresponding PDN connection IP-CAN session, TDF session or TDF in unsolicited reporting mode. The CP function responds with an Sx report ACK message.

6.5 Sx Management Procedures

6.5.1 General

Sx management procedures are used by the CP function to manage the UP function independent of any Sx session.

NOTE: The terminology defined in TS 29.244 [12] is used for the procedures and messages related to the Sx management procedures.

Editor's note: More procedures may be added after stage 3 finalize the work on Sx management procedures.

6.5.2 Sx PFD management Procedure

The Sx PFD management procedure is used by the PGW-C or TDF-C to provision or remove all PFD(s) belonging to an Application ID in the UP function as described in clause 5.11.4. PFD sets belonging to different Application IDs can be managed with the same PFD management request message.

The Sx PFD management procedure is a node level procedure, i.e. independent of any Sx session.

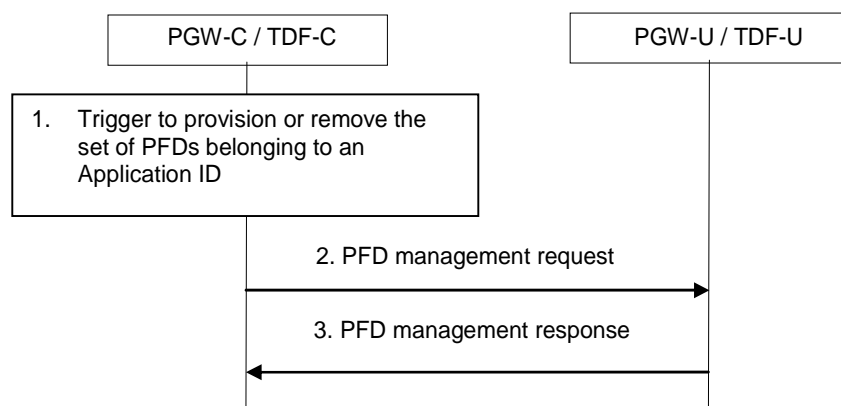

Figure 6.5.2-1: Sx PFD Management Procedure

1. The CP function is triggered to provision or remove the PFD set belonging to an Application ID as described in clause 5.11.4.
2. The CP function sends a PFD management request message to the UP function (containing the parameters described in clause 7.9.1) to provision/remove the PFD set corresponding to the Application ID.
3. The UP function acknowledges by responding with a PFD management response message.

6.5.3 Sx Association Setup Procedure

The Sx Association Setup procedure is used to setup an association between the CP function and the UP function which enables the CP function to subsequently interact with the UP function, e.g. to establish Sx Sessions.

The setup of an Sx association may be initiated by the CP function or the UP function as described TS 29.244 [12], clause 6.2.6. The CP function and the UP function shall support the Sx association setup initiated by the CP function. The CP function and the UP function may additionally support the Sx association setup initiated by the UP function.

6.5.4 Sx Association Update Procedure

The Sx Association Update procedure is used to modify an existing Sx association between the CP function and the UP function. It may be initiated by the UP function or by the CP function, as described TS 29.244 [12], clause 6.2.7.

6.5.5 Sx Association Release Procedure

The Sx Association Release procedure is used to terminate the Sx association between the CP function and the UP function due to e.g. OAM reasons. The Sx Association Release procedure can be only initiated by the CP function, as described TS 29.244 [12], clause 6.2.8.

7 Parameters

7.1 Parameters for Sx session management

These parameters are used to control the functionality of the UP function related to an individual PDN connection, IP-CAN session, TDF session or TDF in unsolicited reporting mode as well as to inform about events occurring at the UP function. As the functionality of the respective UP functions differs, most parameters are specific to one or two of the reference points Sxa (between SGW-C and SGW-U), Sxb (PGW-C and PGW-U) and Sxc (TDF-C and TDF-U).

The Sx session management procedures however will use the relevant parameters in the same way for all Sx reference points: the Sx session establishment procedure as well as the Sx session modification procedure provide the control parameters to the UP function, the Sx session termination procedure removes all control parameters related to an Sx session and the Sx session level reporting procedure informs the CP function about events related to the Sx session that are detected by the UP function.

The parameters over Sx provided from CP function to UP function are grouped into session related parameters and four different rules, one "detection" rule and three different "enforcement" rules:

- Packet Detection Rule (PDR), with information describing what packets should receive a certain treatment (e.g. forwarding and other types of enforcement).
- Forwarding Action Rule (FAR), contains information on whether forwarding, dropping or buffering is to be applied to a packet.
- Usage Reporting Rule (URR), contains information that defines a certain measurement and how it shall be reported.
- QoS Enforcement Rule (QER), contains information related to QoS enforcement of traffic.

The UP function provides parameters over Sx to the CP function sending a Usage Report.

7.2 Session context

The session context comprises the session related parameters and all PDRs, URRs, QERs and FARs with the same Session ID.

The following table describes the session related parameters provided over Sx.

Table 7.2-1: Session related parameters

Attribute	Description	Comment	Applicability		
			SGW	PD N GW	TDF
Session ID	Uniquely identifies a session.	This session corresponds to a PDN connection for SGW, a PDN connection and an IP-CAN session for PGW, TDF session for TDF or a TDF in unsolicited reporting mode.	X	X	X

7.3 Packet Detection Rule

The following table describes the Packet Detection Rule (PDR) containing information required to classify a packet arriving at the UP function. There is at least one PDR per direction, e.g. UL direction or DL direction.

Table 7.3-1: Attributes within Packet Detection Rule

Attribute		Description	Comment	Applicability		
				SGW	PD N GW	TDF
Session ID		Identifies the session associated to this PDR		X	X	X
Rule ID		Unique identifier to identify this information.		X	X	X
Precedence		Determines the order, in which the detection information of all rules is applied			X	X
Packet detection information	Source interface	Contains the values "access side", "core side", "CP function" or "SGi-LAN".	Identifies whether the rule applies to incoming packets from the access side (i.e. up-link), the core side (i.e. down-link), the CP function (the packet from CP function) or the SGi-LAN side (the packet has experienced SGi-LAN Service Functions).	X	X	X
	UE IP address	One IPv4 address and/or one IPv6 prefix with prefix length	Combination of UE IP address (together with Network instance, if necessary), F-TEID, SDF filters, application ID for traffic detection: SGW UL: Local F-TEID SGW DL: Local F-TEID PGW UL: Local F-TEID + UE IP address + SDF/applicat.ID PGW DL: UE IP address + SDF/application ID TDF UL (solicited mode): UE IP address + SDF/application ID TDF DL (solicited mode): UE IP address + SDF/application ID TDF UL/DL (unsolicited mode): application ID		X	X
	Network instance	Identifies the Network instance associated with the incoming packet. (NOTE 1).		X	X	X
	Local F-TEID			X	X	
	List of SDF Filter(s)				X	X
	Application ID				X	X
Outer header removal		Instructs the UP function to remove one or more outer header(s) (e.g. IP+UDP+GTP) from the incoming packet.	Any extension header shall be stored for this packet.	X	X	
Forwarding Action Rule ID		The Forwarding Action Rule ID identifies a forwarding action that has to be applied.		X	X	X
List of Usage Reporting Rule ID(s)		Every Usage Reporting Rule ID identifies a measurement action that has to be applied.		X	X	X
List of QoS Enforcement Rule ID(s)		Every QoS Enforcement Rule ID identifies a QoS enforcement action that has to be applied.		X	X	X

NOTE 1: The Network instance is needed e.g. in the following cases:

- PGW/TDF-U supports multiple APN with overlapping IP addresses;
- PGW-U is connected to SGWs in different IP domains;
- SGW-U is connected to PGWs in different IP domains;
- SGW-U is connected to eNodeBs in different IP domains.

7.4 Usage Reporting Rule

The following table describes the Usage Reporting Rule (URR) that defines how a packet shall be accounted as well as when and how to report the measurements.

Table 7.4-1: Attributes within Usage Reporting Rule

Attribute	Description	Comment	Applicability		
			SGW	PD N GW	TDF
Session ID	Identifies the session associated to this URR		X	X	X
Rule ID	Unique identifier to identify this information.		X	X	X
Reporting triggers	One or multiple of the events can be activated for the generation and reporting of the usage report.	Applicable events include: Start/stop of traffic detection with/without application instance identifier and deduced SDF filter reporting; Deletion of last PDR for a URR; Periodic measurement threshold reached; Volume/Time/Event measurement threshold reached; Immediate report requested; Measurement of incoming UL traffic; Measurement of discarded DL traffic.	X	X	X
Periodic measurement threshold	Defines the point in time for sending a periodic report for this URR key (e.g. timeofday)	This allows generation of periodic usage report for e.g. offline charging. It can also be used for realizing the Monitoring time of the usage monitoring feature. It can also be used for realizing the Quota-Idle-Timeout, i.e. to enable the CP function to check whether any traffic has passed during this time.	X	X	X
Volume measurement threshold	Value in terms of uplink and/or downlink and/or total byte-count when the measurement report is to be generated.		X	X	X
Time measurement threshold	Value in terms of the time duration (e.g. in seconds) when the measurement report is to be generated.		X	X	X
Event measurement threshold	Number of events (identified according to a locally configured policy) after which the measurement report is to be generated.			X	X
Inactivity detection time	Defines the period of time after which the time measurement shall stop, if no packets are received.	Timer corresponding to this duration is restarted at the end of each transmitted packet.		X	X
Event based reporting	Points to a locally configured policy which identifies event(s) trigger for generating usage report.			X	X
Linked URR ID	Points to one or more other URR ID.	This enables the generation of a combined Usage Report for this and other URRs by triggering their reporting. See clause 5.2.2.4, TS 29.244 [12].		X	X

Measurement method	Indicates the method for measuring the network resources usage, i.e. the data volume, duration, combined volume/duration, or event.		X	X	X
Measurement information	Indicates specific conditions to be applied for measurements.	It is used to request: <ul style="list-style-type: none"> - measurement before QoS enforcement, and/or - to pause or set to active a measurement as for the Pause of charging, and/or - to request reduced reporting for application start/stop events. 	X	X	X

7.5 Forwarding Action Rule

The following table describes the Forwarding Action Rule (FAR) that defines how a packet shall be forwarded, including packet encapsulation/decapsulation and forwarding destination.

Table 7.5-1: Attributes within Forwarding Action Rule

Attribute	Description	Comment	Applicability		
			SGW	PDN GW	TDF
Session ID	Identifies the session associated to this FAR		X	X	X
Rule ID	Unique identifier to identify this information.		X	X	X
Network instance	Identifies the Network instance associated with the outgoing packet. (NOTE 1).		X	X	X
Destination interface	Contains the values "access side", "core side", "CP function", or "SGi-LAN".	Identifies the interface for outgoing packets towards the access side (i.e. down-link), the core side (i.e. up-link), the CP function side (i.e. towards CP function) or the SGi-LAN side (i.e. towards SGi-LAN).	X	X	X
Outer header creation	Instructs the UP function to add an outer header (IP+UDP+GTP) to the outgoing packet	Contains the F-TEIDu of peer entity (e.g. eNB, SGW, PGW, CP function). Any extension header stored for this packet shall be added.	X	X	
Send end marker packet(s)	Instructs the UP function to construct end marker packet(s) and send them out as described in clause 5.8.1.	This parameter should be sent together with the "out header creation" parameter of the new F-TEID-u.	X	X	
Transport level marking	Transport level packet marking in the uplink and downlink, e.g. setting the DiffServ Code Point.		X	X	

Forwarding policy	Reference to a preconfigured traffic forwarding treatment for FMSS or http redirection (NOTE 2)	Contains TSP ID or Redirect Destination and values for the forwarding behaviour (always, after measurement report (for termination action "redirect"))		X	X
Container for header enrichment	Contains information to be used by the UP function for header enrichment	Only relevant for the uplink direction		X	X
Buffer Control Information	Instructs the UP function on how to perform buffering	See clause 5.2.4 in TS 29.244 [12].	X		
Delay Downlink Packet Notification Information	D parameter	See clause 5.9.3	X		
Extended buffering Information	DL Data Buffer Expiration Time	See clause 5.9.3	X		
	DL Suggested Packet Count	See clause 5.9.3			
<p>NOTE 1: Needed e.g. in case:</p> <ul style="list-style-type: none"> - PGW/TDF-U supports multiple APN with overlapping IP addresses; - PGW-U is connected to SGWs in different IP domains; - SGW-U is connected to PGWs in different IP domains; - SGW UP-U is connected to eNodeBs in different IP domains. <p>NOTE 2: The TSP ID action is enforced before the Outer header creation actions.</p>					

7.6 QoS Enforcement Rule

The following table describes the QoS Enforcement Rule (QER) that defines how a packet shall be treated in terms of bit rate limitation and packet marking for QoS purposes. All Packet Detection Rules that refer to the same QER share the same QoS resources, e.g. MBR.

Table 7.6-1: Attributes within QoS Enforcement Rule

Attribute	Description	Comment	Applicability		
			SGW	PDN GW	TDF
Session ID	Identifies the session associated to this QER		X	X	X
Rule ID	Unique identifier to identify this information.		X	X	X
QoS Enforcement Rule correlation ID	An identity allowing the UP function to correlate multiple Sessions for the same UE and APN.	Is used to correlate QoS Enforcement Rules for APN-AMBR enforcement		X	
Gate status UL/DL	Instructs the UP function to let the flow pass or to block the flow	Values are: open, close, close after measurement report (for termination action "discard")		X	X
Maximum bitrate	The uplink/downlink maximum bitrate to be enforced for the packets.	This field may e.g. contain any one of: - APN-AMBR (for a QER that is referenced by all relevant Packet Detection Rules of all PDN Connections to an APN) - TDF session MBR (for a QER that is referenced by all Packet Detection Rules of a TDF Session) - bearer MBR (for a QER that is referenced by all Packet Detection Rules of a bearer) - SDF MBR (for a QER that is referenced by the uplink/downlink Packet Detection Rule of a SDF)		X	X
Guaranteed bitrate	The uplink/downlink guaranteed bitrate authorized for the packets.	This field contains: - bearer GBR (for a QER that is referenced by all Packet Detection Rules of a bearer)	X	X	
Down-link flow level marking	Flow level packet marking in the downlink.	For PGW, this is for controlling the SCI marking in the GTP extension header (for service indication towards GERAN as described in TS 23.060 [5]). For TDF, this is for controlling the DSCP marking for application indication.		X	X
Packet rate	Number of packets per time interval to be enforced.	This field contains any one of: - downlink packet rate for Serving PLMN Rate Control (the QER is referenced by all PDRs of the UE belonging to PDN connections using CloT EPS Optimizations as described in TS 23.401 [2]) - uplink/downlink packet rate for APN Rate Control (the QER is referenced by all PDRs of the UE belonging to PDN connections to the same APN using CloT EPS Optimizations as described in TS 23.401 [2]).		X	

7.7 Usage Report generated by UP function

The UP function sends the usage report to inform the CP function about the measurement of an active URR or about the detection of application traffic of an active Packet Detection Rule. For each URR, the usage report may be generated repeatedly, i.e. as long as any one of the valid event triggers applies. A final usage report is sent for a URR when it is no

longer active, i.e. either the URR is removed or all the references to this URR in any of the Packet Detection Rules belonging to the Sx session.

Following attributes can be included in the usage report:

Table 7.7-1: Attributes within Usage Report

Attribute	Description	Comment	Applicability		
			SGW	PDN GW	TDF
Session ID	Uniquely identifies a session.	This corresponds to a PDN connection for SGW and PGW or a TDF session for TDF	X	X	X
Rule ID	Uniquely identifies the Packet Detection Rule or Usage Reporting Rule within a session which triggered the report	Packet Detection Rule is only indicated when Reporting trigger is Detection of 1st DL packet on bearer (SGW) or Start/stop of traffic detection (PGW/TDF). Usage Reporting Rule is indicated for all other Reporting triggers.	X	X	X
Reporting trigger	Identifies the trigger for the usage report.	Applicable values are: Detection of 1st DL packet on bearer (only for SGW); Start/stop of traffic detection with/without application instance identifier and deduced SDF filter reporting (only for PGW and TDF); Deletion of last PDR for a URR; Periodic measurement threshold reached; Volume/Time/Event measurement threshold reached; Immediate report requested; Measurement of incoming UL traffic (only for PGW); Measurement of discarded DL traffic (only for SGW).	X	X	X
Start time	Provides the timestamp, in terms of absolute time, when the collection of the information provided within Usage-Information is started.	Not sent when Reporting trigger is Start/stop of traffic detection	X	X	X
End time	Provides the timestamp, in terms of absolute time, when the information provided within Usage-Information is generated.	Not sent when Reporting trigger is Start/stop of traffic detection	X	X	X
Measurement information	Defines the measured volume/time/events for this URR.	Contains DSCP of received packet when Reporting trigger is Detection of 1 st DL packet on bearer (as described in TS 23.401 [2]) Contains application instance identifier and deduced SDF filter when Reporting trigger is Start/stop of traffic detection with application instance identifier and deduced SDF filter reporting (including deduced UE IP address for TDF in unsolicited mode) Not sent when Reporting trigger is Start/stop of traffic detection without application instance identifier and deduced SDF filter reporting	X	X	X

7.8 Functional description

7.8.1 General

This clause describes how the CP function provides information over Sx to realize forwarding, reporting etc on different aggregation levels.

7.8.2 PDN connection and TDF session level context

The PDN connection or TDF session level context is realized over Sx by generating a Usage Reporting Rule and a QoS Enforcement Rule.

To apply PDN Connection or TDF session level reporting and MBR enforcement, the CP function provides over Sx:

- A URR that describes the reporting requirement for the PDN Connection or TDF session.
- A QER that describes the QoS enforcement actions that apply, i.e. a QER with APN-AMBR value (in case of PGW) or a QER with TDF session MBR (in case of TDF).

For session level reporting, the CP function includes references to the URR (i.e. URR Rule ID) in each Packet Detection Rule activated for the PDN Connection or TDF session. In case of PDN Connection or TDF session level usage monitoring where some SDF(s) are excluded, the CP function only includes a reference to the URR in those Packet Detection Rules that shall be included in the report.

For APN-AMBR policing, the CP function includes references (Rule ID) to the QER containing the APN-AMBR value in each Packet Detection Rule for non GBR traffic activated for the PDN Connection. The CP function shall apply the same QER for all Packet Detection Rules for non GBR traffic associated with any of the active PDN Connections of the same APN.

For TDF session MBR policing, the CP function includes references (Rule ID) to the QER containing the TDF session MBR value in each Packet Detection Rule activated for the TDF session.

7.8.3 Bearer related context

The bearer context is realized over Sx by generating one or two Forwarding Action Rules, a Usage Reporting Rule and a QoS Enforcement Rule that correspond to the bearer. In particular, the CP function may provide to the UP function for each active bearer:

- A Usage Reporting Rule that describes the reporting requirement for the bearer, including reporting events, measurement type etc for the bearer reports
- A QoS Enforcement Rule that describe the QoS enforcement actions that apply to the bearer, including the bearer MBR.
- Forwarding Action Rules describe the forwarding behaviour for the bearer. One Forwarding Action Rule is required for the downlink direction (in case of PGW or SGW) and one for the uplink direction (in case of SGW).

NOTE: The CP function maintains the association between the EPS Bearer ID and the rules on Sx corresponding to bearer level enforcement and reports. There is no need to provide a Bearer ID to the UP function.

The CP function associates, based on the bearer binding decisions, every Packet Detection Rule that is activated for a bearer with the URR, QER and FARs applicable for the this bearer by including references (Rule IDs) in the PDR:

- For bearer level reporting, the CP function includes a reference (Rule ID) to the URR for the bearer.
- For bearer level policing, the CP function includes a reference (Rule ID) to the QER for the bearer.
- For forwarding of packets over a bearer (GTP-U encapsulation), the CP function includes a reference (Rule ID) to the FAR the bearer. This is done per direction (UL and DL).

7.8.4 Measurement key related context

The CP function provides a Usage Reporting Rule for each usage report that needs to be provided by the UP function. The CP function maintains a mapping between the Charging Key and/or Monitoring Key applicable for a SDF and the Measurement Key of the URR provided over Sx. For example, the CP function may provide one URR for each Charging Key and one URR for each Monitoring Key or may decide to provide a single URR for a Charging Key and a Monitoring Key in case there is complete overlap in the measurement requirements. Other mappings are also possible as determined by the CP function and is not limited by the standard as long as the reporting requirements from the CP function towards the OFCS/OCS and PCRF are fulfilled.

To associate traffic covered by a Packet Detection Rule with one or more measurement keys on Sx, the CP function includes in the Packet Detection Rule a reference to each URR (Rule ID) that is applicable for the traffic covered by the PDR.

7.9 Parameters for Sx management

7.9.1 Parameters for PFD management

The PGW-C/TDF-C can manage PFD sets in the applicable PGW-U/TDF-U independent of the Sx session. The management (provision or remove) of multiple PFD sets belonging to different Application IDs can be done with the same PFD management request message.

Table 7.9-1: Attributes within PFD management request message

Attribute	Description	Comment	Applicability		
			SGW	PD N GW	TDF
PFD(s)	Extension to the application detection filter	The provisioning of PFD(s) for an Application ID results in the removal of all PFD(s) stored in the PGW-U/TDF-U for this Application ID and the usage of all newly provided PFD(s) for this Application ID		X	X
Application ID	Application identifier which the PFD(s) is associated with	The provisioning of an Application ID without PFD(s) results in the removal of all stored PFD(s) corresponding to this Application ID		X	X

Annex A (informative): Change history

Change history							
Date	Meeting	TDoc	CR	Rev	Cat	Subject/Comment	New version
2016-09	SP-73	SP-160665	-	-	-	MCC Editorial update for presentation to TSG SA#73 for information and approval	1.0.0
2016-09	SP-73	-	-	-	-	MCC Editorial update for publication after TSG SA#73 approval	14.0.0
2016-12	SP-74	SP-160815	0002	2	F	Corrections to User Plane selection function	14.1.0
2016-12	SP-74	SP-160815	0003	5	F	Corrections to buffering in the user plane	14.1.0
2016-12	SP-74	SP-160815	0004	8	F	Sx parameter corrections	14.1.0
2016-12	SP-74	SP-160815	0005	4	B	SDCI support	14.1.0
2016-12	SP-74	SP-160815	0006	3	F	Update to PCC/ADC related functions	14.1.0
2016-12	SP-74	SP-160815	0007	2	F	Update to UP Selection Section	14.1.0
2016-12	SP-74	SP-160815	0008	2	F	Text updates for 3GPP TS 23.401 call flows	14.1.0
2016-12	SP-74	SP-160815	0009	2	F	Text updates for 3GPP TS 23.402 call flows	14.1.0
2016-12	SP-74	SP-160815	0010	2	B	Buffering and F-TEIDu Allocation	14.1.0
2016-12	SP-74	SP-160815	0012	3	F	Support of PGW Pause of Charging	14.1.0
2016-12	SP-74	SP-160815	0013	3	F	Sx Session Level Reporting Procedure update	14.1.0
2016-12	SP-74	SP-160815	0014	3	F	TDF-U selection in case of unsolicited reporting	14.1.0
2016-12	SP-74	SP-160815	0017	4	F	Corrections of Sx parameters	14.1.0
2016-12	SP-74	SP-160815	0019	-	F	Parameter alignment and corrections for traffic detection clause	14.1.0
2016-12	SP-74	SP-160815	0020	2	F	Parameter alignment and corrections for forwarding section	14.1.0
2016-12	SP-74	SP-160815	0021	2	F	Alignment of function split clause	14.1.0
2016-12	SP-74	SP-160815	0022	3	F	Clarification on the SGW-C partitions for a given UE	14.1.0
2017-03	SP-75	SP-170046	0026	2	F	Correction to enforcement of dynamic PCC/ADC rule	14.2.0
2017-03	SP-75	SP-170046	0027	2	F	Corrections to Sx parameters	14.2.0
2017-03	SP-75	SP-170046	0028	4	F	Session management procedure for TDF in unsolicited mode	14.2.0
2017-03	SP-75	SP-170052	0029	1	C	TS 23.214 support for transport level packet marking	14.2.0
2017-03	SP-75	SP-170046	0032	1	F	Updates Procedures in TS 23.060.	14.2.0
2017-06	SP-76	SP-170366	0033	1	F	Clean up and stage 3 alignment	14.3.0
2017-06	SP-76	SP-170366	0034	2	F	Corrections and clean up for 23.401 related message flows	14.3.0
2017-06	SP-76	SP-170366	0035	1	F	Addition of Sx node level procedures	14.3.0
2017-06	SP-76	SP-170366	0036	-	F	Clarification on pre-defined PCC rules	14.3.0
2017-06	SP-76	SP-170366	0038	-	F	Corrections and clean up for 23.203 related message flows	14.3.0
2017-06	SP-76	SP-170366	0039	1	F	Corrections and clean up for 23.060 related message flows	14.3.0
2017-06	SP-76	SP-170366	0040	-	F	Corrections and clean up for 23.402 related message flows	14.3.0
2017-09	SP-77	SP-170717	0041	2	F	Sx PDN Instance	14.4.0
2017-09	SP-77	SP-170717	0042	2	F	Update on activation of predefined PCC/ADC rules	14.4.0
2017-09	SP-77	SP-170717	0043	-	F	Description on Sx-u tunnel	14.4.0
2017-09	SP-77	SP-170717	0044	1	F	Corrections on PFD management	14.4.0
2017-09	SP-77	SP-170717	0045	-	F	Correlation of Sx Session and UE Context	14.4.0
2017-09	SP-77	SP-170717	0046	2	F	Update of the Procedures Specified in TS 23.401.	14.4.0
2017-09	SP-77	SP-170717	0048	3	F	Clarification of Procedures Specified in TS 23.060.	14.4.0
2017-09	SP-77	SP-170728	0047	2	B	Enable SGW-C & PGW-C selection of UPF to take UE's NR capabilities into account	15.0.0
2017-12	SP-78	SP-170913	0050	1	A	Interface between MME and SGW-U for IoT data transmission	15.1.0
2017-12	SP-78	SP-170913	0052	2	A	Removal of PMIP-based procedures specified	15.1.0
2017-12	SP-78	SP-170920	0055	1	F	Correcting the condition for selection of SGW-U for NR as secondary RAT	15.1.0
2017-12	SP-78	SP-170940	0057	2	A	Update of the Procedures Specified in TS 23.060.	15.1.0
2018-03	SP-79	SP-180086	0060	1	A	Update of the Procedures Specified in TS 23.060.	15.2.0
2018-03	SP-79	SP-180086	0062	-	A	Update to Procedures Specified in TS 23.401	15.2.0
2018-03	SP-79	SP-180086	0064	1	A	Correction of SDF Filter Description in PDR Table	15.2.0
2018-06	SP-80	SP-180472	0066	1	A	Update of Sx parameter tables	15.3.0

History

Document history		
V15.3.0	July 2018	Publication