

ETSI TS 123 246 V7.2.0 (2007-03)

Technical Specification

Universal Mobile Telecommunications System (UMTS); Multimedia Broadcast/Multicast Service (MBMS); Architecture and functional description (3GPP TS 23.246 version 7.2.0 Release 7)



Reference

RTS/TSGS-0223246v720

Keywords

UMTS

ETSI

650 Route des Lucioles
F-06921 Sophia Antipolis Cedex - FRANCE

Tel.: +33 4 92 94 42 00 Fax: +33 4 93 65 47 16

Siret N° 348 623 562 00017 - NAF 742 C
Association à but non lucratif enregistrée à la
Sous-Préfecture de Grasse (06) N° 7803/88

Important notice

Individual copies of the present document can be downloaded from:

<http://www.etsi.org>

The present document may be made available in more than one electronic version or in print. In any case of existing or perceived difference in contents between such versions, the reference version is the Portable Document Format (PDF). In case of dispute, the reference shall be the printing on ETSI printers of the PDF version kept on a specific network drive within ETSI Secretariat.

Users of the present document should be aware that the document may be subject to revision or change of status. Information on the current status of this and other ETSI documents is available at

<http://portal.etsi.org/tb/status/status.asp>

If you find errors in the present document, please send your comment to one of the following services:

http://portal.etsi.org/chaicor/ETSI_support.asp

Copyright Notification

No part may be reproduced except as authorized by written permission.
The copyright and the foregoing restriction extend to reproduction in all media.

© European Telecommunications Standards Institute 2007.
All rights reserved.

DECTTM, **PLUGTESTS**TM and **UMTS**TM are Trade Marks of ETSI registered for the benefit of its Members.
TIPHONTM and the **TIPHON logo** are Trade Marks currently being registered by ETSI for the benefit of its Members.
3GPPTM is a Trade Mark of ETSI registered for the benefit of its Members and of the 3GPP Organizational Partners.

Intellectual Property Rights

IPRs essential or potentially essential to the present document may have been declared to ETSI. The information pertaining to these essential IPRs, if any, is publicly available for **ETSI members and non-members**, and can be found in ETSI SR 000 314: *"Intellectual Property Rights (IPRs); Essential, or potentially Essential, IPRs notified to ETSI in respect of ETSI standards"*, which is available from the ETSI Secretariat. Latest updates are available on the ETSI Web server (<http://webapp.etsi.org/IPR/home.asp>).

Pursuant to the ETSI IPR Policy, no investigation, including IPR searches, has been carried out by ETSI. No guarantee can be given as to the existence of other IPRs not referenced in ETSI SR 000 314 (or the updates on the ETSI Web server) which are, or may be, or may become, essential to the present document.

Foreword

This Technical Specification (TS) has been produced by ETSI 3rd Generation Partnership Project (3GPP).

The present document may refer to technical specifications or reports using their 3GPP identities, UMTS identities or GSM identities. These should be interpreted as being references to the corresponding ETSI deliverables.

The cross reference between GSM, UMTS, 3GPP and ETSI identities can be found under <http://webapp.etsi.org/key/queryform.asp>.

Contents

Intellectual Property Rights	2
Foreword.....	2
Foreword.....	6
1 Scope	7
2 References	7
3 Definitions and abbreviations.....	8
3.1 Definitions	8
3.2 Abbreviations	8
4 MBMS Architecture	8
4.1 Overview	8
4.2 Reference Architecture Model	9
4.3 MBMS Specific Reference points	9
4.3.1 Gmb	9
4.3.2 Mz	10
4.4 MBMS Service Provision.....	10
4.4.1 MULTICAST MODE.....	10
4.4.1.1 Subscription	12
4.4.1.2 Service announcement	12
4.4.1.3 Joining.....	13
4.4.1.4 Session Start.....	13
4.4.1.5 MBMS notification	13
4.4.1.6 Data transfer	13
4.4.1.7 Session Stop	13
4.4.1.8 Leaving	13
4.4.2 Multicast Mode timeline	13
4.4.2.1 Period between Service Announcement and Session Start	13
4.4.2.2 Period between Service Announcement and Service Subscription	13
4.4.2.3 Period between Service Announcement and Joining	14
4.4.2.4 Period between Joining and Session Start	14
4.4.2.5 Period between Session Start and First Data Arrival	14
4.4.2.6 Period between Session Start and Session Stop	14
4.4.2.7 Session Update	14
4.4.3 BROADCAST MODE	14
4.4.3.1 Service announcement	16
4.4.3.1a UE local service activation.....	16
4.4.3.2 Session Start.....	16
4.4.3.3 MBMS notification	16
4.4.3.4 Data transfer	16
4.4.3.5 Session Stop	17
4.4.3.6 Session Update	17
4.4.4 Broadcast Mode timeline	17
4.4.4.1 Period between Service Announcement and Session Start	17
4.4.4.2 Period between Session Start and First Data Arrival	17
4.4.4.3 Period between Session Start and Session Stop	17
5 Functional Entities To Support MBMS.....	17
5.0 General	17
5.1 Broadcast-Multicast Service Centre (BM-SC).....	17
5.1.1 Membership Function	18
5.1.2 Session and Transmission Function.....	18
5.1.3 Proxy and Transport Function	19
5.1.4 Service Announcement Function.....	19
5.1.4a MBMS Security Function.....	19
5.1.5 MBMS Content Transfer for 2G and 3G for the same MBMS User Service	20

5.1.5.1	General	20
5.1.5.2	Separate MBMS Bearer Services for 2G and 3G for the same MBMS User Service	20
5.1.5.3	Same MBMS Bearer Service for 2G and 3G for the same MBMS User Service	20
5.2	User Equipment	20
5.3	UTRAN/GERAN	21
5.4	SGSN	21
5.5	GGSN	21
5.6	MBMS Data Sources and Content Provider	22
5.7	Other Functional Element	22
5.7.1	Void	22
5.7.2	CBC	22
5.7.3	Void	22
6	MBMS Attributes and Parameters	22
6.1	MBMS UE Context	22
6.2	MBMS Bearer Context	23
6.3	Quality-of-Service	25
6.3.1	MBMS QoS distribution tree	26
6.4	Temporary Mobile Group Identity	26
7	Architectural Aspects of MBMS User Services	26
7.1	Alternative User Service Support	26
7.2	Avoid overload in SGSN, GGSN and BM-SC caused by Joining	27
7.3	Access aspects of MBMS user services	27
8	MBMS Procedures	27
8.1	MBMS Notification	27
8.1.1	Iu mode notification (UTRAN and GERAN)	27
8.1.2	A/Gb mode notification (GERAN)	28
8.2	MBMS Multicast Service Activation	28
8.2.1	APN selection for the Direct MBMS Multicast Activation	30
8.3	MBMS Session Start Procedure	31
8.4	MBMS Registration Procedure	33
8.5	MBMS Session Stop Procedure	34
8.6	MBMS De-Registration Procedure	35
8.6.0	Common MBMS De-Registration procedure	35
8.6.1	BM-SC initiated MBMS De-Registration Procedure	36
8.7	MBMS Multicast Service Deactivation	37
8.8	MBMS Session Update procedure	40
8.8.1	General	40
8.8.2	SGSN initiated Session Update for MBMS Multicast service	40
8.8.3	BM-SC initiated Session Update for MBMS Broadcast service	40
8.9	MBMS UE Context Synchronisation Procedure	41
8.9a	MBMS feature support indication	42
8.10	Inter SGSN Routeing Area Update	42
8.10a	Inter-system Intra-SGSN change	44
8.11	Inter SGSN Serving RNS Relocation Procedure	44
8.12	MBMS Broadcast Service Activation	46
8.13	MBMS Broadcast service de-activation	46
8.14	Void	46
8.15	MBMS UE Linking/De-linking mechanism	46
8.16	MBMS Service Request Procedure	47
8.17	Notification in case of parallel services	48
8.17.1	Notification of incoming CS domain call during an ongoing MBMS session	48
8.17.2	Notification of additional MBMS session during an ongoing MBMS session	48
8.17.3	Notification of Mobile Terminating PS data during an ongoing MBMS session	48
8.17.4	Notification of MBMS session during an ongoing CS or PS domain "connection"	48
9	Security	48
10	Charging requirement	49
10.1	General	49
10.2	Bearer level charging for MBMS	49
10.3	Application level charging for MBMS	49

10.4	Generation of charging records in the VPLMN	49
11	Roaming Support for MBMS user services.....	50
11.1	Scenarios description.....	50
11.2	Scenario signalling flow	50
11.2.1	APN selection	50
Annex A (Informative):	Void	52
Annex B (Informative):	Change history	53
History		56

Foreword

This Technical Specification has been produced by the 3rd Generation Partnership Project (3GPP).

The contents of the present document are subject to continuing work within the TSG and may change following formal TSG approval. Should the TSG modify the contents of the present document, it will be re-released by the TSG with an identifying change of release date and an increase in version number as follows:

Version x.y.z

where:

- x the first digit:
 - 1 presented to TSG for information;
 - 2 presented to TSG for approval;
 - 3 or greater indicates TSG approved document under change control.
- y the second digit is incremented for all changes of substance, i.e. technical enhancements, corrections, updates, etc.
- z the third digit is incremented when editorial only changes have been incorporated in the document.

1 Scope

The present document describes the stage 2 description (architectural solution and functionalities) for the MBMS Bearer Service, which includes, together with MBMS User Services defined in TS 26.346 [7], all the elements necessary to realise the stage 1 requirements in TS 22.146 [2] and TS 22.246 [6].

The present document also includes considerations on the manner in which User Services should make use of the MBMS Bearer Service described herein. It should be noted that the specification of MBMS User Services in TS 26.346 [7] takes precedence over User Service aspects described in this document.

The present document includes information applicable to network operators, service providers and manufacturers.

2 References

The following documents contain provisions which, through reference in this text, constitute provisions of the present document.

- References are either specific (identified by date of publication, edition number, version number, etc.) or non-specific.
- For a specific reference, subsequent revisions do not apply.
- For a non-specific reference, the latest version applies. In the case of a reference to a 3GPP document (including a GSM document), a non-specific reference implicitly refers to the latest version of that document *in the same Release as the present document*.

- [1] 3GPP TR 21.905: "Vocabulary for 3GPP Specifications".
- [2] 3GPP TS 22.146: "Multimedia Broadcast/Multicast Service; Stage 1".
- [3] 3GPP TS 23.107: "Quality of Service (QoS) concept and architecture".
- [4] 3GPP TS 29.061: "Interworking between the Public Land Mobile Network (PLMN) supporting packet based services and Packet Data Networks (PDN)".
- [5] 3GPP TS 33.246: "Security of Multimedia Broadcast/Multicast Service".
- [6] 3GPP TS 22.246: "Multimedia Broadcast/Multicast Service (MBMS) user services".
- [7] 3GPP TS 26.346: "MBMS: Protocols and Codecs".
- [8] void.
- [9] void.
- [10] 3GPP TS 25.346: "Introduction of the Multimedia Broadcast Multicast Service (MBMS) in the Radio Access Network".
- [11] 3GPP TS 43.246: "Technical Specification Group GSM/EDGE Radio Access Network; Multimedia Broadcast Multicast Service (MBMS) in the GERAN".
- [12] 3GPP TS 23.125: "Overall high level functionality and architecture impacts of flow based charging; Stage 2".
- [13] 3GPP TS 23.003: "Numbering, addressing and identification".
- [14] 3GPP TS 32.422: "Subscriber and equipment trace; Trace control and Configuration Management (CM)".
- [15] 3GPP TS 23.060: "General Packet Radio Service (GPRS); Service description; Stage 2".

3 Definitions and abbreviations

3.1 Definitions

For the purposes of the present document, the terms and definitions defined in TR 21.905 [1] and TS 22.146 [2] and the following apply:

MBMS Service Announcement: Mechanism to allow users to be informed about the MBMS user services available.

MBMS Bearer Service: the service provided by the PS Domain to MBMS User Services to deliver IP multicast datagrams to multiple receivers using minimum network and radio resources.

MBMS User Service: the MBMS service provided to the end user by means of the MBMS Bearer Service and possibly other capabilities.

MBMS Service Area: The area within which data of a specific MBMS session are sent. Each individual MBMS session of an MBMS Bearer Service may be sent to a different MBMS Service Area. This MBMS Service Area is the same or a subset of the Multicast or Broadcast Service Area as defined in TS 22.146 [2]. An MBMS Service Area smaller than the Multicast or Broadcast Service Area is typically used for localized services.

3.2 Abbreviations

For the purposes of the present document, the abbreviations in TR 21.905 [1] and TS 22.146 [2] apply.

TMGI	Temporary Mobile Group Identity
TPF	Traffic Plane Function

4 MBMS Architecture

4.1 Overview

MBMS is a point-to-multipoint service in which data is transmitted from a single source entity to multiple recipients. Transmitting the same data to multiple recipients allows network resources to be shared.

The MBMS bearer service offers two modes:

- Broadcast Mode;
- Multicast Mode.

MBMS architecture enables the efficient usage of radio-network and core-network resources, with an emphasis on radio interface efficiency.

MBMS is realised by the addition of a number of new capabilities to existing functional entities of the 3GPP architecture and by addition of a number of new functional entities.

The existing PS Domain functional entities (GGSN, SGSN, UTRAN, GERAN and UE) are enhanced to provide the MBMS Bearer Service. In the bearer plane, this service provides delivery of IP Multicast datagrams from the Gi reference point to UEs with a specified Quality of Service. In the control plane, this service provides mechanisms for:

- managing the MBMS bearer service activation status of UEs (in the case of multicast mode);
- outsourcing authorisation decisions to the MBMS User Service (i.e. to the BM-SC) (in the case of multicast mode);
- providing control of session initiation/termination by the MBMS User Service and managing bearer resources for the distribution of MBMS data (in the case of multicast and broadcast modes).

A particular instance of the MBMS Bearer Service is identified by an IP Multicast Address and an APN Network Identifier.

The boundary of the MBMS Bearer Service is the Gmb and Gi reference points as shown in Figure 1 below. The former provides access to the control plane functions and the latter the bearer plane.

A functional entity, the Broadcast Multicast Service Centre (BM-SC) provides a set of functions for MBMS User Services. BM-SC functions for different MBMS User Services may be supported from the same or different physical network elements.

4.2 Reference Architecture Model

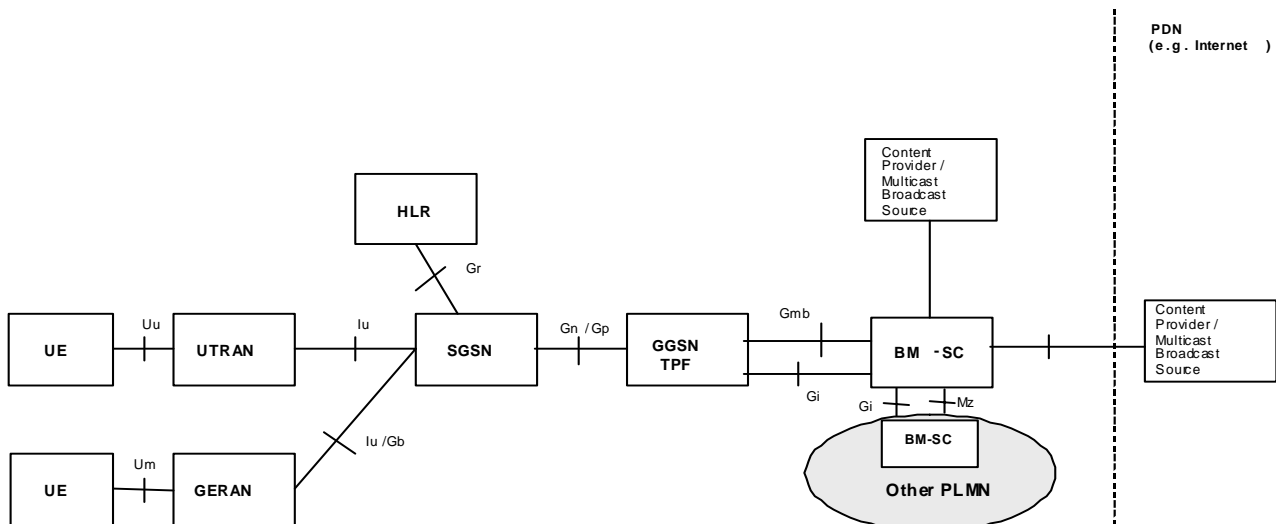

- Note 1: network entities and reference points solely used by the MBMS user service (e.g. for service announcement as described in section 4.4.1.2) are not shown in this figure.
- Note 2: Gp applies only when SGSN and GGSN are in different PLMNs.

Figure 1: Reference architecture to support the MBMS bearer service

4.3 MBMS Specific Reference points

4.3.1 Gmb

Signalling between GGSN and BM-SC is exchanged at Gmb reference point. This represents the network side boundary of the MBMS Bearer Service from a control plane perspective. This includes user specific Gmb signalling and MBMS bearer service specific signalling.

MBMS bearer service specific Gmb signalling:

- The GGSN establishes the MBMS bearer context and registers at BM-SC.
- The GGSN or the BM-SC releases the MBMS bearer context and de-registers the GGSN from the BM-SC.
- The BM-SC indicates session start and stop to the GGSN including session attributes like QoS and MBMS service area.

User specific Gmb signalling:

- The BM-SC authorises the user specific MBMS multicast service activation (join) at the GGSN.
- The GGSN reports to the BM-SC the successful user specific MBMS multicast activation (join) to allow the BM-SC to synchronise the BM-SC MBMS UE context with the MBMS UE contexts in the SGSN and GGSN.

- The GGSN reports to the BM-SC when a user specific MBMS multicast service is released or deactivated (e.g. at implicit detach). The GGSN makes this report in order to synchronise the BM-SC MBMS UE context with the MBMS UE contexts in the SGSN and GGSN.

The BM-SC initiates the deactivation of a user specific MBMS bearer service when the MBMS user service is terminated.

BM-SC functions for different MBMS bearer services may be provided by different physical network elements. Further, MBMS bearer service specific and user specific signalling for the same MBMS bearer service may also be provided by different physical network elements. To allow this distribution of BM-SC functions, the Gmb protocol must support the use of proxies to correctly route the different signalling interactions in a manner which is transparent to the GGSN.

4.3.2 Mz

Mz is the roaming variant of the Gmb reference point with the same functionality as described under Gmb, i.e. with MBMS bearer and User specific signalling.

MBMS bearer and User specific Mz signalling is used between a BM-SC in the visited PLMN and a BM-SC in the home PLMN when MBMS services from the home PLMN are offered by the visited PLMN.

User specific signalling is used between a BM-SC in the visited PLMN and a BM-SC in the home PLMN when the visited PLMN offers MBMS user services to roaming users. This user specific Mz signalling provides home PLMN authorisation for MBMS user services that are provided by the visited PLMN. This mechanism supports only MBMS user service classes that are offered by the visited and by the home PLMN.

Mz may use proxying capabilities as described for Gmb, e.g. to proxy signalling between BM-SCs. An APN may be included in the signalling between BM-SCs, which is used to select an appropriate GGSN to access the MBMS service aiming for an optimized routing, resource saving, or operator policy.

4.4 MBMS Service Provision

4.4.1 MULTICAST MODE

Reception of an MBMS MULTICAST service is enabled by certain procedures that are illustrated in the Figure below.

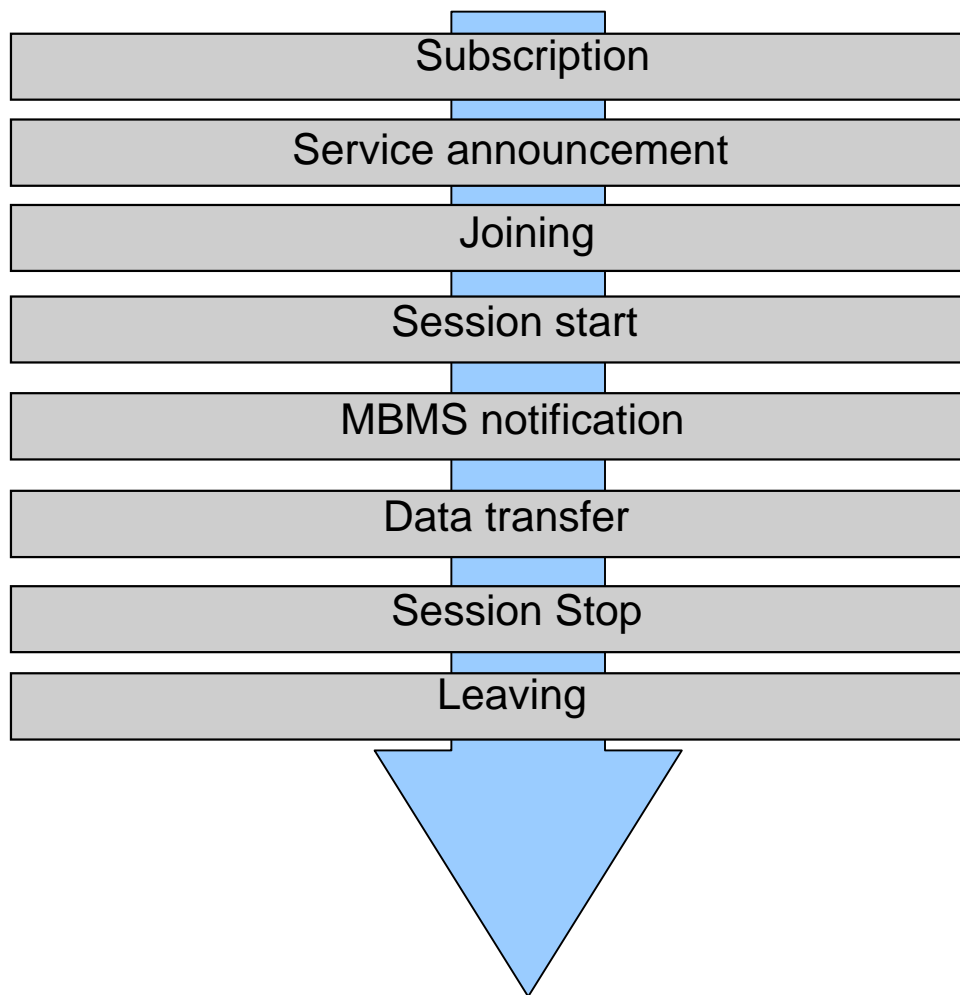

Figure 2: Phases of MBMS Multicast service provision

The phases subscription, joining and leaving are performed individually per user. The other phases are performed for a service, i.e. for all users interested in the related service. The sequence of phases may repeat, e.g. depending on the need to transfer data. Also subscription, joining, leaving, service announcement as well as MBMS notification may run in parallel to other phases.

This is illustrated with the following example of timeline:

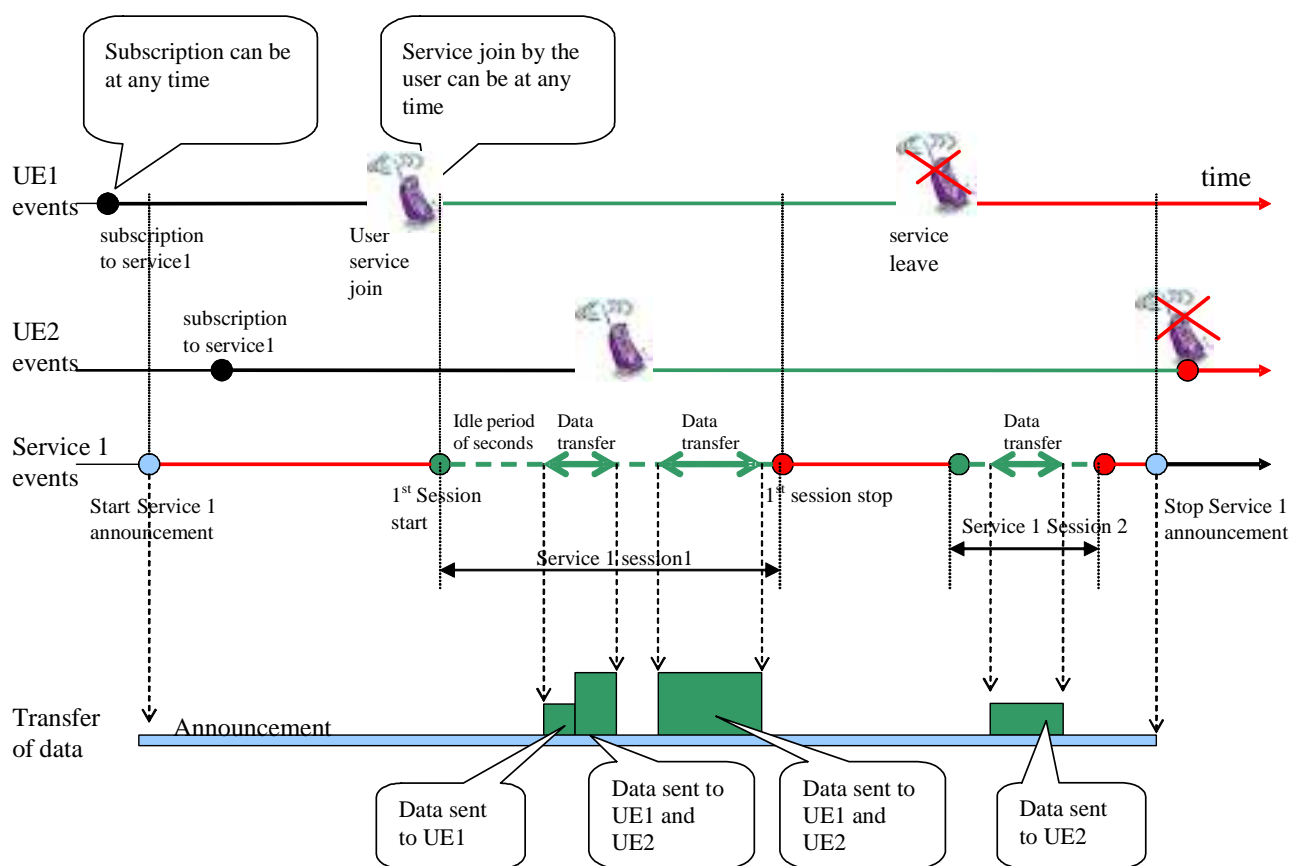

Figure 3: Timeline example

4.4.1.1 Subscription

Establishes the relationship between the user and the service provider, which allows the user to receive the related MBMS multicast service.

Service Subscription is the agreement of a user to receive service(s) offered by the operator. Subscription information is recorded in the BM-SC. Subscription information and other BM-SC functionality may be on separate entities, which is enabled by proxy capability of the Gmb interface.

NOTE: procedures for the subscription phase are out of scope of this specification.

4.4.1.2 Service announcement

MBMS user service announcement/discovery mechanisms shall allow users to request or be informed about the range of MBMS user services available. This includes operator specific MBMS user services as well as services from content providers outside of the PLMN. Service announcement is used to distribute to users information about the service, parameters required for service activation (e.g. IP multicast address(es)) and possibly other service related parameters (e.g. service start time).

Operators/service providers may consider several service discovery mechanisms. This could include standard mechanisms such as SMS, or depending on the capability of the terminal, applications that encourage user interrogation. The method chosen to inform users about MBMS user services may have to account for the user's location, (e.g. current cell, in the HPLMN or VPLMN). Users who have not already subscribed to a MBMS user service should also be able to discover MBMS user services.

The following could be considered useful for MBMS user service announcement mechanisms (not exhaustive):

- SMS Cell Broadcast to advertise MBMS Multicast and Broadcast user services;

- MBMS Broadcast mode to advertise MBMS Multicast and Broadcast user Services;
- MBMS Multicast mode to advertise MBMS Multicast user Services;
- PUSH mechanism (WAP, SMS-PP, MMS);
- URL (HTTP, FTP).

The details of the MBMS service announcement mechanisms are out of scope of this specification, but MBMS shall allow the utilisation of solutions using IETF protocols.

Service announcement is further defined within MBMS User Service specifications TS 26.346 [7].

4.4.1.3 Joining

Joining (i.e. MBMS multicast activation by the user) is the process by which a subscriber joins (becomes a member of) a multicast group, i.e. the user indicates to the network that he/she wants to receive Multicast mode data of a specific MBMS bearer service. An MBMS user service may also be carried by more than one MBMS bearer service. In that case the MBMS user service part in the UE initiates the relevant MBMS bearer services to receive the service (see subclause 8.2).

4.4.1.4 Session Start

Session Start is the point at which the BM-SC is ready to send data. This can be identified with the start of a "Multicast session" as defined in TS 22.146 [2]. Session Start occurs independently of activation of the service by the user – i.e. a given user may activate the service before or after Session Start. Session Start is the trigger for bearer resource establishment for MBMS data transfer. If an MBMS user service is carried by more than one MBMS bearer service, a Session Start message is sent for each MBMS bearer service. In that case the UE may need to initiate the reception of multiple relevant MBMS bearer services to receive the MBMS user service.

4.4.1.5 MBMS notification

Informs the UEs about forthcoming (and potentially about ongoing) MBMS multicast data transfer.

4.4.1.6 Data transfer

It is the phase when MBMS data are transferred to the UEs.

4.4.1.7 Session Stop

It is the point at which the BM-SC determines that there will be no more data to send for some period of time – this period being long enough to justify removal of bearer resources associated with the session. At Session Stop, the bearer resources are released.

4.4.1.8 Leaving

Leaving (i.e. MBMS multicast deactivation by the user) is the process by which a subscriber leaves (stops being a member of) a multicast group, i.e. the user no longer wants to receive Multicast mode data of a specific MBMS bearer service.

4.4.2 Multicast Mode timeline

4.4.2.1 Period between Service Announcement and Session Start

The service announcement may contain a schedule of Session Start times and may be sent some time before the service is due to start. So, this time period could be hours, days or even weeks.

4.4.2.2 Period between Service Announcement and Service Subscription

Service Subscription can be done anytime before or after Service announcement.

4.4.2.3 Period between Service Announcement and Joining

The Joining time is chosen by the user and/or UE possibly in response to a Service Announcement. Users will typically join at the time of their choosing so that the period between announcement and joining may be very long or very short. In order to avoid overload situations being caused by many users attempting to join in a short period of time, the UE shall be able to use parameters sent by the BM-SC in the service announcement to randomise the joining time.

4.4.2.4 Period between Joining and Session Start

Some MBMS bearer services may be 'always on'. In this case, Joining can take place immediately after Service Announcement and possibly many hours before, or after, Session Start.

In other cases, if a Session Start time is known, Joining may take place immediately before Session Start or after Session Start. For these services, the announcement may contain some indication of a time period which users and UEs should use to choose a time to Join the MBMS bearer service.

4.4.2.5 Period between Session Start and First Data Arrival

Session Start indicates that the transmission is about to start. The time delay between a Session Start indication and actual data should be long enough for the network actions required at Session Start to take place e.g. provision of service information to the UTRAN, establishment of the bearer plane.

Session Start may be triggered by an explicit notification from the BM-SC. In the case of bearer plane resources which are set-up after the start of session data transmission, the network is not required to buffer the session data and loss of data can be assumed.

4.4.2.6 Period between Session Start and Session Stop

When the BM-SC knows that there is no more data to be sent for a "long idle period", it should indicate Session Stop to the network, causing the release of bearer resources. However, if this idle period with no data is short, this may not be appropriate as it brings more signalling and processing.

The duration of this "long idle period" is implementation dependent. The order of magnitude should be defined to take into account network constraints (including UTRAN, GERAN, and CN).

If the BM-SC wants to use session repetition identification on the MBMS bearer service level, the BM-SC must stop the MBMS session before starting the next MBMS user service session for that TMGI.

4.4.2.7 Session Update

Session Update is used to update specific parameters of an ongoing MBMS Multicast session. The SGSN can use the procedure to update the list of RAs where MBMS multicast users are located for an ongoing MBMS Multicast service session.

4.4.3 BROADCAST MODE

An example for the phases of MBMS broadcast service provision is described in the figure below:

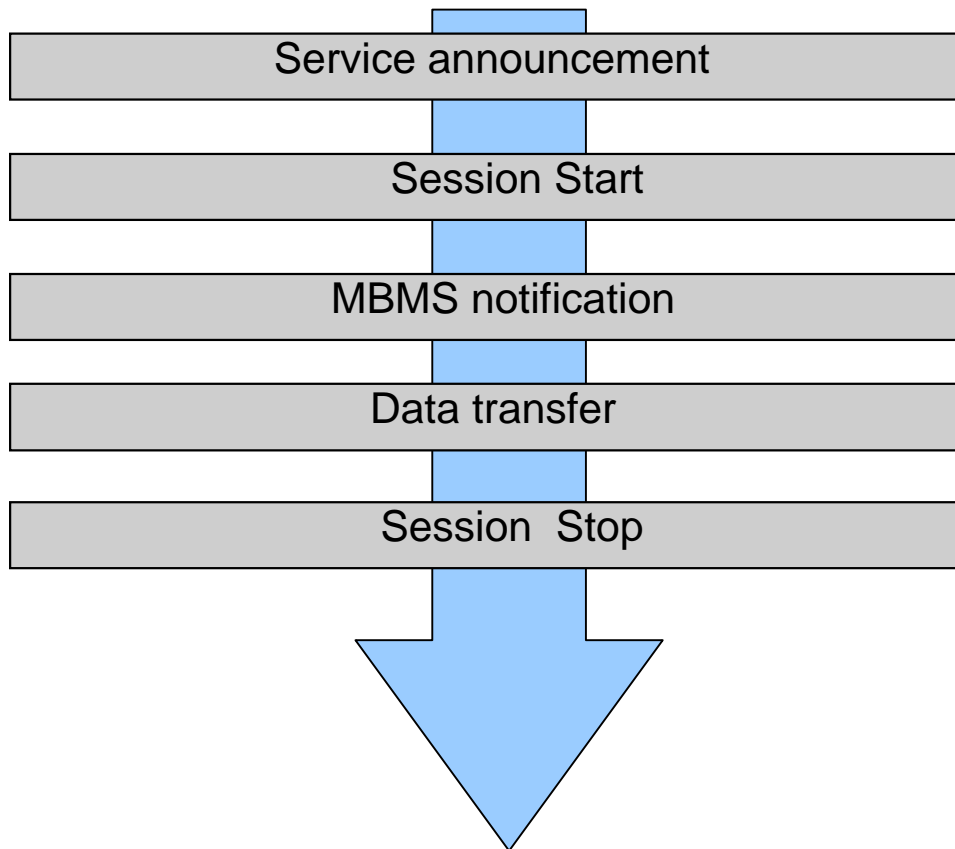

Figure 4: Phases of MBMS broadcast service provision

The sequence of phases may repeat, e.g. depending on the need to transfer data. It is also possible that the service announcement and MBMS notification phase may run in parallel with other phases, in order to inform UEs which have not yet received the related service.

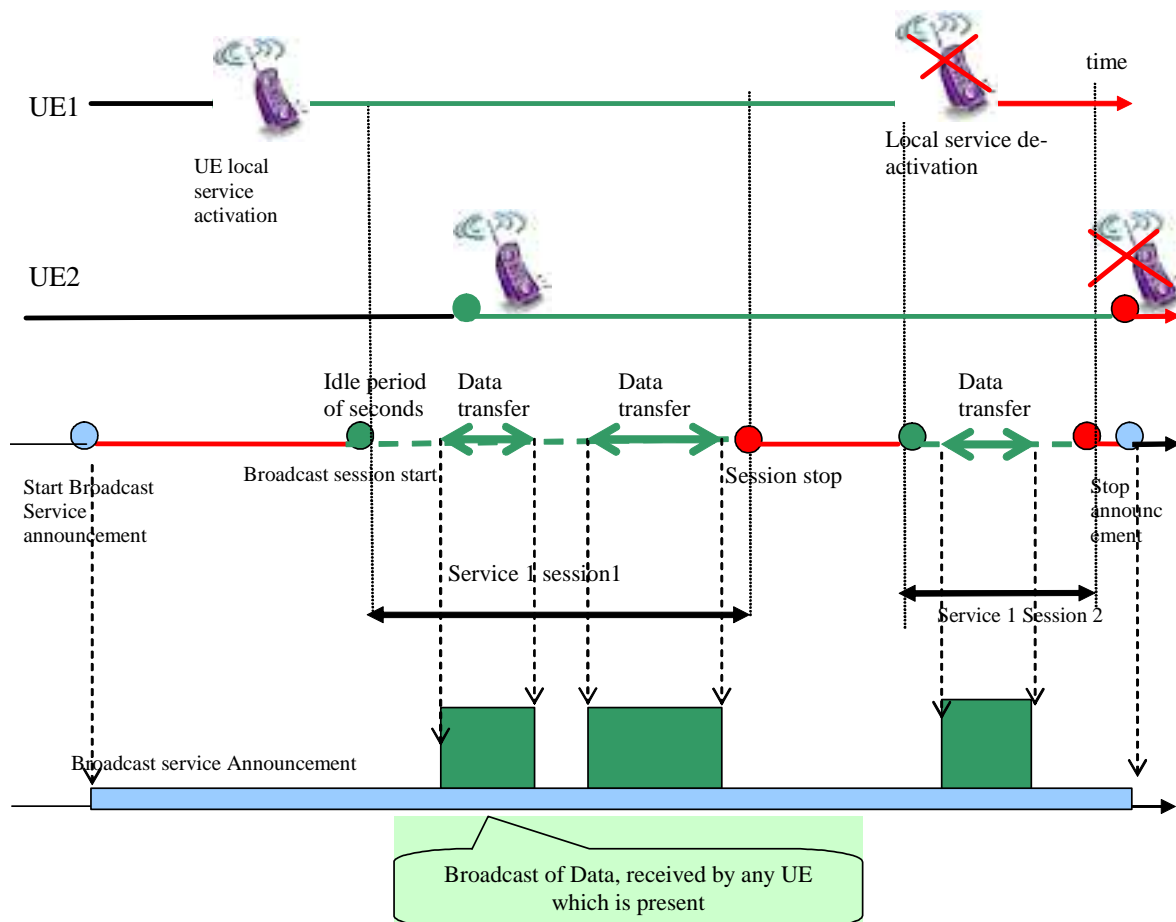

Figure 5: Broadcast service timeline

4.4.3.1 Service announcement

Informs UEs about forthcoming MBMS user services. Also see section on Multicast mode (4.4.1.2).

4.4.3.1a UE local service activation

The MBMS user service part in the UE initiates reception of the MBMS bearer service to receive an MBMS user service. In case one MBMS user service is carried by more than one MBMS bearer service, the UE may need to initiate the reception of multiple relevant MBMS bearer services to receive the MBMS user service (see subclause 8.12).

4.4.3.2 Session Start

Session Start is the point at which the BM-SC is ready to send data. This can be identified with the start of a "Broadcast session" as defined in TS 22.146 [2]. Session Start occurs independently of Service Activation by the user – i.e. a given user may activate the service before or after the start of the session. Session Start is the trigger for bearer resource establishment for MBMS data transfer. If an MBMS user service is carried by more than one MBMS bearer service, a Session Start message is sent for each MBMS bearer service. In that case the UE may need to initiate the reception of multiple relevant MBMS bearer services to receive the MBMS user service.

4.4.3.3 MBMS notification

Informs the UEs about forthcoming (and potentially about ongoing) MBMS broadcast data transfer.

4.4.3.4 Data transfer

It is the phase when MBMS data are transferred to the UEs.

4.4.3.5 Session Stop

It is the point at which the MBMS user service determines that there will be no more data to send for some period of time – this period being long enough to justify removal of bearer resources associated with the service. At Session Stop, the bearer resources are released.

4.4.3.6 Session Update

Session Update is used to update specific parameters of an ongoing MBMS Broadcast session. Parameters which can be updated are MBMS Service Area, and/or the List of SGSNs (only from BM-SC to GGSN). A Session Update received in one node, results in a Session Update being sent to downstream nodes, to inform of the changed MBMS Service Area. When a Session Update is received in the GGSN including the List of SGSN parameter, it results in a Session Start being sent to new downstream nodes, and in a Session Stop being sent to downstream nodes that have been removed from the list.

4.4.4 Broadcast Mode timeline

4.4.4.1 Period between Service Announcement and Session Start

Same as for Multicast mode.

4.4.4.2 Period between Session Start and First Data Arrival

Same as for Multicast mode.

4.4.4.3 Period between Session Start and Session Stop

Same as for Multicast mode.

5 Functional Entities To Support MBMS

5.0 General

To provide MBMS bearer services existing functional entities, GGSN, SGSN, RNC/BSC, perform several MBMS related functions and procedures, some of which are specific to MBMS. An MBMS specific functional entity – Broadcast Multicast Service Centre (BM-SC) supports various MBMS user service specific services such as provisioning and delivery.

5.1 Broadcast-Multicast Service Centre (BM-SC)

The BM-SC provides functions for MBMS user service provisioning and delivery. It may serve as an entry point for content provider MBMS transmissions, used to authorise and initiate MBMS Bearer Services within the PLMN and can be used to schedule and deliver MBMS transmissions.

The BM-SC is a functional entity, which must exist for each MBMS User Service.

The BM-SC consists of five sub-functions:

- Membership function;
- Session and Transmission function;
- Proxy and Transport function;
- Service Announcement function;
- Security function.

This section describes BM-SC functions, which are defined for the standardised MBMS User Services.

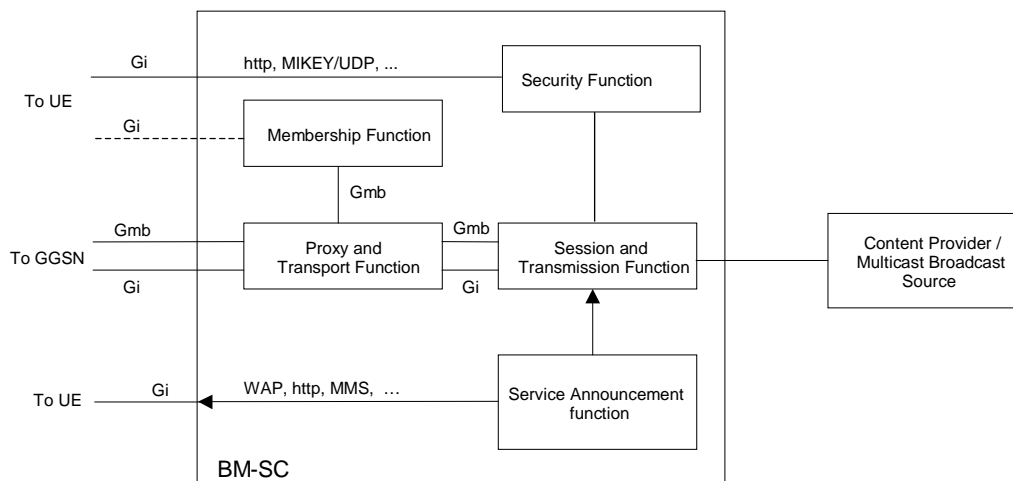

Figure 5a: BM-SC functional structure

5.1.1 Membership Function

The BM-SC Membership function provides authorization for UEs requesting to activate an MBMS service.

The Membership function may have subscription data of MBMS service users.

The Membership Function may generate charging records for MBMS service users.

The Membership Function is an MBMS bearer service level function, but it may also provide user service level functions e.g. membership management etc. In this case it does also have a Gi interface.

5.1.2 Session and Transmission Function

The BM-SC Session and Transmission Function shall be able to schedule MBMS session transmissions.

The BM-SC Session and Transmission Function should be able to schedule MBMS session retransmissions, and label each MBMS session with an MBMS Session Identifier to allow the UE to distinguish the MBMS session retransmissions. The BM-SC Session and Transmission Function allocates TMGIs.

Each transmission and subsequent retransmission(s) of a specific MBMS session are identifiable by a common MBMS Session Identifier (2-3 Octets) passed at the application layer in the content, and also passed in a shortened form (i.e. the least significant octet) in the MBMS Session Start Request message to the RNCs/BSCs. The full MBMS Session Identifier should be used by the UE to identify an MBMS session when completing point-to-point repair, while the shortened MBMS Session Identifier is included by the RANs in the notification messages for MBMS

The BM-SC Session and Transmission Function shall be able to provide the GGSN with transport associated parameters such as quality-of-service and MBMS service area.

The BM-SC Session and Transmission Function shall be able to initiate and terminate MBMS bearer resources prior to and following transmission of MBMS data.

The BM-SC Session and Transmission Function should be able to send MBMS data. It could also apply favourable error resilient schemes e.g. specialized MBMS codecs or Forward Error Correction schemes.

The BM-SC Session and Transmission Function should be able to authenticate and authorize external sources and accept content from them.

The Session and Transmission Function is user service level function and it triggers bearer level functions when MBMS sessions are scheduled.

5.1.3 Proxy and Transport Function

The BM-SC Proxy and Transport Function is a Proxy Agent for signalling over Gmb reference point between GGSNs and other BM-SC sub-functions, e.g. the BM-SC Membership Function and the BM-SC Session and Transmission Function. Further, the BM-SC Proxy and Transport Function shall also be able to handle when BM-SC functions for different MBMS services are provided by multiple physical network elements. Routing of the different signalling interactions shall be transparent to the GGSN.

The BM-SC Proxy and Transport function shall be able to generate charging records for content provider charging of transmitted data. Content provider name is provided to BM-SC Proxy and Transport function over Gmb at session start.

The BM-SC Proxy and Transport function may act as an intermediate device for the MBMS data sent from the BM-SC Session and Transmission function to the GGSN.

The Proxy and Transport Function may be divided further into a Proxy function managing the control plane (Gmb) and a Transport function managing the multicast payload.

The Proxy and Transport Function is an MBMS bearer service function.

5.1.4 Service Announcement Function

The BM-SC Service Announcement function shall be able to provide service announcements for multicast and broadcast MBMS user services.

The BM-SC Service Announcement function shall be able to provide the UE with media descriptions specifying the media to be delivered as part of an MBMS user service (e.g. type of video and audio encodings).

The BM-SC Service Announcement function shall be able to provide the UE with MBMS session descriptions specifying the MBMS sessions to be delivered as part of an MBMS user service (e.g. multicast service identification, addressing, time of transmission, etc.).

The BM-SC Service Announcement function shall be able to deliver media and session descriptions by means of service announcements using IETF specified protocols over MBMS multicast and broadcast bearer services.

The Service Announcement Function is a user service level function.

The following mechanisms should be supported for service announcement. Service announcements may be triggered by the BM-SC but are not necessarily sent by the BM-SC:

- MBMS bearer capabilities to advertise MBMS user Services;
- PUSH mechanism (WAP push);
- URL (WAP, HTTP);
- SMS (point-to-point);
- SMS-CB cell broadcast.

Other mechanisms could be considered in future releases.

5.1.4a MBMS Security Function

MBMS user services may use the Security functions for integrity and/or confidentiality protection of MBMS data. The MBMS Security function is used for distributing MBMS keys (Key Distribution Function) to authorized UEs. Detailed description of the security functions is provided in (TS 33.246 [5]).

5.1.5 MBMS Content Transfer for 2G and 3G for the same MBMS User Service

5.1.5.1 General

Although these procedures mention 2G and 3G extensively, only the BM-SC (which renders the content differently) and the SGSN have to implement functionality to deliver this. The GGSN, RNC and BSC shall all be transparent to this functionality.

5.1.5.2 Separate MBMS Bearer Services for 2G and 3G for the same MBMS User Service

The same MBMS user service may transfer its data on separate MBMS bearer services for 2G or 3G coverage, typically with different QoS. For this purpose two IP multicast addresses and the associated two TMGIs should be allocated for the same MBMS user service. One pair of IP multicast address and TMGI is for 2G coverage and another pair of IP multicast address and TMGI is for 3G coverage. The detailed impacts on the network nodes are listed below:

- a) The service announcement instructs the UE to join two multicast MBMS bearer services (one is for 2G coverage and the other is for 3G coverage), i.e. two IP multicast addresses that are allocated in the BM-SC are sent to UE within one service announcement message.

NOTE 1: One MBMS User Service may use several MBMS Bearer Services.

- b) A UE that might move between 3G coverage areas and 2G coverage areas activates both MBMS bearer services.
- c) The UE monitors the paging/notification channels for both TMGIs and receives MBMS data when transferred by the MBMS bearer services.
- d) When the BM-SC needs to deliver the content, the BM-SC produces two sets of MBMS data from the same content and sends independent Session Start messages for both of the MBMS bearer services. The "different" 2G and 3G content streams for the same MBMS user service are sent on the different IP multicast address associated with 2G and 3G TMGIs. A 2G/3G indicator in the Session Start message (which the GGSN passes transparently to the SGSN) indicates whether the content should be delivered in 2G-only or 3G-only (or both) coverage areas.
- e) The SGSN uses the 2G/3G indicator to decide whether a MBMS Session Start Request message should be sent to the BSCs and/or the RNCs.

NOTE 2: See subclause 7.3 for potential issues.

5.1.5.3 Same MBMS Bearer Service for 2G and 3G for the same MBMS User Service

The same MBMS user service may also transfer its data on the same MBMS bearer service for both 2G and 3G coverage. For this purpose one IP multicast addresses and the associated TMGI should be allocated for the same MBMS user service. In such application, the "different" 2G and 3G content for the same MBMS user service are sent in separate MBMS Sessions sequentially. The 2G/3G indicator in the Session Start message indicates whether the MBMS session should be delivered in 2G-only or 3G-only (or both) coverage areas. The SGSN uses the 2G/3G indicator to decide whether a MBMS Session Start Request message should be sent to the BSCs and/or the RNCs.

5.2 User Equipment

The UE shall support functions for the activation/deactivation of the MBMS bearer service.

Once a particular MBMS bearer service is activated, no further explicit user request is required to receive MBMS data although the user may be notified that data transfer is about to start.

The UE shall support security functions as appropriate for MBMS.

The UE should, depending on terminal capabilities, be able to receive MBMS user service announcements, paging information (non MBMS specific) and support simultaneous services (for example the user can originate or receive a call or send and receive messages whilst receiving MBMS video content). Reception of this paging or announcements

may however, create losses in the MBMS data reception. The MBMS user service should be able to cope with such losses.

The UE shall be able to synchronise with the SGSN, which of its MBMS UE contexts are still active.

Depending upon terminal capability, UEs may be able to store MBMS data. This may involve DRM but this is out of scope of this specification.

The MBMS Session Identifier contained in the notification to the UE shall enable the UE to decide whether it needs to ignore the forthcoming transmission of MBMS session (e.g. because the UE has already received this MBMS session).

5.3 UTRAN/GERAN

UTRAN/GERAN are responsible for efficiently delivering MBMS data to the designated MBMS service area.

Efficient delivery of MBMS data in multicast mode may require mechanisms in the UTRAN/GERAN, e.g. the number of users within a cell prior to and during MBMS transmission could be used to choose an appropriate radio bearer.

MBMS transmissions may be initiated and terminated intermittently. The UTRAN/GERAN shall support the initiation and termination of MBMS transmissions by the core-network. Further, the UTRAN/GERAN shall be able to receive MBMS data from the core-network over Iu bearers shared by many UEs.

The UTRAN/GERAN shall support both intra-RNC/BSC and inter-RNC/BSC mobility of MBMS receivers. Mobility is expected to cause limited data loss. Therefore, MBMS user services should be able to cope with potential data loss caused by UE mobility.

The UTRAN/GERAN shall be able to transmit MBMS user service announcements, paging information (non MBMS specific) and support other services in parallel with MBMS (for example depending on terminal capabilities the user could originate or receive a call or send and receive messages whilst receiving MBMS video content).

5.4 SGSN

The SGSN's role within the MBMS architecture is to perform MBMS bearer service control functions for each individual UE and to provide MBMS transmissions to UTRAN/GERAN.

The SGSN shall provide support for intra-SGSN and inter-SGSN mobility procedures. Specifically this requires the SGSN to store a user-specific MBMS UE context for each activated multicast MBMS bearer service and to pass these contexts to the new SGSN during inter-SGSN mobility procedures.

The SGSN shall be able to indicate its MBMS support to the UE as well as it shall be able to synchronise with the UE, which of the UE's MBMS UE contexts are still active.

The SGSN shall be able to generate charging data per multicast MBMS bearer service for each user. The SGSN does not perform on-line charging for either the MBMS bearer service or the MBMS user service (this is handled in the BM-SC).

The SGSN shall be able to establish Iu and Gn bearers shared by many users upon receiving a session start from the GGSN. Likewise, the SGSN shall be able to tear down these bearers upon instruction from the GGSN.

5.5 GGSN

The GGSN role within the MBMS architecture is to serve as an entry point for IP multicast traffic as MBMS data. Upon notification from the BM-SC the GGSN shall be able to request the establishment of a bearer plane for a broadcast or multicast MBMS transmission. Further, upon BM-SC notification the GGSN shall be able to tear down the established bearer plane. Bearer plane establishment for multicast services is carried out towards those SGSNs that have requested to receive transmissions for the specific multicast MBMS bearer service.

The GGSN shall be able to receive MBMS specific IP multicast traffic and to route this data to the proper GTP tunnels set-up as part of the MBMS bearer service.

The GGSN may also provide features that support the MBMS bearer service that are not exclusive to MBMS. Examples are:

- Message Screening (not needed if the MBMS sources are internal in the PLMN);
- Charging Data Collection;
- Flow Based Charging (see section 10).

5.6 MBMS Data Sources and Content Provider

The reference point from the content provider to the BM-SC is not standardised by 3GPP in this release of the specification.

5.7 Other Functional Element

5.7.1 Void

5.7.2 CBC

The Cell Broadcast Centre (CBC) may be used to announce MBMS user services to the users.

5.7.3 Void

6 MBMS Attributes and Parameters

6.1 MBMS UE Context

The MBMS UE Context contains UE-specific information related to a particular MBMS bearer service that the UE has joined. An MBMS UE Context is created in the UE, SGSN, GGSN and BM-SC Membership function when the UE joins an MBMS bearer service. In the SGSN, an MBMS UE Context is also created as a result of an inter-SGSN routing area update after the transfer of the MBMS UE Context from the old SGSN.

In Iu mode, all MBMS UE Contexts of a UE are provided via MBMS UE Linking mechanism to the BSC/SRNC at least when the first PS RAB is established for the UE, or when the UE performs MBMS Multicast Service Activation. MBMS UE Contexts are provided to the Iu mode BSC/SRNC regardless whether MBMS Sessions are ongoing or not (i.e. before, between and after Sessions). In addition, all MBMS UE Contexts of a UE are provided via MBMS UE Linking mechanism when a UE, which has an MBMS UE Context active, moves to PMM-Connected state via the MBMS Service Request procedure for the purpose of MBMS.

In the UE and SGSN, the MBMS UE Context is stored as part of the MM Context for the UE. The MBMS UE Context is stored in the GGSN. There is one MBMS UE Context per MBMS bearer service that the UE has joined.

In the Iu mode BSC/RNC, the MBMS UE Contexts are stored as part of the UE Context of the BSC/RNC.

The content of the MBMS UE Context is described in Table 1.

Table 1: MBMS UE Context

Parameter	Description	UE	SGSN	GGSN	RNC	BSC	BM-SC
IP multicast address	IP multicast address identifying an MBMS bearer that the UE has joined.	X	X	X	X	Iu - X Gb - none	X
APN	Access Point Name on which this IP multicast address is defined.	X	X	X	X	Iu - X Gb - none	X
GGSN Address in Use	The IP address of the GGSN currently used		X				
SGSN address	The IP address of SGSN			X			
TMGI	Temporary Mobile Group Identity allocated to the MBMS bearer.	X	X		X	Iu - X Gb - none	
RAI	The Routing Area Identity		(5)				
Linked NSAPI	NSAPI of the PDP context used by the UE to carry IGMP/MLD signalling.	X	X				
IMSI	IMSI identifying the user.	(1)	(1)	X	(2)	Iu - (2) Gb - (3)	X
TI	Transaction Identifier	X	X				
TEID for Control Plane	The Tunnel Endpoint Identifier for the control plane between SGSN and GGSN.		X	X			
MBMS_NSAPI	Network layer Service Access Point Identifier which identifies an MBMS UE Context.	X	X	X	X		
Additional MBMS Trace Info	Identifies additional information required to perform trace.		(4)	(4)			(4)
Trace Reference	Identifies a record or a collection of records for a particular trace.		(4)	(4)	(4)	(4)	
Trace Type	Indicates the type of trace.		(4)	(4)	(4)	(4)	
Trigger Id	Identifies the entity that initiated the trace.		(4)	(4)	(4)	(4)	
OMC Identity	Identifies the OMC that shall receive the trace record(s).		(4)	(4)	(4)	(4)	
(1) In the UE and SGSN, the IMSI is available within the MM Context which contains the MBMS UE Context. (2) The IMSI is available within the UE Context which contains the MBMS UE Context. (3) IMSI availability does not depend on MBMS. (4) Trace parameters are only stored if trace is activated. (5) RAI is available within the MM Context of the UE.							

6.2 MBMS Bearer Context

The MBMS Bearer Context, which is referred to as MBMS Service Context in RAN, contains all information describing a particular MBMS bearer service and is created in each node involved in the delivery of the MBMS data.

An MBMS Bearer Context is created in the SGSN and GGSN when the first MBMS UE Context is created in the node or when a downstream node requests it. The MBMS Bearer Context is statically configured in the BM-SC Proxy and Transport Function; how this is done is out of the scope of this specification. The MBMS Bearer Context is created in the Iu mode BSC and in SRNC when a first MBMS UE Context is created in BSC/SRNC. MBMS Session Start procedure may create MBMS Bearer Context in a BSC/RNC which has no MBMS Bearer Context yet.

An MBMS Bearer Context, once created, can be in one of two states reflecting the bearer plane resource status of the corresponding MBMS bearer service.

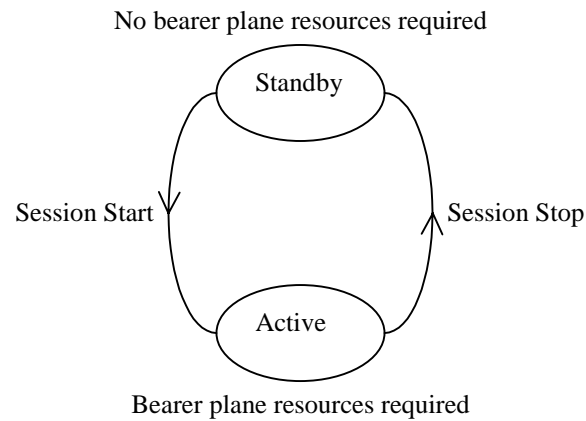

Figure 6: MBMS Bearer Context State Model

'Active' reflects the state of an MBMS Bearer Context in which bearer plane resources are required in the network for the transfer of MBMS data. This state is maintained as long as there is a corresponding MBMS session ongoing.

'Standby' reflects the state of an MBMS Bearer Context in which no bearer plane resources are required in the network for the transfer of MBMS data. This state is maintained as long as there is no corresponding MBMS session ongoing.

The content of the MBMS Bearer Context is described in Table 2.

Table 2: MBMS Bearer Context

Parameter	Description	RAN	SGSN	GGSN	BM-SC
Multicast/broadcast mode	MBMS bearer service in broadcast or multicast mode	X	X	X	X
IP multicast address (multicast mode only)	IP multicast address identifying the MBMS bearer described by this MBMS Bearer Context.	X	X	X	X
APN (multicast mode only)	Access Point Name on which this IP multicast address is defined.	X	X	X	X
TMGI	Temporary Mobile Group Identity allocated to the MBMS bearer service.	X	X	X	X
GGSN TEID-C	Tunnel Endpoint Identifier of GGSN for control plane.		X		
GGSN IP Address for Control Plane in use	The IP address of the GGSN used for the control plane.		X (note 4)		
GGSN TEID-U	Tunnel Endpoint Identifier of GGSN for user plane.		X		
GGSN IP Address for User Plane in use	The IP address of the GGSN used for the user plane.		X (note 4)		
State	State of bearer plane resources ('standby' or 'active')	X	X	X	X
Required MBMS Bearer Capabilities (multicast mode only)	Minimum bearer capabilities the UE needs to support		X	X	X
QoS	Quality of Service required for the MBMS bearer service.	X	X	X	X
MBMS Service Area	Area over which the MBMS bearer service has to be distributed.	X	X	X	X
List of downstream nodes	List of downstream nodes that have requested the MBMS bearer service and to which notifications and MBMS data have to be forwarded.		X (note 5)	X (notes 3, 4)	X
Number of UEs (multicast mode only)	Number of UEs hosted by the node that have joined the multicast MBMS bearer service.		X	X	
List of PMM-CONNECTED UEs	List of PMM-CONNECTED UEs which have activated an MBMS service.	X ²⁾			
List of RAs (multicast mode only)	List of RAs, each of which contains at least one UE that has joined the MBMS bearer service.	X ¹⁾	X ¹⁾		
NOTE 1: It is an optional parameter. NOTE 2: It is available only for UTRAN, not for GERAN. NOTE 3: For GGSN, the list at least includes the couples of the SGSN IP addresses and TEIDs for control plane, and the couples for user plane. NOTE 4: GSN that supports both IPv4 and IPv6 address types, stores only the IP address in use. NOTE 5: For GGSN, the list includes the registered DRNC.					

6.3 Quality-of-Service

It shall be possible for the network to control quality-of-service parameters for sessions of multicast and broadcast MBMS bearer services. All QoS attributes related to the UMTS bearer service described in TS 23.107 [3] are applicable to MBMS bearer services. Compared to point-to-point bearer services the following limitations exist:

- For **traffic class**, only the background and streaming classes shall be supported.
- For **SDU error ratio**, only higher values are supported, i.e. the values describing higher numbers of lost or corrupted SDUs (actual values are for the background and streaming classes are 10^{-2} and 10^{-1}).
- For **maximum bit-rate**, see the values described in TS 22.246 [6].
- For **Guaranteed bit rate** of the Streaming Traffic Class: depending on radio resource usage by other services, some cells of the MBMS Service Area may not have sufficient resources available for a MBMS Session. The RAN may decide not to establish RB in cells where requested resources are not available. The RAN does not reject a MBMS Session Start Request message even if one or more cells do not have enough resources to establish radio bearers.

MBMS bearer services of background class are best suited for the transport of MBMS user services such as messaging or downloading. Buffering, shaping schemes and packet dropping may be applied to the traffic flow to adapt to the available resources and changing network conditions. The total transfer time is not critical for background class bearer services since the content must normally have been received in totality and stored in the UE before the user can access it.

MBMS bearer services of streaming class are best suited for the transport of MBMS user services such as streaming. As for point-to-point bearer services, the network should minimise the packet transfer delay of streaming class bearer services as far as possible. Packet dropping should be the preferred traffic conditioning action applied to the traffic flow to adapt to the available resources.

The principle difference between background and streaming classes for MBMS is the support of a guaranteed bit-rate in the streaming case. No indication is provided to the UE in cases where the RAN cannot provide the requested QoS. As a result, some UEs may not receive the MBMS session or parts of it. For background class, the RAN may continue to distribute data in congestion conditions but at potentially high packet loss rates, therefore the MBMS user service will have to provide sufficient redundancy within the data to be able to cope with the high packet loss.

MBMS user services that would normally use MBMS bearer services of background class may however decide to use a streaming class MBMS bearer service if the MBMS user service cannot cope with high packet loss.

The Allocation and Retention Priority of the MBMS bearer service allows for prioritisation between MBMS bearer services, and between MBMS bearer services and non MBMS bearer services.

As the MBMS bearer service transfers data to many UEs in parallel and because of the lack of feedback channel on radio level low SDU error ratios are difficult to achieve. When the resulting packet error ratio is not suitable for the MBMS user service or when prevention of data loss is required, an MBMS user service may perform retransmission of MBMS data over a point-to-point PDP context.

6.3.1 MBMS QoS distribution tree

MBMS data will be distributed to multiple users through a MBMS distribution tree that can go through many BSCs/RNCs, many SGSNs and one or more GGSNs. Furthermore some bearer resources may be shared between many users accessing the same MBMS bearer service in order to save resources. As a result, each branch of a MBMS distribution tree shall be established with the same QoS.

MBMS distribution tree shall have the same QoS for all its branches.

When a branch of the MBMS distribution tree has been created, it is not possible for another branch (e.g. due to arrival of a new UE or change of location of a UE with removal of a branch and addition of a new one) to impact the QoS of already established branches.

There is no QoS (re-)negotiation between network elements (e.g. between RNC and SGSN). This implies that some branches may not be established if QoS requirement cannot be accepted by the concerned network node.

6.4 Temporary Mobile Group Identity

Temporary Mobile Group Identity (TMGI) is used for MBMS notification purpose. The BM-SC allocates a globally unique TMGI per MBMS bearer service. The structure of the TMGI is defined in TS 23.003 [13].

For Multicast MBMS bearer services the TMGI is transmitted to UE via the MBMS Multicast Service Activation procedure. For Broadcast Service the TMGI can be obtained via service announcement see "Service Announcement".

The TMGI is a radio resource efficient MBMS bearer service identification, which is equivalent to the MBMS bearer service identification consisting of IP multicast address and APN.

7 Architectural Aspects of MBMS User Services

MBMS bearers may be used in numerous ways to provide different types of applications. MBMS user services employ MBMS bearers and possibly point-to-point bearers in order to provide application data in an efficient manner. This section is used to discuss different aspects of MBMS user services that directly relate to the usage of MBMS and point-to-point bearers. This section is not intended to deal with the architecture and interfaces of MBMS user services.

7.1 Alternative User Service Support

For many MBMS services, it will be necessary to provide alternative means for the UE to access the service without using MBMS bearer capabilities. This is required, for example, after completion of the MBMS session for a file

download to permit errors in the file to be corrected; to permit the network to charge for a successful download; to pass a decrypt key to the UE; etc. It may also be useful in cases where all or part of an MBMS transmission has been missed due to the UE being out of coverage, switched off, etc.

Care is needed to ensure that such alternative access mechanisms do not create traffic that overloads the network (radio, RNC, BSC, SGSN, GGSN and BM-SC). In the case that such alternative access requires direct interaction between the UE and a network server, one way for this load to be distributed is for the BM-SC to distribute to each UE, at activation time, one or more server addresses (from a group of addresses), along with parameter(s) that are used to generate a random time dispersion of the requests.

7.2 Avoid overload in SGSN, GGSN and BM-SC caused by Joining

For Joining that is triggered by a service announcement (e.g. CBS or MBMS), then the service announcement needs to be able to contain parameters to help avoid overload in the SGSN, GGSN and BM-SC. The UE uses the defined parameters in the service announcement to randomly select the time at which to join the service. Hence the BM-SC needs to be able to generate the parameters and needs to be able to get them sent to the UE in the service announcement.

7.3 Access aspects of MBMS user services

In networks with multiple accesses, e.g. GERAN and UTRAN, users may in some situations experience problems in receiving MBMS services. These situations include:

- an operator that has chosen to provide a service on one access only (e.g. only on GERAN), and where a UE is camping on the wrong access (i.e. on UTRAN in the previous example) when an MBMS session is started. This UE may miss the MBMS content, as the MBMS architecture doesn't provide any mechanism for paging coordination, etc.
- an operator that has chosen to provide a service with different QoS levels on GERAN and UTRAN (see subclause 5.1.5.2). A UE that is changing access type during an ongoing MBMS session may not be able sort the situation out and receive the MBMS content correctly.

8 MBMS Procedures

8.1 MBMS Notification

8.1.1 lu mode notification (UTRAN and GERAN)

When an MBMS Session starts, UEs interested in the MBMS bearer service (PMM-CONNECTED UEs and PMM-IDLE UEs) shall be notified.

MBMS Session attributes such as Session Identifier and MBMS Service Area(s) are made available in all interested RNCs during the Session Start procedure.

For radio efficiency reasons, the UTRAN may select on a per cell basis whether to establish point-to-point or point-to-multipoint links for the distribution of MBMS data to the UEs.

In order to perform this selection, the UTRAN requests a proportion of UEs to move to PMM-CONNECTED mode by means of MBMS notification sent in the MBMS service Area.

The exact number of UEs moved to PMM-CONNECTED mode is a decision of the RAN node. It is not necessary for all UEs to move to PMM-CONNECTED mode in order for the RAN to decide to use point-to-multipoint, other UEs may remain in PMM-IDLE state. This is a UTRAN choice (based on Radio Resource Management criteria).

Following the decision to set up point-to-point or point-to-multipoint links, the number of UEs that need to be maintained in PMM-CONNECTED mode or moved to PMM-IDLE mode for MBMS data reception is also a decision of the RAN node.

8.1.2 A/Gb mode notification (GERAN)

When an MBMS Session starts, UEs interested in the MBMS bearer service and that are in READY or STANDBY states shall be notified. The MBMS notification triggers detection or counting of UEs per cell for selection of the most appropriate MBMS radio bearer.

MBMS Session attributes such as Session Identifier, MBMS Service Area, QoS are made available in all interested BSCs that are connected to a registered SGSN by the Session Start procedure.

8.2 MBMS Multicast Service Activation

The MBMS multicast service activation procedure registers the user in the network to enable the reception of data from a specific multicast MBMS bearer service. The activation is a signalling procedure between the UE and the network. The procedure establishes MBMS UE contexts in UE, SGSN and GGSN and Iu mode BSC/RNC for each activated multicast MBMS bearer service comparable to regular PDP contexts.

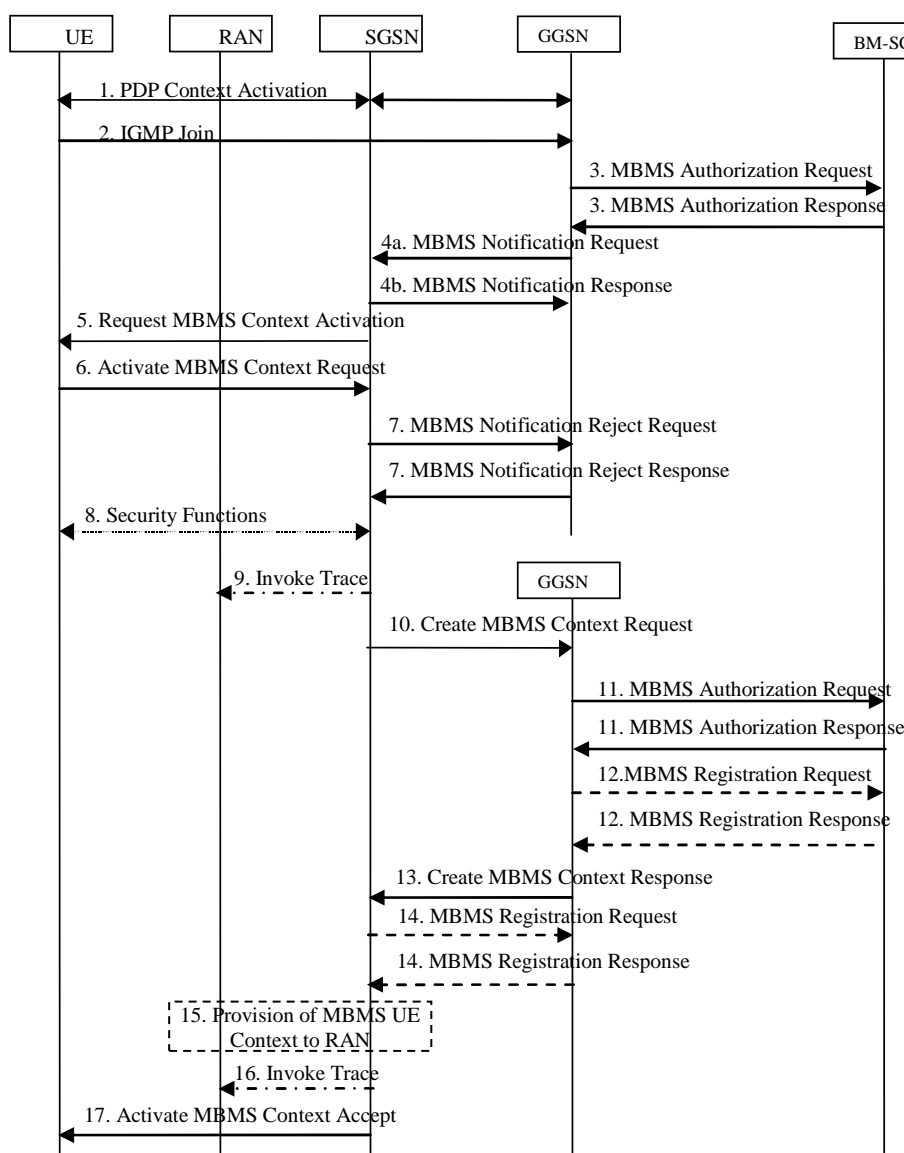

Figure 7: The activation of an MBMS multicast service

- Steps 1) to 5) are not used for UEs that do not use IGMP (IPv4) or MLD (IPv6) for control of MBMS services. The UE activates a general purpose PDP context if one is not already established.

NOTE: Even for the UE that doesn't use the IGMP or MLD, a PDP context may be needed for MBMS user service, e.g. for the transmission of Key.

2. The UE sends an IGMP (IPv4) or MLD (IPv6) Join message over the default PDP context to signal its interest in receiving a particular multicast MBMS bearer service identified by an IP multicast address.
3. The GGSN sends an MBMS Authorization Request seeking authorization for the activating UE to receive data. The MBMS Authorization Request may include trace information (Additional MBMS Trace Info), if activated. The authorization decision, which may be based on subscription data in the BM-SC, Membership function is provided in the MBMS Authorization Response together with the APN to be used for creation of the MBMS UE context. If the MBMS Authorization Response indicates that the UE is not authorized to receive the MBMS data the process terminates with no additional message exchange.
- 4a. The GGSN sends an MBMS Notification Request (IP multicast address, APN, Linked NSAPI) to the SGSN. Linked NSAPI is set equal to the NSAPI of the PDP context over which the Join request was received. The IP multicast address is the one requested by the UE in the Join request. The APN may be different from the APN to which the default PDP context has been activated. In any case, the APN may resolve to a GGSN that is different from the GGSN receiving the IGMP/MLD Join request. The GGSN starts a MBMS Activation Timer as GGSN may receive no response, e.g. in case SGSN or UE does not support MBMS.
- 4b. The SGSN sends a MBMS Notification Response (Cause) to the GGSN that sent the MBMS Notification Request, where Cause shall indicate whether or not the MBMS context activation will proceed. Upon reception of the response message with Cause indicating unsuccessful operation the GGSN should not send any further MBMS Notification Request messages. The procedure is then terminated.
5. The SGSN sends a Request MBMS Context Activation (IP multicast address, APN, Linked NSAPI, TI) to the UE to request it to activate an MBMS UE Context. Linked NSAPI allows the UE to associate the MBMS UE Context with the PDP context over which it sent the IGMP/MLD Join message in step 2. TI was chosen by the SGSN and contains a value not used by any other activated PDP context and MBMS UE context for this UE.
6. The UE creates an MBMS UE context and sends an Activate MBMS Context Request (IP multicast address, APN, MBMS_NSAPI, MBMS bearer capabilities) to the SGSN. The IP multicast address identifies the MBMS multicast service, which the UE wants to join/activate. An APN may indicate a specific GGSN. If the UE does not use IGMP (IPv4) or MLD (IPv6) for MBMS service control, it should indicate the APN it uses for the purpose of MBMS user service. The SGSN may modify the APN by using the APN Selection procedure. The MBMS bearer capabilities indicate the maximum QoS the UE can handle. The MBMS_NSAPI was chosen by the UE and contains a value not used by any other activated PDP context and MBMS UE context for this UE. If the SGSN has the MBMS Bearer Context information for this MBMS bearer service, the SGSN should verify the UE's MBMS bearer capabilities. If the SGSN determines that the UE's MBMS bearer capabilities are less than the Required MBMS Bearer Capabilities, it shall reject the request for activation of an MBMS context with an appropriate cause. If the PLMN does not support MBMS service control without IGMP (IPv4) or MLD (IPv6), the SGSN shall reject the request for activation of an MBMS context. In this case the UE may start the activation procedure with step 2, i.e. by using IGMP (IPv4) or MLD (IPv6).
7. If the MBMS UE Context was not established, the SGSN sends a MBMS Notification Reject Request (Cause) to the GGSN that sent the MBMS Notification Request, where Cause shall indicate the reason why the MBMS UE Context could not be established. The GGSN then sends a MBMS Notification Reject Response back to the SGSN. This should prevent further sending of MBMS Notification Request messages. The procedure is then terminated. This step is only for UEs that use IGMP (IPv4) or MLD (IPv6) for MBMS service control.
8. Security Functions may be performed, e.g. to authenticate the UE.
9. In A/Gb mode and if BSS trace is activated, the SGSN shall send an Invoke Trace (Trace Reference, Trace Type, Trigger Id, and OMC Identity) message to the BSS. Trace Reference, and Trace Type are copied from the trace information received from the HLR or OMC.
10. The SGSN creates an MBMS UE context and sends a Create MBMS Context Requests (IP multicast address, APN, MBMS_NSAPI, IMSI, MSISDN, RAI, IMEI-SV, RAT Type, MS Time Zone, CGI/SAI, Trace Reference, Trace Type, Trigger Id, OMC Identity , Additional MBMS Trace Info) to the GGSN. The SGSN shall include Trace Reference, Trace Type, Trigger Id, and OMC Identity if GGSN trace is activated. The SGSN shall include Additional MBMS Trace Info if BM-SC trace is activated. The SGSN shall copy Trace Reference, Trace Type, and OMC Identity from the trace information received from the HLR or OMC. The inclusion of CGI/SAI shall be according rules detailed in sub-clause 15.1.1a in TS 23.060 [15].

11. The GGSN sends an MBMS Authorization Request (IMSI, MSISDN, RAI, IMEI-SV, RAT Type, MS Time Zone, CGI/SAI, Additional MBMS Trace Info) seeking authorization for the activating UE. The GGSN shall include Additional MBMS Trace Info if BM-SC trace is activated. The CGI/SAI is included, if available. The authorization decision is provided in the MBMS Authorization Response. The BM-SC creates an MBMS UE Context.

12. If the GGSN does not have the MBMS Bearer Context information for this MBMS bearer service, the GGSN sends a MBMS Registration Request to the BM-SC. See subclause "MBMS Registration Procedure".

If no TMGI has been allocated for this MBMS bearer service, the BM-SC will allocate a new TMGI. This TMGI will be passed to GGSN and SGSN via the MBMS Registration Response message and further to UE via Activate MBMS Context Accept message.

The BM-SC responds with a MBMS Registration Response containing the MBMS Bearer Context information for this MBMS bearer service and adds the identifier of the GGSN to the "list of downstream nodes" parameter in its MBMS Bearer Context. See subclause "MBMS Registration Procedure".

13. The GGSN creates an MBMS UE context and sends a Create MBMS Context Response to the SGSN.

14. If the SGSN does not have the MBMS Bearer Context information for this MBMS bearer service, the SGSN sends a MBMS Registration Request to the GGSN. See subclause "MBMS Registration Procedure".

The GGSN responds with a MBMS Registration Response containing the MBMS Bearer Context information for this MBMS bearer service and adds the identifier of the SGSN to the "list of downstream nodes" parameter in its MBMS Bearer Context. See subclause "MBMS Registration Procedure".

15. The SGSN provides Iu mode RAN with the MBMS UE Context(s) if at least one PS RAB is established for the UE.

16. In Iu mode and if trace is activated, the SGSN shall send an Invoke Trace (Trace Reference, Trace Type, Trigger Id, and OMC Identity) message to the RAN. Trace Reference, and Trace Type are copied from the trace information received from the HLR or OMC.

NOTE: Step 16 is applied when the trace activation is triggered by means of signalling. Another alternative is the triggering of trace activation by the OMC. The details of both Trace Activation procedures are described in TS 32.422 [14].

17. The SGSN sends an Activate MBMS Context Accept (TMGI) to the UE. If it was not possible to verify the UE's MBMS bearer capabilities in Step 6, the UE's MBMS bearer capabilities shall be verified now by the SGSN. If the SGSN determines that the UE's MBMS bearer capabilities are lower than the Required MBMS Bearer Capabilities the SGSN rejects the request for activation of an MBMS context indicating an appropriate cause and starts the deactivation of the already established MBMS UE contexts.

8.2.1 APN selection for the Direct MBMS Multicast Activation

When the UE who does not use IGMP (IPv4) or MLD (IPv6) for MBMS service control, it may directly send an Activate MBMS Context Request (IP multicast address, APN, MBMS_NSAPI, MBMS bearer capabilities) to the SGSN, as described in the Activation section. For the purpose of selecting an appropriate GGSN, the APN may be modified by the SGSN by configuration or searching in the existing bearer context based on the service (i.e. IP multicast address), or by indication from the BM-SC.

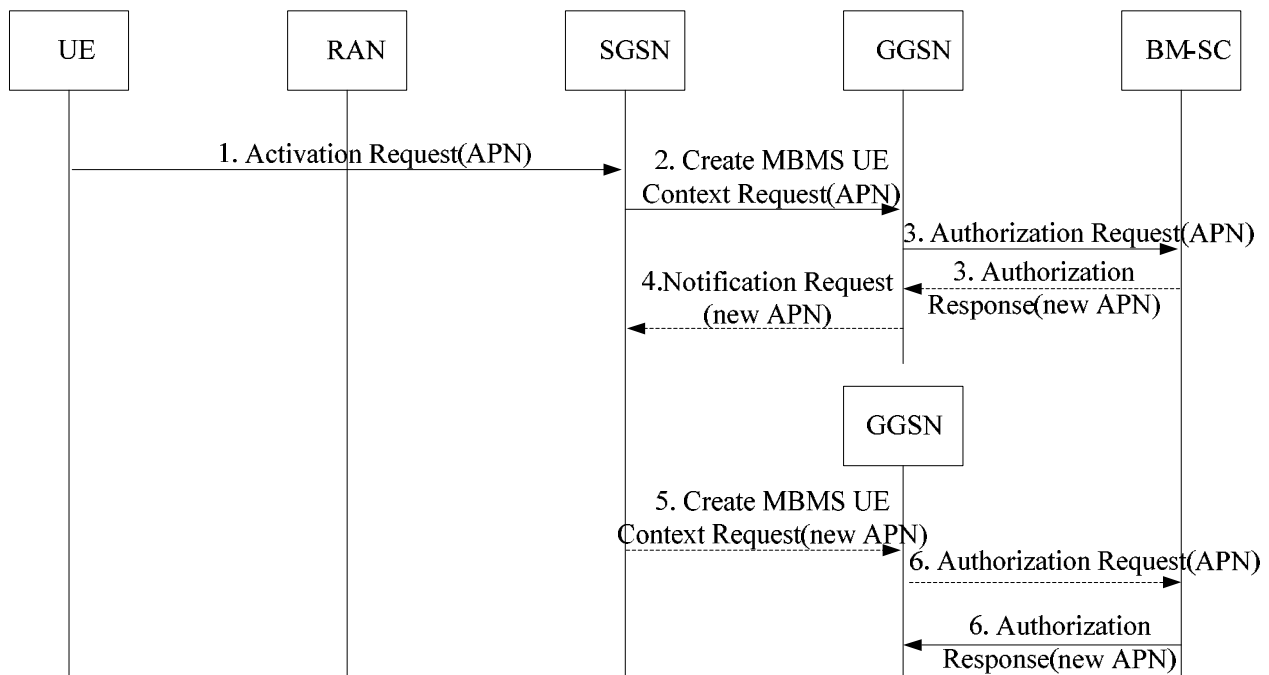
**Figure 7a**

1. The UE who does not use IGMP (IPv4) or MLD (IPv6) for MBMS service control may directly send an Activate MBMS Context Request (IP multicast address, APN, MBMS_NSAPI, MBMS bearer capabilities) to the SGSN. The APN is optional and used to indicate a GGSN for the MBMS user service.
2. The SGSN sends Create MBMS UE Context Request to the GGSN. The SGSN may resolve the GGSN address by using the APN from the request message or using a default one from configuration information, or from the result of searching in the existing user's bearer contexts by using the same IP multicast address.
3. The GGSN sends Authorization request with the APN to the BM-SC, if the APN is not an appropriate one, the BM-SC may response the GGSN with a new APN.
4. After getting the new APN and in the case of successful authorization, the GGSN sends the new APN to the SGSN in the Notification request message, which is same as the mulicast activate an UE using the IGMP (IPv4) or MLD (IPv6) for MBMS services.
5. With the new APN, the SGSN sends the create MBMS UE Context Request to a new GGSN.
6. Authorization procedure, same as that in the Activation procedure.

NOTE: This MBMS APN Selection procedure may also fit for UE that does not use IGMP (IPv4) or MLD (IPv6) in the roaming scenario.

8.3 MBMS Session Start Procedure

The BM-SC initiates the MBMS Session Start procedure when it is ready to send data. This is a request to activate all necessary bearer resources in the network for the transfer of MBMS data and to notify interested UEs of the imminent start of the transmission.

Through this procedure, MBMS session attributes such as QoS, MBMS service Area, estimated session duration, time to MBMS data transfer, are provided to the GGSN(s) and SGSN(s) that have previously registered for the corresponding MBMS bearer service and to all BSCs/RNCs that are connected to a registered SGSN. In addition the procedure allocates the bearer plane to all registered GGSNs and all registered SGSNs and to BSCs/RNCs that respond to the session start request message.

After sending the Session Start Request message the BM-SC waits for a configurable delay (time to MBMS data transfer) before sending MBMS data. This delay should be long enough to avoid buffering of MBMS data in entities other than the BM-SC, i.e. the delay should allow the network to perform all procedures required to enable MBMS data transfer before the BM-SC sends MBMS data. For example notification of UEs and radio bearer establishment should

be performed before MBMS data arrive in the RAN. The delay may be in the region of multiple seconds or tens of seconds. It may be useful for the BM-SC to be able to configure different delays for MBMS bearer services on 2G and 3G, respectively.

For multicast MBMS bearer services the registration of SGSNs and GGSNs is initiated by MBMS multicast Service Activation procedures, Inter SGSN Routeing Area Update procedures, Inter SGSN Serving RNS Relocation procedure and performed by MBMS Registration procedures.

For broadcast MBMS bearer services the list of downstream nodes of BM-SC and GGSN are achieved in the following ways:

- The list of downstream nodes for GGSN will be sent from the BM-SC to the GGSN in the Session Start Request.

Normally, the GGSN contained in the "list of downstream nodes" for BM-SC is the default GGSN (or two for resilience).

The overall Session Start procedure is presented in the following figure:

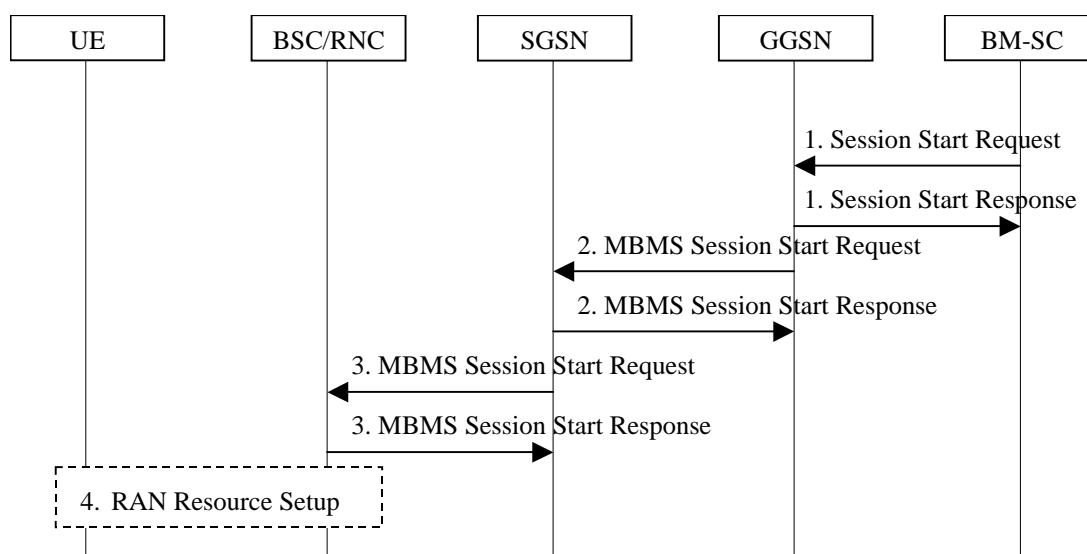

Figure 8 Session Start procedure

1. The BM-SC Session and Transmission function sends a Session Start Request message to indicate the impending start of the transmission and to provide the session attributes (TMGI, QoS, MBMS service Area, Session identifier, estimated session duration, broadcast/multicast, list of downstream nodes for GGSN (Broadcast only), time to MBMS data transfer, ...) and the 2G/3G indicator. The message is sent to the BM-SC Proxy and Transport function, which then forwards it to the GGSNs listed in the "list of downstream nodes" parameter of the corresponding MBMS Bearer Context. The BM-SC Proxy and Transport function sets the state attribute of its MBMS Bearer Context to 'Active'. For a broadcast MBMS bearer service the GGSN creates an MBMS bearer context. The GGSN stores the session attributes and the list of downstream nodes in the MBMS Bearer Context, sets the state attribute of its MBMS Bearer Context to 'Active' and sends a Session Start Response message to the BM-SC. Proxy and Transport function which forwards it to the BM-SC Session and Transmission function. The BM-SC Proxy and Transport function copies Session Start Requests to the BM-SC Membership function for charging purposes.
2. The GGSN sends an MBMS Session Start Request message containing the session attributes (TMGI, QoS, MBMS service Area, Session identifier, estimated session duration, broadcast/multicast, time to MBMS data transfer, ...) and the 2G/3G indicator to the SGSNs listed in the "list of downstream nodes" parameter of the corresponding MBMS Bearer Context. For a broadcast MBMS bearer service the SGSN creates an MBMS bearer context. The SGSN stores the session attributes and the 2G/3G indicator in the MBMS Bearer Context, sets the state attribute of its MBMS Bearer Context to 'Active' and responds with an MBMS Session Start Response message providing the TEID for bearer plane that the GGSN shall use for forwarding the MBMS data. For MBMS bearer service a SGSN receiving multiple MBMS Session Start Request messages establishes only one bearer plane with one GGSN.

3. The SGSN sends an MBMS Session Start Request message including the session attributes (TMGI, QoS, MBMS service Area, Session identifier, estimated session duration, broadcast/multicast, time to MBMS data transfer, list of RAs ...) to each BSC and/or each RNC that is connected to this SGSN. The 2G/3G indicator shall be used by the SGSN to determine whether the MBMS Session Start Request message is sent only to BSCs, or only to RNCs, or to both RNCs and BSCs. For a broadcast MBMS bearer service the BSC/RNC creates an MBMS Service Context. The BSC in Iu mode/RNC stores the session attributes in the MBMS Service Context, sets the state attribute of its MBMS Service Context to 'Active' and responds with an MBMS Session Start Response message and the RNC/Iu mode BSC includes the TEID in the MBMS Session Start Response message for the Iu bearer plane that the SGSN shall use for forwarding the MBMS data. A BSC in Gb mode which does not serve the MBMS Service Area need not store the session attributes. A BSC/RNC receiving multiple MBMS Session Start Request messages establishes only one bearer plane with one SGSN.
4. The BSC/RNC establishes the necessary radio resources for the transfer of MBMS data to the interested UEs. RAN resource set up can be scheduled according to the time to MBMS data transfer parameter.

NOTE: The upstream node normally provides the MBMS Session Start Request message once per MBMS session to a downstream node. Due to "Intra Domain Connection of RAN Nodes to Multiple Core Network Nodes" however, a BSC/RNC may receive the MBMS Session Start Request message from several SGSNs.

8.4 MBMS Registration Procedure

The MBMS Registration is the procedure by which a downstream node informs an upstream node that it would like to receive session attributes and data for a particular MBMS bearer service in order to distribute it further downstream. This procedure builds up a distribution tree for the delivery of MBMS session attributes and data from the BM-SC to the UEs interested in the service. This procedure results in the set-up of a corresponding MBMS Bearer Context in the nodes along the distribution tree, but it does not result in the establishment of bearer plane which will be established by the Session Start procedure.

The MBMS Registration procedure is initiated:

- When the first MBMS UE Context for a particular MBMS bearer service is created in the SGSN or GGSN (see subclause "MBMS UE Context") and the corresponding MBMS Bearer Context is not already established in the node;
- When an MBMS Registration Request for a particular MBMS bearer service is received from a downstream node but the corresponding MBMS Bearer Context is not established in the node; or
- When a DRNC detects that it hosts UEs interested in the MBMS bearer service.

NOTE: The terms 'downstream' and 'upstream' refer to the topological position of one node with respect to another and relative to the direction of the MBMS data flow, i.e. from BM-SC to UE.

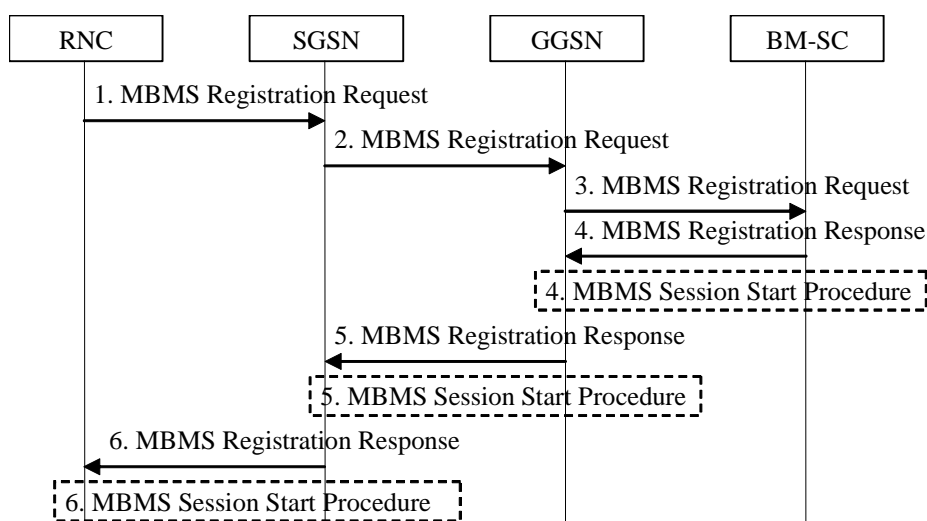

Figure 9: MBMS Registration procedure

1. When the DRNC detects that it hosts UEs interested in the MBMS bearer service, the DRNC sends a MBMS Registration Request message to its parent SGSN if not already done. How the RNC determines its parent SGSN is a matter of implementation.
2. If the SGSN has no MBMS Bearer Context for an MBMS bearer service and the SGSN receives an MBMS Registration Request from an RNC for this MBMS bearer service, or if the first MBMS UE Context is created in the SGSN for an MBMS bearer service for which the SGSN has no corresponding MBMS Bearer Context, the SGSN creates an MBMS Bearer Context (in "Standby" state) and sends an MBMS Registration request (IP multicast address, APN) message to the GGSN. How the SGSN selects a GGSN is a matter of implementation; it may for instance be based on prior signalling related to a particular UE or via APN resolution.
3. If the GGSN has no MBMS Bearer Context for an MBMS bearer service and the GGSN receives an MBMS Registration from an SGSN for this MBMS bearer service, or when the first MBMS UE Context is created in the GGSN for an MBMS bearer service for which the GGSN has no MBMS Bearer Context, the GGSN creates an MBMS Bearer Context (in "Standby" state) and sends a Registration Request (IP multicast address, APN) message to the BM-SC. Proxy and Transport function The exact nature of the signalling between GGSN and BM-SC via Gmb interface is specified in TS 29.061 [4].
4. Upon reception of an MBMS Registration Request from a GGSN, the BM-SC Proxy and Transport function adds the identifier of the GGSN to the "list of downstream nodes" parameter in its MBMS Bearer Context and responds with a MBMS Registration Response (TMGI, Required Bearer Capabilities) message. The exact nature of the signalling between GGSN and BM-SC via Gmb interface is specified in TS 29.061 [4]. If the MBMS Bearer Context is in the 'Active' state, the BM-SC initiates the Session Start procedure with the GGSN, as described in clause "MBMS Session Start Procedure".
5. If the GGSN receives a Registration Request from the SGSN in step 2, the GGSN:
 - adds the identifier of the SGSN to the "list of downstream nodes" parameter in its MBMS Bearer Context,
 - responds with an MBMS Registration Response (TMGI, Required Bearer Capabilities) message, and
 - if the MBMS Bearer Context is in the 'Active' state, initiates the Session Start procedure with the SGSN, as described in clause "MBMS Session Start Procedure".
6. If the SGSN received MBMS Registration Request from the DRNC in step 1, the SGSN:
 - adds the identifier of the RNC to the "list of downstream nodes" parameter in its MBMS Bearer Context,
 - responds with an MBMS Registration Response message, and
 - if the MBMS Bearer Context is in the 'Active' state, initiates the Session Start procedure with the DRNC, as described clause "MBMS Session Start Procedure".

8.5 MBMS Session Stop Procedure

The BM-SC Session and Transmission function initiates the MBMS Session Stop procedure when it considers the MBMS session to be terminated. The session is typically terminated when there is no more MBMS data expected to be transmitted for a sufficiently long period of time to justify a release of bearer plane resources in the network. The procedure is propagated to all SGSNs and GGSNs that are registered for the corresponding MBMS bearer service and to BSCs/RNCs that have an established Iu bearer plane with an SGSN.

The overall MBMS Session Stop procedure is presented in the following figure:

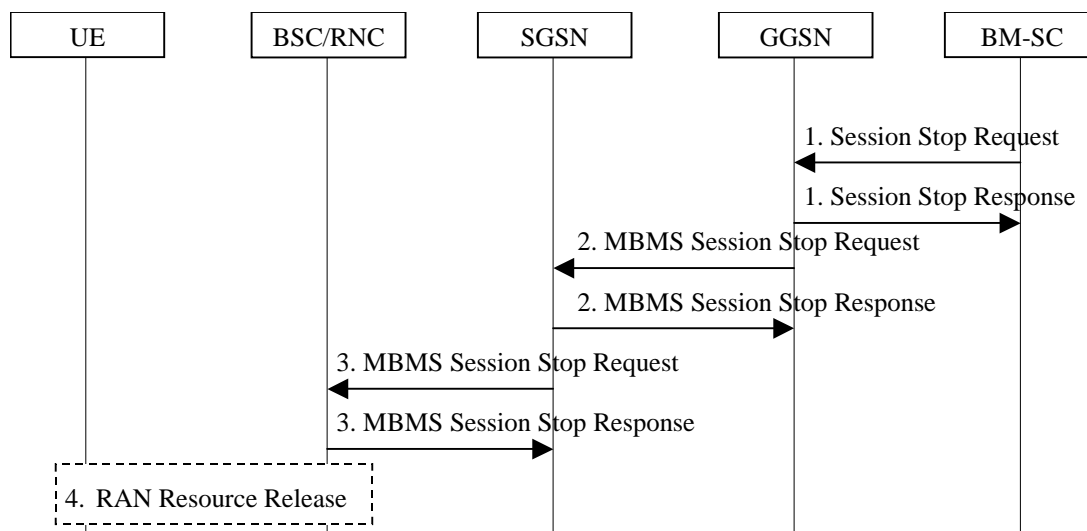

Figure 10: MBMS Session Stop procedure

1. The BM-SC Session and Transmission function sends a Session Stop Request message to the BM-SC Proxy and Transport function, which forwards it to all GGSNs listed in the "list of downstream nodes" parameter of the affected MBMS Bearer Context to indicate that the MBMS session is terminated and the bearer plane resources can be released. The BM-SC Proxy and Transport function sets the state attribute of its MBMS Bearer Context to 'Standby'. The GGSN sends a Session Stop Response message to the BM-SC Proxy and Transport function, which forwards it to the BM-SC Session and Transmission function. The BM-SC Proxy and Transport function copies Session Stop Requests to the BM-SC Membership function for charging purposes.
2. The GGSN sends an MBMS Session Stop Request message to all SGSNs that have a bearer plane established with the GGSN, releases the corresponding bearer plane resources towards these SGSNs and sets the state attribute of its MBMS Bearer Context to 'Standby'. The GGSN releases the MBMS Bearer Context in case of a broadcast MBMS bearer service.
3. The SGSN releases the TEID and bearer plane resources on which it was receiving MBMS data from the GGSN for the affected MBMS bearer service and sends an MBMS Session Stop Request message to all BSCs/RNCs that have a bearer plane established with the SGSN. The SGSN releases the MBMS Bearer Context in case of a broadcast MBMS bearer service.
4. The RNC releases the affected radio and Iu resources; the BSC releases the affected radio resources. The BSC/RNC releases the MBMS Service Context in case of a broadcast MBMS bearer service. A BSC in Gb mode shall send an acknowledgement to the SGSN even if there is no active MBMS context in the BSC.

8.6 MBMS De-Registration Procedure

8.6.0 Common MBMS De-Registration procedure

The MBMS De-Registration is the procedure by which a downstream node informs an upstream node that it does not need to receive signalling, session attributes and data for a particular MBMS bearer service anymore and therefore would like to be removed from the corresponding distribution tree.

The MBMS De-registration procedure is initiated:

- By the SGSN or GGSN when the last MBMS UE Context for a particular MBMS bearer service is deleted from the node and the "list of downstream nodes" parameter in the corresponding MBMS Bearer Context is empty;
- By the SGSN or GGSN when the last node registered in the "list of downstream nodes" de-registers from an MBMS bearer service for which there is no corresponding MBMS UE Context; or
- By the DRNC that registered at an SGSN when it deletes the associated MBMS Service Context.

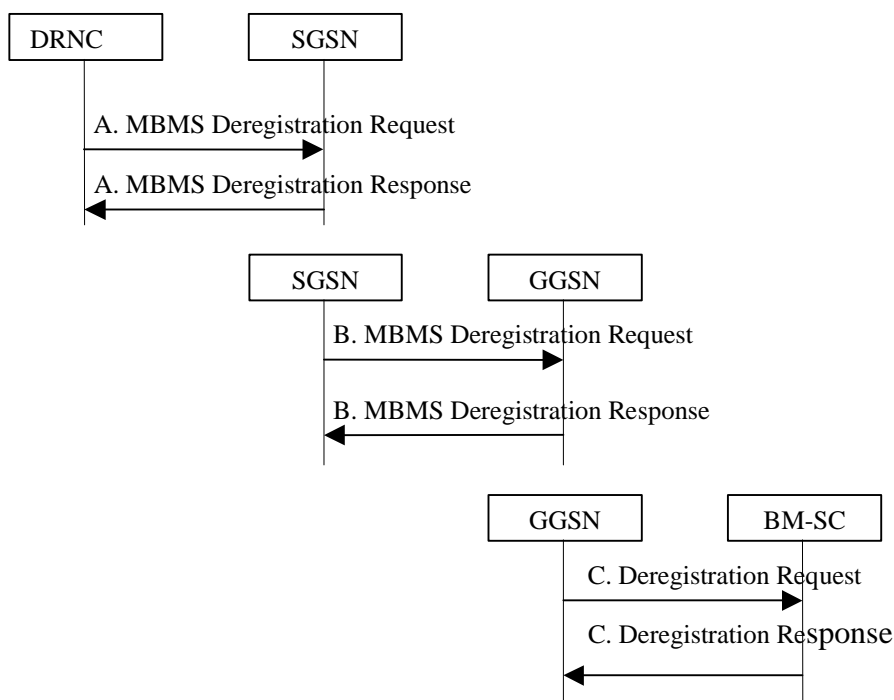

Figure 11: MBMS De-Registration Procedure

- A. When the DRNC that is registered at an SGSN no longer hosts any UE interested in that MBMS bearer service, the DRNC requests the de-registration from the MBMS bearer service to its parent SGSN. As an implementation option, the DRNC may decide not to de-register from the MBMS bearer service immediately when these conditions are met, e.g. in order to avoid unnecessary signalling in the case where the RNC would again need the same MBMS bearer service shortly after.

The SGSN removes the identifier of the RNC from the "list of downstream nodes" parameter of the affected MBMS Bearer Context and confirms the operation by sending an MBMS De-Registration Response message to the RNC. If an Iu bearer plane had been established between the DRNC and the SGSN for this MBMS bearer service, the Iu bearer plane is released.

- B. When the "list of downstream nodes" of a particular MBMS Bearer Context in the SGSN becomes empty and the SGSN has no MBMS UE Contexts linked to that MBMS Bearer Context, the SGSN sends an MBMS De-Registration Request (IP multicast address, APN) message to its upstream GGSN associated with the MBMS Bearer Context.

The GGSN removes the identifier of the SGSN from the "list of downstream nodes" parameter of the affected MBMS Bearer Context and confirms the operation by sending an MBMS De-Registration Response message to the SGSN. If a bearer plane had been established between the SGSN and the GGSN for this MBMS bearer service, the bearer plane is released.

- C. When the "list of downstream nodes" of a particular MBMS Bearer Context in the GGSN becomes empty and the GGSN has no MBMS UE Contexts linked to that MBMS Bearer Context, the GGSN sends a De-Registration Request (IP multicast address, APN) message to the BM-SC. Proxy and Transport function If a bearer plane had been established over Gi for this MBMS bearer service, the bearer plane is released.

The BM-SC removes the identifier of the GGSN from the "list of downstream nodes" parameter of the affected MBMS Bearer Context and confirms the operation by sending a De-Registration Response message to the GGSN.

8.6.1 BM-SC initiated MBMS De-Registration Procedure

This MBMS De-Registration Procedure is initiated by BM-SC when the specific MBMS bearer service is terminated. This procedure tears down the distribution tree for the delivery of session attributes and MBMS data. This procedure results in releasing of all MBMS Bearer Contexts and associated MBMS UE Contexts in the nodes along the distribution tree.

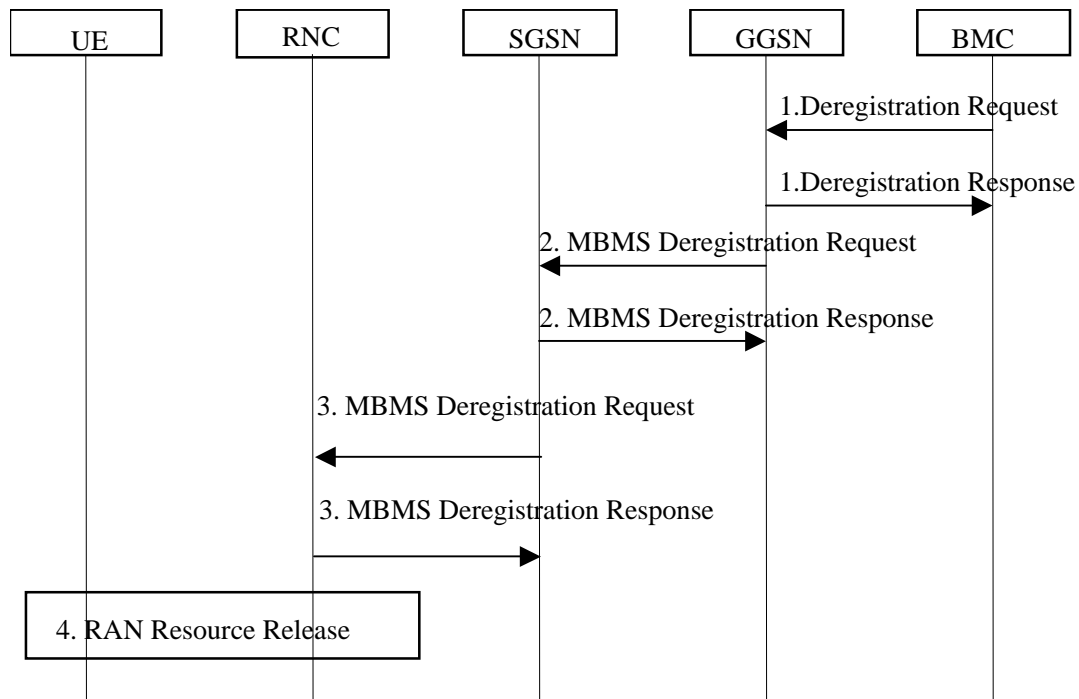

Figure 12: BM-SC initiated MBMS De-Registration Procedure

1. The BM-SC sends a De-Registration Request message to all GGSNs contained in the "list of downstream nodes" parameter of the corresponding MBMS Bearer Context to indicate the session is terminated and any related MBMS bearer resources shall be released.

The GGSN returns a De-Registration Response message to the BM-SC. The BM-SC releases all MBMS UE Contexts and the corresponding MBMS Bearer context.

2. The GGSN sends an MBMS De-Registration Request message to all SGSNs contained in the "list of downstream nodes" parameter. of the corresponding MBMS Bearer Context. The SGSN returns an MBMS De-registration Response message to the GGSN. The GGSN releases all MBMS UE Contexts and the affected MBMS Bearer Context. If a bearer plane had been established over Gi for this MBMS bearer service, the bearer plane is released.
3. The SGSN sends an MBMS De-Registration Request message to all RNCs connected with this SGSN. The RNC returns an MBMS De-Registration Response message to the SGSN, and releases all bearer resources if the state attribute of the MBMS Service Context is 'Active'. The SGSN releases all MBMS UE Contexts and the affected MBMS Bearer Context. If a bearer plane had been established between the SGSN and the GGSN for this MBMS bearer service, the bearer plane is released.
4. The RNC releases the affected radio resources, all MBMS UE Contexts and the MBMS Service Context. The detailed procedures are specified in TS 25.346 [10] and TS 43.246 [11]. RAN may notify the UEs that the MBMS Bearer service has being terminated, so that the UE can locally deactivate its MBMS UE context, detailed procedures are specified in TS 25.346 [10] and TS 43.246 [11].

8.7 MBMS Multicast Service Deactivation

The multicast service deactivation is a signalling procedure between the UE and the network. The procedure removes the MBMS UE Context from the UE, RAN, SGSN and GGSN for a particular MBMS multicast service. The multicast service deactivation can be initiated by:

- The UE;
- The GGSN;
- The BM-SC; or
- The SGSN

All these cases are contained in the procedure illustrated in figure 13. The UE initiated Multicast Service Deactivation starts with step 1) or 6a), the BM-SC initiated Multicast Service Deactivation starts with step 3), the GGSN initiated Multicast Service Deactivation starts with step 4), the SGSN initiated Multicast Service Deactivation starts with step 5) or 9), and the MBMS UE de-linking is performed at step 7).

At GPRS detach, all MBMS UE contexts of the UE are implicitly deactivated in the UE, SGSN and GGSN, i.e. the SGSN performs the deactivation procedure starting with step 7).

If the PDP context linked to the MBMS UE context by the linked NSAPI is deactivated by the UE or SGSN or GGSN, then the SGSN shall perform the MBMS deactivation procedure starting with step 7). The UE will remove all MBMS UE Contexts locally after the Linked PDP Context was deactivated.

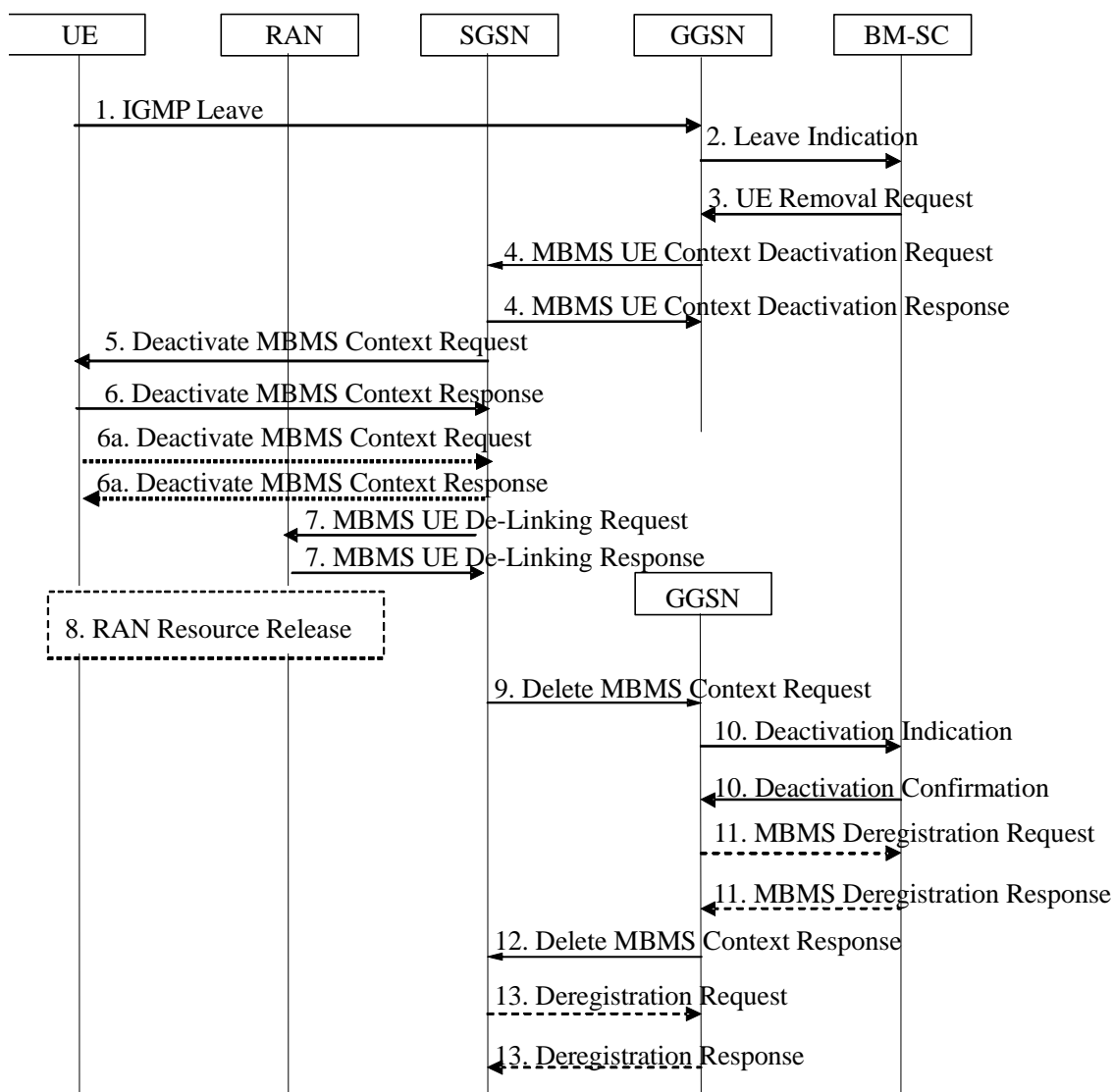

Figure 13: MBMS Multicast Service Deactivation

Steps 1) to 6) are not used for UEs that do not use IGMP (IPv4) or MLD (IPv6) for control of MBMS services.

1. The UE sends an IGMP (IPv4) or MLD (IPv6) Leave message (here, the Leave message means Leave Group message in RFC 2236 for IGMP (IPv4) and Multicast Listener Done in RFC2710 for MLD (IPv6)) over the default PDP context to leave a particular multicast service identified by an IP multicast address.
2. The GGSN sends a Leave Indication (IP multicast address, APN, IMSI) to the BM-SC Proxy and Transport function, which forwards it to the BM-SC Membership function, indicating that the UE is requesting to leave the multicast service identified by the IP multicast address. The exact nature of the signalling between GGSN and BM-SC is specified in TS 29.061 [4].

3. Upon reception of the Leave Indication, the BM-SC Membership function verifies that the IP multicast address corresponds to a valid MBMS bearer service and sends a UE Removal Request (IP multicast address, APN, IMSI) to the GGSN that originated the Leave Indication. The APN shall be the same that was provided during service activation (see "MBMS Multicast Service Activation"). The exact nature of the signalling between GGSN and BM-SC is specified in TS 29.061 [4]. The BM-SC Membership function may also initiate the deactivation of an MBMS UE Context for service-specific reasons (e.g. the service is terminated but the UE has not yet left the multicast group) by directly sending a UE Removal Request message to the GGSN.
4. Upon reception of the UE Removal Request or for other reasons (e.g. Error cases), the GGSN sends an MBMS UE Context Deactivation Request (IP multicast address, APN, IMSI) to the SGSN. The IP multicast address, APN and IMSI together identify the MBMS UE Context to be deleted by the SGSN. The APN is the one received in step 3. The SGSN acknowledges reception of the MBMS UE Context Deactivation Request by sending an MBMS UE Context Deactivation Response to the GGSN.
5. Upon reception of the MBMS UE Context Deactivation Request or for other reasons (e.g. due to a change in the roaming restrictions for the user) the SGSN sends a Deactivate MBMS Context Request (TI) to the UE. The TI identifies the MBMS UE Context to be deleted by the UE.
6. The UE deletes the MBMS UE Context and sends a Deactivate MBMS Context Accept (TI) to the SGSN.
- 6a. The UE deletes the MBMS UE Context and sends a Deactivate MBMS Context Request (TI) to the SGSN. The SGSN confirms the deactivation.
7. If the UE is PMM-CONNECTED and has been already linked towards the RAN, the SGSN sends a MBMS UE De-Linking Request to the RNC (IP multicast address, APN, TMGI). RAN deletes the MBMS UE Context and sends a MBMS UE De-Linking Response (TMGI) to the SGSN.
8. If dedicated radio resources are currently assigned to the UE for the reception of the MBMS data, the RAN releases these radio resources. If shared radio resources are currently assigned for the distribution of the MBMS data, the RAN may decide to move the remaining UEs to dedicated resources. The detailed procedures and conditions are specified in TS 25.346 [10] and TS 43.246 [11].
9. Upon reception of the Deactivate MBMS Context Accept or for other reasons (e.g. due to expiry of the long timer that is started upon a periodic routing area update not being received) the SGSN sends a Delete MBMS Context Request (MBMS_NSAPI) to the GGSN that holds the MBMS UE Context. This GGSN may be different from the GGSN that receives IGMP Leave request in step 1.
10. The GGSN deletes the MBMS UE Context and sends a Deactivation Indication to the BM-SC to confirm the successful deactivation of the MBMS UE Context. The BM-SC, after receiving the Deactivation Indication, deletes the MBMS UE Context and sends a confirmation to the GGSN. The exact nature of the signalling between GGSN and BM-SC is specified in TS 29.061 [4].
11. If the GGSN does not have any more users interested in this MBMS bearer service and the "list of downstream nodes" in the corresponding MBMS Bearer Context is empty, the GGSN sends a MBMS De-Registration Request to the BM-SC Proxy and Transport function. The BM-SC Proxy and Transport function responds with a MBMS De-Registration Response and removes the identifier of the GGSN from the "list of downstream nodes" parameter in its MBMS Bearer Context. See subclause "MBMS De-Registration Procedure".
12. The GGSN confirms the deactivation of the MBMS UE Context to the SGSN by sending a Delete MBMS Context Response to the SGSN, which then deletes the MBMS UE Context.
13. If the SGSN does not have any more users interested in this MBMS bearer service and the "list of downstream nodes" in the corresponding MBMS Bearer Context is empty, the SGSN sends an MBMS De-Registration Request to the GGSN. The GGSN responds with an MBMS De-Registration Response and removes the identifier of the SGSN from the "list of downstream nodes" parameter in its MBMS Bearer Context. See subclause "MBMS De-Registration Procedure".

8.8 MBMS Session Update procedure

8.8.1 General

The MBMS Session Update procedure may be invoked by BM-SC or by SGSN. The BM-SC uses the procedure to update the service area for an ongoing MBMS Broadcast service session. The SGSN can also use the procedure to update the list of RAs where MBMS multicast users are located for an ongoing MBMS Multicast service session.

8.8.2 SGSN initiated Session Update for MBMS Multicast service

If the SGSN has provided a list of RAs in the MBMS Session Start Request message (even if the list was empty) and RAs are added or removed from the list, the SGSN shall use the MBMS Session Update procedure to inform the RNCs that the list has changed. The SGSN sends the Session Update message only to the RNCs that are affected by the list change. The procedure is used only during the MBMS Multicast service session and when SGSN has already sent a MBMS Session Start Request message to the RNC.

If the SGSN has provided a list of RAs in the MBMS Session Start Request message (even if the list was empty) the SGSN shall send the Session Update to a RNC when:

- the first UE which have activated the service enters in a RA that is not in the list;
- the last UE which have activated the service leaves from a RA that was in the list.

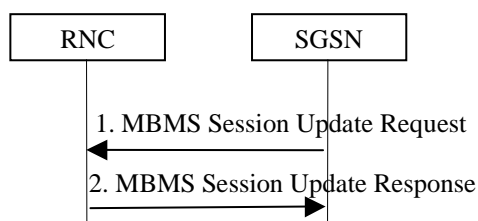

Figure 13a. Session Update procedure

- 1) The SGSN sends MBMS Session Update Request message to a RNC.
- 2) The RNC acknowledges the MBMS Session Update Request with the MBMS Session Update Response message.

8.8.3 BM-SC initiated Session Update for MBMS Broadcast service

The BM-SC initiates the MBMS Session Update procedure when the service area for an ongoing MBMS Broadcast service session shall be modified.

The attributes that can be modified by the Session Update Request are the MBMS Service Area, and the list of downstream nodes for GGSN (Broadcast only). A node receiving the Session Update Request determines how the attributes have changed by comparing the attributes in the message with corresponding attributes in its stored MBMS Bearer Context.

A Session Update received in one node, results in a Session Update being sent to downstream nodes, to inform of the changed MBMS Service Area. If a Session Update with the List of SGSN parameter included is received in the GGSN, it does also result in a Session Start being sent to new downstream nodes, and in a Session Stop being sent to downstream nodes that have been removed from the list.

The overall Session Update procedure is presented in figure 13b.

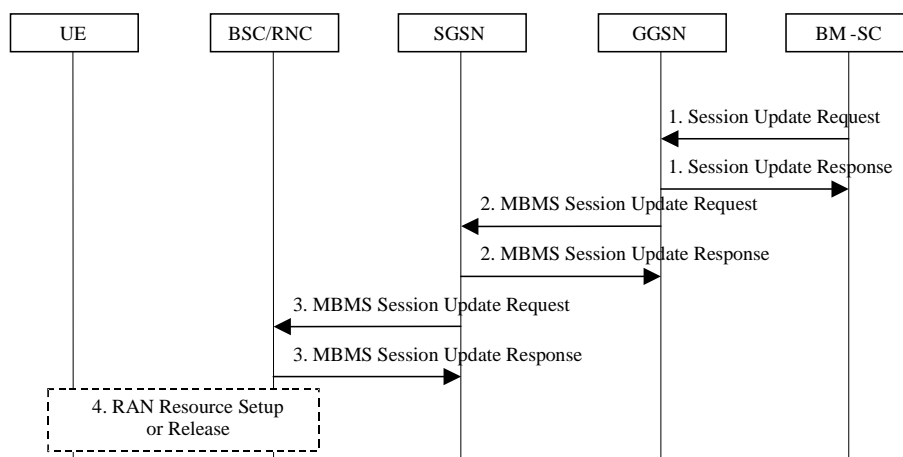

Figure 13b: Session Update procedure

1. The BM-SC Session and Transmission function sends a Session Update Request (TMGI, QoS, MBMS Service Area, Session identifier, estimated session duration, broadcast/multicast, list of downstream nodes for GGSN, time to MBMS data transfer) to the BM-SC Proxy and Transport function, which then forwards it to the GGSNs listed in the "list of downstream nodes" parameter of the corresponding MBMS Bearer Context. The TMGI and Session identifier identifies the ongoing session. The QoS, broadcast/multicast attributes and the 2G/3G indicator shall be identical as in the preceding Session Start message. The MBMS Service Area and the List of downstream nodes for GGSN define the new service area. The time to MBMS data transfer shall be set to 0 and the estimated session duration shall be set to a value corresponding to the remaining part of the session.

The GGSN stores the new session attributes and the list of downstream nodes in the MBMS Bearer Context and sends a Session Update Response message to the BM-SC Proxy and Transport function which forwards it to the BM-SC Session and Transmission function. The BM-SC Proxy and Transport function copies the Session Update Request to the BM-SC Membership function for charging purposes.

2. The GGSN compares the new list of downstream nodes with the list of downstream nodes it has stored in the MBMS Bearer Context. It sends an MBMS Session Start Request message to any added SGSN, an MBMS Session Stop Request to any removed SGSN, and an MBMS Session Update Request to the remaining SGSNs in the new list.
3. The SGSN receiving an MBMS Session Update Request message, sends an MBMS Session Update Request message including the session attributes (TMGI, QoS, MBMS service Area, Session identifier, estimated session duration, broadcast/multicast, time to MBMS data transfer, list of RAs, etc.) to each BSC and/or each RNC that is connected to this SGSN.
4. The BSCs/RNCs establish or release the necessary radio resources for the transfer of MBMS data to the interested UEs.

8.9 MBMS UE Context Synchronisation Procedure

The Routing Area Update procedure transfers the MBMS UE Context status between UE and SGSN. This MBMS UE Context status identifies MBMS UE contexts, which are lost or deactivated only on one side. All MBMS UE Contexts, which are active on one side only shall be deactivated locally. If the UE wishes to re-activate the related MBMS bearer service, it shall join the MBMS bearer service again. See subclause 8.2 "MBMS Multicast Service Activation".

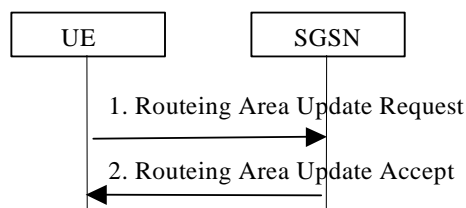

Figure 13b. MBMS UE Context Synchronisation procedure

- 1) The UE sends Routing Area Update Request to the SGSN. It includes the MBMS UE Context status, which indicates the UE's active MBMS UE Contexts.
- 2) The SGSN sends Routing Area Update Accept to the UE. It includes the MBMS UE Context status, which indicates the UE's MBMS UE Contexts that are stored in the SGSN.

8.9a MBMS feature support indication

An SGSN that supports MBMS shall indicate MBMS feature support to the UE during Routing Area Update procedure in the Routing Area Update Accept message and during GPRS attach procedure in the Attach Accept message. The UE then knows it can use already activated MBMS bearers, or activate new MBMS bearers according to subclause 8.2 "MBMS Multicast Service Activation".

An SGSN that does not support MBMS will not indicate MBMS feature support to the UE. This indicates to the UE that MBMS bearers are no longer supported, which may allow the UE to use point-to-point bearers for MBMS data transfer. In this case, the UE shall deactivate all active MBMS UE Contexts locally.

8.10 Inter SGSN Routeing Area Update

This procedure describes the handling of MBMS bearer services when an MBMS UE performs a Routeing Area Update and the serving SGSN changes. It is based on the Inter SGSN Routeing Area Update procedure specified in TS 23.060 [15]. The procedure is performed regardless whether MBMS sessions are ongoing or not. The handling of any PDP contexts established by the UE is not changed compared to the procedure without MBMS. The procedure described below does not show all details of the Routeing Area update procedure. Only for the MBMS specific additions the steps are described.

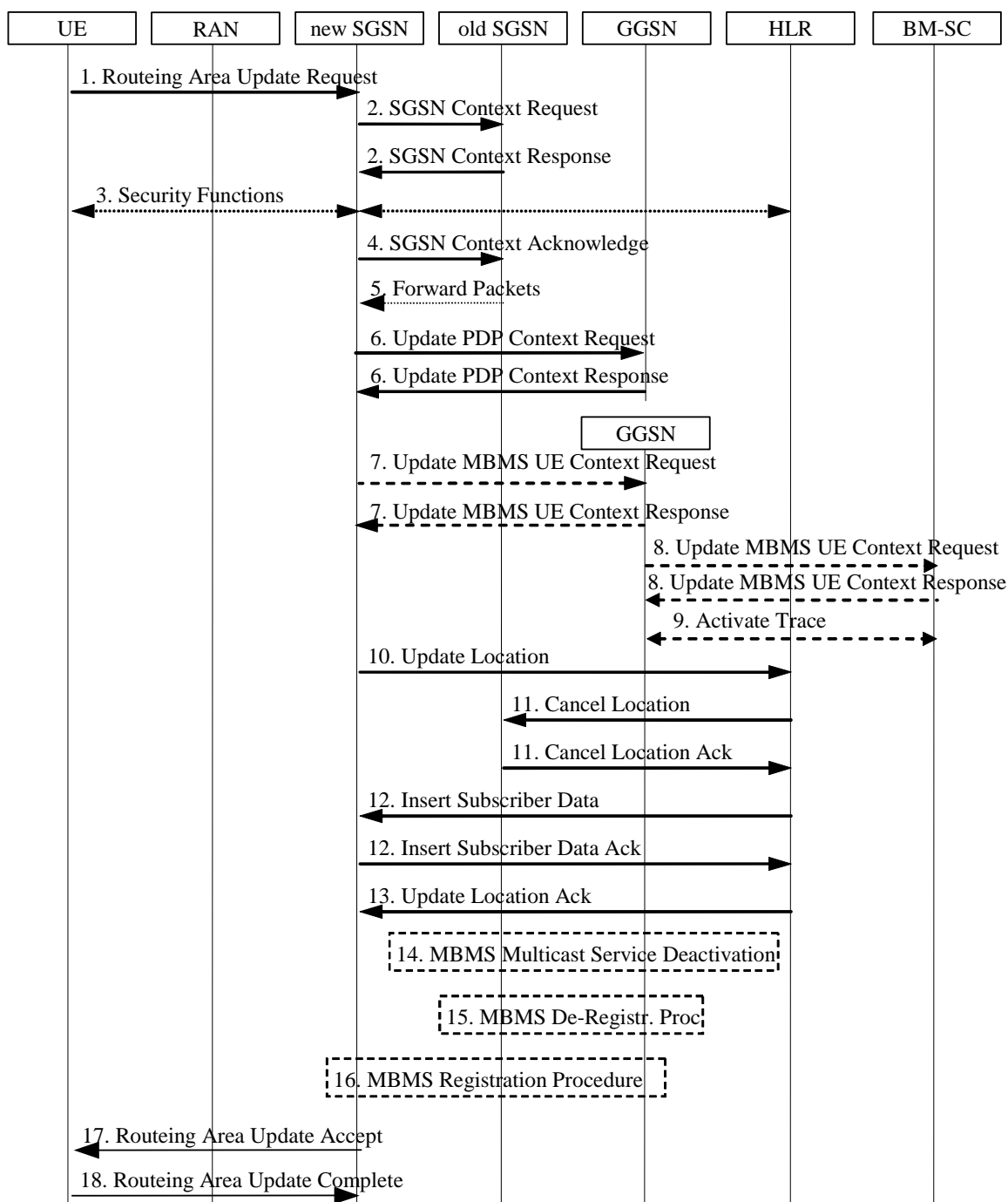

Figure 14: Inter SGSN Routing Area Update

- 2) An SGSN supporting MBMS indicates its MBMS support in the SGSN Context Request message. If the SGSN indicates that it supports MBMS, the old SGSN includes the transfer of the MBMS UE Context(s) in the SGSN Context Response message.
- 7) For the MBMS UE context(s) received in step 2) the new SGSN sends Update MBMS UE Context Request (Serving network identity, MS Time Zone, CGI/SAI, RAT Type, Additional MBMS Trace Info) to the GGSNs concerned. The GGSNs update their MBMS UE Context fields and return Update MBMS UE Context Response.
- 8) The GGSN sends Update MBMS UE Context Request (RAI) to the BM-SC. The inclusion of CGI/SAI shall be according rules detailed in subclause 15.1.1a in TS 23.060 [15]. The BM-SC updates its MBMS UE Context fields and return Update MBMS UE Context Response.
- 9) If the GGSN receives new or updated Additional MBMS Trace Info from the new SGSN, the GGSN sends an Activate Trace (Additional MBMS Trace Info) message to the BM-SC.

- 14) In case the new SGSN indicated no MBMS support in step 2) the old SGSN deactivates all MBMS UE context(s) of the UE in SGSN, GGSN and BM-SC by initiating deactivation procedure(s) as described in subclause "8.7 MBMS Multicast Service Deactivation".
- 15) If the old SGSN does not have any more MBMS UE Contexts for the MBMS bearer service(s) and the "list of downstream nodes" in the corresponding MBMS Bearer Context is empty, the SGSN initiates the MBMS De-Registration Procedure. See subclause "8.6 MBMS De-Registration Procedure".
- 16) In case the new SGSN indicated MBMS support in step 2), the new SGSN verifies for each MBMS UE Context received whether it has a corresponding MBMS Bearer Context. For each MBMS Bearer Context that the SGSN does not already have, the SGSN creates an MBMS Bearer Context (in "Standby" state) and initiates the MBMS Registration Procedure towards the GGSN. See subclause "8.4 MBMS Registration Procedure".
- 17) An SGSN without MBMS support does not indicate MBMS feature support in the Routing Area Update Accept message. On the other hand if the SGSN supports MBMS, the Routing Area Update Accept indicates to the UE that the network supports MBMS.

8.10a Inter-system Intra-SGSN change

For an MBMS UE transitioning between UTRAN and A/Gb mode GERAN, the procedures are the same as the Iu mode to A/Gb mode Intra SGSN Change and A/Gb mode to Iu mode Intra SGSN Change procedures specified in TS 23.060 [15].

Furthermore, the same considerations on Radio Access Technology changes apply as specified in the impacts of applying flow based charging specified in TS 23.060 [15], i.e. the SGSN shall send an Update MBMS UE Context Request to the GGSN. Subsequently the GGSN shall send an Update MBMS UE Context Request to the BM-SC as described in the Inter SGSN Routing Area Update procedure in subclause 8.10.

8.11 Inter SGSN Serving RNS Relocation Procedure

This procedure is performed when the SGSN changes due to SRNS relocation. It bases on the SRNS Relocation procedure specified in TS 23.060 [15]. The procedure is performed regardless whether MBMS sessions are ongoing or not. The handling of any PDP contexts established by the UE is not changed compared to the procedure without MBMS. The procedure described below does not show all details of the SRNS relocation procedure. Only for the MBMS specific additions the steps are described.

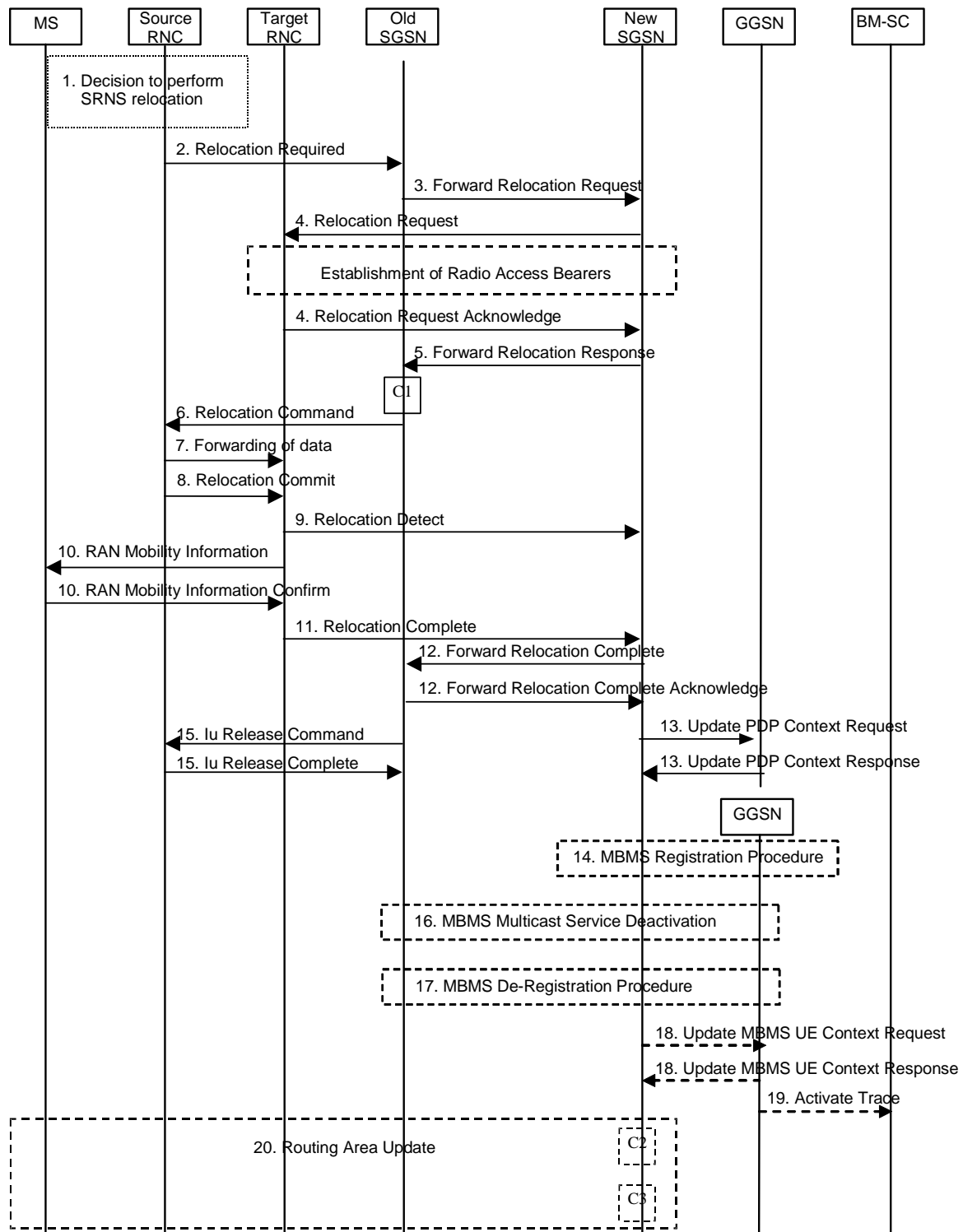

Figure 15: SRNS Relocation Procedure

- 3) The old SGSN transfers the MBMS UE Context(s). in the Forward Relocation Request message to the new SGSN
- 5) An MBMS supporting SGSN indicates its MBMS support in the Forward Relocation Response message.
- 14) In case the new SGSN supports MBMS it verifies for each MBMS UE Context received whether it has a corresponding MBMS Bearer Context. For each MBMS Bearer Context not yet existing in the SGSN the SGSN creates an MBMS Bearer Context (in "Standby" state) and initiates the MBMS Registration Procedure. See subclause "MBMS Registration Procedure".

- 16) In case the new SGSN indicated no MBMS support in step 3) the old SGSN deactivates all MBMS UE contexts of the UE in SGSN, GGSN and BMSC by initiating deactivation procedure(s) as described in clause "8.7 MBMS Multicast Service Deactivation".
- 17) If the old SGSN does not have any more MBMS UE Contexts for this MBMS bearer service and the "list of downstream nodes" in the corresponding MBMS Bearer Context is empty, the SGSN initiates the MBMS De-Registration Procedure. See subclause "MBMS De-Registration Procedure".
- 18) If the new SGSN supports the MBMS and for the MBMS UE context(s) received in step 5) the new SGSN sends Update MBMS UE Context Request (Serving network identity, MS Time Zone, CGI/SAI, RAT Type, Additional MBMS Trace Info) to the GGSNs concerned. The GGSNs update their MBMS UE Context fields and return Update MBMS UE Context Response. The GGSN sends updated Serving network identity to the BM-SC. The inclusion of CGI/SAI shall be according rules detailed in sub-clause 15.1.1a in TS 23.060 [15].
- 19) If the GGSN receives new or updated Additional MBMS Trace Info from the new SGSN, the GGSN sends an Activate Trace (Additional MBMS Trace Info) message to the BM-SC.
- 20) An SGSN without MBMS support does not indicate MBMS feature support in the Routing Area Update Accept message. On the other hand if the SGSN supports MBMS, the Routing Area Update Accept indicates to the UE that the network supports MBMS.

8.12 MBMS Broadcast Service Activation

MBMS Broadcast service activation is the procedure by which a UE locally activates a broadcast MBMS bearer service:

- The MBMS broadcast service activation procedure does not register the user in the network. There is no MBMS bearer service specific signalling exchanged between the UE and the Network.
- The broadcast service activation procedure does not establish MBMS UE contexts in UE, SGSN and GGSN.

8.13 MBMS Broadcast service de-activation

The MBMS Broadcast service de-activation by the UE is local to the UE, i.e. without interaction with the Network.

8.14 Void

8.15 MBMS UE Linking/De-linking mechanism

MBMS UE Linking is the process by which UE MBMS context(s) is (are) provided to an Iu-mode RAN.

MBMS UE linking procedure is performed when the UE is PMM-CONNECTED at least in the following cases.

- When a UE which has a MBMS UE context is moved to the PMM CONNECTED state and a PS RAB is established. This may happen at any point in time e.g. before, during and between Sessions.
- When a UE joins the MBMS bearer service and is in the PMM CONNECTED state due to an existing PS RAB. This may happen at any point in time e.g. before, during and between Sessions.
- When a UE is moved to the PMM CONNECTED state via the MBMS Service Request procedure. This may happen at any point in time during a MBMS session.

The UE linking is performed to link a specific UE to an MBMS service. It provides the SRNC/Iu-mode BSC with a list of MBMS service identifiers (including TMGI) for MBMS bearer services activated by the UE. If no MBMS service context exists for this particular MBMS bearer service then the SRNC/Iu-mode BSC creates an MBMS service context after this procedure.

NOTE: the MBMS Bearer Context is referred to as the MBMS Service Context in 3GPP RAN specifications

MBMS UE De-Linking denotes the process where a MBMS UE context is removed from the RAN.

MBMS UE De-Linking procedure is performed if the UE is PMM-CONNECTED and has been already linked towards the RAN at least when it initiates MBMS Multicast Service Deactivation procedure. This may happen at any point in time during the whole MBMS service availability i.e. before, during and between MBMS sessions.

The UE De-Linking is performed to unlink a specific UE from a MBMS service. The entry for this UE is removed from the concerned MBMS service context(s) in the SRNC.

8.16 MBMS Service Request Procedure

For MBMS, when UTRAN wants to count the number of users that are interested in a specific MBMS service which are present in a cell, it will request a percentage of the interested UEs to transit to PMM-CONNECTED state. The MBMS Service Request procedure is used by a UE in the PMM-IDLE state to move to the PMM-CONNECTED state.

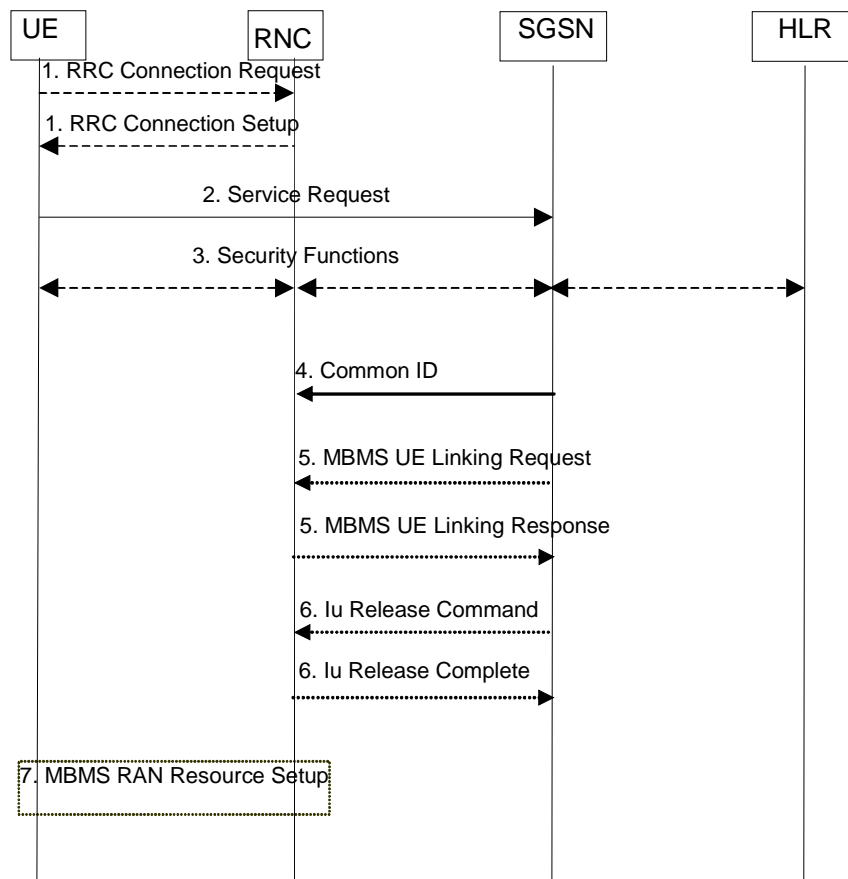

Figure 17: MBMS Service Request procedure

- 2) The UE sends a Service Request message to the SGSN if required to do so by the RAN after an MBMS Session starts. The Service Type shall indicate MBMS multicast service reception or MBMS broadcast service reception.
- 3) The SGSN may perform the security functions.
- 4) The SGSN provides the RAN with the IMSI of the UE.
- 5) The SGSN provides the RAN with the MBMS UE context(s) (IP multicast address/APN, TMGI, MBMS_NSAPI) via MBMS UE Linking procedure, if the SGSN has active MBMS UE context(s) for the UE.
- 6) The SGSN may release the Iu connection.

NOTE: Step 7 is independent of steps 4 to 6 and can occur before or simultaneously with any of these steps.

- 7) The RNC establishes the necessary radio resources for the transfer of MBMS data to the interested UEs.

8.17 Notification in case of parallel services

8.17.1 Notification of incoming CS domain call during an ongoing MBMS session

For the RRC connected mobiles in UTRAN, the RNS will have received the IMSI from the core network and hence is able to perform paging coordination. The UEs in RRC idle state in UTRAN need to perform paging coordination while receiving the MBMS session's user data.

In GERAN, this is achieved by the UE monitoring its paging channels while receiving the MBMS session's user data. If the mobile responds to the CS paging in GERAN, then the ongoing MBMS service is likely to be interrupted in the UE.

8.17.2 Notification of additional MBMS session during an ongoing MBMS session

For the RRC connected mobiles in UTRAN, the SGSN has sent the list of MBMS bearer services that the user has activated to the UTRAN. The RNS needs to notify an RRC connected UE.

For the UEs in RRC idle state, the UTRAN performs MBMS notification for the UE.

In GERAN, this is achieved by the UE monitoring its paging channel(s) where notification is sent while receiving the MBMS session's user data.

If the mobile accepts the new MBMS session in GERAN, then the ongoing MBMS service is likely to be interrupted in the UE.

8.17.3 Notification of Mobile Terminating PS data during an ongoing MBMS session

For the RRC connected mobiles in UTRAN, the SGSN request the establishment of a RAB which will be used to deliver the MT user data.

For the UEs in RRC idle state, the UTRAN performs paging notification for the UE.

In GERAN, this is achieved by the UE monitoring its paging channels while receiving the MBMS session's user data.

If the mobile responds to the PS paging in GERAN, then the ongoing MBMS service is likely to be interrupted in the UE.

8.17.4 Notification of MBMS session during an ongoing CS or PS domain "connection"

When the UE establishes the UTRAN RRC connection for a CS service, the UE shall send a flag indicating that it has activated at least one MBMS bearer service. The RNC requests the SGSN to send the list of MBMS bearer services that the user has activated to enable the RNC to notify the UE when MBMS session starts.

When a UE moves to PMM-connected state, the SGSN sends the list of MBMS bearer services that the user has activated to the RNC. The RNC notifies the UE when an MBMS session of the user's activated MBMS bearer services starts.

These procedures are not supported by GERAN in this version of the specification.

9 Security

Security of MBMS is found in TS 33.246 [5].

10 Charging requirement

10.1 General

The MBMS architecture shall support on-line and off-line charging.

It shall be possible to collect charging information for the multicast mode. It shall also be possible to collect charging information for MBMS services in visited networks.

MBMS shall collect charging information about the transmission of MBMS broadcast or multicast data that are provided by content or service providers (e.g. 3rd parties). This shall enable billing of broadcast and multicast content or service providers.

To enable billing of broadcast and multicast content providers, data shall be collected at the BM-SC.

NOTE: SGSN, GGSN and BM-SC generate charging data for the transmitted data, always under the assumption that the UEs are within the MBMS service area. If the MBMS service area is less than the PLMN, then there is the possibility that a UE will have moved outside the MBMS service area. Charging data will still be generated for that UE causing an inaccuracy in the data. This inaccuracy increases as the size of the MBMS service area is decreased.

10.2 Bearer level charging for MBMS

To provide bearer level charging for MBMS, mechanisms and functional elements described in TS 23.125 [12] are used for MBMS Bearer Contexts.

Flow Based Charging (FBC) may be used to collect charging data records for MBMS Bearer Contexts e.g. for the purpose to charge the service provider, cf. TS 23.125 [12].

NOTE: Since multiple users share an MBMS bearer context FBC cannot be used for creating reports on a per user basis.

10.3 Application level charging for MBMS

In order to meet the MBMS charging requirements in TS 22.146 [2] and TS 22.246 [6], the following elements and functionalities are provided by the MBMS architecture:

- a) The MSISDN and IMSI are passed to the BM-SC. This provides the operator with the ability to associate GPRS location information (i.e. serving network identity) with a user.
- b) In order to permit differential roaming tariffs, the serving network identity is provided to the BM-SC.
- c) Charging for MBMS services is based on application layer mechanisms, since it is only at the application layer that security is provided which can restrict content to authorised users or confirm delivery of content to users:

The following general requirements apply to charging information generated by the BM-SC:

- Charging information generated for application layer charging events should include the above information provided by the GPRS network to facilitate differential roaming tariffs.
- Charging information should include an indication of the point at which the user had access to the content (e.g. if and when decryption keys for encrypted content are sent to the UE.).

10.4 Generation of charging records in the VPLMN

In order to permit the settlement of inter-operator roaming charges, the SGSN needs to raise CDRs. The information that needs to be included on these CDRs is FFS.

11 Roaming Support for MBMS user services

11.1 Scenarios description

There are three specific scenarios to provide MBMS user services to roaming users.

One uses a GGSN in the HPLMN, the other two are enabled by use of the Mz interface and are further described below:

- A visited PLMN may offer to roaming users MBMS user services from their home PLMN. For this case, the PDP connection, which will be used for the JOIN step, may always be from the UE to the V-GGSN due to operator policy or routing optimization, then the authorization is done in the BM-SC in visited PLMN with the authorization information retrieved from the BM-SC in home PLMN. Then the MBMS user traffic is provided by the BM-SC in home PLMN and proxied. An APN indicating a GGSN will be included in the authorisation information sent from home BM-SC to visited BM-SC. Whether GGSN of home or visited PLMN would be used is based on the operator policy, or agreement between PLMNs, for example, the visited BM-SC may modify the APN from the home BM-SC according to configuration of operator policy.
- Or, a visited PLMN may offer its own MBMS user services to roaming users when visited and home PLMN support the same classes of MBMS user services. For this case, the authorization is done in the BM-SC in visited PLMN with the authorization information retrieved from the BM-SC in home PLMN. Then the MBMS user traffic is provided by the BM-SC in visited PLMN.

Editors' note: It is FFS how to deal with the services in the BM-SC in visited network which are not the same service class as supported by the BM-SC in home network.

The usage of any of the scenarios and the offered MBMS user services are subject to the roaming agreement between visited and home PLMN operators.

11.2 Scenario signalling flow

11.2.1 APN selection

When a UE is authorized through the BM-SC in the visited PLMN (by proxying the authorization signalling), an APN may be selected and decided by the BM-SC in the home PLMN or the BM-SC in the visit PLMN depending on the operator policy or agreement between PLMNs. See step 4 of the figure 18.

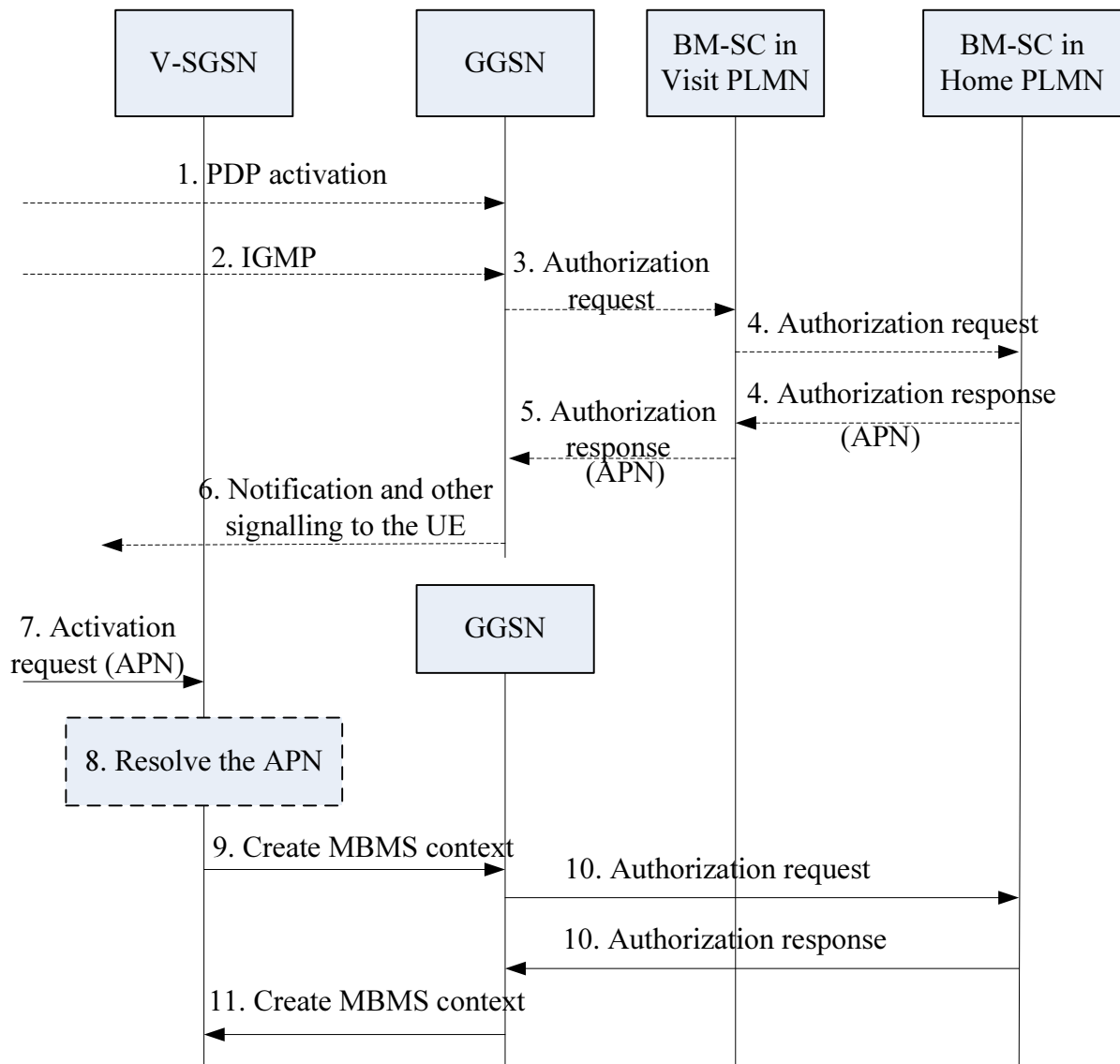

Figure 18: MBMS route optimization for HPLMN provided MBMS services

Figure 18 is an extension of MBMS multicast service activation procedure described in clause 8.2, the only revise is that an authorization step (step 4) is added according to clause 11.1.

4. The BM-SC in visited PLMN finds the BM-SC in home PLMN which will serve the UE based on the multicast IP address, and identity of the user, and sends the authorization request to it. The BM-SC in home PLMN can respond with an APN, which indicates a GGSN in home PLMN which will serve the UE for the specific MBMS service. The BM-SC in the visit network may modify the APN based on the operator policy or agreement between PLMNs.

Annex A (Informative): Void

Annex B (Informative): Change history

Change history								
Date	TSG #	TSG Doc.	CR	Rev	Cat	Subject/Comment	Old	New
2003-09	SA#21	SP-030390				Raised to v.6.0.0 after approval at SA#21	2.0.0	6.0.0
2003-12	SA#22	SP-030660	001	5		Inclusion of GERAN attributes and parameters in MBMS	6.0.0	6.1.0
2003-12	SA#22	SP-030660	002	4		Inclusion of GERAN functionality in MBMS Notification procedure and session ID	6.0.0	6.1.0
2003-12	SA#22	SP-030660	003	4		Inclusion of GERAN functionality in MBMS procedures	6.0.0	6.1.0
2003-12	SA#22	SP-030660	007	4		Clarification of MBMS UE Context plus GERAN functionality	6.0.0	6.1.0
2003-12	SA#22	SP-030660	008	1		Apply TMGI for Broadcast Service	6.0.0	6.1.0
2003-12	SA#22	SP-030660	015	3		MBMS point to point repair/charging/decrypt service	6.0.0	6.1.0
2003-12	SA#22	SP-030660	016	2		Optional provision of duration of the session	6.0.0	6.1.0
2003-12	SA#22	SP-030660	020	2		Corrections for TMGI, linked NSAPI and service ID	6.0.0	6.1.0
2003-12	SA#22	SP-030660	021	1		Removal of superfluous procedures	6.0.0	6.1.0
2003-12	SA#22	SP-030660	022	2		Verification of UE bearer capabilities	6.0.0	6.1.0
2003-12	SA#22	SP-030660	023	1		Various corrections and clarifications	6.0.0	6.1.0
2003-12	SA#22	SP-030660	026	2		Clarification on MBMS deactivation figure	6.0.0	6.1.0
2003-12	SA#22	SP-030660	027	2		MBMS Service Request Procedure	6.0.0	6.1.0
2003-12	SA#22	SP-030660	028			Removal of BG from MBMS Architecture Figure	6.0.0	6.1.0
2003-12	SA#22	SP-030660	030			Removal of security information in TS 23.246	6.0.0	6.1.0
2004-03	SA#23	SP-040039	012	4		Paging Coordination	6.1.0	6.2.0
2004-03	SA#23	SP-040039	030	2		Clarification of MBMS Multicast Service Activation	6.1.0	6.2.0
2004-03	SA#23	SP-040039	031	2		Create MBMS Bearer Context in GGSN	6.1.0	6.2.0
2004-03	SA#23	SP-040039	036	1		TMGI distribution mechanism for Broadcast mode	6.1.0	6.2.0
2004-03	SA#23	SP-040039	038	2		Buffering of MBMS data at the RNC	6.1.0	6.2.0
2004-03	SA#23	SP-040039	039	1		Distribution of BM-SC functionality	6.1.0	6.2.0
2004-03	SA#23	SP-040039	040			MBMS Application Adjunct Server	6.1.0	6.2.0
2004-03	SA#23	SP-040039	041	2		MBMS TS scope	6.1.0	6.2.0
2004-03	SA#23	SP-040039	042	3		SGSN filtering of RAs to support RA-based optimization	6.1.0	6.2.0
2004-03	SA#23	SP-040039	043			Complete the MBMS Service Request Procedure	6.1.0	6.2.0
2004-03	SA#23	SP-040039	044	1		Correction on De-Registration Procedure	6.1.0	6.2.0
2004-03	SA#23	SP-040039	049			TMGI Definition and Objective	6.1.0	6.2.0
2004-03	SA#23	SP-040039	050	1		NSAPI in MBMS Multicast Service Activation	6.1.0	6.2.0
2004-06	SA#24	SP-040322	051	4		Optimization of MBMS multicast service activation procedure	6.2.0	6.3.0
2004-06	SA#24	SP-040322	052	1		Correction of erroneous references	6.2.0	6.3.0
2004-06	SA#24	SP-040322	056	1		Session duration on Broadcast Session Start Procedure	6.2.0	6.3.0
2004-06	SA#24	SP-040322	057	3		Removing FFS from TS 23.246	6.2.0	6.3.0
2004-06	SA#24	SP-040322	058	3		Clarification on relationships between MBMS Session Stop & MBMS De-registration & MBMS De-activation	6.2.0	6.3.0
2004-06	SA#24	SP-040322	059	1		Remove some FFS on PMM-CONNECTED vs RRC-CONNECTED UEs	6.2.0	6.3.0
2004-06	SA#24	SP-040322	061	2		Correction on MBMS deregistration procedure	6.2.0	6.3.0
2004-06	SA#24	SP-040322	062	3		New addition to MBMS bearer context	6.2.0	6.3.0
2004-06	SA#24	SP-040322	066	3		CR for MBMS UE Context in 6.1	6.2.0	6.3.0
2004-06	SA#24	SP-040322	069	1		Removing Security requirements from 23.246	6.2.0	6.3.0
2004-06	SA#24	SP-040322	077	2		Proposed Flow Based Charging for MBMS	6.2.0	6.3.0
2004-06	SA#24	SP-040322	078	1		Notification of Incoming CS Domain Call/PS Data/Additional MBMS Call during An Ongoing MBMS Session for GERAN	6.2.0	6.3.0
2004-06	SA#24	SP-040322	083	2		Clarification of MBMS subscription	6.2.0	6.3.0
2004-09	SA#25	SP-040526	076	2		MBMS Service Area definition	6.3.0	6.4.0
2004-09	SA#25	SP-040526	084	1		Use Correct SA4 MBMS User Service Specification	6.3.0	6.4.0
2004-09	SA#25	SP-040526	085	1		Clarification of BM-SC create MBMS UE Context	6.3.0	6.4.0
2004-09	SA#25	SP-040526	089	1		Remove SDU FFS in section 6.3 Quality of Service	6.3.0	6.4.0
2004-09	SA#25	SP-040526	093	2		Application Level Charging Mechanisms	6.3.0	6.4.0
2004-09	SA#25	SP-040526	094	1		MBMS Session Notification	6.3.0	6.4.0
2004-09	SA#25	SP-040526	095			Removing FFS from TS 23.246	6.3.0	6.4.0

Change history								
Date	TSG #	TSG Doc.	CR	Rev	Cat	Subject/Comment	Old	New
2004-09	SA#25	SP-040526	097			Clarification of reference model	6.3.0	6.4.0
2004-09	SA#25	SP-040526	099	2		Service Context creation in RNC	6.3.0	6.4.0
2004-09	SA#25	SP-040526	101			Correction for error handling in MBMS multicast activation	6.3.0	6.4.0
2004-09	SA#25	SP-040526	103	1		MBMS BSC UE context and bearer plane	6.3.0	6.4.0
2004-09	SA#25	SP-040526	106	2		Allocation and retention priority for MBMS bearers	6.3.0	6.4.0
2004-09	SA#25	SP-040526	107	1		Merged CR 88 Separate Rendering of 2G and 3G Content for the Same Service, CR 90 Definition of Session Identity and CR92 Additional information needed in section 8.3 Session Start Message	6.3.0	6.4.0
2004-12	SA#26	SP-040904	072	7		MBMS Broadcast Session Stop Procedure	6.4.0	6.5.0
2004-12	SA#26	SP-040904	096	5		Clarification of BM-SC functions	6.4.0	6.5.0
2004-12	SA#26	SP-040904	105	2		Change between supporting and non-supporting SGSN	6.4.0	6.5.0
2004-12	SA#26	SP-040904	108	1		Clarification of MBMS Service Area definition	6.4.0	6.5.0
2004-12	SA#26	SP-040904	110	3		MBMS Architecture Modification – CBC (cell broadcast centre) Part	6.4.0	6.5.0
2004-12	SA#26	SP-040904	111	3		How to avoid overloading the central server after sending service announcement	6.4.0	6.5.0
2004-12	SA#26	SP-040904	112	2		Correction for MBMS Multicast Deactivation Procedure	6.4.0	6.5.0
2004-12	SA#26	SP-040904	115	2		Corrections for Inter SGSN Serving RNS Relocation & Routing Area Update Cases	6.4.0	6.5.0
2004-12	SA#26	SP-040904	117	1		Guaranteed bitrate for Streaming MBMS	6.4.0	6.5.0
2004-12	SA#26	SP-040904	119	2		Correction on MBMS Multicast Service Deactivation procedure	6.4.0	6.5.0
2004-12	SA#26	SP-040904	122	2		Charging Related Correction for MBMS	6.4.0	6.5.0
2004-12	SA#26	SP-040904	123	1		MBMS Architecture Related Correction	6.4.0	6.5.0
2004-12	SA#26	SP-040904	124	1		General editorial correction for MBMS	6.4.0	6.5.0
2004-12	SA#26	SP-040904	126	2		Separate MBMS Sessions for 2G and 3G for same MBMS Bearer Service	6.4.0	6.5.0
2004-12	SA#26	SP-040904	129	3		MBMS UE context synchronisation	6.4.0	6.5.0
2004-12	SA#26	SP-040904	131	1		Delaying data transfer at session start	6.4.0	6.5.0
2004-12	SA#26	SP-040904	133	2		List of number of PMM-IDLE UEs per RA parameter for RAN	6.4.0	6.5.0
2004-12	SA#26	SP-040904	134	1		MBMS UE context via MBMS UE Linking procedure	6.4.0	6.5.0
2004-12	SA#26	SP-040904	135	2		Clarification of MBMS UE Linking handling	6.4.0	6.5.0
2005-03	SA#27	SP-050110	138	1		Alignment of BM-SC subfunctions to MBMS User Service level	6.5.0	6.6.0
2005-03	SA#27	SP-050110	139	1		MBMS and the use of FBC	6.5.0	6.6.0
2005-03	SA#27	SP-050110	140	1		Corrections to MBMS Multicast Service Deactivation Procedure	6.5.0	6.6.0
2005-03	SA#27	SP-050110	141	-		Providing the BM-SC with approximate UE location information at MBMS context activation	6.5.0	6.6.0
2005-06	SA#28	SP-050340	142	3		Extension of the use of MBMS support indication from SGSN to UE	6.6.0	6.7.0
2005-06	SA#28	SP-050340	144	-		Clarification of the TMGI	6.6.0	6.7.0
2005-06	SA#28	SP-050340	148	3		Join clarification	6.6.0	6.7.0
2005-06	SA#28	SP-050340	152	4		UE have to join again to activate locally deactivated MBMS bearer services	6.6.0	6.7.0
2005-06	SA#28	SP-050340	153	1		On Estimated Session Duration	6.6.0	6.7.0
2005-06	SA#28	SP-050340	155	2		Corrections	6.6.0	6.7.0
2005-06	SA#28	SP-050355	157	-		Combined CR on MBMS Trace and Charging Information (Combining CR0147R2 and CR0154)	6.6.0	6.7.0
2005-09	SA#29	SP-050480	159	2		Time to Data transfer	6.7.0	6.8.0
2005-09	SA#29	SP-050480	160	1		Inter-system intra-SGSN change	6.7.0	6.8.0
2005-09	SA#29	SP-050480	161	-		GGSN involvement in Routing Area Update and Inter-SRNS relocation procedures	6.7.0	6.8.0
2005-09	SA#29	SP-050480	163	2		Remove provision of number of idle mode UEs in Session Start	6.7.0	6.8.0
2005-09	SA#29	SP-050480	165	3		Correction to limit the number of RAN nodes involved with an MBMS session	6.7.0	6.8.0
2005-12	SA#30	SP-050667	167	1		Clarification of the MBMS 2G/3G access coordination issue	6.8.0	6.9.0
2006-06	SA#32	SP-060277	174	1		3GPP TS 23.246 misalignment regarding the MBMS bearer capabilities	6.9.0	6.10.0

Change history								
Date	TSG #	TSG Doc.	CR	Rev	Cat	Subject/Comment	Old	New
2006-09	SA#33	SP-060650	173	5	C	Allowing update of an MBMS service area	6.10.0	7.0.0
2006-09	SA#33	SP-060573	175	4	B	MBMS Roaming Support	6.10.0	7.0.0
2006-12	SA#34	SP-060896	179	3	C	Optimization on MBMS activation	7.0.0	7.1.0
2006-12	SA#34	SP-060834	182	1	A	GTP information in MBMS bearer context	7.0.0	7.1.0
2006-12	SA#34	SP-060896	183	2	C	Roaming solution based on routing optimization	7.0.0	7.1.0
2006-12	SA#34	SP-060872	186	-	A	Initiation of Service Request to support MBMS broadcast services	7.1.0	7.1.1
2007-03	SA#35	SP-070082	187	3	F	APN selection for the Direct MBMS Multicast Activation	7.1.1	7.2.0
2007-03	SA#35	SP-070082	188	3	F	Support both IPv6 and IPv4 in MBMS	7.1.1	7.2.0
2007-03	SA#35	SP-070082	189	2	F	The Downstream Nodes of SGSN	7.1.1	7.2.0

History

Document history		
V7.1.1	March 2007	Publication
V7.2.0	March 2007	Publication