

ETSI TS 123 247 V17.4.0 (2022-09)



**5G;**  
**Architectural enhancements for 5G multicast-broadcast**  
**services**  
**(3GPP TS 23.247 version 17.4.0 Release 17)**



---

Reference

RTS/TSGS-0223247vh40

---

Keywords

5G

**ETSI**

650 Route des Lucioles  
F-06921 Sophia Antipolis Cedex - FRANCE

Tel.: +33 4 92 94 42 00 Fax: +33 4 93 65 47 16

Siret N° 348 623 562 00017 - APE 7112B  
Association à but non lucratif enregistrée à la  
Sous-Préfecture de Grasse (06) N° w061004871

---

**Important notice**

The present document can be downloaded from:

<http://www.etsi.org/standards-search>

The present document may be made available in electronic versions and/or in print. The content of any electronic and/or print versions of the present document shall not be modified without the prior written authorization of ETSI. In case of any existing or perceived difference in contents between such versions and/or in print, the prevailing version of an ETSI deliverable is the one made publicly available in PDF format at [www.etsi.org/deliver](http://www.etsi.org/deliver).

Users of the present document should be aware that the document may be subject to revision or change of status.

Information on the current status of this and other ETSI documents is available at

<https://portal.etsi.org/TB/ETSIDeliverableStatus.aspx>

If you find errors in the present document, please send your comment to one of the following services:

<https://portal.etsi.org/People/CommitteeSupportStaff.aspx>

If you find a security vulnerability in the present document, please report it through our  
Coordinated Vulnerability Disclosure Program:

<https://www.etsi.org/standards/coordinated-vulnerability-disclosure>

---

**Notice of disclaimer & limitation of liability**

The information provided in the present deliverable is directed solely to professionals who have the appropriate degree of experience to understand and interpret its content in accordance with generally accepted engineering or other professional standard and applicable regulations.

No recommendation as to products and services or vendors is made or should be implied.

No representation or warranty is made that this deliverable is technically accurate or sufficient or conforms to any law and/or governmental rule and/or regulation and further, no representation or warranty is made of merchantability or fitness for any particular purpose or against infringement of intellectual property rights.

In no event shall ETSI be held liable for loss of profits or any other incidental or consequential damages.

Any software contained in this deliverable is provided "AS IS" with no warranties, express or implied, including but not limited to, the warranties of merchantability, fitness for a particular purpose and non-infringement of intellectual property rights and ETSI shall not be held liable in any event for any damages whatsoever (including, without limitation, damages for loss of profits, business interruption, loss of information, or any other pecuniary loss) arising out of or related to the use of or inability to use the software.

---

**Copyright Notification**

No part may be reproduced or utilized in any form or by any means, electronic or mechanical, including photocopying and microfilm except as authorized by written permission of ETSI.

The content of the PDF version shall not be modified without the written authorization of ETSI.

The copyright and the foregoing restriction extend to reproduction in all media.

© ETSI 2022.  
All rights reserved.

---

# Intellectual Property Rights

## Essential patents

IPRs essential or potentially essential to normative deliverables may have been declared to ETSI. The declarations pertaining to these essential IPRs, if any, are publicly available for **ETSI members and non-members**, and can be found in ETSI SR 000 314: "*Intellectual Property Rights (IPRs); Essential, or potentially Essential, IPRs notified to ETSI in respect of ETSI standards*", which is available from the ETSI Secretariat. Latest updates are available on the ETSI Web server (<https://ipr.etsi.org/>).

Pursuant to the ETSI Directives including the ETSI IPR Policy, no investigation regarding the essentiality of IPRs, including IPR searches, has been carried out by ETSI. No guarantee can be given as to the existence of other IPRs not referenced in ETSI SR 000 314 (or the updates on the ETSI Web server) which are, or may be, or may become, essential to the present document.

## Trademarks

The present document may include trademarks and/or tradenames which are asserted and/or registered by their owners. ETSI claims no ownership of these except for any which are indicated as being the property of ETSI, and conveys no right to use or reproduce any trademark and/or tradename. Mention of those trademarks in the present document does not constitute an endorsement by ETSI of products, services or organizations associated with those trademarks.

**DECT™**, **PLUGTESTS™**, **UMTS™** and the ETSI logo are trademarks of ETSI registered for the benefit of its Members. **3GPP™** and **LTE™** are trademarks of ETSI registered for the benefit of its Members and of the 3GPP Organizational Partners. **oneM2M™** logo is a trademark of ETSI registered for the benefit of its Members and of the oneM2M Partners. **GSM®** and the GSM logo are trademarks registered and owned by the GSM Association.

---

# Legal Notice

This Technical Specification (TS) has been produced by ETSI 3rd Generation Partnership Project (3GPP).

The present document may refer to technical specifications or reports using their 3GPP identities. These shall be interpreted as being references to the corresponding ETSI deliverables.

The cross reference between 3GPP and ETSI identities can be found under <http://webapp.etsi.org/key/queryform.asp>.

---

# Modal verbs terminology

In the present document "**shall**", "**shall not**", "**should**", "**should not**", "**may**", "**need not**", "**will**", "**will not**", "**can**" and "**cannot**" are to be interpreted as described in clause 3.2 of the [ETSI Drafting Rules](#) (Verbal forms for the expression of provisions).

"**must**" and "**must not**" are **NOT** allowed in ETSI deliverables except when used in direct citation.

# Contents

Intellectual Property Rights .....	2
Legal Notice .....	2
Modal verbs terminology.....	2
Foreword.....	7
1 Scope .....	9
2 References .....	9
3 Definitions of terms and abbreviations.....	10
3.1 Terms.....	10
3.2 Abbreviations .....	11
4 General Concept.....	11
4.1 Overview of multicast and broadcast communication.....	11
4.2 MB service provisioning .....	13
4.2.1 Multicast data provisioning .....	13
4.2.2 Broadcast data provisioning.....	15
4.3 Multicast session state model .....	16
5 Architecture model.....	19
5.1 General architecture .....	19
5.2 General architecture for interworking with EPS .....	20
5.3 Service-based interfaces, Reference point and functional entities.....	21
5.3.0 Service-based interfaces .....	21
5.3.1 Reference point.....	21
5.3.2 Functional entities.....	22
5.3.2.1 PCF .....	22
5.3.2.2 MB-SMF.....	22
5.3.2.3 SMF.....	23
5.3.2.4 MB-UPF.....	23
5.3.2.5 UPF .....	23
5.3.2.6 AMF.....	23
5.3.2.7 NG-RAN .....	24
5.3.2.8 UE .....	24
5.3.2.9 AF .....	24
5.3.2.10 NEF.....	24
5.3.2.11 MBSF.....	24
5.3.2.12 MBSTF .....	25
5.3.2.13 UDM.....	25
5.3.2.14 UDR .....	25
5.3.2.15 NRF.....	25
5.3.2.15.1 General .....	25
5.3.2.15.2 Extensions to NF profile at NRF .....	26
6 Functionalities and features.....	26
6.1 Authorization to MBS service .....	26
6.1.1 AF authorization to the service for multicast and broadcast.....	26
6.1.2 UE authorization to the service for multicast.....	26
6.2 Local MBS service and Location dependent MBS service .....	26
6.2.1 General.....	26
6.2.2 Local MBS service.....	27
6.2.3 Location dependent MBS service .....	27
6.2.4 Void .....	28
6.2.5 Void .....	28
6.3 Mobility support of MBS service .....	28
6.3.1 Mobility of Multicast MBS session .....	28
6.3.2 Mobility of Broadcast MBS session .....	29

6.4	Subscription to multicast services .....	29
6.4.1	General.....	29
6.4.2	MBS subscription data in UDM .....	29
6.4.3	MBS information in UDR.....	30
6.5	Identifiers .....	30
6.5.1	MBS Session ID .....	30
6.5.2	Temporary Mobile Group Identity.....	30
6.5.3	Source Specific IP Multicast Address.....	30
6.5.4	MBS Frequency Selection Area ID .....	30
6.6	QoS Handling for Multicast and Broadcast services.....	31
6.7	User plane management .....	32
6.8	Interworking with MBMS over E-UTRAN for public safety services.....	34
6.9	MBS Session Context.....	34
6.9.1	MBS Session Context .....	34
6.10	Policy control for Multicast and Broadcast services .....	36
6.10.1	General.....	36
6.10.2	MBS Session policy control data in UDR .....	37
6.11	Service Announcement.....	37
6.12	Paging strategy handling .....	38
6.13	MBS Security function.....	38
6.14	MBS Service Information .....	38
7	MBS procedures.....	39
7.1	Common procedure for Multicast and Broadcast.....	39
7.1.1	MBS Session Management.....	39
7.1.1.1	General.....	39
7.1.1.2	MBS Session Creation without PCC.....	39
7.1.1.3	MBS Session Creation with PCC.....	42
7.1.1.4	MBS Session Deletion without PCC.....	45
7.1.1.5	MBS Session Deletion with PCC.....	47
7.1.1.6	MBS Session Update without PCC.....	48
7.1.1.7	MBS Session Update with PCC.....	50
7.1.2	MB-SMF discovery and selection for multicast/broadcast session.....	53
7.1.3	MB-UPF discovery and selection for multicast/broadcast session .....	53
7.2	MBS procedures for multicast Session.....	54
7.2.1	MBS join and Session establishment procedure .....	54
7.2.1.1	General .....	54
7.2.1.2	Establishment of a PDU Session that can be associated with multicast session(s) .....	54
7.2.1.3	Multicast session join and session establishment procedure .....	54
7.2.1.4	Establishment of shared delivery toward RAN node .....	58
7.2.2	Multicast MBS Session leave and Multicast MBS Session release procedure .....	60
7.2.2.1	General .....	60
7.2.2.2	Multicast Session leave requested by the UE.....	60
7.2.2.3	Multicast session leave requested by the network or MBS session release.....	62
7.2.2.4	Release of shared delivery toward RAN node .....	63
7.2.3	Mobility Procedures for MBS.....	65
7.2.3.1	General .....	65
7.2.3.2	Xn based handover from MBS supporting NG-RAN node.....	65
7.2.3.3	N2 based handover from MBS supporting NG-RAN node.....	66
7.2.3.4	Xn/N2 based handover from non-MBS supporting NG-RAN node .....	67
7.2.3.5	Minimization of data loss.....	68
7.2.3.6	Xn/N2 based handover for inactive MBS session.....	68
7.2.3.7	Connection Resume in RRC Inactive procedure.....	69
7.2.4	Support of Local multicast service and Location dependent multicast service.....	69
7.2.4.1	General .....	69
7.2.4.2	Support of location dependent multicast service.....	69
7.2.4.2.0	Creation for location dependent MBS session.....	69
7.2.4.2.1	UE join location dependent Multicast MBS session and establishment procedure .....	70
7.2.4.2.2	Void.....	71
7.2.4.2.3	Handover procedure .....	71
7.2.4.2.4	Activation of location dependent MBS session.....	73

7.2.4.2.5	UE location change handling within the same NG-RAN node between cells belonging to different MBS service areas during Individual delivery .....	73
7.2.4.2.6	UE location change handling by SMF .....	74
7.2.4.2.7	UE mobility within the same NG-RAN between cells belonging to different MBS service areas for shared delivery .....	74
7.2.4.2.8	Void .....	75
7.2.4.3	Support of local MBS for multicast .....	75
7.2.4.3.1	Local MBS service area information provided by AF .....	75
7.2.4.3.2	Multicast session join and session establishment procedure for local MBS .....	75
7.2.4.3.3	Handover procedure with local MBS session .....	76
7.2.4.3.4	Activation of local MBS session .....	77
7.2.4.3.5	UE location change handling by SMF .....	77
7.2.4.3.6	UE mobility within the same NG-RAN between cells in or out of the MBS service area .....	77
7.2.4.3.7	Void .....	78
7.2.5	MBS session activation and deactivation .....	78
7.2.5.1	General .....	78
7.2.5.2	MBS session activation procedure .....	78
7.2.5.3	MBS session deactivation procedure .....	81
7.2.6	Multicast session update procedure .....	82
7.2.7	Void .....	84
7.2.8	Service request procedure .....	85
7.2.9	AF provisioning multicast MBS Session Authorization information .....	85
7.3	MBS procedures for broadcast Session .....	85
7.3.1	MBS Session Start for Broadcast .....	86
7.3.2	MBS Session Release for Broadcast .....	88
7.3.3	MBS Session Update for Broadcast .....	88
7.3.4	Support for Location dependent Broadcast Service .....	90
7.3.5	MBS Session Delivery Status Indication for Broadcast .....	90
7.3.6	Broadcast MBS Session Release Require .....	91
7.4	MBS procedures for inter System Mobility .....	92
7.4.1	Inter-system mobility with interworking at service layer .....	92
8	Control and user plane stacks .....	93
8.1	Control plane for Multicast and Broadcast services .....	93
8.1.1	General .....	93
8.1.2	NG-RAN – MB-SMF .....	93
8.2	User plane for Multicast and Broadcast services .....	93
9	Network Function Services .....	95
9.1	MB-SMF Services .....	95
9.1.1	General .....	95
9.1.2	Nmbsmf_TMGI service .....	95
9.1.2.1	General .....	95
9.1.2.2	Nmbsmf_TMGI_Allocate service operation .....	95
9.1.2.3	Nmbsmf_TMGI_Deallocate service operation .....	95
9.1.3	Nmbsmf_MBSSession service .....	96
9.1.3.1	General .....	96
9.1.3.2	Nmbsmf_MBSSession_ContextUpdate service operation .....	96
9.1.3.3	Nmbsmf_MBSSession_ContextStatusSubscribe service operation .....	97
9.1.3.4	Nmbsmf_MBSSession_ContextStatusNotify service operation .....	97
9.1.3.5	Nmbsmf_MBSSession_ContextStatusUnsubscribe service operation .....	97
9.1.3.6	Nmbsmf_MBSSession_Create service operation .....	97
9.1.3.7	Nmbsmf_MBSSession_Update service operation .....	98
9.1.3.8	Nmbsmf_MBSSession_Delete service operation .....	98
9.1.3.9	Nmbsmf_MBSSession_StatusNotify service operation .....	98
9.1.3.10	Nmbsmf_MBSSession_StatusSubscribe service operation .....	98
9.1.3.11	Nmbsmf_MBSSession_StatusUnsubscribe service operation .....	99
9.2	PCF Services .....	99
9.2.1	General .....	99
9.2.2	Npcf_MBSPolicyControl service .....	99
9.2.2.1	General .....	99
9.2.2.2	Npcf_MBSPolicyControl_Create service operation .....	100

9.2.2.3	Void.....	100
9.2.2.4	Npcf_MBSPolicyControl_Delete service operation .....	100
9.2.2.5	Npcf_MBSPolicyControl_Update service operation .....	100
9.2.3	Npcf_MBSPolicyAuthorization Service.....	101
9.2.3.1	General .....	101
9.2.3.2	Npcf_MBSPolicyAuthorization_Create service operation .....	101
9.2.3.3	Npcf_MBSPolicyAuthorization_Update service operation .....	101
9.2.3.4	Npcf_MBSPolicyAuthorization_Delete service operation .....	101
9.3	AMF Services.....	102
9.3.1	General.....	102
9.3.2	Namf_MBSBroadcast service.....	102
9.3.2.1	General .....	102
9.3.2.2	Namf_MBSBroadcast_ContextCreate service operation .....	102
9.3.2.3	Namf_MBSBroadcast_ContextUpdate service operation .....	102
9.3.2.4	Namf_MBSBroadcast_ContextRelease service operation .....	102
9.3.2.5	Namf_MBSBroadcast_ContextStatusNotify service operation .....	103
9.3.3	Namf_MBSCommunication Service .....	103
9.3.3.1	General .....	103
9.3.3.2	Namf_MBSCommunication_N2MessageTransfer service operation .....	103
9.4	NEF Services.....	103
9.4.1	General.....	103
9.4.2	Nnef_MBSTMGI service .....	104
9.4.2.1	General .....	104
9.4.2.2	Nnef_MBSTMGI_Allocate service operation .....	104
9.4.2.3	Nnef_MBSTMGI_Deallocate service operation.....	104
9.4.2.4	Nnef_MBSTMGI_ExpiryNotify service operation.....	104
9.4.3	Nnef_MBSSession Service.....	105
9.4.3.1	General .....	105
9.4.3.2	Nnef_MBSSession_Create service operation.....	105
9.4.3.3	Nnef_MBSSession_Update service operation .....	105
9.4.3.4	Nnef_MBSSession_Delete service operation.....	105
9.4.3.5	Nnef_MBSSession_StatusNotify service operation.....	106
9.4.3.6	Nnef_MBSSession_StatusSubscribe service operation.....	106
9.4.3.7	Nnef_MBSSession_StatusUnsubscribe service operation .....	106
9.5	MBSF Services.....	106
<b>Annex A (normative):</b>	<b>Configuration options at Service and/or Application for MBS .....</b>	<b>107</b>
<b>Annex B (informative):</b>	<b>Service levels for multicast communication service.....</b>	<b>109</b>
<b>Annex C (normative):</b>	<b>Interworking at reference points MB2 and xMB.....</b>	<b>110</b>
<b>Annex D (informative):</b>	<b>Change history .....</b>	<b>111</b>
History .....		114

---

# Foreword

This Technical Specification has been produced by the 3rd Generation Partnership Project (3GPP).

The contents of the present document are subject to continuing work within the TSG and may change following formal TSG approval. Should the TSG modify the contents of the present document, it will be re-released by the TSG with an identifying change of release date and an increase in version number as follows:

Version x.y.z

where:

- x the first digit:
  - 1 presented to TSG for information;
  - 2 presented to TSG for approval;
  - 3 or greater indicates TSG approved document under change control.
- y the second digit is incremented for all changes of substance, i.e. technical enhancements, corrections, updates, etc.
- z the third digit is incremented when editorial only changes have been incorporated in the document.

In the present document, modal verbs have the following meanings:

- shall** indicates a mandatory requirement to do something
- shall not** indicates an interdiction (prohibition) to do something

The constructions "shall" and "shall not" are confined to the context of normative provisions, and do not appear in Technical Reports.

The constructions "must" and "must not" are not used as substitutes for "shall" and "shall not". Their use is avoided insofar as possible, and they are not used in a normative context except in a direct citation from an external, referenced, non-3GPP document, or so as to maintain continuity of style when extending or modifying the provisions of such a referenced document.

- should** indicates a recommendation to do something
- should not** indicates a recommendation not to do something
- may** indicates permission to do something
- need not** indicates permission not to do something

The construction "may not" is ambiguous and is not used in normative elements. The unambiguous constructions "might not" or "shall not" are used instead, depending upon the meaning intended.

- can** indicates that something is possible
- cannot** indicates that something is impossible

The constructions "can" and "cannot" are not substitutes for "may" and "need not".

- will** indicates that something is certain or expected to happen as a result of action taken by an agency the behaviour of which is outside the scope of the present document
- will not** indicates that something is certain or expected not to happen as a result of action taken by an agency the behaviour of which is outside the scope of the present document
- might** indicates a likelihood that something will happen as a result of action taken by some agency the behaviour of which is outside the scope of the present document



**might not** indicates a likelihood that something will not happen as a result of action taken by some agency the behaviour of which is outside the scope of the present document

In addition:

**is** (or any other verb in the indicative mood) indicates a statement of fact

**is not** (or any other negative verb in the indicative mood) indicates a statement of fact

The constructions "is" and "is not" do not indicate requirements.

---

# 1 Scope

The present document specifies architectural enhancements to the 5G system using NR to support multicast and broadcast communication services, complying to the requirements in TS 22.146 [2], TS 22.246 [3] and TS 22.261 [4]. This document encompasses support for functions such as how to deliver multicast and broadcast communications including support within certain location areas, mobility, MBS session management and QoS.

The present document also covers interworking with E-UTRAN and EPC based eMBMS for Public Safety (e.g. MCX services).

---

# 2 References

The following documents contain provisions which, through reference in this text, constitute provisions of the present document.

- References are either specific (identified by date of publication, edition number, version number, etc.) or non-specific.
- For a specific reference, subsequent revisions do not apply.
- For a non-specific reference, the latest version applies. In the case of a reference to a 3GPP document (including a GSM document), a non-specific reference implicitly refers to the latest version of that document *in the same Release as the present document*.

- [1] 3GPP TR 21.905: "Vocabulary for 3GPP Specifications".
- [2] 3GPP TS 22.146: "Multimedia Broadcast/Multicast Service (MBMS); Stage 1".
- [3] 3GPP TS 22.246: "Multimedia Broadcast/Multicast Service (MBMS) user services; Stage 1".
- [4] 3GPP TS 22.261: "Service requirements for the 5G system".
- [5] 3GPP TS 23.501: "System architecture for the 5G System (5GS)".
- [6] 3GPP TS 23.502: "Procedures for the 5G System; Stage 2".
- [7] 3GPP TS 23.503: "Policy and charging control framework for the 5G System (5GS); Stage 2".
- [8] 3GPP TS 23.246: "Multimedia Broadcast/Multicast Service (MBMS); Architecture and functional description".
- [9] 3GPP TS 38.300: "NR; Overall description; Stage-2".
- [10] 3GPP TS 23.468: "Group Communication System Enablers for LTE (GCSE\_LTE)".
- [11] 3GPP TS 26.348: "Northbound Application Programming Interface (API) for Multimedia Broadcast/Multicast Service (MBMS) at the xMB reference point".
- [12] 3GPP TS 23.003: "Numbering, Addressing and Identification".
- [13] 3GPP TS 26.346: "MBMS: Protocols and Codecs".
- [14] Void.
- [15] 3GPP TS 38.413: "NG Application Protocol (NGAP)".
- [16] 3GPP TS 38.401: "NG-RAN; Architecture description".
- [17] 3GPP TS 29.244: "Interface between the Control Plane and the User Plane Nodes; Stage 3".
- [18] 3GPP TS 26.502: "5G Multicast-Broadcast User Service Architecture".
- [19] 3GPP TS 29.510: "Network Function Repository Services; Stage 3".

- [20] 3GPP TS 33.501: "Security architecture and procedures for 5G system".
- [21] 3GPP TS 23.289: "Mission Critical services over 5G System; Stage 2".
- [22] 3GPP TS 26.517: "5G Multicast-Broadcast User Services; Protocols and Formats".
- [23] 3GPP TS 29.281: "General Packet Radio System (GPRS) Tunnelling Protocol; User Plane (GTPv1-U)".

---

## 3 Definitions of terms and abbreviations

### 3.1 Terms

For the purposes of the present document, the terms and definitions defined in TR 21.905 [1] and the following apply:

**5GC Individual MBS traffic delivery:** 5G CN receives a single copy of MBS data packets and delivers separate copies of those MBS data packets to individual UEs via per-UE PDU sessions, hence for each such UE one PDU session is required to be associated with a Multicast MBS Session.

**5GC Shared MBS traffic delivery:** 5G CN receives a single copy of MBS data packets and delivers a single copy of those MBS data packets to a RAN node.

**Area Session Identifier:** A unique identifier within an MBS Session used for an MBS session with location dependent content. When present, the Area Session ID, together with the TMGI, is used to uniquely identify the data flow of an MBS Session in a specific MBS service area.

**Associated PDU Session:** A PDU Session associated to a multicast MBS session that is used for 5GC Individual MBS traffic delivery method and for signalling related to a user's participation in a multicast MBS session such as join and leave requests.

**Associated QoS Flow:** A unicast QoS Flow that belongs to the associated PDU Session and is used for 5GC Individual MBS traffic delivery method. The associated QoS Flow is mapped from a multicast QoS Flow in a multicast MBS session.

**Broadcast communication service:** A 5GS communication service in which the same service and the same specific content data are provided simultaneously to all UEs in a geographical area (i.e. all UEs in the broadcast coverage area are authorized to receive the data).

NOTE 1: For the broadcast communication service, the content provider and network may not be aware whether the authorized UEs are actually receiving the data being delivered.

**Broadcast MBS session:** An MBS session to deliver the broadcast communication service. A broadcast MBS session is characterised by the content to send and the geographical area where to distribute it.

**Broadcast service area:** The area within which data of one or multiple Broadcast MBS session(s) are sent.

**MBS QoS Flow:** The finest granularity for QoS forwarding treatment for MBS data. Providing different QoS forwarding treatment requires separate MBS QoS Flows in 5GS supporting MBS.

**MBS Service Announcement:** Mechanism to allow users to be informed about the available MBS services.

**MBS session:** A multicast MBS session or a broadcast MBS session.

**MBS service area:** The area within which data of one Multicast or Broadcast MBS session may be sent. For location dependent MBS, for each MBS service area, an Area Session ID, which is unique per MBS Session ID, is allocated and the same location dependent content data for an MBS session is delivered to the UE(s) within an MBS service area.

**Multicast communication service:** A 5GS communication service in which the same service and the same specific content data are provided simultaneously to a dedicated set of UEs (i.e. not all UEs in the coverage of the MBS service area are authorized to receive the data).

NOTE 2: For multicast communication service, the content provider and network can be aware whether the authorized UEs are actually receiving the data being delivered.

**Multicast MBS session:** An MBS session to deliver the multicast communication service. A multicast MBS session is characterised by the content to send, by the list of UEs that may receive the service and optionally by a geographical area where to distribute it.

## 3.2 Abbreviations

For the purposes of the present document, the abbreviations given in TR 21.905 [1], TS 23.501 [5] and the following apply. An abbreviation defined in the present document takes precedence over the definition of the same abbreviation, if any, in TR 21.905 [1].

CDN	Content Delivery Network
FEC	Forward Error Correction
FSA	Frequency Selection Area
LL SSM	Lower Layer SSM
MBMS	Multimedia Broadcast/Multicast Service
MBS	Multicast/Broadcast Service.
MBSF	Multicast/Broadcast Service Function.
MBSTF	Multicast/Broadcast Service Transport Function.
MB-SMF	Multicast/Broadcast Session Management Function.
MB-UPF	Multicast/Broadcast User Plane Function
PTM	Point To Multipoint
PTP	Point To Point
SSM	Source Specific IP Multicast address.
TMGI	Temporary Mobile Group Identity

---

## 4 General Concept

### 4.1 Overview of multicast and broadcast communication

Multicast and Broadcast Service (MBS) is a point-to-multipoint service in which data is transmitted from a single source entity to multiple recipients, either to all users in a Broadcast service area, or to users in a multicast group as defined in TS 22.146 [2]. The corresponding types of MBS session are:

- Broadcast MBS session
- Multicast MBS session.

The MBS architecture defined in clause 5 follows the 5G System architectural principles as defined in TS 23.501 [5], enabling distribution of the MBS data from the 5GS ingress to NG-RAN node(s) and then to the UE. The MBS architecture provides:

- Efficient usage of RAN and CN resources, with an emphasis on radio interface efficiency;
- Efficient transport for a variety of multicast and broadcast services.

Multicast/Broadcast Service for roaming is not supported in this release.

Interaction between Multicast/Broadcast Service and support of deployments topologies with specific SMF Service Areas is not specified in this Release.

The collection and reporting of MBS specific charging information are not specified in this Release.

The MBS also provides functionalities such as local MBS service and location dependent MBS service, authorization of multicast MBS and QoS differentiation. Refer to clause 6 for more details.

MBS traffic is delivered from a single data source (e.g. Application Service Provider) to multiple UEs. Depending on many factors, there are several delivery methods which may be used to deliver the MBS traffic in the 5GS.

NOTE 1: For clarity, delivery methods are not referred to as unicast/multicast/broadcast but as described below. The term "unicast delivery" refers to a mechanism by which application data and signalling between the UE and the application server are delivered using PDU Session within the 3GPP network and using individual UE and application server addresses (e.g. IP addresses) between the 3GPP network and the application server. It is not equivalent to 5GC Individual MBS traffic delivery method defined in this clause.

Between 5GC and NG-RAN, there are two possible delivery methods to transmit the MBS data:

- 5GC Individual MBS traffic delivery method: This method is only applied for multicast MBS sessions. 5GC receives a single copy of MBS data packets and delivers separate copies of those MBS data packets to individual UEs via per-UE PDU sessions, hence for each such UE one PDU session is required to be associated with a Multicast MBS session.
- 5GC Shared MBS traffic delivery method: This method is applied for both broadcast and multicast MBS sessions. 5GC receives a single copy of MBS data packets and delivers a single copy of those MBS packets to an NG-RAN node, which then delivers the packets to one or multiple UEs.

The 5GC Shared MBS traffic delivery method is required in all MBS deployments. The 5GC Individual MBS traffic delivery method is required to enable mobility when there is an NG-RAN deployment with non-homogeneous support of MBS.

For the Multicast MBS session, a single copy of MBS data packets received by the CN may be delivered via 5GC Individual MBS traffic delivery method for some UE(s) and via 5GC Shared MBS traffic delivery method for other UEs.

Between the NG-RAN and the UE, two delivery methods are available for the transmission of MBS data packets over radio interface:

- Point-to-Point (PTP) delivery method: NG-RAN delivers separate copies of MBS data packets over radio interface to individual UE(s).
- Point-to-Multipoint (PTM) delivery method: NG-RAN delivers a single copy of MBS data packets over radio interface to multiple UEs.

NG-RAN may use a combination of PTP/PTM to deliver an MBS data packets to UEs.

NOTE 2: The PTP and PTM delivery methods are defined in RAN WGs.

As depicted in the following figure, 5GC Shared MBS traffic delivery method (with PTP or PTM delivery) and 5GC Individual MBS traffic delivery method may be used at the same time for a multicast MBS session.

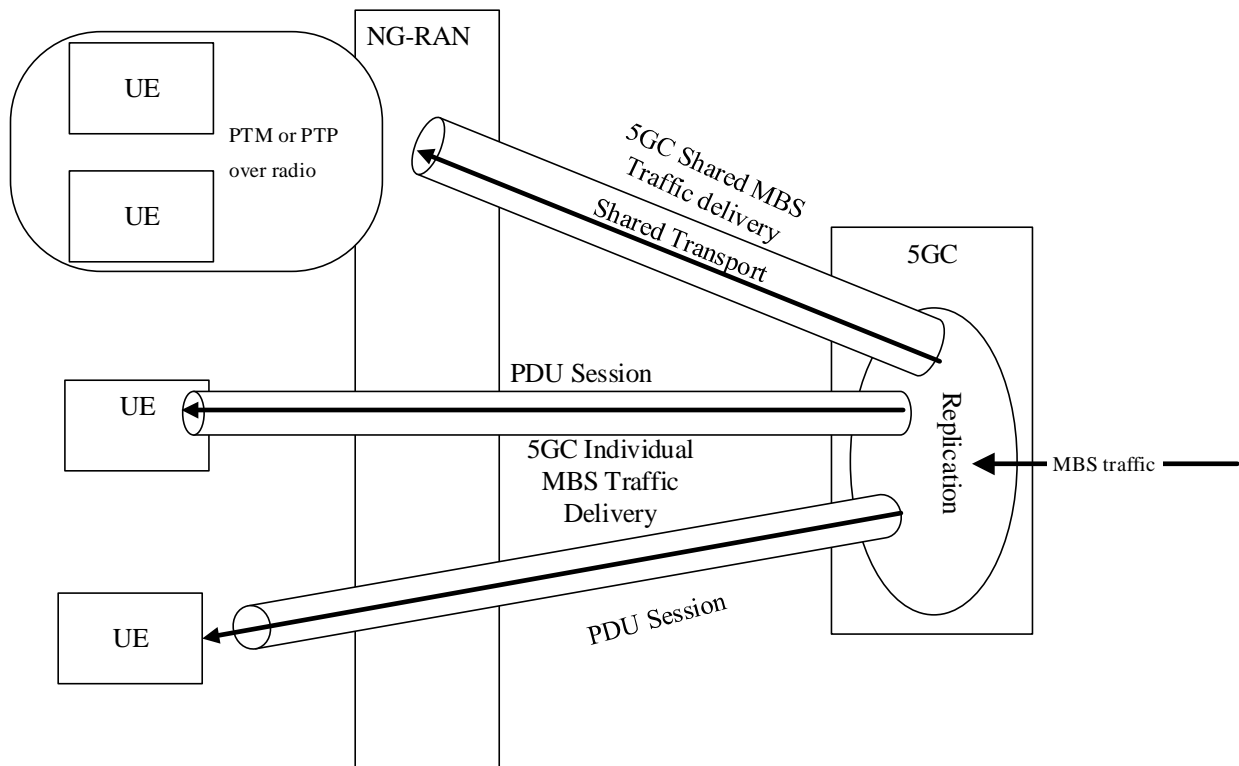

**Figure 4.1-1: Delivery methods**

For MBS broadcast communication, only 5GC Shared MBS traffic delivery method with PTM delivery is applicable.

For MBS multicast communication, if the NG-RAN node supports MBS, the network shall use the 5GC Shared MBS traffic delivery method for MBS data transmission.

NOTE 3: The exception is when the UE moves between NG-RAN node not supporting MBS (with 5GC Individual MBS traffic delivery method) and NG-RAN node supporting MBS, there is temporary co-existence between 5GC Shared MBS traffic delivery method and 5GC Individual MBS traffic delivery method. Refer to clause 6.3 for details.

For MBS multicast communication, the switching between 5GC Shared MBS traffic delivery method and 5GC Individual MBS traffic delivery method is supported. The UE mobility between RAN nodes both supporting MBS, and between a RAN node supporting MBS and a RAN node not supporting MBS is supported, for details see clause 6.3.

For MBS multicast communication, the switching between PTP and PTM delivery methods for 5GC Shared MBS traffic delivery shall be supported. NG-RAN is the decision point for switching between PTP and PTM delivery methods.

## 4.2 MB service provisioning

### 4.2.1 Multicast data provisioning

An example for the sequence of phases for multicast data provisioning is described in the figure below:

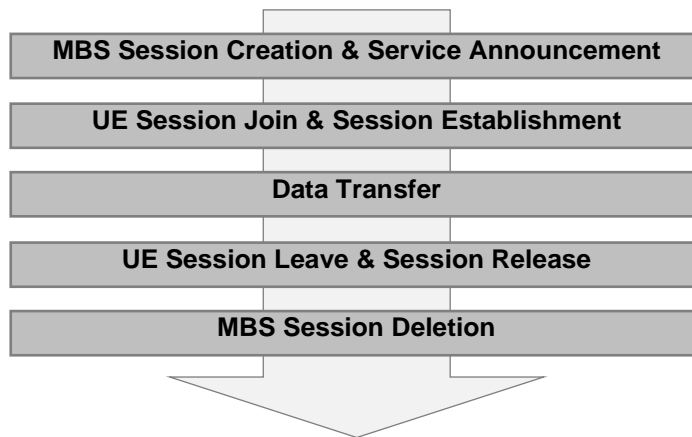

**Figure 4.2.1-1: Phases of Multicast data provisioning example**

The following phases are performed for a specific UE:

- UE Session Join: UE Session Join is the process by which a UE joins an MBS Session, i.e. the UE indicates to 5GC that such UE wants to receive Multicast data identified by a specific MBS Session ID.
- UE Session Leave: UE Session Leave is the process by which a UE leaves a MBS Session, i.e. the UE no longer wants to receive Multicast data identified by a specific MBS Session ID.

The following phases are performed for a specific service:

- MBS Session Creation: It is the phase that the information of Multicast MBS session is created as described in clause 4.3. This step is optional.
- Service announcement: Service announcement is used to distribute information toward UEs about the service required for service reception (e.g. IP multicast address(es)) and possibly other service related parameters (e.g. service start time). This step is optional.
- Session Establishment: It is the phase that Multicast MBS session is established as described in clause 4.3.
- No data receiving: It is the phase when no multicast data is received by 5GC. This step is optional.
- Data transfer: It is the phase when Multicast data are transferred to the UEs.
- Session Release: It is the phase that the resources for Multicast MBS session is released as described in clause 4.3.
- Session Deletion: It is the phase that Multicast MBS session is deleted as described in clause 4.3.

**NOTE:** After session establishment, Multicast MBS session state could be switched between Active and Inactive several times, triggered by AF or User Plane event, see clause 7.2.5. 5GC further updates Multicast MBS session state towards NG-RAN nodes after Session Establishment.

The phase of Multicast data provisioning is illustrated with the following example of timeline:

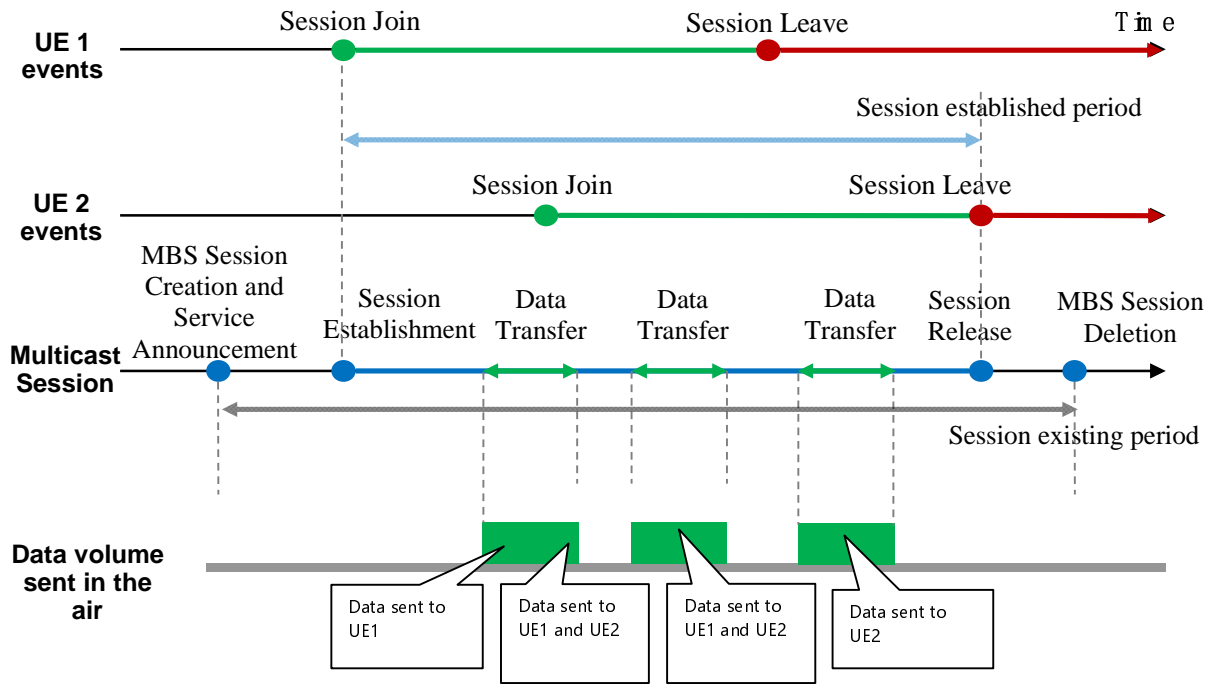

Figure 4.2.1-2: Multicast service timeline example

### 4.2.2 Broadcast data provisioning

An example for the phases of broadcast data provisioning is described in the figure below:

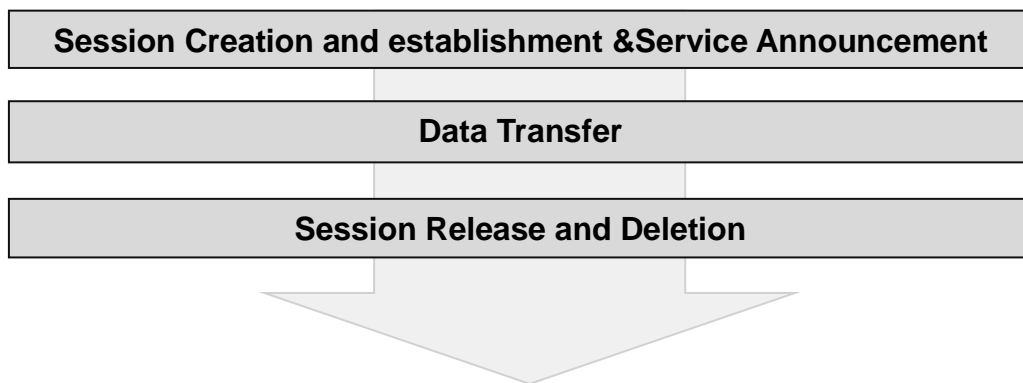

Figure 4.2.2-1: Phases of Broadcast data provisioning

The following phases are performed for a specific service:

- **MBS Session Creation:** MBS Session Creation is used by the AF to create the MBS Session towards 5GC. MBS session creation can occur in several steps (e.g. TMGI allocation, provisioning information about MBS session, request to activate the MBS session). The last step of the MBS session creation triggers resource establishment for transmitting the DL Broadcast data between 5GC and NG-RAN.

**NOTE:** For broadcast communication, after MBS Session Creation and Session Establishment, the established resources are not only between 5GC and NG-RAN, but also between the AF to 5GC.

- **Service announcement:** Service announcement is used to distribute information towards UEs about the service required for service reception (e.g. IP multicast address(es)) and possibly other service related parameters (e.g. service start time). This step can occur in parallel or after the MBS session configuration. However, TMGI allocation is required before. The information of the service announcement could be pre-configured at the UE side, see clause 7.3.1.



- Data transfer: It is the phase when broadcast data are transferred in the air interface.
- Session Release and Deletion: It is the point at which there will be no more need to transmit Broadcast data. At Session Release, the resources in 5GS are released and the broadcast MBS session is deleted.

The phase of Broadcast data provisioning is illustrated with the following example of timeline:

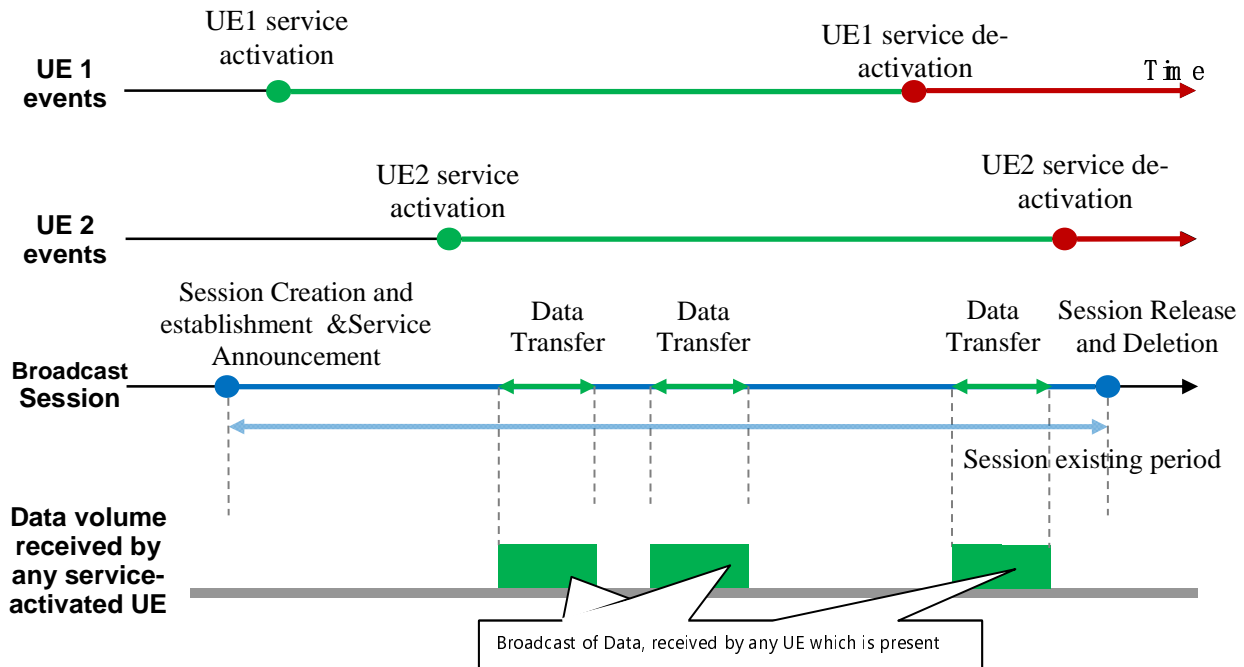

Figure 4.2.2-2: Broadcast service timeline

## 4.3 Multicast session state model

The following illustrate the states for the Multicast MBS session:

- **Configured state:** Information about the Multicast MBS session (e.g. QoS information) is available in 5GC NFs (e.g. MB-SMF) serving the Multicast MBS session, but no User Plane resources towards NG-RAN are reserved and no MBS data can be transmitted. Only resources at MB-SMF, NEF and MB-UPF are reserved and no multicast data are transmitted. A TMGI can be allocated for the Multicast MBS session. UEs may be allowed to join (subject to authorization check and configuration), but the first accepted UE join request will trigger the Multicast MBS session establishment towards the NG-RAN and the UE, see clause 7.2.1.

NOTE 1: The SMF is not involved in the Multicast MBS session while the Multicast MBS session is in created state.

NOTE 2: There may be several interim states in the created state, e.g. TMGI requested, or information about the Multicast MBS session provided, but these interim states will not be specified in this release.

- **Active state:** Multicast MBS session is established and MBS data can be transmitted to the UEs that have joined the Multicast MBS session. Radio resources for the Multicast MBS session are established. To receive multicast MBS session data, UEs that joined the Multicast MBS session shall be in CM-CONNECTED state for receiving data of the Multicast MBS session. UEs are allowed to join the Multicast MBS session (subject to authorization check). 5GC resources and radio resources for the Multicast MBS session are reserved for UEs that joined the Multicast MBS session.
- **Inactive state:** Multicast MBS session is established but no MBS data is transmitted to the UEs that have joined the Multicast MBS session. Radio resources for the Multicast MBS session are released, and the UEs that joined the Multicast MBS session may be in CM-CONNECTED or CM-IDLE state. UEs are allowed to join the Multicast MBS session (subject to authorization check).

The following procedures are defined which result in transition of the Multicast MBS session state:

**Multicast Session Creation:** The AF provides information about the Multicast MBS session and optionally requests the allocation of a TMGI, see clause 7.1.1.2 and 7.1.1.3. Alternatively, the information about the Multicast MBS session can be pre-configured in the network. The creation may indicate whether the Multicast MBS session may be established in active or inactive state and when a Multicast MBS session can become active. The AF may perform creation in several steps, e.g. to first request TMGI and then provide full information about the Multicast MBS session and allow it to be established, or to update the information whether the Multicast MBS session is to be in Active or Inactive state after establishment. Multicast MBS session state transitions from "Start (NULL)" to Configured state.

NOTE 3: A Multicast MBS session can also be created by the operator via OAM configuration or be established without prior creation.

- **Multicast Session Establishment:** When the join request of the first UE for the Multicast MBS session is accepted, the Multicast MBS session is established towards the NG-RAN node and the UE, see clause 7.2.1. Multicast session state transitions from "Start (NULL)" or Configured state to either Inactive or Active state.
- **Multicast Session Activation:** See clause 7.2.5.2, Triggered by the 5GC, the radio resources for the Multicast MBS session are established and Multicast MBS session data starts to be transmitted to the UE. UEs in CM-IDLE state and CM-CONNECTED with RRC Inactive state that joined the Multicast MBS session are notified. Activation can be triggered by AF request or data notification from the MB-UPF. Multicast session state transitions from Inactive state to Active state.

NOTE 4: The AF could not be aware, and the NEF will not be aware, whether a session is in created or established state. An AF may therefore update the session state to request the activation of a session prior to the establishment of the session, and this will determine that the session is subsequently established in Active state when the first UE joins, but will not trigger the Multicast Session Activation state transition.

- **Multicast Session Deactivation:** See clause 7.2.5.3. Triggered by the 5GC, the radio resources for the Multicast MBS session are released and Multicast MBS session data stops to be transmitted to the UE. Deactivation can be triggered by AF request or no reception of multicast data by the MB-UPF. Multicast session state transitions from Active to Inactive state.
- **Multicast Session Release:** Triggered by the last UE leaving the Multicast MBS session (see clause 7.2.2.2), or Multicast Session Deletion procedure (7.1.1.4 or 7.1.1.5), the resources for the Multicast MBS session are released in both 5GC nodes and RAN nodes, see clause 7.2.2. Multicast session state transitions from Active or Inactive state to Configured.
- **Multicast Session Deletion:** All information about the Multicast MBS session is removed from the 5GC, and the TMGI for the Multicast MBS session (if allocated during Multicast Session Configuration) is deallocated, see clause 7.1.1.4 or 7.1.1.5. The deletion may be triggered by an AF request. Multicast session state transitions from Configured, Active or Inactive state to "End (NULL)".

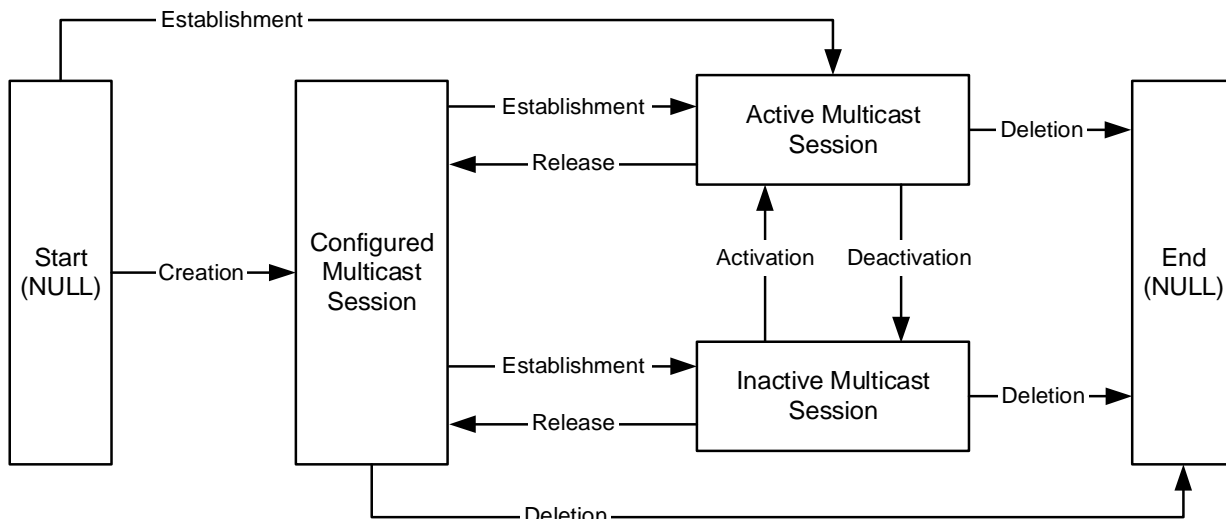

Figure 4.3-1: Multicast session states and state transitions

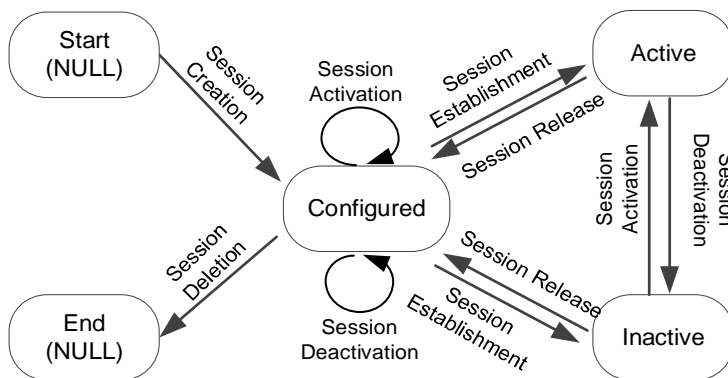

Figure 4.3-2: Multicast session states and state transitions in MB-SMF

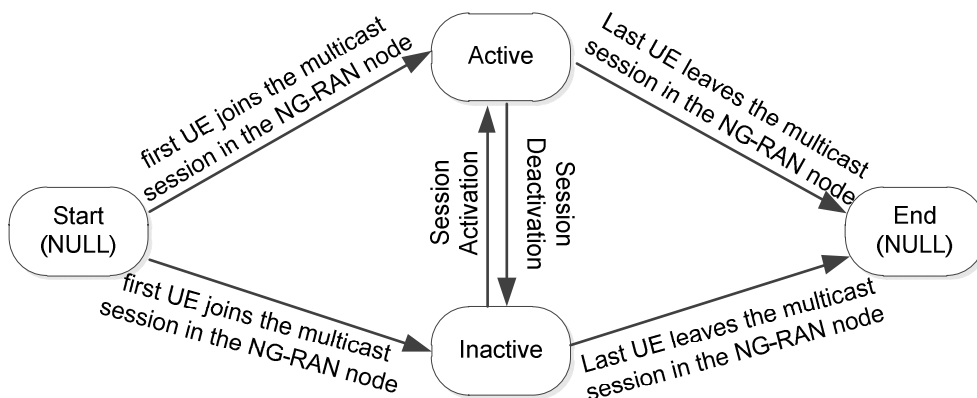

Figure 4.3-3: Multicast session states and state transitions in NG-RAN

NOTE 5: Multicast session states and state transitions in NG-RAN is for illustration purpose, normative procedures are provided by RAN WGs.

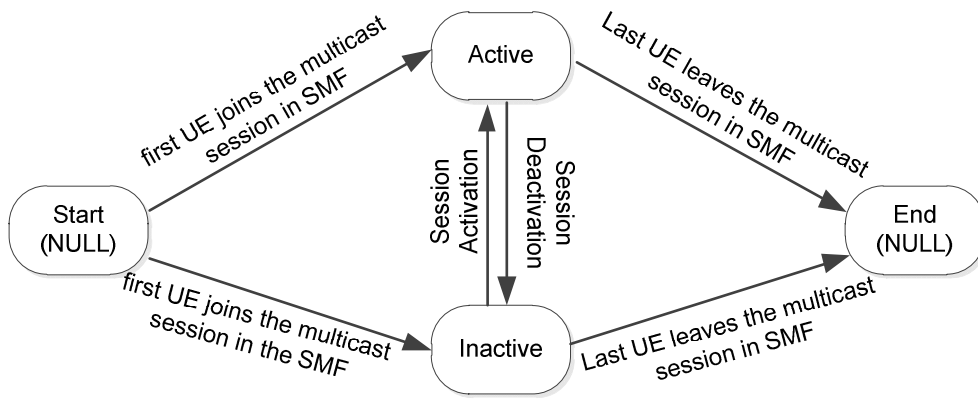

Figure 4.3-4: Multicast session states and state transitions in SMF

## 5 Architecture model

### 5.1 General architecture

Figure 5.1-1 depicts the MBS reference architecture. Service-based interfaces are used within the Control Plane. Support for interworking at reference points xMB and MB2 is described in Annex C.

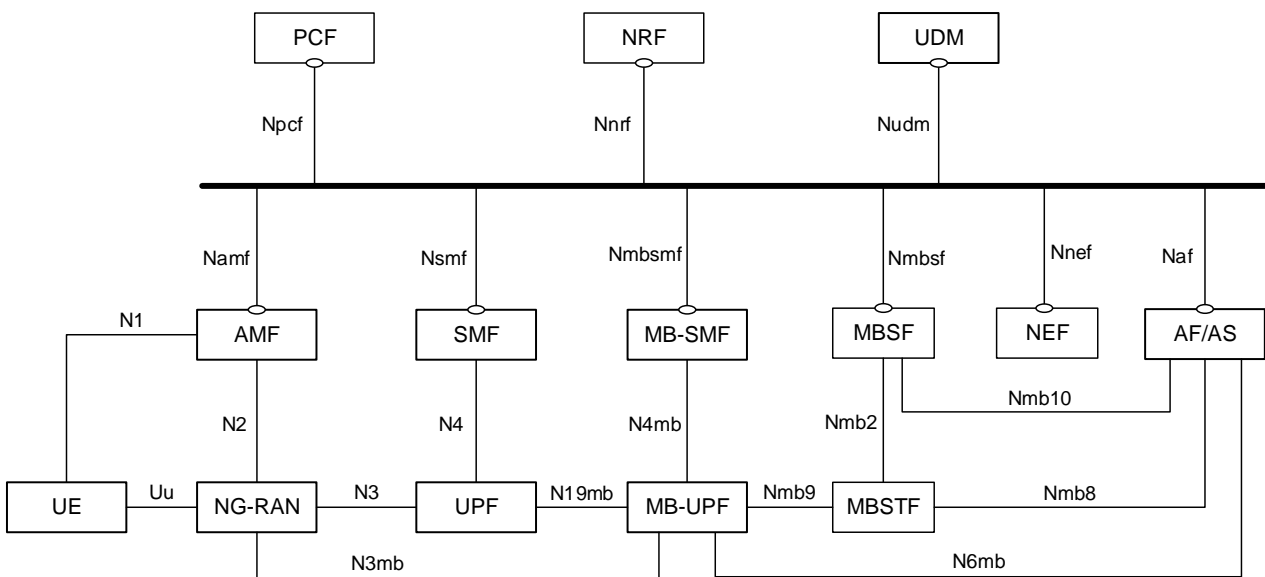

Figure 5.1-1: 5G System architecture for Multicast and Broadcast Service.

NOTE 1: The MBSF is optional and may be collocated with the NEF or AF/AS, and the MBSTF is an optional network function.

NOTE 2: The existing service-based interfaces of Nnrf, Nudm, and Nsmf are enhanced to support MBS. The existing service-based interfaces of Npcf and Nnef are enhanced to support MBS.

NOTE 3: A MBS-enabled AF uses either Nmbsf or Nnef to interact with the MBSF.

Figure 5.1-2 depicts the 5G system architecture for MBS using the reference point representation.

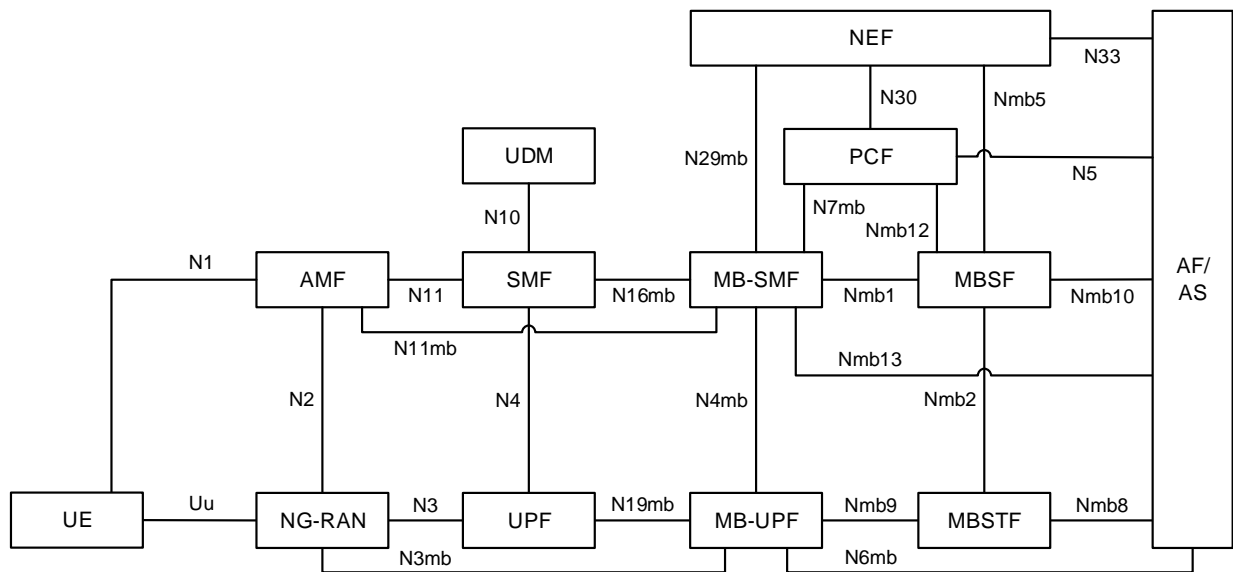

**Figure 5.1-2: 5G System architecture for Multicast and Broadcast Service in reference point representation.**

NOTE 4: The existing reference points of N1, N2, N4, N5, N10, N11, N30 and N33 are enhanced to support MBS.

NOTE 5: Regarding the functionalities, Nmb13, N29mb and Nmb1 are identical, Nmb5 and Nmb10 are identical, Nmb9 and N6mb are identical.

## 5.2 General architecture for interworking with EPS

Interworking between MBS and eMBMS at service layer functionality applies in cases where the same Multicast/Broadcast service is provided via eMBMS and MBS. Figure 5.2-1 depicts the system architecture for interworking between E-UTRAN/EPC eMBMS and MBS at service layer, with collocated BM-SC and MBSF/MBSTF functionalities.

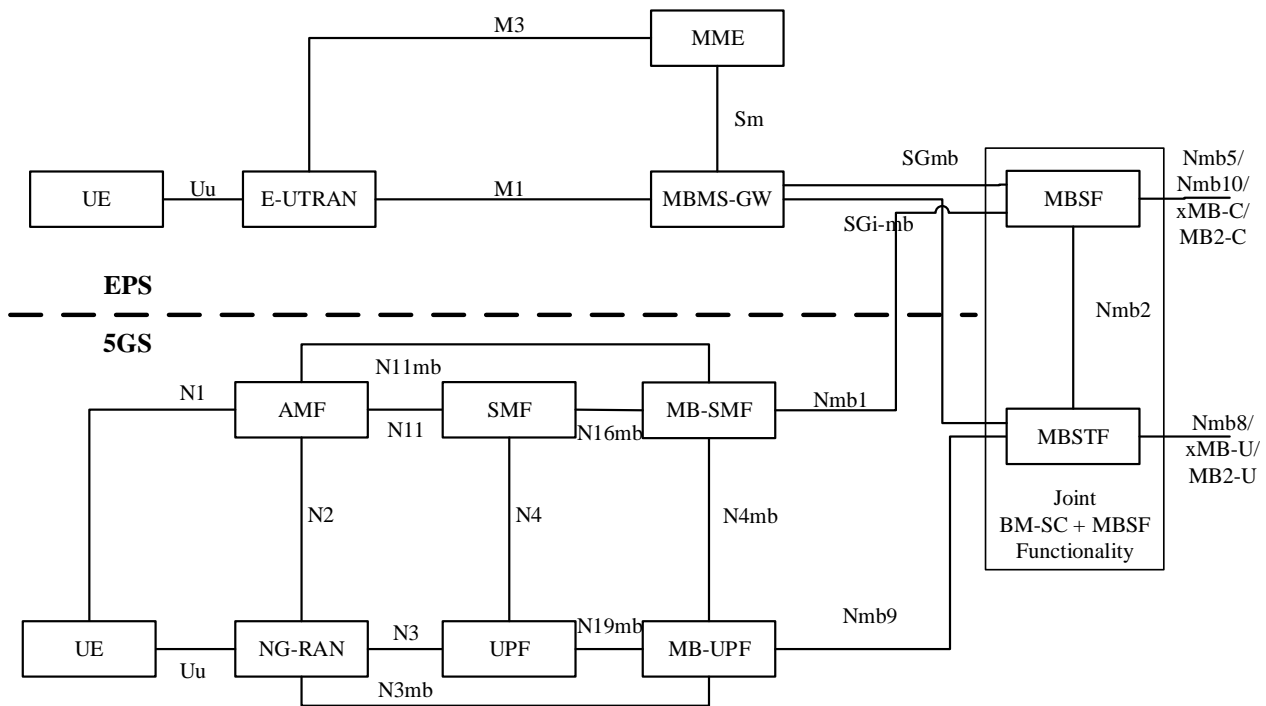

**Figure 5.2-1: MBS-eMBMS interworking system architecture at service layer**

The BM-SC+MBSF/MBSTF exposes common Nmb5/Nmb10/xMB-C/MB2-C and Nmb8/xMB-U/MB2-U reference points to the NEF and/or AF/AS. A common TMGI is used towards the AF/AS. The TMGI is also used as identifier for transport over E-UTRAN/EPC.

NOTE: MB2-C/U are both legacy reference points and 5GS reference points.

## 5.3 Service-based interfaces, Reference point and functional entities

### 5.3.0 Service-based interfaces

The 5G System Architecture for MBS contains the following service-based interfaces:

**Nmb-smf:** Service-based interface exhibited by MB-SMF. Further details are described in clause 9.1.

**Npcf:** Service-based interface exhibited by PCF. Further details are described in clause 9.2.

**Namf:** Service-based interface exhibited by AMF. Further details are described in clause 9.3.

**Nnef:** Service-based interface exhibited by NEF. Further details are described in clause 9.4.

**Nmb-sf:** Service-based interface exhibited by NEF. Further details are described in clause 9.5.

### 5.3.1 Reference point

The 5G System Architecture for MBS contains the following new reference points:

**N3mb:** Reference point between the RAN and the MB-UPF.

**N4mb:** Reference point between the MB-SMF and the MB-UPF.

- N6mb:** Reference point between the MB-UPF and the AF/AS.
- N7mb:** Reference point between the MB-SMF and the PCF.
- N11mb:** Reference point between the AMF and the MB-SMF.
- N16mb:** Reference point between the SMF and the MB-SMF.
- N19mb:** Reference Point between the UPF and the MB-UPF.
- N29mb:** Reference point between the MB-SMF and the NEF.
- Nmb1:** Reference point between the MB-SMF and the MBSF.
- Nmb2:** Reference point between the MBSF and the MBSTF.
- Nmb5:** Reference point between the MBSF and the NEF.
- Nmb8:** Reference point between the MBSTF and the AF.
- Nmb9:** Reference point between the MB-UPF and the MBSTF.
- Nmb10:** Reference point between the MBSF and the AF.
- Nmb12:** Reference point between the MBSF and the PCF.
- Nmb13:** Reference point between the MB-SMF and the AF.

5G System Architecture for MBS reuses the existing reference points of N1, N2, N4, N10, N11, N30 and N33 with enhancement to support MBS.

## 5.3.2 Functional entities

### 5.3.2.1 PCF

In addition to the functions defined in TS 23.501 [5], the PCF performs the following functions to support MBS if dynamic PCC for MBS is needed:

- Supporting QoS handling for MBS Session.
- Providing policy information regarding the MBS Session to MB-SMF for authorizing the related QoS profiles.
- Interacting with UDR for QoS information retrieval.
- The PCF can receive MBS information from AF, NEF or MBSF, e.g. based on the different configuration options in Annex A.

### 5.3.2.2 MB-SMF

The MB-SMF performs the following functions to support MBS:

- General for Multicast and Broadcast MBS sessions:
  - Supporting MBS session management (including QoS control).
  - Configuring the MB-UPF for multicast and broadcast data transport, based on the policy rules for multicast and broadcast services from PCF or local policy.
  - Allocating and de-allocating TMGIs.
- Specific for Broadcast MBS sessions:
  - Interacting with RAN (via AMF) to control data transport using 5GC Shared MBS traffic delivery method.
- Specific for Multicast MBS sessions:

- Interacting with SMF to provide the SMF with MBS Session Context information.
- Interacting with RAN (via AMF) to establish data transmission resources between MB-UPF and RAN nodes for 5GC Shared MBS traffic delivery method.
- Controlling the MB-UPF for multicast data transport using 5GC Individual MBS traffic delivery method.

### 5.3.2.3 SMF

In addition to the functions defined in TS 23.501 [5], the SMF performs the following functions to support MBS:

- Discovering MB-SMF for a Multicast MBS session.
- Authorizing Multicast MBS session join operation for served UEs if needed.
- Interacting with MB-SMF to obtain multicast Session Context information used as input to modify the PDU Session associated with MBS session.
- Interacting with RAN to provide information about a Multicast MBS session that a UE is participating in.
- Interacting with RAN and UPF for multicast data transport using 5GC Individual MBS traffic delivery method.

NOTE: SMF and MB-SMF may be co-located or deployed separately.

### 5.3.2.4 MB-UPF

The MB-UPF performs the following functions to support MBS:

- General for Multicast and Broadcast MBS sessions:
  - Packet processing of incoming downlink packets for multicast and broadcast flows.
  - QoS enforcement (MFBR) based on existing means.
  - Interaction with MB-SMF for receiving multicast and broadcast data.
  - Delivery of multicast and broadcast data to RAN nodes for 5GC Shared MBS traffic delivery method.
- Specific for Multicast MBS sessions:
  - Delivery of multicast data to UPF for 5GC Individual MBS traffic delivery method.

### 5.3.2.5 UPF

In addition to the functions defined in TS 23.501 [5], the UPF performs the following functions to support MBS:

- Interacting with SMF for receiving multicast data from MB-UPF for 5GC Individual MBS traffic delivery method.
- Delivering multicast data to UEs via PDU Session for 5GC Individual MBS traffic delivery method.

NOTE: UPF and MB-UPF may be co-located or deployed separately.

### 5.3.2.6 AMF

In addition to the functions defined in TS 23.501 [5], the AMF performs the following functions to support MBS:

- Signalling with NG-RAN and MB-SMF for MBS Session management.
- Selection of NG-RANs for notification of multicast session activation toward UEs in CM-IDLE state.
- Selection of NG-RANs for broadcast traffic distribution.

Additionally, AMF being aware of NG-RAN 5G MBS capability.



### 5.3.2.7 NG-RAN

In addition to the functions defined in TS 23.501 [5], the NG-RAN performs the following functions to support MBS:

- Management of MBS QoS flows via N2.
- Delivery of MBS data packets for multiple UEs over radio using PTM or PTP.
- Configuration of UE for MBS QoS flow reception at AS layer.
- Control switching between PTM and PTP delivery per UE.
- Support for multicast session service continuity during Xn Handover and N2 Handover.
- Support group paging at multicast session activation over radio toward UEs in CM-IDLE state and CM-CONNECTED with RRC INACTIVE state.
- Reception of MBS data packets from 5GC via shared MBS traffic delivery.

### 5.3.2.8 UE

In addition to the functions defined in TS 23.501 [5], the UE may perform the following functions to support MBS:

- Reception of multicast data using PTM/PTP.
- Reception of broadcast data using PTM.
- Handling of incoming MBS QoS flows.
- Support of signalling for joining and leaving a Multicast MBS session.
- MBS resource management support at AS layer.
- Reception of notification in CM-IDLE state and CM-CONNECTED with RRC \_INACTIVE state for multicast data transmission.

NOTE : UE functionality for MBS security is provided in TS 33.501 [20].

### 5.3.2.9 AF

The AF performs the following functions to support MBS:

- Requesting multicast or broadcast service from the 5GC by providing service information including QoS requirement to 5GC.
- Instructing MBS session operation towards 5GC if needed.
- Interacting with NEF for MBS related service exposure.

### 5.3.2.10 NEF

In addition to the functions defined in TS 23.501 [5], the NEF performs the following functions to support MBS:

- Providing an interface to AFs for MBS procedures including service provisioning, MBS session and QoS management.
- Interacting with AF and NFs in 5GC, e.g. MB-SMF for MBS session operations, determination of transport parameters.
- Selection of MB-SMF to serve an MBS Session.

### 5.3.2.11 MBSF

The MBSF performs the following functions to support MBS:

- Service level functionality to support MBS, and interworking with LTE MBMS
- Interacting with AF and MB-SMF for MBS session operations, determination of transport parameters, and session transport.
- Selection of MB-SMF to serve an MBS Session.
- Controlling MBSTF if the MBSTF is used.
- Determination of destination IP multicast address for the MBS session if IP multicast address is sourced by MBSTF.

NOTE 1: MBSF functionality related to service and MBS data handling (e.g. encoding) is to be determined with SA WG4.

NOTE 2: MBSF functionality for MBS security is provided in TS 33.501 [20].

### 5.3.2.12 MBSTF

The MBSTF performs the following functions to support MBS if deployed:

- Media anchor for MBS data traffic if needed.
- Sourcing of IP Multicast if needed.
- Generic packet transport functionalities available to any IP multicast enabled application such as framing, multiple flows, packet FEC (encoding).
- Multicast/broadcast delivery of input files as objects or object flows.

NOTE 1: MBSTF functionality related to MBS data handling (e.g. encoding) is to be determined with SA WG4.

NOTE 2: MBSTF functionality for MBS security is provided in TS 33.501 [20].

### 5.3.2.13 UDM

In addition to the functions defined in TS 23.501 [5], the UDM performs the following functions to support MBS:

- Support management of subscription for authorization for multicast MBS sessions.

### 5.3.2.14 UDR

In addition to the functions defined in TS 23.501 [5], the UDR performs the following functions to support MBS if deployed:

- Support management of UE authorization information for multicast MBS sessions.
- Support management of policy information for Multicast or Broadcast MBS sessions.

### 5.3.2.15 NRF

#### 5.3.2.15.1 General

In addition to the functions defined in TS 23.501 [5], the NRF performs the following functions to support MBS:

- Support of new NF types MB-SMF and MBSF and their corresponding NF profiles.
- For both multicast and broadcast MBS sessions, support of MB-SMF discovery based on parameters such as DNN, S-NSSAI and MBS service area, at MBS Session creation.
- For multicast MBS sessions, support of MB-SMF discovery based on MBS Session ID by SMF serving the multicast Session at UE join.

NOTE: For broadcast MBS Session, AMF discovery by MB-SMF for an MBS service area is based on tracking area IDs related to that service area, as registered in the AMF profile according to TS 23.501 [5].

#### 5.3.2.15.2 Extensions to NF profile at NRF

In addition to the NF profile contents defined in clause 6.2.6.2 of TS 23.501 [5], the NF profile in the NRF contains the following content:

- For MB-SMF, the NF profile may include MB-SMF service area, MBS Session ID(s), Area Session ID(s) and corresponding MBS service area(s) if available.

---

## 6 Functionalities and features

### 6.1 Authorization to MBS service

#### 6.1.1 AF authorization to the service for multicast and broadcast

The AF should be authorized by the 5GC for delivering MBS data to the 5GC and/or interacting with the 5GC. For signalling exchange with the 5GC, the NEF perform authorization to the external AF for determination of whether the interaction with the 5GC is allowed or not.

#### 6.1.2 UE authorization to the service for multicast

The following authorizations are defined:

- a) Whether the UE is authorized to use the Multicast service in the PLMN.
- b) The authorization for a UE of receiving the content of a specific multicast MBS session.

A Multicast MBS session may be "open to any UEs".

NOTE 1: UE authorization for a specific Multicast MBS session can be implicitly performed when UE is configured for a specific Multicast MBS session, e.g. via Service Announcement for public safety use case.

NOTE 2: The authorization mentioned by a) is required even if an authorization according to b) is available. If the UE is not authorized to use the Multicast service by the PLMN, the UE is not authorized to join any multicast MBS Session even if the Multicast MBS session is "open to any UEs".

For a Multicast MBS session, it is required that the 5GC authorizes the UE based on the MBS subscription data and whether the Multicast MBS session is "open to any UEs", which are preconfigured, or provided by the AF (see clause 7.2.9).

The procedure for UE authorization is a part of UE join procedure and is described in clause 7.2.1.3.

### 6.2 Local MBS service and Location dependent MBS service

#### 6.2.1 General

A Local MBS service is an MBS service provided in one MBS service area. A location dependent MBS service is an MBS service provided in several MBS service area(s). An MBS service area is identified by a cell list or a tracking area list. The MBS service area could be geographical area information or civic address information, and NEF/MBSF translates the location information to Cell ID list or TAI list as MBS service area, see clause 7.1.1.2.

The MBS service area may be updated by the AF for both multicast MBS sessions and broadcast MBS sessions as specified in clause 7.1.1.6.

For more details, refer to clause 7.2.4 for multicast MBS session and refer to clause 7.3.4 for broadcast MBS session.

## 6.2.2 Local MBS service

For a local MBS service, only UEs within the MBS service area may receive content data, while UEs outside the MBS service area are not allowed to receive location specific content. For multicast MBS service, UEs outside the MBS service area are not allowed to join the MBS service, and the network shall not deliver location specific content anymore to the UEs moved out of the MBS service area. Depending on policy, for the multicast MBS service the network may remove UEs outside the MBS service area of the MBS session from the MBS Session Context after a grace period. The SMF may subscribe at the AMF to notifications about "UE moving in or out of a subscribed "Area Of Interest"" event.

For multicast communication, local MBS may be supported via 5GC Individual MBS traffic delivery towards RAN nodes not supporting MBS. If the SMF obtains a notification that the UE is no longer in the MBS service area, the SMF terminates the 5GC Individual MBS traffic delivery towards the UE.

The UE shall be able to obtain service area information of the local multicast service via MBS service announcement or via NAS signalling (UE Session Join Accept/Reject including Cell ID list or TAI list). If the UE Session Join procedure fails due to the UE being outside the MBS service area, the UE does not attempt to join the Multicast MBS session again until the UE moves inside the MBS service area. When the UE Session Join succeeds and if the Multicast MBS session is inactive, the UE does not perform monitoring the session activation notification and any other information related to the Multicast MBS session identified by an MBS Session ID over the radio if outside the MBS service area.

NOTE: Broadcast communication service is the service provided simultaneously to all UEs in a geographical area, therefore for broadcast it is naturally a local MBS service.

## 6.2.3 Location dependent MBS service

A location dependent MBS is identified by MBS Session ID, and provided in several MBS service areas. The location dependent MBS service enables distribution of different content data to different MBS service areas. The same MBS Session ID is used but a different Area Session ID is used for each MBS service area. The Area Session ID is used, in combination with MBS Session ID, to uniquely identify the service area specific part of the content data of the MBS service within 5GS. The network supports the location dependent content distribution for the location dependent MBS services, while UEs are only aware of the MBS Session ID (i.e. UEs are not required to be aware of the Area Session IDs). When UE moves to a new MBS service area, content data from the new MBS service area shall be delivered to the UE, and the network ceases to deliver the content data from the old MBS service areas to the UE. For multicast MBS service, UEs outside all MBS service areas of the location dependent MBS session are not allowed to join the MBS service. When UE moves out of an MBS service area and there is no other MBS service area for the MBS session, the network ceases to deliver the content data to the UE. Depending on policy, for the multicast MBS service the network may remove UEs outside all MBS service areas of the location dependent MBS Session from the multicast MBS Session Context after a grace period. The SMF may subscribe at the AMF to notifications about UE moving in or out of all MBS service areas of the location dependent MBS session.

For multicast communication towards an NG-RAN supporting MBS, the NG-RAN node handles mobility of UEs within the MBS session between MBS service areas served by the same NG-RAN without interaction with SMF.

For multicast communication, location dependent MBS services may be supported via 5GC Individual MBS traffic delivery towards RAN nodes not supporting MBS. If the SMF determines that the UE is in another MBS service area of the Multicast MBS session, the SMF configures the UPF to send multicast data relating to the new MBS service area towards the UE.

Information about different MBS service areas for a location dependent MBS service may be provided by one or several AFs or may be configured. Different ingress points for location dependent points for the MBS session are supported for different MBS service area dependent content of the MBS session; different MB-SMFs and/or MB-UPF may be assigned for different MBS service areas in an MBS session. When the different MB-SMFs are assigned for different MBS service areas in an MBS session, the same TMGI is allocated for this MBS session.

The Area Session ID is allocated by MB-SMF in MBS Session creation procedure. MB-SMF allocates Area Session ID for each MBS services area which is unique within the MBS session. MB-SMF needs to further ensure there is no MBS service area overlapping with other MBS service areas that share the same MBS Session ID.

NOTE 1: In this release, deployments topologies with specific SMF Service Areas are not supported, as a result, location dependent service using multicast communication is not supported when a UE moves outside its SMF service area.

NOTE 2: For location dependent service provided in different MBS service areas within the same SMF service area, it is assumed that one MB-SMF is used for an MBS Session.

NOTE 3: An example of Location dependent MBS is a nationwide weather forecast service with local weather reports.

NOTE 4: Area Session ID is equivalent to Flow ID as specified in TS 23.246 [8].

## 6.2.4 Void

## 6.2.5 Void

# 6.3 Mobility support of MBS service

## 6.3.1 Mobility of Multicast MBS session

The mobility of multicast MBS service is supported when:

- The UE moves from a NG-RAN node that supports MBS to a target NG-RAN node that supports MBS; or
- The UE moves from a NG-RAN node that supports MBS to a target NG-RAN node that does not support MBS and vice versa.

During the mobility from a NG-RAN node that supports MBS to a target NG-RAN node that supports MBS, or between a NG-RAN node that supports MBS and a target NG-RAN node that does not support MBS, minimization of data loss should be supported, see clause 7.2.3.5 for details.

To support Handover from NG-RAN node that supports MBS to a target NG-RAN node that supports MBS:

- If the shared delivery for the MBS session has not been established towards target NG-RAN, the target NG-RAN establishes the shared delivery for the MBS Session with MB-SMF and MB-UPF.

To support Handover from NG-RAN node that supports MBS to a target NG-RAN node that does not support MBS:

- mapping information about unicast QoS flows for multicast data transmission and the information of associated multicast QoS flows are provided to the NG-RAN node. This is already performed during the PDU session modification procedure for the PDU session associated with the MBS session when the UE joins the MBS Session;
- during the handover procedure, the delivery method is switched from 5GC Shared MBS traffic delivery method to 5GC Individual MBS traffic delivery method, i.e. the N3 tunnel of the PDU Session for 5GC Individual MBS traffic delivery needs to be established towards the target NG-RAN node. The SMF realizes that the target NG-RAN node does not support MBS.
- the SMF and the MB-SMF shall activate the GTP tunnel between the UPF and the MB-UPF for 5GC Individual MBS traffic delivery method, if needed.

To support Handover from a NG-RAN node that does not support MBS to a target NG-RAN node that supports MBS:

- The PDU sessions, including the one associated with the MBS session and used for 5GC Individual MBS traffic delivery, are handed over to the target NG-RAN node.
- SMF triggers mode switch, i.e. from 5GC Individual MBS traffic delivery method to 5GC shared MBS traffic delivery method.
- When the MBS Session Context is given to the target NG-RAN node by the SMF, if the shared delivery for the MBS session has not been established towards target NG-RAN, the target NG-RAN establishes the shared delivery for the MBS Session with MB-SMF and MB-UPF.

- The 5GC terminates the 5GC Individual MBS traffic delivery and changes to the 5GC shared MBS traffic delivery.

### 6.3.2 Mobility of Broadcast MBS session

The UE receives the same Broadcast MBS service in the target NG-RAN if the same MBS session is established with 5GC Shared MBS traffic delivery method in the target NG-RAN node.

NOTE: When the UE moves into NG-RAN node not supporting MBS within the Broadcast MBS service area, how the UE get the same content via application level is out scope of this specification.

## 6.4 Subscription to multicast services

### 6.4.1 General

The UDM stores the subscription information to give the user permission to use multicast services, which include the MBS subscription data for a UE in UE subscription data.

At any time, the operator may change the subscription for multicast services in the UDM.

The MBS subscription data in UE subscription data contains the following information:

- Whether the UE is authorized to use the multicast MBS service.
- MBS Session ID(s) of the Multicast MBS session(s) that the UE is allowed to join.

NOTE: The MBS Session ID applies only for MBS session which is not "open to any UEs".

The MBS subscription data is provided by the UDM to the SMF during or after the establishment procedure of PDU Session associated with Multicast MBS session(s) using Nudm\_SDM service for subscription data type "MBS subscription data" as defined in clause 7.2.1.2.

During multicast session join procedure, the SMF retrieves MBS Session information from the MB-SMF, and authorizes the MBS Session join request for the UE based on MBS subscription data of the UE received from UDM and the Any UE indication (i.e. whether the Multicast MBS session is "open to any UEs") received from MB-SMF as described in clause 7.2.1.3.

The UDR stores the MBS data, which may be updated by the UDM or the AF/NEF as specified in clause 4.15.6.2 of TS 23.502 [6], i.e. AF may provision Multicast MBS Session Authorization information for the MBS as described in clause 7.2.9.

### 6.4.2 MBS subscription data in UDM

The information stored in the UDM as defined in clause 5.2.3.3.1 of TS 23.502 [6] is extended as follows:

- MBS subscription data for a UE as part of UE subscription data, as defined in Table 6.4.2-1, with keys defined in Table 6.4.2-2.

**Table 6.4.2-1: MBS subscription data type**

Subscription data type	Field	Description
MBS subscription data	MBS allowed	Indicates whether the UE is authorized to use the multicast MBS service.
	MBS Session ID(s)	Identifies the MBS Session(s) that the UE are allowed to join.

**Table 6.4.2-2: MBS subscription data type keys**

Subscription Data Types	Data Key	Data Sub Key
MBS Subscription data	SUPI	-

### 6.4.3 MBS information in UDR

The MBS information may be stored in the UDR by the UDM as part of the subscription data, as defined in clause 5.2.12.2.1 of TS 23.502 [6].

1. MBS data as defined in Tables 6.4.2-1, with keys defined in Table 6.4.3-1.

**Table 6.4.3-1: MBS data type keys**

Data Set	Data Subset	Data Key	Data Sub Key
Subscription Data	MBS authorization data	SUPI	-

## 6.5 Identifiers

### 6.5.1 MBS Session ID

The MBS session ID is used to identify a Multicast/Broadcast MBS Session by the 5G system on external interface towards AF and between AF and UE, and towards the UE.

MBS Session ID may have the following types:

- TMGI (for broadcast and multicast MBS sessions);
- source specific IP multicast address (for multicast MBS sessions).

If a multicast MBS session is provided within an SNPN, the multicast MBS session can still be identified by a (globally unique) source specific IP multicast address or TMGI. In 5GS internal signalling the PLMN ID, included in TMGI, is complemented with the NID to identify an SNPN.

Source specific IP multicast address or TMGI may be used as MBS Session ID in NAS messages exchange between a UE and a CN when the UE requests to join/leave a Multicast MBS session. For multicast MBS sessions that the UE joined with a source specific IP multicast address, a TMGI is also allocated by 5GC and is sent to the UE and used in other signalling messages between RAN, CN and UE. Details see clause 7.2.1.3.

The UE shall be able to obtain at least one MBS Session ID via MBS service announcement.

For multicast MBS sessions, a source specific IP multicast address can be assigned by external AFs.

### 6.5.2 Temporary Mobile Group Identity

TMGI (Temporary Mobile Group Identity) is defined in TS 23.003 [12] and is used to be able to identify a broadcast MBS Session or a multicast MBS session.

In SNPN (Stand-alone Non-Public Network), TMGI is used together with NID (Network Identifier) defined in TS 23.003 [12] to identify an MBS Session.

### 6.5.3 Source Specific IP Multicast Address

The source specific IP multicast address is used to identify an Multicast MBS session and consists of two IP addresses, one is an IP unicast address used as source address in IP packets for identifying the source of the multicast service (e.g. AF/AS), the other is an IP multicast address used as destination address in related IP packets for identifying a multicast communication service associated with the source.

### 6.5.4 MBS Frequency Selection Area ID

The MBS Frequency Selection Area (FSA) ID is used for broadcast MBS session to guide the frequency selection of the UE.

MBS FSA ID identifies a preconfigured area within, and in proximity to, which the cell(s) announces the MBS FSA ID and the associating frequency (details see TS 38.300 [9]). MBS FSA ID and their mapping to frequencies are provided to RAN nodes via OAM.

Based on this configuration, RAN nodes announce in SIBs over the radio interface information about the MBS FSA IDs and frequencies.

When a broadcast MBS session is created, the AF may provide MBS FSA ID(s) based on the business agreement. If the AF does not provide MBS FSA ID(s), the MB-SMF determines MBS FSA ID(s) based on configured mapping from MBS service area and/or broadcast MBS session information (e.g. application ID) to MBS FSA ID(s) and sends the determined MBS FSA ID(s), to the AF (optionally via NEF).

NOTE: The same MBS FSA ID(s) can be assigned to multiple Broadcast MBS sessions.

The MBS FSA ID(s) of a broadcast MBS session are communicated in the service announcement towards the UE. The UE compares those MBS FSA IDs(s) with the MBS FSA ID(s) in SIBs for frequency selection.

During MBS Session Start for Broadcast in clause 7.3.1 and MBS Session Update for Broadcast in clause 7.3.3, the MB-SMF may include the MBS FSA ID(s) for the MBS session and send them to the NG-RAN nodes via the AMF. The NG-RAN nodes may then use those MBS FSA ID(s) to determine cells/frequencies within the MBS service area to broadcast MBS session data. For details, see TS 38.300 [9] and TS 38.413 [15].

## 6.6 QoS Handling for Multicast and Broadcast services

For MBS services, the network shall support QoS control per MBS session.

The 5G QoS model and parameters as defined in TS 23.501 [5] clause 5.7 also apply to multicast/broadcast communication services with the following differences:

- Reflective QoS is not applicable;
- Wireline access network specific 5G QoS parameters do not apply to MBS services;
- Alternative QoS Profile is not applicable;
- QoS Notification Control is not applicable;
- UE-AMBR is not applicable;

NOTE 1: For multicast communication service, the UE-AMBR applies for associated PDU Session.

- Session-AMBR if provided is enforced at MB-UPF but not communicated to NG-RAN.

NOTE 2: Whether Session-AMBR is required in addition to the MBS service data flow bit rate is determined by operator policy and/or agreement with the service provider.

- For broadcast MBS session, the QoS rule and QoS Flow level QoS parameters are not provided to UE.

NOTE 3: For broadcast MBS session, the associated QoS Flow(s) are not applicable.

- For multicast MBS sessions, the QoS rule and QoS Flow level QoS parameters of MBS QoS Flow are not provided to UE.
- For multicast MBS sessions, the handling of QoS rule and QoS Flow level QoS parameters of the associated QoS Flow(s) is the same as for other QoS Flow without UL in a PDU Session.

NOTE 4: The UE does not need to know a QoS Flow within the PDU session is mapped from MBS QoS Flow.

The network shall support one or multiple QoS flows, which can be either GBR or non-GBR, for an MBS session.

If 5GC Individual MBS traffic delivery method is used to deliver multicast data packets, the network may use dedicated QoS Flows for multicast data packets in a PDU session. For the associated QoS Flow in the PDU session, the SMF uses the same QoS parameters (e.g. 5QI) provided by MB-SMF. These dedicated QoS Flows shall be kept separate from QoS Flows unrelated to multicast even if the same 5QI and other QoS parameters are assigned.



NOTE 5: When there is a need to apply 5GC Individual MBS traffic delivery, the Session-AMBR of the associated PDU Session can be configured with a sufficiently high value to cater for MBS Session-AMBR.

The MB-SMF may obtain QoS information for multicast and broadcast MBS session in different ways depending on the deployment and use cases.

If dynamic PCC is not deployed:

- When an MBS session is started, the MB-SMF is provided with service requirements including QoS information. If MBSF is not used, the service requirement is provided to the MB-SMF by the AF (directly or via the NEF). If the MBSF is used, the MBSF receives request from the AF (or via the NEF) and decides the related QoS requirements (e.g. considering support for FEC) and provides them to the MB-SMF. The MB-SMF determines the QoS profiles and QoS for N4 rules for the MBS session with QoS parameters of the MBS QoS flows, and provides related information to the RAN and the MB-UPF respectively.

NOTE 6: What information is included in the request from AF to MBSF requires collaboration with SA WG4.

If dynamic PCC is deployed:

- It is the PCF that generates policy rules for MBS Session based on the received service requirement and provides the policy rules to the MB-SMF. The MB-SMF, based on the policy rules from the PCF, determines to create, and/or modify MBS QoS Flow(s) including providing QoS information to NG-RAN and MB-UPF, and providing packet detection and forwarding information to MB-UPF.

## 6.7 User plane management

The MB-UPF acts as the MBS Session Anchor of an MBS session, and if the MBSTF is involved in the MBS session, then the MBSTF acts as the media anchor of the MBS traffic. The MB-UPF receives only one copy of MBS data packets from AF or MBSTF.

The user plane between MB-UPF and AF, may use either multicast transport or a unicast tunnel for the MBS session (depending on application and capabilities of control interface). If the transport network does not support multicast transport, the user plane uses a unicast tunnel for the MBS Session. The user plane between MBSTF and AF may use a unicast tunnel, multicast transport or other means (e.g. HTTP download from external CDN). The user plane between MBSTF and MB-UPF uses a unicast tunnel for the MBS session. If a unicast tunnel is used for the MBS Session between MB-UPF and AF or MBSTF, after receiving the downlink MBS data, the MB-UPF forwards the downlink MBS data without the received outer IP header and tunnel header information.

The user plane from the MB-UPF to NG-RAN(s) (for 5GC Shared MBS traffic delivery) and the user plane from the MB-UPF to UPFs (for 5GC Individual MBS traffic delivery) may use multicast transport via a common GTP-U tunnel per MBS session, or use unicast transport via separate GTP-U tunnels at NG-RAN or at UPF per MBS session in the following way

- For 5GC Shared MBS traffic delivery (i.e. MB-UPF delivers user plane data to NG-RAN supporting MBS), if the transport network supports IP multicast, the NG-RAN node uses multicast transport via a common GTP-U tunnel per MBS session, otherwise unicast transport via separate GTP-U tunnel per MBS session per NG-RAN node is used.
- For 5GC Individual MBS traffic delivery (i.e. MB-UPF delivers user plane data to UPF), if the transport network supports IP multicast and the UPF supports reception of multicast data over N19mb, UPF use multicast transport via a common GTP-U tunnel per MBS session, otherwise unicast transport via separate GTP-U tunnel per MBS session per UPF is used.

If the user plane uses unicast transport, the transport layer destination is the IP address of the NG-RAN or UPF, each NG-RAN or UPF allocates the tunnel separately and multiple GTP-U tunnels are used for the MBS Session. If the user plane uses multicast transport, a common GTP-U tunnel is used for both RAN and UPF nodes. The GTP-U tunnel is identified by a common tunnel ID and an IP multicast address as the transport layer destination, both assigned by 5GC.

The above is depicted in Figure 6.7-1. There could be more than one NG-RANs or UPFs that are involved in the MBS traffic delivery.

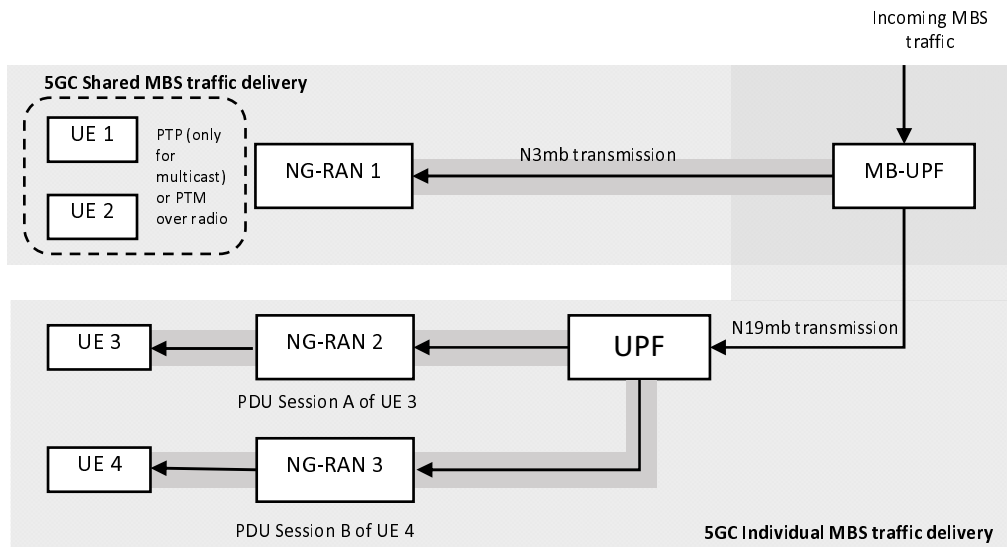

**Figure 6.7-1: Schematic showing user plane data transmission**

The MB-SMF instructs the MB-UPF to receive packets related to an MBS session.

MB-UPF transmits the MBS data with the sequence number for each MBS QoS Flow as defined in TS 29.281 [23].

For shared delivery, if unicast transport over N3mb applies, the MB-SMF instructs MB-UPF to replicate the received MBS packets and forward them towards multiple RAN nodes via separate GTP tunnel. For shared delivery, if multicast transport over N3mb applies, the MB-SMF instructs the MB-UPF to replicate the received MBS data and forwards the data via a single GTP tunnel.

For individual delivery, the MBS data received by the MB-UPF is replicated towards the UPF(s) where individual delivery is performed in the following way:

- The MB-SMF configures the MB-UPF to receive packets related to an MBS session, to replicate those packets and forward them towards multiple UPFs via GTP tunnels if unicast transport over N19mb is applied, or via a single GTP tunnel if multicast transport over N19mb is applied.
- The SMF(s) instructs the UPF to receive packets related to a Multicast MBS session from an MB-UPF over N19mb, to replicate those packets and to forward them in multiple PDU sessions.

For the MB-SMF and MB-UPF, packet detection, replication and forwarding for an MBS session is realized by using for each MBS session one PDR that detects the incoming MBS packets and points to one FAR that describes the forwarding of the data towards multiple destinations (UPFs or RAN nodes):

- A PCF session is created when the MBS Session is started, regardless of multicast or unicast transport over N3mb and N19mb.
- For Multicast transport over N3mb and N19mb, the destination in the FAR contains the MB-UPF IP Multicast Distribution Info.
- For unicast transport over N3mb and N19mb, the FAR in the PCF session may contain multiple destinations represented by the NG-RAN N3mb Tunnel Info and UPF N19mb Tunnel Info (if applicable).

For the SMF and the UPF (for 5GC individual delivery), packet detection, replication and forwarding for an MBS session is realized by PDR and FAR of the PDU session in which the UE has joined the MBS session:

- The SMF instructs the UPF to associate the PCF session of the PDU session with an MBS session.
- A new PDR with Source Interface "Core" is used to detect MBS data from N19mb.

**NOTE:** This PDR is also containing the MBS Session ID to enable a single detection of the incoming MBS data for multiple PDU sessions at the UPF.

- For unicast transport over N19mb, the SMF requests UPF to allocate N19mb Tunnel Info if not allocated.
- For multicast transport over N19mb, the SMF includes the low layer source specific multicast address information and C-TEID to UPF.
- If the SMF wants to maintain the MBS data reception over N19mb but suspends the delivery of the data to the UE's PDU session, the Action of FAR set to "drop" (e.g. when the UE is switching from 5GC Individual delivery to 5GC Shared delivery due to the UE moving from MBS non-supporting NG-RAN to MBS supporting NG-RAN). Otherwise the SMF remove the related PDR and FAR.

See TS 29.244 [17] for the details of user plane handling.

## 6.8 Interworking with MBMS over E-UTRAN for public safety services

In order to minimize the interruption of services, upon mobility for MBS service from NR/5GC to E-UTRAN/EPC and vice versa, the following applies:

- If the same MBS service is provided via eMBMS in E-UTRAN and MBS, interworking is supported at service layer.
  - The UE is always configured with a common TMGI regardless of whether the UE is discovering the MBMS/MBS service via E-UTRAN or NR, for both multicast and broadcast MBS services.
  - When the UE camps on NR and uses a multicast MBS service, the UE joins a multicast MBS session and uses procedures as defined in clause 7.2 for MBS reception for the TMGI. When the UE camps on E-UTRAN, the UE uses procedures as defined in TS 23.246 [8] for MBMS reception for the TMGI.
  - The session context for multicast MBS service transferring is not handed over to E-UTRAN during mobility from 5GS to EPS.

## 6.9 MBS Session Context

### 6.9.1 MBS Session Context

The MBS Session Context contains all information describing a particular MBS session in the 5GS and is created in each node involved in the delivery of the MBS data.

The content of the Multicast MBS Session Context is described in Table 6.9.1-1.

Table 6.9.1-1: Multicast MBS Session Context

Parameter	Description	NG-RAN	AMF	SMF	MB-SMF
State	State of MBS session ('Active' or 'Inactive' or 'Configured')	X (note 2)		X (note 2)	X
SSM (source specific IP multicast address)	IP multicast address identifying the MBS session.			X (note 1)	X (note 1)
TMGI	Temporary Mobile Group Identity allocated to the MBS Session.	X	X	x	X
Area Session Identifier	Used for MBS session with location dependent content. When present, the Area Session Identifier together with the TMGI uniquely identify the MBS Session in a specific MBS service area.	X (note 1)	X	X (note 1)	X (note 1)
MB-SMF	The MB-SMF that handles the MBS session.		X	X	
QoS information	QoS information of the MBS session.	X		X	X
MBS Service Area	Area over which the MBS session data is distributed (i.e. Cell ID list or TAI list).	X (note 1)		X (note 1)	X (note 1)
NG-RAN Node ID(s)	NG-RAN nodes which are involved in the Multicast MBS session		X		
AMF	The AMF(s) which are selected for the MBS session	X			X
IP multicast and source address for data distribution	IP addresses identifying the SSM user plane transport for shared delivery between MB-UPF and NG-RAN and for individual delivery between MB-UPF and UPF when the IP multicast transport is used.	X (note 1)		X (note 1)	X (note 1)
SMF	The SMF(s) that manages the associated PDU session.				X
UE ID	ID identifying the UE that successfully join the Multicast MBS session. For NG-RAN it is NGAP UE ID and for SMF it is SUPI.	X (note 3)		X (note 3)	
IP address for distribution	The IP addresses and TEID of NG-RAN used for the user plane between NG-RAN and MB-UPF and between MB-UPF and UPF when Point to Point tunnel is used.	X (note 1)		X (note 1)	X (note 1)
TEID for data distribution	The tunnel ID used for receiving the multicast data for shared delivery by NG-RAN and for individual delivery by UPF	X		X	X
PCF	The MB-PCF that provides policy control for the MBS session.				X (note 1)
NOTE 1: It is an optional parameter.					
NOTE 2: The value 'Configured' is not applicable for NG-RAN and SMF.					
NOTE 3: the UE ID is available within the UE Context which contains the MBS information.					

In Broadcast MBMS mode, an MBS Session Context is created in the NG-RAN, AMF, MB-SMF and MBSF as a result of the MBS Session Start procedure.

The content of the Broadcast MBS Session Context is described in Table 6.9.1-2.

Table 6.9.1-2: Broadcast MBS Session context

Parameter	Description	NG-RAN	AMF	MB-SMF
TMGI	Temporary Mobile Group Identity allocated to the MBS Session.	X	X	X
Area Session Identifier	Used for MBS session with location dependent content. When present, the Area Session Identifier together with the TMGI uniquely identify the MBS Session in a specific MBS service area.	X (note 1)	X (note 1)	X (note 1)
AMF	The AMF(s) which are selected for the MBS session	X		X
MB-SMF	The MB-SMF that handles the MBS session.		X	
QoS information	QoS information for the MBS Session, including the QoS parameters of QoS flows.	X		X
MBS Service Area	Area over which the MBS session data is distributed (i.e. Cell ID list or TAI list).	X	X	X
NG-RAN Node ID(s)	NG-RAN nodes which are selected for the Broadcast MBS session		X	
IP multicast address for data distribution	IP addresses identifying the user plane transport used for shared delivery between MB-UPF and NG-RAN when the IP multicast transport is used.	X (note 1)		X (note 1)
NG-RAN IP Address for data distribution	The IP address of NG-RAN used for the user plane between NG-RAN and MB-UPF when Point to Point tunnel is used.	X (note 1)		X (note 1)
TEID for data distribution	The tunnel ID used for receiving the broadcast data for shared delivery by NG-RAN	X		X
PCF	The PCF that provides policy control for the MBS session.			X (note 1)
MBS FSA ID	MBS Frequency Selection Area (FSA) ID is used for broadcast MBS sessions to guide the frequency selection of the UE.	X		X
NOTE 1: It is an optional parameter.				

## 6.10 Policy control for Multicast and Broadcast services

### 6.10.1 General

The policy and charging control framework as defined in TS 23.503 [7] applies to Multicast and Broadcast services in the following aspects:

- MBS Session binding: MBS Session binding is the association of an AF Session information to one and only one MBS Session. The PCF shall perform the session binding based on the MBS Session ID, i.e. TMGI or source specific IP multicast address.
- QoS Flow binding: For an MBS Session, QoS Flow binding is the association of a PCC rule to a QoS Flow within an MBS Session. The MB-SMF performs QoS Flow binding for an MBS Session in the same way as the SMF for a PDU Session.
- MBS policy information consists of:
  - PCC rules for MBS Session are used to provide policy for QoS flows: The following PCC rule parameters defined in Table 6.3.1 of TS 23.503 [7] are applicable for MBS:
    - Rule identifier.
    - Service data flow detection: Precedence, Service data flow template (only for IP PDU traffic).
    - Policy Control: 5G QoS Identifier (5QI), DL-maximum bitrate, DL-guaranteed bitrate, ARP, Priority Level, Averaging Window, Maximum Data Burst Volume.
  - Policy information can also be applicable for an entire MBS session. The following parameters defined for a PDU session in Table 6.4.1 of TS 23.503 [7] are applicable for an entire MBS session:

- Authorized Session-AMBR.
- Explicitly signalled QoS Characteristics.
- Policy Control Request Triggers for MBS Session are used to define the conditions when the MB-SMF shall interact again with the PCF to request an update of the policy information for the MBS session by providing information on the condition(s) that have been met. The following Policy Control Request Triggers are defined for MBS:
  - MBS Session Update.

## 6.10.2 MBS Session policy control data in UDR

The policy control profile information may optionally be provided by the UDR at MBS Session establishment, using Nudr service for Data Set "Policy Data" and Data Subset "MBS Session policy control data", with the source specific multicast address used as MBS session ID or with AF Application identifier as data key is described in Table 6.10.2-1.

**Table 6.10.2-1: MBS Session policy control information**

Information element name	Description	Category
5QI(s)	Allowed 5QI(s) for a PCC rule of an MBS session (NOTE 1)	Optional
ARP	Highest ARP for any PCC rule of an MBS session (NOTE 1)	Optional
Session-AMBR	Maximum Session-AMBR for all nonGBR QoS Flows of an MBS session (NOTE 1)	Optional
GBR	Maximum aggregated bitrate that can be provided across all GBR QoS Flows for an MBS session (NOTE 1)	Optional
NOTE 1: This information element may be used to decide whether to authorize received MBS Service Information.		

## 6.11 Service Announcement

Service Announcement provides the UE with descriptions specifying the multicast or broadcast services to be delivered as part of MBS Session.

The Service Announcement includes the MBS Session ID(s), which is represented by TMGI or a Source Specific IP Multicast Address, for the service. When the MBS Session ID is Source Specific IP Multicast Address, the Service Announcement may include the PLMN ID of the PLMN and NID for an SNPN in which the service is delivered.

The Service Announcement includes an MBS Service Type, which indicates whether the MBS Session for the service is multicast or broadcast.

NOTE 1: A Source Specific IP Multicast Address as MBS Session ID indicates a Multicast MBS session.

For local MBS service, the Service Announcement may include the MBS service area. The MBS service area used by AF can be Cell ID list, TAI list, geographical area information or civic address information. Amongst them, Cell ID list and TAI list shall only be used by AFs who reside in trust domain, and when the AFs are aware of such information.

If the MBS Session is multicast, the Service Announcement may include the DNN and S-NSSAI of the PDU Session to indicate which PDU Session is associated with the MBS Session.

NOTE 2: For multicast, AF or MBSF provides Service Announcement only after the MBS information is available to 5GC or the start time need be included, to avoid potential rejection sent by SMF of the MBS session join request.

NOTE 3: The MBS Service related information, e.g. default PLMN ID, DNN and S-NSSAI can be pre-configured in the UE.

NOTE 4: If DNN and S-NSSAI information is not provided in the service announcement or pre-configured, how UE determines the PDU session to join the MBS Session is implementation specific.

If the MBS Session is broadcast, the Service Announcement may include the MBS FSA ID(s) and optional frequency information associated with the broadcast MBS session.

The Service Announcement may be provided to a UE by AF or MBSF, or may be retrieved by the UE from those entities.

NOTE 5: How the UE can get the Service Announcement from other entities is not specified.

NOTE 6: Service announcement can comply with TS 26.502 [18] and TS 23.289 [21] or follow an application specific format.

## 6.12 Paging strategy handling

Compared to the paging strategy handling specified in clause 5.4.3 of TS 23.501 [5], the following additional functionality for multicast MBS service applies:

- At multicast MBS Session Activation, the SMF may provide the most demanding ARP and 5QI of all MBS QoS Flow within the MBS session to the AMF.
- The AMF may take the received ARP and 5QI into consideration in paging differentiation.

## 6.13 MBS Security function

Security function may be needed to protect MBS related signalling/data. Detailed descriptions of security requirements, procedures and handling for 5G Multicast/Broadcast Service (MBS) are provided in TS 33.501 [20].

MBS security function is implemented in the MBSF/MBSTF so that it may apply only when MBSF/MBSTF are used (i.e. Configuration option 2 and 3). For configuration option 1 how to support MBS security is out of 3GPP scope.

## 6.14 MBS Service Information

MBS Service Information is a set of information used by the AF to describe an MBS session. It is directly conveyed from the AF to the MB-SMF or indirectly via NEF and/or MBSF.

In addition, MBS Service Information may be optionally sent from AF/NEF/MBSF to the PCF based on network configuration.

NOTE: Depending on deployment scenarios specified in Annex A, AF, NEF or MBSF interacts with MB-SMF, and optionally that AF, NEF or MBSF interacts with PCF.

The MBS Service Information consists of an optional AF Application Identifier, an optional Session-AMBR and the description of one or more data flows/media components. For each data flow/media component, the following information may be provided:

- Flow description; and
- one of the following:
  - Media information (Media type, Media format, bandwidth) with optional Priority indicator;
  - QoS requirements (5G QoS parameters (i.e. 5QI, ARP, GBR, MBR) or QoS reference).

The following MBS Service Information is mandatory to be supported: 5G QoS parameters (i.e. 5QI, ARP, GBR, MBR) and optional Session-AMBR for one data flow/media component. Additional MBS Service Information is optional to be supported.

---

## 7 MBS procedures

### 7.1 Common procedure for Multicast and Broadcast

#### 7.1.1 MBS Session Management

##### 7.1.1.1 General

The call flows in clause 7.1.1 and clause 7.3 show a "NEF/MBSF", but as detailed in Annex A, there can be different related network deployment involving either only NEF, or MBSF, or both.

The interactions between "NEF/MBSF" and MB-SMF, PCF, BSF and NRF depicted in the call flows apply for NEF, MBSF or a combined NEF and MBSF, depending on network deployment. They may also apply for an AF in the trusted domain where NEF is not mandated.

However, the interactions between AF and "NEF/MBSF" depicted in the call flows only apply for the NEF.

Interactions between AF and MBSF based on the MB2 interface follow TS 23.468 [10] (see Annex C).

Interactions between AF and MBSF based on the xMB interface follow TS 26.348 [11] (see Annex C).

Services offered by the MBSF and related interactions based on that service between MBSF and AF or NEF (if MBSF and NEF are split as shown in configuration 2) are specified in TS 26.502 [18].

Detailed interactions between the MBSF or NEF and the MBSTF are specified in TS 26.502 [18].

##### 7.1.1.2 MBS Session Creation without PCC

This procedure is used by the AF to start the MBS Session towards 5GC and consist of TMGI allocation, and MBS session creation, and they apply to both multicast and broadcast communications unless otherwise stated.

For multicast, MBS session establishment procedure triggered by UE join requests may follow the MBS session creation procedure to reserve resources towards NG-RAN. For broadcast, the MBS session start procedure to reserve resources towards NG-RAN is triggered by the MBS session creation procedure.

For both broadcast and multicast communication, the TMGI allocation may be separated from the MBS Session creation request.

For multicast communication, TMGI allocation procedure is applicable if TMGI is used as MBS Session ID.



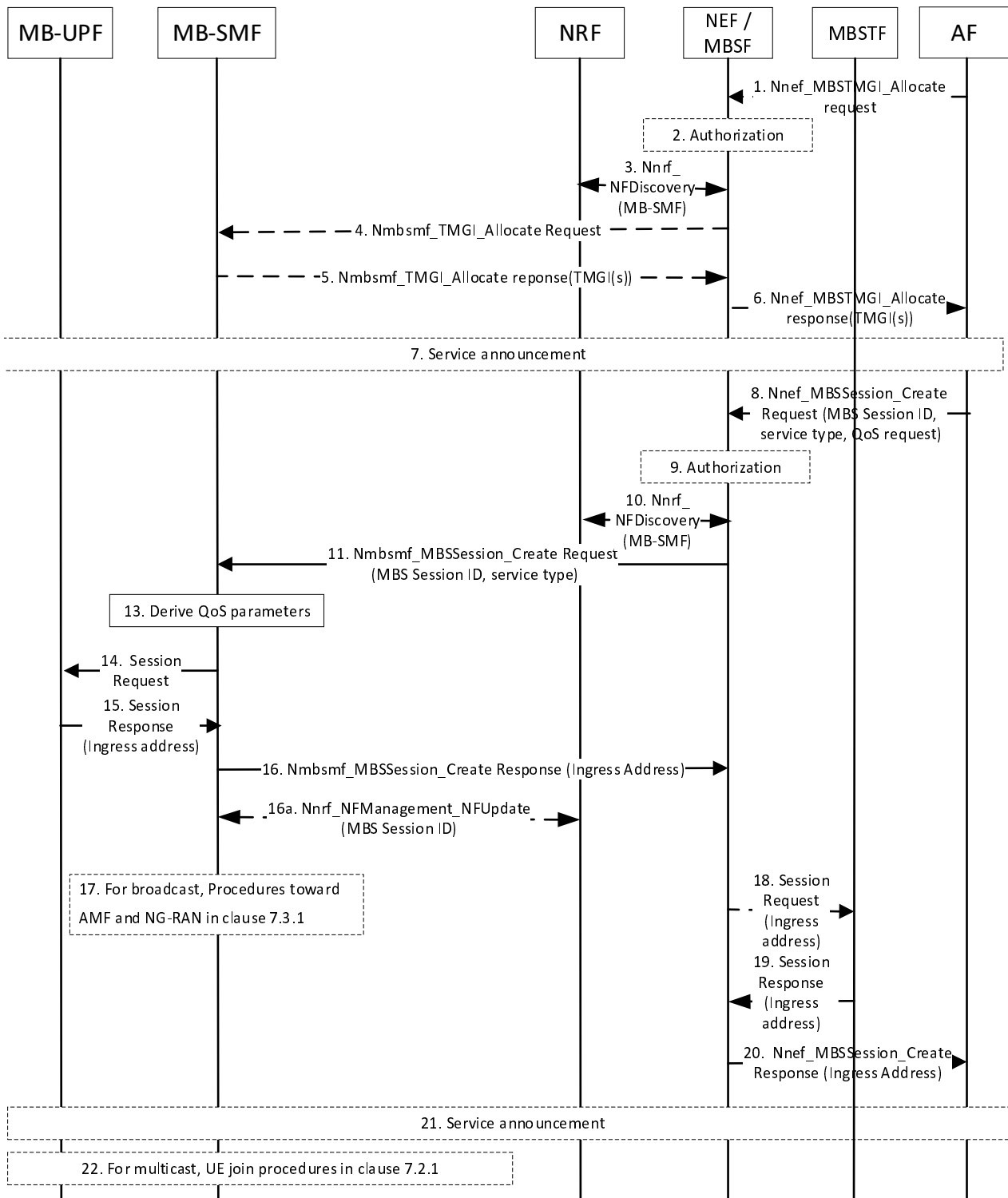

**Figure 7.1.1.2-1: MBS Session Creation without PCC**

Steps 1 to 6 are optional and only applicable if TMGI is used as MBS Session ID and required to be pre-allocated.

1. AF sends Nnef\_MBSTMGI\_Allocate Request (TMGI number, [MBS service area]) message to NEF/MBSF to request allocation of a TMGI(s) to identify new MBS session(s). The MBS service area indicates the possible service area for those TMGI(s) to be allocated, which may be needed for local MBS.

NOTE 1: Depending on the network deployment and use case, MB-SMF may receive requests from AF directly, or via NEF, or via MBSF, or via NEF and MBSF.

2. NEF/MBSF checks authorization of AF. If geographical area information or civic address information was provided by the AF as MBS service area, NEF/MBSF performs the translation.

NOTE 2: NEF is not required if AF is in trusted domain.

3. NEF/MBSF discovers and selects an MB-SMF using NRF or based on local configuration, possibly based on MBS service area.
4. NEF/MBSF sends an Nmbsmf\_TMGI\_Allocate Request (TMGI number) message to the MB-SMF.
5. MB-SMF allocates TMGI(s) and returns the TMGI(s) to the NEF/MBSF via the Nmbsmf\_TMGI\_Allocate response (TMGI(s), expiration time).
6. The NEF or MBSF responds to the AF by sending an Nnef\_MBSTMGI\_Allocate Response (TMGI(s), expiration time).
7. The AF may perform a Service Announcement towards UEs. The AF informs UEs about MBS Session information with MBS Session ID, e.g. TMGI, SSM, and possibly other information e.g. MBS service area, session description information, etc.

The MBS service area information can be Cell ID list, TAI list, geographical area information or civic address information. Amongst them, Cell ID list and TAI list shall only be used by AFs who reside in trust domain, and when the AFs are aware of such information.

The UE needs to be aware if the service is broadcast or multicast to decide if JOIN is to be performed.

8. AF of content provider may provide description for an MBS session (possibly providing information for a previously allocated TMGI to NEF via a Nnef\_MBSSession\_Create request ([MBS Session ID], MBS service type, MBS Service Information, [TMGI allocation request], [MBS service area], [Any UE indication], [start and end time of the MBS session], [MBS session state], [ingress transport address request indication], [Request for location-dependent session], [FSA ID(s)]). If step 1-6 has not been executed before, the AF may provide an MBS Session ID containing an SSM or it may request that the network allocates an MBS Session ID (i.e., TMGI). The AF provides the MBS service type (i.e. either multicast service or broadcast service) and MBS Service Information (as defined in clause 6.14). The AF may provide the "Any UE indication" (indicating whether a multicast MBS session is "open to any UEs"), MBS service area, start and end time of the MBS session and MBS session state (active/inactive). In addition, the AF request may also indicate that the allocation of an ingress transport address is requested and that the AF request is for a location dependent MBS service.

If geographical area information or civic address information was provided by the AF as MBS service area, NEF/MBSF translates the MBS service area to Cell ID list or TAI list.

For broadcast communication, the AF may determine MBS FSA ID(s) for the Broadcast MBS session based on business agreements and include them in the description of the MBS session.

NOTE 3: MBS session state is applicable for multicast MBS Session.

9. NEF/MBSF checks authorization of content provider.
10. NEF/MBSF discovers MB-SMF candidates and selects MB-SMF as ingress control node, possibly based on MBS service area. If a TMGI is included in step 8, NEF/MBSF finds MB-SMF based on that TMGI.
11. NEF/MBSF sends Nmbsmf\_MBSSession\_Create Request ([MBS Session ID], MBS service type, [TMGI allocation request], MBS Service Information (as defined in clause 6.14), [MBS service area], [Any UE indication], [start and end time of the MBS session], [MBS session state], [ingress transport address request indication], [FSA ID(s)]) to MB-SMF, to request MB-SMF to reserve ingress resources for a MBS distribution session. The NEF/MBSF forwards all parameters it has received from the AF in step 8. If the MBSF decides to insert an MBSTF into the user plane for the MBS session, it also indicates that the allocation of an ingress transport address is requested even if this was not requested in step 8. The request also includes the Any UE indication if provided in step 8.

If requested to do so, or if a source specific multicast is provided as MBS Session ID in step 11, the MB-SMF allocates a TMGI.

For broadcast communication, if no MBS FSA ID(s) have been received, the MB-SMF selects MBS FSA ID(s) for the Broadcast MBS session based on local configuration.

12. Void.

13. The MB-SMF derives the required QoS parameters locally based on the MBS Service Information.

14. MB-SMF selects the MB-UPF. If the allocation of an ingress transport address was requested in step 11, the MB-SMF requests the MB-UPF to reserve user plane ingress resources. If multicast transport of the MBS data towards RAN nodes is to be used, the MB-SMF also request the MB-UPF to reserve for the outgoing data a tunnel endpoint and the related identifiers (source IP address, SSM and GTP Tunnel ID) and to forward data received at the user plane ingress resource using that tunnel endpoint.

If the allocation of an ingress transport address was not requested in step 11, the MB-SMF provides the SSM received as MBS Session ID to the MB-UPF and requests the MB-UPF to join the corresponding multicast tree from the content provider. The MB-SMF may also defer the configuration to join the corresponding multicast tree e.g. based on information that the session is inactive, service requirements and MBS start/end time until receiving the first query for the MBS session as part of the establishment procedure in clause 7.2.1.3, or until receiving a request to activate the MBS session via the MBS Session Update procedure in clause 7.1.1.6.

15. If requested, MB-UPF selects an ingress address (IP address and port) and a tunnel endpoint for the outgoing data and provides it to MB-SMF.

16. MB-SMF indicates the possibly allocated ingress address to the NEF/MBSF. MB-SMF may include TMGI if it is allocated in step 11. For broadcast communication, the MB-SMF includes any MBS FSA ID(s) selected in step 11. It also indicates the success or failure of reserving transmission resources.

16a. If a source specific multicast address is provided as MBS Session ID in step 11, the MB-SMF updates its NF profile at the NRF with the serving MBS Session ID. If an MBS service area was received in step 11, the MB-SMF updates its NF profile at the NRF with that information.

NOTE 3: If TMGI is used to represent an MBS Session, MB-SMF does not need to update NRF if the TMGI range(s) supported by an MB-SMF is already included in the MB-SMF profile when MB-SMF register itself into NRF.

17. For broadcast communication, the MB-SMF continues the procedure towards the AMF and NG-RAN as specified in clause 7.3.1 to request the allocation of resources to for the transmission of the broadcast session.

18. [Optional] If the MBSF decides to use an MBSTF, the NEF/MBSF provides the ingress address received in step 16 towards the MBSTF as DL destination. If the allocation of an ingress transport address was requested in step 8, the MBSF requests the MBSTF to allocate the user plane ingress resources. If the allocation of an ingress transport address was not requested in step 8, the MBSF provides the SSM received as Multicast session ID in step 8 and requests the MBSTF to join the corresponding multicast tree from the content provider.

19. [Conditional on step 19] If requested, the MBSTF selects an ingress address (IP address and port) and provides it to NEF/MBSF.

20. The NEF/MBSF-C indicates the possibly allocated ingress address and other parameters (e.g. TMGI) to the AF via an Nnef\_MBSSession\_Create response ([TMGI], [Allocated ingress address]). If MBS Session ID is not provided in step 8, or the MBS Session ID is SSM, the NEF/MBSF provides the allocated TMGI. If AF requested the allocation of an ingress transport address, the message also includes the allocated ingress address. For broadcast communication, the message also includes any MBS FSA ID(s) received in step 17.

21. Same as step 7. The AF may also perform a service announcement at this stage.

22. For multicast communication, depending on configuration UEs can join the MBS Session as specified in clause 7.2.1.

### 7.1.1.3 MBS Session Creation with PCC

Deployment of dynamic PCC is optional. This clause describes the procedure when dynamic PCC is deployed.

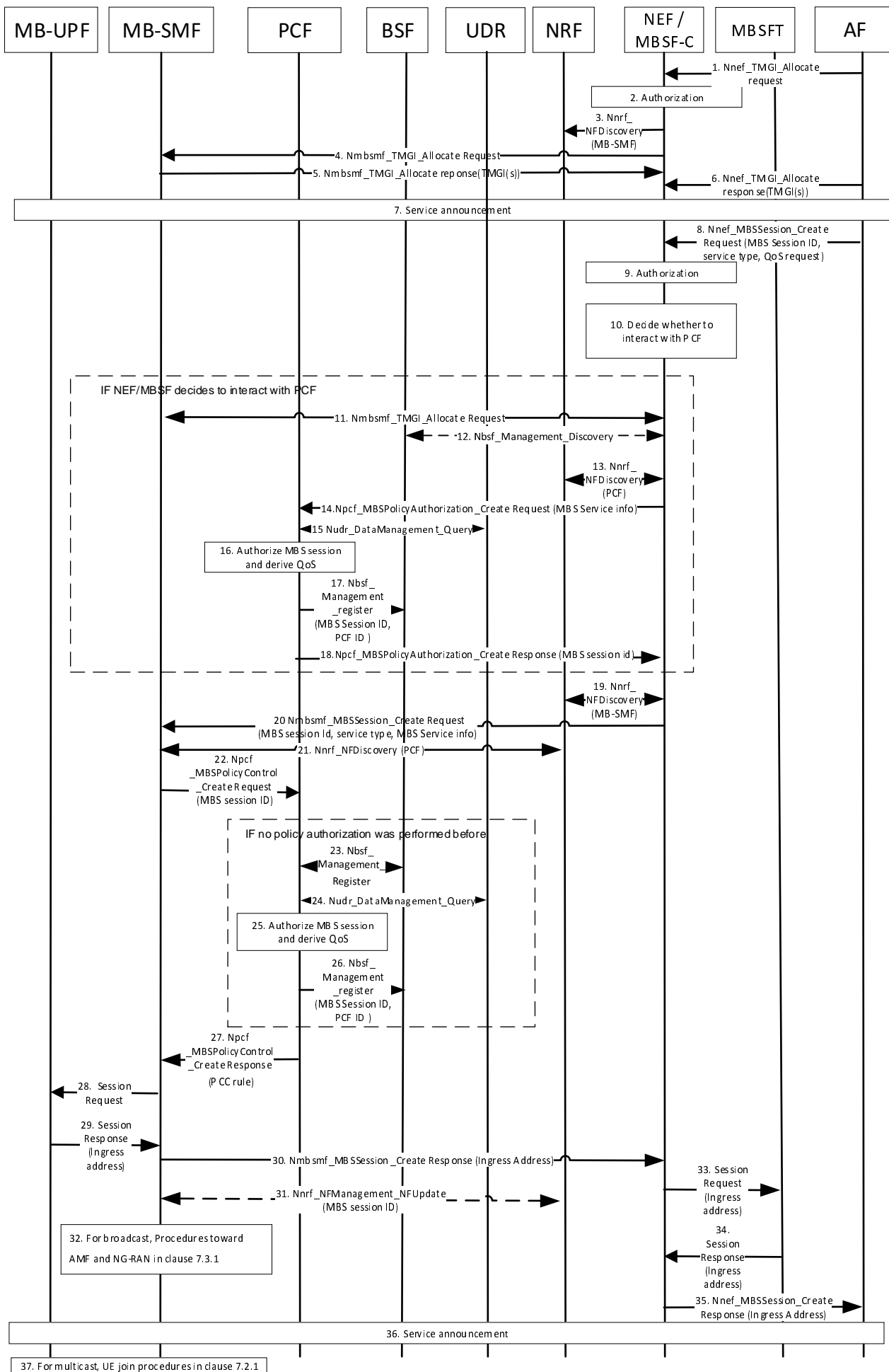

**Figure 7.1.1.3-1: MBS Session Creation with PCC**

Steps 1 to 7 are optional and only applicable if TMGI is used as MBS Session ID and required to be pre-allocated.

1 to 9: Same as in Figure 7.1.1.2-1.

10. The NEF/MBSF may optionally, based on local configuration, decide to interact with the PCF.

NOTE 1: In the deployment without NEF and MBSF, the AF optionally interacts with PCF in steps 11-18.

If the NEF/MBSF decided to interact with the PCF, steps 11 to 19 are performed, and in step 20 the MBS Service Information is not provided to the MB-SMF.

If the NEF/MBSF decided not to interact with the PCF, steps 12 to 19 are skipped, and in step 20 the MBS Service Information is provided to the MB-SMF.

11. [Conditional] If the PCF did not receive an MBS session ID from the AF in step 8, the NEF/MBSF sends an Nmb-smf-TMGI-Allocate Request (1) message to the MB-SMF and the MB-SMF allocates a TMGI and returns the TMGI to the NEF/MBSF via the Nmb-smf-TMGI-Allocate response (TMGI, expiration time).

12. [Conditional] If the NEF/MBSF receives the Request for location-dependent session from the AF and if there is a need to select the same PCF for the location dependent MBS Sessions, the NEF/MBSF first uses the BSF Discovery service to discover whether there is a PCF serving the MBS session with the MBS session ID by using Nbsf-management-Discovery operation. If there is a PCF registered for the MBS session ID, the NEF/MBSF interacts with that PCF and skips the following step 13.

NOTE 2: This step is not necessary in a deployment with a single PCF.

13. [Conditional] If step 12 was not executed or the interaction with the BSF revealed that no PCF is registered for the MBS session ID, the NEF/MBSF discovers the PCF candidates by interacting with the NRF and selects a PCF, possibly based on MBS service area.

14. The NEF/MBSF sends an Npcf-MBSPolicy-Authorization-Create Request (MBS session ID, MBS Service Information (as defined in clause 6.14)) to the PCF.

15. [Optional] The PCF may retrieve authorization information for the MBS session from the UDR (see clause 6.10.2) and takes it into account for the subsequent authorization and QoS allowance check.

NOTE 3: This step is not necessary in a deployment with a single PCF if authorization data are stored in the PCF.

16. The PCF determines whether the request is authorized and if the request is authorized, the PCF derives the required QoS parameters based on the received MBS Service Information and determines whether this QoS is allowed. If the required QoS is allowed, the PCF generates the policy information for the MBS session (as defined in clause 6.10) and stores it together with the MBS session ID.

17. If the request is authorized and the required QoS is allowed, the PCF registers at the BSF that it handles the MBS session by using Nbsf-management-Register Request (MBS Session ID, PCF ID). It provides an identifier that the policy association is for MBS and the MBS Session ID, its own PCF ID and optionally its PCF set ID.

NOTE 4: This step is not necessary in a deployment with a single PCF.

18. The PCF sends an Npcf-MBSPolicy-Authorization-Create Response (Result indication) to the NEF/MBSF.

If the request is not authorized or the required QoS is not allowed, the PCF indicates so in the response to the NEF/MBSF which in turn informs the AF about it (by sending the Nnef-MBSSession-Create Response) and ends this procedure.

19. Same as step 10 in Figure 7.1.1.2-1.

20. Same as step 11 in Figure 7.1.1.2-1 with the difference that the MBS Service Information is not present if the optional interaction between AF/NEF/MBSF and PCF has been performed (as the MBS Service Information was provided to the PCF in step 14).

21. The MB-SMF discovers the PCF using NRF.

22. The MB-SMF sends an Npcf\_MBSPolicyControl\_Create Request (MBS session ID, [MBS Service Information (as defined in clause 6.14)]) for the MBS session towards the PCF. The MB-SMF forwards the MBS Service Information to the PCF if received from the NEF/MBSF in the previous step 20.

If the PCF does not receive MBS Service Information from the MB-SMF, and has previously determined policy information for the MBS session (see step 16) corresponding to the MBS session ID received from the MB-SMF, the PCF continues with step 27. Otherwise, the PCF performs the subsequent steps 23 to 26.

23. If the PCF is not handling the MBS session ID, the PCF uses the BSF Register service to check whether there is already a PCF serving the MBS session. If so, the PCF skips steps 24 to 26 and indicates in step 27 that the PCF serving the MBS session shall be contacted.

NOTE 5: This step is not necessary in a deployment with a single PCF.

24. [Optional] The PCF may retrieve authorization information for the MBS session from the UDR (see clause 6.10.2) and takes it into account for the subsequent authorization and QoS allowance check.

NOTE 6: This step is not necessary if authorization data are stored in the PCF.

25. The PCF determines whether the request is authorized and if the request is authorized, the PCF derives the required QoS parameters based on the received MBS Service Information and determines whether this QoS is allowed. If the required QoS is allowed, the PCF generates the policy information for the MBS session (as defined in clause 6.10) and stores it together with the MBS session ID.

26. If the request is authorized and the required QoS is allowed the PCF registers at the BSF that it handles the MBS session by using Nbsf\_management\_Register Request (MBS Session ID, PCF ID). It provides an identifier that the policy association is for MBS and the MBS Session ID, its own PCF ID and optionally its PCF set ID.

NOTE 7: This step is not necessary in a deployment with a single PCF.

27. The PCF responds with Npcf\_MBSPolicyControl\_Create Response ([policy information for the MBS session (as defined in clause 6.10)], Result indication).

If the request is not authorized or the required QoS is not allowed, the PCF indicates so in the response to the MB-SMF which in turn informs the AF about it (by sending the Nmbsmf\_MBSSession\_Create Response) and ends this procedure.

If another PCF is serving the MBS session, the PCF indicates that another PCF serving the MBS session shall be contacted and provides an ID of that other PCF. The MB-SMF then repeats step 22 towards that other PCF.

28-37: Same as steps 14-22 in Figure 7.1.1.2-1.

NOTE 8: Steps 33-36 can be executed in parallel to step 32.

#### 7.1.1.4 MBS Session Deletion without PCC

This procedure is used by the AF to delete the MBS Session. This procedure may also include TMGI de-allocation. The procedures apply to both multicast and broadcast communications unless otherwise stated. This procedure releases the reserved resources in both 5GC and NG-RAN.

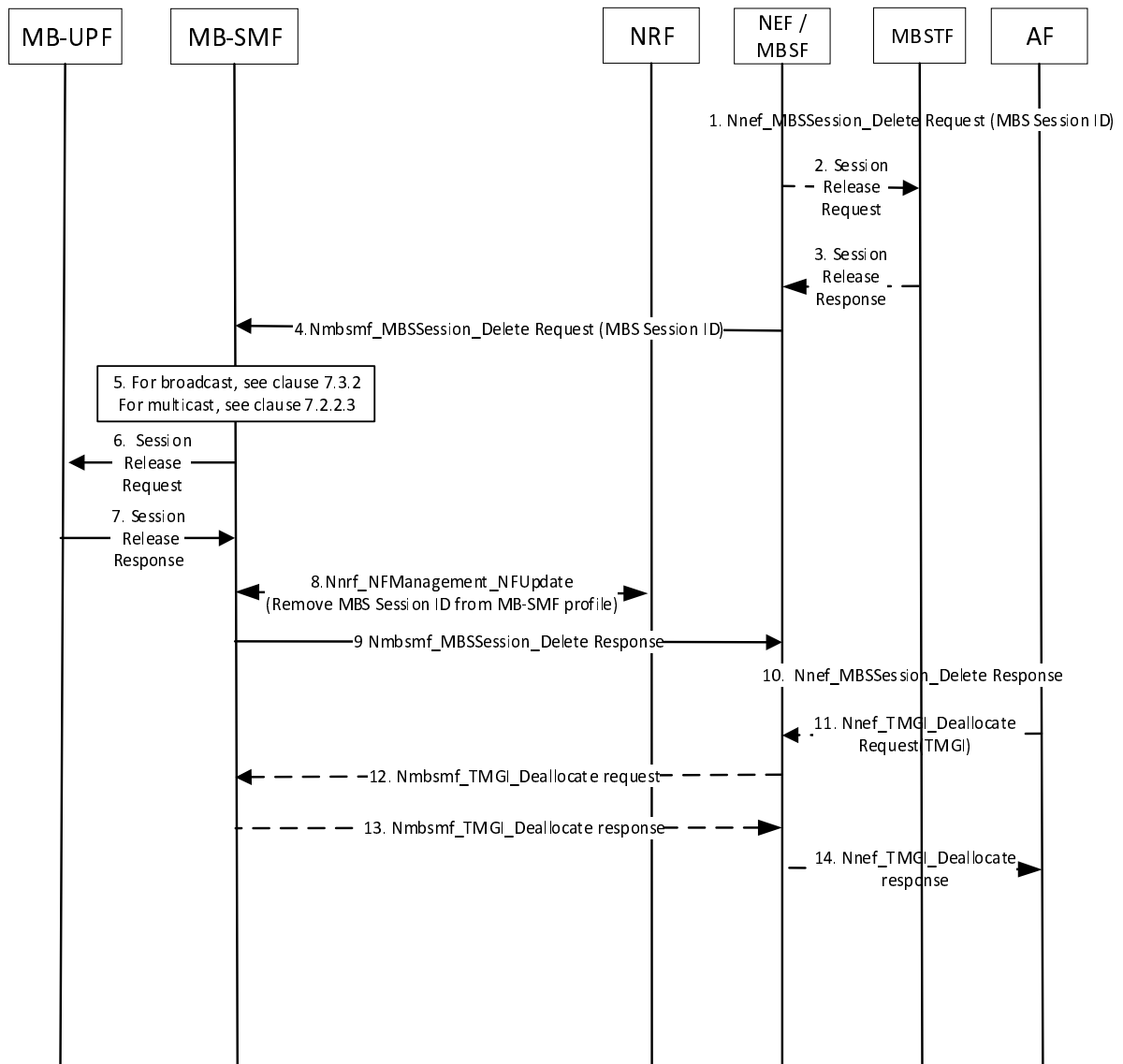

**Figure 7.1.1.4-1: MBS Session Deletion without PCC**

1. AF of content provider may request to delete the MBS session (MBS Session ID).
- 2/3. If an MBSTF was inserted into the user plane, the MBSF request the MBSTF to release user plane resources.
4. NEF/MBSF requests MB-SMF to delete resources for the MBS session.
5. For Broadcast MBS session, the MB-SMF triggers resource release towards the AMFs as specified in clause 7.3.2. For Multicast MBS session, the MB-SMF triggers resource release towards the SMFs as specified in clause 7.2.2.3.
- 6/7. MB-SMF requests the MB-UPF to release user plane resources.
8. [Conditional] If MB-SMF configured the profile with an MBS Session ID when the MBS session was created, the MB-SMF updates its NF profile at NRF to release the MBS Session ID.
9. MB-SMF responds to the NEF/MBSF.
10. The NEF/MBSF responds to the AF.
11. [Optional] AF requests NEF/MBSF to de-allocate TMGI(s),
12. [Conditional on step 11] NEF/MBSF forwards request to de-allocate TMGI(s) to MB-SMF.

13. [Conditional on step 12] The MB-SMF responds to the NEF or MBSF by sending a de-allocate TMGI Response message.

14. [Conditional on step 13] NEF or MBSF forwards de-allocate TMGI Response message to AF.

### 7.1.1.5 MBS Session Deletion with PCC

This procedure is used by the AF to release the MBS Session. This procedure may also include TMGI de-allocation. The procedures apply to both multicast and broadcast communications unless otherwise stated. This procedure releases the reserved resources in both 5GC and NG-RAN.

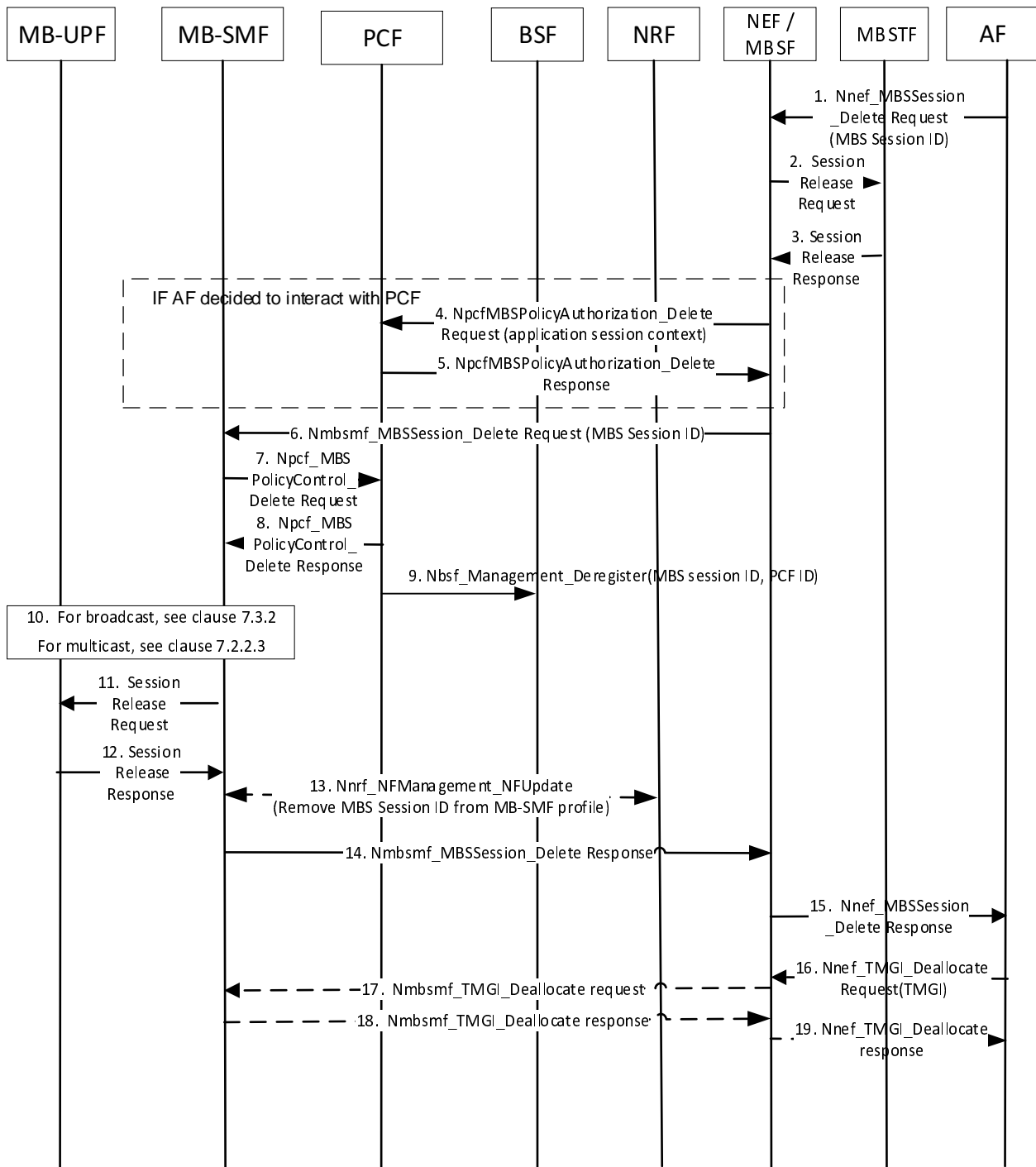

Figure 7.1.1.5-1: MBS Session Deletion with PCC

1-3. Same as in Figure 7.1.1.4-1.



For the interaction with the PCF in this procedure, the NEF/MBSF applies the same decision that was taken in step 10 in Figure 7.1.1.3-1 during the MBS Session Creation with PCC procedure:

If the NEF/MBSF decided to interact with the PCF, steps 4 to 5 are performed.

If the NEF/MBSF decided not to interact with the PCF, steps 4 to 5 are skipped.

NOTE 1: If NEF and MBSF is not deployed, the AF optionally interacts with PCF in steps 4 to 5.

4. The NEF/MBSF sends an Npcf\_MBSPolicyAuthorization\_Delete Request to the PCF that handles the MBS Session.
5. The PCF sends an Npcf\_MBSPolicyAuthorization\_Delete Response to the NEF/MBSF.
6. Same as step 4 in Figure 7.1.1.4-1.
7. The MB-SMF sends the Npcf\_MBSPolicyControl\_Delete Request to request the deletion of the SM Policy Association with the PCF.
8. The PCF sends the Npcf\_MBSPolicyControl\_Delete Response to the MB-SMF.
9. The PCF de-registers at the BSF that it handles the MBS session.
- 10-19. Same as steps 5-14 in Figure 7.1.1.4-1.

#### 7.1.1.6 MBS Session Update without PCC

This procedure is used by the AF to update the MBS service area and/or MBS Service Information. Updating MBS Service Information may lead to addition of new MBS QoS Flow(s), removal of existing MBS QoS Flow(s) or update of existing MBS QoS Flow(s). The procedure applies to both multicast and broadcast communications unless otherwise stated.

For local multicast services and location dependent multicast services, the AF may perform a Service Announcement towards UEs to update the MBS service area before the MBS Session Update procedure is started or after the MBS Session Update procedure is completed.

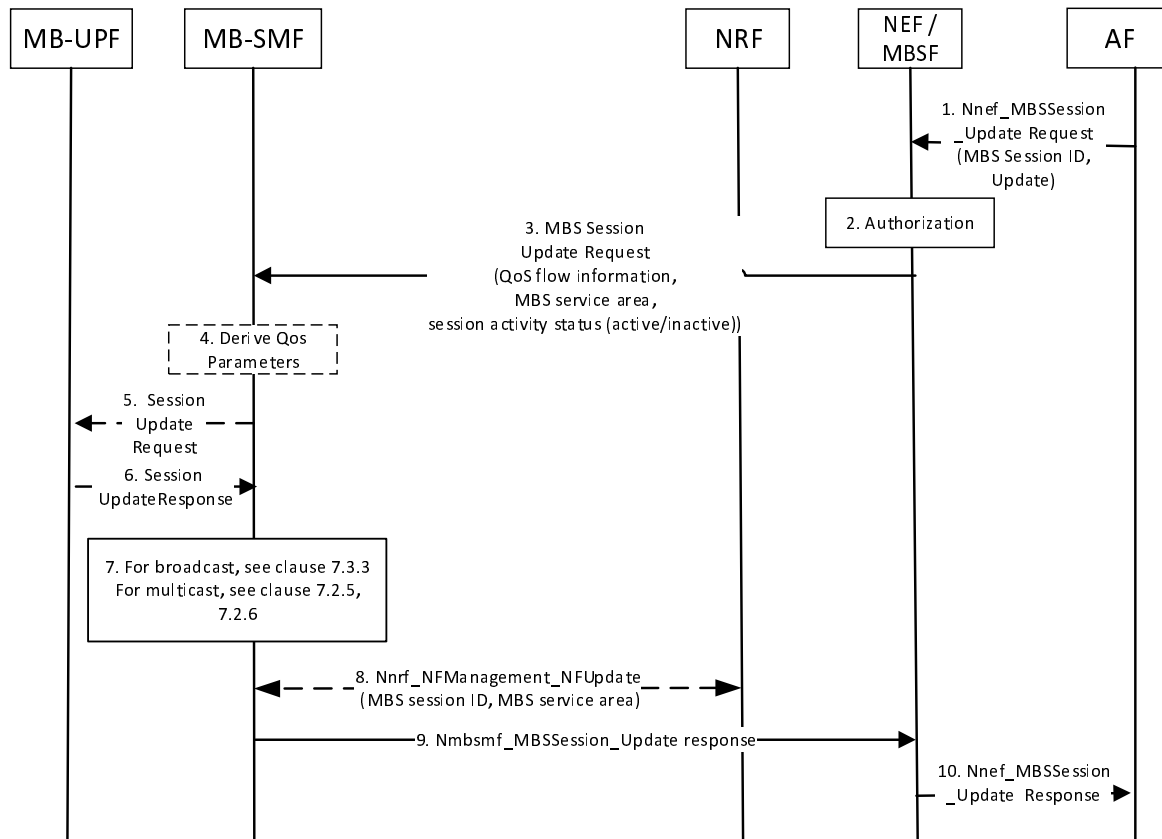

Figure 7.1.1.6-1: MBS Session Update without PCC

1. AF of content provider initiates MBS Session Update to a NEF/MBSF, e.g. to update MBS service area and/or update MBS Service Information (as defined in clause 6.14), or to activate or deactivate an MBS session. AF may provide updated information for an MBS session (identified by MBS session ID) by sending an Nnef\_MBSSession\_Update Request (MBS Session ID, [MBS Service Information], [MBS service area], [MBS session state (active/inactive)]).

If geographical area information or civic address information was provided by the AF as MBS service area, NEF/MBSF translates the MBS service area to Cell ID list or TAI list.

2. NEF checks authorization of AF.
3. NEF/MBSF sends Nmbsmf\_MBSSession\_Update Request to MB-SMF forwarding the updated information received from the AF in step 1.
4. The MB-SMF derives any updated QoS parameters locally under consideration of the updated MBS Service Information. This may lead to addition of new MBS QoS Flow(s), removal of existing MBS QoS Flow(s) or update of existing MBS QoS Flow(s).
- 5-6. MB-SMF may need to update MB-UPF, e.g. if new MBS QoS Flow is to be created, or existing MBS QoS Flow is to be deleted.
7. For broadcast communication, the MB-SMF continues the procedure towards the AMF and NG-RAN as specified in clause 7.3.3. For multicast communication, the MB-SMF continues the procedure towards the AMF and NG-RAN as specified in clause 7.2.5 (for service activation/deactivation), 7.2.6 (for QoS updates and service area updates).
8. If an MBS service area is being updated, the MB-SMF stores the new service area in its profile at the NRF.
9. MB-SMF responds to the NEF/MBSF with a Nmbsmf\_MBSSession\_Update Response.
10. NEF/MBSF responds to the AF with a Nnef\_MBSSession\_Update Response.

### 7.1.1.7 MBS Session Update with PCC

For local multicast services and location dependent multicast services, the AF may perform a Service Announcement towards UEs to update the MBS service area before the MBS Session Update procedure is started or after the MBS Session Update procedure is completed.

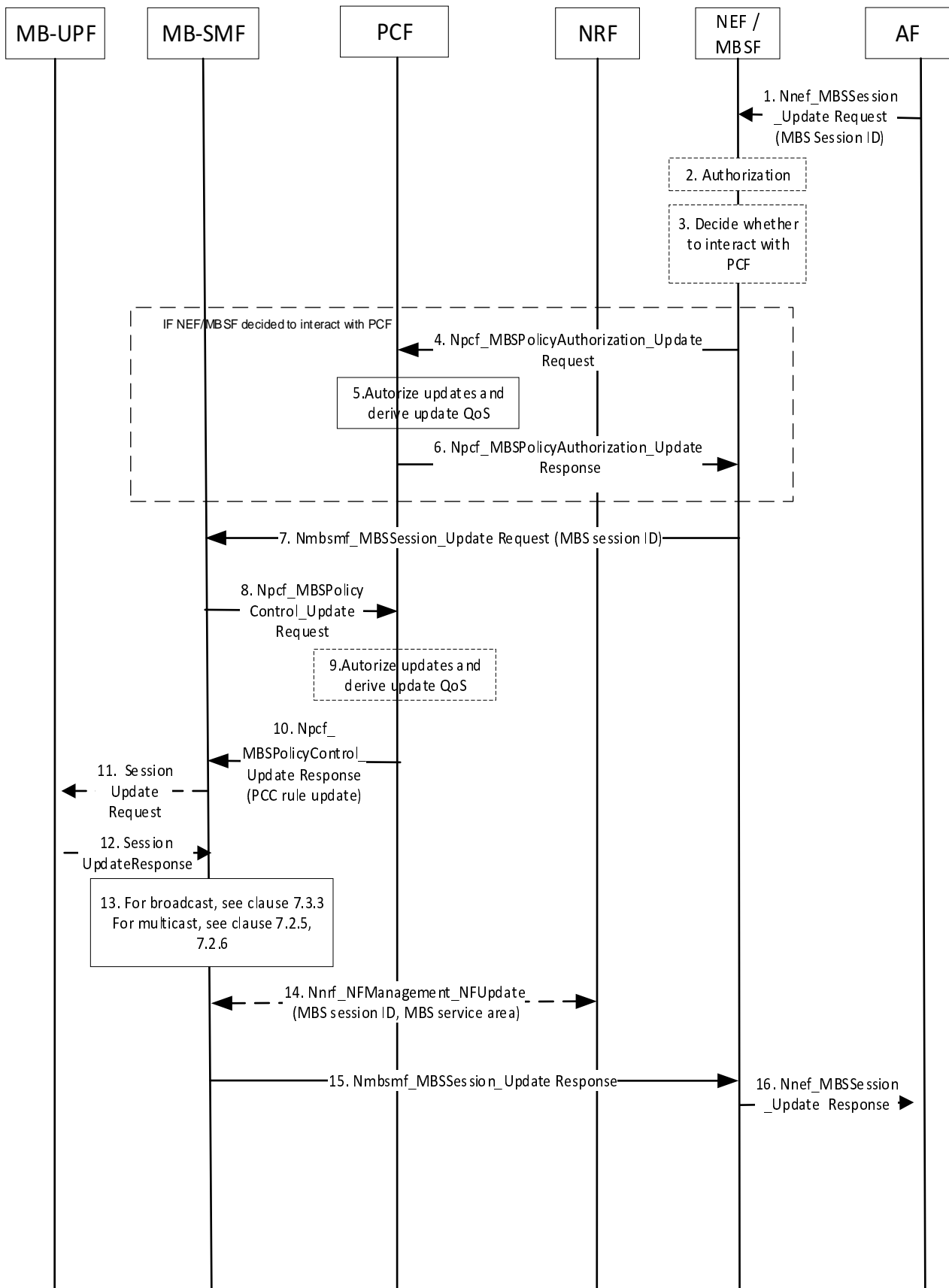

Figure 7.1.1.7-1: MBS Session Update with PCC

1-2. Same as in Figure 7.1.1.6-1.

3. For the interaction with the PCF in this procedure, the NEF/MBSF applies the same decision that was taken in step 10 in Figure 7.1.1.3-1 during the MBS Session Creation with PCC procedure unless the MBS session update only relates to an activation or deactivation of the MBS session and/or an MBS service area update and thus no PCF interactions are required.

If the NEF/MBSF decided to interact with the PCF, steps 4 to 6 are performed and in step 7 an indication that the PCF has to be contacted is provided, and MBS Service Information is not provided to the MB-SMF.

If the NEF/MBSF decided not to interact with the PCF, steps 4 to 6 are skipped and MBS Service Information is provided to the MB-SMF in step 7.

NOTE 1: In the deployment without NEF and MBSF, the AF optionally interacts with PCF in steps 4 - 6.

4. NEF/MBSF sends an Npcf\_MBSPolicy\_Authorization\_Update Request (application session context, [MBS Service Information]) to the PCF forwarding the updated information received from the AF in step 1.
5. The PCF determines whether the update is authorized and if the update is authorized, the PCF derives the update for the QoS parameters based on the received MBS Service Information and determines whether this new QoS is allowed. If the new QoS is allowed, the PCF updates the policy information for the MBS session (as defined in clause 6.10) accordingly. If the policy information for the MBS session has changed, the PCF shall provide an indication that the PCF has to be contacted.
6. The PCF sends an Npcf\_MBSPolicy\_Authorization\_Update Response (Result indication, [indication that the PCF has to be contacted]) to the NEF/MBSF.

If the update is not authorized or the new QoS is not allowed, the PCF indicates so in the response to the NEF/MBSF which in turn informs the AF about it (by sending the Nnef\_MBSSession\_Update Response) and ends this procedure.

7. The NEF/MBSF sends Nmbsmf\_MBSSession\_Update Request to the MB-SMF forwarding the updated information received from the AF in step 1. If the NEF/MBSF has decided not to interact with the PCF, the NEF/MBSF send the indication that the PCF has to be contacted, in addition.

If the NEF/MBSF has decided to interact with the PCF and thus provided the updated MBS Service Information to the PCF in step 4, the updated MBS Service Information is not forwarded. The NEF/MBSF forwards the indication that the PCF has to be contacted, if received from the PCF.

8. If the MB-SMF does not receive the indication that the PCF has to be contacted, the MB-SMF decides whether to interact with the PCF. If it decides not to interact with the PCF, it continues with step 11. Otherwise, the MB-SMF sends an Npcf\_MBSPolicyControl\_Update Request (MBS Policy Association ID, [MBS Service Information]) for the MBS session towards the PCF. The MB-SMF forwards the MBS Service Information to the PCF if received from the NEF/MBSF in the previous step 7.

If the PCF does not receive MBS Service Information from the MB-SMF, the PCF identifies any updated policy information for the MBS session (as defined in clause 6.10) corresponding to the MBS session ID received from the MB-SMF and continues with step 10. Otherwise, if the PCF receives MBS Service Information from MB-SMF, the PCF performs the subsequent step 9.

9. The PCF determines whether the update is authorized and if the update is authorized, the PCF derives the update for the QoS parameters based on the received MBS Service Information and determines whether this new QoS is allowed. If the new QoS is allowed, the PCF updates the policy information for the MBS session (as defined in clause 6.10) accordingly.
10. The PCF responds with Npcf\_MBSPolicyControl\_Update Response ([updated policy information for the MBS session], Result indication).

If the request is not authorized or the required QoS is not allowed, the PCF indicates so in the response to the MB-SMF which in turn informs the AF about it (by sending the Nmbsmf\_MBSSession\_Update Response) and ends this procedure.

- 11.-16. Same as steps 5-10 in Figure 7.1.1.6-1.

## 7.1.2 MB-SMF discovery and selection for multicast/broadcast session

To facilitate the MB-SMF discovery/selection for one multicast/broadcast MBS session, the following mechanism is used:

- The MB-SMF registers its capability related to Multicast/Broadcast Service session management (e.g. S-NSSAI(s) and the associated NSI ID(s) (if available), DNN(s), TMGI range, service area) as part of its profile to the NRF by invoking `Nnrf_NFManagement_NFRegister`. In addition, when a Multicast MBS session is created and the MBS Session ID is not yet included in the MB-SMF profile, the MB-SMF updates its profile towards the NRF with the MB Session ID (i.e. TMGI or source specific IP multicast address).

NOTE: The operator can preconfigure MB-SMF for specific source IP multicast address range or TMGI range.

- When the UE joins the multicast MBS session via PDU session modification procedures, the SMF serving the PDU session invokes the `Nnrf_NFDiscovery_Request` Request including the MBS Session ID for multicast provided by the UE and optionally other information, i.e. the S-NSSAI and the associated NSI ID (if available), DNN, etc. to query the NRF for MB-SMF information. Based on the MBS Session ID and other information for query, the NRF decides whether an MB-SMF serving the MBS session exists (i.e. the NRF decides whether the requested MBS Session ID is in the profile of an MB-SMF, as defined in clause 7.1.1.2 or clause 7.1.1.3 or preconfigured by the operator). If so, the NRF provides in `Nnrf_NFDiscovery_Request` Response the information of the MB-SMF currently serving the MBS session. The SMF serving the PDU session selects the MB-SMF currently serving the multicast MBS session, based on the MB-SMF information provided by the NRF. For local MBS services, the SMF takes MB-SMF service area, UE location into account when selecting the MB-SMF. If no MB-SMF serving the Multicast MBS session exists, the NRF does not provide MB-SMF profiles in the response message to the SMF as defined in TS 29.510 [19].
- When the shared tunnel for shared delivery is established as described in clause 7.2.1.4, the AMF may invoke the `Nnrf_NFDiscovery_Request` Request including MBS Session ID and Area Session ID (if received from the NG-RAN), to query the NRF for the MB-SMF information. In this case, based on the MBS Session ID and Area Session ID, the NRF provides in `Nnrf_NFDiscovery_Request` Response the MB-SMF information currently serving the MBS session and the Area Session ID.
- When the Multicast MBS Session Context is deleted from the MB-SMF, e.g. due to MBS session release, the MB-SMF updates its profile towards the NRF (i.e. removing the MBS Session ID which is no longer served by the MB-SMF), if the MB-SMF performed NRF registration at multicast MBS Session Creation.
- During MBS session information provisioning procedures defined in clause 7.1.1.2, unless the MB-SMF information is available by other means, e.g. locally configured in the NEF/MBSF/AF, the NEF/MBSF/AF queries the NRF with information of the Multicast/Broadcast Service session (e.g. S-NSSAI(s) and the associated NSI ID(s) (if available), DNN(s)), and selects the MB-SMF(s) based on the MB-SMF information provided by the NRF. For local MBS services, the NEF/MBSF/AF takes MB-SMF service area into account when selecting the MB-SMF(s).

## 7.1.3 MB-UPF discovery and selection for multicast/broadcast session

The selection and reselection of the MB-UPF are performed by the MB-SMF by considering MB-UPF deployment. For the local Broadcast/Multicast MBS session and location dependent MBS session, the service area is taken into consideration for MB-UPF selection.

MB-SMF may be locally configured with the information about the available MB-UPFs, e.g. by OA&M system when MB-UPF is instantiated or removed.

The MB-UPF selection functionality in the MB-SMF may optionally utilize the NRF to discover MB-UPF instance(s) which is similar with UPF selection with NRF defined in the TS 23.501 [5] clause 6.3.3.2.

## 7.2 MBS procedures for multicast Session

### 7.2.1 MBS join and Session establishment procedure

#### 7.2.1.1 General

MBS Session Join procedure is used by UEs to inform the 5GC of the UE interest in joining a multicast MBS session. The first accepted UE join request will trigger the multicast MBS session establishment towards the NG-RAN and the UE.

#### 7.2.1.2 Establishment of a PDU Session that can be associated with multicast session(s)

The PDU Session associated with Multicast MBS session(s) (i.e. the associated PDU Session) is established using the procedures as specified in TS 23.502 [6] clause 4.3.2.2 with the following differences:

NOTE 1: The DNN and S-NSSAI are used to establish the PDU session which can carry the operations related to Multicast MBS session(s), i.e. session join/leave, and can be associated with multicast MBS session(s).

- In step 2, the AMF selects an SMF capable of handling Multicast MBS sessions based on DNN and S-NSSAI, locally configured data or a corresponding SMF profile stored in the NRF. For indirect discovery, the AMF requests the SCP to select an SMF capable of handling Multicast MBS sessions.
- In step 4, if MBS subscription data for the UE (i.e. corresponding SUPI), DNN and S-NSSAI of the HPLMN or subscribed SNPN is not available, the SMF retrieves the MBS subscription data using Nudm\_SDM\_Get (SUPI, MBS subscription data, selected DNN, S-NSSAI of the HPLMN or subscribed SNPN, Serving PLMN ID (or PLMN ID and NID)) and subscribes to be notified when this subscription data is modified using Nudm\_SDM\_Subscribe (SUPI, MBS subscription data, selected DNN, S-NSSAI of the HPLMN or SNPN, Serving PLMN ID (or PLMN ID and NID)). UDM may get this information from UDR by Nudr\_DM\_Query (SUPI, MBS data, selected DNN, S-NSSAI of the HPLMN or subscribed SNPN, Serving PLMN ID (or PLMN ID and NID)) and may subscribe to notifications from UDR for the same data by Nudr\_DM\_subscribe. The MBS subscription data can also be retrieved along with the Session Management Subscription data, i.e. with additional input parameter for MBS subscription data in the Nudm\_SDM services.

NOTE 2: In this release, roaming is not supported, i.e. HPLMN and Serving PLMN are the same and subscribed SNPN and serving SNPN are same.

#### 7.2.1.3 Multicast session join and session establishment procedure

The following steps are executed before the UE requests to join the MBS session:

- The MBS Session may have been created in the 5GC (see clause 7.1.1 for details).
- The UE registers in the PLMN or SNPN and may have established a PDU session that can be associated with multicast session(s).
- The UE has known at least the MBS Session ID of a multicast group that the UE can join, e.g. via service announcement.

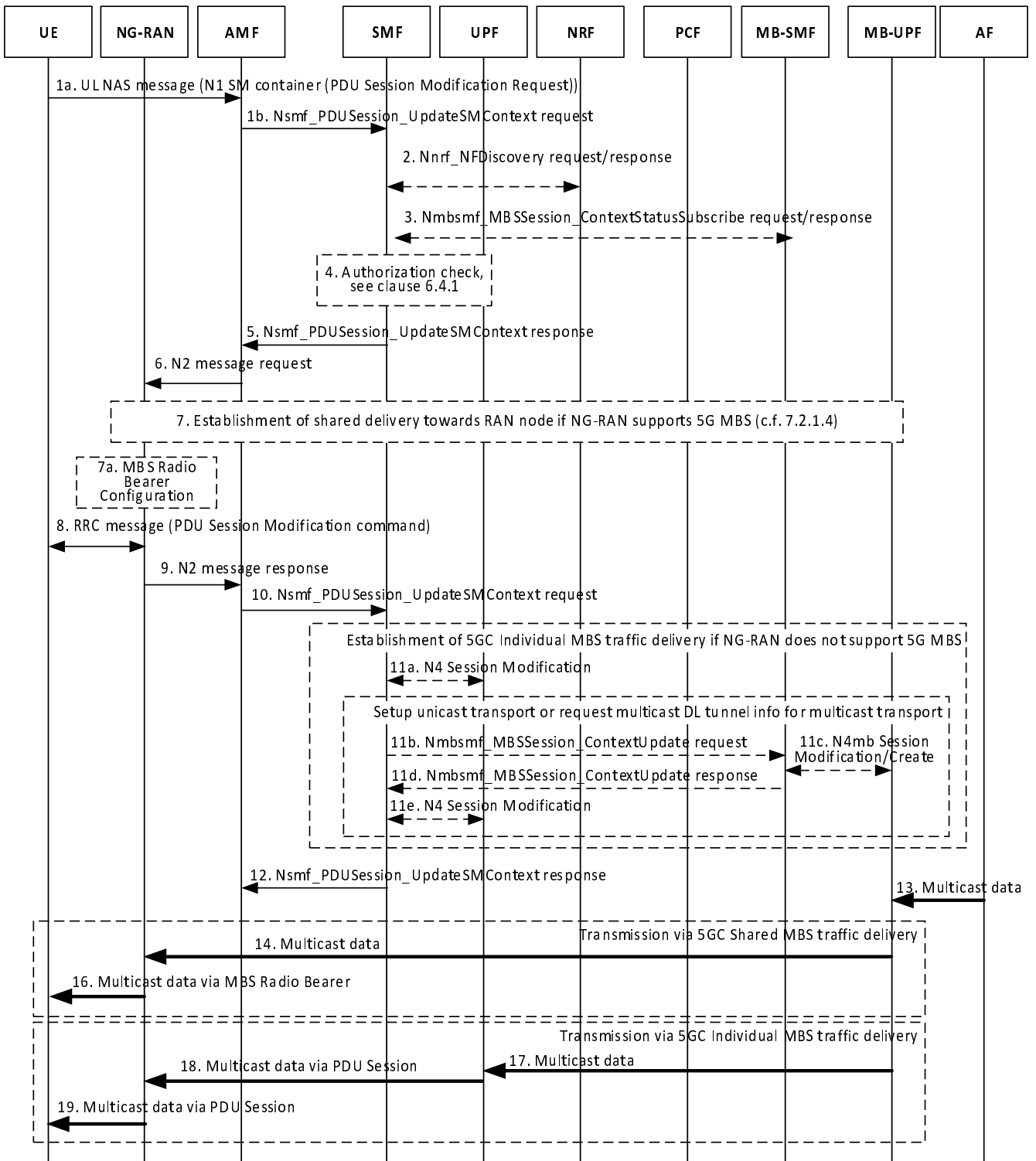

**Figure 7.2.1.3-1: PDU Session modification for UE joining Multicast MBS session**

1. To join a multicast group:

- if there is an existing PDU session that can be used to send the UE join request for the multicast MBS Session, the UE sends a PDU Session Modification Request over that PDU session (i.e. associated PDU Session) which additionally contains one or several MBS Session ID(s) and join request. The MBS Session ID(s) indicate the multicast MBS session(s) that UE wants to join.
- if the UE has no appropriate PDU session established with the DNN and S-NSSAI for the multicast MBS session, the UE joins the multicast MBS session by sending PDU Session Establishment Request for associated PDU session together with one or several MBS Session ID(s) and join request. In that case, before



step 2, the network proceeds with establishment of the associated PDU session executing steps 4 to 10 of PDU Session Establishment procedure as specified in TS 23.502 [6] clause 4.3.2.2.

2. [Conditional] Based on the received MBS Session ID and join request, the SMF determines this is MBS Session join request.

If SMF has no information about MBS Session Context for the indicated MBS Session ID(s), SMF discovers and selects an MB-SMF for the MBS Session via the NRF as described in clause 7.1.2. If no MB-SMF is assigned for the MBS Session ID (i.e. the NRF provides empty MB-SMF profile), the SMF may select an MB-SMF and request it to configure the multicast MBS session or the SMF may reject the join request and respond to the UE with an appropriate cause value.

NOTE 1: Details about how the SMF selects an MB-SMF and requests it to configure the multicast MBS session are left to SMF implementation.

3. [Conditional] For each MBS session in step 1, if the SMF has not subscribed to the MBS Session Context, it invokes Nmbsmf\_MBSSession\_ContextStatusSubscribe request (MBS Session ID) towards the MB-SMF to subscribe to events notifications related to the multicast MBS session and to request information about the MBS Session Context. The MB-SMF responds with the information about the indicated multicast MBS session in Nmbsmf\_MBSSession\_ContextStatusSubscribe response (multicast QoS flow information (e.g. QoS profile(s) for the multicast MBS session), [start time], [session state (Active/Inactive)], [Any UE indication], [multicast DL tunnel info]).

If it is the first time for the MB-SMF to receive Nmbsmf\_MBSSession\_ContextStatusSubscribe request of the indicated MBS Session from any SMF, the MB-SMF learns it is the first UE joining the multicast MBS session. For multicast transport between MB-UPF and content provider, if it is the first UE joining the multicast MBS session, and MB-UPF has not joined the multicast tree in the MBS session creation procedure, described in clause 7.1.1, the MB-SMF requests the MB-UPF to join the multicast tree towards the AF/MBSF, otherwise MB-SMF will not send the request to the MB-UPF.

NOTE 2: The MB-SMF can answer the Nmbsmf\_MBSSession\_ContextStatusSubscribe request either based on information received in the MBS session creation procedures in clause 7.1.1 or based on preconfigured information. The pre-configuration also includes information about the MBS session stored in the NRF. If the MB-SMF uses preconfigured information, the pre-configuration also includes MB-UPF configuration.

4. The SMF determines whether the user is authorized to join the Multicast MBS session taking into account the MBS subscription data received from the UDM and the Any UE indication if received from the MB-SMF. The SMF considers the UE as authorized to the Multicast MBS session if the UE is authorized to use multicast MBS services, and if the MBS Session ID(s) in the PDU Session Modification Request is included in the MBS subscription data or Any UE indication is received. If authorization check fails, the SMF rejects the join request with a cause value. If a UE joins prior to the start time of the multicast MBS session, the SMF may accept the join request and indicate to the UE the start time, or it may reject the join request with an appropriate error cause and optionally a back-off timer. If a UE joins while the multicast MBS session is inactive, the SMF accepts the join request.
5. If the join request is accepted, the SMF responds to the AMF through Nsmf\_PDUSESSION\_UpdateSMContext response (N2 SM information (PDU Session ID, MBS Session ID, [updated PDU Session information], [mapping information between unicast QoS flow(s) and multicast QoS flow (s)]), N1 SM container (PDU Session Modification Command)) to:
  - create an MBS Session Context for the indicated MBS session in the RAN, if it does not exist in the RAN already; and
  - inform the NG-RAN about the relation between the Multicast MBS Session Context and the UE's PDU Session context by including the MBS Session ID and the mapping between the multicast QoS flow(s) and associated QoS flow(s).

Based on operator policy, the SMF may prepare for 5GC Individual MBS traffic delivery fall-back. The SMF maps the received QoS information of the multicast QoS Flow into PDU Session's unicast QoS Flow information, and includes the information of the QoS Flows and the mapping information about the QoS Flows (termed "associated QoS flow information") in the SM information sent to RAN. The SMF compares the QFIs of the multicast QoS Flows received from the MB-SMF with QFIs in use for the PDU Session and assigns unused QFIs to the PDU Session's unicast QoS Flows corresponding to multicast QoS Flows.

NOTE 3: Detailed information included in N2 SM information will be aligned with by RAN WG3.

NOTE 4: The SMF uses the same QoS in the received MBS QoS Flow QoS information for the associated QoS Flow in the unicast PDU session.

If the MBS session join procedure was triggered by the UE together with PDU Session Establishment procedure for the associated PDU session, the SMF provides the N2 SM information and N1 SM container for the associated PDU session in `Nsmf_Communication_N1N2MessageTransfer` service operation towards the AMF, as described in step 11 of clause 4.3.2.2.1 in TS 23.502 [6]. The N2 SM information also includes the MBS Session ID and, if 5GC individual MBS traffic delivery fall-back is supported, the mapping information between unicast QoS flow(s) and multicast QoS flow(s).

If the join request is rejected, the SMF responds to the AMF through `Nsmf_PDUSession_UpdateSMContext` response (N1 SM container (PDU Session Modification Reject)) and the message will not contain any MBS Session Context or the N2 SM information for the associated PDU session. The PDU Session Modification Reject message is forwarded to the UE via the NG-RAN, and the following steps are skipped.

6. The N2 message, which includes the MBS Session ID(s) the UE has joined and, if applicable, associated QoS Flow, is sent to the NG-RAN.

If the MBS is supported by NG-RAN, 5GC Shared MBS traffic delivery is adopted. If the MBS is not supported by NG-RAN, 5GC Individual MBS traffic delivery is used if the PDU Session's unicast QoS Flow include QoS Flows for the multicast session.

If the NG-RAN supports MBS, the NG-RAN uses the MBS Session ID to determine that the PDU Session identified by the PDU Session ID is associated with the indicated multicast MBS session.

If the NG-RAN supports MBS, the associated unicast QoS flow information, if provided, is not used to allocate the radio resource and CN resource for corresponding QoS flows.

NOTE 6: UE join request via PDU Session signalling will fail if NG-RAN rejects the PDU Session Resource setup request (e.g. due to the number of UEs reaching a limit).

7. [Conditional] If shared tunnel has not been established for the multicast MBS session towards the NG-RAN node, the procedures in clause 7.2.1.4 for the establishment of shared delivery toward NG-RAN node are executed. This step is executed separately for each multicast MBS session.

- 7a. If the MBS Session is active, the NG-RAN configures radio resources for MBS session.

8. If the MBS Session is active, the NG-RAN node performs AN specific signalling exchange with the UE to configure the UE with radio resources for the multicast MBS session. If the NG-RAN does not support MBS and the MBS Session is active, radio resources are reconfigured for unicast transmission of the MBS data over the associated PDU session. As part of the AN specific signalling exchange, the N1 SM container (PDU Session Modification Command) is provided to the UE.

9. The NG-RAN node sends the PDU session modification response.

If the MBS is not supported by NG-RAN, the accepted unicast QoS flow is included in the N2 SM information. If the MBS is supported by NG-RAN, the N2 SM information further includes the indication of supporting MBS.

10. The AMF invokes `Nsmf_PDUSession_UpdateSMContext` request ([N2 SM information]) to the SMF.

Per the indication of whether the NG-RAN supports MBS, the SMF determines whether 5GC Individual MBS traffic delivery is used for multicast data transmission.

NOTE 8: If the shared tunnel is used, no interaction with UPF is needed for the indicated multicast MBS session

[Conditional] This step is used for 5GC Individual MBS traffic delivery, if the related NG-RAN does not support MBS. If a shared tunnel between the UPF (PSA) and MB-UPF for 5GC Individual MBS traffic delivery has not yet been established by the SMF for the multicast MBS session, steps 11a to 11d are executed. Step 11e is executed irrespective of that.

- 11a. The SMF contacts the UPF to request the creation of a tunnel and provides the MBS Session ID. The UPF indicates to the SMF whether the tunnel for this multicast MBS session is newly allocated (as there can be multiple SMFs interacting with the same UPF for the same multicast MBS Session).

If the UPF determines to use unicast transport over N19mb, the UPF allocates a DL N19mb Tunnel endpoint for the multicast MBS session if the SMF request is the first one to allocate DL N19mb Tunnel endpoint for the multicast MBS Session in the UPF. The UPF includes the DL Tunnel Info in the response to the SMF. The DL tunnel info includes the downlink tunnel ID and the UPF address.

If the UPF determines to use multicast transport over N19mb, the UPF joins the multicast distribution if the SMF request is the first one for the MBS Session in the UPF. Steps 11b to 11d are skipped.

- 11b. If the UPF indicates the DL N19mb Tunnel is newly allocated, the SMF invokes Nmbmsf\_MBSSession\_ContextUpdate request (MBS Session ID, [DL tunnel info]) towards the MB-SMF for establishing the multicast MBS session transport between MB-UPF and UPF.
- 11c. If the DL tunnel info of the UPF is received, the MB-SMF configures the MB-UPF to transmit the multicast MBS session data towards UPF using the possibly received downlink tunnel ID.
- 11d. The MB-SMF responds to the SMF through Nmbmsf\_MBSSession\_ContextUpdate response (MBS Session ID, [multicast DL tunnel info]). If the UPF DL tunnel info for unicast transport is not received by the MB-SMF, multicast transport between MB-UPF and UPF is to be used, and the MB-SMF includes the downlink tunnel information with the low layer transport multicast address for the multicast MBS session.
- 11e. The SMF configures the UPF to forward the received multicast MBS session data within the PDU session. (This step may be combined with step 11a).
12. The SMF responds to the AMF with Nsmf\_PDUSession\_UpdateSMContext response message.
13. The MB-UPF receives multicast PDUs, either directly from the content provider or via the MBSTF that can manipulate the data.

Steps 14 to 16 are for 5GC Shared MBS traffic delivery:

14. The MB-UPF sends multicast PDUs in the N3mb tunnel associated to the multicast MBS session to the NG-RAN. There is only one tunnel per multicast MBS session per MBS service area and NG-RAN node, i.e. all the UEs which have joined the multicast MBS session via the NG-RAN node share this tunnel for reception of the multicast MBS session data.
15. Void.
16. The NG-RAN transmits the multicast MBS session data to the UE(s) via the MBS Radio Bearer using either PTP or PTM transmission.

Steps 17 to 19 are for 5GC Individual MBS traffic delivery:

17. The MB-UPF sends multicast PDUs in the N19mb tunnel associated to the multicast MBS session to the UPF. There is only one tunnel per multicast MBS session and destination UPF, i.e. all associated PDU sessions served by the destination UPF share this tunnel.
18. The UPF forwards the multicast data towards the NG-RAN via unicast (i.e. in the N3 tunnel of the associated PDU Session).
19. The NG-RAN forwards the multicast MBS session data to the UE via unicast (i.e. over the radio bearer(s) corresponding to the associated QoS flow(s) of the associated PDU Session).

NOTE 9: Details of the DL MBS data transmission are described in clause 6.7.

NOTE 10: When the MBSF is involved in the multicast MBS session, the tunnel between MBSTF and MB-UPF has been established in the MBS session creation procedure.

#### 7.2.1.4 Establishment of shared delivery toward RAN node

In the following cases, the shared tunnel for shared delivery is established between the NG-RAN and MB-UPF:

- The first UE is included in the context of the MBS session in the NG-RAN.

NOTE 1: When the multicast MBS session is inactive, if there is at least one UE joining the multicast MBS session is in RRC-CONNECTED state in the NG-RAN, the shared delivery is not released.

NOTE 2: Share delivery establishment procedures are used when MBS supporting NG-RAN node(s) get involved in the multicast MBS session regardless of the state of the multicast MBS session.

- Handover to the target NG-RAN when the shared delivery tunnel is not established in the target RAN node for this multicast MBS session.

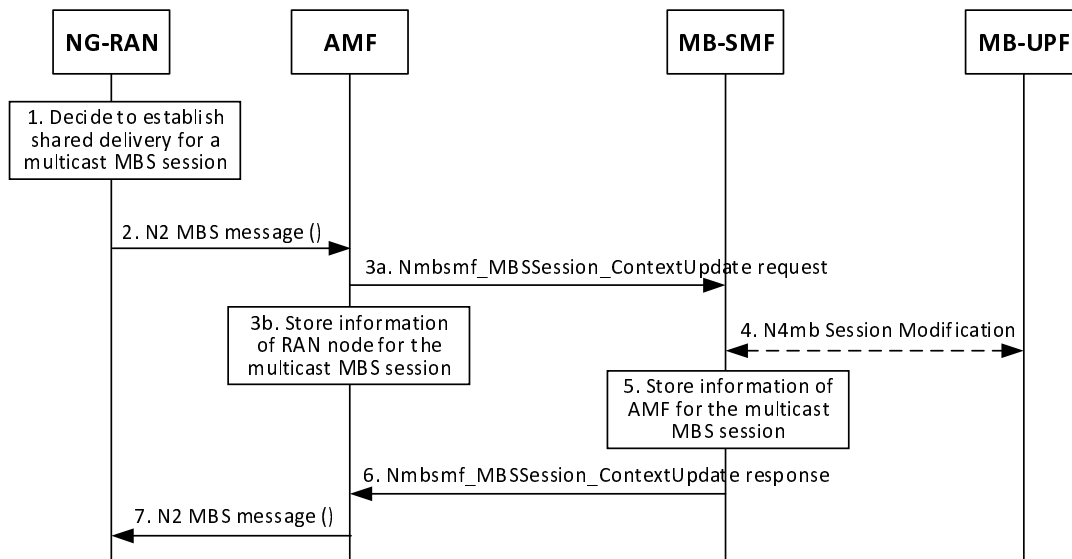

**Figure 7.2.1.4-1: Establishment of shared delivery toward NG-RAN node**

1. A NG-RAN node decides to establish shared delivery for a multicast MBS session when it serves at least one UE within the multicast MBS session. For location dependent services, the NG-RAN node needs to establish shared delivery for the location dependent contents of a multicast MBS session if it serves at least one UE assigned to an MBS Session ID and Area Session ID.
2. The NG-RAN sends an N2 MBS Session request message (MBS Session ID, [Area Session ID], N2 SM information ([unicast DL tunnel Info])) towards the AMF.

If the NG-RAN node is configured to use unicast transport for the shared delivery, it allocates a GTP tunnel endpoint and provides the unicast DL tunnel Info in the request, which includes the GTP tunnel endpoint and NG-RAN node address. For location dependent MBS services, the NG-RAN node also provides the Area Session ID.

3. The AMF selects the MB-SMF serving the multicast MBS session, e.g. using the NRF discovery service or locally stored information. It invokes Nmbsmf\_MBSSession\_ContextUpdate request (MBS Session ID, [Area Session ID], N2 SM information) to the MB-SMF.

The AMF stores the information of the NG-RAN nodes (e.g. NG-RAN node ID) for the subsequent signaling related to the multicast MBS Session.

4. [Conditional] If the MB-SMF received unicast DL tunnel Info in step 3, it configures the MB-UPF to send multicast data for the multicast MBS session (or location dependent content of the multicast MBS session if an Area Session ID was received) towards that GTP tunnel endpoint via unicast transport.
5. The MB-SMF stores the information of the AMF (e.g. AMF ID) in the MBS Multicast MBS session context (or location dependent part of the Multicast MBS Session Context if an Area Session ID was received) to enable subsequent signalling towards that AMF.
6. The MB-SMF sends Nmbsmf\_MBSSession\_ContextUpdate response (MBS Session ID, [Area Session ID], N2 SM information ([TMGI], multicast QoS flow information, session state (Active/Inactive), [multicast DL tunnel Info], [MBS service areas])) to the AMF. If the MB-SMF did not receive unicast DL tunnel Info in step 3, it provides the multicast DL tunnel info that includes transport multicast address (e.g. a LL SSM) and a GTP tunnel endpoint for multicast transport of the shared delivery.
7. The AMF sends an N2 MBS Session response message (MBS Session ID, [Area Session ID], N2 SM information) to the NG-RAN node. If the NG-RAN node receives the multicast DL tunnel Info of the shared

delivery, it uses the transport multicast address included in the multicast DL tunnel info to join the multicast transport distribution.

## 7.2.2 Multicast MBS Session leave and Multicast MBS Session release procedure

### 7.2.2.1 General

This clause describes Multicast MBS Session leave requested by the UE or by the network. This clause also describes Multicast MBS Session release.

### 7.2.2.2 Multicast Session leave requested by the UE

When the UE determines to leave the Multicast MBS session, it shall send PDU session Modification request to inform the 5GC the leaving operation. The Figure 7.2.2.2-1 describes the procedure.

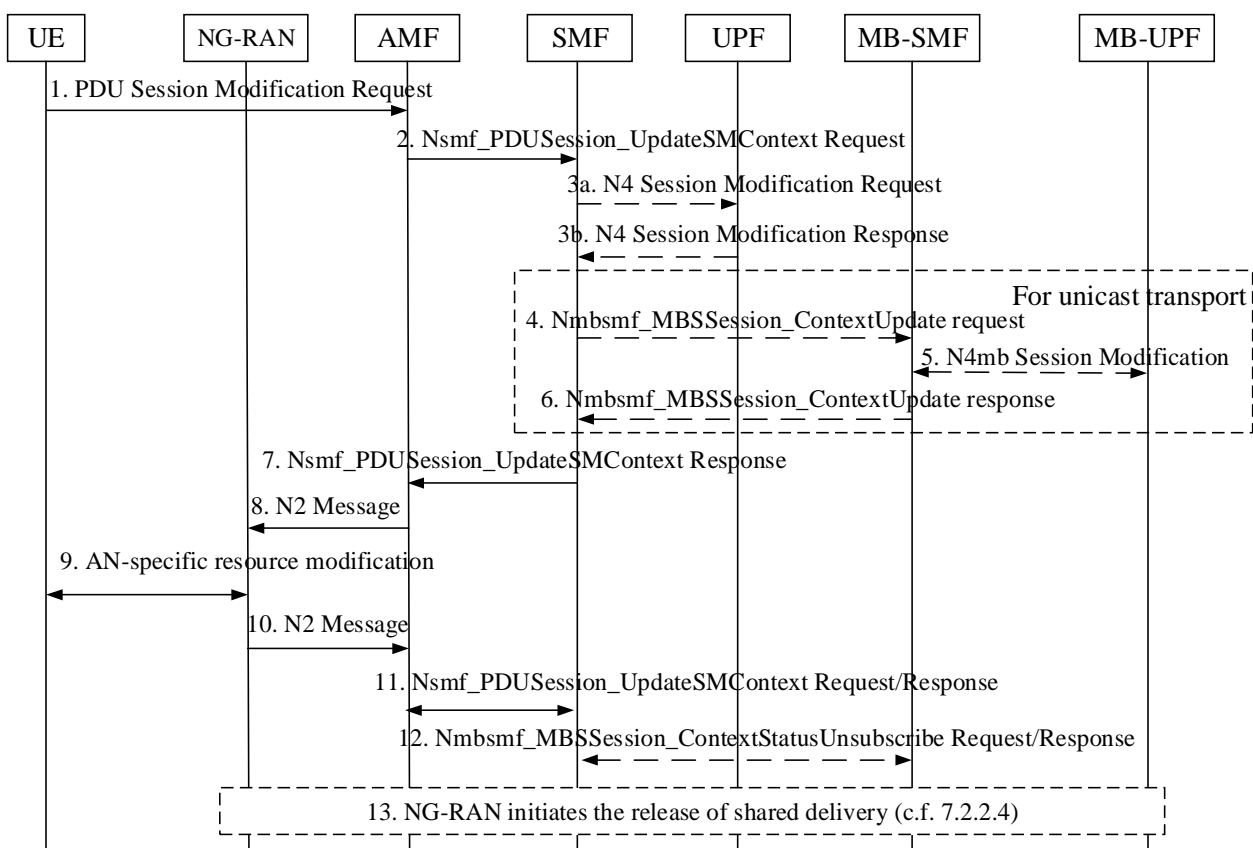

**Figure 7.2.2.2-1: UE initiated Multicast MBS Session leave**

1. The UE sends the PDU Session Modification Request when the UE determine to leave the multicast MBS Session. The PDU Session Modification Request carries leave indication and the MBS Session ID which the UE want to leave.
2. The AMF invokes Nsmf\_PDUSession\_UpdateSMContext (N1 SM container (PDU Session Modification Request)) to the SMF.
- 3a. [Conditional] If 5GC individual MBS traffic delivery is applied towards the UE, the SMF sends an N4 Session Modification Request to the UPF (PSA). The SMF reconfigures the UPF to terminate the distribution of multicast data via the PDU session.
- 3b. [Conditional] The UPF (PSA) sends an N4 Session Modification Response to the SMF.

If there are no PDU sessions to transmit the multicast MBS session data in the UPF, and unicast transport is used over N19mb, the UPF releases the DL N19mb tunnel endpoint and informs the SMF.

If there are no PDU sessions to transmit the multicast MBS session data in the UPF, and multicast transport is used over N19mb, the UPF leaves the multicast distribution tree of MB-UPF.

4. [Conditional] If the UPF indicates the tunnel release (i.e. unicast transport was used), the SMF invokes Nmb-smf\_MBSSession\_ContextUpdate Request (Release, MBS Session ID, tunnel information) to release the tunnel between UPF and MB-UPF for this multicast MBS session. The MB-SMF determines whether the context update is for tunnel release or create based on whether the tunnel information exists in the multicast MBS Session Context stored in the MB-SMF or not.
5. [Conditional] If the MB-SMF determines the context update is for tunnel release, the MB-SMF request to MB-UPF to release the tunnel between UPF and MB-UPF for the multicast MBS session.
6. [Conditional] The MB-SMF responds to the SMF for step 4.

7. The SMF invokes the Nsmf\_PDUSession\_UpdateSMContext Response (PDU Session ID, N2 SM information ([MBS Session ID], [leave indication]), N1 SM container) service operation. In the N2 SM information, the MBS Session ID and the leave indication are included for informing the NG-RAN to remove the UE from this MBS session if 5GC Shared MBS traffic delivery method is used towards the UE. If 5GC Individual MBS traffic delivery method is used towards the UE, the N2 SM information does not include MBS related information.

In the N2 SM information, the SMF also informs the NG-RAN to release the associated QoS Flow(s), which carry or intend to carry the multicast MBS session traffic for 5GC individual MBS traffic delivery.

The associated QoS Flow(s) are released as defined in TS 23.502 [6] clause 4.3.3.2.

8. The AMF send N2 message (N2 SM information, N1 SM container) to the NG-RAN
9. The NG-RAN node performs the necessary AN-specific resource modification procedure toward the UE and transports the N1 SM container received in step 7 to the UE.
10. The NG-RAN node removes the UE from this multicast MBS session and sends a N2 message to the AMF.
11. The AMF transfers the N2 message received in step 9 to the SMF via the Nsmf\_PDUSession\_UpdateSMContext service operation.

The SMF updates the associated PDU session context, e.g. remove the MBS Session ID from the associated PDU session context. In addition, if associated QoS flow is used for the multicast MBS session, the SMF also removes the associated QoS flow information associated with the indicated multicast MBS session from the associated PDU session context.

12. [Conditional] If the UE is the last joined one of the multicast MBS session in the SMF, The SMF also indicates that the last UE served by the SMF leaves the Multicast MBS Session, the SMF unsubscribes the notifications of the MBS Session Context status updates from the MB-SMF by invoking Nmb-smf\_MBSSession\_ContextStatusUnsubscribe service operation. The MB-SMF will no longer notify the SMF of the further context status updates of the multicast MBS session (e.g. activation, deactivation, update, release, etc.). For multicast transport between MB-UPF and content provider, if the SMF is the last remaining SMF that is subscribed for the MBS Session notification from the MB-SMF, i.e. if it is the last UE leaving the MBS session, the MB-SMF requests the MB-UPF to stop forwarding the multicast MBS session data and may request the MB-UPF to leave the multicast tree towards the AF/MBSF, if the MB-UPF joins the multicast tree when the first UE joins the MBS session.
13. [Conditional] If the UE is the last UE in this RAN node for this multicast MBS session, the NG-RAN release shared delivery between NG-RAN and MB-UPF as described in clause 7.2.2.4.

If release of the PDU Session associated with a multicast MBS session is triggered, corresponding procedures between UE, NG-RAN, AMF, and SMF are performed as described in clause 4.3.4 of TS 23.502 [6], and SMF triggers the UE leave the multicast MBS session by performing steps 3-6 in Figure 7.2.2.2-1 for each multicast MBS session(s) associated with the PDU Session, and UE considers as left all the multicast MBS sessions associated with the PDU Session.

NOTE: If the associated PDU Session is released, the UE leaves MBS Session(s) associated with that PDU session implicitly. To resume the reception of the related MBS service(s), the UE needs to initiate the procedures as defined in clause 7.2.1 to re-join the MBS Session(s).

If the UE deregistration procedure is executed, corresponding procedures between UE, NG-RAN, AMF, and SMF are performed as described in clause 4.2.2.3 of TS 23.502 [6], and SMF performs steps 3-6 in Figure 7.2.2.2-1 for all multicast MBS sessions joined by the UE. When the PDU Session Release procedure or UE deregistration procedure is executed, according to the UE context, NG-RAN performs step 12 for each multicast MBS session associated with the released PDU Session(s).

### 7.2.2.3 Multicast session leave requested by the network or MBS session release

This procedure applies to the following scenarios:

1. When the MB-SMF decides to release an MBS Session:
  - based on a request from the AF (directly or via the NEF/MBSF);

In this scenario, the MB-SMF notifies the SMF of multicast session release, and the SMF initiates procedures to remove all joined UEs from the MBS session.

2. When the SMF decides to remove a UE from an MBS session:
  - based on a request from the UDM (subscription change); or
  - due to local and location dependent MBS service is described in clause 7.2.4; or
  - due to network internal reasons.

For the active MBS session, to release radio resources as early as possible, the MB-SMF may trigger Multicast Session Deactivation towards the NG-RAN as specified in steps 5-9 of clause 7.2.5.3, prior to or in parallel with triggering MBS Session Release to the SMF.

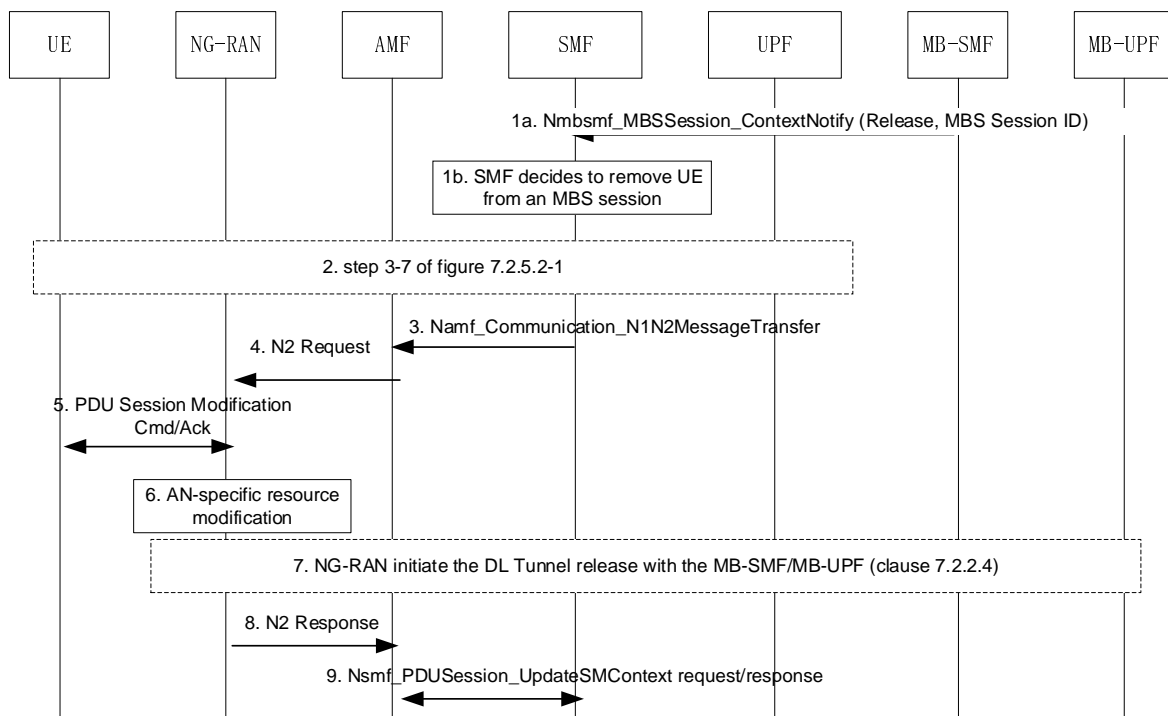

Figure 7.2.2.3-1: MBS Session Release or Multicast session leave requested by the network

- 1a. For MB-SMF triggered MBS session release, the SMF receives Nmb-smf\_MBSSession\_ContextStatusNotify (MBS Session ID, multicast session release) from the MB-SMF with MBS Session ID. The SMF checks all joined UEs and perform step 2 to step 9 for each UE.
- 1b. The SMF decides to remove a UE from the MBS session without MBS session release (e.g. due to UE moving out of MBS service area for local or location dependent MBS service as described in clause 7.2.4).
2. For UEs without activated UP, the SMF may perform the same procedure as defined in step 3-7 in clause 7.2.5.2.  
  
Alternatively, for UEs without activated UP, the SMF does not trigger message to the AMF, instead the SMF marks that the UE is to be informed of the MBS Session release. In this case, the SMF initiates PDU Session Modification to inform the UE of the MBS Session release at next UP activation of the associated PDU Session, if needed.
3. For the joined UEs with UP activated, the SMF invokes Namf\_Communicate\_N1N2MessageTransfer to the AMF. The N1 SM container indicates UE removed from MBS session with appropriate cause (e.g. MBS session release, out of MBS service area, etc.). In N2 SM information, the SMF informs the NG-RAN to remove the UE from the MBS session. If there are associated QoS Flow(s) for individual delivery, the SMF also releases those QoS Flow(s) as specified in TS 23.502 [6] clause 4.3.3.2.
4. The AMF sends N2 Request to the NG-RAN.
5. The NG-RAN transports the N1 SM container (PDU Session Modification Command (MBS Session ID, UE removed from MBS session with appropriate cause)) to the UE.
6. The NG-RAN performs radio resource modification. If there are no joined UEs in the MBS session, the NG-RAN releases the radio resources.
7. If there are no joined UEs in the MBS session, for unicast transport of N3mb, the NG-RAN initiates the DL tunnel release towards MB-UPF via AMF and MB-SMF. For multicast transportation of N3mb, the NG-RAN performs IGMP/MLD Leave for the MBS session. See clause 7.2.2.4 for details.
8. The NG-RAN sends N2 Response to the AMF. If there are no joined UEs in the MBS session, the MBS Session Context is removed from the NG-RAN.
9. The AMF transfers the N2 message received in step 8 to the SMF via the Nsmf\_PDUSession\_UpdateSMContext service operation. The SMF removes the UE from the MBS Session.

#### 7.2.2.4 Release of shared delivery toward RAN node

In the following case, the shared delivery tunnel may be released between NG-RAN and MB-UPF:

- The last UE is excluded from the context of the multicast MBS session in the NG-RAN node;
- Handover to the target NG-RAN when the UE is the last UE for this multicast MBS session in the source NG-RAN node during handover preparation phase known by the source NG-RAN node;
- Handover to the target E-UTRAN when the UE is the last UE for this multicast MBS session in the source NG-RAN node;
- MBS session deletion.

NOTE: When the multicast MBS session is inactive, the shared delivery is not released if there is at least one UE is in RRC-CONNECTED state for this multicast MBS session.



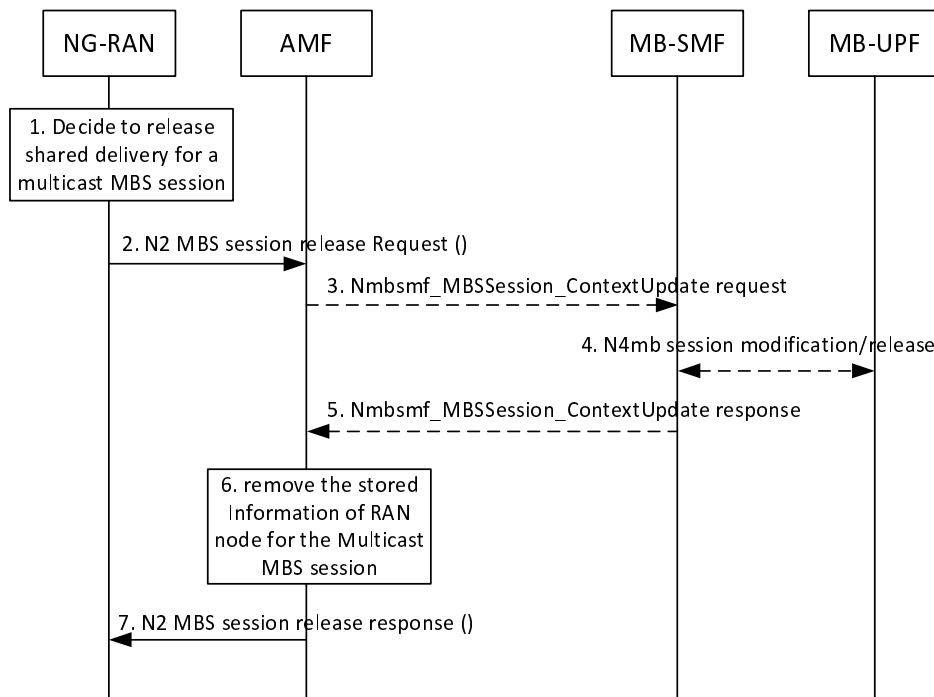

**Figure 7.2.2.4-1: Release of shared delivery toward RAN node**

1. A RAN node decides to release shared delivery for a multicast MBS session, e.g. because it no longer serves at least one UE within the multicast MBS session. For location dependent services, the NG-RAN node may release shared delivery for the location dependent contents of a multicast MBS session if it no longer serves at least one UE assigned to an MBS Session ID and Area Session ID.
2. The NG-RAN node sends N2 MBS Session release request (MBS Session ID, [Area Session ID], [N2 SM information ([GTP tunnel info], release indication)])) to the AMF. For location dependent services, the NG-RAN node also provides the Area Session ID. The RAN node includes the unicast DL tunnel info if unicast transport is used for the shared delivery. If the NG-RAN node was configured to use multicast transport for the 5GC Shared MBS traffic delivery, the NG-RAN node does not include the N2 SM information in the message.
3. [Conditional] If the N2 SM information is received or it is the last RAN node controlled by the AMF serving the multicast MBS session, the AMF invokes Nmbsmf\_MBSsession\_ContextUpdate request (MBS Session ID [Area Session ID], [leave indication], [N2 SM information]) to the MB-SMF corresponding to the MB-SMF ID stored in the AMF for the MBS Session ID. If it is the last RAN node controlled by the AMF serving the multicast MBS session identified by the MBS Session ID or both the MBS Session ID and Area Session ID (if exists), the leave indication is included.
4. [Conditional] If unicast transport was used towards the NG-RAN node, the MB-SMF determines whether the context update is for tunnel release or create based on the release indication in the N2 container. If the MB-SMF determines the context update is for tunnel release, the MB-SMF sends N4mb Session Modification to the MB-UPF to release the N3mb tunnel used for the multicast MBS session (or location dependent content of the multicast MBS session if an Area Session ID was received) towards that RAN node using the received GTP tunnel info.
5. [Conditional] The MB-SMF responds to the AMF with MBS Session ID and Area Session ID if received. If leave indication is received, the MB-SMF also removes the information of the AMF from the context of the multicast MBS session.
6. The AMF removes the information of the RAN node from the context of the multicast MBS session (or location dependent part of the multicast MBS session if an Area Session ID was received).
7. The AMF sends an N2 MBS Session release response (MBS Session ID, [Area Session ID]) to the RAN node. The NG-RAN node deletes the GTP tunnel info (if unicast transport is used for the shared delivery) or sends IGMP/MLD leave message to leave the multicast distribution tree (if multicast transport is used for the shared delivery). The NG-RAN node releases local resources for the multicast MBS session.

## 7.2.3 Mobility Procedures for MBS

### 7.2.3.1 General

UE may move from one NG-RAN node to another NG-RAN node after UE has joined the MB Session. There are various mobility scenarios possible, depending on whether one of the involved NG-RAN nodes supports MBS.

During an active MBS Session, mobility between an NG-RAN supporting MBS and an NG-RAN node not supporting MBS requires the mobility procedure to provide the appropriate MBS traffic delivery method at the target NG-RAN node.

### 7.2.3.2 Xn based handover from MBS supporting NG-RAN node

This clause describes an Xn based handover with MBS traffic delivered to the UE at the source NG-RAN node supporting MBS.

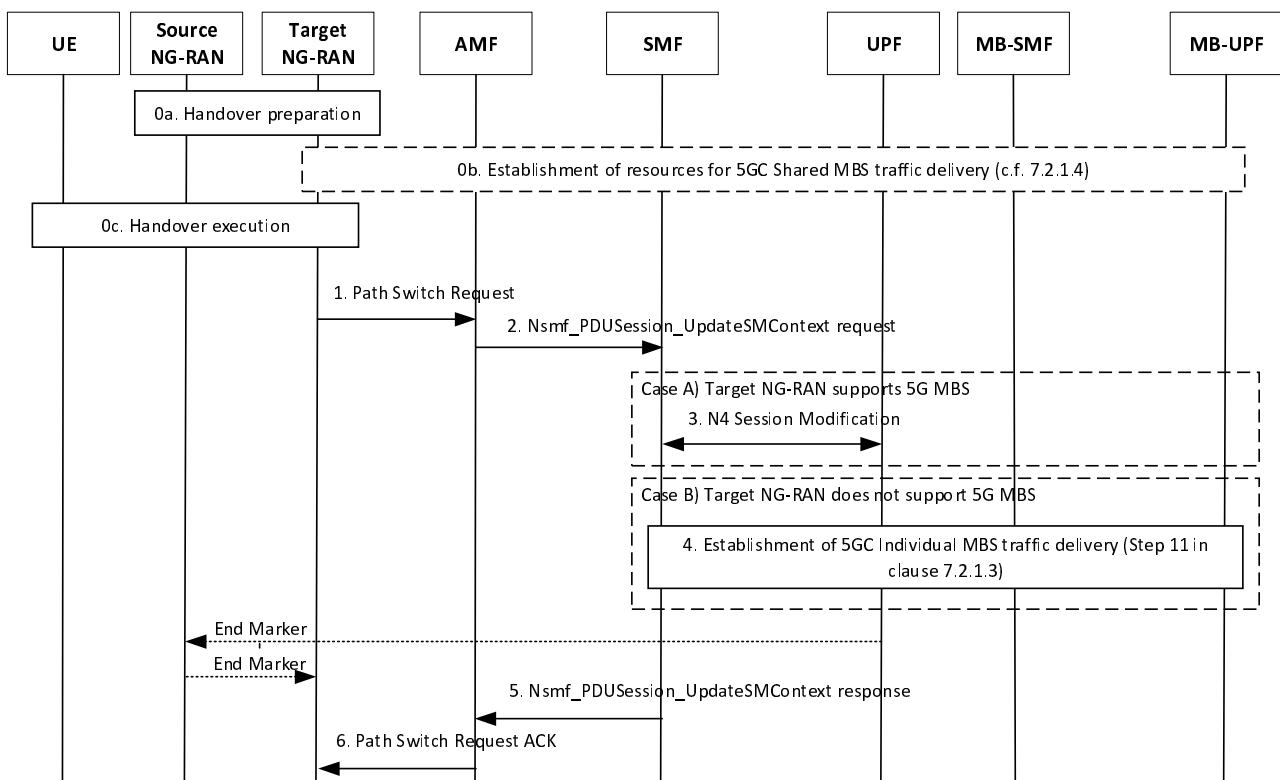

**Figure 7.2.3.2-1: Xn based handover with MBS Session**

The following additions apply compared to clause 4.9.1.2 of TS 23.502 [6]:

#### Before Handover:

The source NG RAN has been provided with MBS Session Resource information (including the MBS Session ID and multicast QoS flow information) and the UE Context information contains a mapping information within the PDU Session Resource associated with the MBS Session Resource, e.g. including mapped unicast QoS Flows associated with the multicast QoS flow(s) of the MBS Session Resource.

#### Handover Preparation Phase:

At Xn handover, the target NG-RAN is provided with MBS session information by the source NG-RAN which causes:

- an MBS non-supporting target NG-RAN node to prepare the unicast resources according to associated QoS flow(s) information.
- an MBS supporting target NG-RAN node to allocate to the UE shared NG-RAN resources according to the MBS session information. If the 5GC Shared MBS traffic delivery for the indicated multicast MBS Session has not

been established in target NG-RAN, target NG-RAN triggers setup of the resources for the 5GC Shared MBS traffic delivery, see clause 7.2.1.4 for details.

1. Target NG-RAN to AMF: the target NG-RAN sends N2 Path Switch Request to AMF.

The target NG-RAN node, if MBS-capable, indicates it supports of MBS to SMF in N2 SM information. Per the received N2 SM information, the SMF knows whether the target NG-RAN node supports MBS and determines the delivery method, i.e. whether the 5GC Shared MBS traffic delivery or 5GC Individual MBS traffic delivery is used for MBS data transferring.

The SMF differentiates two cases:

Case A) The target NG-RAN supports MBS. Step 3 applies and step 4 is skipped.

3. SMF to UPF: The SMF invokes N4 Session Modification procedure with the UPF (PSA) only for unicast PDU Session.

Case B) The target NG-RAN does not support MBS. Step 3 is skipped, step 4 applies.

4. This steps is same as described in step 11 of clause 7.2.1.3.

The details of how to perform data forwarding refers to clause 7.2.3.5.

5. SMF to AMF: The SMF responds to AMF through Nsmf\_PDUSession\_UpdateSMContext response.

6. AMF to target NG-RAN: The AMF sends the path switch Ack to target NG-RAN.

### 7.2.3.3 N2 based handover from MBS supporting NG-RAN node

This clause describes the N2 based handover with MBS traffic delivered to the UE at the source NG-RAN node supporting MBS.

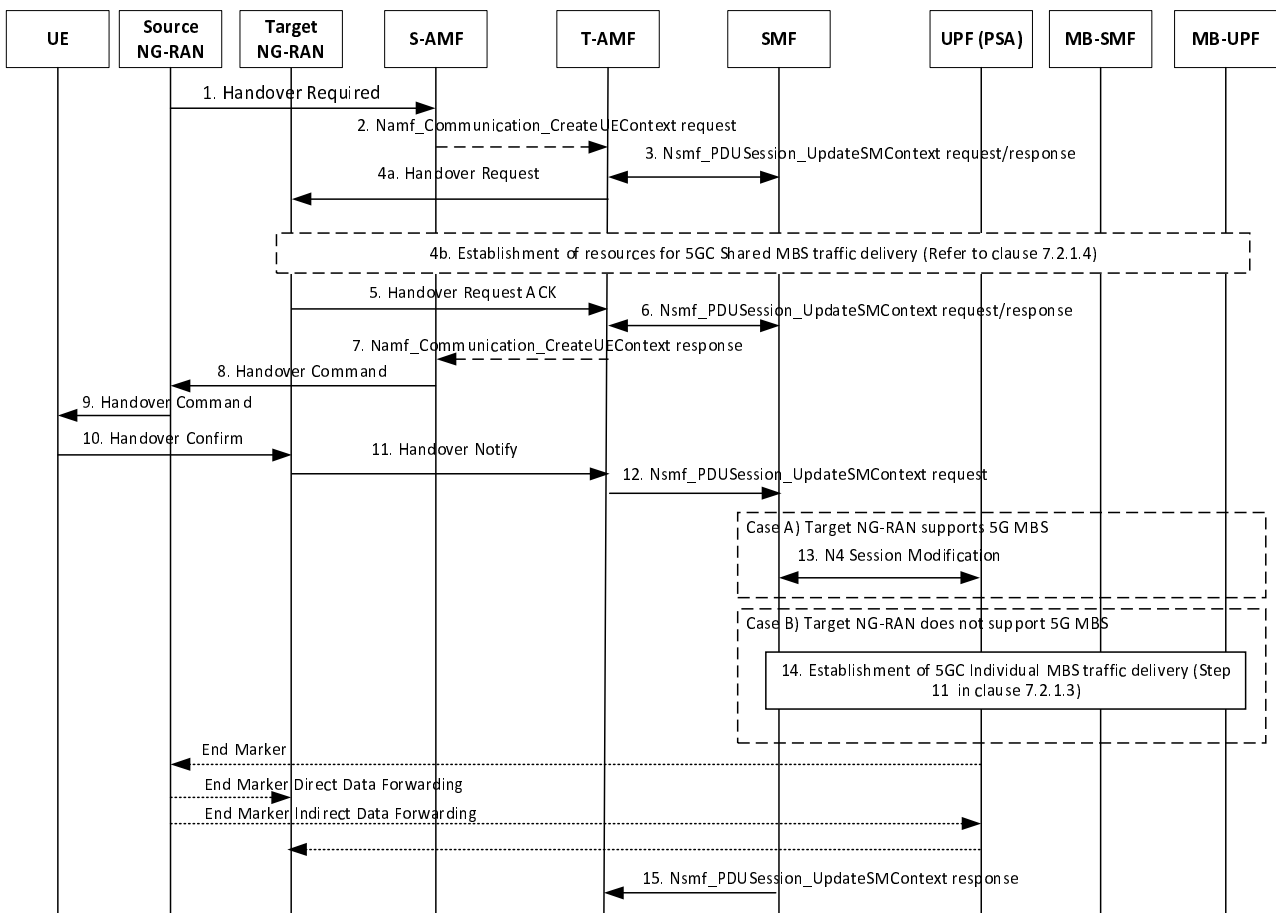

Figure 7.2.3.3-1: N2 based handover with MBS Session

The following additions apply compared to clause 4.9.1.3 of TS 23.502 [6]):

1. Source NG-RAN to S-AMF: Handover Required (RAN container (MBS Session information, associated PDU session information, associated QoS flow information and corresponding multicast QoS flow information)).
2. S-AMF to T-AMF: The T-AMF is provided with associated PDU Session information and the MBS session related information.
4. T-AMF to Target NG-RAN: The Target NG-RAN prepares the radio resource based on the received information:
  - If the Target NG-RAN does not support MBS, the MBS Session related information is not used. The Target NG-RAN uses the associated PDU Session information to allocate resource to deliver MBS data. The MBS data are transmitted via the associated QoS flows within the associated PDU Session.
  - If the Target NG-RAN supports MBS, the Target NG-RAN uses the multicast MBS Session related information to allocate RAN resources to deliver the MBS data. If 5GC Shared MBS traffic delivery for the indicated multicast MBS session has not been established towards the Target NG-RAN, the Target NG-RAN initiates the shared delivery establishment towards the MB-SMF via AMF as described in clause 7.2.1.4.
5. Target NG-RAN to T-AMF: The target NG-RAN sends Handover Request Ack to T-AMF.

The target NG-RAN node, if MBS-capable, indicates it supports MBS to SMF in N2 SM information. Per the received N2 SM information, the SMF knows whether the target NG-RAN node supports MBS and determines the delivery method, i.e. whether the 5GC Shared MBS traffic delivery or 5GC Individual MBS traffic delivery is used for MBS data transferring.

12. T-AMF to SMF: The AMF invokes Nsmf\_PDUSession\_UpdateSMContext request towards SMF, the message includes the received N2 SM information received from the target NG-RAN.

13-14. Same as described in steps 3-4 of clause 7.2.3.2.

The details of how to perform data forwarding, refers to clause 7.2.3.5.

15. SMF to T-AMF: The SMF sends the Nsmf\_PDUSession\_UpdateSMContext Response to the T-AMF.

#### 7.2.3.4 Xn/N2 based handover from non-MBS supporting NG-RAN node

When the UE has joined the multicast MBS session and the source NG-RAN node does not support MBS, the 5GC Individual MBS traffic delivery method is used for the multicast MBS session data delivery. When the Xn/N2 based handover procedure is triggered, the UE is handed over to the target NG-RAN node per existing Xn/N2 based handover procedure defined in TS 23.502 [6].

The following applies for an Xn based handover from an NG-RAN node not supporting 5G MBS:

- The source NG-RAN node requests the associated QoS Flow(s) in the associated PDU session to be handed over to the target NG-RAN node.
- In the Path Switch Request message, the target NG-RAN node, if MBS-capable, indicates it supports MBS to the SMF in the N2 SM information.
- After successful handover, if the target NG-RAN node supports MBS, the SMF triggers modification of the associated PDU Session at the target NG-RAN node by including the multicast MBS session related information in N2 SM Information as described in step 7 of clause 7.2.1.3, which may trigger the target NG-RAN node to initiate establishment of shared delivery as described in clause 7.2.1.4.
- The SMF changes the MBS session data delivery method from 5GC Individual MBS traffic delivery method to 5GC shared MBS traffic delivery method, and sends N4 Session modification message to UPF to configure UPF to not forward the received multicast MBS session data via the associated PDU Session. If there are no multicast MBS session data forwarding via the associated PDU session(s) needed, the SMF may also release the shared tunnel between the UPF and MB-UPF.

The following applies for an N2 based handover from an NG-RAN node not supporting MBS:

- During handover preparation phase, the SMF includes the multicast MBS session related information in N2 SM Information as described in step 7 of clause 7.2.1.3 and sends it to the target NG-RAN. The target NG-RAN, if MBS-capable, indicates it supports MBS to SMF in N2 SM information. If the target NG-RAN node supports MBS, the target NG-RAN node adds the UE into the MBS Session Context. If 5GC Shared MBS traffic delivery for the indicated multicast MBS session has not been established towards the target NG-RAN, the target NG-RAN uses the multicast MBS Session related information to allocate RAN resources to deliver the MBS data and initiates the shared delivery establishment towards the MB-SMF as described in clause 7.2.1.4.
- Based on the received MBS support information in N2 SM information from the target NG-RAN, the SMF determines the MBS data delivery method for the multicast MBS session. The SMF configures UPF to not forward the received multicast service data to the associated PDU Session via N4 Session modification message, i.e. SMF changes 5GC individual MBS traffic delivery to 5GC shared MBS traffic delivery. If there are no multicast MBS session data forwarding via the associated PDU session(s), the SMF may also release the shared tunnel between the UPF and MB-UPF.

### 7.2.3.5 Minimization of data loss

To minimize data loss of a multicast MBS session during the handover procedure the following functions apply:

- For each MBS QoS flow, the MB-UPF adds a sequence number in each data packet of the MBS session sent by the MB-UPF and forwarded to all related NG-RAN nodes and UPFs via GTP-U tunnel. When the UPF forwards the received MBS data packet, the sequence number shall not be changed.
- If both the source NG-RAN node and target NG-RAN node support MBS, to minimize data loss of the MBS session either of, or a combination of, the following methods may be applied, as specified in TS 38.300 [9]:
  - Data may be forwarded from source NG-RAN node to target NG-RAN node. In handover preparation phase, the MBS progress information (i.e. PDCP number) is exchanged between source NG-RAN node and target NG-RAN node.
  - NG-RAN nodes share a common user plane entity, denoted as shared NG-U termination in TS 38.300 [9], which allows the allocation of identical PDCP numbers to MBS users data when delivered to UEs in cells served by different NG-RAN nodes.
- If source NG-RAN node supports MBS and target NG-RAN node does not support MBS, the multicast MBS session data is forwarded from source NG-RAN node to target NG-RAN node via data forwarding tunnels allocated by the target NG-RAN node associated with the mapped unicast QoS flows within the associated PDU session according to the data forwarding mechanism defined in TS 23.502 [6].
- If source NG-RAN node does not support MBS and target NG-RAN node supports MBS, for Xn/N2 handover, the multicast MBS session data is forwarded to the target NG-RAN node as the data forwarding mechanism defined in TS 23.502 [6]. Directly after the handover the target NG-RAN node thus still receives MBS session data via individual delivery. The UPF forwards multicast MBS session data within the associated PDU session which includes the sequence number received from the MB-UPF to the target NG-RAN node. Shared delivery of MBS data towards the target RAN node is being established as described in clause 7.2.1.4 and the target RAN node receives sequence numbers as part of the MBS data with sequence numbers via shared delivery.

NOTE: For N2 handover, the detail mechanism of how to transmit the received forwarded multicast MBS session data to UE is defined by RAN WGs.

### 7.2.3.6 Xn/N2 based handover for inactive MBS session

If the MBS session is in Inactive state, comparing the handover procedure for the MBS session in Active state, the following additional procedures apply:

- For Xn based handover, the information that MBS session is inactive is provided from the source RAN node towards the target RAN node.
- For N2 based handover, the information that MBS session is inactive is provided from SMF towards the target RAN node.

- For the MBS supporting NG-RAN node, the target NG-RAN establishes the shared tunnel with the MB-UPF as usual, if it hasn't been established before. However, as the MBS session is in Inactive state, the NG-RAN node will not allocate related radio resource.
- After a handover to a not supporting MBS target RAN node, the SMF removes the associated QoS flow(s) information.

NOTE: Whether the associated QoS Flow(s) are removed from UE, NG-RAN, or only resource in NG-RAN is removed is up to implementation.

### 7.2.3.7 Connection Resume in RRC Inactive procedure

If an MBS session is in Inactive state, the UE may be in CM-CONNECTED with RRC Inactive state. The UE may resume the connection in a different NG-RAN node as specified in clauses 4.8.2.2 and 4.8.2.2a of TS 23.502 [6], with following enhancement:

- For an MBS supporting NG-RAN:
  - if the UE context retrieved from the last serving NG-RAN includes MBS session information and the NG-RAN node has not yet established the 5GC Shared MBS traffic delivery for the MBS session, the NG-RAN establishes the 5GC Shared MBS traffic delivery as specified in clause 7.2.1.4. The NG-RAN then sends Path Switch Request indicating the MBS support information;
  - if the UE context retrieved from the last serving NG-RAN does not include MBS session information, Path Switch Request sent from NG-RAN includes the MBS support information. Based on the MBS support information, the SMF, after acknowledging the path switch request, provides the MBS related information and if applicable the associated QoS flow(s) information to the NG-RAN as specified in clause 7.2.1.3. The NG-RAN establishes the 5GC Shared MBS traffic delivery as specified in clause 7.2.1.4.
- For an MBS non-supporting NG-RAN, Path Switch Request sent from NG-RAN does not include the MBS support information. If the MBS session is still inactive, the SMF, after acknowledging the path switch request, removes the associated QoS flow(s) information if it was provided before.

## 7.2.4 Support of Local multicast service and Location dependent multicast service

### 7.2.4.1 General

The clause captures the procedural enhancement to support Location dependent MBS service and the Local MBS service described in clause 6.2.

### 7.2.4.2 Support of location dependent multicast service

#### 7.2.4.2.0 Creation for location dependent MBS session

For location dependent MBS, the MBS session creation procedure is performed as defined in clause 7.1.1.2 with the following additions:

- Multiple AFs may start the same Multicast MBS session with different content in different MBS service areas. The AF (or NEF/MBSF if involved) selects MB-SMF for different MBS service areas.
- For each MBS service area, the AF creates a location dependent component of an MBS session for that service area towards the MB-SMF and provides the service area, which may be via NEF or MBSF. The MB-SMF additionally returns the Area Session ID allocated by MB-SMF in the response to a request to create a location dependent component of a Multicast MBS session, and the NEF forwards this Area Session ID to the AF. The AF provides the Area Session ID in subsequent requests related to that location dependent component of the MBS session.
- When requesting the creation of a location dependent component of the MBS session for a service area, the AF provides an indication that the request is for the creation of a location dependent component of the MBS session.

- The NEF, if involved in the MBS Session, maps MBS service areas of external format (if any) to network internal format (list of cells, TAIs).
- MB-SMF allocates Area Session ID, and updates its NF profile towards the NRF with the MBS Session ID, MBS service area and Area Session ID.

NOTE: For a location dependent service provided in different MBS service areas within the same SMF service area, it is assumed that one MB-SMF is used for an MBS Session.

- The QoS of Multicast MBS session is determined based on the service requirements per MBS Session. MB-SMF assign the same QFI for MBS QoS Flow with the same QoS requirement in different MBS service areas.
- The MB-SMF configures the MB-UPF separately for each service area. The MB-SMF may select the MB-UPF based on the MBS service area.
- All MBS service area(s) of the location dependent MBS session are indicated to the UE in the Service Announcement as defined in clause 6.11.

#### 7.2.4.2.1 UE join location dependent Multicast MBS session and establishment procedure

The location dependent multicast session join and establishment procedure is performed as defined in clause 7.2.1 with the following additions:

- The location dependent Multicast MBS session is created as described in clause 7.2.4.2.0.
- The UE may have information about the location dependent multicast service including all MBS service areas of the location dependent MBS session via Service Announcement as specified in clause 7.2.4.3.1.
- If the UE determines that it is in MBS service area of the location dependent MBS session based on the information about local multicast service e.g. obtained via Service Announcement, the UE sends Join Request to join the multicast group. If the UE determines that it is outside all MBS service area of the location dependent MBS session, the UE does not send the Join Request.
- If SMF requires information about the multicast MBS Session Context for the indicated MBS Session ID, the SMF requests MB-SMF information via `Nnrf_NFDiscovery_Request` (MBS Session ID, UE location). The SMF should provide the TAI where the UE is located as input for the MB-SMF discovery. If the NRF does not have information about service areas for an MBS Session ID in the MB-SMF profile but obtains a TAI in combination with MBS Session ID as query parameter, the NRF ignores the TAI and provides the MB-SMF profile matching the MBS Session ID. If the TAI is not included, but the related MB-SMF include the service area, the NRF return all the MB-SMF associated with that MBS Session ID.

NOTE 1: The AMF provides the User Location Information of the UE (cell ID and current tracking area ID) towards the SMF within `Nsmf_PDUSession_CreateSMContext` request and if the location changed also in `Nsmf_PDUSession_UpdateSMContext` request (as used for the join) as specified in clauses 4.3.2.2.1 and 4.3.3.2 of TS 23.502 [6].

- The NRF provides information about the MB-SMF(s) serving the Multicast MBS session at the possible indicated location. The NRF provides the service areas and Area Session IDs for the Multicast MBS session as part of the MB-SMF profile(s), via `Nnrf_NFDiscovery_Request` Response (MB-SMF profile (Area Session ID(s), MBS service area(s))). The SMF selects the MB-SMF based on the location area where the UE is residing (if the TAI is not provided to the NRF) and interacts with MB-SMF to retrieve QoS information of the multicast QoS flow(s) for the MBS Session ID and subscribes to notifications about the MBS Session ID.
- The SMF check whether the UE is inside MBS service areas of the location dependent MBS session by comparing the User Location Information of the UE provided by the AMF with the MBS service areas received from the NRF. If the UE is out of all MBS service area of the location dependent MBS session, the SMF reject the multicast session join request.
- If the Join Request from the UE is accepted, the SMF may subscribe at the AMF using the `Namf_EventExposure` service to notifications about the "UE moving in or out of a subscribed "Area Of Interest"" event. The SMF supplies all MBS service areas of the location dependent MBS session as Area Of Interest.

- The SMF requests the AMF to transfer an N2 message to the RAN node using the Nsmf\_PDUSession\_UpdateSMContext response, to provide the NG-RAN with Multicast MBS session information which additionally includes the Area Session ID.
- If the NG-RAN node supports MBS, the NG-RAN uses the received MBS Session ID and Area Session ID to determine the local Multicast MBS session context and whether the user plane for the local Multicast MBS session is already established. If the RAN determines the shared delivery is not established for the MBS Session ID and Area Session ID, the NG-RAN initiates the shared delivery establishment as specified in clause 7.2.1.4 and provides the Area Session ID, tracking area ID(s) concerning the RAN node in addition to MBS Session ID in the request for shared delivery establishment. The MB-SMF provides MBS service area information (Area Session ID(s), MBS service area(s)) associated with the same MBS session to NG-RAN in the shared delivery establishment response. MB-SMF may either provide only the service areas concerning the target RAN node or all service areas associated with the MBS session. If the MB-SMF only provides the service areas concerning the target RAN node, which includes the cell ID(s), the cell ID is included if the tracking area IDs associated with the indicated cell ID is received by the MB-SMF.
- If the NG-RAN node serving the UE does not support MBS and the UE is in the MBS service area, the SMF apply individual delivery towards the UE. The SMF configures the UPF to send data related to the Multicast MBS session and service area via individual delivery within a PDU session of the UE. The SMF additionally subscribes at the AMF using the Namf\_EventExposure service to notifications about UE location changes (e.g. for a small MBS service area), or to notifications about the "UE moving in or out of a subscribed "Area Of Interest"" event. In the latter case, the SMF supplies the service area associated with the multicast area session where the UE resides as Area Of Interest. The SMF configures separate ingress terminations at the UPF for each service area and interacts separately for each service area (providing MBS Session ID and Area Session ID) with the MB-SMF to request or terminate the distribution of data for the MBS session and service area towards the UPF.

#### 7.2.4.2.2 Void

#### 7.2.4.2.3 Handover procedure

The Handover procedure for the UE is performed as defined in clause 7.2.3.2, 7.2.3.3, and 7.2.3.4 with the following additions:

- If the UE is receiving multicast data corresponding to the MBS Session ID and Area Session ID via the 5GC Shared MBS traffic delivery from cells served by the Source NG-RAN before the handover, for the Xn Handover (comparing with the clause 7.2.3.2), the following applies:
  - The Source RAN node includes MBS Session ID, Area Session ID and MBS service area associated with the cell where the UE resides to the Target RAN node.

NOTE 1: During the handover procedure the associated QoS flow is established towards a NG RAN node not supporting MBS regardless whether the UE is still in the MBS service area associated with the original Area Session ID or not

- If the UE is receiving multicast data corresponding to the MBS Session ID and Area Session ID from cells served by the Source NG-RAN via the 5GC Shared MBS traffic delivery before the handover, for the N2 Handover (comparing with the clause 7.2.3.3), the following applies:
  - The source RAN node includes MBS session area information (MBS Session ID, Area Session ID and MBS service area associated with the cell where the UE resides) for delivery to the Target RAN node within the Source to Target transparent container in the Handover Required message.
  - The SMF forwards the Source to Target transparent container and may also include MBS session area information (MBS Session ID, Area Session ID and MBS service area) to the Target RAN in Handover request.

NOTE 2: The SMF cannot determine the UE location and a possible new service area at this stage.



- If the UE is receiving multicast data corresponding to the MBS Session ID and Area Session ID from cells served by the Source NG-RAN via the 5GC Individual MBS traffic delivery before the Handover, for the Xn/N2 handover procedure (comparing with the clause 7.2.3.4), the following applies:

NOTE 3: During the Xn handover procedure, the associated QoS flow is established at Target RAN side regardless whether the UE is still in the MBS service area associated with the original Area Session ID or not.

- For the N2 handover procedure, the SMF includes MBS session area information (MBS Session ID, Area Session ID, and MBS service area) associated with the last known service area of the UE in N2 SM information to the Target RAN node in Handover Request message.
- If the target RAN node support MBS, it determines whether to establish the resources for multicast distribution and data forwarding for the received MBS Session ID and Area Session ID, based on MBS Session ID, Area Session ID, MBS service area provided by the source RAN (if source RAN support MBS) or SMF (if source RAN not support MBS) and the target location of the UE. If UE is not in the MBS service area provided by the source RAN (if source RAN supports MBS) or SMF (if source RAN does not support MBS), the target RAN does not allocate RAN resources, including the resource for data forwarding, for the multicast MBS Session to the UE.
- If the target RAN node support MBS, when it determines the shared delivery is not established for the multicast session ID and Area Session ID, the target NG-RAN initiates the shared delivery establishment as specified in clause 7.2.1.4 and provides the Area Session ID and tracking area ID(s) concerning the RAN node in addition to MBS Session ID in the request for shared delivery establishment. The MB-SMF provides MBS session area information (Area Session ID(s), MBS service area(s)) associated with the MBS session to the NG-RAN in the shared delivery establishment reply. The MB-SMF may either provide only the service areas concerning the target RAN node or all service areas associated with the MBS session.

NOTE 4: If the target RAN does not support MBS, the associated QoS flow is established at target RAN side during the handover procedure regardless whether the UE is still in the MBS service area associated with the original Area Session ID or not.

- If the target RAN supports MBS, but the Source RAN does not support MBS, the SMF configures the UPF to stop sending data related to the Multicast MBS session and service area via the associated PDU session of the UE. The SMF unsubscribes at the AMF using the Namf\_EventExposure service to notifications about UE location changes, or to notifications about the "UE moving in or out of a subscribed "Area Of Interest"" event (for an individual service area).

NOTE 5: If the UE is still in the MBS session, the subscription for the UE entering or leaving the complete service area does not need to be changed.

- When the AMF receives the User Location Information from target RAN node via the Path Switch Request message or Handover Notify message, the AMF provide it to the SMF. When the SMF get the User Location Information, the SMF determines the MBS service area of the UE camping cell by comparing the User Location Information received from AMF with the MBS service areas received from the NRF. The SMF uses the determined MBS service area and determined user location as follows:
  - The SMF updates the Area Session ID in the locally stored the UE MBS Session Context with the corresponding Area Session ID if the Area Session ID is changed.
  - If the target RAN does not support MBS, the Source RAN supported MBS, and the UE is in a service area of the MBS session, the SMF applies individual delivery towards the UE. The SMF configures the UPF to send data related to the Multicast MBS session and service area via the associated PDU session of the UE. The SMF additionally subscribes at the AMF using the Namf\_EventExposure service to notifications about UE location changes, or to notifications about the "UE moving in or out of a subscribed "Area Of Interest"" event. In the latter case the SMF supplies the service area of the multicast area session as Area Of Interest. If associated QoS flows are not yet included in the PDU session, the SMF updates the PDU session with associated QoS flows.
  - If the UE has moved to another MBS service area of the MBS session:
    - If the target NG-RAN node support MBS and RAN resource has not been allocated, the SMF provides the MBS session information related to the new Area session ID to NG-RAN. For Xn handover, the SMF updates the PDU session with the N2 SM information using the Path Switch Request Ack message. For

N2 handover, the SMF updates the PDU session after the completion of the handover procedure. Per the received the MBS session information, the 5GC shared delivery is established.

- If the target NG-RAN node does not support MBS, the SMF updates the UPF to forward the MBS data packet from the tunnel associated with the old Area Session ID to the new Area Session ID. If the SMF did not configure the UPF to receive the MBS data packet from the tunnel associated with the new Area Session ID before, the SMF informs the MB-SMF of the new Area Session ID and UPF DL N19mb Tunnel information. MB-SMF configure the MB-UPF to transmit the Multicast MBS session data towards UPF using the received downlink tunnel ID. If the SMF subscribed to the "Area Of Interest" event, the SMF also updates the subscription with the new service area as "Area Of Interest".
- If the UE has moved out of all the MBS service areas of the MBS session:
  - If the target NG-RAN node does not support MBS, the SMF deletes the associated QoS flow from NG-RAN and UPF after the completion of the handover.
  - Per operator's policy (e.g. when a local configured timer expires since the UE left the whole MBS service area), the SMF may remove the UE from the MBS session as defined in clause 7.2.2.3. When the UE is removed from the location dependent MBS session, the SMF also unsubscribes to the AMF from the notifications about the "UE moving in or out of a subscribed "Area Of Interest"" event.

#### 7.2.4.2.4 Activation of location dependent MBS session

When the location dependent MBS session is activated, the MBS session is activated in the whole MBS service area of the MBS session. It is not supported that the same MBS session is in Active state in one MBS service area but in Inactive state in another MBS service area.

**NOTE:** As an exception, if the MBS session contains service areas served by several different MB-SMFs, the activation is for all service areas served by the MB-SMF.

When the MB-SMF is requested by an AF to activate the MBS session in a service area of the MBS session or the MB-UPF reports detection of data for a service area of the MBS session, the MB-SMF triggers the activation for all service areas of the MBS session that it serves, i.e. whole MBS session is activated.

For the location dependent MBS session activation, the differences comparing to the procedure defined in clause 7.2.5.2 are as below:

- The SMF invokes Namf\_MT\_EnableGroupReachability service operation to AMF, which includes the whole MBS service area associated with the MBS session, i.e. the sum of all MBS service area associated with the MBS Session ID regardless of the Area Session ID.
- For the UE in CM-IDLE state, when the AMF triggers the paging, it take the receiving MBS service area information into account. Only the NG-RAN nodes which are included in the MBS service area need to be triggered for paging.
- SMF checks whether the UE is in or out of the MBS service area based on the change notification or UE location information included in Nsmf\_PDUSession\_UpdateSMContext Request or Namf\_MT\_UEReachabilityInfoNotify message. Based on that information, the SMF determines how to activate the MBS session in the same way as the handling defined in clause 7.2.4.2.3
- When the SMF provides the MBS session information to the NG-RAN nodes, it includes the MBS service area, and Area Session ID, in the N2 SM information.

#### 7.2.4.2.5 UE location change handling within the same NG-RAN node between cells belonging to different MBS service areas during Individual delivery

If UE has moved out of the MBS service area corresponding to the original Area Session ID, the SMF checks whether UE is in MBS service area corresponding to a new Area Session ID within the same MBS session:

- For the case UE is out of the original MBS service area but in another MBS service area of the MBS session:
  - If the RAN node does not support MBS, the SMF updates the UPF to forward the MBS data packet from the tunnel associated with the old Area Session ID to the new Area Session ID. If the SMF does not configure the UPF receiving the MBS data packet from the tunnel associated with the new Area Session ID before, the

SMF informs the MB-SMF of the new Area Session ID and UPF DL N19mb Tunnel information. The MB-SMF configure the MB-UPF to transmit the Multicast MBS session data towards UPF using the received downlink tunnel ID.

- The SMF updates the AMF of the area of interest event subscription by supplying the new MBS service area as Area Of Interest.
- For the case UE is out of all the MBS service areas of the MBS session:
  - If RAN node does not support MBS, the SMF delete the associated QoS flow from NG-RAN and UPF.
  - Per operator's policy (e.g. when a local configured timer expires since the UE left the whole MBS service area), the SMF may remove the UE from the MBS session as defined in clause 7.2.2.3. When the UE is removed from the location dependent MBS session, the SMF also unsubscribes to the AMF from the notifications about the "UE moving in or out of a subscribed "Area Of Interest"" event.
- For the case UE comes back to the MBS service area of the multicast MBS session after moving out of the whole MBS service area of the multicast MBS session, e.g. before the local configured timer expires:
  - If the UE is still in the multicast MBS session, the SMF adds the associated QoS flow at NG-RAN and UPF.

#### 7.2.4.2.6 UE location change handling by SMF

When the SMF receives a notification about a UE location change or is becoming aware of a UE location change (e.g. during handover), the SMF checks whether the new UE location is inside or outside all MBS service areas of the location dependent MBS session:

- For the case that UE is out of all MBS service area of the location dependent MBS session:
  - If RAN node does not support MBS, the SMF delete the associated QoS flow from the RAN node and the UPF.
  - Per operator's policy (e.g. when a local configured timer expires since the UE left the whole MBS service area of the MBS session) the SMF may remove the UE from the multicast MBS session as defined in clause 7.2.2.3. The SMF also unsubscribes to the AMF from the notifications about the "UE moving in or out of a subscribed "Area Of Interest"" event.
- For the case UE comes back to MBS service area of the location dependent MBS session after moving out of the whole MBS service area of the multicast MBS session, e.g. before the local configured timer expires:
  - If the UE is still in the multicast MBS session and the multicast MBS session is in Active state, the SMF tries to activate the multicast MBS session towards the UE.

#### 7.2.4.2.7 UE mobility within the same NG-RAN between cells belonging to different MBS service areas for shared delivery

When the UE moves from one service area to another served by the same NG-RAN, the NG-RAN node that supports MBS handles content switching due to mobility between service areas it serves without interaction with SMF. If it is the first that UE enters a new location area the RAN node requests shared delivery from the MB-SMF for the corresponding Area Session ID. If the last UE leaves a location area the RAN node requests the termination of shared delivery from the MB-SMF for the corresponding Area Session ID.

UE mobility can happen within the same NG-RAN between cells in or out of all the MBS service areas:

- The NG-RAN detects whether the UE is IN or OUT of all MBS service areas of a location dependent MBS session. If the UE moves in or out of all MBS service areas of a location dependent MBS session, the NG-RAN notifies the SMF.

NOTE: When the UE joins, the SMF subscribes to the "Area Of Interest" event, and provides the combination of all MBS service areas of location dependent MBS session as "Area Of Interest" (see clause 7.2.4.2.1).

- When the SMF knows the UE is IN or OUT of all MBS service area of location dependent MBS session, the SMF behaves as in clause 7.2.4.2.6.

#### 7.2.4.2.8 Void

### 7.2.4.3 Support of local MBS for multicast

#### 7.2.4.3.1 Local MBS service area information provided by AF

For local multicast services, the MBS service area information is provided to the UE and the 5GC as specified in clauses 7.1.1.2 and 7.1.1.3 with the following differences and clarifications:

- For the Service Announcement, MBS service area information is included unless it is preconfigured.
- When performing the MBS session creation request to the 5GC, the MBS service area information for a Multicast MBS session is provided by the AF unless it is preconfigured.

#### 7.2.4.3.2 Multicast session join and session establishment procedure for local MBS

For the case that the multicast service is only available within a limited area, the UEs outside the MBS service area are not allowed to join the multicast service.

The Multicast MBS session join and session establishment for multicast service available within a limited area are performed as specified in clause 7.2.1.3 with the following differences and clarifications:

- The local Multicast MBS session has been created where the AF provided the MBS service area information as specified in clause 7.2.4.3.1.
- The UE may have information about local multicast service including MBS service area via Service Announcement as specified in clause 7.2.4.3.1.
- In step 1, if the UE determines that it is in the MBS service area based on the information about local multicast service e.g. obtained via Service Announcement, the UE sends the PDU Session Modification Request (MBS Session ID) or the PDU Session Establishment Request (MBS Session ID) as a Join Request to join the multicast group. If the UE determines that it is outside the MBS service area, the UE does not send the Join Request.
- In step 3, the SMF obtains the MBS service area (i.e. Cell ID list or TAI list) of the indicated MBS session from the MB-SMF, and the SMF determines the indicated MBS session corresponds to local multicast service based on the MBS service area.
- In step 5, the SMF checks whether the UE is inside or outside the MBS service area.
  - The SMF determines whether the UE is inside the MBS service area by comparing the User Location Information of the UE received from the AMF with the MBS service area received from the MB-SMF.

NOTE 1: The AMF provides the User Location Information of the UE (cell ID and current tracking area ID) towards the SMF within Nsmf\_PDUSession\_CreateSMContext request and if the location changed also in Nsmf\_PDUSession\_UpdateSMContext request (as used for the join) as specified in clauses 4.3.2.2.1 and 4.3.3.2 of TS 23.502 [6].

- If the SMF detects that the UE is inside the MBS service area, the SMF continues the process of multicast session join as specified in clause 7.2.1.3 with the following additions:
  - The SMF sends the UE a PDU Session Modification Command or a PDU Session Establishment Accept indicating a Join Accept as a response to the Join Request. The Joint Accept includes the MBS service area (i.e. Cell ID list or TAI list).
  - The Multicast MBS session information sent by the SMF to the NG-RAN includes the MBS service area (i.e. Cell ID list or TAI list).
  - If the RAN node serving the UE does not support MBS the SMF applies individual delivery towards the UE. The SMF configures the UPF to send data related to the Multicast MBS session via individual delivery within a PDU session of the UE.

- If the SMF detects that the UE is outside the MBS service area, the SMF rejects the multicast session join, so sends a Join Reject to the UE indicating that the MBS join is rejected. The Join Reject includes the reject reason (outside of local service area) and the MBS service area (i.e. Cell ID list or TAI list).

In this case, the MBS Session establishment (i.e. resources establishment for MBS traffic delivery) for the UE is not performed.

NOTE 2: There may be the case that the UE determines that it is inside the MBS service area based on the geographical area information or civic address information as MBS service area information provided by the AF, so sends a Join Request but the UE is outside the MBS service area.

NOTE 3: Which SM NAS message is used to deliver the Join Reject (e.g. PDU Session Modification Reject) is defined in stage 3 specifications.

- If the Join Request from the UE is accepted, the SMF subscribes to the UE mobility event notification from the AMF (e.g. UE moving into or out of Area Of Interest, which is set by MBS service area), by invoking Namf\_EventExposure\_Subscribe service operation as specified in clause 5.2.2.3.2 of TS 23.502 [6]. The SMF supplies the service area associated with the Multicast MBS session as Area Of Interest.
- For the UE that received the Join Reject from the SMF, later, if the UE detects that it is inside the MBS service area based on the MBS service area provided in the Join Reject, the UE sends the PDU Session Modification Request (MBS Session ID) to join the multicast group.

### 7.2.4.3.3 Handover procedure with local MBS session

The Handover procedure for the UE is performed as defined in clause 7.2.3 with the following additions:

- If the UE is camping at the Source RAN node and receiving multicast data corresponding to the MBS Session ID via the 5GC Shared MBS traffic delivery before the Handover, for Xn based handover in clause 7.2.3.2, the Source RAN node includes MBS Session ID and MBS service area to the Target RAN node during Handover Preparation phase. For N2 based handover in clause 7.2.3.3, this step corresponds to Handover Request and Handover Required message, respectively.

NOTE: During the Xn or N2 handover procedures, if the target RAN node does not support MBS, the associated QoS flow is established at the Target RAN side regardless whether the UE is still in the MBS service area.

- If the UE is camping at the Source RAN node and receiving multicast data corresponding to the MBS Session ID via the 5GC individual MBS traffic delivery before the Handover, for the N2 Handover in clause 7.2.3.4, the SMF includes MBS session area information (MBS Session ID and MBS service area) in N2 SM information to the Target RAN node in Handover request.
- If the Target RAN node support MBS, it determines whether to establish the resources for multicast distribution and data forwarding for MBS Session ID, based on the received MBS Session ID provided by the source RAN (if source RAN support MBS) or SMF (if source RAN not support MBS), and target location of the UE. If UE is not in the MBS service area provided by the source RAN (if source RAN support MBS) or SMF (if source RAN not support MBS), the Target RAN does not allocate RAN resources, including the resource for data forwarding, for the multicast MBS Session to the UE.
- If the target RAN node support MBS, when it determines that the UE is in the MBS service area and that the shared delivery is not established for the multicast session ID, the target NG-RAN initiates the shared delivery establishment as specified in clause 7.2.1.4.
- When the AMF receives the User Location Information from target RAN node via the Path Switch Request message or Handover Notify message, the AMF provide it to the SMF. When the SMF get the User Location Information, the SMF check the MBS service area of UE camping cell by comparing the User Location Information received from AMF with the MBS service area received from the MB-SMF. The SMF uses the determined UE location and MBS service area as follows:
  - The SMF determines whether the UE is outside the MBS service area by comparing the received Cell ID and tracking area ID with the MBS service area received from the MB-SMF.
  - If the UE is inside the MBS service area and target RAN node does not support MBS, the SMF applies individual delivery towards the UE. If associated QoS flows are not yet included in the PDU session, the

SMF updates the PDU session with associated QoS flows. If the SMF did not configure the UPF to receive the MBS data packet from the tunnel associated with the Multicast MBS session before, the SMF informs the MB-SMF of the MBS session and UPF DL N19mb Tunnel information. MB-SMF configure the MB-UPF to transmit the Multicast MBS session data towards UPF using the received downlink tunnel ID.

- If the UE is out of the service area of the MBS session:
  - If the target NG-RAN node does not support MBS, the SMF deletes the associated QoS flow from NG-RAN node and the UPF.
  - Per operator's policy (e.g. when a local configured timer expires since the UE left the whole MBS service area of the MBS session) the SMF may remove the UE from the MBS session as defined in clause 7.2.2.3. When the UE is removed from the local MBS session, the SMF also unsubscribes to the AMF from the notifications about the "UE moving in or out of a subscribed "Area Of Interest"" event.

#### 7.2.4.3.4 Activation of local MBS session

For the local MBS session activation, the differences comparing to the procedure defined in clause 7.2.5.2 are as below.

- The SMF invokes Namf\_MT\_EnableGroupReachability service operation to AMF, which include the MBS service area associated with the MBS session.
- For the UE in CM-IDLE state, when the AMF triggers the paging, it takes the received MBS service area information into account and only triggers the paging at the NG-RAN nodes which are included in the MBS service area.
- SMF checks whether the UE is in or out of the MBS service area based on the change notification or UE location information included in Nsmf\_PDUSession\_UpdateSMContext Request or Namf\_MT\_UEReachabilityInfoNotify message. Based on that information, the SMF determines how to activate the MBS session same as the handling when the SMF get the User Location Information defined in clause 7.2.4.3.3.
- When the SMF provides the MBS session information to the NG-RAN nodes, it includes the MBS service area in the N2 SM information.

#### 7.2.4.3.5 UE location change handling by SMF

When the SMF receives a notification about a UE location change or is becoming aware of a UE location change, the SMF checks whether the new UE location is inside or outside the MBS service area of the MBS session.

- For the case UE is out of the MBS service area of the MBS session:
  - If RAN node does not support MBS, the SMF delete the associated QoS flow from the RAN node and the UPF.
  - Per operator's policy (e.g. when a local configured timer expires since the UE left the MBS service area of the MBS session) the SMF may remove the UE from the multicast MBS session as defined in clause 7.2.2.3. When the UE is removed from the local MBS session, the SMF also unsubscribes to the AMF from the notifications about the "UE moving in or out of a subscribed "Area Of Interest"" event.
- For the case UE comes back to the MBS service area of the multicast MBS session after moving out of the MBS service area of the multicast MBS session, e.g. before the local configured timer expires:
  - If the UE is still in the multicast MBS session and the multicast MBS session is in Active state, the SMF tries to activate the multicast MBS session towards the UE.

#### 7.2.4.3.6 UE mobility within the same NG-RAN between cells in or out of the MBS service area

If UE mobility can happen within the same NG-RAN between cells in or out of the service area,

- The NG-RAN detects whether the UE is IN or OUT of an MBS service area and notifies the SMF if the UE moves in or out of the MBS service area.

NOTE: When the UE joins, the SMF subscribes to the "Area Of Interest" event (see clause 7.2.4.3.2).

- When the SMF knows the UE is IN or OUT of an MBS service, the SMF behaves as in clause 7.2.4.3.5.

#### 7.2.4.3.7 Void

## 7.2.5 MBS session activation and deactivation

### 7.2.5.1 General

MBS Session activation procedure is for multicast only. MBS Session activation procedure is triggered by MB-SMF, when it receives the notification from MB-UPF for the downlink MBS DL data, or when it receives the request directly from AF or via NEF. The MBS Session activation procedure is used for activating the resources for MBS data at NG-RAN node. The multicast session state transits from Inactive to Active after MBS Session activation procedure, see clause 4.3.

MBS Session deactivation procedure is for multicast only. MBS Session deactivation procedure is triggered by MB-SMF, when it receives the notification from MB-UPF in the case that there is no downlink data to be transmitted for some duration, or when it receives the request directly from AF or via NEF. The MBS Session deactivation procedure is used for deactivating the resources for MBS data at NG-RAN node. The multicast session state transits from Active to Inactive after MBS Session deactivation procedure, see clause 4.3.

### 7.2.5.2 MBS session activation procedure

The following can trigger the MBS session activation procedure:

- AF requests MB-SMF to activate the MBS session;
- MB-UPF receives the multicast data and notifies MB-SMF.

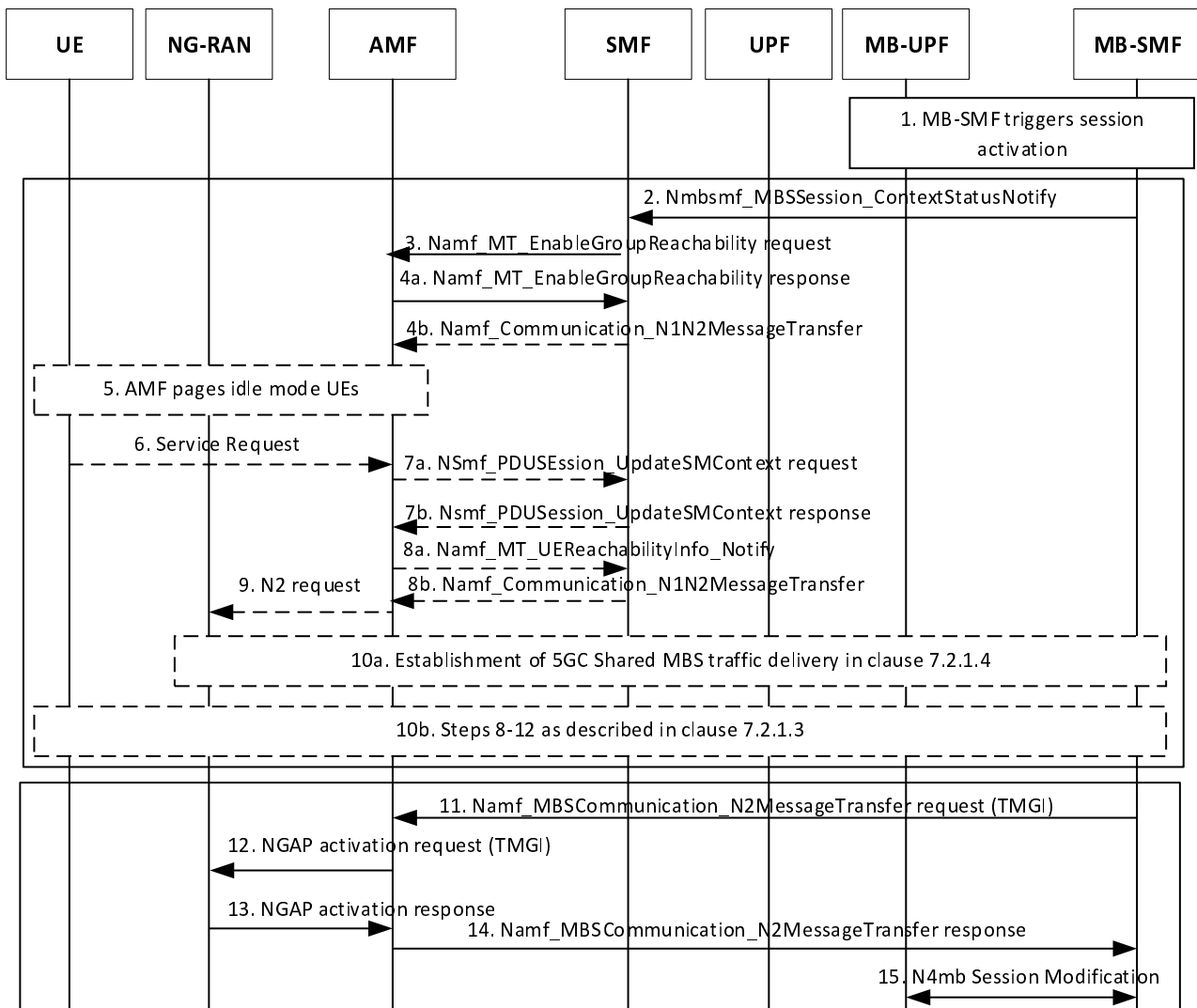

**Figure 7.2.5.2-1: MBS session activation procedure**

In this procedure, steps 11 to 15 are executed if the MB-SMF finds out there are shared tunnel established. Steps 11 to 15, if needed, are executed in parallel with steps 2 to 10.

1. The procedure may be triggered by the following events:
  - When the MB-UPF receives downlink data for a multicast MBS session, based on the instruction from the MB-SMF (as described in clause 7.2.5.3), the MB-UPF sends N4mb Notification (N4 Session ID) to the MB-SMF for indicating the arrival of DL MBS data.
  - The AF sends MBS Activation request (TMGI) to the MB-SMF directly or via NEF.
2. MB-SMF sends Nmbsmf\_MBSSession\_ContextStatusNotify (MBS Session ID, multicast session state = Active) to SMF(s).

The SMF sets the related multicast MBS session state to Active and finds out the list of UEs that joined the multicast MBS session identified by the related TMGI. If the SMF determines the user plane of the associated PDU session(s) of the UE(s) with respect to the TMGI are activated already, steps 3-8a will be skipped for those UE(s), i.e. executed from step 8b.

3. The SMF invokes Namf\_MT\_EnableGroupReachability Request (List of UEs, [PDU Session ID of the associated PDU Sessions], TMGI, [UE reachability Notification Address], [most demanding ARP, 5QI of all MBS QoS Flow within MBS session])) to AMF(s). When later UE is reachable, the UE reachability Notification Address is used by the AMF to identify and notify the related SMF.

After receiving the request, for each UE in the list, the AMF determines CM state of the UE: see steps 4 - 7.



- 4a. If there are UEs involved in the multicast MBS Session and in CM-CONNECTED state, the AMF indicates those UEs to the SMF, using Namf\_MT\_EnableGroupReachability Response (UE list). Otherwise, the response does not include UE list.
- 4b. For each UE in the UE list included in step 4a, if the QoS profile(s) for associated PDU Session has not yet been provided, the SMF invokes Namf\_Communication\_N1N2MessageTransfer (N2 SM information (PDU Session ID, MBS Session ID, [QoS profile(s) for associated QoS flow(s)], [mapping information between the unicast QoS flow and multicast QoS flow])) to the AMF for the UE which is identified in step 4a. The associated unicast QoS Flow(s) as well as the mapping information between the unicast QoS Flow(s) and multicast QoS Flow(s) are included to support the 5GC Individual MBS traffic delivery.

The procedure continues at step 9.

5. [Conditional] If AMF determines that there are UEs in CM-IDLE state and involved in the multicast MBS Session, the AMF figures out the paging area covering all the registration areas of those UE(s), which need to be paged. The AMF may apply paging differentiation as specified in clause 6.12. The AMF sends a Multicast Group paging request message to the NG-RAN node(s) belonging to this Multicast Paging Area with the involved UE list and TMGI as the identifier to be paged if the related NG-RAN node(s) support MBS. If the NG-RAN node(s) do not support MBS, the AMF sends Paging message(s) to the NG-RAN node(s) per UE as described in step 4b in clause 4.2.3.3 of TS 23.502 [6].

NOTE 1: In addition to the paging in clause 6.12, other paging strategies is up to AMF implementation.

NOTE 2: The details of the paging are specified by the RAN WGs.

6. Receiving the paging, the UE(s) in CM-IDLE state sends Service Request message to the AMF, see clause 4.2.3 of TS 23.502 [6].

NOTE 3: Step 6 for a UE can be parallel to step 5 for another UE(s), which has not received any paging yet.

7a/7b. After receiving the Service Request sent by the UE(s),

- Either based on the received PDU Session ID in step 3, the AMF identifies the related SMF and invokes Nsmf\_PDUSession\_UpdateSMContext request. The procedure continues at step 9; or:
- Based on the received UE reachability Notification Address in step 3, the AMF identifies and notifies the related SMF of the UE(s), which are reachable now and the Location Information, by using the Namf\_MT\_UEReachabilityInfoNotify message. In this case, it can be a separated notification or combined with step 8.

- 8a. For UE(s) that do not respond to paging, the AMF informs the SMF of the paging failure in Namf\_MT\_UEReachabilityInfoNotify.

- 8b. For UE(s) that is indicated as reachable via the Namf\_MT\_UEReachabilityInfoNotify message, or user plane of the associated PDU session is activated already but the QoS profile(s) for associated QoS flow(s) needs to be provided for the PDU session, the SMF invokes Namf\_Communication\_N1N2MessageTransfer (N2 SM information ()) to the AMF same as described in step 4b.

9. The AMF sends N2 request message (N2 SM information ()) to the RAN node.

NOTE 4: A joined UE is not able to receive MBS data if NG-RAN rejects the PDU Session Resource setup request (due to implementation specific reasons, e.g. activation of user plane fails due to the number of UEs reaching a limit).

- 10a. If the shared tunnel has not been established before, the shared tunnel is established at this step, as defined in clause 7.2.1.4. The NG-RAN configures UE with RRC messages if needed.

- 10b. Steps 8 to 12 defined in clause 7.2.1.3 are performed. If 5GC Individual MBS traffic delivery is used, the SMF configures the UPF for individual delivery and if necessary, requests the MB-SMF to configure the MB-UPF to send multicast data to the UPF.

11. If the MB-SMF finds out there are shared tunnel established, step 11-15 are performed. The MB-SMF invokes Namf\_MBCommunication\_N2MessageTransfer Request (TMGI, N2 SM Information (Activation, TMGI)) to the AMF for those NG-RAN nodes, which have shared tunnel with MB-UPF. This step may be performed in parallel with step 2.

NOTE 5: The messages in steps 10a, 11 and 12 are MBS-specific and it is possible that the AMF(s) in steps 10a, 11 and 12 are not associate to any UEs involved in the multicast MBS Session.

- 12. The AMF sends NGAP activation request message (N2 SM Information ()) to the NG-RAN nodes. For those UEs that have joined in the MBS Session and are in RRC\_INACTIVE state, the RAN nodes perform RAN paging as specified in TS 38.300 [9].
- 13. The NG-RAN nodes responses to AMF by NGAP activation response message. The NG-RAN nodes establish radio resources to transmit multicast MBS session data to the UE(s). The NG-RAN shall not release the radio connection of a UE that has joined into the Multicast MBS session only because no unicast traffic is received for the UE.
- 14. AMF to MB-SMF: Namf\_MBSCommunication\_N2MessageTransfer Response ().
- 15. The MB-SMF sends N4mb Session Modification Request to the MB-UPF to forward the receiving packet. The MB-UPF responds to the MB-SMF with N4mb Session Modification Response acknowledging the MB-SMF request. See clause 4.4 of TS 23.502 [6] for more details.

### 7.2.5.3 MBS session deactivation procedure

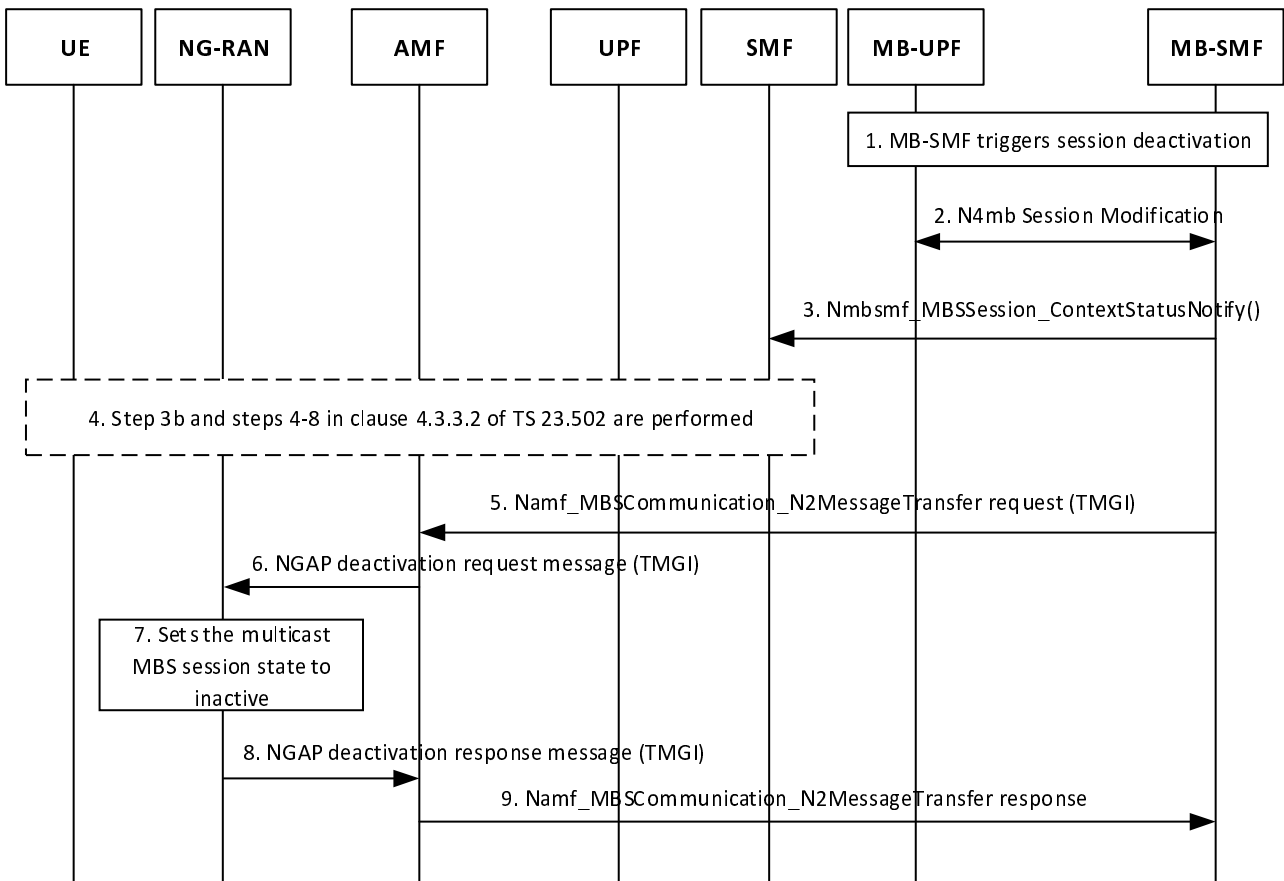

Figure 7.2.5.3-1: MBS session deactivation procedure

In this procedure, steps 3 to 4 and steps 5 to 9 are executed in parallel.

- 1. The procedure may be triggered by the following events:
  - When MB-UPF detects there is no data receives for the MBS Session, MB-UPF sends MB-N4 Notification (N4 Session ID) to the MB-SMF for deactivating the MBS session.
  - AF sends MBS Deactivation request (TMGI) to the MB-SMF directly or via NEF.
- 2. The MB-SMF send N4mb Session Modification Request (TMGI, Buffered Downlink Traffic detection) to the MB-UPF. See clause 4.4 of TS 23.502 [6] for more details. The Buffered Downlink Traffic detection is

requested by MB-SMF for next time MBS session activation. If the MBS session is to be activated via the AF request directly, this indication is not needed. The MB-SMF also indicates the MB-UPF to remove the shared tunnel(s) that are used for Individual MBS traffic delivery over N19mb interface.

MB-UPF to MB-SMF: N4mb Session Modification Response acknowledging the MB-SMF request.

3. The MB-SMF sends Nmbsmf\_MBSSession\_ContextStatusNotify request (MBS Session ID) to the SMFs.

Based on the received MBS Session ID, the SMF sets the indicated multicast MBS session state to Inactive:

- If the SMF finds out there are UE(s) that joined the indicated multicast MBS session and use 5GC Individual MBS traffic delivery, step 4 is performed for those UE(s).
- If SMF find there are no UE(s) that joined the indicated MBS session and use 5GC Individual MBS traffic delivery, no further operation for SMF is required.

4. [Conditional] For those UE(s) that the 5GC individual delivery is used, step 3b and steps 4-8 in clause 4.3.3.2 of TS 23.502 [6] are performed to remove the associated QoS flow(s) related to the multicast MBS session.

NOTE 1: Whether the associated QoS Flow(s) are removed from UE, NG-RAN, or only resource in NG-RAN is removed is up to implementation.

5. If the MB-SMF finds out there are shared tunnel established over N3mb interface, the MB-SMF sends Namf\_MBSCommunication\_N2MessageTransfer Request (TMGI, N2 SM information (Deactivation, TMGI)) to the AMFs.

6. The AMF sends NGAP deactivation request message (N2 SM information ()) to the NG-RAN nodes.

7. The NG-RAN node keeps the multicast MBS Session Context and N3mb shared tunnel for the multicast MBS session.

If the MBS Session Context indicates no UE for the multicast MBS session (e.g. due to UE becomes CM-IDLE state), the NG-RAN triggers release of the shared delivery as described in clause 7.2.2.4.

8. NG-RAN acknowledges the NGAP deactivation Response message.
9. The AMF invokes Namf\_MBSCommunication\_N2MessageTransfer Response to acknowledge the service for MB-SMF.

When the MBS session is in "Inactive" state and handover procedure is triggered, it is defined in clause 7.2.3.6.

NOTE 2: There is no explicit "deactivation" indication to the UE, how the UE is changed to IDLE state is defined in TS 38.300 [9].

## 7.2.6 Multicast session update procedure

Multicast MBS session update procedure is invoked by the AF to update the service requirement (result in multicast QoS parameters update and/or multicast QoS flow addition/removal) and/or MBS Service Area for an ongoing Multicast MBS session. For the interaction between AF and MB-SMF, see clause 7.1.1.6 and 7.1.1.7.

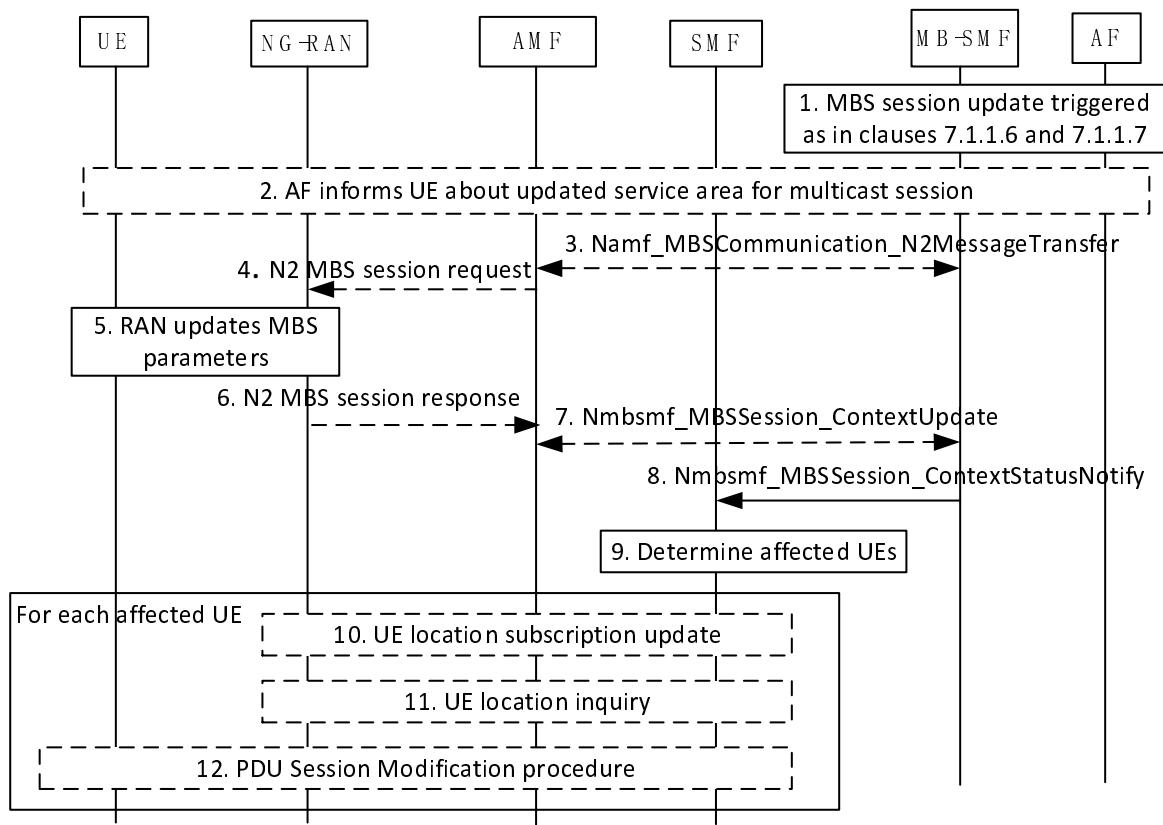

**Figure 7.2.6-1: Multicast MBS Session update procedure**

1. This procedure is triggered by the MB-SMF receiving the updated service requirement and/or MBS Service Area for a multicast MBS Session, see clauses 7.1.1.6 and 7.1.1.7.
2. The AF providing the updated service area may also inform UEs at application level about the new service area via a service announcement.

NOTE 1: If a UE is located in a cell which was previously outside the service area and is now inside the updated service area, the UE can join the multicast service as specified in clause 7.2.1.3.

For QoS updates steps 3 to 7 are performed.

For MBS Service Area update steps 3 to 7 may be performed to allow NG-RAN to terminate data transmission in the area which is no longer in the MBS Service Area.

3. The MB-SMF invokes Namf\_MBSCommunication\_N2MessageTransfer service operation (MBS Session ID, [Area Session ID], N2 SM message container (TMGI, [QoS profile(s) for multicast MBS session], [MBS Service Area], [Area Session Id])) to the AMF(s).
4. The involved AMF sends N2 MBS session request (N2 SM message container) to NG-RAN nodes handling the multicast MBS session and possible Area Session ID based on the RAN node IDs stored in the AMF for the MBS session.
5. The NG-RAN node updates the QoS profile and/or MBS Service Area for the multicast MBS session based on the N2 MBS session request. If only QoS parameters are updated without multicast QoS flows added/removed, the NG-RAN may also update the QoS parameters of the associating PDU Sessions.

For MBS Service Area update, the NG-RAN updates the MBS Session Context with the updated MBS Service Area. The NG-RAN stops transmission of the related multicast data in the cell(s) which is within the old MBS Service Area but now outside the updated MBS Service Area. The NG-RAN also configures the UE not to receive the MBS data over the radio interface if the NG-RAN detects the UE(s) was in the previous MBS Service Area but is outside the updated MBS Service Area. If the NG-RAN node no longer serves any cells within the updated MBS service area, it requests to release shared delivery resource as defined in clause 7.2.2.4.

6. The NG-RAN node(s) acknowledges N2 MBS session request by sending an N2 MBS session Response message to the AMF.
7. The AMF invokes the `NmbSMF_MBSSession_ContextUpdate ()` to the MB-SMF.
8. The MB-SMF sends `NmbSMF_MBSSession_ContextStatusNotify` request (MBS Session ID, [QoS profiles for multicast for MBS session], [MBS Service Area], [Area Session ID]) to the SMFs. For MBS Service Area updates, if an Area Session ID exists, the MB-SMF provides the MBS Service Area corresponding to the Area Session ID to the SMFs involved in the multicast MBS session. For QoS updates, the MB-SMF notifies SMFs handling all MBS service areas.
9. The SMF determines the affected UEs it serves based on the multicast MBS Session ID and Area Session ID (if provided) received in the step 8.

The subsequent steps 10 to 12 are executed for each affected UE. For QoS updates, steps 10 and 11 are skipped.

10. [Conditional] For an MBS Service Area update, if the SMF previously subscribed at the AMF to notifications about the UE moving in or out of a subscribed "Area Of Interest", the SMF updates the subscription with the new MBS Service Area as area of interest.
11. [Optional] When the MBS Service Area is updated, if the SMF does not have the latest UE location, the SMF queries AMF which then query the NG-RAN for the current location of the UE to determine whether the UE is within the updated MBS Service Area.
12. [Conditional] For QoS Updates, if the 5GC Individual MBS traffic delivery is used, or if the associated QoS flows is to be added/removed, the SMF triggers PDU Session Modification procedure as defined in TS 23.502 [6]. If the 5GC Individual MBS traffic delivery is used, the SMF may also configure the UPF with the updated QoS and/or updated or removed QoS flows.

For MBS Service Area update, the SMF triggers the PDU Session Modification procedure as defined in TS 23.502 [6] with the following enhancement:

The SMF also updates the PDU session resources associated to the multicast MBS session with the new MBS service area in an N2 container. The RAN node serving the PDU session starts or terminates transmission of multicast content in cells which are added or removed in the updated service area, respectively, and if necessary, interacts with the MB-SMF to start or terminate the distribution of multicast data to the RAN node.

- Towards the UE, the SMF provides the MBS service area in N1 SM container to the UE. For a UE previously inside the MBS service area but now outside the updated MBS service area of the multicast MBS session, the SMF may alternatively, based on operator policy, inform the UE in the N1 SM container that the UE has been removed from the multicast MBS session.
- Towards the NG-RAN, the SMF provides the updated MBS service area in N2 SM information. For a NG-RAN node supporting MBS, it starts transmission of multicast content in cells which are added in the updated MBS service area if UEs within the Multicast MBS session are within those cells, and if necessary, the NG-RAN interacts with the MB-SMF to start the distribution of multicast data to the RAN node. The RAN node stops transmission of multicast content in cells which are removed from the updated MBS service area, and if necessary, the NG-RAN interacts with the MB-SMF to terminate the distribution of multicast data to the RAN node
- For Individual delivery and a local Multicast MBS session the following applies: For a UE previously inside the service area but now outside the updated MBS service area, the SMF removes associated unicast QoS flows for the multicast MBS session. For a UE previously outside the service area but now inside the updated service area, the SMF adds associated unicast QoS flows for the multicast MBS session to the PDU session resources.

## 7.2.7 Void

## 7.2.8 Service request procedure

If the multicast MBS session is in Inactive state, the UE can go to CM-IDLE state or the user plane of the associated PDU Session may be deactivated even when the UE is in CM-CONNECTED state. When user plane of the associated PDU session is activated again, the SMF sends the MBS session information to NG-RAN during Service Request procedure as specified in TS 23.502 [6]. The MBS session information indicates that this MBS session is in Inactive state; and:

- For the MBS supporting NG-RAN node, the NG-RAN establish the shared tunnel with the MB-UPF as usual. However, as the MBS session is in Inactive state, the NG-RAN node will not allocate related radio resource.
- For the non-MBS supporting NG-RAN node, the unicast QoS flow associated with the MBS session are not established.

If the multicast MBS session is in Active state, the UE can go to CM-IDLE state due to AN release as specified in TS 23.502 [6]. When the UE communicates with the network again, the SMF provides the MBS session information indicating that the UE joined the MBS session to the NG-RAN within N2 SM container for the associated PDU Session.

NOTE: Network triggered Service Request, if triggered for other reason, can also be used by the SMF to provide that MBS session information to NG-RAN.

## 7.2.9 AF provisioning multicast MBS Session Authorization information

The AF provisions the multicast MBS session authorization information for multicast MBS sessions that are not open to "any UE". The procedure specified in clause 4.15.6.2 of TS 23.502 [6] is reused with the following enhancements:

- The AF may provision the MBS Session Authorization information to the 5GC. The MBS Session Authorization information is associated with a group of UEs.

**Table 7.2.9-1: MBS Session Authorization information**

Parameters	Description
MBS Session Authorization information	One or more MBS Session IDs. A group of UEs identified by an External Group ID.

- The AF may support multicast MBS group membership management and provide parameters as described in Table 7.2.9-2.

**Table 7.2.9-2: Multicast MBS group membership management parameters**

Parameters	Description
List of GPSI	List of multicast group members, each member is identified by GPSI.
External Group ID	Identifier for multicast MBS group.

- If a new multicast MBS group is created, the UDM shall assign a unique Internal Group ID for the multicast MBS group and include the newly assigned Internal Group ID in the Nudr\_DM\_Create Request message.
- If the AF is authorised by the UDM to provision the MBS Session Authorization information, the UDM resolves the GPSI of each MBS session group member to SUPI, and requests to create, update or delete the provisioned MBS Session Authorization information as part of the MBS subscription data for each SUPI via Nudr\_DM\_Create/Update/Delete Request message, and the message includes the provisioned MBS Session Authorization information.

## 7.3 MBS procedures for broadcast Session

NOTE: The interactions between the MBSF, the MBSTF and the AF, for example file delivery and HTTP adaptive streaming, will be defined in TS 26.502 [18] and TS 26.517 [22].

### 7.3.1 MBS Session Start for Broadcast

The Broadcast MBS Session Start follows the common procedure specified in clause 7.1.1.2 or clause 7.1.1.3, which consist of TMGI Allocation and MBS Session Create. It is possible for AF to allocate TMGI once but create the MBS Session for multiple times. A combined procedure to perform both TMGI allocation and MBS Session Create is available.

The TMGI Allocation is used by AF to obtain the TMGI as MBS Session ID (i.e. TMGI) and perform service announcement towards UEs.

The MBS Session Create (with MBS service type set to broadcast service) is used by the AF to indicate the impending start of the transmission of MBS data, and to provide the session attributes, so that resources for the MBS Session are set up in the MB-UPF and in the NG-RAN for 5GC Shared MBS traffic delivery. The MBS Session Create can be used if TMGI has not been allocated. In this case, MB-SMF will allocate a unique TMGI for the AF and then start the MBS Session.

NOTE 1: When the multicast transport between NG-RAN and MB-UPF is described below, source specific multicasting is assumed.

To receive the data of broadcast communication service, the UE is either preconfigured with needed configuration (e.g. USD as defined in TS 26.346 [13]) for the UE to receive MBS service, or provisioned with the configuration of Broadcast MBS session on application level (service announcement; the configuration may for instance be performed using SIP signalling, or methods described in TS 26.346 [13]). If the needed configuration is pre-configured, the UE does not need to interact with network.

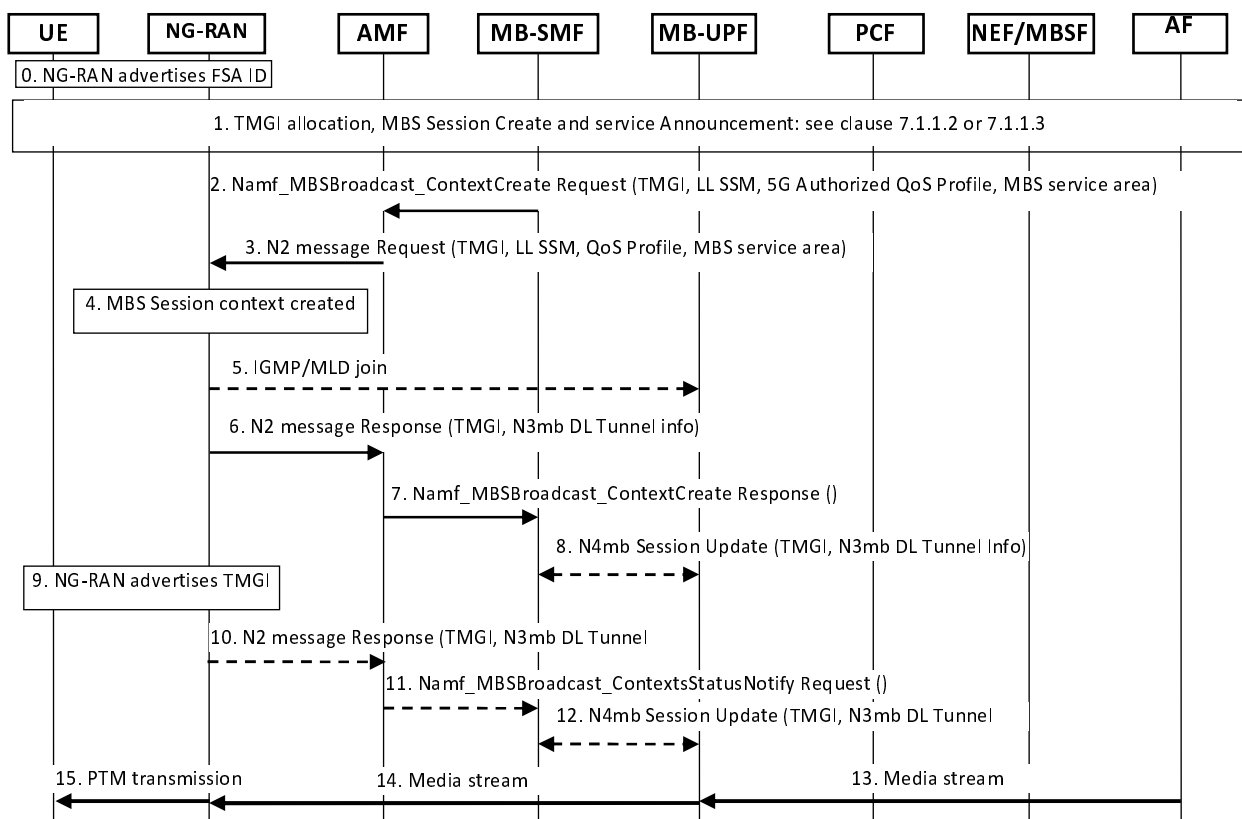

Figure 7.3.1-1: MBS Session Establishment for Broadcast

- 0 Based on OAM configuration, RAN nodes announce in SIBs over the radio interface information about the MBS FSA IDs and frequencies of neighbouring cells.
- 1. To establish broadcast MBS session, the AF performs TMGI allocation and MBS session creation as specified in clause 7.1.1.2 or 7.1.1.3. The MBS service type indicates to be broadcast service. The MBS FSA ID(s) of a broadcast MBS session are communicated in the service announcement towards the UE. The UE compares those MBS FSA IDs(s) with the MBS FSA ID(s) in SIBs for frequency selection.

2. The MB-SMF may use NRF to discover the AMF(s) supporting MBS based on the MBS service area and select the appropriate one(s). Then the MB-SMF sends the Namf\_MBSBroadcast\_ContextCreate (TMGI, N2 SM information ([LL SSM], 5G QoS Profile), MBS service area, [MBS FSA ID(s)]) messages to the selected AMF(s) in parallel if the service type is broadcast service. The MB-SMF may include a maximum response time in the request.
3. The AMF transfers the MBS Session Resource Setup Request message, which contains the N2 SM information in the received Namf\_MBSBroadcast\_ContextCreate Request to all NG-RANs which support MBS in the MBS service area. The AMF includes the MBS service area.
4. NG-RAN creates a Broadcast MBS Session Context and stores the TMGI and the QoS Profile in the MBS Session Context. The LL SSM are optional parameters and only provided by MB-SMF to NG-RAN if N3mb multicast transport is configured to be used in the 5GC. If MBS FSA ID(s) were received, the NG-RAN may use those MBS FSA ID(s) to determine cells/frequencies within the MBS service area to broadcast MBS session data based on OAM configuration about the MBS FSA IDs and related frequencies.
5. If NG-RAN prefers to use N3mb multicast transport (and if LL SSM is available in NG-RAN), the NG-RAN joins the multicast group (i.e. LL SSM).  
  
If NG-RAN prefers to use N3mb unicast transport (or if the LL SSM is not available in NG-RAN) between the NG-RAN and MB-UPF, NG-RAN provides its N3mb DL Tunnel Info.
6. The NG-RAN reports successful establishment of the MBS Session resources (which may include multiple MBS QoS Flows) by sending MBS Session Resource Setup Response (TMGI, N2 SM information ([N3mb DL Tunnel Info])) message(s) to the AMF. N3mb DL Tunnel Info is only available when unicast transport applies between MB-UPF and NG-RAN. For more details, refer to TS 38.413 [15].
7. The AMF transfers the Namf\_MBSBroadcast\_ContextCreate Response () to the MB-SMF. The AMF should respond success when it receives the first success response from the NG-RAN(s). And if all NG-RAN(s) report failure, the AMF should respond failure. The MB-SMF stores the AMF(s) which responds success in the MBS Session Context as the downstream nodes. If the AMF receives the NG-RAN response(s) from all involved NG-RAN(s), the AMF should include an indication of completion of the operation in all NG-RANs.
8. If N3mb unicast transport is to be used (i.e. N3mb DL Tunnel Info is present in the Namf\_MBSBroadcast\_ContextCreate Response message from AMF), the MB-SMF sends an N4mb Session Modification Request to the MB-UPF to allocate the N3mb unicast transport tunnel for a replicated MBS stream for the MBS Session. Otherwise, step 8 can be skipped.
9. NG-RAN broadcasts the TMGI representing the MBS service over radio interface. Step 9 can take place in parallel with step 6.
10. Another NG-RAN may report successful establishment of the MBS Session resources (which may include multiple MBS QoS Flows) by sending MBS Session Resource Setup Response (TMGI, N2 SM information ([N3mb DL Tunnel Info])) message after the AMF transferred the Namf\_MBSBroadcast\_ContextCreate Response () to the MB-SMF.
11. The AMF transfers the Namf\_MBSBroadcast\_ContextStatusNotify request () to the MB-SMF. When the AMF receives the response from all NG-RAN nodes, the AMF includes an indication of the completion of the operation. If the AMF does not receive responses from all NG-RAN nodes before the maximum response time elapses since the reception of the Namf\_MBSBroadcast\_ContextCreate Request, then the AMF should transfer the Namf\_MBSBroadcast\_ContextStatusNotify request () which indicates partial success or failure.
12. If N3mb unicast transport is to be used (i.e. N3mb DL Tunnel Info is present in the MBS Session Start Response message from AMF), the MB-SMF sends an N4mb Session Modification Request to the MB-UPF to allocate the N3mb unicast transport tunnel for a replicated MBS stream for the MBS Session. Otherwise, step 12 can be skipped.
13. The AF starts transmitting the DL media stream to MB-UPF using the N6mb Tunnel, or optionally un-tunnelled i.e. as an IP multicast stream using the HL MC address.
14. The MB-UPF transmits the media stream to NG-RAN via N3mb multicast transport or unicast transport.
15. The NG-RAN transmits the received DL media stream using DL PTM resources.

NOTE 2: Step 6-8 and 2-4 are comparable to step 2-5 and 6-7 in clause 7.2.1.4, respectively.



## 7.3.2 MBS Session Release for Broadcast

The MBS Session Release for broadcast follows the MBS Session Deletion (e.g. TMGI De-allocation and MBS Session Deletion) so that resource for shared MBS delivery is released. It is possible for AF to stop MBS Session but keep TMGI allocated.

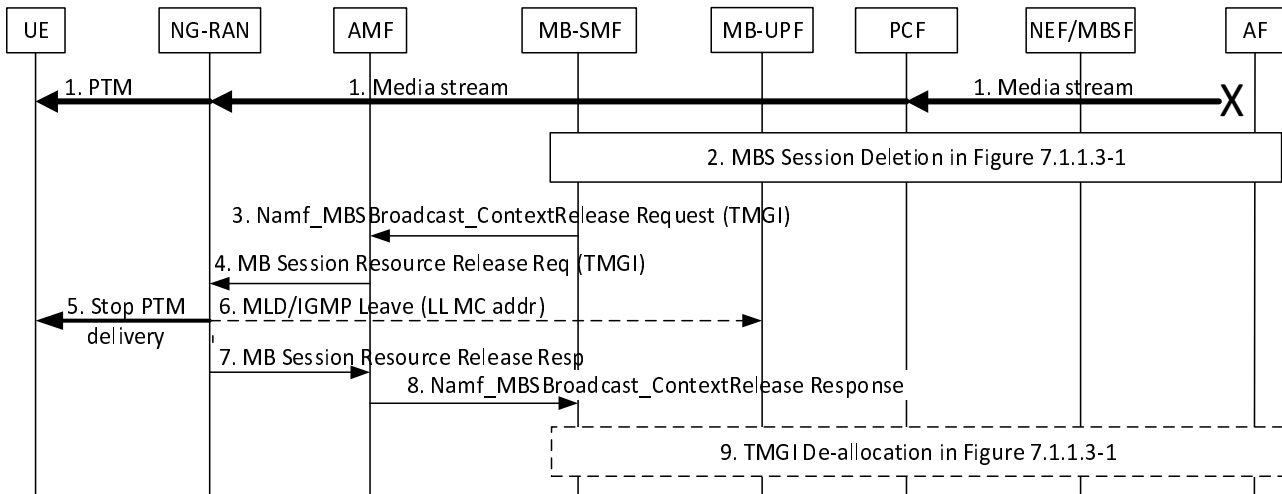
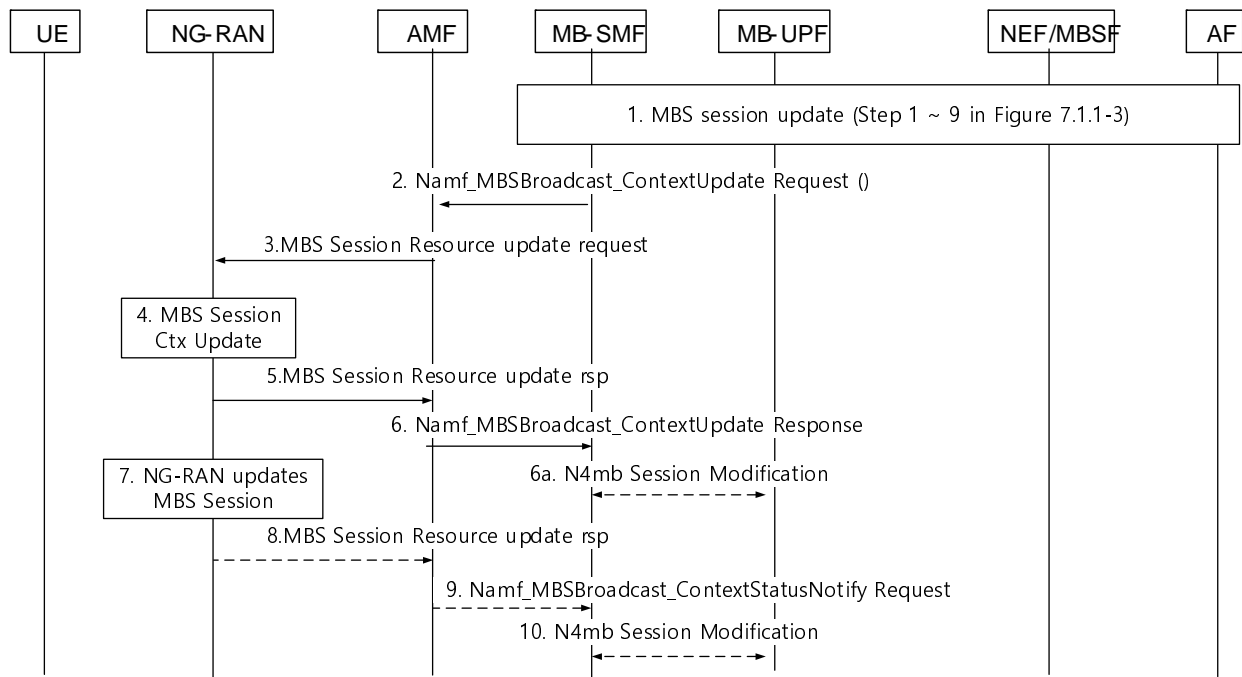

**Figure 7.3.2-1: MBS Session Release for Broadcast**

1. The AF/AS may stop the media stream before sending the MBS Session Release Request (TMGI) message to the 3GPP network.
2. The AF/AS performs MBS Session Deletion procedure to request release of MBS Session (steps 1 ~ 10 in figure 7.1.1.4-1, or steps 1 ~ 13 in figure 7.1.1.5-1).
3. MB-SMF sends Namf\_MBSBroadcast\_ContextRelease request (TMGI) to the AMF(s) that has been involved in the MBS Session.
4. The AMF sends an N2 message to all RAN nodes that have been involved to release MBS session. If a NG-RAN node receives multiple N2 message to release the MBS Session for the same TMGI (e.g. from several AMFs the NG-RAN is connected to), NG-RAN only performs step 5 and step 6 once.
5. The NG-RAN stops the PTM transmission.
6. If N3mb multicast transport has been used, the NG-RAN sends a Leave message (LL SSM) to stop the media stream to this NG-RAN node. If N3mb unicast transport has been used, the NG-RAN release its DL N3mb Tunnel Info. NG-RAN deletes its MBS Session Context.
7. The NG-RAN reports successful release of resources for the MBS Session by sending MBS Session Resource Release Response (TMGI) message(s) to the AMF(s).
8. The AMF sends Namf\_MBSBroadcast\_ContextRelease response (TMGI) to the MB-SMF.
9. The AF may start a TMGI de-allocation procedure (steps 11 ~ 14 in figure 7.1.1.4-1, or steps 14 ~ 17 in figure 7.1.1.5-1).

## 7.3.3 MBS Session Update for Broadcast

The MBS Session Update for broadcast is used by the AF to update the broadcast area or service requirements of the MBS Session which may lead to addition of new MBS QoS Flow(s), removal of existing MBS QoS Flow(s) or update of existing MBS QoS Flow(s).



**Figure 7.3.3-1: MBS Session Update for Broadcast**

1. The AF starts MBS session update procedure by sending Nnef\_MBSSession\_Update Request to the NEF/MBSF with TMGI. The AF may adjust service requirement and/or broadcast area. The service requirements adjustment may lead to addition of new MBS QoS Flow(s), removal of existing MBS QoS Flow(s) or update of existing MBS QoS Flow(s).
2. The MB-SMF sends Namf\_MBSBroadcast\_ContextUpdate Request (TMGI, N2 SM information (MBS Session ID, [MBS QoS profile], [service area(s)], [Area Session ID(s)], [MBS IP Multicast Tunnel Info(s)], [MBS FSA ID(s)], [updated MBS service area]) to the AMFs. For a location dependent service, the MB-SMF may provide information about several location areas. If the broadcast area is updated, the MB-SMF may use NRF to discover the AMF(s) based on the new broadcast area and select the appropriate one(s). The MB-SMF may include a maximum response time in the request.

Depending on the change of the MBS service area, the MB-SMF may send Namf\_MBSBroadcast\_ContextCreate to some AMFs in the new MBS service area, Namf\_MBSBroadcast\_ContextRelease to some other AMFs in the old MBS service area.

3. The AMF sends MBS Session Resource Update to NG-RANs with TMGI, the updated 5G QoS Profile and the updated MBS service area.

Depending on the change of the MBS service area, the AMF may send MBS Session Resource Setup to some NG-RANs in new MBS service area (see clause 7.3.1) and MBS Session Resource Release to some other NG-RANs in old MBS service area.

4. The NG-RAN updates MBS Session Context.
5. The NG-RAN reports successful update of the MBS Session resources (which may include multiple MBS QoS Flows) by sending MBS Session Resource Update Response (TMGI, N2 SM information ([N3mb DL Tunnel Info])) message(s) to the AMF. N3mb DL Tunnel Info is only available when unicast transport applies between MB-UPF and NG-RAN and the NG-RAN wants the transport to be changed. The NG-RAN should be ready to receive using the N3mb DL tunnel. For more details, refer to TS 38.413 [15].
6. The AMF sends Namf\_MBSBroadcast\_ContextUpdate Response to the MB-SMF. If the AMF received the NG-RAN responses from all involved NG-RAN(s), the AMF should include an indication of completion of the operation in all NG-RANs.
- 6a. If MBS service area is changed in such a manner that NG-RAN nodes are added or removed from handling the MBS session, and N3mb unicast transport is used, the MB-SMF sends an N4mb Session Modification Request to the MB-UPF to establish or release the N3mb unicast transport tunnel for establishing, or releasing the MBS stream for the MBS Session. Otherwise, step 6a can be skipped.

7. The NG-RAN updates the MBS Session. It takes place in parallel with step 5 to step 6.
8. Another NG-RAN may report successful update of the MBS Session resources (which may include multiple MBS QoS Flows) by sending MBS Session Resource Update Response (TMGI, N2 SM information ([N3mb DL Tunnel Info])) message after the AMF transferred the Namf\_MBSBroadcast\_ContextUpdate Response () to the MB-SMF. N3mb DL Tunnel Info is only available when unicast transport applies between MB-UPF and NG-RAN and the NG-RAN wants the transport to be changed. The NG-RAN should be ready to receive using the N3mb DL tunnel. For more details, refer to TS 38.413 [15].
9. The AMF transfers the Namf\_MBSBroadcast\_ContextStatusNotify request () to the MB-SMF. When the AMF receives the response from all NG-RAN nodes, the AMF should include an indication of completion of the operation in all NG-RANs. If the AMF does not receive responses from all NG-RAN nodes before the maximum response time elapses since the reception of the Namf\_MBSBroadcast\_ContextUpdate Request, then the AMF should transfer the Namf\_MBSBroadcast\_ContextStatusNotify request () which indicates partial success or failure.
10. If MBS service area is changed in such a manner that NG-RAN nodes are added or removed from handling the MBS session, and N3mb unicast transport is used, the MB-SMF sends an N4mb Session Modification Request to the MB-UPF to establish or release the N3mb unicast transport tunnel for establishing, or releasing the MBS stream for the MBS Session. Otherwise, step 10 can be skipped.

### 7.3.4 Support for Location dependent Broadcast Service

The clause describes procedures to support the Location dependent broadcast service as described in clause 6.2.

The MBS session creation procedure is performed as defined in clause 7.1.1.2 with the following additions:

- Multiple AFs may start the same Broadcast MBS session with different content in different MBS service areas. The NEF selects MB-SMF as ingress control node(s) for different MBS service areas.
- If presented, the NEF maps possible external identifiers for MBS service areas to network-internal identifiers (e.g. list of cells, TAIs).
- For Location dependent Broadcast Service, MB-SMF allocates Area Session ID, and updates its NF profile towards the NRF with the TMGI and Area Session ID.
- The MB-SMF may select the MB-UPF based on the MBS service area.
- The MBS service area(s) are indicated to the UE in the Service Announcement as defined in clause 6.11.

The MBS session establishment procedure is performed as defined in clause 7.3.1 with the following additions:

- MB-SMF requests the AMF to transfer an N2 message (i.e. MBS Session Resource Setup Request) to the NG-RAN nodes of the MBS service area with Broadcast MBS session information which additionally includes the Area Session IDs and MBS service areas.
- The NG-RAN uses the received MBS Session ID and Area Session IDs to determine the local Broadcast MBS session contexts.
- The NG-RAN responds for service areas it handles with the Area Session ID(s) and DL tunnel endpoint(s) for the DL tunnel(s) from MB-SMF if unicast transport applies over N3mb between MB-UPF and NG-RAN.
- According to the Area Session ID(s) and DL tunnel endpoint(s) provided by NG-RAN, the MB-SMF instructs the MB-UPF to send location dependent content.

### 7.3.5 MBS Session Delivery Status Indication for Broadcast

The MBS Session Delivery Status Indication for broadcast is used by the MB-SMF to notify the AF/AS of conditions affecting the delivery of the MBS session (e.g. MBS session created, MBS session terminated, etc.). The occurrence of the indicated condition may have been detected at the MB-SMF or may have been reported to the MB-SMF by other entities involved in the MBS session delivery.

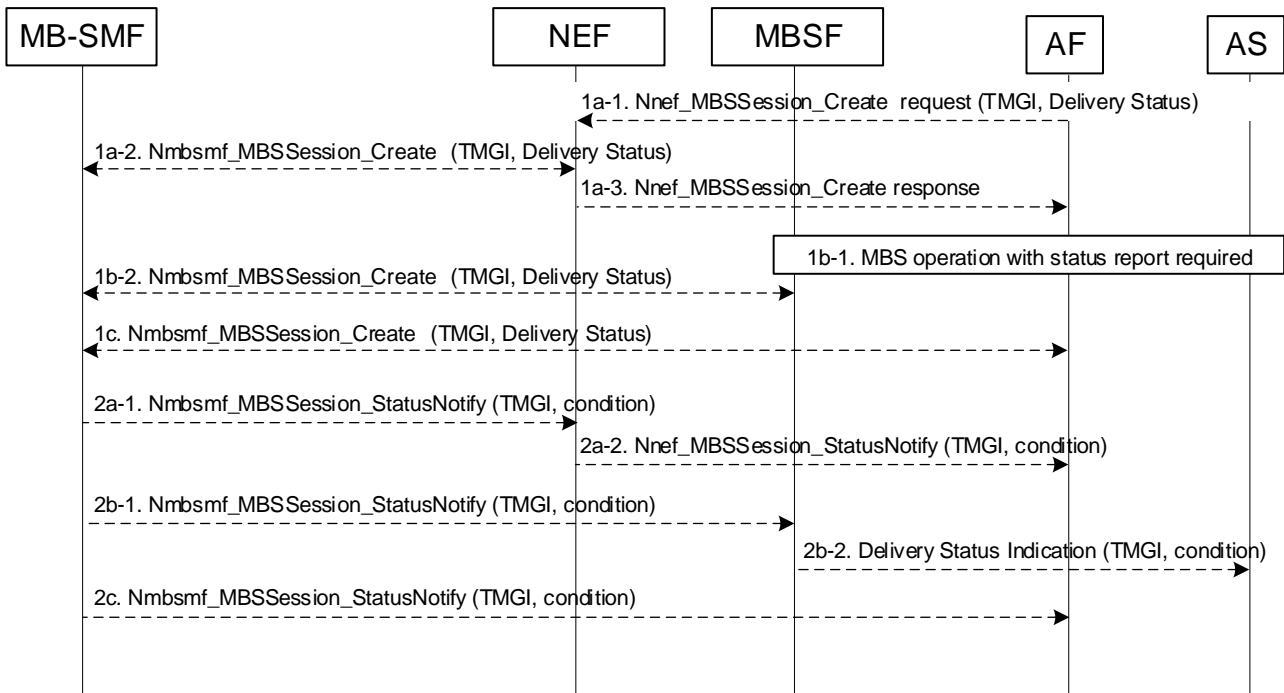

**Figure 7.3.5-1: MBS Session Delivery Status Indication for Broadcast**

1. The external AF subscribes event for delivery status towards the NEF, and the NEF subscribes corresponding event towards the MB-SMF (step 1a), or the legacy AS request status report towards the MBSF, and the MBSF subscribes event for delivery status towards the MB-SMF (step 1b), or the internal AF subscribes event for delivery status towards the MB-SMF (step 1c).
2. The MB-SMF notifies the TMGI and the event towards the NEF, and the NEF notifies the TMGI and corresponding event towards the external AF (step 2a), or the MB-SMF notifies the TMGI and the event towards the MBSF, and the MBSF sends Delivery Status Indication to legacy AS with the TMGI and the corresponding event (step 2b), or the MB-SMF notifies the TMGI and the event towards the internal AF (step 2c).

For the "MBS session started" event, after the MB-SMF contacts AMFs to request the establishment of the Broadcast MBS session, the MB-SMF may wait until it has received a Namf\_MBSBroadcast\_ContextCreate Response or Namf\_MBSBroadcast\_ContextStatusNotify with the indication of the completion of the operation from each AMF (see clause 7.3.1) before determining that the Broadcast MBS session has been started.

### 7.3.6 Broadcast MBS Session Release Require

When NG-RAN is not able continue to provide the Broadcast MBS Session, e.g. due to lack of radiou resources, NG-RAN may intitiate Broadcast Session Release Require procedure.

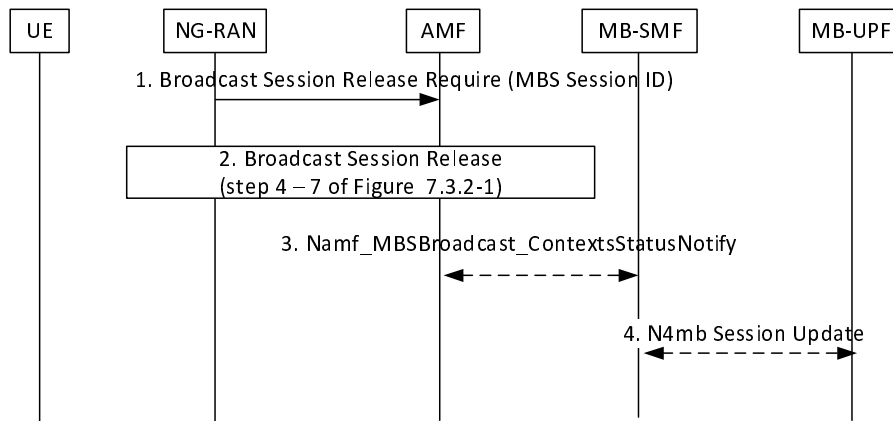

**Figure 7.3.6-1: Broadcast MBS Session Release Require**

1. If NG-RAN cannot continue to provide the Broadcast MBS session, e.g. due to lack of radio resources, the NG-RAN sends Broadcast Session Release Require (MBS Session ID) to the AMF.
2. The AMF initiates Broadcast Session Release towards the NG-RAN as defined in steps 4 - 7 in clause 7.3.2.
3. If unicast transport applies in N3mb, the AMF receives the DL tunnel Info for the Broadcast MBS Session from the NG-RAN in step 2. The AMF notifies the MB-SMF about the DL tunnel release via Namf\_MBSBroadcast\_ContextStatusNotify.
4. The MB-SMF performs N4mb Session Update to let MB-UPF stop the broadcast data forwarding towards the indicated DL tunnel and release the DL tunnel.

## 7.4 MBS procedures for inter System Mobility

### 7.4.1 Inter-system mobility with interworking at service layer

For inter-system mobility with interworking at service layer, i.e. the same multicast service is provided via eMBMS in E-UTRAN and MBS, the UE is instructed to switch between MBS and eMBMS:

NOTE 1: The source network can be configured with the frequencies where the same service is provided in the target network, i.e. the EPC network neighbouring the 5GC network support the same eMBMS service.

NOTE 2: The UE can be configured, per TMGI, to know that the same service is provided over MBS and eMBMS.

- Mobility from MBS to eMBMS.

When moving to E-UTRAN/EPC, the UE initiates procedures as defined in TS 23.246 [8] to receive MBMS service for the TMGI(s).

If the UE has one or more unicast PDU Sessions (including, but not limited to, the PDU Session used for MBS and for another service (e.g. Public Safety service) with the QoS Flow(s) for the other service) moving to EPS, and if the handover procedure from 5GS to EPS using N26 interface described in clause 4.11.1.2.1 of TS 23.502 [6] is used:

- For the PDU Session used also for MBS, the SMF+PGW-C removes the UE from the Multicast MBS session context(s), if it exists, upon receiving a Modify Bearer Request of the PDU Session from the SGW (i.e. step 14a of clause 4.11.1.2.1 of TS 23.502 [6]).
- The NG-RAN removes the UE from the Multicast MBS session context(s) if it exists, or removes the whole multicast session context if the UE is the last one for the Multicast MBS session (e.g. after receiving the UE Context Release Command message sent by the AMF).

For 5GS to EPS Idle mode mobility with no N26, when the UE moves to the EPS and performs E-UTRAN/EPS attach according to step 8 of clause 4.11.2.4.1 of TS 23.502 [6], if the UE does not maintain registration in 5GC, upon reachability time-out, the AMF may implicitly detach the UE and release the possible remaining PDU Session(s) in 5GC. The SMF/PGW-C removes the UE from the Multicast MBS session context(s), if it exists, upon receiving a tracking area update from the UE.

- Mobility from eMBMS to MBS.

When the UE has moved to NR/5GC, it triggers the multicast context and multicast flow setup/modification via PDU Session Modification procedures as defined in clause 6.8 to receive MBS transport for the TMGI(s).

## 8 Control and user plane stacks

### 8.1 Control plane for Multicast and Broadcast services

#### 8.1.1 General

The control plane protocol stacks for Multicast and Broadcast service between NG-RAN and MB-SMF is defined in the clause 8.1.1 and the other control plane protocol stacks for Multicast and Broadcast service are defined in the TS 23.501 [5] clause 8.2.

The control plane protocols for N4mb reference point between MB-SMF and MB-UPF are defined in TS 29.244 [17].

The reference point Nmb2 between MBSF and MBSTF will be defined in TS 26.502 [18] and TS 26.517 [22].

#### 8.1.2 NG-RAN – MB-SMF

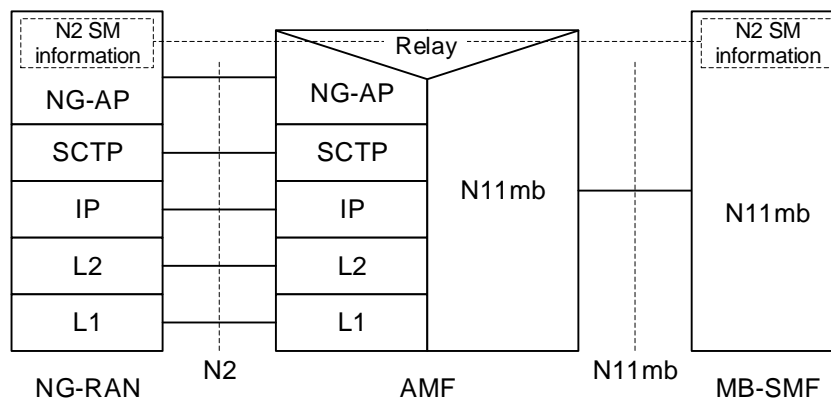

#### Legend:

- **N2 SM information:** This is the subset of NG-AP information that the AMF transparently relays between the NG-RAN and the MB-SMF, and is included in the NG-AP messages and the N11mb related messages, where the NG-RAN node has MBS capability and in this Release the NG-RAN is a 3GPP NR.

**Figure 8.1.1-1: Control Plane between the NG-RAN and the MB-SMF**

### 8.2 User plane for Multicast and Broadcast services

The User plane protocol stack for PDU session which handles the multicast operation is same with the PDU session user plane Protocol Stack defined in the TS 23.501 [5] clause 8.3.1.

The user plane protocol stack for MBS session in case of shared delivery is described in Figure 8.2-1 and Figure 8.2-2. In Figure 8.2-1, the UDP tunnel applies to N6mb and Nmb9, while in Figure 8.2-2, the plain IP multicast applies to N6mb. The user plane protocol stack for MBS session in case of individual delivery is described in Figure 8.2-3.

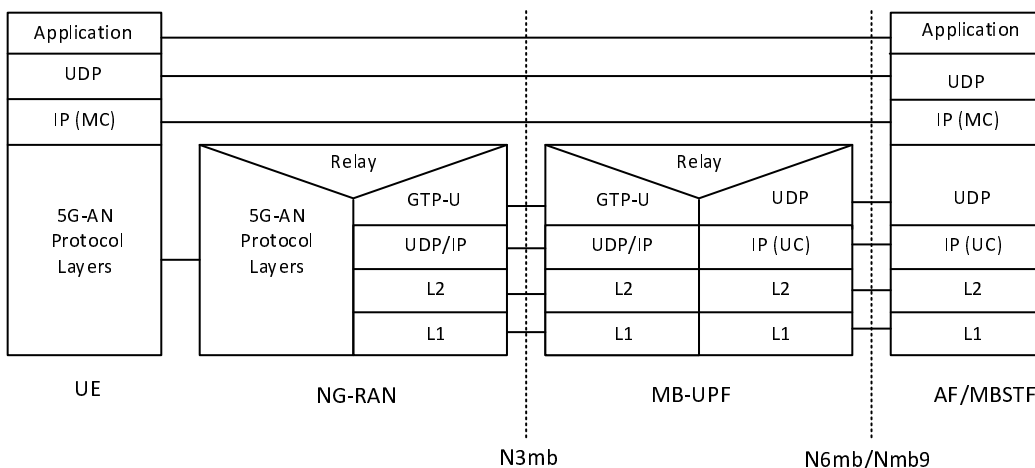

Figure 8.2-1: User Plane Protocol Stack for MBS session (UDP Tunnel)

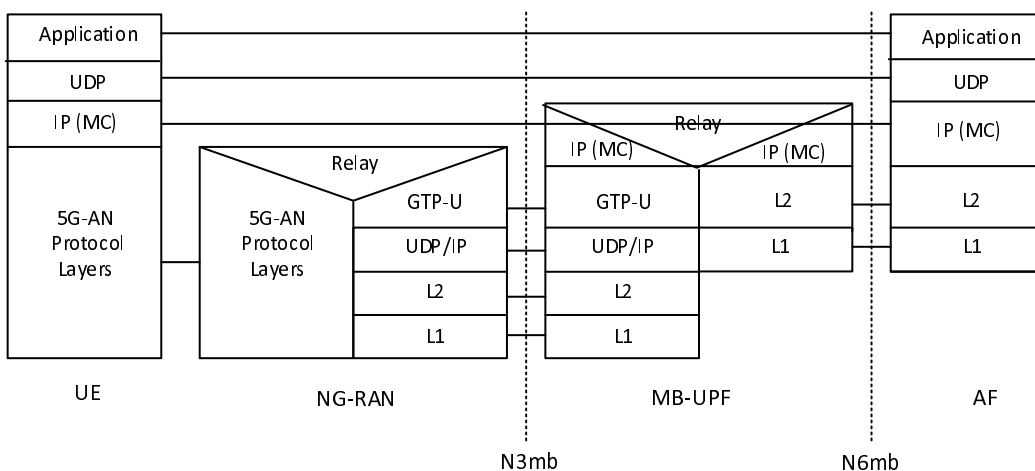

Figure 8.2-2: User Plane Protocol Stack for MBS session (plain IP multicast)

- **5G-AN Protocol Layers:** This set of protocols/layers depends on the AN:
  - in this Release, the 5G-AN is a 3GPP NR, these protocols/layers are defined in TS 38.401 [16]. The radio protocol between the UE and the 5G-AN node (gNodeB) is specified in TS 38.300 [9].

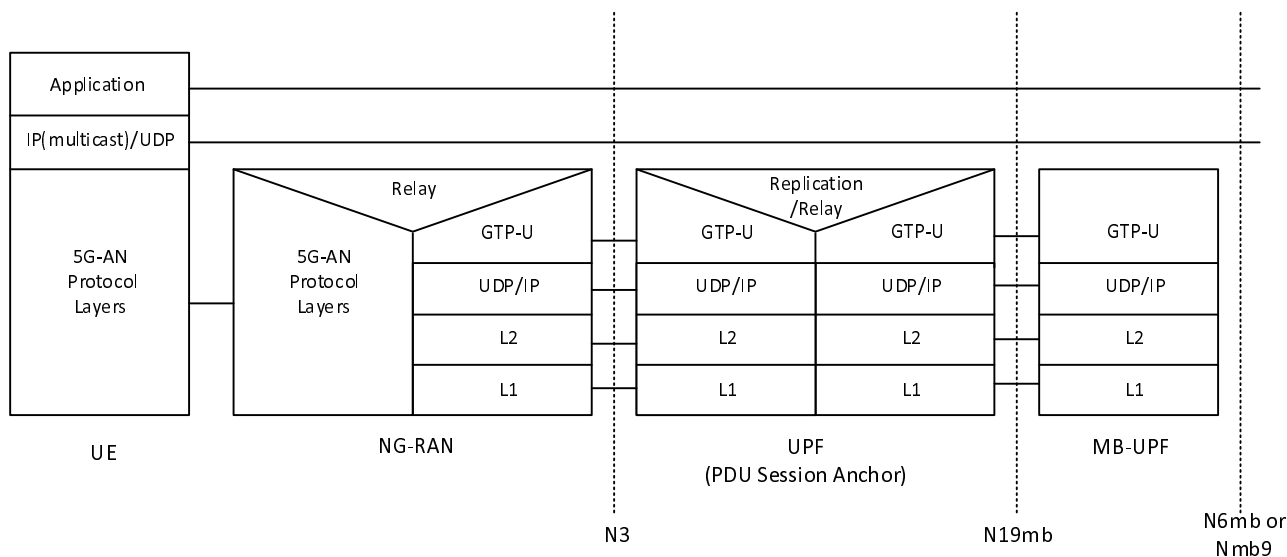

Figure 8.2-3: User Plane Protocol Stack for MBS session in case of Individual delivery

- **5G-AN Protocol Layers:** This set of protocols/layers depends on the AN:
  - in this Release, the 5G-AN is a 3GPP NR, these protocols/layers are defined in TS 38.401 [16]. The radio protocol between the UE and the 5G-AN node (gNodeB) is specified in TS 38.300 [9].

NOTE: In Figure 8.2-3, the User Plane Protocol Stack between MB-UPF and AF/MBSTF is shown in Figure 8.2-1 and Figure 8.2-2.

## 9 Network Function Services

### 9.1 MB-SMF Services

#### 9.1.1 General

The following table illustrates the MB-SMF Services for MBS.

**Table 9.1.1-1: NF services provided by MB-SMF**

Service Name	Service Operations	Operation Semantics	Example Consumer (s)
Nmbsmf_TMGI	Allocate	Request/Response	NEF, MBSF, AF
	Deallocate	Request/Response	NEF, MBSF, AF
Nmbsmf_MBSSession	ContextStatusSubscribe	Subscribe/Notify	SMF
	ContextStatusUnsubscribe		SMF
	ContextStatusNotify		SMF
	ContextUpdate	Request/Response	AMF, SMF
	StatusSubscribe	Subscribe/Notify	MBSF, NEF, AF
	StatusUnsubscribe		MBSF, NEF, AF
	StatusNotify		MBSF, NEF, AF
	Create	Request/Response	MBSF, NEF, AF
	Update	Request/Response	MBSF, NEF, AF
	Delete	Request/Response	MBSF, NEF, AF

#### 9.1.2 Nmbsmf\_TMGI service

##### 9.1.2.1 General

**Service description:** NF Service Consumer can use this service to request the allocation of TMGIs and release allocated TMGIs.

##### 9.1.2.2 Nmbsmf\_TMGI\_Allocate service operation

**Service operation name:** Nmbsmf\_TMGI\_Allocate

**Description:** This service is used by the NF Service Consumer to request the allocation of TMGI(s) or request to refresh previously allocated TMGI(s).

**Inputs, Required:** Number of TMGIs.

**Inputs, Optional:** TMGI(s) (i.e. the TMGI(s) to be extended the expiry time).

**Outputs, Required:** TMGI(s), Expiry Time of the TMGI(s).

**Outputs, Optional:** None.

##### 9.1.2.3 Nmbsmf\_TMGI\_Deallocate service operation

**Service operation name:** Nmbsmf\_TMGI\_Deallocate



**Description:** NF Service Consumer can use this service to request the release of TMGI(s).

**Inputs, Required:** TMGI(s).

**Inputs, Optional:** None.

**Outputs, Required:** Success or not.

**Outputs, Optional:** None.

### 9.1.3 Nmbsmf\_MBSSession service

#### 9.1.3.1 General

**Service description:** The following are the key functionalities of this NF service:

- (between AMF or SMF and MB-SMF) For multicast, NF Service Consumer can use this service to request the reception of MBS data or to terminate the reception of MBS data of a Multicast MBS session, or for a location dependent Multicast MBS session, the part of the MBS multicast session within a service area;
- (between SMF and MB-SMF) For multicast, allow consumer NFs to query information (e.g. QoS information) about MBS Session. This service will be invoked by SMF for UE join event;
- (between SMF (only for multicast) or MBSF/NEF and MB-SMF) Allow consumer NFs to subscribe and unsubscribe for an Event ID and MBS Session, or for a location dependent MBS session, related to the part of the MBS session within a service area (only for MBSF/NEF);
- (between SMF (only for multicast) or MBSF/NEF and MB-SMF) Notifying events on the MBS Session, or for a location dependent MBS session, related to the part of the MBS session within a service area (only for MBSF/NEF), to the subscribed NFs;
- (between MBSF/NEF/AF and MB-SMF) Creation/Modification/Activation/Deactivation/Release of Multicast MBS session, or for a location dependent Multicast MBS session, the part of the Multicast MBS session within a service area; and
- (between MBSF/NEF and MB-SMF) Creation/Modification/Start/Stop/Release of Broadcast MBS sessions, or for a location dependent Broadcast MBS session, the part of the Broadcast MBS session within a service area.

The following events related to MBS Session Context can be subscribed by SMF as consumer NF:

- (between SMF and MB-SMF, only for multicast) QoS change: The event notification is sent when QoS within a Multicast MBS session changes, e.g. adding/removing QoS flow(s);
- (between SMF and MB-SMF only for multicast) multicast session state (Active, Inactive);
- (between SMF and MB-SMF only for multicast) Multicast MBS session service area change (for a location dependent Broadcast MBS session, the notification relates to the part of the Broadcast MBS session within a service area);
- (between SMF and MB-SMF only for multicast) Multicast MBS session release.

The following events related to an MBS session, or for a location dependent MBS session, related to the part of the MBS session within a service area, can be subscribed by MBSF, NEF, or AF as consumer NF:

- (between MBSF/NEF/AF and MB-SMF) MBS session release due to TMGI expiry;
- (between MBSF/NEF/AF and MB-SMF) Broadcast delivery status.

NOTE: Whether event IDs are needed can be determined by stage 3.

#### 9.1.3.2 Nmbsmf\_MBSSession\_ContextUpdate service operation

**Service operation name:** Nmbsmf\_MBSSession\_ContextUpdate

**Description:** NF Service Consumer can use this service to request or terminate the reception of data of a multicast session, or for a location dependent MBS session, related to the part of the MBS session within a service area.

**Inputs, Required:** MBS Session ID, if consumer is AMF: N2 container (Establishment or Release, MBS Session ID, Possible Area Session ID, Possible GTP Tunnel info for unicast transport, Possible tracking Area IDs), AMF ID, if consumer is SMF: SMF ID, MBS Session ID, Action(Establishment or Release).

**Inputs, Optional:** if consumer is SMF: Area Session ID, Unicast GTP Tunnel info of the UPF.

**Outputs, Required:** Success or not.

**Outputs, Optional:** if consumer is AMF: N2 container (MBS Session ID, Possible Multicast DL tunnel info, multicast QoS flow information, session state (Active/Inactive), [MBS service areas]); if consumer is SMF: Multicast DL tunnel info.

### 9.1.3.3 Nmbsmf\_MBSSession\_ContextStatusSubscribe service operation

**Service operation name:** Nmbsmf\_MBSSession\_ContextStatusSubscribe

**Description:** Service Consumer NF can use this service operation to request information (e.g. QoS information) about a multicast session and to subscribe to notification of events about the multicast session context.

**Inputs, Required:** MBS Session ID, Notification Target Address, Events ID(s).

**Inputs, Optional:** None.

**Outputs, Required:** None.

**Outputs, Optional:** Event information (e.g. QoS information for multicast session, multicast MBS session state (Active, Inactive), multicast session service area for local multicast service), Start time of multicast MBS session, multicast DL tunnel info, if consumer is SMF: indication that the multicast MBS session allows any UE to join.

### 9.1.3.4 Nmbsmf\_MBSSession\_ContextStatusNotify service operation

**Service operation name:** Nmbsmf\_MBSSession\_ContextStatusNotify

**Description:** This service operation, which is applicable to multicast MBS session, is used by the MB-SMF to notify its consumers about events of an MBS Session, or for a location dependent MBS session, related to a service area change.

**Inputs, Required:** MBS Session ID, Event ID.

**Inputs, Optional:** Event information (e.g. QoS information of MBS Session, MBS service area, Area Session ID).

**Outputs, Required:** Operation execution result indication.

**Outputs, Optional:** Cause.

### 9.1.3.5 Nmbsmf\_MBSSession\_ContextStatusUnsubscribe service operation

**Service operation name:** Nmbsmf\_MBSSession\_ContextStatusUnsubscribe

**Description:** This service operation, which is applicable to multicast MBS session, is used by the consumer to unsubscribe to notifications about MBS context events.

**Inputs, Required:** MBS Session ID.

**Inputs, Optional:** None.

**Outputs, Required:** Operation execution result indication.

**Outputs, Optional:** None.

### 9.1.3.6 Nmbsmf\_MBSSession\_Create service operation

**Service operation name:** Nmbsmf\_MBSSession\_Create

**Description:** Create a new multicast session or broadcast session, or for a location dependent MBS session, the part of the MBS session within a service area. Optionally subscribe to notifications for this MBS session.

**Input, Required:** MBS Session ID (SSM or TMGI) or TMGI allocation request, MBS Service Type (multicast or broadcast).

**Input, Optional:** DNN, S-NSSAI, MBS service area, MBS Service Information (as defined in clause 6.14), Input Transport Address Request, indication that the PCF has to be contacted. For a multicast session, indication that any UE may join. For a broadcast session, MBS start time, MBS termination time, MBS FSA ID(s). For subscription to notifications event ID(s), Notification Target Address, Request for location dependent MBS session.

**Output, Required:** Result Indication.

**Output, Optional:** TMGI, Expiry Time of the TMGI, Cause, MB-UPF tunnel info, MBS FSA ID(s), Area Session ID.

### 9.1.3.7 Nmbsmf\_MBSSession\_Update service operation

**Service operation name:** Nmbsmf\_MBSSession\_Update

**Description:** Update the established multicast session or broadcast session, or for a location dependent MBS session, the part of the MBS session within a service area, e.g. QoS update.

**Input, Required:** MBS Session ID.

**Input, Optional:** MBS Service Information (as defined in clause 6.14), MBS service area, session state (Active/Inactive), for a broadcast session, MBS FSA ID(s), Area Session ID, indication that the PCF has to be contacted.

**Output, Required:** Result Indication.

**Output, Optional:** Cause, MBS FSA ID(s).

### 9.1.3.8 Nmbsmf\_MBSSession\_Delete service operation

**Service operation name:** Nmbsmf\_MBSSession\_Delete

**Description:** Release the multicast session or broadcast session, or for a location dependent MBS session, the part of the MBS session within a service area. The MBS session is deleted and the subscription (if any) to notifications about events related to the status of the MBS session is terminated.

**Input, Required:** MBS Session ID.

**Input, Optional:** Area Session ID.

**Output, Required:** Result Indication.

**Output, Optional:** Cause.

### 9.1.3.9 Nmbsmf\_MBSSession\_StatusNotify service operation

**Service operation name:** Nmbsmf\_MBSSession\_StatusNotify

**Description:** This service operation is used by the MB-SMF to notify its consumers about the status change of the MBS session, or for a location dependent MBS session, of the part of the MBS session within a service area.

**Input, Required:** MBS Session ID, Event ID.

**Input, Optional:** Event information, Area Session ID.

**Output, Required:** Result Indication.

### 9.1.3.10 Nmbsmf\_MBSSession\_StatusSubscribe service operation

**Service operation name:** Nmbsmf\_MBSSession\_StatusSubscribe

**Description:** This service operation is used by the NF service consumer (e.g. NEF, MBSF, AF) to subscribe notification about events related to the status of the MBS session, or for a location dependent MBS session, the part of the MBS session within a service area.

**Input, Required:** MBS Session ID, event ID(s), Notification Target Address.

**Input, Optional:** Area Session ID.

**Output, Required:** When the subscription is accepted: Subscription Correlation ID.

### 9.1.3.11 Nmbsmf\_MBSSession\_StatusUnsubscribe service operation

**Service operation name:** Nmbsmf\_MBSSession\_StatusUnsubscribe

**Description:** This service operation, is used by the NF service consumer (e.g. NEF, MBSF, AF) to unsubscribe to notification about events related to the status of the MBS session, or for a location dependent MBS session, the part of the MBS session within a service area.

**Input, Required:** Subscription Correlation ID.

**Input, Optional:** Area Session ID.

**Output, Required:** Result Indication.

## 9.2 PCF Services

### 9.2.1 General

The following table illustrates the PCF Services for MBS.

**Table 9.2.1-1: NF services provided by PCF for MBS**

Service Name	Service Operations	Operation Semantics	Example Consumer (s)
<b>Npcf_MBSPolicyControl</b>	Create	Request/Response	MB-SMF
	Update	Request/Response	MB-SMF
	Delete	Request/Response	MB-SMF
<b>Npcf_MBSPolicy Authorization</b>	Create	Request/Response	AF, NEF, MBSF
	Update	Request/Response	AF, NEF, MBSF
	Delete	Request/Response	AF, NEF, MBSF

### 9.2.2 Npcf\_MBSPolicyControl service

#### 9.2.2.1 General

**Service description:** NF Service Consumer, e.g. MB-SMF, can create and manage a MBS Policy Association in the PCF through which the NF Service Consumer receives policy information for the MBS Session.

As part of this service, the PCF may provide the NF Service Consumer, e.g. MB-SMF, with policy information for the MBS Session that may contain (the details are defined in clause 6.10):

- Policy information applicable for an entire MBS Session.
- PCC rule information.
- Policy Control Request Trigger information.

At MBS Session establishment the NF Service Consumer, e.g. MB-SMF, requests the creation of a corresponding MBS Policy Association with the PCF (Npcf\_MBSPolicyControl\_Create) and provides relevant parameters about the MBS Session to the PCF.

- When the PCF has created the "MBS Policy Association", the PCF may provide policy information as defined above.

When a Policy Control Request Trigger condition is met the NF Service Consumer, e.g. MB-SMF, requests the update (Npcf\_MBSPolicyControl\_Update) of the MBS Policy Association by providing information on the condition(s) that have been met. The PCF may provide updated policy information for the MBS session to the NF Service Consumer.

The PCF may at any time provide updated policy information for the MBS session (Npcf\_MBSPolicyControl\_UpdateNotify).

At MBS Session Release the NF Service Consumer, e.g. MB-SMF, requests the deletion of the corresponding MBS Policy Association.

### 9.2.2.2 Npcf\_MBSPolicyControl\_Create service operation

**Service operation name:** Npcf\_MBSPolicyControl\_Create

**Description:** The NF Service Consumer can request the creation of a MBS Policy Association and provide relevant parameters about the MBS Session to the PCF.

**Inputs, Required:** MBS Session ID.

**Inputs, Optional:** MBS Service Information (as defined in clause 6.14), DNN, S-NSSAI.

**Outputs, Required:** Success or Failure. In the case of Success, MBS Policy Association ID and Policy information for the MBS Session (as defined in clause 6.10).

**Outputs, Optional:** In the case of Failure, the Service Information that can be accepted by the PCF. In the case of Failure, indication that another PCF shall be contacted and an ID of that other PCF.

### 9.2.2.3 Void

### 9.2.2.4 Npcf\_MBSPolicyControl\_Delete service operation

**Service operation name:** Npcf\_MBSPolicyControl\_Delete

**Description:** The NF Service Consumer (i.e. MB-SMF) can request the deletion of the MBS Policy Association and of the associated resources.

**Inputs, Required:** MBS Policy Association ID.

**Inputs, Optional:** None.

**Outputs, Required:** Success or Failure.

**Outputs, Optional:** None.

### 9.2.2.5 Npcf\_MBSPolicyControl\_Update service operation

**Service operation name:** Npcf\_MBSPolicyControl\_Update

**Description:** The NF Service Consumer can request an update of the MBS Policy Association.

**Inputs, Required:** MBS Policy Association ID.

**Inputs, Optional:** MBS Service Information (as defined in clause 6.14), Information on the Policy Control Request Trigger condition that has been met.

**Outputs, Required:** Success or Failure.

**Outputs, Optional:** In the case of Failure, the Service Information that can be accepted by the PCF. In the case of Success, Policy information for the MBS Session (as defined in clause 6.10).

## 9.2.3 Npcf\_MBSPolicyAuthorization Service

### 9.2.3.1 General

**Service description:** This service is to authorise an AF / NEF / MBSF request for an MBS service and to create policies as requested by the authorized AF for the MBS Service. This service also allows the NF consumer to subscribe/unsubscribe the notification of events.

### 9.2.3.2 Npcf\_MBSPolicyAuthorization\_Create service operation

**Service operation name:** Npcf\_MBSPolicyAuthorization\_Create

**Description:** Authorize the request, and optionally determines and installs MBS Policy Control Data according to the information provided by the NF Consumer.

**Inputs, Required:** MBS Session ID.

**Inputs, Optional:** DNN if available, S-NSSAI if available, MBS Service Information (as defined in clause 6.14).

**Outputs, Required:** Success (application session context) or Failure (reason for failure).

**Outputs, Optional:** In the case of Failure, the MBS Service Information that can be accepted by the PCF.

### 9.2.3.3 Npcf\_MBSPolicyAuthorization\_Update service operation

**Service operation name:** Npcf\_MBSPolicyAuthorization\_Update

**Description:** Provides updated information to the PCF.

**Inputs, Required:** Identification of the application session context.

**Inputs, Optional:** MBS Service Information (as defined in clause 6.14).

**Outputs, Required:** Success or Failure (reason for failure).

**Outputs, Optional:** In the case of Failure, the MBS Service Information that can be accepted by the PCF. In the case of Success, indication that the PCF has to be contacted.

Provides updated application level information and communicates with Npcf\_MBSPolicyControl service to determine and install the policy according to the information provided by the NF Consumer. Updates an application context in the PCF.

### 9.2.3.4 Npcf\_MBSPolicyAuthorization\_Delete service operation

**Service operation name:** Npcf\_MBSPolicyAuthorization\_Delete

**Description:** Provides means for the NF Consumer to delete the context of application level session information.

**Inputs, Required:** Identification of the application session context.

**Inputs, Optional:** None.

**Outputs, Required:** Success or Failure.

**Outputs, Optional:** None.

## 9.3 AMF Services

### 9.3.1 General

The Namf\_MT\_EnableGroupReachability service operation is defined in TS 23.502 [6].

The following table illustrates the new AMF Service for broadcast communication.

**Table 9.3.1-1: NF services provided by AMF**

Service Name	Service Operations	Operation Semantics	Example Consumer (s)
Namf_MBSBroadcast	ContextCreate	Request/Response	MB-SMF
	ContextUpdate	Request/Response	MB-SMF
	ContextRelease	Request/Response	MB-SMF
	ContextStatusNotify	Subscribe/Notify	MB-SMF
Namf_MBSCommunication	N2MessageTransfer	Request/Response	MB-SMF

### 9.3.2 Namf\_MBSBroadcast service

#### 9.3.2.1 General

**Service description:** This service is used by the consumer for broadcast communication.

#### 9.3.2.2 Namf\_MBSBroadcast\_ContextCreate service operation

**Service operation name:** Namf\_MBSBroadcast\_ContextCreate

**Description:** This service operation is used to create the broadcast session context towards the AMF.

**Inputs, Required:** MBS Session ID, Broadcast service area, N2 container (e.g. MBS Session ID, MBS QoS profile, Broadcast service area).

**Inputs, Optional:** Area Session ID, Optional parameters in the N2 container (MBS IP Multicast Tunnel Info, Area Session ID, MBS FSA ID(s)).

**Outputs, Required:** Result Indication.

**Outputs, Optional:** N2 container (NG-RAN MBS Tunnel Info).

#### 9.3.2.3 Namf\_MBSBroadcast\_ContextUpdate service operation

**Service operation name:** Namf\_MBSBroadcast\_ContextUpdate

**Description:** This service operation is used to update the broadcast session context towards the AMF.

**Inputs, Required:** MBS Session ID.

**Inputs, Optional:** Broadcast service area, N2 container (MBS Session ID, Possible MBS QoS profile, Possible Broadcast service area, Possible Area Session ID, Possible MBS IP Multicast Tunnel Info, MBS FSA ID(s)).

**Outputs, Required:** Result Indication.

**Outputs, Optional:** N2 container (MBS Session ID, NG-RAN MBS Tunnel Info).

#### 9.3.2.4 Namf\_MBSBroadcast\_ContextRelease service operation

**Service operation name:** Namf\_MBSBroadcast\_ContextRelease

**Description:** This service operation is used to release the broadcast session context towards the AMF.

**Inputs, Required:** MBS Session ID, N2 container (MBS Session ID).

**Inputs, Optional:** None.

**Outputs, Required:** Result Indication.

**Outputs, Optional:** None.

### 9.3.2.5 Namf\_MBSBroadcast\_ContextStatusNotify service operation

**Service operation name:** Namf\_MBSBroadcast\_ContextStatusNotify

**Description:** This service operation is used to notify its consumers about the status change of a broadcast session context.

**Inputs, Required:** MBS Session ID.

**Inputs, Optional:** Event ID (e.g. change of NG-RAN MBS Tunnel Info), N2 SM information.

**Outputs, Required:** Result Indication.

**Outputs, Optional:** None.

## 9.3.3 Namf\_MBSCommunication Service

### 9.3.3.1 General

**Service description:** This service enables MBS multicast related N2 message transfer towards the NG-RAN via the AMF, during multicast session activation/deactivation/update/release.

### 9.3.3.2 Namf\_MBSCommunication\_N2MessageTransfer service operation

**Service operation name:** Namf\_MBSCommunication\_N2MessageTransfer

**Description:** This service operation is used by the NF Consumer to request the AMF to transfer the MBS related N2 message to the NG-RAN nodes serving the MBS multicast session.

**Input, Required:** MBS Session ID, N2 SM information.

**Input, Optional:** MBS Area Session ID.

**Output, Required:** Result Indication.

**Output, Optional:** Cause.

## 9.4 NEF Services

### 9.4.1 General

The following table illustrates the NEF Services for MBS.



Table 9.4.1-1: NF services provided by NEF

Service Name	Service Operations	Operation Semantics	Example Consumer (s)
Nnef_MBSTMGI	Allocate	Request/Response	AF
	Deallocate	Request/Response	AF
	ExpiryNotify	Subscribe/Notify	AF
Nnef_MBSSession	Create	Request/Response	AF
	Update	Request/Response	AF
	Delete	Request/Response	AF
	StatusNotify	Subscribe/Notify	AF
	StatusSubscribe		AF
	StatusUnsubscribe		AF

## 9.4.2 Nnef\_MBSTMGI service

### 9.4.2.1 General

**Service description:** NF Service Consumer can use this service to request the allocation of TMGIs and deallocate TMGIs previously allocated.

### 9.4.2.2 Nnef\_MBSTMGI\_Allocate service operation

**Service operation name:** Nnef\_MBSTMGI\_Allocate

**Description:** This service is used by the NF Service Consumer to request allocation of TMGI(s), or to refresh the expiry time for already allocated TMGI(s).

**Inputs, Required:** Number of TMGIs (may be zero if only a refresh of expiry time is requested).

**Inputs, Optional:** TMGI(s) to be refreshed, MBS service area.

**Outputs, Required:** TMGIs, Expiry Time, Success or not.

**Outputs, Optional:** None.

### 9.4.2.3 Nnef\_MBSTMGI\_Deallocate service operation

**Service operation name:** Nnef\_MBSTMGI\_Deallocate

**Description:** This service is used by the NF Service Consumer to request deallocation the TMGI(s).

**Inputs, Required:** TMGI(s).

**Inputs, Optional:** None.

**Outputs, Required:** Success or not.

**Outputs, Optional:** None.

### 9.4.2.4 Nnef\_MBSTMGI\_ExpiryNotify service operation

**Service operation name:** Nnef\_MBSTMGI\_ExpiryNotify

**Description:** This service is used by the NEF to notify the NF service consumer of the timer expiry for TMGI(s).

**Inputs, Required:** TMGI(s).

**Inputs, Optional:** None.

**Outputs, Required:** None.

**Outputs, Optional:** None.

## 9.4.3 Nnef\_MBSSession Service

### 9.4.3.1 General

**Service description:** This service operates on the multicast and broadcast MBS sessions. The following are the key functionalities of this NF service:

- Create/Update Delete for both multicast and broadcast MBS session, or for a location dependent MBS session, the part of the MBS session within a service area;
- Provide a Notification about subscribed events. The following events are supported:
  - MBS session release due to TMGI expiry.
  - Broadcast delivery status.

### 9.4.3.2 Nnef\_MBSSession\_Create service operation

**Service operation name:** Nnef\_MBSSession\_Create

**Description:** Create a new multicast session or broadcast session, or for a location dependent MBS session, the part of the MBS session within a service area. Optionally implicitly subscribe to notifications for this MBS session.

**Input, Required:** MBS Session ID (SSM or TMGI) or TMGI allocation request, MBS Service Type (broadcast or multicast).

**Input, Optional:** MBS service area (mandatory for broadcast. Can be Cell ID list and/or TAI list, or geographical area information, or civic address information), MBS start time, MBS stop time, MBS Service Information (as defined in clause 6.14), Input Transport Address Request, session state (Active/Inactive), for subscription to notifications notification target address. For a multicast session, indication that any UE may join the multicast session. Request for location dependent MBS session. For a broadcast session, MBS FSA ID(s).

**Output, Required:** Result Indication.

**Output, Optional:** TMGI, Cause, MB-UPF tunnel info, MBS FSA ID(s), Area Session ID.

### 9.4.3.3 Nnef\_MBSSession\_Update service operation

**Service operation name:** Nnef\_MBSSession\_Update

**Description:** This service is used by the NF service consumer to update the established multicast session or broadcast session, or for a location dependent MBS session, the part of the MBS session within a service area, e.g. QoS update. For multicast MBS Session, this service is also used to activate or deactivate the MBS Session.

**Input, Required:** MBS Session ID.

**Input, Optional:** MBS Service Information (as defined in clause 6.14), MBS service area, session state (Active/Inactive), Area Session ID. For a broadcast session, MBS FSA ID(s).

**Output, Required:** Result Indication.

**Output, Optional:** Cause, MBS FSA ID(s).

### 9.4.3.4 Nnef\_MBSSession\_Delete service operation

**Service operation name:** Nnef\_MBSSession\_Delete

**Description:** This service is used to delete the multicast or broadcast MBS session, or for a location dependent MBS session, the part of the MBS session within a service area.

**Input, Required:** MBS Session ID.

**Input, Optional:** Area Session ID.

**Output, Required:** Result Indication.

**Output, Optional:** Cause.

#### 9.4.3.5 Nnef\_MBSSession\_StatusNotify service operation

**Service operation name:** Nnef\_MBSSession\_StatusNotify

**Description:** This service is used by the MB-SMF to notify the NF service consumers of the subscribed events related to an MBS session, or for a location dependent MBS session, related to the part of the MBS session within a service area.

**Inputs, Required:** Status Information, MBS Session ID.

**Inputs, Optional:** Area Session ID.

**Outputs, Required:** None.

**Outputs, Optional:** None.

#### 9.4.3.6 Nnef\_MBSSession\_StatusSubscribe service operation

**Service operation name:** Nnef\_MBSSession\_StatusSubscribe

**Description:** This service is used by the NF service consumers to subscribe to the MBS Session status information of an MBS session, or for a location dependent MBS session, of the part of the MBS session within a service area.

**Inputs, Required:** Status Information, MBS Session ID.

**Inputs, Optional:** Area Session ID.

**Outputs, Required:** None.

**Outputs, Optional:** None.

#### 9.4.3.7 Nnef\_MBSSession\_StatusUnsubscribe service operation

**Service operation name:** Nnef\_MBSSession\_StatusUnsubscribe

**Description:** This service is used by the NF service consumers to unsubscribe to the MBS Session status information of an MBS session or for a location dependent MBS session, of the part of the MBS session within a service area.

**Inputs, Required:** Status Information, MBS Session ID.

**Inputs, Optional:** Area Session ID.

**Outputs, Required:** None.

**Outputs, Optional:** None.

## 9.5 MBSF Services

MBSF services are defined in TS 26.502 [18].

## Annex A (normative): Configuration options at Service and/or Application for MBS

Figure A-1 provides the reference architecture with all configuration variants for Application Function interaction with 5G Core Network, usage of NEF or MBSF in the control plane, and usage of N6, MB2-U or xMB-U in user plane.

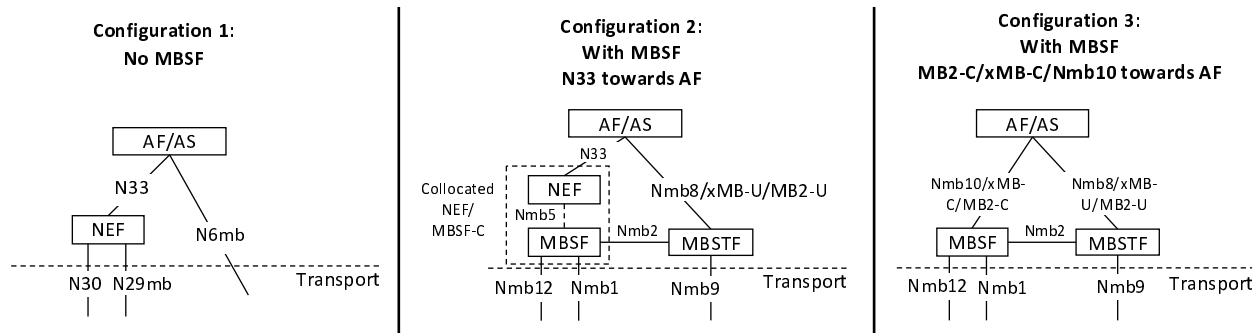

**Figure A-1: Configuration options at Service and/or Application**

The following characteristics describe each of the Configuration options:

- Configuration Option 1: No MBSF:
  - This configuration is used for Transport Only Mode (i.e. MBS provides only transport of MBS data in a transparent manner without modifying the data), when the Multicast service or Broadcast service does not require service layer interworking with LTE MBMS.
  - The control plane entry point for the Application Function outside the trusted domain towards 5GC to request establishment of an MBS session is the NEF via N33.
  - An application function within the trusted domain can directly use the N30, N5 and N29mb service based interfaces. In this case some NEF functionality related to PCF and MB-SMF interaction is incorporated in AF.

NOTE 1: Application function within the trusted domain selects MB-SMF based on e.g. its local configuration, or query NRF based on location, etc.

- The user plane entry point for the Application Function towards 5GC is the MB-UPF via N6mb.
- Configuration Option 2: MBSF, N33 towards AF:
  - This configuration may be used for Service Mode (i.e. MBS provides service layer capability, allows to modify the data), or when service layer interworking with LTE MBMS is required.
  - When interworking with LTE MBMS for Transport Only Mode services, N33/Nmb5 and Nmb8 provide the same functionalities as N33/N13mb and N6mb respectively.
  - The control plane entry point from the Application Function to request establishment of an MBS session is the NEF via N33.
  - The user plane entry point for the Application Function towards 5GC is the MBSTF via MB2-U, xMB-U or Nmb8.
  - The NEF and MBSF may be collocated.
  - If the MBSF is not collocated with the NEF, the reference point between the NEF and MBSF is Nmb5.
  - An application function within the trusted domain may be collocated with MBSF.
- Configuration Option 3: MBSF, MB2-C/xMB-C/Nmb10 towards AF:

- This configuration may be used for Service Mode (xMB-C or Nmb10), or when interworking with LTE MBMS is required (MB2-C, xMB-C or Nmb10).
- When interworking with LTE MBMS for Transport Only Mode services, Nmb10 and Nmb8 provide the same functionalities as Nmb13 and N6mb respectively.
- The control plane entry point from the Application Function to request establishment of an MBS session is the MBSF via MB2-C, xMB-C or Nmb10.
- The user plane entry point for the Application Function is the MBSTF via MB2-U, xMB-U or Nmb8.

For service mode, MBSF shall be used, i.e. either Configuration 2 or Configuration 3 shall be used. In this case, the MBSF instructs the MBSTF to modify the MBS data (e.g. including the FEC or MBS data transcoding).

For Configuration Option 2 and Option 3, when interworking with LTE MBMS is used, LTE MBMS and MBS use the same mode (i.e. both use Transport Only Mode or Service Mode).

For Transport Only mode:

- If interworking with LTE MBMS at 5GC is required for the service, MBSF and MBSTF shall be used, i.e. either Configuration 2 or Configuration 3 shall be used.
- If interworking with LTE MBMS is not required for the service, MBSF and MBSTF are optional.

NOTE 2: Interworking providing by AF is out of scope of this specification.

MBSTF shall be used when MBSF is used.

Any particular deployment may support any combination of these configurations.

---

## Annex B (informative): Service levels for multicast communication service

The following service levels for the multicast communication service are defined:

NOTE 1: Transport Only mode and Full-Service mode of operation as defined in TS 23.246 [8] differ from the service levels defined here.

- **Basic service level.** The following requirements are defined:
  - Media transported transparently through the 5GS.
  - Interactions between UE and network for receiving the multicast communication service.
  - Packet distribution from the 5GS ingress to NG-RAN node(s).
  - Data delivery from NG-RAN node(s) to the UE.
- **Enhanced service level**, with additional requirements on top of basic service level. Different requirements out of the set below may be necessary to address each use case:
  - Local MBS service.
  - User authentication and authorization for Multicast MBS session.

NOTE 2: User authentication and authorization is an optional feature in 5GS.

- Explicit configuration of Multicast MBS session by AF, including group member information.
- Enhanced QoS support. E.g. to differentiate MBS data flow with different QoS over 5GS.

## Annex C (normative): Interworking at reference points MB2 and xMB

To allow the MBS System to interwork with a GCS AS supporting the MB2 interfaces defined in TS 23.468 [10]:

- In addition to supporting the Nmbssf service-based API at Nmb10 (as defined in clause 5.1) the MBSF shall support interfaces MB2 C.
- In addition to supporting content ingest interfaces defined in TS 26.502 [18] at Nmb8 (as defined in clause 5.1) the MBSTF shall support interfaces MB2 U.

To allow the MBS System to interwork with a Content Provider supporting the xMB interfaces defined in TS 26.348 [11]:

- In addition to supporting the Nmbssf service-based API at Nmb10 (as defined in clause 5.1) the MBSF shall support interface xMB C.
- In addition to supporting content ingest interfaces defined in TS 26.502 [18] at Nmb8 (as defined in clause 5.1) the MBSTF shall support interface xMB U.

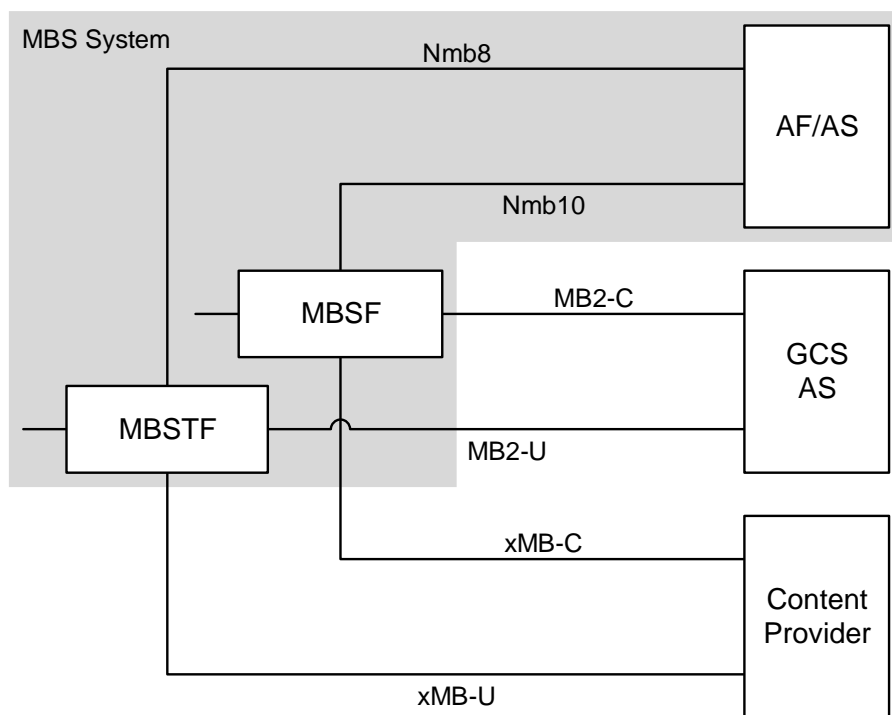

**Figure C-1: Interworking with GCS AS supporting MB2 interfaces and with Content Provider supporting xMB interfaces**

## Annex D (informative): Change history



Change history							
Date	Meeting	TDoc	CR	Rev	Cat	Subject/Comment	New version
2021-03	SA2#143E	S2-2101423	-	-	-	TS skeleton approved at S2#143E	0.0.0
2021-06	SA#92E	SP-210368	-	-	-	MCC editorial update for presentation to TSG SA#92E for information	1.0.0
2021-09	SA#93E	SP-210941	-	-	-	MCC editorial update for presentation to TSG SA#93E for approval	2.0.0
2021-09	SA#93E	-	-	-	-	MCC editorial update for publication after TSG SA#93E approval	17.0.0
2021-12	SA#94E	SP-211285	0001	-	F	Clarification on interworking with EPS	17.1.0
2021-12	SA#94E	SP-211285	0002	3	F	MBS Session Management vs Configuration	17.1.0
2021-12	SA#94E	SP-211285	0006	1	F	Multicast MBS Session: resolving ENs and cleanup	17.1.0
2021-12	SA#94E	SP-211285	0008	2	F	Interworking with MBMS over E-UTRAN for broadcast service	17.1.0
2021-12	SA#94E	SP-211285	0010	2	F	Local MBS service and Location dependent MBS service	17.1.0
2021-12	SA#94E	SP-211285	0012	1	F	Multicast session join and session establishment	17.1.0
2021-12	SA#94E	SP-211285	0014	3	F	Multicast session leave and session release	17.1.0
2021-12	SA#94E	SP-211285	0015	3	F	Clarifications on functional entities	17.1.0
2021-12	SA#94E	SP-211285	0019	2	F	NRF service operation for broadcast service	17.1.0
2021-12	SA#94E	SP-211285	0021	4	F	Clarification of the local MBS service	17.1.0
2021-12	SA#94E	SP-211285	0022	4	F	Leftover issue for MBS session activation and deactivation	17.1.0
2021-12	SA#94E	SP-211285	0023	1	F	Lossless handover for MBS session	17.1.0
2021-12	SA#94E	SP-211285	0025	1	F	When UE joining UE authorization for the multicast MBS session	17.1.0
2021-12	SA#94E	SP-211285	0026	3	F	Miscellaneous corrections	17.1.0
2021-12	SA#94E	SP-211285	0027	1	F	Clarification on User Plane Management	17.1.0
2021-12	SA#94E	SP-211285	0029	4	F	Updates on cases that SMF rejects UE join request	17.1.0
2021-12	SA#94E	SP-211285	0031	1	D	Editorial modification on terms, abbreviations	17.1.0
2021-12	SA#94E	SP-211285	0032	1	F	Modification on session join and shared tunnel establishment related procedures	17.1.0
2021-12	SA#94E	SP-211285	0033	1	F	Modification on session leave and shared tunnel release related procedures	17.1.0
2021-12	SA#94E	SP-211285	0035	2	F	Modification on handover procedures	17.1.0
2021-12	SA#94E	SP-211285	0038	3	F	Replacement reference architecture figures	17.1.0
2021-12	SA#94E	SP-211286	0041	1	F	Update to the Multicast session join and session establishment, and removing procedure.	17.1.0
2021-12	SA#94E	SP-211286	0043	1	F	Clarification on the MBS service activation/deactivation/update and related service operation	17.1.0
2021-12	SA#94E	SP-211286	0044	1	F	modification on the MBS Broadcast session management	17.1.0
2021-12	SA#94E	SP-211286	0045	1	F	Clarification on the Qos handling and Policy control in the clause 6	17.1.0
2021-12	SA#94E	SP-211286	0050	2	F	PCC related MBS corrections	17.1.0
2021-12	SA#94E	SP-211286	0051	1	F	Corrections to MBS Broadcast Session Establishment	17.1.0
2021-12	SA#94E	SP-211286	0054	-	F	Clarification on local multicast	17.1.0
2021-12	SA#94E	SP-211286	0055	1	F	Minimize multicast service interruption caused by unintended PDU session release	17.1.0
2021-12	SA#94E	SP-211286	0057	1	F	Multicast MBS service for SNPN	17.1.0
2021-12	SA#94E	SP-211286	0060	1	F	Updates to NF services for MBS	17.1.0
2021-12	SA#94E	SP-211286	0062	1	F	Modification on activation procedure	17.1.0
2021-12	SA#94E	SP-211286	0064	1	F	Clarification on NF services	17.1.0
2021-12	SA#94E	SP-211286	0066	1	F	Clarification on Annex A for transport mode	17.1.0
2021-12	SA#94E	SP-211286	0067	1	F	Fixing the EN and Nmbsmf_MBSSession service operation parameters.	17.1.0
2021-12	SA#94E	SP-211286	0068	1	F	clarification on PDR and FAR in A-UPF for MBS data traffic in individual delivery	17.1.0
2021-12	SA#94E	SP-211286	0073	1	F	Clarification on the input of PCF/NEF/MB-SMF service operation	17.1.0
2021-12	SA#94E	SP-211286	0074	1	F	Broadcast Frequency selection Identifier	17.1.0
2022-03	SA#95E	SP-220052	0075	1	F	Clarification on MBS Session Update procedures	17.2.0
2022-03	SA#95E	SP-220052	0077	1	D	Adding a heading of clause 5	17.2.0
2022-03	SA#95E	SP-220052	0078	1	F	Corrections for Location dependent MBS session	17.2.0
2022-03	SA#95E	SP-220052	0079	-	F	Removing UE from Multicast MBS Session	17.2.0
2022-03	SA#95E	SP-220052	0081	1	F	Resolving ENs, cleanup and corrections	17.2.0
2022-03	SA#95E	SP-220052	0083	1	F	Corrections to MBS procedures for broadcast Session	17.2.0
2022-03	SA#95E	SP-220052	0085	1	F	Paging strategy handling for multicast MBS session	17.2.0
2022-03	SA#95E	SP-220052	0086	1	F	Restoration of multicast MBS session following AN release	17.2.0
2022-03	SA#95E	SP-220052	0089	1	F	Miscellaneous corrections on TS 23.247	17.2.0
2022-03	SA#95E	SP-220052	0092	1	F	MBS Frequency Selection Area Identifier	17.2.0
2022-03	SA#95E	SP-220052	0093	1	F	Indication whether MBS session is active	17.2.0
2022-03	SA#95E	SP-220052	0095	1	F	Resolving the PCC related EN and issue	17.2.0
2022-03	SA#95E	SP-220052	0096	1	F	Clarification on the MBS session Create and update procedure.	17.2.0
2022-06	SA#96	SP-220395	0090	5	F	Clarification of MBS data forwarding	17.3.0
2022-06	SA#96	SP-220395	0101	1	F	Correction on the mobility procedures for MBS	17.3.0
2022-06	SA#96	SP-220395	0102	-	F	Broadcast MBS Session Release Require Procedure	17.3.0
2022-06	SA#96	SP-220395	0103	1	F	MBS Service Area for MB-SMF selection in TMGI Allocation	17.3.0
2022-06	SA#96	SP-220395	0104	1	F	Alignment with RAN3 and other corrections	17.3.0

2022-06	SA#96	SP-220395	0105	1	F	Correction to MBS Session Context and MBS Session Activation procedure	17.3.0
2022-06	SA#96	SP-220395	0106	1	F	Resolve the residual ENs and Clean-up in TS 23.247	17.3.0
2022-06	SA#96	SP-220395	0107	1	F	Mega CR to clean up	17.3.0
2022-06	SA#96	SP-220395	0110	-	F	Clarification on MBS security function	17.3.0
2022-06	SA#96	SP-220395	0111	1	F	Usage of NAS message for UE joining procedure	17.3.0
2022-06	SA#96	SP-220395	0112	-	F	Clarification on MBS session activation procedure	17.3.0
2022-06	SA#96	SP-220395	0113	-	F	Clarification on Activation procedure	17.3.0
2022-06	SA#96	SP-220395	0115	1	F	Clarification on local dependent MBS session	17.3.0
2022-06	SA#96	SP-220395	0116	1	F	Miscellaneous corrections	17.3.0
2022-06	SA#96	SP-220395	0117	-	F	Clarifications on traffic usage reporting and charging	17.3.0
2022-06	SA#96	SP-220395	0119	1	F	Tunnel between MBSTF and MB-UPF	17.3.0
2022-09	SA#97E	SP-220775	0109	4	F	Update of PCC procedure for 5MBS	17.4.0
2022-09	SA#97E	SP-220775	0122	-	F	MBS Session Status and broadcast MBS Session	17.4.0
2022-09	SA#97E	SP-220775	0124	-	F	Clarification on local multicast	17.4.0
2022-09	SA#97E	SP-220775	0126	1	F	Correction to MB-SMF update in NRF	17.4.0
2022-09	SA#97E	SP-220775	0127	1	F	Correction and editorial improvement	17.4.0
2022-09	SA#97E	SP-220775	0130	1	F	Clarification on the mobility in RRC inactive	17.4.0
2022-09	SA#97E	SP-220775	0132	1	F	Removing the EN on the HO	17.4.0

---

# History

<b>Document history</b>		
V17.2.0	May 2022	Publication
V17.3.0	July 2022	Publication
V17.4.0	September 2022	Publication