

ETSI TS 123 251 V15.1.0 (2018-09)



**Universal Mobile Telecommunications System (UMTS);
LTE;
Network sharing;
Architecture and functional description
(3GPP TS 23.251 version 15.1.0 Release 15)**



Reference

RTS/TSGS-0223251vf10

Keywords

LTE,UMTS

ETSI

650 Route des Lucioles
F-06921 Sophia Antipolis Cedex - FRANCE

Tel.: +33 4 92 94 42 00 Fax: +33 4 93 65 47 16

Siret N° 348 623 562 00017 - NAF 742 C
Association à but non lucratif enregistrée à la
Sous-Préfecture de Grasse (06) N° 7803/88

Important notice

The present document can be downloaded from:

<http://www.etsi.org/standards-search>

The present document may be made available in electronic versions and/or in print. The content of any electronic and/or print versions of the present document shall not be modified without the prior written authorization of ETSI. In case of any existing or perceived difference in contents between such versions and/or in print, the only prevailing document is the print of the Portable Document Format (PDF) version kept on a specific network drive within ETSI Secretariat.

Users of the present document should be aware that the document may be subject to revision or change of status.

Information on the current status of this and other ETSI documents is available at

<https://portal.etsi.org/TB/ETSIDeliverableStatus.aspx>

If you find errors in the present document, please send your comment to one of the following services:

<https://portal.etsi.org/People/CommiteeSupportStaff.aspx>

Copyright Notification

No part may be reproduced or utilized in any form or by any means, electronic or mechanical, including photocopying and microfilm except as authorized by written permission of ETSI.

The content of the PDF version shall not be modified without the written authorization of ETSI.

The copyright and the foregoing restriction extend to reproduction in all media.

© ETSI 2018.

All rights reserved.

DECT™, **PLUGTESTS™**, **UMTS™** and the ETSI logo are trademarks of ETSI registered for the benefit of its Members.

3GPP™ and **LTE™** are trademarks of ETSI registered for the benefit of its Members and of the 3GPP Organizational Partners.

oneM2M logo is protected for the benefit of its Members.

GSM® and the GSM logo are trademarks registered and owned by the GSM Association.

Intellectual Property Rights

Essential patents

IPRs essential or potentially essential to normative deliverables may have been declared to ETSI. The information pertaining to these essential IPRs, if any, is publicly available for **ETSI members and non-members**, and can be found in ETSI SR 000 314: *"Intellectual Property Rights (IPRs); Essential, or potentially Essential, IPRs notified to ETSI in respect of ETSI standards"*, which is available from the ETSI Secretariat. Latest updates are available on the ETSI Web server (<https://ipr.etsi.org/>).

Pursuant to the ETSI IPR Policy, no investigation, including IPR searches, has been carried out by ETSI. No guarantee can be given as to the existence of other IPRs not referenced in ETSI SR 000 314 (or the updates on the ETSI Web server) which are, or may be, or may become, essential to the present document.

Trademarks

The present document may include trademarks and/or tradenames which are asserted and/or registered by their owners. ETSI claims no ownership of these except for any which are indicated as being the property of ETSI, and conveys no right to use or reproduce any trademark and/or tradename. Mention of those trademarks in the present document does not constitute an endorsement by ETSI of products, services or organizations associated with those trademarks.

Foreword

This Technical Specification (TS) has been produced by ETSI 3rd Generation Partnership Project (3GPP).

The present document may refer to technical specifications or reports using their 3GPP identities, UMTS identities or GSM identities. These should be interpreted as being references to the corresponding ETSI deliverables.

The cross reference between GSM, UMTS, 3GPP and ETSI identities can be found under <http://webapp.etsi.org/key/queryform.asp>.

Modal verbs terminology

In the present document "**shall**", "**shall not**", "**should**", "**should not**", "**may**", "**need not**", "**will**", "**will not**", "**can**" and "**cannot**" are to be interpreted as described in clause 3.2 of the [ETSI Drafting Rules](#) (Verbal forms for the expression of provisions).

"**must**" and "**must not**" are **NOT** allowed in ETSI deliverables except when used in direct citation.

Contents

Intellectual Property Rights	2
Foreword.....	2
Modal verbs terminology.....	2
Foreword.....	5
Introduction	5
1 Scope	6
2 References	6
3 Definitions and abbreviations.....	7
3.1 Definitions	7
3.2 Void.....	8
3.3 Abbreviations	8
4 General Description.....	8
4.1 Overview	8
4.2 Core Network Operator and Network Selection.....	9
4.2.1 Core network operator identity	9
4.2.2 Broadcast system information for network sharing	10
4.2.3 Network selection in a shared network	10
4.2.3.1 Behaviour of supporting UEs (GERAN, UTRAN and E-UTRAN).....	10
4.2.3.2 Behaviour of non-supporting UEs (GERAN, UTRAN).....	10
4.2.4 Assignment of core network operator and core network node.....	10
4.2.5 PS and CS domain registration coordination in UTRAN and GERAN	11
4.2.5a PS and CS domain registration coordination in E-UTRAN.....	11
4.2.5.1 Void.....	12
4.2.5.2 Void.....	12
4.2.5.3 CS/PS domain coordination and operator selection in GERAN and UTRAN	12
4.2.6 Attach/detach handling	13
4.3 Network Name Display for Supporting UEs	13
4.4 HPLMN Support	13
4.5 Support of Cell Broadcast Services and Warning System.....	14
4.6 Support of Extended Access Barring.....	14
4.7 Support of service identification for improved radio utilization for GERAN	14
5 Functional description	14
5.1 UE functions.....	14
5.2 RNC functions	14
5.2a eNodeB functions	15
5.2b BSC functions	15
5.3 MSC functions.....	17
5.4 SGSN functions.....	17
5.5 MME functions	18
6 Charging and accounting aspects	20
7 Example signalling flows	20
7.1 Network selection.....	20
7.1.2 Non-supporting UEs in a GWCN configuration.....	20
7.1.3 Supporting UEs in a GWCN configuration	21
7.1.4 Non-supporting UEs in a MOCN configuration	22
7.1.4.1 UTRAN based MOCN configuration.....	22
7.1.4.2 GERAN based MOCN configuration.....	25
7.1.4.3 CS registration after PS Handover	28
7.1.5 Supporting UEs in a MOCN configuration.....	30
7.1.5.1 UTRAN based MOCN configuration.....	30
7.1.5.2 GERAN based MOCN configuration.....	31
7.1.6 Query to opposite domain.....	32

Annex A (informative):	Network Resource Indicator (NRI) allocation examples.....	33
A.1	NRI in shared UTRAN/GERAN networks	33
A.2	Alternatives for NRI split in UTRAN and GERAN.....	34
A.3	NRI and CS/PS coordination in GWCN	35
A.4	CS/PS Coordination	35
Annex B (normative):	Interaction with other network capabilities	38
B.1	General	38
B.2	Support for RAN sharing for CSG and hybrid cells.....	38
Annex C (informative):	Change History	39
History	40

Foreword

This Technical Specification has been produced by the 3rd Generation Partnership Project (3GPP).

The contents of the present document are subject to continuing work within the TSG and may change following formal TSG approval. Should the TSG modify the contents of the present document, it will be re-released by the TSG with an identifying change of release date and an increase in version number as follows:

Version x.y.z

where:

- x the first digit:
 - 1 presented to TSG for information;
 - 2 presented to TSG for approval;
 - 3 or greater indicates TSG approved document under change control.
- y the second digit is incremented for all changes of substance, i.e. technical enhancements, corrections, updates, etc.
- z the third digit is incremented when editorial only changes have been incorporated in the document.

Introduction

Network sharing is a way for operators to share the heavy deployment costs for mobile networks, especially in the roll-out phase. In the current mobile telephony marketplace, functionality that enables various forms of network sharing is becoming more and more important. These aspects have not really been addressed before Release 6 in 3GPP UTRAN based access networks, before Release 8 in 3GPP E-UTRAN based access networks and before Release 10 in 3GPP GERAN based access networks, although there has been functionality that supports a very basic type of network sharing since the Release 5 versions of the 3GPP specifications.

To cope with 3GPP pre-Release 6 UTRAN UEs and with non supporting 3GPP GERAN UEs, this specification describes extra functionality for MSCs, SGSNs, BSCs and RNCs in order to provide network sharing functionality to "non-supporting UEs".

In this Release of the specifications, all UTRAN and E-UTRAN capable UEs are required to support the UTRAN and E-UTRAN network sharing requirements. Hence the E-UTRAN and MMEs (which were introduced in 3GPP Release 8) do not need functionality to handle "non-supporting UEs".

Scenarios and user requirements are described in TR 22.951 [1], while the current document presents the stage 2 details and descriptions of how these requirements are supported in a 3GPP GERAN, UTRAN and/or E-UTRAN based network.

1 Scope

The present document covers the details of Network Sharing for GERAN, UTRAN and E-UTRAN. It shows how several core network operators can share one radio access network and details the impacts on the network architecture. All UEs shall comply with existing requirements, among them PLMN selection and system information reception. The present document also defines requirements for network-sharing supporting UEs.

2 References

The following documents contain provisions which, through reference in this text, constitute provisions of the present document.

- References are either specific (identified by date of publication, edition number, version number, etc.) or non-specific.
- For a specific reference, subsequent revisions do not apply.
- For a non-specific reference, the latest version applies. In the case of a reference to a 3GPP document (including a GSM document), a non-specific reference implicitly refers to the latest version of that document *in the same Release as the present document*.

- [1] 3GPP TR 22.951: "Service Aspects and Requirements for Network Sharing".
- [2] 3GPP TR 21.905: "Vocabulary for 3GPP Specifications".
- [3] 3GPP TS 25.331: "RRC Protocol Specification".
- [4] 3GPP TS 23.122: "NAS Functions related to Mobile Station (MS) in idle mode".
- [5] 3GPP TS 32.250: "Telecommunication management; Charging management; Circuit Switched (CS) domain charging".
- [6] 3GPP TS 32.251: "Telecommunication management; Charging management; Packet Switched (PS) domain charging".
- [7] 3GPP TS 24.008: "Mobile radio interface Layer 3 specification; Core network protocols; Stage 3".
- [8] 3GPP TS 23.236: "Intra-domain connection of Radio Access Network (RAN) nodes to multiple Core Network (CN) nodes".
- [9] 3GPP TS 23.401: "Technical Specification Group Services and System Aspects; GPRS enhancements for E-UTRAN access".
- [10] 3GPP TS 36.300: "Evolved Universal Terrestrial Radio Access (E-UTRA) and Evolved Universal Terrestrial Radio Access (E-UTRAN); Overall description; Stage 2".
- [11] 3GPP TS 36.331: "Evolved Universal Terrestrial Radio Access (E-UTRA); Radio Resource Control (RRC); Protocol specification".
- [12] 3GPP TS 24.301: "Non-Access-Stratum (NAS) protocol for Evolved Packet System (EPS); Stage 3".
- [13] 3GPP TS 25.413: "UTRAN Iu interface, Radio Access Network Application Part (RANAP) signalling".
- [14] 3GPP TS 36.413: "Evolved Universal Terrestrial Radio Access Network (E-UTRAN); S1 Application Protocol (S1AP)".
- [15] 3GPP TS 23.272: "Circuit Switched (CS) fallback in Evolved Packet System (EPS); Stage 2".
- [16] 3GPP TS 44.018: "Radio Resource Control RRC Protocol Specification".
- [17] 3GPP TS 25.467: "UTRAN architecture for 3G Home Node B (HNB); Stage 2".

- [18] 3GPP TS 22.042: "Network Identity and Time Zone (NITZ); Service description; Stage 1".
- [19] 3GPP TS 44.064: "General Packet Radio Service (GPRS); Mobile Station - Serving GPRS Support Node (MS SGSN) Logical Link Control (LLC) layer specification".
- [20] 3GPP TS 23.041: "Technical realization of Cell Broadcast Service (CBS)".
- [21] 3GPP TS 29.280: "3GPP Sv interface (MME to MSC, and SGSN to MSC) for SRVCC".
- [22] 3GPP TS 23.060: "General Packet Radio Service (GPRS); Service description; Stage 2".
- [23] 3GPP TS 22.011: "Service Accessibility".
- [24] 3GPP TS 48.018: "General Packet Radio Service (GPRS); Base Station System (BSS) - Serving GPRS Support Node (SGSN); BSS GPRS Protocol (BSSGP)".
- [25] 3GPP TS 48.008: "Mobile-services Switching Centre Base Station System (MSC BSS) interface; Layer 3 specification".
- [26] 3GPP TS 29.018: "General Packet Radio Service (GPRS); Serving GPRS Support Node (SGSN) Visitors Location Register (VLR); Gs interface layer 3 specification".
- [27] 3GPP TS 29.118: "Mobility Management Entity (MME) - Visitor Location Register (VLR) SGs interface specification".

3 Definitions and abbreviations

3.1 Definitions

For the purposes of the present document, the following terms and definition below apply. Terms and definitions not defined below can be found in TR 21.905 [2].

Conventional network: A PLMN consisting of radio access network and core network, by which only one serving operator provides services to its subscriber. Subscribers of other operators may receive services by national or international roaming.

Common PLMN: The PLMN-id indicated in the system broadcast information as defined for conventional networks, which non-supporting UEs understand as the serving operator.

Core network operator: An operator that provides services to subscribers as one of multiple serving operators that share at least a radio access network. Each core network operator may provide services to subscriber of other operators by national or international roaming.

Gateway Core Network: A network sharing configuration in which parts of the core network (MSCs/SGSNs/MMEs) are also shared.

Multi-Operator Core Network: A network-sharing configuration in which only the RAN is shared.

Non-supporting UE: A UE that does not support network sharing in the sense that it ignores the additional broadcast system information that is specific for network sharing for 3GPP UTRAN and GERAN. In other specifications, the term "network sharing non-supporting UE" may be used.

Supporting UE: A UE that supports network sharing in the sense that it is able to select a core network operator as the serving operator within a shared network. In other specifications, the term "network sharing supporting UE" may be used.

Anchor PLMN: With regard to SRVCC from CS to PS, this Anchor PLMN points to the PS domain operator in which the voice media is anchored in Access Transfer Gateway as part of the SRVCC procedure.

3.2 Void

3.3 Abbreviations

For the purposes of the present document, the abbreviations given in TR 21.905 [2] and the following apply. An abbreviation defined in the present document takes precedence over the definition of the same abbreviation, if any, in TR 21.905 [2].

BSC	Base Station Controller
CN	Core Network
E-UTRAN	Evolved Universal Terrestrial Radio Access Network
eNodeB	E-UTRAN NodeB
gsmSCF	GSM Service Control Function
GERAN	GSM/EDGE Radio Access Network
GUTI	Globally Unique Temporary Identity
GWCN	Gateway Core Network
HLR	Home Location Register
HSS	Home Subscriber Server
MCC	Mobile Country Code
MME	Mobility Management Entity
MNC	Mobile Network Code
MOCN	Multi-Operator Core Network
MSC	Mobile Switching Centre
NITZ	Network Identity and Time Zone
PLMN	Public Land Mobile Network
RNC	Radio Network Controller
SGSN	Serving GPRS Support Node
TMSI	Temporary Mobile Subscriber Identity
UE	User Equipment
UTRAN	Universal Terrestrial Radio Access Network
VLR	Visitor Location Register

4 General Description

4.1 Overview

A network sharing architecture shall allow different core network operators to connect to a shared radio access network. The operators do not only share the radio network elements, but may also share the radio resources themselves. In addition to this shared radio access network the operators may or may not have additional dedicated radio access networks, like for example, 2G radio access networks. There are two identified architectures to be supported by network sharing. They are shown in the figures below.

In both architectures, the radio access network is shared. Figure 1 below shows reference architecture for network sharing in which also MSCs and SGSNs are shared. This configuration will be referred to as a Gateway Core Network (GWCN) configuration.

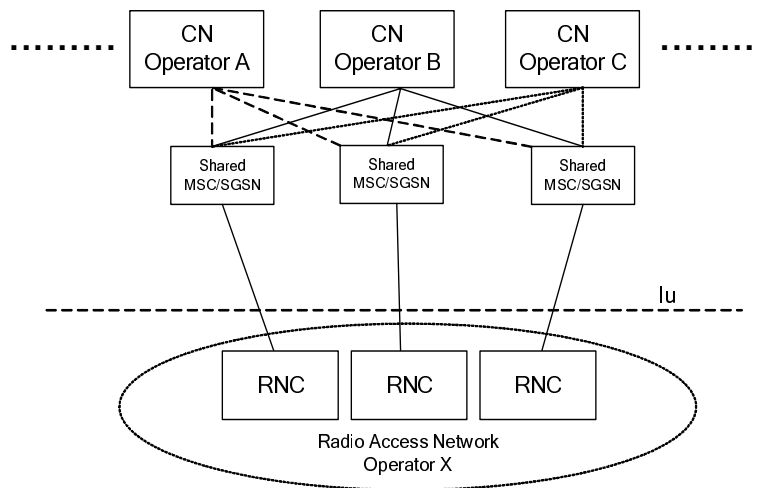

Figure 1: A Gateway Core Network (GWCN) configuration for network sharing. Besides shared radio access network nodes, the core network operators also share core network nodes

Figure 2 below shows the reference architecture for network sharing in which only the radio access network is shared, the Multi-Operator Core Network (MOCN) configuration.

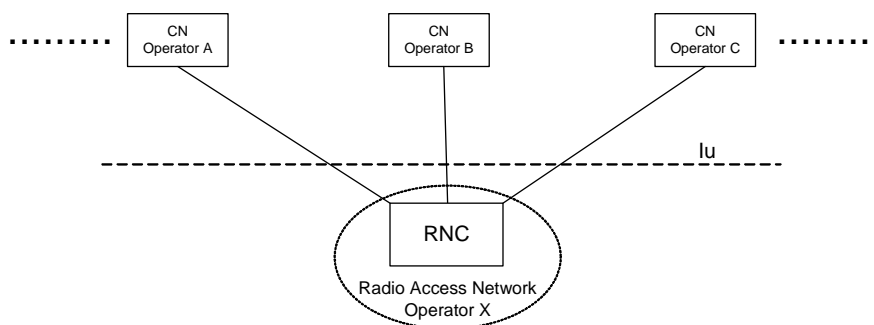

Figure 2: A Multi-Operator Core Network (MOCN) in which multiple CN nodes are connected to the same RNC and the CN nodes are operated by different operators

The UE behaviour in both of these configurations shall be the same. No information concerning the configuration of a shared network shall be indicated to the UE.

For the Evolved Packet System, only the PS domain of the above figures is relevant. For E-UTRAN access Figures 1 and 2 both apply but with the MME replacing the SGSN, the eNodeB replacing the RNC, and the S1 reference point replacing the Iu interface.

For GERAN access, both GWCN and MOCN are applicable but with the BSC replacing the RNC and the A/Gb-Interfaces replacing the Iu interface.

4.2 Core Network Operator and Network Selection

Network sharing is an agreement between operators and shall be transparent to the user. This implies that a supporting UE needs to be able to discriminate between core network operators available in a shared radio access network and that these operators can be handled in the same way as operators in non-shared networks.

4.2.1 Core network operator identity

A core network operator is identified by a PLMN-id (MCC+MNC).

4.2.2 Broadcast system information for network sharing

If a shared RAN is configured to indicate available core network operators for selection by UEs, each cell in shared radio access network shall in the broadcast system information include information concerning available core network operators in the shared network.

The available core network operators shall be the same for all cells of a Location Area in a shared UTRAN or GERAN network.

For E-UTRAN, the Broadcast System Information broadcasts a basic set of PLMN IDs and optionally one or more additional set of PLMN IDs. All E-UTRAN UEs support reception of the basic set, only Release 14 and later E-UTRAN UEs are required to receive the additional set (see TS 36.331 [11]).

The available core network operators shall be the same for all cells of a Tracking Area in a shared E-UTRAN network. The basic and the additional sets allow different (sets of) PLMNs to have different cell ID and TAC.

A supporting UE decodes the broadcast system information and takes the information concerning available core network operators into account in network and cell (re-)selection procedures. Broadcast system information is specified in TS 44.018 [16] for GERAN, TS 25.331 [3] for UTRAN and TS 36.331 [11] for E-UTRAN.

4.2.3 Network selection in a shared network

4.2.3.1 Behaviour of supporting UEs (GERAN, UTRAN and E-UTRAN)

In some sharing scenarios, the sharing operators require the UTRAN/GERAN to broadcast, to non-supporting UEs, a PLMN ID that does not identify any of the sharing core network operators. In this case, it is necessary that a supporting UE does not select this "common PLMN ID".

In other sharing scenarios, the sharing operators may want the PLMN broadcast to non-supporting UEs to be selectable by supporting UEs.

A supporting UE decodes the broadcast system information to determine available core network operators in the shared network. The UE regards both the core network operators indicated in the broadcast system information and conventional networks as individual networks. The core network operators together with all conventional networks are candidate PLMNs for the PLMN selection procedure that shall be performed by the UE as specified in TS 23.122 [4].

In GERAN and UTRAN, non-supporting UEs use the broadcast "common PLMN-id" in their PLMN (re)selection processes.

In UTRAN, supporting UEs shall use the PLMN-ids that are broadcast in the Multiple PLMN ID List information element in their PLMN (re)selection processes. UTRAN AS signalling permits the Multiple PLMN ID List to indicate to supporting UEs whether to include or exclude the MCC+MNC of the "common PLMN-id" in their network (re)selection processes.

For supporting UEs, GERAN provides equivalent functionality to UTRAN.

For E-UTRAN, the UE uses all of the received broadcast PLMN-ids in its PLMN (re)selection processes.

4.2.3.2 Behaviour of non-supporting UEs (GERAN, UTRAN)

Non-supporting UEs ignore the broadcast system information that is relevant for network sharing. The common PLMN together with all conventional networks are candidate PLMNs for the PLMN selection procedure that shall be performed by the UE as specified in TS 23.122 [4].

It is recommended for the network and the UE to support the Network Identity part of the Network Identity and Time Zone (NITZ) feature (see TS 22.042 [18]) for providing the UE with the name of the serving PLMN operator.

4.2.4 Assignment of core network operator and core network node

When a UE performs an initial access to a shared network, one of available CN operators shall be selected to serve the UE. For non-supporting UEs, the shared network selects an operator from the available CN operators. For supporting UEs, the selection of core network operator by the UE shall be respected by the network. Supporting UEs inform the BSC/RNC/eNodeB of the network identity of the chosen core network operator.

In a UTRAN GWCN configuration, the RNC relays the chosen network identity to the shared core network node (in UTRAN MOCN, the RNC indicates that the UE is a "supporting UE" by relaying the chosen network identity to the core network node). To permit GWCN operation, in E-UTRAN, the eNodeB always relays the chosen network identity to the shared MME. In a GERAN GWCN configuration, the BSC relays the chosen network identity to the core network node (in GERAN MOCN, the BSC indicates that the UE is a "supporting UE" by relaying the chosen network identity to the core network node).

In a MOCN configuration, the RAN routes the UE's initial access to the shared network to one of the available CN nodes. Supporting UEs shall inform the RAN of the chosen core network operator so that the RAN can route correctly. For non-supporting UEs the shared network selects an operator from the available CN operators. A redirection to another CN operator may be required for non-supporting UEs until an operator is found that can serve the UE. Redirection is described in clause 7.1.4.

After initial access to the shared network the UE does not change to another available CN operator as long as the selected CN operator is available to serve the UE's location. Only the network selection procedures specified in TS 23.122 [4] may cause a reselection of another available CN operator. Also the network does not move the UE to another available CN operator, e.g. by handover, as long as the selected CN operator is available to serve the UE's location. Furthermore the UE does not change to another CN node as long as the selected CN node is available to serve the UE's location.

In GERAN and UTRAN, when the network signals location/routing area identities to supporting UEs, e.g. in location updating accept messages, these identities shall contain the chosen core network operator identity. For non-supporting UEs, they shall contain the common PLMN. The UE stores the received LAI/RAI on the SIM/USIM, as already specified in TS 24.008 [7].

In E-UTRAN, the chosen core network operator identity is included in the GUTI in e.g. the Attach Accept message. The UE shall store the received GUTI on the USIM according to the rules specified in TS 24.301 [12].

4.2.5 PS and CS domain registration coordination in UTRAN and GERAN

In conventional networks, the same CN operator always serves the UE in CS and PS domains. In a shared network, supporting UEs shall behave as UEs in conventional networks with respect to registration with CS and PS domains and always register with the same operator for the CS and PS domains. CS/PS coordination should be performed at registration when a redirect attempt flag is included in A/Gb/Iu messages carrying the NAS registration message (see TS 48.008 [25], TS 48.018 [24], and TS 25.413 [13]). The term registration includes attach, and LA and RA updates.

When multiple PLMNs are available and SRVCC from UTRAN/GERAN CS domain to E-UTRAN/HSPA PS is deployed, the source BSC/RNC determines a core network operator to be used in the target network based on current PLMN in use, Anchor PLMN provided by PS core network, or other information present in the BSC/RNC. The source BSC/RNC shall at handover indicate the selected core network operator to the source core network node in the handover required message. The anchor MSC Server shall forward the selected core network operator chosen by the source BSC/RNC to the target MME/SGSN.

4.2.5a PS and CS domain registration coordination in E-UTRAN

When multiple core network operators share the E-UTRAN using a GWCN configuration, separate MSCs may still be used for the CS Fall Back functionality. In this case the MME uses the 'selected network' information received from the E-UTRAN to select an MSC from the already selected operator.

When multiple PLMNs are available for CS domain, the MME selects the MSC for CS Fallback functionality based on the 'selected network' information received from the E-UTRAN, current TAI, old LAI provided by the UE and operator selection policies as specified in TS 23.272 [15]. In this case, the selected PLMN-id for CS domain may be different to the PLMN-id for EPS domain. If the selected MSC is shared network configured, the MME selects the CS domain operator as specified in TS 23.272 [15]. If the UE is a GERAN network-sharing non-supporting UE and the preferred RAT of the selected CS network is GERAN with GWCN configuration, or the preferred RAT of the selected CS network is shared network in GWCN configuration not offering the broadcast of available Core Network operators for selection by the UE, the MME sends the 'selected CS domain operator' in addition to the Common PLMN-id included in the LAI to the VLR. If the MSC is GWCN configured, the MSC applies local policy (e.g. uses a fixed split of IMSI ranges or IMSI hash) to determine the CN operator when the PLMN-id included in the LAI contains Common PLMN-id (i.e. does not identify any CS domain operator) and the 'selected CS domain operator' is absent. Otherwise, the MSC accepts the CS domain operator selected by the MME.

When multiple PLMNs are available for CS domain and SRVCC from E-UTRAN PS to UTRAN/GERAN CS domain is deployed, the MME sends the Handover Restriction List (see TS 23.401 [9]) to eNB including the currently serving PLMN and equivalent PLMNs together with information about which PLMNs are preferred for SRVCC. The eNB selects target PLMN for SRVCC from the list based on HRL and local policy and constructs the Neighbour Cell list (NCL) based on this knowledge of the target PLMN. The selected target core network PLMN should, if possible, be the same as the one in use.

4.2.5.1 Void

4.2.5.2 Void

4.2.5.3 CS/PS domain coordination and operator selection in GERAN and UTRAN

At combined or non-combined registration by a non-supporting UE the BSC/RNC routes the request to one of the available CN nodes. In all Attach Request/Routing Area Update Request/Location Area Update Request messages from the BSC/RNC to CN a redirect attempt flag shall be included to indicate that the CN should either return a Reroute Command or a Reroute Complete message. If the BSC/RNC can determine that the UE is already served by a CN operator in the opposite domain, then a CN node from this operator shall be selected and the serving CN operator shall be indicated to the CN node together with an indication that the selected CN operator is already serving the UE in the opposite domain. If the BSC/RNC cannot determine a CN operator this way, the selection of CN node by the BSC/RNC is based on the NRI if provided by the UE. The RAN stores the NRI received from the UE.

If the UE is already served by the CN node that receives the registration request and this CN node can continue to serve the UE (for example if there are no regional roaming restrictions for the target area), or if the UE is a non-roaming subscriber, or if the BSC/RNC indicated a BSC/RNC selected CN operator and that the selected CN operator is serving the UE in the opposite domain then the CN node accepts the registration attempt and completes the registration procedure. Otherwise the CN node returns IMSI and a Reroute Command message to the BSC/RNC with an indication that it is for coordination purposes. The old LAI (for the CS domain) or old RAI (for the PS domain), or an indication whether the UE is attaching shall also be included.

Based on information received from CN node (old LAI or old RAI), UE (CS-NRI or PS-NRI, as stored in the RAN) and BSC/RNC internal configuration the BSC/RNC concludes whether:

- (i) The UE is 'under operator coordination' i.e. if the UEs (CS-NRI, old LAI) tuple for the CS domain or (PS-NRI, old RAI) tuple for the PS domain can be used to uniquely identify one of the operators in the shared network. The old RAI/PS-NRI can be "native" (i.e. no RAT change) or "mapped" (i.e. RAT change).
- (ii) The UE is not 'under operator coordination' i.e. the UEs (CS-NRI, old LAI) tuple for the CS domain or (PS-NRI, old RAI) tuple for the PS domain cannot uniquely identify any operator in the shared network. The old RAI/PS-NRI can be "native" (i.e. no RAT change) or "mapped" (i.e. RAT change).
- (iii) The UE is attaching.

For case (i) the BSC/RNC selects serving CN operator based on the identified operator and routes the request to the selected operator. The IMSI and the BSC/RNC selected CN operator shall be indicated to the CN.

For case (ii) and (iii) the BSC/RNC shall for a (combined or non-combined) registration attempt in the PS domain query its connected MSCs, whether the UE is registered with any of the sharing operators in the CS domain. Similarly for a registration attempt in the CS domain the BSC/RNC shall query its connected SGSNs, whether the UE is registered at any of the sharing operators in the PS domain. For a registration attempt in the CS domain this means that the SGSNs on behalf of the BSC/RNC may be needed to query all MMEs that may hold the UEs context of the sharing operators whether the UE is registered at any of the MMEs of the sharing operators. Registration in MME but not in the CS domain can e.g. occur at cell reselection from LTE for a UE that is not SGs registered. If MMEs are not updated to support registration queries, it may not be possible to guarantee CS/PS coordination in certain scenarios.

For case (ii) and (iii) and if the UE is found to be registered with one of the sharing operators then that operator shall be selected by the BSC/RNC and the registration message shall be forwarded to a CN node of this operator. The BSC/RNC selected CN operator shall be indicated to the CN and the BSC/RNC shall indicate that BSC/RNC selected CN operator is serving the UE in the opposite domain.

For cases (ii) and (iii) and the UE is not found to be registered at one of the sharing operators then the BSC/RNC routes the request to one of the available CN operators. Selection of CN operator is done in the BSC/RNC by IMSI analysis, e.g. using a fixed split of IMSI ranges or IMSI hash table between operators, etc. The CN node / CN operator selection may result in that the registration is sent back to the same CN node or CN operator again. At non-combined registration CS/PS coordination is done in the BSC/RNC (without memorising IMSI information for IDLE mode UEs) by applying the same IMSI analysis for both CS and PS domains. The BSC/RNC selected CN operator shall be indicated to the CN and IMSI shall be included to the CN node.

If a registration attempt is ongoing in the PS domain when a registration attempt starts in the CS domain then the BSC/RNC selects operator as specified below and the IMSI and the BSC/RNC selected CN operator shall be sent to the CN node:

- If for the CS domain case (i) applies then that operator shall be selected for both domains.
- If for the CS domain case (ii) or (iii) applies then depending on:
 - If for the PS domain case (i) applies then that operator shall be selected for both domains
 - If for the PS domain case (ii) or (iii) applies then the BSC/RNC selects operator for both domains based on IMSI analysis

Similar handling applies if a registration attempt is ongoing in the CS domain when a registration attempt starts in the PS domain.

At combined registration the SGSN may indicate over Gs interface the selected CN operator that serves the subscriber.

NOTE: Support for CS/PS domain coordination functionality as specified in this release requires support in shared CN nodes (for GWCN) and non-shared CN nodes (for MOCN) as well as in the shared RAN to achieve CS/PS coordination for UEs in the shared network. If sufficient support is not available, CS/PS coordination is performed as in pre- Release 13.

4.2.6 Attach/detach handling

To attach to the same core network operator from which it detached, a UE uses information stored in the UE (e.g. on the SIM/USIM) when the UE was detached. For a supporting UE in a shared network, the stored information indicates the core network operator it detached from (as specified in clause 4.2.4). This information enables a supporting UE to attach to the same core network operator from which it detached. For non-supporting UEs in a shared network, the stored information indicates the common PLMN.

4.3 Network Name Display for Supporting UEs

A supporting UE shows the name of the PLMN-id it has registered with. In case of a shared network, it is the PLMN-id of the chosen core network operator. The name stored in the UE for the PLMN-id is displayed except when the network indicates to the UE a name to be displayed, as already specified for non-supporting UEs.

4.4 HPLMN Support

The use of a shared VLR/SGSN/MME shall not result in service restrictions, e.g. roaming restrictions. Since the HSS and gsmSCF derives whether the subscriber roams in H- or V-PLMN from the VLR/SGSN/MME identifier, a shared VLR/SGSN/MME in a GWCN shall be allocated a separate identifier from each operator sharing that CN node, i.e. a shared VLR/SGSN/MME has multiple identifiers. The VLR/SGSN/MME identifier of the user's serving CN operator (either the one selected by a supporting UE, or, the one allocated by the network for a non-supporting UE) shall be used in signalling with the HSS and the gsmSCF.

In the roaming scenario, the VPLMN shall ensure that any PLMN ID that is communicated to the HPLMN via any interface is that of the selected Core Network Operator for supporting UEs, or that of the allocated Core Network Operator for non-supporting UEs. An exception to this is that the HPLMN operator may specify in the inter-operator roaming/sharing agreement that for non-supporting UEs any PLMN ID that is communicated to the HPLMN is the Common PLMN ID.

When the MME/SGSN and PGW/GGSN pertain to the same PLMN, i.e. in non-roaming scenario and in roaming local breakout scenario, the PLMN ID (as described in TS 36.300 [10] constructed to define the ECGI) shall be communicated via ECGI to the PGW, and the Common PLMN ID shall be communicated in SAI/CGI to the PGW/GGSN for both supporting and non-supporting UEs.

4.5 Support of Cell Broadcast Services and Warning System

In shared networks Cell Broadcast and Warning System services are provided via a single common CBC, which connects to GERAN/UTRAN as described in TS 23.041 [20] and connects to E-UTRAN as described in TS 23.401 [9]. The deployment and configuration of the common CBC is per agreement between the sharing operators. The sharing operators need to coordinate the broadcast services between each other, e.g. how to provide Warning System services.

4.6 Support of Extended Access Barring

In shared networks, BSC/RNC/eNodeB shall provide independent support for the barring of MSs configured for Extended Access Barring (as defined in TS 22.011 [23]) for each sharing operator. The BSC/RNC/eNodeB may initiate Extended Access Barring for a specific sharing operator when all the SGSNs/MMEs belonging to that sharing operator connected to this BSC/RNC/eNodeB request to restrict the load for UEs configured for low access priority, or if requested by O&M. Broadcast Extended Access Barring information is specified in TS 44.018 [16] for GERAN, TS 25.331 [3] for UTRAN and TS 36.331 [11] for E-UTRAN.

4.7 Support of service identification for improved radio utilization for GERAN

Service Class Indicator (SCI) for improved radio utilization for GERAN (see TS 23.060 [22]) is supported in shared network for A/Gb mode GERAN PS domain. The A/Gb mode GERAN identifies the service class associated with downlink user plane packets according to TS 23.060 [22]. When deciding whether to use or discard the SCI information, the A/Gb mode GERAN may need to take the identity of the MS's Core Network operator into account.

5 Functional description

The new behaviours of network nodes needed in order to describe network sharing are described.

5.1 UE functions

A supporting UE operating in Idle mode selects the core network operator and provides the PLMN-id of this operator to the network for routing purposes and to indicate which of the core network operators is selected. A supporting GERAN UE provides PLMN-index when establishing a connection with the MSC, and, when sending GPRS LLC frames with a non-local TLLI.

A supporting GERAN UE, upon completion of a CS or PS handover, uses the PLMN index received during the CS handover and PS handover procedure to indicate the selected PLMN in the subsequent RAU in connected mode if the conditions for performing a normal RAU are met, see 3GPP TS 24.008, when sending GPRS LLC frames with a non-local TLLI. Normal RAU following a CS handover is performed if the UE and the network support DTM and the conditions for RAU are met whereas a RAU following a PS handover is performed if the conditions for normal RAU are met.

5.2 RNC functions

Network sharing information, i.e. available core network operators in the shared network, shall be transmitted in broadcast system information.

If system information relating to NAS is transmitted to a UE in dedicated signalling, the RNC sends information for both supporting and non-supporting UEs and the UE shall select the appropriate information to use.

The RNC shall indicate the UE selected core network operator to the CN for supporting UEs when transferring initial layer 3 signalling. The selected CN operator is (i) indicated by the UE in RRC signalling or (ii) known implicitly from an already existing signalling connection. For non-supporting UEs, the RNC selected core network operator shall, if available, be indicated by the RNC to the CN. RNC selection of core network operator is described in clause 4.2.5.3.

In case of relocation to a shared network:

- the source RNC determines a core network operator to be used in the target network, including the selection of PLMN(s) to support SRVCC functionality from CS domain to PS, based on available shared networks access control information, current PLMN in use, Anchor PLMN, or similar information present in the node, the source

RNC shall at relocation indicate that selected core network operator to the source core network node as part of the TAI/RAI sent in Target ID in the Relocation Required message. The selected target core network operator should be the same as the one in use. If the source core network operator is not supported in the target cell the RNC selects the target PLMN based on either (i) pre-configured information in the RNC, or (ii) the SNA (Shared Network Area) Access Information IE (see TS 25.413 [13]) provided by the SGSN. When the RNC triggers the enhanced relocation and selects a new PLMN, the selected PLMN is indicated to the SGSN during the following RA update procedure.

- In order to support SRVCC from CS to PS, the source RNC informs the target RNC/BSC of the Anchor PLMN identity.
- The target RNC may need to know whether or not the UE supports UTRAN network sharing.

The behaviour of the RNC in relation to CS/PS coordination for non-supporting UEs is described in clause 4.2.5.3.

NOTE: For PS-to-CS SRVCC, any SRVCC specific PLMN information should be pre-configured in the RNC.

5.2a eNodeB functions

Network sharing information, i.e. available core network operators in the shared network, shall be transmitted in broadcast system information.

The eNodeB shall indicate the selected core network operator when transferring initial layer 3 signalling. The eNodeB uses the selected core network information (provided by the UE at RRC establishment, or, provided by the MME/source eNodeB at S1/X2 handover) to select target cells for future handovers (and radio resources in general) appropriately.

In the case of handover to a shared network:

- the source eNodeB determines a core network operator to be used in the target network based on current PLMN in use, or other information present in the eNodeB, the source eNodeB shall at handover indicate that selected core network operator to the MME as part of the TAI/RAI sent in the HO required message. The selected target core network operator should be the same as the one in use. This is accomplished by not changing the serving PLMN if the PLMN in use is supported in the target cell. If the PLMN in use is not supported in the target cell the eNB selects the target PLMN based on either (i) pre-configured information in the eNB, or (ii) the Equivalent PLMNs list (see TS 36.413 [14]) provided by the MME.
- when multiple PLMNs are available for CS domain to support CS Fallback functionality, the source eNodeB determines a core network operator to be used in the target GERAN/UTRAN network based on the allocated LAI provided by the MME as specified in TS 23.272 [15]. The source eNodeB shall at handover indicate that selected core network operator to the MME as part of the Target ID sent in the HO required message. If the selected PLMN for CS domain is not supported in the target cell the eNodeB selects the target PLMN based on either (i) pre-configured information in the eNodeB, or (ii) the Equivalent PLMNs list (see TS 36.413 [14]) provided by the MME.
- when multiple PLMNs are available for CS domain to support SRVCC functionality, the source eNodeB determines a core network operator to be used in the target GERAN/UTRAN network. If the currently serving PLMN is not supported in the target cell, the eNodeB selects the target PLMN based local configured information in the eNodeB along with the information provided by the MME in HRL (see TS 36.413 [14]). The HRL provides the currently serving PLMN and equivalent PLMNs together with information about which PLMNs are preferred for SRVCC target cell selection. The source eNodeB shall at SRVCC handover indicate the selected core network operator to the MME as part of the Target ID sent in the HO required message.
- the target eNodeB uses the selected core network information to select target cells for future handovers appropriately.

In the case of dual connectivity (as described in TS 36.300 [10]):

- the Master eNodeB uses the selected core network information to select any Secondary Cell Group appropriately (e.g. to respect network sharing agreements).

5.2b BSC functions

Network sharing information, i.e. available core network operators in the shared network, shall be transmitted in broadcast system information.

If system information is transmitted to a supporting UE in dedicated signalling e.g. to support handover to other RATs, the BSC shall indicate the PLMN-id of the core network operator towards which the UE already has a signalling connection (if a PLMN-id is included in the signalling). If the UE is non-supporting, the BSC shall indicate the common PLMN (if a PLMN-id identity is included in the signalling).

The BSC shall indicate the selected core network operator to the CN for supporting UEs. The selected CN operator is:

i) indicated by the UE to the BSC as follows:

- for the CS domain, in the Initial L3 message, a supporting UE shall send the PLMN Index that corresponds to the position of the chosen PLMN in the broadcast system information, as part of the Initial L3 message. The BSC shall then derive the PLMN-id chosen by the UE from the indicated PLMN Index, select the corresponding CN operator and inform the MSC of the chosen PLMN-id;
- for the PS domain, when the UE has a non-local TLLI, a supporting UE shall send the PLMN Index that corresponds to the position of the chosen PLMN in the broadcast system information, as part of the AS signalling. The BSC shall then derive the PLMN-id chosen by the UE from the indicated PLMN Index, select the corresponding CN operator and inform the SGSN of the chosen PLMN-id;

or:

ii) known implicitly from an already existing signalling connection.

For non-supporting UEs, the BSC selected core network operator shall, if available, be indicated by the BSC to the CN.

In the PS domain, when the UE has a local TLLI:

- for MOCN, the BSC uses the NRI bits from within the TLLI to derive the selected CN operator;
- for GWCN, the SGSN passes the selected CN operator identity with the downlink user data/signalling.

For handover to a shared network from GERAN:

- the source BSC determines a core network operator to be used in the target network, including the selection of PLMN(s) to support SRVCC functionality from CS domain to PS, based on current PLMN in use, Anchor PLMN, or other information present in the BSC. The selected target core network operator should be the same as the one in use. If the source core network operator is not supported in the target cell the BSC selects the target PLMN based on pre-configured information in the BSC.
- the source BSC shall indicate the target core network operator PLMN ID to the source core network node as part of the TAI/RAI sent in the Target Cell Identifier IE/Target RNC Identifier IE/Target eNodeB Identifier IE in the PS-Handover-Required message (TS 48.018 [24]) and in the LAI sent in the Cell Identifier List IE in the Handover Required message (TS 48.008 [25]).
- In order to support SRVCC for CS to PS, the source BSC informs the target RNC/BSC of the Anchor PLMN identity.

For handover to a GERAN shared network:

- The target BSS needs to know whether or not the UE supports GERAN network sharing.
- the source RAN determines a core network operator to be used in the target network and indicates the selected target core network operator PLMN ID to the source core network node. The target MSC/SGSN indicates the selected target core network operator to target BSC.
- At CS handover the target BSC (BSS-B) shall, for a GERAN supporting UE, provide PLMN index information corresponding to the selected target PLMN-id via the source RAN. When the UE arrives in the target cell the target BSC shall indicate the RAI corresponding to the selected PLMN.
- At PS handover the target BSC (BSS-B) shall, for a GERAN supporting UE, provide PLMN index information corresponding to the selected target PLMN-id via the source RAN. The target BSC shall also via the source RAN indicate the RAI corresponding to the selected PLMN.
- At normal RAU in connected mode after completing a handover, the target BSC is informed of the PLMN index corresponding to the selected target PLMN when the UE appears in the target access.

In all other non handover signalling from the GERAN to the MSC/SGSN, unless specified differently by stage 3 specifications, any PLMN ID sent is the Common PLMN ID. In signalling from the Core Network to the GERAN, the BSS shall accept signalling that uses any of the PLMN IDs that share the cell.

The behaviour of the BSC in relation to CS/PS coordination for non-supporting UEs is described in clause 4.2.5.3.

5.3 MSC functions

When a UE accesses an MSC the first time, i.e. when there is no VLR entry for this UE, the MSC retrieves the IMSI from another MSC/VLR or from the UE. For GWCN, the MSC determines a serving CN operator based on the UE Selected operator (PLMN) indicated by the RAN, or, for a non-supporting UE, based on the RAN Selected CN operator (PLMN). The MSC/VLR shall also store the identity of the serving core network operator.

In the case of a MOCN configuration, an MSC may not be able to provide service to the UE. The UE may then have to be redirected to a MSC of another core network operator. The MSC/VLR that finally serves the UE assigns a NRI to the UE. This will allow the RAN to route any subsequent UE accesses to the serving MSC/VLR.

The behaviour of the MSC in relation to CS/PS coordination for non-supporting UEs is described in clause 4.2.5.3.

For supporting UEs, i.e. when a UE selected core network operator has been indicated to the MSC by the RNC/BSC, the MSC indicates the selected core network operator PLMN-id in the LAI signalled to the UE in dedicated signalling.

For sharing scenarios with both E-UTRAN and GERAN/UTRAN access, where the network also applies idle-mode signalling reduction (see TS 23.401 [9]), the contents of the SNA Access Information IE (see TS 25.413 [13]) provided by the MSC to the RNC for a specific UE guides the target PLMN selection if the UE's registered PLMN is not available in the target cell. The SNA Access Information IE should be configured such that for any target cell there is only one PLMN-ID that can be selected for the cell.

Also, for the above scenario, in the routing areas and tracking areas between which ISR may be activated the "equivalent PLMNs" list provided by the SGSN, MSC and MME to a UE (see TS 24.008 [7]) should result in a single consistent "equivalent PLMNs" list stored by the UE. The single "equivalent PLMNs" list applies to all the UE's registered routing areas, location areas and tracking areas.

In case of relocation to a GWCN or a MOCN:

- There is no functionality in the source MSC to select a target core network operator or to modify the target core network operator selected by the RNC/BSC.
- For handover to a shared UTRAN the source MSC shall forward the selected core network operator chosen by the source RNC/BSC to the target MSC, which relays this information unchanged to the target RNC so that the appropriate PLMN-id can be signalled to the UE in dedicated system information signalling, as described in clause 5.2.
- For handover to a shared GERAN the source MSC shall forward the PLMN-ID selected by the source RAN to the target MSC. Target MSC sends information of selected operator to the target BSC.
- For SRVCC from E-UTRAN PS to UTRAN/GERAN CS domain, in case of GWCN configuration, the MSC selects the target PLMN based on the indication of the selected target PLMN provided by the MME/SGSN in the PS-to-CS handover command. The MSC receives the Anchor PLMN from the MME/SGSN and forwards that information to the target BSC/RNC.

For SRVCC from UTRAN/GERAN CS domain to E-UTRAN/HSPA PS, the MSC selects the MME based on selected target PLMN provided by the RNC/BSC in handover required message and forwards the selected target PLMN to MME in the CS to PS handover request.

In signalling to the HSS, the MSC shall ensure that any PLMN ID that is sent is the ID of the selected Core Network Operator for supporting UEs, or that of the allocated Core Network Operator for non-supporting UEs (unless the exception to send the Common PLMN ID for a non-supporting UE (see clause 4.4) is in use with that HPLMN).

5.4 SGSN functions

When a UE accesses an SGSN the first time, i.e. when the UE is not yet known by the SGSN the SGSN retrieves the IMSI from another SGSN/MME or from the UE. For GWCN, the SGSN determines a serving CN operator based on the

Selected PLMN indicated by the RAN, or, for a non-supporting UE, based on the RAN Selected CN operator (PLMN). The SGSN shall store the identity of the serving core network operator.

In the case of a MOCN configuration, a SGSN may not be able to provide service to the UE. The UE may then have to be redirected to a SGSN of another core network operator. The SGSN that finally serves the UE assigns a NRI to the UE. This will allow the RAN to route any subsequent UE accesses to the serving SGSN.

The behaviour of the SGSN in relation to CS/PS coordination for non-supporting UEs is described in clause 4.2.5.3.

For supporting UEs, i.e. when a UE selected core network operator has been indicated to the SGSN by the RNC/BSC, the SGSN indicates the selected core network operator PLMN-id in the LAI/RAI signalled to the UE in dedicated signalling.

For sharing scenarios with both E-UTRAN and GERAN/UTRAN access, where the network also applies idle-mode signalling reduction (see TS 23.401 [9]), the contents of the SNA Access Information IE (see TS 25.413 [13]) provided by the SGSN to the RNC for a specific UE guides the target PLMN selection if the UE's registered PLMN is not available in the target cell. The SNA Access Information IE should be configured such that for any target cell there is only one PLMN-ID that can be selected for the cell.

Also, for the above scenario, in the routing areas and tracking areas between which ISR may be activated the "equivalent PLMNs" list provided by the SGSN, MSC and MME to a UE (see TS 24.008 [7]) should result in a single consistent "equivalent PLMNs" list stored by the UE. The single "equivalent PLMNs" list applies to all the UE's registered routing areas, location areas and tracking areas.

At relocation/handover to a GWCN or a MOCN:

- There is no functionality in the source SGSN to select a target core network operator or to modify the target core network operator selected by the RNC/BSC. Instead, the source SGSN uses the selected PLMN received from the RNC/BSC to determine the target core network operator. The source SGSN shall forward the selected core network operator chosen by the source RNC/BSC to the target SGSN/MME.
- For handover to a shared UTRAN the target SGSN indicates the selected core network operator chosen by the source RNC/BSC/eNodeB to the target RNC so that the appropriate PLMN-id can be signalled to the UE in dedicated system information signalling, as described in clause 5.2.
- For handover to a shared GERAN the source SGSN/MME shall forward the PLMN-ID selected by the source RAN to the target SGSN. Target SGSN sends information of selected operator to the target BSC.
- For SRVCC from UTRAN PS to UTRAN/GERAN CS domain, the SGSN selects the MSC based on the selected target PLMN indicated by the RNC. The SGSN includes the indication of the selected target PLMN in the target CGI/RNC ID and Anchor PLMN in the SRVCC PS-to-CS Request sent to the MSC (see TS 29.280 [21]).

In signalling to the GGSN/S-GW/P-GW and HSS, the SGSN shall ensure that any PLMN ID that is sent is the ID of the selected Core Network Operator for supporting UEs, or that of the allocated Core Network Operator for non-supporting UEs (unless the exception to send the Common PLMN ID for a non-supporting UE (see clause 4.4) is in use with that HPLMN).

5.5 MME functions

When a UE accesses an MME for the first time, i.e. when the UE is not yet known by the MME, the MME verifies whether the UE is permitted to access the selected PLMN. For that purpose the MME retrieves the IMSI from another MME/SGSN or from the UE. The MME shall store the identity of the selected core network operator.

The MME indicates the selected core network operator PLMN-id to the UE in the GUTI.

For sharing scenarios with both E-UTRAN and GERAN/UTRAN access, where the network also applies idle-mode signalling reduction (see TS 23.401 [9]), the PLMN IDs included in the equivalent PLMN list (as defined in TS 24.008 [7]) provided by the MME to the eNB guides the target PLMN selection if the UE's registered PLMN is not available in the target cell. The equivalent PLMN list should be configured such that for any target cell there is only one PLMN-ID that can be selected for the cell.

Also, for the above scenario, in the routing areas and tracking areas between which ISR may be activated the "equivalent PLMNs" list provided by the SGSN, MSC and MME to a UE (see TS 24.008 [7]) should result in a single consistent "equivalent PLMNs" list stored by the UE. The single "equivalent PLMNs" list applies to all the UE's registered routing areas, location areas and tracking areas.

For sharing scenarios with both E-UTRAN and GERAN/UTRAN access, when multiple PLMNs are available for CS domain to support CS Fallback functionality, the MME provides the allocated LAI including the selected PLMN ID for CS domain along with "CS Fallback indicator" to the eNodeB as specified in TS 23.272 [15], to guide the selection of the target GERAN/UTRAN network.

If the operator-configured preferred target RAT for CS Fallback is a shared RAN not offering the broadcast of available Core Network operators for selection by the UE, the MME shall always select the common PLMN broadcasted in the shared RAN as the selected PLMN-id for the CS domain.

If the operator-configured preferred target RAT for CS Fallback is a shared RAN offering the broadcast of available Core Network operators for selection by the UE, the MME shall take into account the UE's capability of supporting network sharing in the preferred target RAT when selecting the PLMN for the CS domain for CS Fallback. For GERAN network sharing, the UE signals its capability of GERAN network sharing support explicitly to the MME. If the UE is a network-sharing non-supporting UE with respect to the preferred target RAT, a common PLMN-id shall be selected, while if the UE is a network-sharing supporting UE with respect to the preferred target RAT, one of the PLMN-IDs in the broadcasted multiple PLMN-id list of the preferred target shared RAT shall be selected as the PLMN-id for the CS domain.

The selected PLMN-id for the CS domain shall be included the allocated LAI sent to the MSC/VLR as defined in TS 23.272 [15].

If the shared network is in GWCN configuration, MME sends the 'selected CS domain operator' as indicated in clause 4.2.5a.

The list of PLMN-ID(s) included in the handover restriction list (as defined in TS 36.413 [14]), if provided by the MME to the eNB for the target PLMN selection, shall be configured such that for any target GERAN/UTRAN cell, only PLMN-ID(s) associated with the same CN operator as the one that the UE has registered to in the CS domain can be selected by the eNB when one of the following conditions apply:

- the preferred RAT of the registered network is shared network not offering the broadcast of available Core Network operators for selection by the UE, or,
- the RAT preference for the UE is GERAN and the allocated LAI belongs to a shared GERAN and the UE is a GERAN network-sharing non-supporting UE.

The list of PLMN-ID(s) included in the equivalent PLMN list sent to the UE shall be configured to include the list of PLMN IDs in the handover restriction list.

NOTE: When performing CS Fallback to GERAN/UTRAN cell, if the PLMN-ID(s) in the equivalent PLMN list contains a CS CN operator(s) PLMN different from the registered CS PLMN, then the UE may possibly select a CS CN operator it has not registered to.

At handover/relocation to a GWCN or a MOCN:

- The source MME uses the TAI/RAI information supplied by the eNodeB to select the target MME/SGSN. There is no additional functionality in the source MME to select a target core network operator or to modify the target core network operator selected by the eNodeB. Instead, the source MME uses the selected PLMN received from the eNodeB to determine the target core network operator. The source MME shall forward the selected target core network operator chosen by the source eNodeB to the target MME/SGSN.
- The target MME indicates the selected target core network operator chosen by the source eNodeB/RNC/BSC to the target eNodeB so that the eNodeB can select target cells for future handovers appropriately. Subsequent Tracking Area Update signalling is used to update the UE about any change of core network operator.
- At SRVCC from E-UTRAN PS to UTRAN/GERAN CS domain, the MME selects the MSC based on the selected target PLMN indicated by the eNodeB. The MME includes the indication of the selected target PLMN in the target CGI/RNC ID and Anchor PLMN in the PS-to-CS Request sent to the MSC (see TS 29.280 [21]).

In signalling to the S-GW/P-GW and HSS, the MME shall ensure that any PLMN ID that is sent is the ID of the selected Core Network Operator.

The behaviour of the MME in relation to CS/PS coordination in GERAN and UTRAN for non-supporting UEs is described in clause 4.2.5.3.

6 Charging and accounting aspects

To support inter-operator accounting in a shared network, it shall be possible to distinguish the share of usage of the shared core network node(s) between the sharing partners. The identity of the serving core network operator (i.e. the one selected by a supporting UE in a network broadcasting a multiple PLMN-id list, or, the one allocated by the network for a non-supporting UE in a network broadcasting a multiple PLMN-id list, or, the one allocated for any UE in a shared network only broadcasting a common PLMN) and whether the core network operator was selected by a supporting UE or allocated by the network to a UE shall be included in MSC, SGSN, Serving GW and GGSN/PDN GW CDR types as specified in TS 32.250 [5] (CS) and TS 32.251 [6] (GPRS/EPS). For handover scenarios, it is up to operator configuration whether the core network operator shall be indicated as selected or allocated to a UE in the CS domain CDR. In CSFB scenario, the core network operator is allocated by the network as specified in clause 4.2.5a, but the indication in the CS domain CDR is up to operator configuration.

As specified in clause 4.4, for online charging, the gsmSCF can use the identifier of the MSC/SGSN to determine the operator selected by a supporting UE or the operator allocated to a UE. The MSC/SGSN shall inform gsmSCF as to whether the UE selected, or the network allocated, the serving operator on that RAT.

Whether the Core Network Operator was selected by a supporting UE or allocated by the network to the UE shall be communicated to the Serving GW and the GGSN/PDN GW and be included in MSC, SGSN, Serving GW and GGSN/PDN GW CDR types as specified in TS 32.250 [5] (CS) and TS 32.251 [6] (GPRS/EPS).

7 Example signalling flows

7.1 Network selection

Signalling flows for manual and automatic network selection in a shared network architecture for successful and unsuccessful registration attempts are presented.

7.1.2 Non-supporting UEs in a GWCN configuration

This example shows network selection for a non-supporting UE in a shared UTRAN/GERAN network. The UE is not a subscriber of any of the sharing operators and is under operator coordination. The UE is not coming from E-UTRAN i.e. the UE is not registered in any old MME. The UE is not served by the shared SGSN nor by the shared MSC. After the first registration attempted the operator accepts the UE after CS/PS coordination.

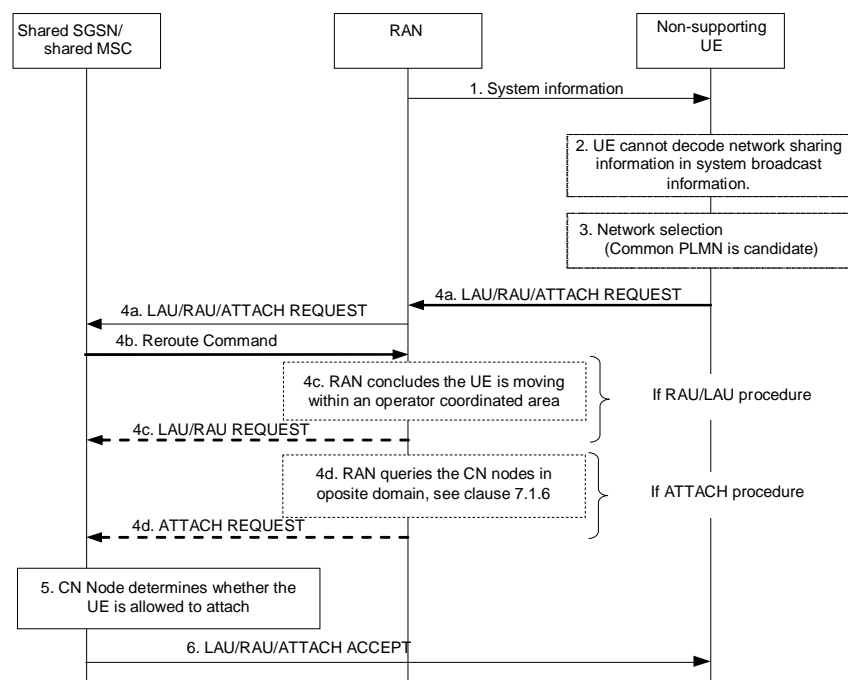

Figure 3: Network selection for a non-supporting UE in a shared UTRAN/GERAN network

1. The UE reads the broadcast system information in the shared RAN.
2. A non-supporting UE cannot decode the shared network information in the broadcast system information. The common PLMN is the only candidate to be considered together with other PLMNs for network selection.
3. The UE performs network selection among available PLMNs.
- 4a. The UE sends an ATTACH REQUEST/ROUTEING AREA UPDATE/LOCATION AREA UPDATE message to the network. The RAN selects CN node based on NRI (valid or invalid) if present or by random selection. A *redirect attempt flag* is included in the signalling from RAN to Core Network. The signalling from the RAN to the Core Network enables the Core Network to determine that the UE did not select a Core Network operator. The RAN stores the NRI received from the UE.
- 4b. A *Reroute Command* message is sent back to the RAN node with an indication that it is for coordination purposes. The *Reroute Command* message includes the LAU/RAU /ATTACH REJECT message and the original ATTACH REQUEST/ROUTING AREA UPDATE/LOCATION AREA UPDATE message received from the UE. Included is also IMSI and old LAI (for the CS domain) or old RAI (for the PS domain), or an indication whether the UE is attaching.
- 4c. At ROUTEING AREA UPDATE/LOCATION AREA UPDATE the RAN node concludes that the UE is roaming under operator coordination and sends a ROUTEING AREA UPDATE/LOCATION AREA UPDATE to the Core Network. The CN operator selected by the RAN is included in the signalling from RAN to Core Network. IMSI and the redirect attempt flag shall be included.
- 4d. At ATTACH REQUEST in PS domain the RAN node queries the MSCs in the CS domain whether the UE (IMSI) is registered at any of the sharing operators in the CS domain. At ATTACH REQUEST in CS domain the RAN node queries the SGSNs in the PS domain whether the UE (IMSI) is registered at any of the sharing operators in the PS domain. For PS domain the SGSNs may need to query all MMEs that may hold the UEs context, refer to sub clause 7.1.6.

In this example the UE is yet neither registered in the CS domain nor in the PS domain. Based on IMSI analysis the RAN node selects an operator. The RAN node sends a ATTACH REQUEST/ to the Core Network. The CN operator selected by the RAN is included in the signalling from RAN to Core Network. IMSI and the *redirect attempt flag* shall be included.

5. The shared SGSN determines whether the UE is allowed to attach.
6. The shared SGSN sends the appropriate ACCEPT message back to the UE.

7.1.3 Supporting UEs in a GWCN configuration

This example shows network selection for a supporting UE in a shared E-UTRAN/UTRAN/GERAN network.

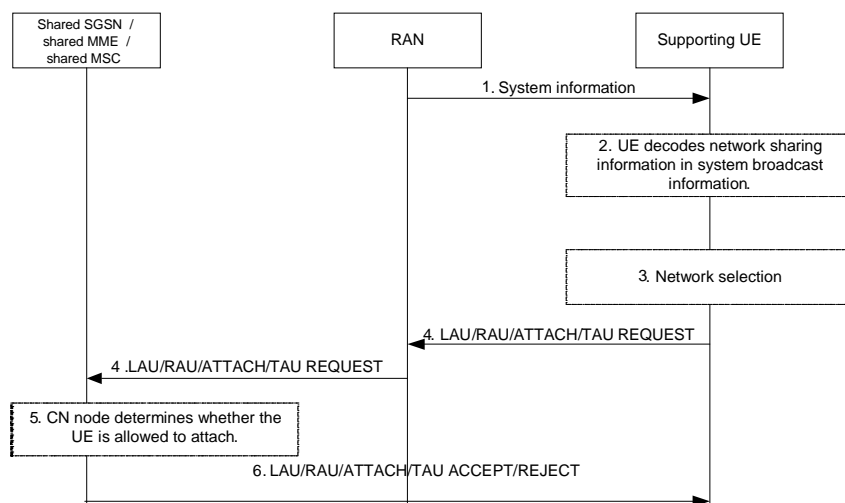

Figure 4: Network selection for a supporting UE in a shared E-UTRAN/UTRAN/GERAN network

1. The UE reads the broadcast system information in the shared RAN.

2. A supporting UE decodes the shared network information and supplies the available core network operator PLMN-ids as candidates to the PLMN selection procedure. Only PLMNs in the Multiple PLMN ID List are candidates for network selection.
3. The UE performs network selection among available PLMNs.
4. The UE sends an ATTACH/ROUTEING AREA UPDATE/TRACKING AREA UPDATE/LOCATION AREA UPDATE REQUEST message to the network indicating, to the RAN, the chosen core network operator. The RAN converts the core network 'indicator' into the actual selected PLMN identity and sends this with the ATTACH/ROUTEING AREA UPDATE/TRACKING AREA UPDATE/LOCATION AREA UPDATE REQUEST to the core network.
5. The shared SGSN determines whether the UE is allowed to attach.
6. The shared SGSN sends the appropriate ACCEPT/REJECT message back to the UE.

7.1.4 Non-supporting UEs in a MOCN configuration

7.1.4.1 UTRAN based MOCN configuration

An example of an information flow for redirection in UTRAN is shown below.

In this example an attach request from a non-supporting UE is directed to three different CN operators. The UE is not a subscriber of any of the sharing operators. The UE is not served by any shared SGSN nor by any shared MSC. The UE is furthermore not under operator coordination. The first rejects since it has no roaming agreement with the subscribers Home PLMN or rejects due to CS/PS coordination required. The second rejects because of a roaming restriction found in HLR. The third CN operator accepts and completes the attach request. The different "MSC/SGSNs" in the example below shall be seen as different CN operators. One specific CN operator may also have several pooled MSCs/SGSNs connected to the RNC if Iu-flex is used.

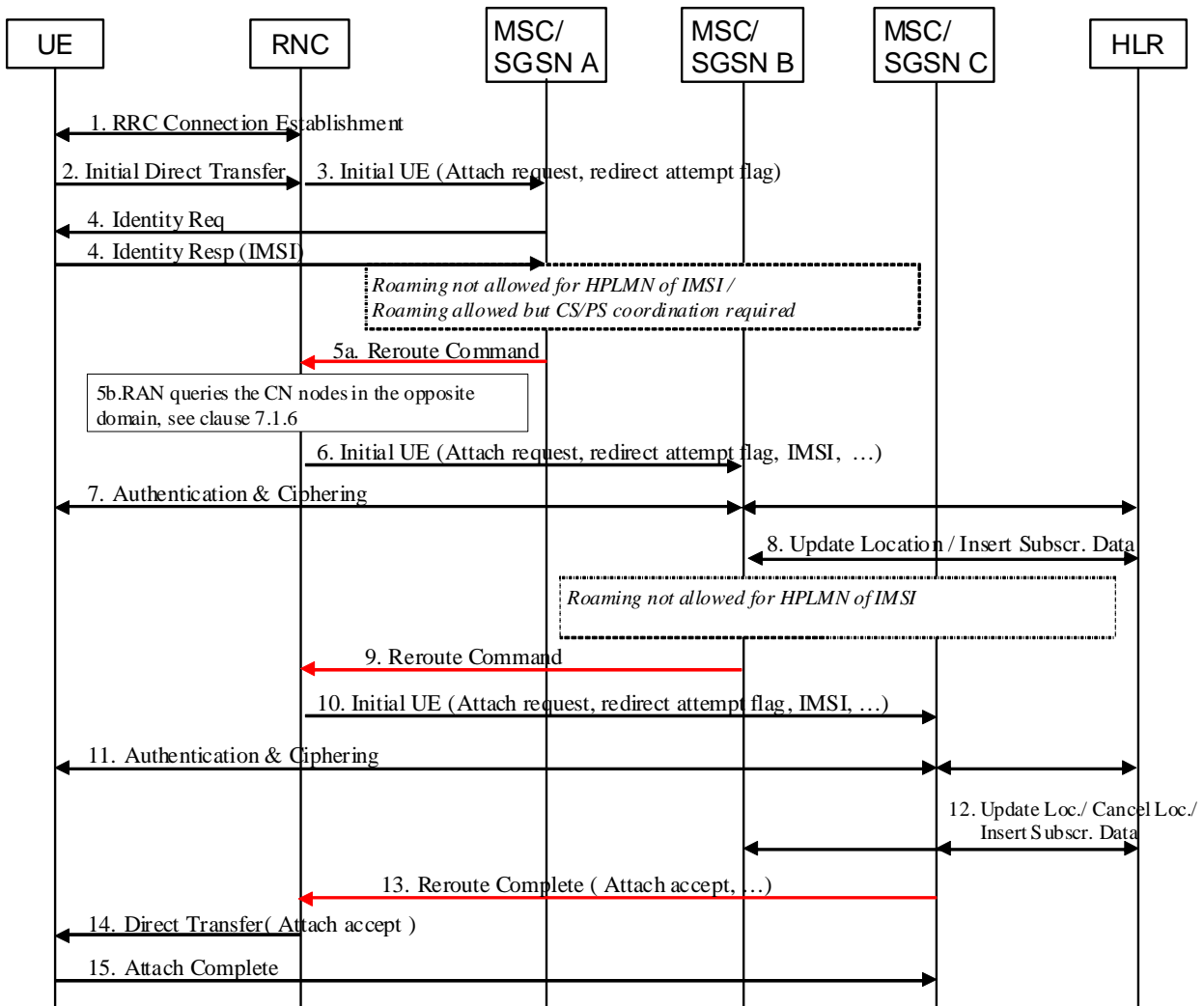

Figure 5: Information flow for redirection in UTRAN

- 1) The RRC connection is established.
- 2) RNC receives an Initial Direct Transfer from an UE. The RNC is configured to work in a Shared RAN MOCN, and therefore it forwards the NAS message in an Initial UE message with an additional *redirect attempt flag* set. The flag indicates that the MSC/SGSN shall respond to the attach request with a *Reroute Command* or *Reroute Complete* IE in the Direct Transfer message. Selection of CN node is based on NRI (valid or invalid) if present in IDNNS or by random selection.

A *redirect attempt flag* could also simply be the fact that the Initial UE message does not include any UE selected PLMN-ID, which a supporting UE would include. Redirect is never done for supporting UEs.
- 3) The MSC/SGSN receives the Initial UE with the *redirect attempt flag* set. It then knows it shall answer with a *Reroute Command* or *Reroute Complete* IE in the Direct Transfer message.
- 4) The MSC/SGSN needs the IMSI of the UE. It is retrieved either from old MSC / old SGSN or from the UE as in this example. By comparing the IMSI with the roaming agreements of the CN operator, the MSC/SGSN discovers that roaming is not allowed or that roaming is allowed but CS/PS coordination required. Attach procedure is aborted.
- 5a) A message is sent back to the RNC with two NAS messages, the attach reject message and the original attach request message received from the UE (alternatively the original NAS message may be stored in the RNC). The IMSI and an indication that the UE is attaching is also included in the message, plus a reject cause code to the RNC. The *Reroute Command* IE is in the Direct Transfer message.
- 5b) The RAN node concludes that UE is attaching. For attach in PS domain the RAN node queries the MSCs in the CS domain whether the UE (IMSI) is served by any of the sharing operators in the CS domain. For attach in CS

domain the RAN node queries the SGSNs in the PS domain whether the UE (IMSI) is served by any of the sharing operators in the PS domain. For PS domain the SGSNs may need to query all MMEs that may hold the UEs context, refer to clause 7.1.6.

In this example the UE is yet neither served by a node in the CS domain nor in the PS domain. The signalling connection between RNC and MSC/SGSN A is released. Based on deterministic IMSI analysis the RNC selects a MSC/SGSN in the next step. If reject was due to CS/PS coordination required then the same operator may be selected again. If reject was not due to CS/PS coordination required then the already tried MSC/SGSNs is stored in the RNC during the redirect procedure so that the same node is not selected twice.

- 6) The RNC sends a new Initial UE to the next selected MSC/SGSN with the original NAS attach request message (in case of CS/PS coordination the Initial UE may also be sent back to the first MSC/SGSN depending on the outcome of the coordination). Redirect attempt flag is set and IMSI shall also be included to avoid a second IMSI retrieval from UE or old MSC/SGSN and to indicate that PS/CS domain coordination has been done in RNC. The CN operator selected by the RAN is included in the signalling from RAN to Core Network The MSC/SGSN receiving the message starts its attach procedure.
- 7) MSC/SGSN B does in general support roaming for the HPLMN of the IMSI and hence authentication is done and RAN ciphering is established.
- 8) MSC/SGSN B updates the HLR and receives subscriber data from HLR.
- 9) The subscription data do not allow roaming (e.g. regional or 3G). MSC/SGSN B sends a Reroute Command message including the attach reject message, a reject cause code, the original attach request message and the N(SD) (for MSC only). IMSI is included in Reroute Command message only if it was not included in the Initial UE received by the MSC/SGSN.

The signalling connection between the RNC and the MSC/SGSN B is released. The RNC then selects a new operator and a new MSC/SGSN based on deterministic IMSI analysis as in step 5b.

- 10) The MSC/SGSN C receives an Initial UE (with the original NAS attach request message) with the redirect attempt flag is set, an IMSI, and N(SD) (if MSC). The MSC/SGSN C also receives the CN operator selected by the RAN. The MSC/SGSN C starts the attach procedure and uses provided information (IMSI and N(SD)).
- 11) MSC/SGSN C does in general support roaming for the HPLMN of the IMSI and hence authentication is done and RAN ciphering is established.
- 12) MSC/SGSN C updates the HLR and receives subscriber data from HLR. Subscriber data allows roaming, and the MSC/SGSN C completes the attach procedure. This includes the assignment of a new TMSI/P-TMSI with an NRI that can be used by RNC to route subsequent signalling between UE and correct MSC/SGSN (Iu-flex functionality). The Update Location sent to HLR also triggers a Cancel Location sent to the MSC/SGSN B.
- 13) A *Reroute Complete* IE in the Direct Transfer message with the NAS Attach accept message is sent to RNC. By this, the RNC knows that the redirect is finished and can both forward the NAS message to the UE and clean up any stored redirect data.
- 14) The Attach Accept is forwarded to the UE. The UE stores the TMSI/P-TMSI with the Iu-flex NRI to be used for future signalling, even after power off.
- 15) UE responds with an Attach Complete message.

If the RNC finds no more MSC/SGSN to redirect to after receiving a Reroute Command message, e.g. step 5 or step 9, it compares the cause code with cause codes from other Reroute Command messages it has earlier received for this UE. A cause code ranking is done and the "softest" cause code is chosen and the corresponding saved NAS attach reject message is returned to the UE.

Each CN node that receives an Initial UE, shall run its own authentication procedure. This may in some rare situations cause the UE to be authenticated more than once, however the trust-model used is that one CN operator shall not trust an authentication done by another CN operator. This will of course not be an optimal usage of radio resources, but given the rare occurrence of this, the increased signalling should not be of any significance.

During the redirect procedure the RNC keeps a timer, which corresponds to the UE timer of releasing the RR connection (20 seconds). If the RNC when receiving a Reroute Command message finds that there is not sufficient time for another redirect, further redirect attempts are stopped (for this attach request message). The UE will repeat its attach request four times (each time waiting 15 seconds before it re-establishes the RR connection for another try).

7.1.4.2 GERAN based MOCN configuration

An example of an information flow for redirection in GERAN is shown below.

In this example an attach request from a non-supporting UE is directed to two different CN operators. The UE is not a subscriber of any of the sharing operators. The UE is not served by any shared SGSN nor by any shared MSC. The UE is furthermore not under operator coordination. The first CN operator rejects since it has no roaming agreement with the subscribers Home PLMN or rejects due to CS/PS coordination required. The second CN operator accepts and completes the attach request. The different "MSC/SGSNs" in the example below shall be seen as different CN operators. One specific CN operator may also have several pooled MSCs/SGSNs connected to the BSC if A/Gb-Flex is used.

Separate call flows are shown for CS domain and for PS domain.

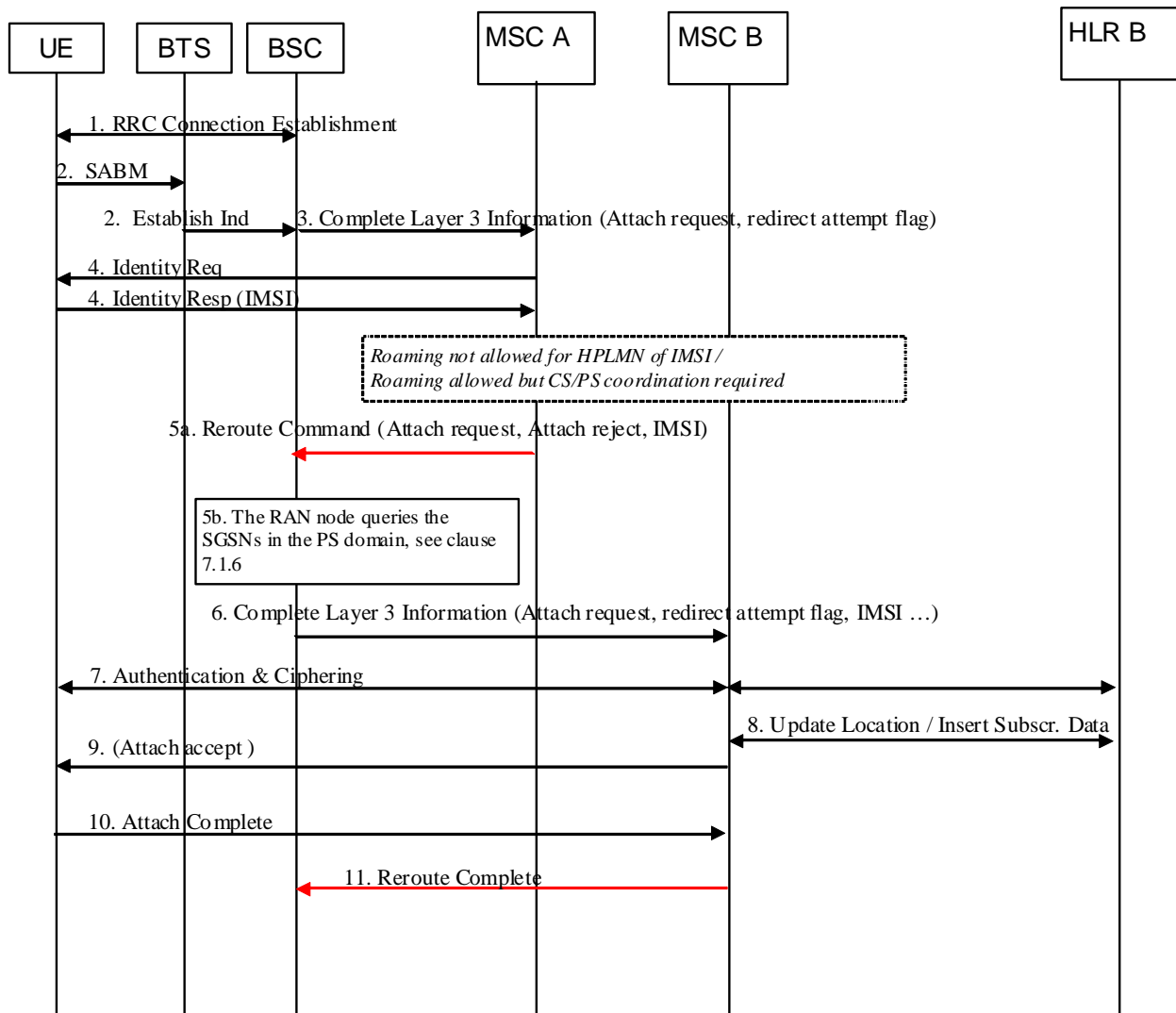

Figure 6: Information flow for redirection in GERAN (CS domain)

- 1) The RRC connection is established.
- 2) BSC receives the Layer 3 message from an UE. The BSC is configured to work in a Shared RAN MOCN, and therefore it forwards the message in a Complete Layer 3 Information message with an additional redirect attempt flag set. The flag indicates that the MSC shall respond to the attach request with a Reroute Command message to inform the BSC that a redirection to another CN has to be performed.

The selection of CN node is based on NRI (valid or invalid) or by random selection. The same mechanism as defined for A-Flex in TS 23.236 [8] is used.

- 3) The MSC receives the Complete Layer 3 Information message with the redirect attempt flag set. It then knows it may have to provide the BSC with a Reroute Command message.

- 4) The MSC needs the IMSI of the UE. It is retrieved either from old MSC or from the UE as in this example. By comparing the IMSI with the roaming agreements of the CN operator, the MSC A discovers that roaming is not allowed or that roaming is allowed but CS/PS coordination required. Attach procedure is aborted.
- 5a) A Reroute Command message is sent back to the BSC with the attach reject message and the original attach request message received from the UE. The IMSI and an indication that the UE is attaching is also included in the message, plus a reject cause code to the BSC.
- 5b) The BSC concludes that UE is attaching. The BSC node queries the SGSNs in the PS domain whether the UE (IMSI) is served by any of the sharing operators in the PS domain. The SGSNs may need to query all MMEs that may hold the UEs context, refer to clause 7.1.6.

In this example the UE is yet not served by a node in the PS domain. The signalling connection between BSC and MSC A is released. Based on deterministic IMSI analysis the BSC selects a MSC B in the next step. If reject was not due to CS/PS coordination required then the already tried MSC A is stored in the BSC during the redirect procedure so that the same node is not selected twice.

- 6) The BSC sends a new Complete Layer 3 Information to the next selected MSC B with the original attach request message (in case of CS/PS coordination the Complete Layer 3 Information may also be sent back to the first MSC depending on the outcome of the coordination). Redirect attempt flag is set and IMSI shall also be included to avoid a second IMSI retrieval from UE or old MSC and to indicate that PS/CS domain coordination has been done in BSC. The CN operator selected by the BSC is included in the signalling from BSC to Core Network. The MSC B receiving the message starts its attach procedure.
- 7) MSC B does in general support roaming for the HPLMN of the IMSI and hence authentication is done and RAN ciphering is established.
- 8) MSC B updates the HLR and receives subscriber data from HLR. Subscriber data allows roaming, and the MSC B completes the attach procedure. This includes the assignment of a new TMSI with an NRI that can be used by BSC to route subsequent signalling between UE and correct MSC (A-Flex functionality).
- 9) The Attach Accept is forwarded to the UE. The UE stores the TMSI with the A-Flex NRI to be used for future signalling, even after power off. This is existing functionality.
- 10) UE responds with an Attach Complete message (TMSI (re-)allocation if not already made in Attach accept).
- 11) A Reroute Complete message is sent to BSC. The BSC knows that the redirect is completed and clean up any stored redirect data.

If the BSC finds no more MSC to redirect to after receiving a Reroute Command message, it compares the cause code with cause codes from other Reroute Command messages it has earlier received for this UE. A cause code ranking is done and the "softest" cause code is chosen and the corresponding saved attach reject message is returned to the UE.

Each CN node that receives a Complete Layer 3 Information shall run its own authentication procedure. This may in some rare situations cause the UE to be authenticated more than once, however the trust-model used is that one CN operator shall not trust an authentication done by another CN operator. This will of course not be an optimal usage of radio resources, but given the rare occurrence of this, the increased signalling should not be of any significance.

During the redirect procedure the BSC keeps a timer, which corresponds to the UE timer of releasing the RR connection (20 seconds). If the BSC when receiving a Reroute Command message finds that there is not sufficient time for another redirect, further redirect attempts are stopped (for this attach request message). The UE will repeat its attach request four times (each time waiting 15 seconds before it re-establishes the RR connection for another try).

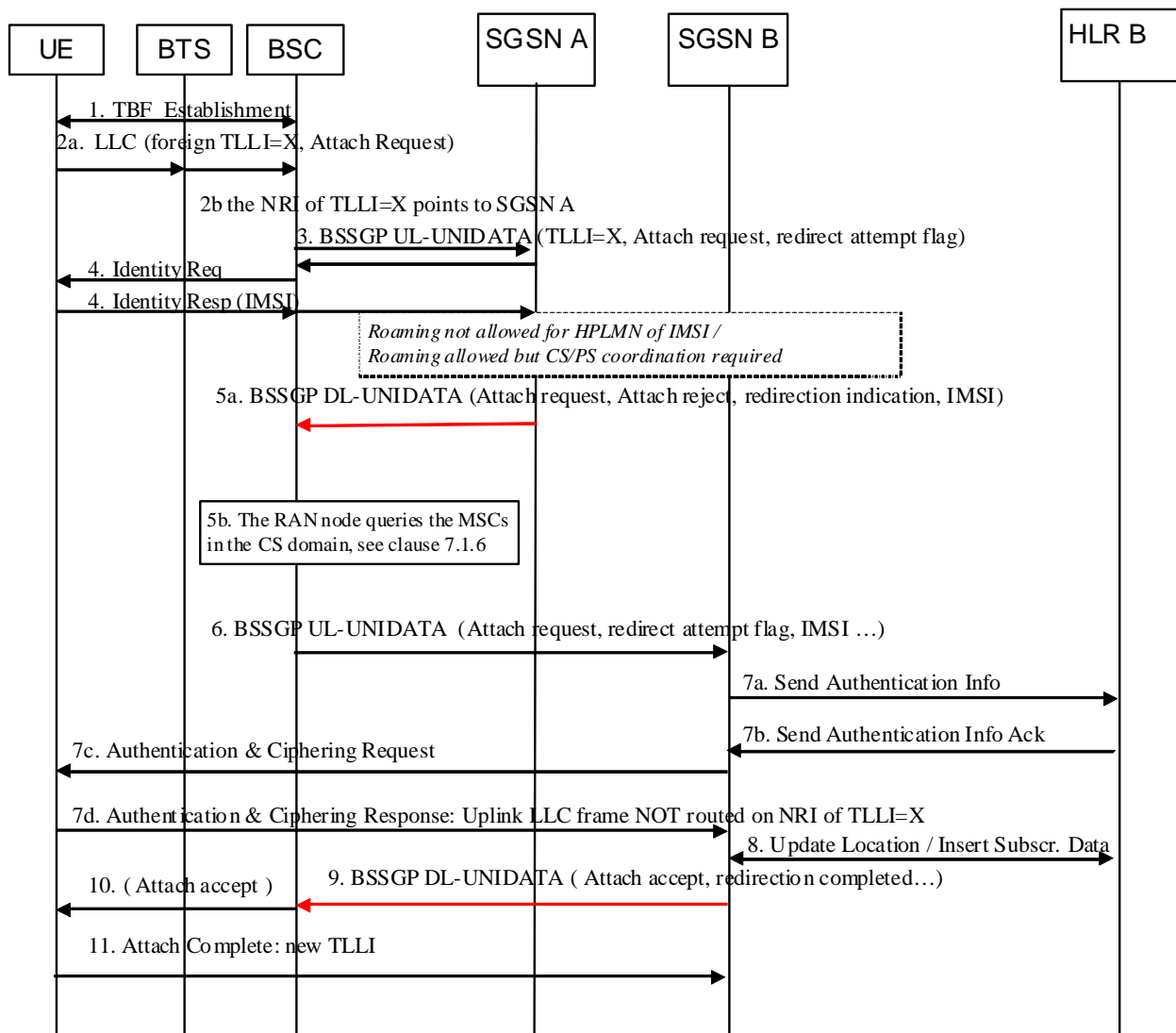

Figure 7-1: Information flow for redirection in GERAN (PS domain)

1) The TBF is established.

2, 2a) BSC receives the LLC frame with foreign [or random] TLLI =X.

The BSC is configured to work in a Shared RAN MOCN, and therefore it forwards the message in a BSSGP UL-UNITDATA message with an additional redirect attempt flag set. The flag indicates that the SGSN shall respond to the attach request with a BSSGP DL-UNITDATA message providing when relevant a redirection indication flag set to inform the BSC that a redirection to another CN has to be performed.

The selection of CN node is based on NRI (valid or invalid) or by random selection. The same mechanism as defined for Gb-Flex in TS 23.236 [8] is used.

3) The SGSN receives the BSSGP UL-UNITDATA message with the redirect attempt flag set. It then knows it may have to provide the BSC with a redirection indication flag set or a redirection completed flag set.

4) The SGSN needs the IMSI of the UE. It is retrieved either from old SGSN or from the UE as in this example. By comparing the IMSI with the roaming agreements of the CN operator, the SGSN A discovers that roaming is not allowed or that roaming is allowed but CS/PS coordination required. Attach procedure is aborted.

5a) A BSSGP DL-UNITDATA message is sent back to the BSC with a redirection indication flag set containing the reject cause, the attach reject message and the original attach request message received from the UE. The V(U) used for LLC-PDU setting (refer to TS 44.064 [19]) is included in the message. The IMSI and an indication that the UE is attaching is also included in the message.

- 5b) The BSC node concludes that UE is attaching. The BSC node queries the MSCs in the CS domain whether the UE (IMSI) is served by any of the sharing operators in the CS domain.

In this example the UE is yet not served by any node in the CS domain. Based on deterministic IMSI analysis the BSC selects a SGSN B in the next step. If reject was not due to CS/PS coordination required then the already tried SGSN A is stored in the BSC during the redirect procedure so that the same node is not selected twice.

The BSC makes a short-lived binding between the TLLI =X and SGSN ID so that it points to SGSN B.

- 6) The BSC sends a new BSSGP UL-UNITDATA to the next selected SGSN B with the original attach request message (in case of CS/PS coordination the BSSGP UL-UNITDATA may also be sent back to the first SGSN depending on the outcome of the coordination). Redirect attempt flag is set and IMSI shall be included to avoid a second IMSI retrieval from UE or old SGSN and to indicate that PS/CS domain coordination has been done in BSC. The V(U) shall also be included in the message. The CN operator selected by the BSC is included in the signalling from BSC to Core Network. The SGSN B receiving the message starts its attach procedure.
- 7) SGSN B does in general support roaming for the HPLMN of the IMSI and hence authentication is done and RAN ciphering is established. The value of V(U) in SGSN-B shall be set according to the received value from BSC.

Uplink LLC frames shall be routed to SGSN B despite the NRI of the TLLI=X pointing to SGSN A.

- 8) SGSN B updates the HLR and receives subscriber data from HLR. Subscriber data allows roaming, and the SGSN B completes the attach procedure. This includes the assignment of a new P-TMSI with an NRI that can be used by BSC to route subsequent signalling between UE and correct SGSN (Gb-Flex functionality).
- 9) A BSSGP DL-UNITDATA Attach accept message is sent to BSC with the redirection completed flag set. The BSC knows that the redirect is finished and can both forward the Attach Accept message to the UE and clean up any stored redirect data.

SGSN B is allowed to reset the XID parameter only after the attach request is accepted.

- 10) The Attach Accept is forwarded to the UE. The UE stores the P-TMSI with the Gb-Flex NRI to be used for future signalling, even after power off. This is existing functionality.
- 11) UE responds with an Attach Complete message (P-TMSI (re-)allocation if not already made in Attach Accept). The Attach Complete uses new TLLI. After this, the BSS releases the binding between TLLI=X and SGSN B.

If the BSC finds no more SGSN to redirect to after receiving a BSSGP DL-UNITDATA message with the redirection indication flag set, it compares the cause code with cause codes from other BSSGP DL-UNITDATA messages it has earlier received for this UE. A cause code ranking is done and the "softest" cause code is chosen and the corresponding saved attach reject message is returned to the UE.

Each CN node that receives a BSSGP UL-UNITDATA, shall run its own authentication procedure. This may in some rare situations cause the UE to be authenticated more than once, however the trust-model used is that one CN operator shall not trust an authentication done by another CN operator. This will of course not be an optimal usage of radio resources, but given the rare occurrence of this, the increased signalling should not be of any significance.

During the redirect procedure the BSC keeps a timer, which corresponds to the UE timer of releasing the RR connection (20 seconds). If the BSC when receiving a BSSGP DL-UNITDATA message with the redirection indication flag set finds that there is not sufficient time for another redirect, further redirect attempts are stopped (for this attach request message). The UE will repeat its attach request four times (each time waiting 15 seconds before it re-establishes the RR connection for another try).

7.1.4.3 CS registration after PS Handover

An example of an information flow at registration in current domain when already registered in opposite domain is shown below.

This example shows network selection for a non-supporting UE in a shared UTRAN network. The UE is not a subscriber of any of the sharing operators. The UE is not under operator coordination. Due to PS Handover the UE is registered in the PS domain of the shared UTRAN network when the registration attempt for the CS domain occurs.

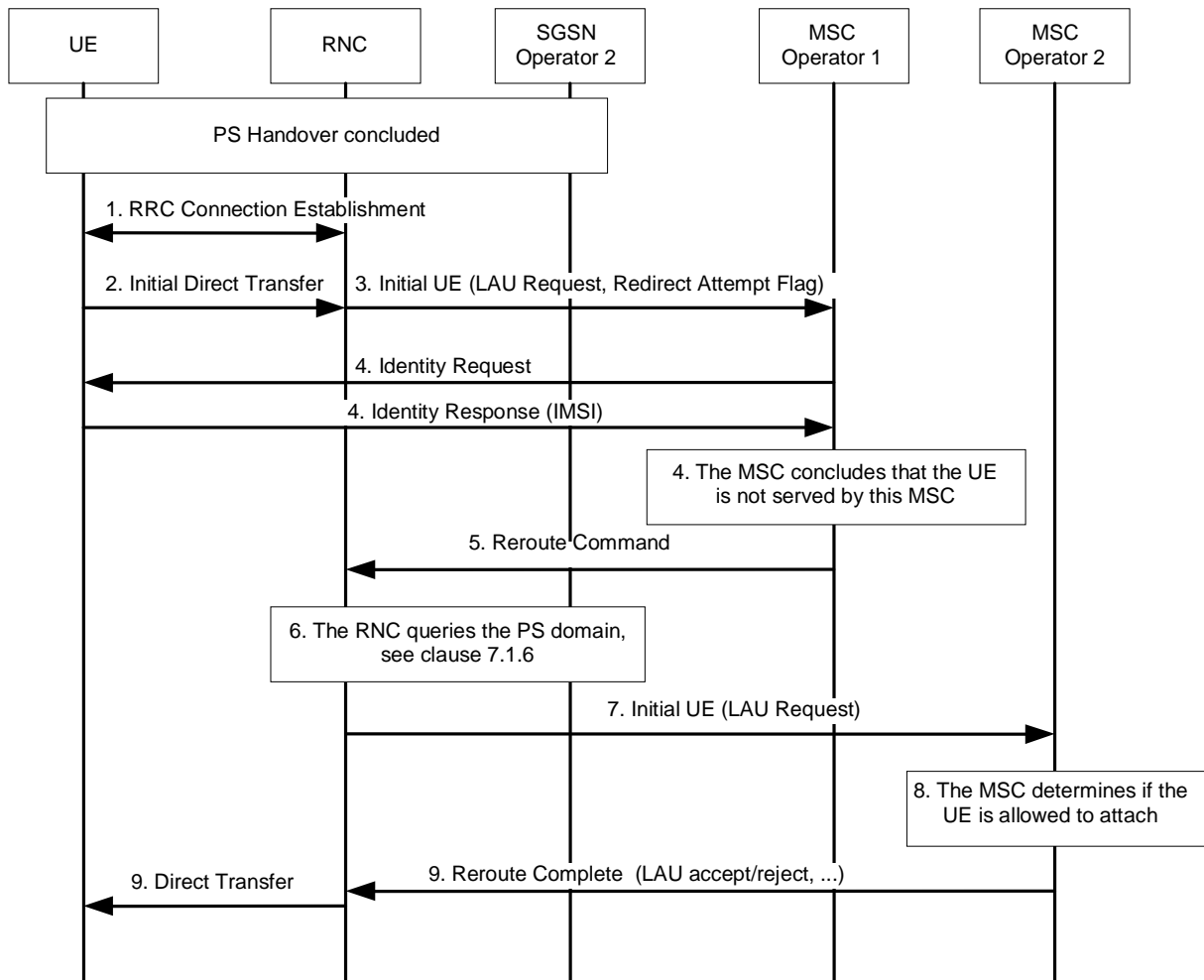

Figure 7-2: Information flow for registration in CS domain after PS Handover

- 1) The RRC connection is established.
- 2) RNC receives an Initial Direct Transfer from an UE. The RNC is configured to work in a Shared RAN MOCN, and therefore it forwards the NAS message in an Initial UE message with an additional redirect attempt flag set. The flag indicates that the MSC shall respond to the attach request with a Reroute Command or Reroute Complete IE in the Direct Transfer message. Selection of CN node is based on NRI (valid or invalid) if present in IDNNS or by random selection. The RAN stores the NRI received from the UE.
- 3) The MSC receives the Initial UE with the redirect attempt flag set. It then knows it shall answer with a Reroute Command or Reroute Complete IE in the Direct Transfer message.
- 4) The MSC needs the IMSI of the UE. It is retrieved either from old MSC or from the UE as in this example. By comparing the IMSI with the roaming agreements of the CN operator, the MSC discovers that the UE has no subscription in operator's network. The MSC concludes also that the UE is not served by the MSC.
- 5) A Reroute Command message is sent back to the RNC with an indication that it is for CSPS coordination purposes. The Reroute Command message includes the IMSI, the LAU REJECT message and the original LOCATION AREA UPDATE message received from the UE. Included is also old LAI. The Reroute Command IE is in the Direct Transfer message.
- 6) The RNC concludes that the UE is not under operator coordination. The RNC queries the SGSNs in the PS domain whether the UE (IMSI) is served by any of the sharing operators in the PS domain. The SGSNs may need to query all MMEs that may hold the UEs context, refer to clause 7.1.6.
- 7) In this example the UE is served by an SGSN node in the PS domain. The RNC selects the same operator for the CS domain and sends the Initial UE to an MSC belonging to the selected operator. The operator selected by the RNC is included in the signalling from RNC to MSC. The redirect attempt flag and an indication that the UE in the PS domain is served by the RNC selected operator shall also be included.

- 8) The MSC determines whether the UE is allowed to attach.
- 9) The MSC sends the appropriate ACCEPT/REJECT message back to the UE.

7.1.5 Supporting UEs in a MOCN configuration

7.1.5.1 UTRAN based MOCN configuration

Supporting UEs can make use of the additional information in the broadcast system information. The UTRAN signalling flow is shown in the figure below.

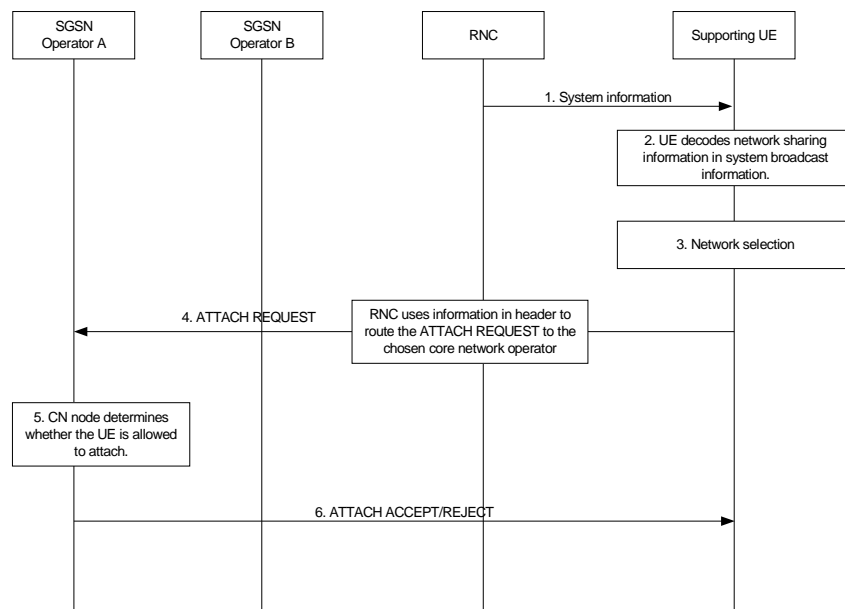

Figure 8: Network selection by a supporting UE in a UTRAN MOCN

1. The UE reads the broadcast system information in the shared RAN.
2. A supporting UE decodes the shared network information and supplies the available core network operator PLMN-ids as candidates to the PLMN selection procedure. Only PLMNs in the Multiple PLMN ID List are candidates for network selection.
3. The UE performs network selection among available PLMNs.
4. The UE sends an ATTACH REQUEST message to the network. It also indicates to the RNC the chosen core network operator. The RNC uses the routing information to determine which core network operator the message should be routed to and the ATTACH REQUEST message is sent to the core network operator chosen by the UE.
5. The core network determines whether the UE is allowed to attach to the network.
6. The shared core network node sends the appropriate ACCEPT/REJECT message back to the UE. In case of an ATTACH ACCEPT message, the core network assigns the UE an appropriate TMSI/P-TMSI so that this identity can be used for any further rerouting of messages by the RNC.

7.1.5.2 GERAN based MOCN configuration

Supporting UEs can make use of the additional information in the broadcast system information. The GERAN signalling flow is shown in the figure below.

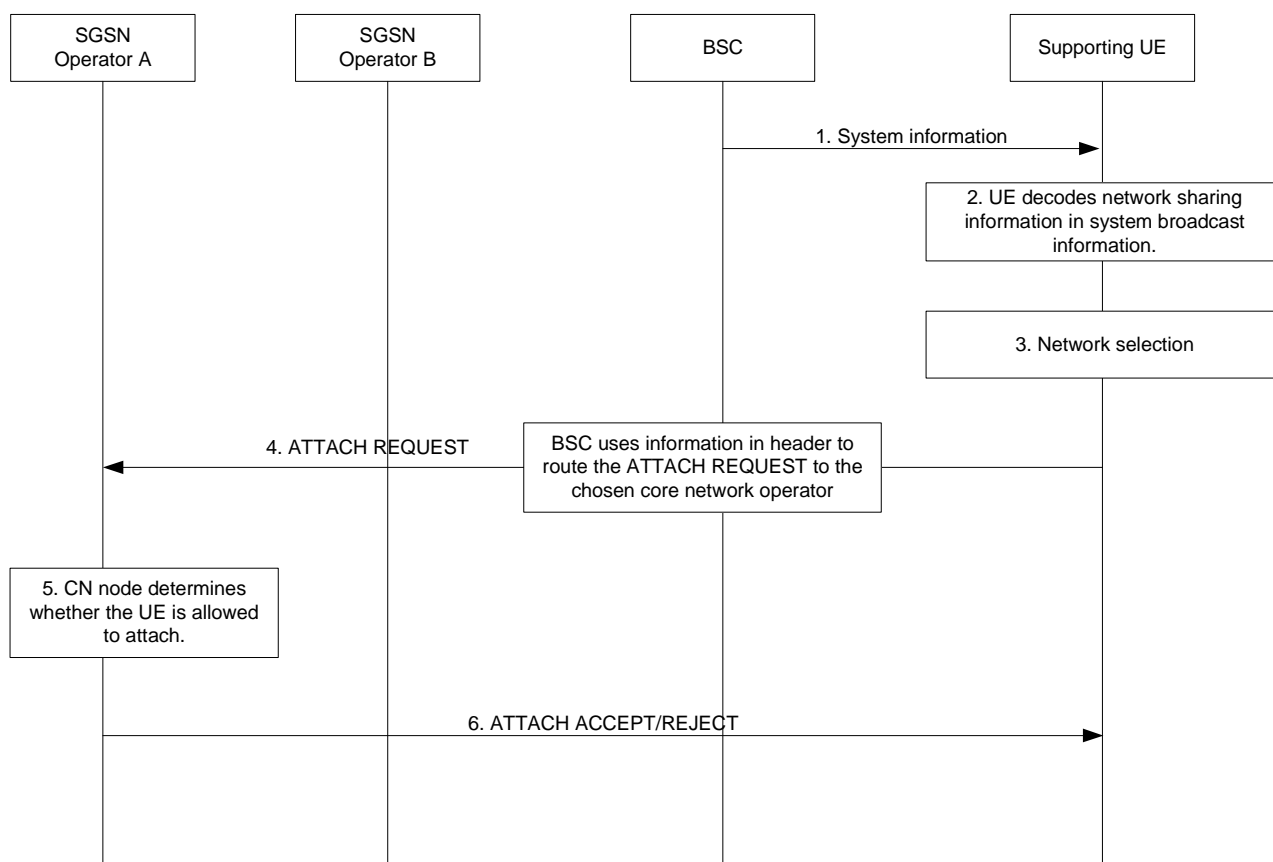

Figure 9: Network selection by a supporting UE in a GERAN MOCN

1. The UE reads the broadcast system information in the shared RAN.
2. A supporting UE decodes the shared network information and supplies the available core network operator PLMN-ids as candidates to the PLMN selection procedure. Only PLMNs in the Multiple PLMN ID List are candidates for network selection.
3. The UE performs network selection among available PLMNs.
4. The UE sends an ATTACH REQUEST message to the network. It also indicates to the BSC the chosen core network operator (via Initial L3 message for CS domain, via AS signalling for the PS domain). The BSC uses the routing information to determine which core network operator the message should be routed to and the ATTACH REQUEST message is sent to the core network operator chosen by the UE together with the chosen PLMN-id.
5. The core network determines whether the UE is allowed to attach to the network.
6. The core network node sends the appropriate ACCEPT/REJECT message back to the UE. In case of an ATTACH ACCEPT message, the core network assigns the UE an appropriate TMSI/P-TMSI so that this identity can be used for any further rerouting of messages by the BSC.

7.1.6 Query to opposite domain

The RAN may query the CN nodes in the opposite domain whether the UE is served by any of the sharing operators in the opposite domain. In the example below a registration attempt is made in the CS domain and the query in the opposite domain is sent to the PS domain i.e. the SGSNs and if not registered in the SGSN the SGSN sends the query to all MMEs that may hold the UEs context. If the registration attempt was made in the PS domain the query to opposite domain is send to the CS domain i.e. the MSCs.

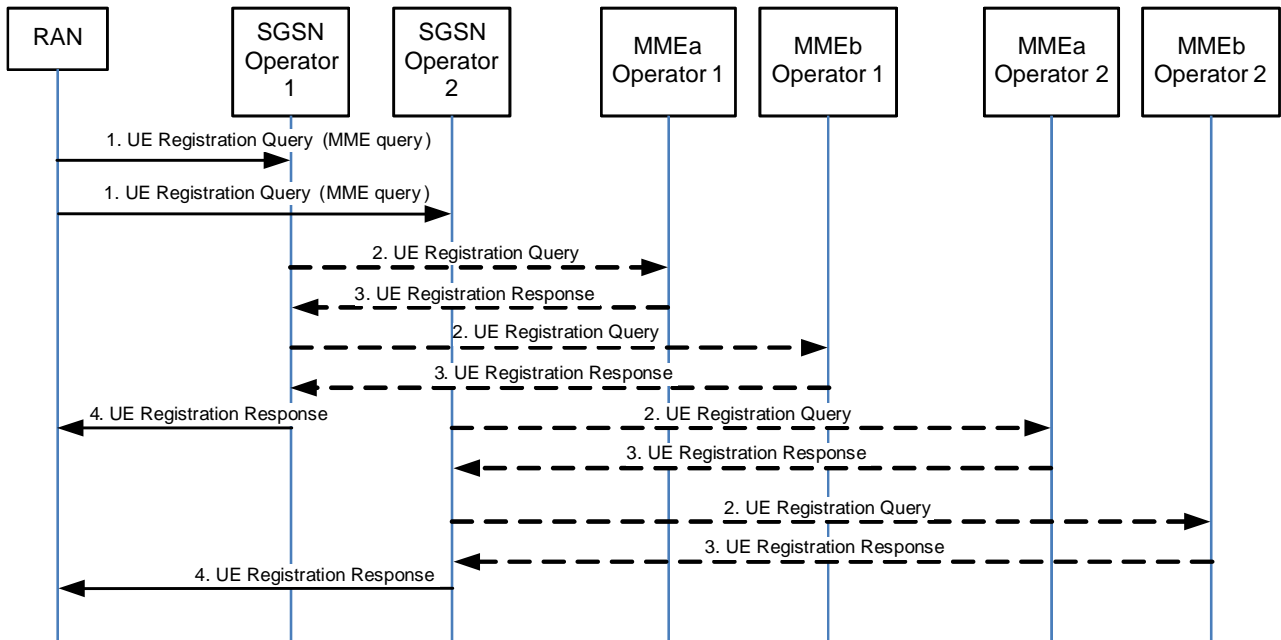

Figure 10: PS domain query

- 1) The SGSN receives a UE (IMSI) query from the RAN node including an indication to also query MMEs if the UE is not served by the SGSN.
- 2) If the UE is not served by the SGSN the SGSN forwards the UE (IMSI) query to all MMEs that may hold the UEs context of the same operator as the SGSN.
- 3) If the UE is not served by any node in E-UTRAN each MME replies with a negative response to the UE query. If the UE is served by any of the MMEs, this MME replies with a positive response.
- 4) If the SGSN or any MME serves the UE, the SGSN replies with a positive response to the UE query from RAN. If the UE is not served by any SGSN or MME, the SGSN replies with a negative response to RAN.

Annex A (informative): Network Resource Indicator (NRI) allocation examples

This annex contains examples for NRI co-ordination for non-supporting UEs in shared networks.

A.1 NRI in shared UTRAN/GERAN networks

The Network Resource Identifier (NRI) is specified in Rel-5 for Intra Domain Connection of RAN Nodes to Multiple CN nodes (see TS 23.236 [8]). NRI is part of the temporary identity TMSI (CS domain) or P-TMSI (PS domain), which is assigned by the serving CN node to the MS. This clause describes NRI usage in MOCN.

Within the shared network NRIs has to be coordinated between the operators at least due to following reasons:

- to avoid redirection or CS/PS un-coordination when the non-supporting UE performs LA/RA update.
- to achieve that correct UE answers to paging (TMSI/P-TMSI shall be unique within shared network).
- to achieve that a non-supporting UE in visited PLMN will not change network due to LA/RA update or Detach/Attach function.
- to achieve that non-supporting UE in visited PLMN remains CS/PS coordinated when the UE moves within shared network.

Operator coordination of CS-NRI and LAI tuple for the CS domain, and PS-NRI and RAI tuple for the PS domain is also required between the shared network and the dedicated networks of the sharing partners:

- to achieve that non-supporting UE in visited PLMN remain registered in the same operators network when the UE moves from dedicated network to a shared network.
- to achieve that non-supporting UE in visited PLMN remains CS/PS coordinated when the UE moves from dedicated network to a shared network.

By coordinating the actual values of the CS-NRIs for the CS domain and the PS-NRIs/MMECs for the PS domains between networks, additional signalling can be avoided when handling LA/RA updates for subscribers of the sharing partners since analysis of LAI/RAI will not be necessary.

Operator coordination of TAI and MMEC (mapped to PS-NRI) is also required between shared UTRAN or GERAN and E-UTRANs of the sharing partners:

- to achieve that non-supporting UE in visited PLMN remain registered in the same operators network when the UE moves from dedicated network to a shared network.
- to achieve that non-supporting UE in visited PLMN becomes CS/PS coordinated when the UE moves from EUTRAN to a shared UTRAN or GERAN network.

If CSFB is configured for a UE, the TAI and MMEC (mapped to PS-NRI) should be operator coordinated so that additional signalling can be avoided. In any case the TAI and MMEC (mapped to PS-NRI) coordinated with another operator than the selected CS domain operator of the UE is not allowed.

CS/PS coordination is achieved by allocating to the UE, an NRI for the CS domain and an NRI for the PS domain that together with LAI and RAI respectively indicates the same operator in the shared network.

At LA/RA update the RNC/BSC routes the NAS message to the operator that is defined by NRI, even if NRI is created in a PLMN different from Common PLMN.

In figure A.1 below operators A, B and C have both shared and dedicated networks, operator D has only dedicated network and operator E only shared network.

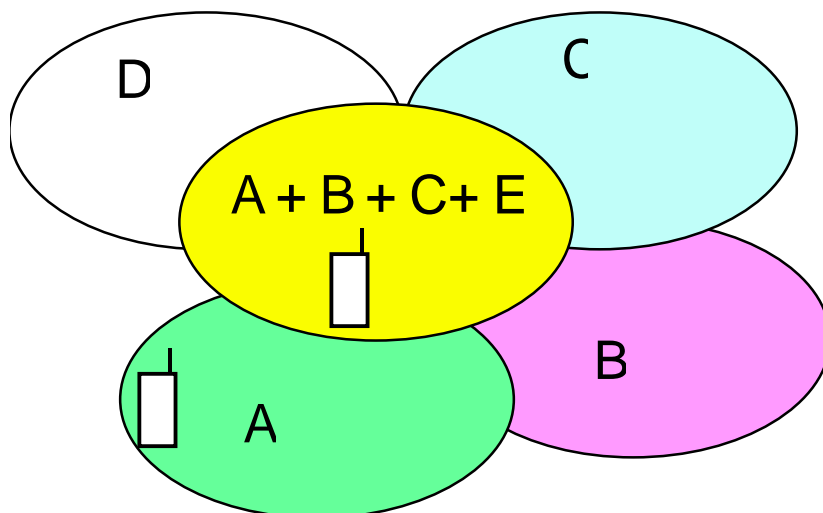

Figure A.1: Shared and Dedicated network example

In the above, one or more of the operators in the shared network may deploy Iu-Flex or A/Gb-Flex between that shared radio access network and their core networks. Additionally, operators may deploy Iu-Flex or A/Gb-Flex within their dedicated core networks. For non-supporting UEs, operator coordination of the CS-NRI and LAI tuple and PS-NRI/MMEC and RAI/TAI tuple is needed not only within the shared network, but also between the shared network and the dedicated networks.

A.2 Alternatives for NRI split in UTRAN and GERAN

Sharing operators need to coordinate the used NRI, following alternatives are considered:

- 1) even split of NRI space, 1...3 most significant bits of NRI is used to identify the CN operator.
- 2) individual NRI values used to identify the CN operator.

Alternative 1; even split of NRI space

31	30	29	28	27	26	25	24	23	22	21	20	19	18	17	16	15	14	13	12	11	10	9	8	7	6	5	4	3	2	1	0		
CS/PS		'VLR-restart'						CN operator ID	Non shared NRI for CN operator internal use.																								

A calculation for the possible number of subscribers in this scenario is:

- With max 4 sharing CN operators, two most significant bits of NRI is required to identify the CN operator.
- 3 bits are used for the restart counter.
- 5 bits of NRI allows 32 independent NRI values for each CN operator.
- This leaves 20 bits for every MSC that is 1 M non-purged TMSI.

The following aspects need to be considered for this solution:

- If more bits are needed for the restart counter or CN operator ID, each additional bit reduces the available TMSI space half.
- The basic configuration allows 32 M TMSI values for each CN operator, a lot of TMSI values are wasted if some sharing partners have substantially less subscribers than others.
- It may not be feasible in large networks that use Iu-Flex or A/Gb-Flex for load balancing (see Annex A, network configuration examples in TS 23.236 [8]).
- The number of NRI bits used for CN operator ID may need to be fixed in the initial planning. Otherwise configuration of all existing nodes must be changed when new partners join the shared network.

Alternative 2; individual NRI values used to identify the CN operator

This could be considered in the case where a network is shared between one big and many small CN operators.

31	30	29	28	27	26	25	24	23	22	21	20	19	18	17	16	15	14	13	12	11	10	9	8	7	6	5	4	3	2	1	0
CS/PS	'VLR-restart'				Shared NRI space																										

- The biggest CN operator who needs more pool areas and TMSI space takes NRI values 32...63, [1xxxxx], this means 32M TMSI values when 4 bit is used for restart counter.
- Rest of shared NRI space is allocated to other CN operators in blocks of 4M TMSI values like NRI = 28 - 31 [0111xx], 24 - 27 [0110xx] 0 - 3 [000xx]. Initially gaps can be left between allocated NRI range that can be used for expansion.

Following aspects need to be considered for this solution:

- If more bits are needed for the restart counter or NRI, each additional bit reduces the available TMSI space half.
- The initial planning of NRI length should take into account the pool area configurations of all sharing operators.

TMSI per LA:

Taking the example configurations mentioned above but changing the TMSI allocation per LA would result in an increase of the addressing space, then the same TMSI value can be used multiple times in the same VLR. More considerations with this TMSI per LA approach can be found in TS 23.236 [8].

A.3 NRI and CS/PS coordination in GWCN

For GWCN, the BSC and RNC determines a serving CN operator for a non-supporting UE based on the principles defined in clause 4.2.5.3, such that determined CN operator outcome (deterministic outcome) is the same in CS and PS domain.

When source network determines target CN operator in handover and CS fallback, the NRI and MMEC coordination is required as for MOCN (see clause A.1) within the shared network and operator coordination of the CS-NRI and LAI tuple and PS-NRI/MMEC and RAI/TAI tuple between the shared network and the dedicated networks of the sharing partners:

- to achieve that a non-supporting UE in visited PLMN will not change network due to LA/RA update;
- to achieve that non-supporting UE in visited PLMN becomes CS/PS coordinated.

A.4 CSPS Coordination

In figure A.4-1 an example is given how the CSPA coordination can be handled, see also clause 4.2.5.3.

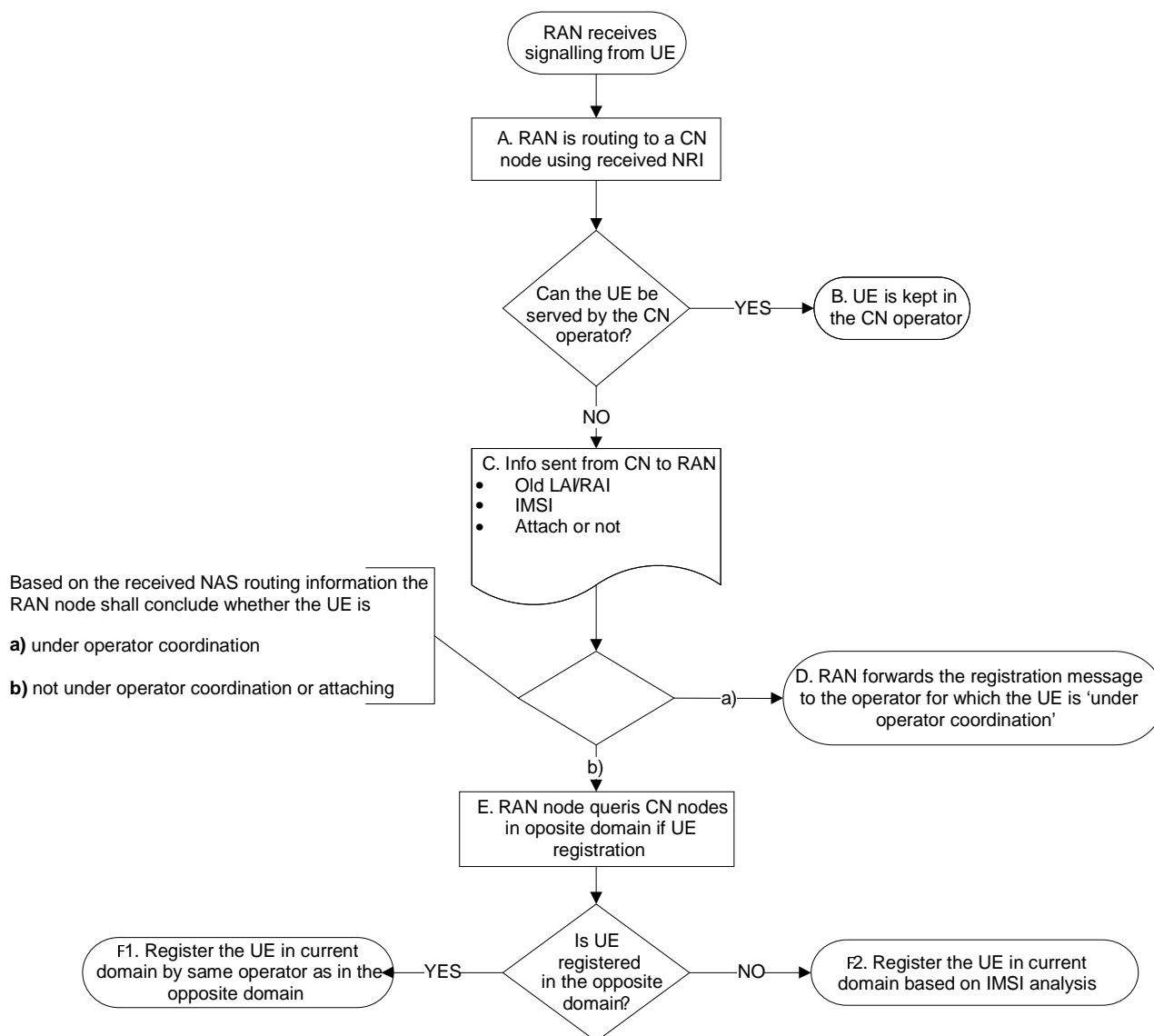

Figure A.4-1: Flow diagram for CSPA Coordination

- A. When the target RAN node receives an idle mode signalling (Attach Request/Routeing Area Update Request/Location Area Update Request messages) from a UE it routes the request to a CN node based on the NRI provided by the UE. For MOCN an operator is thereby selected. For GWCN an operator is selected by the CN node. The RAN stores the NRI received from the UE.
- B. If the UE can be served by the selected CN operator the UE is kept. A 'Redirection Completed' indication shall then be included in the response to the RAN node and the procedure ends. In the following cases the CN operator can serve the UE:
1. The UE is a non-roaming subscriber of the selected CN operator.
 2. The UE is already served by the selected CN operator (e.g. periodic updates or mobility within a pool).
 3. The RAN node indicates a RAN selected CN operator and the selected CN operator is serving the UE in the opposite domain.
- C. If the UE is not kept by the selected CN operator then 'Redirection Indication' with 'CS/PS coordination Required' and IMSI is included in the response to the RAN node. Old LAI (for the CS domain) or old RAI (for the PS domain) or an indication whether the UE is attaching in the current domain, is also included in the response.
- D. If the UE is under operator coordination, the RAN node selects a core node of the identified operator and forwards the message accordingly. The procedure ends.

NOTE 1: If the UE is under operator coordination and is both CS and PS registered in the source network, this operator is kept and CS/PS coordination is achieved.

However, in conditions valid for step E and if the UE lacks CS registration in the source network (e.g. as with source LTE and no SGs registration) then achieving a successful CS/PS coordination and keeping the same serving operator as in the source network will be dependent upon the access to the information about the source network PS domain registration. For that reason it becomes necessary to check if the UE is registered in the PS domain (see step E) and if so register with that operator also in the CS domain. For example at cell reselection from a source LTE to a target GERAN network without DTM there will, during CS registration, be no registration in the PS domain within the shared target network. Therefore a check must also be done in all possible source networks of the sharing operators otherwise users may become CS/PS uncoordinated. The lack of CS registration in the source network implies an initial CS attach in the target network and therefore step E will be performed.

A similar situation can occur when the UE lacks PS registration (as with no Data roaming for the UE) but for normal cases the UE is already registered in the target shared network in the CS domain when the PS registration occur. Checking in the source networks is then not necessary.

E. If the UE is not under operator coordination, or if the UE is making an initial attach, the RAN node sends requests to all connected CN nodes or by a possible optimization to one CN node per operator in the opposite domain in the target shared network, to inquire if the UE is served by the opposite domain. To not risk a change of serving operator for cases described in step D (i.e. when attaching to CS domain) then it is also necessary to check in the all MMEs that may hold the UEs context, of the sharing operators, if the UE is registered in the PS domain. Checking the source MMEs is done by relaying requests from target RAN via the CN in the target shared network. However in deployments where these cases are not applicable (e.g. always CS registration in source networks) or when it is sufficient to achieve CS/PS coordination, then the source networks need not to be checked.

NOTE 2: Checking CN nodes in the opposite domain in the target shared network is also used at e.g. CS and PS Handover when the UE is not under operator coordination. For such cases the idle mode domain registration needs to select the same operator as is already in use for the connected domain.

F1. If the UE is registered in the opposite domain then the RAN node retrieves the PLMN of that registered operator and selects the same operator for the current domain. The procedure ends.

F2. If the UE is not registered in the opposite domain then the RAN node selects operator based on the IMSI analysis. The procedure ends.

If during execution of step D or E, a registration in the opposite domain occurs, then the RAN node can optionally select as follows:

- If the UE is registered in the opposite domain and is under operator coordination and is not performing an initial attach, then the RAN node, for both domains, selects serving operator based on the registration information from the opposite domain.
- If the UE is registered in the opposite domain and is not under operator coordination or is attaching, but with regards to the current domain the UE:
 - is under operator coordination and is not performing an initial attach, then the RAN node, for both domains, selects serving operator based on the registration information applicable to the current domain.
 - is not under operator coordination or is attaching then the RAN node, for both domains, selects serving operator based on IMSI analysis.

For parallel registrations in the CS and PS domains the above means that CS/PS coordination is achieved and that serving operator is kept.

Annex B (normative): Interaction with other network capabilities

B.1 General

The provision of services and service capabilities in a network should not be restricted by the existence of network sharing. Therefore, all new features (or enhancements to existing features) should be specified to work in network sharing environments. If it is not possible to specify complete support for Network Sharing (i.e. PLMNs in a Shared Network has the same features/capabilities and the same operational situation as a stand alone PLMN) then such deviations are documented in this Annex.

B.2 Support for RAN sharing for CSG and hybrid cells

A cell with closed/hybrid access can only broadcast one CSG ID but may broadcast several PLMN IDs. If a cell with closed/hybrid access broadcasts several PLMNs (see clauses 5.2 and 5.2a) for a UE supporting shared network or a non-supporting UE that performs the PLMN selection (see clause 4.2.3.2), it is the operator responsibility to coordinate the CSG IDs between the operators' PLMNs.

For handover into a shared hybrid or shared CSG cell, the source RAN shall determine a target core network operator for which the UE is a CSG member since otherwise the handover is likely to fail. In case the UE is capable of reporting the subset of the broadcasted PLMN IDs in the target cell to which its CSG membership is verified, the source RAN bases its core network operator selection on this information. If this information is not reported by the UE the selection of a target core network operator is based on pre-configured information in the RAN.

NOTE: To ensure that handovers do not fail due to the source RAN selecting a core network operator for which the UE is not a CSG member in the case when the UE only reports the Primary PLMN-ID (E-UTRAN) as described in TS 36.331 [11] or no PLMN ID (UTRAN), the following RAN configuration can be used. The source RAN is configured with all broadcasted PLMN identities of neighbouring shared hybrid and closed access mode CSG cells, so that this data can be retrieved based on the UE-provided information (ECGI/TAC/CSG ID in E-UTRAN and Cell ID in UTRAN) of the target H(e)NB. The source RAN determines a target PLMN ID from the Handover Restriction List (HRL, see TS 36.413 [14]) in E-UTRAN or Shared Network Area (SNA) access information (see TS 25.413 [13]) in UTRAN. If HRL or SNA are not supported, local configuration in the RAN could be used. For a target cell, the allowed PLMN identities according to CSG membership should be the same as the allowed PLMN identities for handover because otherwise handovers can fail. If the target is hybrid cell and the UE is not a CSG member, the handover may be solved in the same way.

For further details on Closed Subscriber Group (CSG) and closed/hybrid access, see TS 36.300 [10] and TS 25.467 [17].

Annex C (informative): Change History

Change history							
Date	Meeting	TDoc	CR	Rev	Cat	Subject/Comment	New version
2011-09	SP-53	SP-110457	0034	5	B	Introduction of FULL-MOCN-GERAN feature	11.0.0
2012-03	SP-55	SP-120088	0037	2	B	SRVCC and Network Sharing from E-UTRAN	11.1.0
2012-03	SP-55	SP-120088	0039	-	D	Editorial corrections on redirection message for Non-supporting UEs in a MOCN configuration	11.1.0
2012-03	SP-55	SP-120079	0040	1	B	Introduction of FULL-MOCN-GERAN feature	11.1.0
2012-03	SP-55	SP-120079	0043	1	C	FULL-MOCN-GERAN support	11.1.0
2012-03	SP-55	SP-120088	0045	2	B	EAB for network sharing	11.1.0
2012-06	SP-56	SP-120251	0046	2	F	Support for RAN sharing for CSG and hybrid cells	11.2.0
2012-06	SP-56	SP-120237	0051	2	A	SRVCC and Network Sharing	11.2.0
2012-06	SP-56	SP-120251	0053	2	F	EAB overload control from CN to RAN for UTRAN/GERAN in shared networks	11.2.0
2012-06	SP-56	SP-120248	0054	1	B	rSRVCC in network sharing with LTE to CS and back to LTE	11.2.0
2012-06	SP-56	SP-120251	0060	1	F	Network Sharing Corrections for SRVCC	11.2.0
2012-06	SP-56	SP-120246	0061	2	F	Corrections for MOCN GERAN	11.2.0
2012-06	SP-56	SP-120251	0062	2	B	GWCN for GERAN	11.2.0
2012-06	SP-56	SP-120252	0063	3	B	SIRIG support in shared networks	11.2.0
2012-06	SP-56	SP-120246	0064	1	B	Selection of PLMN for the CS Domain in CSFB towards a shared GERAN	11.2.0
2012-06	SP-56	SP-120239	0068	4	F	EAB in shared networks	11.2.0
2012-09	SP-57	SP-120486	0057	6	F	Network Sharing Corrections following review of GWCN UTRAN	11.3.0
2012-09	SP-57	SP-120483	0074	-	F	Impact of SIRIG on the BSS in a shared network	11.3.0
2012-12	SP-58	SP-120726	0059	5	F	GWCN UTRAN and charging	11.4.0
2012-12	SP-58	SP-120902	0067	8	F	Network sharing impact on the CSFB	11.4.0
2012-12	SP-58	SP-120722	0077	5	F	Using NRI for CS/PS coordination	11.4.0
2012-12	SP-58	SP-120724	0078	1	F	Incorrect definition of Anchor PLMN	11.4.0
2012-12	SP-58	SP-120722	0080	3	C	Indicating selected PLMN to target BSC during handover	11.4.0
2012-12	SP-58	SP-120710	0085	-	A	HPLMN needs to be unaware of network sharing in VPLMN	11.4.0
2013-03	SP-59	SP-130085	0086	2	F	Further consideration on the network sharing impact on the CSFB	11.5.0
2013-03	SP-59	SP-130085	0087	2	F	CDRs needs to reflect whether the core network operator was selected by a UE or allocated by the network to a UE	11.5.0
2013-03	SP-59	SP-130085	0089	4	C	Indicating selected PLMN to target BSC during handover	11.5.0
2013-12	SP-62	SP-130523	0095	2	F	RNC functionality in GWCN deployments	11.6.0
2013-12	SP-62	SP-130534	0096	5	F	Core Network Operator selection origin	12.0.0
2013-12	SP-62	SP-130536	0097	2	F	Support of inbound mobility to a shared CSG cell	12.0.0
2014-06	SP-64	SP-140262	0099	2	B	Master eNB is responsible to select Secondary eNBs compliant to network sharing agreements	12.1.0
2014-06	SP-64	SP-140377	0100	3	F	Exchange of PLMN identities in Shared Networks	12.1.0
2014-12	SP-66	SP-140692	0101	2	C	CSPS Coordination General Description	13.0.0
2014-12	SP-66	SP-140692	0102	1	C	Example signalling flows	13.0.0
2014-12	SP-66	SP-140692	0103	1	C	Example logics for CSPS Coordination	13.0.0
2014-12	SP-66	SP-140692	0104	1	C	Functional description	13.0.0
2015-03	SP-67	SP-150026	0105	3	C	CSPS Coordination Annex A.1 and A.3 updates	13.1.0
2016-06	SP-72	SP-160288	0106	1	F	Removing CS/PS-NRI signalling from MSC/SGSN to RNC/BSC	13.2.0
2017-03	-	-	-	-	-	Update to Rel-14 version (MCC)	14.0.0
2017-09	SP-77	SP-170723	0107	2	C	EUTRAN sharing enhancement alignment	14.1.0
2018-06	SP-80	-	-	-	-	Update to Rel-15 version (MCC)	15.0.0
2018-09	SP-81	SP-180729	0108	2	F	Definition of Primary PLMN ID	15.1.0

History

Document history		
V15.0.0	June 2018	Publication
V15.1.0	September 2018	Publication