

ETSI TS 123 255 V17.5.0 (2023-04)



LTE;
Application layer support for Uncrewed Aerial System (UAS);
Functional architecture and information flows;
(3GPP TS 23.255 version 17.5.0 Release 17)



Reference

RTS/TSGS-0623255vh50

Keywords

LTE

ETSI

650 Route des Lucioles
F-06921 Sophia Antipolis Cedex - FRANCE

Tel.: +33 4 92 94 42 00 Fax: +33 4 93 65 47 16

Siret N° 348 623 562 00017 - APE 7112B
Association à but non lucratif enregistrée à la
Sous-Préfecture de Grasse (06) N° w061004871

Important notice

The present document can be downloaded from:

<https://www.etsi.org/standards-search>

The present document may be made available in electronic versions and/or in print. The content of any electronic and/or print versions of the present document shall not be modified without the prior written authorization of ETSI. In case of any existing or perceived difference in contents between such versions and/or in print, the prevailing version of an ETSI deliverable is the one made publicly available in PDF format at www.etsi.org/deliver.

Users of the present document should be aware that the document may be subject to revision or change of status.

Information on the current status of this and other ETSI documents is available at

<https://portal.etsi.org/TB/ETSIDeliverableStatus.aspx>

If you find errors in the present document, please send your comment to one of the following services:

<https://portal.etsi.org/People/CommitteeSupportStaff.aspx>

If you find a security vulnerability in the present document, please report it through our
Coordinated Vulnerability Disclosure Program:

<https://www.etsi.org/standards/coordinated-vulnerability-disclosure>

Notice of disclaimer & limitation of liability

The information provided in the present deliverable is directed solely to professionals who have the appropriate degree of experience to understand and interpret its content in accordance with generally accepted engineering or other professional standard and applicable regulations.

No recommendation as to products and services or vendors is made or should be implied.

No representation or warranty is made that this deliverable is technically accurate or sufficient or conforms to any law and/or governmental rule and/or regulation and further, no representation or warranty is made of merchantability or fitness for any particular purpose or against infringement of intellectual property rights.

In no event shall ETSI be held liable for loss of profits or any other incidental or consequential damages.

Any software contained in this deliverable is provided "AS IS" with no warranties, express or implied, including but not limited to, the warranties of merchantability, fitness for a particular purpose and non-infringement of intellectual property rights and ETSI shall not be held liable in any event for any damages whatsoever (including, without limitation, damages for loss of profits, business interruption, loss of information, or any other pecuniary loss) arising out of or related to the use of or inability to use the software.

Copyright Notification

No part may be reproduced or utilized in any form or by any means, electronic or mechanical, including photocopying and microfilm except as authorized by written permission of ETSI.

The content of the PDF version shall not be modified without the written authorization of ETSI.

The copyright and the foregoing restriction extend to reproduction in all media.

© ETSI 2023.
All rights reserved.

Intellectual Property Rights

Essential patents

IPRs essential or potentially essential to normative deliverables may have been declared to ETSI. The declarations pertaining to these essential IPRs, if any, are publicly available for **ETSI members and non-members**, and can be found in ETSI SR 000 314: "*Intellectual Property Rights (IPRs); Essential, or potentially Essential, IPRs notified to ETSI in respect of ETSI standards*", which is available from the ETSI Secretariat. Latest updates are available on the ETSI Web server (<https://ipr.etsi.org/>).

Pursuant to the ETSI Directives including the ETSI IPR Policy, no investigation regarding the essentiality of IPRs, including IPR searches, has been carried out by ETSI. No guarantee can be given as to the existence of other IPRs not referenced in ETSI SR 000 314 (or the updates on the ETSI Web server) which are, or may be, or may become, essential to the present document.

Trademarks

The present document may include trademarks and/or tradenames which are asserted and/or registered by their owners. ETSI claims no ownership of these except for any which are indicated as being the property of ETSI, and conveys no right to use or reproduce any trademark and/or tradename. Mention of those trademarks in the present document does not constitute an endorsement by ETSI of products, services or organizations associated with those trademarks.

DECT™, **PLUGTESTS™**, **UMTS™** and the ETSI logo are trademarks of ETSI registered for the benefit of its Members. **3GPP™** and **LTE™** are trademarks of ETSI registered for the benefit of its Members and of the 3GPP Organizational Partners. **oneM2M™** logo is a trademark of ETSI registered for the benefit of its Members and of the oneM2M Partners. **GSM®** and the GSM logo are trademarks registered and owned by the GSM Association.

Legal Notice

This Technical Specification (TS) has been produced by ETSI 3rd Generation Partnership Project (3GPP).

The present document may refer to technical specifications or reports using their 3GPP identities. These shall be interpreted as being references to the corresponding ETSI deliverables.

The cross reference between 3GPP and ETSI identities can be found under <https://webapp.etsi.org/key/queryform.asp>.

Modal verbs terminology

In the present document "**shall**", "**shall not**", "**should**", "**should not**", "**may**", "**need not**", "**will**", "**will not**", "**can**" and "**cannot**" are to be interpreted as described in clause 3.2 of the [ETSI Drafting Rules](#) (Verbal forms for the expression of provisions).

"**must**" and "**must not**" are **NOT** allowed in ETSI deliverables except when used in direct citation.

Contents

Intellectual Property Rights	2
Legal Notice	2
Modal verbs terminology.....	2
Foreword.....	7
Introduction	8
1 Scope	9
2 References	9
3 Definitions of terms and abbreviations.....	9
3.1 Terms.....	9
3.2 Abbreviations	10
4 Architectural requirements	11
4.1 General	11
4.2 Support for communications between UAVs	11
4.2.1 Description.....	11
4.2.2 Requirements	11
4.3 QoS provisioning for C2 communication.....	11
4.3.1 Description.....	11
4.3.2 Requirements	11
4.4 C2 communication mode switching	11
4.4.1 Description.....	11
4.4.2 Requirements	11
4.5 Support for monitoring of UAV location deviation	12
4.5.1 Description.....	12
4.5.2 Requirements	12
4.6 Support for reporting of UAV events	12
4.6.1 Description.....	12
4.6.2 Requirements	12
5 Functional model	12
5.1 General	12
5.2 Functional model description	12
5.3 Functional entities description.....	15
5.3.1 General.....	15
5.3.2 UAS application specific client	15
5.3.3 UAS application specific server.....	16
5.3.4 UAE client	16
5.3.5 UAE server	16
5.3.6 SEAL client	16
5.3.7 SEAL server.....	16
5.4 Reference points description	17
5.4.1 General.....	17
5.4.2 U1-AE.....	17
5.4.3 U1-APP.....	17
5.4.4 U2-AE.....	17
5.4.5 U2-APP.....	17
5.4.6 Us.....	17
5.4.7 Uc.....	17
5.4.8 SEAL-C	17
5.4.9 SEAL-S.....	18
5.4.10 SEAL-PC5	18
5.4.11 SEAL-UU	18
5.4.12 UAE-E	18
5.5 External reference points.....	19

5.5.1	General.....	19
5.5.2	Rx.....	19
5.5.3	MB2-C.....	19
5.5.4	MB2-U.....	19
5.5.5	xMB-C.....	19
5.5.6	xMB-U.....	19
5.5.7	T8.....	19
5.5.8	N5.....	19
5.5.9	N33/Nnef.....	19
6	Identities.....	20
6.1	General.....	20
6.2	UAV Identifier (UAV ID).....	20
6.3	UAS Identifier (UAS ID).....	20
6.4	UAS Application Specific Server Identifier (UASS ID).....	20
6.5	UAE Server Identifier (UAE Server ID).....	20
7	Procedures and information flows.....	20
7.1	Usage of SEAL services.....	20
7.1.1	General.....	20
7.1.2	Group management service.....	20
7.1.2.1	General.....	20
7.1.2.2	Information flows.....	21
7.1.2.3	Procedures.....	22
7.1.2.4	APIs.....	22
7.1.3	Location management service.....	22
7.1.3.1	General.....	22
7.1.3.2	Information flows.....	22
7.1.3.3	Procedures.....	23
7.1.3.4	APIs.....	23
7.1.4	Network resource management service.....	23
7.1.4.1	General.....	23
7.1.4.2	Information flows.....	24
7.1.4.3	Procedures.....	24
7.1.4.4	APIs.....	24
7.1a	UAE layer registration.....	25
7.1a.1	General.....	25
7.1a.2	Procedures.....	25
7.1a.2.1	UAS UE registration.....	25
7.1a.2.1.1	General.....	25
7.1a.2.1.2	Procedure.....	25
7.1a.2.2	UAS UE deregistration.....	25
7.1a.2.2.1	General.....	25
7.1a.2.2.2	Procedure.....	25
7.1a.2.3	UAS UE registration update.....	26
7.1a.2.3.1	General.....	26
7.1a.2.3.2	Procedure.....	26
7.1a.3	Information flows.....	26
7.1a.3.1	Registration request.....	26
7.1a.3.2	Registration response.....	27
7.1a.3.3	Deregistration request.....	27
7.1a.3.4	Deregistration response.....	27
7.1a.3.5	Registration update request.....	27
7.1a.3.6	Registration update response.....	27
7.2	Communications between UAVs within a geographical area.....	28
7.2.1	General.....	28
7.2.2	Procedures.....	28
7.2.2.1	Communications between UAVs within a geographical area using unicast Uu.....	28
7.2.3	Information flows.....	29
7.2.3.1	UAV application message.....	29
7.3	UAV and UAV-C Pairing and C2 QoS Provisioning using Group ID.....	29
7.3.1	General.....	29

7.3.2	Procedures.....	29
7.3.2.1	Procedure for group creation for one pair of UAV and UAV-C	29
7.3.2.2	Procedure for group-based approach for C2 QoS provisioning	30
7.3.3	Information flows	31
7.4	C2 Communication mode selection and switching	31
7.4.1	General.....	31
7.4.2	Procedures.....	32
7.4.2.1	Management of C2 mode selection / switching capability	32
7.4.2.2	C2 communication modes configuration	32
7.4.2.3	C2 communication mode selection by UAE Client	33
7.4.2.4	UAE layer assisted dynamic C2 mode switching.....	34
7.4.2.5	UAS application specific server triggered C2 communication mode switching	35
7.4.3	Information flows	36
7.4.3.1	C2 operation mode management request	36
7.4.3.2	C2 operation mode management response.....	36
7.4.3.3	C2 operation mode management complete	37
7.4.3.4	C2-related trigger event report	37
7.4.3.5	C2 mode switching confirmation request.....	37
7.4.3.6	C2 mode switching confirmation response	37
7.4.3.7	C2 operation mode switching.....	38
7.4.3.8	C2 communication modes configuration request.....	38
7.4.3.9	C2 communication modes configuration response.....	38
7.4.3.10	C2 communication mode notification	39
7.4.3.11	C2 communication mode notification acknowledgement	39
7.4.3.12	C2 operation mode switching performed	39
7.5	Real-Time UAV Connection Status Monitoring and Location reporting.....	39
7.5.1	General.....	39
7.5.2	Procedures.....	40
7.5.2.1	Procedure for real-time UAV network connection status monitoring and location update.....	40
7.5.2.2	Subscription for real-time UAV status information	40
7.5.2.3	Notification of real-time UAV status information	41
7.5.2.4	Unsubscription for real-time UAV status information	41
7.5.3	Information flows	42
7.5.3.1	Information flows between UAE server and SEAL servers.....	42
7.5.3.2	Subscribe real-time UAV status information request.....	42
7.5.3.3	Subscribe real-time UAV status information response	42
7.5.3.4	Notify real-time UAV status information	42
7.5.3.5	Unsubscribe real-time UAV status information request.....	43
7.5.3.6	Unsubscribe real-time UAV status information response	43
8	APIs.....	43
8.1	General	44
8.2	UAE server APIs.....	44
8.2.1	General.....	44
8.2.2	UAE_C2OperationModeManagement API.....	45
8.2.2.1	General	45
8.2.2.2	Manage_C2OperationMode operation	45
8.2.2.3	Notify_SelectedC2Mode	45
8.2.2.4	Notify_C2ModeSwitching	45
8.2.2.5	Notify_C2OperationModeManagementComplete	45
8.2.3	UAE_ RealtimeUAVStatus API.....	46
8.2.3.1	General	46
8.2.3.2	Subscribe_ RealtimeUAVStatus operation	46
8.2.3.3	Unsubscribe_ RealtimeUAVStatus operation	46
8.2.3.4	Notify_ RealtimeUAVStatus operation.....	46
Annex A (informative):	Support for edge deployments.....	47
Annex B (Informative):	Deployment models.....	48
B.1	General	48
B.2	Deployment of UAE server	48
B.2.1	Centralized deployments.....	48

B.2.2 Distributed deployment.....50

Annex C (informative): Examples of usage of SEAL by UAS application specific server.....53

Annex D (informative): Change history54

History55

Foreword

This Technical Specification has been produced by the 3rd Generation Partnership Project (3GPP).

The contents of the present document are subject to continuing work within the TSG and may change following formal TSG approval. Should the TSG modify the contents of the present document, it will be re-released by the TSG with an identifying change of release date and an increase in version number as follows:

Version x.y.z

where:

- x the first digit:
 - 1 presented to TSG for information;
 - 2 presented to TSG for approval;
 - 3 or greater indicates TSG approved document under change control.
- y the second digit is incremented for all changes of substance, i.e. technical enhancements, corrections, updates, etc.
- z the third digit is incremented when editorial only changes have been incorporated in the document.

In the present document, modal verbs have the following meanings:

- shall** indicates a mandatory requirement to do something
- shall not** indicates an interdiction (prohibition) to do something

The constructions "shall" and "shall not" are confined to the context of normative provisions, and do not appear in Technical Reports.

The constructions "must" and "must not" are not used as substitutes for "shall" and "shall not". Their use is avoided insofar as possible, and they are not used in a normative context except in a direct citation from an external, referenced, non-3GPP document, or so as to maintain continuity of style when extending or modifying the provisions of such a referenced document.

- should** indicates a recommendation to do something
- should not** indicates a recommendation not to do something
- may** indicates permission to do something
- need not** indicates permission not to do something

The construction "may not" is ambiguous and is not used in normative elements. The unambiguous constructions "might not" or "shall not" are used instead, depending upon the meaning intended.

- can** indicates that something is possible
- cannot** indicates that something is impossible

The constructions "can" and "cannot" are not substitutes for "may" and "need not".

- will** indicates that something is certain or expected to happen as a result of action taken by an agency the behaviour of which is outside the scope of the present document
- will not** indicates that something is certain or expected not to happen as a result of action taken by an agency the behaviour of which is outside the scope of the present document
- might** indicates a likelihood that something will happen as a result of action taken by some agency the behaviour of which is outside the scope of the present document

might not indicates a likelihood that something will not happen as a result of action taken by some agency the behaviour of which is outside the scope of the present document

In addition:

is (or any other verb in the indicative mood) indicates a statement of fact

is not (or any other negative verb in the indicative mood) indicates a statement of fact

The constructions "is" and "is not" do not indicate requirements.

Introduction

In order to ensure efficient use and deployment of UAS on 3GPP networks an architecture for UAS application layer consisting of UAS application enabler is specified in this document.

The UAE application enabler capabilities takes into consideration the existing stage 1 and stage 2 work within 3GPP related to UAS in 3GPP TS 22.125 [2] and 3GPP TS 23.256 [4].

1 Scope

The present document specifies the functional architecture, procedures and information flows for UAS application enabler layer. This specification includes the capabilities of the application layer support for UAS that are necessary to ensure efficient use and deployment of UAS over 3GPP systems. The UAS application enabler capabilities applies to both EPS and 5GS.

2 References

The following documents contain provisions which, through reference in this text, constitute provisions of the present document.

- References are either specific (identified by date of publication, edition number, version number, etc.) or non-specific.
- For a specific reference, subsequent revisions do not apply.
- For a non-specific reference, the latest version applies. In the case of a reference to a 3GPP document (including a GSM document), a non-specific reference implicitly refers to the latest version of that document *in the same Release as the present document*.

- [1] 3GPP TR 21.905: "Vocabulary for 3GPP Specifications".
- [2] 3GPP TS 22.125: "Unmanned Aerial System (UAS) support in 3GPP; Stage 1".
- [3] 3GPP TS 23.222: "Functional architecture and information flows to support Common API Framework for 3GPP Northbound APIs; Stage 2".
- [4] 3GPP TS 23.256: "Support of Uncrewed Aerial Systems (UAS) connectivity, identification, and tracking; Stage 2".
- [5] 3GPP TS 23.434: "Service Enabler Architecture Layer for Verticals (SEAL); Functional architecture and information flows".
- [6] 3GPP TS 23.501: "System architecture for the 5G System (5GS); Stage 2".
- [7] 3GPP TS 23.558: "Architecture for enabling Edge Applications"
- [8] 3GPP TS 23.682: "Architecture enhancements to facilitate communications with packet data networks and applications".
- [9] 3GPP TS 26.346: "Multimedia Broadcast/Multicast Service (MBMS); Protocols and codecs".
- [10] 3GPP TS 26.348: "Northbound Application Programming Interface (API) for Multimedia Broadcast/Multicast Service (MBMS) at the xMB reference point".
- [11] 3GPP TS 29.214: "Policy and Charging Control over Rx reference point".
- [12] 3GPP TS 29.468: "Group Communication System Enablers for LTE (GCSE_LTE); MB2 Reference Point; Stage 3".

3 Definitions of terms and abbreviations

3.1 Terms

For the purposes of the present document, the terms given in 3GPP TR 21.905 [1] and the following apply. A term defined in the present document takes precedence over the definition of the same term, if any, in 3GPP TR 21.905 [1].

Remote Identification (Remote ID) of UAS: The ability of a UAS to provide identification and tracking information that can be received by other parties, to facilitate advanced operations for the UAS (such as Beyond Visual Line of Sight operations as well as operations over people), assist regulatory agencies, air traffic management agencies, law enforcement, and security agencies when a UAS appears to be flying in an unsafe manner or where the UAS is not allowed to fly.

UAS Service Supplier (USS): An entity that provides services to support the safe and efficient use of airspace by providing services to the operator / pilot of a UAS in meeting UTM operational requirements. A USS can provide any subset of functionality to meet the provider's business objectives (e.g., UTM, Remote Identification).

UAV: The Uncrewed Aerial Vehicle (also called remotely piloted aircraft or drone) of a UAS.

For the purposes of the present document, the following terms given in 3GPP TS 22.125 [2] apply

Command and Control (C2) Communication

Uncrewed Aerial System (UAS)

Uncrewed Aerial System Traffic Management (UTM)

UAV controller

For the purposes of the present document, the following terms given in clause 4.2 of 3GPP TS 22.125 [2] apply

Direct C2 Communication

Network-Assisted C2 communication

UTM-Navigated C2 communication

3.2 Abbreviations

For the purposes of the present document, the abbreviations given in 3GPP TR 21.905 [1] and the following apply. An abbreviation defined in the present document takes precedence over the definition of the same abbreviation, if any, in 3GPP TR 21.905 [1].

BVLOS	Beyond Visual Line Of Sight
C2	Command and Control
CAPIF	Common API Framework for northbound APIs
QoS	Quality of Service
SEAL	Service Enabler Architecture Layer
UAE	UAS Application Enabler
UAS	Uncrewed Aerial System
UAV	Uncrewed Aerial Vehicle
UAV-C	Uncrewed Aerial Vehicle-Controller
USS	UAS Service Supplier
UTM	UAS Traffic Management

4 Architectural requirements

4.1 General

[AR-4.1-a] The UAS application enabler layer shall support one or more UAS applications.

[AR-4.1-b] The UAE capabilities should be offered as APIs to the UAS applications.

4.2 Support for communications between UAVs

4.2.1 Description

This clause specifies the requirements for support for communications between UAVs.

4.2.2 Requirements

[AR-4.2-a] The UAS application enabler layer shall provide mechanism to support communications between UAVs in a geographical area using unicast Uu.

4.3 QoS provisioning for C2 communication

4.3.1 Description

This clause specifies the C2 QoS provisioning related requirements.

4.3.2 Requirements

[AR-4.3.2-a] The UAE layer capabilities shall enable C2 application QoS parameter provisioning for network-assisted C2 communications to the 3GPP network system.

[AR-4.3.2-b] The UAE layer capabilities shall enable QoS differentiation for UAV operations.

[AR-4.3.2-c] The UAE server shall be capable of obtaining monitoring events related to the C2 QoS fulfilment/unfulfilment from the UAE clients (UAV and/or UAV controller).

[AR-4.3.2-d] The UAE layer capabilities shall enable QoS parameters modification to support meeting the C2 end-to-end application requirements, for paired-Uu connections between a UAV and UE-based UAV-C.

4.4 C2 communication mode switching

4.4.1 Description

This clause specifies the C2 communication mode switching related requirements.

4.4.2 Requirements

[AR-4.4.2-a] The UAE Server shall provide a mechanism for configuring the C2 communication modes at the UAE Client (UAV and UAV-C).

[AR-4.4.2-b] The UAE Client (UAV and UAV-C) and UAV Server shall provide mechanisms for switching between the C2 communication links.

[AR-4.4.2-c] The UAE Client (UAV and UAV-C) shall provide a mechanism for selecting a primary and a secondary communication link based on C2 communication mode configuration information.

[AR-4.4.2-d] The UAE Client (UAV or UAV-C) shall provide a mechanism to switch C2 communication link without involving the UAE Server when an immediate change of C2 communication mode is needed.

4.5 Support for monitoring of UAV location deviation

4.5.1 Description

This clause specifies the requirements for location reporting capabilities to monitor the UAV location deviation.

4.5.2 Requirements

[AR-4.5.2-a] The SEAL layer shall provide mechanism to support the monitoring of UAV location.

4.6 Support for reporting of UAV events

4.6.1 Description

This clause specifies the requirements for support for reporting of UAV events to USS/UTM.

4.6.2 Requirements

[AR-4.6.2-a] The SEAL layer shall provide mechanism to support the reporting of the 3GPP related UAV events to the USS/UTM.

5 Functional model

5.1 General

The functional model for the UAS application layer is organized into functional entities to describe a functional architecture which addresses the application layer support aspects for UAS applications.

5.2 Functional model description

Figures 5.2-1 and 5.2-2 illustrates the simplified architectural models for the UAS application layer.



Figure 5.2-1: Simplified architectural model for the UAS application layer

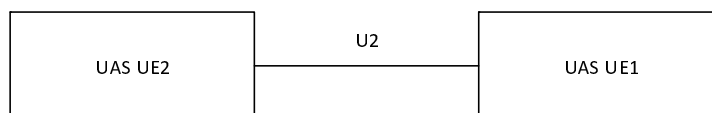

Figure 5.2-2: Simplified architectural model for U2 connectivity between UAS UE1 and UAS UE2 at the UAS application layer

The UAS UE1 communicates with UAS application server over U1 reference point. The UAS UE1 and UAS UE2 communicate over U2 reference point.

NOTE 1: Support for UE-to-network relay architecture for UAS communications is out of scope of the present document.

The UAS UE1 and the UAS UE2 may be a UAV Controller or a UAV.

NOTE 2: The UAV Controller can connect to the UAV via a transport independent of 3GPP. Such UAV Controller is not a 3GPP UE and is out of scope of the present document.

NOTE 3: Support of PC5 at the U2 reference point for 5GS is out of scope of the present document.

The reference point U1 supports the UAS application related interactions between UAS UE and UAS application server. It is expected that this reference point is supported at least for unicast delivery mode, and may support multicast delivery mode. The reference point U2 supports the interactions between the UAS UEs. The UAS application server can be the USS/UTM.

The reference point U1 is based on Uu connectivity as specified in 3GPP TS 23.256 [4].

The reference point U2 is based on Uu connectivity as specified in 3GPP TS 23.256 [4].

NOTE 4: Support of multicast delivery over Uu for 5GS is out of scope of the present document.

Figure 5.2-3 illustrates the detailed UAS application layer functional model. It enhances the simplified architectural model for the UAS application layer by specifying the functional entities at the UAS application layer.

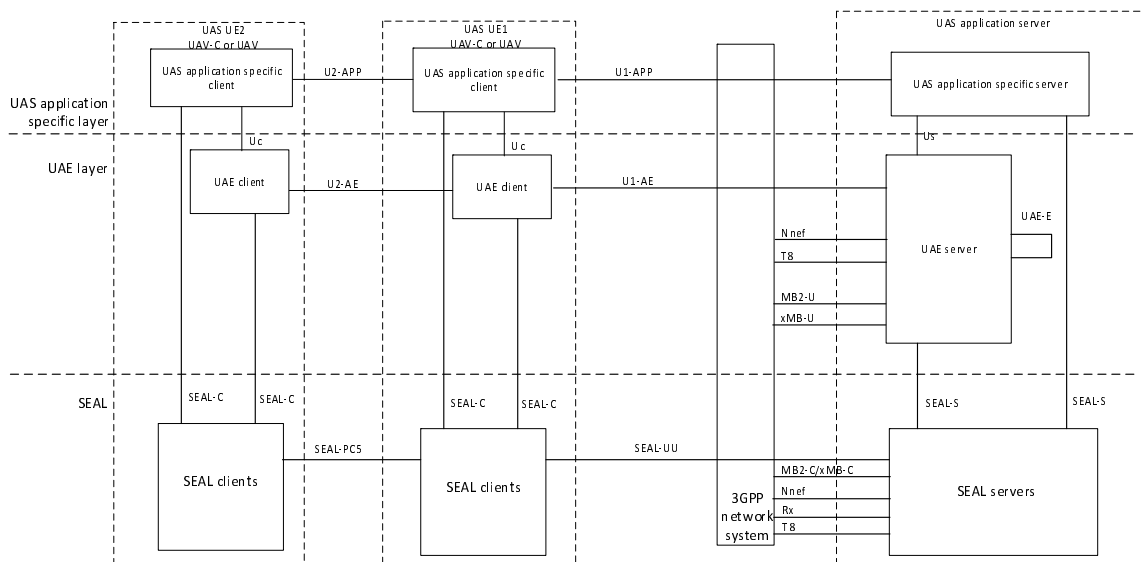

Figure 5.2-3: UAS application layer functional model

Figure 5.2-4 illustrates the detailed UAS application layer functional model where the UAV-C has a network-assisted connectivity with the UAV.

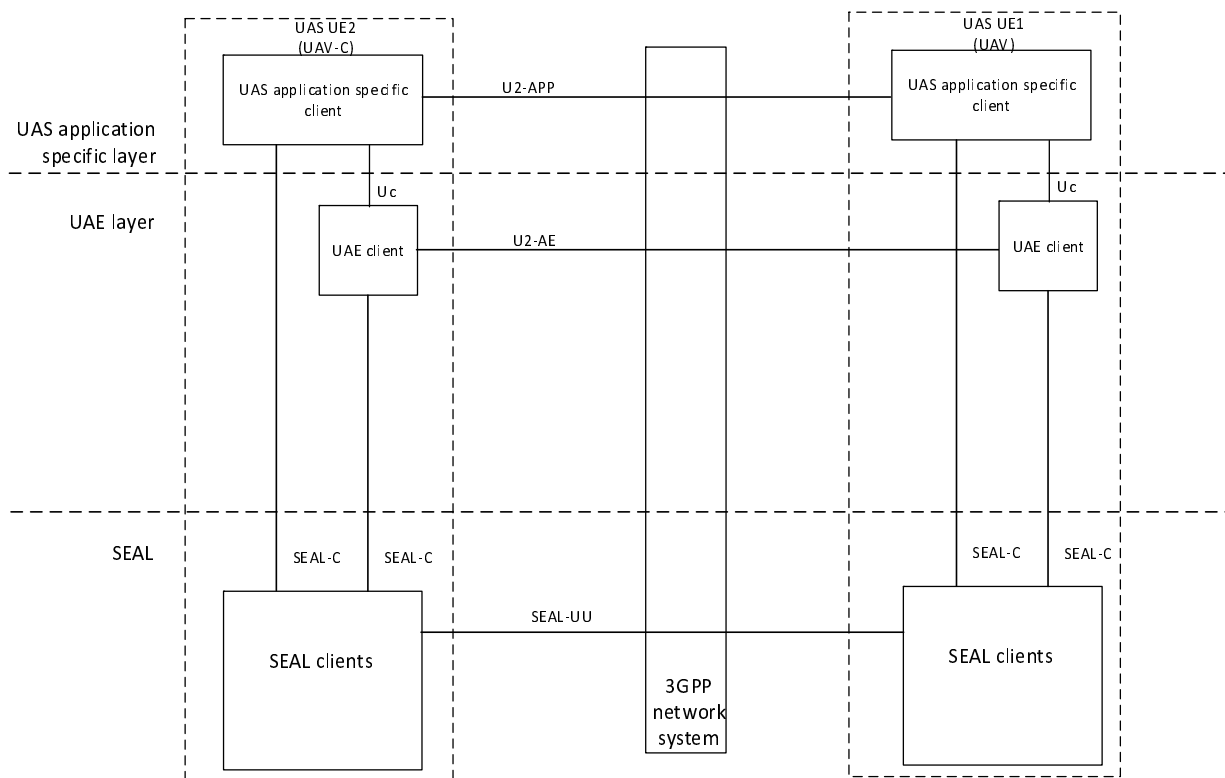

Figure 5.2-4: UAS application layer functional model with UAV-C having network-assisted connectivity with UAV

The UAS application layer functional entities for the UAS UE and the UAS application server are grouped into the UAS application specific layer and the UAE layer. The UAE layer offers the UAE capabilities to the UAS application specific layer. The UAS application layer functional model utilizes the SEAL services as specified in 3GPP TS 23.434 [5].

The UAE server is located in the UAE layer. The SEAL services/UAS application specific layer utilized by UAE layer may include location management, group management, configuration management, identity management, key management and network resource management. The UAS application specific layer consists of the UAS application specific functionalities.

NOTE 5: The functionalities of the UAS application specific layer include the USS/UTM and are out of scope of the present document.

The following connectivity path for the UAS is supported when both the UAV-C and the UAV are 3GPP UEs:

- UAV-C to UAV over U2 (Uu connectivity).

The UAS application server consists of the UAE server, the SEAL servers and the UAS application specific server. The UAE server provides the UAS application layer support functions to the UAS application specific server over U_s reference point. The SEAL servers provide the SEAL services to the UAS application specific server/UAE server over SEAL-S reference point.

The UAS UE consists of the UAE client, the SEAL clients and the UAS application specific client. The UAE client provides the UAS application layer support functions to the UAS application specific client over U_c reference point. The SEAL clients provide the SEAL services to the UAS application specific client/UAE client over SEAL-C reference point.

NOTE 6: In some deployments, the client and server entities of SEAL can be part of UAE client and UAE server respectively.

The UAS application specific client/UAE client acts as a VAL client for its interaction with the SEAL clients as specified in 3GPP TS 23.434 [5]. The UAS application specific server/UAE server acts as a VAL server for its interaction with the SEAL servers as specified in 3GPP TS 23.434 [5].

In the UAE layer, the UAE client communicates with the UAE server over U1-AE reference point. In the UAS application specific layer, the UAS application specific client communicates with UAS application specific server over U1-APP reference point.

NOTE 7: The U1-APP reference point includes UAV Controller/UAV to USS/UTM communication and is out of scope of the present document.

In the UAE layer, the UAE client of UAS UE2 communicates with UAE client of UAS UE1 over U2-AE reference point. In the UAS application specific layer, the UAS application specific client of UAS UE2 communicates with UAE client of UAS UE1 over U2-APP reference point.

NOTE 8: The U2-APP reference point is out of scope of the present document.

The following SEAL services for UAS applications may include:

- Location management as specified in 3GPP TS 23.434 [5];
- Group management as specified in 3GPP TS 23.434 [5];
- Configuration management as specified in 3GPP TS 23.434 [5];
- Identity management as specified in 3GPP TS 23.434 [5];
- Key management as specified in 3GPP TS 23.434 [5]; and
- Network resource management as specified in 3GPP TS 23.434 [5].

The UAS application specific client/UAE client interacts with SEAL clients over the SEAL-C reference point specified for each SEAL service. The UAS application specific server/UAE server interacts with SEAL servers over the SEAL-S reference point specified for each SEAL service. The interaction between the SEAL clients is supported by SEAL-PC5 reference point specified for each SEAL service. The interaction between a SEAL client and the corresponding SEAL server is supported by SEAL-UU reference point specified for each SEAL service.

NOTE 9: The SEAL-C, SEAL-S, SEAL-PC5, SEAL-UU reference points for each SEAL service is specified in 3GPP TS 23.434 [5].

To support distributed UAE server deployments, the UAE server interacts with another UAE server over UAE-E reference point.

A U1-AE message can be sent over at least unicast, and may be sent over transparent multicast via xMB or transparent multicast via MB2. The non-transparent multicast via xMB (as specified in 3GPP TS 26.348 [10]) is triggered by a U1-AE message. Multicast distribution can be supported by both transparent and non-transparent multicast modes.

The UAE server interacts with the 3GPP network system over U2, MB2, xMB, Rx, T8 and Nnef reference points.

5.3 Functional entities description

5.3.1 General

Each clause specifies a description of a functional entity corresponding to UAS application layer and does not imply a physical entity.

5.3.2 UAS application specific client

The UAS application specific client provides the client side functionalities corresponding to the UAS applications (e.g. Client interacting with USS/UTM). The UAS application specific client utilizes the UAE client for the UAS application layer support functions.

NOTE: The details of the UAS application specific client is out of scope of the present document.

5.3.3 UAS application specific server

The UAS application specific server provides the server side functionalities corresponding to the UAS applications (e.g. USS/UTM). The UAS application specific server utilizes the UAE server for the UAS application layer support functions. If CAPIF is supported, the UAS application specific server acts as CAPIF's API invoker as specified in 3GPP TS 23.222 [3].

NOTE: The details of the UAS application specific server is out of scope of the present document.

5.3.4 UAE client

The UAE client supports interactions with the UAS application specific client(s).

The UAE client provides the client side UAS application layer support functions as below:

- receiving and storing C2 operation mode configurations;
- selecting primary and secondary C2 communication modes based on the configurations;
- switching of C2 communication in emergency scenarios; and
- supporting UAV application message communication handling.

5.3.5 UAE server

If CAPIF is supported, the UAE server acts as CAPIF's API exposing function to provide service APIs to the UAS application specific server (e.g. USS/UTM) or another UAE server as specified in 3GPP TS 23.222 [3], or acts as CAPIF's API invoker to consume the service APIs provided by another UAE server.

The UAE server provides the server side UAS application layer support functions as below:

- performing group based QoS management for the UAS (i.e. pair of UAV and UAV-C) by using SEAL APIs.
- receiving C2 operation mode configuration from UAS application specific servers (e.g. USS/UTM) and further configuring the UAS UEs (i.e. UAV, UAV-C);
- triggering C2 communication mode switching with the UAS UEs;
- receiving and storing the selected C2 communication modes from the UAS UEs;
- monitoring the real-time status of UAS UEs by using SEAL APIs; and
- supporting UAV application message communications between UAVs.

5.3.6 SEAL client

The following SEAL clients as specified in 3GPP TS 23.434 [5] are supported:

- Location management client;
- Group management client;
- Configuration management client;
- Identity management client;
- Key management client; and
- Network resource management client.

5.3.7 SEAL server

The following SEAL servers as specified in 3GPP TS 23.434 [5] are supported:

- Location management server;
- Group management server;
- Configuration management server;
- Identity management server;
- Key management server; and
- Network resource management server.

5.4 Reference points description

5.4.1 General

The reference points for the UAS application layer are described in the following clauses.

5.4.2 U1-AE

The interactions related to UAS application layer support functions between UAE client and UAE server are supported by U1-AE reference point.

5.4.3 U1-APP

The interactions related to UAS applications between UAS application specific client and UAS application specific server are supported by U1-APP reference point. The details of U1-APP reference point is out of scope of the present document.

5.4.4 U2-AE

The interactions related to UAS application layer support functions between the UAE clients are supported by U2-AE reference point.

5.4.5 U2-APP

The interactions related to UAS applications between UAS application specific clients are supported by U2-APP reference point. The details of U2-APP reference point is out of scope of the present document.

5.4.6 Us

The interactions related to UAS application layer support functions between the UAE server and the UAS application specific server are supported by Us reference point. If CAPIF is supported, this reference point is an instance of CAPIF-2/2e reference point as specified in 3GPP TS 23.222 [3].

5.4.7 Uc

The interactions related to UAS application layer support functions between the UAE client and the UAS application specific client are supported by Uc reference point.

5.4.8 SEAL-C

The following SEAL-C reference points specified in 3GPP TS 23.434 [5] are supported:

- LM-C reference point for location management;
- GM-C reference point for group management;

- CM-C reference point for configuration management;
- IM-C reference point for identity management;
- KM-C reference point for key management; and
- NRM-C reference point for network resource management.

5.4.9 SEAL-S

The following SEAL-S reference points specified in 3GPP TS 23.434 [5] are supported:

- LM-S reference point for location management;
- GM-S reference point for group management;
- CM-S reference point for configuration management;
- IM-S reference point for identity management;
- KM-S reference point for key management; and
- NRM-S reference point for network resource management.

5.4.10 SEAL-PC5

The following SEAL-PC5 reference points specified in 3GPP TS 23.434 [5] are supported:

- LM-PC5 reference point for location management;
- GM-PC5 reference point for group management;
- CM-PC5 reference point for configuration management;
- IM-PC5 reference point for identity management;
- KM-PC5 reference point for key management; and
- NRM-PC5 reference point for network resource management.

5.4.11 SEAL-UU

The following SEAL-UU reference points specified in 3GPP TS 23.434 [5] are supported:

- LM-UU reference point for location management;
- GM-UU reference point for group management;
- CM-UU reference point for configuration management;
- IM-UU reference point for identity management;
- KM-UU reference point for key management; and
- NRM-UU reference point for network resource management.

5.4.12 UAE-E

The interactions related to UAS application support functions between the UAE servers in a distributed deployment are supported by UAE-E reference point. If CAPIF is supported, this reference point is an instance of CAPIF-2/2e reference point as specified in 3GPP TS 23.222 [3].

5.5 External reference points

5.5.1 General

The reference points between the UAS application layer and the 3GPP network systems (EPS, 5GS) are described in the following clauses.

5.5.2 Rx

The reference point Rx supports the interactions between the UAS application server and the PCRF and is specified in 3GPP TS 29.214 [11]. The functions for Rx reference point are supported by the network resource management server of the SEAL.

5.5.3 MB2-C

The reference point MB2-C supports the control plane interactions between the UAS application server and the BM-SC and is specified in 3GPP TS 29.468 [12]. The functions for MB2-C reference point are supported by the network resource management server of the SEAL.

5.5.4 MB2-U

The reference point MB2-U supports the user plane interactions between the UAS application server and the BM-SC and is specified in 3GPP TS 29.468 [12]. The functions for MB2-U reference point are supported by the UAE server.

5.5.5 xMB-C

The reference point xMB-C supports the control plane interactions between the UAS application server and the BM-SC and is specified in 3GPP TS 26.346 [9]. The functions for xMB reference point are supported by the network resource management server of the SEAL.

5.5.6 xMB-U

The reference point xMB-U supports the user plane interactions between the UAS application server and the BM-SC and is specified in 3GPP TS 26.346 [9]. The functions for xMB-U reference point are supported by the UAE server.

5.5.7 T8

The reference point T8 supports the interactions between the UAS application server and the SCEF and is specified in 3GPP TS 23.682 [8]. The functions of T8 interface are supported by UAE server and the functions related to location management of T8 are supported by the location management server.

5.5.8 N5

The reference point N5 supports the interactions between the UAS application server and the PCF and is specified in 3GPP TS 23.501 [6]. The functions of N5 interface are supported by UAE server.

5.5.9 N33/Nnef

The reference point N33 supports the interactions between the UAS application server and the NEF and is specified in 3GPP TS 23.501 [6]. Nnef is the service based interface exposed by the NEF as per the N33 reference point. The functions of Nnef interface are supported by UAE server and the functions related to location management of Nnef are supported by the location management server.

6 Identities

6.1 General

This clause describes the identities associated with the entities in the UAS application layer and used in this specification.

6.2 UAV Identifier (UAV ID)

The UAV identifier is used to uniquely identify a UAV. The UAV ID is in the form of a 3GPP UE ID (e.g. GPSI, External Identifier) as specified in 3GPP TS 23.501 [6] or CAA level UAV ID as assigned by civil aviation authorities (e.g. FAA) via USS/UTM.

6.3 UAS Identifier (UAS ID)

The UAS identifier is used to uniquely identify a pair of UAV and UAV-C collectively known as UAS. The UAS ID is in the form of a Group ID as specified in 3GPP TS 23.434 [5] or a collection of individual identifiers of the entities in the UAS (e.g. CAA level UAV IDs, 3GPP UE IDs).

6.4 UAS Application Specific Server Identifier (UASS ID)

The UAS application specific server identifier is used to uniquely identify the UAS application specific server. The UASS ID is in the form of URI.

6.5 UAE Server Identifier (UAE Server ID)

The UAE server identifier is used to uniquely identify the UAE server. The UAE Server ID is in the form of URI.

7 Procedures and information flows

7.1 Usage of SEAL services

7.1.1 General

The UAE capabilities (UAE client and UAE server) utilize the SEAL services. Also the UAS application specific server(s) may directly utilize the SEAL services. All SEAL services specified in 3GPP TS 23.434 [5] are available to the UAS application layer (i.e. the UAE layer and the UAS application specific layer).

In this clause, the details of the information flows, procedures and APIs utilized by the UAS application layer are described.

7.1.2 Group management service

7.1.2.1 General

The UAE capabilities (UAE client and UAE server) utilize the group management service procedures (e.g. creation, join, leave) of SEAL based on the group configuration information (e.g. group join policy, group leader) provided by the UAS application specific layer. The decisions and corresponding triggers (e.g. group creation, join, leave) for group management are responsibility of the UAS application specific layer. The group management service of SEAL provides support for creating group for UAS for supporting UAS applications and C2 communications.

The UAS application specific server(s) may directly utilize the group management service procedures of SEAL.

7.1.2.2 Information flows

The following information flows of group management service of SEAL as specified in 3GPP TS 23.434 [5] are applicable for the UAS applications:

- Group creation request specified in clause 10.3.2.1;
- Group creation response specified in clause 10.3.2.2;
- Group creation notification specified in clause 10.3.2.3;
- Group information query request specified in clause 10.3.2.4;
- Group information query response specified in clause 10.3.2.5;
- Group membership update request specified in clause 10.3.2.6;
- Group membership update response specified in clause 10.3.2.7;
- Group membership notification specified in clause 10.3.2.8;
- Group deletion request specified in clause 10.3.2.9;
- Group deletion response specified in clause 10.3.2.10;
- Group deletion notification specified in clause 10.3.2.11;
- Group information request specified in clause 10.3.2.12;
- Group information response specified in clause 10.3.2.13;
- Group information subscribe request specified in clause 10.3.2.14;
- Group information subscribe response specified in clause 10.3.2.15;
- Group information notify request specified in clause 10.3.2.16;
- Group information notify response specified in clause 10.3.2.17;
- Store group configuration request specified in clause 10.3.2.18;
- Store group configuration response specified in clause 10.3.2.19;
- Get group configuration request specified in clause 10.3.2.20;
- Get group configuration response specified in clause 10.3.2.21;
- Subscribe group configuration request specified in clause 10.3.2.22;
- Subscribe group configuration response specified in clause 10.3.2.23;
- Notify group configuration request specified in clause 10.3.2.24;
- Notify group configuration response specified in clause 10.3.2.25;
- Configure VAL group request specified in clause 10.3.2.26;
- Configure VAL group response specified in clause 10.3.2.27;
- Group announcement specified in clause 10.3.2.28;
- Group registration request specified in clause 10.3.2.29;
- Group registration response specified in clause 10.3.2.30;
- Identity list notification specified in clause 10.3.2.31;

- Group de-registration request specified in clause 10.3.2.32;
- Group de-registration response specified in clause 10.3.2.33;

The usage of the above information flows are clarified as below:

- The identity is the UE ID or CAA Level ID;
- The identity list or identities list is the list of UE IDs or CAA Level IDs; and
- The VAL server is the UAE server or the UAS application specific server.

7.1.2.3 Procedures

The following procedures of group management service of SEAL as specified in 3GPP TS 23.434 [5] are applicable for the UAS applications:

- Group creation specified in clause 10.3.3;
- Group information query specified in clause 10.3.4;
- Group membership specified in clause 10.3.5;
- Group configuration management specified in clause 10.3.6;
- Group announcement and join specified in clause 10.3.8;
- Group member leave specified in clause 10.3.9;

7.1.2.4 APIs

The following APIs of group management service of SEAL as specified in 3GPP TS 23.434 [5] are applicable for the UAS applications:

- SS_GroupManagement API specified in clause 10.4.2;

7.1.3 Location management service

7.1.3.1 General

The UAE capabilities (UAE client and UAE server) utilize location management (e.g. network location of UEs) service procedures of SEAL to support UAS applications.

The UAS application specific server(s) may directly utilize the location management service procedures of SEAL.

7.1.3.2 Information flows

The following information flows of location management service of SEAL as specified in 3GPP TS 23.434 [5] are applicable for the UAS applications:

- Location reporting configuration request specified in clause 9.3.2.0;
- Location reporting configuration response specified in clause 9.3.2.1;
- Location information report specified in clause 9.3.2.2;
- Location information request specified in clause 9.3.2.3;
- Location reporting trigger specified in clause 9.3.2.4;
- Location information subscription request specified in clause 9.3.2.5;
- Location information subscription response specified in clause 9.3.2.6;

- Location information notification specified in clause 9.3.2.7;
- Location reporting configuration cancel specified in clause 9.3.2.8;
- Get UE(s) information request specified in clause 9.3.2.9;
- Get UE(s) information response specified in clause 9.3.2.10;
- Monitor location subscription request specified in clause 9.3.2.11;
- Monitor location subscription response specified in clause 9.3.2.12;
- Notify location monitoring event specified in clause 9.3.2.13;

The usage of the above information flows are clarified as below:

- The identity is the UE ID or CAA Level ID;
- The identity list or identities list is the list of UE IDs or CAA Level IDs; and
- The VAL server is the UAE server or the UAS application specific server.

7.1.3.3 Procedures

The following procedures of location management service of SEAL as specified in 3GPP TS 23.434 [5] are applicable for the UAS applications:

- Event-triggered location reporting procedure specified in clause 9.3.3;
- On-demand location reporting procedure specified in clause 9.3.4;
- Location reporting event triggers configuration cancel specified in clause 9.3.6;
- Location information subscription procedure specified in clause 9.3.7;
- Event-trigger location information notification procedure specified in clause 9.3.8;
- On-demand usage of location information procedure specified in clause 9.3.9;
- Obtaining UE(s) information at a location specified in clause 9.3.10;
- Monitoring Location Deviation specified in clause 9.3.11

7.1.3.4 APIs

The following APIs of location management service of SEAL as specified in 3GPP TS 23.434 [5] are applicable for the UAS applications:

- SS_LocationReporting API as specified in clause 9.4.2;
- SS_LocationInfoEvent API as specified in clause 9.4.3;
- SS_LocationInfoRetrieval API as specified in clause 9.4.4;
- SS_LocationAreaInfoRetrieval API as specified in clause 9.4.5;
- SS_LocationMonitoring API as specified in clause 9.4.6;

7.1.4 Network resource management service

7.1.4.1 General

The UAE capabilities (UAE client and UAE server) and UAS application specific servers utilize network resource management service procedures of SEAL to support UAS applications and C2 communications.

The UAS application specific server(s) may directly utilize the network management service procedures of SEAL.

7.1.4.2 Information flows

The following information flows of network resource management service of SEAL as specified in 3GPP TS 23.434 [5] are applicable for the UAS applications:

- Network resource adaptation request specified in clause 14.3.2.1;
- Network resource adaptation response specified in clause 14.3.2.2;
- Resource request specified in clause 14.3.2.6;
- Resource response specified in clause 14.3.2.7;
- Resource modification request specified in clause 14.3.2.8;
- Resource modification response specified in clause 14.3.2.9;
- Monitoring Events Subscription Request specified in clause 14.3.2.17;
- Monitoring Events Subscription Response specified in clause 14.3.2.18;
- Monitoring Events Notification message specified in clause 14.3.2.19;

The usage of the information flows are clarified as below:

- The identity is the 3GPP UE ID or CAA Level UAV ID;
- The identity list or identities list is the list of 3GPP UE IDs or CAA Level UAV IDs; and
- The VAL server is the UAE server or the UAS application specific server.

7.1.4.3 Procedures

The following procedures of network resource management service of SEAL specified 3GPP TS 23.434 [5] are applicable for the UAS applications and C2 communications:

- Request for unicast resources at VAL service communication establishment specified in clause 14.3.3.2.1;
- Request for modification of unicast resources specified in clause 14.3.3.2.2;
- Network resource adaptation specified in clause 14.3.3.3.1;
- QoS/resource management capability initiation in network assisted UE-to-UE communications procedure specified in clause 14.3.5.2;
- Coordinated QoS provisioning operation in network assisted UE-to-UE communications procedure specified in clause 14.3.5.3;
- Monitoring Events Subscription procedure specified in clause 14.3.6.2;
- Monitoring Events Notification procedure specified in clause 14.3.6.3;

7.1.4.4 APIs

The following APIs of network resource management service of SEAL specified 3GPP TS 23.434 [5] are applicable for the UAS applications and C2 communications:

- SS_NetworkResourceAdaptation API specified in clause 14.4.2;
- SS_EventsMonitoring API specified in clause 14.4.3;

7.1a UAE layer registration

7.1a.1 General

The UAE capabilities provide support for registering UAV/UAV-C at the UAE server. The UAE server uses the registration information to distribute UAE layer messages or UAS application specific layer messages to the appropriate UAS UEs.

7.1a.2 Procedures

7.1a.2.1 UAS UE registration

7.1a.2.1.1 General

This clause describes the procedure for UAS UE (UAV/UAV-C) to register with the UAE server.

7.1a.2.1.2 Procedure

Pre-conditions:

- The UAE client has discovered the UAE server and is aware of the address of the UAE server (e.g. FDQN).

NOTE: How the UAE client is provisioned with the UAE server information is outside the scope of the current document.

- The UAV/UAV-C has already been assigned with the UAV ID.

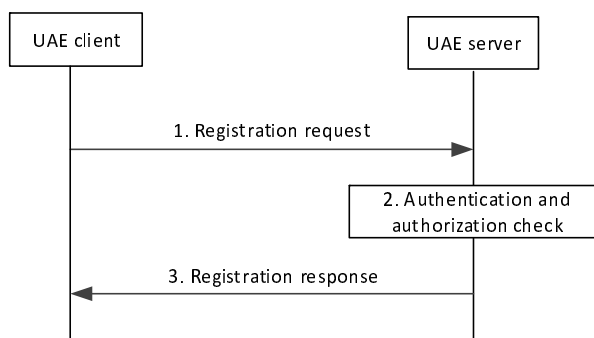

Figure 7.1a.2.1.1-1: Procedure for registering the UAE client at the UAE server

1. The UAE client sends a registration request to the UAE server.
2. The UAE server performs authentication and authorization check (e.g. based on pre-provisioned security information or by interacting with UAS application specific server (e.g. USS/UTM)).
3. The UAE server sends an registration response to the UAE client indicating success or failure of the registration.

7.1a.2.2 UAS UE deregistration

7.1a.2.2.1 General

This clause describes the procedures for UAS UE (UAV/UAV-C) to deregister at the UAE server.

7.1a.2.2.2 Procedure

Pre-condition:

- The UAE client has already registered with the UAE server as described in subclause 7.1a.2.1.

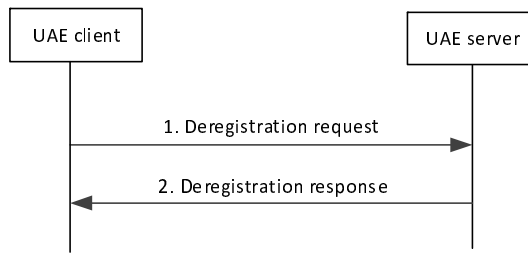

Figure 7.1a.2.2.2-1: Procedure for deregistering the UAE client at the UAE server

1. The UAE client sends a deregistration request to the UAE server.
2. The UAE server sends a deregistration response to the UAE client.

7.1a.2.3 UAS UE registration update

7.1a.2.3.1 General

This clause describes the procedures for UAS UE (UAV/UAV-C) to update its registration with the UAE server.

7.1a.2.3.2 Procedure

Pre-conditions:

- The UAE client has already registered with the UAE server as described in subclause 7.1a.2.1.

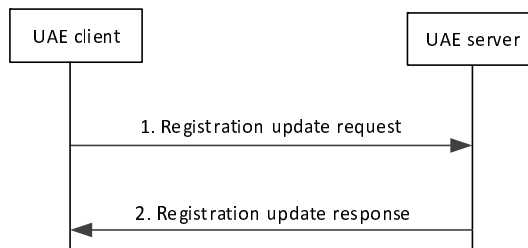

Figure 7.1a.2.3.1-1: Procedure for registration update by the UAE client at the UAE server

1. The UAE client sends a registration update request to the UAE server.
2. The UAE server sends an acknowledgement to the UAE client.

7.1a.3 Information flows

7.1a.3.1 Registration request

Table 7.1a.3.1-1 describes the information flow for a UAE client to register with the UAE server.

Table 7.1a.3.1-1: Registration request

Information element	Status	Description
UAV ID	M	The identifier of the UAV/UAV-C (e.g. 3GPP UE ID or CAA level UAV ID) which initiates the registration request
UAS UE information	O	UAS UE information like IP address, etc.
Proposed registration lifetime (NOTE)	O	Proposed to registration lifetime.
NOTE:	If Proposed registration lifetime IE is not included, then the registration lifetime is valid until explicit deregistration is performed.	

7.1a.3.2 Registration response

Table 7.1a.3.2-1 describes the information flow for UAE server to respond for registration request from the UAE client.

Table 7.1a.3.2-1: Registration response

Information element	Status	Description
Result	M	Result from the UAE server in response to registration request indicating success or failure
Registration lifetime	O	The registration lifetime provided by UAE server if registration is successful

7.1a.3.3 Deregistration request

Table 7.1a.3.3-1 describes the information flow for a UAE client to deregister at the UAE server.

Table 7.1a.3.3-1: Deregistration request

Information element	Status	Description
UAV ID	M	The identifier of the UAV/UAV-C (e.g. 3GPP UE ID or CAA level UAV ID) which initiates the deregistration request

7.1a.3.4 Deregistration response

Table 7.1a.3.4-1 describes the information flow for UAE server to respond for deregistration request from the UAE client.

Table 7.1a.3.4-1: Deregistration response

Information element	Status	Description
Result	M	Result from the UAE server in response to the deregistration request

7.1a.3.5 Registration update request

Table 7.1a.3.5-1 describes the information flow for a UAE client to update registration with the UAE server.

Table 7.1a.3.5-1: Registration update request

Information element	Status	Description
UAV ID	M	The identifier of the UAV/UAV-C (e.g. 3GPP UE ID or CAA level UAV ID) which initiates the registration request
UAS UE information	M	UAS UE information like IP address, etc.
Proposed registration lifetime	O	Proposed to registration lifetime.

7.1a.3.6 Registration update response

Table 7.1a.3.6-1 describes the information flow for UAE server to respond for registration update request from the UAE client.

Table 7.1a.3.6-1: Registration update response

Information element	Status	Description
Result	M	Result from the UAE server in response to registration update request indicating success or failure
Registration lifetime	O	The registration lifetime provided by UAE server if registration update is successful

7.2 Communications between UAVs within a geographical area

7.2.1 General

This clause describes the procedure for communications between UAVs within a geographical area. The geographical area is from the perspective of the UAV initiating the communication with other UAVs.

The following transport mechanisms can be supported for communications between UAVs within a geographical area:

- a. Using unicast Uu.

NOTE: The mechanisms for communications between UAVs using multicast/broadcast Uu and ProSe are out of scope of the current release of the present document.

7.2.2 Procedures

7.2.2.1 Communications between UAVs within a geographical area using unicast Uu

Figure 7.2.2.1-1 illustrates the procedure for communications between UAVs within a geographical area using unicast Uu.

Pre-conditions:

1. The UAE clients of UAVs have successfully registered and connected to the UAE server.
2. The SEAL's LM server information is configured at the UAE server.

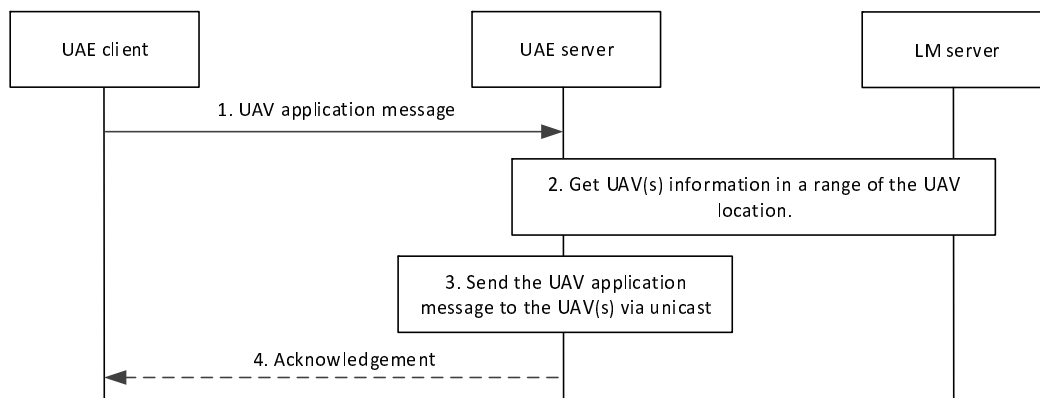

Figure 7.2.2.1-1: Communications between UAVs within a geographical area using unicast Uu

1. The UAE client of UAV sends a UAV application message to the UAE server in order to communicate the payload information of the UAV application message to other UAVs in a range of the location corresponding to the UAV.
2. The UAE server obtains the other UAV(s) information in the location of the UAV from the LMS as specified in 3GPP TS 23.434 [5].
3. Upon receiving the list of other UAV(s), the UAE server sends the payload in UAV application message to each of the UAV via unicast channel.

4. Upon completing step 3, the UAE server may send an acknowledgement to the UAE client.

7.2.3 Information flows

7.2.3.1 UAV application message

Table 7.2.3.1-1 describes the information flow for the UAV application message from UAE client to UAE server and from UAE server to UAE client.

Table 7.2.3.1-1: UAV application message

Information element	Status	Description
UAV ID	M	The identifier of the UAV (e.g. 3GPP UE ID or CAA level UAV ID) which initiates the UAV application message.
Application defined proximity range information (NOTE 2)	M	Description of the range information over which the UAV application message is to be sent.
Application Payload (NOTE 1)	M	Application payload that is to be delivered to the other UAVs
NOTE 1: This IE is provided by the UAS application specific client and its details are out of scope of 3GPP.		
NOTE 2: This IE is not included when the UAV application message is sent from UAE server to UAE client.		

7.3 UAV and UAV-C Pairing and C2 QoS Provisioning using Group ID

7.3.1 General

This clause describes the procedure for UAV and UAV-C grouping C2 QoS provisioning using subsequent group ID. It also provides the procedure for UAV replacement resulting in group ID update.

7.3.2 Procedures

7.3.2.1 Procedure for group creation for one pair of UAV and UAV-C

Figure 7.3.2.1-1 illustrates a high-level procedure for group creation.

Pre-conditions:

- Both UAV-C and UAV have successfully registered and connected to the UAE server.
- A CAA-level UAV ID is already assigned to the UAV-C and UAV.

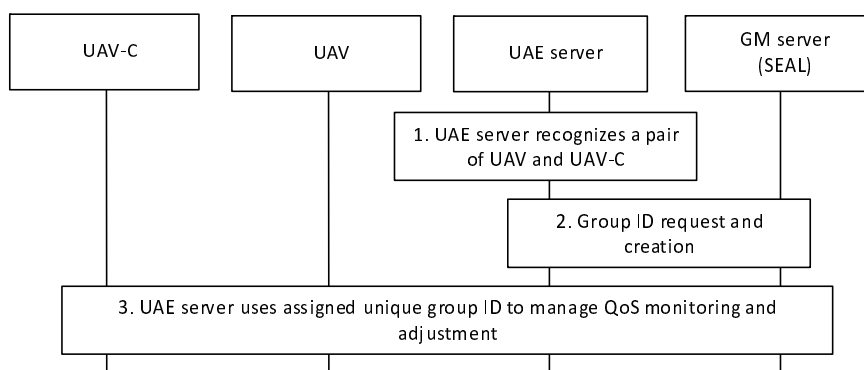

Figure 7.3.2.1-1: Procedure for group creation for one pair of UAV and UAV-C

1. The UAE server recognizes a unique pair of UAV and UAV-C either by 3GPP UE ID or CAA-level UAV ID.

NOTE: The mechanisms for how the UAE server recognizes a pair of UAV-C and UAV is out of scope of the present document.

2. The UAE server sends a group creation request to the SEAL GM server, if there is no pre-assigned group ID, by using the GM-S reference link as specified in 3GPP TS 23.434 [5] using the procedure defined in clause 10.3. The SEAL GM server creates one group ID for one pair of UAV and UAV-C as specified in 3GPP TS 23.434 [5].
3. The UAE server uses the returned group ID for UAS for QoS management.

7.3.2.2 Procedure for group-based approach for C2 QoS provisioning

Figure 7.3.2.2-1 illustrates a high-level workflow of group-based C2 QoS provisioning.

Pre-conditions:

- Both UAV and UAV-C have registered to 3GPP 5G network respectively. C2 communication is established.
- The procedure specified in clause 7.3.2.1 is performed and the group ID for the UAS group is available at the UAE server.

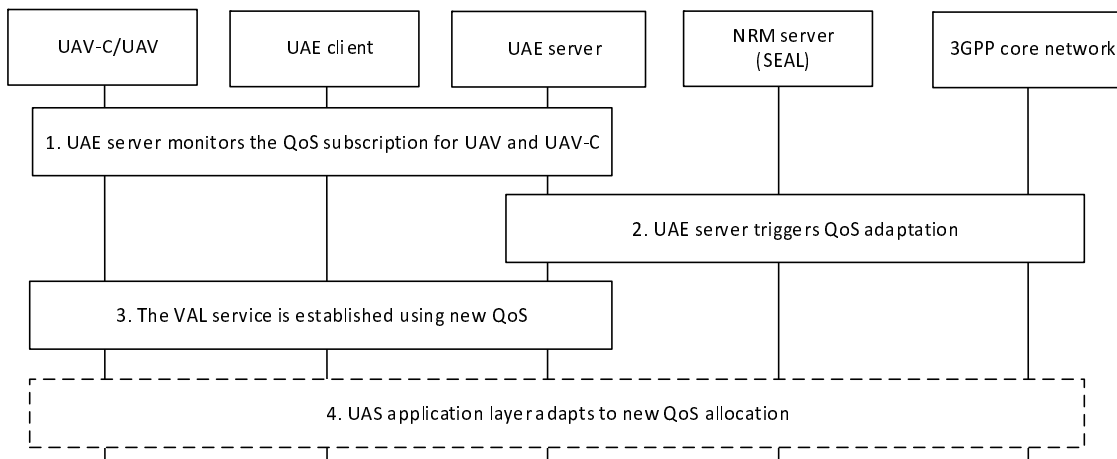

Figure 7.3.2.2-1: Procedure of group-based approach for C2 QoS provisioning.

1. The UAE server monitors the QoS for the UAS group (which includes a UAV and UAV-C) by SEAL NRM as specified in 3GPP TS 23.434 [5].
2. In cases where the network condition for C2 communication does not satisfy the pre-defined QoS requirement, the UAE server may choose to send QoS adaptation request to the SEAL NRM server using the NRM-S reference point as specified in 3GPP TS 23.434 [5]. The QoS adaptation request needs to be sent per group ID for a pair of UAV and UAV-C created in the procedure specified in clause 7.3.2.1. The subsequent network resource adaptation procedure is triggered by the UAE server as specified in clause 14.3.3.3.1 of 3GPP TS 23.434 [5].
3. The UAE client and UAE server established communication based on new QoS requirements as specified in clause 14.3.3.2.1.2 of 3GPP TS 23.434 [5].
4. UAS application layer adapts the updated QoS assignment.

NOTE: The mechanisms for how the UAS application layer is adapting newly assigned QoS is out of scope of the present document.

7.3.2.3 Procedure for group update

Figure 7.3.2.3-1 illustrates the group membership update when UAV-2 is used to replace UAV-1.

Pre-conditions:

- The UAV-C, UAV-1, and UAV-2 are all previously successfully subscribed with 3GPP Core Network and UAS application specific server (e.g. USS/UTM) and have received a 3GPP UE ID (e.g. GPSI) and a CAA-level UAV ID.
- The UAV-1 and UAV-C have been grouped by a group ID by SEAL GMS as specified in clause 7.3.2.1.

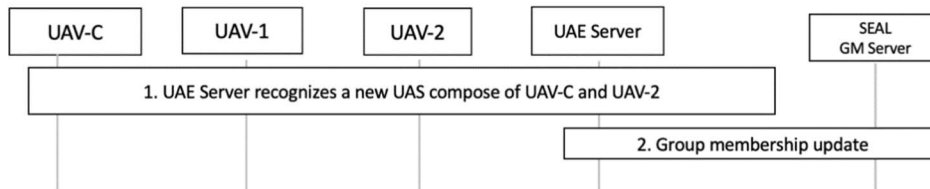

Figure 7.3.2.3-1: Procedure for group update

1. The UAE server recognizes a new pair of UAV-2 and UAV-C by the new CAA-level UAV ID.

NOTE: The mechanisms for how the UAE server recognizes a new pair of UAV-C and UAV is out of scope of the present document.

2. The UAE server sends a group membership update request to the SEAL GM server using the procedure specified in clause 10.3.2.6 of 3GPP TS 23.434 [5]. The SEAL GM server sends a group membership update response as specified in clause 10.3.2.7 of 3GPP TS 23.434 [5].

7.3.3 Information flows

The usage of information flows between UAE server and SEAL's Group management Server is specified in clause 7.1.2.2.

The usage of information flows between UAE server and SEAL's Network Resource Management Server is specified in clause 7.1.4.2.

7.4 C2 Communication mode selection and switching

7.4.1 General

This feature introduces the UAS application enablement services for supporting the selection and re-selection of C2 communication modes. In particular, the UAE layer provides support for the following operations:

- Support the switch between the Network-Assisted C2 communication and Direct C2 communication (e.g. when the direct link becomes feasible/available, or when a UAV is moving towards BVLOS or has poor direct link conditions, etc.) as described in clause 7.4.2.4.
- Support the switch between the Network-Assisted/Direct C2 communication and UTM-Navigated C2 communication (e.g. for air traffic control, the UAV is approaching a No Drone Zone, and detected potential security threats, etc.) as described in clause 7.4.2.5.
- Support the selection of the communication mode between: utilizing more than one C2 communication links, and among applicable C2 communication links, selecting a mode as the primary one as described in clause 7.4.2.3.
- Activation for the support of the above operations in the UAE Server in the UAE client is performed using procedure described respectively in clause 7.4.2.1 and clause 7.4.2.2.

Below, the different procedures for C2 communication mode selection and switching are described using UAE Client assisted and UAE Server controlled based mechanisms. Such functionality is supported by means of policies delivered to the UAV/UAV-C via the UAE layer and assisting the dynamic switching of C2 modes.

NOTE: For direct C2 communication mode, usage of ProSe/PC5 is not considered in the present specification (e.g. direct wireless communication over a technology outside the scope of 3GPP is assumed).

7.4.2 Procedures

7.4.2.1 Management of C2 mode selection / switching capability

This procedure manages the C2 mode selection/switching capability at the UAE server, based on an application request from UAS application specific server (which can be the USS/UTM) to manage the C2 operation modes (direct, network-assisted) of C2 communication for a UAS.

Figure 7.4.2.1-1 illustrates the procedure where the UAE server receives an application request for managing the operation mode for C2 communications for a UAS.

Pre-condition:

- The UAV has received its UAS ID from the UAS application specific server.

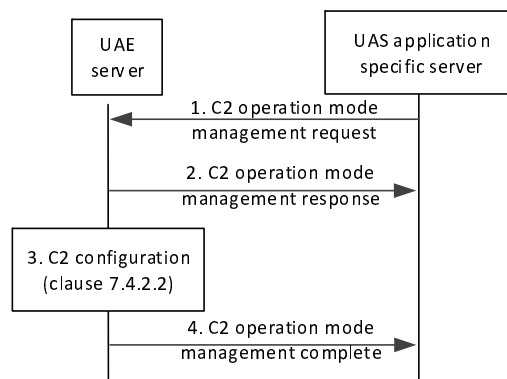

Figure 7.4.2.1-1: C2 operation mode management request / response

1. The UAS application specific server sends to the UAE Server a C2 operation mode management request for managing the operation modes for the C2 communication for a UAS (consisting a UAV and a UAV-C) and to subscribe for UAE notifications.
2. The UAE Server sends to the UAS application specific server a C2 operation mode management response with a positive or negative acknowledgement of the request, based on capability of UAE server to undertake this task.
3. UAE server executes C2 communication modes configuration according to clause 7.4.2.2.
4. After execution of C2 communication modes configuration, the UAE server notifies the UAS application specific server with a C2 operation mode management complete.

7.4.2.2 C2 communication modes configuration

This procedure enables the configuration of the UAE Client, based on an application request from UAS application specific server (which can be the USS/UTM) to manage the C2 operation modes (direct, network-assisted) of C2 communication for a UAS.

Figure 7.4.2.2-1 illustrates the C2 communication modes configuration procedure.

Pre-conditions:

1. The UAS UEs are connected to 5GS and authenticated and authorized by UAS application specific server as specified in clause 5.2 of 3GPP TS 23.256 [4].
2. UAE Server has established a UAE session with the respective UAE Clients as the UAE clients are successfully registered to the UAE server.
3. UAE Server has performed the C2 mode switching/selection capability initiation as in clause 7.4.2.1.

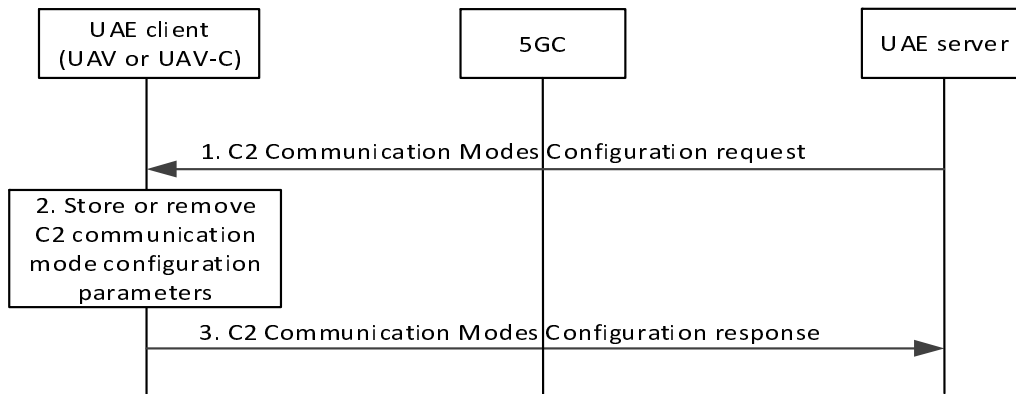

Figure 7.4.2.2-1: C2 communication modes configuration

1. The UAE Server sends a C2 communication modes configuration request including the UAS identifier, allowed C2 communication modes (e.g., direct, network assisted, UTM-Navigated), primary and optionally secondary C2 communication mode and policy for switching. In the case of removal of C2 communication mode configuration parameters from the UAV or UAV-C, then the request shall only include the UAS identifier.
2. The UAE Client stores or removes the C2 communication mode configuration parameters as per the information received in step 1.
3. The UAE Client sends a C2 communication modes configuration response to the UAE Server.

7.4.2.3 C2 communication mode selection by UAE Client

This procedure provides a mechanism for the UAE client to select a primary C2 communication mode and optional secondary C2 communication mode based on C2 communication mode configuration enabled as described in clause 7.4.2.2.

Figure 7.4.2.3-1 illustrates the C2 communication mode selection and redundant C2 link negotiation.

Pre-conditions:

1. The UAE Clients are configured with a C2 communication modes configuration as described in clause 7.4.2.2.
2. UAE Server has activated the dynamic C2 mode switching capability, as described in clause 7.4.2.1.

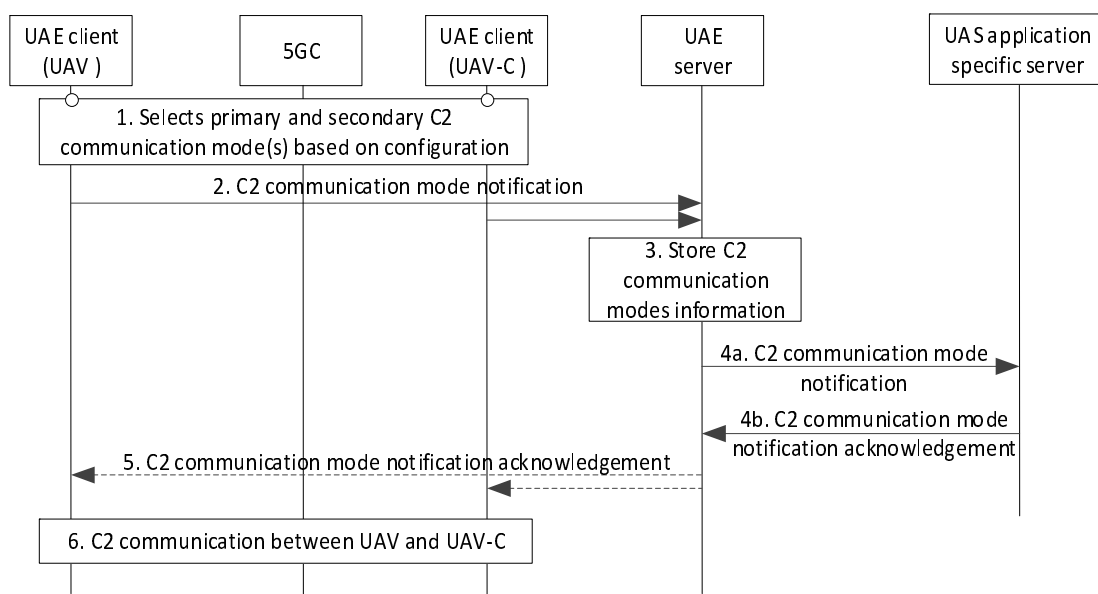

Figure 7.4.2.3-1: C2 communication mode selection

1. UAE Clients (UAV and UAV-C) select a primary and secondary C2 communication mode based on C2 communication mode configuration.
2. The UAE Client sends a C2 communication mode notification to the UAE Server indicating the selected primary and secondary C2 communication modes and associated C2 link information which may include UAE Client and peer address information (e.g., IP/MAC address).
3. The UAE Server stores the C2 communication modes and links information.
- 4a-4b. The UAE Server forwards the C2 communication mode and links information to the UAS application specific server and receives a C2 communication mode notification acknowledgement from the UAS application specific server.
5. The UAE Server may forward the C2 communication mode notification acknowledgement to the UAE Client.
6. The UAV and UAV-C start C2 communication using the selected C2 communication mode.

NOTE: The details of step 6 are outside the scope of the present specification.

7.4.2.4 UAE layer assisted dynamic C2 mode switching

This procedure provides a mechanism for supporting dynamic switching between direct and network assisted C2 communications, which may be required while the UAV flight is ongoing, due to possible change of network conditions, expected location/mobility of the UAV, unpredictable events etc.

Figure 7.4.2.4-1 illustrates the procedure where the UAE server supports the dynamic C2 mode switching for network-assisted C2 communications.

Pre-conditions:

1. UAE Server has activated the dynamic C2 mode switching capability, as described in clause 7.4.2.1
2. UAE Server has subscribed for using SEAL/LMS services and has configured the location event reporting, based on 3GPP TS 23.434 [5].
3. UAE Client has selected a C2 communication mode as described in clause 7.4.2.3, and UAV and UAV-C are engaged in C2 communication.

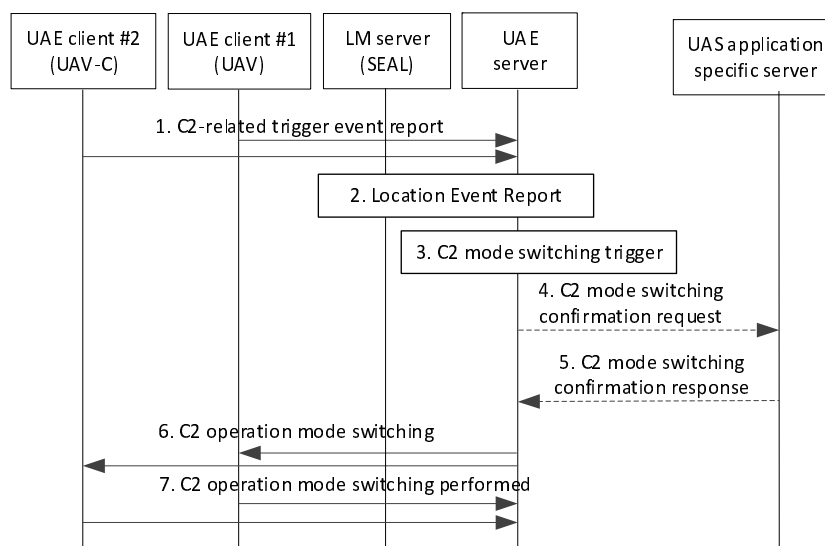

Figure 7.4.2.4-1: UAE-assisted dynamic C2 mode switching

1. The UAE Client detects a condition for switching C2 communication mode based on local conditions (e.g. using the C2 communication mode switching policy) or based on a command from the UAS application specific server (as described in clause 7.4.2.5). A C2-related trigger event report is sent from the UAE Client of the UAV and/or the UAV-C to the UAE Server, denoting a command from the UAS application specific server or an application

QoS attribute change (experienced or expected) e.g. based on the experienced packet delay or packet loss for the Uu or direct link (e.g. packet loss greater than a pre-defined threshold).

2. Additionally, the UAE Server receives a location report for the UAV/UAV-C by the SEAL's LM server. The report can be either periodical or event-based (e.g. UAV moving towards an area covered by a different cell or different operator), as specified in 3GPP TS 23.434 [5] SEAL's LM server procedures (UAE Server acting as a VAL server).
3. The UAE Server determines the switching of the C2 mode from direct to network assisted or vice versa or to UTM-Navigated. If the switching is from direct to network assisted or vice versa, this is done by calculating the relative actual or expected UAV-to-UAV-C location, as well as other factors like QoS fulfilment/unfulfilment, augmented location, mobility/speed, direction, topography, weather conditions.
4. The UAE Server sends a C2 mode switching confirmation request to the UAS application specific server, which includes the UAS identifier as well as the cause for switching and the switching option (direct to network-assisted or network-assisted to direct or to UTM-Navigated). The UAE Server sends this request to obtain confirmation from the UAS application specific server before proceeding with switching to UTM-Navigated. This step is optional in the case of switching from direct to network assisted or vice versa.
5. Conditional on Step 3, the UAE Server receives from the UAS application specific server a C2 mode switching confirmation response indicating a positive or negative result for the requested change.
6. The UAE Server sends to the involved UAE Clients, a C2 operation mode switching message which provides an instruction to the UAV and UAV-C to switch to network-assisted mode or to direct mode or to UTM-Navigated. The UAV and UAV-C start C2 communication using the indicated C2 communication mode (e.g., direct, network assisted, UTM-Navigated).
7. If an emergency switch of the C2 communication is deemed necessary by the UAE Client (e.g. sudden loss of the active C2 link), the UAE Client changes the link prior to the steps 1-6, which are skipped. The UAE Clients send a C2 operation mode switching performed message to the UAE Server to confirm the switching of the C2 communication mode.

7.4.2.5 UAS application specific server triggered C2 communication mode switching

This procedure provides a mechanism for supporting dynamic switching between direct or network assisted C2 communications to UTM-Navigated, initiated by the UAS application specific server (which can be the USS/UTM) after detecting a C2 switching condition which may be required while the UAV enters a no-fly zone. For example, the UAS application specific server needs to take over the control of UAV and fly it to safety (see 3GPP TS 22.125 [2] clause 4.2).

Figure 7.4.2.5-1 illustrates a UAS application specific server triggered C2 communication mode switching.

Pre-conditions:

1. UAE Server has activated the dynamic C2 mode switching capability, as described in clause 7.4.2.1.
2. UAE Client has selected a primary C2 communication mode as described in clause 7.4.2.3, and UAV and UAV-C are engaged in (e.g., direct or network assisted) C2 communication.

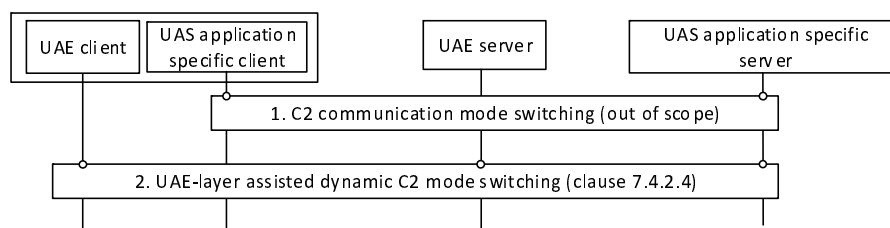

Figure 7.4.2.5-1: UAS application specific server triggered C2 communication mode switching

1. The UAS application specific client is instructed directly by a command from the UAS application specific server to switch to UTM-Navigated mode.

NOTE: This procedure between the UAS application specific server and the UAS application specific client is out of scope of the present document.

- The UAE Client initiates the procedure described in clause 7.4.2.4.

7.4.3 Information flows

7.4.3.1 C2 operation mode management request

Table 7.4.3.1-1 describes the information flow C2 operation mode management request from the UAS application specific server to the UAE server.

Table 7.4.3.1-1: C2 operation mode management request

Information element	Status	Description
UASS ID	M	Identity of the UAS application specific server which requests the C2 operation mode management. This ID can be the USS/UTM identifier, when the UAS application specific server is the USS/UTM.
UAS ID	M	The identification of the UAS for which the C2 QoS management request applies. This could be in form of identifier for the UAS, e.g group ID; or collection of individual identifiers for the UAV and UAV-C, e.g. CAA level UAV ID, GPSI
C2 operation mode management container (see NOTE 2)	O	The C2 operation mode management container consists of the requirements and policy for C2 operation mode management
> C2 operation mode management requirement	M	Identification of the type of the C2 mode switching to be supported by the UAE server. This can be either from direct to network-assisted C2, or from network-assisted to direct C2 or to UTM-Navigated.
> Allowed C2 communication modes	M	direct, network assisted, UTM-Navigated
> Primary C2 communication mode	M	Primary C2 communication mode (direct, network assisted)
> Secondary C2 communication mode	O	Secondary C2 communication mode (direct, network assisted)
> Policy of C2 switching	M	Parameters for C2 switching <ul style="list-style-type: none"> - QoS thresholds on active link - QoS thresholds on target link
> C2 service area	O	The area where the C2 operation mode management request applies. This can be geographical area, or topological area in which the capability is active.
NOTE 1: Void		
NOTE 2: If C2 operation mode management container IE is not included, it indicates removal of the C2 operation mode management related information.		

7.4.3.2 C2 operation mode management response

Table 7.4.3.2-1 describes the information flow C2 operation mode management response from the UAE server to the UAS application specific server.

Table 7.4.3.2-1: C2 operation mode management response

Information element	Status	Description
Result	M	The positive or negative result of the C2 operation mode management request.

7.4.3.3 C2 operation mode management complete

Table 7.4.3.3-1 describes the information flow C2 operation mode management complete from the UAE server to the UAS application specific server.

Table 7.4.3.3-1: C2 operation mode management complete

Information element	Status	Description
Result	M	The positive or negative result of the C2 communication mode configuration.

7.4.3.4 C2-related trigger event report

Table 7.4.3.4-1 describes the information flow C2-related trigger event report from the UAE client (of the UAV or the UAV-C) to the UAE server.

Table 7.4.3.4-1: C2-related trigger event report

Information element	Status	Description
UAE client ID	M	The identifier of the UAE client which indicates the QoS downgrade
Application QoS-related event	M	The report including the expected or actual application QoS / QoE parameters which were change (i.e. latency, throughput, reliability, jitter). The event configuration (thresholds, policies) is provided to the UAE client as described in clause 7.3.2.2.

7.4.3.5 C2 mode switching confirmation request

Table 7.4.3.5-1 describes the information flow C2 mode switching confirmation request from the UAE server to the UAS application specific server.

Table 7.4.3.5-1: C2 mode switching confirmation request

Information element	Status	Description
UAE server ID	M	The identifier of the UAE server which requests the C2 mode switching confirmation from USS/UTM
UAS ID	M	The identification of the UAS. This could be in form of identifier for the UAS, e.g. group ID; or collection of individual identifiers for the UAV and UAV-C, e.g. CAA level UAV ID, GPSI.
C2 operation mode switching type	M	The type of the C2 mode switching to be applied (direct to network-assisted, or network-assisted to direct, or to UTM-Navigated).
Switching cause	O	Cause information for initiating the switching (e.g. poor radio link quality)

7.4.3.6 C2 mode switching confirmation response

Table 7.4.3.6-1 describes the information flow C2 mode switching confirmation response from the UAS application specific server (USS/UTM) to the UAE server.

Table 7.4.3.6-1: C2 mode switching confirmation response

Information element	Status	Description
Result	M	The positive or negative result of the C2 mode switching confirmation response.

7.4.3.7 C2 operation mode switching

Table 7.4.3.7-1 describes the information flow C2 operation mode switching from the UAE server to the UAE client(s) of the affected UAS.

Table 7.4.3.7-1: C2 operation mode switching

Information element	Status	Description
UAE server ID	M	The identifier of the UAE server which instructs the UAS to apply the C2 mode switching.
C2 operation mode switching requirement	M	The type of the C2 mode switching to be applied (direct to network-assisted, or network-assisted to direct).
Time Validity	O	Time validity for the C2 switching requirement
Geographical Area	O	Area for which the C2 switching applies

7.4.3.8 C2 communication modes configuration request

Table 7.4.3.8-1 describes the information flow C2 communication modes configuration request from the UAE server to the UAE client.

Table 7.4.3.8-1: C2 communication modes configuration request

Information element	Status	Description
UAS ID	M	The identification of the UAS for which the C2 QoS management request applies. This could be in form of identifier for the UAS, e.g. group ID; or collection of individual identifiers for the UAV and UAV-C, e.g. CAA level UAV ID, GPSI.
C2 operation mode management configuration (see NOTE 2)	O	The C2 operation mode management configuration information to be configured at the UAS
> C2 operation mode management requirement	M	Identification of the type of the C2 mode switching to be supported by the UAE server. This can be either from direct to network-assisted C2, or from network-assisted to direct C2 or to UTM-Navigated.
> Allowed C2 communication modes	M	direct, network assisted, UTM-Navigated
> Primary C2 communication mode	M	Primary C2 communication mode (direct, network assisted)
> Secondary C2 communication mode	O	Secondary C2 communication mode (direct, network assisted)
> Policy of C2 switching	M	Parameters for C2 switching <ul style="list-style-type: none"> - QoS thresholds on active link - QoS thresholds on target link
NOTE 1: Void		
NOTE 2: If C2 operation mode management configuration IE is not included, it indicates removal of the C2 operation mode management configuration at the UAS ID.		

7.4.3.9 C2 communication modes configuration response

Table 7.4.3.9-1 describes the information flow C2 communication modes configuration response from the UAE client to the UAE server.

Table 7.4.3.9-1: C2 communication modes configuration response

Information element	Status	Description
Result	M	The positive or negative result of reception and storing or removal of the communication mode configuration parameters

7.4.3.10 C2 communication mode notification

Table 7.4.3.10-1 describes the information flow C2 communication mode notification from the UAE client to the UAE server and from the UAE server to the UAS application specific server.

Table 7.4.3.10-1: C2 communication mode notification

Information element	Status	Description
UAS ID	M	The identification of the UAS. This could be in form of identifier for the UAS, e.g. group ID; or collection of individual identifiers for the UAV and UAV-C, e.g. CAA level UAV ID, GPSI.
Selected primary C2 communication mode	M	Selected primary C2 communication mode (direct, network assisted)
Selected secondary C2 communication mode	O	Selected secondary C2 communication mode (direct, network assisted)

7.4.3.11 C2 communication mode notification acknowledgement

Table 7.4.3.11-1 describes the information flow C2 communication mode notification acknowledgement from the UAE server to the UAE client and from the UAS application specific server to the UAE server.

Table 7.4.3.11-1: C2 communication mode notification acknowledgement

Information element	Status	Description
Acknowledgement	M	Acknowledgement of selected C2 communication mode(s)

7.4.3.12 C2 operation mode switching performed

Table 7.4.3.12-1 describes the information flow C2 operation mode switching performed from the UAE client to the UAE server.

Table 7.4.3.12-1: C2 operation mode switching performed

Information element	Status	Description
Result	M	The result of the C2 mode switching

7.5 Real-Time UAV Connection Status Monitoring and Location reporting

7.5.1 General

This clause enables the UAE server to provide a real-time view of UAV network status and location reporting based on current network connection status, in particular with the supporting of following use cases:

- Support of real-time monitor the 3GPP network connection with UAVs.
- Support of reporting of loss of communication with UAVs.

- Support of location reporting such as last known location after loss of communication.

7.5.2 Procedures

7.5.2.1 Procedure for real-time UAV network connection status monitoring and location update

Figure 7.5.2.1-1 illustrates the real-time network monitoring and location update support for UAV operations.

Pre-conditions:

- UAE server has subscribed to the monitoring event API for connection monitoring by the NRM server for both UAV and/or UAV client as specified in clause 14.3.6.2.2 of 3GPP TS 23.434 [5].
- UAE server has subscribed for the location information and location deviation monitoring events of UAV from LM server as per the clause 9.3.7 and clause 9.3.11.2 specified in 3GPP TS 23.434 [5].
- Subscription for real-time UAV status information is performed as specified in clause 7.5.2.2.

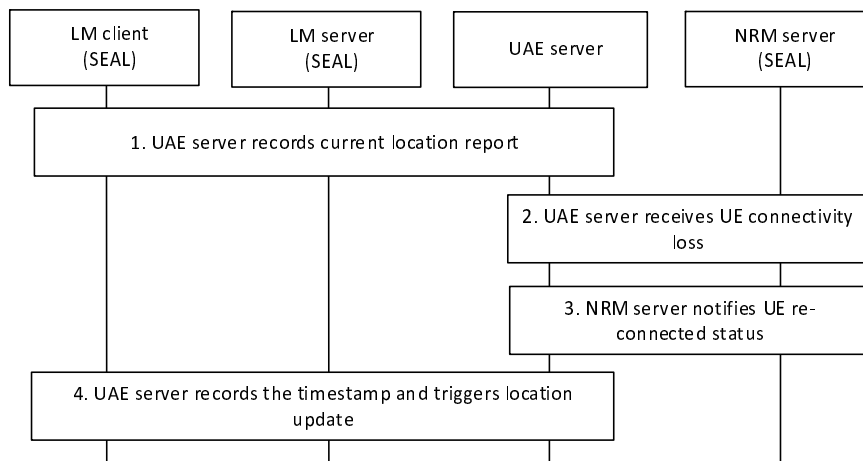

Figure 7.5.2.1-1: Real-time UAV network connection status monitoring and location update

1. The UAE server receives location report and location deviation monitoring event notifications from LM server as specified in clause 9.3.8 and clause 9.3.11.2 of 3GPP TS 23.434 [5]. UAE server shall record the current location reporting timestamp as specified in clause 9.3.2.2 of 3GPP TS 23.434 [5].
2. The UAE server receives monitoring events notification as specified in clause 14.3.6.3.2 of 3GPP TS 23.434 [5]. If events are regarding loss of UE reachability such as when received "Loss_of_connectivity_notification", the UAE server shall record such event with current timestamp.
3. NRM server sends notification when UE re-connected status is detected as specified in clause 14.3.6.3.2 of 3GPP TS 23.434 [5].
4. The UAE server shall record such event with current timestamp, plus with last known location information and timestamp as specified in clause 9.3.2.7 of 3GPP TS 23.434 [5] and trigger location update as specified in clause 9.3.4 of 3GPP TS 23.434 [5].

7.5.2.2 Subscription for real-time UAV status information

Figure 7.5.2.2-1 describes the procedure for subscription for real-time UAV status information.

Pre-condition:

- UAS application specific server has been provisioned with UAE server information.

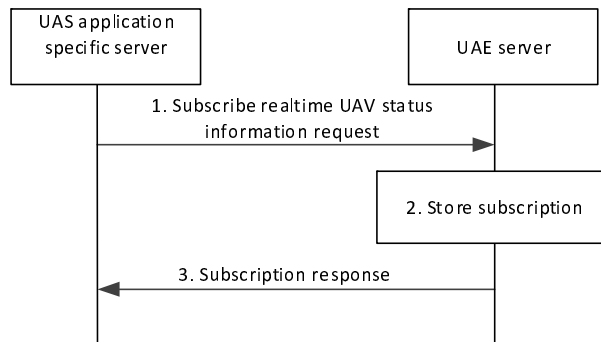

Figure 7.5.2.2-1: Subscription for real-time UAV status information

1. The UAE application specific server sends subscribe real-time UAV status information request to the UAE server. The request includes the UAV ID.
2. The UAE server stores the subscription information.
3. The UAE server sends subscription response to the UAS application specific server.

7.5.2.3 Notification of real-time UAV status information

Pre-conditions:

- UAS application specific server has performed subscription as per procedure in clause 7.5.2.2 with UAE server and the procedure for processing real-time UAV status as specified in clause 7.5.2.1 has performed.

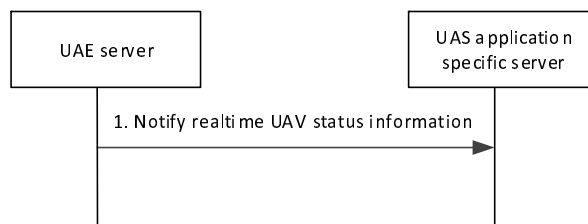

Figure 7.5.2.3-1: Notification for real-time UAV status information

1. When real-time UAV status information is available at the UAE as per the subscription then, the UAE server sends notification of real-time UAV status information to the UAS application specific server.

7.5.2.4 Unsubscription for real-time UAV status information

Figure 7.5.2.4-1 describes the procedure for unsubscription for real-time UAV status information.

Pre-condition:

- UAS application specific server has performed the subscription procedure as specified in clause 7.5.2.2.

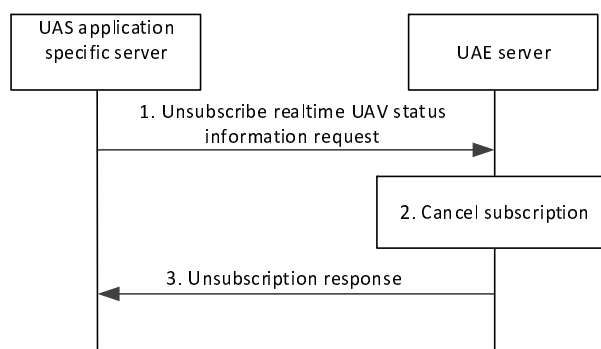

Figure 7.5.2.4-1: Unsubscription for real-time UAV status information

1. The UAE application specific server sends unsubscribe real-time UAV status information request to the UAE server. The request includes the subscription ID.
2. The UAE server cancels the subscription information.
3. The UAE server sends unsubscription response to the UAS application specific server.

7.5.3 Information flows

7.5.3.1 Information flows between UAE server and SEAL servers

The usage of information flows between UAE server and SEAL's Location Management Server is specified in clause 7.1.3.2.

The usage of information flows between UAE server and SEAL's Network Resource Management Server is specified in clause 7.1.4.2.

7.5.3.2 Subscribe real-time UAV status information request

Table 7.5.3.2-1 describes the information flow for a UAS application specific server to subscribe to real-time UAV status information at the UAE server.

Table 7.5.3.2-1: Subscribe real-time UAV status information request

Information element	Status	Description
UASS ID	M	The identifier of the UAS application specific server which initiated this request.
UAV ID	M	The identifier of the UAV (e.g. 3GPP UE ID or CAA level UAV ID) for which the real-time UAV status is requested.
Area of Interest	M	Geographic area location information where the UASS server wishes to monitor the UAS's location adherence.
Notification Target URI	M	Target URI where the UAS application specific server wishes to receive the notifications about real-time UAV status information.

7.5.3.3 Subscribe real-time UAV status information response

Table 7.5.3.3-1 describes the information flow for UAE server to respond for real-time UAV status subscription request from the UAS application specific server.

Table 7.5.3.3-1: Subscribe real-time UAV status information response

Information element	Status	Description
Result	M	Result from the UAE server in response to subscription request indicating success or failure
Subscription ID (NOTE)	O	Identifier of a successful subscription.
NOTE: This IE is included when the Result indicates success		

7.5.3.4 Notify real-time UAV status information

Table 7.5.3.4-1 describes the information flow for a UAS application specific server to receive notification about real-time UAV status information from the UAE server.

Table 7.5.3.4-1: Notify real-time UAV status information

Information element	Status	Description
Subscription ID	M	Identifier of the subscription for this notification.
Real-time UAV status information	M	The real-time UAV status information
>UAV ID	M	The identifier of the UAV (e.g. 3GPP UE ID or CAA level UAV ID) for which the real-time UAV status information is notified.
>UAV status information	M	The UAV status information includes the UAV network connection status information, location information and timestamp.

7.5.3.5 Unsubscribe real-time UAV status information request

Table 7.5.3.5-1 describes the information flow for a UAS application specific server to unsubscribe to real-time UAV status information at the UAE server.

Table 7.5.3.5-1: Unsubscribe real-time UAV status information request

Information element	Status	Description
Subscription ID	M	Identifier of the subscription for this notification.

7.5.3.6 Unsubscribe real-time UAV status information response

Table 7.5.3.6-1 describes the information flow for UAE server to respond for real-time UAV status unsubscription request from the UAS application specific server.

Table 7.5.3.6-1: Unsubscribe real-time UAV status information response

Information element	Status	Description
Result	M	Result from the UAE server in response to unsubscription request indicating success or failure

8 APIs

8.1 General

The following UAE capabilities are offered as APIs:

- UAE server APIs;

The following SEAL service APIs are specified in 3GPP TS 23.434 [5]:

- Group management server APIs;
- Location management server APIs;
- Configuration management server APIs;
- Identity management server APIs; and
- Key management server APIs.

When UAS application specific server invokes a SEAL server API directly, the UAS application specific server acting as VAL server shall interact with the corresponding SEAL server over the SEAL-S reference point for the API invocation request and response as specified in 3GPP TS 23.434 [5].

8.2 UAE server APIs

8.2.1 General

Table 8.2.1-1 illustrates the UAE server APIs.

Table 8.2.1-1: List of UAE server APIs

API Name	API Operations	Known Consumer(s)	Communication Type
UAE_C2OperationModeManagement API	Manage_C2OperationMode	UAS application specific server	Request/Response
	Notify_SelectedC2Mode (NOTE)	UAS application specific server	Subscribe/notify
	Notify_C2ModeSwitching (NOTE)	UAS application specific server	Subscribe/notify
	Notify_C2OperationModeManagementComplete (NOTE)	UAS application specific server	Subscribe/notify
UAE_RealtimeUAVStatus API	Subscribe_RealtimeUAVStatus	UAS application specific server	Subscribe/notify
	Unsubscribe_RealtimeUAVStatus	UAS application specific server	Subscribe/notify
	Notify_RealtimeUAVStatus	UAS application specific server	Subscribe/notify
NOTE: The subscribe operation for Notify_C2OperationModeManagementComplete, Notify_SelectedC2Mode and Notify_C2ModeSwitching is part of Manage_C2OperationMode			

8.2.2 UAE_C2OperationModeManagement API

8.2.2.1 General

API description: This API enables the UAS application specific server to communicate with the UAE server to send configurations for C2 operation modes for the UAS and receive notifications of the selected C2 communication modes from the UAS UEs (i.e. UAV, UAV-C).

8.2.2.2 Manage_C2OperationMode operation

API operation name: Manage_C2OperationMode

Description: Manage (initiate, change or delete) the configuration of the C2 operation modes for the UAS UEs.

Known Consumers: UAS application specific server.

Inputs: Refer clause 7.4.3.1.

Outputs: Refer clause 7.4.3.2.

See clause 7.4.2.1 for the details of usage of this API operation.

8.2.2.3 Notify_SelectedC2Mode

API operation name: Notify_SelectedC2Mode

Description: Notification of the selected C2 communication modes from the UAS UEs.

Known Consumers: UAS application specific server.

Inputs: Refer clause 7.4.3.10.

Outputs: Refer clause 7.4.3.11.

See clause 7.4.2.3 for the details of usage of this API operation.

8.2.2.4 Notify_C2ModeSwitching

API operation name: Notify_C2ModeSwitching

Description: Notification of the C2 communication mode switching from the UAS UEs.

Known Consumers: UAS application specific server.

Inputs: Refer clause 7.4.3.5.

Outputs: Refer clause 7.4.3.6.

See clause 7.4.2.4 for the details of usage of this API operation.

8.2.2.5 Notify_C2OperationModeManagementComplete

API operation name: Notify_C2OperationModeManagementComplete

Description: Notification about the C2 operation mode management completion by UAE server.

Known Consumers: UAS application specific server.

Inputs: Refer clause 7.4.3.3.

Outputs: None.

See clause 7.4.2.1 for the details of usage of this API operation.

8.2.3 UAE_ RealtimeUAVStatus API

8.2.3.1 General

API description: This API enables the UAS application specific server to subscribe for and receive notifications for the realtime status information of the UAV.

8.2.3.2 Subscribe_ RealtimeUAVStatus operation

API operation name: Subscribe_ RealtimeUAVStatus

Description: Subscription for obtaining the realtime UAV status information.

Known Consumers: UAS application specific server.

Inputs: Refer clause 7.5.3.2.

Outputs: Refer clause 7.5.3.3.

See clause 7.5.2.2 for the details of usage of this API operation.

8.2.3.3 Unsubscribe_ RealtimeUAVStatus operation

API operation name: Unsubscribe_ RealtimeUAVStatus

Description: Unsubscription for a existing subscription for obtaining the realtime UAV status information.

Known Consumers: UAS application specific server.

Inputs: Refer clause 7.5.3.5.

Outputs: Refer clause 7.5.3.6.

See clause 7.5.2.4 for the details of usage of this API operation.

8.2.3.4 Notify_ RealtimeUAVStatus operation

API operation name: Notify_ RealtimeUAVStatus

Description: Notification of the realtime UAV status information.

Known Consumers: UAS application specific server.

Inputs: Refer clause 7.5.3.4.

Outputs: None.

See clause 7.5.2.3 for the details of usage of this API operation.

Annex A (informative): Support for edge deployments

The application architecture for supporting edge applications are specified in 3GPP TS 23.558 [7]. The UAS application layer as specified in clause 5 can be deployed in edge computing environment.

Figure A-1 illustrates a UAS application layer deployment in edge computing environments.

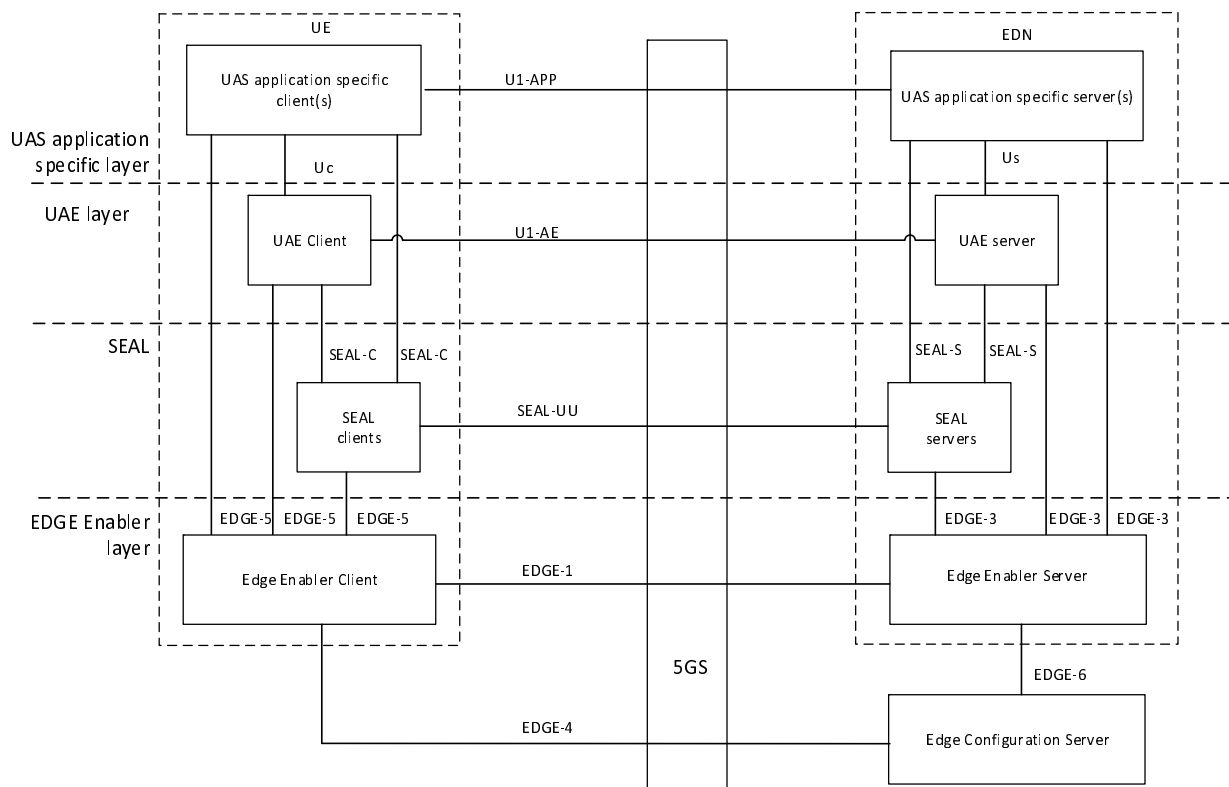

Figure A-1: UAS application layer deployment in edge computing environment

Figure A-1 illustrates how the UAS application architecture with EDGEAPP support for edge deployments can be deployed. In a UE, the UAS application specific client(s), UAE client and SEAL clients interact with the Edge Enabler Client (EEC) via EDGE-5 reference point in order to consume edge services. In an Edge Data Network (EDN), the UAS application specific server(s), UAE server and SEAL servers acting as Edge Application Server (EAS), interacts with the Edge Enabler Server (EES) via EDGE-3 reference point. The service provisioning and EAS discovery enable the UAS application layer entities in the UE to communicate with the application layer entities in the EDN. The interactions between the entities and 5GS are not shown for the sake of simplicity.

NOTE: This clause illustrates an example edge deployment using edge enabler layer. There can be other valid edge deployments enabled for UAS application layer.

Annex B (Informative): Deployment models

B.1 General

This clause describes deployments of the functional model specified in clause 5. The reference points utilized from underlying 3GPP network as specified in clause 5.5 is represented as 3GPP interfaces in the deployment models.

NOTE: The representation of SEAL functionalities in the vertical deployment is specified in 3GPP TS 23.434 [5].

B.2 Deployment of UAE server

The UAE server deployments can be centralized and distributed.

B.2.1 Centralized deployments

A centralized deployment is where a single UAE server offers the UAE capabilities to one or more UAS application specific servers (e.g. USS/UTM). The UAE server and the UAS application specific server can be co-located in a single physical entity. The UAE server can be deployed either in the PLMN operator domain or deployed in the UAS operator domain. The UAE server connects with the 3GPP network systems (EPS, 5GS) in one or more PLMN operator domain. When UAE server and UAS application specific server are co-located in a single physical entity, the Us reference point between the UAE server and the UAS application specific server is not used.

Figure B.2.1-1 illustrates a deployment of the UAE server and the UAS application specific server in a single physical entity and deployed in UAS operator domain. The UAE server can be deployed in a separate physical entity from the UAS application specific server in the UAS operator domain. In such deployments, the Us reference point is used for the communication between the UAE server and the UAS application specific server.

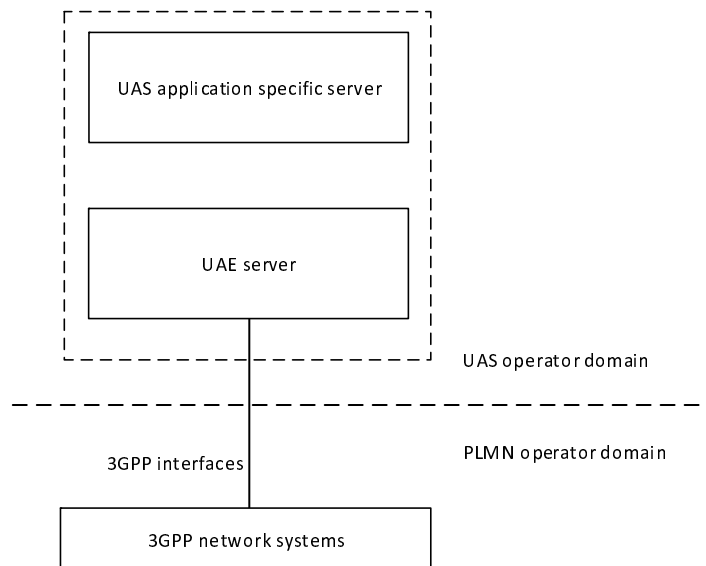

Figure B.2.1-1: UAE server co-located with UAS application specific server in a single physical entity

Figure B.2.1-2 illustrates a deployment of the UAE server in the PLMN operator domain and the UAS application specific server in the UAS operator domain. The Us reference point is used for the communication between UAS application specific server and the UAE server. The UAE server can support multiple UAS application specific servers.

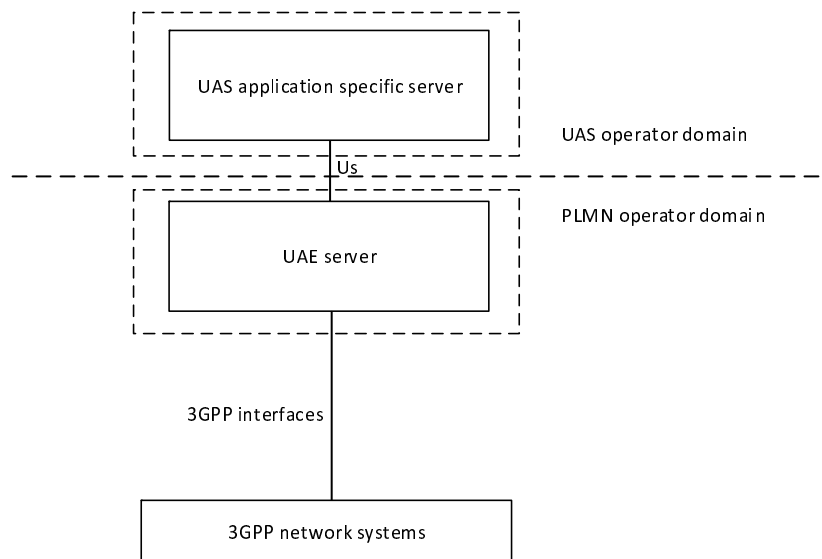

Figure B.2.1-2: UAE server deployed in the PLMN operator domain

Figure B.2.1-3 illustrates a deployment of the UAE server which connects to the 3GPP network systems (EPS, 5GS) in multiple PLMN operator domain. The UAE server can be co-located with the UAS application specific server in a single physical entity or deployed in different physical entities.

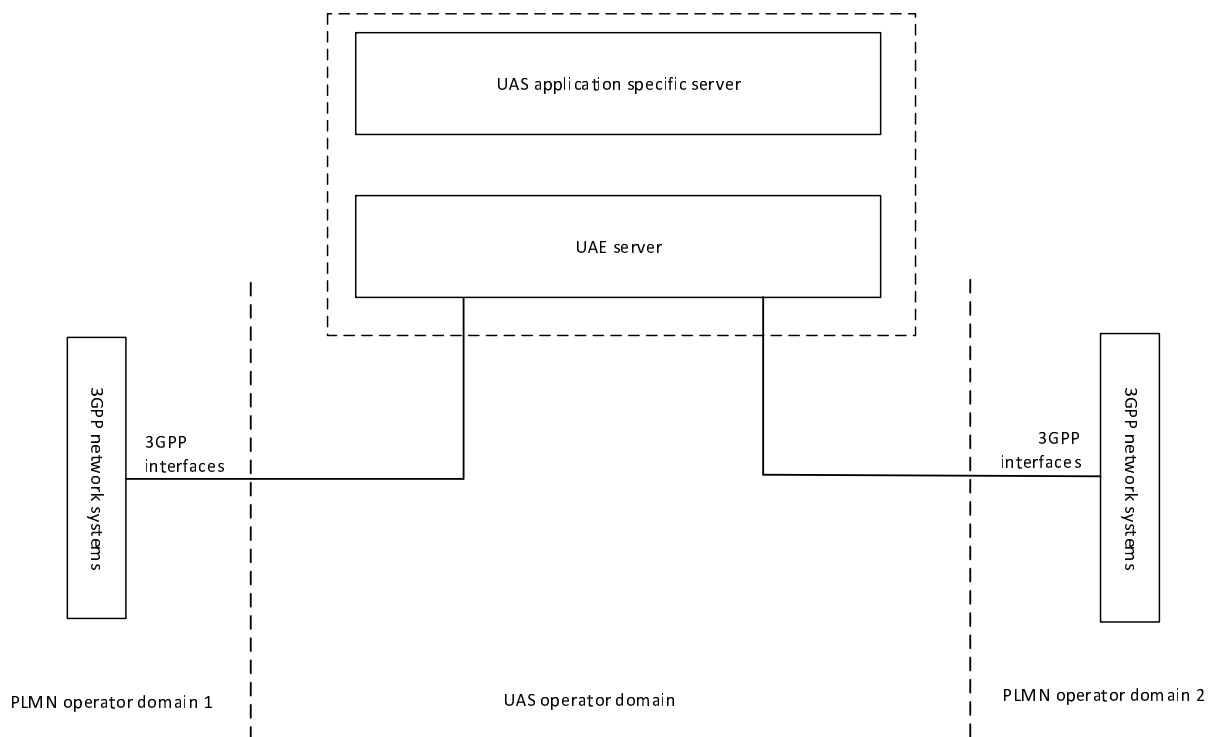

Figure B.2.1-3: Deployment of UAE server with connections to 3GPP network systems in multiple PLMN operator domains

Figure B.2.1-4 illustrates a deployment of the UAE server which provides UAE capabilities to multiple UAS application specific servers over Us reference point and connects to the 3GPP network systems (EPS, 5GS) in multiple PLMN operator domain.

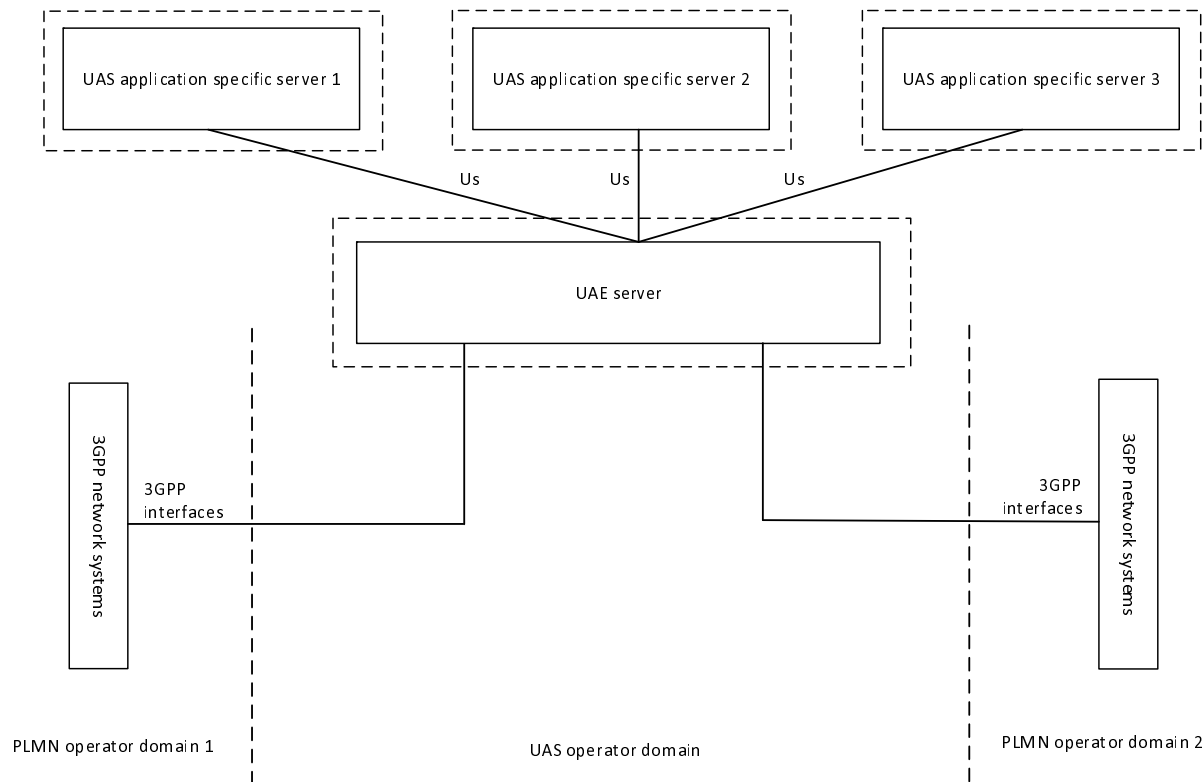

Figure B.2.1-4: Deployment of UAE server with connections to multiple UAS application specific servers

B.2.2 Distributed deployment

The distributed deployment is where multiple UAE servers are deployed either in the UAS operator domain or in the PLMN operator domain. The distributed deployment of the UAE servers provide geographical coverage or support multiple PLMN operator domains in a geographical location. The UAE servers interconnect via UAE-E and the Us reference point is used for interaction between UAS application specific server and the UAE server.

Figure B.2.2-1 illustrates the deployment of UAE servers in multiple PLMN operator domain and provides UAE capabilities to the UAS application specific server deployed in the UAS operator domain. The UAS application specific server connects via Us to the UAE servers.

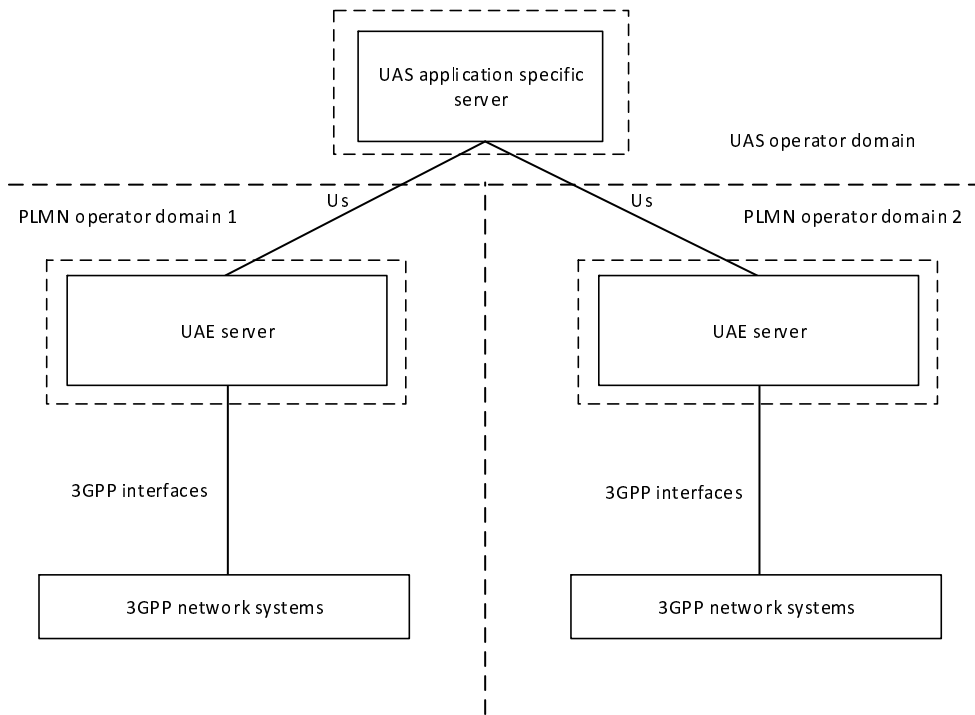

Figure B.2.2-1: Distributed deployment of UAE servers in multiple PLMN operator domain without interconnection between UAE servers

Figure B.2.2-2 illustrates the deployment of multiple UAE servers deployed in multiple PLMN operator domains. The UAS application specific server connects via Us to the UAE server. The interconnection between UAE servers is via UAE-E and supports the UAS applications for the UAS UEs connected to the UAE servers in multiple PLMN operator domains.

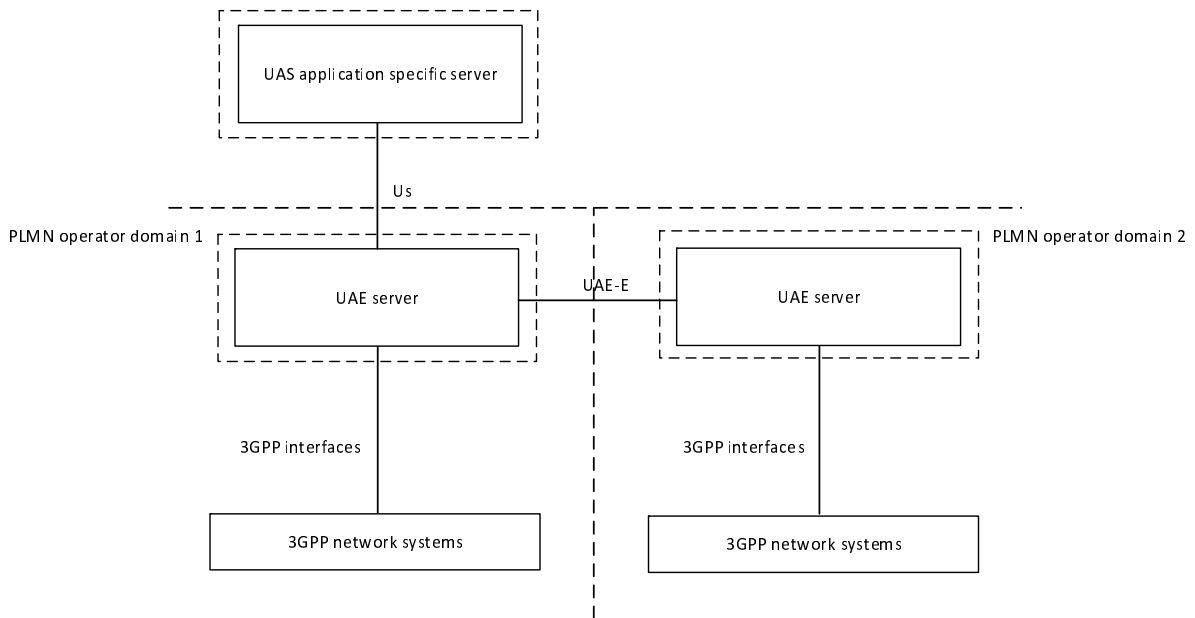

Figure B.2.2-2: Distributed deployment of UAE servers in multiple PLMN operator domain with interconnection between UAE servers

Figure B.2.2-3 illustrates the deployment of multiple UAE servers in PLMN operator domain based on geographical coverage. The UAS application specific server connects via Us to the UAE server 1. The UAE servers interconnect via UAE-E and support the UAS communications to the UAS UEs (i.e., UAV, UAV-C) connected to the UAE servers.

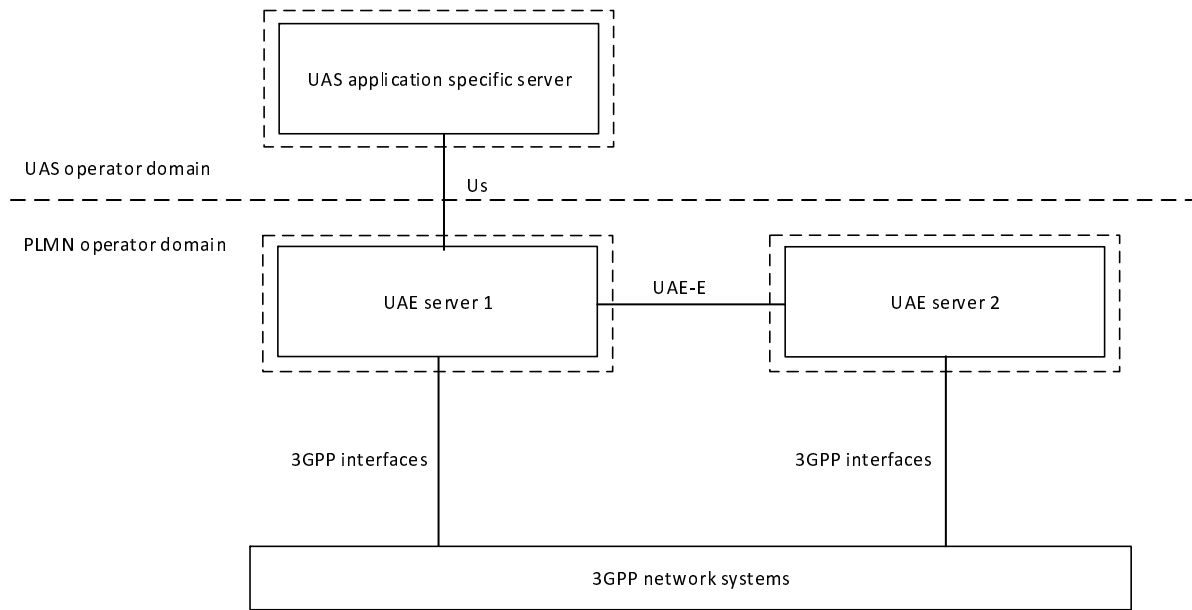

Figure B.2.2-3: Distributed deployment of UAE servers in PLMN operator domain

Figure B.2.2-4 illustrates the deployment of multiple UAE servers in the UAS operator domain where UAE server 1 and UAE server 2 connect with 3GPP network system of PLMN operator domain 1 and PLMN operator domain 2 respectively. The UAS application specific server connects via Us to the UAE server 1. The UAE servers interconnect via UAE-E and support the UAS applications for the UAS UEs connected via both the PLMN operator domains.

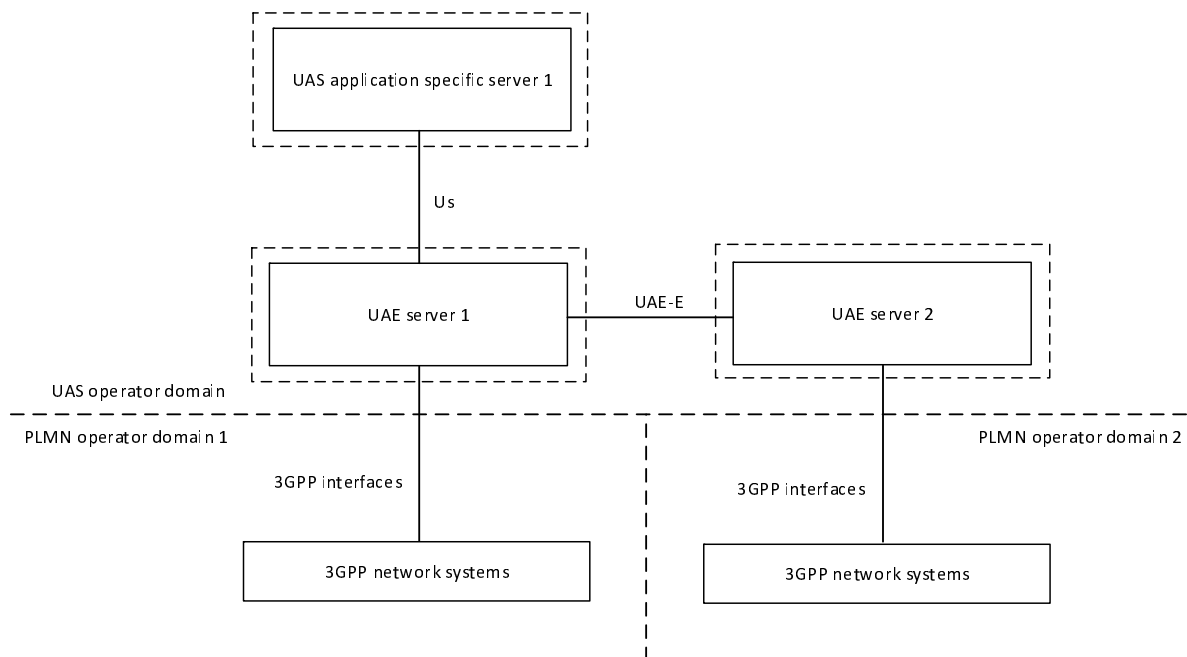

Figure B.2.2-4: Distributed deployment of UAE servers in UAS operator domain

Annex C (informative): Examples of usage of SEAL by UAS application specific server

All procedures of SEAL services (e.g. GMS, LMS) are available directly for usage by UAS application specific server. Some examples of the usage of SEAL by the UAS application specific server is illustrated below:

- Group creation procedures of Group Management server provides support for the UAS applications (e.g. paired UAV and UAV-C are grouped) to provide a dedicated group for the UAV and UAV-C to communicate with each other.
- The UAS application specific server (e.g. USS/UTM) monitors the presence of UAVs in a given geographic area by using the Monitoring Location Deviation procedure of the LM server.
- The UAS application specific server (e.g. USS/UTM) can directly fetch the multiple UAV related events from NRM server (e.g. to detect any events related to the UAV, the UAS application specific server can need multiple events related to the UAV (UE) from the 3GPP core network).
- The UAS application specific client and UAS application specific server can utilize the resource management procedures of the NRM server to manage unicast resources associated to SIP sessions.

Annex D (informative): Change history

Change history							
Date	Meeting	TDoc	CR	Rev	Cat	Subject/Comment	New version
2020-11	SA6#40-e					TS skeleton approved in S6-202322	0.0.0
2020-11	SA6#40-e					Implementation of the following pCRs approved by SA6: S6-202204, S6-202324, S6-202354	0.1.0
2021-01	SA6#41-e					Implementation of the following pCRs approved by SA6: S6-210149, S6-210296, S6-210349	0.2.0
2021-01	SA6#41-e					Editorial correction of ref [3] specification number from 23.254 to 23.256.	0.2.1
2021-03	SA6#42-e					Implementation of the following pCRs approved by SA6: S6-210555, S6-210556, S6-210718, S6-210719	0.3.0
2021-04	SA6#42-BIS-e					Implementation of the following pCRs approved by SA6: S6-211008, S6-211035, S6-211099, S6-211100, S6-211101, S6-211102, S6-211103, S6-211104, S6-211105	0.4.0
2021-04	SA6#43-e					Implementation of the following pCRs approved by SA6: S6-211254, S6-211304, S6-211308, S6-211311, S6-211363, S6-211364, S6-211365, S6-211366, S6-211386, S6-211458, S6-211459, S6-211460, S6-211461, S6-211462, S6-211463, S6-211468	0.5.0
2021-06	SA#92-e	SP-210471				Presentation for approval at SA#92-e	1.0.0
2021-06	SA#92-e	SP-210471				MCC Editorial update for publication after TSG SA approval (SA#92)	17.0.0
2021-06	SA#92-e	SP-210579				MCC Editorial update of the titles of the present document as well as ref [4] to align UAS terminology (SA#92)	17.0.1
2021-09	SA#93-e	SP-210966	0003	1	F	Correction of SEAL references	17.1.0
2021-09	SA#93-e	SP-210966	0004	1	D	Terminology alignment to use uncrewed	17.1.0
2021-09	SA#93-e	SP-210966	0005	1	F	Alignment with 5GC architecture	17.1.0
2021-09	SA#93-e	SP-210966	0006	1	F	Resolve EN about Geographical Area	17.1.0
2021-09	SA#93-e	SP-210966	0007		F	Alignment of text in clause 7.4.2.3	17.1.0
2021-09	SA#93-e	SP-210966	0008		F	Correction to the UAV ID assignment assumption	17.1.0
2021-09	SA#93-e	SP-210966	0009		F	Correction to add the missing reference of UUAA 5GC procedure	17.1.0
2021-09	SA#93-e	SP-210966	0010		F	Correction to the UAV application message information flow	17.1.0
2021-09	SA#93-e	SP-210966	0011		F	Correction to the input and output of Notify C2 communication mode switching operation	17.1.0
2021-09	SA#93-e	SP-210966	0012	1	F	Correction to add the missing API operation for C2 operation mode configuration complete notification	17.1.0
2021-09	SA#93-e	SP-210966	0013	1	F	Correction about IP address use as UAV ID	17.1.0
2021-09	SA#93-e	SP-210966	0014	1	F	Correction to the usage of UAS ID	17.1.0
2021-09	SA#93-e	SP-210966	0015		F	Correction to the C2 operation mode switching confirmation	17.1.0
2021-09	SA#93-e	SP-210966	0016	1	F	Correction to add the missing UAE layer registration procedure	17.1.0
2021-09	SA#93-e	SP-210966	0017	1	F	Resolving the editor's note regarding usage of realtime UAV status	17.1.0
2021-12	SA#94-e	SP-211528	0018		F	Missing API on Realtime UAV status	17.2.0
2021-12	SA#94-e	SP-211528	0019		F	Alignment of the term "USS/UTM" throughout TS 23.255	17.2.0
2021-12	SA#94-e	SP-211528	0020		D	Removal of Editor's Note in Introduction	17.2.0
2021-12	SA#94-e	SP-211528	0021		F	Missing IE for Realtime UAV status subscription request	17.2.0
2021-12	SA#94-e	SP-211528	0022		F	Removal of Editor's Notes in clause 5.2	17.2.0
2021-12	SA#94-e	SP-211528	0023	1	F	Removal of Editor's Notes in clause 7.3	17.2.0
2022-03	SA#95-e	SP-220104	0024	1	F	Corrections for operations of C2 communication mode switching	17.3.0
2022-03	SA#95-e	SP-220104	0025		F	Correction for realtime UAV status	17.3.0
2022-12	SA#98-e	SP-221237	0027	2	F	Clarifications on usage of EDGE in Annex A	17.4.0
2022-12	SA#98-e	SP-221237	0028		F	Removal of normative text in an informative annex	17.4.0
2023-03	SA#99	SP-230277	0032	2	F	Correction of various inconsistencies and unclariities	17.5.0

History

Document history		
V17.3.0	May 2022	Publication
V17.4.0	January 2023	Publication
V17.5.0	April 2023	Publication