

ETSI TS 123 271 V4.5.0 (2002-03)

Technical Specification

**Digital cellular telecommunications system (Phase 2+) (GSM);
Universal Mobile Telecommunications System (UMTS);
Functional stage 2 description of location services
(3GPP TS 23.271 version 4.5.0 Release 4)**



Reference

RTS/TSGS-0223271Uv4R4

Keywords

GSM, UMTS

ETSI

650 Route des Lucioles
F-06921 Sophia Antipolis Cedex - FRANCE

Tel.: +33 4 92 94 42 00 Fax: +33 4 93 65 47 16

Siret N° 348 623 562 00017 - NAF 742 C
Association à but non lucratif enregistrée à la
Sous-Préfecture de Grasse (06) N° 7803/88

Important notice

Individual copies of the present document can be downloaded from:

<http://www.etsi.org>

The present document may be made available in more than one electronic version or in print. In any case of existing or perceived difference in contents between such versions, the reference version is the Portable Document Format (PDF). In case of dispute, the reference shall be the printing on ETSI printers of the PDF version kept on a specific network drive within ETSI Secretariat.

Users of the present document should be aware that the document may be subject to revision or change of status. Information on the current status of this and other ETSI documents is available at

<http://portal.etsi.org/tb/status/status.asp>

If you find errors in the present document, send your comment to:

editor@etsi.fr

Copyright Notification

No part may be reproduced except as authorized by written permission.
The copyright and the foregoing restriction extend to reproduction in all media.

© European Telecommunications Standards Institute 2002.
All rights reserved.

DECTTM, **PLUGTESTS**TM and **UMTS**TM are Trade Marks of ETSI registered for the benefit of its Members.
TIPHONTM and the **TIPHON logo** are Trade Marks currently being registered by ETSI for the benefit of its Members.
3GPPTM is a Trade Mark of ETSI registered for the benefit of its Members and of the 3GPP Organizational Partners.

Intellectual Property Rights

IPRs essential or potentially essential to the present document may have been declared to ETSI. The information pertaining to these essential IPRs, if any, is publicly available for **ETSI members and non-members**, and can be found in ETSI SR 000 314: "*Intellectual Property Rights (IPRs); Essential, or potentially Essential, IPRs notified to ETSI in respect of ETSI standards*", which is available from the ETSI Secretariat. Latest updates are available on the ETSI Web server (<http://webapp.etsi.org/IPR/home.asp>).

Pursuant to the ETSI IPR Policy, no investigation, including IPR searches, has been carried out by ETSI. No guarantee can be given as to the existence of other IPRs not referenced in ETSI SR 000 314 (or the updates on the ETSI Web server) which are, or may be, or may become, essential to the present document.

Foreword

This Technical Specification (TS) has been produced by ETSI 3rd Generation Partnership Project (3GPP).

The present document may refer to technical specifications or reports using their 3GPP identities, UMTS identities or GSM identities. These should be interpreted as being references to the corresponding ETSI deliverables.

The cross reference between GSM, UMTS, 3GPP and ETSI identities can be found under www.etsi.org/key .

Contents

Intellectual Property Rights	2
Foreword.....	2
Foreword.....	7
1 Scope	8
2 References	8
2.1 Normative references	8
2.2 Informative references.....	9
3 Definitions, symbols and abbreviations	9
3.1 Definitions.....	9
3.2 Symbols.....	12
3.3 Abbreviations	12
4 Main concepts	14
4.1 Assumptions	14
4.2 Location Services Categories	15
4.3 Positioning methods	15
4.3.1 Standard LCS Methods in UTRAN	15
4.3.2 Standard LCS Methods in GERAN	15
4.4 Types of Location Request.....	16
4.4.1 Immediate Location Request	16
4.4.2 Deferred Location Request	16
4.4.2.1 Types of event.....	16
5 General LCS architecture	16
5.1 LCS access interfaces and reference points.....	16
5.2 LCS Functional diagram, high level functions.....	17
5.3 LCS Client functional group	18
5.3.1 External Location Client Function (LCF).....	18
5.4 LCS Server functional group.....	18
5.4.1 Client handling component.....	18
5.4.1.1 Location Client Control Function (LCCF).....	18
5.4.1.2 Location Client Authorization Function (LCAF).....	19
5.4.1.2.1 Access Subfunction	19
5.4.1.2.2 Subscription Subfunction	19
5.4.1.3 Location Client Co-ordinate Transformation Function (LCCTF).....	19
5.4.2 System handling component.....	20
5.4.2.1 Location System Control Function(LSCF)	20
5.4.2.2 Location System Billing Function (LSBF)	20
5.4.2.3 Location System Operations Function (LSOF).....	20
5.4.2.4 Location System Broadcast Function (LSBcF).....	20
5.4.3 Subscriber handling Component.....	20
5.4.3.1 Location Subscriber Authorization Function (LSAF).....	20
5.4.3.2 Location Subscriber Privacy Function (LSPF).....	20
5.4.4 Positioning components.....	20
5.5 Information Flows between Client and Server	21
5.5.1 Location Service Request	21
5.5.2 Location Service Response	21
6 LCS Architecture.....	21
6.1 Schematic functional description of LCS operations	22
6.2 Allocation of LCS functions to network elements	23
6.3 Functional description of LCS per network element.....	25
6.3.1 Access Network	25
6.3.2 LCS Clients and LCS applications	25
6.3.3 Gateway Mobile Location Center, GMLC	25

6.3.4	LCS support in the UE.....	26
6.3.5	MSC/VLR.....	26
6.3.6	MSC Server	26
6.3.7	SGSN.....	26
6.3.8	Home Location Register, HLR.....	26
6.3.9	HSS.....	26
6.3.10	gsmSCF	27
6.4	Addressing the target UE for LCS purposes	27
7	Signaling and Interfaces	27
7.1	LCS signaling between Access and Core Networks.....	27
7.1.1	Core network Location Request.....	27
7.1.2	Location Report	27
7.2	Um and Uu Interfaces.....	28
7.3	MAP Interfaces	28
8	General network location procedures.....	29
8.1	State description for GMLC	29
8.1.1	GMLC states.....	29
8.1.1.1	NULL State.....	29
8.1.1.2	INTERROGATION State	29
8.1.1.3	LOCATION State	29
8.1.2	State functionality.....	29
8.1.2.1	State Transitions.....	29
8.1.2.2	INTERROGATION Timer Function	30
8.1.2.3	LOCATION Timer Function	30
8.2	State description for VMSC and MSC Server.....	30
8.2.1	VMSC and MSC Server States.....	30
8.2.1.1	LCS IDLE State	30
8.2.1.2	LOCATION State	30
8.2.2	State Functionality	31
8.2.2.1	State Transitions.....	31
8.2.2.2	LOCATION Timer Function	31
8.3	LCS State description for SGSN.....	31
8.3.1	SGSN States.....	31
8.3.1.1	LCS IDLE State	31
8.3.1.2	LOCATION State	31
8.3.2	State Functionality	32
8.3.2.1	State Transitions.....	32
8.3.2.2	LOCATION Timer Function	32
8.4	Signaling connection for the Iu interface	32
8.5	Signaling connection for the A-interface.....	32
9	General Network Positioning Procedures	33
9.1	Mobile Terminating Location Request.....	33
9.1.1	MT-LR routing procedure in PS and CS domain.....	33
9.1.2	Circuit Switched Mobile Terminating Location Request (CS-MT-LR)	35
9.1.2.1	Location Preparation Procedure	35
9.1.2.2	Positioning Measurement Establishment Procedure	36
9.1.2.3	Location Calculation and Release Procedure.....	36
9.1.3	CS-MT-LR without HLR Query - applicable to North America Emergency Calls only.....	37
9.1.4	CS-MT-LR and PS-MT-LR for a previously obtained location estimate	38
9.1.4.1	Initial Location.....	38
9.1.4.2	Current Location	38
9.1.4.3	Last known Location.....	38
9.1.4.4	Security and Privacy	38
9.1.4.5	Failing to locate the target UE.....	38
9.1.4.5.1	Target UE is "Not Reachable"	39
9.1.4.5.2	Target UE is "Detached"	39
9.1.4.5.3	Target UE is Reachable but Positioning Fails	39
9.1.4.5.4	MSC Server or SGSN.Target UE is "Purged"	39
9.1.5	Network Induced Location Request (NI-LR)	40
9.1.5.1	Location Preparation Procedure	40

9.1.5.2	Positioning Measurement Establishment Procedure	41
9.1.5.3	Location Calculation and Release Procedure	41
9.1.6	Packet Switched Mobile Terminating Location Request (PS-MT-LR)	42
9.1.6.1	Location Preparation Procedure	42
9.1.6.2	Positioning Measurement Establishment Procedure	43
9.1.6.3	Location Calculation and Release Procedure	44
9.1.7	Packet Switched Network Induced Location Request (PS-NI-LR)	44
9.1.7.1	Positioning Measurement Establishment Procedure	45
9.1.7.2	Location Calculation and Release Procedure	45
9.1.8	Mobile Terminating Deferred Location Request	45
9.1.8.1	Deferred Location Request Procedure	46
9.1.8.2	Location Report Procedure	46
9.1.8.3	Cancellation of a Deferred Location Request	47
9.2	Mobile Originating Location Request	47
9.2.1	Mobile Originating Location Request, Circuit Switched (CS-MO-LR)	47
9.2.1.1	Location Preparation Procedure	48
9.2.1.2	Positioning Measurement Establishment Procedure	49
9.2.1.3	Location Calculation and Release Procedure	49
9.2.2	Mobile Originating Location Request, Packet Switched (PS-MO-LR)	50
9.2.2.1	Location Preparation Procedure	50
9.2.2.2	Positioning Measurement Establishment Procedure	51
9.2.2.3	Location Calculation and Release Procedure	51
9.3	LCS signaling procedures specified in UTRAN and GERAN Stage 2	51
9.4	Exception Procedures	51
9.4.1	Procedures in the VMSC	52
9.4.2	Procedures in the MSC Server	52
9.4.3	Procedures in the 3G-SGSN	52
9.4.4	Procedures in the UE	53
9.4.5	Further Procedures for Handover	53
9.4.5.1	MSC procedure for Inter-MSC Handover	53
9.4.5.2	Handling of an ongoing handover while a request for positioning arrives at MSC/VLR	53
9.5	Privacy	54
9.5.1	Privacy Override Indicator (POI)	54
9.5.2	Privacy Procedures	54
9.5.3	UE Privacy Options	54
9.5.3.1	The classes and corresponding subscription options are described below. Universal class	55
9.5.3.2	Call/Session related class	55
9.5.3.2.1	Call/session-related class in the CS-domain	56
9.5.3.2.2	Call/session-related class in the PS-domain	56
9.5.3.2.3	Call/session-related class when LCS client not in SLPP	56
9.5.3.3	Call/Session-unrelated class	56
9.5.3.3.1	Call/session-unrelated class when LCS client identities match	57
9.5.3.3.2	Call/session-unrelated class when LCS client identities do not match	57
9.5.3.4	PLMN operator class	58
9.5.3.5	Matching of LCS client identities	58
9.6	Mobile Originating Location	59
9.7	CM Procedures	59
9.7.1	Location request for a mobile in idle-mode	59
9.7.2	Location request for a mobile in dedicated-mode	59
10	Information storage	59
10.1	HLR and HSS	59
10.1.1	LCS Data in the HLR/HSS for an UE Subscriber	59
10.2	VLR	62
10.3	GMLC	62
10.4	Recovery and Restoration Procedures	64
10.5	Interworking with pre-Rel'4 LCS	64
10.5.1	Interworking with the VLR supporting only pre-Rel'4 LCS	64
11	Operational Aspects	64
11.1	Charging	64
11.2	Charging Information Collected by the Visited PLMN	65

Annex A (normative): Privacy Class selection rule.....66
Annex B (normative): Presence of LCS client ID Components in MT-LR.....68
Annex C: void 69
Annex D (informative): Change history70
History71

Foreword

This Technical Specification (TS) has been produced by the 3rd Generation Partnership Project (3GPP).

The contents of the present document are subject to continuing work within the TSG and may change following formal TSG approval. Should the TSG modify the contents of the present document, it will be re-released by the TSG with an identifying change of release date and an increase in version number as follows:

Version x.y.z

where:

- x the first digit:
 - 1 presented to TSG for information;
 - 2 presented to TSG for approval;
 - 3 or greater indicates TSG approved document under change control.
- y the second digit is incremented for all changes of substance, i.e. technical enhancements, corrections, updates, etc.
- z the third digit is incremented when editorial only changes have been incorporated in the document.

1 Scope

The present document specifies the stage 2 of the LoCation Services (LCS) feature in UMTS and GSM, which provides the mechanisms to support mobile location services for operators, subscribers and third party service providers.

The present document replaces the specifications TS 23.171 (Release 1999) and the system and core network parts of GSM 03.71 (Release 1999). TS 43.059[16] replaces the radio access network parts of GSM 03.71 (Release 1999).

Location Services may be considered as a network provided enabling technology consisting of standardised service capabilities, which enable the provision of location applications. The application(s) may be service provider specific. The description of the numerous and varied possible location applications which are enabled by this technology are outside the scope of the present document. However, clarifying examples of how the functionality being described may be used to provide specific location services may be included.

This stage 2 service description covers the LCS system functional model for the whole system, the LCS system architecture, state descriptions, message flows, etc.

2 References

The following documents contain provisions which, through reference in this text, constitute provisions of the present document.

- References are either specific (identified by date of publication, edition number, version number, etc.) or non-specific.
- For a specific reference, subsequent revisions do not apply.
- For a non-specific reference, the latest version applies. In the case of a reference to a 3GPP document (including a GSM document), a non-specific reference implicitly refers to the latest version of that document *in the same Release as the present document*.

2.1 Normative references

- [1] 3G TS 25.305: "Stage 2 functional specification of UE positioning in UTRAN".
- [2] GSM 01.04 (ETR 350): "Abbreviations and acronyms".
- [3] 3G TS 21.905: "UMTS Abbreviations and acronyms".
- [4] 3G TS 22.071: "Technical Specification Group Systems Aspects; Location Services (LCS); Stage 1".
- [5] (void)
- [6] 3G TS 48.008: "Mobile-services Switching Centre - Base Station System (MSC - BSS) interface; Layer 3 specification".
- [7] 3G TS 22.100: "UMTS phase 1 (Release 1999)".
- [8] 3G TS 22.101: "Service principles".
- [9] 3G TS 22.105: "Services and Service Capabilities".
- [10] 3G TS 22.115: "Charging and Billing".
- [11] 3G TS 23.032 (GSM 03.32): "Universal Geographical Area Description (GAD)".
- [12] 3G TS 22.121: "The Virtual Home Environment".
- [13] 3G TS 23.110: "UMTS Access Stratum Services and Functions".

- [14] 3G TS 25.413: "UTRAN Iu Interface RANAP signaling".
- [15] 3G TS 23.060: "General Packet Radio Service (GPRS); Service description; Stage 2".
- [16] 3G TS 43.059: "Functional Stage 2 description of Location Services in GERAN".
- [17] 3G TS 23.003: "Numbering, addressing and identification".
- [18] 3G TS 29.002: "Mobile Application Part (MAP) Specification".
- [19] GSM 04.02: "GSM Public Land Mobile Network (PLMN) access reference configuration".
- [20] 3G TS 23.002: "Network architecture".
- [21] 3G TS 23.078: "Customised Applications for Mobile network Enhanced Logic (CAMEL) - stage 2".
- [22] 3G TS 23.011: "Technical realization of Supplementary Services".
- [23] 3G TS 23.007: "Restoration procedures".
- [24] 3G TS 24.008: "Mobile Radio Interface - Layer 3 MM/CC Specification".
- [25] 3G TS 25.331 "RRC protocol specification".
- [26] 3G TS 23.127: "Virtual Home Environment".
- [27] 3G TS 29.198-1: "Open Service Access (OSA); Application Programming Interface (API); Part 1; Overview".
- [28] 3G TS 29.198-2: "Open Service Access (OSA); Application Programming Interface (API); Part 2; Common Data".
- [29] 3G TS 29.198-3: "Open Service Access (OSA); Application Programming Interface (API); Part 3; Framework".
- [30] 3G TS 29.198-6: "Open Service Access (OSA); Application Programming Interface (API); Part 6: Mobility".

2.2 Informative references

- [31] Third generation (3G) mobile communication system; Technical study report on the location services and technologies, ARIB ST9 December 1998.
- [32] The North American Interest Group of the GSM MoU ASSOCIATION: Location Based Services, Service Requirements Document of the Services Working Group.

3 Definitions, symbols and abbreviations

3.1 Definitions

For the purposes of the present document, the following terms and definitions apply:

CAMEL: CAMEL is a network functionality, which provides the mechanisms of Intelligent Network to a mobile user

Call Related: any LCS related operation which is associated with an established call in CS domain and a session via an active PDP context in PS domain.

Current Location: after a location attempt has successfully delivered a location estimate and its associated time stamp, the location estimate and time stamp is referred to as the "current location" at that point in time

Deferred location request: location request where the location response (responses) is (are) not required immediately

Global Positioning System: Global Positioning System (GPS) consists of three functional elements: Space Segment (satellites), User Segment (receivers), and Control Segment (maintenance etc.). The GPS receiver calculates its own position based on the received time differences for several satellites

Immediate location request: location request where a single location response only is required immediately

Initial Location: in the context of an originating emergency call the location estimate and the associated time stamp at the commencement of the call set-up is referred to as "initial location"

Last Known Location: current location estimate and its associated time stamp for Target UE stored in the LCS Server is referred to as the "last known location" and until replaced by a later location estimate and a new time stamp is referred to as the "last known location"

LCS (LoCation Services): LCS is a service concept in system (e.g. GSM or UMTS) standardization. LCS specifies all the necessary network elements and entities, their functionalities, interfaces, as well as communication messages, due to implement the positioning functionality in a cellular network. Note that LCS does not specify any location based (value added) services except locating of emergency calls

LCS Client: software and/or hardware entity that interacts with a LCS Server for the purpose of obtaining location information for one or more Mobile Stations. LCS Clients subscribe to LCS in order to obtain location information. LCS Clients may or may not interact with human users. The LCS Client is responsible for formatting and presenting data and managing the user interface (dialogue). The LCS Client may reside in the Mobile Station (UE)

LCS Client Access barring list: optional list of MSISDNs per LCS Client where the LCS Client is not allowed to locate any MSISDN therein

LCS Client Subscription Profile: collection of subscription attributes of LCS related parameters that have been agreed for a contractual period of time between the LCS client and the service provider

LCS Feature: capability of a PLMN to support LCS Client/server interactions for locating Target UEs

LCS Server: software and/or hardware entity offering LCS capabilities. The LCS Server accepts requests, services requests, and sends back responses to the received requests. The LCS server consists of LCS components, which are distributed to one or more PLMN and/or service provider

Local Service: service, which can be exclusively provided in the current serving network by a Value added Service Provider

Local Information: information related to a given location, or general information, which is made available in a given location

Location (Based) Application: location application is an application software processing location information or utilizing it in some way. The location information can be input by a user or detected by network or UE. Navigation is one location application example

Location Based Service (LBS): service provided either by teleoperator or a 3rd party service provider that utilizes the available location information of the terminal. Location Application offers the User Interface for the service. LBS is either a pull or a push type of service (see Location Dependent Services and Location Independent Services). In ETSI/GSM documentation of SoLSA, LBS is called "Location Related Service". ETSI and/or 3GPP -wide terminology harmonization is expected here

Location Dependent Service: service provided either by teleoperator or a 3rd party service provider that is available (pull type) or is activated (push type) when the user arrives to a certain area. It doesn't require any subscription in advance, but the push type activation shall be confirmed by the user. The offered service itself can be any kind of service (e.g. a public Xerox machine or the discount list in a store)

Location Estimate: geographic location of an UE and/or a valid Mobile Equipment (ME), expressed in latitude and longitude data. The Location Estimate shall be represented in a well-defined universal format. Translation from this universal format to another geographic location system may be supported, although the details are considered outside the scope of the primitive services

Location Independent Service: service provided either by teleoperator or a 3rd party service provider that is available and therefore can be activated anywhere in the network coverage. It is activated by the user's request or by other user's

activated service, and therefore it requires a subscription in advance (pull type). The offered service itself can be any kind of service (e.g. MMS, SWDL, or LBS!)

Mobile Assisted positioning: any mobile centric positioning method (e.g. IPDL-OTDOA, E-OTD, GPS) in which the UE provides position measurements to the network for computation of a location estimate by the network. The network may provide assistance data to the UE to enable position measurements and/or improve measurement performance

Mobile Based positioning: any mobile centric positioning method (e.g. IPDL-OTDOA, E-OTD, GPS) in which the UE performs both position measurements and computation of a location estimate and where assistance data useful or essential to one or both of these functions is provided to the UE by the network. Position methods where an UE performs measurements and location computation without network assistance data are not considered within this category

Mobile Station: mobile station (MS) consists of Mobile or User Equipment (ME or UE) with a valid SIM or USIM attached. The abbreviation "UE" in this specification refers both to MS and User Equipment, see below.

PLMN Access barring list: optional list of MSISDN per PLMN where any LCS Client is not allowed to locate any MSISDN therein except for certain exceptional cases

Positioning (/location detecting): positioning is a functionality, which detects a geographical location (of e.g. a mobile terminal)

Positioning method (/locating method): principle and/or algorithm which the estimation of geographical location is based on, e.g. AOA, TOA, TDOA. For example, GPS is based on TOA, whilst OTDOA and E-OTD (on GSM) are based on TDOA

Positioning technology (/locating technology): technology or system concept including the specifications of RF interfaces, data types, etc. to process the estimation of a geographical location, e.g. GPS, E-OTD (GSM), and OTDOA (WCDMA)

Predefined area: geographical area, which is not related to cell or radio coverage. The mobile may take special action when it recognises it has entered or left a predefined area

Privacy Class: list of LCS Clients defined within a privacy exception class to which permission may be granted to locate the target UE. The permission shall be granted either on activation by the target UE or permanently for a contractual period of time agreed between the target UE and the service provider

Privacy Exception List: list consisting of various types of privacy classes (i.e. operator related, personal etc.). Certain types of classes may require agreement between the service provider and the target UE

Prohibited area: area where the mobile must not activate its transmitter. The Prohibited area may be a Predefined area described above or related to radio cell(s)

Subscription Profile: profile detailing the subscription to various types of privacy classes

Target UE: UE being positioned

User Equipment: term 'User Equipment', or 'UE', should for GSM be interpreted as 'MS', as defined in GSM TS 04.02 [19]. UE in this specification may also refer to a Mobile Equipment or User Equipment used for emergency calls, that do not have valid SIM or USIM

Further UMTS related definitions are given in 3G TS 22.101.

3.2 Symbols

For the purposes of the present document, the following symbols apply:

Gb	Interface between 2G-SGSN and BSS
Gs	Interface between MSC and SGSN
Lc	Interface between gateway MLC and gsmSCF (CAMEL interface)
Le	Interface between External User and MLC (external interface)
Lg	Interface between Gateway MLC - VMSC, GMLC - MSC Server, GMLC - SGSN (gateway MLC interface)
Lh	Interface between Gateway MLC and HLR (HLR interface)
Um	GERAN Air Interface
Uu	UTRAN Air Interface

3.3 Abbreviations

For the purposes of the present document, the following abbreviations apply:

2G-	Second Generation
3G-	Third Generation
AC	Admission Control
AI	Application Interface (prefix to interface class method)
ANM	Answer Message (ISUP)
APN	Access Point Name
APN-NI	APN Network Identifier
ARIB	Association of Radio Industries and Business
ATD	Absolute Time Difference
BCCH	Broadcast Control Channel
BER	Bit Error Rate
BSS	Base Station Subsystem
BTS	Base Transceiver Station
CAMEL	Customised Application For Mobile Network Enhanced Logic
CAP	CAMEL Application Part
CM	Connection Management
CN	Core Network
CSE	Camel Service Environment
DL	Downlink
DRNC	Drift RNC
E-OTD	Enhanced Observed Time Difference
FER	Frame Error Rate
GERAN	GSM EDGE Radio Access Network
GGSN	Gateway GPRS Support Node
GMLC	Gateway MLC
GPRS	General Packet Radio Service
GPS	Global Positioning System
HE	Home Environment
HSS	Home Subscriber Server
HLR	Home Location Register
HPLMN	Home Public Land Mobile Network
IMEI	International Mobile Equipment Identity
IMSI	International Mobile Subscriber Identity
IP	Internet Protocol
IPDL	Idle Period Downlink
LA	Location Application
LAF	Location Application Function
LBS	Location Based Services
LCAF	Location Client Authorization Function
LCCF	Location Client Control Function
LCCTF	Location Client Co-ordinate Transformation Function
LCF	Location Client Function
LCS	LoCation Services

LDR	Location Deferred Request
LIR	Location Immediate Request,
LMU	Location Measurement Unit
LSAF	Location Subscriber Authorization Function
LSBcF	Location System Broadcast Function
LSBF	Location System Billing Function
LSCF	Location System Control Function
LSOF	Location System Operation Function
LSPF	Location Subscriber Privacy Function
MAP	Mobile Application Part
ME	Mobile Equipment
MExE	Mobile Execution Environment
MLC	Mobile Location Center
MM	Mobility Management
MO-LR	Mobile Originated Location Request
MS	Mobile Station
MSC	Mobile Services switching Center
MSC	Mobile services Switching Centre
MSISDN	Mobile Station Integrated Services Data Network
MT-LR	Mobile Terminated Location Request
NA-ESRD	North American Emergency Service Routing Digits
NA-ESRK	North American Emergency Service Routing Key
NI-LR	Network Induced Location Request
OSA	Open Service Architecture
OTDOA	Observed Time Difference Of Arrival
PC	Power Control
PCF	Power Calculation Function
PLMN	Public Land Mobile Network
POI	Privacy Override Indicator
PRCF	Positioning Radio Co-ordination Function
PRRM	Positioning Radio Resource Management
PSE	Personal Service Environment
PSMF	Positioning Signal Measurement Function
PSTN	Public Switched Telephone Network
QoS	Quality of Service
RA	Routing Area
RACH	Random Access Channel
RAN	Radio Access Network
RANAP	Radio Access Network Application Part
RIS	Radio Interface Synchronization
RNC	Radio Network Controller
RRM	Radio Resource Management
RTD	Real Time Difference
SAT	SIM Application Tool-Kit
SCCP	Signalling Connection Control Part
SCS	Service Capability Server
SGSN	Serving GPRS Support Node, SGSN in this specification normally refers to 3G-SGSN only, SGSN in GSM is noted 2G-SGSN
SI	Service Interface (prefix to interface class method)
SIM	Subscriber Identity Module
SIR	Signal Interference Ratio
SLPP	Subscriber LCS Privacy Profile
SMLC	Serving Mobile Location Center
SMS	Short Message Service
SP	Service Point
SRNC	Serving RNC
SS7	Signaling System No 7
TA	Timing Advance
TMSI	Temporary Mobile Subscriber Identity
TOA	Time Of Arrival
UDT	SCCP Unitdata message
UE	User Equipment

UL	Uplink
UMTS	Universal Mobile Telecommunication System
USIM	Universal Subscriber Identity Module
UTRAN	Universal Terrestrial Radio Access Network
VASP	Value Added Service Provider
VHE	Virtual Home Environment
WCDMA	Wideband Code Division Multiple Access

Further GSM related abbreviations are given in GSM 01.04. Further UMTS related abbreviations are given in 3G TS 21.905 [3].

4 Main concepts

A general description of location services and service requirements are given in the specification TS 22.071 [4]. The positioning of the UE is a service provided by the Access Network. In particular, all Access Networks (e.g. UTRAN, GERAN), that facilitate determination of the locations of User Equipments, shall be able to exchange location information with the core network as defined in the present document (when connected to a Core Network).

By making use of the radio signals the capability to determine the (geographic) location of the user equipment (UE) or mobile station (UE) shall be provided. The location information may be requested by and reported to a client (application) associated with the UE, or by a client within or attached to the Core Network. The location information may also be utilised internally in the system; for example, for location assisted handover or to support other features such as home location billing. The position information shall be reported in standard, i.e. geographical co-ordinates, together with the time-of-day and the estimated errors (uncertainty) of the location of the UE according to specification TS 23.032 [11].

It shall be possible for the majority of the UE (active or idle) within a network to use the feature without compromising the radio transmission or signaling capabilities of the GSM/UMTS networks.

The UE and the network may support a number of different positioning methods and the UE may support or not support privacy invocation request and response. The UE informs the core network and radio access network about its LCS capabilities in this respect as defined in TS 24.008 [24] and TS 25.331 [25].

The uncertainty of the location measurement shall be network design (implementation) dependent at the choice of the network operator, this is further described in TS 25.305 [1] and TS 43.059 [16].

There are many different possible uses for the location information. The positioning feature may be used internally by the GSM/UMTS network (or attached networks), by value-added network services, by the UE itself or through the network, and by "third party" services. The positioning feature may also be used by an emergency service (which may be mandated or "value-added"), but the position service is not exclusively for emergencies.

4.1 Assumptions

As a basis for the further development work on LCS in GSM and UMTS the following assumptions apply:

- positioning methods are Access Network specific, although commonalities should be encouraged between Access Networks;
- commercial location services are only applicable for an UE with a valid SIM or USIM;
- the provision of the location services in the Access Network is optional through support of the specified method(s);
- the provision of location services is optional in MSC and SGSN;
- LCS is applicable to any target UE whether or not the UE supports LCS, but with restrictions on choice of positioning method or notification of a location request to the UE user when LCS or individual positioning methods, respectively, are not supported by the UE;
- LCS shall be applicable for both circuit switched and packet switched services;
- the location information may be used for internal system operations to improve system performance;

- it shall be possible to accommodate future techniques of measurement and processing to take advantage of advancing technology so as to meet new service requirements;
- it may be necessary to support LCS signaling between separate access networks via the core network. The Iur interface should be used if available.
- Provide positioning procedures through the circuit-switched domain are also applicable to GPRS UEs which are GPRS and IMSI attached.

4.2 Location Services Categories

Generally there are four categories of usage of the location service. These are the Commercial LCS, the Internal LCS, the Emergency LCS and the Lawful Intercept LCS. The definition of these services and their categories is outside the scope of the present document.

- The Commercial LCS (or Value Added Services) will typically be associated with an application that provides a value-added service through knowledge of the UE location to the subscriber of the service. This may be, for example, a directory of restaurants in the local area of the UE, together with directions for reaching them from the current UE location.
- The Internal LCS will typically be developed to make use of the location information of the UE for Access Network internal operations. This may include; for example, location assisted handover and traffic and coverage measurement. This may also include support certain O&M related tasks, supplementary services, IN related services and GSM bearer services and teleservices.
- The Emergency LCS will typically be part of a service provided to assist subscribers who place emergency calls. In this service, the location of the UE caller is provided to the emergency service provider to assist them in their response. This service may be mandatory in some jurisdictions. In the United States, for example, this service is mandated for all mobile voice subscribers.
- The Lawful Intercept LCS will use the location information to support various legally required or sanctioned services.

4.3 Positioning methods

The LCS feature utilises one or more positioning methods in order to determine the location of user equipment (UE). Determining the position of a UE involves two main steps:

- Radio signal measurements; and
- Position estimate computation based on the measurements.

The positioning methods for UTRAN are further described in TS 25.305 [1].

4.3.1 Standard LCS Methods in UTRAN

The specification TS 25.305 UTRAN Stage 2 specifies the locating methods to be supported:

- cell coverage based positioning method;
- OTDOA positioning method;
- GPS based positioning methods.

For more details on these positioning methods, refer to TS 25.305 [1].

4.3.2 Standard LCS Methods in GERAN

The specification TS 43.059 GERAN LCS Stage 2 specifies the locating methods to be supported in GERAN:

- cell coverage based positioning method;

- Enhanced Observed Time Difference (E-OTD) positioning method;
- GPS based positioning methods.

4.4 Types of Location Request

4.4.1 Immediate Location Request

Request for location where the LCS Server replies immediately to the LCS Client with the current location estimate if this could be obtained.

4.4.2 Deferred Location Request

Request for location contingent on some current or future events where the response from the LCS Server to the LCS Client may occur some time after the request was sent.

4.4.2.1 Types of event

- a) UE available: Any event in which the MSC/SGSN has established a contact with the UE. Note, this event is considered to be applicable when the UE is temporarily unavailable due to inaction by the UE user, temporarily loss of radio connectivity or IMSI detach and so on. Note that IMSI detach is only applicable in the case UE has previously been registered and information is still kept in the node.
- b) Other events are FFS (Release 5)

5 General LCS architecture

5.1 LCS access interfaces and reference points

There is one reference point between the LCS server and LCS client called *Le*, see figure 5.1. *Le* is described in TS 22.071 [4], however the protocol specifics are for further study. There may be more than a single LCS network interface to several different LCS clients or other networks. These networks may both differ in ownership as well as in communications protocol. The network operator should define and negotiate interconnect with each external LCS client or other network.

An interface differs from a reference point in that an interface is defined where specific LCS information is exchanged and needs to be fully recognized.

There is an interface called *Lg* that connects two independent LCS networks (different PLMNs) for message exchange.

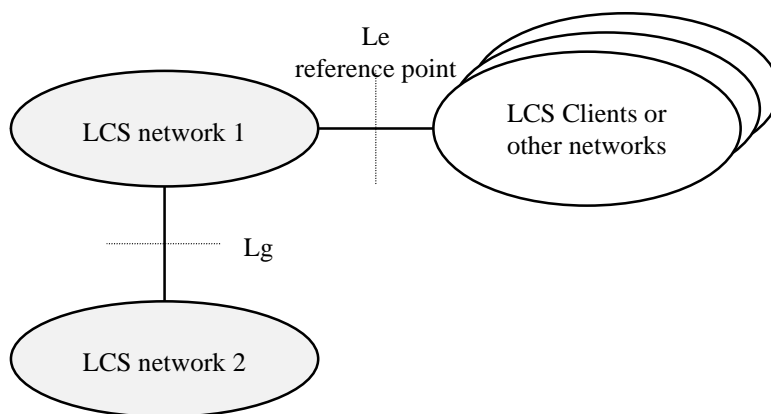

Figure 5.1: LCS Access Interfaces and Reference Points

5.2 LCS Functional diagram, high level functions

TS 22.071 [4] describes LCS services from the LCS client point of view. In the present document, a more detailed description of LCS is given. The LCS functional diagram shown in figure 5.2 depicts the interaction of the LCS client and the LCS server within the PLMN. The PLMN uses the various LCS components within the LCS server to provide the target UE Location Information to the LCS client.

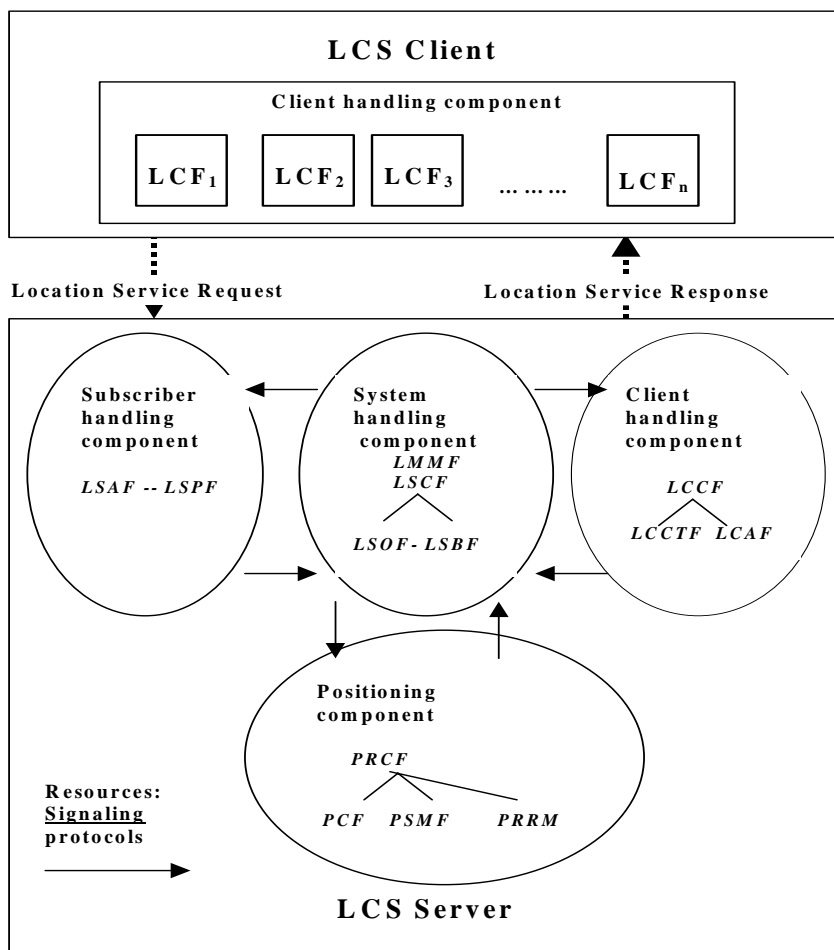

Figure 5.2: LCS capability server Functional Diagram

The following list gives the logical functional entities for the LCS. Two main functional groupings are defined which encompass a number of smaller functions.

The LCS Functional entities are grouped as follows:

- the LCS Client functional group;
- the LCS Server functional group consists of functions in the UMTS PLMN supporting LCS:
 - client handling component;
 - system handling component;
 - subscriber handling component;
 - positioning component.

The functions of the LCS Client and the LCS Server in the PLMN are described in more detail in this clause.

The allocation of LCS functions to network elements is specified in clause 6.

5.3 LCS Client functional group

An LCS client contains an LCS component with one or more client(s), which by using location information can provide location, based services.

An LCS client is a logical functional entity that requests from the LCS server in the PLMN location information for one or more than one target UE within a specified set of parameters such as Quality of Service (QoS). The LCS Client may reside in an entity (including the UE) within the PLMN or in an entity external to the PLMN.

The specification of the LCS Client's internal logic and its relation to the external use is outside the scope of the present document.

5.3.1 External Location Client Function (LCF)

The Location Client Function (LCF) provides a logical interface between the LCS client and the LCS server.

This function is responsible for requesting location information for one or more UEs, with a specified "QoS" and receiving a response, which contains either location information or a failure indicator.

[Editor's note: this is only possible if the location request originates in the core network].

5.4 LCS Server functional group

The LCS server functional group consists of the functions that are needed for GSM and UMTS to support Location Services.

5.4.1 Client handling component

5.4.1.1 Location Client Control Function (LCCF)

The Location Client Control Function (LCCF) manages the external interface towards LCF. The LCCF identifies the LCS client by requesting client verification and authorization (i.e. verifies that the LCS client is allowed to position the subscriber) through interaction with the Location Client Authorization Function (LCAF). The LCCF handles mobility management for location services (LCS) e.g., forwarding of positioning requests to VMSC or SGSN. The LCCF determines if the final positioning estimate satisfies the QoS for the purpose of retry/reject. The LCCF provides flow control of positioning requests between simultaneous positioning requests. It may order the Location Client Co-ordinate Transformation Function (LCCTF) to perform a transformation to local co-ordinates. It also generates charging and billing related data for LCS via the Location System Billing Function (LSBF).

5.4.1.2 Location Client Authorization Function (LCAF)

The Location Client Authorization Function (LCAF) is responsible for providing access and subscription authorization to a client. Specifically, it provides authorization to a LCS client requesting access to the network and authorizes the subscription of a client. LCAF provides authorization to a LCS client requesting Location Information of a specific UE.

5.4.1.2.1 Access Subfunction

An *Access Subfunction* enables LCS clients to access LCS services. This subfunction provides verification and authorization of the requesting client.

When a LCS is requested, the Access Subfunction uses the information stored in the LCS client *subscription profile* to verify that:

- the LCS client is registered; and
- the LCS client is authorized to use the specified LCS request type;
- the LCS client is allowed to request location information for the subscriber(s) specified in the LCS request.

5.4.1.2.2 Subscription Subfunction

The LCS client Subscription profile shall contain a minimum set of parameters assigned on per LCS client basis for an agreed contractual period. The LCS client profile shall contain the following set of access parameters:

- LCS client identity;
- allowed LCS request types (i.e. LIR, LDR or both) (see note);
- maximum number of subscribers allowed in a single LCS request;
- priority;
- position override indicator;
- state(s);
- event(s) (applicable to LDR requests only);
- local coordinate system;
- LCS client access barring list (optional);
- PLMN access barring list applicability.

NOTE: LIR = Location Immediate Request; and
LDR = Location Deferred Request.

For certain authorized LCS client internal to the PLMN, a subscription profile is unnecessary. These clients are empowered to access any defined service that is not barred for an UE subscriber. This permits positioning of emergency calls without the need for pre-subscription.

5.4.1.3 Location Client Co-ordinate Transformation Function (LCCTF)

The Location Client Co-ordinate Transformation Function (LCCTF) provides conversion of a location estimate expressed according to a universal latitude and longitude system into an estimate expressed according to a local geographic system understood by the LCF and known as location information. The local system required for a particular LCF will be either known from subscription information or explicitly indicated by the LCF.

5.4.2 System handling component

5.4.2.1 Location System Control Function(LSCF)

The Location System Control Function (LSCF) is responsible for co-ordinating location requests. This function manages call-related and non-call-related positioning requests of LCS and allocates network resources for handling them. The LSCF retrieves UE classmark information for the purpose of determining the LCS capabilities of UE.

The LSCF performs call setup if required as part of a LCS e.g., putting the UE on dedicated radio resources. It also caters for co-ordinating resources and activities with regard to requests related to providing assistance data needed for positioning. This function interfaces with the LCCF, LSPF, LSBF and PRCF. Using these interfaces, it conveys positioning requests to the PRCF, relays positioning data to the LCCF and passes charging related data to the LSBF.

The U-LSCF for UTRAN is further described in TS 25.305 [1], LSCF for GERAN is described in TS 43.059 [16].

5.4.2.2 Location System Billing Function (LSBF)

The Location System Billing Function (LSBF) is responsible for charging and billing activity within the network related to location services (LCS). This includes charging and billing of both clients and subscribers. Specifically, it collects charging related data and data for accounting between PLMNs.

5.4.2.3 Location System Operations Function (LSOF)

The Location System Operations Function (LSOF) is responsible for provisioning of data, positioning capabilities, data related to clients and subscription (LCS client data and UE data), validation, fault management and performance management of LCS.

An LSOF may be associated with each entity.

5.4.2.4 Location System Broadcast Function (LSBcF)

The Location System Broadcast Function (LSBcF) provides broadcast capability. The LSBcF capability is only used when broadcast data is required for E-OTD, OTDOA or assisted GPS positioning methods.

5.4.3 Subscriber handling Component

5.4.3.1 Location Subscriber Authorization Function (LSAF)

The Location Subscriber Authorization Function (LSAF) is responsible for authorizing the provision of a location service (LCS) for a particular mobile station (UE with SIM/USIM). Specifically, this function validates that a LCS can be applied to a given subscriber. In case LCF is in the UE then LSAF verifies that the UE subscriber has subscribed to the requested LCS service.

5.4.3.2 Location Subscriber Privacy Function (LSPF)

The Location Subscriber Privacy function is responsible performs all privacy related authorizations. For a target UE it shall authorize the positioning request versus the privacy options of the target UE, if any.

5.4.4 Positioning components

The positioning components Positioning Radio Co-ordination Function (PRCF), Positioning Calculation Function (PCF), Positioning Signal Measurement Function (PSMF) and Positioning Radio Resource Management (PRRM) are described in documents specific to each Access Network type.

For location services the Access Network shall send the result of the positioning to the core network in geographical co-ordinates as defined in TS 23.032. The Access Network shall map the cell(s) the Target UE is associated with into geographical co-ordinates, but this mapping is not standardized.

These entities are defined in TS 25.305 [1] for UTRAN and in TS 43.059 [16] for GERAN.

5.5 Information Flows between Client and Server

Other types of national specific information flows may be supported in addition to the information flow specified here.

Any of the information flows here indicated may not be externally realized if the information does not flow over an open interface. On the other hand, if a flow goes over an open interface, it shall abide to a well-defined protocol, which will be further specified in other relevant specifications.

5.5.1 Location Service Request

Via the Location Service Request, the LCS client communicates with the LCS server to request for the location information of one or more than one UE within a specified quality of service. There exist two types of location service requests:

- Location Immediate Request (LIR); and
- Location Deferred Request (LDR).

The attributes for the information exchange between the LCS Client and the LCS Server have not been standardized for GSM. This information exchange may be standardized in later releases.

The following generic attributes are identified for the Location Service Request information flow:

- Target UE identity;
- LCS Client identity;
- Number dialled by the target mobile user or APN-NI, if the request is call or session related ;
- Event (applicable to LDR requests only);
- Timing information (applicable for periodical requests only);
- Requested Quality of Service information, if needed;
- Type of location, i.e. current location or last known location;
- Priority, if needed;

Local coordinate reference system, if needed;

Some of the information may be stored in GMLC and the LCS client does not need to include such information in the location service request.

5.5.2 Location Service Response

The LCS server (GMLC) sends the Location Service Response to the LCS client either as an:

- Immediate Response; or a
- Deferred Response, these deferred responses can be either single or periodic.

The following generic attributes are identified for the Location Service Response information flow:

- Location indication of UE in geographical coordinates or local coordinate system;

In addition the information attributes of the location service request may be used also in the location service response.

6 LCS Architecture

Figure 6.1 shows the general arrangement of the Location Service feature in GSM and UMTS. This illustrates, generally, the relation of LCS Clients and servers in the core network with the GERAN and UTRAN Access Networks. The LCS entities within the Access Network communicate with the Core Network (CN) across the A, Iu interfaces.

Communication among the Access Network LCS entities makes use of the messaging and signaling capabilities of the Access Network.

As part of their service or operation, the LCS Clients may request the location information of UE. There may be more than one LCS client. These may be associated with the GSM/UMTS networks or the Access Networks operated as part of a UE application or accessed by the UE through its access to an application (e.g. through the Internet).

The clients make their requests to a LCS Server. There may be more than one LCS Server. The client must be authenticated and the resources of the network must be co-ordinated including the UE and the calculation functions, to estimate the location of the UE and result returned to the client. As part of this process, information from other systems (other Access Networks) can be used. As part of the location information returned to the client, an estimate of the accuracy of the estimate and the time-of-day the measurement was made may be provided.

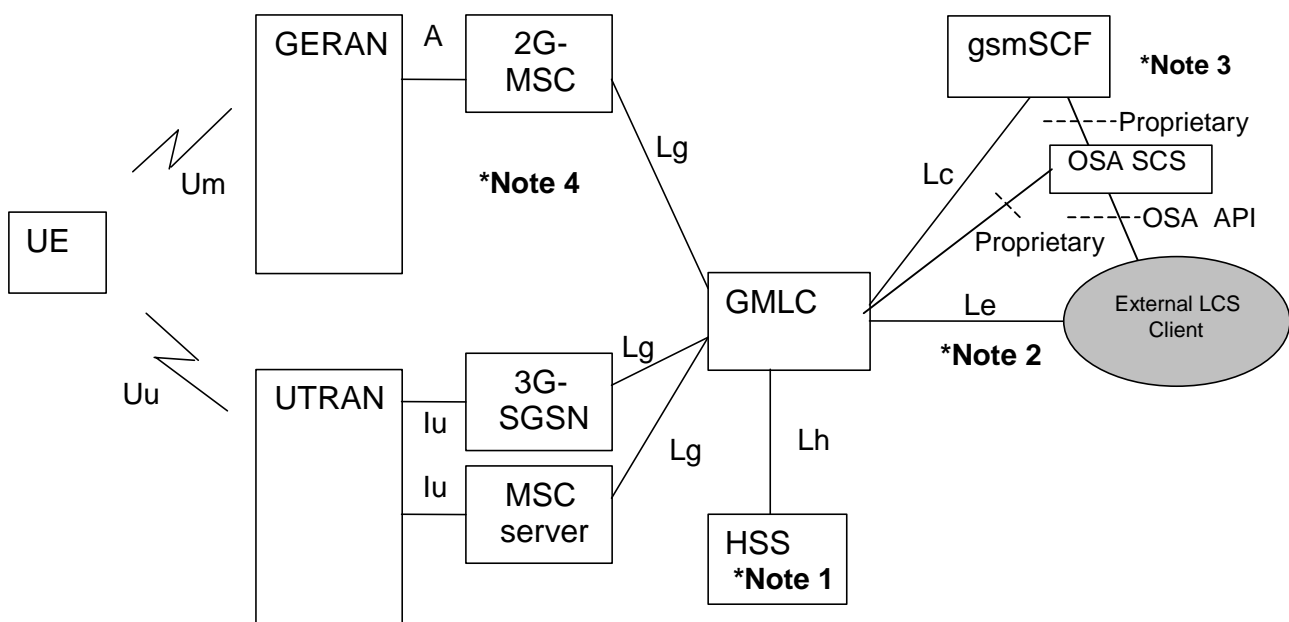

NOTE 1: HSS includes both 2G-HLR and 3G-HLR functionality. LCS should be included in the overall network architecture in TS 23.002 [20].

NOTE 2: The Le interface is FFS.

NOTE 3: As one alternative the LCS client may get location information directly from GMLC, which may contain OSA Mobility SCS with support for the OSA user location interfaces. See TS 23.127 [26] and TS 29.198 [27, 28, 29 and 30].

NOTE 4: In GSM (Rel-4), positioning is only supported on the A interface

Figure 6.1: General arrangement of LCS

6.1 Schematic functional description of LCS operations

The allocation of LCS functional blocks to the Client, LCS server, Core Network, Access Network and UE is based on the schematic functional description below. The detailed functions and interactions are specified later in the present document and in TS 25.305 [1] for UTRAN, in TS 43.059 [16] for GERAN and in corresponding Stage 3 specifications.

The operation begins with a LCS Client requesting location information for a UE from the LCS server. The LCS server will pass the request to the LCS functional entities in the core network. The LCS functional entities in the core network shall then:

- verify that the LCS Client is authorized to request the location of the UE or subscriber;

- verify that LCS is supported by the UE;
- establish whether it is allowed to locate the UE or subscriber, for privacy or other reasons;
- establish which network element in the Access Network should receive the Location request;
- request the Access Network (via the A or Iu interface) to provide location information for an identified UE, with indicated QoS;
- receive information about the location of the UE from the Access Network and forward it to the Client;
- send appropriate accounting information to an accounting function.

The Access Network LCS functional entities shall determine the position of the target UE according to TS 25.305 [1] for UTRAN and TS 43.059 [16] for GERAN.

6.2 Allocation of LCS functions to network elements

Table 6.1 shows a summary of the Functional Groups and Functional Blocks for Location services. Table 6.2 and figure 6.2 show the generic configuration for LCS and the distribution of LCS functional blocks to network elements. Different positioning methods, including network-based, mobile-based, mobile-assisted and network-assisted positioning methods may be used. With this configuration both the network and the mobiles are able to measure the timing of signals and compute the mobile's location estimate. Depending on the applied positioning method it is possible to utilise the corresponding configuration containing all needed entities. For instance, if network-based positioning is applied, the entities that are involved in measuring the mobile's signal and calculating its location estimate are allocated to the network elements of the access stratum. On the other hand, in case mobile-based or network-assisted methods are used these entities should be allocated to the UE.

LCS is logically implemented on the network structure through the addition of one network node, the Mobile Location Center (MLC). It is necessary to name a number of new interfaces. The LCS generic architecture can be combined to produce LCS architecture variants.

Table 6.1: Summary of Functional Groups and Functional Blocks for Location services

Func. Group	Functional component	Full name of Functional Block	Abbrev.
Loc. Client	Location Client Component	(External) Location Client Function	LCF
		Internal Location Client Function	LCF -internal
LCS Server in PLMN	Client handling component	Location Client Control Function	LCCF
		Location Client Authorization Function	LCAF
	System handling component	Location System Control Function	LSCF
		Location System Billing Function	LSBF
		Location System Operations Function	LSOF
	Subscr. handling component	Location Subscriber Authorization Function	LSAF
		Location Subscriber Privacy function	LSPF
	Positioning component	Positioning Radio Control Function	PRCF
		Positioning Calculation Function	PCF
		Positioning Signal Measurement Function	PSMF
Positioning Radio Resource Management		PRRM	

Table 6.2 and figure 6.2 illustrate the allocation of functional entities in the reference configuration of LCS. It is assumed that the CS and PS have either their own independent mobility management or use the joint mobility management through the optional Gs interface.

It is also seen that LCS may take benefit of the Iur interface between RNCs, when uplink radio information and measurement results are collected.

The functional model presented in the figure includes functional entities for both CS and PS related LCS. In addition, it consists of all the entities needed for different positioning methods, i.e. network based, mobile based, mobile assisted, and network assisted positioning, exploiting either uplink or downlink measurements. It is noted that the UE may use

e.g. the GPS positioning mechanism, but still demand e.g. auxiliary measurements from the serving network. RAN specific functional entities are specified in TS 25.305 [1] for UTRAN and in TS 43.059 [16] for GERAN.

Table 6.2: Allocation of LCS functional entities to network elements

	UE	RAN	GMLC	SGSN	MSC/MSC Server	HLR/HSS	Client
Location client functions							
LCF	X			X	X		X
LCF Internal	Ffs	X					
Client handling functions							
LCCTF			X				
LCCF			X				
LCAF			X				
System handling functions							
LSCF		X		X	X		
LSBF			X	X	X		
LSOF	X	X	X	X	X		
Subscriber handling functions							
LSAF				X	X		
LSPF				X	X	X	
Positioning functions							
PRCF		X					
PCF	X	X					
PSMF	X	X					
PRRM		X					
	UE	RAN	GMLC	SGSN	MSC/MSC Server		Client

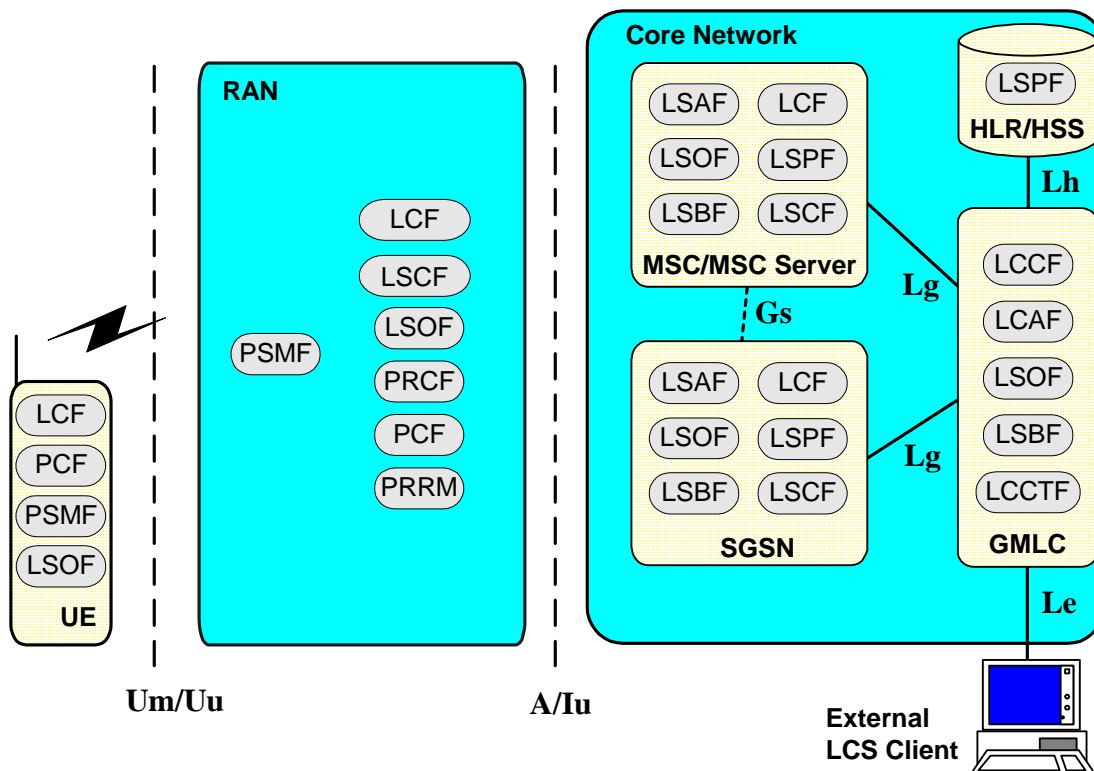

Figure 6.2: Generic LCS Logical Architecture

6.3 Functional description of LCS per network element

6.3.1 Access Network

The Access Network is involved in the handling of various positioning procedures.

The LCS specific functionalities of the radio access network elements are specified in TS 25.305 [1] for UTRAN and TS 43.059 [16] for GERAN.

6.3.2 LCS Clients and LCS applications

There are two classes of LCS Application - Internal applications and External applications. Internal applications represent entities internal to the GSM/UMTS that make use of location information for the (improved) operation of the network. Internal LCS client can be identified by LCS client internal ID. LCS client Internal ID distinguishes the following classes: (LCS client broadcasting location related information, O&M LCS client in the HPLMN, O&M LCS client in the VPLMN, LCS client recording anonymous location information, LCS Client supporting a bearer service, teleservice or supplementary service to the target UE). External applications represent entities (such as Commercial or Emergency services) that make use of location information for operations external to the mobile communications network. External LCS client can be identified by LCS client external ID. The LCS Applications interface to the LCS entities through their Location Client functions (LCF).

The LCS Client and LCS applications are outside the scope of the present document.

6.3.3 Gateway Mobile Location Center, GMLC

The Gateway Mobile Location Center (GMLC) contains functionality required to support LCS. In one PLMN, there may be more than one GMLC.

The GMLC is the first node an external LCS client accesses in a GSM PLMN (i.e. the Le reference point is supported by the GMLC). The GMLC may request routing information from the HLR or HSS via the Lh interface. After

performing registration authorization, it sends positioning requests to either VMSC, SGSN or MSC Server and receives final location estimates from the corresponding entity via Lg interface.

6.3.4 LCS support in the UE

The UE may be involved in the various positioning procedures. Specific UE involvement is specified in each of the positioning procedures specified in TS 25.305 [1] for UTRAN and TS 43.059 [16] for GERAN.

The UE interacts with the measurement co-ordination functions to transmit the needed signals for uplink based LCS measurements and to make measurements of downlink signals. The measurements to be made will be determined by the chosen location method.

The UE may also contain LCS applications, or access a LCS application through communication with a network accessed by the UE or an application residing in the UE. This application may include the needed measurement and calculation functions to determine the UE's location with or without assistance of the GSM/UMTS LCS entities.

In GSM the positioning methods supported by the UE are signalled by the UE to the core network and radio access network using Classmark3 in CS mode, as specified in TS 24.008 [24].

In UMTS the UE capability to support different positioning methods is only communicated within UTRAN, as specified in TS 25.331 [25].

The UE informs the core network about its capability to support privacy invocation request and response using Classmark2 in CS mode and MS Network Capability in PS mode, as specified in TS 24.008 [24].

The UE may also, for example, contain an independent location function (e.g. Global Satellite Positioning Service GPS) and thus be able to report its location, independent of the RAN transmissions. The UE with an independent location function may also make use of information broadcast by the RAN that assists the function.

6.3.5 MSC/VLR

The MSC/VLR contains functionality responsible for UE subscription authorization and managing call-related and non-call related positioning requests of LCS. The MSC is accessible to the GMLC via the Lg interface. The LCS functions of MSC are related to charging and billing, LCS co-ordination, location request, authorization and operation of the LCS services. If connected to SGSN through the Gs interface, it checks whether the UE is GPRS attached to decide whether to page the UE on the A/Iu or Gs interface.

6.3.6 MSC Server

The MSC Server handles the same functionality as the MSC/VLR including charging and billing, LCS co-ordination, location request, authorization and operation of the LCS services. The MSC Server is accessible to the GMLC via the Lg interface.

6.3.7 SGSN

In UMTS, the 3G-SGSN contains functionality responsible for UE subscription authorization and managing positioning requests of LCS. The 3G-SGSN is accessible to the GMLC via the Lg interface. The LCS functions of 3G-SGSN are related to charging and billing, LCS co-ordination, location request, authorization and operation of the LCS services.

The SGSN forwards the circuit-switched paging request received from the Gs interface to the BSS/RNC.

6.3.8 Home Location Register, HLR

The HLR contains LCS subscription data and routing information. The HLR is accessible from the GMLC via the Lh interface. For a roaming UE, HLR may be in a different PLMN.

6.3.9 HSS

The HSS contains LCS subscription data and routing information. The HSS is accessible from the GMLC via the Lh interface. For roaming UEs, HSS may be in a different PLMN.

6.3.10 gsmSCF

The Lc interface supports CAMEL access to LCS and is applicable only in CAMEL [phase 3?]. The procedures and signaling associated with it are defined in TS 23.078 [21] and TS 29.002 [18], respectively.

6.4 Addressing the target UE for LCS purposes

It shall be possible to address and indicate the target UE using MSISDN. It may be possible in certain cases to address the target UE using IP address when a static or dynamic IP address (IPv4 or IPv6) has been allocated for the UE.

In the mobile terminated location request procedures in the PS domain (as well as in the CS domain), the target UE is always identified using MSISDN.

NOTE: It is recognized that IP-addressing of the target UE is only possible when there is an active PDP context established between the target UE and the external LCS client. Using the established PDP context, the LCS client can request the target UE, as identified with the IP address it currently uses, to initiate a Mobile originated location request. The actual signaling exchange between the LCS Client/server and the target UE or the user of the target UE is outside the scope of this specification. The resulting MO-LR is performed as specified in this document.

7 Signaling and Interfaces

7.1 LCS signaling between Access and Core Networks

The core network sends location requests to the access network, which then sends the corresponding responses back to the core network.

Communication between access and core networks is accomplished through Iu interface in UMTS whereas the A interface is used for the purpose in GSM (see TS 25.305 [1] and TS 43.059 [16]).

7.1.1 Core network Location Request

The core network request for a location estimate of a target UE shall contain sufficient information to enable location of the Target UE according to the required QoS using any positioning method supported by the PLMN and, where necessary, UE. For location services the core network may request the geographical co-ordinates of the Target UE.

In UMTS the core network may also request in which Service Area the Target UE is located. The Service Area information may be used for routing of corresponding Emergency calls, or for CAMEL services. (The MSC Server or SGSN shall not send the Service Area Identity to GMLC).

In GSM this corresponds to the usage of Cell ID in the core network.

It should be noted that the Service Area concept is different from the Localized Service Area concept used for SoLSA services.

When the location of a Target UE in Idle Mode is requested, the core network shall determine which RAN entity is associated with the Target UE.

7.1.2 Location Report

The access network reports the location of the Target UE to the core network entities. The location report may contain the following information as defined in the corresponding location request:

- the geographical co-ordinates of the Target UE;
- the service area in which the Target UE is located;
- achieved quality level of the location estimate.

7.2 Um and Uu Interfaces

NOTE: This chapter may change depending on whether air interface LMU will exist in the logical architecture or not.

The Um and Uu interfaces are used to communicate among the LCS entities associated with the BSC and RNC, the UE and the stand-alone Location Measurement Units (LMU). The Um and Uu interfaces are also used to communicate between the LCS entities in the core network and the UE.

The Um/Uu interfaces may pass measurement requests and results to and from UE or the stand-alone LMU.

The Um/Uu interfaces may also pass location requests from internal or external LCS Clients (Applications) at the UE. Note that these requests may require the services of the LCS entities associated with the core network to authenticate clients and subscriber subscriptions to aspects of the LCS.

The Um/Uu interfaces may also be used for broadcast of information that may be used by the UE or stand-alone LMU for their LCS operations. This may, for example, include timing information about nearby Node-B/BTS transmissions that may assist the UE or LMU in making their measurements. In UTRAN code information may be included.

The Um and Uu interfaces may also pass messages relating to changes or reporting of the data associated with the Location System Operations Function (LSOF) in the UE or the remote LMU.

UTRAN Stage 2 specification TS 25.305 [1] specifies LCS signaling over the Uu interface and GERAN Stage 2 specification TS 43.059 [16] over the Um interface correspondingly.

Message segmentation is specified in GERAN LCS Stage 2, TS 43.059 [16].

7.3 MAP Interfaces

The following interfaces are based on MAP in LCS.

- Lh interface: interface between GMLC and HLR. This interface is used by the GMLC to request the address of the visited MSC or SGSN for a particular target UE whose location has been requested.
- Lg interface: interface between GMLC MSC and GMLC - SGSN. This interface is used by the GMLC to convey a location request to the MSC or SGSN currently serving a particular target UE whose location was requested. The interface is used by the MSC or SGSN to return location results to the GMLC.
- Lc: interface between GMLC and gsmSCF, CAMEL. This interface is used to get location information for CAMEL based services.

The following MAP services are defined for LCS.

- MAP-SEND-ROUTING-INFO-FOR-LCS Service.

This service is used between the GMLC and the HLR/HSS to retrieve the routing information needed for routing a location service request to the serving VMSC, SGSN. The service may be used in GMLC - HSS interface to retrieve routing information in order to route the location service request to the correct VMSC, SGSN and MSC Server.

- MAP-PROVIDE-SUBSCRIBER-LOCATION Service.

This service is used by a GMLC to request the location of a target UE from the visited MSC, SGSN or MSC Server at any time.

- MAP-SUBSCRIBER-LOCATION-REPORT Service.

This service is used by a VMSC, SGSN or MSC Server to provide the location of a target UE to a GMLC when a request for location is either implicitly administered or made at some earlier time.

The MAP Subscriber Location Report could also be used to send information about location of the Target UE (for MO-LR) to an external client.

8 General network location procedures

8.1 State description for GMLC

8.1.1 GMLC states

8.1.1.1 NULL State

In the NULL state, a particular location request from some LCS client either has not been received yet or has already been completed. After a location request is received from a LCS client, the GMLC remains in the NULL state while the identity of the client and nature of its location request are verified. While the NULL state exists conceptually, it need not be represented explicitly in the GMLC.

8.1.1.2 INTERROGATION State

In this state, the GMLC has sent an interrogation to the home HLR/HSS of the UE to be located and is awaiting a response giving one or several of the following addresses: the VMSC, MSC Server, SGSN address and IMSI for this UE.

8.1.1.3 LOCATION State

In this state, the GMLC has sent a location request to the VMSC, MSC Server, SGSN or serving the UE to be located and is awaiting a response containing a location estimate.

8.1.2 State functionality

8.1.2.1 State Transitions

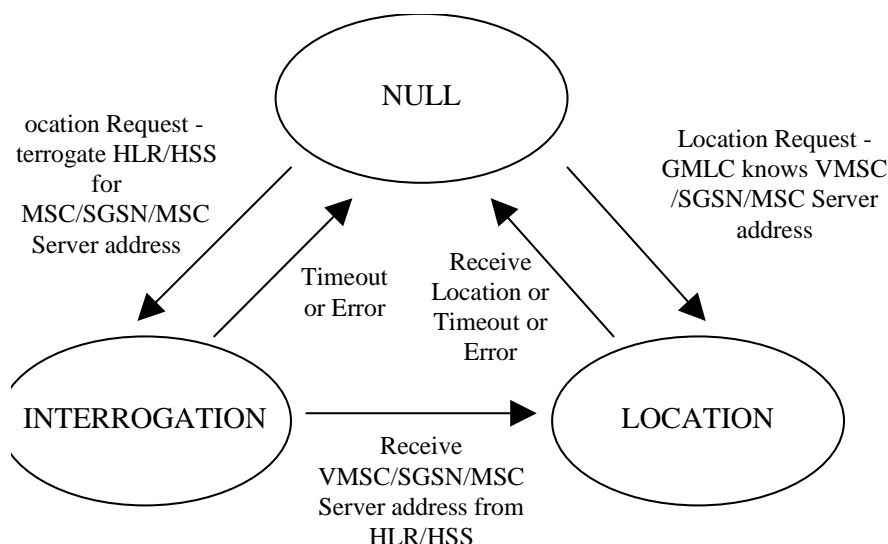

Figure 8.1: State Transitions in the GMLC

Moving from NULL to INTERROGATION state:

If the GMLC does not know any of the following addresses: VMSC, MSC Server, SGSN address or IMSI when it receives a location service request from some LCS client, it moves from the NULL state to the INTERROGATION state and sends a request to the UE's home HLR/HSS for the VMSC/ MSC Server/ SGSN address and IMSI.

Moving from NULL to LOCATION state:

If the GMLC already knows one of the following addresses: VMSC, MSC Server, SGSN or UE IMSI, when it receives a location service request from some LCS client (e.g. from information retained for an earlier location request for the same UE), it moves from the NULL state to the LOCATION state and sends a location request to either the VMSC, MSC Server or SGSN.

NOTE: It is for further study how GMLC selects if it shall send the location request to VMSC, MSC server and/or SGSN in different cases. This should be specified in the signaling procedures.

Moving from INTERROGATION to LOCATION state:

After the GMLC, in the INTERROGATION state, receives one or several of the addresses VMSC, MSC Server, SGSN, and IMSI from the home HLR/HSS, it enters the LOCATION state and sends a location request to either the VMSC, MSC Server or SGSN of the UE being located.

Moving from LOCATION to NULL state:

After the GMLC receives a location estimate response from the VMSC, MSC Server or SGSN, it forwards the location estimate to the requesting LCS client and re-enters the NULL state.

8.1.2.2 INTERROGATION Timer Function

The GMLC runs a timer while in the INTERROGATION state to limit the amount of time waiting for an interrogation response from the HLR/HSS. If the timer expires before an interrogation response is received, the GMLC indicates a location failure to the LCS client and re-enters the NULL state.

8.1.2.3 LOCATION Timer Function

The GMLC runs a timer while in the LOCATION state to limit the amount of time waiting for a location estimate response from the VMSC/ MSC Server /SGSN. If the timer expires before a response is received, the GMLC indicates a location failure to the LCS client and re-enters the NULL state.

8.2 State description for VMSC and MSC Server

8.2.1 VMSC and MSC Server States

NOTE: Periodic location service may need to be covered in the state descriptions.

8.2.1.1 LCS IDLE State

In this state, the VMSC/MSC Server location service is inactive for a particular UE. The UE may be known in the VMSC/MSC Server (except for a USIM less or SIM less Emergency call or where the UE information has been cancelled or lost in the VMSC/MSC Server), but there may not be an active Mobility Management to the UE.

8.2.1.2 LOCATION State

In this state, the VMSC/MSC Server is awaiting a response from RAN after requesting the location for a particular UE.

8.2.2 State Functionality

8.2.2.1 State Transitions

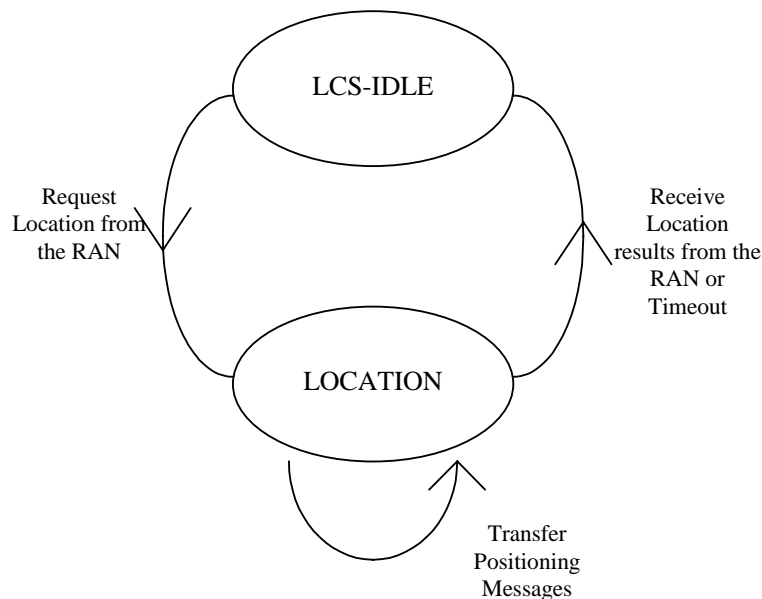

Figure 8.2: State Transitions in the VMSC/MSC Server

Moving from LCS IDLE to LOCATION state:

After a request has been received to locate a particular UE and the UE subscription options have been verified, a location request is sent to the RAN of the UE to be located: the VMSC/MSC Server then enters the LOCATION state. Before entering this state, the VMSC/MSC Server must have setup a Mobility Management connection to the UE if none was previously active. The mobile is paged and authenticated before positioning.

Moving from LOCATION to LCS IDLE state:

After the return of a location estimate result from RAN, the VMSC/MSC Server shall re-enter IDLE state.

8.2.2.2 LOCATION Timer Function

The VMSC/MSC Server runs a timer while in the LOCATION state to limit the amount of time waiting for a location response from the RAN. If the timer expires before such information is received, the VMSC/MSC Server indicates a location failure to the original requesting entity and re-enters IDLE state.

8.3 LCS State description for SGSN

8.3.1 SGSN States

8.3.1.1 LCS IDLE State

In this state, the SGSN location service is inactive for a particular UE. The UE is known in the SGSN except in case where the UE data has been cancelled or lost in the SGSN. There is not an active Mobility Management to the UE.

8.3.1.2 LOCATION State

In this state, the SGSN is awaiting a response from the RAN after requesting the location for a particular UE. In this state, a Mobility Management connection to the target UE will be active.

8.3.2 State Functionality

8.3.2.1 State Transitions

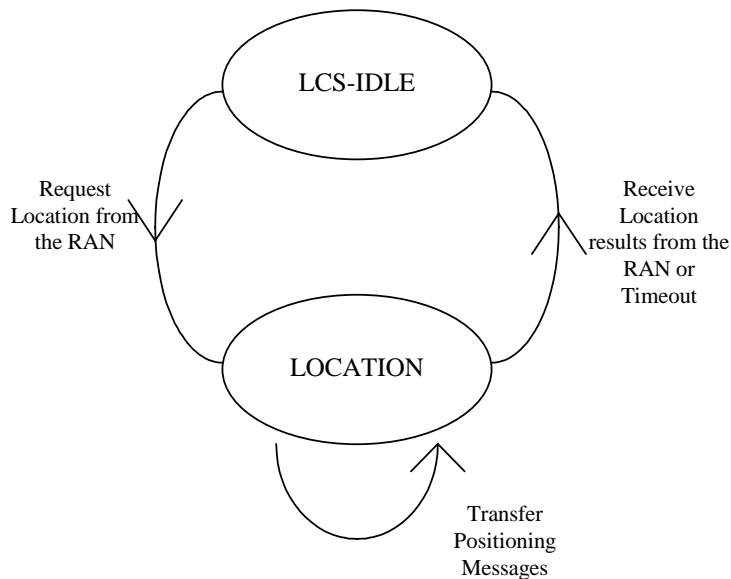

Figure 8.3: State Transitions in the SGSN

Moving from LCS-IDLE to LOCATION state:

After a request has been received to locate a particular UE and the UE subscription options have been verified to allow this, the SGSN sends a location request to the RAN. The SGSN then enters the LOCATION state. Before entering this state, the SGSN must have setup a Mobility Management connection to the UE if none was previously active. The mobile is paged and authenticated before positioning.

Moving from LOCATION to LCS IDLE state:

After the return of a location estimate result from RAN, or if the Location Timer described below expires, the SGSN shall re-enter IDLE state.

8.3.2.2 LOCATION Timer Function

The SGSN runs a timer while in the LOCATION state to limit the amount of time waiting for a location response from the RAN. If the timer expires before such information is received, the SGSN indicates a location failure to the original requesting entity and re-enters IDLE state.

8.4 Signaling connection for the Iu interface

When using the Iu interface, before SGSN/MSC server can request location information of a target UE from RAN, an Iu signaling connection must have been established between SGSN/MSC server and RAN. The SGSN/MSC server sends a location request message to RAN, which determines the location of the target UE related to this Iu signaling connection and sends a location report to SGSN/MSC server over the same Iu signaling connection.

8.5 Signaling connection for the A-interface

When using the A interface, before MSC can request location information of a target UE from RAN, an A interface signaling connection must have been established between MSC and RAN. The MSC sends a location request message to RAN, which determines the location of the target UE related to this A interface signaling connection and sends a location report to MSC over the same A interface signaling connection.

9 General Network Positioning Procedures

The generic network positioning procedure of providing the location information of an UE subscriber can be partitioned into the following procedures.

Location Preparation Procedure

This generic procedure is concerned with verifying the privacy restrictions of the UE subscriber, reserving network resources, communicating with the UE to be located and determining the positioning method to be used for locating the UE subscriber based on the requested QoS and the UE and network capabilities.

Positioning Measurement Establishment Procedure

This procedure is concerned with performing measurements by involving the necessary network and/or UE resources. Depending on the positioning method to be used for locating the UE the internals of this procedure can be positioning method dependent. The procedure is completed with the end of the positioning measurements.

Location Calculation and Release Procedure

This generic procedure is initiated after the measurements are completed and is concerned with calculating the location of the UE and releasing all network and/or UE resources involved in the positioning.

9.1 Mobile Terminating Location Request

9.1.1 MT-LR routing procedure in PS and CS domain

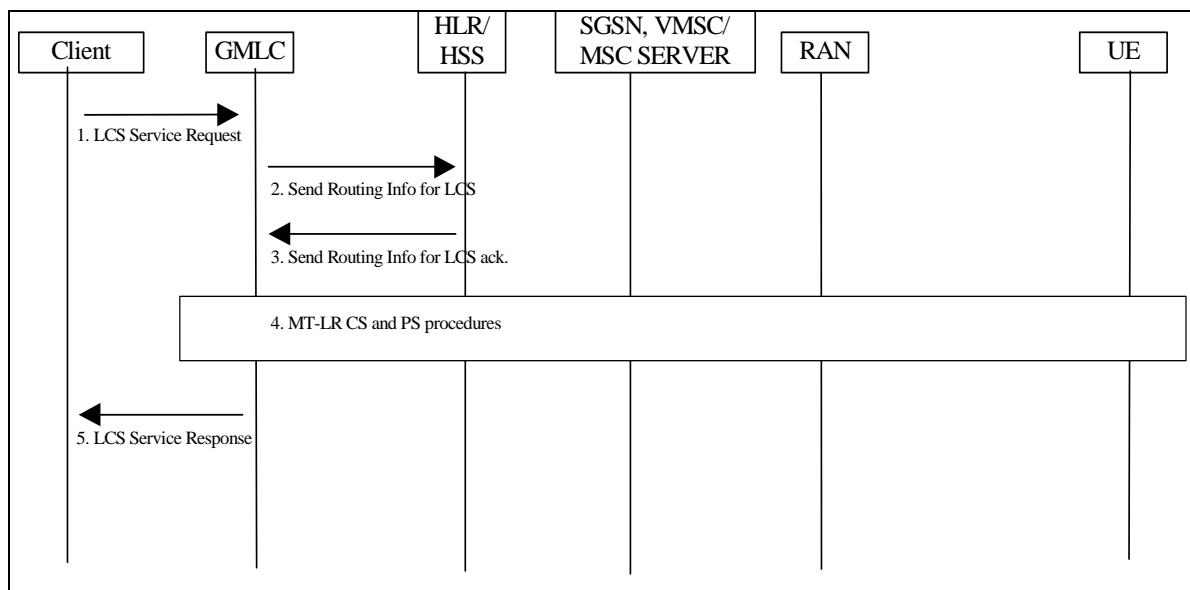

Figure 9.1: General Network Positioning for a MT-LR

- 1) An external LCS client requests the current location of a target UE from a GMLC. The LCS Client may also request a deferred location request, i.e. based on event. The GMLC verifies the identity of the LCS client and its subscription to the LCS service requested and derives the MSISDN or IMSI or PDP address, (NOTE: IP addressing in this context is FFS, one reason is the dynamic IP addressing used in IPv4.) of the target UE to be located and the LCS QoS from either subscription data or data supplied by the LCS client. For a call related location request, the GMLC obtains and authenticates the called party number of the LCS client. For a session related location request, the GMLC obtains and authenticates the APN-NI of the LCS client. If location is required for more than one UE, or if periodic location is requested, the steps following below may be repeated. Note: This means that GMLC handles the periodicity of location requests as requested by the LCS client both in CS and PS domain.

- 2) If the GMLC already knows both the VMSC/MSC server or SGSN (Note: only applicable to 3G-SGSN in Rel-4) location and IMSI for the particular MSISDN or PDP address, (e.g. from a previous location request), this step and step 3 may be skipped. Otherwise, the GMLC sends a SEND_ROUTING_INFO_FOR_LCS message to the home HLR/HSS of the target UE to be located with the IMSI or MSISDN of this UE.
- 3) The HLR/HSS verifies that the calling party SCCP address of the GMLC corresponds to a known GSM/UMTS network element that is authorized to request UE location information. The HLR/HSS then returns one or several of the addresses, the current SGSN and/or VMSC/MSC server and whichever of the IMSI and MSISDN was not provided in step (2) for the particular UE.
Note: HLR may prioritize between the MSC/VLR or SGSN address sent to GMLC. The priority criteria are for further study.
- 4) In case GMLC receives only the MSC/VLR address, the MT LR proceeds as the CS-MT-LR procedure described in 9.1.2. In case GMLC receives only the SGSN address, the MT LR proceeds as the PS-MT-LR procedure described in 9.1.6. In case the GMLC receives several of the following addresses, SGSN, VMSC and/or MSC Server, it has to decide where to send the location request. If the requested MT-LR is known to be associated with a CS call, the CS-MT-LR procedure shall be invoked. If the requested MT-LR is associated with a PS session, the PS-MT-LR procedure only shall be invoked. Otherwise, both CS-MT-LR and PS-MT-LR are applicable. If LCS Client indicated deferred location request, GMLC shall indicate this together with applicable event type (ex. MS available) in requested PS/CS-MT-LR, see 9.1.8.

NOTE: The order in which these procedures are invoked and whether one or both procedures are used may depend on subscription information for the LCS client, possible priority information returned by the HSS or information already stored in the GMLC (e.g. obtained from previous location requests).

- 5) GMLC sends the location service response to the LCS client. If the LCS client requires it, the GMLC may first transform the universal location co-ordinates provided by the SGSN or MSC/MSC server into some local geographic system. The GMLC may record billing for both the LCS client and inter-network revenue charges from the SGSN or MSC/MSC server's network.

The detailed CS-MT-LR and PS-MT-LR procedures in step 4 of figure 9.1 are described in 9.1.2 and 9.1.6.

The detailed procedure for deferred PS/CS-MT-LR is described in 9.1.8.

9.1.2 Circuit Switched Mobile Terminating Location Request (CS-MT-LR)

Figure 9.2 illustrates general network positioning for LCS clients external to the PLMN. In this scenario, it is assumed that the target UE is identified using either an MSISDN or IMSI.

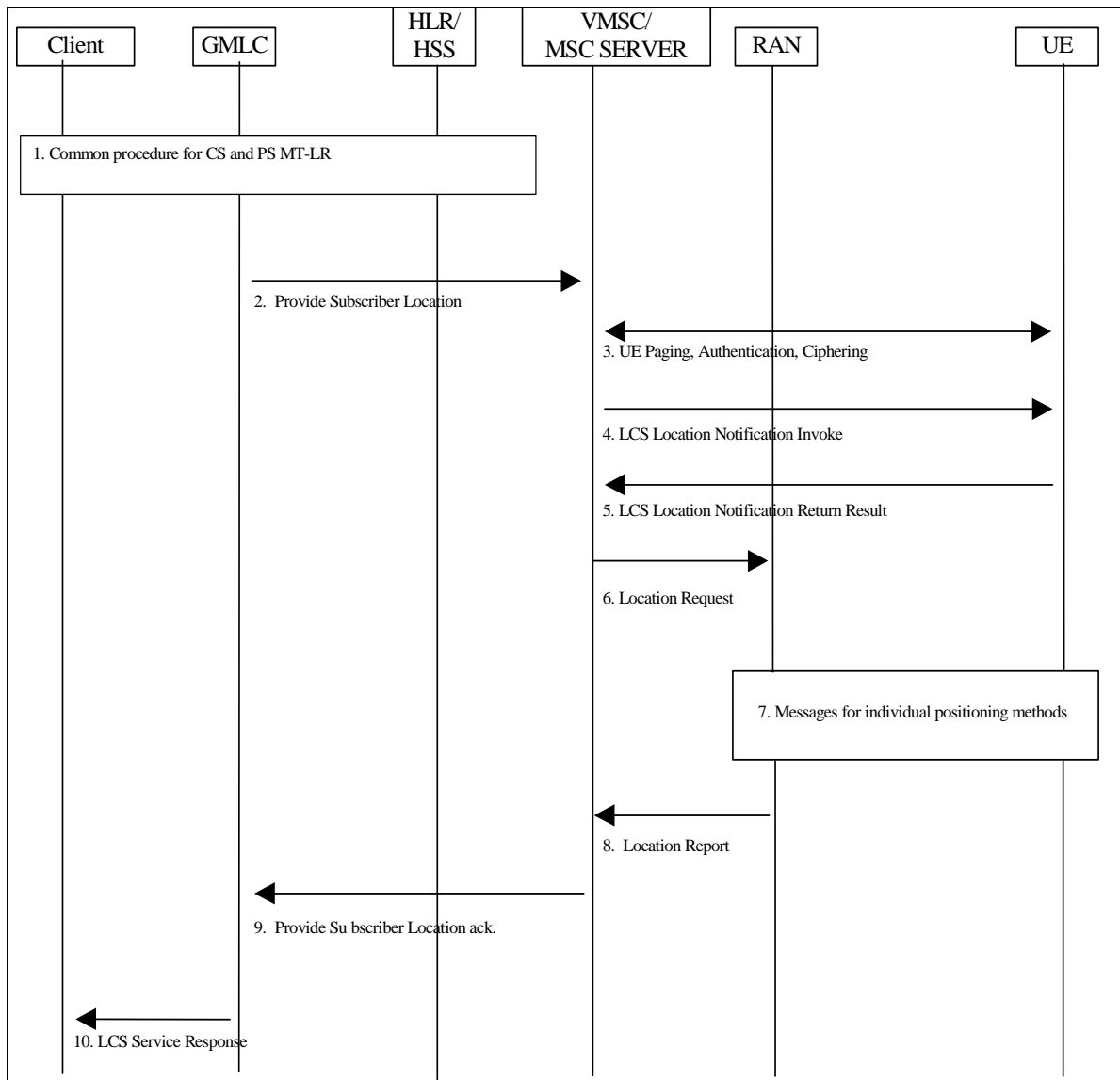

Figure 9.2: Network Positioning for a CS-MT-LR

9.1.2.1 Location Preparation Procedure

- 1) Common PS and CS MT-LR procedure as described in 9.1.1.
- 2) The GMLC sends a PROVIDE_SUBSCRIBER_LOCATION message to the MSC/MSC server indicated by the HLR/HSS. This message carries the type of location information requested (e.g. current location), the UE subscriber's IMSI, LCS QoS information (e.g. accuracy, response time) and an indication of whether the LCS client has the override capability. For a call related location request, the message also carries the LCS client's called party number. For a value added LCS client, the message shall carry the client name and the external identity of the LCS client. For a PLMN operator LCS client, the message shall carry the internal identity of the LCS client.
- 3) If the GMLC is located in another PLMN or another country, the VMSC/MSC server first authenticates that a location request is allowed from this PLMN or from this country. If not, an error response is returned. The VMSC/MSC server then verifies LCS barring restrictions in the UE user's subscription profile in the MSC server. In verifying the barring restrictions, barring of the whole location request is assumed if any part of it is

barred or any requisite condition is not satisfied. If LCS is to be barred without notifying the target UE and a LCS client accessing a GMLC in the same country does not have the override capability, an error response is returned to the GMLC. Otherwise, if the UE is in idle mode, the Core Network performs paging, authentication and ciphering. The MSC will page a GPRS attached UE either through A/Iu or Gs interface, depending on the presence of the Gs interface (see Note). The UE will inform the network about its LCS capabilities, as described in chapter 6.3.4.. If the UE is instead in dedicated mode, the VMSC/MSC server will already have UE classmark information. In GSM this is supported by controlled early classmark sending.

[Note 1: In GSM, if the target UE has an established circuit call other than speech, the location request may be denied and an error response is then returned to the GMLC. If the location request is allowed for a non-speech circuit call, it shall be up to RAN to decide, on the basis of the applicable position methods and requested QoS, whether positioning is possible. This is FFS]

Note: In some network mode of operation, a GPRS capable UE may not receive the CS paging. In addition, upon receipt of a CS paging, a GPRS capable UE may immediately answer to the Paging Request or delay the answer, as defined in 3GPP TS 22.060 and 23.060. A GPRS UE in class B mode may also suspend its GPRS traffic, sending a GPRS Suspension Request to the network.

4) If the location request comes from a value added LCS client and the UE subscription profile indicates that the UE must either be notified or notified with privacy verification and the UE supports notification of LCS (according to the UE Capability information), an LCS Location Notification Invoke message is sent to the target UE indicating the type of location request (e.g. current location) and the identity of the LCS client and whether privacy verification is required. [FFS: For a call related location request, the LCS client identity shall be set to the LCS client's called party number if no separate LCS client identity was received from the GMLC.] Optionally, the VMSC/MSC server may after sending the LCS Location Notification Invoke message continue in parallel the location process, i.e. continue to step 6 without waiting for a LCS Location Notification Return Result message in step 5.

NOTE 2: This step is for further study, it should be investigated e.g. which client identities to include in the Privacy Notification message to be shown to the end-user.

5) The target UE notifies the UE user of the location request. If privacy verification was requested, the target UE indicates to the UE user whether the location request will be allowed or not allowed in the absence of a response and waits for the user to grant or withhold permission. The UE then returns an LCS Location Notification Return Result to the VMSC/MSC server indicating, if privacy verification was requested, whether permission is granted or denied. Optionally, the LCS Location Notification Return Result message can be returned some time after step 4, but before step 9. If the UE user does not respond after a predetermined time period, the VMSC/MSC server shall infer a "no response" condition. The VMSC/MSC server shall return an error response to the GMLC if privacy verification was requested and either the UE user denies permission or there is no response with the UE subscription profile indicating barring of the location request in the absence of a response.

6) The MSC/MSC server sends a Location Request message to RAN. This message includes the type of location information requested and requested QoS and, in GSM, the UE's location capabilities.

9.1.2.2 Positioning Measurement Establishment Procedure

7) RAN determines the positioning method and instigates the particular message sequence for this method, as specified in UTRAN Stage 2, TS 25.305 [1] and GERAN Stage 2, TS 43.059 [16].

9.1.2.3 Location Calculation and Release Procedure

8) When a location estimate best satisfying the requested QoS has been obtained, RAN returns it to the MSC/MSC server in a Location Report message. If a location estimate could not be obtained, RAN returns a Location Report message containing a failure cause and no location estimate.

9) The MSC/MSC server returns the location information and its age to the GMLC, if the VMSC/MSC server has not initiated the Privacy Verification process in step 4. If step 4 has been performed for privacy verification, the VMSC/MSC server returns the location information only, if it has received a LCS Location Notification Return Result indicating that permission is granted. If a LCS Location Notification Return Result message indicating that permission is not granted is received, or there is no response, with the UE subscription profile indicating barring of location in the absence of a response, the VMSC/MSC server shall return an error response to the GMLC. If RAN did not return a successful location estimate, but the privacy checks in steps 4 - 5 were successfully executed, the VMSC/MSC server may return the last known location of the target UE if this is

known and the LCS client is requesting the current or last known location. The MSC server may then release the Mobility Management connection to the UE, if the UE was previously idle, and the MSC/MSC server may record billing information.

10) The GMLC returns the UE location estimate to the requesting LCS client as described in chapter 9.1.1.

9.1.3 CS-MT-LR without HLR Query - applicable to North America Emergency Calls only

Figure 9.3 illustrates location for a North American Emergency Services call, where an emergency services client identifies the target UE using an IMSI, MSISDN or NA-ESRK plus, possibly IMEI, that were previously provided to it by the VMSC. The emergency services client also identifies the VMSC to the GMLC by providing an NA-ESRD or NA-ESRK or by referring to information for the target UE already stored in the GMLC. This allows the GMLC to request location from the VMSC without first querying the home HLR of the target UE. This is necessary when the home HLR either cannot be identified (e.g. client provides an NA-ESRK but not IMSI or MSISDN) or does not support the LCS query procedure.

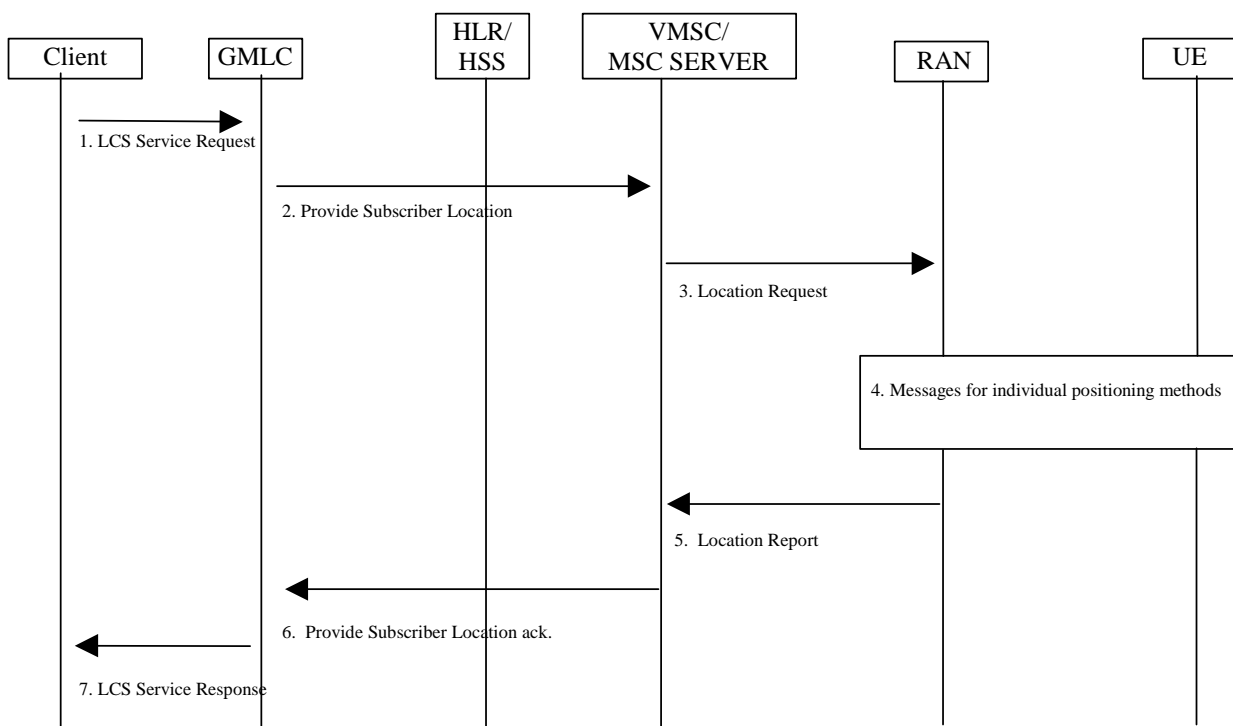

Figure 9.3: Positioning for a Emergency Services MT-LR without HLR Query

- 1) Same as step 1 in figure 9.1 but with the LCS client identifying first the target UE by an IMSI, MSISDN or NA-ESRK and possibly IMEI and, second, the VMSC by an NA-ESRK or NA-ESRD.
- 2) If the GMLC already has stored information for the target UE (e.g. from a prior location estimate delivery to the LCS client), the GMLC may determine the VMSC from this information. Otherwise, the GMLC determines the VMSC using the NA-ESRK or NA-ESRD - with use of the NA-ESRK taking priority over that of the NA-ESRD. The MAP_PROVIDE_SUBSCRIBER_LOCATION message sent to the VMSC carries the IMSI, if available or MSISDN and, if provided, the IMEI for the target UE, as well as the required QoS and an indication of a location request from an emergency services client. The VMSC identifies the target UE using the IMSI or MSISDN and, if provided, the IMEI.
- 3) The MSC verifies that UE privacy is overridden by the emergency services provider and that positioning is not prevented for other reasons (e.g. unreachable UE, inapplicable call type to the UE). The VMSC then sends a Location Request to the RAN, as for a normal MT-LR.
- 4) RAN performs positioning as for a normal CS-MT-LR.

- 5) RAN returns a location estimate to the VMSC as for a normal CS-MT-LR.
- 6) Same as steps 9 for a normal CS-MT-LR.
- 7) Same as steps 10 for a normal CS-MT-LR.

9.1.4 CS-MT-LR and PS-MT-LR for a previously obtained location estimate

Every time the location estimate of a target UE subscriber is returned by the RAN to the VMSC, MSC Server or SGSN, the corresponding entity may store the location estimate together with a time stamp. The MSC/MSC server may store this information in the subscriber's MSC server record.

The time stamp is the time at which the location estimate is stored at the corresponding entity i.e. after the RAN returns the location estimate to the VMSC, MSC Server or SGSN. The time stamp indicates the "age" of the location estimate.

9.1.4.1 Initial Location

In the context of an originating emergency call the location estimate and the associated time stamp at the commencement of the call set-up is referred to as "*initial location*".

9.1.4.2 Current Location

After a location attempt has successfully delivered a location estimate and its associated time stamp, the location estimate and time stamp is referred to as the "*current location*" at that point in time.

9.1.4.3 Last known Location

The current location estimate and its associated time stamp are stored in MSC/VLR, MSC Server or SGSN and until replaced by a later location estimate and a new time stamp is referred to as the "*last known location*". The last known location may be distinct from the initial location - i.e. more recent.

9.1.4.4 Security and Privacy

The handling of security and privacy of the target UE with regard to returning the last known or initial location estimate of the target UE shall be the same as when the target UE is reachable for positioning. (i.e. the requesting LCS client is authorized and the privacy of the target UE is secured before the VMSC/MSC server check the MSC server status of the target UE (i.e. whether the UE is marked as attached or detached in the MSC server). A similar status check apply for SGSN and MSC Server.

9.1.4.5 Failing to locate the target UE

In case of a "Detached" or "Not Reachable" target UE, the last known location and a time stamp stored at the VLR, MSC Server or SGSN, may be returned to a LCS client requesting location information if the LCS client specifically requested the current or last known location. This does not apply to a value added LCS client where the target UE subscribes to notification of the location request: if the notification cannot be performed, the VMSC, MSC Server or SGSN shall reject the location request.

NOTE: Due to CAMEL, the MSC/MSC server/VLR may already be storing other location information parameters like location number, service area identity and MSC server number in the subscriber's MSC server record.

When a request for location information is received at the VMSC, MSC Server or SGSN, the request shall indicate whether the "last known location of the target UE" should be returned in case of a "detached" or "not reachable" target UE.

If the VLR, MSC Server or SGSN has a valid copy of the subscriber's permanent data and the target UE's privacy settings are such that positioning is allowed, then the following two cases can occur.

9.1.4.5.1 Target UE is "Not Reachable"

If the target UE is marked as "attached" in the VLR, MSC Server or SGSN, the corresponding entity orders paging of the target UE. If paging fails, due to target UE being "not reachable" then the corresponding VMSC, MSC Server or SGSN shall check whether the LCS client has requested "last known location" in case of "not reachable" target UE.

If such a request exists and notification to the target UE does not apply for a value added LCS client, the VMSC, MSC Server or SGSN shall include the last known location together with the time stamp available in its response to the request for location information.

An indicator of "last known location" returned shall be marked at the CDR at VMSC, MSC Server or SGSN correspondingly.

9.1.4.5.2 Target UE is "Detached"

If the target UE is marked as "detached" in the VLR, MSC Server or SGSN, the corresponding entity shall check whether the LCS client has requested "last known location" in case of "detached" target UE.

If such a request exists and notification to the target UE does not apply for a value added LCS client, the VMSC, MSC Server or SGSN includes the "last known location" together with the time stamp available in its response to the request for location information.

An indicator of "last known location" returned shall be marked at the CDR at VMSC, MSC Server or SGSN.

9.1.4.5.3 Target UE is Reachable but Positioning Fails

If the target UE is reachable (e.g. paging succeeds), but the VMSC, MSC Server or SGSN is unable to obtain a current location estimate, then the corresponding entity shall check whether the LCS client has requested "last known location".

If such a request exists and notification to the target UE either does not apply or was successfully executed for a value added LCS client, the VMSC, MSC Server or SGSN includes the "last known location" together with the time stamp available in its response to the request for location information. An indicator of "last known location" returned shall be marked at the CDR at VMSC.

9.1.4.5.4 MSC Server or SGSN.Target UE is "Purged"

If the target UE is marked as "Purged" in HLR/HSS, then an indication "Absent Subscriber" is returned to the GMLC.

9.1.5 Network Induced Location Request (NI-LR)

Figure 9.4 illustrates positioning for an emergency service call.

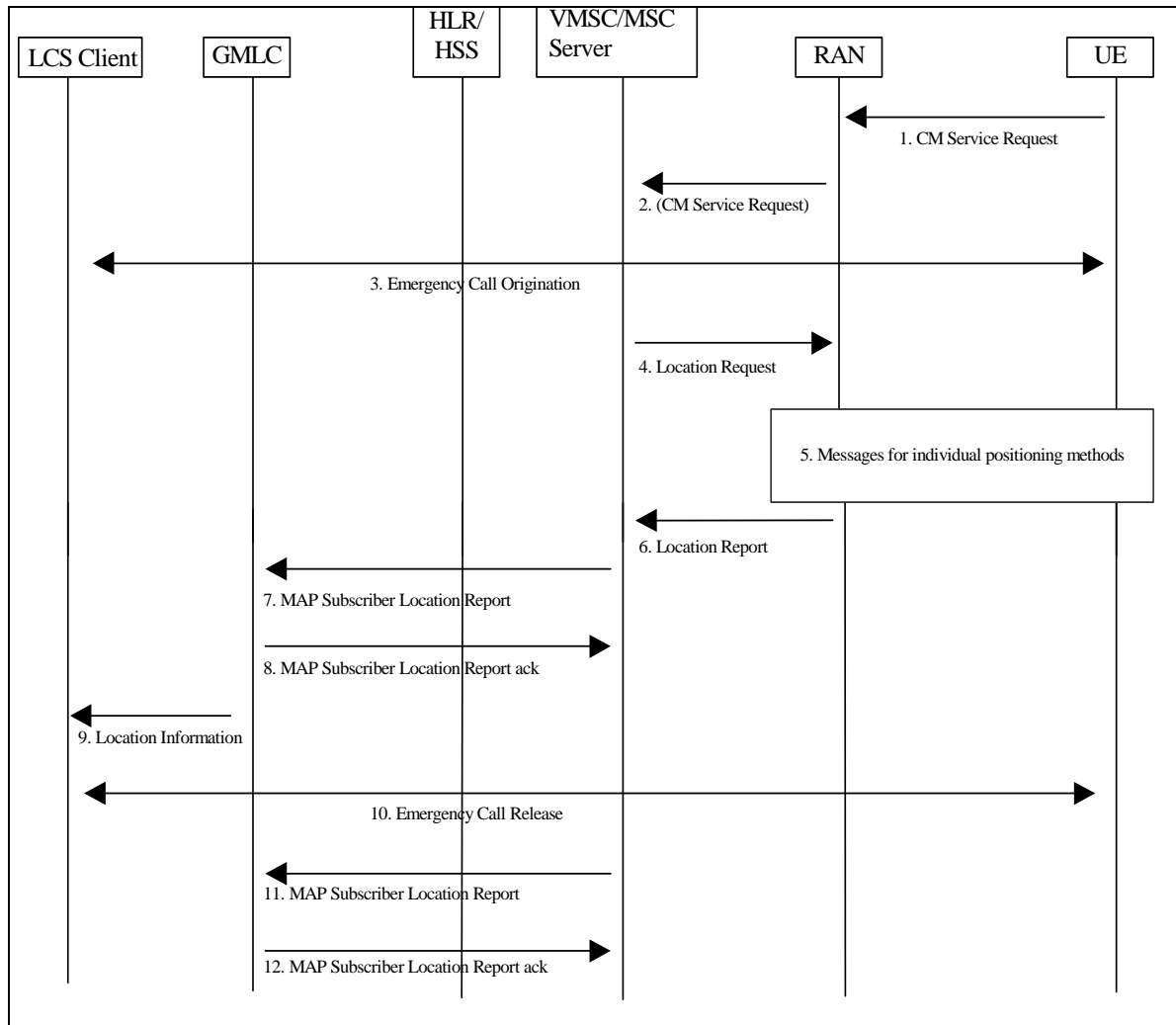

Figure 9.4: Positioning for a NI-LR Emergency Service Call

9.1.5.1 Location Preparation Procedure

- 1) An initially idle UE requests radio connection setup indicating a request for an Emergency Service call to the VMSC/MSC server via RAN.
- 2) RAN shall convey the CM service request to the core network. (Before having a CM connection there must be a radio connection.) The UE may identify itself using a TMSI, IMSI or IMEI.
- 3) The emergency call procedure is applied. The VMSC/MSC server, RAN and UE continue the normal procedure for emergency call origination towards the appropriate emergency services client. Depending on local regulatory requirements, the sending of call setup information into the PSTN may be delayed until either the UE's location has been obtained or the location attempt has failed or a PLMN defined timer has expired before location was obtained. Call setup information sent into the PSTN may include the UE location (if already obtained) plus information that will enable the emergency service provider to request UE location at a later time (e.g. NA-ESRD and NA-ESRK in North America).
- 4) At any time after step 1, the VMSC/MSC server may initiate procedures to obtain the UE's location. These procedures may run either in parallel with the emergency call origination or while emergency call origination is suspended to delay sending of call setup information into the PSTN according to step 3. The VMSC/MSC server sends a Location Request message to RAN associated with the UE's current location area (see step 6 for a MT-LR). This message includes the QoS required for an emergency call.

9.1.5.2 Positioning Measurement Establishment Procedure

- 5) When a location estimate best satisfying the requested QoS has been obtained, the RAN returns it to the MSC server in a location response. If a location estimate could not be obtained, the RAN returns a location response containing a failure cause and no location estimate.

9.1.5.3 Location Calculation and Release Procedure

- 6) When a location estimate best satisfying the requested QoS has been obtained, RAN returns it to the VMSC/MSC server.
- 7) Depending on local regulatory requirements, the VMSC/MSC server may send a MAP Subscriber Location report to a GMLC associated with the emergency services provider to which the emergency call has been or will be sent. This message shall carry any location estimate returned in step 6, the age of this estimate and may carry the MSISDN, IMSI and IMEI of the calling UE. In North America, any NA-ESRD and any NA-ESRK that may have been assigned by the VMSC/MSC server shall be included. The message shall also indicate the event that triggered the location report. If location failed (i.e. an error result was returned by RAN in step 6), an indication of failure rather than a location estimate may be sent to the GMLC: the indication of failure is conveyed by not including a location estimate in the MAP Subscriber Location Report.
- 8) The GMLC acknowledges receipt of the location information. For a North American Emergency Services call, the GMLC shall store the location information for later retrieval by the emergency services LCS client.
- 9) The GMLC may optionally forward the information received in step 8 to the emergency services LCS client. For a North American emergency services call the client is expected to obtain the location information by requesting it from the GMLC.
- 10) At some later time, the emergency services call is released.
- 11) For a North American Emergency Services call, the MSC/MSC server sends another MAP Subscriber Location Report to the GMLC. This message may include the same parameters as before except that there is no position estimate and an indication of emergency call termination is included.
- 12) The GMLC acknowledges the MSC/MSC server notification and may then release all information previously stored for the emergency call.

Editorial Note: The procedure for Network Induced Location Request (NI-LR and PS-NI-LR) for a Target UE in dedicated mode should be defined in UTRAN system stage 2 [1] and GERAN Stage 2 specifications [16].

9.1.6 Packet Switched Mobile Terminating Location Request (PS-MT-LR)

Figure 9.5 illustrates the general network positioning for LCS clients external to the PLMN for packet switched services. In this scenario, it is assumed that the target UE is identified using an MSISDN, PDP address or IMSI.

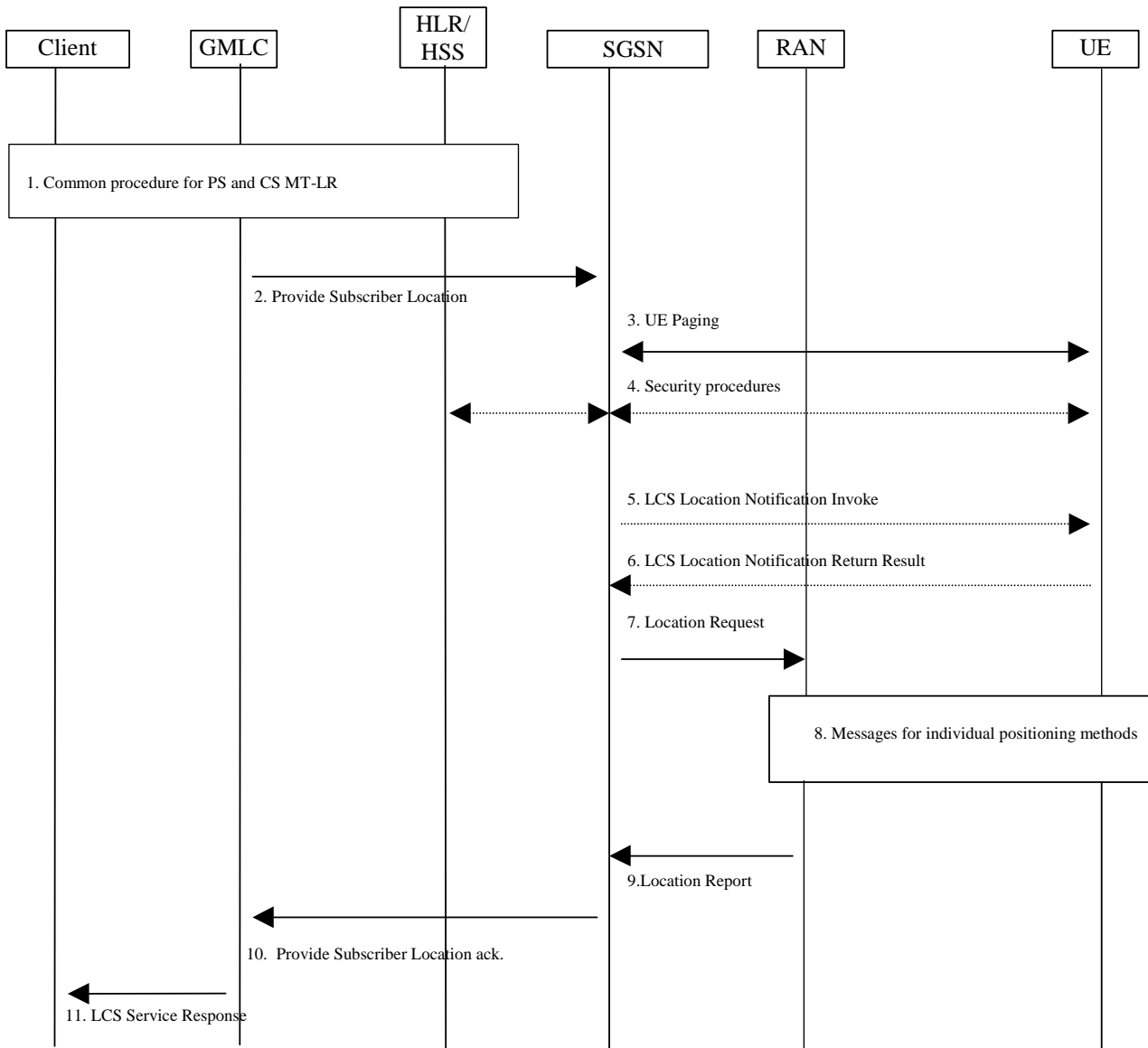

Figure 9.5: General Network Positioning for Packet Switched MT-LR

9.1.6.1 Location Preparation Procedure

- 1) Common PS and CS MT-LR procedure as described in 9.1.1.
- 2) GMLC sends a Provide Subscriber Location message to the SGSN indicated by the HLR/HSS. This message carries the type of location information requested (e.g. current location), the UE subscriber's IMSI, LCS QoS information (e.g. accuracy, response time) and an indication of whether the LCS client has the override capability. For a session related location request, the message also carries the APN-NI to which the user has established the session. For a value added LCS client, the message shall carry the client name and the external identity of the LCS client. For a PLMN operator LCS client, the message shall carry the internal identity of the LCS client.

- 3) If the GMLC is located in another PLMN or another country, the SGSN first authenticates that a location request is allowed from this PLMN or from this country. If not, an error response is returned. The SGSN then verifies LCS barring restrictions in the UE user's subscription profile in the SGSN. In verifying the barring restrictions, barring of the whole location request is assumed if any part of it is barred or any requisite condition is not satisfied. If LCS is to be barred without notifying the target UE and a LCS client accessing a GMLC in the same country does not have the override capability, an error response is returned to the GMLC. Otherwise, if the UE is in idle mode, the SGSN performs paging. The paging procedure is defined in TS 23.060[15].

FFS: The UE may be paged for location services even when in UMTS a signaling connection between mobile station and the network is established. This makes it possible for the UE to start preparing an anticipated location service coming later by e.g. starting to measure GPS signals.

- 4) Security functions may be executed. These procedures are defined in TS 23.060 [15].
- 5) If the location request comes from a value added LCS client and the UE subscription profile indicates that the UE must either be notified or notified with privacy verification and the UE supports notification of LCS, a notification invoke message is sent to the target UE indicating the type of location request (e.g. current location) and the identity of the LCS client and whether privacy verification is required. Optionally, the SGSN may after sending the LCS Location Notification Invoke message continue in parallel the location process, i.e. continue to step 7 without waiting for a LCS Location Notification Return Result message in step 6.
- 6) The target UE notifies the UE user of the location request and, if privacy verification was requested, waits for the user to grant or withhold permission. The UE then returns a notification result to the SGSN indicating, if privacy verification was requested, whether permission is granted or denied. Optionally, this message can be returned some time after step 5, but before step 10. If the UE user does not respond after a predetermined time period, the SGSN shall infer a "no response" condition. The SGSN shall return an error response to the GMLC if privacy verification was requested and either the UE user denies permission or there is no response with the UE subscription profile indicating barring of the location request.
- 7) The SGSN sends a Location Request message to the RAN. This message includes the type of location information requested, the requested QoS and any other location information received in paging response.

9.1.6.2 Positioning Measurement Establishment Procedure

- 8) If the requested location information and the location accuracy within the QoS can be satisfied based on parameters received from the SGSN and the parameters obtained by the RAN e.g. cell coverage and timing information (i.e. RTT), the RAN may send a Location Report immediately. Otherwise, the RAN determines the positioning method and instigates the particular message sequence for this method in UTRAN Stage 2 TS 25.305. If the position method returns position measurements, the RAN uses them to compute a location estimate. If there has been a failure to obtain position measurements, the RAN may use the current cell information and, if available, RTT value to derive an approximate location estimate. If an already computed location estimate is returned for an UE based position method, the RAN may verify consistency with the current cell and, if available, RTT. If the location estimate so obtained does not satisfy the requested accuracy and sufficient response time still remains, the RAN may instigate a further location attempt using the same or a different position method. If a vertical location co-ordinate is requested but the RAN can only obtain horizontal co-ordinates, these may be returned.

9.1.6.3 Location Calculation and Release Procedure

- 9) When location information best satisfying the requested location type and QoS has been obtained, the RAN returns it to the SGSN in a Location Report message. If a location estimate could not be obtained, the RAN returns a Location Report message containing a failure cause and no location estimate.
- 10) The SGSN returns the location information and its age to the GMLC, if the SGSN has not initiated the Privacy Verification process in step 5. If step 5 has been performed for privacy verification, the SGSN returns the location information only, if it has received a LCS Location Notification Return Result indicating that permission is granted. If a LCS Location Notification Return Result message indicating that permission is not granted is received, or there is no response, with the UE subscription profile indicating barring of location, the SGSN shall return an error response to the GMLC. If the SGSN did not return a successful location estimate, but the privacy checks were successfully executed, the SGSN may return the last known location of the target UE if this is known and the LCS client is requesting the current or last known location. The SGSN may record billing information.
- 11) The GMLC returns the UE location information to the requesting LCS client. If the LCS client requires it, the GMLC may first transform the universal location co-ordinates provided by the SGSN into some local geographic system. The GMLC may record billing for both the LCS client and inter-network revenue charges from the SGSN's network.

9.1.7 Packet Switched Network Induced Location Request (PS-NI-LR)

Figure 9.6 illustrates a network induced location request from the SGSN. This procedure may be used e.g. for positioning of an emergency call.

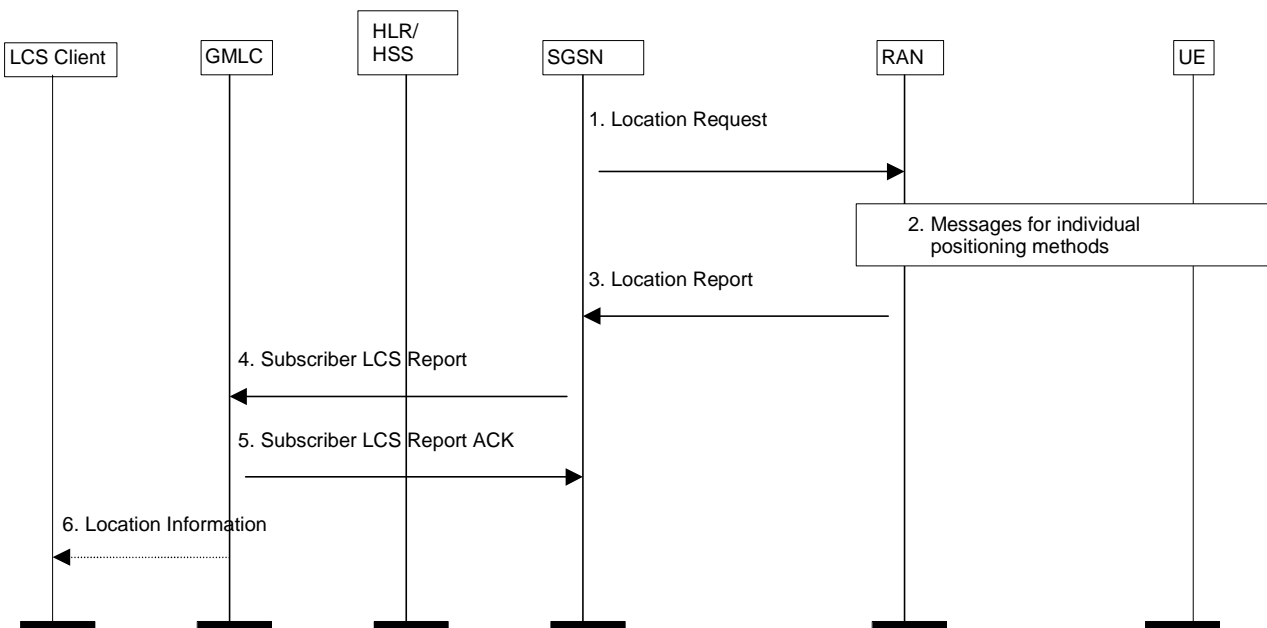

Figure 9.6: Network Induced Location Request

- 1) The SGSN sends a Location Request message to the RAN. This message indicates the type of location information requested and requested QoS.

9.1.7.1 Positioning Measurement Establishment Procedure

- 2) If the requested location information and the location accuracy within the QoS can be satisfied based on parameters received from the SGSN and the parameters obtained by the RAN e.g. cell coverage and timing information (i.e. RTT), the RAN may send a Location Report immediately. Otherwise, the RAN determines the positioning method and instigates the particular message sequence for this method. If the position method returns position measurements, the RAN uses them to compute a location estimate. If there has been a failure to obtain position measurements, the RAN may use the current cell information and, if available, RTT value to derive an approximate location estimate. If an already computed location estimate is returned for an UE based position method, the RAN may verify consistency with the current cell and, if available, RTT value. If the location estimate so obtained does not satisfy the requested accuracy and sufficient response time still remains, the RAN may instigate a further location attempt using the same or a different position method. If a vertical location co-ordinate is requested but the RAN can only obtain horizontal co-ordinates, these may be returned.

9.1.7.2 Location Calculation and Release Procedure

- 3) When a location estimate best satisfying the requested QoS has been obtained , the RAN returns a Location Report to the SGSN. This message carries the location estimate that was obtained. If a location estimate was not successfully obtained , a failure cause is included in the Location Report.
- 4) The SGSN shall send a MAP Subscriber Location Report to the GMLC obtained in step 1 carrying the MSISDN or PDP address of the UE, the identity of the LCS client, the event causing the location estimate (NI-LR-PS) and the location estimate and its age.
- 5) The GMLC shall acknowledge receipt of the location estimate provided that it serves the identified LCS client and the client is accessible.
- 6) The GMLC may transfer the location information to the LCS client either immediately or upon request from the client.

9.1.8 Mobile Terminating Deferred Location Request

Figure 9.6a illustrates the procedures for a Deferred Location Request, where the Location Report is returned based on an event.

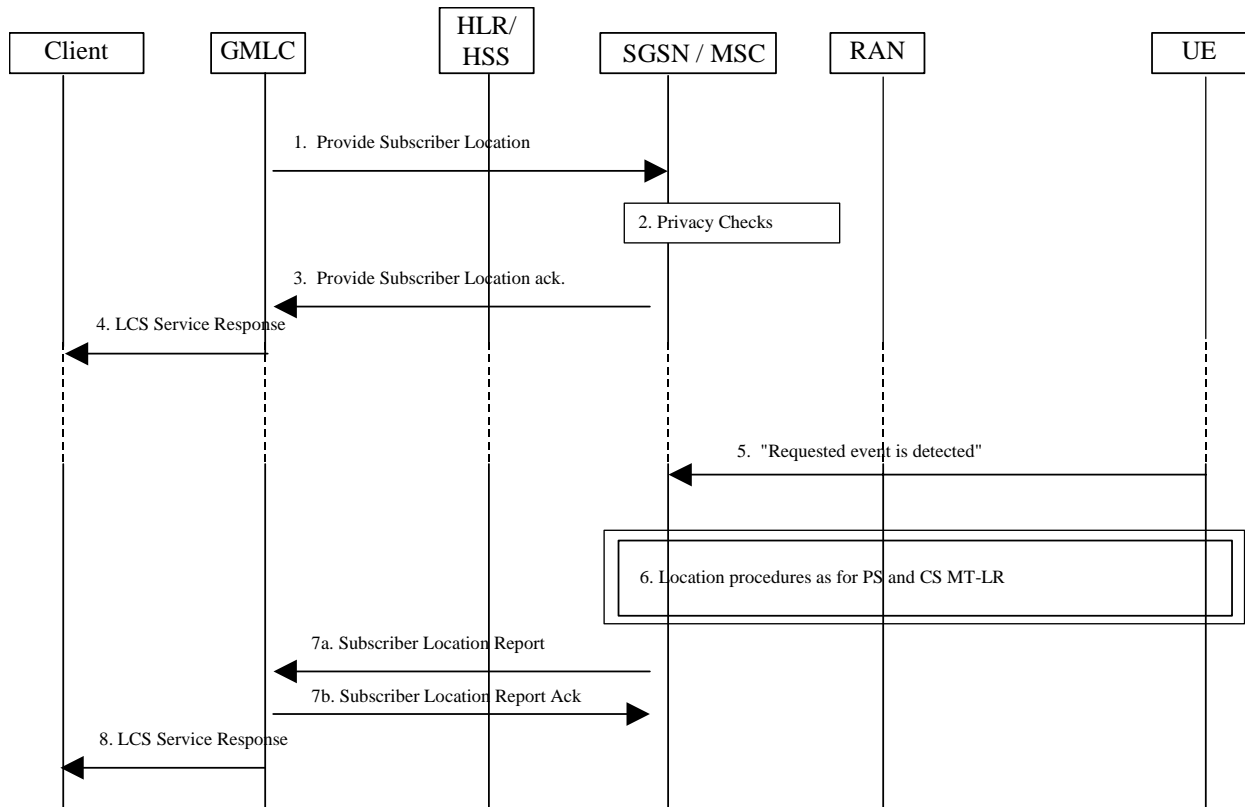

Figure 9.6a: General Network Positioning for a Deferred MT-LR

9.1.8.1 Deferred Location Request Procedure

- 1) Provide Subscriber Location is received in SGSN/MSC as described in 9.1.2/9.1.6. In addition, the Deferred Location Request includes the event that shall trigger the sending of Location Report.
- 2) If the SGSN/MSC cannot support the deferred location request for the specified event (for temporary or permanent reasons), a Provide Subscriber Location return error shall be returned in step 3 with a suitable cause. The SGSN/MSC verifies that the LCS client is allowed to position the requested UE according to subscription information (no interaction at this stage with the UE). If not, a Provide Subscriber Location return error is returned in step 3.
- 3) If the SGSN/MSC can support the deferred location request for the specified event and the privacy checks in step 2 are satisfied, a Provide Subscriber Location ack. shall be returned to the GMLC without a location estimate.
- 4) The GMLC then returns the LCS Service Response to the LCS Client to notify whether the request was successfully accepted or not.

9.1.8.2 Location Report Procedure

- 5) Immediately following step 3, the SGSN/MSC shall verify if the requested event is already satisfied (e.g. UE available inferred from a current transaction) or can be invoked immediately (e.g. by paging the UE and receiving a page response). If requested event is not existing the SGSN/MSC waits until it has occurred or until some maximum time has expired.
- => In case the SGSN/MSC receives an indication that the UE has moved to another SGSN/MSC while it is waiting for the requested event to happen, a Subscriber Location Report is directly sent to the GMLC with the information that MT-LR must be re-initiated against the new SGSN/MSC. The address of the new SGSN/MSC is included in Subscriber Location Report if available. (If new SGSN/MSC address was included, the GMLC continues at step 1 above, otherwise it continues with an interrogation against HLR as described in 9.1.1.)
- 6) When the requested event is detected, the SGSN/MSC will proceed with the location request as described in 9.1.2/9.1.6.

If either security or privacy checks fails, a Subscriber Location Report is returned with appropriate error cause indicating termination of the deferred location request.

- 7) When location information has been obtained from the RAN, the SGSN/MSC returns the Subscriber Location Report. Included in the report is an indication that this is a response to a previously sent deferred location request.

If the location information could not be obtained, or the SGSN/MSC for some other reason decides to not wait any longer for the requested event to occur (ex. timer expires), the Subscriber Location Report will be returned with an appropriate error cause indicating termination of the deferred location request.

- 8) GMLC then returns the LCS Service Response to the LCS Client as in 9.1.2/9.1.6.

9.1.8.3 Cancellation of a Deferred Location Request

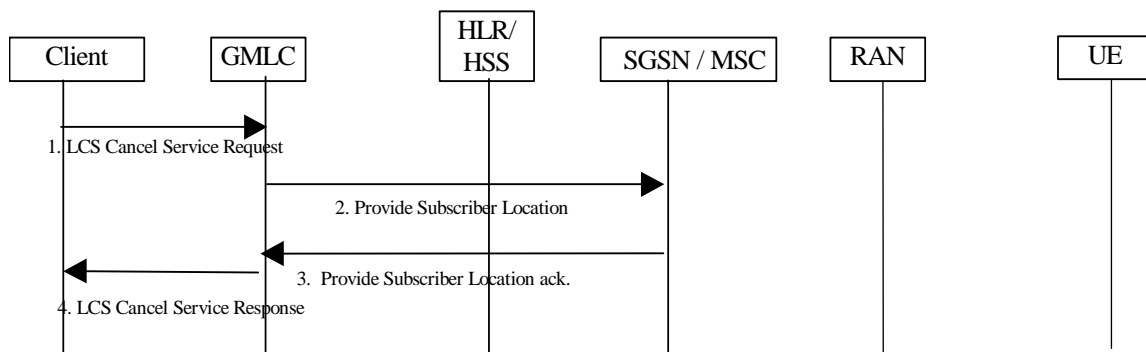

Figure 9.6b: Cancellation of a Deferred MT-LR procedure

- 1) The LCS Client requests the cancellation of a previously requested Deferred Location Request. The cancellation could be initiated by the GMLC itself for some reasons (e.g. implementation dependent timer in the GMLC expired). The event type to cancel must be indicated in the Cancellation procedure.
- 2) The GMLC will indicate this cancellation request in the Provide Subscriber Location toward the SGSN/MSC.
- 3) When the SGSN/MSC completes the cancellation procedure, it notifies it to the GMLC in the Provide Subscriber Location Ack (with no location estimate included).
- 4) The GMLC informs the LCS Client that the cancellation procedure has been successfully completed.

9.2 Mobile Originating Location Request

9.2.1 Mobile Originating Location Request, Circuit Switched (CS-MO-LR)

The following procedure shown in figure 9.7 allows an UE to request either its own location, location assistance data or broadcast assistance data message ciphering keys from the network. Location assistance data may be used subsequently by the UE to compute its own location throughout an extended interval using a mobile based position method. The ciphering key enables the UE to decipher other location assistance data broadcast periodically by the network. The MO-LR after location update request may be used to request ciphering keys or GPS assistance data using the follow-on procedure described in TS 24.008 [24]. The procedure may also be used to enable an UE to request that its own location be sent to another LCS client.

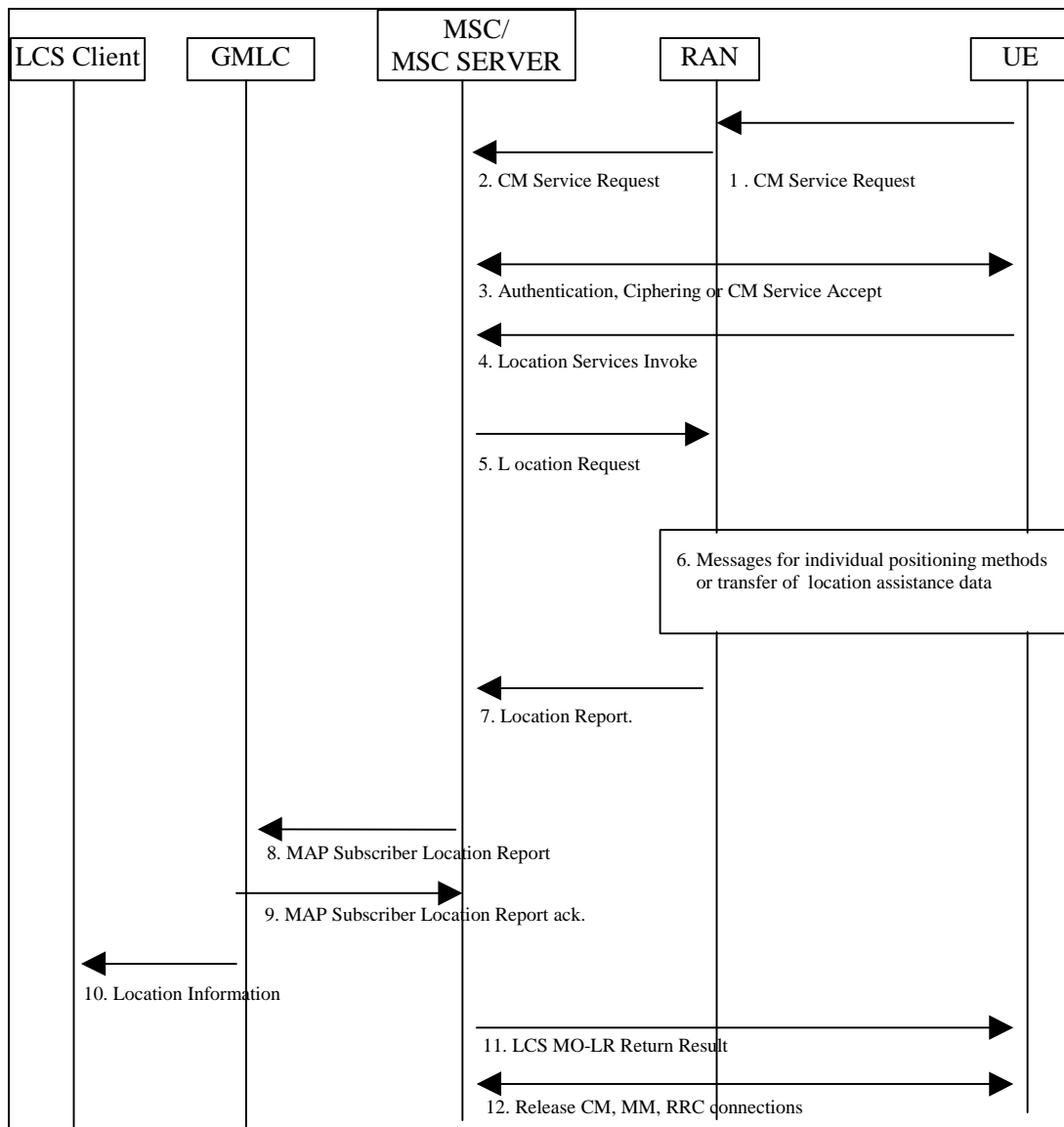

Figure 9.7: General Network Positioning for CS-MO-LR

9.2.1.1 Location Preparation Procedure

- 1) If the UE is in idle mode, the UE requests a radio connection setup and sends a CM service request indicating a request for a call independent supplementary services to the VMSC/MSC server via RAN.
- 2) RAN shall convey the CM service request to the core network. If the UE is in dedicated mode, the UE sends a CM Service Request on the already established radio connection.
- 3) The VMSC/MSC server instigates authentication and ciphering if the UE was in idle mode or returns a Direct Transfer CM Service Accept if the UE was in dedicated mode. The UE will inform the network about its LCS capabilities, as described in chapter 6.3.4.

- 4) The UE sends a LCS CS-MO-LR Location Services invoke to the VMSC/MSC server. If the UE is requesting its own location or that its own location be sent to another LCS client, this message carries LCS requested QoS information (e.g. accuracy, response time). If the UE is requesting that its location be sent to another LCS client, the message shall include the identity of the LCS client and may include the address of the GMLC through which the LCS client should be accessed. If a GMLC address is not included, the VMSC/MSC server may assign its own GMLC address and may verify that the identified LCS client is supported by this GMLC. If a GMLC address is not available for this case, the VMSC/MSC server shall reject the location request. If the UE is instead requesting location assistance data or ciphering keys, the message specifies the type of assistance data or deciphering keys and the positioning method for which the assistance data or ciphering applies. The VMSC/MSC server verifies in the UE's subscription profile that the UE has permission to request its own location, request that its location be sent to another LCS client or request location assistance data or deciphering keys (whichever applies). If the UE is requesting positioning and has an established call, the VMSC/MSC server may reject the request for certain non-speech call types.
- 5) The VMSC/MSC server sends a Location Request message to RAN associated with the Target UE. The message indicates whether a location estimate or location assistance data is requested and, in GSM, includes the UE's location capabilities. If the UE's location is requested, the message also includes the requested QoS. If location assistance data is requested, the message carries the requested types of location assistance data.

9.2.1.2 Positioning Measurement Establishment Procedure

- 6) If the UE is requesting its own location, RAN determines the positioning method and instigates the particular message sequence for this method, as specified in UTRAN Stage 2, TS 25.305 [1] and GERAN Stage 2, TS 43.059 [16]. If the UE is instead requesting location assistance data, RAN transfers this data to the UE as described in subsequent clauses in TS 25.305 [1] and TS 43.059 [16] UE.

9.2.1.3 Location Calculation and Release Procedure

- 7) When a location estimate best satisfying the requested QoS has been obtained or when the requested location assistance data has been transferred to the UE, RAN returns a Location Report to the VMSC/MSC server. This message carries the location estimate or ciphering keys if this was obtained. If a location estimate or deciphering keys were not successfully obtained or if the requested location assistance data could not be transferred successfully to the UE, a failure cause is included in the Location Report.
- 8) If the UE requested transfer of its location to another LCS client and a location estimate was successfully obtained, the VMSC/MSC server shall send a MAP Subscriber Location Report to the GMLC obtained in step 4 carrying the MSISDN of the UE, the identity of the LCS client, the event causing the location estimate (CS-MO-LR) and the location estimate and its age.
- 9) The GMLC shall acknowledge receipt of the location estimate provided that it serves the identified LCS client and the client is accessible.
- 10) The GMLC transfers the location information to the LCS client either immediately or upon request from the client.
- 11) The VMSC/MSC server returns an CS-MO-LR Return Result to the UE carrying any location estimate requested by the UE, ciphering keys or a confirmation that a location estimate was successfully transferred to the GMLC serving an LCS client.
- 12) The VMSC/MSC server may release the CM, MM and radio connections to the UE, if the UE was previously idle, and the VMSC/MSC server may record billing information.

NOTE: In case of positioning of emergency call stage 3 of the previous sequence is naturally omitted.

9.2.2 Mobile Originating Location Request, Packet Switched (PS-MO-LR)

The following procedure shown in figure 9.8 allows an UE to request either its own location; location assistance data or broadcast assistance data message ciphering keys from the network. Location assistance data may be used subsequently by the UE to compute its own location throughout an extended interval using a mobile based position method. A ciphering key enables the UE to decipher other location assistance data broadcast periodically by the network. The PS-MO-LR may be used to request ciphering keys or GPS assistance data. The procedure may also be used to enable an UE to request that its own location be sent to another LCS client.

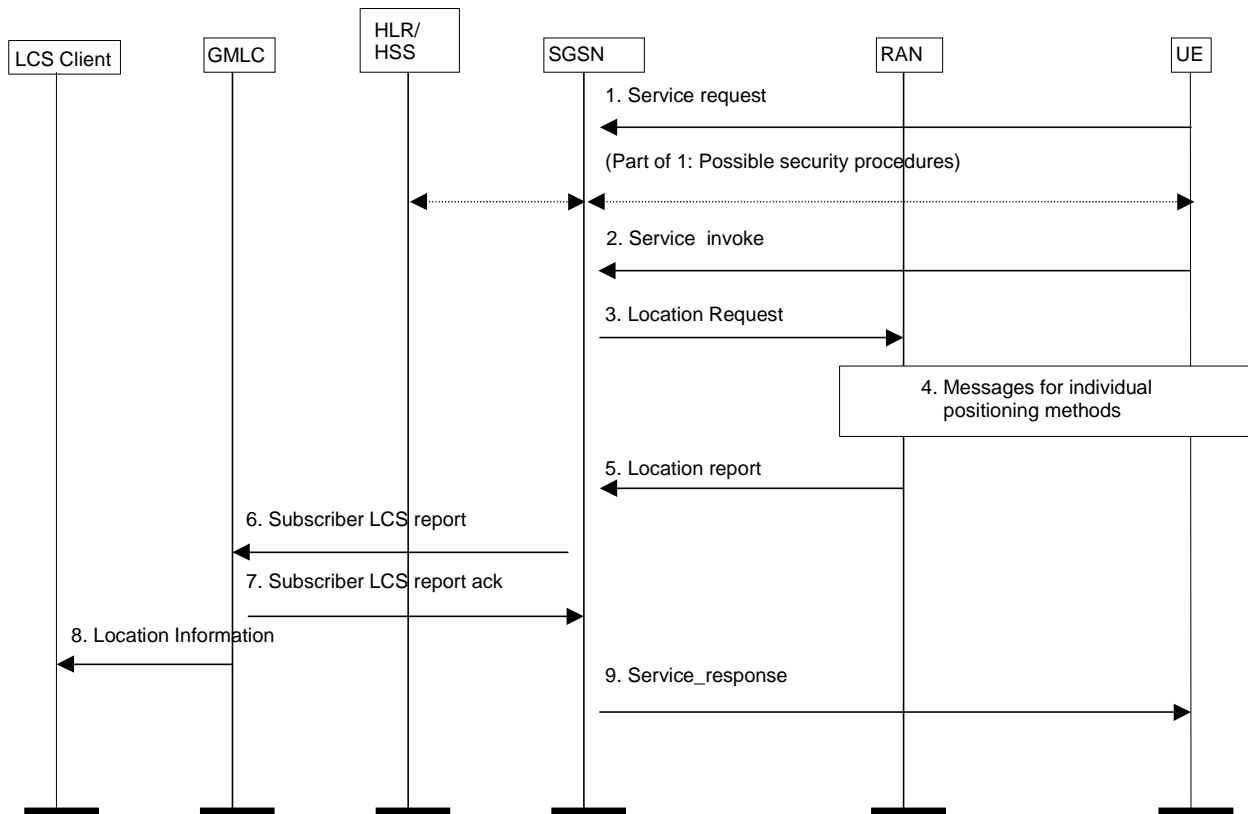

Figure 9.8: General Network Positioning for packet switched MO-LR

9.2.2.1 Location Preparation Procedure

- 1) In UMTS, if the UE is in idle mode, the UE requests a PS signaling connection and sends a Service request indicating signaling to the SGSN via the RAN. If the UE already has PS signaling connection, the UE does not need to send Service request. Security functions may be executed. These procedures are described in TS 23.060 [15].
- 2) The mobile station sends a service invoke message to the SGSN. Different types of location services can be requested: location of the UE, location of the UE to be sent to another LCS client, location assistance data or ciphering keys. If the UE is requesting its own location or that its own location be sent to another LCS client, this message carries LCS requested QoS information (e.g. accuracy, response time). If the UE is requesting that its location be sent to another LCS client, the message shall include the identity of the LCS client and may include the address of the GMLC through which the LCS client should be accessed. If a GMLC address is not included, the SGSN may assign its own GMLC address and may verify that the identified LCS client is supported by this GMLC. If a GMLC address is not available for this case, the SGSN shall reject the location request. If the UE is instead requesting location assistance data or ciphering keys, the message specifies the type of assistance data or deciphering keys and the positioning method for which the assistance data or ciphering keys applies. The SGSN verifies the subscription profile of the UE and decides if the requested service is allowed or not.

- 3) The SGSN sends a Location Request message to the RAN associated with the Target UE's location. The message indicates whether a location estimate or location assistance data is requested. If the UE's location is requested, the message also includes the requested QoS. If location assistance data is requested, the message carries the requested types of location assistance data. The message carries also location parameters received in the Service Invoke message.

9.2.2.2 Positioning Measurement Establishment Procedure

- 4) If the UE is requesting its own location, the actions described in UTRAN Stage 2, TS 25.305 [1] are performed. If the UE is instead requesting location assistance data, the RAN transfers this data to the UE as described in subsequent clauses. The RAN determines the exact location assistance data to transfer according to the type of data specified by the UE, the UE location capabilities and the current cell.

9.2.2.3 Location Calculation and Release Procedure

- 5) When a location estimate best satisfying the requested QoS has been obtained or when the requested location assistance data has been transferred to the UE, the RAN returns a Location Report to the SGSN. This message carries the location estimate or ciphering keys if this was obtained. If a location estimate or deciphering keys were not successfully obtained or if the requested location assistance data could not be transferred successfully to the UE, a failure cause is included in the Location Report.
- 6) If the UE requested transfer of its location to another LCS client and a location estimate was successfully obtained, the SGSN shall send a Subscriber Location Report to the GMLC obtained in step 1 carrying the MSISDN or PDP address of the UE, the identity of the LCS client, the event causing the location estimate (MO-LR-PS) and the location estimate and its age.
- 7) The GMLC shall acknowledge receipt of the location estimate provided that it serves the identified LCS client and the client is accessible.
- 8) The GMLC transfers the location information to the LCS client either immediately or upon request from the client.
- 9) The SGSN returns a Service Response message to the UE carrying any location estimate requested by the UE, ciphering keys or a confirmation that a location estimate was successfully transferred to the GMLC serving an LCS client.

NOTE: Steps 3 - 9 may be repeated a number of times in case of periodic location request.

9.3 LCS signaling procedures specified in UTRAN and GERAN Stage 2

The signaling procedures in UTRAN and GERAN are defined in TS 25.305 [1] and TS 43.059 [16] respectively.

9.4 Exception Procedures

The procedures in this clause apply to all variants of an MT-LR, NI-LR and MO-LR where a Location Request message has been sent to RAN requesting some location service (e.g. provision of a location estimate for a target UE or transfer of assistance data to a target UE).

9.4.1 Procedures in the VMSC

After the VMSC has requested a location service for a particular UE from RAN, certain events may occur that may temporarily or permanently interfere with the location service attempt. For each such event notified to the VMSC, the VMSC shall employ one of the following error recovery actions.

Restart the Location Service

This action shall be employed for any event that temporarily impedes a location service attempt and cannot be delayed until the location service attempt is complete. When such an event is notified to the VMSC, it shall immediately cancel the location service attempt and the associated signaling dialogue with RAN, if this still exists by sending a "stop reporting" message to RAN. The "stop reporting" message shall contain the reason for the location procedure cancellation in case of GERAN in A/Gb mode or the indication about the type of location request to cancel (e.g. direct) in case of GERAN and UTRAN in Iu mode.

After aborting the location request dialogue with RAN, the VMSC may queue the location service request until the event causing the restart has terminated (if not already terminated). The VMSC may optionally wait for an additional time period (e.g. if the queuing delay is minimal) to ensure that any resources allocated in and by RAN have time to be released. The VMSC may then send another location service request to RAN associated with the target UE.

Abort the Location Service

This action shall be employed for any event that permanently impedes a location service attempt, such as loss of the dedicated signaling channel to the target UE. When such an event is notified to the VMSC, it shall cancel the current location service attempt and the associated signaling dialogue with RAN, if still existing, by sending a "stop reporting" message to RAN. The "stop reporting" message shall contain the reason for the location procedure cancellation in case of GERAN in A/Gb mode or the indication about the type of location request to cancel (e.g. direct) in case of GERAN and UTRAN in Iu mode. The VMSC shall then return an error response to the client or network entity from which the location request was originally received. The VMSC shall also release all resources specifically allocated for the location attempt.

The following table indicates the appropriate error recovery procedure for certain events. For events not listed in the table, the VMSC need take no action.

Table 9.1: LCS Error Recovery Procedures in the VMSC for certain Events

Event	VMSC Error Recovery
Release of radio channel to the UE	Abort
Any error response from RAN except for SRNC relocation or inter-MSC handover	Abort
In UMTS SRNC relocation	[Note: This is being discussed in RAN WG2 and RAN WG3.]
In GSM inter-MSC Handover and inter-BSC handover	Restart after handover completed

If the RNC is in an overload condition, it may reject a location request by indicating congestion. The MSC may reduce the frequency of future location service requests until rejection due to overload has ceased.

9.4.2 Procedures in the MSC Server

9.4.3 Procedures in the 3G-SGSN

After the SGSN has requested a location service for a particular UE from RAN, certain events may occur that may temporarily or permanently interfere with the location service attempt. For each such event notified to the SGSN, the SGSN shall employ one of the following error recovery actions.

Restart the Location Service

This action shall be employed for any event that temporarily impedes a location service attempt and cannot be delayed until the location service attempt is complete. When such an event is notified to the SGSN, it shall immediately cancel the location service attempt and the associated signaling dialogue with RAN, if this still exists by sending a "stop reporting" message to RAN. The "stop reporting" message shall contain the reason for the location procedure cancellation.

After aborting the location request dialogue with RAN, the SGSN may queue the location service request until the event causing the restart has terminated (if not already terminated). The SGSN may optionally wait for an additional time period (e.g. if the queuing delay is minimal) to ensure that any resources allocated in and by RAN have time to be released. The SGSN may then send another location service request to RAN associated with the target UE.

Abort the Location Service

This action shall be employed for any event that permanently impedes a location service attempt, such as loss of the radio channel to the target UE. When such an event is notified to the SGSN, it shall cancel the current location service attempt and the associated signaling dialogue with RAN, if still existing, by sending a "stop reporting" message to RAN. The "stop reporting" message shall contain the reason for the location procedure cancellation. The SGSN shall then return an error response to the client or network entity from which the location request was originally received. The SGSN shall also release all resources specifically allocated for the location attempt.

The following table indicates the appropriate error recovery procedure for certain events. For events not listed in the table, the SGSN need take no action.

Table 9.2: LCS Error Recovery Procedures in the SGSN for certain Events

Event	SGSN Error Recovery
Release of radio channel to the UE	Abort
Any error response from RAN causing unavailable signalling connections	Abort
SRNC relocation (UMTS only)	[Note: This is being discussed in RAN WG2 and RAN WG3.]

9.4.4 Procedures in the UE

9.4.5 Further Procedures for Handover

[Editor's note: During soft and softer handovers in WCDMA (inter Node-B, inter RNC) the existing RRC connection can be used with no need for aborting the on-going positioning process. In case of hard handovers, e.g. inter RNC hard handover (or SRNC relocation) and inter CN (MSC, SGSN) handovers the same approach can be followed as for any service connection (e.g. call handover). Therefore, aborting the service requests, including LCS request, because of handovers is not needed. The exception procedures and error cases in UMTS need to be further studied. It is currently being discussed between RAN WG2 and WG3 how to handle the LCS request during SRNC relocation.]

9.4.5.1 MSC procedure for Inter-MSC Handover

[When a location estimate is required for a target UE with an established call in a state of inter-MSC handover, the serving location area ID shall be used by the visited MSC to identify the correct RAN to perform the location. All Location request related messages that are transferred over the Iu-interface shall now be sent via MAP/E interface piggy-backed in MAP_FORWARD_ACCESS_SIGNALLING and MAP_PROCESS_ACCESS_SIGNALLING between the visited and serving MSCs. The handling of LCS request during Inter-MSC handover in UMTS is FFS.]

9.4.5.2 Handling of an ongoing handover while a request for positioning arrives at MSC/VLR

[If during an ongoing radio handover procedure a request for location information arrives at RAN, the request shall be suspended until the handover is completed. On completion of the handover, RAN shall continue with location preparation procedure.]

9.5 Privacy

9.5.1 Privacy Override Indicator (POI)

The POI is used to determine whether the privacy settings of the subscriber to be positioned shall be overridden by the request for location services. The POI is applicable only to Emergency service and Lawful intercept service. The assignment of a POI value with an "override" or "not override" value in the LCS client profile is done during the LCS client provisioning. The type of LCS client requesting location information (i.e. emergency, law-enforcement etc.) shall determine the value of the POI assigned to the LCS client profile.

There are two distinct cases regarding the handling of the privacy override indicator.

Procedure A: If the subscriber to be positioned is in the same country as the GMLC then the POI shall override the subscriber's privacy options, as allowed by regulatory requirements.

Procedure B: Otherwise the POI shall not override the subscriber's privacy options.

9.5.2 Privacy Procedures

The SLPP shall contain the privacy options defined in the HLR of the UE subscriber.

The SLPP shall be downloaded to the VMSC, MSC Server and SGSN together with the rest of his subscription information in the existing operation INSERT_SUBSCRIBER_DATA. It will be deleted with the existing operation DELETE_SUBSCRIBER_DATA.

The POI is transferred from the GMLC to the VMSC/MSC Server/SGSN in the location request. Based on the location of the GMLC the VMSC/MSC Server/SGSN evaluates whether to accept or ignore the received POI according to the definition in clause.

If the POI is accepted the location requested is unconditionally performed. Otherwise if the POI is ignored the VMSC/MSC Server/SGSN evaluates the privacy options in the UE subscriber's subscription profile (assuming this is held in the VLR/MSC Server/SGSN). If the corresponding register does not contain the UE subscription profile, LCS will rely on the existing GSM recovery mechanisms to obtain the profile.

If more than one privacy class are subscribed, privacy class for an MT-LR is selected according to the rule described in the ANNEX A.

If the location request is allowed by the privacy options the location request is performed. Otherwise, if the location request is barred by the privacy options, the location request is refused an error response is returned to the GMLC with a cause code indicating that the request was rejected by the subscriber.

9.5.3 UE Privacy Options

The UE privacy options in the SLPP apply to an CS-MT-LR/PS-MT-LR or NI-LR/PS-NI-LR and either indicate that no CS-MT-LR/PS-MT-LR or NI-LR/PS-NI-LR is allowed for the UE (except as may be overridden by the POI or local regulatory requirements) or define the particular classes of LCS client for which an CS-MT-LR/PS-MT-LR or NI-LR/PS-NI-LR for location are allowed, with the following classes being possible:

[Editor's note: An e-mail comment pointed out that there are different cases still to be covered in the description of the classes: 1. the LCS Client identity is included in SLPP or 2. the LCS Client identity is NOT included in SLPP. Also some GMLC restriction conditions need to be mentioned.]

- a) Universal Class - allow positioning by all LCS clients;
- b) Call/Session related Class
- c) Call/Session-unrelated Class
- d) PLMN operator Class

All UE privacy options of above four classes are commonly used for both CS and PS domain.

Note: If a privacy option setting in a domain is updated, the same modification will be applied to the other domain.

9.5.3.1 The classes and corresponding subscription options are described below. Universal class

When the user of the UE subscribes to the "Universal Class" the CS-MT-LR/PS-MT-LR or NI-LR/PS-NI-LR positioning is allowed by all LCS clients.

If the UE subscribes to the universal class, any CS-MT-LR or NI-LR shall be allowed by the VMSC/MSC Server and any PS-MT-LR or PS-NI-LR shall be allowed by the SGSN. If local regulatory requirements mandate it, any MT-LR for an emergency services LCS client and any NI-LR for an emergency services call origination shall be allowed by the VMSC/MSC Server.

9.5.3.2 Call/Session related class

When the user of the UE subscribes to the "Call/Session related Class" the CS-MT-LR/PS-MT-LR or NI-LR/PS-NI-LR positioning is allowed in the following cases:

Allow positioning by specific identified value added LCS client or groups of value added LCS Client to which the UE originated a call in CS domain or a value added LCS client with which the UE has a session via an active PDP context in PS domain indicated by a specific APN-NI. For all clients in the call related class, OR For each identified LCS client or group of LCS Clients, one of the following subscription options shall apply:

- * location request allowed only from GMLCs identified in the SLPP;
- * location request allowed only from a GMLC in the home country;
- * location request allowed from any GMLC (default case).

For each identified value added LCS client or group of LCS Clients in the privacy exception list, one of the following subscription options shall apply:

- * positioning allowed without notifying the UE user (default case);
- * positioning allowed with notification to the UE user;
- * positioning requires notification and verification by the UE user; positioning is allowed only if granted by the UE user or if there is no response to the notification;
- * positioning requires notification and verification by the UE user; positioning is allowed only if granted by the UE user.

For all value added LCS clients sending a call related CS-MT-LR/PS-MT-LR that are not identified in the privacy exception list, one of the following subscription option shall apply:

- * positioning not allowed;
- * positioning allowed without notifying the UE user (default case);
- * positioning allowed with notification to the UE user;
- * positioning requires notification and verification by the UE user; positioning is allowed only if granted by the UE user or if there is no response to the notification;
- * positioning requires notification and verification by the UE user; positioning is allowed only if granted by the UE user.

NOTE 2: The usage of Call/Session related Class in the IM subsystem is FFS.

9.5.3.2.1 Call/session-related class in the CS-domain

If the UE subscribes to the call/session-related class, an CS-MT-LR may be allowed if both of following conditions are met:

- The UE previously originated a call in CS domain that is still established and the called party number dialled by the UE matches the called party number received from the GMLC.
- The identity of the LCS client or LCS client group supplied by the GMLC matches the identity of any LCS Client or LCS Client group contained in the UE's SLPP and any other GMLC restrictions associated with this LCS Client identity in the SLPP are also met

If these conditions are satisfied, the CS-MT-LR shall be allowed if the UE user subscribes to either location without notification or location with notification. If the UE user subscribes to location with notification and privacy verification, the CS-MT-LR shall be allowed following notification to the UE if the UE user either returns a response indicating that location is allowed or returns no response but subscribes to allowing location in the absence of a response. In all other cases, the CS-MT-LR shall be restricted.

9.5.3.2.2 Call/session-related class in the PS-domain

If the UE subscribes to the call/session-related class, a PS-MT-LR may be allowed if all of the following conditions are met:

- The UE previously originated a PDP-context towards the network where the external client is located and that this context is still established
- The APN-NI negotiated between the UE and SGSN matches the APN-NI received from the GMLC.
- The identity of the LCS client or LCS client group supplied by the GMLC matches the identity of any LCS Client or LCS Client group contained in the UE's SLPP and any other GMLC restrictions associated with this LCS Client identity in the SLPP are also met

If these conditions are satisfied, the PS-MT-LR shall be allowed if the UE user subscribes to either location without notification or location with notification. If the UE user subscribes to location with notification and privacy verification, the PS-MT-LR shall be allowed following notification to the UE if the UE user either returns a response indicating that location is allowed or returns no response but subscribes to allowing location in the absence of a response. In all other cases, the PS-MT-LR shall be restricted.

9.5.3.2.3 Call/session-related class when LCS client not in SLPP

If the UE subscribes to the call/session related class, a CS-MT-LR or PS-MT-LR from an LCS client that is NOT contained in the SLPP of the target UE shall be allowed or restricted according to the following conditions:

- For any non-matched LCS client, the CS-MT-LR or PS-MT-LR shall be allowed, if the UE user subscribes to either location without notification or location with notification.

If the UE user subscribes to location with notification and privacy verification, the CS-MT-LR or PS-MT-LR shall be allowed following notification to the UE if the UE user either returns a response indicating that location is allowed or returns no response but subscribes to location in the absence of a response. In all other cases, the CS-MT-LR or PS-MT-LR shall be restricted.

9.5.3.3 Call/Session-unrelated class

When the user of the UE subscribes to the "Call/Session unrelated Class" the CS-MT-LR/PS-MT-LR or NI-LR/PS-NI-LR positioning is allowed in the following cases:

Allow positioning by specific identified value added LCS Clients or groups of value added LCS Client with the following restrictions allowed for each identified value added LCS Client or group of value added LCS Clients:

- * location request allowed only from GMLCs identified in the SLPP;
- * location request allowed only from a GMLC in the home country;
- * location request allowed from any GMLC (default case).

For each identified value added LCS client in the privacy exception list, one of the following subscription options shall apply:

- * positioning allowed without notifying the UE user (default case);
- * positioning allowed with notification to the UE user;
- * positioning requires notification and verification by the UE user; positioning is allowed only if granted by the UE user or if there is no response to the notification;
- * positioning requires notification and verification by the UE user; positioning is allowed only if granted by the UE user.

For all value added LCS clients sending a non-call related CS-MT-LR/PS-MT-LR that are not identified in the privacy exception list, one of the following subscription option shall apply:

- * positioning not allowed (default case);
- * positioning allowed with notification to the UE user;
- * positioning requires notification and verification by the UE user; positioning is allowed only if granted by the UE user or if there is no response to the notification;
- * positioning requires notification and verification by the UE user; positioning is allowed only if granted by the UE user.

9.5.3.3.1 Call/session-unrelated class when LCS client identities match

If the UE subscribes to the call/session-unrelated class, an CS-MT-LR/PS-MT-LR may be allowed by the MSC/MSC server or SGSN if the identity of the LCS client or LCS client group supplied by the GMLC matches the identity of any LCS Client or LCS Client group contained in the UE's SLPP and any other GMLC restrictions associated with this LCS Client identity in the SLPP are also met.

If the LCS client is correctly matched in this way and any GMLC restrictions are satisfied, the CS-MT-LR/PS-MT-LR shall be allowed if the UE user subscribes to either location without notification or location with notification. If the UE user subscribes to location with notification and privacy verification, the CS-MT-LR/PS-MT-LR shall be allowed following notification to the UE if the UE user either returns a response indicating that location is allowed or returns no response but subscribes to location in the absence of a response. In all other cases, the CS-MT-LR/PS-MT-LR shall be restricted.

9.5.3.3.2 Call/session-unrelated class when LCS client identities do not match

If the UE subscribes to the call/session-unrelated class, an CS-MT-LR/PS-MT-LR from an LCS client that is not contained in the UE's SLPP shall be allowed or restricted according to the following conditions. For any non-matched LCS client, the CS-MT-LR/PS-MT-LR shall be allowed if the UE user subscribes to location with notification. If the UE user subscribes to location with notification and privacy verification, the CS-MT-LR/PS-MT-LR shall be allowed following notification to the UE if the UE user either returns a response indicating that location is allowed or returns no response but subscribes to location in the absence of a response. In all other cases, the CS-MT-LR/PS-MT-LR shall be restricted.

9.5.3.4 PLMN operator class

When the user of the UE subscribes to the "PLMN operator Class" the CS-MT-LR/PS-MT-LR or NI-LR/PS-NI-LR positioning is allowed in the following cases:

Allow positioning by specific types of client within or associated with the VPLMN, with the following types of client identified:

- * clients providing a location related broadcast service;
- * O&M client in the HPLMN (when the UE is currently being served by the HPLMN);
- * O&M client in the VPLMN;
- * clients recording anonymous location information without any UE identifier;
- * clients enhancing or supporting any supplementary service, IN service, bearer service or teleservice subscribed to by the target UE subscriber.

If the UE subscribes to the PLMN class, an NI-LR/PS-NI-LR or CS-MT-LR/PS-MT-LR shall be allowed if the client within the VPLMN, for an NI-LR/PS-NI-LR, or the client identified by the GMLC, for an CS-MT-LR/PS-MT-LR, either matches a generic type of client contained in the UE's SLPP or is otherwise authorized by local regulatory requirements to locate the UE.

9.5.3.5 Matching of LCS client identities

In evaluating privacy where any address "A" associated with the LCS client (e.g. LCS client ID or GMLC address) needs to be compared with a corresponding address "B" in the target UE's SLPP, a match shall be determined if a match is found for each of the following components of each address:

- a) numbering plan;
- b) nature of address indicator;
- c) corresponding address digits for all digits in "B" (the digits or initial digits in "A" must match all the digits in "B", but "A" may contain additional digits beyond those in "B").

All addresses shall be transferred to the MSC/VLR, MSC server or SGSN in international format, except for the called party number received from the GMLC during a Call-Related CS MT-LR when the LCS client was reached via IN or abbreviated number routing (e.g. toll-free number or emergency call routing). In these cases it is up to the GMLC to use the valid national specific number of the visited country.

In evaluating privacy where an APN-NI associated with the LCS client notified by the GMLC needs to be compared with a corresponding APN-NI that is used to set up the associated PDP context, a match shall be determined if a match is found for each component of APN-NI.

9.6 Mobile Originating Location

An UE may subscribe to any of the following classes of mobile originating location:

- a) Basic Self Location;
- b) Autonomous Self Location;
- c) Transfer to Third Party.

An MO-LR shall be allowed by the VMSC if the type of request is supported by the appropriate subscription according to the following table.

Table 9.3: Required UE Subscription Options for MO-LR Requests

Type of MO-LR Request	Required UE Subscription
UE requests own location	Basic Self Location
UE requests location assistance data	Autonomous Self Location
UE requests transfer of own location to another LCS Client	Transfer to Third Party

9.7 CM Procedures

9.7.1 Location request for a mobile in idle-mode

When a request for location information is received at the VMSC the LCS-layer shall order paging of the UE subscriber. In case of first unsuccessful paging, normal paging procedures should apply. After successful paging the LCS-layer shall invoke the location preparation procedure.

9.7.2 Location request for a mobile in dedicated-mode

When a request for location information is received at the VMSC, if the UE is already busy on CM level, the LCS-layer shall attempt to establish a parallel transaction to the existing one. If successful, the LCS-layer shall invoke the location preparation procedure.

10 Information storage

This clause describes information storage structures that are mandatory (M), conditional (C) or optional (O) for LCS, and the recovery and restoration procedures needed to maintain service if inconsistencies in databases occur and for lost or invalid database information. Information storage in RAN network elements is specified in UTRAN Stage 2 (TS 25.305 [1]) and GERAN Stage 2 (TS 43.059 [16]) specifications.

10.1 HLR and HSS

The HLR/HSS holds LCS data for both UE subscribers and LMUs.

10.1.1 LCS Data in the HLR/HSS for an UE Subscriber

The IMSI is the primary key for LCS UE subscription data in the HLR/HSS. This subscription data may be stored in a Multiple Subscriber Profile (MSP), with the HLR/HSS able to hold a number of MSPs per IMSI.

LCS UE subscription data includes a privacy exception list containing the privacy classes for which location of the target UE is permitted. Each privacy class is treated as a distinct supplementary service with its own supplementary service code. The following logical states are applicable to each privacy class (refer to TS 23.011 [22] for an explanation of the notation).

Table 10.1: Logical States for each LCS Privacy Class

Provisioning State	Registration State	Activation State	HLR Induction State
(Not Provisioned,	Not Applicable,	Not Active,	Not Induced)
(Provisioned,	Not Applicable,	Active and Operative,	Not Induced)

For each LCS privacy class, the HLR/HSS shall store the logical state of the class on a per-subscriber (or per subscriber MSP) basis. In addition, the permanent data indicated below shall be stored on a per subscriber (or per subscriber MSP) basis when the logical provisioning state of the associated LCS privacy class is "provisioned". For the meaning of each LCS privacy class, refer to clause 9 and to TS 22.071 [4].

**Table 10.2: LCS data stored in the HLR privacy exception list for an UE Subscriber
(or UE Subscriber MSP)**

LCS Privacy Class	Status	Additional HLR Data when Class is provisioned
Universal Class	-	No additional data
Call/session Related Class	M	Indication of one of the following mutually exclusive options for any LCS client not in the external LCS client list: <ul style="list-style-type: none"> • Location not allowed • Location allowed without notification (default case) • Location allowed with notification • Location with notification and privacy verification; location allowed if no response • Location with notification and privacy verification; location restricted if no response
	O	External LCS client list: a list of zero or more LCS clients, with the following data stored for each LCS client in the list: <ul style="list-style-type: none"> • International E.164 address identifying a single LCS client or a single group of LCS clients that are permitted to locate this target UE
	C	<ul style="list-style-type: none"> • Restriction on the GMLC. Possible values are: <ul style="list-style-type: none"> - Identified GMLCs only - Any GMLC in the home country
	O	<ul style="list-style-type: none"> • Indication of one of the following mutually exclusive options: <ul style="list-style-type: none"> - Location allowed without notification (default case) - Location allowed with notification - Location with notification and privacy verification; location allowed if no response - Location with notification and privacy verification; location restricted if no response
	C	<ul style="list-style-type: none"> • Indication of one of the following mutually exclusive options: <ul style="list-style-type: none"> - Location allowed without notification (default case) - Location allowed with notification - Location with notification and privacy verification; location allowed if no response - Location with notification and privacy verification; location restricted if no response
Call/session Unrelated Class	M	Indication of one of the following mutually exclusive options for any LCS client not in the external LCS client list: <ul style="list-style-type: none"> • Location not allowed (default case) • Location allowed with notification • Location with notification and privacy verification; location allowed if no response • Location with notification and privacy verification; location restricted if no response
	O	External LCS client list: a list of zero or more LCS clients, with the following data stored for each LCS client in the list: <ul style="list-style-type: none"> • International E.164 address identifying a single LCS client or a single group of LCS clients that are permitted to locate this target UE
	C	<ul style="list-style-type: none"> • Restriction on the GMLC. Possible values are: <ul style="list-style-type: none"> - Identified GMLCs only - Any GMLC in the home country
	O	<ul style="list-style-type: none"> • Indication of one of the following mutually exclusive options: <ul style="list-style-type: none"> - Location allowed without notification (default case) - Location allowed with notification - Location with notification and privacy verification; location allowed if no response - Location with notification and privacy verification; location restricted if no response
	C	<ul style="list-style-type: none"> • Indication of one of the following mutually exclusive options: <ul style="list-style-type: none"> - Location allowed without notification (default case) - Location allowed with notification - Location with notification and privacy verification; location allowed if no response - Location with notification and privacy verification; location restricted if no response
PLMN Operator Class	O	LCS client list: a list of one or more generic classes of LCS client that are allowed to locate the particular UE. The following classes are distinguished: <ul style="list-style-type: none"> • LCS client broadcasting location related information • O&M LCS client in the HPLMN • O&M LCS client in the VPLMN • LCS client recording anonymous location information • LCS Client supporting a bearer service, teleservice or supplementary service to the target UE

LCS UE subscription data may include a mobile originating list containing the LCS mobile originating classes that an UE is permitted to request. Each LCS mobile originating class is treated as a distinct supplementary service with its own supplementary service code. The following logical states are applicable to each mobile originating class (refer to TS 23.011 [22] for an explanation of the notation).

Table 10.3: Logical States for each Mobile Originating LCS Class

Provisioning State	Registration State	Activation State	HLR Induction State
(Not Provisioned,	Not Applicable,	Not Active,	Not Induced)
(Provisioned,	Not Applicable,	Active and Operative,	Not Induced)

For each LCS Mobile Originating class, the HLR/HSS shall store the logical state of the class on a per-subscriber (or per subscriber MSP) basis. In this version of LCS, there is no additional permanent data in the HLR. The table below shows the defined mobile originating classes. For the meaning of each LCS mobile originating class, refer to clause 8 and to TS 22.071 [4].

Table 10.4: Data stored in the HLR for the LCS Mobile Originating List for an UE (or UE Subscriber MSP)

LCS Mobile Originating Class	Status	Additional HLR Data when Class is provisioned
Basic Self Location	-	No additional data
Autonomous Self Location	-	No additional data
Transfer to Third Party	-	No additional data

In addition to the privacy exception list, the following other data items may be stored in the UE subscription profile in the HLR to support LCS.

Table 10.5: Temporary LCS data in the HLR

Other Data in the HLR	Status	Description
GMLC List	O	List of one or more E.164 addresses of the GMLCs from which a location request for an MT-LR is allowed, The addresses are only relevant to an LCS client that is restricted (in the UE privacy exception list) to making call/session related or call/session unrelated location requests.

10.2 VLR

The VLR contains the same LCS permanent data for each registered UE subscriber, as does the HLR/HSS. This data is downloaded to the VLR as part of the location update procedure between the VLR and HLR/HSS for an UE subscriber.

10.3 GMLC

The GMLC holds data for a set of external LCS clients that may make call related or non-call related CS-MT-LR/PS-MT-LR requests to this GMLC. The permanent data administered for each LCS client is as follows.

Table10.6: GMLC Permanent Data for a LCS Client

LCS Client data in GMLC	Status	Description
LCS Client Type	M	Identifies the type LCS client from among the following: <ul style="list-style-type: none"> - Emergency Services - Value Added Services - PLMN Operator Services - Lawful Intercept Services
External identity	O	A list of one or more identifiers used to identify an external LCS client. The identity may be used when making an MT-LR and/or MO-LR. The format of the identity is international E.164 addresses. Each external identity shall be associated with a logical client name.
Authentication data	M	Data employed to authenticate the identity of an LCS client – details are outside the scope of the present document
Call/session related identity	O	A list of one or more international E.164 addresses, which are used to make calls by mobile subscribers, or APN-NIs (see NOTE) to identify the client for a call related MT-LR In case the LCS client was reached via IN or abbreviated number routing (e.g. toll free number or emergency call routing), the E.164 number(s) stored in the GMLC shall be the number(s) that the UE has to dial to reach the LCS Client. In these cases the E.164 number is not to be in international format. The country in which the national specific number(s) is (are) applicable is (are) also stored (or implied) in this case. Each call related identity may be associated with a specific external identity. Each call/session-related identity shall be associated with a logical client name.
Internal identity	O	Identifies the type PLMN operator services and the following classes are distinguished: <ul style="list-style-type: none"> - LCS client broadcasting location related information - O&M LCS client in the HPLMN - O&M LCS client in the VPLMN - LCS client recording anonymous location information - LCS Client supporting a bearer service, teleservice or supplementary service to the target UE This identity is applicable only to PLMN Operator Services.
Client name	O	An address string which is a logical name associated with LCS client's external identity (i.e., E.164 address).
Override capability	O	Indication of whether the LCS client possesses the override capability (not applicable to a value added and PLMN operator service)
Authorized UE List	O	A list of MSISDNs or groups of MSISDN for which the LCS client may issue a non-call related MT-LR. Separate lists of MSISDNs and groups of MSISDN may be associated with each distinct external or non-call related client identity.
Priority	M	The priority of the LCS client – to be treated as either the default priority when priority is not negotiated between the LCS server and client or the highest allowed priority when priority is negotiated
QoS parameters	M	The default QoS requirements for the LCS client, comprising: <ul style="list-style-type: none"> - Accuracy - Response time Separate default QoS parameters may be maintained for each distinct LCS client identity (external, non-call related, call related)
Allowed LCS Request Types	M	Indicates which of the following are allowed: <ul style="list-style-type: none"> - Non-call related CS-MT-LR/PS-MT-LR - Call/session related CS-MT-LR/PS-MT-LR - Specification or negotiation of priority - Specification or negotiation of QoS parameters - Request of current location - Request of current or last known location
Local Co-ordinate System	O	Definition of the co-ordinate system(s) in which a location estimate shall be provided – details are outside the scope of the present document
Access Barring List(s)	O	List(s) of MSISDNs or groups of MSISDN for which a location request is barred

NOTE: The LCS Client is identified with E.164 number or APN. APN is specified in TS 23.003.

10.4 Recovery and Restoration Procedures

The LCS recovery and restoration procedures allow temporary data to be recovered or reinitialized following loss or corruption of data, such that normal LCS service is rapidly restored and inconsistency between the data held by different LCS network elements is removed. For a full description, refer to TS 23.007 [23].

10.5 Interworking with pre-Rel'4 LCS

This clause describes possible scenarios for interworking with a node which support only pre-Rel'4 LCS features and functions. Since LCS service performed in PS domain was introduced in REL4, there is no Pre-REL4 interworking issue for PS domain.

10.5.1 Interworking with the VLR supporting only pre-Rel'4 LCS

The VLR that supports only pre-Rel'4 LCS cannot handle the extended privacy control for call-related/call-unrelated class of the Rel'4 LCS. That is, the VLR cannot provide the extended call-related/call-unrelated class service to the user who subscribes to the Rel'4 LCS. Therefore HLR/HSS does not send the subscriber data on call-related/call-unrelated class for users who subscribe to the call-related class of Rel'4 LCS to the VLR that supports only pre-Rel'4 LCS. The HLR/HSS is notified whether the VLR supports Rel'4 LCS or not by an indication, which indicates all the LCS core network signalling capabilities the VLR supports, from the VLR during location update procedure. The following two LCS core network signalling capabilities are identified in the current version of this specification.

- LCS core network signalling capability set 1: R98 and R99 LCS (pre-Rel'4 LCS)
- LCS core network signalling capability set 2: Rel'4 or later LCS

The serving node, which notified the HLR/HSS that it supports LCS core network signalling capability set 2, shall be able to handle the extended LCS Client list and LCS Client List for call-related class from the HLR.

11 Operational Aspects

11.1 Charging

Charging Information collected by the PLMN serving the LCS Client.

The following charging information shall be collected by the PLMN serving the LCS Client:

- type and identity of the LCS Client;
- identity of the target UE;
- results (e.g. success/failure, method used if known, response time, accuracy) - to be repeated for each instance of positioning for a deferred location request;
- identity of the visited PLMN;
- LCS request type (i.e. LDR or LIR);
- state;
- event (applicable to LDR requests only);
- time stamp;
- type of co-ordinate system used.

11.2 Charging Information Collected by the Visited PLMN

The following charging information shall be collected by the visited PLMN:

- date and time;
- type and identity of the LCS Client (if known);
- identity of the target UE;
- location of the target UE (e.g., MSC, MSC Server, SGSN, location area ID, cell ID, location co-ordinates);
- which location services were requested;
- results (e.g. success/failure, positioning method used, response time, accuracy) - to be repeated for each instance of positioning for a batch location request;
- identity of the GMLC or PLMN serving the LCS Client;
- state;
- event (applicable to LDR requests only).

Annex A (normative): Privacy Class selection rule

If more than one privacy class are subscribed, privacy class for an MT-LR is selected according to the following flow diagram.

An MT-LR may be applied to more than one privacy class. In this case, looser privacy setting shall be selected. All possible privacy setting values are listed in the table below. The privacy settings to be compared are the results of the privacy checks for each applicable class. The interrelation among each privacy setting in terms of privacy strictness is shown as follows:

loose	Positioning allowed without notifying the UE user
↑	Positioning allowed with notification to the UE user
	Positioning requires notification and verification by the UE user; positioning is allowed only if granted by the UE user or if there is no response to the notification
↓	Positioning requires notification and verification by the UE user; positioning is allowed only if granted by the UE user
strict	Positioning not allowed

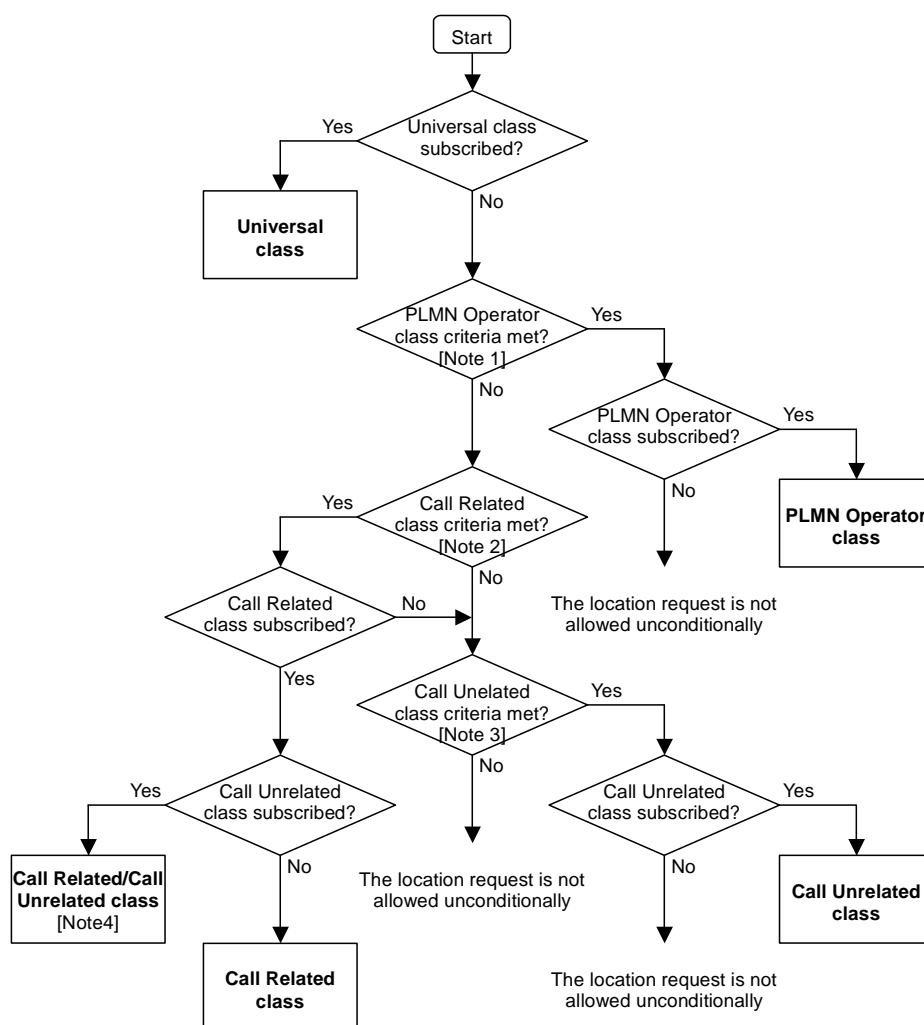

Figure A.1: Privacy Class selection flow diagram

- Note 1: The client type indicates PLMN Operator service, and the client is within or associated with the VPLMN.
- Note 2: The client type indicates value added service, and the Dialed by UE is available and matched with a call/session established.
- Note 3: The client type indicates value added service.
- Note 4: The looser privacy setting shall be selected.

Annex B (normative): Presence of LCS client ID Components in MT-LR

The LCS client identity is composed of one or more than one of the following components: LCS client type, external identity, internal identity, call/session related identity, APN-NI, and client name. The LCS client type shall always be present and for each LCS client type the presence of the other components are defined as follows:

Component	External identity	Internal identity	Call/session related identity	Client name
LCS Client type				
Emergency	O	N.A.	N.A.	N.A.
Value added	M	N.A.	O [Note]	M
PLMN operator	N.A.	M	N.A.	N.A.
Lawful Intercept	N.A.	N.A.	N.A.	N.A.

Note: This component shall be present if the MT-LR is associated to either CS call or PS session. If the MT-LR is associated with the CS call, the number dialled by UE is used. Otherwise if the MT-LR is associated with the PS session, the APN-NI is used.

Annex C: void

(void)

Annex D (informative): Change history

Date	Version	Comment
September 2000	1.0.0	Presented for information to SA#9.
21.11.00	1.1.0	Changes and additions from LCS drafting group 16.11.00, sent out for S2 e-mail approval
4.12.00	1.2.0	S2 e-mail comments received before 4.12.00 included
10.12.00	2.0.0	For approval at SA#10. Same content as v.1.2.0
31.01.01	4.0.0	Cleaning up of v.2.0.0. Same technical content as in 2.0.0.
05.04.01	4.1.0	CRs approved at TSG SA Plenary #11 in March 2001 included
30.06.01	4.2.0	CRs approved at TSG SA Plenary #12 in June 2001 included (SP-010371)

Document history		
4.0.0	December 2000	Approval at TSG SA#10.
4.1.0	March 2001	CRs approved at TSG SA#11 included.
4.2.0	June 2001	CRs approved at TSG SA#12 included.
4.3.0	October 2001	CRs approved at TSG SA#13 included: 032rev1 Applicability of Privacy Override Indicator 028rev1 Correction on the categorization of the periodical location request 029 Addition of the notification on the acceptance of the deferred location request 031rev1 Correction on the handling of the deferred location request in detached case 033 Privacy Check procedures for CS Call related MT-LR 034rev1 Privacy Class selection rule clarification
4.4.0	December 2001	CRs approved at TSG SA#14 included: 036 Clarification on the interworking issue with Pre-REL4 LCS PS Domain 041 Removal of PDP address from HLR/HSS in the MT-LR procedure 043 Response to LCS client in case of deferred MT-LR 050 Correction of referred signaling step in MO-Location Request
4.5.0	March 2002	CRs approved at TSG SA#15 included: 056 Supported LCS capabilities set 058rev3 Clarification of OSA support for LCS in TS23.271 063rev2 Essential correction for session related class 073rev1 Correction of information flows LCS client – GMLC 076rev1 Removal of NA-ESRK from MT-LR request for North American Emergency call

History

Document history		
V4.1.0	March 2001	Publication
V4.2.0	June 2001	Publication
V4.3.0	October 2001	Publication
V4.4.0	December 2001	Publication
V4.5.0	March 2002	Publication