

ETSI TS 123 272 V10.13.0 (2013-12)



**Digital cellular telecommunications system (Phase 2+);
Universal Mobile Telecommunications System (UMTS);
LTE;
Circuit Switched (CS)
fallback in Evolved Packet System (EPS);
Stage 2
(3GPP TS 23.272 version 10.13.0 Release 10)**



Reference

RTS/TSGS-0223272vad0

Keywords

GSM,LTE,UMTS

ETSI

650 Route des Lucioles
F-06921 Sophia Antipolis Cedex - FRANCE

Tel.: +33 4 92 94 42 00 Fax: +33 4 93 65 47 16

Siret N° 348 623 562 00017 - NAF 742 C
Association à but non lucratif enregistrée à la
Sous-Préfecture de Grasse (06) N° 7803/88

Important notice

Individual copies of the present document can be downloaded from:

<http://www.etsi.org>

The present document may be made available in more than one electronic version or in print. In any case of existing or perceived difference in contents between such versions, the reference version is the Portable Document Format (PDF). In case of dispute, the reference shall be the printing on ETSI printers of the PDF version kept on a specific network drive within ETSI Secretariat.

Users of the present document should be aware that the document may be subject to revision or change of status. Information on the current status of this and other ETSI documents is available at

<http://portal.etsi.org/tb/status/status.asp>

If you find errors in the present document, please send your comment to one of the following services:

http://portal.etsi.org/chaicor/ETSI_support.asp

Copyright Notification

No part may be reproduced except as authorized by written permission.
The copyright and the foregoing restriction extend to reproduction in all media.

© European Telecommunications Standards Institute 2013.
All rights reserved.

DECT™, **PLUGTESTS™**, **UMTS™** and the ETSI logo are Trade Marks of ETSI registered for the benefit of its Members.
3GPP™ and **LTE™** are Trade Marks of ETSI registered for the benefit of its Members and of the 3GPP Organizational Partners.
GSM® and the GSM logo are Trade Marks registered and owned by the GSM Association.

Intellectual Property Rights

IPRs essential or potentially essential to the present document may have been declared to ETSI. The information pertaining to these essential IPRs, if any, is publicly available for **ETSI members and non-members**, and can be found in ETSI SR 000 314: *"Intellectual Property Rights (IPRs); Essential, or potentially Essential, IPRs notified to ETSI in respect of ETSI standards"*, which is available from the ETSI Secretariat. Latest updates are available on the ETSI Web server (<http://ipr.etsi.org>).

Pursuant to the ETSI IPR Policy, no investigation, including IPR searches, has been carried out by ETSI. No guarantee can be given as to the existence of other IPRs not referenced in ETSI SR 000 314 (or the updates on the ETSI Web server) which are, or may be, or may become, essential to the present document.

Foreword

This Technical Specification (TS) has been produced by ETSI 3rd Generation Partnership Project (3GPP).

The present document may refer to technical specifications or reports using their 3GPP identities, UMTS identities or GSM identities. These should be interpreted as being references to the corresponding ETSI deliverables.

The cross reference between GSM, UMTS, 3GPP and ETSI identities can be found under <http://webapp.etsi.org/key/queryform.asp>.

Contents

Intellectual Property Rights	2
Foreword.....	2
Foreword.....	6
1 Scope	7
2 References	7
3 Definitions and abbreviations.....	9
3.1 Definitions	9
3.2 Abbreviations	9
4 Overall Description	9
4.1 General Considerations	9
4.2 Reference Architecture	10
4.2.1 Reference points	10
4.3 Functional entities	10
4.3.1 UE.....	10
4.3.2 MME.....	11
4.3.3 MSC.....	12
4.3.4 E-UTRAN.....	12
4.3.5 SGSN.....	12
4.3.6 BSS	13
4.3.7 RNS	13
4.4 Control plane.....	13
4.4.1 MME - MSC Server.....	13
4.5 Co-existence with IMS services	13
4.6 Emergency Calls	13
4.6.1 General.....	13
4.6.2 Procedures to handle emergency call setup with IMSI.....	14
4.6a Interaction with IMS Emergency session.....	14
4.7 CSFB Priority Call Handling.....	14
4.8 CS services handling in specific cases	15
4.8.1 SGs paging without LAI.....	15
4.8.2 Handling of SGs paging when MME cannot retrieve the S-TMSI.....	15
5 Mobility Management	15
5.1 General	15
5.1A TAI list and LAI allocation	15
5.2 Attach procedure	16
5.3 Detach procedure.....	17
5.3.1 UE-initiated Detach procedure	17
5.3.1A UE-initiated Detach procedure for GERAN/UTRAN with ISR activated.....	18
5.3.2 MME-initiated Detach procedure	19
5.3.2A SGSN-initiated Detach procedure with ISR activated	19
5.3.3 HSS-initiated Detach procedure	20
5.3.4 Administration of the MME - MSC/VLR Association	20
5.4 TA/LA Update procedure.....	20
5.4.0 General.....	20
5.4.1 Combined TA/LA Update Procedure	21
5.4.2 Periodic TA and LA Update Procedure	22
5.4.3 Non-EPS Alert procedure	22
5.4.4 Void	23
5.5 Idle Mode Signalling Reduction.....	23
5.6 Mobility Management for SMS over SGs only UEs	24
6 Mobile Originating Call	24
6.1 General	24

6.2	Mobile Originating call in Active Mode - PS HO supported	25
6.3	Mobile Originating call in Active Mode – No PS HO support	27
6.4	Mobile Originating call in Idle Mode.....	31
6.5	Returning back to E-UTRAN.....	31
6.6	Mobile Originated or Mobile terminated call rejected by the MME.....	32
7	Mobile Terminating Call.....	34
7.1	General	34
7.2	Mobile Terminating call in idle mode	34
7.3	Mobile Terminating call in Active Mode - PS HO supported	36
7.4	Mobile Terminating call in Active Mode - No PS HO support.....	39
7.5	Roaming Retry for CS fallback	43
7.5a	Roaming Forwarding for CS fallback	44
7.5b	Coexistence of Roaming Retry and Roaming Forwarding for CS fallback.....	47
7.6	Returning back to E-UTRAN.....	47
7.7	Interaction with ISR	47
7.7.1	Void	47
7.7.2	Mobile Terminating Call when ISR is active and SGs is active between MSC/VLR and MME	48
7.7.3	Void.....	49
7.8	Mobile Terminating Call when SGs is not active.....	49
8	Other CS Services	49
8.1	General	49
8.2	Short Message Service (SMS).....	49
8.2.1	General.....	49
8.2.2	Mobile originating SMS in Idle Mode.....	49
8.2.3	Mobile originating SMS in Active Mode	51
8.2.3a	Multiple Mobile originating SMSs	51
8.2.4	Mobile terminating SMS in idle mode.....	51
8.2.5	Mobile terminating SMS in Active Mode.....	52
8.2.5a	Multiple Mobile terminating SMSs	52
8.2.5b	Simultaneous Mobile terminating and Mobile originating SMSs.....	52
8.2.5c	Unsuccessful Mobile terminating SMS delivery attempt	52
8.2.5d	Non-SMS Mobile terminating activity during SMS delivery	53
8.2.5e	Non-SMS Mobile originating activity during SMS delivery	53
8.2.5f	Mobile Terminating SMS when ISR is active and SGs is active between MSC/VLR and MME	53
8.2.6	Co-Existence with SMS over generic 3GPP IP access	53
8.3	Location Services (LCS)	54
8.3.1	MO-LR procedure	54
8.3.1.1	General	54
8.3.1.2	MO-LR in Active Mode with IMS VoIP session - PS HO supported.....	55
8.3.1.3	MO-LR in Active Mode with IMS VoIP session - No PS HO supported	55
8.3.2	MT-LR procedure.....	56
8.3.2.1	MT-LR procedure if UE is not in IMS VoIP session.....	56
8.3.2.2	MT-LR procedure while UE is in IMS VoIP session.....	57
8.3.3	NI-LR procedure.....	58
8.3.4	Returning back to E-UTRAN	58
8.3.5	Co-Existence with Other Location Services	58
8.3.5.1	Co-Existence with SUPL	58
8.4	Other CS Services	58
8.4.0	General.....	58
8.4.1	Mobile-Initiated CS Services.....	58
8.4.2	NW-Initiated CS Services.....	59
8.4.3	Returning back to E-UTRAN	59
Annex A:	 Void	60
Annex B (normative):	 CS Fallback to 1xRTT	61
B.1	Overall Description	61
B.1.1	General Considerations	61
B.1.2	Reference Architecture	61
B.1.2.1	Reference points	62

B.1.3	Functional entities	62
B.1.3.1	UE.....	62
B.1.3.2	MME.....	62
B.1.3.3	E-UTRAN.....	63
B.1.4	Co-existence with IMS services	63
B.1.5	CSFB Priority Call Handling.....	63
B.2	Procedures	64
B.2.1	Mobility Management	64
B.2.1.1	1x RTT CS Pre-Registration over EPS Procedure	64
B.2.1.2	S102 Tunnel Redirection	65
B.2.1.3	UE-initiated Detach Procedure	66
B.2.2	Mobile Originating Call in Active Mode	66
B.2.2a	Mobile Originating call in Idle Mode.....	68
B.2.3	Mobile Terminating Call	68
B.2.3a	Enhanced CS fallback to 1xRTT Procedure.....	70
B.2.3a.1	General	70
B.2.3a.2	Mobile Originating Call without concurrent PS handover, or with concurrent non-optimised PS handover or optimised idle-mode PS handover.....	71
B.2.3a.3	Mobile Originating Call with concurrent optimised PS handover	73
B.2.3a.4	Mobile Terminating Call without PS handover, or with concurrent non-optimised PS handover or optimised idle-mode PS handover.....	75
B.2.3a.5	Mobile Terminating Call with concurrent optimised PS handover	76
B.2.3a.6	Interaction between enhanced CS Fallback to 1xRTT and optimised PS handover.....	77
B.2.3b	Mobile Originated or Mobile terminated call rejected by the MME	77
B.2.4	Short Message Service (SMS).....	79
B.2.4.1	General.....	79
B.2.4.2	Mobile originating SMS	79
B.2.4.3	Mobile terminating SMS	80
B.2.5	Emergency Calls	81
B.3	CS Fallback for UEs with dual Rx configuration.....	81
B.3.1	General Considerations	81
B.3.2	Procedures for leaving E-UTRAN	82
B.3.3	Procedures for returning to E-UTRAN	83
Annex C (informative):	Change history	84
History		86

Foreword

This Technical Specification has been produced by the 3rd Generation Partnership Project (3GPP).

The contents of the present document are subject to continuing work within the TSG and may change following formal TSG approval. Should the TSG modify the contents of the present document, it will be re-released by the TSG with an identifying change of release date and an increase in version number as follows:

Version x.y.z

where:

- x the first digit:
 - 1 presented to TSG for information;
 - 2 presented to TSG for approval;
 - 3 or greater indicates TSG approved document under change control.
- y the second digit is incremented for all changes of substance, i.e. technical enhancements, corrections, updates, etc.
- z the third digit is incremented when editorial only changes have been incorporated in the document.

1 Scope

This document defines the Stage 2 architecture and specification for the CS Fallback and for SMS over SGs for EPS or CS Fallback and SMS over S102. The scope of this document includes the architecture enhancements for functionality to enable fallback from E-UTRAN access to UTRAN/GERAN CS domain access and to CDMA 1x RTT CS domain access, and functionality to reuse of voice and other CS-domain services (e.g. CS UDI video / LCS / USSD) by reuse of the CS domain. The functionality specified to support SMS over SGs does not trigger any CS Fallback to UTRAN/GERAN. The functionality specified to support SMS over S102 does not trigger any CS Fallback to CDMA 1xRTT CS domain.

The architecture enhancements to support CS fallback to CDMA 1x RTT CS domain access for UEs with single and dual receiver configurations are specified in Annex B.

In this Release of the specification no mechanisms are specified to support CS Fallback to both UTRAN/GERAN and CDMA 1xRTT in the same PLMN. So, even when a UE has the capability to support both CS Fallback to UTRAN/GERAN CS domain and CS Fallback to CDMA 1xRTT CS domain in a given PLMN, the PLMN implements only one of the two.

2 References

The following documents contain provisions which, through reference in this text, constitute provisions of the present document.

- References are either specific (identified by date of publication, edition number, version number, etc.) or non-specific.
- For a specific reference, subsequent revisions do not apply.
- For a non-specific reference, the latest version applies. In the case of a reference to a 3GPP document (including a GSM document), a non-specific reference implicitly refers to the latest version of that document *in the same Release as the present document*.

- [1] 3GPP TR 21.905: "Vocabulary for 3GPP Specifications".
- [2] 3GPP TS 23.401: "GPRS Enhancements for E-UTRAN Access".
- [3] 3GPP TS 23.060: "General Packet Radio Service (GPRS); Service description; Stage 2".
- [4] 3GPP TS 44.018: "Mobile radio interface layer 3 specification Radio Resource Control (RRC) protocol".
- [5] 3GPP TS 23.018: "Basic call handling; Technical realization".
- [6] 3GPP TS 48.008: "MSC-BSS interface layer 3 specification; Protocol specification".
- [7] 3GPP TS 25.331: "Radio Resource Control (RRC); Protocol specification".
- [8] 3GPP TS 23.271: "Functional stage 2 description of Location Services (LCS)".
- [9] Open Mobile Alliance, OMA AD SUPL: "Secure User Plane Location Architecture", <http://www.openmobilealliance.org>.
- [10] 3GPP TS 23.090: "Unstructured Supplementary Service Data (USSD); Stage 2".
- [11] Void.
- [12] 3GPP TS 44.060: "MS-BSS interface; RLC/MAC protocol".
- [13] 3GPP TS 24.010: "Supplementary services specification; General aspects".
- [14] 3GPP TS 23.040: "Technical realization of the Short Message Service (SMS)".

- [15] 3GPP TS 23.204: "Short Message Service (SMS) over generic 3GPP Internet Protocol (IP) access".
- [16] 3GPP2 A.S0008-C: "Interoperability Specification (IOS) for High Rate Packet Data (HRPD) Radio Access Network Interfaces with Session Control in the Access Network".
- [17] 3GPP2 A.S0009-C: "Interoperability Specification (IOS) for High Rate Packet Data (HRPD) Radio Access Network Interfaces with Session Control in the Packet Control Function".
- [18] 3GPP2 A.S0013-C: "Interoperability Specification (IOS) for cdma2000 Access Network Interfaces – part 3 Features".
- [19] 3GPP TR 36.938: "Improved Network Controlled Mobility between E-UTRAN and 3GPP2/Mobile WiMAX Radio Technologies".
- [20] 3GPP TS 23.216: "Single Radio Voice Call Continuity (SRVCC); Stage 2".
- [21] 3GPP TS 24.008: "Mobile radio interface Layer 3 specification; Core network protocols; Stage 3".
- [22] 3GPP2 X.S0042-0: "Voice Call Continuity between IMS and Circuit Switched System".
- [23] 3GPP TS 23.236: "Intra-domain connection of Radio Access Network (RAN) nodes to multiple Core Network (CN) nodes".
- [24] 3GPP TS 43.055: "Radio Access Network; Dual Transfer Mode (DTM); Stage 2".
- [25] 3GPP TS 23.292: "IMS Centralised Services (ICS); Stage 2".
- [26] 3GPP TS 23.221: "Architectural Requirements".
- [27] 3GPP TS 23.402: "Architecture enhancements for non-3GPP accesses".
- [28] 3GPP TS 24.011: "Point-to-Point (PP) Short Message Service (SMS) support on mobile radio interface".
- [29] 3GPP TS 25.413: "UTRAN Iu interface Radio Access Network Application Part (RANAP) signalling".
- [30] 3GPP TS 48.018: "General Packet Radio Service (GPRS); BSS GPRS Protocol (BSSGP)".
- [31] 3GPP TS 23.082: "Call Forwarding (CF) supplementary services; Stage 2".
- [32] 3GPP2 C.S0005-A: "Upper Layer (Layer 3) Signaling Standard for cdma2000 Spread Spectrum Systems - Release A, Addendum 2".
- [33] 3GPP TS 36.331: "Evolved Universal Terrestrial Radio Access (E-UTRA) Radio Resource Control (RRC)"
- [34] 3GPP TS 24.301: "Non-Access-Stratum (NAS) protocol for Evolved Packet System (EPS); Stage 3".
- [35] 3GPP TS 36.413: "S1 Application Protocol (S1AP)".
- [36] 3GPP TS 22.153: "Multimedia Priority Services".
- [37] 3GPP TS 22.067: "enhanced Multi Level Precedence and Pre emption service (eMLPP) - Stage 1".
- [38] 3GPP TS 22.011: "Service accessibility".
- [39] 3GPP2 A.S0008-C: "Interoperability Specification (IOS) for High Rate Packet Data (HRPD) Radio Access Network Interfaces with Session Control in the Access Network".
- [40] 3GPP2 A.S0009-C: "Interoperability Specification (IOS) for High Rate Packet Data (HRPD) Radio Access Network Interfaces with Session Control in the Packet Control Function".
- [41] 3GPP TS 23.146: "Technical realization of facsimile group 3 non-transparent".

3 Definitions and abbreviations

3.1 Definitions

For the purposes of the present document, the terms and definitions given in TR 21.905 [1] apply. A term defined in the present document takes precedence over the definition of the same term, if any, in TR 21.905 [1].

1xCS: The 3GPP2 legacy circuit Switched signalling system as defined in 3GPP2 X.S0042-0 [22].

CSMT flag: A flag in LA update request message used in CS fallback for MT call to avoid missing paging in roaming retry.

CSMO flag: A flag in CM Service Request and LA Update request message used in CS fallback for MO calls.

Service User: See TS 22.153 [36].

3.2 Abbreviations

For the purposes of the present document, the abbreviations given in TR 21.905 [1] apply. An abbreviation defined in the present document takes precedence over the definition of the same abbreviation, if any, in TR 21.905 [1].

1xCS IWS	Circuit Switched fallback Interworking solution Function for 3GPP2 1xCS.
CSMT	Circuit Switched fallback Mobile Terminated call.
CSMO	Circuit Switched fallback Mobile Originated call.
eMLPP	enhanced Multi Level Precedence and Pre-emption
ICS	IMS Centralised Services
MPS	Multimedia Priority Service
MTRF	Mobile Terminating Roaming Forwarding
NEAF	Non-EPS Alert Flag.
SRVCC	Single Radio Voice Call Continuity

4 Overall Description

4.1 General Considerations

The CS fallback in EPS enables the provisioning of voice and other CS-domain services (e.g. CS UDI video/ LCS/ USSD) by reuse of CS infrastructure when the UE is served by E-UTRAN. A CS fallback enabled terminal, connected to E-UTRAN may use GERAN or UTRAN to connect to the CS-domain. This function is only available in case E-UTRAN coverage is overlapped by either GERAN coverage or UTRAN coverage.

CS Fallback and IMS-based services shall be able to co-exist in the same operator's network.

The ICS architecture as defined in TS 23.292 [25] shall be able to co-exist with utilising CS Fallback as the CS domain in the same operator's network.

This specification also specifies the architecture required for SMS over SGs. The MO SMS and MT SMS are signalled over SGs and do not cause any CS Fallback to GERAN/UTRAN RATs, and consequently does not require any overlapped GERAN/UTRAN coverage.

The support of SMS over SGs is mandatory for UE and MME and MSC supporting CS fallback, whereas UE and MME and MSC supporting SMS over SGs are not required to support CS fallback.

NOTE: An MME supporting only SMS over SGs (i.e. not supporting CS fallback) will either reply with "SMS-only" or reject an IMSI attach.

The support of CS fallback (and to a lesser extent SMS over SGs) can impose some operational constraints on Tracking Area boundary planning and the use of the "tracking area list concept" (see TS 23.401 [2]).

4.2 Reference Architecture

The CS fallback and SMS over SGs in EPS function is realized by using the SGs interface mechanism between the MSC Server and the MME.

The SGs interface functionality is based on the mechanisms specified for the Gs interface, TS 23.060 [3].

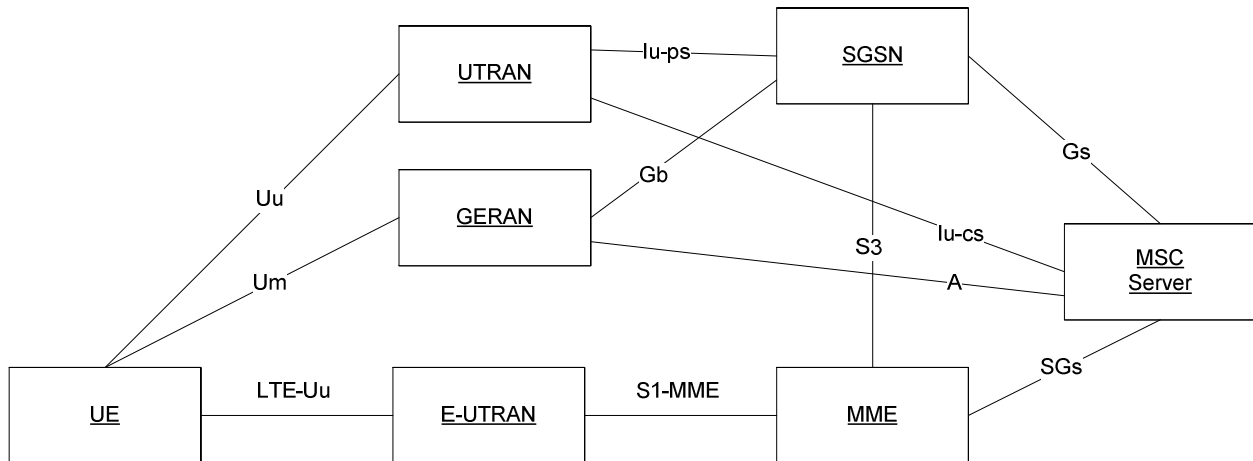

Figure 4.2-1: EPS architecture for CS fallback and SMS over SGs

NOTE 1: The MGW is not shown in the figure 4.2-1 since neither CS fallback in EPS nor SMS over SGs has any impacts on the U-plane handling.

NOTE 2: SGSN and S3 have additional functionality related to ISR and CS fallback/SMS over SGs. If ISR is not used, this functionality is not required.

4.2.1 Reference points

SGs: It is the reference point between the MME and MSC server. The SGs reference point is used for the mobility management and paging procedures between EPS and CS domain, and is based on the Gs interface procedures. The SGs reference point is also used for the delivery of both mobile originating and mobile terminating SMS. Additional procedures for alignment with the Gs reference point are not precluded.

S3: It is defined in TS 23.401 [2] with the additional functionality to support ISR for CS fallback/SMS over SGs as defined in this specification.

4.3 Functional entities

4.3.1 UE

The CS fallback capable UE supports access to E-UTRAN/EPC as well as access to the CS domain over GERAN and/or UTRAN.

The SMS over SGs capable UE supports access to E-UTRAN/EPC and may support access to the CS domain over GERAN and/or UTRAN.

The support of SMS over SGs is mandatory for a UE that supports CS fallback, whereas a UE that supports SMS over SGs is not required to support CS fallback.

These UEs support the following additional functions:

- Combined procedures specified in this document for EPS/IMSI attach, update and detach.
- CS fallback and/or SMS over SGs procedures specified in this document for using CS domain services.

A UE using CS fallback and/or SMS over SGs supports ISR according to TS 23.401 [2]. In particular a UE deactivates ISR at reception of LAU accept or at reception of combined RAU/LAU accept response with no ISR indication.

The coexistence with IMS services for voice/SMS is defined in clause 4.5.

There are no other CS fallback/SMS over SGs ISR-specifics for the UE compared to ISR description in TS 23.401 [2], i.e. if ISR is active the UE can change between all registered areas and RATs without performing update signalling. The UE listens for paging on the RAT it is currently camped on.

If the UE is service user with subscription to CS domain priority service, the UE's USIM belongs to one of Access Class that indicates the priority is needed and the UE shall set the RRC establishment cause to "HighPriorityAccess" as specified in TS 36.331 [33].

4.3.2 MME

The CS fallback and/or SMS over SGs enabled MME supports the following additional functions:

- Multiple PLMNs selection for the CS domain.
- RAT selection for the CS domain.
- Deriving a VLR number and LAI from the TAI of the current cell and based on the selected PLMN or the selected RAT for CS domain, or using a default VLR number and LAI.
- Deliver the registered PLMN ID for CS domain (included in the LAI) to the eNodeB.
- Includes the PLMN ID for the CS domain (included in the LAI provided to the UE) in the equivalent PLMNs list if it is different compared to the PLMN ID provided as part of the GUTI.
- For CS fallback, generating a TAI list such that the UE has a low chance of "falling back" to a cell in a LA different to the derived LAI (e.g. the TAI list boundary should not cross the LA boundary).

NOTE: Alignment of the TAI list boundary with a LA boundary can prevent the MME from making effective use of the "tracking area list" concept. To compensate for this, appropriate cell reselection hysteresis may need to be used within the E-UTRAN.

- Maintaining of SGs association towards MSC/VLR for EPS/IMSI attached UE.
- Initiating IMSI or EPS detach.
- Initiating paging procedure specified in this document towards eNodeB when MSC pages the UE for CS services.
- Supporting SMS procedures defined in this document.
- Rejecting CS Fallback call request (e.g. due to O&M reasons)

An MME that supports CS Fallback uses the LAI and a hash value from the IMSI to determine the VLR number as defined in TS 23.236 [23] when multiple MSC/VLRs serve the same LAI. The same hash value/function is used by SGSN to determine the VLR number. An MME that supports SMS over SGs may use the same procedure as for CS Fallback. In some networks, the MME may be configured to select the MSC/VLR for UEs that send low access priority indication with a different load balance to that used for MSC/VLR selection for other UEs. In this case the MME maintains a separate hash/value function for UEs that send low access priority indication.

If the network supports CSFB priority call handling, the MME supports the following additional functions:

- For paging message received on the SGs interface with priority indication, the MME provides preferential treatment to this message and also the subsequent CS fallback procedure compared to other normal procedures. If UE needs to be paged, the MME sets priority indication on the paging request to eNodeB. The MME also sets priority indication, i.e. "CSFB High Priority", in S1AP message to the eNodeB, so that eNodeB can initiate the CSFB procedure with priority, as specified in TS 36.413 [35].
- For a CSFB request from a service user, the MME determines that the CSFB request needs priority handling based on the MPS CS Priority stored in UE's EPS subscription. The MME provides preferential treatment to this

request and also sets priority indication, i.e. "CSFB High Priority", in S1AP message to eNodeB to initiate CSFB procedure with priority, as specified in TS 36.413 [35].

4.3.3 MSC

The CS fallback and/or SMS over SGs enabled MSC supports the following additional functions:

- Maintaining SGs association towards MME for EPS/IMSI attached UE.
- Supporting SMS procedures defined in this document.

NOTE 1: The CS Fallback enabled MSC can also be enhanced to support ICS as defined in TS 23.292 [25] and/or SRVCC as defined in TS 23.216 [20].

NOTE 2: In order to speed up the potential LAU procedure during CS fallback the MSC may be configured to lower the frequency of Authentication, TMSI reallocation and Identity check for UEs that are EPS/IMSI attached via the SGs interface.

NOTE 3: The MSC/VLR uses the CSMO flag in LAU and CM service request message for CS Fallback statistics.

If the network supports a priority call handling, the MSC maps priority indication of the IAM message to a priority indication of the paging message sent over the SGs interface.

4.3.4 E-UTRAN

The CS fallback enabled E-UTRAN supports the following additional functions:

- Forwarding paging request for CS domain to the UE.
- Directing the UE to the target CS capable cell considering the registered PLMN ID and possibly the LAC for CS domain received from the MME.
- The configuration of appropriate cell reselection hysteresis at Location Area boundaries (or across the whole E-UTRAN) to reduce Tracking Area Update traffic.
- To facilitate the configuration of TA boundaries with LA boundaries, the E-UTRAN can gather statistics (from the inbound inter-RAT mobility events of all UEs) of the most common LAs indicated in the RRC signalling.
- Configuration to permit the operator to choose the target 'fallback' RAT and frequency.

For SMS over SGs, no specific E-UTRAN functionality is required.

If the network supports CSFB priority call handling, the E-UTRAN supports the following additional functions:

- For paging message received on S1AP with priority indication, the E-UTRAN should provide preferential treatment to this request compared to other normal paging requests.
- For CS fallback S1AP message with priority indication, i.e. "CSFB High Priority", if UE is in IDLE mode, the eNodeB should provide preferential treatment, in allocating E-UTRAN radio bearer resources compared to other normal resource requests. When CSFB based on PS handover is employed, the eNodeB may forward priority indication to the target GERAN/UTRAN.

4.3.5 SGSN

If the SGSN supports ISR, SGSN shall follow the rules and procedures described in TS 23.401 [2] and TS 23.060 [3] with the following additions and clarifications:

- The SGSN shall not send the ISR activated indication at combined RAU/LAU procedure.

An SGSN that supports Gs uses LAI and a hash value from the IMSI to determine the VLR number as defined in TS 23.236 [23] when multiple MSC/VLRs serve the same LAI. The same hash value/function is used by MME to determine the VLR number.

4.3.6 BSS

If the BSS receives indication from the MSC that the CS service (Call, CISS or LCS) was established as a result of CS fallback the BSS may e.g. select to use RR Connection Release with Redirect to send the UE back to E-UTRAN at release of the CS service.

If the network supports ISR, the CS fallback enabled BSS exhibits the following behaviour:

- Even if the network is operating in NMO II/III the BSS shall forward Gb interface paging messages onto the radio interface. The BSS in a network operating in NMO II/III shall not be configured to use PBCCH.

4.3.7 RNS

If the RNS receives indication from the MSC that the CS service (Call, CISS or LCS) was established as a result of CS fallback the RNS may e.g. select to use RRC Connection Release with Redirect to send the UE back to E-UTRAN at release of the CS service.

4.4 Control plane

4.4.1 MME - MSC Server

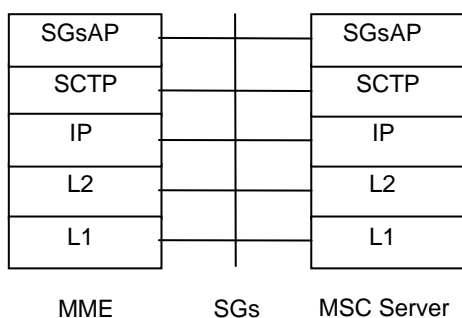

Legend:

SGsAP: This protocol is used to connect an MME to an MSC Server based on the BSSAP+.

Stream Control Transmission Protocol (SCTP): This protocol transfers signalling messages.

Figure 4.4.1-1: SGs Interface

4.5 Co-existence with IMS services

A CS Fallback and IMS capable UE shall follow the procedures for domain selection for UE originating session/calls according to TS 23.221 [26] 'Domain selection for UE originating sessions / calls'.

An IMS capable UE which supports SMS over IP networks shall follow the procedures for domain selection for UE originating SMS according to TS 23.221 [26] 'Domain selection for UE originating SMS'.

4.6 Emergency Calls

4.6.1 General

When UE is performing CS fallback procedure for Mobile Originating Call for the purpose of emergency call, it shall indicate to the MME that this CS fallback request is for emergency purpose. MME indicates to the E-UTRAN via the appropriate S1-AP message that this CS fallback procedure has high priority. If PS handover is initiated, E-UTRAN may indicate priority level of the CS fallback to the target RAT, as specified in TS 25.413 [29], in order to prepare radio resource at target RAT in appropriate way, e.g. priority allocation of the RAB resource.

NOTE 1: E-UTRAN may use the CSFB high priority indication for selecting a particular radio access network (2G or 3G).

Based on local operator policy, if the MSC/VLR is required to handle emergency call setup with IMSI, the network may perform the additional procedure defined in clause 4.6.2.

NOTE 2: When the target RAT for emergency call due to CSFB is selected based on cell re-selection or redirection by the network and the UE moves to a different LA then it is possible that the UE continues the emergency call setup without performing a location updating procedure. In this case, the UE performs the emergency call setup with IMSI.

4.6.2 Procedures to handle emergency call setup with IMSI

This procedure is only invoked when permitted by the operator policy.

When MME detects that the CSFB request is due to emergency call and eNodeB indicates that the UE is not available for the PS service at the target RAT, it shall mark the SGs association as not valid (i.e., move to SGs-NULL state) and shall not send IMSI Detach Indication (IMSI) message to the MSC/VLR. After that, MME continues with the CSFB procedure. If ISR is active, MME shall initiate DETACH REQUEST message with the detach type set to "Local Detach" via S3 to the associated SGSN.

The SGSN in NMO I configuration with ISR capability shall support the "EMM combined UE Waiting Flag".

NOTE 1: If the target RAT is operating in NMO-I, the DETACH REQUEST is to ensure the UE performs combined EPS/IMSI TAU when the UE returns to E-UTRAN as described in clause 6.5.

When MSC/VLR receives CS emergency call setup with IMSI due to CSFB and this IMSI is unknown, the MSC/VLR shall perform a Location Update procedure to the HLR on behalf of the UE after it successfully authenticated the UE.

4.6a Interaction with IMS Emergency session

If the MME receives a paging request which is not for SMS and detects that the UE currently has an ongoing IMS emergency session, the MME shall respond with a Paging Reject towards MSC to stop CS Paging procedure.

NOTE: If the IMS emergency session uses dedicated emergency bearers service for the media, the MME can detect an ongoing IMS emergency session by the presence of at least two EPS bearers with ARP value reserved for emergency services (one bearer for signalling and one for media). If the network allows media for IMS emergency session without a dedicated bearer, the MME can only use the presence of PS bearer with ARP value reserved for emergency services for detection.

4.7 CSFB Priority Call Handling

CSFB Priority call handling ensures that, when GERAN/UTRAN supports eMLPP service (TS 22.067 [37]), end-to-end priority handling is provided for both mobile originated CSFB calls by a service user in E-UTRAN and for mobile terminated CSFB call from a service user to a normal or service user in E-UTRAN. A service user's EPS subscription contains an indication of the users CS domain priority status, i.e. MPS CS Priority. If the UE is subscribed to CS domain priority, the UE's USIM shall belong to one of Access Class 11 to 15.

For mobile terminated CS fallback calls from a service user, the MSC provides a priority indication to the MME along with a paging message. The MME shall set a priority indication to the eNodeB when requesting the eNodeB to page the UE if the UE is idle. For mobile originated CS fallback calls from a service user in E-UTRAN, the MME determines that the CSFB request requires priority handling based on the UE's MPS CS Priority. For both mobile originated and mobile terminated CSFB, the MME shall also provide priority indication, i.e. "CSFB High Priority", when requesting the eNodeB to execute the CSFB priority procedure as specified in TS 36.413 [35]. The eNodeB should handle the paging message with priority and also prioritize the subsequent CS fallback procedure to GERAN/UTRAN or 1xRTT. If PS handover to GERAN or UTRAN is initiated, E-UTRAN may forward CS fallback priority indicator to the target RAT, as specified in TS 25.413 [29], in order to prepare radio resource at target RAT in appropriate way, e.g. priority allocation of the RAB resource

NOTE 1: For a Mobile Terminating Call from a normal user to a service user, no special handling is required.

NOTE 2: In this release, eNB does not differentiate between high priority CSFB due to emergency or due to CSFB priority call handling. Therefore, for both cases any Access and Roaming restriction may be ignored by the eNB when selecting a target cell, see TS 36.413 [35].

4.8 CS services handling in specific cases

4.8.1 SGs paging without LAI

If the SGs Paging Request does not contain the LAI, and if the MME can retrieve the S-TMSI associated to the IMSI, the MME shall temporarily store this MSC/VLR number and force the UE to re-attach to the non-EPS services based on:

- If the UE is in connected mode, the MME shall send a Detach Request (IMSI Detach) to the UE as described in clause 5.3.2;
- If the UE is in idle mode, the MME shall send Detach Indication (Local Detach) message to the SGSN via S3 interface if ISR is active. If the mobile reachable timer is still running the MME shall page the UE with IMSI and the CS indicator (for CSFB) or with S-TMSI and the PS indicator (for SMS). At the reception of Extended Service Request (for CSFB) or Service Request (for SMS) from the UE, the MME shall not send a SGs Service Request to the MSC/VLR as it normally would, but instead shall send a Detach Request (IMSI Detach) to the UE as described in clause 5.3.2.

The MME shall not send IMSI Detach Indication message to the MSC/VLR in the above scenarios.

MME shall then wait for the UE to re-attach to non-EPS services via a Tracking Area Update Request; the MME shall IMSI attach the UE to the MSC/VLR using the stored MSC/VLR number. After successful IMSI attach, if the paging timer has not expired, the MSC/VLR shall page the UE again using SGs Paging Request with LAI.

4.8.2 Handling of SGs paging when MME cannot retrieve the S-TMSI

Upon receiving SGs Paging Request, if the MME cannot retrieve the S-TMSI associated with IMSI, the MME shall page the UE with IMSI and PS indicator to force the UE to re-attach to EPS and non-EPS services.

5 Mobility Management

5.1 General

The CS fallback and SMS over SGs in EPS is realized by using the SGs interface mechanism between the MSC Server and the MME.

The use of the "pool-area" concept as specified in TS 23.236 [23] allows to minimize the occurrence of MSC change at CS fallback.

5.1A TAI list and LAI allocation

For CS fallback, the fallback procedure is likely to be faster if the network can allocate a Location Area to the UE that is the LA of the overlapping target RAT's coverage. For this situation, the MME should avoid allocating TAI lists that span multiple Location Areas of the target RAT (which may be contrary to the normal usage of the "tracking area list" concept described in TS 23.401 [2]).

This can be achieved by:

- configuring the E-UTRAN cell's TAI to take into account the LA boundary of the target RAT;
- the MME being configured to know which TAIs are within which LA; and
- the MME using the TAI of the current E-UTRAN cell to derive the LAI.

The operator should be able to configure the MME as to whether it either:

- provides normal usage of the "tracking area list" concept, or,
- the TAI list allocation is adjusted, for CS fallback mobiles, to provide "TAI lists that do not span multiple LAs".

The MME may use alternative approaches for LAI and TAI list allocation. In particular, this is appropriate for:

- the case of SMS over SGs without overlapping GERAN/UTRAN coverage; and
- the case when not all MSCs in the VPLMN support the SGs interface.

In these situations, one approach is to configure the MME to allocate a default (e.g. non-broadcast) LAI which is associated with a VLR that supports the SGs interface.

5.2 Attach procedure

The attach procedure for the CS fallback and SMS over SGs in EPS is realized based on the combined GPRS/IMSI Attach procedure specified in TS 23.060 [3].

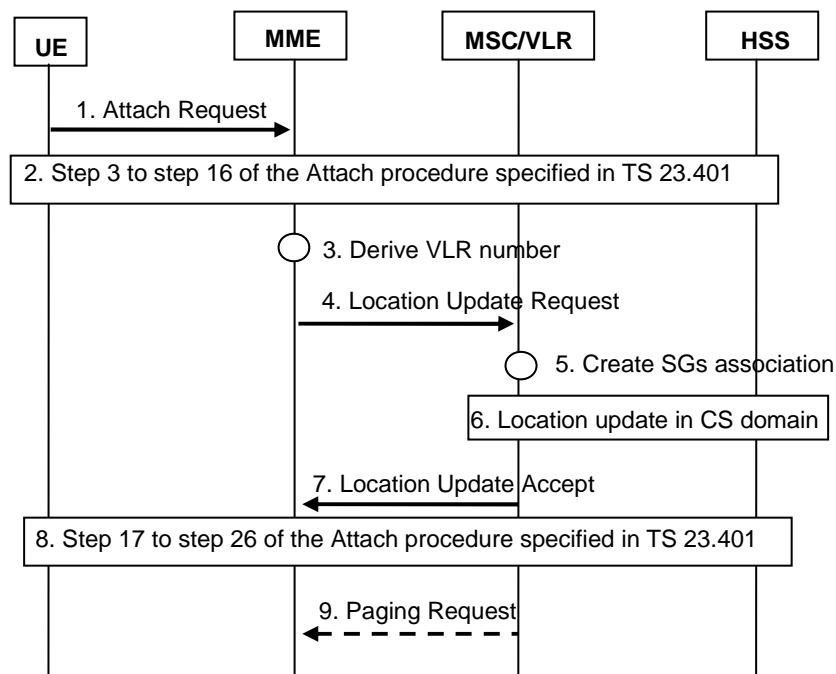

Figure 5.2-1: Attach Procedure

- 1) The UE initiates the attach procedure by the transmission of an Attach Request (parameters as specified in TS 23.401 [2] including the Attach Type, old LAI and Mobile Station Classmark 2) message to the MME. The Attach Type indicates that the UE requests a combined EPS/IMSI attach and informs the network that the UE is capable and configured to use CS fallback and/or SMS over SGs. If the UE needs SMS service but not CSFB, the UE shall include an "SMS-only" indication in the combined EPS/IMSI Attach Request. See clause 5.4.4.
- 2) Step 3 to step 16 of the EPS Attach procedure are performed as specified in TS 23.401 [2].

If the UE subscribes the eMLPP (TS 22.067 [37]) service in the CS domain, the UE EPS subscription received from HSS contains MPS CS Priority which indicates the UE's CS domain priority status.

- 3) If the Attach Request message includes an Attach Type indicating that the UE requests a combined EPS/IMSI attach, the MME allocates a LAI for the UE. If multiple PLMNs are available for the CS domain, the MME performs selection of the PLMN for CS domain based on selected PLMN information received from the eNodeB, current TAI, old LAI and operator selection policies on preferred RAT for CS domain. The PLMN selected for CS should be the same that is used for this UE as a target PLMN for PS handovers or for any other mobility procedures related to CSFB. The MME may take any access restrictions provided by the HSS into

account, if the network is using separate location areas for GERAN and UTRAN cells. The selected PLMN ID is included in the LAI which is sent to MSC/VLR in step 4 and in Attach Accept to the UE.

The MME derives a VLR number based on the allocated LAI and on an IMSI hash function defined in TS 23.236 [23]. The MME starts the location update procedure towards the new MSC/VLR upon receipt of the subscriber data from the HSS in step 2). This operation marks the MS as EPS-attached in the VLR.

- 4) The MME sends a Location Update Request (new LAI, IMSI, MME name, Location Update Type) message to the VLR. MME name is a FQDN string.
- 5) The VLR creates an association with the MME by storing MME name.
- 6) The VLR performs the normal subscription checks for CS and if all checks are successful performs Location Updating procedure in CS domain.
- 7) The VLR responds with Location Update Accept (VLR TMSI) to the MME.
- 8) The EPS Attach procedure is completed by performing step 17 to step 26 as specified in TS 23.401 [2]. Attach Accept message includes the parameters as specified in TS 23.401 [2]: VLR TMSI and LAI as allocated in step 3 above. The existence of LAI and VLR TMSI indicates successful attach to CS domain.

If the UE requests combined EPS/IMSI Attach Request without the "SMS-only" indication, and if the network supports only SMS over SGs, the network shall perform the IMSI attach and the MME shall indicate in the Attach Accept message that the IMSI attach is for "SMS-only". When the network accepts a combined EPS/IMSI attach without limiting to "SMS-only", the network may provide a "CSFB Not Preferred" indication to the UE.

If the UE requests combined EPS/IMSI Attach Request with the "SMS-only" indication, and if the network supports SMS over SGs only or if it supports CSFB and SMS over SGs, the network shall perform the IMSI attach and the MME shall indicate in the Attach Accept message that the IMSI attach is for "SMS-only".

The network provides the "SMS-only" or "CSFB Not Preferred" indications based on locally configured operator policies based on e.g. roaming agreement.

The UE behaviour upon receiving such indications is described in TS 23.221 [26].

If the PLMN ID for the CS domain (included in the LAI provided to the UE) differs from the PLMN ID provided as part of the GUTI, the equivalent PLMNs list includes the PLMN ID for the CS domain.

- 9) If the VLR has updated the SGs association and if a paging timer is still running for a MT service for this UE, the VLR shall repeat SGs Paging Request towards the updated SGs association.

NOTE: The case of unsuccessful attach to CS domain is documented in stage 3 specifications, taking into account reachability for CS services of UEs that have the user preference to prioritize voice over data services and are not configured/supporting to use IMS voice services.

5.3 Detach procedure

5.3.1 UE-initiated Detach procedure

The UE-initiated Detach procedure for the CS fallback and SMS over SGs in EPS is realized based on the MS-Initiated Detach Procedure specified in TS 23.060 [3].

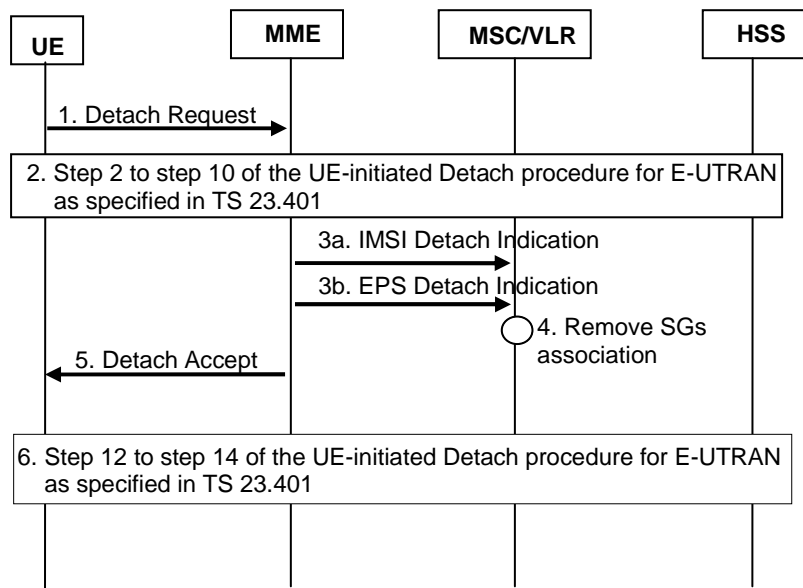

Figure 5.3.1-1: UE-initiated Detach Procedure

- 1) The UE initiates the detach procedure by the transmission of a Detach Request (parameters as specified in TS 23.401 [2], Detach Type) message to the MME. Detach Type indicates which type of detach is to be performed, i.e., IMSI Detach only, EPS Detach only or combined EPS and IMSI Detach.
- 2) The UE-initiated Detach procedure for E-UTRAN is continued as specified in TS 23.401 [2].
- 3a) If the detach type indicates "IMSI Detach only" or "combined EPS and IMSI Detach", the MME sends an IMSI Detach Indication (IMSI) message to the MSC/VLR.
- 3b) If the detach type indicates "EPS Detach only", the MME sends an EPS Detach Indication (IMSI) message to the MSC/VLR.
- 4) The MSC/VLR removes the association with the MME.
- 5) The MME sends a Detach Accept message to the UE as specified in TS 23.401 [2]. When the UE receives the Detach Accept message and the Detach Type indicated "EPS Detach only" in step 1, the UE disables E-UTRAN, selects an appropriate GERAN or UTRAN cell.
- 6) The UE-initiated Detach procedure for E-UTRAN is completed with step 12 to step 14 as specified in TS 23.401 [2].

5.3.1A UE-initiated Detach procedure for GERAN/UTRAN with ISR activated

When ISR is activated, UE initiates detach procedure as specified in TS 23.401 [2], clause 5.3.8.2.2. The procedure is performed with the exception as follows:

- In step 4, the SGSN sends Detach Notification (Cause, Detach type) message to the associated MME. Cause indicates "IMSI Detach only" when UE performs IMSI Detach only procedure. Otherwise, Cause indicates "complete detach", and Detach type indicates "PS detach" in case of UE-initiated GRPS Detach only procedure, or indicates "combined PS/CS detach" in case of UE-initiated combined GPRS/IMSI detach procedure.
- When the MME receives the Detach Notification message, it sends an IMSI Detach Indication (IMSI) message to the MSC/VLR if the cause indicates "IMSI Detach only" or the detach type indicates "combined PS/CS detach", or sends an EPS Detach Indication (IMSI) message to the MSC/VLR if the detach type indicates "PS detach".
- If Cause indicates "IMSI Detach only", the MME shall not deactivate ISR and steps 5 to 9 shall be skipped.

5.3.2 MME-initiated Detach procedure

The MME-initiated detach procedure for the CS fallback and SMS over SGs in EPS is realized based on the SGSN-Initiated Detach Procedure specified in TS 23.060 [3].

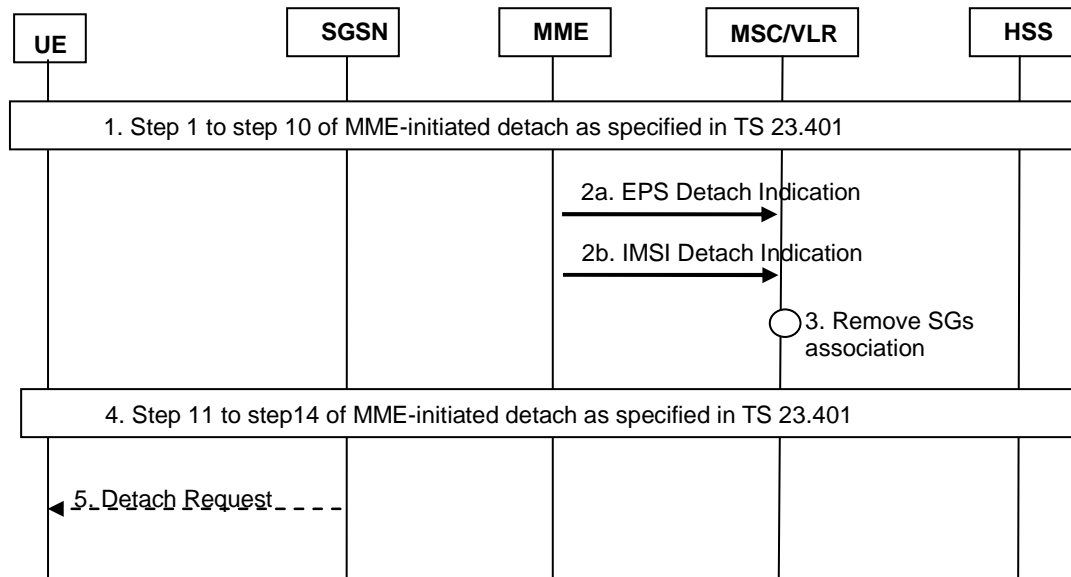

Figure 5.3.2-1: MME-initiated Detach Procedure

- 1) The MME-initiated Detach procedure is performed as specified in TS 23.401 [2].
- 2a) If EPS service is not allowed for the UE the MME sends an EPS Detach Indication (IMSI detach from EPS service) message to the MSC/VLR.
- 2b) If the UE is required to be IMSI detached, the MME sends an IMSI Detach Indication (IMSI) message to the MSC/VLR.
- 3) The MSC/VLR removes the association with the MME.
- 4) The MME-initiated Detach procedure is completed with step 11 to step 14 as specified in TS 23.401 [2].
- 5) If ISR is activated in SGSN and the UE is EMM combined procedures capable, when SGSN receives Detach Indication message sent from MME with "Detach Type" IE that indicates "Local Detach" or Delete Bearer Request message from SGW for last PDP Context, then the SGSN shall send Detach Request (IMSI Detach) to the UE. The SGSN turns on "EMM Combined UE Waiting Flag". When SGSN may have the capability to use this flag and how the SGSN uses this flag is described in clause 5.5.

5.3.2A SGSN-initiated Detach procedure with ISR activated

When ISR is activated, SGSN initiates detach procedure as specified in TS 23.401 [2], clause 5.3.8.3A. The procedure is performed with the exception as follows:

- In step 4, the SGSN sends Detach Notification (Cause, Detach type) message to the associated MME. If this detach is local to the SGSN (e.g. implicit detach), Cause indicates local detach. Otherwise, Cause indicates complete detach, and Detach type indicates "PS detach".
- When the MME receives the Detach Notification message, it sends an EPS Detach Indication (IMSI) message to the MSC/VLR if the detach type indicates "PS detach". If the cause indicates local detach, the MME shall not remove SGs association.
- If Cause indicates local detach, the MME deactivates ISR and steps 5 to 9 shall be skipped.

5.3.3 HSS-initiated Detach procedure

The HSS-initiated detach procedure for the CS fallback and SMS over SGs in EPS is realized based on the HLR-Initiated Detach Procedure specified in TS 23.060 [3].

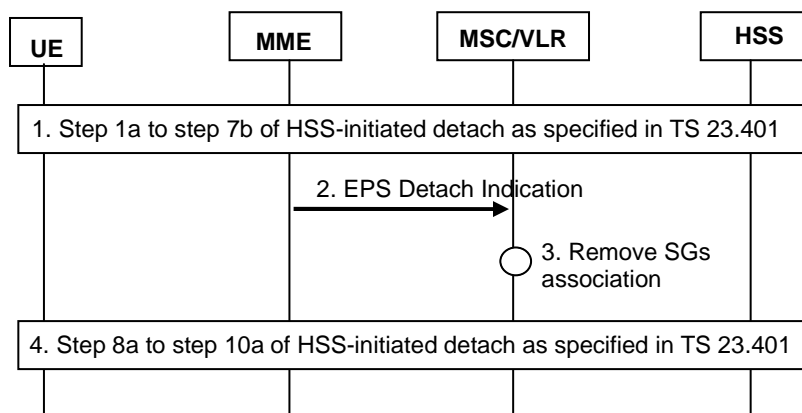

Figure 5.3.3-1: HSS-initiated Detach Procedure

- 1) The HSS-initiated Detach procedure is performed as specified in TS 23.401 [2].
- 2) The MME sends an EPS Detach Indication (IMSI) message to the MSC/VLR.
- 3) The MSC/VLR removes the association with the MME.
- 4) The HSS-initiated Detach procedure is completed with step 8a to step 10a as specified in TS 23.401 [2].

5.3.4 Administration of the MME - MSC/VLR Association

The MME - MSC/VLR association is created at the following occasions:

- Combined EPS/ IMSI attach in clause 5.2.
- Combined TA/LA Update in clause 5.4.

The association is updated on the following occasions:

- When an UE changes MME.

The MME - MSC/VLR association is removed at the following occasions:

- UE-initiated Detach in clause 5.3.1.
- MME initiated Detach in clause 5.3.2.
- HSS initiated Detach in clause 5.3.3.
- Gs association establishment in 2/3G, see TS 23.060 [3].
- MSC/VLR receives a LA update via the A or Iu interface.

5.4 TA/LA Update procedure

5.4.0 General

When a CS fallback and/or SMS over SGs capable UE is EPS/IMSI attached, it initiates the combined TA/LA procedure based on the triggers specified in TS 23.401 [2].

When a CS fallback and/or SMS over SGs capable UE is not EPS/IMSI attached, it may initiate a combined TA/LA procedure in order to use CS Fallback or SMS over SGs services.

5.4.1 Combined TA/LA Update Procedure

NOTE: The combined TA/LA Update procedure for the CS fallback and SMS over SGs in EPS is realized based on the combined RA/LA Update procedure specified in TS 23.060 [3].

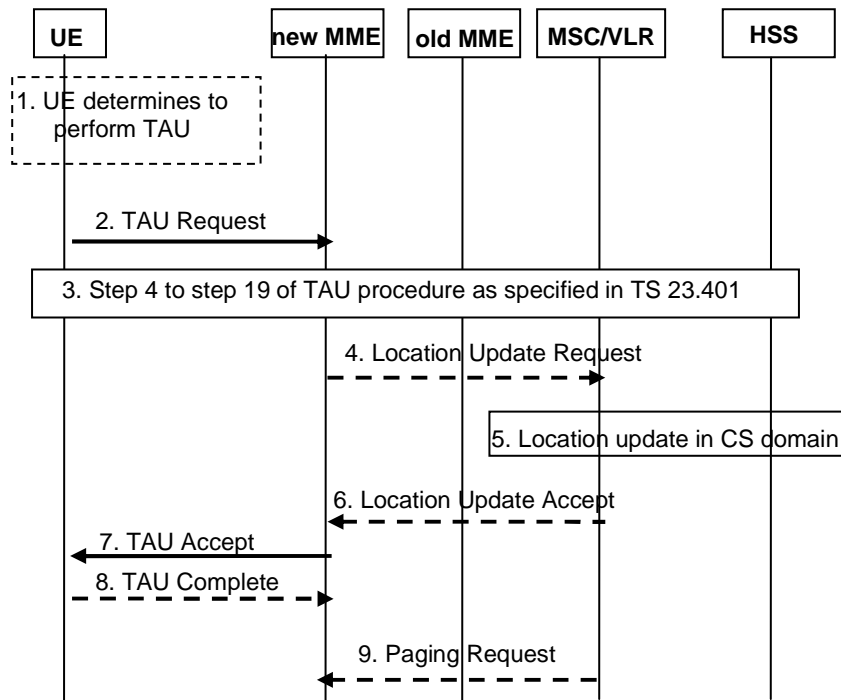

Figure 5.4.1-1: Combined TA / LA Update Procedure

- 1) The UE detects a change to a new TA by discovering that its current TAI is not in the list of TAIs that the UE registered with the network or the UE's TIN indicates the need for a TAU when re-selecting to E-UTRAN. The combined TA/LA Update Procedure is also performed in order to re-establish the SGs association.
- 2) The UE initiates the TAU procedure by sending a TAU Request (parameters as specified in TS 23.401 [2] including the Update Type, old LAI and Mobile Station Classmark 2) message to the MME. The Update Type indicates that this is a combined Tracking Area/Location Area Update Request or a combined Tracking Area/Location Area Update with IMSI attach Request. If the UE needs SMS service but not CSFB, the UE shall include an "SMS-only" indication in the combined TA/LA Update procedure, see clause 5.4.4.
- 3) Step 4 to step 19 of the EPS TAU procedure are performed as specified in TS 23.401 [2].
- 4) If multiple PLMNs are available for CS domain, the MME performs selection of the PLMN for CS domain based on selected PLMN information received from the eNodeB, current TAI, old LAI and operator selection policies on preferred RAT for CS domain. The PLMN selected for CS should be the same that is used for this UE as a target PLMN for PS handovers or for any other mobility procedures related to CSFB. The MME may take any access restrictions provided by the HSS into account, if the network is using separate location areas for GERAN and UTRAN cells. The selected PLMN ID is included in the LAI. If the association has to be established or if the LA changed, the new MME sends a Location Update Request (new LAI, IMSI, MME name, Location Update Type) message to the VLR. The MME retrieves the corresponding VLR number from the determined LAI. If multiple MSC/VLRs serve this LAI an IMSI hash function is used to retrieve the VLR number for the LAI as defined in TS 23.236 [23]. The Location Update Type shall indicate normal location update. The MME name is a FQDN string.
- 5) The VLR performs the normal subscription checks for CS and if all checks are successful performs Location Update procedure in CS domain.
- 6) The VLR responds with Location Update Accept (VLR TMSI) to the MME.
- 7) The MME sends a TAU Accept (parameters as specified in TS 23.401 [2], LAI, VLR TMSI) message to the UE. The VLR TMSI is optional if the VLR has not changed. LAI is determined in step 4 above. The presence of the LAI indicates to the UE that it is IMSI attached. If the UE requests combined TA/LA Update Request without

the "SMS-only" indication, and if the network supports SGs for SMS only, the network shall perform the IMSI attach and the MME shall indicate in the TAU Accept message that the IMSI attach is for "SMS-only".

If the UE requests combined TA/LA Update (or combined TA/LA Update with IMSI attach) without the "SMS-only" indication, and if the network supports only SMS over SGs, the network shall perform the combined TA/LA Update procedure and the MME shall indicate "SMS-only" in the TAU Accept message. However, if the network supports CSFB and SMS over SGs and accepts a combined TA/LA Update procedure but does not indicate "SMS-only", the MME may provide a "CSFB Not Preferred" indication to the UE.

If the UE requests combined TA/LA Update (or combined TA/LA Update with IMSI attach) with the "SMS-only" indication, and if the network only supports SMS over SGs or if it supports CSFB and SMS over SGs, the network shall perform the combined TA/LA Update procedure and the MME shall indicate in the TAU Accept message that the combined TA/LA Update procedure is for "SMS-only".

The network provides the "SMS-only" or "CSFB Not Preferred" indications based on locally configured operator policies based on e.g. roaming agreement.

The UE behaviour upon receiving such indications is described in TS 23.221 [26].

If the PLMN ID for the CS domain (included in the LAI provided to the UE) differs from the PLMN ID provided as part of the GUTI, the equivalent PLMNs list includes the PLMN ID for the CS domain.

- 8) The UE may send a TAU complete message as specified in TS 23.401 [2] for the TAU procedure.
- 9) If the VLR has updated the SGs association and if a paging timer is still running for a MT service for this UE, the VLR shall repeat SGs Paging Request towards the updated SGs association.

5.4.2 Periodic TA and LA Update Procedure

When the UE is camped on E-UTRAN, periodic LA updates shall not be performed, but periodic TA updates shall be performed. In this case, an SGs association is established and the MSC/VLR shall disable implicit detach for EPS-attached UEs and instead rely on the MME to receive periodic TA updates.

When a periodic TA update is not received in the MME, the MME clears the PPF. The lack of periodic TA update may be caused by reselection or handover to GERAN/UTRAN when ISR is active. To ensure CS paging can reach the EPS/IMSI attached UE, the UE shall perform combined RA/LA update in NMO I or LAU in NMO II/III when the periodic TAU timer expires and the UE is in GERAN/UTRAN (or next returns to coverage in GERAN/UTRAN) and ISR is active.

In addition, when a periodic TA update is not received in the MME, the MME may implicitly detach the UE as specified in TS 23.401 [2]. This MME implicit detach does not affect any SGSN attach status. At an implicit detach, the MME also releases the SGs association with the MSC/VLR. The MSC continues to maintain the registered LA for the UE. The MSC changes to supervise LA updates and pages in the still registered LA when mobile terminated services arrive.

When the UE camps on GERAN/UTRAN it may perform combined RA/LA updates. The combined RA/LA update procedures and the conditions for their usage are described in TS 23.060 [3].

5.4.3 Non-EPS Alert procedure

The MSC/VLR may request an MME to report activity from a specific UE. In this case, the MSC/VLR shall send a SGsAP Alert Request (IMSI) message to the MME where the UE is currently EPS-attached.

Upon reception of the SGsAP Alert Request (IMSI) message, the MME shall set NEAF (Non-EPS Alert Flag). If NEAF is set for an UE, the MME shall inform the MSC/VLR when the next activity from that UE (and the UE is both IMSI- and EPS attached) is detected, and shall clear NEAF.

If the activity detected by the MME leads to a procedure towards the MSC/VLR, the MME shall just follow this procedure. If the activity detected by the MME does not lead to any procedure towards the MSC/VLR, the MME shall send an UE Activity Indication (IMSI) message towards the MSC/VLR.

5.4.4 Void

5.5 Idle Mode Signalling Reduction

In relation with CSFB and/or SMS over SGs, when ISR is activated, the UE follows regular ISR behaviour. It may reselect between E-UTRAN and GERAN/UTRAN without a need to update the CN. When a mobile terminated service arrives, the MSC/VLR sends a paging message via SGs to the MME. The MME pages in the TA(s) registered for the UE, and, the MME uses the S3 interface to request the SGSN (i.e. the SGSN that has an ISR relation with the MME for that UE) to page the UE in the registered RA. When the UE is already connected with the MME, the MME forwards the paging request only to the UE via the established signalling connection.

When the UE is IMS registered for voice service, even if the UE is configured for CSFB or SMS over SGs, it may need to ignore ISR activation based on the conditions for ISR activation/de-activation for UEs registered for IMS voice service as defined in TS 23.401 [2].

CSFB and/or SMS over SGs enabled UE includes the "EMM combined procedures capability" indication as part of the "MS Network Capability" in the Attach, RAU or combined RAU/LAU Request message, if the UE has been configured to use CSFB service or SMS over SGs. SGSN stores the "EMM combined procedures capability" indication for ISR operation. If the UE has not been configured to use CSFB or SMS over SGs, the CSFB/SMS over SGs capable UE shall not include the "EMM combined procedures capability" indication in the Attach, RAU or combined RAU/LAU Request message to SGSN.

ISR remains activated until the CSFB/SMS over SGs enabled UE performs a combined RAU/LAU procedure (e.g. a UE in NMO I moves to a new RA or LA or the periodic TAU timer expires while the UE is in NMO I of GERAN/UTRAN) or separate LAU procedure (e.g. a UE moves to a different LA in NMO II or III or the periodic TAU timer expires while the UE is in NMO II/III of GERAN/UTRAN). Normal re-selection between registered RA/TA(s) does not cause ISR deactivated condition. When the UE needs to perform a combined RAU/LAU, the SGSN checks the "EMM combined procedures capability" bit in MS Network Capability and if it indicates that CSFB and/or SMS over SGs is enabled then SGSN deactivates ISR by not indicating ISR activated in the combined RAU Accept message, which is a regular ISR functionality as specified in TS 23.401 [2]. So an SGSN in a CSFB/SMS over SGs configuration never indicates ISR activated in combined RAU procedures for CSFB/SMS over SGs enabled UEs. An SGSN with ISR capability in a CSFB/SMS over SGs configuration shall always maintain ISR by indicating ISR Activated in Periodic RAU Accept for a CSFB/SMS over SGs enabled UE if the SGSN has the status that ISR is activated for the UE. After a combined RA/LA update procedure, the MSC pages via Gs for mobile terminated services. When Gs is not used, the MSC/VLR pages in the LA via Iu/A for mobile terminated services.

If ISR is deactivated and the UE re-selects to E-UTRAN with the TIN indicating "P-TMSI", it initiates a TAU procedure, which is a regular ISR functionality as specified in TS 23.401 [2], and ISR can be activated again. The CS fallback/SMS over SGs enabled UE shall perform this TAU procedure as a combined TA/LA Update Procedure.

In case of the detach procedure for E-UTRAN when ISR is activated, the MME notifies the associated SGSN with indicating detach cause (i.e. local detach or complete detach) as specified in clause 5.3.1, 5.3.2, 5.3.3 and TS 23.401 [2] except UE-initiated IMSI detach only procedure.

In case of the detach procedure for GERAN/UTRAN when ISR is activated, the SGSN notifies the associated MME with indicating detach cause (i.e. local detach, complete detach or IMSI detach only) and detach type (i.e. PS detach or combined PS/CS detach) in case of complete detach, and the MME sends IMSI Detach Indication or EPS Detach Indication message to the MSC/VLR accordingly, which is specified in clause 5.3.1A and 5.3.2A.

When the MME receives a SGs paging for CS service, if ISR is activated and the mobile reachable timer has expired but the Implicit Detach timer has not expired, the MME shall not notify the MSC/VLR that the UE is unreachable via SGs and instead shall page the UE via S3 interface.

When implicit detach timer expires in the MME, the MME shall send EPS Detach Indication message. .

The SGSN in NMO I configuration with ISR capability shall support the "EMM combined UE Waiting Flag". The "EMM Combined UE Waiting Flag" shall be turned on if SGSN sends Detach Request (IMSI Detach) to the UE as specified in clause 5.3.2.

If "EMM Combined UE Waiting Flag" is turned on in the SGSN, then the SGSN shall behave as follows:

- If the SGSN receives Periodic RAU from the UE, the SGSN shall send Detach Request (IMSI Detach) to the UE.
- If the SGSN receives Combined RAU from the UE, the SGSN shall continue the procedure as specified in TS 23.060 [3].
- If the SGSN receives Service Request from the UE, the SGSN handles the Service Request normally and shall send Detach Request (IMSI Detach) to the UE.
- The SGSN shall turn off the "EMM Combined UE Waiting Flag" if the SGSN receives Combined RAU from the UE.

5.6 Mobility Management for SMS over SGs only UEs

UEs that need SMS service but not CSFB indicate this specific condition with the "SMS-only" indication in the EPS/IMSI Attach Request and combined TA/LA update procedures. This allows an operator to deploy the SGs for SMS delivery over LTE only without the need for CSFB support. In addition, this allows the MME to use a dedicated algorithm for the selection of the MSC that supports those UEs.

NOTE: SMS delivery does not cause the terminal to fallback to the CS-capable network. It is possible that only certain MSCs in the network (one in minimum) is configured to support SGs when the network only supports SMS for SGs operation. However such a minimal configuration can cause inter-MSC location updates to be performed at every movement into/out of E-UTRAN coverage.

6 Mobile Originating Call

6.1 General

This clause describes the mobile originating call procedures for the CS Fallback in EPS.

6.2 Mobile Originating call in Active Mode - PS HO supported

This flow may be executed when the eNodeB knows that both the UE and the network support PS HO, in the normal case. Clause 6.6 describes the procedure when the procedure is rejected by the MME.

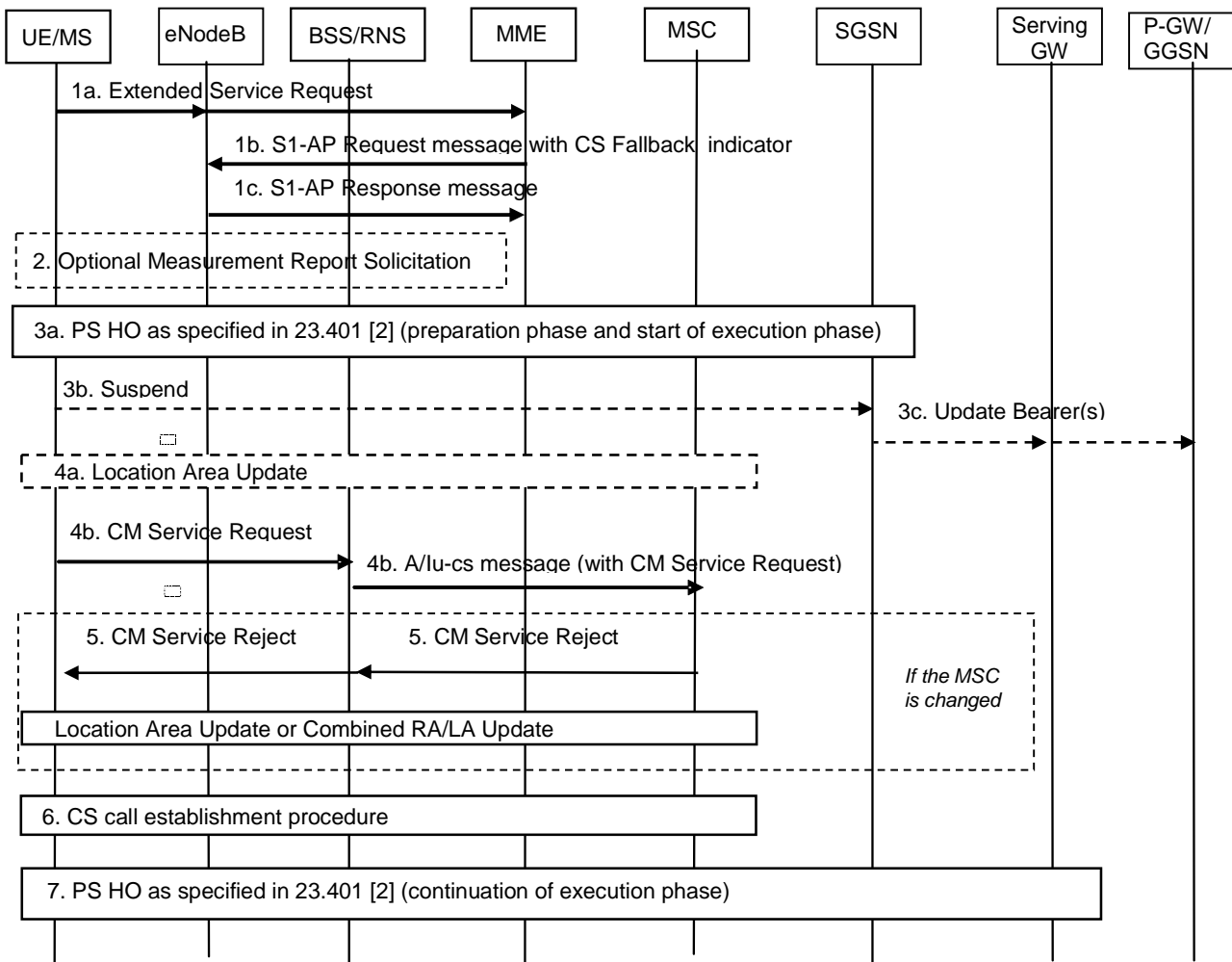

Figure 6.2-1: CS Call Request in E-UTRAN, Call in GERAN/UTRAN

NOTE 1: DTM is not mandatory for CS Fallback to work and is not linked to PS HO.

1a. The UE sends an Extended Service Request for mobile originating CS fallback to MME. Extended Service Request message is encapsulated in RRC and S1-AP messages. The UE only transmits this request if it is attached to CS domain (with a combined EPS/IMSI Attach) and can not initiate an IMS voice session (because e.g. the UE is not IMS registered or IMS voice services are not supported by the serving IP-CAN, home PLMN or UE).

1b. The MME sends an S1-AP UE Context Modification Request (CS Fallback Indicator, LAI) message to eNodeB. This message indicates to the eNodeB that the UE should be moved to UTRAN/GERAN. The registered PLMN for CS domain is identified by the PLMN ID included in the LAI, which is allocated by the MME.

If MME determines the CS Fallback procedure needs priority handling based on MPS CS Priority in the UE's EPS subscription, it also sets priority indication, i.e. "CSFB High Priority", in the S1AP message to the eNodeB as specified in TS 36.413 [35].

1c. The eNodeB shall reply with S1-AP UE Context Modification Response message.

2. The eNodeB may optionally solicit a measurement report from the UE to determine the target GERAN/UTRAN cell to which PS handover will be performed.

NOTE 2: Based on operator policy, the priority indicator received in step1b may be used by eNodeB to decide whether to continue CS Fallback procedures with PS HO, i.e. step3a, or to initiate radio release procedure to redirect the UE to 2G/3G Circuit Switch as specified in clause 6.3.

3a. The eNodeB triggers PS handover to a GERAN/UTRAN neighbour cell by sending a Handover Required message to the MME. The eNodeB selects the target PS handover cell considering the PLMN ID and possibly the LAC for CS domain provided by the MME in step 1b.

If the eNB is a HeNB, the HeNB should perform step 3 through step 6 of clause 6.3 instead of PS HO if the HeNB detects that the UE has only LIPA PDN Connections. CSFB will not be completed successfully when PS HO is performed if the UE has only LIPA PDN Connections as PS HO would result in the MME detaching the UE.

NOTE 3: For details how the HeNodeB determines whether a PDN connection is a LIPA PDN connection see TS 23.401 [2], clause 4.3.16.

In the following an inter-RAT handover from E-UTRAN to UTRAN or GERAN as specified in TS 23.401 [2] begins. The eNodeB indicates in the Source RNC to Target RNC Transparent container that PS handover was triggered due to CSFB. The eNodeB also indicates whether CSFB requires priority handling by forwarding the CSFB high priority indication to the target GERAN/UTRAN in the Source to Target Transparent Container, and the target GERAN/UTRAN allocates radio bearer resources taking received priority indication into account. As part of this handover, the UE receives a HO from E-UTRAN Command and tries to connect to a cell in the target RAT. The HO from E-UTRAN Command may contain a CS Fallback Indicator which indicates to UE that the handover is triggered due to a CS fallback request. If the HO from E-UTRAN Command contains a CS Fallback Indicator and the UE fails to establish connection to the target RAT, then the UE considers that CS fallback has failed. Service Request procedure is considered to be successfully completed when PS Handover procedure is completed successfully.

NOTE 4: During the PS HO the SGSN does not create a Gs association with the MSC/VLR.

NOTE 5: Service Request procedure supervision timer shall be sufficiently long considering the optional measurement reporting at step 2.

When the UE arrives at the target cell, if the target RAT is UTRAN, the UE establishes the radio signalling connection by sending an RRC Initial Direct Transfer message as specified in TS 25.331 [7] that contains a NAS message. The CN Domain Indicator is set to "CS" in the Initial Direct Transfer message.

If the target RAT is GERAN A/Gb mode: The UE establishes a radio signalling connection by using the procedures specified in TS 44.018 [4] (i.e. UE requests and is assigned a dedicated channel where it sends a SABM containing a NAS message to the BSS and the BSS responds by sending a UA). Upon receiving the SABM (containing the NAS message) the BSS sends a COMPLETE LAYER 3 INFORMATION message (containing the NAS message) to the MSC which indicates CS resources have been allocated in the GERAN cell. If both the UE and the target cell support enhanced CS establishment in DTM (indicated by GERAN system information included within the HO from E-UTRAN Command) a RR connection may be established while in packet transfer mode without release of the packet resources, see TS 43.055 [24]. After the establishment of the main signalling link as described in TS 44.018 [4] the UE enters either Dual Transfer Mode or Dedicated Mode.

3b. If the target RAT is GERAN and the UE has entered Dedicated Mode, the UE starts the Suspend procedure (see TS 44.018 [4]) unless both the UE and the Target cell support DTM in which case TBF re-establishment may be performed.

3c. A Gn/Gp-SGSN that receives the Suspend message from the UE follows the Suspend procedure specified in TS 23.060 [3], clause 16.2.1.1.1.

An S4-SGSN that receives the Suspend message from the UE follows the Suspend procedure specified in TS 23.060 [3]. The S4-SGSN deactivates GBR bearers towards S-GW and P-GW(s) by initiating MS- and SGSN Initiated Bearer Deactivation procedure as specified in TS 23.060 [3], and starts the preservation and suspension of non-GBR bearers by sending Suspend Notification message to the S-GW. The S-GW releases all RNC related information (address and TEIDs) for the UE if Direct Tunnel is established, and sends Suspend Notification message to the P-GW(s). The SGSN stores in the UE context that UE is in suspended status. All the preserved non-GBR bearers are marked as suspended status in the S-GW and P-GW(s). The P-GW should discard packets if received for the suspended UE.

- 4a. If the LA of the new cell is different from the one stored in the UE (which is received as part of Combined Attach/TAU procedure in E-UTRAN), the UE shall initiate a Location Area Update procedure as follows:
- if the network is operating in NMO-I (Network Modes of Operation), the UE shall initiate a separate Location Area Update before initiating the RAU procedure instead of a Combined RA/LA Update procedure (to speed up the CSFB procedure); or
 - if the network is operating in NMO-II or NMO-III, the UE shall initiate a Location Area Update before initiating the RAU procedure required for PS handover.

When the UE initiates a Location Area Update the UE shall set the "follow-on request" flag in the LAU Request in order to indicate to the MSC not to release the Iu/A connection after the LAU procedure completion. The UE shall indicate to the target MSC that this is an originating call establishment as a result of CSFB by including the "CSMO" flag. Further the UE performs any Routing Area Update procedure as specified by TS 23.060 [3].

The UE may initiate a Location Area Update procedure immediately when the UE is handed over to the target cell i.e. before the UE receives e.g. LAI or NMO information as part of the RAN Mobility Information.

- 4b. The UE sends a CM Service Request to the MSC. The UE shall indicate to the MSC that this is an originating call establishment as a result of CSFB by including the "CSMO" flag.
5. If the UE is not registered in the MSC serving the 2G/3G target cell or the UE is not allowed in the LA, the MSC shall reject the CM service request, if implicit location update is not performed. The CM Service Reject shall trigger the UE to perform a Location Area Update or a Combined RA/LA Update procedure as specified in TS 23.060 [3] for the different Network Modes of Operation (NMO).
6. The UE initiates the CS call establishment procedure and the UE shall include the CSMO flag in the CM Service Request to the MSC.
7. The UE performs any remaining steps of the inter-RAT handover from E-UTRAN to UTRAN or GERAN as specified in TS 23.401 [2].

If the UE remains on UTRAN/GERAN after the CS voice call is terminated the UE performs normal mobility management procedures as defined in TS 23.060 [3] and TS 24.008 [21].

6.3 Mobile Originating call in Active Mode – No PS HO support

This procedure is executed when PS HO is not supported, in the normal case. Clause 6.6 describes the procedure when the procedure is rejected by the MME.

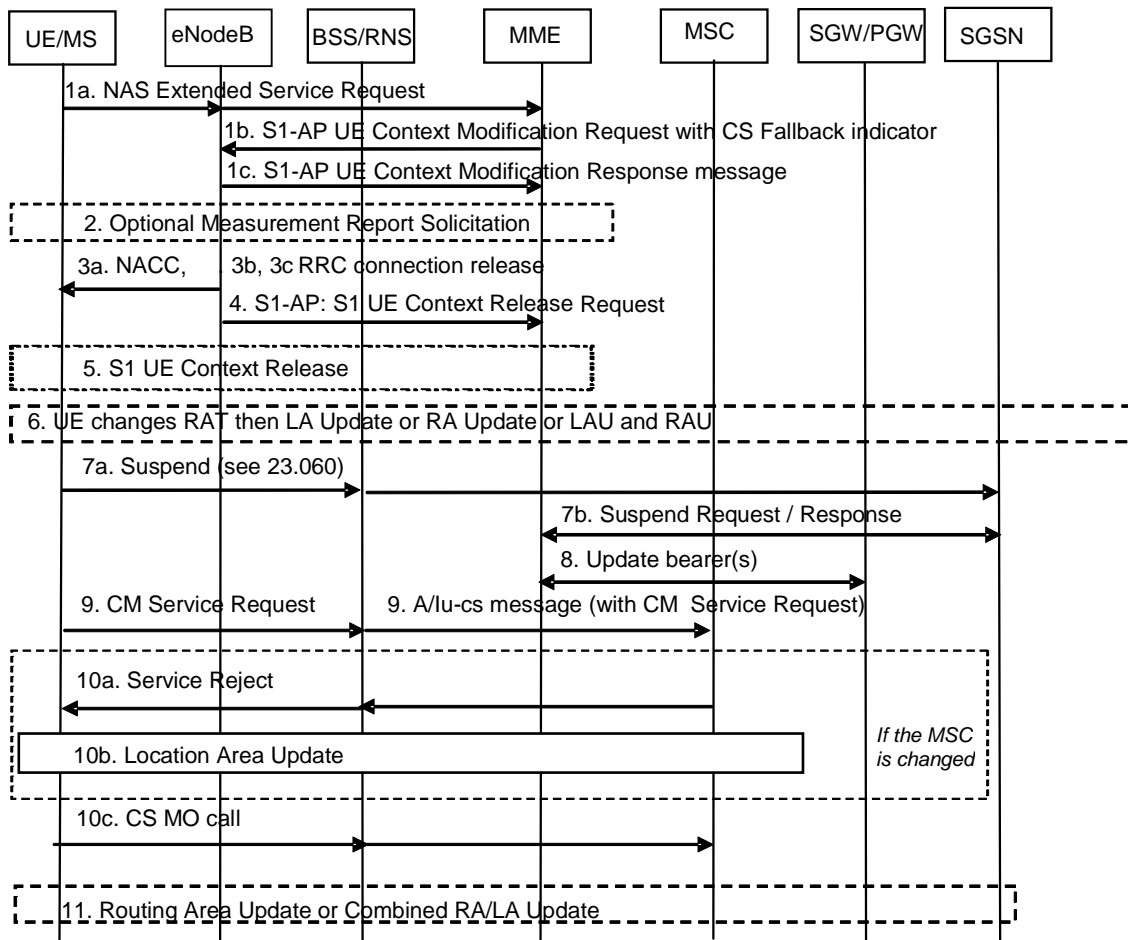

Figure 6.3-1: CS Call Request in E-UTRAN, Call in GERAN/UTRAN without PS HO

1a. The UE sends an Extended Service Request for mobile originating CS fallback to the MME. Extended Service Request message is encapsulated in RRC and S1-AP messages. The UE only transmits this request if it is attached to CS domain (with a combined EPS/IMSI Attach) and can not initiate an IMS voice session (because e.g. the UE is not IMS registered or IMS voice services are not supported by the serving IP-CAN, home PLMN or UE).

1b. The MME sends an S1-AP UE Context Modification Request (CS Fallback Indicator, LAI) message to eNodeB. This message indicates to the eNodeB that the UE should be moved to UTRAN/GERAN. The registered PLMN for CS domain is identified by the PLMN ID included in the LAI, which is allocated by the MME.

If MME determines the CS Fallback procedure needs priority handling based on MPS CS Priority in the UE's EPS subscription, it sets priority indication, i.e. "CSFB High Priority", in the S1AP message to the eNodeB as specified in TS 36.413 [35].

1c. The eNodeB shall reply with S1-AP UE Context Modification Response message.

2. The eNodeB may optionally solicit a measurement report from the UE to determine the target GERAN/UTRAN cell to which the redirection procedure will be performed.

The network performs one of steps 3a or 3b or 3c.

3a. If the UE and network support inter-RAT cell change order to GERAN and the target cell is GERAN:

The eNodeB can trigger an inter-RAT cell change order (optionally with NACC) to a GERAN neighbour cell by sending an RRC message to the UE. The inter-RAT cell change order may contain a CS Fallback Indicator which indicates to UE that the cell change order is triggered due to a CS fallback request. If the inter-RAT cell change order contains a CS Fallback Indicator and the UE fails to establish connection to the target RAT, then

the UE considers that CS fallback has failed. Service Request procedure is considered to be successfully completed when cell change order procedure is completed successfully.

The eNodeB selects the target cell considering the PLMN ID and possibly the LAC for CS domain provided by the MME in step 1b for CCO/NACC purpose.

- 3b. If the UE or the network does not support inter-RAT PS handover from E-UTRAN to GERAN/UTRAN nor inter-RAT cell change order to GERAN or the network does not wish to use these procedures:

The eNodeB can trigger RRC connection release with redirection to GERAN or UTRAN.

NOTE 1: When performing CS Fallback to UTRAN, the RRC connection release with redirection can be optimized if both the UE and UTRAN support the optional "Deferred measurement control reading" feature specified in TS 25.331 [7].

- 3c. If the UE and network support "RRC connection release with redirection and Multi Cell System Information to GERAN/UTRAN":

The eNodeB can trigger RRC connection release with redirection to GERAN or UTRAN and include one or more physical cell identities and their associated System Information.

In step 3b or step 3c, the eNodeB includes the redirection control information into the RRC Connection Release message based on the PLMN ID for CS domain and the RAT/frequency priority configured in the eNodeB, so that the UE registered PLMN for CS domain can be preferably selected.

NOTE 2: Service Request procedure supervision timer shall be sufficiently long considering the optional measurement reporting at step 2.

4. The eNodeB sends an S1-AP UE Context Release Request message to the MME. If the target cell is GERAN and either the target cell or the UE does not support DTM the message includes an indication that the UE is not available for the PS service.
5. The MME releases the UE Context in the eNodeB as well as all eNodeB related information in the S-GW as specified in TS 23.401 [2].

In case the Cause indicates that RRC was released due to abnormal conditions, e.g. radio link failure, the MME suspends the EPS bearers (Step 8).

The UE performs one of steps 6a or 6b or 6c and THEN performs step 6d.

- 6a. (Step 6a is performed if step 3a, Cell Change Order to GERAN, was performed)

The UE moves to the new cell in GERAN. The UE uses the NACC information and/or the broadcast System Information and when it has all of the necessary information to access the GERAN cell, establishes a radio signalling connection.

- 6b. (Step 6b is performed if step 3b, RRC release with redirection, was performed).

The UE moves to the target RAT, identifies a suitable cell preferably of the same PLMN as received in LAI IE of combined EPS/IMSI Attach/TAU Accept message, receives the broadcast System Information and when it has the necessary information to access GERAN/UTRAN, establishes a radio signalling connection.

- 6c. (Step 6c is performed if step 3c, RRC connection release with redirection and Multi Cell System Information, was performed).

The UE moves to the target RAT and identifies a suitable cell preferably of the same PLMN as received in LAI IE of combined EPS/IMSI Attach/TAU Accept message. The UE uses the Multi Cell System Information and/or the broadcast System Information and when it has all of the necessary information to access GERAN/UTRAN, the UE establishes the radio signalling connection.

- 6d. When the UE arrives at the target cell, if target RAT is UTRAN: The UE establishes the radio signalling connection by sending an RRC Initial Direct Transfer message as specified in TS 25.331 [7] that contains a NAS message. The CN Domain Indicator is set to "CS" in the Initial Direct Transfer message. If the eNodeB indicated UE to go to GERAN in step 3 but the UE finally camps on an UTRAN cell of the same RA that the UE is registered with and ISR active, the UE should locally deactivate ISR.

If target RAT is GERAN A/Gb mode: The UE establishes a radio signalling connection by using the procedures specified in TS 44.018 [4] (i.e. UE requests and is assigned a dedicated channel where it sends a SABM containing a NAS message to the BSS and the BSS responds by sending a UA). Upon receiving the SABM (containing the NAS message) the BSS sends a COMPLETE LAYER 3 INFORMATION message (containing the NAS message) to the MSC which indicates CS resources have been allocated in the GERAN cell. After the establishment of the main signalling link as described in TS 44.018 [4] the UE enters either Dual Transfer Mode or Dedicated Mode.

If the LA of the new cell is different from the one stored in the UE, the UE (which is received as part of Combined Attach/TAU procedure in E-UTRAN) shall initiate a Location Area Update regardless of the different Network Modes of Operation (NMO). The UE shall set the "follow-on request" flag in the LAU Request in order to indicate to the MSC not to release the Iu/A connection after the LAU procedure is complete. The UE shall indicate to the target MSC that this is an originating call establishment as a result of CSFB by including the CSMO flag. Further the UE performs any Routing Area Update procedure as specified by TS 23.060 [3].

In NMO I a CSFB UE shall perform separate LAU with "follow-on request" flag and "CSMO" flag, and RAU procedures instead of a Combined RA/LA Update procedure to speed up the CSFB procedure.

7. If the target RAT is GERAN and DTM is not supported or the UE does not support DTM, the UE starts the Suspend procedure specified in TS 23.060 [3]. This triggers the (serving) SGSN to send a Suspend Request (TLLI, RAI) message to the old CN node identified by the RAI and TLLI. If ISR is not active, the RAI and TLLI refer to an MME. The MME returns a Suspend Response to the SGSN even though the GUTI cannot be derived from the P-TMSI and RAI pair. If ISR is active, the RAI and TLLI refer to the old S4-SGSN. In this case, if the serving SGSN is different from the old SGSN which has ISR association with MME, the old SGSN returns a Suspend Response to the serving SGSN.

NOTE 3: For step 7b and 8, the inter-SGSN suspending procedure of ISR active case are not shown in the figure.

8. If the S1-AP UE Context Release Request message, received from the eNodeB in step 4, indicates that the UE is not available for the PS service in the target cell, the MME deactivates GBR bearers towards S-GW and P-GW(s) by initiating MME-initiated Dedicated Bearer Deactivation procedure as specified in TS 23.401 [2], and starts the preservation and suspension of non-GBR bearers by sending Suspend Notification message to the S-GW. If ISR is active, the (old) S4-SGSN deactivates GBR bearers towards S-GW and P-GW(s) by initiating MS- and SGSN initiated Bearer Deactivation procedure as specified in TS 23.060 [3], and starts the preservation and suspension of non-GBR bearers by sending the Suspend Notification message to the S-GW, which is all triggered by the Suspend procedure in step 7. The S-GW sends Suspend Notification message to the P-GW(s) when it receives the Suspend Notification message from MME or S4-SGSN. If the S-GW receives two Suspend Notification messages for the same UE, it ignores the second one except for sending response. The MME stores in the UE context that UE is suspended status. If ISR is active, the (old) S4-SGSN stores in the UE context that UE is in suspended status. All the preserved non-GBR bearers are marked as suspended status in the S-GW and P-GW(s). The P-GW should discard packets if received for the suspended UE.

NOTE 4: Step 8 can not be triggered by the Suspend procedure since the full GUTI can not be derived from the P-TMSI and RAI included in the Suspend Request message.

9. The UE continues with the MO call setup procedure with sending CM Service Request. The UE shall indicate to the MSC that this is an originating call establishment as a result of CSFB by including the "CSMO" flag.
- 10a. If the UE is not registered in the MSC serving the 2G/3G cell or the UE is not allowed in the LA, the MSC shall reject the service request, if implicit location update is not performed.
- 10b. A UE detecting that the MSC rejected the service request shall perform the Location Area Update or a Combined RA/LA procedure according to existing GERAN or UTRAN procedures as specified in TS 23.060 [3] for the different Network Modes of Operation (NMO).
- 10c. The UE initiates the CS call establishment procedure and the UE shall include the CSMO flag in the CM Service Request to the MSC.
11. After the CS voice call is terminated and if the UE is in GERAN and PS services are suspended, then the UE shall resume PS services as specified in TS 23.060 [3]. A Gn/Gp -SGSN will follow TS 23.060 [3] to resume the PDP Context(s); in addition, the Gn/Gp SGSN sends a Update PDP Context Request message to the GGSN/P-GW, the GGSN/P-GW resumes the PDP Context(s). An S4 SGSN will follow TS 23.060 [3] to resume the bearers, and informs the S-GW and P-GW(s) to resume the suspended bearers. If the UE has returned to E-UTRAN after the CS voice call was terminated, then the UE shall resume PS service by sending TAU to MME.

The MME will in addition inform S-GW and P-GW(s) to resume the suspended bearers. Resuming the suspended bearers in the S-GW and in the P-GW should be done by implicit resume using the Modify Bearer request message if it is triggered by the procedure in operation, e.g. RAU, TAU or Service Request. The S-GW is aware of the suspend state of the bearers and will forward the Modify Bearer request to the P-GW. Explicit resume using the Resume Notification message should be used in cases when Modify Bearer Request is not triggered by the procedure in operation.

If the UE remains on UTRAN/GERAN after the CS voice call is terminated the UE performs normal mobility management procedures as defined in TS 23.060 [3] and TS 24.008 [21].

6.4 Mobile Originating call in Idle Mode

Mobile Originating call in Idle Mode procedure is specified by reusing the Mobile Originating Call in Active mode procedures as specified in clauses 6.2 and 6.3 with Extended Service Request for mobile originating CS fallback to the MME where the messages S1-AP UE Context Modification Request and Response are replaced by S1-AP Initial UE Context Request and Response. The LAI is included in the S1-AP Initial UE Context Request message and sent to the eNodeB. The UE is transited to ECM-CONNECTED mode by following the applicable procedures specified in TS 23.401 [2].

NOTE: Even in case both the UE and the network support PS HO, the eNodeB may choose to use a different inter-RAT mobility procedure.

If UE has only LIPA PDN connection and the cell accessed by the UE does not link to the L-GW where the UE had the LIPA PDN Connection, the MME shall reject the Extended Service Request with a reason code which results in the UE selecting GERAN or UTRAN as specified in TS 24.301 [34].

If the UE is service user with subscription to CS domain priority service, the UE will set the RRC establishment cause to "HighPriorityAccess" based on the access class as specified in TS 36.331 [33]. If the network supports a priority call handling, the MME determines that the Extended Service Request requires priority handling of CS Fallback based on the "HighPriorityAccess" establishment cause forwarded by eNodeB to the MME and/or MPS CS Priority in the UE's EPS subscription. According to operator policy, the MME may use MPS CS Priority in the UE's EPS subscription to verify the priority handling of the CS Fallback procedure.

If MME decides to perform CS Fallback with priority, it sets priority indication, i.e. "CSFB High Priority", in the S1-AP Initial UE Context Request message to the eNodeB as specified in TS 36.413 [35]. The eNodeB allocates radio bearer resources to the UE preferentially compared to other normal calls.

6.5 Returning back to E-UTRAN

Once CS service ends in CS domain, existing mechanisms can be used to move the UE to E-UTRAN, no specific CS Fallback mechanisms are needed.

During the release of an RR connection the MSC should indicate to GERAN/UTRAN that the RR connection (for call or CISS or LCS) was established as a result of CS fallback. GERAN and UTRAN may use the indication to determine which of the existing mechanisms that should be used to move the UE to E-UTRAN.

When the UE moves to E-UTRAN, if the EPS service was suspended during the CS service, it is resumed according to the procedure shown in the figure 6.5-1 below.

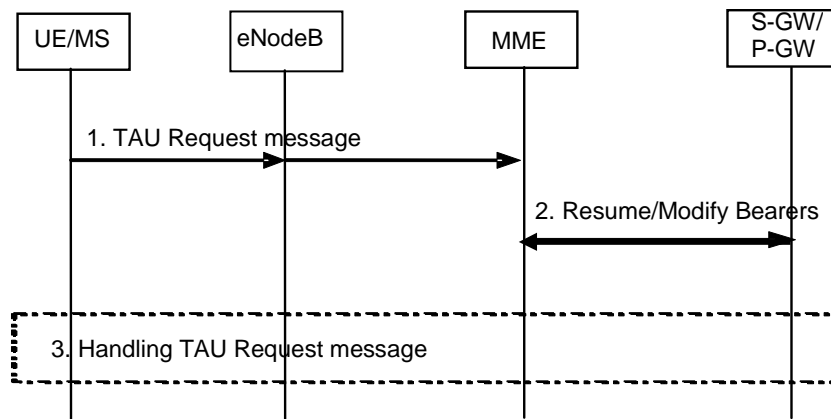

Figure 6.5-1: Resume Procedure returning from CS fallback no PS HO

1. The UE sends a TAU Request message, to the MME.
2. If the UE context in the MME indicates that UE is in suspended status, the MME informs the S-GW and P-GW(s) to re-activate the EPS bearers for the UE.

If the procedure triggered by the NAS message in step 1 activates Modify Bearer Request message to the S-GW, this message should be used as an implicit resume. The S-GW is aware of the suspend state of the bearers and shall forward the Modify Bearer request to the P-GW. The P-GW and S-GW shall clear the suspend state and confirm with Modify Bearer response to the MME.

3. The NAS message is processed accordingly.

6.6 Mobile Originated or Mobile terminated call rejected by the MME

The MME may reject an Extended Service Request either for mobile originated or mobile terminated CSFB. The following procedure covers this scenario.

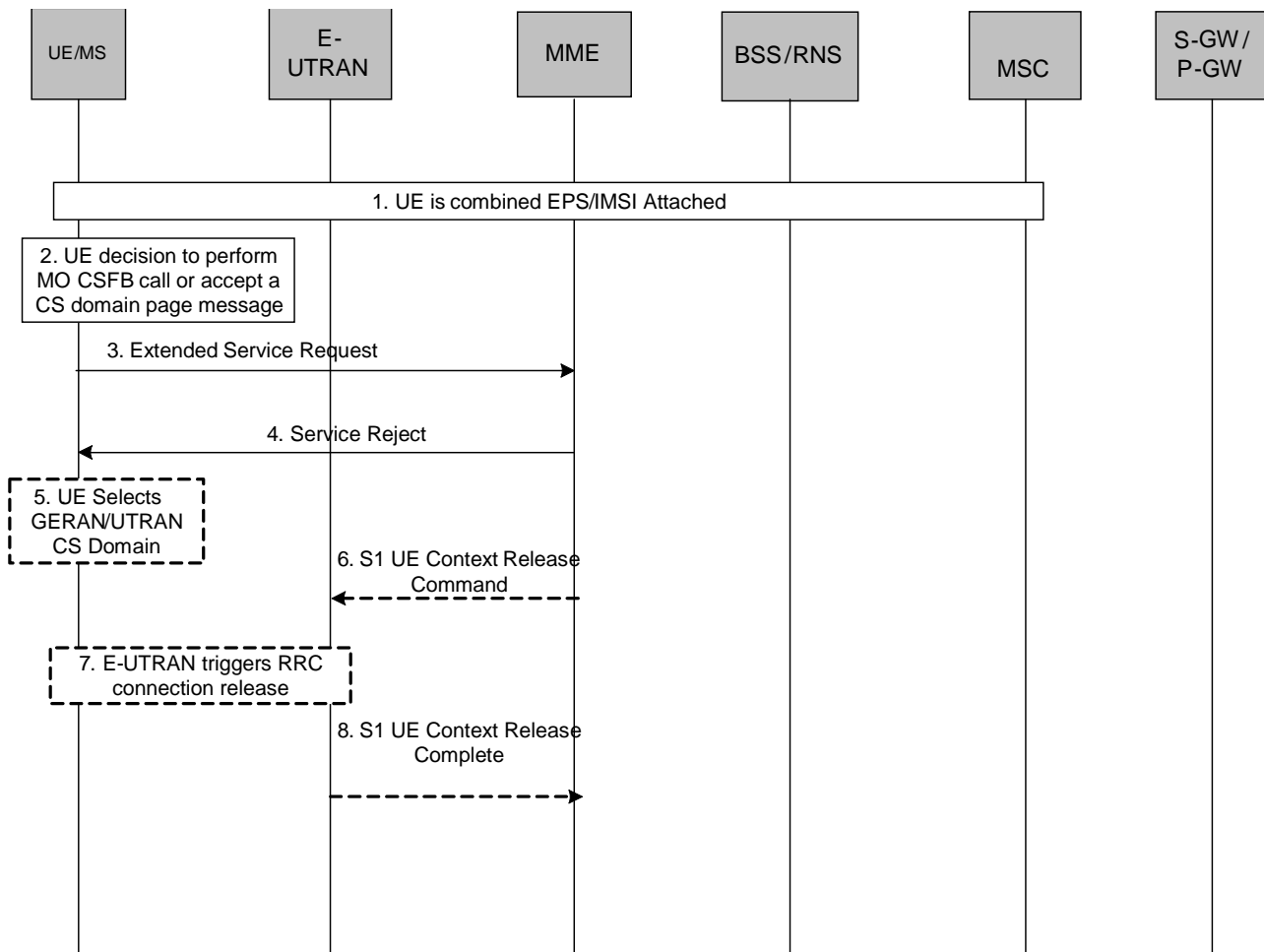

Figure 6.6-1: CSFB MO or MT call, rejected by MME

1. UE is combined EPS/IMSI attached.
2. UE makes a decision to perform a mobile originated CS call or accepts CS paging for the CS Fallback to GERAN/UTRAN.
3. UE sends an Extended Service Request for mobile originating/mobile terminating CS fallback to the MME.
4. If the MME decides to reject the Extended Service Request, the MME sends a Service Reject message to the UE.

Steps 5 – 8 are executed when Service Reject is sent with a reason code which results in the UE selecting GERAN or UTRAN, as specified in TS 24.301 [34].

5. The UE selects GERAN or UTRAN CS Domain without waiting for RRC Release.
6. The MME releases S1 by sending the S1 UE Context Release Command (Cause) message to the eNodeB. Cause value indicates that release is triggered due to CS Fallback procedure.
7. If the RRC connection is not already released, the E-UTRAN sends a RRC Connection Release message to the UE.
8. The E-UTRAN confirms the S1 Release by returning an S1 UE Context Release Complete message to the MME.

7 Mobile Terminating Call

7.1 General

This clause describes the mobile terminating call procedures for the CS Fallback in EPS.

The MSC handles the timers, queuing and retransmission for sending the SGsAP-PAGING-REQUEST message on the SGs interface in the same way that it handles the sending of a PAGING message on the A or Iu interface. As a consequence, the MME and (if ISR is active) the SGSN shall not implement local retransmission schemes for this paging.

7.2 Mobile Terminating call in idle mode

The procedure for Mobile Terminating Call in idle mode is illustrated in figure 7.2-1, in the normal case. Clause 6.6 describes the procedure when the procedure is rejected by the MME.

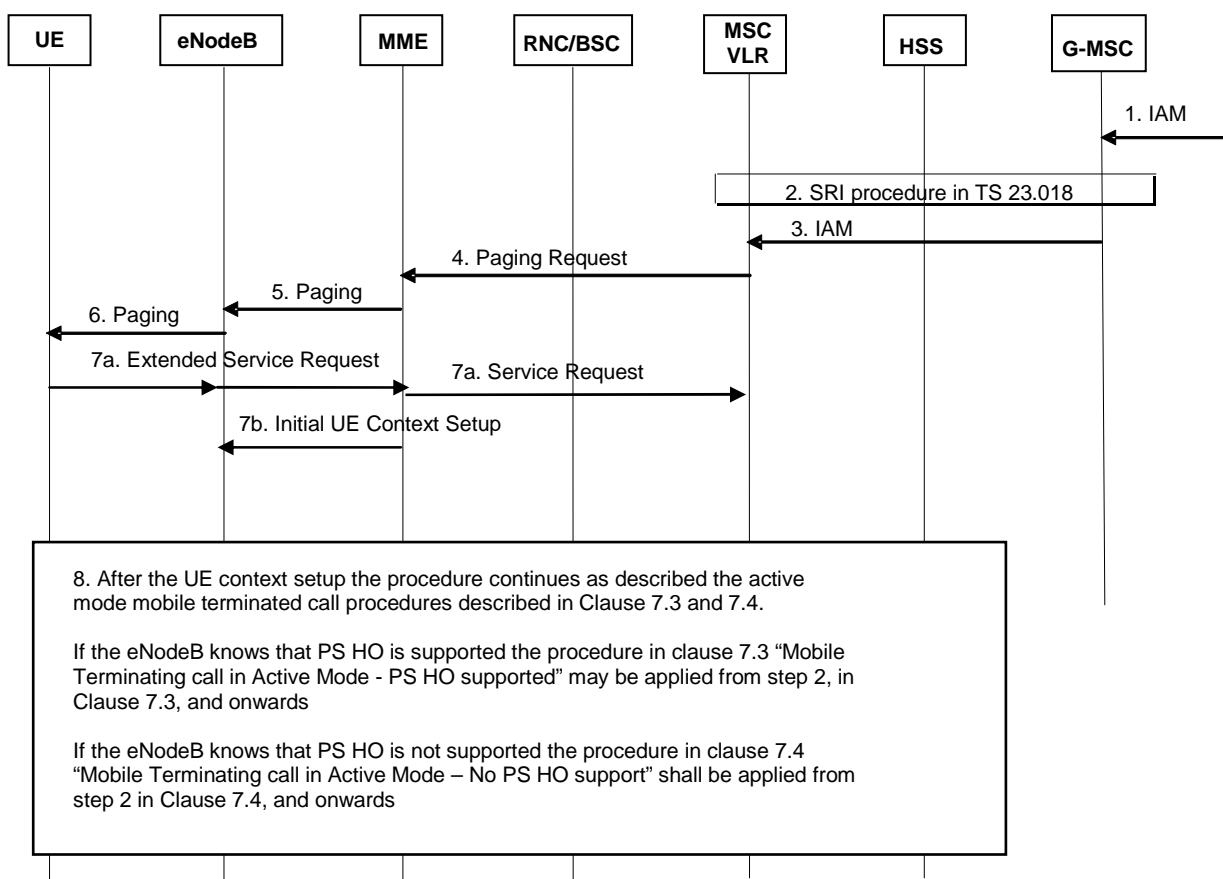

Figure 7.2-1: Mobile Terminating Call in idle mode

1. G-MSC receives IAM.
2. G-MSC retrieves routing information of the terminating UE by Send Routing Info procedures as specified in TS 23.018 [5].
3. G-MSC sends IAM to the MSC on the terminating side as specified in TS 23.018 [5].
4. The MME receives a Paging Request (IMSI, VLR TMSI, Location Information, priority indication) message from the MSC over a SGs interface. IMSI is used by the MME to find the S-TMSI. If the TMSI and the LAI are received from the MSC/VLR, the S-TMSI is used as the paging address on the radio interface. If the TMSI is not received from the MSC/VLR, the IMSI shall be used as the paging address on the radio interface. If location information is reliably known by MME (i.e. MME stores the list of TAs), the MME shall page the UE in all the

TAs. If the MME does not have a stored TA list for the UE, the MME may use the location information received from the MSC to page the UE.

NOTE 1: The case when LAI is not received from MSC/VLR and the case when S-TMSI is not available are further described in clause 4.8.

NOTE 2: This procedure takes place before step 3, immediately after MSC receives MAP_PRN from HSS, if pre-paging is deployed.

If the MME receives a Paging Request message for an UE which is considered as detach for EPS services, the MME sends the Paging reject message to the MSC with an appropriate cause value. This rejection triggers the MSC to page the UE over A or Iu-CS interface.

NOTE 3: In case of a CS fallback capable UE in NMO II or III, there is a case where, for example, the MME releases the SGs association due to the UE idle mode mobility while the VLR still maintains the SGs association.

If the MME receives Paging Request with priority indication, e.g. eMLPP priority, from the MSC, then the MME processes this message and also the subsequent CS Fallback procedure preferentially compared to other normal procedures.

5. If the MME did not return an "SMS-only" indication to the UE during Attach or Combined TA/LA Update procedures, the MME sends a Paging (as specified in TS 23.401 [2]) message to each eNodeB. The Paging message includes a suitable UE Identity (i.e. S-TMSI or IMSI) and a CN Domain Indicator that indicates which domain (CS or PS) initiated the paging message. In this case it shall be set to "CS" by the MME.

If the MME returned the "SMS-only" indication to the UE during Attach or Combined TA/LA Update procedures, the MME shall not send the paging to the eNodeBs and sends Paging Reject towards MSC to stop CS Paging procedure and this CSFB procedure stops.

If the MME received Paging Request with priority indication in step4, the Paging message also includes priority indication.

6. The radio resource part of the paging procedure takes place. The message contains a suitable UE Identity (i.e. S-TMSI or IMSI) and a CN Domain indicator. If eNodeB received Paging with Priority Indication in step 5, it performs the paging procedure preferentially compared to other normal paging.

7a. The UE establishes an RRC connection and sends an Extended Service Request for mobile terminating CS fallback to MME. The UE indicates its S-TMSI in the RRC signalling. The Extended Service Request message is encapsulated in RRC and S1-AP messages. The MME sends the SGs Service Request message to the MSC containing an indication that the UE was in idle mode (and hence, for example, that the UE has not received any Calling Line Identification information). Receipt of the SGs Service Request message stops the MSC retransmitting the SGs interface Paging message.

NOTE 4: In order to avoid the calling party experiencing a potentially long period of silence, the MSC may use the SGs Service Request message containing the idle mode indication as a trigger to inform the calling party that the call is progressing.

If the MME had received paging request with Priority Indication in step4 and receives subsequent Extended Service Request in Step 7a, it detects this message is the response to the priority CS Fallback procedure initiated in step5. In this case, the MME processes this message with priority and set the priority indication, i.e. "CSFB High Priority", in step7b as specified in TS 36.413 [35].

If UE has only LIPA PDN connection and the cell accessed by the UE does not link to the L-GW where the UE had the LIPA PDN Connection, the MME shall reject the Extended Service Request with a reason code which results in the UE selecting GERAN or UTRAN as specified in TS 24.301 [34].

7b. MME sends S1-AP: Initial UE Context Setup (UE capabilities, CS Fallback Indicator, LAI and other parameters specified in TS 23.401 [2]) to indicate the eNodeB to move the UE to UTRAN/GERAN. The registered PLMN for CS domain is identified by the PLMN ID included in the LAI, which is allocated by the MME.

7c. The eNodeB shall reply with S1-AP: Initial UE Context Setup Response message.

8a. If the eNodeB knows that both the UE and the network support PS handover: The information flow may continue as described in clause 7.3 "Mobile Terminating call in Active Mode - PS HO supported" from step 2, in clause 7.3, and onwards.

If the eNodeB knows that either the UE or the network does not support PS handover: The information flow shall continue as described in clause 7.4 "Mobile Terminating call in Active Mode – No PS HO support" from step 2, in clause 7.4, and onwards.

NOTE 5: Even in case both the UE and the network support PS HO, the eNodeB may choose to use a different inter-RAT mobility procedure.

7.3 Mobile Terminating call in Active Mode - PS HO supported

This flow may be executed when the eNodeB knows that both the UE and the network support PS HO in the normal case. Clause 6.6 describes the procedure when the procedure is rejected by the MME.

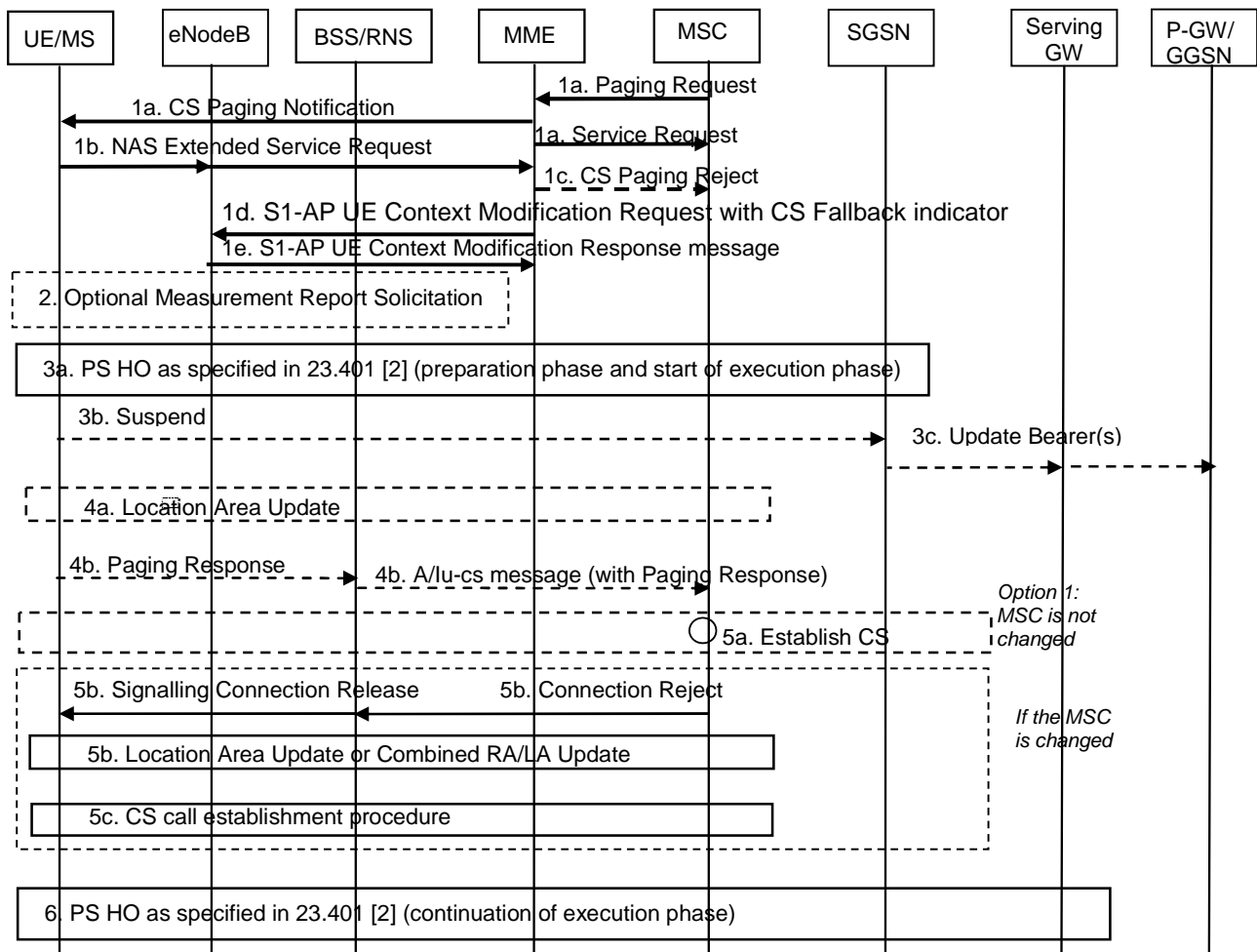

Figure 7.3-1: CS Page in E-UTRAN, Call in GERAN/UTRAN

1a. The MSC receives an incoming voice call and responds by sending a Paging Request (IMSI or TMSI, optional Caller Line Identification and Connection Management information, CS call indicator, priority indication) to the MME over a SGs interface. The MSC only sends a CS Page for an UE that provides location update information using the SGs interface. In active mode the MME has an established S1 connection and if the MME did not return the "SMS-only" indication to the UE during Attach or Combined TA/LA Update procedures, the MME reuses the existing connection to relay the CS Page to the UE.

If the MME returned the "SMS-only" indication to the UE during Attach or Combined TA/LA Update procedures, the MME shall not send the CS Service Notification to the UE and shall send Paging Reject towards MSC to stop CS Paging procedure, and this CSFB procedure stops.

The eNodeB forwards the paging message to the UE. The message contains CN Domain indicator and, if received from the MSC, the Caller Line Identification.

The MME immediately sends the SGs Service Request message to the MSC containing an indication that the UE was in connected mode. The MSC uses this connected mode indication to start the Call Forwarding on No Reply timer for that UE and the MSC should send an indication of user alerting to the calling party. Receipt of the SGs Service Request message stops the MSC retransmitting the SGs interface Paging message.

NOTE 1: The pre-configured policy may be used by UE to avoid being disturbed without Caller Line Identification display and the detailed handling is to be decided by CT1 and CT6.

NOTE 2: This procedure can also take place immediately after MSC receives MAP_PRN from HSS, if pre-paging is deployed. Caller Line Identification and CS call indicator are also provided in the case of pre-paging.

NOTE 3: In order to avoid the calling party experiencing a potentially long period of silence, the MSC may use the SGs Service Request message as a trigger to inform the calling party that the call is progressing.

If the MME receives paging request message with priority indication, e.g. eMLPP priority, from the MSC, then the MME processes this message and also the subsequent CS fallback procedure preferentially compared to other normal procedures.

- 1b. UE sends an Extended Service Request (Reject or Accept) message to the MME for mobile terminating CS fallback. The Extended Service Request message is encapsulated in RRC and S1-AP messages. The UE may decide to reject CSFB based on Caller Line Identification.
- 1c. Upon receiving the Extended Service Request (Reject) for mobile terminating CS fallback, the MME sends Paging Reject towards MSC to stop CS Paging procedure and this CSFB procedure stops.
- 1d. MME sends an S1-AP UE Context Modification Request (CS Fallback Indicator, LAI) message to eNodeB. This message: indicates to the eNodeB that the UE should be moved to UTRAN/GERAN. The registered PLMN for CS domain is identified by the PLMN ID included in the LAI, which is allocated by the MME.

If MME received priority indication in Step 1a, the MME sends S1-AP UE Context Modification Request message to the eNodeB with priority indication, i.e. "CSFB High Priority", as specified in TS 36.413 [35].

- 1e. The eNodeB shall reply with S1-AP UE Context Modification Response message.
2. The eNodeB may optionally solicit a measurement report from the UE to determine the target GERAN/UTRAN cell to which PS handover will be performed.

NOTE 4: Based on operator policy, the priority indicator received in step1b may be used by eNodeB to decide whether to continue CS Fallback procedures with PS HO, i.e. step3a, or to initiate radio release procedure to redirect the UE to 2G/3G Circuit Switch.

- 3a. The eNodeB triggers PS handover to a GERAN/UTRAN neighbour cell by sending a Handover Required message to MME. The eNodeB selects the target PS handover cell considering the PLMN ID and possibly the LAC for CS domain provided by the MME in step 1d.

If the eNB is a HeNB, the HeNB should perform step 3 through step 6 of clause 7.4 instead of PS HO if the HeNB detects that the UE has only LIPA PDN Connections. CSFB will not be completed successfully when PS HO is performed if the UE has only LIPA PDN Connections as PS HO would result in the MME detaching the UE.

NOTE 5: For details how the HeNodeB determines whether a PDN connection is a LIPA PDN connection see TS 23.401 [2], clause 4.3.16.

In the following an inter-RAT handover from E-UTRAN to UTRAN or GERAN as specified in TS 23.401 [2] begins. The eNodeB indicates in the Source RNC to Target RNC Transparent container that PS handover was triggered due to CSFB. The eNodeB also indicates whether CSFB requires priority handling by forwarding the CSFB high priority indication to the target GERAN/UTRAN in the Source to Target Transparent Container, and the target GERAN/UTRAN allocates radio bearer resources taking received priority indication take into account.

As part of this handover, the UE receives a HO from E-UTRAN Command and tries to connect to a cell in the target RAT. The HO from E-UTRAN Command may contain a CS Fallback Indicator which indicates to UE that the handover was triggered due to a CS fallback request. If the HO from E-UTRAN Command contains a CS Fallback Indicator and the UE fails to establish connection to the target RAT, then the UE considers that CS fallback has failed.

The UE establishes the signalling connection as described in step 4b.

NOTE 6: During the PS HO the SGSN does not create a Gs association with the MSC/VLR.

3b. If the target RAT is GERAN and the UE has entered Dedicated Mode, the UE starts the Suspend procedure (see TS 44.018 [4]) unless both the UE and the Target cell support DTM in which case TBF re-establishment may be performed.

3c. A Gn/Gp-SGSN that receives the Suspend message from the UE follows the Suspend procedure specified in TS 23.060 [3], clause 16.2.1.1.1.

An S4-SGSN that receives the Suspend message from the UE follows the Suspend procedure specified in TS 23.060 [3]. The S4-SGSN deactivates GBR bearers towards S-GW and P-GW(s) by initiating MS- and SGSN Initiated Bearer Deactivation procedure as specified in TS 23.060 [3], and starts the preservation and suspension of non-GBR bearers by sending Suspend Notification message to the S-GW. The S-GW releases all RNC related information (address and TEIDs) for the UE if Direct Tunnel is established, and sends Suspend Notification message to the P-GW(s). The SGSN stores in the UE context that UE is in suspended status. All the preserved non-GBR bearers are marked as suspended status in the S-GW and P-GW(s). The P-GW should discard packets if received for the suspended UE.

4a. If the LA of the new cell is different from the one stored in the UE, the UE shall initiate a Location Area Update procedure as follows:

- If the network is operating in NMO-I (Network Modes of Operation), the UE shall initiate a separate Location Area Update before initiating the RAU procedure instead of a Combined RA/LA Update procedure (to speed up the CSFB procedure); or
- if the network is operating in NMO-II or NMO-III the UE shall initiate a Location Area Update procedure before initiating the RAU procedure required for PS handover.

The UE shall set the "CSMT" flag in the LAU Request. The "CSMT" flag is used to avoid missing MT call in roaming retry case. Further the UE performs any Routing Area Update procedure as specified in TS 23.060 [3].

The UE may initiate a Location Area Update procedure immediately when the UE is handed over to the target cell i.e. before the UE receives e.g. LAI or NMO information as part of the RAN Mobility Information.

When the MSC receives a LA Update Request, it shall check for pending terminating CS calls and, if the "CSMT" flag is set, maintain the CS signalling connection after the Location Area Update procedure for pending terminating CS calls.

4b. If the UE does not initiate a LAU procedure, it shall respond with a Paging Response message to the MSC as follows:

- If the Target RAT is UTRAN or GERAN Iu mode: The UE establishes a radio signalling connection and responds to the paging by sending an RRC Paging Response as specified in TS 25.331 [7]. The CN Domain Indicator is set to "CS" in the Initial Direct Transfer message.
- If the Target RAT is GERAN A/Gb mode: The UE establishes a radio signalling connection and responds to paging by using the procedures specified in TS 44.018 [4] (i.e. UE requests and is assigned a dedicated channel where it sends a SABM containing a Paging Response to the BSS and the BSS responds by sending a UA). Upon receiving the SABM (containing a Paging Response message) the BSS sends a COMPLETE LAYER 3 INFORMATION message (containing a Paging Response message) to the MSC which indicates CS resources have been allocated in the GERAN cell. If both the UE and the target cell support enhanced CS establishment in DTM (indicated by GERAN system information included within the HO from E-UTRAN Command) an RR connection may be established while in packet transfer mode without release of the packet resources, see TS 43.055 [24]. After the establishment of the main signalling link as described in TS 44.018 [4] the UE enters either Dual Transfer Mode or Dedicated Mode and the CS call establishment procedure completes.

NOTE 7: The BSS should be prepared to receive a Paging Response even when the corresponding Paging Request has not been sent by this BSS.

5a. After performing the LAU procedure or after receiving the Paging Response the MSC shall establish the CS call if the UE is allowed in the LA.

5b. If the UE is not registered in the MSC that receives the Paging Response or the UE is not allowed in the LA, the MSC shall reject the Paging Response message by releasing the A/Iu-CS. The BSC/RNC in turn releases the signalling connection for UTRAN or GERAN CS domain. The signalling connection release shall trigger the UE to obtain the LAI, which causes the initiation of a Location Area Update or a Combined RA/LA procedure as specified in TS 23.060 [3] for the different Network Modes of Operation (NMO).

The Location Area Update triggers the Roaming Retry for CS Fallback procedure as defined in clause 7.5.

5c. After performing the LAU procedure the MSC shall establish the CS call if the UE is allowed in the LA.

6. The UE performs any remaining steps of the inter-RAT handover from E-UTRAN to UTRAN or GERAN as specified in TS 23.401 [2]

With the exception of steps 1a and 1c, above, Call Forwarding (see TS 23.082 [31]) is performed on the basis of the TS 24.008 [21] signalling received on the GERAN/UTRAN cell.

If the UE remains on UTRAN/GERAN after the CS voice call is terminated the UE performs normal mobility management procedures as defined in TS 23.060 [3] and TS 24.008 [21].

7.4 Mobile Terminating call in Active Mode - No PS HO support

This procedure is executed when PS HO is not supported, in the normal case. Clause 6.6 describes the procedure when the procedure is rejected by the MME.

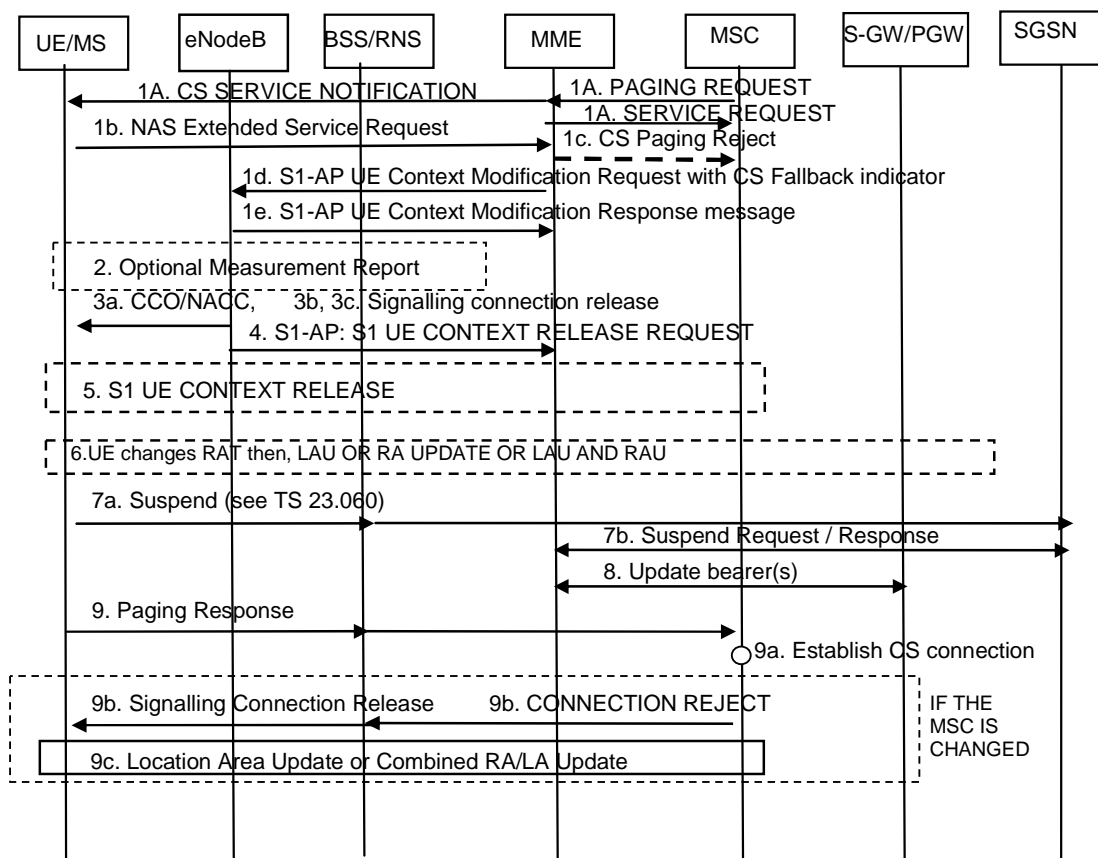

Figure 7.4-1: CS Page in E-UTRAN, Call in GERAN/UTRAN without PS HO

1a. The MSC receives an incoming voice call and responds by sending a Paging Request (IMSI or TMSI, optional Caller Line Identification and Connection Management information, priority indication) to the MME over a SGs interface. The MSC only sends a CS Page for an UE that provides location update information using the SGs interface. In active mode the MME has an established S1 connection and if the MME did not return the "SMS-only" indication to the UE during Attach or Combined TA/LA Update procedures, the MME reuses the existing connection to relay the CS Service Notification to the UE.

If the MME returned the "SMS-only" indication to the UE during Attach or Combined TA/LA Update procedures, the MME shall not send the CS Page to the UE and sends CS Paging Reject towards MSC to stop CS Paging procedure, and this CSFB procedure stops.

The eNodeB forwards the paging message to the UE. The message contains CN Domain indicator and, if received from the MSC, the Caller Line Identification.

The MME immediately sends the SGs Service Request message to the MSC containing an indication that the UE was in connected mode. The MSC uses this connected mode indication to start the Call Forwarding on No Reply timer for that UE and the MSC should send an indication of user alerting to the calling party. Receipt of the SGs Service Request message stops the MSC retransmitting the SGs interface Paging message.

NOTE 1: The pre-configured policy may be used by UE to avoid being disturbed without Caller Line Identification display and the detailed handling is to be decided by CT WG1 and CT WG6.

NOTE 2: This procedure can also take place immediately after MSC receives MAP_PRN from HSS, if pre-paging is deployed. Caller Line Identification is also provided in the case of pre-paging.

If the MME receives paging request message with priority indication, e.g. eMLPP priority, from the MSC, then the MME processes this message and also the subsequent CS fallback procedure preferentially compared to other normal procedures.

1b. UE sends an Extended Service Request (Reject or Accept) message to the MME for mobile terminating CS fallback. Extended Service Request message is encapsulated in RRC and S1-AP messages. The UE may decide to reject CSFB based on Caller Line Identification.

1c. Upon receiving the Extended Service Request (Reject) for mobile terminating CS fallback, the MME sends Paging Reject towards MSC to stop CS Paging procedure and this CSFB procedure stops.

1d. The MME sends an S1-AP UE Context Modification Request (CS Fallback Indicator, LAI) message to eNodeB. This message indicates to the eNodeB that the UE should be moved to UTRAN/GERAN. The registered PLMN for CS domain is identified by the PLMN ID included in the LAI, which is allocated by the MME.

If MME received priority indication in Step 1a, the MME sends S1-AP UE Context Modification Request message to the eNodeB with priority indication, i.e. "CSFB High Priority", as specified in TS 36.413 [35].

1e. The eNodeB shall reply with S1-AP UE Context Modification Response message.

2. The eNodeB may optionally solicit a measurement report from the UE to determine the target GERAN/UTRAN cell to which the redirection procedure will be performed.

The network performs one of steps 3a or 3b or 3c.

3a. If the UE and network support inter-RAT cell change order to GERAN and the target cell is GERAN:

The eNodeB can trigger an inter-RAT cell change order (optionally with NACC) to a GERAN neighbour cell by sending an RRC message to the UE. The inter-RAT cell change order may contain a CS Fallback Indicator which indicates to UE that the cell change order is triggered due to a CS fallback request. If the inter-RAT cell change order contains a CS Fallback Indicator and the UE fails to establish connection to the target RAT, then the UE considers that CS fallback has failed. Service Request procedure is considered to be successfully completed when cell change order procedure is completed successfully.

The eNodeB selects the target cell considering the PLMN ID and possibly the LAC for CS domain provided by the MME in step 1d for CCO/NACC purpose.

3b. If the UE or the network does not support inter-RAT PS handover from E-UTRAN to GERAN/UTRAN nor inter-RAT cell change order to GERAN:

The eNodeB can trigger RRC connection release with redirection to GERAN or UTRAN instead of PS HO or NACC.

NOTE 3: When performing CS Fallback to UTRAN, the RRC connection release with redirection can be optimized if both the UE and UTRAN support the optional "Deferred measurement control reading" feature specified in TS 25.331 [7].

3c. If the UE and network support "RRC connection release with redirection and Multi Cell System Information to GERAN/UTRAN":

The eNodeB can trigger RRC connection release with redirection to GERAN or UTRAN and include one or more physical cell identities and their associated System Information.

In step 3b or step 3c, the eNodeB includes the redirection control information into the RRC Connection Release message based on the PLMN ID for CS domain and the RAT/frequency priority configured in the eNodeB, so that the UE registered PLMN for CS domain can be preferably selected.

Also in Steps 3b or 3c, the eNB sets the "CS Fallback High Priority" indication in the RRC Release message, if the S1AP message in Step 1d contains the "CSFB High Priority" indication.

NOTE 4: Service Request procedure supervision timer shall be sufficiently long considering the optional measurement reporting at step 2.

4. The eNodeB sends an S1-AP UE Context Release Request message to the MME. If the target cell is GERAN and either the target cell or the UE does not support DTM the message includes an indication that the UE is not available for PS service.

5. The MME releases the UE Context in the eNodeB as well as all eNodeB related information in the S-GW as specified in TS 23.401 [2].

In case the Cause indicates that RRC was released due to abnormal conditions, e.g. radio link failure, the MME suspends the EPS bearers (Step 8).

The UE performs one of steps 6a or 6b or 6c and THEN performs step 6d.

6a. (Step 6a is performed if step 3a, Cell Change Order to GERAN, was performed).

The UE moves to the new cell in GERAN. The UE uses the NACC information and/or the broadcast System Information and when it has the necessary information to access the GERAN cell, establishes a radio signalling connection.

6b. (Step 6b is performed if step 3b, RRC release with redirection, was performed).

The UE moves to the target RAT, identifies a suitable cell preferably of the same PLMN as received in LAI IE of combined EPS/IMSI Attach/TAU Accept message, receives the broadcast System Information and when it has the necessary information to access GERAN/UTRAN, establishes a radio signalling connection.

6c. (Step 6c is performed if step 3c, RRC connection release with redirection and Multi Cell System Information, was performed)

The UE moves to the target RAT and identifies a suitable cell preferably of the same PLMN as received in LAI IE of combined EPS/IMSI Attach/TAU Accept message. The UE uses the Multi Cell System Information and/or the broadcast System Information and when it has the necessary information to access GERAN/UTRAN, the UE establishes the radio signalling connection.

If the UE receives the "CS Fallback High Priority" indication in the RRC Release message in Step 3b or 3c and the target is UTRAN, the UE sets the establishment cause value to "Terminating High Priority Signalling" in the RRC Connection Request in Steps 6b and 6c. If the target is GERAN, no special establishment cause value is set by the UE.

6d. If the LA of the new cell is different from the one stored in the UE, the UE shall initiate a Location Area Update regardless of the different Network Modes of Operation (NMO). The UE shall set the "CSMT" flag in the LAU Request. The "CSMT" flag is used to avoid missing MT call in roaming retry case. In NMO I, the UE in GERAN may perform LA update over the RR connection instead of combined RA/LA update over the packet access as defined in TS 24.008 [21], clause 4.7.5.2.5, unless enhanced CS establishment in DTM is supported. Further the UE performs any Routing Area Update procedure as specified in TS 23.060 [3].

In NMO I a CSFB UE shall perform LAU (and if it does so, shall set the "CSMT" flag) and RAU procedures instead of a Combined RA/LA Update procedure to speed up the CSFB procedure.

When the MSC receives a LA Update Request, it shall check for pending terminating CS calls and, if the "CSMT" flag is set, maintain the CS signalling connection after the Location Area Update procedure for pending terminating CS calls.

If the eNodeB indicated UE to go to GERAN in step 3 but the UE finally camps on an UTRAN cell of the same RA that the UE is registered with and ISR active, the UE should locally deactivate ISR.

7. If the target RAT is GERAN and DTM is not supported or the UE does not support DTM, the UE starts the Suspend procedure specified in TS 23.060 [3]. This triggers the (serving) SGSN to send a Suspend Request (TLLI, RAI) message to the old CN node identified by the RAI and TLLI. If ISR is not active, the RAI and TLLI refer to an MME. The MME returns a Suspend Response to the SGSN even though GUTI cannot be derived from the P-TMSI and RAI pair. If ISR is active, the RAI and TLLI refer to the old S4-SGSN. In this case, if the serving SGSN is different from the old SGSN which has ISR association with MME, the old SGSN returns a Suspend Response to the serving SGSN.

NOTE 5: For step 7b and 8, the inter-SGSN suspending procedure of ISR active case are not shown in the figure.

8. If the S1-AP UE Context Release Request message, received from the eNodeB in step 4, indicates that the UE is not available for the PS services in the target cell, the MME deactivates GBR bearers towards S-GW and P-GW(s) by initiating MME-initiated Dedicated Bearer Deactivation procedure as specified in TS 23.401 [2], and starts the preservation and suspension of non-GBR bearers by sending Suspend Notification message to the S-GW. If ISR is active, the (old) S4-SGSN deactivates GBR bearers towards S-GW and P-GW(s) by initiating MS- and SGSN initiated Bearer Deactivation procedure as specified in TS 23.060 [3], and starts the preservation and suspension of non-GBR bearers by sending the Suspend Notification message to the S-GW, which is all triggered by the Suspend procedure in step 7. The S-GW sends Suspend Notification message to the P-GW(s) when it receives the Suspend Notification message from MME or S4-SGSN. If the S-GW receives two Suspend Notification messages for the same UE, it ignores the second one except for sending response. The MME stores in the UE context that the UE is in suspended status. If ISR is active, the (old) S4-SGSN stores in the UE context that UE is in suspended status. All the preserved non-GBR bearers are marked as suspended status in the S-GW and P-GW(s). The P-GW should discard packets if received for the suspended UE.

NOTE 6: Step 8 can not be triggered by the Suspend procedure since the full GUTI can not be derived from the P-TMSI and RAI included in the Suspend Request message.

9. If the UE does not initiate a LAU procedure, the UE responds to the paging by sending a Paging Response message as specified in TS 44.018 [4] or TS 25.331 [7]. When received at the BSS/RNS, the Paging Response is forwarded to the MSC.

NOTE 7: The MSC should be prepared to receive a Paging Response after a relatively long time from when the CS Paging Request was sent (step 1a).

- 9a. If UE is registered in the MSC serving the 2G/3G cell and the UE is allowed in the LA the MSC shall establish the CS call.
- 9b. If the UE is not registered in the MSC that receives the Paging Response or the UE is not allowed in the LA, the MSC shall reject the Paging Response by releasing the A/Iu-cs connection. The BSS/RNS in turn releases the signalling connection for CS domain.
- 9c. The signalling connection release shall trigger the UE to obtain the LAI, which causes the initiation of a Location Area Update or a Combined RA/LA procedure as specified in TS 23.060 [3] for the different Network Modes of Operation (NMO).

The Location Area Update triggers the Roaming Retry for CS Fallback procedure as defined in clause 7.5.

After performing the LAU procedure the MSC shall establish the CS call if the UE is allowed in the LA.

With the exception of steps 1a and 1c, above, Call Forwarding (see TS 23.082 [31]) is performed on the basis of the TS 24.008 [21] signalling received on the GERAN/UTRAN cell.

After the CS voice call is terminated and if the UE is still in GERAN and PS services are suspended, then the UE shall resume PS services as specified in TS 23.060 [3]. A Gn/Gp- SGSN will follow TS 23.060 [3] to resume the PDP Context(s), which is done by the Routing Area Update procedure. During the Routing Area Update procedure in which

the Gn/Gp SGSN sends a Update PDP Context Request message to the GGSN/P-GW, the GGSN/P-GW resumes the PDP Context(s). An S4 SGSN will follow TS 23.060 [3] to resume the bearers, and informs the S-GW and P-GW(s) to resume the suspended bearers. If the UE has returned to E-UTRAN after the CS voice call was terminated, then the UE shall resume PS service by sending TAU to MME. The MME will in addition inform S-GW and P-GW(s) to resume the suspended bearers. Resuming the suspended bearers in the S-GW and in the P-GW should be done by implicit resume using the Modify Bearer request message if it is triggered by the procedure in operation e.g. RAU, TAU or Service Request. The S-GW is aware of the suspend state of the bearers and shall forward the Modify Bearer request to the P-GW. Explicit resume using the Resume Notification message should be used in cases when Modify Bearer Request is not triggered by the procedure in operation.

If the UE remains on UTRAN/GERAN after the CS voice call is terminated the UE performs normal mobility management procedures as defined in TS 23.060 [3] and TS 24.008 [21].

7.5 Roaming Retry for CS fallback

The procedure in this section may be applied for mobile terminated calls where the MSC, to which the UE sends the LAU, is different from the MSC that sent the paging message to the UE. The procedure is based on the 'Mobile Terminating Roaming Retry Call' procedure defined in TS 23.018 [5] and there is an only minor adaptation of the procedure to support CS fallback.

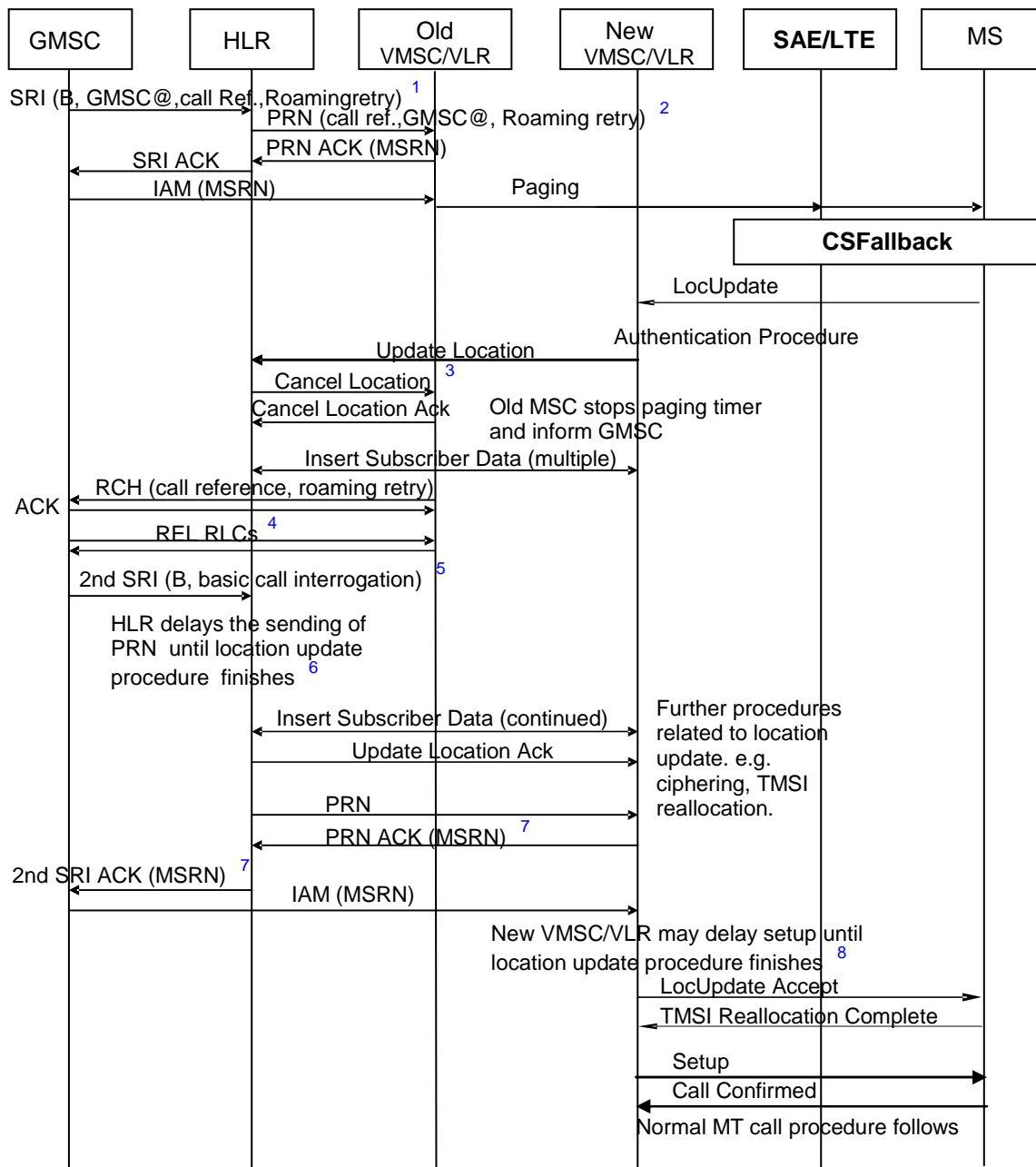

Figure 7.5-1: Roaming Retry for CS fallback

There are only 2 differences in this procedure compared to the 'Mobile Terminating Roaming Retry Call' procedure defined in TS 23.018 [5].

- The first difference is that the paging message in E-UTRAN triggers the CS fallback which is followed by a location update in the new RAT. This functionality is already supported in the CS fallback flows for terminating calls and no additional functionality is needed.
- The second difference is that the UE includes the "CSMT" flag in the location update request message so that the signalling link is maintained for longer in case the IAM is delayed by the HLR.

7.5a Roaming Forwarding for CS fallback

The procedure in this clause may be applied for mobile terminated calls where the MSC/VLR, to which the UE sends the LAU, is different from the MSC/VLR that sent the paging message to the UE. The procedure is based on the "Mobile Terminating Roaming Forwarding" procedure defined in TS 23.018 [5]; the specific behaviour for CSFB is

described in this section. This procedure avoids impacting all GMSC nodes and can coexist with Mobile Terminating Roaming Retry procedure described in clause 7.5.

NOTE 1: In order to support Mobile Terminating Roaming Forwarding both the MSC controlling the target cell, the MSC that sent the paging message to the UE and the HLR need to support the feature.

NOTE 2: This procedure has smaller call setup delay than Mobile Terminating Roaming Retry procedure especially in roaming cases.

NOTE 3: If the network does not support this procedure, the Mobile Terminating Roaming Retry procedure specified in clause 7.5 can be used.

In order to ensure roaming forwarding can be offered in all scenarios (e.g. in case of IMSI in the LAU Request from UE), HLRs should be updated to support MTRF. In order to permit Mobile Terminating Roaming Forwarding from the old VLR if the HLR is not updated to support MTRF but the visited network does support MTRF, the new VLR may include MTRF supported flag in Send Identification when it receives a Location Updating Request containing the "CSMT" flag.

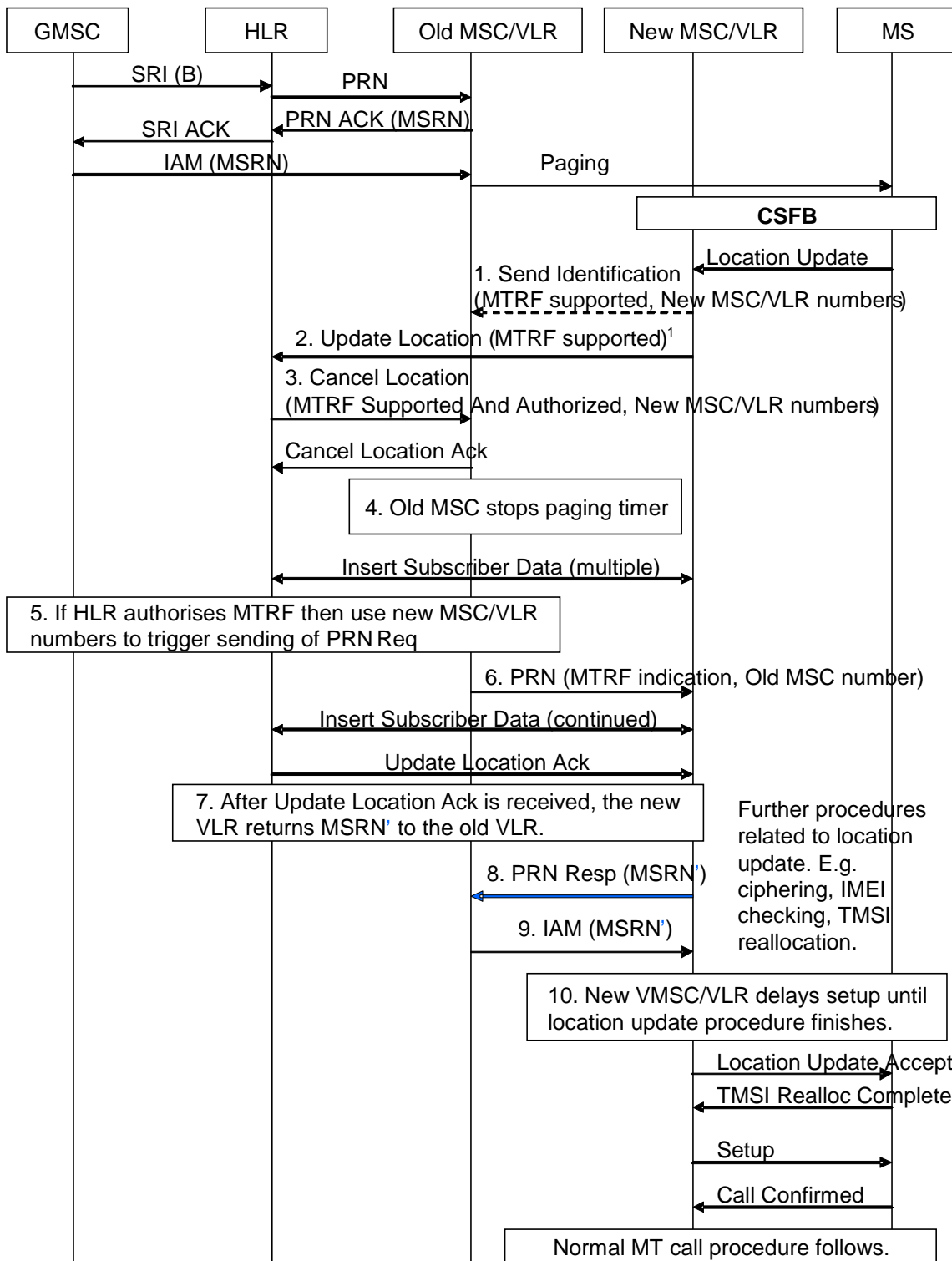

Figure 7.5a-1: Roaming Forwarding for CSFB

The main differences compared to the "Mobile Terminating Roaming Forwarding" procedure defined in TS 23.018 [5] are described below:

- The paging message in E-UTRAN triggers the CS fallback which is followed by a location update in the new RAT.

NOTE 4: This functionality is already supported in the CS fallback flows for terminating calls and no additional functionality is needed.

- The UE includes the "CSMT" flag in the location update request message so that the signalling link is maintained for longer in case the IAM is delayed by the old MSC/VLR.
- If the Location Update Request contains the "CSMT" flag set and a valid TMSI/old LAI, the new MSC/VLR may indicate to the old MSC/VLR that it supports MTRF in the Send Identification message. The new VLR then performs authentication to the Location update and updates the HSS. If the Location Update Request contains the IMSI, only HLR-based MTRF procedure can be used.
- After Cancel Location is received from HSS, if the HLR authorised the MTRF call between the old and the new terminating MSCs or if the HLR did not disallow the MTRF call between the old and the new terminating MSCs but the new MSC/VLR indicated its MTRF support earlier in Send Identification message, the old MSC/VLR stops paging timer and checks roaming and charging pre-configured agreements with regards to call routing to the new MSC/VLR. If these checks are successful, the old MSC/VLR sends a Provide Roaming Number request (MTRF Indicator, parameters received from the HLR) to the new MSC/VLR.

7.5b Coexistence of Roaming Retry and Roaming Forwarding for CS fallback

If an MSC/VLR supports both the procedures as specified in clause 7.5 and 7.5a, and the GMSC has indicated support roaming retry as specified in clause 7.5, the old MSC/VLR which sends the initial paging request can decide based on operator policy whether to follow the procedure specified in clause 7.5 or clause 7.5a.

7.6 Returning back to E-UTRAN

Once CS service ends in CS domain, existing mechanisms can be used to move the UE to E-UTRAN, no specific CS Fallback mechanisms are needed.

During the release of an RR connection the MSC should indicate to GERAN/UTRAN that the RR connection (for call or CISS or LCS) was established as a result of CS fallback. GERAN and UTRAN may use the indication to determine which of the existing mechanisms that should be used to move the UE to E-UTRAN.

When the UE moves to E-UTRAN, if the EPS service was suspended during the CS service, it is resumed as specified in clause 6.5.

7.7 Interaction with ISR

7.7.1 Void

7.7.2 Mobile Terminating Call when ISR is active and SGs is active between MSC/VLR and MME

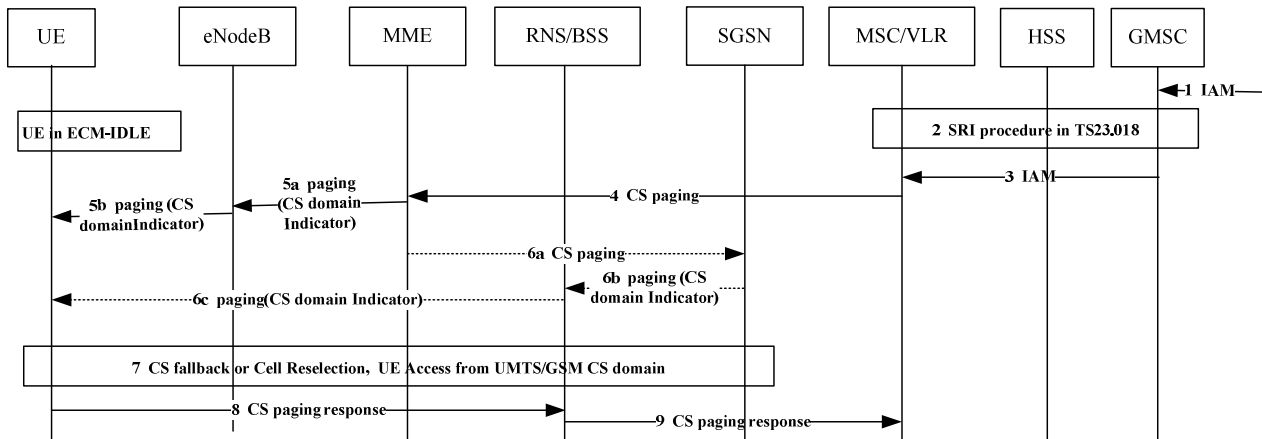

Figure 7.7.2-1: Mobile Terminating Call when ISR is active and SGs is active between MSC/VLR and MME

- 1) G-MSC receives IAM.
 - 2) G-MSC retrieves routing information of the terminating UE by Send Routing Info procedures as specified in TS 23.018 [5].
 - 3) G-MSC sends IAM to the MSC/VLR on the terminating side as specified in TS 23.018 [5].
 - 4) The MSC/VLR sends a Page message to the MME via SGs (details on the Page message can be found in clauses 7.2 or 7.3).
 - 5a) The MME receives the Page message from the MSC/VLR. If the UE is in ECM-IDLE state, the MME sends a Paging (as specified in TS 23.401 [2], and CN Domain Indicator) message to each eNodeB serving the TA list the UE is registered to as specified in clause 7.2. If the UE is in ECM-CONNECTED, the MME relays the CS Page message to the serving eNodeB over the S1 interface as specified in clause 7.3.
 - 5b) The eNodeBs receive CS paging messages from the MME, and the procedures take place as specified in clause 7.2.
 - 6a) As ISR is active and the UE is in ECM_IDLE state, the MME forwards the CS paging message received from the MSC/VLR to the associated SGSN. The MME gets the SGSN information in the regular ISR activation process. If MME received the priority marking in step4, it forwards CS paging message with priority marking, e.g. eMLPP priority, to the SGSN.
 - 6b) The SGSN receives the CS paging message from the MME, the SGSN sends paging messages to RNS/BSSs, which is described in detail in TS 23.060 [3].
The SGSN shall not implement a local retransmission scheme for the Iu/Gb paging messages.
 - 6c) When RNS/BSS nodes receive paging message from the SGSN, paging is initiated as described in detail in TS 23.060 [3].
- NOTE: If ISR is not active or the UE is in ECM-CONNECTED state, the MME does not send the CS paging message to the SGSN. That means, the steps of 6a, 6b, 6c are not needed in the MT call procedure.
- 7) Upon receipt of a Paging Request message for a circuit-switched service, the CS Fallback (as defined in this specification) or Cell Reselection (as defined in TS 23.060 [3]) take place, and the UE accesses CS domain from UMTS/GSM.
 - 8) When the CS Fallback or Cell Reselection completes, the UE responds to the CS paging request and returns the CS paging response as described in detail in this specification and TS 23.060 [3] to the RNS/BSS.

- 9) When received at the RNS/BSS, the CS Paging Response message is sent to the MSC/VLR as described in detail in TS 23.060 [3]. The MSC/VLR receives CS paging response contained in corresponding message which shall then stop the paging response timer and establish the CS connection, then the MT call process as described in detail in TS 23.018 [5].

7.7.3 Void

7.8 Mobile Terminating Call when SGs is not active

Regular pre-Release 8 MSC procedures are performed without any ISR or SGs specifics.

8 Other CS Services

8.1 General

The MSC handles the timers, queuing and retransmission for sending the SGsAP-PAGING-REQUEST message on the SGs interface in the same way that it handles the sending of a PAGING message on the A or Iu interface. As a consequence, the MME and (if ISR is active) the SGSN shall not implement local retransmission schemes for this paging.

8.2 Short Message Service (SMS)

8.2.1 General

The procedures for SMS in this specification apply only if the UE is EPS/IMSI attached and the CS access domain is chosen by the UE and/or the home PLMN for delivering short messages.

This clause describes both the mobile originating and mobile terminating SMS over SGs procedures in EPS. SMS support is based on the connectionless SGs reference point between the MME and the MSC Server and use of NAS signalling between the UE and the MME, i.e. no CS Fallback is performed for SMS.

The SMS protocol entities are reused from the existing MS/UE and MSC implementations. This means that the SMS over SGs procedures reuse the different protocol layers as defined in TS 23.040 [14].

- NOTE. With SMS over SGs, the MSC/VLR produces the Call Detail Record. The stage 3 changes to the CDR for SMS over SGs were made in a manner that should permit an unmodified Release 7 entity to receive the CDR. However, for correct operation of, e.g. customer care services, when using an unmodified Release 7 entity to receive the CDR, the VPLMN should ensure that the TAC values do not overlap with the LAC values.

8.2.2 Mobile originating SMS in Idle Mode

The following sequence flow shows the delivery of mobile originating SMS in idle mode. The message flows between the ME/UE and MSC/VLR are also broadly applicable to the Memory Available Notification.

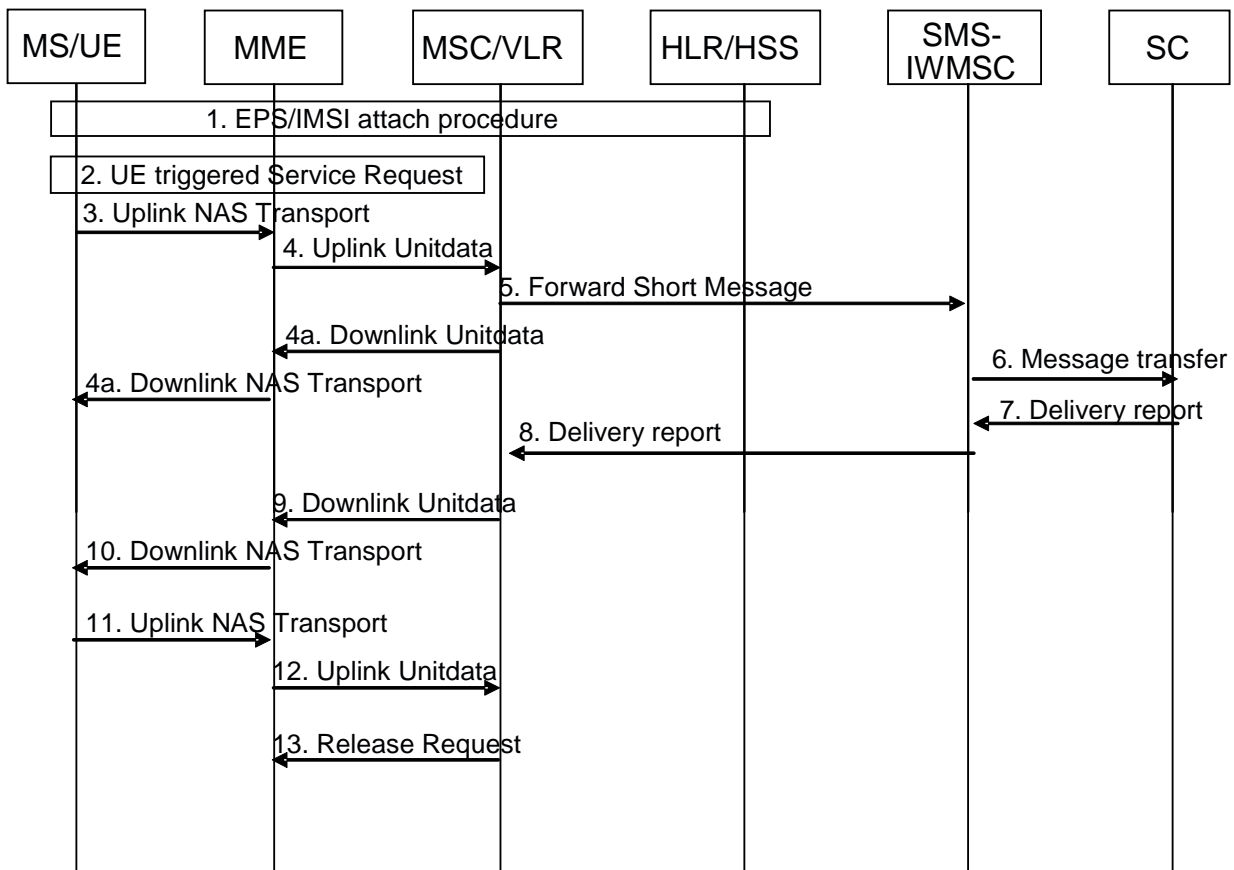

Figure 8.2.2-1: Mobile originating SMS in idle mode

1. The combined EPS/IMSI attach procedure as described in clause 5.2 has been performed earlier.
2. A mobile originating SMS is triggered and the MS/UE is in idle mode. The MS/UE initiates the UE triggered Service Request procedure, which is defined in TS 23.401 [2]. The UE indicates its S-TMSI in the RRC signalling.
3. The MS/UE builds the SMS message to be sent as defined in TS 23.040 [14] (i.e. the SMS message consists of CP-DATA/RP-DATA/TPDU/SMS-SUBMIT parts). Following the activation of the Radio Bearers, the SMS message is encapsulated in an NAS message and sent to the MME.
4. The MME forwards the SMS message to the MSC/VLR in an Uplink Unitdata message. In order to permit the MSC to create an accurate charging record, the MME adds the IMEISV, the local time zone, the Mobile Station Classmark 2, and the UE's current TAI and E-CGI.
- 4a. The MSC/VLR acknowledges receipt of the SMS to the UE.
- 5.-8. These steps are performed as defined in TS 23.040 [14]. The SMS message is forwarded to the SC that returns a delivery report message.
9. The MSC/VLR forwards the received delivery report to the MME associated with the MS/UE in a Downlink Unitdata message.
10. The MME encapsulates the received delivery report in an NAS message and sends the message to the MS/UE.
- 11, 12. The UE acknowledges receipt of the delivery report to the MSC/VLR.
13. The MSC/VLR indicates to the MME that no more NAS messages need to be tunnelled.

The MME should not use the SGs Release Request message as a trigger for the release of S1 resources.

NOTE: This is because the MME does not know whether the Service Request performed in step 2 was solely for the purpose of SMS, or, was for SMS and user plane data, or, whether or not the mobile has additional SMSs to send.

8.2.3 Mobile originating SMS in Active Mode

Mobile Originating SMS in active Mode procedure is specified by reusing the Mobile Originating SMS in Idle Mode with the following modification:

- The established signalling connection between the MS/UE and the MME is reused for the transport of the SMS message and the delivery report (i.e. the UE triggered Service Request procedure defined in step 2 is skipped).

8.2.3a Multiple Mobile originating SMSs

In clause 3.2 of TS 24.011 [28], the simultaneous transmission of more than one MO SMS/notification per domain is prohibited.

If the UE has more than one SMS/notification to send, the subsequent SMS/notification is sent at step 11 of clause 8.2.2 and the acknowledgement of the delivery report for the previous SMS/notification is not sent.

8.2.4 Mobile terminating SMS in idle mode

The following sequence flow shows the delivery of mobile terminating SMS in idle mode.

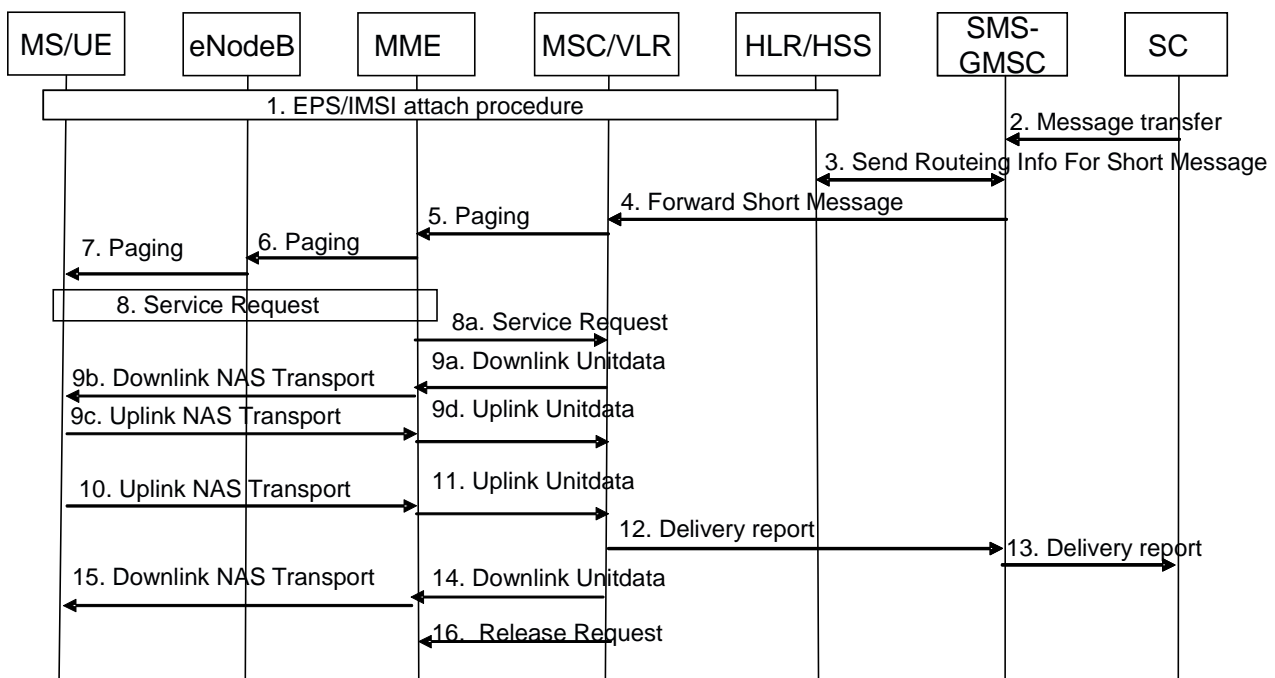

Figure 8.2.4-1: Mobile terminating SMS in idle mode

1. The combined EPS/IMSI attach procedure as described in clause 5.2 has been performed.
- 2-4. The SC initiates transfer of mobile terminating SMS. The HLR is requested for routing number for SMS services and the SMS message is forwarded to the MSC/VLR where the MS/UE is CS attached.
5. The MSC/VLR sends a Paging (IMSI, VLR TMSI, Location Information, SMS indicator) message to the MME.
6. The MME initiates the paging procedure by sending the Paging (as specified in TS 23.401 [2]) message to each eNodeB with cells belonging to the tracking area(s) in which the UE is registered. The UE is paged with its S-TMSI.
7. The MS/UE is paged by the eNodeBs.
8. The UE sends a Service Request message to the MME. The UE indicates its S-TMSI in the RRC signalling. The MME sends the S1-AP Initial Context Setup Request message to the eNodeB and the eNodeB establishes the Radio Bearers.

- 8a. The MME sends a Service Request message to the MSC. In order to permit the MSC to create an accurate charging record, the MME adds the IMEISV, the local time zone, the Mobile Station Classmark 2, and the UE's current TAI and E-CGI.
- 9a. The MSC/VLR builds the SMS message to be sent as defined in TS 23.040 [14] (i.e. the SMS message consists of CP-DATA/RP-DATA/TPDU/SMS-DELIVER parts). The MSC/VLR forwards the SMS message to the MME in a Downlink Unitdata message.
- 9b. The MME encapsulates the SMS message in a NAS message and sends the message to the MS/UE.
- 9c, 9d. The MS/UE acknowledges receipt of the SMS message to the MSC/VLR.
10. The MS/UE returns a delivery report as defined in TS 23.040 [14]. The delivery report is encapsulated in an NAS message and sent to the MME.
11. The MME forwards the delivery report to the MSC/VLR in an Uplink Unitdata message.
- 12-13. These steps are performed as defined in TS 23.040 [14]. The delivery report is forwarded to the SC.
- 14-15. In parallel to steps 12-13, the MSC/VLR acknowledges receipt of the delivery report to the MS/UE.
16. The MSC/VLR indicates to the MME that no more NAS messages need to be tunnelled.

The MME should not use the SGs Release Request message as a trigger for the release of S1 resources.

NOTE: Although the MME could use the RRC establishment cause (set to mt-Access) sent in the S1-AP Initial UE Message in step 8 to deduce that the MS/UE sent the Service Request solely for receiving the SMS), the MME does not know whether the MT-SMS might cause the initiation of user plane traffic or an MO SMS. So, for simplicity of MME implementation, the normal eNodeB procedures should be used to initiate the release of S1 resources.

8.2.5 Mobile terminating SMS in Active Mode

Mobile terminating SMS in Active Mode procedure is specified by reusing the Mobile Terminating SMS in Idle Mode with the following modification:

- There is no need for the MME to perform Paging of the MS/UE after step 5. MME continues with step 8a (i.e. steps 6 to 8 are skipped). The MME immediately sends a Downlink Unitdata to the UE.
- The MME also includes the E-CGI and TAI in step 9d.

8.2.5a Multiple Mobile terminating SMSs

In clause 3.2 of TS 24.011 [28], the simultaneous transmission of more than one MT SMS per domain is prohibited.

If the MSC/VLR has more than one SMS to send, the subsequent SMS is sent in a Downlink Unitdata message after step 14 and instead of the Release Request in step 16 of clause 8.2.4. i.e. the MSC/VLR does not need to send another SGs Paging message.

8.2.5b Simultaneous Mobile terminating and Mobile originating SMSs

The above sections on mobile originating and mobile terminating SMS handling in active and idle mode can be reused such that no special treatment is needed for this case.

8.2.5c Unsuccessful Mobile terminating SMS delivery attempt

As specified in clause 3.2.8 of TS 23.040 [14], setting the Mobile Station Not Reachable Flag (MNRF) in the MSC/VLR is mandatory. However, when using the SGs interface, the MSC/VLR has delegated the 'implicit detach' functionality to the MME (and/or, if Network Mode of Operation 1 is in use in GERAN/UTRAN, to the SGSN).

If an SGs based MT SMS delivery attempt fails, the MSC/VLR shall set its MNRF and send an SGs interface Alert Request message to the MME. Upon receipt of Alert Request message, MME shall set its Non-EPS Alert Flag (NEAF)

and if ISR is activated, the MME shall then send an S3 interface Alert-MME-Request message to the SGSN. SGSN shall set the S3 SMS Alert Flag (SSAF).

If the MME operator knows (e.g. because it is in the HPLMN) that the receiving UE's HPLMN deploys SMS-Router, and if the receiving UE's HPLMN uses both SMS via MSC and SMS via SGSN, then the MME need not send the Alert-MME-Request message to the SGSN for that UE.

NOTE: The receiving UE's HPLMN should ensure that the SMS-Router in the receiving UE's HPLMN only returns SMS-Router address to the SMS-GMSC of the sender UE's PLMN.

Subsequently, if the UE makes radio contact with the SGSN and SSAF is set, the SGSN informs the MME with an S3 interface UE-Activity-Indication. Upon receipt of the S3 interface UE-Activity-Indication, or, if the UE makes radio contact with the MME, the MME sends an SGs AP UE-Activity-Indication message to the MSC/VLR. Upon receipt of an SGs AP UE-Activity-Indication message, or signalling on the A, Iu-cs or Gs interface for that UE, the MSC/VLR shall inform the HLR.

8.2.5d Non-SMS Mobile terminating activity during SMS delivery

While one or more SMS is being transferred, other mobile terminating requests (e.g. an MT voice call) may arrive in the MSC/VLR. If this happens the MSC/VLR continues the SMS activities but shall also send the SGs Paging message for the non-SMS activity to the MME. The MME shall handle this SGs Paging message as if no SMS transfers are ongoing. Typically this should lead to the MME invoking the handover/call redirection to GERAN/UTRAN features and it may lead to disruption of the SMS delivery. The MSC/VLR and UE shall recover from any such SMS disruption using the normal RP and CP layer retransmission timers/mechanisms.

8.2.5e Non-SMS Mobile originating activity during SMS delivery

While one or more SMS is being transferred, other mobile originating requests (e.g. an MO voice call or USSD) may be requested by the user. If this happens the MS/UE continues the SMS activities but shall also send the Extended Service Request message for the non-SMS activity to the MME. The MME shall handle this Extended Service Request message as if no SMS transfers are ongoing. Typically this should lead to the MME invoking the handover/call redirection to GERAN/UTRAN features and it may lead to disruption of the SMS delivery. The MSC/VLR and UE shall recover from any such SMS disruption using the normal RP and CP layer retransmission timers/mechanisms.

8.2.5f Mobile Terminating SMS when ISR is active and SGs is active between MSC/VLR and MME

When the MME receives the SGs Paging message for SMS, and ISR is active, and the UE is in idle mode, the MME sends the S1 interface paging message to the E-UTRAN (using the S-TMSI as temporary identity) and sends a CS paging message (SMS indicator) to the SGSN using the MSC TMSI as temporary identity (unless the MSC did not allocate a TMSI, in which case the IMSI is used for paging).

The UE is paged on E-UTRAN and by the SGSN on GERAN and/or UTRAN. For GERAN A/Gb mode, the SGSN sends a PAGING CS message to the BSS (see TS 48.018 [30]). For UTRAN, the SGSN sends a PAGING message to the UTRAN (see TS 25.413 [29]) with the CN Domain Indicator set to 'CS domain' and the Paging Cause set to 'Terminating Low Priority Signalling'. The UE responds on the cell on which it is camped. When camped on E-UTRAN, the UE responds to the MME. When camped on GERAN or UTRAN, the UE responds to the MSC.

8.2.6 Co-Existence with SMS over generic 3GPP IP access

If the home operator has deployed SMS over generic 3GPP IP access and/or SMS-Instant Messaging Interworking as defined in TS 23.204 [15], and has configured the network and the UE for using SMS over IP or SMS-Instant Messaging Interworking, then an SMS or IM will be delivered over EPS in any visited network whether or not the visited network supports SMS over generic 3GPP IP access.

If the home operator has not deployed SMS over generic 3GPP IP access and the UE fails to successfully complete the combined EPS/IMSI attach procedure in the visited network (i.e. the visited network supports SMS over generic 3GPP IP access and does not support SGs for SMS capability), then the UE cannot execute MT or MO SMS procedures in the visited network.

8.3 Location Services (LCS)

8.3.1 MO-LR procedure

8.3.1.1 General

MO-LR procedure in the CS fallback in EPS is performed as specified in TS 23.271 [8].

When the MO-LR procedure is triggered by the UE's application, UE will check the LCS Support Indication provided by the Attach and TAU procedures as specified in TS 23.401 [2]:

- If the LCS Support Indication indicates EPC-MO-LR is supported, and if the UE supports EPC-MO-LR, the UE stays in LTE and initiates the EPC-MO-LR procedure.
- If EPC-MO-LR is not supported by either the network or the UE and if the LCS Support Indication indicates CS-MO-LR is supported, and the UE supports CS-MO-LR, the UE assumes CS-MO-LR is provided. Also, if EPC-MO-LR is not supported by either the network or the UE and if network does not provide information on whether CS-MO-LR is supported, then UE assumes CS-MO-LR may be provided. In these cases, if the previous combined EPS/IMSI Attach or Combined TA/LA Update is accepted with no "SMS only" indication, then the UE initiates CS Fallback to perform CS-MO-LR.

NOTE: Based on UE implementation, UE may avoid initiating CS-MO-LR when an IMS VoIP session is active.

- Otherwise, the UE shall not attempt the EPC-MO-LR procedure, i.e. neither EPC-MO-LR nor CS-MO-LR with CS Fallback.

If the UE decided to initiate the CS Fallback for the LCS based on LCS Support Indication check, then, the following applies:

- When the UE is in active mode without an IMS VoIP session, the UE and the network follow the procedure in clause 6.2 "Mobile Originating Call in Active Mode - PS HO supported" or clause 6.3 "Mobile Originating call in Active Mode - No PS HO supported". After the UE changes its RAT from E-UTRAN to UTRAN/GERAN, it performs CS-MO-LR procedures as specified in TS 23.271 [8].
- When the UE is in active mode with an IMS VoIP session and if the UE supports SRVCC procedures, the UE and the network follow the procedure in clause 8.3.1.2 "MO-LR in Active Mode with IMS VoIP session - PS HO supported".
- When the UE is in active mode without an IMS VoIP session but the network decides not to perform PS-Handover, then the UE and the network follow the procedure in clause 6.3 "Mobile Originating Call in Active Mode - No PS HO Support". After the UE changes its RAT from E-UTRAN to UTRAN/GERAN, it performs CS-MO-LR procedure as specified in TS 23.271 [8].
- When the UE is in active mode with an IMS VoIP session and if the UE supports SRVCC procedures but the network decides not to perform PS-Handover, then the UE and the network follow the procedure in clause 8.3.1.3 "MO-LR in Active Mode with IMS VoIP session – No PS HO supported".
- When UE is in idle mode, UE follows the procedure in clause 6.4 "Mobile Originating Call in Idle Mode". After UE changes its RAT from E-UTRAN to UTRAN/GERAN, it performs CS-MO-LR procedure as specified in TS 23.271 [8].

8.3.1.2 MO-LR in Active Mode with IMS VoIP session - PS HO supported

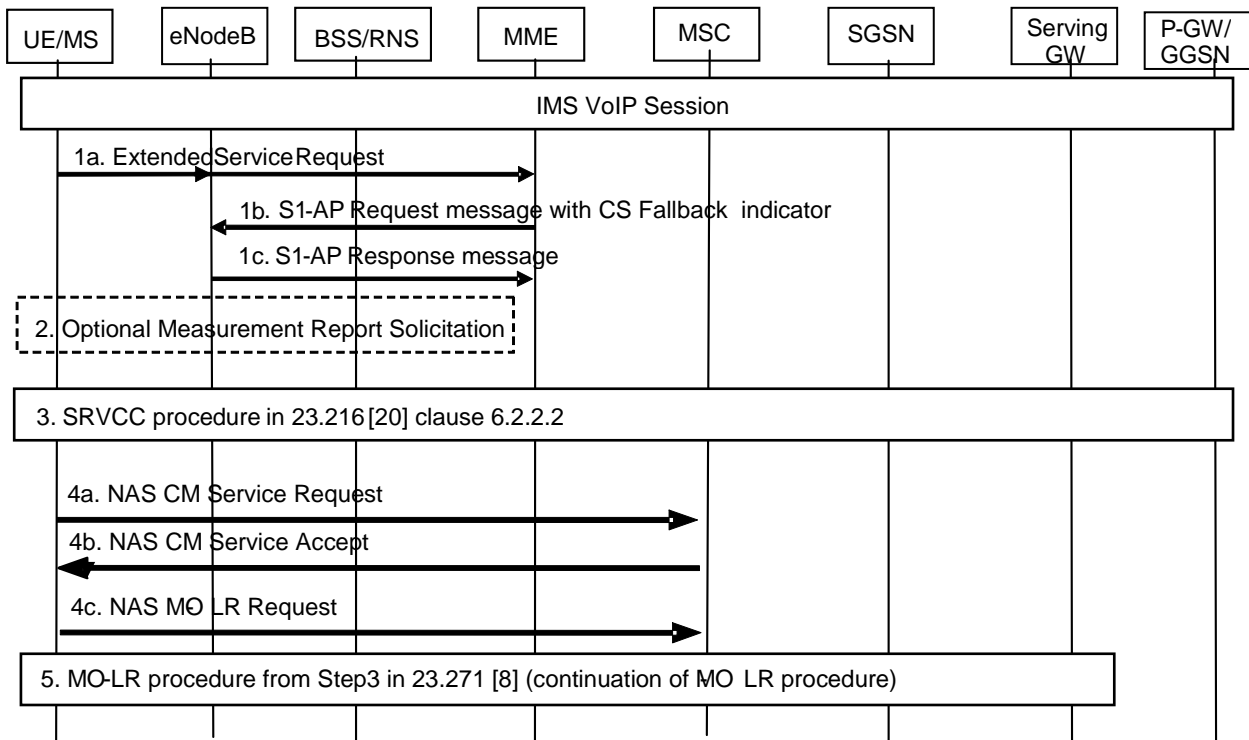

Figure 8.3.1.2-1: MO-LR Request in E-UTRAN while UE is in IMS VoIP session

1a.-2. These steps are performed as defined in clause 6.2.

3. Based on UE measurement reports and CS Fallback Indicator in step 1b, the source E-UTRAN decides to trigger an SRVCC handover to UTRAN/GERAN. Continuous SRVCC procedures are continued as specified in TS 23.216 [20], clause 6.2.2.2.

4. After sending a Handover Complete message via the RNS/BSS to the MSC in step 3, the UE sends a CM Service Request to the MSC indicating a request for location services. After the HLR is updated and the subscriber data are downloaded from the HLR, the MSC sends a CM Service Accept to the UE. Then the UE sends a NAS MO-LR Request to the MSC.

5. Continuation of MO-LR procedures as specified in TS 23.271 [8], clause 9.2.6.

NOTE: When SRVCC capable UE is in active mode with an IMS VoIP session but the network does not support SRVCC, MME sends Extended Service Reject in response to step 1a based on EPS bearer information, i.e. MME rejects the request if UE has EPS bearer with QCI=1, i.e. IMS VoIP session.

8.3.1.3 MO-LR in Active Mode with IMS VoIP session - No PS HO supported

The same procedure as described in clause 8.3.1.2 applies for "MO-LR in Active Mode with IMS VoIP session - No PS HO supported" case except that the SRVCC procedure in step 3 follows TS 23.216 [20], clause 6.2.2.1a.

8.3.2 MT-LR procedure

8.3.2.1 MT-LR procedure if UE is not in IMS VoIP session

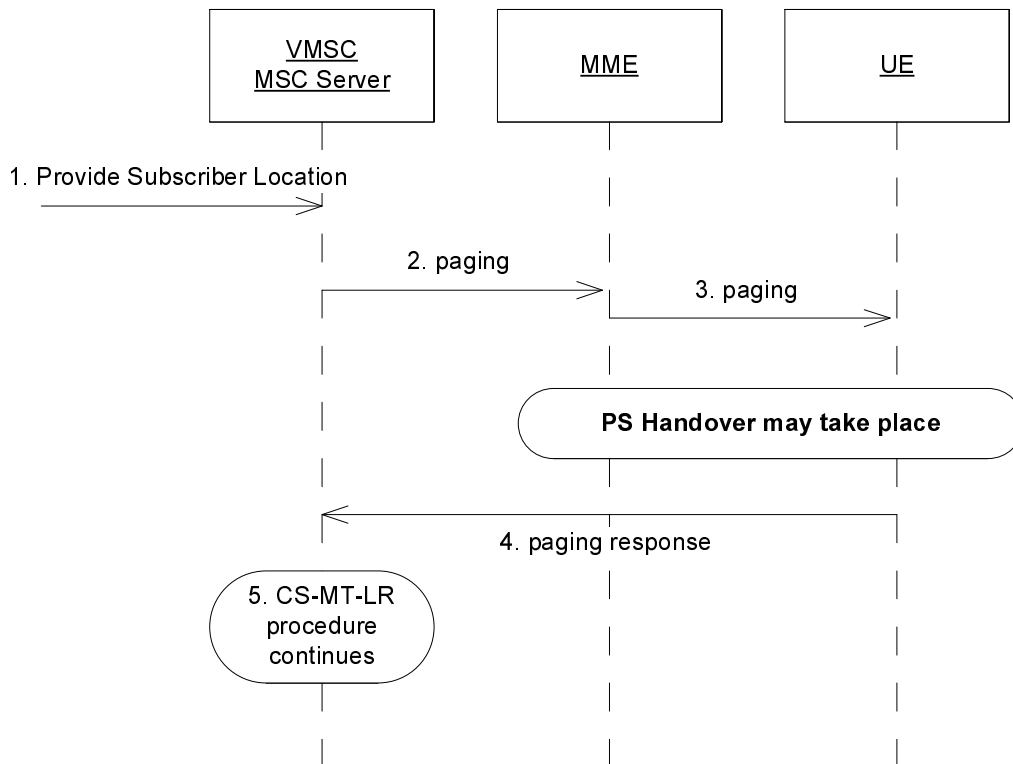

Figure 8.3.2.1-1: MT-LR procedure if UE is not in IMS VoIP session

1. MSC receives a PROVIDE_SUBSCRIBER_LOCATION message due to CS-MT-LR (TS 23.271 [8], clause 9.1.2).
2. MSC sends Paging (LCS Client Identity, LCS indicator) message to MME.
3. If the MME did not return the "SMS-only" indication to the UE during Attach or Combined TA/LA Update procedures, the MME sends Paging (parameters as specified in TS 23.401 [2], CN Domain Indicator, LCS Client Identity, LCS indicator) message to UE. LCS indicator is used to inform the UE that this paging is for MT-LR request. LCS Client Identity and LCS indicator are only included in CS Page if UE is in active mode.

If the MME returned the "SMS-only" indication to the UE during Attach or Combined TA/LA Update procedures, the MME shall not send Paging to the UE, and the MME sends CS Paging Reject towards MSC to stop CS Paging procedure and this CSFB procedure stops.
4. UE responds with Paging_Resp message in UMTS/GERAN. Service based redirection/reselection or PS Handover may take place as specified in clause 7.
5. MSC continues with the CS-MT-LR procedure as defined in TS 23.271 [8], clause 9.1.2.

8.3.2.2 MT-LR procedure while UE is in IMS VoIP session

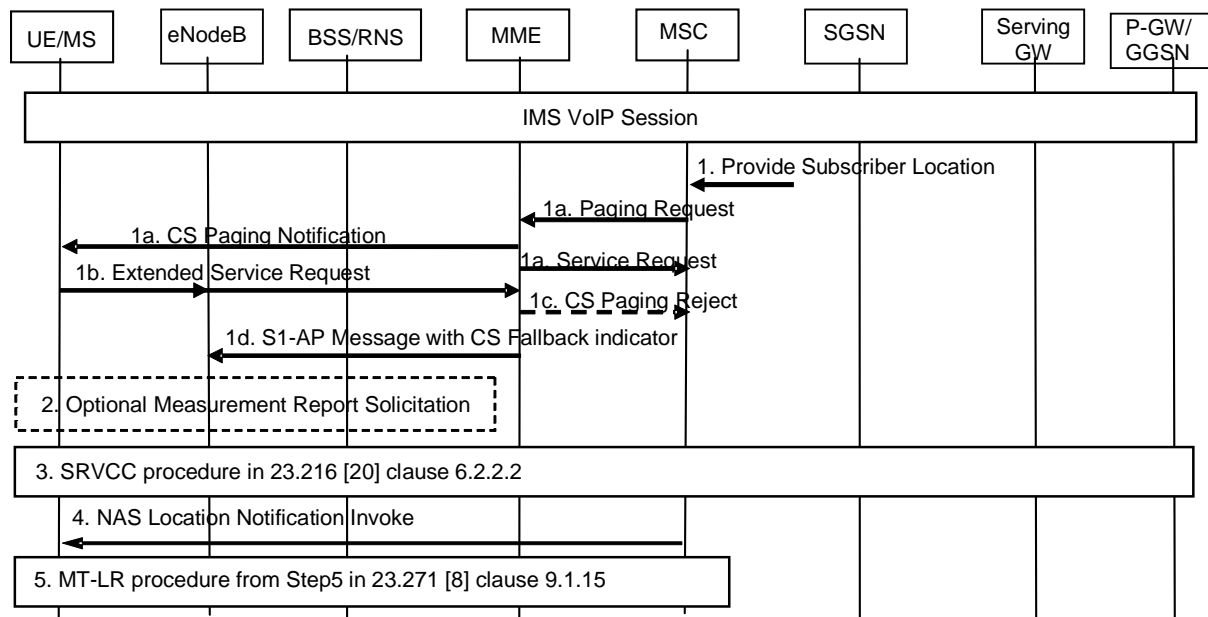

Figure 8.3.2.2-1: MT-LR procedure while UE is in IMS VoIP session

1. MSC receives a PROVIDE_SUBSCRIBER_LOCATION message due to CS MT LR (TS 23.271 [8], clause 9.1.2).

1a. The MSC responds by sending a Paging Request (LCS Client Identity, LCS indicator) to the MME over a SGs interface. The MSC only sends a CS Page for an UE that provides location update information using the SGs interface. The MME has an established S1 connection for IMS VoIP session.

If the MME did not return the "SMS-only" indication to the UE during Attach or Combined TA/LA Update procedures, the MME sends Paging (parameters as specified in TS 23.401 [2], CN Domain Indicator, LCS Client Identity, LCS indicator) message to UE. LCS indicator is used to inform the UE that this paging is for MT-LR request.

If the MME returned the "SMS-only" indication to the UE during Attach or Combined TA/LA Update procedures, the MME shall not send Paging to the UE, and the MME sends CS Paging Reject towards MSC to stop CS Paging procedure and this CSFB procedure stops.

The eNodeB forwards the paging message to the UE.

1b. UE sends an Extended Service Request (Reject or Accept) message to the MME for mobile terminating CS Fallback. The Extended Service Request message is encapsulated in RRC and S1-AP messages. The UE may decide to reject CSFB based on LCS Client Identity.

1c. Upon receiving the Extended Service Request (Reject) for mobile terminating CS Fallback, the MME sends Paging Reject towards MSC to stop CS Paging procedure and this CSFB procedure stops. Corresponding error handling is returned to the GMLC as specified in TS 23.271 [8].

1d. MME sends an S1-AP Request message to eNodeB that includes the UE Radio Capabilities and a CS Fallback Indicator. This message: indicates to the eNodeB that the UE should be moved to UTRAN/GERAN.

1e. The eNodeB shall reply with S1-AP Response message.

2. These steps are performed as defined in clause 7.3 for PS handover supported case and clause 7.4 for No PS handover supported case.

3. Based on UE measurement reports and CS Fallback Indicator in step 1d, the source E-UTRAN decides to trigger an SRVCC handover to UTRAN/GERAN. Continuous SRVCC procedures as specified in TS 23.216 [20], clause 6.2.2.2 for PS handover supported case and clause 6.2.2.1a for No PS HO supported case are performed.

4. After receiving Relocation/Handover Complete message from the RNS/BSS in step 3, MSC sends LCS Location Notification Invoke to the UE.
5. Continuation of CS-MT-LR procedures as specified in TS 23.271 [8], clause 9.1.2.

NOTE: When SRVCC capable UE is in active mode with an IMS VoIP session but the network does not support SRVCC, MME sends Paging Reject towards MSC and this CSFB procedure stops. This is based on the bearer information at MME indicating UE has IMS VoIP session, i.e. EPS bearer with QCI=1. Corresponding error handling is returned to the GMLC as specified in TS 23.271 [8].

8.3.3 NI-LR procedure

NI-LR procedure takes place during emergency calls, and is thus performed in GERAN/UTRAN during the Mobile Originating call procedure.

8.3.4 Returning back to E-UTRAN

Once CS service ends in CS domain, existing mechanisms as specified in TS 23.401 [2] can be used to move the UE to E-UTRAN, no specific CS Fallback mechanisms are needed.

During the release of an RR connection the MSC should indicate to GERAN/UTRAN that the RR connection (for call or CISS or LCS) was established as a result of CS fallback. GERAN and UTRAN may use the indication to determine which of the existing mechanisms that should be used to move the UE to E-UTRAN.

8.3.5 Co-Existence with Other Location Services

8.3.5.1 Co-Existence with SUPL

There is no race condition between OMA AD SUPL [9] and CS Fallback for LCS. When network initiated SUPL procedure takes place, the paging message does not contain CN Domain Indicator by default. This prevents CS Fallback for LCS to take place. For SET initiated SUPL procedure, changing of RAT does not take place.

8.4 Other CS Services

8.4.0 General

The procedures specified in this clause apply when the UE is EPS/IMSI attached and the CS domain is chosen by the UE and/or the home PLMN to deliver other types of CS services, i.e. services not covered explicitly in previous sections, such as Call Independent Supplementary Services, real time end-to-end facsimile group 3 services, TS 23.146 [41], etc.

8.4.1 Mobile-Initiated CS Services

When UE is in active mode, UE and the network follow the procedure in clause 6.2 "Mobile Originating Call in Active-Mode". After UE changes its RAT from E-UTRAN to UTRAN/GERAN, it performs Mobile-Initiated CS procedures relevant to the initiated CS service, e.g. Call Independent Supplementary Service procedure as specified in TS 24.010 [13], real time end-to-end facsimile group 3 procedure as specified in TS 23.146 [41], etc.

When UE is in active mode and network initiates NACC procedure, then UE and the network follow the procedure in clause 6.3 "Mobile Originating Call in Active Mode - No PS HO Support in GERAN". After UE changes its RAT from E-UTRAN to UTRAN/GERAN, it performs Mobile-Initiated CS procedures relevant to the initiated CS service, e.g. Supplementary Service procedure as specified in TS 24.010 [13], real time end-to-end facsimile group 3 procedure as specified in TS 23.146 [41], etc.

When UE is in idle mode, UE and the network follows the procedure in clause 6.4. After UE changes its RAT from E-UTRAN to UTRAN/GERAN, it performs Mobile-Initiated CS procedures relevant to the initiated CS service, e.g. Supplementary Services procedure as specified in specifications such as TS 23.090 [10], real time end-to-end facsimile group 3 procedure as specified in TS 23.146 [41], etc.

8.4.2 NW-Initiated CS Services

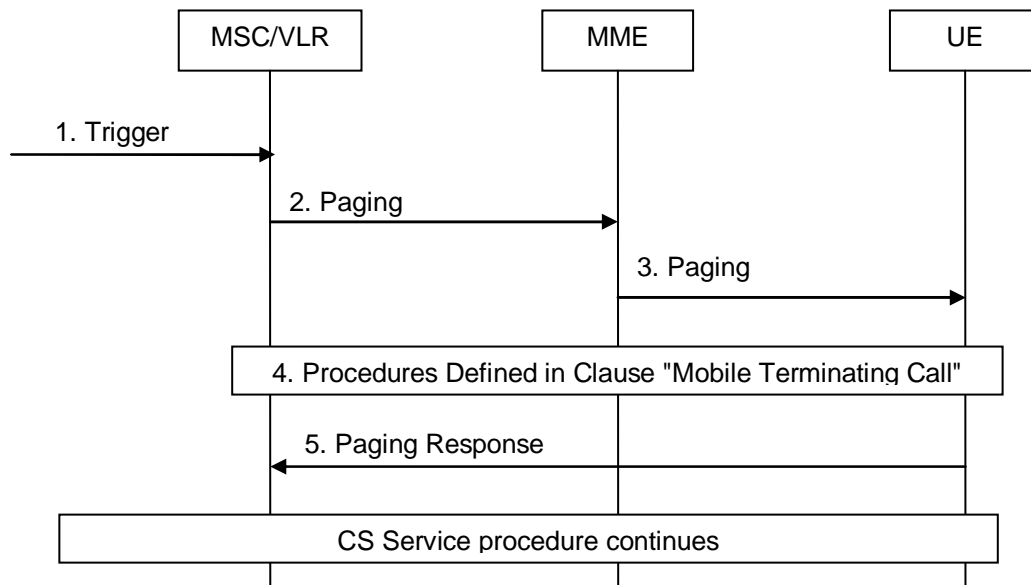

Figure 8.4.2-1: NW-Initiated CS Service procedure

1. MSC/VLR receives a trigger for a NW-Initiated CS procedure.
2. MSC/VLR sends Paging message to MME. For call independent supplementary service, the Paging message may include the SS service ID.
3. If the MME did not return the "SMS-only" indication to the UE during Attach or Combined TA/LA Update procedures, the MME sends Paging (parameters as specified in TS 23.401 [2], CN Domain Indicator) message to UE. For call independent supplementary service the Paging message may include the SS service ID. SS service ID is used to indicate the type of the supplementary service (e.g. USSD) to the UE. The SS service ID is only included in CS Page if UE is in active mode.

If the MME returned the "SMS-only" indication to the UE during Attach or Combined TA/LA Update procedures, the MME shall not send the Paging to the UE, and the MME sends CS Paging Reject towards MSC to stop CS Paging procedure and this CSFB procedure stops.

4. The mobile terminating call procedure then takes place as specified in clause 7 "Mobile Terminating Call Procedure".
5. Once the paging is successfully returned to MSC, the applicable CS procedures continues, e.g. for Supplementary Service as specified in specifications such as TS 23.090 [10].

8.4.3 Returning back to E-UTRAN

Once CS service ends in CS domain, existing mechanisms as specified in TS 23.401 [2] can be used to move the UE to E-UTRAN, no specific CS Fallback mechanisms are needed.

During the release of an RR connection the MSC should indicate to GERAN/UTRAN that the RR connection (for call or CISS or LCS) was established as a result of CS fallback. GERAN and UTRAN may use the indication to determine which of the existing mechanisms that should be used to move the UE to E-UTRAN.

Annex A:
Void

Annex B (normative): CS Fallback to 1xRTT

This annex describes a CS Fallback to 1xRTT and an SMS solution for dual mode 1xRTT/E-UTRAN terminals.

CS Fallback to 1xRTT is supported for UEs with both single Rx and dual Rx configuration (see TS 36.331 [33]). UEs with single Rx configuration are not able to camp in 1xRTT when they are active in E-UTRAN. The network therefore provides mechanisms for the UE to perform registration to 1xRTT, receive 1xRTT paging, SMS etc. while the UE is in E-UTRAN. UEs with dual Rx configuration can camp in 1xRTT while they are active in E-UTRAN, they may however not be able to stay in E-UTRAN when they handle a CS call and/or perform registration signalling, and/or sending or receiving SMS in 1xRTT.

Clause B.1 and B.2 describes the architecture and procedures for CS Fallback (and enhanced CS Fallback) to 1xRTT when the UE has single Rx, dual Rx, or dual Rx/Tx configuration. In this scenario the network need to support the S102 interface between the MME and 1xCS system in order to support CS Fallback (this is indicated by the presence of CSFB registration parameters on E-UTRAN broadcast channel, TS 36.331 [33]).

Clause B.3 describes the procedures for CS Fallback when the UE has dual Rx configuration. In this scenario the network needs to support the Extended Service Request procedure in order to support CS Fallback (this is indicated by either the presence of CSFB registration parameters or indication of support for dual rx CSFB on E-UTRAN broadcast channel, TS 36.331 [33]).

If the UE has a dual Rx configuration and indicates support for enhanced CS fallback to 1xRTT in the UE radio capabilities, the principles and procedures in clauses B.1 and B.2 are followed when the network indicates support for S102.

B.1 Overall Description

B.1.1 General Considerations

The CS fallback for 1xRTT in EPS enables the delivery of CS-domain services (e.g. CS voice) by reuse of the 1xCS infrastructure when the UE is served by E-UTRAN. A CS fallback enabled terminal, while connected to E-UTRAN may register in the 1x RTT CS domain in order to be able to use 1xRTT access to establish one or more CS services in the CS domain. The CS Fallback function is only available where E-UTRAN coverage overlaps with 1xRTT coverage.

This specification also specifies the architecture required for SMS over S102 in EPS. The MO SMS and MT SMS are tunnelled in EPS and over S102 and do not cause any CS Fallback to CDMA 1xRTT, and consequently does not require any overlapped CDMA 1xRTT coverage.

CS Fallback to 1xRTT and IMS-based services shall be able to co-exist in the same operator's network.

CS Fallback to 1xRTT with PS Handover procedure to HRPD access for Optimised HO, non-Optimised HO, and Optimised Idle mode mobility as defined in TS 23.402 [27] shall be able to co-exist in the same operator's network.

B.1.2 Reference Architecture

The CS fallback to 1xRTT and SMS over S102 in EPS function is realised by reusing the S102 reference point between the MME and the 1xCS IWS. The reference architecture described in figure B.1.2-1 is similar to the SRVCC architecture for E-UTRAN to 3GPP2 1xCS described in TS 23.216 [20], with the additional aspect that the S102 session is long-lived (similar to pre-registration for S101).

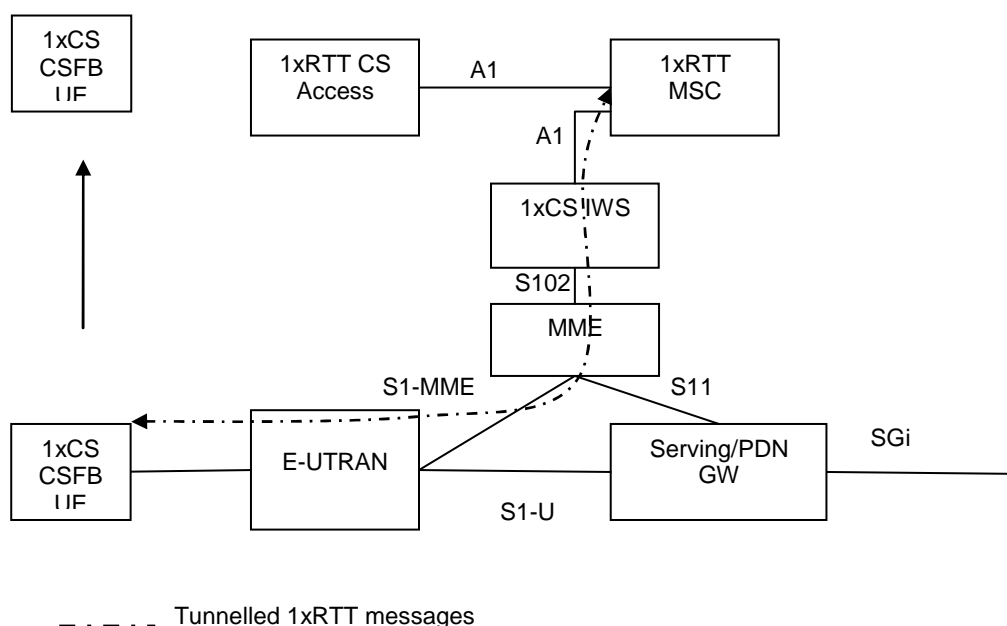

Figure B.1.2-1: Reference architecture for CS fallback to 1xRTT CS

Reference architecture for PS handover procedure between E-UTRAN and HRPD access is defined in TS 23.402 [27].

B.1.2.1 Reference points

S102: It is the reference point between the MME and the 1xCS IWS. The S102 reference point provides a tunnel between MME and 3GPP2 1xCS IWS to relay 3GPP2 1xCS signalling messages. 1x CS signalling messages are those messages that are defined for A21 interface as described in 3GPP2 A.S0008-C [16] and 3GPP2 A.S0009 [17].

B.1.3 Functional entities

B.1.3.1 UE

The UE capable of CS fallback to 1xRTT and SMS over S102 supports access to E-UTRAN/EPC as well as access to the 1xCS domain over 1xRTT. It supports the following additional functions:

- 1xRTT CS registration over the EPS after the UE has completed the E-UTRAN attachment;
- 1xRTT CS re-registration due to mobility;
- CS fallback procedures specified for 1xRTT CS domain voice service;
- Procedures for mobile originated and mobile terminated SMS tunnelled over EPS and S102;
- Includes enhanced CS fallback to 1xRTT capability indication as part of the UE radio capabilities;
- Includes concurrent 1xRTT and HRPD capability indication as part of the UE radio capabilities if supported by the enhanced CS fallback to 1xRTT capable UE.

If the UE is service user with subscription to CS domain priority service, the UE's USIM belongs to one of the special Access Classes as specified in TS 22.011 [38] and the UE shall set the RRC establishment cause to "HighPriorityAccess" as specified in TS 36.331 [33].

B.1.3.2 MME

The MME enabled for CS fallback to 1xRTT supports the following additional functions:

- It serves as a signalling tunnelling end point towards the 3GPP2 1xCS IWS via S102 interface for sending/receiving encapsulated 3GPP2 1xCS signalling messages to/from the UE, which are encapsulated in S1-MME S1 Information Transfer messages, as defined in TR 36.938 [19];
- 1xCS-IWS (terminating S102 reference point) selection for CSFB procedures;
- Handling of S102 tunnel redirection in case of MME relocation;
- Buffering of messages received via S102 for UEs in idle state.

If the network supports CSFB priority call handling, the MME supports the following additional functions:

- For page message received on the S102 interface with priority indication, the MME provides preferential treatment to this message and also the subsequent CS fallback procedure compared to other normal transactions. If UE needs to be paged, the MME sets priority indication on the paging request to eNodeB. The MME also sets priority indication, i.e. "CSFB High Priority", in S1AP message to the eNodeB, so that eNodeB may initiate the CSFB procedure with priority, as specified in TS 36.413 [35].
- For a CSFB request from service user, the MME determines that the CSFB request need priority handling based on the UE's EPS subscription information. The MME in congestion situation provides preferential treatment to this request and also sets priority indication, i.e. "CSFB High Priority", in S1AP message to eNodeB to initiate CSFB procedure, as specified in TS 36.413 [35].

B.1.3.3 E-UTRAN

The E-UTRAN enabled for CS fallback to 1xRTT supports the following additional functions:

- Provision of control information that causes the UE to trigger 1xCS registration;
- Forwarding 1x RTT CS paging request to the UE;
- Forwarding 1x RTT CS related messages between MME and UE;
- Release of E-UTRAN resources after UE leaves E-UTRAN coverage subsequent to a page for CS fallback to 1xRTT CS if PS handover procedure is not performed in conjunction with 1xCS fallback;
- Invoking the optimised or non-optimised PS handover procedure concurrently with enhanced 1xCS fallback procedure when supported by the network and UE, and based on network configuration.

If the network supports CSFB priority call handling, the E-UTRAN supports the following additional functions:

- For page message received on S1AP with priority indication, the E-UTRAN should provide preferential treatment to this request compared to other normal paging requests.
- For CS fallback S1AP message with priority indication and if the UE is idle, the E-UTRAN should provide preferential treatment in allocating E-UTRAN radio bearer resources compared to other normal resource requests. Also, E-UTRAN shall not trigger enhanced 1xCSFB with concurrent optimized PS handover to HRPD access.

B.1.4 Co-existence with IMS services

Clause 4.4 of this specification also applies here.

B.1.5 CSFB Priority Call Handling

Priority call handling support for CSFB ensures that end-to-end priority handling is provided for both mobile originated CSFB calls by a service user in E-UTRAN and for mobile terminated CSFB call from a service user to a normal or service user in E-UTRAN. A service user's EPS subscription information contains an indication of the users 1xRTT CS domain priority status, i.e. a MPS CS priority. If the UE is subscribed to CS domain priority, the UE's USIM shall belong to one of special Access Classes as specified in TS 22.011 [38].

For mobile terminated CS fallback calls from a service user, the 1x MSC via the 1xCS IWS provides a priority indication to the MME along with a page message. The MME shall set a priority indication to the eNodeB when

requesting the eNodeB to page the UE if the UE is idle. For mobile originated CS fallback calls from a service user in E-UTRAN, the MME determines that the CSFB requires priority handling based on the MPS CS priority in the UE's EPS subscription. For both mobile originated and mobile terminated CSFB, the MME shall also provide priority indication, i.e. "CSFB High Priority", when requesting the eNodeB to execute the CSFB priority procedure. The eNodeB should handle the page message with priority and also prioritize the subsequent CS fallback procedure to 1xRTT as specified in TS 36.413 [35].

B.2 Procedures

B.2.1 Mobility Management

B.2.1.1 1x RTT CS Pre-Registration over EPS Procedure

This clause describes how the UE in an E-UTRAN system establishes and maintains pre-registration in the 1xCS system.

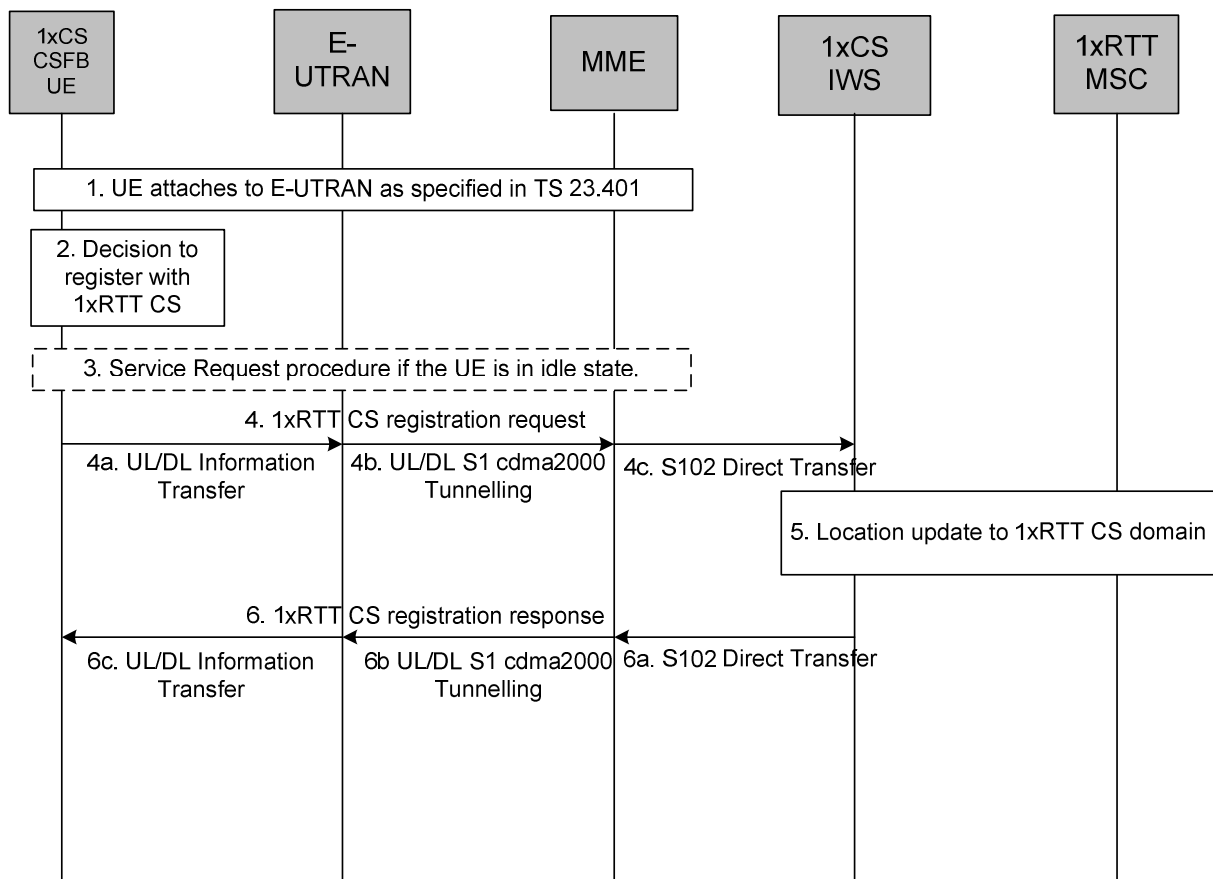

Figure B.2.1.1-1: 1xRTT CS registration procedure

1. The UE attaches to E-UTRAN as specified in TS 23.401 [2]. The UE includes an indication of enhanced CS fallback to 1xRTT and may also include concurrent 1xRTT and HRPD PS session handling capabilities as part of the UE radio capabilities.

If the UE is a service user with subscription to 1x priority service in the 1xRTT CS domain, the UE's EPS subscription contains MPS CS priority.

2. Based on a radio layer trigger (e.g. an indication from the E-UTRAN when the UE is in connected state or an indication over the broadcast channel), the UE decides to register with the 1xRTT CS domain.

3. If the UE is in idle state, in order to create a signalling connection with the MME, it performs the Service Request procedure.
4. The UE generates a 1xRTT CS registration request.
 - 4a. The 1xRTT CS message is transferred from the UE to E-UTRAN.
 - 4b. E-UTRAN forwards the 1xRTT CS message to the MME including the CDMA2000 Reference Cell ID.
 - 4c. The MME selects a 1xCS IWS node based on the CDMA2000 Reference Cell ID. The IMSI is used to distinguish S102 signalling transactions belonging to different UEs. The MME sends a S102 Direct Transfer message (IMSI, 1xCS message) to the 1xCS IWS node.
5. 1xRTT CS registration is then performed by the 1xCS IWS node based on 3GPP2 A.S0008 [16].
- 6a. 1xRTT CS registration response is tunnelled back to the MME in a S102 Direct Transfer message (IMSI, 1xCS message).
- 6b. The MME forwards the 1xRTT CS message to the E-UTRAN.
- 6c. The E-UTRAN forwards the 1xRTT CS message to the UE.

If the triggers for 1xCS registration change over time, the UE (both in idle or connected state), uses this information to update the 1xCS registration via the tunnel.

B.2.1.2 S102 Tunnel Redirection

S102 Tunnel Redirection Procedure is used when the UE perform Tracking Area Update with MME change while the UE is registered with the 1xRTT CS domain as described in clause B.2.1.1 and the S102 session exists between the MME and the 1xCS IWS.

The detail procedure for the idle case is depicted as figure B.2.1.2-1.

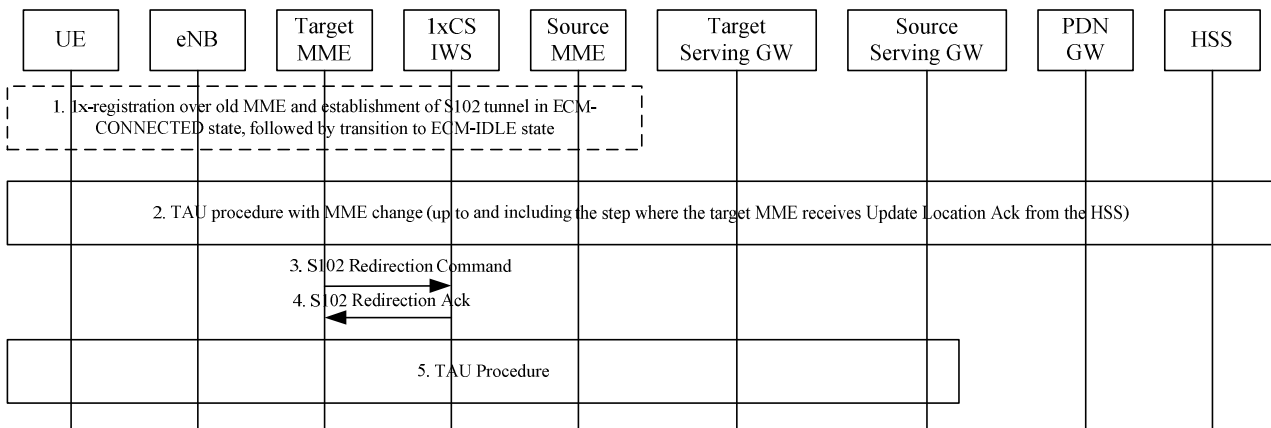

Figure B.2.1.2-1: S102 tunnel redirection during TAU with MME change

1. UE performs 1x-registration over the source MME while in ECM-CONNECTED state, followed by transition to ECM-IDLE state. The S102 tunnel exists between the source MME and the 1xCS IWS.
2. TAU procedure with MME change as described in TS 23.401 [2], figure 5.3.3.1-1, up to and including the step where the target MME receives Update Location Ack from the HSS, is executed. The 1xCS IWS ID is transferred to the target MME via the Context Response message.
3. The target MME sends S102 Redirection Command message to the 1xCS IWS. After receiving this message, the 1xCS IWS associates the S102 tunnel for this specific UE with the target MME. Then the 1xCS IWS releases any context associated with the source MME.
4. In response to the S102 Redirection Command message, the 1xCS IWS sends a S102 Redirection Ack message to the target MME.

5. The TAU procedure is completed.

The detailed procedure for the active case is depicted as figure B.2.1.2-2.

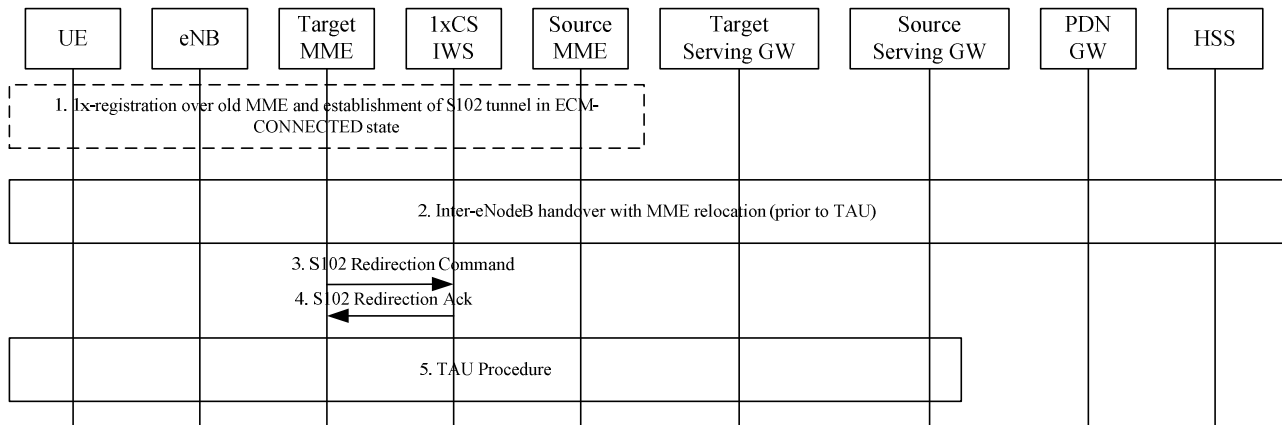

Figure B.2.1.2-2: S102 tunnel redirection during inter-eNodeB handover with MME relocation

1. UE performs 1x-registration over the source MME while in ECM-CONNECTED state. The S102 tunnel exists between the source MME and the 1xCS IWS.
2. Inter-eNodeB handover with MME relocation procedure as described in TS 23.401 [2], figure 5.5.1.2.2-1, steps prior to TAU, is executed. The 1xCS IWS ID is transferred to the target MME via the Forward Relocation Request message.
3. The target MME sends S102 Redirection Command message to the 1xCS IWS. After receiving this message, the 1xCS IWS associates the S102 tunnel with the target MME. Then the 1xCS IWS releases any context associated with the source MME.
4. In response to the S102 Redirection Command message, the 1xCS IWS sends a S102 Redirection Ack message to the target MME.
5. The TAU procedure occurs.

B.2.1.3 UE-initiated Detach Procedure

If a 1xRTT CS Fallback UE, pre-registered to the 1xRTT CS system, initiates the detach procedure in E-UTRAN access due to switch off and the UE is required to perform a "power-down registration" in the 1xRTT CS system (see C.S0005-A [32]), the UE shall first perform the "power-down registration" procedure with the 1xRTT CS system via the S102 tunnel, before initiating the detach procedure in E-UTRAN access as specified in TS 23.401 [2].

A 1xCSF UE, pre-registered to the 1xCS system, performing detach due to reasons other than switch off is not required to perform "power-down registration" with the 1xCS system prior to performing the detach procedure in E-UTRAN.

B.2.2 Mobile Originating Call in Active Mode

This clause describes the mobile originating call procedures for the CS Fallback to 1xRTT in the normal case. For enhanced CS fallback to 1xRTT procedure, see clause B.2.3a. Clause B.2.3b describes the procedure when the procedure is rejected by the MME.

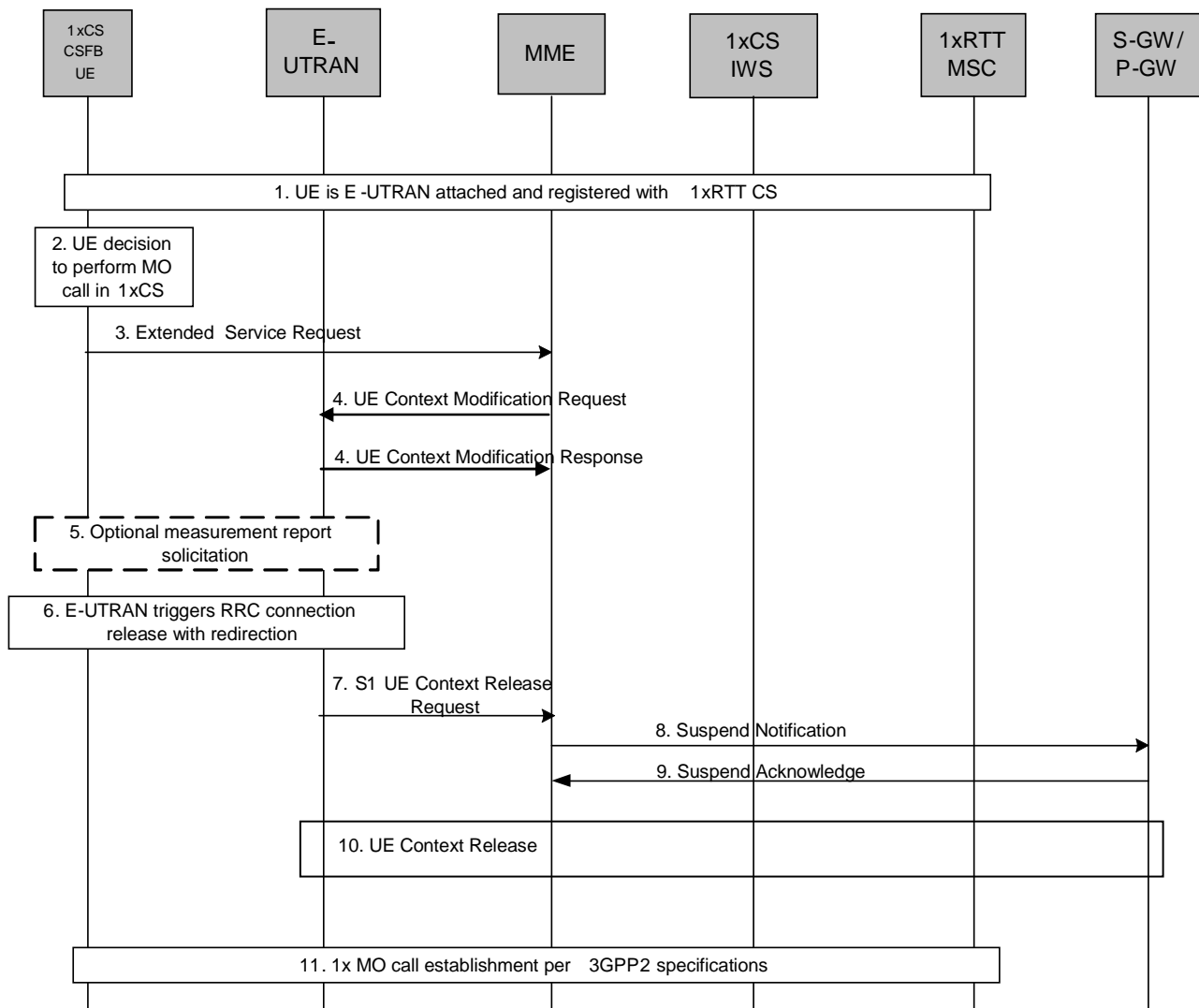

Figure B.2.2-1: CS MO call using fallback to CDMA 1x RTT network

1. UE is E-UTRAN attached and registered with 1xRTT CS as defined in clause B.2.1.1.
2. UE makes a decision to perform a mobile originated CS call.
3. UE sends an Extended Service Request for mobile originating 1xCS fallback to the MME.
4. MME sends UE Context Modification Request (CS Fallback Indicator, priority indicator) to E-UTRAN. CS Fallback Indicator indicates to the E-UTRAN to move the UE to 1xRTT.

If MME determines the CS Fallback procedure needs priority handling based on the MPS CS priority in the UE's EPS subscription, it sets priority indication in the S1AP message to the E-UTRAN. E-UTRAN responds with UE Context Modification Response

5. E-UTRAN may optionally solicit a 1xRTT measurement report from the UE to determine the target 1xRTT cell to which the CS Fallback will be performed.
- 6a. The E-UTRAN triggers RRC connection release with redirection to 1xCS and continue with step 7.
7. E-UTRAN sends an S1 UE Context Release Request (Cause) message to the MME. Cause indicates that the S1 UE Context Release was caused by CS fallback to 1xRTT.

In case the Cause indicates that RRC was released due to abnormal conditions, e.g. radio link failure, the MME should continue with steps 8 -10.

8. The MME deactivates GBR bearers towards S-GW and P-GW(s) by initiating MME-initiated Dedicated Bearer Deactivation procedure as specified in TS 23.401 [2], and starts the preservation and suspension of non-GBR

bearers by sending Suspend Notification message to the S-GW. The S-GW releases all eNodeB related information (address and TEIDs) for the UE, and sends Suspend Notification message to the P-GW(s).

9. S-GW and P-GW(s) acknowledges the bearer updates by responding with Suspend Acknowledge. The MME stores in the UE context that UE is in suspended status. All the preserved non-GBR bearers are marked as suspended status in S-GW and P-GW. The P-GW discards downlink data if the UE is marked as suspended.
10. S1 UE Context in the E-UTRAN is released as specified in TS 23.401 [2].
11. UE moves to 1xRTT and performs the procedure for mobile originating call as specified in 3GPP2 A.S0013 [18].

Once CS service ends in the 1xCS domain, the UE returns to E-UTRAN by performing reselection. The EPS service is resumed as described in clause 6.5.

B.2.2a Mobile Originating call in Idle Mode

Mobile Originating call in Idle Mode procedure is specified by reusing the Mobile Originating Call in Active mode procedure with Extended Service Request for mobile originating 1xCS fallback to the MME where the messages S1-AP UE context Modification Request and Response are replaced by S1-AP Initial UE Context Request and Response. UE is transitioned to ECM-CONNECTED mode by following the applicable procedures specified in TS 23.401 [2].

If UE has only LIPA PDN connection and the cell accessed by the UE does not link to the L-GW where the UE had the LIPA PDN Connection, the MME shall reject the Extended Service Request with a reason code which results in the UE selecting 1xRTT access as specified in TS 24.301 [34].

If the UE is a service user with subscription to CS domain priority service, the UE's USIM shall belong to one of special Access Classes as specified in TS 22.011 [38] and sets the RRC establishment cause to "HighPriorityAccess" as specified in TS 36.331 [33]. If the network supports a priority call handling, the MME determines that the Extended Service Request requires priority handling of CS Fallback based on the "HighPriorityAccess" establishment cause forwarded by eNodeB to the MME and/or MPS CS priority in the UE's EPS subscription. According to operator policy, the MME may use MPS CS priority to verify the priority handling of the CS Fallback procedure.

If MME decides to perform CS Fallback with priority, it sets priority indication in the S1-AP Initial UE Context Request message to the eNodeB. The eNodeB should allocate radio bearer resources to the UE preferentially compared to other normal calls.

B.2.3 Mobile Terminating Call

This clause describes the mobile terminating call procedures when the UE accepts or rejects CS paging for the CS Fallback to 1xRTT, in the normal case. Clause B.2.3b describes the procedure when the procedure is rejected by the MME.

When the 1x MSC receives a registration from a UE, it makes note of the RAN equipment from which it received the registration. Subsequent paging activities may thus be directed toward that RAN equipment. However, paging activities by the 1xMSC are not limited to the single RAN equipment from which the registration was received. The MSC may choose to page a wider area, including inter-system paging. If the 1xMSC has direct interfaces to 1xCS IWS, as well as to 1xRTT access, the MSC may choose to do direct paging activities to both E-UTRAN and 1x RAN equipments in its attempts to contact the UE.

The 1x paging request sent by the 1xMSC to the 1xCS IWS is delivered to the UE via the tunnel. The UE tunes to 1xRTT access, acknowledges the 1x page and performs the 1xCS procedures for mobile terminated call.

The detailed procedure using RRC connection release with redirection to 1xCS is described in figure B.2.3-1. For enhanced 1xRTT CS Fall Back procedure, see clause B.2.3a.

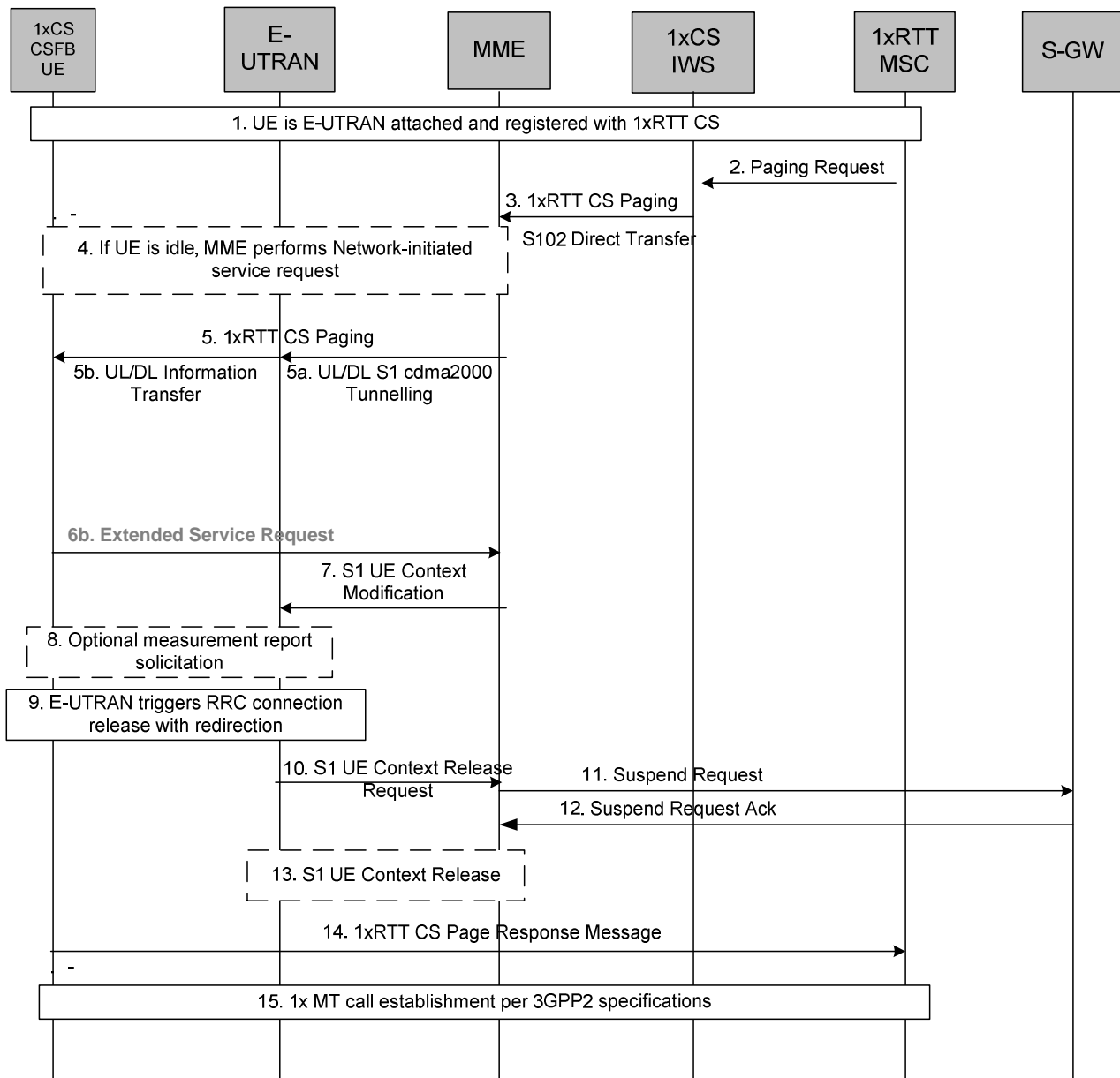

Figure B.2.3-1: CS MT call using fallback to CDMA 1x RTT network

1. UE is E-UTRAN attached and pre-registered with 1xRTT CS as defined in clause B.2.1.1.
2. 1xMSC sends a paging request to the 1xCS IWS node with Caller Line Identification if available.

If the call is originated by a priority user or an emergency callback from PSAP, the paging request message from the 1xRTT MSC to the IWS contains a priority value or an emergency indicator, respectively, as specified in 3GPP2 specification A.S0008-C v3.0 [39] / A.S0009-C v3.0 [40].
3. 1xCS IWS node forwards the 1x RTT CS paging request via the S102 tunnel to the MME.

If a priority value or emergency indication was received in the previous step, the S102 message also reflects the same.
4. If the UE is in idle state, the MME performs the network initiated Service Request procedure in order to bring the UE to active state prior to tunnelling of the 1x RTT CS paging request toward the UE. The paging is performed using S-TMSI with CN domain indicator set to "PS".

If the S102 message contains a priority value or emergency indication, the MME also sets priority indication in the S1AP paging request message to the E-UTRAN. The E-UTRAN handles the paging process with priority.

5. MME forwards the 1xRTT CS paging request to the UE.
- 6a. Void.
- 6b. If the UE accepts CS paging for the CS Fallback to 1xRTT, the UE sends an Extended Service Request for mobile terminating 1xCS fallback to the MME and proceeds with step 7 to step 15 below.
7. MME sends UE Context Modification Request (CS Fallback Indicator) to indicate the E-UTRAN to move the UE to 1xRTT.

If priority value or emergency indication was received in Step 3, the MME also sets priority indication to the E-UTRAN in UE Context Modification Request. The E-UTRAN provides preferential treatment to this call in the subsequent steps. E-UTRAN responds with UE Context Modification Response.

8. E-UTRAN may optionally solicit a 1xRTT measurement report from the UE to determine the target 1xRTT cell to which the CS Fallback will be performed.
9. E-UTRAN triggers RRC connection release with redirection to 1xCS.
10. E-UTRAN sends an S1 UE Context Release Request (Cause) message to the MME. Cause indicates that the S1 UE Context Release was caused by CS fallback to 1xRTT.
11. The MME deactivates GBR bearers towards S-GW and P-GW(s) by initiating MME-initiated Dedicated Bearer Deactivation procedure as specified in TS 23.401 [2], and starts the preservation and suspension of non-GBR bearers by sending Suspend Notification message to the S-GW. The S-GW releases all eNodeB related information (address and TEIDs) for the UE, and sends Suspend Notification message to the P-GW(s).
12. S-GW and P-GW(s) acknowledges the bearer updates by responding with Suspend Acknowledge. The MME stores in the UE context that UE is in suspended status. All the preserved non-GBR bearers are marked as suspended status in S-GW and P-GW. The P-GW discards downlink data if the UE is marked as suspended.
13. S1 UE Context in the E-UTRAN is released as specified in TS 23.401 [2].
14. UE tunes to 1xRTT and acknowledges the page by transmitting a 1xRTT Paging Response message over the 1x Access Channel.
15. Subsequently UE performs the procedure for mobile terminated call establishment as specified in 3GPP2 A.S0013 [18].

Once CS service ends in the 1xCS domain the UE returns to E-UTRAN by performing reselection. The EPS service is resumed as described in clause 6.5.

B.2.3a Enhanced CS fallback to 1xRTT Procedure

B.2.3a.1 General

Enhanced CS fallback to 1xRTT procedure may be used when the UE indicates its support of this capability to the network. If in addition, the UE also indicates its support of concurrent 1xRTT and HRPD PS session handling, this indication also allows the network to invoke optimised or non-optimised PS handover procedure concurrently with the enhanced CS fallback to 1xRTT procedure.

A network that advertises support for enhanced CS fallback to 1xRTT may also advertise support for UEs with dual 1xRTT and E-UTRAN receiver/transmitter configuration. In such networks, UEs that support enhanced CS fallback to 1xRTT for dual receiver/transmitter configuration may switch off their 1xRTT receiver/transmitter while camped in E-UTRAN and register in the 1xRTT domain via the S102 tunnel. A network advertising these capabilities does not suspend the EPS bearers for mobile originated or mobile terminated 1x CS calls for such UEs. Concurrent enhanced CS fallback to 1xRTT and PS handover to HRPD is not performed for UEs that support enhanced CS fallback to 1xRTT for dual receiver/transmitter configuration.

If enhanced CS fallback to 1xRTT procedure is not used by the network (i.e., not supported or not configured), the network uses RRC connection release with redirection as specified in clauses B.2.2 and B.2.3.

NOTE 1. Other 3GPP2 specific procedure (e.g. how UE performs concurrent operation in 3GPP2 network) is outside the scope of this specification.

NOTE 2. E-UTRAN may invoke concurrent optimised active-mode PS handover procedure or non-optimised PS handover procedure when it receives S1-AP: UE Context Modification with CSFB indication, based on UE capability and operator configuration.

B.2.3a.2 Mobile Originating Call without concurrent PS handover, or with concurrent non-optimised PS handover or optimised idle-mode PS handover

The following figure describes the mobile originating call procedures for the enhanced CS Fallback to 1xRTT with concurrent non-optimised PS handover or optimised idle-mode PS handover, or without concurrent PS handover, in the normal case. Clause B.2.3b describes the procedure when the procedure is rejected by the MME.

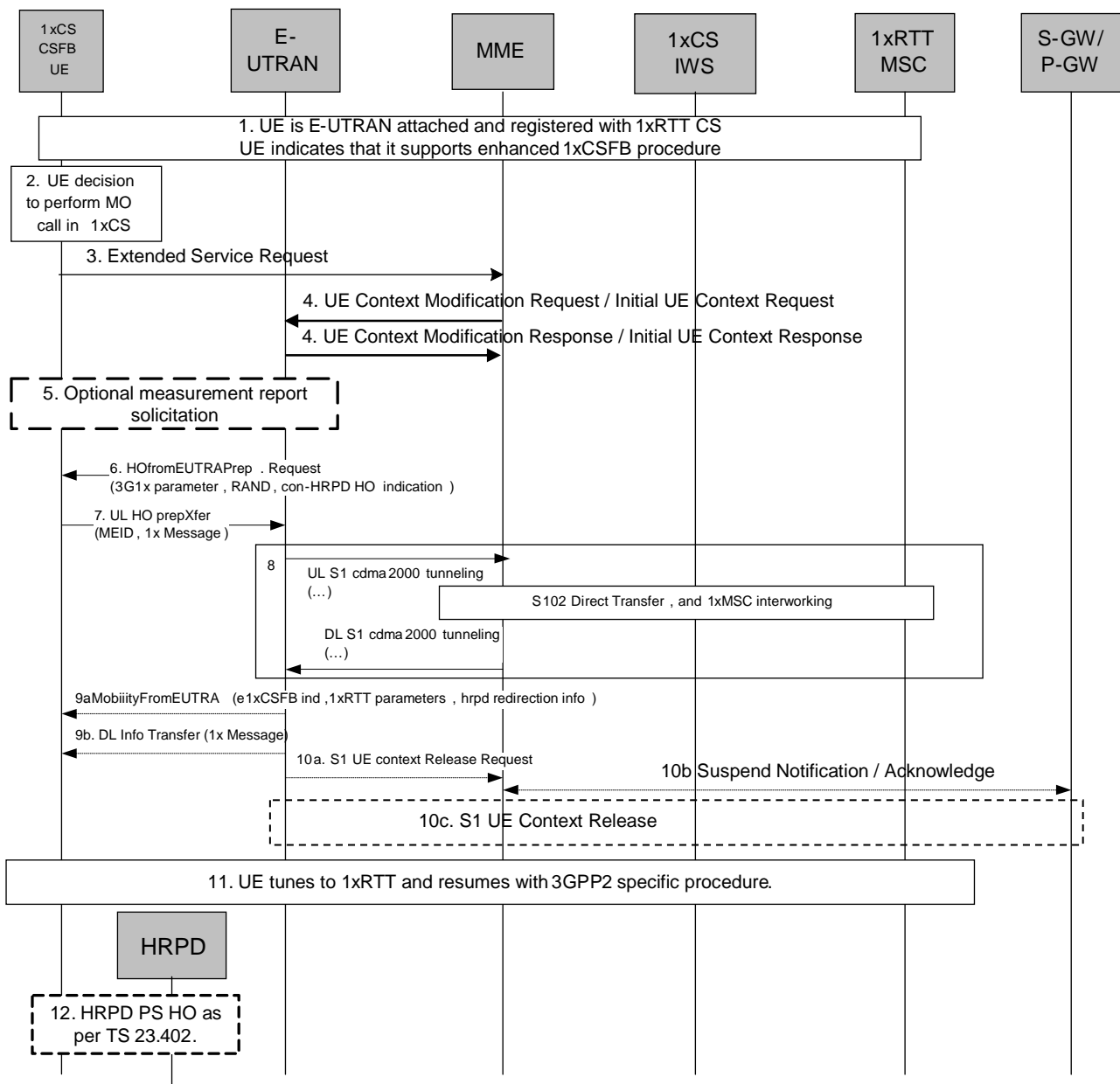

Figure B.2.3a.2-1: Enhanced CS fallback to 1xRTT MO Call with no PS handover, or with concurrent non-optimised PS handover or optimised idle-mode PS handover

1. UE is E UTRAN attached and registered with 1xRTT CS as defined in clause B.2.1.1 with enhanced CS fallback to 1xRTT capability indication to E-UTRAN. The UE may also indicate that it supports concurrent 1xRTT and HRPD capability. The UE may also be pre-registered with HRPD access using procedures defined in

TS 23.402 [27], clause 9.3.1. The UE may also indicate support of enhanced CS Fallback to 1xRTT for dual receiver/transmitter configuration to E-UTRAN.

2. UE makes a decision to perform a mobile originated CS call.
3. UE sends an Extended Service Request for mobile originating 1xCS fallback to the MME.
4. For a UE in active mode, MME sends UE Context Modification Request (CS Fallback Indicator) to E-UTRAN. CS Fallback Indicator indicates to the E-UTRAN to move the UE to 1xRTT. E-UTRAN responds with UE Context Modification Response.

For a UE in idle mode, MME sends Initial UE Context Request (CS Fallback Indicator) to E-UTRAN. CS Fallback Indicator indicates to the E-UTRAN to move the UE to 1xRTT. E-UTRAN responds with Initial UE Context Response.

If MME determines the CS Fallback procedure needs priority handling based on MPS CS priority in the UE's EPS subscription and/or the high priority access indication that the eNodeB includes in the S1AP message in step 3, it sets priority indication as well as CS Fallback indicator in the S1AP message to the eNodeB. According to operator policy the MME may use CS priority indicator to verify the priority handling of the CS Fallback procedure, in the case high priority access indication is received in the S1-AP message. The E-UTRAN, in congestion conditions, provides preferential treatment for this call in the subsequent steps. Also, the E-UTRAN shall not trigger enhanced 1xCSFB with concurrent optimized PS handover to HRPD access.

5. E-UTRAN may optionally solicit a 1xRTT measurement report from the UE to determine the target 1xRTT cell to which the CS Fallback will be performed.

If the network supports PS handover procedure to HRPD then E-UTRAN may optionally solicit an HRPD measurement report from the UE to determine whether the target HRPD candidates exist or not.

6. E-UTRAN sends a HandoverFromE-UTRANPreparation Request message to the UE to start the enhanced 1xCS fallback procedure. It includes 3G1x Overhead Parameters and RAND value. This message also includes an indication that concurrent HRPD handover preparation is not required.

When both the network and the UE support enhanced CS Fallback to 1xRTT for dual receiver/transmitter configuration, the E-UTRAN may after Step 4 decide, e.g. due to RF conditions, to direct the UE to turn on its second radio to 1xRTT and retry the 1xCS call directly on the 1xRTT access network. For this case, the E-UTRAN in the HandoverFromE-UTRANPreparation Request message includes a redirection indicator along with optional redirection information. The procedure stops after this step and the UE tunes its 1x radio and retries its 1x call in 1xRTT while still receiving/transmitting data on E-UTRAN.

7. The UE initiates signalling for establishment of the CS access leg by sending UL HandoverPreparation Transfer message which contains the 1xRTT Origination message with called party number.
8. Messages between MME and 1xIWS are tunnelled using the S102 interface. The 1xRTT MSC initiates the call with the called party number carried in the 1xRTT Origination message.
9. The E-UTRAN performs either Step 9a or Step 9b. Step 9b is only performed when both the E-UTRAN and UE support enhanced 1x CS fallback to 1xRTT for dual receiver/transmitter configuration.
- 9a. The E-UTRAN sends Mobility from EUTRA Command to the UE with indication that this is for enhanced 1x CS Fallback operation, 1xRTT related information, and optionally the HRPD redirection information. The 1xRTT information contains 1xRTT messages related to 1x channel assignment and cause the UE to tune to and acquire this 1x channel. This is perceived by the UE as a Handover Command message to 1xRTT.
 - If the network does not support PS handover procedure to HRPD or if no target HRPD candidates exist then E-UTRAN shall release the S1 UE context (see step 10a/b) after executing the enhanced CS fallback to 1xRTT procedure.
 - For either concurrent non-optimised PS handover procedure or optimised idle-mode PS handover procedure along with enhanced CS fallback to 1xRTT, E-UTRAN may also redirect the UE to HRPD as part of this procedure. This is indicated by the HRPD redirection information in the Mobility from EUTRA Command.

If 1xRTT CS network cannot support this CSFB request (for example due to resource availability), the DL information transfer message is sent instead, with an embedded 1x message that indicates failure to the UE. In this case, steps 10, 11, 12 shall be skipped.

- 9b. The E-UTRAN sends DL information transfer message, with the embedded 1x message indicating 1xRTT preparation success to the UE. Steps 10 and 12 are not performed in this case.
- 10a/b/c. If PS handover procedure is not performed then E-UTRAN sends an S1 UE Context Release Request (Cause) message to the MME. Cause indicates that the S1 UE Context Release was caused by CS fallback to 1xRTT. The S1-U bearers are released and the MME starts the preservation and suspension of non-GBR bearers and the deactivation of GBR bearers towards S-GW and P-GW(s). The MME sets the UE context to suspended status.
11. UE tunes to the 1xRTT radio access network and performs 1xchannel acquisition with the 1xRTT CS access (e.g. 1xRTT BSS). A UE supporting enhanced 1xCSFB to 1xRTT for dual receiver/transmitter configuration continues to receive/transmit data on E-UTRAN.
12. UE and Network follow the appropriate procedure for handling non-optimised PS handover procedure or optimised idle-mode PS handover as defined in TS 23.402 [27] if performed. S1 UE Context release procedure is as specified in TS 23.402 [27] for non-optimised PS handover (clause 8.2.2) or optimised idle-mode PS handover (clause 9.4). This step occurs in parallel with step 11.

B.2.3a.3 Mobile Originating Call with concurrent optimised PS handover

The following figure describes the mobile originating call procedures for the enhanced CS Fallback procedure to 1xRTT with concurrent optimised PS handover, in the normal case. Clause B.2.3b describes the procedure when the procedure is rejected by the MME. This procedure is not executed for mobile originated priority 1x CS Fallback. This procedure is not performed when both the network and the UE support enhanced CS Fallback to 1xRTT for dual receiver/transmitter configuration.

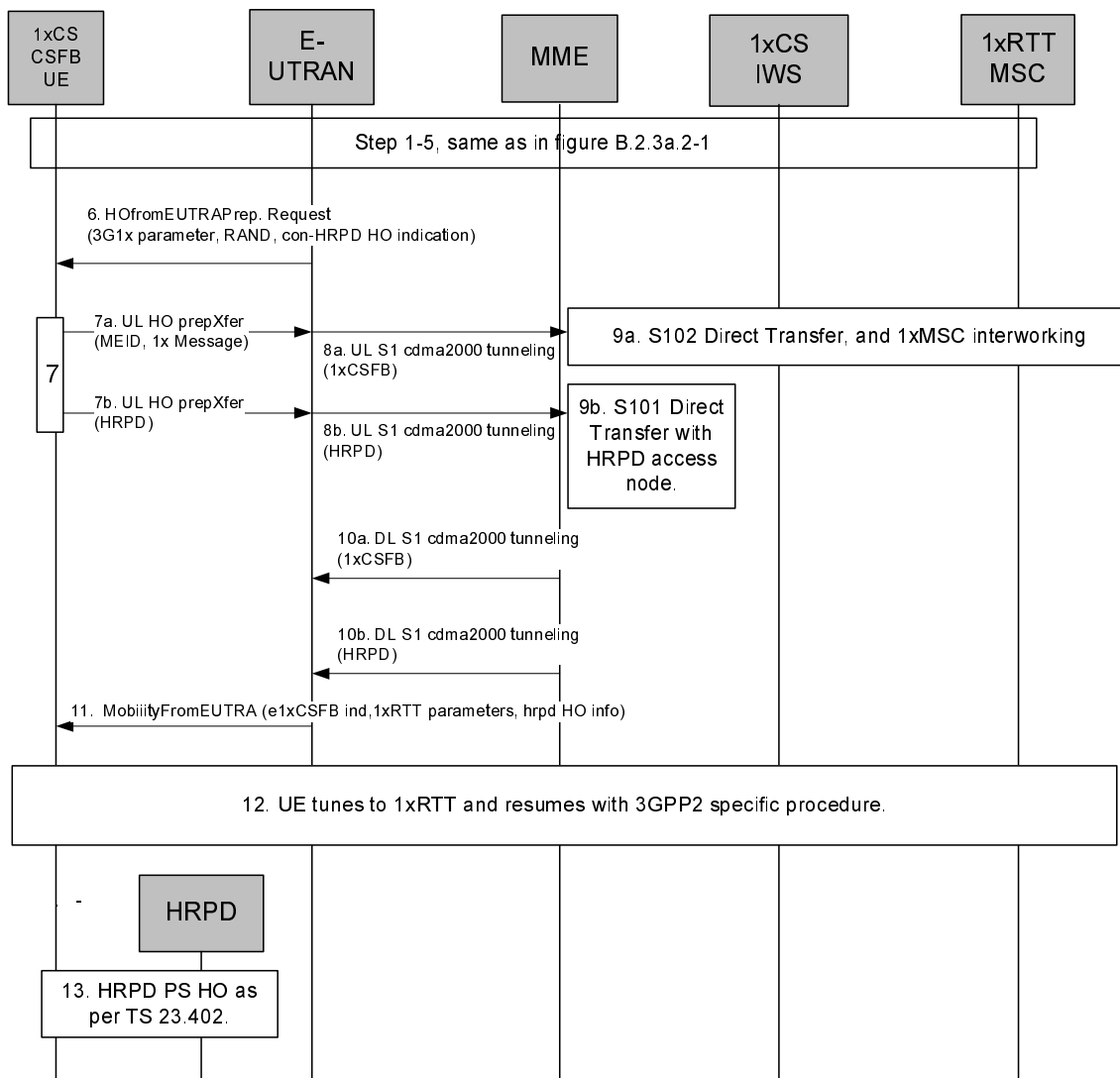

Figure B.2.3a.3-1: Enhanced CS fallback to 1xRTT MO Call with concurrent optimised PS handover

- 1-5. Same as steps 1-5 in figure B.2.3a.2-1. The UE indicates that it supports enhanced CS fallback to 1xRTT procedure and concurrent 1xRTT and HRPD capability.
- 6. E-UTRAN sends an Handover From E-UTRA Preparation Request message to the UE to start the enhanced 1xCS fallback procedure. It includes 3G1x Overhead Parameters and RAND value. This message also includes an indication that concurrent HRPD handover preparation is required.
- 7. UE starts the enhanced 1xCS fallback and optimised PS handover messages (7a, 7b) in a sequential manner. Step 7a contains the 1xRTT Origination message with called party number.
- 8a, 9a, 10a, and 8b, 9b, 10b. MME treats the enhanced 1xCS fallback and HRPD PS handover procedure independently (i.e. MME does not link the HRPD message and 1xCS fallback message together).
- 8a, 9a, 10a is same as shown in step 8 in figure B.2.3a.2-1
- 8b, 9b, 10b are messages/procedure for optimised E-UTRAN to HRPD handover procedure as defined in TS 23.402 [27], clause 9.3.2.

11. The E-UTRAN sends Mobility from EUTRA Command to the UE with indication that this is for enhanced 1x CS Fallback operation including the 1xRTT message and the HRPD message received over the S102 and S101 tunnels.

If handover preparation to HRPD is successful but preparation failure message is received from the 1xRTT CS network via the S102 tunnel, the message for 1xRTT preparation failure indication is sent to the UE as part of the Mobility from EUTRA Command. If handover to HRPD is successful and the eNodeB times out waiting for preparation completion message from 1xRTT, the E-UTRAN sends a Mobility from EUTRA command with only the HRPD message included. In the case that the preparation to HRPD failed but 1xRTT is successful, E-UTRAN may optionally include HRPD redirection info as part of the Mobility from EUTRA Command.

In case preparation on 1xRTT and HRPD failed with explicit failure messages received on S102 and S01 tunnels, the E-UTRAN forwards the received failure messages as DL Information transfers. In this case, steps 12 and 13 are skipped.

12. UE retunes to the 1xRTT radio access network and performs 1x channel acquisition with the 1xRTT CS access (e.g. 1xRTT BSS), see TS 23.216 [20], clause 6.1.3.
13. UE and network follow the optimised E-UTRAN to HRPD handover procedure. UE context release procedure follows the optimised E-UTRAN to HRPD handover procedure as defined in TS 23.402 [27], clause 9.3.2. This step occurs in parallel with step 12.

B.2.3a.4 Mobile Terminating Call without PS handover, or with concurrent non-optimised PS handover or optimised idle-mode PS handover

The following figure describes the mobile terminating call procedures for the enhanced CS Fallback to 1xRTT with concurrent non-optimised PS handover or optimised idle-mode PS handover, or without PS handover, in the normal case. Clause B.2.3b describes the procedure when the procedure is rejected by the MME.

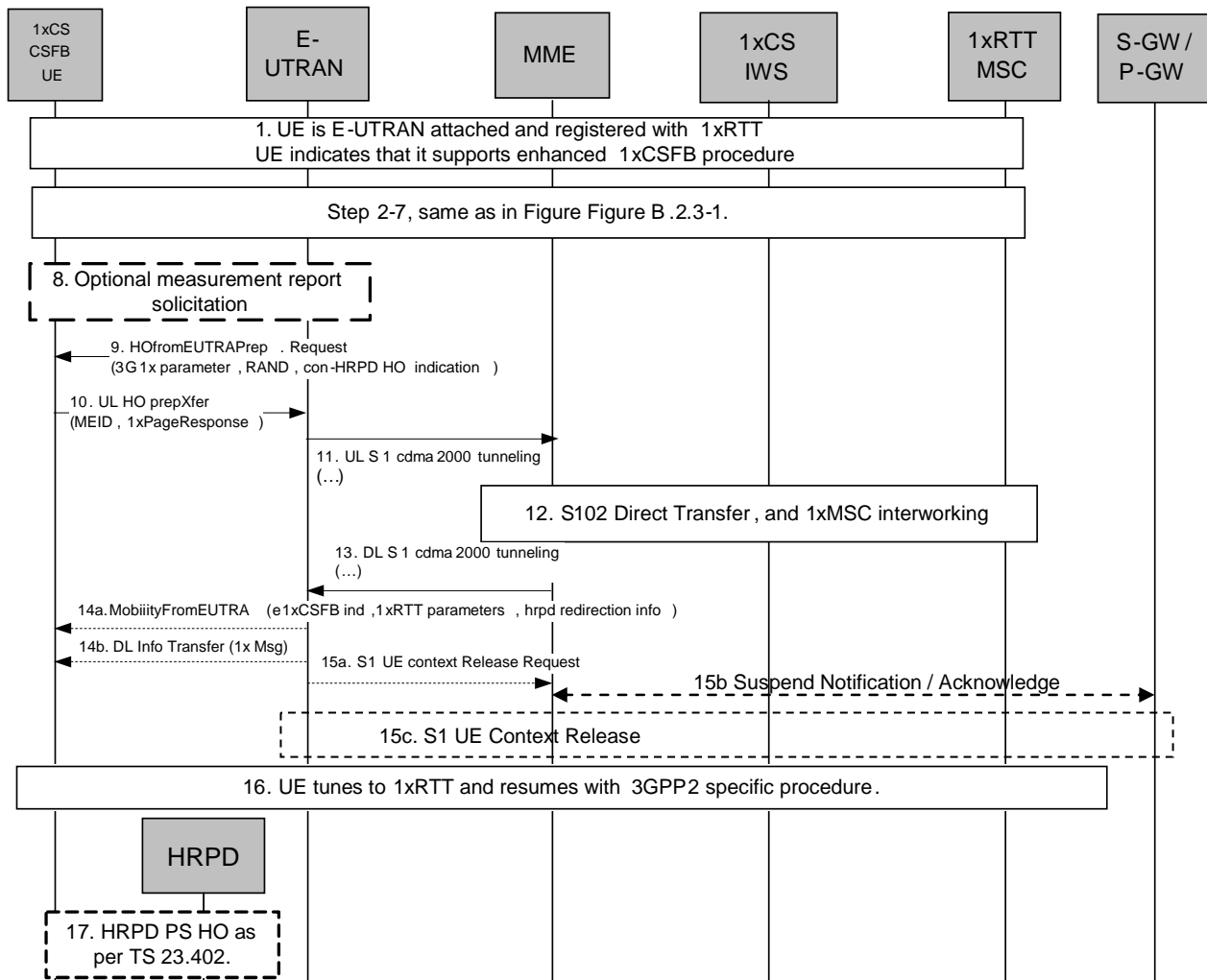

Figure B.2.3a.4-1: Enhanced CS fallback to 1xRTT MT call without PS handover, or with concurrent non-optimised PS handover or optimised idle-mode PS handover

1. UE is E-UTRAN attached and pre-registered with 1xRTT CS as defined in clause B.2.1.1 with enhanced CS fallback to 1xRTT capability indication to E-UTRAN. The UE may also indicate that it supports concurrent 1xRTT and HRPD capability. The UE may also be pre-registered with HRPD access using procedures defined in TS 23.402 [27], clause 9.3.1. The UE may also indicate support of enhanced CS fallback to 1xRTT for dual receiver/transmitter configuration to E-UTRAN.

2-7. Same as step 2-7 in figure B.2.3-1.

If priority indication is included in the S1AP UE Context Setup or modification message from the MME to the E-UTRAN, the E-UTRAN shall not initiate enhanced 1xCsfb with concurrent optimized PS handover to HRPD access.

8-17. Same as steps 5 – 12 of Figure B.2.3a.2-1, with the modifications that the 1x message in step 7 of Figure B.2.3a.2-1 provided by the UE to the E-UTRAN is a 1xPage Response message and 1x messages in step 9a of Figure B.2.3.a.2-1 (step 14a of Figure B.2.3a.4-1) provided by the E-UTRAN to UE may also contain Alert With Information message to provide caller line Identification and alerting trigger with 1x channel assignment message.

B.2.3a.5 Mobile Terminating Call with concurrent optimised PS handover

The following figure describes the mobile terminating call procedures for the enhanced CS Fallback to 1xRTT with concurrent optimised PS handover, in the normal case. Clause B.2.3b describes the procedure when the procedure is rejected by the MME. This procedure is not executed for mobile terminated priority 1x CS Fallback. This procedure is not performed when both the network and the UE support enhanced CS Fallback to 1xRTT for dual receiver/transmitter configuration.

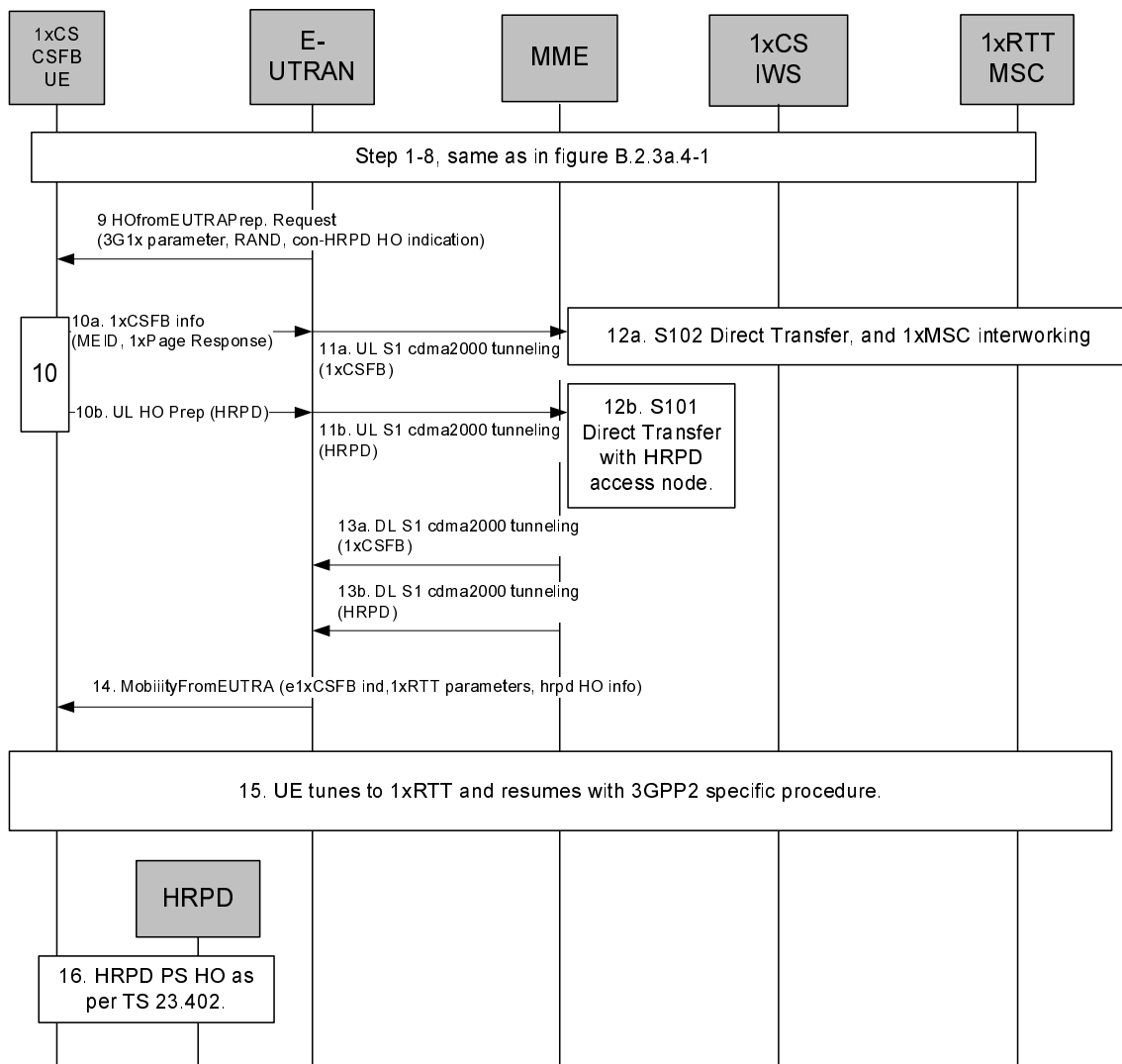

Figure B.2.3a.5-1: Enhanced CS fallback to 1xRTT MT Call with concurrent optimised PS handover

1-8. Same as steps 1-8 in figure B.2.3a.4-1. The UE indicates that it supports enhanced CS fallback to 1xRTT procedures and concurrent 1xRTT and HRPD capability. The UE may also be pre-registered with HRPD access using procedures defined in TS 23.402 [27], clause 9.3.1.

9-16. Same as steps 6 – 13 of Figure B.2.3a.3-1, with the modifications that the 1x message in step 7 of Figure B.2.3a.2-1 provided by the UE to the E-UTRAN is a 1xPage Response message and 1x messages in step 9a of Figure B.2.3a.2-1 (step 14 of Figure B.2.3a.5-1) provided by the E-UTRAN to UE may also contain Alert With Information message to provide caller line Identification and alerting trigger with 1x channel assignment message.

B.2.3a.6 Interaction between enhanced CS Fallback to 1xRTT and optimised PS handover

For regular optimized PS handover procedure, it is possible that the UE receives 1xRTT CS paging from EPS while optimized PS handover to HRPD is in progress. In this case, UE shall ignore the 1xRTT CS paging locally.

B.2.3b Mobile Originated or Mobile terminated call rejected by the MME

The MME may reject an Extended Service Request either for mobile originated or mobile terminated CSFB. In this case, the following procedure is executed.

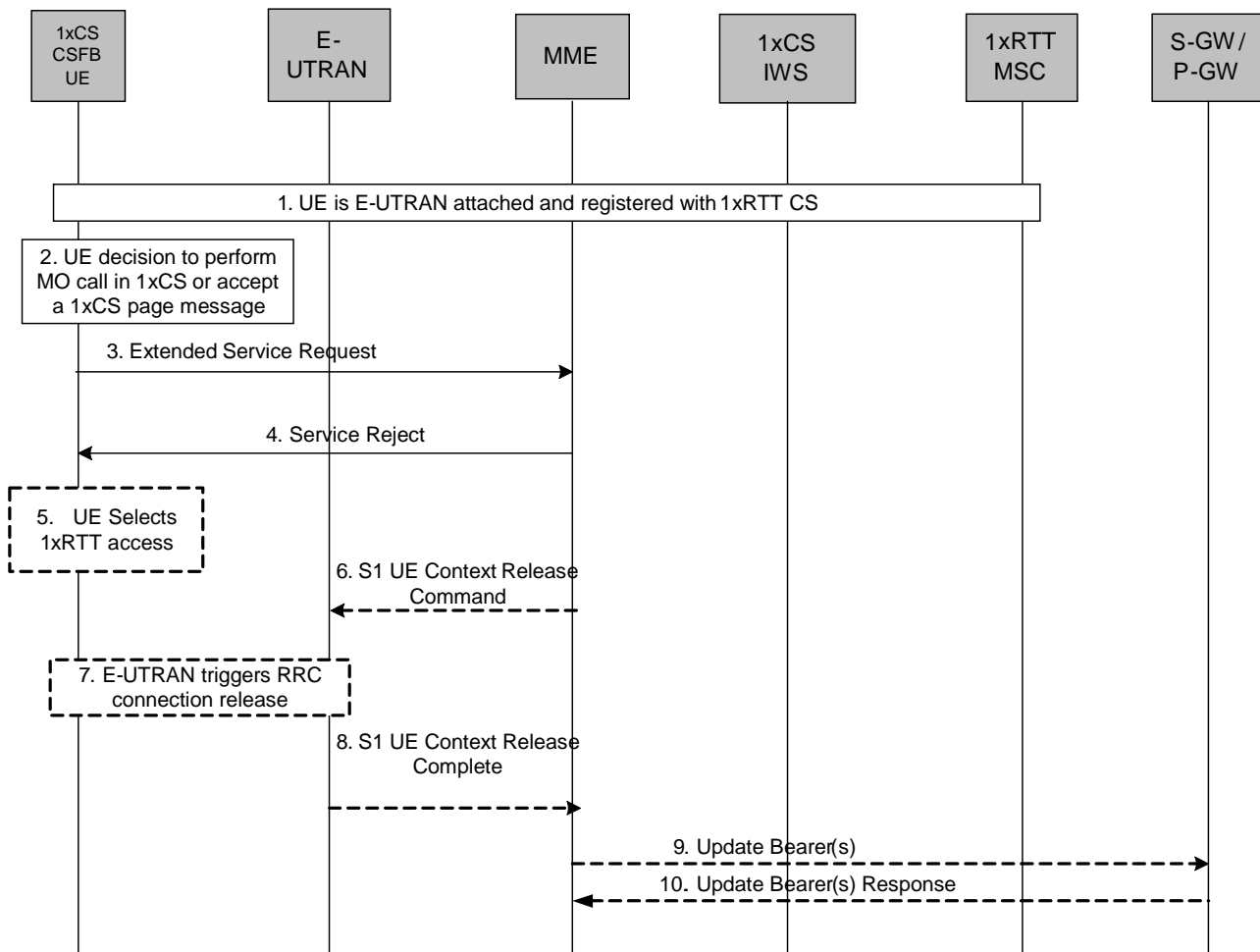

Figure B.2.3b-1: 1xCSFB MO or MT call, rejected by MME

1. UE is E-UTRAN attached and pre-registered with 1xRTT CS as defined in clause B.2.1.1.
2. UE makes a decision to perform a mobile originated CS call or accepts CS paging for the CS Fallback to 1xRTT (Step 6a, Clause 5.2.3).
3. UE sends an Extended Service Request for mobile originating/mobile terminating 1xCS fallback to the MME.
4. If the MME decides to reject the Extended Service Request, the MME sends a Service Reject message to the UE.

Steps 5 – 10 are executed when Service Reject is sent with a reason code which results in the UE selecting 1xRTT access, as specified in TS 24.301 [34].

5. The UE selects 1xRTT access without waiting for RRC Release.
6. The MME releases S1 by sending the S1 UE Context Release Command (Cause) message to the eNodeB. Cause value indicates that the release is triggered by CS Fallback procedure.
7. If the RRC connection is not already released, the E-UTRAN sends a RRC Connection Release message to the UE.
8. The E-UTRAN confirms the S1 Release by returning an S1 UE Context Release Complete message to the MME.
- 9-10. Depending on the reason for rejection, MME may start Suspend Notification:
 - Suspend Notification: The S1-U bearers are released and the MME starts the preservation and suspension of non-GBR bearers and the deactivation of GBR bearers towards S-GW and P-GW(s).
 - S-GW and P-GW(s) acknowledges the bearer updates Suspend Notification and marks the UE as suspended. The P-GW discards downlink data if the UE is marked as suspended.

B.2.4 Short Message Service (SMS)

B.2.4.1 General

The procedures for SMS in this annex apply only if the UE is 1xRTT CS Registered and the CS access domain is chosen by the UE and/or the home PLMN for delivering short messages.

This clause describes both the mobile originating and mobile terminating SMS over S102 which uses 1xCS procedures in EPS. SMS support is based on the S102 reference point between the MME and the 1xCS IWS, use of RRC Information Transfer message between the UE and the E-UTRAN, and use of S1 cdma2000 Tunnelling message between the E-UTRAN and the MME.

B.2.4.2 Mobile originating SMS

The following sequence flow shows the delivery of mobile originating SMS sent via the 1xMSC while in E-UTRAN.

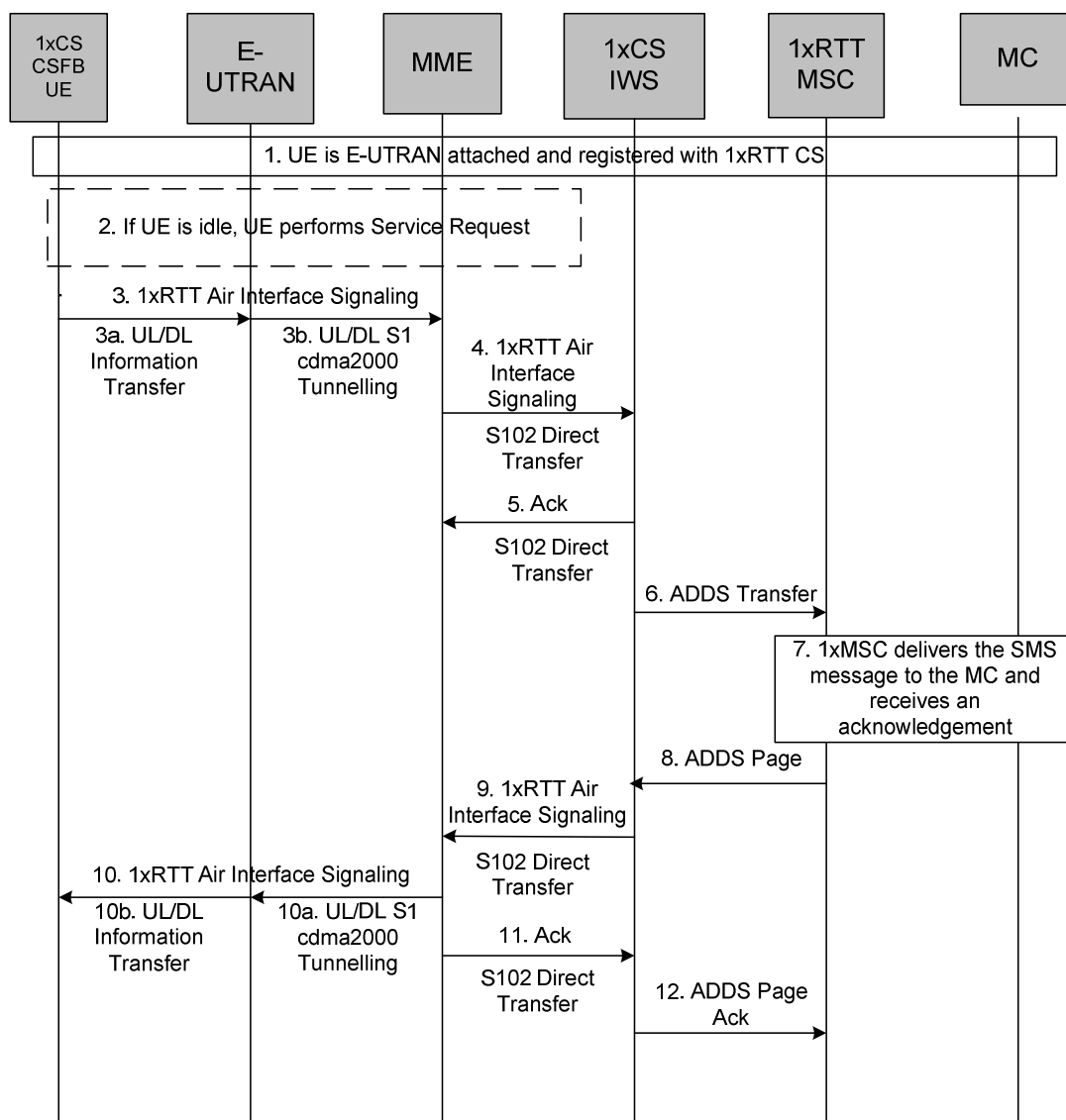

Figure B.2.4.2-1: Mobile originating SMS sent via the 1xMSC while in E-UTRAN

1. The 1xRTT CS Registration procedure as described in clause B.2.1.1 has been performed earlier.
2. A mobile originating short message is triggered. If the UE is in idle state, the UE performs the UE triggered Service Request procedure, which is defined in TS 23.401 [2].

3. The UE builds the SMS message to be sent as defined in 3GPP2 A.S0008 [16] and 3GPP2 A.S0009 [17].
- 3a. The 1xRTT SMS message is transferred from the UE to the E-UTRAN.
- 3b. The E-UTRAN forwards the SMS message to the MME.
4. The MME forwards the SMS message to the 1xCS IWS in an S102 Direct Transfer message.
5. The 1xCS IWS acknowledges the message.
6. The 1xCS IWS sends an ADDS Transfer message to the 1xMSC containing the SMS message as defined in 3GPP2 A.S0008 [16] and 3GPP2 A.S0009 [17].
7. The 1xMSC forwards the SMS message to the Message Centre (MC). If an acknowledgement was requested by the UE, the MC responds with an acknowledgement.
8. The 1xMSC forwards the SMS acknowledgement to the 1xCS IWS in an ADDS Page message.
9. The 1xCS IWS forwards the SMS acknowledgement to the MME in an S102 Direct Transfer message.
10. The MME forwards the SMS acknowledgement to the UE.
11. The MME sends an S102 Ack message to the 1xCS IWS. This occurs immediately after step 9 if the MSC has not requested an acknowledgement from the 1xCS IWS.
12. If the MSC requested an acknowledgement, the 1xCS IWS sends an ADDS Page Ack message to the 1xMSC.

B.2.4.3 Mobile terminating SMS

The following sequence flow shows the delivery of mobile terminating SMS sent via the 1xMSC while in E-UTRAN.

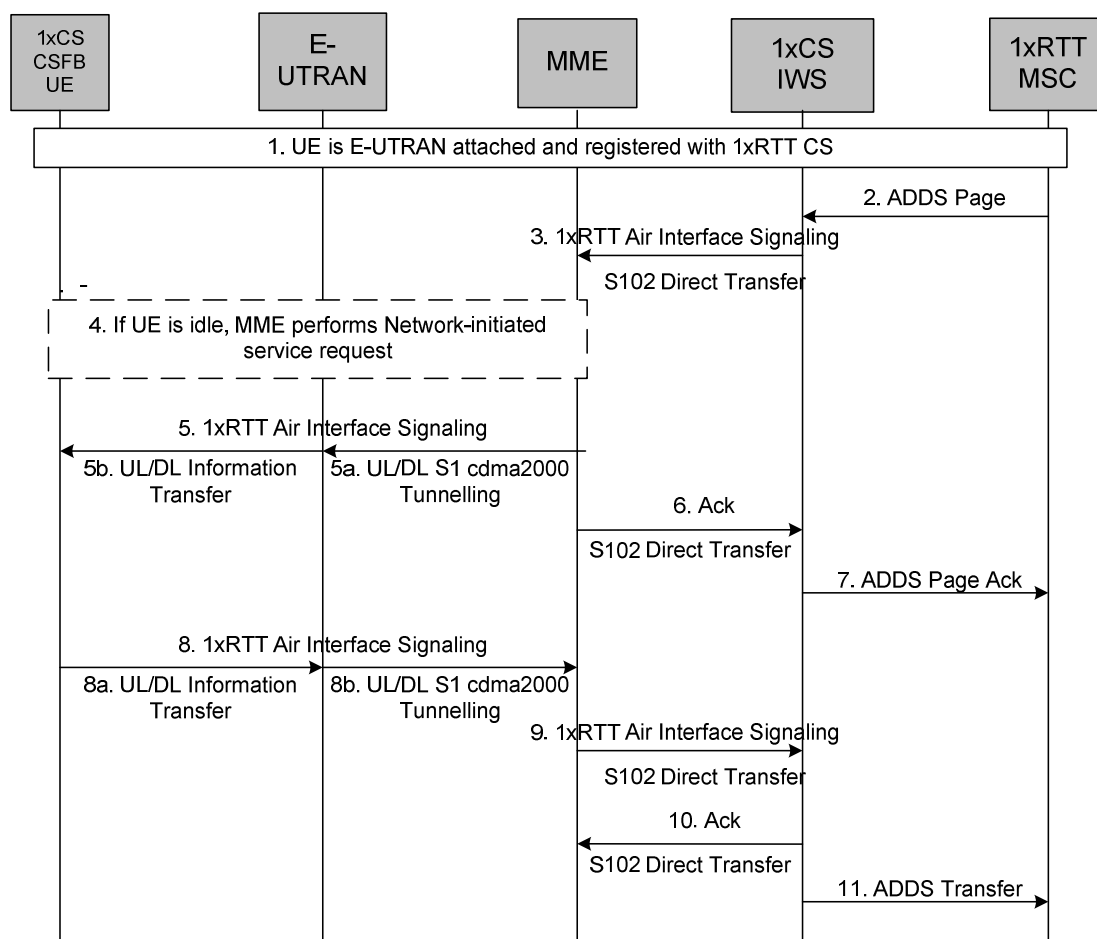

Figure B.2.4.3-1: Mobile terminating SMS sent via the 1xMSC while in E-UTRAN

1. The UE is E-UTRAN attached and registered with 1xRTT CS as defined in clause B.2.1.1.
2. The 1xMSC receives the SMS message from the MC and sends an ADDS Page message to the 1xCS as defined in 3GPP2 A.S0008 [16] and 3GPP2 A.S0009 [17]. The ADDS Page contains the SMS message.
3. The 1xCS IWS sends the SMS message in an S102 Direct Transfer message.
4. If the UE is in idle state, the MME performs the network initiated Service Request procedure to bring the UE to active state prior to tunnelling of the SMS message toward the UE.
5. The MME forwards the SMS message to the UE.
6. The MME sends an S102 Ack message to the 1xCS IWS. This occurs immediately after step 3 if the MSC has not requested an acknowledgement from the 1xCS IWS.
7. If the MSC requested an acknowledgement, the 1xCS IWS sends an ADDS Page Ack message to the 1xMSC.
8. After receiving the SMS message at step 5, the UE sends an SMS acknowledgement toward the MC.
9. The MME forwards the SMS acknowledgement in an S102 Direct Transfer message to the 1xCS IWS.
10. The 1xCS IWS sends an S102 Ack message to the MME.
11. The 1xCS IWS forwards the SMS acknowledgement to the 1xMSC. The 1xMSC then forwards the SMS acknowledgement to the MC.

NOTE: In addition to above MT SMS procedure (Common Channel SMS), 3GPP2 also defines Traffic Channel SMS delivering method in 3GPP2 A.S0008[16] and A.S0009 [17] that can be used in E-UTRAN-1x interworking architecture. In this method, the messages between 1xRTT IWS and 1xMSC are different from those messages specified in this section. There is no additional functional requirement to EPS.

B.2.5 Emergency Calls

When UE is performing CS fallback procedure to 1xRTT for the purpose of emergency call, it shall indicate to the MME that this CS fallback request is for emergency purpose. MME also indicates to the E-UTRAN via the appropriate S1-AP message that this CS fallback procedure is for emergency purpose.

Emergency call with enhanced 1xRTT CS fallback procedure shall be executed without the concurrent PS handover procedure.

B.3 CS Fallback for UEs with dual Rx configuration

B.3.1 General Considerations

The following principles are used for supporting CS Fallback for dual receiver UEs:

- The UE with dual Rx configuration attaches separately to each RAT (E-UTRAN, 1xRTT) and maintains separate registration and mobility procedure handling to each RAT. No coordination is required between the E-UTRAN and 1xRTT network.
- The UE with dual Rx configuration is able to camp in 1xRTT at the same time as it is active or idle in E-UTRAN. Camping in 1xRTT includes performing 1xRTT cell re-selection, reading broadcast channels, monitoring paging, performing location updates, etc. according to 3GPP2 specifications.
- The UE with dual Rx configuration is allowed to leave E-UTRAN in order to handle a CS call and/or perform registration signalling, and/or sending or receiving SMS in 1xRTT. The procedures for leaving E-UTRAN is described in clause B.3.2 and are only allowed if the network indicates that it supports them (this is indicated by either the presence of CSFB registration parameters or indication of support for dual Rx CSFB on E-UTRAN broadcast channel, TS 36.331 [33]).
- The UE that reports dual Rx configuration to E-UTRAN does not require redirection information.

NOTE: Further clarification to the UE behaviour may be needed if the procedure in clause B.3.2, i.e. time between transmission of Extended Service Request (3) and reception of RRC Connection Release (5) takes too long.

B.3.2 Procedures for leaving E-UTRAN

The UE with dual Rx configuration is allowed to leave E-UTRAN in order to handle a CS call and/or perform registration signalling, and/or perform location management signalling, and/or sending or receiving SMS in 1xRTT. When the UE needs to leave E-UTRAN it indicates this to E-UTRAN by using the Extended Service Request procedure similar to how MT/MO calls are handed in clauses B.2.2, B.2.2a and B.2.3. The procedure is the same regardless what activity is performed in the 1xRTT system (e.g. if it is a page response, MO call, re-registration). The procedure is shown in Figure B.3.2-1.

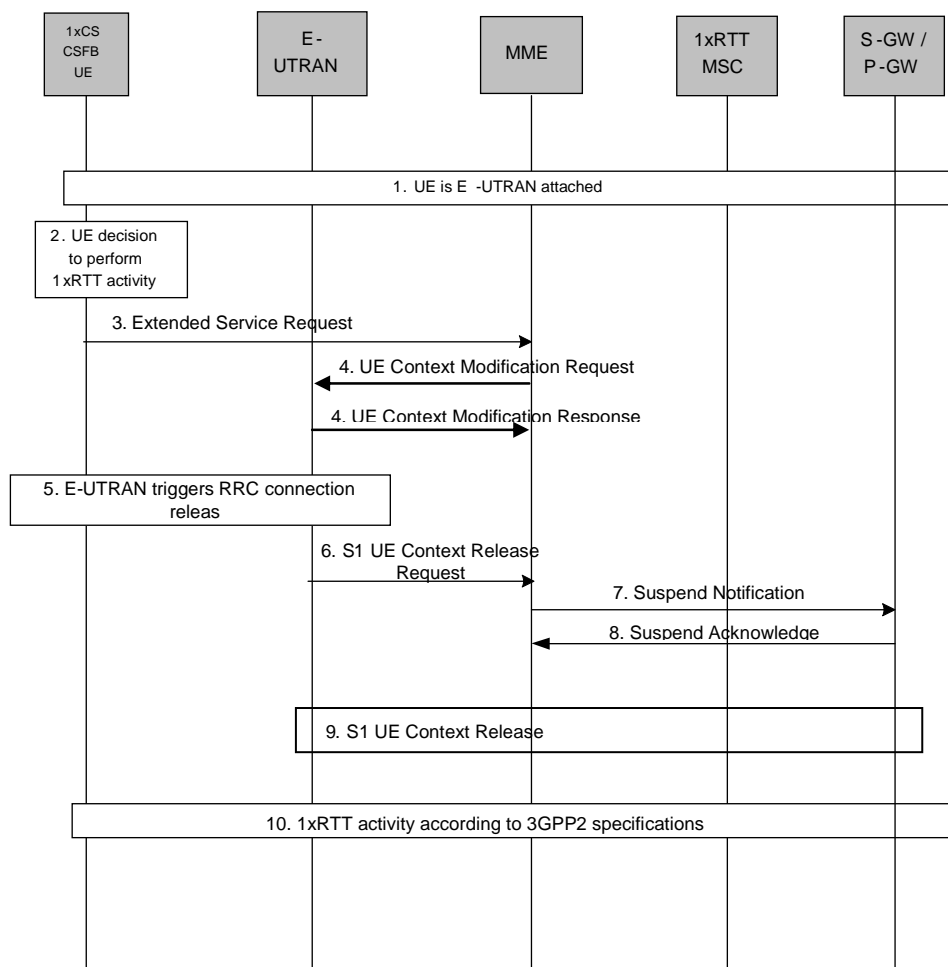

Figure B.3.2-1: Performing 1xRTT related activity for dual receiver UEs

1. UE is E-UTRAN attached the UE may also be registered in 1xRTT CS.
2. UE makes a decision that it needs to perform some 1xRTT activity (e.g. in order to respond to an incoming 1xRTT page, setup a MO call, perform location management signalling, or perform re-registration).
3. UE sends an Extended Service Request for mobile originating/mobile terminating 1xCS fallback to the MME. The figure shows the case the UE is in active state in E-UTRAN but the same principles applies if the UE is in idle state, TS 23.401 [2].
4. MME sends UE Context modification Request (CS Fallback Indicator) to E-UTRAN. CS Fallback Indicator indicates to the E-UTRAN to move the UE to 1xRTT. E-UTRAN responds with UE Context Modification Response.

5. The E-UTRAN triggers RRC connection release and continues with step 6. This step may include re-direction information if the E-UTRAN indicates support for S102. E-UTRAN that indicates support for dual Rx CSFB shall not include any redirection information towards the UE that indicates dual Rx configuration but no support for enhanced CS fallback to 1xRTT.
6. E-UTRAN sends an S1 UE Context Release Request (Cause) message to the MME. Cause indicates that the S1 UE Context Release was caused by CS fallback to 1xRTT.
7. The S1-U bearers are released and the MME starts the preservation and suspension of non-GBR bearers and the deactivation of GBR bearers towards S-GW and P-GW(s), by sending Suspend Notification to S-GW and P-GW. The MME sets the UE context to suspended status.
8. The S-GW and P-GW(s) acknowledges the bearer updates by responding with Suspend Acknowledge and marks the UE as suspended in S-GW and P-GW. When a downlink data arrives at the P-GW, the P-GW should not send downlink data if the UE is marked as suspended.
9. S1 UE Context in the E-UTRAN is released as specified in TS 23.401 [2].

B.3.3 Procedures for returning to E-UTRAN

The procedure for returning to E-UTRAN is the same as specified in clause 6.5.

Annex C (informative): Change history

Change history								
Date	TSG #	TSG Doc.	CR	Rev	Cat	Subject/Comment	Old	New
2010-06	SP-48	SP-100444	0218	4	B	CSFB triggered by LCS while UE is in active VoIP session	9.4.0	10.0.0
2010-09	SP-49	SP-100531	0596	-	A	Removing UE rejection on CLI for 1x MT call	10.0.0	10.1.0
2010-09	SP-49	SP-100531	0609	-	A	Correction to the paging issue for CS fallback capable UEs in NMO II or III	10.0.0	10.1.0
2010-09	SP-49	SP-100541	0575	1	A	Correction to Paging in MT CSFB	10.0.0	10.1.0
2010-09	SP-49	SP-100541	0577	1	A	CS domain access rights handling in CSFB	10.0.0	10.1.0
2010-09	SP-49	SP-100541	0585	1	A	Suspend clarification for CSFB	10.0.0	10.1.0
2010-09	SP-49	SP-100544	0580	3	B	eMPS CR for CSFB (reference, definition and overall description)	10.0.0	10.1.0
2010-09	SP-49	SP-100544	0581	2	B	eMPS CR for CSFB (attach procedure)	10.0.0	10.1.0
2010-09	SP-49	SP-100544	0582	2	B	eMPS CR for CSFB (Mobile Originating Call)	10.0.0	10.1.0
2010-09	SP-49	SP-100544	0583	2	B	eMPS CR for CSFB (Mobile Terminating Call)	10.0.0	10.1.0
2010-09	SP-49	SP-100544	0597	1	B	MPS Support for 1xCSFB – Intro and impacts to Network Elements	10.0.0	10.1.0
2010-09	SP-49	SP-100544	0598	1	B	MPS 1xCSFB impacts on MO and MT calls	10.0.0	10.1.0
2010-09	SP-49	SP-100558	0589	2	F	MSC reselection in case of roaming restriction	10.0.0	10.1.0
2010-09	SP-49	SP-100558	0599	2	C	Adding e1xCSFB support for dual Rx/Tx UE	10.0.0	10.1.0
2010-12	SP-50	SP-100681	0587	7	A	Multiple PLMNs selection in eNodeB	10.1.0	10.2.0
2010-12	SP-50	SP-100691	0591	2	F	Clarification of CSFB indication in Extended Service Request	10.1.0	10.2.0
2010-12	SP-50	SP-100691	0614	2	F	UE behaviour with ISR active after CSFB with suspended PS bearers	10.1.0	10.2.0
2010-12	SP-50	SP-100691	0618	6	C	Correction to CSFB MO flow	10.1.0	10.2.0
2010-12	SP-50	SP-100681	0620	1	A	Clarification on CSFB in idle mode	10.1.0	10.2.0
2010-12	SP-50	SP-100681	0622	2	A	Clarification on PLMN selection for CSFB	10.1.0	10.2.0
2010-12	SP-50	SP-100709	0629	1	F	MTC related NNSF in MME for SMS over SGs	10.1.0	10.2.0
2010-12	SP-50	SP-100681	0636	2	A	Correction to Abnormal Service Reject Procedure	10.1.0	10.2.0
2010-12	SP-50	SP-100681	0642	-	A	CSFB with Release with Redirection to UMTS and 'deferred SIB reading'	10.1.0	10.2.0
2011-01	-	-	-	-	-	Update of LTE logo to LTE-Advanced logo	10.2.0	10.2.1
2011-03	SP-51	SP-110059	0643	-	A	Correction on CLI in page message for 1x MT call	10.2.1	10.3.0
2011-03	SP-51	SP-110064	0646	1	A	S102 Redirection Timing	10.2.1	10.3.0
2011-03	SP-51	SP-110076	0648	2	F	CS PLMN reselection requirement for CSFB and RAT/LA checking	10.2.1	10.3.0
2011-03	SP-51	SP-110064	0651	3	A	PS Suspending Clarification	10.2.1	10.3.0
2011-03	SP-51	SP-110064	0656	1	A	SMS-CSFB cell ID reporting correction	10.2.1	10.3.0
2011-03	SP-51	SP-110076	0660	1	F	Correction about the paging area in case of no available stored TAI list in MME	10.2.1	10.3.0
2011-03	SP-51	SP-110064	0663	1	A	3GPP2 alignment for 1xCSFB MT	10.2.1	10.3.0
2011-03	SP-51	SP-110076	0665	3	F	3GPP2 alignment for 1xCSFB SMS MT	10.2.1	10.3.0
2011-03	SP-51	SP-110064	0671	2	A	CSFB procedures for other types of CS services	10.2.1	10.3.0
2011-03	SP-51	SP-110064	0673	-	A	Correction to CSFB NACC/CCO	10.2.1	10.3.0
2011-03	SP-51	SP-110076	0674	3	B	Introduction of MT Roaming Forwarding for CSFB	10.2.1	10.3.0
2011-04	-	-	-	-	-	MCC Correction to History table version numbers	10.3.0	10.3.1
2011-06	SP-52	SP-110330	0658	5	F	Correction to CSFB procedure for UEs with LIPA PDN connections only	10.3.1	10.4.0
2011-06	SP-52	SP-110335	0666	3	F	Updating dual rx/tx e1xCSFB to use explicit UE support indicator	10.3.1	10.4.0
2011-06	SP-52	SP-110335	0681	2	F	RRC release with system information clarification	10.3.1	10.4.0
2011-06	SP-52	SP-110327	0684	4	F	Priority for terminating CSFB sessions for eMPS	10.3.1	10.4.0
2011-06	SP-52	SP-110330	0686	3	F	Interaction between LIPA and CSFB service	10.3.1	10.4.0
2011-06	SP-52	SP-110335	0689	-	F	Correct detach procedure with ISR activated	10.3.1	10.4.0
2011-06	SP-52	SP-110324	0691	-	A	Correction of PS suspension procedure in CSFB to GERAN A/Gb mode	10.3.1	10.4.0
2011-06	SP-52	SP-110324	0694	1	A	Correction of CSFB Paging to avoid the use of TMSI	10.3.1	10.4.0
2011-09	SP-53	SP-110456	0702	2	A	Clarification about suspend and resume handling	10.4.0	10.5.0
2011-12	SP-54	SP-110738	0706	4	F	Handling of SGs paging in VLR and MME failure cases	10.5.0	10.6.0
2011-12	SP-54	SP-110738	0709	2	F	VLR SGs paging retry	10.5.0	10.6.0
2011-12	SP-54	SP-110738	0710	3	F	Fast Return after CSFB	10.5.0	10.6.0
2011-12	SP-54	SP-110733	0714	1	A	Correction of CSFB Paging procedure in MME	10.5.0	10.6.0
2011-12	SP-54	SP-110733	0717	2	A	Separate LAU and RAU procedures in CS fallback procedure	10.5.0	10.6.0
2012-03	SP-55	SP-120068	0725	2	A	Clarification of LAU/RAU trigger for CSFB UE when ISR is activated	10.6.0	10.7.0

Change history								
Date	TSG #	TSG Doc.	CR	Rev	Cat	Subject/Comment	Old	New
2012-03	SP-55	SP-120066	0722	1	A	Clarification of ISR activation condition for NMO II RAU and Periodic RAU	10.6.0	10.7.0
2012-03	SP-55	SP-120066	0750	1	A	Correction of system behaviour upon MME implicit detach timer expiry when SGs is associated and ISR is activated	10.6.0	10.7.0
2012-03	SP-55	SP-120075	0703	3	F	CM Service Request during MO-LR procedure	10.6.0	10.7.0
2012-03	SP-55	SP-120075	0736	1	F	Corrections to SGs paging for CSFB	10.6.0	10.7.0
2012-06	SP-56	SP-120237	0765	1	F	Handling of SMS over SGs in case of absent LAI	10.7.0	10.8.0
2012-06	SP-56	SP-120237	0771	3	F	Correction for downlink unreachable due to wrong suspending	10.7.0	10.8.0
2012-06	SP-56	SP-120232	0792	2	A	Correction of system behaviour upon PGW initiated last PDP Context Deactivation when SGs is associated and ISR is activated	10.7.0	10.8.0
2012-06	SP-56	SP-120237	0794	4	F	Partial VLR failure or VLR restart with CSFB and ISR	10.7.0	10.8.0
2012-12	SP-58	SP-120713	0845	1	A	Suitable cell selected after CSFB	10.8.0	10.9.0
2013-03	SP-59	SP-130081	0849	-	F	Correction to enhanced CSFB to 1xRTT	10.9.0	10.10.0
2013-03	SP-59	SP-130080	0855	-	F	Priority setting for 1xCSFB correction	10.9.0	10.10.0
2013-06	SP-60	SP-130241	0862	2	A	LAU-less Emergency call with CSFB	10.10.0	10.11.0
2013-06	SP-60	SP-130211	0870	4	A	CSFB interactions with IMS Emergency call	10.10.0	10.11.0
2013-06	SP-60	SP-130212	0878	-	F	MSC/VLR selection for MTC devices	10.10.0	10.11.0
2013-09	SP-61	SP-130368	0891	1	A	ISR with CSFB/ emergency handling with IMSI	10.11.0	10.12.0
2013-12	SP-62	SP-130520	0904	2	F	Alignment of CSFB/emergency and eMPS (priority service)	10.12.0	10.13.0

History

Document history		
V10.3.1	April 2011	Publication
V10.4.0	June 2011	Publication
V10.5.0	October 2011	Publication
V10.6.0	January 2012	Publication
V10.7.0	March 2012	Publication
V10.8.0	July 2012	Publication
V10.9.0	January 2013	Publication
V10.10.0	April 2013	Publication
V10.11.0	June 2013	Publication
V10.12.0	September 2013	Publication
V10.13.0	December 2013	Publication