

ETSI TS 123 334 V14.3.0 (2017-07)



**Digital cellular telecommunications system (Phase 2+) (GSM);
Universal Mobile Telecommunications System (UMTS);
LTE;
IP Multimedia Subsystem (IMS)
Application Level Gateway (IMS-ALG) -
IMS Access Gateway (IMS-AGW) interface:
Procedures descriptions
(3GPP TS 23.334 version 14.3.0 Release 14)**



Reference

RTS/TSGC-0423334ve30

Keywords

GSM,LTE,UMTS

ETSI

650 Route des Lucioles
F-06921 Sophia Antipolis Cedex - FRANCE

Tel.: +33 4 92 94 42 00 Fax: +33 4 93 65 47 16

Siret N° 348 623 562 00017 - NAF 742 C
Association à but non lucratif enregistrée à la
Sous-Préfecture de Grasse (06) N° 7803/88

Important notice

The present document can be downloaded from:

<http://www.etsi.org/standards-search>

The present document may be made available in electronic versions and/or in print. The content of any electronic and/or print versions of the present document shall not be modified without the prior written authorization of ETSI. In case of any existing or perceived difference in contents between such versions and/or in print, the only prevailing document is the print of the Portable Document Format (PDF) version kept on a specific network drive within ETSI Secretariat.

Users of the present document should be aware that the document may be subject to revision or change of status.

Information on the current status of this and other ETSI documents is available at

<https://portal.etsi.org/TB/ETSIDeliverableStatus.aspx>

If you find errors in the present document, please send your comment to one of the following services:

<https://portal.etsi.org/People/CommiteeSupportStaff.aspx>

Copyright Notification

No part may be reproduced or utilized in any form or by any means, electronic or mechanical, including photocopying and microfilm except as authorized by written permission of ETSI.

The content of the PDF version shall not be modified without the written authorization of ETSI.

The copyright and the foregoing restriction extend to reproduction in all media.

© ETSI 2017.

All rights reserved.

DECT™, PLUGTESTS™, UMTS™ and the ETSI logo are trademarks of ETSI registered for the benefit of its Members.

3GPP™ and LTE™ are trademarks of ETSI registered for the benefit of its Members and of the 3GPP Organizational Partners.

oneM2M logo is protected for the benefit of its Members

GSM® and the GSM logo are trademarks registered and owned by the GSM Association.

Intellectual Property Rights

IPRs essential or potentially essential to the present document may have been declared to ETSI. The information pertaining to these essential IPRs, if any, is publicly available for **ETSI members and non-members**, and can be found in ETSI SR 000 314: *"Intellectual Property Rights (IPRs); Essential, or potentially Essential, IPRs notified to ETSI in respect of ETSI standards"*, which is available from the ETSI Secretariat. Latest updates are available on the ETSI Web server (<https://ipr.etsi.org>).

Pursuant to the ETSI IPR Policy, no investigation, including IPR searches, has been carried out by ETSI. No guarantee can be given as to the existence of other IPRs not referenced in ETSI SR 000 314 (or the updates on the ETSI Web server) which are, or may be, or may become, essential to the present document.

Foreword

This Technical Specification (TS) has been produced by the ETSI 3rd Generation Partnership Project (3GPP).

The present document may refer to technical specifications or reports using their 3GPP identities, UMTS identities or GSM identities. These should be interpreted as being references to the corresponding ETSI deliverables.

The cross reference between GSM, UMTS, 3GPP and ETSI identities can be found under <http://webapp.etsi.org/key/queryform.asp>.

Modal verbs terminology

In the present document "**shall**", "**shall not**", "**should**", "**should not**", "**may**", "**need not**", "**will**", "**will not**", "**can**" and "**cannot**" are to be interpreted as described in clause 3.2 of the [ETSI Drafting Rules](#) (Verbal forms for the expression of provisions).

"**must**" and "**must not**" are **NOT** allowed in ETSI deliverables except when used in direct citation.

Contents

Intellectual Property Rights	2
Foreword.....	2
Modal verbs terminology.....	2
Foreword.....	8
1 Scope	9
2 References	9
3 Definitions, symbols and abbreviations	13
3.1 Definitions	13
3.2 Symbols.....	14
3.3 Abbreviations	14
4 Architecture	15
4.1 Reference architecture	15
4.2 NAT Function	16
4.3 ATCF/ATGW Function	17
4.4 eP-CSCF/eIMS-AGW Function.....	17
5 Functional Requirements.....	18
5.1 General	18
5.2 Gate Control & Local NAT	18
5.3 IP realm indication and availability.....	18
5.4 Remote NAT traversal support.....	19
5.5 Remote Source Address/Port Filtering	19
5.6 Traffic Policing	19
5.7 Hanging Termination Detection	19
5.8 QoS Packet Marking	20
5.9 Handling of RTCP streams.....	20
5.9.1 General.....	20
5.9.2 RTP/RTCP transport multiplexing	21
5.10 Media Inactivity Detection	21
5.11 IMS Media Plane Security	22
5.11.1 General.....	22
5.11.2 End-to-access-edge Security	22
5.11.2.1 End-to-access-edge security for RTP based media using SDES	22
5.11.2.2 End-to-access-edge security for TCP based media using TLS.....	23
5.11.2.2.1 General	23
5.11.2.2.2 e2ae security for session based messaging (MSRP).....	24
5.11.2.2.3 e2ae security for conferencing (BFCP)	25
5.11.2.3 End-to-access-edge security for UDP based media using DTLS	25
5.11.2.3.1 General	25
5.11.2.3.2 e2ae security for T.38 fax over UDP/UDPTL transport	25
5.11.2.4 End-to-access-edge security for RTP based media using DTLS-SRTP	26
5.11.2.5 End-to-access-edge security for RTP based voice and video media using DTLS-SRTP over TCP.....	27
5.11.2.6 End-to-access-edge security for WebRTC data channels using UDP/DTLS/SCTP transport	28
5.11.3 End-to-end Security	28
5.11.3.1 End-to-end security for RTP based media	28
5.11.3.2 End-to-end security for TCP-based media using TLS	28
5.12 Explicit Congestion Notification support	29
5.12.1 General.....	29
5.12.2 Incoming SDP offer with ECN	29
5.12.3 Incoming SDP offer without ECN.....	29
5.12.4 Detection of ECN failures by IMS-AGW	29
5.13 Transcoding.....	30
5.13.1 General.....	30
5.13.2 Handling of common codec parameters.....	30

5.13.3	Handling of the EVS speech codec.....	31
5.13.4	Handling of the OPUS speech and audio codec for WebRTC.....	49
5.14	Multimedia Priority Service (MPS) Support.....	52
5.15	Coordination of Video Orientation.....	53
5.16	Generic image attributes.....	54
5.17	TCP bearer connection control.....	54
5.17.1	Stateless TCP handling.....	54
5.17.2	State-aware TCP handling.....	55
5.17.2.1	General.....	55
5.17.2.2	State-aware TCP handling without support of modifying the TCP setup direction.....	55
5.17.2.3	State-aware TCP handling with support of modifying the TCP setup direction.....	56
5.18	Interactive Connectivity Establishment (ICE).....	58
5.18.1	General.....	58
5.18.2	ICE lite.....	58
5.18.3	Full ICE.....	60
5.18.4	STUN consent freshness for WebRTC.....	62
5.19	MSRP handling.....	62
5.19.1	General.....	62
5.19.2	IMS-ALG procedures to support IETF RFC 6714 with application agnostic MSRP handling by the IMS-AGW.....	63
5.19.3	IMS-ALG procedures to support IETF draft-ietf-simple-msrp-sessmatch with application agnostic MSRP handling by the IMS-AGW.....	63
5.19.4	IMS-ALG procedures for application aware MSRP interworking by the IMS-AGW.....	64
5.19.5	Application-aware MSRP interworking at the IMS-AGW.....	64
5.19.6	MSRP data channels.....	64
5.20	Web Real-Time Communication (WebRTC).....	65
5.20.1	General.....	65
5.20.2	WebRTC data channel.....	66
5.20.2.1	General.....	66
5.20.2.2	Data Channel Establishment.....	66
5.20.2.3	Data Channel Release.....	72
5.20.2.3.1	General.....	72
5.20.2.3.2	Release of one WebRTC data channel.....	72
5.20.2.3.3	Release of all or last active WebRTC data channels within an SCTP Association.....	73
5.20.2.4	MSRP within WebRTC data channel.....	74
5.20.2.5	BFCP within WebRTC data channel.....	74
5.20.2.6	T.140 within WebRTC data channel.....	74
5.20.3	Media Plane Optimization.....	75
5.20.3.1	General.....	75
5.20.3.2	WIC originating call.....	75
5.20.3.3	WIC terminating call.....	77
5.21	Alternate Connection (ALTC) Addresses Management.....	78
5.21.1	General.....	78
5.22	Video Region-of-Interest (ROI).....	79
5.22.1	General.....	79
5.22.2	"Far End Camera Control" mode.....	79
5.22.3	"Predefined ROI" mode.....	79
5.22.4	"Arbitrary ROI" mode.....	80
5.23	SDP Capability Negotiation (SDPCapNeg).....	81
5.24	RTP-level pause and resume.....	82
5.25	RTCP Codec Control Commands and Indications.....	82
6	IMS-ALG to IMS-AGW Procedures.....	84
6.1	Non-Call Related Procedures.....	84
6.1.1	General.....	84
6.1.2	IMS-AGW Unavailable.....	84
6.1.3	IMS-AGW Available.....	85
6.1.4	IMS-AGW Recovery.....	86
6.1.5	IMS-ALG Recovery.....	86
6.1.5.1	General.....	86
6.1.5.2	IMS-ALG Restoration.....	87
6.1.6	IMS-AGW Re-register.....	87

6.1.7	IMS-AGW Re-registration Ordered by IMS-ALG	88
6.1.8	Audit of IMS-AGW	88
6.1.8.1	Audit of Value.....	88
6.1.8.2	Audit of Capability.....	89
6.1.9	IMS-AGW Capability Change.....	89
6.1.10	IMS-ALG Out of service	89
6.1.11	IMS-AGW Resource Congestion Handling - Activate	90
6.1.12	MGW Resource Congestion Handling -Indication	90
6.1.13	Control association monitoring.....	90
6.1.14	Realm Availability Monitoring.....	91
6.1.15	Failure of IP Port, Interface or Group of Interfaces	92
6.2	Call Related Procedures	92
6.2.1	Gate Control & Local NA(P)T procedure.....	92
6.2.2	IP realm indication procedure	95
6.2.3	Remote NA(P)T traversal support procedure	95
6.2.4	Remote Source Address/Port Filtering	95
6.2.5	Traffic Policing	96
6.2.6	Hanging Termination Detection	96
6.2.7	QoS Packet Marking	97
6.2.8	Media Inactivity Detection	97
6.2.9	Handling of RTCP streams	98
6.2.10	IMS end-to-access-edge Media Plane Security.....	98
6.2.10.1	General	98
6.2.10.2	End-to-access-edge security for RTP based media using SDES	98
6.2.10.3	End-to-access-edge security for TCP-based media using TLS	98
6.2.10.3.1	End-to-access-edge security for session based messaging (MSRP)	98
6.2.10.3.1.1	IMS UE originating procedures for e2ae	98
6.2.10.3.1.1.1	Incoming TCP bearer establishment triggers an outgoing TCP bearer establishment	98
6.2.10.3.1.1.2	IMS-ALG requests sending an outgoing TCP bearer establishment	101
6.2.10.3.1.2	IMS UE terminating procedures for e2ae	103
6.2.10.3.1.2.1	Incoming TCP bearer establishment triggers an outgoing TCP bearer establishment	103
6.2.10.3.1.2.2	IMS-ALG requests sending an outgoing TCP bearer establishment.....	106
6.2.10.3.2	End-to-access-edge security for conferencing (BFCP).....	108
6.2.10.3.2.1	IMS UE originating procedures for e2ae	108
6.2.10.3.2.1.1	Incoming TCP bearer establishment triggers an outgoing TCP bearer establishment	108
6.2.10.3.2.2	IMS UE terminating procedures for e2ae	111
6.2.10.3.2.2.1	Incoming TCP bearer establishment triggers an outgoing TCP bearer establishment	111
6.2.10.4	End-to-access-edge security for UDP based media using DTLS	114
6.2.10.4.1	General	114
6.2.10.4.2	Session establishment from IMS access network for T.38 fax using "UDP/TLS/UDPTL"	114
6.2.10.4.3	Session establishment towards IMS access network for T.38 fax using "UDP/TLS/UDPTL"	117
6.2.10.4.4	IMS-AGW procedure for e2ae security of T.38 fax using "UDP/TLS/UDPTL"	119
6.2.10.4.5	DTLS session establishment failure indication	119
6.2.10.5	End-to-access-edge security for RTP based media using DTLS-SRTP.....	120
6.2.10.6	End-to-access-edge security for WebRTC data channels using SCTP-over-DTLS transport.....	124
6.2.10.6.1	General	124
6.2.10.6.2	Call flow for data channel establishment from WIC towards IMS access network and MSRP session establishment.....	124
6.2.10A	IMS end-to-end Media Plane Security.....	127
6.2.10A.1	End-to-end security for RTP based media using SDES	127
6.2.10A.2	End-to-end security for TCP-based media using TLS	127
6.2.11	Change Through-Connection.....	127
6.2.12	Emergency Calls.....	127
6.2.13	Explicit Congestion Notification support	127
6.2.13.1	General	127
6.2.13.2	ECN Active Indicated (ECN transparent).....	127
6.2.13.3	ECN support requested (ECN endpoint)	128
6.2.13.4	ECN Failure Indication (ECN endpoint).....	128
6.2.14	Access Transfer procedures with media anchored in IMS-AGW (ATGW)	129
6.2.14.1	General	129
6.2.14.2	H.248 context model	129

6.2.14.3	PS session origination or termination with media anchoring in IMS-AGW (ATGW) signaling procedures	131
6.2.14.4	PS to CS Access Transfer procedure with media anchored in IMS-AGW (ATGW)	133
6.2.14.5	ECN support during PS to CS Access Transfer procedure with media anchored in IMS-AGW (ATGW)	134
6.2.14.6	Support of generic image attributes	135
6.2.14.6.1	General	135
6.2.14.6.2	Indication of generic image attributes	136
6.2.14.7	Handling of common codec parameters	136
6.2.14.8	EVS speech codec support	137
6.2.15	Multimedia Priority Congestion Control Procedures	152
6.2.15.1	General	152
6.2.15.2	IMS-AGW Resource Congestion in ADD response, request is queued	152
6.2.15.3	IMS-AGW Resource Congestion in ADD response, IMS-ALG seizes new IMS-AGW	153
6.2.15.4	IMS-AGW Priority Resource Allocation	153
6.2.15.5	IMS-AGW Priority User Data marking	154
6.2.15.6	IMS-AGW Priority Modification	154
6.2.16	Coordination of Video Orientation	155
6.2.17	Procedures for Interactive Connectivity Establishment (ICE)	156
6.2.17.1	ICE lite	156
6.2.17.2	Full ICE	156
6.2.17.3	Connectivity check result notification (full ICE)	157
6.2.17.4	New peer reflexive candidate notification (full ICE)	157
6.2.17.5	STUN consent freshness test	158
6.2.17.6	STUN Consent Freshness Test Failure Notification	159
6.2.18	TCP bearer connection control	159
6.2.18.1	General	159
6.2.18.2	Stateless TCP handling	159
6.2.18.3	State-aware TCP handling without support of modifying the TCP setup direction	159
6.2.18.4	State-aware TCP handling with support of modifying the TCP setup direction	159
6.2.19	Application-aware MSRP interworking at the IMS-AGW	161
6.2.20	Alternate Connection (ALTC) Addresses Management	162
6.2.21	Video Region-of-Interest (ROI)	164
6.2.21.1	Video Region-of-Interest (ROI) using FECC	164
6.2.21.2	"Predefined ROI" mode	165
6.2.21.3	"Arbitrary ROI" mode	166
6.2.22	WebRTC	167
6.2.22.1	Establishment of a WebRTC data channel	167
6.2.22.2	Release of a WebRTC data channel	167
6.2.22.3	Media Plane Optimization	169
6.2.22.3.1	Media Plane Optimization including DTLS layer for WIC originating call	169
6.2.22.3.2	Media Plane Optimization excluding DTLS layer for WIC originating call	171
6.2.23	RTP-level pause and resume	173
6.2.24	RTCP Codec Control Commands and Indications	173
7	Charging	174
8	Messages/Procedures and Contents	175
8.1	General	175
8.2	Reserve and Configure AGW Connection Point	176
8.3	Reserve AGW Connection Point Procedure	185
8.4	Configure AGW Connection Point Procedure	192
8.5	Release AGW Termination	200
8.6	Termination heartbeat indication	200
8.7	IMS-AGW Out-of-Service	201
8.8	IMS-AGW Communication Up	201
8.9	IMS-AGW Restoration	202
8.10	IMS-AGW Register	202
8.11	IMS-ALG Restoration	203
8.12	IMS-AGW Re-register	203
8.13	IMS-ALG Ordered Re-registration	204
8.14	Audit Value	204

8.15	Audit Capability	205
8.16	Capability Update	205
8.17	IMS-ALG Out of Service	206
8.18	IMS-AGW Resource Congestion Handling - Activate.....	206
8.19	IMS-AGW Resource Congestion Handling - Indication.....	207
8.20	Inactivity Timeout Activate.....	207
8.21	Inactivity Timeout Notification	208
8.22	Command Reject	208
8.23	Realm Availability Activate	209
8.24	Realm Availability Notification	209
8.25	IP Bearer Released	210
8.26	Media Inactivity Notification	210
8.27	Termination Out-of-Service	211
8.28	Change Through-Connection	211
8.29	Change Flow Direction	212
8.30	ECN Failure Indication	212
8.31	Notify (D)TLS session establishment Failure Indication	213
8.32	Notify TCP connection establishment Failure Indication.....	213
8.33	ICE Connectivity Check Result Notification	214
8.34	ICE New Peer Reflexive Candidate Notification	214
8.35	STUN Consent Freshness Test Failure Notification	215
8.36	Notify SCTP Stream Reset.....	215
8.37	Notify SCTP Stream Reset Result.....	216
Annex A (informative): Change history		217
History		219

Foreword

This Technical Specification has been produced by the 3rd Generation Partnership Project (3GPP).

The contents of the present document are subject to continuing work within the TSG and may change following formal TSG approval. Should the TSG modify the contents of the present document, it will be re-released by the TSG with an identifying change of release date and an increase in version number as follows:

Version x.y.z

where:

- x the first digit:
 - 1 presented to TSG for information;
 - 2 presented to TSG for approval;
 - 3 or greater indicates TSG approved document under change control.
- y the second digit is incremented for all changes of substance, i.e. technical enhancements, corrections, updates, etc.
- z the third digit is incremented when editorial only changes have been incorporated in the document.

1 Scope

Annex G of 3GPP TS 23.228 [2] gives out an IMS Application Level Gateway (IMS-ALG) and IMS Access Media Gateway (IMS-AGW) based reference model to support NAPT-PT, gate control and traffic policing between IP-CAN and IMS domain.

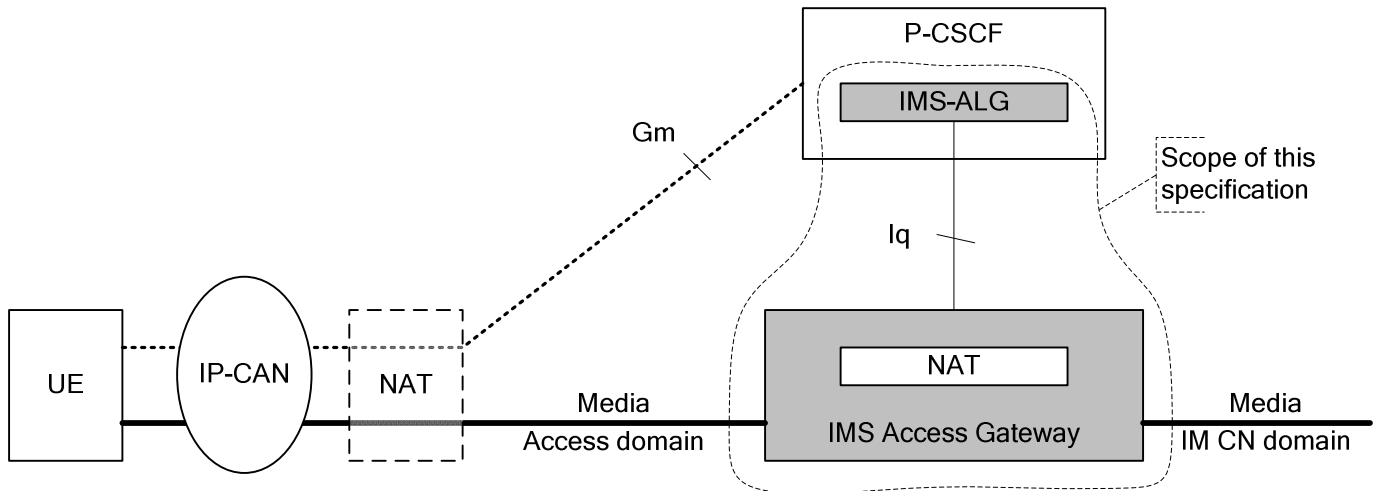

Figure 1.1: Scope of the specification

Figure 1.1 illustrates the reference model for Iq:

- the dashed line represents the IP signalling-path with SIP (at Gm) as call/session control protocol between the UE and the P-CSCF (IMS-ALG);
- the bold, horizontal line represents the IP media-path (also known as (IP) bearer-path or (IP) data-path; the notion 'media' is used as generic term for "IP application data"); and
- the vertical line represents the Iq control-path with H.248 as gateway/policy control protocol between the IMS-ALG and the IMS-AGW (H.248 messages are transported over IP).

The Iq reference point is between the P-CSCF (IMS-ALG) and the IMS-AGW. It conveys the necessary information that is needed to allocate, modify and release (IP) transport addresses.

The present document defines the stage 2 description for the Iq reference point. The stage 2 shall cover the information flow between the P-CSCF (IMS-ALG) and IMS-AGW. The protocol used over the Iq interface is the gateway control protocol according ITU-T Recommendation H.248 (which is specified for Iq by an H.248 profile according 3GPP TS 29.334 [3]).

2 References

The following documents contain provisions which, through reference in this text, constitute provisions of the present document.

- References are either specific (identified by date of publication, edition number, version number, etc.) or non-specific.
- For a specific reference, subsequent revisions do not apply.
- For a non-specific reference, the latest version applies. In the case of a reference to a 3GPP document (including a GSM document), a non-specific reference implicitly refers to the latest version of that document *in the same Release as the present document*.

[1] 3GPP TR 21.905: "Vocabulary for 3GPP Specifications".

[2] 3GPP TS 23.228: "IP Multimedia Subsystem (IMS), stage 2".

- [3] 3GPP TS 29.334: "IMS Application Level Gateway (IMS-ALG) – IMS Access Gateway (IMS-AGW) Iq interface, stage 3".
- [4] IETF RFC 2663: "IP Network Address Translator (NAT) Terminology and Considerations".
- [5] 3GPP TS 32.260: "Telecommunication management; Charging management; IP Multimedia Subsystem (IMS) charging".
- [6] IETF RFC 3556: "Session Description Protocol (SDP) Bandwidth Modifiers for RTP Control Protocol (RTCP) Bandwidth".
- [7] IETF RFC 3605: "Real Time Control Protocol (RTCP) attribute in Session Description Protocol (SDP)".
- [8] 3GPP TS 23.205: "Bearer independent circuit-switched core network; Stage 2".
- [9] ITU-T Recommendation H.248.1 (05/2002): "Gateway Control Protocol: Version 2" including the Corrigendum1 for Version 2 (03/04).
- [10] IETF RFC 2216: "Network Element Service Template".
- [11] 3GPP TS 24.229: "IP Multimedia Call Control Protocol based on SIP and SDP".
- [12] 3GPP TS 33.328: "IMS Media Plane Security".
- [13] IETF RFC 4568: "Session Description Protocol (SDP) Security Descriptions for Media Streams".
- [14] IETF RFC 3711: "The Secure Real-time Transport Protocol (SRTP)".
- [15] IETF RFC 5124: "Extended Secure RTP Profile for Real-time Transport Control Protocol (RTCP)-Based Feedback (RTP/SAVPF)".
- [16] IETF RFC 3168: "The Addition of Explicit Congestion Notification (ECN) to IP".
- [17] IETF RFC 6679: "Explicit Congestion Notification (ECN) for RTP over UDP".
- [18] 3GPP TS 23.237: "IP Multimedia subsystem (IMS) Service Continuity; Stage 2".
- [19] 3GPP TS 24.237: "IP Multimedia subsystem (IMS) Service Continuity; Stage 3".
- [20] 3GPP TS 29.162: "Interworking between the IM CN subsystem and IP networks".
- [21] 3GPP TS 26.114: "IP Multimedia Subsystem (IMS); Multimedia Telephony; Media handling and interaction".
- [22] 3GPP TS 22.153: "Multimedia Priority Service".
- [23] IETF RFC 5285: "A General Mechanism for RTP Header Extensions".
- [24] IETF RFC 6236: "Negotiation of Generic Image Attributes in the Session Description Protocol (SDP)".
- [25] IETF RFC 4975: "The Message Session Relay Protocol (MSRP)".
- [26] IETF RFC 6714: "Connection Establishment for Media Anchoring (CEMA) for the Message Session Relay Protocol (MSRP)".
- [27] IETF RFC 4583: "Session Description Protocol (SDP) Format for Binary Floor Control Protocol (BFCP) Streams".
- [28] IETF RFC 5246: "The Transport Layer Security (TLS) Protocol Version 1.2".
- [29] IETF RFC 793: "Transmission Control Protocol – DARPA Internet Program – Protocol Specification".
- [30] IETF RFC 4145: "TCP-Based Media Transport in the Session Description Protocol (SDP)".
- [31] IETF RFC 4582: "The Binary Floor Control Protocol (BFCP)".

- [32] IETF RFC 6347: "Datagram Transport Layer Security Version 1.2".
- [33] IETF RFC 7345: "UDP Transport Layer (UDPTL) over Datagram Transport Layer Security (DTLS)".
- [34] IETF draft-schwarz-mmusic-sdp-for-gw-04: "SDP codepoints for gateway control".
- Editor's note: The above document cannot be formally referenced until it is published as an RFC.**
- [35] GSM Association RCC.07: "Rich Communication Suite 5.1 Advanced Communications Services and Client Specification, Version 2.0, 03 May 2013".
- [36] GSM Association RCC.07: "Rich Communication Suite 5.1 Advanced Communications Services and Client Specification, Version 3.0, 25 September 2013".
- [37] Void.
- [38] ITU-T Recommendation H.248.84 (07/2012): "Gateway control protocol: NAT-traversal for peer-to-peer services".
- [39] IETF RFC 5245: "Interactive Connectivity Establishment (ICE): A Protocol for Network Address Translator (NAT) Traversal for Offer/Answer Protocols".
- [40] IETF RFC 5389: "Session Traversal Utilities for NAT (STUN)".
- [41] IETF RFC 5766: "Traversal Using Relays around NAT (TURN): Relay Extensions to Session Traversal Utilities for NAT (STUN)".
- [42] IETF RFC 5763: "Framework for Establishing a Secure Real-time Transport Protocol (SRTP) Security Context Using Datagram Transport Layer Security (DTLS)".
- [43] IETF RFC 5764: "Datagram Transport Layer Security (DTLS) Extension to Establish Keys for the Secure Real-time Transport Protocol (SRTP)".
- [44] 3GPP TS 24.371: "Web Real-Time Communications (WebRTC) client access to the IP Multimedia (IM) Core Network (CN) subsystem; Protocol specification".
- [45] IETF RFC 6135: "An Alternative Connection Model for the Message Session Relay Protocol (MSRP)".
- [46] [OMA-TS-CPM_Conversation_Function-V2_0-20150113-C](#): "CPM Conversation Functions, Candidate Version 2.0 – 13 Jan 2015".
- [47] IETF RFC 5746: "Transport Layer Security (TLS) Renegotiation Indication Extension".
- [48] 3GPP TS 33.310: "Network Domain Security (NDS); Authentication Framework (AF)".
- [49] IETF RFC 7675: "Session Traversal Utilities for NAT (STUN) Usage for Consent Freshness".
- [50] IETF RFC 6716: "Definition of the Opus Audio Codec".
- [51] 3GPP TS 26.441: "Codec for Enhanced Voice Services (EVS); General Overview".
- [52] 3GPP TS 26.445: "Codec for Enhanced Voice Services (EVS); Detailed Algorithmic Description".
- [53] IETF RFC 4566: "SDP: Session Description Protocol".
- [54] IETF RFC 4867: "RTP Payload Format and File Storage Format for the Adaptive Multi-Rate (AMR) and Adaptive Multi-Rate Wideband (AMR-WB) Audio Codecs".
- [55] IETF RFC 4566: "SDP: Session Description Protocol".
- [56] IETF RFC 7587: "RTP Payload Format for the Opus Speech and Audio Codec".
- [57] IETF RFC 6544: "TCP Candidates with Interactive Connectivity Establishment (ICE)".

- [58] IETF RFC 4571: "Framing Real-time Transport Protocol (RTP) and RTP Control Protocol (RTCP) Packets over Connection-Oriented Transport".
- [59] IETF RFC 6947: "The Session Description Protocol (SDP) Alternate Connectivity (ALTC) Attribute".
- [60] IETF RFC 5761: "Multiplexing RTP Data and Control Packets on a Single Port".
- [61] IETF draft-ietf-rtcweb-data-channel-13: "WebRTC Data Channels".

Editor's note: The above document cannot be formally referenced until it is published as an RFC.

- [62] IETF draft-ietf-mmusic-msrp-usage-data-channel-03: "MSRP over Data Channels".

Editor's note: The above document cannot be formally referenced until it is published as an RFC.

- [63] IETF RFC 4960: "Stream Control Transmission Protocol".
- [64] IETF draft-ietf-mmusic-sctp-sdp-26: "Session Description Protocol (SDP) Offer/Answer Procedures For Stream Control Transmission Protocol (SCTP) over Datagram Transport Layer Security (DTLS) Transport".

Editor's note: The above document cannot be formally referenced until it is published as an RFC.

- [65] IETF draft-ietf-mmusic-data-channel-sdpneg-10: "SDP-based Data Channel Negotiation".

Editor's note: The above document cannot be formally referenced until it is published as an RFC.

- [66] IETF RFC 5939: "Session Description Protocol (SDP) Capability Negotiation".
- [67] IETF RFC 6871: "Session Description Protocol (SDP) Media Capabilities Negotiation".
- [68] IETF RFC 4573: "MIME Type Registration for RTP Payload Format for H.224".
- [69] ITU-T Recommendation H.224 (01/2005): "A real time control protocol for simplex applications using the H.221 LSD/HSD/MLP channels".
- [70] ITU-T Recommendation H.281 (11/1994): "A far end camera control protocol for videoconferences using H.224".
- [71] IETF draft-ietf-mmusic-mux-exclusive-11: "Indicating Exclusive Support of RTP/RTCP Multiplexing using SDP".

Editor's note: The above document cannot be formally referenced until it is published as an RFC.

- [72] IETF RFC 8035: "Session Description Protocol (SDP) Offer/Answer Clarifications for RTP/RTCP Multiplexing".
- [73] ITU-T Recommendation T.140 (02/98): "Text conversation presentation protocol".
- [74] IETF RFC 4103: "RTP Payload for Text Conversation".
- [75] IETF draft-schwarz-mmusic-t140-usage-data-channel-03: "T.140 Text Conversation over Data Channels".

Editor's note: The above document cannot be formally referenced until it is published as an RFC.

- [76] IETF draft-schwarz-mmusic-bfcp-usage-data-channel-02: "BFCP floor control signalling over Data Channels".

Editor's note: The above document cannot be formally referenced until it is published as an RFC.

- [77] IETF RFC 4585: "Extended RTP Profile for Real-time Transport Control Protocol (RTCP)-Based Feedback (RTP/AVPF)".
- [78] IETF RFC 5104: "Codec Control Messages in the RTP Audio-Visual Profile with Feedback (AVPF)".

- [79] IETF RFC 7728: "RTP Stream Pause and Resume".
- [80] IETF RFC 8122: "Connection-Oriented Media Transport over the Transport Layer Security (TLS) Protocol in the Session Description Protocol (SDP)".
- [81] IETF draft-ietf-mmusic-dtls-sdp-24: "Using the SDP Offer/Answer Mechanism for DTLS".

Editor's note: The above document cannot be formally referenced until it is published as an RFC.

3 Definitions, symbols and abbreviations

3.1 Definitions

For the purposes of the present document, the terms and definitions given in TR 21.905 [1] and the following apply. A term defined in the present document takes precedence over the definition of the same term, if any, in TR 21.905 [1].

End-to-access edge security: media protection extending between an IMS UE and the first IMS core network node in the media path without being terminated by any intermediary node.

End-to-end security: media protection between two IMS UEs without being terminated by any intermediary node.

Full ICE: The full implementation of the Interactive Connectivity Establishment (ICE) specified in IETF RFC 5245 [39].

ICE lite: The lite implementation of the Interactive Connectivity Establishment (ICE) specified in IETF RFC 5245 [39].

Local (near-end) NAT control: the operation of providing network address mapping information and NAT policy rules to a near-end NAT in the media flow.

NAT-PT/NAPT-PT: see definition in 3GPP TS 23.228 [2].

NAPT control and NAT traversal: controls network address translation for both near-end NA(P)T and far-end NA(P)T

Network Address Translation (NA(P)T): see definition in 3GPP TS 23.228 [2].

Remote (far-end) NAT traversal: the operation of adapting the IP addresses so that the packets in the media flow can pass through a far-end (remote) NAT.

RTP / RTCP transport multiplexing: a single IP transport (L4) port for RTP and RTCP packets.

TLS-client: the entity that initiates a TLS session establishment to a server (see IETF RFC 5246 [28]).

TLS-server: the entity that responds to requests for TLS session establishment from clients (see IETF RFC 5246 [28]).

TLS endpoint: either a TLS-client or a TLS-server.

Convention:

Wherever the **term NAT** is used in this specification, it may be replaced by **NA(P)T** or **NA(P)T-PT**.

For the purposes of the present document, the following terms and definitions given in 3GPP TS 23.237 [18] apply:

Access Leg
Access Transfer Control Function (ATCF)
Access Transfer Gateway (ATGW)
Remote Leg
Target Access Leg
Source Access Leg

3.2 Symbols

For the purposes of the present document, the following symbols apply:

Iq Interface between the IMS Application Level Gateway and the IMS Access Media Gateway

3.3 Abbreviations

For the purposes of the present document, the abbreviations given in TR 21.905 [1] and the following apply. An abbreviation defined in the present document takes precedence over the definition of the same abbreviation, if any, in TR 21.905 [1].

ALTC	Alternate Connectivity
AMR	Adaptive Multi-Rate
AMR-WB	Adaptive Multi-Rate - WideBand
AMR-WB IO	Adaptive Multi-Rate - WideBand Inter-operable Mode, included in the EVS codec
APP	Application-defined RTCP packet
ATCF	Access Transfer Control Function
ATGW	Access Transfer Gateway
BFCP	Binary Floor Control Protocol
CCM	Codec Control Messages
CVO	Coordination of Video Orientation
DC	Data Channel
DTLS	Datagram Transport Layer Security
DTX	Discontinuous Transmission
e2ae security	End-to-access-edge security
e2e security	End-to-end security
ECN	Explicit Congestion Notification
ECN-CE	ECN Congestion Experienced
eIMS-AGW	IMS Access Gateway enhanced for WebRTC
eP-CSCF	P-CSCF enhanced for WebRTC
EVS	Enhanced Voice Services
FECC	Far End Camera Control
FIR	Full Intra Request
GTT	Global Text Telephony
ICE	Interactive Connectivity Establishment
IMS-AGW	IMS Access Media Gateway
IMS-ALG	IMS Application Level Gateway
IM CN	IMS Core Network
MSRP	Message Session Relay Protocol
NA(P)T	Network Address and optional Port Translation
NAPT	Network Address Port Translation
NAT	Network Address Translation
NA(P)T-PT	NAT Address (and optional Port-) Translation and Protocol Translation
P-CSCF	Proxy-CSCF
ROI	Region of Interest
RTCP	RTP Control Protocol
RTP	Real-time Transport Protocol
SDPCapNeg	SDP Capability Negotiation
SRTSP	Secure Real-time Transport Protocol
SRVCC	Single Radio Voice Call Continuity
STUN	Session Traversal Utilities for NAT
TLS	Transport Layer Security
TMMBN	Temporary Maximum Media Stream Bit Rate Notification
TMMBR	Temporary Maximum Media Stream Bit Rate Request
TURN	Traversal Using Relay NAT
UDPTL	User Datagram Protocol Transport Layer
URN	Uniform Resource Name
WebRTC	Web Real-Time Communication
WIC	WebRTC IMS Client
WWSF	WebRTC Web Server Function

4 Architecture

4.1 Reference architecture

The reference architecture for the IMS-ALG and the IMS-AGW when NAT is invoked between the UE and the IMS domain is shown in figure 4.1.1 below.

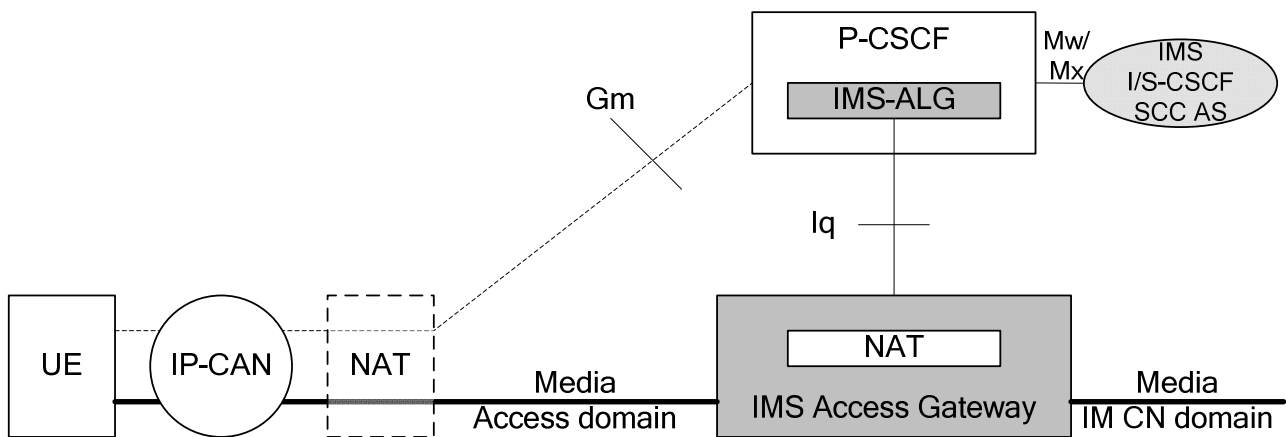

Figure 4.1.1: Reference Architecture with NAT invoked between the UE and the IMS domain

See 3GPP TS 23.228 [2] Annexes G.1 and G.2 for a comprehensive description of the reference models.

The reference architecture for the IMS-ALG and the IMS-AGW supporting the ATCF/ATGW function is shown in figure 4.1.2 below.

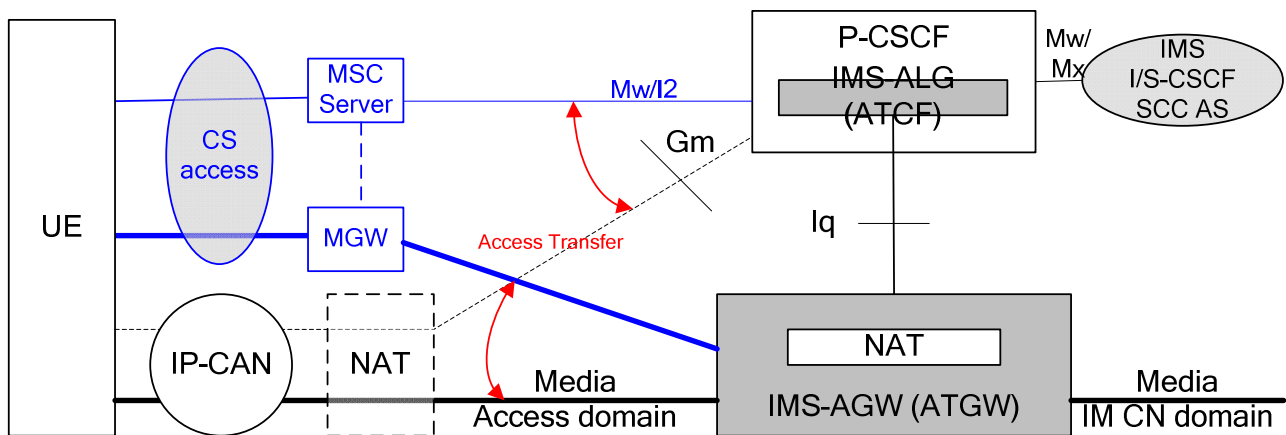
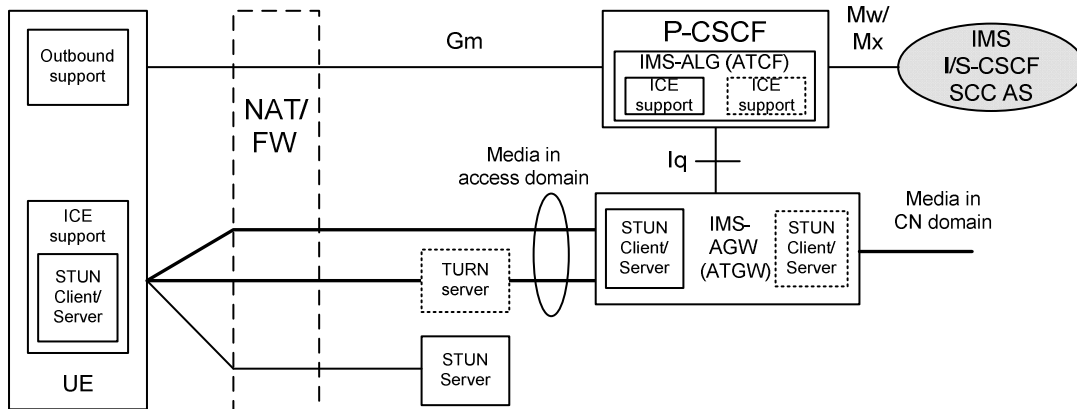

Figure 4.1.2: Reference Architecture for IMS-ALG/IMS-AGW with ATCF/ATGW function

See 3GPP TS 23.237 [18] subclause 5.2 for a comprehensive description of the reference model.

The reference architecture for the IMS-ALG and IMS-AGW supporting Interactive Connectivity Establishment (ICE) is shown in figure 4.1.3, for the case when both the signalling and media traverses NAT devices. There might be an ICE process towards access network domain and/or an ICE process towards core network domain. Both ICE processes are independent of each other. The network entities that support Session Traversal Utilities for NAT (STUN) and Traversal Using Relays NAT (TURN) are described in IETF RFC 5389 [40] and IETF RFC 5766 [41] respectively.



- NOTE 1: If the IMS-AGW only supports ICE lite, it will only contain a STUN server.
- NOTE 2: The IMS-AGW and IMS-ALG may support ICE only towards the served UE, and will then only contain a STUN client/server and ICE support on related terminations.
- NOTE 3: The TURN server is a deployment option but not required for all ICE deployments.
- NOTE 4: The separate STUN server is used by the served UE while it gathers ICE candidates. The STUN server in the IMS-AGW is used to answer ICE connectivity checks.

Figure 4.1.3: Reference architecture for ICE

The reference architecture for the P-CSCF enhanced for WebRTC (eP-CSCF) and the IMS-AGW enhanced for WebRTC (eIMS-AGW) to support WebRTC client access to IMS is shown in figure 4.1.4 as below, see Annex U in 3GPP TS 23.228 [2] for a comprehensive description of the reference model.

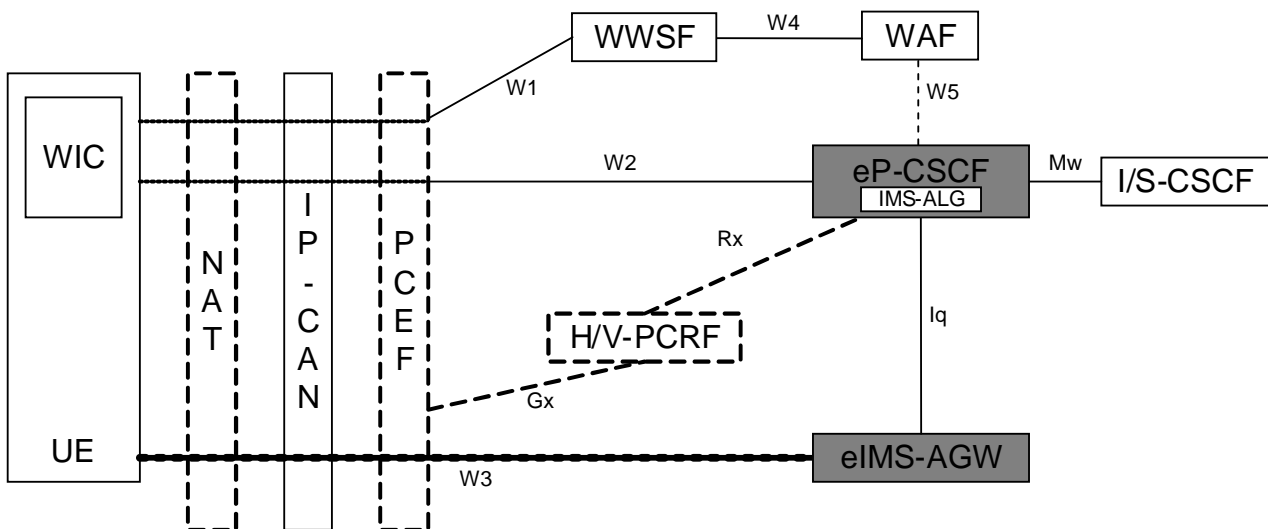

Figure 4.1.4: Reference Architecture for eP-CSCF/eIMS-AGW supporting WebRTC access to IMS

- NOTE 1: The presence of dashed elements in the figure depends on the configuration. PCC functional elements are present only for EPC access with QoS. The corresponding PCC elements for fixed access are also optionally supported but not shown. The NAT in figure 4.1.4 is meant for non-cellular access to IMS.

4.2 NAT Function

An operator may need NAT function between UE and IMS domain. Such function can be provided by the IMS-AGW and can be called local (near-end) NAT or IM CN hosted NAT (see subclause 5.2). There can also be an independent NAT device between UE and IMS domain (see subclause 5.4), referred as remote (far end) NAT. Thus the IMS-AGW shall support remote NA(P)T traversal.

Figure 4.1.1 illustrates the particular IP media-path scenario with both a remote NAT and local NAT function. Each NAT function is partitioning an IP domain into two address domains, or partitioning the used IP address space (realm) into two realms.

The reference architecture of Figure 4.1.1 may be mapped on various network scenarios, like e.g. to three IPv4 realms, indicated by a) IP-CAN (connectivity access network), b) (Media) Access Domain and c) (Media) IM CN domain. If there would not be any remote NAT device between the UE and IMS-AGW, then there would be just two IP domains (a and c).

The two types of NATs are also typically different from control perspective: local (near-end) NAT can be controlled by the operators directly, and remote (far-end) NAT that cannot be controlled by the operators directly.

The support of local NAT is thus implicitly leading to the requirement for IP realm indication at Iq (see subclause 5.3).

The edge node of the IP-CAN may be a remote (far-end) NAT device (see Figure 4.1.1). This NAT device provides NAT or NAPT or NA(P)T-PT for IP traffic in the media-path and signalling path (e.g. IP network addresses and possibly L4 transport port values may be translated of SIP Gm messages).

The remote NAT device cannot be directly controlled by the operators of the (Media) Access and IP CN domain. The IMS-ALG is consequently lacking the direct information with regards to the applied NAT bindings by the remote NAT device.

4.3 ATCF/ATGW Function

The ATCF/ATGW functions may be supported by the IMS-ALG/IMS-AGW when SRVCC enhanced with ATCF is used. In this case, the Iq reference point is used for IMS sessions that the IMS-ALG (ATCF) decides to anchor at the IMS-AGW (ATGW) to provide the following functions:

- reservation and configuration of IMS-AGW (ATGW) resources for media anchoring during PS session origination or termination;
- reconfiguration of IMS-AGW (ATGW) resources during access transfer to the CS domain;
- release of IMS-AGW (ATGW) resources upon completion of the access transfer or release of the session;
- media transcoding if the media that was used prior to the access transfer is not supported by the MSC server;
- IP version interworking if different IP versions are used between the access and the remote legs;
- Indication of IP realm during allocation of transport addresses/resources (the PS and CS accesses may be reachable via different IP realms);
- the ability to configure ECN properties towards the transferred to Access if ECN is supported/requested;
- the ability to reconfigure the ECN mode e.g. from ECN transparent to ECN endpoint towards the IMS CN if ECN transparent cannot be maintained after access transfer to the CS domain;
- provide priority treatment to calls identified as Multimedia Priority Service (see 3GPP TS 22.153 [22]).

See 3GPP TS 23.237 [18] and 3GPP TS 24.237 [19] for a comprehensive description of the ATCF and ATGW functions.

4.4 eP-CSCF/eIMS-AGW Function

The Iq reference point is used between the P-CSCF enhanced for WebRTC (eP-CSCF) and the IMS-AGW enhanced for WebRTC (eIMS-AGW), with the following additional functions:

- media plane interworking extensions as needed for WICs;
- media security of type "e2ae" (as specified in 3GPP TS 33.328 [12]) for media protocols specific to WebRTC, including media consent, and DTLS-SRTP as key exchange mechanism for media components using SRTP;
- media security of type "e2ae" (as specified in 3GPP TS 33.328 [12]) for data channels using DTLS-SCTP.

- NAT traversal support including ICE;
- the ability to perform any transcoding needed for audio and video codecs supported by the browser; and
- transport level interworking between data channels and other transport options supported by IMS.

See 3GPP TS 23.228 [2] Annex U for a comprehensive description of the eP-CSCF and eIMS-AGW functions.

5 Functional Requirements

5.1 General

A single IMS-ALG may control one or multiple IMS-AGW(s).

5.2 Gate Control & Local NAT

The IMS-ALG shall provide the NAPT control function, i.e. obtain the address binding information (according to IETF RFC 2663 [4]) and perform the NAPT policy control along with gate control (i.e. instruct the opening/closing of a gate).

The IMS-ALG shall request the IMS-AGW to allocate transport addresses/resources to enable media to traverse the IMS-AGW. The IMS-ALG may indicate the corresponding IP realm to the IMS-AGW – see subclause 5.3. The IMS-AGW shall provide the corresponding external transport addresses to the IMS-ALG.

Terminations for the Iq interface may be pre-defined with different levels of granularity for specific IP ports, interfaces, or groups of interfaces. These may then be defined as an IP realm (see subclause 5.3) known by both the IMS-ALG and the IMS-AGW, however IP Realms may also be defined for multiple physical interfaces. In order to efficiently report a failure affecting a large number of terminations associated to specific physical interfaces, the IMS-AGW shall, when allocating a new termination, return to the IMS-ALG an associated Interface ID.

An IMS-AGW not supporting this procedure may allocate the same Interface ID for all IP terminations.

An IMS-AGW supporting the Termination Out-of-Service procedure (see subclause 6.1.15) shall maintain a local mapping of Interface ID to its internal resources.

The IMS-AGW shall provide the NAPT enforcement function, i.e. change the address and port number of the media packets as they traverse the IMS-AGW, along with gate control (i.e. open/close a gate under the control of the IMS-ALG).

The IMS-AGW may provide IP version interworking. If the IP version interworking is performed and the IMS-ALG passes an SDP offer or answer, the IMS-ALG may adjust any SDP bandwidth information contained in the SDP offer or answer in accordance with 3GPP TS 29.162 [20] subclause 9.1.5.

The IMS-ALG shall request the IMS-AGW to release its transport resources at the end of a session.

5.3 IP realm indication and availability

The IMS-ALG and the IMS-AGW shall support IP realm indication.

The IMS-ALG, when requesting the allocation of transport resources at the IMS-AGW, may indicate the correspondent IP realm to the IMS-AGW. The IMS-AGW shall assign the IP termination in the IP realm indicated. The same IP realm shall be applied to all media streams associated with the termination. The IP realm identifier cannot be changed after the initial assignment.

A default IP realm may be configured such that if the IMS-AGW has not received the IP realm identifier and the IMS-AGW supports multiple IP realms then the default IP realm shall be used.

In order to prevent the IMS-ALG requesting an unavailable IP Realm, the IMS-ALG may audit the list of currently available realms on the IMS-AGW and may request the IMS-AGW to report any changes to that list as they occur over time.

The monitoring of IP realm availability is optional and if supported by IMS-AGW may be requested by the IMS-ALG.

5.4 Remote NAT traversal support

The IMS-ALG and the IMS-AGW shall support remote NA(P)T traversal support using procedures according to the present subclause. In addition they may support remote NA(P)T traversal support using Interactive Connectivity Establishment (ICE) according to subclause 5.17.

The IMS-ALG is responsible for determining whether there is a remote NAT device (the mechanism by which this achieved is out of scope of the current document).

If a remote NAT device is present, the IMS-ALG shall request the IMS-AGW to perform latching or re-latching when requesting the IMS-AGW to reserve transport addresses/resources.

If remote NAT is applicable, the IMS-AGW shall not use the remote media address/port information (supplied by the IMS-ALG) as the destination address for outgoing media. Instead, the IMS-AGW shall dynamically learn the required destination address via the source address/port of incoming media. This mechanism is known as "latching".

When remote NAT Traversal is applied to a stream associated with multiple flows (e.g. RTP and RTCP), the IMS-AGW shall perform individual latching and/or re-latching on the various flows. This means that an RTP and an RTCP flow of a single stream can be latched to different remote addresses and/or ports.

5.5 Remote Source Address/Port Filtering

The IMS-ALG may support and the IMS-AGW shall support policing of the remote source address/port of incoming media flow(s).

The IMS-ALG may determine that the source address/port of received media packets should be policed.

When the IMS-ALG requests the IMS-AGW to reserve transport addresses/resources, the IMS-ALG may indicate to the IMS-AGW that policing of source address and/or port of received media packets is required.

If such policing is applicable, the IMS-AGW shall check the source address and/or port of all received media packets and silently discard any packets that do not conform to the expected source address and/or port.

5.6 Traffic Policing

The IMS-ALG may support traffic policing of incoming media flows.

The IMS-AGW shall support traffic policing of the maximum average bitrate, defined as sustainable data rate (see IETF RFC 2216 [10]) of incoming media flows and may support traffic policing of the peak data rate of incoming media flows.

The IMS-ALG may require the IMS-AGW to police the media flows to ensure that they conform to the expected data rates.

When the IMS-ALG requests the IMS-AGW to reserve transport addresses/resources, the IMS-ALG may indicate to the IMS-AGW that policing of the related media streams is required and provide traffic policing related parameters as detailed in subclause 6.2.5.

If such policing is requested, the IMS-AGW shall police the corresponding media streams as detailed in subclause 6.2.5 by measuring the data rate for the received packets within that media stream. If the permissible data rate provided by the IMS-ALG is exceeded, the IMS-AGW shall discard packets to reduce their data rate to the permissible data rate.

For RTP flows where RTCP resources are reserved together with the RTP resources (see subclause 5.9), the permissible data rate shall include the bandwidth used by RTP and RTCP together.

5.7 Hanging Termination Detection

The IMS-ALG and the IMS-AGW shall support detection of hanging termination.

The IMS-ALG, when requesting the IMS-AGW to reserve an AGW connection point, shall indicate to the IMS-AGW to perform detection of hanging terminations.

The IMS-AGW shall determine a termination to be hanging if there is no signalling sent/received within a specified period.

On being informed of the hanging termination, the IMS-ALG shall check/determine whether the cited termination is valid and initiate any appropriate corrective action, e.g. release an invalid termination.

5.8 QoS Packet Marking

The IMS-ALG may support and the IMS-AGW shall support control via the Iq interface of the setting of the DiffServ Code Point (DSCP) for media packets sent on a termination.

When the IMS-ALG requests the IMS-AGW to reserve transport addresses/resources, the IMS-ALG may indicate to the IMS-AGW that the DSCP of outgoing media packets shall be explicitly set or copied from the DSCP of the corresponding received packet.

If such modification of the DSCP is required by the IMS-ALG, the IMS-AGW shall set the DSCP for outgoing packets on a termination.

5.9 Handling of RTCP streams

5.9.1 General

The IMS-ALG and the IMS-AGW shall support control via the Iq interface of the specific RTCP behaviour associated to an RTP flow.

When the IMS-ALG requests the IMS-AGW to reserve transport addresses/resources for an RTP flow, the IMS-ALG should also request the IMS-AGW to reserve resources for the corresponding RTCP flow, but may alternatively request the IMS-AGW not to reserve resources for the corresponding RTCP flow. When the IMS-ALG requests the IMS-AGW to reserve transport addresses/resources for a non-RTP flow, the IMS-ALG shall not request the IMS-AGW to reserve resources for an RTCP flow.

To request the IMS-AGW to reserve resources for an RTCP flow, the IMS ALG shall provide the RTCP handling information element with a value indicating that resources for RTCP shall be reserved.

To request the IMS-AGW not to reserve resources for an RTCP flow, the IMS ALG shall either provide the RTCP handling information element with a value indicating that resources for RTCP shall not be reserved or omit the RTCP handling information element.

If the IMS-AGW receives the indication to reserve RTCP resources, the IMS-AGW shall allocate a local port with even number for an RTP flow and shall allocate the consecutive local port with odd number for the associated RTCP flow, and it shall send and be prepared to receive RTCP packets.

If the IMS-AGW receives the indication to not reserve RTCP resources, or if it does not receive any indication at all, it shall not allocate an RTCP port when allocating a port for an RTP flow. The IMS-AGW shall not send any RTCP packets and shall silently discard any received RTCP packets.

When RTCP resources are requested, the IMS-ALG may also specify:

- the explicit RTCP transport address information element containing the remote RTCP port, and optionally the remote address, where to send RTCP packets; if not specified, the IMS-AGW shall send RCTP packets to the port contiguous to the remote RTP port; and
- bandwidth allocation requirements for RTCP, if the RTCP bandwidth level for the session is different than the default RTCP bandwidth as specified in RFC 3556 [6].

The explicit RTCP transport address information element contains the "a=rtcp" SDP attribute (as specified in IETF RFC 3605 [7]) received within the SDP body. The explicit RTCP transport address information element is only allowed for remote endpoints and shall not be used for the local endpoint. When the IMS-ALG requests the IMS-AGW to reserve resources for an RTCP flow and provides in addition the explicit RTCP port information element, then the

IMS-AGW shall use this network address and transport port as destination when sending RTCP packets towards the remote endpoint.

The IMS-AGW shall return an error if it can not allocate the requested RTCP resources.

5.9.2 RTP/RTCP transport multiplexing

The procedure in subclause 5.9.1 describing the default case of RTP/RTCP transport non-multiplexed scenarios may be extended for the transport multiplexed mode by addition of the RTP/RTCP transport multiplexing information element to indicate to the IMS-AGW that RTP and RTCP traffic shall be multiplexed on a single port (as described in IETF RFC 5761 [60]). The RTP/RTCP transport multiplexing information element may only be sent to the IMS-AGW in combination with the RTCP handling information element with the value indicating that resources for RTCP shall be reserved. The support of these procedures is optional for the IMS ALG and the IMS-AGW. The IMS-ALG shall only use these procedures when knowing support at IMS-AGW side (e.g., via configuration management).

The usage is conditional, given by following restrictions:

- 1) The transport multiplexed mode may be only supported for terminations at the access network side of the IMS-AGW.
- 2) The transport multiplexed mode shall be only enabled for the local connection endpoint if agreed via SIP SDP offer/answer negotiation with the served UE using:
 - the "a=rtcp-mux" SDP attribute, see IETF RFC 5761 [60], as updated by IETF RFC 8035 [72]; and/or
 - the "a=rtcp-mux-only" SDP attribute, see IETF draft-ietf-mmusic-mux-exclusive [71].

NOTE 1: Usage of an "rtcp-mux-only" attribute in an SDP answer is forbidden, see IETF draft-ietf-mmusic-mux-exclusive [71]. If the associated SDP answer does not contain an SDP "rtcp-mux" attribute, the offerer (the IMS ALG or the UE) needs to disable the associated RTP based media by sending a new SDP offer:

- with a zero port value associated with the SDP media description ("m=" line); or
- without associating an SDP "rtcp-mux-only" attribute with the SDP media description ("m=" line).

- 3) When transport multiplexed mode is agreed with the served UE, then it may be applied in both traffic directions.

NOTE 2: The last two conditions enforce a symmetrical usage of RTP/RTCP transport multiplexing in the related network domain (here the access network).

5.10 Media Inactivity Detection

The IMS-ALG and the IMS-AGW may support the detection of inactive media flows.

The IMS-ALG may require an IMS-AGW that supports media inactivity detection to detect if a media flow is inactive.

NOTE: The decision to apply or not media inactivity is general for all sessions with the same media characteristics (i.e. not user specific). It is for further study under which conditions inactivity media detection may be requested.

When the IMS-ALG requests the IMS-AGW to reserve transport addresses/resources, the IMS-ALG may indicate to the IMS-AGW that detection of an inactive media flow is required and may additionally specify inactivity detection time and inactivity detection direction.

The IMS-AGW shall determine a media flow on termination to be inactive if there is no media sent and/or received within the inactivity detection time period.

On being informed of the inactive media, the IMS-ALG shall initiate any appropriate corrective action.

5.11 IMS Media Plane Security

5.11.1 General

The IMS-ALG and the IMS-AGW may support IMS media plane security as specified in 3GPP TS 33.328 [12]. They may support end-to-access edge security, or end-to-end security, or both, for

- RTP based media (such as e.g. audio, video information) using SRTP security, and/or
- TCP based media (such as MSRP and BFCP) using TLS security; and/or
- UDP based media (such as T.38 fax over UDPTL/UDP) using DTLS security.

If supported the IMS-ALG and the IMS-AGW shall use the procedures in the following subclauses.

NOTE: For the support of end-to-end security, the presence of an IMS-ALG is not required.

Procedures for the IMS-ALG to determine if end-to-access edge security or end-to-end security is applicable to a session are specified in 3GPP TS 33.328 [12] and 3GPP TS 24.229[11].

5.11.2 End-to-access-edge Security

5.11.2.1 End-to-access-edge security for RTP based media using SDES

Procedures for the IMS-ALG to determine if end-to-access edge security is applicable to RTP based media and to exchange cryptography related SDP parameters with the served UE during the SIP session setup are specified in 3GPP TS 33.328 [12] and 3GPP TS 24.229[11].

For media lines that can be subject to e2ae security, the IMS-ALG will receive "RTP/AVP" or "RTP/AVPF" as transport protocol in SDP from the core network. When the IMS-ALG determines that e2ae security is applicable, it will indicate "RTP/SAVP" (see IETF RFC 3711 [14]) or "RTP/SAVPF" (see IETF RFC 5124 [15]), respectively, as transport protocol in the corresponding SDP media lines send towards the served UE. When e2ae security is applied, the IMS-ALG will also receive "RTP/SAVP" or "RTP/SAVPF" in SDP from the served UE. The IMS-ALG will then indicate "RTP/AVP" or "RTP/AVPF" respectively, as transport protocol in the corresponding SDP media lines send towards the core network. When the IMS-ALG requests the IMS-AGW to reserve transport addresses/resources for media to which e2ae security is applicable, the IMS ALG shall configure "RTP/SAVP" or "RTP/SAVPF" as transport protocol at the access side termination. The IMS ALG shall configure "RTP/AVP" or "RTP/AVPF" as transport protocol at the core network side termination for media where e2ae security is applicable.

When the IMS-ALG determines that e2ae security is applicable, it will generate appropriate cryptographic context parameters, in particular key(s), and will transfer them to the served UE within SDES SDP "crypto" attribute(s) according to IETF RFC 4568 [13]. The IMS-ALG will also receive cryptographic context parameters, in particular key(s), from the served UE within SDES SDP "crypto" attribute(s). When the IMS-ALG requests the IMS-AGW to reserve or configure transport addresses/resources for media to which e2ae security is applicable, the IMS-ALG shall provide cryptography related parameters as SDES SDP "crypto" attributes applicable at the access side termination.

On the originating side of the SIP session setup, the IMS-ALG shall provide as "Remote cryptographic SDES attribute" the SDES crypto attribute it selected from the ones received from the IMS UE in the SDP Offer . The IMS-ALG shall provide as "Local cryptographic SDES attribute" the SDES crypto attribute the IMS-ALG generated and inserted in the SDP Answer sent to IMS UE.

On the terminating side of the SIP session setup, the IMS-ALG shall provide as "Remote cryptographic SDES attribute" the SDES crypto attribute received from the IMS UE in the SDP Answer. The IMS-ALG shall provide as "Local cryptographic SDES attribute" the SDES crypto attribute selected by the UE from the ones the IMS-ALG generated and inserted in the SDP Offer sent to UE. If the IMS-ALG offers only one SDES crypto attribute to the UE, the IMS-ALG may provide this attribute as "Local cryptographic SDES attribute" within the Reserve AGW Connection Point Procedure before receiving the SDP answer from the UE. In the present release, a modification of an established e2ae crypto session is not supported. Thus, the IMS-ALG shall not modify any previously provided "Local cryptographic SDES attribute" or "Remote cryptographic SDES attribute".

If the IMS-ALG applies e2ae media security for a media stream and receives an SDP bandwidth modifier related to that media stream in SIP/SDP signalling, it should modify this bandwidth modifier to adjust the bandwidth overhead due to

e2ae security before forwarding the SDP. The IMS-ALG should add the bandwidth overhead caused by e2ae media security to the bandwidth information received from the remote peer. The IMS-ALG should subtract the bandwidth overhead caused by e2ae media security from the bandwidth information received from the served UE.

The IMS Access GW shall, upon reception of an SDES crypto attribute, establish an SRTP security context (as described in RFC 4568 [13] and RFC 3711 [14]) and be prepared to convert RTP packets to SRTP packets and vice versa, using the corresponding SRTP security contexts.

5.11.2.2 End-to-access-edge security for TCP based media using TLS

5.11.2.2.1 General

E2ae security for TCP based media using TLS is applicable for MSRP (see IETF RFC 4975 [25]; used in IMS session-based messaging) and BFCP (see IETF RFC 4582 [31]; used in IMS conferencing). The IMS-ALG and IMS-AGW may support e2ae security for MSRP, BFCP, or both protocols.

E2ae protection of MSRP and BFCP media is based on TLS, according to the TLS profile specified in Annex E of 3GPP TS 33.310 [48] and Annex M of 3GPP TS 33.328 [12]. TLS shall be supported over the TCP transport (see IETF RFC 793 [29]).

Key management for e2ae protection of MSRP and BFCP is based on the ciphersuites and session keys negotiated via the TLS handshake protocol between the UE and the IMS-AGW (see 3GPP TS 33.328 [12]).

Procedures for the IMS-ALG to determine if e2ae security for MSRP and/or BFCP is applicable to a session and to exchange the cryptographic information (i.e. certificate fingerprints, see IETF RFC 8122 [80]) over SDP with the served UE during the SIP session setup are specified in 3GPP TS 33.328 [12] and 3GPP TS 24.229 [11]. If e2ae security is not required, the e2e security procedures may apply, see subclause 5.11.3.

According to the TLS profile specified in Annex E of 3GPP TS 33.310 [48], the IMS-AGW shall accept TLS renegotiation only if it is secured according to IETF RFC 5746 [47].

NOTE 1: IETF RFC 5746 [47] defines a "TLS secure renegotiation" procedure, which leaves the definition of a basic TLS renegotiation still open. H.248 based support to enable the IMS-ALG to allow or not allow the IMS-AGW to perform client initiated or server initiated TLS renegotiation is not addressed in the present release. The behaviour of the IMS-AGW for "TLS session renegotiation" procedure is hence not further defined in the present release.

If the IMS-ALG applies e2ae media security for a media stream and receives an SDP bandwidth modifier related to that media stream in SIP/SDP signalling, it should modify this bandwidth modifier to adjust the bandwidth overhead due to e2ae security before forwarding the SDP. The IMS-ALG should add the bandwidth overhead caused by e2ae media security to the bandwidth information received from the remote peer. The IMS-ALG should subtract the bandwidth overhead caused by e2ae media security from the bandwidth information received from the served UE.

For each MSRP or BFCP media stream to be set-up with e2ae security, the P-CSCF (IMS-ALG) shall:

- include the IMS-AGW in the media path and allocate the required resources for the media stream in the IMS-AGW;
- request a certificate fingerprint from the IMS-AGW;
- include the certificate fingerprint received from the IMS-AGW in the SDP it sends to the IMS UE;
- send the certificate fingerprint(s) received in the SDP from the IMS UE to the IMS-AGW;
- instruct the IMS-AGW to perform state-aware TCP handling by including information about the TCP setup direction;
- for each termination determine via SDP negotiation as specified in IETF RFC 4145 [30] if the IMS-AGW needs to act as TCP client or server for the terminations towards the core network and towards the access network;
- indicate to the IMS-AGW how to perform the TCP connection establishment by:
 - a) either instructing the IMS-AGW to start a TCP connection establishment on any terminations where it needs to act as TCP client; or

- b) indicating to the IMS-AGW to use an incoming TCP connection establishment request at one termination as a trigger to send a TCP connection establishment request at the interconnected termination in the same context (support of this alternative is optional for the IMS-AGW and IMS-ALG);
- determine via SDP negotiation if the IMS-AGW needs to act as TLS client or server as specified in the subclauses below;

NOTE 2: The determination of the TLS client/server role relies on different rules for MSRP and BFCP.

- if the IMS-AGW needs to act as TLS client, request the IMS-AGW to start the TLS session setup once the TCP connection is established towards the UE; and
- apply additional specific procedures for MSRP in subclause 5.11.2.2.2 or for BFCP in subclause 5.11.2.2.3.

For each MSRP or BFCP media stream to be set-up with e2ae security the IMS-AGW shall:

- upon request from the IMS-ALG, select an own certificate for the media stream, uniquely associate own certificate with the media stream, and send the fingerprint of the own certificate to the IMS-ALG;
- uniquely associate the certificate fingerprint(s) received from the IMS-ALG with the corresponding MSRP or BFCP media stream, and subsequently use the certificate fingerprint(s) (as described in IETF RFC 4975 [25]) to verify the establishment of the TLS session of the corresponding media stream to belong to the served user;
- if the verification of the remote certificate fingerprint(s) during the TLS session establishment fails, regard the remote TLS endpoint as not authenticated, terminate the TLS session and report the unsuccessful TLS session setup to the IMS-ALG;
- negotiate the TLS protocol configurations with the TLS peer based on locally provisioned TLS profile parameters;
- when the TLS session has been established, convert unprotected media received from the network to protected media to send to the served UE and vice versa;
- be capable to support both the TLS server and TLS client roles;
- when being instructed to start the TLS session setup, act as a TLS client and establish the TLS session as soon as the underlying TCP bearer connection is established;
- upon instruction of the IMS-ALG to perform state-aware TCP handling, not forward any TCP connection establishment request received on one termination towards the interconnected termination;
- upon corresponding instructions from the IMS-ALG, start a TCP connection establishment on the indicated termination by sending a TCP SYN, or use an incoming TCP connection establishment request received at one termination as a trigger to send a TCP connection establishment request at the interconnected termination in the same context;
- release the underlying TCP bearer connection as soon as the TLS session is released; and
- apply additional specific procedures for MSRP in subclause 5.11.2.2.2 or for BFCP in subclause 5.11.2.2.3.

5.11.2.2.2 e2ae security for session based messaging (MSRP)

For each MSRP media stream outside WebRTC data channels requiring e2ae security, the IMS-ALG shall indicate to the IMS-AGW as transport protocol:

- a) for application-agnostic e2ae security support:
 - "TCP" at the termination towards the core network; and
 - "TCP/TLS" at the termination towards the access network; or
- b) for application-aware e2ae security support:
 - "TCP/MSRP" at the termination towards the core network; and
 - "TCP/TLS/MSRP" at the termination towards the access network.

The IMS-ALG shall determine via SDP negotiation if the IMS-AGW needs to act as TLS client or TLS server using the IETF RFC 4145 [30] "a=setup" SDP attribute as follows:

- if the IMS-ALG send an "a=setup:active" SDP attribute in an SDP answer towards the UE, the IMS-AGW shall act as TLS client;
- if the IMS-ALG send an "a=setup:passive" SDP attribute in an SDP answer towards the UE, the IMS-AGW shall act as TLS server;
- if the IMS-ALG receives an "a=setup:active" SDP attribute in an SDP answer from the UE, the IMS-AGW shall act as TLS server; and
- if the IMS-ALG receives an "a=setup:passive" SDP attribute in an SDP answer from the UE, the IMS-AGW shall act as TLS client.

5.11.2.2.3 e2ae security for conferencing (BFCP)

For each BFCP media stream requiring e2ae security, the IMS-ALG shall indicate to the IMS-AGW as transport protocol:

- "TCP" at the termination towards the core network; and
- "TCP/TLS" at the termination towards the access network.

The IMS-ALG shall determine via SDP negotiation (see IETF RFC 4583 [27]) if the IMS-AGW needs to act as TLS client or TLS server as follows:

- if the IMS-ALG receives an initial SDP offer from the UE, the IMS-AGW shall act as TLS server; and
- if the IMS-ALG sends an initial SDP offer towards the UE, the IMS-AGW shall act as TLS client.

5.11.2.3 End-to-access-edge security for UDP based media using DTLS

5.11.2.3.1 General

The IMS-ALG and the IMS-AGW may support end-to-access-edge (e2ae) security for an UDP based media. The e2ae protection of the UDP based media relies on the usage of DTLS (see IETF RFC 6347 [32]), according to the DTLS profile specified in Annex E of 3GPP TS 33.310 [48] and exchange of self-signed certificates as defined in 3GPP TS 33.328 [12].

Key management solution for the e2ae media security of UDP is based on the cipher suites and session keys negotiated via the DTLS handshake protocol between the served UE and the IMS-AGW as specified in 3GPP TS 33.328 [12]. Procedures for the IMS-ALG to determine if e2ae security is applicable to UDP based media and to exchange the cryptographic information (i.e. certificate fingerprints, see IETF RFC 8122 [80]) via SDP negotiation with the served UE during the SIP session establishment are specified in 3GPP TS 33.328 [12] and 3GPP TS 24.229 [11].

If the IMS-ALG applies e2ae media security for a media stream and receives an SDP bandwidth modifier related to that media stream in SIP/SDP signalling, it should modify this bandwidth modifier to adjust the bandwidth overhead due to e2ae security before forwarding the SDP. The IMS-ALG should add the bandwidth overhead caused by e2ae media security to the bandwidth information received from the remote peer. The IMS-ALG should subtract the bandwidth overhead caused by e2ae media security from the bandwidth information received from the served UE.

Subclause 5.11.2.3.2 defines specific requirements for e2ae protection of T.38 fax media stream over UDPTL/UDP transport. The usage of UDPTL over DTLS is defined in IETF RFC 7345 [33] and IETF draft-ietf-mmusic-dtls-sdp [81].

5.11.2.3.2 e2ae security for T.38 fax over UDP/UDPTL transport

If the IMS-ALG and the IMS-AGW support e2ae security for the UDP based media using DTLS and certificate fingerprints, then for each T.38 fax media stream over UDPTL/UDP transport to be setup with e2ae security, the IMS-ALG shall:

- include the IMS-AGW in the media path and allocate the required resources for the media stream in the IMS-AGW;
- determine via SDP negotiation with the served UE if the IMS-AGW needs to act as DTLS client or DTLS server as specified in IETF RFC 7345 [33] and IETF draft-ietf-mmusic-dtls-sdp [81];
- when requesting resources towards the access network:
 - a) indicate to the IMS-AGW "UDP/DTLS" as transport protocol;

NOTE 1: For IANA registry of "UDP/DTLS" see IETF draft-schwarz-mmusic-sdp-for-gw [34].

- b) send the certificate fingerprint(s) received from the served UE to the IMS-AGW; and
 - c) request from the IMS-AGW the certificate fingerprint;
- include the certificate fingerprint received from the IMS-AGW in the SDP body it sends to the served UE;
 - if the IMS-ALG received from the served UE an SDP offer with "a=tls-id" media-level SDP attribute (as specified in IETF draft-ietf-mmusic-dtls-sdp [81]), create a new DTLS association identity and include the "a=tls-id" SDP attribute with the new DTLS association identity in the SDP answer which the IMS-ALG sends to the served UE;
 - if the IMS-ALG sends to the served UE an SDP offer, create a new DTLS association identity and include the "a=tls-id" SDP attribute with the new DTLS association identity in the SDP offer;

NOTE 2: Already used certificate fingerprints can be assigned to a new DTLS association. If the IMS-AGW uses the same set of fingerprints for a new DTLS association then the IMS-ALG creates a new local "tls-id" attribute value so that the combination of the "tls-id" attribute values of the IMS-ALG and the served UE is unique across all DTLS associations that might be handled by the IMS-ALG and the served UE, as specified in IETF draft-ietf-mmusic-dtls-sdp [81].

- request the IMS-AGW to start the DTLS session setup if the IMS-AGW needs to act as DTLS client; and
- when requesting resources towards the core network:
 - a) indicate to the IMS-AGW "UDP" as transport protocol.

For each T.38 fax media stream over UDPTL/UDP transport to be setup with e2ae security, the IMS-AGW shall:

- be capable to support both the DTLS server and DTLS client roles;
- upon request from the IMS-ALG, act as DTLS client and start DTLS session establishment;
- upon request from the IMS-ALG, select an own certificate for the T.38 fax media stream, uniquely associate its own certificate with the media stream, and send the fingerprint of the own certificate to the IMS-ALG;
- uniquely associate the certificate fingerprint(s) received from the IMS-ALG with the corresponding T.38 fax media stream; and
- verify during the subsequent DTLS handshake with the served UE (as described in IETF RFC 7345 [33] and IETF draft-ietf-mmusic-dtls-sdp [81]) that the fingerprint of the certificate passed by the served UE during DTLS handshake matches the certificate fingerprint received from the IMS-ALG:
 - a) if the verification fails, the IMS-AGW shall regard the remote DTLS endpoint as not authenticated, terminate the DTLS session and report the unsuccessful DTLS session setup to the IMS-ALG;
 - b) otherwise, the IMS-AGW shall continue with DTLS session setup and when the DTLS session is established, the IMS-AGW shall be prepared to receive and convert unprotected media from the core network to the protected media to be sent to the served UE and vice versa.

5.11.2.4 End-to-access-edge security for RTP based media using DTLS-SRTP

The eP-CSCF (IMS-ALG) and eIMS-AGW for WebRTC provide end-to-access edge security by using DTLS-SRTP, where DTLS is used to establish keys for SRTP according to IETF RFC 5763 [42], IETF draft-ietf-mmusic-dtls-sdp [81] and IETF RFC 5764 [43].

During the establishment of a WebRTC session, the IMS-ALG receives "UDP/TLS/RTP/SAVP" or "UDP/TLS/RTP/SAVPF" as the transport protocol in SDP from the served WebRTC IMS Client (WIC). The IMS-ALG then shall indicate "RTP/AVP" or "RTP/AVPF" over UDP, respectively, as the transport protocol in the corresponding SDP media lines send towards the core network. When an IMS-ALG receives "RTP/AVP" or "RTP/AVPF" in SDP from the core network, the IMS-ALG shall indicate "UDP/TLS/RTP/SAVP" or "UDP/TLS/RTP/SAVPF" as transport protocol in SDP send towards the served WIC. When the IMS-ALG requests the eIMS-AGW to reserve transport addresses/resources for e2ae media security, the IMS ALG shall configure "UDP/TLS/RTP/SAVP" or "UDP/TLS/RTP/SAVPF" as transport protocol at the access side termination, and "RTP/AVP" or "RTP/AVPF" over UDP as transport protocol at the core network side termination.

The IMS-ALG shall send the received WIC certificate fingerprint(s) to the eIMS-AGW that is then able to correlate the fingerprint within the media stream uniquely. For each SRTP/SRTCP media stream to be established with e2ae media security, the eIMS-AGW shall send the fingerprint of its certificate via Iq interface to the IMS-ALG.

If the IMS-ALG received from the WIC an SDP offer with "a=tls-id" media-level SDP attribute (as specified in IETF draft-ietf-mmusic-dtls-sdp [81]), create a new DTLS association identity and include the "a=tls-id" SDP attribute with the new DTLS association identity in the SDP answer which the IMS-ALG sends to the WIC.

If the IMS-ALG sends to the WIC an SDP offer, create a new DTLS association identity and include the "a=tls-id" SDP attribute with the new DTLS association identity in the SDP offer.

NOTE: Already used certificate fingerprints can be assigned to a new DTLS association. If the IMS-AGW uses the same set of fingerprints for a new DTLS association then the IMS-ALG creates a new local "tls-id" attribute value so that the combination of the "tls-id" attribute values of the IMS-ALG and the WIC is unique across all DTLS associations that might be handled by the IMS-ALG and the WIC, as specified in IETF draft-ietf-mmusic-dtls-sdp [81].

According to procedures defined in 3GPP TS 24.371 [44], the eIMS-AGW shall act as either a DTLS server or client in the DTLS session.

In DTLS-SRTP case, RTP and RTCP data are encrypted using SRTP and SRTCP as defined in IETF RFC 3711 [14].

When the DTLS session is established between the WIC and the eIMS-AGW, the eIMS-AGW shall be prepared to send and receive SRTP/SRTCP packets of the incoming network side from the WIC, and convert SRTP/SRTCP packets to RTP/RTCP packets to the outgoing network side and vice versa, if the media stream toward the IMS core network is using RTP/RTCP.

5.11.2.5 End-to-access-edge security for RTP based voice and video media using DTLS-SRTP over TCP

The eP-CSCF (IMS-ALG) and eIMS-AGW for WebRTC may support end-to-access-edge security for RTP based voice and video media using DTLS-SRTP over TCP. If they do so, they shall apply the procedures in the present clause.

NOTE 1: RTP over TCP may be used to traverse NAT/Firewalls that perform UDP blocking.

TCP transport may be offered as an alternative to UDP transport using the ICE procedures in subclause 5.18. The eP-CSCF (IMS-ALG) and eIMS-AGW for WebRTC shall then provide end-to-access edge security for voice and video by using DTLS-SRTP over TCP, where DTLS is used to establish keys for SRTP according to IETF RFC 5763 [42], IETF draft-ietf-mmusic-dtls-sdp [81] and IETF RFC 5764 [43]. Framing according to RFC 4571 [58] shall be used for RTP streams transferred over TCP.

The IMS-ALG shall send the received WIC certificate fingerprint(s) to the eIMS-AGW that is then able to correlate the fingerprint within the media stream uniquely. For each SRTP/SRTCP media stream to be established with e2ae media security, the eIMS-AGW shall send the fingerprint of its certificate via Iq interface to the IMS-ALG.

NOTE 2: The same fingerprint also applies for End-to-access-edge security for RTP based media using DTLS-SRTP, as described in subclause 5.11.2.4.

If the IMS-ALG received from the WIC an SDP offer with "a=tls-id" media-level SDP attribute (as specified in IETF draft-ietf-mmusic-dtls-sdp [81]) create a new DTLS association identity and include the "a=tls-id" SDP attribute with the new DTLS association identity in the SDP answer which the IMS-ALG sends to the WIC.

If the IMS-ALG sends to the WIC an SDP offer, create a new DTLS association identity and include the "a=tls-id" SDP attribute with the new DTLS association identity in the SDP offer.

NOTE 3: Already used certificate fingerprints can be assigned to a new DTLS association. If the IMS-AGW uses the same set of fingerprints for a new DTLS association then the IMS-ALG creates a new local "tls-id" attribute value so that the combination of the "tls-id" attribute values of the IMS-ALG and the WIC is unique across all DTLS associations that might be handled by the IMS-ALG and the WIC, as specified in IETF draft-ietf-mmusic-dtls-sdp [81].

According to procedures defined in 3GPP TS 24.371 [44], the eIMS-AGW shall act as either a DTLS server or client in the DTLS session.

In DTLS-SRTP over TCP case, RTP and RTCP data are encrypted using SRTP and SRTCP as defined in IETF RFC 3711 [14].

When the DTLS session is established between the WIC and the eIMS-AGW, the eIMS-AGW shall be prepared to send and receive SRTP/SRTCP packets over TCP of the incoming network side from the WIC, and convert SRTP/SRTCP packets to RTP/RTCP packets over UDP to the outgoing network side and vice versa, if the media stream towards the IMS core network is using RTP/RTCP over UDP.

5.11.2.6 End-to-access-edge security for WebRTC data channels using UDP/DTLS/SCTP transport

The procedures in subclause 5.20.2 are applicable.

5.11.3 End-to-end Security

5.11.3.1 End-to-end security for RTP based media

For the support of e2e-security, the IMS-ALG and the IMS-AGW shall support "RTP/SAVP" (see IETF RFC 3711 [14]) and/or "RTP/SAVPF" (see IETF RFC 5124 [15]) as transport protocol.

If the IMS-ALG receives SDP containing media lines with "RTP/SAVP" (see IETF RFC 3711 [14]) or "RTP/SAVPF" (see IETF RFC 5124 [15]) as transport protocol, but did not receive any request for end-to-access-edge security, the IMS-ALG shall:

- forward the SDP with unmodified transport protocol for those media lines;
- provide "RTP/SAVP" or "RTP/SAVPF", as received in the SDP, to the IMS-AGW as transport protocol for all related terminations, and provide no media related information to these terminations, to configure the IMS-AGW to pass media transparently.

If the IMS-ALG receives SDP containing SDES SDP attribute(s) according to IETF RFC 4568 [13], and did not receive any request for end-to-access-edge security, it shall forward the SDP with unmodified SDES SDP attribute(s), but shall not provide the SDES SDP attribute(s) to the IMS-AGW.

5.11.3.2 End-to-end security for TCP-based media using TLS

End-to-end protection of MSRP (used in IMS session-based messaging) and BFCP (used in IMS conferencing) media is based on TLS, according to the TLS profile specified in Annex E of 3GPP TS 33.310 [48] and Annex M of 3GPP TS 33.328 [12].

If the IMS-ALG receives SDP containing media lines with "TCP/TLS/MSRP" (see IETF RFC 4975 [25] and IETF RFC 6714 [26]) and/or "TCP/TLS/BFCP" (see IETF RFC 4583 [27]) as transport protocol but did not receive any request for end-to-access-edge security, the IMS-ALG shall:

- forward the SDP with unmodified transport protocol for those media lines and unmodified TLS related SDP attribute(s);
- indicate "TCP" to the IMS-AGW as transport protocol for all related terminations, and provide no media related information to these terminations, to configure the IMS-AGW to pass media transparently.

NOTE: End-to-end security for TCP-based media using TLS is not supported between two terminals being located behind firewalls/NATs.

5.12 Explicit Congestion Notification support

5.12.1 General

An IMS-ALG and IMS-AGW may support Explicit Congestion Notification (see IETF RFC 3168 [16], IETF RFC 6679 [17] and 3GPP TS 26.114 [21]).

An IMS-ALG and IMS-AGW which supports ECN shall support the ECN transparent procedure i.e. the transparent forwarding of ECN bits in the IP header (see IETF RFC 3168 [16]). If the IMS-AGW does not support the transparent forwarding of ECN bits then the IMS-ALG shall not permit ECN in the SDP Offer/Answer negotiation.

The IMS-AGW shall treat RTCP for ECN as a RTP translator with no media translation.

An IMS-ALG and IMS-AGW which supports ECN may then act as an ECN endpoint to enable ECN towards the IMS access network or/and towards the IMS Core Network. The subsequent sub-sections describe the general support for ECN, further details on the support of ECN during PS to CS access transfer is described in sub-clause 6.2.14.3.

NOTE: It is out of the scope of this profile to support interworking with a non-3GPP ECN IP terminal.

An IMS-ALG and IMS-AGW that support ECN Transparent as well as transcoding shall also support the ECN endpoint procedure.

An IMS-ALG/IMS-AGW supporting the ATCF/ATGW function and ECN shall support ECN Endpoint (see sub-clause 6.2.14).

When acting as an ECN endpoint, the IMS-AGW shall be capable of enabling end-to-end rate adaptation between the local terminal and the remote entity by performing the following towards the ECN-capable peer:

- trigger rate adaptation request towards the ECN-capable peer when receiving in the incoming IMS media flow IP packets marked with ECN-CE, regardless of whether the IMS-AGW applies or does not apply transcoding;
- forward adaptation requests between the local and the remote peer when the IMS-AGW bridges compatible codec configurations between the interfaces without applying a transcoding function;
- perform media adaptation (e.g. reduce media bit-rate) towards the ECN-capable peer when receiving from the latter an adaptation request. and the IMS-AGW applies transcoding.

5.12.2 Incoming SDP offer with ECN

The IMS-ALG and IMS-AGW shall apply the requirements specified in clause 10.2.13.2 of 3GPP TS 29.162 [20] replacing the IBCF and TrGW with IMS-ALG and IMS-AGW respectively.

5.12.3 Incoming SDP offer without ECN

The IMS-ALG and IMS-AGW shall apply the requirements specified in clause 10.2.13.3 of 3GPP TS 29.162 [20] replacing the IBCF and TrGW with IMS-ALG and IMS-AGW respectively with the following additions:

- if the IMS-ALG or IMS-AGW does not support the procedure to act as an ECN endpoint, the IMS-ALG shall not include the "a=ecn-capable-rtp" attribute in the SDP offer it forwards to the succeeding node.

5.12.4 Detection of ECN failures by IMS-AGW

An IMS-ALG and IMS-AGW that support the procedure to act as an ECN endpoint shall support the requirements specified in clause 10.2.13.3a of 3GPP TS 29.162 [20] replacing the IBCF and TrGW with IMS-ALG and IMS-AGW respectively.

5.13 Transcoding

5.13.1 General

The transcoding functionality, where the IMS-AGW processes and possibly converts media data (like e.g. RTP payload) is optional for the P-CSCF and IMS-AGW to support. Transcoding should be supported if the IMS-ALG and IMS-AGW support the ATCF and ATGW functions for use after an SRVCC handover if the media that was used prior to the access transfer is not supported by the MSC Server.

An IMS-ALG and IMS-AGW that support transcoding shall support the requirements specified for Media Control in clause 10.2.5 of 3GPP TS 29.162 [20] respectively for the IBCF and TrGW, with the following additions:

- During an originating or terminating PS session establishment, the IMS-ALG (ATCF) may remove codecs when passing SDP offers (e.g. codecs known not to be supported by either the IMS-AGW (ATGW) or the MSC Server), but the IMS-ALG (ATCF) should pass SDP offers without adding codecs to the SDP offer and pass SDP answers without modification to the contained codecs to avoid the potential need for transcoding in the IMS-AGW (ATGW) before the PS to CS access transfer;
- During the PS to CS access transfer procedure, the IMS-ALG (ATCF) shall preferentially select from the SDP offer it receives from the MSC Server the codec already configured on the corresponding remote leg, if available.

The procedures for the IMS-ALG (ATCF) and IMS-AGW (ATGW) are further detailed in subclause 6.2.14.

5.13.2 Handling of common codec parameters

When receiving an SDP offer, the IMS-ALG may add a payload type to offer transcoding before forwarding the SDP offer (denoted as "codec 3" in figures 10.2.5.1 and 10.2.5.2 of 3GPP TS 29.162 [20]). If that payload type is selected in the SDP answer, the IMS-ALG needs to transcode. Table 5.13.2.1 describes the IMS-ALG handling of codec related parameters applicable to multiple codecs when the IMS-ALG adds the payload type to the SDP offer, and that payload type is selected in the SDP answer.

Table 5.13.2.1: IMS-ALG handling of common codec parameters for transcoding.

Parameter	Handling of common codec parameter in the sent SDP offer	Handling of common codec parameter in the received SDP answer
ptime (NOTE)	If the ptime parameter is included in the received SDP offer, the IMS-ALG shall supply the parameter to the IMS-AGW for the termination towards the offerer in the remote descriptor. If the value is supported by the IMS-AGW for receiving media, the IMS-ALG should keep the value from the received SDP offer unchanged in the SDP offer it sends. If the IMS-AGW only supports a lower ptime value, the IMS-ALG shall supply the ptime value according to configured preferences in the SDP offer it forwards. If no ptime value was contained in the received SDP offer, the IMS-ALG may add the parameter with a value according to configured preferences to the SDP offer.	If the ptime parameter is included in the received SDP answer, the IMS-ALG shall supply the parameter to the IMS-AGW for the termination towards the SDP answerer in the remote descriptor. If the value is supported by the IMS-AGW for receiving media, the IMS-ALG should keep the value from the received SDP answer unchanged in the SDP answer it sends. If the IMS-AGW only supports a lower ptime value, the IMS-ALG shall supply the ptime value according to configured preferences in the SDP answer it forwards. If no ptime value was contained in the received SDP answer, the IMS-ALG may add the parameter with a value according to configured preferences to the SDP answer.
maxptime (NOTE)	If the maxptime parameter is included in the received SDP offer, the IMS-ALG shall supply the parameter to the IMS-AGW for the termination towards the offerer in the remote descriptor. If the value is supported by the IMS-AGW for receiving media, the IMS-ALG should keep the value from the received SDP offer unchanged in the SDP offer it sends. If the IMS-AGW only supports a lower maxptime value, the IMS-ALG shall supply the maxptime value according to the IMS-AGW capabilities in the SDP offer it forwards. If no maxptime value was contained in the received SDP offer, the IMS-ALG may add the parameter with a value according to the IMS-AGW capabilities to the SDP offer.	If the maxptime parameter is included in the received SDP answer, the IMS-ALG shall supply the parameter to the IMS-AGW for the termination towards the SDP answerer in the remote descriptor. If the value is supported by the IMS-AGW for receiving media, the IMS-ALG should keep the value from the received SDP answer unchanged in the SDP answer it sends. If the IMS-AGW only supports a lower maxptime value, the IMS-ALG shall supply the maxptime value according to the IMS-AGW capabilities in the SDP answer it forwards. If no maxptime value was contained in the received SDP answer, the IMS-ALG may add the parameter with a value according to the IMS-AGW capabilities to the SDP answer.
NOTE: This SDP attribute is defined in IETF RFC 4566 [53]. It applies to all codecs offered in an SDP media line.		

Table 5.13.2.2 describes the IMS-AGW handling of codec related parameters applicable to multiple codecs.

Table 5.13.2.2: IMS-AGW handling of common codec parameters

Parameter	Handling in local descriptor	Handling in remote descriptor
ptime (NOTE)	The IMS-AGW should expect to receive packets with this ptime value and may use this information when deciding upon the required resources.	The IMS-AGW should use this ptime value when sending packets.
maxptime (NOTE)	The IMS-AGW should expect to receive packets with this maxptime value and may use this information when deciding upon the required resources.	The IMS-AGW shall use this maxptime value when sending packets.
NOTE: This SDP attribute is defined in IETF RFC 4566 [53]. It applies to all codecs offered in an SDP media line.		

5.13.3 Handling of the EVS speech codec

The Enhanced Voice Services (EVS) speech codec is defined in 3GPP TS 26.441 [51]. Its RTP payload type is defined in 3GPP TS 26.445 [52], and procedures for its usage as IMS Multimedia Telephony speech codec are defined in 3GPP TS 26.114 [21].

The IMS-ALG and the IMS-AGW may support transcoding to and from the EVS speech codec. If they do so, the procedures in the present subclause apply.

When receiving an SDP offer, the IMS-ALG may add an EVS codec payload type before forwarding the SDP offer (denoted as "codec 3" in figures 10.2.5.1 and 10.2.5.2 of 3GPP TS 29.162 [20]). If that EVS payload type is selected in

the SDP answer, the IMS-ALG needs to transcode the EVS codec. Table 5.13.3.1 describes the IMS-ALG handling of EVS codec parameters when the IMS-ALG adds the EVS payload type to the SDP offer, and that EVS payload type is selected in the SDP answer. In addition, rules for the parameter handling in 3GPP TS 26.445 [52] shall apply.

Table 5.13.3.1: IMS-ALG handling of EVS related SDP parameters when the IMS-ALG adds the EVS payload type to the SDP offer.

Parameter	Handling for EVS payload type added to the SDP offer to offer transcoding	Handling if offered EVS payload type is accepted in the SDP answer
evs-mode-switch (NOTE 1)	If the IMS-ALG expects that interworking between AMR-WB and EVS is required (e.g. because AMR-WB was the first payload type in the received SDP offer), it shall include the evs-mode-switch with value 1. Otherwise the IMS-ALG shall not include the evs-mode-switch.	If the evs-mode-switch parameter is contained in the SDP answer, the IMS-ALG shall forward this parameter to the IMS-AGW for the termination towards the answerer in the remote descriptor.
hf-only (NOTE 1)	If the IMS-ALG is configured to negotiate using only the header-full EVS RTP payload format, the IMS-ALG shall include the hf-only parameter with a value 1.	If the hf-only parameter is contained in the SDP answer, the IMS-ALG shall forward this parameter to the IMS-AGW in the remote descriptor.
dtx (NOTE 1)	If the usage of DTX is not desired in the sending and receiving direction (e.g. due to DTX capabilities of expected codecs to transcode with, e.g. other codecs in the received SDP offer), the IMS-ALG shall include the dtx parameter with a value 0.	If the dtx parameter is contained in the SDP answer, the IMS-ALG shall forward this parameter to the IMS-AGW in the remote descriptor.
dtx-recv (NOTE 1)	If receiving DTX is not desired and the dtx parameter is not included, the IMS-ALG shall include the dtx-recv parameter with a value 0. If both the dtx and dtx-recv parameters are included, those parameters shall have the same value; however, inclusion of the dtx-recv parameter is not required if the dtx parameter is included.	If the dtx-recv parameter is contained in the SDP answer, the IMS-ALG shall forward this parameter to the IMS-AGW in the remote descriptor.
br (NOTE 1)	If the IMS-ALG desires the same bit rate range for the send and receive direction in EVS primary mode, and wants to restrict the bit rate range to match IMS-AGW capabilities and possible configured policies, it shall supply the br parameter in the SDP offer it sends. Otherwise the IMS-ALG shall not include this parameter in the SDP offer. If the IMS-ALG also supplies the bw, bw-send or bw-recv parameter, the value of the br parameter shall be compatible with the values of those parameters.	If the br parameter is contained in the SDP answer, the IMS-ALG shall forward this parameter to the IMS-AGW in the remote descriptor.
br-send (NOTE 1)	If the IMS-ALG desires a different bit rate (range) for the send and receive direction in EVS primary mode, and wants to restrict the bit rate range for the send direction to match IMS-AGW capabilities and possible configured policies, it shall supply the br-send parameter in the SDP offer it sends. Otherwise the IMS-ALG shall not include this parameter in the SDP offer. If the IMS-ALG also supplies the bw or bw-send parameter, the value of the br-send parameter shall be compatible with the values of those parameters.	If the br-send parameter is contained in the SDP answer, the IMS-ALG shall forward this parameter to the IMS-AGW in the remote descriptor.
br-recv (NOTE 1)	If the IMS-ALG desires a different bit rate (range) for the send and receive direction in EVS primary mode, and wants to restrict the bit rate range for the receive direction to match IMS-AGW capabilities and possible configured policies, it shall supply the br-recv parameter in the SDP offer it sends. Otherwise the IMS-ALG shall not include this parameter in the SDP offer. If the IMS-ALG also supplies the bw or bw-recv parameter, the value of the br-recv parameter shall be compatible with the values of those parameters.	If the br-recv parameter is contained in the SDP answer, the IMS-ALG shall forward this parameter to the IMS-AGW in the remote descriptor.

bw (NOTE 1)	If the IMS-ALG desires the same sampling bandwidth(s) for the send and receive direction in EVS primary mode, and wants to restrict the sampling bandwidths to match IMS-AGW capabilities, sampling bandwidths of expected codecs EVS will be transcoded to (e.g. the first payload type in the received SDP offer), and possible configured policies, it shall supply the bw parameter in the SDP offer it sends. Otherwise the IMS-ALG shall not include this parameter in the SDP offer.	If the bw parameter is contained in the SDP answer, the IMS-ALG shall forward this parameter to the IMS-AGW in the remote descriptor.
bw-send (NOTE 1)	If the IMS-ALG desires different sampling bandwidths for the send and receive direction in EVS primary mode, and wants to restrict the sampling bandwidths in the send direction to match IMS-AGW capabilities, sampling bandwidths of expected codecs EVS will be transcoded to (e.g. the first payload type in the received SDP offer) and possible configured policies, it shall supply the bw-send parameter in the SDP offer it sends. Otherwise the IMS-ALG shall not include this parameter in the SDP offer.	If the bw-send parameter is contained in the SDP answer, the IMS-ALG shall forward this parameter to the IMS-AGW in the remote descriptor.
bw-recv (NOTE 1)	If the IMS-ALG desires different sampling bandwidths for the send and receive direction in EVS primary mode, and wants to restrict the sampling bandwidths in the receive direction to match IMS-AGW capabilities, sampling bandwidths of expected codecs EVS will be transcoded to (e.g. the first payload type in the received SDP offer), and possible configured policies, it shall supply the bw-recv parameter in the SDP offer it sends. Otherwise the IMS-ALG shall not include this parameter in the SDP offer.	If the bw-recv parameter is contained in the SDP answer, the IMS-ALG shall forward this parameter to the IMS-AGW in the remote descriptor.
cmr (NOTE 1)	If the IMS-ALG desires to disable codec mode requests within the RTP payload of the EVS primary mode (due to the IMS-AGW capabilities or policies), it shall include the cmr parameter with value -1 in the SDP offer it sends.	If the cmr parameter is contained in the SDP answer, the IMS-ALG shall forward this parameter to the IMS-AGW in the remote descriptor.
ch-aw-recv (NOTE 1)	The IMS-ALG shall include the ch-aw-recv parameter in the SDP offer if it desires to control the channel-aware mode of EVS in the receive direction, e.g. to disable it with value -1. The IMS-ALG shall consider the capabilities of the IMS-AGW when it chooses an appropriate value.	If the ch-aw-recv parameter is contained in the SDP answer, the IMS-ALG shall forward this parameter to the IMS-AGW in the remote descriptor.
number of channels (NOTE 2)	The IMS-ALG shall only include the "number of channels" parameter in the SDP offer if it desires to send or receive multiple channels. If the desired number of channels in the send and receive direction differs, the IMS-ALG shall include the higher value. The IMS-ALG should consider the number of channels of expected codecs EVS will be transcoded to (e.g. the first payload type in the received SDP offer).	If the "number of channels" parameter is contained in the SDP answer, the IMS-ALG shall forward this parameter to the IMS-AGW in the remote descriptor.
ch-send (NOTE 1)	The IMS-ALG shall only include the ch-send parameter in the SDP offer if it desires to send multiple channels, with different numbers of channels in the send and receive direction. The IMS-ALG should consider the number of channels of expected codecs EVS will be transcoded to (e.g. the first payload type in the received SDP offer).	If the ch-send parameter is contained in the SDP answer, the IMS-ALG shall forward this parameter to the IMS-AGW in the remote descriptor.

ch-recv (NOTE 1)	The IMS-ALG shall only include the ch-recv parameter in the SDP offer if it desires to receive multiple channels, with different numbers of channels in the send and receive direction. The IMS-ALG should consider the number of channels of expected codecs EVS will be transcoded to (e.g. the first payload type in the received SDP offer).	If the ch-recv parameter is contained in the SDP answer, the IMS-ALG shall forward this parameter to the IMS-AGW in the remote descriptor.
mode-set (NOTE 3)	The IMS-ALG shall only include the mode-set parameter in the SDP offer if it desires to restrict the mode-set of AMR-WB IO mode. The IMS-ALG should only restrict the mode-set if the expected codec EVS will be interworked with (e.g. the first payload type in the received SDP offer) is AMR-WB and has a restricted mode-set.	If the mode-set parameter is contained in the SDP answer, the IMS-ALG shall forward this parameter to the IMS-AGW in the remote descriptor. If the IMS-ALG decides that EVS will be transcoded to AMR-WB, the IMS-ALG should include the mode-set parameter for the AMR-WB payload in the SDP offer it forwards if this is permissible by AMR-WB offer answer rules in IETF RFC 4867 [54].
mode-change-period (NOTE 3)	The IMS-ALG shall only include the mode-change-period parameter with value 2 in the SDP offer if it desires to restrict the mode-change-period of received packets in AMR-WB IO mode. The IMS-ALG should only restrict the mode-change-period if the expected codec EVS will be interworked with (e.g. the first payload type in the received SDP offer) is AMR-WB and has such a restriction.	If the mode-change-period parameter is contained in the SDP answer, the IMS-ALG shall forward this parameter to the IMS-AGW in the remote descriptor. If the IMS-ALG decides that EVS will be transcoded to AMR-WB, the IMS-ALG should include the mode-change-period parameter for the AMR-WB payload in the SDP offer it forwards.
mode-change-capability (NOTE 3)	The IMS-ALG shall include the mode-change-capability parameter with value 2 in the SDP offer if it is capable of restricting the mode-change-period of packets it sends in AMR-WB IO mode. The IMS-ALG should consider the mode-change-period of the expected codec EVS will be interworked with (e.g. the first payload type in the received SDP offer) if this is AMR-WB.	If the mode-change-capability parameter is contained in the SDP answer, the IMS-ALG may forward this parameter to the IMS-AGW in the remote descriptor. If the IMS-ALG decides that EVS will be transcoded to AMR-WB, the IMS-ALG should include the mode-change-capability parameter for the AMR-WB payload in the SDP offer it forwards.
mode-change-neighbor (NOTE 3)	The IMS-ALG shall only include the mode-change-neighbor parameter in the SDP offer if it desires to restrict the mode-change within received packets of AMR-WB IO mode to neighboring modes. The IMS-ALG should consider the mode-change-neighbor parameter of the expected codec EVS will be interworked with (e.g. the first payload type in the received SDP offer) if this is AMR-WB.	If the mode-change-neighbor parameter is contained in the SDP answer, the IMS-ALG shall forward this parameter to the IMS-AGW in the remote descriptor. If the IMS-ALG decides that EVS will be transcoded to AMR-WB, the IMS-ALG should include the mode-change-neighbor parameter for the AMR-WB payload in the SDP offer it forwards.
max-red (NOTE 5)	The IMS-ALG shall only include the max-red parameter in the SDP offer if it desires to restrict the maximum redundancy of received packets. IMS-ALG shall consider the capabilities of the IMS-AGW, and should consider the max-red parameter of the expected codec EVS will be interworked with (e.g. the first payload type in the received SDP offer) if this is AMR-WB.	If the max-red parameter is contained in the SDP answer, the IMS-ALG shall forward this parameter to the IMS-AGW in the remote descriptor. If the IMS-ALG decides that EVS will be interworked with AMR-WB, the IMS-ALG should include the max-red parameter for the AMR-WB payload in the SDP offer it forwards.
3gpp_mtsi_app_adapt (NOTE 4)	If the IMS-AGW supports RTCP APP based adaptation messages defined in 3GPP TS 26.114 [21], and the IMS-ALG has a policy to negotiate the usage of those messages, the IMS-ALG shall include the 3gpp_mtsi_app_adapt SDP attribute indicating the supported APP messages in the SDP offer.	If the 3gpp_mtsi_app_adapt attribute is contained in the SDP answer, the IMS-ALG shall forward this parameter to the IMS-AGW in the remote descriptor.
<p>NOTE 1: This MIME parameter of the EVS RTP payload type is defined in 3GPP TS 26.445 [51]. It is encapsulated within the SDP "a=fmtp" attribute defined IETF RFC 4566 [53].</p> <p>NOTE 2: This number of channels are encoded as "encoding parameters" of the SDP "a=rtmpmap" attribute defined in IETF RFC 4566 [53].</p> <p>NOTE 3: This MIME parameter of the EVS RTP payload type relates to AMR-WB IO mode and is defined in IETF RFC 4867 [54]. It is encapsulated within the SDP "a=fmtp" attribute defined IETF RFC 4566 [53].</p> <p>NOTE 4: This SDP attribute is defined in 3GPP TS 26.114 [21]. It applies to all codecs offered in an SDP media line. However, some values are specific to EVS.</p> <p>NOTE 5: This MIME parameter of the EVS RTP payload type is defined in IETF RFC 4867 [54]. It is encapsulated within the SDP "a=fmtp" attribute defined IETF RFC 4566 [53].</p>		

When receiving an SDP offer that contains an EVS codec payload type (denoted as "codec 1" in figure 10.2.5.2 of 3GPP TS 29.162 [20]), the IMS-ALG may add other payload types before forwarding the SDP offer (denoted as "codec 3" in figure 10.2.5.2 of 3GPP TS 29.162 [20]). If that added payload type is selected in the SDP answer, the IMS-ALG needs to transcode, and may select to transcode to the EVS codec. Table 5.13.3.2 describes the IMS-ALG handling of EVS codec parameters when the IMS-ALG receives an EVS payload type in an SDP offer, and selects to transcode between the EVS codec and some other codec. In addition, rules for the parameter handling in 3GPP TS 26.445 [52] shall apply.

Table 5.13.3.2: IMS-ALG handling of EVS related SDP parameters when the IMS-ALG receives the EVS payload type in the SDP offer and decides to transcode between the EVS payload type and some other codec.

Parameter	Handling of EVS payload type parameter received in the SDP offer	EVS payload type supplied in the SDP answer
evs-mode-switch (NOTE 1)	If the evs-mode-switch parameter is contained in the SDP offer and the IMS-ALG select the EVS payload type for transcoding, the IMS-ALG shall forward this parameter to the IMS-AGW for the termination towards the offerer in the remote descriptor.	If the evs-mode-switch parameter is contained in the SDP offer, the IMS-ALG shall include the evs-mode-switch parameter with unmodified value in the SDP answer. Otherwise, if the IMS-ALG decides to interwork between AMR-WB and EVS (e.g. because AMR-WB was selected in the received SDP answer), it shall include the evs-mode-switch with value 1. Otherwise the IMS-ALG shall not include the evs-mode-switch. If the IMS-ALG supplies the evs-mode-switch in the SDP answer, it shall also supply it to the IMS-AGW in the local descriptor for the termination towards the offerer with the same value.
hf-only (NOTE 1)	If the hf-only parameter is contained in the SDP offer and the IMS-ALG select the EVS payload type for transcoding, the IMS-ALG shall forward this parameter to the IMS-AGW for the termination towards the offerer in the remote descriptor.	If the hf-only parameter is contained in the SDP offer, the IMS-ALG shall include the hf-only parameter with unmodified value in the SDP answer. Otherwise, if the IMS-ALG is configured to negotiate using only the header-full EVS RTP payload format, the IMS-ALG shall include the hf-only parameter with a value 1. If the IMS-ALG supplies the hf-only parameter in the SDP answer, it shall also supply it to the IMS-AGW in the local descriptor for the termination towards the offerer with the same value.
dtx (NOTE 1)	If the dtx parameter is contained in the SDP offer and the IMS-ALG select the EVS payload type for transcoding, the IMS-ALG shall forward this parameter to the IMS-AGW for the termination towards the offerer in the remote descriptor.	If the dtx parameter is contained in the SDP offer, the IMS-ALG shall include the dtx parameter with unmodified value in the SDP answer. If the dtx parameter is not contained in the SDP offer and if a dtx-recv parameter is contained in the SDP offer, the IMS-ALG may include the dtx parameter in the SDP answer, and the value of the dtx parameter shall then be identical to that of the dtx-recv parameter in the SDP offer (e.g. if that value matches DTX capabilities of expected codecs to transcode with). If the dtx parameter is not contained in the SDP offer and if the dtx-recv parameter is not contained in the SDP offer, and if the usage of DTX is not desired (e.g. due to DTX capabilities of expected codecs to transcode with, e.g. other codecs in the received SDP answer), the IMS-ALG shall include in the SDP answer the dtx parameter with a value 0. If the IMS-ALG supplies the dtx parameter in the SDP answer, it shall also supply it to the IMS-AGW in the local descriptor for the termination towards the offerer with the same value.
dtx-recv (NOTE 1)	If the dtx-recv parameter is contained in the SDP offer and the IMS-ALG select the EVS payload type for transcoding, the IMS-ALG shall forward this parameter to the IMS-AGW for the termination towards the offerer in the remote descriptor.	If no dtx parameter is included in the SDP answer and if the reception of DTX is not desired, the IMS-ALG shall include in the SDP answer the dtx-recv parameter with a value 0. If both the dtx and dtx-recv parameters are included, those parameters shall have the same value; however, inclusion of the dtx-recv parameter is not required if the dtx parameter is included. If the IMS-ALG supplies the dtx-recv parameter in the SDP answer, it should also supply it to the IMS-AGW in the local descriptor for the termination towards the offerer with the same value.

br (NOTE 1)	<p>If the br parameter is contained in the SDP offer, the IMS-ALG shall check if the IMS-AGW supports the indicated bitrates, or a subset of them, in EVS primary mode in the send and receive direction. If the indicated bitrates, and even each subset of them, are not supported, the IMS-ALG shall not select the EVS payload type for transcoding. If the IMS-ALG selects the EVS payload type, it shall forward this parameter to the IMS-AGW for the termination towards the offerer in the remote descriptor.</p>	<p>If the br parameter is contained in the SDP offer, the IMS-ALG shall select a bitrate value, which is either the received br value or a subset of it, based on IMS-AGW capabilities and possible configured policies, and shall include the br parameter with the selected value that is also supplied towards the IMS-AGW in the SDP answer.</p> <p>Otherwise, if the IMS-ALG desires the same bit rate range for the send and receive direction in EVS primary mode, and wants to restrict the bit rate range to match IMS-AGW capabilities and possible configured policies, it shall supply the br parameter in the SDP answer it sends.</p> <p>Otherwise the IMS-ALG shall not include this parameter in the SDP answer.</p> <p>If the IMS-ALG also supplies the bw, bw-send or bw-recv parameter, the value of the br parameter shall be compatible with the values of those parameters.</p> <p>If the IMS-ALG supplies the br parameter in the SDP answer, it shall also supply to the IMS-AGW the br parameter in the local descriptor for the termination towards the offerer with the same value.</p>
br-send (NOTE 1)	<p>If the br-send parameter is contained in the SDP offer, the IMS-ALG shall check if the IMS-AGW supports the indicated bitrates, or a subset of them, in EVS primary mode in the receive direction. If the indicated bitrates, and even each subset of them, are not supported, the IMS-ALG shall not select the EVS payload type for transcoding. If the IMS-ALG selects the EVS payload type, it shall forward this parameter to the IMS-AGW for the termination towards the offerer in the remote descriptor.</p>	<p>If the br-recv parameter is contained in the SDP offer, the IMS-ALG shall select a bitrate value, which is either the received br-recv value or a subset of it, based on IMS-AGW capabilities and possible configured policies, and shall include the br-send parameter with the selected value that is also supplied towards the IMS-AGW in the SDP answer.</p> <p>Otherwise, if the IMS-ALG desires a different bit rate (range) for the send and receive direction in EVS primary mode, and wants to restrict the bit rate range for the send direction to match IMS-AGW capabilities and possible configured policies, it shall supply the br-send parameter in the SDP answer it sends.</p> <p>Otherwise the IMS-ALG shall not include the br-send parameter in the SDP answer.</p> <p>If the IMS-ALG also supplies the bw or bw-send parameter, the value of the br-send parameter shall be compatible with the values of those parameters.</p> <p>If the IMS-ALG supplies the br-send parameter in the SDP answer, it shall also supply to the IMS-AGW the br-send parameter in the local descriptor for the termination towards the offerer with the same value.</p>

<p>br-recv (NOTE 1)</p>	<p>If the br-recv parameter is contained in the SDP offer, the IMS-ALG shall check if the IMS-AGW supports the indicated bitrates, or a subset of them, in EVS primary mode in the send direction. If the indicated bitrates, and even each subset of them, are not supported, the IMS-ALG shall not select the EVS payload type for transcoding. If the IMS-ALG selects the EVS payload type, it shall forward this parameter to the IMS-AGW for the termination towards the offerer in the remote descriptor.</p>	<p>If the br-send parameter is contained in the SDP offer, the IMS-ALG shall select a bitrate value, which is either the received br-send value or a subset of it, based on IMS-AGW capabilities and possible configured policies, and shall include the br-recv parameter with the selected value that is also supplied towards the IMS-AGW in the SDP answer. Otherwise, if the IMS-ALG desires a different bit rate (range) for the send and receive direction in EVS primary mode, and wants to restrict the bit rate range for the receive direction to match IMS-AGW capabilities and possible configured policies, it shall supply the br-recv parameter in the SDP answer it sends. Otherwise the IMS-ALG shall not include the br-recv parameter in the SDP answer. If the IMS-ALG also supplies the bw or bw-recv parameter, the value of the br-recv parameter shall be compatible with the values of those parameters. If the IMS-ALG supplies the br-recv parameter in the SDP answer, it shall also supply to the IMS-AGW the br-recv parameter in the local descriptor for the termination towards the offerer with the same value.</p>
<p>bw (NOTE 1)</p>	<p>If the bw parameter is contained in the SDP offer, the IMS-ALG shall check if the IMS-AGW supports the indicated sampling bandwidth(s), or a subset of them, in EVS primary mode in the send and receive direction. If the indicated sampling bandwidth(s), and even each subset of them, are not supported, the IMS-ALG shall not select the EVS payload type for transcoding. If the IMS-ALG selects the EVS payload type, it shall forward this parameter to the IMS-AGW for the termination towards the offerer in the remote descriptor.</p>	<p>If the bw parameter is contained in the SDP offer, the IMS-ALG shall select a sampling bandwidth value, which is either the received bw value or a subset of it, based on IMS-AGW capabilities and possible configured policies, and shall include the bw parameter with the selected value that is also supplied towards the IMS-AGW in the SDP answer. Otherwise, if the IMS-ALG desires the same sampling bandwidth(s) for the send and receive direction in EVS primary mode, and wants to restrict the sampling bandwidth(s) to match IMS-AGW capabilities and possible configured policies, it shall supply the bw parameter in the SDP answer it sends. Otherwise the IMS-ALG shall not include this parameter in the SDP answer. If the IMS-ALG also supplies the br, br-send or br-recv parameter, the value of the bw parameter shall be compatible with the values of those parameters. If the IMS-ALG supplies the bw parameter in the SDP answer, it shall also supply to the IMS-AGW the bw parameter in the local descriptor for the termination towards the offerer with the same value.</p>

bw-send (NOTE 1)	If the bw-send parameter is contained in the SDP offer, the IMS-ALG shall check if the IMS-AGW supports the indicated sampling bandwidths, or a subset of them, in EVS primary mode in the receive direction. If the indicated sampling bandwidths, and even each subset of them, are not supported, the IMS-ALG shall not select the EVS payload type for transcoding. If the IMS-ALG selects the EVS payload type, it shall forward this parameter to the IMS-AGW for the termination towards the offerer in the remote descriptor.	If the bw-recv parameter is contained in the SDP offer, the IMS-ALG shall select a sampling bandwidths value, which is either the received bw-recv value or a subset of it, based on IMS-AGW capabilities and possible configured policies, and shall include the bw-send parameter with the selected value in the SDP answer. Otherwise, if the IMS-ALG desires different sampling bandwidths for the send and receive direction in EVS primary mode, and wants to restrict the sampling bandwidths for the send direction to match IMS-AGW capabilities and possible configured policies, it shall supply the bw-send parameter in the SDP answer it sends. Otherwise the IMS-ALG shall not include the br-send parameter in the SDP answer. If the IMS-ALG also supplies the bw or bw-send parameter, the value of the br-send parameter shall be compatible with the values of those parameters. If the IMS-ALG supplies the bw-send parameter in the SDP answer, it shall also supply to the IMS-AGW the bw-send parameter in the local descriptor for the termination towards the offerer with the same value.
bw-recv (NOTE 1)	If the br-recv parameter is contained in the SDP offer, the IMS-ALG shall check if the IMS-AGW supports the indicated sampling bandwidths, or a subset of them, in EVS primary mode in the send direction. If the indicated sampling bandwidths, and even each subset of them, are not supported, the IMS-ALG shall not select the EVS payload type for transcoding. If the IMS-ALG selects the EVS payload type, it shall forward the bw-recv parameter to the IMS-AGW for the termination towards the offerer in the remote descriptor.	If the bw-send parameter is contained in the SDP offer, the IMS-ALG shall select a sampling bandwidths value, which is either the received bw-send value or a subset of it, based on IMS-AGW capabilities and possible configured policies, and shall include the bw-recv parameter with the selected value in the SDP answer. Otherwise, if the IMS-ALG desires a different sampling bandwidths for the send and receive direction in EVS primary mode, and wants to restrict the sampling bandwidths for the receive direction to match IMS-AGW capabilities and possible configured policies, it shall supply the bw-recv parameter in the SDP answer it sends. Otherwise the IMS-ALG shall not include the bw-recv parameter in the SDP answer. If the IMS-ALG also supplies the br or br-recv parameter, the value of the bw-recv parameter shall be compatible with the values of those parameters. If the IMS-ALG supplies the bw-send parameter in the SDP answer, it shall also supply it to the IMS-AGW in the local descriptor for the termination towards the offerer with the same value.
cmr (NOTE 1)	If the cmr parameter is contained in the SDP offer and the IMS-ALG select the EVS payload type for transcoding, the IMS-ALG shall forward this parameter to the IMS-AGW for the termination towards the offerer in the remote descriptor.	If the cmr parameter is contained in the SDP offer, the IMS-ALG shall include the cmr parameter with unmodified value in the SDP answer. Otherwise, if the IMS-AGW desires to disable codec mode requests within the RTP payload of the EVS primary mode (due to the IMS-AGW capabilities or policies), it shall include the cmr parameter with value -1 in the SDP answer it sends. If the IMS-ALG supplies the cmr parameter in the SDP answer, it shall also supply it to the IMS-AGW in the local descriptor for the termination towards the offerer with the same value.

ch-aw-recv (NOTE 1)	If the ch-aw-recv parameter is contained in the SDP offer the IMS-ALG shall check if the IMS-AGW supports the indicated mode in the send direction. If the indicated mode is not supported, the IMS-ALG shall not select the EVS payload type for transcoding. If the IMS-ALG selects the EVS payload type for transcoding, the IMS-ALG shall forward this parameter to the IMS-AGW for the termination towards the offerer in the remote descriptor.	If the IMS-ALG it desires to control the channel-aware mode of EVS in the receive direction, e.g. to disable it with value -1, it shall include the ch-aw-recv parameter in the SDP offer and shall also supply the ch-aw-recv parameter to the IMS-AGW in the local descriptor for the termination towards the offerer with the same value. The IMS-ALG shall consider the capabilities of the IMS-AGW when it chooses an appropriate value.
number of channels (NOTE 2)	If the "number of channels" parameter is contained in the SDP offer the IMS-ALG shall check if the IMS-AGW supports the indicated number of channels. If the indicated number of channels is not supported, the IMS-ALG shall not select the EVS payload type for transcoding. If the IMS-ALG selects the EVS payload type for transcoding, the IMS-ALG shall forward this parameter to the IMS-AGW for the termination towards the offerer in the remote descriptor.	If the "number of channels" parameter is contained in the SDP offer, the IMS-ALG shall include the "number of channels" parameter with unmodified value in the SDP answer and shall also supply it to the IMS-AGW in the local descriptor for the termination towards the offerer with the same value.
ch-send (NOTE 1)	If the ch-send parameter is contained in the SDP offer the IMS-ALG shall check if the IMS-AGW supports the indicated number of channels in the receive direction. If the indicated number of channels is not supported, the IMS-ALG shall not select the EVS payload type for transcoding. If the IMS-ALG selects the EVS payload type for transcoding, the IMS-ALG shall forward the ch-send parameter to the IMS-AGW for the termination towards the offerer in the remote descriptor.	If the ch-recv parameter is contained in the SDP offer, the IMS-ALG shall include the ch-send parameter with unmodified value in the SDP answer and shall also supply the ch-send parameter to the IMS-AGW in the local descriptor for the termination towards the offerer with the same value.
ch-recv (NOTE 1)	If the ch-recv parameter is contained in the SDP offer the IMS-ALG shall check if the IMS-AGW supports the indicated number of channels in the send direction. If the indicated number of channels is not supported, the IMS-ALG shall not select the EVS payload type for transcoding. If the IMS-ALG selects the EVS payload type for transcoding, the IMS-ALG shall forward the ch-recv parameter to the IMS-AGW for the termination towards the offerer in the remote descriptor.	If the ch-send parameter is contained in the SDP offer, the IMS-ALG shall include the ch-recv parameter with unmodified value in the SDP answer and shall also supply the ch-recv parameter to the IMS-AGW in the local descriptor for the termination towards the offerer with the same value.
mode-set (NOTE 3)	If the mode-set parameter is contained in the SDP offer and the IMS-ALG select the EVS payload type for transcoding, the IMS-ALG shall forward this parameter to the IMS-AGW for the termination towards the offerer in the remote descriptor. If the mode-set parameter is contained in the SDP offer and the IMS-ALG expects that EVS will be interworked with AMR-WB (e.g. if EVS is the first payload type in the received SDP offer, and the IMS-ALG adds a AMR-WB payload type), the IMS-ALG should include the mode-set parameter with the same value for the AMR-WB payload in the SDP offer it forwards.	If the mode-set parameter is contained in the SDP offer, the IMS-ALG shall include the mode-set parameter with unmodified value in the SDP answer. Otherwise, if the mode-set parameter is contained in the SDP answer for an AMR-WB payload type and the IMS-ALG decides that the EVS codec will be interworked with that AMR-WB payload type, the IMS-ALG should include that mode-set parameter for the EVS payload in the SDP offer it forwards. If the IMS-ALG supplies the mode-set parameter in the SDP answer, it shall also supply it to the IMS-AGW in the local descriptor for the termination towards the offerer with the same value.

mode-change-period (NOTE 3)	<p>If the mode-change-period parameter is contained in the SDP offer and the IMS-ALG select the EVS payload type for transcoding, the IMS-ALG shall forward this parameter to the IMS-AGW for the termination towards the offerer in the remote descriptor.</p> <p>If the mode-change-period parameter is contained in the SDP offer and the IMS-ALG expects that EVS will be interworked with AMR-WB (e.g. if EVS is the first payload type in the received SDP offer, and the IMS-ALG adds the AMR-WB payload type), the IMS-ALG should include the mode-change-period parameter with the same value for the AMR-WB payload type in the SDP offer it forwards.</p>	<p>If the mode-change-period parameter is contained in the SDP answer for the AMR-WB payload type and the IMS-ALG decides the EVS codec will be interworked with that AMR-WB payload type, the IMS-ALG should include the mode-change-period parameter for the EVS payload in the SDP offer it forwards.</p> <p>If the IMS-ALG supplies the mode-change-period parameter in the SDP answer, it shall also supply it to the IMS-AGW in the local descriptor for the termination towards the offerer with the same value.</p>
mode-change-capability (NOTE 3)	<p>If the mode-change-capability parameter is contained in the SDP offer and the IMS-ALG select the EVS payload type for transcoding, the IMS-ALG may forward this parameter to the IMS-AGW for the termination towards the offerer in the remote descriptor.</p> <p>If the IMS-ALG expects that EVS will be interworked with AMR-WB (e.g. if EVS is the first payload type in the received SDP offer, and the IMS-ALG adds the AMR-WB payload type), the IMS-ALG should include the mode-change-capability parameter with value 2 for the AMR-WB payload in the SDP offer it forwards.</p>	<p>If the IMS-ALG decides that the EVS codec is selected, the IMS-ALG shall either include the mode-change-capability parameter with value 2 or omit the parameter for the EVS payload in the SDP offer it forwards.</p> <p>If the IMS-ALG supplies the mode-change-capability parameter in the SDP answer, it may also supply it to the IMS-AGW in the local descriptor for the termination towards the offerer with the same value.</p>
mode-change-neighbor (NOTE 3)	<p>If the mode-change-neighbor parameter is contained in the SDP offer and the IMS-ALG select the EVS payload type for transcoding, the IMS-ALG shall forward this parameter to the IMS-AGW for the termination towards the offerer in the remote descriptor.</p> <p>If the mode-change-neighbor parameter is contained in the SDP offer and the IMS-ALG expects that EVS will be interworked with AMR-WB (e.g. if EVS is the first payload type in the received SDP offer, and the IMS-ALG adds the AMR-WB payload type), the IMS-ALG should include the mode-change-neighbor with the same value for the AMR-WB payload in the SDP offer it forwards.</p>	<p>If the mode-change-neighbor parameter is contained in the SDP answer for the AMR-WB payload type and the IMS-ALG decides that the EVS codec will be interworked with that AMR-WB payload type, the IMS-ALG should include the mode-change-neighbor parameter for the EVS payload in the SDP offer it forwards.</p> <p>If the IMS-ALG supplies the mode-change-neighbor parameter in the SDP answer, it shall also supply it to the IMS-AGW in the local descriptor for the termination towards the offerer with the same value.</p>
max-red (NOTE 5)	<p>If the max-red parameter is contained in the SDP offer and the IMS-ALG select the EVS payload type for transcoding, the IMS-ALG shall forward this parameter to the IMS-AGW for the termination towards the offerer in the remote descriptor.</p> <p>If the max-red parameter is contained in the SDP offer and the IMS-ALG expects that EVS will be interworked with AMR-WB (e.g. if EVS is the first payload type in the received SDP offer, and the IMS-ALG adds the AMR-WB payload type), the IMS-ALG should include the max-red parameter with the same value for the AMR-WB payload in the SDP offer it forwards with a value that considers the received value and the capabilities of the IMS-AGW.</p>	<p>The IMS-ALG shall only include the max-red parameter in the SDP answer if it desires to restrict the maximum redundancy of received packets. When selecting the value of the max-red parameter, the IMS-ALG shall consider the capabilities of the IMS-AGW and, if the max-red parameter is contained in the SDP answer for the AMR-WB payload type and the IMS-ALG decides that the EVS codec will be interworked with that AMR-WB payload type, the received value.</p> <p>If the IMS-ALG supplies the max-red parameter in the SDP answer, it shall also supply it to the IMS-AGW in the local descriptor for the termination towards the offerer with the same value.</p>
3gpp_mtsi_app_adapt (NOTE 4)	<p>If the 3gpp_mtsi_app_adapt parameter is contained in the SDP answer, and the IMS-ALG select the EVS payload type for transcoding, the IMS-ALG shall forward this parameter to the IMS-AGW. The IMS-ALG shall forward this parameter to the IMS-AGW in the remote descriptor.</p>	<p>If the IMS-AGW supports RTCP APP based adaptation messages defined in 3GPP TS 26.114 [21], and the IMS-ALG has a policy to negotiate the usage of those messages, the IMS-ALG shall include the 3gpp_mtsi_app_adapt SDP attribute indicating the supported APP messages in the SDP answer.</p>

- NOTE 1: This MIME parameter of the EVS RTP payload type is defined in 3GPP TS 26.445 [51]. It is encapsulated within the SDP "a=fmtp" attribute defined IETF RFC 4566 [53].
- NOTE 2: This number of channels are encoded as "encoding parameters" of the SDP "a=rtpmap" attribute defined in IETF RFC 4566 [53].
- NOTE 3: This MIME parameter of the EVS RTP payload type relates to AMR-WB IO mode and is defined in IETF RFC 4867 [54]. It is encapsulated within the SDP "a=fmtp" attribute defined IETF RFC 4566 [53].
- NOTE 4: This SDP attribute is defined in 3GPP TS 26.114 [21]. It applies to all codecs offered in an SDP media line. However, some values are specific to EVS.
- NOTE 5: This MIME parameter of the EVS RTP payload type is defined in IETF RFC 4867 [54]. It is encapsulated within the SDP "a=fmtp" attribute defined IETF RFC 4566 [53].

Table 5.13.3.3 describes the IMS-AGW handling of EVS codec parameters. The IMS-AGW should support transcoding of EVS with bandwidths (sampling rates) which are supported by codec the IMS-AGW is capable to transcode EVS to/from (e.g. NB for AMR, and WB for AMR-WB).

Table 5.13.3.3: IMS-AGW handling of EVS codec parameters

Parameter	Handling in local descriptor	Handling in remote descriptor
evs-mode-switch (NOTE 1)	The IMS-AGW should expect to receive packets with the indicated EVS mode and may use this information when deciding upon the required resources.	The IMS-AGW shall use the indicated EVS mode (e.g. AMR-WB interoperable mode for value 1) when sending packets.
hf-only (NOTE 1)	The IMS-AGW should expect to receive packets with the indicated mode and may use this information when deciding upon the required resources.	The IMS-AGW shall use the indicated mode (e.g. header-full EVS RTP payload format for value 1) when sending packets.
dtx (NOTE 1)	The IMS-AGW should expect to receive packets with this dtx mode and may use this information when deciding upon the required resources. (NOTE 8)	The IMS-AGW shall use this dtx mode (i.e. no usage of DTX for value 0) when sending packets. (NOTE 8)
dtx-recv (NOTE 1)	The IMS-AGW should expect to receive packets with this dtx mode and may use this information when deciding upon the required resources. (NOTE 8)	The IMS-AGW shall use this dtx mode (i.e. no usage of DTX for value 0) when sending packets. (NOTE 8)
br (NOTE 1)	If different values for the br parameter are provided in the local and remote descriptors, one will be a subset of the other, and the smaller range shall apply. The IMS-AGW should expect to receive packets with this bitrate range and may use this information when deciding upon the required resources. The IMS-AGW shall use this bitrate range when sending packets.	If different values for the br parameter are provided in the local and remote descriptors, one will be a subset of the other, and the smaller range shall apply. The IMS-AGW should expect to receive packets with this bitrate range and may use this information when deciding upon the required resources. The IMS-AGW shall use this bitrate range when sending packets.
br-send (NOTE 1)	If different values for the br-send parameter in the local descriptor and for the br-recv parameter in the remote descriptor are provided, one will be a subset of the other, and the smaller range shall apply. The IMS-AGW shall use this bitrate range when sending packets.	If different values for the br-send parameter in the remote descriptor and for the br-recv parameter in the local descriptor are provided, one will be a subset of the other, and the smaller range shall apply. The IMS-AGW should expect to receive packets with this bitrate range and may use this information when deciding upon the required resources.
br-recv (NOTE 1)	If different values for the br-send parameter in the remote descriptor and for the br-recv parameter in the local descriptor are provided, one will be a subset of the other, and the smaller range shall apply. The IMS-AGW should expect to receive packets with this bitrate range and may use this information when deciding upon the required resources.	If different values for the br-send parameter in the local descriptor and for the br-recv parameter in the remote descriptor are provided, one will be a subset of the other, and the smaller range shall apply. The IMS-AGW shall use this bitrate range when sending packets.
bw (NOTE 1)	If different values for the bw parameter are provided in the local and remote descriptors, one will be a subset of the other, and the smaller range shall apply. The IMS-AGW should expect to receive packets with these sampling bandwidth(s) and may use this information when deciding upon the required resources. The IMS-AGW shall use these sampling bandwidth(s) when sending packets.	If different values for the bw parameter are provided in the local and remote descriptors, one will be a subset of the other, and the smaller range shall apply. The IMS-AGW should expect to receive packets with these sampling bandwidth(s) and may use this information when deciding upon the required resources. The IMS-AGW shall use these sampling bandwidth(s) when sending packets.
bw-send (NOTE 1)	If different values for the bw-send parameter in the local descriptor and for the bw-recv parameter in the remote descriptor are provided, one will be a subset of the other, and the smaller range shall apply. The IMS-AGW shall use these sampling bandwidth(s) when sending packets.	If different values for the bw-send parameter in the remote descriptor and for the bw-recv parameter in the local descriptor are provided, one will be a subset of the other, and the smaller range shall apply. The IMS-AGW should expect to receive packets with these sampling bandwidth(s) and may use this information when deciding upon the required resources.

bw-recv (NOTE 1)	If different values for the bw-send parameter in the remote descriptor and for the bw-recv parameter in the local descriptor are provided, one will be a subset of the other, and the smaller range shall apply. The IMS-AGW should expect to receive packets with these sampling bandwidth(s) and may use this information when deciding upon the required resources.	If different values for the bw-send parameter in the local descriptor and for the bw-recv parameter in the remote descriptor are provided, one will be a subset of the other, and the smaller range shall apply. The IMS-AGW shall use these sampling bandwidth(s) when sending packets.
cmr (NOTE 1)	For cmr with value -1 or 0, the IMS-AGW should expect to receive no RTP packets containing codec mode requests for EVS primary mode and may use this information when deciding upon the required resources. For cmr with value -1 or 0, the IMS-AGW shall also send no RTP packets containing codec mode requests for EVS primary mode. Different cmr values in the local and remote descriptors are an error situation, but it is permissible that this parameter is only supplied in one of those descriptors.	For cmr with value -1 or 0, the IMS-AGW should expect to receive no RTP packets containing codec mode requests for EVS primary mode and may use this information when deciding upon the required resources. For cmr with value -1 or 0, the IMS-AGW shall also send no RTP packets containing codec mode requests for EVS primary mode. Different cmr values in the local and remote descriptors are an error situation, but it is permissible that this parameter is only supplied in one of those descriptors.
ch-aw-recv (NOTE 1, NOTE 7)	The IMS-AGW should expect to receive RTP packets containing the indicated partial redundancy mode and may use this information when deciding upon the required resources.	The IMS-AGW shall send RTP packets containing the indicated partial redundancy mode.
number of channels (NOTE 2)	If no ch-recv parameter in the local descriptor and no ch-send parameter in the remote descriptors are received, the IMS-AGW should expect to receive RTP packets containing the indicated number of channels and may use this information when deciding upon the required resources. If no ch-send parameter in the local descriptor and no ch-recv parameter in the remote descriptors are received, the IMS-AGW shall also send RTP packets containing the indicated number of channels. Different number of channels values in the local and remote descriptors is an error situation, but it is permissible that this parameter is only supplied in one of those descriptors.	If no ch-recv parameter in the local descriptor and no ch-send parameter in the remote descriptors are received, the IMS-AGW should expect to receive RTP packets containing the indicated number of channels and may use this information when deciding upon the required resources. If no ch-send parameter in the local descriptor and no ch-recv parameter in the remote descriptors are received, the IMS-AGW shall also send RTP packets containing the indicated number of channels. Different number of channels values in the local and remote descriptors is an error situation, but it is permissible that this parameter is only supplied in one of those descriptors.
ch-send (NOTE 1)	The IMS-AGW shall send RTP packets containing the indicated number of channels. Different number of channels in the ch-send parameter in the local descriptor and the ch-recv parameter in the remote descriptors is an error situation, but it is permissible that this parameter is only supplied in one of those descriptors.	The IMS-AGW should expect to receive RTP packets containing the indicated number of channels and may use this information when deciding upon the required resources. Different number of channels in the ch-send parameter in the local descriptor and the ch-recv parameter in the remote descriptors is an error situation, but it is permissible that this parameter is only supplied in one of those descriptors.
ch-recv (NOTE 1)	The IMS-AGW should expect to receive RTP packets containing the indicated number of channels and may use this information when deciding upon the required resources. Different number of channels in the ch-send parameter in the local descriptor and the ch-recv parameter in the remote descriptors is an error situation, but it is permissible that this parameter is only supplied in one of those descriptors.	The IMS-AGW shall send RTP packets containing the indicated number of channels. Different number of channels in the ch-send parameter in the local descriptor and the ch-recv parameter in the remote descriptors is an error situation, but it is permissible that this parameter is only supplied in one of those descriptors.

mode-set (NOTE 4)	For AMR-WB IO mode, the IMS-AGW should expect to receive RTP packets using only the indicated mode-set and may use this information when deciding upon the required resources. The IMS-AGW shall also send RTP packets only using the indicated mode-set. Different mode-set values in the local and remote descriptors are an error situation, but it is permissible that this parameter is only supplied in one of those descriptors.	For AMR-WB IO mode, the IMS-AGW should expect to receive RTP packets using only the indicated mode-set and may use this information when deciding upon the required resources. The IMS-AGW shall also send RTP packets only using the indicated mode-set. Different mode-set values in the local and remote descriptors are an error situation, but it is permissible that this parameter is only supplied in one of those descriptors.
mode-change-period (NOTE 3)	For AMR-WB IO mode, the IMS-AGW should expect to receive packets with this mode-change-period and may use this information when deciding upon the required resources.	For AMR-WB IO mode, the IMS-AGW shall use this mode-change-period when sending packets.
mode-change-capability (NOTE 6)	For AMR-WB IO mode, mode-change-capability with value 2 indicates that the IMS-AGW should expect to be requested to send packets with restricted mode-change-period and may use this information when deciding upon the required resources.	No IMS-AGW handling of this parameter id defined.
mode-change-neighbor (NOTE 3)	The IMS-AGW should expect to receive packets with this mode-change-period and may use this information when deciding upon the required resources.	The IMS-AGW shall use this mode-change-period when sending packets.
max-red (NOTE 5)	The IMS-AGW should expect to receive packets with redundancy up to the indicated max-red value and may use this information when deciding upon the required resources.	The IMS-AGW shall only send packet with redundancy up to the indicated max-red value.
3gpp_mtsi_app_adapt (NOTE 4)	The IMS-AGW should expect to receive RTCP APP packets of the indicated types and may use this information when deciding upon the required resources.	The IMS-AGW may send RTCP APP packets of the indicated types. The IMS-AGW shall not send other RTCP APP packets. If the parameter is not supplied, the IMS-AGW shall not send any RTCP APP packets.
<p>NOTE 1: This MIME parameter of the EVS RTP payload type is defined in 3GPP TS 26.445 [51]. The values and the defaults if a parameter is omitted, as defined in 3GPP TS 26.445 [51] shall apply.</p> <p>NOTE 2: This number of channels are encoded as "encoding parameters" of the SDP "a=rtmpmap" attribute defined in IETF RFC 4566 [53].</p> <p>NOTE 3: This MIME parameter of the EVS RTP payload type relates to AMR-WB IO mode and is defined in IETF RFC 4867 [54]. The values and the defaults if a parameter is omitted, as defined in IETF RFC 4867 [54] shall apply.</p> <p>NOTE 4: This SDP attribute is defined in 3GPP TS 26.114 [21]. It applies to all codecs offered in an SDP media line. However, some values are specific to EVS.</p> <p>NOTE 5: This MIME parameter of the EVS RTP payload type is defined in IETF RFC 4867 [54]. The values and the defaults if a parameter is omitted, as defined in IETF RFC 4867 [54] shall apply.</p> <p>NOTE 6: This MIME parameter of the EVS RTP payload type relates to AMR-WB IO mode and is defined in IETF RFC 4867 [54]. The values and the defaults if a parameter is omitted, as defined in 3GPP TS 26.445 [51], shall apply.</p> <p>NOTE 7: The frame erasure rate indicator for the channel-aware mode has two permissible values (LO, HI) and this indicator has to be initialized to HI, as specified in clause 5.8.4 of 3GPP TS 26.445 [51].</p> <p>NOTE 8: If both the dtx and the dtx-recv parameter are provided either in the local or in the remote descriptor, both parameters will have the same value within that descriptor.</p>		

5.13.4 Handling of the OPUS speech and audio codec for WebRTC

The OPUS speech and audio codec is defined in IETF RFC 6716 [50]. Its RTP payload type is defined in IETF RFC 7587 [56].

The eP-CSCF and the eIMS-AGW should support transcoding to and from the OPUS speech codec. If they do so, the procedures in the present subclause apply.

When receiving an SDP offer from the core network, the IMS-ALG may add an OPUS codec payload type (as specified in IETF RFC 7587 [56]) before forwarding the SDP offer towards the served WebRTC UE (denoted as "codec 3" in figure 10.2.5.2 of 3GPP TS 29.162 [20]). If that OPUS payload type is selected in the SDP answer, the IMS-ALG needs to transcode the OPUS codec. Table 5.13.4.1 describes the IMS-ALG handling of the OPUS codec parameters when the

IMS-ALG adds an OPUS payload type to the SDP offer, and that OPUS payload type is selected in the SDP answer. In addition, rules for the parameter handling in IETF RFC 7587 [56] shall apply.

Table 5.13.4.1: IMS-ALG handling of OPUS related SDP parameters when the IMS-ALG adds the OPUS payload type to the SDP offer.

Parameter	Handling for OPUS payload type added to the SDP offer to offer transcoding	Handling if offered OPUS payload type is accepted in the SDP answer
maxplaybackrate (NOTE)	Should be set according to IMS-AGW capabilities and sampling rates of expected codecs to transcode with (E.g. other codecs in the received SDP offer).	If parameter is contained in the SDP answer, the IMS-ALG should forward this parameter to the IMS-AGW for the termination towards the answerer in the remote descriptor.
sprop-maxcapture rate (NOTE)	Should be set according to IMS-AGW capabilities and sampling rates of expected codecs to transcode with (E.g. other codecs in the received SDP offer).	If parameter is contained in the SDP answer, the IMS-ALG should forward this parameter to the IMS-AGW for the termination towards the answerer in the remote descriptor.
maxaveragebitrate (NOTE)	Should be set according to IMS-AGW capabilities and sampling rates of expected codecs to transcode with (E.g. other codecs in the received SDP offer), see IETF RFC 7587 [56].	If parameter is contained in the SDP answer, the IMS-ALG should forward this parameter to the IMS-AGW for the termination towards the answerer in the remote descriptor.
stereo (NOTE)	Should be set to 0 or omitted, unless the expected codecs to transcode with (E.g. other codecs in the received SDP offer) support stereo and the IMS-AGW supports stereo transcoding.	If parameter is contained in the SDP answer, the IMS-ALG should forward this parameter to the IMS-AGW for the termination towards the answerer in the remote descriptor.
sprop-stereo (NOTE)	Should be set to 0 or omitted, unless the expected codecs to transcode with (E.g. other codecs in the received SDP offer) support stereo and the IMS-AGW supports stereo transcoding.	If parameter is contained in the SDP answer, the IMS-ALG should forward this parameter to the IMS-AGW for the termination towards the answerer in the remote descriptor.
cbr (NOTE)	Should be set or omitted according to IMS-AGW capabilities and used encryption.	If parameter is contained in the SDP answer, the IMS-ALG shall forward this parameter to the IMS-AGW for the termination towards the answerer in the remote descriptor.
useinbandfec (NOTE)	Should be set or omitted according to IMS-AGW capabilities and delay budget.	If parameter is contained in the SDP answer, the IMS-ALG should forward this parameter to the IMS-AGW for the termination towards the answerer in the remote descriptor.
usedtx (NOTE)	Should be set according to IMS-AGW preferences and DTX capabilities of expected codecs to transcode with (E.g. other codecs in the received SDP offer).	If parameter is contained in the SDP answer, the IMS-ALG shall forward this parameter to the IMS-AGW for the termination towards the answerer in the remote descriptor.
NOTE: This MIME parameter of the OPUS RTP payload type is defined in IETF RFC 7587 [56]. It is encapsulated within the SDP "a=fmtp" attribute defined in IETF RFC 4566 [55].		

When receiving an SDP offer from the served WebRTC UE that contains an OPUS codec payload type, the IMS-ALG may add other payload types before forwarding the SDP offer (denoted as "codec 3" in figure 10.2.5.2 of 3GPP TS 29.162 [20]). If that added payload type is selected in the SDP answer, the IMS-ALG needs to transcode, and may select to transcode to the OPUS codec. Table 5.13.4.2 describes the IMS-ALG handling of the OPUS codec parameters when the IMS-ALG receives the OPUS payload type in the SDP offer, and selects to transcode between the OPUS codec and some other codec. In addition, rules for the parameter handling in IETF RFC 7587 [56] shall apply.

Table 5.13.4.2: IMS-ALG handling of OPUS related SDP parameters when the IMS-ALG receives the OPUS payload type to the SDP offer and decides to transcode between the OPUS payload type and some other codec.

Parameter	Handling of OPUS payload type parameter received in the SDP offer	OPUS payload type supplied in the SDP answer
maxplaybackrate (NOTE)	If parameter is contained in the SDP offer, the IMS-ALG should forward this parameter to the IMS-AGW for the termination towards the offerer in the remote descriptor.	Should be set according to IMS-AGW capabilities and sampling rates of expected codecs to transcode with (E.g. other codecs in the received SDP offer).
sprop-maxcapture rate (NOTE)	If parameter is contained in the SDP offer, the IMS-ALG should forward this parameter to the IMS-AGW for the termination towards the offerer in the remote descriptor.	Should be set according to IMS-AGW capabilities and sampling rates of expected codecs to transcode with (E.g. other codecs in the received SDP offer).
maxaveragebitrate (NOTE)	If parameter is contained in the SDP offer, the IMS-ALG should forward this parameter to the IMS-AGW for the termination towards the offerer in the remote descriptor.	Should be set according to IMS-AGW capabilities and sampling rates of expected codecs to transcode with (E.g. other codecs in the received SDP offer), see IETF RFC 7587 [56].
stereo (NOTE)	If parameter is contained in the SDP offer, the IMS-ALG should forward this parameter to the IMS-AGW for the termination towards the offerer in the remote descriptor.	Should be set to 0 or omitted, unless the expected codecs to transcode with (E.g. other codecs in the received SDP offer) support stereo and the IMS-AGW supports stereo transcoding.
sprop-stereo (NOTE)	If parameter is contained in the SDP offer, the IMS-ALG should forward this parameter to the IMS-AGW for the termination towards the offerer in the remote descriptor.	Should be set to 0 or omitted, unless the expected codecs to transcode with (E.g. other codecs in the received SDP offer) support stereo and the IMS-AGW supports stereo transcoding.
cbr (NOTE)	If parameter is contained in the SDP offer, the IMS-ALG shall forward this parameter to the IMS-AGW for the termination towards the offerer in the remote descriptor.	Should be set or omitted according to IMS-AGW capabilities and used encryption.
useinbandfec (NOTE)	If parameter is contained in the SDP offer, the IMS-ALG should forward this parameter to the IMS-AGW for the termination towards the offerer in the remote descriptor.	Should be set or omitted according to IMS-AGW capabilities and delay budget.
usedtx (NOTE)	If parameter is contained in the SDP offer, the IMS-ALG shall forward this parameter to the IMS-AGW for the termination towards the offerer in the remote descriptor.	Should be set according to IMS-AGW preferences and DTX capabilities of expected codecs to transcode with (E.g. other codecs in the received SDP offer).
NOTE 1: This MIME parameter of the OPUS RTP payload type is defined in IETF RFC 7587 [56]. It is encapsulated within the SDP "a=fmtp" attribute defined in IETF RFC 4566 [55].		

Table 5.13.4.3 describes the IMS-AGW handling of the OPUS codec parameters. The IMS-AGW should support transcoding of OPUS with at least the bandwidths (sampling rates) which are supported by codec the IMS-AGW is capable to transcode OPUS to/from (e.g. NB for AMR, and WB for AMR-WB).

Table 15.3.4.3: IMS-AGW handling of OPUS codec parameters.

Parameter	Handling in local descriptor	Handling in remote descriptor
maxplaybackrate (NOTE)	The IMS-AGW should expect to receive RTP packets with sampling rates up to the indicated maximum and may use this information when deciding upon the required resources.	The IMS-AGW should send RTP packets with the indicated sampling rate.
sprop-maxcapture rate (NOTE)	No IMS-AGW handling of this parameter is defined.	The IMS-AGW should expect to receive RTP packets with sampling rates up to the indicated maximum and may use this information when deciding upon the required resources.
maxaveragebitrate (NOTE)	The IMS-AGW should expect to receive RTP packets with average bit rates up to the indicated maximum and may use this information when deciding upon the required resources.	The IMS-AGW shall send RTP packets with average bit rates up to the indicated maximum.
stereo (NOTE)	The IMS-AGW should expect to receive RTP packets containing the indicated stereo mode and may use this information when deciding upon the required resources.	The IMS-AGW should send RTP packets containing the indicated stereo mode.
sprop-stereo (NOTE)	No IMS-AGW handling of this parameter is defined.	The IMS-AGW should expect to receive RTP packets containing the indicated stereo mode and may use this information when deciding upon the required resources.
cbr (NOTE)	The IMS-AGW should expect to receive RTP packets containing the indicated constant bit rate mode and may use this information when deciding upon the required resources.	The IMS-AGW should send RTP packets containing the indicated constant bit rate mode.
useinbandfec (NOTE)	The IMS-AGW should expect to receive RTP packets containing the indicated forward error correction mode and may use this information when deciding upon the required resources.	The IMS-AGW should send RTP packets containing the indicated forward error correction mode.
usedtx (NOTE)	The IMS-AGW should expect to receive RTP packets containing the indicated DTX mode and may use this information when deciding upon the required resources.	The IMS-AGW should send RTP packets using the indicated DTX mode.
NOTE 1: This MIME parameter of the OPUS RTP payload type is defined in IETF RFC 7587 [56]. The default value if a parameter is omitted, as defined in IETF RFC 7587 [56], shall apply.		

5.14 Multimedia Priority Service (MPS) Support

The Multimedia Priority Service (MPS) is specified in 3GPP TS 22.153 [22]. The IMS-ALG and IMS-AGW may support the priority treatment of a call/session identified as an MPS call/session. If MPS is supported, the following functional requirements apply:

- Upon receipt of the MPS priority information in the call control signalling:
 - The IMS-ALG shall recognise the call/session as having priority.
 - The IMS-ALG shall send the priority information for a context to the IMS-AGW to enable the priority treatment described below related to the IMS-AGW.
 - The IMS-ALG shall apply priority handling to H.248 transactions related to priority calls/sessions when network resources are congested, e.g., preferential treatment in any queues or buffers.
 - The IMS-ALG may send the updated priority information and, if DiffServ is used, provision a suitable DSCP marking for the updated MPS priority level to the IMS-AGW if it needs to change the priority information previously communicated to the IMS-AGW for an MPS call/session.
 - If the H.248 control association utilises a transport with the possibility for prioritisation, the IMS-ALG may apply priority using the appropriate prioritisation procedures.

- If the MPS Priority service requires a specific MPS DSCP setting the IMS-ALG shall configure the IMS-AGW to apply a specific MPS DSCP marking to the user data transport packets to indicate that the packets are of a higher priority than those for normal calls.
- If the IMS-AGW receives an indication to apply a specific MPS DSCP marking to the user data transport packets, it shall apply this DSCP marking to the IP headers.

NOTE 1: Support of Diffserv procedures by the IMS-AGW assumes an operator uses Diffserv for prioritising user plane traffic related to an MPS call/session.

- When the IMS-ALG marks a Context with priority information, the IMS-AGW may use the priority information for selecting resources for the media and signaling transport with priority. The following actions may be taken by the IMS-AGW if it has reached a congested state:
 - i) seize priority reserved resources; or
 - ii) if resources are congested, indicate that in aCommand Response error code.

NOTE 2: The Priority information can be used to derive Layer 2 QoS marking and trigger priority identification and priority treatment for other QoS technologies than Diffserv.

5.15 Coordination of Video Orientation

The IMS-ALG and the IMS-AGW may support the Coordination of Video Orientation (CVO) as defined in 3GPP TS 26.114 [21].

If the IMS-ALG receives an SDP body containing "a=extmap" attribute(s), as defined in IETF RFC 5285 [23], and the "a=extmap" attribute(s) contain CVO URN(s) (i.e. the CVO URN for a 2 bit granularity of rotation and/or the CVO URN for a higher granularity of rotation) as defined in 3GPP TS 26.114 [21], then:

- a) if the IMS-ALG and the IMS-AGW support the CVO feature:
 - the IMS-ALG shall include the "extended RTP header for CVO" information element when seizing resources in the IMS-AGW to indicate the IMS-AGW that it shall allow the RTP header extension for CVO to pass; and
- Editor's Note: It is ffs if the IMS-ALG needs to include the "extended RTP header for CVO" information element when seizing terminations of a media agnostic IMS-AGW, or if a media agnostic IMS-AGW always passes any RTP header extension.**
- the IMS-ALG shall forward within SIP signalling, the SDP body received from the preceding node with unmodified "a=extmap" attribute(s) to the succeeding node; or
- b) if the IMS-AGW does not support the CVO feature, the IMS-ALG shall forward within SIP signalling, the SDP body received from the preceding node without any "a=extmap" attributes to the succeeding node.

NOTE 1: The UE supporting the CVO feature will not send the extended RTP headers for CVO if the UE did not receive any SDP body with the CVO related "a=extmap" attribute.

If the IMS-AGW supports the CVO feature and has been instructed to pass on the extended RTP header for CVO as described above for both incoming and outgoing terminations then:

- if the IMS AGW does not apply video transcoding, it shall pass any received RTP CVO header extension to succeeding RTP streams; or
- if the IMS-AGW applies video transcoding, it shall keep the video orientation unchanged during the transcoding and copy the received RTP CVO header extension to the succeeding outgoing RTP stream(s) after transcoding the associated group of packets.

NOTE 2: IETF RFC 5285 [23] provides a framework for header extensions and can also be used for non-CVO related purposes. It is an implementation decision of the IMS-AGW if it only passes CVO related RTP header extensions, or if it passes any RTP header extension when being instructed with the "extended RTP header for CVO" information element.

NOTE 3: The behaviour of the IMS-AGW when being instructed with an "extended RTP header for CVO" information element only at one termination is an implementation decision.

NOTE 4: Unknown IETF RFC 5285 [23] RTP header extensions are ignored by the destination RTP end system.

5.16 Generic image attributes

The IMS-ALG and the IMS-AGW may support a media-level SDP image attribute "a=imageattr" defined in IETF RFC 6236 [24] to negotiate the image size for sending and receiving video as required by 3GPP TS 26.114 [21].

NOTE: The image attribute may be used within the SDP capability negotiation framework and its use is then specified using the "a=acap" parameter.

If the IMS-ALG:

- supports the negotiation of the image size;
- receives an SDP body containing the image attribute(s) "imageattr" defined in IETF RFC 6236 [24]; and
- does not support or does not apply the video transcoding procedure defined in subclause 5.13;

the IMS-ALG shall forward the SDP body with unmodified image attribute(s).

If the IMS-ALG and the IMS-AGW support the ATCF/ATGW functions then during the access transfer procedures the IMS-ALG may apply the procedure described in subclause 6.2.14.6 to negotiate and adjust the image size for sending and receiving video of the session.

5.17 TCP bearer connection control

5.17.1 Stateless TCP handling

An IMS-ALG and IMS-AGW that supports TCP as transport protocol (see IETF RFC 793 [29] and IETF RFC 4145 [30]) shall support the following procedures.

NOTE 1: It is assumed that pre-Release 12 IMS-ALGs and IMS-AGWs also apply these procedures.

When receiving an SDP offer or answer containing a media line for a new TCP based media stream (e.g. with "TCP", "TCP/MSRP" as transport protocol), the IMS-ALG:

- shall indicate "TCP" (for application-agnostic interworking) or "TCP/MSRP" (for application-aware MSRP interworking) as transport protocol to the IMS-AGW;
- shall indicate the TCP port numbers received in the SDP from the remote peer as destination port in the remote descriptor at the termination towards the SDP sender;
- shall request the IMS-AGW to allocate a TCP port number at the destination towards the SDP receiver;
- shall replace the TCP port in the received SDP with the TCP port number allocated by the IMS-AGW and forward the SDP; and
- shall indicate to the IMS-AGW to perform TCP stateless handling by not including the TCP session setup direction attribute at the interconnected terminations in the same context.

An IMS-AGW receiving an indication of "TCP", or "TCP/MSRP" as transport protocol, but no indication to perform TCP state-aware handling (via information about the directionality of the TCP session setup):

- shall send a TCP SYN when receiving a TCP SYN at the interconnected termination in the same context;
- shall forward received TCP payload; and
- shall use its own port number as TCP source port numbers and the remote port number received from the IMS-ALG as TCP destination port numbers and calculate a new TCP checksum for all TCP packets it sends.

NOTE 2: This mode of operation corresponds to the "TCP Relay" mode in ITU-T Recommendation H.248.84 [38].

5.17.2 State-aware TCP handling

5.17.2.1 General

An IMS-ALG and IMS-AGW that supports TCP as transport protocol (see IETF RFC 793 [29] and IETF RFC 4145 [30]) may support the procedures specified in subclause 5.17.2 for state-aware TCP handling.

NOTE 1: State-aware TCP handling enables modifications of TCP payloads by the IMS-AGW such as changing the size of the payload and inserting extra protocol layers, e.g. for e2ae media security.

An IMS-ALG and IMS-AGW that supports state-aware TCP handling shall support the procedures specified in subclause 5.17.2.2 and may additionally support the procedures specified in subclause 5.17.2.3.

NOTE 2: The procedures in subclause 5.17.2.3 enable TCP connections between two peers behind remote (far-end) NATs without any other intermediate server capable of acting as a TCP B2BUA (such as a messaging server). However, they are not possible if e2e security is applied for MSRP based media.

5.17.2.2 State-aware TCP handling without support of modifying the TCP setup direction

When the IMS-ALG receives an SDP offer containing a media line for a new TCP based media stream (e.g. with "TCP", "TCP/MSRP" as transport protocol), for that TCP based media stream the IMS-ALG:

- if no media security is applied, shall indicate "TCP" (for application-agnostic interworking) or "TCP/MSRP" (for application-aware MSRP interworking) as transport protocol to the IMS-AGW;
- if media security is applied, shall indicate a transport protocol according to subclause 5.11 to the IMS-AGW;
- shall request the IMS-AGW to allocate a TCP port at the destination towards the SDP answerer;
- shall request the IMS-AGW to allocate a TCP port at the destination towards the SDP offerer;
- shall indicate the TCP port numbers received in the SDP offer as destination in the remote descriptor at the termination towards the SDP offerer;
- shall indicate to the IMS-AGW to perform TCP state-aware handling (by indicating the "actpass" TCP session setup direction at both interconnected terminations in the same context in the local descriptor);
- if supported by the IMS-AGW, may indicate to the IMS-AGW for a given termination to use an incoming TCP connection establishment request (TCP SYN) at that termination as a trigger for sending a TCP connection establishment request at the interconnected termination in the same context;
- if supported by the IMS-AGW, may indicate to the IMS-AGW to discard incoming TCP connection establishment requests; and
- shall replace the TCP port in the received SDP offer with the TCP port number allocated by the IMS-AGW at the termination towards the SDP answerer, shall maintain a received "a=setup:active" or "a=setup:passive" SDP attribute (see IETF RFC 4145 [30]) in the SDP offer without modification, and shall forward the SDP offer.

When the IMS-ALG then receives the SDP answer containing a media line for a new TCP based media stream, for that TCP based media stream the IMS-ALG:

- shall indicate the TCP port numbers received in the SDP answer as destination in the remote descriptor at the termination towards the SDP answerer;
- if supported by the IMS-AGW, may indicate to the IMS-AGW for a given termination to use an incoming TCP connection establishment request (TCP SYN) at that termination as a trigger for sending a TCP connection establishment request at the interconnected termination in the same context;
- if the IMS-ALG did not indicate to the IMS-AGW to use the incoming TCP connection establishment request (TCP SYN) at one termination as a trigger for sending a TCP connection establishment request at the interconnected termination in the same context,

- if the SDP answer contains an "a=setup:active" SDP attribute (see IETF RFC 4145 [30]), shall indicate to the IMS-AGW to start a TCP connection establishment at the termination towards the SDP offerer; and
- if the SDP answer contains an "a=setup:passive" SDP attribute, shall indicate to the IMS-AGW to start a TCP connection establishment at the termination towards the SDP answerer;

NOTE 1: Clients only supporting MSRP according to IETF RFC 4975 [25] will not use the SDP "a=setup" attribute, but will assign the TCP client role to the SDP offerer. However, in 3GPP (Release 8 onwards), OMA and GSMA the support of IETF RFC 6135 [45] is mandated, and the "a=setup" attribute will thus be used.

- if the IMS-ALG previously indicated to the IMS-AGW to discard incoming TCP connection establishment requests, shall indicate to the IMS-AGW to process incoming TCP connection establishment requests; and
- shall replace the destination TCP port in the received SDP answer with the TCP port number allocated by the IMS-AGW at the termination towards the SDP offerer, shall maintain the received "a=setup" SDP attribute (RFC 4145 [30]) in the SDP answer without modification, and shall forward the SDP answer.

An IMS-AGW receiving an indication of "TCP", or "TCP/MSRP" as transport protocol and an indication to perform TCP state-aware handling (via information about the directionality of the TCP session setup):

- if the IMS-ALG indicated to start a TCP connection establishment at a given termination, shall start the TCP connection establishment at that TCP termination by sending a TCP SYN;
- if the IMS-ALG indicated to discard incoming TCP connection establishment requests, shall discard any incoming TCP connection establishment requests (support optional for the IMS-AGW);
- if
 - a) the IMS-ALG indicated to use the incoming TCP connection establishment request (TCP SYN) at one termination as a trigger for sending a TCP connection establishment request at the interconnected termination in the same context, and
 - b) the IMS-ALG did not indicate to discard incoming TCP connection establishment requests, shall send a TCP SYN when receiving a TCP SYN at the interconnected termination in the same context (support optional for the IMS-AGW);
- if
 - a) the IMS-ALG did not indicate to use the incoming TCP connection establishment request (TCP SYN) at one termination as a trigger for sending a TCP connection establishment request at the interconnected termination in the same context, and
 - b) the IMS-ALG did not indicate to discard incoming TCP connection establishment requests, and
 - c) the IMS-ALG already configured the remote IP address and port or requested latching, shall answer any received TCP SYN at a given termination with appropriate messages according to TCP procedures;
- shall forward received TCP payload, performing any required modifications on the TCP payload according to procedures in other parts of this specification; and
- shall use its own port number as TCP source port and the remote port number indicated by the IMS-ALG as TCP destination port numbers and shall calculate a new TCP checksum for all TCP packets it sends.

NOTE 2: This mode of operation corresponds to the "TCP Proxy" mode in ITU-T Recommendation H.248.84 [38].

5.17.2.3 State-aware TCP handling with support of modifying the TCP setup direction

The IMS-ALG and IMS-AGW shall perform the same procedures as in subclause 5.17.2.2 with modification according to the present subclause.

When the IMS-ALG receives an SDP offer containing a media line for a new TCP based media stream (e.g. with "TCP", "TCP/MSRP" as transport protocol), for that TCP based media stream the IMS-ALG:

- if an "a=setup:active" SDP attribute (see IETF RFC 4145 [30]) is received in an SDP offer towards a served UE that is possibly behind a remote NAT, the IMS-ALG
 - should replace this attribute with a "a=setup:actpass" or "a=setup:passive" SDP attribute; and
 - shall then not indicate to the IMS-AGW to use the incoming TCP connection establishment request (TCP SYN) at the termination towards the offerer as a trigger for sending a TCP connection establishment request at the interconnected termination in the same context towards the answerer;
- if an "a=setup:active" SDP attribute (see IETF RFC 4145 [30]) is received in an SDP offer from a served UE, the IMS-ALG
 - may replace this attribute with a "a=setup:actpass" SDP attribute; and
 - shall then not indicate to the IMS-AGW to use the incoming TCP connection establishment request (TCP SYN) at the termination towards the answerer as a trigger for sending a TCP connection establishment request at the interconnected termination in the same context towards the offerer;

NOTE 1: Clients only supporting MSRP according to IETF RFC 4975 [25] will not use the SDP "a=setup" attribute, but will assign the TCP client role to the SDP offerer. However, in 3GPP (Release 8 onwards), OMA and GSMA the support of IETF RFC 6135 [45] is mandated, and the "a=setup" attribute will thus be used.

- shall indicate to the IMS-AGW to perform TCP state-aware handling, either by indicating the "actpass" TCP session setup direction at both interconnected terminations in the same context in the local descriptors, or by indicating the "passive" TCP session setup direction at both interconnected terminations in the same context.

When the IMS-ALG then receives the SDP answer containing a media line for a new TCP based media stream, for that TCP based media stream the IMS-ALG:

- if
 - a) the IMS-ALG received an "a=setup:active" SDP attribute in the SDP offer, and
 - b) the SDP answer contains an "a=setup:active" SDP attribute,
 then
 - if the IMS-ALG previously indicated "actpass" TCP session setup direction at both interconnected terminations to the IMS-AGW, shall indicate to the IMS-AGW the "passive" TCP session setup direction at both interconnected terminations in the same context in the local descriptors, and
 - shall replace the "a=setup:active" SDP attribute in the SDP answer with an "a=setup:passive" SDP attribute before forwarding the answer.
- if
 - a) the IMS-ALG received an "a=setup:active" SDP attribute in the SDP offer, and
 - b) the SDP answer contains an "a=setup:passive" SDP attribute,
 then
 - if the IMS-ALG previously indicated "passive" TCP session setup direction at both interconnected terminations to the IMS-AGW, shall indicate to the IMS-AGW the "actpass" TCP session setup direction at both interconnected terminations in the same context in the local descriptors, and
 - shall retain the "a=setup:passive" SDP attribute in the forwarded SDP answer;
- if the IMS-ALG did not indicate to the IMS-AGW to use the incoming TCP connection establishment request (TCP SYN) at one termination as a trigger for sending a TCP connection establishment request at the interconnected termination in the same context,
 - if the sent SDP answer towards the offerer contains an "a=setup:active" SDP attribute (RFC 4145 [30]), indicate to the IMS-AGW to start a TCP connection establishment at the termination towards the SDP offerer; and

- if the received SDP answer contains an "a=setup:passive" SDP attribute, indicate to the IMS-AGW to start a TCP connection establishment at the termination towards the SDP answerer.

When the IMS-ALG indicated a "passive" TCP setup direction for a termination, the IMS-AGW shall wait for an incoming TCP connection establishment at that termination and shall not start a TCP connection establishment on its own.

NOTE 2: If the "passive" TCP session setup direction has been indicated to the IMS-AGW at both interconnected terminations, the mode of operation corresponds to the "TCP Merge" mode in ITU-T Recommendation H.248.84 [38]. If the "actpass" TCP session setup direction has been indicated to the IMS-AGW at both interconnected terminations, the mode of operation corresponds to the "TCP Proxy" mode in ITU-T Recommendation H.248.84 [38].

5.18 Interactive Connectivity Establishment (ICE)

5.18.1 General

The IMS-ALG and the IMS-AGW may support ICE functionality as specified in IETF RFC 5245 [39] and 3GPP TS 24.229 [11] to support a UE residing behind a remote NAT. The present subclause describes the requirements for P-CSCF (IMS-ALG) and IMS-AGW when the ICE procedures are supported.

Support of full ICE functionality is optional, but if ICE is supported, the IMS-ALG and IMS-AGW shall at least support ICE lite as specified in IETF RFC 5245 [39].

An IMS-ALG and IMS-AGW supporting ICE lite may in addition support ICE for TCP according to IETF RFC 6544 [57].

NOTE 1: ICE for TCP can be used to offer an alternative transport for media streams with default UDP transport to enable a traversal of UDP-blocking NATs or firewalls. In the present release, the support of ICE for TCP is restricted to media streams with default UDP transport, and to ICE lite.

The IMS-ALG and IMS-AGW shall only use host candidates as local ICE candidates.

NOTE 2: IMS-ALG and IMS-AGW are not located behind a NAT (from perspective of the ICE deployment model according to Figure 1 in IETF RFC 5245 [39]).

The IMS-ALG with IMS-AGW inserted on the media plane shall perform separate ICE negotiation and procedures with the offerer and the answerer and ICE may be applied independently at either side. Furthermore, the IMS-ALG may be configured to apply ICE procedures only towards the access network side.

When the P-CSCF (IMS-ALG) detects no ICE parameters in the received SDP, it shall not configure the IMS-AGW to apply any ICE and STUN related procedures toward the call leg from where the SDP has been received, and if applicable may apply the remote NAT traversal using latching according to subclause 5.4.

Any IMS-AGW supporting ICE shall advertise its support of incoming STUN continuity check procedures. An IMS-AGW supporting full ICE procedures shall in addition advertise its support for originating STUN connectivity check procedures.

If the IMS-AGW does not indicate the support of STUN procedures, or if the IMS-ALG is configured not to apply ICE toward a call leg, the IMS-ALG:

- shall not configure the IMS-AGW to apply STUN procedures;
- shall remove any received SDP candidate information from the SDP it forwards; and
- may apply remote NAT traversal using latching according to subclause 5.4.

5.18.2 ICE lite

If the IMS-ALG is configured to use ICE lite, or supports only ICE lite, or controls an IMS-AGW that only support ICE lite, the procedures in the present subclause apply.

If the IMS-ALG receives an initial SDP offer with ICE candidate information but no "a=ice-lite" attribute, the IMS-ALG:

- shall not forward the received candidate information in the SDP it sends towards the answerer;
- shall request the IMS-AGW for each media line with UDP as default transport where it decides to use ICE to reserve an ICE host candidate and provide its address information and a related ICE user name fragment and password;

NOTE 1: Requesting only one host candidate per m-line prevents that the IMS-ALG will receive "a=remote-candidates" SDP attributes in a subsequent SDP. Requesting separate ufrag and password for each media line simplifies H.248 encoding.

- may request the IMS-AGW for each media line with UDP as default transport where it decides to use ICE to reserve an additional passive TCP ICE host candidate and provide its address information and a related ICE user name fragment and password;
- shall configure the IMS-AGW to act as STUN server at the host candidate address, i.e. to answer STUN connectivity checks;
- may provide received remote ICE candidates and the received related ICE user name fragment and password to the IMS-AGW;
- shall include the host candidate and related ICE user name fragment and password received from the IMS-AGW in the SDP answer it forwards;
- shall include the "a=ice-lite" attribute in the SDP answer it forwards; and
- shall not apply the remote NAT traversal using latching according to subclause 5.4.

If the IMS-ALG receives SDP offer with ICE candidate information and an "a=ice-lite" attribute, the IMS-ALG shall not apply ICE towards that call leg and not include any ICE related SDP attributes in the SDP answer.

NOTE 2: This avoids that the ICE lite peer needs to send extra SDP offers to complete ICE procedures.

If the IMS-ALG sends an SDP offer (or forwards a received SDP offer) towards a call leg where ICE is to be applied, the IMS-ALG:

- shall request the IMS-AGW to reserve a host candidate for each media line with UDP as default transport where it decides to use ICE and provide its address information, user name fragment and password;
- may request the IMS-AGW for each media line with UDP as default transport where it decides to use ICE to reserve an additional passive TCP ICE host candidate and provide its address information and a related ICE user name fragment and password;
- shall configure the IMS-AGW to act as STUN server at the host candidate address, i.e. to answer STUN connectivity checks;
- shall include the host candidate provided by the IMS-AGW and related ICE user name fragment and password in the SDP offer it forwards; and
- shall include the "a=ice-lite" attribute in the SDP offer.

If the IMS-ALG then receives an SDP answer with candidate information from the call leg where ICE is to be applied, the IMS-ALG:

- shall not forward the received candidate information in the SDP it sends towards the offerer;
- may provide received remote ICE candidates and the received related ICE user name fragment and password to the IMS-AGW; and
- shall not apply the remote NAT traversal using latching according to subclause 5.4.

After the initial SDP offer-answer exchange, the IMS-ALG can receive a new offer from the peer that includes updated address and port information in the SDP "c=" line, "m=" line, or "a=rtcp" line SDP attributes. If the ICE user name

fragment and password in the SDP offer differ from the ones received in the previous SDP (i.e. the peer restarts ICE), the IMS-ALG shall apply the same procedures as for the initial SDP offer.

When receiving a request for a host candidate for a media line, the IMS-AGW shall allocate one host candidate for that media line and send it to the IMS-ALG within the reply. The IP address and port shall be the same as indicated separately as Local IP Resources. The IMS-AGW shall also indicate that it supports ICE lite in the reply.

For a passive TCP ICE host candidate, the IMS-AGW shall be prepared to receive and answer the TCP connection establishment requests.

NOTE 3: The TCP connection control procedures in subclause 5.17 do not apply to TCP host candidates.

When receiving a request for an ICE user name fragment and password, the IMS-AGW shall generate an ICE user name fragment and password and send it to the IMS-ALG within the reply. The IMS-AGW shall store the password and user name fragment to be able to authenticate incoming STUN binding request according to subclause 7.2 of IETF RFC 5245 [39].

When receiving a request to act as STUN server, the IMS-AGW shall be prepared to answer STUN binding request according to subclause 7.2 of IETF RFC 5245 [39]. Once a STUN binding request with the "USE-CANDIDATE" flag has been received, the IMS-AGW may send media towards the source of the binding request.

5.18.3 Full ICE

If the IMS-ALG supports and is configured to use full ICE, and controls an IMS-AGW that supports full ICE, the procedures in the present subclause apply.

If the IMS-ALG receives an initial SDP offer with ICE candidate information, the IMS-ALG:

- shall not forward the received candidate information in the SDP it sends towards the answerer;
- shall request the IMS-AGW for each media line where it decides to use ICE to reserve an ICE host candidate and provide its address information and a related ICE user name fragment and password;

NOTE: Requesting only one host candidate per m-line prevents that the IMS-ALG will receive "a=remote-candidates" SDP attributes in a subsequent SDP. Requesting separate ufrag and password for each media line simplifies H.248 encoding.

- shall configure the IMS-AGW to act as STUN server at the host candidate address, i.e. to answer STUN connectivity checks;
- shall provide received remote ICE candidates and the received related ICE user name fragment and password to the IMS-AGW;
- shall include the host candidate and related ICE user name fragment and password received from the IMS-AGW in the SDP answer it forwards;
- shall determine the role of IMS-ALG in ICE (controlling or controlled) according to subclause 5.2 of IETF RFC 5245 [39];
- shall configure the IMS-AGW to perform connectivity checks in accordance with the determined ICE role;
- shall configure the IMS-AGW to report connectivity check results;
- shall configure the IMS-AGW to report a new peer reflexive candidate if discovered during the connectivity check; and
- shall not apply the remote NAT traversal using latching according to subclause 5.4.

If the IMS-ALG sends an SDP offer (or forwards a received SDP offer) towards a call leg where ICE is to be applied, the IMS-ALG:

- shall request the IMS-AGW to reserve a host candidate for each media line where it decides to use ICE and provide its address information, ICE user name fragment and password;

- shall configure the IMS-AGW to act as STUN server at the host candidate address, i.e. to answer STUN connectivity checks; and
- shall include the host candidate provided by the IMS-AGW and related ICE user name fragment and password in the SDP offer it forwards.

If the IMS-ALG then receives an SDP answer with candidate information from the call leg where ICE is to be applied, the IMS-ALG:

- shall not forward the received candidate information in the SDP it sends towards the offerer;
- shall provide received remote ICE candidates and the received related ICE user name fragment and password to the IMS-AGW;
- shall determine the role of IMS-ALG in ICE (controlling or controlled) according to subclause 5.2 of IETF RFC 5245 [39];
- shall configure the IMS-AGW to perform connectivity checks in accordance with the determined ICE role;
- shall configure the IMS-AGW to report connectivity check results;
- shall configure the IMS-AGW to report a new peer reflexive candidate if discovered during the connectivity check; and
- shall not apply the remote NAT traversal using latching according to subclause 5.4.

When the IMS-ALG is informed by the IMS-AGW about new peer reflexive candidate(s) discovered by the connectivity checks, it shall configure the IMS-AGW to perform additional connectivity checks for those candidates.

When the IMS-ALG is informed by the IMS-AGW about successful candidate pairs determined by the connectivity checks, the IMS-ALG shall send a new SDP offer to its peer with contents according to subclause 9.2.2.2 of IETF RFC 5245 [39] if it has the controlling role and the highest-priority candidate pair differs from the default candidates in previous SDP.

After the initial SDP offer-answer exchange, the IMS-ALG can receive a new offer from the peer that includes updated address and port information in the SDP "c=" line, "m=" line, or "a=rtcp" line SDP attributes. If the ICE user name fragment and password in the SDP offer differ from the ones received in the previous SDP (i.e. the peer restarts ICE), the IMS-ALG shall apply the same procedures as for the initial SDP offer.

When receiving a request for a host candidate for a media line, the IMS-AGW shall allocate one host candidate for that media line and send it to the IMS-ALG within the reply. The IP address and port shall be the same as indicated separately as Local IP Resources.

When receiving a request for an ICE user name fragment and password, the IMS-AGW shall generate an ICE user name fragment and password and send it to the IMS-ALG within the reply. The IMS-AGW shall store the password and user name fragment to be able to authenticate incoming STUN binding request according to subclause 7.2 of IETF RFC 5245 [39].

When receiving a request to act as STUN server, the IMS-AGW shall be prepared to answer STUN binding request according to subclause 7.2 of IETF RFC 5245 [39]. Once a STUN binding request with the "USE-CANDIDATE" flag has been received, the IMS-AGW may send media towards the source of the binding request.

When receiving a request to perform connectivity checks and to report connectivity check results, the IMS AGW:

- shall compute ICE candidate pairs according to subclause 5.7 of IETF RFC 5245 [39];
- shall schedule checks for the ICE candidate pairs according to subclause 5.8 of IETF RFC 5245 [39];
- shall send STUN connectivity checks for the scheduled checks according to subclause 7.1 of IETF RFC 5245 [39];
- shall inform the IMS-ALG about successful candidate pairs determined by the connectivity checks;
- shall inform the IMS-ALG about new peer reflexive candidate(s) discovered by the connectivity checks; and
- should send media using the highest priority candidate pair for which connectivity checks have been completed.

5.18.4 STUN consent freshness for WebRTC

The eIMS-AGW, which implements ICE, shall support the STUN consent freshness test defined in IETF RFC 7675 [49].

If the eP-CSCF supports and is configured to use full ICE, and controls an eIMS-AGW that supports full ICE, to initiate the STUN consent freshness procedures, the eP-CSCF shall request the eIMS-AGW to perform periodic STUN consent tests towards the WIC (WebRTC IMS Client). On receipt of requesting STUN consent test signal, the eIMS-AGW shall start sending STUN binding requests in order to verify consent, based on the interval value indicated by the eP-CSCF, after the transport address has been selected via the ICE-related connectivity check.

If the eP-CSCF is configured to use ICE lite, or supports only ICE lite, or controls an IMS-AGW that only support ICE lite, the eIMS-AGW shall not send STUN consent request checks. Instead, the IMS-AGW shall act as STUN server and only respond to incoming STUN binding requests received from the WIC (WebRTC IMS Client).

If STUN consent expires on a given transport address, the eIMS-AGW shall stop forwarding media on that transport address, and inform the eP-CSCF about the failure. In addition, the eIMS-AGW shall stop sending STUN consent request checks on the transport address. Once upon an indicated test failure, the eP-CSCF may request for appropriate action related to the H.248 stream, such as the removal of the H.248 stream.

5.19 MSRP handling

5.19.1 General

The IMS-ALG and IMS-AGW may support MSRP handling. If they support MSRP handling, they shall apply the procedures as specified in the present subclause 5.19.

For WebRTC terminations, MSRP is transferred over data channels. For WebRTC terminations the procedures in the present subclause 5.19 shall apply with the modifications described in subclause 5.19.6.

The IMS-AGW shall support application-agnostic MSRP handling.

NOTE 1: Application-agnostic MSRP handling suffices when IETF RFC 6714 [26] or IETF draft-ietf-simple-msrp-sessmatch is supported by both ends (e.g. between Rel-8 onwards IMS UEs) and no MSRP relays are used.

NOTE 2: The expired IETF draft-ietf-simple-msrp-sessmatch modifies the session matching procedure defined by IETF RFC 4975 [25]. A peer applying IETF draft-ietf-simple-msrp-sessmatch will only compare the session-id part of the first MSRP URI in the SDP "a=path" attribute with the session-id part of the first MSRP URI in the "To-Path" header field of the received MSRP packets. This draft is still used by OMA and GSMA as an alternative option to IETF RFC 6714 [26].

The IMS-AGW may in addition support application-aware MSRP interworking, as described in subclause 5.19.5..

NOTE 3: Application-aware MSRP interworking enables direct communication:

- between an MSRP client applying IETF RFC 6714 [26] and an MSRP client applying IETF RFC 4975 [25] without extensions by either IETF RFC 6714 [25] or IETF draft-ietf-simple-msrp-sessmatch.
- between an MSRP client applying IETF draft-ietf-simple-msrp-sessmatch and an MSRP client applying IETF RFC 4975 [25] without extensions by either IETF RFC 6714 [26] or IETF draft-ietf-simple-msrp-sessmatch.
- between an MSRP client applying IETF RFC 6714 [26] and an MSRP client applying IETF draft-ietf-simple-msrp-sessmatch.
- between two MSRP clients applying IETF RFC 4975 [25] without extensions by either IETF RFC 6714 [26] or IETF draft-ietf-simple-msrp-sessmatch.

However, to address these scenarios, application aware MSRP interworking can also be applied in other network elements than the IMS-ALG and IMS-AGW, for instance in an CPM Participating Function or CPM Interworking Function as defined in OMA-TS-CPM_Conversation_Function-V2 [46].

NOTE 4: MSRP relays external to the IMS-AGW are not supported in the present release.

The IMS-ALG procedures depend on whether the IMS-AGW applies application-agnostic MSRP interworking or application-aware MSRP interworking, and on the MSRP extensions applied on the interconnected call legs. The support of related procedures in subclauses 5.19.2 to 5.19.4 below are all optional, but the IMS-ALG shall support at least one of them.

Table 5.19.1-1: Behaviour of MSRP clients and related IMS-ALG and IMS-AGW procedures for MSRP with different extensions.

IETF document:	MSRP client takes destination address for TCP connection setup from	Session matching at MSRP client between SDP path and "To-Path" in MSRP messages includes address information	IMS-AGW needs to insert own address into "To-Path" in MSRP messages	IMS-ALG needs to modify SDP path attribute	Support of extension is negotiated
IETF RFC 4975 [25]	SDP MSRP path attribute	Yes	Yes	Yes	-
Expired draft-ietf-simple-msrp-sessmatch	SDP MSRP path attribute	No	No	Yes	No
IETF RFC 6714 [26]	SDP c-line and m-line	Yes	No (Yes if fallback to IETF RFC 4975 [6] occurs and is supported)	No	Yes, via SDP CEMA attribute

5.19.2 IMS-ALG procedures to support IETF RFC 6714 with application agnostic MSRP handling by the IMS-AGW

A peer applying IETF RFC 6714 [26] will include the "a=msrp-cema" SDP attribute in the first SDP offer it sends.

If the "a=msrp-cema" SDP attribute is contained in an SDP offer, the IMS-ALG:

- shall ensure that the IMS-AGW performs application agnostic MSRP handling by not configuring the IMS-AGW to apply application-aware MSRP interworking;
- shall indicate "TCP" or "TCP/TLS" (if e2ae media security is applied) as transport protocol to the IMS-AGW;
- shall forward the "a=path" attribute and the "a=msrp-cema" SDP attribute in the SDP offer without modification; and
- shall forward the "a=path" SDP attribute in the corresponding SDP answer without modification (even if the "a=msrp-cema" SDP attribute is not contained in the answer).

NOTE: If the "a=msrp-cema" SDP attribute is not contained in the SDP answer and the "a=path" SDP attribute is not modified, the offerer will discover a mismatch and send a new SDP offer without the "a=msrp-cema" SDP attribute according to IETF RFC 6714 [26] procedures.

If the "a=msrp-cema" SDP attribute is not contained in an SDP offer, the IMS ALG shall either apply the procedures in subclause 5.19.3 or subclause 5.19.4 (if supported).

5.19.3 IMS-ALG procedures to support IETF draft-ietf-simple-msrp-sessmatch with application agnostic MSRP handling by the IMS-AGW

A peer applying the expired IETF draft-ietf-simple-msrp-sessmatch will not include the "a=msrp-cema" SDP attribute in the SDP it sends, and will only compare the session-id part of the first MSRP URI in the SDP "a=path" attribute with the session-id part of the first MSRP URI in the "To-Path" header field of the first received MSRP packet.

If the "a=msrp-cema" SDP attribute is not contained in an SDP offer, the IMS-ALG:

- shall ensure that the IMS-AGW performs application agnostic MSRP handling by not configuring the IMS-AGW to apply application-aware MSRP interworking;

- shall indicate "TCP" or "TCP/TLS" (if e2ae media security is applied) as transport protocol to the IMS-AGW; and
- shall replace the IP address and TCP port in the only entry of the "a=path" SDP attribute in received SDP offer or answer with the IP address and TCP port allocated for the media stream at the IMS-AGW before forwarding the SDP.

5.19.4 IMS-ALG procedures for application aware MSRP interworking by the IMS-AGW

The IMS ALG:

- shall provide the SDP "a=path" attribute, as received in SIP/SDP signalling, to the IMS-AGW as "MSRP Path" with the remote descriptor of the corresponding call leg;
- shall ensure that the IMS-AGW performs application aware MSRP interworking by configuring the IMS-AGW to apply application-aware MSRP interworking; and
- shall indicate "TCP/MSRP" or "TCP/TLS/MSRP" (if e2ae media security is applied) as transport protocol to the IMS-AGW.

If interworking between an MSRP client applying IETF RFC 6714 [26] and an MSRP client applying IETF RFC 4975 [25] without extensions by either IETF RFC 6714 [26] or IETF draft-ietf-simple-msrp-sessmatch needs to be supported, the IMS ALG should:

- when receiving an SDP offer including the "a=msrp-cema" SDP attribute, include the "a=msrp-cema" SDP attribute in the SDP answer on that call leg;
- when sending an SDP offer, include the "a=msrp-cema" SDP attribute; and
- if the "a=msrp-cema" SDP attribute is not contained in a received SDP answer and the SDP c/m-line address information does not match the "a=path" attribute, send a new SDP offer without the "a=msrp-cema" SDP attribute according to IETF RFC 6714 [26] procedures.

NOTE: The second SDP offer can be omitted if the IMS-ALG knows that there is no SBC in the path (e.g. between the IMS-ALG and the UE).

5.19.5 Application-aware MSRP interworking at the IMS-AGW

The IMS-AGW shall apply application-aware MSRP interworking either if being statically configured to do so, or if being instructed from the IMS-ALG. Support of dynamic instructions from the IMS-ALG is optional.

To apply application-aware MSRP interworking, the IMS-AGW:

- shall modify the MSRP "To-Path" header field in application (i.e. MSRP) data by replacing the IP address and TCP port of the only entry with the corresponding information in the "MSRP path" provided by the IMS_ALG while retaining the MSRP session ID part of the entry as received in the MSRP "To-Path"; and
- shall forward the MSRP data without further modification.

NOTE: MSRP session matching will be performed only by the MSRP clients.

5.19.6 MSRP data channels

MSRP signalling can be transferred over WebRTC data channels as a data channel sub-protocol using the SDP offer/answer negotiation according to IETF draft-ietf-mmusic-msrp-usage-data-channel [62]. WebRTC data channels are described in subclause 5.20.2. For WebRTC terminations the procedures in subclause 5.19 shall apply with the modifications described in the present subclause.

Within received SIP/SDP signalling related to a WebRTC termination MSRP contents within a data channel will be marked with the "subprotocol="MSRP"" subfield in the "a=dcmapp" SDP attribute according to IETF draft-ietf-mmusic-data-channel-sdpneg [65]. The MSRP related "a=msrp-cema", "a=path", "a=accept-types" and "a=setup" SDP attributes will be encapsulated in "a=dcsa" SDP attributes according to IETF draft-ietf-mmusic-data-channel-sdpneg [65]. The

"a=msrp-cema" can be present or omitted in received SIP/SDP signalling, but IETF RFC 6714 [26] is always applicable for MSRP within WebRTC data channels.

When receiving an SDP offer including such MSRP related information in SIP/SDP signalling related to a WebRTC data channel, and forwarding the SDP offer towards a termination where no WebRTC data channel is to be used, the IMS-ALG shall:

- describe each MSRP data channel in a separate SDP media line in the SDP offer it forwards;
- include "a=msrp-cema", "a=path", "a=accept-types" and "a=setup" SDP attributes received encapsulated in "a=dcsa" SDP attributes in the forwarded SDP offer for the corresponding MSRP media line(s) without the encapsulation;
- include an "a=msrp-cema" SDP attribute for the corresponding MSRP media line(s); and
- execute the procedures in the subclause 5.19 as if an "a=msrp-cema" SDP attribute had been received.

When receiving an SDP offer including MSRP related information without an indication of WebRTC data channel usage in SIP/SDP signalling, and forwarding the SDP offer towards a termination where a WebRTC data channel is to be used, the IMS-ALG shall:

- describe each received MSRP media line as a separate data channel;
- include any received "a=msrp-cema", "a=path", "a=accept-types" and "a=setup" SDP attributes received for the MSRP media line(s) encapsulated in "a=dcsa" SDP attributes in the forwarded SDP offer;
- include an "subprotocol="MSRP"" subfield in a "a=dcmapp" SDP attribute; and
- not include the "max-retr", "max-time" and "ordered" parameters in the "a=dcmapp" SDP attribute.

For terminations with MSRP within a WebRTC data channel, the IMS-ALG shall:

- indicate a transport protocol according to subclause 5.20.2 to the eIMS-AGW; and
- for application aware MSRP interworking:
 - a) indicate that MSRP is used within the data channel to the eIMS-AGW; and
 - b) provide the SDP "a=path" attribute encapsulated in "a=dcsa" SDP attribute, as received in SIP/SDP signalling, to the eIMS-AGW as "Encapsulated MSRP Path" with the remote descriptor of the corresponding call leg.

5.20 Web Real-Time Communication (WebRTC)

5.20.1 General

The following requirements apply for a "P-CSCF enhanced for WebRTC (eP-CSCF)" and an "IMS-AGW enhanced for WebRTC (eIMS-AGW)":

- End-to-access-edge security for RTP based media using DTLS-SRTP, subclause 5.11.2.4, shall be supported.
- End-to-access-edge security for RTP based media using DTLS-SRTP over TCP transport, subclause 5.11.2.5, may be supported.
- Interactive Connectivity Establishment (ICE), subclause 5.18, shall be supported. ICE for TCP may be supported in addition to offer an alternative transport for UDP based media as specified in subclause 5.18.
- STUN Consent Freshness, subclause 5.18.4, shall be supported.
- RTP/RTCP transport multiplexing, subclause 5.9.2 shall be supported.
- Audio transcoding, subclause 5.13, shall be supported. Video transcoding may be supported.

- Transcoding to/from the Opus Audio Codec, IETF RFC 6716 [50], subclause 5.13.4, should be supported.
- Procedures for the eIMS-AGW to act as a data channel endpoint should be supported according to IETF draft ietf-rtcweb-data-channel [61], see subclause 5.20.2.
- Data channels used for WebRTC to transport MSRP as a data channel sub-protocol, i.e. MSRP data channels between the UE and the eIMS-AGW should be supported according to IETF draft-ietf-mmusic-msrp-usage-data-channel [62] and the procedures in subclause 5.19.6. SCTP/DTLS/UDP should be transported as protocol stack for data channels and SCTP/DTLS/TCP may be supported.
- Data channels used for WebRTC to transport BFCP as a data channel sub-protocol, i.e. BFCP data channels between the UE and the eIMS-AGW may be supported according to IETF draft-schwarz-mmusic-bfcp-usage-data-channel [76] and the procedures in subclause 5.20.2.5.
- Data channels used for WebRTC to transport T.140 (used for Global Text Telephony, GTT) as a data channel sub-protocol, i.e. T.140 data channels between the UE and the eIMS-AGW may be supported according to IETF draft-schwarz-mmusic-t140-usage-data-channel [75] and the procedures in subclause 5.20.2.6.
- The media plane optimization procedures in subclause 5.20.3 may be supported.

5.20.2 WebRTC data channel

5.20.2.1 General

In the WebRTC framework, non-media data communication between UEs is handled by using data channels according to IETF draft-ietf-rtcweb-data-channel [61]; within SCTP (see IETF RFC 4960 [63]), encapsulated in DTLS (see IETF RFC 6347 [32]). The related SDP signalling is described in IETF draft-ietf-mmusic-sctp-sdp [64] and IETF draft-ietf-mmusic-data-channel-sdpneg [65].

5.20.2.2 Data Channel Establishment

Data channels can use either a SCTP/DTLS/UDP or SCTP/DTLS/TCP based transport. If the eP-CSCF (IMS-ALG) and the eIMS-AGW support data channels, they shall support the SCTP/DTLS/UDP based transport and may support the SCTP/DTLS/TCP based transport.

NOTE 1: This subclause assumes that the UDP based option is used as default ICE candidate for WebRTC terminations. TCP based transport can be offered in addition as alternative transport using ICE for TCP as specified in subclause 5.18.

Upon receipt of an SDP offer containing SDP attributes for new SCTP associations and/or new data channels according to IETF draft-ietf-mmusic-sctp-sdp [64] and IETF draft-ietf-mmusic-data-channel-sdpneg [65] from the WebRTC access network, the eP-CSCF (IMS-ALG):

- shall check if a new DTLS association and SCTP association is to be set up or an existing DTLS association and SCTP association are to be reused (NOTE 1) according to IETF draft-ietf-mmusic-dtls-sdp [81] and IETF draft-ietf-mmusic-sctp-sdp [64];

NOTE 2: The present procedures assume that the DTLS association and SCTP association are established together. A separate establishment of DTLS association and SCTP association is not supported in the present release.

- if a new DTLS connection and SCTP association are to be set up:
 - 1) shall request a new H.248 stream group (see details below) on a new termination towards the WebRTC access network from the eIMS-AGW;
 - 2) shall request a deaggregation stream to handle the SCTP association and DTLS association, and for the H.248 deaggregation stream:
 - a) shall send the remote UDP port and SCTP port to the eIMS-AGW;
 - b) shall request the local UDP port and SCTP port from the eIMS-AGW;

- c) shall insert the local UDP port and SCTP port received from the eIMS-AGW into the SDP answer towards the WebRTC access network;
- d) shall provide the remote SCTP maximum message size, as received within the "a=max-message-size" SDP attribute, to the eIMS-AGW;
- e) shall request the eIMS-AGW to provide its own local SCTP maximum message size;
- f) shall insert the SCTP maximum message size received from the eIMS-AGW into the SDP answer towards the WebRTC access network;
- g) shall check the received value of the "a=setup" SDP attribute to determine if the eIMS-AGW needs to act as DTLS client or DTLS server. When the received value is equal to:
 - i) "active" the eIMS-AGW needs to act as DTLS server;
 - ii) "passive" the eIMS-AGW needs to act as DTLS client; or
 - iii) "actpass" the eP-CSCF (IMS-ALG) shall decide if the eIMS-AGW needs to act as DTLS client or DTLS server;
- h) if the eIMS-AGW needs to act as DTLS client;
 - i) shall provide the Establish (D)TLS session information element to request the eIMS-AGW to start the DTLS session setup; and
 - ii) shall provide the Establish SCTP association information element to request the eIMS-AGW to start the SCTP association setup as soon as DTLS association is data transfer ready;

NOTE 3: Such an H.248 control leads to the emulation of "simultaneous SCTP association establishment" (i.e., the eIMS-AGW behaves according to clause 5.2.1 of IETF RFC 4960 [63]).

- i) if the eIMS-AGW needs to act as DTLS server, may include the Notify (D)TLS session establishment information element to request the eIMS-AGW to notify the eP-CSCF (IMS-ALG) about an incoming DTLS session setup;
 - j) shall indicate to the eIMS-AGW "UDP/DTLS/SCTP" as transport protocol;
 - k) shall provide to the eIMS-AGW the Remote certificate fingerprint information element with the value of the received fingerprint SDP attribute(s) from the WIC;
 - l) shall include the Local certificate fingerprint Request information element to request the certificate fingerprint of the eIMS-AGW; and
 - m) shall indicate to the eIMS-AGW the SCTP stream identifiers of H.248 component stream(s) (i.e. SCTP streams corresponding to data channels) to be de-multiplexed;
- 3) shall indicate the grouping of the H.248 deaggregation stream and the H.248 component stream(s) with SCTP semantics to the eIMS-AGW; and
- 4) shall request the eIMS-AGW to provide a notification when receiving an SCTP stream reset request and to autonomously answer that SCTP stream reset request;
- if an existing DTLS association and SCTP association are to be reused, shall modify the existing termination for that SCTP association by:
- 1) indicating to the eIMS-AGW the SCTP stream identifiers of H.248 component stream(s) (i.e. SCTP streams corresponding to data channels) to be de-multiplexed; and
 - 2) indicating the H.248 stream grouping of the H.248 deaggregation stream and the H.248 component stream(s) with SCTP semantics to the eIMS-AGW;

NOTE 4: The information element relates to an H.248 Stream Group (SG) which allows:

- a) to separate the protocol stack in the levels of data channels (DC) and the commonly shared lower transport, and
- b) to support multiple DCs. The SG is part of the WebRTC termination.

- for each data channel to be established:
 - 1) shall reserve a separate H.248 stream at the termination towards the WebRTC access network;
 - 2) shall provide the SCTP stream identifier to the eIMS-AGW;
 - 3) shall provide the information received in the SDP "a=dcmap" attribute to the eIMS-AGW;

NOTE 5: For MSRP, BFCP and T.140 within data channels, the default values of the "max-retr" parameter, the "max-time" parameter and the "ordered" parameter apply and those parameters are not included.

- 4) if application aware handling of the contents within the data channel is required, may provide the information received in SDP "a=dcsa" attributes to the eIMS-AGW as "remote dcsa" information elements, taking into account the specific procedures defined for the subprotocols within the data channel;
 - 5) if the first data channel is to be established, shall reserve a termination towards the core network;
 - 6) shall reserve a H.248 stream towards the core network;
 - 7) shall indicate to the eIMS-AGW how to interwork the information send or received in data channels with information send or received on streams towards the IMS core network by using the same H.248 stream identifier for the H.248 stream towards the WebRTC access network and towards the core network;
 - 8) shall indicate to the eIMS-AGW an appropriate transport protocol towards the IMS core network (e.g. "TCP" for MSRP and BFCP) for the media described in the dcmap attribute for the data channel when reserving the transport addresses/resources towards the IMS core network;
 - 9) shall provide an appropriate media line for the media described in the dcmap attribute in the SDP offer towards the IMS core network; and
 - 10) should de-encapsulate SDP attributes within the received SDP "a=dcsa" attributes in the SDP offer and include the de-encapsulated SDP attributes in the SDP offer towards the IMS core network as media attributes for the media line corresponding to the data channel, taking into account specific procedures defined for the subprotocol within the data channel; and
- shall remove the "a=setup", "a=connection" "a=dcmap" and possible "a=dcsa" SDP attributes and fingerprint information from the SDP offer towards the IMS core network.

Upon receipt of a corresponding SDP answer from the IMS core network, if the SDP answer does not indicate that media plane optimization is to be applied (see subclause 5.20.3.2), the eP-CSCF (IMS-ALG):

- instead of the media line(s) describing media that are to be transported within data channel(s), shall provide an "m=" line with the transport protocol "UDP/DTLS/SCTP";
- shall insert the fingerprint SDP attribute with the value of the Local certificate fingerprint information element received from the eIMS-AGW;
- if the IMS-ALG received from the WIC an SDP offer with "a=tls-id" media-level SDP attribute for the DTLS association:
 - 1) if an existing DTLS association is reused, shall include the "a=tls-id" SDP attribute with the value assigned to that DTLS association in the SDP answer which the IMS-ALG sends to the WIC; and
 - 2) if a new DTLS association is to be established, shall include the "a=tls-id" SDP attribute with a new unique value in the SDP answer which the IMS-ALG sends to the WIC;
- shall insert the "a=setup" SDP attribute with the value:
 - 1) "active" if the eP-CSCF (IMS-ALG) requested the eIMS-AGW to act as DTLS client; or
 - 2) "passive" if the eIMS-AGW shall take the DTLS server role; and
- for each received media line describing media that are to be transported within a data channel:
 - 1) shall insert an "a=dcmap" attribute with the same values for the SCTP stream identifier, "subprotocol" and "label" parameters as received in the SDP offer, and with possible values for the "max-retr", "max-time", and

"ordered" parameters according to the requirements of the transported data flow and capabilities of the eIMS-AGW;

NOTE 6: For MSRP, BFCP and T.140 within data channels, the default values of the "max-retr" parameter, the "max-time" parameter and the "ordered" parameter apply and those parameters are not included.

- 2) should insert SDP "a=dcsa" attributes into the SDP answer towards the WebRTC access network encapsulating subprotocol specific SDP attributes received in the SDP answer, taking into account specific procedures defined for the subprotocol within the data channel;
- 3) shall provide the information in the sent SDP "a=dcmap" attribute to the eIMS-AGW; and
- 4) may provide the information within the sent SDP "a=dcsa" attributes to the eIMS-AGW as "local dcsa" information elements, taking into account specific procedures defined for the subprotocol within the data channel.

Upon receipt of an SDP offer from the IMS core network for new media streams that need to be transported within a WebRTC data channel on the WebRTC access network, if the SDP offer does not indicate that media plane optimization is to be applied (see subclause 5.20.3.3), the eP-CSCF (IMS-ALG):

- shall determine if it can reuse an existing DTLS association and SCTP association or if it needs to set up a new DTLS association and SCTP association;
- if a new DTLS association and SCTP association are to be set up:
 - 1) shall request a new termination towards the WebRTC access network from the eIMS-AGW;
 - 2) shall request a deaggregation stream to handle the SCTP association and DTLS association, and for the H.248 deaggregation stream:
 - a) shall request the local UDP port and SCTP port from the eIMS-AGW;
 - b) shall insert the local UDP port and SCTP port received from the eIMS-AGW into the SDP offer towards the WebRTC access network;
 - c) shall request the eIMS-AGW to provide its own local SCTP maximum message size;
 - d) shall insert the SCTP maximum message size received from the eIMS-AGW into the SDP offer towards the WebRTC access network;
 - e) shall add an SDP "a=setup" attribute with value "actpass" into the SDP offer;
 - f) shall indicate to the eIMS-AGW "UDP/DTLS/SCTP" as transport protocol;
 - g) shall include the Local certificate fingerprint Request information element to request the certificate fingerprint of the eIMS-AGW;
 - h) shall insert the fingerprint SDP attribute with the value of the Local certificate fingerprint information element received from the eIMS-AGW into the SDP offer towards the WebRTC access network; and
 - i) shall indicate to the eIMS-AGW the SCTP stream identifiers of H.248 component stream(s) (i.e. SCTP streams corresponding to data channels) to be de-multiplexed;
 - 3) shall indicate the H.248 stream grouping of the H.248 deaggregation stream and the H.248 component stream(s) with SCTP semantics to the eIMS-AGW; and
 - 4) shall request the eIMS-AGW to provide a notification when receiving an SCTP stream reset request and to autonomously answer that SCTP stream reset request;
- if an existing DTLS association and SCTP association are to be reused, shall modify the existing termination towards the WebRTC access network for that SCTP association by:
 - 1) indicating to the eIMS-AGW the SCTP stream identifiers of H.248 component stream(s) (i.e. SCTP streams corresponding to data channels) to be de-multiplexed; and
 - 2) indicating the H.248 stream grouping of the H.248 deaggregation stream and the H.248 component stream(s) with SCTP semantics to the eIMS-AGW;

- instead of the media line(s) describing media that are to be transported within data channel(s), shall provide an "m=" line with the transport protocol "UDP/DTLS/SCTP";
- shall insert an "a=tls-id" SDP attribute in the SDP offer with a new or reused value (depending on whether an existing DTLS association is reused); and
- for each received media line describing media that are to be transported within a data channel:
 - 1) shall reserve a separate H.248 stream at the termination towards the WebRTC access network;
 - 2) shall insert an "a=dcmmap" attribute with an unused SCTP stream identifier, and with "subprotocol" and "label" parameters according to the requirements of the transported data flow, and with possible values for the "max-retr", "max-time", and "ordered" parameters according to the requirements of the transported data flow and capabilities of the eIMS-AGW;

NOTE 7: For MSRP, BFCP and T.140 within data channels, the default values of the "max-retr" parameter, the "max-time" parameter and the "ordered" parameter apply and those parameters are not included.

- 3) shall provide the SCTP stream identifier to the eIMS-AGW;
- 4) shall provide the information in the sent SDP "a=dcmmap" attribute to the eIMS-AGW;
- 5) should insert SDP "a=dcsa" attributes into the SDP offer towards the WebRTC access network encapsulating any subprotocol specific SDP attributes received in the SDP offer, taking into account specific procedures defined for the subprotocol within the data channel;
- 6) if application aware handling of the contents within the data channel is required, may provide the information within the sent SDP "a=dcsa" attributes to the eIMS-AGW as "local dcsa" information elements, taking into account specific procedures defined for the subprotocol within the data channel;
- 7) if the first data channel is to be established, shall reserve a termination towards the core network;
- 8) shall reserve a H.248 stream towards the core network; and
- 9) shall indicate to the eIMS-AGW how to interwork the information sent or received in data channels with information sent or received on terminations and/or streams towards the IMS core network by using the same H.248 stream identifier for the stream towards the WebRTC access network and towards the core network.

Upon receipt of a corresponding SDP answer from the WebRTC access network, the eP-CSCF (IMS-ALG):

- if a new DTLS association and SCTP association are to be set up, for the H.248 deaggregation stream to handle the SCTP association and DTLS connection:
 - 1) shall send the received remote UDP port and SCTP port to the eIMS-AGW;
 - 2) shall include the Remote certificate fingerprint information element with the value of the received fingerprint SDP attribute(s) from the WebRTC access network;
 - 3) shall check the received value of the "a=setup" SDP attribute to determine if the eIMS-AGW needs to act as DTLS client or DTLS server. When the received value is equal to:
 - a) "active" the eIMS-AGW needs to act as DTLS server;
 - b) "passive" the eIMS-AGW needs to act as DTLS client; or
 - c) "actpass" the eP-CSCF (IMS-ALG) shall decide if the eIMS-AGW needs to act as DTLS client or DTLS server;
 - 4) if the eIMS-AGW needs to act as DTLS client:
 - a) shall include the Establish (D)TLS session information element to request the eIMS-AGW to start the DTLS session setup; and
 - b) shall provide the Establish SCTP association information element to request the eIMS-AGW to start the SCTP association setup as soon as DTLS connection is data transfer ready;

- 5) if the eIMS-AGW needs to act as DTLS server, may include the Notify (D)TLS session establishment information element to request the eIMS-AGW to notify the eP-CSCF (IMS-ALG) about an incoming DTLS session setup; and
 - 6) shall provide the remote SCTP maximum message size, as received within the "a=max-message-size" SDP attribute, to the eIMS-AGW;
- shall remove the "a=setup", "a=connection" "a=dcmmap" and possible "a=dcsa" SDP attributes and fingerprint information from the SDP answer and indicate the transport protocol "TCP" in the SDP answer towards the IMS core network; and
 - for each accepted data channel:
 - 1) shall provide the information received in the SDP "a=dcmmap" attribute to the eIMS-AGW;
 - 2) if application aware handling of the contents within the data channel is required, may provide the information within the received SDP "a=dcsa" attributes in the SDP answer to the eIMS-AGW as "remote dcsa" information elements, taking into account specific procedures defined for the subprotocol within the data channel; and
 - 3) should de-encapsulate SDP attributes within the received SDP "a=dcsa" attributes in the SDP answer and include the de-encapsulated SDP attributes in the SDP answer towards the IMS core network, taking into account specific procedures defined for the subprotocol within the data channel.

If requested to set up a new DTLS association and SCTP association, the eIMS-AGW shall:

- allocate the local UDP port and SCTP port, and send them to the eP-CSCF (IMS-ALG);
- when being instructed to start the DTLS bearer session setup, act as a DTLS client and establish the DTLS bearer session;
- upon request from the eP-CSCF (IMS-ALG), provide the SCTP maximum message size;
- upon request from the eP-CSCF (IMS-ALG), select an own certificate, and send the fingerprint of the own certificate to the eP-CSCF (IMS-ALG);
- uniquely associate the certificate fingerprint(s) received from the eP-CSCF (IMS-ALG) with the corresponding DTLS association, and subsequently use the certificate fingerprint(s) to verify the establishment of the DTLS bearer session;
- if the verification of the remote certificate fingerprint(s) during the DTLS bearer session establishment fails, regard the remote DTLS endpoint as not authenticated, terminate the DTLS bearer session and report the unsuccessful DTLS bearer session setup to the eP-CSCF (IMS-ALG);
- upon completion of the DTLS association establishment, set up the SCTP association according to IETF RFC 4960 [63]; and
- deaggregate H.248 component streams upon request from the eP-CSCF (IMS-ALG).

If the eP-CSCF (IMS-ALG) requests that a termination with an existing SCTP association is being modified, the eIMS-AGW shall reuse an existing DTLS association and SCTP association.

If the eP-CSCF (IMS-ALG) requests that a new H.248 component stream with a H.248 stream group related to an SCTP association is being reserved, the eIMS-AGW shall set up the data channel according to IETF draft-ietf-rtcweb-data-channel [61] procedures. The eIMS-AGW shall also interwork the information sent or received in data channels with information sent or received on terminations and/or streams towards the IMS core network according to the configuration received by the eP-CSCF (IMS-ALG).

NOTE 8: The handling of priority information that is part of the dcmmap information received from the eP-CSCF (IMS-ALG) is left to the eIMS-AGW implementation.

5.20.2.3 Data Channel Release

5.20.2.3.1 General

In the present Release, the closure of individual WebRTC data channels (subclause 5.20.2.3.2) and the complete release of the entire WebRTC data service (subclause 5.20.2.3.3) are supported.

NOTE 1: The hierarchical protocol stack for WebRTC data ("DC/SCTP/DTLS/(UDP/TCP)/IP") contains up to four levels of user plane bearer control procedures, from top to bottom:

- 1) DC: SCTP Stream reconfiguration procedures for resetting SCTP Streams;
- 2) SCTP Association: shutdown procedure;
- 3) DTLS: DTLS connection release procedure (apart from resumption and renegotiation procedures); and
- 4) TCP: TCP connection release procedure. (However, TCP transport of WebRTC data channels is not supported in the present Release).

The present Release does not consider specific release variations at levels 2 to 4, such as the shutdown of an SCTP Association without a DTLS connection release.

A data channel can be closed before the end of the WebRTC call. In the present Release, the H.248 Stream endpoint related to a data channel may be removed after the closure of the data channel, but a subsequent reuse of the corresponding SCTP Stream identifier is possible via an SDP offer-answer exchange triggering the reservation of new H.248 Stream endpoint.

NOTE 2: There are multiple variations possible because the "CLOSURE of a data channel" results in a reset of the SCTP Stream (see subclause 6.7 of IETF draft-ietf-rtcweb-data-channel [61]), i.e. the concerned SCTP Stream still exists from protocol stack perspective. Such a reset SCTP Stream could be reused again (for the same or another WebRTC data application). There are consequently two options from the eP-CSCF (IMS-ALG) perspective: the correspondent H.248 Stream endpoint remains allocated and part of the H.248 Stream Group for a possible future reuse, or the H.248 Stream endpoint is completely removed from the termination.

5.20.2.3.2 Release of one WebRTC data channel

When the eP-CSCF (IMS-ALG) receives:

- an SDP offer or answer from the WebRTC access network releasing a particular WebRTC data channel while maintaining the corresponding SCTP Association, encoded according to IETF draft-ietf-mmusic-data-channel-sdpneg [65]; or

NOTE 1: Such an SDP offer or answer is characterized by the exclusion of the "a=dcmmap:" and "a=dcsa:" attribute lines for an existing data channel (DC). See subclause 5.2.4 of IETF draft-ietf-mmusic-data-channel-sdpneg [65] related to the general closure of an application-agnostic DC and subclause 5.1.5 of IETF draft-ietf-mmusic-msrp-usage-data-channel [62] for an example of an application-aware DC closure.

- an SDP offer or answer from the IMS core network disabling media streams that need to be transported within a WebRTC data channel on the WebRTC access network (i.e. media line with port zero) while maintaining other media streams that are transported within another data channel within the same SCTP Association enabled; or
- a notification from the eIMS-AGW that the peer has reset the incoming SCTP Stream that corresponds to a data channel;

then the eP-CSCF (IMS-ALG):

- 1) shall provide the *Send SCTP Stream Reset Requests Indicator* information element to the eIMS-AGW to request the eIMS-AGW to start the SCTP Stream reset for the corresponding outgoing SCTP Stream;

NOTE 2: This will trigger the peer to also reset the corresponding incoming SCTP Stream, unless the peer has already done so before.

- 2) may provide the *Received SCTP Stream Reset Response* information element to the eIMS-AGW if the eP-CSCF (IMS-ALG) wants to receive an explicit notification from the eIMS-AGW that the peer has reset the corresponding incoming SCTP Stream;

- 3) upon the reception of a Notification from the eIMS-AGW that the peer has reset the corresponding incoming SCTP Stream and the additional notification from the eIMS-AGW about the result of the outgoing SCTP Stream (if requested), may release the corresponding H.248 Stream endpoints at the terminations towards the WebRTC access network and towards the IMS core network;
- 4) if an received SDP offer or answer from the WebRTC access network triggered the release of the data channel, shall forward the SDP offer or answer to IMS core network with the media line corresponding to the media stream in the data channel disabled by port zero;
- 5) if an received SDP offer or answer from the IMS core network triggered the release of the data channel, shall forward the SDP offer or answer to WebRTC access network with the corresponding WebRTC data channel released with encoding according to IETF draft-ietf-mmusic-data-channel-sdpneg [65]; and
- 6) if all of the following conditions apply:
 - a notification from the eIMS-AGW that the peer has reset the incoming SCTP Stream triggered the release of the data channel;
 - the application subprotocol does not mandate that the closing of a data channel is also signalled via a new SDP offer/answer exchange; and
 - no corresponding SIP/SDP information is received in due time;

should send the appropriate SIP message with the SDP body to the IMS core network with the media line corresponding to the media stream in the data channel disabled by port zero.

NOTE 3: According to IETF draft-ietf-mmusic-data-channel-sdpneg [65], it is specific to the subprotocol whether this closing of a data channel MUST in addition the the SCTP SSSN reset also be signalled to the peer via a new SDP offer/answer exchange. For MSRP, if the peer triggers a data channel release by resetting the incoming SCTP Stream, it is also mandated to send corresponding SIP/SDP information.

5.20.2.3.3 Release of all or last active WebRTC data channels within an SCTP Association

When the eP-CSCF (IMS-ALG) receives:

- an SDP offer or answer from the WebRTC access network requesting to release the SCTP Association used to transport data channels, encoded according to IETF draft-ietf-mmusic-data-channel-sdpneg [65] (i.e. media line with port zero); or
- an SDP offer or answer from the IMS core network disabling all media stream(s) that need to be transported within a WebRTC data channel on the WebRTC access network (i.e. media line(s) with port zero);

then the eP-CSCF (IMS-ALG):

- 1) shall release the corresponding H.248 Stream group or termination towards the WebRTC access network;

NOTE 1: In the present release, a separate DTLS connection is used for each for each SCTP Association and for each audio or video media stream (for their DTLS-SRTP-based key exchange).

- 2) shall release the corresponding H.248 streamendpoint(s) or termination towards the IMS core network;

NOTE 2: If a new SDP offer from the access network arrives that requests a new data channel, then a stream endpoint and possibly a termination towards the IMS core network has to be added again.

- 3) if an received SDP offer or answer from the WebRTC access network triggered the release of the SCTP Association, shall forward the SDP offer or answer to the IMS core network with all media line(s) corresponding to the media stream(s) in the data channel(s) within that SCTP Association disabled by port zero; and
- 4) if an received SDP offer or answer from the IMS core network triggered the release of the SCTP Association, shall forward the SDP offer or answer to WebRTC access network with the corresponding release of the SCTP Association with encoding according to IETF draft-ietf-mmusic-data-channel-sdpneg [65] (i.e. media line with port zero).

When the eP-CSCF (IMS-ALG) requests the eIMS-AGW to release an entire H.248 Stream group or termination associated with an SCTP Association, then the eIMS-AGW should execute appropriate bearer control procedures to release the DTLS connection.

NOTE 3: If one DTLS connection endpoint closes the DTLS connection (e.g. sends a DTLS fatal alert), then the other DTLS connection endpoint unambiguously knows that also the SCTP association and all previously existing data channel instances are implicitly closed.

NOTE 4: 'TCP' as L4 protocol is supported for WebRTC audio and video, but not for data in the present release.

5.20.2.4 MSRP within WebRTC data channel

See subclause 5.19.6.

5.20.2.5 BFCP within WebRTC data channel

The Binary Floor Control Protocol (BFCP, see IETF RFC 4582 [31]) can be transferred over WebRTC data channels as a data channel sub-protocol according to IETF draft-schwarz-mmusic-bfcp-usage-data-channel [76]. The WebRTC data channel procedures in subclause 5.20.2.2 shall apply with the modifications described in the present subclause. BFCP within a data channel is identified via the "BFCP" value of the "subprotocol" parameter of the SDP "a=dcmap" attribute.

BFCP transported outside the data channel in the IMS core network is identified via the "TCP/BFCP" value of the "proto" parameter of the SDP m-line (see IETF RFC 4583 [27]).

NOTE 1: Procedures to terminate TLS at core network terminations are not defined in the present specification, and the value "TCP/TLS/BFCP" is thus not supported.

The eIMS-AGW shall forward the BFCP protocol layer in an application agnostic manner, and the eIMS-ALG shall not apply the procedures in subclause 5.20.2.2 to configure the eIMS-AGW for an application-aware handling of the contents within the data channel.

NOTE 2: Procedures for an application-aware handling of BFCP are not defined in the present specification.

The eIMS-ALG shall provision "TCP" as transport protocol to the eIMS-AGW for the termination towards the IMS core network.

The eIMS-ALG shall de-encapsulate SDP "floorctrl", "confid", "userid", "floorid" and "bfcprver" attributes received within "a=dcsa" attributes from the served WIC and forward them within the SDP body in the corresponding SIP message sent to the IMS core network.

The eIMS-ALG shall encapsulate SDP "floorctrl", "confid", "userid", "floorid" and "bfcprver" SDP attributes received from the IMS core network within "a=dcsa" attributes and forward those attributes within the SDP body in the corresponding SIP message sent to the served WIC.

The eIMS-ALG shall not provision the SDP "floorctrl", "confid", "userid", "floorid" and "bfcprver" attributes to the eIMS-AGW.

5.20.2.6 T.140 within WebRTC data channel

T.140 (see ITU-T Recommendation T.140 [73]) is used for Global Text Telephony (GTT). T.140 signalling can be transferred over WebRTC data channels as a data channel sub-protocol according to IETF draft-schwarz-mmusic-t140-usage-data-channel [75]. The WebRTC data channel procedures in subclause 5.20.2.2 shall apply with the modifications described in the present subclause.

T.140 within a data channel is identified via the "t140" value of the "subprotocol" parameter of the SDP "a=dcmap" attribute.

T.140 transported outside the data channel in the IMS core network is identified via the "RTP/AVP" or "RTP/AVPF" value of the "proto" parameter and the "text" value of the "media" parameter of the SDP m-line, and via the "t140" MIME subtype signalled in the SDP "a=rtpmap" attribute (see IETF RFC 4103 [74]).

The eIMS-ALG shall apply the procedures in subclause 5.20.2.2 to configure the eIMS-AGW for an application-aware handling of the contents within the data channel.

For the termination toward the IMS core network, the eIMS-ALG shall provision "RTP/AVP" or "RTP/AVPF" as transport and the "t140" payload type.

The eIMS-ALG shall de-encapsulate the SDP "fmt:cp" attributes received within "a=dcsa" attributes from the served WIC, provision them to the eIMS-AGW, and forward them within the SDP body in the corresponding SIP message sent to the IMS core network.

The eIMS-ALG shall provision SDP "fmt:cp" attributes received from the IMS core network to the eIMS-AGW, encapsulate them within "a=dcsa" attributes, and forward those attributes within the SDP body in the corresponding SIP message sent to the served WIC.

The eIMS-AGW should handle T.140 protocol layer in the following application specific manner:

- The eIMS-AGW should detect inactivity of T.140 traffic from the served WIC and then send empty RTP packets towards the IMS core network;
- the eIMS-AGW should buffer the T.140 payload received within incoming RTP packets from the IMS core network to correct out-of-order delivery; and
- the eIMS-AGW should detect missing RTP packets from the IMS core network and then send new T140 blocks with "missing text marker" information to the served WIC.

5.20.3 Media Plane Optimization

5.20.3.1 General

Media plane optimization procedures for WebRTC are described in 3GPP TS 23.228 [2], annex U.2.4, and in 3GPP TS 24.371 [44], subclause 7.4.5. The purpose of media plane optimization procedures is to convey media between WebRTC clients without bearer level protocol conversion. When both ends are WebRTC IMS clients (WIC), the eIMS-AGWs remain allocated but media plane interworking is disabled, except when LI is needed. Depending on configuration in the eP-CSCF (IMS-ALG), the eIMS-AGW then forwards all protocol layers either including DTLS, or on top of DTLS transparently.

NOTE 1: Terminating the DTLS protocol layer for all calls can improve the transparency of LI.

NOTE 2: In Rel-13, the media plane optimization procedure only supports the transparent forwarding of all protocol layers including DTLS, and no related configuration in the eP-CSCF (IMS-ALG) is thus required. The configuration in the eP-CSCF (IMS-ALG) needs to take into account if the eIMS-AGW supports the media plane optimization procedures with DTLS layer termination added in Rel-14.

The SDP attributes associated with WebRTC media plane optimization procedures "tra-contact", "tra-m-line", "tra-att", "tra-SCTP-association", "tra-media-line-number" and "tra-bw" are defined in 3GPP TS 24.229 [11], subclause 7.5.4.

5.20.3.2 WIC originating call

If an eP-CSCF (IMS-ALG) forwards an SDP offer from the WIC, and supports media plane optimization, and does not need to perform legal interception, then the eP-CSCF (IMS-ALG) will include media suitable for non-WebRTC IMS UEs, but also encapsulate information about the media in the original encoding as received in the SDP offer from the WIC in "tra-m-line", "tra-att" and "tra-bw" SDP attributes, as described in 3GPP TS 24.371 [44]. The eP-CSCF (IMS-ALG) shall:

- configure the eIMS-AGW to reserve resources suitable for the media described in the SDP offer outside the "tra-m-line", "tra-att" and "tra-bw" SDP attributes;
- include the IP address received from the eIMS-AGW for the termination towards the IMS core network in the SDP contact line and also encapsulate the address information provided by the eIMS-AGW into a "tra-contact" attribute;
- if the eP-CSCF (IMS-ALG) is configured to apply media plane optimization including the DTLS layer, for each media line in the SDP offer sent on the Mw interface that does not relate to a data channel or that is the first media line within the SDP offer that relates to a data channel, replace the UDP port number with a port number provided by the eIMS-AGW and encapsulate the UDP port number allocated by the eIMS-AGW in the "tra-m-line" SDP attribute; and

- if the eP-CSCF (IMS-ALG) is configured to apply media plane optimization excluding the DTLS layer, in addition for each media line in the SDP offer sent on the Mw interface that does not relate to a data channel or that is the first media line within the SDP offer that relates to a data channel within one SCTP association:
 - a) reserve a stream endpoint or termination towards the IMS core network in "inactive" mode with "UDP/DTLS" as transport protocol, and the same IP address as allocated by the eIMS-AGW for the termination or stream endpoint with resources suitable for the media described in the SDP offer outside the "tra-m-line", "tra-att" and "tra-bw" SDP attributes;
 - b) request from the eIMS-AGW a certificate fingerprint for that stream endpoint or termination;
 - c) encapsulate a "fingerprint" attribute as provided by the eIMS-AGW into an "tra-att" attribute, and add this attribute as a media level attribute in the SDP offer; and
 - d) for a DTLS association that will be established towards the IMS core network create a DTLS association identity;
 - e) encapsulate an "a=tls-id" SDP attribute with the new DTLS association identity into an "tra-att" attribute, and add this attribute as a media level attribute in the SDP offer; and
 - f) replace the UDP port number with a port number provided by the eIMS-AGW and encapsulate the UDP port number allocated by the eIMS-AGW for the stream endpoint or termination towards the IMS core network with "UDP/DTLS" transport in the "tra-m-line" SDP attribute.

If an ePCSCF (IMS-ALG) receives an SDP answer from the IMS core network and the SDP answer includes "tra-m-line" media level SDP attributes, the eP-CSCF (IMS-ALG) will de-encapsulate information to the optimized media from the received SDP answer and construct the SDP answer towards the WIC based on that de-encapsulated information as described in 3GPP TS 24.371 [44]. The eP-CSCF (IMS-ALG) shall:

- for each media line in the SDP answer, which is not marked with a "tra-SCTP-association" SDP attribute or which is the first media line in the SDP answer marked with a "tra-SCTP-association" SDP attribute that indicates an SCTP association:
 1. if the eP-CSCF (IMS-ALG) is configured to apply media plane optimization including the DTLS layer, reconfigure the terminations or stream endpoints towards the IMS core network and towards the WIC related to that media line to transport "UDP" and media format agnostic information; or

NOTE: If interconnected H.248 Stream endpoints or terminations at the eIMS-AGW are configured with transport "UDP", they will pass the payload within UDP without modifications, known as UDP transparent forwarding. For WebRTC media plane optimization, the UDP payload will be either DTLS encapsulating SCTP and data channel(s), DTLS-SRTP encapsulating key management information, or SRTP encapsulating audio or video media. However, the eIMS-AGW will be configured at terminations towards the WIC to apply ICE procedures according to subclause 5.18.

2. if the eP-CSCF (IMS-ALG) is configured to apply media plane optimization excluding the DTLS layer:
 - a) configure the eIMS-AGW to release the termination or stream endpoint towards the IMS core network with resources suitable for the media described in the SDP offer outside the "tra-m-line", "tra-att" and "tra-bw" SDP attributes;
 - b) configure the eIMS-AGW to through-connect the stream endpoint or termination towards the IMS core network with "UDP/DTLS" as transport protocol;

provide the fingerprint(s) received in the corresponding "tra-att" SDP attribute(s) to the eIMS-AGW for the stream endpoint or termination towards the IMS core network and do not provide those fingerprint attribute(s) towards the WIC;

 - d) reserve a stream endpoint or termination towards the WIC with "UDP/DTLS" as transport protocol;
 - e) provide the fingerprint(s) received in the corresponding "fingerprint" SDP attribute(s) in the previous SDP offer from the WIC to the eIMS-AGW for the stream endpoint or termination towards the WIC;
 - f) request from the eIMS-AGW a certificate fingerprint for the stream endpoint or termination towards the WIC;

- g) include fingerprint provided by the eIMS-AGW into an "fingerprint" attribute, and add this attribute as a media level attribute in the SDP answer sent towards the WIC;
 - h) for a DTLS association that will be established towards WIC create a DTLS association identity and include an "a=tls-id" attribute with the new DTLS association identity in the SDP answer sent towards the WIC;
 - i) determine via the SDP "a=setup" attribute (see IETF RFC 7345 [33]) encapsulated in "tra-att" SDP attribute if the eIMS-AGW needs to act as DTLS client or DTLS server towards the IMS core network and towards the WIC; and
 - j) for the termination where the eIMS-AGW needs to act as DTLS server, provide the Establish (D)TLS session information element to request the eIMS-AGW to start the DTLS session setup; and
3. include the UDP port number allocated by the eIMS-AGW for the termination or stream endpoint towards the WIC in the SDP media line in the SDP answer to the WIC;
- include the IP address received from the eIMS-AGW for the termination towards the WIC in the SDP contact line sent toward the WIC; and
 - if several media lines in the SDP answer are marked with "tra-SCTP-association" SDP attributes indicating the same SCTP association, release the stream endpoints related to the second and subsequent of those media lines (in the order they appear in the SDP answer).

5.20.3.3 WIC terminating call

If an eP-CSCF (IMS-ALG) receives an SDP offer from the IMS core network and the eP-CSCF (IMS-ALG) supports media plane optimization, then the eP-CSCF (IMS-ALG) will determine whether media plane optimization is to be applied as described in 3GPP TS 24.371 [44]. If media plane optimization is to be applied, then the eP-CSCF (IMS-ALG) will de-encapsulate information to the optimized media from the received SDP offer and construct the SDP offer towards the WIC based on that de-encapsulated information as described in 3GPP TS 24.371 [44], and the eP-CSCF (IMS-ALG) shall:

- for each media line in the SDP offer, which is not marked with a "tra-SCTP-association" SDP attribute or which is the first media line in the SDP answer marked with "tra-SCTP-association" SDP attribute that indicates an SCTP association:
 1. reserve a termination or stream endpoint towards the WIC related to that media line;
 2. if the eP-CSCF (IMS-ALG) is configured to apply media plane optimization including the DTLS layer, provide transport "UDP" and media format agnostic information for the termination or stream endpoint towards the WIC;

NOTE: If interconnected H.248 Stream endpoints or terminations at the eIMS-AGW are configured with transport "UDP", they will pass the payload within UDP without modifications, known as UDP transparent forwarding. For WebRTC media plane optimization, the UDP payload will be either DTLS encapsulating SCTP and data channel(s) or DTLS-SRTP encapsulating key management information, or SRTP encapsulating audio or video media. However, the eIMS-AGW will be configured at terminations towards the WIC to apply ICE procedures according to subclause 5.18.

3. if the eP-CSCF (IMS-ALG) is configured to apply media plane optimization excluding the DTLS layer:
 - a) provide transport "UDP/DTLS" and media format agnostic information for the termination or stream endpoints toward the WIC;
 - b) request from the eIMS-AGW a certificate fingerprint for the stream endpoint or termination towards the WIC;
 - c) encapsulate fingerprint provided by the eIMS-AGW into an "fingerprint" attribute, and add this attribute as a media level attribute in the SDP offer sent towards the WIC; and
 - d) do not provide the fingerprint received in the SDP offer in the corresponding "tra-att" SDP attributes towards the WIC;

- e) for a DTLS association that will be established towards WIC create a DTLS association identity, and add an "a=tls-id" SDP attribute with the new DTLS association identity in the SDP offer sent towards the WIC; and
- 4. include the UDP port number allocated by the eIMS-AGW for the stream endpoint or termination towards the WIC in the SDP media line; and
- include the IP address received from the eIMS-AGW for the termination towards the WIC in the SDP contact line sent toward the WIC.

If the eP-CSCF (IMS-ALG) receives an SDP answer from the WIC and the eP-CSCF (IMS-ALG) decided to apply media plane optimization when processing the corresponding SDP offer, then the eP-CSCF (IMS-ALG) will construct the SDP answer towards the IMS core network encapsulating received information as described in 3GPP TS 24.371 [44], and the eP-CSCF (IMS-ALG) shall:

- reserve a termination or stream endpoint towards the IMS core network;
- for each media line in the received SDP answer:
 1. if the eP-CSCF (IMS-ALG) is configured to apply media plane optimization including the DTLS layer, provide transport "UDP" and media format agnostic information for the termination or stream endpoint towards the IMS core network;
 2. if the eP-CSCF (IMS-ALG) is configured to apply media plane optimization excluding the DTLS layer:
 - a) provide the fingerprint(s) received in the "fingerprint" SDP attribute from the WIC to the eIMS-AGW for the stream endpoint or termination towards the WIC;
 - b) provide transport "UDP/DTLS" and media format agnostic information for the termination or stream endpoint towards the IMS core network;
 - c) request from the eIMS-AGW a certificate fingerprint for the stream endpoint or termination towards the IMS core network;
 - d) encapsulate fingerprint provided by the eIMS-AGW for the termination or stream endpoint towards the IMS core network into a "tra-att" SDP attribute, and add this attribute as a media level attribute in the SDP answer sent towards the IMS core network;
 - e) for a DTLS association that will be established towards the IMS core network create a DTLS association identity;
 - f) encapsulate an "a=tls-id" SDP attribute with the new DTLS association identity into an "tra-att" attribute, and add this attribute as a media level attribute in the SDP answer sent towards the IMS core network;
 - g) determine via the SDP "a=setup" attribute (see IETF RFC 7345 [33]) if the eIMS-AGW needs to act as DTLS client or DTLS server towards the IMS core network and towards the WIC; and
 - h) for the termination where the eIMS-AGW needs to act as DTLS server, provide the Establish (D)TLS session information element to request the eIMS-AGW to start the DTLS session setup; and
 3. encapsulate the UDP port number allocated by the eIMS-AGW for the stream endpoint or termination towards the IMS core network in the "tra-m-line" SDP attribute; and
- include the IP address received from the eIMS-AGW for the termination towards the IMS core network in the SDP contact line.

5.21 Alternate Connection (ALTC) Addresses Management

5.21.1 General

The IMS-ALG and the IMS-AGW may support the functionalities related to the support of the ALTC functionality as specified in IETF RFC 6947 [59] and 3GPP TS 24.229 [11] to support dual stack UEs. The present subclause describes the requirements for P-CSCF (IMS-ALG) and IMS-AGW when the ALTC procedures are supported.

If the IMS-ALG supports ALTC and, based on local policies, decides to insert ALTC information in the SDP offer sent to the terminating side, the IMS-ALG shall request the IMS-AGW to reserve two sets of transport addresses/resources towards the access network to enable media to traverse the IMS-AGW, one for each media line associated to ALTC information. The IMS-ALG shall request the IMS-AGW to release the transport resources reserved for the address type finally not used.

5.22 Video Region-of-Interest (ROI)

5.22.1 General

The IMS-ALG and the IMS-AGW may support the video Region-of-Interest (ROI) as defined in 3GPP TS 26.114 [21]. Three modes are specified for supporting ROI, including "Far End Camera Control (FECC)", "Arbitrary ROI" and "Predefined ROI". The IMS-ALG and the IMS-AGW may independently support any of these modes.

5.22.2 "Far End Camera Control" mode

The IMS-ALG and IMS-AGW may support the "Far End Camera Control" mode as specified in 3GPP TS 26.114 [21]. If the IMS-ALG and IMS-AGW support the "Far End Camera Control" mode, the IMS-ALG and IMS-AGW shall apply the procedures in the present subclause.

If the IMS-ALG receives an SDP body containing an "m=" line with a media type "application/h224", as defined by IETF RFC 4573 [68] which indicates support for FECC (ITU-T Recommendation H.281 [70]) using ITU-T Recommendation H.224 [69], the IMS-ALG shall:

- forward within SIP signalling the SDP body received from the preceding node with unmodified SDP "m=" and "a=" lines related to the "application/h224" media types (see the related SDP examples in annex A.4.2e of 3GPP TS 26.114 [21]) to the succeeding node; and

NOTE 1: There may be one media type "application/h224" "m=" line for each video "m=" line.

- request the IMS-AGW to provide a separate IP/UDP/RTP transport for the "application/h224" media stream by setting the "m=" line media type to "application" and "RTP/AVP" or "RTP/AVPF" over UDP as transport protocol when reserving the transport addresses/resources towards the MTSI client and IMS core network.

NOTE 2: The use of FECC itself is internal to the H.224 frame and is identified by the client ID field of the H.224 packet. The IMS-ALG only indicates the use of IP/UDP/RTP. The use of FECC is signalled via H.224 by a MTSI client.

The IMS-AGW shall then:

- assign resources for the requested media stream, i.e., resources for a media-format agnostic RTP flow; and
- forward transparently RTP/UDP packets (with the transparent (H.224)-PDU) between the incoming and outgoing network.

5.22.3 "Predefined ROI" mode

The IMS-ALG and IMS-AGW may support the "Predefined ROI" mode as specified in 3GPP TS 26.114 [21]. If the IMS-ALG and IMS-AGW support the "Predefined ROI", the IMS-ALG and IMS-AGW shall apply the procedures in the present subclause.

If the IMS-ALG receives an SDP body containing an "a=rtp-fb" line with the "Predefined ROI" type expressed by the parameter "3gpp-roi-predefined", as described in 3GPP TS 26.114 [21], the IMS-ALG shall:

- forward within SIP signalling the SDP body received from the preceding node with unmodified SDP "a=rtp-fb" lines related to the "3gpp-roi-predefined" parameter to the succeeding node (see the related SDP examples in annex A.4.2e of 3GPP TS 26.114 [21]); and
- include the "Predefined ROI" information element when seizing resources in the IMS-AGW to request the IMS-AGW to assign the resources for the corresponding RTCP control flow to convey pre-defined ROI information.

The IMS-AGW shall then assign resources for the requested RTCP control flow and forward transparently the RTCP "FB ROI" packets between the incoming and outgoing network. The procedures described in subclause 5.9 shall also apply.

NOTE 1: The RTCP control flow contains multiple RTCP packet types.

If the IMS-ALG receives an SDP body containing the predefined ROI attribute(s) "a=predefined_ROI" defined in 3GPP TS 26.114 [21], the IMS-ALG shall forward the SDP body with unmodified predefined ROI attribute(s) for the send and receive directions when seizing or modifying resources in the IMS-AGW.

If the IMS-ALG receives an SDP body containing "a=extmap" attribute(s), as defined in IETF RFC 5285 [23], and the "a=extmap" attribute(s) contain the pre-defined ROI URN(s) (i.e. the ROI URN for carriage of pre-defined region of interest information in the sent video stream is given by "urn:3gpp:predefined-roi-sent") as defined in 3GPP TS 26.114 [21], then the IMS-ALG shall:

- include the "Extended RTP header for Sent ROI" information element when seizing resources in the IMS-AGW to indicate to the IMS-AGW that it shall allow the RTP header extension for predefined ROI to pass; and
- forward within SIP signalling, the SDP body received from the preceding node with unmodified "a=extmap" attribute(s) to the succeeding node (see the related SDP examples in annex A.4.2e of 3GPP TS 26.114 [21]).

NOTE 2: The UE supporting the Predefined ROI feature will not send the extended RTP headers for Sent ROI if the UE did not receive any SDP body with the Predefined ROI related "a=extmap" attribute.

If the IMS-AGW has been instructed to pass on the extended RTP header for predefined ROI as described above for both incoming and outgoing terminations then:

- if the IMS AGW does not apply video transcoding, it shall pass any received RTP header extension for Predefined ROI to succeeding RTP streams; or
- if the IMS-AGW applies video transcoding, it shall keep the predefined ROI information unchanged during the transcoding and copy the received RTP header extension for Predefined ROI to the succeeding outgoing RTP stream(s) after transcoding the associated group of packets.

5.22.4 "Arbitrary ROI" mode

The IMS-ALG and IMS-AGW may support the "Arbitrary ROI" mode as specified in 3GPP TS 26.114 [21]. If the IMS-ALG and IMS-AGW support the "Arbitrary ROI", the IMS-ALG and IMS-AGW shall apply the procedures in the present subclause.

If the IMS-ALG receives an SDP body containing an "a=rtcp-fb" line with the "Arbitrary ROI" type expressed by the parameter "3gpp-roi-arbitrary", as described in 3GPP TS 26.114 [21], the IMS-ALG shall:

- forward within SIP signalling the SDP body received from the preceding node with unmodified SDP "a=rtcp-fb" lines related to the "3gpp-roi-arbitrary" parameter to the succeeding node (see the related SDP examples in annex A.4.2e of 3GPP TS 26.114 [21]); and
- include the "Arbitrary ROI" information element when seizing resources in the IMS-AGW to request the IMS-AGW to assign the resources for the corresponding RTCP control flow to convey arbitrary ROI information.

The IMS-AGW shall then assign resources for the requested RTCP control flow and forward transparently the RTCP "FB ROI" packets between the incoming and outgoing network. The procedures described in subclause 5.9 shall also apply.

NOTE 1: The RTCP control flow contains multiple RTCP packet types.

If the IMS-ALG receives an SDP body containing "a=extmap" attribute(s), as defined in IETF RFC 5285 [23], and the "a=extmap" attribute(s) contain the arbitrary ROI URN(s) (i.e. the ROI URN for carriage of arbitrary region of interest information in the sent video stream is given by "urn:3gpp:roi-sent") as defined in 3GPP TS 26.114 [21], then the IMS-ALG shall:

- include the "Extended RTP header for Sent ROI" information element when seizing resources in the IMS-AGW to indicate to the IMS-AGW that it shall allow the RTP header extension for arbitrary ROI to pass; and

- forward within SIP signalling, the SDP body received from the preceding node with unmodified "a=extmap" attribute(s) to the succeeding node (see the related SDP examples in annex A.4.2e of 3GPP TS 26.114 [21]).

NOTE 2: The UE supporting the Arbitrary ROI feature will not send the extended RTP headers for Sent ROI if the UE did not receive any SDP body with the Arbitrary ROI related "a=extmap" attribute.

If the IMS-AGW has been instructed to pass on the extended RTP header for arbitrary ROI as described above for both incoming and outgoing terminations then:

- if the IMS AGW does not apply video transcoding, it shall pass any received RTP header extension for Arbitrary ROI to succeeding RTP streams; or
- if the IMS-AGW applies video transcoding, it shall keep the arbitrary ROI information unchanged during the transcoding and copy the received RTP header extension for Arbitrary ROI to the succeeding outgoing RTP stream(s) after transcoding the associated group of packets.

5.23 SDP Capability Negotiation (SDPCapNeg)

The SDP Capability Negotiation (SDPCapNeg) as specified in IETF RFC 5939 [66] is adopted as an optional functionality to negotiate capabilities and their associated configurations according to 3GPP TS 24.229 [11]. If the ICS service is supported then the IMS-ALG and the IMS-AGW may further optionally support SDP Media Capability Negotiation as specified in IETF RFC 6871 [67] for alternative CS configuration.

Upon receipt of an incoming SDP offer containing the attributes of SDP capability negotiation, e.g. offer AVPF and AVP together for the RTP profile negotiation using "a=tcap", "a=pcfg" and "a=acfg" attributes, the IMS-ALG shall:

- request the IMS-AGW to reserve resources only for the default configuration without SDPCapNeg, and make the decision on support of the alternative configurations based on the IMS-ALG/IMS-AGW capability as provisioned before forwarding the SDP offer, i.e. handling SDPCapNeg at the controller level; or
- request the IMS-AGW to reserve resources for all of these configurations by signalling SDPCapNeg to the IMS-AGW, and update the SDP offer based on the response from the IMS-AGW before forwarding.

NOTE: The additional benefit of signalling SDPCapNeg between the IMS-ALG and the IMS-AGW is to check the resource availability for the corresponding configurations and to avoid the further session failure in case of inadequate resources for the configuration changes in the final confirmation. However, due to the extra resources reserved only during the call establishment phase, there is increased risk of call establishment failure.

In case the IMS-ALG decides to request the IMS-AGW to reserve resources for all of those configurations, the IMS-ALG shall:

- use legacy SDP attributes as specified in IETF RFC 4566 [53] to do the mapping of actual and potential configurations with the H.248 ReserveGroup concept; or
- use SDP extensions for SDP capability negotiation as specified in IETF RFC 5939 [66], if supported by the IMS-AGW.

Before using SDP extensions for SDP capability negotiation as specified in IETF RFC 5939 [66] towards the IMS-AGW, the IMS-ALG shall perform the necessary checks (i.e. through auditing or via prior provisioning) to ensure that the IMS-AGW supports the syntax and capabilities requested. For an auditing the procedure in subclause 6.1.8.1 is used with the "SDPCapNeg Supported Capabilities" as the object.

When receiving a request from the IMS-ALG with information element "SDPCapNeg configuration" indicating the potential use of multiple configurations, the IMS-AGW shall reserve resources for all of those configurations that it supports and shall send indicate the configurations for which it reserved resources in an "SDPCapNeg configuration" information element in the response. The IMS-ALG shall update the SDP offer with SDPCapNeg configurations in the response from the IMS-AGW and shall forward the SDP offer to the next hop.

The IMS-ALG may also provide SDP configurations to the IMS-AGW with no dependency on the incoming SDP offer, e.g. the IMS-ALG may wildcard the supported configurations in order to construct or update an SDP offer with the addition of alternative configurations via SDPCapNeg attributes.

On receipt of an SDP answer with SDPCapNeg, the IMS-ALG shall request the IMS-AGW to configure the resources for the selected configuration. If the IMS-AGW previously reserved any temporary resources for configurations that were not selected, the IMS-ALG shall also request the IMS-AGW to release those resources.

5.24 RTP-level pause and resume

The IMS-ALG and the IMS-AGW may support the "RTP-level pause and resume" signalling as defined in 3GPP TS 26.114 [21] and IETF RFC 7728 [79].

RTCP feedback messages to request for pause and resume of media streams can be used by conference participants supporting Multi-stream Multiparty Conferencing Media Handling feature, as specified in 3GPP TS 26.114 [21] annex S. Usage of the RTCP feedback "pause and resume" messages is negotiated via SDP offer/answer exchange through an extension of RTCP feedback capability attribute "a=rtcp-fb" (defined in IETF RFC 4585 [77]).

If the IMS-ALG and IMS-AGW support the "RTP-level pause and resume" signalling, the IMS-ALG and IMS-AGW shall apply the procedures in the present subclause.

If the IMS-ALG receives an SDP offer containing "a=rtcp-fb" line(s) with a "CCM" parameter (as defined in IETF RFC 5104 [78]) and a "pause" CCM parameter (as defined in IETF RFC 7728 [79]), and if the IMS-ALG does not support or does not apply the transcoding procedure defined in subclause 5.13, the IMS-ALG shall forward within SIP signalling, the SDP offer received from the preceding node with unmodified "a=rtcp-fb" line(s) with a "pause" CCM parameter. Otherwise, if the IMS-ALG does insert any transcoding or if the IMS-AGW does not support the "RTP-level pause and resume" signalling, the IMS-ALG shall forward within SIP signalling, the SDP offer received from the preceding node without any "a=rtcp-fb" line(s) with a "pause" CCM parameter.

If the IMS-ALG forwarded the SDP offer containing the "a=rtcp-fb" line(s) with a "pause" CCM parameter and receives an SDP answer also containing the "a=rtcp-fb" line(s) with a "pause" CCM parameter (the reception of the attribute indicates a successful "RTP-level pause and resume" negotiation) then the IMS-ALG shall:

- a) when requesting the IMS-AGW to configure resources towards the succeeding node and towards the preceding node, include the "CCM pause-resume" information element to indicate that the IMS-AGW shall forward RTCP feedback "CCM PAUSE-RESUME" messages transparently; and
- b) forward the SDP answer containing the "a=rtcp-fb" line(s) with a "pause" CCM parameter to its preceding node.

The IMS-AGW shall then assign resources for the requested RTCP control flow and shall transparently forward the RTCP "CCM PAUSE" packets between incoming and outgoing networks.

5.25 RTCP Codec Control Commands and Indications

The IMS-ALG and the IMS-AGW may support signalling of "RTCP Codec Control Commands and Indications", as defined in 3GPP TS 26.114 [21] and IETF RFC 5104 [78].

- NOTE 1: 3GPP TS 26.114 [21] specifies support of the following RTCP feedback codec control messages (CCM): "Full Intra Request (FIR)", "Temporary Maximum Media Stream Bit Rate Request (TMMBR)" and "Temporary Maximum Media Stream Bit Rate Notification (TMMBN)".

The RTCP feedback FIR message can be used both by point-to-point video calls, and by conference participants supporting Multi-stream Multiparty Conferencing Media Handling feature, as specified in 3GPP TS 26.114 [21] annex S, to request the media sender to send a decoder refresh point.

The RTCP TMMBR and TMMBN feedback messages can also be used in reaction to the Explicit Congestion Notification, as specified in subclause 5.12.

Usage of the RTCP feedback "CCM" messages is negotiated via SDP offer/answer exchange through an extension (defined in IETF RFC 5104 [78]) of the RTCP feedback capability attribute "a=rtcp-fb" (defined in IETF RFC 4585 [77]).

- NOTE 2: The SDP offer/answer negotiation is performed with a separate "a=rtcp-fb" attribute line for each CCM message type.

If the IMS-ALG and IMS-AGW support the "RTCP Codec Control Commands and Indications" signalling, the IMS-ALG and IMS-AGW shall apply the procedures in the present subclause.

If the IMS-ALG receives an SDP offer containing "a=rtcp-fb" line(s) with a "CCM" parameter and with a "fir" and/or "tmmbr" CCM parameters (defined in IETF RFC 5104 [78]) under video "m=" line(s), and if the IMS-ALG does not configure the IMS-AGW to transcode the corresponding video media stream and/or to act as ECN endpoint for the corresponding video media stream, the IMS-ALG shall forward within SIP signalling, the SDP offer received from the preceding node with unmodified "a=rtcp-fb" line(s) with the "CCM" parameter and with "fir" and/or "tmmbr" CCM parameters.

NOTE 3: If the IMS-ALG configures the IMS-AGW to transcode a video media stream and/or to act as ECN endpoint for the corresponding video media stream, the IMS-ALG can insert "a=rtcp-fb" line(s) with the "CCM" parameter and with "fir" and/or "tmmbr" CCM parameters within SDP offer irrespective of whether they were received from the preceding node.

If the IMS-ALG does not configure the IMS-AGW to transcode the corresponding video media stream and/or to act as ECN endpoint, and if the IMS-ALG received an SDP answer also containing the "a=rtcp-fb" line(s) with the "CCM" parameter and with the same "fir" and/or "tmmbr" CCM parameters (the presence of the same "a=rtcp-fb ccm" line(s) in the SDP answer indicates a successful negotiation of the particular CCM message), then the IMS-ALG shall:

- when requesting the IMS-AGW to configure resources towards the succeeding node and towards the preceding node, include the "CCM BASE" information element with the "fir" and/or "tmmbr" CCM parameters to indicate that the IMS-AGW shall be prepared to receive and is allowed to send the RTCP CCM "FIR" and/or "TMMBR/TMMBN" feedback messages; and
- forward the SDP answer containing the "a=rtcp-fb" line(s) with the "fir" and/or "tmmbr" CCM parameters (from the received SDP answer) to its preceding node.

If the IMS-ALG configures the IMS-AGW to transcode the corresponding video media stream and/or to act as ECN endpoint:

- if the IMS-ALG did not send towards the succeeding node the SDP offer containing the "a=rtcp-fb" line(s) with the "CCM" parameter and the with "fir" and/or "tmmbr" CCM parameters, then the IMS-ALG may:
 - a) when requesting the IMS-AGW to configure resources towards the preceding node, include the "CCM BASE" information element with the "fir" and/or "tmmbr" CCM parameters to indicate that the IMS-AGW shall be prepared to receive and is allowed to send the RTCP CCM "FIR" and/or "TMMBR/TMMBN" feedback messages; and
 - b) include in the SDP answer it sends to the preceding node the "a=rtcp-fb" line(s) with the "fir" and/or "tmmbr" CCM parameters (as received SDP offer); and
- if the IMS-ALG sent towards the succeeding node the SDP offer containing the "a=rtcp-fb" line(s) with the "CCM" parameter and the with "fir" and/or "tmmbr" CCM parameters, and received an SDP answer also containing the "a=rtcp-fb" line(s) with the "CCM" parameter and with the same "fir" and/or "tmmbr" CCM parameters, then the IMS-ALG shall:
 - a) when requesting the IMS-AGW to configure resources towards the succeeding node, include the "CCM BASE" information element with the "fir" and/or "tmmbr" CCM parameters to indicate that the IMS-AGW shall be prepared to receive and is allowed to send the RTCP CCM "FIR" and/or "TMMBR/TMMBN" feedback messages; and
 - b) if the the IMS-ALG received from the preceding node the SDP offer containing the "a=rtcp-fb" line(s) with the "CCM" parameter and the with "fir" and/or "tmmbr" CCM parameters, include in the SDP answer it sends to the preceding node the "a=rtcp-fb" line(s) with the "fir" and/or "tmmbr" CCM parameters (as received SDP offer).

The IMS-AGW shall then assign resources for the requested RTCP control flow:

- if the IMS-AGW acts as an ECN endpoint (as described in subclause 5.12) or applies the video transcoding procedure, the IMS-AGW:
 - a) may send the RTCP TMMBR feedback message with an "IMS-AGW-generated" value in an "SSRC of media sender" field that is kept constant for the duration of the session, different from any SSRC value in the active RTP streams for the session, to request the media sender to limit the maximum bit rate for a media stream to, or below, the provided value;

NOTE 4: Trigger for sending of the RTCP TMMBR feedback message can be reception of RTP packets marked with ECN-CE, as described in subclause 5.12. The reason to use an "IMS-AGW-generated" value in "SSRC of media sender" and to keep that value constant in the session is that the IMS-AGW must be possible to identify as being a separate source of sending TMMBR messages, to avoid TMMBR induced by ECN restrictions interfering with other TMMBR restrictions set by other media receivers in the media path, as described in section 3.5.4 of IETF RFC 5104 [78].

- b) upon reception of the RTCP TMMBR feedback message and if performing transcoding, shall adjust the sent media rate to the requested rate or lower and shall respond by sending the RTCP TMMBN feedback message; and
- c) may send the RTCP FIR feedback message to request the media sender to send a decoder refresh point; or
- if the IMS-AGW does not act as an ECN endpoint and does not apply the video transcoding procedure, the IMS-AGW shall transparently forward received RTCP FIR feedback message, and received RTCP TMMBR and TMMBN feedback messages between the incoming and outgoing networks.

6 IMS-ALG to IMS-AGW Procedures

6.1 Non-Call Related Procedures

6.1.1 General

The non-call related procedures are based on corresponding procedures of 3GPP TS 23.205 [8] where the IMS-ALG takes the place of the MSC server and the IMS-AGW takes the place of the MGW.

6.1.2 IMS-AGW Unavailable

The IMS-ALG server recognises that the IMS-AGW is unavailable in the following 4 cases:

1. The signalling connection is unavailable

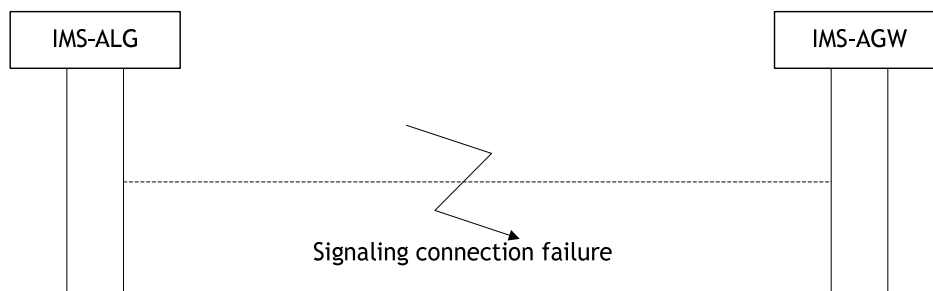

Figure 6.1.2.1: Signalling connection failure

2. The IMS-AGW indicates the failure or the maintenance locking condition to all connected IMS-ALG servers

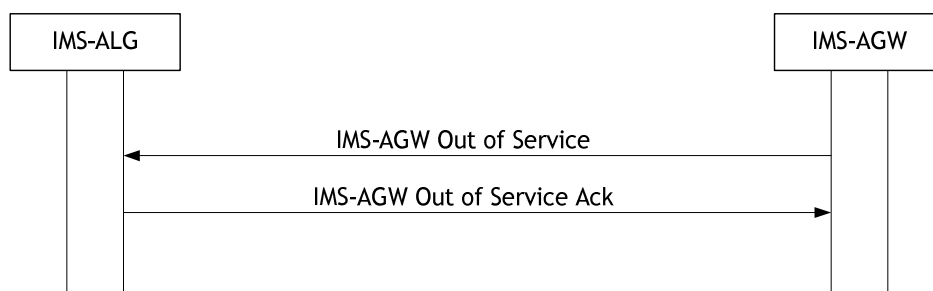

Figure 6.1.2.2: IMS-AGW indicates the Failure/Maintenance locking

The failure or maintenance locking indication indicates that the IMS-AGW is locked for new calls or will soon go out of service and that no new connections should be established using this IMS-AGW. The IMS-AGW can choose between the "graceful" and the "forced" method. In the graceful method the connections are cleared when the corresponding calls are disconnected. In the forced method all connection are cleared immediately.

3. The IMS-ALG recognises that the IMS-AGW is not functioning correctly, e.g. because there is no reply on periodic sending of Audits. The periodic sending of Audits by IMS-ALG should go on.

In all of the above cases the IMS-ALG shall prevent the usage of the IMS-AGW until the IMS-AGW has recovered or the communication with the IMS-AGW is restored.

6.1.3 IMS-AGW Available

The IMS-ALG discovers that the IMS-AGW is available when it receives an IMS-AGW Communication Up message or an IMS-AGW Restoration message. If the IMS-ALG does not wish to sustain an association with the IMS-AGW, the response sent to the IMS-AGW may indicate an alternative IMS-ALG signalling address, in which case the IMS-AGW shall not consider itself registered and should preferably attempt to re-register with this alternative IMS-ALG before any further alternate IMS-ALGs. Otherwise, the response shall not indicate any alternative IMS-ALG signalling address.

When the IMS-ALG discovers that the IMS-AGW is available the following shall occur:

1. Signalling recovery

The IMS-AGW indicates to all connected IMS-ALGs that the signalling connection is restored.

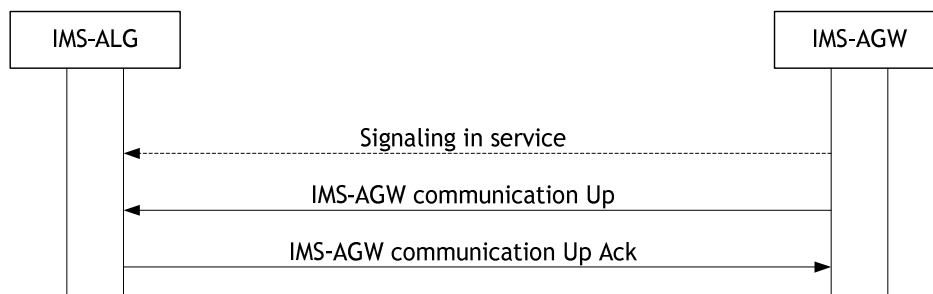

Figure 6.1.3.1: Communication goes up

2. IMS-AGW restoration/maintenance unlocking indication.

The IMS-AGW indicates to all connected IMS-ALGs that normal operation has resumed.

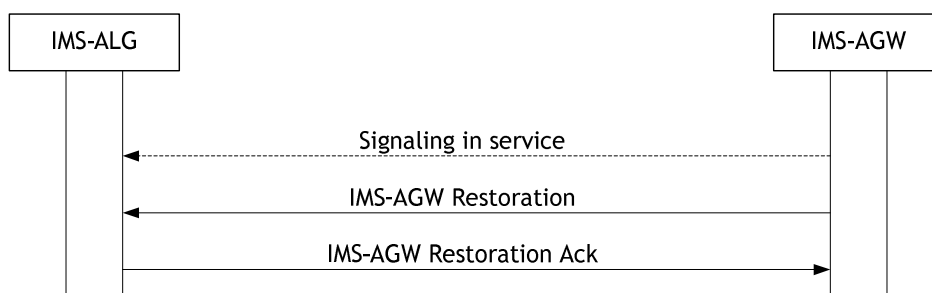

Figure 6.1.3.2: IMS-AGW indicates recovery from a failure/or maintenance unlocking

NOTE: This procedure may be used after recovery from a signalling failure.

3. The IMS-ALG recognises that the IMS-AGW is now functioning correctly, e.g. because there is a reply on periodic sending of Audits.

After this the IMS-ALG can use the IMS-AGW.

If none of 1, 2, and 3 happens the IMS-ALG server can initiate the IMS-ALG Ordered Re-register procedure.

6.1.4 IMS-AGW Recovery

If the IMS-AGW recovers from a failure, is maintenance unlocked, or it has been restarted, it registers to its known IMS-ALGs using the IMS-AGW Restoration procedure or the IMS-AGW Registration procedure. The IMS-AGW can indicate whether the Service has been restored or whether it has restarted with a cold or warm boot. If the IMS-ALG does not wish to sustain an association with the IMS-AGW, the response sent to the IMS-AGW may indicate an alternative IMS-ALG signalling address, in which case the IMS-AGW shall not consider itself registered and should preferably attempt to re-register with this alternative IMS-ALG before any further alternate IMS-ALGs. Otherwise, the response shall not indicate any alternative IMS-ALG signalling address.

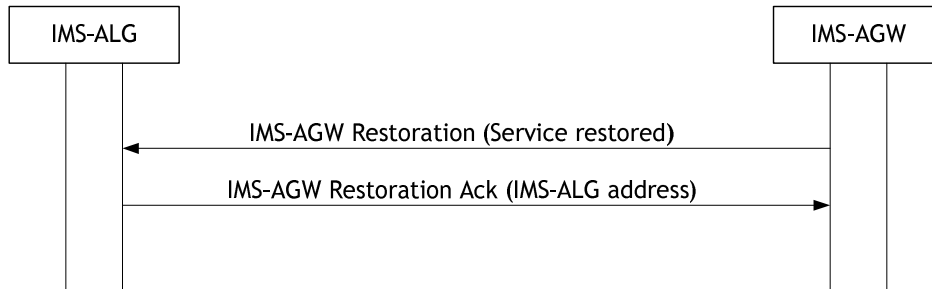

Figure 6.1.4.1: IMS-AGW Restoration

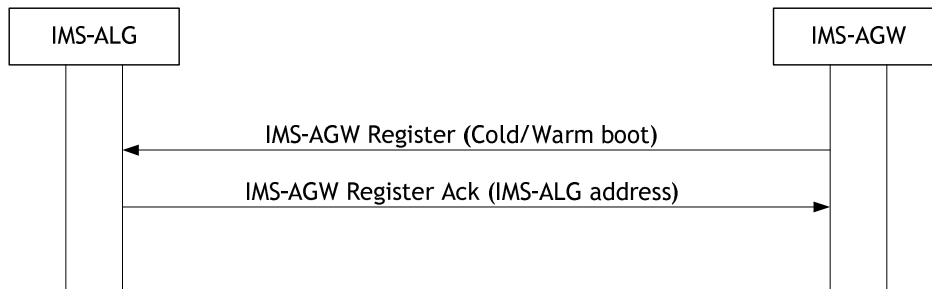

Figure 6.1.4.2 IMS-AGW Registration

After the recovery the IMS-ALG can use the IMS-AGW.

6.1.5 IMS-ALG Recovery

6.1.5.1 General

If an IMS-AGW-unavailable condition is provoked by a failure/recovery action, the IMS-ALG recovery sequence will, from an information flow point of view, look like IMS-AGW unavailable and then IMS-AGW available. If an IMS-AGW-unavailable condition is not provoked, the IMS-ALG recovery sequence will look like IMS-AGW available.

After the information flow, the terminations affected by the recovery action are released.

6.1.5.2 IMS-ALG Restoration

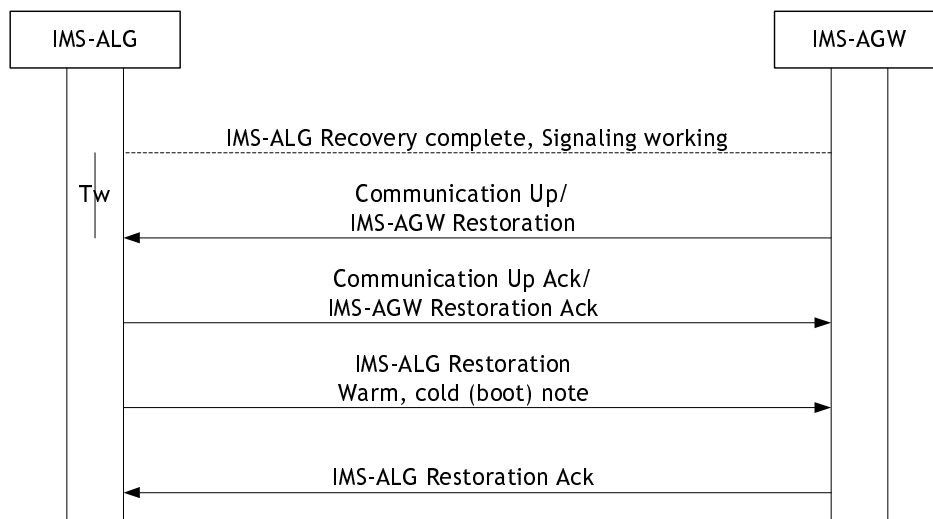

NOTE: Normal release procedure may also be initiated.

Figure 6.1.5.2.1: IMS-ALG Restoration

After the recovery action is complete and it is possible to signal to the IMS-AGW the IMS-ALG starts a timer T_w . If recovery indications are not received (IMS-AGW Communication Up or IMS-AGW Restoration) from the IMS-AGW during T_w an Audit is sent. If the IMS-ALG receives a recovery indication or IMS-AGW communication up indication, it shall acknowledge the indication before the IMS-ALG Restoration may be sent or the release procedure is initiated.

6.1.6 IMS-AGW Re-register

When the IMS-ALG requests an IMS-AGW to perform a registration (see subclauses 6.1.3, 6.1.4 and 6.1.7), the IMS-AGW performs a re-registration to the IMS-ALG which is defined in the IMS-ALG address.

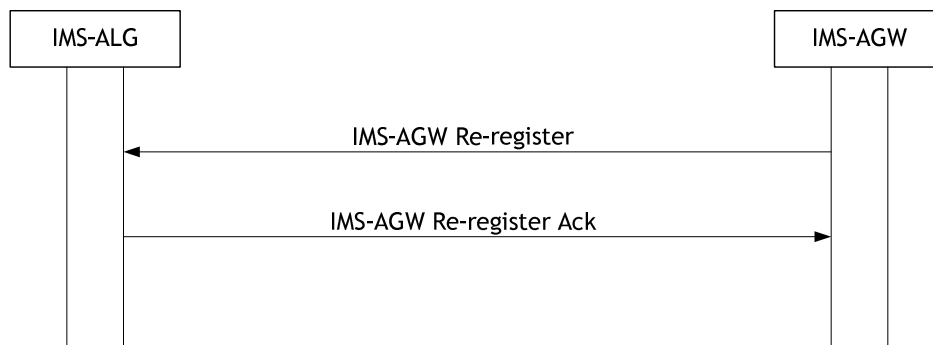

Figure 6.1.6.1: Re-registration of an IMS-AGW

6.1.7 IMS-AGW Re-registration Ordered by IMS-ALG

If the IMS-ALG knows that communication is possible, but the IMS-AGW has not registered, the IMS-ALG can order re-registration of the IMS-AGW.

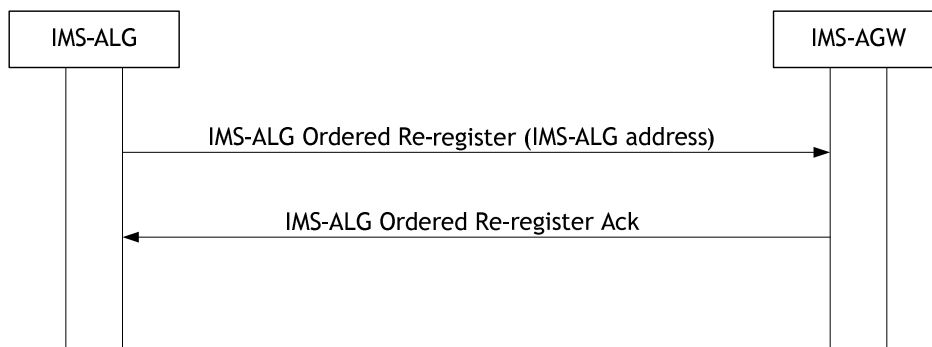

Figure 6.1.7.1: Re-registration ordered by the IMS-ALG

If the re-registration request is accepted the IMS-AGW uses the IMS-AGW Re-register procedure to register with the IMS-ALG.

6.1.8 Audit of IMS-AGW

6.1.8.1 Audit of Value

The IMS-ALG may request the IMS-AGW to report the current values assigned to distinct objects in the IMS-AGW. This procedure may be used when a change has occurred in the IMS-ALG such that the IMS-ALG is unsure of the current Service State of Terminations.

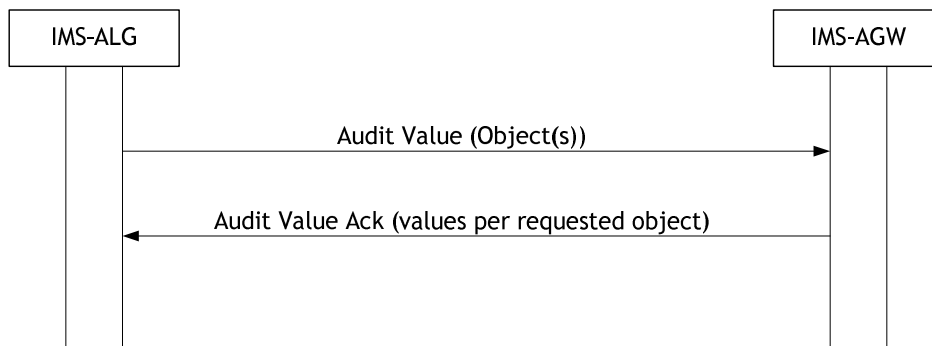

Figure 6.1.8.1.1: Audit Value

6.1.8.2 Audit of Capability

The IMS-ALG may request the IMS-AGW to report the capabilities of distinct objects in the MGW.

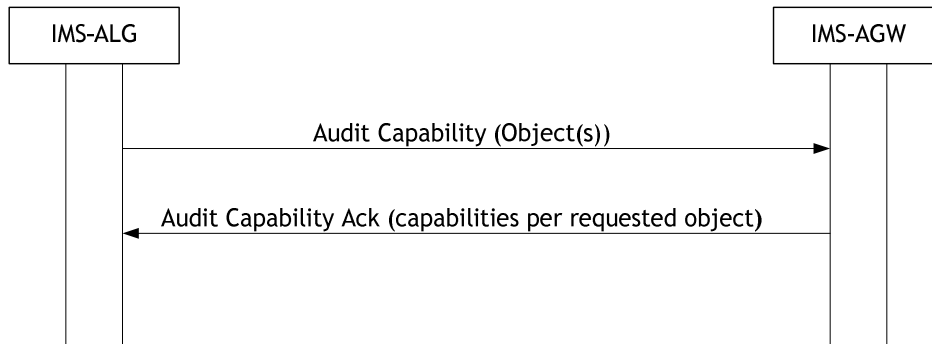

Figure 6.1.8.2.1: Audit Capability

6.1.9 IMS-AGW Capability Change

The IMS-AGW reports a change of capability of distinct objects in the MGW.

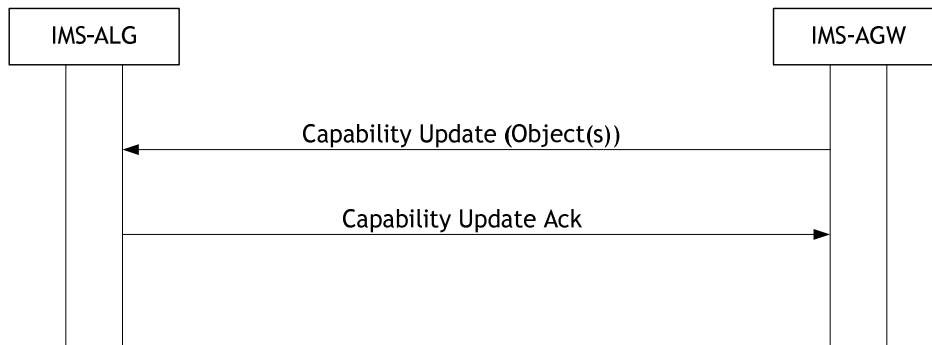

Figure 6.1.9.1: Capability Update

The IMS-ALG may use the Audit Value and/or Audit Capability procedures to obtain further information, about the objects whose capabilities have changed.

6.1.10 IMS-ALG Out of service

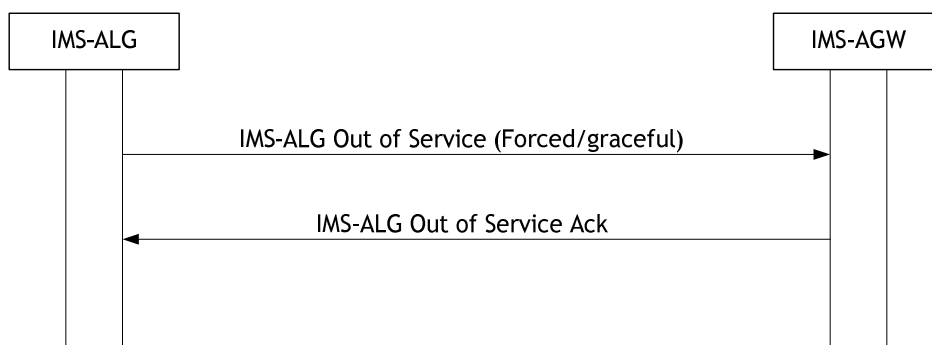

Figure 6.1.10.1: IMS-ALG Out of Service

If an IMS-ALG discovers that it wants to go out of service it may start an IMS-ALG Out of Service procedure. The IMS-ALG can indicate whether it requires the context to be cleared immediately (forced) or cleared as the bearer control protocol clears the bearer (Graceful).

6.1.11 IMS-AGW Resource Congestion Handling - Activate

When the IMS-ALG requires that an IMS-AGW congestion notification mechanism be applied in the MGW, the IMS-ALG shall use the IMS-AGW Resource Congestion Handling - Activate procedure towards the IMS-AGW.

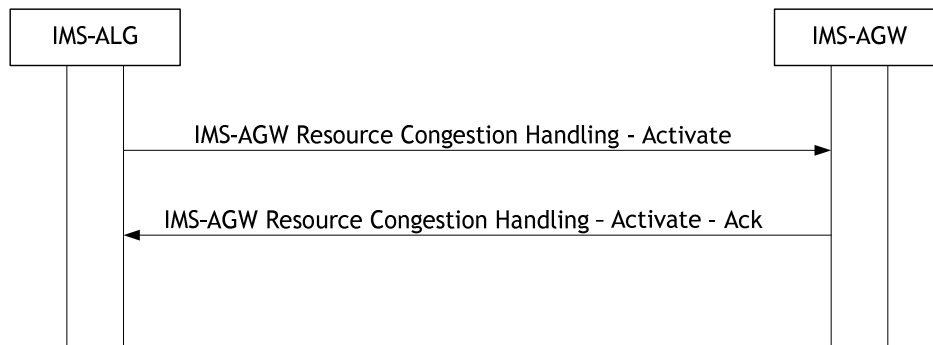

Figure 6.1.11.1: IMS-AGW Resource Congestion Handling - Activate

6.1.12 MGW Resource Congestion Handling - Indication

When the IMS-ALG receives a load reduction notification from the IMS-AGW via the IMS-AGW Resource Congestion Handling - Indication procedure, the IMS-ALG tries to reduce the processing load that the IMS-ALG creates on the IMS-AGW. The IMS-AGW shall decide the actual level of traffic reduction.

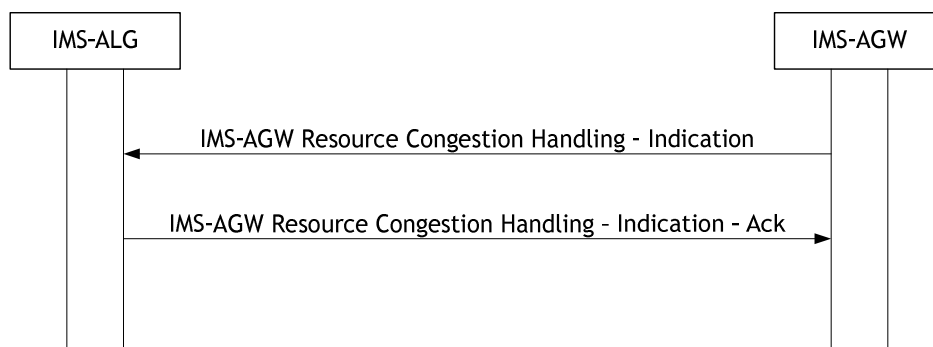

Figure 6.1.12.1: IMS-AGW Resource Congestion Handling – Indication

6.1.13 Control association monitoring

Monitoring of the H.248 control association may be performed by monitoring the status of the transport link association where the transport protocol provides sufficient coupling to the H.248.1 protocol, i.e. if the transport link association is disconnected when no local H.248.1 protocol connection exists.

An alternative method for the IMS-AGW to detect loss of the IMS-ALG may be achieved by requesting the IMS-AGW to poll the IMS-ALG periodically

Upon registration of an IMS-AGW, the IMS-ALG may use the Inactivity Timeout - Activate procedure towards the IMS-AGW to request the IMS-AGW to monitor incoming messages for periods of silence exceeding the maximum inactivity timer value.

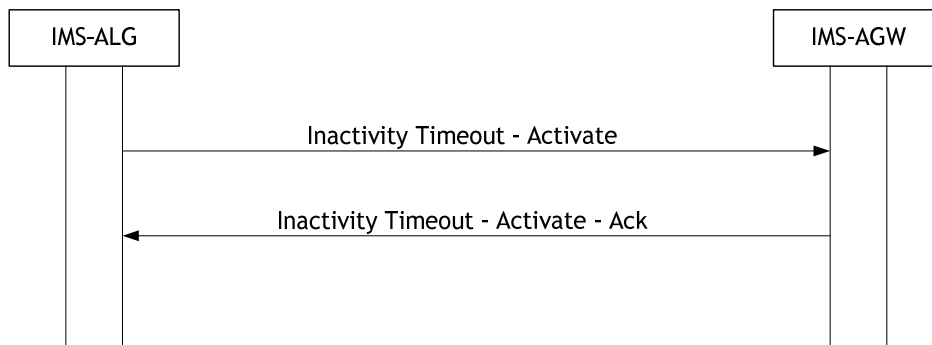

Figure 6.1.13.1: Inactivity Timeout - Activate

Upon receipt of an inactivity timeout notification from the IMS-AGW via the Inactivity Timeout - Indication procedure, the IMS-ALG shall send a reply to the IMS-AGW. If the IMS-ALG has failed, the IMS-AGW will not receive a reply.

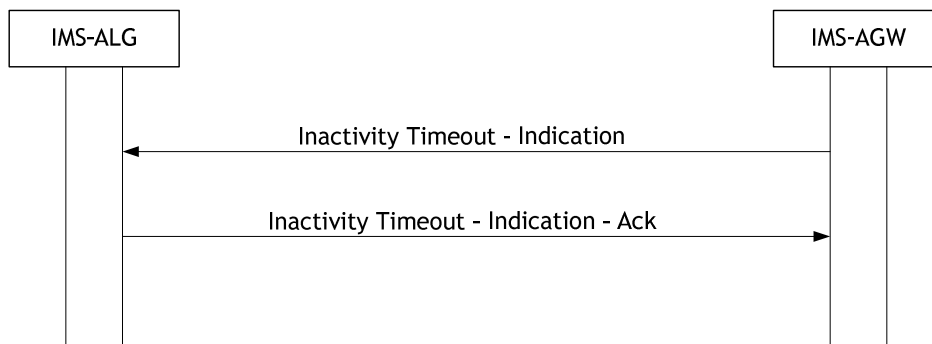

Figure 6.1.13.2: Inactivity Timeout - Indication

If no Inactivity Timeout – Indication Ack reply is received, the IMS-AGW shall consider the IMS-ALG to have failed. The IMS-AGW may then attempt to re-contact its controlling IMS-ALG by performing IMS-AGW Communication Up. If not successful, the IMS-AGW may then attempt to register to a new IMS-ALG.

6.1.14 Realm Availability Monitoring

If the IMS-AGW supports IP Realm Availability monitoring, the IMS-ALG may request the monitoring of the available IP Realms by the IMS-AGW; the IMS-AGW shall inform the IMS-ALG of any changes in realm availability.

NOTE: The IMS-ALG can use the AuditValue procedure to determine which IP realms are currently available.

The IMS-ALG may use the Realm Availability - Activate procedure towards the IMS-AGW to request the IMS-AGW to monitor the status of its IP Realms.

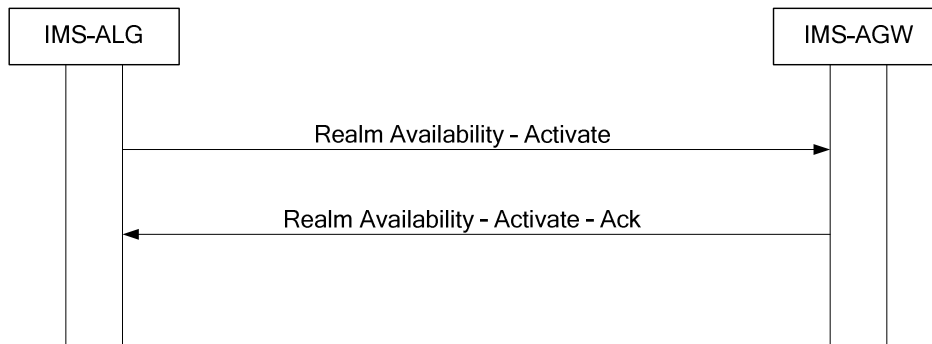

Figure 6.1.14.1: Realm Availability - Activate

The IMS-AGW shall inform the IMS-ALG via the Realm Availability – Notification procedure.

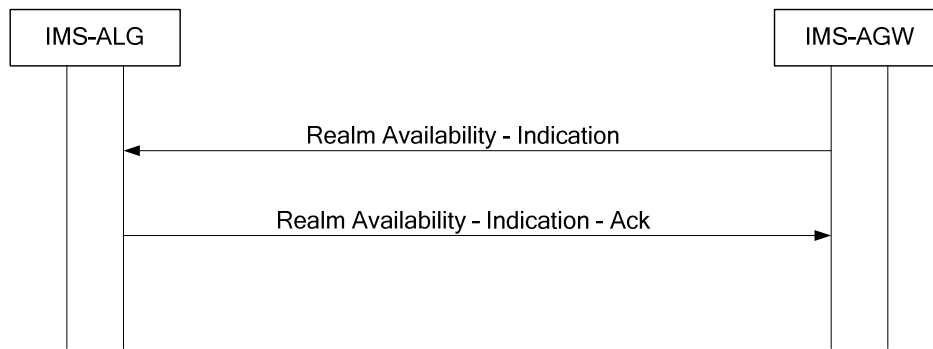

Figure 6.1.14.2: Realm Availability - Indication

On being informed of newly available/unavailable realms, IMS-ALG shall take appropriate action (e.g. update its list of available realms etc.).

6.1.15 Failure of IP Port, Interface or Group of Interfaces

This procedure only applies when text encoding is used on the H.248 interface.

The IMS-ALG shall and the IMS-AGW may support the Termination Out-of-Service procedure.

If the IMS AGW suffers a loss of physical IP device(s) that pertain to a whole IP Realm it may report the IP Realm as unavailable (see subclause 6.1.14). However, it is possible that a failure affects a physical port or group of ports that forms a subset of the IP Realm and therefore many terminations are affected. In such cases the IMS-AGW may initiate a Termination Out of Service procedure to inform the IMS-ALG that the set of terminations is out of service. This is shown in Figure 6.1.15.1.

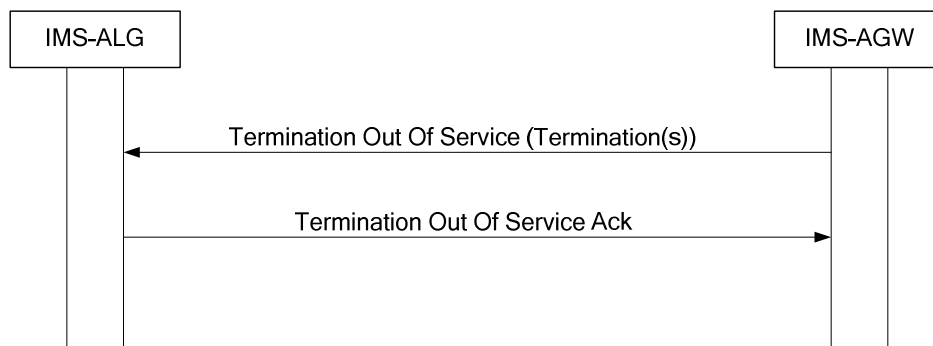

Figure 6.1.15.1: Termination Out of Service

On receipt of the Termination Out Of Service the IMS-ALG shall initiate the appropriate actions, e.g. by subtracting the affected terminations and releasing the affected calls.

NOTE: This procedure provides an alternative failure reporting to the IP Bearer Released procedure (which allows reporting the failure of one IP Bearer / termination). The Termination Out-of-Service procedure avoids sending an avalanche of notifications when the failure affects multiple ephemeral terminations.

6.2 Call Related Procedures

6.2.1 Gate Control & Local NA(P)T procedure

The session establishment and session release procedures are specified in 3GPP TS 23.228 [2] Annex G.4.3 and G.4.4.

Figure 6.2.1.2 depicts the signalling flow for a session setup from the IMS access network towards the IMS core network when the P-CSCF invokes the IMS-ALG function for a session. The same signalling flow applies for a session setup from the IMS core network towards the IMS access network with the exception that terminations T1 and T2 are then exchanged.

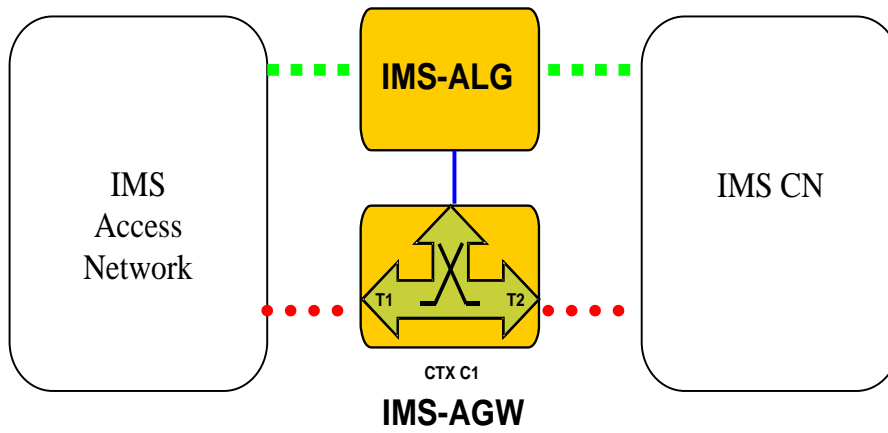

Figure 6.2.1.1: H.248 Context Model

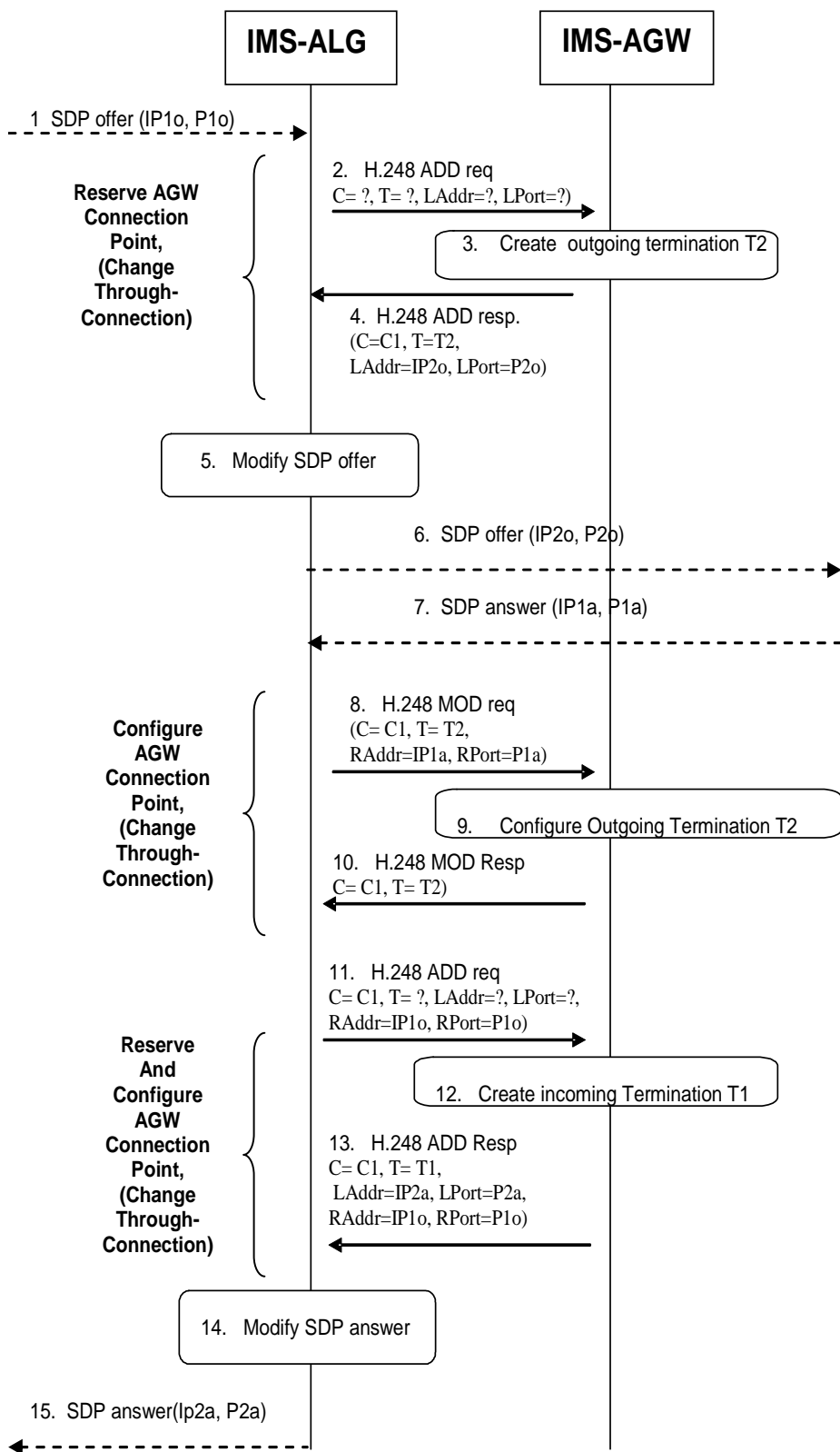

Figure 6.2.1.2: IMS-ALG and IMS-AGW interaction at session establishment

Upon receipt of a session initiation request, the IMS-ALG shall extract the offerer's destination network address(es) and port number(s) from the signalling message body received from the calling party endpoint. It shall then request the IMS-AGW to allocate transport resources (T2) via the Reserve AGW Connection Point procedure. Upon receipt of the

response from the IMS-AGW, the IMS-ALG shall modify the offerer's destination address(es) and/or port(s) contained in the application signalling message body and propagate the session establishment toward the terminating party.

On receipt of the terminating end SDP in the session establishment response, the IMS-ALG shall pass the information to the IMS-AGW in the Configure AGW Connection Point procedure and shall request the IMS-AGW to allocate transport resources (T1) via the Reserve and Configure AGW Connection Point. Upon receiving the response from the IMS-AGW, the IMS-ALG shall modify the answerer's destination address(es) and/or port(s) contained in the application signalling message body and pass the information to the originating party.

On session termination, the IMS-ALG shall request the IMS-AGW to release its transport resources via the Release AGW Termination procedure.

6.2.2 IP realm indication procedure

This procedure is identical to that of subclause 6.2.1 apart from the IMS-ALG optionally specifying the required IP Realm to the IMS-AGW when requesting the allocation of transport resources on the IMS-AGW.

6.2.3 Remote NA(P)T traversal support procedure

This procedure is identical to that of subclause 6.2.1 apart from the IMS-ALG optionally indicating to the IMS-AGW that the remote media address/port information (supplied by the IMS-ALG) shall not be used as the destination address for outgoing media. Instead, the IMS-AGW shall "latch" or "relatch" onto the required destination address via the source address/port of the incoming media. The IMS-ALG may command the IMS-AGW to latch once (on the first received packet) or to re-latch (i.e. to check for a change of source address on the incoming media stream and latch once on this new address).

6.2.4 Remote Source Address/Port Filtering

This procedure is identical to that of subclause 6.2.1 apart from the IMS-ALG optionally specifying the required IP address and/or port to be used to screen received media packets on a termination.

This subclause considers when the IMS-ALG is acting as an Entry point and remote source transport address filtering is required towards the external network.

As a security related option, on request from the IMS-ALG, filtering may be enabled to check/validate the source address or source address and port number of incoming packets from the external network. If the IMS-ALG requests address filtering, it may additionally provide an address specification, which may identify either a single address or a range of addresses, against which filtering is to be performed. The absence of such an address specification in the request shall implicitly request filtering against the IP address of the remote connection address. In addition to address filtering, the IMS-ALG may also request port filtering. If the IMS-ALG requests port filtering, it may additionally include either a port or a range of ports, against which filtering is to be performed. The absence of a port specification in the request shall implicitly request filtering against the port of the remote connection address.

If the IMS-AGW is requested to apply source IP address and possibly source port filtering, it shall only pass incoming IP packets from the identified source, and discard IP packets from other sources.

If remote source address filtering is required for the created termination, then the IMS-ALG shall include the information element "Remote source address filtering" in the request sent to the IMS-AGW. In addition, it may also include the information element "Remote source address mask" in order to request filtering of a range of addresses.

If remote source port filtering is required for the created termination (in addition to remote source address filtering), then the IMS-ALG shall include the information element "Remote source port filtering" in the request sent to the IMS-AGW. It may also include one of the information elements "Remote source port" or "Remote source port range".

Subsequently, the IMS-AGW shall apply filtering as requested to the packets arriving from the external network. Any packet arriving, which does not meet the filtering requirement, shall be discarded.

6.2.5 Traffic Policing

This procedure is identical to that of subclause 6.2.1 apart from the IMS-ALG optionally requesting the IMS-AGW to police the media stream flow according to one or more of the following media policing(s) through the IMS-AGW, in accordance with IETF RFC 2216 [10].

NOTE 1: In order to support services that generate media with variable bitrate (e.g. video), the policing function needs to provide sufficient buffer space. The derivation of the correspondent token bucket size can be based on the estimated traffic volume over the expected maximum burst length (supposed time interval of the burst). For example, for MTSI media, 3GPP TS 26.114 [21] subclause 7.5.5 recommends a default period of 2 seconds for the derivation of average bitrates and provides further considerations regarding suitable time periods for speech and video.

NOTE 2: The decision to apply or not traffic policing is general for all sessions with the same media characteristics (i.e. not user specific). The conditions which media policing to apply are beyond the scope of this specification. This can be based on the media characteristics of the session (e.g. media type).

The following media policing shall be supported at the IMS-AGW:

- **Sustainable Data Rate (SDR) Policing:**

To request policing of the sustainable data rate of a media stream, the IMS-ALG shall request media policing for that media stream and shall provide the sustainable data rate, and shall provide a maximum burst size (MBS) indicating the expected maximum size of packet bursts for that media stream. The IMS-AGW shall then measure the data rate for the received packets within that media stream as per IETF RFC 2216 [10] for "Token Bucket", where $r = \text{SDR}$ and $b = \text{MBS}$. If the permissible sustainable data rate is exceeded, the IMS-AGW shall discard packets to reduce the data rate to the permissible sustainable data rate.

NOTE 3: The IMS-ALG can derive the sustainable data rate from bandwidth parameters if it receives them within an SDP media description. The IMS-ALG can:

- use the "b=AS" bandwidth modifier if received within an SDP body; or
- if the IMS-ALG supports the enhanced bandwidth negotiation mechanism, use the "maximum supported bandwidth for the receiving direction" property value from the "a=bw-info" SDP attribute received within an SDP answer.

If the value of the "maximum supported bandwidth for the receiving direction" for the selected RTP payload type differs from the value of the "b=AS" bandwidth modifier then the IMS-ALG can use "maximum supported bandwidth for the receiving direction" property value from the "a=bw-info" SDP attribute to determine the sustainable data rate for the selected RTP payload.

The following media policing may be supported in addition at the IMS-AGW ; if supported then the following applies:

- **Peak Data Rate Policing:**

To request policing of the peak data rate of a media stream, the IMS-ALG shall request media policing for that media stream and shall provide the peak data rate, and may provide a Delay Variation Tolerance indicating the expected maximum delay variation due to jitter for that media stream. The IMS-AGW shall then measure the data rate for the received packets within that media stream. If the permissible peak data rate is exceeded, the IMS-AGW shall discard packets to reduce the data rate to the permissible peak data rate. If both peak data rate and sustainable data rate have been provided for the same media stream, the IMS-AGW shall discard packets to reduce the data rate to the permissible peak data rate and should discard packets to reduce the data rate to the permissible sustainable data rate.

6.2.6 Hanging Termination Detection

This procedure is identical to that of subclause 6.2.1 apart from the IMS-ALG requesting the IMS-AGW to periodically report termination heartbeat indications to detect hanging context and termination in the IMS-AGW that may result e.g. from a loss of communication between the IMS-ALG and the IMS-AGW.

When the IMS-ALG receives a termination heartbeat notification from the IMS-AGW via the Termination heartbeat - Indication procedure, the IMS-ALG shall return a Termination heartbeat -Indication Ack (without an error) if the context id / termination identity combination exists in the IMS-ALG. If it does not exist, the IMS-ALG shall return an error and shall correct the mismatch, e.g. by requesting the IMS-AGW to subtract the indicated termination and to clear any associated context.

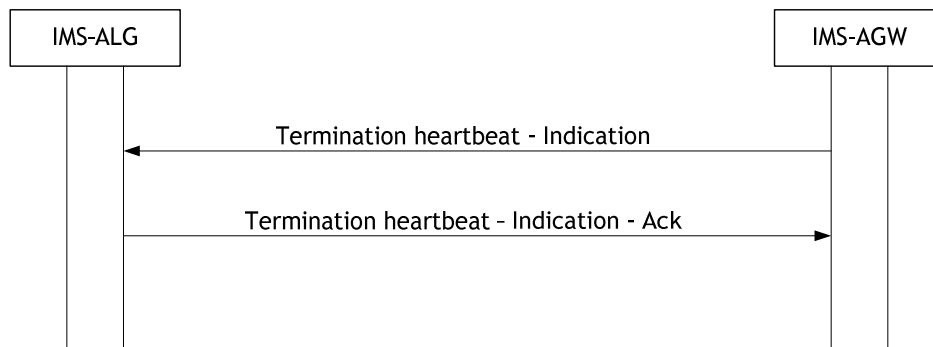

Figure 6.2.6.1: Termination heartbeat – Indication

6.2.7 QoS Packet Marking

This procedure is identical to that of subclause 6.2.1 apart from the IMS-ALG optionally specifying the setting of the DSCP for outgoing packets on a termination. The DSCP value may be explicitly set by the IMS-AGW or else copied from that received in the corresponding received packet.

If differentiated services are required for the created termination, then the IMS-ALG shall include the information elements "DiffServ Code Point" and/or "DiffServ Tagging Behaviour" in the request sent to the IMS-AGW.

Subsequently, for all egress packets, the IMS-AGW shall set the DiffServ Code Point in the IP header as specified by the IMS-ALG:

- If the DiffServ Tagging Behaviour information element was received with a value to indicate that the DiffServ Code Point should be copied, then the DiffServ Code Point in the IP header of the egress packet is copied from the ingress packet.
- If the Diffserv Tagging Behaviour information element was not received, or was received with a value to indicate that the DiffServ Code Point should be set to a specific value, then:
 - If the DiffServ Code Point information element was received, then the DiffServ Code Point in the IP header of the egress packet shall be set to the value received in the DiffServ Code Point information element.
 - If the DiffServ Code Point information element was not received, then the DiffServ Code Point in the IP header of the egress packet shall be set to a configured default value.

6.2.8 Media Inactivity Detection

This procedure is identical to that of subclause 6.2.1 apart from the IMS-ALG optionally requesting the IMS-AGW to detect inactive media.

If media inactivity detection is required for the created termination, the IMS-ALG may include the information elements "Inactivity detection time" and "Inactivity detection direction" in the request sent to the IMS-AGW. The IMS-ALG may request the detection of media inactivity on a termination or a stream basis.

When the IMS-ALG receives a notification of inactive media from the IMS-AGW via the Media Inactivity Notification procedure, the IMS-ALG shall return a Media Inactivity Notification Ack and shall take appropriate action (e.g. release the termination).

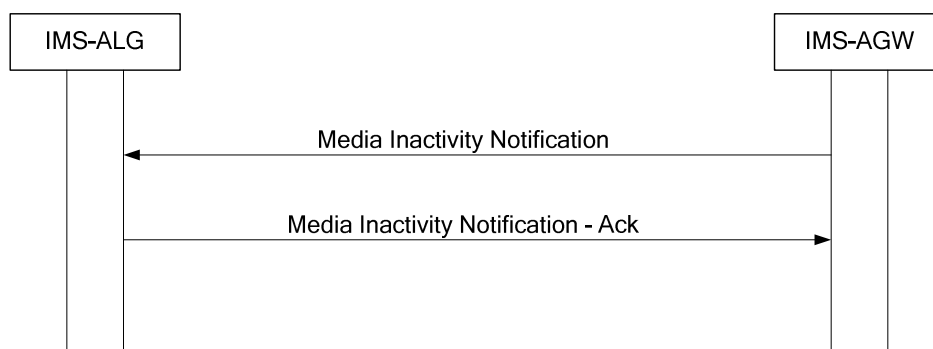

Figure 6.2.8.1: Media Inactivity Notification

6.2.9 Handling of RTCP streams

This procedure is identical to that of subclause 6.2.1 apart from the IMS-ALG optionally requesting the IMS-AGW to allocate or not allocate RTCP resources. Additionally if RTCP handling is requested, the IMS ALG may include:

- the explicit RTCP transport address information element;
- the RTP/RTCP transport multiplexing information element; and
- the bandwidth allocation for RTCP,

as described in subclause 5.9.

6.2.10 IMS end-to-access-edge Media Plane Security

6.2.10.1 General

All message sequence charts in this clause are examples.

The H.248 context model is defined in Figure 6.2.1.1.

6.2.10.2 End-to-access-edge security for RTP based media using SDES

This procedure is identical to that of subclause 6.2.1 apart from the IMS-ALG optionally requesting the IMS-AGW to provide IMS media plane security in accordance with 3GPP TS 33.328 [12].

The IMS-ALG shall provide the following media plane security related parameters to the IMS-AGW:

- the SDES crypto attributes

6.2.10.3 End-to-access-edge security for TCP-based media using TLS

6.2.10.3.1 End-to-access-edge security for session based messaging (MSRP)

6.2.10.3.1.1 IMS UE originating procedures for e2ae

6.2.10.3.1.1.1 Incoming TCP bearer establishment triggers an outgoing TCP bearer establishment

Figure 6.2.10.3.1.1.1.1 shows an example call flow for the originating session set-up procedures for one MSRP media stream using e2ae security, where an incoming TCP bearer establishment triggers an outgoing TCP bearer establishment.

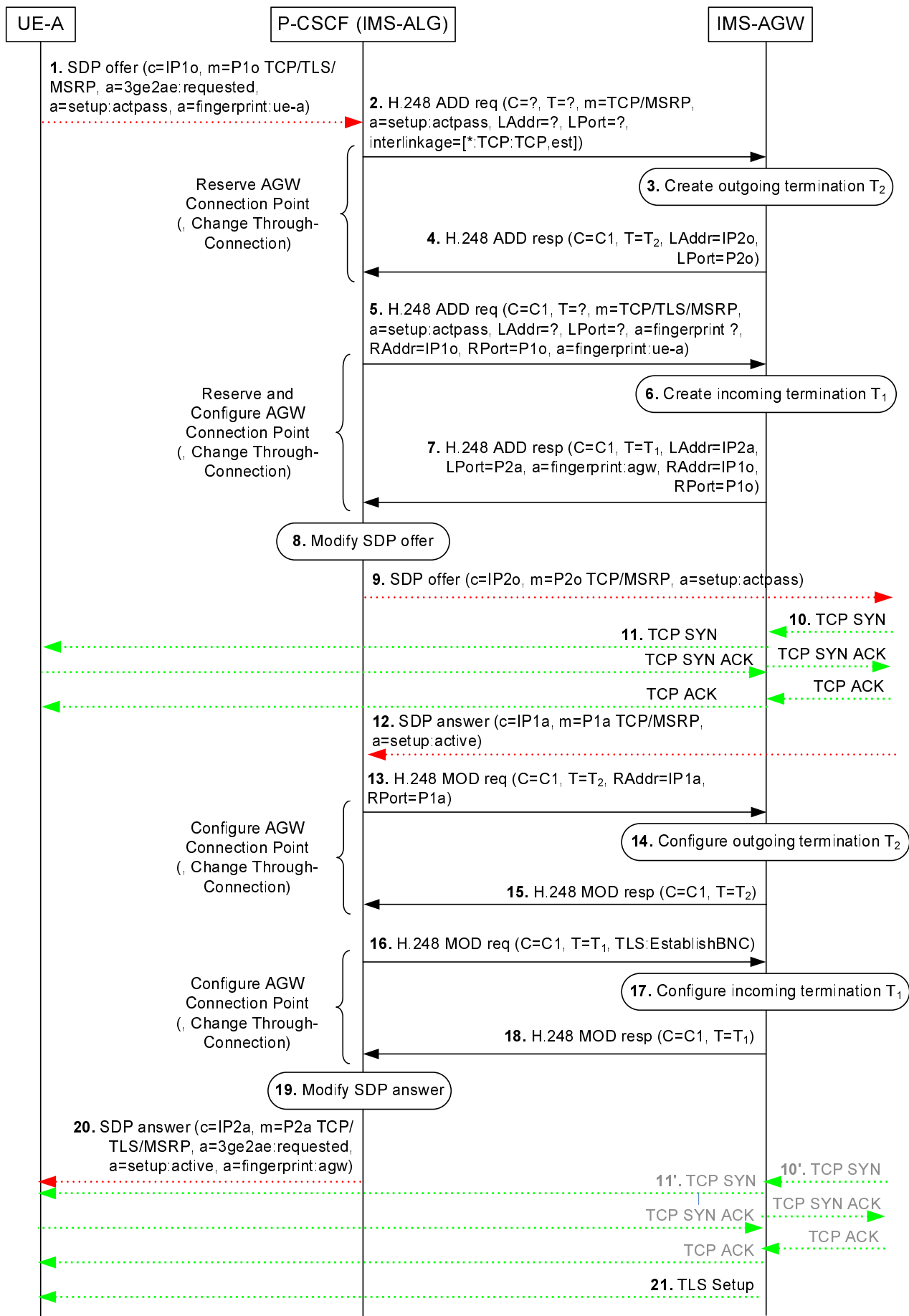

Figure 6.2.10.3.1.1.1.1: Originating example call flow for e2ae security for MSRP where an incoming TCP bearer establishment triggers an outgoing TCP bearer establishment

The IMS UE A performs an IMS originating session set-up according to 3GPP TS 23.228 [2], with modifications as described in 3GPP TS 33.328 [12].

The procedure in the above figure for requesting e2ae security for a media stream is described step-by-step with an emphasis on the additional aspects for IMS-ALG and IMS-AGW of media protection using TLS.

1. IMS UE A sends an SDP offer for a media stream containing cryptographic information, together with an "a=3ge2ae:requested" SDP attribute for the MSRP-related SDP m-line, to the P-CSCF (IMS-ALG). For e2ae protection of MSRP the cryptographic information contained in the SDP offer consists of the fingerprint of the certificate of IMS UE A in accordance to IETF RFC 4975 [25]. For each media stream that uses transport "TCP/TLS/MSRP", the P-CSCF (IMS-ALG) checks for the presence of the "a=3ge2ae:requested" SDP attribute. If that indication is present and the P-CSCF (IMS-ALG) indicated support of e2ae-security for MSRP during registration, the P-CSCF (IMS-ALG) allocates the required resources, includes the IMS-AGW in the media path and proceeds as specified in this clause.

NOTE 1: An operator can choose to terminate TLS in the IMS-AGW according to the following steps for all media streams that are signalled in SIP INVITE messages with transport TCP/TLS/MSRP and a certificate fingerprint attribute, even if the UE did not indicate support for e2ae security during registration and did not indicate usage of e2ae security for the respective media streams in the INVITE. This can lead to session failures for pre-Rel-12 IMS UEs or non-IMS UEs due to a mismatch of security parameters sent by the network and expected by the UE, but on the other hand, it will ensure compatibility with GSM A RCS 5.1 [35, 36], which specifies that TLS for MSRP is always terminated in the network.

- 2.-4. The IMS-ALG uses the "Reserve AGW Connection Point" procedure to request a termination for "TCP" media (for application-agnostic interworking) or "TCP/MSRP" media (for application-aware interworking) towards the core network. To indicate that the IMS-AGW shall operate in TCP Proxy mode, the IMS-ALG provides "a=setup:actpass" attribute. The IMS-ALG sets the interlinkage topology on the termination T2 to configure the IMS-AGW to use the TCP connection establishment request (TCP SYN) received at the termination T2 as a trigger to send a TCP connection establishment on the termination T1.

NOTE 2: If "a=setup:passive" is received in the SDP answer in step 12, the IMS-ALG then needs to set the interlinkage topology on the termination T1 (not depicted).

- 5.-7. The IMS-ALG uses the "Reserve And Configure AGW Connection Point" procedure to request a termination for "TCP/TLS" media (for application-agnostic interworking) or "TCP/TLS/MSRP" media (for application-aware interworking) towards the access network. In the remote descriptor, it provides the IP address, port and fingerprint attribute received from the UE containing the fingerprint of the UE's certificate in accordance to IETF RFC 4975 [25]. This instructs the IMS-AGW to verify during the subsequent TLS handshake with the IMS UE that the fingerprint of the certificate passed by the IMS UE during this TLS handshake matches the fingerprint passed by the P-CSCF (IMS-ALG) to the IMS-AGW. In turn, the IMS-AGW communicates the fingerprint of the certificate it is going to use for setting up protection for this media stream to the P-CSCF (IMS-ALG). To indicate that the IMS-AGW shall operate in TCP Proxy mode, the IMS-ALG provides "a=setup:actpass" attribute.

NOTE 3: These steps could be combined with steps 16.-18. This saves H.248 signalling interactions but can delay the TCP connection setup.

8. The P-CSCF (IMS-ALG) changes the transport from "TCP/TLS/MSRP" to "TCP/MSRP" in the SDP offer, removes the "a=3ge2ae:requested" SDP attribute and the fingerprint SDP attribute, and inserts the address information received from the IMS-AGW.

9. The P-CSCF (IMS-ALG) forwards the SDP offer.

10. The remote peer chooses to become the active party in the TCP connection establishment and sends a TCP SYN to establish the TCP connection. If the P-CSCF (IMS-ALG) indicated to the IMS-AGW at step 2 that it shall ignore any incoming TCP connection establishment requests (TCP SYN), e.g. to enable a remote source transport address filtering, or if the P-CSCF (IMS-ALG) did not indicate to the IMS-AGW at step 2 that it shall latch onto the required destination address via the source address/port of the incoming media, the IMS-AGW shall drop the TCP SYN received from the remote peer.

If the TCP SYN is not answered before a timer expiry, the remote peer will send the TCP SYN a second time

(step 10'). The IMS-AGW will answer a repeated TCP SYN if it is received after step 13 (step 10'). The IMS-AGW answers the TCP SYN and the remote peer completes the TCP connection establishment.

11. The IMS-AGW uses the TCP SYN received at the termination T2 (at step 10 or step 10' if the TCP SYN is dropped at step 10) as a trigger to send a TCP SYN towards the UE to establish a TCP connection (effectively making the IMS-AGW acting as the TCP client towards the UE).. The UE answers the TCP SYN and the IMS-AGW completes the TCP connection establishment.
 12. The P-CSCF (IMS-ALG) receives the SDP answer.
 - 13.-15. The IMS-ALG uses the "Configure AGW Connection Point" procedure to configure the termination towards the core network with remote address information. If the P-CSCF (IMS-ALG) indicated to the IMS-AGW at step 2 that it shall ignore any incoming TCP connection establishment requests (TCP SYN), the IMS-ALG indicates to the IMS-AGW to accept incoming TCP connection establishment (TCP SYN) only from the indicated remote transport address.
- NOTE 4: For "a=setup:active" in the SDP answer, these steps could possibly be skipped if the P-CSCF (IMS-ALG) indicated to the IMS-AGW at step 2 that it shall latch onto the required destination address via the source address/port of the incoming media, as the IMS-AGW will then use the address information in the TCP SYN when replying.
- 16.-18. The IMS-ALG uses the "Configure AGW Connection Point" procedure to configure the termination towards the access network with the request to establish the TLS session once the TCP connection is established (effectively making the IMS-AGW acting as the TLS client), in accordance with the information in the "a=setup" attribute in the SDP answer.
 19. The P-CSCF (IMS-ALG) modifies the SDP answer before sending it to the UE A. The P-CSCF (IMS-ALG) sets the transport to "TCP/TLS/MSRP" and includes the fingerprint of the IMS-AGW's certificate in accordance to IETF RFC 4975 [25].
 20. The P-CSCF (IMS-ALG) then sends the updated SDP answer to IMS UE A. After receiving this message IMS UE A completes the media security setup.
 21. Upon completion of the TCP connection establishment, the IMS-AGW starts the establishment of the TLS session.

6.2.10.3.1.1.2 IMS-ALG requests sending an outgoing TCP bearer establishment

Figure 6.2.10.3.1.1.2.1 shows an example call flow for the originating session set-up procedures for one MSRP media stream using e2ae security, where the IMS-ALG requests sending an outgoing TCP bearer establishment.

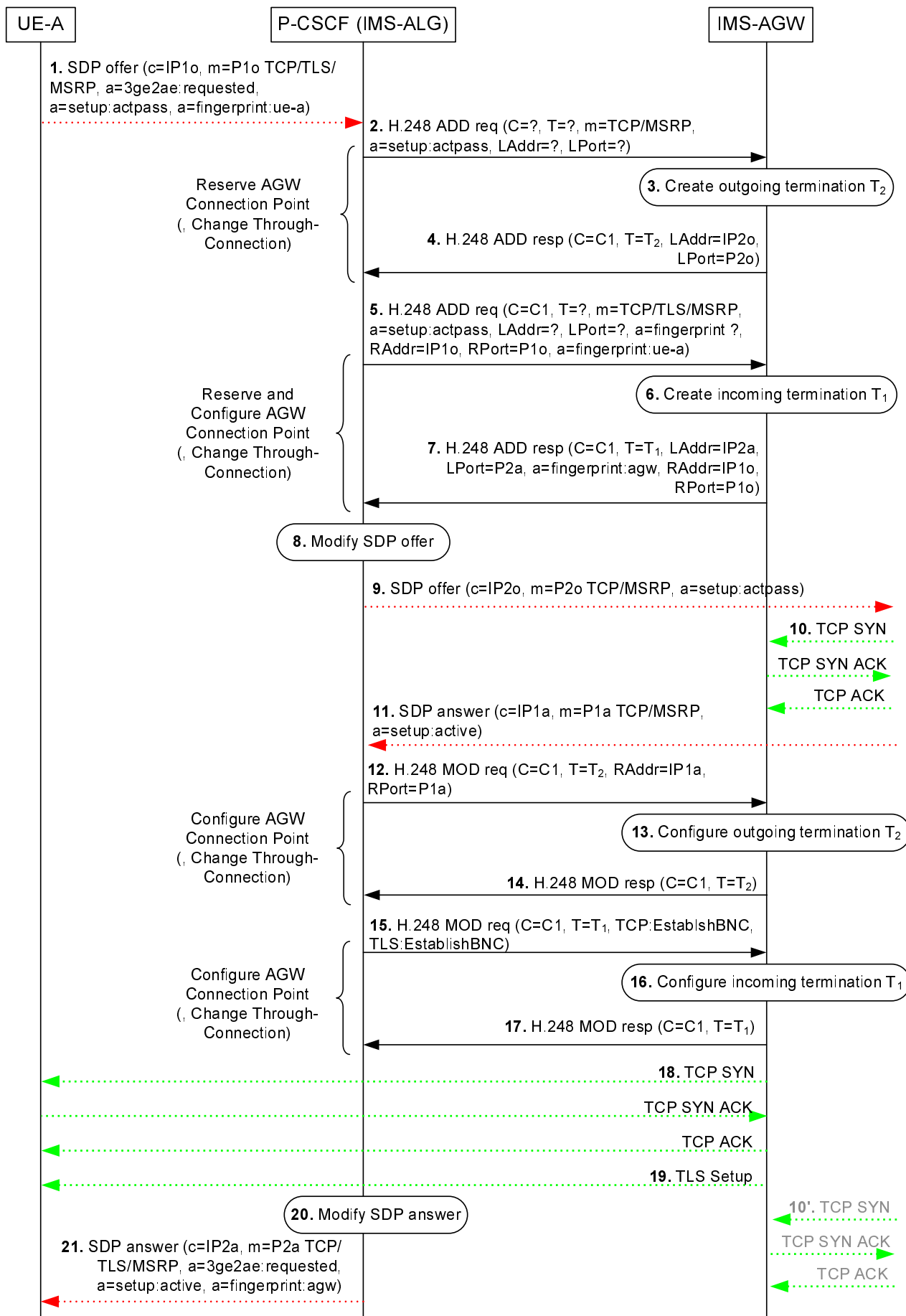

Figure 6.2.10.3.1.1.2.1: Originating example call flow for e2ae security for MSRP where the IMS-ALG requests sending an outgoing TCP bearer establishment

The IMS UE A performs an IMS originating session set-up according to 3GPP TS 23.228 [2], with modifications as described in 3GPP TS 33.328 [12].

The procedure in the above figure for requesting e2ae security for a media stream is described step-by-step with an emphasis on the additional aspects for IMS-ALG and IMS-AGW of media protection using TLS.

1. As step 1 in figure 6.2.10.3.1.1.1.1.
- 2.-4. As steps 2-4 in figure 6.2.10.3.1.1.1.1 with the exception that the IMS-ALG does not set the interlinkage topology on the termination T2.
- 5.-7. As steps 5-7 in figure 6.2.10.3.1.1.1.1.
8. As step 8 in figure 6.2.10.3.1.1.1.1.
9. As step 9 in figure 6.2.10.3.1.1.1.1.
10. As step 10 in figure 6.2.10.3.1.1.1.1.

NOTE: The incoming TCP SYN does not trigger the sending of an outgoing TCP SYN, and step 11 in figure 6.2.10.3.1.1.1.1 thus does not apply.

11. As step 12 in figure 6.2.10.3.1.1.1.1.
- 12.-14. As steps 13-15 in figure 6.2.10.3.1.1.1.1.
- 15.-17. As steps 16-18 in figure 6.2.10.3.1.1.1.1 with the exception that the IMS-ALG uses the "Configure AGW Connection Point" procedure also to configure the termination towards the access network with the request to establish the TCP connection (effectively making the IMS-AGW acting as the TCP client), in accordance with the information in the "a=setup" attribute in the SDP answer.
18. The IMS-AGW sends a TCP SYN towards the UE to establish a TCP connection. The UE answers with a TCP SYN ACK and the IMS-AGW replies with a TCP ACK, completing the TCP connection establishment.
19. As step 21 in figure 6.2.10.3.1.1.1.1.
20. As step 19 in figure 6.2.10.3.1.1.1.1.
21. As step 20 in figure 6.2.10.3.1.1.1.1.

6.2.10.3.1.2 IMS UE terminating procedures for e2ae

6.2.10.3.1.2.1 Incoming TCP bearer establishment triggers an outgoing TCP bearer establishment

Figure 6.2.10.3.1.2.1.1 shows an example call flow for the terminating session set-up procedures for one MSRP media stream using e2ae security, where an incoming TCP bearer establishment triggers an outgoing TCP bearer establishment.

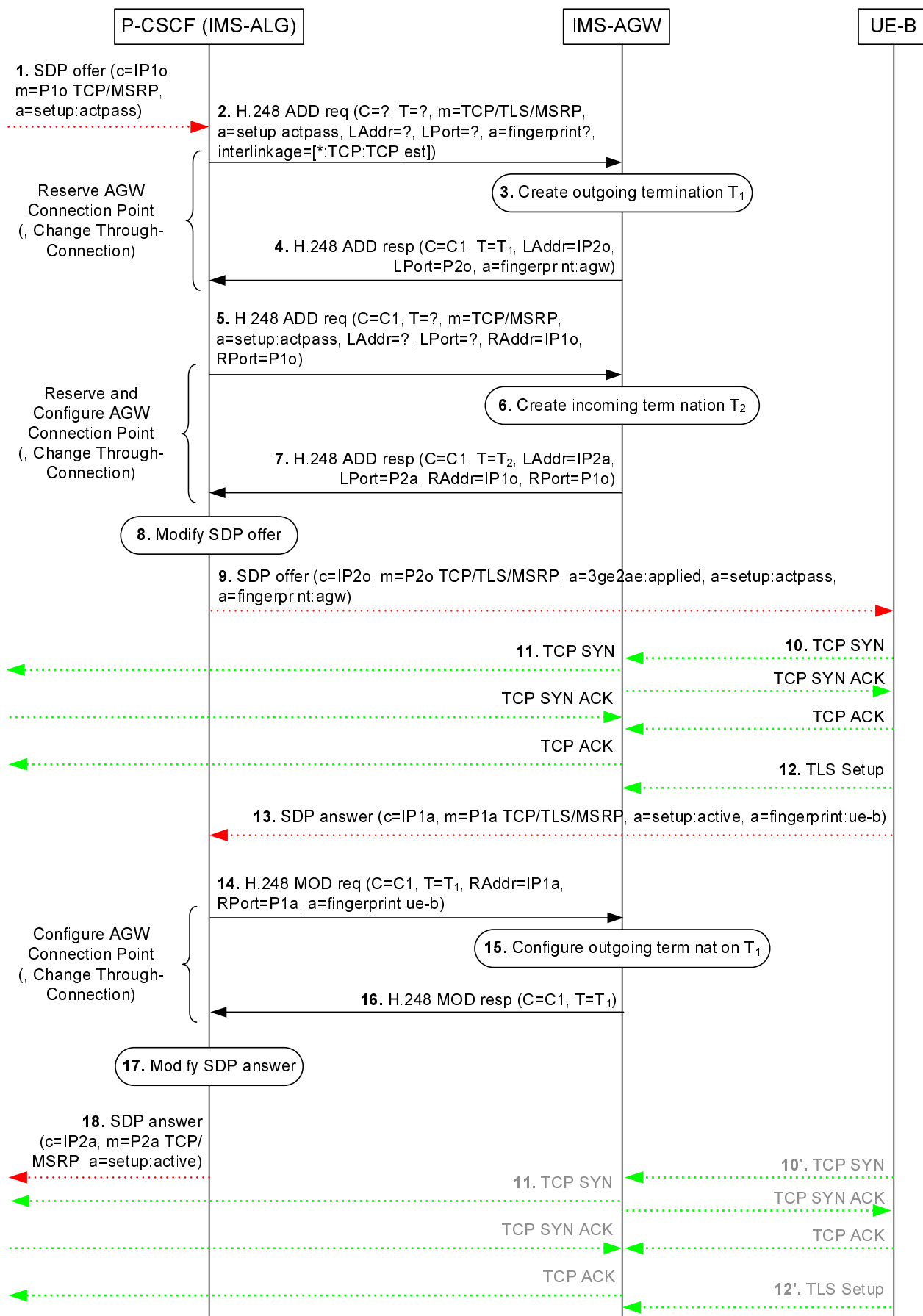

Figure 6.2.10.3.1.2.1.1: Terminating example call flow for e2ae security for MSRP where an incoming TCP bearer establishment triggers an outgoing TCP bearer establishment

The IMS UE B performs an IMS terminating session set-up according to 3GPP TS 23.228 [2], with modifications as described in 3GPP TS 33.328 [12].

The procedure in the above figure for requesting e2ae security for a media stream is described step-by-step with an emphasis on the additional aspects for IMS-ALG and IMS-AGW of media protection using TLS.

1. The P-CSCF (IMS-ALG) receives an SDP offer for an MSRP media stream. For each MSRP media stream offered with transport "TCP/MSRP", if both the IMS UE and P-CSCF (IMS-ALG) indicated support for e2ae security for MSRP during registration, the P-CSCF (IMS-ALG) allocates the required resources, includes the IMS-AGW in the media path and proceeds as specified in this clause.

NOTE 1: An operator can choose to terminate TLS in the IMS-AGW according to the following steps for all media streams that are signalled in SIP INVITE messages with transport TCP/MSRP, even if the UE did not indicate support for e2ae security during registration. This can lead to session failures for pre-Rel-12 IMS UEs or non-IMS UEs due to a mismatch of security parameters sent by the network and expected by the UE, but on the other hand, it will ensure compatibility with GSMA RCS 5.1 [35, 36], which recommends to always use e2ae security for MSRP on the terminating leg.

- 2.-4. The IMS-ALG uses the "Reserve AGW Connection Point" procedure to request a termination for "TCP/TLS" media (for application-agnostic interworking) or "TCP/TLS/MSRP" media (for application-aware interworking) towards the access network. In turn, the IMS-AGW communicates the fingerprint of the certificate it is going to use for setting up protection for this media stream to the P-CSCF (IMS-ALG). To indicate that the IMS-AGW shall operate in TCP Proxy mode, the IMS-ALG provides "a=setup:actpass" attribute. The IMS-ALG sets the interlinkage topology on the termination T1 to configure the IMS-AGW to use the TCP connection establishment request (TCP SYN) received at the termination T1 as a trigger to send a TCP connection establishment on the termination T2.

NOTE 2: If "a=setup:passive" is received in the SDP answer in step 13, the IMS-ALG then needs to sets the interlinkage topology on the termination T2 (not depicted)

- 5.-7. The IMS-ALG uses the "Reserve And Configure AGW Connection Point" procedure to request a termination for "TCP" media (for application-agnostic interworking) or "TCP/MSRP" media (for application-aware interworking) towards the core network. To indicate that the IMS-AGW shall operate in TCP Proxy mode, the IMS-ALG provides "a=setup:actpass" attribute.
8. The P-CSCF (IMS-ALG) changes the transport from "TCP/MSRP" to "TCP/TLS/MSRP" in the SDP offer, adds the "a=3ge2ae:applied" SDP attribute and the fingerprint SDP attribute received from the IMS-AGW, and inserts the address information received from the IMS-AGW.
9. The P-CSCF (IMS-ALG) forwards the SDP offer.
10. The UE B chooses to become the active party in the TCP connection establishment and sends a TCP SYN to establish the TCP connection. If the P-CSCF (IMS-ALG) indicated to the IMS-AGW at step 2 that it shall ignore any incoming TCP connection establishment requests (TCP SYN), e.g. to enable a remote source transport address filtering, or if the P-CSCF (IMS-ALG) did not indicate to the IMS-AGW at step 2 that it shall latch onto the required destination address via the source address/port of the incoming media, the IMS-AGW shall drop the TCP SYN received from the UE.
If the TCP SYN is not answered before a timer expiry, the UE will send the TCP SYN a second time (step 10').
The IMS-AGW will answer a repeated TCP SYN if it is received after step 14 (step 10').
The IMS-AGW answers the TCP SYN and the remote peer completes the TCP connection establishment.
11. The IMS-AGW uses the TCP SYN received at the termination T1 (at step 10 or step 10' if the TCP SYN is dropped at step 10) as a trigger to send a TCP SYN towards the core network to establish a TCP connection (effectively making the IMS-AGW acting as the TCP client towards the core network). The remote peer answers the TCP SYN and the IMS-AGW completes the TCP connection establishment.
12. Upon completion of the TCP connection establishment, the UE B starts the establishment of the TLS session. The IMS-AGW needs to wait until step 14 to verify the received fingerprint.
13. The P-CSCF (IMS-ALG) receives the SDP answer. It contains the fingerprint attribute with the UE's certificate in accordance to IETF RFC 4975 [25].

- 14.-16. The IMS-ALG uses the "Configure AGW Connection Point" procedure to configure the termination towards the UE B with remote address information. In the remote descriptor, it also provides fingerprint attribute received from the UE. This instructs the IMS-AGW to verify during the subsequent TLS handshake with the IMS UE that the fingerprint of the certificate passed by the IMS UE during this TLS handshake matches the fingerprint passed by the P-CSCF (IMS-ALG) to the IMS-AGW. If the P-CSCF (IMS-ALG) indicated to the IMS-AGW at step 2 that it shall ignore any incoming TCP connection establishment requests (TCP SYN), the IMS-ALG indicates to the IMS-AGW to accept incoming TCP connection establishment (TCP SYN) only from the indicated remote transport address.
17. The P-CSCF (IMS-ALG) modifies the SDP answer before sending it to the core network. The P-CSCF (IMS-ALG) sets the transport to "TCP/MSRP" and removes the SDP fingerprint attribute.
18. The P-CSCF (IMS-ALG) then sends the updated SDP answer to core network.

6.2.10.3.1.2.2 IMS-ALG requests sending an outgoing TCP bearer establishment

Figure 6.2.10.3.1.2.2.1 shows an example call flow for the terminating session set-up procedures for one MSRP media stream using e2ae security, where the IMS-ALG requests sending an outgoing TCP bearer establishment.

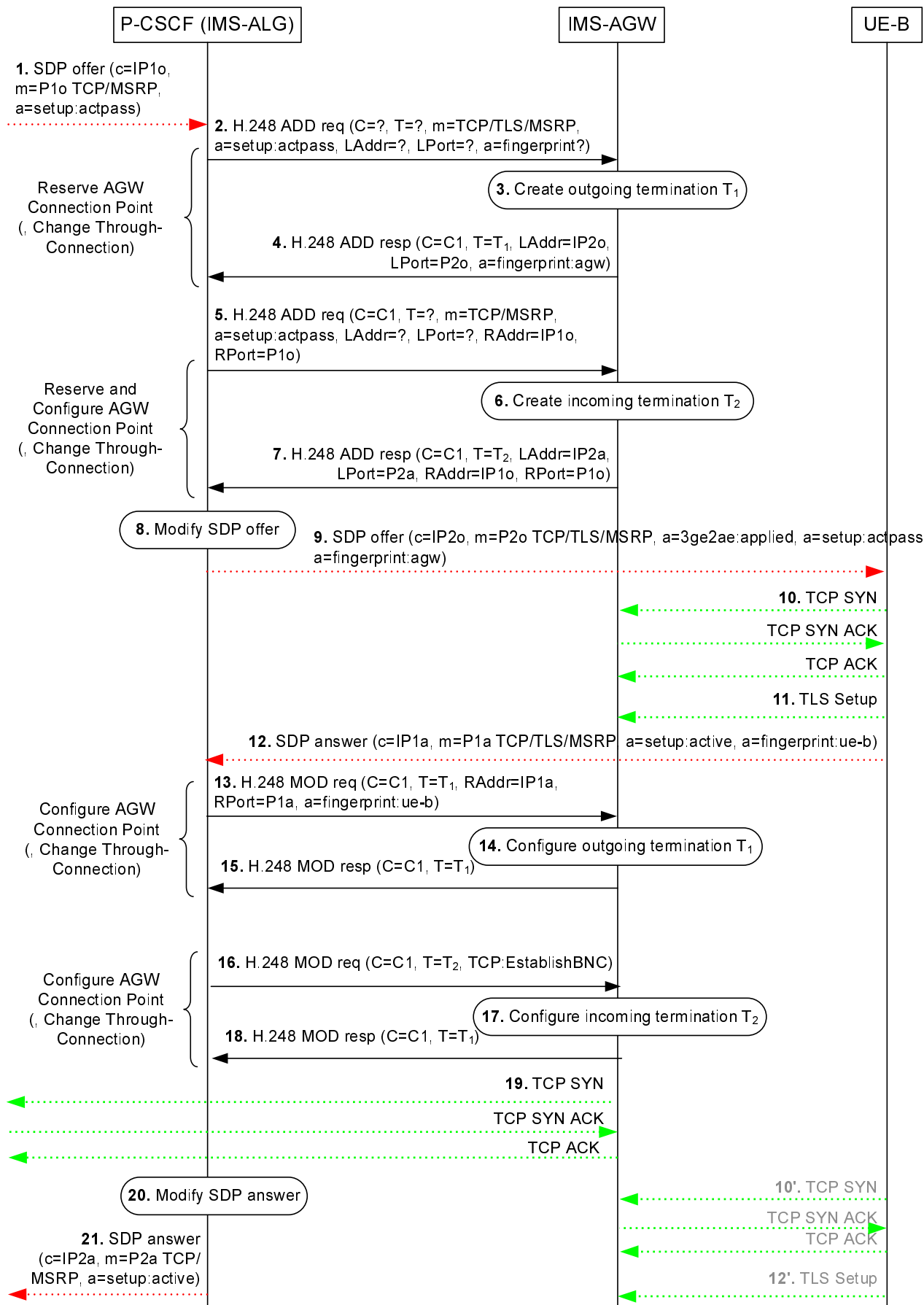

Figure 6.2.10.3.1.2.2.1: Terminating example call flow for e2ae security for MSRP where the IMS-ALG requests sending an outgoing TCP bearer establishment

The IMS UE B performs an IMS terminating session set-up according to 3GPP TS 23.228 [2], with modifications as described in 3GPP TS 33.328 [12].

The procedure in the above figure for requesting e2ae security for a media stream is described step-by-step with an emphasis on the additional aspects for IMS-ALG and IMS-AGW of media protection using TLS.

1. As step 1 in figure 6.2.10.3.1.2.1.1.
- 2.-4. As steps 2-4 in figure 6.2.10.3.1.2.1.1 with the exception that the IMS-ALG does not set the interlinkage topology on the termination T1.
- 5.-7. As steps 7-7 in figure 6.2.10.3.1.2.1.1.
8. As step 8 in figure 6.2.10.3.1.2.1.1.
9. As step 9 in figure 6.2.10.3.1.2.1.1.
10. As step 10 in figure 6.2.10.3.1.2.1.1.

NOTE: The incoming TCP SYN does not trigger the sending of an outgoing TCP SYN, and step 11 in figure 6.2.10.3.1.2.1.1 thus does not apply.

11. As step 12 in figure 6.2.10.3.1.2.1.1.
12. As step 13 in figure 6.2.10.3.1.2.1.1.
- 13.-15. As steps 14-16 in figure 6.2.10.3.1.2.1.1.
- 16.-18. The IMS-ALG uses the "Configure AGW Connection Point" procedure to configure the termination towards the core network with the request to establish the TCP connection, in accordance with the information in the "a=setup" attribute in the SDP answer.
19. The IMS-AGW sends a TCP SYN towards the core network to establish a TCP connection. The remote peer answers with a TCP SYN ACK and the IMS-AGW replies with a TCP ACK, completing the TCP connection establishment.
20. As step 17 in figure 6.2.10.3.1.2.1.1.
21. As step 18 in figure 6.2.10.3.1.2.1.1.

6.2.10.3.2 End-to-access-edge security for conferencing (BFCP)

6.2.10.3.2.1 IMS UE originating procedures for e2ae

6.2.10.3.2.1.1 Incoming TCP bearer establishment triggers an outgoing TCP bearer establishment

Figure 6.2.10.3.2.1.1.1 shows the originating session set-up procedures for one or more BFCP media stream(s) using e2ae security.

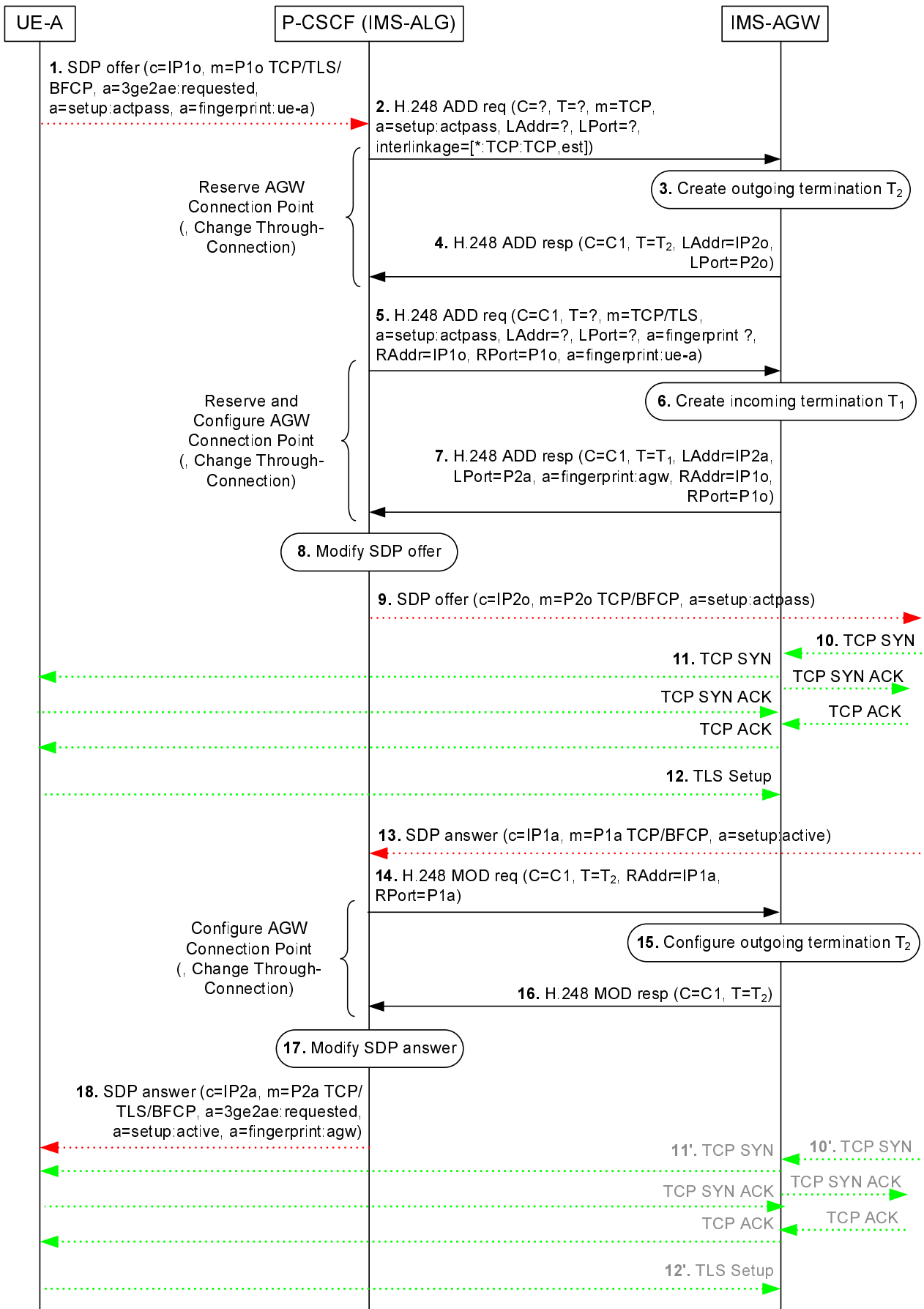

Figure 6.2.10.3.2.1.1.1: Originating example call flow for e2ae security for BFCP where an incoming TCP bearer establishment triggers an outgoing TCP bearer establishment

The IMS UE A performs an IMS originating session set-up according to 3GPP TS 23.228 [2], with modifications as described in 3GPP TS 33.328 [12].

The procedure in the above figure for requesting e2ae security for a media stream is described step-by-step with an emphasis on the additional aspects for IMS-ALG and IMS-AGW of media protection using TLS.

1. IMS UE A sends an SDP offer for a media stream containing cryptographic information, together with an "a=3ge2ae:requested" SDP attribute for the BFCP-related SDP m-line, to the P-CSCF (IMS-ALG). For e2ae protection of BFCP the cryptographic information contained in the SDP offer consists of the fingerprint of the certificate of IMS UE A in accordance to IETF RFC 4975 [25]. For each media stream that uses transport "TCP/TLS/BFCP", the P-CSCF (IMS-ALG) checks for the presence of the "a=3ge2ae:requested" SDP attribute. If that indication is present and the P-CSCF (IMS-ALG) indicated support of e2ae-security for BFCP during registration, the P-CSCF (IMS-ALG) allocates the required resources, includes the IMS-AGW in the media path and proceeds as specified in this clause.
- 2.-4. The IMS-ALG uses the "Reserve AGW Connection Point" procedure to request a termination for "TCP" media towards the core network. To indicate that the IMS-AGW shall operate in TCP Proxy mode, the IMS-ALG provides "a=setup:actpass" attribute. The IMS-ALG sets the interlinkage topology on the termination T2 to configure the IMS-AGW to use the TCP connection establishment request (TCP SYN) received at the termination T2 as a trigger to send a TCP connection establishment on the termination T1.

NOTE 1: If "a=setup:passive" is received in the SDP answer in step 13, the IMS-ALG then needs to set the interlinkage topology on the termination T1 (not depicted).

- 5.-7. The IMS-ALG uses the "Reserve And Configure AGW Connection Point" procedure to request a termination for "TCP/TLS" media towards the access network. In the remote descriptor, it provides the IP address, port and fingerprint attribute received from the UE containing the fingerprint of the UE's certificate in accordance to IETF RFC 4975 [25]. This instructs the IMS-AGW to verify during the subsequent TLS handshake with the IMS UE that the fingerprint of the certificate passed by the IMS UE during this TLS handshake matches the fingerprint passed by the P-CSCF (IMS-ALG) to the IMS-AGW. In turn, the IMS-AGW communicates the fingerprint of the certificate it is going to use for setting up protection for this media stream to the P-CSCF (IMS-ALG). To indicate that the IMS-AGW shall operate in TCP Proxy mode, the IMS-ALG provides "a=setup:actpass" attribute.
8. The P-CSCF (IMS-ALG) changes the transport from "TCP/TLS/BFCP" to "TCP/BFCP" in the SDP offer, removes the "a=3ge2ae:requested" SDP attribute and the fingerprint SDP attribute, and inserts the address information received from the IMS-AGW.
9. The P-CSCF (IMS-ALG) forwards the SDP offer.
10. The remote peer chooses to become the active party in the TCP connection establishment and sends a TCP SYN to establish the TCP connection. If the P-CSCF (IMS-ALG) indicated to the IMS-AGW at step 2 that it shall ignore any incoming TCP connection establishment requests (TCP SYN), e.g. to enable a remote source transport address filtering, or if the P-CSCF (IMS-ALG) did not indicate to the IMS-AGW at step 2 that it shall latch onto the required destination address via the source address/port of the incoming media, the IMS-AGW shall drop the TCP SYN received from the remote peer.
If the TCP SYN is not answered before a timer expiry, the remote peer will send the TCP SYN a second time (step 10'). The IMS-AGW will answer a repeated TCP SYN if it is received after step 14 (step 10'). The IMS-AGW answers the TCP SYN and the remote peer completes the TCP connection establishment.
11. The IMS-AGW uses the TCP SYN received at the termination T2 (at step 10 or step 10' if the TCP SYN is dropped at step 10) as a trigger to send a TCP SYN towards the UE to establish a TCP connection (effectively making the IMS-AGW acting as the TCP client towards the UE). The UE answers the TCP SYN and the IMS-AGW completes the TCP connection establishment.
12. Upon completion of the TCP connection establishment, the UE B starts the establishment of the TLS session. The IMS-AGW needs to wait until step 14 to verify the received fingerprint.
13. The P-CSCF (IMS-ALG) receives the SDP answer.
- 14.-16. The IMS-ALG uses the "Configure AGW Connection Point" procedure to configure the termination towards the core network with remote address information. If the P-CSCF (IMS-ALG) indicated to the IMS-AGW at step 2 that it shall ignore any incoming TCP connection establishment requests (TCP SYN), the IMS-ALG indicates

to the IMS-AGW to accept incoming TCP connection establishment (TCP SYN) only from the indicated remote transport address.

NOTE 2: For "a=setup:active" in the SDP answer, these steps could possibly be skipped if the P-CSCF (IMS-ALG) indicated to the IMS-AGW at step 2 that it shall latch onto the required destination address via the source address/port of the incoming media, as the IMS-AGW will then use the address information in the TCP SYN when replying.

17. The P-CSCF (IMS-ALG) modifies the SDP answer before sending it to the UE A. The P-CSCF (IMS-ALG) sets the transport to "TCP/TLS/BFCP" and includes the fingerprint of the IMS-AGW's certificate in accordance to IETF RFC 4975 [25].

18. The P-CSCF (IMS-ALG) then sends the updated SDP answer to IMS UE A. After receiving this message IMS UE A completes the media security setup.

6.2.10.3.2.2 IMS UE terminating procedures for e2ae

6.2.10.3.2.2.1 Incoming TCP bearer establishment triggers an outgoing TCP bearer establishment

Figure 6.2.10.3.2.2.1.1 shows the terminating session set-up procedures for one or more BFCP media stream(s) using e2ae security.

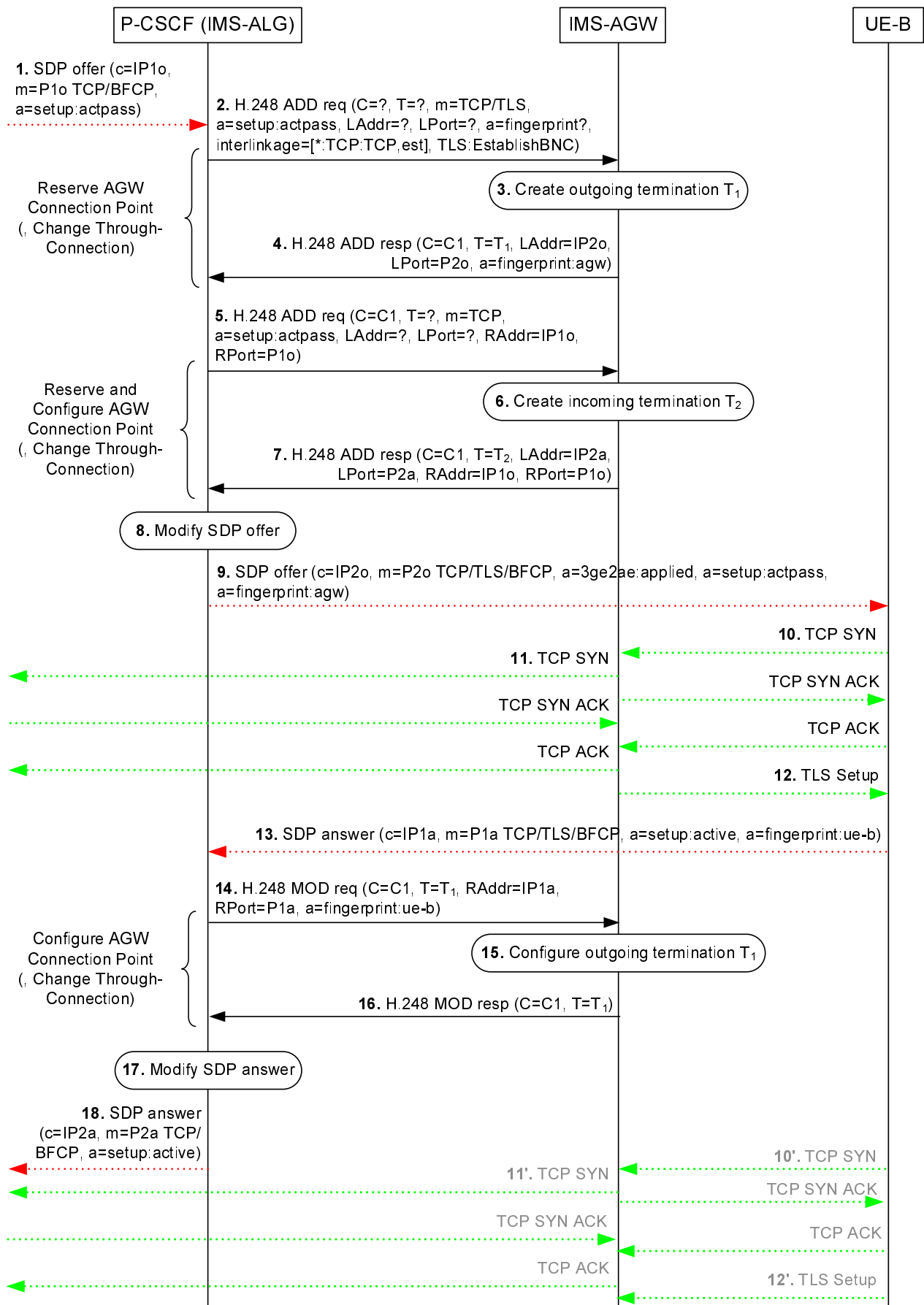

Figure 6.2.10.3.2.2.1.1: Terminating example call flow for e2ae security for MSRP where an incoming TCP bearer establishment triggers an outgoing TCP bearer establishment

The IMS UE B performs an IMS terminating session set-up according to 3GPP TS 23.228 [2], with modifications as described in 3GPP TS 33.328 [12].

The procedure in the above figure for requesting e2ae security for a media stream is described step-by-step with an emphasis on the additional aspects for IMS-ALG and IMS-AGW of media protection using TLS.

1. The P-CSCF (IMS-ALG) receives an SDP offer for an MSRP media stream. For each BFCP media stream offered with transport "TCP/BFCP", if both the IMS UE and P-CSCF (IMS-ALG) indicated support for e2ae-security for BFCP during registration, the P-CSCF (IMS-ALG) allocates the required resources, includes the IMS-AGW in the media path and proceeds as specified in this clause.
- 2.-4. The IMS-ALG uses the "Reserve AGW Connection Point" procedure to request a termination for "TCP/TLS" media towards the access network. The IMS-ALG configures the IMS-AGW with the request to start the establishment of the TLS session once the TCP connection is established (effectively making the IMS-AGW acting as the TLS client). To indicate that the IMS-AGW shall operate in TCP Proxy mode, the IMS-ALG provides "a=setup:actpass" attribute. The IMS-ALG sets the interlinkage topology on the termination T1 to configure the IMS-AGW to use the TCP connection establishment request (TCP SYN) received at the termination T1 as a trigger to send a TCP connection establishment on the termination T2. The IMS-AGW communicates the fingerprint of the certificate it is going to use for setting up protection for this media stream to the P-CSCF (IMS-ALG).

NOTE: If "a=setup:passive" is received in the SDP answer in step 13, the IMS-ALG then needs to sets the interlinkage topology on the termination T2 (not depicted)

- 5.-7. The IMS-ALG uses the "Reserve And Configure AGW Connection Point" procedure to request a termination for "TCP" media towards the core network. To indicate that the IMS-AGW shall operate in TCP Proxy mode, the IMS-ALG provides "a=setup:actpass" attribute.
8. The P-CSCF (IMS-ALG) changes the transport from "TCP/ BFCP" to "TCP/TLS/BFCP" in the SDP offer, adds the "a=3ge2ae:applied" SDP attribute and the fingerprint SDP attribute received from the IMS-AGW, and inserts the address information received from the IMS-AGW.
9. The P-CSCF (IMS-ALG) forwards the SDP offer.
10. The UE B chooses to become the active party in the TCP connection establishment and sends a TCP SYN to establish the TCP connection. If the P-CSCF (IMS-ALG) indicated to the IMS-AGW at step 2 that it shall ignore any incoming TCP connection establishment requests (TCP SYN), e.g. to enable a remote source transport address filtering, or if the P-CSCF (IMS-ALG) did not indicate to the IMS-AGW at step 2 that it shall latch onto the required destination address via the source address/port of the incoming media, the IMS-AGW shall drop the TCP SYN received from the UE.
If the TCP SYN is not answered before a timer expiry, the UE will send the TCP SYN a second time (step 10'). The IMS-AGW will answer a repeated TCP SYN if it is received after step 14 (step 10'). The IMS-AGW answers the TCP SYN and the remote peer completes the TCP connection establishment.
11. The IMS-AGW sends a TCP SYN towards the core network to establish a TCP connection. The remote peer answers the TCP SYN and the IMS-AGW completes the TCP connection establishment.
12. Upon completion of the TCP connection establishment, the IMS-AGW starts the establishment of the TLS session. The IMS-AGW needs to wait until step 14 to verify the received fingerprint.
13. The P-CSCF (IMS-ALG) receives the SDP answer. It contains the fingerprint attribute with the UE's certificate in accordance to IETF RFC 4975 [25].
- 14.-16. The IMS-ALG uses the "Configure AGW Connection Point" procedure to configure the termination towards the UE B with remote address information. In the remote descriptor, it also provides fingerprint attribute received from the UE. This instructs the IMS-AGW to verify during the TLS handshake with the IMS UE (see step 12) that the fingerprint of the certificate passed by the IMS UE during this TLS handshake matches the fingerprint passed by the P-CSCF (IMS-ALG) to the IMS-AGW. If the P-CSCF (IMS-ALG) indicated to the IMS-AGW at step 2 that it shall ignore any incoming TCP connection establishment requests (TCP SYN), the IMS-ALG indicates to the IMS-AGW to accept incoming TCP connection establishment (TCP SYN) only from the indicated remote transport address.
17. The P-CSCF (IMS-ALG) modifies the SDP answer before sending it to the core network. The P-CSCF (IMS-ALG) sets the transport to "TCP/ BFCP" and removes the SDP fingerprint attribute.

18. The P-CSCF (IMS-ALG) then sends the updated SDP answer to core network.

6.2.10.4 End-to-access-edge security for UDP based media using DTLS

6.2.10.4.1 General

The IMS-ALG and the IMS-AGW may support e2ae security for the UDP based media using DTLS and certificate fingerprints.

The following subclauses describe extensions to the Iq signalling procedures and their interactions with SIP signalling in the control plane and with user plane procedures if the e2ae security for the UDP based media using DTLS and certificate fingerprints is supported by the IMS-ALG and the IMS-AGW and if the IMS-ALG indicated support of e2ae security for the UDPTL using DTLS and certificate fingerprints during registration.

6.2.10.4.2 Session establishment from IMS access network for T.38 fax using "UDP/TLS/UDPTL"

Upon receipt of an SDP offer from the IMS access network containing T.38 fax media using the "UDP/TLS/UDPTL" transport protocol with the associated:

- 3ge2ae SDP attribute, as defined in 3GPP TS 24.229 [11], with a value "requested";
- fingerprint SDP attribute(s) as defined in IETF RFC 8122 [80];
- DTLS association identity SDP attribute "a=tls-id" defined in IETF draft-ietf-mmusic-dtls-sdp [81]; and
- setup SDP attribute as defined in IETF RFC 4145 [30];

the IMS-ALG shall:

- check the received value of the setup SDP attribute to determine if the IMS-AGW needs to act as DTLS client or DTLS server. When the received value is equal to:
 - a) "active" the IMS-AGW needs to act as DTLS server;
 - b) "passive" the IMS-AGW needs to act as DTLS client; or
 - c) "actpass" the IMS-ALG shall decide if the IMS-AGW needs to act as DTLS client or DTLS server;
- when reserving the transport addresses/resources towards the IMS access network:
 - a) indicate to the IMS-AGW "UDP/DTLS" as transport protocol;
 - b) if the IMS-AGW needs to act as DTLS client, include the Establish (D)TLS session information element to request the IMS-AGW to start the DTLS session setup;
 - c) include the Notify (D)TLS session establishment Failure Event information element to request the IMS-AGW to report the unsuccessful DTLS session setup;
 - d) include the Remote certificate fingerprint information element with the value of the received fingerprint SDP attribute(s); and
 - e) include the Local certificate fingerprint Request information element to request the certificate fingerprint of the IMS-AGW;
- indicate to the IMS-AGW "UDP" as transport protocol when reserving the transport addresses/resources towards the IMS core network; and
- remove the setup SDP attribute and indicate the transport protocol "UDPTL" in the SDP offer towards the IMS core network.

Upon receipt of an SDP answer from the IMS core network, the IMS-ALG shall:

- in the "m=" line indicating T.38 fax using UDPTL, change the transport protocol to "UDP/TLS/UDPTL";

- insert the fingerprint SDP attribute with the value of the Local certificate fingerprint information element received from the IMS-AGW;
- insert the "a=tls-id" SDP attribute containing a new DTLS association identity; and
- insert the setup SDP attribute with the value:
 - a) "active" if the IMS-ALG requested the IMS-AGW to act as DTLS client; or
 - b) "passive" if the IMS-AGW shall take the DTLS server role.

The message sequence chart shown in the figure 6.2.10.4.2.1 gives an example of a session establishment from the IMS access network with an emphasis on the additional aspects for the IMS-ALG and the IMS-AGW for the e2ae protection of the T.38 fax media using UDPTL over DTLS.

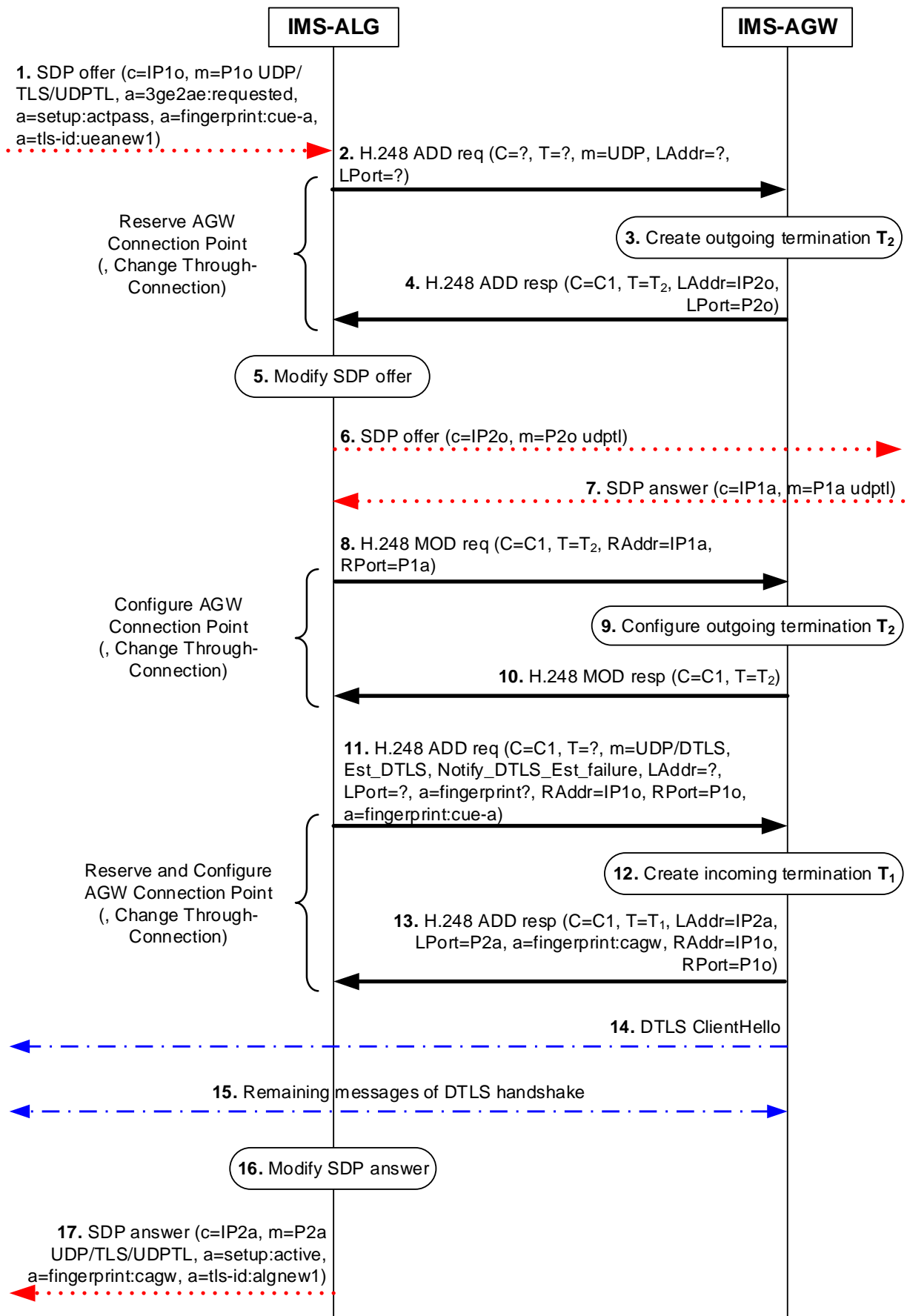

Figure 6.2.10.4.2.1: Session setup from the IMS access network with e2ae protection of T.38 fax

6.2.10.4.3 Session establishment towards IMS access network for T.38 fax using "UDP/TLS/UDPTL"

Upon receipt of an SDP offer from the IMS core network containing T.38 fax media using the "UDPTL" transport protocol the IMS-ALG shall:

- when reserving the transport addresses/resources towards the IMS access network:
 - a) indicate to the IMS-AGW "UDP/DTLS" as transport protocol;
 - b) include the Notify (D)TLS session establishment Failure Event information element to request the IMS-AGW to report the unsuccessful DTLS session setup; and

NOTE 1: The IMS-ALG may omit this information element when reserving resources and instead send it to the IMS-AGW when modifying the resources towards the IMS access network.

- when reserving the transport addresses/resources towards the IMS core network indicate to the IMS-AGW "UDP" as transport protocol.
- modify the SDP offer that will be sent to the IMS access network by:
 - in the "m=" line indicating T.38 fax using UDPTL, changing the transport protocol to "UDP/TLS/UDPTL";
 - inserting the 3ge2ae SDP attribute, as defined in 3GPP TS 24.229 [11], with a value "applied";
 - inserting the fingerprint SDP attribute, as defined in IETF RFC 8122 [80], with the value of the Local certificate fingerprint information element received from the IMS-AGW;
 - inserting the "tls-id" SDP attribute with the new DTLS association identity; and
 - inserting the setup SDP attribute, as defined in IETF RFC 4145 [30], e.g. with the value "actpass".

NOTE 2: Alternatively, the IMS-ALG can set the value of the setup SDP attribute to "active" if the IMS-ALG wants that the IMS-AGW provides the DTLS client role or to "passive" if the IMS-ALG wants that the IMS-AGW provides the DTLS server role e.g. for NAT traversal.

Upon receipt of an SDP answer from the IMS access network containing T.38 fax media using the "UDP/TLS/UDPTL" transport protocol with the associated fingerprint and setup SDP attributes, the IMS-ALG shall:

- check the value of the received setup SDP attribute to determine if the IMS-AGW needs to act as DTLS client or DTLS server. When the received value is equal to:
 - a) "active" the IMS-AGW needs to act as DTLS server; or
 - b) "passive" the IMS-AGW needs to act as DTLS client;
- when modifying the transport addresses/resources towards the IMS access network:
 - a) if the IMS-AGW needs to act as DTLS client, include the Establish (D)TLS session information element to request the IMS-AGW to start the DTLS session setup;
 - b) include the Remote certificate fingerprint information element with the value of the received fingerprint SDP attribute(s); and
 - c) if not already provided, include the Notify (D)TLS session establishment Failure Event information element to request the IMS-AGW to report the unsuccessful DTLS session setup; and
- remove the setup SDP attribute and indicate the transport protocol "UDPTL" in the SDP answer sent towards the IMS core network.

The message sequence chart shown in the figure 6.2.10.4.3.1 gives an example of a session establishment towards the IMS access network with an emphasis on the additional aspects for the IMS-ALG and the IMS-AGW for the e2ae protection of the T.38 fax media using UDPTL over DTLS.

NOTE 3: In the shown example it is assumed that the IMS-ALG requested the IMS-AGW at step 2 to latch onto the address of the received media packets to determine the corresponding destination address. Otherwise, the DTLS ClientHello message received at the step 10 will be dropped until the IMS-AGW receives a repeated DTLS ClientHello message after the step 13.

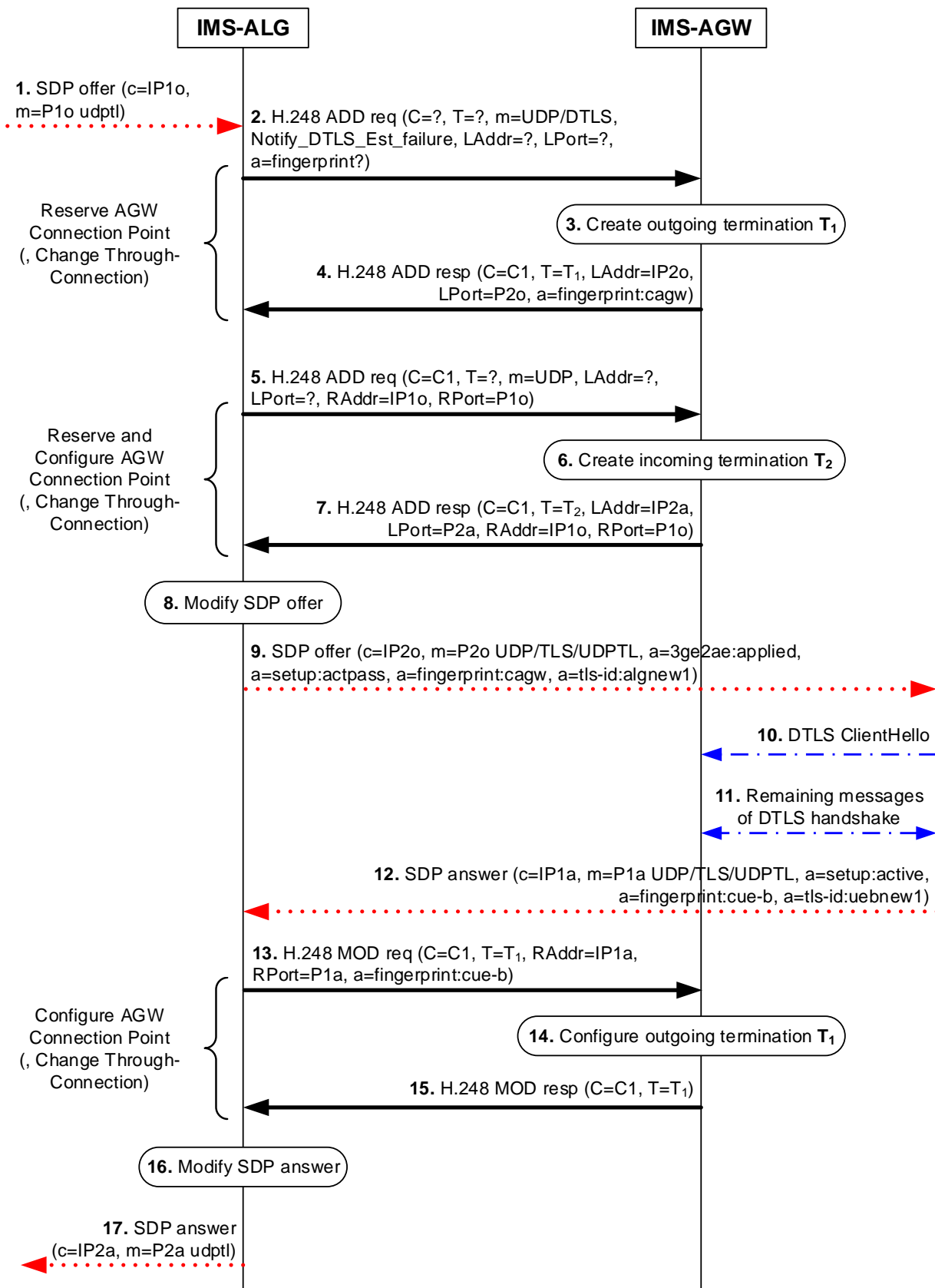

Figure 6.2.10.4.3.1: Session setup towards the IMS access network with e2ae protection of T.38 fax

6.2.10.4.4 IMS-AGW procedure for e2ae security of T.38 fax using "UDP/TLS/UDPTL"

The IMS-AGW shall:

- upon reception of the Local certificate fingerprint Request information element, select an own certificate for the T.38 fax media stream, uniquely associate the own certificate with the T.38 media stream, and send to the IMS-ALG the Local certificate fingerprint information element with the fingerprint of the own certificate;
- uniquely associate the value of the Remote certificate fingerprint information element, received from the IMS-ALG, with the corresponding T.38 fax media stream;
- take a DTLS server role and be prepared to receive a DTLS ClientHello message from the served UE;
- upon reception of the Establish (D)TLS session information element, take a DTLS client role and start DTLS session establishment by sending the DTLS ClientHello message to the served UE; and
- verify during the subsequent DTLS handshake with the served UE (as described in IETF RFC 7345 [33] and IETF draft-ietf-mmusic-dtls-sdp [81]) that the fingerprint of the certificate passed by the served UE during DTLS handshake matches the value of the Remote certificate fingerprint information element received from the IMS-ALG:
 - a) if the verification fails, the IMS-AGW shall regard the remote DTLS endpoint as not authenticated, terminate the DTLS session and as specified in subclause 6.2.10.4.5, shall report the unsuccessful DTLS session setup to the IMS-ALG; or
 - b) if the verification succeeds, the IMS-AGW shall continue with DTLS session setup and when the DTLS session is established, the IMS-AGW shall be prepared to receive and convert the protected media from the served UE to the unprotected media to be sent to the core network and vice versa.

6.2.10.4.5 DTLS session establishment failure indication

The IMS-AGW shall use a Notify (D)TLS session establishment Failure Indication procedure to report DTLS session establishment related failures.

The figure 6.2.10.4.5.1 shows the message sequence chart example when the IMS-AGW reports the unsuccessful DTLS session setup to the IMS-ALG.

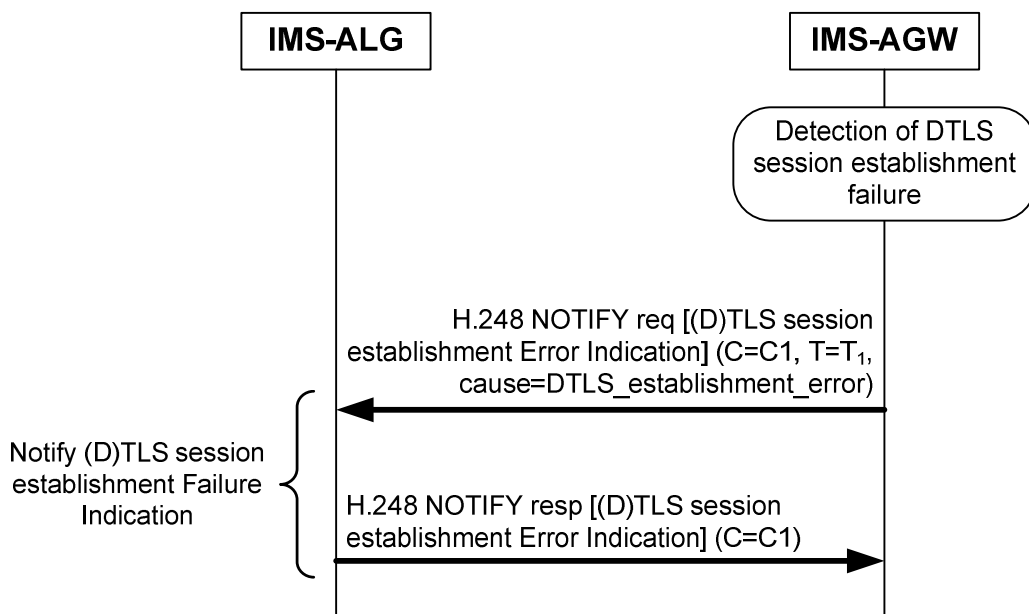

Figure 6.2.10.4.5.1: DTLS session establishment failure indication

6.2.10.5 End-to-access-edge security for RTP based media using DTLS-SRTP

Editor's Note: There are two served user instances of the DTLS service within WebRTC: the data channel and the key exchange for SRTP. Thus, there are either two DTLS connections behind a single DTLS session, or two separate DTLS sessions.

The procedures are similar to that of subclause 6.2.1 apart from the IMS-ALG optionally requesting the eIMS-AGW to provide IMS media plane security using DTLS.

Upon receipt of an SDP offer from the IMS access network, the IMS-ALG shall:

- check the received value of the setup SDP attribute to determine if the IMS-AGW needs to act as DTLS client or DTLS server. When the received value is equal to:
 - a) "active" the IMS-AGW needs to act as DTLS server;
 - b) "passive" the IMS-AGW needs to act as DTLS client; or
 - c) "actpass" the IMS-ALG shall decide if the IMS-AGW needs to act as DTLS client or DTLS server;
- if the received SDP offer contains "a=tls-id" media-level SDP attribute (as specified in IETF draft-ietf-mmusic-dtls-sdp [81]), create a new DTLS association identity;
- when reserving the transport addresses/resources towards the IMS access network:
 - a) indicate to the eIMS-AGW "UDP/TLS/RTP/SAVP" or "UDP/TLS/RTP/SAVPF" as transport protocol;
 - b) include the Remote certificate fingerprint information element with the value of the received fingerprint SDP attribute from the WIC;
 - c) include the Local certificate fingerprint Request information element to request the certificate fingerprint of the eIMS-AGW; and
 - d) if the IMS-AGW needs to act as DTLS client, include the Establish (D)TLS session information element to request the IMS-AGW to start the DTLS session setup;
- indicate to the eIMS-AGW "RTP/AVP" or "RTP/AVPF" over UDP as transport protocol when reserving the transport addresses/resources towards the IMS core network; and
- remove the setup SDP attribute and indicate the transport protocol "RTP/AVP" in the offer towards the IMS core network.

Upon receipt of an SDP answer from the IMS core network, the IMS-ALG shall:

- in the "m=" line indicating the use of SRTP, change the transport protocol to "UDP/TLS/RTP/SAVP" or "UDP/TLS/RTP/SAVPF";
- insert the fingerprint SDP attribute with the value of the Local certificate fingerprint information element received from the eIMS-AGW; and
- insert the "a=tls-id" SDP attribute containing a new DTLS association identity; and
- insert the setup SDP attribute with the value:
 - a) "active" if the IMS-ALG requested the IMS-AGW to act as DTLS client; or
 - b) "passive" if the IMS-AGW shall take the DTLS server role.

Figure 6.2.10.5.1 shows the message sequence chart example of WIC originated procedure using DTLS-SRTP.

NOTE 1: Below establishment procedures are based on the assumption that there wasn't yet any DTLS procedure triggered from WebRTC data channel side.

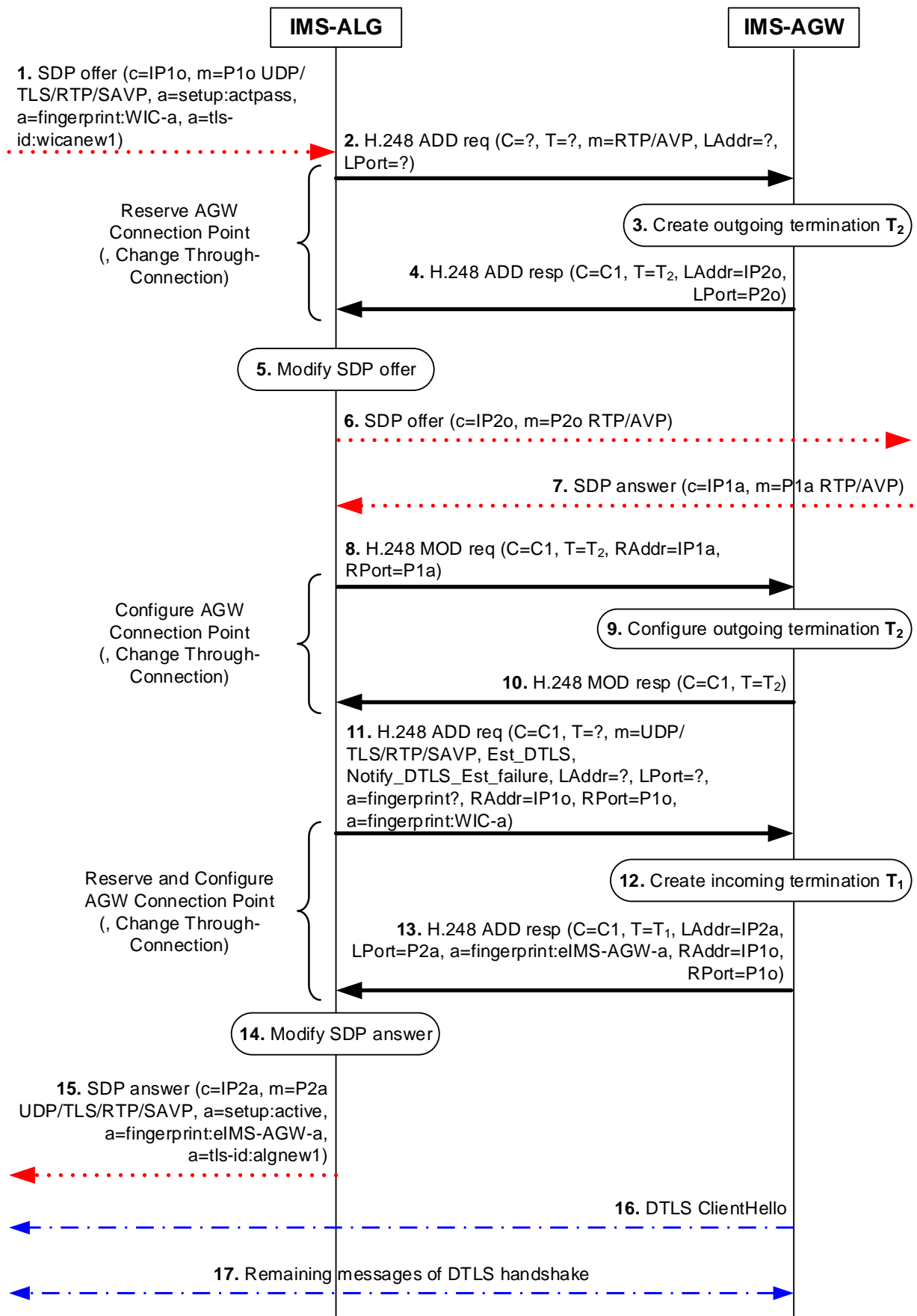

Figure 6.2.10.5.1: WIC originated procedure using DTLS-SRTP

NOTE 2: The WIC may receive the ClientHello prior the SDP answer, thus the handshake might be initiated, but the handshake will not complete until the SDP answer has been received by the WIC.

Upon receipt of an SDP offer from the IMS core network using the "RTP/AVP" or "RTP/AVPF" over UDP as transport protocol the IMS-ALG shall:

- when reserving the transport addresses/resources towards the IMS access network:
 - a) indicate to the eIMS-AGW "UDP/TLS/RTP/SAVP" or "UDP/TLS/RTP/SAVPF" as transport protocol; and
 - b) include the Local certificate fingerprint Request information element to request the certificate fingerprint of the eIMS-AGW;
- when reserving the transport addresses/resources towards the IMS core network indicate to the eIMS-AGW "RTP/AVP" or "RTP/AVPF" over UDP as transport protocol; and
- modify the SDP offer that will be sent to the IMS access network by:
 - a) in the "m=" line that is indicating the use of SRTP, changing the transport protocol to "UDP/TLS/RTP/SAVP" or "UDP/TLS/RTP/SAVPF";
 - b) inserting the fingerprint SDP attribute with the value of the Local certificate fingerprint information element received from the eIMS-AGW;
 - c) inserting the "tls-id" SDP attribute with the new DTLS association identity; and
 - d) inserting the setup SDP attribute, as defined in IETF RFC 4145 [30], with the value "actpass".

Upon receipt of an SDP answer from the IMS access network containing the use of the "UDP/TLS/RTP/SAVP" or "UDP/TLS/RTP/SAVPF" transport protocol with the associated fingerprint and setup SDP attributes, the IMS-ALG shall:

- check the value of the received setup SDP attribute to determine if the IMS-AGW needs to act as DTLS client or DTLS server. When the received value is equal to:
 - a) "active" the IMS-AGW needs to act as DTLS server; or
 - b) "passive" the IMS-AGW needs to act as DTLS client;
- when modifying the transport addresses/resources towards the IMS access network:
 - a) if the IMS-AGW needs to act as DTLS client, include the Establish (D)TLS session information element to request the IMS-AGW to start the DTLS session setup;
 - b) include the Remote certificate fingerprint information element with the value of the received fingerprint SDP attribute; and
 - c) if not already provided, include the Notify (D)TLS session establishment Failure Event information element to request the IMS-AGW to report the unsuccessful DTLS session setup; and
- remove the setup SDP attribute and indicate the transport protocol "RTP/AVP" in the SDP answer towards the IMS core network.

The message sequence chart shown in the figure 6.2.10.5.2 shows the message sequence chart example of WIC terminated procedure using DTLS-SRTP.

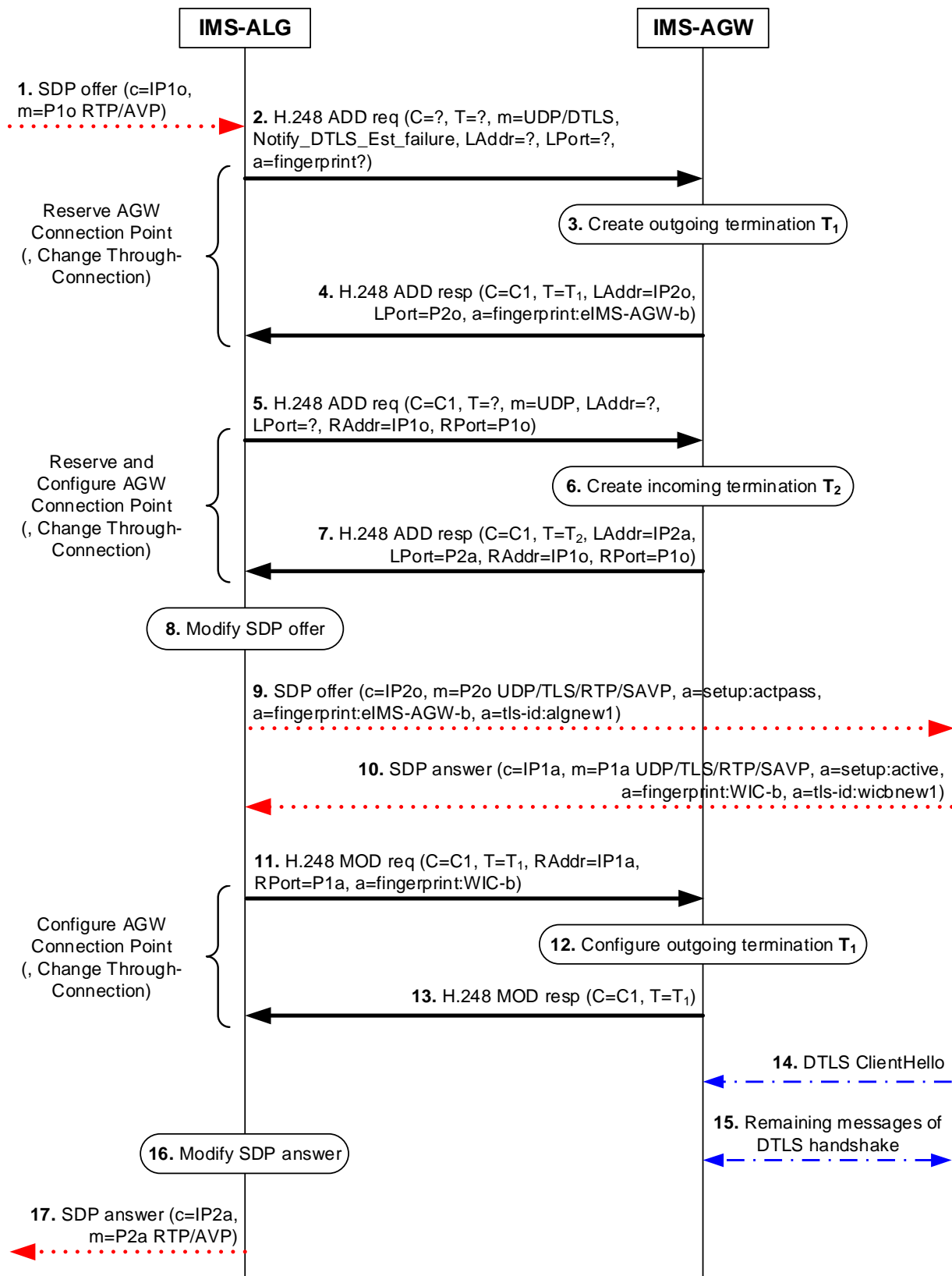

Figure 6.2.10.5.2: WIC terminated procedure using DTLS-SRTP

NOTE 3: The eIMS-AGW might receive the ClientHello prior receiving the MOD-request, but the DTLS handshake will not finish before the MOD-request (more specific: the fingerprint from WIC-b) has been received.

6.2.10.6 End-to-access-edge security for WebRTC data channels using SCTP-over-DTLS transport

6.2.10.6.1 General

The requirements on eP-CSCF (IMS-ALG) and eIMS-AGW for the procedures to establish WebRTC data channels are specified in subclause 5.20.2.

The following subclauses describe extensions to the Iq signalling procedures and their interactions with SIP signalling in the control plane and with user plane procedures if the e2ae security for the WebRTC data channels using "SCTP over DTLS" is supported by the eP-CSCF (IMS-ALG) and the eIMS-AGW.

All message sequence charts in this clause are examples. The example high-level H.248 context model is defined in Figure 6.2.1.1 and further detailed below.

6.2.10.6.2 Call flow for data channel establishment from WIC towards IMS access network and MSRP session establishment

Support of multiple WebRTC data channels per WebRTC calls implies support of so called H.248 stream grouping. Figure 6.2.10.6.2.1 shows an example H.248 Context model for a WebRTC call with unbundled audio and video, and with multiple data components.

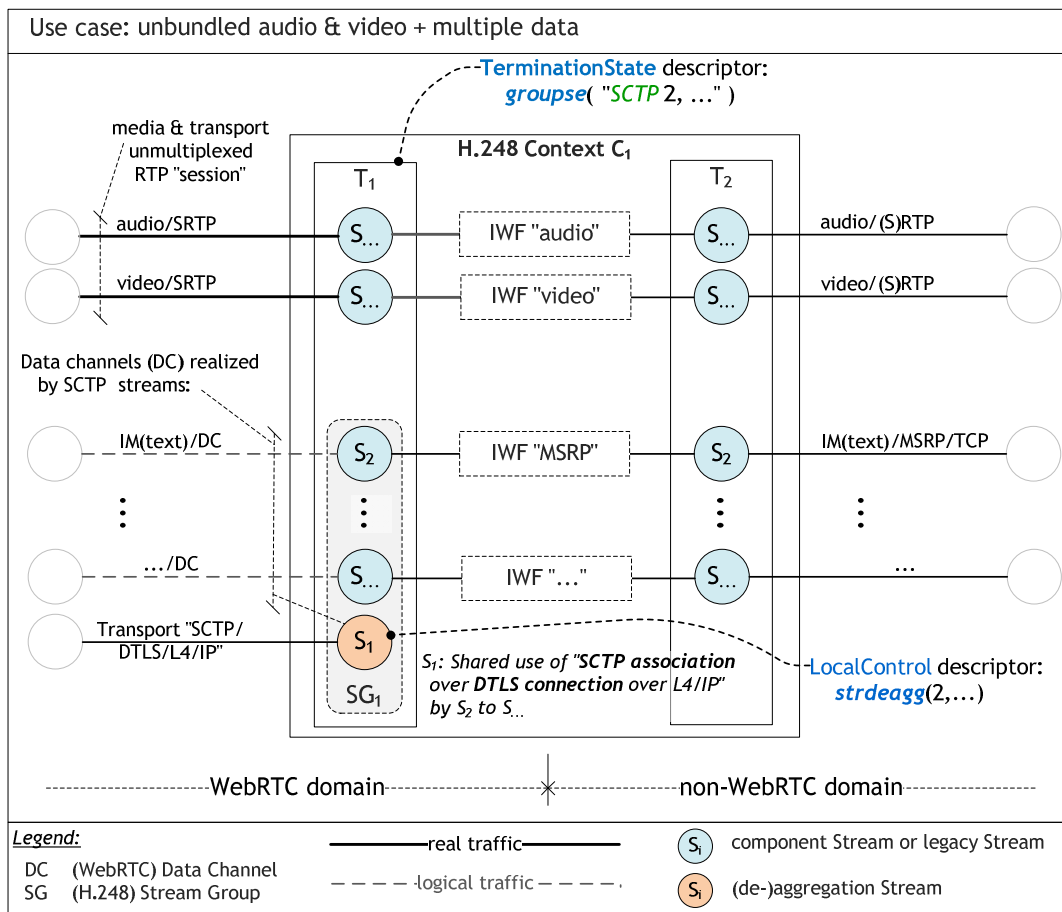

Figure 6.2.10.6.2.1: eIMS-AGW – H.248 Context model for WebRTC gateway inclusive H.248 Stream Group for WebRTC data components

The example flow in this clause focuses on the WebRTC data channel part only. Thus, only H.248 Streams S1 (for deaggregation of multiple data channels) and S2 (for MSRP traffic) are indicated subsequently.

Figure 6.2.10.6.2.2 shows the message sequence chart example for the WIC originated procedure to establish a WebRTC MSRP data channel using SCTP-over-DTLS transport.

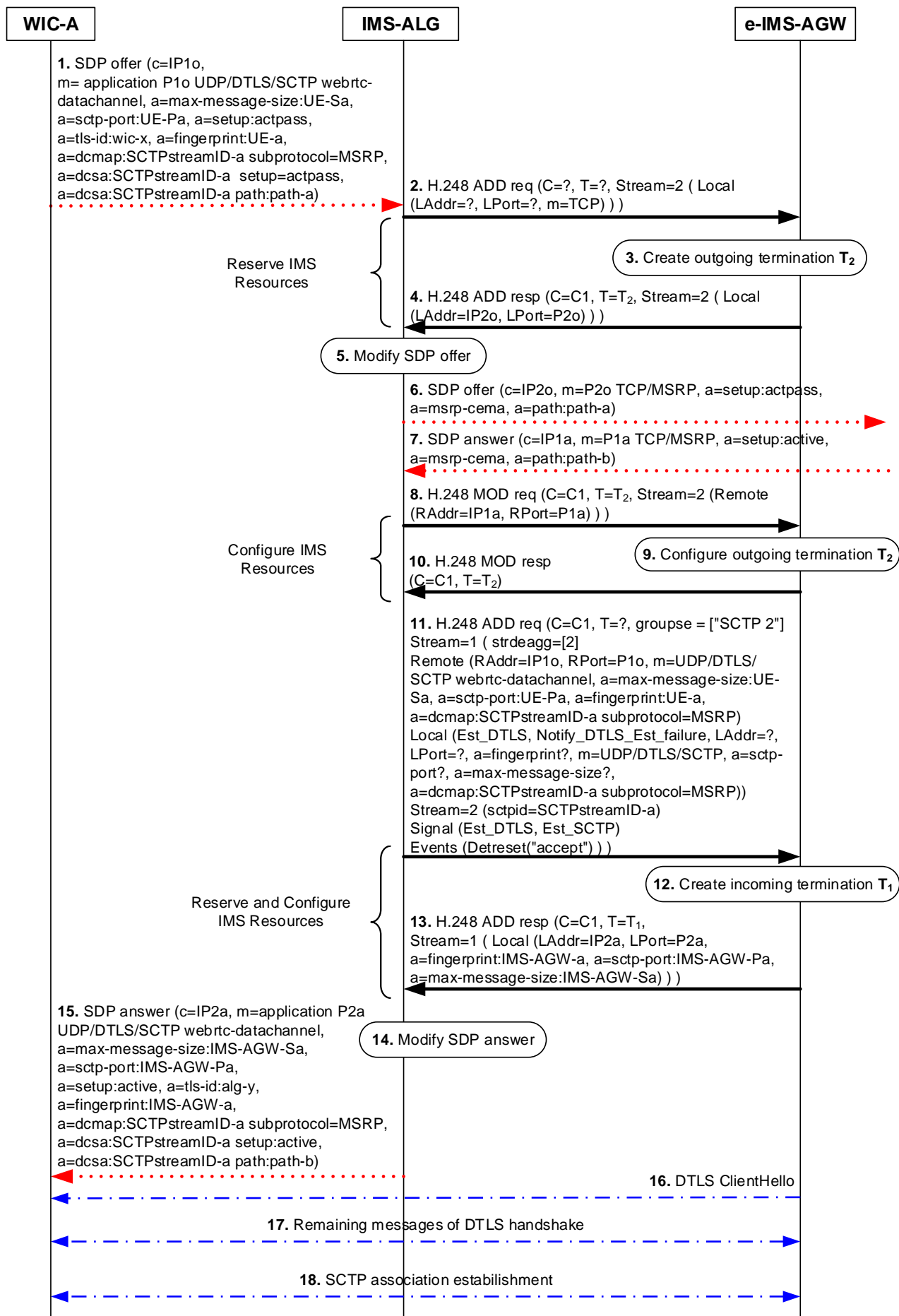

Figure 6.2.10.6.2.2: WIC originated procedure for WebRTC data channel establishment and MSRP stream establishment

The IMS UE A embedded WIC-A performs an IMS originating session set-up according to 3GPP TS 23.228 [2] with modifications for support of WebRTC service control.

The procedure in the above figure for requesting an MSRP profiled WebRTC data channel is described step-by-step with an emphasis on the additional aspects for eP-CSCF (IMS-ALG) and eIMS-AGW with regards to the creation of an H.248 Context for interworking MSRP-over-DC to MSRP-over-TCP:

1. IMS UE-A (WIC-A) sends an SDP offer for an MSRP WebRTC data channel. A new "SCTP association over DTLS association " is requested.
2. - 4. The eP-CSCF (IMS-ALG) uses the "Reserve AGW Connection Point" procedure to request a termination and H.248 Stream '2' for "MSRP-over-TCP" media towards the core network.
5. The eP-CSCF (IMS-ALG) modifies the SDP offer to offers TCP transport for MSRP, and to requests the remote peer to select the TCP setup direction.
6. The eP-CSCF (IMS-ALG) forwards the SDP offer.
7. – 10. The configuration of core network side H.248 Stream endpoint S_2/T_2 is completed based on the received SDP answer (7).
11. The eP-CSCF (IMS-ALG) uses the "Reserve and Configure AGW Connection Point" procedure to request a termination inclusive an H.248 Stream Group for WebRTC DC traffic. The eP-CSCF (IMS-ALG) uses an H.248 Context model with H.248 Stream grouping as required for WebRTC DC support. The Stream Group (SG) configurations according to Figure 6.2.10.6.2.1 is applied: The eP-CSCF (IMS-ALG) decides to assign H.248 StreamID value '1' to the H.248 deaggregation stream and to use H.248 StreamID value '2' for the WebRTC data channel. The following aspects should be emphasized:
 - a) H.248 deaggregation stream (S_1):
 - covers the protocol stack segment "SCTP Association over DTLS connection over L4/IP";
 - the 'UDP' is indicated as L4 protocol;
 - the SDP information related to the underlying ICE procedures is omitted in the abstracted ADD.req command;
 - the deaggregation stream embedded SDP covers the attributes for configuration of the SCTP Association;
 - b) H.248 component stream (S_2):
 - covers the upper protocol levels of the logical DC and the IP application layer (here 'MSRP');
 - c) DTLS session/DTLS association establishment:
 - an outgoing establishment procedure is enabled ("which will be executed by the eIMS-AGW after successful L4 connectivity");
 - d) SCTP association establishment:
 - both, an incoming and outgoing establishment procedure is enabled ("in order to emulate "SCTP simultaneous open" behaviour");
 - the eIMS-AGW would start to send an SCTP INIT chunk as soon as the DTLS connection is "data transfer ready" (see step 16);
 - e) Preparation of DC release already in DC establishment phase:
 - Background: DC release is based on SCTP Association level SCTP Stream reset procedures. Incoming reset requests could be either autonomously handled by the eIMS-AGW or explicitly controlled by the eP-CSCF (IMS-ALG).
 - The activation of a notification mechanism is required in any case (indicating the autonomous behaviour by the default value 'accept' of the correspondent event parameter).

12./13. The eIMS-AGW confirms the successful creation and configuration of the requested H.248 Stream Group for WebRTC DC traffic.

14./15. The eP-CSCF (IMS-ALG) then sends the updated SDP answer to the IMS UE-A embedded WIC-A.

NOTE: In figure 6.2.10.6.2.2. "a=dmap" does not contain priority information and the default priority thus applies.

6.2.10A IMS end-to-end Media Plane Security

6.2.10A.1 End-to-end security for RTP based media using SDES

This procedure is identical to that of subclause 6.2.1 apart from the IMS-ALG providing "RTP/SAVP" or "RTP/SAVPF", as received in the SDP, to the IMS-AGW as transport protocol and not providing any other media related information to the corresponding terminations, and configuring the IMS-AGW to pass media transparently.

The IMS-ALG shall forward the SDP with unmodified transport protocol for those media lines and unmodified SDES SDP attribute(s).

6.2.10A.2 End-to-end security for TCP-based media using TLS

This procedure is identical to that of subclause 6.2.1 apart from the IMS-ALG providing "TCP" to the IMS-AGW as transport protocol and not providing any TLS related information nor any other media related information to the corresponding terminations, and configuring the IMS-AGW to pass media transparently.

The IMS-ALG shall forward the SDP with unmodified transport protocol for those media lines and unmodified TLS related SDP attribute(s).

NOTE: End-to-end security for TCP-based media using TLS is not supported between two terminals being located behind firewalls/NATs.

6.2.11 Change Through-Connection

The Change Through-Connection procedure is used for opening and closing of gates and is mandatory for IMS-ALG and IMS-AGW to support. The IMS-ALG sets the Stream mode parameter using the Change Through-Connection procedure to request the IMS-AGW to one-way or both-way through-connect or block media streams on a termination.

The IMS-ALG may combine the Change Through-Connection procedure with the Reserve and Configure AGW Connection Point, Reserve AGW Connection Point or Configure AGW Connection Point procedure as in Figure 6.2.1.2., or may apply this procedure separately.

6.2.12 Emergency Calls

This procedure is identical to that of subclause 6.2.1 apart from the IMS-ALG requesting the IMS-AGW to treat the call as emergency call with a preferential handling by including the information element "Emergency Call Indicator" within the "Reserve and Configure AGW Connection Point" or "Reserve AGW Connection Point procedure".

6.2.13 Explicit Congestion Notification support

6.2.13.1 General

An IMS-ALG may configure the IMS-AGW to transfer the ECN bits in the IP header transparent (see subclause 6.2.13.2) or to act as an ECN endpoint (see subclause 6.2.13.3). See subclause 5.12.

6.2.13.2 ECN Active Indicated (ECN transparent)

Figure 6.2.13.2.1 shows the message sequence chart example for indicating ECN transparent.

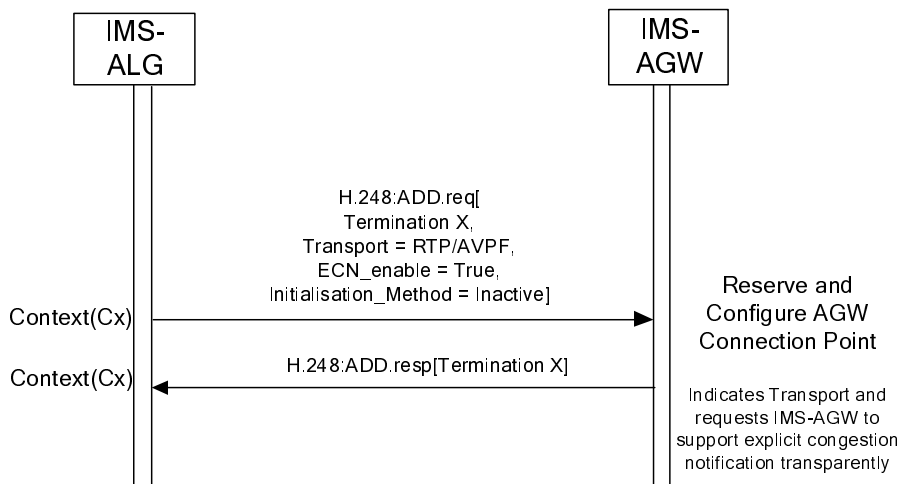

Figure 6.2.13.2.1: Procedure to indicate ECN transparent negotiated

Upon receipt of the indication that ECN transparent has been negotiated, the IMS-AGW shall forward ECN bits within IP packets unmodified. Any RTCP feedback received shall be passed unchanged.

6.2.13.3 ECN support requested (ECN endpoint)

Figure 6.2.13.3.1 shows the message sequence chart example for requesting ECN endpoint.

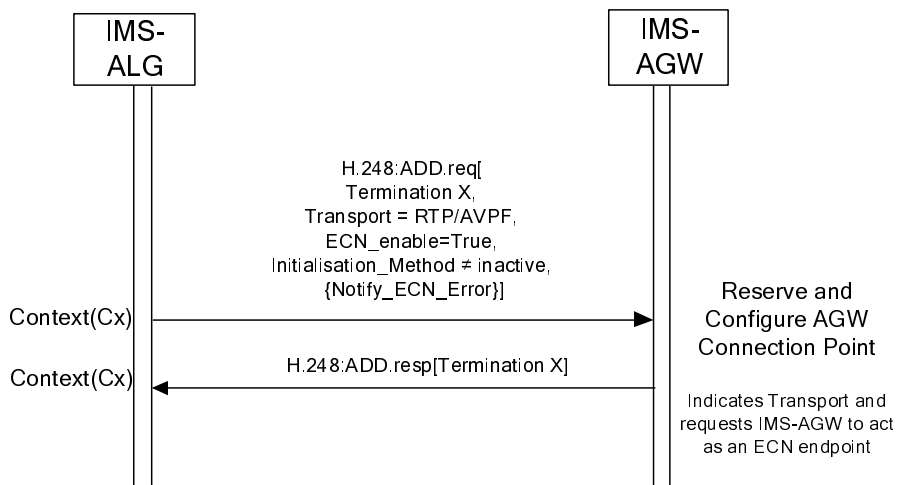

Figure 6.2.13.3.1: Procedure to Request ECN endpoint

Upon receipt of a request to apply ECN the IMS-AGW shall set the ECN field of the IP header in accordance with 3GPP TS 26.114 [21] when sending any data packets.

Upon receipt of any IP headers indicating ECN Congestion Experienced (ECN-CE) the IMS-AGW shall trigger rate adaptation in accordance with 3GPP TS 26.114 [21].

NOTE: ECN endpoint requires the IMS-ALG to configure the IMS-AGW with all media attributes to allow rate adaptation even if no transcoding is required/supported in the IMS-AGW.

6.2.13.4 ECN Failure Indication (ECN endpoint)

Figure 6.2.13.4.1 shows the message sequence chart example for an ECN Failure Event.

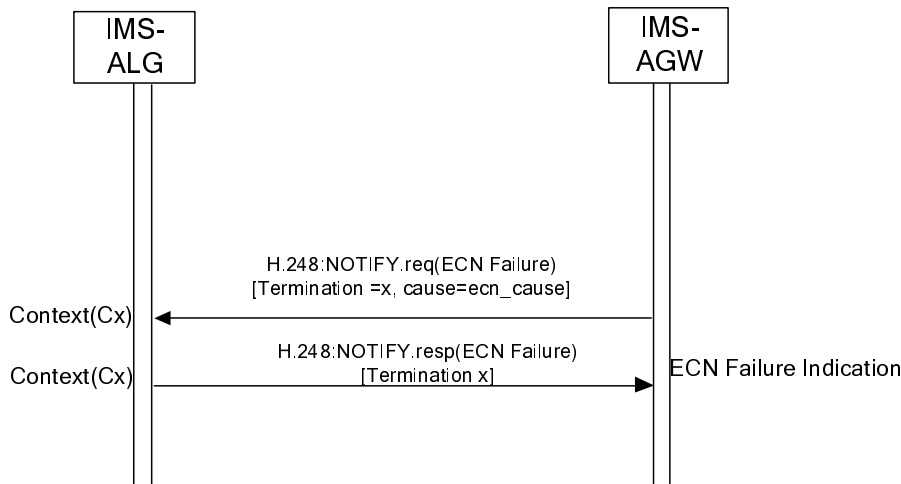

Figure 6.2.13.4.1: Procedure to Report ECN Failure

When the IMS-ALG receives a Notification indicating that a failure has occurred, the IMS-ALG may trigger a new SDP offer to disable ECN.

6.2.14 Access Transfer procedures with media anchored in IMS-AGW (ATGW)

6.2.14.1 General

This clause describes extensions to the Iq signalling procedures and their interactions with SIP signalling in the control plane and with user plane procedures to support the "SRVCC enhanced with ATCF" procedures between the IMS-ALG (ATCF) and IMS-AGW (ATGW) when the IMS-ALG and IMS-AGW support the ATCF and ATGW functionality, as specified in 3GPP TS 23.237 [18] and 3GPP TS 24.237 [19].

The Access Transfer procedures are optional to support on the Iq reference point. The requirements in this clause shall apply if these procedures are supported.

All message sequence charts in this clause are examples.

6.2.14.2 H.248 context model

Figure 6.2.14.2.1 shows the H.248 context model after the PS originating or terminating session establishment and before the PS to CS access transfer procedure. The "squared" line represents the call control signalling. The "dotted" line represents the bearer. The bearer termination T1 is used for the media path of the PS access leg, the bearer termination T2 is used for the media path of the remote leg.

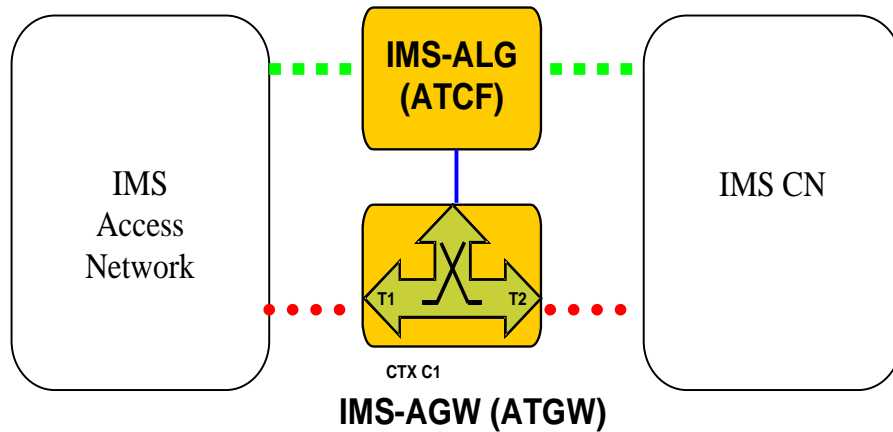

Figure 6.2.14.2.1: H.248 Context Model before Access Transfer

Figure 6.2.14.2.2 shows the H.248 context model during the PS to CS access transfer procedure. The IMS-ALG (ATCF) may seize a new bearer termination T3 for the new media path of the CS access leg, e.g. if the PS and CS nodes before and after the handover are reachable via different IP realms or use a different IP version. The IMS-ALG (ATCF) may alternatively reconfigure the T1 termination with the new remote configuration (e.g. IP address and media) instead of seizing a new termination; in that case, the H.248 context model remains as before access transfer.

Bi-casting is not supported during access transfer, i.e. the IMS-AGW (ATGW) does not duplicate downlink media packets received from the remote leg to the source and target access legs simultaneously.

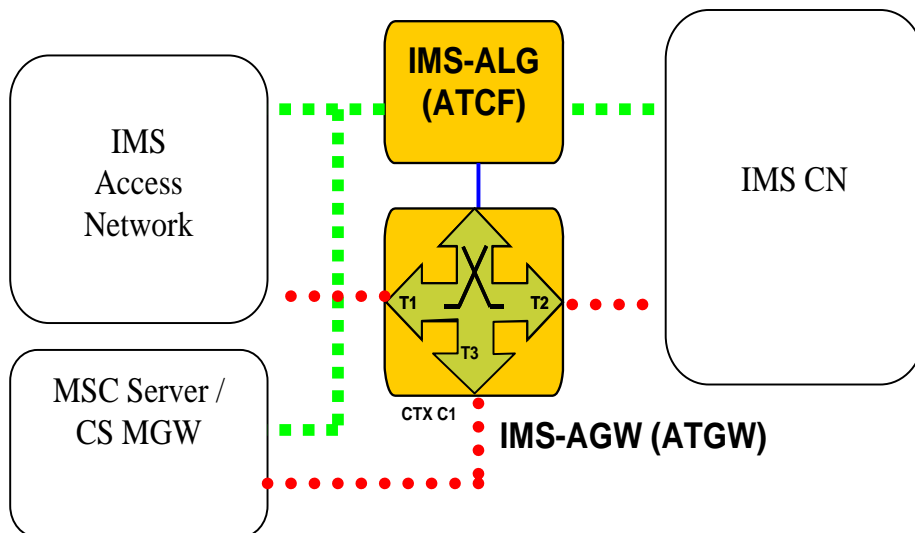

Figure 6.2.14.2.2: H.248 Context Model during Access Transfer

Figure 6.2.14.2.3 shows the H.248 context model after the PS to CS access transfer procedure if the source access leg is released. If the UE chooses to retain some media flow(s) in the transferred-out access, the H.248 context model remains as during access transfer.

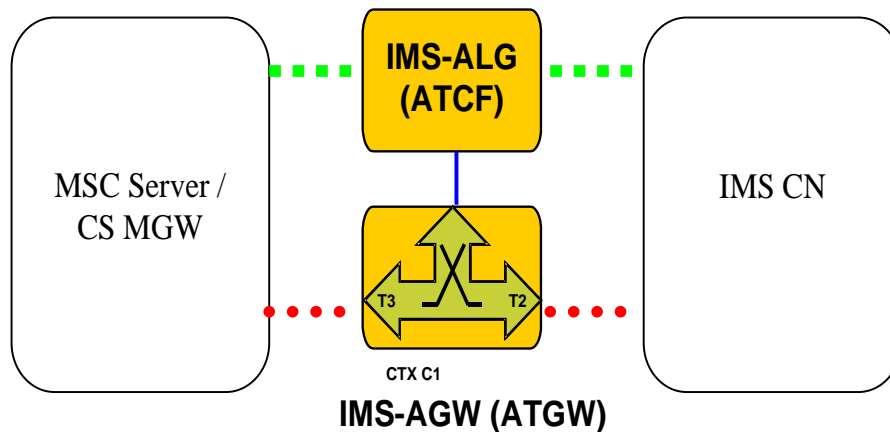

Figure 6.2.14.2.3: H.248 Context Model after Access Transfer

6.2.14.3 PS session origination or termination with media anchoring in IMS-AGW (ATGW) signaling procedures

If the IMS-ALG (ATCF) decides to anchor the media of a session in the IMS-AGW (ATGW) the call related procedures shall follow the basic procedures for IMS ALG (i.e. as specified in clause 6.2.1) with the following differences:

- The IMS-ALG (ATCF) shall seize a termination towards the terminating user, using the "Reserve AGW Connection Point" procedure before sending a SDP offer to the terminating user. The IMS-ALG (ATCF) may signal media related information to the IMS-AGW (ATGW) or omit media when adding the IP termination at this stage.

NOTE : The signalling of media related information to a MGW requires that it reserve the indicated resources before returning a positive response to the H.248 command, by omitting media related information the IMS-AGW (ATGW) does not need to reserve any associated resources at this stage.

- When the IMS-ALG (ATCF) receives the SDP answer from the terminating user, the IMS-ALG (ATCF) shall configure the IMS-AGW (ATGW) accordingly by either supplying the same media related information for all interconnected terminations or by omitting the media related information.

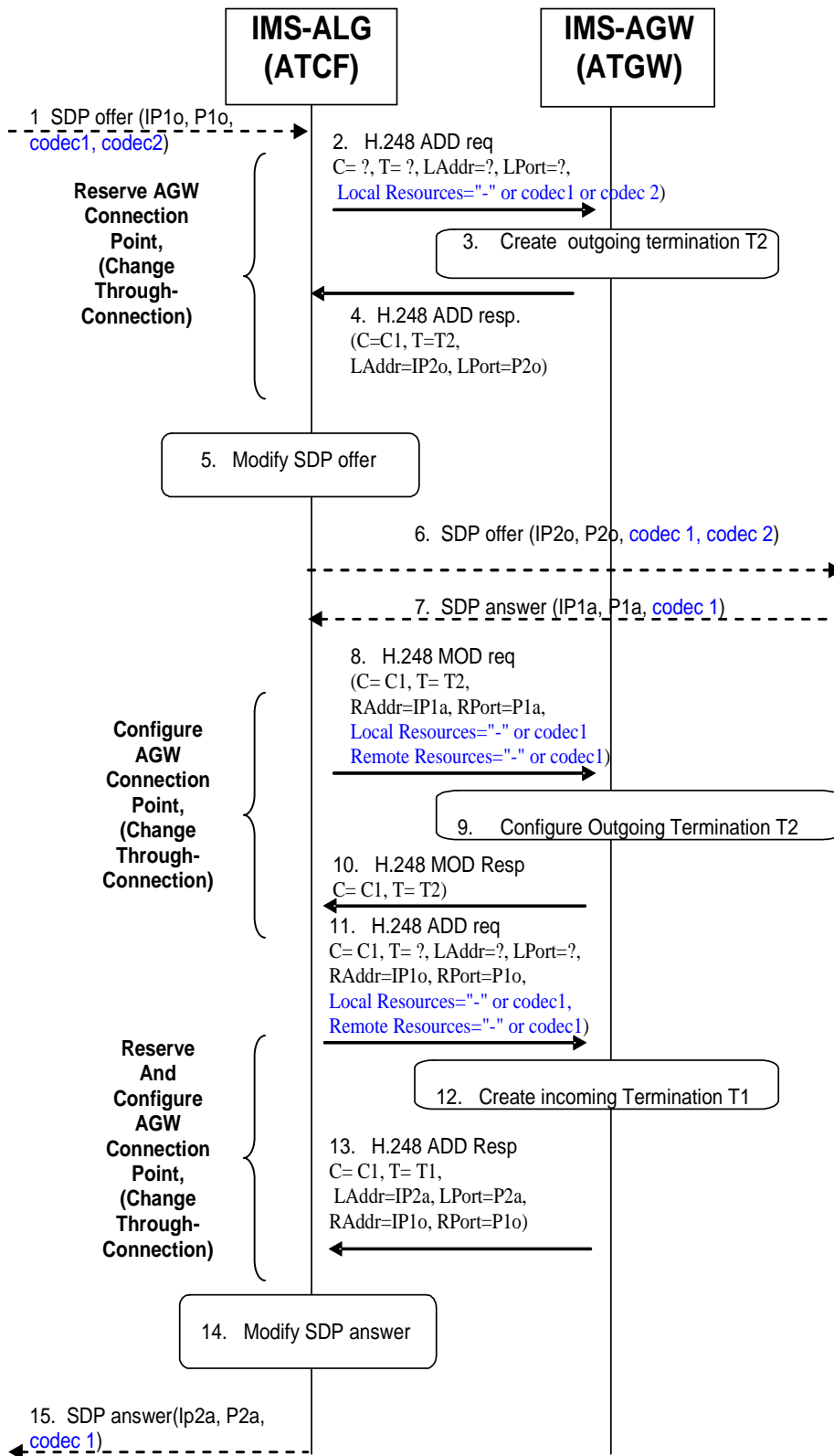

Figure 6.2.14.3.1: PS session establishment with media anchoring in IMS-AGW (ATGW)

1. The IMS-ALG (ATCF) receives an SDP offer in SIP signalling. The IMS-ALG (ATCF) requires an IMS-AGW (ATGW) for media anchoring (or for another IMS-AGW use case) but does not offer transcoding.
2. The IMS-ALG (ATCF) sends a H.248 ADD request command to create the outgoing termination and to request IP resources to execute ATGW function. As no media transcoding is required this may be indicated by signalling "-". Alternatively any codec (e.g. Codec 1) can be signalled. If the IMS-ALG (ATCF) selects an IMS-AGW (ATGW) that does not support transcoding, the IMS-ALG (ATCF) may signal media related sub-fields in the media descriptor to the IMS-AGW (ATGW) if the IMS-AGW (ATGW) supports media encoding. The IMS-AGW (ATGW) shall accept the ADD request even though it cannot reserve any transcoding resources for the indicated media.
3. The IMS-AGW (ATGW) creates the outgoing termination.
4. The IMS-AGW (ATGW) replies to IMS-ALG (ATCF) with a H.248 ADD reply command and provides the local address and port of the outgoing termination.
5. The IMS-ALG (ATCF) replaces the IP address inside the SDP using the information coming from IMS-AGW (ATGW).
6. The IMS-ALG (ATCF) forwards the new offer to the succeeding node.
7. The SDP answer is received by IMS-ALG (ATCF). In this example the codec1 received in the original SDP offer in step1 has been selected.
8. The IMS-ALG (ATCF) sends a H.248 MOD request command to configure the outgoing termination with address and port information. As no media transcoding is needed this may be indicated by signalling "-". Alternatively the selected codec (Codec 1) can be signalled.
9. The IMS-AGW (ATGW) configures the outgoing termination.
10. The IMS-AGW (ATGW) replies to IMS-ALG (ATCF) with a H.248 MOD reply command.
11. The IMS-ALG (ATCF) sends a H.248 ADD command to create the incoming termination to configure this termination with remote address and port information and to request resources to execute ATGW function. As no media transcoding is needed this may be indicated by signalling "-". Alternatively media related sub-fields in the media descriptor for the codec indicated to the incoming termination may be signalled (e.g. the selected codec received in step 7 (Codec 1)).
12. The IMS-AGW (ATGW) creates the incoming termination.
13. The IMS-AGW (ATGW) replies to the IMS-ALG (ATCF) with a H.248 ADD reply command and provides the local address and port of the incoming termination.
14. The IMS-ALG (ATCF) replaces the IP address inside the SDP answer using the information coming from IMS-AGW (ATGW).
15. SDP answer is sent to the network at the incoming side.

Similar principles shall apply during the establishment of a mobile terminating session.

6.2.14.4 PS to CS Access Transfer procedure with media anchored in IMS-AGW (ATGW)

The signalling flow shown in figure 6.2.14.4.1 gives an example for PS to CS access transfer with media anchored in the IMS-AGW (ATGW). In this case, the media has been anchored in IMS-AGW (ATGW) as specified in subclause 6.2.14.3.

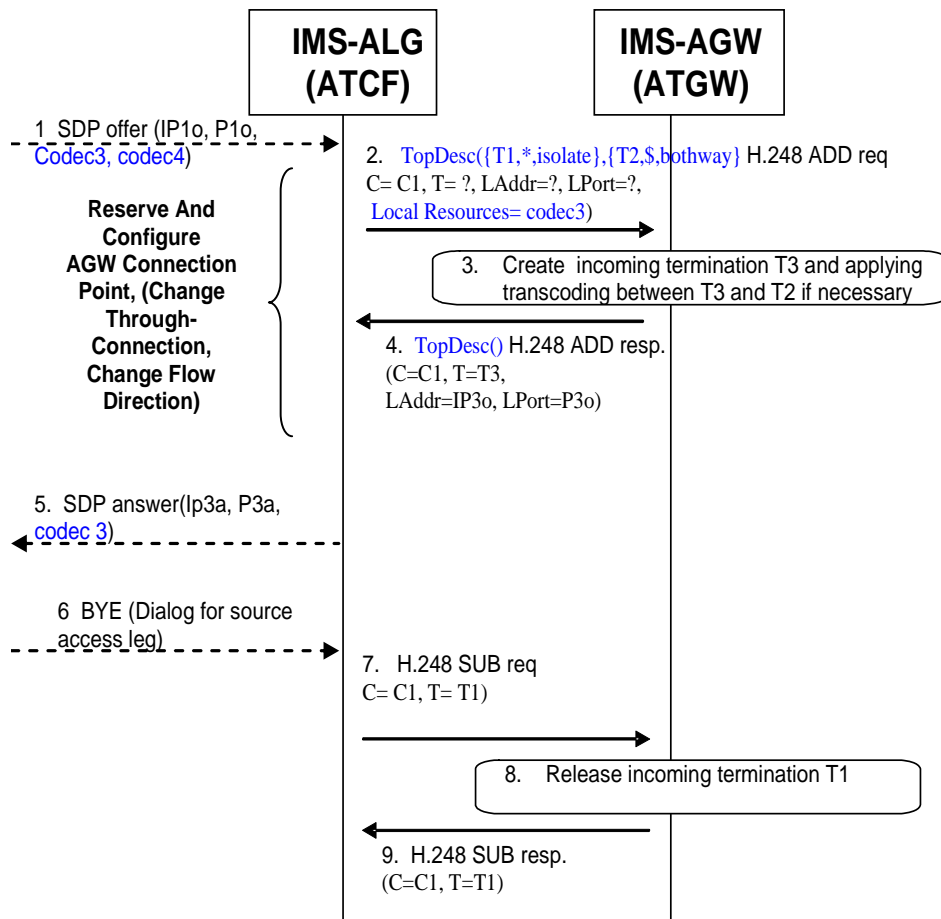

1. The IMS-ALG (ATCF) receives an SDP offer in SIP signalling from the MSC Server. The IMS-ALG (ATCF) checks whether transcoding is required.
 2. The IMS-ALG (ATCF) sends a H.248 ADD request command to create the target access leg termination and to request IP resources to execute ATGW function. Topology is changed and media reconfigured to connect media between T2 and T3. If no media transcoding is required this may be indicated by signalling "-" or by signalling the same media information on T3 as is configured on T2, following the principles specified in subclause 6.2.14.3. If media transcoding is required (as illustrated in this example), the IMS-ALG (ATCF) signals media related sub-fields in the media descriptor to the IMS-AGW (ATGW). The IMS-AGW (ATGW) determines from the media configuration whether transcoding is required on a stream between two terminations between which data flow is permitted.
3. The IMS-AGW (ATGW) creates the target access leg termination T3 and starts to apply transcoding between T2 and T3 (if required).
4. The IMS-AGW (ATGW) replies to IMS-ALG (ATCF) with a H.248 ADD reply command and provides the local address and port of the outgoing termination.
5. The IMS-ALG (ATCF) returns an SDP answer to the MSC Server; the IP address inside the SDP uses the information coming from IMS-AGW (ATGW).
6. Upon successful completion of the access transfer procedure, the IMS-ALG (ATCF) receives a BYE request from the SCC AS if there is no more media flows on the PS access.
7. The IMS-ALG (ATCF) sends a H.248 SUB request command to subtract the source access leg termination.
8. The IMS-AGW (ATGW) releases the source access leg termination.
9. The IMS-AGW (ATGW) replies to IMS-ALG (ATCF) with a H.248 SUB reply command.

Figure 6.2.14.4.1: PS to CS Access Transfer with transcoding in IMS-AGW (ATGW)

6.2.14.5 ECN support during PS to CS Access Transfer procedure with media anchored in IMS-AGW (ATGW)

The signalling flow shown in figure 6.2.14.4.1 gives an example for PS to CS access transfer with media anchored in the IMS-AGW (ATGW). The following additional actions are required if ECN is supported by the IMS-ALG/IMS-AGW:

1.
 - a) If ECN was supported during the PS session transparently and the SDP offer received from the MSC Server does not indicate ECN support, it is not possible to maintain transparent ECN support to the IMS CN. The IMS-ALG (ATCF) shall modify the Termination T2 to act as an ECN endpoint toward the IMS CN (see Subclause 5.12). Additionally the IMS-ALG (ATCF) shall disable ECN on the termination T3 (or T1).
 - b) If ECN was supported during the PS session transparently and the SDP offer received from the MSC Server does indicate ECN support and no transcoding is required (codec types and modes are aligned between ICS side and IMS CN), then the IMS-ALG (ATCF) shall request ECN transparent properties when seizing T3 and respond to the MSC Server with ECN supported in the SDP answer (step 5).
 - c) If ECN was supported during the PS session transparently and the SDP offer received from the MSC Server does indicate ECN support and transcoding is required between the CS leg and the IMS-CN, then the IMS-ALG (ATCF) shall request ECN endpoint properties when seizing T3 (or modify the termination T1 with ECN endpoint properties) and respond to the MSC Server with ECN supported in the SDP answer (step 5). Additionally the IMS-ALG (ATCF) shall modify the Termination T2 to act as an ECN endpoint toward the IMS CN (see Subclause 5.12).
 - d) If ECN was not supported during the PS session and the SDP Offer received from the MSC Server indicates ECN support, the IMS-ALG (ATCF) shall not accept ECN support in the SDP answer (step 5).

6.2.14.6 Support of generic image attributes

6.2.14.6.1 General

The IMS-ALG (ATCF) and the IMS-AGW (ATGW) may support a media-level SDP image attribute "a=imageattr" defined in IETF RFC 6236 [24] to negotiate the image size for sending and receiving video.

The list of image sizes per payload type supported by the IMS-AGW (ATGW) shall be preconfigured in the IMS-ALG (ATCF). If the image sizes received within an SDP body on the Mw/Mx interface are not all supported by the IMS-AGW (ATGW) then the IMS-ALG (ATCF) shall only send the list of corresponding IMS-AGW (ATGW) supported image sizes to the IMS-AGW (ATGW). If no image size is supported by the IMS-AGW (ATGW), the IMS-ALG (ATCF) shall not send the generic image attribute parameter to the IMS-AGW (ATGW).

The signalling flow shown in figure 6.2.14.3.1 gives an example for a PS session establishment with media anchored in the IMS-AGW (ATGW). The following additional actions may be performed if the negotiation of the image size is supported by the IMS-ALG/IMS-AGW:

- a) upon receipt of an SDP offer containing the image attribute(s) and if the received image sizes are supported by the IMS-AGW (ATGW) then the IMS-ALG (ATCF) may send the generic image attribute parameters for the send and receive directions to the IMS-ALG (ATCF) (step 2 or step 8) when seizing or modifying an outgoing termination;

NOTE 1: If the offered image attributes are not supported by the IMS-AGW (ATGW) then the IMS-ALG (ATCF) will not send the generic image attribute parameter to the IMS-AGW (ATGW).

- b) the IMS-ALG (ATCF) shall include the SDP image attribute(s) "a=imageattr" indicating the supported image sizes in the modified SDP offer (step 5);
- c) upon receipt of an SDP answer containing the generic image attribute(s) and if the received image sizes are supported by the IMS-AGW (ATGW) then the IMS-ALG (ATCF) may include the generic image attribute parameter to the IMS-AGW (ATGW) (step 11) when seizing an incoming termination; and
- d) the IMS-ALG (ATCF) shall include the SDP image attribute(s) "a=imageattr" indicating the supported image sizes in the modified SDP answer (step 14).

NOTE 2: The IMS-ALG (ATCF) not supporting the negotiation of generic image attributes will ignore the SDP image attribute received in the SDP offer and will send the SDP offer/answer without any associated SDP image attribute.

When sending the SDP body with image attribute(s) on the Mw/Mx interface the IMS-ALG (ATCF) shall include in the "a=imageattr":

- "recv" keyword and corresponding image sizes which the IMS-AGW (ATGW) supports in the receiving direction; and

- "send" keyword and corresponding image sizes which the IMS-AGW (ATGW) supports in the sending direction.

The signalling flow shown in figure 6.2.14.4.1 gives an example for PS to CS access transfer with media anchored in the IMS-AGW (ATGW). The following additional actions may be performed if the negotiation of the image size is supported by the IMS-ALG/IMS-AGW:

- a) if the image sizes were negotiated during the PS session and if the IMS-AGW (ATGW) applies the video transcoding (step 3) and if the IMS-AGW (ATGW) is configured with different image sizes on the receive direction of one termination and the send direction of another interconnected termination, then it shall adjust the frame sizes accordingly when forwarding video media streams and use the image size as described in 3GPP TS 26.114 [21] when sending media.

NOTE 3: The relation between the negotiated image sizes and CVO are specified in 3GPP TS 26.114 [21].

NOTE 4: The generic image attribute includes information related to the send and receive capabilities of a single termination, and the adjustment of image sizes is typically based on the setting of two connected terminations in a single context.

6.2.14.6.2 Indication of generic image attributes

The IMS-ALG (ATCF) may include the generic image attributes to the IMS-AGW (ATGW). The example sequence is shown in figure 6.2.14.6.2.1.

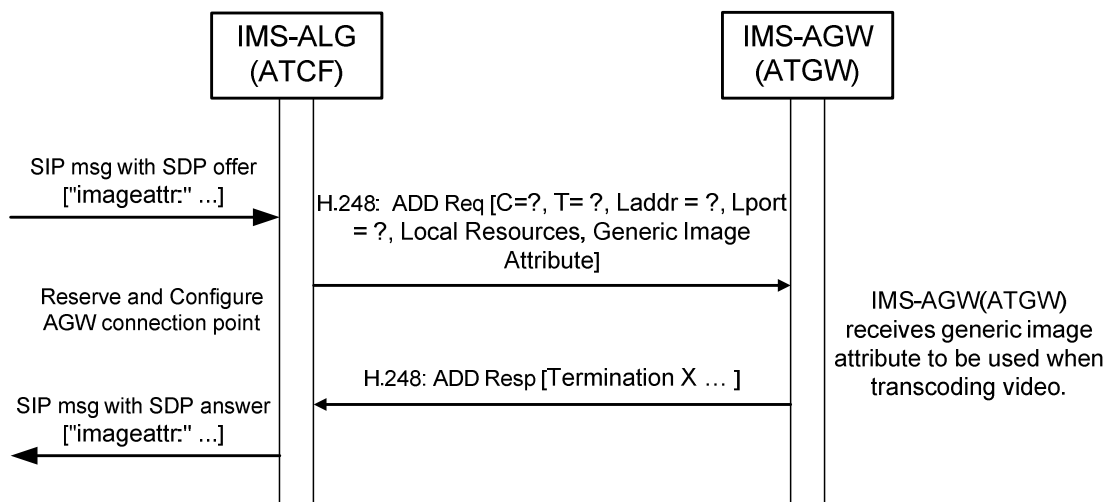

Figure 6.2.14.6.2.1: Request to reserve AGW connection point with generic image attribute

6.2.14.7 Handling of common codec parameters

For PS session origination, figure 6.2.14.3.1 shall apply with the handling of codec related parameters applicable to multiple codecs in table 6.2.14.7.1, assuming that codec related information is signalled to the IMS-AGW(ATGW) at this stage. If no codec related information is signalled to the IMS-AGW at this stage, the common codec related parameters for the termination towards the SDP answerer in table 6.2.14.7.1 shall be signalled towards the IMS-AGW during a PS to CS Access Transfer procedure.

Table 6.2.14.7.1: IMS-ALG handling of common codec related SDP parameters during PS session origination.

Parameter	Handling in SDP offer	Handling in the SDP answer
ptime (NOTE)	If the ptime parameter is included in the received SDP offer, the IMS-ALG shall supply the parameter to the IMS-AGW for the termination towards the offerer in the remote descriptor. If the value is supported by the IMS-AGW for receiving media, the IMS-ALG should keep the value from the received SDP offer unchanged in the SDP offer it sends. If the IMS-AGW only supports a lower ptime value, the IMS-ALG shall supply the ptime value according to configured preferences in the SDP offer it forwards. If no ptime value was contained in the received SDP offer, the IMS-ALG may add the parameter with a value according to configured preferences to the SDP offer.	If the ptime parameter is included in the received SDP answer, the IMS-ALG shall supply the parameter to the IMS-AGW for the termination towards the answerer in the remote descriptor. If the value is supported by the IMS-AGW for receiving media, the IMS-ALG should keep the value from the received SDP answer unchanged in the SDP answer it sends. If the IMS-AGW only supports a lower ptime value, the IMS-ALG shall supply the ptime value according to configured preferences in the SDP answer it forwards. If no ptime value was contained in the received SDP answer, the IMS-ALG may add the parameter with a value according to configured preferences to the SDP answer.
maxptime (NOTE)	If the maxptime parameter is included in the received SDP offer, the IMS-ALG shall supply the parameter to the IMS-AGW for the termination towards the offerer in the remote descriptor. If the value is supported by the IMS-AGW for receiving media, the IMS-ALG should keep the value from the received SDP offer unchanged in the SDP offer it sends. If the IMS-AGW only supports a lower maxptime value, the IMS-ALG shall supply the maxptime value according to the IMS-AGW capabilities in the SDP offer it forwards. If no maxptime value was contained in the received SDP offer, the IMS-ALG may add the parameter with a value according to the IMS-AGW capabilities to the SDP offer.	If the maxptime parameter is included in the received SDP answer, the IMS-ALG shall supply the parameter to the IMS-AGW for the termination towards the answerer in the remote descriptor. If the value is supported by the IMS-AGW for receiving media, the IMS-ALG should keep the value from the received SDP answer unchanged in the SDP answer it sends. If the IMS-AGW only supports a lower maxptime value, the IMS-ALG shall supply the maxptime value according to the IMS-AGW capabilities in the SDP answer it forwards. If no maxptime value was contained in the received SDP answer, the IMS-ALG may add the parameter with a value according to the IMS-AGW capabilities to the SDP answer.
NOTE: This SDP attribute is defined in IETF RFC 4566 [53]. It applies to all codecs offered in an SDP media line.		

For PS to CS Access Transfer, figure 6.2.14.4.1 shall apply with the handling of codec related parameters applicable to multiple codecs in in table 6.2.14.A.2.

Table 6.2.14.7.2: IMS-ALG handling of common codec related SDP parameters during PS to CS Access Transfer.

Parameter	Handling of common codec parameters received in the SDP offer	Common Codec parameters supplied in the SDP answer
ptime (NOTE)	If the ptime parameter is included in the received SDP offer, the IMS-ALG shall supply the parameter to the IMS-AGW for the termination towards the offerer in the remote descriptor.	The IMS-ALG may add the parameter with a value according to configured preferences to the SDP answer.
maxptime (NOTE)	If the maxptime parameter is included in the received SDP offer, the IMS-ALG shall supply the parameter to the IMS-AGW for the termination towards the offerer in the remote descriptor.	The IMS-ALG may add the parameter with a value according to the IMS-AGW capabilities to the SDP answer.
NOTE: This SDP attribute is defined in IETF RFC 4566 [53]. It applies to all codecs offered in an SDP media line.		

6.2.14.8 EVS speech codec support

For PS session origination, figure 6.2.14.3.1 shall apply with the EVS parameter handling in table 6.2.14.8.1, assuming that EVS is "codec 1", which is selected, and that "codec 1" related information is signalled to the IMS-AGW(ATGW) at this stage. If no codec related information is signalled to the IMS-AGW at this stage, the EVS related parameters for the termination towards the SDP answerer in table 6.2.14.8.1 shall be signalled towards the IMS-AGW during a PS to CS Access Transfer procedure.

Table 6.2.14.8.1: IMS-ALG handling of EVS related SDP parameters during PS session origination.

Parameter	Handling for EVS payload type in SDP offer	Handling if offered EVS payload type is accepted in the SDP answer
evs-mode-switch (NOTE 1)	If the evs-mode-switch parameter is contained in the SDP offer, the IMS-ALG shall forward this parameter to the IMS-AGW in the remote descriptor for the termination towards the SDP offerer and shall retain the parameter in the SDP offer it forwards.	If the evs-mode-switch parameter is contained in the SDP answer, the IMS-ALG shall forward this parameter to the IMS-AGW for the termination towards the answerer in the remote descriptor, and the IMS-ALG shall retain this parameter in the SDP answer it forwards.
hf-only (NOTE 1)	If the n hf-only parameter is contained in the SDP offer, the IMS-ALG shall forward this parameter to the IMS-AGW in the remote descriptor for the termination towards the SDP offerer and shall retain the parameter in the SDP offer it forwards. Otherwise, if the IMS-ALG is configured to negotiate using only the header-full EVS RTP payload format, the IMS-ALG shall provide the hf-only parameter with a value 1 to the IMS-AGW in the remote descriptor for the termination towards the SDP offerer, and within the SDP offer it forwards.	If the hf-only parameter is contained in the SDP answer, the IMS-ALG shall forward this parameter to the IMS-AGW in the remote descriptor for the termination towards the answerer, and the IMS-ALG shall retain this parameter in the SDP answer it forwards.
dtx (NOTE 1)	If the dtx parameter is contained in the SDP offer, the IMS-ALG shall forward this parameter to the IMS-AGW in the remote descriptor for the termination towards the SDP offerer and shall retain the parameter in the SDP offer it forwards. Otherwise, if the dtx-recv parameter is contained in the SDP offer, the IMS-ALG may include the dtx parameter in the SDP offer it forwards with the same value as the dtx-recv parameter in the SDP offer. Otherwise, if the usage of DTX is not desired in the sending and receiving direction, the IMS-ALG shall include the dtx parameter with a value 0 to the IMS-AGW in the remote descriptor for the termination towards the SDP offerer, and within the SDP offer it forwards.	If the dtx parameter is contained in the SDP answer, the IMS-ALG shall forward this parameter to the IMS-AGW in the remote descriptor for the termination towards the answerer, and the IMS-ALG shall retain this parameter in the SDP answer it forwards.
dtx-recv (NOTE 1)	If the dtx-recv parameter is contained in the SDP offer, the IMS-ALG shall forward this parameter to the IMS-AGW in the remote descriptor for the termination towards the SDP offerer and shall retain the parameter in the SDP offer it forwards. Otherwise, if the reception of DTX is not desired and the dtx parameter is not included in the forwarded SDP offer, the IMS-ALG shall include the dtx-recv parameter with a value 0 to the IMS-AGW in the remote descriptor for the termination towards the SDP offerer, and within the SDP offer it forwards. If both the dtx and dtx-recv parameters are included, those parameters shall have the same value; however, inclusion of the dtx-recv parameter is not required if the dtx parameter is included.	If the dtx-recv parameter is contained in the SDP answer, the IMS-ALG shall forward this parameter to the IMS-AGW in the remote descriptor for the termination towards the answerer, and the IMS-ALG shall retain this parameter in the SDP answer it forwards.

<p>br (NOTE 1)</p>	<p>If the br parameter is contained in the SDP offer, the IMS-ALG shall check if the IMS-AGW supports the indicated bitrates, or a subset of them, in EVS primary mode in the send and receive direction. If the indicated bitrates, and even each subset of them, are not supported, the IMS-ALG should remove the EVS payload from the SDP offer.</p> <p>Otherwise, If the br parameter is contained in the SDP offer, the IMS-ALG shall select a bitrate value, which is either the received br value or a subset of it, based on IMS-AGW capabilities and possible configured policies, and shall include that br parameter with the selected value in the SDP offer if forwards.</p> <p>Otherwise, if the IMS-ALG desires the same bit rate range for the send and receive direction in EVS primary mode, and wants to restrict the bit rate range to match IMS-AGW capabilities and possible configured policies, it shall supply the br parameter in the SDP offer it sends.</p> <p>If the IMS-ALG also supplies the bw, bw-send or bw-recv parameter, the value of the br parameter shall be compatible with the values of those parameters.</p> <p>If the IMS-ALG supplies the br parameter in the SDP offer if forwards, it shall also supply to the IMS-AGW the br parameter in the local descriptor for the termination towards the offerer with the same value.</p>	<p>If the br parameter is contained in the SDP answer, the IMS-ALG shall forward this parameter to the IMS-AGW in the remote descriptor for the termination towards the answerer, and the IMS-ALG shall retain this parameter in the SDP answer it forwards.</p>
<p>br-send (NOTE 1)</p>	<p>If the br-send parameter is contained in the SDP offer, the IMS-ALG shall check if the IMS-AGW supports the indicated bitrates, or a subset of them, in EVS primary mode in the send and receive direction. If the indicated bitrates, and even each subset of them, are not supported, the IMS-ALG should remove the EVS payload from the SDP offer.</p> <p>Otherwise, If the br-send parameter is contained in the SDP offer, the IMS-ALG shall select a bitrate value, which is either the received br-send value or a subset of it, based on IMS-AGW capabilities and possible configured policies, and shall include that br-send parameter with the selected value in the SDP offer if forwards.</p> <p>Otherwise, if the IMS-ALG desires a different bit rate (range) for the send and receive direction in EVS primary mode, and wants to restrict the bit rate range for the send direction towards the offerer to match IMS-AGW capabilities and possible configured policies, it shall supply the br-send parameter in the SDP offer it sends.</p> <p>Otherwise the IMS-ALG shall not include this parameter in the SDP offer.</p> <p>If the IMS-ALG also supplies the bw or bw-send parameter, the value of the br-send parameter shall be compatible with the values of those parameters.</p> <p>If the IMS-ALG supplies the br-send parameter in the SDP offer if forwards, it shall also supply to the IMS-AGW the br-send parameter in the local descriptor for the termination towards the offerer with the same value.</p>	<p>If the br-send parameter is contained in the SDP answer, the IMS-ALG shall forward this parameter to the IMS-AGW in the remote descriptor for the termination towards the answerer, and the IMS-ALG shall retain this parameter in the SDP answer it forwards.</p>

br-recv (NOTE 1)	<p>If the br-recv parameter is contained in the SDP offer, the IMS-ALG shall check if the IMS-AGW supports the indicated bitrates, or a subset of them, in EVS primary mode in the send and receive direction. If the indicated bitrates, and even each subset of them, are not supported, the IMS-ALG should remove the EVS payload from the SDP offer.</p> <p>Otherwise, If the br-recv parameter is contained in the SDP offer, the IMS-ALG shall select a bitrate value, which is either the received br-recv value or a subset of it, based on IMS-AGW capabilities and possible configured policies, and shall include that br-recv parameter with the selected value in the SDP offer if forwards.</p> <p>Otherwise, if the IMS-ALG desires a different bit rate (range) for the send and receive direction in EVS primary mode, and wants to restrict the bit rate range for the recv direction towards the offerer to match IMS-AGW capabilities and possible configured policies, it shall supply the br-recv parameter in the SDP offer it sends.</p> <p>Otherwise the IMS-ALG shall not include this parameter in the SDP offer.</p> <p>If the IMS-ALG also supplies the bw or bw-recv parameter, the value of the br-recv parameter shall be compatible with the values of those parameters.</p> <p>If the IMS-ALG supplies the br-recv parameter in the SDP offer if forwards, it shall also supply to the IMS-AGW the br-recv parameter in the local descriptor for the termination towards the offerer with the same value.</p>	<p>If the br-recv parameter is contained in the SDP answer, the IMS-ALG shall forward this parameter to the IMS-AGW in the remote descriptor for the termination towards the answerer, and the IMS-ALG shall retain this parameter in the SDP answer it forwards.</p>
bw (NOTE 1)	<p>If the bw parameter is contained in the SDP offer, the IMS-ALG shall check if the IMS-AGW supports the indicated sampling bandwidth(s), or a subset of them, in EVS primary mode in the send and receive direction. If the indicated sampling bandwidth(s), and even each subset of them, are not supported, the IMS-ALG should remove the EVS payload from the SDP offer.</p> <p>Otherwise, If the bw parameter is contained in the SDP offer, the IMS-ALG shall select a bitrate value, which is either the received bw value or a subset of it, based on IMS-AGW capabilities and possible configured policies, and shall include that bw parameter with the selected value in the SDP offer if forwards.</p> <p>Otherwise, if the IMS-ALG desires the same sampling bandwidth(s) for the send and receive direction in EVS primary mode, and wants to restrict the sampling bandwidth(s) to match IMS-AGW capabilities and possible configured policies, it shall supply the bw parameter in the SDP offer it sends.</p> <p>If the IMS-ALG also supplies the br, br-send or br-recv parameter, the value of the bw parameter shall be compatible with the values of those parameters.</p> <p>If the IMS-ALG supplies the bw parameter in the SDP offer if forwards, it shall also supply to the IMS-AGW the bw parameter in the local descriptor for the termination towards the offerer with the same value.</p>	<p>If the bw parameter is contained in the SDP answer, the IMS-ALG shall forward this parameter to the IMS-AGW in the remote descriptor for the termination towards the answerer, and the IMS-ALG shall retain this parameter in the SDP answer it forwards.</p>

<p>bw-send (NOTE 1)</p>	<p>If the bw-send parameter is contained in the SDP offer, the IMS-ALG shall check if the IMS-AGW supports the indicated sampling bandwidth(s), or a subset of them, in EVS primary mode in the send and receive direction. If the indicated bitrates, and even each subset of them, are not supported, the IMS-ALG should remove the EVS payload from the SDP offer. Otherwise, If the bw-send parameter is contained in the SDP offer, the IMS-ALG shall select a sampling bandwidth value, which is either the received bw-send value or a subset of it, based on IMS-AGW capabilities and possible configured policies, and shall include that bw-send parameter with the selected value in the SDP offer if forwards.</p> <p>Otherwise, if the IMS-ALG desires different sampling bandwidth(s) for the send and receive direction in EVS primary mode, and wants to restrict the sampling bandwidth(s) for the send direction towards the offerer to match IMS-AGW capabilities and possible configured policies, it shall supply the bw-send parameter in the SDP offer it sends. Otherwise the IMS-ALG shall not include this parameter in the SDP offer.</p> <p>If the IMS-ALG also supplies the br or br-send parameter, the value of the bw-send parameter shall be compatible with the values of those parameters.</p> <p>If the IMS-ALG supplies the bw-send parameter in the SDP offer if forwards, it shall also supply to the IMS-AGW the bw-send parameter in the local descriptor for the termination towards the offerer with the same value.</p>	<p>If the bw-send parameter is contained in the SDP answer, the IMS-ALG shall forward this parameter to the IMS-AGW in the remote descriptor for the termination towards the answerer, and the IMS-ALG shall retain this parameter in the SDP answer it forwards.</p>
<p>bw-recv (NOTE 1)</p>	<p>If the bw-recv parameter is contained in the SDP offer, the IMS-ALG shall check if the IMS-AGW supports the indicated sampling bandwidth(s), or a subset of them, in EVS primary mode in the send and receive direction. If the indicated sampling bandwidth(s), and even each subset of them, are not supported, the IMS-ALG should remove the EVS payload from the SDP offer. Otherwise, If the bw-recv parameter is contained in the SDP offer, the IMS-ALG shall select a sampling bandwidth(s) value, which is either the received bw-recv value or a subset of it, based on IMS-AGW capabilities and possible configured policies, and shall include that bw-recv parameter with the selected value in the SDP offer if forwards.</p> <p>Otherwise, if the IMS-ALG desires different sampling bandwidth(s) for the send and receive direction in EVS primary mode, and wants to restrict the sampling bandwidth(s) for the recv direction towards the offerer to match IMS-AGW capabilities and possible configured policies, it shall supply the bw-recv parameter in the SDP offer it sends. Otherwise the IMS-ALG shall not include this parameter in the SDP offer.</p> <p>If the IMS-ALG also supplies the br or br-recv parameter, the value of the bw-recv parameter shall be compatible with the values of those parameters.</p> <p>If the IMS-ALG supplies the bw-recv parameter in the SDP offer if forwards, it shall also supply to the IMS-AGW the bw-recv parameter in the local descriptor for the termination towards the offerer with the same value.</p>	<p>If the bw-recv parameter is contained in the SDP answer, the IMS-ALG shall forward this parameter to the IMS-AGW in the remote descriptor for the termination towards the answerer, and the IMS-ALG shall retain this parameter in the SDP answer it forwards.</p>

cmr (NOTE 1)	If the cmr parameter is contained in the SDP offer, the IMS-ALG shall forward this parameter to the IMS-AGW in the remote descriptor for the termination towards the SDP offerer and shall retain the parameter in the SDP offer it forwards. Otherwise, if the IMS-ALG desires to disable codec mode requests within the RTP payload of the EVS primary mode (due to the IMS-AGW capabilities or policies), it shall include the cmr parameter with value -1 to the IMS-AGW in the remote descriptor for the termination towards the SDP offerer, and within the SDP offer it forwards.	If the cmr parameter is contained in the SDP answer, the IMS-ALG shall forward this parameter to the IMS-AGW in the remote descriptor for the termination towards the answerer, and the IMS-ALG shall retain this parameter in the SDP answer it forwards.
ch-aw-recv (NOTE 1)	If the ch-aw-recv parameter is contained in the SDP offer the IMS-ALG shall check if the IMS-AGW supports the indicated mode in the send direction. If the indicated mode is not supported, the IMS-ALG shall remove the payload type from the SDP offer. If the IMS-AGW supports the indicated mode in the send direction for transcoding, the IMS-ALG shall forward this parameter to the IMS-AGW for the termination towards the offerer in the remote descriptor, and shall include the unmodified parameter within the SDP offer it forwards. Otherwise, if the IMS-ALG desires to disable partial redundancy mode, it shall include the ch-aw-send parameter with value -1 in the SDP offer it forwards.	If the ch-aw-recv parameter is contained in the SDP answer, the IMS-ALG shall forward this parameter to the IMS-AGW in the remote descriptor for the termination towards the answerer, and the IMS-ALG shall retain this parameter in the SDP answer it forwards.
number of channels (NOTE 2)	If the "number of channels" parameter is contained in the SDP offer, the IMS-ALG shall check if the IMS-AGW supports the indicated number of channels. If the indicated number of channels is not supported, the IMS-ALG should remove the EVS payload from the SDP offer. Otherwise, if the "number of channels" parameter is contained in the SDP offer, the IMS-ALG shall forward this parameter to the IMS-AGW for the termination towards the offerer in the remote descriptor and shall retain the parameter in the SDP offer it forwards.	If the "number of channels" parameter is contained in the SDP answer, the IMS-ALG shall forward this parameter to the IMS-AGW in the remote descriptor for the termination towards the answerer, and the IMS-ALG shall retain this parameter in the SDP answer it forwards.
ch-send (NOTE 1)	If the ch-send parameter is contained in the SDP offer, the IMS-ALG shall check if the IMS-AGW supports the indicated number of channels in the send and receive direction. If the indicated number of channels is not supported, the IMS-ALG should remove the EVS payload from the SDP offer. Otherwise, if the ch-send parameter is contained in the SDP offer, the IMS-ALG shall forward this parameter to the IMS-AGW for the termination towards the offerer in the remote descriptor and shall retain the parameter in the SDP offer it forwards.	If the ch-send parameter is contained in the SDP answer, the IMS-ALG shall forward this parameter to the IMS-AGW in the remote descriptor for the termination towards the answerer, and the IMS-ALG shall retain this parameter in the SDP answer it forwards.
ch-recv (NOTE 1)	If the ch-recv parameter is contained in the SDP offer, the IMS-ALG shall check if the IMS-AGW supports the indicated number of channels in the send and receive direction. If the indicated number of channels is not supported, the IMS-ALG should remove the EVS payload from the SDP offer. Otherwise, if the ch-recv parameter is contained in the SDP offer, the IMS-ALG shall forward this parameter to the IMS-AGW for the termination towards the offerer in the remote descriptor and shall retain the parameter in the SDP offer it forwards.	If the ch-recv parameter is contained in the SDP answer, the IMS-ALG shall forward this parameter to the IMS-AGW in the remote descriptor for the termination towards the answerer, and the IMS-ALG shall retain this parameter in the SDP answer it forwards.

mode-set (NOTE 3)	If the mode-set parameter is contained in the SDP offer, the IMS-ALG shall forward this parameter to the IMS-AGW in the remote descriptor for the termination towards the SDP offerer and shall retain the parameter in the SDP offer it forwards.	If the mode-set parameter is contained in the SDP answer, the IMS-ALG shall forward this parameter to the IMS-AGW for the termination towards the answerer in the remote descriptor, and the IMS-ALG shall retain this parameter in the SDP answer it forwards.
mode-change-period (NOTE 3)	If the mode-change-period parameter is contained in the SDP offer, the IMS-ALG shall forward this parameter to the IMS-AGW in the remote descriptor for the termination towards the SDP offerer and shall retain the parameter in the SDP offer it forwards.	If the mode-change-period parameter is contained in the SDP answer, the IMS-ALG shall forward this parameter to the IMS-AGW for the termination towards the answerer in the remote descriptor, and the IMS-ALG shall retain this parameter in the SDP answer it forwards.
mode-change-capability (NOTE 3)	If the mode-change-capability parameter is contained in the SDP offer, the IMS-ALG may forward this parameter to the IMS-AGW in the remote descriptor for the termination towards the SDP offerer and shall retain the parameter in the SDP offer it forwards.	If the mode-change-capability parameter is contained in the SDP answer, the IMS-ALG may forward this parameter to the IMS-AGW for the termination towards the answerer in the remote descriptor, and the IMS-ALG shall retain this parameter in the SDP answer it forwards.
mode-change-neighbor (NOTE 3)	If the mode-change-neighbor parameter is contained in the SDP offer, the IMS-ALG shall forward this parameter to the IMS-AGW in the remote descriptor for the termination towards the SDP offerer and shall retain the parameter in the SDP offer it forwards.	If the mode-change-neighbor parameter is contained in the SDP answer, the IMS-ALG shall forward this parameter to the IMS-AGW for the termination towards the answerer in the remote descriptor, and the IMS-ALG shall retain this parameter in the SDP answer it forwards.
max-red (NOTE 5)	If the max-red parameter is contained in the SDP offer, the IMS-ALG shall forward this parameter to the IMS-AGW in the remote descriptor for the termination towards the SDP offerer and shall retain the parameter in the SDP offer it forwards with a value that considers the received value and the capabilities of the IMS-AGW.	If the max-red parameter is contained in the SDP answer, the IMS-ALG shall forward this parameter to the IMS-AGW for the termination towards the answerer in the remote descriptor, and the IMS-ALG shall retain this parameter in the SDP answer it forwards with a value that considers the received value and the capabilities of the IMS-AGW.
3gpp_mtsi_app_adapt (NOTE 4)	If the IMS-AGW supports RTCP APP based adaptation messages defined in 3GPP TS 26.114 [21], and the IMS-ALG has a policy to negotiate the usage of those messages, the IMS-ALG shall include the 3gpp_mtsi_app_adapt SDP attribute indicating the supported APP messages in the SDP offer.	If the 3gpp_mtsi_app_adapt parameter is contained in the SDP answer, the IMS-ALG shall forward this parameter to the IMS-AGW in the remote descriptor.
<p>NOTE 1: This MIME parameter of the EVS RTP payload type is defined in 3GPP TS 26.445 [51]. It is encapsulated within the SDP "a=fmtp" attribute defined IETF RFC 4566 [53].</p> <p>NOTE 2: This number of channels are encoded as "encoding parameters" of the SDP "a=rtpmap" attribute defined in IETF RFC 4566 [53].</p> <p>NOTE 3: This MIME parameter of the EVS RTP payload type relates to AMR-WB IO mode and is defined in IETF RFC 4867 [54]. It is encapsulated within the SDP "a=fmtp" attribute defined IETF RFC 4566 [53].</p> <p>NOTE 4: This SDP attribute is defined in 3GPP TS 26.114 [21]. It applies to all codecs offered in an SDP media line. However, some values are specific to EVS.</p> <p>NOTE 5: This MIME parameter of the EVS RTP payload type is defined in IETF RFC 4867 [54]. It is encapsulated within the SDP "a=fmtp" attribute defined IETF RFC 4566 [53].</p>		

For PS to CS Access Transfer, figure 6.2.14.4.1 shall apply with the EVS parameter handling in table 6.2.14.8.2, assuming that EVS is "codec 3", which is selected.

Table 6.2.14.8.2: IMS-ALG handling of EVS related SDP parameters during PS to CS Access Transfer.

Parameter	Handling of EVS payload type parameter received in the SDP offer	EVS payload type supplied in the SDP answer
evs-mode-switch (NOTE 1)	If the evs-mode-switch parameter is contained in the SDP offer and the IMS-ALG select the EVS payload type for transcoding, the IMS-ALG shall forward this parameter to the IMS-AGW for the termination towards the offerer in the remote descriptor.	If the evs-mode-switch parameter is contained in the SDP offer, the IMS-ALG shall include the evs-mode-switch parameter with unmodified value in the SDP answer. Otherwise, if EVS was used before the access transfer, the IMS-ALG should include the evs-mode-switch parameter with a value indicating the mode that was negotiated before the access transfer. Otherwise, if the IMS-ALG decides to transcode between AMR-WB and EVS (e.g. because AMR-WB was used before the access transfer), it shall include the evs-mode-switch with value 1. Otherwise the IMS-ALG shall not include the evs-mode-switch. If the IMS-ALG supplies the evs-mode-switch in the SDP answer, it shall also supply it to the IMS-AGW in the local descriptor for the termination towards the offerer with the same value.
hf-only (NOTE 1)	If the hf-only parameter is contained in the SDP offer and the IMS-ALG select the EVS payload type for transcoding, the IMS-ALG shall forward this parameter to the IMS-AGW for the termination towards the offerer in the remote descriptor.	If the hf-only parameter is contained in the SDP offer, the IMS-ALG shall include the hf-only parameter with unmodified value in the SDP answer. Otherwise, if the IMS-AGW is configured to negotiate using only the header-full EVS RTP payload format, the IMS-ALG shall include the hf-only parameter with a value 1. Otherwise, if EVS was used before the access transfer, the IMS-ALG should include the hf-only parameter with a value indicating the mode that was negotiated before the access transfer. If the IMS-ALG supplies the hf-only parameter in the SDP answer, it shall also supply it to the IMS-AGW in the local descriptor for the termination towards the offerer with the same value.
dtx (NOTE 1)	If the dtx parameter is contained in the SDP offer and the IMS-ALG select the EVS payload type for transcoding, the IMS-ALG shall forward this parameter to the IMS-AGW for the termination towards the offerer in the remote descriptor.	If the dtx parameter is contained in the SDP offer, the IMS-ALG shall include the dtx parameter with unmodified value in the SDP answer. Otherwise, if the dtx-recv parameter is contained in the SDP offer, the IMS-ALG may include the dtx parameter in the SDP answer with the same value as the dtx-recv parameter in the SDP offer. Otherwise, if the usage of DTX is not desired (e.g. due to DTX capabilities of expected codecs to transcode with), the IMS-ALG shall include the dtx parameter with a value 0. Otherwise, if EVS was used before the access transfer, the IMS-ALG should include the dtx parameter with a value indicating the mode that was negotiated before the access transfer. If the IMS-ALG supplies the dtx parameter in the SDP answer, it shall also supply it to the IMS-AGW in the local descriptor for the termination towards the offerer with the same value.
dtx-recv (NOTE 1)	If the dtx-recv parameter is contained in the SDP offer and the IMS-ALG select the EVS payload type for transcoding, the IMS-ALG shall forward this parameter to the IMS-AGW for the termination towards the offerer in the remote descriptor.	If the reception of DTX is not desired and the dtx parameter is not included, the IMS-ALG shall include the dtx-recv parameter with a value 0. If both the dtx and dtx-recv parameters are included, those parameters shall have the same value; however, inclusion of the dtx-recv parameter is not required if the dtx parameter is included. If the IMS-ALG supplies the dtx-recv parameter in the SDP answer, it should also supply it to the IMS-AGW in the local descriptor for the termination towards the offerer with the same value.

<p>br (NOTE 1)</p>	<p>If the br parameter is contained in the SDP offer, the IMS-ALG shall check if the IMS-AGW supports the indicated bitrates, or a subset of them, in EVS primary mode in the send and receive direction. If the indicated bitrates, and even each subset of them, are not supported, the IMS-ALG shall not select the EVS payload type for transcoding. If the IMS-ALG selects the EVS payload type, it shall forward this parameter to the IMS-AGW for the termination towards the offerer in the remote descriptor.</p>	<p>If the br parameter is contained in the SDP offer, the IMS-ALG shall select a bitrate value, which is either the received br value or a subset of it, based on IMS-AGW capabilities, possible configured policies, and the negotiated br range of an EVS codec used before the access transfer, and shall include the br parameter with the selected value that is also supplied towards the IMS-AGW in the SDP answer. Otherwise, if the IMS-ALG desires the same bit rate range for the send and receive direction in EVS primary mode, and wants to restrict the bit rate range to match IMS-AGW capabilities possible configured policies, and the negotiated br range of the EVS codec used before the access transfer, the IMS-ALG shall supply the br parameter in the SDP answer it sends. Otherwise the IMS-ALG shall not include this parameter in the SDP answer. If the IMS-ALG also supplies the bw, bw-send or bw-recv parameter, the value of the br parameter shall be compatible with the values of those parameters. If the IMS-ALG supplies the br parameter in the SDP answer, it shall also supply to the IMS-AGW the br parameter in the local descriptor for the termination towards the offerer with the same value.</p>
<p>br-send (NOTE 1)</p>	<p>If the br-send parameter is contained in the SDP offer, the IMS-ALG shall check if the IMS-AGW supports the indicated bitrates, or a subset of them, in EVS primary mode in the receive direction. If the indicated bitrates, and even each subset of them, are not supported, the IMS-ALG shall not select the EVS payload type for transcoding. If the IMS-ALG selects the EVS payload type, it shall forward this parameter to the IMS-AGW for the termination towards the offerer in the remote descriptor.</p>	<p>If the br-recv parameter is contained in the SDP offer, the IMS-ALG shall select a bitrate value, which is either the received br-recv value or a subset of it, based on IMS-AGW capabilities possible configured policies, and the negotiated br range of an EVS codec used before the access transfer, and the IMS-ALG shall include the br-send parameter with the selected value that is also supplied towards the IMS-AGW in the SDP answer. Otherwise, if the IMS-ALG desires a different bit rate (range) for the send and receive direction in EVS primary mode, and wants to restrict the bit rate range for the send direction to match IMS-AGW capabilities and possible configured policies, it shall supply the br-send parameter in the SDP answer it sends. Otherwise the IMS-ALG shall not include the br-send parameter in the SDP answer. If the IMS-ALG also supplies the bw or bw-send parameter, the value of the br-send parameter shall be compatible with the values of those parameters. If the IMS-ALG supplies the br-send parameter in the SDP answer, it shall also supply to the IMS-AGW the br-send parameter in the local descriptor for the termination towards the offerer with the same value.</p>

br-recv (NOTE 1)	<p>If the br-recv parameter is contained in the SDP offer, the IMS-ALG shall check if the IMS-AGW supports the indicated bitrates, or a subset of them, in EVS primary mode in the send direction. If the indicated bitrates, and even each subset of them, are not supported, the IMS-ALG shall not select the EVS payload type for transcoding. If the IMS-ALG selects the EVS payload type, it shall forward this parameter to the IMS-AGW for the termination towards the offerer in the remote descriptor.</p>	<p>If the br-send parameter is contained in the SDP offer, the IMS-ALG shall select a bitrate value, which is either the received br-send value or a subset of it, based on IMS-AGW capabilities, possible configured policies, and the negotiated br range of an EVS codec used before the access transfer, and the IMS-ALG shall include the br-recv parameter with the selected value that is also supplied towards the IMS-AGW in the SDP answer. Otherwise, if the IMS-ALG desires a different bit rate (range) for the send and receive direction in EVS primary mode, and wants to restrict the bit rate range for the receive direction to match IMS-AGW capabilities and possible configured policies, it shall supply the br-recv parameter in the SDP answer it sends.</p> <p>Otherwise the IMS-ALG shall not include the br-recv parameter in the SDP answer.</p> <p>If the IMS-ALG also supplies the bw or bw-recv parameter, the value of the br-recv parameter shall be compatible with the values of those parameters. If the IMS-ALG supplies the br-recv parameter in the SDP answer, it shall also supply to the IMS-AGW the br-recv parameter in the local descriptor for the termination towards the offerer with the same value.</p>
bw (NOTE 1)	<p>If the bw parameter is contained in the SDP offer, the IMS-ALG shall check if the IMS-AGW supports the indicated sampling bandwidth(s), or a subset of them, in EVS primary mode in the send and receive direction. If the indicated sampling bandwidth(s), and even each subset of them, are not supported, the IMS-ALG shall not select the EVS payload type for transcoding. If the IMS-ALG selects the EVS payload type, it shall forward this parameter to the IMS-AGW for the termination towards the offerer in the remote descriptor.</p>	<p>If the bw parameter is contained in the SDP offer, the IMS-ALG shall select a sampling bandwidth value, which is either the received bw value or a subset of it, based on IMS-AGW capabilities, possible configured policies, and the negotiated bw range of an EVS codec used before the access transfer, and the IMS-ALG shall include the bw parameter with the selected value that is also supplied towards the IMS-AGW in the SDP answer. Otherwise, if the IMS-ALG desires the same sampling bandwidth(s) for the send and receive direction in EVS primary mode, and wants to restrict the sampling bandwidth(s) to match IMS-AGW capabilities, possible configured policies, and the negotiated bw range of the EVS codec used before the access transfer, the IMS-ALG shall supply the bw parameter in the SDP answer it sends.</p> <p>Otherwise the IMS-ALG shall not include this parameter in the SDP answer.</p> <p>If the IMS-ALG also supplies the br, br-send or br-recv parameter, the value of the bw parameter shall be compatible with the values of those parameters. If the IMS-ALG supplies the bw parameter in the SDP answer, it shall also supply to the IMS-AGW the bw parameter in the local descriptor for the termination towards the offerer with the same value.</p>

<p>bw-send (NOTE 1)</p>	<p>If the bw-send parameter is contained in the SDP offer, the IMS-ALG shall check if the IMS-AGW supports the indicated sampling bandwidths, or a subset of them, in EVS primary mode in the receive direction. If the indicated sampling bandwidths, and even each subset of them, are not supported, the IMS-ALG shall not select the EVS payload type for transcoding. If the IMS-ALG selects the EVS payload type, it shall forward this parameter to the IMS-AGW for the termination towards the offerer in the remote descriptor.</p>	<p>If the bw-recv parameter is contained in the SDP offer, the IMS-ALG shall select a sampling bandwidths value, which is either the received bw-recv value or a subset of it, based on IMS-AGW capabilities, possible configured policies, and the negotiated bw range of an EVS codec used before the access transfer, and the IMS-ALG shall include the bw-send parameter with the selected value in the SDP answer.</p> <p>Otherwise, if the IMS-ALG desires a different sampling bandwidths for the send and receive direction in EVS primary mode, and wants to restrict the sampling bandwidths for the send direction to match IMS-AGW capabilities, possible configured policies, and the negotiated bw range of the EVS codec used before the access transfer, the IMS-ALG shall supply the bw-send parameter in the SDP answer it sends.</p> <p>Otherwise the IMS-ALG shall not include the br-send parameter in the SDP answer.</p> <p>If the IMS-ALG also supplies the bw or bw-send parameter, the value of the br-send parameter shall be compatible with the values of those parameters. If the IMS-ALG supplies the bw-send parameter in the SDP answer, it shall also supply to the IMS-AGW the bw-send parameter in the local descriptor for the termination towards the offerer with the same value.</p>
<p>bw-recv (NOTE 1)</p>	<p>If the br-recv parameter is contained in the SDP offer, the IMS-ALG shall check if the IMS-AGW supports the indicated sampling bandwidths, or a subset of them, in EVS primary mode in the send direction. If the indicated sampling bandwidths, and even each subset of them, are not supported, the IMS-ALG shall not select the EVS payload type for transcoding. If the IMS-ALG selects the EVS payload type, it shall forward the bw-recv parameter to the IMS-AGW for the termination towards the offerer in the remote descriptor.</p>	<p>If the bw-send parameter is contained in the SDP offer, the IMS-ALG shall select a sampling bandwidths value, which is either the received bw-send value or a subset of it, based on IMS-AGW capabilities, possible configured policies, and the negotiated bw range of an EVS codec used before the access transfer, and the IMS-ALG shall include the bw-recv parameter with the selected value in the SDP answer.</p> <p>Otherwise, if the IMS-ALG desires a different sampling bandwidths for the send and receive direction in EVS primary mode, and wants to restrict the sampling bandwidths for the receive direction to match IMS-AGW capabilities, possible configured policies, and the negotiated bw range of the EVS codec used before the access transfer, the IMS-ALG shall supply the bw-recv parameter in the SDP answer it sends.</p> <p>Otherwise the IMS-ALG shall not include the bw-recv parameter in the SDP answer.</p> <p>If the IMS-ALG also supplies the br or br-recv parameter, the value of the bw-recv parameter shall be compatible with the values of those parameters. If the IMS-ALG supplies the bw-send parameter in the SDP answer, it shall also supply it to the IMS-AGW in the local descriptor for the termination towards the offerer with the same value.</p>

cmr (NOTE 1)	If the cmr parameter is contained in the SDP offer and the IMS-ALG select the EVS payload type for transcoding, the IMS-ALG shall forward this parameter to the IMS-AGW for the termination towards the offerer in the remote descriptor.	If the cmr parameter is contained in the SDP offer, the IMS-ALG shall include the cmr parameter with unmodified value in the SDP answer. Otherwise, if the IMS-AGW desires to disable codec mode requests within the RTP payload of the EVS primary mode (due to the IMS-AGW capabilities, possible configured policies, and the negotiated CMR mode of an EVS codec used before the access transfer), it shall include the cmr parameter with value -1 in the SDP answer it sends. If the IMS-ALG supplies the cmr parameter in the SDP answer, it shall also supply it to the IMS-AGW in the local descriptor for the termination towards the offerer with the same value.
ch-aw-recv (NOTE 1)	If the ch-aw-recv parameter is contained in the SDP offer the IMS-ALG shall check if the IMS-AGW supports the indicated mode in the send direction. If the indicated mode is not supported, the IMS-ALG shall not select the EVS payload type for transcoding. If the IMS-ALG selects the EVS payload type for transcoding, the IMS-ALG shall forward this parameter to the IMS-AGW for the termination towards the offerer in the remote descriptor.	If the IMS-ALG it desires to control the channel-aware mode of EVS in the receive direction, e.g. to disable it with value -1, it shall include the ch-aw-recv parameter in the SDP offer and shall also supply the ch-aw-recv parameter to the IMS-AGW in the local descriptor for the termination towards the offerer with the same value. The IMS-ALG shall consider the capabilities of the IMS-AGW and the negotiated ch-aw-recv mode of an EVS codec used before the access transfer when it chooses an appropriate value.
number of channels (NOTE 2)	If the "number of channels" parameter is contained in the SDP offer the IMS-ALG shall check if the IMS-AGW supports the indicated number of channels. If the indicated number of channels is not supported, the IMS-ALG shall not select the EVS payload type for transcoding. If the IMS-ALG selects the EVS payload type for transcoding, the IMS-ALG shall forward this parameter to the IMS-AGW for the termination towards the offerer in the remote descriptor.	If the "number of channels" parameter is contained in the SDP offer, the IMS-ALG shall include the "number of channels" parameter with unmodified value in the SDP answer and shall also supply it to the IMS-AGW in the local descriptor for the termination towards the offerer with the same value.
ch-send (NOTE 1)	If the ch-send parameter is contained in the SDP offer the IMS-ALG shall check if the IMS-AGW supports the indicated number of channels in the receive direction. If the indicated number of channels is not supported, the IMS-ALG shall not select the EVS payload type for transcoding. If the IMS-ALG selects the EVS payload type for transcoding, the IMS-ALG shall forward the ch-send parameter to the IMS-AGW for the termination towards the offerer in the remote descriptor.	If the ch-recv parameter is contained in the SDP offer, the IMS-ALG shall include the ch-send parameter with unmodified value in the SDP answer and shall also supply the ch-send parameter to the IMS-AGW in the local descriptor for the termination towards the offerer with the same value.
ch-recv (NOTE 1)	If the ch-recv parameter is contained in the SDP offer the IMS-ALG shall check if the IMS-AGW supports the indicated number of channels in the send direction. If the indicated number of channels is not supported, the IMS-ALG shall not select the EVS payload type for transcoding. If the IMS-ALG selects the EVS payload type for transcoding, the IMS-ALG shall forward the ch-recv parameter to the IMS-AGW for the termination towards the offerer in the remote descriptor.	If the ch-send parameter is contained in the SDP offer, the IMS-ALG shall include the ch-recv parameter with unmodified value in the SDP answer and shall also supply the ch-recv parameter to the IMS-AGW in the local descriptor for the termination towards the offerer with the same value.

mode-set (NOTE 3)	If the mode-set parameter is contained in the SDP offer and the IMS-ALG select the EVS payload type for transcoding, the IMS-ALG shall forward this parameter to the IMS-AGW for the termination towards the offerer in the remote descriptor.	If the mode-set parameter is contained in the SDP offer, the IMS-ALG shall include the mode-set parameter with unmodified value in the SDP answer. Otherwise, if EVS or AMR-WB was used before the access transfer, the IMS-ALG should include the mode-set parameter with a value indicating the mode that was negotiated before the access transfer (or omit it if no restrictions applied before). If the IMS-ALG supplies the mode-set parameter in the SDP answer, it shall also supply it to the IMS-AGW in the local descriptor for the termination towards the offerer with the same value.
mode-change-period (NOTE 3)	If the mode-change-period parameter is contained in the SDP offer and the IMS-ALG select the EVS payload type for transcoding, the IMS-ALG shall forward this parameter to the IMS-AGW for the termination towards the offerer in the remote descriptor.	If EVS or AMR-WB was used before the access transfer, the IMS-ALG should include the mode-change-period parameter with a value indicating the mode that was negotiated before the access transfer (or omit it if no restrictions applied before). the IMS-ALG should include the mode-change-period parameter for the EVS payload in the SDP offer it forwards. If the IMS-ALG supplies the mode-change-period parameter in the SDP answer, it shall also supply it to the IMS-AGW in the local descriptor for the termination towards the offerer with the same value.
mode-change-capability (NOTE 3)	If the mode-change-capability parameter is contained in the SDP offer and the IMS-ALG select the EVS payload type for transcoding, the IMS-ALG may forward this parameter to the IMS-AGW for the termination towards the offerer in the remote descriptor.	The IMS-ALG shall either include the mode-change-capability parameter with a value 2 or omit the parameter. If the IMS-ALG supplies the mode-change-capability parameter in the SDP answer, it may also supply it to the IMS-AGW in the local descriptor for the termination towards the offerer with the same value.
mode-change-neighbor (NOTE 3)	If the mode-change-neighbor parameter is contained in the SDP offer and the IMS-ALG select the EVS payload type for transcoding, the IMS-ALG shall forward this parameter to the IMS-AGW for the termination towards the offerer in the remote descriptor.	If EVS or AMR-WB was used before the access transfer, the IMS-ALG should include the mode-change-neighbor parameter with a value indicating the mode that was negotiated before the access transfer (or omit it if no restrictions applied before). If the IMS-ALG supplies the mode-change-neighbor parameter in the SDP answer, it shall also supply it to the IMS-AGW in the local descriptor for the termination towards the offerer with the same value.
max-red (NOTE 5)	If the max-red parameter is contained in the SDP offer and the IMS-ALG select the EVS payload type for transcoding, the IMS-ALG shall forward this parameter to the IMS-AGW for the termination towards the offerer in the remote descriptor.	The IMS-ALG shall only include the max-red parameter in the SDP answer if it desires to restrict the maximum redundancy of received packets. When selecting the value of the max-red parameter, the IMS-ALG shall consider the capabilities of the IMS-AGW and, If EVS or AMR-WB was used before the access transfer, the redundancy that was negotiated before the access transfer. If the IMS-ALG supplies the max-red parameter in the SDP answer, it shall also supply it to the IMS-AGW in the local descriptor for the termination towards the offerer with the same value.
3gpp_mtsi_app_adapt (NOTE 4)	If the 3gpp_mtsi_app_adapt parameter is contained in the SDP answer, and the IMS-ALG select the EVS payload type for transcoding, the IMS-ALG shall forward this parameter to the IMS-AGW the IMS-ALG shall forward this parameter to the IMS-AGW in the remote descriptor.	If the IMS-AGW supports RTCP APP based adaptation messages defined in 3GPP TS 26.114 [21], and the IMS-ALG has a policy to negotiate the usage of those messages, the IMS-ALG shall include the 3gpp_mtsi_app_adapt SDP attribute indicating the allowed APP messages in the SDP answer. If EVS was used before the access transfer, the IMS-ALG should consider the negotiated RTCP APP packet types the access transfer in addition to the IMS AGW capabilities when selecting the allowed RTCP APP messages.

- NOTE 1: This MIME parameter of the EVS RTP payload type is defined in 3GPP TS 26.445 [51]. It is encapsulated within the SDP "a=fmtp" attribute defined IETF RFC 4566 [53].
- NOTE 2: This number of channels are encoded as "encoding parameters" of the SDP "a=rtpmap" attribute defined in IETF RFC 4566 [53].
- NOTE 3: This MIME parameter of the EVS RTP payload type relates to AMR-WB IO mode and is defined in IETF RFC 4867 [54]. It is encapsulated within the SDP "a=fmtp" attribute defined IETF RFC 4566 [53].
- NOTE 4: This SDP attribute is defined in 3GPP TS 26.114 [21]. It applies to all codecs offered in an SDP media line. However, some values are specific to EVS.
- NOTE 5: This MIME parameter of the EVS RTP payload type is defined in IETF RFC 4867 [54]. It is encapsulated within the SDP "a=fmtp" attribute defined IETF RFC 4566 [53].

6.2.15 Multimedia Priority Congestion Control Procedures

6.2.15.1 General

The IMS-ALG and IMS-AGW may support the priority treatment of a call/session identified as an MPS call/session. This clause describes the Iq signalling procedures and their interactions with SIP signalling in the control plane and with user plane procedures to support the requirements for Multimedia Priority Service. These Iq signalling procedures may or may not apply depending on the network configuration (e.g. whether the IMS-AGW is shared by multiple IMS-ALGs or whether the IMS-ALG controls multiple IMS-AGWs for a given route – Media Gateway Group).

The IMS-ALG can receive a SIP INVITE with MPS priority information (see 3GPP TS 23.228 [2], subclause 5.21).

6.2.15.2 IMS-AGW Resource Congestion in ADD response, request is queued

If the IMS-ALG requests a resource via the procedure Reserve and Configure AGW Connection Point or Reserve AGW Connection Point and receives an error indicating that the requested resource could not be seized (e.g. H.248 error code #510 "insufficient resources") and the IMS-ALG does not have alternative IMS-AGW through which it can route the call it queues the priority session and gives it priority over any further Reserve and Configure AGW Connection Point or Reserve AGW Connection Point procedures for lower priority sessions towards this IMS-AGW until the requested resource for this queued session is successful seized. The example sequence is shown in Figure 6.2.15.2.1.

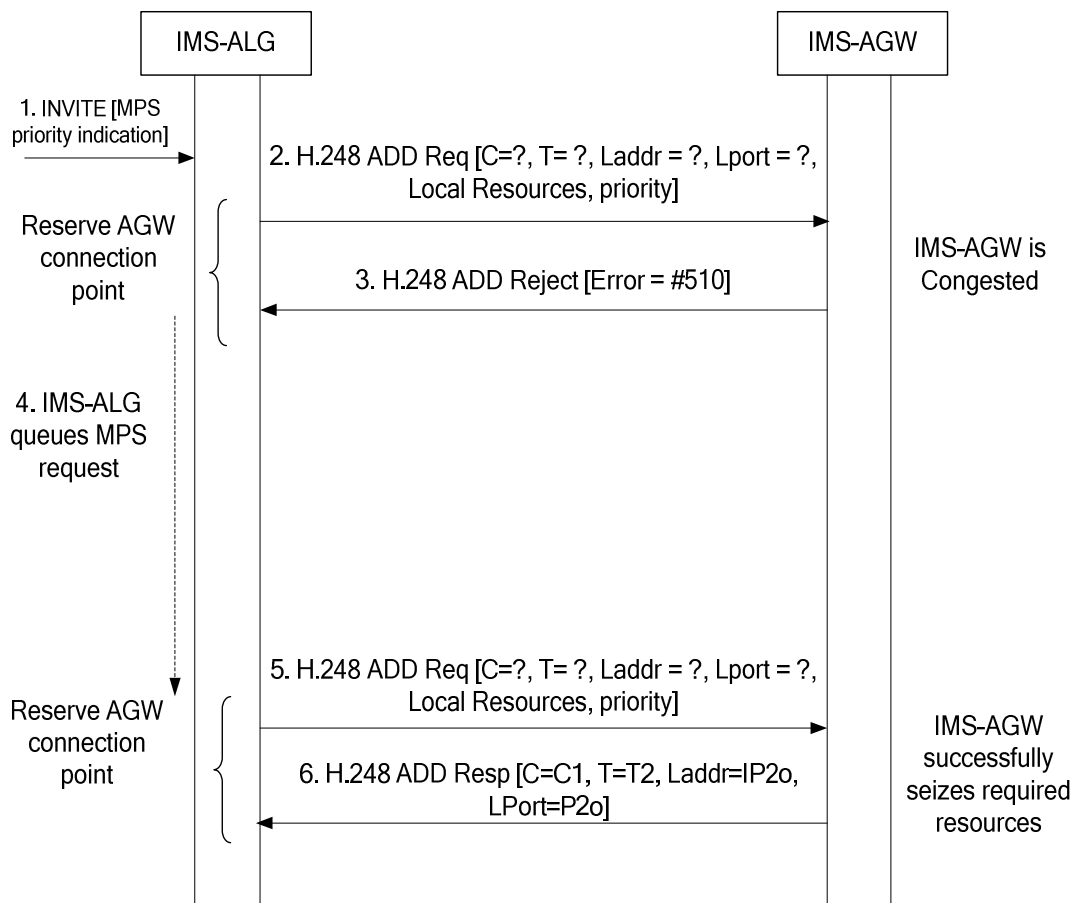

Figure 6.2.15.2.1: Request to reserve IMS-AGW MPS Priority call resources when IMS-AGW is congested

6.2.15.3 IMS-AGW Resource Congestion in ADD response, IMS-ALG seizes new IMS-AGW

If the IMS-ALG requests a resource via the procedure Reserve and Configure AGW Connection Point or Reserve AGW Connection Point and receives an error indicating that the requested resources could not be seized (e.g. H.248 error code #510 "insufficient resources") and Media Gateway Groups are implemented it should seize a new IMS-AGW from the same Media Gateway Group before resorting to any queuing of the priority session (as described in 6.2.15.2) to enable the MPS call/session to proceed as early as possible.

6.2.15.4 IMS-AGW Priority Resource Allocation

If the IMS-AGW supports the Priority information (e.g. determined through provisioning or package profile) the IMS-ALG requests a resource via the procedure Reserve and Configure AGW Connection Point or Reserve AGW Connection Point and includes the Priority information. The IMS-AGW may then provide priority allocation of resources once a congestion threshold is reached. If the IMS-AGW is completely congested it shall indicate this to the IMS-ALG as described in 6.2.15.2. The example sequence is shown in Figure 6.2.15.4.1.

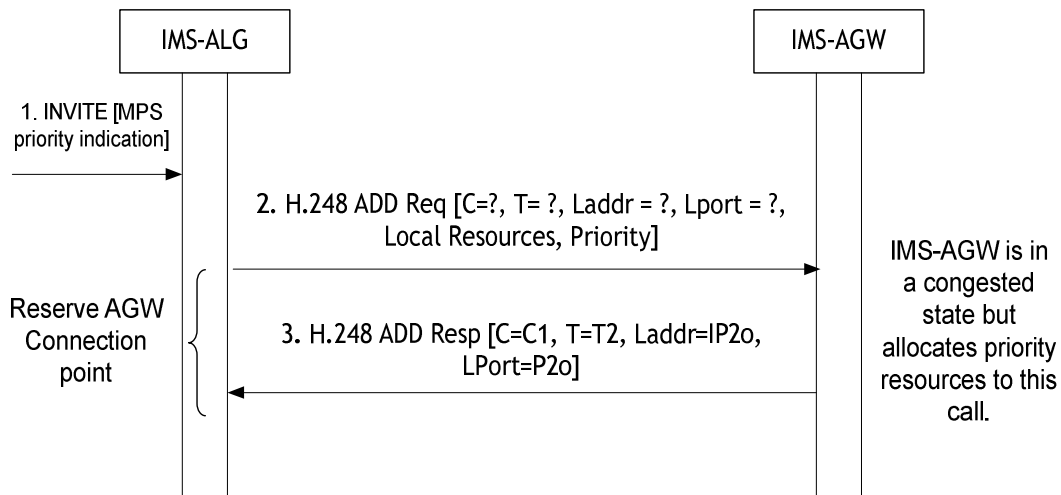

Figure 6.2.15.4.1: Request to reserve IMS-AGW MPS Priority call resources when IMS-AGW is congested, priority resources are allocated

6.2.15.5 IMS-AGW Priority User Data marking

The IMS-ALG may request the streams associated to an MPS Priority Call to be marked with certain priority code point as described in subclause 6.2.7. The IMS-AGW shall then mark each IP packet header accordingly. The example sequence is shown in Figure 6.2.15.5.1.

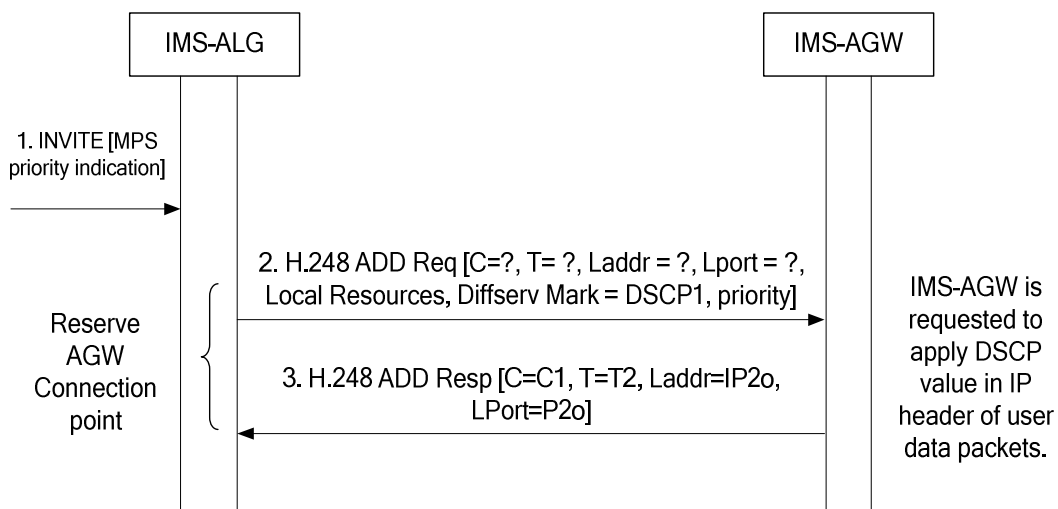

Figure 6.2.15.5.1: Request to reserve IMS-AGW call resources and apply DCSP marking for MPS

The IMS-AGW may also provide priority allocation for resources requested via a subsequent Configure AGW Connection Point procedure not including Priority information if the related context has been marked with priority information during the Reserve AGW Connection Point or Reserve and Configure AGW Connection Point procedure.

6.2.15.6 IMS-AGW Priority Modification

If the IMS-ALG seized an IP termination for a priority call/session with a default priority and subsequently needs to modify the priority information previously communicated to the IMS-AGW (e.g. subject to subsequent authorisation by an authorisation point, see 3GPP TS 24.229 [11] subclause 4.11), the IMS-ALG may modify the existing IP termination for the MPS call/session with the actual priority and, if DiffServ is used, provision a suitable DSCP marking for the updated MPS priority level to the IMS-AGW via the Configure AGW Connection Point Procedure.

NOTE: The specific Iq related call sequence which details the handling to support the requirements defined in 3GPP TS 24.229 [11], subclause 4.11 and 3GPP TS 23.228 [2], subclause 5.21 is not specified, and therefore implementations might exist which fulfil these requirements but do not require modification of the priority information across the Iq interface.

6.2.16 Coordination of Video Orientation

Figure 6.2.16.1 shows the message sequence chart example for indicating extended RTP header for Coordination of Video Orientation.

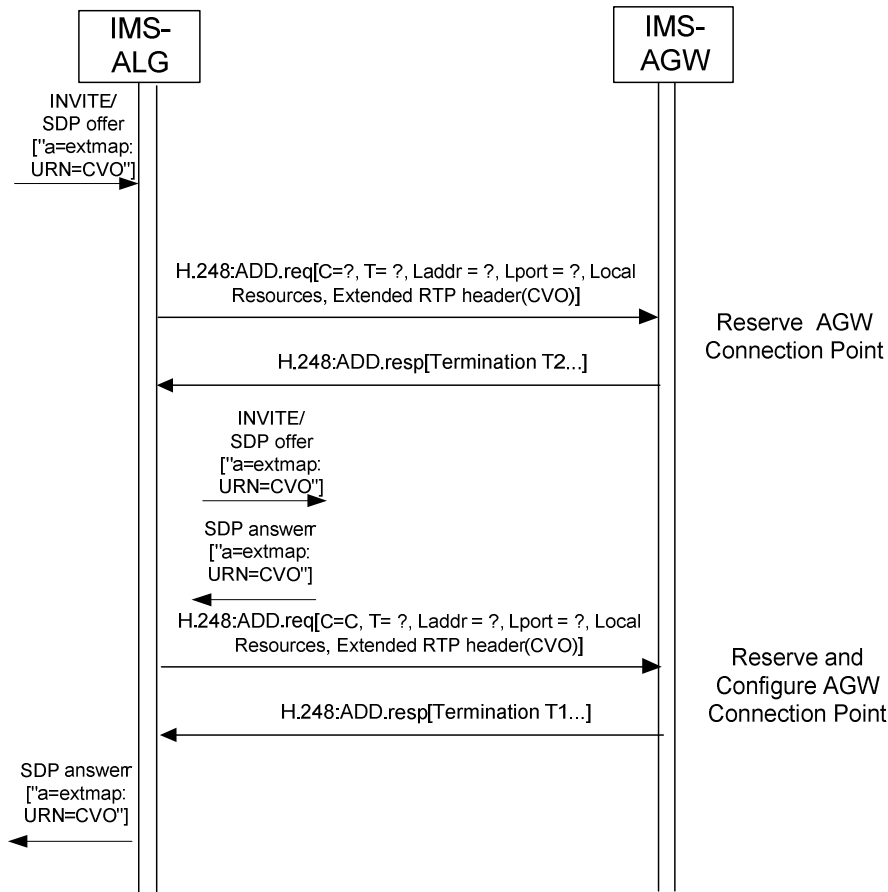

Figure 6.2.16.1: Procedure to indicate RTP extension header for CVO

This procedure is identical to that of subclause 6.2.1 apart from the IMS-ALG optionally requesting the IMS-AGW to support the RTP Header Extension capability as defined in IETF RFC 5285 [23].

NOTE: If the IMS-ALG receives an SDP answer, which includes the "a=extmap" attribute with a CVO URN with a granularity that the IMS-AGW has not included in its response, or if the SDP answer does not include any "a=extmap" CVO related attribute, it is not necessary to modify the IMS-AGW settings for this reason alone. Doing that would only add unnecessary signalling without requiring any action or changes in the IMS-AGW. However, if the IMS-ALG needs to modify the media attributes for other purposes, in particular due to transcoding, then the IMS-AGW is updated in accordance with the received SDP answer, that is, either with the received CVO related "a=extmap" attribute if present in the received SDP answer or without it if not included in the received SDP answer (thus removing the requirement for supporting "a=extmap" and for sending the header and CVO bits for the transcoded stream).

6.2.17 Procedures for Interactive Connectivity Establishment (ICE)

6.2.17.1 ICE lite

Figure 6.2.17.1.1 shows a message sequence chart example for performing the ICE lite procedure towards the offerer.

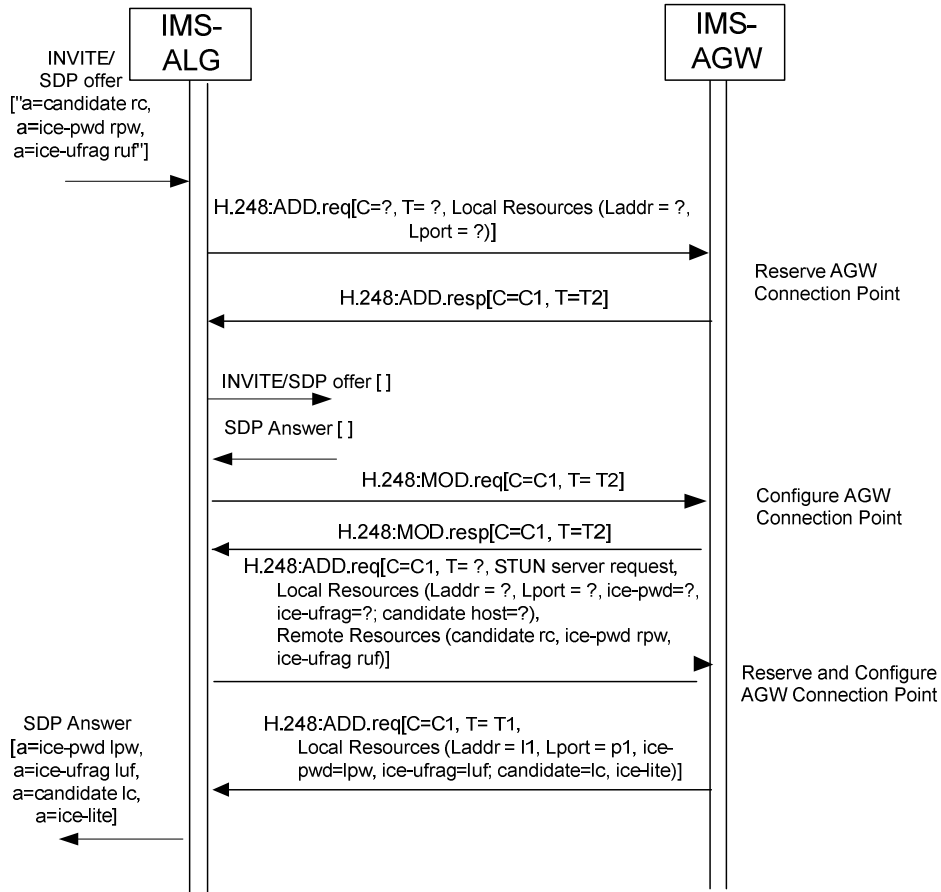

Figure 6.2.17.1.1: Procedure for interactive connectivity establishment using ICE lite towards the offerer

6.2.17.2 Full ICE

Figure 6.2.17.2.1 shows a message sequence chart example for performing the full ICE procedure towards the offerer.

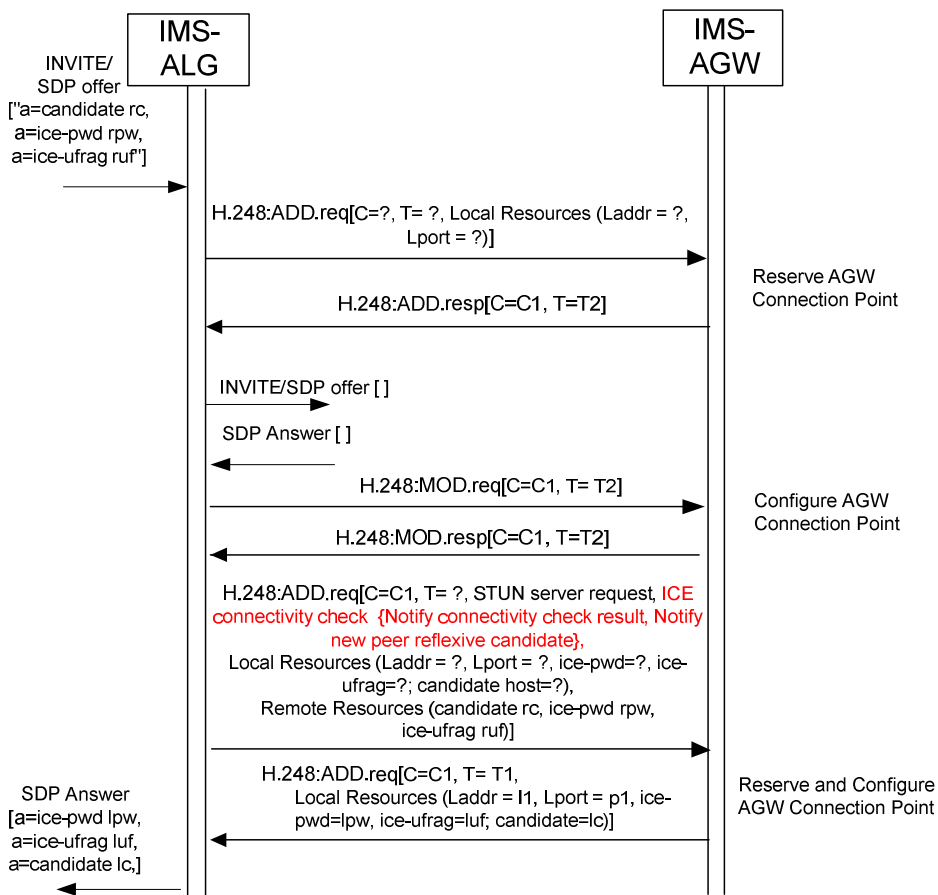

Figure 6.2.17.2.1: Procedure for interactive connectivity establishment using full ICE towards the offerer

6.2.17.3 Connectivity check result notification (full ICE)

Figure 6.2.17.3.1 shows the message sequence chart example for an ICE connectivity check result Event.

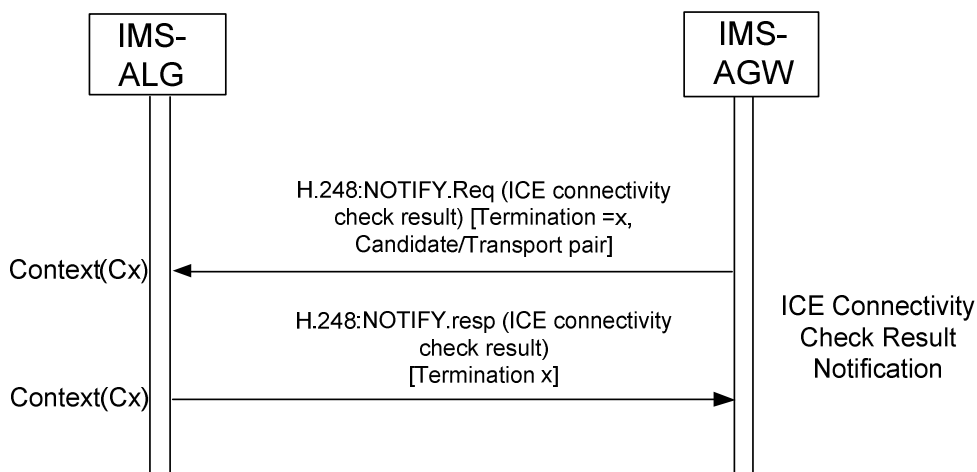

Figure 6.2.17.3.1: Procedure to report ICE connectivity check result

6.2.17.4 New peer reflexive candidate notification (full ICE)

Figure 6.2.17.4.1 shows the message sequence chart example for additional connectivity check when new peer reflexive candidate is discovered in full ICE.

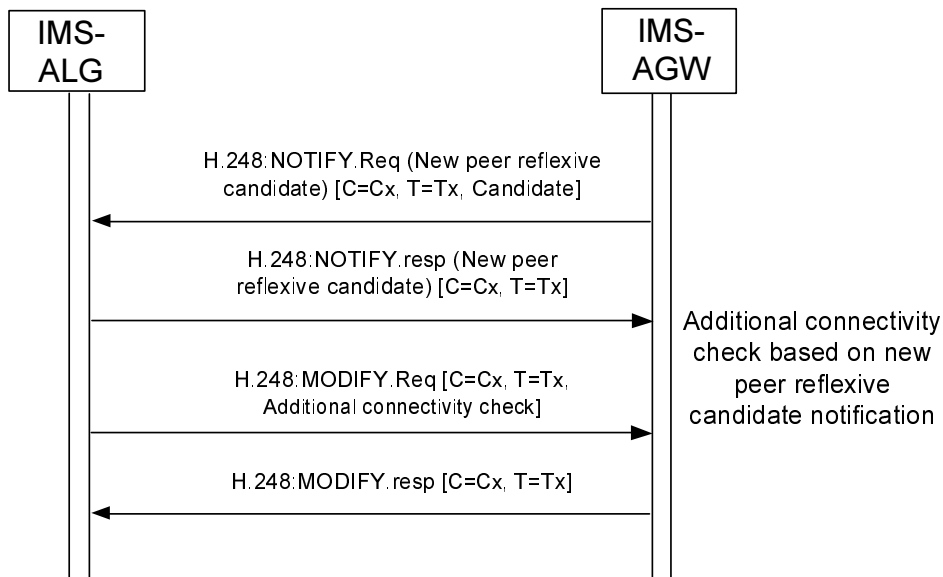

Figure 6.2.17.4.1: Procedure to perform additional connectivity check upon the report of new peer reflexive candidate

6.2.17.5 STUN consent freshness test

Figure 6.2.17.5.1 shows a message sequence chart example for requesting the STUN consent freshness test procedure towards the offerer when full ICE is supported by the eIMS-AGW.

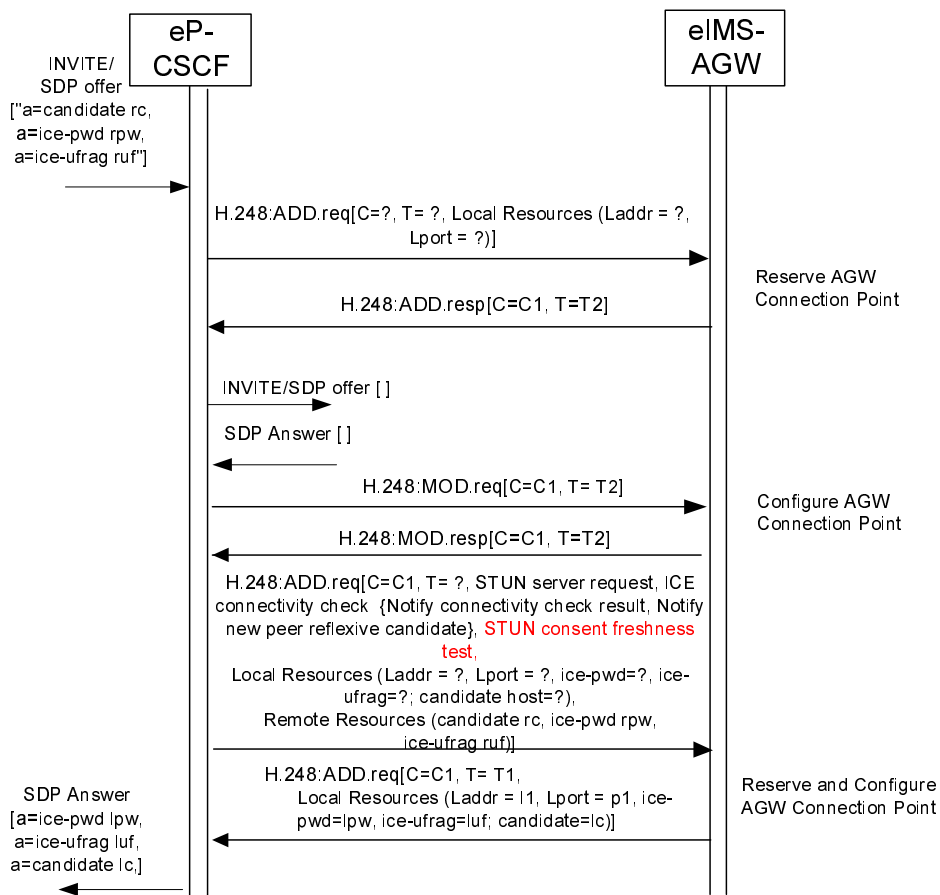

Figure 6.2.17.5.1: Procedure for STUN consent freshness test towards the offerer

6.2.17.6 STUN Consent Freshness Test Failure Notification

Figure 6.2.17.6.1 shows the message sequence chart example for an ICE STUN consent freshness test failure Event.

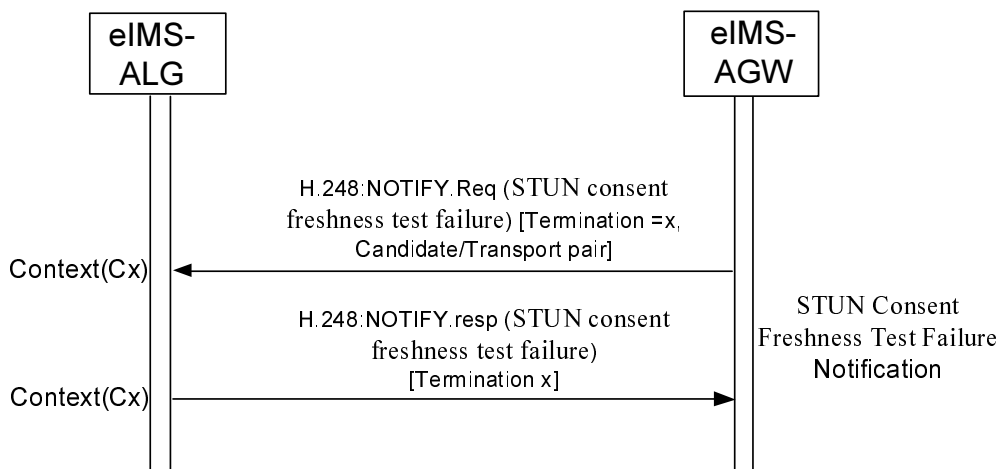

Figure 6.2.17.6.1: Procedure to report STUN consent freshness test failure

6.2.18 TCP bearer connection control

6.2.18.1 General

All message sequence charts in this clause are examples. The H.248 context model is defined in Figure 6.2.1.1.

6.2.18.2 Stateless TCP handling

This procedure is identical to that of subclause 6.2.1 apart from the IMS-ALG and IMS-AGW applying the requirements specified in subclause 5.16.1.

6.2.18.3 State-aware TCP handling without support of modifying the TCP setup direction

This procedure is identical to that of subclause 6.2.1 apart from the IMS-ALG and IMS-AGW applying the requirements specified in subclause 5.16.2.2.

Subclause 6.2.10.3.1 provides example call flows for TCP bearer connection establishment without modifying the TCP setup direction.

6.2.18.4 State-aware TCP handling with support of modifying the TCP setup direction

This procedure is identical to that of subclause 6.2.1 apart from the IMS-ALG and IMS-AGW applying the requirements specified in subclause 5.16.2.3.

Figure 6.2.18.4.1 shows an example call flow for a terminating session set-up procedure, where the IMS-ALG receives an incoming SDP offer containing media line for a new MSRP media stream with an "a=setup:active" SDP attribute towards a served UE located behind a remote NAT.

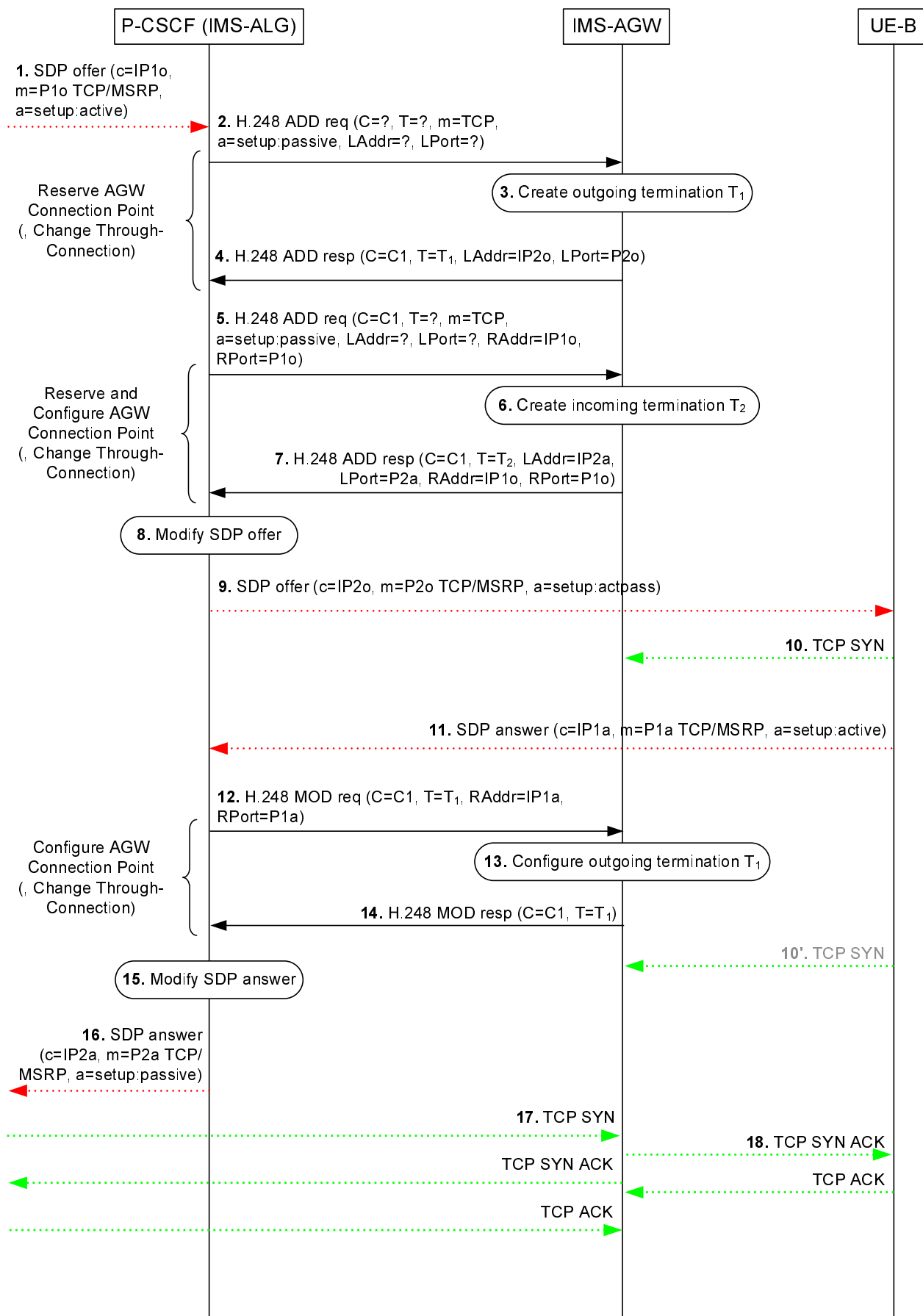

Figure 6.2.18.4.1: Terminating example call flow for MSRP between UEs located behind NAT

The IMS UE B performs an IMS terminating session set-up according to 3GPP TS 23.228 [2], with modifications as described in 3GPP TS 33.328 [12].

The procedure in the above figure is described step-by-step with an emphasis on the additional aspects for IMS-ALG and IMS-AGW of TCP bearer connection control.

1. The P-CSCF (IMS-ALG) receives an SDP offer for an MSRP media stream with an "a=setup:active" attribute. For the MSRP media stream offered with transport "TCP/MSRP", the P-CSCF (IMS-ALG) allocates the required resources, includes the IMS-AGW in the media path and proceeds as specified in this clause.
- 2.-4. The IMS-ALG uses the "Reserve AGW Connection Point" procedure to request a termination for "TCP" media (for application-agnostic interworking) or "TCP/MSRP" media (for application-aware interworking) towards the access network. The IMS-ALG preconfigures the IMS-AGW to operate in TCP merge mode by providing the "a=setup:passive" attribute.
- 5.-7. The IMS-ALG uses the "Reserve And Configure AGW Connection Point" procedure to request a termination for "TCP" media (for application-agnostic interworking) or "TCP/MSRP" media (for application-aware interworking) towards the core network. The IMS-ALG preconfigures the IMS-AGW to operate in TCP Merge mode by providing the "a=setup:passive" attribute.
8. The P-CSCF (IMS-ALG) changes the "a=setup" SDP attribute to "actpass" in the SDP offer and inserts the address information received from the IMS-AGW.
9. The P-CSCF (IMS-ALG) forwards the SDP offer.
10. The UE B chooses to become the active party in the TCP connection establishment and sends a TCP SYN to establish the TCP connection. If the P-CSCF (IMS-ALG) indicated to the IMS-AGW at step 2 that it shall ignore any incoming TCP connection establishment requests (TCP SYN), e.g. to enable a remote source transport address filtering, or if the P-CSCF (IMS-ALG) did not indicate to the IMS-AGW at step 2 that it shall latch onto the required destination address via the source address/port of the incoming media, the IMS-AGW shall drop the TCP SYN received from the UE.
If the TCP SYN is not answered before a timer expiry, the UE will send the TCP SYN a second time (step 10').
11. The P-CSCF (IMS-ALG) receives the SDP answer. It contains the SDP answer with an "a=setup:active" attribute.
- 12.-14. The IMS-ALG uses the "Configure AGW Connection Point" procedure to configure the termination towards the UE B with remote address information.
15. The P-CSCF (IMS-ALG) modifies the SDP answer before sending it to the core network. The P-CSCF (IMS-ALG) sets the "a=setup:passive" SDP attribute.
16. The P-CSCF (IMS-ALG) then sends the updated SDP answer to core network.
17. The IMS-AGW answers the TCP SYN and the remote peer completes the TCP connection establishment.
18. The IMS-AGW answers the TCP SYN and UE B completes the TCP connection establishment.

6.2.19 Application-aware MSRP interworking at the IMS-AGW

This procedure is identical to that of subclause 6.2.1 apart from the IMS-ALG:

- indicating "TCP/MSRP" or "TCP/TLS/MSRP" (if e2ae media security is applied) as transport protocol to the IMS-AGW;
- configuring the IMS-AGW to apply application-aware MSRP interworking; and
- providing the SDP "a=path" attribute, as received in SIP/SDP signalling, to the IMS-AGW as "MSRP Path" with the remote descriptor of the corresponding call leg.

The IMS-AGW applies application-aware MSRP interworking if being instructed from the IMS-ALG. Support of dynamic instructions from the IMS-ALG is optional.

If the IMS-AGW applies application-aware MSRP interworking, it modifies the MSRP "To-Path" header field in MSRP packets by replacing the IP address and TCP port of the only entry with the corresponding information in the "MSRP

path" provided by the IMS_ALG while retaining the MSRP session ID part of the entry as received in the MSRP "To-Path" and then forward the MSRP data without further modification.

6.2.20 Alternate Connection (ALTC) Addresses Management

Figure 6.2.20.1 shows a message sequence chart example for a terminating session setup with a dual stack UE using the SDP attributes "altc" inserted by the IMS-ALG in the SDP offer to indicate the IP addresses for potential alternative connection addresses.

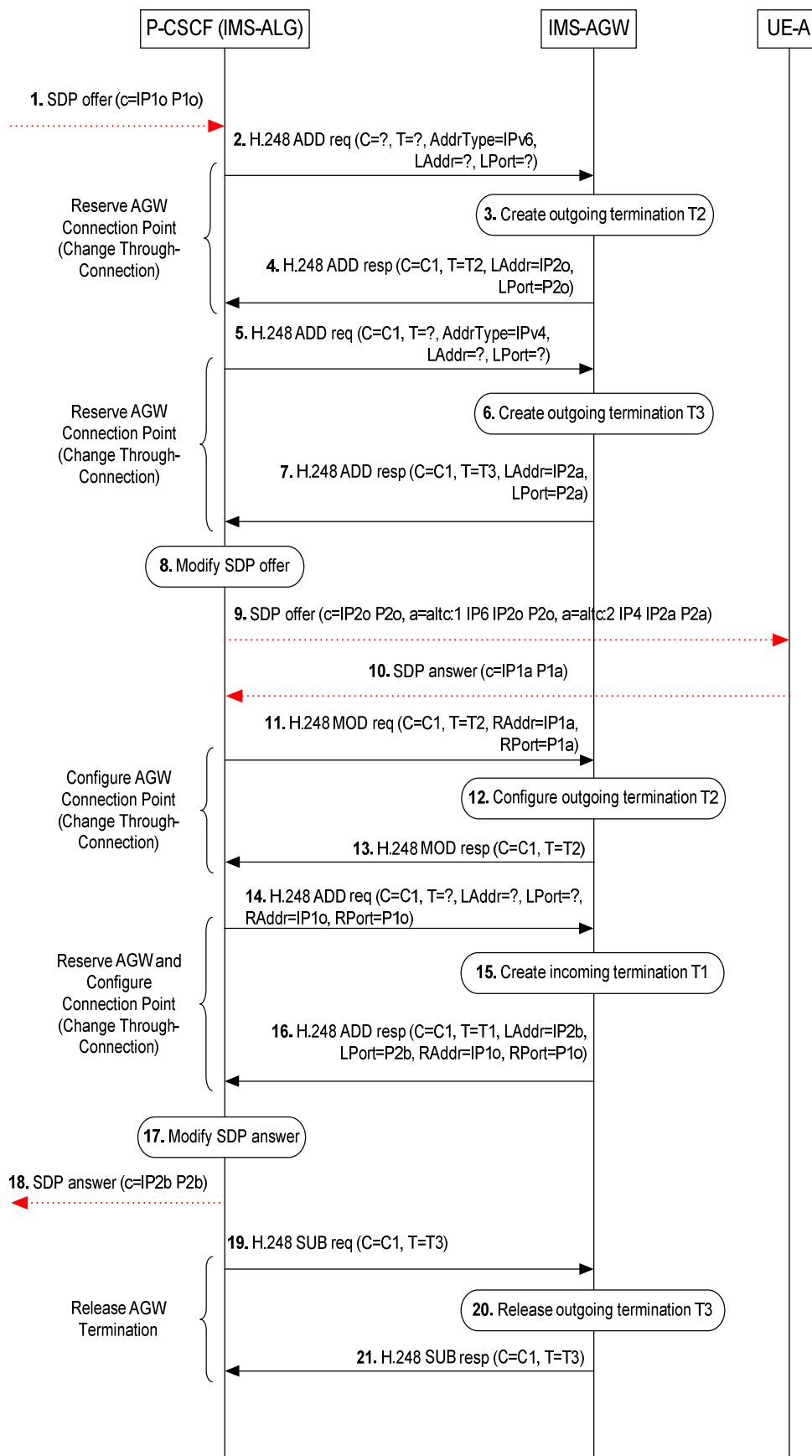

Figure 6.2.20.1: Terminating session setup with insertion of the SDP attribute "altc" by the IMS-ALG

Upon receipt of a session initiation request, the IMS-ALG shall extract the offerer's destination network address(es) and port number(s) from the SDP offer received from the calling party endpoint. Based on local policies, the IMS-ALG may decide to provide an alternative IP address and to insert then "altc" attributes in the SDP offer sent to the terminating side. The IMS-ALG shall then request the IMS-AGW to allocate transport resources for the terminating side (e.g. terminations T2 for IPv6 and T3 for IPv4) via two Reserve AGW Connection Point procedures, one per address type.

NOTE: The IMS-AGW is "ALTC agnostic" and does not have any awareness about preferred and alternate IP connection resources as described in the in IETF RFC 6947 [59]. Moreover, there is not any context-internal topology between terminations T1, T2 and T3 (via the H.248 topology descriptor) defined: T1 is either implicitly interlinked with T2 or T3 dependent on the used H.248 Stream identifier values. However, such aspects are ignored due to the expected short-term aspects of the temporary context configuration with three terminations.

Based on the responses received from the IMS-AGW, the IMS-ALG shall modify the offerer's destination addresses and/or ports initially contained in the SDP offer, insert the "altc" SDP attributes carrying the preferred and alternate IP addresses and propagate the session establishment toward the terminating party.

On receipt of the SDP answer of the called party endpoint, the IMS-ALG shall pass the IP address, port and address type chosen by the called party endpoint for the session to the IMS-AGW in the Configure AGW Connection Point procedure and shall request the IMS-AGW to allocate transport resources (T1) for the calling party endpoint via the Reserve and Configure AGW Connection Point. Upon receiving the response from the IMS-AGW, the IMS-ALG shall modify the answerer's destination address(es) and/or port(s) contained in the application SDP answer and pass the information to the calling party endpoint. The IMS-ALG shall also request the IMS-AGW to release the transport resources (e.g. termination T3 with IPv4) reserved for the unused address type via the Release AGW Termination procedure.

6.2.21 Video Region-of-Interest (ROI)

6.2.21.1 Video Region-of-Interest (ROI) using FECC

Figure 6.2.21.1.1 shows the message sequence chart example for indicating Video Region-of-Interest (ROI) using FECC.

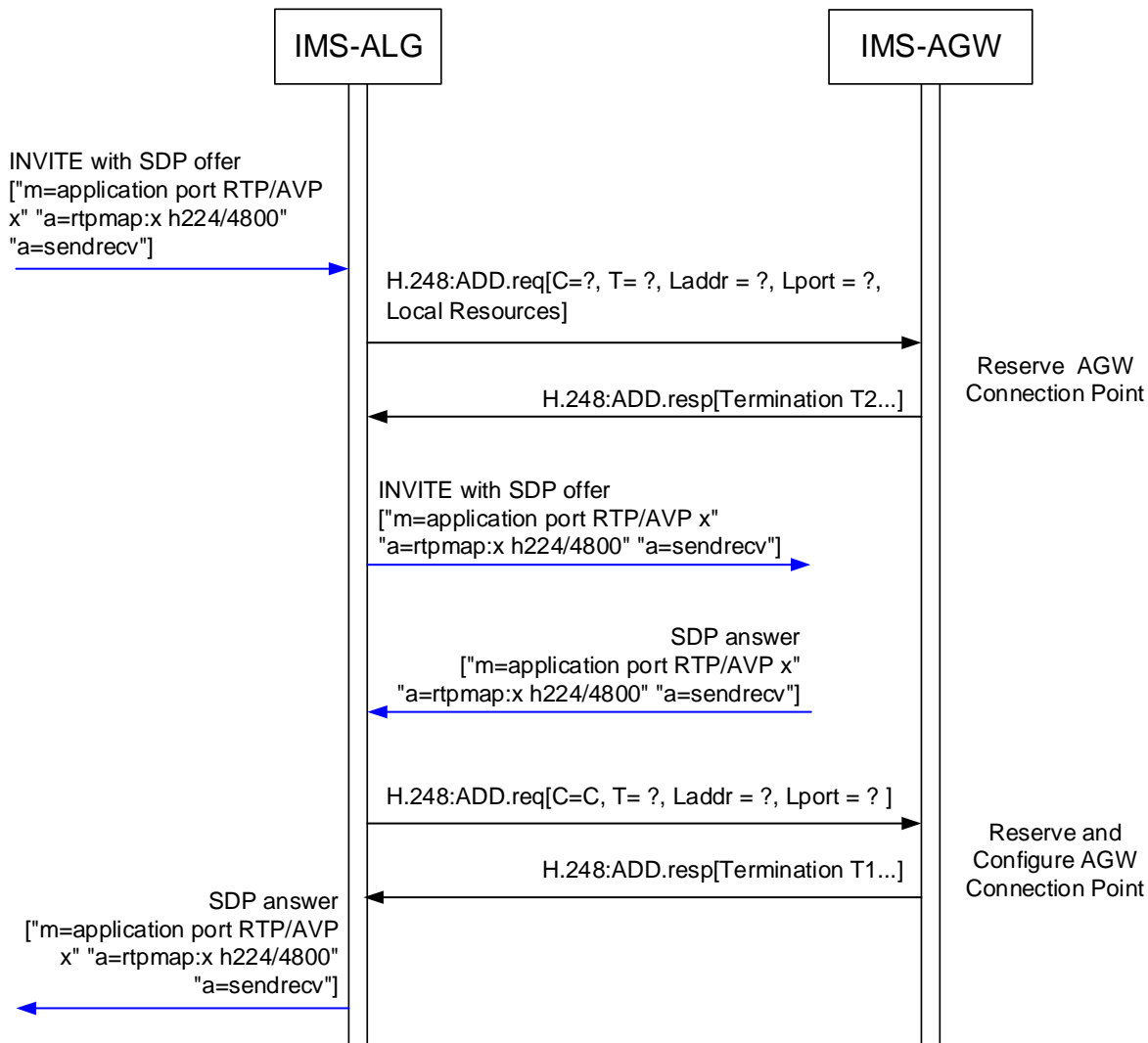

Figure 6.2.21.1.1: Procedure to indicate Video ROI using FECC

This procedure is identical to that of subclause 6.2.1.

6.2.21.2 "Predefined ROI" mode

Figure 6.2.21.2.1 shows the message sequence chart example for indicating Predefined ROI mode.

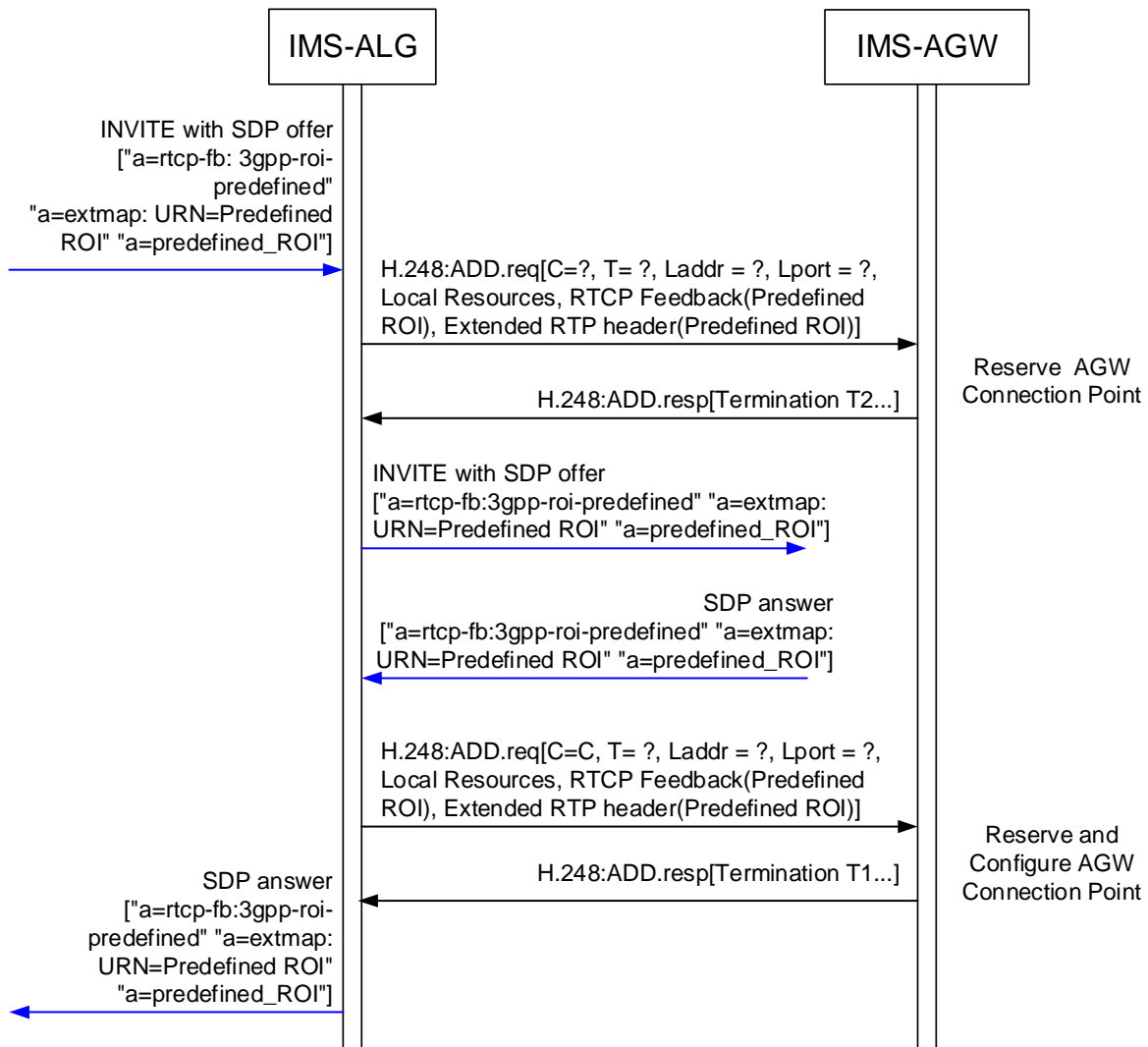

Figure 6.2.21.2.1: Procedure to indicate Predefined ROI mode

This procedure is identical to that of subclause 6.2.1 apart from the IMS-ALG optionally requesting the IMS-AGW to support the RTCP feedback message capability for "Predefined ROI" type expressed by the parameter "3gpp-roi-predefined", as described in 3GPP TS 26.114 [21], and the RTP Header Extension capability for carriage of predefined ROI information as defined in IETF RFC 5285 [23] and 3GPP TS 26.114 [21].

6.2.21.3 "Arbitrary ROI" mode

Figure 6.2.21.3.1 shows the message sequence chart example for indicating Arbitrary ROI mode.

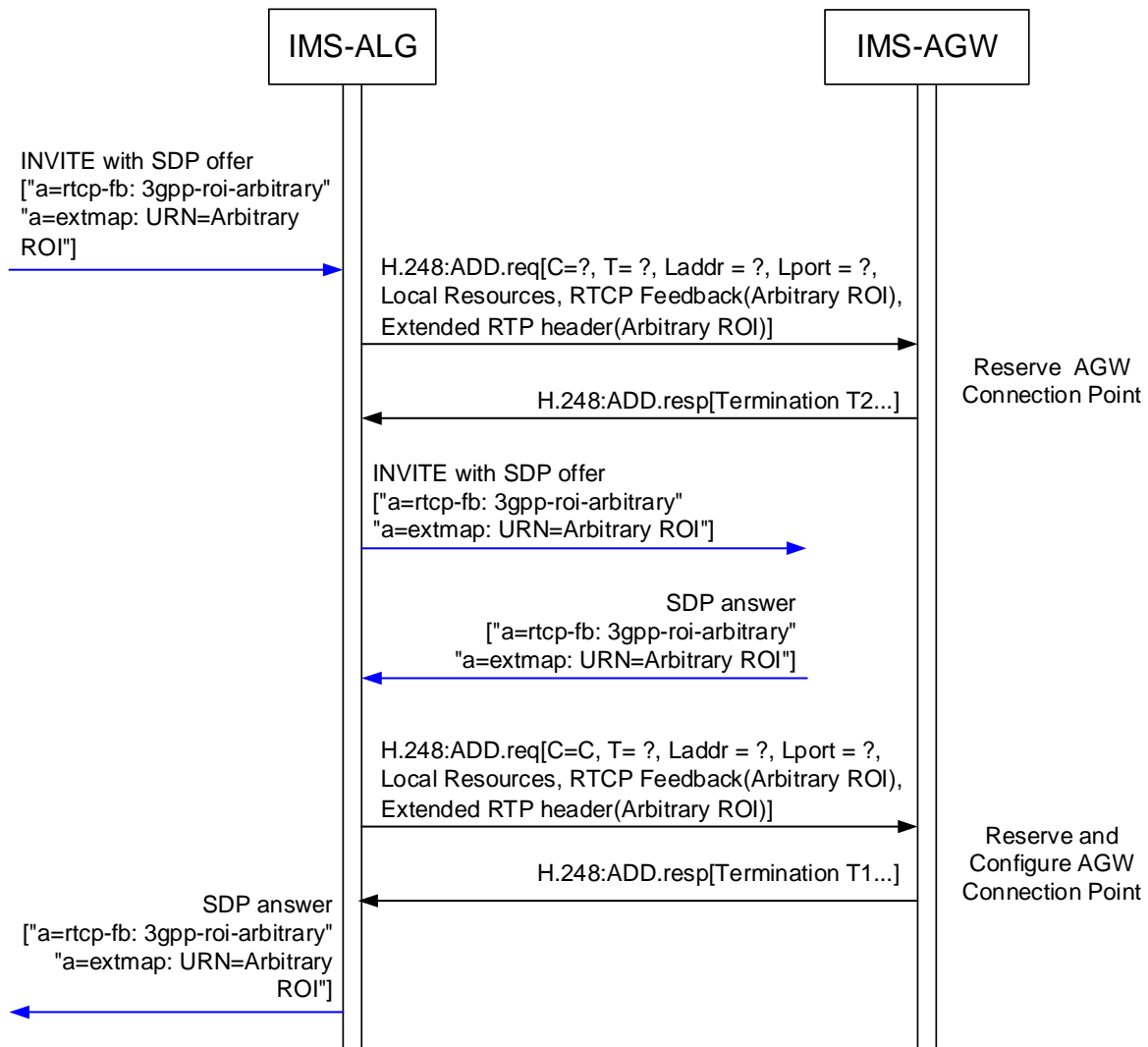

Figure 6.2.21.3.1: Procedure to indicate Arbitrary ROI mode

This procedure is identical to that of subclause 6.2.1 apart from the IMS-ALG optionally requesting the IMS-AGW to support the RTCP feedback message capability for "Arbitrary ROI" type expressed by the parameter "3gpp-roi-arbitrary", as described in 3GPP TS 26.114 [21], and the RTP Header Extension capability for carriage of arbitrary ROI information as defined in IETF RFC 5285 [23] and 3GPP TS 26.114 [21].

6.2.22 WebRTC

6.2.22.1 Establishment of a WebRTC data channel

See subclause 6.2.10.6.2.

6.2.22.2 Release of a WebRTC data channel

The H.248 Context model for a WebRTC call in figure 6.2.10.6.2.1 is assumed. However, the example flow in this subclause focuses on the WebRTC data channel part only. Thus, only H.248 Streams S1 (for de-aggregation of multiple data channels) and S2 (for MSRP traffic) are indicated subsequently.

Figure 6.2.22.2.1 shows the message sequence chart example for the WIC originated procedure to release a WebRTC MSRP data channel following the procedures in subclause 5.20.2.3.2.

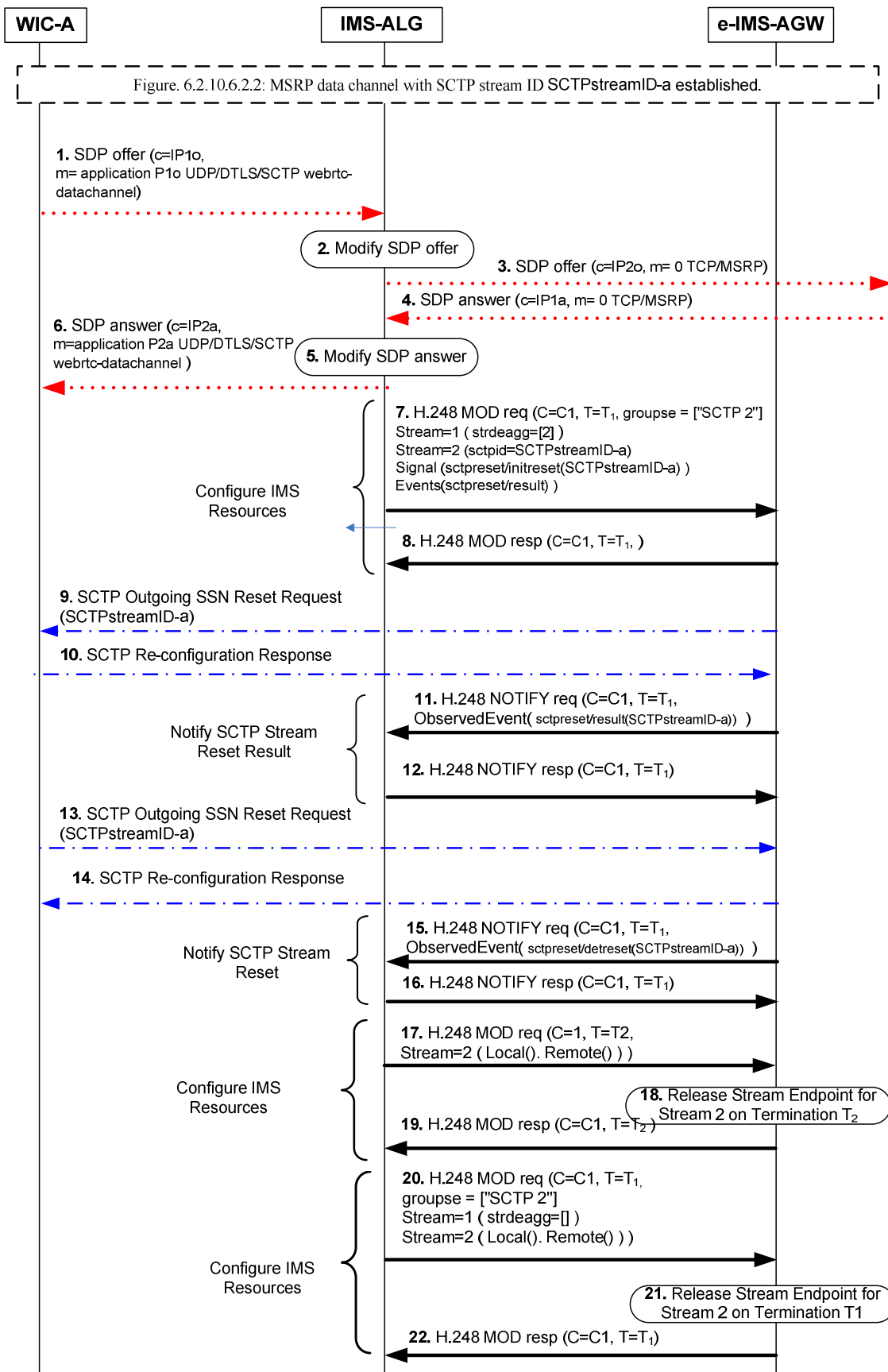

Figure 6.2.22.2.1: Call flow for the Release of a single WebRTC data channel

NOTE: Steps 9, 10, 13 and 14: A data channel is constituted by a pair of unidirectional SCTP Streams (with the same SCTP Stream identifier value in above flow). The SCTP Outgoing SSN Reset Request procedure does reset a single SCTP Stream only (due to the configuration in this example), hence the procedure will be executed twice (towards and from remote WIC).

6.2.22.3 Media Plane Optimization

6.2.22.3.1 Media Plane Optimization including DTLS layer for WIC originating call

The H.248 Context model for a WebRTC call in figure 6.2.10.6.2.1 is assumed. However, the example flow in this subclause focuses on the WebRTC data channel part only. Thus, only H.248 Streams S1 (for de-aggregation of multiple data channels) and S2 (for MSRP traffic) are indicated subsequently.

Figure 6.2.22.3.1.1 shows the message sequence chart example for the WIC originated procedure to establish a WebRTC data channel with media plane optimization following the procedures in subclause 5.20.3.2.

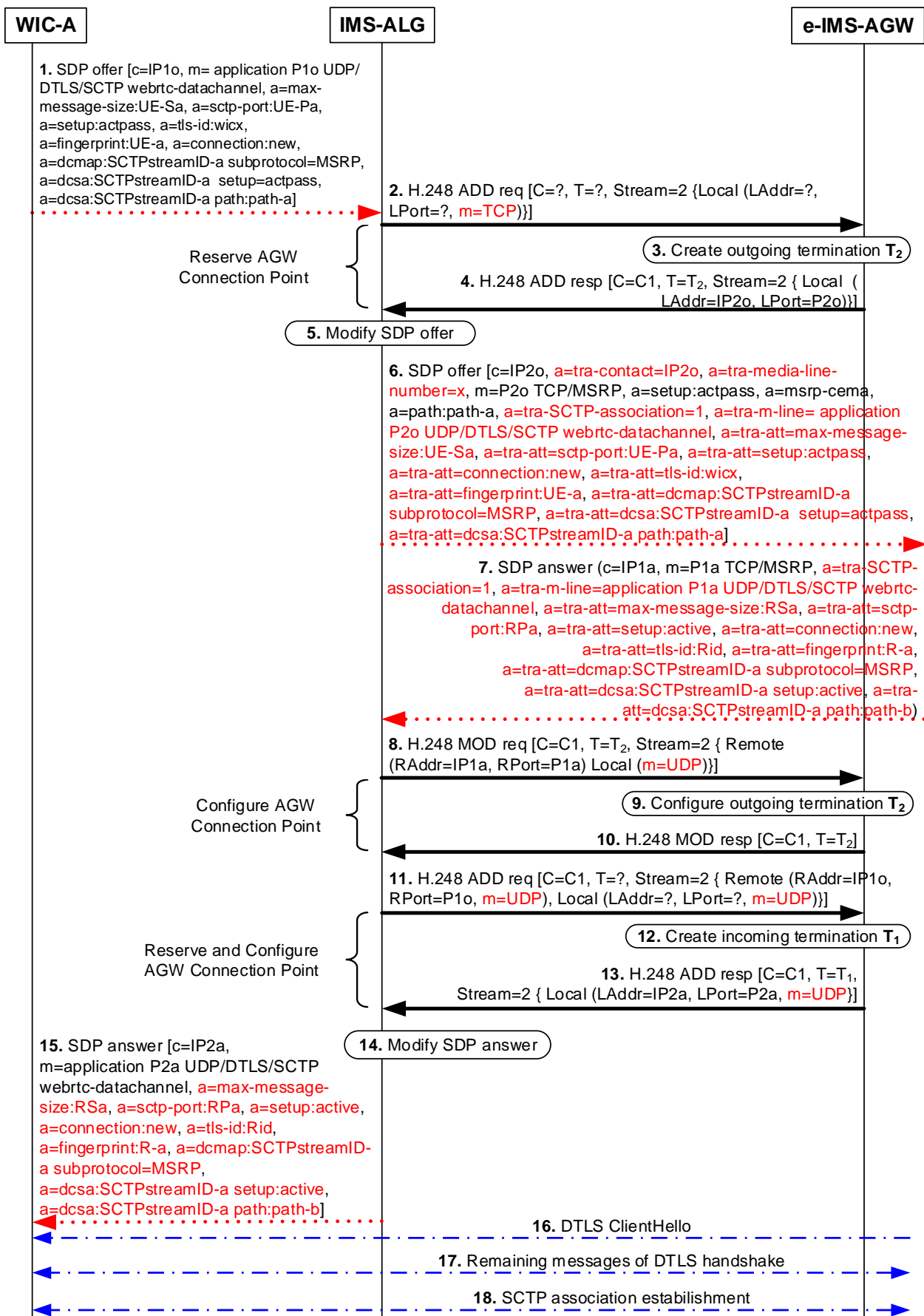

NOTE: Message 16 (DTLS ClientHello) can be received by the eIMS-AGW from the remote peer before the eIMS-AGW is configured to pass it (in steps 8.-13.) and will then be dropped by the eIMS-AGW. However, the remote peer will then resend message 16 after a timeout while waiting for a response.

Figure 6.2.22.3.1.1: WIC originated procedure for WebRTC data channel establishment with media plane optimization including DTLS layer

6.2.22.3.2 Media Plane Optimization excluding DTLS layer for WIC originating call

The H.248 Context model for a WebRTC call in figure 6.2.10.6.2.1 is assumed. However, the example flow in this subclause focuses on the WebRTC data channel part only. Thus, only H.248 Streams S1 (for de-aggregation of multiple data channels) and S2 (for MSRP traffic) are indicated subsequently. Furthermore, there is an additional termination T3 towards the IMS core network to handle DTLS.

Figure 6.2.22.3.2.1 shows the message sequence chart example for the WIC originated procedure to establish a WebRTC data channel with media plane optimization following the procedures in subclause 5.20.3.2.

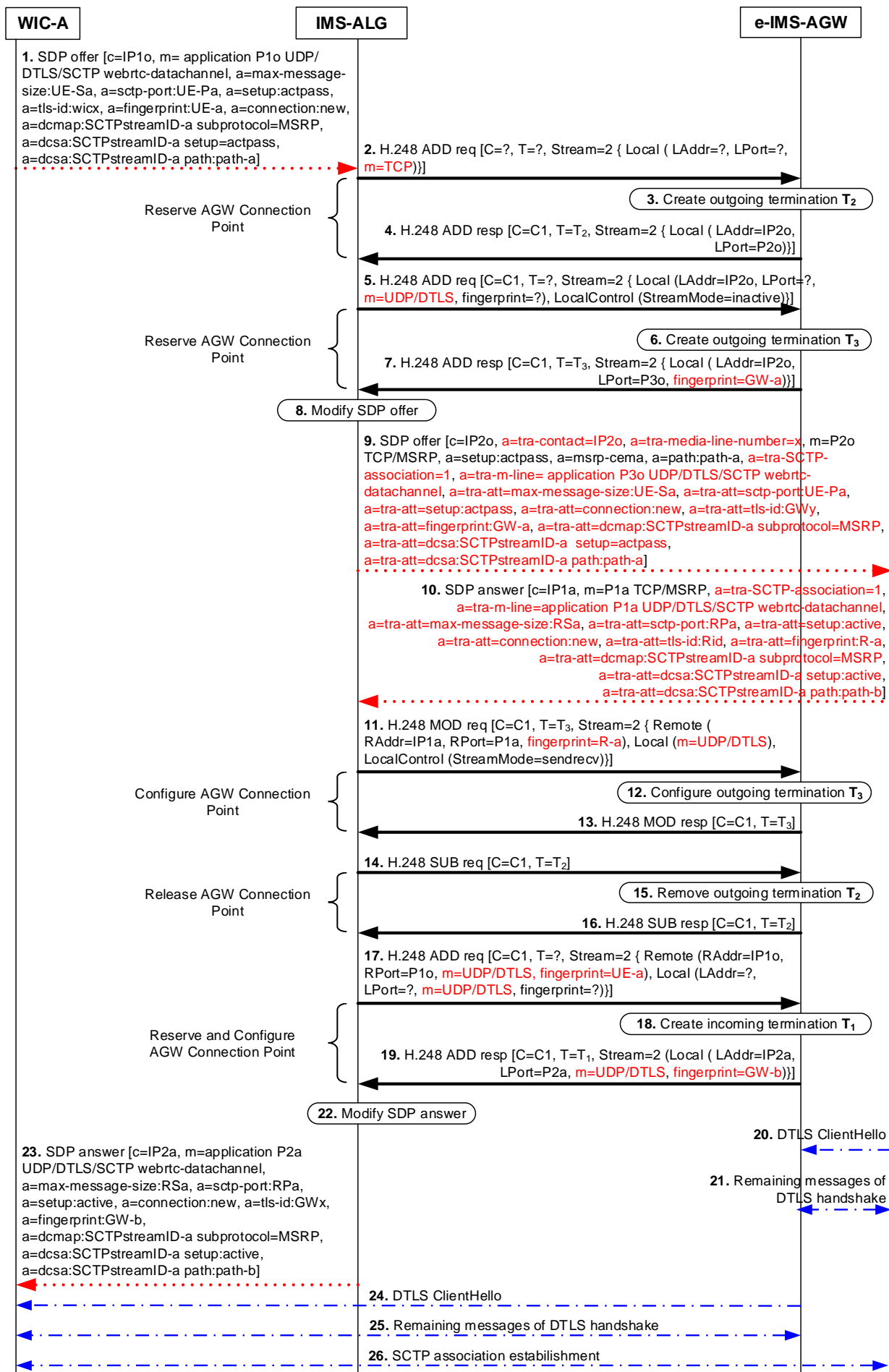

Figure 6.2.22.3.2.1: WIC originated procedure for WebRTC data channel establishment with media plane optimization excluding DTLS layer

6.2.23 RTP-level pause and resume

Figure 6.2.23.1 shows the message sequence chart example for indicating RTP-level pause and resume.

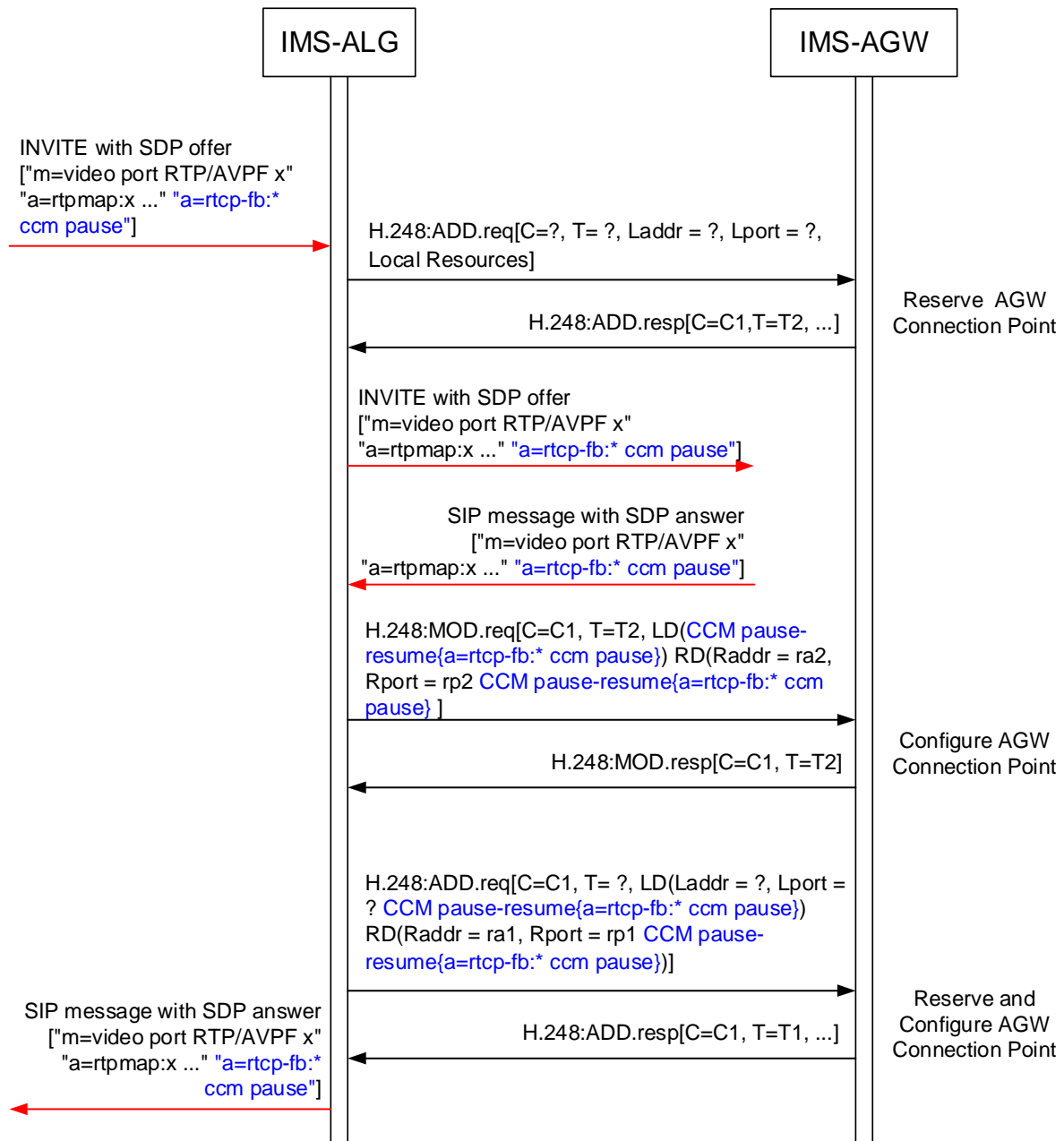

Figure 6.2.23.1: Procedure to indicate RTP-level pause and resume

This procedure is identical to that of subclause 6.2.1 apart from the IMS-ALG optionally requesting the IMS-AGW to transparently forward the RTCP "CCM PAUSE" packets (as defined in IETF RFC 7728 [79]) between incoming and outgoing network.

6.2.24 RTCP Codec Control Commands and Indications

Figure 6.2.24.1 shows the message sequence chart example for indicating "RTCP Codec Control Commands and Indications".

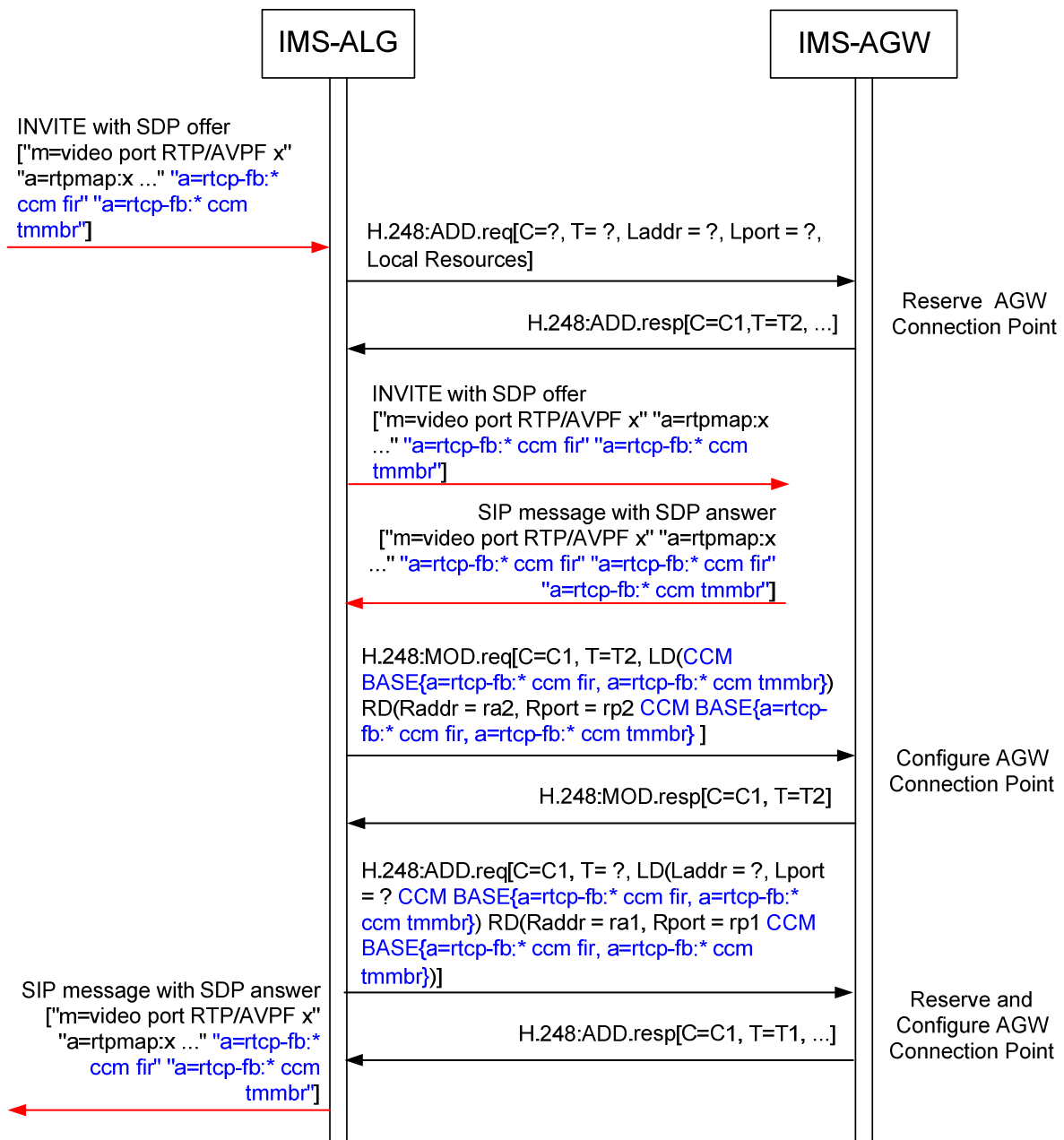

Figure 6.2.24.1: Procedure to indicate RTCP Codec Control Commands and Indications

This procedure is identical to that of subclause 6.2.1 apart from the IMS-ALG optionally indicates that the IMS-AGW shall be prepared to receive and is allowed to send the RTCP CCM "FIR" and/or "TMMBR/TMMBN" feedback messages (as defined in IETF RFC 5104 [78]).

7 Charging

The charging is specified in 3GPP TS 32.260 [5]. No requirements are identified for the Iq interface.

8 Messages/Procedures and Contents

8.1 General

This clause describes logical signalling procedures between the IMS-ALG and IMS-AGW. The procedures within this clause are intended to be implemented using the standard H.248 procedure as defined in ITU recommendation H.248.1 [9] with appropriate parameter combinations.

NOTE: Whenever the stage 2 description is referring to a "(stage 2) information element", then there is the premise of a one-to-one mapping to a stage 3 signalling element.

8.2 Reserve and Configure AGW Connection Point

This procedure is used to reserve multimedia-processing resources for the Iq interface connection.

Table 8.2.1: Procedures between IMS-ALG and IMS-AGW: Reserve and Configure AGW Connection Point

Procedure	Initiated	Information element name	Information element required	Information element description
Reserve and Configure AGW Connection Point	IMS-ALG	Context/Context Request	M	This information element indicates the existing context or requests a new context for the bearer termination.
		Emergency Call Indicator	O	This information element identifies the call as emergency call that requires a preferential handling.
		Priority information	O	This information element requests the IMS-AGW to apply priority treatment for the terminations and bearer connections in the specified context.
		Bearer Termination Request	M	This information element indicates the existing bearer termination or requests a new bearer termination for the bearer to be established.
		Local IP Resources	O	This information element indicates the resource(s) for which the IMS-AGW shall be prepared to receive user data. May be excluded (i.e. "-" is used in SDP m-line) if no transcoding or media related functions are required. For terminations supporting any combination of video, audio and messaging this IE shall contain separate resources per stream.
		ReserveValue	O	This information element indicates if multiple local resources are to be reserved. This information element shall be included if a speech codec and auxiliary payload types are configured.
		Remote IP Resources	O	This information element indicates the resource(s) for which the IMS-AGW shall send data. For terminations supporting any combination of video, audio and messaging this IE shall contain separate resources per stream. May be excluded (i.e. "-" is used in SDP m-line) if no transcoding or media related functions are required.
		Local Connection Address Request	M	This information element requests an IP address and port number(s) on the IMS-AGW that the remote end can send user plane data to. For terminations supporting any combination of video, audio and messaging this may contain multiple addresses.
Remote Connection Address	M	This information element indicates the remote IP address and port number(s) that the IMS-AGW can send user plane data to. For terminations supporting any combination of video, audio and messaging this may contain multiple addresses.		

		Notify termination heartbeat	M	This information element requests termination heartbeat indications. This information element shall be included when requesting a new bearer termination. Otherwise the information element is optional.
		Notify Released Bearer	O	This information element requests a notification of a released bearer.
		Latching Requirement	O	This information element indicates that the IMS-AGW should (re)latch onto the address of received media packets to determine the corresponding destination address.
		IP Realm Identifier	O	This information element indicates the IP realm of the bearer termination.
		Remote Source Address Filtering	O	This information element indicates that remote source address filtering is required.
		Remote Source Address Mask	C	This information element provides information on the valid remote source addresses. This is required if a range of remote source address filtering is required.
		Remote Source Port Filtering	O	This information element indicates that remote source port filtering is required.
		Remote Source Port	C	This information element identifies the valid remote source port. This may be included if remote source port filtering is included. (NOTE 1)
		Remote Source Port Range	C	This information element identifies a range of valid remote source ports. This may be included if remote source port filtering is included. (NOTE 1)
		Traffic Policing Required	O	This information element indicates that policing of the media flow is required.
		Peak Data Rate	O	This information element may be present if Policing is required and specifies the permissible peak data rate for a media stream. (NOTE 2)..
		Sustainable Data Rate	O	This information element may be present if Policing is required and specifies the permissible sustainable data rate for a media stream. (NOTE 2).
		Delay Variation Tolerance	O	This information element may be present if Policing on Peak Data Rate is required and specifies the maximum expected delay variation tolerance for the corresponding media stream.
		Maximum Burst Size	C	This information element shall be present if Policing on Sustainable Data Rate is required and specifies the maximum expected burst size for the corresponding media stream.
		DiffServ Code Point	O	This information element indicates a specific DiffServ code point to be used in the IP header in packets sent on the bearer termination.
		DiffServ Tagging Behaviour	O	This information element indicates whether the Diffserv code point in the IP header in packets sent on the bearer termination shall be copied from the received value or set to a specific value.
		Media Inactivity Detection Required	O	This information element indicates that detection of inactive media flows is required.
		Media Inactivity Detection Time	C	This information element may be present if Inactive Media Detection is required and specifies the Inactivity Detection time.
		Media Inactivity Detection Direction	C	This information element may be present if Inactive Media Detection is required and specifies the Inactivity Detection direction.

		RTCP handling	O	This information element is present if IMS-ALG wants to explicitly control the reservation of RTCP resources (NOTE 4).
		RTP/RTCP transport multiplexing	C	This information element requests the IMS-AGW to apply the RTP/RTCP transport multiplexing. This information element may only be present if RTCP handling is required.
		Explicit RTCP transport address	C	This information element indicates the remote RTCP port and optionally the remote network address where to send RTCP packets. This information element may only be present if RTCP handling is required.
		Local cryptographic SDES attribute	C	This information element is present if IMS-ALG wants that the media is encrypted and/or integrity protected by the IMS-AGW (NOTE 3). It indicates the SDES local cryptographic parameters such as key(s)
		Remote cryptographic SDES attribute	C	This information element is present if IMS-ALG wants that the media is decrypted, and/or integrity checked by the IMS-AGW (NOTE 3). It indicates the SDES remote cryptographic parameters such as key(s)
		ECN Enable	O	This information element requests the IMS-AGW to apply ECN procedures.
		ECN Initiation Method	C	This information element specifies the ECN Initiation method and requests the IMS-AGW to perform IP header settings as an ECN endpoint, or indicates that ECN bits shall be passed transparently. It may be included only if ECN is enabled.
		Notify ECN Failure Event	C	This information element requests a notification if a ECN failure occurs due to ECN. It may only be supplied if ECN is enabled and the IMS-AGW acts as ECN endpoint.
		Extended RTP Header for CVO	O	This information element requests the IMS-AGW to pass on the CVO extended RTP header as defined by IETF RFC 5285 [23].
		Extended RTP Header for Sent ROI	O	This information element requests the IMS-AGW to pass on the ROI extended RTP header for carriage of predefined and/or arbitrary ROI information as defined by IETF RFC 5285 [23] and 3GPP TS 26.114 [21].
		Predefined ROI	O	This information element requests the IMS-AGW to support the RTCP feedback message capability for "Predefined ROI" type expressed by the parameter "3gpp-roi-predefined", as described in 3GPP TS 26.114 [21].
		Arbitrary ROI	O	This information element requests the IMS-AGW to support the RTCP feedback message capability for "Arbitrary ROI" type expressed by the parameter "3gpp-roi-arbitrary", as described in 3GPP TS 26.114 [21].
		Generic Image Attributes	O	This information element indicates image attributes (e.g. image size) as defined by IETF RFC 6236 [24].
		Local certificate fingerprint Request	O	This information element is present if the IMS-ALG wants that the media is decrypted, and/or integrity protected by the IMS-AGW (NOTE 3). It requests the IMS-AGW to provide a local certificate fingerprint.

	Remote certificate fingerprint	O	This information element is present if the IMS-ALG wants that the media is decrypted, and/or integrity checked by the IMS-AGW (NOTE 3). It indicates the remote certificate fingerprint.
	Establish (D)TLS session	O	This information element requests the IMS-AGW to take the (D)TLS client role and to initiate the establishment of the (D)TLS session. (NOTE 3)
	Notify (D)TLS session establishment Failure Event	O	This information element requests a notification if a (D)TLS session establishment failure occurs. (NOTE 3)
	TCP State-aware Handling Indicator and Setup Direction	C	This information element indicates that TCP state-aware handling is required and indicates the TCP setup direction. It may only be included if the IMS-AGW supports TCP state-aware handling.
	Discard Incoming TCP Connection Establishment Requests Indicator	C	This information element indicates whether incoming TCP connection establishment requests (TCP SYN) shall be discarded. It may only be included if the IMS-AGW supports TCP state-aware handling and discarding incoming TCP connection establishment requests.
	Forward Incoming TCP Connection Establishment Requests Indicator	C	This information element indicates for a given termination to use the incoming TCP connection establishment request (TCP SYN) at that termination as a trigger for sending a TCP connection establishment request at the interconnected termination in the same context. It may only be included if the IMS-AGW supports TCP state-aware handling and the Forward Incoming TCP Connection Establishment Requests Indicator.
	Notify TCP Connection Establishment Failure Event	C	This information element requests a notification if a TCP connection establishment failure occurs. It may only be included if the IMS-AGW supports TCP state-aware handling.
	STUN server request	O	This information element is present if IMS-ALG requests the IMS-AGW to answer STUN connectivity checks for ICE.
	ICE Connectivity Check	C	This information element requests the IMS-AGW to perform ICE connectivity check as defined by IETF RFC 5245 [39]. It is only applicable for full ICE.
	Notify ICE Connectivity Check Result	C	This information element requests a notification of ICE connectivity check result. It is only applicable for full ICE.
	Notify New Peer Reflexive Candidate	C	This information element requests a notification of new peer reflexive candidate was discovered during a connectivity check. It is only applicable for full ICE.
	ICE password request	O	This information element is present if IMS-ALG requests an ICE password.
	ICE Ufrag request	O	This information element is present if IMS-ALG requests an ICE ufrag.
	ICE host candidate request	O	This information element is present if IMS-ALG requests an ICE host candidate.
	ICE received candidate	O	This information element is present if IMS-ALG indicates a received candidate for ICE.
	ICE received password	O	This information element is present if IMS-ALG indicates a received password for ICE.
	ICE received Ufrag	O	This information element is present if IMS-ALG indicates a received Ufrag for ICE.

		MSRP Path	O	This information element is present for application-aware MSRP Interworking. It provides the path information that the IMS-AGW shall insert in the MSRP layer "To-Path" Information element.
		Application-aware MSRP interworking request	O	This information element is present if IMS-ALG requests the IMS-AGW to perform application-aware MSRP Interworking.
		Notify STUN consent freshness test failure Event	O	This information element requests a notification if a STUN consent freshness test failure occurs (full ICE only).
		STUN consent freshenss test request	O	This information element is present if eP-CSCF requests the eIMS-AGW to perform a STUN consent freshness test (full ICE only).
		Local SCTP Port Request	O	This information element is present if the IMS-ALG requests the IMS-AGW to establish an SCTP association. It requests the IMS-AGW to provide a local SCTP Port.
		Remote SCTP Port	O	This information element is present if the IMS-ALG requests the IMS-AGW to establish an SCTP association. It indicates the remote SCTP port.
		Local SCTP maximum message size Request	O	This information element is present if the IMS-ALG requests the IMS-AGW to establish an SCTP association. It requests the IMS-AGW to provide a local max message size.
		Remote SCTP maximum message size	O	This information element is present if the IMS-ALG requests the IMS-AGW to establish an SCTP association. It indicates the remote max message size.
		SCTP Group Semantics	O	This information element is present if the IMS-ALG requests the IMS-AGW to establish an SCTP association. It indicates the H.248 component streams that are grouped in the same SCTP association.
		SCTP stream deaggregation	O	This information element is present if the IMS-ALG requests the IMS-AGW to establish an SCTP association. It indicates the H.248 component streams that transport media that are to be deaggregated from the H.248 deaggregation stream used to control the SCTP association.
		SCTP stream ID	O	This information element is present if the IMS-ALG requests the IMS-AGW to establish an WEBRTC data channel. It indicates the SCTP stream ID to be used for that data channel.
		Local Dcmap	O	This information element is present if the IMS-ALG requests the IMS-AGW to establish the WEBRTC data channel. It indicates the information within an SDP "dcmap" attribute sent towards the remote peer, including the Subprotocol to exchange via the data channel.
		Remote Dcmap	O	This information element is present if the IMS-ALG requests the IMS-AGW to establish the WEBRTC data channel. It indicates the information within an SDP "dcmap" attribute received from the remote peer, including the Subprotocol to exchange via the data channel.

		Local Dcsa	O	This information element can be present if the IMS-ALG requests the IMS-AGW to establish the WEBRTC data channel and to handle its contents in an application-aware manner. It indicates the information within an SDP "dcsa" attribute sent towards the remote peer, encapsulating a subprotocol specific SDP attribute.
		Remote Dcsa	O	This information element can be present if the IMS-ALG requests the IMS-AGW to establish the WEBRTC data channel and to handle its contents in an application-aware manner. It indicates the information within an SDP "dcsa" attribute received from the remote peer, encapsulating a subprotocol specific SDP attribute.
		Received SCTP Stream Reset Request	O	This information element is present if the eP-CSCF (IMS-ALG) requests the eIMS-AGW to establish the WEBRTC data channel. It requests the eIMS-AGW to provide a notification when receiving an SCTP Stream reset request and to autonomously answer that SCTP Stream reset request
		Allowed RTCP APP message types	O	This information element is present if IMS-ALG allows the IMS-AGW to send RTCP APP packets of the indicated types. The IMS-AGW shall not send other RTCP APP packets. If the parameter is not supplied, the IMS-AGW shall not send any RTCP APP packets.
		SDPCapNeg configuration	O	This information element provides SDPCapNeg configuration(s) using as "a=acap", "a=tcap", "a=pcfg" and "a=acfg" SDP attributes.
		Additional Bandwidth Properties	O	This information element indicates additional bandwidth properties using "a=bw-info" SDP attribute(s) as defined by 3GPP TS 26.114 [21].
		CCM BASE	O	This information element indicates that the IMS-AGW shall be prepared to receive and is allowed to send, respectively, the RTCP feedback "CCM FIR" and/or "CCM TMMBR" messages (defined in IETF RFC 5104 [78]).
		CCM pause-resume	O	This information element indicates to the IMS-AGW that RTCP feedback "CCM PAUSE-RESUME" messages shall be passed transparently.
Reserve and Configure AGW Connection Point Ack	IMS-AGW	Context	M	This information element indicates the context where the command was executed.
		Bearer Termination	M	This information element indicates the bearer termination where the command was executed.
		Local IP Resources	C	This information element indicates the resource(s) for which the IMS-AGW shall be prepared to receive user data. This IE shall be present if it was contained in the request. If the IE was not contained in the request, it may be present in the reply. For terminations supporting any combination of video, audio and messaging this IE shall contain separate resources per stream.

		Remote IP Resources	O	<p>This information element indicates the resource(s) for which the IMS-AGW shall send data.</p> <p>For terminations supporting any combination of video, audio and messaging this IE shall contain separate resources per stream.</p>
		Local Connection Address	M	<p>This information element indicates the IP address and port number(s) the IMS-AGW shall receive user plane data from IMS.</p> <p>For terminations supporting any combination of video, audio and messaging this may contain multiple addresses.</p>
		Remote Connection Address	O	<p>This information element indicates the remote IP address and port number(s) that the IMS-AGW can send user plane data to.</p> <p>For terminations supporting any combination of video, audio and messaging this may contain multiple addresses.</p>
		Local cryptographic SDES attribute	C	<p>This information element may be present only if it was contained in the request. It indicates the SDES local cryptographic parameters such as key(s)</p>
		Remote cryptographic SDES attribute	C	<p>This information element may be present only if it was contained in the request. It indicates the SDES remote cryptographic parameters such as key(s)</p>
		Local certificate fingerprint	C	<p>This information element may be present only if the Local certificate fingerprint Request was contained in the request. It indicates the local certificate fingerprint. (NOTE 3)</p>
		ICE password	C	<p>This information element shall be present only if it was contained in the request. It indicates the ICE password assigned by the IMS-AGW.</p>
		ICE Ufrag	C	<p>This information element shall be present only if it was contained in the request. It indicates the ICE Ufrag assigned by the IMS-AGW.</p>
		ICE host candidate	C	<p>This information element shall be present only if it was contained in the request. It indicates the ICE host candidate assigned by the IMS-AGW.</p>
		Local SCTP Port	C	<p>This information element may be present only if the Local SCTP Port Request was contained in the request. It indicates the local SCTP Port.</p>
		Local SCTP maximum message size	C	<p>This information element may be present only if the Local max message size Request was contained in the request. It indicates the local max message size.</p>
		ICE lite indication	C	<p>This information element shall be present only if an ICE host candidate request was contained in the request, and the IMS-AGW supports ICE lite, but not full ICE. It indicates that the IMS-AGW only supports ICE lite.</p>

		SDPCapNeg configuration	C	This information element shall be present only if it was contained in the request. It provides SDPCapNeg configuration(s) using as "a=acap", "a=tcap", "a=pcfg" and "a=acfg" SDP attributes.
NOTE 1: Remote Source Port and Remote Source Port Range are mutually exclusive. NOTE 2: One of those IEs shall at least be present when policing is required. NOTE 3: This IE may only be present for access network terminations. NOTE 4: The concerned RTCP resource component is related to the RTCP port value.				

8.3 Reserve AGW Connection Point Procedure

This procedure is used to reserve local connection addresses and local resources in IMS-AGW.

Table 8.3.1: Procedures between IMS-ALG and IMS-AGW: Reserve AGW Connection Point

Procedure	Initiated	Information element name	Information element required	Information element description
Reserve AGW Connection Point	IMS-ALG	Context /Context Request	M	This information element indicates the existing context or requests a new context for the bearer termination.
		Emergency Call Indicator	O	This information element identifies the call as emergency call that requires a preferential handling.
		Priority information	O	This information element requests the IMS-AGW to apply priority treatment for the terminations and bearer connections in the specified context.
		Bearer Termination Request	M	This information element requests a new bearer termination
		Local IP Resources	O	This information element indicates the resource(s) for which the IMS-AGW shall be prepared to receive user data. For terminations supporting any combination of video, audio and messaging this IE shall contain separate resources per stream. May be excluded (i.e. "-" is used in SDP m-line) if no transcoding or media related functions are required.
		ReserveValue	O	This information element indicates if multiple local resources are to be reserved. This information element shall be included if a speech codec and auxiliary payload types are configured.
		Local Connection Address Request	M	This information element requests an IP address and port number(s) on the IMS-AGW that the remote end can send user plane data to. For terminations supporting any combination of video, audio and messaging this may contain multiple addresses.
		Notify termination heartbeat	M	This information element requests termination heartbeat indications.
		Notify Released Bearer	O	This information element requests a notification of a released bearer.
		Latching Requirement	O	This information element indicates that the IMS-AGW should (re)latch onto the address of received media packets to determine the corresponding destination address.
		IP Realm Identifier	O	This information element indicates the IP realm of the bearer termination.
		Remote Source Address Filtering	O	This information element indicates that remote source address filtering is required.
		Remote Source Address Mask	C	This information element provides information on the valid remote source addresses. This is required if a range of remote source address filtering is required.
		Remote Source Port Filtering	O	This information element indicates that remote source port filtering is required.
Remote Source Port	C	This information element identifies the valid remote source port. This may be included if remote source port filtering is included. (NOTE 1)		

	Remote Source Port Range	C	This information element identifies a range of valid remote source ports. This may be included if remote source port filtering is included. (NOTE 1)
	Policing Required	O	This information element indicates that policing of the media flow is required.
	Peak Data Rate	O	This information element may be present if Policing is required and specifies the permissible peak data rate for a media stream. (NOTE 2).
	Sustainable Data Rate	O	This information element may be present if Policing is required and specifies the permissible sustainable data rate for a media stream. (NOTE 2).
	Delay Variation Tolerance	O	This information element may be present if Policing on Peak Data Rate is required and specifies the maximum expected delay variation tolerance for the corresponding media stream.
	Maximum Burst Size	C	This information element shall be present if Policing on Sustainable Data Rate is required and specifies the maximum expected burst size for the corresponding media stream.
	DiffServ Code Point	O	This information element indicates a specific DiffServ code point to be used in the IP header in packets sent on the bearer termination.
	DiffServ Tagging Behaviour	O	This information element indicates whether the Diffserv code point in the IP header in packets sent on the bearer termination should be copied from the received value or set to a specific value.
	Media Inactivity Detection Required	O	This information element indicates that detection of inactive media flows is required.
	Media Inactivity Detection Time	C	This information element may be present if Inactive Media Detection is required and specifies the Inactivity Detection time.
	Media Inactivity Detection Direction	C	This information element may be present if Inactive Media Detection is required and specifies the Inactivity Detection direction.
	RTCP handling	O	This information element is present if IMS-ALG wants explicitly control the reservation of RTCP resources by the IMS-AGW.
	RTP/RTCP transport multiplexing	C	This information element requests the IMS-AGW to apply the RTP/RTCP transport multiplexing. This information element may only be present if RTCP handling is required.
	Local cryptographic SDES attribute	C	This information element is present if IMS-ALG wants that the media is encrypted and/or integrity protected by the IMS-AGW (NOTE 3). It indicates the SDES local cryptographic parameters such as key(s).
	ECN Enable	O	This information element requests the IMS-AGW to apply ECN procedures.
	ECN Initiation Method	C	This information element specifies the ECN Initiation method and requests the IMS-AGW to perform IP header settings as an ECN endpoint, or indicates that ECN bits shall be passed transparently. It may be included only if ECN is enabled.
	Notify ECN Failure Event	C	This information element requests a notification if a ECN failure occurs due to ECN. It may only be supplied if ECN is enabled and the IMS-AGW acts as ECN endpoint.
	Extended RTP Header for CVO	O	This information element requests the IMS-AGW to pass on the CVO extended RTP header as defined by IETF RFC 5285 [23].

		Extended RTP Header for Sent ROI	O	This information element requests the IMS-AGW to pass on the ROI extended RTP header for carriage of predefined and/or arbitrary ROI information as defined by IETF RFC 5285 [23] and 3GPP TS 26.114 [21].
		Predefined ROI	O	This information element requests the IMS-AGW to support the RTCP feedback message capability for "Predefined ROI" type expressed by the parameter "3gpp-roi-predefined", as described in 3GPP TS 26.114 [21].
		Arbitrary ROI	O	This information element requests the IMS-AGW to support the RTCP feedback message capability for "Arbitrary ROI" type expressed by the parameter "3gpp-roi-arbitrary", as described in 3GPP TS 26.114 [21].
		Generic Image Attributes	O	This information element indicates image attributes (e.g. image size) as defined by IETF RFC 6236 [24].
		Local certificate fingerprint Request	O	This information element is present if the IMS-ALG wants that the media is decrypted, and/or integrity protected by the IMS-AGW (NOTE 4). It requests the IMS-AGW to provide a local certificate fingerprint.
		Establish (D)TLS session	O	This information element requests the IMS-AGW to take the (D)TLS client role and to initiate the establishment of the (D)TLS session. (NOTE 4)
		Notify (D)TLS session establishment Failure Event	O	This information element requests a notification if a (D)TLS session establishment failure occurs. (NOTE 4)
		TCP State-aware Handling Indicator and Setup Direction	C	This information element indicates that TCP state-aware handling is required and indicates the TCP setup direction. It may only be included if the IMS-AGW supports TCP state-aware handling.
		Discard Incoming TCP Connection Establishment Requests Indicator	C	This information element indicates whether incoming TCP connection establishment requests (TCP SYN) shall be discarded. It may only be included if the IMS-AGW supports TCP state-aware handling and discarding incoming TCP connection establishment requests.
		Forward Incoming TCP Connection Establishment Requests Indicator	C	This information element indicates for a given termination to use the incoming TCP connection establishment request (TCP SYN) at that termination as a trigger for sending a TCP connection establishment request at the interconnected termination in the same context. It may only be included if the IMS-AGW supports TCP state-aware handling and the Forward Incoming TCP Connection Establishment Requests Indicator.
		Notify TCP Connection Establishment Failure Event	C	This information element requests a notification if a TCP connection establishment failure occurs. It may only be included if the IMS-AGW supports TCP state-aware handling.
		ICE password request	O	This information element is present if IMS-ALG requests an ICE password.
		ICE Ufrag request	O	This information element is present if IMS-ALG requests an ICE ufrag.
		ICE host candidate request	O	This information element is present if IMS-ALG requests an ICE host candidate.

		STUN server request	O	This information element is present if IMS-ALG requests the IMS-AGW to answer STUN connectivity checks for ICE.
		Application-aware MSRP interworking request	O	This information element is present if IMS-ALG requests the IMS-AGW to perform application-aware MSRP Interworking.
		Notify STUN consent freshness test failure Event	O	This information element requests a notification if a STUN consent freshness test failure occurs (full ICE only).
		STUN consent freshenss test request	O	This information element is present if eP-CSCF requests the eIMS-AGW to perform a STUN consent freshness test (full ICE only).
		Local SCTP Port Request	O	This information element is present if the IMS-ALG requests the IMS-AGW to establish an SCTP association. It requests the IMS-AGW to provide a local SCTP Port.
		Local SCTP maximum message size Request	O	This information element is present if the IMS-ALG requests the IMS-AGW to establish an SCTP association. It requests the IMS-AGW to provide a local max message size.
		Local Dcmap	O	This information element is present if the IMS-ALG requests the IMS-AGW to establish the WEBRTC data channel. It indicates the information within an SDP "dcmmap" attribute sent towards the remote peer, including the Subprotocol to exchange via the data channel.
		Local Dcsa	O	This information element can be present if the IMS-ALG requests the IMS-AGW to establish the WEBRTC data channel and to handle its contents in an application-aware manner. It indicates the information within an SDP "dcsa" attribute sent towards the remote peer, encapsulating a subprotocol specific SDP attribute.
		SCTP Group Semantics	O	This information element is present if the IMS-ALG requests the IMS-AGW to establish an SCTP association. It indicates the H.248 component streams that are grouped in the same SCTP association.
		SCTP stream deaggregation	O	This information element is present if the IMS-ALG requests the IMS-AGW to establish an SCTP association. It indicates the H.248 component streams that transport media that are to be deaggregated from the H.248 deaggregation stream used to control the SCTP association.
		SCTP stream ID	O	This information element is present if the IMS-ALG requests the IMS-AGW to establish an WEBRTC data channel. It indicates the SCTP stream ID to be used for that data channel.
		Received SCTP Stream Reset Request	O	This information element is present if the eP-CSCF (IMS-ALG) requests the eIMS-AGW to establish the WEBRTC data channel. It requests the eIMS-AGW to provide a notification when receiving an SCTP Stream reset request and to autonomously answer that SCTP Stream reset request
		SDPCapNeg configuration	O	This information element provides SDPCapNeg configuration(s) using as "a=acap", "a=tcap", "a=pcfg" and "a=acfg" SDP attributes.
	IMS-AGW	Context	M	This information element indicates the context where the command was executed.

Reserve AGW Connection Point Ack	Bearer Termination	M	This information element indicates the bearer termination where the command was executed.
	Local IP Resources	C	This information element indicates the resource(s) for which the IMS-AGW shall be prepared to receive user data. This IE shall be present if it was contained in the request. If the IE was not contained in the request, it may be present in the reply. For terminations supporting any combination of video, audio and messaging this IE shall contain separate resources per stream.
	Local Connection Address	M	This information element indicates the IP address and port number(s) the IMS-AGW shall receive user plane data from IMS. For terminations supporting any combination of video, audio and messaging this may contain multiple addresses.
	Local cryptographic SDES attribute	C	This information element may be present only if it was contained in the request. It indicates the SDES local cryptographic parameters such as key(s)
	Local certificate fingerprint	C	This information element may be present only if the Local certificate fingerprint Request was contained in the request. It indicates the local certificate fingerprint. (NOTE 4)
	ICE password	C	This information element shall be present only if it was contained in the request. It indicates the ICE password assigned by the IMS-AGW.
	ICE Ufrag	C	This information element shall be present only if it was contained in the request. It indicates the ICE Ufrag assigned by the IMS-AGW.
	ICE host candidate	C	This information element shall be present only if it was contained in the request. It indicates the ICE host candidate assigned by the IMS-AGW.
	ICE lite indication	C	This information element shall be present only if an ICE host candidate request was contained in the request, and the IMS-AGW supports ICE lite, but not full ICE. It indicates that the IMS-AGW only supports ICE lite.
	Local SCTP Port	C	This information element may be present only if the Local SCTP Port Request was contained in the request. It indicates the local SCTP Port.
	Local SCTP maximum message size	C	This information element may be present only if the Local max message size Request was contained in the request. It indicates the local max message size.
	SDPCapNeg configuration	C	This information element shall be present only if it was contained in the request. It provides SDPCapNeg configuration(s) using as "a=acap", "a=tcap", "a=pcfg" and "a=acfg" SDP attributes.

- | |
|--|
| <p>NOTE 1: Remote Source Port and Remote Source Port Range are mutually exclusive.</p> <p>NOTE 2: One of those IEs shall at least be present when policing is required.</p> <p>NOTE 3: This IE may only be present for access network terminations, and only if the IMS-ALG includes only one SDES crypto attribute in the SDP sent towards the served UE.</p> <p>NOTE 4: This IE may only be present for access network terminations.</p> |
|--|

8.4 Configure AGW Connection Point Procedure

This procedure is used to select or modify multimedia-processing resources for the Iq interface connection.

Table 8.4.1: Procedures between IMS-ALG and IMS-AGW: Configure AGW Connection Point

Procedure	Initiated	Information element name	Information element required	Information element description
Configure AGW Connection Point	IMS-ALG	Context	M	This information element indicates the context for the bearer termination.
		Priority information	O	This information element shall be present if the priority information needs to be modified, it may be present otherwise.
		Bearer Termination	M	This information element indicates the existing bearer termination.
		Local IP Resources	O	This information element indicates the resource(s) for which the IMS-AGW shall be prepared to receive user data. For terminations supporting any combination of video, audio and messaging this IE shall contain separate resources per stream. May be excluded (i.e. "-" is used in SDP m-line) if no transcoding or media related functions are required.
		Remote IP Resources	O	This information element indicates the resource(s) for which the IMS-AGW shall send data. For terminations supporting any combination of video, audio and messaging this IE shall contain separate resources per stream. May be excluded (i.e. "-" is used in SDP m-line) if no transcoding or media related functions are required.
		Local Connection Address	O	This information element indicates the IP address and port number(s) on the IMS-AGW that the IMS user can send user plane data to. For terminations supporting video any combination of video, audio and messaging may contain multiple addresses.
		Remote Connection Address	O	This information element indicates the remote IP address and port number(s) that the IMS-AGW can send user plane data to. For terminations supporting any combination of video, audio and messaging this may contain multiple addresses.
		Latching Requirement	O	This information element indicates that the IMS-AGW should (re)latch onto the address of received media packets to determine the corresponding destination address.
		IP Realm Identifier	O	This information element indicates the IP realm of the bearer termination. (NOTE 3)
		Remote Source Address Filtering	O	This information element indicates that remote source address filtering is required.
Remote Source Address Mask	C	This information element provides information on the valid remote source addresses. This is required if a range of remote source address filtering is required.		

		Remote Source Port Filtering	O	This information element indicates that remote source port filtering is required.
		Remote Source Port	C	This information element identifies the valid remote source port. This may be included if remote source port filtering is included. (NOTE 1)
		Remote Source Port Range	C	This information element identifies a range of valid remote source ports. This may be included if remote source port filtering is included. (NOTE 1)
		Policing Required	O	This information element indicates that policing of the media flow is required.
		Peak Data Rate	O	This information element may be present if Policing is required and specifies the permissible peak data rate for a media stream. (NOTE 2).
		Sustainable Data Rate	O	This information element may be present if Policing is required and specifies the permissible sustainable data rate for a media stream. (NOTE 2).
		Delay Variation Tolerance	O	This information element may be present if Policing on Peak Data Rate is required and specifies the maximum expected delay variation tolerance for the corresponding media stream.
		Maximum Burst Size	C	This information element shall be present if Policing on Sustainable Data Rate is required and specifies the maximum expected burst size for the corresponding media stream.
		DiffServ Code Point	O	This information element indicates a specific DiffServ code point to be used in the IP header in packets sent on the bearer termination.
		DiffServ Tagging Behaviour	O	This information element indicates whether the Diffserv code point in the IP header in packets sent on the bearer termination should be copied from the received value or set to a specific value.
		Media Inactivity Detection Required	O	This information element indicates that detection of inactive media flows is required.
		Media Inactivity Detection Time	C	This information element may be present if Inactive Media Detection is required and specifies the Inactivity Detection time.
		Media Inactivity Detection Direction	C	This information element may be present if Inactive Media Detection is required and specifies the Inactivity Detection direction.
		RTCP handling	O	This information element is present if IMS-ALG wants to explicitly control the reservation of RTCP resources (NOTE 5).
		RTP/RTCP transport multiplexing	C	This information element requests the IMS-AGW to apply the RTP/RTCP transport multiplexing. This information element may only be present if RTCP handling is required.

		Explicit RTCP transport address	C	This information element indicates the remote RTCP port and optionally the remote network address where to send RTCP packets. This information element may only be present if RTCP handling is required.
		Local cryptographic SDES attribute	C	This information element is present if IMS-ALG wants that the media is encrypted and/or integrity protected by the IMS-AGW (NOTE 4). It indicates the SDES local cryptographic parameters such as key(s).
		Remote cryptographic SDES attribute	C	This information element is present if IMS-ALG wants that the media is decrypted, and/or integrity checked by the IMS-AGW (NOTE 4). It indicates the SDES remote cryptographic parameters such as key(s).
		ECN Enable	O	This information element requests the IMS-AGW to apply ECN procedures.
		ECN Initiation Method	C	This information element specifies the ECN Initiation method and requests the IMS-AGW to perform IP header settings as an ECN endpoint, or indicates that ECN bits shall be passed transparently. It may be included only if ECN is enabled.
		Notify ECN Failure Event	C	This information element requests a notification if a ECN failure occurs due to ECN. It may only be supplied if ECN is enabled and the IMS-AGW acts as ECN endpoint.
		Extended RTP Header for CVO	O	This information element requests the IMS-AGW to pass on the CVO extended RTP header as defined by IETF RFC 5285 [23].
		Extended RTP Header for Sent ROI	O	This information element requests the IMS-AGW to pass on the ROI extended RTP header for carriage of predefined and/or arbitrary ROI information as defined by IETF RFC 5285 [23] and 3GPP TS 26.114 [21].
		Predefined ROI	O	This information element requests the IMS-AGW to support the RTCP feedback message capability for "Predefined ROI" type expressed by the parameter "3gpp-roi-predefined", as described in 3GPP TS 26.114 [21].
		Arbitrary ROI	O	This information element requests the IMS-AGW to support the RTCP feedback message capability for "Arbitrary ROI" type expressed by the parameter "3gpp-roi-arbitrary", as described in 3GPP TS 26.114 [21].
		Generic Image Attributes	O	This information element indicates image attributes (e.g. image size) as defined by IETF RFC 6236 [24].
		Remote certificate fingerprint	O	This information element is present if the IMS-ALG wants that the media is decrypted, and/or integrity checked by the IMS-AGW (NOTE 4). It indicates the remote certificate fingerprint.

		Establish (D)TLS session	O	This information element requests the IMS-AGW to take the (D)TLS client role and to initiate the establishment of the (D)TLS session. (NOTE 4)
		Release (D)TLS session	O	This information element requests the IMS-AGW to release the (D)TLS session. (NOTE 4)
		Notify (D)TLS session establishment Failure Event	O	This information element requests a notification if a TLS session establishment failure occurs. (NOTE 4)
		TCP State-aware Handling Indicator and Setup Direction	C	This information element indicates that TCP state-aware handling is required and indicates the TCP setup direction. It may only be included if the IMS-AGW supports TCP state-aware handling.
		Discard Incoming TCP Connection Establishment Requests Indicator	C	This information element indicates whether incoming TCP connection establishment requests (TCP SYN) shall be discarded. It may only be included if the IMS-AGW supports TCP state-aware handling and discarding incoming TCP connection establishment requests.
		Forward Incoming TCP Connection Establishment Requests Indicator	C	This information element indicates for a given termination to use the incoming TCP connection establishment request (TCP SYN) at that termination as a trigger for sending a TCP connection establishment request at the interconnected termination in the same context. It may only be included if the IMS-AGW supports TCP state-aware handling and the Forward Incoming TCP Connection Establishment Requests Indicator.
		Send TCP Connection Establishment Requests Indicator	C	This information element indicates for a given termination to send a TCP connection establishment request (TCP SYN). It may only be included if the IMS-AGW supports TCP state-aware handling.
		Notify TCP Connection Establishment Failure Event	C	This information element requests a notification if a TCP connection establishment failure occurs. It may only be included if the IMS-AGW supports TCP state-aware handling.
		ICE Connectivity Check	C	This information element requests the IMS-AGW to perform ICE connectivity check as defined by IETF RFC 5245 [39]. It is only applicable for full ICE.
		Notify ICE Connectivity Check Result	C	This information element requests a notification of ICE connectivity check result. It is only applicable for full ICE.
		Notify New Peer Reflexive Candidate	C	This information element requests a notification of new peer reflexive candidate was discovered during a connectivity check. It is only applicable for full ICE.

		Additional ICE Connectivity Check	C	This information element requests the IMS-AGW to perform additional ICE connectivity check as defined by IETF RFC 5245 [39]. It is only applicable for full ICE.
		ICE received candidate	O	This information element is present if IMS-ALG indicates a received candidate for ICE.
		ICE received password	O	This information element is present if IMS-ALG indicates a received password for ICE.
		ICE received Ufrag	O	This information element is present if IMS-ALG indicates a received Ufrag for ICE.
		MSRP Path	O	This information element is present for application-aware MSRP Interworking. It provides the path information that the IMS-AGW shall insert in the MSRP layer "To-Path" Information element.
		Notify STUN consent freshness test failure Event	O	This information element requests a notification if a STUN consent freshness test failure occurs (full ICE only).
		STUN consent freshness test request	O	This information element is present if eP-CSCF requests the eIMS-AGW to perform a STUN consent freshness test (full ICE only).
		Allowed RTCP APP message types	O	This information element is present if IMS-ALG allows the IMS-AGW to send RTCP APP packets of the indicated types. The IMS-AGW shall not send other RTCP APP packets. If the parameter is not supplied, the IMS-AGW shall not send any RTCP APP packets.
		Local Dcmap	O	This information element is present if the IMS-ALG requests the IMS-AGW to establish the WEBRTC data channel. It indicates the information within an SDP "dcmap" attribute sent towards the remote peer, including the Subprotocol to exchange via the data channel.
		Remote Dcmap	O	This information element is present if the IMS-ALG requests the IMS-AGW to establish the WEBRTC data channel. It indicates the information within an SDP "dcmap" attribute received from the remote peer, including the Subprotocol to exchange via the data channel.
		Local Dcsa	O	This information element can be present if the IMS-ALG requests the IMS-AGW to establish the WEBRTC data channel and to handle its contents in an application-aware manner. It indicates the information within an SDP "dcsa" attribute sent towards the remote peer, encapsulating a subprotocol specific SDP attribute.
		Remote Dcsa	O	This information element can be present if the IMS-ALG requests the IMS-AGW to establish the WEBRTC data channel and to handle its contents in an application-aware manner. It indicates the information within an SDP "dcsa" attribute received from the remote peer, encapsulating a subprotocol specific SDP attribute.

	Remote SCTP port	O	This information element is present if the IMS-ALG requests the IMS-AGW to establish an SCTP association. It indicates the remote SCTP port.
	Remote SCTP max message size	O	This information element is present if the IMS-ALG requests the IMS-AGW to establish an SCTP association. It indicates the remote max message size.
	SCTP Group Semantics	O	This information element is present if the IMS-ALG requests the IMS-AGW to modify an SCTP association. It indicates the H.248 component streams that are grouped in the same SCTP association.
	SCTP stream deaggregation	O	This information element is present if the IMS-ALG requests the IMS-AGW to modify an SCTP association. It indicates the H.248 component streams that transport media that are to be deaggregated from the H.248 deaggregation stream used to control the SCTP association.
	SCTP stream ID	O	This information element is present if the IMS-ALG requests the IMS-AGW to establish an WEBRTC data channel. It indicates the SCTP stream ID to be used for that data channel.
	Received SCTP Stream Reset Request	O	This information element is present if the eP-CSCF (IMS-ALG) requests the eIMS-AGW to establish the WEBRTC data channel. It requests the eIMS-AGW to provide a notification when receiving an SCTP Stream reset request and to autonomously answer that SCTP Stream reset request.
	Send SCTP Stream Reset Requests Indicator	O	This information element is present if the eP-CSCF (IMS-ALG) requests the eIMS-AGW to reset an SCTP Stream to release the WEBRTC data channel. It requests the eIMS-AGW to send an SCTP Stream reset request.
	Received SCTP Stream Reset Response	O	This information element may be present if the eP-CSCF (IMS-ALG) requests the eIMS-AGW to reset an SCTP Stream to release the WEBRTC data channel. It requests the eIMS-AGW to provide a notification when receiving a response to an SCTP Stream reset request.
	Initiate Outgoing SCTP Stream Reset	O	This information element is present if the IMS-ALG requests the IMS-AGW to close an individual WEBRTC data channel.
	Outgoing SCTP Stream Response	O	This information element is present if the IMS-ALG requests the IMS-AGW to acknowledge the request to close an individual WEBRTC data channel.
	Notify Detect Outgoing SCTP Stream Reset	O	This information element requests a notification of outgoing SCTP Stream reset requests from remote peers (here IMS WebRTC client).
	Notify Outgoing SCTP Stream Reset Result	O	This information element requests a notification of the result of an outgoing SCTP Stream reset sent to the remote peer (here IMS WebRTC client).
	SDPCapNeg configuration	O	This information element provides SDPCapNeg configuration(s) using as "a=acap", "a=tcap", "a=pcfg" and "a=acfg" SDP attributes.
	Additional Bandwidth Properties	O	This information element indicates additional bandwidth properties using "a=bw-info" SDP attribute(s) as defined by 3GPP TS 26.114 [21].

		CCM BASE	O	This information element indicates that the IMS-AGW shall be prepared to receive and is allowed to send, respectively, the RTCP feedback "CCM FIR" and/or "CCM TMMBR" messages (defined in IETF RFC 5104 [78]).
		CCM pause-resume	O	This information element indicates to the IMS-AGW that RTCP feedback "CCM PAUSE-RESUME" messages shall be passed transparently.
Configure AGW Connection Point Ack	IMS-AGW	Context	M	This information element indicates the context where the command was executed.
		Bearer Termination	M	This information element indicates the bearer termination where the command was executed.
		Local IP Resources	O	This information element indicates the resource(s) for which the IMS-AGW shall be prepared to receive user data For terminations supporting any combination of video, audio and messaging this IE shall contain separate resources per stream.
		Remote IP Resources	O	This information element indicates the resource(s) for which the IMS-AGW shall send data. For terminations supporting any combination of video, audio and messaging this IE shall contain separate resources per stream.
		Local Connection Address	O	This information element indicates the IP address and port number(s) on the IMS-AGW that the IMS user can send user plane data to. For terminations supporting any combination of video, audio and messaging this may contain multiple addresses.
		Remote Connection Address	O	This information element indicates the remote IP address and port number(s) that the IMS-AGW can send user plane data to. For terminations supporting any combination of video, audio and messaging this may contain multiple addresses.
		Local cryptographic SDES attribute	C	This information element may be present only if it was contained in the request. It indicates the SDES local cryptographic parameters such as key(s)
		Remote cryptographic SDES attribute	C	This information element may be present only if it was contained in the request. It indicates the SDES remote cryptographic parameters such as key(s)
NOTE 1: Remote Source Port and Remote Source Port Range are mutually exclusive.				
NOTE 2: One of those IEs shall at least be present when policing is required.				
NOTE 3: Additional streams may be added by the Configure AGW Connection Point procedure. The additional streams shall then carry the same IP Realm Identifier as the very first Stream.				
NOTE 4: This IE may only be present for access network terminations.				
NOTE 5: The concerned RTCP resource component is related to the RTCP port value.				

Editor's Note : The details of how the transparent indication included in ECN Control is subject of stage 3 specification. It also needs to be determined if this indication is needed on both incoming and outgoing terminations.

8.5 Release AGW Termination

This procedure is used to release a termination towards the IMS and free all related resources.

Table 8.5.1: Procedures between IMS-ALG and IMS-AGW: Release AGW Termination

Procedure	Initiated	Information element name	Information element required	Information element description
Release AGW Termination	IMS-ALG	Context	M	This information element indicates the existing context for the bearer termination.
		Bearer Termination	M	This information element indicates the bearer termination to be released.
Release AGW Termination Ack	IMS-AGW	Context	M	This information element indicates the context where the command was executed.
		Bearer Termination	M	This information element indicates the bearer termination where the command was executed.

8.6 Termination heartbeat indication

This procedure is used to report a termination heartbeat.

Table 8.6.1: Procedures between IMS-ALG and IMS-AGW: Termination heartbeat indication

Procedure	Initiated	Information element name	Information element required	Information element description
Termination heartbeat indication	IMS-AGW	Context	M	This information element indicates the context for the bearer termination.
		Bearer Termination	M	This information element indicates the bearer termination for which the termination heartbeat is reported.
		Termination heartbeat	M	Hanging Termination event, as defined in 3GPP TS 29.334 [3].
Termination heartbeat indication Ack	IMS-ALG	Context	M	This information element indicates the context where the command was executed.
		Bearer Termination	M	This information element indicates the bearer termination where the command was executed.

8.7 IMS-AGW Out-of-Service

This procedure is used to indicate that the IMS-AGW will go out of service or is maintenance locked.

Table 8.7.1: Procedures between IMS-ALG and IMS-AGW: IMS-AGW Out-of-Service

Procedure	Initiated	Information element name	Information element required	Information element description
IMS-AGW Out-of-Service	IMS-AGW	Context	M	This information element indicates the context for the command.
		Root Termination	M	This information element indicates the root termination for the command.
		Reason	M	This information element indicates the reason for service change.
		Method	M	This information element indicates the method for service change.
IMS-AGW Out-of-Service Ack	IMS-ALG	Context	M	This information element indicates the context where the command was executed.
		Root Termination	M	This information element indicates the root termination where the command was executed.

8.8 IMS-AGW Communication Up

This procedure is used to indicate that the IMS-AGW is back in service using an existing control association.

Table 8.8.1: Procedures between IMS-ALG and IMS-AGW: IMS-AGW Communication Up

Procedure	Initiated	Information element name	Information element required	Information element description
IMS-AGW Communication Up	IMS-AGW	Context	M	This information element indicates the context for the command.
		Root Termination	M	This information element indicates the root termination for the command.
		Reason	M	This information element indicates the reason for service change.
		Method	M	This information element indicates the method for service change.
IMS-AGW Communication Up Ack	IMS-ALG	Context	M	This information element indicates the context where the command was executed.
		Root Termination	M	This information element indicates the root termination where the command was executed.
		IMS-ALG Address	O	This information element indicates the IMS-ALG signalling address to which the IMS-AGW should preferably attempt to re-register.

8.9 IMS-AGW Restoration

This procedure is used to indicate the IMS-AGW has recovered from a failure.

Table 8.9.1: Procedures between IMS-ALG and IMS-AGW: IMS-AGW Restoration

Procedure	Initiated	Information element name	Information element required	Information element description
IMS-AGW Restoration	IMS-AGW	Context	M	This information element indicates the context for the command.
		Root Termination	M	This information element indicates the root termination for the command.
		Reason	M	This information element indicates the reason for the service change.
		Method	M	This information element indicates the method for service change.
IMS-AGW Restoration Ack	IMS-ALG	Context	M	This information element indicates the context where the command was executed.
		Root Termination	M	This information element indicates the root termination where the command was executed.
		IMS-ALG Address	O	This information element indicates the IMS-ALG signalling address to which the IMS-AGW should preferably attempt to re-register.

8.10 IMS-AGW Register

This procedure is used to register the IMS-AGW after a cold/warm boot.

Table 8.10.1: Procedures between IMS-ALG and IMS-AGW: IMS-AGW Register

Procedure	Initiated	Information element name	Information element required	Information element description
IMS-AGW Register	IMS-AGW	Context	M	This information element indicates the context for the command.
		Root Termination	M	This information element indicates the root termination for the command.
		Reason	M	This information element indicates the reason for the service change.
		Method	M	This information element indicates the method for service change.
		Protocol Version	M	This information element indicates the protocol version for Iq interface requested by the IMS-AGW.
		Service Change Profile	M	This information element indicates the profile for the Iq interface requested by the IMS-AGW.
IMS-AGW Register Ack	IMS-ALG	Context	M	This information element indicates the context where the command was executed.
		Root Termination	M	This information element indicates the root termination where the command was executed.
		Protocol Version	O	This information element indicates the protocol version for Iq interface supported by the IMS-ALG.
		Service Change Profile	O	This information element indicates the profile for the Iq interface supported by the IMS-ALG.
		IMS-ALG Address	O	This information element indicates the IMS-ALG signalling address to which the IMS-AGW should preferably attempt to re-register.

8.11 IMS-ALG Restoration

This procedure is used to indicate the IMS-ALG has recovered from a failure.

Table 8.11.1: Procedures between IMS-ALG and IMS-AGW: IMS-ALG Restoration

Procedure	Initiated	Information element name	Information element required	Information element description
IMS-ALG Restoration	IMS-ALG	Context	M	This information element indicates the context for the command.
		Root Termination	M	This information element indicates the root termination for the command.
		Reason	M	This information element indicates the reason for the service change.
		Method	M	This information element indicates the method for service change.
IMS-ALG Restoration Ack	IMS-AGW	Context	M	This information element indicates the context where the command was executed.
		Root Termination	M	This information element indicates the root termination where the command was executed.

8.12 IMS-AGW Re-register

This procedure is used to re-register the IMS-AGW (having been requested to do so by the IMS-ALG).

Table 8.12.1: Procedures between IMS-ALG and IMS-AGW: IMS-AGW Re-register

Procedure	Initiated	Information element name	Information element required	Information element description
IMS-AGW Re-register	IMS-AGW	Context	M	This information element indicates the context for the command.
		Root Termination	M	This information element indicates the root termination for the command.
		Reason	M	This information element indicates the reason for the service change.
		Method	M	This information element indicates the method for service change.
		Protocol Version	M	This information element indicates the protocol version for Iq interface requested by the IMS-AGW.
		Service Change Profile	M	This information element indicates the profile for the Iq interface requested by the IMS-AGW.
IMS-AGW Re-register Ack	IMS-ALG	Context	M	This information element indicates the context where the command was executed.
		Root Termination	M	This information element indicates the root termination where the command was executed.
		Protocol Version	O	This information element indicates the protocol version for Iq interface supported by the IMS-ALG.
		Service Change Profile	O	This information element indicates the profile for the Iq interface supported by the IMS-ALG.
		IMS-ALG Address	O	This information element indicates the IMS-ALG signalling address to which the IMS-AGW should preferably attempt to re-register.

8.13 IMS-ALG Ordered Re-registration

This procedure is used by the IMS-ALG to request the IMS-AGW to re-register.

Table 8.13.1: Procedures between IMS-ALG and IMS-AGW: IMS-ALG Ordered Re-register

Procedure	Initiated	Information element name	Information element required	Information element description
IMS-ALG Ordered Re-register	IMS-ALG	Context	M	This information element indicates the context for the command.
		Root Termination	M	This information element indicates the root termination for the command.
		Reason	M	This information element indicates the reason for the service change.
		IMS-ALG Address	O	This information element indicates the IMS-ALG signalling address.
IMS-ALG Ordered Re-register Ack	IMS-AGW	Context	M	This information element indicates the context where the command was executed.
		Root Termination	M	This information element indicates the root termination where the command was executed.

8.14 Audit Value

This procedure is used to audit values of different object(s).

Table 8.14.1: Procedures between IMS-ALG and IMS-AGW: Audit Value

Procedure	Initiated	Information element name	Information element required	Information element description
Audit Value	IMS-ALG	Context	M	This information element indicates the context for the command.
		Bearer Termination	M	This information element indicates the bearer termination(s) for the command.
		Object(s)	M	This information element indicates the object(s) to be audited.
Audit Value Ack	IMS-AGW	Context	M	This information element indicates the context where the command was executed.
		Bearer Termination	M	This information element indicates the bearer termination where the command was executed.
		Value(s)	M	This information element indicates the value(s) of the object(s).

8.15 Audit Capability

This procedure is used to audit capabilities of different object(s).

Table 8.15.1: Procedures between IMS-ALG and IMS-AGW: Audit Capability

Procedure	Initiated	Information element name	Information element required	Information element description
Audit Capability	IMS-ALG	Context	M	This information element indicates the context for the command.
		Bearer Termination	M	This information element indicates the bearer termination(s) for the command.
		Object(s)	M	This information element indicates the object(s) which capability is requested.
Audit Capability Ack	IMS-AGW	Context	M	This information element indicates the context where the command was executed.
		Bearer Termination	M	This information element indicates the bearer termination where the command was executed.
		Capabilities(s)	M	This information element indicates the capabilities of the object(s).

8.16 Capability Update

This procedure is used to indicate update of an object capability.

Table 8.16.1: Procedures between IMS-ALG and IMS-AGW: Capability Update

Procedure	Initiated	Information element name	Information element required	Information element description
Capability Update	IMS-AGW	Context	M	This information element indicates the context for the command.
		Bearer Termination	M	This information element indicates the bearer termination(s) for the command.
		Reason	M	This information element indicates the reason for service change.
		Method	M	This information element indicates the method for service change.
Capability Update Ack	IMS-ALG	Context	M	This information element indicates the context where the command was executed.
		Bearer Termination	M	This information element indicates the bearer termination where the command was executed.

8.17 IMS-ALG Out of Service

This procedure is used to indicate that IMS-ALG has gone out of service.

Table 8.17.1: Procedures between IMS-ALG and IMS-AGW: IMS-ALG Out of Service

Procedure	Initiated	Information element name	Information element required	Information element description
IMS-ALG Out of Service	IMS-ALG	Context	M	This information element indicates the context for the command.
		Root Termination	M	This information element indicates the root termination for the command.
		Reason	M	This information element indicates the reason for the service change.
		Method	M	This information element indicates the method for service change.
IMS-ALG Out of Service Ack	IMS-AGW	Context	M	This information element indicates the context where the command was executed.
		Root Termination	M	This information element indicates the root termination where the command was executed.

8.18 IMS-AGW Resource Congestion Handling - Activate

This procedure is used to activate the congestion handling mechanism.

Table 8.18.1: Procedures between IMS-ALG and IMS-AGW: IMS-AGW Resource Congestion Handling - Activate

Procedure	Initiated	Information element name	Information element required	Information element description
IMS-AGW Resource Congestion Handling – Activate	IMS-ALG	Context	M	This information element indicates that all context are applicable for the root termination.
		Root Termination	M	This information element indicates that root termination is where the congestion mechanism is activated.
		Congestion Activate	M	This information element requests to activate the congestion mechanism.
IMS-AGW Resource Congestion Handling - Activate Ack	IMS-AGW	Context	M	This information element indicates that all context are where the command was executed.
		Root Termination	M	This information element indicates that root termination is where the command was executed.

8.19 IMS-AGW Resource Congestion Handling - Indication

This procedure is used to inform the IMS-ALG that traffic restriction is advised.

Table 8.19.1: Procedures between IMS-ALG and IMS-AGW: IMS-AGW Resource Congestion Handling -Indication

Procedure	Initiated	Information element name	Information element required	Information element description
IMS-AGW Resource Congestion Handling - Indication	IMS-AGW	Context	M	This information element indicates all context are applicable for the root termination.
		Root Termination	M	This information element indicates that root termination is where the congestion mechanism was activated.
		Reduction	M	This information element indicates the load percentage to be reduced.
IMS-AGW Resource Congestion Handling - Indication Ack	IMS-ALG	Context	M	This information element indicates all context are where the command was executed.
		Root Termination	M	This information element indicates that root termination is where the command was executed.

8.20 Inactivity Timeout Activate

This procedure is used to activate the inactivity timeout mechanism.

Table 8.20.1: Procedures between IMS-ALG and IMS-AGW: Inactivity Timeout Activate

Procedure	Initiated	Information element name	Information element required	Information element description
Inactivity Timeout Activate	IMS-ALG	Context	M	This information element indicates all context are applicable for the root termination.
		Root Termination	M	This information element indicates that root termination is where inactivity timeout mechanism was activated.
		Inactivity Timeout Activate	M	This information element activates the Inactivity Timeout request.
		Inactivity Timeout	O	This information element indicates the maximum length of time before triggering the related notification.
Inactivity Timeout Activate Ack	IMS-AGW	Context	M	This information element indicates all context are where the command was executed.
		Root Termination	M	This information element indicates that root termination is where the command was executed.

8.21 Inactivity Timeout Notification

This command is used to notify the IMS-ALG of an inactive control association.

Table 8.21.1: Procedures between IMS-AGW and IMS-ALG: Inactivity Timeout Notification

Procedure	Initiated	Information element name	Information element required	Information element description
Inactivity Timeout Notification	IMS-AGW	Context	M	This information element indicates all context are applicable for the root termination.
		Root Termination	M	This information element indicates that root termination is where the inactivity timeout mechanism was activated.
		Inactivity Timeout Notification	M	This information element notifies the IMS-ALG of an inactivity time period.
Inactivity Timeout Notification Ack	IMS-ALG	Context	M	This information element indicates all context are where the command was executed.
		Root Termination	M	This information element indicates that root termination is where the command was executed.

8.22 Command Reject

This command is used to reject the received command request. It may be used as response to any of the procedures.

Table 8.22.1: Procedures between IMS-ALG and IMS-AGW: Command Reject

Procedure	Initiated	Information element name	Information element required	Information element description
Command Reject	Both	Context	O	This information element indicates the context where the command was rejected.
		Bearer Termination	O	This information element indicates the bearer termination where the command was rejected.
		Error	M	This information element indicates the error that caused command rejection.

8.23 Realm Availability Activate

This command is used to request the IMS-AGW to monitor the status of its IP Realms and to report any changes to the IMS-ALG.

Table 8.23.1: Procedures between IMS-ALG and IMS-AGW: Realm Availability Activate

Procedure	Initiated	Information element name	Information element required	Information element description
Realm Availability Activate	IMS-ALG	Context	M	This information element indicates all context are applicable for the root termination.
		Root Termination	M	This information element indicates that root termination is where the realm availability monitoring was activated.
		Realm Availability Activate	M	This information element activates the monitoring of the availability of IP Realms on the IMS-AGW.
Realm Availability Activate Ack	IMS-AGW	Context	M	This information element indicates all context are where the command was executed.
		Root Termination	M	This information element indicates that root termination is where the command was executed.

8.24 Realm Availability Notification

This command is used to notify the IMS-ALG of any changes in the availability of IP Realms on the IMS-AGW.

Table 8.24.1: Procedures between IMS-ALG and IMS-AGW: Realm Availability Notification

Procedure	Initiated	Information element name	Information element required	Information element description
Realm Availability Notification	IMS-AGW	Context	M	This information element indicates all context are applicable for the root termination.
		Root Termination	M	This information element indicates that root termination is where the realm availability monitoring was activated.
		Realm Availability Changes	M	This information element notifies the IMS-ALG of newly available/unavailable IP Realms.
Realm Availability Notification Ack	IMS-ALG	Context	M	This information element indicates all context are where the command was executed.
		Root Termination	M	This information element indicates that root termination is where the command was executed.

8.25 IP Bearer Released

Table 8.25.1: Procedures between IMS-ALG and IMS-AGW: IP Bearer Released

Procedure	Initiated	Information element name	Information element required	Information element description
IP Bearer Released	IMS-AGW	Context	M	This information element indicates the context for the bearer termination.
		Bearer Termination	M	This information element indicates the bearer termination where the bearer was released.
		Bearer Released	M	This information element notifies a bearer release.
		Release Cause	M	This information element indicates the cause of a bearer release.
IP Bearer Released Ack	IMS-ALG	Context	M	This information element indicates all context are where the command was executed.
		Bearer Termination	M	This information element indicates that Bearer termination is where the command was executed.

8.26 Media Inactivity Notification

This command is used to notify the IMS-ALG of media inactivity on the IMS-AGW.

Table 8.26.1: Procedures between IMS-ALG and IMS-AGW: Media Inactivity Notification

Procedure	Initiated	Information element name	Information element required	Information element description
Media Inactivity Notification	IMS-AGW	Context	M	This information element indicates the existing context for the bearer termination.
		Bearer Termination	M	This information element indicates that bearer termination is where the media inactivity detection was activated.
		Media Inactivity	M	This information element notifies the IMS-ALG of Media inactivity detection on the bearer termination.
Media Inactivity Notification Ack	IMS-ALG	Context	M	This information element indicates the context where the command was executed.
		Bearer Termination	M	This information element indicates the bearer termination where the command was executed.

8.27 Termination Out-of-Service

This procedure is used to indicate that a termination on the IMS-AGW has gone out of service

Table 8.27.1: Procedures between IMS-ALG and IMS-AGW: Termination Out-of-Service

Procedure	Initiated	Information element name	Information element required	Information element description
Termination Out-of-Service	IMS-AGW	Context	M	This information element indicates the context for the command.
		Bearer Termination	M	This information element indicates the bearer termination(s) for the command.
		Reason	M	This information element indicates the reason for service change.
		Method	M	This information element indicates the method for service change.
Termination Out-of-Service Ack	IMS-ALG	Context	M	This information element indicates the context where the command was executed.
		Bearer Termination	M	This information element indicates the bearer termination(s) where the command was executed.

8.28 Change Through-Connection

This procedure is used to change the through-connection in the bearer termination

Table 8.28.1: Procedures between IMS-ALG and IMS-AGW: Change Through-Connection

Procedure	Initiated	Information element name	Information element required	Information element description
Change Through-Connection	IMS-ALG	Context/Context Request	M	This information element indicates the existing context or requests a new context for the bearer termination.
		Bearer Termination/Bearer Termination Request	M	This information element indicates the existing bearer termination or requests a new bearer termination where the through-connection is changed.
		Through-Connection	M	This information element indicates the through-connection of the bearer termination
Change Through-Connection Ack	IMS-AGW	Context	M	This information element indicates the context where the command was executed.
		Bearer Termination	M	This information element indicates the bearer termination where the command was executed.

NOTE: This procedure may be combined with Reserve and Configure AGW Connection Point, Reserve AGW Connection Point or Configure AGW Connection Point procedure. This list of procedures is not exhaustive.

8.29 Change Flow Direction

This procedure is used to change the flow direction between bearer terminations within the context.

Table 8.29: Procedures between IMS-ALG and IMS-AGW: Configure AGW Connection Point

Procedure	Initiated	Information element name	Information element required	Information element description
Change Flow Direction	IMS-ALG	Context/Context Request	M	This information element indicates the existing context or a new context where the flow direction is changed.
		Bearer Termination 1/ Bearer Termination 1 Request	M	This information element indicates the existing bearer termination or a new bearer termination from where the new flow direction is applied.
		Bearer Termination 2/ Bearer Termination 2 Request	M	This information element indicates the existing bearer termination or a new bearer termination where to the new flow direction is applied.
		Flow Direction	M	This information element indicates the flow direction from the bearer termination 1 to bearer termination 2 within the context.
Change Flow Direction Ack	IMS-AGW	Context	M	This information element indicates the context where the command was executed.

8.30 ECN Failure Indication

This procedure is used to report ECN related failures (see clause 6.2.13.4).

Table 8.30.1: Procedures between IMS-ALG and IMS-AGW: ECN Failure Indication

Procedure	Initiated	Information element name	Information element required	Information element description
ECN Failure Indication	IMS-AGW	Context	M	This information element indicates the context for the bearer termination.
		Bearer Termination	M	This information element indicates the bearer termination for which the ECN failure is reported.
		ECN Error Indication	M	This information element indicates an ECN failure event.
ECN Failure Indication Ack	IMS-ALG	Context	M	This information element indicates the context where the command was executed.
		Bearer Termination	M	This information element indicates the bearer termination where the command was executed.

8.31 Notify (D)TLS session establishment Failure Indication

This procedure is used to report (D)TLS session establishment failures.

Table 8.31.1: Procedures between IMS-ALG and IMS-AGW: (D)TLS session establishment Failure Indication

Procedure	Initiated	Information element name	Information element required	Information element description
(D)TLS session establishment Failure Indication	IMS-AGW	Context	M	This information element indicates the context for the bearer termination.
		Bearer Termination	M	This information element indicates the bearer termination for which the (D)TLS session establishment failure is reported.
		(D)TLS session establishment Error Indication	M	This information element indicates a (D)TLS session establishment failure event.
(D)TLS session establishment Failure Indication Ack	IMS-ALG	Context	M	This information element indicates the context where the command was executed.
		Bearer Termination	M	This information element indicates the bearer termination where the command was executed.

8.32 Notify TCP connection establishment Failure Indication

This procedure is used to report TCP connection establishment failures.

Table 8.32.1: Procedures between IMS-ALG and IMS-AGW: TCP connection establishment Failure Indication

Procedure	Initiated	Information element name	Information element required	Information element description
TCP connection establishment Failure Indication	IMS-AGW	Context	M	This information element indicates the context for the bearer termination.
		Bearer Termination	M	This information element indicates the bearer termination for which the TCP connection establishment failure is reported.
		TCP connection establishment Error Indication	M	This information element indicates a TCP connection establishment failure event.
TCP connection establishment Failure Indication Ack	IMS-ALG	Context	M	This information element indicates the context where the command was executed.
		Bearer Termination	M	This information element indicates the bearer termination where the command was executed.

8.33 ICE Connectivity Check Result Notification

This procedure is used to report ICE connectivity check result for Full ICE (see clause 6.2.17.3).

Table 8.33.1: Procedures between IMS-ALG and IMS-AGW: ICE Connectivity Check Result Notification

Procedure	Initiated	Information element name	Information element required	Information element description
ICE Connectivity Check Result Notification	IMS-AGW	Context	M	This information element indicates the context for the bearer termination.
		Bearer Termination	M	This information element indicates the bearer termination for which the ICE Connectivity Check Result is reported.
		ICE Connectivity Check Result	M	This information element indicates an ICE Connectivity Check Result event.
ICE Connectivity Check Result Notification Ack	IMS-ALG	Context	M	This information element indicates the context where the command was executed.
		Bearer Termination	M	This information element indicates the bearer termination where the command was executed.

8.34 ICE New Peer Reflexive Candidate Notification

This procedure is used to report ICE new peer reflexive candidate for Full ICE (see clause 6.2.17.4).

Table 8.34.1: Procedures between IMS-ALG and IMS-AGW: ICE New Peer Reflexive Candidate Notification

Procedure	Initiated	Information element name	Information element required	Information element description
ICE New Peer Reflexive Candidate Notification	IMS-AGW	Context	M	This information element indicates the context for the bearer termination.
		Bearer Termination	M	This information element indicates the bearer termination for which the ICE New Peer Reflexive Candidate is reported.
		ICE New Peer Reflexive Candidate	M	This information element indicates an ICE New Peer Reflexive Candidate event.
ICE New Peer Reflexive Candidate Notification Ack	IMS-ALG	Context	M	This information element indicates the context where the command was executed.
		Bearer Termination	M	This information element indicates the bearer termination where the command was executed.

8.35 STUN Consent Freshness Test Failure Notification

This procedure is used to report STUN consent freshness test failures.

Table 8.35.1: Procedures between eP-CSCF and eIMS-AGW: STUN Consent Freshness Test Failure Notification

Procedure	Initiated	Information element name	Information element required	Information element description
STUN consent freshness test Failure Notification	eIMS-AGW	Context	M	This information element indicates the context for the bearer termination.
		Bearer Termination	M	This information element indicates the bearer termination for which the STUN consent freshness test failure is reported.
		STUN consent freshness test failure	M	This information indicates a STUN consent freshness failure event.
STUN consent freshness test Failure Notification	eP-CSCF	Context	M	This information element indicates the context where the command was executed.
		Bearer Termination	M	This information element indicates the bearer termination where the command was executed.

8.36 Notify SCTP Stream Reset

Table 8.36.1: Procedures between IMS-ALG and IMS-AGW: Notify SCTP Stream Reset

Procedure	Initiated	Information element name	Information element required	Information element description
Notify SCTP Stream Reset	IMS-AGW	Context	M	This information element indicates the context for the bearer termination.
		Bearer Termination	M	This information element indicates the bearer termination where the bearer was released.
		Received SCTP Stream Reset Request	M	This information element indicates that an SCTP Stream reset request has been received
		SCTP Stream ID	M	This information element indicates the SCTP Stream ID of the related SCTP Stream.
Notify SCTP Stream Reset Ack	IMS-ALG	Context	M	This information element indicates all context are where the command was executed.
		Bearer Termination	M	This information element indicates that Bearer termination is where the command was executed.

8.37 Notify SCTP Stream Reset Result

Table 8.37.1: Procedures between IMS-ALG and IMS-AGW: Notify SCTP Stream Reset Result

Procedure	Initiated	Information element name	Information element required	Information element description
Notify SCTP Stream Reset Result	IMS-AGW	Context	M	This information element indicates the context for the bearer termination.
		Bearer Termination	M	This information element indicates the bearer termination where the bearer was released.
		Received SCTP Stream Reset Result	M	This information element indicates that an SCTP Stream reset result has been received and the received result.
		SCTP Stream ID	M	This information element indicates the SCTP Stream ID of the related SCTP Stream.
Notify SCTP Stream Reset Result Ack	IMS-ALG	Context	M	This information element indicates all context are where the command was executed.
		Bearer Termination	M	This information element indicates that Bearer termination is where the command was executed.

Annex A (informative): Change history

Change history								
Date	TSG #	TSG Doc.	CR	Rev	Subject/Comment	Old	New	
2009-12	CT#46	CP-090822			3GPP TS Presented for approval in CT#46	2.0.0	9.0.0	
2009-12					Editorial clean up	9.0.0	9.0.1	
2010-03	CT#47	CP-100050	0001	2	IMS media plane security stage 2	9.0.1	9.1.0	
2010-06	CT#48	CP-100289	0003	1	Transport protocol to be indicated to gateway for end-to-end media security	9.1.0	9.2.0	
			0004	1	Handling of Through Connection			
			0005	-	Handling of RTCP streams requirement update			
2010-09	CT#49	CP-100461	0006	1	Procedures for Emergency call	9.2.0	9.3.0	
			0007	1	Local IP Resources IE: changing of property			
2010-12	CT#50	CP-100685	0008	-	Support of ECN	9.3.0	10.0.0	
2011-03	CT#51	CP-110058	0009	2	Handling of ICE Initialisation method for ECN	10.0.0	10.1.0	
			0010	2	ECN Support in Iq Interface			
2011-09	CT#53	CP-110573	0011	2	Transcoding at ATCF/ATGW during eSRVCC	10.1.0	10.2.0	
2011-12	CT#54	CP-110798	0012	1	Explicit Congestion Notification	10.2.0	10.3.0	
			0013	1	Corrections to Stage 2 Procedures for Access Transfer Function			
2012-03	CT#55	CP-120046	0014	2	Functional Requirements for eMPS MGW control	10.3.0	11.0.0	
2012-06	CT#56	CP-120239	0015	3	Multimedia Priority Control of Media Gateway resources	11.0.0	11.1.0	
2012-06	CT#56	CP-120226	0018	1	Reference update: draft-ietf-avtcore-ecn-for-rtp	11.0.0	11.1.0	
2012-11					Version in the header corrected	11.1.0	11.1.1	
2012-12	CT#58	CP-120723	0025	-	Reference update: RFC 6679	11.1.1	11.2.0	
			0026	3	Support of Multimedia Priority Service (MPS) in Modify over Iq Interface			
2013-06	CT#60	CP-130299	0029	3	Introduction of support for Coordination of Video Orientation (CVO)	11.2.0	12.0.0	
2013-09	CT#61	CP-130471	0030	3	Introduction of support for Generic Image Attribute/signalling of image size	12.0.0	12.1.0	
			0034	2	CVO Procedural Clarifications			
2013-12	CT#62	CP-130636	0035	1	Usage of generic image attributes	12.1.0	12.2.0	
			0038	1	Correction of Image Size description			
			0037	1	Correction of CVO description			
2014-03	CT#63	CP-140025	0040	-	Alignment of IE name for CVO	12.2.0	12.3.0	
2014-06	CT#64	CP-140245	0041	1	e2e media security for TCP-based media using TLS – Functional requirements	12.3.0	12.4.0	
			0042	4	e2ae media security for TCP based media using TLS – Functional requirements			
			0043	2	e2ae media security for UDP-based media using DTLS – Functional requirements			
			0054	1	e2e media security for TCP-based media using TLS - Procedures			
			0055	2	e2ae media security for TCP-based media using TLS - Procedures			
			0056	1	e2ae media security for UDP-based media using DTLS – procedures			
			0057	3	Iq requirements for end-to-end TCP bearer connection control and related NAT traversal support			
			0045	1	Functional requirements – clarification of "stage 2" convention			
			0046	3	Support for Interactive Connectivity Establishment (ICE)			
			0052	2	WebRTC media security using DTLS-SRTP			
			0053	2	WebRTC support for Iq			
2014-09	CT#65	CP-140504	0058	1	Procedures for TCP bearer connection control	12.4.0	12.5.0	
			0060	1	Bandwidth adjustment due to e2ae media security			
			0061	-	MSRP handling			
2014-12	CT#66	CP-140798	0047	3	RTCP port allocation rules – Semantical clarification	12.5.0	12.6.0	
			0062	2	E2e media security for TCP-based media – terminals behind NAT			
			0066	-	Reference update: RFC 7345 (draft-ietf-mmusic-udptl-dtls)			
			0074	-	Reference update: draft-schwarz-mmusic-sdp-for-gw			
			0075	2	Client-initiated TLS session renegotiation not supported on the Iq interface			
			0063	1	WebRTC Architecture Update			
			0064	4	Consent Refreshness in WebRTC			
			0067	4	H.248 requirements for WebRTC			
			0068	3	Iq requirements for OPUS codec in WebRTC			
			0069	3	Iq requirements for ICE-TCP			
			0072	5	End-to-access-edge security for DTLS over TCP			
0070	3	Iq requirements for EVS						

		CP-140791	0071	3	Alternative connection (ALTC) addresses management		
2014-12	CT#66	CP-140799	0039	7	Support of RTP transport multiplexing (Iq, stage 2)	12.6.0	13.0.0
2015-03	CT#67	CP-150027	0077	1	IMS WebRTC reference updates	13.0.0	13.1.0
		CP-150030	0079	1	DTLS roles and cross-reference correction		
2015-06	CT#68	CP-150258	0085	-	3GPP TLS profile reference	13.1.0	13.2.0
		CP-150260	0083	1	Bearer Termination in Acknowledgements		
		CP-150259	0081	1	EVS corrections		
2015-09	CT#69	CP-150457	0088	2	MSRP and WebRTC data channels	13.2.0	13.3.0
		CP-150452	0091	4	Support for Video Enhancements by Region-of-Interest Information Signalling		
2015-12	CT#70	CP-150786	0092	7	Support of SDP capability negotiation	13.3.0	13.4.0
		CP-150779	0093	4	WebRTC Data Channel Call flows		
		CP-150779	0095	3	Update of WebRTC data channel references		
		CP-150779	0100	2	Support of WebRTC data channels (stage 2)		
		CP-150779	0101	1	WebRTC Data Channel Procedures		
		CP-150779	0102	1	WebRTC Data Channel Information Elements		
		CP-150779	0094	4	Support for Video Enhancements by Region-of-Interest Information Signalling		
		CP-150779	0097	1	Update of media security references		
		CP-150779	0099	2	Update of IMS WebRTC references		
2016-03	CT#71	CP-160015	0109	1	Corrections to EVS AMR-WB IO mode-change-capability MIME parameter handling	13.4.0	13.5.0
		CP-160028	0104	2	Release of WebRTC Data Channels		
		CP-160034	0106	2	Support of enhanced bandwidth negotiation mechanism for MTSI sessions		
		CP-160032	0107	2	WebRTC media plane optimization procedure		
2016-09	CT#73	CP-160429	0112	1	Mandatory support of RTP/RTCP multiplexing	13.5.0	14.0.0
2016-09	CT#73	CP-160429	0114	1	Transport of T.140 and BFCP within data channels	13.5.0	14.0.0
2016-12	CT#74	CP-160684	0115	1	Support of RTP-level pause and resume functionality	14.0.0	14.1.0
2016-12	CT#74	CP-160648	0116	4	SDP offer/answer for TLS and DTLS protected media	14.0.0	14.1.0
2016-12	CT#74	CP-160671	0118	2	WebRTC Media plane optimization with DTLS termination	14.0.0	14.1.0
2016-12	CT#74	CP-160671	0119	1	TCP transport for WebRTC data channels	14.0.0	14.1.0
2016-12	CT#74	CP-160647	0125	1	Corrections to handling of the DTX related EVS MIME parameter	14.0.0	14.1.0
2016-12	CT#74	CP-160661	0127	2	Reference update for draft-ietf-mmusic-data-channel-sdpneg	14.0.0	14.1.0
2017-03	CT#75	CP-170023	0129	-	Reference update: draft-ietf-mmusic-dtls-sdp	14.1.0	14.2.0
2017-03	CT#75	CP-170023	0131	-	RFC 4572 obsoleted by draft-ietf-mmusic-4572-update	14.1.0	14.2.0
2017-03	CT#75	CP-170030	0135	1	Updates for WebRTC media plane optimization procedures related to the usage of the "dtls-id" SDP attribute and multiple fingerprints	14.1.0	14.2.0
2017-03	CT#75	CP-170033	0132	-	Reference update: RFC 8035	14.1.0	14.2.0
2017-03	CT#75	CP-170051	0133	2	RTCP Codec Control Commands and Indications	14.1.0	14.2.0
2017-06	CT#76	CP-171015	0137	-	Reference update: RFC 8122	14.2.0	14.3.0
2017-06	CT#76	CP-171027	0138	-	Reference update: draft-ietf-mmusic-mux-exclusive	14.2.0	14.3.0
2017-06	CT#76	CP-171024	0140	-	Reference update: draft-ietf-mmusic-sctp-sdp	14.2.0	14.3.0
2017-06	CT#76	CP-171015	0142	-	Reference update: draft-ietf-mmusic-dtls-sdp	14.2.0	14.3.0

History

Document history		
V14.2.0	May 2017	Publication
V14.3.0	July 2017	Publication