

ETSI TS 123 379 V15.4.0 (2018-07)



LTE;
Functional architecture and information flows to support
Mission Critical Push To Talk (MCPTT);
Stage 2
(3GPP TS 23.379 version 15.4.0 Release 15)



Reference

RTS/TSGS-0623379vf40

Keywords

LTE

ETSI

650 Route des Lucioles
F-06921 Sophia Antipolis Cedex - FRANCE

Tel.: +33 4 92 94 42 00 Fax: +33 4 93 65 47 16

Siret N° 348 623 562 00017 - NAF 742 C
Association à but non lucratif enregistrée à la
Sous-Préfecture de Grasse (06) N° 7803/88

Important notice

The present document can be downloaded from:

<http://www.etsi.org/standards-search>

The present document may be made available in electronic versions and/or in print. The content of any electronic and/or print versions of the present document shall not be modified without the prior written authorization of ETSI. In case of any existing or perceived difference in contents between such versions and/or in print, the only prevailing document is the print of the Portable Document Format (PDF) version kept on a specific network drive within ETSI Secretariat.

Users of the present document should be aware that the document may be subject to revision or change of status.

Information on the current status of this and other ETSI documents is available at

<https://portal.etsi.org/TB/ETSIDeliverableStatus.aspx>

If you find errors in the present document, please send your comment to one of the following services:

<https://portal.etsi.org/People/CommiteeSupportStaff.aspx>

Copyright Notification

No part may be reproduced or utilized in any form or by any means, electronic or mechanical, including photocopying and microfilm except as authorized by written permission of ETSI.

The content of the PDF version shall not be modified without the written authorization of ETSI.

The copyright and the foregoing restriction extend to reproduction in all media.

© ETSI 2018.

All rights reserved.

DECT™, **PLUGTESTS™**, **UMTS™** and the ETSI logo are trademarks of ETSI registered for the benefit of its Members.
3GPP™ and **LTE™** are trademarks of ETSI registered for the benefit of its Members and of the 3GPP Organizational Partners.

oneM2M logo is protected for the benefit of its Members.

GSM® and the GSM logo are trademarks registered and owned by the GSM Association.

Intellectual Property Rights

Essential patents

IPRs essential or potentially essential to normative deliverables may have been declared to ETSI. The information pertaining to these essential IPRs, if any, is publicly available for **ETSI members and non-members**, and can be found in ETSI SR 000 314: *"Intellectual Property Rights (IPRs); Essential, or potentially Essential, IPRs notified to ETSI in respect of ETSI standards"*, which is available from the ETSI Secretariat. Latest updates are available on the ETSI Web server (<https://ipr.etsi.org/>).

Pursuant to the ETSI IPR Policy, no investigation, including IPR searches, has been carried out by ETSI. No guarantee can be given as to the existence of other IPRs not referenced in ETSI SR 000 314 (or the updates on the ETSI Web server) which are, or may be, or may become, essential to the present document.

Trademarks

The present document may include trademarks and/or tradenames which are asserted and/or registered by their owners. ETSI claims no ownership of these except for any which are indicated as being the property of ETSI, and conveys no right to use or reproduce any trademark and/or tradename. Mention of those trademarks in the present document does not constitute an endorsement by ETSI of products, services or organizations associated with those trademarks.

Foreword

This Technical Specification (TS) has been produced by ETSI 3rd Generation Partnership Project (3GPP).

The present document may refer to technical specifications or reports using their 3GPP identities, UMTS identities or GSM identities. These should be interpreted as being references to the corresponding ETSI deliverables.

The cross reference between GSM, UMTS, 3GPP and ETSI identities can be found under <http://webapp.etsi.org/key/queryform.asp>.

Modal verbs terminology

In the present document "**shall**", "**shall not**", "**should**", "**should not**", "**may**", "**need not**", "**will**", "**will not**", "**can**" and "**cannot**" are to be interpreted as described in clause 3.2 of the [ETSI Drafting Rules](#) (Verbal forms for the expression of provisions).

"**must**" and "**must not**" are **NOT** allowed in ETSI deliverables except when used in direct citation.

Contents

Intellectual Property Rights	2
Foreword.....	2
Modal verbs terminology.....	2
Foreword.....	10
1 Scope	11
2 References	11
3 Definitions, symbols and abbreviations	12
3.1 Definitions	12
3.2 Symbols.....	13
3.3 Abbreviations	13
4 Introduction	15
5 Architectural requirements	15
5.1 Media routing requirements	15
5.2 Requirements for user identity management	15
5.3 MCPTT group affiliation and MCPTT group de-affiliation.....	15
5.4 MCPTT call requirements	16
5.4.1 General.....	16
5.4.2 Group call requirements.....	16
5.5 GCS AS requirements for the MCPTT service	16
5.6 Group selection	16
5.7 Bearer management.....	16
5.7.1 General.....	16
5.7.2 EPS bearer considerations	16
5.7.2.1 Void.....	16
5.7.2.2 Void.....	16
5.7.3 EPS unicast bearer considerations for MCPTT	16
5.7.4 MBMS bearer management	17
5.8 MCPTT system interconnect requirements	17
6 Involved business relationships.....	17
7 Functional model.....	17
7.1 General	17
7.2 Description of the planes	17
7.3 Functional model description	17
7.3.1 On-network functional model	17
7.3.2 Off-network functional model	19
7.4 Functional entities description.....	20
7.4.1 General.....	20
7.4.2 Application plane of MCPTT service	20
7.4.2.1 General	20
7.4.2.2 Common services core	20
7.4.2.3 MCPTT application service	20
7.4.2.3.1 MCPTT client.....	20
7.4.2.3.2 MCPTT server.....	20
7.4.2.3.3 Floor participant	22
7.4.2.3.4 Floor control server	22
7.4.2.3.5 Media distribution function	22
7.4.2.3.6 Media mixer	22
7.4.2.3.7 MCPTT user database	22
7.4.2.3.8 MC gateway server.....	22
7.4.3 Signalling control plane	23
7.5 Reference points	23
7.5.1 General reference point principle.....	23

7.5.2	Application plane of MCPTT service	23
7.5.2.1	General	23
7.5.2.2	Reference point MCPTT-1 (between the MCPTT client and the MCPTT server).....	23
7.5.2.3	Reference point MCPTT-2 (between the MCPTT server and the MCPTT user database).....	23
7.5.2.4	Reference point MCPTT-3 (between the MCPTT server and the MCPTT server and between the MCPTT server and the MC gateway server).....	24
7.5.2.5	Reference point MCPTT-4 (unicast between the floor control server and the floor participant)	24
7.5.2.6	Reference point MCPTT-5 (between the media distribution function and the EPS)	24
7.5.2.7	Reference point MCPTT-6 (between the MCPTT server and the EPS).....	24
7.5.2.8	Reference point MCPTT-7 (unicast between the media distribution function and the media mixer).....	24
7.5.2.9	Reference point MCPTT-8 (multicast between the media distribution function and the media mixer).....	24
7.5.2.10	Reference point MCPTT-9 (multicast between the floor control server and the floor participant).....	24
7.5.2.11	Reference point IWF-1 (between the MCPTT server and the interworking function to legacy systems).....	25
7.5.2.12	Reference points of common services core used in the MCPTT service	25
7.5.2.13	Reference point MCPTT-10 (between the MC gateway server and the MC gateway server in a different MCPTT system)	25
8	Identities	25
9	Application of functional model to deployments	25
10	Procedures and information flows.....	25
10.1	MCPTT service configuration.....	25
10.2	User authentication and authorization for MCPTT service	25
10.3	Affiliation and de-affiliation to/from MCPTT group(s).....	26
10.3a	Activation and de-activation of/from functional alias(es)	26
10.4	MCPTT group selection	27
10.4.1	General.....	27
10.4.2	Information flows for group selection	27
10.4.2.1	Group selection change request.....	27
10.4.2.2	Group selection change response	27
10.4.2.3	Group selection change notification.....	27
10.4.3	Authorized user remotely changes another MCPTT user's selected MCPTT group – mandatory mode....	27
10.5	Pre-established session (on-network)	28
10.5.1	General.....	28
10.5.2	Information flows for pre-established session	29
10.5.2.1	Pre-established session establishment	29
10.5.2.2	Pre-established session modification	29
10.5.2.3	Pre-established session release - client initiated.....	30
10.5.2.4	Pre-established session release - server initiated.....	30
10.5.2.5	Pre-established session call connect request	30
10.5.2.6	Pre-established session call disconnect request.....	31
10.5.3	Procedures.....	31
10.5.3.1	General	31
10.5.3.2	Call connect and disconnect procedures using pre-established session	31
10.5.3.2.1	Call connect over unicast.....	31
10.5.3.2.2	Call disconnect over unicast	32
10.6	Group call.....	33
10.6.1	General.....	33
10.6.2	On-network group call	33
10.6.2.1	General	33
10.6.2.2	Information flows for group call in on-network.....	33
10.6.2.2.1	MCPTT emergency group call request.....	33
10.6.2.2.1a	MCPTT emergency group call response	33
10.6.2.2.2	MCPTT in-progress emergency group state cancel request	33
10.6.2.2.2a	MCPTT in-progress emergency group state cancel response	34
10.6.2.2.3	MCPTT emergency alert request.....	34
10.6.2.2.3a	MCPTT emergency alert response	35
10.6.2.2.3b	MCPTT emergency alert area trigger	35
10.6.2.2.4	MCPTT emergency alert cancel request.....	35

10.6.2.2.4a	MCPTT emergency alert cancel response	35
10.6.2.2.5	MCPTT imminent peril group call request.....	36
10.6.2.2.5a	MCPTT imminent peril group call response	36
10.6.2.2.6	MCPTT in-progress imminent peril group state cancel request	36
10.6.2.2.6a	MCPTT in-progress imminent peril group state cancel response.....	37
10.6.2.2.7	Group call request (MCPTT client – MCPTT server).....	37
10.6.2.2.8	Group call request (MCPTT server – MCPTT server).....	37
10.6.2.2.9	Group call request (MCPTT server – MCPTT client).....	38
10.6.2.2.10	Group call response (MCPTT server – MCPTT client).....	38
10.6.2.2.11	Group call response (MCPTT server – MCPTT server).....	39
10.6.2.2.12	Group call response (MCPTT client – MCPTT server).....	39
10.6.2.2.13	Group call notify (MCPTT server – MCPTT client).....	39
10.6.2.2.14	Group call release request (MCPTT server – MCPTT client).....	39
10.6.2.2.14a	Group call release request (MCPTT client – MCPTT server).....	40
10.6.2.2.15	Group call release request (MCPTT server – MCPTT server).....	40
10.6.2.2.16	Group call release response (MCPTT client – MCPTT server).....	40
10.6.2.2.17	Group call release response (MCPTT server – MCPTT server).....	41
10.6.2.2.18	Group call rejoin request (MCPTT client – MCPTT server).....	41
10.6.2.2.19	Group call rejoin response (MCPTT server – MCPTT client).....	41
10.6.2.2.20	Group join request (MCPTT client – MCPTT server).....	42
10.6.2.2.21	Group join response (MCPTT server – MCPTT client).....	42
10.6.2.2.22	Group call leave request (MCPTT server – MCPTT client).....	43
10.6.2.2.23	Group call leave response (MCPTT client – MCPTT server).....	43
10.6.2.2.24	Group interrogate request (MCPTT server – MCPTT server).....	43
10.6.2.2.25	Group interrogate response (MCPTT server – MCPTT server).....	44
10.6.2.2.26	Group-broadcast group call request (MCPTT client – MCPTT server).....	44
10.6.2.2.27	Group-broadcast group call request (MCPTT server – MCPTT client).....	44
10.6.2.2.28	Group-broadcast group call response (MCPTT client – MCPTT server).....	45
10.6.2.2.29	Group-broadcast group call response (MCPTT server – MCPTT client).....	45
10.6.2.2.30	Group-broadcast group call release request (MCPTT client – MCPTT server).....	45
10.6.2.2.31	Group-broadcast group call release request (MCPTT server – MCPTT client).....	45
10.6.2.2.32	Group-broadcast group call release response (MCPTT server – MCPTT client).....	46
10.6.2.2.33	Group-broadcast group call release response (MCPTT client – MCPTT server).....	46
10.6.2.3	Group call within one MCPTT system.....	46
10.6.2.3.1	Group call models.....	46
10.6.2.3.1.1	Pre-arranged group call.....	46
10.6.2.3.1.2	Chat group call.....	51
10.6.2.3.2	Exiting group call due to de-affiliation.....	56
10.6.2.4	Group call involving groups from multiple MCPTT systems.....	57
10.6.2.4.1	Group call for temporary groups across multiple MCPTT systems	57
10.6.2.4.1.1	Group call setup	57
10.6.2.4.1.2	Group call release	59
10.6.2.4.2	Group call for temporary group formed by group regroup procedure involving multiple MCPTT systems via trusted mode.....	60
10.6.2.4.3	Group call for an MCPTT group defined in the partner MCPTT system.....	62
10.6.2.4.3.1	Group call setup procedure – initiating side	62
10.6.2.4.3.2	Group call setup – terminating side	63
10.6.2.4.4	Merging of groups involving multiple MCPTT systems	64
10.6.2.5	Broadcast group call.....	65
10.6.2.5.1	General	65
10.6.2.5.2	Common broadcast group call procedure	65
10.6.2.5.2.1	Group-broadcast group call procedure.....	66
10.6.2.5.2.2	Group-broadcast group call procedure when a subordinate group has an on-going MCPTT emergency group call.....	68
10.6.2.5.2.3	Group-broadcast group call release procedure.....	69
10.6.2.5.2.4	Server-initiated broadcast group call release procedure.....	70
10.6.2.5.3	Temporary group – broadcast group call procedure.....	71
10.6.2.6	Emergency and imminent peril procedures.....	72
10.6.2.6.1	MCPTT emergency group call	72
10.6.2.6.1.1	MCPTT emergency group call commencement.....	72
10.6.2.6.1.2	MCPTT group call upgraded to an MCPTT emergency group call.....	74
10.6.2.6.1.3	MCPTT in-progress emergency group state cancel	76

10.6.2.6.2	MCPTT imminent peril group call	78
10.6.2.6.2.1	MCPTT imminent peril group call commencement	78
10.6.2.6.2.2	Imminent peril group call upgrade	80
10.6.2.6.2.3	MCPTT in-progress imminent peril group state cancel	81
10.6.2.6.3	MCPTT emergency alert	82
10.6.2.6.3.1	MCPTT emergency alert initiation	83
10.6.2.6.3.2	MCPTT emergency alert cancel	85
10.6.2.6.3.3	Entering MCPTT emergency alert area	86
10.6.2.7	Location of current talker	87
10.6.2.8	Temporary group call – user regroup	88
10.6.2.8.1	General	88
10.6.2.8.2	Group call setup	88
10.6.2.8.3	Group call end (by authorized user)	89
10.6.3	Off-network group call	91
10.6.3.1	General	91
10.6.3.2	Information flows for group call in off-network	91
10.6.3.2.1	Group call announcement	91
10.6.3.2.2	MCPTT upgrade to emergency call	91
10.6.3.2.3	MCPTT emergency group state cancel	92
10.6.3.2.4	Response	92
10.6.3.2.5	MCPTT emergency alert announcement	92
10.6.3.2.6	MCPTT emergency alert cancel announcement	92
10.6.3.2.7	MCPTT upgrade to imminent peril call	93
10.6.3.2.8	MCPTT imminent peril group call cancel	93
10.6.3.3	Group call setup	93
10.6.3.4	Passive join to group call	94
10.6.3.5	Join to ongoing group call when new entry member initiates the call with on-going group call id	95
10.6.3.6	Immediate group call announcement to join an ongoing group call	96
10.6.3.7	Group call release due to inactivity	97
10.6.3.8	Broadcast group call	97
10.6.3.9	Emergency and imminent peril procedures	98
10.6.3.9.1	Emergency group call	98
10.6.3.9.2	MCPTT imminent peril	99
10.6.3.9.3	MCPTT emergency alert	99
10.6.3.9.3.1	MCPTT emergency alert initiation	99
10.6.3.9.3.2	MCPTT emergency alert cancel	101
10.7	Private call	101
10.7.1	General	101
10.7.2	Private call in on-network	102
10.7.2.1	Information flows for private call in on-network	102
10.7.2.1.1	MCPTT private call request (MCPTT client to MCPTT server)	102
10.7.2.1.2	MCPTT private call request (MCPTT server to MCPTT server)	102
10.7.2.1.2a	MCPTT private call request (MCPTT server to MCPTT client)	102
10.7.2.1.3	MCPTT private call response (MCPTT client to MCPTT server)	103
10.7.2.1.4	MCPTT private call response	103
10.7.2.1.4a	MCPTT private call end request	103
10.7.2.1.4b	MCPTT private call end response	104
10.7.2.1.5	MCPTT emergency private call request (MCPTT client to MCPTT server)	104
10.7.2.1.5a	MCPTT emergency private call request (MCPTT server to MCPTT client)	104
10.7.2.1.6	MCPTT progress indication	105
10.7.2.1.7	MCPTT ringing	105
10.7.2.2	Private call within one MCPTT system	105
10.7.2.2.1	Private call setup in automatic commencement mode	105
10.7.2.2.2	Private call setup in manual commencement mode	107
10.7.2.2.2.1	Description	107
10.7.2.2.2.2	Procedure	107
10.7.2.2.3	Private call release	109
10.7.2.2.3.1	Client initiated	109
10.7.2.2.3.2	Server initiated	110
10.7.2.3	Private call within several MCPTT systems	111
10.7.2.3.1	Private call setup in automatic commencement mode – MCPTT users in multiple MCPTT systems	111

10.7.2.3.2	Private call setup in manual commencement mode – MCPTT users in multiple MCPTT systems	113
10.7.2.3.3	Private call release – MCPTT users in multiple MCPTT systems	115
10.7.2.4	MCPTT emergency private call	115
10.7.2.4.1	MCPTT emergency private call commencement	115
10.7.2.4.2	MCPTT private call emergency upgrade	117
10.7.3	Private call in off-network	118
10.7.3.1	Information flows for private call in off-network	118
10.7.3.1.1	Call setup request	118
10.7.3.1.2	Call setup response	118
10.7.3.1.3	Call release request	118
10.7.3.1.4	Call release response	118
10.7.3.2	Use of ProSe capability for private call	118
10.7.3.3	Private call setup in automatic commencement mode	119
10.7.3.4	Private call setup in manual commencement mode	120
10.7.3.5	Private call release	121
10.7.3.6	MCPTT emergency private call	122
10.7.4	MCPTT private call call-back request	122
10.7.4.1	Information flows for MCPTT private call call-back request	122
10.7.4.1.1	MCPTT private call call-back request	122
10.7.4.1.2	MCPTT private call call-back response	122
10.7.4.1.3	MCPTT private call call-back cancel request	122
10.7.4.1.4	MCPTT private call call-back cancel response	123
10.7.4.2	MCPTT private call call-back request within one MCPTT system	123
10.7.4.3	MCPTT private call call-back cancel request within one MCPTT system	124
10.7.4.4	MCPTT private call call-back request fulfillment within one MCPTT system	125
10.8	Simultaneous session for MCPTT calls (on-network)	126
10.8.1	General	126
10.9	Floor control	126
10.9.1	Floor control for on-network MCPTT service	126
10.9.1.1	General	126
10.9.1.2	Information flows for floor control for on-network	126
10.9.1.2.1	General	126
10.9.1.2.2	Floor request	127
10.9.1.2.3	Floor granted	127
10.9.1.2.4	Floor rejected	127
10.9.1.2.5	Floor request cancel	128
10.9.1.2.6	Floor request cancel response	128
10.9.1.2.7	Floor request cancel notify	128
10.9.1.2.8	Floor idle	128
10.9.1.2.9	Floor release	129
10.9.1.2.9a	Multi-talker floor release	129
10.9.1.2.10	Floor taken	129
10.9.1.2.10a	Multi-talker floor taken	129
10.9.1.2.11	Floor revoked	130
10.9.1.2.12	Floor acknowledgement	130
10.9.1.2.13	Queue position request	130
10.9.1.2.14	Queue position info	130
10.9.1.2.15	Unicast media stop request	131
10.9.1.2.16	Unicast media resume request	131
10.9.1.3	Floor control within one MCPTT system	131
10.9.1.3.1	Floor request, floor granted and floor taken during an MCPTT session	131
10.9.1.3.1a	Floor request, floor granted and multi-talker floor taken during an MCPTT session enhanced with multi-talker control	133
10.9.1.3.2	Floor override	134
10.9.1.3.2.1	Floor override using floor revoked (also floor rejected) during an MCPTT session	134
10.9.1.3.2.2	Floor override without using floor revoked during an MCPTT session	136
10.9.1.3.2.3	Floor override using floor revoked (also floor rejected) during an MCPTT session enhanced with multi-talker control	137
10.9.1.3.2.4	Floor release during an MCPTT session enhanced with multi-talker control	139
10.9.1.3.3	Queue position during an MCPTT session	140
10.9.1.3.4	Floor request cancellation from the floor request queue	141

10.9.1.3.4.1	Floor request cancellation from the queue – MCPTT user initiated	141
10.9.1.3.4.2	Floor request cancellation from the queue - floor control server initiated	142
10.9.1.4	Floor control involving groups from multiple MCPTT systems	143
10.9.1.4.1	Partner MCPTT system routes all floor control messages to primary MCPTT system's floor control server	143
10.9.1.4.2	Partner MCPTT system performs filtering of floor control messages entering and leaving the partner MCPTT system	145
10.9.1.5	Floor control for audio cut-in enabled group	148
10.9.1.6	Unicast media stop and resume requests	149
10.9.2	Floor control for off-network MCPTT service	151
10.9.2.1	General	151
10.9.2.2	Information flows for floor control for off-network.....	152
10.9.2.2.1	General	152
10.9.2.2.2 Floor granted	152
10.9.2.3	Floor control during silence	152
10.9.2.3.1	Successful floor taken (No floor contention).....	152
10.9.2.4	Simultaneous floor requests	153
10.9.2.5	Floor request during speaking with queue	154
10.9.2.6	Floor request during speaking without queue	155
10.9.2.7	Override	156
10.9.2.8	Floor queue status	157
10.10	Use of MBMS transmission (on-network)	158
10.10.1	Information flows for MBMS Transmission	158
10.10.1.1	MapGroupToBearer	158
10.10.1.2	UnmapGroupFromBearer	159
10.10.1.3	Application group paging	159
10.10.2	Use of pre-established MBMS bearers	159
10.10.3	Use of dynamic MBMS bearer establishment	159
10.10.4	Call connect and disconnect over MBMS.....	159
10.10.4.1	General	159
10.10.4.2	Procedure	160
10.10.4.2.1	Call connect over MBMS	160
10.10.4.2.2	Call disconnect over MBMS	161
10.10.5	Switching from MBMS bearer to unicast bearer	161
10.10.6	Enhanced MCPTT group call setup procedure with MBMS bearer	162
10.10.6.1	Description	162
10.10.6.2	Procedure	162
10.11	MCPTT resource management (on-network).....	163
10.11.1	General.....	163
10.11.2	Request for unicast resources at session establishment	163
10.11.3	Request for modification of unicast resources	163
10.11.4	Management of multicast media bearers	164
10.11.5	Request for resources with shared priority	164
10.11.5.1	General	164
10.11.5.2	Procedure	164
10.12	MCPTT media plane transmissions with partner MCPTT systems (on-network).....	164
10.13	Location information (on-network).....	165
10.14	Ambient listening call	166
10.14.1	General.....	166
10.14.2	Information flows for ambient listening call.....	166
10.14.2.1	Ambient listening call request.....	166
10.14.2.2	Ambient listening call response	166
10.14.2.3	Ambient listening call release request.....	167
10.14.2.4	Ambient listening call release response	167
10.14.2.5	Ambient listening call release notification.....	167
10.14.3	Ambient listening call procedures	168
10.14.3.1	Remotely initiated ambient listening call setup.....	168
10.14.3.2	Locally initiated ambient listening call setup.....	169
10.14.3.3	Ambient listening call release – server initiated.....	170
10.14.3.4	Remotely initiated ambient listening call release – "listening" user initiated	171
10.14.3.5	Ambient listening call release – "listened to" user initiated	171

10.15	First-to-answer call setup	172
10.15.1	Description.....	172
10.15.2	Information flows for first-to-answer call.....	172
10.15.3	Procedure	172
10.16	Remotely initiated MCPTT call	174
10.16.1	General.....	174
10.16.2	Information flows for remotely initiated MCPTT call	174
10.16.2.1	Remotely initiated MCPTT call request	174
10.16.2.2	Remotely initiated MCPTT call response.....	175
10.16.3	Procedure	175
10.16.3.1	Remotely initiated MCPTT call request.....	175
10.17	Support for multiple devices	177
10.17.1	General.....	177
Annex A (normative): MCPTT related configuration data		178
A.1	General	178
A.2	MCPTT UE configuration data	178
A.3	MCPTT user profile configuration data	179
A.4	MCPTT related group configuration data	186
A.5	MCPTT service configuration data	190
Annex B (informative): Local UE settings for MCPTT		194
B.1	Local UE settings for MCPTT	194
Annex C (informative): Change history		195
History		198

Foreword

This Technical Specification has been produced by the 3rd Generation Partnership Project (3GPP).

The contents of the present document are subject to continuing work within the TSG and may change following formal TSG approval. Should the TSG modify the contents of the present document, it will be re-released by the TSG with an identifying change of release date and an increase in version number as follows:

Version x.y.z

where:

- x the first digit:
 - 1 presented to TSG for information;
 - 2 presented to TSG for approval;
 - 3 or greater indicates TSG approved document under change control.
- y the second digit is incremented for all changes of substance, i.e. technical enhancements, corrections, updates, etc.
- z the third digit is incremented when editorial only changes have been incorporated in the document.

1 Scope

This document specifies the functional architecture, procedures and information flows needed to support the mission critical push to talk (MCPTT) service. The MCPTT service utilizes the common functional architecture to support MC services over LTE including the common services core defined in 3GPP TS 23.280 [16]. Support for both MCPTT group calls and MCPTT private calls operating in on-network and off-network modes of operation is specified.

The corresponding service requirements are defined in 3GPP TS 22.179 [2] and 3GPP TS 22.280 [17].

The present document is applicable primarily to MCPTT voice service using E-UTRAN access based on the EPC architecture defined in 3GPP TS 23.401 [8]. Certain application functions of the MCPTT service such as dispatch and administrative functions could also be supported via non-3GPP access networks but no additional functionality is specified to support non-3GPP access.

The MCPTT service requires preferential handling compared to normal telecommunication services e.g. in support of police or fire brigade including the handling of prioritised MCPTT calls for emergency and imminent threats.

The MCPTT service can be used for public safety applications and also for general commercial applications e.g. utility companies and railways.

In the present document, MCPTT calls between MCPTT users on different MCPTT systems are considered.

2 References

The following documents contain provisions which, through reference in this text, constitute provisions of the present document.

- References are either specific (identified by date of publication, edition number, version number, etc.) or non-specific.
- For a specific reference, subsequent revisions do not apply.
- For a non-specific reference, the latest version applies. In the case of a reference to a 3GPP document (including a GSM document), a non-specific reference implicitly refers to the latest version of that document *in the same Release as the present document*.

- [1] 3GPP TR 21.905: "Vocabulary for 3GPP Specifications".
- [2] 3GPP TS 22.179: "Mission Critical Push to Talk (MCPTT)"; Stage 1.
- [3] 3GPP TS 23.002: "Network Architecture".
- [4] 3GPP TS 23.203: "Policy and charging control architecture".
- [5] 3GPP TS 23.228: "IP Multimedia Subsystem (IMS); Stage 2".
- [6] 3GPP TS 23.237: "IP Multimedia Subsystem (IMS) Service Continuity; Stage 2".
- [7] 3GPP TS 23.303: "Proximity-based services (ProSe); Stage 2".
- [8] 3GPP TS 23.401: "General Packet Radio Service (GPRS) enhancements for Evolved Universal Terrestrial Radio Access Network (E-UTRAN) access".
- [9] 3GPP TS 23.468: "Group Communication System Enablers for LTE (GCSE_LTE); Stage 2".
- [10] 3GPP TS 29.468: "Group Communication System Enablers for LTE (GCSE_LTE); MB2 Reference Point; Stage 3".
- [11] Void
- [12] 3GPP TS 36.331: "Evolved Universal Terrestrial Radio Access (E-UTRA); Radio Resource Control (RRC); Protocol specification".

- [13] IETF RFC 5245 (April 2010): "Interactive Connectivity Establishment (ICE): A Protocol for Network Address Translator (NAT) Traversal for Offer/Answer Protocols".
- [14] void
- [15] void
- [16] 3GPP TS 23.280: "Common functional architecture to support mission critical services".
- [17] 3GPP TS 22.280: "Mission Critical Common Requirements (MCCoRe); Stage 1".
- [18] 3GPP TS 29.283: "Diameter data management applications".
- [19] 3GPP TS 33.180: "Security of the mission critical service".
- [20] 3GPP TS 23.283: "Mission Critical Communication Interworking with Land Mobile Radio Systems; Stage 2".

3 Definitions, symbols and abbreviations

3.1 Definitions

For the purposes of the present document, the terms and definitions given in 3GPP TR 21.905 [1] and the following apply. A term defined in the present document takes precedence over the definition of the same term, if any, in 3GPP TR 21.905 [1].

Automatic commencement mode: A mode in which the initiation of the private call does not require any action on the part of the receiving MCPTT user.

First-to-answer call: A call that is started when the first MCPTT user among multiple potential target recipients' answers. This call requires the answering MCPTT user to answer manually; automatic answer is not allowed

Group call: A mechanism by which an MCPTT user can make a one-to-many MCPTT transmission to other users that are members of MCPTT group(s).

Group home MCPTT system: The MCPTT system where the MCPTT group is defined.

Group host MCPTT server: The MCPTT server within an MCPTT system that provides centralised support for MCPTT services of an MCPTT group defined in a group home MCPTT system.

Manual commencement mode: A mode in which the initiation of the private call requires the receiving MCPTT user to perform some action to accept or reject the call setup.

MCPTT client: An instance of an MC service client that provides the client application function for the MCPTT service.

MCPTT group: An MC service group configured for MCPTT service.

MCPTT group affiliation: An MC service group affiliation for MCPTT.

MCPTT group de-affiliation: An MC service group de-affiliation for MCPTT.

MCPTT ID: An instance of an MC service ID within the MCPTT service.

MCPTT server: An instance of an MC service server that provides the server application function for the MCPTT service.

On-network MCPTT service: The collection of functions and capabilities required to provide MCPTT via EPS bearers using E-UTRAN to provide the last hop radio bearers.

Pre-selected MCPTT user profile: An instance of the pre-selected MC service user profile for MCPTT.

UE-to-network relay MCPTT service: The collection of functions and capabilities required to provide MCPTT via a ProSe UE-to-network relay using ProSe direct communication paths to provide the last hop radio bearer(s).

For the purposes of the present document, the following terms and definitions given in 3GPP TS 22.179 [2] apply:

Dispatcher
Floor control
MCPTT administrator
MCPTT service
MCPTT system
MCPTT UE
MCPTT user
MCPTT User Profile
Mission Critical Organization
Mission Critical Push To Talk
Off-network MCPTT service
Partner MCPTT system
Primary MCPTT system
Private call
Multi-talker control

For the purposes of the present document, the following terms and definitions given in IETF RFC 5245 [13] apply:

Candidate
Candidate pair

For the purposes of the present document, the following terms and definitions given in 3GPP TS 23.280 [16] apply:

Active MC service user profile
MC service client
MC service group
MC service group affiliation
MC service group de-affiliation
MC service ID
MC service server
Pre-selected MC service user profile

For the purposes of the present document, the following terms and definitions given in 3GPP TS 22.280 [17] apply:

Functional alias

3.2 Symbols

For the purposes of the present document, the following symbols given in 3GPP TS 22.179 [2] apply:

B1
B2
N2
N3
N4
N5
N6
N7
N10
N11

3.3 Abbreviations

For the purposes of the present document, the abbreviations given in 3GPP TR 21.905 [1] and the following apply. An abbreviation defined in the present document takes precedence over the definition of the same abbreviation, if any, in 3GPP TR 21.905 [1].

APN	Access Point Name
ARP	Allocation and Retention Priority
BM-SC	Broadcast Multicast Service Centre
CHAP	Challenge-Handshake Authentication Protocol

CSCF	Call Server Control Function
DL	Downlink
DPF	Direct Provisioning Function
E-UTRAN	Evolved Universal Terrestrial Radio Access Network
E2EE	End to End Encryption
ECGI	E-UTRAN Cell Global Identifier
EPC	Evolved Packet Core
EPS	Evolved Packet System
GBR	Guaranteed Bit Rate
GCS AS	Group Communication Service Application Server
GCSE_LTE	Group Communication Service Enabler over LTE
GRUU	Globally Routable User agent URI
HLR	Home Location Register
HSS	Home Subscriber Server
HTTP	Hyper Text Transfer Protocol
I-CSCF	Interrogating CSCF
ICE	Interactive Connectivity Establishment
IM CN	IP Multimedia Core Network
IMPI	IP Multimedia Private Identity
IMPU	IP Multimedia PUblic identity
IMS	IP Multimedia Subsystem
ITSI	Individual TETRA Subscriber Identity
LMR	Land Mobile Radio
MBMS	Multimedia Broadcast and Multicast Service
MBSFN	Multimedia Broadcast multicast service Single Frequency Network
MC	Mission Critical
MC ID	Mission Critical user identity
MCPTT	Mission Critical Push To Talk
MCPTT AS	MCPTT Application Server
MCPTT group ID	MCPTT group identity
MCPTT ID	MCPTT user identity
NAT	Network Address Translation
PAP	Password Authentication Protocol
P-CSCF	Proxy CSCF
PCC	Policy and Charging Control
PCRF	Policy and Charging Rules Function
PLMN	Public Land Mobile Network
ProSe	Proximity-based Services
PSI	Public Service Identity
PTT	Push To Talk
QCI	QoS Class Identifier
QoS	Quality of Service
RAN	Radio Access Network
RF	Radio Frequency
RSI	Radio Set Identity
S-CSCF	Serving CSCF
SAI	Service Area Identifier
SDF	Service Data Flow
SIP	Session Initiated Protocol
SSL	Secure Sockets Layer
TLS	Transport Layer Security
TMGI	Temporary Mobile Group Identity
UM	Unacknowledged Mode
URI	Uniform Resource Identifier
USB	Universal Serial Bus
WLAN	Wireless Local Area Network

4 Introduction

The MCPTT service supports communication between several users (i.e. group call), where each user has the ability to gain access to the permission to talk in an arbitrated manner. The MCPTT service also supports private calls between two users.

The MCPTT architecture utilises the common functional architecture to support mission critical services over LTE defined in 3GPP TS 23.280 [16] and aspects of the IMS architecture defined in 3GPP TS 23.228 [5], the Proximity-based Services (ProSe) architecture defined in 3GPP TS 23.303 [7], the Group Communication System Enablers for LTE (GCSE_LTE) architecture defined in 3GPP TS 23.468 [9] and the PS-PS access transfer procedures defined in 3GPP TS 23.237 [6] to enable support of the MCPTT service.

The MCPTT UE primarily obtains access to the MCPTT service via E-UTRAN, using the EPS architecture defined in 3GPP TS 23.401 [8]. Certain application functions of MCPTT service such as dispatch and administrative functions can be supported using either MCPTT UEs in E-UTRAN or using MCPTT UEs via non-3GPP access networks.

NOTE: Dispatch consoles and devices used by MCPTT service administrators are considered MCPTT UEs in the MCPTT architecture.

MCPTT UEs that use non-3GPP access can only support a subset of the functionality specified in this specification that is supported by the non-3GPP access network.

The MCPTT system provides the function to support interworking with LMR systems defined in 3GPP TS 23.283 [20].

5 Architectural requirements

5.1 Media routing requirements

The voice media flow for a private call shall be routed according to one of the following two options:

- a) Option 1:
 - 1) Through the primary MCPTT system if both users in the call belong to the same organisation; or
 - 2) Through the primary MCPTT system of both users, if the users in the call do not belong to the same organisation.
- b) Option 2: The voice media flow may be routed locally, under the control of the primary MCPTT system, through an entity allowing the duplication of the media flow to the primary MCPTT system of each user.

The voice media flow for a group call shall be routed to the group home MCPTT system.

The routing of media flow shall be end-to-end from transmitter to receiver(s), except for the MCPTT control function.

5.2 Requirements for user identity management

To allow for confidentiality of user identities in various cases of business relationship as defined in clause 6, the MCPTT application may provide public user identities to the MCPTT UE, to be used by MCPTT UE for MCPTT services.

5.3 MCPTT group affiliation and MCPTT group de-affiliation

MCPTT group affiliation shall be as specified in clause 5.2.5 of 3GPP TS 23.280 [16]. In addition, the following requirements shall be fulfilled by the MCPTT service for MCPTT users affiliated to MCPTT groups:

- MCPTT users receive notifications for MCPTT group call setup and invitations for their affiliated MCPTT group(s).
- MCPTT users receive media and events from their affiliated MCPTT group(s).

5.4 MCPTT call requirements

5.4.1 General

The on-network MCPTT service shall support the use of pre-established sessions.

5.4.2 Group call requirements

The MCPTT service shall support the chat group (restricted) call model for MCPTT group call.

The MCPTT service shall support the pre-arranged group call model for MCPTT group call.

5.5 GCS AS requirements for the MCPTT service

The GCS AS architecture requirements for MC services are specified in 3GPP TS 23.280 [16].

5.6 Group selection

The following functionalities shall be supported by the MCPTT service.

- a. The MCPTT user shall select an affiliated group to initiate a new group call or transmit media in an existing group call.
- b. An authorized MCPTT user (e.g., dispatcher) may remotely force or request to change other on-network MCPTT users' selected MCPTT group to a particular affiliated group.

5.7 Bearer management

5.7.1 General

The MCPTT UE shall use the APNs as defined in subclause 5.2.7.0 of 3GPP TS 23.280 [16].

5.7.2 EPS bearer considerations

The EPS bearer considerations specified in subclause 5.2.7.2 of 3GPP TS 23.280 [16] shall apply.

5.7.2.1 Void

5.7.2.2 Void

5.7.3 EPS unicast bearer considerations for MCPTT

For an MCPTT call session request, resources shall be requested utilising interaction with dynamic PCC. The MCPTT system shall request resources over Rx to a PCRF. The dedicated bearer for voice and MCPTT-4 reference point messaging shall utilise the QCI value of 65 (as specified in 3GPP TS 23.203 [4]). The request of resources over Rx shall include an application identifier for MCPTT in order for the PCRF to evaluate the correct QCI.

The UE is required to support at minimum one UM bearer which is used for MCPTT voice (see annex A in 3GPP TS 36.331 [12]).

Depending on operator policy:

- the MCPTT system may be able to request modification of the priority (ARP) of an existing bearer without the need to initiate a new dedicated GBR bearer; or
- the EPS bearers for MCPTT call may enable pre-emption of lower priority EPS bearers if the maximum number of UM bearers has been reached in favour of MCPTT initiated EPS bearer, if the EPS bearer used for MCPTT call has higher priority level (ARP) than the UM bearer(s) used for other application(s) and if the bearers for non MCPTT application are pre-emptable. In this case, the EPS bearer for MCPTT call pre-empts one of the existing EPS bearers when the maximum number of bearers is established for other applications.

NOTE 1: Operator policy takes into account regional/national requirements.

The EPS bearer for MCPTT emergency call shall have highest priority level among MCPTT call types. The EPS bearer for MCPTT imminent peril call shall have higher priority level than one for MCPTT call.

To ensure that the MCPTT service always has access to a dedicated bearer for MCPTT media, a pre-established session may be setup that includes a request for resources at the first MCPTT group affiliation.

This means that the PCC may multiplex MCPTT media streams from multiple concurrent MCPTT calls into one EPS bearer on one shared network priority regardless of MCPTT call priority.

NOTE 2: A single UM bearer is used to multiplex the media streams from multiple concurrent MCPTT calls.

NOTE 3: The sharing of a single GBR bearer for voice means that different QCI and/or ARP values are not possible for different voice media streams.

NOTE 4: Multi-talker control may require additional bearer resources if multiple audio streams are sent to the UE when the floor is granted to additional participants during an established MCPTT group session.

5.7.4 MBMS bearer management

The MBMS bearer management for MC services is specified in subclause 5.2.7.1 of 3GPP TS 23.280 [16].

5.8 MCPTT system interconnect requirements

The architecture for interconnect between MCPTT systems is specified, allowing the affiliation of MCPTT users from an MCPTT system with MCPTT groups defined in another MCPTT system. When both MCPTT systems are served by different networks, interconnect of signalling and media is achieved using the interfaces defined for interconnect between PLMNs.

6 Involved business relationships

The description of the involved business relationships for the MCPTT service is contained in clause 6 of 3GPP TS 23.280 [16].

7 Functional model

7.1 General

The functional model for the support of MCPTT is defined as a series of planes to allow for the breakdown of the architectural description.

7.2 Description of the planes

The description of the planes and the relationship between the planes are contained in the common functional architecture to support MC services in 3GPP TS 23.280 [16].

7.3 Functional model description

7.3.1 On-network functional model

Figure 7.3.1-1 shows the functional model for the application plane of the MCPTT service.

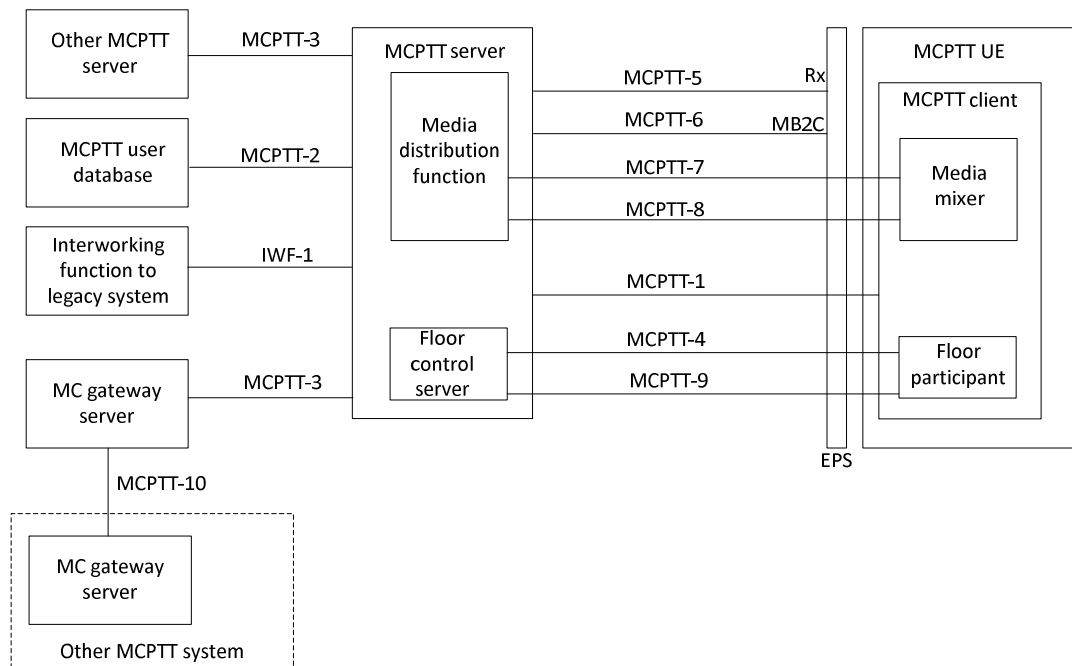

Figure 7.3.1-1: Functional model for application plane of the MCPTT service

In the model shown in figure 7.3.1-1, the following apply:

- The MCPTT server is an instantiation of a MC service server in accordance with 3GPP TS 23.280 [16].
- The MCPTT server is an instantiation of a GCS AS in accordance with 3GPP TS 23.468 [9].
- MCPTT-9 carries multicast floor control signalling between the floor control server of the MCPTT server and the floor participant of the MCPTT UE.
- MCPTT-4 carries unicast floor control signalling between the floor control server of the MCPTT server and the floor participant of the MCPTT UE.
- MCPTT-7 carries unicast media between the media distribution function of the MCPTT server and the media mixer of the MCPTT UE.
- MCPTT-8 carries multicast media from the media distribution function of the MCPTT server to the media mixer of the MCPTT UE.

Figure 7.3.1-2 shows the relationships between the reference points of the application plane and the signalling plane.

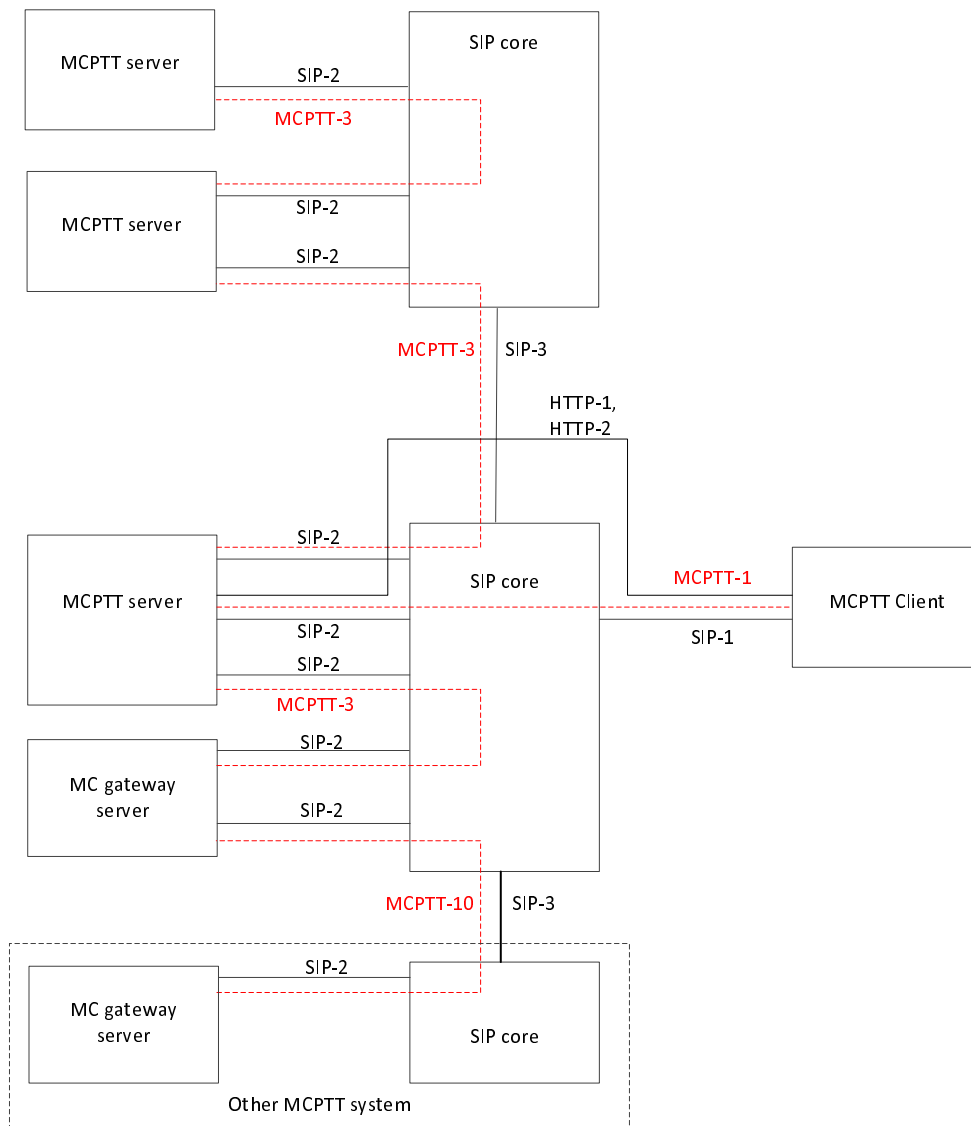

Figure 7.3.1-2: Relationships between reference points of MCPTT application and signalling control planes

7.3.2 Off-network functional model

Figure 7.3.2-1 shows the functional model for off-network operation of MCPTT service.

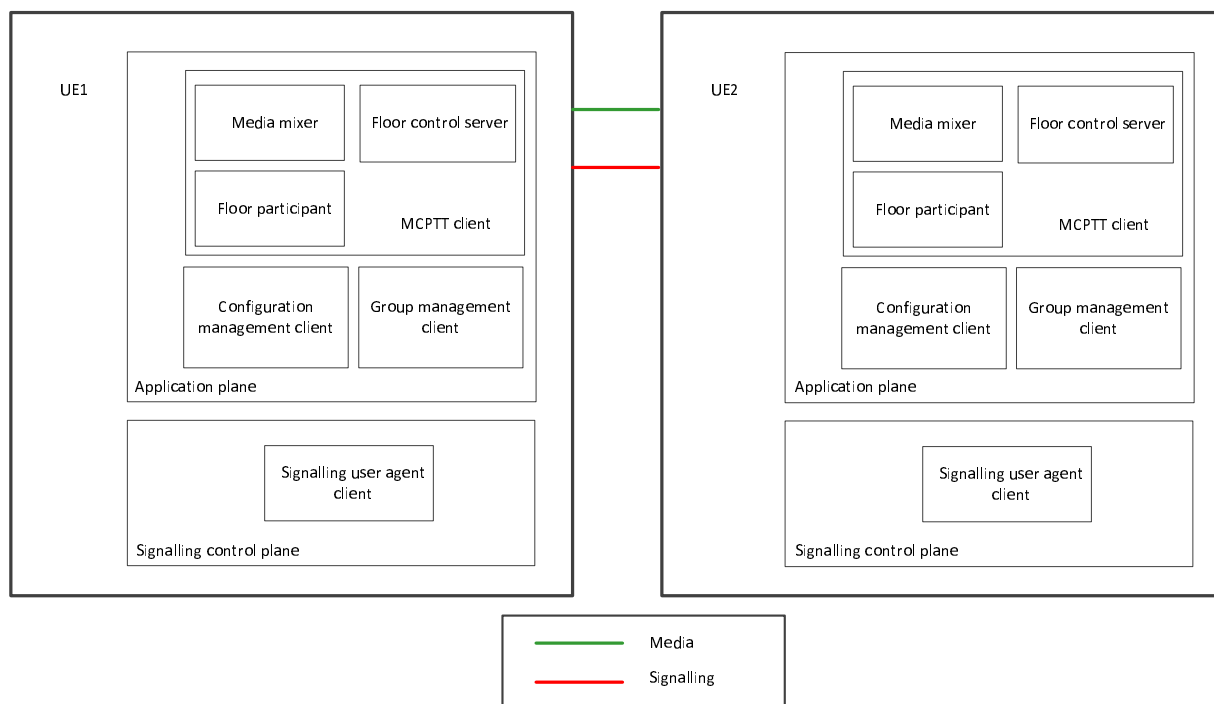

Figure 7.3.2-1: Functional model for off-network operation of MCPTT service

7.4 Functional entities description

7.4.1 General

Each subclause is a description of a functional entity and does not imply a physical entity.

7.4.2 Application plane of MCPTT service

7.4.2.1 General

Entities within the application plane of MCPTT service provide application control, media control and distribution functions.

7.4.2.2 Common services core

The description of the common services core entities are contained in common functional architecture to support MC services in 3GPP TS 23.280 [16].

7.4.2.3 MCPTT application service

7.4.2.3.1 MCPTT client

The MCPTT client functional entity acts as the user agent for all MCPTT application transactions. The client reports the information of where the client is currently located.

7.4.2.3.2 MCPTT server

The MCPTT server functional entity provides centralised support for MCPTT services.

All the MCPTT clients supporting users belonging to a single group are required to use the same MCPTT server for that group. An MCPTT client supporting a user involved in multiple groups can have relationships with multiple MCPTT servers.

NOTE 1: Possible requirements for handling multiple distinct media on different MCPTT servers are not covered in this version of the document.

The MCPTT server functional entity represents a specific instantiation of the GCS AS described in 3GPP TS 23.468 [9] to control multicast and unicast operations for group communications.

The MCPTT server functional entity is supported by the SIP AS, HTTP client and HTTP server functional entities of the signalling control plane.

By assuming the role of a GCS AS, the MCPTT server functional entity is responsible for:

- requesting the allocation of multicast resources utilizing the media distribution function;
- announcing the association of multicast resources to calls to MCPTT UEs;
- determining for each MCPTT UE involved in a given call whether to use unicast or multicast transport;
- announcing the assignment of multicast transport for specific calls to MCPTT UEs; and
- informing the media distribution function of the media streams requiring support for a given call.

The MCPTT server shall support the controlling role and the participating role. The MCPTT server may perform the controlling role for private calls and group calls. The MCPTT server performing the controlling role for a private call or group call may also perform a participating role for the same private call or group call. For each private call and group call, there shall be only one MCPTT server assuming the controlling role, while one or more MCPTT servers in participating role may be involved.

The MCPTT server performing the controlling roles is responsible for:

- call control (e.g. policy enforcement for participation in the MCPTT group calls) towards all the MCPTT users of the group call and private call;
- interfacing with the group management server for group policy and affiliation status information of this MCPTT server's served affiliated users;
- interfacing with the functional alias management server for functional alias policy;- functional alias activation and deactivation support for MCPTT user;
- managing floor control entity in a group call and private call; and
- managing media handling entity in call i.e. conferencing, transcoding.

The controlling roles for group call, private call and functional alias are independent with each other.

The MCPTT server performing the participating roles is responsible for:

- call control (e.g. authorization for participation in the MCPTT group calls) to its MCPTT users for group call and private call;
- group affiliation support for MCPTT user, including enforcement of maximum N2 number of simultaneous group affiliations by a user;
- functional alias activation and deactivation support for MCPTT user;
- relaying the call control and floor control messages between the MCPTT client and the MCPTT server performing the controlling role; and
- media handling in call for its MCPTT users, i.e. transcoding, recording, lawful interception for both unicast and multicast media.

NOTE 2: The MCPTT server in the controlling role and the MCPTT server in the participating role can belong to the same MCPTT system or to different MCPTT systems.

For group regrouping involving multiple groups from primary and partner MCPTT systems,

- the group host MCPTT server of the temporary group performs the controlling role and is responsible for the centralized floor control, and for arbitration according to the temporary group or user policies (e.g., priority);

- the group host MCPTT server of the constituent MCPTT group is responsible for providing call invitations to their group members, and for filtering between constituent group members' floor control requests according to the constituent group or user policies (e.g., priority); and
- the MCPTT server responsible for the constituent MCPTT group members performs the participating role.

7.4.2.3.3 Floor participant

The floor participant functional entity is responsible for floor requests. This functional entity is located in the UE for both on-network and off-network operations.

7.4.2.3.4 Floor control server

This functional entity provides support for centralised floor control for on-network and distributed floor control for off-network operation. It may provide arbitration between floor control requests between different users, grant the floor in response to successful requests, and provide queuing in cases of contention. For on-network operation, this functional entity is located with the MCPTT server. For off-network operation, this functional entity is located in the UE.

7.4.2.3.5 Media distribution function

The media distribution function is responsible for the distribution of media to call participants. By means of information provided by the MCPTT server (e.g. IP addresses, transport layer ports), it will provide the following functionality:

- provide for the reception of uplink MCPTT UE media transmission by means of the MCPTT-7 reference point;
- replicate the media as needed for distribution to those participants using unicast transport;
- distribute downlink media to MCPTT UEs by IP unicast transmission to those participants utilizing unicast transport by means of the MCPTT-7 reference point;
- distribute downlink media to MCPTT UEs using multicast downlink transport of media for the call by means of the MCPTT-8 reference point; and
- provide a media mixing function where multiple media streams are combined (e.g. multi-talker control) into a single media stream for transmission to the MCPTT UE.

NOTE 1: If media mixing function occurs within the media distribution function, it operates independently of the media mixer in the UE.

NOTE 2: A media mixing function within the media distribution function is not possible where the media is end to end encrypted.

Group configuration data determines whether audio mixing for multi-talker control is applied by the media mixing function in the MCPTT server.

NOTE 3: If media mixing in the network is utilized, care should be taken to minimize the feedback of the user's own voice from the mixed audio in order to avoid echoes.

7.4.2.3.6 Media mixer

This functional entity exists on the UE and provides support for combining multiple media streams (e.g. multi-talker control) into one media stream through the enforcement of media policy information. Group configuration data determines whether audio mixing for multi-talker control is applied by the media mixing function in the UE.

7.4.2.3.7 MCPTT user database

This functional entity contains information of the MCPTT user profile associated with an MCPTT ID that is held by the MCPTT service provider at the application plane. The MCPTT user profile is determined by the mission critical organization, the MCPTT service provider, and potentially the MCPTT user.

7.4.2.3.8 MC gateway server

The MC gateway server provides support for MCPTT interconnection services with a partner MCPTT system in a different trust domain whilst providing topology hiding. It acts as a proxy for one or more MCPTT servers in the partner MCPTT system without needing to expose the MCPTT servers in the primary MCPTT system outside the trusted

domain of the primary MCPTT system. It may be a role of the MCPTT server described in subclause 7.4.2.3.2 of the present document.

The MC gateway server is responsible for relaying call control and floor control signalling messages, and media between MCPTT servers within the MCPTT system and the interconnected MCPTT system.

Editor's note: It is FFS whether the gateway MC server can act as a signalling proxy as defined in 3GPP TS 33.180 [25].

7.4.3 Signalling control plane

The description of the signalling control plane is contained in the common functional architecture to support MC services as specified in 3GPP TS 23.280 [16].

7.5 Reference points

7.5.1 General reference point principle

The protocols on any reference point that is exposed for MCPTT service interoperability with other SIP core or other IMS entities in other systems shall be compatible with the protocols defined for the corresponding reference point defined in 3GPP TS 23.002 [3].

7.5.2 Application plane of MCPTT service

7.5.2.1 General

The reference points for the application plane of MCPTT service are described in the following subclauses.

7.5.2.2 Reference point MCPTT-1 (between the MCPTT client and the MCPTT server)

The MCPTT-1 reference point, which exists between the MCPTT client and the MCPTT server, is used for MCPTT application signalling for establishing a session in support of MCPTT. The MCPTT-1 reference point shall use the SIP-1 and SIP-2 reference points for transport and routing of SIP signalling. The MCPTT-1 reference point may use the HTTP-1 and HTTP-2 reference points.

The TMGI is communicated between the MCPTT server and the MCPTT client using the MCPTT-1 reference point.

Information that is reported to the MCPTT server from the MCPTT client shall be configurable at the application layer. This interface may include the area where a UE is currently located, described as ECGI of the serving and neighbouring cell(s), MBMS SAIs, MBSFN Area ID. This information comes from the broadcast by the local cell, e.g. from SIB1 and SIB15 (see 3GPP TS 36.331 [12]) as decoded by the UE.

NOTE: This reference point includes the GC1 reference point as described in 3GPP TS 23.468 [9]. It is assumed that the MCPTT server is performing the function of GCS AS. While 3GPP TS 23.468 [9] does not specify GC1 it does include high level descriptions of certain interactions on GC1, including those relating to the availability of multicast delivery for the application client. The MCPTT-1 reference point fulfils the requirements of the GC1 reference point for MCPTT.

Messages supported on this interface may also include the MCPTT server providing the MCPTT client with information describing the mapping of transport resources to specific group calls.

7.5.2.3 Reference point MCPTT-2 (between the MCPTT server and the MCPTT user database)

The MCPTT-2 reference point, which exists between the MCPTT server and the MCPTT user database, is used by the MCPTT server to obtain information about a specific user. The MCPTT-2 reference point utilises a diameter management application protocol as defined in 3GPP TS 29.283 [18] and shall be intra-network.

7.5.2.4 Reference point MCPTT-3 (between the MCPTT server and the MCPTT server and between the MCPTT server and the MC gateway server)

The MCPTT-3 reference point exists between the MCPTT server and the MCPTT server and between the MCPTT server and the MC gateway server for MCPTT application signalling for establishing MCPTT sessions. The MCPTT-3 reference point shall use the SIP-2 reference point for transport and routing of signalling. If a pair of MCPTT servers, or an MCPTT server and an MC gateway server, are served by different SIP cores then the MCPTT-3 reference point shall also use the SIP-3 reference point for transport and routing of signalling. Floor control signalling and media are also transferred using the MCPTT-3 reference point.

7.5.2.5 Reference point MCPTT-4 (unicast between the floor control server and the floor participant)

The MCPTT-4 reference point, which exists between the floor control server in the MCPTT server and the floor participant in the MCPTT client, provides floor control signalling between the floor control server in the MCPTT server and the floor participant over a unicast bearer. The MCPTT-4 reference point uses the SGI reference point defined in 3GPP TS 23.002 [3].

7.5.2.6 Reference point MCPTT-5 (between the media distribution function and the EPS)

The MCPTT-5 reference point, which exists between the media distribution function and the EPS, is used, subject to the conditions below, by the media distribution function of the MCPTT server to obtain unicast bearers with appropriate QoS from the EPS. It utilises the Rx interface of the EPS according to 3GPP TS 23.203 [4].

MCPTT-5 is not used when the MCPTT service provider and the PLMN operator do not have an operational agreement for QoS control to be provided directly from the MCPTT service provider domain.

MCPTT-5 may be used when the MCPTT service provider and the PLMN operator have an operational agreement where QoS control is provided directly from the MCPTT service provider domain.

NOTE: Any coordination between the P-CSCF use of Rx and the MCPTT server use of Rx (via MCPTT-5) from the MCPTT service provider domain is not specified in this release of this specification.

7.5.2.7 Reference point MCPTT-6 (between the MCPTT server and the EPS)

The MCPTT-6 reference point, which exists between the MCPTT server and the EPS, is used to request the allocation and activation of multicast transport resources for MCPTT application usage. The MCPTT-6 reference point uses the MB2-C interface as defined in 3GPP TS 29.468 [10].

7.5.2.8 Reference point MCPTT-7 (unicast between the media distribution function and the media mixer)

The MCPTT-7 reference point, which exists between the media distribution function and the media mixer, is used to exchange unicast media between the media distribution function of the MCPTT server and the media mixer of the MCPTT client. The MCPTT-7 reference point uses the SGI reference point defined in 3GPP TS 23.002 [3].

7.5.2.9 Reference point MCPTT-8 (multicast between the media distribution function and the media mixer)

The MCPTT-8 reference point, which exists between the media distribution function and the media mixer, is used by the media distribution function of the MCPTT server to send multicast media to the media mixer of the MCPTT client. The MCPTT-8 reference point uses the MB2-U interface defined in 3GPP TS 23.468 [9].

7.5.2.10 Reference point MCPTT-9 (multicast between the floor control server and the floor participant)

The MCPTT-9 reference point, which exists between the floor control server and the floor participant, provides floor control signalling between the floor control server and the floor participant over a multicast bearer. The MCPTT-9 reference point uses the MB2-U interface defined in 3GPP TS 23.468 [9].

7.5.2.11 Reference point IWF-1 (between the MCPTT server and the interworking function to legacy systems)

The IWF-1 reference point is specified in 3GPP TS 23.283 [20].

7.5.2.12 Reference points of common services core used in the MCPTT service

The descriptions for reference points of the common services core are contained in the common functional architecture to support MC services specified in 3GPP TS 23.280 [16].

7.5.2.13 Reference point MCPTT-10 (between the MC gateway server and the MC gateway server in a different MCPTT system)

The MCPTT-10 reference point, which exists between the MC gateway server and the MC gateway server in an interconnected MCPTT system for MCPTT application signalling for establishing MCPTT sessions, shall use the SIP-3 reference point for transport and routing of signalling. Floor control signalling and media are also transferred using the MCPTT-10 reference point between interconnected MCPTT systems.

8 Identities

The MCPTT service specific identities (e.g. MCPTT ID, MCPTT group ID) are described in clause 8 of 3GPP TS 23.280 [16].

9 Application of functional model to deployments

The application of the functional model to deployments, and description of various deployment scenarios for the MCPTT service, can be found in clause 9 of 3GPP TS 23.280 [16].

10 Procedures and information flows

10.1 MCPTT service configuration

The MCPTT service shall support the procedures and related information flows as specified in subclause 10.1 of 3GPP TS 23.280 [16] with the following clarifications:

- The MC service client is the MCPTT client;
- The MC service server is the MCPTT server;
- The MC service ID is the MCPTT ID; and
- The MC service user profile index is the MCPTT user profile index.

10.2 User authentication and authorization for MCPTT service

NOTE: Flow 10.2-1 is a high level user authentication and authorization flow. 3GPP TS 33.180 [19] defines the specific user authentication and authorization architecture required by the MCPTT service in order to realize the MCPTT user authentication and authorization requirements as defined in 3GPP TS 22.179 [2].

A procedure for user authentication is illustrated in figure 10.2-1. The user authentication is performed based on the procedure specified in 3GPP TS 23.280[16].

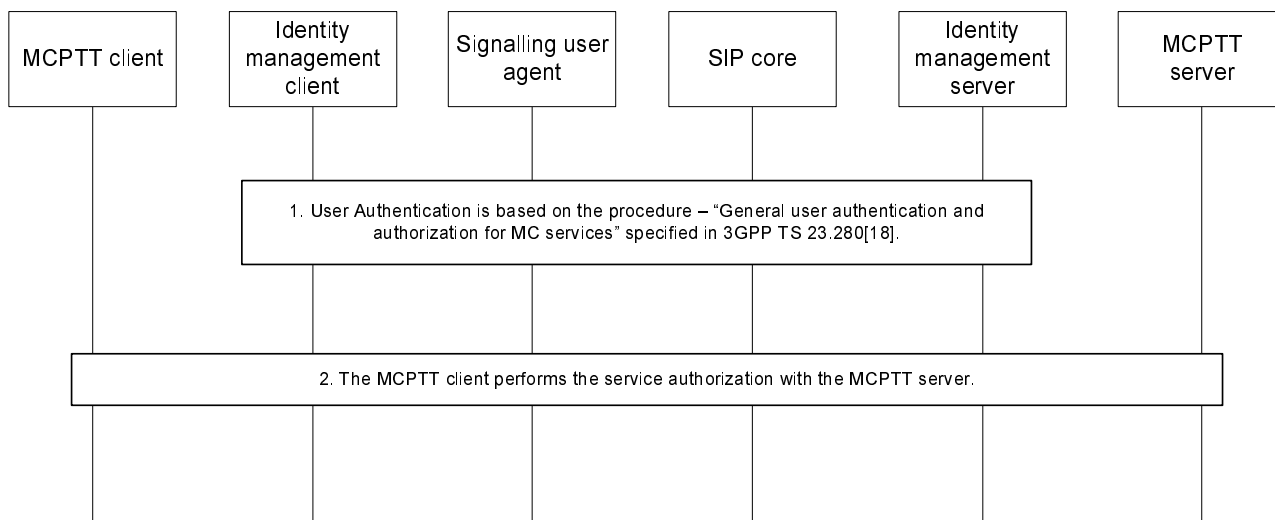

Figure 10.2-1: MCPTT user authentication and registration, single domain

1. The user authentication is performed as per the general user authentication procedure specified in 3GPP TS 23.280[16].
2. MCPTT client performs the MCPTT service authorization for the user. Step 2 utilizes the results of step 1.

10.3 Affiliation and de-affiliation to/from MCPTT group(s)

The MCPTT service shall support the procedures and related information flows as specified in subclause 10.8 of 3GPP TS 23.280 [16] with the following clarifications:

- The MC service client is the MCPTT client;
- The MC service server is the MCPTT server;
- The MC service group is the MCPTT group;
- The MC service ID is the MCPTT ID; and
- The MC service group ID is the MCPTT group ID.

When an MCPTT user has affiliated to an MCPTT group then the MCPTT user can send and receive MCPTT related media for that MCPTT group. When an MCPTT user has de-affiliated from an MCPTT group then the MCPTT user cannot send and receive MCPTT related media to and from that MCPTT group.

10.3a Activation and de-activation of/from functional alias(es)

The MCPTT service shall support the procedures and related information flows as specified in subclause 10.13.4 and subclause 10.13.5 of 3GPP TS 23.280 [16].

- The MC service client is the MCPTT client;
- The MC service server is the MCPTT server;
- The MC service ID is the MCPTT ID.

10.4 MCPTT group selection

10.4.1 General

When an MCPTT user wants to transmit on a MCPTT group, an affiliated MCPTT group shall be set as the selected MCPTT group to the MCPTT user. Only one MCPTT group can be set as the selected MCPTT group to an MCPTT user from one particular MCPTT UE at any given time. This sub-clause describes the detailed procedures for the MCPTT group selection.

10.4.2 Information flows for group selection

10.4.2.1 Group selection change request

Table 10.4.2.1-1 describes the information flow group selection change request from the MCPTT client to the MCPTT server.

Table 10.4.2.1-1: Group selection change request

Information element	Status	Description
MCPTT ID	M	MCPTT user identity whose group selection information is to be changed
MCPTT group ID	M	MCPTT group identity for which the selection is made for the MCPTT ID

10.4.2.2 Group selection change response

Table 10.4.2.2-1 describes the information flow group selection change response from the MCPTT server to the MCPTT client.

Table 10.4.2.2-1: Group selection change response

Information element	Status	Description
Result	M	Result indicates success or failure of group selection change

10.4.2.3 Group selection change notification

Table 10.4.2.3-1 describes the information flow group selection change notification from the MCPTT server to the MCPTT client.

Table 10.4.2.3-1: Group selection change notification

Information element	Status	Description
MCPTT ID	M	MCPTT user identity whose group selection information is to be changed
MCPTT group ID	M	MCPTT group identity for which the selection is made for the MCPTT ID

10.4.3 Authorized user remotely changes another MCPTT user's selected MCPTT group – mandatory mode

Procedure for an authorized user to change other MCPTT users' selected MCPTT group without requiring target user's approval is described in figure 10.4.3-1.

Pre-conditions:

- The MCPTT client 1 has already been provisioned (statically or dynamically) with the target MCPTT user's information and its group information, that the selected MCPTT group of target MCPTT user 2 is allowed to be changed;

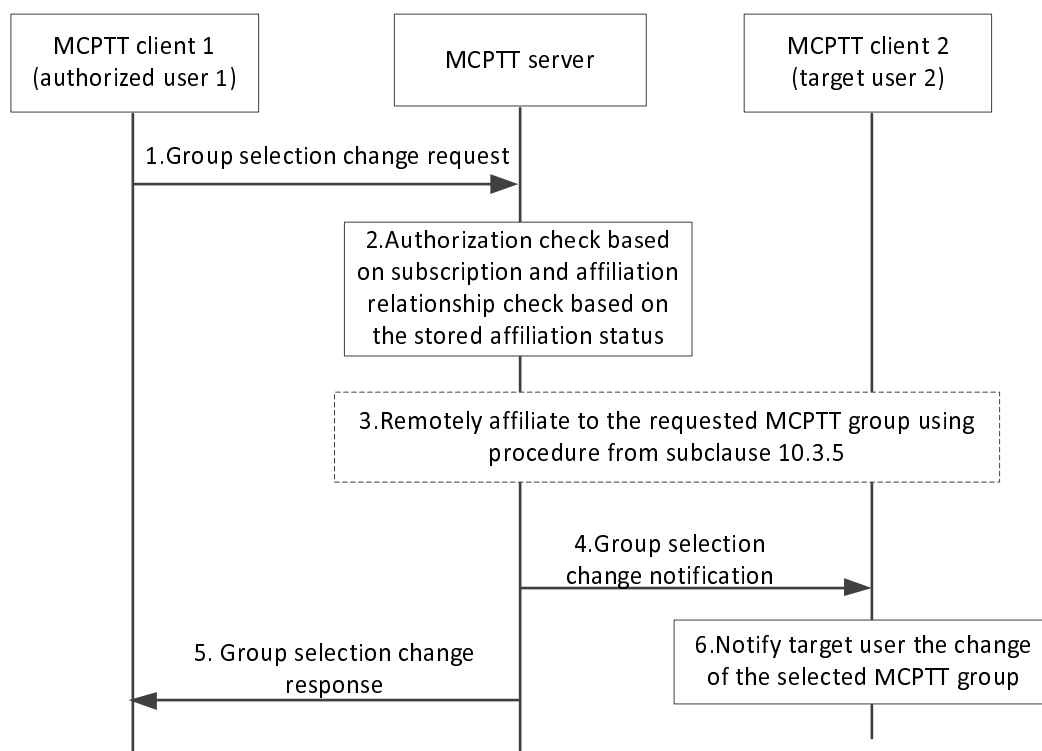

Figure 10.4.3-1: Remotely change MCPTT group selection – mandatory mode

1. When an authorized user changes other MCPTT users' selected MCPTT group, the MCPTT client 1 sends MCPTT group selection change request to the MCPTT server. The information (i.e. target MCPTT ID(s), MCPTT group ID(s)) used to set the requested MCPTT group as the selected MCPTT group of the target MCPTT user shall be included.
2. The MCPTT server shall check if the MCPTT user 1 is authorized to change the target MCPTT user's selected MCPTT group. The MCPTT server shall perform the affiliation relationship check based on the stored affiliation status.
3. If the MCPTT user 1 is authorized to change the target MCPTT user's selected MCPTT group, and if the target MCPTT user is not already affiliated to the requested MCPTT group, the remotely change of affiliation procedures in shall be performed (see subclause 10.8 in 3GPP TS 23.280 [16]).
4. The MCPTT server then shall send the MCPTT group selection change notification including the target user ID and the selected MCPTT group ID to the MCPTT client 2.
5. The group selection change response then returns to the MCPTT client 1.
6. Target MCPTT client 2 are notified about the change of its selected MCPTT group.

10.5 Pre-established session (on-network)

10.5.1 General

The MCPTT server may use one or more pre-established sessions as defined in 3GPP TS 23.280 [16] for the following procedures for on-network:

- Group calls (as specified in subclause 10.6.2.3 and subclause 10.6.2.4);
- Private calls (as specified in subclause 10.7.2.2 and subclause 10.7.2.3);
- MCPTT emergency group calls (as specified in subclause 10.6.2.6.1);
- MCPTT imminent peril group calls (as specified in subclause 10.6.2.6.2);
- MCPTT emergency private calls (as specified in subclause 10.7.2.4); and

- MCPTT emergency alerts (as specified in subclause 10.6.2.6.3).

For outgoing MCPTT call setup for a private call or a pre-arranged group call using a pre-established session, an MCPTT UE uses SIP procedures to establish the call.

For incoming MCPTT call setup for a pre-arranged group call using a pre-established session, an MCPTT UE is notified of the start of the MCPTT call using floor control messages.

For incoming MCPTT call setup for a private call using a pre-established session, an MCPTT UE is notified of the start of the MCPTT call control using SIP procedures in manual commencement mode and using floor control procedures in automatic commencement mode.

An MCPTT UE can join an MCPTT chat group using a pre-established session by sending a group join request using SIP procedures.

NOTE: A chat group call is started and notified using floor control messages regardless of whether pre-established session is used.

10.5.2 Information flows for pre-established session

10.5.2.1 Pre-established session establishment

Table 10.5.2.1-1 describes the information flow create pre-established session request from the MCPTT client to the MCPTT server, for the procedure defined in 3GPP TS 23.280 [16].

Table 10.5.2.1-1: Create pre-established session request

Information element	Status	Description
MCPTT ID of requester (originator)	M	This element identifies the MCPTT user that wishes to create a pre-established session.
SDP offer	M	SDP with media information offered by client (e.g. ports, codec, protocol id).

Table 10.5.2.1-2 describes the information flow create pre-established session response from the MCPTT server to the MCPTT client, for the procedure defined in 3GPP TS 23.280 [16].

Table 10.5.2.1-2: Create pre-established session response

Information element	Status	Description
SDP Answer	M	SDP with media information offered by server (e.g. ports, codec, protocol id)
Session ID	M	This element identifies the specific session ID used for pre-established sessions.

10.5.2.2 Pre-established session modification

Table 10.5.2.2-1 describes the information flow modify pre-established session request from the MCPTT client to the MCPTT server, for the procedure defined in 3GPP TS 23.280 [16].

Table 10.5.2.2-1: Modify pre-established session request

Information element	Status	Description
MCPTT ID of requester (originator)	M	This element identifies the MCPTT user that wishes to create a pre-established session.
Session ID	M	This element identifies the specific session ID used for pre-established sessions.
SDP offer	M	SDP with media information offered by client (e.g. ports, codec, protocol id).

Table 10.5.2.2-2 describes the information flow modify pre-established session response from the MCPTT server to the MCPTT client, for the procedure defined in 3GPP TS 23.280 [16].

Table 10.5.2.2-2: Modify pre-established session response

Information element	Status	Description
SDP Answer	M	SDP with media information offered by server (e.g. ports, codec, protocol id).
Session ID	M	This element identifies the specific session ID used for pre-established sessions.

10.5.2.3 Pre-established session release - client initiated

Table 10.5.2.3-1 describes the information flow release pre-established session request from the MCPTT client to the MCPTT server, for the procedure defined in 3GPP TS 23.280 [16].

Table 10.5.2.3-1: Release pre-established session request - client initiated

Information element	Status	Description
MCPTT ID of requester (originator)	M	This element identifies the MCPTT user that wishes to release a pre-established session.
Session ID	M	This element identifies the specific session ID used for pre-established sessions.
Release reason	M	This element indicates that reason for the session release.

Table 10.5.2.3-2 describes the information flow release pre-established session response from the MCPTT server to the MCPTT client, for the procedure defined in 3GPP TS 23.280 [16].

Table 10.5.2.3-2: Release pre-established session response - client initiated

Information element	Status	Description
Session ID	M	This element identifies the specific session ID used for pre-established sessions.

10.5.2.4 Pre-established session release - server initiated

Table 10.5.2.4-1 describes the information flow release pre-established session request from the MCPTT server to the MCPTT client, for the procedure defined in 3GPP TS 23.280 [16].

Table 10.5.2.4-1: Release pre-established session release request - server initiated

Information element	Status	Description
MCPTT ID of target	M	This element identifies the MCPTT user that is the target of the for pre-established session release.
Session ID	M	This element identifies the specific session ID used for pre-established sessions.
Release reason	M	This element indicates the reason for the session release.

Table 10.5.2.4-2 describes the information flow release pre-established session response from the MCPTT client to the MCPTT server, for the procedure defined in 3GPP TS 23.280 [16].

Table 10.5.2.4-2: Release pre-established session response - server initiated

Information element	Status	Description
Session ID	M	This element identifies the specific session ID used for pre-established sessions.

10.5.2.5 Pre-established session call connect request

Table 10.5.2.5-1 describes the information flow pre-established session call connect request from the MCPTT server to the MCPTT client, for the procedure defined in subclause 10.5.3.2.1 of the present document.

Table 10.5.2.5-1: Pre-established session call connect request

Information element	Status	Description
MCPTT group ID	O	Identity of the MCPTT group (NOTE)
MCPTT ID	O	MCPTT ID of the private call MCPTT user (NOTE)
Session ID	M	This element identifies the specific session ID used for pre-established sessions.
NOTE: Depending on type of connection either MCPTT group ID or MCPTT ID shall be present		

10.5.2.6 Pre-established session call disconnect request

Table 10.5.2.1.6-1 describes the information flow pre-established session call disconnect request from the MCPTT server to the MCPTT client, for the procedure defined in subclause 10.5.3.2.2 of the present document.

Table 10.5.2.6-1: Pre-established session call disconnect request

Information element	Status	Description
MCPTT group ID	O	Identity of the MCPTT group (NOTE)
MCPTT ID	O	MCPTT ID of the private call MCPTT user (NOTE)
Session ID	M	This element identifies the specific session ID used for pre-established sessions.
NOTE: Depending on type of connection either MCPTT group ID or MCPTT ID shall be present		

10.5.3 Procedures

10.5.3.1 General

The MCPTT server and MCPTT client make use of the procedures defined in the following subclauses of the present document and the following procedures in 3GPP TS 23.280 [16]:

- pre-established session establishment;
- pre-established session modification; and
- pre-established session release.

10.5.3.2 Call connect and disconnect procedures using pre-established session

10.5.3.2.1 Call connect over unicast

Call connect and disconnect information flows are sent over non-SIP media plane signalling using MCPTT-4 for including or releasing an MCPTT client in the call using a pre-established session.

Figure 10.5.3.2.1-1 shows the high level procedure where a call connect information flow is sent by the MCPTT server to inform MCPTT client(s) using a pre-established session that the MCPTT client(s) has/have been connected to an MCPTT private call or group call.

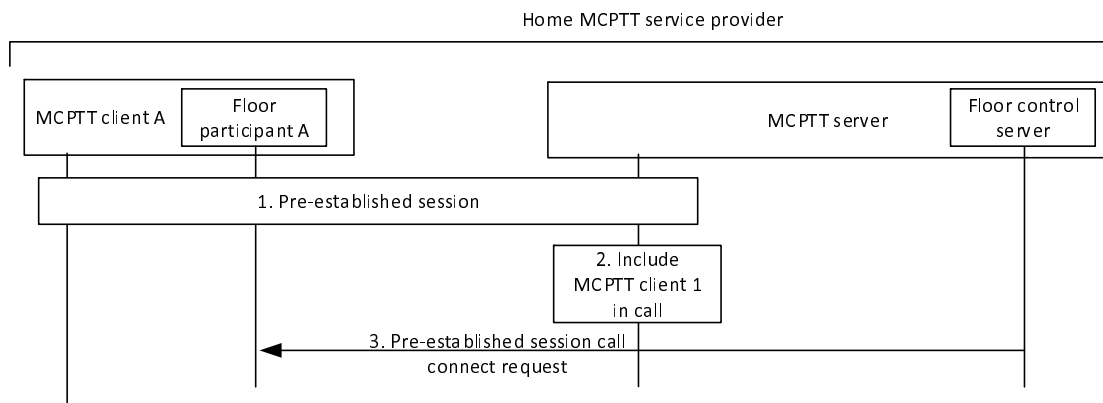

Figure 10.5.3.2.1-1: Connect procedure

1. Pre-established session exists between MCPTT client A and MCPTT server.
2. MCPTT server has determined to include MCPTT client A in the call e.g., upon receiving the request from another MCPTT client to include MCPTT client A in the call.
3. Pre-established session call connect request information flow is sent by the MCPTT server to inform MCPTT client A using a pre-established session that it has been connected to MCPTT private or group call. The floor control is established between floor participant A and floor control server.

10.5.3.2.2 Call disconnect over unicast

Figure 10.5.3.2.2-1 shows the high level procedure where a disconnect information flow is sent by the MCPTT server to the MCPTT client A to indicate that the MCPTT private call or group call using a pre-established session has been released.

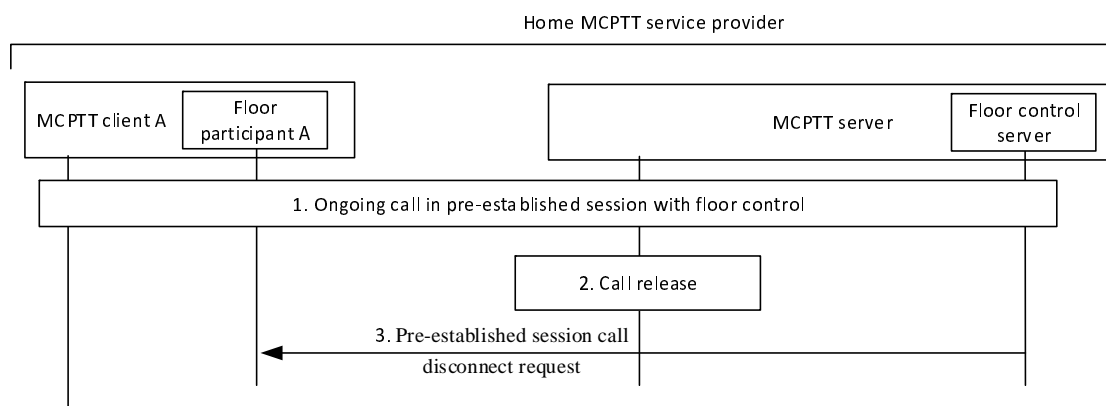

Figure 10.5.3.2.2-1: Disconnect procedure

1. Floor control is ongoing within a private or group call established using pre-established session.
2. MCPTT server has determined to release MCPTT client A from the call e.g., due to call release.
3. Pre-established session call disconnect request message is sent by the MCPTT server to indicate to MCPTT client A that the MCPTT private call or group call using a pre-established session has been released. Pre-established session between MCPTT client A and MCPTT server remains for further use.

10.6 Group call

10.6.1 General

Group calls are enabled in both on-network and off-network.

10.6.2 On-network group call

10.6.2.1 General

This subclause contains procedures for group call across a single and multiple MCPTT servers, and associated functions such as emergency call, broadcast call and others.

Two variations of group call model are described in subclause 10.6.2.3, the pre-arranged group call and the chat group call. Each of the subsequent group call types in subclause 10.6.2.4 onwards are applicable to either call model.

10.6.2.2 Information flows for group call in on-network

10.6.2.2.1 MCPTT emergency group call request

Table 10.6.2.2.1-1 describes the information flow MCPTT emergency group call request from the MCPTT client to the MCPTT server and from the MCPTT server to the MCPTT client.

Table 10.6.2.2.1-1 MCPTT emergency group call request information elements

Information Element	Status	Description
MCPTT ID	M	The identity of the calling party
MCPTT group ID	M	The MCPTT group ID on which the call is to be conducted
Emergency indicator	M	Indicates that the group call request is an MCPTT emergency call
Alert indicator	M	Indicates whether an emergency alert is to be sent
Implicit floor request (NOTE)	O	Indicates that the originating client requests the floor.
NOTE: This element shall be included only when this information flow is from the client to the server and the originating client requests the floor.		

10.6.2.2.1a MCPTT emergency group call response

Table 10.6.2.2.1a-1 describes the information flow MCPTT emergency group call response from the MCPTT client to the MCPTT server and from the MCPTT server to the MCPTT client.

Table 10.6.2.2.1a-1 MCPTT emergency group call response information elements

Information Element	Status	Description
MCPTT ID	M	The identity of the calling party
MCPTT group ID	M	The MCPTT group ID on which the call is to be conducted
Result	M	Result of the MCPTT emergency group call request (success or failure)

10.6.2.2.2 MCPTT in-progress emergency group state cancel request

Table 10.6.2.2.2-1 describes the information flow MCPTT in-progress emergency group state cancel request from the MCPTT client to the MCPTT server.

NOTE: In Rel-14 and Rel-13 versions of this specification the name of this information flow is "MCPTT emergency group call cancel request".

Table 10.6.2.2.2-1: MCPTT in-progress emergency group state cancel request information elements

Information Element	Status	Description
MCPTT ID	M	The identity of the cancelling party
MCPTT group ID	M	The MCPTT group ID on which the MCPTT in-progress emergency state is to be cancelled.
Alert indicator	O	Indicates whether the emergency alert of the cancelling party is to be cancelled

10.6.2.2.2a MCPTT in-progress emergency group state cancel response

Table 10.6.2.2.2a-1 describes the information flow MCPTT in-progress emergency group state cancel response from the MCPTT server to the MCPTT client.

NOTE: In Rel-14 and Rel-13 versions of this specification the name of this information flow is "MCPTT emergency group call cancel response".

Table 10.6.2.2.2a-1: MCPTT in-progress emergency group state cancel response information elements

Information Element	Status	Description
MCPTT ID	M	The identity of the cancelling party
MCPTT group ID	M	The MCPTT group ID on which the MCPTT in-progress emergency in-progress is to be cancelled.

10.6.2.2.3 MCPTT emergency alert request

Table 10.6.2.2.3-1 describes the information flow MCPTT emergency alert request from the MCPTT client to the MCPTT server.

Table 10.6.2.2.3-1 MCPTT emergency alert request information elements

Information Element	Status	Description
MCPTT ID	M	The identity of the alerting party
MCPTT group ID	M	The MCPTT group ID with which the alert is associated
Location	O	The alerting MCPTT client's location

Table 10.6.2.2.3-2 describes the information flow MCPTT emergency alert request from the MCPTT server to the MCPTT client.

Table 10.6.2.2.3-2 MCPTT emergency alert request information elements

Information Element	Status	Description
MCPTT ID	M	The identity of the alerting party
MCPTT group ID	M	The MCPTT group ID with which the alert is associated
Organization name	M	The alerting MCPTT user's mission critical organization name
Location	O	The alerting MCPTT client's location

10.6.2.2.3a MCPTT emergency alert response

Table 10.6.2.2.3a-1 describes the information flow MCPTT emergency alert response from the MCPTT client to the MCPTT server and from the MCPTT server to the MCPTT client.

Table 10.6.2.2.3a-1 MCPTT emergency alert response information elements

Information Element	Status	Description
MCPTT ID	M	The identity of the alerting party
MCPTT group ID	M	The MCPTT group ID with which the alert is associated

10.6.2.2.3b MCPTT emergency alert area trigger

Editor's Note: This subclause is added as a place holder for describing the information flow of MCPTT emergency alert area trigger.

10.6.2.2.4 MCPTT emergency alert cancel request

Table 10.6.2.2.4-1 describes the information flow MCPTT emergency alert cancel request from the MCPTT client to the MCPTT server and from the MCPTT server to the MCPTT client.

Table 10.6.2.2.4-1 MCPTT emergency alert cancel request information elements

Information Element	Status	Description
MCPTT ID	M	MCPTT user identity of the cancelling party
MCPTT ID (NOTE)	O	MCPTT user identity whose emergency alert is to be cancelled
MCPTT group ID	M	The MCPTT group ID with which the alert is associated
Group's in-progress emergency state cancel request	O	Requests cancellation of the in-progress emergency state of the group
NOTE:		This information shall be present if the message is requesting cancellation of another MCPTT user's alert. If not present, then the alert of the MCPTT ID of the cancelling party is being cancelled

10.6.2.2.4a MCPTT emergency alert cancel response

Table 10.6.2.2.4a-1 describes the information flow MCPTT emergency alert cancel response from the MCPTT client to the MCPTT server and from the MCPTT server to the MCPTT client.

Table 10.6.2.2.4a-1 MCPTT emergency alert cancel response information elements

Information Element	Status	Description
MCPTT ID	M	The identity of the cancelling party
MCPTT group ID	M	The MCPTT group ID with which the alert is associated

10.6.2.2.5 MCPTT imminent peril group call request

Table 10.6.2.2.5-1 describes the information flow MCPTT imminent peril group call request from the MCPTT client to the MCPTT server and from the MCPTT server to the MCPTT client.

Table 10.6.2.2.5-1 MCPTT imminent peril group call request information elements

Information Element	Status	Description
MCPTT ID	M	The identity of the calling party
MCPTT group ID	M	The MCPTT group ID on which the call is to be conducted
Imminent peril indicator	M	Indicates that the group call request is an imminent peril call
Implicit floor request (NOTE)	O	Indicates that the originating client requests the floor
NOTE: This element shall be included only when this information flow is from the client to the server and the originating client requests the floor.		

10.6.2.2.5a MCPTT imminent peril group call response

Table 10.6.2.2.5a-1 describes the information flow MCPTT imminent peril group call response from the MCPTT client to the MCPTT server and from the MCPTT server to the MCPTT client.

Table 10.6.2.2.5a-1 MCPTT imminent peril group call response information elements

Information Element	Status	Description
MCPTT ID	M	The identity of the calling party
MCPTT group ID	M	The MCPTT group ID on which the call is to be conducted
Result	M	Result of the MCPTT imminent peril group call request (success or failure)

10.6.2.2.6 MCPTT in-progress imminent peril group state cancel request

Table 10.6.2.2.6-1 describes the information flow MCPTT in-progress imminent peril group state cancel request from the MCPTT client to the MCPTT server and from the MCPTT server to the MCPTT client.

NOTE: In Rel-14 and Rel-13 versions of this specification the name of this information flow is "MCPTT imminent peril group call cancel request".

Table 10.6.2.2.6-1 MCPTT in-progress imminent peril group state cancel request information elements

Information Element	Status	Description
MCPTT ID	M	The identity of the cancelling party
MCPTT group ID	M	The MCPTT group ID on which the imminent peril group state is to be cancelled

10.6.2.2.6a MCPTT in-progress imminent peril group state cancel response

Table 10.6.2.2.6a-1 describes the information flow MCPTT in-progress imminent peril group state cancel response from the MCPTT client to the MCPTT server and from the MCPTT server to the MCPTT client.

NOTE: In Rel-14 and Rel-13 versions of this specification the name of this information flow is "MCPTT imminent peril group call cancel response".

Table 10.6.2.2.6a-1 MCPTT in-progress imminent peril group state cancel response information elements

Information Element	Status	Description
MCPTT ID	M	The identity of the cancelling party
MCPTT group ID	M	The MCPTT group ID on which the imminent peril group state is to be cancelled

10.6.2.2.7 Group call request (MCPTT client – MCPTT server)

Table 10.6.2.2.7-1 describes the information flow group call request from the MCPTT client to the MCPTT server.

Table 10.6.2.2.7-1 Group call request information elements

Information Element	Status	Description
MCPTT ID	M	The MCPTT ID of the calling party
Functional alias	O	The functional alias of the calling party
MCPTT group ID (NOTE)	O	The MCPTT group ID of the group on which the call is requested
SDP offer	M	Media parameters of MCPTT clients
Implicit floor request	O	When originating client requests the floor, this element shall be included
Broadcast indicator	O	Indicates that the group call request is for a broadcast group call
MCPTT ID list	O	The MCPTT ID of users being invited to the temporary group call - user regroup
Temporary group indicator	O	Indicates that the group call request is for a temporary group call - user regroup
NOTE: the MCPTT group ID shall not be present for the temporary group call - user regroup.		

10.6.2.2.8 Group call request (MCPTT server – MCPTT server)

Table 10.6.2.2.8-1 describes the information flow group call request between the MCPTT servers.

Table 10.6.2.2.8-1 Group call request information elements

Information Element	Status	Description
MCPTT ID	M	The MCPTT ID of the calling party
Functional alias	O	The functional alias of the calling party
MCPTT group ID	M	The MCPTT group ID of the group on which the call is initiated
SDP offer	M	Media parameters of MCPTT server
Broadcast indicator	O	Indicates that the group call request is for a broadcast group call
Implicit floor request (NOTE)	O	Indicates that the originating client requests the floor.
NOTE: This element shall be included only when the originating client requests the floor.		

10.6.2.2.9 Group call request (MCPTT server – MCPTT client)

Table 10.6.2.2.9-1 describes the information flow group call request from the MCPTT server to the MCPTT client.

Table 10.6.2.2.9-1 Group call request information elements

Information Element	Status	Description
MCPTT ID	M	The MCPTT ID of the calling party
Functional alias	O	The functional alias of the calling party
MCPTT group ID	M	The MCPTT group ID of the group on which the call is initiated
SDP offer	M	Media parameters of MCPTT server
Broadcast indicator	O	Indicates that the group call request is for a broadcast group call
Temporary group indicator	O	Indicates that the group call request is for a temporary group call performed by user regroup

10.6.2.2.10 Group call response (MCPTT server – MCPTT client)

Table 10.6.2.2.10-1 describes the information flow group call response from the MCPTT server to the MCPTT client.

Table 10.6.2.2.10-1 Group call response information elements

Information Element	Status	Description
MCPTT ID	M	The MCPTT ID of the calling party
Functional alias	O	The functional alias of the calling party
MCPTT group ID	M	The MCPTT group ID of the group on which the call is requested
SDP answer	M	Media parameters selected
Result	M	Result of the group call request (success or failure)

10.6.2.2.11 Group call response (MCPTT server – MCPTT server)

Table 10.6.2.2.11-1 describes the information flow group call response between the MCPTT servers.

Table 10.6.2.2.11-1 Group call response information elements

Information Element	Status	Description
MCPTT ID	M	The MCPTT ID of the target MCPTT group member
Functional alias	O	The functional alias of the target MCPTT group member
MCPTT group ID	M	The MCPTT group ID of the group on which the call is requested
SDP answer	M	Media parameters selected
Result	M	Result of the group call request (success or failure)

10.6.2.2.12 Group call response (MCPTT client – MCPTT server)

Table 10.6.2.2.12-1 describes the information flow group call response from the MCPTT client to the MCPTT server.

Table 10.6.2.2.12-1 Group call response information elements

Information Element	Status	Description
MCPTT ID	M	The MCPTT ID of the target MCPTT group member
Functional alias	O	The functional alias of the target MCPTT group member
MCPTT group ID	M	The MCPTT group ID of the group on which the call is initiated
SDP answer	M	Media parameters selected
Result	M	Result of the group call request (success or failure)

10.6.2.2.13 Group call notify (MCPTT server – MCPTT client)

Table 10.6.2.2.13-1 describes the information flow group call notify from the MCPTT server to the MCPTT client.

Table 10.6.2.2.13-1 Group call notify information elements

Information Element	Status	Description
MCPTT ID	M	The MCPTT ID of the calling party
Functional alias	O	The functional alias of the calling party
MCPTT group ID	M	The MCPTT group ID of the group on which the call is requested
MCPTT ID list	O	The list of MCPTT IDs of the MCPTT group members whose acknowledgement is not required

10.6.2.2.14 Group call release request (MCPTT server – MCPTT client)

Table 10.6.2.2.14-1 describes the information flow group call release request from the MCPTT server to the MCPTT client.

Table 10.6.2.2.14-1 Group call release request information elements

Information Element	Status	Description
MCPTT ID	M	The MCPTT ID of the MCPTT group member
Functional alias	O	The functional alias of the MCPTT group member
MCPTT group ID	M	The MCPTT group ID of the group on which the call is released
Temporary group indicator	O	Indicates that the group call release request is for a temporary group call - user regroup

10.6.2.2.14a Group call release request (MCPTT client – MCPTT server)

Table 10.6.2.2.14a-1 describes the information flow group call release request from the MCPTT client to the MCPTT server.

Table 10.6.2.2.14a-1 Group call release request information elements

Information Element	Status	Description
MCPTT ID	M	The MCPTT ID of the MCPTT group member
Functional alias	O	The functional alias of the MCPTT group member
MCPTT group ID	M	The MCPTT group ID of the group on which the call is released
Temporary group indicator	O	Indicates that the group call release request is for a temporary group call - user regroup

10.6.2.2.15 Group call release request (MCPTT server – MCPTT server)

Table 10.6.2.2.15-1 describes the information flow group call release request between the MCPTT servers.

Table 10.6.2.2.15-1 Group call release request information elements

Information Element	Status	Description
MCPTT ID	M	The MCPTT ID of the MCPTT group member
Functional alias	O	The functional alias of the MCPTT group member
MCPTT group ID	M	The MCPTT group ID of the group on which the call is released

10.6.2.2.16 Group call release response (MCPTT client – MCPTT server)

Table 10.6.2.2.16-1 describes the information flow group call release response from the MCPTT client to the MCPTT server.

Table 10.6.2.2.16-1 Group call release response information elements

Information Element	Status	Description
MCPTT ID	M	The MCPTT ID of the MCPTT group member
Functional alias	O	The functional alias of the MCPTT group member
MCPTT group ID	M	The MCPTT group ID of the group on which the call is released

10.6.2.2.17 Group call release response (MCPTT server – MCPTT server)

Table 10.6.2.2.17-1 describes the information flow group call release response between the MCPTT servers.

Table 10.6.2.2.17-1 Group call release response information elements

Information Element	Status	Description
MCPTT ID	M	The MCPTT ID of the MCPTT group member
Functional alias	O	The functional alias of the MCPTT group member
MCPTT group ID	M	The MCPTT group ID of the group on which the call is released

10.6.2.2.18 Group call rejoin request (MCPTT client – MCPTT server)

Table 10.6.2.2.18-1 describes the information flow group call rejoin request from the MCPTT client to the MCPTT server.

Table 10.6.2.2.18-1 Group call rejoin request information elements

Information Element	Status	Description
MCPTT ID	M	The MCPTT ID of the re-joining MCPTT group member
Functional alias	O	The functional alias of the re-joining MCPTT group member
MCPTT group ID	M	The MCPTT group ID of the group on which the call is on-going
SDP offer	M	Media parameters of MCPTT client

10.6.2.2.19 Group call rejoin response (MCPTT server – MCPTT client)

Table 10.6.2.2.19-1 describes the information flow group call rejoin response from the MCPTT server to the MCPTT client.

Table 10.6.2.2.19-1 Group call rejoin response information elements

Information Element	Status	Description
MCPTT ID	M	The MCPTT ID of the MCPTT group member rejoining the group call
Functional alias	O	The functional alias of the MCPTT group member re-joining the group call
MCPTT group ID	M	The MCPTT group ID of the group on which the call is on-going
SDP answer	M	Media parameters selected
Emergency indicator	O	Indicates that the ongoing group call is an MCPTT emergency group call
Imminent peril indicator	O	Indicates that the ongoing group call is an MCPTT imminent peril group call

10.6.2.2.20 Group join request (MCPTT client – MCPTT server)

Table 10.6.2.2.20-1 describes the information flow group join request from the MCPTT client to the MCPTT server.

Table 10.6.2.2.20-1 Group join request information elements

Information Element	Status	Description
MCPTT ID	M	The MCPTT ID of the MCPTT group member joining the group communications for the group
Functional alias	O	The functional alias of the MCPTT group member joining the group communication for the group
MCPTT group ID	M	The MCPTT group ID of the group to which the group communication is requested
SDP offer	M	Media parameters of MCPTT client
Implicit floor request (NOTE)	O	Indicates that the originating client requests the floor.
NOTE: This element shall be included only when the originating client requests the floor.		

10.6.2.2.21 Group join response (MCPTT server – MCPTT client)

Table 10.6.2.2.21-1 describes the information flow group join response from the MCPTT server to the MCPTT client.

Table 10.6.2.21-1 Group join response information elements

Information Element	Status	Description
MCPTT ID	M	The MCPTT ID of the MCPTT group member joining the group communications for the group
Functional alias	O	The functional alias of the MCPTT group member joining the group communication for the group
MCPTT group ID	M	The MCPTT group ID of the group to which the group communication is requested
SDP answer	M	Media parameters selected

10.6.2.2.22 Group call leave request (MCPTT server – MCPTT client)

Table 10.6.2.2.22-1 describes the information flow group call leave request from the MCPTT server to the MCPTT client.

Table 10.6.2.2.22-1 Group call leave request information elements

Information Element	Status	Description
MCPTT ID	M	The MCPTT ID of the MCPTT group member which has been de-affiliated
Functional alias	O	The functional alias of the MCPTT group member which has been de-affiliated
MCPTT group ID	M	The MCPTT group ID of the group on which the call is on-going

10.6.2.2.23 Group call leave response (MCPTT client – MCPTT server)

Table 10.6.2.2.23-1 describes the information flow group call leave response from the MCPTT client to the MCPTT server.

Table 10.6.2.2.23-1 Group call leave response information elements

Information Element	Status	Description
MCPTT ID	M	The MCPTT ID of the MCPTT group member which has been de-affiliated
Functional alias	O	The functional alias of the MCPTT group member which has been de-affiliated
MCPTT group ID	M	The MCPTT group ID of the group on which the call is on-going

10.6.2.2.24 Group interrogate request (MCPTT server – MCPTT server)

Table 10.6.2.2.24-1 describes the information flow group interrogate request between two MCPTT servers.

Table 10.6.2.2.24-1 Group interrogate request information elements

Information Element	Status	Description
MCPTT ID	M	The MCPTT ID of the requester
MCPTT group ID	M	The MCPTT group ID of the group being interrogated

10.6.2.2.25 Group interrogate response (MCPTT server – MCPTT server)

Table 10.6.2.2.25-1 describes the information flow group interrogate response between two MCPTT servers.

Table 10.6.2.2.25-1 Group interrogate response information elements

Information Element	Status	Description
MCPTT ID	M	The MCPTT ID of the requester
MCPTT group ID	M	The MCPTT group ID of the group being interrogated
MCPTT ID list	M	List of the MCPTT IDs for the MCPTT group members that are members of the MCPTT group ID

10.6.2.2.26 Group-broadcast group call request (MCPTT client – MCPTT server)

Table 10.6.2.2.26-1 describes the information flow group-broadcast group call request from the MCPTT client to the MCPTT server.

Table 10.6.2.2.26-1 Group-broadcast group call request information elements

Information Element	Status	Description
MCPTT ID	M	The MCPTT ID of the calling party
Functional alias	O	The functional alias of the calling party
MCPTT group ID	M	The MCPTT group ID of the group on which the call is requested
SDP offer	M	Media parameters of MCPTT clients
Implicit floor request	M	When originating client requests the floor, this element shall be included
Broadcast indicator	M	Indicates that the group call request is for a broadcast group call

10.6.2.2.27 Group-broadcast group call request (MCPTT server – MCPTT client)

Table 10.6.2.2.27-1 describes the information flow group-broadcast group call request from the MCPTT server to the MCPTT client.

Table 10.6.2.2.27-1 Group-broadcast group call request information elements

Information Element	Status	Description
MCPTT ID	M	The MCPTT ID of the calling party
Functional alias	O	The functional alias of the calling party
MCPTT group ID	M	The MCPTT group ID of the group on which the call is requested
SDP offer	M	Media parameters of MCPTT clients
Broadcast indicator	M	Indicates that the group call request is for a broadcast group call

10.6.2.2.28 Group-broadcast group call response (MCPTT client – MCPTT server)

Table 10.6.2.2.28-1 describes the information flow group-broadcast group call response from the MCPTT client to the MCPTT server.

Table 10.6.2.2.28-1 Group-broadcast group call response information elements

Information Element	Status	Description
MCPTT ID	M	The MCPTT ID of the target MCPTT group member
Functional alias	O	The functional alias of the target MCPTT group member
MCPTT group ID	M	The MCPTT group ID of the group on which the call is initiated
SDP answer	M	Media parameters selected
Result	M	Result of the group-broadcast group call request (success or failure)

10.6.2.2.29 Group-broadcast group call response (MCPTT server – MCPTT client)

Table 10.6.2.2.29-1 describes the information flow group-broadcast group call response from the MCPTT server to the MCPTT client.

Table 10.6.2.2.29-1 Group-broadcast group call response information elements

Information Element	Status	Description
MCPTT ID	M	The MCPTT ID of the calling party
Functional alias	O	The functional alias of the calling party
MCPTT group ID	M	The MCPTT group ID of the group on which the call is requested
SDP answer	M	Media parameters selected
Result	M	Result of the group-broadcast group call request (success or failure)

10.6.2.2.30 Group-broadcast group call release request (MCPTT client – MCPTT server)

Table 10.6.2.2.30-1 describes the information flow group-broadcast group call release request from the MCPTT client to the MCPTT server.

Table 10.6.2.2.30-1 Group-broadcast group call release request information elements

Information Element	Status	Description
MCPTT ID	M	The MCPTT ID of the MCPTT group member
Functional alias	O	The functional alias of the MCPTT group member
MCPTT group ID	M	The MCPTT group ID of the group on which the call is released

10.6.2.2.31 Group-broadcast group call release request (MCPTT server – MCPTT client)

Table 10.6.2.2.31-1 describes the information flow group-broadcast group call release request from the MCPTT server to the MCPTT client.

Table 10.6.2.2.31-1 Group-broadcast group call release request information elements

Information Element	Status	Description
MCPTT ID	M	The MCPTT ID of the MCPTT group member
Functional alias	O	The functional alias of the MCPTT group member
MCPTT group ID	M	The MCPTT group ID of the group on which the call is released

10.6.2.2.32 Group-broadcast group call release response (MCPTT server – MCPTT client)

Table 10.6.2.2.32-1 describes the information flow group-broadcast group call release response from the MCPTT server to the MCPTT client.

Table 10.6.2.2.32-1 Group-broadcast group call release response information elements

Information Element	Status	Description
MCPTT ID	M	The MCPTT ID of the MCPTT group member
Functional alias	O	The functional alias of the MCPTT group member
MCPTT group ID	M	The MCPTT group ID of the group on which the call is released

10.6.2.2.33 Group-broadcast group call release response (MCPTT client – MCPTT server)

Table 10.6.2.2.33-1 describes the information flow group-broadcast group call release response from the MCPTT client to the MCPTT server.

Table 10.6.2.2.33-1 Group-broadcast group call release response information elements

Information Element	Status	Description
MCPTT ID	M	The MCPTT ID of the MCPTT group member
Functional alias	O	The functional alias of the MCPTT group member
MCPTT group ID	M	The MCPTT group ID of the group on which the call is released

10.6.2.3 Group call within one MCPTT system

10.6.2.3.1 Group call models

10.6.2.3.1.1 Pre-arranged group call

10.6.2.3.1.1.1 General

A pre-arranged group call is initiated by one of the group members. The initiation of a pre-arranged group call results in all other affiliated group members being invited.

10.6.2.3.1.1.2 Pre-arranged group call setup

The procedure focuses on the case where an MCPTT client is initiating an MCPTT group call with unicast signalling for communicating with the affiliated MCPTT members of that group.

Procedures in figure 10.6.2.3.1.1.2-1 are the signalling control plane procedures for the MCPTT client initiating establishment of an MCPTT group call with a pre-arranged group i.e., MCPTT users on client 1, client 2 and client 3 belong to the same group which is defined in the MCPTT group management server.

Pre-conditions:

1. A pre-arranged group is an MCPTT group that is pre-defined with MCPTT group ID and member list in the group management server. All members of the group belong to the same MCPTT system.
2. It is assumed that MCPTT users on MCPTT client 1, MCPTT client 2 and MCPTT client 3 are already registered for receiving MCPTT service and affiliated. Optionally, they may have an activated functional alias to be used during the group communication.

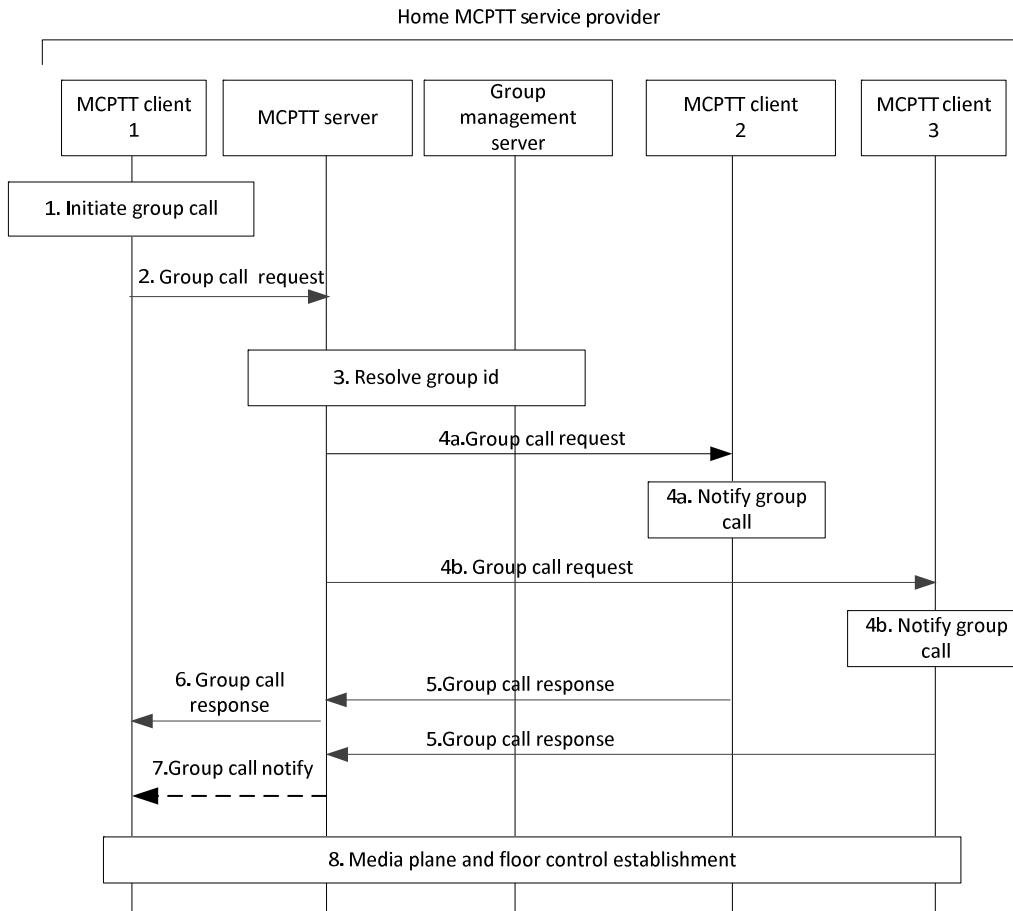

Figure 10.6.2.3.1.1.2-1: Pre-arranged group call setup

1. User at MCPTT client 1 would like to initiate an MCPTT group call with a selected group (identified by MCPTT group ID). The MC service user may select a functional alias, which is displayed to other MC service users.

NOTE 1: MCPTT client 1 need not be aware of the affiliation status of other MCPTT clients to the group while initiating the group call.

NOTE 2: The selected functional alias is not changed during the group call, i.e. a MCPTT client uses the same functional alias until the group call is released or the MCPTT client has left the group call.

2. MCPTT client 1 sends a group call request towards the MCPTT server via the SIP core, which hosts the group selected by the user and identified by MCPTT group ID. The group call request also contains the MCPTT group ID and an SDP offer containing the MCPTT client media parameters. If there is a floor request to transmit, then the group call request contains an indication of an implicit floor request. If the MC service user of MCPTT client 1 has selected a functional alias, then the group call request contains that functional alias.
3. MCPTT server checks whether the user of MCPTT client 1 is authorized to initiate a group call for the selected group. If authorized and the group call is ongoing for that MCPTT group ID, the MCPTT server adds the requesting MCPTT client 1 to the existing MCPTT group call and notifies the MCPTT client 1 that the MCPTT group call is already in progress. Otherwise, MCPTT server resolves the MCPTT group ID to determine the members of that group and their affiliation status, based on the information from the group management server.

If present, the MCPTT server checks whether the provided functional alias is allowed to be used and has been activated for the user.

NOTE 3: MCPTT server can have already retrieved the user/group configuration data and locally cached. If the user/group configuration data is not locally cached on the MCPTT server then MCPTT server requests the user/group configuration data from the MCPTT user database/group management server.

4. MCPTT server includes information that it communicates using MCPTT service, offers the same media parameters or a subset of the media parameters contained in the initial received request and sends the corresponding group call request via the SIP core towards the MCPTT clients of each of those affiliated group members. MCPTT users are notified about the incoming group call and the functional alias of the group call initiating user is displayed if present. The MCPTT server indicates whether acknowledgement is required for the call and the functional alias of the group call initiating MC service user may be displayed.
5. The receiving MCPTT clients accept the group call request, and a group call response is sent to the group host MCPTT server. This response may contain an acknowledgement. The conditions for sending acknowledgement may be based on configuration. The response may also contain a functional alias of the responding MC service user, which is verified (valid and activated for the user) by the MCPTT server.
6. MCPTT server sends the group call response including the selected media parameters to the MCPTT client 1 through the signalling path to inform about successful call establishment. The response may contain the functional alias, which may be displayed

NOTE 4: Step 6 can occur at any time following step 4b, and prior to step 7 depending on the conditions to proceed with the call.

7. If the initiating MCPTT user requires the acknowledgement from affiliated MCPTT group members, and the required MCPTT group members do not acknowledge the call setup within a configured time (the "acknowledged call setup timeout"), then the MCPTT server may proceed with or abandon the call and then notify the initiating MCPTT user that the acknowledgements did not include all required members according to group policy. This notification may be sent to the initiating MCPTT user by the MCPTT server more than once during the call when MCPTT users join or leave the MCPTT group call.
8. MCPTT client 1, client 2 and client 3 have successfully established media plane for communication. MCPTT floor participant 1, floor participant 2 and floor participant 3 exchange floor control information e.g., MCPTT client 1 receives the floor granted information over the established media plane assuming implicit floor control request from MCPTT client 1 while at the same time floor participants at other MCPTT client's receive floor taken information. MCPTT client 1 indicates to the MCPTT user that the floor is available to send media, while the other MCPTT clients in the group call will be receiving that media. If audio cut-in policy is enabled for the MCPTT group, floor arbitration follows the logic defined in subclause 10.9.1.5.

NOTE 5: The clients use the same functional alias within floor control procedures as used during group call setup.

10.6.2.3.1.1.3 Release pre-arranged group call

The procedure focuses on the case where an MCPTT server initiates the termination of an ongoing MCPTT group call for all the participants of that group call, since at least one of the termination conditions are met e.g., due to hang time expiry, last participant leaving, second last participant leaving, initiator leaving, or minimum number of affiliated MCPTT group members are not present.

NOTE: The procedure for MCPTT user leaving the group call is a different scenario and is not considered in this solution.

Procedures in figure 10.6.2.3.1.1.3-1 are the signalling control plane procedures for the MCPTT server initiating termination of an ongoing MCPTT group call.

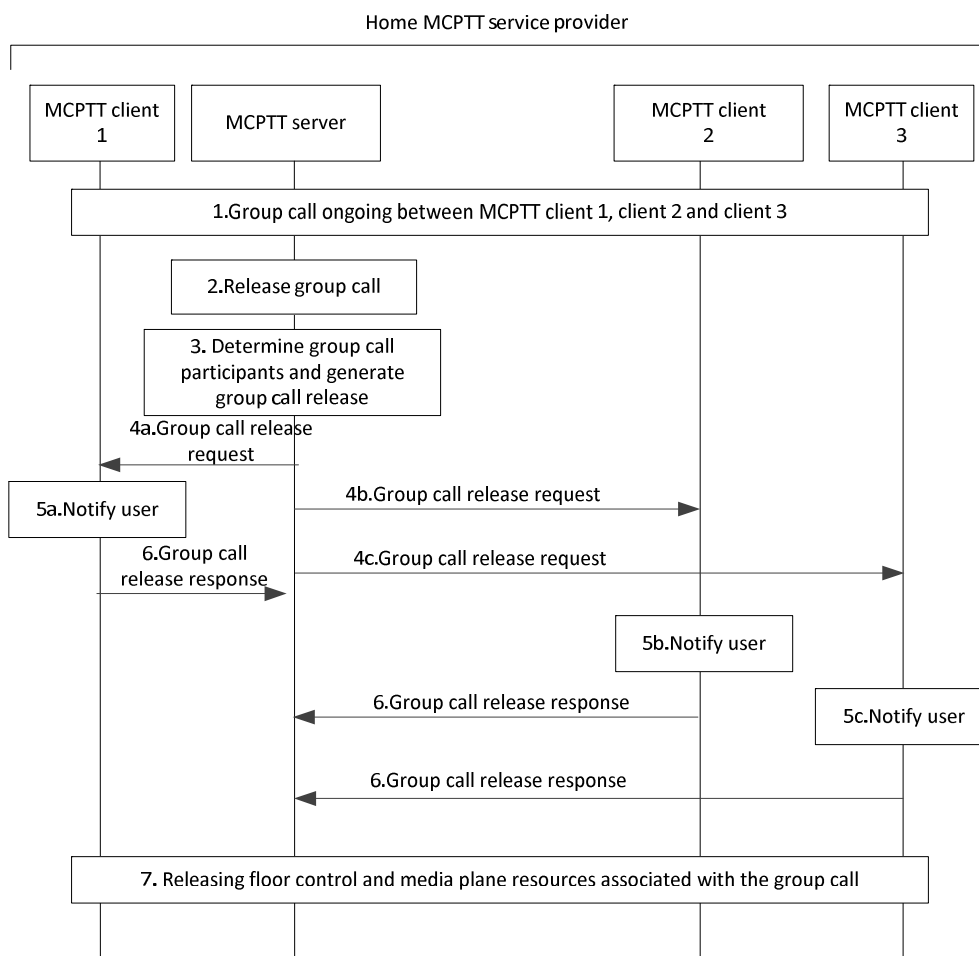

Figure 10.6.2.3.1.1.3-1: Release pre-arranged group call

1. It is assumed that MCPTT users on MCPTT client 1, client 2 and client 3 are already part of the ongoing group call (e.g., as a result of pre-arranged group call setup).
2. MCPTT server would like to release the MCPTT group call which is ongoing e.g., due to hang time expiry, last participant leaving, second last participant leaving, initiator leaving, or minimum number of affiliated MCPTT group members are not present.
3. MCPTT server identifies the participants of the ongoing group call and generates group call release request to release ongoing session.
4. MCPTT server sends a group call release request via SIP core towards each participant of the ongoing group call.
5. MCPTT users are notified about the release of the group call.
6. MCPTT client(s) receiving group call release request, acknowledge towards the MCPTT server by sending a group call release response.
7. MCPTT client 1, client 2 and client 3 have successfully released the floor control and media plane resources associated with the group call that is terminated.

10.6.2.3.1.1.4 Late entry pre-arranged group call

Procedures in figure 10.6.2.3.1.1.4-1 are the signalling control plane procedures for the MCPTT server requesting a newly affiliated member or a member coming back from out of coverage to join an ongoing MCPTT group call.

Pre-condition:

1. MCPTT group is previously defined on the group management server with MCPTT users affiliated to that group. All members of the group belong to the same MCPTT system.
2. It is assumed that MCPTT users on MCPTT client 2 to MCPTT client n are on an ongoing call. Optionally, the MCPTT users may use activated functional aliases.

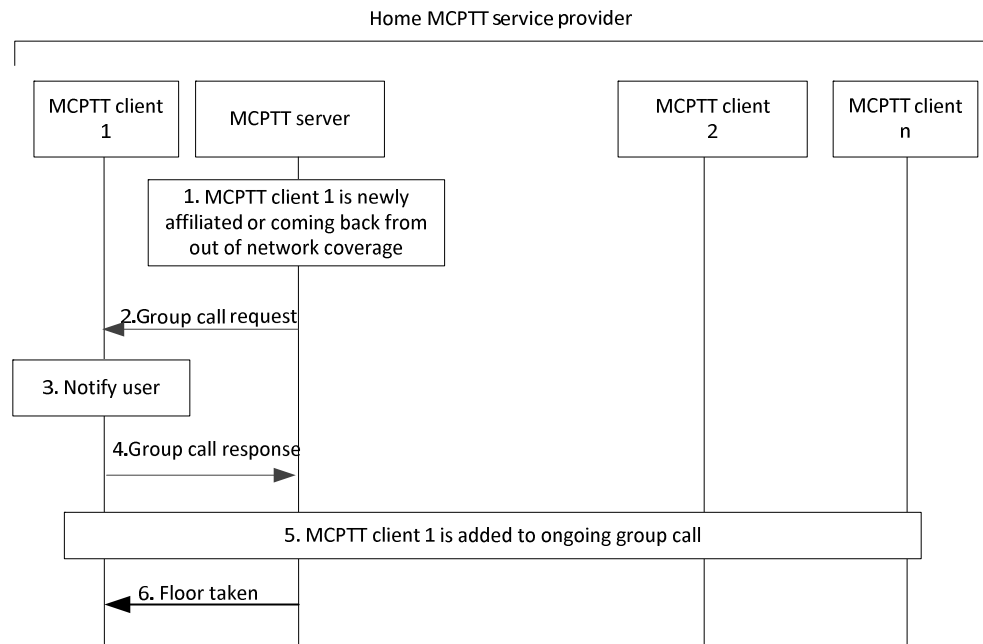

Figure 10.6.2.3.1.1.4-1: Late entry pre-arranged group call

1. MCPTT server determines that MCPTT client 1 which is newly affiliated or coming back from out of coverage has to be invited to join an ongoing group call (late entry).
2. MCPTT server generates group call request including the information such as MCPTT service identifier (possible for the SIP core to route the request to the MCPTT server), MCPTT group ID of the group invited to join, offer one or more media types and sends towards the MCPTT client 1 via SIP core.
3. MCPTT user at MCPTT client 1 is notified about the incoming group call.
4. Upon MCPTT user at MCPTT client 1 accepting the incoming group call request, MCPTT client 1 sends the group call response including the selected media types to the MCPTT server through the signalling path. If the incoming group call request is rejected by the MCPTT client 1, the MCPTT server should not resend the group call request. The group call response may also contain a functional alias of MCPTT client 1.
5. MCPTT client 1 is successfully added to the ongoing group call and MCPTT users at MCPTT client 1 to MCPTT client n may be notified about the MCPTT client 1 joining the group call and the functional alias of MCPTT client 1 may be displayed.
6. The floor taken with the information of the current talker is sent to MCPTT client 1.

10.6.2.3.1.1.5 Rejoining call

Procedures in figure 10.6.2.3.1.1.5-1 are the signalling control plane procedures for the MCPTT client to rejoin an ongoing MCPTT group call (e.g. coming back from out of coverage).

Pre-conditions:

- It is assumed that MCPTT users on MCPTT client 2 to MCPTT client n are on an ongoing call. Optionally, the MCPTT users may use activated functional aliases.

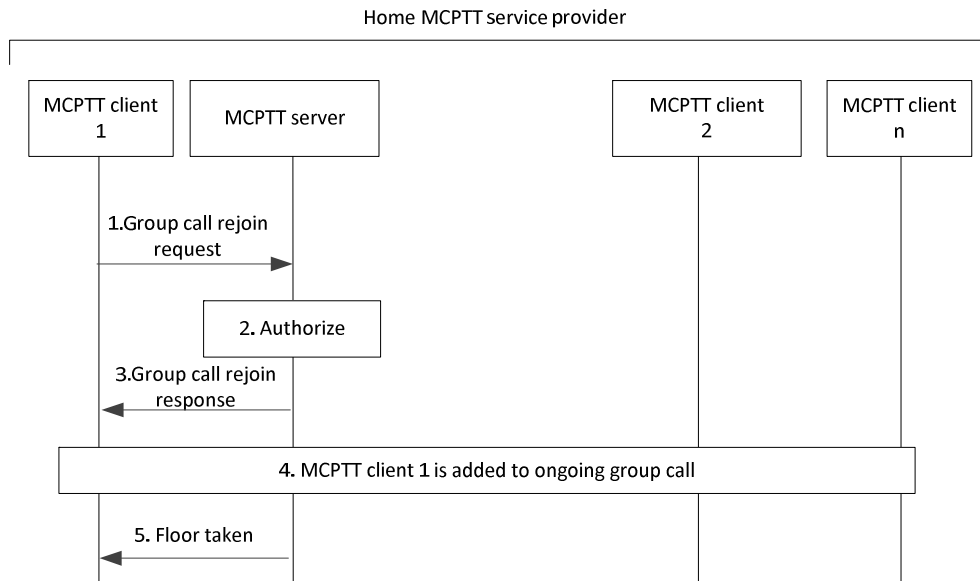

Figure 10.6.2.3.1.1.5-1: Rejoin call

1. MCPTT client 1 has necessary information for rejoining an ongoing group call, then the MCPTT client 1 initiates group call rejoin request including the ongoing group call information. The group call rejoin request may contain a functional alias of MCPTT client 1 as selected by the MC service user.
2. MCPTT server checks whether the MCPTT client 1 can rejoin the ongoing call (e.g. based upon affiliation status) and checks the functional alias, if present.
3. MCPTT client 1 is informed that the group call rejoin is successful by sending a group call rejoin response. If the ongoing group call is emergency or imminent peril group call, the response shall contain emergency or imminent peril indicator.
4. MCPTT client 1 is successfully added to the ongoing group call and MCPTT users at MCPTT client 1 to MCPTT client n may be notified about the MCPTT client 1 joining the group call and the functional alias of MCPTT client 1 may be displayed.
5. The floor taken with the information of the current talker is sent to MCPTT client 1.

10.6.2.3.1.2 Chat group call

10.6.2.3.1.2.1 General

In a chat group (restricted) call model, the MCPTT user individually joins a group call without being invited. The establishment of a chat group (restricted) call does not result in other group members being invited.

Figure 10.6.2.3.1.2.2-1 describes the basic procedure for the MCPTT client initiating an MCPTT group call which uses the chat group (restricted) call model. Restricted means that only users that have been configured as members of the given group are allowed to join the group communications for the given group.

Chat group join mechanism:

- Each MCPTT client sends a group join request when the MCPTT user wants to participate in the group communication for the group. (This message does not impact the MCPTT user's membership in the group; the MCPTT server will verify that the MCPTT user is an authorized member of the group.)
- The group join request may include a request to transmit. It is assumed that the group join request will be delivered from MCPTT client to MCPTT server using SIP.
- The group join request is used to indicate to the MCPTT server that the MCPTT user associated with the given MCPTT client wishes to participate (begin to receive media) from the group.

- The group join request may cause the MCPTT server to generate an implicit affiliation for the MCPTT user to the group, if the user is not already affiliated to the group.
- The group join request normally contains the information needed to negotiate media parameters between MCPTT server and MCPTT client for the group call. The group join request can take the form of a SIP invite.
- A selected functional alias is not changed by a MCPTT client during the whole participation within a chat group call, i.e. a MCPTT client uses the same functional alias selected when joining the chat group call until the chat group call is released or the MCPTT client leaves the chat group call.

Subsequent participation in a group call when the group is using the chat model:

- Once an MCPTT client successfully joins a group call which is using the chat model, the MCPTT client connects to the media plane for the call if the call is currently ongoing.
- If the MCPTT group call is not currently ongoing (i.e.: when MCPTT clients on the group call are not sending or receiving media, and the time out between floor control exchanges has expired) then the newly joined MCPTT client will only have pre-established its media parameters for the call.
- If the newly joined MCPTT user wishes to transmit media (start or re-start the call) to the affiliated users of the group using the chat model, then the MCPTT client using its associated floor control participant would follow a normal floor control procedure for requesting the floor.
- Since subsequent group call media transmissions are controlled using floor control signalling, additional SIP signalling messages may not be required for subsequent call stop and start.
- Each request to transmit from an MCPTT user could be viewed as a new instance of a group call for the given group when the floor idle timer expires and no media is present for an extended time.
- The MCPTT server may tear down the media plane between successive group calls using the chat model, or the MCPTT server may allow the media plane to remain up between successive group calls using the chat model depending on resources.

10.6.2.3.1.2.2 Chat group call setup

MCPTT client 1, client 2, and client 3 are served by the home MCPTT service provider in figure 10.6.2.3.1.2.2-1.

Pre-condition:

1. The MCPTT server may use the group join request to generate an implicit affiliation (using the affiliation procedure in subclause 10.8.3 in 3GPP TS 23.280 [16]) on behalf of the client that sends the MCPTT group join request.
2. MCPTT user 2 and MCPTT user 3 have previously joined (affiliated) to the group. MCPTT client 1, client 2, and client 3 are registered and all users (MCPTT user 1, user 2, and user 3) have been authenticated and authorized to use the MCPTT service.
3. MCPTT client 1, MCPTT client 2 and MCPTT client 3 may have activated functional alias(es) configured to be used during the group call communication. No call is currently in progress for the group.

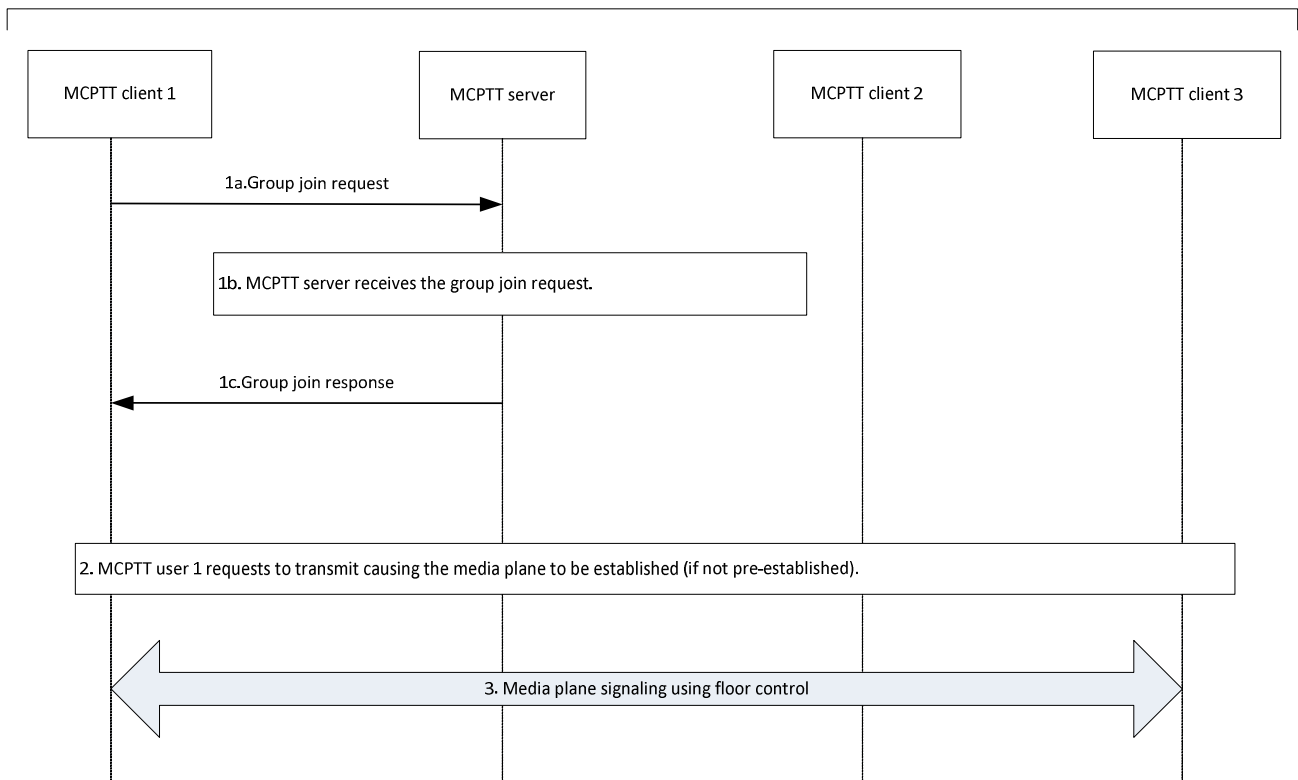

Figure 10.6.2.3.1.2.2-1: MCPTT chat group call

1. MCPTT user 1 indicates to join the group communication for the group. This may include a request to transmit.
 - 1a. MCPTT client 1 sends a group join request with the MCPTT group ID of the desired group. It contains the MCPTT user's MCPTT ID, the MCPTT client media parameters and optionally a functional alias. If there is a request to transmit, then the group joint request contains an indication of an implicit floor request.
 - 1b. The MCPTT server receives the group join request. MCPTT server generates an implicit affiliation (if the MCPTT user is not already affiliated to the group) and verifies that MCPTT user 1 is authorized to affiliate to the group by following the affiliation procedure (subclause 10.8.3 in 3GPP TS 23.280 [16]).

If present, the MCPTT server checks whether the provided functional alias is allowed to be used and has been activated for the user.
 - 1c. The MCPTT server replies with a group join response indicating the acceptance of the group join request and also returns the MCPTT server selected media parameters for the group call in the group join response.
2. If MCPTT user 1 requests to transmit, the MCPTT server establishes the media plane (if not already established) for the call. The associated floor participants for MCPTT client 1, client 2, and client 3 use the floor control procedure to initiate the call. E.g., the floor participant for MCPTT client 1 receives the MCPTT floor grant. The corresponding floor participants for MCPTT client 2 and MCPTT client 3 receive the MCPTT floor taken. If present, the functional alias of MCPTT client 1, MCPTT client 2 and MCPTT client 3 are displayed where appropriate.
3. Floor control will continue to be used by the floor participants associated with MCPTT client 1, MCPTT client 2 and MCPTT client 3 for the duration of the call. Media plane signalling using floor control will be used for subsequent calls for the group as long as one or more users are affiliated. If audio cut-in policy is enabled for the MCPTT group, floor arbitration follows the logic defined in subclause 10.9.1.5.

10.6.2.3.1.2.3 Release chat group call

The procedure describes the case where the MCPTT server releases an ongoing MCPTT group call for all the participants of that group call, since at least one of the conditions for release are met e.g. due to hang time expiry, last participant leaving, second last participant leaving, initiator leaving, or the number of affiliated MCPTT group members is below the minimum number permitted.

NOTE 1: The procedure for an MCPTT user leaving the group call is a different procedure.

Procedures in figure 10.6.2.3.1.2.3-1 are the procedures for the MCPTT server initiating the release of an ongoing MCPTT group call.

The following precondition applies:

- A group call is ongoing between MCPTT clients 1, 2 and 3

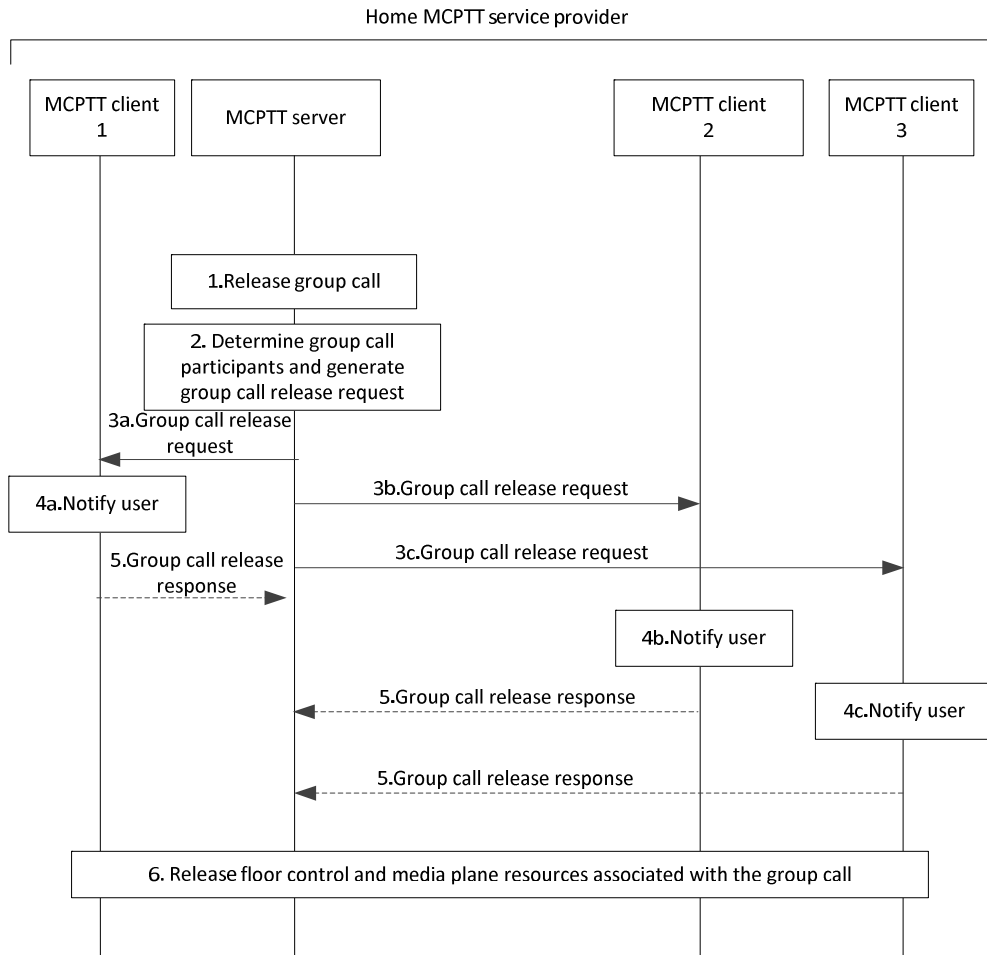

Figure 10.6.2.3.1.2.3-1: Release chat group call

1. MCPTT server would like to release the MCPTT group call which is ongoing e.g., due to hang time expiry, last participant leaving, second last participant leaving, initiator leaving, or minimum number of affiliated MCPTT group members are not present.

2. MCPTT server identifies the participants of the ongoing group call and generates group call release request to release the ongoing session.

3. MCPTT server sends a group call release request towards each participant of the ongoing group call.

NOTE 2: The group call release request can also be sent over SIP signalling on the signalling plane.

4. MCPTT users are notified about the release of the group call.

5. Optionally the MCPTT client(s) receiving group call release request, may send a group call release response to the MCPTT server.

NOTE 3: The MCPTT client can send group call release response when the group call release request is sent using a unicast bearer.

- MCPTT client 1, client 2 and client 3 release the floor control and media plane resources associated with the group call that is released. Successful release of the group call does not affect the status of affiliation of any of the clients.

10.6.2.3.1.2.4 Late entry chat group call

Procedures in figure 10.6.2.3.1.2.4-1 are those for the MCPTT server requesting a group member that is newly affiliated or coming back from out of coverage to join an ongoing MCPTT group call.

Pre-conditions:

- MCPTT group is previously defined on the group management server with MCPTT users affiliated to that group. All members of the group belong to the same MCPTT system.
- MCPTT users using MCPTT client 2 to MCPTT client n are in an ongoing call. Optionally, the MCPTT users may use activated functional aliases.

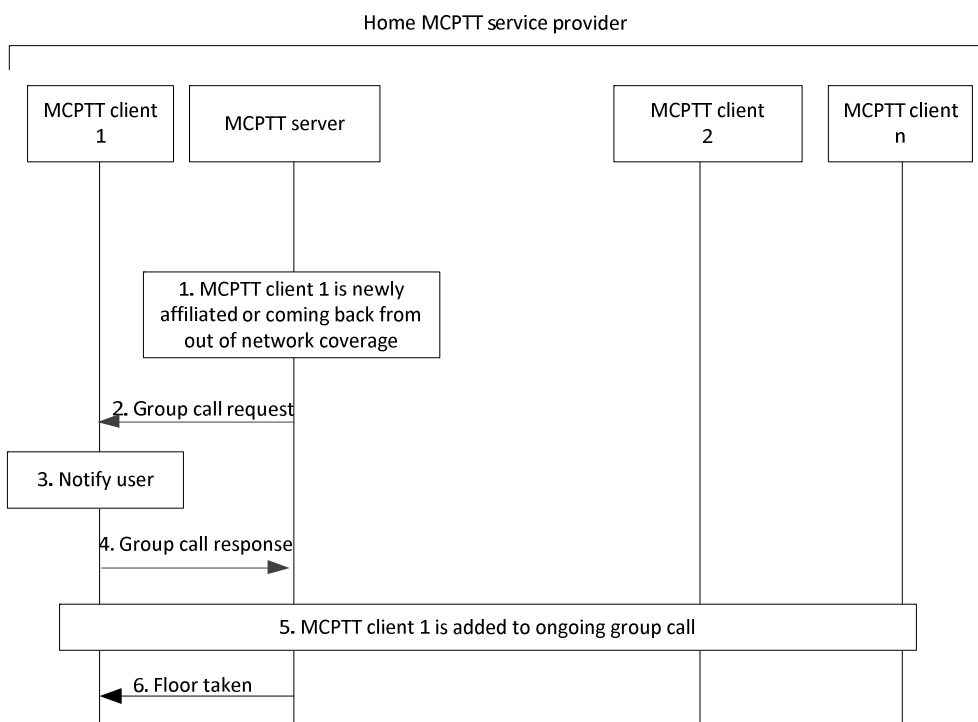

Figure 10.6.2.3.1.2.4-1: Late entry chat group call

- MCPTT server determines that MCPTT client 1 which is newly affiliated or has returned from being out of coverage has to be requested to join an ongoing group call (late entry).
- MCPTT server sends group call request to MCPTT client 1.
- MCPTT user at MCPTT client 1 is notified about the incoming group call.
- Upon MCPTT user at MCPTT client 1 accepting the incoming request, MCPTT client 1 sends a group call response to the MCPTT server. If the incoming request is rejected by MCPTT client 1, the MCPTT server should not resend the group call request. If the group call response includes a functional alias, it is the same functional alias as used before and checked by the MCPTT server.
- MCPTT client 1 is successfully added to the ongoing group call and MCPTT users at MCPTT client 1 to MCPTT client n may be notified about the MCPTT client 1 joining the group call. The functional aliases of MCPTT client 1 displayed, if present.
- Floor taken with the information of the current talker is sent to MCPTT client 1.

10.6.2.3.2 Exiting group call due to de-affiliation

Procedures in figure 10.6.2.3.2-1 are the signalling control plane procedures for the MCPTT server requesting a newly de-affiliated member to leave an ongoing MCPTT group call.

Pre-conditions:

1. MCPTT group is previously defined on the group management server with MCPTT users affiliated to that group. All members of the group belong to the same MCPTT system.
2. MCPTT users on MCPTT client 1 to MCPTT client n are on an ongoing call.
3. MCPTT client 1 has been de-affiliated from the MCPTT group.

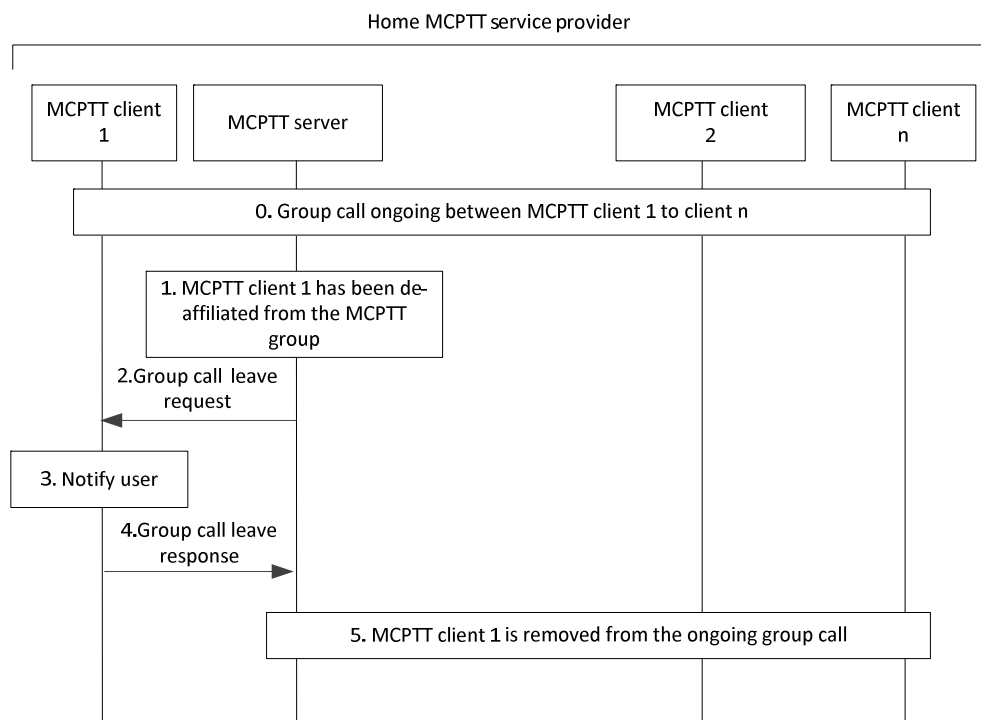

Figure 10.6.2.3.2-1: Exiting MCPTT group call due to de-affiliation

1. MCPTT client 1 which has been de-affiliated is instructed to leave the ongoing group call.
2. MCPTT server sends a group call leave request to MCPTT client 1.
3. MCPTT user at MCPTT client 1 is notified about leaving the group call.
4. MCPTT client 1 sends the group call leave response and leaves the group call.
5. MCPTT client 1 is now removed from the ongoing group call and MCPTT users at MCPTT client 2 to MCPTT client n may be notified that MCPTT client 1 has left the group call.

10.6.2.4 Group call involving groups from multiple MCPTT systems

10.6.2.4.1 Group call for temporary groups across multiple MCPTT systems

10.6.2.4.1.1 Group call setup

10.6.2.4.1.1.1 Group call setup procedure – originating side

Figure 10.6.2.4.1.1.1-1 illustrates the originating side group call involving groups from multiple MCPTT systems. It considers the scenario for group hierarchies and temporary groups formed by group regroup. The protocol followed may be SIP.

Pre-conditions:

1. The security aspects of sharing the user information between primary and partner MCPTT systems shall be governed as per the service provider agreement between them. In this case, we consider the partner MCPTT system does not share their users' information to the primary MCPTT system.
2. The MCPTT user belongs to an MCPTT group hosted by the primary MCPTT system.
3. A temporary group is formed by authorized MCPTT user/dispatcher by the group regroup procedure (subclause 10.2.4.2 in 3GPP TS 23.280 [16]) and identified via a temporary MCPTT group ID.
4. The MCPTT group members of the constituent MCPTT groups belonging to the temporary group are affiliated to participate in a group call for the temporary group.
5. The authorized MCPTT user/dispatcher created the temporary group on the MCPTT server of the primary MCPTT system.
6. The constituent groups of the temporary group may belong to MCPTT servers of the partner MCPTT systems.

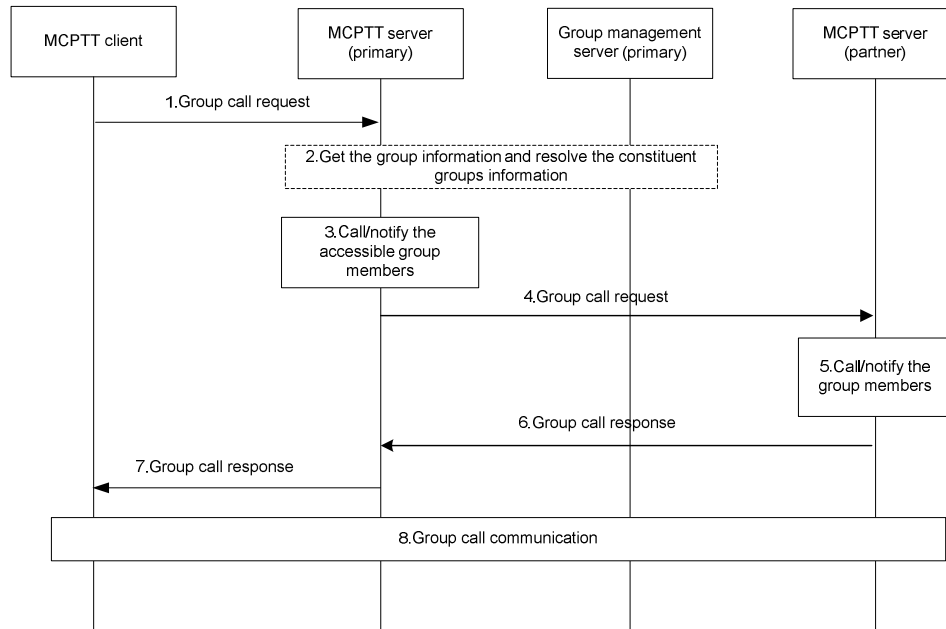

Figure 10.6.2.4.1.1.1-1: Group call setup involving temporary groups from multiple MCPTT systems (originating)

1. The affiliated MCPTT user via MCPTT client initiates a group call with an MCPTT group ID. A group call request message with the MCPTT group ID is routed to the MCPTT server of the primary MCPTT system, which owns the group and is where the authorized MCPTT user/dispatcher created the temporary group. If the group call is for a temporary group formed by the group regroup procedure, the MCPTT group ID will be a temporary MCPTT group ID.

2. The MCPTT server of the primary MCPTT system gets the group information (either from group management server or itself) including the constituent MCPTT groups' identities, accessible group members list of the constituent groups, and other related data.
3. The MCPTT server of the primary MCPTT system initiates directly a call request to the accessible group members using the detailed user information and/or location information. The group members upon receipt of the call request may accept or reject the call. Alternatively, the MCPTT server of the primary MCPTT system notifies the group members via a notification message containing the MCPTT group ID and/or the group call session identity information. Upon receipt of the notification message, the group members may perform a late call entry.
4. The MCPTT server of the primary MCPTT system may not have access to group members' information of the constituent group belonging to the partner MCPTT system. For such group members, the MCPTT server of the primary MCPTT system initiates a group call request message to the MCPTT server of the partner MCPTT system with the target group's MCPTT group ID information.
5. The MCPTT server of the partner MCPTT system further initiates a call request or call notification to the constituent group's members as described in step 3.
6. The MCPTT server of the partner MCPTT system provides a group call response to the MCPTT server of the primary MCPTT system with success or failure result and/or detailed reason information if there is a failure.
7. The MCPTT server of the primary MCPTT system provides a group call response message to the MCPTT client of the affiliated MCPTT user upon receiving responses to the call requests sent to members of primary and partner MCPTT systems. The group call response message will consist of the success or failure result and/or detailed reason information if there is a failure.

NOTE: The group call response message is triggered depending on the conditions to proceed with the call.

8. Upon successful call setup completion a group call is established for the group members from constituent groups of multiple MCPTT servers.

10.6.2.4.1.1.2 Group call setup procedure – terminating side

The procedure in figure 10.6.2.4.1.1.2-1 illustrates the terminating side group call involving groups from multiple MCPTT systems. It considers the scenario for group hierarchies and temporary groups formed by group regroup. The protocol followed may be SIP.

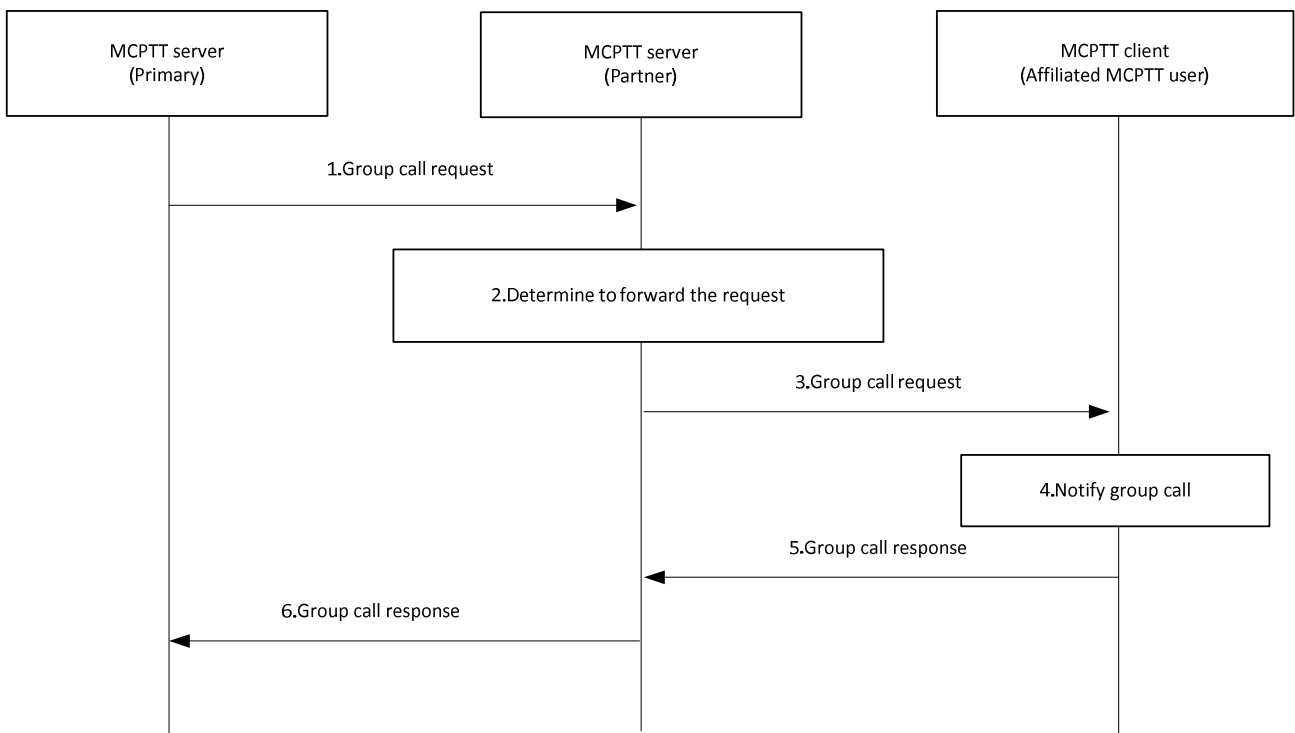

Figure 10.6.2.4.1.1.2-1: Group call involving groups from multiple MCPTT systems (terminating)

1. The MCPTT server of the primary MCPTT system sends the group call request message to the MCPTT server(s) of the partner MCPTT system.
2. The MCPTT server of the partner MCPTT system determines whether to forward the group call request message to the MCPTT client(s) based on the user affiliation.
3. The MCPTT server of the partner MCPTT system forwards the group call request message to MCPTT client(s). The MCPTT server indicates whether acknowledgement is required for the call.
4. The MCPTT user is notified about the incoming MCPTT group call.
5. The receiving MCPTT client(s) accept the group call request and a group call response message is sent to the MCPTT server of the partner MCPTT system. This response may contain an acknowledgement. The conditions for sending acknowledgement may be based on configuration.
6. The MCPTT server of the partner MCPTT system forwards the group call response message to the MCPTT server of the primary MCPTT system (i.e. group hosting MCPTT server for the group call involving groups from multiple MCPTT systems).

10.6.2.4.1.2 Group call release

The procedure focuses on the case where the group host MCPTT server releases an ongoing MCPTT group call for all the participants of that group call involving groups from multiple MCPTT systems, since at least one of the release conditions are met e.g., due to hang time expiry, last participant leaving, second last participant leaving, initiator leaving, or minimum number of affiliated MCPTT group members are not present.

NOTE: The scenario of MCPTT user leaving the group call is not considered in this procedure.

Figure 10.6.2.4.1.2-1 illustrates the procedure for the MCPTT server releasing an ongoing MCPTT group call involving groups from multiple MCPTT systems.

Pre-conditions:

1. The MCPTT server of the primary MCPTT system is controlling the group call involving groups from multiple MCPTT systems.
2. The MCPTT client 1 belongs to group of the MCPTT server of the primary MCPTT system and the MCPTT client 2 and client 3 belong to the groups of the MCPTT server of the partner MCPTT system.
3. The MCPTT users on MCPTT client 1, client 2 and client 3 are already part of the ongoing group call (e.g., as a result of group call setup involving groups from multiple MCPTT systems).

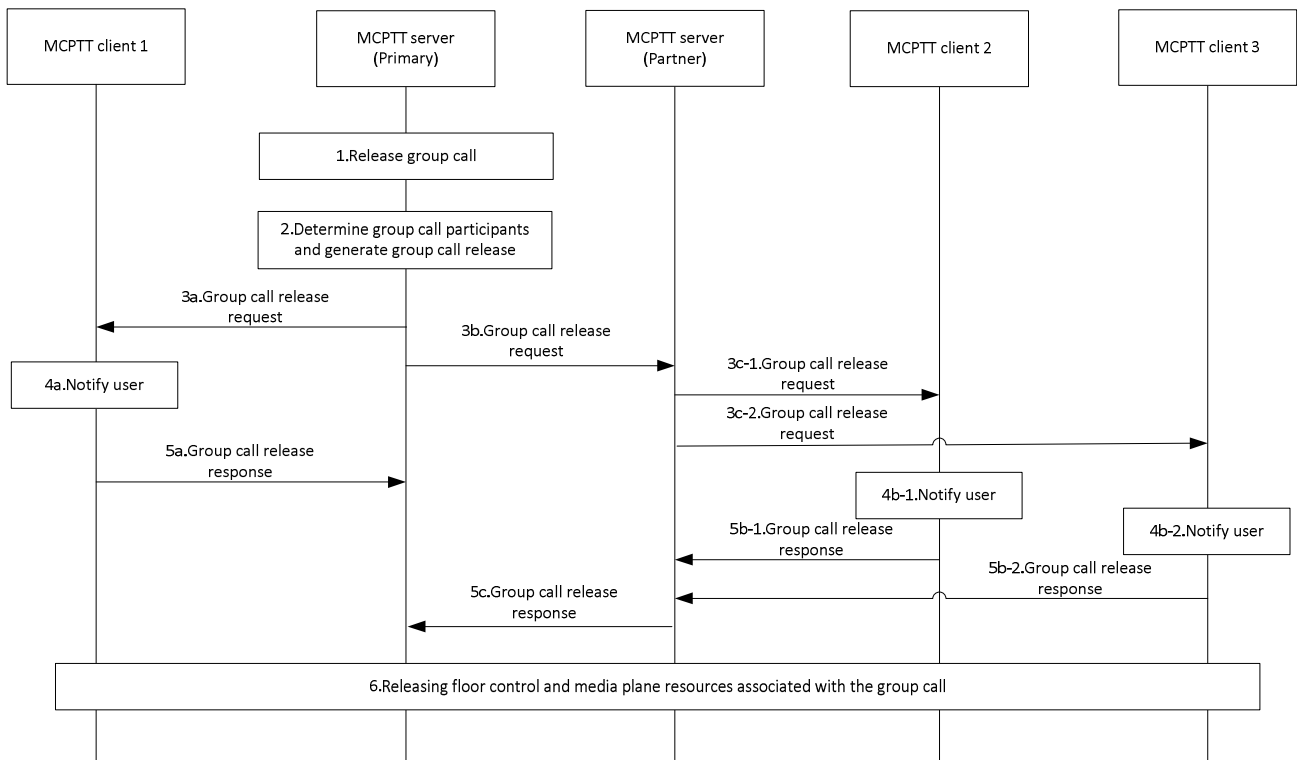

Figure 10.6.2.4.1.2-1: Group call release involving groups from multiple MCPTT systems

1. The MCPTT server of primary MCPTT system would like to release the MCPTT group call which is ongoing e.g., due to hang timer expiry, last participant leaving, second last participant leaving, initiator leaving, or minimum number of affiliated MCPTT group members are not present.
2. The MCPTT server of the primary MCPTT system identifies the participants of the ongoing group call and generates group call release message to release ongoing session.
3. The MCPTT server of the primary MCPTT system initiates a group call release request message via SIP core towards each accessible participant of the ongoing group call (3a). The MCPTT server of the primary MCPTT system may not have access to group members' information of the constituent group belonging to a partner MCPTT system. For such group members, the MCPTT server of the primary MCPTT system initiates a group call release request message (3b) to the MCPTT server(s) of the partner MCPTT system(s) with the target group's MCPTT group ID information. The MCPTT server(s) of the partner MCPTT system(s) further initiate group call release request messages (3c-1, 3c-2) to its group's users.
4. The MCPTT users are notified about the release of the group call.
5. The MCPTT client(s) receiving the group call release request messages provide group call release response to the MCPTT server of the primary MCPTT system. The MCPTT client(s) of the MCPTT users belonging to partner MCPTT system(s) route their responses via the MCPTT server(s) of the partner MCPTT system(s).
6. The MCPTT client 1, client 2 and client 3 have successfully released the floor control and media plane resources associated with the group call that is released.

10.6.2.4.2 Group call for temporary group formed by group regroup procedure involving multiple MCPTT systems via trusted mode

Figure 10.6.2.4.2-1 illustrates a group call involving a temporary group formed by group regroup from multiple MCPTT systems. The protocol followed may be SIP.

Pre-conditions:

1. The security aspects of sharing the user information between primary and partner MCPTT systems shall be governed as per the service provider agreement between them. In this case, we consider the partner MCPTT system shares their users' information to the primary MCPTT system.

2. The MCPTT user belongs to an MCPTT group hosted by the primary MCPTT system.
3. A temporary group is formed by authorized MCPTT user/dispatcher by the group regroup procedure (subclause 10.2.4.2 in 3GPP TS 23.280 [16]) and identified via a temporary MCPTT group ID.
4. The MCPTT group members of the constituent MCPTT groups belonging to the temporary group are affiliated to participate in a group call for the temporary group.
5. The authorized MCPTT user/dispatcher created the temporary group on the MCPTT server of the primary MCPTT system.
6. The constituent groups of the temporary group may belong to MCPTT servers of the partner MCPTT systems.

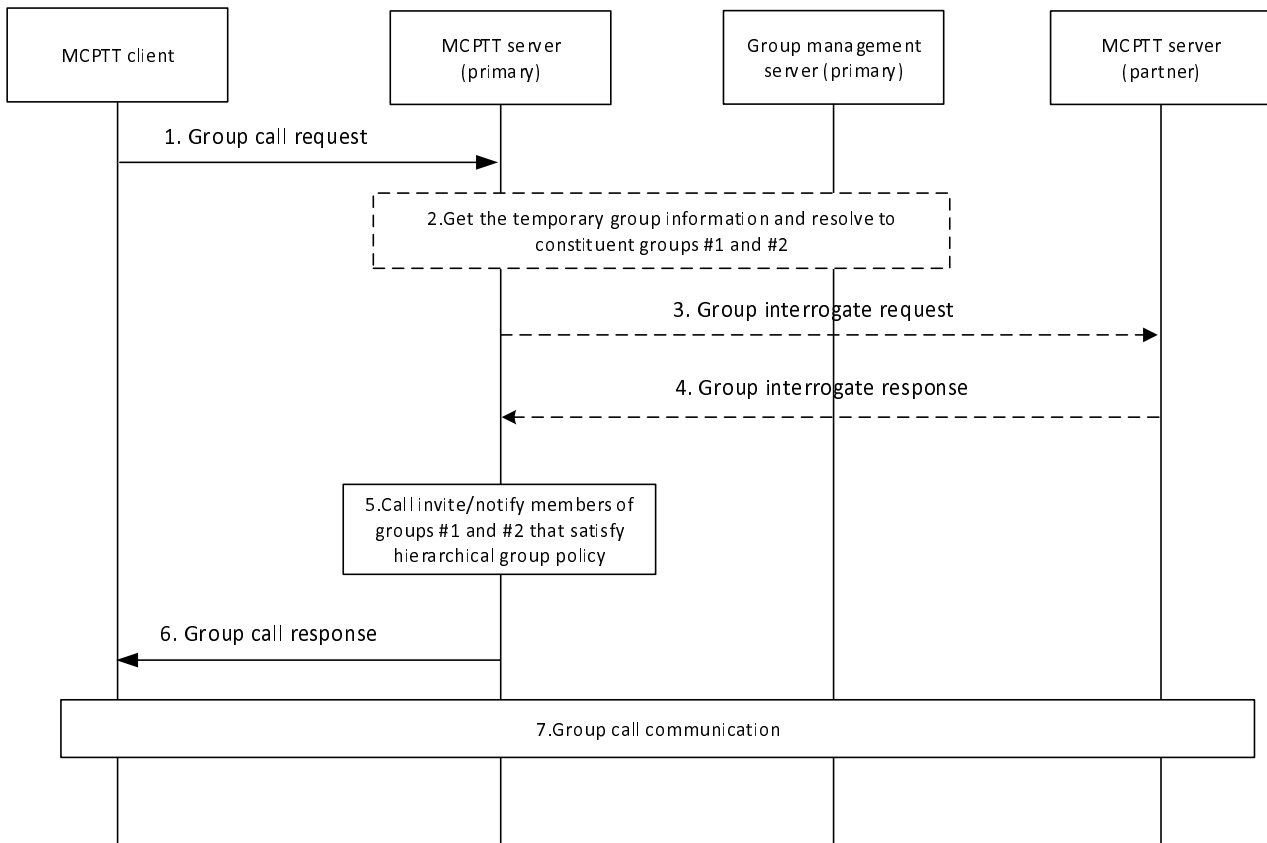

Figure 10.6.2.4.2-1: Group call involving temporary group formed by group regroup from multiple MCPTT systems

1. The affiliated MCPTT user via MCPTT client initiates a group call with an MCPTT group ID. A group call request message with the MCPTT group ID is routed to the MCPTT server of the primary MCPTT system, which owns the temporary group formed by group regroup procedure, and is also where the authorized MCPTT user/dispatcher has created the temporary group. The MCPTT group ID will be a temporary MCPTT group ID.
2. The MCPTT server of the primary MCPTT system gets the group information (either from group management server or itself) including the constituent MCPTT groups' identities, and other related data.
3. The MCPTT server of the primary MCPTT system may interrogate the MCPTT server of the partner MCPTT system for the affiliated group 2 members.
4. The MCPTT server of the partner MCPTT system responds with a list of the affiliated group members of group 2.

NOTE 1: Steps 3 and 4 do not occur if the constituent groups' information is available and up to date at primary MCPTT system due to the procedure for temporary group formation as defined in subclause 10.2.4.2 in 3GPP TS 23.280 [16].

5. The MCPTT server of the primary MCPTT system verifies the commencement policies of the temporary group, and initiates a call invitation or call notification to the affiliated members of groups 1 and 2.
6. The MCPTT server of the primary MCPTT system provides group call response message to the MCPTT UE of authorized MCPTT user/dispatcher upon receiving responses to the call invitations sent to members of primary and partner MCPTT systems. The group call response will consist of the success or failure result and/or detailed reason information if there is a failure.
7. Upon successful call setup completion a group call is established for the group members belonging to constituent groups of multiple MCPTT systems.

NOTE 2: MCPTT clients are generally aware that their (constituent) groups have been regrouped (e.g., see subclause 10.1.5.3 in 3GPP TS 23.280 [16]); however, if not, the partner MCPTT server of the constituent group can also respond to a group call request with a redirection response, such as "moved temporarily" that includes the group URI of the temporary group formed by group regroup procedure.

10.6.2.4.3 Group call for an MCPTT group defined in the partner MCPTT system

10.6.2.4.3.1 Group call setup procedure – initiating side

Figure 10.6.2.4.3.1-1 illustrates the group call setup procedure for an MCPTT group defined in the partner MCPTT system.

Pre-conditions:

1. MCPTT group is defined on the group management server which is located in the partner MCPTT system with MCPTT users affiliated to that group.
2. The members of the MCPTT group defined in partner MCPTT system belong to different MCPTT systems.

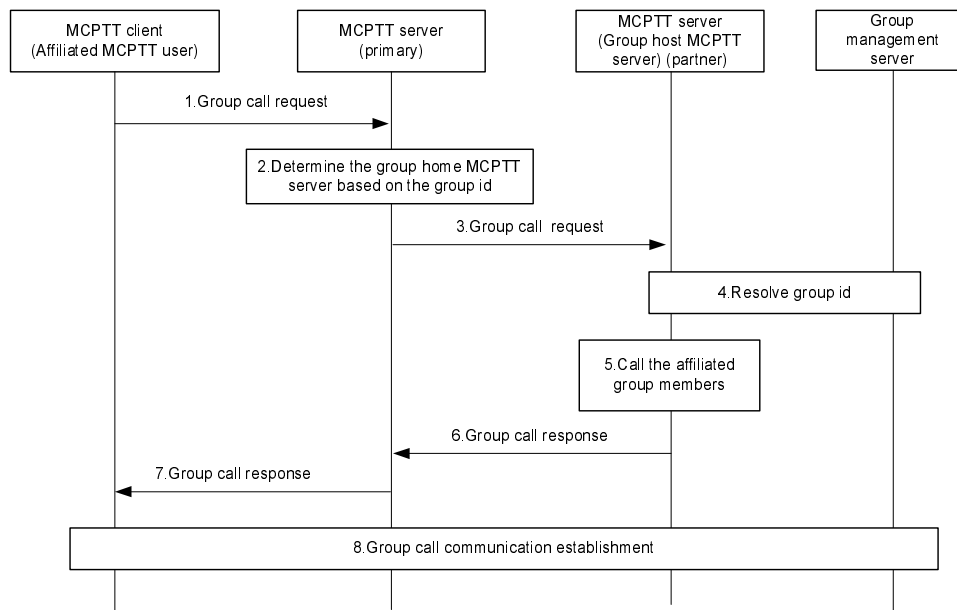

Figure 10.6.2.4.3.1-1: Group call for an MCPTT group defined in partner MCPTT system (initiating)

1. The affiliated MCPTT user via MCPTT client initiates a group call with an MCPTT group ID. A group call request message with the MCPTT group ID is routed to the MCPTT server of the primary MCPTT system.
2. The MCPTT server of the primary MCPTT system determines the group home MCPTT server where the MCPTT group is defined.
3. The MCPTT server of the primary MCPTT system forwards the group call request to the MCPTT server of the partner MCPTT system which owns the group and is where the authorized MCPTT user/dispatcher created the temporary group.

4. The MCPTT server of the partner MCPTT system checks whether the user of MCPTT client is authorized for initiating the group call for the selected group. If authorized, it resolves the MCPTT group ID to determine the members of that group and their affiliation status, based on the information from group management server.
5. The MCPTT server of the partner MCPTT system initiates a call request to the group's affiliated members.
6. The MCPTT server of the partner MCPTT system provides a group call response message to the MCPTT server of the primary MCPTT system of the MCPTT client. The group call response message will consist of the success or failure result and/or detailed reason information if there is a failure.
7. The MCPTT server of the primary MCPTT system forwards the group call response message to the MCPTT client.
8. Upon successful call setup completion a group call is established for the group members.

10.6.2.4.3.2 Group call setup – terminating side

The procedure described in figure 10.6.2.4.3.2-1 is used for group call setup when acknowledgement is required from at least some of the call recipients.

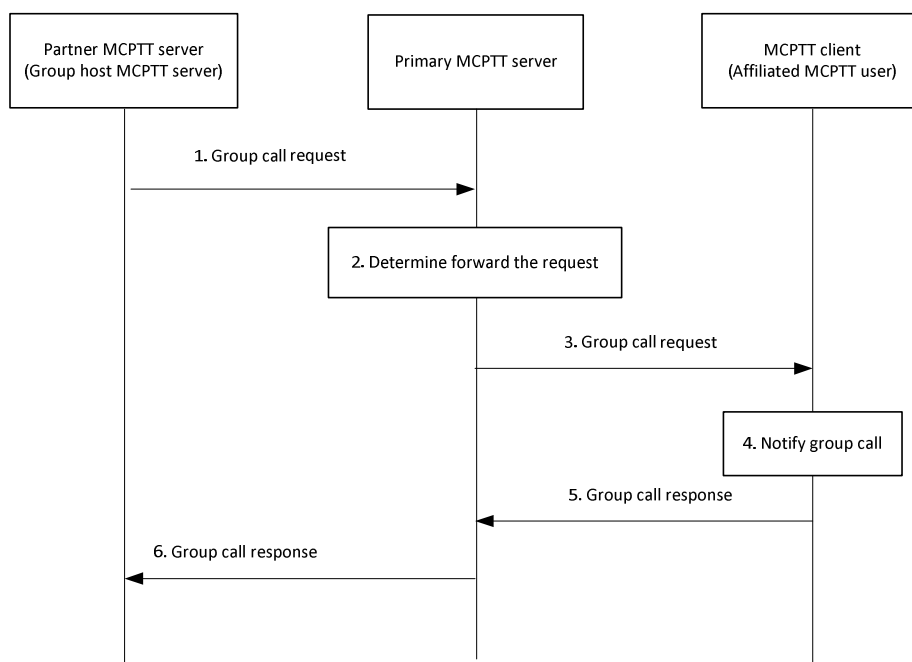

Figure 10.6.2.4.3.2-1: Group call for an MCPTT group defined in partner MCPTT system (terminating)

1. MCPTT server of the partner MCPTT system sends the group call request message towards to the MCPTT server of the primary MCPTT system of the MCPTT client.
2. The MCPTT server of the primary MCPTT system determines whether to forward the group call request message to the MCPTT client based on the user subscription.
3. The MCPTT server of the primary MCPTT system forwards the group call request message to MCPTT client. The MCPTT server indicates whether acknowledgement is required for the call.
4. MCPTT user is notified about the incoming group call.
5. The receiving MCPTT client accepts the group call and a response message is sent to the MCPTT server of the primary MCPTT system. This response may contain an acknowledgement. The conditions for sending acknowledgement may be based on configuration.
6. The MCPTT server of the primary MCPTT system forwards the response message to the MCPTT server of the partner MCPTT system (i.e. group hosting MCPTT server).

10.6.2.4.4 Merging of groups involving multiple MCPTT systems

Figure 10.6.2.4.4-1 below illustrates the merging of MCPTT clients in a newly formed temporary group with active group calls.

Pre-conditions:

1. The temporary group consists of group 1, which is hosted by the primary MCPTT system, and group 2, which is hosted by the partner MCPTT system.
2. Both group 1 and group 2 have active calls.
3. The group management client of the authorized MCPTT user belongs to the primary MCPTT system.

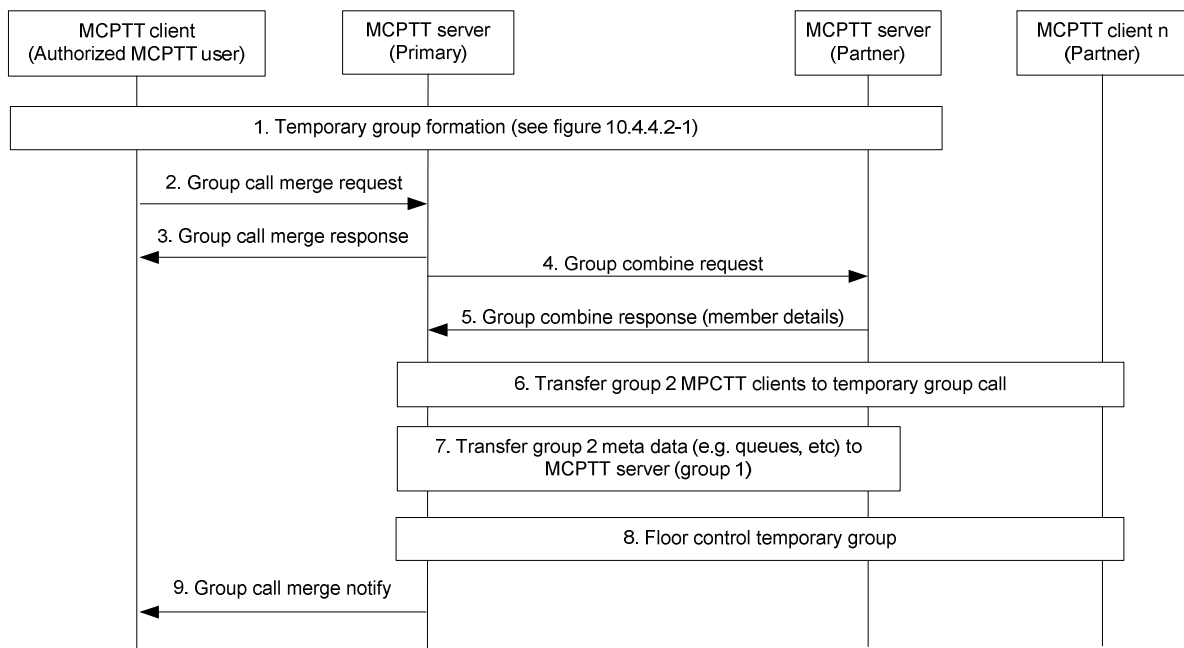

Figure 10.6.2.4.4-1: Merging of groups involving multiple MCPTT systems

1. The temporary group formation - group regrouping involving multiple MCPTT systems, according to subclause 10.2.4.2 in 3GPP TS 23.280 [16], takes place.
2. The MCPTT client of the authorized MCPTT user requests group call merge operation to MCPTT server hosting group 1. The identities of the groups being combined are included in this message.
3. The MCPTT server (primary) responds with an OK response.
4. The MCPTT server (primary) sends a group combine request to the MCPTT server (partner) that is hosting group 2.
5. The MCPTT server (partner) responds with a list members of group 2 and an indication of which members are affiliated and which are active in the call.
6. The MCPTT server (primary) contacts the active members of group 2 inviting them to join the temporary group call.
7. The MCPTT server (partner) transfers group 2's floor status data (including pending requests and queue positions) to the primary MCPTT server and combines this with the group 1's floor status data in order to create the temporary group's floor status data.
8. The MCPTT server (primary) performs floor control for the temporary group.

9. The MCPTT server (primary) notifies the MCPTT client of the authorised MCPTT user that the active calls have been merged.

NOTE: The MCPTT server in primary system revokes and queues floor given to one of the two talkers based on the arbitration result for the temporary group.

10.6.2.5 Broadcast group call

10.6.2.5.1 General

A broadcast group call is a special group call where the initiating MCPTT user expects no response from the other MCPTT users, so that when his transmission is complete, so is the call.

10.6.2.5.2 Common broadcast group call procedure

The group-broadcast group and the regrouped group are similar in structure (a collection of groups). Similarly the user-broadcast group and the pre-arranged group (a collection of users) are similar in structure. Only the call originator can transmit media during the broadcast group call and the broadcast group call is released when the transmission is complete, unless the call originator is overridden.

Figure 10.6.2.5.2-1 illustrates the common procedure both for group-broadcast group call and user-broadcast group call.

Pre-conditions:

1. MCPTT client 1 and MCPTT client 2 are members of a group-broadcast group/user-broadcast group.

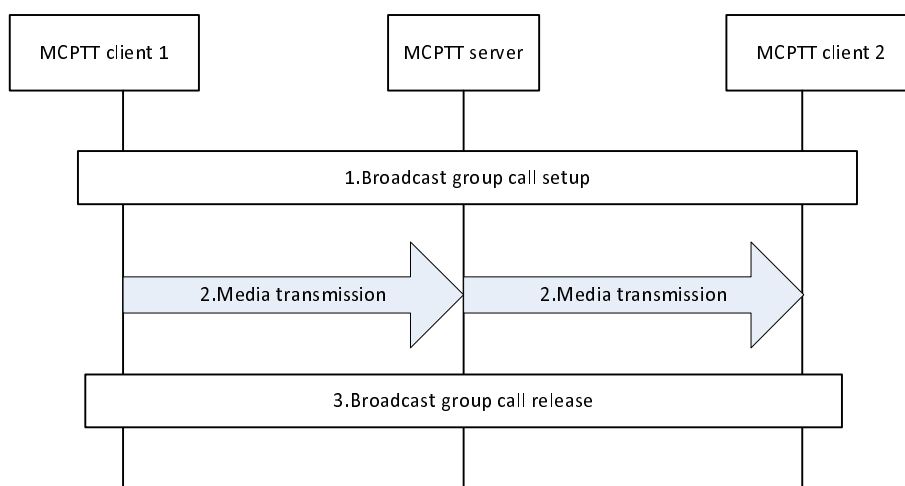

Figure 10.6.2.5.2-1: Broadcast group call

1. MCPTT user at MCPTT client 1 initiates the broadcast group call setup procedure with the indication of broadcast group call. The signalling procedure is identical to the group call setup as described in subclause 10.6.2 with the inclusion of the parameter for broadcast group call indicator.

NOTE 1: Broadcast group call applies to both pre-arranged and chat group call model. In the chat group call model case, the broadcast group call setup procedure is done by floor control signalling.

2. MCPTT client 1 starts to transmit media.

NOTE 2: Only the call originating MCPTT user is allowed to transmit media on broadcast group call, unless overridden.

NOTE 3: A broadcast group call transmitted on a user-broadcast group has priority over group calls involving users within the user hierarchy. A broadcast group call transmitted on a group-broadcast group has priority over group calls on its subordinate groups.

3. If the media transmission from call originating MCPTT user is complete, the broadcast group call is released.

10.6.2.5.2.1 Group-broadcast group call procedure

The group-broadcast group is defined as a set of groups, not a set of MCPTT users. The group-broadcast group is also defined with a hierarchy. It is expected that the MCPTT user that originates the group-broadcast group call is the only one transmitting media during the group-broadcast group call and that the group-broadcast group call is terminated when the transmission is complete. However, if the override feature is enabled, then the call originator may be overridden.

Figure 10.6.2.5.2.1-1 illustrates the procedure for group-broadcast group call establishment.

Pre-conditions:

1. The group (e.g. A) to which MCPTT client 1 and MCPTT client 2 are members is a subordinate group of the group-broadcast group (i.e., the group-broadcast group was defined with group A as a subordinate group).
2. The group (e.g. A) currently has an on-going MCPTT group call that is not an MCPTT emergency group call.
3. The call initiator of the group-broadcast group is a member of another group (e.g., X, not group A) which is also a subordinate group of the group-broadcast group (i.e., the group-broadcast group was defined with group X as a subordinate group).
4. The group-broadcast group and its subordinated groups are defined in the same group management server and served by the same MCPTT server.

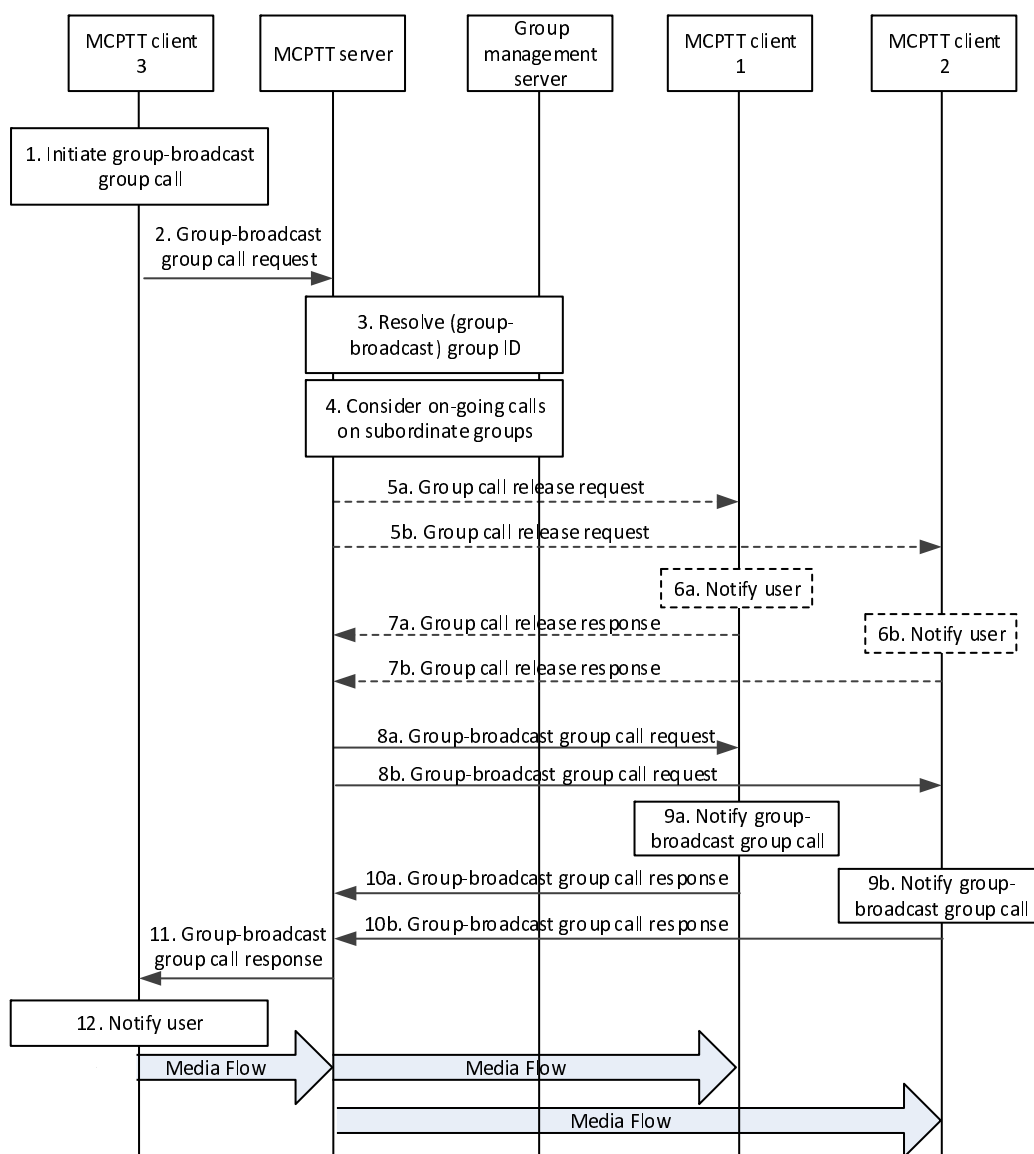

Figure 10.6.2.5.2.1-1: Group-broadcast group call

1. MCPTT user at MCPTT client 3 initiates the group-broadcast group call setup procedure.
2. The MCPTT client 3 sends a group-broadcast group call request to the MCPTT server.
3. The MCPTT server needs to resolve the group-broadcast group ID into its subordinate groups in order to contact the affiliated MCPTT users of those subordinate groups.
4. The MCPTT server then needs to consider any on-going group calls on those subordinate groups because this may effect the behaviour for what happens next. In this case a group call exists on a subordinate group. Thus the MCPTT users involved in the group call on this subordinate group.
5. Optionally the on-going group call on a subordinate group may be terminated in which case the MCPTT client 1 and MCPTT client 2 need to be sent a Group call release request.
6. The MCPTT client 1 and MCPTT client 2 then notify their users of the group call release request.
7. The MCPTT client 1 and MCPTT client 2 respond to the group call release request by sending a group call release response.
8. A group-broadcast group call request is sent to both the MCPTT client 1 and the MCPTT client 2.
9. MCPTT client 1 and MCPTT client 2 notify their users of the incoming group-broadcast group call.

10. MCPTT client 1 and MCPTT client 2 respond to the group-broadcast group call request by sending a group-broadcast group call response.
11. The MCPTT server responds to MCPTT client 3 (the call initiator) that the group-broadcast group call has been established by sending a group-broadcast group call response.
12. The MCPTT client 3 notifies its user that the user can begin transmitting using the group-broadcast group call resources.

Resources are now available for the transmission from MCPTT client 3 to MCPTT client 1 and MCPTT client 2. Once the user of MCPTT client 3 completes transmitting, the group-broadcast group call is released as are the resources.

10.6.2.5.2.2 Group-broadcast group call procedure when a subordinate group has an on-going MCPTT emergency group call

The group-broadcast group is defined as a set of groups, not MCPTT users. The affiliated MCPTT group members of a subordinate group with an on-going MCPTT emergency group call are not interrupted by a group-broadcast group call.

Figure 10.6.2.5.2.2-1 illustrates the procedure for group-broadcast group call when a subordinate group has an on-going MCPTT emergency group call.

Pre-conditions:

1. MCPTT The group (e.g. A) to which MCPTT client 1 and MCPTT client 2 are members is a subordinate group of the group-broadcast group (i.e., the group-broadcast group was defined with group A as a subordinate group).
2. The group (e.g. A) currently has an on-going MCPTT emergency group call.
3. The call initiator (user of MCPTT client 3) of the group-broadcast group is a member of another group (e.g., X, not group A) which is also a subordinate group of the group-broadcast group (i.e., the group-broadcast group was defined with group X as a subordinate group).

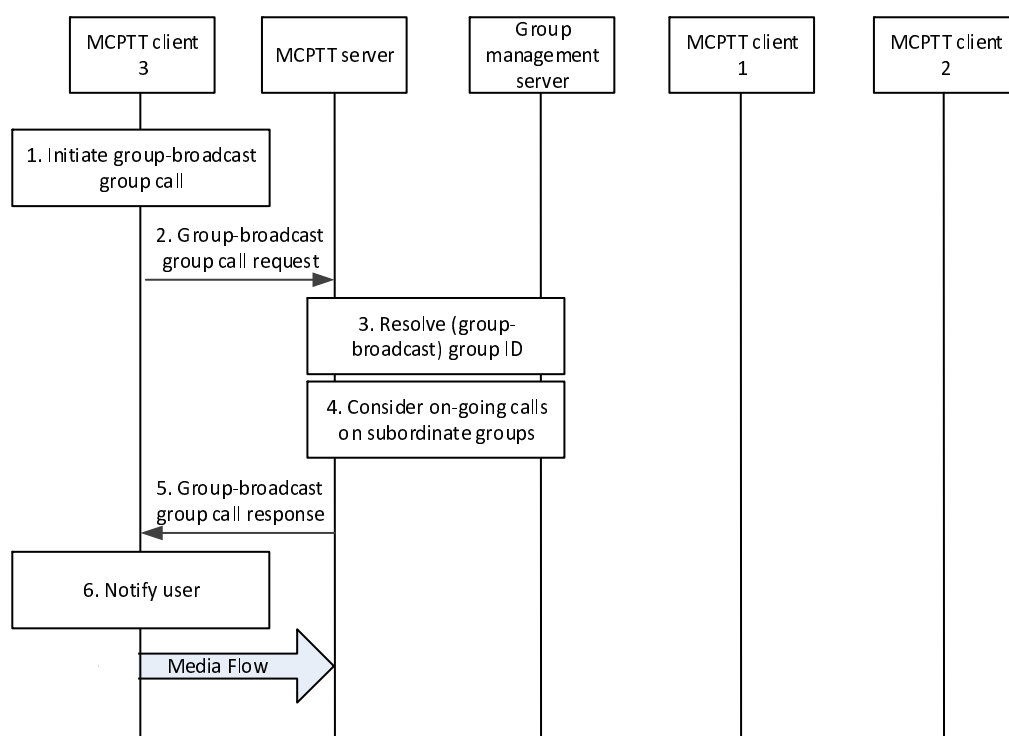

Figure 10.6.2.5.2.2-1: Group-broadcast group call when an emergency group call is on-going in one of the subordinate groups

1. The MCPTT user at MCPTT client 3 initiates the group-broadcast group call setup procedure.
2. The MCPTT client 3 sends a group-broadcast group call request to the MCPTT server.

3. The MCPTT server needs to resolve the group-broadcast group ID into its subordinate groups in order to contact the affiliated MCPTT group members of those subordinate groups.
4. The MCPTT server then considers any on-going group calls on those subordinate groups (e.g. A) because this may effect the behaviour for what happens next. In this case an emergency group call exists on a subordinate group.

NOTE: Not shown - The group-broadcast group call request is sent to the MCPTT clients of the MCPTT users who are affiliated members of any other subordinate groups of the group-broadcast group being set up

5. The MCPTT server responds to the call initiator that the group-broadcast group call has been established.
6. The MCPTT client 3 notifies its user that the user can begin transmitting using the group-broadcast group call resources.

Resources are now available for the transmission from MCPTT client 3 to the MCPTT clients (not shown) of other subordinate groups (i.e., not A). Once the user of MCPTT client 3 completes transmitting, the group-broadcast group call is released as are the resources.

10.6.2.5.2.3 Group-broadcast group call release procedure

When the call originator has completed transmitting, the group-broadcast group call is terminated and resources released.

Figure 10.6.2.5.2.3-1 illustrates the procedure for group-broadcast group call release.

Pre-conditions:

1. An on-going group-broadcast group call involving MCPTT client 1, MCPTT client 2, and MCPTT client 3 exists.

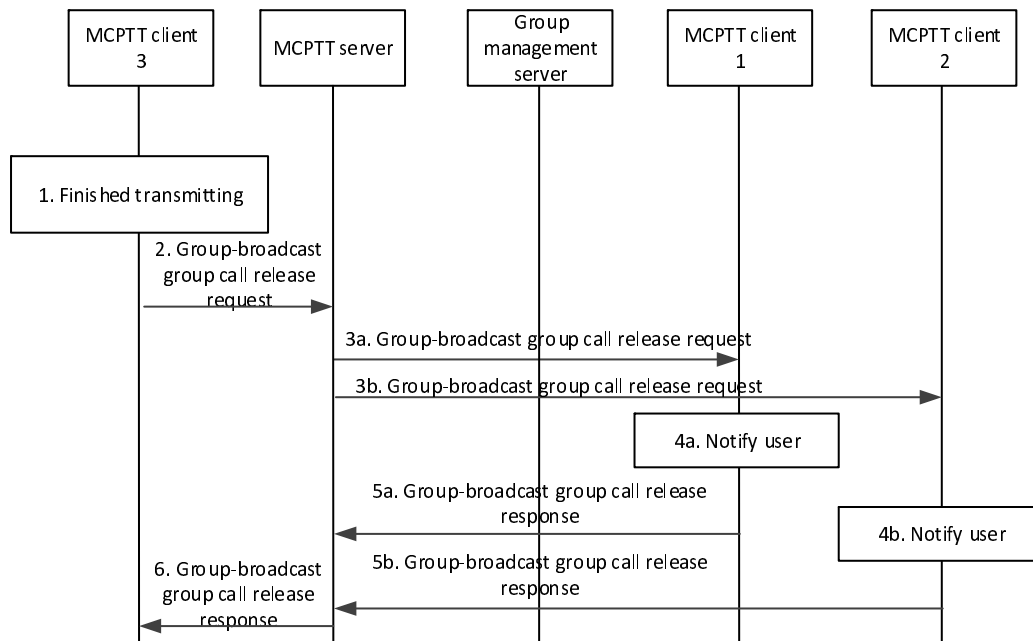

Figure 10.6.2.5.2.3-1: Group-broadcast group call transmission ended

1. MCPTT user on MCPTT client 3 finished transmitting.
2. A group-broadcast group call release request is sent to the MCPTT server of the group-broadcast group.
3. The MCPTT users of MCPTT client 1 and MCPTT client 2 of the group-broadcast group's subordinate groups are sent a group-broadcast group call release request
4. MCPTT client 1 and MCPTT client 2 notify their users that the group-broadcast group call has ended.

5. MCPTT client 1 and MCPTT client 2 respond to confirm the release of the group-broadcast group call by sending a group-broadcast group call release response.
6. The MCPTT server sends a group-broadcast group call release response indicating to the initiator that the call is now terminated.

10.6.2.5.2.4 Server-initiated broadcast group call release procedure

In a broadcast group call, when the call originator has completed transmitting, the MCPTT client releases the floor. Upon receiving the floor release message the MCPTT server then determines if the broadcast call should be released.

Figure 10.6.2.5.2.4-1 illustrates the procedure for server-initiated broadcast group call release.

Pre-conditions:

1. An on-going broadcast group call involving MCPTT client 1, MCPTT client 2, and MCPTT client 3 exists.
2. MCPTT client 3 is transmitting.

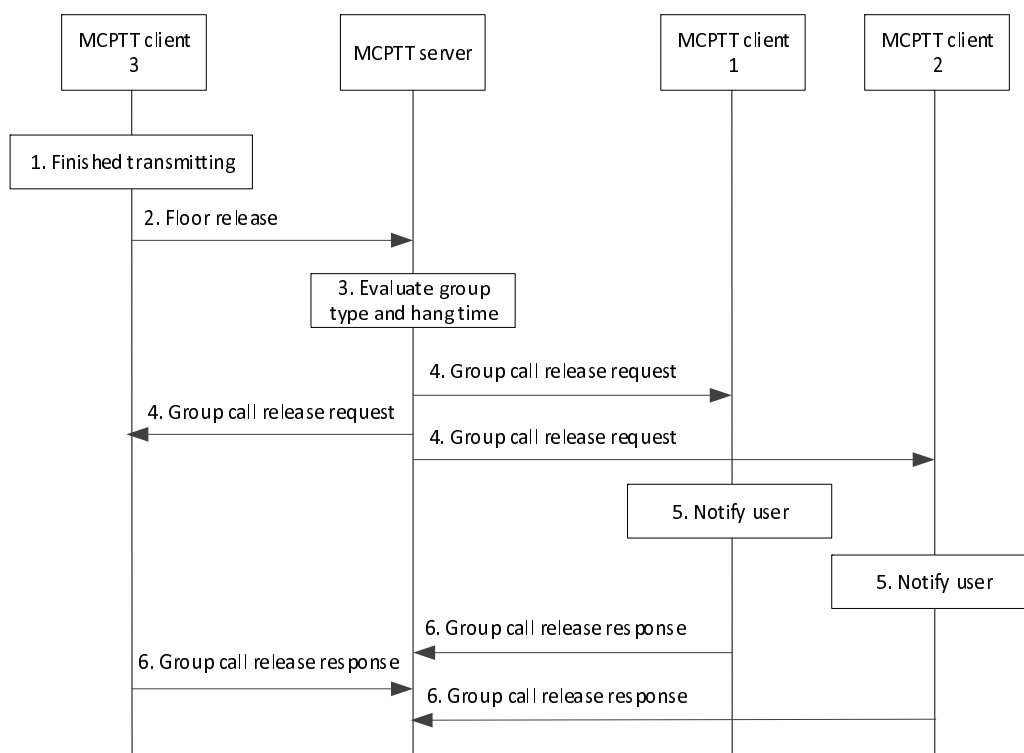

Figure 10.6.2.5.2.4-1: Server-initiated broadcast group call release

1. MCPTT user on MCPTT client 3 finished transmitting.
2. MCPTT client 3 sends a Floor release message to the MCPTT server of the group.
3. The MCPTT Server determines that the group is a broadcast group and decides that the call should be released.

NOTE 1: Whether the MCPTT server uses the Broadcast indicator in the originating group call request message or uses the configured Group call hang timer to determine whether the call should be released is left to implementation.

4. The MCPTT server sends a Group call release request to MCPTT clients 1, 2, and 3.
5. MCPTT client 1 and MCPTT client 2 notify their users that the group call has ended.

6. MCPTT clients 1, 2, and 3 respond to confirm the release of the group call by sending a group call release response.

NOTE 2: If the group call release request is sent from the MCPTT server via MBMS, no response is expected from the MCPTT clients.

10.6.2.5.3 Temporary group – broadcast group call procedure

Figure 10.6.2.5.3-1 illustrates the procedure for temporary group-broadcast group call procedure. The protocol used may be SIP.

Pre-conditions:

1. The security aspects of sharing the user information between primary and partner MCPTT systems shall be governed as per the service provider agreement between them. In this case, we consider the partner MCPTT system does not share their users' information to the primary MCPTT system.
2. The authorized MCPTT user/dispatcher belongs to the primary MCPTT system.
3. The MCPTT server of the primary MCPTT system is where the authorized MCPTT user/dispatcher created the temporary group.
4. Other groups in the temporary group – broadcast group may belong to partner MCPTT systems.

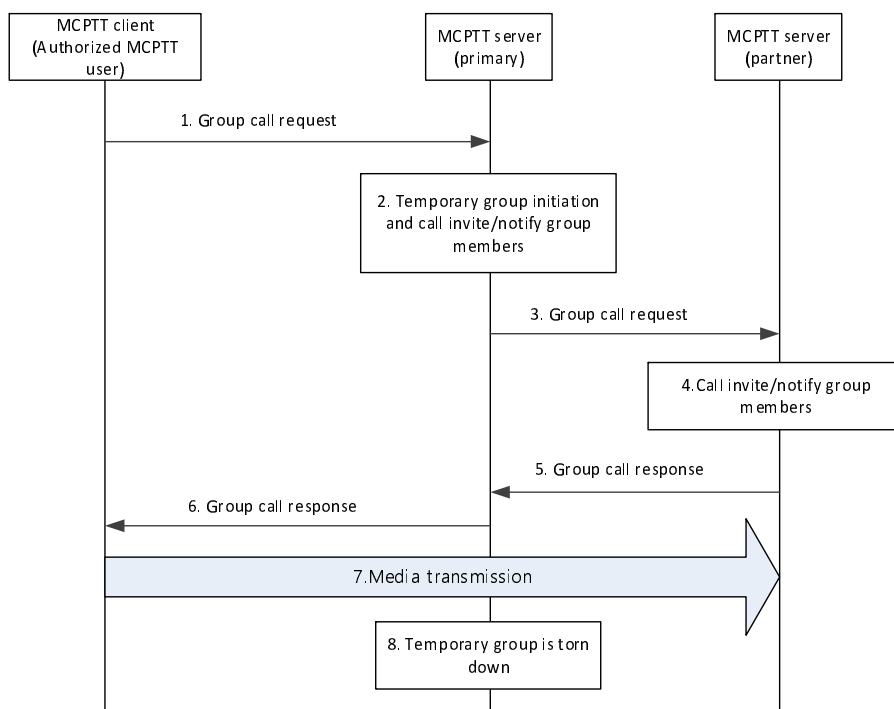

Figure 10.6.2.5.3-1: Temporary group – broadcast group call

1. The MCPTT client of authorized user initiates a group call with multiple groups from primary and partner MCPTT systems. A group call request message with the MCPTT group IDs (group1's MCPTT group ID, group2's MCPTT group ID) is routed to the MCPTT server of the primary MCPTT system, which is where the authorized MCPTT user/dispatcher created the temporary group.
2. The MCPTT server of the primary MCPTT system forms the temporary group with the groups' information received. It resolves the MCPTT group IDs and identifies the appropriate MCPTT server responsible for the groups. It further triggers a temporary group – broadcast group call via a group call request message to the affiliated group members of group1's MCPTT group ID of the MCPTT server of the primary MCPTT system.

NOTE 1: The temporary group information is not notified to the group members of the constituent groups.

3. A group call request message is further initiated with the MCPTT server of the partner MCPTT system for group2's MCPTT group ID.
4. Upon receiving the group call request message from the MCPTT server of the primary MCPTT system, the MCPTT server of the partner MCPTT system initiates a call invitation to their affiliated group members. The group members upon receipt of the invitation may accept or reject the call. Alternatively, the MCPTT server of the partner MCPTT system notifies the group members via a notification message containing the group call session identity information. Upon receipt of the notification message, the group members may perform a late call entry.
5. The MCPTT server of the partner MCPTT system provides a group call response message to the MCPTT server of the primary MCPTT system with success or failure result and/or detailed reason information in case of failure.
6. The MCPTT server of the primary MCPTT system provides a group call response message to the MCPTT client of the authorized MCPTT user upon receiving response to the corresponding group call request with the MCPTT server of the partner MCPTT system. The group call response will consist of the success or failure result and/or detailed reason information in case of failure.

NOTE 2: The group call response message is triggered depending on the conditions to proceed with the call.

7. Upon successful group call setup, a group call is established amongst the multiple group members from primary and partner MCPTT systems. The call originating MCPTT user starts transmitting media to other group call participants.

NOTE 3: Only the call originating MCPTT user is allowed to transmit media on broadcast group call.

NOTE 4: A broadcast group call transmitted on a temporary group-broadcast group has priority over group calls on its subordinate groups.

8. At the completion of the media transmission, the broadcast group call is released, and the temporary group – broadcast group is torn down.

10.6.2.6 Emergency and imminent peril procedures

10.6.2.6.1 MCPTT emergency group call

10.6.2.6.1.1 MCPTT emergency group call commencement

The procedure focuses on the case where an MCPTT client is initiating an MCPTT emergency group call with the affiliated MCPTT members of that MCPTT group. An MCPTT client in the MCPTT emergency state gains elevated access privilege for all of the MCPTT user's mission critical applications.

Procedures in figure 10.6.2.6.1.1-1 are the signalling control plane procedures for the MCPTT client initiating establishment of an MCPTT emergency group call with an MCPTT group i.e., MCPTT users on MCPTT client 1, MCPTT client 2 and MCPTT client 3 belong to the same MCPTT group which is defined on MCPTT group management server.

NOTE 1: For simplicity, a single MCPTT server is shown in place of a user home MCPTT server and a group hosting MCPTT server.

Pre-conditions:

1. The MCPTT group is previously defined on the group management server with MCPTT client 2 and MCPTT client 3 affiliated to that MCPTT group.
2. All members of the MCPTT group belong to the same MCPTT system.
3. The initiating MCPTT client 1 has been provisioned with an MCPTT group that has been designated via provisioning as the MCPTT emergency group.

NOTE 2: Alternatively, the client could have been provisioned for emergency behaviour on the selected group.

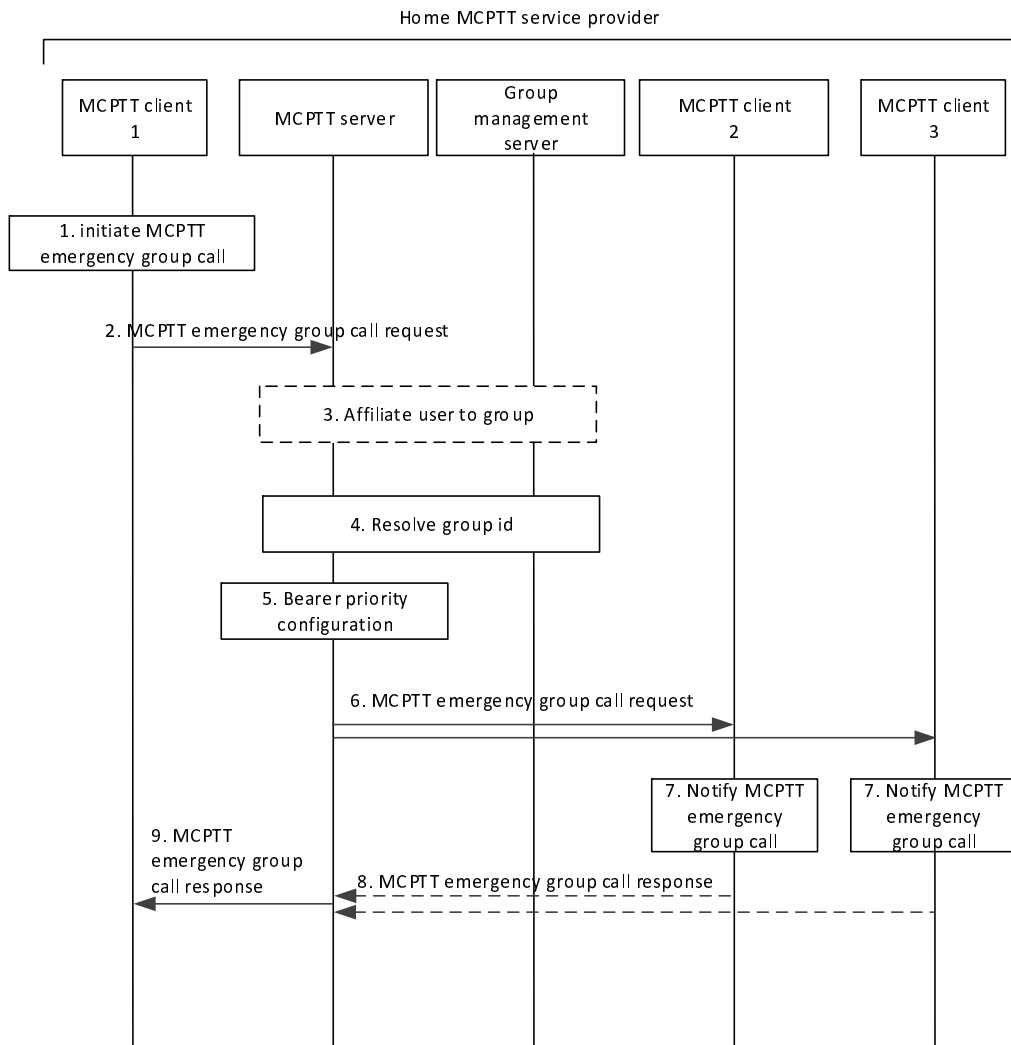

Figure 10.6.2.6.1.1-1: MCPTT emergency group call

1. The user at the MCPTT client 1 initiates an MCPTT emergency group call. MCPTT client 1 sets its MCPTT emergency state. The MCPTT emergency state is retained until explicitly cancelled.
2. MCPTT client 1 sends an MCPTT group call request towards the MCPTT server. The request contains an indication of the MCPTT emergency. The MCPTT server records the identity of the MCPTT user that initiated the MCPTT emergency group call until the MCPTT emergency is cancelled. Once an MCPTT emergency call has been initiated, the MCPTT group is considered to be in an in-progress emergency state until cancelled. If configured to send an MCPTT emergency alert when initiating an MCPTT emergency group call, the request also contains an indication that an MCPTT emergency alert is to be initiated. The request may contain an indication of an implicit floor request.
3. The MCPTT server implicitly affiliates MCPTT client 1 to the emergency group if the client is not already affiliated.
4. MCPTT server checks whether the MCPTT user of MCPTT client 1 is authorized for initiation of MCPTT emergency calls on the indicated MCPTT group, and if authorized, it resolves the MCPTT group ID to determine the members of that MCPTT group and their affiliation status, based on the information from group management server.
5. The MCPTT server configures the priority of the underlying bearers for all participants in the MCPTT group.

NOTE 3: Successive calls during the MCPTT group's in-progress emergency state will all receive the adjusted bearer priority.

6. MCPTT server sends the MCPTT emergency group call request towards the MCPTT clients of each of those affiliated MCPTT group members. The request contains an indication of the in-progress emergency. The request

contains an indication of an MCPTT emergency alert if the request from the originator indicated MCPTT emergency alert.

7. MCPTT users are notified of the incoming MCPTT group call.
8. The receiving MCPTT clients send the MCPTT emergency group call response to the MCPTT server to acknowledge the MCPTT emergency group call request. For a multicast call, these acknowledgements are not sent.
9. The MCPTT server sends the MCPTT emergency group call response to the MCPTT user 1 to inform the successful MCPTT emergency call establishment.

NOTE 4: Step 9 can occur at any time following step 5, and prior to step 10 depending on the conditions to proceed with the call.

MCPTT client 1, MCPTT client 2 and MCPTT client 3 have successfully established media plane for communication. MCPTT floor participant 1, floor participant 2 and floor participant 3 exchange floor control information e.g., MCPTT client 1 receives the floor granted information over the established media plane, while the other MCPTT client's receive floor taken information. MCPTT client 1 indicates to the MCPTT user that the floor is available to send media, while the other MCPTT clients in the MCPTT emergency group call will be receiving that media. MCPTT client 1 can override other clients in the call except those that are also in the MCPTT emergency state.

10.6.2.6.1.2 MCPTT group call upgraded to an MCPTT emergency group call

The procedure focuses on the case where an authorized MCPTT user is upgrading an MCPTT group call to an MCPTT emergency group call while the MCPTT group call is already in progress.

Procedures in figure 10.6.2.6.1.2-1 are the signalling control plane procedures for the MCPTT client upgrading an MCPTT group call on an MCPTT group to an MCPTT emergency group call.

NOTE 1: For simplicity, a single MCPTT server is shown in place of a user home MCPTT server and a group hosting MCPTT server.

Pre-conditions:

1. The MCPTT group is previously defined on the group management server with MCPTT client 2 and MCPTT client 3 affiliated to that MCPTT group.
2. All members of the MCPTT group belong to the same MCPTT system.
3. An MCPTT group call is already in progress.
4. The initiating MCPTT client 1 has been configured to send an MCPTT emergency alert when upgrading an MCPTT emergency group call.

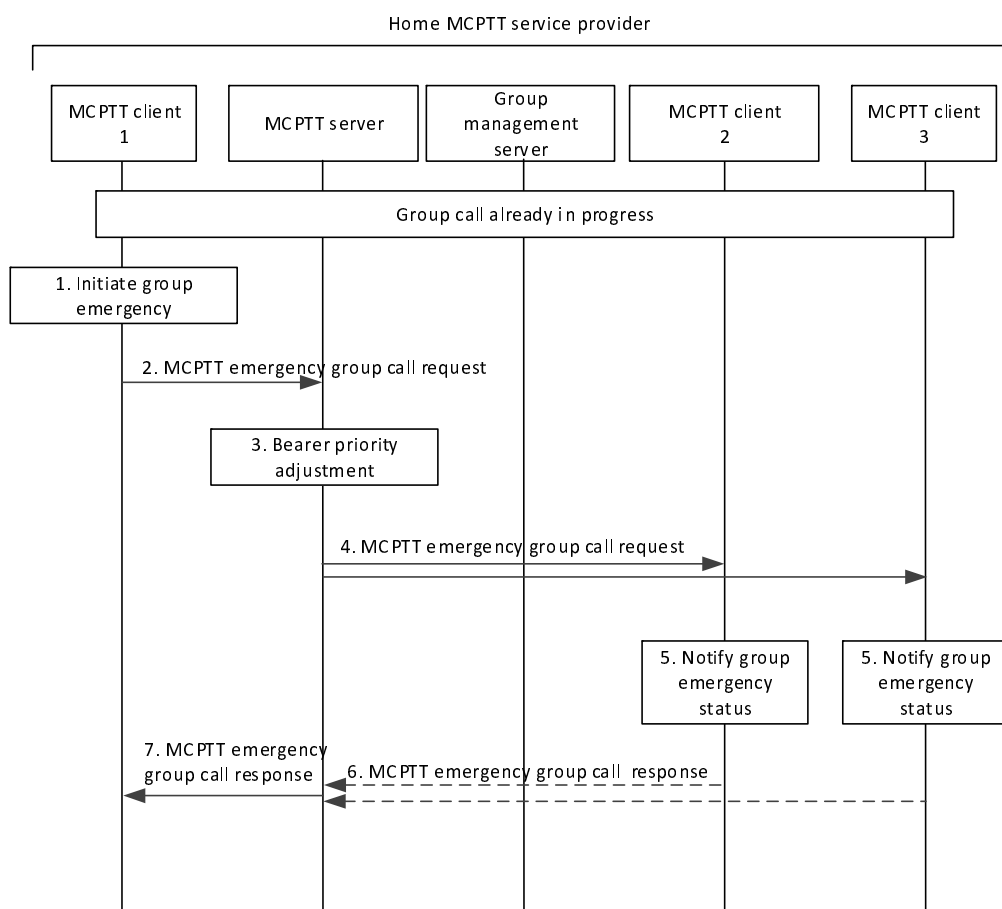

Figure 10.6.2.6.1.2-1: MCPTT group call upgraded to an MCPTT emergency group call

1. The MCPTT user at MCPTT client 1 initiates a group emergency. MCPTT client 1 sets its MCPTT emergency state. The MCPTT emergency state is retained until explicitly cancelled.
2. MCPTT client 1 requests the MCPTT server to upgrade the MCPTT group to an in-progress emergency state by sending an MCPTT emergency group call request. If configured to send an MCPTT alert when initiating an MCPTT emergency upgrade, the request also contains an indication that an MCPTT alert is to be initiated. The request may contain an indication of an implicit floor request.
3. The MCPTT server adjusts the priority of the underlying bearer for all or selected participants in the MCPTT group call that receive the communication over unicast.

NOTE 2: The determination of the selected participants whose bearers have to be upgraded is left to implementation.

4. MCPTT server sends the MCPTT emergency group call request towards the MCPTT clients of each of those affiliated MCPTT group members. The request contains an indication of an MCPTT emergency alert if the request from the originator indicated MCPTT emergency alert.
5. MCPTT users are notified of the in-progress emergency state of the MCPTT group.
6. The receiving MCPTT clients send the MCPTT emergency group call response to the MCPTT server to acknowledge the MCPTT group emergency request. For a multicast call, these acknowledgements are not sent.
7. The MCPTT server sends the MCPTT emergency group call response to the MCPTT user 1 to confirm the upgrade request.

NOTE 3: Step 7 can occur at any time following step 3, and prior to step 8 depending on the conditions to proceed with the call.

MCPTT client 1, MCPTT client 2 and MCPTT client 3 continue with the MCPTT group call, which has been transformed into an MCPTT emergency group call. MCPTT client 1 can override other clients in the call except those that are also in the MCPTT emergency state.

10.6.2.6.1.3 MCPTT in-progress emergency group state cancel

NOTE 1: In Rel-14 and Rel-13 versions of this specification the title of this subclause is "MCPTT emergency group call cancel".

The procedure focuses on the case where an MCPTT client cancels an MCPTT group's in-progress emergency.

Procedures in figure 10.6.2.6.1.3-1 are the signalling control plane procedures for the MCPTT client cancelling an in-progress emergency of a group.

NOTE 2: For simplicity, a single MCPTT server is shown in place of a user home MCPTT server and a group hosting MCPTT server.

NOTE 3: The end of the MCPTT emergency group call does not cancel the MCPTT group's in-progress emergency state. It is explicitly cancelled by an authorized user using this procedure.

Pre-conditions:

1. The MCPTT group is previously defined on the group management server with MCPTT client 2 and MCPTT client 3 affiliated to that MCPTT group.
2. All members of the MCPTT group belong to the same MCPTT system.
3. MCPTT group members have been notified about the in-progress emergency.
4. The MCPTT group is in the in-progress emergency state and has prioritized bearer support.
5. MCPTT client 1 previously initiated the in-progress emergency for the group.

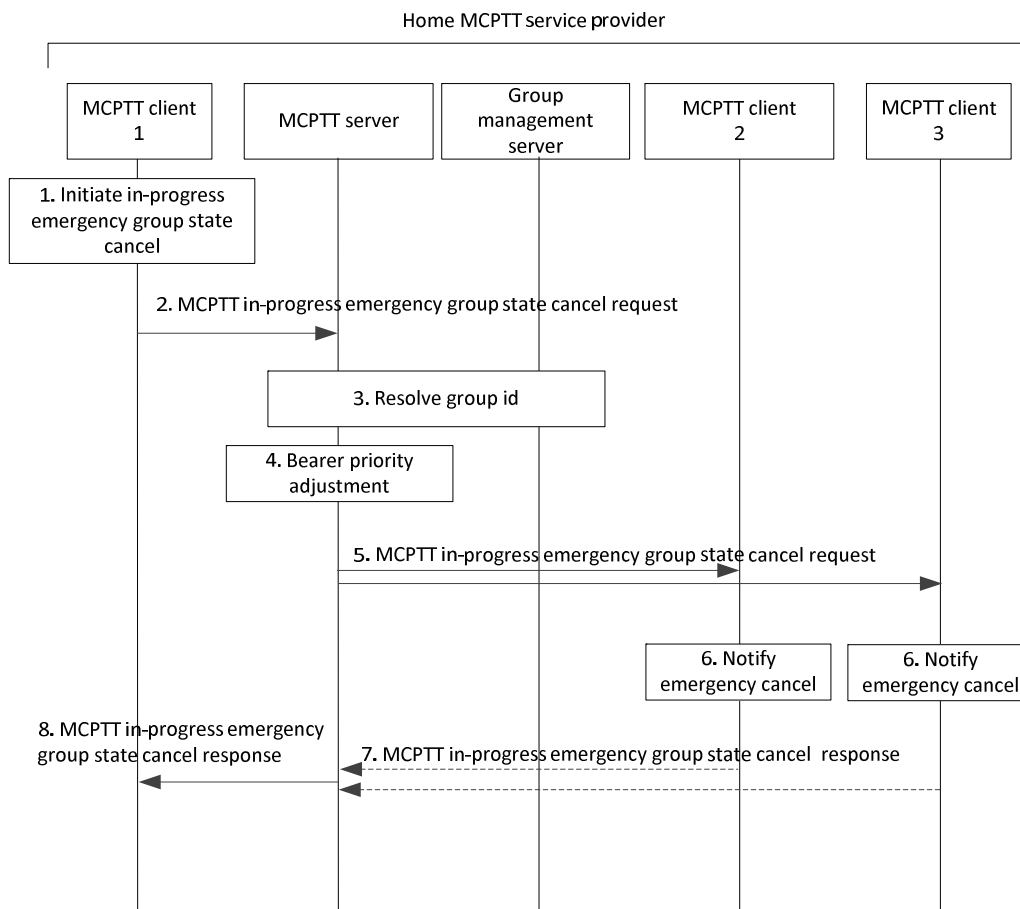

Figure 10.6.2.6.1.3-1: MCPTT in-progress emergency group state cancel

1. The user at the MCPTT client 1 initiates an MCPTT in-progress emergency group state cancel.

NOTE 3: An MCPTT user authorized to cancel in-progress emergencies on the MCPTT group can also be authorised to cancel the MCPTT emergency alert in addition to the initiator. However, only the initiator can cancel the initiator's local MCPTT emergency state.

2. MCPTT client 1 sends an MCPTT in-progress emergency group state cancel request to the MCPTT server.

NOTE 4: When MCPTT emergency alerts are in effect together with an MCPTT in-progress emergency group state on the same MCPTT group, the MCPTT emergency alert can, under some circumstances be cancelled at the same time. In that case, the MCPTT in-progress emergency group state cancel request carries an indication that the alert is also being cancelled.

3. MCPTT server resolves the MCPTT group ID to determine the members of that MCPTT group and their affiliation status, based upon the information from group management server.

4. The MCPTT server adjusts the priority of the underlying bearer; priority treatment is no longer required. The MCPTT server cancels/resets the emergency in-progress state of the MCPTT group.

5. The MCPTT server sends an MCPTT in-progress emergency group state cancel request to the MCPTT group members.

6. MCPTT group members are notified of the MCPTT in-progress emergency group state cancel.

7. The receiving MCPTT clients send the MCPTT in-progress emergency group state cancel response to the MCPTT server to acknowledge the MCPTT in-progress emergency group state cancel. For a multicast call scenario, these acknowledgements are not sent.

8. The MCPTT server sends the MCPTT in-progress emergency group state cancel response to the MCPTT user 1 to confirm the MCPTT in-progress emergency group state cancel. If the MCPTT in-progress emergency group state cancel request (in step 2) contained the "Alert indicator" IE, the MCPTT client 1 resets its local emergency status.

NOTE 5: Step 8 can occur at any time following step 4, depending on the conditions to proceed with the call.

10.6.2.6.2 MCPTT imminent peril group call

10.6.2.6.2.1 MCPTT imminent peril group call commencement

The procedure focuses on the case where an authorized MCPTT user is initiating an imminent peril group call for communicating with the affiliated MCPTT members of that MCPTT group. This procedure will gain elevated access privilege for the MCPTT client if it is not already in that state. The access privilege for other applications will not necessarily be affected.

Procedures in figure 10.6.2.6.2.1-1 are the signalling control plane procedures for the MCPTT client initiating establishment of an imminent peril group call with an MCPTT group i.e., MCPTT users on MCPTT client 1, MCPTT client 2 and MCPTT client 3 belong to the same MCPTT group which is defined on MCPTT group management server.

Pre-conditions:

1. The MCPTT group is previously defined on the group management server with MCPTT client 2 and MCPTT client 3 affiliated to that MCPTT group.
2. All members of the MCPTT group belong to the same MCPTT system.
3. The initiating MCPTT client 1 has been provisioned with an MCPTT group that has been designated in the provisioning to be used for imminent peril communications.

NOTE 1: Alternatively, the client could have been provisioned for imminent peril behaviour on the selected group.

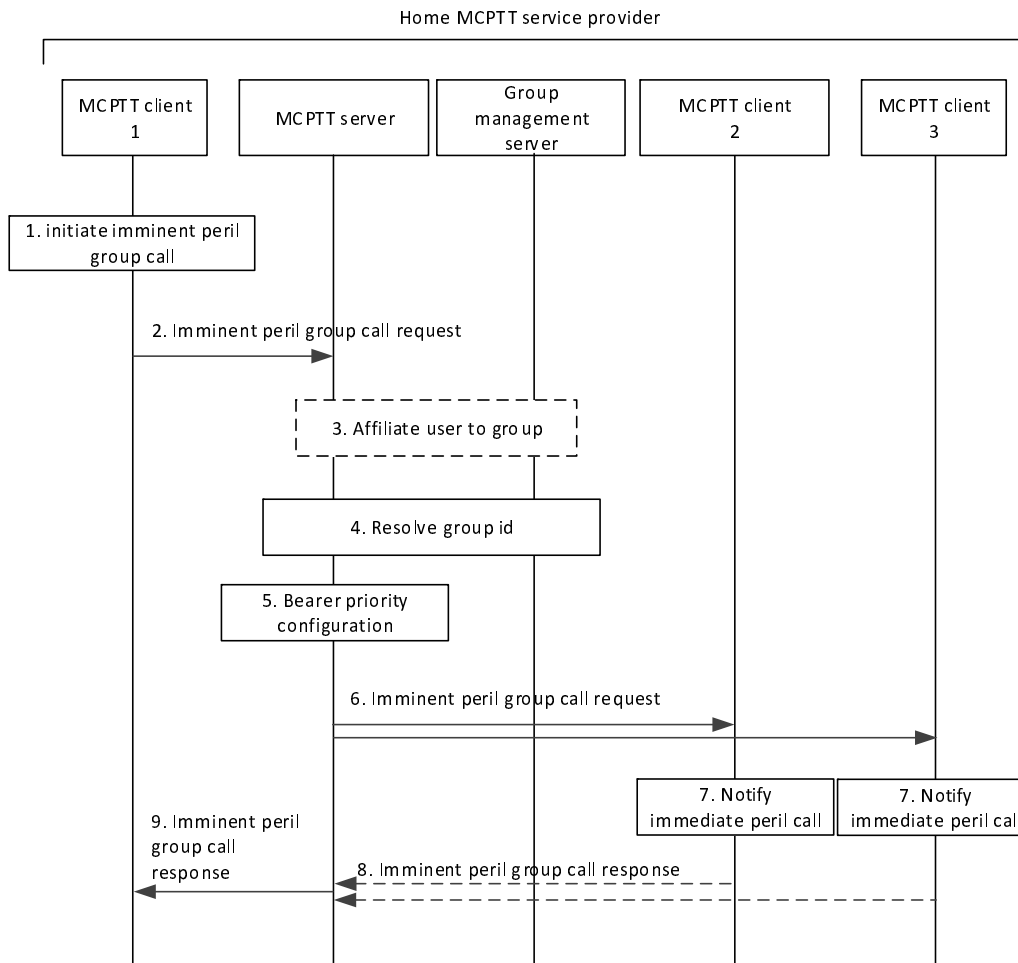

Figure 10.6.2.6.2.1-1: MCPTT imminent peril group call

1. The user at the MCPTT client 1 initiates an imminent peril group call.
 2. MCPTT client 1 sends an MCPTT imminent peril group call request towards the MCPTT server. The request contains an indication of the in-progress imminent peril. The MCPTT server records the identity of the MCPTT user that initiated the imminent peril group call until the in-progress imminent peril state is cancelled. Once an imminent peril group call has been initiated, the MCPTT group is considered to be in an in-progress imminent peril state until cancelled. The request may contain an indication of an implicit floor request.
 3. The MCPTT server implicitly affiliates MCPTT client 1 to the imminent peril group if the client is not already affiliated.
 4. MCPTT server checks whether the MCPTT user of MCPTT client 1 is authorized for initiation of imminent peril group calls on the indicated MCPTT group, and if authorized, it resolves the MCPTT group ID to determine the members of that MCPTT group and their affiliation status, based on the information from group management server.
 5. The MCPTT server configures the priority of the underlying bearers for all participants in the MCPTT group.
- NOTE 2: Successive calls during the in-progress imminent peril state will all receive the adjusted bearer priority.
6. MCPTT server sends the imminent peril group call request towards the MCPTT clients of each of those affiliated MCPTT group members. The request contains an indication of the in-progress imminent peril.
 7. MCPTT users are notified of the incoming imminent peril call.

8. The receiving MCPTT clients send the MCPTT imminent peril group call response to the MCPTT server to acknowledge the imminent peril call request. For a multicast call, these acknowledgements are not set.
9. The MCPTT server sends the MCPTT imminent peril group call response to the MCPTT user 1 to inform the successful imminent peril call establishment.

NOTE 3: Step 9 can occur at any time following step 5, and prior to step 10 depending on the conditions to proceed with the imminent peril call.

MCPTT client 1, MCPTT client 2 and MCPTT client 3 have successfully established media plane for communication. MCPTT floor participant 1, floor participant 2 and floor participant 3 exchange floor control information e.g., MCPTT client 1 receives the floor granted information over the established media plane, while the other MCPTT clients receive floor taken information. MCPTT client 1 indicates to the MCPTT user that the floor is available to send media, while the other MCPTT clients in the imminent peril call will be receiving that media.

10.6.2.6.2.2 Imminent peril group call upgrade

The procedure focuses on the case where an authorized MCPTT user is upgrading an MCPTT group call to an imminent peril group call while the MCPTT group call is already in progress.

Procedures in figure 10.6.2.6.2.2-1 are the signalling control plane procedures for the MCPTT client upgrading an MCPTT group call on an MCPTT group to an imminent peril group call.

Pre-conditions:

1. The MCPTT group is previously defined on the group management server with MCPTT client 1, MCPTT client 2 and MCPTT client 3 affiliated to that MCPTT group.
2. All members of the MCPTT group belong to the same MCPTT system.
3. An MCPTT group call is already in progress.

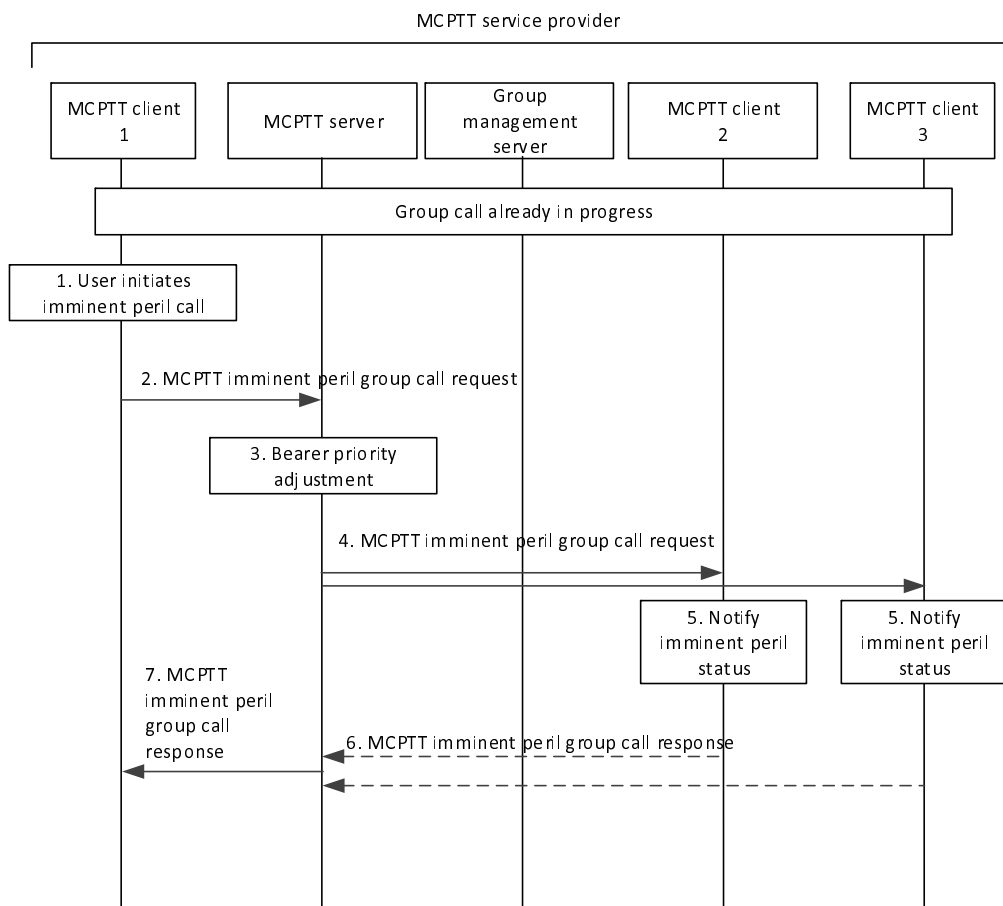

Figure 10.6.2.6.2.2-1: MCPTT group call upgrade to an imminent peril group call

1. The MCPTT user at MCPTT client 1 initiates an imminent peril call.
2. MCPTT client 1 requests the MCPTT server to upgrade the MCPTT group to an in-progress imminent peril state by sending an MCPTT imminent peril group call request. The request may contain an indication of an implicit floor request.
3. The MCPTT server adjusts the priority of the underlying bearer for all participants in the MCPTT group.
4. MCPTT server sends the MCPTT imminent peril group call request towards the MCPTT clients of each of those affiliated MCPTT group members.
5. MCPTT users are notified of the in-progress imminent peril state of the MCPTT group.
6. The receiving MCPTT clients send the MCPTT imminent peril group call response to the MCPTT server to acknowledge the MCPTT imminent peril group call request. For a multicast call, these acknowledgements are not set.
7. The MCPTT server sends the MCPTT imminent peril group call response to the MCPTT user 1 to confirm the upgrade request.

NOTE: Step 7 can occur at any time following step 4, and prior to step 8 depending on the conditions to proceed with the call.

MCPTT client 1, MCPTT client 2 and MCPTT client 3 continue with the MCPTT group call, which has been transformed into an imminent peril group call.

10.6.2.6.2.3 MCPTT in-progress imminent peril group state cancel

NOTE 1: In Rel-14 and Rel-13 versions of this specification the title of this subclause is "MCPTT imminent peril group call cancel".

The procedure focuses on the case where an authorized MCPTT user cancels an MCPTT group's in-progress imminent peril state.

Procedures in figure 10.6.2.6.2.3-1 are the signalling control plane procedures for the MCPTT client cancelling an MCPTT group's in-progress imminent peril state.

NOTE 2: The end of the imminent peril call does not cancel the MCPTT group's in-progress imminent peril state. It is explicitly cancelled by an authorized user using this procedure.

Pre-conditions:

1. The MCPTT group is previously defined on the group management server with MCPTT client 1, MCPTT client 2 and MCPTT client 3 affiliated to that MCPTT group.
2. All members of the MCPTT group belong to the same MCPTT system.
3. The MCPTT group is in an in-progress imminent peril state and has prioritized bearer support.
4. MCPTT group members have been notified about the MCPTT group's in-progress imminent peril state.
5. MCPTT client 1 previously initiated the in-progress imminent peril.

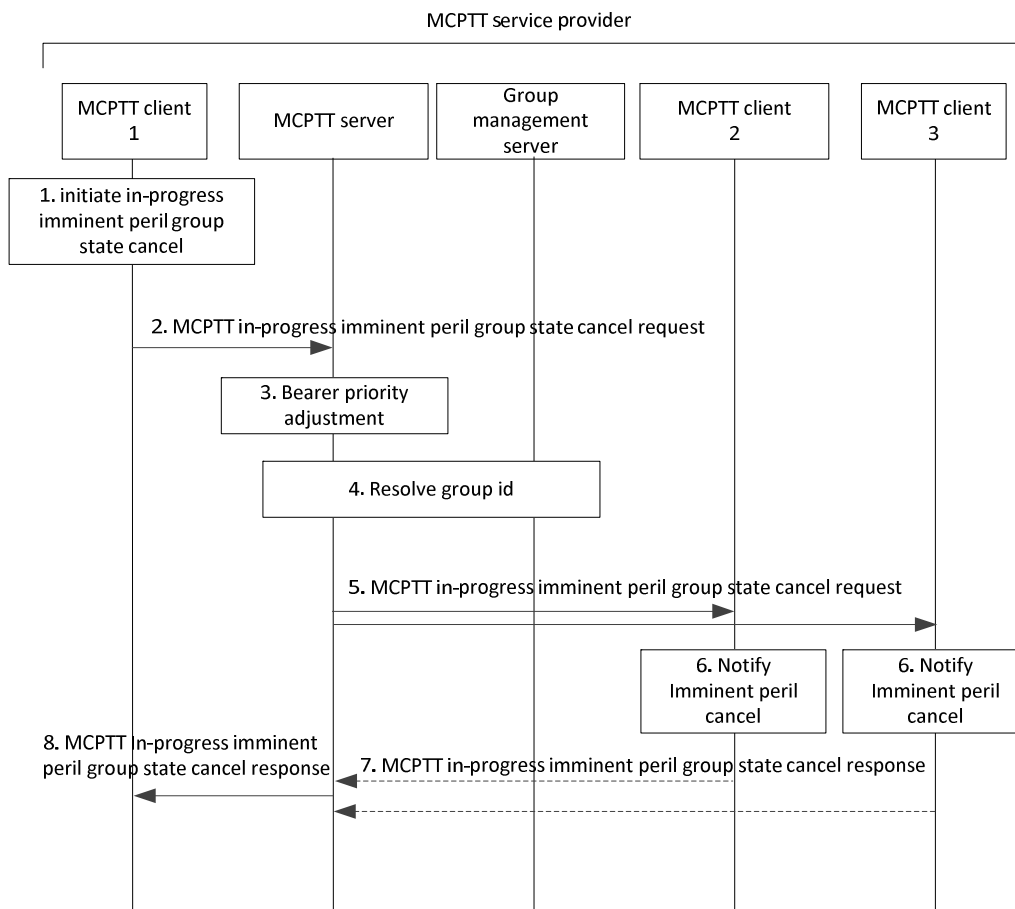

Figure 10.6.2.6.2.3-1: MCPTT in-progress imminent peril group state cancel

1. The user at the MCPTT client 1 initiates an in-progress imminent peril group state cancel.
2. MCPTT client 1 sends an MCPTT in-progress imminent peril group state cancel request to the MCPTT server.
3. The MCPTT server adjusts the priority of the underlying bearer; priority treatment is no longer required. The MCPTT server cancels/resets the in-progress imminent peril group state.
4. MCPTT server resolves the MCPTT group ID to determine the members of that MCPTT group and their affiliation status, based upon the information from group management server.
5. The MCPTT server sends an MCPTT imminent peril group state cancel request to the MCPTT group members.
6. MCPTT group members are notified of the in-progress imminent peril group state cancel.
7. The receiving MCPTT group members send the MCPTT in-progress imminent peril group state cancel response to the MCPTT server to acknowledge the MCPTT in-progress imminent peril group state cancel request. For a multicast scenario, these acknowledgements are not set.
8. The MCPTT server sends the MCPTT in-progress imminent peril group state cancel response to the MCPTT user 1 to confirm the MCPTT in-progress imminent peril group state cancel request.

NOTE 3: Step 8 can occur at any time following step 4, depending on the conditions to proceed with the call.

10.6.2.6.3 MCPTT emergency alert

Editor's note: whether the following procedures for emergency alert initiation and emergency alert cancel remain in this specification is FFS.

10.6.2.6.3.1 MCPTT emergency alert initiation

The procedure focuses on the case where an MCPTT client is initiating an MCPTT emergency alert unicast signalling for communicating the alert with the affiliated MCPTT members of that MCPTT group. An MCPTT client in the MCPTT emergency state gains elevated access privilege for all of the MCPTT user's mission critical applications. This procedure will place the MCPTT client in the MCPTT emergency state if the MCPTT client is not already in that state.

Procedures in figure 10.6.2.6.3.1-1 are the signalling control plane procedures for the MCPTT client initiating an MCPTT emergency alert with an MCPTT group i.e., MCPTT users on MCPTT client 1, MCPTT client 2 and MCPTT client 3 belong to the same MCPTT group which is defined on MCPTT group management server.

NOTE 1: For simplicity, a single MCPTT server is shown in place of a user home MCPTT server and a group hosting MCPTT server.

Pre-conditions:

1. The MCPTT group is previously defined on the group management server with MCPTT client 2 and MCPTT client 3 affiliated to that MCPTT group.
2. All members of the MCPTT group belong to the same MCPTT system.
3. The initiating MCPTT client 1 is affiliated with one or more MCPTT groups.
4. The initiating MCPTT client 1 has been provisioned with an MCPTT group designated as the MCPTT emergency group.

NOTE 2: Alternatively, the client could have been provisioned for emergency behaviour on the currently selected group.

5. The initiating MCPTT client 1 may not have carried out an explicit affiliation procedure with the MCPTT group designated as the MCPTT emergency group.

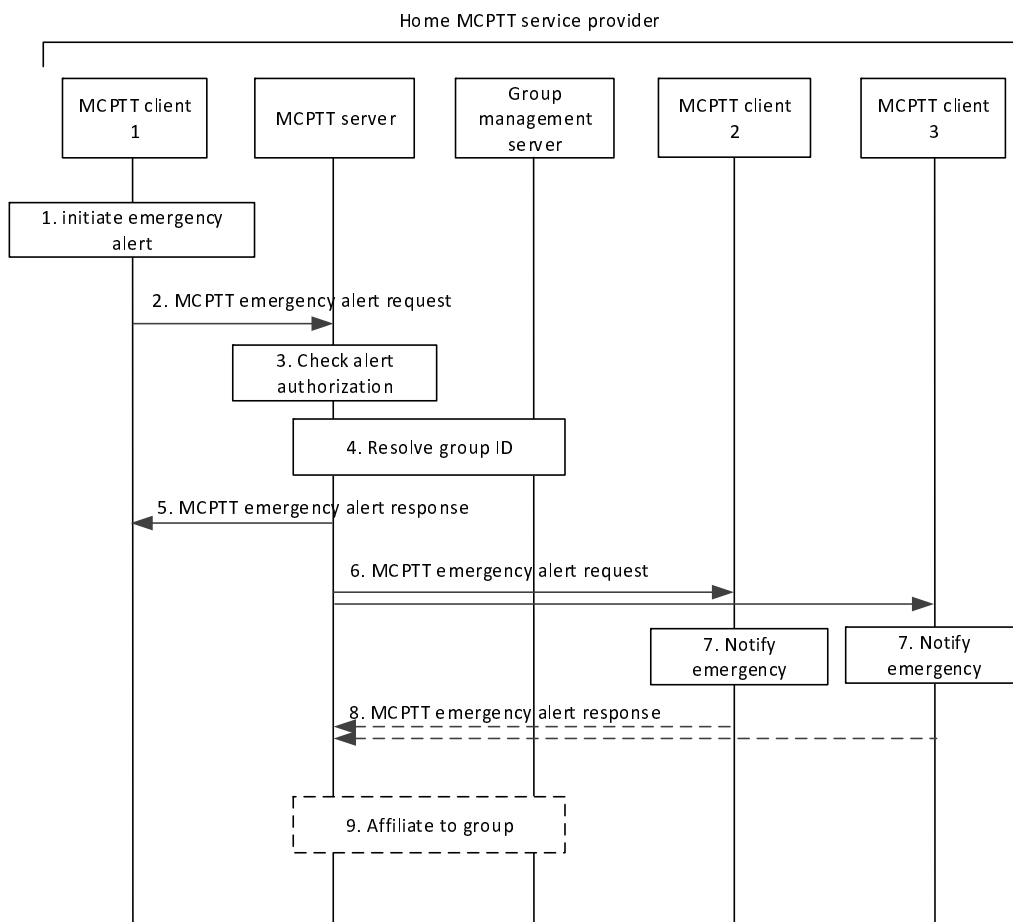

Figure 10.6.2.6.3.1-1 MCPTT emergency alert

1. The user at the MCPTT client 1 initiates an MCPTT emergency alert. MCPTT client 1 sets its MCPTT emergency state. The MCPTT emergency state is retained by the MCPTT client until explicitly cancelled.
2. MCPTT client 1 requests the MCPTT server to send an MCPTT emergency alert request to the MCPTT group designated as the MCPTT emergency group.
3. MCPTT server checks whether the MCPTT user of MCPTT client 1 is authorized for initiation of MCPTT emergency alerts for the indicated MCPTT group.
4. MCPTT server resolves the MCPTT group ID to determine the members of that MCPTT group and their affiliation status, based on the information from group management server.
5. The MCPTT server sends the MCPTT emergency alert response to the MCPTT user 1 to confirm the MCPTT emergency alert request. MCPTT group calls made to this MCPTT group by the MCPTT client 1 will be sent as emergency calls until the emergency state on the MCPTT client 1 is cancelled.
6. The MCPTT server sends an MCPTT emergency alert request towards the MCPTT clients of each of those affiliated MCPTT group members. The MCPTT emergency alert request message shall contain the following information: Location, MCPTT ID and MCPTT group ID (i.e., MCPTT user's selected MCPTT group or dedicated MCPTT emergency group, as per MCPTT group configuration) and the MCPTT user's mission critical organization name. If in step 2, the MCPTT client 1 does not include the location information in the MCPTT emergency alert request to the MCPTT server, the MCPTT server acquires the location of user at the MCPTT client 1 from the location management server. If the location is included in step 2, then the MCPTT server acquires the location from MCPTT client 1.
7. MCPTT users are notified of the MCPTT emergency.

8. For a unicast MCPTT emergency alert, the receiving MCPTT clients send the MCPTT emergency alert response to the MCPTT server to acknowledge the MCPTT emergency alert. For a multicast MCPTT emergency alert, these acknowledgements are not sent unless the MCPTT clients have been configured to do so.
9. The MCPTT server implicitly affiliates MCPTT client 1 to the emergency group if the client is not already affiliated.

NOTE 3: Sending the emergency alert without making a request to also start an emergency call does not put the group into the in-progress emergency state.

NOTE 4: Sending the emergency alert does not put the other UEs in the group into an emergency state.

NOTE 5: The MCPTT client 1 need not initiate a group call. For example, the MCPTT client can be configured to only allow alerts or the MCPTT user can choose not to make an MCPTT emergency group call.

10.6.2.6.3.2 MCPTT emergency alert cancel

The procedure focuses on the case where an MCPTT client has initiated an MCPTT emergency alert and entered the emergency state, and wishes to cancel the alert, informing the MCPTT server and other group members of this cancellation. By doing so, the MCPTT client may also request the cancellation of the in-progress emergency state of the group.

Procedures in figure 10.6.2.6.3.2-1 are the signalling control plane procedures for the MCPTT client cancelling an MCPTT emergency alert with an MCPTT group i.e., MCPTT users on MCPTT client 1, MCPTT client 2 and MCPTT client 3 belong to the same MCPTT group which is defined on MCPTT group management server.

NOTE 1: For simplicity, a single MCPTT server is shown in place of a user home MCPTT server and a group hosting MCPTT server.

Pre-conditions:

1. The MCPTT client 1 had previously successfully initiated an MCPTT emergency alert.
2. The MCPTT client 1 is still in the emergency state.
3. The initiating MCPTT client 1 has affiliated with the MCPTT group designated as the MCPTT emergency group.

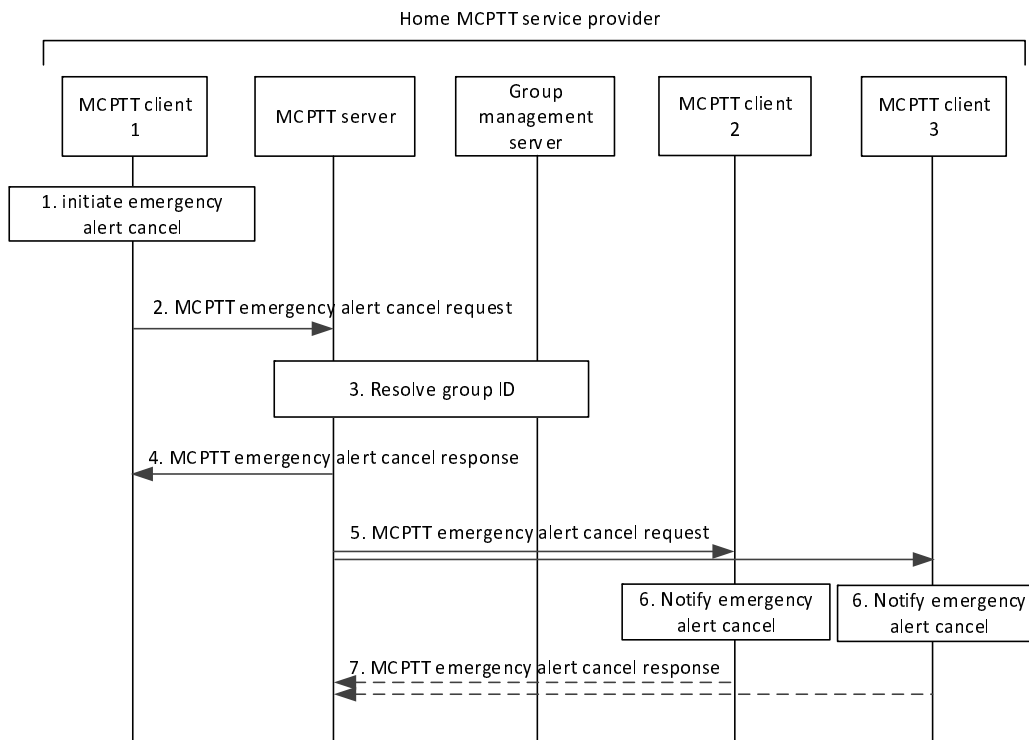

Figure 10.6.2.6.3.2-1 MCPTT emergency alert cancel

1. The user at the MCPTT client 1 initiates an MCPTT emergency alert cancel.

NOTE 2: The MCPTT emergency alert cancel request carries an indication to also request that the in-progress emergency is to be cancelled. The MCPTT server can accept or deny the request to cancel the in-progress emergency state of the group as a whole, separately from accepting or denying the request to cancel the emergency alert at MCPTT client 1. Additionally, an authorized user can cancel either or both the in-progress emergency state of the group and the initiator's local MCPTT emergency state.

2. MCPTT client 1 requests the MCPTT server to send an MCPTT emergency alert cancel to the MCPTT group to which MCPTT client 1 had previously sent the emergency alert.
3. MCPTT server resolves the MCPTT group ID to determine the members of that MCPTT group and their affiliation status, based on the information from group management server.
4. The MCPTT server sends the MCPTT emergency alert cancel response to the MCPTT client 1 to confirm the MCPTT emergency alert cancel request. MCPTT client 1 resets its emergency state.
5. The MCPTT server sends an MCPTT emergency alert cancel request towards the MCPTT clients of each of those affiliated MCPTT group members.
6. MCPTT users are notified of the MCPTT emergency alert cancellation of MCPTT client 1.
7. For a unicast MCPTT emergency alert cancel, the receiving MCPTT clients send the MCPTT emergency alert cancel response to the MCPTT server to acknowledge the MCPTT emergency alert cancel. For a multicast MCPTT emergency alert cancel, these acknowledgements are not sent unless the MCPTT clients have been configured to do so.

10.6.2.6.3.3 Entering MCPTT emergency alert area

Editor's Note: MCPTT emergency alert triggered by MCPTT client locally which stores the predefined area is another possible solution. How to define this procedure and how to combine the two solutions is FFS.

The procedure focuses on the case where an MCPTT service emergency alert to be triggered when an MCPTT UE moves into a predefined area. This procedure will place the MCPTT client in the MCPTT emergency state if the MCPTT client is not already in that state.

Procedures in figure 10.6.2.6.3.3-1 are the signalling control plane procedures for the MCPTT server triggers an MCPTT emergency alert with an MCPTT group i.e., MCPTT users on MCPTT client 1, MCPTT client 2 and MCPTT client 3 belong to the same MCPTT group which is defined on MCPTT group management server.

NOTE: For simplicity, a single MCPTT server is shown in place of a user home MCPTT server and a group hosting MCPTT server.

Pre-conditions:

1. The MCPTT group is previously defined on the group management server with MCPTT client 2 and MCPTT client 3 affiliated to that MCPTT group.
2. All members of the MCPTT group belong to the same MCPTT system.
3. An area in which the MCPTT client should send emergency alert is pre-defined in MCPTT server.

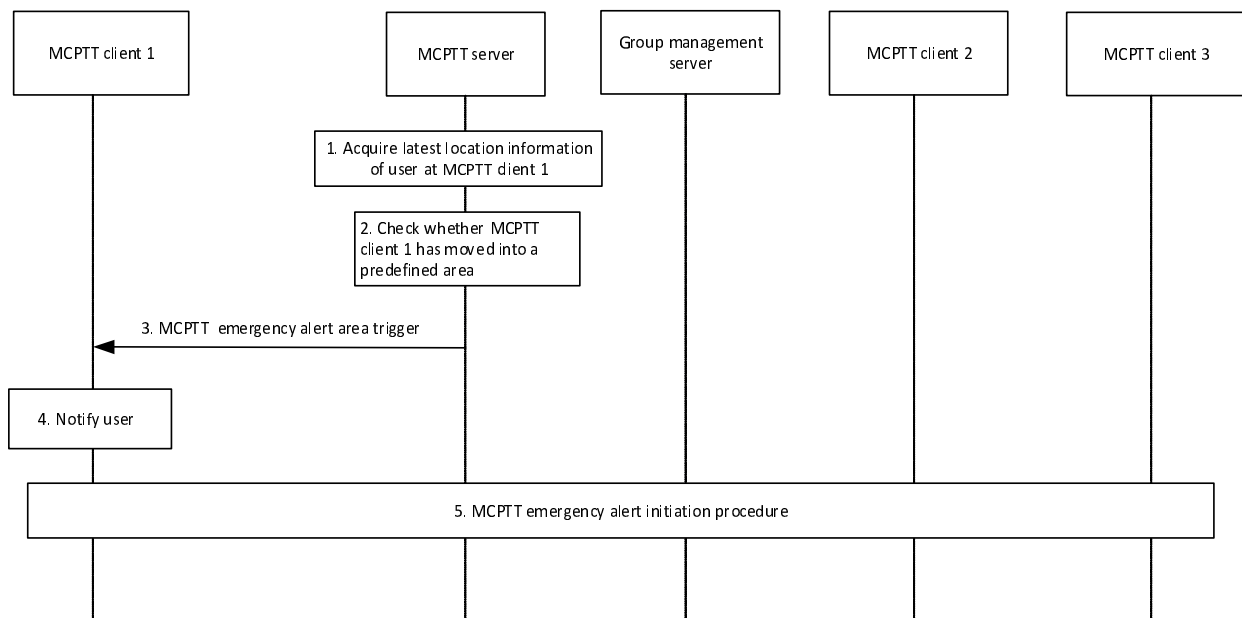

Figure 10.6.2.6.3.3-1 Entering MCPTT emergency alert area

1. MCPTT server acquires the latest location information of user at MCPTT client 1 from location management server as described in subclause 10.9.3.6 in 3GPP TS 23.280[16].
2. MCPTT server checks whether MCPTT client 1 has moved into a predefined area.
3. If so, MCPTT server sends an MCPTT emergency alert area trigger to MCPTT client 1 to notify that it has moved in to the area in potential danger.
4. MCPTT client 1 notifies the MCPTT user about the MCPTT emergency alert area.
5. MCPTT client 1 initiates MCPTT emergency alert procedure as described in 10.6.2.6.3.1.

10.6.2.7 Location of current talker

Figure 10.6.2.7-1 shows the high level procedure for MCPTT service to provide the location information about the current talking user to all the receiving MCPTT users.

Precondition:

1. There is on-going group call involving MCPTT client 1 and MCPTT client 2.
2. MCPTT client 1 is the current talking user.
3. MCPTT server has obtained the location information of MCPTT client 1 according to subclause 10.9 in 3GPP TS 23.280 [16].

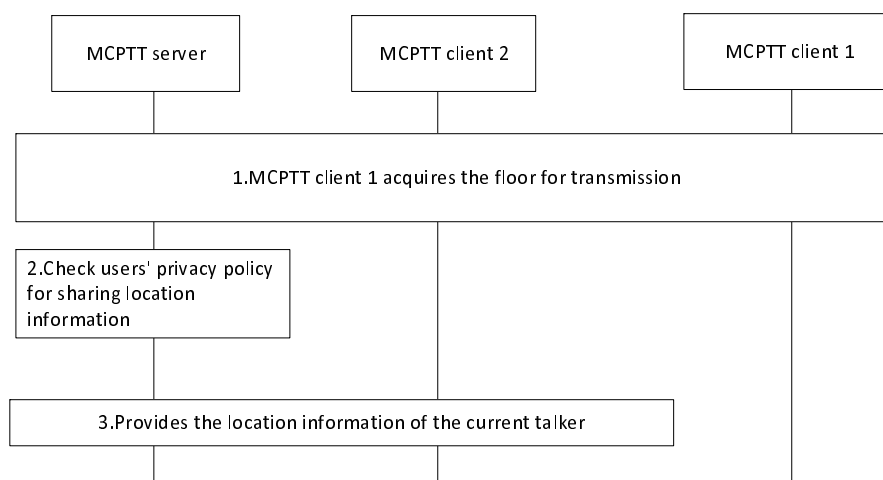

Figure 10.6.2.7-1: Providing location information of the current talker

1. MCPTT client 1 gets the floor to transmit voice media.
2. MCPTT server checks the privacy policy (authorisation to provide location information to other MCPTT users on a call when talking, as defined in Annex A.3) of the current talking MCPTT user to decide if the location information of MCPTT client 1 can be provided to other MCPTT users on the call. MCPTT server acquires the location of the current talker from the location management server as described in subclause 10.9.3.6 in 3GPP TS 23.280[16]
3. MCPTT server provides the location information of MCPTT client 1 to MCPTT client 2.

10.6.2.8 Temporary group call – user regroup

10.6.2.8.1 General

The temporary group call performed by user regroup can be initiated by an authorized user inviting a list of MCPTT users. The group ID for this temporary group may be obtained during call setup, or prior to call setup. The users being invited are implicitly affiliated to this temporary group during call setup, and can be implicitly de-affiliated with the release of the group call. The group call is terminated by either the MCPTT server releasing the call or the authorized user ending the call. The release of the call may be followed by release of the temporary group ID.

10.6.2.8.2 Group call setup

Figure 10.6.2.8.2-1 below illustrates the group call setup procedure initiated by an authorized user.

Pre-conditions:

1. The authorized user is aware of the MCPTT users who will be invited to the temporary group call.
2. The MCPTT server is allowed to perform implicit affiliation/de-affiliation operation for this type of group call based on relevant configurations.
3. The MCPTT users being invited have relevant configurations that allow them to be implicitly affiliated for this type of group call.

4. A group ID may be available prior to group call setup.

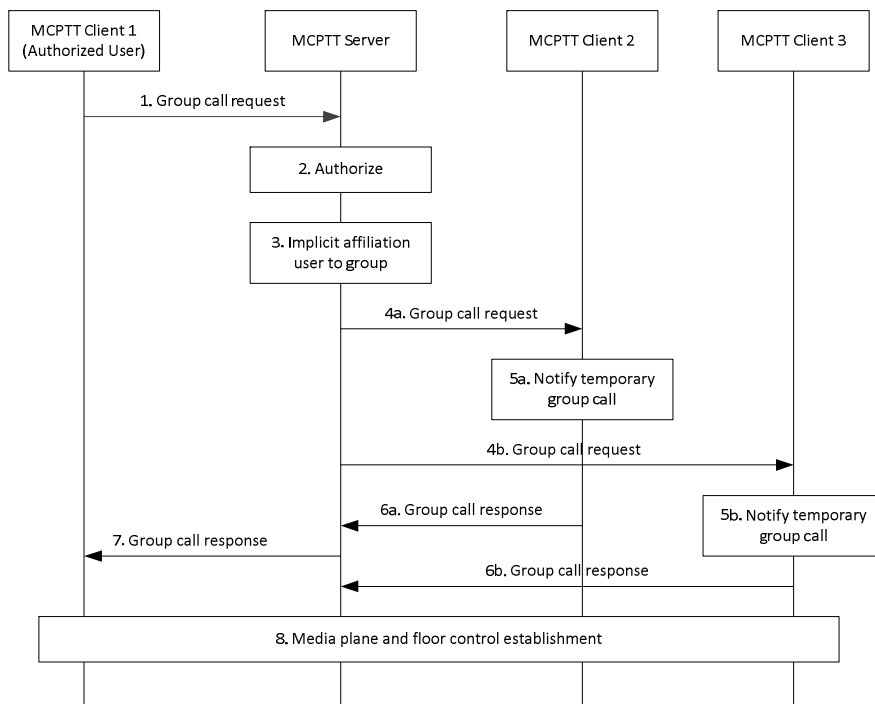

Figure 10.6.2.8.2-1: Group call setup for temporary group call – user regroup

1. MCPTT client 1 (of an authorized user) initiates the group call by sending the group call request to the MCPTT server.
2. The MCPTT server checks whether the MCPTT client 1 can initiate the group call.

Editor's note: It is FFS how the MCPTT server obtains the group ID for the temporary group call.

3. The MCPTT server implicitly affiliates the clients to the group.
4. The MCPTT server sends the group call requests towards the MCPTT clients. The message contains the temporary group indicator.
5. The receiving MCPTT clients are notified about the incoming group call. The users verify they are authorized to participate in the temporary group call.
6. The receiving MCPTT clients accept the group call requests and send group call responses to the MCPTT server. This response may contain an acknowledgement. The conditions for sending acknowledgement may be based on configuration.
7. The MCPTT server sends the group call response to MCPTT client 1 through the signalling path to inform about successful call establishment.

NOTE: Step 7 can occur at any time following step 6a, and prior to step 8 depending on the conditions to proceed with the call.

8. MCPTT client 1, client 2 and client 3 establish media plane and floor control resources.

10.6.2.8.3 Group call end (by authorized user)

Figure 10.6.2.8.3-1 below illustrates the group call end requested by the authorized user.

Pre-conditions:

1. The MCPTT server is allowed to perform implicit affiliation/de-affiliation operation for this type of group call.

2. MCPTT users on MCPTT client 1, client 2 and client 3 are already part of the ongoing temporary group call.

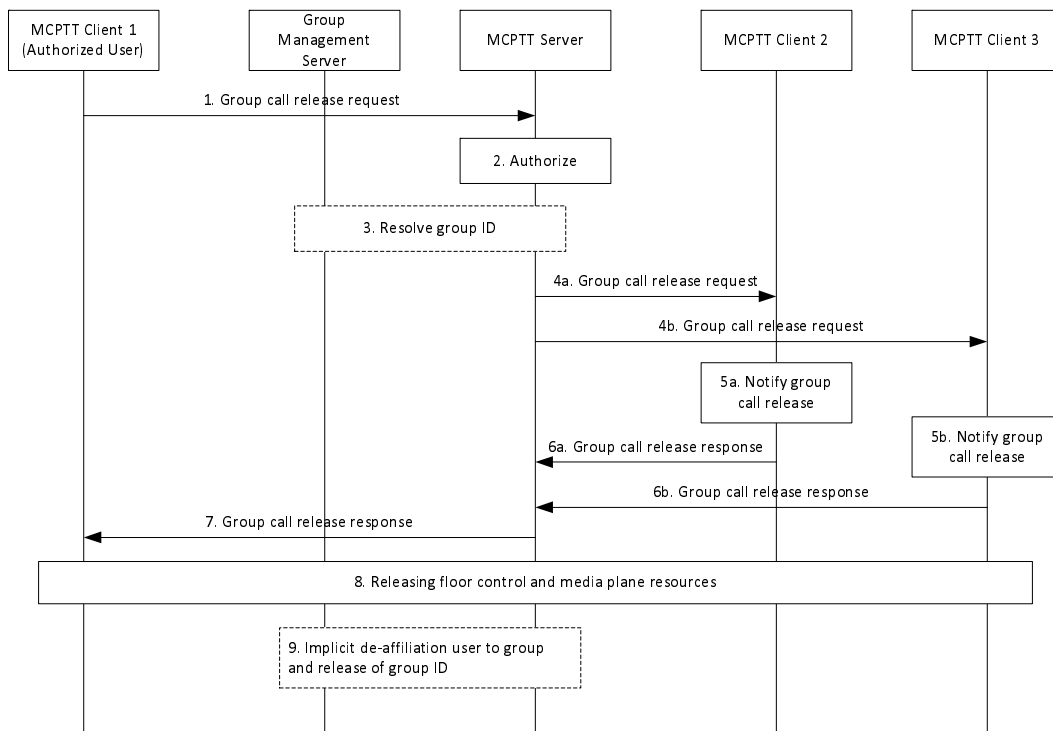

Figure 10.6.2.8.3-1: Group call end (by authorized user) for temporary group call – user regroup

1. The MCPTT client 1 (of an authorized user) requests to end the group call by sending group call release request to MCPTT server.
2. The MCPTT server checks whether the MCPTT client 1 can end the group call.
3. In this optional step the MCPTT server resolves the MCPTT group ID to determine the members of the group based upon the information from group management server.
4. The MCPTT server sends group call release requests to MCPTT clients of the group members.
5. The MCPTT clients are notified about the group call release.
6. The MCPTT clients send the group call release responses to MCPTT server to acknowledge the group call release. For a multicast call scenario, these acknowledgements are not sent.
7. The MCPTT server sends the group call release response to MCPTT client 1 to confirm the call is released.

NOTE: Step 7 can occur at any time following step 6a, and prior to step 8 depending on the conditions to release the call.

8. MCPTT client 1, client 2 and client 3 released the floor control and media plane resources associated with the group call.
9. MCPTT server implicitly de-affiliates MCPTT clients to the group. The group management server releases the temporary group ID. This step is optional.

10.6.3 Off-network group call

10.6.3.1 General

Off-network group calls can use pre-defined configuration information provided to MCPTT clients prior to the off-network group call or configuration information that is transmitted to MCPTT clients during group call setup or late entry procedures.

If off-network group configuration information is pre-defined (e.g. codec to be used) and provided to the MCPTT clients prior to the off-network group call (e.g. as part of group metadata), the MCPTT client will be able to participate in the off-network group call without needing to follow the group call setup or late joining procedures as they will be able to receive the media and signalling without the need for the announcement or invitation.

If off-network group configuration information is not pre-defined or provided, call parameters need to be transmitted to MCPTT clients via group call announcement or invitation.

NOTE: When the MCPTT client receives a message that is not addressed to either its MCPTT ID or to any MCPTT group of which the MCPTT client is an affiliated group member, the MCPTT client ignores the message.

10.6.3.2 Information flows for group call in off-network

10.6.3.2.1 Group call announcement

Table 10.6.3.2.1-1 describes the information flow for the group call announcement from the MCPTT client to other MCPTT clients.

Table 10.6.3.2.1-1: Group call announcement

Information Element	Status	Description
MCPTT ID	M	The identity of the calling party
MCPTT group ID	M	The MCPTT group ID on which the call is to be conducted
Media type	M	Type of the media to be used for the call
Media codec	M	The media codec to be used for the call
Multi-cast port	M	Multicast port number for media
Floor control port number	M	Port number for floor control protocol
Announcement period	M	Period of the group call announcement
Encryption parameters	O	Encryption parameters to be used for the call, if the call is to be encrypted
Confirm mode indicator	O	Indicates whether the MCPTT group call is to be confirmed
Emergency indicator	O	Indicates that the MCPTT group call is an MCPTT emergency call
Imminent peril indicator	O	Indicates that the MCPTT group call is an MCPTT imminent peril call

10.6.3.2.2 MCPTT upgrade to emergency call

Table 10.6.3.2.2-1 describes the information flow for the MCPTT upgrade to emergency call from the MCPTT client to other MCPTT clients.

Table 10.6.3.2.2-1: MCPTT upgrade to emergency call

Information Element	Status	Description
MCPTT ID	M	The identity of the upgrading party
MCPTT group ID	M	The MCPTT group ID on which the call is to be conducted

10.6.3.2.3 MCPTT emergency group state cancel

Table 10.6.3.2.3-1 describes the information flow for the MCPTT emergency group state cancel from the MCPTT client to other MCPTT clients.

NOTE: In Rel-14 and Rel-13 versions of this specification the name of this information flow is "MCPTT emergency group cancel".

Table 10.6.3.2.3-1: MCPTT emergency group state cancel

Information Element	Status	Description
MCPTT ID	M	The identity of the cancelling party
MCPTT group ID	M	The MCPTT group ID which emergency state is to be cancelled

10.6.3.2.4 Response

Table 10.6.3.2.4-1 describes the information flow for the response.

Table 10.6.3.2.4-1: Response

Information Element	Status	Description
MCPTT ID	M	The identity of the called party

10.6.3.2.5 MCPTT emergency alert announcement

Table 10.6.3.2.5-1 describes the information flow for the MCPTT emergency alert announcement from the MCPTT client to the other MCPTT clients.

Table 10.6.3.2.5-1: MCPTT emergency alert announcement

Information Element	Status	Description
MCPTT ID	M	The identity of the alerting MCPTT user
MCPTT group ID	M	The MCPTT group ID with which the alert is associated
Location	O	The alerting client's location, if known
Organization name	M	The alerting user's mission critical organization name

10.6.3.2.6 MCPTT emergency alert cancel announcement

Table 10.6.3.2.6-1 describes the information flow for the MCPTT emergency alert cancel announcement from the MCPTT client to other MCPTT clients.

Table 10.6.3.2.6-1: MCPTT emergency alert cancel announcement

Information Element	Status	Description
MCPTT ID	M	The identity of the cancelling MCPTT user
MCPTT group ID	M	The MCPTT group ID with which the alert is associated

10.6.3.2.7 MCPTT upgrade to imminent peril call

Table 10.6.3.2.7-1 describes the information flow for the MCPTT upgrade to imminent peril call from the MCPTT client to other MCPTT clients.

Table 10.6.3.2.7-1: MCPTT upgrade to imminent peril call

Information Element	Status	Description
MCPTT ID	M	The identity of the upgrading party
MCPTT group ID	M	The MCPTT group ID of the group to be upgraded

10.6.3.2.8 MCPTT imminent peril group call cancel

Table 10.6.3.2.8-1 describes the information flow MCPTT imminent peril group call cancel from the MCPTT client to other MCPTT clients.

Table 10.6.3.2.8-1: MCPTT imminent peril group call cancel

Information Element	Status	Description
MCPTT ID	M	The identity of the cancelling party
MCPTT group ID	M	The MCPTT group ID on which the imminent peril is to be cancelled

10.6.3.3 Group call setup

The flow in figure 10 6.3.3-1 illustrates the control plane procedures for MCPTT group call establishment for off-network. The procedure describes how an MCPTT client initiates an MCPTT group call with other MCPTT client within the off-network radio coverage and how the group call is established.

Pre-conditions:

- It is assumed that information for ProSe direct communications corresponding to the mappings of MCPTT group ID and ProSe Layer-2 Group ID (see subclause 8.1.3.2 in 3GPP TS 23.280 [16]) are pre-configured;
- It is assumed that a multicast IP address and port for the call setup signalling are pre-configured;
- All messages exchanged between the MCPTT clients for the MCPTT group follows ProSe direct communications as defined in 3GPP TS 23.303 [7]; and
- The MCPTT users of MCPTT client 1, 2 and 3 belong to the same MCPTT group.

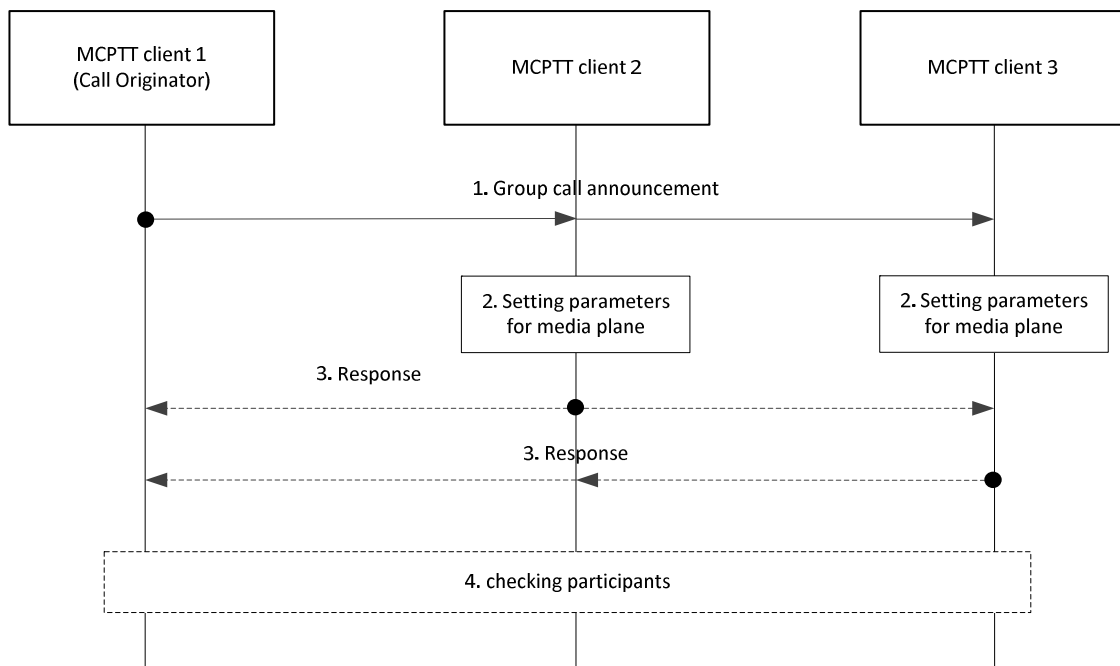

Figure 10.6.3.3-1: Off-network group call setup

1. MCPTT client 1 as the group call originator sends group call announcement message to the group. This message contains the following parameters such as MCPTT group ID, group call originator identity, media type, media codec, multicast port number for media, port number for floor control protocol, period of group call announcement, and any encryption key for the media encryption if needed, and optionally confirm mode indication.

NOTE 1: The group call announcement includes at least one common set of parameters and values for media transfer. Additional values per parameter will not be prohibited for the better user experience.

NOTE 2: By using the ProSe Layer-2 Group ID mapping with the MCPTT group ID, ProSe layer ensures that the messages sent for the corresponding MCPTT group are only received by its group's members.

2. MCPTT client 2, 3 join the group call. The MCPTT clients configure the parameters for media delivery by making use of the received parameters in group call announcement.

3. MCPTT client 2, 3 may send the response message to the group when the group call announcement from originator includes confirm mode indication. This message contains MCPTT ID.

4. MCPTT client 2, 3 recognize the group call originator through the group call announcement and MCPTT client 1 checks the participants of the group call through the received response message.

NOTE 3: Due to the movement of the participants (in and out of the radio coverage) during the off-network group call, the group call announcement message including parameters for media delivery is periodically sent.

NOTE 4: The participating MCPTT clients do not need to respond to the periodic group call announcement.

10.6.3.4 Passive join to group call

Figure 10.6.3.4-1 illustrates the control plane procedures for the passive MCPTT client to join the on-going MCPTT group call. The passive MCPTT client does not initiate to establish an MCPTT group call, but receives the group call announcement to be transferred periodically. When receiving the announcement message with parameters for media transfer, the passive MCPTT client configures the parameter to receive the voice and joins the announced MCPTT group call.

This procedure happens after the MCPTT group call is established. The group call announcement including the parameters for the media transfer has been performed periodically, in order for the MCPTT client later to join the MCPTT group call.

The MCPTT client 4 enters the coverage of the MCPTT group call lately.

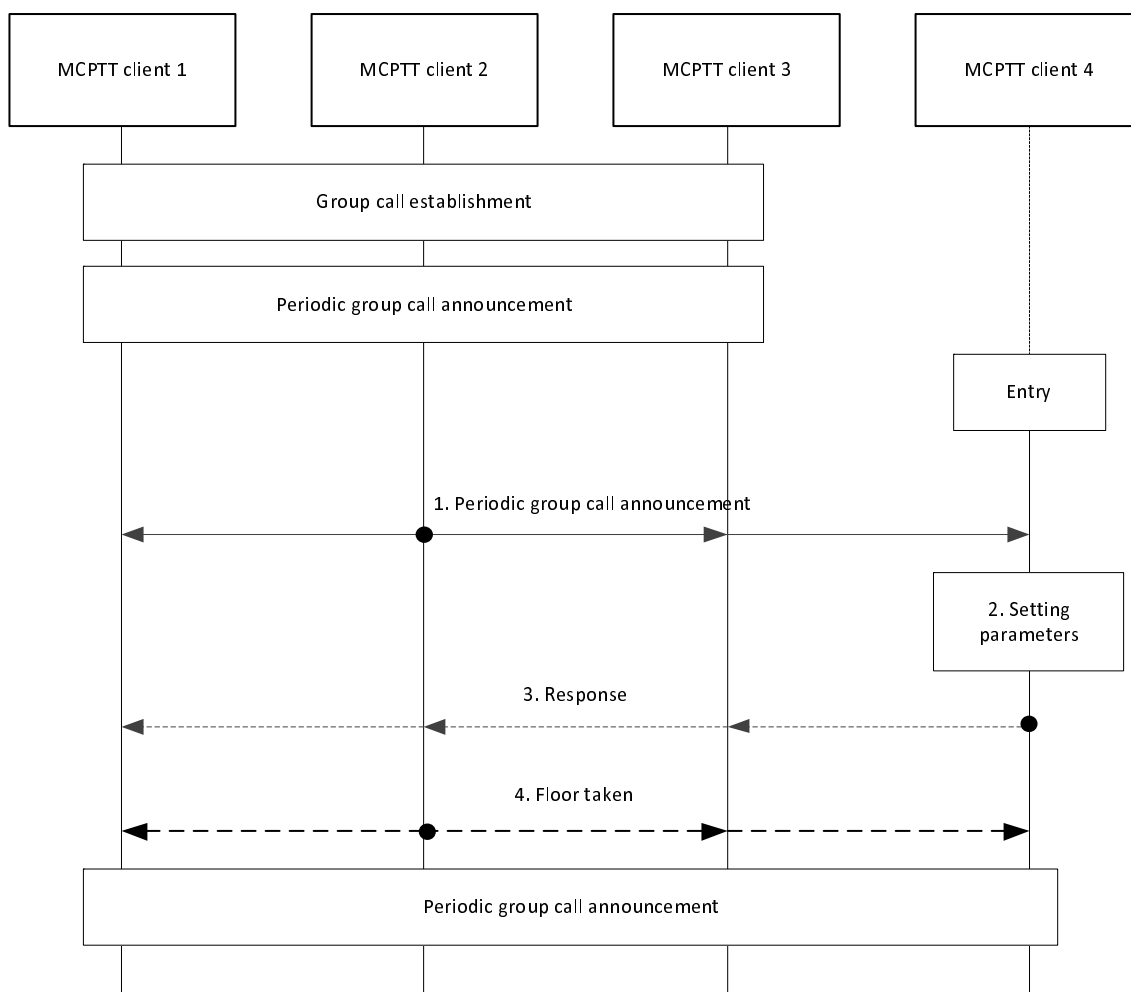

Figure 10.6.3.4-1: Passive join to group call

1. MCPTT client 2 sends the group call announcement message. This message contains parameters such as MCPTT group ID, group call originator identity, media type, media codec, multicast port number for media, port number for floor control protocol, any encryption key for the media encryption if needed, and optionally confirm mode indication.

NOTE 1: The group call announcement includes at least one common set of parameters and values for media transfer. Additional values per parameter will not be prohibited for the better user experience.

2. MCPTT client 4 configures the parameters for media transfer by making use of the received parameters in group call announcement.
3. MCPTT client 4 may send the response message to the group when the periodic group call announcement includes confirm mode indication. This message contains the MCPTT ID.
4. MCPTT client 1, 2, 3 check through the received response message that the MCPTT client 4 joins the group call. The MCPTT client 2, as the floor control arbitrator, may send a floor taken message.

NOTE 2: Due to the movement of the participants (in and out of the radio coverage) during the off-network group call, the group call announcement message including parameters for media delivery is periodically sent.

NOTE 3: The participating MCPTT clients do not need to respond to the periodic group call announcement.

10.6.3.5 Join to ongoing group call when new entry member initiates the call with on-going group call id

Figure 10 6.3.5-1 illustrates the control plane procedures for an MCPTT client to join an on-going MCPTT group call. When entering the coverage of on-going group call, new MCPTT client may send group call setup announcement message with on-going group call id. Upon receiving the group call setup announcement, the MCPTT client as a

participant of on-going MCPTT group call sends parameters for media transfer to the newly entered MCPTT client (entrant) to join the on-going MCPTT group call. When receiving the parameters for media transfer of on-going MCPTT group call, the MCPTT client configures the parameters to receive the voice and becomes the participant of the on-going MCPTT group call.

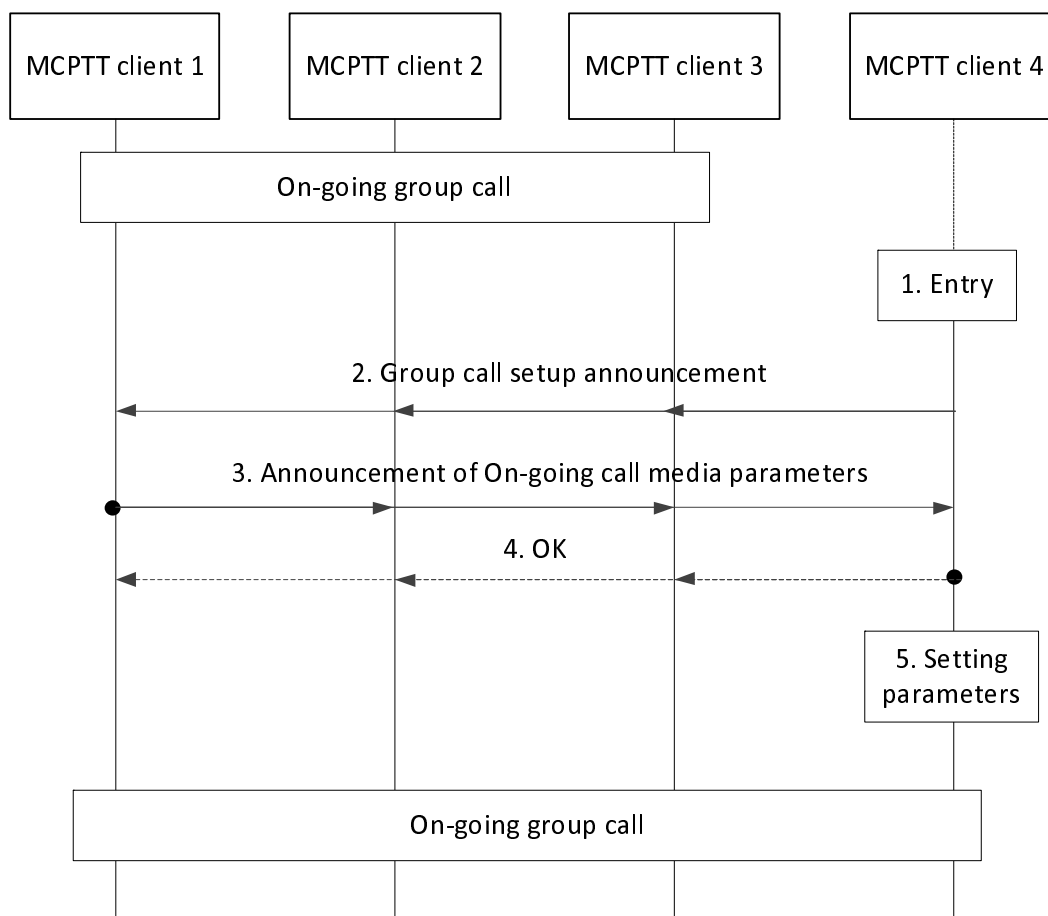

Figure 10.6.3.5-1: Late entry join when receiving MCPTT group call announcement with on-going MCPTT group ID

1. MCPTT client 4 enters the coverage of the on-going MCPTT group call.
2. The new entry of MCPTT client 4 sends group call setup announcement with MCPTT group id.
3. MCPTT client 1 as a participant of on-going MCPTT group call acknowledges that on-going MCPTT group call exists with MCPTT group call id sent by MCPTT client 4 and sends parameters for media transfer to MCPTT client 4.
4. MCPTT client 4 may send a response message.
5. MCPTT client 4 sets the parameters for media delivery in the on-going MCPTT group call.

MCPTT client 4 joins and becomes participants of the on-going MCPTT group call.

10.6.3.6 Immediate group call announcement to join an ongoing group call

Figure 10.6.3.6-1 illustrates the control plane procedures for an MCPTT client to immediately join an on-going MCPTT group call. Upon the detection of a new entrant, the MCPTT client that is the current talker (floor arbitrator) immediately sends the group call announcement. When receiving the group call announcement message with parameters for media transfer, that MCPTT client configures the parameters to receive the voice and joins the on-going MCPTT group call.

Pre-conditions:

1. There is on-going group call. MCPTT client 1 is the current talker and therefore the floor arbitrator.

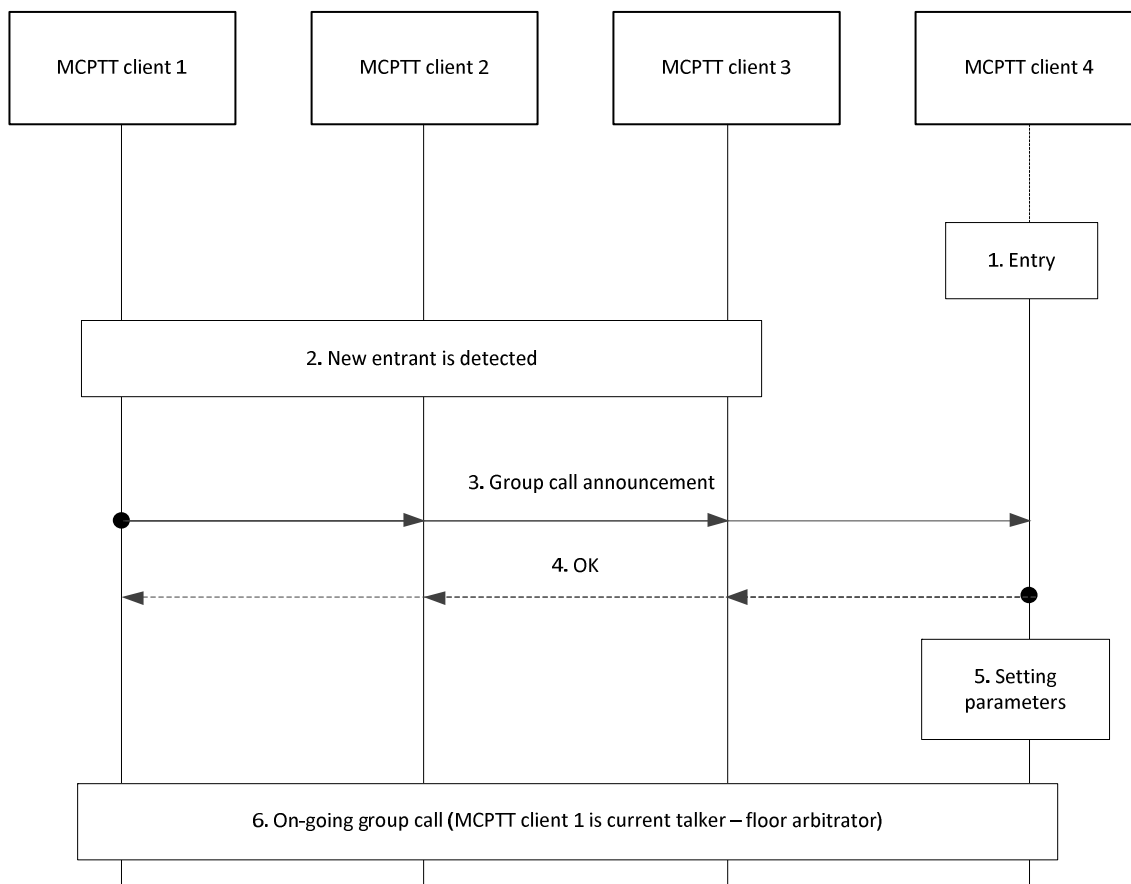

Figure 10.6.3.6-1: Immediate group call announcement to join an ongoing group call

1. MCPTT client 4 enters the coverage of the on-going MCPTT group call.
2. The entry of MCPTT client 4 is detected by the current participants.
3. Since MCPTT client 1 is the current talker (floor arbitrator), MCPTT client 1 immediately sends the group call announcement with the call parameters to the group.
4. MCPTT client 4 may send a response message.
5. MCPTT client 4 sets the parameters for the group call.
6. All participants are now considered part of the on-going group call.

10.6.3.7 Group call release due to inactivity

If the on-going MCPTT group call is inactive for a specific duration, the participating MCPTT clients release the MCPTT group call by themselves.

NOTE: Inactivity time can be set according to the policy of MCPTT service provider.

10.6.3.8 Broadcast group call

Group call on group-broadcast group and user-broadcast group are handled without distinction in off-network.

Figure 10 6.3.8.1-1 illustrates the control plane procedures for broadcast group call in off-network.

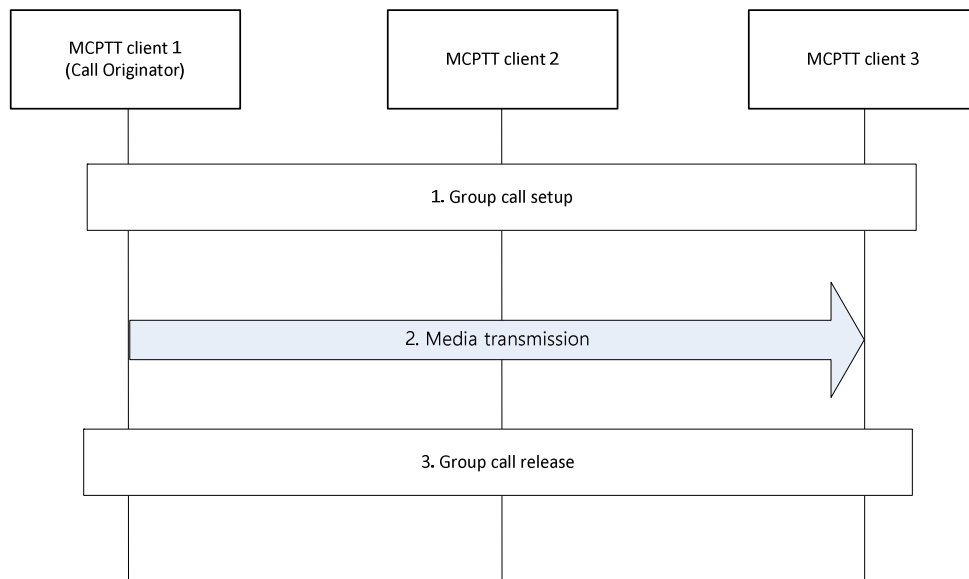

Figure 10.6.3.8.1-1: Broadcast group call in off-network

1. An authorized MCPTT client 1 initiates broadcast group call setup as described in subclause 10.6.3.3. The group call announcement message includes the indication of broadcast group call.
2. The MCPTT client 1 initiating broadcast group call starts to transmit media.

NOTE: Other clients of group member are not allowed to transmit media in broadcast group call.

3. The broadcast group call is released as described in subclause 10.6.3.7.

10.6.3.9 Emergency and imminent peril procedures

10.6.3.9.1 Emergency group call

The off-network emergency group call is a special case of off-network (non-emergency) group call as defined in subclauses 10.6.3.2, 10.6.3.3, 10.6.3.4, 10.6.3.5, 10.6.3.6 and 10.6.3.7. The following are modifications to the aforementioned subclauses to support MCPTT emergency group calls:

- As a pre-condition, the client initiating the emergency call has previously been provisioned with an MCPTT group designated as the MCPTT emergency group. The MCPTT client initiates MCPTT emergency group calls on this group. Alternatively, the MCPTT client could have been provisioned for emergency behaviour on the selected MCPTT group.
- The group call announcement contains an indication that the MCPTT group call is to be an MCPTT emergency call regardless of whether or not the MCPTT client is in call. Group call participants learn of the MCPTT group's in-progress emergency state from the indication.
- Every call initiated by the MCPTT client will be an emergency call while the MCPTT client is in MCPTT emergency state.
- The MCPTT client enters the MCPTT emergency state when initiating an MCPTT emergency call or MCPTT emergency alert. Only the MCPTT user of the MCPTT client can clear the client's local MCPTT emergency state.
- The MCPTT group in-progress emergency state is cancelled when the call ends.
- The MCPTT user who initiated an emergency call, or upgraded a group call to an emergency call, or an authorized user, may cancel the in-progress emergency state with an MCPTT emergency group state cancel message. The message is sent to the call participants.
- When the MCPTT group is no longer in the in-progress emergency state, every client returns its default value of Prose Per Packet Priority.

- An MCPTT group call in-progress is upgraded to an emergency group call when the periodic group call announcement contains the emergency indicator.
- The value of ProSe Per Packet Priority is upgraded according to emergency state of MCPTT group call.
- An MCPTT group call becoming an emergency group call does not affect the state of other MCPTT call(s) in the client.
- The MCPTT group remains in the in-progress emergency state until the emergency group call ends or the in-progress emergency state is cancelled.

10.6.3.9.2 MCPTT imminent peril

The off-network imminent peril group call is a special case of off-network (non-imminent peril) group call as defined in subclauses 10.6.3.2, 10.6.3.3, 10.6.3.4, 10.6.3.5, 10.6.3.6 and 10.6.3.7. The following are modifications to the aforementioned subclauses to support MCPTT imminent peril calls:

- As a pre-condition, the user initiating the imminent peril call has previously an MCPTT group to be used as the MCPTT imminent peril group. The MCPTT client initiates MCPTT imminent peril group calls on this group.
- The group call announcement contains an indication that the MCPTT group call is to be an MCPTT imminent peril call. Group call participants learn of the MCPTT group in-progress imminent peril condition from the indication.
- The MCPTT group in-progress imminent peril state is considered cancelled when the call ends.
- The originating MCPTT user of the in-progress imminent peril or an authorized user may cancel the in-progress imminent peril state with an MCPTT imminent peril group cancel. The message is sent to the call participants.
- When the MCPTT in-progress imminent peril is no longer in the in-progress imminent peril state, every MCPTT client returns its bearer to the priority it had prior to the in-progress imminent peril state.
- An MCPTT upgrade to imminent peril call is used to upgrade an MCPTT group call already in progress. The message is sent to all call participants so that they are aware of the in-progress imminent peril.
- The bearer is upgraded by all participants for the MCPTT group call already in progress when the MCPTT group call is upgraded to in-progress imminent peril state.
- An MCPTT imminent peril call puts the MCPTT group into the in-progress imminent peril state.

10.6.3.9.3 MCPTT emergency alert

Editor's note: whether the following procedures for emergency alert initiation and emergency alert cancel remain in this specification is FFS.

10.6.3.9.3.1 MCPTT emergency alert initiation

An MCPTT client initiates an MCPTT emergency alert to the members of an MCPTT group. This procedure will place the MCPTT client in the MCPTT emergency state if the MCPTT client is not already in that state.

Procedures in figure 10.6.3.9.3.1-1 are the signalling control plane procedures for the MCPTT client initiating an MCPTT emergency alert with an MCPTT group i.e., MCPTT users on MCPTT client 1, MCPTT client 2 and MCPTT client 3 belong to the same MCPTT group.

Pre-conditions:

1. The pre-conditions for off-network group calls as described in subclause 10.6.3.3 apply.
2. The initiating MCPTT client 1 has been provisioned with an MCPTT group designated as the MCPTT emergency group.

NOTE 1: Alternatively, MCPTT client 1 could have been provisioned for emergency behaviour on the currently selected group.

3. MCPTT clients 2 and 3 belong to and are ready for off-network communications on the MCPTT group.

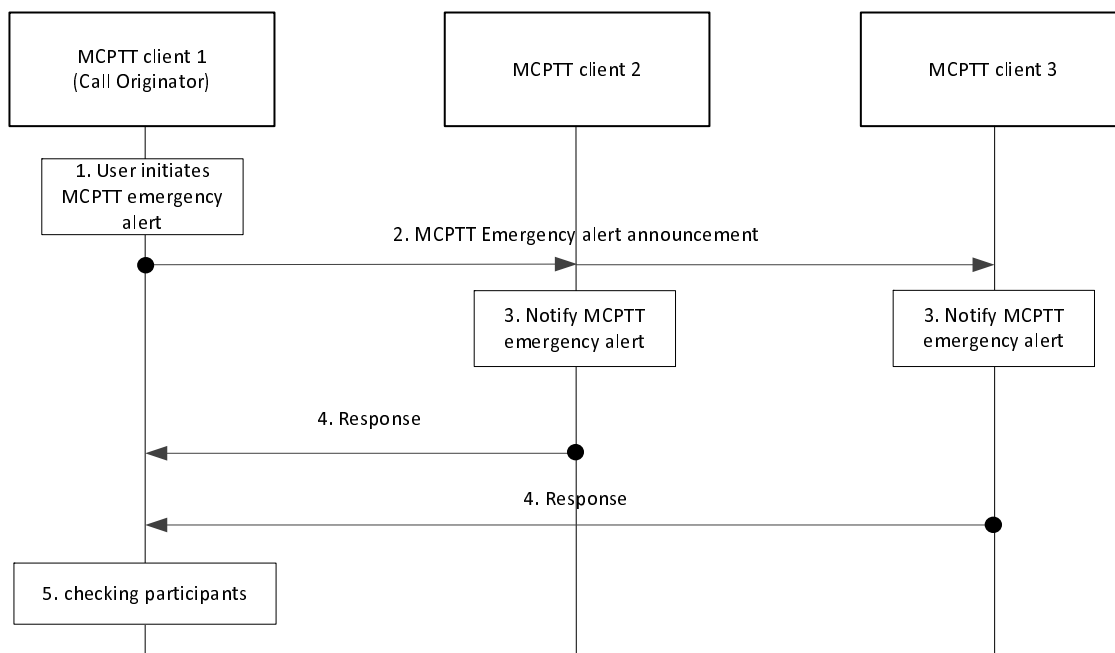

Figure 10.6.3.9.3.1-1: MCPTT emergency alert

1. The user at the MCPTT client 1 initiates an MCPTT emergency alert by sending an MCPTT emergency alert announcement to the other clients. MCPTT client 1 sets its MCPTT emergency state. The MCPTT emergency state is retained by the MCPTT client until explicitly cancelled. Once MCPTT client1 is in the MCPTT emergency state, any calls initiated by MCPTT client 1, group or private, shall be initiated as emergency calls and receive priority treatment. The MCPTT emergency alert announcement is sent periodically so that late joining MCPTT group members are notified.

2. MCPTT client 1 sends an MCPTT emergency alert announcement to the other participants on the MCPTT emergency group.

NOTE 2: Sending the emergency alert without making a request to also start an MCPTT emergency call does not put the group into the in-progress emergency state.

3. MCPTT users are notified of the MCPTT emergency state of the originating MCPTT user.

4. The receiving MCPTT clients acknowledge the MCPTT emergency alert to the originating MCPTT client.

NOTE 3: Sending the emergency alert without making a request to also start an emergency call does not put the group into the in-progress emergency state.

NOTE 4: The MCPTT client 1 need not initiate a group call. For example, the MCPTT client can be configured to only allow alerts or the MCPTT user can choose not to make an MCPTT emergency group call.

NOTE 5: MCPTT clients receiving subsequent MCPTT emergency alert announcements that are sent periodically need only respond to the first one that they receive.

5. The originating MCPTT client 1 checks the responses and may inform the MCPTT user of the MCPTT group members whose MCPTT clients responded.

10.6.3.9.3.2 MCPTT emergency alert cancel

An MCPTT client has initiated an MCPTT emergency alert, has entered the MCPTT emergency state and wishes to cancel the alert, informing the other MCPTT group members of the cancellation. As part of this process, the MCPTT client may also request the cancellation of the in-progress emergency state of the group if authorized to do so.

Procedures in figure 10.6.3.9.3.2-1 are the signalling control plane procedures for the MCPTT client cancelling an MCPTT emergency alert with an MCPTT group i.e., MCPTT users on MCPTT client 1, MCPTT client 2 and MCPTT client 3 belong to the same MCPTT group.

Pre-conditions:

1. The MCPTT client 1 had previously successfully initiated an MCPTT emergency alert.
2. The MCPTT client 1 is still in the MCPTT emergency state.
3. The initiating MCPTT client 1 and MCPTT clients 2 and 3 are still in off-network contact via the MCPTT group designated provisioned to MCPTT client 1 as the MCPTT emergency group.

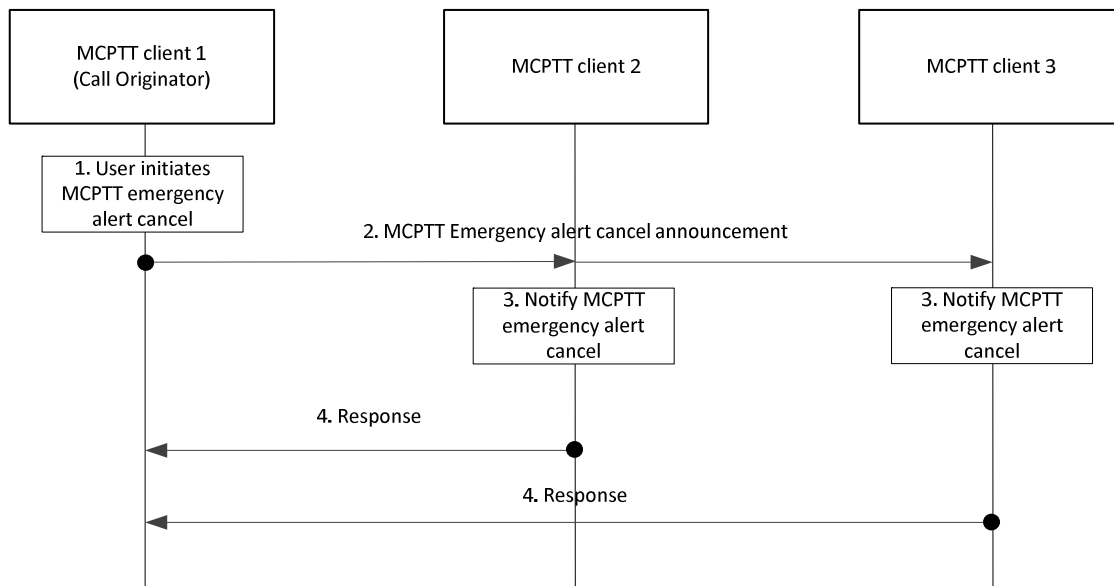

Figure 10.6.3.9.3.2-1 MCPTT emergency alert cancel

1. The user at the MCPTT client 1 initiates an MCPTT emergency alert cancel.
2. MCPTT client 1 sends an MCPTT emergency alert cancel announcement to the MCPTT group to which MCPTT client 1 had previously sent the emergency alert.
3. MCPTT users are notified of the MCPTT emergency alert cancellation by MCPTT client 1.
4. The receiving MCPTT clients acknowledge the MCPTT emergency alert cancel to the originating MCPTT client.

NOTE: MCPTT clients that track the MCPTT emergency alerts of other MCPTT users, e.g. consoles that fail to receive subsequent periodic MCPTT emergency alert announcements after a configured timeout can consider the alert to be cancelled.

10.7 Private call

10.7.1 General

Private calls are enabled in both on-network and off-network.

Private calls can be setup in two different commencement modes, automatic commencement mode and manual commencement mode.

Private calls in on-network can be with or without floor control. Private calls in off-network are with floor control.

10.7.2 Private call in on-network

10.7.2.1 Information flows for private call in on-network

10.7.2.1.1 MCPTT private call request (MCPTT client to MCPTT server)

Table 10.7.2.1.1-1 describes the information flow MCPTT private call request from the MCPTT client to the MCPTT server.

Table 10.7.2.1.1-1: MCPTT private call request (MCPTT client to MCPTT server) information elements

Information Element	Status	Description
MCPTT ID	M	The MCPTT ID of the calling party
MCPTT ID	M	The MCPTT ID of the called party
Use floor control indication	M	This element indicates whether floor control will be used for the private call.
SDP offer	O	Media parameters of MCPTT client.
Requested commencement mode	O	An indication that is included if the user is requesting a particular commencement mode
Implicit floor request	O	An indication that the user is also requesting the floor.

10.7.2.1.2 MCPTT private call request (MCPTT server to MCPTT server)

Table 10.7.2.1.2-1 describes the information flow MCPTT private call request from the MCPTT server to the MCPTT server.

Table 10.7.2.1.2-1: MCPTT private call request (MCPTT server to MCPTT server) information elements

Information Element	Status	Description
MCPTT ID	M	The MCPTT ID of the calling party
MCPTT ID	M	The MCPTT ID of the called party
Use floor control indication	M	This element indicates whether floor control will be used for the private call.
SDP offer	M	Media parameters of MCPTT client.
Requested commencement mode	O	An indication of the commencement mode to be used.
Implicit floor request	O	An indication that the user is also requesting the floor.

10.7.2.1.2a MCPTT private call request (MCPTT server to MCPTT client)

Table 10.7.2.1.2a describes the information flow MCPTT private call request from the MCPTT server to the MCPTT client.

Table 10.7.2.1.2a: MCPTT private call request (MCPTT server to MCPTT client) information elements

Information Element	Status	Description
MCPTT ID	M	The MCPTT ID of the calling party
MCPTT ID	M	The MCPTT ID of the called party
Use floor control indication	M	This element indicates whether floor control will be used for the private call.
SDP offer	M	Media parameters of MCPTT client.
Requested commencement mode	O	An indication of the commencement mode to be used.
Implicit floor request	O	An indication that the user is also requesting the floor.

10.7.2.1.3 MCPTT private call response (MCPTT client to MCPTT server)

Table 10.7.2.1.3-1 describes the information flow MCPTT private call response from the MCPTT client to the MCPTT server.

Table 10.7.2.1.3-1: MCPTT private call response (MCPTT client to MCPTT server) information elements

Information Element	Status	Description
MCPTT ID	M	The MCPTT ID of the calling party
MCPTT ID	O	The MCPTT ID of the called party
SDP answer	M	Media parameters selected
Requested commencement mode	O	An indication of the commencement mode to be used.

10.7.2.1.4 MCPTT private call response

Table 10.7.2.1.4-1 describes the information flow MCPTT private call response from the MCPTT server to the MCPTT server and the MCPTT server to the MCPTT client.

Table 10.7.2.1.4-1: MCPTT private call response information elements

Information Element	Status	Description
MCPTT ID	M	The MCPTT ID of the calling party
MCPTT ID	O	The MCPTT ID of the called party
Acceptance confirmation	O	An indication whether the user has positively accepted the call.
SDP answer	M	Media parameters selected

10.7.2.1.4a MCPTT private call end request

Table 10.7.2.1.4a-1 describes the information flow MCPTT private call end request from the MCPTT client to the MCPTT server and from the MCPTT server to the MCPTT client.

Table 10.7.2.1.4a-1: MCPTT private call end request information elements

Information Element	Status	Description
MCPTT ID	M	The MCPTT ID of the calling party
MCPTT ID	M	The MCPTT ID of the called party

10.7.2.1.4b MCPTT private call end response

Table 10.7.2.1.4b-1 describes the information flow MCPTT private call end response from the MCPTT client to the MCPTT server and from the MCPTT server to the MCPTT client.

Table 10.7.2.1.4b-1: MCPTT private call end response information elements

Information Element	Status	Description
MCPTT ID	M	In the direction MCPTT client to MCPTT server this shall be the MCPTT ID of the responding MCPTT client. In the direction MCPTT server to MCPTT client this shall be the MCPTT ID of the destination MCPTT client

10.7.2.1.5 MCPTT emergency private call request (MCPTT client to MCPTT server)

Table 10.7.2.1.5-1 describes the information flow MCPTT emergency private call request from the MCPTT client to the MCPTT server.

Table 10.7.2.1.5-1: MCPTT emergency private call request (MCPTT client to MCPTT server) information elements

Information Element	Status	Description
MCPTT ID	M	The MCPTT ID of the calling party
MCPTT ID	M	The MCPTT ID of the called party
Emergency indicator	M	Indicates that the private call request is an MCPTT emergency call
Alert indicator	M	Indicates whether an emergency alert is to be sent
Requested commencement mode	O	An indication of the commencement mode to be used.
Implicit floor request	O	An indication that the user is also requesting the floor.
SDP offer	M	Media parameters of MCPTT client.

10.7.2.1.5a MCPTT emergency private call request (MCPTT server to MCPTT client)

Table 10.7.2.1.5a-1 describes the information flow MCPTT emergency private call request from the MCPTT server to the MCPTT client.

Table 10.7.2.1.5a-1: MCPTT emergency private call request (MCPTT server to MCPTT client) information elements

Information Element	Status	Description
MCPTT ID	M	The MCPTT ID of the calling party
MCPTT ID	M	The MCPTT ID of the called party
Emergency indicator	M	Indicates that the private call request is an MCPTT emergency call
Alert indicator	M	Indicates whether an emergency alert is to be sent
Requested commencement mode	O	An indication of the commencement mode to be used.
Implicit floor request	O	An indication that the user is also requesting the floor.
SDP offer	M	Media parameters of MCPTT client.

10.7.2.1.6 MCPTT progress indication

Table 10.7.2.1.6-1 describes the information flow MCPTT progress indication from the MCPTT server to the MCPTT client.

Table 10.7.2.1.6-1: MCPTT progress indication information elements

Information Element	Status	Description
MCPTT ID	M	The MCPTT ID of the calling party
MCPTT ID	M	The MCPTT ID of the called party
Progress indication	O	Indication to the caller.

10.7.2.1.7 MCPTT ringing

Table 10.7.2.1.7-1 describes the information flow MCPTT ringing from the MCPTT client to the MCPTT server, from the MCPTT server to the MCPTT server, and from the MCPTT server to the MCPTT client.

Table 10.7.2.1.7-1: MCPTT ringing information elements

Information Element	Status	Description
MCPTT ID	M	The MCPTT ID of the calling party
MCPTT ID	M	The MCPTT ID of the called party
Ringing indication	O	Indication to the caller.

10.7.2.2 Private call within one MCPTT system

10.7.2.2.1 Private call setup in automatic commencement mode

The procedure focuses on the case where an MCPTT user is initiating an MCPTT private call for communicating with another MCPTT user, with or without floor control enabled, in an automatic commencement mode.

Procedures in figure 10.7.2.2.1-1 are the basic signalling control plane procedures for the MCPTT client initiating establishment of MCPTT private call with the chosen MCPTT user.

Pre-conditions:

1. The calling MCPTT user has selected automatic commencement mode for the call; or
2. The called MCPTT client is set to automatic commencement mode.

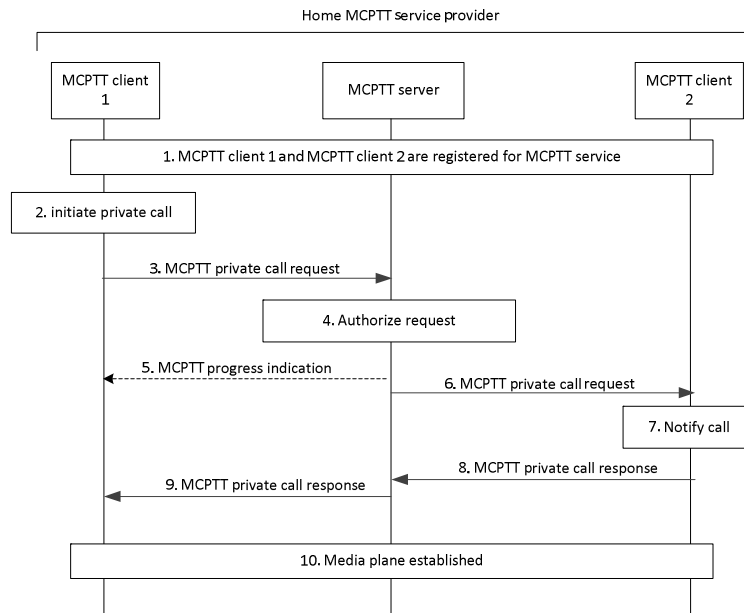

Figure 10.7.2.2.1-1: Private call setup in automatic commencement mode– MCPTT users in the same MCPTT system

1. MCPTT users on MCPTT client 1 and MCPTT client 2 are already registered for receiving MCPTT service, as per procedure in subclause 10.2.
 2. User at MCPTT client 1 would like to initiate an MCPTT private call for the chosen MCPTT user. For a private call with floor control, floor control is to be established.
 3. MCPTT client 1 sends an MCPTT private call request towards the MCPTT server (via SIP core) using a service identifier as defined in 3GPP TS 23.228 [5] for MCPTT, for establishing a private call with the chosen MCPTT user. The MCPTT private call request contains the MCPTT id of invited user, an SDP offer containing one or more media types. For a private call with floor control, the MCPTT private call request also contains an element that indicates that MCPTT client 1 is requesting the floor. The MCPTT client 1 may include a Requested commencement mode that indicates that the call is to be established in automatic commencement mode if automatic commencement mode is requested by the initiating user.
 4. MCPTT server checks whether the MCPTT user at MCPTT client 1 is authorized to initiate the private call, and that MCPTT user at MCPTT client 2 is authorized to receive the private call. If the MCPTT private call request requested automatic commencement mode then the MCPTT server also checks whether the MCPTT user at MCPTT client 1 is authorized to initiate a private call in automatic commencement mode.
 5. MCPTT server may provide a progress indication to MCPTT client 1 to indicate progress in the call setup process.
- NOTE: Step 5 can occur at any time following step 4, and prior to step 9.
6. If authorized, MCPTT server includes information that it communicates using MCPTT service, offers the same media types or a subset of the media types contained in the initial received request, includes the requested automatic commencement mode indication based on a requested automatic commencement mode by the calling user or based upon the setting of the called MCPTT client and sends the corresponding MCPTT private call request towards the MCPTT client 2, including the MCPTT ID of the calling MCPTT user 1. If the called MCPTT user has registered to the MCPTT service with multiple MCPTT UEs and has designated the MCPTT UE for receiving the private calls, then the incoming MCPTT private call request is delivered only to the designated MCPTT UE.
 7. The receiving MCPTT client 2 notifies the user about the incoming private call.
 8. The receiving MCPTT client 2 accepts the private call automatically, and an MCPTT private call response is sent to the MCPTT server (via SIP core).

9. Upon receiving the MCPTT private call response from MCPTT client 2 accepting the private call request, the MCPTT server informs the MCPTT client 1 about successful call establishment.
10. MCPTT client 1 and MCPTT client 2 have successfully established media plane for communication and either user can transmit media. For successful call establishment for private call with floor control request from MCPTT client 1, floor participant at MCPTT client 1 is granted floor by the floor control server, giving it permission to transmit. At the same time floor participant at MCPTT client 2 is informed by the floor control server that floor is taken.

10.7.2.2.2 Private call setup in manual commencement mode

10.7.2.2.2.1 Description

Figure 10.7.2.2.2.2-1 describes the basic procedure for the MCPTT client initiating an MCPTT private call that uses manual commencement mode. The flow may use a floor request in the MCPTT private call request indicating that the originator will be given the floor when the call starts and eliminates the need for a separate initial floor request message during media plane establishment. Alternatively the call initiation may be sent without the floor request, which allows the called party to request the floor first.

10.7.2.2.2.2 Procedure

Both clients are served by the primary MCPTT service provider in figure 10.7.2.2.2.2-1.

Pre-conditions:

1. The calling MCPTT user has selected manual commencement mode or has not specified a commencement mode for the call; and
2. The called MCPTT client is set to manual commencement mode.

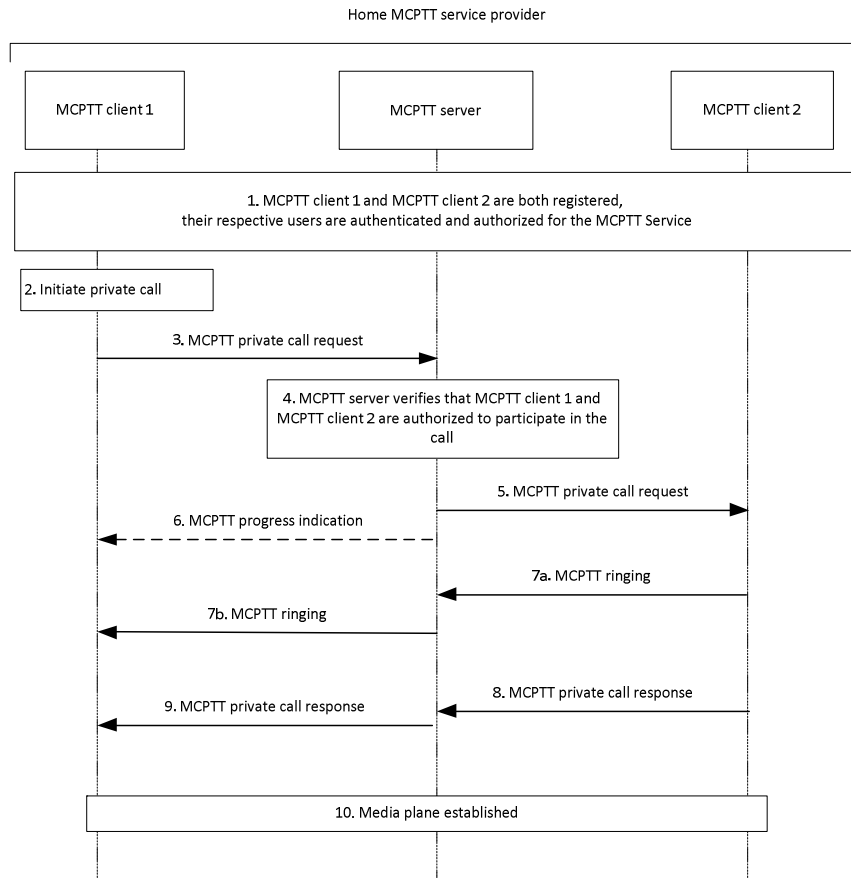

Figure 10.7.2.2.2-1: MCPTT private call in manual commencement mode– MCPTT users in the same MCPTT system

- MCPTT client 1 and MCPTT client 2 are both registered and their respective users, MCPTT user 1 and MCPTT user 2, are authenticated and authorized to use the MCPTT service, as per procedure in subclause 10.2.
- MCPTT user at MCPTT client 1 would like to initiate an MCPTT private call for the selected MCPTT user. For a private call with floor control, floor control is to be established. For private call without floor control, both users will have the ability to transmit without floor arbitration.
- MCPTT client 1 sends an MCPTT private call request addressed to the MCPTT ID of MCPTT user 2 using an MCPTT service identifier as defined in 3GPP TS 23.228 [5] (possible for the SIP core to route the request to the MCPTT server). The MCPTT private call request contains the MCPTT ID of invited user and an SDP offer containing one or more media types. The MCPTT private call request may also contain a data element that indicates that MCPTT client 1 is requesting the floor, for a private call with floor control. The MCPTT client 1 may include a requested commencement mode that indicates that the call is to be established in manual commencement mode if manual commencement mode is requested by the initiating user.
- The MCPTT server confirms that both MCPTT users are authorized for the private call. The MCPTT server checks the commencement mode setting of the called MCPTT client and also checks whether the MCPTT user at MCPTT client 1 is authorized to initiate a call in manual commencement mode.
- The MCPTT server includes information that it communicates using MCPTT service, offers the same media types or a subset of the media types contained in the initial received request and sends an MCPTT private call request for the call to MCPTT client 2, including the MCPTT ID of the calling MCPTT user 1. If the called MCPTT user has registered to the MCPTT service with multiple MCPTT UEs and has designated the MCPTT UE for receiving the private calls, then the incoming MCPTT private call request is delivered only to the designated MCPTT UE.

6. MCPTT server may provide a progress indication to MCPTT client 1 to indicate progress in the call setup process.

NOTE: Step 6 can occur at any time following step 4, and prior to step 7b.

7a. The MCPTT user is alerted. MCPTT client 2 sends an MCPTT ringing to the MCPTT server.

7b. The MCPTT server sends an MCPTT ringing to MCPTT client 1, indicating that MCPTT client 2 is being alerted.

8. MCPTT user 2 has accepted the call using manual commencement mode (i.e., has taken some action to accept via the user interface) which causes MCPTT client 2 to send an MCPTT private call response to the MCPTT server. If MCPTT user 2 has not accepted the incoming call, the MCPTT client 2 sends a call failure response to the MCPTT server without adding reason for call failure.

9. The MCPTT server sends an MCPTT private call response to MCPTT client 1 indicating that MCPTT user 2 has accepted the call, including the accepted media parameters.

10. The media plane for communication is established. Either user can transmit media individually when using floor control. For successful call establishment for private call with floor request from MCPTT client 1, the floor participant associated with MCPTT client 1 is granted the floor initially. At the same time the floor participant associated with MCPTT client 2 is informed that the floor is taken. The meaning of the floor request (give floor initially to originator [client 1], or give floor initially to target [client 2]) may be configurable. For a private call without floor control both users are allowed to transmit simultaneously.

10.7.2.2.3 Private call release

10.7.2.2.3.1 Client initiated

The procedure focuses on the case where an MCPTT client is requesting to release an ongoing MCPTT private call (with or without floor control) and the call established in either of the two commencement modes (manual or automatic).

Procedures in figure 10.7.2.2.3.1-1 are the basic signalling control plane procedures for the MCPTT client initiating the release of an ongoing MCPTT private call.

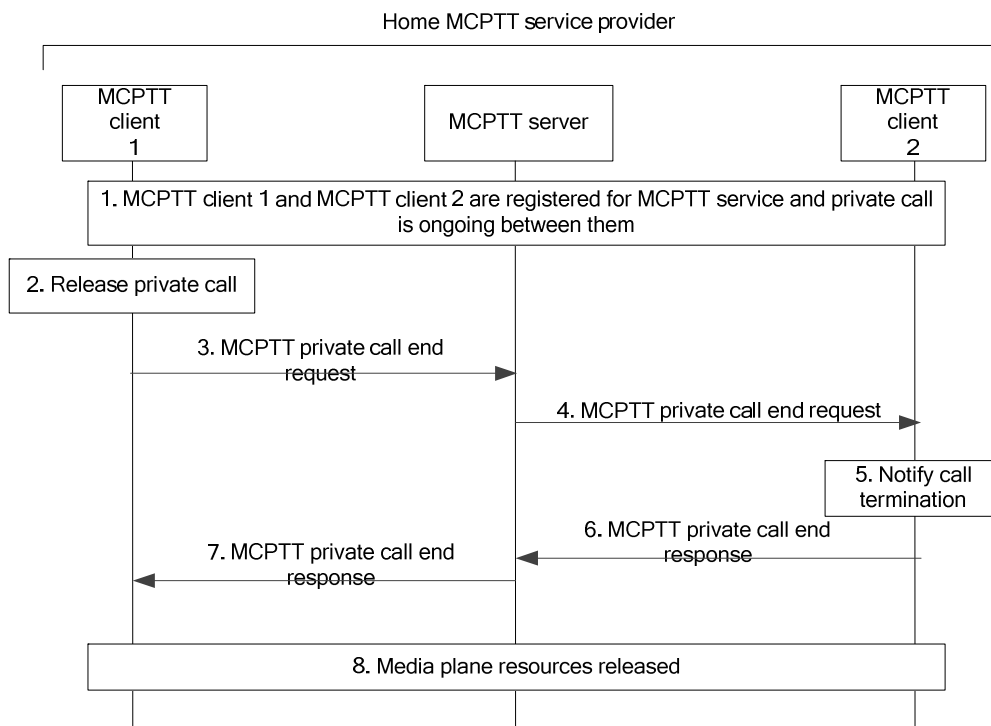

Figure 10.7.2.2.3.1-1: Private call release – client initiated

1. It is assumed that MCPTT users on MCPTT client 1 and MCPTT client 2 are already registered for receiving MCPTT service and are involved in private call with or without floor control established either in manual or automatic commencement mode, as described in subclause 10.7.2.2.1 and subclause 10.7.2.2.2.
2. User at MCPTT client 1 would like to release an ongoing MCPTT private call with MCPTT client 2.
3. MCPTT client 1 sends an MCPTT private call end request towards the MCPTT server (via SIP core), for tearing down the private call with the other client.
4. MCPTT server sends the corresponding MCPTT private call end request towards the MCPTT client specified in the original MCPTT private call end request.
5. MCPTT user is notified about the release of the private call.
6. The receiving MCPTT client 2 acknowledges the MCPTT private call end request with an MCPTT private call end response.
7. After receiving the MCPTT private call end response from MCPTT client 2, the MCPTT server generates an acknowledgement for the MCPTT client 1's MCPTT private call end request.
8. MCPTT clients release all the media plane resources used for the private call. Further, if the private call was established with floor control, floor control resources are released and MCPTT clients cannot make further requests for floor control or send media.

10.7.2.2.3.2 Server initiated

The procedure focuses on the case where an MCPTT server is terminating an ongoing MCPTT private call (with or without floor control) and the call established in either of the two commencement modes (manual or automatic), upon conditions to terminate call e.g., MCPTT administrator configured maximum duration for MCPTT private calls has expired or timed out due to MCPTT private call without transmission/reception.

Procedures in figure 10.7.2.2.3.2-1 are the basic signalling control plane procedures for the MCPTT server initiating termination of an ongoing MCPTT private call.

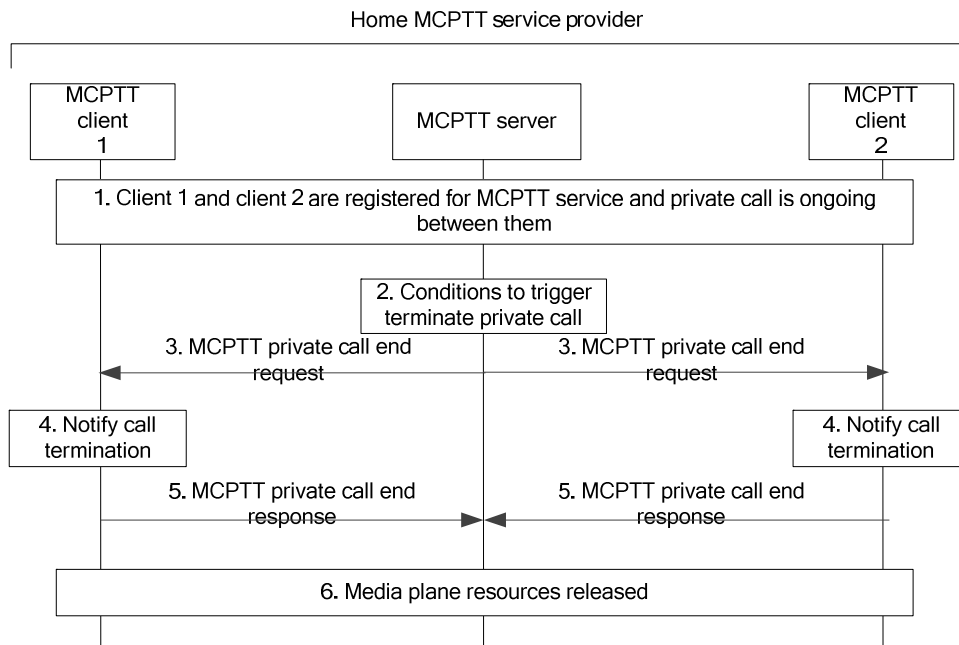

Figure 10.7.2.2.3.2-1: End private call – server initiated

1. It is assumed that MCPTT users on MCPTT client 1 and MCPTT client 2 are already registered for receiving MCPTT service and are involved in private call with or without floor control established either in manual or automatic commencement mode.

2. Upon conditions to terminate call e.g., MCPTT administrator configured maximum duration for MCPTT private calls has expired or timed out due to MCPTT private call without transmission/reception, the MCPTT server decides to initiate termination of an ongoing MCPTT private call between MCPTT client 1 and MCPTT client 2.
3. MCPTT server sends an MCPTT private call end request towards the MCPTT clients 1 and 2 (via SIP core), for tearing down the private call between them.
4. MCPTT users at client 1 and client 2 are notified about the termination of the private call.
5. The MCPTT private call end request receiving MCPTT clients 1 and 2 acknowledge the request with an MCPTT private call end response.
6. MCPTT clients release all the media plane resources used for the private call. Further, if the private call was established with floor control, floor control resources are released and MCPTT clients cannot make further requests for floor control or send media.

10.7.2.3 Private call within several MCPTT systems

10.7.2.3.1 Private call setup in automatic commencement mode – MCPTT users in multiple MCPTT systems

The procedure focuses on the case where an MCPTT user is initiating an MCPTT private call (automatic commencement mode) for communicating with MCPTT user in another MCPTT system with or without floor control enabled.

Procedures in figure 10.7.2.3.1-1 are the procedures for the MCPTT client initiating establishment of MCPTT private call with the chosen MCPTT user.

Pre-conditions:

1. The calling MCPTT user has selected automatic commencement mode for the call; or
2. The called MCPTT client is set to automatic commencement mode.

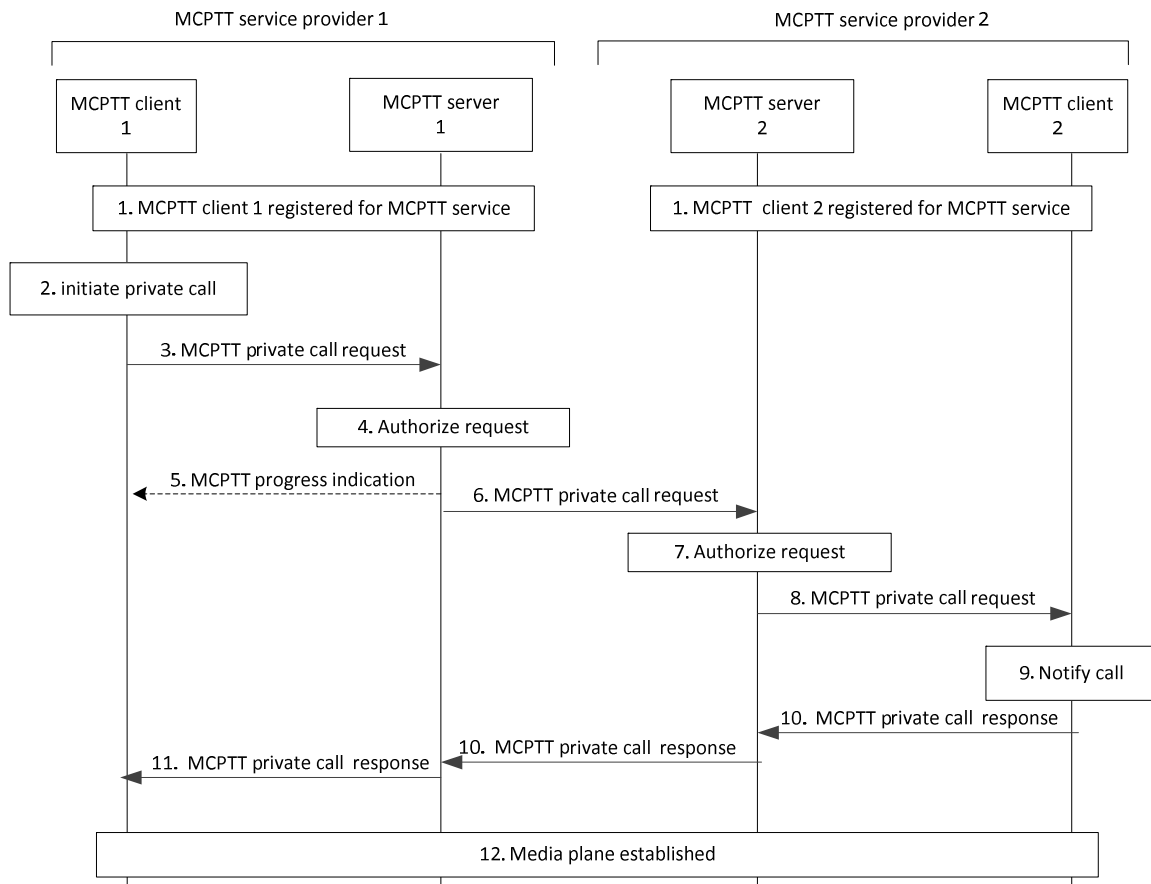

Figure 10.7.2.3.1-1: Private call setup in automatic commencement mode – users in multiple MCPTT systems

1. It is assumed that MCPTT users on MCPTT client 1 and MCPTT client 2 are already registered for receiving MCPTT service to their respective MCPTT service provider, as per procedure in subclause 10.2.
2. MCPTT user at MCPTT client 1 would like to initiate an MCPTT private call for the chosen MCPTT user. For a private call with floor control, floor control is to be established.
3. MCPTT client 1 sends an MCPTT private call request towards the home MCPTT server 1 (via SIP core) using a service identifier as defined in 3GPP TS 23.228 [5] for MCPTT, for establishing private call with the MCPTT client 2 registered at MCPTT service provider 2. The MCPTT private call request contains the MCPTT id of invited user and an SDP offer containing one or more media types. For a private call with floor control, the MCPTT private call request also contains an element that indicates that MCPTT client 1 is requesting the floor. The MCPTT client 1 may include a requested commencement mode that indicates that the call is to be established in automatic commencement mode if automatic commencement mode is requested by the initiating user.
4. MCPTT server 1 checks whether the MCPTT user at MCPTT client 1 is authorized to initiate the private call. If the MCPTT private call request requested automatic commencement mode then the MCPTT server 1 also checks whether the MCPTT user at MCPTT client 1 is authorized to initiate a call in automatic commencement mode.
5. MCPTT server 1 may provide a progress indication to MCPTT client 1 to indicate progress in the call setup process.

NOTE: Step 5 can occur at any time following step 4, and prior to step 11.

6. If authorized, MCPTT server 1 includes information that it communicates using MCPTT service, offers the same media types or a subset of the media types contained in the initial received request, includes an automatic commencement mode indication if automatic commencement mode was requested by and authorised for the

calling user and sends the corresponding MCPTT private call request towards the MCPTT system (via SIP core) of the MCPTT client specified in the original MCPTT private call request (MCPTT client 2) i.e., MCPTT server 2.

7. MCPTT server 2 checks whether the MCPTT user at MCPTT client 2 is authorized to receive a private call.
8. MCPTT server 2 includes information that it communicates using MCPTT service, offers the same media types or a subset of the media types contained in the initial received request, includes a requested automatic commencement mode indication based on a requested automatic commencement mode by the calling user or based upon the setting of the called MCPTT client and sends the received MCPTT private call request towards the MCPTT client specified in the received MCPTT private call request (i.e., MCPTT client 2). If the called MCPTT user has registered to the MCPTT service with multiple MCPTT UEs and has designated the MCPTT UE for receiving the private calls, then the incoming MCPTT private call request is delivered only to the designated MCPTT UE.
9. The receiving MCPTT client 2 notifies the user about the incoming private call.
10. The receiving MCPTT client 2 accepts the private call automatically, and an acknowledgement is sent to the MCPTT server 1 (via SIP core and MCPTT server 2).
11. Upon receiving the MCPTT private call response from MCPTT client 2 accepting the private call request, MCPTT client 1 is informed about successful call establishment.
12. MCPTT client 1 and MCPTT client 2 have successfully established media plane for communication and either user can transmit media. For successful call establishment of a private call with implicit floor control request from MCPTT client 1, floor participant at MCPTT client 1 is granted floor by the floor control server at MCPTT service provider 1, giving it permission to transmit. At the same time floor participant at MCPTT client 2 is informed by the floor control server at MCPTT service provider 1 that the floor is taken.

10.7.2.3.2 Private call setup in manual commencement mode – MCPTT users in multiple MCPTT systems

The procedure focuses on the case where an MCPTT user is initiating an MCPTT private call (manual commencement mode) for communicating with MCPTT user in another MCPTT system with or without floor control enabled.

Procedures in figure 10.7.2.3.2-1 are the procedures for the MCPTT client initiating establishment of MCPTT private call with the selected MCPTT user.

Pre-conditions:

1. The calling MCPTT user has selected manual commencement mode or has not specified a commencement mode for the call; and
2. The called MCPTT client is set to manual commencement mode.

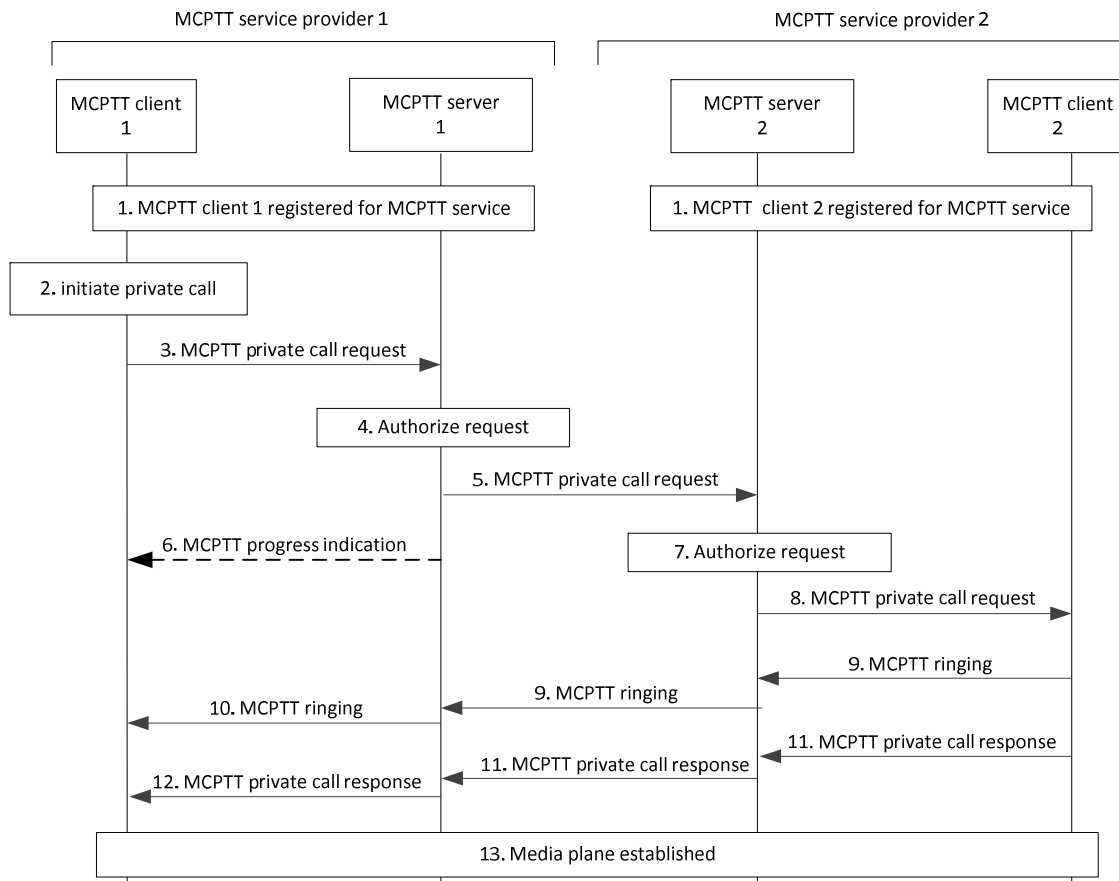

Figure 10.7.2.3.2-1: Private call setup in manual commencement mode – users in multiple MCPTT systems

1. It is assumed that MCPTT users on MCPTT client 1 and MCPTT client 2 are already registered for receiving MCPTT service to their respective MCPTT service provider, as per procedure in subclause 10.2.
2. MCPTT user at MCPTT client 1 would like to initiate an MCPTT private call for the selected MCPTT user. For a private call with floor control, floor control is to be established.
3. MCPTT client 1 sends an MCPTT private call request towards the home MCPTT server 1 (via SIP core), for establishing private call with the MCPTT client 2 registered at MCPTT service provider 2. For a private call with floor control, the MCPTT private call request contains an element that indicates that MCPTT client 1 is requesting the floor. The MCPTT client 1 may include a requested commencement mode that indicates that the call is to be established in manual commencement mode if manual commencement mode is requested by the initiating user.
4. MCPTT server 1 checks whether the MCPTT user at MCPTT client 1 is authorized to initiate the private call. The MCPTT server 1 also checks whether the MCPTT user at MCPTT client 1 is authorized to initiate a call in manual commencement mode.
5. If authorized, MCPTT server 1 sends the corresponding MCPTT private call request towards the MCPTT system (via SIP core) of the MCPTT client specified in the original MCPTT private call request (MCPTT client 2) i.e., MCPTT server 2.
6. MCPTT server may provide a progress indication to MCPTT client 1 to indicate progress in the call setup process.

NOTE: Step 6 can occur at any time following step 4, and prior to step 10.

7. The MCPTT server 2 checks whether the MCPTT user at MCPTT client 2 is authorized to receive a private call and also checks the commencement mode setting of MCPTT client 2.
8. The MCPTT server 2 offers the same media types or a subset of the media types contained in the initial received request and sends an MCPTT private call request towards the MCPTT client specified in the received MCPTT private call request (i.e., MCPTT client 2). If the called MCPTT user has registered to the MCPTT service with multiple MCPTT UEs and has designated the MCPTT UE for receiving the private calls, then the incoming MCPTT private call request is delivered only to the designated MCPTT UE.
9. The MCPTT user is alerted. MCPTT client 2 sends an MCPTT ringing to the MCPTT server 1 (via server 2).
10. The MCPTT server 1 sends an MCPTT ringing to MCPTT client 1, indicating that MCPTT client 2 is being alerted.
11. MCPTT user 2 has accepted the call using manual commencement mode (i.e. has taken some action to accept via the user interface) which causes MCPTT client 2 to send an MCPTT private call response to the MCPTT server 1 (via SIP core and MCPTT server 2)
12. Upon receiving the MCPTT private call response from MCPTT client 2 accepting the private call request, MCPTT client 1 is informed about successful call establishment.
13. MCPTT client 1 and client 2 have successfully established media plane for communication and either user can transmit media. For successful call establishment of a private call with implicit floor control request from MCPTT client 1, floor participant at MCPTT client 1 is granted the floor by the floor control server at MCPTT service provider 1, giving it permission to transmit. At the same time floor participant at MCPTT client 2 is informed by the floor control server at MCPTT service provider 1 that the floor is taken.

10.7.2.3.3 Private call release – MCPTT users in multiple MCPTT systems

The procedure in this subclause is for the case where an MCPTT client is requesting to release an ongoing MCPTT private call (with or without floor control) established in either of the two commencement modes (manual or automatic), and the MCPTT users are in multiple MCPTT systems.

Procedures are similar to those described for private call release when MCPTT users are in single MCPTT system as in subclause 10.7.2.2.3.1, with the addition that the MCPTT call end request and the corresponding acknowledgement are routed through the MCPTT server in partner MCPTT system.

10.7.2.4 MCPTT emergency private call

10.7.2.4.1 MCPTT emergency private call commencement

This procedure focuses on the case where an authorized MCPTT user is initiating an MCPTT emergency private call with unicast signalling for communicating with another MCPTT user. An MCPTT client in the MCPTT emergency state gains elevated access privilege for all of the MCPTT user's mission critical applications.

Procedures in figure 10.7.2.4.1-1 are the signalling control plane procedures for the MCPTT client initiating establishment of an MCPTT emergency private call.

Pre-conditions:

1. Both members of the MCPTT private call belong to the same MCPTT system.
2. The initiating MCPTT client 1 has been configured to send an MCPTT emergency alert prior to initiating an MCPTT emergency private call.

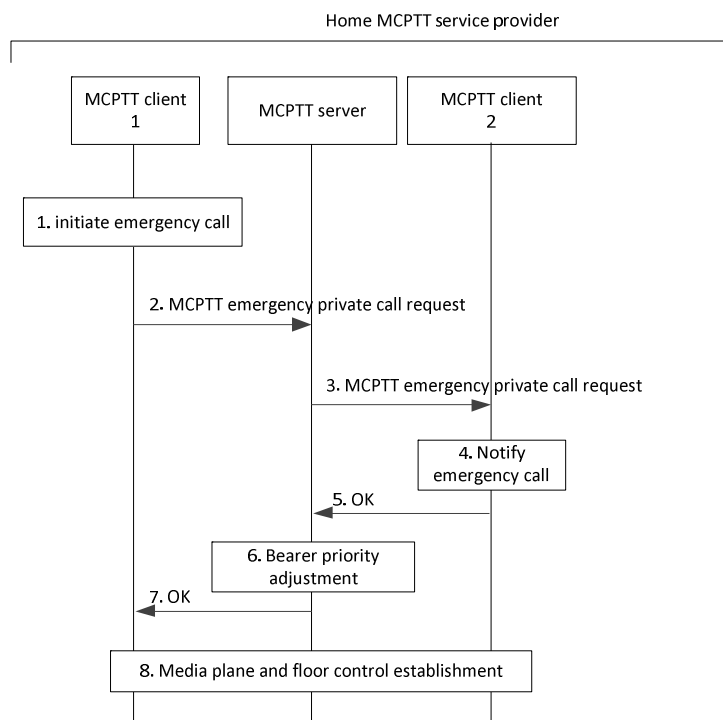

Figure 10.7.2.4.1-1 MCPTT emergency private call

1. The user at the MCPTT client 1 initiates an MCPTT emergency private call. MCPTT client 1 sets its MCPTT emergency state. The MCPTT emergency state is retained until explicitly cancelled.
2. MCPTT client 1 sends an MCPTT emergency private call request towards the MCPTT server. The request contains an indication of the MCPTT emergency. The MCPTT server records the identity of the MCPTT user that initiated the MCPTT emergency private call until the MCPTT emergency is cancelled. If the MCPTT client is configured to send an MCPTT emergency alert when initiating an MCPTT emergency private call, the request also contains an indication that an MCPTT emergency alert is to be initiated.
3. MCPTT server sends the MCPTT emergency private call request towards the target MCPTT client. The request contains an indication of the in-progress emergency. The request contains an indication of an MCPTT emergency alert if the request from the originator indicated MCPTT emergency alert.
4. The MCPTT user on MCPTT client 2 is notified of the incoming MCPTT emergency private call.
5. The receiving MCPTT client acknowledges the MCPTT emergency private call request to the MCPTT server.
6. The MCPTT server adjusts the priority of the underlying bearer.
7. The MCPTT server informs MCPTT client 1 about the successful MCPTT emergency private call establishment.
8. MCPTT client 1 and MCPTT client 2 establish the media plane for communication. The MCPTT client 1 can override MCPTT client 2 unless MCPTT client 2 is also in the MCPTT emergency state.

NOTE 1: The priority for the MCPTT emergency private call is retained until cancelled according to system policy (e.g. timeout or call end) or cancelled by an authorized MCPTT user.

NOTE 2: The initiating MCPTT user's MCPTT emergency state is retained by the system until cancelled as in subclause 10.6.2.6.1.3. The initiating MCPTT user's MCPTT emergency state is also retained locally by the MCPTT client until explicitly cancelled by the MCPTT user.

10.7.2.4.2 MCPTT private call emergency upgrade

This procedure focuses on the case where an authorized MCPTT user is upgrading a private call to an MCPTT emergency private call while the private call is already in progress.

Procedures in figure 10.7.2.4.2-1 are the signalling procedures for the MCPTT client upgrading a private call to an MCPTT emergency private call.

Pre-conditions:

1. Both members of the private call belong to the same MCPTT system.
2. A private call is already in progress.

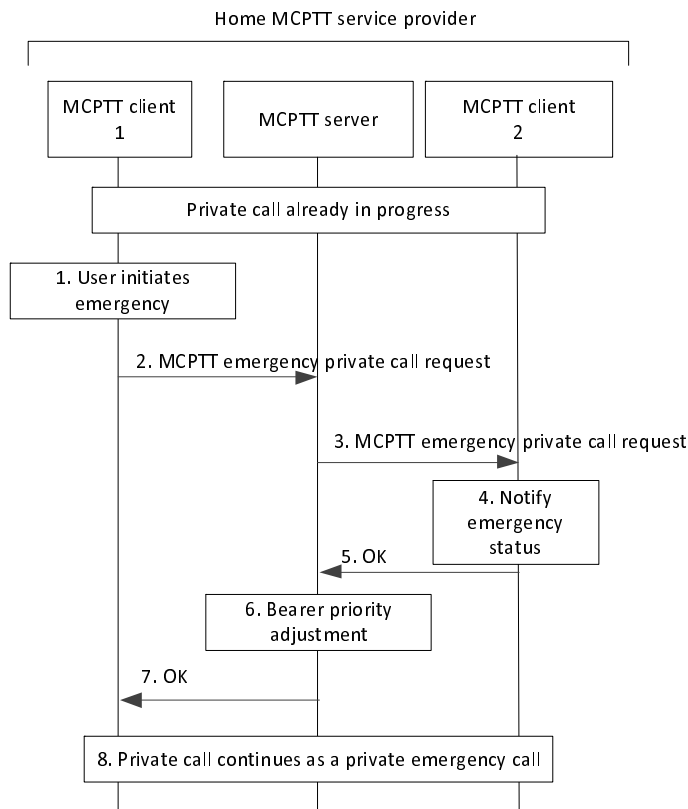

Figure 10.7.2.4.2-1: MCPTT private call upgrade

1. The MCPTT user at MCPTT client 1 initiates an emergency. MCPTT client 1 sets its MCPTT emergency state. The MCPTT emergency state is retained until explicitly cancelled.
2. MCPTT client 1 requests the MCPTT server to upgrade the private call to in-progress emergency by sending an MCPTT emergency request. If configured to send an MCPTT alert when initiating an MCPTT emergency upgrade, the request also contains an indication that an MCPTT alert is to be initiated. The request may contain an indication of an implicit floor request.
3. MCPTT server sends the MCPTT emergency request towards the MCPTT client of the other participant.
4. The MCPTT user is notified of the in-progress emergency of the MCPTT emergency private call.
5. The receiving MCPTT client acknowledges the MCPTT emergency request to the MCPTT server.
6. The MCPTT server adjusts the priority of the underlying bearer for both participants in the private call. The priority is retained until the call ends.
7. The MCPTT server confirms the upgrade request to MCPTT client 1.

8. MCPTT client 1 and MCPTT client 2 continue with the private call, which has been transformed into an MCPTT emergency private call. The MCPTT client 1 can override MCPTT client 2 unless MCPTT client 2 is also in the MCPTT emergency state.

10.7.3 Private call in off-network

10.7.3.1 Information flows for private call in off-network

10.7.3.1.1 Call setup request

Table 10.7.3.1.1-1 describes the information flow call setup request from one MCPTT client to another MCPTT client.

Table 10.7.3.1.1-1: call setup request

Information element	Status	Description
MCPTT ID of the caller	M	The identity of the calling party
MCPTT ID of the callee	M	The identity of the called party
SDP offer for private call	M	SDP with media information offered by (to) client

10.7.3.1.2 Call setup response

Table 10.7.3.1.2-1 describes the information flow call setup response from one MCPTT client to another MCPTT client.

Table 10.7.3.1.2-1: call setup response

Information element	Status	Description
MCPTT ID of the caller	M	The identity of the calling party
MCPTT ID of the callee	M	The identity of the called party
SDP answer for private call	M	SDP with media information offered by (to) client

10.7.3.1.3 Call release request

Table 10.7.3.1.3-1 describes the information flow call release request from one MCPTT client to another MCPTT client.

Table 10.7.3.1.3-1: call release request

Information element	Status	Description
MCPTT ID of the caller	M	The identity of the calling party
MCPTT ID of the callee	M	The identity of the called party
MCPTT private call release reason	O	This element indicates that reason for the private call release. e.g., Originating client requested, target client requested.

10.7.3.1.4 Call release response

Table 10.7.3.1.4-1 describes the information flow call release response from one MCPTT client to another MCPTT client.

Table 10.7.3.1.4-1: call release response

Information element	Status	Description
MCPTT ID of the caller	M	The identity of the calling party
MCPTT ID of the callee	M	The identity of the called party
MCPTT private call release reason	O	This element indicates that reason for the private call release. e.g., Originating client requested, target client requested, server requested.

10.7.3.2 Use of ProSe capability for private call

When an MCPTT user using a ProSe-enabled UE wants to communicate with a specific MCPTT user using a ProSe-enabled UE by a ProSe mechanism, the MCPTT client retrieves the ProSe discovery group ID and user info ID of the

target MCPTT user from the "List of user(s) who can be called in private call" in the MCPTT user profile and requests the IP address of the MCPTT UE associated with the target MCPTT user from the ProSe layer.

The MCPTT client enables the ProSe layer to determine IP address for the target MCPTT UE by providing the ProSe discovery group ID and user info ID (as defined in specification 3GPP TS 23.303 [7]) of the target MCPTT user. This may trigger the ProSe layer procedure (e.g. discovery). The user info ID of the target MCPTT user is used by the ProSe layer as the target info (as defined in specification 3GPP TS 23.303 [7]).

The ProSe layer can then provide the IP address related to the target MCPTT user's MCPTT ID to the MCPTT client.

NOTE: The ProSe procedures for one-to-one direct communications specified in 3GPP TS 23.303 [7] retrieves a layer-2 ID associated with the user info ID of the target MCPTT user by the discovery procedure to establish direct communications between ProSe users.

10.7.3.3 Private call setup in automatic commencement mode

The procedure focuses on the case where an MCPTT user is initiating an MCPTT private call for communicating with another MCPTT user when off-network using an automatic commencement mode.

Procedures in figure 10.7.3.3-1 are the basic signalling procedures for the MCPTT client initiating establishment of an off-network MCPTT private call with the chosen MCPTT user.

Pre-conditions:

1. MCPTT user profile used for off-network operation mode is pre-provisioned in the MCPTT UEs.

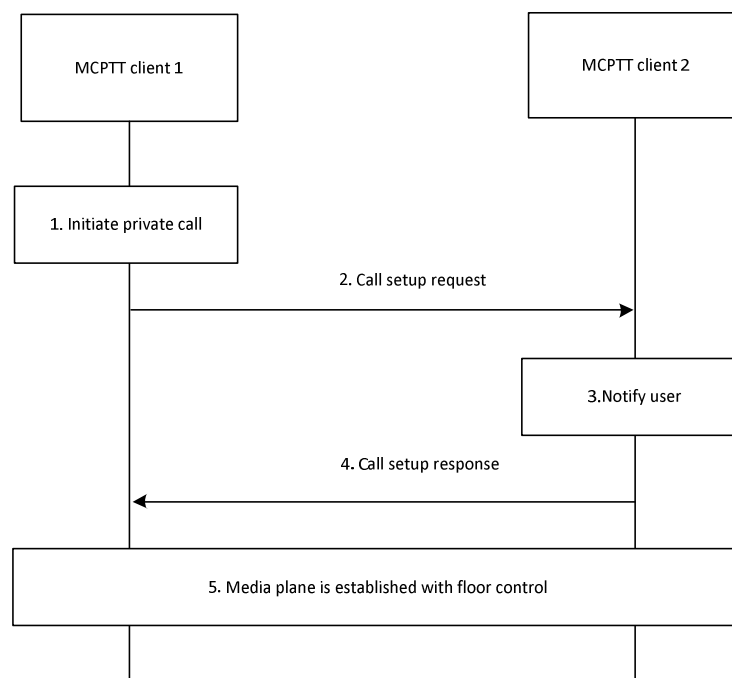

Figure 10.7.3.3-1: Private call setup in automatic commencement mode

1. The MCPTT user at MCPTT client 1 would like to initiate a private call to the MCPTT user at MCPTT client 2.
2. The MCPTT client 1 sends a call setup request towards the MCPTT client 2. The call setup request contains an SDP offer, an automatic commencement mode indication, and an element that indicates that MCPTT client 1 is requesting the floor.
3. The MCPTT client 2 notifies the MCPTT user about the incoming private call.
4. The receiving MCPTT client 2 accepts the private call automatically, and a call setup response indicating the successful call establishment is sent to MCPTT client 1. If MCPTT client 2 rejected the incoming call, the MCPTT client 2 sends a call setup response indicating the failure reason to the MCPTT client 1.

NOTE: Step 4 can also occur prior to step 3.

- The MCPTT client 1 and the MCPTT client 2 have successfully established the media plane for communication with floor control and the MCPTT client 1 is automatically granted the floor.

10.7.3.4 Private call setup in manual commencement mode

The procedure focuses on the case where an MCPTT user is initiating an MCPTT private call for communicating with another MCPTT user when off-network using a manual commencement mode.

Procedures in figure 10.7.3.4-1 are the basic signalling procedures for the MCPTT client initiating establishment of an off-network MCPTT private call with the chosen MCPTT user.

Pre-conditions:

- MCPTT user profile used for off-network operation mode is pre-provisioned in the MCPTT UEs.

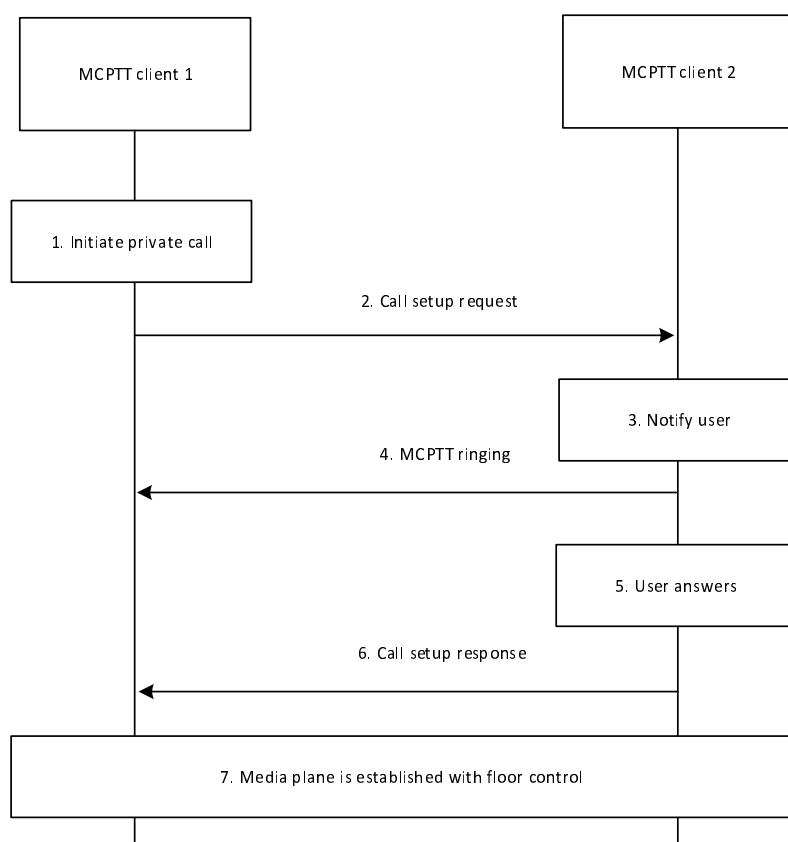

Figure 10.7.3.4-1: Private call setup in manual commencement mode

- The MCPTT user at MCPTT client 1 would like to initiate an MCPTT private call to the MCPTT user at MCPTT client 2.
- The MCPTT client 1 sends a call setup request towards the MCPTT client 2. The MCPTT private call setup request contains an SDP offer, a manual commencement mode indication, and an element that indicates that MCPTT client 1 is requesting the floor.
- The receiving MCPTT client 2 notifies the MCPTT user about the incoming private call.
- The MCPTT client 2 sends MCPTT ringing message to the MCPTT client 1.

NOTE: Step 4 can also occur prior to step 3.

5. The MCPTT user at the MCPTT client 2 has accepted the call using manual commencement mode (i.e., has taken some action to accept via the user interface). The MCPTT user may also reject or fail to answer the incoming call.
6. The MCPTT client 2 sends a call setup response indicating the successful call establishment to MCPTT client 1. If the MCPTT client 2 rejected the call or the MCPTT user 2 rejected or failed to answer the incoming call, the MCPTT client 2 sends a call setup response indicating the failure reason to the MCPTT client 1.
7. The MCPTT client 1 and the MCPTT client 2 have successfully established the media plane for communication with floor control and the MCPTT client 1 is automatically granted the floor.

10.7.3.5 Private call release

The procedure focuses on the case where an MCPTT client is requesting to release an ongoing MCPTT private call whether the call was established using either of the two commencement modes (manual or automatic), as described in subclause 10.7.3.3 and subclause 10.7.3.4. Either MCPTT client can initiate the call release procedure.

Procedures in figure 10.7.3.5-1 are the basic signalling control plane procedures for an MCPTT client initiating the release of an ongoing off-network MCPTT private call.

Pre-conditions:

1. Two MCPTT users are currently engaged in an off-network MCPTT private call.

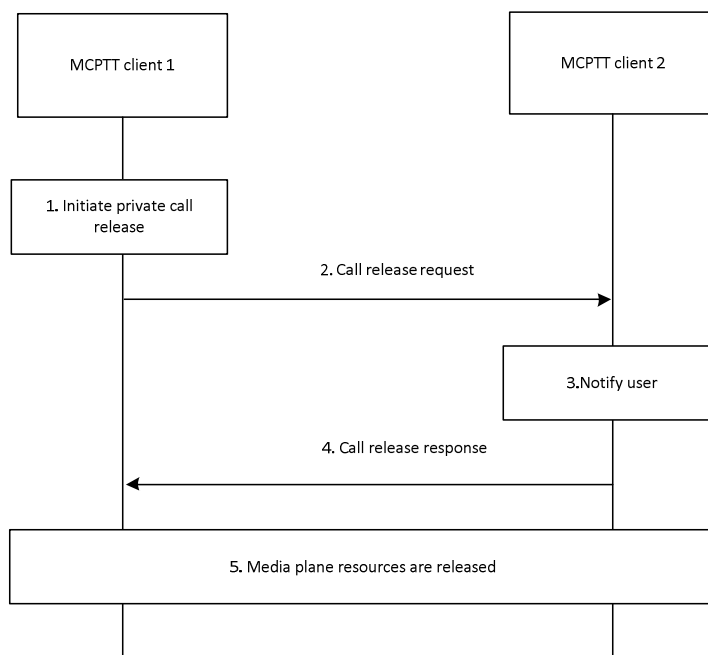

Figure 10.7.3.5-1: Private call release

1. The MCPTT user at MCPTT client 1 would like to initiate an MCPTT private call release to the MCPTT user at MCPTT client 2.
2. The MCPTT client 1 sends a call release request towards the MCPTT client 2.
3. The MCPTT client 2 notifies the MCPTT user about the private call release.
4. The MCPTT client 2 sends a call release response indicating the successful call release to MCPTT client 1.

NOTE: Step 4 can also occur prior to step 3.

5. The MCPTT client 1 and the MCPTT client 2 release all associated media plane resources.

10.7.3.6 MCPTT emergency private call

The off-network emergency private call is a special case of off-network private call as defined in subclause 10.7.3. The following are modifications to the aforementioned subclause to support MCPTT private calls:

- The call setup contains an indication that the MCPTT private call is to be an MCPTT emergency private call,
- the bearers of both MCPTT private call participants are given MCPTT emergency priority prior to media transfer,
- either participant in an MCPTT private call may upgrade the call to the MCPTT emergency state during the call by sending an MCPTT upgrade private emergency request,
- placing an MCPTT emergency private call places the MCPTT client in the MCPTT emergency state,
- the bearer priority of each participant is restored to the priority as it was prior to the MCPTT emergency private call initiation, when the call ends or when the MCPTT emergency priority is cancelled
- an authorized user or the originator of the call may cancel the MCPTT emergency priority of the call by sending an MCPTT cancel private emergency request and
- the MCPTT emergency priority of the MCPTT private call may be cancelled when criteria established by the MCPTT Administrator are met (e.g., timeout).

10.7.4 MCPTT private call call-back request

10.7.4.1 Information flows for MCPTT private call call-back request

10.7.4.1.1 MCPTT private call call-back request

Table 10.7.4.1.1-1 describes the information flow MCPTT private call call-back request from the MCPTT client to the MCPTT server and from the MCPTT server to the MCPTT client.

Table 10.7.4.1.1-1: MCPTT private call call-back request information elements

Information Element	Status	Description
MCPTT ID	M	The MCPTT ID of the calling party
MCPTT ID	M	The MCPTT ID of the called party
Urgency indication	M	This element indicates the urgency (i.e., low, normal, high) of the call-back request.

10.7.4.1.2 MCPTT private call call-back response

Table 10.7.4.1.2-1 describes the information flow MCPTT private call call-back response from the MCPTT client to the MCPTT server and from the MCPTT server to the MCPTT client.

Table 10.7.4.1.2-1: MCPTT private call call-back response information elements

Information Element	Status	Description
MCPTT ID	M	The MCPTT ID of the calling party
MCPTT ID	M	The MCPTT ID of the called party
Result	M	Result of the MCPTT call-back request – success or fail.

10.7.4.1.3 MCPTT private call call-back cancel request

Table 10.7.4.1.3-1 describes the information flow MCPTT private call call-back cancel request from the MCPTT client to the MCPTT server and from the MCPTT server to the MCPTT client.

Table 10.7.4.1.3-1: MCPTT private call call-back cancel request information elements

Information Element	Status	Description
MCPTT ID	M	The MCPTT ID of the calling party
MCPTT ID	M	The MCPTT ID of the called party

10.7.4.1.4 MCPTT private call call-back cancel response

Table 10.7.4.1.4-1 describes the information flow MCPTT private call call-back cancel response from the MCPTT client to the MCPTT server and from the MCPTT server to the MCPTT client.

Table 10.7.4.1.4-1: MCPTT private call call-back cancel response information elements

Information Element	Status	Description
MCPTT ID	M	The MCPTT ID of the calling party
MCPTT ID	M	The MCPTT ID of the called party
Result	M	Result of the MCPTT private call call-back cancel request – success or fail.

10.7.4.2 MCPTT private call call-back request within one MCPTT system

The MCPTT private call call-back request procedure includes the initial MCPTT private call call-back request from the MCPTT user and the indication to the receiving MCPTT user of the who called, the time when the call request was made, and the urgency indication.

Procedures in figure 10.7.4.2-1 show the signalling control plane procedures for the MCPTT client initiating an MCPTT private call call-back request with the chosen MCPTT user.

Pre-conditions:

- MCPTT user 1 is the current user at MCPTT client 1 and MCPTT user 2 is the current user at MCPTT client 2;
- MCPTT client 1 and MCPTT client 2 are registered for MCPTT service.

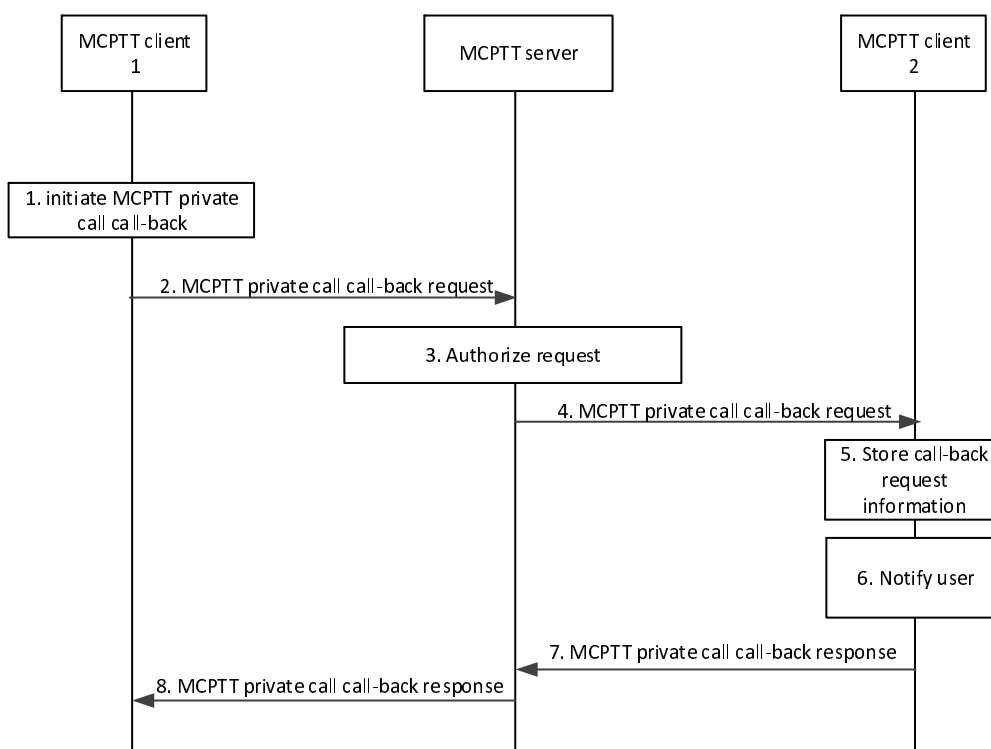

Figure 10.7.4.2-1: MCPTT private call call-back request – MCPTT users in the same MCPTT system

1. MCPTT user on MCPTT client 1 initiates an MCPTT private call call-back request to the MCPTT user of MCPTT client 2.
2. MCPTT client 1 sends an MCPTT private call call-back request towards the MCPTT server.
3. MCPTT server checks whether the MCPTT user 1 at MCPTT client 1 is authorized to initiate the MCPTT private call call-back request.
4. If authorized, MCPTT server sends the corresponding MCPTT private call call-back request towards the MCPTT client 2.
5. The receiving MCPTT client 2 stores the MCPTT user who initiated the MCPTT private call call-back request, the time the MCPTT private call call-back request was received, and the urgency indication for the MCPTT private call call-back request.
6. The MCPTT client 2 notifies the MCPTT user 2 that there is an MCPTT private call call-back request awaiting his attention.
7. The receiving MCPTT client 2 sends an MCPTT private call call-back response to the MCPTT server.
8. Upon receiving the MCPTT private call call-back response from MCPTT client 2, the MCPTT server informs the MCPTT client 1 about successful call-back request.

10.7.4.3 MCPTT private call call-back cancel request within one MCPTT system

Once an MCPTT private call call-back request has been successfully made and before the receiving MCPTT user has made an MCPTT private call to the calling MCPTT user, the calling MCPTT user may cancel the outstanding MCPTT private call request.

Procedures in figure 10.7.4.3-1 show the signalling control plane procedures for the MCPTT client initiating an MCPTT private call call-back cancel request with the chosen MCPTT user.

Pre-conditions:

1. A previously successfully made MCPTT private call call-back request from MCPTT client 1 to MCPTT client 2.

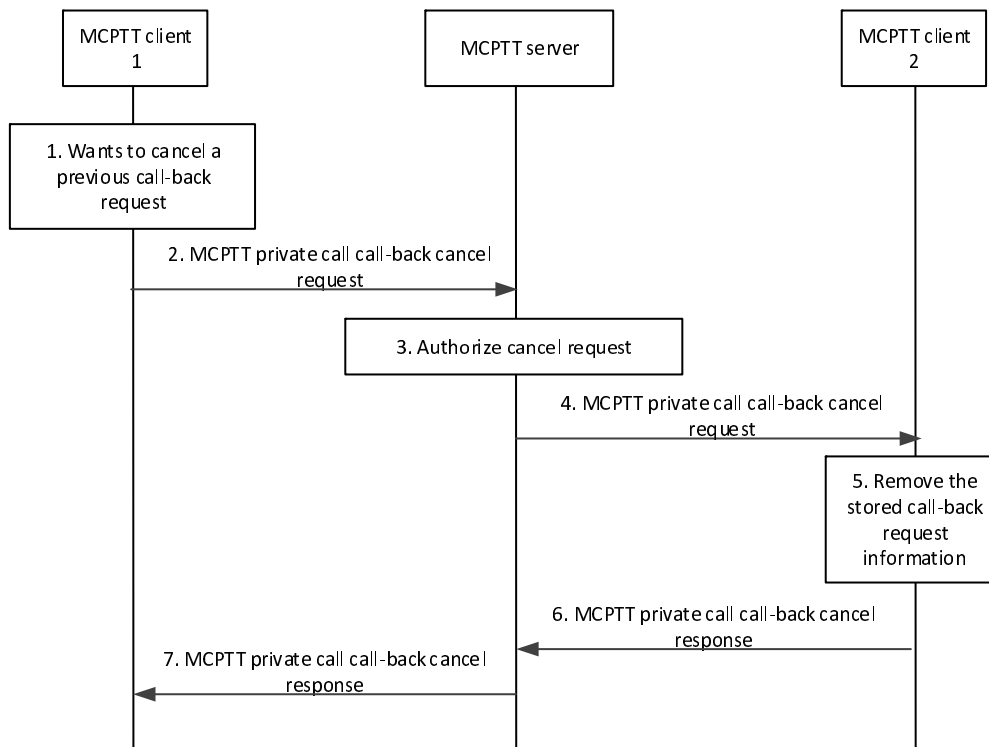

Figure 10.7.4.3-1: MCPTT private call call-back cancel request – MCPTT users in the same MCPTT system

1. MCPTT user on MCPTT client 1 wants to cancel a previously created MCPTT private call call-back request to the MCPTT user 2 of MCPTT client 2.
2. MCPTT client 1 sends an MCPTT private call call-back cancel request towards the MCPTT server.
3. MCPTT server checks whether the MCPTT user 1 at MCPTT client 1 is authorized to cancel the previous MCPTT private call call-back request, if one exists.
4. If authorized, MCPTT server sends the corresponding MCPTT private call call-back cancel request towards the MCPTT client 2.
5. The receiving MCPTT client 2 removes all stored information about the previous MCPTT private call call-back request from the MCPTT user 1 on MCPTT client 1.
6. The receiving MCPTT client 2 sends an MCPTT private call call-back cancel response to the MCPTT server.
7. Upon receiving the MCPTT private call call-back cancel response from MCPTT client 2, the MCPTT server informs the MCPTT client 1 about successful call-back request cancellation.

10.7.4.4 MCPTT private call call-back request fulfillment within one MCPTT system

Once an MCPTT private call call-back request has been successfully made, it is expected that the receiving MCPTT user will make an MCPTT private call to the MCPTT user who sent the MCPTT private call call-back request. The procedures for establishing the MCPTT private call between the two users is the same as an MCPTT private call (10.7.2.2.2).

Procedures in figure 10.7.4.4-1 show the signalling control plane procedures for the MCPTT client returning an MCPTT private call to the MCPTT user who initiated the MCPTT private call call-back request.

Pre-conditions:

1. A previously successfully made MCPTT private call call-back request from MCPTT client 1 to MCPTT client 2.

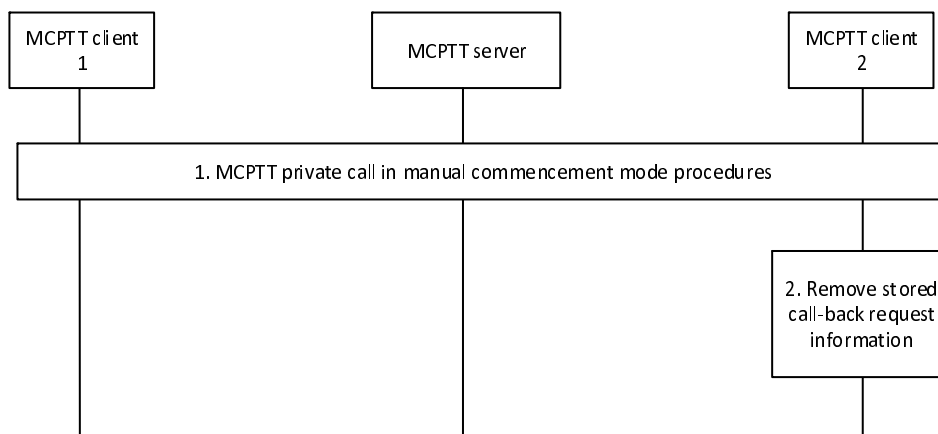

Figure 10.7.4.4-1: MCPTT private call-back request fulfillment – MCPTT users in the same MCPTT system

1. MCPTT user 2 on MCPTT client 2 decides to initiate an MCPTT private call based on the stored MCPTT private call call-back request to the MCPTT user 1 on MCPTT client 1 using the MCPTT private call procedures of 10.7.2.2.2.
2. Once a successful MCPTT private call has been made between the MCPTT user 1 on MCPTT client 1 and MCPTT user 2, then the MCPTT client 2 removes the stored call-back request information.

10.8 Simultaneous session for MCPTT calls (on-network)

10.8.1 General

An MCPTT client and MCPTT server may use a simultaneous session as defined in 3GPP TS 23.280 [16] for MCPTT calls. The MCPTT client becomes involved in a simultaneous session for MCPTT calls by inviting, joining or accepting more than one MCPTT call, or affiliating to a group.

NOTE: An MCPTT client affiliating to multiple MCPTT groups with active calls will result in the MCPTT client being invited simultaneously to multiple MCPTT calls.

The MCPTT client can also still handle multiple MCPTT calls in parallel at the same time i.e. using multiple dialogs.

The simultaneous session is established during either an originating on-demand call establishment or during pre-established session establishment or a modification of an already established pre-established session or on-demand call.

It is possible to change the prioritisation while the MCPTT client is engaged in multiple MCPTT calls. The setting of the priority can be made at MCPTT call setup or by performing a modification after the MCPTT call is established. This may result in more than one media bearer.

10.9 Floor control

10.9.1 Floor control for on-network MCPTT service

10.9.1.1 General

The procedure is for providing a floor control to MCPTT UE in an on-network case and applies for both private call and group call. Floor control is performed by using floor control information flows between the floor participant and the floor control server.

10.9.1.2 Information flows for floor control for on-network

10.9.1.2.1 General

When the floor control server receives a floor request from the floor participant, it decides whether to give a grant or not based on, e.g., the session status (i.e., whether the grant is given to another user or not), user profile, priority. The result

is informed to the requesting floor participant. When the floor participant receives a floor granted message, it can send voice media over the uplink bearer established beforehand. The floor revoked message can be used as part of override. The floor queue status request can be used to know current position in the queue for floor.

Some floor control information flows can also piggyback call control information flows to provide efficient call setup and clearing:

- Call setup request is optionally carried in floor request (uplink) or floor taken (downlink, can be broadcast); and
- Call release request is optionally carried in floor release (uplink) or floor idle (downlink, can be broadcast).

10.9.1.2.2 Floor request

Table 10.9.1.2.2-1 describes the information flow floor request, from the floor participant to the floor control server and from the floor control server to the floor control server, which is used to request the floor for media transfer. This information flow is sent in unicast to the floor control server.

Table 10.9.1.2.2-1: Floor request

Information element	Status	Description
MCPTT ID	M	Requester identity
Functional alias	O	Functional alias of the requester
Floor priority	M	Priority of the request
Source identifier	O	Identifies the communication, e.g. by identifying the media flow within a media multiplex, present only if media multiplexing

10.9.1.2.3 Floor granted

Table 10.9.1.2.3-1 describes the information flow floor granted, from the floor control server to the floor participant and from the floor control server to the floor control server, which is used to indicate that a request for floor is granted and media transfer is possible. This information flow is sent in unicast (to the granted floor participant).

Table 10.9.1.2.3-1: Floor granted

Information element	Status	Description
Duration	M	The time for which the granted party is allowed to transmit
Source identifier	O	Identifies the communication, e.g. by identifying the media flow within a media multiplex, present only if media multiplexing
Acknowledgement required	O	Indicates if acknowledgement from the floor participant is required

10.9.1.2.4 Floor rejected

Table 10.9.1.2.4-1 describes the information flow floor rejected, from the floor control server to the floor participant, which is used to indicate that a request for the floor is rejected. This information flow is sent in unicast (to the refused floor participant).

Table 10.9.1.2.4-1: Floor rejected

Information element	Status	Description
Source identifier	O	Identifies the communication, e.g. by identifying the media flow within a media multiplex, present only if media multiplexing
Rejection cause	O	Indicates the cause for floor rejection
Acknowledgement required	O	Indicates if acknowledgement from the floor participant is required

10.9.1.2.5 Floor request cancel

Table 10.9.1.2.5-1 describes the information flow floor request cancel, from the floor participant to the floor control server, which is used to request cancelling the floor request from the floor request queue. This information flow is sent in unicast to the floor control server.

Table 10.9.1.2.5-1: Floor request cancel

Information element	Status	Description
MCPTT ID	M	Identity for the requester
Functional alias	O	Functional alias for the requester
List of MCPTT IDs	M	Target identity (Identities) whose floor request is to be cancelled
Source identifier	O	Identifies the communication, e.g. by identifying the media flow within a media multiplex, present only if media multiplexing

10.9.1.2.6 Floor request cancel response

Table 10.9.1.2.6-1 describes the information flow floor request cancel response, from the floor control server to the floor control participant, which is used to indicate the response for the floor request cancellation. This information flow is sent in unicast.

Table 10.9.1.2.6-1: Floor request cancel response

Information element	Status	Description
Source identifier	O	Identifies the communication, e.g. by identifying the media flow within a media multiplex, present only if media multiplexing
Acknowledgement required	O	Indicates if acknowledgement from the floor participant is required

10.9.1.2.7 Floor request cancel notify

Table 10.9.1.2.7-1 describes the information flow floor request cancel notify, from the floor control server to the floor control participant, which is used to indicate the floor request is cancelled by the administrator/floor control server. This information flow is sent in unicast or broadcast.

Table 10.9.1.2.7-1: Floor request cancel notify

Information element	Status	Description
MCPTT ID	M	Identity of the administrator
Functional alias	O	Functional alias of the administrator
Source identifier	O	Identifies the communication, e.g. by identifying the media flow within a media multiplex, present only if media multiplexing
Acknowledgement required	O	Indicates if acknowledgement from the floor participant is required

10.9.1.2.8 Floor idle

Table 10.9.1.2.8-1 describes the information flow floor idle, from the floor control server to the floor participant, which is used to indicate that a session is in idle status, i.e. the floor is not granted to any party. This information flows is sent in unicast or broadcast.

Table 10.9.1.2.8-1: Floor idle

Information element	Status	Description
Source identifier	O	Identifies the communication, e.g. by identifying the media flow within a media multiplex, present only if media multiplexing
Acknowledgement required	O	Indicates if acknowledgement from the floor participant is required

10.9.1.2.9 Floor release

Table 10.9.1.2.9-1 describes the information flow floor release, from the floor participant to the floor control server, which is used to indicate the media transfer is completed and floor is released. This information flow is sent in unicast to the floor control server.

Table 10.9.1.2.9-1: Floor release

Information element	Status	Description
Source identifier	O	Identifies the communication, e.g. by identifying the media flow within a media multiplex, present only if media multiplexing

10.9.1.2.9a Multi-talker floor release

Table 10.9.1.2.9a-1 describes the information elements of floor release for multi-talker control, from the floor control server to the floor participants, which is used to indicate the media transfer is completed and floor is released. This information flow is sent in unicast from the floor control server.

Table 10.9.1.2.9a-1: Multi-talker floor release

MCPTT ID (NOTE)	M	Identity of participant releasing the floor
List of functional aliases (NOTE)	O	Functional alias(es) of participant releasing the floor
Source identifier	O	Identifies the communication, e.g. by identifying the media flow within a media multiplex, present only if media multiplexing
NOTE: One or more functional aliases may be associated with the MCPTT ID.		

10.9.1.2.10 Floor taken

Table 10.9.1.2.10-1 describes the information flow floor taken, from the floor control server to the floor participant, which is used to indicate the floor is granted to another MCPTT user. This information flows is sent in unicast or broadcast.

Table 10.9.1.2.10-1: Floor taken

Information element	Status	Description
MCPTT ID	M	Identity for the granted party
Functional alias	O	Functional alias for the granted party
Source identifier	O	Identifies the communication, e.g. by identifying the media flow within a media multiplex, present only if media multiplexing
Permission to request the floor	O	Indicates whether receiving parties are allowed to request the floor or not (e.g. broadcast call).
Acknowledgement required	O	Indicates if acknowledgement from the floor participant is required

10.9.1.2.10a Multi-talker floor taken

Table 10.9.1.2.10a-1 describes the information elements of floor taken for multi-talker control, from the floor control server to the floor participant, which is used to indicate when the floor is simultaneously granted to multiple MCPTT users. The multi-talker floor taken is sent in unicast or broadcast.

Table 10.9.1.2.10a-1: Multi-talker floor taken

Information element	Status	Description
List of MCPTT IDs (NOTE)	M	Identity (identities) of the granted participant(s)
List of functional aliases (NOTE)	O	Functional alias(es) of the granted participant(s)
List of source identifiers (NOTE)	O	Identifies the communication, e.g. by identifying the media flow within a media multiplex, present only if media multiplexing
Acknowledgement required	O	Indicates if acknowledgement from the floor participant is required
NOTE: One or more functional aliases and one source identifier may be associated with an MCPTT ID.		

10.9.1.2.11 Floor revoked

Table 10.9.1.2.11-1 describes the information flow floor revoked, from the floor control server to the floor participant, which is used to indicate the floor is revoked from its current holder (the floor participant who was granted the floor). This information flow is sent in unicast (to the revoked floor participant).

Table 10.9.1.2.11-1: Floor revoked

Information element	Status	Description
Source identifier	O	Identifies the communication, e.g. by identifying the media flow within a media multiplex, present only if media multiplexing
Acknowledgement required	O	Indicates if acknowledgement from the floor participant is required

10.9.1.2.12 Floor acknowledgement

Table 10.9.1.2.12-1 describes the information flow floor acknowledgement, from the floor participant to the floor control server, which is used to provide an acknowledgement if the acknowledgement is required in the received floor control message.

NOTE: The floor acknowledgement flow can be sent by the floor participant after each floor control information flow that includes an indication that an acknowledgement is required. The procedures defined in subclauses 10.9.1.3 to 10.9.1.5 do not explicitly illustrate all scenarios when floor acknowledgement can be used.

Table 10.9.1.2.12-1: Floor acknowledgement

Information element	Status	Description
MCPTT ID	M	Identity of the sender.
Functional alias	O	Functional alias of the sender.

10.9.1.2.13 Queue position request

Table 10.9.1.2.13-1 describes the information flow queue position request, from the floor participant to the floor control server, which is used to request the position in the floor request queue. The MCPTT server and the MCPTT client support queuing of the floor control requests shall support this information flow. This information flow is sent in unicast to the floor control server.

Table 10.9.1.2.13-1: Queue position request

Information element	Status	Description
Source identifier	O	Identifies the communication, e.g. by identifying the media flow within a media multiplex, present only if media multiplexing

10.9.1.2.14 Queue position info

Table 10.9.1.2.14-1 describes the information flow queue position info, from the floor control server to the floor participant, which is used to indicate the floor request is queued and the queue position to the floor requesting UE. The

MCPTT server and the MCPTT client support queuing of the floor control requests shall support this information flow. This information flows is sent in unicast (to the queued floor participant).

Table 10.9.1.2.14-1: Queue position info

Information element	Status	Description
Queue position info	M	Position of the queued floor request in the queue
Source identifier	O	Identifies the communication, e.g. by identifying the media flow within a media multiplex, present only if media multiplexing
Acknowledgement required	O	Indicates if acknowledgement from the floor participant is required

10.9.1.2.15 Unicast media stop request

Table 10.9.1.2.15-1 describes the information flow unicast media stop request from the floor participant to the floor control server, which is used by the floor participant to indicate that the unicast media flow of the designated communication does not need to be sent to the MCPTT client.

Table 10.9.1.2.15-1: Unicast media stop request

Information element	Status	Description
MCPTT ID	M	Identity of the requester
Functional alias	O	Functional alias for the requester
Source identifier	O	Identifies the communication whose media flow is to be stopped, e.g. by identifying the media flow within a media multiplex, present only if media multiplexing

10.9.1.2.16 Unicast media resume request

Table 10.9.1.2.16-1 describes the information flow unicast media resume request from the floor participant to the floor control server, which is used by the floor participant to request that the unicast media flow of the designated communication is to be sent to the MCPTT client.

Table 10.9.1.2.16-1: Unicast media resume request

Information element	Status	Description
MCPTT ID	M	Identity of the requester
Functional alias	O	Functional alias of the requester
Source identifier	O	Identifies the communication whose media flow is to be resumed, e.g. by identifying the media flow within a media multiplex, present only if media multiplexing

10.9.1.3 Floor control within one MCPTT system

10.9.1.3.1 Floor request, floor granted and floor taken during an MCPTT session

Figure 10.9.1.3.1-1 shows the high level procedure that the floor control is conducted for the MCPTT session already established between the floor participant and the floor control server. Only two UEs involved in the session are shown for the simplicity.

Pre-condition:

1. MCPTT session is established between MCPTT clients (client A and client B) and MCPTT server.

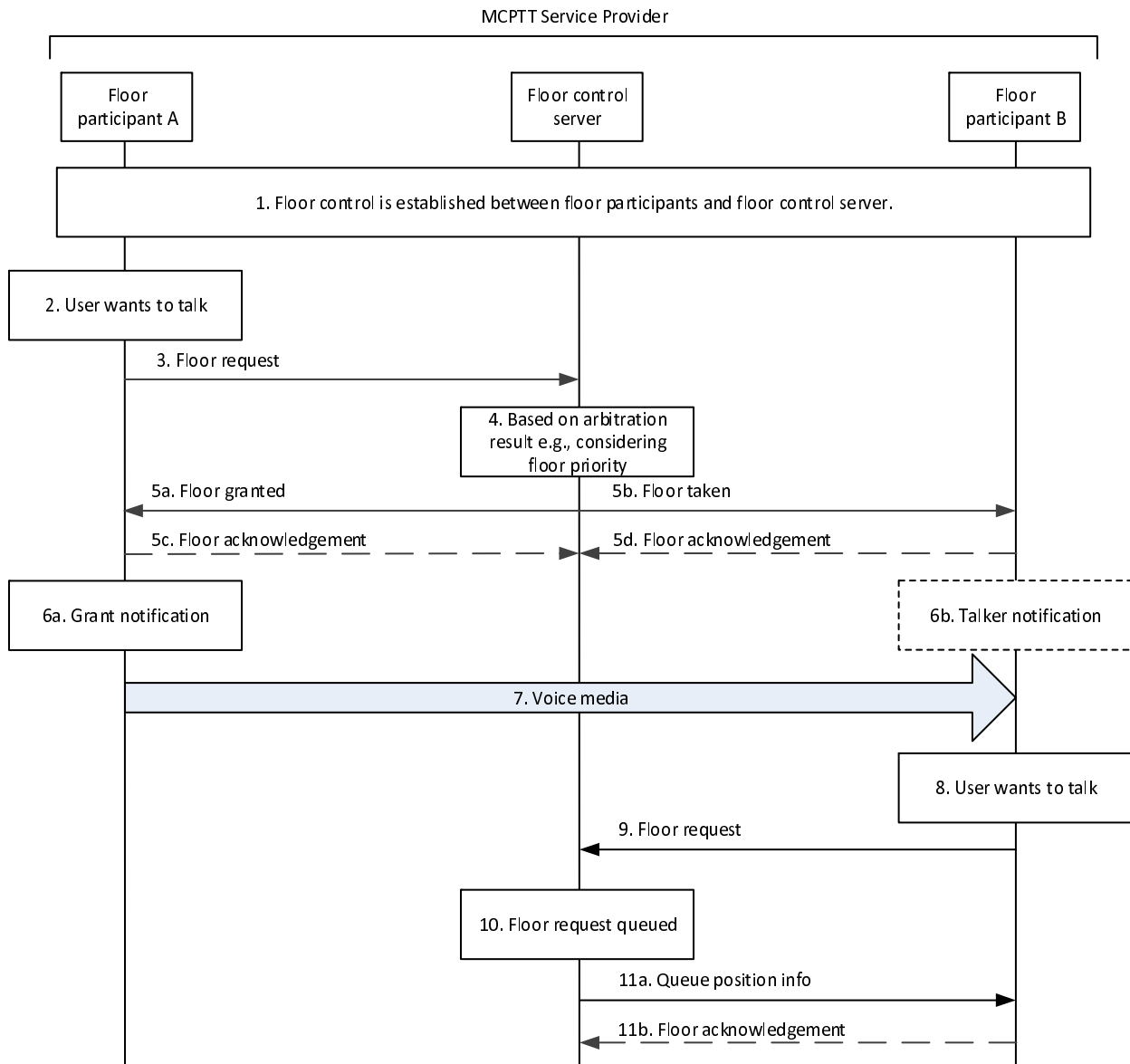

Figure 10.9.1.3.1-1: Floor request, floor granted, floor taken during an MCPTT session

1. The floor control is established between the floor participants and floor control server. It is assumed that the floor is now in idle status.
2. Floor participant A wants to send voice media over the session.
3. Floor participant A sends a floor request message to floor control server which includes floor priority and other information as necessary.
4. Floor control server makes the determination on what action (grant, deny, or queue) to take on the request based on criteria (e.g., floor priority, participant type) and determines to accept the floor request from floor participant A. The floor control server may limit the time a user talks (hold the floor) as allowed by the configuration.
- 5a. Floor control server responds with a floor granted message to floor participant A including the maximum floor granted duration e.g., if no other floor participant has the permission for transmission.
- 5b. Floor control server sends a floor taken message to the other floor participant (floor participant B) including information about who is granted the floor.
- 5c. Floor participant A sends a floor acknowledgement if indicated to do so by the floor granted message.
- 5d. Floor participant B sends a floor acknowledgement if indicated to do so by the floor taken message.

- 6a. The floor granted shall cause the user of UE A where the floor participant A is located to be notified.
- 6b. The receipt of the floor taken may be used to inform the user of UE B where the floor participant B is located.
- 7. Floor participant A starts sending voice media over the session established beforehand.

NOTE: Voice media can continue to be sent while steps 8 through 11 occur.

- 8. Suppose there are one or more users requesting to talk at this time, the floor request(s) are queued as decided by floor control server e.g., based on floor priority.
- 9. Floor participant B sends a floor request message.
- 10. Floor control server queues the request of floor participant B.
- 11a. Floor control server sends queue position info to floor participant B.
- 11b. Floor participant B sends a floor acknowledgement if indicated to do so by the queue position info message.

10.9.1.3.1a Floor request, floor granted and multi-talker floor taken during an MCPTT session enhanced with multi-talker control

Figure 10.9.1.3.1a-1 shows the high level procedure that allows several participants to talk simultaneously in a MCPTT session already established between the floor participant and the floor control server. Three UEs involved in the session are shown for simplicity.

Pre-conditions:

- 1. The MCPTT group is configured to support multi-talker control and audio mixing by the network is applied.
- 2. MCPTT session is established between MCPTT clients (client A, client B and client C) and MCPTT server.
- 3. Participants A and B have the permission to talk to all other participants and the floor is granted to floor participant B.

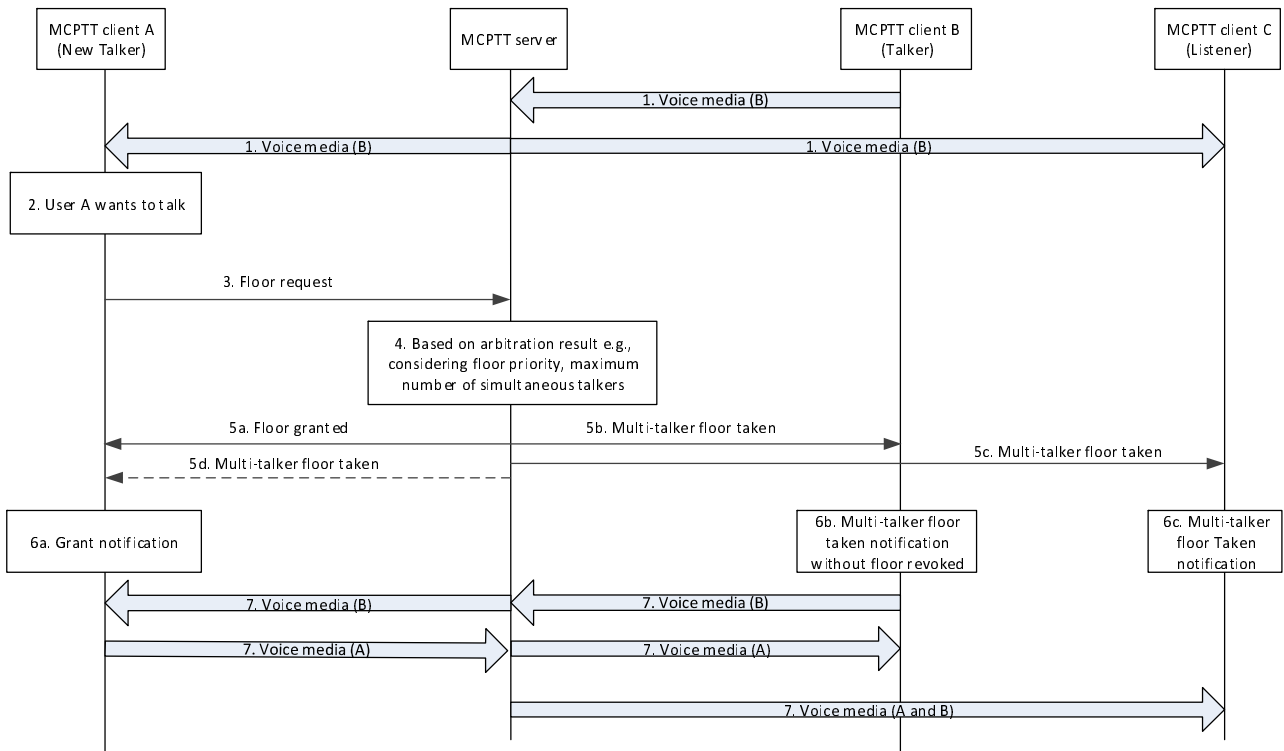

Figure 10.9.1.3.1a-1: Floor request, floor granted and multi-talker floor taken during an MCPTT session

- 1. Floor participant B is talking and is sending the voice media.

2. Floor participant A wants to send voice media over the session.
3. Floor participant A sends a floor request message to the floor control server which includes the necessary information, e.g. floor priority.
4. Based on applicable criteria (e.g. floor priority, participant type, allowance to transmit, maximum number of simultaneous talkers) floor control server determines what action (grant, deny, or queue) shall be applied to the request. In this case, the floor request from floor participant A will be accepted. Simultaneous floor requests to transmit are handled in a sequential order. Based on the group configuration repository data, the floor control server may limit the time a floor participant is allowed to talk.
- 5a. Floor control server responds with a floor granted message to floor participant A.
- 5b. Floor control server sends a multi-talker floor taken message to floor participant B.
- 5c. Floor control server sends a multi-talker floor taken message to floor participant C.
- 5d. Floor control server may send a multi-talker floor taken message to floor participant A.
- 6a. The floor granted shall cause the user of UE A, where the floor participant A is located, to be notified.
- 6b. The multi-talker floor taken shall inform the user of UE B, that the floors are granted to other floor participants, but the floor is not revoked.
- 6c. The multi-talker floor taken shall inform the user of UE C floor participants list the floor are currently granted to.
7. Floor participant A starts sending voice media over the session established beforehand, i.e. participants A and B receive and transmit voice media; participant C only receives voice media.

NOTE: Floor control is independent from whether audio mixing is performed by the MCPTT server or by the UE.

10.9.1.3.2 Floor override

10.9.1.3.2.1 Floor override using floor revoked (also floor rejected) during an MCPTT session

Figure 10.9.1.3.2.1-1 shows the high level procedure that the floor control is conducted for the MCPTT session already established between the floor participant (with floor granted to floor participant B) and the floor control server (with an override based on priority). Only two UEs involved in the session are shown for the simplicity.

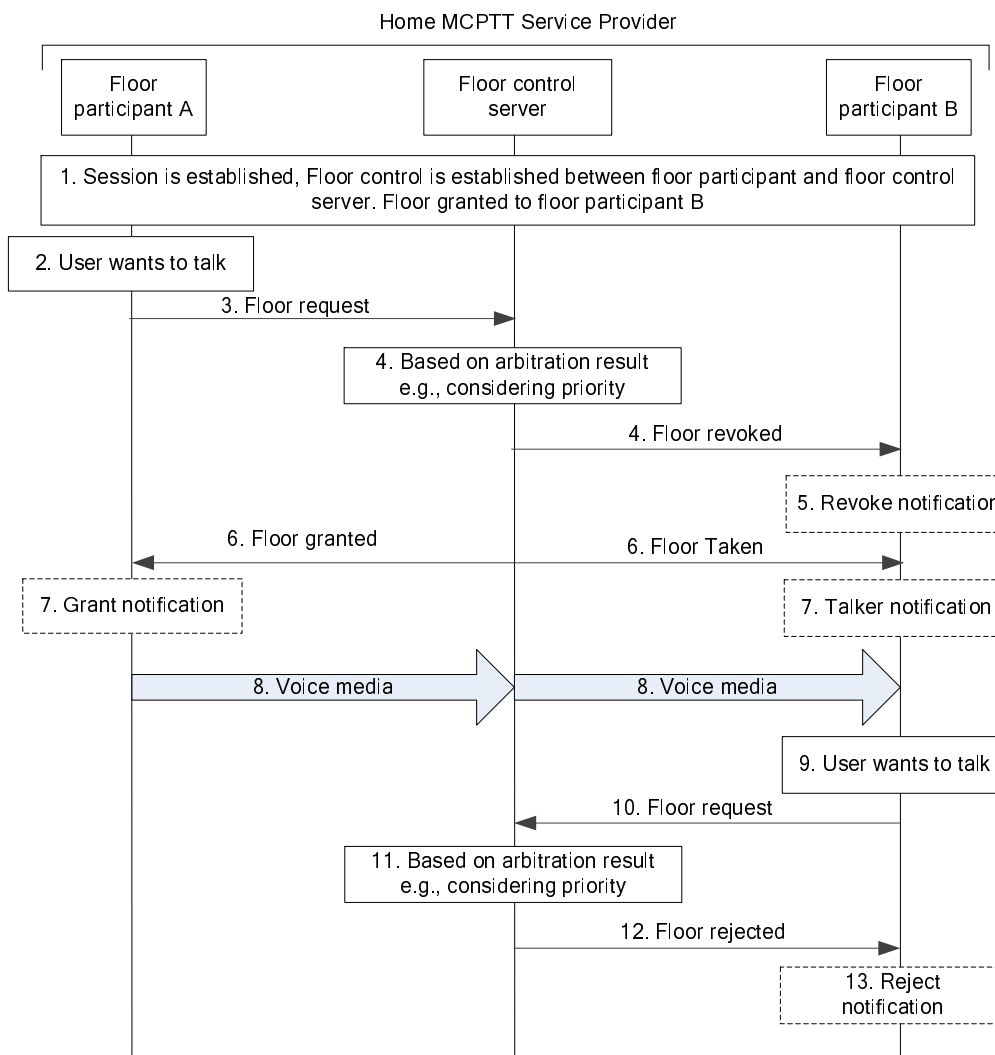

Figure 10.9.1.3.2.1-1: Floor override using floor revoked (also floor rejected) during an MCPTT session

1. It is assumed that floor participant B has been given floor and is transmitting voice media.
2. Floor participant A having a priority which is relatively higher than that of floor participant B wants to send voice media over the session.
3. Floor participant A sends a floor request message to the floor control server.
4. The floor control server determines to accept the floor request from floor participant A based on arbitration result e.g., according to the priority information that is received in the floor request message. The floor control server sends a floor revoked message to floor participant B stopping the voice media transmission from floor participant B.
5. The user of floor participant B may be notified that the floor is revoked.
6. The Floor control server sends a floor granted message to floor participant A, while sending a floor taken message to floor participant B with information of who is granted the floor.
7. The user of floor participant A may be notified that he is granted the floor. Similarly, the user of floor participant B may be notified who is granted the floor.
8. Floor participant A starts sending voice media over the session established beforehand.
9. Now floor participant B may want the floor to start sending voice media.
10. Floor participant B sends a floor request message to floor control server which may include priority information.

11. Floor control server determines whether to accept the floor request from floor participant B based on arbitration result e.g., according to the priority information that is received in the floor request message.
12. The floor control server responds with a floor rejected message to floor participant B.
13. Floor participant B may be notified that he is rejected.

10.9.1.3.2.2 Floor override without using floor revoked during an MCPTT session

Figure 10.9.1.3.2.2-1 shows the high level procedure that the floor control is conducted for the MCPTT session already established between the floor participants (with floor granted to floor participant B) and the floor control server (with an override based on priority and configured to permit the transmission of the overridden floor participant B to continue). Only two UEs involved in the session are shown for the simplicity.

Pre-conditions

- The floor control server has been configured to support override.
- The override supported in this case permits both the overridden floor participant and the overriding floor participant to be transmitting.

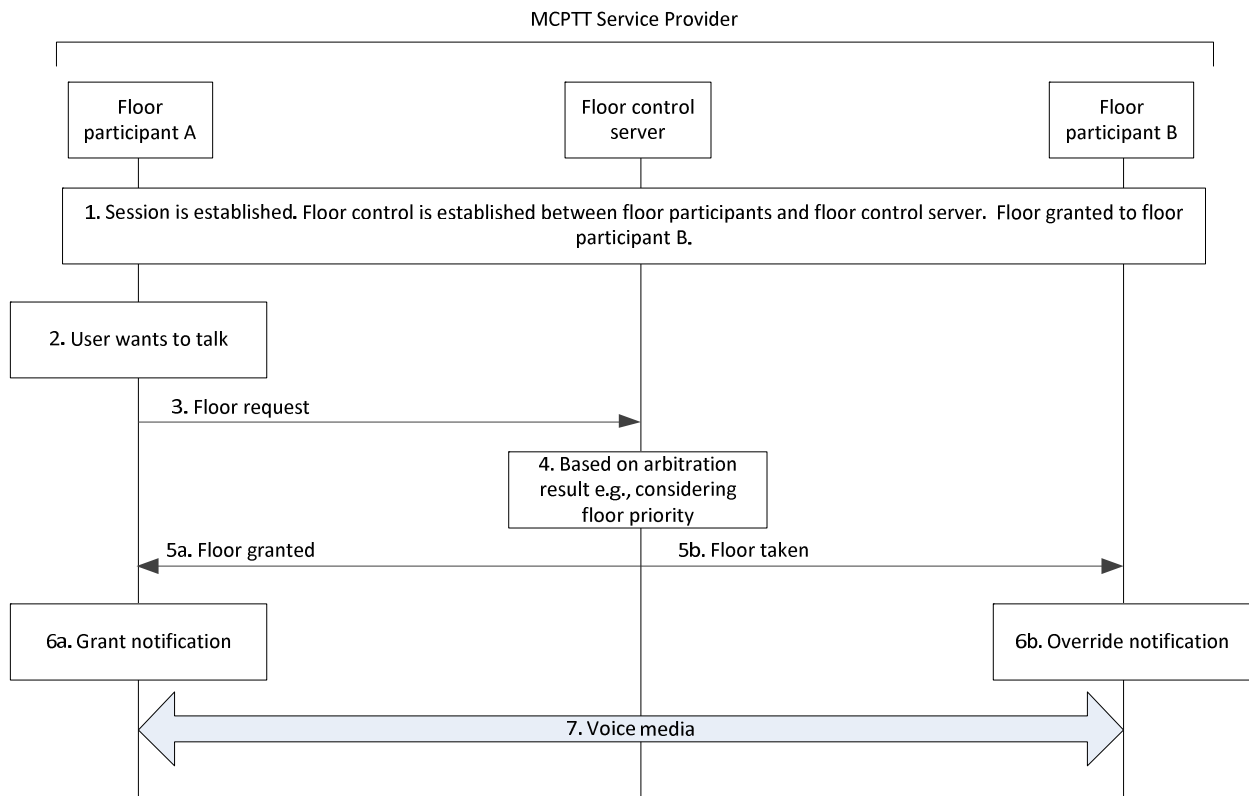

Figure 10.9.1.3.2.2-1: Floor override (overridden continues to transmit) during an MCPTT session

1. It is assumed that floor participant B has been given the floor and is transmitting voice media.
2. Floor participant A having a floor priority which is relatively higher than that of floor participant B wants to send voice media over the session.
3. Floor participant A sends a floor request message to the floor control server.
4. The floor control server determines to accept the floor request from floor participant A based on arbitration result e.g., according to the floor priority information that is received in the floor request message.
- 5a. Floor control server responds with a floor granted message to floor participant A.
- 5b. Floor control server sends a floor taken message to the other floor participants (including floor participant B). Floor participant B continues transmitting the (overridden) voice media transmission.

NOTE 1: All other floor participants (not shown) that are part of this group call receive a floor taken message, so that the other floor participants learn who the newly granted talker (overriding) is.

6a. The floor granted causes the user of floor participant A to be notified.

6b. The user of floor participant B is notified of the status that the floor is now taken by floor participant A.

7. Floor participant A (overriding) starts sending voice media over the session established beforehand.

NOTE 2: Floor participant B is still sending voice (overridden). The list of floor participants that receive the overriding, overridden, or both transmissions is based on configuration.

10.9.1.3.2.3 Floor override using floor revoked (also floor rejected) during an MCPTT session enhanced with multi-talker control

Figure 10.9.1.3.2.3-1 shows the high-level procedure that the floor control allows several participants to talk simultaneously in a MCPTT session already established between the floor participant (with floor granted to floor participant B) and the floor control server. Only two UEs involved in the session are shown for the simplicity.

Pre-conditions:

1. The MCPTT group is configured to support multi-talker control.
2. MCPTT session is established between MCPTT clients (client A, client B and client C) and MCPTT server.
3. The maximum number of simultaneous talkers is set to 2.
4. The floor priority of floor participant A is higher than of floor participant B.
5. The floor is granted to floor participant B and floor participant C.

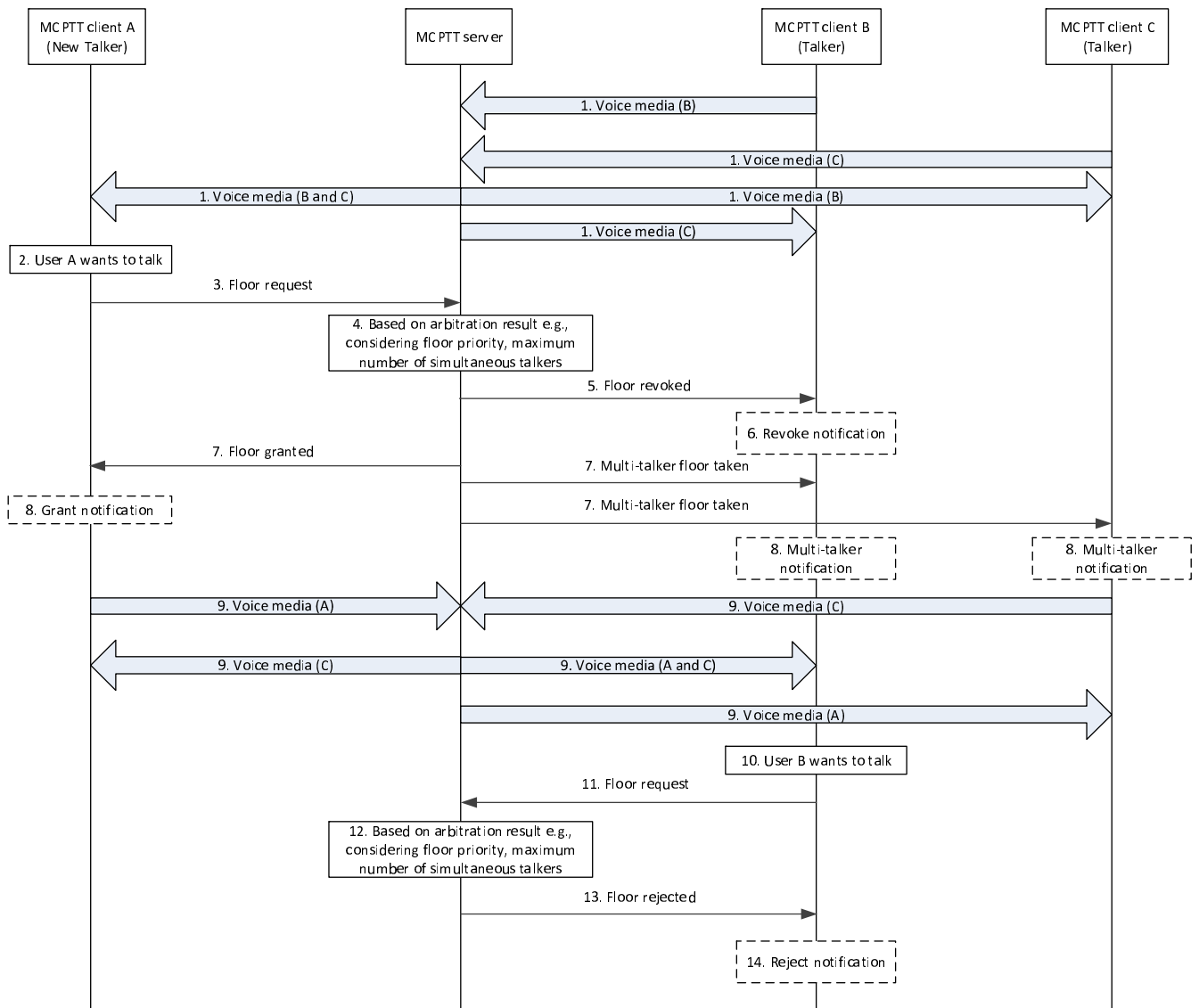

Figure 10.9.1.3.2.3-1: Floor override using floor revoked (also floor rejected) during an MCPTT session

1. Floor participant B and floor participant C are sending voice media over the session established.
2. Floor participant A wants to send voice media over the session.
3. Floor participant A wants to talk (i.e. send voice media) over the session. Floor participant A sends a floor request message to the floor control server.
4. Based on an arbitration result (e.g. per the priority information that is received in the floor request message), the floor control server determines to accept the floor request from floor participant A. The maximum number of simultaneous talkers in the MCPTT group has been reached, the floor control server decides to apply the override mechanism.
5. The floor control server sends a floor revoked message to floor participant B stopping the voice media transmission of floor participant B.
6. The user of floor participant B may be notified that the floor is revoked.
7. The Floor control server sends a floor granted message to floor participant A, while sending a multi-talker floor taken message to floor participant B and floor participant C including the information to whom the floor has been granted.
8. The user of floor participant A may be notified that the floor has been granted to him. Similarly, the user of floor participant B and floor participant C may be notified to whom the floor has been granted.

9. Floor participant A starts sending voice media over the session established beforehand.
10. Now floor participant B may want the floor to start sending voice media.
11. Floor participant B sends a floor request message to floor control server that may include participant priority information.
12. Based on arbitration result, e.g. per the priority information that is received in the floor request message, and if the number of MCPTT Users has already reached the maximum number of simultaneous talkers in the group, the floor control server determines whether to accept or reject the floor request from floor participant B. Due to lower priority of participant B and the applicable limitation of simultaneous talkers, the floor control server rejects the floor request.
13. The floor control server responds with a floor rejected message to floor participant B.
14. Floor participant B may be notified about the floor rejection.

NOTE: Floor control procedure is independent from whether audio mixing is performed by the MCPTT server or by the UE.

10.9.1.3.2.4 Floor release during an MCPTT session enhanced with multi-talker control

Figure 10.9.1.3.2.4-1 shows the high-level procedure where the floor controller allows a participant to release the floor while other participants continue to talk simultaneously in a MCPTT session already established between the floor participants and the floor control server. Only three UEs involved in the session are shown for simplicity.

Pre-conditions:

1. The MCPTT group is configured to support multi-talker control and audio mixing by the network is applied.
2. MCPTT session is established between MCPTT clients (client A, client B, and client C) and the MCPTT server.
3. Participants A, B, and C have the permission to talk to all other participants, and the floor is granted to floor participants A, B, and C.

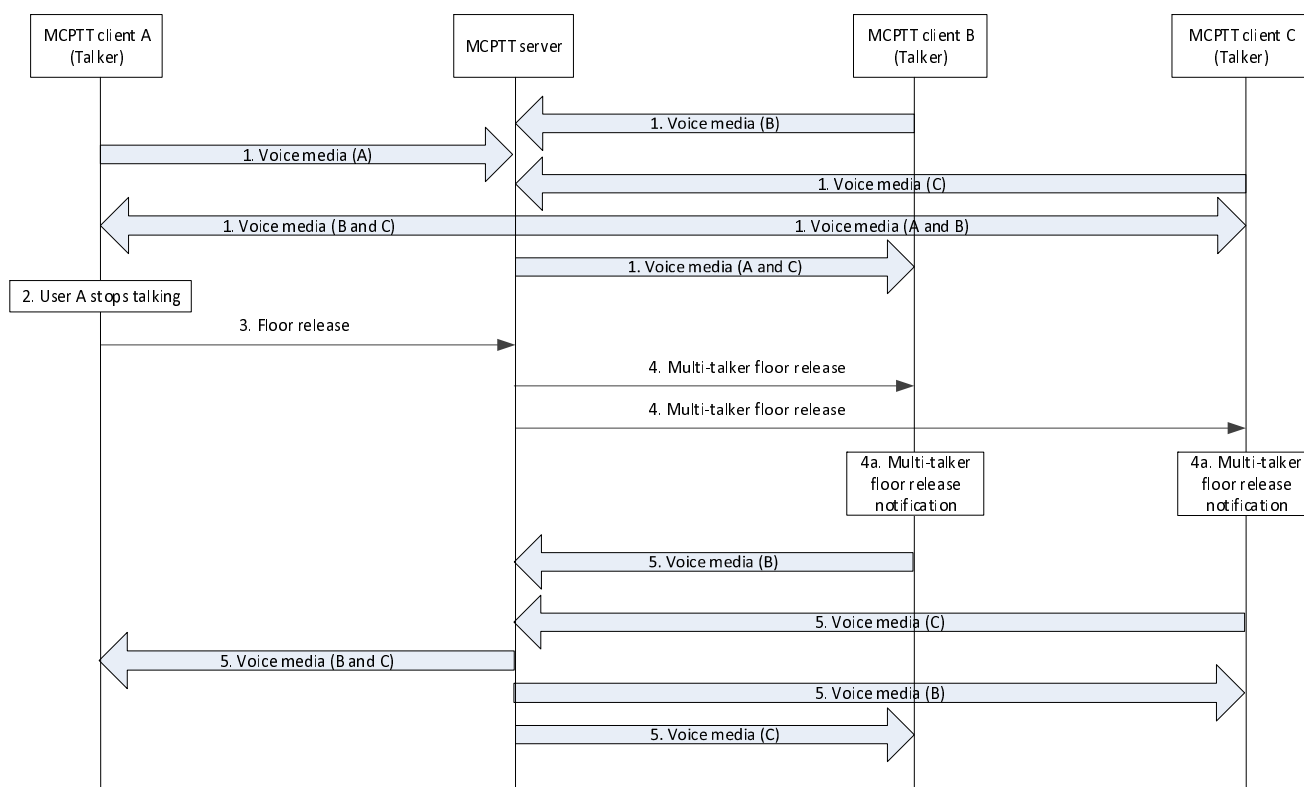

Figure 10.9.1.3.2.4-1: Floor release during an MCPTT session

1. Floor participants A, B and C are sending voice media over the established session.
2. User A stops talking and wants to stop sending voice media over the session.
3. Floor participant A sends a floor release message to the floor control server.
4. The floor control server accepts the floor release from floor participant A and sends a multi-talker floor release message to floor participant B and floor participant C.
- 4a. The users of floor participant B and floor participant C may be notified that floor participant A has released the floor.
5. Floor participants B and C continue sending voice media over the established session.

NOTE: Floor control procedures are independent from whether audio mixing is performed by the MCPTT server or by the UE.

10.9.1.3.3 Queue position during an MCPTT session

Figure 10.9.1.3.3-1 shows the high level procedure that the floor control is conducted for the MCPTT session already established between MCPTT clients (with floor granted to floor participant B) and server (with an override based on priority at floor control server). Only two UEs involved in the session are shown for the simplicity.

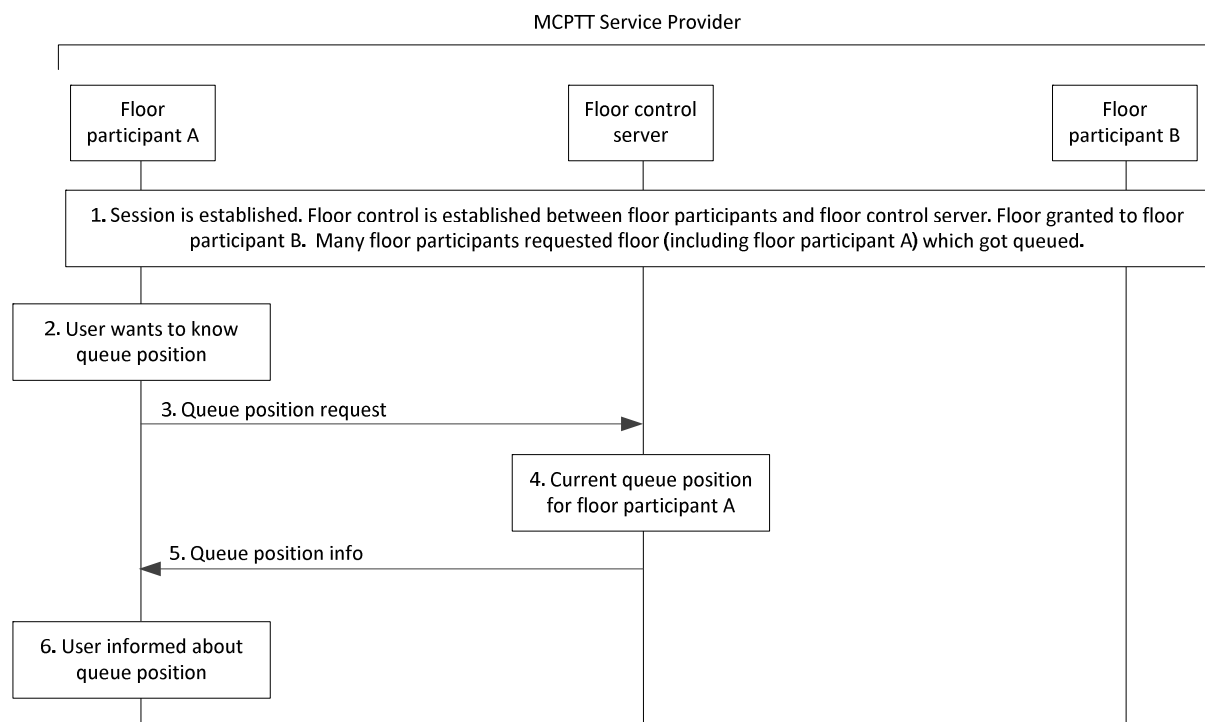

Figure 10.9.1.3.3-1: Queue status during an MCPTT session

1. It is assumed that floor participant B has been given a floor granted and is transmitting voice media. There are several other floor participants (including floor participating A) requesting floor which get queued at the floor control server.
2. Floor participant A would like to know its current position in the floor request queue.
3. Floor participant A sends a queue position request message to the floor control server.
4. Floor control server determines the current queue position of floor participant A from the floor request queue.
5. Floor control server responds with the current position in queue position info message.
6. User at floor participant A is informed about the current queue position.

10.9.1.3.4 Floor request cancellation from the floor request queue

10.9.1.3.4.1 Floor request cancellation from the queue – MCPTT user initiated

Figure 10.9.1.3.4.1-1 illustrates the procedure for floor request cancellation from the floor queue initiated by the MCPTT user. The MCPTT user may be an authorized user who has rights to cancel the floor requests of other MCPTT users, whose floor requests are in floor control queue.

Pre-conditions:

- It is assumed that floor participant B has been granted the floor and is transmitting voice media. There are several other floor participants (including floor participant A and floor participant C) requesting the floor which have been queued at the floor control server.

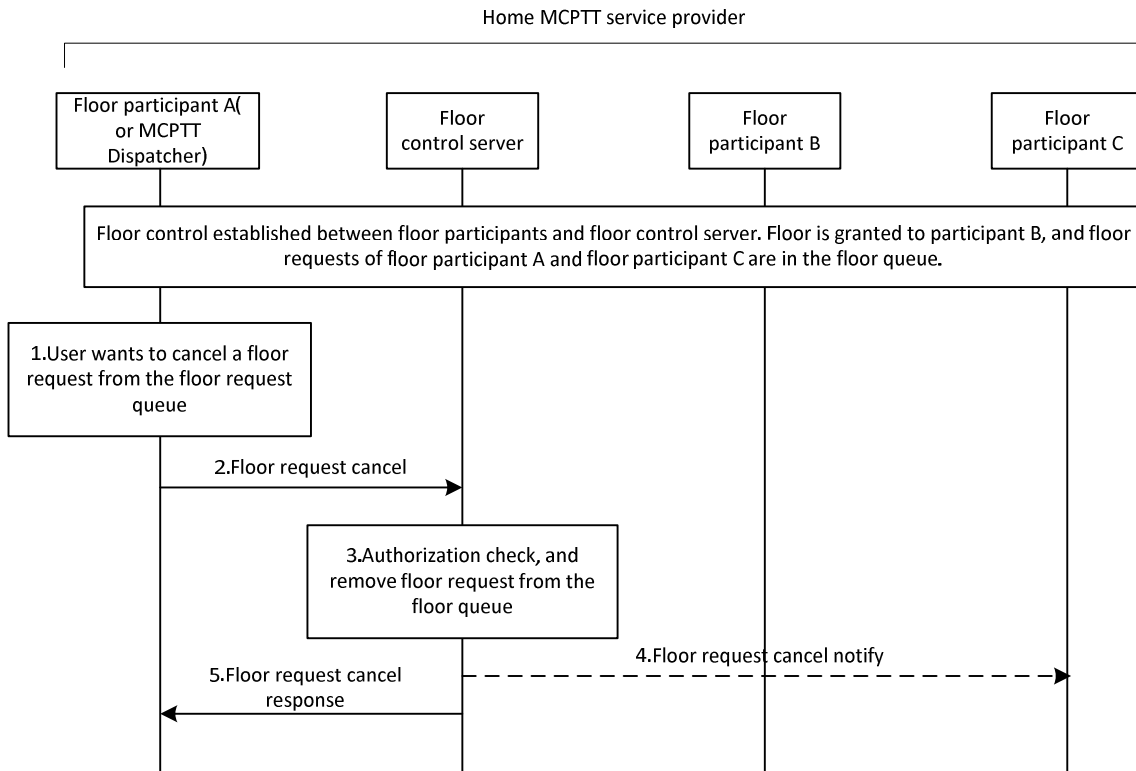

Figure 10.9.1.3.4.1-1: Floor request cancellation from queue initiated by MCPTT user

1. The floor participant A wants to remove the floor request from the floor request queue. If floor participant A is an authorized MCPTT user with the rights to cancel another MCPTT user's floor request, the authorized MCPTT user may request floor request cancellation for one or more floor participants, whose floor request needs to be removed from the floor queue.
2. The floor participant A sends a floor request cancel (initiating MCPTT ID) message to the floor control server. If the floor participant A wants to remove the floor request(s) of other participant(s), the target participant(s)' MCPTT ID should be included in this message.
3. The floor control server shall check whether the requesting floor participant has authorization to cancel the floor request(s). If authorized, the floor request(s) will be removed from the floor request queue. When current transmission is completed, floor control server will process the floor request from the updated floor request queue.
4. If the floor request cancel in step 3 is sent by an authorized user (e.g., dispatcher) to cancel the floor request(s) of other participant(s) from the floor request queue, the floor request cancel notify message is sent to the floor participant whose floor request was cancelled from the floor queue.
5. The floor control server provides a floor request cancel response to the floor participant A when the floor cancellation is completed. Optionally, the new queue position information may be notified to the floor participants whose floor requests are in the floor request queue (not shown in the figure).

10.9.1.3.4.2 Floor request cancellation from the queue - floor control server initiated

Figure 10.9.1.3.4.2-1 illustrates the procedure for floor request cancellation from the queue initiated by the floor control server. Only two UEs involved in the session are shown for the simplicity.

Pre-conditions:

- It is assumed that floor participant B has been granted the floor and is transmitting voice media. There are several other floor participants (including floor participant A and participant C) requesting the floor which have been queued at the floor control server.

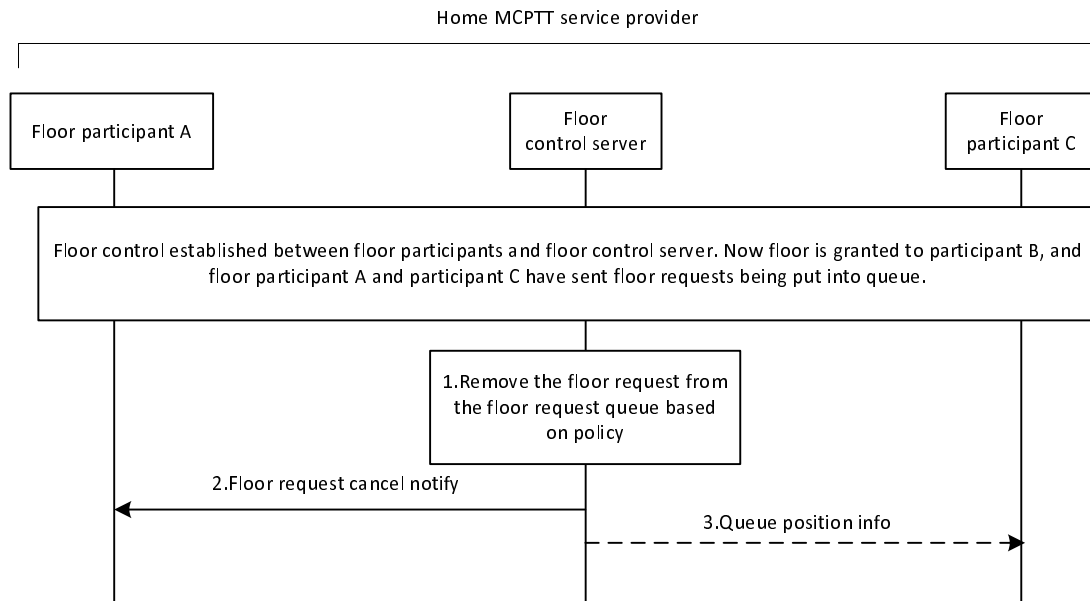

Figure 10.9.1.3.4.2-1: Floor request cancellation from queue initiated by floor control server

1. The floor control server removes the floor request from the floor request queue based on policy. e.g., expiration of a timer. In the case when floor control server receives repeated floor requests from a floor participant while the floor is occupied, the new floor request is accepted and added into the floor queue and the existing/former floor request is removed from the floor queue or the new floor request is rejected and the existing/former floor request of this floor participant is retained in the floor request queue.
2. The floor control server sends a floor request cancel notify to the floor participant(s) whose floor request is removed from the floor request queue.
3. Optionally, the newly queue position information is notified to the other floor participants whose floor requests are queued.

10.9.1.4 Floor control involving groups from multiple MCPTT systems

10.9.1.4.1 Partner MCPTT system routes all floor control messages to primary MCPTT system's floor control server

The MCPTT users belonging to different groups in multiple MCPTT systems will participate in MCPTT media services (group communication, private calls, etc.) in scenarios like group hierarchies and temporary groups formed by group regroup. In this service delivery model involving multiple groups from different MCPTT systems, the floor control arbitration resides with the primary MCPTT system. This is determined in the group call setup stage. The MCPTT users of groups involved in the call session will transmit their floor control messages through the partner MCPTT systems to which they belong. In this scenario, the partner MCPTT systems request the floor control for its MCPTT user(s) from the floor control server of the primary MCPTT system. The protocol used for media plane signalling is non-SIP like RTCP.

Figure 10.9.1.4.1-1 describes the procedure for floor control involving groups from multiple MCPTT systems.

Pre-conditions:

1. The security aspects of sharing the user information between primary and partner MCPTT systems shall be governed as per the service provider agreement between them. In this case, we consider the partner MCPTT system does not share all information of their users' to the primary MCPTT system (public information would still need to be shared).
2. The group 1 is hosted by primary MCPTT system and group 2 and 3 are hosted by the partner MCPTT system.
3. The floor participant 1 corresponds to the MCPTT user of group 1. The floor participant 2 corresponds to the MCPTT user of group 2. The floor participant 3 corresponds to the MCPTT user of group 3. The floor control server 1 belongs to primary MCPTT system. The floor control server 2 belongs to partner MCPTT system.

4. The floor control server 1 is the floor arbitrator of the MCPTT group call. The floor control server 2 routes all floor control messages to and from the floor participants 2 and 3 and then floor control server 1.

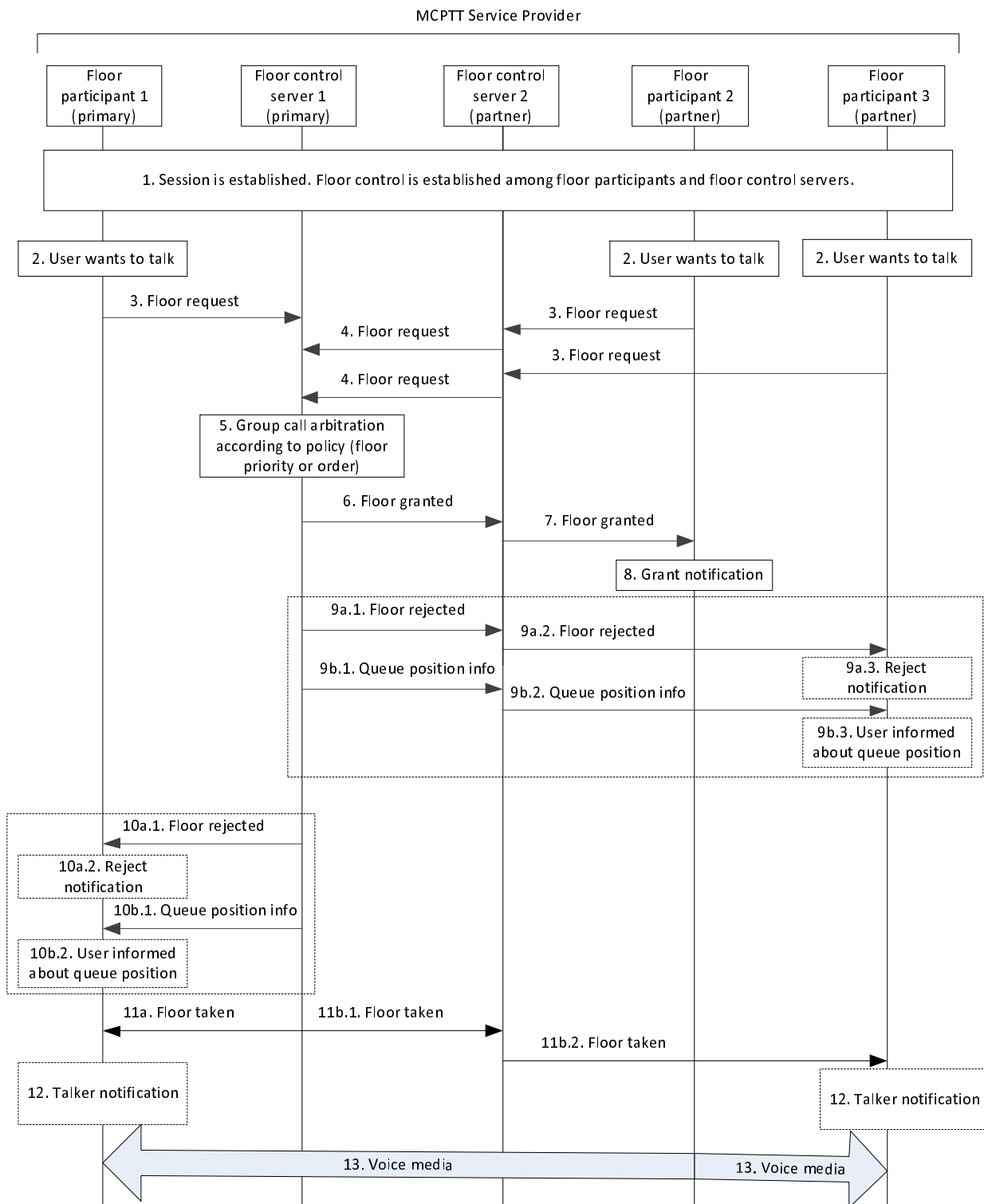

Figure 10.9.1.4.1-1: Floor control (partner MCPTT system forwarding) involving groups from multiple MCPTT systems

1. An MCPTT group call involving group1, group 2 and group 3 is setup and active.
2. The MCPTT users want to talk.
3. The floor participants initiate a floor request to the floor control server of their corresponding MCPTT systems. (The requests may or may not occur at the same time).

4. If only one floor request is received, or floor control server 2 handles the floor request sequentially, there is no arbitration performed and the corresponding floor request is forwarded to the floor control server 1. If the floor control server 2 receives multiple floor requests at the same time or during an interval, then it forwards the floor requests to the floor control server 1 (floor arbitrator for the MCPTT group call). As the floor participant information shall not be exposed, the floor priority related information or/and group information to be used by floor control server 1 should be included in the forwarded request.
 5. The floor control server 1 performs floor arbitration for the MCPTT group call and determines the floor request to be accepted.
 6. If the floor request from floor participant 2 of the partner MCPTT system is accepted, a floor granted is sent with permission to talk. The floor control messages from floor control server 1 are routed to floor participant 2 via the floor control server 2.
 7. When the floor control server 2 (partner) receives the floor granted, the floor control server 2 sends a floor granted message on to floor participant 2.
 8. The floor granted shall cause the user of the UE where the floor participant 2 is located to be notified.
 9. The primary floor control server 1 may (9a.1) send a floor rejected message, or (9b.1) send a queue position info message for each non-granted received floor requests forwarded from the floor control server 2 (partner). When the floor control server 2 (partner) receives the floor rejected message, then the floor control server 2 (partner) (9a.2) sends a floor rejected message to the appropriate floor participant. When the floor control server 2 (partner) receives the queue position info, then the floor control server 2 (partner) (9b.2) sends a queue position info message to the appropriate floor participant.
 - 10a.1 If floor control server 1 rejects the floor request from floor participant 1, then a floor reject message is sent.
 - 10a.2 Upon this being received the user of the UE where floor participant 1 is located may be notified.
 - 10b.1 If floor control server 1 supports floor queue, queue position info message is sent to the floor participant 1.
 - 10b.2 Upon this being received the user of the UE where floor participant 1 is located may be notified.
- NOTE 1: Steps 10a.1 through 10.b2 are optional as indicated by the dashed box enclosing them. However if this box is implemented then either information flow 10a or 10b would occur.
11. Since the floor is granted to floor participant 2 of the partner MCPTT system, then a floor taken is sent to all other floor participants ((11a) floor participant 1 and (11b.1) to floor control server 2 (partner) for forwarding to (11b.2) floor participant 3.
 12. The receipt of the floor taken may be used to inform the users of the UEs where the floor participant entity 1 and floor participant 3 are located to be notified.
 13. Upon successful floor granted, the group call media transmission occurs.

NOTE 2: The media flow between the media gateways of primary and partner MCPTT systems have not been depicted in the figure for clarity.

10.9.1.4.2 Partner MCPTT system performs filtering of floor control messages entering and leaving the partner MCPTT system

The MCPTT users belonging to different groups in multiple MCPTT systems will participate in MCPTT media services (group communication, private calls, etc.) in scenarios like group hierarchies and temporary groups formed by group regroup. In this service delivery model involving multiple groups from different MCPTT systems, the floor control arbitration resides with the primary MCPTT system. This is determined in the group call setup stage. The MCPTT users of groups involved in the call session will transmit their floor control messages through the partner MCPTT systems to which they belong. In this scenario, the partner MCPTT system filters its MCPTT users' floor requests before communicating with the floor control server of the primary MCPTT system. The protocol used for media plane signalling is non-SIP like RTCP.

Figure 10.9.1.4.2-1 describes the procedure for floor control involving groups from multiple MCPTT systems.

Pre-conditions:

1. The security aspects of sharing the user information between primary and partner MCPTT systems shall be governed as per the service provider agreement between them. In this case, we consider the partner MCPTT system does not share all information of their users to the primary MCPTT system (public information would still need to be shared).
2. The group 1 is hosted by primary MCPTT system and group 2 and 3 are hosted by the partner MCPTT system.
3. The floor participant 1 corresponds to the MCPTT user of group 1. The floor participant 2 corresponds to the MCPTT user of group 2. The floor participant 3 corresponds to the MCPTT user of group 3. The floor control server 1 belongs to primary MCPTT system. The floor control server 2 belongs to partner MCPTT system.
4. The floor control server 1 is the floor arbitrator of the MCPTT group call. The floor control server 2 does floor control filtering with its floor participants 2 and 3 before communicating with the floor control server 1.

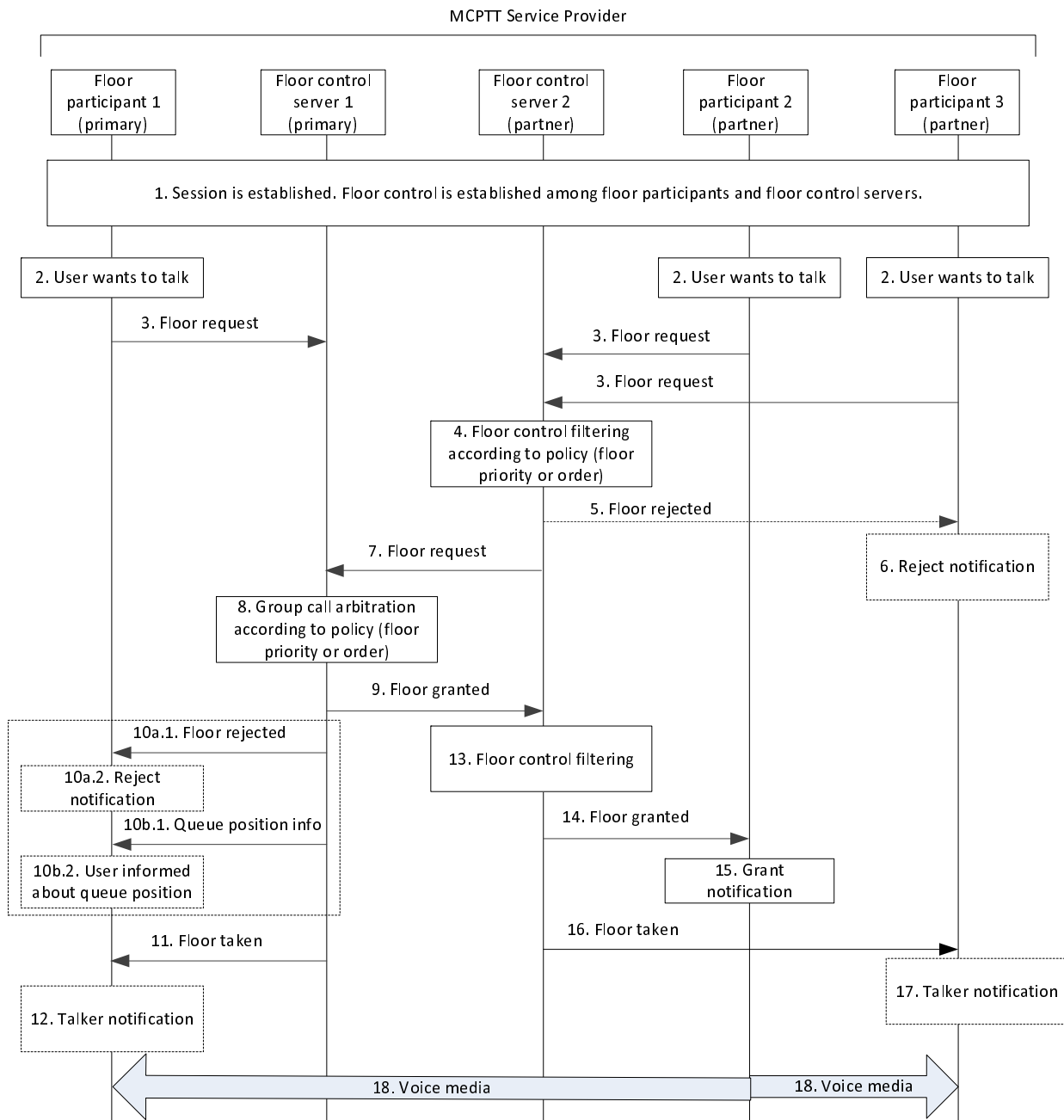

Figure 10.9.1.4.2-1: Floor control (filtering by partner MCPTT system) involving groups from multiple MCPTT systems

1. An MCPTT group call involving group 1, group 2 and group 3 is setup and active.

2. The MCPTT users want to talk
3. The floor participants initiate a floor request to the floor control server of their corresponding MCPTT systems. (The requests may or may not occur at the same time).
4. Floor control server 2 receives a floor request from floor participant 2 and from participant 3 at the same time or during an interval, then the floor control server 2 (partner) performs filtering of the floor requests received according to its local policy such as priority or order based on its own users, and forwards the selected floor request (floor participant 2) to the floor control server 1 (floor arbitrator for the MCPTT group call). As the floor participant information shall not be exposed, the priority related information or/and group information to be used by floor control server 1 should be included in the forwarded request.
5. The floor control server 2 (partner) may send a floor rejected towards the floor participant 3, since its floor request was not chosen to be forwarded on to the floor control server 1.
6. The user on the UE where the floor participant 3 is located may be notified of the rejection.

NOTE 1: Steps 5 and 6 can occur any time between step 4 and step 16.

7. The floor control server 2 (partner) forwards the floor request of floor participant 2 to the floor server 1.
8. The floor control server 1 performs floor arbitration for the MCPTT group call and determines the floor request to be accepted. The floor request message from floor participant 2 of the partner system is accepted by the floor control server 1 (arbitrator) and is determined that a floor granted is sent with permission to talk.
9. The floor granted message from floor control server 1 is routed to floor participant 2 via the floor control server 2 (partner).

10. Since floor participant 1 sent a floor request but was not granted,

10a.1 the primary floor control server may send a floor rejected message to floor participant 1.

10a.2 The user of the UE where the floor participant 1 is located may be notified of the rejection.

10b.1 if floor control server supports floor queuing, send a queue position info message to floor participant 1.

10b.2 The user of the UE where the floor participant 1 is located may be notified of the queue position.

NOTE 2: Steps 10a.1 through 10b.2 are optional as indicated by the dashed box enclosing them. However if this box is implemented then either information flow 10a or 10b would occur.

11. A floor taken message is sent to floor participant 1.

12. The user of the UE where the floor participant 1 is located may be notified.

NOTE 3: Step 10 through Step 12 can occur any time between step 8 and step 18.

13. Since the floor control server 2 (partner) filters floor requests, when the floor control server 2 (partner) receives the floor granted for floor participant 2 from floor control server 1, the floor control server 2 (partner) needs to use the information received to generate the floor taken which will be sent to all other floor participants (floor control participant 3).

14. The floor control server 2 (partner) sends a floor granted message to floor participant 2.

15. The user of the UE where the floor participant 2 is located is notified.

16. The floor control server 2 (partner) sends a floor taken message to all other floor participants (floor participant 3).

17. The user of the UE where the floor participant 1 is located may be notified.

18. Upon successful floor grant, the group call media transmission occurs.

NOTE 4: The media flow between the media gateways of primary and partner MCPTT systems have not been depicted in the figure for clarity.

10.9.1.5 Floor control for audio cut-in enabled group

Figure 10.9.1.5-1 shows the procedure for audio cut-in for the session already established between the floor participants from same MCPTT service provider. Floor participants may request the floor while Floor Participant B is transmitting voice media. Floor control server grants floor immediately to the floor request received.

Editor's note: Configuration parameter for queue depth is FFS.

Pre-conditions:

- The floor control server has been configured to support audio cut-in.
- It is assumed that the floor has been granted to floor participant B and floor participant B is transmitting voice media. There are several other floor participants (including floor participant A).

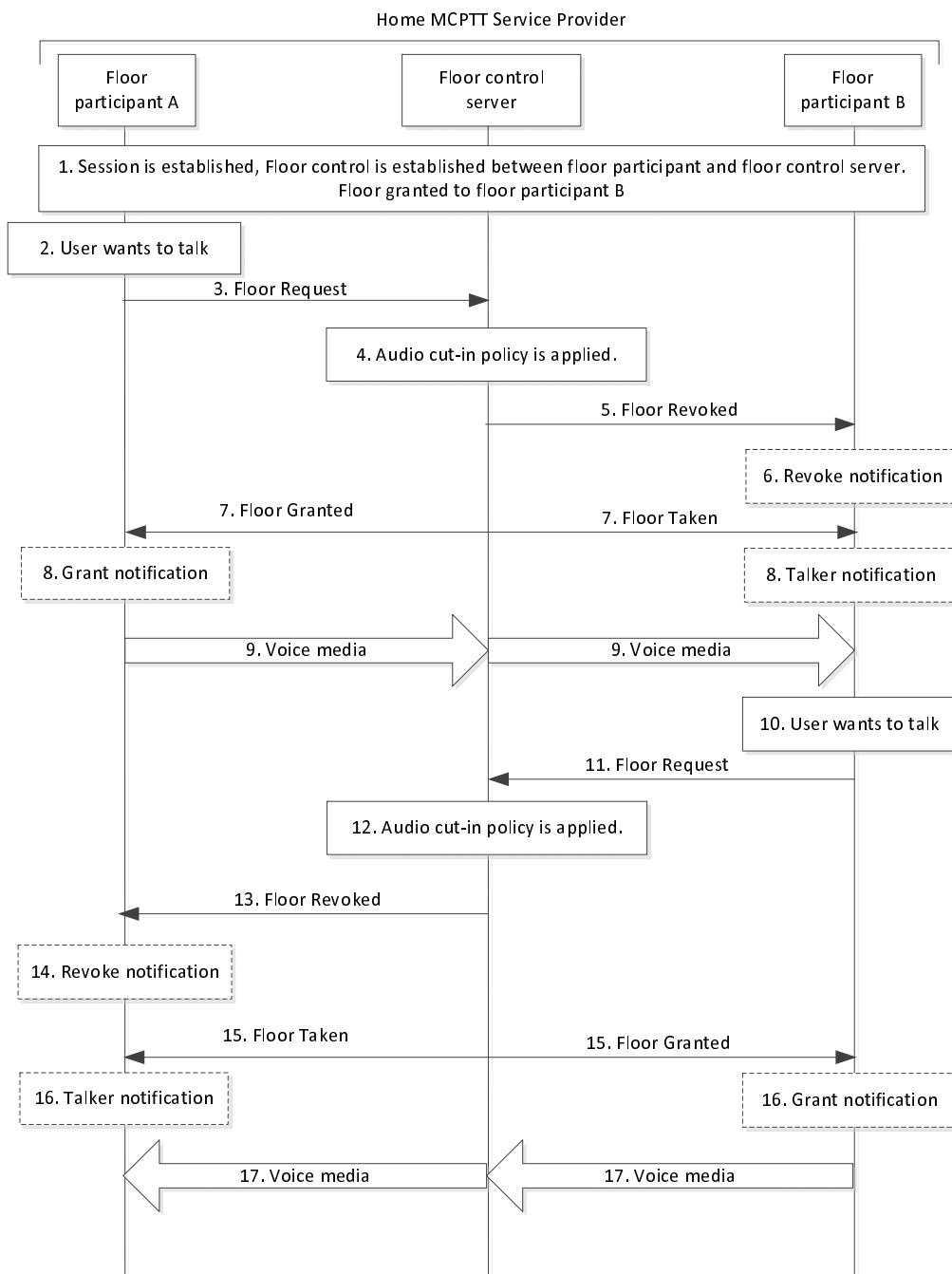

Figure 10.9.1.5-1: Floor control for audio cut-in enabled group in single MCPTT system

1. Floor participant B has been given floor and is transmitting voice media.

2. Floor participant A wants to send voice media over the session.
3. Floor participant A sends a floor request message to the floor control server.
4. The floor control server applies the audio cut-in policy with floor queue disabled i.e., floor is immediately granted to the floor participant A, and revoked from floor participant B.
5. The floor control server sends a floor revoked message to floor participant B stopping the voice media transmission from floor participant B.
6. The user of floor participant B may be notified that the floor is revoked.
7. The Floor control server sends a floor granted message to floor participant A, and sends a floor taken message to floor participant B with information of who is granted the floor. The floor control server may limit the time a user talks (holds the floor).
8. The user of floor participant A may be notified that he is granted the floor. Similarly, the user of floor participant B may be notified who is granted the floor.
9. Floor participant A starts sending voice media over the session established.
10. Now floor participant B may want the floor to start sending voice media.
11. Floor participant B sends a floor request message to floor control server.
12. The floor control server applies the audio cut-in policy with floor queue disabled.
13. The floor control server sends a floor revoked message to floor participant A stopping the voice media transmission from floor participant A.
14. The user of floor participant A may be notified that the floor is revoked.
15. The Floor control server sends a floor granted message to floor participant B, and sends a floor taken message to floor participant A with information of who is granted the floor. The floor control server may limit the time a user talks (holds the floor).
16. The user of floor participant B may be notified that he is granted the floor. Similarly, the user of floor participant A may be notified who is granted the floor.
17. Floor participant B starts sending voice media over the session established.

10.9.1.6 Unicast media stop and resume requests

Figure 10.9.1.6-1 shows the procedure for a floor participant to indicate to the floor control server that the unicast media flow of an active MCPTT group call can be stopped.

Pre-condition:

1. An MCPTT session is established between MCPTT client A and MCPTT server for an MCPTT group call. Other participants to the call are not shown in the figure for simplicity.
2. The floor control is established between the floor participant and the floor control server.

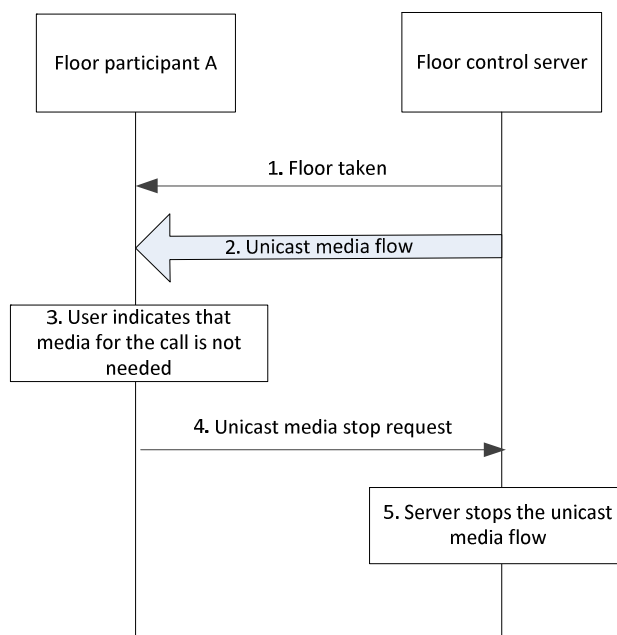

Figure 10.9.1.6-1: Unicast media stop request during an MCPTT session

1. Another floor participant has requested and has been granted the floor. The floor control server sends a floor taken message to floor participant A. The floor taken message may include an identifier of the associated media flow.
2. Floor control server sends the voice media flow to floor participant A over unicast.
3. Floor participant A gets the information, e.g. from the user, that media for the call is not needed.
4. Floor participant A sends a unicast media stop request to floor control server, identifying the media flow to be stopped.
5. Floor control server stops sending that unicast media flow to floor participant A. Associated bearer resources may be de-allocated by the MCPTT server.

Figure 10.9.1.6-2 shows the procedure for a floor participant to request from the floor control server that the unicast media flow of an active MCPTT group call be restarted.

Pre-condition:

1. An MCPTT session is established between MCPTT client A and MCPTT server for an MCPTT group call. Other participants to the call are not shown in the figure for simplicity
2. The floor control is established between the floor participant and the floor control server.
3. Floor participant A has previously indicated to the floor control server that unicast media flow for that call should be stopped, using the procedure described in Figure 10.9.1.6-1.

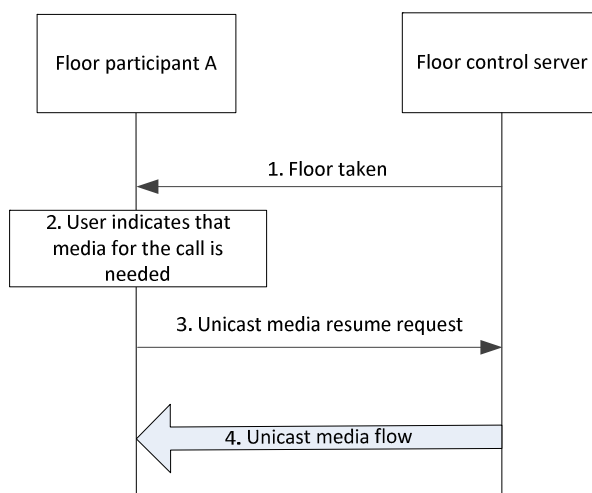

Figure 10.9.1.6-2: Unicast media resume request during an MCPTT session

1. Another floor participant has requested and has been granted the floor. The floor control server sends a floor taken message to floor participant A. The floor taken message may include an identifier of the associated media flow.
2. Floor participant A gets the information, e.g. from the user, that media for the call is needed again.
3. Floor participant A sends a unicast media resume request to floor control server, identifying the media flow to be re-started.
4. Floor control server starts sending that unicast media flow to floor participant A. This may need new bearer resources to be allocated.

NOTE 1: The identifier of the flow to be stopped or resumed is known by the floor participant from the floor control information flows associated with that MCPTT session.

NOTE 2: Stopping a media flow is not leaving the session and subsequent floor control messages will still be sent by the floor control server to the floor participant which has requested a unicast media stop.

NOTE 3: Both requests have no effect on a possible ongoing transmission of the media flow over MBMS. In particular, they are not interpreted by the MCPTT server as MBMS listening status reports.

10.9.2 Floor control for off-network MCPTT service

10.9.2.1 General

The procedures defined in this subclause provide floor control to MCPTT UEs in off-network operation. The procedures apply to both private calls and group calls.

In off-network, floor control is performed by using floor control messages among the MCPTT clients without centralized MCPTT server. The MCPTT client can transmit voice packets once it is granted the right to speak, either locally in the UE or by reception of a floor granted message from another MCPTT client.

In off-network, the MCPTT client currently speaking performs the temporary floor arbitrator during speaking since there is no centralized MCPTT floor control server. The floor arbitrator controls the floor whether or not queue is supported, and when floor is requested with override. If queue is supported, the MCPTT client performing floor arbitrator grants the right to speak to the next speaker and transfers the floor arbitrator role after completing the voice transfer and releasing the floor. For group calls, the floor arbitrator also transfers the floor control queue when granting

the floor. The next MCPTT client receiving the right to speak becomes the new floor arbitrator and, for group calls, has the floor control queue.

For group calls, the floor control message is delivered in multicast based communication and can be monitored by all the members within the MCPTT group.

The following information flows apply among MCPTT clients.

- Floor request (from the floor participants to the floor arbitrator): used to request a floor for voice transfer.
- Floor release (from the floor arbitrator to the floor participants): used to inform that the voice transfer is completed and the floor is released.
- Floor granted (from the floor arbitrator to a floor participant): used to indicate that the request for floor is granted, that voice transfer is possible and the current queue list.
- Queue position request (from the floor participant to the floor arbitrator): used to request the position in the floor request queue.
- Queue position info (from the floor arbitrator to the floor participant): used to indicate the floor request is queued and the current queue status.
- Floor rejected (from the floor arbitrator to the floor participant): used to indicate that a request for the floor is rejected.
- Floor taken (from the floor arbitrator to the floor participant): used to indicate the floor is granted to another MCPTT user.

10.9.2.2 Information flows for floor control for off-network

10.9.2.2.1 General

For floor control for off-network, the information flows defined under subclause 10.9.1.2 apply unless it is explicitly defined under this subclause.

10.9.2.2.2 Floor granted

Table 10.9.2.2.2-1 describes the information flow floor granted, from the floor participant to the floor participant, which is used to indicate that a request for floor is granted and media transfer is possible.

Table 10.9.2.2.2-1: Floor granted

Information element	Status	Description
MCPTT ID	M	Requester identity
Duration	M	The time for which the granted party is allowed to transmit
Source identifier	O	Identifies the communication, e.g. by identifying the media flow within a media multiplex, present only in case of media multiplexing
Acknowledgement required	O	Indicates if acknowledgement from the floor participant is required

10.9.2.3 Floor control during silence

10.9.2.3.1 Successful floor taken (No floor contention)

If a floor arbitrator still exists, the expected behaviour for floor requests during periods of silence is described in subclauses 10.9.2.5 and 10.9.2.6 (with the exception that no media was being generated prior to the floor request).

If a floor arbitrator does not exist, figure 10.9.2.3.1-1 shows the successful high level floor control procedure during periods when there is no detectable talker.

NOTE 1: The description also applies to private calls.

Pre-conditions:

1. An off-network group call had been established and all MCPTT clients have the call parameters. No participant is currently talking and no floor arbitrator is identified.

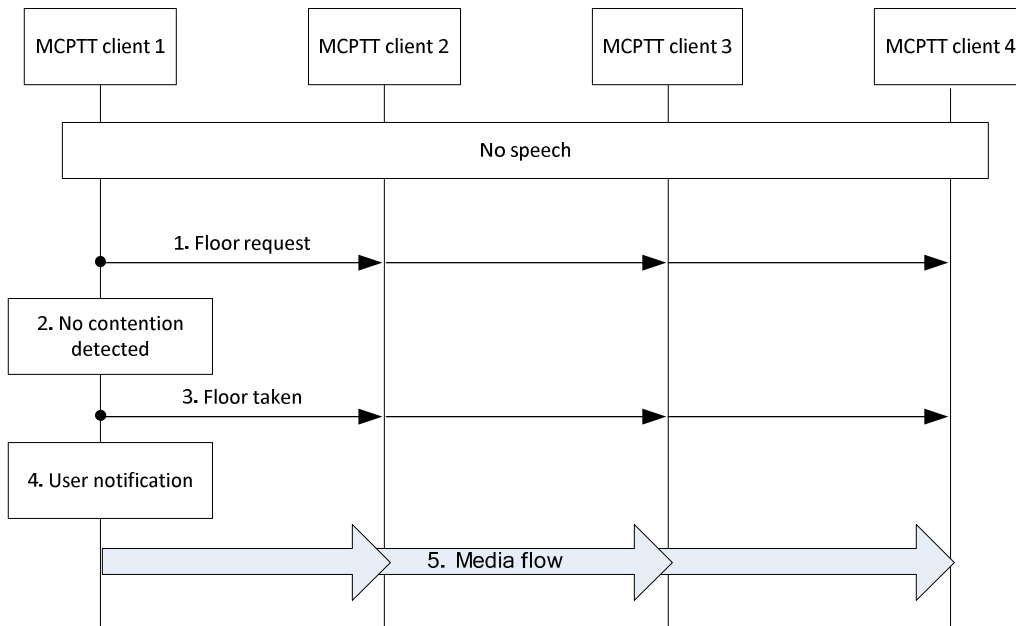

Figure 10.9.2.3.1-1: Successful floor taken flow (No floor contention)

1. The MCPTT client 1 sends the floor request message to the MCPTT group.
2. The MCPTT client 1 does not detect any floor contention. Floor contention occurs when multiple floor requests may exist simultaneously.

NOTE 2: The mechanism for detecting floor contention is out of scope of the present document.

3. The MCPTT client 1 sends the floor taken message to the MCPTT group.
4. The user gets a notification that the floor request was successful (the floor has been granted).
5. The MCPTT client 1 begins voice transmission.

10.9.2.4 Simultaneous floor requests

If a floor arbitrator does not exist, figure 10.9.2.4.1-1 shows the expected behaviour in case of simultaneous floor requests are generated when there is no detectable talker.

Pre-conditions:

1. An off-network group call is established and all MCPTT clients have the call parameters. No participant is currently talking and no floor arbitrator is identified.
2. MCPTT client 1 has higher priority than MCPTT client 2.

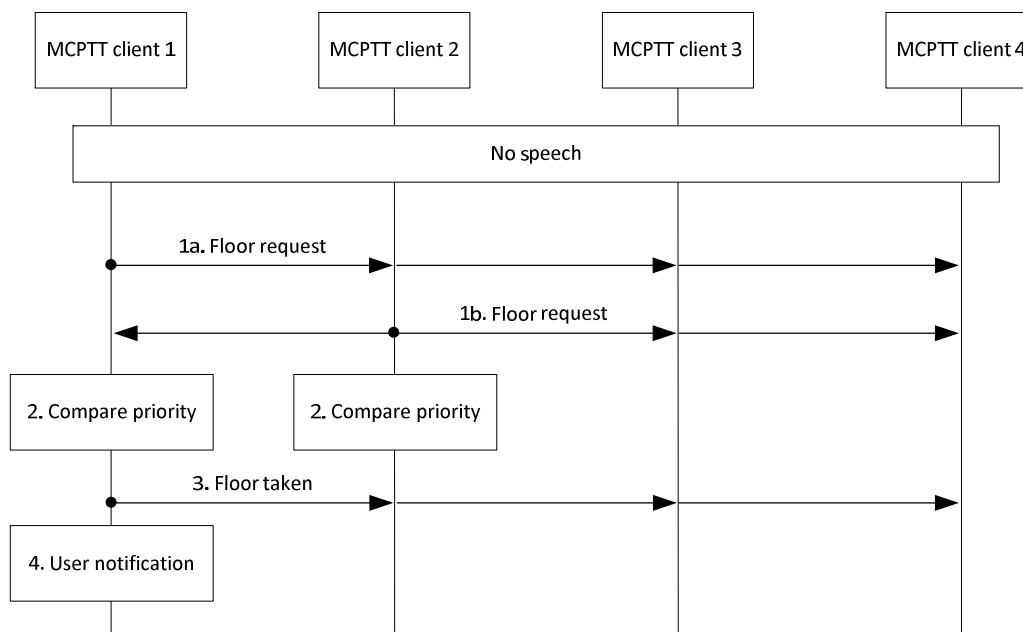

Figure 10.9.2.4.1-1: Simultaneous floor requests

1a. The MCPTT client 1 sends the floor request message to the MCPTT group.

1b. The MCPTT client 2 sends the floor request message to the MCPTT group.

NOTE 1: Step 1a and 1b happen in parallel

2. On receiving a floor request message, while waiting for a response to the sent floor request message, the MCPTT client compares its floor priority with the floor priority indicated in the received floor request message.

3. On determining that it has higher floor priority than the received floor request message(s), and no response to the sent floor request message is received, the MCPTT client 1 sends the floor taken message to the MCPTT group.

4. The user at MCPTT client 1 gets notification that the floor request was successful (the floor has been granted).

NOTE 2: If the floor priority in the received floor request message is same as its own floor priority, the MCPTT client can use another scheme to decide who gets the floor.

10.9.2.5 Floor request during speaking with queue

Figure 10.9.2.5-1 shows the high level procedure that the floor control is conducted when the MCPTT off-network session is already established among MCPTT floor participants and while voice media is transmitting. In the case, MCPTT clients should support queue function. The current speaking MCPTT client acting as the floor arbitrator put the floor request into the queue list when receiving the floor request from other MCPTT clients. This procedure happens while voice media is transmitting. In the flow, MCPTT client 1 transmits the voice media to the MCPTT group and acts as the floor arbitrator.

NOTE: The description only applies to group calls.

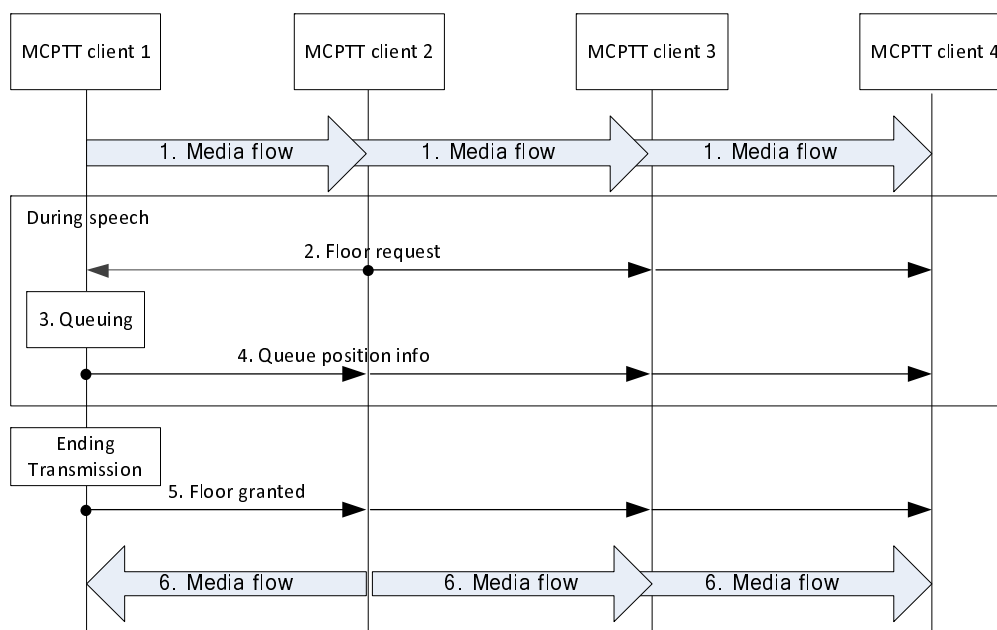

Figure 10.9.2.5-1: Floor request during speaking with queue

1. MCPTT client 1 is transmitting voice media to the MCPTT group.
2. MCPTT client 2 sends the floor request message to the MCPTT group.
3. MCPTT client 1 acting as the floor arbitrator put the floor request of MCPTT client 2 into the queue list.
4. MCPTT client 1 sends the queue position info message with the queuing status regarding the floor request of MCPTT client 2 in order to inform the floor request is queued.
5. MCPTT client 1 sends the floor granted message to the MCPTT group when releasing the floor. The message contains the MCPTT ID to be granted to send the voice media, and queue list, if any. MCPTT client 1 may include the maximum duration that MCPTT client 2 transmits in the floor granted message.
6. MCPTT client 2 sends the voice media when receiving the floor granted message and being granted as next speaker in the floor granted message. In addition, MCPTT client 2 becomes the floor arbitrator.

10.9.2.6 Floor request during speaking without queue

Figure 10.9.2.6-1 shows the high level procedure that the floor control is conducted when the MCPTT off-network session is already established among MCPTT floor participants. In the case, MCPTT clients do not support queue function. The current speaking MCPTT client acting as the floor arbitrator controls the floor request when receiving the floor request from other MCPTT clients. This procedure happens while voice media is transmitting. In the flow, MCPTT client 1 transmits the voice media to the MCPTT group and acts as the floor arbitrator.

NOTE: The description also applies to private calls.

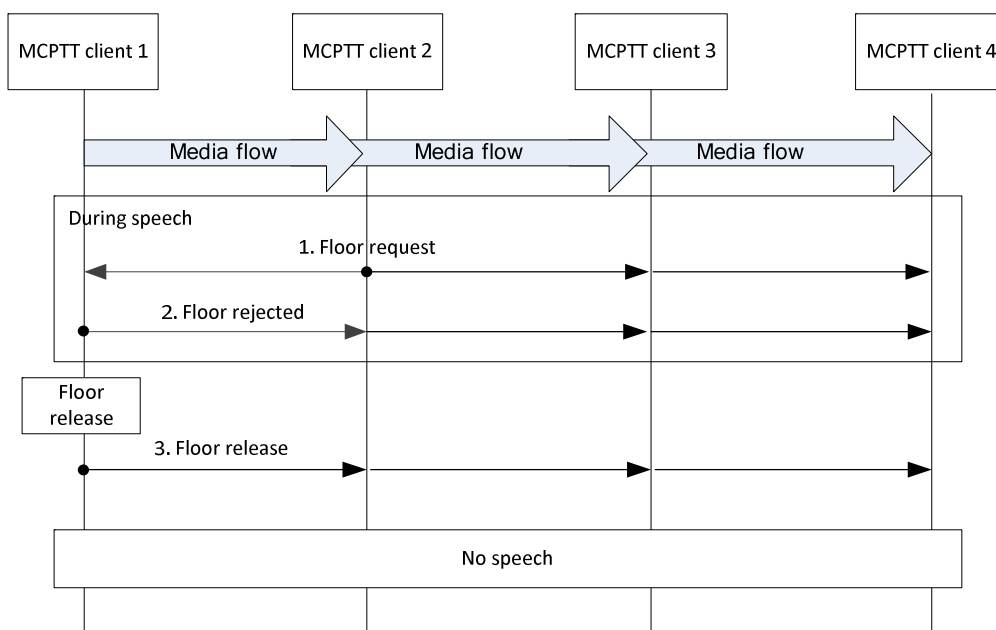

Figure 10.9.2.6-1: Floor request during speaking without queue

1. MCPTT client 2 sends the floor request message to the MCPTT group.
2. MCPTT client 1 acting as the floor arbitrator rejects the floor request from MCPTT client 2 if no queue function is supported and sends the floor rejected message to the MCPTT group.
3. MCPTT client 1 sends the floor release message to the MCPTT group when releasing the floor, in order to indicate that MCPTT client 1 finishes to send the voice media and releases the floor.

When the floor release message is transmitted, there are no voice media in the MCPTT group until an MCPTT client requests the floor as described in subclause 10.9.2.3.

10.9.2.7 Override

Figure 10.9.2.7-1 shows the high level procedure that the floor control is conducted when the MCPTT off-network session is already established among MCPTT floor participants and while voice media is transmitting. When the currently speaking MCPTT floor participant receives the floor request message from another floor participant who is authorized to revoke the active transmission (e.g. higher hierarchy), the current speaking MCPTT floor participant immediately stops sending the audio media and then grants the permission to that authorized floor participant.

NOTE: The description also applies to private calls.

Pre-condition:

- MCPTT client 1, who acts as the floor arbitrator, transmits the audio media to the MCPTT group.

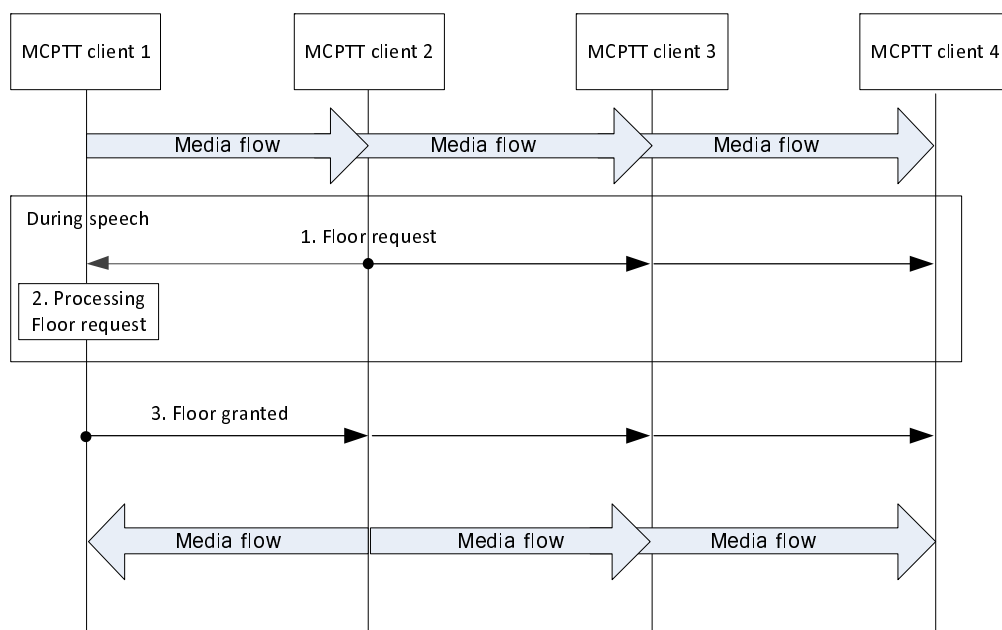

Figure 10.9.2.7-1: Floor request with override authorization

1. MCPTT client 2 sends the floor request message with override criteria (e.g., priority level) to the MCPTT group.
2. MCPTT client 1 acting as the floor arbitrator determines if the floor is to be revoked based on override criteria. If this is the case, MCPTT client 1 revokes its right of the floor and stops sending the voice media immediately.
3. MCPTT client 1 sends the floor granted message to the MCPTT group. The floor granted message contains the MCPTT ID to be granted, the floor and the floor control queue (if supported). MCPTT client 1 may also include the maximum duration that MCPTT client 2 can transmit voice in the floor granted message.

MCPTT client2 who has revoked the floor is the new floor arbitrator and transmits the audio media to the MCPTT group.

10.9.2.8 Floor queue status

Figure 10.9.2.8-1 shows the high level procedure that the floor control is conducted when the MCPTT off-network session is already established among MCPTT floor participants and while voice media is transmitting. If the floor control queueing is supported by the floor control mechanism, the current speaking MCPTT group member who is acting as the floor arbitrator collects the information about the queue status based on the received request(s) from the MCPTT group participant(s). The current speaker can then share information about the queue status of the MCPTT floor participant upon request.

NOTE: The description only applies to group calls.

Pre-condition:

- MCPTT client 1, who acts as the floor arbitrator, transmits the audio media to the MCPTT group.

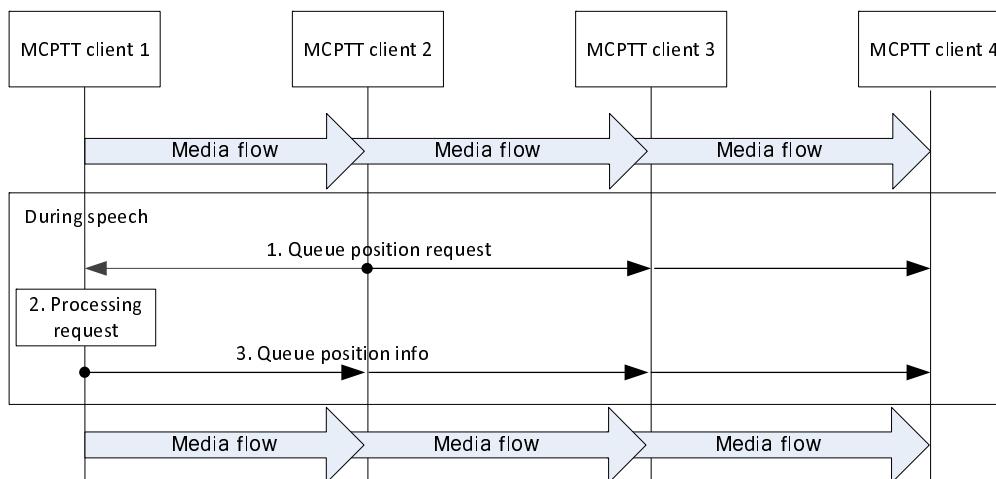

Figure 10.9.2.8-1: Queue status request

1. MCPTT client 2 sends the queue position request message targeted to MCPTT client 1 i.e. the floor arbitrator by broadcasting the message to the MCPTT group to get its queue status.
2. Since the queue function is assumed to be supported in this call flow, MCPTT client 1 i.e. the floor arbitrator processes the queue position request to find out the status of MCPTT client 1 in the queue.
3. MCPTT client 1 constructs the queue position info message containing the MCPTT client 2's queue status and sends it toward MCPTT client 2 by broadcasting the message to the MCPTT group.

MCPTT client1 continues being the floor arbitrator and transmits the audio media to the MCPTT group.

10.10 Use of MBMS transmission (on-network)

10.10.1 Information flows for MBMS Transmission

10.10.1.1 MapGroupToBearer

Table 10.10.1.1-1 describes the information flow to associate a MCPTT group call to a MBMS bearer. It is sent from the MCPTT server to the MCPTT client.

Table 10.10.1.1-1: MapGroupToBearer

Information element	Status	Description
MCPTT group ID	M	This element identifies the MCPTT group, in which the call is started.
Media stream identifier	M	This element identifies the media stream of the SDP used for the group call (e.g. MBMS subchannel).
TMGI (NOTE)	O	The MBMS bearer identifier if the media of the MCPTT group call is not sent on the same MBMS bearer as this MapGroupToBearer message.
Call acknowledgement indicator	O	Indication that the MCPTT group call requires acknowledgement from receiving MCPTT clients.
NOTE: TMGI shall be present if this message is sent over a different MBMS bearer than the media of the group call; TMGI may be present if this message is sent over the same MBMS bearer as the media of the group call.		

10.10.1.2 UnmapGroupFromBearer

Table 10.10.1.2-1 describes the information flow to disconnect a MCPTT group call from a MBMS bearer. It is sent from the MCPTT server to the MCPTT client.

Table 10.10.1.2-1: UnmapGroupFromBearer

Information element	Status	Description
MCPTT group ID	M	This element identifies the MCPTT group which will no longer use the MBMS bearer.

10.10.1.3 Application group paging

Table 10.10.1.3-1 describes the information flow application group paging from the MCPTT server to the MCPTT client.

Table 10.10.1.3-1: Application group paging

Information element	Status	Description
MCPTT Group ID	M	This element identifies the MCPTT group which is paged by the application.

10.10.2 Use of pre-established MBMS bearers

The MCPTT service shall support the procedure for using pre-established MBMS bearers as specified 3GPP TS 23.280 [16]. The MCPTT service shall use the MCPTT-1, MCPTT-6, MCPTT-8 and MCPTT-9 reference points for this procedure.

MCPTT may use pre-established MBMS bearer for the different types of MCPTT group calls. Both pre-arranged group calls and chat group calls can use the pre-established MBMS bearer for distributing the media. The MBMS bearer can be used by any group. Depending on the capacity of the MBMS bearer, the bearer can be used to broadcast one or more group calls in parallel.

Both the media packets as well as the floor control messages to the receiving users are sent on the MBMS bearer. Optionally a separate MBMS bearer could be used for the floor control messages, due to different bearer characteristic requirements.

When using the pre-established procedure for MCPTT, the MCPTT server perform the procedure of call connect and disconnect over MBMS as defined in subclause 10.10.4 at the group communication session establishment step.

10.10.3 Use of dynamic MBMS bearer establishment

The MCPTT service shall support the procedure for using dynamic MBMS bearers as specified 3GPP TS 23.280 [16]. The MCPTT service shall use the MCPTT-1, MCPTT-4, MCPTT-6, MCPTT-7, MCPTT-8 and MCPTT-9 reference points for this procedure.

MCPTT may use dynamic MBMS bearer establishment for the different types of MCPTT group calls. Both pre-arranged group calls and chat group calls can use the dynamic MBMS bearer for distributing the media.

Both the media packets as well as the floor control messages to the receiving users are sent on the MBMS bearer.

When using the procedures for dynamic MBMS bearer establishment for MCPTT, the MCPTT server perform the procedure of call connect and disconnect over MBMS as defined in subclause 10.10.4 at the group communication session establishment step.

10.10.4 Call connect and disconnect over MBMS

10.10.4.1 General

MBMS bearer can be used for MCPTT group calls. One MBMS bearer is not permanently associated to one specific group or group call. Before sending media packets of a group call over MBMS bearer, the MCPTT server shall send the

association information between group call and the MBMS bearer. The group call setup procedure indicates the media stream within one MBMS bearer that is used for the specific group call. When the group call over the MBMS bearer is finished, this temporary association information of an MCPTT group call to specific resources on a MBMS bearer is undone. The procedure in figure 10.10.4.2.1-1 requires that the group session is setup before the call start. This eliminates the need for the receiving clients to continuously use a unicast bearer. Prior to this the MBMS bearer is activated and announced to the MCPTT clients.

10.10.4.2 Procedure

10.10.4.2.1 Call connect over MBMS

In figure 10.10.4.2.1-1 the MCPTT client 1 is the client that initiate an MCPTT chat group call and also the transmitting client. MCPTT client 1 may, but does not have to be in an MBMS service area. The MCPTT client 2 and MCPTT client 3 represents MCPTT clients receiving the MCPTT call over an MBMS bearer. There may be other receiving clients both over unicast bearers and over this or other MBMS bearer(s), however they are not illustrated in this figure.

The same procedure as for chat group call can also be applied for pre-arranged calls. However that requires that the pre-arranged sessions are already active. If a pre-arranged group session is initiated the use of pre-established sessions are required.

Pre-conditions:

- All users participating in the MCPTT group call are already affiliated to the group.
- All participating users have joined the group session.

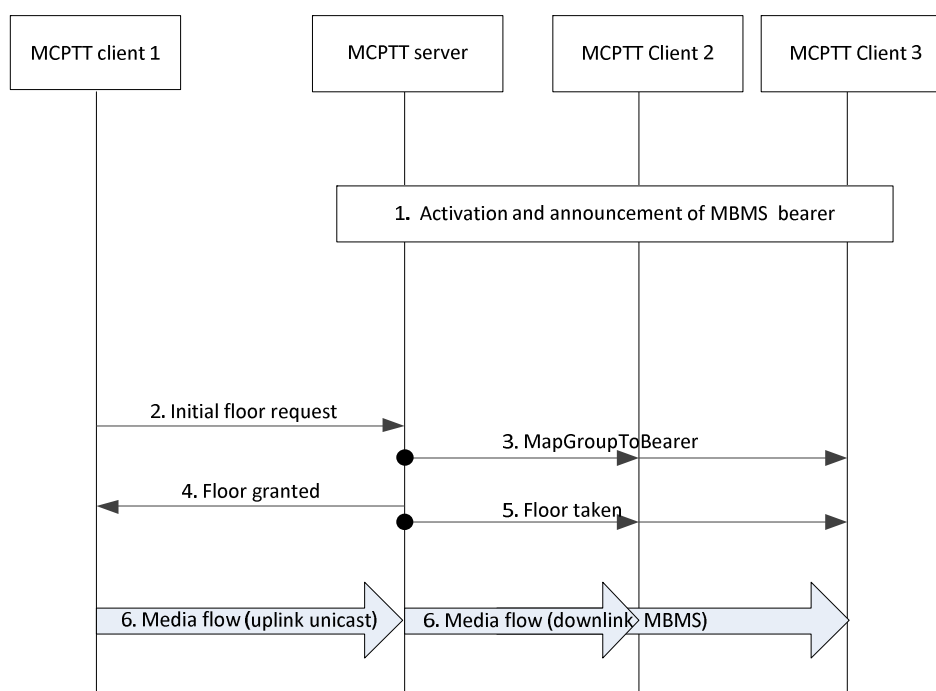

Figure 10.10.4.2.1-1: Chat group call connect on MBMS bearer

1. Activation and announcement of MBMS bearer availability.

NOTE 1: The procedure does not include the steps for MCPTT client location reporting, or for MBMS capability information exchange.

2. MCPTT client 1 initiate the MCPTT group call by sending an initial floor request over a unicast bearer to the MCPTT server (reference point MCPTT-4).
3. The MCPTT server will send a MapGroupToBearer message over a previously activated MBMS bearer to all users that will receive the call over an MBMS bearer. The MapGroupToBearer message includes association information between the group call and MBMS bearer. The MapGroupToBearer message includes MCPTT group ID and information about the media stream identifier of the activated MBMS bearer and may include the

identifier (i.e. the TMGI) of the MBMS bearer broadcasting the call. The message is sent over reference point MCPTT-9.

NOTE 2: Step 3 can be deferred until step 5 and the MapGroupToBearer message can then be included in the floor taken message.

4. The MCPTT server grants the right to transmit for MCPTT client 1 and by that sends a floor granted message to the MCPTT client 1. This message is sent over a unicast bearer (reference point MCPTT-4).
5. A floor taken message is sent from the MCPTT server to all receiving users. This message includes the MCPTT ID of the transmitting MCPTT client as well as the MCPTT group ID. The message is sent over a MBMS bearer to all users that have previously been setup to receive calls over the MBMS bearer. The message is sent over reference point MCPTT-9.
6. The media is sent from MCPTT client 1 to the MCPTT server over unicast bearer and from the MCPTT server to the MCPTT client 2 and MCPTT client 3 over MBMS bearer.

NOTE 3: Additional floor request messages in the same call will not trigger the MapGroupToBearer message to be sent.

10.10.4.2.2 Call disconnect over MBMS

Figure 10.10.4.2.2-1 shows the high level procedure where an UnmapGroupFromBearer message is sent by the MCPTT server to the MCPTT clients to indicate that the MCPTT group call is being dissociated from the MBMS bearer.

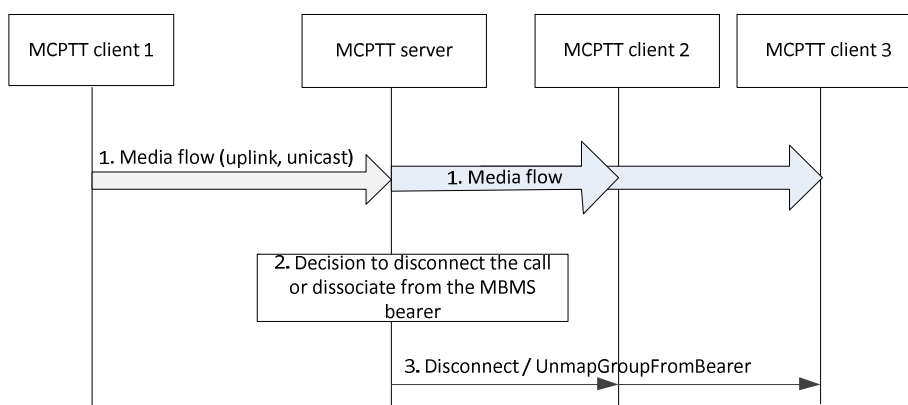

Figure 10.10.4.2.2-1: Chat group call disconnect on MBMS bearer

1. An MCPTT group call is ongoing; the media is broadcasted over MBMS bearer to MCPTT client 2 and MCPTT client 3.
2. MCPTT server has determined to disconnect the call over the MBMS bearer for the MCPTT clients
3. An UnmapGroupFromBearer message is sent by the MCPTT server to MCPTT client 2, MCPTT client 3 and possibly to MCPTT client 1 (if in MBMS coverage area) on MBMS bearer(s).

NOTE 4: The UnmapGroupFromBearer message can be sent as part of other messages.

NOTE 5: The UnmapGroupFromBearer message and the MapGroupToBearer message can be combined, to facilitate switching bearers in one signalling step, as necessary.

10.10.5 Switching from MBMS bearer to unicast bearer

The MCPTT service shall support the procedure for switching from MBMS bearer to unicast bearer as specified 3GPP TS 23.280 [16]. The MCPTT service shall use the MCPTT-1, MCPTT-4, MCPTT-7, MCPTT-8 and MCPTT-9 reference points for this procedure.

10.10.6 Enhanced MCPTT group call setup procedure with MBMS bearer

10.10.6.1 Description

When the MCPTT server initiates a new MCPTT call, the MCPTT server shall decide to use unicast bearers or broadcast bearers for the downlink media. A similar decision may also be made for other types of media communication e.g. MCVideo. To decide to use broadcast or unicast involves a number of aspects. The figure 10.10.6.1-1 specifies a procedural flow to perform such decision.

The flow described evaluates which bearer type to use for a new MCPTT group call. It is assumed that if an MBMS bearer is active it is also announced to the MCPTT client.

When using an MBMS bearer for application level control signalling, the announcement of an already active MBMS bearer could be part of the MCPTT group call setup, however that will have an impact on the call setup time.

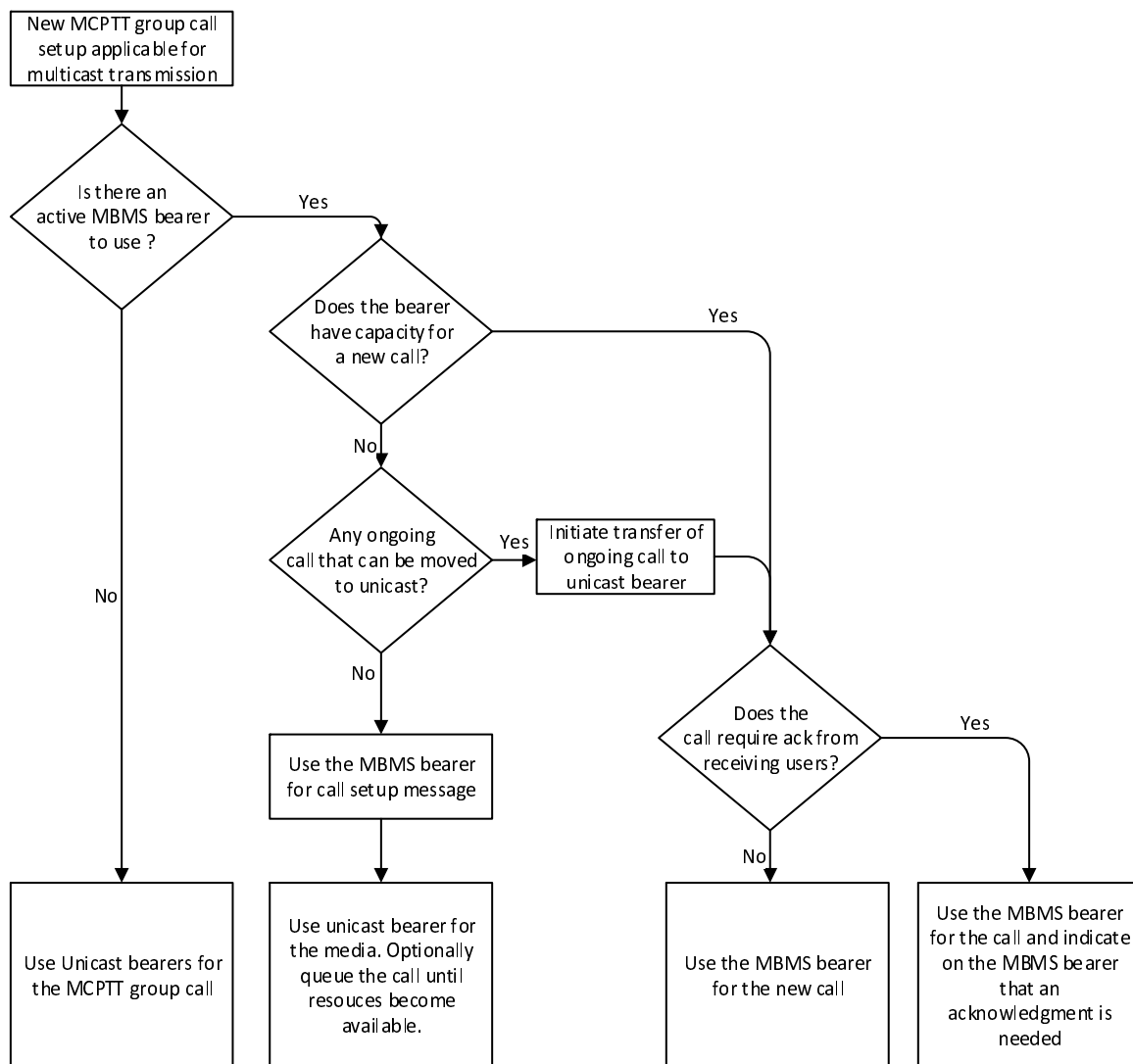

Figure 10.10.6.1-1: MBMS bearer decision flow

On a high level the procedure outcome is to use unicast or broadcast bearers for the new MCPTT group call. For an enhanced group call setup procedure, the MBMS bearer may be used to trigger the use of a unicast bearer.

10.10.6.2 Procedure

The procedure in figure 10.10.6.2-1 can be used in the following scenarios:

- Initiate a new call on unicast bearer
- Transfer an ongoing call from broadcast bearer to unicast bearers

Pre-conditions:

- There must be an active and announced MBMS bearer

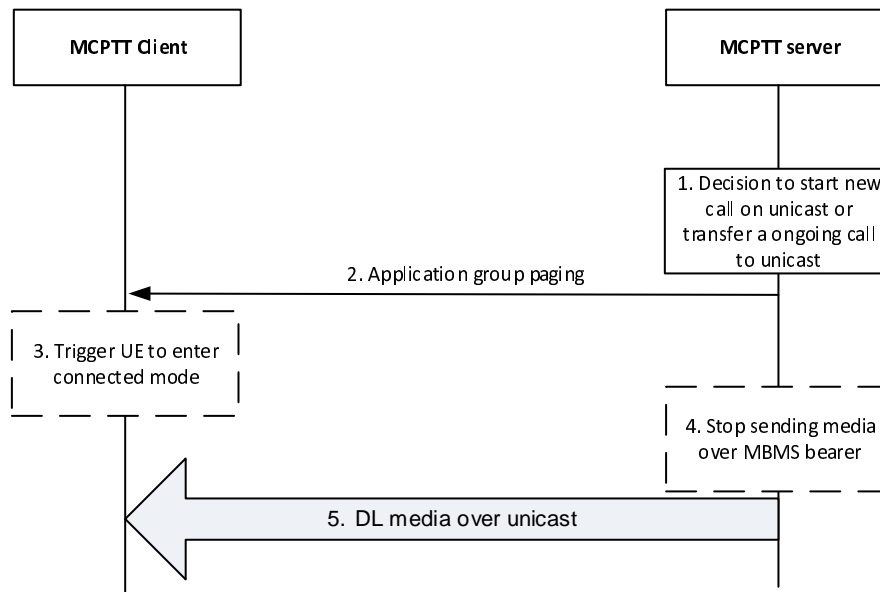

Figure 10.10.6.2-1: Application Group paging over an MBMS bearer

1. The MCPTT server initiates a new MCPTT group call on unicast or decides to transfer an ongoing call to unicast.
2. The MCPTT sends an application group paging message on the MBMS bearer to inform the MCPTT client that the MCPTT server will initiate media transmission over a unicast bearer.

NOTE: The group paging message is sent with the assumption that there are UEs in idle mode. Furthermore, this message is an application level paging message and does not replace the normal paging procedure executed by EPC and RAN.

3. In the case that the UE is in idle mode the UE will initiate a service request to transfer the UE to connected mode.
4. The MCPTT server stops sending the media over an MBMS bearer. This step is only performed if transferring an ongoing call.
5. The MCPTT server initiates the media transmission over the unicast bearer.

Step 4-5 may be performed in parallel with step 2-3. Step 5 will trigger a normal paging in EPC and RAN if the client is still in idle mode.

10.11 MCPTT resource management (on-network)

10.11.1 General

Procedures for resource management are defined in subclause 10.11 of 3GPP TS 23.280 [16].

10.11.2 Request for unicast resources at session establishment

Void

10.11.3 Request for modification of unicast resources

Void

10.11.4 Management of multicast media bearers

Void

10.11.5 Request for resources with shared priority

10.11.5.1 General

Void

10.11.5.2 Procedure

Void

10.12 MCPTT media plane transmissions with partner MCPTT systems (on-network)

The MCPTT user is able to receive MCPTT media services (e.g. group communication, private calls) from partner MCPTT systems in normal and roaming conditions. In this service delivery model, the media plane transmissions between the MCPTT UE of the user and the partner MCPTT system can be achieved directly or via the primary MCPTT system, selected by the PLMN operator's policy. The protocol used for media plane signalling is non-SIP like RTCP.

Figure 10.12-1 provides the procedure for media related signalling.

Figure 10.12-2 provide the procedure for the media transmission (directly) between MCPTT UE of the user and the partner MCPTT system.

Figure 10.12-3 provides the procedure for the media transmission (via the primary MCPTT system) between MCPTT UE of the user and the partner MCPTT system.

Pre-conditions:

1. The MCPTT group is defined in the partner MCPTT system, where the MCPTT client of user receives the MCPTT service.
2. An MCPTT group call is set up and active.
3. The partner MCPTT system is the group host MCPTT server that is hosting the MCPTT group. The corresponding floor control server manages the media corresponding to the group call.
4. Protocol used for signalling of media plane is non-SIP, it can be protocol like RTCP.
5. Media related signalling is sent via the primary MCPTT system.
6. The path for media between the MCPTT UE and partner MCPTT system has been selected to be sent directly to the partner MCPTT system or via the primary MCPTT system based on PLMN operator's policy.

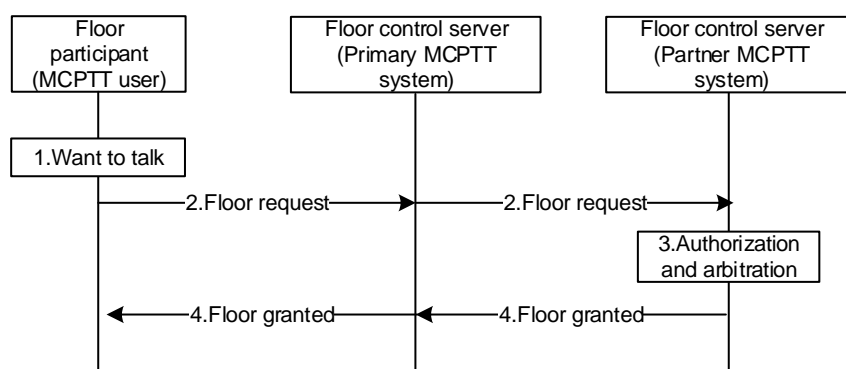

Figure 10.12-1: Media related signalling communication

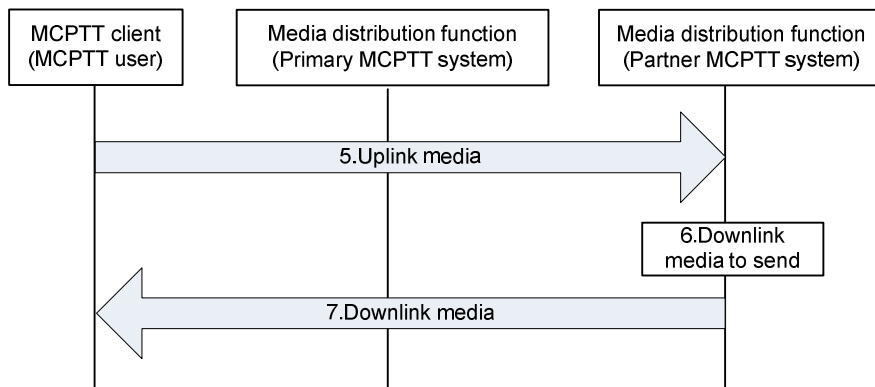

Figure 10.12-2: Media communication direct

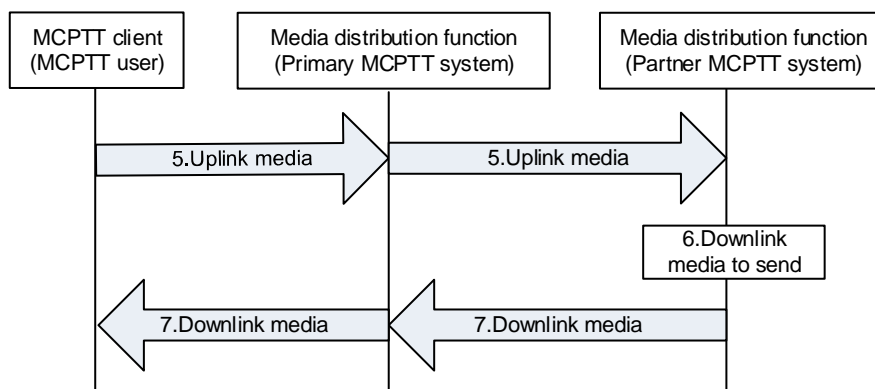

Figure 10.12-3: Media communication via primary MCPTT system

For media related signalling communication:

1. An MCPTT user wants to talk.
2. The floor participant corresponding to the MCPTT user sends a floor request message to floor control server (partner MCPTT system) to get the authorization and/or permission to talk.
3. The floor control server (partner MCPTT system) performs the authorization and arbitrates between requests that are in contention (i.e., floor control).
4. If the floor control server (partner MCPTT system) allows the floor participant to talk, a floor granted is provided with permission granted to talk.

For media communication:

5. The MCPTT client can now send uplink media data to the media distribution function of the MCPTT server (partner MCPTT system).
6. The media distribution function of the MCPTT server (partner MCPTT system) has downlink media data to transfer.
7. The media distribution function of the MCPTT server (partner MCPTT system) transfers the downlink media to the MCPTT client of the MCPTT user.

10.13 Location information (on-network)

The MCPTT system makes use of all of the procedures for location management as specified in 3GPP TS 23.280 [16], utilising the CSC-14 reference point between the location management client and location management server and the CSC-15 reference point between the MCPTT server and location management server.

- The MC service client is the MCPTT client;

- The MC service server is the MCPTT server;
- The MC service group is the MCPTT group;
- The MC service ID is the MCPTT ID; and
- The MC service group ID is the MCPTT group ID.

10.14 Ambient listening call

10.14.1 General

The ambient listening call is a type of a private MCPTT call that only allows a "listened to" user to transmit media to a "listening" user such that there is no indication on the MCPTT UE of the "listened to" user about the call and the media transmission.

NOTE 1: "listened to" user refers to the user who is transmitting media in an ambient listening call.

NOTE 2: "listening" user refers to the user who is receiving media in an ambient listening call.

There are two types of ambient listening call as below:

- Remotely initiated ambient listening is initiated by the authorized user (e.g., dispatcher) who wants to listen to another user. In this case, the "listened to" user is the called party, and shall automatically accept the call without causing any indication about the call and transmit the media to the "listening" user.
- Locally initiated ambient listening is initiated by an authorized user who wants another user to listen to the MCPTT UE communication. In this case, the "listened to" user is the calling party and shall automatically transmit the media to the "listening" user without causing any indication about the call processing and media transmission.

10.14.2 Information flows for ambient listening call

10.14.2.1 Ambient listening call request

Table 10.14.2.1-1 describes the information flow ambient listening call request from the MCPTT client to the MCPTT server and MCPTT server to the MCPTT client.

Table 10.14.2.1-1: Ambient listening call request

Information Element	Status	Description
MCPTT ID	M	The MCPTT ID of the "listening" user
MCPTT ID	M	The MCPTT ID of the "listened to" user
SDP offer	M	Media parameters of MCPTT client.
Ambient listening type	M	The ambient listening type indicates remotely initiated ambient listening call or locally initiated ambient listening call.

10.14.2.2 Ambient listening call response

Table 10.14.2.2-1 describes the information flow ambient listening call response from the MCPTT client to the MCPTT server and MCPTT server to the MCPTT client.

Table 10.14.2.2-1: Ambient listening call response

Information Element	Status	Description
MCPTT ID	M	The MCPTT ID of the "listening" user
MCPTT ID	M	The MCPTT ID of the "listened to" user
SDP answer	M	Media parameters selected

10.14.2.3 Ambient listening call release request

Table 10.14.2.3-1 describes the information flow ambient listening call release request from the MCPTT client to the MCPTT server and MCPTT server to the MCPTT client.

Table 10.14.2.3-1: Ambient listening call release request

Information Element	Status	Description
MCPTT ID	M	The MCPTT ID of the "listening" user
MCPTT ID	M	The MCPTT ID of the "listened to" user
Ambient listening type	M	The ambient listening type indicates a remotely initiated ambient listening call or a locally initiated ambient listening call.

10.14.2.4 Ambient listening call release response

Table 10.14.2.4-1 describes the information flow ambient listening call release response from the MCPTT client to the MCPTT server and MCPTT server to the MCPTT client.

Table 10.14.2.4-1: Ambient listening call release response

Information Element	Status	Description
MCPTT ID	M	The MCPTT ID of the "listening" user
MCPTT ID	M	The MCPTT ID of the "listened to" user
Ambient listening type	M	The ambient listening type indicates a remotely initiated ambient listening call or a locally initiated ambient listening call.

10.14.2.5 Ambient listening call release notification

Table 10.14.2.5-1 describes the information flow ambient listening call release notification from the MCPTT server to the MCPTT client.

Table 10.14.2.5-1: Ambient listening call release notification

Information Element	Status	Description
MCPTT ID	M	The MCPTT ID of the "listening" user
MCPTT ID	M	The MCPTT ID of the "listened to" user
Call release reason	M	The reason for call release by the MCPTT server
Ambient listening type	M	The ambient listening type indicates a remotely initiated ambient listening call or a locally initiated ambient listening call.

10.14.3 Ambient listening call procedures

10.14.3.1 Remotely initiated ambient listening call setup

The MCPTT service provides the capability for an authorised user to initiate a remotely initiated ambient listening call at an MCPTT client.

Figure 10.14.3.1-1 illustrates the information flow for remotely initiated ambient listening call setup.

Pre-conditions:

- MCPTT client 1 is the client of the authorized user who is authorized to invoke a remotely initiated ambient listening call to be set up at the requested MCPTT client 2.
- MCPTT user 1 is the "listening" user at MCPTT client 1, and MCPTT user 2 is the "listened to" user at MCPTT client 2.

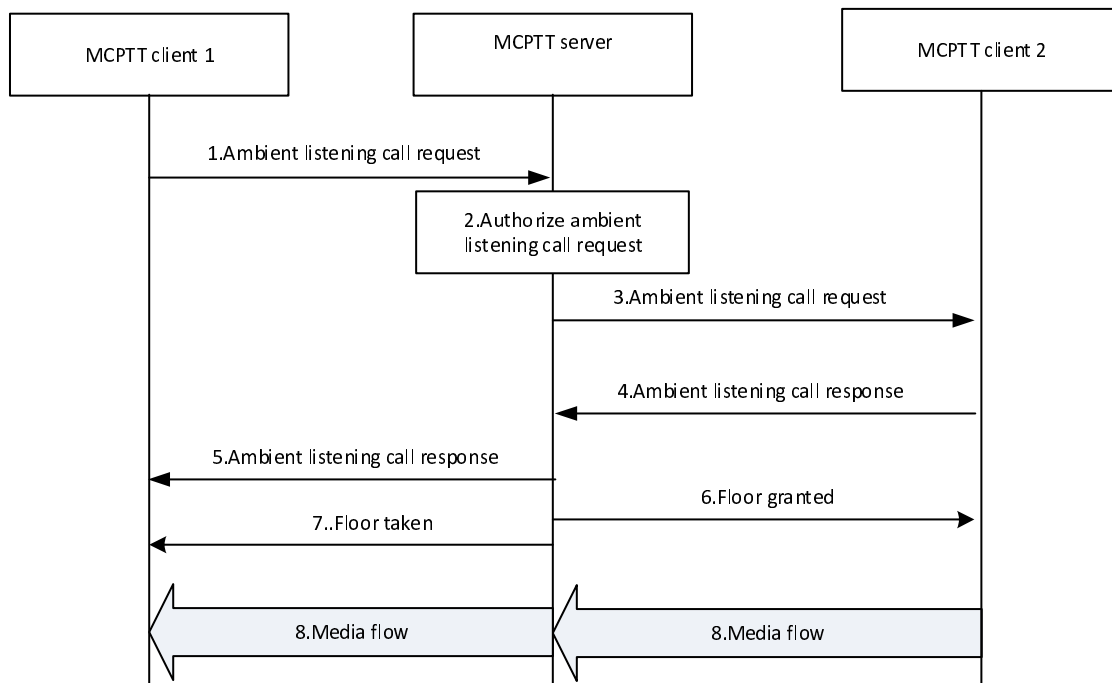

Figure 10.14.3.1-1: Remotely initiated ambient listening call

1. MCPTT client 1 initiates a remotely initiated ambient listening call by sending the ambient listening call request to the MCPTT server. The remotely initiated ambient listening call type is included.
2. The MCPTT server performs an authorization check for the authorized user 1 for the remotely initiated ambient listening call. If authorization fails, the MCPTT server provides a failure response to MCPTT client 1.

3. The MCPTT server sends the ambient listening call request to MCPTT client 2.
4. MCPTT client 2 returns the ambient listening call response to the MCPTT server.
5. MCPTT server provides an ambient listening call response to MCPTT client 1, indicating whether the call is set up successfully or not.
6. The floor control server of the MCPTT server then sends a floor granted to MCPTT client 2 according to the ambient listening type received in step 1.
7. Accordingly, the floor control server of the MCPTT server sends a floor taken to MCPTT client 1.
8. After receiving the floor granted message at the MCPTT client 2, the media is transmitted from MCPTT client 2 to MCPTT client 1.

NOTE: MCPTT client 2 does not provide any indication of the ambient listening call release to its user.

10.14.3.2 Locally initiated ambient listening call setup

The MCPTT service provides the capability for an authorised user to initiate a locally initiated ambient listening call at an MCPTT client.

Figure 10.14.3.2-1 illustrates the information flow for locally initiated ambient listening call setup.

Pre-conditions:

- MCPTT client 2 is the client of the authorized user who is authorized to invoke a locally initiated ambient listening call to be set up at the requested MCPTT client 1.
- MCPTT user 1 is the "listening" user at MCPTT client 1, and MCPTT user 2 is the "listened to" user at MCPTT client 2.

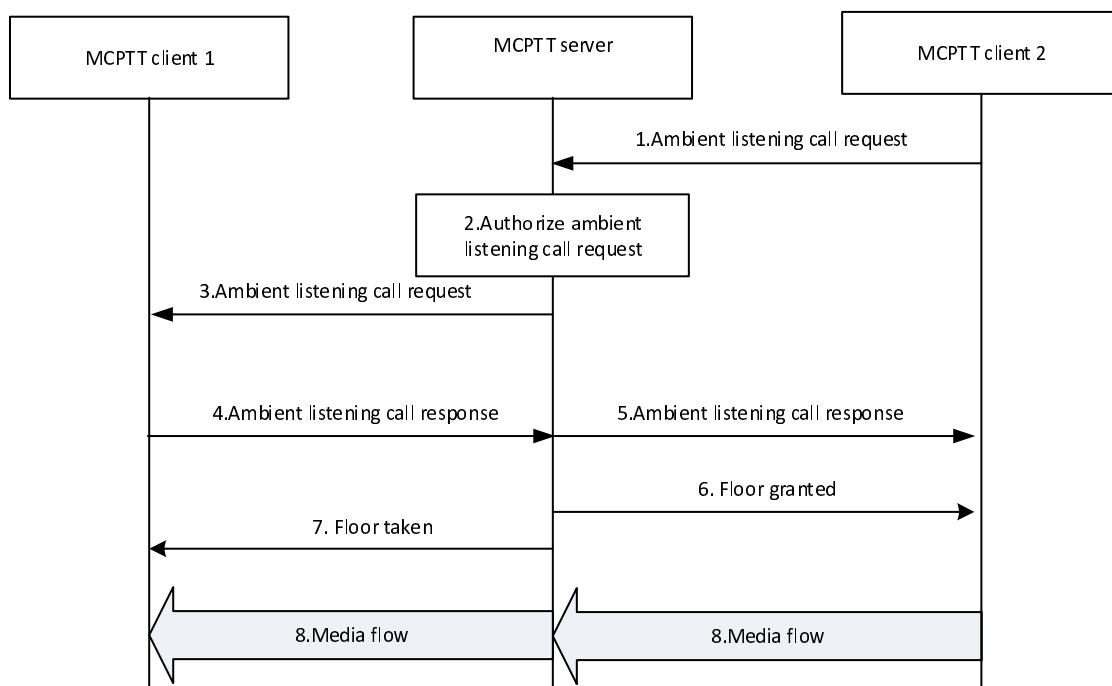

Figure 10.14.3.1-1: Locally initiated ambient listening call

1. MCPTT client 2 initiates a locally initiated ambient listening call by sending the ambient listening call request to the MCPTT server. The locally initiated ambient listening call type is included.
2. The MCPTT server performs an authorization check for the authorized user 2 for the locally initiated ambient listening call. If authorization fails, the MCPTT server provides a failure response to MCPTT client 2.
3. The MCPTT server sends the ambient listening call request to MCPTT client 1.

4. MCPTT client 1 returns the ambient listening call response to the MCPTT server.
5. MCPTT server provides an ambient listening call response to MCPTT client 2, indicating whether the call is set up successfully or not.
6. The floor control server of the MCPTT server then sends a floor granted to MCPTT client 2 according to the ambient listening type received in step 1.
7. Accordingly, the floor control server of the MCPTT server sends a floor taken to MCPTT client 1.
8. After receiving the floor granted message at the MCPTT client 2, the media is transmitted from MCPTT client 2 to MCPTT client 1.

NOTE: MCPTT client 2 does not provide any indication of the ambient listening call release to its user.

10.14.3.3 Ambient listening call release – server initiated

Figure 10.14.3.3-1 illustrates the information flow for ambient listening call release – server initiated when trigger by the MCPTT administrator. This procedure is applied for both remotely initiated ambient listening call and the locally initiated ambient listening call.

Pre-conditions:

- MCPTT client 1 is the MCPTT client of the authorized user, who initiated the ambient listening call at MCPTT client 2.
- There is an ongoing ambient listening call between MCPTT client 2 and MCPTT client 1.
- MCPTT user 1 is the current user at MCPTT client 1 who is listening, and MCPTT user 2 is the current user at MCPTT client 2 who is being listened to.

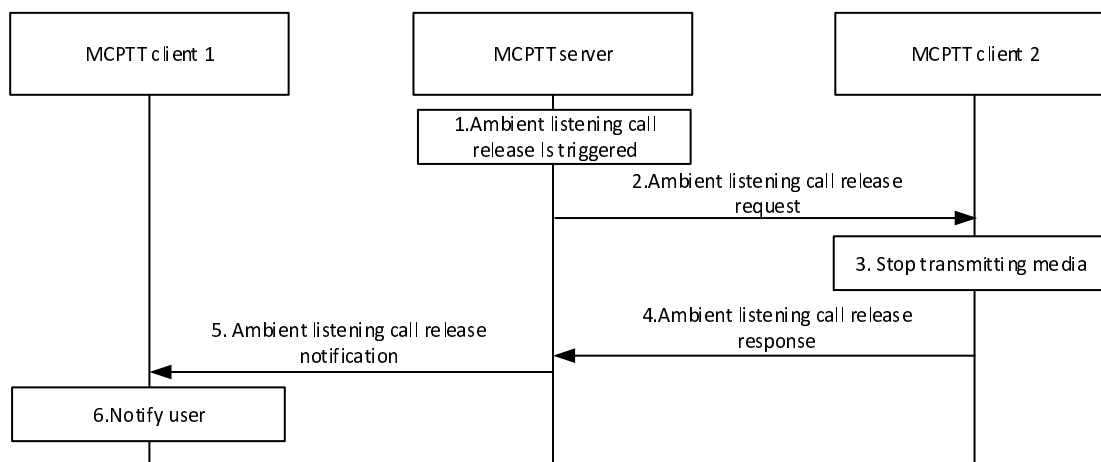

Figure 10.14.3.3-1: Ambient listening call release – server initiated

1. The ambient listening call release is triggered by the MCPTT administrator or by one of the following events:
 - the MCPTT server receives MCPTT call requests towards MCPTT client 2; or
 - the MCPTT client 2 initiates MCPTT call requests;

2. The MCPTT server sends an ambient listening call release request to MCPTT client 2.
3. MCPTT client 2 stops transmitting media to MCPTT client 1.

NOTE: MCPTT client 2 does not provide any indication of the ambient listening call release to its user.

4. MCPTT client 2 provides an ambient listening call release response to the MCPTT server.

5. The MCPTT server sends an ambient listening call release notification to MCPTT client 1 together with a reason code identifying that the call was released.
6. MCPTT client 1 notifies the authorized user 1.

10.14.3.4 Remotely initiated ambient listening call release – "listening" user initiated

Figure 10.14.3.4-1 illustrates the information flow for ambient listening call release – "listening" user initiated. This procedure is applied for both remotely initiated ambient listening call and the locally initiated ambient listening call.

Pre-conditions:

- MCPTT client 1 is the MCPTT client of the authorized user, who is authorized to release the ambient listening call at MCPTT client 2.
- There is an ongoing ambient listening call between MCPTT client 2 and MCPTT client 1.
- MCPTT user 1 is the "listening" user at MCPTT client 1, and MCPTT user 2 is the "listened to" user at MCPTT client 2.

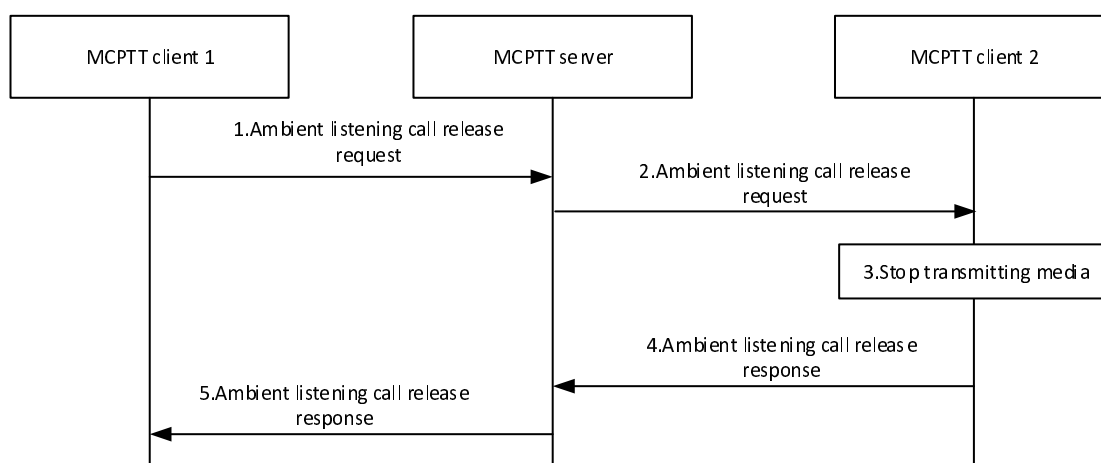

Figure 10.14.3.4-1: Ambient listening call release – "listening" user initiated

1. The authorized user 1 at MCPTT client 1 initiates the ambient listening call release by sending an ambient listening call release request to the MCPTT server.
2. The MCPTT server provides an ambient listening call release request to MCPTT client 2.
3. MCPTT client 2 stops transmitting media to MCPTT client 1.
NOTE: MCPTT client 2 does not provide any indication of the ambient listening call release to its user.
4. MCPTT client 2 provides an ambient listening call release response to the MCPTT server.
5. The MCPTT server provides the ambient listening call release response to MCPTT client 1.

10.14.3.5 Ambient listening call release – "listened to" user initiated

Figure 10.14.3.5-1 illustrates the information flow for ambient listening call release – "listened to" user initiated. This procedure is only applied for the locally initiated ambient listening call.

Pre-conditions:

- There is an ongoing ambient listening call between MCPTT client 1 and MCPTT client 2.
- MCPTT user 1 is the "listening" user at MCPTT client 1, and MCPTT user 2 is the "listened to" user at MCPTT client 2.

- MCPTT client 2 is the MCPTT client of the authorized user, who is authorized to release the locally initiated ambient listening call at MCPTT client 2.

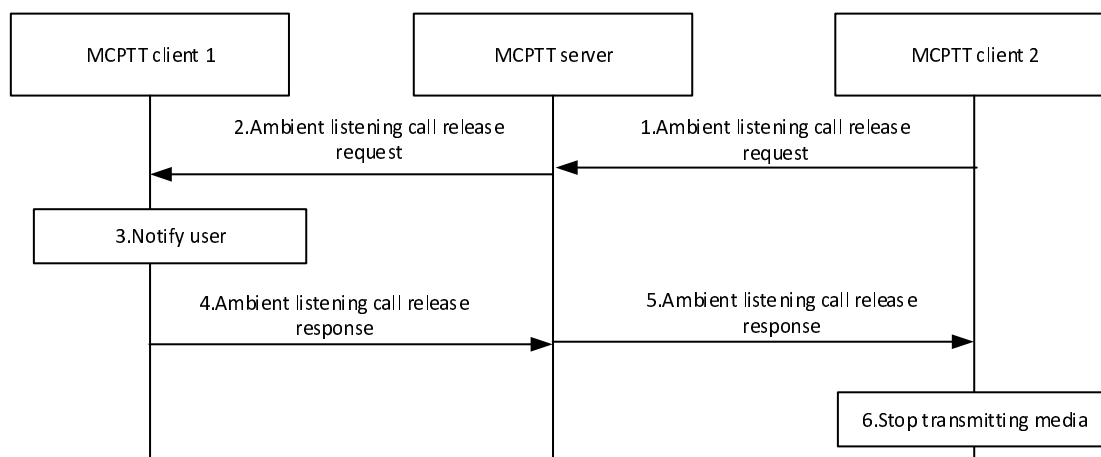

Figure 10.14.3.5-1: Ambient listening call release – "listened to" user initiated

1. The authorized user 2 at MCPTT client 2 initiates the ambient listening call release by sending an ambient listening call release request to the MCPTT server.
2. The MCPTT server provides an ambient listening call release request to MCPTT client 1.
3. MCPTT client 1 is notified about the ambient listening call release.
4. MCPTT client 1 provides an ambient listening call release response to the MCPTT server.
5. The MCPTT server provides the ambient listening call release response to MCPTT client 2.
6. MCPTT client 1 stops transmitting media to MCPTT client 2.

NOTE: MCPTT client 1 does not provide any indication of the ambient listening call release to its user.

10.15 First-to-answer call setup

10.15.1 Description

Figure 10.15.3-1 describes the basic procedure for the MCPTT client initiating MCPTT first-to-answer call. The flow may use a floor request in the MCPTT call request indicating that the originator will be given the floor when the call starts and eliminates the need for a separate initial floor request message during media plane establishment. Alternatively the call initiation may be sent without the floor request, which allows the called party to request the floor first. For a MCPTT first-to-answer call without floor control, floor control is not established.

10.15.2 Information flows for first-to-answer call

Editor's note: Information flows for first-to-answer call to be included.

10.15.3 Procedure

All clients are served by the primary MCPTT service provider in figure 10.15.3-1.

Pre-conditions:

1. The calling MCPTT user has selected first-to-answer call
2. MCPTT clients 1 to n are registered and their respective users, MCPTT user 1 to MCPTT user n, are authenticated and authorized to use the MCPTT service, as per procedure in subclause 10.2.

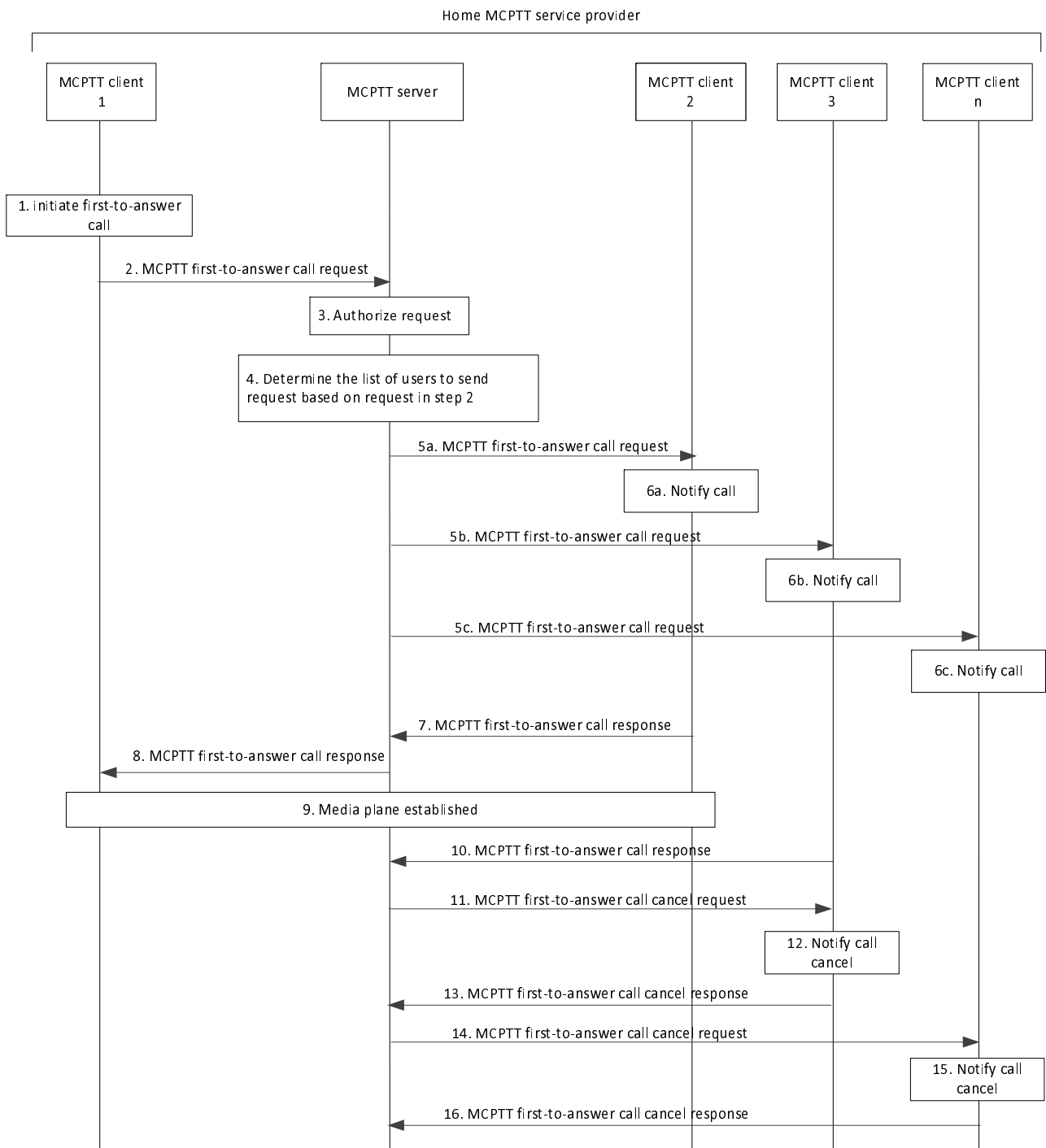

Figure 10.15.3-1: MCPTT first-to-answer call – MCPTT users in the same MCPTT system

1. MCPTT user at MCPTT client 1 would like to establish a MCPTT first-to-answer call indicating a set of potential target recipients. For a MCPTT first-to-answer call with floor control, floor control is to be established. For first-to-answer call without floor control, both users will have the ability to transmit without floor arbitration.
2. MCPTT client 1 sends an MCPTT first-to-answer call request including a set of potential target recipients, using an MCPTT service identifier as defined in 3GPP TS 23.228 [5] (possible for the SIP core to route the request to the MCPTT server). The MCPTT first-to-answer call request contains the MCPTT ID of originating user and an SDP offer containing one or more media types. The MCPTT first-to-answer call request may also contain a data element that indicates that MCPTT client 1 is requesting the floor, for a first-to-answer call with floor control.

The MCPTT client 1 includes a first-to-answer call indication that the call is to be established only to the first answering user.

Editor's note: It is FFS whether the target recipients are pre-configured and included by the MCPTT server.

3. The MCPTT server confirms that MCPTT users are authorized for the call and whether the MCPTT user at MCPTT client 1 is authorized to initiate a first-to-answer call.
4. The MCPTT server determines the list of MCPTT users to send MCPTT first-to-answer call request, based on a set of potential target recipients obtained from the request from MCPTT client 1
- 5a, 5b, 5c. The MCPTT server includes information that it communicates using MCPTT service, offers the same media types or a subset of the media types contained in the initial received request and sends similar MCPTT first-to-answer call request to each potential target recipient, including the MCPTT ID of the calling MCPTT user at MCPTT client 1. If one or more called MCPTT users have registered to the MCPTT service with multiple MCPTT UEs and has designated the MCPTT UE for receiving the calls, then the incoming MCPTT first-to-answer call request is delivered only to the designated MCPTT UE. Otherwise MCPTT first-to-answer call request may be delivered to all the registered MCPTT UEs.

6a, 6b, 6c. The MCPTT users are alerted, regardless of the commencement mode.

7. MCPTT user at MCPTT client 2 accepted the call which causes MCPTT client 2 to send an MCPTT first-to-answer call response to the MCPTT server.

NOTE: MCPTT server does not divert MCPTT first-to-answer call to voicemail if MCPTT user at MCPTT client 2 has not accepted the incoming call.

8. The MCPTT server sends an MCPTT first-to-answer call response to MCPTT client 1 indicating that MCPTT user at MCPTT client 2 has accepted the call, including the accepted media parameters.
9. The media plane for communication is established. Either user can transmit media individually when using floor control. For successful call establishment for first-to-answer call with floor request from MCPTT client 1, the floor participant associated with MCPTT client 1 is granted the floor initially. At the same time the floor participant associated with MCPTT client 2 is informed that the floor is taken. For a first-to-answer call without floor control both users are allowed to transmit simultaneously.
10. MCPTT user at MCPTT client 3 has also accepted the call which causes MCPTT client 3 to send an MCPTT first-to-answer call response to the MCPTT server.
11. Since the MCPTT first-to-answer call response from MCPTT client 2 is already accepted, the MCPTT server sends a MCPTT first-to-answer call cancel request to MCPTT client 3.
- 12-13. MCPTT user at MCPTT client 3 may be notified that the MCPTT first-to-answer call is released with a reason for call release and MCPTT client 3 sends a MCPTT first-to-answer call cancel response.
14. MCPTT server sends a MCPTT first-to-answer call cancel request to all other MCPTT first-to-answer call request receiving users from that call. This step may happen immediately after Step 9.
- 15-16. MCPTT user at MCPTT client n may be notified that the MCPTT first-to-answer call is cancelled with a reason for call cancel and MCPTT client n sends a MCPTT first-to-answer call cancel response.

10.16 Remotely initiated MCPTT call

10.16.1 General

A remotely initiated MCPTT call allows an authorized user to cause a remote MCPTT UE to initiate a call by itself, without its user explicitly initiating the call.

10.16.2 Information flows for remotely initiated MCPTT call

10.16.2.1 Remotely initiated MCPTT call request

Table 10.16.2.1-1 describes the information flow remotely initiated MCPTT call request from the MCPTT client to the MCPTT server and from the MCPTT server to MCPTT client.

Table 10.16.2.1-1: remotely initiated MCPTT call request information elements

Information Element	Status	Description
MCPTT ID	M	The MCPTT ID of the called party (remote)
Notification to remote user of remotely initiated call	M	Use to determine whether the called party (remote) receives any indication of the remotely initiated MCPTT call.
MCPTT ID	O (NOTE)	For a remotely initiated MCPTT private call the MCPTT User ID to be called
MCPTT Group	O (NOTE)	For a remotely initiated MCPTT group call to use.
NOTE: One and only one of these shall be present.		

10.16.2.2 Remotely initiated MCPTT call response

Table 10.16.2.2-1 describes the information flow remotely initiated MCPTT call response from the MCPTT client to the MCPTT server and from the MCPTT server to MCPTT client.

Table 10.16.2.2-1: Remotely initiated MCPTT call response information elements

Information Element	Status	Description
MCPTT ID	M	The MCPTT ID of the calling party
MCPTT ID	M	The MCPTT ID of the called party
Result	M	Result of the remotely initiated MCPTT call request – success or fail.

10.16.3 Procedure

10.16.3.1 Remotely initiated MCPTT call request

The remotely initiated MCPTT call request procedure includes the initial remotely initiated MCPTT call request from the MCPTT user to the remote UE and either the MCPTT private call procedures or the MCPTT group call procedures originating at the remote UE.

Procedures in figure 10.16.3.1-1 show the signalling control plane procedures for the MCPTT client initiating a remotely initiated MCPTT call request with the chosen MCPTT user.

Pre-conditions:

1. If the MCPTT user on MCPTT client 1 wants the resulting remotely initiated MCPTT call to be:
 - a. an MCPTT group call, then MCPTT user 2 on MCPTT client 2 is an affiliated MCPTT group member of the MCPTT group that is the target of the remotely initiated MCPTT call. Otherwise prior to these procedures the MCPTT user 1 on MCPTT client 1 can use existing procedures (e.g., remotely change MCPTT group affiliation (10.3.5.1.1), if authorized, to satisfy the necessary preconditions for the MCPTT user 2 on MCPTT client 2 to initiate a MCPTT group call from that MCPTT group.
 - b. an MCPTT private call, then the MCPTT user 2 on MCPTT client 2 is permitted to initiate an MCPTT private call to the identified MCPTT user.

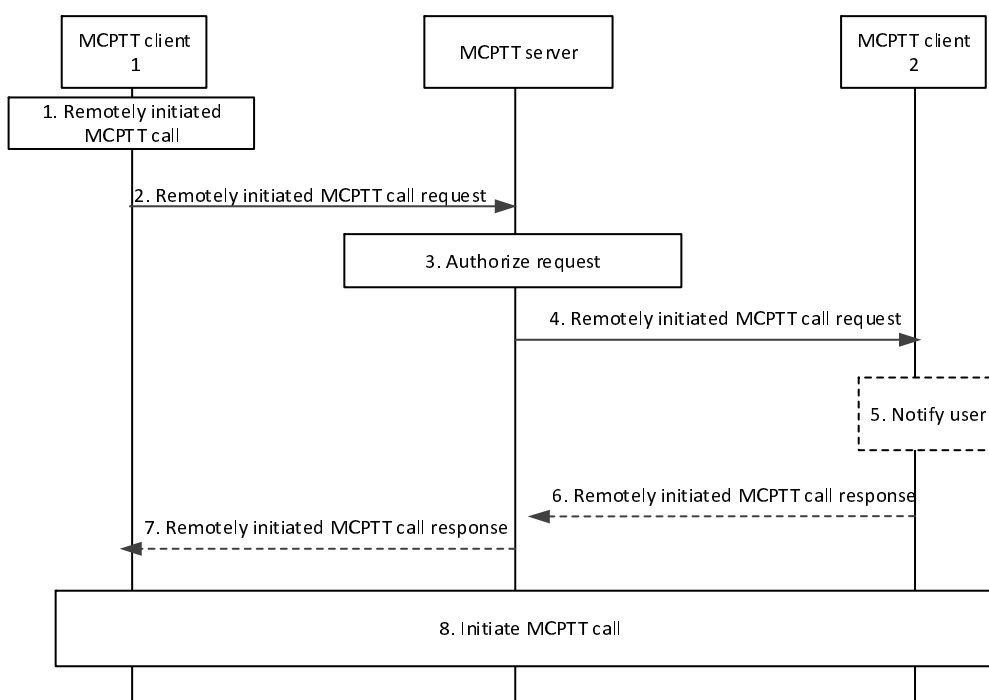

Figure 10.16.3.1-1: Remotely initiated MCPTT call request

1. MCPTT user on MCPTT client 1 initiates a remotely initiated MCPTT call request to the MCPTT user of MCPTT client 2.
2. MCPTT client 1 sends a remotely initiated MCPTT call request towards the MCPTT server.
3. MCPTT server checks whether the MCPTT user at MCPTT client 1 is authorized to initiate a remotely initiated MCPTT call request.
4. If authorized, MCPTT server sends the corresponding remotely initiated MCPTT call request towards the MCPTT client 2.
5. Based on the received information the receiving MCPTT client 2 may notify the user of the remotely initiated MCPTT call request.
6. Optionally the receiving MCPTT client 2 sends a remotely initiated MCPTT call response to the MCPTT server.
7. After receiving the remotely initiated MCPTT call response from MCPTT client 2, the MCPTT server informs the MCPTT client 1 about successful remotely initiated MCPTT call request.

NOTE 1: Step 6 and step 7 might not be sent, since it could be determined that the remotely initiated MCPTT call was successful by receiving the MCPTT call initiated by MCPTT client 2.

8. Based on the received information the MCPTT client 2 initiates an MCPTT call (either an MCPTT group call or an MCPTT private call) using the normal MCPTT call establishment procedures (10.6.2.3.1.1.2 or 10.7.2.2) with implicit floor request.

NOTE 2: Step 6 and step 7 are received in this order. However, step 6 or step 7 or both might occur before or after step 8.

The result of these procedures is an on-going MCPTT (group or private) call which includes MCPTT client 1.

10.17 Support for multiple devices

10.17.1 General

An MCPTT user may be authorized to use the MCPTT service from multiple MCPTT UEs as per the procedure in subclause 10.2.

If an MCPTT server receives a service authorization request for an MCPTT user who is previously MCPTT service authorized on another MCPTT UE, then the MCPTT server shall process this service authorization request as described in subclause 10.2. In the MCPTT service authorization response to the MCPTT user, the MCPTT server shall also indicate that the MCPTT user is already MCPTT service authorized from another MCPTT UE.

Editor's Note: How to log off remotely from MCPTT clients on one or more other MCPTT UEs that the MCPTT user is already MCPTT service authorized from is FFS.

Annex A (normative): MCPTT related configuration data

A.1 General

This Annex provides information about the static data needed for configuration for the MCPTT service, which belongs to one of the following categories:

- MCPTT UE configuration data (see subclause A.2);
- MCPTT user profile configuration data (see subclause A.3);
- MCPTT related group configuration data (see subclause A.4); and
- MCPTT service configuration data (see subclause A.5).

For each configuration category, data is split between configuration data that is applicable to both on-network and off-network, configuration data that is applicable to on-network only, and configuration data that is applicable to off-network only. The configuration data in each configuration category corresponds to a single instance of the category type i.e. the MCPTT UE, MCPTT group, MCPTT user and MCPTT service configuration data refers to the information that will be stored against each MCPTT UE, MCPTT group, MCPTT user and MCPTT service. This means that the three separate tables (on-network and off-network, on-network only, off-network only) for each configuration category represent the complete set of data for each configuration data category element.

The columns in the tables have the following meanings:

- Reference: the reference of the corresponding requirement in 3GPP TS 22.179 [2] or 3GPP TS 22.280 [17] or 3GPP TS 23.280 [16] or the corresponding subclause from the present document.
- Parameter description: A short definition of the semantics of the corresponding item of data, including denotation of the level of the parameter in the configuration hierarchy.
- When it is not clear to which functional entities the parameter is configured, then one or more columns indicating this are provided where the following nomenclature is used:
 - "Y" to denote "Yes" i.e. the parameter denoted for the row needs to be configured to the functional entity denoted for the column.
 - "N" to denote "No" i.e. the parameter denoted for the row does not need to be configured to the functional entity denoted for the column.

Parameters within a set of configuration data have a level within a hierarchy that pertains only to that configuration data. The hierarchy of the configuration data is common across all three tables of on-network and off-network, on network only and off network only. The level of a parameter within the hierarchy of the configuration data is denoted by use of the character ">" in the parameter description field within each table, one per level. Parameters that are at the top most level within the hierarchy have no ">" character. Parameters that have one or more ">" characters are child parameters of the first parameter above them that has one less ">" character. Parent parameters are parameters that have one or more child parameters. Parent parameters act solely as a "grouping" of their child parameters and therefore do not contain an actual value themselves i.e. they are just containers for their child parameters.

Each parameter that can be configured online shall only be configured through one online reference point. Each parameter that can be configured offline shall only be configured through one offline reference point. The most recent configuration data made available to the MCPTT UE shall always overwrite previous configuration data, irrespective of whether the configuration data was provided via the online or offline mechanism.

A.2 MCPTT UE configuration data

The general aspects of UE configuration are specified in 3GPP TS 23.280 [16]. Data in tables A.2-1 and A.2-2 have to be known by the MCPTT UE after MCPTT authorization.

Data in table A.2-1 can be configured offline using the CSC-11 reference point. Table A.2-2 contains the UE configuration required to support the use of off-network MCPTT service.

Table A.2-1: UE configuration data (on and off network)

Reference	Parameter description
[R-5. 4.2-002] of 3GPP TS 22.280 [17]	Maximum number of simultaneous group calls (Nc4)
[R-5.4.2-003] of 3GPP TS 22.280 [17]	Maximum number of transmissions (Nc5) in a group
[R-5.5.2-007] of 3GPP TS 22.280 [17]	Maximum number of private calls (N10)

Table A.2-2: UE configuration data (on network)

Reference	Parameter description
Subclause 5.2.3 of 3GPP TS 23.280 [16]	Relay service (Y/N)
Subclause 5.2.3 of 3GPP TS 23.280 [16]	List of allowed relayed MCPTT groups and their relay service code (as specified in 3GPP TS 23.303 [7]) (optional) (see NOTE)
	> MCPTT group ID
	> Relay service code (as specified in 3GPP TS 23.303 [7])
Subclause 5.2.7 of 3GPP TS 23.280 [16]	Indication of whether the UE shall use IPv4 or IPv6 for on-network MCPTT
	MCPTT server
	> Server URI
NOTE:	When the value of the parameter Relay service is N, this parameter and its child parameters are not needed.

A.3 MCPTT user profile configuration data

The general aspects of MC service user profile configuration data are specified in 3GPP TS 23.280 [16]. The MCPTT user profile configuration data is stored in the MCPTT user database. The MCPTT server obtains the MCPTT user profile configuration data from the MCPTT user database (MCPTT-2).

Tables A.3-1 and A.3-2 contain the MCPTT user profile configuration required to support the use of on-network MCPTT service. Tables A.3-1 and A.3-3 contain the MCPTT user profile configuration required to support the use of off-network MCPTT service. Data in table A.3-1 and A.3-3 can be configured offline using the CSC-11 reference point.

Table A.3-1: MCPTT user profile data (on and off network)

Reference	Parameter description	MCPTT UE	MCPTT Server	Configuration management server	MCPTT user database
Subclause 8.1.2 of 3GPP TS 23.280 [16]	MCPTT user identity (MCPTT ID)	Y	Y	Y	Y
3GPP TS 33.180 [19]	KMSUri for security domain of MCPTT ID (see NOTE 4)	Y	Y	Y	Y
Subclause 5.2.4 of 3GPP TS 23.280 [16]	Pre-selected MCPTT user profile indication (see NOTE 3)	Y	Y	Y	Y
Subclause 5.2.4 of 3GPP TS 23.280 [16]	MCPTT user profile index	Y	Y	Y	Y
Subclause 5.2.4 of 3GPP TS 23.280 [16]	MCPTT user profile name	Y	Y	Y	Y
[R-5.19-007], [R-6.13.4-002] of 3GPP TS 22.280 [17]	User profile status (enabled/disabled)		Y	Y	Y
[R-5.8-001], [R-6.9-003] of 3GPP TS 22.280 [17]	Authorised to create and delete aliases of an MCPTT User and its associated user profiles.			Y	Y
[R-5.8-002], [R-6.9-003] of 3GPP TS 22.280 [17]	Alphanumeric aliases of user	Y	Y	Y	Y
[R-5.10-001] of 3GPP TS 22.280 [17]	Participant type of the user	Y	Y	Y	Y
[R-5.3-002], [R-5.10-001] of 3GPP TS 22.280 [17]	User's Mission Critical Organization (i.e. which organization a user belongs to)	Y	Y	Y	Y
[R-5.5.2-008] of 3GPP TS 22.280 [17]	Maximum number of simultaneously received group calls (Nc5)		Y	Y	Y
[R-5.6.5-004] of 3GPP TS 22.179 [2]	Authorised to make a private call	Y	Y	Y	Y
[R-5.6.5-001] of 3GPP TS 22.179 [2]	Authorised to make a private call with manual commencement	Y	Y	Y	Y
[R-5.6.5-003] of 3GPP TS 22.179 [2] [R-6.7.4-004] of 3GPP TS 22.280 [17]	List of user(s) who can be called in private call				
	> MCPTT ID	Y	Y	Y	Y
	> User info ID	Y	Y	Y	Y
	> ProSe discovery group ID	Y	Y	Y	Y
3GPP TS 33.180 [19]	> KMSUri for security domain of MCPTT ID (see NOTE 4)	Y	Y	Y	Y
	> Presentation priority relative to other users and groups (see NOTE 2)	Y	Y	Y	Y
[R-5.6.5-003] of 3GPP TS 22.179 [2]	Authorised to make a private call to users not included in "list of user(s) who can be called in private call"	Y	Y	Y	Y
[R-5.6.5-002] of 3GPP TS 22.179 [2]	Authorised to make a private call with automatic commencement	Y	Y	Y	Y
[R-5.6.3-011], [R-6.7.4-010] of 3GPP TS 22.179 [2]	Authorisation of user to force automatic answer for a private call	Y	Y	Y	Y
[R-5.6.5-006], [R-6.7.5-002] of 3GPP TS 22.179 [2]	Authorised to restrict the provision of a notification of call failure reason for private call	Y	Y	Y	Y
[R-5.13-001] of 3GPP TS 22.280 [17]	Authorisation to protect confidentiality and integrity of media in a private call (see NOTE 1)	Y	Y	Y	Y
[R-5.13-001] of 3GPP TS 22.280 [17]	Authorisation to protect confidentiality and integrity of floor control signalling in a private call (see NOTE 1)	Y	Y	Y	Y
[R-5.7.2.1.1-001] of 3GPP TS 22.280 [17]	Authorisation to make an MCPTT emergency group call functionality enabled for user	Y	Y	Y	Y

[R-5.7.2.1.1-001] of 3GPP TS 22.280 [17]	Group used on initiation of an MCPTT emergency group call (currently selected/ dedicated)	Y	Y	Y	Y
[R-5.7.2.1.2-005] of 3GPP TS 22.280 [17]	Authorisation to cancel an in progress emergency associated with a group	Y	Y	Y	Y
[R-5.7.2.2.1-001] of 3GPP TS 22.280 [17]	Authorised to make an Imminent Peril group call	Y	Y	Y	Y
[R-5.7.2.2.1-009] of 3GPP TS 22.280 [17]	Group used on initiation of an MCPTT imminent peril group call (currently selected/ dedicated/ default if no group selected)	Y	Y	Y	Y
[R-5.7.2.2.2-002] of 3GPP TS 22.280 [17]	Authorised for imminent in- peril cancelation	Y	Y	Y	Y
[R-5.7.2.3.1-001] of 3GPP TS 22.179 [2]	Recipient for an emergency private call (Pre-configured/ user locally determined)	Y	Y	Y	Y
[R-5.7.2.3.1-001] of 3GPP TS 22.179 [2]	Authorised to make an emergency private call	Y	Y	Y	Y
[R-5.7.2.3.2-001] of 3GPP TS 22.179 [2]	Authorised to cancel emergency priority in a private emergency call by an authorized user	Y	Y	Y	Y
[R-5.7.2.4.1-002] of 3GPP TS 22.280 [17]	Authorised to activate emergency alert	Y	Y	Y	Y
[R-5.7.2.4.1-004], [R-5.7.2.4.1-008], [R-5.7.2.4.1-012] of 3GPP TS 22.280 [17]	Group / user recipient of an emergency alert (Pre-defined group, currently selected group, pre-defined recipient/ user locally defined recipient/ default if no recipient selected)	Y	Y	Y	Y
[R-5.7.2.4.2-002] of 3GPP TS 22.280 [17]	Authorisation to cancel an MCPTT emergency alert	Y	Y	Y	Y
[R-5.1.7-002] of 3GPP TS 22.280 [17]	Priority of the user for initiating/receiving calls		Y	Y	Y
[R-5.2.2-003] of 3GPP TS 22.280 [17]	Authorisation to create a group-broadcast group			Y	Y
[R-5.2.2-003] of 3GPP TS 22.280 [17]	Authorisation to create a user-broadcast group			Y	Y
[R-5.3-003], [R-6.12-001], [R-7.2-005] of 3GPP TS 22.280 [17]	Authorisation to provide location information to other MCPTT users on a call when talking		Y	Y	Y
3GPP TS 23.283 [20]	Authorised to use LMR E2EE for interworking	Y	Y	Y	Y
3GPP TS 23.283 [20]	> List of supported LMR technology types				
3GPP TS 23.283 [20]	>> LMR technology type (P25, TETRA etc.)	Y	N	Y	Y
3GPP TS 23.283 [20]	>> URI of LMR key management functional entity (see NOTE 4)	Y	N	Y	Y
3GPP TS 23.283 [20]	>> LMR specific identity (RSI for P25 or ITSI for TETRA) (see NOTE 5)	Y	N	Y	Y
3GPP TS 23.283 [20]	>> LMR specific security information (see NOTE 5)	Y	N	Y	Y

NOTE 1: Security mechanisms are specified in 3GPP TS 33.180 [11].

NOTE 2: The use of this parameter by the MCPTT UE is outside the scope of the present document.

NOTE 3: As specified in 3GPP TS 23.280 [16], for each MCPTT user's set of MCPTT user profiles, only one MCPTT user profile shall be indicated as being the pre-selected MCPTT user profile.

NOTE 4: If this parameter is absent, the KMSUri shall be that identified in the initial MC service UE configuration data (on-network) configured in table A.6-1 of 3GPP TS 23.280 [16].

NOTE 4: The LMR key management functional entity is part of the LMR system and is outside the scope of the present document.

NOTE 5: This is an LMR specific parameter with no meaning within MC services.

Table A.3-2: MCPTT user profile data (on network)

Reference	Parameter description	MCPTT UE	MCPTT Server	Configuration management server	MCPTT user database
[R-5.1.5-001], [R-5.1.5-002], [R-5.10-001], [R-6.4.7-002], [R-6.8.1-008] of 3GPP TS 22.280 [17]	List of on-network MCPTT groups for use by an MCPTT user				
	> MCPTT Group ID	Y	Y	Y	Y
	> Application plane server identity information of group management server where group is defined				
	>> Server URI	Y	N	Y	Y
	> Application plane server identity information of identity management server which provides authorization for group (see NOTE 1)				
	>> Server URI	Y	N	Y	Y
3GPP TS 33.180 [19]	> KMSUri for security domain of group (see NOTE 3)	Y	Y	Y	Y
	> Presentation priority of the group relative to other groups and users (see NOTE 2)	Y	Y	Y	Y
[R-6.2.3.7.2-006] of 3GPP TS 22.179 [2]	> Authorisation of an MCPTT user to change the maximum number of simultaneous talkers	Y	Y	Y	Y
Subclause 5.2.5 of 3GPP TS 23.280 [16]	List of groups user implicitly affiliates to after MCPTT service authorization for the user				
	> MCPTT Group IDs	Y	Y	Y	Y
[R-6.4.2-006] of 3GPP TS 22.280 [17]	Authorisation of an MCPTT user to request a list of which groups an MCPTT user has affiliated to		Y	Y	Y
[R-6.4.6.1-002], [R-6.4.6.1-003] of 3GPP TS 22.280 [17]	Authorisation to change affiliated groups of other specified user(s)		Y	Y	Y
[R-6.4.6.2-001], [R-6.4.6.2-002] of 3GPP TS 22.280 [17]	Authorisation to recommend to specified user(s) to affiliate to specific group(s)		Y	Y	Y
[R-6.6.1-004] of 3GPP TS 22.280 [17]	Authorisation to perform regrouping	Y	Y	Y	Y
[R-6.7.2-001] of 3GPP TS 22.280 [17]	Presence status is available/not available to other users	Y	Y	Y	Y
[R-6.7.1-002], [R-6.7.2-002] of 3GPP TS 22.280 [17]	List of MCPTT users that an MCPTT user is authorised to obtain presence of				
	> MCPTT IDs	Y	Y	Y	Y
[R-6.7.2-003] of 3GPP TS 22.280 [17]	User is able/ unable to participate in private calls	Y	Y	Y	Y
[R-6.7.1-004], [R-6.7.2-003], [R-6.7.2-004] of 3GPP TS 22.280 [17]	Authorisation to query whether MCPTT User is available for private calls		Y	Y	Y
[R-6.7.1-010] of 3GPP TS 22.179 [2]	Authorisation to override transmission in a private call	Y	Y	Y	Y
[R-6.7.1-013] of 3GPP TS 22.179 [2]	Authorisation to restrict provision of private call set-up failure cause to the caller		Y	Y	Y
[R-6.7.6-001] of 3GPP TS 22.179 [2]	Authorized to make a private call-back request	Y	Y	Y	Y
[R-6.7.6-004] of 3GPP TS 22.179 [2]	Authorized to cancel a private call-back request	Y	Y	Y	Y

[R-6.8.7.4.2-001], [R-6.8.7.4.2-002] of 3GPP TS 22.280 [17]	Authorisation of an MCPTT user to cancel an emergency alert on any MCPTT UE of any MCPTT user		Y	Y	Y
[R-6.13.4-001] of 3GPP TS 22.280 [17]	Authorisation for a MCPTT user to enable/disable an MCPTT user		Y	Y	Y
[R-6.13.4-003], [R-6.13.4-005], [R-6.13.4-006], [R-6.13.4-007] of 3GPP TS 22.280 [17]	Authorisation for an MCPTT user to (permanently /temporarily) enable/disable a UE		Y	Y	Y
[R-6.2.3.4-001] of 3GPP TS 22.179 [2]	Authorisation to revoke permission to transmit		Y	Y	Y
[R-7.14-002], [R-7.14-003] of 3GPP TS 22.280 [17]	Authorization for manual switch to off-network while in on-network	Y	Y	Y	Y
[R-5.1.5-004] of 3GPP TS 22.280 [17]	Limitation of number of affiliations per user (N2)	N	Y	Y	Y
[R-5.5.2-009] of 3GPP TS 22.179 [2]	Maximum number of simultaneous transmissions received in one group call for override (N7)		Y	Y	Y
[R-6.4.6.1-001], [R-6.4.6.1-004] of 3GPP TS 22.280 [17]	List of MCPTT users whose selected groups are authorized to be remotely changed				
	> MCPTT IDs	Y	Y	Y	Y
Subclause 10.15.3	Authorization to make a first-to-answer call	Y	Y	Y	Y
[R-6.15.2.2.2-001] of 3GPP TS 22.280 [17]	Authorization to make a remotely initiated ambient listening private call	Y	Y	Y	Y
[R-6.15.2.2.3-001] of 3GPP TS 22.280 [17]	Authorization to make a locally initiated ambient listening private call	Y	Y	Y	Y
[R-6.15.3.2-001] of 3GPP TS 22.280 [17]	Authorization to make a remotely initiated private call	Y	Y	Y	Y
[R-6.15.3.2-003] of 3GPP TS 22.280 [17]	Authorization to make a remotely initiated group call	Y	Y	Y	Y
[R-5.9a-013] of 3GPP TS 22.280 [17]	Authorised to interrogate the functional alias(es) active for another MCPTT user		Y	Y	Y
[R-5.9a-012] of 3GPP TS 22.280 [17]	Authorised to take over a functional alias from another MCPTT user		Y	Y	Y
	List of functional alias(es) of the MCPTT user				
[R-5.9a-005] of 3GPP TS 22.280 [17]	> Functional alias	Y	Y	Y	Y
Subclause 5.2.9 of 3GPP TS 23.280 [16]	List of partner MCPTT systems in which this profile is valid for use during migration				
Subclause 5.2.9 of 3GPP TS 23.280 [16]	> Identity of partner MCPTT system	Y	Y	Y	Y
Subclause 10.1.1 of 3GPP TS 23.280 [16]	> Access information for partner MCPTT system (see NOTE 4)	Y		Y	Y
NOTE 1: If this parameter is not configured, authorization to use the group shall be obtained from the identity management server identified in the initial MC service UE configuration data (on-network) configured in table A.6-1 of 3GPP TS 23.280 [16].					
NOTE 2: The use of this parameter by the MCPTT UE is outside the scope of the present document.					
NOTE 3: If this parameter is absent, the KMSUri shall be that identified in the initial MC service UE configuration data (on-network) configured in table A.6-1 of 3GPP TS 23.280 [16].					
NOTE 4: Access information for each partner MCPTT system comprises the list of information required for initial UE configuration to access an MCPTT system, as defined in table A.6-1 of 3GPP TS 23.280 [16]					

Table A.3-3: MCPTT user profile data (off network)

Reference	Parameter description	MCPTT UE	MCPTT Server	Configuration management server	MCPTT user database
[R-7.2-003], [R-7.6-004] of 3GPP TS 22.280 [17]	List of off-network MCPTT groups for use by an MCPTT user	Y	N	Y	Y
	> MCPTT Group ID	Y	N	Y	Y
	> Application plane server identity information of group management server where group is defined				
	>> Server URI	Y	N	Y	Y
	> Application plane server identity information of identity management server which provides authorization for group (see NOTE 1)				
	>> Server URI	Y	N	Y	Y
3GPP TS 33.180 [19]	> KMSUri for security domain of group (see NOTE 3)	Y	N	Y	Y
	> Presentation priority of the group relative to other groups and users (see NOTE 2)	Y	N	Y	Y
[R-7.3.3-008] of 3GPP TS 22.179 [2]	Allowed listening of both overriding and overridden	Y	N	Y	Y
[R-7.3.3-006] of 3GPP TS 22.179 [2]	Allowed transmission for override (overriding and/or overridden)	Y	N	Y	Y
[R-7.8.1-001] of 3GPP TS 22.280 [17]	Authorization for participant to change an off-network group call in-progress to off-network emergency group call	Y	N	Y	Y
[R-7.8.3.1-003] of 3GPP TS 22.280 [17]	Authorization for participant to change an off-network group call in-progress to off-network imminent peril group call	Y	N	Y	Y
[R-7.12-002], [R-7.12-003] of 3GPP TS 22.280 [17]	Authorization for off-network services	Y	N	Y	Y
Subclause 10.7.2	User info id (as specified in 3GPP TS 23.303 [7])	Y	N	Y	Y
NOTE 1: If this parameter is not configured, authorization to use the group shall be obtained from the identity management server identified in the initial MC service UE configuration data (on-network) configured in table A.6-1 of 3GPP TS 23.280 [16].					
NOTE 2: The use of this parameter by the MCPTT UE is outside the scope of the present document.					
NOTE 3: If this parameter is absent, the KMSUri shall be that identified in the initial MC service UE configuration data (on-network) configured in table A.6-1 of 3GPP TS 23.280 [16].					

A.4 MCPTT related group configuration data

The general aspects of group configuration are specified in 3GPP TS 23.280 [16].

Parameters specified in table A.4-1 are child parameters of the "MCPTT configuration" parameter specified in table A.4-1 in 3GPP TS 23.280 [16]. Parameters specified in table A.4-2 are child parameters of the "MCPTT configuration" parameter specified in table A.4-2 in 3GPP TS 23.280 [16]. Parameters specified in table A.4-3 are child parameters of the "MCPTT configuration" parameter specified in table A.4-3 in 3GPP TS 23.280 [16].

Table A.4-1: Group configuration data (on and off network)

Reference	Parameter description	MCPTT UE	MCPTT Server	Group management server
[R-6.4.9-006] of 3GPP TS 22.280 [17]	>> Preferred voice codecs for MCPTT group	Y	Y	Y
[R-5.7.2.1.1-013], [R-5.7.2.4.1-008] of 3GPP TS 22.280 [17]	>> Indication whether emergency group call is permitted on the MCPTT group	Y	Y	Y
[R-5.7.2.2.1-009] of 3GPP TS 22.280 [17]	>> Indication whether imminent peril group call is permitted on the MCPTT group	Y	Y	Y
[R-5.7.2.4.1-012] of 3GPP TS 22.280 [17]	>> Indication whether emergency alert is possible on the MCPTT group	Y	Y	Y
[R-5.13-001] of 3GPP TS 22.280 [17]	>> Media confidentiality and integrity protection (see NOTE)	Y	Y	Y
[R-5.13-001] of 3GPP TS 22.280 [17]	>> Floor control confidentiality and integrity protection (see NOTE)	Y	Y	Y
[R-5.13-001] of 3GPP TS 22.280 [17]	>> Group media protection security material (see NOTE)	Y	N	Y
NOTE: Security mechanisms are specified in 3GPP TS 33.180 [19].				

Table A.4-2: Group configuration data (on-network)

Reference	Parameter description	MCPTT UE	MCPTT Server	Group management server
[R-5.7.2.1.2-002] of 3GPP TS 22.280 [17]	>> Timeout value for the cancellation of an in-progress emergency for an on-network group call	N	Y	Y
[R-5.7.2.2.2-004] of 3GPP TS 22.280 [17]	>> Timeout value for the cancellation of an in progress imminent-peril group call for an on-network group call	N	Y	Y
[R-6.2.4-003], [R-6.4.9-002] of 3GPP TS 22.179 [2]	>> Group call hang timer	N	Y	Y
[R-6.4.9-003] of 3GPP TS 22.280 [17]	>> Maximum duration of group calls	N	Y	Y
Subclause 10.6.2	>> Group call model used for group (chat/ pre-arranged)	Y	Y	Y
[R-6.2.1-004], [R-6.2.1-007] of 3GPP TS 22.179 [2]	>> Minimum number of affiliated group members acknowledging before start of audio transmission	N	Y	Y
[R-6.2.1-007] of 3GPP TS 22.179 [2]	>> List of affiliated group members which have to acknowledge before start of audio transmission			
	>>>MCPTT IDs	N	Y	Y
[R-6.2.1-006], [R-6.2.1-007] of 3GPP TS 22.179 [2]	>> Geographical area where acknowledgement of all affiliated group members is required before start of audio transmission	N	Y	Y
[R-6.2.1-008], [R-6.2.1-009] of 3GPP TS 22.179 [2]	>> Timeout for acknowledgement of required group members	N	Y	Y
[R-6.2.1-008], [R-6.2.1-009], [R-6.2.1-012] of 3GPP TS 22.179 [2]	>> Action upon failure to receive acknowledgement from required group members before call timeout (proceed or abandon)	N	Y	Y
[R-6.4.9-004] of 3GPP TS 22.280 [17]	>> List of group members with receive-only capability (see NOTE 1)			
	>>>MCPTT IDs	N	Y	Y
[R-6.4.5-001], [R-6.4.5-003] of 3GPP TS 22.280 [17]	>> Authorisation of a user to request a list of affiliated members of a group	Y	Y	Y
[R-5.1.7-002], [R-6.2.2-001], [R-6.6.2.2-006,] [R-6.8.6.2-003] of 3GPP TS 22.280 [17]	>> Priority of the group	N	Y	Y
[R-6.8.6.2-003] of 3GPP TS 22.280 [17]	>> Pre-emption capability	Y	Y	Y
[R-6.8.6.2-003] of 3GPP TS 22.280 [17]	>> Pre-empted capability	Y	Y	Y
[R-5.13-001] of 3GPP TS 22.280 [17]	>> Group floor control protection security material for multicast use (see NOTE 2)	Y	Y	Y
[R-6.2.3.6.2-001] of 3GPP TS 22.179 [2]	>> Audio cut-in policy (enabled/disabled)	N	Y	Y
[R-6.2.3.7.2-001] of 3GPP TS 22.179 [2]	>> Support of multi-talker control	Y	Y	Y
[R-6.2.3.7.2-005] of 3GPP TS 22.179 [2]	>> Maximum number of simultaneous talkers applicable for multi-talker control	N	Y	Y
Subclause 7.4.2.3.5 and subclause 7.4.2.3.6	>> Audio mixing is performed in the UE or in the network to support multi-talker control	Y	Y	Y
[R-6.2.3.7.2-003] of 3GPP TS 22.179 [2]	>> List of group members which are allowed to talk (see NOTE 1)			
	>>> MCPTT IDs	N	Y	Y

Subclause 10.2.7 of 3GPP TS 23.280 [16]	>> List of partner MCPTT systems where system specific configuration applies for interconnection			
	>>> MC system identity of partner MCPTT system	N	Y	Y
[R-6.4.9-004] of 3GPP TS 22.280 [17]	>>> List of group members with receive-only capability (see NOTE 1)			
	>>>>MCPTT IDs	N	Y	Y
[R-6.2.3.7.2-003] of 3GPP TS 22.179 [2],	>>> List of group members which are allowed to talk (see NOTE 1)			
	>>>> MCPTT IDs	N	Y	Y
3GPP TS 23.283 [20]	>> Indication whether use of LMR E2EE is permitted on the MCPTT group	Y	N	Y
3GPP TS 23.283 [20]	>> LMR specific identity for MCPTT group (see NOTE 3)	Y	N	Y
3GPP TS 23.283 [20]	>> Group to key binding (see NOTE 3)	Y	N	Y
NOTE 1: A group member shall not be listed in both the list of group members with receive only capability and the list of group members which are allowed to talk.				
NOTE 2: The details of security related elements are specified in 3GPP TS 33.180 [19].				
NOTE 3: This is an LMR specific parameter with no meaning within MC services.				

Table A.4-3: Group configuration data (off-network)

Reference	Parameter description	MCPTT UE	MCPTT Server	Group management server
[R-5.7.2.1.2-002] of 3GPP TS 22.280 [17]	>> Timeout value for the cancellation of an in-progress emergency for an off-network group call	Y	N	Y
[R-5.7.2.2.2-004] of 3GPP TS 22.280 [17]	>> Timeout value for the cancellation of an in progress imminent-peril group call for an off-network group call	Y	N	Y
[R-7.4-002] of 3GPP TS 22.179 [2]	>> Group call hang timer	Y	N	Y
[R-7.4-003] of 3GPP TS 22.280 [17]	>> Max duration of group calls	Y	N	Y
Subclause 10.6.3.9.1	>> Default Prose Per-Packet priority (as specified in 3GPP TS 23.303 [7]) values			
	>>> MCPTT group call signalling	Y	N	Y
	>>> MCPTT group call media	Y	N	Y
	>>> MCPTT emergency group call signalling	Y	N	Y
	>>> MCPTT emergency group call media	Y	N	Y
	>>> MCPTT imminent peril group call signalling	Y	N	Y
	>>> MCPTT imminent peril group call media	Y	N	Y

A.5 MCPTT service configuration data

The general aspects of MC service configuration are specified in 3GPP TS 23.280 [16]. The MCPTT service configuration data is stored in the MCPTT server.

Tables A.5-1 and A.5-2 describe the configuration data required to support the use of on-network MCPTT service. Tables A.5-1 and A.5-3 describe the configuration data required to support the use of off-network MCPTT service. Data in tables A.5-1 and A.5-3 can be configured offline using the CSC-11 reference point.

Table A.5-1: MCPTT service configuration data (on and off network)

Reference	Parameter description	MCPTT UE	MCPTT Server	Configuration management server
[R-5.2.2-001] of 3GPP TS 22.280 [17]	Levels of group hierarchy for group-broadcast groups (Bc1)	Y	Y	Y
[R-5.2.3-001] of 3GPP TS 22.280 [17]	Levels of user hierarchy for user-broadcast groups (Bc2)	Y	Y	Y
[R-5.8-002] of 3GPP TS 22.280 [17]	Minimum length (Nc3) of an alphanumeric identifier (i.e. alias) assigned by an MCPTT administrator.	Y	N	Y

Table A.5-2: MCPTT service configuration data (on-network)

Reference	Parameter description	MCPTT UE	MCPTT Server	Configuration management server
[R-5.7.2.3.2-002] of 3GPP TS 22.179 [2]	Timeout value for the cancellation of an in-progress emergency for an on-network private call	N	Y	Y
[R-5.7.2.1.2-002] of 3GPP TS 22.280 [17]	Time limit for an in-progress emergency related to an on-network MCPTT group	N	Y	Y
[R-5.6.5-004] of 3GPP TS 22.179 [2]	Max on-network private call (with floor control) duration	N	Y	Y
[R-6.2.4-003] of 3GPP TS 22.179 [2]	Hang timer for private calls	N	Y	Y
[R-6.7.2-008] of 3GPP TS 22.280 [17]	Max duration of private call (without floor control)	N	Y	Y
[R-6.2.3.3.1-001] of 3GPP TS 22.179 [2]	Hierarchy of participant rights to override	N	Y	Y
[R-6.2.3.5-002] of 3GPP TS 22.179 [2]	Transmit time limit from a single request to transmit in a group or private call transmission	N	Y	Y
[R-6.2.3.5-003], [R-6.2.3.5-004] of 3GPP TS 22.179 [2]	Configuration of warning time before time limit of transmission is reached (on-network)	N	Y	Y
[R-6.2.4-005] of 3GPP TS 22.179 [2]	Configuration of warning time before call hang time (on-network)	N	Y	Y
[R-6.2.3.2-006] of 3GPP TS 22.179 [2]	Depth of floor control queue	N	Y	Y
[R-6.2.3.2-012] of 3GPP TS 22.179 [2]	Max time for a user's floor control request to be queued	N	Y	Y
[R-5.13-001] of 3GPP TS 22.280 [17]	Protect confidentiality of signalling (see NOTE)	Y	Y	Y
[R-5.13-001] of 3GPP TS 22.280 [17]	Protect integrity of signalling (see NOTE)	Y	Y	Y
[R-5.13-001] of 3GPP TS 22.280 [17]	Use signalling protection between MCPTT servers (see NOTE)	N	Y	Y
[R-5.13-001] of 3GPP TS 22.280 [17]	Use floor control protection between MCPTT servers (see NOTE)	N	Y	Y
	List of functional alias identities			
[R-5.9a-005] of 3GPP TS 22.280 [17]	> Functional alias	Y	Y	Y
[R-5.9a-005] of 3GPP TS 22.280 [17]	> Limit number of simultaneous activations		Y	Y
[R-5.9a-005] of 3GPP TS 22.280 [17]	> This functional alias can be taken over	Y	Y	Y
	> List of users			
[R-5.9a-005] of 3GPP TS 22.280 [17]	>> MCPTT ID		Y	Y
NOTE: Security mechanisms are specified in 3GPP TS 33.180 [19].				

Table A.5-3: MCPTT service configuration data (off-network)

Reference	Parameter description	MCPTT UE	MCPTT Server	Configuration management server
[R-5.7.2.3.2-002] of 3GPP TS 22.179 [2]	Timeout value for the cancellation of an in-progress emergency for an off-network private call	Y	N	Y
[R-5.7.2.1.2-002] of 3GPP TS 22.280 [17]	Time limit for an in-progress emergency related to an off-network MCPTT group	Y	N	Y
[R-5.6.5-004] of 3GPP TS 22.179 [2]	Max off-network private call (with floor control) duration	Y	N	Y
[R-7.4-002] of 3GPP TS 22.179 [2] [R-7.4-003] of 3GPP TS 22.280 [17]	Hang timer for private calls in off-network	Y	N	Y
[R-7.3.3-001], [R-7.3.3-002], [R-7.3.3-003] of 3GPP TS 22.179 [2]	Priority hierarchy for floor control override in off-network	Y	N	Y
[R-7.3.5-001], [R-7.3.5-002], [R-7.3.5-003] of 3GPP TS 22.179 [2]	Transmit time limit from a single request to transmit in a group or private call.	Y	N	Y
[R-7.3.5-001], [R-7.3.5-004] of 3GPP TS 22.179 [2]	Configuration of warning time before time limit of transmission is reached (off-network)	Y	N	Y
[R-7.4-004] of 3GPP TS 22.280 [17]	Configuration of warning time before hang time is reached (off-network)	Y	N	Y
[R-7.7-001], [R-7.7-003] of 3GPP TS 22.280 [17] [R-7.7-002] of 3GPP TS 22.179 [2]	Default ProSe Per-Packet priority (as specified in 3GPP TS 23.303 [7]) values			
	> MCPTT private call signalling	Y	N	Y
	> MCPTT private call media	Y	N	Y
	> MCPTT Emergency private call signalling	Y	N	Y
	> MCPTT Emergency private call media	Y	N	Y
[R-7.15-001], [R-7.7-003] of 3GPP TS 22.280 [17]	Configuration of metadata to log	Y	N	Y

Annex B (informative): Local UE settings for MCPTT

B.1 Local UE settings for MCPTT

Table B.1-1 details local UE settings for MCPTT that represent important functionalities that may be required by MCPTT UEs, however these functionalities do not require central configuration like the parameters in annex A, so these are detailed in this annex for information to UE vendors interested in producing MCPTT UEs. The various columns in the tables have the following meanings:

- Reference: Is the reference of the corresponding requirement in 3GPP TS 22.179 [2].
- Definition: A short definition of the local UE setting.

Table B.1-1: Local UE settings for MCPTT

Reference	Definition
[R-5.1.1-003] of 3GPP TS 22.280 [17]	Call reception signalling method
[R-5.1.1-004] of 3GPP TS 22.280 [17]	Disabling of call reception signalling
[R-5.8-003] of 3GPP TS 22.280 [17]	Configuration of display of MCPTT ID (on/off)
[R-5.8-003] of 3GPP TS 22.280 [17]	Configuration of display of aliases associated with the MCPTT ID (on/off)
[R-5.8-003] of 3GPP TS 22.280 [17]	Configuration of display of Selected MCPTT Group (on/off)
[R-5.8-003] of 3GPP TS 22.280 [17]	Configuration of display of Mission Critical Organization name (on/off)
[R-6.8.7.4.1-003] of 3GPP TS 22.280 [17]	Configuration of the notification of an emergency alert

Annex C (informative): Change history

Date	Meeting	TDoc	CR	R ev	Cat	Subject/Comment	New
2016-04						Initial version.	0.0.0
2016-04						Alignment with the following Rel-13 CRs agreed at SA6#10: CR0053(S6-160271), CR0055(S6-160307), CR0057(S6-160312), CR0058(S6-160289), CR0059(S6-160346), CR0060(S6-160335), CR0061(S6-160268), CR0062(S6-160333), CR0067(S6-160274), CR0069(S6-160313), CR0071(S6-160199), CR0072(S6-160334), CR0075(S6-160331), CR0076(S6-160269), CR0078(S6-160284), CR0079(S6-160360), CR0080(S6-160297), CR0081(S6-160332), CR0085(S6-160361), CR0088(S6-160291), CR0089(S6-160347), CR0090(S6-160310), CR0093(S6-160293), CR0094(S6-160294), CR0099(S6-160342)	0.1.0
2016-06						Implemented the following pCRs approved during SA6#11: S6-160414, S6-160475, S6-160497, S6-160499, S6-160501, S6-160508, S6-160514, S6-160518, S6-160530, S6-160532, S6-160568, S6-160571, S6-160581, S6-160584, S6-160588, and merged relevant content from S6-160489. Editorial changes: renumbering subclauses as needed; added top level subclauses where needed with editor's notes; added a few missing subclauses at level 2 with editor's notes; use actual TS numbers made available at SA plenary: 23.379 and 23.280.	0.2.0
2016-09						Implemented the following pCRs approved during SA6#12: S6-160681, S6-160698, S6-160707, S6-160790, S6-160802, S6-160828, S6-160873, S6-160908, S6-160909, S6-160921, S6-160925. Editorial changes: renumbering subclauses as needed; added a few missing headings at level 2 and level 3 with editor's notes for consistency.	0.3.0
2016-10						Implemented the following pCRs approved during SA6#13: S6-160961, S6-161016, S6-161112, S6-161113, S6-161116, S6-161124, S6-161210, S6-161211, S6-161212, S6-161219, S6-161231, S6-161249, S6-161251, S6-161258, S6-161268 Editorial changes: renumbering subclauses as needed.	0.4.0
2016-11						Implemented the following pCRs approved during SA6#14: S6-161330, S6-161522, S6-161538, S6-161564, S6-161572, S6-161584, S6-161591, S6-161595, S6-161596, S6-161597, S6-161598, S6-161607. Editorial changes: renumbering subclauses as needed.	0.5.0
2016-12	SA#74	SP-160876				Submitted for Approval at SA#74	1.0.0
2016-12	SA#74	SP-160876				MCC Editorial update for publication after TSG SA approval (SA#74)	14.0.0
2017-03	SA#75	SP-170068	0003	1	F	Alignment of definitions	14.1.0
2017-03	SA#75	SP-170068	0004	2	F	Alignment of group affiliation and de-affiliation requirements	14.1.0
2017-03	SA#75	SP-170068	0005	1	F	Alignment of bearer management	14.1.0
2017-03	SA#75	SP-170068	0006	1	F	Resolve editor's note in clause 10.6.2.8.1	14.1.0
2017-03	SA#75	SP-170069	0008	1	F	Store and update affiliation status in the GMS	14.1.0
2017-03	SA#75	SP-170068	0009	2	F	Duplicated reference remove	14.1.0
2017-03	SA#75	SP-170068	0011	1	F	Corrections to MCPTT UE configuration data	14.1.0
2017-03	SA#75	SP-170068	0013	1	D	Correction of references	14.1.0
2017-03	SA#75	SP-170068	0016	1	D	Message title alignment	14.1.0

2017-03	SA#75	SP-170068	0017	3	F	Resolve group ID issue for temporary group call – user regroup	14.1.0
2017-03	SA#75	SP-170068	0018	1	F	Addition of definition for MCPTT ID	14.1.0
2017-03	SA#75	SP-170068	0019		F	Correction of requirement reference for list of implicitly affiliated groups in MCPTT user profile config	14.1.0
2017-03	SA#75	SP-170068	0020	2	F	Simultaneous floor requests	14.1.0
2017-03	SA#75	SP-170068	0021	2	F	Correction on floor control	14.1.0
2017-03	SA#75	SP-170068	0022	2	F	Miscellaneous corrections on term	14.1.0
2017-06	SA#76	SP-170389	0042	1	F	Miscellaneous corrections to configuration	14.2.0
2017-06	SA#76	SP-170389	0043	6	F	Addition of identity management server address per group	14.2.0
2017-06	SA#76	SP-170389	0049	1	F	Correction in Ambient Listening	14.2.0
2017-06	SA#76	SP-170389	0050	1	F	Clarifications on response in off-network	14.2.0
2017-06	SA#76	SP-170389	0062	2	F	Inclusion of KMSUri to allow multiple security domains	14.2.0
2017-06	SA#76	SP-170389	0068	1	F	Corrections to configuration for ambient listening	14.2.0
2017-06	SA#76	SP-170389	0069	1	F	Correction to configuration for first-to-answer call	14.2.0
2017-06	SA#76	SP-170389	0070		F	Corrections to Group configuration data for all MC services	14.2.0
2017-06	SA#76	SP-170340	0044	1	B	MCPTT unicast media flow stop and resume	15.0.0
2017-06	SA#76	SP-170398	0063	1	D	Editorial corrections in call back cancel request	15.0.0
2017-06	SA#76	SP-170340	0066	1	C	Resource Management enhancements for MCPTT	15.0.0
2017-06	SA#76	SP-170340	0067	2	C	Addition of Floor acknowledgement	15.0.0
2017-09	SA#77	SP-170685	0074	2	B	Updating IWF-1 description	15.1.0
2017-09	SA#77	SP-170678	0075	2	A	CR on MapGroupToBearer message	15.1.0
2017-09	SA#77	SP-170678	0077	1	A	Corrections for configuration references	15.1.0
2018-01	SA#78	SP-170895	0079	3	B	Functional model for MCPTT interconnection	15.2.0
2018-01	SA#78	SP-170896	0086	2	B	Introduction of the multi-talker control	15.2.0
2018-01	SA#78	SP-170896	0087	3	B	Introduction of Functional alias(es)	15.2.0
2018-01	SA#78	SP-170896	0089	1	C	Multi-talker floor release message and procedure	15.2.0
2018-01	SA#78	SP-170886	0101	2	A	Rejection of group call	15.2.0
2018-01	SA#78	SP-170886	0103	2	A	MCPTT server PSI configuration	15.2.0
2018-01	SA#78	SP-170886	0110	1	A	authorization for remotely initiated MCPTT call	15.2.0
2018-01	SA#78	SP-170890	0090	2	F	Renaming of MCPTT emergency group call cancel	15.2.0
2018-01	SA#78	SP-170890	0091	1	F	Renaming of MCPTT "emergency condition"	15.2.0
2018-01	SA#78	SP-170890	0093	2	F	Renaming of MCPTT imminent peril group call cancel	15.2.0
2018-01	SA#78	SP-170890	0094	2	F	Renaming Off-network MCPTT emergency group cancel	15.2.0
2018-01	SA#78	SP-170890	0095	2	F	Adding implicit floor request IE to MCPTT emergency group call request	15.2.0
2018-01	SA#78	SP-170890	0096	3	B	Server-initiated Broadcast group call release procedure	15.2.0
2018-01	SA#78	SP-170890	0107	2	F	Renaming of "MCPTT emergency state cancel" and corrections to information flow	15.2.0
2018-04	SA#79	SP-180146	0112	1	A	Correction of security specification references	15.3.0
2018-04	SA#79	SP-180154	0113	1	A	User profile for MCPTT migration	15.3.0
2018-04	SA#79	SP-180154	0114	4	B	MCPTT specific group configuration for interconnection	15.3.0
2018-04	SA#79	SP-180155	0115	3	B	LMR E2EE user profile and group parameters	15.3.0
2018-04	SA#79	SP-180158	0116	2	F	Introduction of MCPTT call end response message	15.3.0
2018-04	SA#79	SP-180150	0117	1	F	Update of references to stage 1 specifications	15.3.0
2018-04	SA#79	SP-180154	0119		B	Definition of MCPTT-3	15.3.0
2018-04	SA#79	SP-180154	0120		D	Editorial correction to gateway server entity	15.3.0
2018-06	SA#80	SP-180365	0123	3	A	Addition of implicit floor request IEs	15.4.0
2018-06	SA#80	SP-180365	0125	1	A	Corrections to implicit floor request handling	15.4.0
2018-06	SA#80	SP-180373	0129	1	F	Correction of referenced subclauses	15.4.0
2018-06	SA#80	SP-180365	0133		A	Clarification for presentation priority in MCPTT UE configuration	15.4.0
2018-06	SA#80	SP-180369	0134	2	F	Update of MCPTT emergency alert for multicast	15.4.0
2018-06	SA#80	SP-180369	0135	1	F	Correction of Group call rejoin response	15.4.0

History

Document history		
V15.4.0	July 2018	Publication