

ETSI TS 123 434 V16.7.0 (2021-07)



**5G;**  
**Service Enabler Architecture Layer for Verticals (SEAL);**  
**Functional architecture and information flows**  
**(3GPP TS 23.434 version 16.7.0 Release 16)**



---

**Reference**

RTS/TSGS-0623434vg70

---

**Keywords**

5G

**ETSI**

650 Route des Lucioles  
F-06921 Sophia Antipolis Cedex - FRANCE

---

Tel.: +33 4 92 94 42 00 Fax: +33 4 93 65 47 16

Siret N° 348 623 562 00017 - APE 7112B  
Association à but non lucratif enregistrée à la  
Sous-Préfecture de Grasse (06) N° w061004871

---

**Important notice**

The present document can be downloaded from:

<http://www.etsi.org/standards-search>

The present document may be made available in electronic versions and/or in print. The content of any electronic and/or print versions of the present document shall not be modified without the prior written authorization of ETSI. In case of any existing or perceived difference in contents between such versions and/or in print, the prevailing version of an ETSI deliverable is the one made publicly available in PDF format at [www.etsi.org/deliver](http://www.etsi.org/deliver).

Users of the present document should be aware that the document may be subject to revision or change of status.

Information on the current status of this and other ETSI documents is available at

<https://portal.etsi.org/TB/ETSIDeliverableStatus.aspx>

If you find errors in the present document, please send your comment to one of the following services:

<https://portal.etsi.org/People/CommitteeSupportStaff.aspx>

---

**Notice of disclaimer & limitation of liability**

The information provided in the present deliverable is directed solely to professionals who have the appropriate degree of experience to understand and interpret its content in accordance with generally accepted engineering or other professional standard and applicable regulations.

No recommendation as to products and services or vendors is made or should be implied.

No representation or warranty is made that this deliverable is technically accurate or sufficient or conforms to any law and/or governmental rule and/or regulation and further, no representation or warranty is made of merchantability or fitness for any particular purpose or against infringement of intellectual property rights.

In no event shall ETSI be held liable for loss of profits or any other incidental or consequential damages.

Any software contained in this deliverable is provided "AS IS" with no warranties, express or implied, including but not limited to, the warranties of merchantability, fitness for a particular purpose and non-infringement of intellectual property rights and ETSI shall not be held liable in any event for any damages whatsoever (including, without limitation, damages for loss of profits, business interruption, loss of information, or any other pecuniary loss) arising out of or related to the use of or inability to use the software.

---

**Copyright Notification**

No part may be reproduced or utilized in any form or by any means, electronic or mechanical, including photocopying and microfilm except as authorized by written permission of ETSI.

The content of the PDF version shall not be modified without the written authorization of ETSI.

The copyright and the foregoing restriction extend to reproduction in all media.

© ETSI 2021.  
All rights reserved.

---

## Intellectual Property Rights

### Essential patents

IPRs essential or potentially essential to normative deliverables may have been declared to ETSI. The declarations pertaining to these essential IPRs, if any, are publicly available for **ETSI members and non-members**, and can be found in ETSI SR 000 314: "*Intellectual Property Rights (IPRs); Essential, or potentially Essential, IPRs notified to ETSI in respect of ETSI standards*", which is available from the ETSI Secretariat. Latest updates are available on the ETSI Web server (<https://ipr.etsi.org/>).

Pursuant to the ETSI Directives including the ETSI IPR Policy, no investigation regarding the essentiality of IPRs, including IPR searches, has been carried out by ETSI. No guarantee can be given as to the existence of other IPRs not referenced in ETSI SR 000 314 (or the updates on the ETSI Web server) which are, or may be, or may become, essential to the present document.

### Trademarks

The present document may include trademarks and/or tradenames which are asserted and/or registered by their owners. ETSI claims no ownership of these except for any which are indicated as being the property of ETSI, and conveys no right to use or reproduce any trademark and/or tradename. Mention of those trademarks in the present document does not constitute an endorsement by ETSI of products, services or organizations associated with those trademarks.

**DECT™**, **PLUGTESTS™**, **UMTS™** and the ETSI logo are trademarks of ETSI registered for the benefit of its Members. **3GPP™** and **LTE™** are trademarks of ETSI registered for the benefit of its Members and of the 3GPP Organizational Partners. **oneM2M™** logo is a trademark of ETSI registered for the benefit of its Members and of the oneM2M Partners. **GSM®** and the GSM logo are trademarks registered and owned by the GSM Association.

---

## Legal Notice

This Technical Specification (TS) has been produced by ETSI 3rd Generation Partnership Project (3GPP).

The present document may refer to technical specifications or reports using their 3GPP identities. These shall be interpreted as being references to the corresponding ETSI deliverables.

The cross reference between 3GPP and ETSI identities can be found under <http://webapp.etsi.org/key/queryform.asp>.

---

## Modal verbs terminology

In the present document "**shall**", "**shall not**", "**should**", "**should not**", "**may**", "**need not**", "**will**", "**will not**", "**can**" and "**cannot**" are to be interpreted as described in clause 3.2 of the [ETSI Drafting Rules](#) (Verbal forms for the expression of provisions).

"**must**" and "**must not**" are **NOT** allowed in ETSI deliverables except when used in direct citation.

# Contents

Intellectual Property Rights .....	2
Legal Notice .....	2
Modal verbs terminology.....	2
Foreword.....	11
Introduction .....	11
1 Scope .....	12
2 References .....	12
3 Definitions, symbols and abbreviations .....	13
3.1 Definitions .....	13
3.2 Abbreviations .....	14
4 Architectural requirements .....	14
4.1 General .....	14
4.1.1 Description.....	14
4.1.2 Requirements .....	14
4.2 Deployment models.....	15
4.2.1 Description.....	15
4.2.2 Requirements .....	15
4.3 Location management .....	15
4.3.1 Description.....	15
4.3.2 Requirements .....	15
4.4 Group management .....	15
4.4.1 Description.....	15
4.4.2 Requirements .....	16
4.5 Configuration management .....	16
4.5.1 Description.....	16
4.5.2 Requirements .....	16
4.6 Key management.....	16
4.6.1 Description.....	16
4.6.2 Requirements .....	16
4.7 Identity management .....	16
4.7.1 Description.....	16
4.7.2 Requirements .....	16
4.8 Network resource management .....	16
4.8.1 Description.....	16
4.8.2 Requirements .....	17
5 Involved business relationships.....	17
6 Generic functional model for SEAL services.....	18
6.1 General .....	18
6.2 On-network functional model description.....	18
6.3 Off-network functional model description .....	21
6.4 Functional entities description.....	22
6.4.1 General.....	22
6.4.2 Application plane.....	22
6.4.2.1 General.....	22
6.4.2.2 VAL client.....	22
6.4.2.3 VAL server.....	22
6.4.2.4 SEAL client.....	22
6.4.2.5 SEAL server.....	22
6.4.2.6 VAL user database .....	22
6.4.3 Signalling control plane .....	23
6.4.3.1 SIP entities .....	23
6.4.3.1.1 Signalling user agent .....	23

6.4.3.1.2	SIP AS .....	23
6.4.3.1.3	SIP core .....	23
6.4.3.1.3.1	General.....	23
6.4.3.1.3.2	Local inbound / outbound proxy.....	23
6.4.3.1.3.3	Registrar finder .....	23
6.4.3.1.3.4	Registrar / application service selection.....	24
6.4.3.1.4	Diameter proxy.....	24
6.4.3.2	SIP database .....	24
6.4.3.2.1	General .....	24
6.4.3.2.2	SIP database logical functions.....	25
6.4.3.3	HTTP entities .....	26
6.4.3.3.1	HTTP client .....	26
6.4.3.3.2	HTTP proxy.....	26
6.4.3.3.3	HTTP server .....	26
6.5	Reference points description .....	26
6.5.1	General reference point principle.....	26
6.5.2	Application plane.....	26
6.5.2.1	General.....	26
6.5.2.2	VAL-UU .....	26
6.5.2.3	VAL-PC5 .....	27
6.5.2.4	SEAL-UU.....	27
6.5.2.5	SEAL-PC5 .....	27
6.5.2.6	SEAL-C.....	27
6.5.2.7	SEAL-S .....	27
6.5.2.8	SEAL-E.....	27
6.5.2.9	SEAL-X .....	27
6.5.2.9.1	General .....	27
6.5.2.9.2	Reference point SEAL-X1 (between the key management server and the group management server).....	27
6.5.2.9.3	Reference point SEAL-X2 (between the group management server and the location management server).....	28
6.5.2.10	Reference point VAL-UDB (between the VAL user database and the SEAL server).....	28
6.5.3	Signalling control plane .....	28
6.5.3.1	General .....	28
6.5.3.2	Reference point SIP-1 (between the signalling user agent and the SIP core).....	28
6.5.3.3	Reference point SIP-2 (between the SIP core and the SIP AS).....	28
6.5.3.4	Reference point SIP-3 (between the SIP core and SIP core).....	29
6.5.3.5	Reference point HTTP-1 (between the HTTP client and the HTTP proxy).....	29
6.5.3.6	Reference point HTTP-2 (between the HTTP proxy and the HTTP server).....	29
6.5.3.7	Reference point HTTP-3 (between the HTTP proxy and HTTP proxy) .....	29
6.5.3.8	Reference point AAA-1 (between the SIP database and the SIP core) .....	29
6.5.3.9	Reference point AAA-2 (between the SIP core and Diameter proxy) .....	29
7	Identities .....	30
7.1	User identity (User ID).....	30
7.2	VAL user identity (VAL user ID) .....	30
7.3	VAL UE identity (VAL UE ID).....	30
7.4	VAL service identity (VAL service ID) .....	30
7.5	VAL group identity (VAL group ID).....	30
7.6	VAL system identity (VAL system ID) .....	30
8	Application of functional model to deployments .....	31
8.1	General .....	31
8.2	Deployment of SEAL server(s).....	31
8.2.1	SEAL server(s) deployment in PLMN operator domain .....	31
8.2.2	SEAL server(s) deployment in VAL service provider domain.....	33
8.2.3	SEAL server(s) deployment outside of VAL service provider domain and PLMN operator domain .....	34
9	Location management .....	35
9.1	General .....	35
9.2	Functional model for location management .....	35
9.2.1	General.....	35
9.2.2	On-network functional model description .....	35

9.2.3	Off-network functional model description.....	36
9.2.4	Functional entities description .....	36
9.2.4.1	General .....	36
9.2.4.2	Location management client .....	37
9.2.4.3	Location management server .....	37
9.2.5	Reference points description.....	37
9.2.5.1	General .....	37
9.2.5.2	LM-UU .....	37
9.2.5.3	LM-PC5 .....	37
9.2.5.4	LM-C.....	37
9.2.5.5	LM-S .....	37
9.2.5.6	LM-E.....	37
9.2.5.7	T8 .....	38
9.3	Procedures and information flows for Location management (on-network).....	38
9.3.1	General.....	38
9.3.2	Information flows for location information .....	38
9.3.2.0	Location reporting configuration request .....	38
9.3.2.1	Location reporting configuration response.....	38
9.3.2.2	Location information report .....	38
9.3.2.3	Location information request .....	39
9.3.2.4	Location reporting trigger .....	39
9.3.2.5	Location information subscription request.....	39
9.3.2.6	Location information subscription response .....	40
9.3.2.7	Location information notification .....	40
9.3.2.8	Location reporting configuration cancel request.....	40
9.3.3	Event-triggered location reporting procedure .....	40
9.3.3.1	General .....	40
9.3.3.2	Fetching location reporting configuration .....	41
9.3.3.3	Location reporting .....	41
9.3.4	On-demand location reporting procedure .....	42
9.3.5	Client-triggered or VAL server-triggered location reporting procedure.....	43
9.3.6	Location reporting triggers configuration cancel.....	43
9.3.7	Location information subscription procedure .....	44
9.3.8	Event-trigger location information notification procedure .....	45
9.3.9	On-demand usage of location information procedure.....	45
9.4	SEAL APIs for location management .....	46
9.4.1	General.....	46
9.4.2	SS_LocationReporting API .....	46
9.4.2.1	General .....	46
9.4.2.2	Create_Trigger_Location_Reporting operation .....	47
9.4.2.3	Update_Trigger_Location_Reporting operation .....	47
9.4.2.4	Cancel_Trigger_Location_Reporting operation.....	47
9.4.3	SS_LocationInfoEvent API .....	47
9.4.3.1	General .....	47
9.4.3.2	Subscribe_Location_Info operation .....	47
9.4.3.3	Notify_Location_Info operation .....	48
9.4.4	SS_LocationInfoRetrieval API.....	48
9.4.4.1	General .....	48
9.4.4.2	Obtain_Location_Info operation .....	48
10	Group management .....	48
10.1	General .....	48
10.2	Functional model for group management.....	48
10.2.1	General.....	48
10.2.2	On-network functional model description .....	48
10.2.3	Off-network functional model description.....	49
10.2.4	Functional entities description .....	49
10.2.4.1	General .....	49
10.2.4.2	Group management client .....	49
10.2.4.3	Group management server .....	50
10.2.5	Reference points description.....	50
10.2.5.1	General .....	50

10.2.5.2	GM-UU .....	50
10.2.5.3	GM-PC5 .....	50
10.2.5.4	GM-C .....	50
10.2.5.5	GM-S.....	50
10.2.5.6	GM-E .....	51
10.3	Procedures and information flows for group management.....	51
10.3.1	General.....	51
10.3.2	Information flows for group management .....	51
10.3.2.1	Group creation request .....	51
10.3.2.2	Group creation response.....	51
10.3.2.3	Group creation notification .....	52
10.3.2.4	Group information query request .....	52
10.3.2.5	Group information query response.....	52
10.3.2.6	Group membership update request.....	52
10.3.2.7	Group membership update response .....	53
10.3.2.8	Group membership notification .....	53
10.3.2.9	Group deletion request .....	53
10.3.2.10	Group deletion response.....	54
10.3.2.11	Group deletion notification .....	54
10.3.2.12	Group information request .....	54
10.3.2.13	Group information response.....	54
10.3.2.14	Group information subscribe request .....	54
10.3.2.15	Group information subscribe response.....	55
10.3.2.16	Group information notify request.....	55
10.3.2.17	Group information notify response .....	55
10.3.2.18	Store group configuration request .....	55
10.3.2.19	Store group configuration response.....	56
10.3.2.20	Get group configuration request.....	56
10.3.2.21	Get group configuration response .....	56
10.3.2.22	Subscribe group configuration request.....	56
10.3.2.23	Subscribe group configuration response .....	57
10.3.2.24	Notify group configuration request.....	57
10.3.2.25	Notify group configuration response.....	57
10.3.2.26	Configure VAL group request.....	57
10.3.2.27	Configure VAL group response .....	58
10.3.2.28	Group announcement .....	58
10.3.2.29	Group registration request.....	58
10.3.2.30	Group registration response .....	59
10.3.2.31	Identity list notification .....	59
10.3.2.32	Group de-registration request.....	59
10.3.2.33	Group de-registration response .....	60
10.3.3	Group creation .....	60
10.3.4	Group information query .....	61
10.3.4.1	General .....	61
10.3.4.2	Procedure .....	61
10.3.5	Group membership .....	61
10.3.5.1	Group membership notification .....	61
10.3.5.2	Group membership update by authorized user/UE/VAL server .....	62
10.3.6	Group configuration management .....	63
10.3.6.1	Store group configurations at the group management server .....	63
10.3.6.2	Retrieve group configurations.....	64
10.3.6.3	Subscription and notification for group configuration data.....	65
10.3.6.4	Structure of group configuration data .....	66
10.3.7	Location-based group creation.....	66
10.3.8	Group announcement and join.....	67
10.3.8.1	General .....	67
10.3.8.2	Procedure .....	67
10.3.9	Group member leave.....	68
10.3.9.1	General .....	68
10.3.9.2	Procedure .....	68
10.4	SEAL APIs for group management.....	69
10.4.1	General.....	69

10.4.2	SS_GroupManagement API.....	69
10.4.2.1	General.....	69
10.4.2.2	Query_Group_Info operation.....	69
10.4.2.3	Update_Group_Info operation.....	69
10.4.3	Void.....	70
10.4.3.1	Void.....	70
10.4.3.2	Void.....	70
10.4.4	Void.....	70
10.4.4.1	Void.....	70
10.4.4.2	Void.....	70
10.4.5	SS_Group_Management_Event API.....	70
10.4.5.1	General.....	70
10.4.5.2	Subscribe_Group_Info_Modification operation.....	70
10.4.5.3	Notify_Group_Info_Modification operation.....	70
10.4.5.4	Notify_Group_Creation operation.....	70
11	Configuration management.....	71
11.1	General.....	71
11.2	Functional model for configuration management.....	71
11.2.1	General.....	71
11.2.2	On-network functional model description.....	71
11.2.3	Off-network functional model description.....	72
11.2.4	Functional entities description.....	72
11.2.4.1	General.....	72
11.2.4.2	Configuration management client.....	72
11.2.4.3	Configuration management server.....	72
11.2.5	Reference points description.....	72
11.2.5.1	General.....	72
11.2.5.2	CM-UU.....	73
11.2.5.3	CM-PC5.....	73
11.2.5.4	CM-C.....	73
11.2.5.5	CM-S.....	73
11.2.5.6	CM-E.....	73
11.2.5.7	Reference point CM-VAL-UDB (between the configuration management server and the VAL user database).....	73
11.3	Procedures and information flows for configuration management.....	74
11.3.1	General.....	74
11.3.2	Information flows.....	74
11.3.2.1	Get VAL UE configuration request.....	74
11.3.2.2	Get VAL UE configuration response.....	74
11.3.2.3	Get VAL user profile request.....	74
11.3.2.4	Get VAL user profile response.....	74
11.3.2.5	Notification for VAL user profile data update.....	75
11.3.2.6	Get updated VAL user profile data request.....	75
11.3.2.7	Get updated VAL user profile data response.....	75
11.3.2.8	Update VAL user profile data request.....	75
11.3.2.9	Update VAL user profile data response.....	76
11.3.2.10	Updated user profile subscription request.....	76
11.3.2.11	Updated user profile subscription response.....	76
11.3.2.12	Updated user profile notification.....	76
11.3.3	VAL UE configuration data.....	76
11.3.3.1	General.....	76
11.3.3.2	Procedures.....	77
11.3.3.3	Structure of VAL UE configuration data.....	77
11.3.4	VAL user profile data.....	77
11.3.4.1	General.....	77
11.3.4.2	Obtaining the VAL user profile(s) from the network.....	77
11.3.4.2.1	Obtaining the VAL user profile(s) in primary VAL system.....	77
11.3.4.2.2	VAL user receiving VAL service from a partner VAL system.....	78
11.3.4.3	VAL user receives updated VAL user profile data from the network.....	80
11.3.4.4	VAL user updates VAL user profile data to the network.....	80
11.3.4.5	Updated user profile subscription procedure.....	81



11.4	SEAL APIs for configuration management.....	82
11.4.1	General.....	82
11.4.2	SS_UserProfileRetrieval API.....	82
11.4.2.1	General.....	82
11.4.2.2	Obtain_User_Profile operation.....	82
11.4.3	SS_UserProfileEvent API.....	83
11.4.3.1	General.....	83
11.4.3.2	Subscribe_User_Profile_Update operation.....	83
11.4.3.3	Notify_User_Profile_Update operation.....	83
12	Identity management.....	83
12.1	General.....	83
12.2	Functional model for identity management.....	83
12.2.1	General.....	83
12.2.2	On-network functional model description.....	84
12.2.3	Off-network functional model description.....	84
12.2.4	Functional entities description.....	84
12.2.4.1	General.....	84
12.2.4.2	Identity management client.....	85
12.2.4.3	Identity management server.....	85
12.2.5	Reference points description.....	85
12.2.5.1	General.....	85
12.2.5.2	IM-UU.....	85
12.2.5.3	IM-PC5.....	85
12.2.5.4	IM-C.....	85
12.2.5.5	IM-S.....	85
12.2.5.6	IM-E.....	85
12.3	Procedures and information flows for identity management.....	85
12.3.1	General.....	85
12.3.2	Information flows.....	86
12.3.3	General user authentication and authorization for VAL services.....	86
12.3.3.1	General.....	86
12.3.3.2	Primary VAL system.....	86
12.3.3.3	Interconnection partner VAL system.....	87
12.4	SEAL APIs for identity management.....	87
12.4.1	General.....	87
12.4.2	Void.....	87
12.4.2.1	Void.....	87
12.4.2.2	Void.....	87
13	Key management.....	87
13.1	General.....	87
13.2	Functional model for key management.....	87
13.2.1	General.....	87
13.2.2	On-network functional model description.....	87
13.2.3	Off-network functional model description.....	88
13.2.4	Functional entities description.....	88
13.2.4.1	General.....	88
13.2.4.2	Key management client.....	88
13.2.4.3	Key management server.....	89
13.2.5	Reference points description.....	89
13.2.5.1	General.....	89
13.2.5.2	KM-UU.....	89
13.2.5.3	KM-PC5.....	89
13.2.5.4	KM-C.....	89
13.2.5.5	KM-S.....	89
13.2.5.6	KM-E.....	89
13.2.5.7	SEAL-X1.....	90
13.3	Procedures and information flows for key management.....	90
13.4	SEAL APIs for key management.....	90
13.4.1	General.....	90
13.4.2	Void.....	90

13.4.2.1	Void.....	90
13.4.2.2	Void.....	90
14	Network resource management .....	90
14.1	General .....	90
14.2	Functional model for network resource management.....	90
14.2.1	General.....	90
14.2.2	On-network functional model description .....	90
14.2.3	Off-network functional model description.....	91
14.2.4	Functional entities description .....	92
14.2.4.1	General .....	92
14.2.4.2	Network resource management client .....	92
14.2.4.3	Network resource management server .....	92
14.2.5	Reference points description.....	92
14.2.5.1	General .....	92
14.2.5.2	NRM-UU .....	92
14.2.5.3	NRM-PC5 .....	92
14.2.5.4	NRM-C .....	92
14.2.5.5	NRM-S.....	92
14.2.5.6	NRM-E.....	92
14.2.5.7	MB2-C .....	93
14.2.5.8	xMB-C .....	93
14.2.5.9	Rx.....	93
14.2.5.10	N5.....	93
14.3	Procedures and information flows for network resource management.....	93
14.3.1	General.....	93
14.3.2	Information flows .....	93
14.3.2.1	Network resource adaptation request .....	93
14.3.2.2	Network resource adaptation response.....	93
14.3.2.3	MBMS bearer announcement.....	94
14.3.2.4	MBMS listening status report .....	94
14.3.2.5	MBMS suspension reporting instruction.....	95
14.3.2.6	Resource request .....	95
14.3.2.7	Resource response.....	95
14.3.2.8	Resource modification request.....	95
14.3.2.9	Resource modification response.....	96
14.3.2.10	MBMS bearers request.....	96
14.3.2.11	MBMS bearers response .....	96
14.3.2.12	User plane delivery mode.....	97
14.3.3	Unicast resource management .....	97
14.3.3.1	General .....	97
14.3.3.2	Unicast resource management with SIP core .....	97
14.3.3.2.1	Request for unicast resources at VAL service communication establishment .....	97
14.3.3.2.1.1	General.....	97
14.3.3.2.1.2	Procedure .....	97
14.3.3.2.2	Request for modification of unicast resources.....	98
14.3.3.2.2.1	General.....	98
14.3.3.2.2.2	Procedure .....	98
14.3.3.3	Unicast resource management without SIP core.....	100
14.3.3.3.1	Network resource adaptation .....	100
14.3.3.3.1.1	General.....	100
14.3.3.3.1.2	Procedure .....	100
14.3.3.3.2	Request for unicast resources at VAL service communication establishment .....	100
14.3.3.3.2.1	General.....	100
14.3.3.3.2.2	Procedure .....	100
14.3.3.3.3	Request for modification of unicast resources.....	101
14.3.3.3.3.1	General.....	101
14.3.3.3.3.2	Procedure .....	101
14.3.4	Multicast resource management for EPS .....	102
14.3.4.1	General .....	102
14.3.4.2	Use of pre-established MBMS bearers.....	103
14.3.4.2.1	General .....	103

14.3.4.2.2	Procedure.....	103
14.3.4.3	Use of dynamic MBMS bearer establishment.....	104
14.3.4.3.1	General .....	104
14.3.4.3.2	Procedure.....	104
14.3.4.4	MBMS bearer announcement over MBMS bearer.....	106
14.3.4.4.1	General .....	106
14.3.4.4.2	Procedure.....	106
14.3.4.5	MBMS bearer quality detection .....	108
14.3.4.5.1	General .....	108
14.3.4.5.2	Procedure.....	108
14.3.4.6	Service continuity in MBMS scenarios.....	109
14.3.4.6.1	General .....	109
14.3.4.6.2	Service continuity when moving from one MBSFN to another .....	109
14.3.4.7	MBMS suspension notification.....	112
14.3.4.7.1	General .....	112
14.3.4.7.2	Procedure.....	112
14.3.4.8	MBMS bearer event notification.....	113
14.3.4.8.1	General .....	113
14.3.4.8.2	Procedure.....	113
14.3.4.9	Switching between MBMS bearer and unicast bearer .....	115
14.3.4.9.1	General .....	115
14.3.4.9.2	Procedure.....	115
14.4	SEAL APIs for network resource management.....	116
14.4.1	General.....	116
14.4.2	SS_NetworkResourceAdaptation API .....	116
14.4.2.1	General .....	116
14.4.2.2	Reserve_Network_Resource operation .....	116
14.4.2.3	Request_Unicast_Resource .....	116
14.4.2.4	Update_Unicast_Resource .....	117
14.4.2.5	Request_Multicast_Resource .....	117
14.4.2.6	Notify_UP_Delivery_Mode.....	117
15	Service-based interface representation of the functional model for SEAL services .....	118
15.1	General .....	118
15.2	Functional model representation .....	118
15.3	Service-based interfaces .....	118
<b>Annex A (informative):</b>	<b>SEAL integration with 3GPP network exposure systems .....</b>	<b>119</b>
<b>Annex B (informative):</b>	<b>SEAL functional model mapping with Common functional architecture (CFA).....</b>	<b>121</b>
<b>Annex C (informative):</b>	<b>Change history .....</b>	<b>122</b>
History .....		123

---

# Foreword

This Technical Specification has been produced by the 3rd Generation Partnership Project (3GPP).

The contents of the present document are subject to continuing work within the TSG and may change following formal TSG approval. Should the TSG modify the contents of the present document, it will be re-released by the TSG with an identifying change of release date and an increase in version number as follows:

Version x.y.z

where:

- x the first digit:
  - 1 presented to TSG for information;
  - 2 presented to TSG for approval;
  - 3 or greater indicates TSG approved document under change control.
- y the second digit is incremented for all changes of substance, i.e. technical enhancements, corrections, updates, etc.
- z the third digit is incremented when editorial only changes have been incorporated in the document.

---

# Introduction

This document specifies a functional architecture for service enabler architecture layer (SEAL) over 3GPP networks to support vertical applications (e.g. V2X applications). This functional architecture will include common application plane and signalling plane entities. A set of common services (e.g. group management, configuration management, location management) specified in this document can be shared across vertical applications.

The SEAL functional architecture takes into consideration the common capabilities to support mission critical and other vertical applications.

---

# 1 Scope

The present document specifies the functional architecture for service enabler architecture layer (SEAL) and the procedures, information flows and APIs for each service within SEAL in order to support vertical applications over the 3GPP system. The present document is applicable to vertical applications using E-UTRAN or NR access based on the EPC or 5GS architecture defined in 3GPP TS 23.401 [9] and 3GPP TS 23.501 [10]. To ensure efficient use and deployment of vertical applications over 3GPP systems this specification for SEAL services includes the group management, configuration management, location management, identity management, key management and network resource management.

NOTE: In the present document, the multicast services offered by SEAL are only applicable for EPS.

---

# 2 References

The following documents contain provisions which, through reference in this text, constitute provisions of the present document.

- References are either specific (identified by date of publication, edition number, version number, etc.) or non-specific.
- For a specific reference, subsequent revisions do not apply.
- For a non-specific reference, the latest version applies. In the case of a reference to a 3GPP document (including a GSM document), a non-specific reference implicitly refers to the latest version of that document *in the same Release as the present document*.

- [1] 3GPP TR 21.905: "Vocabulary for 3GPP Specifications".
- [2] 3GPP TS 22.104: "Service requirements for cyber-physical control applications in vertical domains".
- [3] 3GPP TS 23.379: "Functional architecture and information flows to support Mission Critical Push To Talk (MCPTT); Stage 2".
- [4] 3GPP TS 23.280: "Common functional architecture to support mission critical services; Stage 2".
- [5] 3GPP TS 23.281: "Functional architecture and information flows to support Mission Critical Video (MCVideo); Stage 2".
- [6] 3GPP TS 23.282: "Functional architecture and information flows to support Mission Critical Data (MCData); Stage 2".
- [7] 3GPP TS 23.286: "Application layer support for V2X services; Functional architecture and information flows".
- [8] 3GPP TS 23.222: "Functional architecture and information flows to support Common API Framework for 3GPP Northbound APIs; Stage 2".
- [9] 3GPP TS 23.401: "General Packet Radio Service (GPRS) enhancements for Evolved Universal Terrestrial Radio Access Network (E-UTRAN) access".
- [10] 3GPP TS 23.501: "System Architecture for the 5G System; Stage 2".
- [11] 3GPP TS 23.502: "Procedures for the 5G System; Stage 2".
- [12] 3GPP TS 23.303: "Proximity-based services (ProSe); Stage 2".
- [13] 3GPP TS 23.682: "Architecture enhancements to facilitate communications with packet data networks and applications".
- [14] 3GPP TS 23.002: "Network Architecture".
- [15] 3GPP TS 23.228: "IP Multimedia Subsystem (IMS); Stage 2".

- [16] 3GPP TS 23.468: "Group Communication System Enablers for LTE (GCSE\_LTE); Stage 2".
- [17] 3GPP TS 23.246: "Multimedia Broadcast/Multicast Service (MBMS); Architecture and functional description".
- [18] 3GPP TS 23.203: "Policy and charging control architecture".
- [19] 3GPP TS 23.503: "Policy and Charging Control Framework for the 5G System; Stage 2".
- [20] 3GPP TS 26.348: "Northbound Application Programming Interface (API) for Multimedia Broadcast/Multicast Service (MBMS) at the xMB reference point".
- [21] 3GPP TS 29.214: "Policy and charging control over Rx reference point".
- [22] 3GPP TS 29.468: "Group Communication System Enablers for LTE (GCSE\_LTE); MB2 Reference Point; Stage 3".
- [23] 3GPP TS 36.300: "Evolved Universal Terrestrial Radio Access (E-UTRA) and Evolved Universal Terrestrial Radio Access Network (E-UTRAN); Overall description; Stage 2".
- [24] IETF RFC 6733 (October 2012): "Diameter Base Protocol".
- [25] ETSI TS 102 894-2 (V1.2.1): "Intelligent Transport Systems (ITS); Users and applications requirements; Part 2: Applications and facilities layer common data dictionary Multimedia Broadcast/Multicast Service (MBMS); Protocols and codecs".
- [26] ETSI TS 102 965 (V1.4.1): "Intelligent Transport Systems (ITS); Application Object Identifier (ITS-AID); Registration".
- [27] ISO TS 17419: "Intelligent Transport Systems - Cooperative systems - Classification and management of ITS applications in a global context".
- [28] 3GPP TS 26.346: "Multimedia Broadcast/Multicast Service (MBMS); Protocols and codecs".
- [29] 3GPP TS 33.434: "Service Enabler Architecture Layer (SEAL); Security aspects for Verticals".
- [30] 3GPP TS 29.549: "Service Enabler Architecture Layer for Verticals (SEAL); Application Programming Interface (API) specification; Stage3".

---

## 3 Definitions, symbols and abbreviations

### 3.1 Definitions

For the purposes of the present document, the terms and definitions given in 3GPP TR 21.905 [1] and the following apply. A term defined in the present document takes precedence over the definition of the same term, if any, in 3GPP TR 21.905 [1].

**VAL user:** An authorized user, who can use a VAL UE to participate in one or more VAL services.

**VAL user ID:** A generic name for the user ID of a VAL user within a specific VAL service.

**VAL UE:** A UE that can be used to participate in one or more VAL services.

**VAL client:** An entity that provides the client side functionalities corresponding to the vertical applications.

**SEAL client:** An entity that provides the client side functionalities corresponding to the specific SEAL service.

**VAL service:** A generic name for any service offered by the VAL service provider to their VAL users.

**SEAL service:** A generic name for a common service (e.g. group management, configuration management, location management) that can be utilized by multiple vertical applications.

**SEAL provider:** Provider of SEAL service(s).

**VAL server:** A generic name for the server application function of a specific VAL service.

**SEAL server:** An entity that provides the server side functionalities corresponding to the specific SEAL service.

**VAL system:** The collection of applications, services, and enabling capabilities required to support a VAL service.

**Primary VAL system:** VAL system where the VAL user profiles of a VAL user are defined.

**Partner VAL system:** A VAL system that has a business relationship with the primary VAL system such that service can be offered to primary VAL system users.

**VAL group:** A defined set of VAL UEs or VAL users configured for specific purpose in a VAL service.

NOTE: The set could be of either VAL UEs or VAL users depending on the specific VAL service.

**VAL group home system:** The VAL system where the VAL group is defined.

**VAL group member:** A VAL service user, whose VAL user ID is listed in a particular VAL group.

**Vertical:** See vertical domain.

**Vertical application:** An application catering to a specific vertical.

For the purposes of the present document, the following terms and definitions given in 3GPP TS 22.104 [2] apply:

#### Vertical domain

## 3.2 Abbreviations

For the purposes of the present document, the abbreviations given in 3GPP TR 21.905 [1] and the following apply. An abbreviation defined in the present document takes precedence over the definition of the same abbreviation, if any, in 3GPP TR 21.905 [1].

5GS	5G System
CAPIF	Common API Framework for northbound APIs
CRUDN	Create, Retrieve, Update, Delete and Notify
EPC	Evolved Packet Core
NR	New Radio
PCC	Policy and Charging Control
SCEF	Service Capability Exposure Function
SEAL	Service Enabler Architecture Layer for Verticals
VAL	Vertical Application Layer

---

## 4 Architectural requirements

### 4.1 General

#### 4.1.1 Description

This subclause specifies the general requirements for SEAL.

#### 4.1.2 Requirements

[AR-4.1.2-a] The SEAL shall support applications from one or more verticals.

[AR-4.1.2-b] The SEAL shall support multiple applications from the same vertical.

[AR-4.1.2-c] The SEAL shall offer SEAL services as APIs to the vertical applications.

[AR-4.1.2-d] The SEAL shall support notification mechanism for SEAL service events.

[AR-4.1.2-e] The API interactions between the vertical application server(s) and SEAL server(s) shall conform to CAPIF as specified in 3GPP TS 23.222 [8].

[AR-4.1.2-f] The SEAL server(s) shall provide a service API compliant with CAPIF as specified in 3GPP TS 23.222 [8].

## 4.2 Deployment models

### 4.2.1 Description

This subclause specifies the requirements for various deployment models.

### 4.2.2 Requirements

[AR-4.2.2-a] The SEAL shall support deployments in which SEAL services are deployed only within PLMN network.

[AR-4.2.2-b] The SEAL shall support deployments in which SEAL services are deployed only outside of PLMN network.

[AR-4.2.2-c] The SEAL shall support deployments in which SEAL services are deployed both within and outside the PLMN domain at the same time.

[AR-4.2.2-d] The SEAL shall support SEAL capabilities for centralized deployment of vertical applications.

[AR-4.2.2-e] The SEAL shall support SEAL capabilities for distributed deployment of vertical applications.

## 4.3 Location management

### 4.3.1 Description

This subclause specifies the requirements for location management service.

### 4.3.2 Requirements

[AR-4.3.2-a] The SEAL shall enable sharing location data between client and server for vertical applications usage.

[AR-4.3.2-b] The SEAL shall support different granularity of location data, as required by the vertical application.

[AR-4.3.2-c] The SEAL shall support requests for on-demand location reporting.

[AR-4.3.2-d] The SEAL shall support client location reporting based on triggers.

[AR-4.3.2-e] The SEAL shall enable vertical applications to receive updates to the location information.

[AR-4.3.2-f] The SEAL shall enable sharing the network location information obtained from the 3GPP network systems to the vertical applications.

## 4.4 Group management

### 4.4.1 Description

This subclause specifies the requirements for group management service.



## 4.4.2 Requirements

[AR-4.4.2-a] The SEAL shall enable group management operations (e.g. CRUDN) by the authorized users or VAL server.

[AR-4.4.2-b] The SEAL shall enable creation of group to be used by one or more vertical applications within the same VAL system.

[AR-4.4.2-c] The SEAL shall enable two or more groups to be merged (temporarily or permanently) into a single group by the authorized users or VAL server wherein all the group members of the constituent groups are designated as members of the merged group.

## 4.5 Configuration management

### 4.5.1 Description

This subclause specifies the requirements for configuration management service.

### 4.5.2 Requirements

[AR-4.5.2-a] The SEAL shall enable configuring service specific configuration data applicable to vertical applications.

[AR-4.5.2-b] The SEAL shall support configuring data applicable to different vertical applications.

## 4.6 Key management

### 4.6.1 Description

This subclause specifies the requirements for key management service.

### 4.6.2 Requirements

[AR-4.6.2-a] The SEAL shall support secure distribution of security related information (e.g. encryption keys).

[AR-4.6.2-b] The SEAL shall support all communications in SEAL ecosystem to be secured.

## 4.7 Identity management

### 4.7.1 Description

This subclause specifies the requirements for identity management service.

### 4.7.2 Requirements

[AR-4.7.2-a] The SEAL shall enable the access to SEAL services from the vertical application layer entities to be authorized.

**Editor's Note: The relationship between identity management service and authorization is FFS.**

## 4.8 Network resource management

### 4.8.1 Description

This subclause specifies the requirements for network resource management service.

## 4.8.2 Requirements

[AR-4.8.2-a] The SEAL shall enable support for unicast bearer establishment and modification to support service KPIs for VAL communications.

[AR-4.8.2-b] The SEAL shall enable support for multicast bearer establishment and modification to support service KPIs for VAL communications.

[AR-4.8.2-c] The SEAL shall support announcement of multicast bearers to the UEs.

[AR-4.8.2-d] The SEAL shall support switching of bearers between unicast and multicast.

[AR-4.8.2-e] The SEAL shall support multicast bearer quality detection.

## 5 Involved business relationships

Figure 5-1 shows the business relationships that exist and that are needed to support a single VAL user.

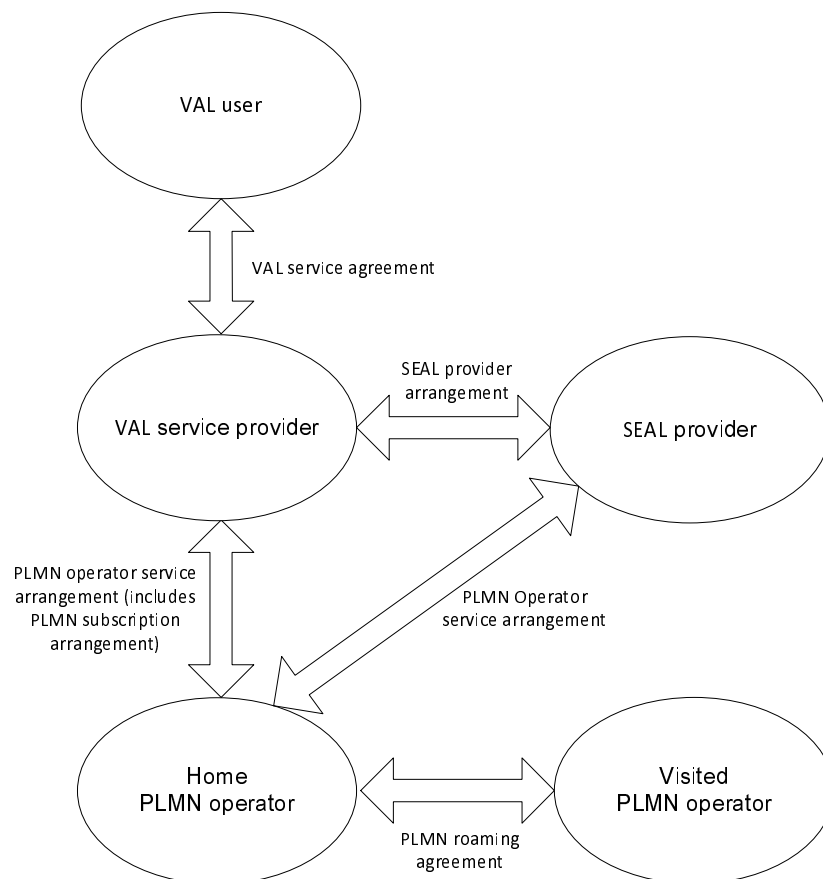

**Figure 5-1: Business relationships for VAL services**

The VAL user belongs to a VAL service provider based on a VAL service agreement between the VAL user and the VAL service provider. The VAL service provider can have VAL service agreements with several VAL users. The VAL user can have VAL service agreements with several VAL service providers.

The VAL service provider and the home PLMN operator can be part of the same organization, in which case the business relationship between the two is internal to a single organization.

The VAL service provider can have SEAL provider arrangements with multiple SEAL providers and the SEAL provider can have PLMN operator service arrangements with multiple home PLMN operators. The SEAL provider and the VAL service provider or the home PLMN operator can be part of the same organization, in which case the business relationship between the two is internal to a single organization.

The home PLMN operator can have PLMN operator service arrangements with multiple VAL service providers and the VAL service provider can have PLMN operator service arrangements with multiple home PLMN operators. As part of the PLMN operator service arrangement between the VAL service provider and the home PLMN operator, PLMN subscription arrangements can be provided which allows the VAL UEs to register with home PLMN operator network.

The home PLMN operator can have PLMN roaming agreements with multiple visited PLMN operators and the visited PLMN operator can have PLMN roaming agreements with multiple home PLMN operators.

## 6 Generic functional model for SEAL services

### 6.1 General

The functional model for SEAL is organized into generic SEAL service functional model and specific SEAL service functional models. The generic SEAL service functional model will be used as the reference model for the specific SEAL service functional models.

The following SEAL services are supported towards the vertical application layer:

- Location management;
- Group management;
- Configuration management;
- Identity management;
- Key management; and
- Network resource management.

The generic functional model for the SEAL is organized into generic functional entities to describe a functional architecture which addresses the application layer support aspects for vertical applications. The on-network and off-network functional model is specified in this clause.

### 6.2 On-network functional model description

Figure 6.2-1 illustrates the generic on-network functional model for SEAL.

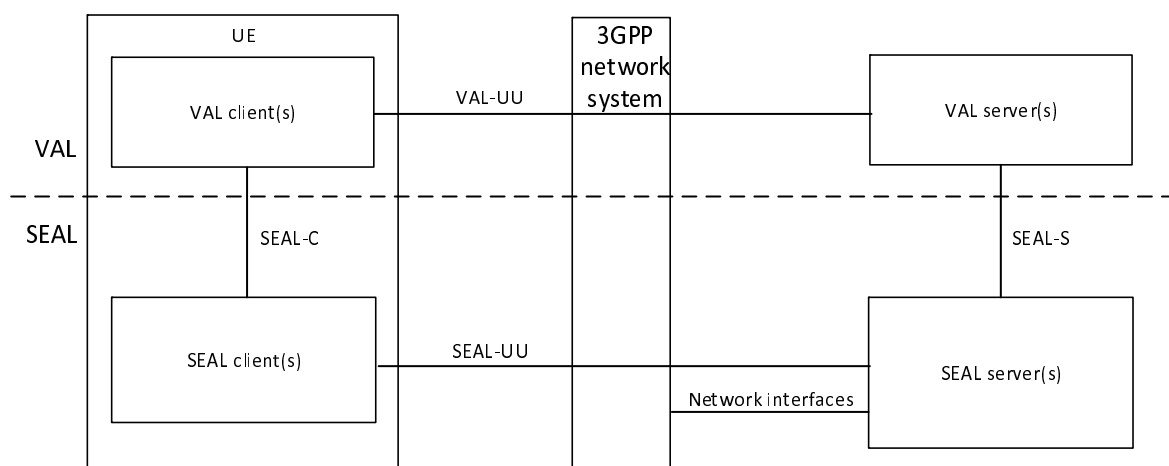

Figure 6.2-1: Generic on-network functional model

In the vertical application layer, the VAL client communicates with the VAL server over VAL-UU reference point. VAL-UU supports both unicast and multicast delivery modes.

NOTE 1: The VAL-UU reference point is out of scope of the present document.

The SEAL functional entities on the UE and the server are grouped into SEAL client(s) and SEAL server(s) respectively. The SEAL consists of a common set of services (e.g. group management, location management) and reference points. The SEAL offers its services to the vertical application layer (VAL).

NOTE 2: The functionalities and reference points of the vertical application layer are out of scope of the present document.

NOTE 3: The vertical application layer may further consist of vertical application enabler layer functionalities (specified by 3GPP) and application specific functionalities, which is out of scope of the present document.

The SEAL client(s) communicates with the SEAL server(s) over the SEAL-UU reference points. SEAL-UU supports both unicast and multicast delivery modes. The SEAL client(s) provides the service enabler layer support functions to the VAL client(s) over SEAL-C reference points. The VAL server(s) communicate with the SEAL server(s) over the SEAL-S reference points. The SEAL server(s) may communicate with the underlying 3GPP network systems using the respective 3GPP interfaces specified by the 3GPP network system.

**Editor's Note: SEAL-UU support for multicast delivery is FFS.**

The specific SEAL client(s) and the SEAL server(s) along with their specific SEAL-UU reference points and the specific network interfaces of 3GPP network system used are described in the respective on-network functional model for each SEAL service.

Figure 6.2-2 illustrates the functional model for interconnection between SEAL servers.

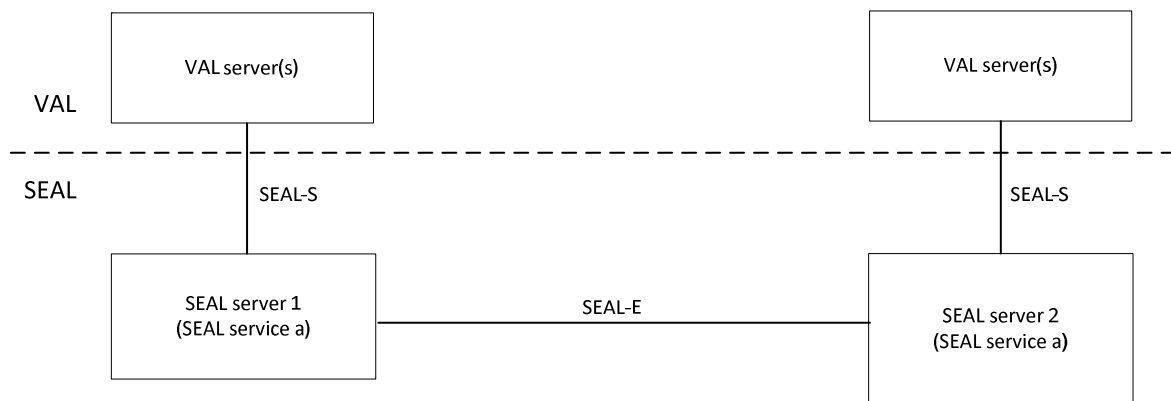

**Figure 6.2-2: Interconnection between SEAL servers**

To support distributed SEAL server deployments, the SEAL server interacts with another SEAL server for the same SEAL service over SEAL-E reference point.

Figure 6.2-3 illustrates the functional model for inter-service communication between SEAL servers.

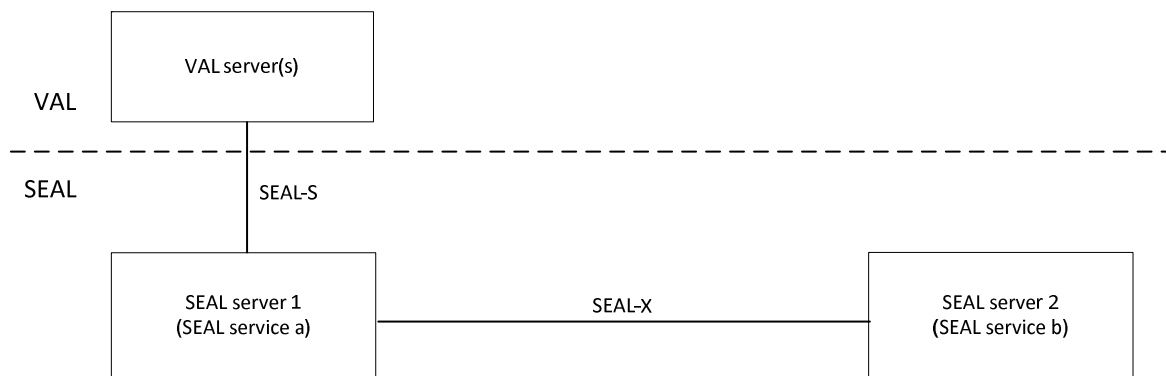

**Figure 6.2-3: Inter-service communication between SEAL servers**

The SEAL server interacts with another SEAL server for inter-service communication over SEAL-X reference point.

Figure 6.2-4 illustrates the functional model for communication between SEAL server and VAL user database.

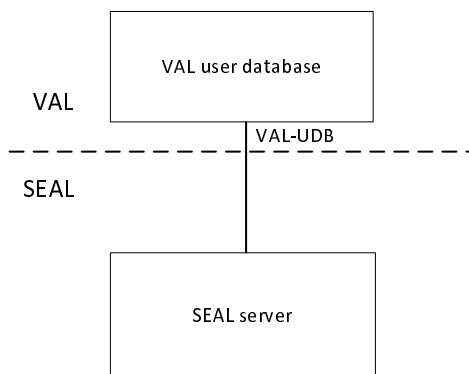

**Figure 6.2-4: Communication between SEAL server and VAL user database**

The SEAL server interacts with the VAL user database for storing and retrieving user profile over VAL-UDB reference point.

Figure 6.2-5 shows the functional model for the signalling control plane.

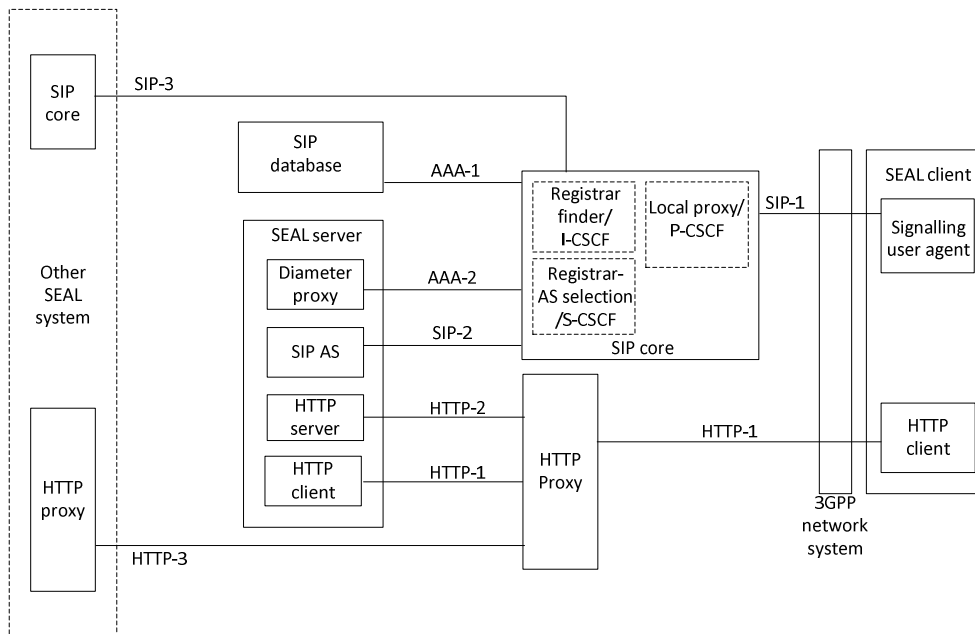

Figure 6.2-5: Functional model for signalling control plane

### 6.3 Off-network functional model description

Figure 6.3-1 illustrates the generic off-network functional model for SEAL.

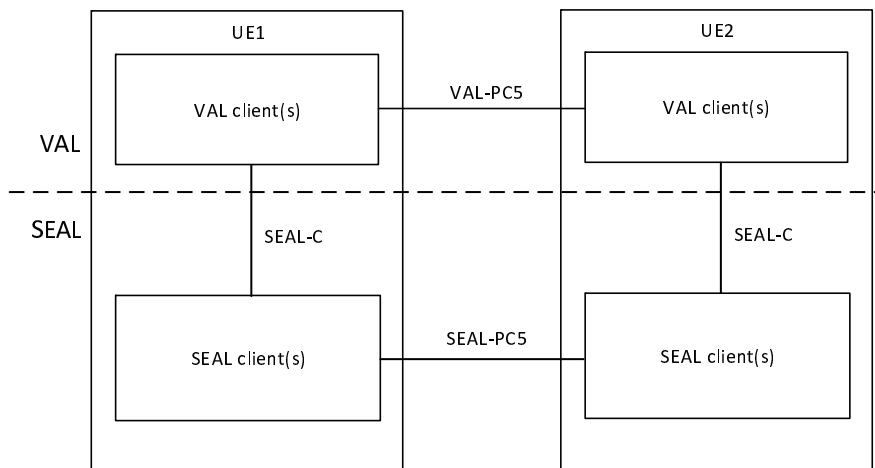

Figure 6.3-1: Generic off-network functional model

In the vertical application layer, the VAL client of UE1 communicates with VAL client of UE2 over VAL-PC5 reference point. A SEAL client of UE1 interacts with the corresponding SEAL client of UE2 over SEAL-PC5 reference points. The UE1, if connected to the network via Uu reference point, can also act as a UE-to-network relay, to enable UE2 to access the VAL server(s) over the VAL-UU reference point.

NOTE: The VAL-PC5 reference point is out of scope of the present document.

**Editor's Note: The functionalities of reference points between the SEAL clients of two UEs over SEAL-PC5 reference point is FFS.**

The specific SEAL client(s) along with their specific SEAL-PC5 reference points are described in the respective off-network functional model for each SEAL service.

## 6.4 Functional entities description

### 6.4.1 General

Each subclause is a description of a functional entity corresponding to SEAL and does not imply a physical entity.

### 6.4.2 Application plane

#### 6.4.2.1 General

Entities within the application plane of a VAL system provide application control and media specific functions to support one or more VAL services.

#### 6.4.2.2 VAL client

The VAL client provides the client side functionalities corresponding to the vertical applications (e.g. V2X client). The VAL client supports interactions with the SEAL client(s).

NOTE: The details of the VAL client is specific to the vertical and out of scope of the present document.

#### 6.4.2.3 VAL server

The VAL server provides the server side functionalities corresponding to the vertical applications (e.g. V2X application servers). The VAL server acts as CAPIF's API invoker as specified in 3GPP TS 23.222 [8].

NOTE: The details of the VAL server is specific to the vertical and out of scope of the present document.

#### 6.4.2.4 SEAL client

The SEAL client provides the client side functionalities corresponding to the specific SEAL service. The SEAL client(s) supports interactions with the VAL client(s). The SEAL client also supports interactions with the corresponding SEAL client between the two UEs.

NOTE: It is up to each SEAL client to support the appropriate signalling plane entities.

#### 6.4.2.5 SEAL server

The SEAL server provides the server side functionalities corresponding to the specific SEAL service. The SEAL server supports interactions with the VAL server(s). The SEAL server acts as CAPIF's API exposing function as specified in 3GPP TS 23.222 [8]. The SEAL server also supports interactions with the corresponding SEAL server in distributed SEAL deployments.

NOTE: It is up to each SEAL server to support the appropriate signalling plane entities.

#### 6.4.2.6 VAL user database

This functional entity contains information of the user profile associated with a VAL service that is served by the VAL service provider at the application plane.

Each VAL service may have a corresponding user database e.g. MCPTT user database as defined in 3GPP TS 23.379 [3], MCVideo user database as defined in 3GPP TS 23.281 [5] and MCDData user database as defined in 3GPP TS 23.282 [6].

NOTE: It is up to each SEAL server to support the appropriate signalling plane entities.

## 6.4.3 Signalling control plane

### 6.4.3.1 SIP entities

#### 6.4.3.1.1 Signalling user agent

This functional entity acts as the SIP user agent (both client and server) for all SIP transactions.

#### 6.4.3.1.2 SIP AS

The SIP AS functional entity supports the following functions on behalf of the VAL service:

- influencing and impacting the SIP session; and
- supporting event subscription and event notification.

NOTE: In the IM CN subsystem, this is provided by the Application Server as defined in 3GPP TS 23.002 [14].

#### 6.4.3.1.3 SIP core

##### 6.4.3.1.3.1 General

The SIP core contains a number of sub-entities responsible for registration, service selection and routing in the signalling control plane.

The SIP core shall be either:

1. compliant with 3GPP TS 23.228 [15], i.e. the SIP core is a 3GPP IP multimedia core network subsystem; or
2. a SIP core, which internally need not comply with the architecture of 3GPP TS 23.228 [15], but with the reference points that are defined in subclause 6.5.3 (if exposed), compliant to the reference points defined in 3GPP TS 23.002 [14].

The data related to the functions of the SIP core, e.g. for data for application service selection, the identity of the serving registrar or authentication related information may be provided by the PLMN operator responsible for the bearer plane. In this case, the SIP database that is the source of the data may be part of the HSS. Alternatively, this data may be provided by the VAL service provider. In this case, the source of the data may be the VAL service provider's SIP database.

##### 6.4.3.1.3.2 Local inbound / outbound proxy

The local inbound / outbound proxy functional entity acts as both an inbound proxy and an outbound proxy for all SIP transactions. This functional entity can provide the following functions:

- NAT traversal;
- Resource control;
- Route/forward requests and responses to the user agents;
- SIP signalling security; and
- Depending on the PLMN operator policy, discovery and address resolution, including E.164 numbers.

NOTE: In the IM CN subsystem, this functional entity is provided by the P-CSCF as defined in 3GPP TS 23.228 [15].

##### 6.4.3.1.3.3 Registrar finder

The registrar finder functional entity is responsible for:

- a) Identifying the serving registrar / application service selection functional entity. The serving registrar / application service selection functional entity is identified using information provided either by the PLMN



operator's own SIP database or the VAL service provider's SIP database, and optionally using the PLMN operator's internal information e.g. network topology, registrar availability.

- 1) Registrar finder and registrar in the VAL service provider domain: registrar finder in the VAL service provider's domain uses the information from the VAL service provider's SIP database to identify the serving registrar in the VAL service provider domain.
- 2) Registrar finder and registrar in the PLMN operator domain: registrar finder uses information from PLMN operator's SIP database to identify the serving registrar in the PLMN operator domain.
- 3) Registrar finder in PLMN operator domain and registrar in VAL service provider domain: registrar finder uses information from the VAL service provider's SIP database to identify the serving registrar in the VAL service provider domain.

NOTE 1: The need for the registrar finder is deployment specific e.g. a deployment that has only one registrar does not need the registrar finder and the related SIP database information.

b) Providing discovery and address resolution, including E.164 numbers.

NOTE 2: In the IM CN subsystem, this is provided by the I-CSCF as defined in 3GPP TS 23.228 [15].

#### 6.4.3.1.3.4 Registrar / application service selection

The registrar / application service selection functional entity provides the following functions:

- Registrar function (with integral provision of a location server) and also acts as an inbound proxy (with access to the integral location server), and outbound proxy for all SIP transactions where application service selection is required. It registers the user and maintains the association of the location and identity of the user in a location service. It provides notifications of the registration states.
- Supports authentication for identities provided within SIP signalling. Both the registrar (with integral location server) and authentication functions are supported by access either to the public network's own SIP database or the VAL service provider's SIP database.
- Can provide the application service selection for all SIP transactions, possibly based on application service selection information stored by either the public network's own SIP database or the VAL service provider's SIP database.
- Performs SIP signalling security.

NOTE: In the IM CN subsystem, this is provided by the S-CSCF as defined in 3GPP TS 23.228 [15].

#### 6.4.3.1.4 Diameter proxy

This functional entity acts as a proxy agent for Diameter messaging as specified in IETF RFC 6733 [24].

The Diameter proxy, when used on the AAA-2 interface, is collocated with the migration management server.

Other instances of the Diameter proxy may also be present in the SIP core / IMS.

NOTE: The number of instances of the Diameter proxy is deployment specific.

### 6.4.3.2 SIP database

#### 6.4.3.2.1 General

The SIP database contains information concerning the SIP subscriptions and corresponding identity and authentication information required by the SIP core, and such information as application service selection.

In deployment scenarios where the PLMN operator provides the SIP core, this database is provided by the HSS.

In deployment scenarios where the VAL service provider provides the SIP core, the SIP database may be provided by the VAL service provider.

Access to the data residing in the SIP database is restricted to the SIP core entities that are specifically serving the subscriber/user whose data are stored, i.e. registrars and registrar finders can access SIP databases only when they are part of the same trust domain for the data being provided.

NOTE: The SIP database can be in a different network than the registrar finder since the trust domain for the criteria for registrar selection can be different than the trust domain for the signalling plane user identities.

The SIP database is responsible for storing the following user related information:

- signalling plane user identities: Numbering and addressing information;
- signalling plane security information: SIP core access control information for authentication and authorization;
- VAL UE Location information at inter-system level: the SIP database supports the user registration, and stores inter-system location information, etc.; and
- signalling plane subscription profile (including initial filter criteria).

The SIP database also generates signalling plane security information for mutual authentication, communication integrity check and ciphering.

Based on this information, the SIP database is also responsible to support the call control and session management entities of the SIP core.

The SIP database consists of the following functionalities:

- support for control functions of the SIP core such as the Registrar and Registrar finder. This is needed to enable subscriber usage of the SIP core services. This functionality is independent of the access network used to access the SIP core; and
- authentication functionality required by the SIP core to authenticate the VAL UE.

#### 6.4.3.2.2 SIP database logical functions

The SIP database provides the following logical functions:

- a) mobility management;
  - provides the UE mobility through the SIP core.
- b) registrar assignment support;
  - provides to the registrar finder the required capabilities for VAL services based on VAL service provider requirements on a per-user basis, (e.g. whether a particular registrar within the PLMN operator's network (e.g. a registrar reserved for VAL service use or a registrar in a secure location) or a registrar within the VAL service provider network is assigned.
- c) call and/or session establishment support;
  - provides the call and/or session establishment procedures in the SIP core. For terminating traffic, it provides information on which registrar currently hosts the user.
- d) user security information generation;
  - provides generation of user authentication, integrity and ciphering data for the SIP core.
- e) signalling plane security support;
  - provides authentication procedures to access VAL services by storing the generated data for authentication, integrity and ciphering at the signalling plane and by providing these data to the appropriate registrar.
- f) user identification handling;
  - provides the appropriate relations among all the identifiers uniquely determining the signalling plane identities in the SIP core e.g. IMS public identities.
- g) access authorisation; and

- provides authorisation of the user for mobile access when requested by the registrar e.g. by checking that the user is allowed to roam to that visited network.

h) service authorisation support.

- provides basic authorisation for terminating call/session establishment and service invocation. The SIP database may update the registrar with filter criteria to trigger the VAL server(s).

### 6.4.3.3 HTTP entities

#### 6.4.3.3.1 HTTP client

This functional entity acts as the client for all hypertext transactions.

#### 6.4.3.3.2 HTTP proxy

This functional entity acts as a proxy for hypertext transactions between the HTTP client and one or more HTTP servers. The HTTP proxy terminates a TLS session on HTTP-1 with the HTTP client of the VAL UE allowing the HTTP client to establish a single TLS session for hypertext transactions with multiple HTTP servers that are reachable by the HTTP proxy.

The HTTP proxy terminates the HTTP-3 reference point that lies between different HTTP proxies. It may provide a topology hiding function from HTTP entities outside the trust domain of the VAL system.

The HTTP proxy shall be in the same trust domain as the HTTP clients and HTTP servers that are located within a VAL service provider's network. There can be multiple instances of an HTTP proxy e.g. one per trust domain.

NOTE: The number of instances of the HTTP proxy is deployment specific.

#### 6.4.3.3.3 HTTP server

This functional entity acts as the HTTP server for all hypertext transactions.

## 6.5 Reference points description

### 6.5.1 General reference point principle

The protocols on any reference point that is exposed for VAL service interoperability with other SIP core or other IMS entities in other systems shall be compatible with the protocols defined for the corresponding reference point defined in 3GPP TS 23.002 [14].

### 6.5.2 Application plane

#### 6.5.2.1 General

The reference points for the generic functional model for SEAL are described in the following subclauses.

#### 6.5.2.2 VAL-UU

The interactions related to vertical application layer support functions between VAL client and VAL server are supported by VAL-UU reference point. This reference point is an instance of Uu reference point as described in 3GPP TS 23.401 [9] and 3GPP TS 23.501 [10].

NOTE: The details of VAL-UU reference point is out of scope of the present document.

### 6.5.2.3 VAL-PC5

The interactions related to vertical application layer support functions between the VAL clients of two UEs are supported by VAL-PC5 reference point. This reference point is an instance of PC5 reference point as described in 3GPP TS 23.303 [12].

NOTE: The details of VAL-PC5 reference point is out of scope of the present document.

### 6.5.2.4 SEAL-UU

The interactions between a SEAL client and the corresponding SEAL server are generically referred to as SEAL-UU reference point. The specific SEAL service reference point corresponding to SEAL-UU is specified in the specific SEAL service functional model.

### 6.5.2.5 SEAL-PC5

The interactions between the SEAL clients of two VAL UEs are generically referred to as SEAL-PC5 reference point. The specific SEAL service reference point corresponding to SEAL-PC5 is specified in the specific SEAL service functional model.

### 6.5.2.6 SEAL-C

The interactions between the VAL client(s) and the SEAL client(s) within a VAL UE are generically referred to as SEAL-C reference point. The specific SEAL service reference point corresponding to SEAL-C is specified in the specific SEAL service functional model.

### 6.5.2.7 SEAL-S

The interactions between the VAL server and the SEAL server are generically referred to as SEAL-S reference point. The specific SEAL service reference point corresponding to SEAL-S is specified in the specific SEAL service functional model.

### 6.5.2.8 SEAL-E

The interactions between the SEAL servers of the same type are generically referred to as SEAL-E reference point. The specific SEAL service reference point corresponding to SEAL-E is specified in the specific SEAL service functional model.

### 6.5.2.9 SEAL-X

#### 6.5.2.9.1 General

The interactions between the SEAL servers of different type are generically referred to as SEAL-X reference point. The specific SEAL server interactions corresponding to SEAL-X are described in the following subclauses.

#### 6.5.2.9.2 Reference point SEAL-X1 (between the key management server and the group management server)

The SEAL-X1 reference point, which exists between the key management server and the group management server, provides a means for the key management server to provide security related information (e.g. encryption keys) to the group management server.

The SEAL-X1 reference point shall use the HTTP-1 and HTTP-2 reference points and may use the HTTP-3 reference point for transport and routing of security related information to the group management server.

NOTE: SEAL-X1 is specified in subclause 5.1.1.1 of 3GPP TS 33.434 [29].

#### 6.5.2.9.3 Reference point SEAL-X2 (between the group management server and the location management server)

The SEAL-X2 reference point enables the group management server to interact with the location management server.

The SEAL-X2 reference point supports:

- the group management server to create a location-based group with the help from the location management server.

#### 6.5.2.10 Reference point VAL-UDB (between the VAL user database and the SEAL server)

The VAL-UDB reference point, which exists between the VAL user database and the SEAL server, is used for:

- storing the user profile data in the specific VAL user database; and
- obtaining the user profile from the specific VAL user database for further configuration in the UE.

NOTE: The details of the VAL-UDB reference point is out of scope of the present document.

### 6.5.3 Signalling control plane

#### 6.5.3.1 General

The reference points for the SIP and HTTP signalling are described in the following subclauses.

#### 6.5.3.2 Reference point SIP-1 (between the signalling user agent and the SIP core)

The SIP-1 reference point, which exists between the signalling user agent and the SIP core for establishing a session in support of VAL service, shall use the Gm reference point as defined in 3GPP TS 23.002 [14] (with necessary enhancements to support VAL service requirements and profiled to meet the minimum requirements for support of VAL service). The SIP-1 reference point fulfils the requirements of the GC1 reference point specified in 3GPP TS 23.468 [16]. The SIP-1 reference point is used for:

- SIP registration;
- authentication and security to the service layer;
- event subscription and event notification;
- communication of the TMGI for multicast operation;
- overload control;
- session management; and
- media negotiation.

#### 6.5.3.3 Reference point SIP-2 (between the SIP core and the SIP AS)

The SIP-2 reference point, which exists between the SIP core and the SIP AS for establishing a session in support of VAL service, shall use the ISC and Ma reference points as defined in 3GPP TS 23.002 [14]. The SIP-2 reference point is used for:

- notification to the VAL service server(s) of SIP registration by the VAL UE;
- authentication and security to the service layer;
- event subscription and event notification;
- communication of the TMGI for multicast operation;

- session management; and
- media negotiation.

#### 6.5.3.4 Reference point SIP-3 (between the SIP core and SIP core)

The SIP-3 reference point, which exists between one SIP core and another SIP core for establishing a session in support of VAL service, shall use the Mm and ICi reference points as defined in 3GPP TS 23.002 [14]. The SIP-3 reference point is used for:

- event subscription and event notification;
- session management; and
- media negotiation.

**Editor's note: it is FFS whether changes are needed to SIP-3 when used between servers in different trust domains.**

#### 6.5.3.5 Reference point HTTP-1 (between the HTTP client and the HTTP proxy)

The HTTP-1 reference point exists between the HTTP client and the HTTP proxy. Between the VAL UE and the HTTP proxy, the HTTP-1 reference point shall use the Ut reference point as defined in 3GPP TS 23.002 [14] (with necessary enhancements to support specific VAL service requirements). The HTTP-1 reference point is based on HTTP (which may be secured using e.g. SSL, TLS).

#### 6.5.3.6 Reference point HTTP-2 (between the HTTP proxy and the HTTP server)

The HTTP-2 reference point, which exists between the HTTP proxy and the HTTP server, is based on HTTP (which may be secured using e.g. SSL, TLS).

#### 6.5.3.7 Reference point HTTP-3 (between the HTTP proxy and HTTP proxy)

The HTTP-3 reference point, which exists between the HTTP proxy and another HTTP proxy in a different network, is based on HTTP (which may be secured using e.g. SSL, TLS).

**Editor's note: it is FFS whether changes are needed to HTTP-3 when used between servers in different trust domains.**

#### 6.5.3.8 Reference point AAA-1 (between the SIP database and the SIP core)

The AAA-1 reference point, which exists between the SIP database and the SIP core, is used by the SIP core to retrieve signalling plane data from the SIP database. The AAA-1 reference point utilises the Cx reference point as defined in 3GPP TS 23.002 [14].

In some deployment scenarios the registrar and SIP database are located in the VAL service provider's network while the registrar finder is in the PLMN operator's network and the AAA-1 reference point is an inter-network interface.

#### 6.5.3.9 Reference point AAA-2 (between the SIP core and Diameter proxy)

The AAA-2 reference point, which exists between the SIP core / IMS and Diameter proxy for SIP registration during migration, shall use the Cx reference point as defined in 3GPP TS 23.002 [14]. The AAA-2 reference point is used for:

- authentication and security to the service layer for migration;

---

## 7 Identities

### 7.1 User identity (User ID)

The VAL user presents the user identity to the identity management server during a user authentication transaction, to provide the identity management client a means for VAL service authentication. In general, since identity management is a common SEAL service, it uses a set of credentials (e.g. biometrics, secureID, username/password) that may not necessarily be tied to a single VAL service. The user credentials uniquely identifies the VAL user to the identity management server.

NOTE: The specific security and authentication mechanisms required in order to use the user ID is specified in 3GPP TS 33.434 [29].

*Editor's note: The naming and definition of the identities in subclause 7 may require further study (e.g. renaming user identity to VAL user identity, and renaming VAL user identity to VAL service user identity).*

### 7.2 VAL user identity (VAL user ID)

The VAL user ID is a unique identifier within the VAL service that represents the VAL user. For example, the VAL user ID may be a URI. The VAL user ID is used for authentication and authorization purposes for providing the VAL service towards the VAL user via the VAL UE. The VAL user ID also indicates the VAL service provider with whom the VAL user has a VAL service agreement. The VAL user may have VAL service agreement with several VAL service providers and thus will have obtained unique VAL user ID per VAL service provider. The VAL user ID can be used to access any SEAL service.

### 7.3 VAL UE identity (VAL UE ID)

The VAL UE ID is a unique identifier within the VAL service that represents the VAL UE. For example, the VAL UE ID for V2X service is mapped to the StationID as specified in ETSI TS 102 894-2 [25]. The VAL UE ID is used to address the VAL UE in order to send VAL messages.

### 7.4 VAL service identity (VAL service ID)

The VAL service ID is a unique identifier that represents the VAL service. A VAL server provides a list of VAL services towards the VAL users or VAL UE. Each VAL service is uniquely identified by a VAL service ID, which is an identifier of the VAL application providing that VAL service. The VAL service ID can be used for policy mapping, QoS handling for VAL communication and VAL message distribution. For example, an identifier of a V2X service, e.g. ITS-AID or PSID specified in ETSI TS 102 965 [26] and ISO TS 17419 [27], can be used as a V2X service ID.

### 7.5 VAL group identity (VAL group ID)

The VAL group ID is a unique identifier within the VAL service that represents a set of VAL users or VAL UE according to the VAL service. The set of VAL users may belong to the same or different VAL service providers. It indicates the VAL application server where the group is defined.

### 7.6 VAL system identity (VAL system ID)

The VAL system ID is a globally unique identifier representing a VAL system.

## 8 Application of functional model to deployments

### 8.1 General

This clause describes deployments of the functional model specified in clause 6.

### 8.2 Deployment of SEAL server(s)

The SEAL server(s) may be deployed either in the PLMN operator domain or deployed in the VAL service provider domain. The SEAL server(s) connects with the 3GPP network system in one or more PLMN operator domain. The SEAL server(s) may be supporting multiple VAL servers.

#### 8.2.1 SEAL server(s) deployment in PLMN operator domain

Figure 8.2.1-1 illustrates deployment of the SEAL server(s) in a single PLMN operator domain and the VAL server(s) in the VAL service provider domain.

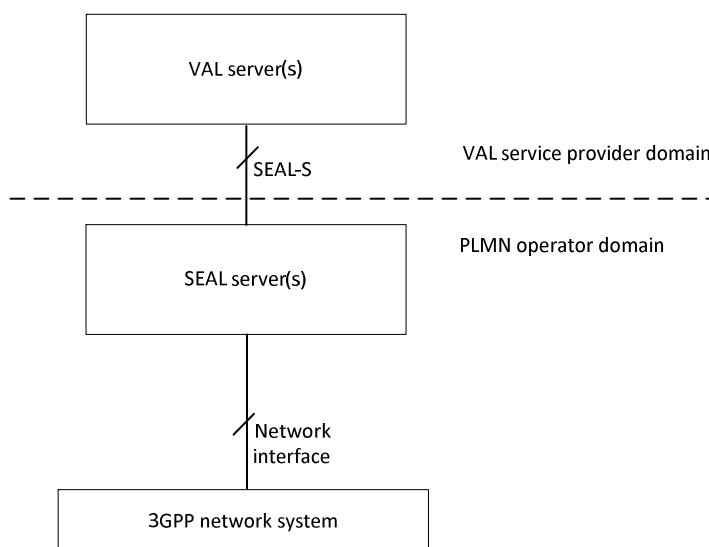

**Figure 8.2.1-1: SEAL server(s) deployed in a single PLMN operator domain**

Figure 8.2.1-2 illustrates the deployment of SEAL server(s) in multiple PLMN operator domain and provides SEAL services to the VAL server(s) deployed in the VAL service provider domain. SEAL servers deployed in multiple PLMN operator domain are not interconnected.



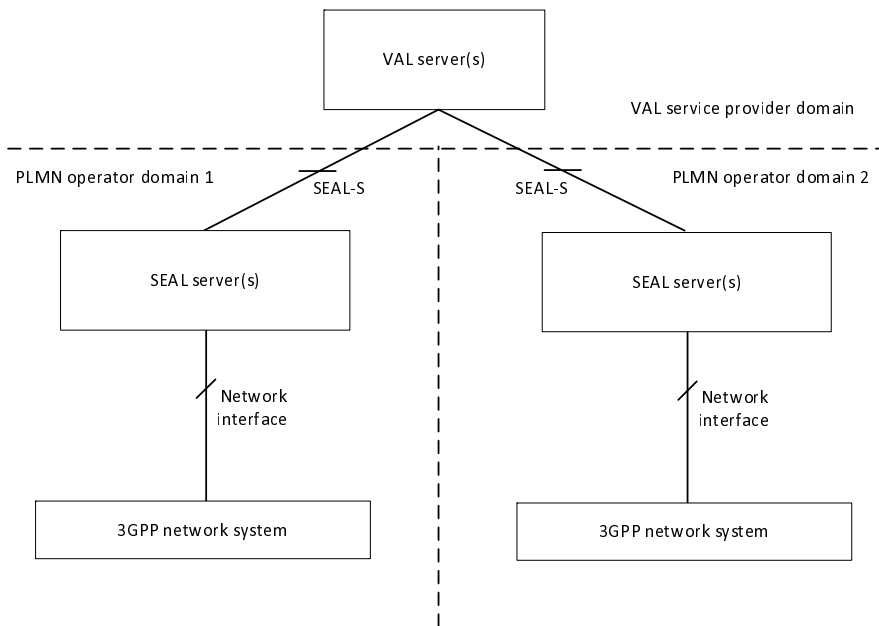

**Figure 8.2.1-2: SEAL server(s) deployed in multiple PLMN operator domain without interconnection between SEAL servers**

Figure 8.2.1-3 illustrates the deployment of SEAL servers in multiple PLMN operator domain and provides SEAL services to the VAL server(s) deployed in the VAL service provider domain. SEAL servers deployed in multiple PLMN operator domain are interconnected.

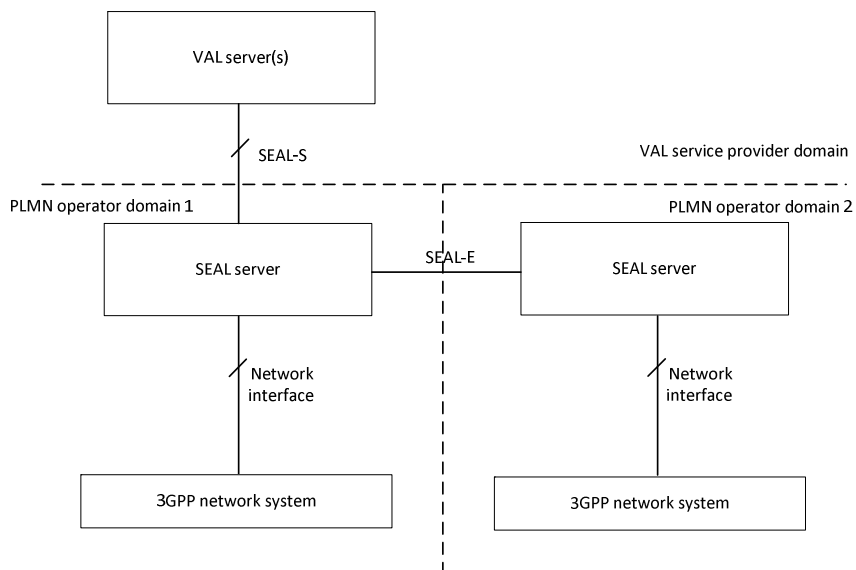

**Figure 8.2.1-3: SEAL server(s) deployed in multiple PLMN operator domain with interconnection between SEAL servers**

Figure 8.2.1-4 illustrates the deployment of SEAL servers in a single PLMN operator domain and provides SEAL services to the VAL server(s) deployed in the VAL service provider domain. SEAL servers deployed in a single PLMN operator domain are interconnected.

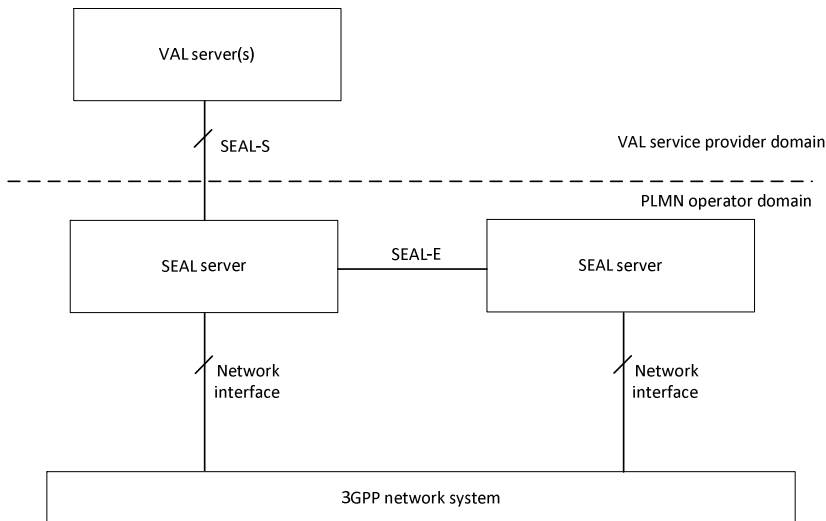

**Figure 8.2.1-4: SEAL server(s) deployed in a single PLMN operator domain with interconnection between SEAL servers**

### 8.2.2 SEAL server(s) deployment in VAL service provider domain

Figure 8.2.2-1 illustrates deployment of the SEAL server(s) and the VAL server(s) in VAL service provider domain.

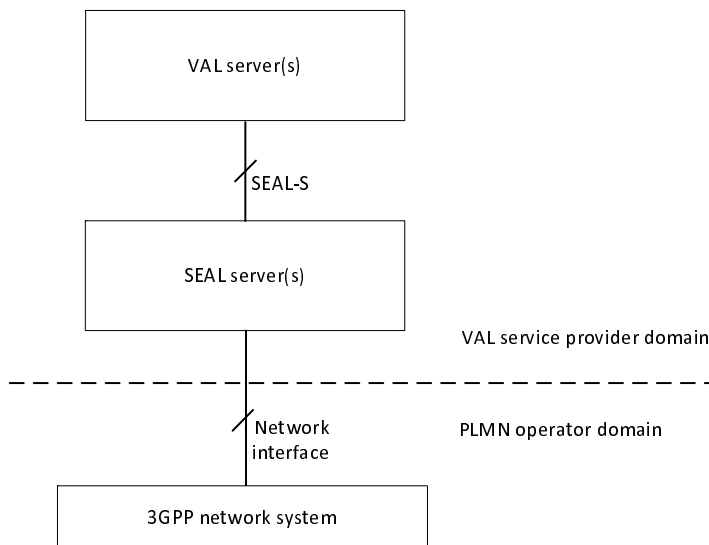

**Figure 8.2.2-1: Deployment of SEAL server(s) with connections to 3GPP network system in a single PLMN operator domain**

Figure 8.2.2-2 illustrates deployment of the SEAL server(s) which connects to the 3GPP network system in multiple PLMN operator domain.

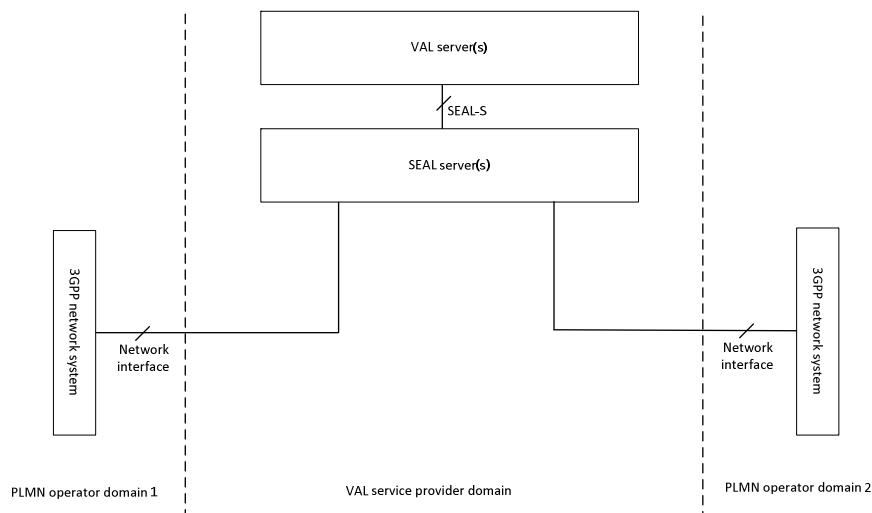

**Figure 8.2.2-2: Deployment of SEAL server(s) with connections to 3GPP network system in multiple PLMN operator domains**

Figure 8.2.2-3 illustrates the deployment of multiple SEAL servers in the VAL service provider domain where SEAL server 1 and SEAL server 2 connect with 3GPP network system of PLMN operator domain 1 and PLMN operator domain 2 respectively. The SEAL servers interconnect via SEAL-E and support the VAL service provider domain applications for the VAL UEs connected via both the PLMN operator domains.

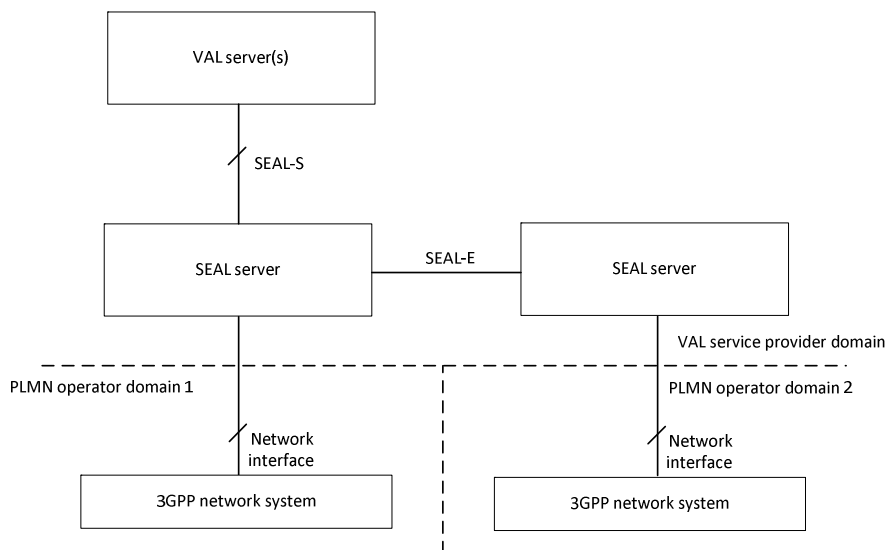

**Figure 8.2.2-3: Distributed deployment of SEAL servers in VAL service provider domain**

### 8.2.3 SEAL server(s) deployment outside of VAL service provider domain and PLMN operator domain

Figure 8.2.3-1 illustrates deployment of the SEAL server(s) outside of both the VAL service provider domain and PLMN operator domain i.e. in SEAL provider domain.

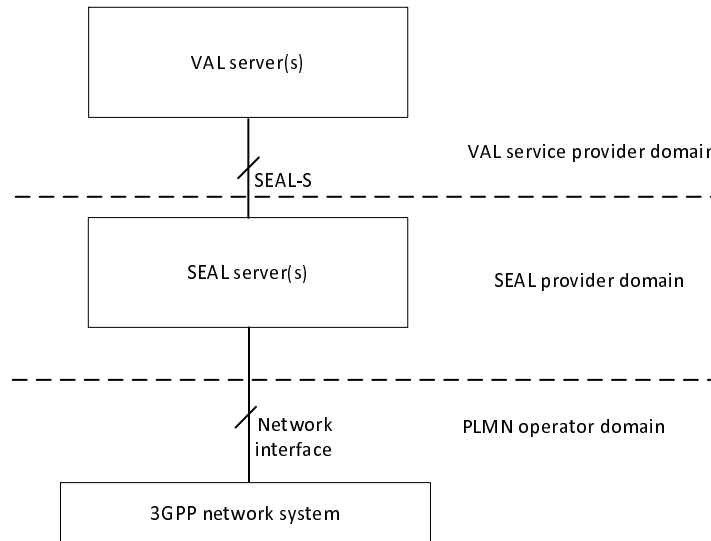

**Figure 8.2.3-1: Deployment of SEAL server(s) outside of VAL service domain and PLMN operator domain**

---

## 9 Location management

### 9.1 General

The location management is a SEAL service that offers the location management related capabilities to one or more vertical applications.

### 9.2 Functional model for location management

#### 9.2.1 General

The functional model for the location management is based on the generic functional model specified in clause 6. It is organized into functional entities to describe a functional architecture which addresses the support for location management aspects for vertical applications. The on-network and off-network functional model is specified in this clause.

#### 9.2.2 On-network functional model description

Figure 9.2.2-1 illustrates the generic on-network functional model for location management.

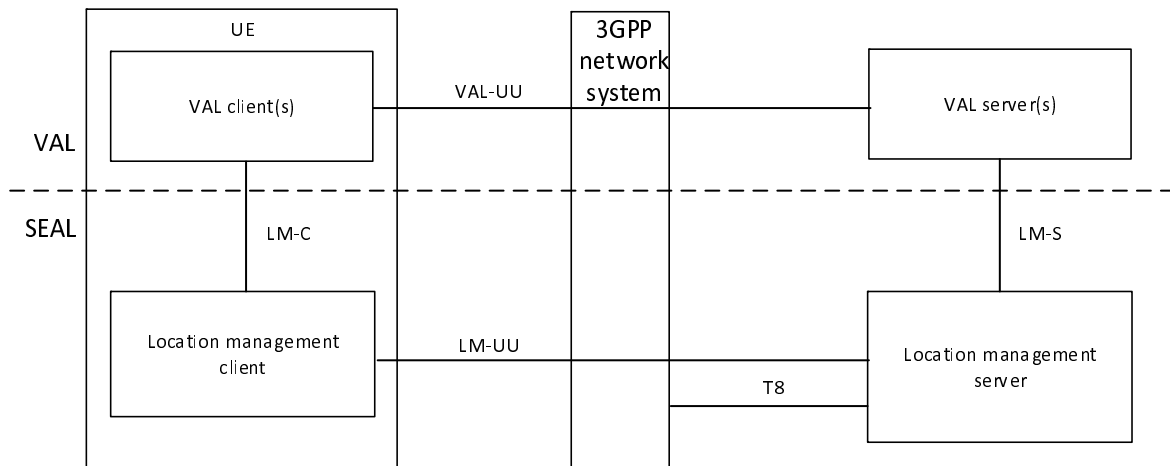

**Figure 9.2.2-1: On-network functional model for location management**

The location management client communicates with the location management server over the LM-UU reference point. The location management client provides the support for location management functions to the VAL client(s) over LM-C reference point. The VAL server(s) communicate with the location management server over the LM-S reference point.

The location management server communicates with the SCEF via T8 reference point to obtain location information from the underlying 3GPP network system.

NOTE: Location information from LCS of 4G system is not exposed by SCEF.

### 9.2.3 Off-network functional model description

Figure 9.2.3-1 illustrates the off-network functional model for location management.

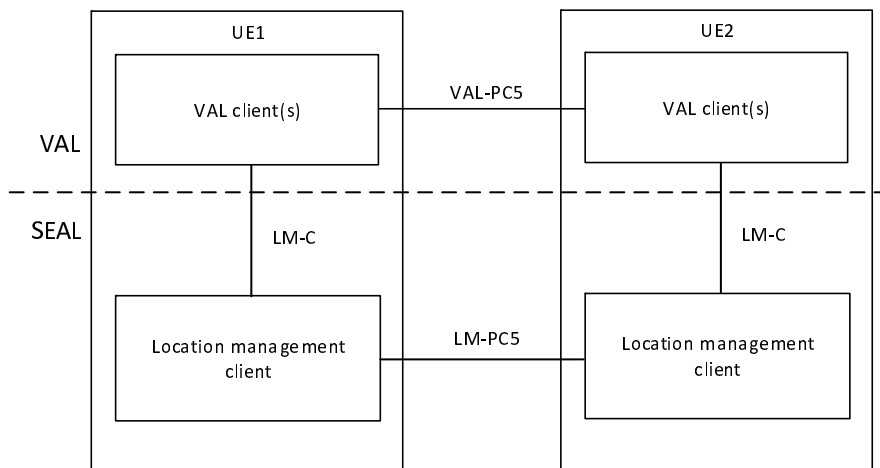

**Figure 9.2.3-1: Off-network functional model for location management**

The location management client of the UE1 communicates with the location management client of the UE2 over the LM-PC5 reference point.

### 9.2.4 Functional entities description

#### 9.2.4.1 General

The functional entities for location management SEAL service are described in the following subclauses.

### 9.2.4.2 Location management client

The location management client functional entity acts as the application client for location management functions. It interacts with the location management server. The location management client also supports interactions with the corresponding location management client between the two UEs.

### 9.2.4.3 Location management server

The location management server is a functional entity that receives and stores user location information and provides user location information to the vertical application server. The location management server may also acquire location information provided by PLMN operator via T8 reference point. The location management server acts as CAPIF's API exposing function as specified in 3GPP TS 23.222 [8]. The location management server also supports interactions with the corresponding location management server in distributed SEAL deployments.

NOTE: The accuracy of location information acquired from 4G system via T8 reference point is not higher than at cell level (ECGI) for E-UTRAN.

## 9.2.5 Reference points description

### 9.2.5.1 General

The reference points for the functional model for location management are described in the following subclauses.

### 9.2.5.2 LM-UU

The interactions related to location management functions between the location management client and the location management server are supported by LM-UU reference point. This reference point utilizes Uu reference point as described in 3GPP TS 23.401 [9] and 3GPP TS 23.501 [10].

LM-UU reference point provides a means for the location management server to receive location information report from the location management client. The LM-UU reference point shall use SIP-1 and SIP-2 reference points for subscription/notification related signalling. And for transport and routing of location management related signalling LM-UU reference point uses the HTTP-1 and HTTP-2 signalling control plane reference points.

### 9.2.5.3 LM-PC5

The interactions related to location management functions between the location management clients located in different VAL UEs are supported by LM-PC5 reference point. This reference point utilizes PC5 reference point as described in 3GPP TS 23.303 [12].

### 9.2.5.4 LM-C

The interactions related to location management functions between the VAL client(s) and the location management client within a VAL UE are supported by LM-C reference point.

### 9.2.5.5 LM-S

The interactions related to location management functions between the VAL server(s) and the location management server are supported by LM-S reference point. This reference point is an instance of CAPIF-2 reference point as specified in 3GPP TS 23.222 [8].

LM-S reference point is used by the VAL server to request and receive location information from location management server. The LM-S reference point shall use SIP-1 and SIP-2 reference points for subscription/notification related signalling. And for transport and routing of location management related signalling LM-S reference point uses the HTTP-1 and HTTP-2 signalling control plane reference points.

### 9.2.5.6 LM-E

The interactions related to location management functions between the location management servers in a distributed deployment are supported by LM-E reference point.

Editor's Note: The functions enabled over LM-E reference point is FFS.

### 9.2.5.7 T8

The reference point T8 supports the interactions between the location management server and the SCEF and is specified in 3GPP TS 23.682 [13]. The functions related to location management of T8 are supported by the location management server.

## 9.3 Procedures and information flows for Location management (on-network)

### 9.3.1 General

Location information of VAL service user shall be provided by the location management client to the location management server. The location information reporting triggers are based on the location reporting configuration. Different type of location information can be provided.

### 9.3.2 Information flows for location information

#### 9.3.2.0 Location reporting configuration request

Table 9.3.2.0-1 describes the information flow from the location management client to the location management server for requesting the location reporting configuration.

**Table 9.3.2.0-1: Location reporting configuration request**

Information element	Status	Description
Identity	M	Identity of the VAL user or identity of the VAL UE.

#### 9.3.2.1 Location reporting configuration response

Table 9.3.2.1-1 describes the information flow from the location management server to the location management client for the location reporting configuration. This information flow may be sent individually addressed or group addressed on unicast or multicast.

**Table 9.3.2.1-1: Location reporting configuration response**

Information element	Status	Description
Identity	M	Identity of the VAL user or VAL group to which the location reporting configuration is targeted or identity of the VAL UE.
Requested location information	O (NOTE)	Identifies what location information is requested
Triggering criteria	O (NOTE)	Identifies when the location management client will send the location report
Minimum time between consecutive reports	O (NOTE)	Defaults to 0 if absent otherwise indicates the time interval between consecutive reports
NOTE:	If none of the information element is present, this represents a cancellation for location reporting.	

#### 9.3.2.2 Location information report

Table 9.3.2.2-1 describes the information flow from the location management client to the location management server for the location information reporting or from the location management server to the requesting location management client or VAL server to report location information.

**Table 9.3.2.2-1: Location information report**

Information element	Status	Description
Set of identities	M	Set of identities of the reporting VAL users or VAL UEs
Triggering event	M	Identity of the event that triggered the sending of the report
Location Information	M	Location information

### 9.3.2.3 Location information request

Table 9.3.2.3-1 describes the information flow from the VAL server to the location management server and from the location management server to the location management client for requesting an immediate location information report.

**Table 9.3.2.3-1: Location information request**

Information element	Status	Description
Identity list	M	List of VAL users or VAL UEs whose location information is requested

### 9.3.2.4 Location reporting trigger

Table 9.3.2.4-1 describes the information flow from the location management client or VAL server to the location management server for triggering a location reporting procedure.

**Table 9.3.2.4-1: Location reporting trigger**

Information element	Status	Description
Identity	M (NOTE 1)	Identity of the requesting authorized VAL user or VAL UE
Identity	M (NOTE 1)	Identity of the requested VAL user or VAL UE
Immediate Report Indicator	O (NOTE 2)	Indicates whether an immediate location report is required
Requested location information	O (NOTE 2)	Identifies what location information is requested
Triggering criteria	O (NOTE 2)	Identifies when the requesting client/VAL server is expecting to receive the location report from the requested VAL user/ VAL UE
Minimum time between consecutive reports	O (NOTE 2)	Defaults to 0 if absent otherwise indicates the interval time between consecutive reports
Endpoint information	O	Information of the endpoint of the requesting VAL server to which the location report notification has to be sent. It is provided if Immediate Report Indicator is set to required.
NOTE 1: The identity of the requesting VAL user/UE and the requested VAL user/UE should belong to the same VAL service.		
NOTE 2: At least one of these rows shall be present.		

### 9.3.2.5 Location information subscription request

Table 9.3.2.5-1 describes the information flow from the VAL server or location management client to the location management server for location information subscription request.



**Table 9.3.2.5-1: Location information subscription request**

Information element	Status	Description
Identity	M	Identity of the requesting VAL server/VAL user or VAL UE
Identities list	M	List of VAL users or VAL UEs whose location information is requested.
Time between consecutive reports	M	It indicates the interval time between consecutive reports

### 9.3.2.6 Location information subscription response

Table 9.3.2.6-1 describes the information flow from the location management server to the VAL server or location management client for location information subscription response.

**Table 9.3.2.6-1: Location information subscription response**

Information element	Status	Description
Identity	M	Identity of the requesting VAL server/VAL user or VAL UE
Subscription status	M	It indicates the subscription result

### 9.3.2.7 Location information notification

Table 9.3.2.7-1 describes the information flow from the location management server to the VAL server or the location management client.

**Table 9.3.2.7-1: Location information notification**

Information element	Status	Description
Identities list	M	List of the VAL users or VAL UEs whose location information needs to be notified
Identity	M	Identity of the VAL user or VAL UE subscribed to location of another VAL user or VAL UE (NOTE)
Triggering event	M	Identity of the event that triggered the sending of the notification
Location Information	M	Location information
NOTE: This is only used for location management server sends location information notification to the VAL user or VAL UE who has subscribed the location.		

### 9.3.2.8 Location reporting configuration cancel request

Table 9.3.2.8-1 describes the location reporting configuration cancel request information flow from the location management client or VAL server to the location management server.

**Table 9.3.2.8-1: Location reporting configuration cancel request**

Information element	Status	Description
Identity	M	Identity of the requesting authorized VAL user or VAL UE
Identity	M	Identity of the requested VAL user or VAL UE

## 9.3.3 Event-triggered location reporting procedure

### 9.3.3.1 General

The location management server provides location reporting configuration to the location management clients, indicating what information the location management server expects and what events will trigger the sending of this

information to the location management server. The decision to report location information can be triggered at the location management client by different conditions, e.g., the reception of the location reporting configuration, initial registration, distance travelled, elapsed time, cell change, MBMS SAI change, MBMS session change, leaving a specific MBMS bearer service area, tracking area change, PLMN change, call initiation, or other types of events such as emergency. The location report can include information described as ECGI, MBMS SAIs, geographic coordinates and other location information.

### 9.3.3.2 Fetching location reporting configuration

Figure 9.3.3.2-1 illustrates the procedure for fetching location reporting configuration.

Pre-condition:

- If multicast delivery mode is used, the MBMS bearer being used is activated by the location management server.
- The location management client is aware that the location reporting configuration is available at the location management server.

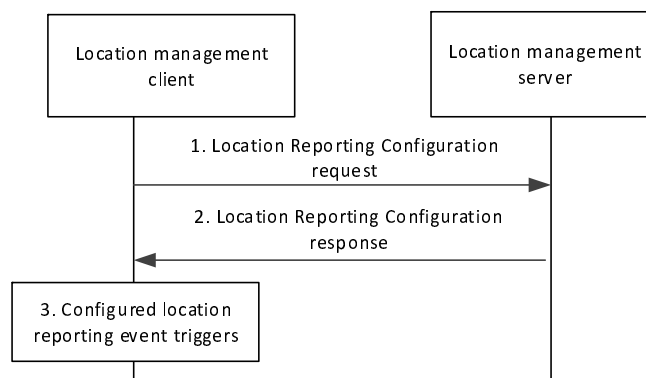

**Figure 9.3.3.2-1: Fetching location reporting configuration procedure**

1. The location management client sends location reporting configuration request message to the location management server.
2. The location management server sends location reporting configuration message to the location management client(s) containing the initial location reporting event triggers configuration (or a subsequent update), e.g. minimum time between consecutive reports, SAI changes, or ECGI changes for reporting the location of the VAL UE. This message can be sent over a unicast bearer to a specific location management client or as a group message over an MBMS bearer to update the location reporting configuration for multiple location management clients at the same time.

NOTE 1: The location reporting configuration information can be made part of the user profile, in which case the sending of the message is not necessary.

NOTE 2: Different location management clients may be given different location reporting criteria.

3. The location management client stores or updates the location reporting event triggers configuration. A location reporting event occurs, triggering step 3.

### 9.3.3.3 Location reporting

Figure 9.3.3.3-1 illustrates the procedure for location reporting.

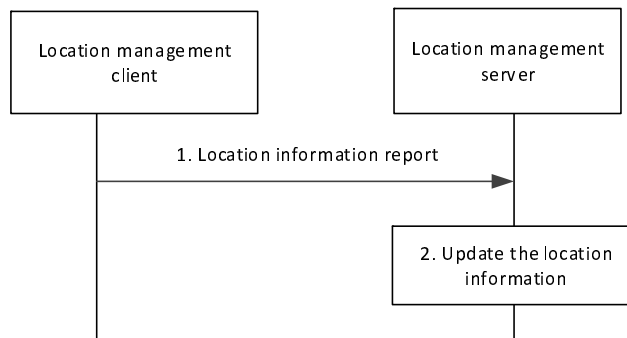
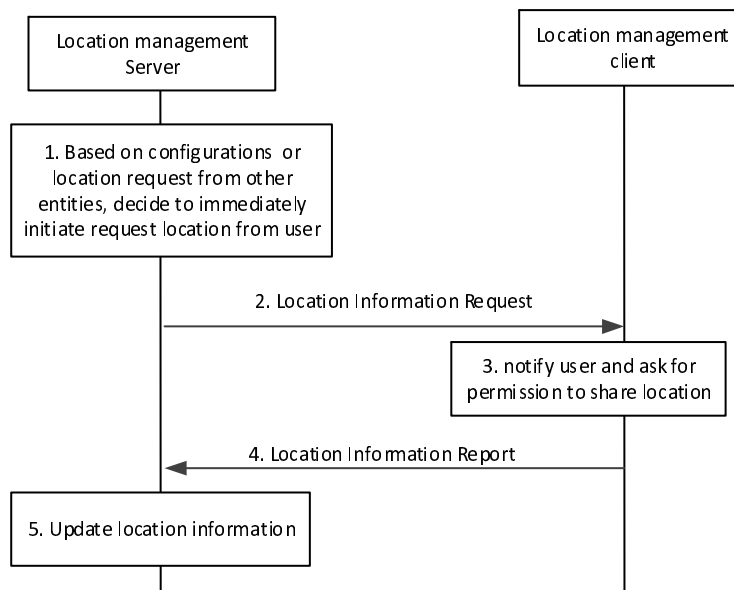

**Figure 9.3.3.3-1: Location reporting procedure**

1. The location management client sends a location information report to the location management server, containing location information identified by the location management server and available to the location management client.
2. Upon receiving the report, the location management server updates location of the reporting location management client. If the location management server does not have location information of the reporting location management client before, then just stores the reporting location information for that location management client.

### 9.3.4 On-demand location reporting procedure

The location management server can request UE location information at any time by sending a location information request to the location management client, which may trigger location management client to immediately send the location report.



**Figure 9.3.4-1: On-demand location information reporting procedure**

1. Based on configurations such as periodical location information timer, or location information request from other entities (e.g., another location management client, VAL server), location management server initiates the immediately request location information from the location management client.
2. The location management server sends a location information request to the location management client.
3. VAL user or VAL UE is notified and asked about the permission to share its location. VAL user can accept or deny the request

4. The location management client immediately responds to the location management server with a report containing location information identified by the location management server and available to the location management client.
5. Upon receiving the report, the location management server updates location of the reporting location management client. If the location management server does not have location information of the reporting location management client before, then just stores the reporting location information for that location management client.

### 9.3.5 Client-triggered or VAL server-triggered location reporting procedure

Figure 9.3.5-1 illustrates the high level procedure of client-triggered or VAL server-triggered location reporting.

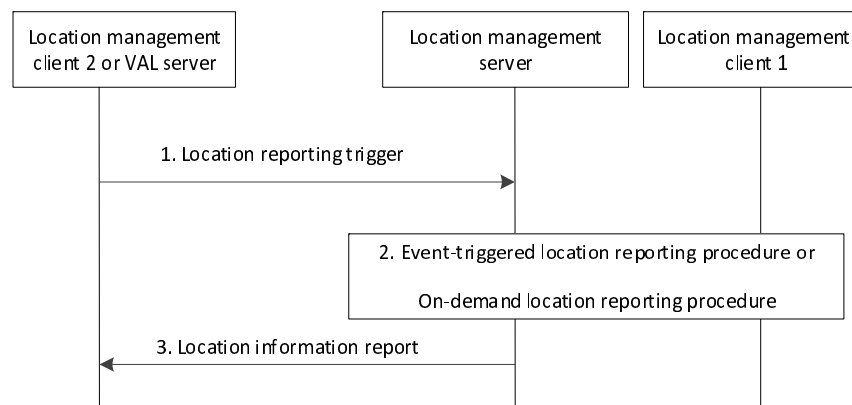

**Figure 9.3.5-1: Client-triggered location reporting procedure**

1. Location management client 2 (authorized VAL user or VAL UE) or VAL server sends a location reporting trigger to the location management server to activate a location reporting procedure for obtaining the location information of location management client 1.

NOTE: Step 1 can be performed when Location management client 2 or VAL server require to update the location reporting trigger.

2. Location management server checks whether location management client 2 or VAL server is authorized to send a location reporting trigger. Depending on the information specified by the location reporting trigger, location management server initiates an on-demand location reporting procedure or an event-triggered location reporting procedure for the location of location management client 1.
3. Once the location information of the location management client 1 is available in the location management server by the on-demand location reporting procedure, a location information report is sent to the location management client 2 or VAL server.

### 9.3.6 Location reporting triggers configuration cancel

Figure 9.3.6-1 illustrates the procedure used for cancelling the location reporting triggers configuration at the target Location management client.

Pre-conditions:

1. The location management server has subscribed the location management client 2 location with the location reporting event triggers.
2. If multicast delivery mode is used, the MBMS bearer being used is activated by the location management server.

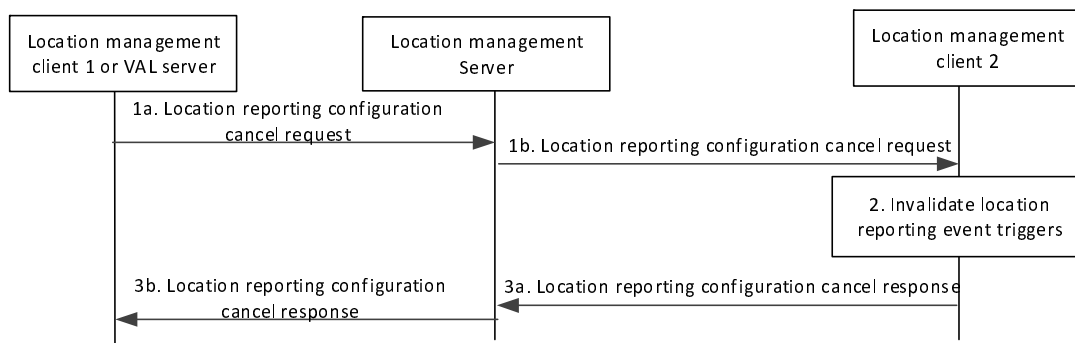

**Figure 9.3.6-1: Location reporting triggers configuration cancel**

1. The location management client 1 (authorized VAL user or VAL UE) or VAL server sends a location reporting configuration cancel request to the location management server (1a). The location management server sends the location reporting configuration cancel request to the location management client 2 to stop receiving the UE location information (1b). This message can be sent via unicast or multicast.

NOTE: Step 1b can be initiated without step 1a.

2. The location management client invalidates the location reporting triggers configuration and no longer reports its location to the location management server.
3. The location management client 2 sends the location reporting configuration cancel response to the location management server (3a) as an acknowledgement. The location management server sends the location reporting configuration cancel response to the location management client 1 (3b) as an acknowledgement.

### 9.3.7 Location information subscription procedure

Figure 9.3.7-1 illustrates the high level procedure of location information subscription request. The same procedure can be applied for location management client and other entities that would like to subscribe to VAL user or VAL UE location information.

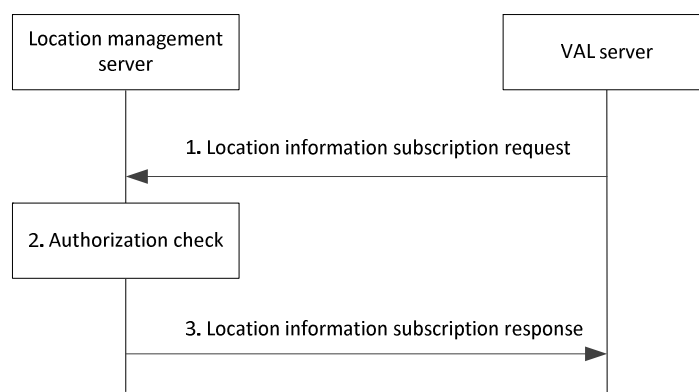

**Figure 9.3.7-1: Location information subscription request procedure**

1. VAL server sends a location information subscription request to the location management server to subscribe location information of one or more VAL users or VAL UEs.
2. The location management server shall check if the VAL server is authorized to initiate the location information subscription request.

3. The location management server replies with a location information subscription response indicating the subscription status.

### 9.3.8 Event-trigger location information notification procedure

Figure 9.3.8-1 illustrates the high level procedure of event-trigger usage of location information. The same procedure can be applied for location management client and other entities that would like to subscribe to location information of VAL user or VAL UE.

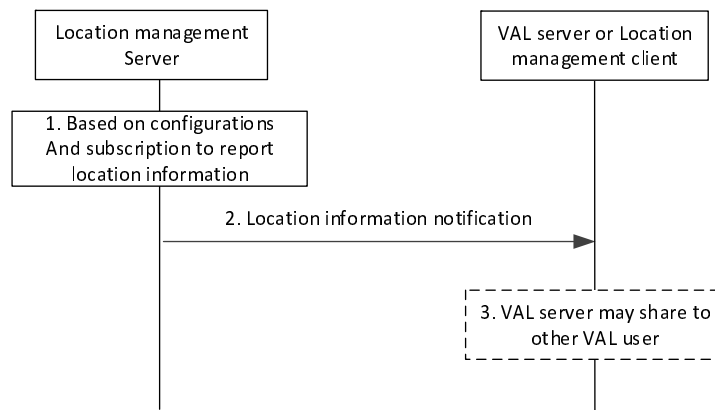

**Figure 9.3.8-1: Event-trigger usage of location information procedure**

1. Based on the configurations, e.g., subscription, periodical location information timer, location management server is triggered to report the latest user location information to VAL server.
2. The location management server sends the location information report including the latest location information of one or more VAL users or VAL UEs to the VAL server or to the location management client that has previously configured. The latest location information is from the location report procedure as described in subclause 9.3.3, or from PLMN operator.
3. VAL server may further share this location information to a group or to another VAL user or VAL UE.

NOTE: For other entities, the step 3 can be skipped if not needed.

### 9.3.9 On-demand usage of location information procedure

The VAL server can request UE location information at any time by sending a location information request to the location management server, which may trigger location management server to immediately send the location report.

Figure 9.3.9-1 illustrates the high level procedure of on demand usage of location information. The same procedure can be applied for location management client and other entities that would like to subscribe to location information of VAL user or VAL UE.

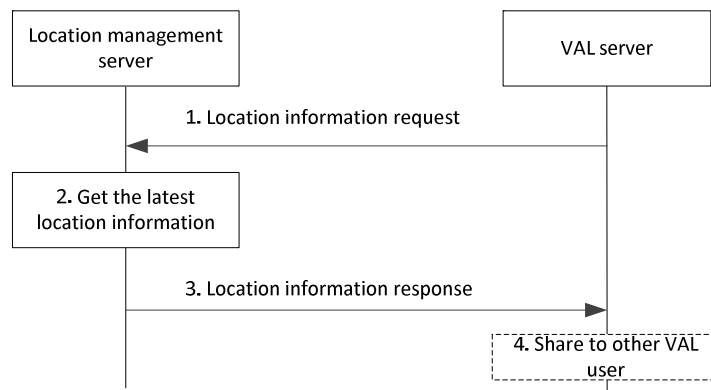

**Figure 9.3.9-1: On-demand usage of location information procedure**

1. VAL server sends a location information request to the location management server.
2. The location management server acquires the latest location of the UEs being requested, by triggering an on-demand location report procedure as described in subclause 9.3.4, or from PLMN operator.
3. Then, location management server immediately sends the location information report including the latest location information acquired of one or more VAL users or VAL UEs.
4. VAL server may further share this location information to a group or to another VAL user or VAL UE.

NOTE: For other entities, the step 3 can be skipped if not needed.

## 9.4 SEAL APIs for location management

### 9.4.1 General

Table 9.4.1-1 illustrates the SEAL APIs for location management.

**Table 9.4.1-1: List of SEAL APIs for location management**

API Name	API Operations	Known Consumer(s)	Communication Type
SS_LocationReporting	Create_Trigger_Location_Reporting Update_Trigger_Location_Reporting Cancel_Trigger_Location_Reporting	VAL server	Request /Response
SS_LocationInfoEvent	Subscribe_Location_Info	VAL server	Subscribe/Notify
	Notifiy_Location_Info	VAL server	
SS_LocationInfoRetrieval	Obtain_Location_Info	VAL server	Request /Response

### 9.4.2 SS\_LocationReporting API

#### 9.4.2.1 General

**API description:** This API enables the VAL server to trigger reporting of location information to the location management server over LM-S.

#### 9.4.2.2 Create\_Trigger\_Location\_Reporting operation

**API operation name:** Create\_Trigger\_Location\_Reporting

**Description:** Creates the trigger to report location information.

**Known Consumers:** VAL server.

**Inputs:** Refer subclause 9.3.2.4

**Outputs:** Refer subclause 9.3.2.4

See subclause 9.3.5 for the details of usage of this API operation.

#### 9.4.2.3 Update\_Trigger\_Location\_Reporting operation

**API operation name:** Update\_Trigger\_Location\_Reporting

**Description:** Updates the trigger to report location information.

**Known Consumers:** VAL server.

**Inputs:** Refer subclause 9.3.2.4

**Outputs:** Refer subclause 9.3.2.4

See subclause 9.3.5 for the details of usage of this API operation.

#### 9.4.2.4 Cancel\_Trigger\_Location\_Reporting operation

**API operation name:** Cancel\_Trigger\_Location\_Reporting

**Description:** Cancels the trigger to report location information.

**Known Consumers:** VAL server.

**Inputs:** Refer subclause 9.3.2.X

**Outputs:** Refer subclause 9.3.2.X

See subclause 9.3.6 for the details of usage of this API operation.

### 9.4.3 SS\_LocationInfoEvent API

#### 9.4.3.1 General

**API description:** This API enables the VAL server to subscribe and receive the UEs location information from the location management server over LM-S.

#### 9.4.3.2 Subscribe\_Location\_Info operation

**API operation name:** Subscribe\_Location\_Info

**Description:** Subscription to the location information.

**Known Consumers:** VAL server.

**Inputs:** Refer subclause 9.3.2.5

**Outputs:** Refer subclause 9.3.2.6

See subclause 9.3.7 for the details of usage of this API operation.



### 9.4.3.3 Notify\_Location\_Info operation

**API operation name:** Notify\_Location\_Info

**Description:** Location information notification to the existing subscription.

**Known Consumers:** VAL server.

**Inputs:** Refer subclause 9.3.2.7

**Outputs:** Refer subclause 9.3.2.7

See subclause 9.3.8 for the details of usage of this API operation.

## 9.4.4 SS\_LocationInfoRetrieval API

### 9.4.4.1 General

**API description:** This API enables the VAL server to obtain UEs location information from the location management server over LM-S.

### 9.4.4.2 Obtain\_Location\_Info operation

**API operation name:** Obtain\_Location\_Info

**Description:** Request UEs location information.

**Known Consumers:** VAL server.

**Inputs:** Refer subclause 9.3.2.3

**Outputs:** Refer subclause 9.3.2.2

See subclause 9.3.9 for the details of usage of this API operation.

---

# 10 Group management

## 10.1 General

The group management is a SEAL service that offers the group management related capabilities to one or more vertical applications.

## 10.2 Functional model for group management

### 10.2.1 General

The functional model for the group management is based on the generic functional model specified in clause 6. It is organized into functional entities to describe a functional architecture which addresses the support for group management aspects for vertical applications. The on-network and off-network functional model is specified in this clause.

### 10.2.2 On-network functional model description

Figure 10.2.2-1 illustrates the generic on-network functional model for group management.

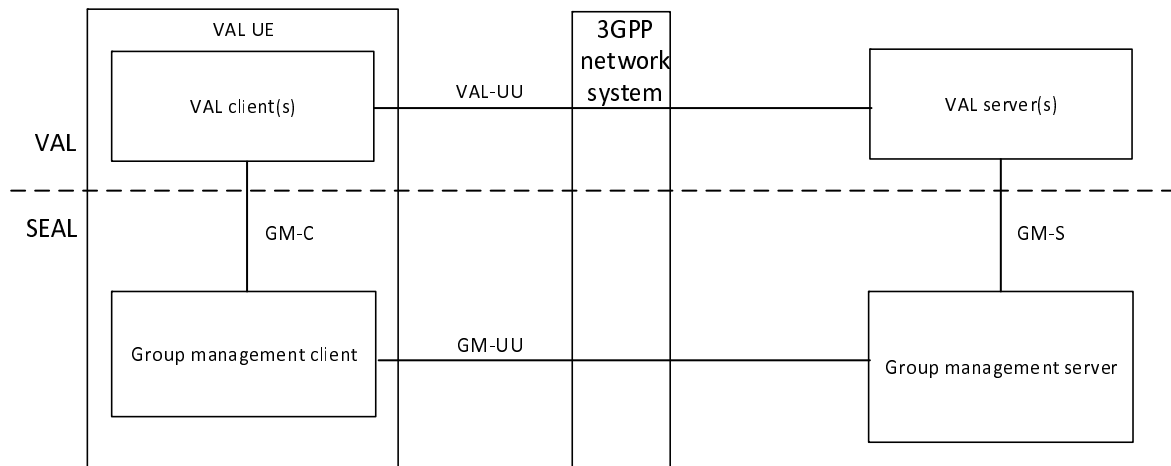
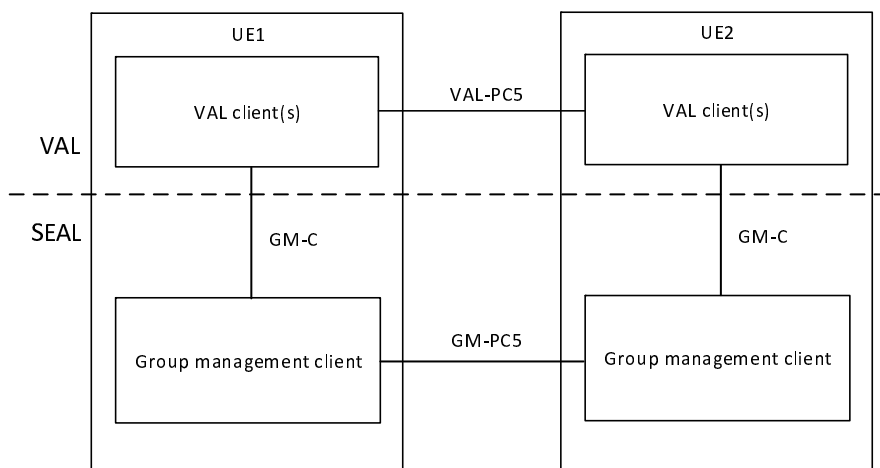

**Figure 10.2.2-1: On-network functional model for group management**

The group management client communicates with the group management server over the GM-UU reference point. The group management client provides the support for group management functions to the VAL client(s) over GM-C reference point. The VAL server(s) communicate with the group management server over the GM-S reference point.

### 10.2.3 Off-network functional model description

Figure 10.2.3-1 illustrates the off-network functional model for group management.



**Figure 10.2.3-1: Off-network functional model for group management**

The group management client of the UE1 communicates with the group management client of the UE2 over the GM-PC5 reference point.

### 10.2.4 Functional entities description

#### 10.2.4.1 General

The functional entities for group management SEAL service are described in the following subclauses.

#### 10.2.4.2 Group management client

The group management client functional entity acts as the application client for management of groups. A VAL system maintains groups corresponding to one or more vertical applications. The group management client interacts with the group management server. The group management client also supports interactions with the corresponding group management client between the two UEs.

The group management client functional entity is supported by the signalling user agent and HTTP client functional entities of the signalling control plane.

### 10.2.4.3 Group management server

The group management server functional entity provides for management of groups supported within the vertical application layer. The group management server acts as CAPIF's API exposing function as specified in 3GPP TS 23.222 [8]. The group management server also supports interactions with the corresponding group management server in distributed SEAL deployments.

The group management server functional entity is supported by the SIP AS and HTTP server functional entities of the signalling control plane.

All the group management clients supporting users belonging to a single group are required to use the same group management server for that group. A group management client supporting a user involved in multiple groups can have relationships with multiple group management servers.

## 10.2.5 Reference points description

### 10.2.5.1 General

The reference points for the functional model for group management are described in the following subclauses.

### 10.2.5.2 GM-UU

The interactions related to group management functions between the group management client and the group management server are supported by GM-UU reference point. This reference point utilizes Uu reference point as described in 3GPP TS 23.401 [9] and 3GPP TS 23.501 [10].

GM-UU reference point is used for VAL service signalling for VAL service data management of the VAL service. The GM-UU reference point supports:

- Configuration of group related data at the group management client by the group management server; and
- Configuration of group related data at the group management server by the group management client.

The GM-UU reference point uses the HTTP-1/HTTP-2 reference points for transport and routing of group management related signalling. The GM-UU reference point uses the SIP-1/SIP-2 reference points for subscription/notification related signalling.

### 10.2.5.3 GM-PC5

The interactions related to group management functions between the group management clients located in different VAL UEs are supported by GM-PC5 reference point. This reference point utilizes PC5 reference point as described in 3GPP TS 23.303 [12].

### 10.2.5.4 GM-C

The interactions related to group management functions between the VAL client(s) and the group management client within a VAL UE are supported by GM-C reference point.

### 10.2.5.5 GM-S

The interactions related to group management functions between the VAL server(s) and the group management server are supported by GM-S reference point. This reference point is an instance of CAPIF-2 reference point as specified in 3GPP TS 23.222 [8].

GM-S reference point supports the VAL server to obtain group information corresponding to the VAL service. The GM-S reference point uses HTTP-1/HTTP-2 reference points for transport and routing of group management related signalling. The GM-S reference point uses SIP-2 reference point for subscription/notification related signalling.

### 10.2.5.6 GM-E

The interactions related to group management functions between the group management servers in a distributed deployment are supported by GM-E reference point.

**Editor's Note:** The functions enabled over GM-E reference point is FFS.

## 10.3 Procedures and information flows for group management

### 10.3.1 General

Group management procedures apply to on-network VAL service only.

Group creation provides a dedicated VAL group to individual VAL users to enable the required communication for one or multiple VAL services. This includes the normal group creation by administrators or by authorized user/UE.

**NOTE:** If an authorized VAL user/UE wants to participate in a new group created by the authorized VAL user/UE, then the authorized VAL user/UE needs to have been included in the new group as a member.

### 10.3.2 Information flows for group management

#### 10.3.2.1 Group creation request

Table 10.3.2.1-1 describes the information flow group creation request from the group management client to the group management server.

**Table 10.3.2.1-1: Group creation request**

Information element	Status	Description
Requester Identity	M	The identity of the group management client performing the request.
Identity list	M	List of VAL user IDs or VAL UE IDs that are part of the group to be created corresponding to the list of the configured services
VAL service ID list (see NOTE 1)	O	List of VAL services whose service communications are to be enabled on the group.
VAL service specific information (NOTE 2)	O	Placeholder for VAL service specific information
NOTE 1: This information element shall be included in the message for creating a group configured for multiple VAL services.		
NOTE 2: The details of this information element are specified in VAL service specific specification and are out of scope of the present document.		

#### 10.3.2.2 Group creation response

Table 10.3.2.2-1 describes the information flow group creation response from the group management server to the group management client.

**Table 10.3.2.2-1: Group creation response**

Information element	Status	Description
VAL group ID	M (see NOTE)	VAL group ID of the group
Result	M	Indicates the success or failure for the operation
NOTE: If the Result information element indicates failure then the value of VAL group ID information element has no meaning.		

### 10.3.2.3 Group creation notification

Table 10.3.2.3-1 describes the information flow group creation notification from the group management server to the VAL server(s).

NOTE: When group is configured for multiple VAL services, the group creation notification message is sent from the group management server to the VAL servers configured for the group.

**Table 10.3.2.3-1: Group creation notification**

Information element	Status	Description
VAL group ID	M	VAL group ID that was created based on the VAL user ID list and the VAL services enabled on them
Identity list	M	List of VAL user IDs or VAL UE IDs that are part of the created group

### 10.3.2.4 Group information query request

Table 10.3.2.4-1 describes the information group information query request from group management client to group management server.

**Table 10.3.2.4-1: Group information query request**

Information element	Status	Description
Identity	M	The identity of the VAL user or VAL UE performing the query.
VAL group ID	M	The identity of the VAL group to be queried.
Query type	M	It indicates the query type, i.e., membership information.

### 10.3.2.5 Group information query response

Table 10.3.2.5-1 describes the information flow group information query response from group management server to group management client.

**Table 10.3.2.5-1: Group information query response**

Information element	Status	Description
VAL group ID	M (see NOTE)	The identity of the VAL group to be queried.
Query type	M (see NOTE)	It indicates the query type, e.g. membership information.
Query result	M (see NOTE)	The group information retrieved from the group management server based on the query type, i.e., a list of group members.
Result	M	Indicates the success or failure for the operation
NOTE:	If the Result information element indicates failure then the values of other information elements have no meaning.	

### 10.3.2.6 Group membership update request

Table 10.3.2.6-1 describes the information flow group membership update request from the group management client to the group management server.

**Table 10.3.2.6-1: Group membership update request**

Information element	Status	Description
Requester Identity	M	The identity of the group management client performing the request.
VAL group ID	M	Identity of the VAL group
Identity	M	List of identities of the VAL users and VAL UEs affected by this operation
Operations	M	Add to or delete from the group

### 10.3.2.7 Group membership update response

Table 10.3.2.7-1 describes the information flow group membership update response from the group management server to the group management client.

**Table 10.3.2.7-1: Group membership update response**

Information element	Status	Description
VAL group ID	M	Identity of the VAL group
Result	M	Indicates the success or failure for the operation

### 10.3.2.8 Group membership notification

Table 10.3.2.8-1 describes the information flow group membership notification from the group management server to the VAL server.

**Table 10.3.2.8-1: Group membership notification**

Information element	Status	Description
VAL group ID	M	Identity of the VAL group
Identity	M	List of identities of the VAL users and VAL UEs affected by this operation
Operations	M	Add to or delete from the group

Table 10.3.2.8-2 describes the information flow group membership notification from the group management server to the group management client.

**Table 10.3.2.8-2: Group membership notification**

Information element	Status	Description
VAL group ID	M	Identity of the VAL group
Operations	M	Add to or delete from the group

### 10.3.2.9 Group deletion request

Table 10.3.2.9-1 describes the information flow group deletion request from the group management client to the group management server.

**Table 10.3.2.9-1: Group deletion request**

Information element	Status	Description
Requester Identity	M	The identity of the group management client performing the request.
VAL group ID	M	VAL group ID of the group to delete

### 10.3.2.10 Group deletion response

Table 10.3.2.10-1 describes the information flow group deletion response from the group management server to the group management client.

**Table 10.3.2.10-1: Group deletion response**

Information element	Status	Description
VAL group ID	M	Identity of the VAL group requested to be deleted
Result	M	Indicates success (group no longer exists), or failure (group deletion did not occur, e.g. authorization failure).

### 10.3.2.11 Group deletion notification

Table 10.3.2.11-1 describes the information flow group deletion notification from the group management server to the VAL server, and from the group management server to the group management clients for VAL users which are members of the group.

**Table 10.3.2.11-1: Group deletion notification**

Information element	Status	Description
VAL group ID	M	VAL group ID has been deleted.

### 10.3.2.12 Group information request

Table 10.3.2.12-1 describes the information flow group information request from the group management server in the partner VAL system of the VAL group to the group management server in the primary VAL system of the VAL group.

**Table 10.3.2.12-1: Group information request**

Information element	Status	Description
Requester Identity	M	The identity of the group management server performing the request.
VAL group ID	M	VAL group ID of the group

### 10.3.2.13 Group information response

Table 10.3.2.13-1 describes the information flow group information response from the group management server in the primary VAL system of the VAL group to the group management server in the partner VAL system of the VAL group.

**Table 10.3.2.13-1: Group information response**

Information element	Status	Description
VAL group ID	M	VAL group ID of the group
VAL group configuration information	O (see NOTE 1)	Configuration information for the VAL group
Failure reason	O (see NOTE 2)	Indicates reason for failure to provide VAL group configuration information
NOTE 1: Shall be present if the request can be fulfilled by the group management server in the primary VAL system of the VAL group.		
NOTE 2: Shall be present if the request cannot be fulfilled by the group management server in the primary VAL system of the VAL group.		

### 10.3.2.14 Group information subscribe request

Table 10.3.2.14-1 describes the information flow group information subscribe request from the group management server in the partner VAL system of the VAL group to the group management server in the primary VAL system of the VAL group.

**Table 10.3.2.14-1: Group information subscribe request**

Information element	Status	Description
Requester Identity	M	The identity of the group management server performing the request.
VAL group ID	M	VAL group ID of the group

### 10.3.2.15 Group information subscribe response

Table 10.3.2.15-1 describes the information flow group information subscribe response from the group management server in the primary VAL system of the VAL group to the group management server in the partner VAL system of the VAL group.

**Table 10.3.2.15-1: Group information subscribe response**

Information element	Status	Description
VAL group ID	M	VAL group ID of the group
Result	M	Indicates success or failure of the subscribe request

### 10.3.2.16 Group information notify request

Table 10.3.2.16-1 describes the information flow group information notify request from the group management server in the primary VAL system of the VAL group to the group management server in the partner VAL system of the VAL group.

**Table 10.3.2.16-1: Group information notify request**

Information element	Status	Description
Requester Identity	M	The identity of the group management server performing the request.
VAL group ID	M	VAL group ID of the group
VAL group configuration information	M	Configuration information for the VAL group

### 10.3.2.17 Group information notify response

Table 10.3.2.17-1 describes the information flow group information notify response from the group management server in the partner VAL system of the VAL group to the group management server in the primary VAL system of the VAL group.

**Table 10.3.2.17-1: Group information notify response**

Information element	Status	Description
VAL group ID	M	VAL group ID of the group
Result	M	Indicates success or failure of the notification request

### 10.3.2.18 Store group configuration request

Table 10.3.2.18-1 describes the information flow store group configuration request from the group management client to the group management server.



**Table 10.3.2.18-1: Store group configuration request**

Information element	Status	Description
Requester Identity	M	The identity of the group management client performing the request.
VAL group ID	M	VAL group ID of the group
VAL group configuration data	M	VAL group configuration data

### 10.3.2.19 Store group configuration response

Table 10.3.2.19-1 describes the information flow store group configuration response from the group management server to the group management client.

**Table 10.3.2.19-1: Store group configuration response**

Information element	Status	Description
VAL group ID	M	VAL group ID of the group
Result	M	Indicates the success or failure for the result

### 10.3.2.20 Get group configuration request

Table 10.3.2.20-1 describes the information flow get group configuration request from the group management client to the group management server.

**Table 10.3.2.20-1: Get group configuration request**

Information element	Status	Description
Requester Identity	M	The identity of the group management client performing the request.
VAL group ID	M	VAL group ID of the group
VAL group information reference	M	Reference to configuration data for the VAL group
VAL services requested (see NOTE)	O	Service(s) for which group configuration is requested
NOTE: If 'VAL services requested' is not present, group configuration is requested for all services defined for the VAL group		

### 10.3.2.21 Get group configuration response

Table 10.3.2.21-1 describes the information flow get configuration response from the group management server to the group management client.

**Table 10.3.2.21: Get group configuration response**

Information element	Status	Description
VAL group ID	M	VAL group ID of the group
VAL group configuration data	M (see NOTE)	VAL group configuration data
Result	M	Indicates the success or failure for the operation
NOTE: If the Result information element indicates failure then the value of the VAL group configuration data information element has no meaning.		

### 10.3.2.22 Subscribe group configuration request

Table 10.3.2.22-1 describes the information flow subscribe group configuration request from the group management client to the group management server.

**Table 10.3.2.22-1: Subscribe group configuration request**

Information element	Status	Description
Requester Identity	M	The identity of the group management client performing the request.
VAL group ID	M	VAL group ID of the group
VAL services requested (see NOTE)	O	Service(s) for which group configuration is requested
NOTE: If 'VAL services requested' is not present, group configuration is requested for all services defined for the VAL group		

### 10.3.2.23 Subscribe group configuration response

Table 10.3.2.23-1 describes the information flow subscribe group configuration response from the group management server to the group management client.

**Table 10.3.2.23-1: Subscribe group configuration response**

Information element	Status	Description
VAL group ID	M	VAL group ID of the group
Result	M	Indicates the success or failure for the result

### 10.3.2.24 Notify group configuration request

Table 10.3.2.24-1 describes the information flow notify group configuration request from the group management server to the group management client.

**Table 10.3.2.24-1: Notify group configuration request**

Information element	Status	Description
Requester Identity	M	The identity of the group management server performing the request.
VAL group ID	M	VAL group ID of the group
VAL group information reference (see NOTE)	O	Reference to information stored relating to the VAL group
Group related key material (see NOTE)	O	Key material for use with the VAL group
NOTE: At least one of these information elements shall be present.		

### 10.3.2.25 Notify group configuration response

Table 10.3.2.25-1 describes the information flow notify group configuration response from the group management client to the group management server.

**Table 10.3.2.25-1: Notify group configuration response**

Information element	Status	Description
VAL group ID	M	VAL group ID of the group
Result	M	Indicates the success or failure for the result

### 10.3.2.26 Configure VAL group request

Table 10.3.2.26-1 describes the information flow for configure VAL group request from a VAL server to a group management server.

**Table 10.3.2.26-1: Configure VAL group request**

Information element	Status	Description
Requester Identity	M	The identity of the VAL server performing the request.
VAL group ID	M	The group ID used for the VAL group.
VAL group description	M	Information related to the VAL group e.g. group definition including policy, group size, group leader.
VAL service ID list (see NOTE)	O	List of VAL services whose service communications are to be enabled on the group.
Geo ID list (see NOTE)	O	List of geographical areas to be addressed by the group.
Identity list (see NOTE)	O	List of VAL UE IDs who are invited to be member of the group.
Identity list subscription	O	Indicates interest to receive notifications of newly registered or de-registered VAL UE IDs.
NOTE: At least one of these IEs shall be present.		

### 10.3.2.27 Configure VAL group response

Table 10.3.2.27-1 describes the information flow for configure VAL group response from group management server to a VAL server.

**Table 10.3.2.27-1: Configure VAL group response**

Information element	Status	Description
Result	M	The result of the configure VAL group operation
Subscription result	O (see NOTE)	Indicates whether subscription to receive notifications of newly registered or de-registered VAL UE IDs is successful or not
NOTE: Shall be present only if there is a subscription in the configure VAL group request and successful.		

### 10.3.2.28 Group announcement

Table 10.3.2.28-1 describes the information flow for a group management server to announce a VAL group to the group management clients.

**Table 10.3.2.28-1: Group announcement**

Information element	Status	Description
VAL group ID	M	The group ID used for the VAL group.
VAL group description	M	Information related to the VAL group e.g. group definition including policy, group size, group leader.
VAL service ID list (see NOTE 1)	O	List of VAL services whose service communications are to be enabled on the group.
Geo ID list (see NOTE 1)	O	List of geographical areas to be addressed by the group.
Identity list (see NOTE 1, NOTE 2)	O	List of VAL UE IDs who are invited to be member of the group.
NOTE 1: At least one of these IEs shall be present.		
NOTE 2: This element is not present if it results in privacy concerns.		

### 10.3.2.29 Group registration request

Table 10.3.2.29-1 describes the information flow for a group management client to register to a VAL group in response to a group announcement from the group management server.

**Table 10.3.2.29-1: Group registration request**

Information element	Status	Description
VAL UE ID	M	Identity of the VAL UE registering to the VAL group.
VAL Group ID	M	The group ID to be registered by the VAL UE for the VAL group.
Identity list subscription	M	Indicates interest to receive notifications of newly registered or de-registered VAL UE IDs

### 10.3.2.30 Group registration response

Table 10.3.2.30-1 describes the information flow for a group management server to respond for a group registration request from the group management client.

**Table 10.3.2.30-1: Group registration response**

Information element	Status	Description
Result	M	Result from the VAL server in response to VAL group registration request indicating success or failure
Subscription result	M	Indicates whether subscription to receive notifications of newly registered or de-registered VAL UE IDs is successful or not

### 10.3.2.31 Identity list notification

Table 10.3.2.31-1 describes the information flow identity list notification from the group management server to the group management client.

**Table 10.3.2.31-1: Identity list notification**

Information element	Status	Description
VAL group ID	M	Identity of the VAL group
Identity list	M	List of VAL UE IDs who are newly registered or de-registered members of the group

Table 10.3.2.31-2 describes the information flow identity list notification from the group management server to the VAL server.

**Table 10.3.2.31-2: Identity list notification**

Information element	Status	Description
VAL group ID	M	Identity of the VAL group
Identity list	M	List of VAL UE IDs who are newly registered or de-registered members of the group

### 10.3.2.32 Group de-registration request

Table 10.3.2.32-1 describes the information flow for a group management client to de-register to a VAL group.

**Table 10.3.2.32-1: Group de-registration request**

Information element	Status	Description
VAL UE ID	M	Identity of the VAL UE de-registering to the VAL group.
VAL Group ID	M	The group ID to be de-registered by the VAL UE for the VAL group.

### 10.3.2.33 Group de-registration response

Table 10.3.2.33-1 describes the information flow for a group management server to respond for a group de-registration request from the group management client.

**Table 10.3.2.33-1: Group de-registration response**

Information element	Status	Description
Result	M	Result from the group management server in response to VAL group de-registration request indicating success or failure

### 10.3.3 Group creation

Figure 10.3.3-1 below illustrates the group creation operations by authorized VAL user/UE/administrator to create a group. It applies to the scenario of normal group creation by a VAL administrator or by authorized user/UE.

Pre-conditions:

1. The group management client, group management server, VAL server and the VAL group members belong to the same VAL system.
2. The authorized VAL user/UE/administrator is aware of the users' identities which will be combined to form the VAL group.

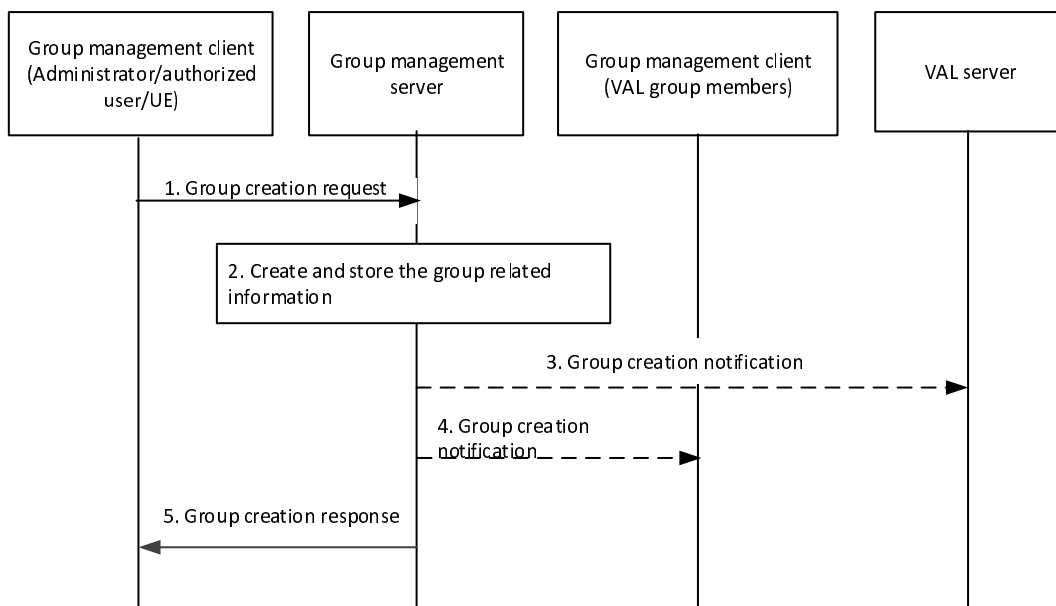

**Figure 10.3.3-1: Group creation**

1. The group management client of the authorized VAL user/UE/administrator requests group create operation to the group management server. The identities of the users or UEs being combined and the information of the VAL services that are enabled on the group shall be included in this message.
2. During the group creation, the group management server creates and stores the information of the group. The group management server performs the check on the policies e.g. maximum limit of the total number of VAL group members for the VAL group(s).

NOTE: The exact policies are out of scope of the present document.

3. The group management server may conditionally notify the VAL server regarding the group creation with the information of the group members.
4. The VAL group members of the VAL group are notified about the newly created VAL group configuration data.
5. The group management server provides a group creation response to the group management client of the administrator/authorized VAL user/UE.

## 10.3.4 Group information query

### 10.3.4.1 General

A VAL user/UE can request the membership list on an VAL group regardless the user or UE's group membership.

### 10.3.4.2 Procedure

Figure 10.3.4.2-1 below illustrates the group information query on a VAL group.

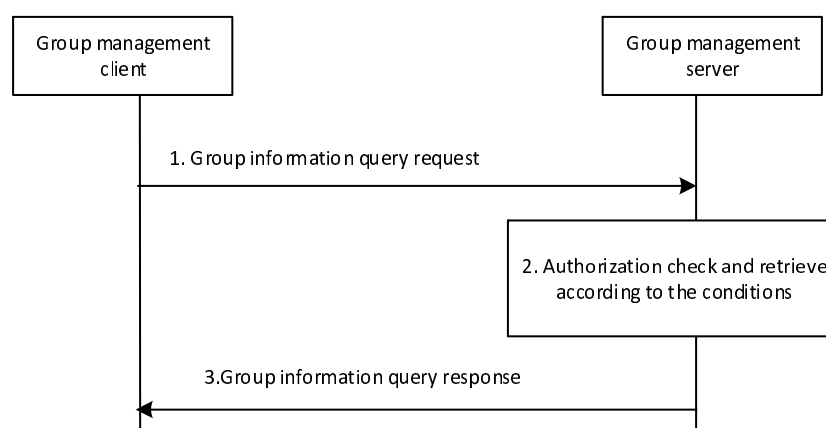

**Figure 10.3.4.2-1: Group information query**

1. The group management client of the VAL user/UE requests the group information on the VAL group from the group management server by sending a group information query request. The query type is included.
2. The group management server checks whether the VAL user/UE is authorized to perform the query. If authorized, then the group management server retrieves the requested group information based on the query type.
3. The group management server sends a group information query response including the retrieved group information to the group management client.

## 10.3.5 Group membership

### 10.3.5.1 Group membership notification

Figure 10.3.5.1-1 illustrates the group membership notification operations to the VAL server(s) and group management clients upon the group membership change at group management server.

Pre-conditions:

1. VAL group is created on the group management server.

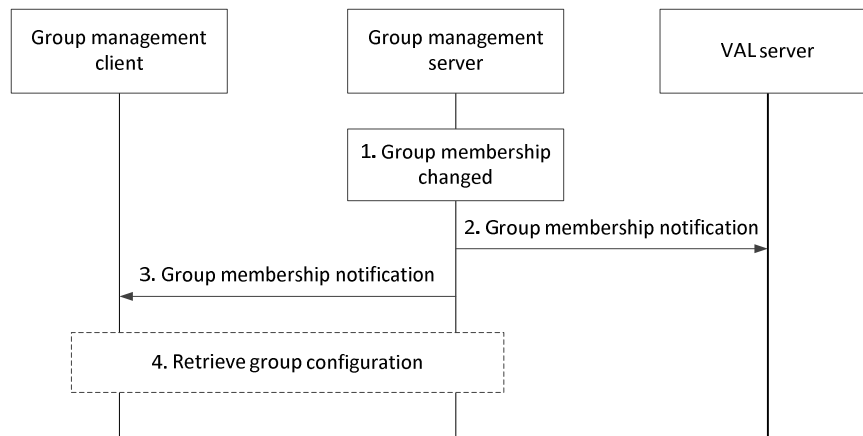

**Figure 10.3.5.1-1: group membership notification**

1. The membership of a specific VAL group is changed at group management server.
2. The group management server notifies the VAL server(s) regarding the group membership change with the information of the updated group members.
3. The group management server updates the group management clients of the VAL users/UEs who have been added to or removed from the group.
4. The group management client requests to retrieve the relevant group configurations from group management server, if the user or UE is added to the group. If the user or UE is deleted from the group, the locally stored group configurations in the VAL UE may be removed.

### 10.3.5.2 Group membership update by authorized user/UE/VAL server

Figure 10.3.5.2-1 below illustrates the group membership update operations by an authorized user/UE/administrator/VAL server to change the membership of a VAL group (e.g. to add or delete group members).

Pre-conditions:

1. The group management server and VAL server serve the same VAL system;
2. The initiator of this operation is aware of the current group membership of the VAL group;
3. The authorized user/UE/administrator/VAL server is aware of the users' identities which will be added to or deleted from the VAL group.

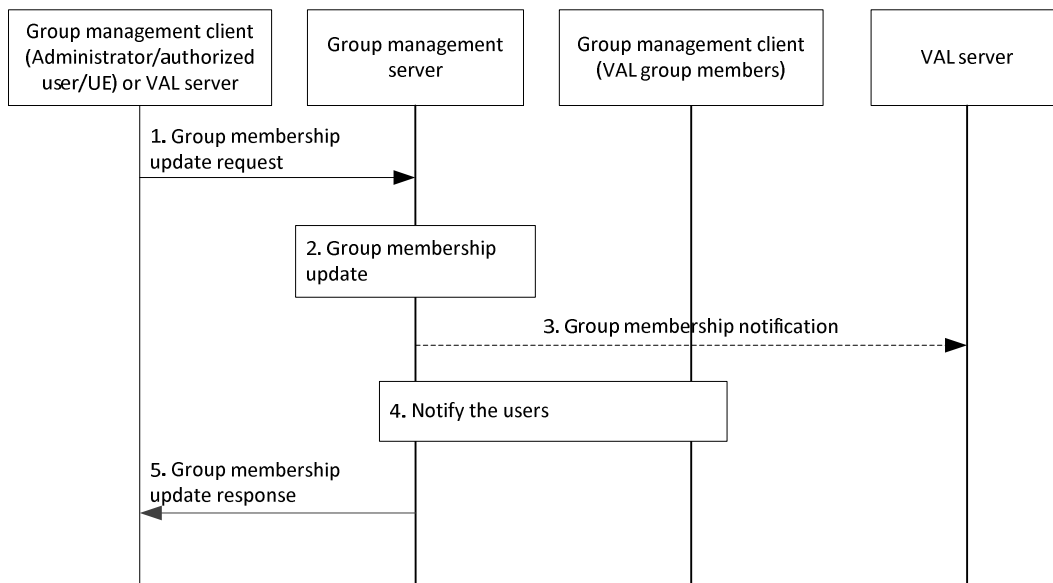

**Figure 10.3.5.2-1: Group membership update by authorized user/UE/VAL server**

1. The group management client of the authorized user/UE/administrator or VAL server requests group membership update operation to the group management server.
2. The group management server updates the group membership information. The group management server may perform the check on policies e.g. the maximum limit of the total number of VAL group members.

NOTE 1: The exact policies are out of scope of the present document.

3. The group management server notifies the VAL server(s) regarding the group membership change with the information of the updated group members.

NOTE 2: Step 3 does not happen when the VAL server is requesting group membership update operation.

4. The group members that are added to or deleted from the group by this operation are notified about the group membership change. This step may be followed by retrieving group configurations.
5. The group management server provides a group membership response to the group management client of the authorized user/UE/administrator or the VAL server.

## 10.3.6 Group configuration management

### 10.3.6.1 Store group configurations at the group management server

The procedure for store group configurations at the group management server is described in figure 10.3.6.1-1.

Pre-conditions:

- The group management server may have some pre-configuration data which can be used for online group configuration validation;



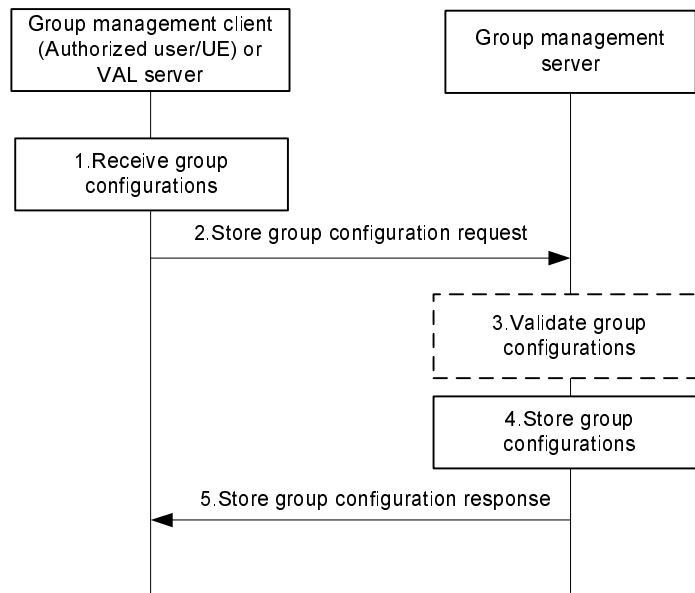

**Figure 10.3.6.1-1: Store group configurations at group management server**

1. The group configurations are received by the group management client of an authorized user/UE or VAL server.
2. The received group configurations are sent to the group management server for storage using a store group configuration request.
3. The group management server may validate the group configurations before storage.
4. The group management server stores the group configurations.
5. The group management server provides a store group configuration response indicating success or failure. If any validation or storage fails, the group management server provides a failure indication in the store group configuration response.

### 10.3.6.2 Retrieve group configurations

The procedure for retrieve group configurations at the group management client or the VAL server is described in figure 10.3.6.2-1. This procedure can be used following service authorisation when the configuration management client has received the list of groups and the group management client needs to obtain the group configurations, or following a notification from the group management server that new group configuration information is available.

Pre-conditions:

- The group management server has received configuration data for groups, and has stored this configuration data;
- The VAL UE has registered for service and the group management client or the VAL server needs to download group configuration data applicable to the user/UE.

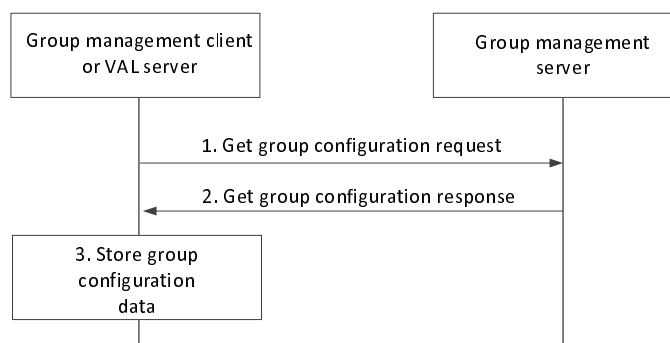

**Figure 10.3.6.2-1: Retrieve group configurations**

1. The group management client or the VAL server requests the group configuration data.
2. The group management server provides the group configuration data to the client or the VAL user.
3. The group management client or the VAL server stores the group configuration information.

### 10.3.6.3 Subscription and notification for group configuration data

The procedure for subscription for group configuration data as described in figure 10.3.6.3-1 is used by the group management client to indicate to the group management server that it wishes to receive updates of group configuration data for groups for which it is authorized.

Pre-conditions:

- The group management server has some group configurations stored.

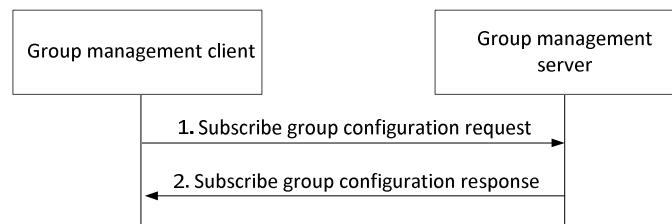

**Figure 10.3.6.3-1: Subscription for group configurations**

1. The group management client subscribes to the group configuration information stored at the group management server using the subscribe group configuration request.
2. The group management server provides a subscribe group configuration response to the group management client indicating success or failure of the request.

The procedure for notification of group configuration data as described in figure 10.3.6.3-2 is used by the group management server to inform the group management client that new group configuration data is available. It can also be used by the group management server to provide new group related key material to the group management client.

Pre-conditions:

- The group management client has subscribed to the group configuration information
- The group management server has received and stored new group configuration information, or the group management server has generated and stored new key material, or both of these have occurred.

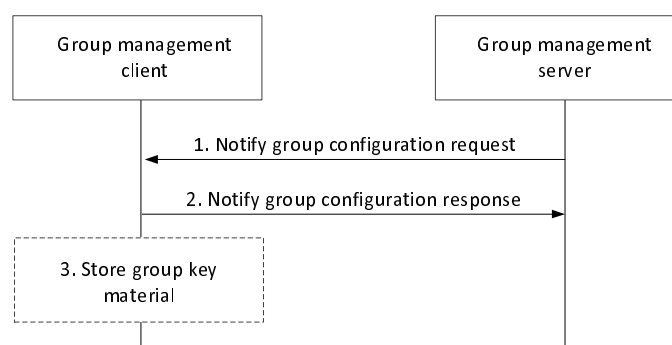

**Figure 10.3.6.3-2: Notification of group configurations**

1. The group management server provides the notification to the group management client, who previously subscribed for the group configuration information. Optionally, the notify group configuration request may contain group related key material for the group management client.
2. The group management client provides a notify group configuration response to the group management server.

3. If the group management server had provided group related key material to the group management client, the group management client stores the key material.

If the group management server has notified the group management client about new group configuration information through this procedure, the group management client may then follow the procedure described in subclause 10.3.6.2 in order to retrieve that group configuration information.

### 10.3.6.4 Structure of group configuration data

The group configuration data contains group configuration data common to all VAL services and group configuration data specific to each VAL service.

- NOTE: For a VAL service, the VAL group configuration data is listed in the corresponding VAL service specification and is outside the scope of the present document.

### 10.3.7 Location-based group creation

Figure 10.3.7-1 below illustrates the location-based group creation.

Pre-conditions:

1. The group management client, group management server, VAL server, location management server and the VAL group members belong to the same VAL system.
2. The authorized VAL user/UE/administrator is not aware of the users' or UE identities which will be combined to form the VAL group.

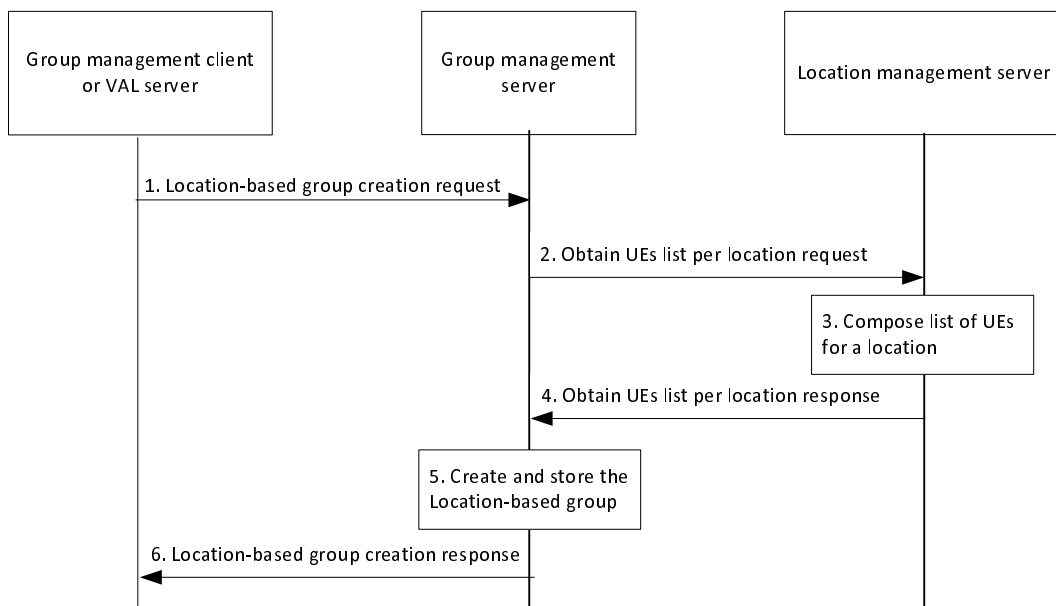

**Figure 10.3.7-1: Location-based group creation**

1. The group management client or the VAL server requests location-based group create operation to the group management server. The location criteria for determining the identities of the users or UEs to be combined shall be included in this message.
2. The group management server requests the location management server for obtaining the users or UEs corresponding to the location information.
3. The location management server composes the list of users or UEs within the requested location.

4. The group management server receives the composed list of users or UEs from the location management server.
5. During the group creation, the group management server creates and stores the information of the location-based group. The group management server performs the check on the policies e.g. maximum limit of the total number of VAL group members for the VAL group(s).

NOTE: The exact policies are out of scope of the present document.

**Editor's Note:** Group updates due to Users or UEs moving in or out of the location is FFS.

6. The group management server provides a location-based group creation response to the group management client or the VAL server.

### 10.3.8 Group announcement and join

#### 10.3.8.1 General

This subclause describes the procedures for establishing group communication from the group management server to the group management clients.

#### 10.3.8.2 Procedure

Pre-conditions:

1. The group management client, group management server, VAL server and the VAL clients belong to the same VAL system.
2. The VAL server is aware of the users' identities and is authorized to form a VAL group.

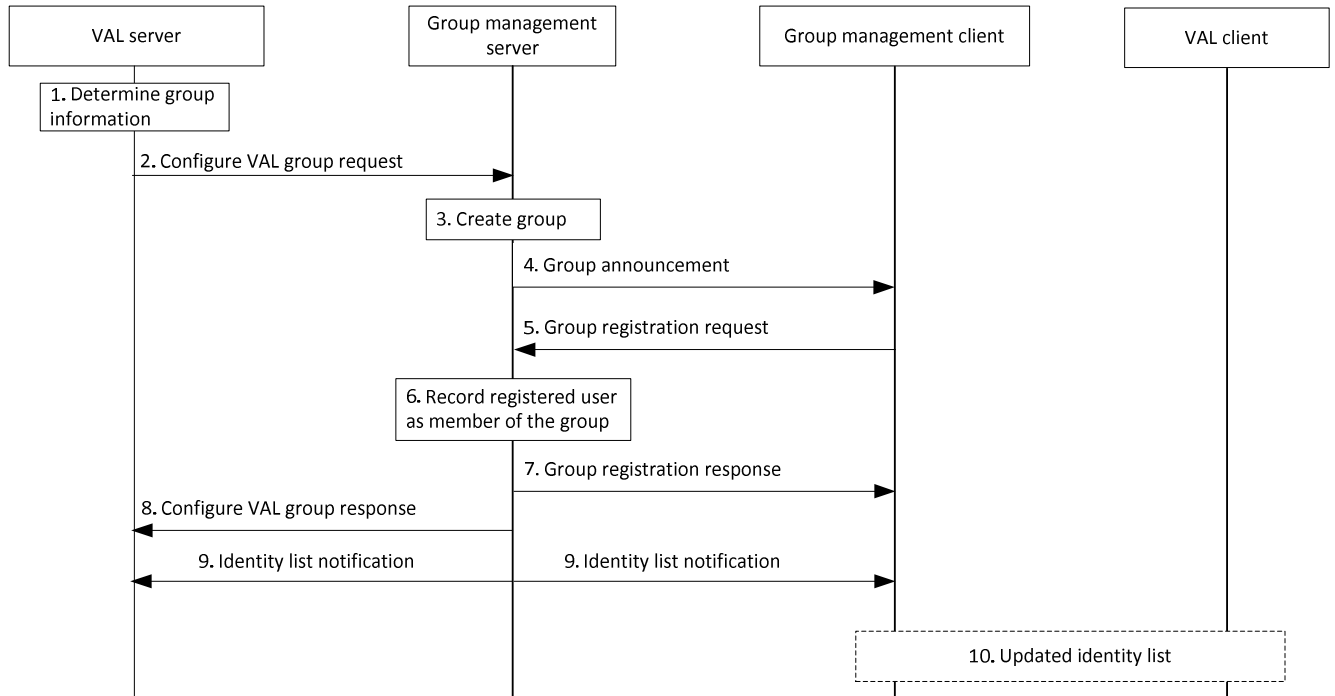

**Figure 10.3.8.2-1: Procedure for establishing VAL group communication between the group management server and group management client1.**

1. The VAL server determines group information and the identity list to which the group announcement shall be sent. The decision can be based on the list of authorized UEs and other criteria (e.g. user consent, service, or vehicle driving profile).

2. The VAL server configures VAL group for Uu communication defined by VAL Group ID for one or more VAL services with list of VAL Service ID with the group management server.
3. The group management server creates an empty group based on the information provided in the Configure VAL group request.
4. The group management server announces the VAL group to the group management clients.
5. The group management client registers to VAL group communication using the VAL Group ID.
6. The group management server records the users who have registered to be the members of the group.
7. The group management server sends a VAL group registration response to the group management client.
8. The group management server sends a configure VAL group response to the VAL server.

NOTE: Step 8 may occur any time after step 4.

9. The group management server sends identity list notification about the newly registered users to the other members of the group and VAL server, whose subscription to receive notifications of newly registered VAL UE IDs is successful in step 7 and step 8 respectively.

10. The group management client may inform VAL client about the updated identity list.

### 10.3.9 Group member leave

#### 10.3.9.1 General

This subclause describes the procedures for group member to leave the group by de-registering.

#### 10.3.9.2 Procedure

Pre-conditions:

1. Group is previously defined on the group management server including the list of registered users and each member of the group and VAL server is aware of it.

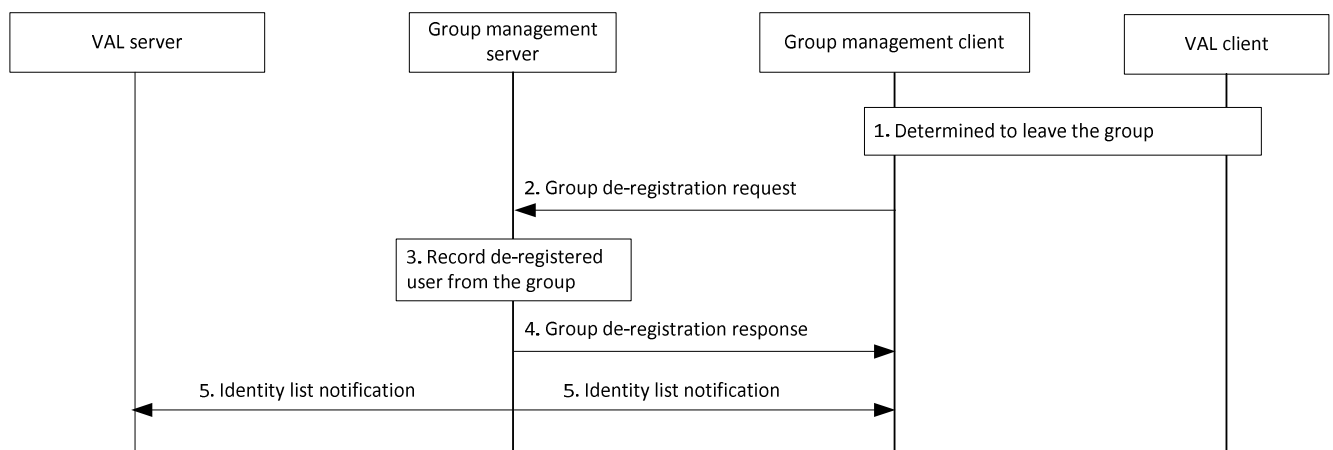

**Figure 10.3.9.2-1: Procedure for group member leaving the group.**

1. The VAL client determines to de-register member from the group and group management client is aware of it.
2. The group management client initiates the group de-registration request towards the group management server.

3. The group management server checks the authorization of group de-registration request and updates the group member list.
4. The group management server sends a group de-registration response to the group management client.
5. The group management server sends identity list notification about the leaving registered user to the other members of the group and the VAL server, whose subscription to receive notifications of de-registered VAL UE IDs is successful in step 7 and step 8 of the procedure in clause 10.3.8.2 respectively.

## 10.4 SEAL APIs for group management

### 10.4.1 General

Table 10.4.1-1 illustrates the SEAL APIs for group management.

**Table 10.4.1-1: List of SEAL APIs for group management**

API Name	API Operations	Known Consumer(s)	Communication Type
SS_GroupManagement	Query_Group_Info	VAL server	Request /Response
	Update_Group_Info	VAL server	Request /Response
SS_GroupManagementEvent	Subscribe_Group_Info_Modification	VAL server	Subscribe/Notify
	Notify_Group_Info_Modification	VAL server	
	Notify_Group_Creation	VAL server	

### 10.4.2 SS\_GroupManagement API

#### 10.4.2.1 General

**API description:** This API enables the VAL server to communicate with the group management server for querying group information, obtaining stored group configuration, modify the group membership and configuration information on the group management server over GM-S.

#### 10.4.2.2 Query\_Group\_Info operation

**API operation name:** Query\_Group\_Info

**Description:** Query group information and obtaining group configuration information.

**Known Consumers:** VAL server.

**Inputs:** See subclause 10.3.2.4, 10.3.2.20

**Outputs:** See subclause 10.3.2.5, 10.3.2.21

See subclause 10.3.4 and 10.3.6.2 for the details of usage of this API operation.

#### 10.4.2.3 Update\_Group\_Info operation

**API operation name:** Update\_Group\_Info

**Description:** Storing group membership and configuration information.

**Known Consumers:** VAL server.

**Inputs:** See subclause 10.3.2.6, 10.3.2.18

**Outputs:** See subclause 10.3.2.7, 10.3.2.19

See subclause 10.3.6.5 and 10.3.6.1 for the details of usage of this API operation.

### 10.4.3 Void

10.4.3.1 Void

10.4.3.2 Void

### 10.4.4 Void

10.4.4.1 Void

10.4.4.2 Void

## 10.4.5 SS\_Group\_Management\_Event API

### 10.4.5.1 General

**API description:** This API enables the VAL server to communicate with the group management server to subscribe and receive subsequent notification events over GM-S.

### 10.4.5.2 Subscribe\_Group\_Info\_Modification operation

**API operation name:** Subscribe\_Group\_Info\_Modification

**Description:** Subscribing to changes to group membership and configuration information.

**Known Consumers:** VAL server.

**Inputs:** See subclause 10.3.2.14

**Outputs:** See subclause 10.3.2.15

See subclause 10.3.6.3 for the details of usage of this API operation.

### 10.4.5.3 Notify\_Group\_Info\_Modification operation

**API operation name:** Notify\_Group\_Info\_Modification

**Description:** Notification for changes to group membership and configuration information.

**Known Consumers:** VAL server.

**Inputs:** See subclause 10.3.2.8

**Outputs:** See subclause 10.3.2.8

See subclause 10.3.5.1 and 10.3.5.2 for the details of usage of this API operation.

### 10.4.5.4 Notify\_Group\_Creation operation

**API operation name:** Notify\_Group\_Creation

**Description:** Notification for new group creation.

**Known Consumers:** VAL server.

**Inputs:** See subclause 10.3.2.3

**Outputs:** See subclause 10.3.2.3

See subclause 10.3.3 for the details of usage of this API operation.

## 11 Configuration management

### 11.1 General

The configuration management is a SEAL service that offers the configuration management related capabilities to one or more vertical applications.

### 11.2 Functional model for configuration management

#### 11.2.1 General

The functional model for the configuration management is based on the generic functional model specified in clause 6. It is organized into functional entities to describe a functional architecture which addresses the support for configuration management aspects for vertical applications. The on-network and off-network functional model is specified in this clause.

#### 11.2.2 On-network functional model description

Figure 11.2.2-1 illustrates the generic on-network functional model for configuration management.

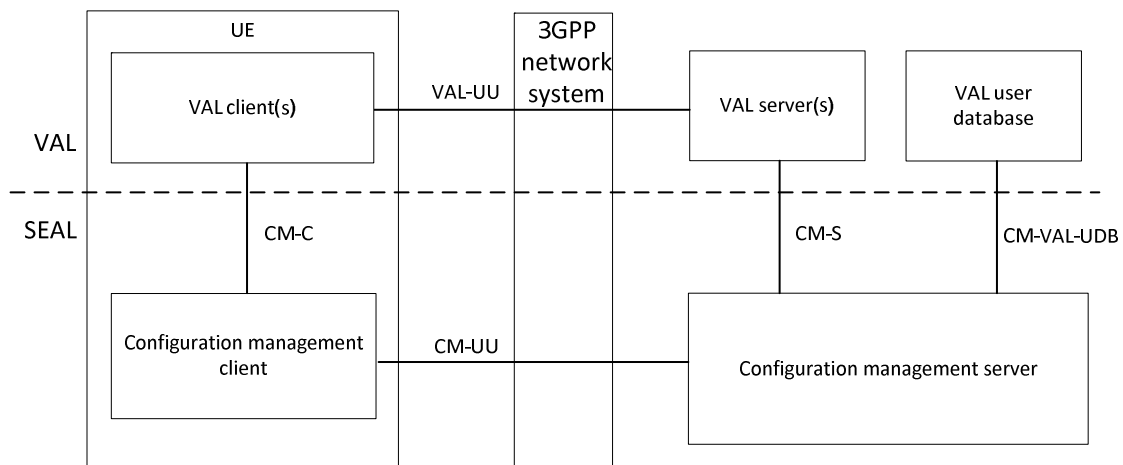

**Figure 11.2.2-1: On-network functional model for configuration management**

The configuration management client communicates with the configuration management server over the CM-UU reference point. The configuration management client provides the support for configuration management functions to the VAL client(s) over CM-C reference point. The VAL server(s) communicate with the configuration management server over the CM-S reference point. The configuration management server communicates with the VAL user database over the CM-VAL-UDB reference point.



### 11.2.3 Off-network functional model description

Figure 11.2.3-1 illustrates the off-network functional model for configuration management.

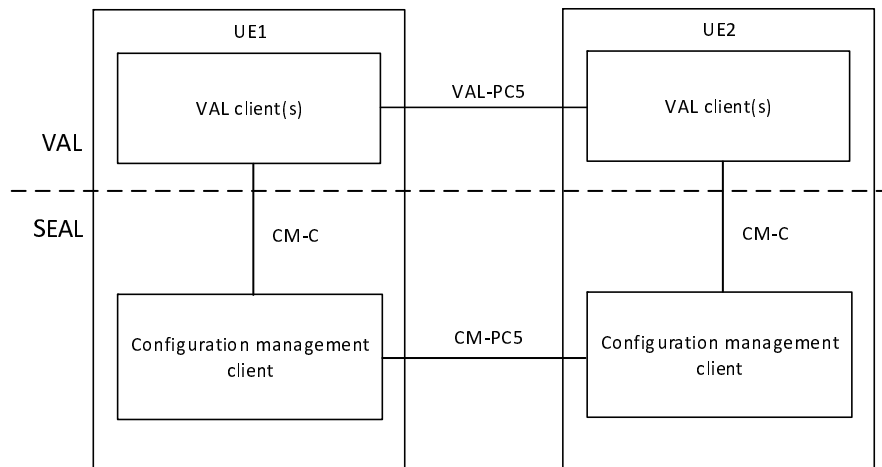

**Figure 11.2.3-1: Off-network functional model for configuration management**

The configuration management client of the UE1 communicates with the configuration management client of the UE2 over the CM-PC5 reference point.

### 11.2.4 Functional entities description

#### 11.2.4.1 General

The functional entities for configuration management SEAL service are described in the following subclauses.

#### 11.2.4.2 Configuration management client

The configuration management client functional entity acts as the application client for configuration related transactions. The configuration management client interacts with the configuration management server and provides and receives configuration data. The configuration management client also supports interactions with the corresponding configuration management client between the two UEs.

The configuration management client functional entity is supported by the signalling user agent and HTTP client functional entities of the signalling control plane.

#### 11.2.4.3 Configuration management server

The configuration management server is a functional entity used to configure one or more vertical applications with 3GPP system related vertical applications provisioning information and configure data on the configuration management client. The configuration management server manages vertical application configuration supported within the vertical's service provider. The configuration management server acts as CAPIF's API exposing function as specified in 3GPP TS 23.222 [8]. The configuration management server also supports interactions with the corresponding configuration management server in distributed SEAL deployments.

The configuration management server functional entity is supported by the SIP AS and HTTP server functional entities of the signalling control plane.

### 11.2.5 Reference points description

#### 11.2.5.1 General

The reference points for the functional model for configuration management are described in the following subclauses.

### 11.2.5.2 CM-UU

The interactions related to configuration management functions between the configuration management client and the configuration management server are supported by CM-UU reference point. This reference point utilizes Uu reference point as described in 3GPP TS 23.401 [9] and 3GPP TS 23.501 [10].

The CM-UU reference point provides the configuration information required for VAL services and supports:

- configuration of the VAL UE by the VAL service; and
- configuration of the VAL application with the VAL service related information e.g. policy information by the VAL UE.

The CM-UU reference point shall use the HTTP-1/HTTP-2 reference points for transport and routing of configuration management related signalling. The CM-UU reference point shall use SIP-1/SIP-2 reference points for subscription/notification related signalling.

### 11.2.5.3 CM-PC5

The interactions related to configuration management functions between the configuration management clients located in different VAL UEs are supported by CM-PC5 reference point. This reference point utilizes PC5 reference point as described in 3GPP TS 23.303 [12].

### 11.2.5.4 CM-C

The interactions related to configuration management functions between the VAL client(s) and the configuration management client within a VAL UE are supported by CM-C reference point.

### 11.2.5.5 CM-S

The interactions related to configuration management functions between the VAL server(s) and the configuration management server are supported by CM-S reference point. The CM-S reference point supports VAL server to obtain the VAL service related vertical applications provisioning information. This reference point is an instance of CAPIF-2 reference point as specified in 3GPP TS 23.222 [8].

The CM-S reference point shall use HTTP-1/ HTTP-2 reference points for transport and routing of configuration management related signalling. The CM-S reference point shall use SIP-2 reference point for subscription/notification related signalling.

### 11.2.5.6 CM-E

The interactions related to configuration management functions between the configuration management servers in a distributed deployment are supported by CM-E reference point.

**Editor's Note: The functions enabled over CM-E reference point is FFS.**

### 11.2.5.7 Reference point CM-VAL-UIDB (between the configuration management server and the VAL user database)

The CM-VAL-UIDB reference point is an instance of VAL-UIDB reference point, which exists between the VAL user database and the configuration management server, is used for:

- the configuration management server to store the user profile data in the specific VAL user database; and
- the configuration management server to obtain the user profile from the specific VAL user database for further configuration in the VAL UE.

## 11.3 Procedures and information flows for configuration management

### 11.3.1 General

The procedures related to the configuration management are described in the following subclauses.

### 11.3.2 Information flows

#### 11.3.2.1 Get VAL UE configuration request

Table 11.3.2.1-1 describes the information flow get VAL UE configuration request from the configuration management client to the configuration management server.

**Table 11.3.2.1-1: Get VAL UE configuration request**

Information element	Status	Description
VAL UE ID	M	Identify of the VAL UE requesting the configuration information.
VAL service ID	O (see NOTE)	Identify of the VAL service for which the configuration information is requested.
NOTE: If the VAL service ID information element is not present, then the default service is service.		

#### 11.3.2.2 Get VAL UE configuration response

Table 11.3.2.2-1 describes the information flow get VAL UE configuration response from the configuration management server to the configuration management client.

**Table 11.3.2.2-1: Get VAL UE configuration response**

Information element	Status	Description
Result	M	Indicates the success or failure of getting the configuration information
VAL UE configuration data	O (see NOTE)	The VAL UE configuration data as specified in the corresponding VAL service specification and outside the scope of the present document
NOTE: If the Result information element indicates failure then VAL UE configuration data information element is not included.		

#### 11.3.2.3 Get VAL user profile request

Table 11.3.2.3-1 describes the information flow get VAL user profile request from the configuration management client to the configuration management server.

**Table 11.3.2.3-1: Get VAL user profile request**

Information element	Status	Description
Requester Identity	M	The identity of the configuration management client performing the request.
Identity	M	The VAL user ID of the VAL user or VAL UE ID.

#### 11.3.2.4 Get VAL user profile response

Table 11.3.2.4-1 describes the information flow get VAL user profile response from the configuration management server to the configuration management client.

**Table 11.3.2.4-1: Get VAL user profile response**

Information element	Status	Description
VAL user profile data	M (see NOTE)	One or more VAL user profiles associated with the VAL user ID or VAL UE ID provided in the associated get VAL user profile request.
Result	M	Indicates the success or failure for the operation
NOTE: If the Result information element indicates failure then the value of VAL user profile data information element has no meaning.		

### 11.3.2.5 Notification for VAL user profile data update

Table 11.3.2.5-1 describes the information flow notification for VAL user profile data update from the configuration management server to the configuration management client.

**Table 11.3.2.5-1: Notification for VAL user profile data update**

Information element	Status	Description
Pointer to modified VAL user profile data.	M	Pointer to the modified VAL user profile data.

### 11.3.2.6 Get updated VAL user profile data request

Table 11.3.2.6-1 describes the information flow get updated VAL user profile data request from the configuration management client to the configuration management server.

**Table 11.3.2.6-1: Get updated VAL user profile data request**

Information element	Status	Description
Identity	M	The VAL user ID of the originating VAL user or VAL UE ID.
Pointer to modified VAL user profile data.	M	Pointer to the modified VAL user profile data.

### 11.3.2.7 Get updated VAL user profile data response

Table 11.3.2.7-1 describes the information flow get updated VAL user profile data response from the configuration management server to the configuration management client.

**Table 11.3.2.7-1: Get updated VAL user profile data response**

Information element	Status	Description
Updated VAL user profile data	M (see NOTE)	VAL user profile data that has been modified.
Result	M	Indicates the success or failure for the operation
NOTE: If the Result information element indicates failure then the value of Updated VAL user profile data information element has no meaning.		

### 11.3.2.8 Update VAL user profile data request

Table 11.3.2.8-1 describes the information flow update VAL user profile data request from the configuration management client to the configuration management server.

**Table 11.3.2.8-1: Update VAL user profile data request**

Information element	Status	Description
Identity	M	The VAL user ID of the originating VAL user or VAL UE ID.
Updated VAL user profile data	M	The contents of the user profile data to be updated.

### 11.3.2.9 Update VAL user profile data response

Table 11.3.2.9-1 describes the information flow update VAL user profile data response from the configuration management server to the configuration management client.

**Table 11.3.2.9-1: Update VAL user profile data response**

Information element	Status	Description
Result	M	Indicates the success or failure

### 11.3.2.10 Updated user profile subscription request

Table 11.3.2.10-1 describes the information flow from the VAL server to the configuration management server for updated user profile subscription request.

**Table 11.3.2.10-1: Updated user profile subscription request**

Information element	Status	Description
Requester Identity	M	The identity of the VAL server performing the request.
Identities list	M	List of VAL users or VAL UEs whose updates on user profile is requested.
Time between consecutive user profile updates	M	It indicates the interval time between consecutive user profile updates

### 11.3.2.11 Updated user profile subscription response

Table 11.3.2.11-1 describes the information flow from the configuration management server to the VAL server for updated user profile subscription response.

**Table 11.3.2.11-1: Updated user profile subscription response**

Information element	Status	Description
Subscription status	M (see NOTE)	It indicates the subscription result
Result	M	Indicates the success or failure for the operation
NOTE:	If the Result information element indicates failure then the value of the Subscription status information element has no meaning.	

### 11.3.2.12 Updated user profile notification

Table 11.3.2.12-1 describes the information flow updated user profile notification from the configuration management server to the VAL server.

**Table 11.3.2.12-1: Notify updated user profile event**

Information element	Status	Description
Identities list	M	List of VAL users or VAL UEs whose user profile is modified.
Updated user profile data	M	User profile data that has been modified.

## 11.3.3 VAL UE configuration data

### 11.3.3.1 General

The VAL UE configuration data has to be known by the VAL UE before it can use the VAL service.

### 11.3.3.2 Procedures

The procedure for VAL UE obtaining the VAL UE related configuration data is illustrated in figure 11.3.3.2-1.

Pre-conditions:

- The VAL UE has the secure access to the configuration management server.

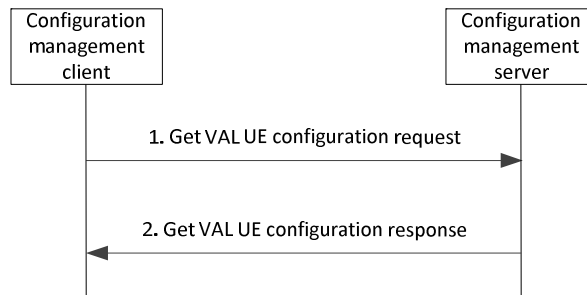

**Figure 11.3.3.2-1: VAL UE obtains the configuration data**

1. The configuration management client sends a get VAL UE configuration request to the configuration management server for obtaining VAL UE configuration data.
2. The configuration management server sends get VAL UE configuration response to the configuration management client. This message carries the VAL UE configuration data.

### 11.3.3.3 Structure of VAL UE configuration data

NOTE: For a VAL service, the VAL UE configuration data is listed in the corresponding VAL service specification and outside the scope of the present document.

## 11.3.4 VAL user profile data

### 11.3.4.1 General

The VAL user profile procedures are described in the following subclauses.

### 11.3.4.2 Obtaining the VAL user profile(s) from the network

#### 11.3.4.2.1 Obtaining the VAL user profile(s) in primary VAL system

The procedure for the VAL user or VAL server obtaining VAL user profiles in the primary VAL system of that VAL user is illustrated in figure 11.3.4.2.1-1.

Pre-conditions:

- The VAL user has performed user authentication in the identity management server.
- The VAL UE or VAL server has secure access to the configuration management server.

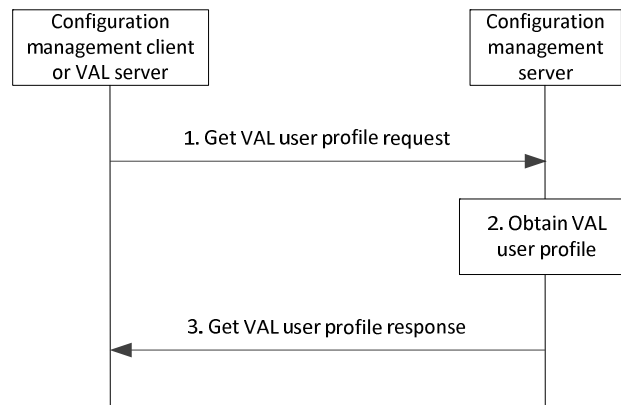

**Figure 11.3.4.2.1-1: VAL user obtains the VAL user profile(s) from the network**

1. The configuration management client or VAL server sends a get VAL user profile request message to the configuration management server, which includes the VAL user ID or VAL UE ID.
2. The configuration management server obtains the VAL user profile information.
3. The configuration management server sends get VAL user profile response message to the configuration management client or VAL server. When a download is necessary, this message includes all VAL user profiles that are associated with the VAL user ID or VAL UE ID.

#### 11.3.4.2.2 VAL user receiving VAL service from a partner VAL system

Figure 11.3.4.2.2-1 below illustrates mechanism for the configuration management client to retrieve the VAL user profile for the migrating VAL user from the partner VAL system.

**NOTE:** Any proxy servers at the edges of the primary and partner VAL systems which are used to hide the topology of the VAL systems from external entities are not shown in this procedure.

##### Preconditions

- The VAL user is permitted to migrate to the partner VAL system, and the relevant authorizations are configured in both the primary and partner VAL systems of that VAL user
- The VAL user has performed VAL user authentication in the partner VAL system, and has received the necessary credentials to retrieve configuration information and to request service authorization.
- The VAL UE has been provided with addressing information to allow the configuration management client in the VAL UE to access the configuration management server in the partner VAL system.

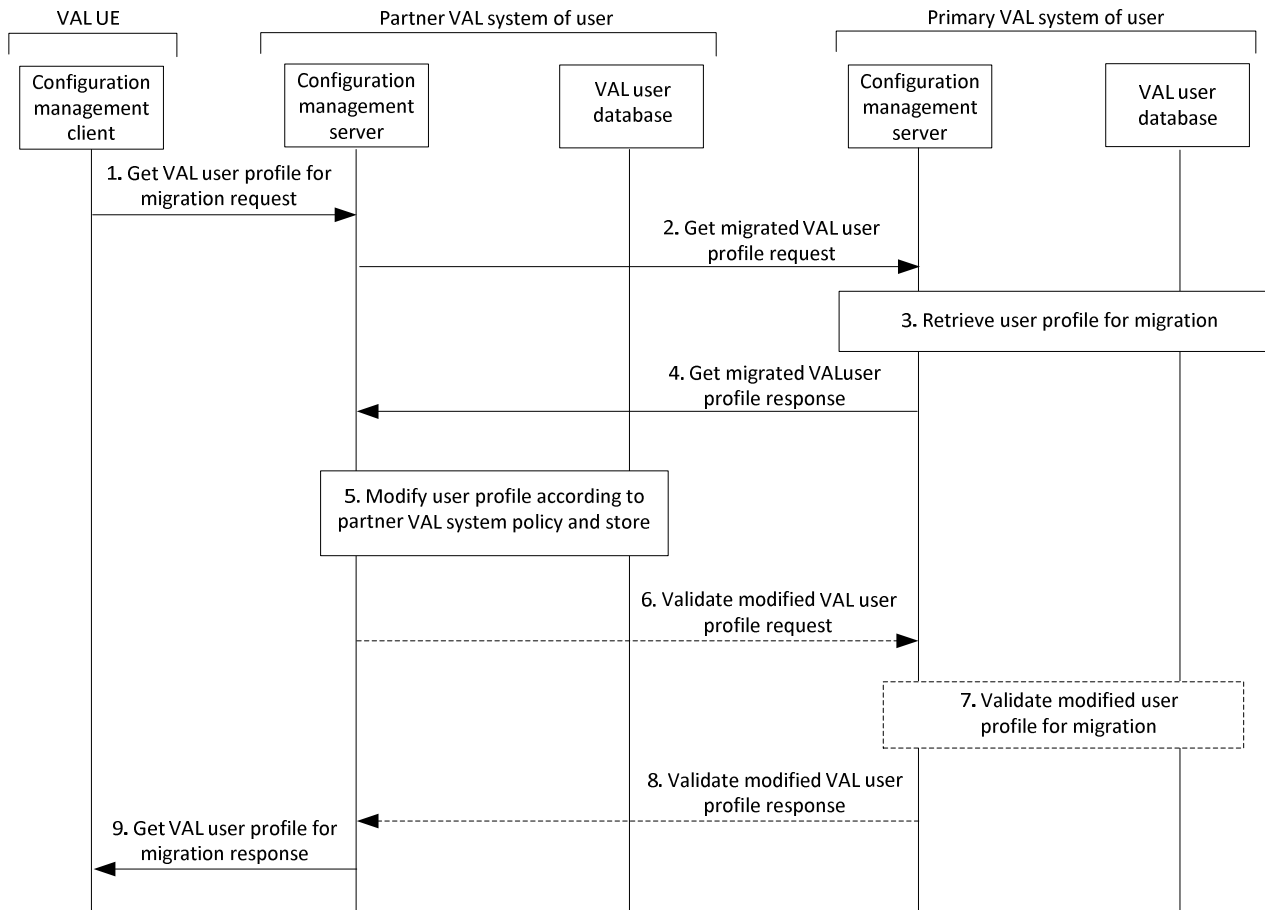

**Figure 11.3.4.2.2-1: Retrieval of user profile in partner VAL system**

1. The configuration management client in the VAL UE of the migrating VAL user requests the VAL user profile for migration from the configuration management server in the partner VAL system.
2. The configuration management server in the partner VAL system requests the VAL user profile from the configuration management server in the primary VAL system of the VAL user.
3. The configuration management server in the primary VAL system of the VAL user retrieves the VAL user profile from the VAL user database in that primary VAL system. The identification of the partner VAL system to which the VAL user is attempting to migrate is used to determine which VAL user profile is retrieved for that VAL user for migration to that partner VAL system.
4. The configuration management server in the primary VAL system provides the VAL user profile to the configuration management server in the partner VAL system of the VAL user, optionally requesting validation of the modified VAL user profile.
5. The partner VAL system of the VAL user modifies the VAL user profile according to local configuration information and stores the modified VAL user profile in the VAL user database in the partner VAL system.
6. If the primary VAL system requested validation of the VAL user profile in step 4, the configuration management server in the partner VAL system of the migrating VAL user may send the modified VAL user profile to the configuration management server of the primary VAL system of the VAL user to allow the primary VAL system of the VAL user to validate the modified VAL user profile.
7. The primary VAL system of the migrated VAL user validates the modified VAL service profile of the migrated VAL user.
8. The primary VAL system of the migrated VAL user responds to the partner VAL system with the results of the validation process.
9. The configuration management server in the partner VAL system provides the VAL user profile to the configuration management client of the migrating VAL user,



NOTE: Step 9 is not followed if the validation process fails.

### 11.3.4.3 VAL user receives updated VAL user profile data from the network

The procedure for VAL user obtaining updated VAL user profile data that is initiated by the network is illustrated in figure 11.3.4.3-1.

Pre-conditions:

- The VAL user has performed user authentication in identity management server.
- The VAL UE has secure access to the configuration management server.
- The VAL UE has already obtained one or more VAL user profiles.
- The configuration management server has access to the VAL user profile(s) associated with the VAL user ID of the VAL user or VAL UE ID.

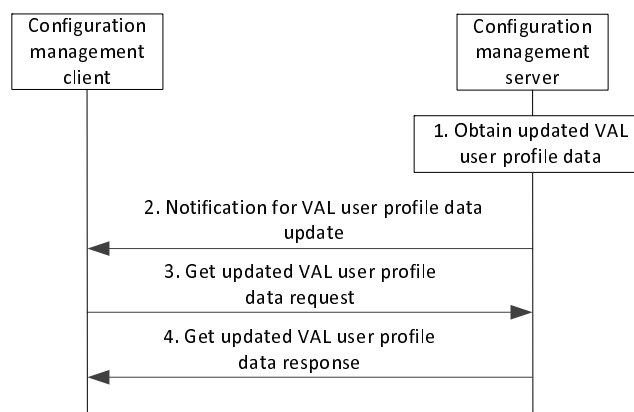

**Figure 11.3.4.3-1: VAL user receives updated VAL user profile data from the network**

1. The configuration management server obtains updated VAL user profile data.
2. The configuration management server sends a notification for VAL user profile data update to the configuration management client.
3. The configuration management client sends get updated VAL user profile data request to the configuration management server, which includes the VAL user ID or VAL UE ID.
4. The configuration management server sends get updated VAL user profile data response to the configuration management client which includes the updated VAL user profile data requested in step 3.

NOTE: The updated VAL user profile data could be for a specific VAL user profile, a specific parameter in an VAL user profile, a set of VAL user profiles, or all the VAL user profiles for the VAL user ID or VAL UE ID. VAL user profile data is defined per VAL service.

### 11.3.4.4 VAL user updates VAL user profile data to the network

The procedure for VAL user updating the VAL user profile data is illustrated in figure 11.3.4.4-1.

Pre-conditions:

- The VAL user has performed user authentication in identity management server.
- The VAL UE has secure access to the configuration management server.
- The VAL UE has already obtained one or more VAL user profiles.

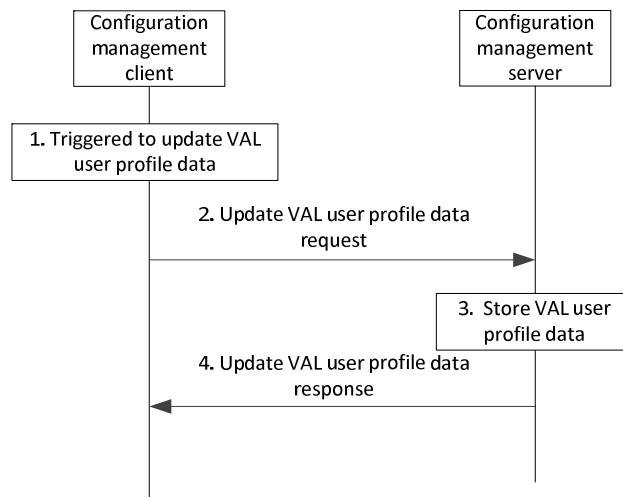

**Figure 11.3.4.4-1: VAL user updates VAL user profile data to the network**

1. The configuration management client is triggered (e.g. by user interaction operation) to update the VAL user profile data on the configuration management server.
2. The configuration management client sends update VAL user profile data request to the configuration management server, which includes the VAL user profile data to be updated.
3. The configuration management server stores the received VAL user profile data.
4. The configuration management server sends update VAL user profile data response to the configuration management client to confirm the VAL user profile data update is complete.

NOTE: The updated VAL user profile data could be for a specific VAL user profile, a specific parameter in an VAL user profile, a set of VAL user profiles, or all the VAL user profiles for the VAL user ID and VAL UE ID. VAL user profile data is defined per VAL service.

### 11.3.4.5 Updated user profile subscription procedure

Figure 11.3.4.5-1 illustrates the high level procedure for obtaining updated user profile data based on subscription request.

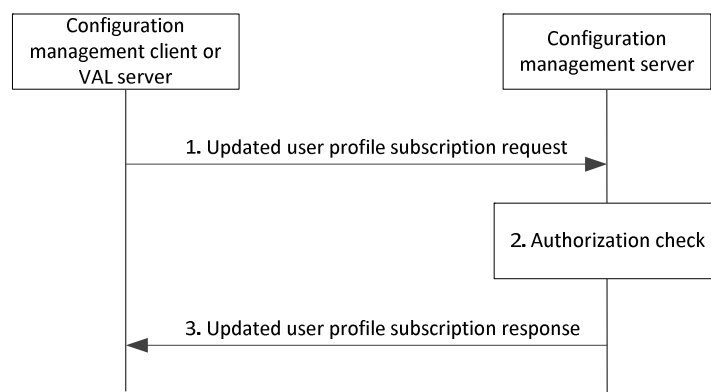

**Figure 11.3.4.5-1: Updated user profile subscription procedure**

1. Configuration management client or VAL server sends an updated user profile subscription request to the configuration management server to subscribe any updates to user profile of one or more VAL users or VAL UEs.
2. The configuration management server shall check if the configuration management client or VAL server is authorized to initiate the updated user profile subscription request.
3. The configuration management server replies with a updated user profile subscription response indicating the subscription status.

Figure 11.3.4.5-2 illustrates the high level procedure of updated user profile notification event.

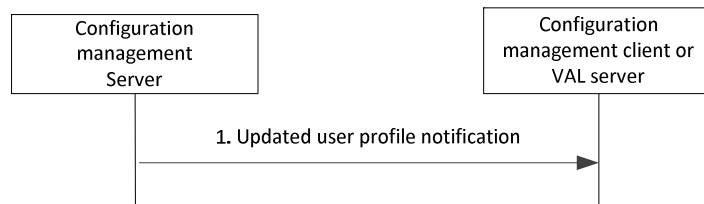

**Figure 11.3.4.5-2: Updated user profile notification**

1. The configuration management server sends the updated user profile notification including the changes to user profile of one or more VAL users or VAL UEs to the configuration management client or VAL server.

NOTE: Updated user profile notification is based on the subscription.

## 11.4 SEAL APIs for configuration management

### 11.4.1 General

Table 11.4.1-1 illustrates the SEAL APIs for configuration management.

**Table 11.4.1-1: List of SEAL APIs for configuration management**

API Name	API Operations	Known Consumer(s)	Communication Type
SS_UserProfileRetrieval	Obtain_User_Profile	VAL server	Request /Response
SS_UserProfileEvent	Subscribe_User_Profile_Update	VAL server	Subscribe/Notify
	Notify_User_Profile_Update	VAL server	

### 11.4.2 SS\_UserProfileRetrieval API

#### 11.4.2.1 General

**API description:** This API enables the VAL server to communicate with the configuration management server for obtaining user profile over CM-S.

#### 11.4.2.2 Obtain\_User\_Profile operation

**API operation name:** Obtain\_User\_Profile

**Description:** Obtaining user profile.

**Known Consumers:** VAL server.

**Inputs:** See subclause 11.3.2.3

**Outputs:** See subclause 11.3.2.4

See subclause 11.3.4.2 for the details of usage of this API operation.

## 11.4.3 SS\_UserProfileEvent API

### 11.4.3.1 General

**API description:** This API enables the VAL server to communicate with the configuration management server for obtaining updated user profile over CM-S.

### 11.4.3.2 Subscribe\_User\_Profile\_Update operation

**API operation name:** Subscribe\_User\_Profile\_Update

**Description:** Subscribing to changes to user profile.

**Known Consumers:** VAL server.

**Inputs:** See subclause 11.3.2.10

**Outputs:** See subclause 11.3.2.11

See subclause 11.3.4.5 for the details of usage of this API operation.

### 11.4.3.3 Notify\_User\_Profile\_Update operation

**API operation name:** Notify\_User\_Profile\_Update

**Description:** Notification for changes to user profile.

**Known Consumers:** VAL server.

**Inputs:** See subclause 11.3.2.12

**Outputs:** See subclause 11.3.2.12

See subclause 11.3.4.5 for the details of usage of this API operation.

---

## 12 Identity management

### 12.1 General

The identity management is a SEAL service that offers the identity management related capabilities to one or more vertical applications.

### 12.2 Functional model for identity management

#### 12.2.1 General

The functional model for the identity management is based on the generic functional model specified in clause 6. It is organized into functional entities to describe a functional architecture which addresses the support for identity management aspects for vertical applications. The on-network and off-network functional model is specified in this clause.

## 12.2.2 On-network functional model description

Figure 12.2.2-1 illustrates the generic on-network functional model for identity management.

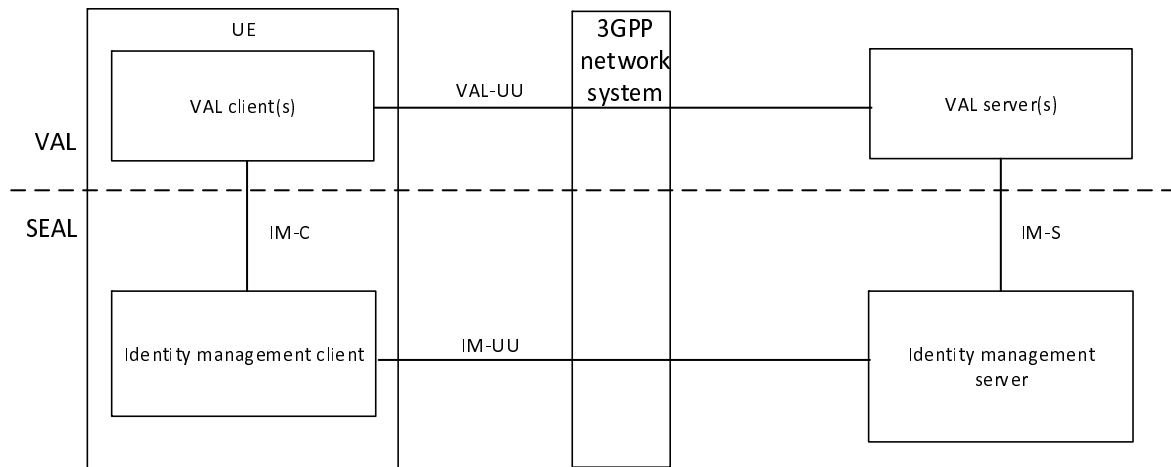

**Figure 12.2.2-1: On-network functional model for identity management**

The identity management client communicates with the identity management server over the IM-UU reference point. The identity management client provides the support for identity management functions to the VAL client(s) over IM-C reference point. The VAL server(s) communicate with the identity management server over the IM-S reference point.

*Editor's Note: The role of VAL-UU in the context of identity management is FFS.*

## 12.2.3 Off-network functional model description

Figure 12.2.3-1 illustrates the off-network functional model for identity management.

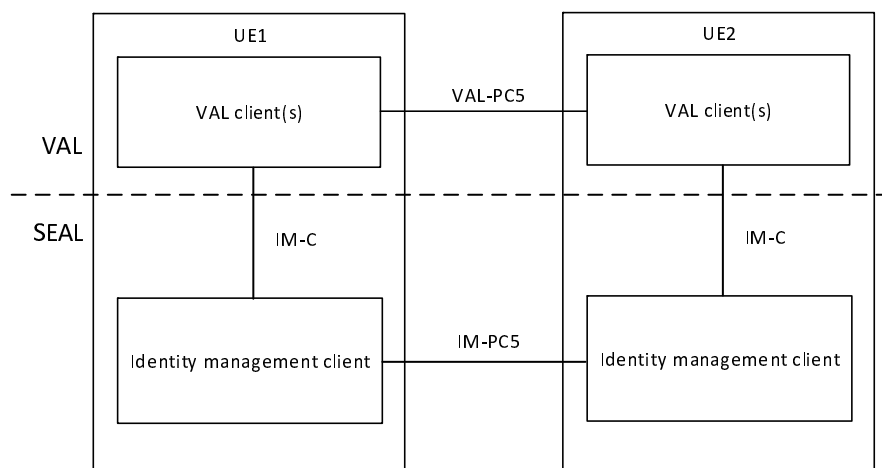

**Figure 12.2.3-1: Off-network functional model for identity management**

The identity management client of the UE1 communicates with the identity management client of the UE2 over the IM-PC5 reference point.

## 12.2.4 Functional entities description

### 12.2.4.1 General

The functional entities for identity management SEAL service are described in the following subclauses.

### 12.2.4.2 Identity management client

The identity management client functional entity acts as the application client for vertical applications layer user identity related transactions. The identity management client interacts with the identity management server. The identity management client also supports interactions with the corresponding identity management client between the two UEs.

### 12.2.4.3 Identity management server

The identity management server is a functional entity that authenticates the vertical application layer user identity. The authentication is performed by verifying the credentials provided by the vertical applications' user. The identity management server acts as CAPIF's API exposing function as specified in 3GPP TS 23.222 [8]. The identity management server also supports interactions with the corresponding identity management server in distributed SEAL deployments.

## 12.2.5 Reference points description

### 12.2.5.1 General

The reference points for the functional model for identity management are described in the following subclauses.

### 12.2.5.2 IM-UU

The interactions related to identity management functions between the identity management client and the identity management server are supported by IM-UU reference point. This reference point utilizes Uu reference point as described in 3GPP TS 23.401 [9] and 3GPP TS 23.501 [10].

### 12.2.5.3 IM-PC5

The interactions related to identity management functions between the identity management clients located in different VAL UEs are supported by IM-PC5 reference point. This reference point utilizes PC5 reference point as described in 3GPP TS 23.303 [12].

### 12.2.5.4 IM-C

The interactions related to identity management functions between the VAL client(s) and the identity management client within a VAL UE are supported by IM-C reference point.

### 12.2.5.5 IM-S

The interactions related to identity management functions between the VAL server(s) and the identity management server are supported by IM-S reference point. This reference point is an instance of CAPIF-2 reference point as specified in 3GPP TS 23.222 [8].

### 12.2.5.6 IM-E

The interactions related to identity management functions between the identity management servers in a distributed deployment are supported by IM-E reference point.

**Editor's Note:** The functions enabled over IM-E reference point is FFS.

## 12.3 Procedures and information flows for identity management

### 12.3.1 General

The procedures related to the identity management are described in the following subclauses.

## 12.3.2 Information flows

NOTE: The procedure for identity management is specified in subclause 5.2.3 and 5.2.4 of 3GPP TS 33.434 [29].

## 12.3.3 General user authentication and authorization for VAL services

### 12.3.3.1 General

The high level user authentication and authorization procedure is described in the following subclause.

### 12.3.3.2 Primary VAL system

Figure 12.3.3.2-1 is a high level user authentication and authorization flow.

NOTE: The specific user authentication and authorization architecture required by the VAL services in order to realize the VAL user authentication and authorization is specified in subclauses 5.2.3, 5.2.4 and 5.2.5 of 3GPP TS 33.434 [29].

The user authentication process shown in figure 12.3.3.2-1 may take place in some scenarios as a separate step independently from a SIP registration phase, for example if the SIP core is outside the domain of the VAL server.

**Editor's note:** The procedure described in this subclause as shown in Figure 12.3.3.2-1 may require further study.

A procedure for user authentication is illustrated in figure 12.3.3.2-1. Other alternatives may be possible, such as authenticating the user within the SIP registration phase.

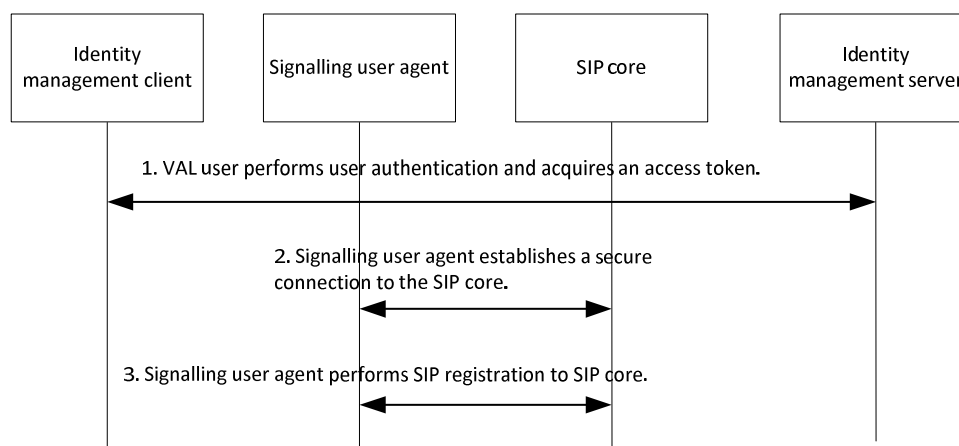

**Figure 12.3.3.2-1: VAL user authentication and registration with Primary VAL system, single domain**

1. In this step the identity management client begins the user authorization procedure. The VAL user supplies the user credentials (e.g. biometrics, secureID, username/password) for verification with the identity management server. This step may occur before or after step 3. In a VAL system with multiple VAL services, a single user authentication as in step 1 can be used for multiple VAL service authorizations for the user.
2. The signalling user agent establishes a secure connection to the SIP core for the purpose of SIP level authentication and registration.
3. The signalling user agent completes the SIP level registration with the SIP core (and an optional third-party registration with the VAL service server(s)).

NOTE 1: The VAL client(s) perform the corresponding VAL service authorization for the user by utilizing the result of this procedure.

NOTE 2: Steps 2 and 3 are not required to be performed if the VAL service does not use SIP.

### 12.3.3.3 Interconnection partner VAL system

Where communications with a partner VAL system using interconnection are required, user authorization takes place in the serving VAL system of the VAL service user, using the VAL user service authorization procedure specified in subclauses 5.2.5 and 5.2.6 of 3GPP TS 33.434 [29].

## 12.4 SEAL APIs for identity management

### 12.4.1 General

There are no APIs defined for SEAL Identity Management.

### 12.4.2 Void

#### 12.4.2.1 Void

#### 12.4.2.2 Void

---

## 13 Key management

### 13.1 General

The key management is a SEAL service that offers the key management related capabilities to one or more vertical applications.

## 13.2 Functional model for key management

### 13.2.1 General

The functional model for the key management is based on the generic functional model specified in clause 6. It is organized into functional entities to describe a functional architecture which addresses the support for key management aspects for vertical applications. The on-network and off-network functional model is specified in this clause.

### 13.2.2 On-network functional model description

Figure 13.2.2-1 illustrates the generic on-network functional model for key management.



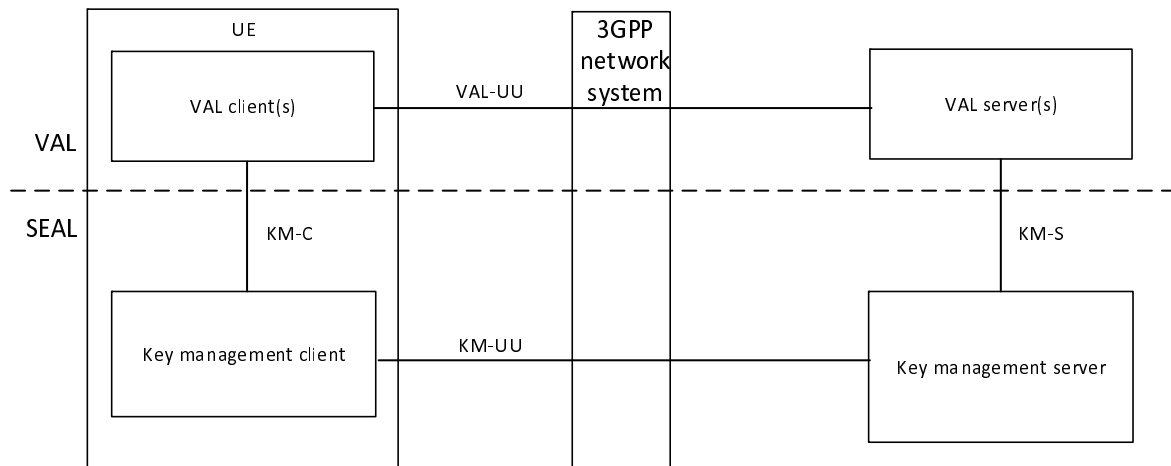
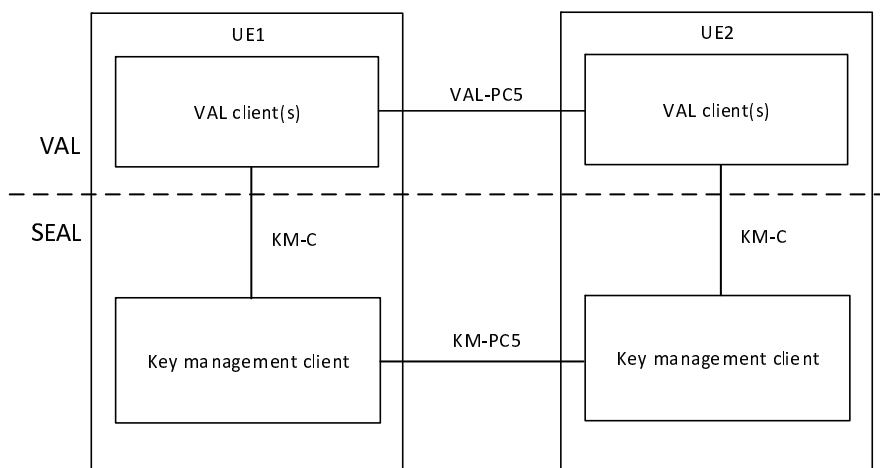

**Figure 13.2.2-1: On-network functional model for key management**

The key management client communicates with the key management server over the KM-UU reference point. The key management client provides the support for key management functions to the VAL client(s) over KM-C reference point. The VAL server(s) communicate with the key management server over the KM-S reference point.

### 13.2.3 Off-network functional model description

Figure 13.2.3-1 illustrates the off-network functional model for key management.



**Figure 13.2.3-1: Off-network functional model for key management**

The key management client of the UE1 communicates with the key management client of the UE2 over the KM-PC5 reference point.

### 13.2.4 Functional entities description

#### 13.2.4.1 General

The functional entities for key management SEAL service are described in the following subclauses.

#### 13.2.4.2 Key management client

The key management functional entity acts as the application client for key management functions. It interacts with the key management server. The key management client also supports interactions with the corresponding key management client between the two UEs.

NOTE: The functionality of the key management client is specified in subclause 5.3 of 3GPP TS 33.434 [29].

### 13.2.4.3 Key management server

The key management server is a functional entity that stores and provides security related information (e.g. encryption keys) to the key management client, group management server and vertical application server to achieve the security goals of confidentiality and integrity of media and signalling. The key management server acts as CAPIF's API exposing function as specified in 3GPP TS 23.222 [8]. The key management server also supports interactions with the corresponding key management server in distributed SEAL deployments.

NOTE: The functionality of the key management server is specified in subclause 5.3 of 3GPP TS 33.434 [29].

## 13.2.5 Reference points description

### 13.2.5.1 General

The reference points for the functional model for key management are described in the following subclauses.

### 13.2.5.2 KM-UU

The interactions related to key management functions between the key management client and the key management server are supported by KM-UU reference point. This reference point utilizes Uu reference point as described in 3GPP TS 23.401 [9] and 3GPP TS 23.501 [10].

KM-UU reference point provides a means for the key management server to provide security related information (e.g. encryption keys) to the key management client. The KM-UU reference point shall use the HTTP-1 and HTTP-2 signalling control plane reference points for transport and routing of security related information to the key management client.

NOTE: KM-UU reference point is specified in subclause 5.1.1.4 of 3GPP TS 33.434 [29].

### 13.2.5.3 KM-PC5

The interactions related to key management functions between the key management clients located in different VAL UEs are supported by KM-PC5 reference point. This reference point utilizes PC5 reference point as described in 3GPP TS 23.303 [12].

### 13.2.5.4 KM-C

The interactions related to key management functions between the VAL client(s) and the key management client within a VAL UE are supported by KM-C reference point.

### 13.2.5.5 KM-S

The interactions related to key management functions between the VAL server(s) and the key management server are supported by KM-S reference point. This reference point is an instance of CAPIF-2 reference point as specified in 3GPP TS 23.222 [8].

KM-S reference point provides a means for the key management server to provide security related information (e.g. encryption keys) to the VAL server. The KM-S reference point shall use the HTTP-1 and HTTP-2 signalling control plane reference points for transport and routing of security related information to the VAL server.

NOTE: KM-S is specified in subclause 5.1.1.4 of 3GPP TS 33.434 [29].

### 13.2.5.6 KM-E

The interactions related to key management functions between the key management servers in a distributed deployment are supported by KM-E reference point.

**Editor's Note: The functions enabled over KM-E reference point is FFS.**

### 13.2.5.7 SEAL-X1

NOTE: SEAL-X1 reference point between the key management server and the group management server is described in subclause 6.5.9.2.

## 13.3 Procedures and information flows for key management

NOTE: The procedure for key management is specified in subclause 5.3 of 3GPP TS 33.434 [29].

## 13.4 SEAL APIs for key management

### 13.4.1 General

The SEAL APIs for Key Management are specified in subclauses 5.7.1 and 7.6.1 of 3GPP TS 29.549 [30].

### 13.4.2 Void

#### 13.4.2.1 Void

#### 13.4.2.2 Void

---

## 14 Network resource management

### 14.1 General

The network resource management is a SEAL service that offers the network resource management (e.g. unicast and multicast network resources) related capabilities to one or more vertical applications.

## 14.2 Functional model for network resource management

### 14.2.1 General

The functional model for the network resource management is based on the generic functional model specified in clause 6. It is organized into functional entities to describe a functional architecture which addresses the support for network resource management aspects for vertical applications. The on-network and off-network functional model is specified in this clause.

### 14.2.2 On-network functional model description

Figure 14.2.2-1 illustrates the generic on-network functional model for network resource management.

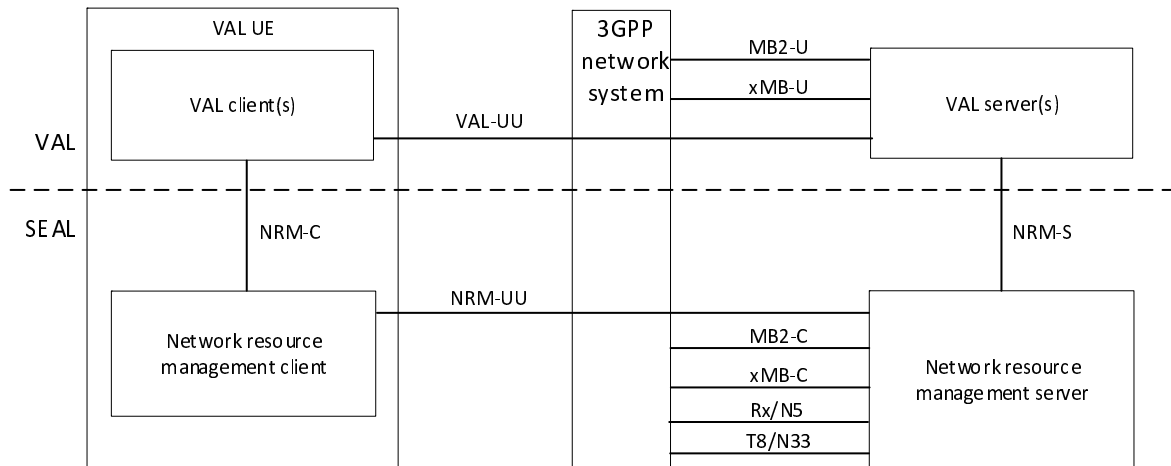

**Figure 14.2.2-1: On-network functional model for network resource management**

The network resource management client communicates with the network resource management server over the NRM-UU reference point. The network resource management client provides the support for network resource management functions to the VAL client(s) over NRM-C reference point. The VAL server(s) communicate with the network resource management server over the NRM-S reference point.

The network resource management server communicates with the BM-SC via MB2-C and xMB-C reference points to obtain and control the multicast resources from the underlying 3GPP network system. The network resource management server communicates with the PCRF via Rx reference point or communicates with the PCF via N5 reference point to control the unicast resources from the underlying 3GPP network system. The network resource management server communicates with the SCEF via T8 reference point or communicates with the NEF via N33 reference point to perform event monitoring procedures from the underlying 3GPP network system.

### 14.2.3 Off-network functional model description

Figure 14.2.3-1 illustrates the off-network functional model for network resource management.

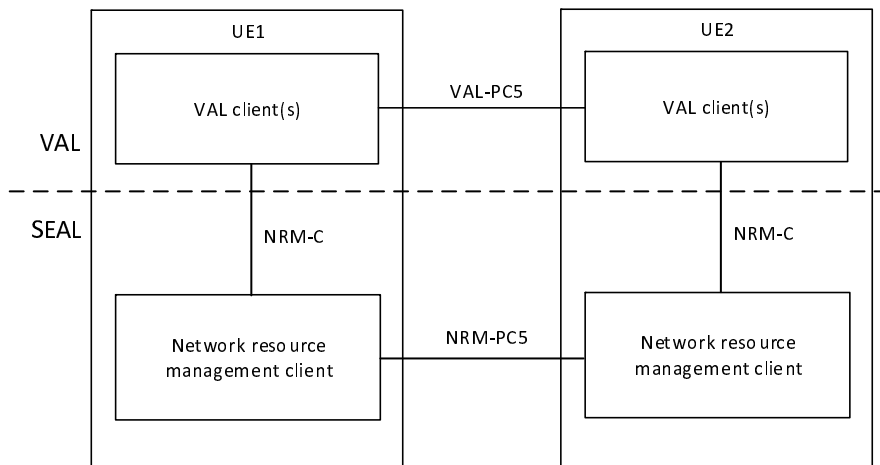

**Figure 14.2.3-1: Off-network functional model for network resource management**

The network resource management client of the UE1 communicates with the network resource management client of the UE2 over the NRM-PC5 reference point.

**Editor's note: Whether off-network support is required for network resource management is FFS.**

## 14.2.4 Functional entities description

### 14.2.4.1 General

The functional entities for network resource management SEAL service are described in the following subclauses.

### 14.2.4.2 Network resource management client

The network resource management client functional entity acts as the application client for the management of network resources. The network resource management client interacts with the network resource management server.

### 14.2.4.3 Network resource management server

The network resource management server functional entity provides for management of 3GPP system network resources (e.g. unicast, multicast) to support the VAL applications. The network resource management server acts as CAPIF's API exposing function as specified in 3GPP TS 23.222 [8]. The network resource management server also supports interactions with the corresponding network resource management server in distributed SEAL deployments. The NRM server's role may be assumed by the VAL server in some deployments, in which case, the VAL server performs the procedures for network resource management of the NRM server.

## 14.2.5 Reference points description

### 14.2.5.1 General

The reference points for the functional model for network resource management are described in the following subclauses.

### 14.2.5.2 NRM-UU

The interactions related to network resource management functions between the network resource management client and the network resource management server are supported by NRM-UU reference point. This reference point utilizes Uu reference point as described in 3GPP TS 23.401 [9] and 3GPP TS 23.501 [10].

### 14.2.5.3 NRM-PC5

The interactions related to network resource management functions between the network resource management clients located in different VAL UEs are supported by the NRM-PC5 reference point. This reference point utilizes PC5 reference point as described in 3GPP TS 23.303 [12].

**Editor's note: Whether NRM-PC5 reference point is required for network resource management is FFS.**

### 14.2.5.4 NRM-C

The interactions related to network resource management functions between the VAL client(s) and the network resource management client within a VAL UE are supported by the NRM-C reference point.

**Editor's note: Whether NRM-C reference point is required for network resource management is FFS.**

### 14.2.5.5 NRM-S

The interactions related to network resource management functions between the VAL server(s) and the network resource management server are supported by the NRM-S reference point. This reference point is an instance of CAPIF-2 reference point as specified in 3GPP TS 23.222 [8].

### 14.2.5.6 NRM-E

The interactions related to network resource management functions between the network resource management servers in a distributed deployment are supported by NRM-E reference point.

**Editor's Note:** The functions enabled over NRM-E reference point is FFS.

### 14.2.5.7 MB2-C

The reference point MB2-C supports the control plane interactions between the network resource management server and the BM-SC and is specified in 3GPP TS 29.468 [22].

### 14.2.5.8 xMB-C

The reference point xMB-C supports the control plane interactions between the network resource management server and the BM-SC and is specified in 3GPP TS 26.348 [20].

### 14.2.5.9 Rx

The reference point Rx supports the interactions between the network resource management server and the PCRF and is specified in 3GPP TS 29.214 [21].

### 14.2.5.10 N5

The reference point N5 supports the interactions between the network resource management server and the PCF and is specified in 3GPP TS 23.501 [10].

## 14.3 Procedures and information flows for network resource management

### 14.3.1 General

The procedures related to the network resource management are described in the following subclauses.

### 14.3.2 Information flows

#### 14.3.2.1 Network resource adaptation request

Table 14.3.2.1-1 describes the information flow network resource adaptation request from the VAL server to the NRM server.

**Table 14.3.2.1-1: Network resource adaptation request**

Information element	Status	Description
Requester Identity	M	The identity of the VAL server performing the request.
List of VAL UE IDs	M (see NOTE)	List consisting of one or more VAL UE IDs for whom the network resource adaptation occurs.
VAL group ID	M (see NOTE)	The VAL group ID for whom the network resource adaptation occurs.
Resource adaptation requirement	M	The resource adaptation requirement corresponds to the VAL service QoS requirements as applied for a UE or group of UEs (E.g. bandwidth, resource).
NOTE: Either of the information elements should be present.		

#### 14.3.2.2 Network resource adaptation response

Table 14.3.2.2-1 describes the information flow network resource adaptation response from the NRM server to the VAL server.

**Table 14.3.2.2-1: Network resource adaptation response**

Information element	Status	Description
Result	M	Result includes success or failure of the network resource adaptation with the underlying network. The response can also include an updated value for some of the parameters included in the network resource adaptation request (e.g. negotiation of resource offering)

### 14.3.2.3 MBMS bearer announcement

Table 14.3.2.3-1 describes the information flow MBMS bearer announcement from the NRM server to the NRM client.

**Table 14.3.2.3-1: MBMS bearer announcement**

Information element	Status	Description
TMGI	M	TMGI information
Alternative TMGI	O	A list of additional alternative TMGI may be included and used in roaming scenarios.
QCI	O	QCI information used by the ProSe UE-Network Relay to determine the ProSe Per-Packet Priority value to be applied for the multicast packets relayed to Remote UE over PC5
List of service area identifier	M	A list of service area identifier for the applicable MBMS broadcast area.
Frequency	O	Identification of frequency if multi carrier support is provided
SDP information	M	SDP with media and application control information applicable to groups that can use this bearer (e.g. codec, protocol id, FEC information)
Monitoring state	O	The monitoring state is used to control if the client is actively monitoring the MBMS bearer quality or not.
Announcement acknowledgment	O	Indicate if the NRM server requires an acknowledgement of the MBMS bearer announcement.
Unicast status	O	An indication that the listening status of the unicast bearer is requested.
ROHC information	O	Indicate the usage of ROHC and provide the parameters of the ROHC channel to signal to the ROHC decoder.
NOTE: When MBMS bearer announcement is done on a MBMS bearer all attributes above are optional except the TMGI.		

### 14.3.2.4 MBMS listening status report

Table 14.3.2.4-1 describes the information flow for the MBMS listening status report from NRM client to NRM server.

**Table 14.3.2.4-1: MBMS listening status report**

Information element	Status	Description
VAL user ID or VAL UE ID	M	The identity of the VAL user or VAL UE who wants to report the MBMS listening status.
TMGI(s)	M	TMGI(s) information.
MBMS listening status(s)	M	The MBMS listening status per TMGI.
MBMS reception quality level	O	The reception quality level per TMGI (see NOTE)
Unicast listening status	O	The unicast listening status.
NOTE: The set of quality levels helps service continuity in MBMS scenarios. A reception quality level may help to make an efficient switching decision to another bearer. How these levels are used is implementation specific.		

### 14.3.2.5 MBMS suspension reporting instruction

Table 14.3.2.5-1 describes the information flow for the MBMS suspension reporting instruction from NRM server to NRM client in a unicast bearer for MBMS suspension reporting.

**Table 14.3.2.5-1: MBMS suspension reporting instruction (unicast)**

Information element	Status	Description
VAL user ID or VAL UE ID	M	The identity of the VAL user or VAL UE.
Suspension reporting	M	Enables or disable the suspension reporting for a specific NRM client

Table 14.3.2.5-2 describes the information flow for the MBMS suspension reporting instruction from NRM server to NRM client in a multicast bearer for MBMS suspension reporting.

**Table 14.3.2.5-2: MBMS suspension reporting instruction (multicast)**

Information element	Status	Description
Suspension reporting client subset	M	Contains a uniquely defined subset of NRM clients that shall report MBMS suspension

### 14.3.2.6 Resource request

Table 14.3.2.6-1 describes the information flow for the resource request from VAL server to NRM server for unicast resources.

**Table 14.3.2.6-1: Resource request**

Information element	Status	Description
Requester Identity	M	The identity of the VAL server performing the request.
VAL user ID or VAL UE ID	M	The identity of the VAL user or VAL UE.
VAL service requirement information (see NOTE)	O	VAL service requirements for unicast resource (e.g. VAL service ID, Bitrate)
NOTE: When this information element is not included, the NRM server considers default VAL service requirement for the unicast resources.		

### 14.3.2.7 Resource response

Table 14.3.2.7-1 describes the information flow for the resource response from NRM server to VAL server for unicast resources.

**Table 14.3.2.6-1: Resource response**

Information element	Status	Description
Result	M	The result indicates success or failure of the resource request operation.

### 14.3.2.8 Resource modification request

Table 14.3.2.8-1 describes the information flow for the resource modification request from VAL server to NRM server for unicast resources.



**Table 14.3.2.8-1: Resource modification request**

Information element	Status	Description
Requester Identity	M	The identity of the VAL server performing the request.
VAL user ID or VAL UE ID	M	The identity of the VAL user or VAL UE.
VAL service requirement information	M	VAL service requirements for unicast resource (e.g. VAL service ID, Bitrate)

### 14.3.2.9 Resource modification response

Table 14.3.2.9-1 describes the information flow for the resource modification response from NRM server to VAL server for unicast resources.

**Table 14.3.2.9-1: Resource modification response**

Information element	Status	Description
Result	M	The result indicates success or failure of the resource modification operation.

### 14.3.2.10 MBMS bearers request

Table 14.3.2.10-1 describes the information flow for the MBMS bearers request from VAL server to NRM server.

**Table 14.3.2.10-1: MBMS bearers request**

Information element	Status	Description
Requester Identity	M	The identity of the VAL server performing the request.
VAL group ID	M	The identity of the group that the MBMS bearer is requested for.
Service announcement mode	M	Indicates whether the request is sent by NRM server or by the VAL server
QoS	M	Indicates the requested QoS for the bearer
Broadcast area	O	Indicate the area where the MBMS bearer is requested for
Endpoint information	M	Information of the endpoint of the VAL server to which the user plane notifications have to be sent.

### 14.3.2.11 MBMS bearers response

Table 14.3.2.11-1 describes the information flow for the MBMS bearers response from NRM server to VAL server.

**Table 14.3.2.11-1: MBMS bearers response**

Information element	Status	Description
Result	M	The result indicates success or failure of the MBMS bearers request operation.
TMGI	O (see NOTE 1)	TMGI information.
User plane address	M (see NOTE 2)	BM-SC user plane IP address and port
Service description	O (see NOTE 2)	Indicates MBMS bearer related configuration information as defined in 3GPP TS 26.346 [28] (e.g. radio frequency and MBMS Service Area Identities)
NOTE 1: TMGI may not be required if the service announcement mode indicates that the request is sent by the NRM server.		
NOTE 2: If the Result Information element indicates failure then the values of the other information elements have no meaning.		

### 14.3.2.12 User plane delivery mode

Table 14.3.2.12-1 describes the information flow for the user plane delivery mode from NRM server to VAL server.

**Table 14.3.2.12-1: User plane delivery mode**

Information element	Status	Description
Delivery mode	M	Indicates whether to deliver the user data to the UE(s) via unicast mode or multicast mode
MBMS media stream identifier	M	Indicates the MBMS media stream to be used to deliver the media currently over unicast, or the MBMS media stream currently being used.
Unicast media stream identifier(s)	M	Indicates the unicast media stream to be used to deliver the media currently over multicast, or the unicast to be stopped and switched to multicast.

## 14.3.3 Unicast resource management

### 14.3.3.1 General

The following subclauses specify the procedures for unicast resource management for vertical application layer. The NRM server sets up bearers and may need to modify the bearers for an already established VAL service communication.

Characteristics that may need to be modified include:

- activation and deactivation of the bearer;
- modification of the QoS characteristics of the bearer (e.g. bearer priority adjustment); and
- modification of GBR due to application requirement

NOTE: A VAL service communication can consist of both unicast and multicast bearers which can all need modification due to the same event.

Vertical application layer specific pre-requisites and resultant behaviour by functional entities in performing these procedures are specified in the respective vertical application layer TS (e.g. for V2X application layer, see 3GPP TS 23.286 [7]).

Unicast resource management is supported with PCC interactions with SIP core and PCC interactions with NRM server. The PCC procedures for EPS are specified in 3GPP TS 23.203 [18] and the PCC procedures for 5GS are specified in 3GPP TS 23.503 [19].

### 14.3.3.2 Unicast resource management with SIP core

#### 14.3.3.2.1 Request for unicast resources at VAL service communication establishment

##### 14.3.3.2.1.1 General

The procedure defined in this subclause specifies how network resources are requested at VAL service communication establishment. If concurrent sessions are used the NRM server may utilize the capability of resource sharing specified for underlying network policy and charging functions. The request for resources includes application type, bandwidth, priority, application identifier and resource sharing information.

##### 14.3.3.2.1.2 Procedure

The procedure is generic to any type of session establishment that requires requests for network resources.

Procedures in figure 14.3.3.2.1.2-1 are the signalling procedures for the requesting resource at session establishment.

Pre-condition:

- The VAL client has requested VAL service communication with the VAL server.

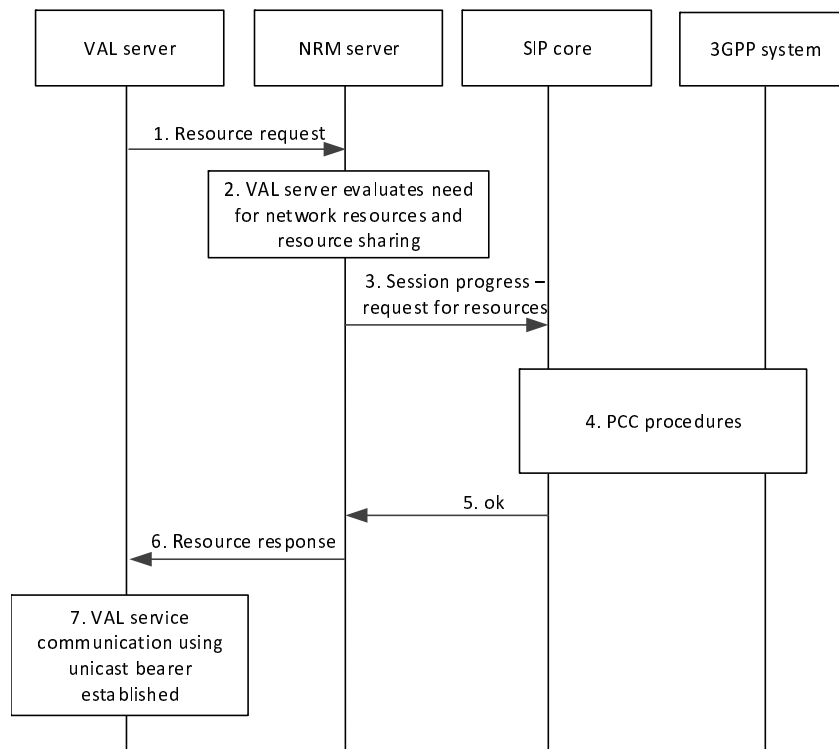

**Figure 14.3.3.2.1.2-1: Resource request at VAL service communication establishment**

1. The VAL server sends request for resources to the NRM server.
2. The NRM server evaluates the need for network resources and use of resource sharing.
3. The NRM server sends a session progress request containing request for resources.
4. PCC procedures are initiated from SIP core local inbound/outbound proxy.
5. The SIP core local inbound / outbound proxy sends a OK message to the NRM server.
6. The NRM server sends a resource response to the VAL server.
7. The VAL service communication is established and resources have been allocated.

### 14.3.3.2.2 Request for modification of unicast resources

#### 14.3.3.2.2.1 General

To modify unicast bearers, the NRM server shall send a resource modification request containing the parameters to be modified for the UE.

Possible scenarios when this procedure may be used are:

- Modify the allocation and retention priority for unicast resources;
- Release and resume resources in-between VAL service communications; or
- Release and resume resources when a UE is able to receive the VAL service communications over multicast transmission

#### 14.3.3.2.2.2 Procedure

Procedures in figure 14.3.3.2.2.2-1 are the signalling procedures for the modification of a unicast:

Pre-condition:

- A VAL service communication is already in progress;

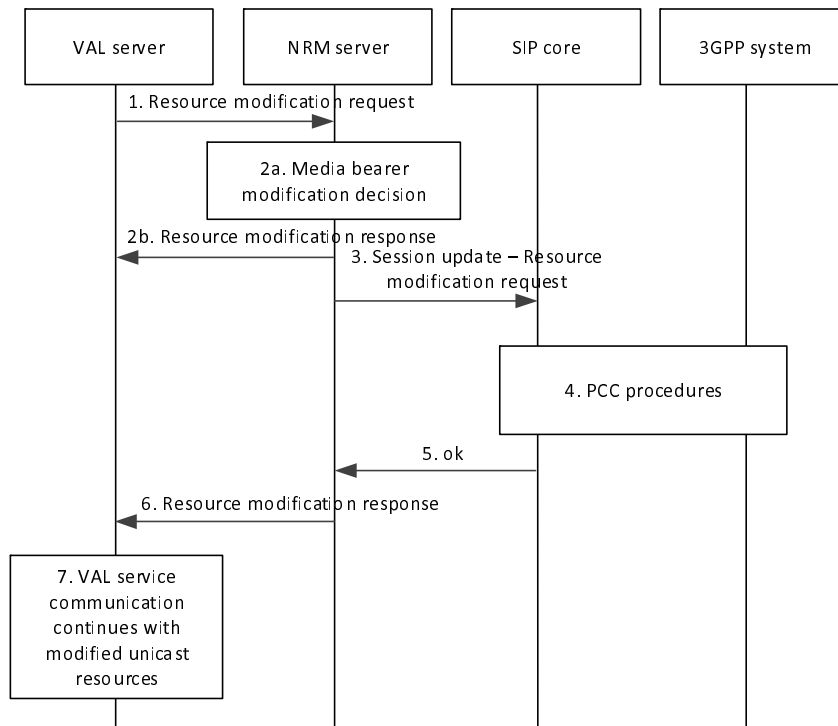

**Figure 14.3.3.2.2-1: Bearer modification request**

1. The VAL server sends a resource modification request to the NRM server.
- 2a. The NRM server decides to modify the parameters of a unicast bearer.
- 2b. If the media bearer modification is not required, the NRM server sends a resource modification response to the VAL server.
3. The NRM server sends a session update which includes a resource modification request containing the modified parameters of the unicast bearer.
4. PCC procedures are initiated from SIP core local inbound/outbound proxy.
5. The SIP core local inbound / outbound proxy sends a OK message to the NRM server.
6. The NRM server sends a resource modification response to the VAL server.
7. The VAL service communication continues with the modified unicast resources.

NOTE 1: If the VAL service communication is transferred to multicast transmission, the unicast resources could be temporarily be released.

NOTE 2: If multiple VAL service communication streams are sent to the UE, additional bearer resources could be required during an established VAL service communication. Pre-allocation of additional bearer resources already at VAL service communication establishment could be useful.

### 14.3.3.3 Unicast resource management without SIP core

#### 14.3.3.3.1 Network resource adaptation

##### 14.3.3.3.1.1 General

This subclause describes the procedure for network resource adaptation using PCC procedures. This procedure satisfies the requirements for requesting unicast resources and modification to already allocated unicast resources to VAL communications.

##### 14.3.3.3.1.2 Procedure

Figure 14.3.3.3.1.2-1 illustrates the procedure for the network resource adaptation.

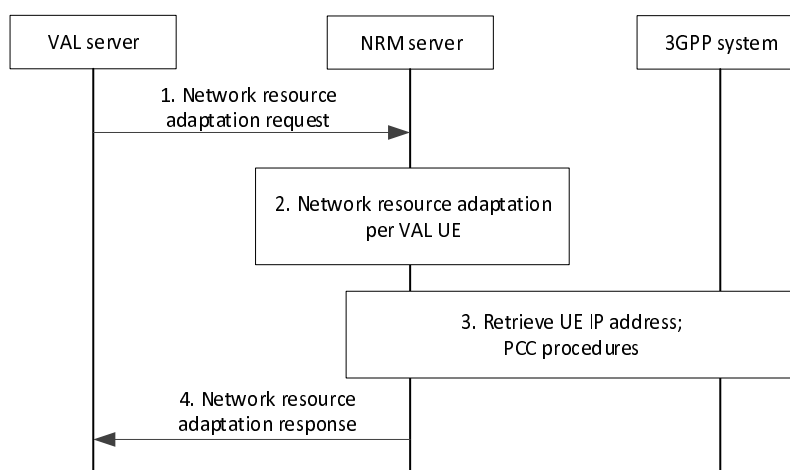

**Figure 14.3.3.3.1.2-1: Network resource adaptation**

1. The VAL server sends a network resource adaptation request to the NRM server for one or more users belonging to one or more VAL services, and may comprise one or more VAL UEs that will have updated resource requirement. This requirement may be in the form of exact resources /resource pools to be used or indication of bandwidth increase/decrease for the corresponding VAL UEs or set of VAL UEs.
2. The NRM server processes the request and applies / enforces the resource adaptation per VAL UE.
3. The NRM server retrieves UE IP address by using event monitoring capability for PDU session status (or PDN connectivity status) and initiates the PCC procedures for each VAL UE.
4. The NRM server provides a network resource adaptation response to the VAL server, providing information on the fulfilment of the network resource adaptation request. This will include information either per VAL UE or per set of VAL UEs, as indicated by the request of the VAL server in step 1.

#### 14.3.3.3.2 Request for unicast resources at VAL service communication establishment

##### 14.3.3.3.2.1 General

The procedure defined in this subclause specifies how network resources are requested at VAL service communication establishment. If concurrent sessions are used the NRM server may utilize the capability of resource sharing specified for underlying network policy and charging functions. The request for resources includes application type, bandwidth, priority, application identifier and resource sharing information.

##### 14.3.3.3.2.2 Procedure

The procedure is generic to any type of session establishment that requires requests for network resources.

Procedures in figure 14.3.3.3.2.2-1 are the signalling procedures for the requesting resource at session establishment.

Pre-condition:

- The VAL client has requested VAL service communication with the VAL server.

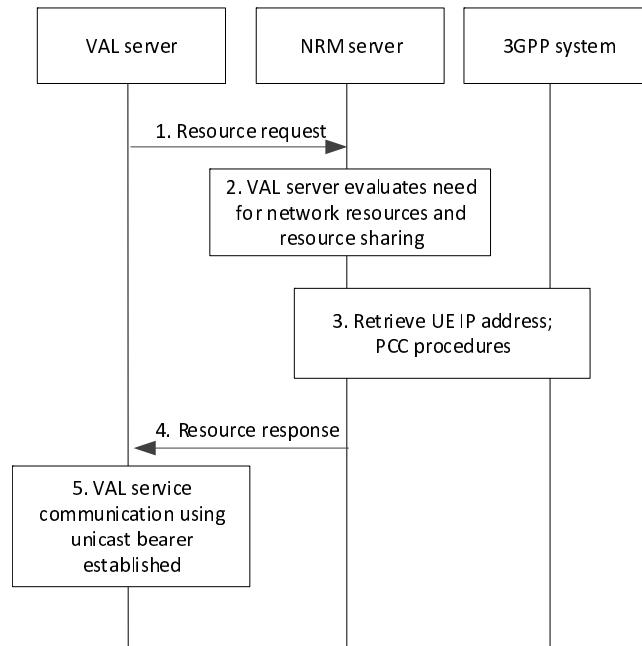

**Figure 14.3.3.3.2-1: Resource request at VAL service communication establishment**

1. The VAL server sends request for resources to the NRM server.
2. The NRM server evaluates the need for network resources and use of resource sharing.
3. The NRM server retrieves UE IP address by using event monitoring capability for PDU session status (or PDN connectivity status), and then PCC procedures are initiated from NRM server.
4. The NRM server sends a resource response to the VAL server.
5. The VAL service communication is established and resources have been allocated.

### 14.3.3.3.3 Request for modification of unicast resources

#### 14.3.3.3.3.1 General

To modify unicast resources, the NRM server shall send a resource modification request containing the parameters to be modified for the UE.

Possible scenarios when this procedure may be used are:

- Modify the allocation and retention priority for unicast resources;
- Release and resume resources in-between VAL service communications; or
- Release and resume resources when a UE is able to receive the VAL service communications over multicast transmission

#### 14.3.3.3.3.2 Procedure

Procedures in figure 14.3.3.3.2-1 are the signalling procedures for the modification of a unicast:

Pre-condition:

- A VAL service communication is already in progress;

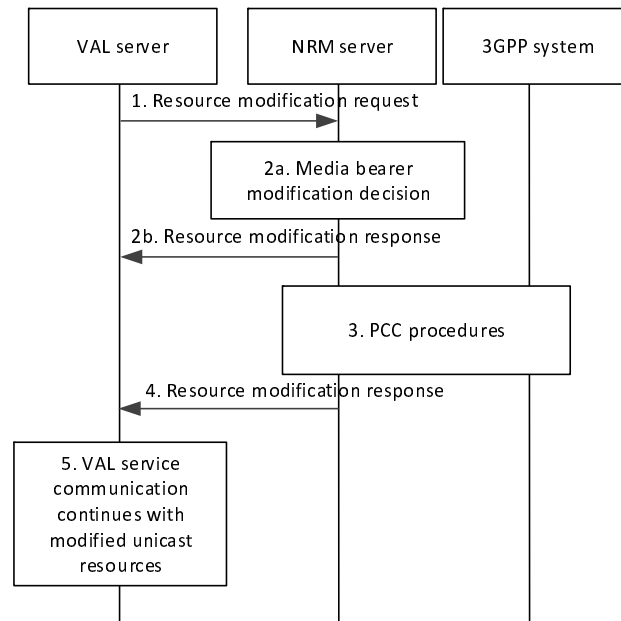

**Figure 14.3.3.3.2-1: Bearer modification request**

1. The VAL server sends a resource modification request to the NRM server.
- 2a. The NRM server decides to modify the parameters of a unicast bearer.
- 2b. If the media bearer modification is not required, the NRM server sends a resource modification response to the VAL server.
3. PCC procedures are initiated from NRM server.
4. The NRM server sends a resource modification response to the VAL server.
5. The VAL service communication continues with the modified unicast resources.

NOTE 1: If the VAL service communication is transferred to multicast transmission, the unicast resources could be temporarily be released.

NOTE 2: If multiple VAL service communication streams are sent to the UE, additional bearer resources could be required during an established VAL service communication. Pre-allocation of additional bearer resources already at VAL service communication establishment could be useful.

## 14.3.4 Multicast resource management for EPS

### 14.3.4.1 General

The VAL server utilizes the NRM server for multicast resource management.

To activate the multicast bearers in the EPS, the NRM server shall use the Activate MBMS Bearer procedure specified in 3GPP TS 23.468 [16] with the NRM server performing the GCS AS function.

To deactivate the multicast bearers in the EPS, the NRM server shall use the Deactivate MBMS Bearer procedure specified in 3GPP TS 23.468 [16] with the NRM server performing the GCS AS function.

To modify multicast bearers in the EPS, the NRM server shall use the Modify MBMS Bearer procedure specified in 3GPP TS 23.468 [16] with the NRM server performing the GCS AS function.

**Editor's note:** To support other modes of MBMS is FFS.

### 14.3.4.2 Use of pre-established MBMS bearers

#### 14.3.4.2.1 General

In this scenario, upon triggered by VAL server, the NRM server pre-establishes MBMS bearer(s) in certain pre-configured areas before the initiation of the VAL service group communication session. When a user originates a request for a VAL service group communication session for one of these areas, the pre-established MBMS bearer(s) is used for the DL VAL service communication.

The following steps need to be performed prior to the start of the VAL service group communication session over pre-established MBMS bearer:

- Pre-establish MBMS bearer(s)
- Announce the pre-established MBMS bearer to the NRM clients

When these preparation steps have been done the VAL service group communication session using MBMS bearer can start.

The vertical application level communications are sent on the MBMS bearer. Optionally a separate MBMS bearer could be used for the application level control messages, due to different bearer characteristic requirements.

#### 14.3.4.2.2 Procedure

The procedure figure 14.3.4.2.2-1 shows only one of the receiving VAL clients using an MBMS bearer. There might also be VAL clients in the same VAL service group communication session that receive the communication on unicast bearers.

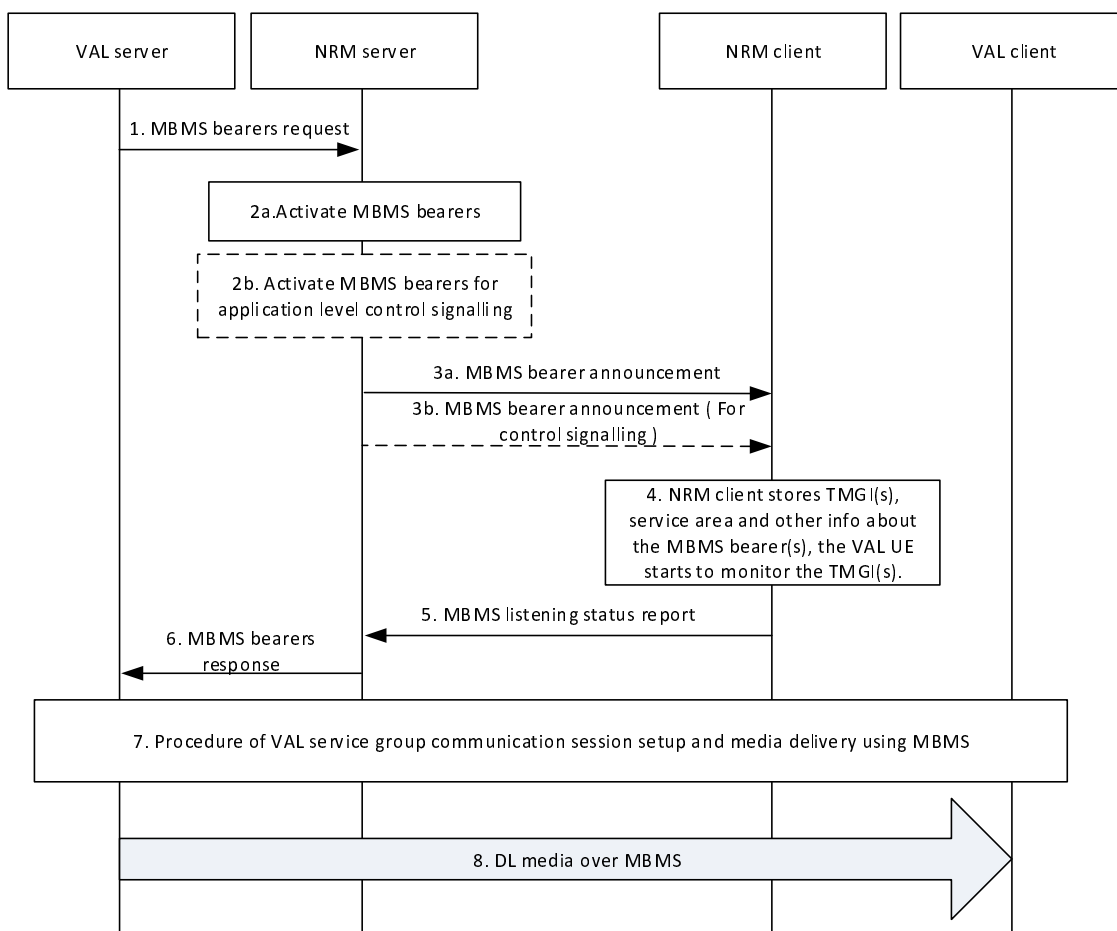

Figure 14.3.4.2.2-1: Use of pre-established MBMS bearers



1. The VAL server sends a MBMS bearers request to the NRM server including service description(s) for which the MBMS bearers are requested.
- 2a. The NRM server determines to activate MBMS bearer. The activation of the MBMS bearer in EPS is done on the MB2-C reference point and according to 3GPP TS 23.468 [16]. This bearer will be used for the VAL service communication.
- 2b. Optionally, the NRM server may also activate an MBMS bearer dedicated for application level control signalling. The activation of the MBMS bearer is done on MB2-C reference point and according to 3GPP TS 23.468 [16].

NOTE 1: The procedure to determine the activation of MBMS bearers is implementation specific.

- 3a. The NRM server passes the MBMS bearer info for the service description associated with the pre-established MBMS bearer to the NRM client. The NRM client obtains the TMGI, identifying the MBMS bearer, from the service description.
- 3b. The NRM server may pass the MBMS bearer info for the service description associated with the application control MBMS bearer to the NRM client. The NRM client obtains the TMGI, identifying the MBMS bearer, from the service description.

NOTE 2: Step 3a and step 3b can be done in one MBMS bearer announcement message.

4. The NRM client stores the information associated with the TMGI(s). The NRM service client uses the TMGI and other MBMS bearer related information to activate the monitoring of the MBMS bearer by the VAL UE. The NRM client shares the MBMS bearer related information with the VAL client.
5. The NRM client that enters or is in the service area of at least one announced TMGI indicates to the NRM server that the VAL UE is able to receive VAL service communication over MBMS, whereby the NRM server may decide to use the MBMS bearer instead of unicast bearer for VAL service communication sessions based on available information at the NRM server including the MBMS listening status report as described in clause 14.3.4.5.

NOTE 3: Step 5 is optional for the VAL UE on subsequent MBMS bearer announcements.

6. The NRM server provides a MBMS bearers response to the VAL server.
7. A VAL service group communication session is established.
8. As the VAL server transmits the VAL service communication over the MBMS bearer, the VAL service communication packets are detected and delivered to the VAL client.

### 14.3.4.3 Use of dynamic MBMS bearer establishment

#### 14.3.4.3.1 General

In this scenario, the VAL server uses a unicast bearer for communication with the UE on the DL at the start of the group communication session. When the VAL server triggers to use an MBMS bearer in EPS for the DL VAL service communication, the NRM server decides to establish an MBMS bearer in EPS using the procedures defined in 3GPP TS 23.468 [16]. The NRM server provides MBMS service description information associated with MBMS bearer(s), obtained from the BM-SC, to the UE. The UE starts using the MBMS bearer(s) to receive DL VAL service and stops using the unicast bearer for the DL VAL service communication.

#### 14.3.4.3.2 Procedure

Figure 14.3.4.3.2-1 illustrates the use of dynamic MBMS bearer establishment.

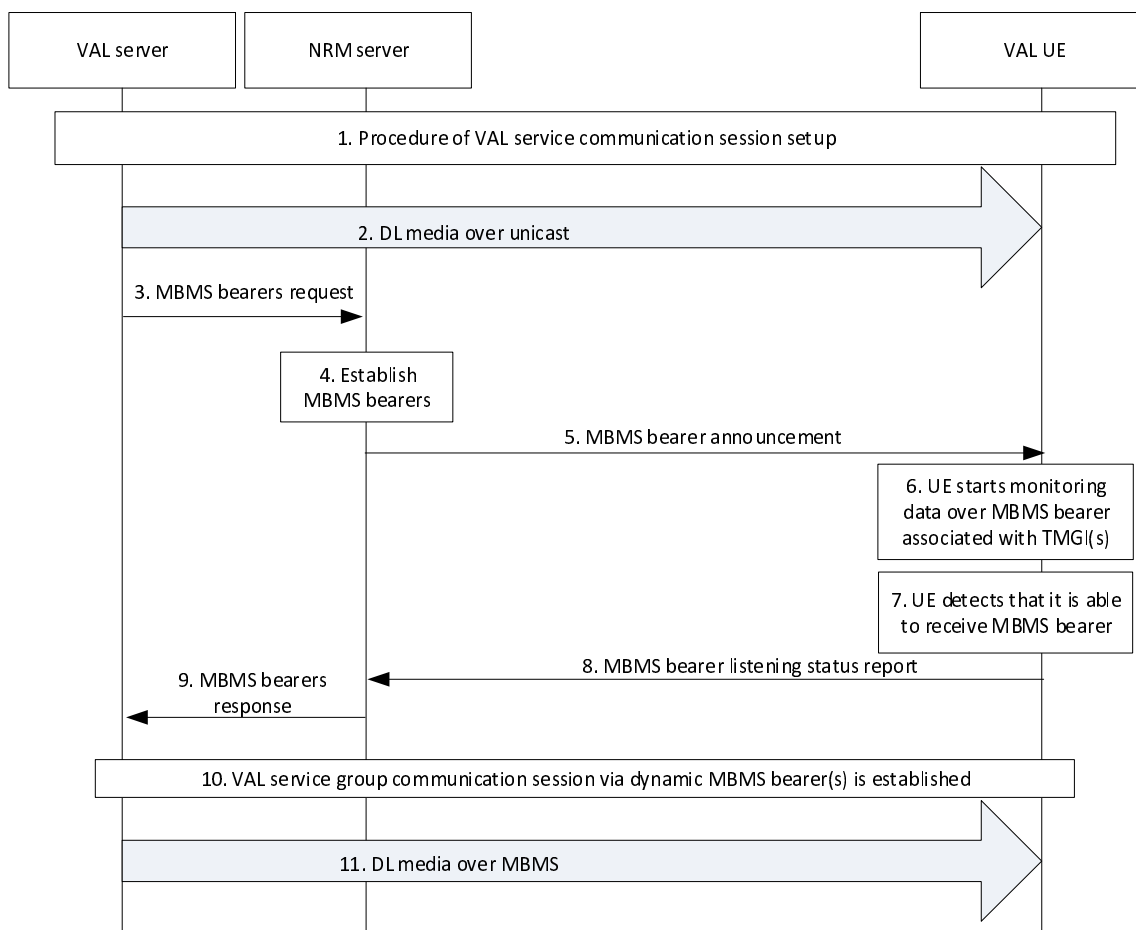

**Figure 14.3.4.3.2-1: Use of dynamic MBMS bearer establishment**

1. A VAL service group communication session is established.
2. The downlink data is sent by unicast delivery.
3. The VAL server sends MBMS bearers request to the NRM server.
4. The NRM server establishes the MBMS bearer(s) for the VAL service group communication session according to the procedures defined in 3GPP TS 23.468 [16]. Service description associated with the MBMS bearer(s) is returned from the BM-SC.
5. The NRM server provides service description information associated with the MBMS bearer to the UE. The VAL UE obtains the TMGI from the announcement message. This message may be sent on an application level control signalling bearer.
6. The VAL UE starts monitoring data over MBMS associated with the TMGI, while in the service area associated with the TMGI.
7. The VAL UE detects that it is able to receive data over MBMS associated with the TMGI.
8. The NRM client notifies the NRM server the MBMS listening status associated to the monitored TMGI, (e.g. that it is successfully receiving the TMGI). The NRM client may also notify the MBMS reception quality level of the TMGI. The NRM server may decide to use the MBMS bearer instead of unicast bearer for VAL service communication sessions based on available information at the NRM server including the MBMS listening status report as described in clause 14.3.4.5.
9. The NRM server provides an MBMS bearer response to the VAL server with the dynamic MBMS bearer(s) information. The VAL server stops sending VAL service communication data over unicast way to the VAL client.

NOTE: The MBMS reception quality level may be used by the NRM server to make an efficient decision to switch again to a unicast transmission or to take measures to prepare such a switch (e.g. when the quality level indicates that the reception quality of the MBMS bearer is decreasing or reaching an insufficient quality level for the reception of VAL services).

10. A VAL service group communication session via dynamic MBMS bearer(s) is established.

11. The VAL server sends the downlink VAL service communication for the VAL service group communication session over the MBMS.

#### 14.3.4.4 MBMS bearer announcement over MBMS bearer

##### 14.3.4.4.1 General

The MBMS announcement may be done on either a unicast bearer or a MBMS bearer. Using a unicast bearer for MBMS bearer announcement provides an interactive way of doing announcement. The NRM server will send the MBMS bearer announcement message to the NRM client regardless if there is an MBMS bearer active or the VAL client can receive the data on the MBMS bearer with sufficient quality. The benefit of the existing procedure is that it gives a secure way to inform the NRM client about the MBMS bearer and how to retrieve the data on the MBMS bearer.

When there is more than one MBMS bearer active in the same service area for VAL service, there are not the same reasons to use unicast bearer for additional MBMS bearer announcement. Instead a MBMS bearer for application level control signalling can be used to announce additional MBMS bearers.

The MBMS bearer announcement messages are sent on an MBMS bearer used for application control messages. This bearer will have a different QoS setting compared to an MBMS bearer used for VAL service communication, since application signalling messages are more sensitive to packet loss.

##### 14.3.4.4.2 Procedure

Figure 14.3.4.4.2-1 illustrates a procedure that enables the NRM server to announce a new MBMS bearer.

Pre-conditions:

1. An MBMS bearer used for VAL service application control messages must have been pre-established and announced to the NRM client.
2. Additional MBMS bearer information may have already been announced to the NRM client.

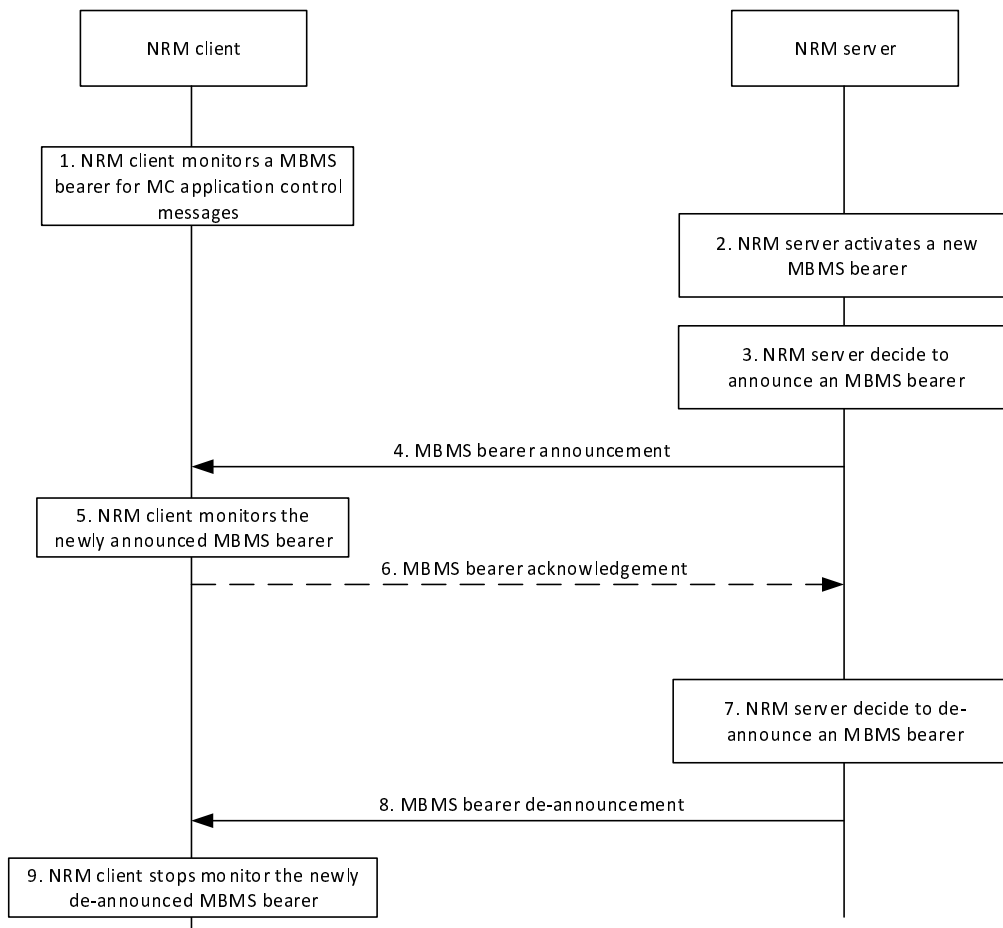

**Figure 14.3.4.4.2-1: MBMS bearer announcement over an MBMS bearer used for application control messages**

1. The NRM client monitors an MBMS bearer that is used for VAL service application signalling messages, such as bearer announcement messages.
2. The NRM server activates a new MBMS bearer.
3. The NRM server announces the MBMS bearer to the NRM client. The bearer may have just been activated or may have already been running for some time. The step may be repeated as needed.
4. The NRM server sends a MBMS bearer announcement on the MBMS bearer used for VAL application control messages. The MBMS bearer announcement contains the identity of the MBMS bearer (i.e. the TMGI) and may optionally include additional information about the newly announced bearer. Required and optional MBMS bearer announcement details may have already been provided. In this case the MBMS bearer identity could be used as a key for such MBMS bearer details.
5. The NRM client start to monitor the newly announced MBMS bearer.
6. If requested by the NRM server, the NRM client sends an acknowledgement of the MBMS bearer to the NRM server.
7. The NRM server de-announce the MBMS bearer.
8. The NRM server sends a MBMS bearer de-announcement message that contains the identity of the MBMS bearer.
9. The NRM client stops monitoring the de-announced MBMS bearer.

The same procedure can also be used to modify existing MBMS bearer announcement information. Example of such modification could be addition of UDP ports or modification of codec in the SDP.

### 14.3.4.5 MBMS bearer quality detection

#### 14.3.4.5.1 General

The NRM client and NRM server use this procedure to report and take action on the MBMS bearer quality towards VAL service communications. A NRM client monitors an MBMS bearer to enable receiving VAL service communication. Based on the received quality (e.g. radio level quality, transport level quality), the NRM client needs to inform the NRM server that the VAL UE is able to receive the VAL service communication on the MBMS bearer with sufficient quality or not able to receive the VAL service communication on the MBMS bearer with sufficient quality. Furthermore, based on the received quality, the NRM client may notify the NRM server at which MBMS reception quality level it has received the VAL service communication on the MBMS bearer.

The issue can be more complex since the NRM client needs to estimate the quality of the bearer even in the scenario when there are no data currently transmitted on the MBMS bearer. The reason for this is that an NRM client that has entered an area with significantly degraded MBMS quality, might not even notice that a VAL service communication is ongoing, meanwhile the NRM server still assumes that the VAL UE can receive the VAL service communication being broadcasted.

To estimate the MBMS bearer quality, for example as an equivalent BLER (Block Error Rate), when no data is sent is implementation specific. This estimation can be dependent on for example the modulation and coding scheme (MCS) and measurements from the reference signals from the eNB(s). Other metrics (e.g. RTP packet loss) may be used to estimate the MBMS bearer quality.

Based on the MBMS bearer quality reported from the NRM clients, the NRM server may decide to use the MBMS bearer for a group communication if a certain number of NRM clients located in the MBMS service area are able to receive the VAL service communication. And if a NRM client is not able to receive the VAL service communication on the MBMS bearer, the NRM server may decide to switch the user plane deliver mode for the NRM client from MBMS bearer to unicast bearer.

#### 14.3.4.5.2 Procedure

The NRM client shall indicate the ability of the NRM client to receive the MBMS bearer.

Pre-conditions:

1. There is an MBMS bearer activated and the MBMS bearer information is announced to the NRM client
2. The NRM client is located in the MBMS broadcasting area
3. The VAL UE monitors SIB-13 (or SIB-20) and (SC-)MCCH to receive the modulation and coding scheme
4. The VAL UE monitors the cell specific reference signal and when MBSFN transmission is used, the MBSFN specific reference signals

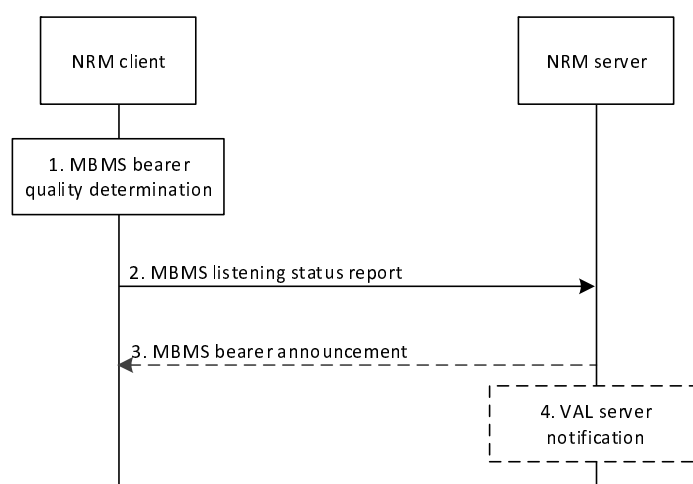

Figure 14.3.4.5.2-1: MBMS bearer quality detection

1. The NRM client determines that the MBMS bearer quality shall be reported to the NRM server. The NRM client may determine the MBMS bearer quality by using the BLER of the received data. When no data is received, the quality estimation can consider the reference signals and the modulation and coding scheme (MCS). The UE may also use predictive methods to estimate the expected MBMS bearer quality (e.g. speed and direction) to proactively inform the NRM server of an expected loss of the MBMS bearer quality. The NRM client may also map the determined MBMS bearer quality to a MBMS reception quality level. The MBMS reception quality level indicates at which specific MBMS bearer quality level the VAL service communication has been received.

**Editor's note:** The set of MBMS reception quality levels and the mapping of the determined MBMS bearer quality to those levels are FFS.

NOTE 1: When MBSFN transmission is used, the MBSFN reference signal needs to be used and when SC-PTM is used the cell specific reference signal needs to be used. With the measured reference signal, the reference signal received quality (RSRQ) can be calculated.

2. If the MBMS bearer quality reaches a certain threshold, the NRM client sends an MBMS listening status report. The threshold is used to define the MBMS listening status, which indicates if the MBMS bearer quality has been acceptable or not to receive a specific VAL service communication. If the MBMS bearer quality is mapped to a different MBMS reception quality level, the NRM client may send an MBMS listening status report including the MBMS reception quality level. Based on the MBMS listening status, if MBMS reception quality level is received, then the NRM server may efficiently decide to switch to another bearer (e.g., MBMS bearer or unicast bearer) or to take measures to prepare such a switch and further notify the VAL server.

NOTE 2: Prior sending the MBMS listening status report, it could be beneficial to also include information for different alternatives e.g. another MBMS bearer might have better quality and could be a better option than a transfer of the communication to unicast.

NOTE 3: The threshold used to indicate MBMS bearer quality depends on VAL service type (i.e. V2X, MCPTT, MCVideo or MCDATA) and the metrics used. The metrics used and the associated thresholds are out of scope of this specification.

3. The NRM server may send additional proposal for measurements e.g. information about neighbouring MBMS bearers. This message may be an MBMS bearer announcement message.
4. The NRM server may send user plane delivery mode to VAL server based on the MBMS listening status to preserve the service continuity as described in clause 14.3.4.6 and clause 14.3.4.9.

#### 14.3.4.6 Service continuity in MBMS scenarios

##### 14.3.4.6.1 General

This subclause specifies service continuity scenarios when MBMS bearers are used. There are different solutions for different scenarios.

##### 14.3.4.6.2 Service continuity when moving from one MBSFN to another

The service continuity solution described in this subclause is suitable in the scenario when multiple MBMS bearers are used with the purpose to cover a larger area. In VAL communications several VAL service communication streams may be multiplexed in one MBMS bearer. Furthermore, one VAL service communication stream may be sent on more than one MBMS bearer if the receiving users are distributed over more than one MBMS service area. A VAL UE that is interested in receiving a VAL service communication stream that is broadcasted in both MBMS bearers is a candidate for this service continuity procedure.

Figure 14.3.4.6.2-1 illustrates a deployment scenario that provides service continuity between two MBSFN areas. Two different MBMS bearers are activated (TMGI 1 and TMGI 2), the activation of the bearers is done in the two MBSFN areas (MBSFN 1 and MBSFN 2). The MBSFN areas 1 and 2 are partially overlapping, meaning that some transmitting cells belong to both MBSFN area 1 and MBSFN area 2.

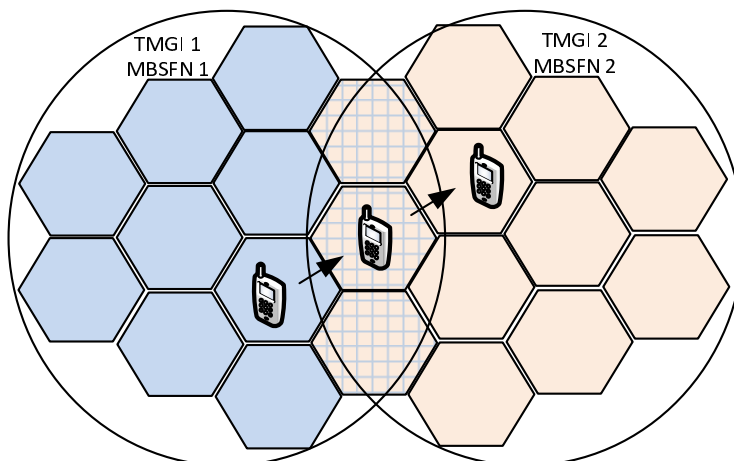

**Figure 14.3.4.6.2-1: Two MBMS bearer using overlapping MBSFN areas**

Figure 14.3.4.6.2-2 illustrates the procedure:

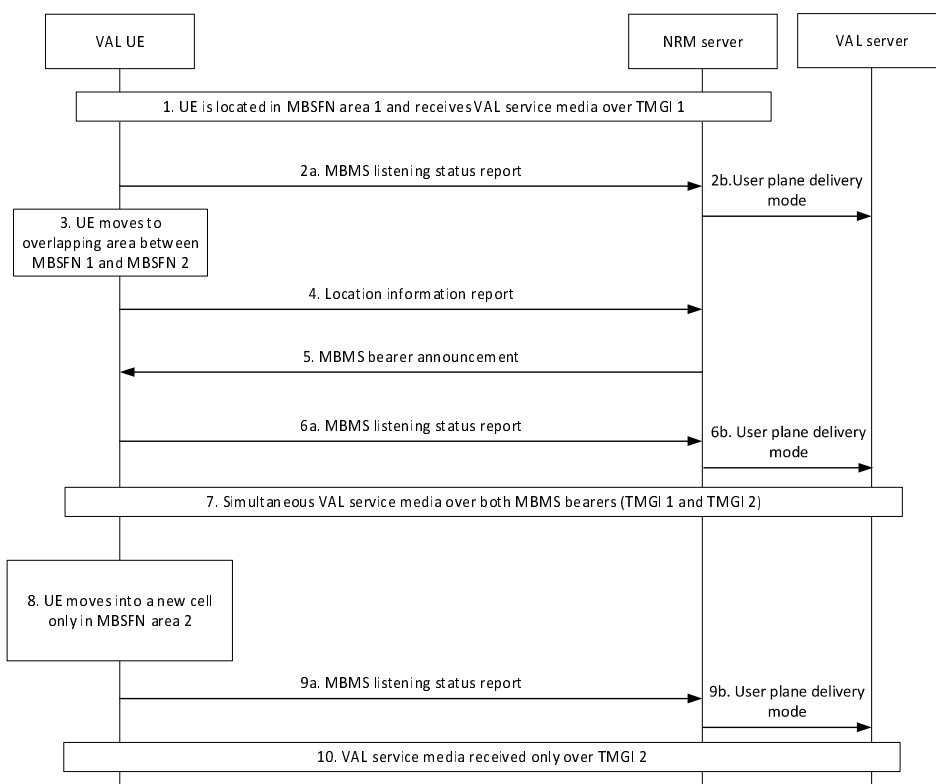

**Figure 14.3.4.6.2-2: Service continuity when moving from one MBSFN to another**

1. The VAL UE is located in MBSFN 1 and can listen to TMGI 1. No additional MBMS bearers that the NRM client is interested in are active in the current cell.
- 2a. The NRM client notifies the NRM server that the VAL UE is successfully receiving the VAL service communication over TMGI 1. The NRM client may also notify the MBMS reception quality level of TMGI 1.
- 2b. The NRM server notifies a user plane delivery mode to the VAL server.

**NOTE:** The MBMS reception quality level may be used by the NRM server to make an efficient decision to switch to another MBMS bearer or to a unicast bearer, or to take measures to prepare such a switch (e.g. when the quality level indicates that the reception quality of the MBMS bearer is decreasing or reaching an insufficient quality level for the reception of VAL services).

3. The VAL UE moves into a new cell in which both TMGI 1 and TMGI 2 are active. This cell is part of both MBSFN area 1 and MBSFN area 2, and broadcast the same service on both TMGIs.
4. The NRM client sends a location information report to the NRM server. For that, the UE uses the SAI information found in the system information block (SIB) transmitted by the radio cells.
5. The NRM server sends to the NRM client a MBMS bearer announcement with information related to TMGI 2 (if the NRM server had not done it before). Hence, the NRM client knows that TMGI 2 transmits the same VAL service communication.
- 6a. The NRM client notifies the NRM server that it is successfully receiving TMGI 1 and TMGI 2. The NRM client may also notify the MBMS reception quality level per TMGI.
- 6b. The NRM server notifies a user plane delivery mode to the VAL server.
7. The VAL UE may receive the VAL service communication over both MBMS bearers, i.e. TMGI 1 and TMGI 2. The VAL UE may also verify that it is the same content sent on both bearers. The duplicated packets may also be used to perform error corrections.
8. The VAL UE moves into a new cell in MBSFN area 2, where only TMGI 2 is active.
- 9a. The NRM client notifies the NRM server that the VAL UE is successfully receiving the VAL service communication over TMGI 2. The NRM client may also notify the MBMS reception quality level of TMGI 2.
- 9b. The NRM server notifies a user plane delivery mode to the VAL server.
10. The VAL UE receives the VAL service communication only over TMGI 2.

This service continuity procedure mitigates the risk of packet loss that may occur if the VAL UE would request to transfer the VAL service communication stream to a unicast bearer when moving into the new area and then back to a multicast bearer when the UE can listen to TMGI 2. However, it is still required that the NRM client sends a location report (and MBMS listening report), as described in steps 4-6 above. To send the location report and the MBMS listening report by the NRM client to the NRM server a unicast bearer is needed. The location report from the NRM client is required, since the NRM server must know that the VAL UE has entered a new area and can only listen to MBMS bearer active in that area. If this is not done the VAL server might send a VAL service communication stream that the VAL UE is required to listen to on the MBMS bearer 1, since the NRM server still assumes that the VAL:UE is located in the MBSFN area 1.

The solution can be improved as illustrated in figure 14.3.4.6.2-3. In this case two different MBMS bearers are activated (TMGI 1 and TMGI 2), these MBMS bearers are used only for VAL service communication. An application level signalling bearer is activated (TMGI 9), in both MBSFN areas. This bearer is used for application level signalling messages that are sent on the MBMS bearer TMGI 9. By using an application level signalling bearer (e.g. TMGI 9) the VAL UEs can receive application control messages for all VAL service communication going on in the areas of both TMGI 1 and TMGI 2. A VAL UE that is located in the area of TMGI 2 and is interested in a VAL service group transmission (e.g. V2X) only going on in TMGI 1, can with the information received in TMGI 9 initiate a unicast bearer and request to receive that specific VAL service communication over a unicast instead. Without the information received over TMGI 9 the NRM client must immediately report that the VAL UE has left the broadcast area that the NRM server assumes that the VAL UE is located in. With the use of TMGI 9 there is no immediate need for the NRM client to inform the NRM server of a location change.



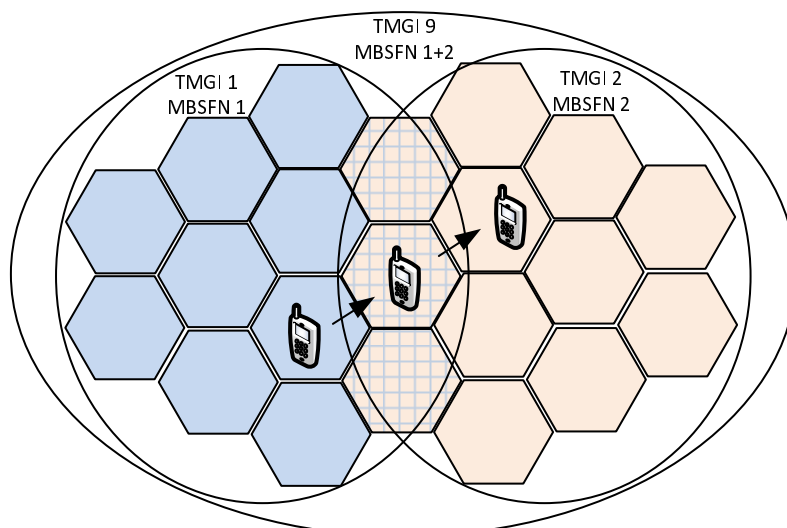

**Figure 14.3.4.6.2-3: Two MBMS bearer using overlapping MBSFN areas with a separate application signalling bearer**

The procedural steps in this scenario will be the same as described above in this subclause. However, in this scenario the NRM client is not required to initiate a unicast bearer to send location report (or MBMS listening report). The VAL UE may move between the two MBMS bearers (TMGI 1 and TMGI 2) without the need to report an area change. A condition for this to work is that there is an application level signalling bearer (TMGI 9) activated in the full area (i.e. the area of both TMGI 1 and TMGI 2). The TMGI 9 will broadcast all application control messages for all VAL service communications ongoing in both areas. If the VAL UE is in coverage of one of the two MBMS bearers that does not transmit the VAL service communication of interest the VAL UE can report to the NRM server that it is not able to listen to the VAL service communication over the MBMS bearer, which triggers the NRM server to switch to a unicast bearer instead.

#### 14.3.4.7 MBMS suspension notification

##### 14.3.4.7.1 General

In this procedure the NRM client is requested by the NRM server to send a MBMS suspension report. This request for MBMS suspension report can be included in the MBMS bearer announcement and the NRM server may choose to only send this request for MBMS suspension report to a subset of all NRM clients.

##### 14.3.4.7.2 Procedure

Figure 14.3.4.7.2.-1 illustrates a procedure in which the NRM client notifies the NRM server about an MBMS suspension decision in RAN.

The NRM server can decide on a subset of all VAL UEs in the MBMS broadcast area that shall report on MBMS bearer suspension. When the NRM server makes the decision of the VAL UE subset, consideration shall be taken to the location of the VAL UEs, since VAL UEs' location is dynamically changed. This means that the MBMS suspension reporting instruction may need to be updated regularly based on the VAL UEs mobility.

Pre-condition:

- It is assumed that there is at least one active MBMS bearer

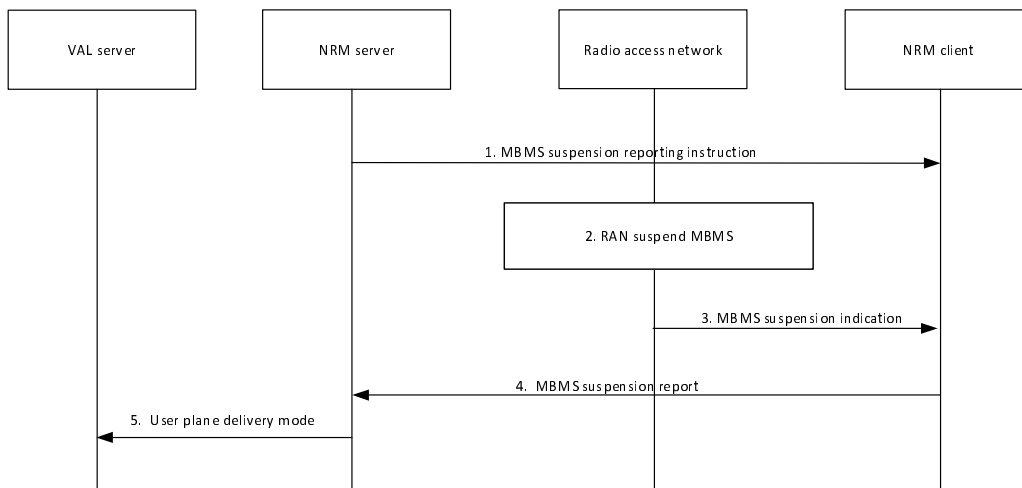

**Figure 14.3.4.7.2-1: MBMS suspension notification**

1. The NRM server sends an MBMS suspension reporting instruction to the NRM client.

NOTE: This message may be included in the MBMS bearer announcement message and may be sent both on a unicast bearer and a multicast bearer.

2. RAN decides to suspend the MBMS bearer, according to existing procedures in 3GPP TS 36.300 [23].
3. An MBMS suspension indication is sent in the MSI (MCH Scheduling Information), according to existing procedures in 3GPP TS 36.300 [23].
4. The NRM client detect the MBMS suspension and sends an MBMS suspension report.
5. Based on the MBMS suspension report received, the NRM server determines whether to switch to a new bearer (unicast or MBMS). If NRM server determines to switch to unicast bearer, then the NRM server sends the user plane delivery mode message to VAL server , and the VAL server sends the downlink data over the new bearer.

The NRM client that is not instructed to send an MBMS suspension report shall still detect the MBMS suspension indication from RAN (step 3). A NRM client shall in this case not send other types of report (e.g. MBMS listening reports).

The same procedure can be applied at MBMS resumption or other MBMS events that may be detected by the NRM client.

## 14.3.4.8 MBMS bearer event notification

### 14.3.4.8.1 General

The NRM server is an instantiation of a GCS AS. For the NRM server to know the status of the MBMS bearer, and thus know the networks ability to deliver the VAL service, it is required that the network provides MBMS bearer event notifications to the NRM server. The different events notified to the NRM server include the MBMS bearer start result (e.g. when the first cell successfully allocated MBMS resources), including information if any cells fail to allocate MBMS resources to a specific MBMS bearer, the current status of the MBMS bearer, MBMS bearer suspension/resume or overload scenarios.

**Editor's note:** The procedure defined in this sub clause requires an enhancement to GCSE and RAN and is therefore subject to implementation in EPC and RAN.

### 14.3.4.8.2 Procedure

The procedure in figure 14.3.4.8.2-1 shows notification information flows from NRM server to BM-SC.

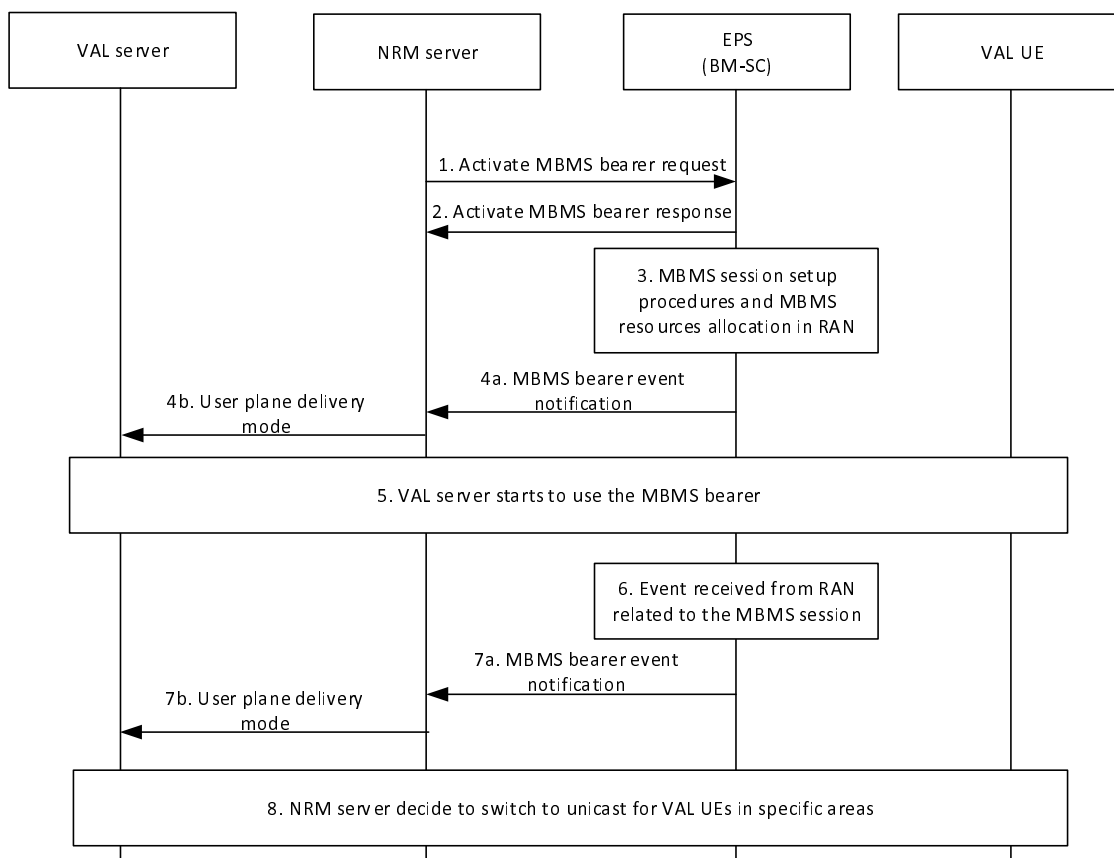

**Figure 14.3.4.8.2-1: MBMS bearer event notification**

1. The NRM server activates an MBMS bearer. The activation of the MBMS bearer is done on the MB2-C reference point and according to 3GPP TS 23.468 [16].
2. The BMSC will respond to the activation with an Activate MBMS bearer response message, according to 3GPP TS 23.468 [16].
3. The EPC and RAN will initiate the MBMS session start procedure according to 3GPP TS 23.246 [17]. This procedure is outside the scope of this specification.
- 4a. At the first indication of a successful MBMS session start procedure, the BM-SC sends a MBMS bearer event notification, indicating that the MBMS bearer is ready to use.
- 4b. The NRM server notifies user plane delivery mode to the VAL server.
5. The VAL server starts to use the MBMS bearer according to the MBMS procedures in this specification.
6. An event from RAN related to the MBMS session is received by the BM-SC.
- 7a. The BM-SC notifies the NRM server of certain MBMS related events including references to affected MBMS services areas or list of cells. Example of such events may be radio resources not available, overload, MBMS suspension.
- 7b. The NRM server notifies user plane delivery mode to the VAL server.
8. The NRM server may decide, based on the received events, to switch to unicast transmission for relevant VAL UEs.

**NOTE:** Steps 6-8 should be seen as example events from the network that may occur and possible actions taken by the NRM server. These steps may be done at any time and repeatedly during the life time of an MBMS bearer.

## 14.3.4.9 Switching between MBMS bearer and unicast bearer

### 14.3.4.9.1 General

The NRM server monitors the bearers used for VAL service communications and decides to switch between MBMS and unicast bearers.

### 14.3.4.9.2 Procedure

Figure 14.3.4.9.2-1 shows the procedure for service continuity when a UE is about to move out of MBMS coverage or getting into good MBMS coverage by switching between MBMS bearer and unicast bearer.

Pre-condition:

- It is assumed that a bearer (unicast or MBMS) has been activated by the VAL server for downlink delivery.

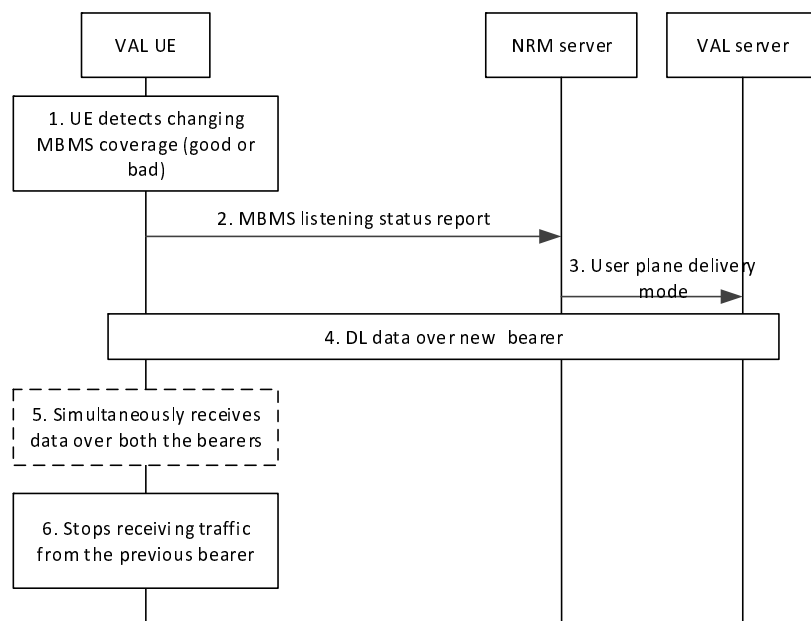

**Figure 14.3.4.9.2-1: Switching between MBMS delivery and unicast delivery**

1. The VAL UE detects changing MBMS bearer condition (good or bad MBMS coverage) for the corresponding MBMS service. The method to detect is implementation specific.
2. The NRM client notifies the NRM server about the MBMS bearer condition for the corresponding MBMS service by sending the MBMS listening status report.

NOTE 1: To efficiently notify the NRM server, e.g., when the NRM client detects that the reception quality of the MBMS bearer is decreasing or reaching an insufficient quality level for the reception of VAL services, the NRM client proactively may send to the NRM server a MBMS listening status report including the MBMS reception quality level.

3. The NRM server makes the decision to switch between MBMS delivery and unicast delivery based on available information at the NRM server including the MBMS listening status report as described in clause 14.3.4.5. The NRM server notifies a user plane delivery mode to the VAL server.
4. The VAL server sends the downlink data over the new bearer (unicast or MBMS) to the VAL client as per step 3.

NOTE 2: The new bearer (unicast or MBMS) may be set up on demand after step 3 or before.

5. During the switching, the VAL client simultaneously receives downlink data through both bearers (unicast bearer and MBMS bearer). If there is no downlink data to the VAL client, this step can be skipped.

6. The VAL client ceases to receive the downlink data through previous bearer but continues receiving data through new bearer.

## 14.4 SEAL APIs for network resource management

### 14.4.1 General

Table 14.4.1-1 illustrates the SEAL APIs for configuration management.

**Table 14.4.1-1: List of SEAL APIs for network resource management**

API Name	API Operations	Known Consumer(s)	Communication Type
SS_NetworkResourceAdaptation	Reserve_Network_Resource	VAL server	Request /Response
	Request_Unicast_Resource	VAL server	Request /Response
	Update_Unicast_Resource	VAL server	Request /Response
	Request_Multicast_Resource	VAL server	Request /Response
	Notify_UP_Delivery_Mode	VAL server	Subscribe/Notify

### 14.4.2 SS\_NetworkResourceAdaptation API

#### 14.4.2.1 General

**API description:** This API enables the VAL server to communicate with the network resource management server for network resource adaptation over NRM-S.

#### 14.4.2.2 Reserve\_Network\_Resource operation

**API operation name:** Reserve\_Network\_Resource

**Description:** Requesting for network resource adaptation.

**Known Consumers:** VAL server.

**Inputs:** See subclause 14.3.2.1

**Outputs:** See subclause 14.3.2.2

See subclause 14.3.3 for the details of usage of this API operation.

#### 14.4.2.3 Request\_Unicast\_Resource

**API operation name:** Request\_Unicast\_Resource

**Description:** Requesting unicast resource.

**Known Consumers:** VAL server.

**Inputs:** See subclause 14.3.2.6

**Outputs:** See subclause 14.3.2.7

See subclause 14.3.3 for the details of usage of this API operation.

#### 14.4.2.4 Update\_Unicast\_Resource

**API operation name:** Update\_Unicast\_Resource

**Description:** Updating unicast resource.

**Known Consumers:** VAL server.

**Inputs:** See subclause 14.3.2.8

**Outputs:** See subclause 14.3.2.9

See subclause 14.3.3 for the details of usage of this API operation.

#### 14.4.2.5 Request\_Multicast\_Resource

**API operation name:** Request\_Multicast\_Resource

**Description:** Requesting multicast resource.

**Known Consumers:** VAL server.

**Inputs:** See subclause 14.3.2.10

**Outputs:** See subclause 14.3.2.11

See subclause 14.3.4 for the details of usage of this API operation.

#### 14.4.2.6 Notify\_UP\_Delivery\_Mode

**API operation name:** Notify\_UP\_Delivery\_Mode

**Description:** Notifying the user plane delivery mode.

**Known Consumers:** VAL server.

**Inputs:** See subclause 14.3.2.12

**Outputs:** None.

See subclause 14.3.4 for the details of usage of this API operation.

## 15 Service-based interface representation of the functional model for SEAL services

### 15.1 General

The functional models for SEAL services is represented using functional entities and reference points between the functional entities as specified in subclause 6. The vertical applications consume the SEAL services in the form of APIs. Each SEAL service offers these APIs on a service-based interface to all its consumer entities.

### 15.2 Functional model representation

Figure 15.2-1 illustrates the service-based interface representation of the functional model for SEAL services.

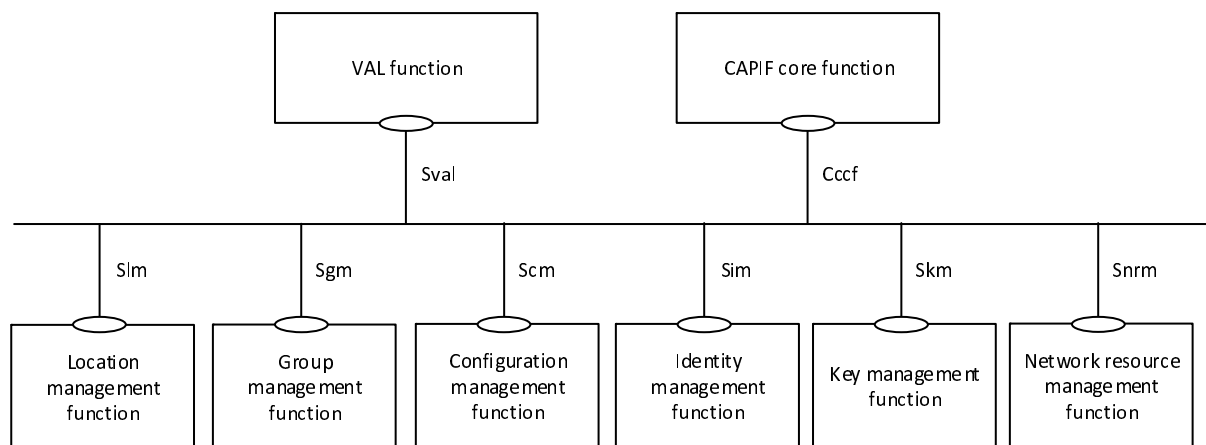

**Figure 15.2-1: SEAL generic functional model representation using service-based interfaces**

The SEAL function(s) exhibit the service-based interfaces which are used for providing and consuming SEAL services. The service APIs are specified for each SEAL function enabled over the service-based interface. The service-based interfaces of specific SEAL services are specified in this document. All the interactions with SEAL are governed based on the reference point interactions of the functional models specified in subclause 6. VAL function represents the functionalities of the VAL server.

**NOTE:** The service-based interface Sval for the VAL function is out of scope of the present document.

The service APIs offered by the SEAL function(s) are published and discovered on the CAPIF core function as specified in 3GPP TS 23.222 [8].

**Editor's note:** Refinement of the SEAL services in service-based interface representation is FFS.

### 15.3 Service-based interfaces

Table 15.3-1 specifies the service-based interfaces supported by SEAL.

**Table 15.3-1: Service-based interfaces supported by SEAL**

Service-based interface	Application functionEntity	Mapping server entity	APIs offered
Slm	Location management function	Location Management Server	Specified in subclause 9.4
Sgm	Group management function	Group management server	Specified in subclause 10.4
Scm	Configuration management function	Configuration management server	Specified in subclause 11.4
Sim	Identity management function	Identity management server	Specified in subclause 12.4
Skm	Key management function	Key management server	Specified in subclause 13.4
Snrm	Network resource management function	Network resource management server	Specified in subclause 14.4
Cccf	CAPIF core function	Not applicable	Specified in subclause 10 of 3GPP TS 23.222 [8]

## Annex A (informative): SEAL integration with 3GPP network exposure systems

NOTE: Not all possible SEAL integration with 3GPP network exposure systems are illustrated in this subclause.

Figure A-1 illustrates the service-based interface representation of the functional model for SEAL services integration with 5GC network exposure system.

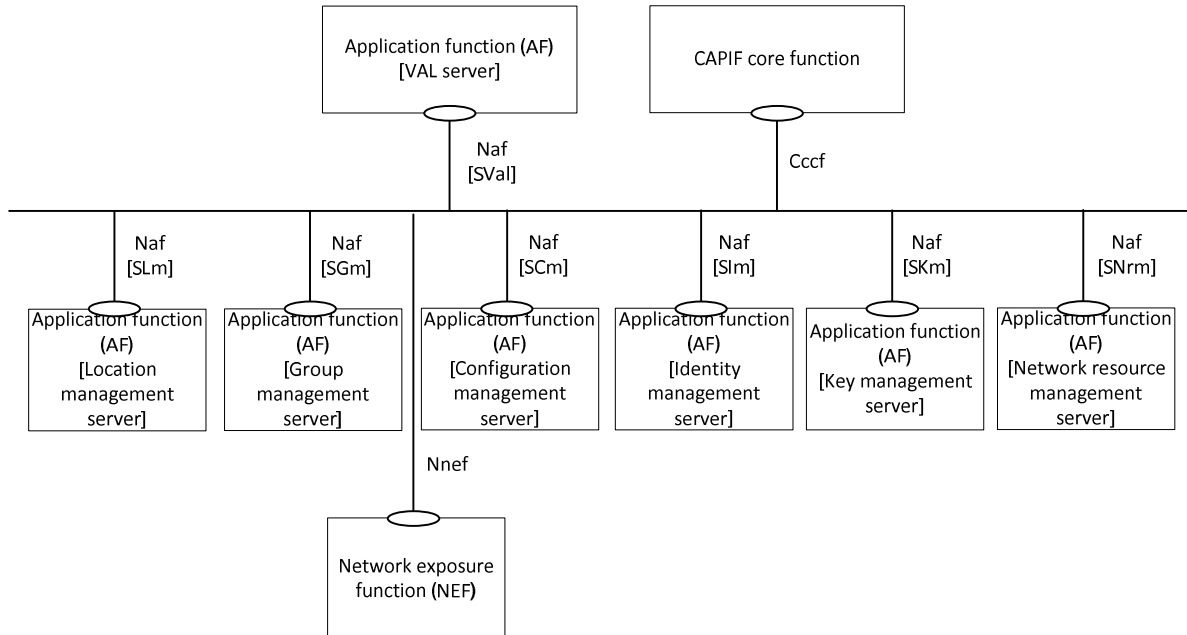
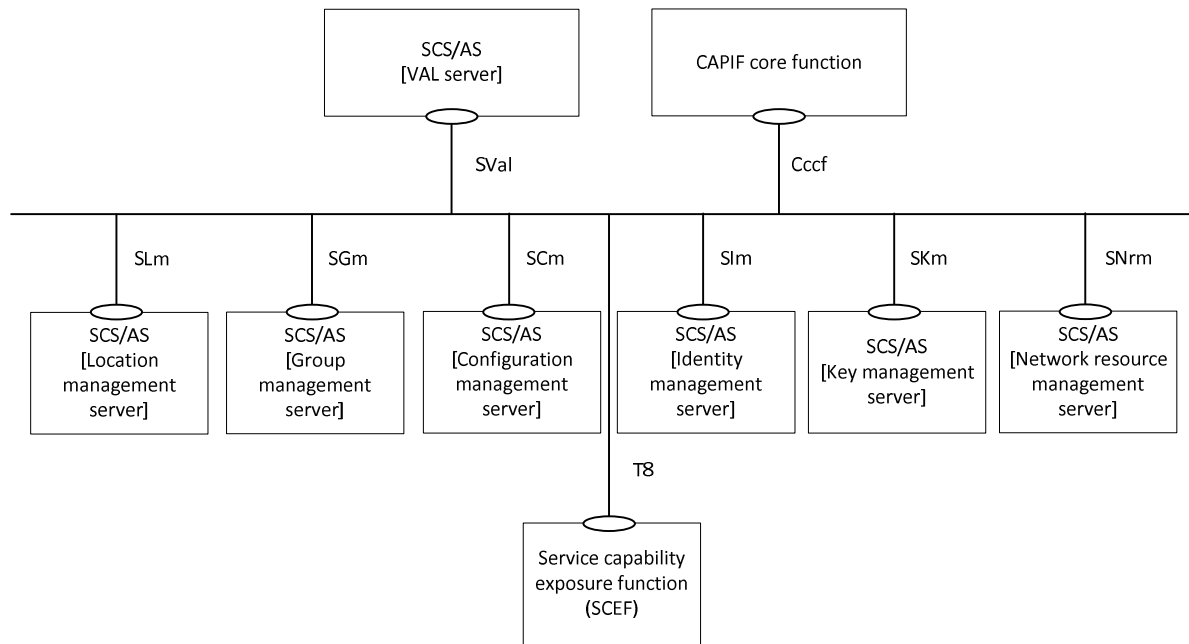

**Figure A-1: SEAL integration with 5GC network exposure system**

The details of NEF and its role in exposing network capabilities of 5GS to 3rd party applications are specified in 3GPP TS 23.501 [10] and the details of NEF service operations are specified in 3GPP TS 23.502 [11].

Figure A-2 illustrates the service-based interface representation of the functional model for SEAL services integration with EPC network exposure system.





**Figure A-2: SEAL integration with EPC network exposure system**

The details of SCEF and its role in exposing network capabilities of EPS to 3rd party applications are specified in 3GPP TS 23.682 [13].

## Annex B (informative): SEAL functional model mapping with Common functional architecture (CFA)

The table B-1 shows the mapping between the SEAL functional model and the Common functional architecture (CFA). The details of CFA functional entities and reference points are specified in 3GPP TS 23.280 [4].

**Table B-1: SEAL functional model mapping with CFA**

SEAL service	Aspects	SEAL	CFA
Location management	Functional entity	Location management client	Location management client
		Location management server	Location management server
	Reference points	LM-UU	CSC-14
		LM-S	CSC-15
		LM-C	Not defined
		LM-E	Not defined
Group management	Functional entity	Group management client	Group management client
		Group management server	Group management server
	Reference points	GM-UU	CSC-2
		GM-S	CSC-3
		GM-C	Not defined
		GM-E	CSC-16
Configuration management	Functional entity	Configuration management client	Configuration management client
		Configuration management server	Configuration management server
	Reference points	CM-UU	CSC-4
		CM-S	CSC-5
		CM-C	Not defined
		CM-E	CSC-17
Identity management	Functional entity	Identity management client	Identity management client
		Identity management server	Identity management server
	Reference points	IM-UU	CSC-1
		IM-S	Not defined
		IM-C	Not defined
		IM-E	Not defined
Key management	Functional entity	Key management client	Key management client
		Key management server	Key management server
	Reference points	KM-UU	CSC-8
		KM-S	CSC-9
		KM-PC5	Not defined
		Network resource management	Functional entity
Network resource management server	Not defined (See NOTE)		
Reference points	NRM-UU		Not defined (See NOTE)
	NRM-S		Not defined
	NRM-C		Not defined
	NRM-E		Not defined
	NRM-PC5	Not defined	

NOTE: Defined in the application layer for Mission Critical service (e.g. MCPTT).

## Annex C (informative): Change history

Change history							
Date	Meeting	TDoc	CR	Rev	Cat	Subject/Comment	New version
2019-01	SA6#28					TS skeleton	0.0.0
2019-01	SA6#28					Implementation of the following pCRs approved by SA6: S6-190283, S6-190284, S6-190285, S6-190301, S6-190210, S6-190286, S6-190272, S6-190287, S6-190295, S6-190215, S6-190296, S6-190297	0.1.0
2019-03	SA6#29					Implementation of the following pCRs approved by SA6: S6-190446, S6-190447, S6-190448, S6-190509, S6-190526, S6-190515, S6-190452, S6-190453, S6-190510, S6-190511, S6-190456, S6-190457, S6-190458	0.2.0
2019-03	SA#83	SP-190063				Presentation for information at SA#83	1.0.0
2019-04	SA6#30					Implementation of the following pCRs approved by SA6: S6-190661, S6-190663, S6-190848, S6-190746, S6-190747, S6-190748, S6-190749, S6-190750, S6-190872	1.1.0
2019-05	SA6#31					Implementation of the following pCRs approved by SA6: S6-191003, S6-191115, S6-191005, S6-191116, S6-191117, S6-191007, S6-191189, S6-191212, S6-191121, S6-191012, S6-191229, S6-191191, S6-191124, S6-191013, S6-191192, S6-191193	1.2.0
2019-05	SA#84	SP-190473				Presentation for Approval at SA#84	2.0.0
2019-06	SA#84	SP-190473				MCC Editorial update for publication after TSG SA approval (SA#84)	16.0.0
2019-09	SA#85	SP-190733	0001	2	F	Architecture requirements group management	16.1.0
2019-09	SA#85	SP-190733	0002	3	F	Group announcement and join	16.1.0
2019-09	SA#85	SP-190733	0003	6	F	Corrections to network resource management procedures	16.1.0
2019-09	SA#85	SP-190733	0004		F	N5 reference point description	16.1.0
2019-09	SA#85	SP-190733	0006	1	F	Change of service-based interface representation of the functional model for SEAL	16.1.0
2019-09	SA#85	SP-190733	0007		F	Remove EN on bearer type identification	16.1.0
2019-09	SA#85	SP-190733	0008		F	Remove EN on granularity of decision of NRM server	16.1.0
2019-12	SA#86	SP-191111	0009	1	F	Corrections to naming and other fixes	16.2.0
2019-12	SA#86	SP-191111	0010	2	F	Result element missing	16.2.0
2019-12	SA#86	SP-191111	0011	1	F	Anonymous requests	16.2.0
2019-12	SA#86	SP-191111	0012	1	F	No multicast resource management in 5GS	16.2.0
2019-12	SA#86	SP-191111	0013	2	F	Mention of SA3 responsibility in a published TS is not relevant.	16.2.0
2019-12	SA#86	SP-191111	0014	2	F	SEAL APIs corrections	16.2.0
2019-12	SA#86	SP-191111	0015	1	F	Update to location configuration procedure	16.2.0
2020-03	SA#87-E	SP-200114	0016		F	Complete SS_NetworkResourceAdaptation API	16.3.0
2020-03	SA#87-E	SP-200114	0017		F	Correct dynamic MBMS bearer establishment	16.3.0
2020-03	SA#87-E	SP-200114	0019		F	MBMS procedures alignment	16.3.0
2020-07	SA#88-E	SP-200338	0021	1	F	Align the Group Management API operation name with CT3	16.4.0
2020-07	SA#88-E	SP-200338	0022	2	F	Clarification and correction on media direction mode	16.4.0
2020-09	SA#89-E	SP-200841	0023	2	F	Correct location trigger configuration	16.5.0
2020-09	SA#89-E	SP-200841	0024	1	F	Clarifications on MBMS listening status uage	16.5.0
2020-09	SA#89-E	SP-200841	0025	2	F	Correct SEAL location API operations	16.5.0
2020-09	SA#89-E	SP-200841	0026	1	F	Correction to NRM unicast procedures	16.5.0
2020-12	SA#90-E	SP-200991	0029	1	F	Clarification on group join notification	16.6.0
2020-12	SA#90-E	SP-200991	0030	1	F	Resolution of ENs on security aspects	16.6.0
2020-12	SA#90-E	SP-200991	0033	1	F	Clarifications for T8 interface	16.6.0
2020-12	SA#90-E	SP-200991	0036	1	F	Correction to location notification to VAL server	16.6.0
2021-06	SA#92-E	SP-210483	0068	1	F	Fixing the descriptions of IEs in Information flows for location information	16.7.0
2021-06	SA#92-E	SP-210483	0072	1	F	Complete resource reservation with PCC procedure	16.7.0

---

# History

<b>Document history</b>		
V16.4.0	October 2020	Publication
V16.5.0	October 2020	Publication
V16.6.0	January 2021	Publication
V16.7.0	July 2021	Publication