

# ETSI TS 123 502 V15.6.0 (2019-10)



**5G;  
Procedures for the 5G System (5GS)  
(3GPP TS 23.502 version 15.6.0 Release 15)**



---

Reference

RTS/TSGS-0223502vf60

---

Keywords

5G

**ETSI**

650 Route des Lucioles  
F-06921 Sophia Antipolis Cedex - FRANCE

Tel.: +33 4 92 94 42 00 Fax: +33 4 93 65 47 16

Siret N° 348 623 562 00017 - NAF 742 C  
Association à but non lucratif enregistrée à la  
Sous-Préfecture de Grasse (06) N° 7803/88

---

**Important notice**

The present document can be downloaded from:

<http://www.etsi.org/standards-search>

The present document may be made available in electronic versions and/or in print. The content of any electronic and/or print versions of the present document shall not be modified without the prior written authorization of ETSI. In case of any existing or perceived difference in contents between such versions and/or in print, the prevailing version of an ETSI deliverable is the one made publicly available in PDF format at [www.etsi.org/deliver](http://www.etsi.org/deliver).

Users of the present document should be aware that the document may be subject to revision or change of status.

Information on the current status of this and other ETSI documents is available at

<https://portal.etsi.org/TB/ETSIDeliverableStatus.aspx>

If you find errors in the present document, please send your comment to one of the following services:

<https://portal.etsi.org/People/CommitteeSupportStaff.aspx>

---

**Copyright Notification**

No part may be reproduced or utilized in any form or by any means, electronic or mechanical, including photocopying and microfilm except as authorized by written permission of ETSI.

The content of the PDF version shall not be modified without the written authorization of ETSI.

The copyright and the foregoing restriction extend to reproduction in all media.

© ETSI 2019.

All rights reserved.

**DECT™**, **PLUGTESTS™**, **UMTS™** and the ETSI logo are trademarks of ETSI registered for the benefit of its Members.

**3GPP™** and **LTE™** are trademarks of ETSI registered for the benefit of its Members and of the 3GPP Organizational Partners.

**oneM2M™** logo is a trademark of ETSI registered for the benefit of its Members and of the oneM2M Partners.

**GSM®** and the GSM logo are trademarks registered and owned by the GSM Association.

---

## Intellectual Property Rights

### Essential patents

IPRs essential or potentially essential to normative deliverables may have been declared to ETSI. The information pertaining to these essential IPRs, if any, is publicly available for **ETSI members and non-members**, and can be found in ETSI SR 000 314: "*Intellectual Property Rights (IPRs); Essential, or potentially Essential, IPRs notified to ETSI in respect of ETSI standards*", which is available from the ETSI Secretariat. Latest updates are available on the ETSI Web server (<https://ipr.etsi.org/>).

Pursuant to the ETSI IPR Policy, no investigation, including IPR searches, has been carried out by ETSI. No guarantee can be given as to the existence of other IPRs not referenced in ETSI SR 000 314 (or the updates on the ETSI Web server) which are, or may be, or may become, essential to the present document.

### Trademarks

The present document may include trademarks and/or tradenames which are asserted and/or registered by their owners. ETSI claims no ownership of these except for any which are indicated as being the property of ETSI, and conveys no right to use or reproduce any trademark and/or tradename. Mention of those trademarks in the present document does not constitute an endorsement by ETSI of products, services or organizations associated with those trademarks.

---

## Legal Notice

This Technical Specification (TS) has been produced by ETSI 3rd Generation Partnership Project (3GPP).

The present document may refer to technical specifications or reports using their 3GPP identities. These shall be interpreted as being references to the corresponding ETSI deliverables.

The cross reference between 3GPP and ETSI identities can be found under <http://webapp.etsi.org/key/queryform.asp>.

---

## Modal verbs terminology

In the present document "**shall**", "**shall not**", "**should**", "**should not**", "**may**", "**need not**", "**will**", "**will not**", "**can**" and "**cannot**" are to be interpreted as described in clause 3.2 of the [ETSI Drafting Rules](#) (Verbal forms for the expression of provisions).

"**must**" and "**must not**" are **NOT** allowed in ETSI deliverables except when used in direct citation.

# Contents

Intellectual Property Rights .....	2
Legal Notice .....	2
Modal verbs terminology.....	2
Foreword.....	13
1 Scope .....	14
2 References .....	14
3 Definitions, symbols and abbreviations .....	16
3.1 Definitions .....	16
3.2 Abbreviations .....	16
4 System procedures.....	16
4.1 General .....	16
4.2 Connection, Registration and Mobility Management procedures .....	16
4.2.1 General.....	16
4.2.2 Registration Management procedures.....	16
4.2.2.1 General .....	16
4.2.2.2 Registration procedures.....	16
4.2.2.2.1 General .....	16
4.2.2.2.2 General Registration.....	18
4.2.2.2.3 Registration with AMF re-allocation.....	28
4.2.2.3 Deregistration procedures .....	30
4.2.2.3.1 General .....	30
4.2.2.3.2 UE-initiated Deregistration.....	30
4.2.2.3.3 Network-initiated Deregistration.....	32
4.2.3 Service Request procedures .....	33
4.2.3.1 General .....	33
4.2.3.2 UE Triggered Service Request.....	33
4.2.3.3 Network Triggered Service Request .....	42
4.2.4 UE Configuration Update .....	49
4.2.4.1 General .....	49
4.2.4.2 UE Configuration Update procedure for access and mobility management related parameters .....	49
4.2.4.3 UE Configuration Update procedure for transparent UE Policy delivery .....	52
4.2.5 Reachability procedures.....	53
4.2.5.1 General .....	53
4.2.5.2 UE Reachability Notification Request procedure .....	54
4.2.5.3 UE Activity Notification procedure .....	54
4.2.6 AN Release .....	55
4.2.7 N2 procedures .....	57
4.2.7.1 N2 Configuration .....	57
4.2.7.2 NGAP UE-TNLA-binding related procedures.....	58
4.2.7.2.1 Creating NGAP UE-TNLA-bindings during Registration and Service Request .....	58
4.2.7.2.2 Creating NGAP UE-TNLA-bindings during handovers.....	58
4.2.7.2.3 Re-Creating NGAP UE-TNLA-bindings subsequent to NGAP UE-TNLA-binding release .....	59
4.2.7.2.4 NGAP UE-TNLA-binding update procedure .....	59
4.2.7.2.5 NGAP UE-TNLA-binding per UE Release procedure .....	59
4.2.7.3 AMF Failure or Planned Maintenance handling procedure .....	60
4.2.8 Void .....	60
4.2.8a UE Capability Match Request procedure.....	60
4.3 Session Management procedures .....	61
4.3.1 General.....	61
4.3.2 PDU Session Establishment.....	62
4.3.2.1 General .....	62
4.3.2.2 UE Requested PDU Session Establishment .....	62
4.3.2.2.1 Non-roaming and Roaming with Local Breakout.....	62
4.3.2.2.2 Home-routed Roaming .....	71

4.3.2.2.3	SMF selection.....	75
4.3.2.3	Secondary authorization/authentication by an DN-AAA server during the PDU Session establishment.....	78
4.3.3	PDU Session Modification .....	80
4.3.3.1	General .....	80
4.3.3.2	UE or network requested PDU Session Modification (non-roaming and roaming with local breakout) .....	80
4.3.3.3	UE or network requested PDU Session Modification (home-routed roaming).....	84
4.3.4	PDU Session Release.....	87
4.3.4.1	General .....	87
4.3.4.2	UE or network requested PDU Session Release for Non-Roaming and Roaming with Local Breakout.....	87
4.3.4.3	UE or network requested PDU Session Release for Home-routed Roaming .....	91
4.3.5	Session continuity, service continuity and UP path management.....	93
4.3.5.1	Change of SSC mode 2 PDU Session Anchor with different PDU Sessions .....	93
4.3.5.2	Change of SSC mode 3 PDU Session Anchor with multiple PDU Sessions .....	94
4.3.5.3	Change of SSC mode 3 PDU Session Anchor with IPv6 Multi-homed PDU Session.....	95
4.3.5.4	Addition of additional PDU Session Anchor and Branching Point or UL CL .....	97
4.3.5.5	Removal of additional PDU Session Anchor and Branching Point or UL CL.....	99
4.3.5.6	Change of additional PDU Session Anchor for IPv6 multi-homing or UL CL.....	101
4.3.5.7	Simultaneous change of Branching Point or UL CL and additional PSA for a PDU Session.....	102
4.3.6	Application Function influence on traffic routing .....	104
4.3.6.1	General .....	104
4.3.6.2	Processing AF requests to influence traffic routing for Sessions not identified by an UE address.....	105
4.3.6.3	Notification of User Plane Management Events .....	106
4.3.6.4	Transferring an AF request targeting an individual UE address to the relevant PCF.....	108
4.3.7	CN-initiated selective deactivation of UP connection of an existing PDU Session.....	109
4.4	SMF and UPF interactions .....	110
4.4.1	N4 session management procedures .....	110
4.4.1.1	General .....	110
4.4.1.2	N4 Session Establishment procedure .....	110
4.4.1.3	N4 Session Modification procedure.....	111
4.4.1.4	N4 Session Release procedure .....	112
4.4.2	N4 Reporting Procedures.....	112
4.4.2.1	General .....	112
4.4.2.2	N4 Session Level Reporting Procedure.....	112
4.4.3	N4 Node Level Procedures .....	113
4.4.3.1	N4 Association Setup Procedure.....	113
4.4.3.2	N4 Association Update Procedure .....	114
4.4.3.3	N4 Association Release Procedure .....	114
4.4.3.4	N4 Report Procedure.....	115
4.4.3.5	N4 PFD management Procedure .....	115
4.4.4	SMF Pause of Charging procedure .....	116
4.5	User Profile management procedures.....	117
4.5.1	Subscriber Data Update Notification to AMF .....	117
4.5.2	Session Management Subscriber Data Update Notification to SMF .....	118
4.5.3	Purge of subscriber data in AMF .....	118
4.6	Security procedures .....	119
4.7	ME Identity check procedure .....	119
4.8	RAN-CN interactions .....	119
4.8.1	Connection Inactive procedure .....	119
4.8.2	Connection Resume procedure .....	119
4.8.3	N2 Notification procedure .....	120
4.9	Handover procedures.....	121
4.9.1	Handover procedures in 3GPP access.....	121
4.9.1.1	General .....	121
4.9.1.2	Xn based inter NG-RAN handover .....	121
4.9.1.2.1	General .....	121
4.9.1.2.2	Xn based inter NG-RAN handover without User Plane function re-allocation.....	121
4.9.1.2.3	Xn based inter NG-RAN handover with insertion of intermediate UPF .....	124
4.9.1.2.4	Xn based inter NG-RAN handover with re-allocation of intermediate UPF .....	126
4.9.1.3	Inter NG-RAN node N2 based handover .....	127

4.9.1.3.1	General .....	127
4.9.1.3.2	Preparation phase.....	129
4.9.1.3.3	Execution phase.....	134
4.9.1.4	Inter NG-RAN node N2 based handover, Cancel .....	137
4.9.2	Handover of a PDU Session procedure between 3GPP and untrusted non-3GPP access .....	138
4.9.2.1	Handover of a PDU Session procedure from untrusted non-3GPP to 3GPP access (non-roaming and roaming with local breakout).....	138
4.9.2.2	Handover of a PDU Session procedure from 3GPP to untrusted non-3GPP access (non-roaming and roaming with local breakout).....	138
4.9.2.3	Handover of a PDU Session procedure from untrusted non-3GPP to 3GPP access (home routed roaming).....	139
4.9.2.3.1	The target AMF is in the PLMN of the N3IWF .....	139
4.9.2.3.2	The target AMF is not in the PLMN of the N3IWF (i.e. N3IWF in HPLMN).....	140
4.9.2.4	Handover of a PDU Session procedure from 3GPP to untrusted non-3GPP access (home routed roaming).....	140
4.9.2.4.1	The selected N3IWF is in the registered PLMN.....	140
4.9.2.4.2	The UE is roaming and the selected N3IWF is in the home PLMN.....	141
4.10	NG-RAN Location reporting procedures .....	142
4.11	System interworking procedures with EPC.....	143
4.11.0	General.....	143
4.11.0a	Impacts to EPS Procedures .....	143
4.11.0a.1	General .....	143
4.11.0a.2	Interaction with PCC.....	143
4.11.0a.3	Mobility Restrictions.....	144
4.11.0a.4	PGW Selection.....	144
4.11.0a.5	PDN Connection Establishment.....	144
4.11.1	N26 based Interworking Procedures .....	144
4.11.1.1	General .....	144
4.11.1.2	Handover procedures .....	146
4.11.1.2.1	5GS to EPS handover using N26 interface .....	146
4.11.1.2.2	EPS to 5GS handover using N26 interface .....	150
4.11.1.2.3	Handover Cancel .....	156
4.11.1.3	Idle Mode Mobility procedures.....	157
4.11.1.3.1	General .....	157
4.11.1.3.2	5GS to EPS Idle mode mobility using N26 interface .....	157
4.11.1.3.3	EPS to 5GS Mobility Registration Procedure (Idle and Connected State) using N26 interface ...	160
4.11.1.4	Procedures for EPS bearer ID allocation.....	164
4.11.1.4.1	EPS bearer ID allocation .....	164
4.11.1.4.2	EPS bearer ID transfer .....	167
4.11.1.4.3	EPS bearer ID revocation .....	168
4.11.1.5	Impacts to EPS Procedures .....	169
4.11.1.5.1	General .....	169
4.11.1.5.2	E-UTRAN Initial Attach .....	169
4.11.1.5.3	Tracking Area Update .....	170
4.11.1.5.4	Session Management .....	170
4.11.1.5.5	5GS to EPS handover using N26 interface .....	172
4.11.1.6	EPS interworking information storing Procedure .....	173
4.11.2	Interworking procedures without N26 interface .....	173
4.11.2.1	General .....	173
4.11.2.2	5GS to EPS Mobility.....	173
4.11.2.3	EPS to 5GS Mobility.....	176
4.11.2.4	Impacts to EPS Procedures .....	178
4.11.2.4.1	E-UTRAN Attach.....	178
4.11.2.4.2	Session Management .....	180
4.11.2.4.3	Initial Attach on S2b.....	180
4.11.3	Handover procedures between EPS and 5GC-N3IWF .....	181
4.11.3.1	Handover from EPS to 5GC-N3IWF .....	181
4.11.3.2	Handover from 5GC-N3IWF to EPS .....	181
4.11.4	Handover procedures between EPC/ePDG and 5GS .....	182
4.11.4.1	Handover from EPC/ePDG to 5GS .....	182
4.11.4.2	Handover from 5GS to EPC/ePDG.....	183
4.11.5	Impacts to 5GC Procedures .....	184

4.11.5.1	General .....	184
4.11.5.2	Registration procedure .....	184
4.11.5.3	UE Requested PDU Session Establishment procedure .....	184
4.11.5.4	UE or Network Requested PDU Session Modification procedure .....	185
4.11.5.5	Xn based inter NG-RAN handover .....	185
4.11.5.6	Inter NG-RAN node N2 based handover .....	185
4.12	Procedures for non-3GPP access .....	185
4.12.1	General .....	185
4.12.2	Registration via Untrusted non-3GPP Access .....	185
4.12.2.1	General .....	185
4.12.2.2	Registration procedure for untrusted non-3GPP access .....	186
4.12.2.3	Emergency Registration for untrusted non-3GPP Access .....	188
4.12.3	Deregistration procedure for untrusted non-3gpp access .....	189
4.12.4	N2 procedures via Untrusted non-3GPP Access .....	190
4.12.4.1	Service Request procedures via Untrusted non-3GPP Access .....	190
4.12.4.2	Procedure for the UE context release in the N3IWF .....	190
4.12.4.3	CN-initiated selective deactivation of UP connection of an existing PDU Session associated with Untrusted non-3GPP Access .....	192
4.12.5	UE Requested PDU Session Establishment via Untrusted non-3GPP Access .....	192
4.12.6	UE or Network Requested PDU Session Modification via Untrusted non-3GPP access .....	194
4.12.7	UE or network Requested PDU Session Release via Untrusted non-3GPP access .....	195
4.12.8	Mobility from a non-geographically selected AMF to a geographically selected AMF .....	197
4.13	Specific services .....	198
4.13.1	General .....	198
4.13.2	Application Triggering .....	198
4.13.2.1	General .....	198
4.13.2.2	The procedure of "Application Triggering" Service .....	199
4.13.3	SMS over NAS procedures .....	201
4.13.3.1	Registration procedures for SMS over NAS .....	201
4.13.3.2	Deregistration procedures for SMS over NAS .....	202
4.13.3.3	MO SMS over NAS in CM-IDLE (baseline) .....	203
4.13.3.4	Void .....	204
4.13.3.5	MO SMS over NAS in CM-CONNECTED .....	204
4.13.3.6	MT SMS over NAS in CM-IDLE state via 3GPP access .....	204
4.13.3.7	MT SMS over NAS in CM-CONNECTED state via 3GPP access .....	205
4.13.3.8	MT SMS over NAS via non-3GPP access .....	205
4.13.3.9	Unsuccessful Mobile terminating SMS delivery attempt .....	206
4.13.4	Emergency Services .....	206
4.13.4.1	General .....	206
4.13.4.2	Emergency Services Fallback .....	206
4.13.5	Location Services procedures .....	208
4.13.5.1	5GC-NI-LR Procedure .....	208
4.13.5.2	5GC-MT-LR Procedure without UDM Query .....	209
4.13.5.3	5GC-MT-LR Procedure .....	210
4.13.5.4	UE Assisted and UE Based Positioning Procedure .....	211
4.13.5.5	Network Assisted Positioning Procedure .....	212
4.13.5.6	Obtaining Non-UE Associated Network Assistance Data .....	213
4.13.5.7	Location continuity for Handover of an Emergency session from NG-RAN .....	213
4.13.6	Support of IMS Voice .....	215
4.13.6.1	EPS fallback for IMS voice .....	215
4.13.6.2	Inter RAT Fallback in 5GC for IMS voice .....	217
4.14	Support for Dual Connectivity .....	218
4.14.1	RAN Initiated QoS Flow Mobility .....	218
4.15	Network Exposure .....	220
4.15.1	General .....	220
4.15.2	External Exposure of Network Capabilities .....	221
4.15.3	Event Exposure using NEF .....	221
4.15.3.1	Monitoring Events .....	221
4.15.3.2	Information flows .....	223
4.15.3.2.1	AMF service operations information flow .....	223
4.15.3.2.2	UDM service operations information flow .....	223
4.15.3.2.3	NEF service operations information flow .....	225

4.15.3.2.4	Exposure with bulk subscription .....	227
4.15.4	Core Network Internal Event Exposure .....	228
4.15.4.1	General .....	228
4.15.4.2	Exposure of Mobility Events from AMF .....	228
4.15.5	Void .....	229
4.15.6	External Parameter Provisioning .....	229
4.15.6.1	General .....	229
4.15.6.2	NEF service operations information flow .....	229
4.15.6.3	Expected UE Behaviour parameters.....	230
4.15.6.4	Set a chargeable party at AF session setup.....	231
4.15.6.5	Change the chargeable party during the session.....	232
4.15.6.6	Setting up an AF session with required QoS procedure.....	233
4.16	Procedures and flows for Policy Framework .....	234
4.16.1	AM Policy Association Establishment .....	234
4.16.1.1	General .....	234
4.16.1.2	AM Policy Association Establishment with new Selected PCF.....	234
4.16.1.3	Void.....	235
4.16.2	AM Policy Association Modification .....	235
4.16.2.0	General .....	235
4.16.2.1	AM Policy Association Modification initiated by the AMF .....	235
4.16.2.1.1	AM Policy Association Modification initiated by the AMF without AMF relocation .....	235
4.16.2.1.2	AM Policy Association Modification with old PCF during AMF relocation .....	236
4.16.2.2	AM Policy Association Modification initiated by the PCF.....	237
4.16.3	AM Policy Association Termination .....	237
4.16.3.1	General .....	237
4.16.3.2	AMF-initiated AM Policy Association Termination.....	238
4.16.3.3	Void.....	238
4.16.4	SM Policy Association Establishment .....	239
4.16.5	SM Policy Association Modification.....	240
4.16.5.0	General .....	240
4.16.5.1	SMF initiated SM Policy Association Modification .....	240
4.16.5.2	PCF initiated SM Policy Association Modification .....	241
4.16.6	SM Policy Association Termination .....	242
4.16.7	Negotiations for future background data transfer .....	243
4.16.7.1	General .....	243
4.16.7.2	Procedures for future background data transfer .....	244
4.16.8	Procedures on interaction between PCF and CHF .....	245
4.16.8.1	General .....	245
4.16.8.2	Initial Spending Limit Retrieval.....	245
4.16.8.3	Intermediate Spending Limit Report Retrieval .....	246
4.16.8.4	Final Spending Limit Report Retrieval .....	246
4.16.8.5	Spending Limit Report.....	247
4.16.8.6	CHF report the removal of the subscriber .....	247
4.16.9	Update of the subscription information in the PCF .....	248
4.16.10	Void .....	249
4.16.11	UE Policy Association Establishment .....	249
4.16.12	UE Policy Association Modification .....	251
4.16.12.1	UE Policy Association Modification initiated by the AMF .....	251
4.16.12.1.1	UE Policy Association Modification initiated by the AMF without AMF relocation .....	251
4.16.12.1.2	UE Policy Association Modification with old PCF during AMF relocation.....	253
4.16.12.2	UE Policy Association Modification initiated by the PCF.....	254
4.16.13	UE Policy Association Termination .....	255
4.16.13.1	AMF-initiated UE Policy Association Termination.....	255
4.16.13.2	PCF-initiated UE Policy Association Termination .....	256
4.17	Network Function Service Framework Procedure .....	257
4.17.1	NF service Registration .....	257
4.17.2	NF service update .....	258
4.17.3	NF service deregistration .....	258
4.17.4	NF/NF service discovery in the same PLMN .....	259
4.17.5	NF/NF service discovery across PLMNs.....	260
4.17.6	SMF Provisioning of available UPFs using the NRF .....	260
4.17.6.1	General .....	260



4.17.6.2	SMF provisioning of UPF instances using NRF .....	261
4.17.7	NF/NF service status subscribe/notify in the same PLMN .....	262
4.17.8	NF/NF service status subscribe/notify across PLMNs.....	262
4.18	Procedures for Management of PFDs.....	263
4.18.1	General.....	263
4.18.2	PFD management via NEF (PFDF) .....	263
4.18.3	PFD management in the SMF.....	264
4.18.3.1	PFD Retrieval by the SMF.....	264
4.18.3.2	Management of PFDs in the SMF.....	264
4.19	Network Data Analytics .....	265
4.19.1	Network data analytics Subscribe/Unsubscribe.....	265
4.19.2	Network data analytics Request.....	265
4.20	UE Parameters Update via UDM Control Plane Procedure .....	266
4.20.1	General.....	266
4.20.2	UE Parameters Update via UDM Control Plane Procedure.....	267
4.20.3	Void.....	268
4.21	Secondary RAT Usage Data Reporting Procedure.....	268
5	Network Function Service procedures .....	269
5.1	Network Function Service framework procedures .....	269
5.1.1	Network Function Service Discovery .....	269
5.2	Network Function services .....	269
5.2.1	General.....	269
5.2.2	AMF Services .....	269
5.2.2.1	General .....	269
5.2.2.2	Namf_Communication service.....	270
5.2.2.2.1	General .....	270
5.2.2.2.2	Namf_Communication_UEContextTransfer service operation.....	270
5.2.2.2.3	Namf_Communication_RegistrationCompleteNotify service operation.....	274
5.2.2.2.4	Namf_Communication_N1MessageNotify service operation.....	275
5.2.2.2.5	Namf_Communication_N1MessageSubscribe service operation.....	275
5.2.2.2.6	Namf_Communication_N1MessageUnSubscribe service operation.....	275
5.2.2.2.7	Namf_Communication_N1N2MessageTransfer service operation.....	276
5.2.2.2.7A	Namf_Communication_N1N2TransferFailureNotification service operation.....	277
5.2.2.2.8	Namf_Communication_N2InfoSubscribe service operation.....	277
5.2.2.2.9	Namf_Communication_N2InfoUnsubscribe service operation.....	277
5.2.2.2.10	Namf_Communication_N2InfoNotify service operation .....	277
5.2.2.2.11	Namf_Communication_CreateUEContext service operation.....	278
5.2.2.2.12	Namf_Communication_ReleaseUEContext service operation.....	278
5.2.2.2.13	Namf_Communication_EBIAssignment service operation.....	278
5.2.2.2.14	Namf_Communication_AMFStatusChangeSubscribe service operation.....	279
5.2.2.2.15	Namf_Communication_AMFStatusChangeUnSubscribe service operation.....	279
5.2.2.2.16	Namf_Communication_AMFStatusChangeNotify service operation .....	279
5.2.2.3	Namf_EventExposure service .....	279
5.2.2.3.1	General .....	279
5.2.2.3.2	Namf_EventExposure_Subscribe service operation.....	280
5.2.2.3.3	Namf_EventExposure_UnSubscribe service operation .....	281
5.2.2.3.4	Namf_EventExposure_Notify service operation.....	281
5.2.2.4	Namf_MT service .....	282
5.2.2.4.1	General .....	282
5.2.2.4.2	Namf_MT_EnableUEReachability service operation .....	282
5.2.2.4.3	Namf_MT_ProvideDomainSelectionInfo .....	282
5.2.2.5	Namf_Location service .....	282
5.2.2.5.1	General .....	282
5.2.2.5.2	Namf_Location_ProvidePositioningInfo service operation.....	283
5.2.2.5.3	Namf_Location_EventNotify service operation.....	283
5.2.2.5.4	Namf_Location_ProvideLocationInfo service operation .....	283
5.2.3	UDM Services .....	283
5.2.3.1	General .....	283
5.2.3.2	Nudm_UECM (UECM) service.....	284
5.2.3.2.1	Nudm_UECM_Registration service operation.....	284
5.2.3.2.2	Nudm_UECM_DeregistrationNotification service operation .....	284

5.2.3.2.3	Nudm_UECM_Deregistration service operation.....	285
5.2.3.2.4	Nudm_UECM_Get service operation.....	285
5.2.3.2.5	Nudm_UECM_Update service operation.....	285
5.2.3.2.6	Nudm_UECM_PCscfRestoration service operation.....	286
5.2.3.3	Nudm_SubscriberDataManagement (SDM) Service .....	286
5.2.3.3.1	General .....	286
5.2.3.3.2	Nudm_SDM_Get service operation .....	291
5.2.3.3.3	Nudm_SDM_Notification service operation.....	291
5.2.3.3.4	Nudm_SDM_Subscribe service operation .....	292
5.2.3.3.5	Nudm_SDM_Unsubscribe service operation .....	292
5.2.3.3.6	Nudm_SDM_Info service operation.....	292
5.2.3.4	Nudm_UEAuthentication Service.....	293
5.2.3.4.1	General .....	293
5.2.3.4.2	Nudm_UEAuthentication_Get service operation .....	293
5.2.3.4.3	Nudm_UEAuthentication_ResultConfirmation service operation .....	293
5.2.3.5	Nudm_EventExposure service .....	293
5.2.3.5.1	General .....	293
5.2.3.5.2	Nudm_EventExposure_Subscribe service operation.....	293
5.2.3.5.3	Nudm_EventExposure_Unsubscribe service operation.....	293
5.2.3.5.4	Nudm_EventExposure_Notify service operation .....	294
5.2.3.6	Nudm_ParameterProvision service .....	294
5.2.3.6.1	General .....	294
5.2.3.6.2	Nudm_ParameterProvision_Update service operation .....	294
5.2.4	5G-EIR Services .....	294
5.2.4.1	General .....	294
5.2.4.2	N5g-eir_EquipmentIdentityCheck service .....	294
5.2.4.2.1	General .....	294
5.2.4.2.2	N5g-eir_EquipmentIdentityCheck_Get service operation.....	295
5.2.5	PCF Services.....	295
5.2.5.1	General .....	295
5.2.5.2	Npcf_AMPolicyControl service.....	295
5.2.5.2.1	General .....	295
5.2.5.2.2	Npcf_AMPolicyControl_Create service operation.....	296
5.2.5.2.3	Npcf_AMPolicyControl_UpdateNotify service operation .....	296
5.2.5.2.4	Npcf_AMPolicyControl_Delete service operation.....	297
5.2.5.2.5	Npcf_AMPolicyControl_Update service operation.....	297
5.2.5.3	Npcf_PolicyAuthorization Service .....	297
5.2.5.3.1	General .....	297
5.2.5.3.2	Npcf_PolicyAuthorization_Create service operation .....	297
5.2.5.3.3	Npcf_PolicyAuthorization_Update service operation .....	298
5.2.5.3.4	Npcf_PolicyAuthorization_Delete service operation .....	298
5.2.5.3.5	Npcf_PolicyAuthorization_Notify service operation .....	298
5.2.5.3.6	Npcf_PolicyAuthorization_Subscribe service operation.....	298
5.2.5.3.7	Npcf_PolicyAuthorization_Unsubscribe service operation.....	299
5.2.5.4	Npcf_SMPolicyControl service .....	299
5.2.5.4.1	General .....	299
5.2.5.4.2	Npcf_SMPolicyControl_Create service operation .....	300
5.2.5.4.3	Npcf_SMPolicyControl_UpdateNotify service operation.....	300
5.2.5.4.4	Npcf_SMPolicyControl_Delete service operation .....	300
5.2.5.4.5	Npcf_SMPolicyControl_Update service operation .....	300
5.2.5.5	Npcf_BDTPolicyControl Service .....	301
5.2.5.5.1	General .....	301
5.2.5.5.2	Npcf_BDTPolicyControl_Create service operation .....	301
5.2.5.5.3	Npcf_BDTPolicyControl_Update service operation.....	301
5.2.5.6	Npcf_UEPolicyControl Service .....	301
5.2.5.6.1	General .....	301
5.2.5.6.2	Npcf_UEPolicyControl_Create service operation.....	302
5.2.5.6.3	Npcf_UEPolicyControl_UpdateNotify service operation .....	302
5.2.5.6.4	Npcf_UEPolicyControl_Delete service operation.....	303
5.2.5.6.5	Npcf_UEPolicyControl_Update service operation.....	303
5.2.5.7	Npcf_EventExposure service .....	303
5.2.5.7.1	General .....	303

5.2.5.7.2	Npcf_EventExposure_Subscribe service operation.....	303
5.2.5.7.3	Npcf_EventExposure_Unsubscribe service operation.....	304
5.2.5.7.4	Npcf_EventExposure_Notify service operation .....	304
5.2.6	NEF Services .....	304
5.2.6.1	General .....	304
5.2.6.2	Nnef_EventExposure service .....	305
5.2.6.2.1	General .....	305
5.2.6.2.2	Nnef_EventExposure_Subscribe operation.....	305
5.2.6.2.3	Nnef_EventExposure_Unsubscribe service operation.....	305
5.2.6.2.4	Nnef_EventExposure_Notify service operation .....	306
5.2.6.3	Nnef_PFDManagement service .....	306
5.2.6.3.1	General .....	306
5.2.6.3.2	Nnef_PFDManagement_Fetch service operation.....	306
5.2.6.3.3	Nnef_PFDManagement_Subscribe service operation .....	306
5.2.6.3.4	Nnef_PFDManagement_Notify service operation .....	306
5.2.6.3.5	Nnef_PFDManagement_Unsubscribe service operation.....	307
5.2.6.3.6	Nnef_PFDManagement_Create service operation .....	307
5.2.6.3.7	Nnef_PFDManagement_Update service operation .....	307
5.2.6.3.8	Nnef_PFDManagement_Delete service operation .....	307
5.2.6.4	Nnef_ParameterProvision service .....	307
5.2.6.4.1	General .....	307
5.2.6.4.2	Nnef_ParameterProvision_Update service operation.....	307
5.2.6.5	Nnef_Trigger service .....	308
5.2.6.5.1	General .....	308
5.2.6.5.2	Nnef_Trigger_Delivery service operation.....	308
5.2.6.5.3	Nnef_Trigger_DeliveryNotify service operation.....	308
5.2.6.6	Nnef_BDTPNegotiation service .....	308
5.2.6.6.1	General .....	308
5.2.6.6.2	Nnef_BDTPNegotiation_Create service operation .....	308
5.2.6.6.3	Nnef_BDTPNegotiation_Update service operation .....	308
5.2.6.7	Nnef_TrafficInfluence service .....	309
5.2.6.7.1	General .....	309
5.2.6.7.2	Nnef_TrafficInfluence_Create operation.....	309
5.2.6.7.3	Nnef_TrafficInfluence_Update operation .....	309
5.2.6.7.4	Nnef_TrafficInfluence_Delete operation.....	309
5.2.6.7.5	Nnef_TrafficInfluence_Notify operation.....	310
5.2.6.8	Nnef_ChargeableParty service .....	310
5.2.6.8.1	General .....	310
5.2.6.8.2	Nnef_ChargeableParty_Create service operation.....	310
5.2.6.8.3	Nnef_ChargeableParty_Update service operation.....	310
5.2.6.8.4	Nnef_ChargeableParty_Notify service operation.....	310
5.2.6.9	Nnef_AFsessionWithQoS service.....	311
5.2.6.9.1	General .....	311
5.2.6.9.2	Nnef_AFsessionWithQoS_Create service operation.....	311
5.2.6.9.3	Nnef_AFsessionWithQoS_Notify service operation.....	311
5.2.7	NRF Services.....	311
5.2.7.1	General.....	311
5.2.7.2	Nnrf_NFManagement service .....	312
5.2.7.2.1	General .....	312
5.2.7.2.2	Nnrf_NFManagement_NFRegister service operation .....	312
5.2.7.2.3	Nnrf_NFManagement_NFUpdate service operation.....	313
5.2.7.2.4	Nnrf_NFManagement_NFDeregister service operation.....	313
5.2.7.2.5	Nnrf_NFManagement_NFStatusSubscribe service operation.....	313
5.2.7.2.6	Nnrf_NFManagement_NFStatusNotify service operation .....	314
5.2.7.2.7	Nnrf_NFManagement_NFStatusUnsubscribe service operation.....	314
5.2.7.3	Nnrf_NFDiscovery service .....	314
5.2.7.3.1	General .....	314
5.2.7.3.2	Nnrf_NFDiscovery_Request service operation.....	315
5.2.7.4	Nnrf_AccessToken_service .....	316
5.2.7.4.1	General .....	316
5.2.7.4.2	Nnrf_AccessToken_Get Service Operation.....	316
5.2.8	SMF Services.....	316

5.2.8.1	General .....	316
5.2.8.2	Nsmf_PDUSession Service .....	316
5.2.8.2.1	General .....	316
5.2.8.2.2	Nsmf_PDUSession_Create service operation .....	317
5.2.8.2.3	Nsmf_PDUSession_Update service operation .....	318
5.2.8.2.4	Nsmf_PDUSession_Release service operation .....	318
5.2.8.2.5	Nsmf_PDUSession_CreateSMContext service operation .....	318
5.2.8.2.6	Nsmf_PDUSession_UpdateSMContext service operation .....	319
5.2.8.2.7	Nsmf_PDUSession_ReleaseSMContext service operation .....	320
5.2.8.2.8	Nsmf_PDUSession_SMContextStatusNotify service operation .....	320
5.2.8.2.9	Nsmf_PDUSession_StatusNotify service operation .....	320
5.2.8.2.10	Nsmf_PDUSession_ContextRequest service operation .....	320
5.2.8.3	Nsmf_EventExposure Service .....	321
5.2.8.3.1	General .....	321
5.2.8.3.2	Nsmf_EventExposure_Notify service operation .....	321
5.2.8.3.3	Nsmf_EventExposure_Subscribe service operation .....	322
5.2.8.3.4	Nsmf_EventExposure_UnSubscribe service operation .....	322
5.2.9	SMSF Services .....	323
5.2.9.1	General .....	323
5.2.9.2	Nsmsf_SMSservice service .....	323
5.2.9.2.1	General .....	323
5.2.9.2.2	Nsmsf_SMSservice_Activate service operation .....	323
5.2.9.2.3	Nsmsf_SMSservice_Deactivate service operation .....	323
5.2.9.2.4	Nsmsf_SMSservice_UplinkSMS service operation .....	323
5.2.10	AUSF Services .....	324
5.2.10.1	General .....	324
5.2.10.2	Nausf_UEAuthentication service .....	324
5.2.10.2.1	General .....	324
5.2.10.2.2	Nausf_UEAuthentication_Authenticate service operation .....	324
5.2.10.2.3	Void .....	324
5.2.10.3	Nausf_SoRProtection service .....	324
5.2.10.3.1	General .....	324
5.2.10.3.2	Nausf_SoRProtection_Protect service operation .....	324
5.2.11	NWDAF Services .....	324
5.2.11.1	General .....	324
5.2.11.2	Nnwdaf_EventsSubscription Service .....	325
5.2.11.2.1	General .....	325
5.2.11.2.2	Nnwdaf_EventsSubscription_Subscribe service operation .....	325
5.2.11.2.3	Nnwdaf_EventsSubscription_Unsubscribe service operation .....	325
5.2.11.2.4	Nnwdaf_EventsSubscription_Notify service operation .....	326
5.2.11.3	Nnwdaf_Analytics_Info service .....	326
5.2.11.3.1	General .....	326
5.2.11.3.2	Nnwdaf_AnalyticsInfo_Request service operation .....	326
5.2.12	UDR Services .....	326
5.2.12.1	General .....	326
5.2.12.2	Nudr_DataManagement (DM) service .....	328
5.2.12.2.1	General .....	328
5.2.12.2.2	Nudr_DM_Query service operation .....	329
5.2.12.2.3	Nudr_DM_Create service operation .....	330
5.2.12.2.4	Nudr_DM_Delete service operation .....	330
5.2.12.2.5	Nudr_DM_Update service operation .....	330
5.2.12.2.6	Nudr_DM_Subscribe service operation .....	330
5.2.12.2.7	Nudr_DM_Unsubscribe service operation .....	331
5.2.12.2.8	Nudr_DM_Notify service operation .....	331
5.2.13	BSF Services .....	331
5.2.13.1	General .....	331
5.2.13.2	Nbsf_Management service .....	331
5.2.13.2.1	General .....	331
5.2.13.2.2	Nbsf_Management_Register service operation .....	332
5.2.13.2.3	Nbsf_Management_Deregister service operation .....	332
5.2.13.2.4	Nbsf_Management_Discovery service operation .....	332
5.2.14	UDSF Services .....	332

5.2.14.1	General .....	332
5.2.14.2	Nudsf_UnstructuredDataManagement service.....	333
5.2.14.2.1	General .....	333
5.2.14.2.2	Nudsf_UnstructuredDataManagement_Query service operation .....	333
5.2.14.2.3	Nudsf_UnstructuredDataManagement_Create service operation.....	333
5.2.14.2.4	Nudsf_UnstructuredDataManagement_Delete service operation.....	333
5.2.14.2.5	Nudsf_UnstructuredDataManagement_Update service operation.....	333
5.2.15	LMF Services.....	334
5.2.15.1	General .....	334
5.2.15.2	Nlmf_Location service.....	334
5.2.15.2.1	General .....	334
5.2.15.2.2	Nlmf_Location_DetermineLocation service operation .....	334
5.2.16	NSSF Services .....	334
5.2.16.1	General .....	334
5.2.16.2	Nnssf_NSSelection service .....	335
5.2.16.2.1	Nnssf_NSSelection_Get service operation.....	335
5.2.16.3	Nnssf_NSSAIAvailability service.....	336
5.2.16.3.1	General .....	336
5.2.16.3.2	Nnssf_NSSAIAvailability_Update service operation.....	336
5.2.16.3.3	Nnssf_NSSAIAvailability_Notify service operation.....	337
5.2.16.3.4	Nnssf_NSSAIAvailability_Subscribe service operation .....	337
5.2.16.3.5	Nnssf_NSSAIAvailability_Unsubscribe service operation .....	337
5.2.16.3.6	Nnssf_NSSAIAvailability_Delete service operation.....	337
5.2.17	CHF Spending Limit Control Service.....	338
5.2.17.1	General .....	338
5.2.17.2	Nchf_SpendingLimitControl service .....	338
5.2.17.2.1	General .....	338
5.2.17.2.2	Nchf_SpendingLimitControl Subscribe service operation .....	338
5.2.17.2.3	Nchf_SpendingLimitControl Unsubscribe service operation .....	338
5.2.17.2.4	Nchf_SpendingLimitControl Notify service operation .....	338
<b>Annex A (informative):    Drafting rules and conventions for NF services .....</b>		<b>340</b>
A.1	General .....	340
A.2	Naming .....	340
A.2.1	Service naming .....	340
A.2.2	Service operation naming .....	340
A.3	Representation in an information flow .....	341
A.4	Reference to services and service operations in procedures.....	342
A.5	Service and service operation description template .....	342
A.6	Design Guidelines for NF services.....	342
A.6.1	Self-Containment .....	342
A.6.2	Reusability.....	343
A.6.3	Use Independent Management Schemes .....	343
<b>Annex B (informative):    Drafting Rules for Information flows .....</b>		<b>344</b>
<b>Annex C (informative):    Generating EPS PDN Connection parameters from 5G PDU Session parameters.....</b>		<b>345</b>
<b>Annex D (normative):    UE Presence in Area of Interest .....</b>		<b>346</b>
D.1	Determination of UE presence in Area of Interest by AMF.....	346
D.2	Determination of UE presence in Area of Interest by NG-RAN.....	346
<b>Annex D (informative):    Change history .....</b>		<b>348</b>
History .....		361

---

# Foreword

This Technical Specification has been produced by the 3rd Generation Partnership Project (3GPP).

The contents of the present document are subject to continuing work within the TSG and may change following formal TSG approval. Should the TSG modify the contents of the present document, it will be re-released by the TSG with an identifying change of release date and an increase in version number as follows:

Version x.y.z

where:

- x the first digit:
  - 1 presented to TSG for information;
  - 2 presented to TSG for approval;
  - 3 or greater indicates TSG approved document under change control.
- y the second digit is incremented for all changes of substance, i.e. technical enhancements, corrections, updates, etc.
- z the third digit is incremented when editorial only changes have been incorporated in the document.

---

# 1 Scope

The present document defines the Stage 2 procedures and Network Function Services for the 5G system architecture which is described in the TS 23.501 [2] and for the policy and charging control framework which is described in TS 23.503 [20].

---

# 2 References

The following documents contain provisions which, through reference in this text, constitute provisions of the present document.

- References are either specific (identified by date of publication, edition number, version number, etc.) or non-specific.
- For a specific reference, subsequent revisions do not apply.
- For a non-specific reference, the latest version applies. In the case of a reference to a 3GPP document (including a GSM document), a non-specific reference implicitly refers to the latest version of that document *in the same Release as the present document*.

- [1] 3GPP TR 21.905: "Vocabulary for 3GPP Specifications".
- [2] 3GPP TS 23.501: " System Architecture for the 5G System; Stage 2".
- [3] IETF RFC 7296: "Internet Key Exchange Protocol Version 2 (IKEv2)".
- [4] IETF RFC 5998: "An Extension for EAP-Only Authentication in IKEv2".
- [5] IETF RFC 4282: "The Network Access Identifier".
- [6] IETF RFC 4861: "Neighbor Discovery for IP version 6 (IPv6)".
- [7] 3GPP TS 23.040: "Technical realization of the Short Message Service (SMS)".
- [8] IETF RFC 4862: "IPv6 Stateless Address Autoconfiguration".
- [9] 3GPP TS 38.300: "NR and NG-RAN Overall Description; Stage 2".
- [10] 3GPP TS 38.413: "NG-RAN; NG Application Protocol (NGAP)".
- [11] 3GPP TS 23.335:" User Data Convergence (UDC); Technical realization and information flows; Stage 2".
- [12] 3GPP TS 38.331: "NR; Radio Resource Control (RRC); Protocol Specification".
- [13] 3GPP TS 23.401: "General Packet Radio Service (GPRS) enhancements for Evolved Universal Terrestrial Radio Access Network (E-UTRAN) access".
- [14] 3GPP TS 23.221: "Architectural requirements ".
- [15] 3GPP TS 33.501: "Security Architecture and Procedures for 5G System".
- [16] 3GPP TS 36.331: "Evolved Universal Terrestrial Radio Access (E-UTRA); Radio Resource Control (RRC); Protocol specification".
- [17] 3GPP TS 29.500: "5G System; Technical Realization of Service Based Architecture; Stage 3".
- [18] 3GPP TS 29.518: "5G System; Access and Mobility Management Services; Stage 3".
- [19] 3GPP TS 29.519: "5G System; Usage of the Unified Data Repository service for Policy Control Data and Structured Data; Stage 3".
- [20] 3GPP TS 23.503: "Policy and Charging Control Framework for the 5G System ".

- [21] IETF RFC 4191: "Default Router Preferences and More-Specific Routes".
- [22] 3GPP TS 23.122: "Non-Access-Stratum (NAS) functions related to Mobile Station in idle mode".
- [23] 3GPP TS 23.682: "Architecture enhancements to facilitate communications with packet data networks and applications".
- [24] 3GPP TS 23.203: "Policy and charging control architecture".
- [25] 3GPP TS 24.501: "Non-Access-Stratum (NAS) protocol for 5G System (5GS); Stage 3".
- [26] 3GPP TS 23.402: "Architecture enhancements for non-3GPP accesses".
- [27] OMA-TS-ULP-V2\_0\_3: "UserPlane Location Protocol".
- [28] 3GPP TS 23.167: "IP Multimedia Subsystem (IMS) emergency sessions".
- [29] 3GPP TS 23.271: "Functional stage 2 description of Location Services (LCS)".
- [30] 3GPP TS 36.355: "LTE Positioning Protocol (LPP)".
- [31] 3GPP TS 38.455: "NR Positioning Protocol A (NRPPa)".
- [32] 3GPP TS 29.507: "Access and Mobility Policy Control Service; Stage 3".
- [33] 3GPP TS 23.003: "Numbering, Addressing and Identification".
- [34] 3GPP TS 32.240: "Charging management; Charging architecture and principles".
- [35] 3GPP TS 23.251: "Network sharing; Architecture and functional description".
- [36] 3GPP TS 29.502: "5G System; Session Management Services; Stage 3".
- [37] 3GPP TS 29.510: "5G System; Network function repository services; Stage 3".
- [38] 3GPP TS 23.380: "IMS Restoration Procedures".
- [39] 3GPP TS 32.421: "Telecommunication management; Subscriber and equipment trace; Trace concepts and requirements".
- [40] IETF RFC 4555: "IKEv2 Mobility and Multihoming Protocol (MOBIKE)".
- [41] 3GPP TS 24.502: "Access to the 3GPP 5G Core Network (5GCN) via Non-3GPP Access Networks (N3AN); Stage 3".
- [42] 3GPP TS 32.290: "Services, operations and procedures of charging using Service Based Interface (SBI)".
- [43] 3GPP TS 36.304: "Evolved Universal Terrestrial Radio Access (E-UTRA); User Equipment (UE) procedures in idle mode".
- [44] 3GPP TS 38.304: "NR; User Equipment (UE) procedures in idle mode".
- [45] 3GPP TS 32.255: "5G system; 5G data connectivity domain charging; Stage 2".
- [46] 3GPP TS 36.300: "Evolved Universal Terrestrial Radio Access (E-UTRA) and Evolved Universal Terrestrial Radio Access Network (E-UTRAN); Overall description; Stage 2".
- [47] 3GPP TS 29.513: "5G System; Policy and Charging Control signalling flows and QoS parameter mapping; Stage 3".
- [48] 3GPP TS 29.512: "5G System; Session Management Policy Control Service; Stage 3".
- [49] 3GPP TS 29.525: "5G System; UE Policy Control Service; Stage 3".
- [50] 3GPP TS 23.272: "Circuit Switched (CS) fallback in Evolved Packet System (EPS); Stage 2".



---

## 3 Definitions, symbols and abbreviations

### 3.1 Definitions

For the purposes of the present document, the terms and definitions given in TR 21.905 [1], TS 23.501 [2] and TS 23.503 [20] apply. A term defined in TS 23.501 [2] or TS 23.503 [20] takes precedence over the definition of the same term, if any, in any other specifications.

### 3.2 Abbreviations

For the purposes of the present document, the abbreviations given in TR 21.905 [1], TS 23.501 [2] and TS 23.503 [20] apply. An abbreviation defined in TS 23.501 [2] or TS 23.503 [20] takes precedence over the definition of the same abbreviation, if any, in any other specifications.

---

## 4 System procedures

### 4.1 General

The clause 4 describes the procedures and Network Function services for the 5GS by end-to-end information flows, and these information flows make use of NF service operations, defined in clause 5, for the communication within the 5GC Control Plane.

### 4.2 Connection, Registration and Mobility Management procedures

#### 4.2.1 General

The Connection Management is used to establish and release the Control Plane signalling connection between the UE and the AMF. The Registration Management is used to register or deregister a UE/user with the 5GS, and establish the user context in the 5GS. The Mobility Management functions are used to keep track of the current location of a UE. The procedures in clause 4.2 provides Connection, Registration and Mobility Management functionality.

#### 4.2.2 Registration Management procedures

##### 4.2.2.1 General

The Registration and Deregistration procedures in clause 4.2.2 provides the required functionality to register or deregister a UE/user with the 5GS. Additional functionality to support Registration Management for non-3GPP access is defined in clause 4.12. Additional functionality to support Registration Management for specific services such as SMS over NAS is defined in clause 4.13.

##### 4.2.2.2 Registration procedures

###### 4.2.2.2.1 General

A UE needs to register with the network to get authorized to receive services, to enable mobility tracking and to enable reachability. The UE initiates the Registration procedure using one of the following Registration types:

- Initial Registration to the 5GS;
- Mobility Registration Update upon changing to a new Tracking Area (TA) outside the UE's Registration Area in both CM-CONNECTED and CM-IDLE state, or when the UE needs to update its capabilities or protocol

parameters that are negotiated in Registration procedure with or without changing to a new TA; or when the UE intends to retrieve LADN Information; or

- Periodic Registration Update (due to a predefined time period of inactivity); or
- Emergency Registration.

The General Registration call flow in clause 4.2.2.2.2 applies on all these Registration procedures, but the periodic registration need not include all parameters that are used in other registration cases.

The following are the cleartext IEs, as defined in TS 24.501 [25] that can be sent by the UE in the Registration Request message if the UE has no NAS security context:

- Registration type
- SUCI or 5G-GUTI or PEI
- Security parameters
- additional GUTI
- 4G Tracking Area Update
- the indication that the UE is moving from EPS.

Aspects related to dual registration in 3GPP and non-3GPP access are described in clause 4.12. The general Registration call flow in clause 4.2.2.2.2 is also used for the case of registration in 3GPP access when the UE is already registered in a non-3GPP access, and vice versa. Registration in 3GPP access when the UE is already registered in a non-3GPP access scenario may require an AMF change, as further detailed in clause 4.12.8.

The general Registration call flow in clause 4.2.2.2.2 is also used by UEs in limited service state (see TS 23.122 [22]) registering for emergency services only (referred to as Emergency Registration), see TS 23.501 [2] clause 5.16.4.

During the initial registration the PEI is obtained from the UE. The AMF operator may check the PEI with an EIR. The AMF passes the PEI (IMEISV) to the UDM, to the SMF and the PCF, then UDM may store this data in UDR by Nudr\_SDM\_Update.

NOTE 1: The use of NSI ID in the 5GC is optional and depends on the deployment choices of the operator.

During the registration the Home Network can provide Steering of Roaming information to the UE via the AMF (i.e. a list of preferred PLMN/access technology combinations or HPLMN indication that 'no change of the "Operator Controlled PLMN Selector with Access Technology" list stored in the UE is needed). The Home Network can include an indication for the UE to send an acknowledgement of the reception of this information. Details regarding the handling of Steering of Roaming information including how this information is managed between the AMF and the UE are defined in TS 23.122 [22].

4.2.2.2.2 General Registration

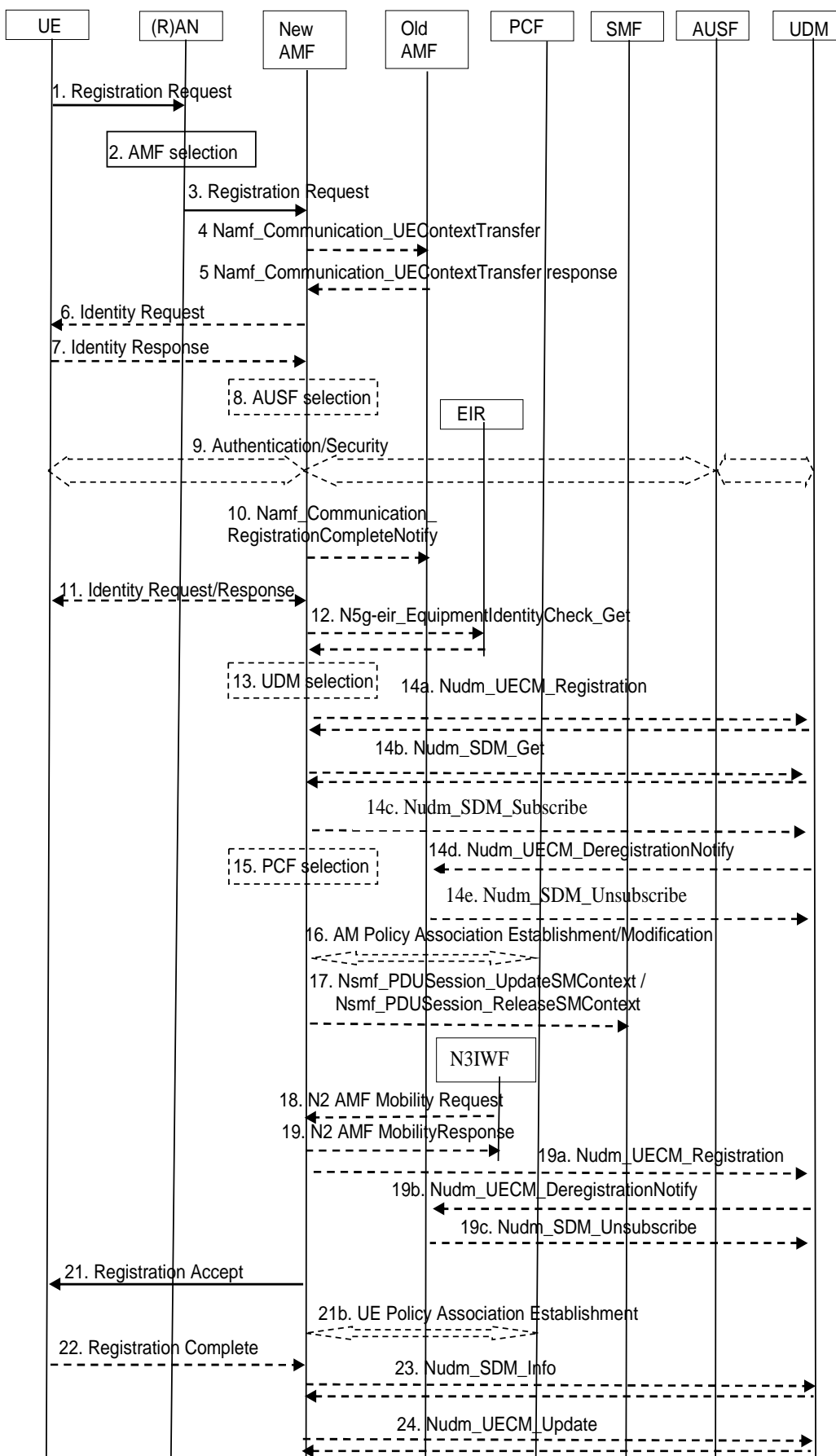

### Figure 4.2.2.2-1: Registration procedure

1. UE to (R)AN: AN message (AN parameters, Registration Request (Registration type, SUCI or 5G-GUTI or PEI, last visited TAI (if available), Security parameters, Requested NSSAI, [Mapping Of Requested NSSAI], Default Configured NSSAI Indication, UE Radio Capability Update, UE MM Core Network Capability, PDU Session status, List Of PDU Sessions To Be Activated, Follow-on request, MICO mode preference, Requested DRX parameters, [LADN DNN(s) or Indicator Of Requesting LADN Information], [NAS message container]) and UE Policy Container (the list of PSIs, indication of UE support for ANDSP and the operating system identifier)).

NOTE 1: The UE Policy Container and its usage is defined in TS 23.503 [20].

In the case of NG-RAN, the AN parameters include e.g. 5G-S-TMSI or GUAMI, the Selected PLMN ID and Requested NSSAI, the AN parameters also include Establishment cause. The Establishment cause provides the reason for requesting the establishment of an RRC connection. Whether and how the UE includes the Requested NSSAI as part of the AN parameters is dependent on the value of the Access Stratum Connection Establishment NSSAI Inclusion Mode parameter, as specified in clause 5.15.9 of TS 23.501 [2].

The Registration type indicates if the UE wants to perform an Initial Registration (i.e. the UE is in RM-DEREGISTERED state), a Mobility Registration Update (i.e. the UE is in RM-REGISTERED state and initiates a Registration procedure due to mobility or due to the UE needs to update its capabilities or protocol parameters, or to request a change of the set of network slices it is allowed to use), a Periodic Registration Update (i.e. the UE is in RM-REGISTERED state and initiates a Registration procedure due to the Periodic Registration Update timer expiry, see clause 4.2.2.2.1) or an Emergency Registration (i.e. the UE is in limited service state).

When the UE is performing an Initial Registration the UE shall indicate its UE identity in the Registration Request message as follows, listed in decreasing order of preference:

- a native 5G-GUTI assigned by the which the UE is attempting to register, if available;
- a native 5G-GUTI assigned by an equivalent PLMN to the PLMN to which the UE is attempting to register, if available;
- a native 5G-GUTI assigned by any other PLMN, if available.

NOTE 2: This can also be a 5G-GUTIs assigned via another access type.

- Otherwise, the UE shall include its SUCI in the Registration Request as defined in TS 33.501 [15].

The NAS message container shall be included if the UE is sending a Registration Request message as an Initial NAS message and the UE has a valid 5G NAS security context and the UE needs to send non-clear-text IEs, see clause 4.4.6 in TS 24.501 [25]. If the UE does not need to send non-clear-text IEs, the UE shall send a Registration Request message without including the NAS message container.

If the UE does not have a valid 5G NAS security context, the UE shall send the Registration Request message without including the NAS message container. The UE shall include the entire Registration Request message (i.e. containing clear-text IEs and non-clear-text IEs) in the NAS message container that is sent as part of the Security Mode Complete message in step 9b.

When the UE is performing an Initial Registration (i.e., the UE is in RM-DEREGISTERED state) with a native 5G-GUTI then the UE shall indicate the related GUAMI information in the AN parameters. When the UE is performing an Initial Registration with its SUCI, the UE shall not indicate any GUAMI information in the AN parameters.

For an Emergency Registration, the SUCI shall be included if the UE does not have a valid 5G-GUTI available; the PEI shall be included when the UE has no SUPI and no valid 5G-GUTI. In other cases, the 5G-GUTI is included and it indicates the last serving AMF.

The UE may provide the UE's usage setting based on its configuration as defined in TS 23.501 [2] clause 5.16.3.7. The UE provides Requested NSSAI as described in TS 23.501 [2] clause 5.15.5.2.1, and in the case of Initial Registration or Mobility Registration Update, the UE includes the Mapping Of Requested NSSAI (if available), which is the mapping of each S-NSSAI of the Requested NSSAI to the HPLMN S-NSSAIs, to ensure that the network is able to verify whether the S-NSSAI(s) in the Requested NSSAI are permitted based on the Subscribed S-NSSAIs.

The UE includes the Default Configured NSSAI Indication if the UE is using a Default Configured NSSAI, as defined in TS 23.501 [2].

In the case of Mobility Registration Update, the UE includes in the List Of PDU Sessions To Be Activated the PDU Sessions for which there are pending uplink data. When the UE includes the List Of PDU Sessions To Be Activated, the UE shall indicate PDU Sessions only associated with the access the Registration Request is related to. As defined in TS 24.501 [25] the UE shall include always-on PDU Sessions which are accepted by the network in the List Of PDU Sessions To Be Activated even if there are no pending uplink data for those PDU Sessions.

NOTE 3: A PDU Session corresponding to a LADN is not included in the List Of PDU Sessions To Be Activated when the UE is outside the area of availability of the LADN.

The UE MM Core Network Capability is provided by the UE and handled by AMF as defined in TS 23.501 [2] clause 5.4.4a The UE includes in the UE MM Core Network Capability an indication if it supports Request Type flag "handover" for PDN connectivity request during the attach procedure as defined in clause 5.17.2.3.1 of TS 23.501 [2].

The UE may provide either the LADN DNN(s) or an Indication Of Requesting LADN Information as described in TS 23.501 [2] clause 5.6.5.

If available, the last visited TAI shall be included in order to help the AMF produce Registration Area for the UE.

The Security parameters are used for Authentication and integrity protection, see TS 33.501 [15]. Requested NSSAI indicates the Network Slice Selection Assistance Information (as defined in clause 5.15 of TS 23.501 [2]). The PDU Session status indicates the previously established PDU Sessions in the UE. When the UE is connected to the two AMFs belonging to different PLMN via 3GPP access and non-3GPP access then the PDU Session status indicates the established PDU Session of the current PLMN in the UE.

The Follow-on request is included when the UE has pending uplink signalling and the UE doesn't include List Of PDU Sessions To Be Activated, or the Registration type indicates the UE wants to perform an Emergency Registration. In Initial Registration and Mobility Registration Update, UE provides the UE Requested DRX parameters, as defined in clause 5.4.5 of TS 23.501 [2].

The UE provides UE Radio Capability Update indication as described in TS 23.501 [2].

2. If a 5G-S-TMSI or GUAMI is not included or the 5G-S-TMSI or GUAMI does not indicate a valid AMF the (R)AN, based on (R)AT and Requested NSSAI, if available, selects an AMF

The (R)AN selects an AMF as described in TS 23.501 [2], clause 6.3.5. If UE is in CM-CONNECTED state, the (R)AN can forward the Registration Request message to the AMF based on the N2 connection of the UE.

If the (R)AN cannot select an appropriate AMF, it forwards the Registration Request to an AMF which has been configured, in (R)AN, to perform AMF selection.

3. (R)AN to new AMF: N2 message (N2 parameters, Registration Request (as described in step 1) and UE Policy Container.

When NG-RAN is used, the N2 parameters include the Selected PLMN ID, Location Information and Cell Identity related to the cell in which the UE is camping, UE Context Request which indicates that a UE context including security information needs to be setup at the NG-RAN.

When NG-RAN is used, the N2 parameters also include the Establishment cause.

Mapping Of Requested NSSAI is provided only if available.

If the Registration type indicated by the UE is Periodic Registration Update, then steps 4 to 19 may be omitted.

When the Establishment cause is associated with priority services (e.g. MPS, MCS), the AMF includes a Message Priority header to indicate priority information. Other NFs relay the priority information by including the Message Priority header in service-based interfaces, as specified in TS 29.500 [17].

4. [Conditional] new AMF to old AMF: Namf\_Communication\_UEContextTransfer (complete Registration Request) or new AMF to UDSF: Nudsf\_Unstructured Data Management\_Query().

(With UDSF Deployment): If the UE's 5G-GUTI was included in the Registration Request and the serving AMF has changed since last Registration procedure, new AMF and old AMF are in the same AMF Set and UDSF is deployed, the new AMF retrieves the stored UE's SUPI and UE context directly from the UDSF using Nudsf\_UnstructuredDataManagement\_Query service operation or they can share stored UE context via implementation specific means if UDSF is not deployed. This includes also event subscription information by each NF consumer for the given UE. In this case, the new AMF uses integrity protected complete Registration request NAS message to perform and verify integrity protection.

(Without UDSF Deployment): If the UE's 5G-GUTI was included in the Registration Request and the serving AMF has changed since last Registration procedure, the new AMF may invoke the Namf\_Communication\_UEContextTransfer service operation on the old AMF including the complete Registration Request NAS message, which may be integrity protected, as well as the Access Type, to request the UE's SUPI and UE Context. See clause 5.2.2.2.2 for details of this service operation. In this case, the old AMF uses either 5G-GUTI and the integrity protected complete Registration request NAS message, or the SUPI and an indication that the UE is validated from the new AMF, to verify integrity protection if the context transfer service operation invocation corresponds to the UE requested. The old AMF also transfers the event subscriptions information by each NF consumer, for the UE, to the new AMF.

If the old AMF has PDU Sessions for another access type (different from the Access Type indicated in this step) and if the old AMF determines that there is no possibility for relocating the N2 interface to the new AMF, the old AMF returns UE's SUPI and indicates that the Registration Request has been validated for integrity protection, but does not include the rest of the UE context.

NOTE 4: The new AMF sets the indication that the UE is validated according to step 9a, in case the new AMF has performed successful UE authentication after previous integrity check failure in the old AMF.

NOTE 5: The NF consumers does not need to subscribe for the events once again with the new AMF after the UE is successfully registered with the new AMF.

If the new AMF has already received UE contexts from the old AMF during handover procedure, then step 4,5 and 10 shall be skipped.

For an Emergency Registration, if the UE identifies itself with a 5G-GUTI that is not known to the AMF, steps 4 and 5 are skipped and the AMF immediately requests the SUPI from the UE. If the UE identifies itself with PEI, the SUPI request shall be skipped. Allowing Emergency Registration without a user identity is dependent on local regulations.

5. [Conditional] old AMF to new AMF: Response to Namf\_Communication\_UEContextTransfer (SUPI, UE Context in AMF (as per Table 5.2.2.2.2-1)) or UDSF to new AMF: Nudsf\_Unstructured Data Management\_Query(). The old AMF may start an implementation specific (guard) timer for the UE context.

If the UDSF was queried in step 4, the UDSF responds to the new AMF for the Nudsf\_Unstructured Data Management\_Query invocation with the related contexts including established PDU Sessions, the old AMF includes SMF information DNN, S-NSSAI(s) and PDU Session ID, active NGAP UE-TNLA bindings to N3IWF, the old AMF includes information about the NGAP UE-TNLA bindings. If the Old AMF was queried in step 4, Old AMF responds to the new AMF for the Namf\_Communication\_UEContextTransfer invocation by including the UE's SUPI and UE Context.

If old AMF holds information about established PDU Session(s), the old AMF includes SMF information, DNN(s), S-NSSAI(s) and PDU Session ID(s).

If old AMF holds UE context established via N3IWF, the old AMF includes the CM state for UE connected via N3IWF. If the UE is in CM-CONNECTED state via N3IWF, the old AMF includes information about the NGAP UE-TNLA bindings.

If old AMF fails the integrity check of the Registration Request NAS message, the old AMF shall indicate the integrity check failure.

If old AMF holds information about AM Policy Association and the information about UE Policy Association (i.e. the Policy Control Request Trigger for updating UE Policy as defined in TS 23.503 [20]), the old AMF includes the information about the AM Policy Association, the UE Policy Association and PCF ID. In the roaming case, V-PCF ID and H-PCF ID are included.

NOTE 6: When new AMF uses UDSF for context retrieval, interactions between old AMF, new AMF and UDSF due to UE signaling on old AMF at the same time is implementation issue.

6. [Conditional] new AMF to UE: Identity Request ().

If the SUCI is not provided by the UE nor retrieved from the old AMF the Identity Request procedure is initiated by AMF sending an Identity Request message to the UE requesting the SUCI.

7. [Conditional] UE to new AMF: Identity Response ().

The UE responds with an Identity Response message including the SUCI. The UE derives the SUCI by using the provisioned public key of the HPLMN, as specified in TS 33.501 [15].

8. The AMF may decide to initiate UE authentication by invoking an AUSF. In that case, the AMF selects an AUSF based on SUPI or SUCI, as described in TS 23.501 [2], clause 6.3.4.

If the AMF is configured to support Emergency Registration for unauthenticated SUPIs and the UE indicated Registration type Emergency Registration, the AMF skips the authentication or the AMF accepts that the authentication may fail and continues the Registration procedure.

9a. If authentication is required, the AMF requests it from the AUSF; if Tracing Requirements about the UE are available at the AMF, the AMF provides Tracing Requirements in its request to AUSF. Upon request from the AMF, the AUSF shall execute authentication of the UE. The authentication is performed as described in TS 33.501 [15]. The AUSF selects a UDM as described in TS 23.501 [2], clause 6.3.8 and gets the authentication data from UDM.

Once the UE has been authenticated the AUSF provides relevant security related information to the AMF. In case the AMF provided a SUCI to AUSF, the AUSF shall return the SUPI to AMF only after the authentication is successful.

After successful authentication in new AMF, which is triggered by the integrity check failure in old AMF at step 5, the new AMF invokes step 4 above again and indicates that the UE is validated (i.e. through the reason parameter as specified in clause 5.2.2.2.2).

9b. If NAS security context does not exist, the NAS security initiation is performed as described in TS 33.501 [15]. If the UE had no NAS security context in step 1, the UE includes the full Registration Request message as defined in TS 24.501 [25].

The AMF decides if the Registration Request needs to be rerouted as described in clause 4.2.2.2.3, where the initial AMF refers to the AMF.

9c. The AMF initiates NGAP procedure to provide the 5G-AN with security context as specified in TS 38.413 [10] if the 5G-AN had requested for UE Context. Also, if the AMF does not support N26 for EPS interworking and it received UE MM Core Network Capability including an indication that it supports Request Type flag "handover" for PDN connectivity request during the attach procedure as defined in clause 5.17.2.3.1 of TS 23.501 [2], AMF provides an indication "Redirection for EPS fallback for voice is possible" towards 5G-AN as specified in TS 38.413 [10]. In addition, if Tracing Requirements about the UE are available at the AMF, the AMF provides the 5G-AN with Tracing Requirements in the NGAP procedure.

9d. The 5G-AN stores the security context and acknowledges to the AMF. The 5G-AN uses the security context to protect the messages exchanged with the UE as described in TS 33.501 [15].

10. [Conditional] new AMF to old AMF: Namf\_Communication\_RegistrationCompleteNotify ().

If the AMF has changed the new AMF notifies the old AMF that the registration of the UE in the new AMF is completed by invoking the Namf\_Communication\_RegistrationCompleteNotify service operation.

If the authentication/security procedure fails, then the Registration shall be rejected, and the new AMF invokes the Namf\_Communication\_RegistrationCompleteNotify service operation with a reject indication reason code towards the old AMF. The old AMF continues as if the UE context transfer service operation was never received.

If one or more of the S-NSSAIs used in the old Registration Area cannot be served in the target Registration Area, the new AMF determines which PDU Session cannot be supported in the new Registration Area. The new AMF invokes the Namf\_Communication\_RegistrationCompleteNotify service operation including the rejected

PDU Session ID and a reject cause (e.g. the S-NSSAI becomes no longer available) towards the old AMF. Then the new AMF modifies the PDU Session Status correspondingly. The old AMF informs the corresponding SMF(s) to locally release the UE's SM context by invoking the Nsmf\_PDUSession\_ReleaseSMContext service operation.

See clause 5.2.2.2.3 for details of Namf\_Communication\_RegistrationCompleteNotify service operation.

If new AMF received in the UE context transfer in step 2 the information about the AM Policy Association and the UE Policy Association and decides, based on local policies, not to use the PCF(s) identified by the PCF ID(s) for the AM Policy Association and the UE Policy Association, then it will inform the old AMF that the AM Policy Association and the UE Policy Association in the UE context is not used any longer and then the PCF selection is performed in step 15.

#### 11. [Conditional] new AMF to UE: Identity Request/Response (PEI).

If the PEI was not provided by the UE nor retrieved from the old AMF the Identity Request procedure is initiated by AMF sending an Identity Request message to the UE to retrieve the PEI. The PEI shall be transferred encrypted unless the UE performs Emergency Registration and cannot be authenticated.

For an Emergency Registration, the UE may have included the PEI in the Registration Request. If so, the PEI retrieval is skipped.

#### 12. Optionally the new AMF initiates ME identity check by invoking the N5g-eir\_EquipmentIdentityCheck\_Get service operation (see clause 5.2.4.2.2).

The PEI check is performed as described in clause 4.7.

For an Emergency Registration, if the PEI is blocked, operator policies determine whether the Emergency Registration procedure continues or is stopped.

#### 13. If step 14 is to be performed, the new AMF, based on the SUPI, selects a UDM, then UDM may select a UDR instance. See TS 23.501 [2], clause 6.3.9.

The AMF selects a UDM as described in TS 23.501 [2], clause 6.3.8.

#### 14a-c. If the AMF has changed since the last Registration procedure, or if the UE provides a SUPI which doesn't refer to a valid context in the AMF, or if the UE registers to the same AMF it has already registered to a non-3GPP access (i.e. the UE is registered over a non-3GPP access and initiates this Registration procedure to add a 3GPP access), the new AMF registers with the UDM using Nudm\_UECM\_Registration for the access to be registered (and subscribes to be notified when the UDM deregisters this AMF).

The AMF provides the "Homogenous Support of IMS Voice over PS Sessions" indication (see clause 5.16.3.3 of TS 23.501 [2]) to the UDM. The "Homogenous Support of IMS Voice over PS Sessions" indication shall not be included unless the AMF has completed its evaluation of the support of "IMS Voice over PS Session" as specified in clause 5.16.3.2 of TS 23.501 [2].

NOTE 7: At this step, the AMF may not have all the information needed to determine the setting of the IMS Voice over PS Session Supported indication for this UE (see clause 5.16.3.2 of TS 23.501 [2]). Hence the AMF can send the "Homogenous Support of IMS Voice over PS Sessions" later on in this procedure.

If the AMF does not have subscription data for the UE, the AMF retrieves the Access and Mobility Subscription data, SMF Selection Subscription data and UE context in SMF data using Nudm\_SDM\_Get. This requires that UDM may retrieve this information from UDR by Nudr\_DM\_Query. After a successful response is received, the AMF subscribes to be notified using Nudm\_SDM\_Subscribe when the data requested is modified, UDM may subscribe to UDR by Nudr\_DM\_Subscribe. The GPSI is provided to the AMF in the Access and Mobility Subscription data from the UDM if the GPSI is available in the UE subscription data. The UDM may provide indication that the subscription data for network slicing is updated for the UE. If the UE is subscribed to MPS in the serving PLMN, "MPS priority" is included in the Access and Mobility Subscription data provided to the AMF. If the UE is subscribed to MCX in the serving PLMN, "MCX priority" is included in the Access and Mobility Subscription data provided to the AMF.

The new AMF provides the Access Type it serves for the UE to the UDM and the Access Type is set to "3GPP access". The UDM stores the associated Access Type together with the serving AMF and does not remove the AMF identity associated to the other Access Type if any. The UDM may store in UDR information provided at the AMF registration by Nudr\_DM\_Update.



If the UE was registered in the old AMF for an access, and the old and the new AMFs are in the same PLMN, the new AMF sends a separate/independent Nudm\_UECM\_Registration to update UDM with Access Type set to access used in the old AMF, after the old AMF relocation is successfully completed.

The new AMF creates an UE context for the UE after getting the Access and Mobility Subscription data from the UDM. The Access and Mobility Subscription data includes whether the UE is allowed to include NSSAI in the 3GPP access RRC Connection Establishment in clear text.

For an Emergency Registration in which the UE was not successfully authenticated, the AMF shall not register with the UDM.

For an Emergency Registration, the AMF shall not check for access restrictions, regional restrictions or subscription restrictions. For an Emergency Registration, the AMF shall ignore any unsuccessful registration response from UDM and continue with the Registration procedure.

- 14d. When the UDM stores the associated Access Type (e.g. 3GPP) together with the serving AMF as indicated in step 14a, it will cause the UDM to initiate a Nudm\_UECM\_DeregistrationNotification (see clause 5.2.3.2.2) to the old AMF corresponding to the same (e.g. 3GPP) access, if one exists. If the timer started in step 5 is not running, the old AMF may remove the UE context. Otherwise, the AMF may remove UE context when the timer expires. If the serving NF removal reason indicated by the UDM is Initial Registration, then, as described in clause 4.2.2.3.2, the old AMF invokes the Nsmf\_PDUSession\_ReleaseSMContext (SUPI, PDU Session ID) service operation towards all the associated SMF(s) of the UE to notify that the UE is deregistered from old AMF. The SMF(s) shall release the PDU Session on getting this notification.

If the old AMF has established an AM Policy Association and a UE Policy Association with the PCF(s), and the old AMF did not transfer the PCF ID(s) to the new AMF (e.g. new AMF is in different PLMN), the old AMF performs an AMF-initiated Policy Association Termination procedure, as defined in clause 4.16.3.2, and performs an AMF-initiated UE Policy Association Termination procedure, as defined in clause 4.16.13.1. In addition, if the old AMF transferred the PCF ID(s) in the UE context but the new AMF informed in step 10 that the AM Policy Association information and UE Policy Association information in the UE context will not be used then the old AMF performs an AMF-initiated Policy Association Termination procedure, as defined in clause 4.16.3.2, and performs an AMF-initiated UE Policy Association Termination procedure, as defined in clause 4.16.13.1.

If the old AMF has an N2 connection for that UE (e.g. because the UE was in RRC Inactive state but has now moved to E-UTRAN or moved to an area not served by the old AMF), the old AMF shall perform AN Release (see clause 4.2.6) with a cause value that indicates that the UE has already locally released the NG-RAN's RRC Connection.

- 14e. [Conditional] If old AMF does not have UE context for another access type (i.e. non-3GPP access), the Old AMF unsubscribes with the UDM for subscription data using Nudm\_SDM\_unsubscribe.

15. If the AMF decides to initiate PCF communication, the AMF acts as follows.

If the new AMF decides to use the (V-)PCF identified by (V-)PCF ID included in UE context from the old AMF in step 5, the AMF contacts the (V-)PCF identified by the (V-)PCF ID to obtain policy. If the AMF decides to perform PCF discovery and selection and the AMF selects a (V-)PCF and may select an H-PCF (for roaming scenario) as described in TS 23.501 [2], clause 6.3.7.1 and according to the V-NRF to H-NRF interaction described in clause 4.3.2.2.3.3.

16. [Optional] new AMF performs an AM Policy Association Establishment/Modification. For an Emergency Registration, this step is skipped.

If the new AMF selects a new (V-)PCF in step 15, the new AMF performs AM Policy Association Establishment with the selected (V-)PCF as defined in clause 4.16.1.2.

If the (V-)PCF identified by the (V-)PCF ID included in UE context from the old AMF is used, the new AMF performs AM Policy Association Modification with the (V-)PCF as defined in clause 4.16.2.1.2.

If the AMF notifies the Mobility Restrictions (e.g. UE location) to the PCF for adjustment, or if the PCF updates the Mobility Restrictions itself due to some conditions (e.g. application in use, time and date), the PCF shall provide the updated Mobility Restrictions to the AMF. If the subscription information includes Tracing Requirements, the AMF provides the PCF with Tracing Requirements.

17. [Conditional] AMF to SMF: Nsmf\_PDUSession\_UpdateSMContext ().

For an Emergency Registered UE (see TS 23.501 [2]), this step is applied when the Registration Type is Mobility Registration Update.

The AMF invokes the Nsmf\_PDUSession\_UpdateSMContext (see clause 5.2.8.2.6) in the following scenario(s):

- If the List Of PDU Sessions To Be Activated is included in the Registration Request in step 1, the AMF sends Nsmf\_PDUSession\_UpdateSMContext Request to SMF(s) associated with the PDU Session(s) in order to activate User Plane connections of these PDU Session(s). Steps from step 5 onwards described in clause 4.2.3.2 are executed to complete the User Plane connection activation without sending the RRC Inactive Assistance Information and without sending MM NAS Service Accept from the AMF to (R)AN described in step 12 of clause 4.2.3.2.

When the serving AMF has changed, the new serving AMF notifies the SMF for each PDU Session that it has taken over the responsibility of the signalling path towards the UE: the new serving AMF invokes the Nsmf\_PDUSession\_UpdateSMContext service operation using SMF information received from the old AMF at step 5. It also indicates whether the PDU Session is to be re-activated.

NOTE 8: If the UE moves into a different PLMN, the AMF in the serving PLMN can not insert, change or remove the V-SMF(s) even for Home Routed PDU session(s). During inter-PLMN change, if the same SMF is used, session continuity can be supported depending on operator policies.

Steps from step 5 onwards described in clause 4.2.3.2 are executed. In the case that the intermediate UPF insertion, removal, or change is performed for the PDU Session(s) not included in "PDU Session(s) to be re-activated", the procedure is performed without N11 and N2 interactions to update the N3 user plane between (R)AN and 5GC.

The AMF invokes the Nsmf\_PDUSession\_ReleaseSMContext service operation towards the SMF in the following scenario:

- If any PDU Session status indicates that it is released at the UE, or a change of the set of network slices for a UE where a network slice instance is no longer available (as described in TS 23.501 [2] clause 5.15.5.2.2), the AMF invokes the Nsmf\_PDUSession\_ReleaseSMContext service operation towards the SMF in order to release any network resources related to the PDU Session.

If the serving AMF is changed, the new AMF shall wait until step 18 is finished with all the SMFs associated with the UE. Otherwise, steps 19 to 22 can continue in parallel to this step.

18. [Conditional] If the new AMF and the old AMF/N3IWF are in the same PLMN, New AMF to N3IWF: N2 AMF Mobility Request ().

If the AMF has changed and the old AMF has indicated that the UE is in CM-CONNECTED state via N3IWF and if the new AMF and the old AMF/N3IWF are in the same PLMN, the new AMF creates an NGAP UE association towards the N3IWF to which the UE is connected. This automatically releases the existing NGAP UE association between the old AMF and the N3IWF

19. N3IWF to new AMF: N2 AMF Mobility Response ().

19a. [Conditional] After the new AMF receives the response message from the N3IWF in step 19, the new AMF registers with the UDM using Nudm\_UECM\_Registration as step 14c, but with the Access Type set to "non-3GPP access". The UDM stores the associated Access Type together with the serving AMF and does not remove the AMF identity associated to the other Access Type if any. The UDM may store in UDR information provided at the AMF registration by Nudr\_DM\_Update.

19b. [Conditional] When the UDM stores the associated Access Type (i.e. non-3GPP) together with the serving AMF as indicated in step 19a, it will cause the UDM to initiate a Nudm\_UECM\_DeregistrationNotification (see clause 5.2.3.2.2) to the old AMF corresponding to the same (i.e. non-3GPP) access. The old AMF removes the UE context for non-3GPP access.

19c. The Old AMF unsubscribes with the UDM for subscription data using Nudm\_SDM\_unsubscribe.

20a. Void.

21. New AMF to UE: Registration Accept (5G-GUTI, Registration Area, Mobility restrictions, PDU Session status, Allowed NSSAI, [Mapping Of Allowed NSSAI], [Configured NSSAI for the Serving PLMN], [Mapping Of Configured NSSAI], [rejected S-NSSAIs], Periodic Registration Update timer, LADN Information and accepted

MICO mode, IMS Voice over PS session supported Indication, Emergency Service Support indicator, Accepted DRX parameters, Network support of Interworking without N26, Access Stratum Connection Establishment NSSAI Inclusion Mode, Network Slicing Subscription Change Indication, Operator-defined access category definitions, [List of equivalent PLMNs]). The Allowed NSSAI for the Access Type for the UE is included in the N2 message carrying the Registration Accept message.

The AMF sends a Registration Accept message to the UE indicating that the Registration Request has been accepted. 5G-GUTI is included if the AMF allocates a new 5G-GUTI. If the UE is already in RM-REGISTERED state via another access in the same PLMN, the UE shall use the 5G-GUTI received in the Registration Accept for both registrations. If no 5G-GUTI is included in the Registration Accept, then the UE uses the 5G-GUTI assigned for the existing registration also for the new registration. If the AMF allocates a new Registration area, it shall send the Registration area to the UE via Registration Accept message. If there is no Registration area included in the Registration Accept message, the UE shall consider the old Registration Area as valid. Mobility Restrictions is included in case mobility restrictions applies for the UE and Registration Type is not Emergency Registration. The AMF indicates the established PDU Sessions to the UE in the PDU Session status. The UE removes locally any internal resources related to PDU Sessions that are not marked as established in the received PDU Session status. If the AMF invokes the Nsmf\_PDUSession\_UpdateSMContext procedure for UP activation of PDU Session(s) in step 18 and receives rejection from the SMF, then the AMF indicates to the UE the PDU Session ID and the cause why the User Plane resources were not activated. When the UE is connected to the two AMFs belonging to different PLMN via 3GPP access and non-3GPP access then the UE removes locally any internal resources related to the PDU Session of the current PLMN that are not marked as established in received PDU Session status. If the PDU Session status information was in the Registration Request, the AMF shall indicate the PDU Session status to the UE.

The Allowed NSSAI provided in the Registration Accept is valid in the Registration Area and it applies for all the PLMNs which have their Tracking Areas included in the Registration Area. The Mapping Of Allowed NSSAI is the mapping of each S-NSSAI of the Allowed NSSAI to the HPLMN S-NSSAIs. The Mapping Of Configured NSSAI is the mapping of each S-NSSAI of the Configured NSSAI for the Serving PLMN to the HPLMN S-NSSAIs.

The AMF shall include in the Registration Accept message the LADN Information for the list of LADNs, described in TS 23.501 [2] clause 5.6.5, that are available within the Registration area determined by the AMF for the UE. If the UE included MICO mode in the request, then AMF responds whether MICO mode should be used. The AMF may include Operator-defined access category definitions to let the UE determine the applicable Operator-specific access category definitions as described in TS 24.501 [25].

In the case of registration over 3GPP access, the AMF sets the IMS Voice over PS session supported Indication as described in clause 5.16.3.2 of TS 23.501 [2]. In order to set the IMS Voice over PS session supported Indication the AMF may need to perform the UE Capability Match Request procedure in clause 4.2.8a to check the compatibility of the UE and NG-RAN radio capabilities related to IMS Voice over PS. If the AMF hasn't received Voice Support Match Indicator from the NG-RAN on time then, based on implementation, AMF may set IMS Voice over PS session supported Indication and update it at a later stage.

In the case of registration over non-3GPP access, the AMF sets the IMS Voice over PS session supported Indication as described in clause 5.16.3.2a of TS 23.501 [2].

The Emergency Service Support indicator informs the UE that emergency services are supported, i.e. the UE is allowed to request PDU Session for emergency services. If the AMF received "MPS priority" from the UDM as part of Access and Mobility Subscription data, based on operator policy, "MPS priority" is included in the Registration Accept message to the UE to inform the UE whether configuration of Access Identity 1 is valid within the selected PLMN, as specified in TS 24.501 [25]. If the AMF received "MCX priority" from the UDM as part of Access and Mobility Subscription data, based on operator policy and UE subscription to MCX Services, "MCX priority" is included in the Registration Accept message to the UE to inform the UE whether configuration of Access Identity 2 is valid within the selected PLMN, as specified in TS 24.501 [25]. The Accepted DRX parameters are defined in clause 5.4.5 of TS 23.501 [2]. The AMF sets the Interworking without N26 parameter as described in clause 5.17.2.3.1 of TS 23.501 [2].

If the UDM intends to indicate the UE that subscription has changed, the Network Slicing Subscription Change Indication is included. If the AMF includes Network Slicing Subscription Change Indication, then the UE shall locally erase all the network slicing configuration for all PLMNs and, if applicable, update the configuration for the current PLMN based on any received information.

The Access Stratum Connection Establishment NSSAI Inclusion Mode, as specified in TS 23.501 [2] clause 5.15.9, is included to instruct the UE on what NSSAI, if any, to include in the Access Stratum connection establishment. The AMF can set the value to modes of operation a,b,c defined in TS 23.501 [2] clause 5.15.9 in the 3GPP Access only if the Inclusion of NSSAI in RRC Connection Establishment Allowed indicates that it is allowed to do so.

The AMF may provide a List of equivalent PLMNs which is handled as specified in TS 24.501 [25].

- 21b. [Optional] The new AMF performs a UE Policy Association Establishment as defined in clause 4.16.11. For an Emergency Registration, this step is skipped.

The new AMF sends a Npcf\_UEPolicyControl Create Request to PCF. PCF sends a Npcf\_UEPolicyControl Create Response to the new AMF.

PCF triggers UE Configuration Update Procedure as defined in clause 4.2.4.3.

22. [Conditional] UE to new AMF: Registration Complete ().

The UE sends a Registration Complete message to the AMF when it has successfully updated itself after receiving any of the [Configured NSSAI for the Serving PLMN], [Mapping Of Configured NSSAI] and a Network Slicing Subscription Change Indication in step 21.

The UE sends a Registration Complete message to the AMF to acknowledge if a new 5G-GUTI was assigned.

If new 5G-GUTI was assigned, then the UE passes the new 5G-GUTI to its 3GPP access' lower layer when a lower layer (either 3GPP access or non-3GPP access) indicates to the UE's RM layer that the Registration Complete message has been successfully transferred across the radio interface.

- NOTE 9: The above is needed because the NG-RAN may use the RRC Inactive state and a part of the 5G-GUTI is used to calculate the Paging Frame (see TS 38.304 [44] and TS 36.304 [43]). It is assumed that the Registration Complete is reliably delivered to the AMF after the 5G-AN has acknowledged its receipt to the UE.

When the List Of PDU Sessions To Be Activated is not included in the Registration Request and the Registration procedure was not initiated in CM-CONNECTED state, the AMF releases the signalling connection with UE, according to clause 4.2.6.

When the Follow-on request is included in the Registration Request, the AMF should not release the signalling connection after the completion of the Registration procedure.

If the AMF is aware that some signalling is pending in the AMF or between the UE and the 5GC, the AMF should not release the signalling connection immediately after the completion of the Registration procedure.

- 23a. For Registration over 3GPP Access, if the AMF does not release the signalling connection, the AMF sends the RRC Inactive Assistance Information to the NG-RAN.

For Registration over non-3GPP Access, if the UE is also in CM-CONNECTED state on 3GPP access, the AMF sends the RRC Inactive Assistance Information to the NG-RAN.

23. [Conditional] AMF to UDM: If the Access and Mobility Subscription data provided by UDM to AMF in 14b includes Steering of Roaming information with an indication that the UDM requests an acknowledgement of the reception of this information from the UE, the AMF provides the UE acknowledgement to UDM using Nudm\_SDM\_Info. For more details regarding the handling of Steering of Roaming information refer to TS 23.122 [22].

The AMF also uses the Nudm\_SDM\_Info service operation to provide an acknowledgment to UDM that the UE received the Network Slicing Subscription Change Indication (see step 21 and step 22) and acted upon it.

24. [Conditional] AMF to UDM: After step 14a, and in parallel to any of the preceding steps, the AMF shall send a "Homogeneous Support of IMS Voice over PS Sessions" indication to the UDM using Nudm\_UECM\_Update:
- If the AMF has evaluated the support of IMS Voice over PS Sessions, see clause 5.16.3.2 of TS 23.501 [2], and
  - If the AMF determines that it needs to update the Homogeneous Support of IMS Voice over PS Sessions, see clause 5.16.3.3 of TS 23.501 [2].

The mobility related event notifications towards the NF consumers are triggered at the end of this procedure for cases as described in clause 4.15.4.

4.2.2.2.3 Registration with AMF re-allocation

When an AMF receives a Registration request, the AMF may need to reroute the Registration request to another AMF, e.g. when the initial AMF is not the appropriate AMF to serve the UE. The Registration with AMF re-allocation procedure, described in figure 4.2.2.2.3-1, is used to reroute the NAS message of the UE to the target AMF during a Registration procedure.

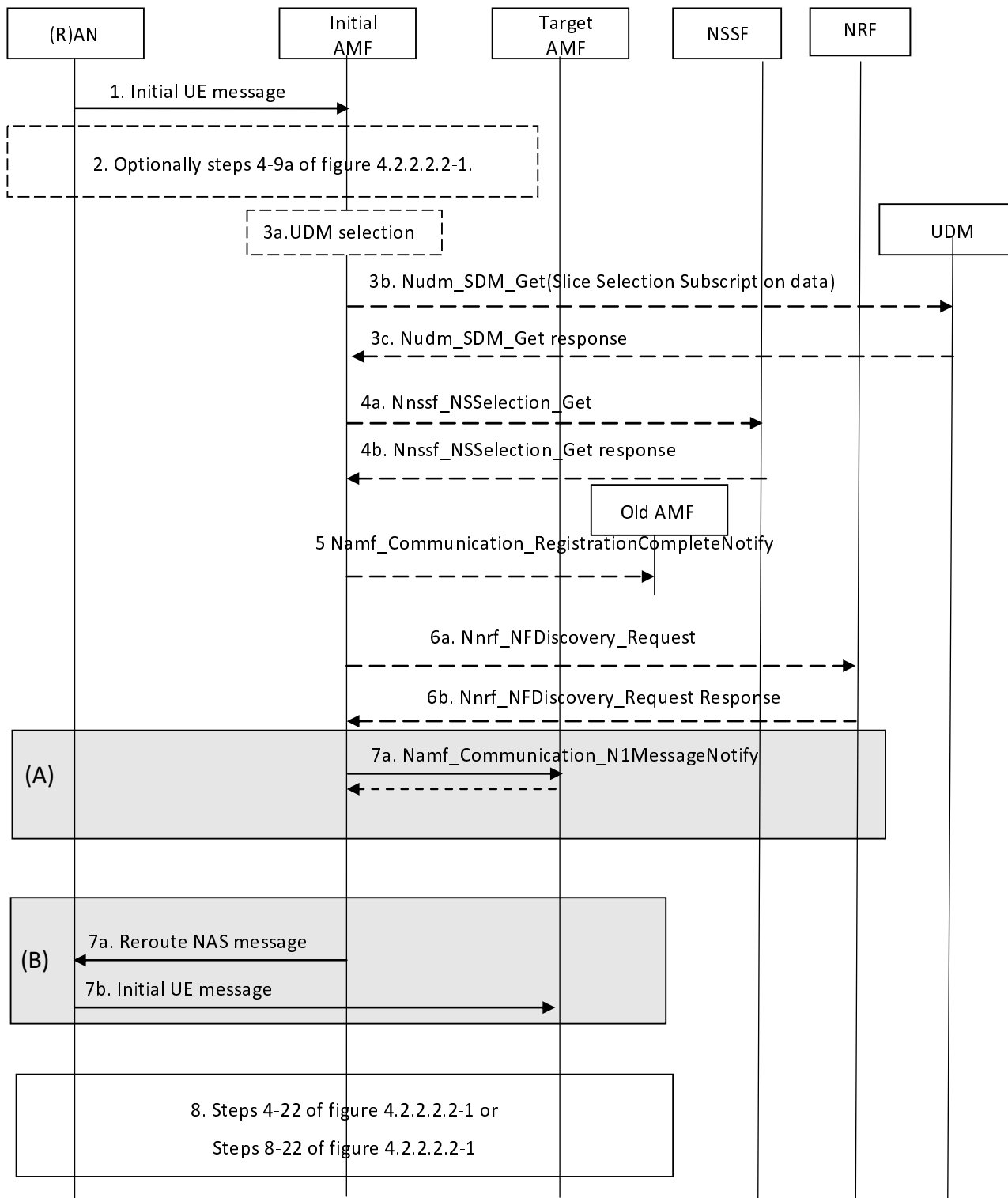

Figure 4.2.2.2.3-1: Registration with AMF re-allocation procedure

The initial AMF and the target AMF register their capability at the NRF.

1. Steps 1 and 2 of figure 4.2.2.2-1 have occurred, and the (R)AN sends the Registration request message within an Initial UE message to the initial AMF.
2. If the AMF needs the SUPI and/or UE's subscription information to decide whether to reroute the Registration Request or if the Registration Request was not sent integrity protected or integrity protection is indicated as failed, then AMF performs steps 4 to 9b of figure 4.2.2.2-1.
- 3a. [Conditional] If the initial AMF needs UE's subscription information to decide whether to reroute the Registration Request and UE's slice selection subscription information was not provided by old AMF, the AMF selects a UDM as described in TS 23.501 [2], clause 6.3.8.
- 3b. Initial AMF to UDM: Nudm\_SDM\_Get (SUPI, Slice Selection Subscription data).

The initial AMF request UE's Slice Selection Subscription data from UDM by invoking the Nudm\_SDM\_Get (see clause 5.2.3.3.1) service operation. UDM may get this information from UDR by Nudr\_DM\_Query(SUPI, Subscribed S-NSSAIs).

- 3c. UDM to initial AMF: Response to Nudm\_SDM\_Get. The AMF gets the Slice Selection Subscription data including Subscribed S-NSSAIs. The UDM may provide indication that the subscription data for network slicing is updated for the UE.

UDM responds with slice selection data to initial AMF.

- 4a. [Conditional] Initial AMF to NSSF: Nnssf\_NSSelection\_Get (Requested NSSAI, [Mapping Of Requested NSSAI], Subscribed S-NSSAI(s) with the default S-NSSAI indication, TAI, Allowed NSSAI for the other access type (if any), [Mapping of Allowed NSSAI], PLMN ID of the SUPI).

If there is a need for slice selection, (see clause 5.15.5.2.1 of TS 23.501 [2]), e.g. the initial AMF cannot serve all the S-NSSAI(s) from the Requested NSSAI permitted by the subscription information, the initial AMF invokes the Nnssf\_NSSelection\_Get service operation from the NSSF by including Requested NSSAI, optionally Mapping Of Requested NSSAI, Subscribed S-NSSAIs with the default S-NSSAI indication, Allowed NSSAI for the other access type (if any), Mapping of Allowed NSSAI, PLMN ID of the SUPI and the TAI of the UE.

- 4b. [Conditional] NSSF to Initial AMF: Response to Nnssf\_NSSelection\_Get (AMF Set or list of AMF addresses, Allowed NSSAI for the first access type, [Mapping Of Allowed NSSAI], [Allowed NSSAI for the second access type], [Mapping of Allowed NSSAI], [NSI ID(s)], [NRF(s)], [List of rejected (S-NSSAI(s), cause value(s))], [Configured NSSAI for the Serving PLMN], [Mapping Of Configured NSSAI]).

The NSSF performs the steps specified in point (B) in clause 5.15.5.2.1 of TS 23.501 [2]. The NSSF returns to initial AMF the Allowed NSSAI for the first access type, optionally the Mapping Of Allowed NSSAI, the Allowed NSSAI for the second access type (if any), optionally the Mapping of Allowed NSSAI and the target AMF Set or, based on configuration, the list of candidate AMF(s). The NSSF may return NSI ID(s) associated to the Network Slice instance(s) corresponding to certain S-NSSAI(s). The NSSF may return the NRF(s) to be used to select NFs/services within the selected Network Slice instance(s). It may return also information regarding rejection causes for S-NSSAI(s) not included in the Allowed NSSAI. The NSSF may return Configured NSSAI for the Serving PLMN, and possibly the associated mapping of the Configured NSSAI.

NOTE: The NRF(s) returned by the NSSF, if any, belong to any level of NRF (see clause 6.2.6 of TS 23.501 [2]) according to the deployment decision of the operator.

5. [Conditional] Initial AMF to old AMF: Namf\_Communication\_RegistrationCompleteNotify (failure cause ).

The initial AMF decides to reroute the NAS message to another AMF. The initial AMF sends a reject indication to the old AMF telling that the UE Registration procedure did not fully complete at the initial AMF. The old AMF continues as if the Namf\_Communication\_UEContextTransfer had never been received.

- 6a. [Conditional] Initial AMF to NRF: Nnrf\_NFDDiscovery\_Request (NF type, AMF Set).

If the initial AMF does not locally store the target AMF address, and if the initial AMF intends to use direct reroute to target AMF or the reroute via (NG-R)AN message needs to include AMF address, then the initial AMF invokes the Nnrf\_NFDDiscovery\_Request service operation from the NRF to find a proper target AMF which has required NF capabilities to serve the UE. The NF type is set to AMF. The AMF Set is included in the Nnrf\_NFDDiscovery\_Request.

- 6b. [Conditional] NRF to AMF: Response to Nnrf\_NFDiscovery\_Request (list of (AMF pointer, AMF address, plus additional selection rules and NF capabilities)).

The NRF replies with the list of potential target AMF(s). The NRF may also provide the details of the services offered by the candidate AMF(s) along with the notification end-point for each type of notification service that the selected AMF had registered with the NRF, if available. As an alternative, it provides a list of potential target AMFs and their capabilities, and optionally, additional selection rules. Based on the information about registered NFs and required capabilities, a target AMF is selected by the initial AMF.

If the initial AMF is not part of the target AMF set, and is not able to get a list of candidate AMF(s) by querying the NRF with the target AMF set (e.g. the NRF locally pre-configured on AMF does not provide the requested information, the query to the appropriate NRF provided by the NSSF is not successful, or the initial AMF has knowledge that the initial AMF is not authorized as serving AMF etc.) then the initial AMF shall forward the NAS message to the target AMF via (R)AN executing step 7(B); the Allowed NSSAI and the AMF Set are included to enable the (R)AN to select the target AMF as described in TS 23.501 [2] clause 6.3.5.

- 7(A). If the initial AMF, based on local policy and subscription information, decides to forward the NAS message to the target AMF directly, the initial AMF invokes the Namf\_Communication\_N1MessageNotify to the target AMF, carrying the rerouted NAS message. The Namf\_Communication\_N1MessageNotify service operation includes the information enabling (R)AN to identify the N2 terminating point, and the full Registration Request message, and the UE's SUPI and MM Context if available. If the initial AMF has obtained the information from the NSSF as described at step 4b, that information except the AMF Set or list of AMF addresses is included. The target AMF then updates the (R)AN with a new updated N2 termination point for the UE in the first message from target AMF to RAN in step 8.
- 7(B). If the initial AMF, based on local policy and subscription information, decides to forward the NAS message to the target AMF via (R)AN unless the target AMF(s) are returned from the NSSF and identified by a list of candidate AMF(s), the initial AMF sends a Reroute NAS message to the (R)AN (step 7a). The Reroute NAS message includes the information about the target AMF, and the full Registration Request message. If the initial AMF has obtained the information as described at step 4b, that information is included. The (R)AN sends the Initial UE message to the target AMF (step 7b) indicating reroute due to slicing including the information from step 4b that the NSSF provided.
8. After receiving the Registration Request message transmitted at step 7(A)a or step 7(B)b, if no UE context is received from the initial AMF, the target AMF, based on rerouting due to slicing, continues with the Registration procedure from step 4 until 22 of figure 4.2.2.2-1 (with the target AMF corresponding to the new AMF). If the UE context is received from the initial AMF, the target AMF continues with the Registration procedure from step 8 or step 9b (depending on whether it decides to re-authenticate the UE) or step 9c (if new NAS security context shall be applied) until step 22 of figure 4.2.2.2-1, skipping step 10. If the initial AMF decides to forward the NAS message to the target AMF (step 7(A)), the first message from the target AMF to RAN (either Initial Context Setup Request, or Downlink NAS Transport) contain the AMF name of the initial AMF.

### 4.2.2.3 Deregistration procedures

#### 4.2.2.3.1 General

The Deregistration procedure allows:

- the UE to inform the network that it does not want to access the 5GS any longer, and
- the network to inform the UE that it does not have access to the 5GS any longer.

The Deregistration request by the UE and Deregistration request by the network include whether the Deregistration applies to the 3GPP access, to the non-3GPP access, or to both. When the UE is registered to both accesses in the same PLMN, the Deregistration message can be sent over any access regardless of the access the Deregistration is applied to.

#### 4.2.2.3.2 UE-initiated Deregistration

The UE uses this procedure to deregister from the registered PLMN as shown in Figure 4.2.2.3.2-1.

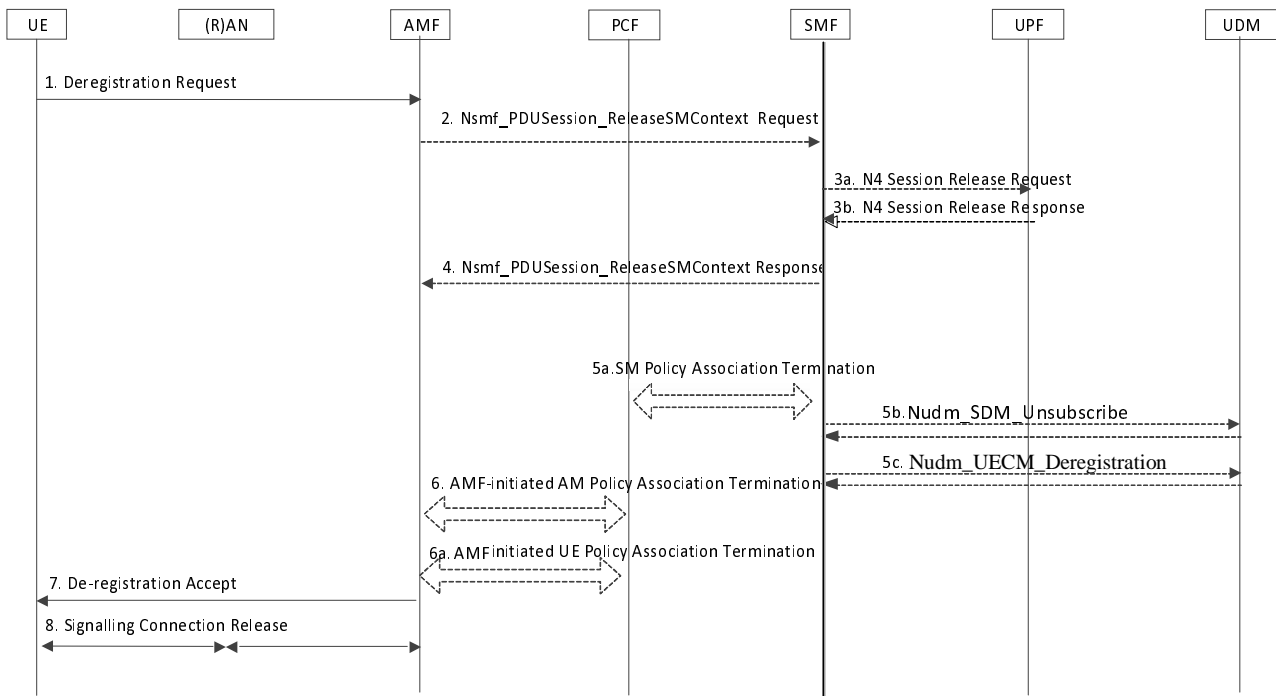

**Figure 4.2.2.3.2-1: UE-initiated Deregistration**

1. The UE sends NAS message Deregistration Request (5G-GUTI, Deregistration type (e.g. Switch off), Access Type) to the AMF.

Access type indicates whether the Deregistration procedure applies to the 3GPP access, to the non-3GPP access, or to both if the 3GPP access and non-3GPP access of the UE are served by the same AMF (refer to TS 23.501 [2]). The AMF shall invoke the Deregistration procedure for the target access indicated by the UE.

2. [Conditional] AMF to SMF: Nsmf\_PDUSession\_ReleaseSMContext (SUPI, PDU Session ID).

If the UE has no established PDU Session over the target access indicated in step 1, then steps 2 to 5 are not executed. All PDU Sessions over the target access(es), which belong to the UE are released by the AMF sending Nsmf\_PDUSession\_ReleaseSMContext Request (SUPI, PDU Session ID) message to the SMF for each PDU Session.

3. [Conditional] The SMF releases all resources e.g. the IP address / Prefix(es) that were allocated to the PDU Session and releases the corresponding User Plane resources:

- 3a. [Conditional] The SMF sends N4 Session Release Request (N4 Session ID) message to the UPF(s) of the PDU Session. The UPF(s) shall drop any remaining packets of the PDU Session and release all tunnel resource and contexts associated with the N4 Session.

- 3b. [Conditional] The UPF(s) acknowledges the N4 Session Release Request by the transmission of an N4 Session Release Response (N4 Session ID) message to the SMF.

4. [Conditional] The SMF responds with Nsmf\_PDUSession\_ReleaseSMContext Response message.

- 5a. [Conditional] If dynamic PCC applied to this session the SMF performs an SM Policy Association Termination procedure as defined in clause 4.16.6.

- 5b-c. [Conditional] If it is the last PDU Session the SMF is handling for the UE for the associated (DNN, S-NSSAI), the SMF unsubscribes from Session Management Subscription data changes notification with the UDM by means of the Nudm\_SDM\_Unsubscribe service operation. The SMF invokes the Nudm\_UECM\_Deregistration service operation so that the UDM removes the association it had stored between the SMF identity and the associated DNN and PDU Session Id.

6. [Conditional] If there is any association with the PCF for this UE and the UE is no more registered over any access, the AMF performs a AMF-initiated AM Policy Association Termination procedure as defined in clause 4.16.3.2 delete the association with the PCF.



- 6a. [Conditional] If there is any association with the PCF for this UE and the UE is no more registered over any access, the AMF performs a AMF-initiated UE Policy Association Termination procedure as defined in clause 4.16.13.1 delete the association with the PCF.
7. [Conditional] The AMF sends NAS message Deregistration Accept to UE depending on the Deregistration type i.e. if Deregistration type is switch-off, AMF does not send Deregistration Accept message.
8. [Conditional] AMF to AN: N2 UE Context Release Request (Cause)

If the target access for Deregistration procedure is 3GPP access or both 3GPP access and non-3GPP access, and there is N2 signalling connection to NG-RAN, the AMF sends N2 UE Release command to NG-RAN with Cause set to Deregistration to release N2 signalling connection. The details of this step are covered by steps 2 to 4 in the AN Release procedure, as described in clause 4.2.6.

If the target access for Deregistration procedure is non-3GPP access or both 3GPP access and non-3GPP access, and there is N2 signalling connection to the N3IWF, the AMF sends N2 UE Release command to N3IWF with Cause set to Deregistration to release N2 signalling connection. The details of this step are covered by steps 2 to 5 in the "Deregistration procedure for untrusted non-3gpp access", as described in clause 4.12.3.

#### 4.2.2.3.3 Network-initiated Deregistration

The procedure depicted in Figure 4.2.2.3.3-1 shows Network-initiated Deregistration procedure. The AMF can initiate this procedure for either explicit (e.g. by O&M intervention) or implicit (e.g. expiring of Implicit Deregistration timer). The UDM can trigger this procedure for operator-determined purposes to request the removal of a subscriber's RM context and PDU Session(s) of the UE.

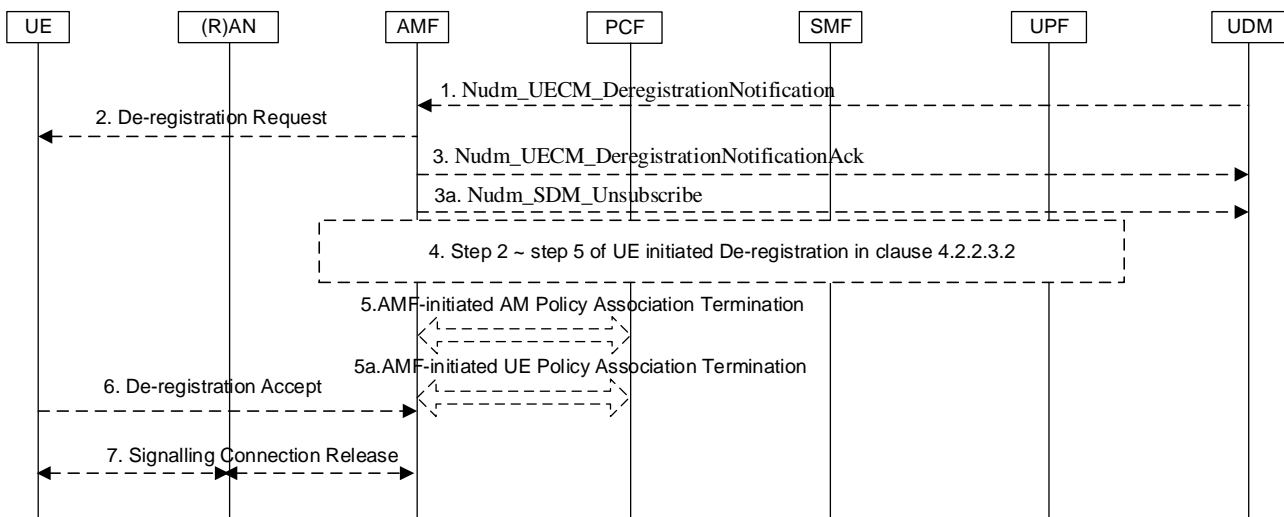

Figure 4.2.2.3.3-1: Network-initiated Deregistration

- [Conditional] If the UDM wants to request the immediate deletion of a subscriber's RM contexts and PDU Sessions, the UDM shall send a Nudm\_UECM\_DeregistrationNotification (SUPI, Access Type, Removal Reason) message with Removal Reason set to Subscription Withdrawn to the registered AMF. The Access Type may indicate 3GPP Access, non-3GPP Access or both.
- If the AMF receives Nudm\_UECM\_DeregistrationNotification in Step 1 with Removal Reason as Subscription Withdrawn, the AMF executes Deregistration procedure over the access(es) the Access Type indicates.

The AMF-initiated Deregistration procedure is either explicit (e.g. by O&M intervention) or implicit. The AMF does not send the Deregistration Request message to the UE for Implicit Deregistration. If the UE is in CM-CONNECTED state, the AMF may explicitly deregister the UE by sending a Deregistration Request message (Deregistration type, Access Type) to the UE. The Deregistration type may be set to Re-registration in which case the UE should re-register at the end of the Deregistration procedure. Access Type indicates whether Deregistration procedure applies to the 3GPP access or non-3GPP access, or both. If the Deregistration Request message is sent over 3GPP access and the UE is in CM-IDLE state in 3GPP access, the AMF pages the UE.

If the UE has established PDU Session associated with emergency service, the AMF shall not initiate Deregistration procedure. In this case, the AMF performs network requested PDU Session Release for any PDU session associated with non-emergency service as described in clause 4.3.4.

3. [Conditional] If the Deregistration procedure is triggered by UDM (Step 1), the AMF acknowledges the Nudm\_UECM\_DeRegistrationNotification to the UDM. The AMF also unsubscribes with the UDM using Nudm\_SDM\_Unsubscribe service operation.
4. [Conditional] If the UE has any established PDU Session over the target access for deregistration indicated in step 2, then step 2 ~ step 5 of UE-initiated Deregistration procedure in clause 4.2.2.3.2 is performed.
5. [Conditional] As in step 6 of Figure 4.2.2.3.2-1.
- 5a. [Conditional] As in step 6a of Figure 4.2.2.3.2-1.
6. [Conditional] If the UE receives the Deregistration Request message from the AMF in step 2, the UE sends a Deregistration Accept message to the AMF any time after step 2. The NG-RAN forwards this NAS message to the AMF along with the TAI+ Cell identity of the cell which the UE is using.
7. [Conditional] AMF to AN: N2 UE Context Release Request (Cause): as in step 8 of Figure 4.2.2.3.2.

## 4.2.3 Service Request procedures

### 4.2.3.1 General

The Service Request procedure is used by a UE in CM-IDLE state or the 5GC to request the establishment of a secure connection to an AMF. The Service Request procedure is also used both when the UE is in CM-IDLE and in CM-CONNECTED to activate a User Plane connection for an established PDU Session.

The UE shall not initiate a Service Request procedure if there is an ongoing Service Request procedure.

### 4.2.3.2 UE Triggered Service Request

The UE in CM-IDLE state initiates the Service Request procedure in order to send uplink signalling messages, user data, or as a response to a network paging request. After receiving the Service Request message, the AMF may perform authentication. After the establishment of the signalling connection to an AMF, the UE or network may send signalling messages, e.g. PDU Session establishment from UE to the SMF, via the AMF.

The Service Request procedure is used by a UE in CM-CONNECTED to request activation of a User Plane connection for PDU Sessions and to respond to a NAS Notification message from the AMF. When a User Plane connection for a PDU Session is activated, the AS layer in the UE indicates it to the NAS layer.

For any Service Request, the AMF responds with a Service Accept message to synchronize PDU Session status between UE and network, if necessary. The AMF responds with a Service Reject message to UE, if the Service Request cannot be accepted by network. The Service Reject message may include an indication or cause code requesting the UE to perform Registration procedure.

For this procedure, the impacted SMF and UPF, if any, are all under control of the PLMN serving the UE, e.g. in Home Routed roaming case the SMF and UPF in HPLMN are not involved.

For Service Request due to user data, network may take further actions if User Plane connection activation is not successful.

The procedure in this clause 4.2.3.2 is applicable to the scenarios with or without intermediate UPF, and with or without intermediate UPF reselection.

If the UE initiates Service Request procedures via non-3GPP Access, functions defined in the clause 4.12.4.1 are applied.

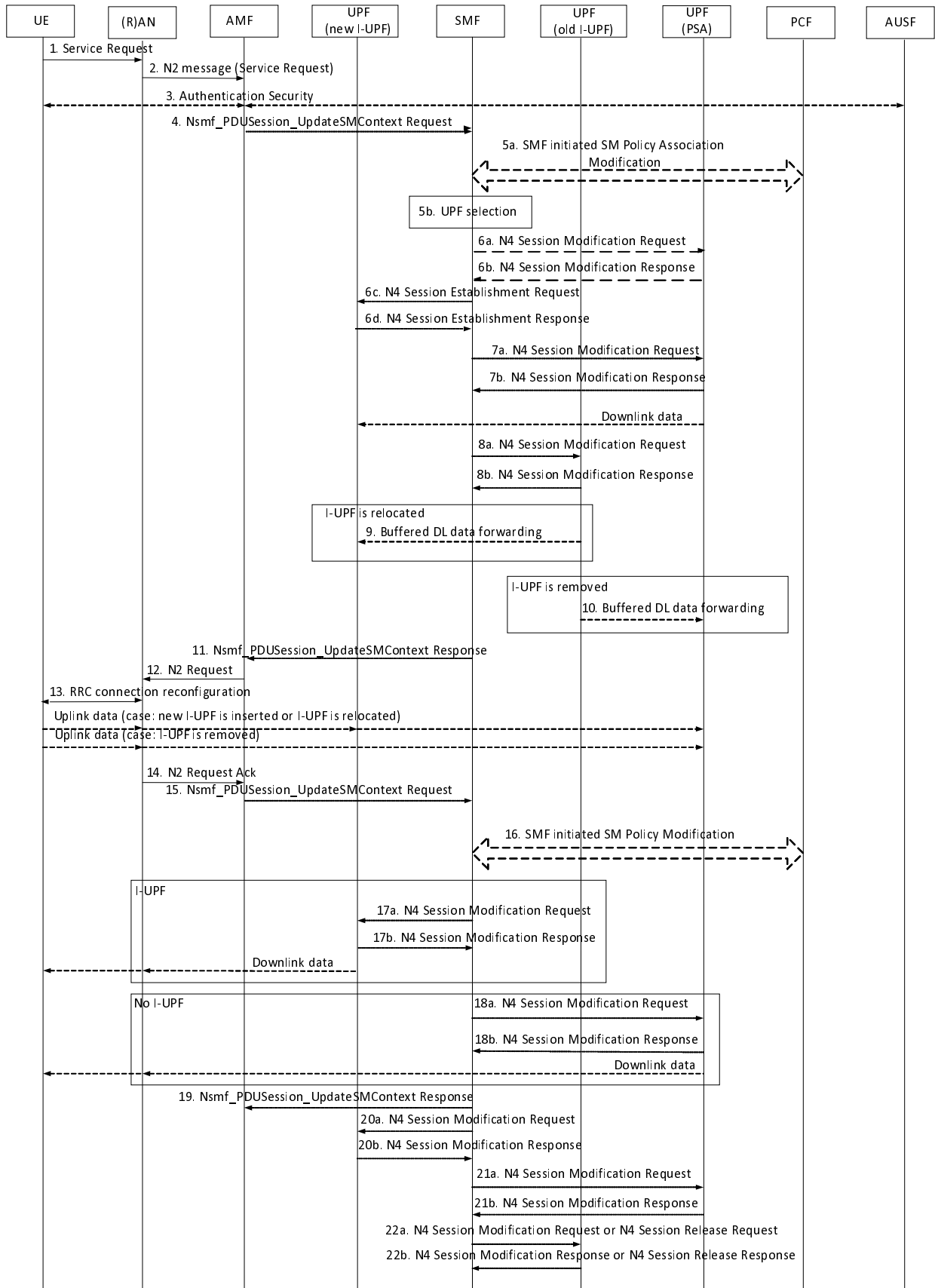

Figure 4.2.3.2-1: UE Triggered Service Request procedure

1. UE to (R)AN: AN message (AN parameters, Service Request (List Of PDU Sessions To Be Activated, List Of Allowed PDU Sessions, security parameters, PDU Session status, 5G-S-TMSI, [NAS message container], Exempt Indication)).

The NAS message container shall be included if the UE is sending a Service Request message as an Initial NAS message and the UE needs to send non-clear-text IEs, see clause 4.4.6 in TS 24.501 [25].

The List Of PDU Sessions To Be Activated is provided by UE when the UE wants to re-activate the PDU Session(s). The List Of Allowed PDU Sessions is provided by the UE when the Service Request is a response of a Paging or a NAS Notification for a PDU Session associated with non-3GPP access, and identifies the PDU Sessions that can be transferred to 3GPP access.

In case of NG-RAN:

- The AN parameters include 5G-S-TMSI, Selected PLMN ID and Establishment cause. The Establishment cause provides the reason for requesting the establishment of an RRC connection.
- The UE sends Service Request message towards the AMF encapsulated in an RRC message to the NG-RAN. The RRC message(s) that can be used to carry the 5G-S-TMSI and this NAS message are described in TS 38.331 [12] and TS 36.331 [16].

If the Service Request is triggered by the UE for user data, the UE identifies, using the List Of PDU Sessions To Be Activated, the PDU Session(s) for which the UP connections are to be activated in Service Request message. When the UE includes the List Of PDU Sessions To Be Activated, the UE shall indicate PDU Sessions only associated with the access the Service Request is related to. If the Service Request is triggered by the UE for signalling only, the UE doesn't identify any List Of PDU Sessions To Be Activated. If this procedure is triggered for paging response, and the UE has at the same time some user data to be transferred, the UE identifies the PDU Session(s) whose UP connections are to be activated in Service Request message, by the List Of PDU Sessions To Be Activated. Otherwise the UE does not identify any PDU Session(s) in the Service Request message for paging response. As defined in TS 24.501 [25] the UE shall include always-on PDU Sessions which are accepted by the network in the List Of PDU Sessions To Be Activated even if there are no pending uplink data for those PDU Sessions or when the Service Request is triggered for signalling only or when the Service Request is triggered for paging response.

If the Service Request over 3GPP access is triggered in response to the paging or NAS Notification indicating non-3GPP access, the Service Request message shall identify the list of PDU Sessions associated with the non-3GPP access that can be re-activated over 3GPP in the List Of Allowed PDU Sessions, as described in clause 4.2.3.3 (step 6) of this specification and in clause 5.6.8 of TS 23.501 [2].

If the Service Request is triggered to report PS Data Off status change and the UE is in Non-Allowed Area, the UE shall send Service Request message with an indication that the message is exempted from restriction (e.g. Non-Allowed Area). In this case, if the UE is in Non-Allowed Area, the UE shall not include the List Of PDU Sessions To Be Activated and as a result the always-on PDU Session is not re-activated during the Service Request procedure.

The PDU Session status indicates the PDU Sessions available in the UE.

The UE shall not trigger a Service Request procedure for a PDU Session corresponding to a LADN when the UE is outside the area of availability of the LADN.

NOTE 1: A PDU Session corresponding to a LADN is not included in the List Of PDU Sessions To Be Activated when the UE is outside the area of availability of the LADN.

For UE in CM-CONNECTED state, only the List Of PDU Sessions To Be Activated and List Of Allowed PDU Sessions need to be included in the Service Request.

## 2. (R)AN to AMF: N2 Message (N2 parameters, Service Request).

Details of this step are described in TS 38.413 [10]. If the AMF can't handle the Service Request it will reject it.

When NG-RAN is used, the N2 parameters include the 5G-S-TMSI, Selected PLMN ID, Location information and Establishment cause, UE Context Request.

If the UE is in CM-IDLE state, the NG-RAN obtains the 5G-S-TMSI in RRC procedure. NG-RAN selects the AMF according to 5G-S-TMSI. The Location Information relates to the cell in which the UE is camping.

Based on the PDU Session status, the AMF may initiate PDU Session Release procedure in the network for the PDU Sessions whose PDU Session ID(s) were indicated by the UE as not available.

When the Establishment cause is associated with priority services (e.g. MPS, MCS), the AMF includes a Message Priority header to indicate priority information. Other NFs relay the priority information by including the Message Priority header in service-based interfaces, as specified in TS 29.500 [17].

- 3a) AMF to (R)AN: N2 Request (security context, Mobility Restriction List, list of recommended cells / TAs / NG-RAN node identifiers).

If the 5G-AN had requested for UE Context or there is a requirement for AMF to provide this e.g. the AMF needs to initiate fallback procedure as in clause 4.13.4.2 for Emergency services, AMF initiates NGAP procedure as specified in TS 38.413 [10]. For UE in CM-IDLE state, 5G-AN stores the Security Context in the UE AN context. Mobility Restriction List is described in TS 23.501 [2] clause 5.3.4.1 "Mobility Restrictions".

The 5G-AN uses the Security Context to protect the messages exchanged with the UE as described in TS 33.501 [15].

If the NG-RAN node had provided the list of recommended cells / TAs / NG-RAN node identifiers during the AN Release procedure (see clause 4.2.6), the AMF shall include it in the N2 Request. The RAN may use this information to allocate the RAN Notification Area when the RAN decides to enable RRC Inactive state for the UE.

3. If the Service Request was not sent integrity protected or integrity protection verification failed, the AMF shall reject the Service Request as stated in TS 24.501 [25].

If the UE in CM-IDLE state triggered the Service Request to establish a signalling connection only, after successful establishment of the signalling connection the UE and the network can exchange NAS signalling and steps 4 to 11 and 15 to 22 are skipped.

If the UE triggered the Service Request with an indication that the message is exempted from restriction (e.g. Non-Allowed Area), the AMF should accept the Service Request. In this case, if the UE is in Non-Allowed Area, the AMF rejects user plane setup request from the SMF except for emergency services.

If the procedure was triggered in response to paging or NAS notification indicating non-3GPP access, and the AMF received N1 SM Container only from the SMF in step 3a of clause 4.2.3.3, the AMF sends the NAS signalling including the N1 SM Container to the UE in step 7 of clause 4.2.3.3 without updating the access associated to the PDU Session.

4. [Conditional] AMF to SMF: Nsmf\_PDUSession\_UpdateSMContext Request (PDU Session ID(s), Operation Type, UE location information, Access Type, RAT Type, UE presence in LADN service area, Indication of Access Type can be changed).

The Nsmf\_PDUSession\_UpdateSMContext Request is invoked:

- If the UE identifies List Of PDU Sessions To Be Activated in the Service Request message;
- This procedure is triggered by the SMF but the PDU Session(s) identified by the UE correlates to other PDU Session ID(s) than the one triggering the procedure; or
- If this procedure is triggered by the SMF but the current UE location is outside the "Area of validity for the N2 SM information" provided by the SMF in step 3a of clause 4.2.3.3. In this case the AMF shall not send the N2 information provided by the SMF in step 3a of clause 4.2.3.3. If the current UE location is in the "Area of validity for the N2 SM information", steps 4 to 11 are skipped; or
- In response to paging or NAS notification indicating non-3GPP access and the AMF received N2 SM Information only, or both N1 SM Container and N2 SM Information in step 3a of clause 4.2.3.3.

If the DNN corresponds to an LADN then the "UE presence in LADN service area" indicates if the UE is IN or OUT of the LADN service area. If the AMF does not provide the "UE presence in LADN service area" indication and the SMF determines that the DNN corresponds to a LADN, then the SMF considers that the UE is OUT of the LADN service area.

The AMF determines the PDU Session(s) for which the UP connection(s) shall be activated and sends an Nsmf\_PDUSession\_UpdateSMContext Request to SMF(s) associated with the PDU Session(s) with Operation Type set to "UP activate" to indicate establishment of User Plane resources for the PDU Session(s). The AMF determines Access Type and RAT Type based on the Global RAN Node ID associated with the N2 interface.

If the procedure was triggered in response to paging or NAS Notification indicating non-3GPP access, the AMF received N2 SM Information in step 3a of clause 4.2.3.3 and the PDU Session for which the UE was paged or notified is not in the List Of Allowed PDU Sessions provided by the UE, the AMF notifies the SMF that the UE is not reachable. For other PDU Sessions in the List Of Allowed PDU Sessions the Service Request Procedure succeeds without re-activating the User Plane of any PDU Sessions, unless they have also been included by the UE in the List Of PDU Sessions To Be Activated.

If the procedure was triggered in response to paging or NAS notification indicating non-3GPP access, and the PDU Session for which the UE was paged or notified is in the List Of Allowed PDU Sessions provided by the UE, and the AMF received N2 SM Information only or N1 SM Container and N2 SM Information from the SMF in step 3a of clause 4.2.3.3, the AMF notifies the SMF that the access type of the PDU session can be changed. The AMF discards any already received N1 SM Container and N2 SM Information. In Home Routed roaming case, the V-SMF triggers Nsmf\_PDUSession\_Update service operation towards the H-SMF to notify the access type of the PDU Session can be changed and the procedure continues as specified in clause 4.3.3.3 from step 1a to step 10.

The AMF may receive a Service Request to establish another NAS signalling connection via a NG-RAN while it has maintained an old NAS signalling connection for UE still via NG-RAN. In this case, AMF shall trigger the AN release procedure toward the old NG-RAN to release the old NAS signalling connection as defined in clause 4.2.6 with following logic:

- For the PDU Sessions indicated in the List Of PDU Sessions To Be Activated, the AMF requests the SMF to activate the PDU Session(s) immediately by performing this step 4.
- For the PDU Sessions indicated in the "List of PDU Session ID(s) with active N3 user plane" but not in the List Of PDU Sessions To Be Activated, the AMF requests the SMF to deactivate the PDU Session(s).

5a. [Conditional] SMF to PCF: If the AMF notified the SMF that the access type of the PDU session can be changed in step 4, and if PCC is deployed, the SMF perform an SMF initiated SM Policy Association Modification procedure as defined in clause 4.16.5.1 if Policy Control Request Trigger condition(s) have been met (i.e. change of Access Type). The PCF may provide updated PCC Rule(s).

5b. If the PDU Session ID corresponds to a LADN and the SMF determines that the UE is outside the area of availability of the LADN based on the "UE presence in LADN service area" from the AMF, the SMF decides to (based on local policies) either:

- keep the PDU Session, but reject the activation of User Plane connection for the PDU Session and inform the AMF about it. If the procedure has been triggered by a Network Triggered Service Request as described in clause 4.3.2.3, the SMF may notify the UPF that originated the Data Notification to discard downlink data for the PDU Sessions and/or to not provide further Data Notification messages; or
- to release the PDU Session: the SMF releases the PDU Session and informs the AMF that the PDU Session is released.

In any case of the two cases above the SMF answers to the AMF (step10) with an appropriate reject cause and the User Plane Activation of PDU Session is stopped.

Otherwise, based on the location info received from the AMF, the SMF checks the UPF Selection Criteria according to clause 6.3.3 of TS 23.501 [2], and determines to perform one of the following:

- accepts the activation of UP connection and continue using the current UPF(s);
- accepts the activation of UP connection and selects a new intermediate UPF (or add/remove an intermediate UPF), if the UE has moved out of the service area of the UPF that was previously connecting to the AN, while maintaining the UPF(s) acting as PDU Session Anchor. The steps to perform I-UPF addition/change/removal are described as conditional steps in the following of the current procedure; or

NOTE 2: If the old and/or new I-UPF implements an UL CL or BP functionality and a PDU Session Anchor for connectivity to the local access to the Data Network as described in TS 23.501 [2] clause 5.6.4.2, the signalling described in the current clause is intended as the signalling to add, remove or change the PDU Session Anchor, and must be complemented by the signalling to add, release or change the UL CL or BP as described respectively in clauses 4.3.5.4, 4.3.5.5 and 4.3.5.7.

- rejects the activation of UP connection of a PDU Session of SSC mode 2, and trigger re-establishment of the PDU Session after Service Request procedure to perform the allocation of a new UPF to act as PDU Session Anchor, e.g. the UE has moved out of the service area of the anchor UPF which is connecting to NG-RAN.

In the case that the SMF fails to find suitable I-UPF, the SMF decides to (based on local policies) either:

- trigger re-establishment of PDU Session. After Service Request procedure, SMF sends N1 SM message to the UE via the AMF by invoking `Namf_Communication_N1N2MessageTransfer` containing the cause indicating PDU Session re-establishment is required for the UE; or
- keep the PDU Session, but reject the activation request of User Plane connection for the PDU Session and inform the AMF about it; or
- release the PDU Session after Service Request procedure.

6a. [Conditional] SMF to UPF (PSA): N4 Session Modification Request.

Depending on the network deployment, the CN Tunnel Info of UPF (PSA) allocated for N3 or N9 interface may be changed during the Service Request procedure, e.g. UPF connected to different IP domains. If the different CN Tunnel Info need be used, and the CN tunnel info is allocated by the UPF, the SMF sends N4 Session Modification Request message to UPF (PSA). If the CN Tunnel Info is allocated by the SMF, the SMF may provide updated CN tunnel info and UL Packet detection rules in step 7 instead.

6b. [Conditional] UPF (PSA) to SMF: N4 Session Modification Response.

The UPF (PSA) sends an N4 Session Establishment Response message to the SMF. If the UPF (PSA) allocates CN Tunnel Info of UPF (PSA), it provides CN Tunnel Info to the SMF. The UPF (PSA) associate the CN Tunnel Info with UL Packet detection rules provided by the SMF.

6c. [Conditional] SMF to new UPF (intermediate): N4 Session Establishment Request.

If the SMF selects a new UPF to act as intermediate UPF for the PDU Session, or if the SMF selects to insert an intermediate UPF for a PDU Session which did not have an intermediate UPF, an N4 Session Establishment Request message is sent to the new UPF, providing Packet detection, Data forwarding, enforcement and reporting rules to be installed on the intermediate UPF. The CN Tunnel Info (on N9) of PSA, i.e. which is used to establish the N9 tunnel, for this PDU Session is also provided to the intermediate UPF.

If the Service Request is triggered by the network and a new UPF is selected by the SMF to replace the old (intermediate) UPF, and if UPF allocates UP tunnel endpoint information, the SMF may also include a request for the UPF to allocate a second tunnel endpoint for buffered DL data from the old I-UPF.

6d. New UPF (intermediate) to SMF: N4 Session Establishment Response.

The new intermediate UPF sends an N4 Session Establishment Response message to the SMF. In case the UPF allocates CN Tunnel Info, it provides DL CN Tunnel as requested by SMF in step 6a. The SMF starts a timer, to be used in step 22a to release the resource in old intermediate UPF if there is one.

7a. [Conditional] SMF to UPF (PSA): N4 Session Modification Request.

If the SMF selects a new UPF to act as intermediate UPF for the PDU Session, the SMF sends N4 Session Modification Request message to PDU Session Anchor UPF, providing DL Tunnel Info from new intermediate UPF. The SMF may also provide updated UL CN Tunnel Information. If the new intermediate UPF was added for the PDU Session, the UPF (PSA) begins to send the DL data to the new I-UPF as indicated in the DL Tunnel Info.

If the Service Request is triggered by the network, and the SMF removes the old I-UPF but does not replace it with a new I-UPF, and if UPF allocates UP tunnel endpoint information, the SMF may also include a request for the UPF to allocate a second tunnel endpoint for buffered DL data from the old I-UPF. In this case, the UPF (PSA) begins to buffer the DL data it may receive at the same time from the N6 interface.

7b. The UPF (PSA) sends N4 Session Modification Response message to SMF.

If requested by SMF, the UPF (PSA) sends CN DL tunnel info for the old (intermediate) UPF to the SMF. The SMF starts a timer, to be used in step 22a to release the resource in old intermediate UPF if there is one.

If the UPF that connects to RAN is the UPF (PSA), and if the SMF finds that the PDU Session is activated when receiving the Nsmf\_PDUSession\_UpdateSMContext Request in step 4 with Operation Type set to "UP activate" to indicate establishment of User Plane resources for the PDU Session(s), it deletes the AN Tunnel Info and initiates an N4 Session Modification procedure to remove Tunnel Info of AN in the UPF.

8a. [Conditional] SMF to old UPF (intermediate): N4 Session Modification Request (New UPF address, New UPF DL Tunnel ID)

If the service request is triggered by the network, and the SMF removes the old (intermediate) UPF, the SMF sends the N4 Session Modification Request message to the old (intermediate) UPF, providing the DL Tunnel Info for the buffered DL data. If the SMF allocated new I-UPF, the DL Tunnel Info is from the new (intermediate) UPF acting as N3 terminating point. If the SMF did not allocate a new I-UPF, the DL Tunnel Info is from the new UPF (PSA) acting as N3 terminating point. The SMF starts a timer to monitor the forwarding tunnel as step 6b or 7b.

If the SMF find the PDU Session is activated when receiving the Nsmf\_PDUSession\_UpdateSMContext Request in step 4 with Operation Type set to "UP activate" to indicate establishment of User Plane resources for the PDU Session(s), it deletes the AN Tunnel Info and initiates an N4 Session Modification procedure to remove Tunnel Info of AN in the UPF.

8b. old UPF (intermediate) to SMF: N4 Session Modification Response

The old (intermediate) UPF sends N4 Session Modification Response message to SMF.

9. [Conditional] old UPF (intermediate) to new UPF (intermediate): buffered downlink data forwarding

If the I-UPF is changed and forwarding tunnel was established to the new I-UPF, the old (intermediate) UPF forwards its buffered data to the new (intermediate) UPF acting as N3 terminating point.

10. [Conditional] old UPF (intermediate) to UPF (PSA): buffered downlink data forwarding

If the old I-UPF is removed and no new I-UPF is assigned for the PDU Session and forwarding tunnel was established to the UPF (PSA), the old (intermediate) UPF forwards its buffered data to the UPF (PSA) acting as N3 Terminating Point.

11. [Conditional] SMF to AMF: Nsmf\_PDUSession\_UpdateSMContext Response (N2 SM information (PDU Session ID, QFI(s), QoS profile(s), CN N3 Tunnel Info, S-NSSAI, User Plane Security Enforcement, UE Integrity Protection Maximum Data Rate), N1 SM Container, Cause) to the AMF. If the UPF that connects to RAN is the UPF (PSA), the CN N3 Tunnel Info is the UL Tunnel Info of the UPF (PSA). If the UPF that connects to RAN is the new intermediate UPF, the CN N3 Tunnel Info is the UL Tunnel Info of the intermediate UPF.

The SMF shall send N1 SM Container and/or N2 SM Information to the AMF when applicable. (e.g. when the SMF was notified from the AMF that the access type of the PDU Session can be changed in step 4).

For a PDU Session that the SMF has determined to accept the activation of UP connection in step 5a or 5b, the SMF generates only N2 SM information and sends Nsmf\_PDUSession\_UpdateSMContext Response to the AMF to establish the User Plane(s). The N2 SM information contains information that the AMF shall provide to the NG-RAN. If the SMF decided to change the PSA UPF for the SSC mode 3 PDU Session, the SMF triggers the change of SSC mode 3 PDU Session anchor as an independent procedure described in clause 4.3.5.2 or clause 4.3.5.3 after accepting the activation of UP of the PDU Session.

The SMF can reject the activation of UP of the PDU Session by including a cause in the Nsmf\_PDUSession\_UpdateSMContext Response. Following are some of the cases:

- If the PDU Session corresponds to a LADN and the UE is outside the area of availability of the LADN as described in step 5b;
- If the AMF notified the SMF that the UE is reachable only for regulatory prioritized service, and the PDU Session to be activated is not for a regulatory prioritized service; or
- If the SMF decided to change the PSA UPF for the requested PDU Session as described in step 5b. In this case, after sending Nsmf\_PDUSession\_UpdateSMContext Response, the SMF triggers another procedure to instruct UE to re-establish the PDU Session as described in clause 4.3.5.1 for SSC mode 2.



- If the SMF received negative response in Step 6b due to UPF resource unavailability.

If the PDU Session has been assigned any EPS bearer ID, the SMF also includes the mapping between EPS bearer ID(s) and QFI(s) into the N2 SM information to be sent to the NG-RAN.

The User Plane Security Enforcement information is determined by the SMF upon PDU session establishment as described in clause 5.10.3 of TS 23.501 [2]. If the User Plane Security Enforcement information indicates that Integrity Protection is "Preferred" or "Required", the SMF also includes the UE Integrity Protection Maximum Data Rate.

12. AMF to (R)AN: N2 Request (N2 SM information received from SMF, security context, Mobility Restriction List, Subscribed UE-AMBR, MM NAS Service Accept, list of recommended cells / TAs / NG-RAN node identifiers, UE Radio Capability, Core Network Assistance Information, Tracing Requirements). The Allowed NSSAI for the Access Type for the UE is included in the N2 message. If the subscription information includes Tracing Requirements, the AMF includes Tracing Requirements in the N2 Request.

If the UE triggered the Service Request while in CM-CONNECTED state, only N2 SM information received from SMF and MM NAS Service Accept are included in the N2 Request.

If the Service Request procedure is triggered by the Network (as described in clause 4.2.3.3) while the UE is in CM-CONNECTED state, only N2 SM information received from SMF is included in the N2 Request.

If the Service Request procedure is triggered by the Network (as described in clause 4.2.3.3) while the UE is in CM-IDLE state, only N2 SM information received from SMF and MM NAS Service Accept is included in the N2 Request.

For a UE that was in CM-IDLE state when the Service Request was triggered, the NG-RAN stores the Security Context. If the Service Request is not triggered by UE for a signalling connection only, RAN also stores QoS Information for the QoS Flows of the PDU Sessions that are activated and N3 Tunnel IDs in the UE RAN context and Mobility Restriction List (as described in TS 23.501 [2] clause 5.3.4.1).

MM NAS Service Accept includes PDU Session status in AMF. Any local PDU Session Release during the Session Request procedure is indicated to the UE via the Session Status. PDU Session Reactivation Result is provided in Service Accept for the PDU sessions in the List Of PDU Sessions To Be Activated, and the PDU Session in the List of Allowed PDU Sessions which has caused paging or NAS notification. If the PDU Session Reactivation Result of a PDU Session is failure, the cause of the failure is also provided.

If there are multiple PDU Sessions that involves multiple SMFs, AMF does not need to wait for responses from all SMFs in step 11 before it send N2 SM information to the RAN. However, the AMF shall wait for all responses from the SMFs before it sends MM NAS Service Accept message to the UE.

AMF shall include at least one N2 SM information from SMF if this step is triggered for PDU Session User Plane activation. AMF may send additional N2 SM information from SMFs in separate N2 message(s) (e.g. N2 tunnel setup request), if there is any. Alternatively, if multiple SMFs are involved, the AMF may send one N2 Request message to (R)AN after all the Nsmf\_PDUSession\_UpdateSMContext Response service operations from all the SMFs associated with the UE are received.

If the NG-RAN node had provided the list of recommended cells / TAs / NG-RAN node identifiers during the AN Release procedure (see clause 4.2.6), the AMF shall include it in the N2 Request. The NG-RAN may use this information to allocate the RAN Notification Area when the NG-RAN decides to enable RRC Inactive state for the UE.

The AMF includes the UE's "RRC Inactive Assistance Information" as defined in TS 23.501 [2] clause 5.3.3.2.5.

The AMF shall include the UE Radio Capability information, if available, to the NG-RAN node as described in TS 23.501 [2].

The AMF may include the Core Network Assistance Information which includes Core Network assisted RAN parameters tuning and Core Network assisted RAN paging information as defined in TS 23.501 [2].

13. (R)AN to UE: The NG-RAN performs RRC Connection Reconfiguration with the UE depending on the QoS Information for all the QoS Flows of the PDU Sessions whose UP connections are activated and Data Radio Bearers. For a UE that was in CM-IDLE state, if the Service Request is not triggered by UE for a signalling connection only, the User Plane security is established at this step, which is described in detail in TS 38.331 [12]

and TS 36.331 [16]. For a UE that was in CM-IDLE state, if the Service Request is triggered by UE for a signaling connection only, AS security context may be established in this step, which is described in detail in TS 38.331 [12] and TS 36.331 [16].

If the N2 Request includes a NAS message, the NG-RAN forwards the NAS message to the UE. The UE locally deletes context of PDU Sessions that are not available in 5GC.

NOTE 3: The reception of the Service Accept message does not imply the successful activation of the User Plane radio resources.

NOTE 4: In case not all the requested User Plane AN resources are successfully activated, TS 38.413 [10] will define how to handle this.

After the User Plane radio resources are setup, the uplink data from the UE can now be forwarded to NG-RAN. The NG-RAN sends the uplink data to the UPF address and Tunnel ID provided in the step 11.

14. [Conditional] (R)AN to AMF: N2 Request Ack (List of PDU Sessions To Be Established with N2 SM information (AN Tunnel Info, List of accepted QoS Flows for the PDU Sessions whose UP connections are activated, List of rejected QoS Flows for the PDU Sessions whose UP connections are activated), List of PDU Sessions that failed to be established with the failure cause given in the N2 SM information element).

The message may include N2 SM information(s), e.g. AN Tunnel Info. NG-RAN may respond N2 SM information with separate N2 message (e.g. N2 tunnel setup response) if AMF sends separate N2 message in step 11.

If multiple N2 SM information are included in the N2 Request message in step 12, the N2 Request Ack includes multiple N2 SM information and information to enable the AMF to associate the responses to relevant SMF.

15. [Conditional] AMF to SMF: Nsmf\_PDUSession\_UpdateSMContext Request (N2 SM information, RAT Type, Access Type) per PDU Session to the SMF. The AMF determines Access Type and RAT Type based on the Global RAN Node ID associated with the N2 interface.

If the AMF received N2 SM information (one or multiple) in step 14, then the AMF shall forward the N2 SM information to the relevant SMF per PDU Session ID. If the UE Time Zone has changed compared to the last reported UE Time Zone then the AMF shall include the UE Time Zone IE in this message.

If the PDU Session is moved from the non-3GPP access to 3GPP access (i.e. N3 tunnel for the PDU Session is established successfully), the SMF and AMF update associated access of the PDU Session. The UE updates associated access of the PDU Session when the user plane resource for the PDU Session is successfully established.

Procedure for unpause a charging pause initiated earlier is specified in clause 4.4.4.

If a PDU Session is rejected by the serving NG-RAN with an indication that the PDU Session was rejected because User Plane Security Enforcement is not supported in the serving NG-RAN and the User Plane Enforcement Policy indicates "Required" as described in clause 5.10.3 of TS 23.501 [2], the SMF shall trigger the release of this PDU Session. In all other cases of PDU Session rejection, the SMF can decide whether to release the PDU Session or to deactivate the UP connection of this PDU Session.

If some of the QoS Flows of a PDU Session are not accepted by the serving NG-RAN, the SMF shall initiate the PDU Session Modification procedure to remove the non-accepted QoS Flows from the PDU Session after this procedure is completed.

16. [Optional] SMF to PCF: If dynamic PCC is deployed, SMF may initiate notification about new location information to the PCF (if subscribed) by performing an SMF initiated SM Policy Modification procedure as defined in clause 4.16.5.1. The PCF may provide updated policies.

- 17a. [Conditional] SMF to new intermediate UPF: N4 Session Modification Request (AN Tunnel Info and List of accepted QFI(s)).

If the SMF selected a new UPF to act as intermediate UPF for the PDU Session in step 5b, the SMF initiates a N4 Session Modification procedure to the new I-UPF and provides AN Tunnel Info. The Downlink Data from the new I-UPF can now be forwarded to NG-RAN and UE.

- 17b. [Conditional] UPF to SMF: N4 Session Modification Response.

18a. [Conditional] SMF to UPF (PSA): N4 Session Modification Request (AN Tunnel Info, List of rejected QoS Flows).

If a User Plane is to be setup or modified and after the modification there is no I-UPF, the SMF initiates a N4 Session Modification procedure to UPF (PSA) and provides AN Tunnel Info. The Downlink Data from the UPF (PSA) can now be forwarded to NG-RAN and UE.

For QoS Flows in the List of rejected QoS Flows, the SMF shall instruct the UPF to remove the rules (e.g., Packet Detection Rules etc.) which are associated with the QoS Flows.

18b. [Conditional] UPF to SMF: N4 Session Modification Response.

19. [Conditional] SMF to AMF: Nsmf\_PDUSession\_UpdateSMContext Response.

20a. [Conditional] SMF to new UPF (intermediate): N4 Session Modification Request.

If forwarding tunnel has been established to the new I-UPF and if the timer SMF set for forwarding tunnel at step 8a has expired, SMF sends N4 Session modification request to new (intermediate) UPF acting as N3 terminating point to release the forwarding tunnel.

20b. [Conditional] new UPF (intermediate) to SMF: N4 Session modification response.

New (intermediate) UPF acting as N3 terminating point sends N4 Session Modification response to SMF.

21a. [Conditional] SMF to UPF (PSA): N4 Session Modification Request.

If forwarding tunnel has been established to the UPF (PSA) and if the timer SMF set for forwarding tunnel at step 7b has expired, SMF sends N4 Session modification request to UPF (PSA) acting as N3 Terminating Point to release the forwarding tunnel.

21b. [Conditional] UPF (PSA) to SMF: N4 Session Modification Response.

UPF (PSA) acting as N3 Terminating Point sends N4 Session Modification Response to SMF.

22a. [Conditional] SMF to old UPF: N4 Session Modification Request or N4 Session Release Request.

If the SMF decided to continue using the old UPF in step 5b, the SMF sends an N4 Session Modification Request, providing AN Tunnel Info.

If the SMF decided to select a new UPF to act as intermediate UPF in step 5b, and the old UPF is not PSA UPF, the SMF initiates resource release, after timer in step 6b or 7b expires, by sending an N4 Session Release Request (Release Cause) to the old intermediate UPF.

22b. Old intermediate UPF to SMF: N4 Session Modification Response or N4 Session Release Response.

The old UPF acknowledges with an N4 Session Modification Response or N4 Session Release Response message to confirm the modification or release of resources.

For the mobility related events described in clause 4.15.4, the AMF invokes the Namf\_EventExposure\_Notify service operation after step 4.

Upon reception of the Namf\_EventExposure\_Notify with an indication that the UE is reachable, if the SMF has pending DL data the SMF invokes the Namf\_Communication\_N1N2MessageTransfer service operation to the AMF to establish the User Plane(s) for the PDU Sessions, otherwise the SMF resumes sending DL data notifications to the AMF in case of DL data.

Upon reception of the Namf\_EventExposure\_Notify with an indication that UE is reachable only for regulatory prioritized service, the SMF deactivates the PDU Session if the service of the PDU Session is not regulatory prioritized. For home routed roaming case, the V-SMF triggers the deactivation of the PDU Session, in addition, the H-SMF refrains from sending downlink signalling if the signalling is not related to regulatory prioritized service upon receiving the notification.

#### 4.2.3.3 Network Triggered Service Request

This procedure is used when the network needs to signal (e.g. N1 signalling to UE, Mobile-terminated SMS, User Plane connection activation for PDU Session(s) to deliver mobile terminating user data) with a UE. When the procedure is

triggered by SMSF, PCF, LMF, GMLC, NEF or UDM, the SMF in the following figure should be replaced by the respective NF. If the UE is in CM-IDLE state or CM-CONNECTED state in 3GPP access, the network initiates a Network Triggered Service Request procedure. If the UE is in CM-IDLE state, and asynchronous type communication is not activated, the network sends a Paging Request to (R)AN/UE. The Paging Request triggers the UE Triggered Service Request procedure in the UE. If asynchronous type communication is activated, the network stores the received message and forward the message to the (R)AN and/or the UE (i.e. synchronizes the context with the (R)AN and/or the UE) when the UE enters CM-CONNECTED state.

If the UE is in CM-IDLE state in non-3GPP access and if the UE is simultaneously registered over 3GPP and non-3GPP accesses in a PLMN, the network shall initiate a Network Triggered Service Request procedure over 3GPP access.

If the UE is in CM-IDLE state in 3GPP access and in CM-CONNECTED state in non-3GPP access, and if the UE is simultaneously registered over 3GPP and non-3GPP accesses in the same PLMN, the network may initiate a Network Triggered Service Request procedure for 3GPP access via non-3GPP access.

For this procedure, the impacted SMF and UPF are all under control of the PLMN serving the UE, e.g. in Home Routed roaming case the SMF and UPF in HPLMN are not involved.

The procedure below covers the following non exhaustive list of use-cases for 3GPP access (detailed conditions of when the steps apply are stated in the procedure below):

- The SMF needs to setup N3 tunnel to deliver downlink packet to the UE for a PDU Session and the UE is in CM-IDLE state: Step 3a contains an N2 message and Step 4b (paging) is performed.
- The SMF needs to setup N3 tunnel to deliver downlink packet to the UE for a PDU Session and the UE is in CM-CONNECTED state: Step 3a contains an N2 message and Step 4a (UP reactivation) is performed.
- NF (e.g. SMF, SMSF, PCF or LMF) needs to send an N1 message to the UE, using the Namf\_Communication\_N1N2MessageTransfer service operation, and the UE is in CM-IDLE state: Step 3a contains an N1 message, Step 3b contains cause "Attempting to reach UE", and Step 4b (paging) occurs.
- The LMF triggers AMF, using the Namf\_Communication\_N1N2MessageTransfer service operation, to setup a NAS connection with the UE and the UE is in CM-IDLE state: Step 3b contains cause "Attempting to reach UE", and step 4b (paging) occurs.
- The GMLC triggers AMF, using the Namf\_Location\_ProvideLocation service operation, to setup a NAS connection with the UE and the UE is in CM-IDLE state: Step 4b (paging) occurs.
- The PCF needs to send a message to the UE, using the Npcf\_AMPolicyControl\_Create Response service operation, or the Npcf\_AMPolicyControl\_UpdateNotify service operation and the UE is in CM-IDLE state: Step 3a contains a message, and step 4b (paging) occurs.
- NF (e.g. SMSF) triggers AMF, using the Namf\_MT\_EnableUEReachability service operation, to setup a NAS connection with the UE and the UE is in CM-IDLE state: The trigger is specific to the procedure and Step 4b (paging) occurs.

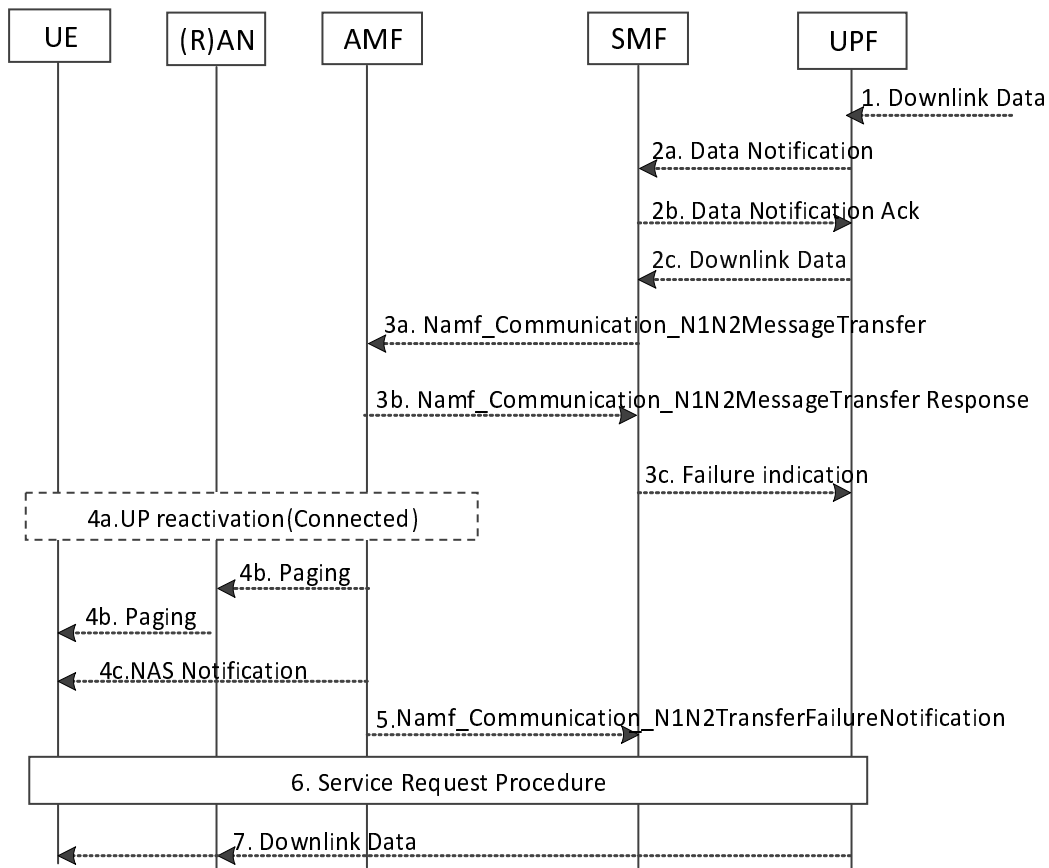

**Figure 4.2.3.3-1: Network Triggered Service Request**

1. When a UPF receives downlink data for a PDU Session and there is no AN Tunnel Info stored in UPF for the PDU Session, based on the instruction from the SMF (as described in TS 23.501 [2], clause 5.8.3), the UPF may buffer the downlink data (steps 2a and 2b), or forward the downlink data to the SMF (step 2c).
- 2a. UPF to SMF: Data Notification (N4 Session ID, Information to identify the QoS Flow for the DL data packet, DSCP).
  - On arrival of the first downlink data packet for any QoS Flow, the UPF shall send Data Notification message to the SMF, if the SMF has not previously notified the UPF to not send the Data Notification to the SMF (in which case the next steps are skipped).
  - If the UPF receives downlink data packets for another QoS Flow in the same PDU Session, the UPF shall send another Data Notification message to the SMF.
  - If the Paging Policy Differentiation feature (as specified in TS 23.501 [2] clause 5.4.3) is supported by the UPF and if the PDU Session type is IP, the UPF shall also include the DSCP in TOS (IPv4) / TC (IPv6) value from the IP header of the downlink data packet and the information to identify the QoS Flow for the DL data packet.
- 2b. SMF to UPF: Data Notification Ack.
- 2c. The UPF forwards the downlink data packets towards the SMF if the SMF instructed the UPF to do so (i.e. the SMF will buffer the data packets).
  - If the Paging Policy Differentiation feature is supported by the SMF and if the PDU Session type is IP, the SMF determines the Paging Policy Indicator based on the DSCP in TOS (IPv4) / TC (IPv6) value from the IP header of the received downlink data packet and identifies the corresponding QoS Flow from the QFI of the received DL data packet.
- 3a. [Conditional] SMF to AMF: Namf\_Communication\_N1N2MessageTransfer (SUPI, PDU Session ID, N1 SM container (SM message), N2 SM information (QFI(s), QoS profile(s), CN N3 Tunnel Info, S-NSSAI), Area of

validity for N2 SM information, ARP, Paging Policy Indicator, 5QI, N1N2TransferFailure Notification Target Address), or NF to AMF: Namf\_Communication\_N1N2MessageTransfer (SUPI, N1 message).

The SMF shall not include both N1 SM Container and N2 SM Information in Namf\_Communication\_N1N2MessageTransfer unless the N1 SM Container is related to the N2 SM Information.

If this step is triggered by a notification from UPF, upon reception of a Data Notification message, for a PDU Session corresponding to a LADN, the SMF takes actions as specified in TS 23.501 [2], clause 5.6.5. The SMF may notify the UPF that originated the Data Notification to discard downlink data for the PDU Sessions and/or to not provide further Data Notification messages.

Otherwise, the SMF determines whether to contact the AMF. The SMF does not contact the AMF:

- if the SMF had previously been notified that the UE is unreachable; or
- if the UE is reachable only for regulatory prioritized service and the PDU Session is not for regulatory prioritized service.

The SMF determines the AMF and invokes the Namf\_Communication\_N1N2MessageTransfer to the AMF including the PDU Session ID of the PDU Session. In case this step is triggered by a notification from the UPF in step 2a, the SMF determines the PDU Session ID based on the N4 Session ID received in step 2a.

If the SMF, while waiting for the User Plane Connection to be activated, receives any additional Data Notification message or, in the case that the SMF buffers the data packets, additional data packets for a QoS Flow associated with a higher priority (i.e. ARP priority level) than the priority indicated to the AMF in the previous Namf\_Communication\_N1N2MessageTransfer, or the SMF derive a different Paging Policy Indicator according to the additional Data Notification or the DSCP of the data packet, the SMF invokes a new Namf\_Communication\_N1N2MessageTransfer indicating the higher priority or different Paging Policy Indicator to the AMF.

If the SMF, while waiting for the User Plane to be activated, receives a message from a new AMF other than the one to which the SMF invoked the Namf\_Communication\_N1N2MessageTransfer, the SMF re-invokes the Namf\_Communication\_N1N2MessageTransfer towards the new AMF.

When supporting Paging Policy Differentiation, the SMF determines the Paging Policy Indicator related to the downlink data that has been received from the UPF or triggered the Data Notification message, based on the DSCP as described in TS 23.501 [2] clause 5.4.3, and indicates the Paging Policy Indicator in the Namf\_Communication\_N1N2MessageTransfer.

NOTE 1: AMF may receive request message(s) from other network functions which leads to signalling towards UE/RAN, e.g. Network-initiated Deregistration, SMF initiated PDU Session Modification. If the UE is in CM-CONNECTED state and the AMF only delivers N1 message towards UE, the flow continues in step 6 below.

The N2 SM information is optional and is not provided e.g. in case the SMF only wants to send an N1 message such as PDU Session Modification Command with only updating the UE with a PCO.

3b. [conditional] The AMF responds to the SMF.

If the UE is in CM-IDLE state at the AMF, and the AMF is able to page the UE the AMF sends a Namf\_Communication\_N1N2MessageTransfer response to the SMF immediately with a cause "Attempting to reach UE" which indicates to the SMF that the N2 SM information provided in step 3a, may be ignored by the AMF once the UE is reachable and the SMF may be asked to provide the N2 SM information again.

While waiting for the UE to respond to a previous paging request, if the AMF receives an Namf\_Communication\_N1N2MessageTransfer Request message with the same or a lower priority than the previous message triggering the paging, or if the AMF has determined not to trigger additional paging requests for this UE based on local policy, the AMF rejects the Namf\_Communication\_N1N2MessageTransfer Request message.

If the UE is in CM-CONNECTED state at the AMF then the AMF sends a Namf\_Communication\_N1N2MessageTransfer response to the SMF immediately with a cause "N1/N2 transfer success".

If the UE is in CM-IDLE state, and the AMF determines that the UE is not reachable for paging, the AMF shall send an `Namf_Communication_N1N2MessageTransfer` response to the NF from which AMF received the request message in step 3a, or the AMF performs asynchronous type communication and stores the UE context based on the received message. If asynchronous type communication is invoked, the AMF initiates communication with the UE and (R)AN when the UE is reachable e.g. when the UE enters CM-CONNECTED state.

If the AMF has determined the UE is unreachable for the SMF (e.g., due to the UE in MICO mode or the UE is only registered over non-3GPP access and its state is CM-IDLE), then the AMF rejects the request from the SMF. The AMF may include in the reject message an indication that the SMF need not trigger the `Namf_Communication_N1N2MessageTransfer` Request to the AMF, if the SMF has not subscribed to the event of the UE reachability. The AMF stores an indication that the SMF has been informed that the UE is unreachable.

If the UE is not in MICO mode and the AMF detects the UE is in a Non-Allowed Area unless the request from the SMF is for regulatory prioritized service, the AMF rejects the request from the SMF and notifies the SMF that the UE is reachable only for regulatory prioritized service. The AMF stores an indication that the SMF has been informed that the UE is reachable only for regulatory prioritized service.

If the Registration procedure with AMF change is in progress when the old AMF receives the `Namf_Communication_N1N2MessageTransfer`, the old AMF may reject the request with an indication that the `Namf_Communication_N1N2MessageTransfer` has been temporarily rejected.

Upon reception of an `Namf_Communication_N1N2MessageTransfer` response with an indication that its request has been temporarily rejected, the SMF shall start a locally configured guard timer and wait for any message to come from an AMF. Upon reception of a message from an AMF, the SMF shall re-invoke the `Namf_Communication_N1N2MessageTransfer` (with N2 SM info and/or N1 SM info) to the AMF from which it received the message. Otherwise the SMF takes the step 3c at expiry of the guard timer. If the SMF decides that the control plane buffering applies, the SMF shall request UPF to start forwarding the downlink data PDU towards the SMF.

### 3c. [Conditional] SMF responds to the UPF

SMF may notify the UPF about the User Plane setup failure.

If the SMF receives an indication from the AMF that the UE is unreachable or reachable only for regulatory prioritized service, the SMF may, based on network policies, either:

- indicate to the UPF to stop sending Data Notifications;
- indicate to the UPF to stop buffering DL data and discard the buffered data;
- indicate to the UPF to stop sending Data Notifications and stop buffering DL data and discard the buffered data; or
- refrains from sending further `Namf_Communication_N1N2MessageTransfer` message for DL data to the AMF while the UE is unreachable.

Based on operator policies, the SMF applies the pause of charging procedure as specified in clause 4.4.4.

If the SMF receives an indication from the AMF that the `Namf_Communication_N1N2MessageTransfer` message requested from an SMF has been temporarily rejected, the SMF may, based on network policies, indicate to the UPF to apply temporary buffering.

4a. [Conditional] If the UE is in CM-CONNECTED state in the access associated with the PDU Session ID received from the SMF in step 3a, the steps 12 to 22 in UE Triggered Service Request procedure (see clause 4.2.3.2) are performed for this PDU Session (i.e. establish the radio resources and, in the case that the User Plane is to be activated, to establish the N3 tunnel) without sending a Paging message to the (R)AN node and the UE. In step 12 of clause 4.2.3.2, the AMF does not send the NAS Service Accept message to the UE. The rest of this procedure is omitted.

4b. [Conditional] If the UE is in CM-IDLE state in 3GPP access and the PDU Session ID received from the SMF in step 3a has been associated with 3GPP access and based on local policy the AMF decides to notify the UE through 3GPP access even when UE is in CM-CONNECTED state for non-3GPP access, the AMF may send a Paging message to NG-RAN node(s) via 3GPP access.

If the UE is simultaneously registered over 3GPP and non-3GPP accesses in the same PLMN, the UE is in CM-IDLE state in both 3GPP access and non-3GPP access, and the PDU Session ID in step 3a is associated with non-3GPP access, the AMF sends a Paging message with associated access "non-3GPP" to NG-RAN node(s) via 3GPP access.

If the UE is in RM-REGISTERED state and CM-IDLE and reachable in 3GPP access, the AMF sends a Paging message (NAS ID for paging, Registration Area list, Paging DRX length, Paging Priority, access associated to the PDU Session) to (R)AN node(s) belonging to the Registration Area(s) in which the UE is registered, then the NG-RAN node pages the UE, including the access associated to the PDU Session in the paging message if received from the AMF, see TS 38.331 [12].

NOTE 2: The usage of the Access associated with a PDU Session when paging an UE is defined in TS 23.501 [2] clause 5.6.8.

Different paging strategies may be configured in the AMF for different combinations of DNN, Paging Policy Indicator (if supported), ARP and 5QI.

For RRC-inactive state, the paging strategies may be configured in the (R)AN for different combinations of Paging Policy Indicator, ARP and 5QI.

Paging Priority is included only:

- if the AMF receives an `Namf_Communication_N1N2MessageTransfer` message with an ARP value associated with priority services (e.g., MPS, MCS), as configured by the operator.
- One Paging Priority level can be used for multiple ARP values. The mapping of ARP values to Paging Priority level (or levels) is configured by operator policy in the AMF and in NG-RAN.

The (R)AN may prioritise the paging of UEs according to the Paging Priority.

If the AMF, while waiting for a UE response to the Paging Request message sent without Paging Priority, receives an `Namf_Communication_N1N2MessageTransfer` message, which indicates an ARP value associated with priority services (e.g., MPS, MCS), as configured by the operator, the AMF shall send another paging message with the suitable Paging Priority. For subsequent received `Namf_Communication_N1N2MessageTransfer` messages with the same or higher priority, the AMF may determine whether to send the Paging message with suitable Paging Priority based on local policy.

Paging strategies may include:

- paging retransmission scheme (e.g. how frequently the paging is repeated or with what time interval);
- determining whether to send the Paging message to the (R)AN nodes during certain AMF high load conditions;
- whether to apply sub-area based paging (e.g. first page in the last known cell-id or TA and retransmission in all registered TAs).

NOTE 3: Setting of Paging Priority in the Paging message is independent from any paging strategy.

The AMF and the (R)AN may support further paging optimisations in order to reduce the signalling load and the network resources used to successfully page a UE by one or several of the following means:

- by the AMF implementing specific paging strategies (e.g. the N2 Paging message is sent to the (R)AN nodes that served the UE last);
- by the AMF considering Information On Recommended Cells And NG-RAN nodes provided by the (R)AN at transition to CM-IDLE state. The AMF takes the (R)AN nodes related part of this information into account to determine the (R)AN nodes to be paged, and provides the information on recommended cells within the N2 Paging message to each of these (R)AN nodes;
- by the (R)AN considering the Paging Attempt Count Information provided by the AMF at paging.

If the UE Radio Capability for Paging Information is available in the AMF, the AMF adds the UE Radio Capability for Paging Information in the N2 Paging message to the (R)AN nodes.



If the Information On Recommended Cells And (R)AN nodes For Paging is available in the AMF, the AMF shall take that information into account to determine the (R)AN nodes for paging and, when paging a (R)AN node, the AMF may transparently convey the information on recommended cells to the (R)AN node.

The AMF may include in the N2 Paging message(s) the paging attempt count information. The paging attempt count information shall be the same for all (R)AN nodes selected by the AMF for paging.

- 4c. [Conditional] If the UE is simultaneously registered over 3GPP and non-3GPP accesses in the same PLMN, and the UE is in CM-CONNECTED state in 3GPP access and the PDU Session ID in step 3a is associated with non-3GPP access, the AMF sends a NAS Notification message containing the non-3GPP Access Type to the UE over 3GPP access and sets a Notification timer. Step 5 is omitted.

If the UE is simultaneously registered over 3GPP and non-3GPP accesses in the same PLMN, and the UE is in CM-CONNECTED state for non-3GPP access and in CM-IDLE for 3GPP access, and if the PDU Session ID in step 3a is associated with 3GPP access, and based on local policy the AMF decides to notify the UE through non-3GPP access, the AMF may send a NAS Notification message containing the 3GPP Access Type to the UE over non-3GPP access and sets a Notification timer.

5. [Conditional] AMF to SMF: Namf\_Communication\_N1N2Transfer Failure Notification.

The AMF supervises the paging procedure with a timer. If the AMF receives no response from the UE to the Paging Request message, the AMF may apply further paging according to any applicable paging strategy described in step 4b.

The AMF notifies the SMF by sending Namf\_Communications\_N1N2MessageTransfer Failure Notification to the Notification Target Address provided by the SMF in step 3a if the UE does not respond to paging, unless the AMF is aware of an ongoing MM procedure that prevents the UE from responding, i.e. the AMF receives an N14 Context Request message indicating that the UE performs Registration procedure with another AMF.

When a Namf\_Communication\_N1N2Transfer Failure Notification is received, SMF informs the UPF (if applicable).

Procedure for pause of charging at SMF is specified in clause 4.4.4.

6. If the UE is in CM-IDLE state in 3GPP access, upon reception of paging request for a PDU Session associated to 3GPP access, the UE shall initiate the UE Triggered Service Request procedure (clause 4.2.3.2). In step 4 of clause 4.2.3.2, the AMF invokes Nsmf\_PDUSession\_UpdateSMContext request to the SMF(s) associated with the PDU Session identified in Service Request message if there is any, except for the PDU Session ID included in the Namf\_Communication\_N1N2MessageTransfer in step 3a. To support the buffered data forwarding, the SMF instructs the UPF to establish a Data forwarding tunnel between the old UPF and the new UPF or to the PSA as described at steps 6a, 7a, 8a of clause 4.2.3.2.

If the UE is in CM-IDLE state in both non-3GPP and 3GPP accesses, upon reception of paging request for a PDU Session associated to non-3GPP access, the UE shall initiate the UE Triggered Service Request procedure (clause 4.2.3.2) which shall contain the List Of Allowed PDU Sessions that, according to UE policies and whether the S-NSSAIs of these PDU Sessions are within the Allowed NSSAI for 3GPP access, can be re-activated over the 3GPP access. If there is no PDU Session that can be re-activated over the 3GPP access, the UE includes an empty List Of Allowed PDU Sessions. If the AMF receives a Service Request message from the UE via non-3GPP access as described in clause 4.12.4.1 (e.g. because the UE successfully connects to a non-3GPP access), the AMF stops the paging procedure and processes the received Service Request procedure. If the AMF receives the Service Request message and the List Of Allowed PDU Sessions provided by the UE does not include the PDU Session for which the UE was paged, the AMF notifies the SMF that the UE was reachable but did not accept to re-activate the PDU Session by invoking Namf\_EventExposure\_Notify service as described in step 4 of clause 4.2.3.2.

If the UE is in CM-IDLE state in non-3GPP access and in CM-CONNECTED state in 3GPP access, upon reception of NAS Notification message over 3GPP access containing the non-3GPP Access Type, the UE shall initiate the UE Triggered Service Request procedure (clause 4.2.3.2) with the List Of Allowed PDU Sessions that, according to UE policies and whether the S-NSSAIs of these PDU Sessions are within the Allowed NSSAI for 3GPP access, can be re-activated over the 3GPP access. If there is no PDU Session that can be re-activated over the 3GPP access, the UE include an empty List Of Allowed PDU Sessions. When the AMF receives the Service Request message and the List of Allowed PDU Sessions provided by the UE does not include the PDU Session for which the UE was notified, the AMF notifies the SMF that the UE was reachable but did not accept to re-activate the PDU Session by invoking Namf\_EventExposure\_Notify service. If the AMF receives a Service

Request message from the UE via non-3GPP access as described in clause 4.12.4.1 (e.g. because the UE successfully connects to a non-3GPP access), the AMF stops the Notification timer and processes the received Service Request procedure.

If the UE is in CM-IDLE state in 3GPP access and in CM-CONNECTED state in non-3GPP access, upon reception of NAS Notification message over non-3GPP access identifying the 3GPP access type, the UE shall initiate the UE triggered Service Request procedure (clause 4.2.3.2) over the 3GPP access when 3GPP access is available. If the AMF does not receive the Service Request message before Notification timer expires, the AMF may either page the UE through 3GPP access or notify the SMF that the UE was not able to re-activate the PDU Session.

7. The UPF transmits the buffered downlink data toward UE via (R)AN node which performed the Service Request procedure.

The network also sends downlink signalling to the UE if the procedure is triggered due to request from other NFs, as described in step 3a.

## 4.2.4 UE Configuration Update

### 4.2.4.1 General

UE configuration may be updated by the network at any time using UE Configuration Update procedure. UE configuration includes:

- Access and Mobility Management related parameters decided and provided by the AMF. This includes the Configured NSSAI and its mapping to the Subscribed S-NSSAIs, the Allowed NSSAI and its mapping to Subscribed S-NSSAIs.
- UE Policy provided by the PCF.

When AMF wants to change the UE configuration for access and mobility management related parameters the AMF initiates the procedure defined in clause 4.2.4.2. When the PCF wants to change or provide new UE Policies in the UE, the PCF initiates the procedure defined in clause 4.2.4.3.

If the UE Configuration Update procedure requires the UE to initiate a Registration procedure, the AMF indicates this to the UE explicitly.

### 4.2.4.2 UE Configuration Update procedure for access and mobility management related parameters

This procedure is initiated by the AMF when the AMF wants to update access and mobility management related parameters in the UE configuration.

This procedure is also used to trigger UE to perform, based on network indication, either Mobility Registration Update procedure while the UE is in CM-CONNECTED state to modify NAS parameters that require negotiation (e.g. MICO mode) or Mobility Registration Update procedure after the UE enters CM-IDLE state (e.g. for changes to Allowed NSSAI that require re-registration). If a Registration procedure is needed, the AMF provides an indication to the UE to initiate a Registration procedure.

UE Configuration Update shall be sent over the Access Type (i.e. 3GPP access or non-3GPP access) the UE Configuration Update is applied to, when applicable. If the AMF wants to update NAS parameters in the UE which require UE acknowledgement, then the AMF provides an indication to the UE of whether the UE shall acknowledge the command or not. The AMF should not request acknowledgement of the NITZ command. The AMF shall request acknowledgement for NSSAI information (e.g. Allowed NSSAI), 5G-GUTI, TAI List, and Mobility Restrictions, LADN Information, MICO, Operator-defined access category definitions and SMS subscription.

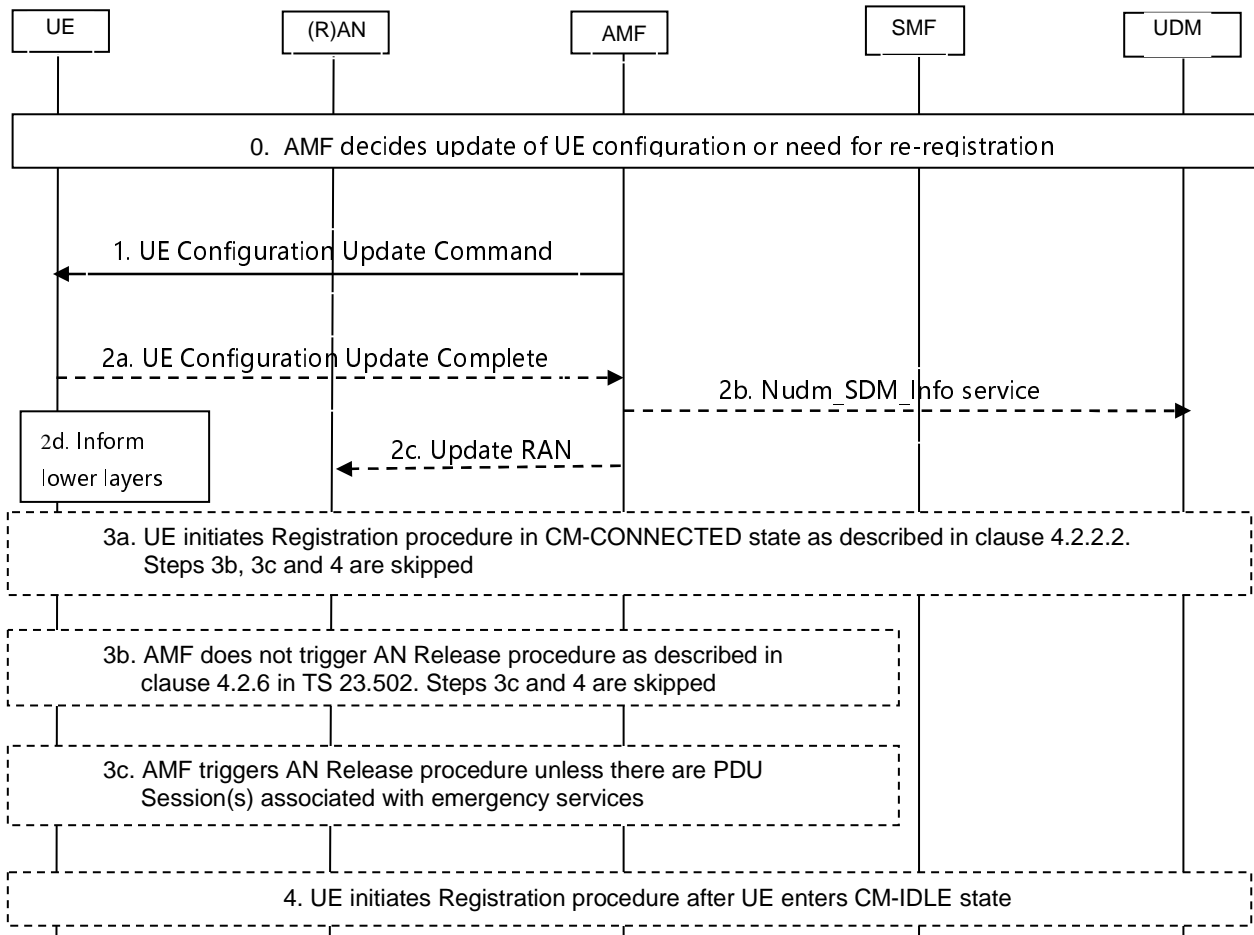

**Figure 4.2.4.2-1: UE Configuration Update procedure for access and mobility management related parameters**

0. AMF determines the necessity of UE configuration change due to various reasons (e.g. UE mobility change, NW policy, reception of Subscriber Data Update Notification from UDM, change of Network Slice configuration) or that the UE needs to perform a Registration Procedure. If a UE is in CM-IDLE, the AMF can wait until the UE is in CM-CONNECTED state or triggers Network Triggered Service Request (in clause 4.2.3.3).

NOTE 1: It is up to the network implementation whether the AMF can wait until the UE is in CM-CONNECTED state or trigger the Network Triggered Service Request.

NOTE 2: The AMF can check whether Network Slice configuration needs to be updated by using the Nssf\_NSSelection\_Get service operation and in such case the AMF compares the stored information with the output from the NSSF to decide whether an update of the UE is required.

The AMF may include Mobility Restriction List in N2 message that delivers UE Configuration Update Command to the UE if the service area restriction for the UE is updated.

1. The AMF sends UE Configuration Update Command containing one or more UE parameters (Configuration Update Indication, 5G-GUTI, TAI List, Allowed NSSAI, Mapping Of Allowed NSSAI, Configured NSSAI for the Serving PLMN, Mapping Of Configured NSSAI, rejected S-NSSAIs, NITZ, Mobility Restrictions, LADN Information, MICO, Operator-defined access category definitions, SMS Subscribed Indication) to UE. Optionally, the AMF may update the rejected S-NSSAIs in the UE Configuration Update command.

The AMF includes one or more of 5G-GUTI, TAI List, Allowed NSSAI, Mapping Of Allowed NSSAI, Configured NSSAI for the Serving PLMN, Mapping Of Configured NSSAI, rejected S-NSSAIs, NITZ (Network Identity and Time Zone), Mobility Restrictions parameters, LADN Information, Operator-defined access category definitions or SMS Subscribed Indication if the AMF wants to update these NAS parameters without triggering a UE Registration procedure.

The AMF may include in the UE Configuration Update Command also Configuration Update Indication parameters indicating whether:

- Network Slicing Subscription Change has occurred;
- the UE shall acknowledge the command; and
- whether a Registration procedure is requested.

If the AMF indicates Network Slicing Subscription Change, then the UE shall locally erase all the network slicing configuration for all PLMNs and, if applicable, update the configuration for the current PLMN based on any received information. If the AMF indicates Network Slicing Subscription Change, the UE shall also be requested to acknowledge in step 2.

- 2a. If the UE Configuration Update Indication requires acknowledgement of the UE Configuration Update Command, then the UE shall send a UE Configuration Update complete message to the AMF. The AMF should request acknowledgement for all UE Configuration Updates, except when only NITZ is provided. If Registration procedure is not required, steps 3a, 3b, 3c and step 4 are skipped. If the Configuration Update Indication is included in the UE Configuration Update Command message, and it requires a Registration procedure, depending on the other NAS parameters included in the UE Configuration Update command, the UE shall execute steps 3a or 3b or 3c+4 as applicable.
- 2b. [Conditional] The AMF also uses the Nudm\_SDM\_Info service operation to provide an acknowledgment to UDM that the UE received the Network Slicing Subscription Change Indication (if this was indicated in step 1) and acted upon it.
- 2c. [Conditional] If the AMF has reconfigured the 5G-GUTI over 3GPP access, the AMF informs the NG-RAN of the new UE Identity Index Value (derived from the new 5G-GUTI) when the AMF receives the acknowledgement from the UE in step 2a.
- [Conditional] If the UE is registered to the same PLMN via both 3GPP and non-3GPP access and if the AMF has reconfigured the 5G-GUTI over non-3GPP access, and the UE is in CM-CONNECTED state over 3GPP access, then the AMF informs the NG-RAN of the new UE Identity Index Value (derived from the new 5G-GUTI) when the AMF receives the acknowledgement from the UE in step 2a.
- 2d [Conditional] If the UE is configured with a new 5G-GUTI in step 2a via non-3GPP access and the UE is registered to the same PLMN via both 3GPP and non-3GPP access, then the UE passes the new 5G-GUTI to its 3GPP access' lower layers.

If the UE is configured with a new 5G-GUTI in step 2a over the 3GPP access, the UE passes the new 5G-GUTI to its 3GPP access' lower layers.

NOTE 3: Steps 2c and 2d are needed because the NG-RAN may use the RRC Inactive state and a part of the 5G-GUTI is used to calculate the Paging Frame (see TS 38.304 [44] and TS 36.304 [43]). It is assumed that the UE Configuration Update Complete is reliably delivered to the AMF after the 5G-AN has acknowledged its receipt to the UE.

- 3a. If only NAS parameters that can be updated without transition from CM-IDLE are included, e.g. MICO mode, the UE shall initiate a Registration procedure immediately after the acknowledgement to re-negotiate the updated NAS parameter(s) with the network. Steps 3b, 3c and step 4 are skipped.
- 3b. If a new Allowed NSSAI and/or a new Mapping Of Allowed NSSAI and/or a new Configured NSSAI provided by the AMF to the UE does not affect the existing connectivity to slices (i.e. any S-NSSAI(s) the UE is connected to), the AMF needs not release the NAS signalling connection for the UE after receiving the acknowledgement in step 2, and immediate registration is not required. The UE can start immediately using the new Allowed NSSAI and/or the new Mapping Of Allowed NSSAI. The UE cannot connect to an S-NSSAI included in the new Configured NSSAI for the Serving PLMN but not included in the new Allowed NSSAI until the UE performs a Registration procedure and includes a Requested NSSAI based on the new Configured NSSAI, following the requirements described in TS 23.501 [2] clause 5.15.5.2. Steps 3c and 4 are skipped.
- 3c. If a new Allowed NSSAI and/or a new Mapping Of Allowed NSSAI and/or a new Configured NSSAI provided by the AMF to the UE affects ongoing existing connectivity to Network Slices, then the AMF also includes in the UE Configuration Update Command message a new Allowed NSSAI with, if available, the associated Mapping Of Allowed NSSAI.

If the AMF cannot determine the new Allowed NSSAI after the Subscribed S-NSSAI(s) are updated, then the AMF does not include in the UE Configuration Update Command message any Allowed NSSAI. The AMF provides an indication that the UE shall initiate a Registration procedure. After receiving the acknowledgement in step 2, the AMF shall release the NAS signalling connection for the UE, unless there is one established PDU Sessions associated with regulatory prioritized services. If there is one established PDU Session associated with regulatory prioritized services, the AMF informs SMFs to release the PDU Session(s) associated with non regulatory prioritized services for this UE (see clause 4.3.4).

The AMF shall reject any NAS Message from the UE carrying PDU Session Establishment Request for a non-emergency PDU Session before the required Registration procedure has been successfully completed by the UE.

4. The UE initiates the appropriate Registration procedure (see clauses 4.2.2.2.2 and 4.13.3.1) after the UE enters CM-IDLE state and does not include the 5G-S-TMSI or GUAMI in Access Stratum signalling. If there is an established PDU Session associated with emergency service and the UE has received an indication to perform the Registration procedure, the UE shall initiate the Registration procedure only after the PDU Session associated with emergency service is released.

NOTE 4: Receiving UE Configuration Update command without an indication requesting to perform re-registration, can still trigger Registration procedure by the UE for other reasons.

#### 4.2.4.3 UE Configuration Update procedure for transparent UE Policy delivery

This procedure is initiated when the PCF wants to update UE access selection and PDU Session selection related policy information (i.e. UE policy) in the UE configuration. In the non-roaming case the V-PCF is not involved and the role of the H-PCF is performed by the PCF. For the roaming scenarios, the V-PCF interacts with the AMF and the H-PCF interacts with the V-PCF.

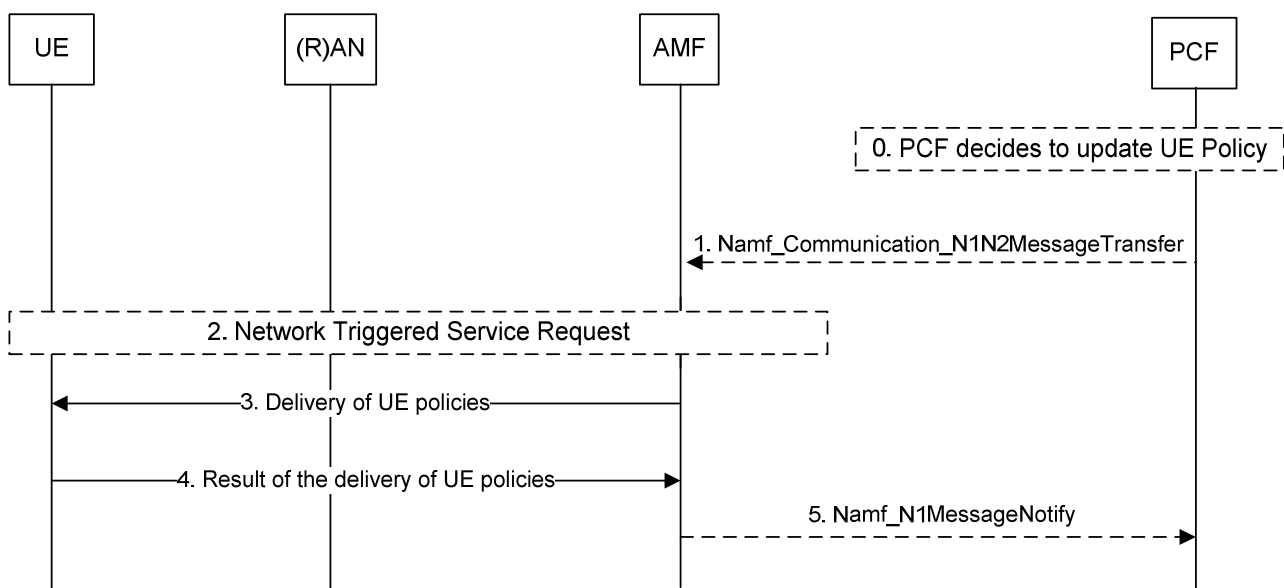

**Figure 4.2.4.3-1: UE Configuration Update procedure for transparent UE Policy delivery**

0. PCF decides to update UE policy procedures based on triggering conditions such as an initial registration, registration with 5GS when the UE moves from EPS to 5GS, or need for updating UE policy as follows:

- For the case of initial registration and registration with 5GS when the UE moves from EPS to 5GS, the PCF compares the list of PSIs included in the UE access selection and PDU session selection related policy information in Npcf\_UEPolicyControl\_Create request and determines whether UE access selection and PDU Session selection related policy information have to be updated and be provided to the UE via the AMF using DL NAS TRANSPORT message; and
- For the network triggered UE policy update case (e.g. the change of UE location, the change of Subscribed S-NSSAIs as described in clause 6.1.2.2.2 of TS 23.503 [20]), the PCF checks the latest list of PSIs to decide which UE access selection and/or PDU Session selection related policies have to be sent to the UE.

The PCF checks if the size of the resulting UE access selection and PDU Session selection related policy information exceeds a predefined limit:

- If the size is under the limit, then UE access selection and PDU Session selection related policy information are included in a single Namf\_Communication\_N1N2MessageTransfer service operation as described below.
- If the size exceeds the predefined limit, the PCF splits the UE access selection and PDU Session selection related policy information in smaller, logically independent UE access selection and PDU Session selection related policy information ensuring the size of each is under the predefined limit. Each UE access selection and PDU Session selection related policy information will be then sent in separated Namf\_Communication\_N1N2MessageTransfer service operations as described below.

NOTE 1: NAS messages from AMF to UE do not exceed the maximum size limit allowed in NG-RAN (PDCP layer), so the predefined size limit in PCF is related to that limitation.

NOTE 2: The mechanism used to split the UE access selection and PDU Session selection related policy information is described in TS 29.507 [32].

1. PCF invokes Namf\_Communication\_N1N2MessageTransfer service operation provided by the AMF. The message includes SUPI, UE Policy Container.
2. If the UE is registered and reachable by AMF in either 3GPP access or non-3GPP access, AMF shall transfers transparently the UE Policy container to the UE via the registered and reachable access.

If the UE is registered in both 3GPP and non-3GPP accesses and reachable on both access and served by the same AMF, the AMF transfers transparently the UE Policy container to the UE via one of the accesses based on the AMF local policy.

If the UE is not reachable by AMF over both 3GPP access and non-3GPP access, the AMF reports to the PCF that the UE Policy container could not be delivered to the UE using Namf\_Communication\_N1N2TransferFailureNotification as in the step 5 in clause 4.2.3.3.

If AMF decides to transfer transparently the UE Policy container to the UE via 3GPP access, e.g. the UE is registered and reachable by AMF in 3GPP access only, or if the UE is registered and reachable by AMF in both 3GPP and non-3GPP accesses served by the same AMF and the AMF decides to transfer transparently the UE Policy container to the UE via 3GPP access based on local policy, and the UE is in CM-IDLE and reachable by AMF in 3GPP access, the AMF starts the paging procedure by sending a Paging message described in the step 4b of Network Triggered Service Request (in clause 4.2.3.3). Upon reception of paging request, the UE shall initiate the UE Triggered Service Request procedure (clause 4.2.3.2).

3. If the UE is in CM-CONNECTED over 3GPP access or non-3GPP access, the AMF transfers transparently the UE Policy container (UE access selection and PDU Session selection related policy information) received from the PCF to the UE. The UE Policy container includes the list of Policy Sections as described in TS 23.503 [20].
4. The UE updates the UE policy provided by the PCF and sends the result to the AMF.
5. If the AMF received the UE Policy container and the PCF subscribed to be notified of the reception of the UE Policy container then the AMF forwards the response of the UE to the PCF using Namf\_N1MessageNotify.

The PCF maintains the latest list of PSIs delivered to the UE and updates the latest list of PSIs in the UDR by invoking Nudr\_DM\_Update (SUPI, Policy Data, Policy Set Entry, updated PSI data) service operation.

## 4.2.5 Reachability procedures

### 4.2.5.1 General

Elements of this procedure are used for UDM/NF initiated UE Reachability Notification requests, e.g. for "SMS over NAS".

The procedure applies to UEs that are in RRC-Idle, RRC-Inactive and RRC-Connected states.

There are two procedures necessary for any service related entity that would need to be notified by the reachability of the UE:

- UE Reachability Notification Request procedure; and

- UE Activity Notification procedure.

#### 4.2.5.2 UE Reachability Notification Request procedure

The UE Reachability Notification Request procedure is illustrated in figure 4.2.5.2-1.

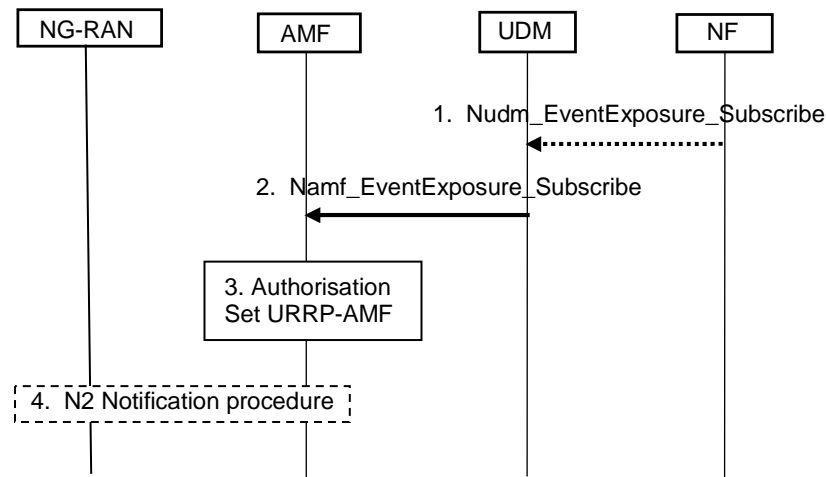

**Figure 4.2.5.2-1: UE Reachability Notification Request Procedure**

1. If a service-related entity requests the UDM to provide an indication regarding UE reachability, the UDM checks whether that service-related entity is authorized to perform this request on this subscriber, by retrieving from the UDR the list of NF IDs for Network Functions authorized by the HPLMN to request notifications on this UE's reachability.

If the entity is not authorized, the UDM may reject the request (e.g. if the requesting entity is recognized as being a valid entity, but not authorized for that subscriber) or discard it silently (e.g. if the requesting entity is not recognized). Appropriate O&M reports are generated.

2. The UDM stores locally the identity of the service-related entity and sets the URRP-AMF flag parameter to indicate that such request is received from an authorised NF. If the value of URRP-AMF flag parameter changes from "not set" to "set", the UDM initiates Namf\_EventExposure\_Subscribe service operation towards the AMF. The UDM may indicate if direct notification to NF shall be used by the AMF.

**NOTE:** The UDM can trigger UE Reachability Notification Request procedure with two different AMFs for a UE which is connected to 5G Core Network over 3GPP access and non-3GPP access simultaneously. Also, for interworking with EPC, the UDM/HSS can trigger UE Reachability Notification Request procedure with MME as described in TS 23.401 [13].

3. The AMF checks that the requesting entity is authorized to perform this request on this subscriber.

If the AMF has an MM Context for that user, the AMF stores the NF ID in the URRP-AMF information, associated with URRP-AMF information flag to indicate the need to report to the UDM or directly to the NF with a UE Activity Notification (see clause 4.2.5.3).

4. [Conditional] If the UE state in AMF is in CM-CONNECTED state and the Access Type is 3GPP access, the AMF initiates N2 Notification procedure (see clause 4.8.3) with reporting type set to Single RRC-Connected state notification.

#### 4.2.5.3 UE Activity Notification procedure

The UE Activity Notification procedure is illustrated in figure 4.2.5.3-1.

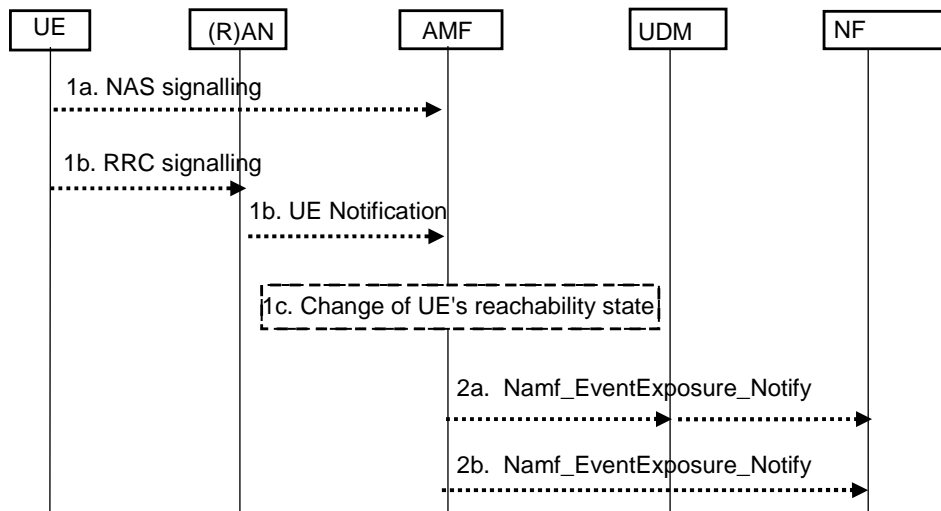

**Figure 4.2.5.3-1: UE Activity Procedure**

- 1a. For a UE in CM-IDLE, the AMF receives (N1) NAS signalling implying UE reachability, e.g. a Registration Request or Service Request message from the UE;
- 1b. For a UE in CM-CONNECTED, if the AMF has initiated the N2 Notification procedure in Step 4 of clause 4.2.5.2 and the AMF receives a (N2) UE Notification (see clause 4.8.3) or a (N2) Path Switch Request (see clause 4.9.1.2) from the NG-RAN. Otherwise (i.e. UE is in CM-CONNECTED and AMF has not initiated N2 Notification procedure), AMF performs step 2; or
- 1c. The UE's reachability state changes from reachable to unreachable, then AMF performs step 2.
2. If the AMF has an MM context for the UE and the URRP-AMF information flag associated with the subscribing NF is set to report once that the UE is reachable, the AMF initiates the `Namf_EventExposure_Notify` service operation (SUPI, UE-Reachable) message to the UDM or directly to the NF (if direct notification is previously indicated to AMF in step 2 in clause 4.2.5.2). The AMF clears the corresponding URRP-AMF information for the UE. If the UE was in CM-IDLE and the UE's reachability state changes from reachable to unreachable, the AMF initiates the `Namf_EventExposure_Notify` service operation (SUPI, UE-UnReachable).
- 2a. When the UDM receives the `Namf_EventExposure_Notify` service operation (SUPI, UE-Reachable) message or `Nudm_UECM_Registration` service for a UE that has URRP-AMF information flag set in the UDM, it triggers appropriate notifications to the NFs associated with the URRP-AMF information flag (e.g. SMSF or SMS-GMSC) that have subscribed to the UDM for this notification. UDM clears the local URRP-AMF information for the UE.
- 2b. When the AMF receives `Namf_EventExposure_Subscribe_service` operation directly from an NF authorised to receive direct notifications, or the UDM indicates that the notification needs to be sent directly to the NF, the AMF initiates the `Namf_EventExposure_Notify` service operation (SUPI, UE-Reachable) message directly to the NF.

## 4.2.6 AN Release

This procedure is used to release the logical NG-AP signalling connection and the associated N3 User Plane connections, and (R)AN RRC signalling and resources.

When the NG-AP signalling connection is lost due to (R)AN or AMF failure, the AN release is performed locally by the AMF or the (R)AN as described in the procedure flow below without using or relying on any of the signalling shown between (R)AN and AMF. The AN release causes all UP connections of the UE to be deactivated.

The initiation of AN release may be due to:

- (R)AN-initiated with cause e.g. O&M Intervention, Unspecified Failure, (R)AN (e.g. Radio) Link Failure, User Inactivity, Inter-System Redirection, request for establishment of QoS Flow for IMS voice, Release due to UE generated signalling connection release, mobility restriction etc.; or
- AMF-initiated with cause e.g. Unspecified Failure, etc.



Both (R)AN-initiated and AMF-initiated AN Release procedures are shown in Figure 4.2.6-1.

For this procedure, the impacted SMF and UPF are all under control of the PLMN serving the UE, e.g. in Home Routed roaming case the SMF and UPF in HPLMN are not involved.

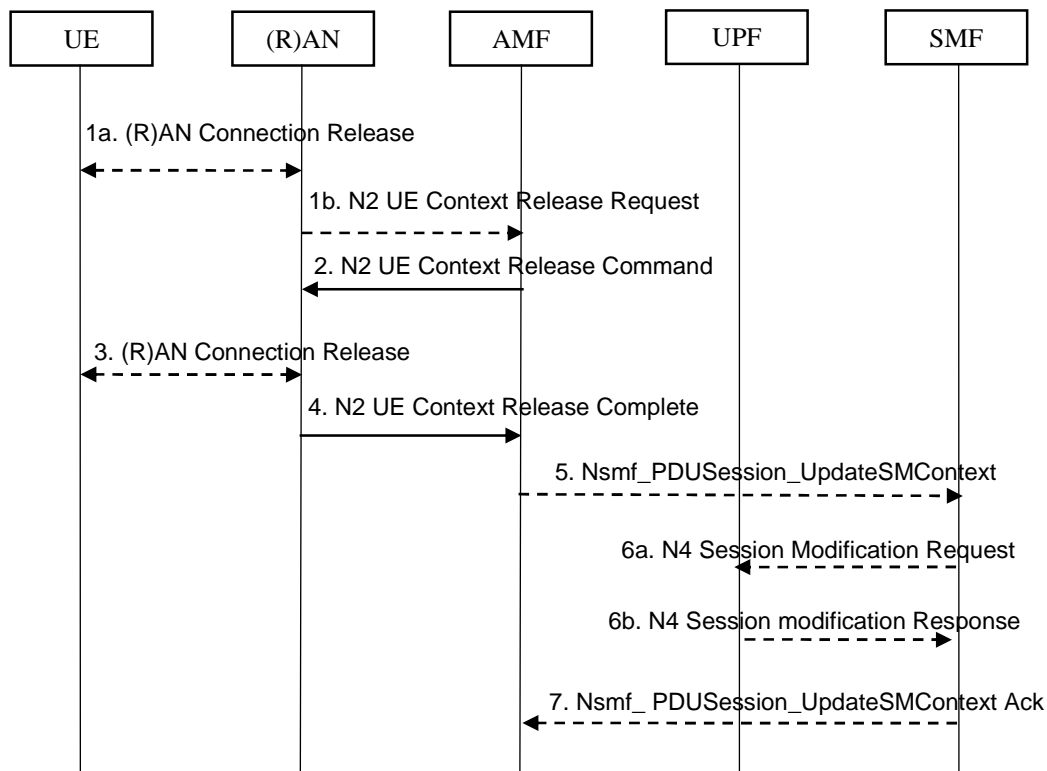

**Figure 4.2.6-1: AN Release procedure**

1. If there is some confirmed (R)AN conditions (e.g. Radio Link Failure) or for other (R)AN internal reason, the (R)AN may decide to initiate the UE context release in the (R)AN. In this case, the (R)AN sends an N2 UE Context Release Request (Cause, List of PDU Session ID(s) with active N3 user plane) message to the AMF. Cause indicates the reason for the release (e.g. AN Link Failure, O&M intervention, unspecified failure, etc.). The List of PDU Session ID(s) indicates the PDU Sessions served by (R)AN of the UE. This step is described in TS 38.413 [10], clause 8.3.2 "UE Context Release Request (gNB initiated)".

2. AMF to (R)AN: If the AMF receives the N2 UE Context Release Request message or due to an internal AMF event, including the reception of Service Request or Registration Request to establish another NAS signalling connection still via NG-RAN, the AMF sends an N2 UE Context Release Command (Cause) to the (R)AN. The Cause indicates either the Cause from (R)AN in step 1 or the Cause due to an AMF event. In case the (R)AN is a NG-RAN this step is described in detail in TS 38.413 [10], clause 8.3.3 "UE Context Release (AMF initiated)". In case the (R)AN is an N3IWF this step is described in clause 4.12.

If the AMF receives Service Request or Registration Request to establish another NAS signalling connection still via NG-RAN, after successfully authenticating the UE, the AMF releases the old NAS signalling connection, and then continues the Service Request or Registration Request procedure.

3. [Conditional] If the (R)AN connection (e.g. RRC connection or NWu connection) with the UE is not already released (step 1), either:
  - a) the (R)AN requests the UE to release the (R)AN connection. Upon receiving (R)AN connection release confirmation from the UE, the (R)AN deletes the UE's context, or
  - b) if the Cause in the N2 UE Context Release Command indicates that the UE has already locally released the RRC connection, the (R)AN locally releases the RRC connection.
4. The (R)AN confirms the N2 Release by returning an N2 UE Context Release Complete (List of PDU Session ID(s) with active N3 user plane, UE Radio Capability, User Location Information, Age of Location Information) message to the AMF. The List of PDU Session ID(s) indicates the PDU Sessions served by (R)AN of the UE.

The AMF stores always the latest UE Radio Capability information received from the NG-RAN node. The N2 signalling connection between the AMF and the (R)AN for that UE is released. The (R)AN provides the list of recommended cells / TAs / NG-RAN node identifiers for paging to the AMF.

If the PLMN has configured secondary RAT usage reporting, the NG-RAN node may provide RAN usage data Report.

This step shall be performed promptly after step 2, i.e. it shall not be delayed, for example, in situations where the UE does not acknowledge the RRC Connection Release.

5. [Conditional] AMF to SMF: For each of the PDU Sessions in the N2 UE Context Release Complete, the AMF invokes Nsmf\_PDUSession\_UpdateSMContext Request (PDU Session ID, PDU Session Deactivation, Cause, Operation Type, User Location Information, Age of Location Information, N2 SM Information (Secondary RAT usage data)). The Cause in step 5 is the same Cause in step 2. If List of PDU Session ID(s) with active N3 user plane is included in step 1b, the step 5 to 7 are performed before step 2. The Operation Type is set to "UP deactivate" to indicate deactivation of user plane resources for the PDU Session.
- 6a [Conditional] SMF to UPF: N4 Session Modification Request (AN or N3 UPF Tunnel Info to be removed, Buffering on/off).

The SMF initiates an N4 Session Modification procedure indicating the need to remove Tunnel Info of AN or UPF terminating N3. Buffering on/off indicates whether the UPF shall buffer incoming DL PDU or not.

If multiple UPFs are used in the PDU Session and the SMF determines to release the UPF terminating N3, step 6a is performed towards the UPF (e.g. PSA) terminating N9 towards the current N3 UPF. The SMF then releases the N4 session towards the N3 UPF (the N4 release is not shown on the call flow).

See clause 4.4 for more details.

If the cause of AN Release is because of User Inactivity, or UE Redirection, the SMF shall preserve the GBR QoS Flows. Otherwise, the SMF shall trigger the PDU Session Modification procedure (see clause 4.3.3) for the GBR QoS Flows of the UE after the AN Release procedure is completed.

- 6b. [Conditional] UPF to SMF: N4 Session Modification Response acknowledging the SMF request.

See clause 4.4 for more details.

7. [Conditional] SMF to AMF: Nsmf\_PDUSession\_UpdateSMContext Response for step 5.

Upon completion of the procedure, the AMF considers the N2 and N3 as released and enters CM-IDLE state.

After completion of the procedure, the AMF reports towards the NF consumers are triggered for cases in clause 4.15.4.

## 4.2.7 N2 procedures

### 4.2.7.1 N2 Configuration

At power up, restart and when modifications are applied, the 5G-AN node and AMF use non-UE related N2 signalling to exchange configuration data. Full details of this configuration data are specified in TS 38.300 [9], but the following highlights some aspects.

The AMF supplies the 5G-AN node with information about:

- a) the AMF Name and the GUAMI(s) configured on that AMF Name;
- b) the set of TNL associations to be established between the NG-RAN node and the AMF;
- c) weight factor associated with each of the TNL association within the AMF; and
- d) weight factor for each AMF Name within the AMF set; and
- e) (optional) for each GUAMI(s) configured on that AMF the corresponding backup AMF Name.

The weight factors are used for load distribution of the initial N2 messages. The AMF chooses whether or not to use the same TNL association for the initial N2 message and subsequent messages for that UE. TNL associations configured

with a weight factor set to zero are not permitted for the initial N2 message, but can be used for subsequent N2 messages.

Deployments that rely solely on 5GC-based load balancing can set the weight factors associated with TNL associations that are permitted for the initial N2 message to the same value.

## 4.2.7.2 NGAP UE-TNLA-binding related procedures

### 4.2.7.2.1 Creating NGAP UE-TNLA-bindings during Registration and Service Request

When a UE connects to the 5GC via a 5G-AN node without a GUAMI or with a GUAMI not associated with the 5G-AN node, the following steps are performed:

1. The 5G-AN node selects an AMF as defined in TS 23.501 [2] clause 6.3.5.
2. The 5G-AN node creates an NGAP UE-TNLA-binding for the UE by selecting a TNL association from the available TNL associations permitted for the initial message e.g. N2 INITIAL UE MESSAGE for the selected AMF, as defined in TS 23.501 [2] clause 5.21.1.3, and forwards the UE message to the AMF via the selected TNL association.
3. The AMF may decide to use the TNL association selected by the 5G-AN or the AMF may modify the NGAP UE-TNLA-binding by triangular redirection.

NOTE 1: This process could take place during the Registration procedure (for Initial Registration, Mobility Registration Update).

4. The AMF may decide to modify the NGAP UE-TNLA-binding toward other 5G-AN nodes such as N3IWF. This is done in case AMF is changed and old AMF have existing NGAP UE-TNLA-bindings toward other 5G-AN nodes.

When a UE connects to the 5GC via a 5G-AN node with a 5G-S-TMSI or GUAMI associated with the AMF usable by the 5G-AN node, the following steps are performed:

1. The 5G-AN node creates an NGAP UE-TNLA-binding for the UE by selecting a TNL association from the available TNL associations permitted for the initial N2 message for the AMF identified by the UE's 5G-S-TMSI or GUAMI.
2. The AMF may decide to use the TNL association selected by the 5G-AN or the AMF may modify the NGAP UE-TNLA-binding by triangular redirection.

NOTE 2: This process could take place during the Registration procedure or Service Request procedure.

### 4.2.7.2.2 Creating NGAP UE-TNLA-bindings during handovers

During an Xn-based inter NG-RAN node handover, the following applies

- If an NGAP UE-TNLA-binding exists for a UE, the source 5G-AN node supplies the target 5G-AN node with the corresponding TNL address of the AMF for the currently used TNL association.
- If the target 5G-AN receives the TNL address of the AMF from the source 5G-AN node, the target 5G-AN node establishes a TNL association towards the TNL address received from the source 5G-AN node, creates an NGAP UE-TNLA-binding to this TNL association and sends the N2 Path Switch Request via this TNL association.
- If the target 5G-AN does not receive the TNL address of the AMF from the source 5G-AN node, the 5G-AN node creates an NGAP UE-TNLA-binding for the UE by selecting a TNL association from the available TNL associations permitted for the initial N2 message for the AMF identified by the UE's GUAMI.
- The AMF may decide to use the TNL association selected by the 5G-AN or the AMF may modify the NGAP UE-TNLA-binding by triangular redirection.

During an inter NG-RAN node handover without Xn interface (i.e. during an N2 handover) the following applies:

- If an NGAP UE-TNLA-binding exists for a UE, the source 5G-AN node sends the N2 Handover Required message using the corresponding TNL address of the AMF.

- Otherwise the 5G-AN node creates an NGAP UE-TNLA-binding for the UE by selecting a TNL association from the available TNL associations permitted for the initial N2 message for the AMF identified by the UE's GUAMI.
- The target AMF selects a TNL association from the available TNL associations for the target 5G-AN node and sends the N2 Handover Request message via this TNL association. The target 5G-AN node creates an NGAP UE-TNLA-binding for the UE based on the TNL association selected by the target AMF.

#### 4.2.7.2.3 Re-Creating NGAP UE-TNLA-bindings subsequent to NGAP UE-TNLA-binding release

If the AMF has released the NGAP UE-TNLA-binding in the 5G-AN node for a UE, and the 5G-AN node needs to send an N2 message for this UE, the following applies:

- The 5G-AN node checks the GUAMI stored in the UE context and the associated AMF:
  - If the GUAMI is available, 5G-AN selects the AMF which owns that GUAMI.
  - If GUAMI has been marked as unavailable (i.e. based on AMF unavailable status indication received from AMF) but one corresponding target AMF has been indicated, 5G-AN selects that target AMF even if the GUAMI has not been updated as available by the target AMF.
  - If GUAMI has been marked as unavailable (i.e. based on AMF unavailable status indication received from AMF) and no corresponding target AMF has been indicated, the 5G-AN selects an AMF from the AMF Set based on AMF Set ID of the GUAMI, as defined in TS 23.501 [2] clause 6.3.5.
- The 5G-AN node creates an NGAP UE-TNLA-binding for the UE by selecting a TNL association from the available TNL associations permitted for the initial N2 message with the selected AMF, as defined in TS 23.501 [2] clause 5.21.1.3, and sends the N2 message to the AMF via the selected TNL association.
- The AMF may decide to use the TNL association selected by the 5G-AN or the AMF may modify the NGAP UE-TNLA-binding by triangular redirection.

If the NGAP UE-TNLA-binding has been released for a UE and the AMF needs to send an N2 message for this UE, the following applies:

- The AMF selects a TNL association from the available TNL associations for the target 5G-AN node and sends the N2 message via this TNL association. The target 5G-AN node creates an NGAP UE-TNLA-binding for the UE based on the TNL association selected by the AMF.

The TNL association chosen by the AMF always takes precedence.

NOTE: This addresses situations where 5G-AN node and AMF select a TNL association for a UE concurrently.

#### 4.2.7.2.4 NGAP UE-TNLA-binding update procedure

At any time the AMF may decide to re-bind the NGAP UE association to a new TNL association either:

- by sending a UE-specific NGAP message on a new TNL association (triangular redirection), or
- by sending a UE-specific NGAP UE-TNLA binding release message to 5G-AN and the 5G-AN node updates the NGAP UE-TNLA binding with the new TNL association.

#### 4.2.7.2.5 NGAP UE-TNLA-binding per UE Release procedure

At any time the AMF may decide to release the NGAP UE-TNLA binding while keeping the UE in CM-CONNECTED state while keeping the corresponding N3 interface. The AMF releases the NGAP UE-TNLA binding by sending a UE-specific NGAP UE-TNLA binding release message on the current TNL association.

If the AMF releases the NGAP UE-TNLA-binding without sending AMF unavailable status indication, then the AN may immediately trigger creation of a new NGAP-UE-TNLA-binding with the same AMF for subsequent N2 messages or may leave the NGAP UE association without NGAP UE-TNLA-binding. In the latter case the new NGAP UE-TNLA-binding is re-created upon the subsequent AN-initiated or AMF-initiated UE-specific N2 signalling as specified in clause 4.2.7.2.3.

If the AMF releases the NGAP UE-TNLA-binding after AMF unavailable status indication, then the AN has to re-create the NGAP-UE-TNLA-binding with a different AMF. The 5G-AN re-creates N2AP UE-TNLA-binding for subsequent N2 messages for the given UE as specified in clause 4.2.7.2.3.

### 4.2.7.3 AMF Failure or Planned Maintenance handling procedure

For UE(s) in CM-CONNECTED state:

- If AMF failure is detected by 5G-AN, all NGAP UE TNLA binding for UEs served by that AMF are released.
- If AMF becomes unavailable due to planned maintenance, the AMF notifies the 5G-AN about the unavailable GUAMI(s) and provides optionally a target AMF Name corresponding to each unavailable GUAMI. The 5G-AN releases all NGAP UE TNLA binding of the UEs related to the indicated unavailable GUAMI(s) unless the notification from the AMF includes an indicator that the AMF will rebind or release the NGAP UE TNLA binding on a per UE-basis. In that case, if 5G-AN supports, the 5G-AN waits the release until the timer expires so that the AMF may release or rebind the N2AP UE-TNLA binding on per UE-basis.
- For the release NGAP TNLA binding, the affected UE is kept in CM-CONNECTED state and the corresponding N3 interface is also kept.

For UE(s) in CM-IDLE state, when it subsequently returns from CM-IDLE state and the 5G-AN receives an initial NAS message with a 5G S-TMSI or GUAMI, the 5G-AN uses 5G S-TMSI or GUAMI to select the target AMF, the 5G-AN forwards N2 message.

## 4.2.8 Void

### 4.2.8a UE Capability Match Request procedure

If the AMF requires more information on the UE radio capabilities support to be able to set the IMS voice over PS Session Supported Indication (see TS 23.501 [2] clause 5.16.3), then the AMF may send a UE Radio Capability Match Request message to the NG-RAN. This procedure is typically used during the registration procedure or when AMF has not received the Voice Support Match Indicator (as part of the 5GMM Context).

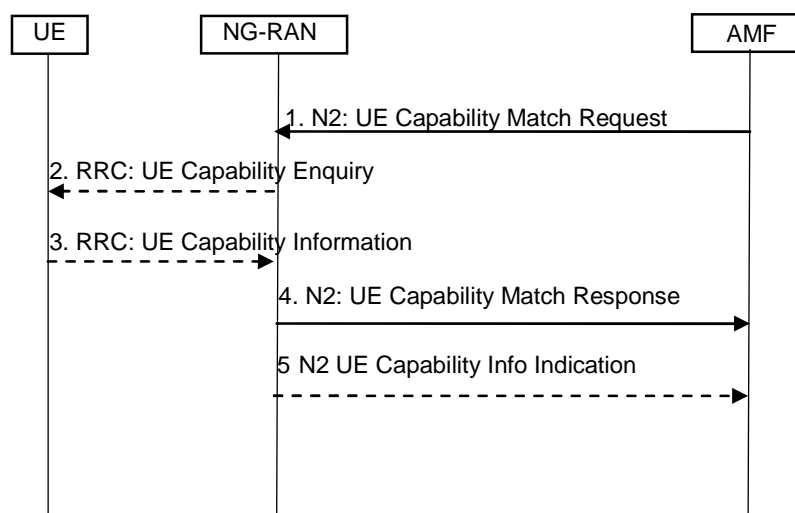

**Figure 4.2.8a-1: UE Capability Match Request**

1. The AMF indicates whether the AMF wants to receive Voice support match indicator. The AMF may include the UE radio capability information it has previously received from NG-RAN.
2. Upon receiving the UE Capability Match Request message, if the NG-RAN has not already received the UE radio capabilities from the UE or from AMF in step 1, the NG-RAN requests the UE to upload the UE radio capability information.

3. The UE provides the NG-RAN with its UE radio capabilities sending the RRC UE Capability Information.
4. The NG-RAN checks whether the UE radio capabilities are compatible with the network configuration for ensuring voice service continuity of voice calls initiated in IMS.

For determining the appropriate UE Radio Capability Match Response, the NG-RAN is configured by the operator to check whether the UE supports certain capabilities required for Voice continuity of voice calls using IMS PS. In a shared network, the NG-RAN keeps a configuration separately per PLMN.

NOTE 1: What checks to perform depends on network configuration, i.e. following are some examples of UE capabilities to be taken into account:

- E-UTRAN/NG-RAN Voice over PS capabilities;
- the Radio capabilities for E-UTRAN/NG-RAN FDD and/or TDD; and/or
- the support of E-UTRAN/NG-RAN frequency bands.

NOTE 2: The network configuration considered in the decision for the Voice Support Match Indicator is homogenous within a certain area (e.g. AMF set) in order to guarantee that the Voice Support Match Indicator from the NG-RAN is valid within such area.

The NG-RAN provides a Voice Support Match Indicator to the AMF to indicate whether the UE capabilities and networks configuration are compatible for ensuring voice service continuity of voice calls initiated in IMS.

The AMF stores the received Voice support match indicator in the 5GMM Context and uses it as an input for setting the IMS voice over PS Session Supported Indication.

5. If NG-RAN requested radio capabilities from UE in step 2 and 3, the NG-RAN also sends the UE radio capabilities to the AMF. The AMF stores the UE radio capabilities without interpreting them for further provision to the NG-RAN according to TS 23.501 [2], clause 5.4.4.1.

NOTE 3: Steps 4 and 5 could be received by the AMF in any order.

## 4.3 Session Management procedures

### 4.3.1 General

Clause 4.3 defines the Session Management related procedures. It refers to clause 4.4 for the N4 interactions.

As defined in 23.501 [2] clause 5.6.3, considering the case of Home Routed PDU Session, the NAS SM information processing by SMF considers following kind of NAS SM information:

- Information that both the V-SMF and H-SMF process: indication of the nature of the NAS SM signalling (e.g. PDU Session Establishment Request), PDU Session Type, Session-AMBR, UE addressing information (allocated IPv4 address, interface identifier).
- Information that is not visible to the V-SMF, only processed by the H-SMF: SSC mode, Protocol Configuration Options, SM PDU DN Request Container, QoS Rule(s) and QoS Flow level QoS parameters if any for the QoS Flow(s) associated with the QoS rule(s).

NOTE 1: "Information that is not visible to the V-SMF" refers to information that the V-SMF is to relay between the UE and the H-SMF (and that it can store in CDR) but that the V-SMF is not assumed to process otherwise.

The NAS SM information processing split between V-SMF and H-SMF is transparent to the UE.

Both V-SMF and H-SMF process information interpreted by the AMF as the PDU Session ID, the DNN, the S-NSSAI (with values for the Serving PLMN and HPLMN processed by the V-SMF, and with a value for the HPLMN processed by the H-SMF).

In the case of Home Routed PDU Session the H-SMF provides also the V-SMF with the IPv6 Prefix allocated to the PDU Session.

NOTE 2: IPv6 Prefix allocated to the PDU Session is provided to allow the V-SMF fulfilling regulatory requirements for data storage in the visited country.

In non roaming and LBO cases the SMF processes all NAS SM information.

In HR roaming scenarios, in order to support SM features only requiring support from the H-SMF without impacting the V-SMF, as specified in detail in TS 29.502 [36]:

- The V-SMF transfers NAS SM information, which is not visible to the V-SMF, in a container towards the H-SMF;
- The V-SMF transfers NAS SM information which it does not comprehend (unknown IEs or IEs with an unknown value not set to "reserved" according to the release to which the V-SMF complies), in a different container towards the H-SMF;
- The H-SMF transfers NAS SM information which the V-SMF does not need to interpret, in one container towards the V-SMF;
- The V-SMF appends unknown NAS SM information received in the N16 container at the end of the NAS SM message it sends to the UE.

## 4.3.2 PDU Session Establishment

### 4.3.2.1 General

A PDU Session establishment may correspond to:

- a UE initiated PDU Session Establishment procedure.
- a UE initiated PDU Session handover between 3GPP and non-3GPP.
- a UE initiated PDU Session handover from EPS to 5GS.
- a Network triggered PDU Session Establishment procedure. In this case the network sends the device trigger message to application(s) on the UE side. The payload included in Device Trigger Request message contains information on which application on the UE side is expected to trigger the PDU Session establishment request. Based on that information, the application(s) on the UE side trigger the PDU Session Establishment procedure. For more detail refer to clause 4.13.2.

If the UE is simultaneously registered to a non-3GPP access via a N3IWF located in a PLMN different from the PLMN of the 3GPP access, the functional entities in the following procedures are located in the PLMN of the access used to exchange NAS with the UE for the PDU Session.

### 4.3.2.2 UE Requested PDU Session Establishment

#### 4.3.2.2.1 Non-roaming and Roaming with Local Breakout

Clause 4.3.2.2.1 specifies PDU Session establishment in the non-roaming and roaming with local breakout cases. The procedure is used to:

- Establish a new PDU Session;
- Handover a PDN Connection in EPS to PDU Session in 5GS without N26 interface;
- Switching an existing PDU Session between non-3GPP access and 3GPP access. The specific system behaviour in this case is further defined in clause 4.9.2; or
- Request a PDU Session for Emergency services.

In case of roaming, the AMF determines if a PDU Session is to be established in LBO or Home Routing. In the case of LBO, the procedure is as in the case of non-roaming with the difference that the AMF, the SMF, the UPF and the PCF are located in the visited network. PDU Sessions for Emergency services are never established in Home Routed mode.

NOTE 1: UE provides both the S-NSSAIs of the Home PLMN and Visited PLMN to the network as described in clause 5.15.5.3 of TS 23.501 [2].

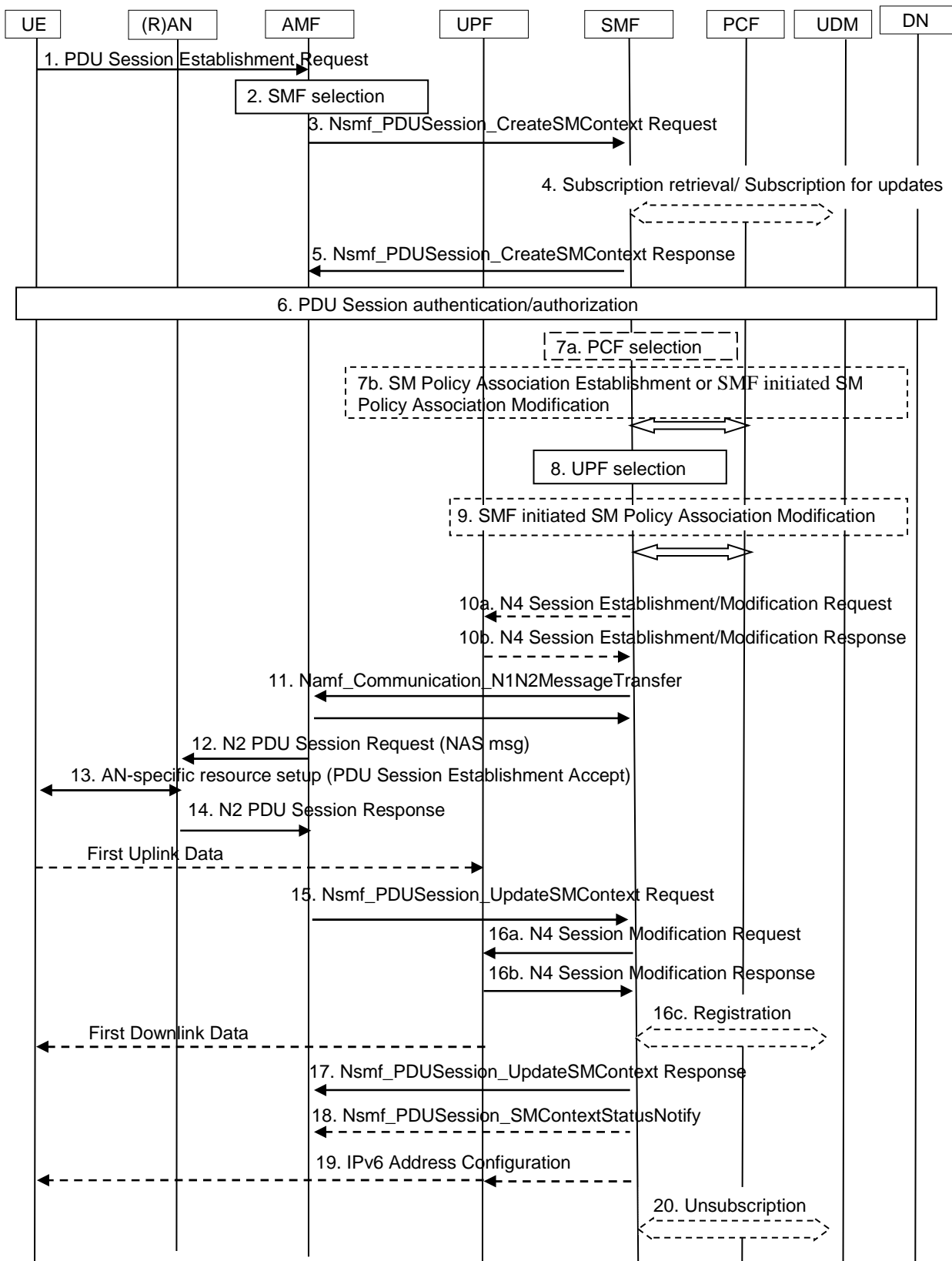

Figure 4.3.2.1-1: UE-requested PDU Session Establishment for non-roaming and roaming with local breakout



The procedure assumes that the UE has already registered on the AMF thus unless the UE is Emergency Registered the AMF has already retrieved the user subscription data from the UDM.

1. From UE to AMF: NAS Message (S-NSSAI(s), DNN, PDU Session ID, Request type, Old PDU Session ID, N1 SM container (PDU Session Establishment Request)).

In order to establish a new PDU Session, the UE generates a new PDU Session ID.

The UE initiates the UE Requested PDU Session Establishment procedure by the transmission of a NAS message containing a PDU Session Establishment Request within the N1 SM container. The PDU Session Establishment Request includes a PDU session ID, Requested PDU Session Type, a Requested SSC mode, 5GSM Capability PCO, SM PDU DN Request Container, Number Of Packet Filters, UE Integrity Protection Maximum Data Rate, and optionally Always-on PDU Session Requested.

The Request Type indicates "Initial request" if the PDU Session Establishment is a request to establish a new PDU Session and indicates "Existing PDU Session" if the request refers to an existing PDU Session switching between 3GPP access and non-3GPP access or to a PDU Session handover from an existing PDN connection in EPC. If the request refers to an existing PDN connection in EPC, the S-NSSAI is set as described in TS 23.501 [2] clause 5.15.7.2

When Emergency service is required and an Emergency PDU Session is not already established, a UE shall initiate the UE Requested PDU Session Establishment procedure with a Request Type indicating "Emergency Request".

The Request Type indicates "Emergency Request" if the PDU Session Establishment is a request to establish a PDU Session for Emergency services. The Request Type indicates "Existing Emergency PDU Session" if the request refers to an existing PDU Session for Emergency services switching between 3GPP access and non-3GPP access or to a PDU Session handover from an existing PDN connection for Emergency services in EPC.

The 5GSM Core Network Capability is provided by the UE and handled by SMF as defined in TS 23.501 [2] clause 5.4.4b.

The Number Of Packet Filters indicates the number of supported packet filters for signalled QoS rules for the PDU Session that is being established. The number of packet filters indicated by the UE is valid for the lifetime of the PDU Session.

The UE Integrity Protection Maximum Data Rate indicates the maximum data rate up to which the UE can support UP integrity protection. The UE shall provide the UE Integrity Protection Data Rate capability independently of the Access Type over which the UE sends the PDU Session Establishment Request.

The NAS message sent by the UE is encapsulated by the AN in a N2 message towards the AMF that should include User location information and Access Type Information.

The PDU Session Establishment Request message may contain SM PDU DN Request Container containing information for the PDU Session authorization by the external DN.

The UE includes the S-NSSAI from the Allowed NSSAI of the current access type. If the Mapping of Allowed NSSAI was provided to the UE, the UE shall provide both the S-NSSAI of the VPLMN from the Allowed NSSAI and the corresponding S-NSSAI of the HPLMN from the Mapping Of Allowed NSSAI.

If the procedure is triggered for SSC mode 3 operation, the UE shall also include the Old PDU Session ID which indicates the PDU Session ID of the on-going PDU Session to be released, in NAS message. The Old PDU Session ID is an optional parameter which is included only in this case.

The AMF receives from the AN the NAS SM message (built in step 1) together with User Location Information (e.g. Cell Id in case of the NG-RAN).

The UE shall not trigger a PDU Session establishment for a PDU Session corresponding to a LADN when the UE is outside the area of availability of the LADN.

If the UE is establishing a PDU session for IMS, and the UE is configured to discover the P-CSCF address during connectivity establishment, the UE shall include an indicator that it requests a P-CSCF IP address(es) within the SM container.

The PS Data Off status is included in the PCO in the PDU Session Establishment Request message.

If the UE requests to establish always-on PDU session, the UE includes an Always-on PDU Session Requested indication in the PDU Session Establishment Request message.

2. The AMF determines that the message corresponds to a request for a new PDU Session based on that Request Type indicates "initial request" and that the PDU Session ID is not used for any existing PDU Session(s) of the UE. If the NAS message does not contain an S-NSSAI, the AMF determines a default S-NSSAI of the HPLMN for the requested PDU Session either according to the UE subscription, if it contains only one default S-NSSAI, or based on operator policy and, in the case of LBO, an S-NSSAI of the Serving PLMN which matches the S-NSSAI of the HPLMN. When the NAS Message contains an S-NSSAI of the Serving PLMN but it does not contain a DNN, the AMF determines the DNN for the requested PDU Session by selecting the default DNN for this S-NSSAI if the default DNN is present in the UE's Subscription Information (or for the corresponding S-NSSAI of the HPLMN, in the case of LBO); otherwise the serving AMF selects a locally configured DNN for this S-NSSAI of the Serving PLMN. If the AMF cannot select an SMF (e.g. the UE provided DNN is not supported by the network, or the UE provided DNN is not in the Subscribed DNN List for the S-NSSAI (or its mapped value for the HPLMN in the case of LBO) and wildcard DNN is not included in the Subscribed DNN list), the AMF shall reject the NAS Message containing PDU Session Establishment Request from the UE with an appropriate cause

The AMF selects an SMF as described in clause 6.3.2 of TS 23.501 [2] and clause 4.3.2.2.3. If the Request Type indicates "Initial request" or the request is due to handover from EPS or from non-3GPP access serving by a different AMF, the AMF stores an association of the S-NSSAI(s), the DNN, the PDU Session ID, the SMF ID as well as the Access Type of the PDU Session.

If the Request Type is "initial request" and if the Old PDU Session ID indicating the existing PDU Session is also contained in the message, the AMF selects an SMF as described in clause 4.3.5.2 and stores an association of the new PDU Session ID, the S-NSSAI(s), the selected SMF ID as well as Access Type of the PDU Session.

If the Request Type indicates "Existing PDU Session", the AMF selects the SMF based on SMF-ID received from UDM. The case where the Request Type indicates "Existing PDU Session", and either the AMF does not recognize the PDU Session ID or the subscription context that the AMF received from UDM during the Registration or Subscription Profile Update Notification procedure does not contain an SMF ID corresponding to the PDU Session ID constitutes an error case. The AMF updates the Access Type stored for the PDU Session.

If the Request Type indicates "Existing PDU Session" referring to an existing PDU Session moved between 3GPP access and non-3GPP access, then if the Serving PLMN S-NSSAI of the PDU Session is present in the Allowed NSSAI of the target access type, the PDU Session Establishment procedure can be performed in the following cases:

- the SMF ID corresponding to the PDU Session ID and the AMF belong to the same PLMN;
- the SMF ID corresponding to the PDU Session ID belongs to the HPLMN;

Otherwise the AMF shall reject the PDU Session Establishment Request with an appropriate reject cause.

NOTE 2: The SMF ID includes the PLMN ID that the SMF belongs to.

The AMF shall reject a request coming from an Emergency Registered UE and the Request Type indicates neither "Emergency Request" nor "Existing Emergency PDU Session". When the Request Type indicates "Emergency Request", the AMF is not expecting any S-NSSAI and DNN value provided by the UE and uses locally configured values instead. The AMF stores the Access Type of the PDU Session.

If the Request Type indicates "Emergency Request" or "Existing Emergency PDU Session", the AMF selects the SMF as described in TS 23.501 [2], clause 5.16.4.

3. From AMF to SMF: Either Nsmf\_PDUSession\_CreateSMContext Request (SUPI, DNN, S-NSSAI(s), PDU Session ID, AMF ID, Request Type, PCF ID, Priority Access, N1 SM container (PDU Session Establishment Request), User location information, Access Type, PEI, GPSI, UE presence in LADN service area, Subscription For PDU Session Status Notification, DNN Selection Mode, Trace Requirements) or Nsmf\_PDUSession\_UpdateSMContext Request (SUPI, DNN, S-NSSAI(s), SM Context ID, AMF ID, Request Type, N1 SM container (PDU Session Establishment Request), User location information, Access Type, RAT type, PEI).

If the AMF does not have an association with an SMF for the PDU Session ID provided by the UE (e.g. when Request Type indicates "initial request"), the AMF invokes the Nsmf\_PDUSession\_CreateSMContext Request,

but if the AMF already has an association with an SMF for the PDU Session ID provided by the UE (e.g. when Request Type indicates "existing PDU Session"), the AMF invokes the Nsmf\_PDUSession\_UpdateSMContext Request.

The AMF sends the S-NSSAI of the Serving PLMN from the Allowed NSSAI to the SMF. For roaming scenario in local breakout (LBO), the AMF also sends the corresponding S-NSSAI of the HPLMN from the Mapping Of Allowed NSSAI to the SMF.

The AMF ID is the UE's GUAMI which uniquely identifies the AMF serving the UE. The AMF forwards the PDU Session ID together with the N1 SM container containing the PDU Session Establishment Request received from the UE. The GPSI shall be included if available at AMF.

The AMF determines Access Type and RAT Type based on the Global RAN Node ID associated with the N2 interface.

The AMF provides the PEI instead of the SUPI when the UE in limited service state has registered for Emergency services (i.e. Emergency Registered) without providing a SUPI. The PEI is defined in TS 23.501 [2] clause 5.9.3. In case the UE in limited service state has registered for Emergency services (i.e. Emergency Registered) with a SUPI but has not been authenticated the AMF indicates that the SUPI has not been authenticated. The SMF determines that the UE has not been authenticated when it does not receive a SUPI for the UE or when the AMF indicates that the SUPI has not been authenticated.

If the AMF determines that the DNN corresponds to an LADN then the AMF provides the "UE presence in LADN service area" that indicates if the UE is IN or OUT of the LADN service area.

If the Old PDU Session ID is included in step 1, and if the SMF is not to be reallocated, the AMF also includes Old PDU Session ID in the Nsmf\_PDUSession\_CreateSMContext Request.

DNN Selection Mode is determined by the AMF. It indicates whether an explicitly subscribed DNN has been provided by the UE in its PDU Session Establishment Request.

The SMF may use DNN Selection Mode when deciding whether to accept or reject the UE request.

When the Establishment cause received as part of AN parameters during the Registration procedure or Service Request procedure is associated with priority services (e.g. MPS, MCS), the AMF includes a Message Priority header to indicate priority information. The SMF uses the Message Priority header to determine if the UE request is subject to exemption from NAS level congestion control. Other NFs relay the priority information by including the Message Priority header in service-based interfaces, as specified in TS 29.500 [17].

In the local breakout case, if the SMF (in the VPLMN) is not able to process some part of the N1 SM information that Home Routed Roaming is required, and the SMF responds to the AMF that it is not the right SMF to handle the N1 SM message by invoking Nsmf\_PDUSession\_CreateSMContext Response service operation. The SMF includes a proper N11 cause code triggering the AMF to proceed with home routed case. The procedure starts again at step 2 of clause 4.3.2.2.2.

The AMF may include a PCF ID in the Nsmf\_PDUSession\_CreateSMContext Request. This PCF ID identifies the H-PCF in the non-roaming case and the V-PCF in the local breakout roaming case.

The AMF includes Trace Requirements if Trace Requirements have been received in subscription data.

4. If Session Management Subscription data for corresponding SUPI, DNN and S-NSSAI of the HPLMN is not available, then SMF retrieves the Session Management Subscription data using Nudm\_SDM\_Get (SUPI, Session Management Subscription data, DNN, S-NSSAI of the HPLMN) and subscribes to be notified when this subscription data is modified using Nudm\_SDM\_Subscribe (SUPI, Session Management Subscription data, DNN, S-NSSAI of the HPLMN). UDM may get this information from UDR by Nudr\_DM\_Query (SUPI, Subscription Data, Session Management Subscription data, DNN, S-NSSAI of the HPLMN) and may subscribe to notifications from UDR for the same data by Nudr\_DM\_subscribe.

The SMF may use DNN Selection Mode when deciding whether to retrieve the Session Management Subscription data e.g. in case the (DNN, S-NSSAI of the HPLMN) is not explicitly subscribed, the SMF may use local configuration instead of Session Management Subscription data.

If the Request Type in step 3 indicates "Existing PDU Session" or "Existing Emergency PDU Session" the SMF determines that the request is due to switching between 3GPP access and non-3GPP access or due to handover from EPS. The SMF identifies the existing PDU Session based on the PDU Session ID. In such a case, the SMF

does not create a new SM context but instead updates the existing SM context and provides the representation of the updated SM context to the AMF in the response.

If the Request Type is "Initial request" and if the Old PDU Session ID is included in Nsmf\_PDUSession\_CreateSMContext Request, the SMF identifies the existing PDU Session to be released based on the Old PDU Session ID.

Subscription data includes the Allowed PDU Session Type(s), Allowed SSC mode(s), default 5QI and ARP, subscribed Session-AMBR.

Static IP address/prefix may be included in the subscription data if the UE has subscribed to it.

The SMF checks the validity of the UE request: it checks

- Whether the UE request is compliant with the user subscription and with local policies;
- (If the DNN corresponds to an LADN), whether the UE is located within the LADN service area based on the "UE presence in LADN service area" indication from the AMF. If the AMF does not provide the "UE presence in LADN service area" indication and the SMF determines that the DNN corresponds to a LADN, then the SMF considers that the UE is OUT of the LADN service area

If the UE request is considered as not valid, the SMF decides to not accept to establish the PDU Session.

5. From SMF to AMF: Either Nsmf\_PDUSession\_CreateSMContext Response (Cause, SM Context ID or N1 SM container (PDU Session Reject (Cause))) or an Nsmf\_PDUSession\_UpdateSMContext Response depending on the request received in step 3.

If the SMF received Nsmf\_PDUSession\_CreateSMContext Request in step 3 and the SMF is able to process the PDU Session establishment request, the SMF creates an SM context and responds to the AMF by providing an SM Context ID.

In case the UP Security Policy for the PDU Session is determined to have Integrity Protection set to "Required", the SMF may, based on local configuration, decide whether to accept or reject the PDU Session request based on the UE Integrity Protection Maximum Data Rate.

NOTE 3: The SMF can e.g. be configured to reject a PDU Session if the UE Integrity Protection Maximum Data Rate has a very low value, in case the services provided by the DN would require higher bitrates.

When the SMF decides to not accept to establish a PDU Session, the SMF rejects the UE request via NAS SM signalling including a relevant SM rejection cause by responding to the AMF with Nsmf\_PDUSession\_CreateSMContext Response. The SMF also indicates to the AMF that the PDU Session ID is to be considered as released, the SMF proceeds to step 20 and the PDU Session Establishment procedure is stopped.

6. Optional Secondary authentication/authorization.

If the Request Type in step 3 indicates "Existing PDU Session", the SMF does not perform secondary authentication/authorization.

If the Request Type received in step 3 indicates "Emergency Request" or "Existing Emergency PDU Session", the SMF shall not perform secondary authentication\authorization.

If the SMF needs to perform secondary authentication/authorization during the establishment of the PDU Session by a DN-AAA server as described in TS 23.501 [2] clause 5.6.6, the SMF triggers the PDU Session establishment authentication/authorization as described in clause 4.3.2.3.

- 7a. If dynamic PCC is to be used for the PDU Session, the SMF performs PCF selection as described in TS 23.501 [2], clause 6.3.7.1. If the Request Type indicates "Existing PDU Session" or "Existing Emergency PDU Session", the SMF shall use the PCF already selected for the PDU Session.

Otherwise, the SMF may apply local policy.

- 7b. The SMF may perform an SM Policy Association Establishment procedure as defined in clause 4.16.4 to establish an SM Policy Association with the PCF and get the default PCC Rules for the PDU Session. The GPSI shall be included if available at SMF. If the Request Type in step 3 indicates "Existing PDU Session", the SMF may provide information on the Policy Control Request Trigger condition(s) that have been met by an SMF

initiated SM Policy Association Modification procedure as defined in clause 4.16.5.1. The PCF may provide policy information defined in clause 5.2.5.4 (and in TS 23.503 [20]) to SMF.

The PCF, based on the Emergency DNN, sets the ARP of the PCC rules to a value that is reserved for Emergency services as described in TS 23.503 [20].

NOTE 4: The purpose of step 7 is to receive PCC rules before selecting UPF. If PCC rules are not needed as input for UPF selection, step 7 can be performed after step 8.

8. If the Request Type in step 3 indicates "Initial request", the SMF selects an SSC mode for the PDU Session as described in TS 23.501 [2] clause 5.6.9.3. The SMF also selects one or more UPFs as needed as described in TS 23.501 [2] clause 6.3.3. In case of PDU Session Type IPv4 or IPv6 or IPv4v6, the SMF allocates an IP address/prefix for the PDU Session as described in TS 23.501 [2] clause 5.8.1. In case of PDU Session Type IPv6 or IPv4v6, the SMF also allocates an interface identifier to the UE for the UE to build its link-local address. For Unstructured PDU Session Type the SMF may allocate an IPv6 prefix for the PDU Session and N6 point-to-point tunnelling (based on UDP/IPv6) as described in TS 23.501 [2] clause 5.6.10.3. For Ethernet PDU Session Type, neither a MAC nor an IP address is allocated by the SMF to the UE for this PDU Session.

If the Request Type in Step 3 is "Existing PDU Session", the SMF maintains the same IP address/prefix that has already been allocated to the UE in the source network.

If the Request Type in step 3 indicates "Existing PDU Session" referring to an existing PDU Session moved between 3GPP access and non-3GPP access the SMF maintains the SSC mode of the PDU Session, the current PDU Session Anchor and IP address.

NOTE 5: The SMF may decide to trigger e.g. new intermediate UPF insertion or allocation of a new UPF as described in step 5 in clause 4.2.3.2.

If the Request Type indicates "Emergency Request", the SMF selects the UPF as described in TS 23.501 [2] clause 5.16.4 and selects SSC mode 1.

9. SMF may perform an SMF initiated SM Policy Association Modification procedure as defined in clause 4.16.5.1 to provide information on the Policy Control Request Trigger condition(s) that have been met. If Request Type is "initial request" and dynamic PCC is deployed and PDU Session Type is IPv4 or IPv6 or IPv4v6, SMF notifies the PCF (if the Policy Control Request Trigger condition is met) with the allocated UE IP address/prefix(es).

When PCF is deployed, the SMF shall further report the PS Data Off status to PCF if the PS Data Off Policy Control Request Trigger is provisioned, the additional behaviour of SMF and PCF for 3GPP PS Data Off is defined in TS 23.503 [20].

NOTE 6: If an IP address/prefix has been allocated before step 7 (e.g. subscribed static IP address/prefix in UDM/UDR) or the step 7 is performed after step 8, the IP address/prefix can be provided to PCF in step 7, and the IP address/prefix notification in this step can be skipped.

PCF may provide updated policies to the SMF. The PCF may provide policy information defined in clause 5.2.5.4 (and in TS 23.503 [20]) to SMF.

10. If Request Type indicates "initial request", the SMF initiates an N4 Session Establishment procedure with the selected UPF, otherwise it initiates an N4 Session Modification procedure with the selected UPF:

- 10a. The SMF sends an N4 Session Establishment/Modification Request to the UPF and provides Packet detection, enforcement and reporting rules to be installed on the UPF for this PDU Session. If CN Tunnel Info is allocated by the SMF, the CN Tunnel Info is provided to UPF in this step. If the selective User Plane deactivation is required for this PDU Session, the SMF determines the Inactivity Timer and provides it to the UPF. The SMF provides Trace Requirements to the UPF if it has received Trace Requirements.

- 10b. The UPF acknowledges by sending an N4 Session Establishment/Modification Response. If CN Tunnel Info is allocated by the UPF, the CN Tunnel Info is provided to SMF in this step.

If multiple UPFs are selected for the PDU Session, the SMF initiates N4 Session Establishment/Modification procedure with each UPF of the PDU Session in this step.

If the Request Type indicates "Existing PDU Session", and the SMF creates CN Tunnel Info, then this step is skipped. Otherwise, this step is performed to obtain the CN Tunnel Info from the UPF using the N4 Session Modification Procedure.

11. SMF to AMF: Namf\_Communication\_N1N2MessageTransfer (PDU Session ID, N2 SM information (PDU Session ID, QFI(s), QoS Profile(s), CN Tunnel Info, S-NSSAI from the Allowed NSSAI, Session-AMBR, PDU Session Type, User Plane Security Enforcement information, UE Integrity Protection Maximum Data Rate), N1 SM container (PDU Session Establishment Accept (QoS Rule(s) and QoS Flow level QoS parameters if needed for the QoS Flow(s) associated with the QoS rule(s), selected SSC mode, S-NSSAI(s), DNN, allocated IPv4 address, interface identifier, Session-AMBR, selected PDU Session Type, Reflective QoS Timer (if available), P-CSCF address(es), [Always-on PDU Session]))). If multiple UPFs are used for the PDU Session, the CN Tunnel Info contain tunnel information related with the UPF that terminates N3.

The N2 SM information carries information that the AMF shall forward to the (R)AN which includes:

- The CN Tunnel Info corresponds to the Core Network address of the N3 tunnel corresponding to the PDU Session.
- One or multiple QoS profiles and the corresponding QFIs can be provided to the (R)AN. This is further described in TS 23.501 [2] clause 5.7.
- The PDU Session ID may be used by AN signalling with the UE to indicate to the UE the association between (R)AN resources and a PDU Session for the UE.
- A PDU Session is associated to an S-NSSAI of the HPLMN and, if applicable, to a S-NSSAI of the VPLMN, and a DNN. The S-NSSAI provided to the (R)AN, is the S-NSSAI with the value for the Serving PLMN (i.e. the HPLMN S-NSSAI or, in LBO roaming case, the VPLMN S-NSSAI).
- User Plane Security Enforcement information is determined by the SMF as described in clause 5.10.3 of TS 23.501 [2],
- If the User Plane Security Enforcement information indicates that Integrity Protection is "Preferred" or "Required", the SMF also includes the UE Integrity Protection Maximum Data Rate as received in the PDU Session Establishment Request.

The N1 SM container contains the PDU Session Establishment Accept that the AMF shall provide to the UE. If the UE requested P-CSCF discovery then the message shall also include the P-CSCF IP address(es) as determined by the SMF. The PDU Session Establishment Accept includes S-NSSAI from the Allowed NSSAI. For LBO roaming scenario, the PDU Session Establishment Accept includes the S-NSSAI from the Allowed NSSAI for the VPLMN and also it includes the corresponding S-NSSAI of the HPLMN from the Mapping Of Allowed NSSAI that SMF received in step 3. If the PDU Session being established was requested to be an always-on PDU Session, the SMF shall indicate whether the request is accepted by including an Always-on PDU Session Granted indication in the PDU Session Establishment Accept message. If the PDU Session being established was not requested to be an always-on PDU Session but the SMF determines that the PDU Session needs to be established as an always-on PDU Session, the SMF shall include an Always-on PDU Session Granted indication in the PDU Session Establishment Accept message indicating that the PDU session is an always-on PDU Session.

Multiple QoS Rules, QoS Flow level QoS parameters if needed for the QoS Flow(s) associated with those QoS rule(s) and QoS Profiles may be included in the PDU Session Establishment Accept within the N1 SM and in the N2 SM information.

The Namf\_Communication\_N1N2MessageTransfer contains the PDU Session ID allowing the AMF to know which access towards the UE to use.

If the PDU session establishment failed anywhere between step 5 and step 11, then the Namf\_Communication\_N1N2MessageTransfer request shall include the N1 SM container with a PDU Session Establishment Reject message (see clause 8.3.3 of TS 24.501 [25]) and shall not include any N2 SM container. The (R)AN sends the NAS message containing the PDU Session Establishment Reject to the UE. In this case, steps 12-17 are skipped.

12. AMF to (R)AN: N2 PDU Session Request (N2 SM information, NAS message (PDU Session ID, N1 SM container (PDU Session Establishment Accept))).

The AMF sends the NAS message containing PDU Session ID and PDU Session Establishment Accept targeted to the UE and the N2 SM information received from the SMF within the N2 PDU Session Request to the (R)AN.

13. (R)AN to UE: The (R)AN may issue AN specific signalling exchange with the UE that is related with the information received from SMF. For example, in case of a NG-RAN, an RRC Connection Reconfiguration may

take place with the UE establishing the necessary NG-RAN resources related to the QoS Rules for the PDU Session request received in step 12.

(R)AN also allocates (R)AN N3 Tunnel Info for the PDU Session. In case of Dual Connectivity, the Master RAN node may assign some (zero or more) QFIs to be setup to a Master RAN node and others to the Secondary RAN node. The AN Tunnel Info includes a tunnel endpoint for each involved (R)AN node, and the QFIs assigned to each tunnel endpoint. A QFI can be assigned to either the Master RAN node or the Secondary RAN node and not to both.

(R)AN forwards the NAS message (PDU Session ID, N1 SM container (PDU Session Establishment Accept)) provided in step 12 to the UE. (R)AN shall only provide the NAS message to the UE if the AN specific signalling exchange with the UE includes the (R)AN resource additions associated to the received N2 command.

If MICO mode is active and the NAS message Request Type in step 1 indicated "Emergency Request", then the UE and the AMF shall locally deactivate MICO mode.

14. (R)AN to AMF: N2 PDU Session Response (PDU Session ID, Cause, N2 SM information (PDU Session ID, AN Tunnel Info, List of accepted/rejected QFI(s), User Plane Enforcement Policy Notification)).

The AN Tunnel Info corresponds to the Access Network address of the N3 tunnel corresponding to the PDU Session.

If the (R)AN rejects QFI(s) the SMF is responsible of updating the QoS rules and QoS Flow level QoS parameters if needed for the QoS Flow associated with the QoS rule(s) in the UE accordingly.

The NG-RAN rejects the establishment of UP resources for the PDU Session when it cannot fulfil User Plane Security Enforcement information with a value of Required. The NG-RAN notifies the SMF when it cannot fulfil a User Plane Security Enforcement with a value of Preferred.

15. AMF to SMF: Nsmf\_PDUSession\_UpdateSMContext Request (SM Context ID, N2 SM information, Request Type).

The AMF forwards the N2 SM information received from (R)AN to the SMF.

If the list of rejected QFI(s) is included in N2 SM information, the SMF shall release the rejected QFI(s) associated QoS profiles.

If the User Plane Enforcement Policy Notification in the N2 SM information indicates that no user plane resources could be established, and the User Plane Enforcement Policy indicated "required" as described in clause 5.10.3 of TS 23.501 [2], the SMF shall reject the PDU session establishment by including a N1 SM container with a PDU Session Establishment Reject message (see clause 8.3.3 of TS 24.501 [25]) in the Nsmf\_PDUSession\_UpdateSMContext Response in step 17. Step 16 is skipped in this case.

- 16a. The SMF initiates an N4 Session Modification procedure with the UPF. The SMF provides AN Tunnel Info to the UPF as well as the corresponding forwarding rules.

NOTE 7: If the PDU Session Establishment Request was due to mobility between 3GPP and non-3GPP access or mobility from EPC, the downlink data path is switched towards the target access in this step.

- 16b. The UPF provides an N4 Session Modification Response to the SMF.

If multiple UPFs are used in the PDU Session, the UPF in step 16 refers to the UPF terminating N3.

After this step, the UPF delivers any down-link packets to the UE that may have been buffered for this PDU Session.

- 16c. If Request Type in step 3 indicates neither "Emergency Request" nor "Existing Emergency PDU Session" and, if the SMF has not yet registered for this PDU Session, then the SMF registers with the UDM using Nudm\_UECM\_Registration (SUPI, DNN, PDU Session ID, SMF Identity) for a given PDU Session. As a result, the UDM stores following information: SUPI, SMF identity and the associated DNN and PDU Session ID. The UDM may further store this information in UDR by Nudr\_DM\_Update (SUPI, Subscription Data, UE context in SMF data).

If the Request Type received in step 3 indicates "Emergency Request":

- For an authenticated non-roaming UE, based on operator configuration (e.g. related with whether the operator uses a fixed SMF for Emergency calls, etc.), the SMF may register in the UDM using Nudm\_UECM\_Registration (SUPI, PDU Session ID, SMF identity, Indication of Emergency Services) for a given PDU Session that is applicable for emergency services. As a result, the UDM shall store the applicable PDU Session for Emergency services.
- For an unauthenticated UE or a roaming UE, the SMF shall not register in the UDM for a given PDU Session.

17. SMF to AMF: Nsmf\_PDUSession\_UpdateSMContext Response (Cause).

The SMF may subscribe to the UE mobility event notification from the AMF (e.g. location reporting, UE moving into or out of Area Of Interest), after this step by invoking Namf\_EventExposure\_Subscribe service operation as specified in clause 5.2.2.3.2. For LADN, the SMF subscribes to the UE moving into or out of LADN service area event notification by providing the LADN DNN as an indicator for the Area Of Interest (see clause 5.6.5 and 5.6.11 of TS 23.501 [2]).

After this step, the AMF forwards relevant events subscribed by the SMF.

18. [Conditional] SMF to AMF: Nsmf\_PDUSession\_SMContextStatusNotify (Release)

If during the procedure, any time after step 5, the PDU Session establishment is not successful, the SMF informs the AMF by invoking Nsmf\_PDUSession\_SMContextStatusNotify (Release). The SMF also releases any N4 session(s) created, any PDU Session address if allocated (e.g. IP address) and releases the association with PCF, if any. In this case, step 19 is skipped.

19. SMF to UE, via UPF: In case of PDU Session Type IPv6 or IPv4v6, the SMF generates an IPv6 Router Advertisement and sends it to the UE via N4 and the UPF.

20. If the PDU Session establishment failed after step 4, the SMF shall perform the following:

The SMF unsubscribes to the modifications of Session Management Subscription data for the corresponding (SUPI, DNN, S-NSSAI of the HPLMN), using Nudm\_SDM\_Unsubscribe (SUPI, Session Management Subscription data, DNN, S-NSSAI of the HPLMN), if the SMF is no more handling a PDU Session of the UE for this (DNN, S-NSSAI of the HPLMN). The UDM may unsubscribe to the modification notification from UDR by Nudr\_DM\_Unsubscribe (SUPI, Subscription Data, Session Management Subscription data, S-NSSAI of the HPLMN, DNN).

#### 4.3.2.2.2 Home-routed Roaming

This procedure is used in case of home-routed roaming scenarios.



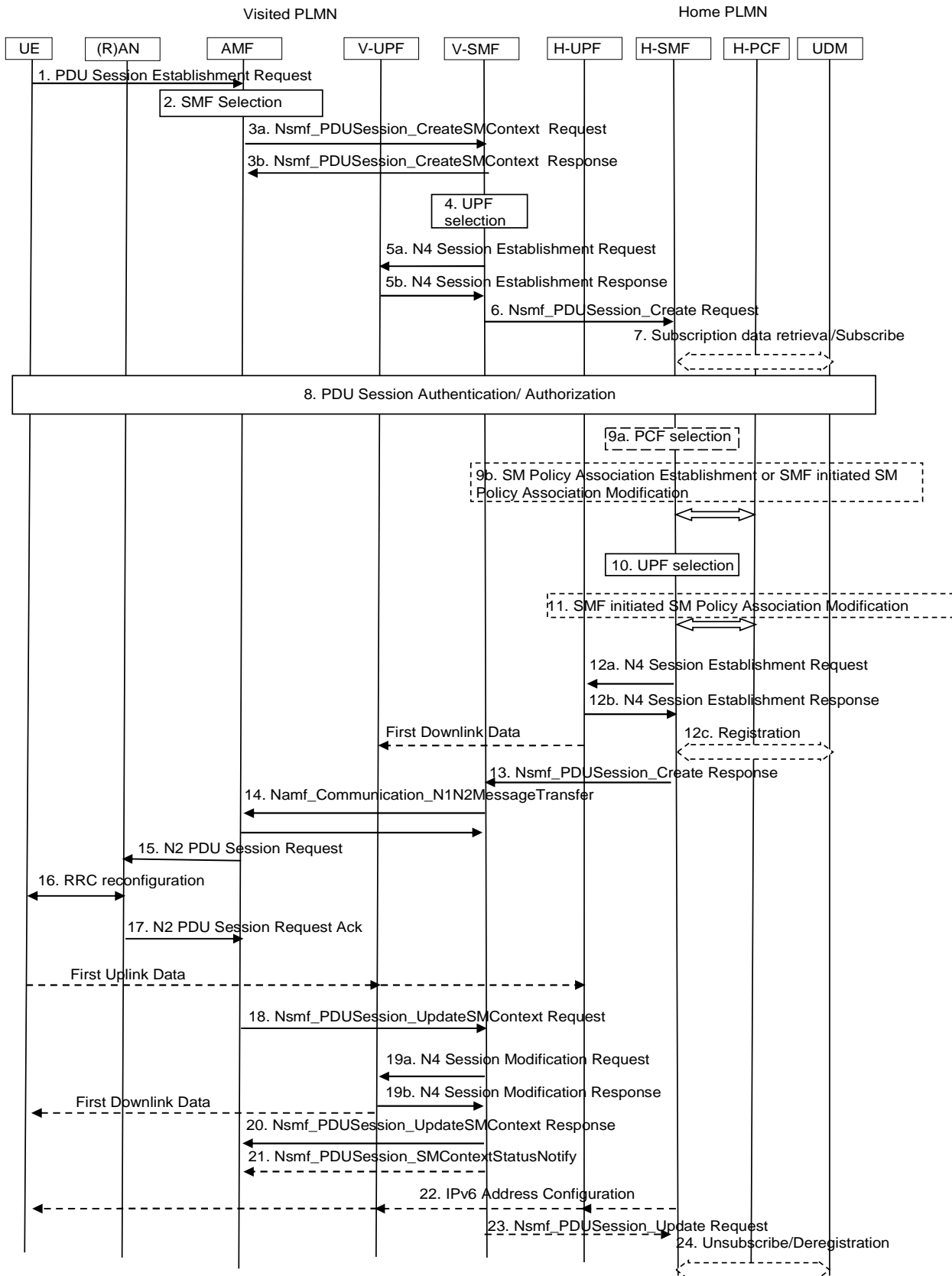

Figure 4.3.2.2-1: UE-requested PDU Session Establishment for home-routed roaming scenarios

1. This step is the same as step 1 in clause 4.3.2.2.1.
2. As in step 2 of clause 4.3.2.2.1 with the addition that the AMF also selects an SMF in HPLMN using the S-NSSAI with the value defined by the HPLMN, as described in clause 4.3.2.2.3. The AMF may also receive

alternative H-SMFs from the NRF. The AMF stores the association of the S-NSSAI(s), the DNN, the PDU Session ID, the SMF ID in VPLMN as well as Access Type of the PDU Session.

In step 3 of clause 4.3.2.2.1, in local breakout roaming case, if V-SMF responds to AMF indicating that V-SMF is not able to process some part of the N1 SM information, the AMF proceeds with home routed case from this step and may select an SMF in the VPLMN different from the V-SMF selected earlier.

3a. As in step 3 of clause 4.3.2.2.1 with the addition that:

- the AMF also provides the identity of the H-SMF it has selected in step 2 and both the VPLMN S-NSSAI from the Allowed NSSAI and the corresponding S-NSSAI of the HPLMN, which is in the mapping the VPLMN S-NSSAI from the Allowed NSSAI. The H-SMF is provided when the PDU Session is home-routed. The AMF may also provide the identity of alternative H-SMFs, if it has received in step 2.
- The V-SMF does not use DNN Selection Mode received from the AMF but relays this information to the H-SMF.

The AMF may include the H-PCF ID in this step and V-SMF will pass it to the H-SMF in step 6. This will enable the H-SMF to select the same H-PCF in step 9a.

3b: This step is the same as step 5 of clause 4.3.2.2.1.

4. The V-SMF selects a UPF in VPLMN as described in TS 23.501 [2], clause 6.3.3.

5. The V-SMF initiates an N4 Session Establishment procedure with the selected V-UPF:

5a. The V-SMF sends an N4 Session Establishment Request to the V-UPF. If CN Tunnel Info is allocated by the SMF, the CN Tunnel Info is provided to V-UPF in this step.

5b. The V-UPF acknowledges by sending an N4 Session Establishment Response. If CN Tunnel Info is allocated by the V-UPF, the CN Tunnel Info is provided to V-SMF in this step.

6. V-SMF to H-SMF: Nsmf\_PDUSession\_Create Request (SUPI, GPSI (if available), V-SMF SM Context ID, DNN, S-NSSAI with the value defined by the HPLMN, PDU Session ID, V-SMF ID, V-CN-Tunnel-Info, PDU Session Type, PCO, Number Of Packet Filters, User location information, Access Type, PCF ID, SM PDU DN Request Container, DNN Selection Mode, [Always-on PDU Session Requested], AMF ID). Protocol Configuration Options may contain information that H-SMF may needs to properly establish the PDU Session (e.g. SSC mode or SM PDU DN Request Container to be used to authenticate the UE by the DN-AAA as defined in clause 4.3.2.3). The H-SMF may use DNN Selection Mode when deciding whether to accept or reject the UE request. If the V-SMF does not receive any response from the H-SMF due to communication failure on the N16 interface, depending on operator policy the V-SMF may create the PDU Session to one of the alternative H-SMF(s) if additional H-SMF information is provided in step 3a, as specified in detail in TS 29.502 [36].

V-SMF SM Context ID contains the addressing information it has allocated for service operations related with this PDU Session. The H-SMF stores an association of the PDU Session and V-SMF Context ID for this PDU Session for this UE.

If the H-SMF needs to use V-SMF services for this PDU Session (invoking Nsmf\_PDUSession\_Update Request) before step 13, at the first invocation of Nsmf\_PDUSession\_Update Request the H-SMF provides the V-SMF with the H-SMF SM Context ID it has allocated for service operations related with this PDU Session.

7-12b. These steps are the same as steps 4-10 in clause 4.3.2.2.1 with the following differences:

- These steps are executed in Home PLMN;
- The H-SMF does not provides the Inactivity Timer to the H-UPF as described in step 9a in clause 4.3.2.2.1.
- Step 5 of clause 4.3.2.2.1 is not executed.

When PCF is deployed, the SMF shall further report the PS Data Off status to PCF if the PS Data Off event trigger is provisioned, the additional behaviour of SMF and PCF for 3GPP PS Data Off is defined in TS 23.503 [20].

12c. This step is the same as step 16c in clause 4.3.2.2.1 with the following difference:

- The H-SMF registers for the PDU Session with the UDM using Nudm\_UECM\_Registration (SUPI, DNN, S-NSSAI with the value defined by the HPLMN, PDU Session ID).

13. H-SMF to V-SMF: Nsmf\_PDUSession\_Create Response (QoS Rule(s), QoS Flow level QoS parameters if needed for the QoS Flow(s) associated with the QoS rule(s), PCO including session level information that the V-SMF is not expected to understand, selected PDU Session Type and SSC mode, H-CN Tunnel Info, QFI(s), QoS profile(s), Session-AMBR, Reflective QoS Timer (if available), information needed by V-SMF in case of EPS interworking such as the PDN Connection Type, User Plane Policy Enforcement)

If the PDU Session being established was requested to be an always-on PDU Session, the H-SMF shall indicate to the V-SMF whether the request is accepted or not via the Always-on PDU Session Granted indication in the response message to V-SMF. If the PDU Session being established was not requested to be an always-on PDU Session but the H-SMF determines that the PDU Session needs to be established as an always-on PDU Session, the H-SMF shall indicate it to the V-SMF by including Always-on PDU Session Granted indication that the PDU Session is an always-on PDU Session.

The information that the H-SMF may provide is the same than defined for step 11 of Figure 4.3.2.2.1-1.

The H-CN Tunnel Info contains the tunnel information for uplink traffic towards H-UPF.

Multiple QoS Rules and QoS Flow level QoS parameters for the QoS Flow(s) associated with the QoS rule(s) may be included in the Nsmf\_PDUSession\_Create Response.

14-18. These steps are the same as steps 11-15 in clause 4.3.2.2.1 with the following differences:

- These steps are executed in Visited PLMN;
- The V-SMF stores an association of the PDU Session and H-SMF ID for this PDU Session for this UE;
- If the H-SMF indicates the PDU Session can be established as an always-on PDU Session, the V-SMF shall further check whether the PDU Session can be established as an always-on PDU Session based on local policies. The V-SMF notifies the UE whether the PDU Session is an always-on PDU Session or not via the Always-on PDU Session Granted indication in the PDU Session Establishment Accept message.

19a. The V-SMF initiates an N4 Session Modification procedure with the V-UPF. The V-SMF provides Packet detection, enforcement and reporting rules to be installed on the V-UPF for this PDU Session, including AN Tunnel Info, H-CN Tunnel Info and V-CN Tunnel Info.

19b. The V-UPF provides a N4 Session Modification Response to the V-SMF.

After this step, the V-UPF delivers any down-link packets to the UE that may have been buffered for this PDU Session.

20. This step is the same as step 17 in clause 4.3.2.2.1 with the following differences:

- The SMF is a V-SMF. The H-SMF and V-SMF subscribe to UE reachability event from AMF.

21. This step is same as step 18 in clause 4.3.2.2.1. In addition, if during the procedure, after step 14, the PDU Session establishment is not successful as specified in step 15 of clause 4.3.2.2.1, the V-SMF triggers the V-SMF initiated PDU Session release procedure from step 1b-3b as defined in clause 4.3.4.3.

22. H-SMF to UE, via H-UPF and V-UPF in VPLMN: In case of PDU Session Type IPv6 or IPv4v6, the H-SMF generates an IPv6 Router Advertisement and sends it to the UE via N4 and the H-UPF and V-UPF.

23. If the V-SMF received in step 18 an indication that the (R)AN has rejected some QFI(s) the V-SMF notifies the H-SMF via a Nsmf\_PDUSession\_Update Request. The H-SMF is responsible of updating accordingly the QoS rules and QoS Flow level QoS parameters if needed for the QoS Flow(s) associated with the QoS rule(s) in the UE.

24. This step is the same as step 20 in clause 4.3.2.2.1 with the following differences:

- this step is executed in the Home PLMN;
- the SMF also deregisters for the given PDU Session using Nudm\_UECM\_Deregistration (SUPI, DNN, PDU Session ID). The UDM may update corresponding UE context by Nudr\_DM\_Update (SUPI, Subscription Data, UE context in SMF data).

NOTE: The SMF in HPLMN can initiate H-SMF initiated PDU Session release procedure as defined in clause 4.3.4.3, already after step 13.

#### 4.3.2.2.3 SMF selection

##### 4.3.2.2.3.1 General

The SMF selection function, as described in TS 23.501 [2] clause 6.3.2, is supported by the AMF and is used to allocate an SMF that manages the PDU Session.

The SMF selection function described in this clause does not apply to the selection of an SMF for Emergency services. For SMF selection for Emergency services is described in clause 5.16.4.5 of TS 23.501 [2].

Two main branches of deployment scenarios to consider:

- Non-roaming and roaming with local breakout, see clause 4.3.2.2.3.2
- Home routed roaming, see clause 4.3.2.2.3.3

In the case of non-roaming and local breakout, there are two operational scenarios dependent on the configuration of AMF and the deployment option of NSSF in the serving PLMN.

In the case of home-routed, there are two main options dependent on the operators' choices in terms of involvement of NRF, NSSF and configuration of AMF. The decision of which option to use is part of the roaming agreements.

NOTE: The use of NSI ID and the use of multiple NRFs in the network are optional and depend on the deployment choices of the operator.

##### 4.3.2.2.3.2 Non-roaming and roaming with local breakout

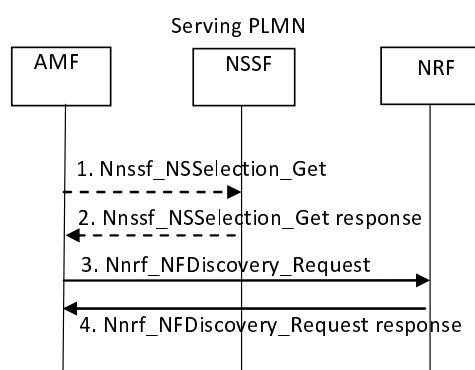

**Figure 4.3.2.2.3.2-1: SMF selection for non-roaming and roaming with local breakout scenarios**

This procedure may be skipped altogether if SMF information is available in the AMF by other means (e.g. locally configured); otherwise:

- when the serving AMF is aware of the appropriate NRF to be used to select NFs/services within the corresponding Network Slice instance based on configuration or based on the Network Slice selection information received during Registration, only steps 3 and 4 in the following procedure are executed as described in Figure 4.3.2.2.3.2-1;
- when the serving AMF is not aware of the appropriate NRF to be used to select NFs/services within the corresponding Network Slice instance, all steps in the following procedure are executed as described in Figure 4.3.2.2.3.2-1.

1. The AMF invokes the Nnssf\_NSSelection\_Get service operation from the NSSF in serving PLMN with the S-NSSAI of the VPLMN from the Allowed NSSAI requested by the UE, PLMN ID of the SUPI, TAI of the UE and the indication that the request is within a procedure of PDU Session establishment in either the non-roaming or roaming with local breakout scenario.

2. The NSSF in serving PLMN selects the Network Slice instance, determines and returns the appropriate NRF to be used to select NFs/services within the selected Network Slice instance, and optionally may return a NSI ID corresponding to the Network Slice instance.
3. AMF queries the appropriate NRF in serving PLMN by issuing the `Nnrf_NFDiscovery_Request` including S-NSSAI of the VPLMN for this PDU Session from the Allowed NSSAI, PLMN ID of the SUPI, DNN and possibly NSI ID in case the AMF has stored an NSI ID for the S-NSSAI of the VPMN for this PDU Session from the Allowed NSSAI.
4. The NRF in serving PLMN provides to the AMF, e.g. FQDN or IP address, of a set of the discovered SMF instance(s) or Endpoint Address(es) of SMF service instance(s) in `Nnrf_NFDiscovery_Request` response message, and possibly an NSI ID for the selected Network Slice instance corresponding to the S-NSSAI for subsequent NRF queries.

#### 4.3.2.2.3.3 Home routed roaming

The selection of the SMF in VPLMN is performed in the same way as for non-roaming and roaming with local breakout (see clause 4.3.2.2.3.2). The selection of the SMF in HPLMN is performed by means of one of two main options. Which of these two options to use is decided based on Service Level Agreements between the operators.

NOTE 1: The procedures described in this clause are not limited to SMF selection but can be used to discover and select any NF/NF service in the HPLMN part of a Network Slice instance.

In the first option, requiring the use of NSSF in both the VPLMN and the HPLMN, the selection of the SMF in HPLMN is performed by means of the procedure depicted in Figure 4.3.2.2.3.3-1.

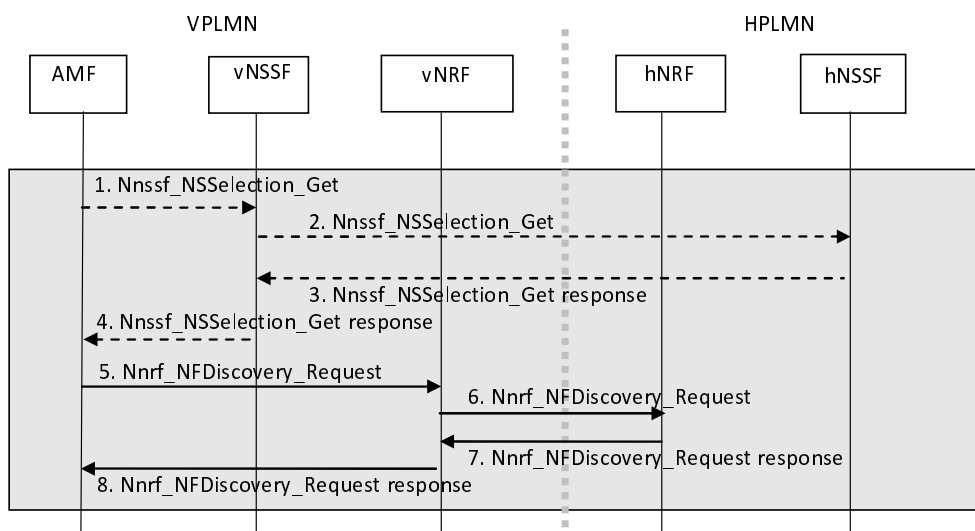

Figure 4.3.2.2.3.3-1: Option 1 for SMF selection for home-routed roaming scenarios

1. Based on the operator's configuration, if the AMF is not aware of the appropriate NRF to be used to select NFs/services in the HPLMN, the AMF invokes the `Nnssf_NSSelection_Get` service operation from the NSSF in VPLMN with the VPLMN S-NSSAI from the Allowed NSSAI requested by the UE for this PDU Session, the HPLMN S-NSSAI that maps to the VPLMN S-NSSAI, PLMN ID of the SUPI, the TAI of the UE and the indication that the request is within a procedure of PDU Session establishment in the home-routed roaming scenario.
2. If slicing configuration information for the S-NSSAI in the HPLMN is not available (e.g. the NSSF has no cached information), the NSSF of the VPLMN invokes the `Nnssf_NSSelection_Get` service operation from NSSF of the HPLMN according to the PLMN ID of SUPI by including the HPLMN S-NSSAI.
3. The NSSF in HPLMN may include the NSI ID, if needed, for the Network Slice instance in HPLMN selected for the corresponding S-NSSAI of the HPLMN in the `Nnssf_NSSelection_Get` response. The NSSF in HPLMN also includes the appropriate hNRF to be used to select NFs/services within HPLMN in the `Nnssf_NSSelection_Get` response.

4. The serving NSSF includes in the Nssf\_NSSelection\_Get response all the information that has been received from the NSSF in HPLMN when responding to the AMF.
5. The AMF queries the target vNRF using the Nnrf\_NFDiscovery\_Request by including PLMN ID of the SUPI, DNN, HPLMN S-NSSAI, and possibly an HPLMN NSI ID in case the AMF has stored an NSI ID for the selected Network Slice instance corresponding to the HPLMN S-NSSAI.
6. The NRF in serving PLMN identifies NRF in HPLMN (hNRF) based on the information provided by the NSSF in the serving PLMN, and it invokes the Nnrf\_NFDiscovery\_Request service from hNRF according to the procedure in Figure 4.17.4-1 to get the expected SMF instance(s) deployed in the HPLMN. As the vNRF in VPLMN triggers the "NF Discovery" on behalf of the AMF, the NRF in the VPLMN shall not replace the information of the NF, i.e. AMF ID, in the Nnrf\_NFDiscovery\_Request message it sends to the hNRF.
- 7-8. The hNRF provides to the AMF, via vNRF, the information e.g. FQDN or IP address, of a set of the SMF instance(s) in Nnrf\_NFDiscovery\_Request response message and possibly an NSI ID for the selected Network Slice instance corresponding to the S-NSSAI of the HPLMN for subsequent NRF queries.

When the NSSF is not deployed in HPLMN then the AMF in VPLMN relies on either the configuration to obtain the NRF in HPLMN or on the option below.

The second option for the selection of the SMF in HPLMN is performed by means of the procedure depicted in Figure 4.3.2.2.3.3-2.

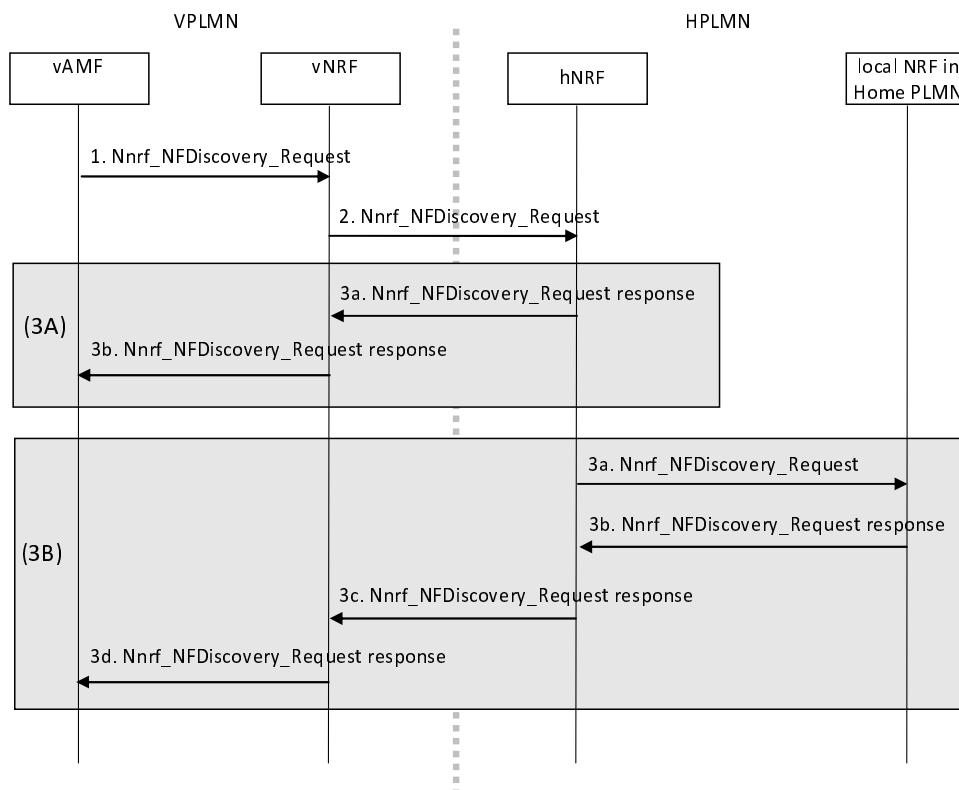

**Figure 4.3.2.2.3.3-2: Option 2 for SMF selection for home-routed roaming scenarios**

1. Based on the operator's configuration, the AMF queries the vNRF with PLMN ID of the SUPI, PLMN ID of the serving PLMN, DNN, the HPLMN S-NSSAI that maps to the S-NSSAI from the Allowed NSSAI of the Serving PLMN the UE has requested, NSI ID (if the AMF has stored an HPLMN NSI ID for the selected Network Slice instance corresponding to the S-NSSAI of the HPLMN) and DNN.
2. The vNRF queries, on behalf of the AMF in VPLMN, the hNRF identified by means of the PLMN ID of the SUPI. The NRF in VPLMN requests "NF Discovery" service from hNRF according to the procedure in Figure 4.17.4-1 to get the expected SMF instance(s) deployed in the HPLMN. As the NRF in the serving PLMN triggers the "NF Discovery" on behalf of the AMF, the NRF in the VPLMN shall not replace the information of the NF, i.e. AMF ID, in the Nnrf\_NFDiscovery\_Request message it sends to the hNRF.

Depending on the available information and based on configuration, the hNRF may either execute steps in 3(A) or in 3(B).

3(A) The hNRF provides to the AMF, via vNRF, the information e.g. FQDN or IP address, of a set of the discovered SMF instance(s) and possibly an NSI ID for the selected HPLMN part of the Network Slice instance corresponding to the S-NSSAI of the HPLMN for subsequent NRF queries in Nnrf\_NFDiscovery\_Request response message(steps 3a and 3b).

3(B) The hNRF queries, on behalf of the AMF, an appropriate local NRF in HPLMN (e.g. a slice level NRF); this local NRF provides the IP address or the FQDN of expected SMF instance(s) and possibly an NSI ID for the selected HPLMN part of the Network Slice instance corresponding to the S-NSSAI of the HPLMN for subsequent NRF queries (steps 3a and 3b) that the hNRF returns, via vNRF, to the AMF (steps 3c and 3d).

### 4.3.2.3 Secondary authorization/authentication by an DN-AAA server during the PDU Session establishment

The PDU Session establishment authentication/authorization is optionally triggered by the SMF during a PDU Session establishment and performed transparently via a UPF or directly with the DN-AAA server without involving the UPF if the DN-AAA server is located in the 5GC and reachable directly, as described in TS 23.501 [2], clause 5.6.6.

In the case of Home Routed Roaming, unless specified otherwise, the SMF in the information flow defined in this clause is the H-SMF.

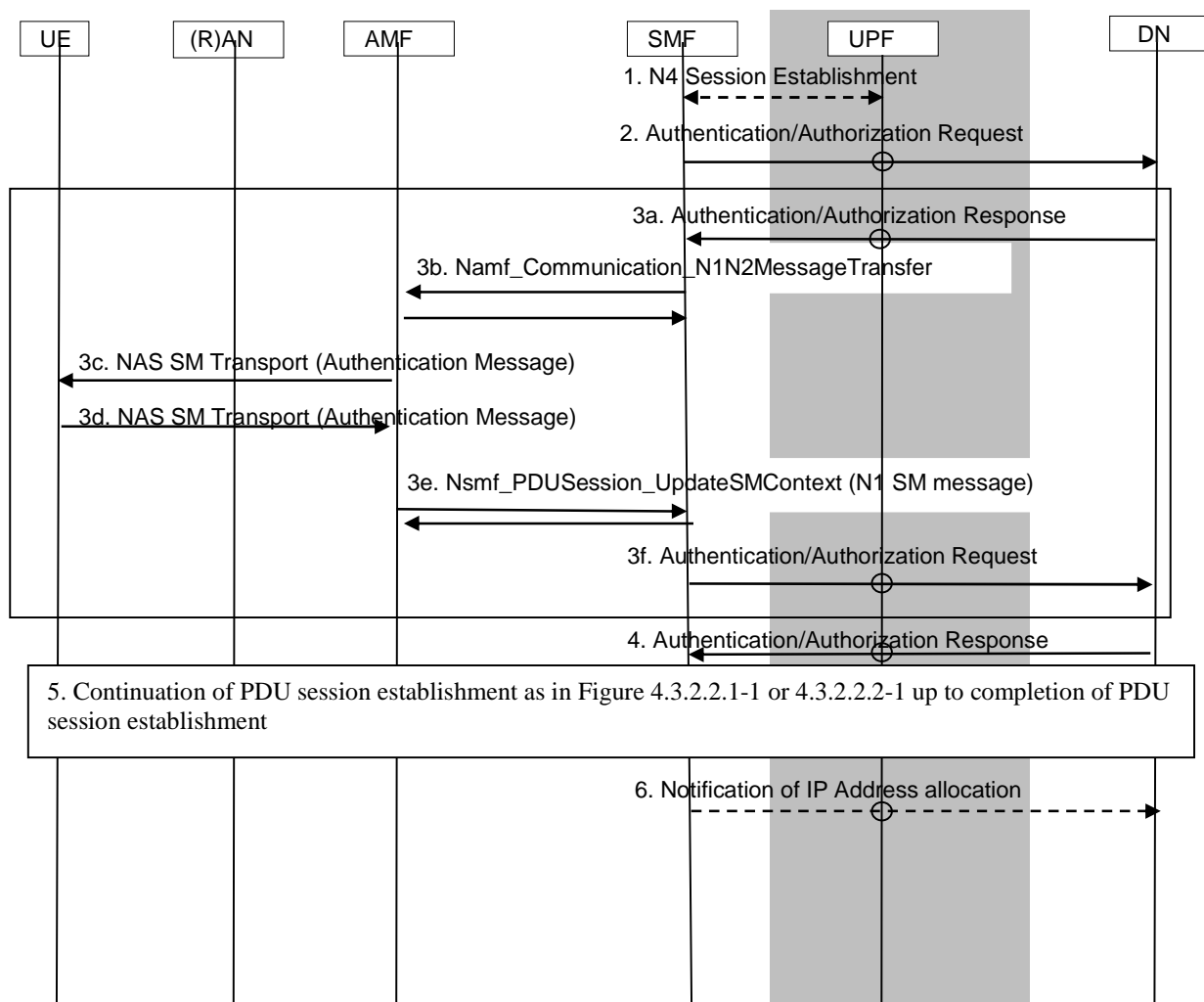

Figure 4.3.2.3-1: PDU Session Establishment authentication/authorization by a DN-AAA server

NOTE 1: Steps 2, 3a, 3f and 4 are not defined in this specification. Steps 3 can be repeated depending on the mechanism used.

NOTE 2: When the SMF directly communicates with the DN-AAA server without involving the UPF, Step 1 is skipped and Step 2, 3a, 3f, 4 and 6 are executed without involving the UPF.

0. The SMF determines that it needs to contact the DN-AAA server. The SMF identifies the DN-AAA server based on local configuration, possibly using the SM PDU DN Request Container provided by the UE in its NAS request.
1. If there is no existing N4 session that can be used to carry DN-related messages between the SMF and the DN, the SMF selects a UPF and triggers N4 session establishment.
2. The SMF provides a SM PDU DN Request Container received from the UE to the DN-AAA via the UPF.

When available, the SMF provides the GPSI in the signalling exchanged with the DN-AAA.

The UPF transparently relays the message received from the SMF to the DN-AAA server.

NOTE 2: The content of the SM PDU DN Request Container is defined in TS 33.501 [15].

- 3a. The DN-AAA server sends an Authentication/Authorization message towards the SMF. The message is carried via the UPF.

- 3b. Transfer of DN Request Container information received from DN-AAA towards the UE.

In non-roaming and LBO cases, the SMF invokes the `Namf_Communication_N1N2MessageTransfer` service operation on the AMF to transfer the DN Request Container information within N1 SM information sent towards the UE.

In the case of Home Routed roaming, the H-SMF initiates a `Nsmf_PDUSession_Update` service operation to request the V-SMF to transfer DN Request Container to the UE and the V-SMF invokes the `Namf_Communication_N1N2MessageTransfer` service operation on the AMF to transfer the DN Request Container information within N1 SM information sent towards the UE. In `Nsmf_PDUSession_Update` Request, the H-SMF additionally includes the H-SMF SM Context ID.

- 3c: The AMF sends the N1 NAS message to the UE

- 3d-3e. Transfer of DN Request Container information received from UE towards the DN-AAA.

When the UE responds with a N1 NAS message containing DN Request Container information, the AMF informs the SMF by invoking the `Nsmf_PDUSession_UpdateSMContext` service operation. The SMF issues an `Nsmf_PDUSession_UpdateSMContext` response.

In the case of Home Routed roaming, the V-SMF relays the N1 SM information to the H-SMF using the information of PDU Session received in step 3b via a `Nsmf_PDUSession_Update` service operation.

- 3f: The SMF (In HR case it is the H-SMF) sends the content of the DN Request Container information (authentication message) to the DN-AAA server via the UPF.

Step 3 may be repeated until the DN-AAA server confirms the successful authentication/authorization of the PDU Session.

4. The DN-AAA server confirms the successful authentication/authorization of the PDU Session. The DN-AAA server may provide:

- an SM PDU DN Response Container to the SMF to indicate successful authentication/authorization;
- DN Authorization Data as defined in TS 23.501 [2] clause 5.6.6;
- a request to get notified with the IP address(es) allocated to the PDU Session and/or with N6 traffic routing information or MAC address(es) used by the UE for the PDU Session; and
- an IP address (or IPV6 Prefix) for the PDU Session.

The N6 traffic routing information is defined in TS 23.501 [2] clause 5.6.7.

After the successful DN authentication/authorization, a session is kept between the SMF and the DN-AAA. If the SMF receives a DN Authorization Data, the SMF uses the DN Authorization Profile Index to apply the policy and charging control (see TS 23.501 [2] clause 5.6.6).



5. The PDU Session establishment continues and completes. In the step 7b of the Figure 4.3.2.2.1-1, if the SMF receives the DN Authorization Profile Index in DN Authorization Data from the DN-AAA, it sends the DN Authorization Profile Index to retrieve the PDU Session related policy information (described in TS 23.503 [20] clause 6.4) and the PCC rule(s) (described in TS 23.503 [20] clause 6.3) from the PCF. If the SMF receives the DN authorized Session AMBR in DN Authorization Data from the DN-AAA, it sends the DN authorized Session AMBR within the Session AMBR to the PCF to retrieve the authorized Session AMBR (described in TS 23.503 [20] clause 6.4).
6. If requested so in step 4 or if configured so by local policies, the SMF notifies the DN-AAA with the IP/MAC address(es) and/or with N6 traffic routing information allocated to the PDU Session together with the GPSI.

Later on the SMF notifies the DN-AAA if the DN-AAA had requested to get notifications about:

- allocation or release of an IPV6 Prefix for the PDU Session of IP type or addition or removal of source MAC addresses for the PDU Session of Ethernet type (e.g. using IPV6 multi-homing as defined in TS 23.501 [2] clause 5.6.4.3),
- Change of N6 traffic routing information.

When later on the PDU Session gets released as described in clause 4.3.4, the SMF notifies the DN-AAA.

The DN-AAA server may revoke the authorization for a PDU Session or update DN authorization data for a PDU Session. According to the request from DN-AAA server, the SMF may release or update the PDU Session.

At any time after the PDU Session establishment, the DN-AAA server or SMF may initiate Secondary Re-authentication procedure for the PDU Session as specified in clause 11.1.3 in TS 33.501 [15]. Step 3a to step 3f are performed to transfer the Secondary Re-authentication message between the UE and the DN-AAA server. The Secondary Re-authentication procedure may start from step 3a (DN-AAA initiated Secondary Re-authentication procedure) or step 3b (SMF initiated Secondary Re-authentication procedure). For the DN-AAA server initiated Secondary Re-authentication, the message in step 3a shall include GPSI, if available, and the IP/MAC address(es) of the PDU session, for SMF to identify the corresponding UE and PDU session.

DN-AAA may initiate DN-AAA Re-authorization without performing re-authentication based on local policy. DN-AAA Re-authorization procedure may start from step 4.

During Secondary Re-authentication/Re-authorization, if the SMF receives DN Authorization Profile Index and/or DN authorized Session AMBR, the SMF reports the received value(s) to the PCF (as described in TS 23.501 [2]) by triggering the Policy Control Request Trigger as described in TS 23.503 [20].

### 4.3.3 PDU Session Modification

#### 4.3.3.1 General

The procedure is used when one or several of the QoS parameters exchanged between the UE and the network are modified.

NOTE: The conditions when to use this procedure for QoS change as well as the QoS parameters exchanged between the UE and the network are defined in TS 23.501 [2] clause 5.7.

#### 4.3.3.2 UE or network requested PDU Session Modification (non-roaming and roaming with local breakout)

The UE or network requested PDU Session Modification procedure (non-roaming and roaming with local breakout scenario) is depicted in figure 4.3.3.2-1.

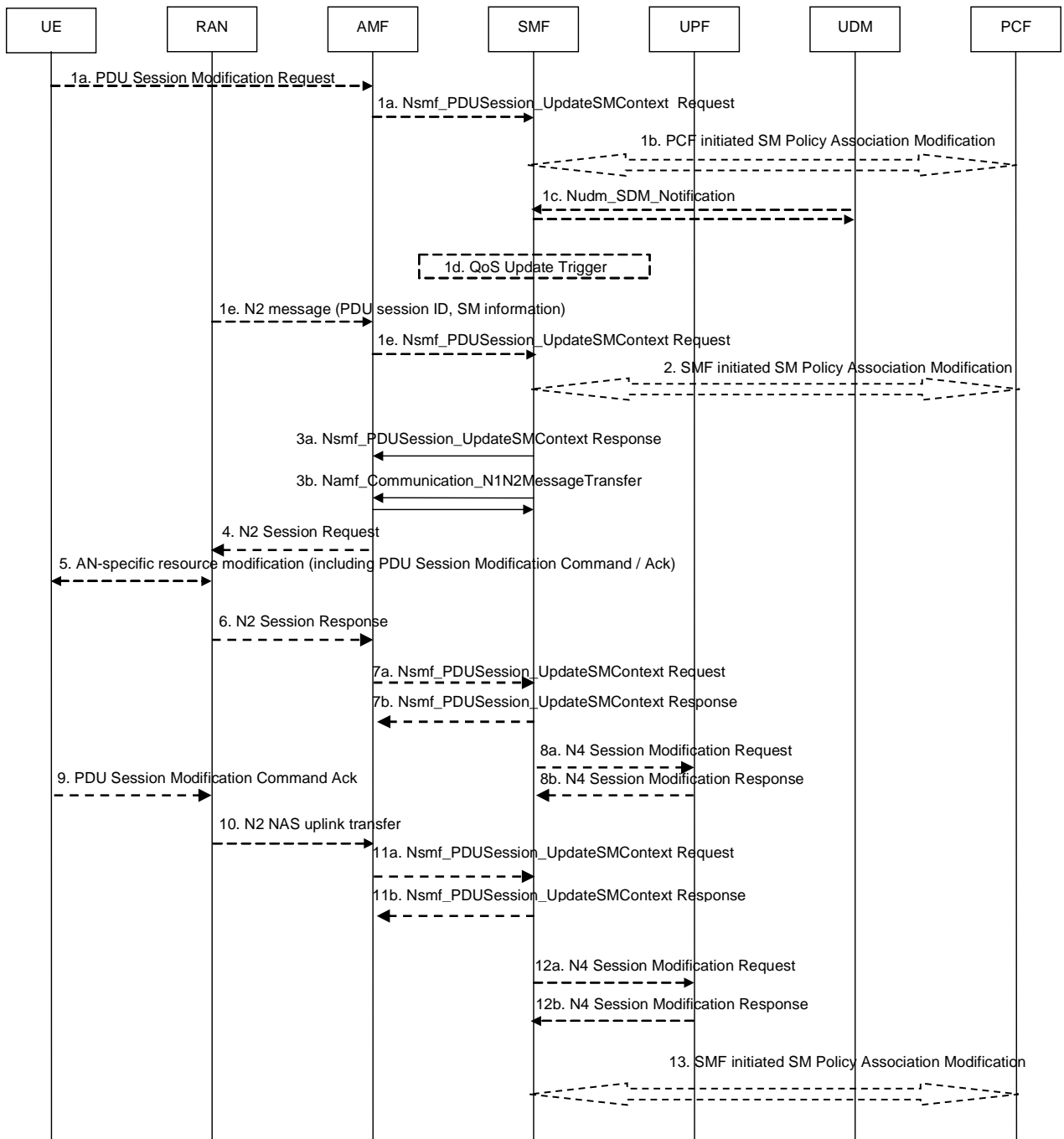

**Figure 4.3.3.2-1: UE or network requested PDU Session Modification (for non-roaming and roaming with local breakout)**

1. The procedure may be triggered by following events:

1a. (UE initiated modification) The UE initiates the PDU Session Modification procedure by the transmission of an NAS message (N1 SM container (PDU Session Modification Request (PDU session ID, Packet Filters, Operation, Requested QoS, Segregation, 5GSM Core Network Capability, Number Of Packet Filters, [Always-on PDU Session Requested])), PDU Session ID, and UE Integrity Protection Maximum Data Rate) message. Depending on the Access Type, if the UE was in CM-IDLE state, this SM-NAS message is preceded by the Service Request procedure. The NAS message is forwarded by the (R)AN to the AMF with an indication of User location Information. The AMF invokes Nsmf\_PDUSession\_UpdateSMContext (SM Context ID, N1 SM container (PDU Session Modification Request)).

When the UE requests specific QoS handling for selected SDF(s), the PDU Session Modification Request includes Packet Filters describing the SDF(s), the requested Packet Filter Operation (add, modify, delete) on the indicated Packet Filters, the Requested QoS and optionally a Segregation indication. The Segregation

indication is included when the UE recommends to the network to bind the applicable SDF(s) on a distinct and dedicated QoS Flow e.g. even if an existing QoS Flow can support the requested QoS. The network should abide by the UE request, but is allowed to proceed instead with binding the selected SDF(s) on an existing QoS Flow.

NOTE 1: Only one QoS Flow is used for traffic segregation. If UE makes subsequent requests for segregation of additional SDF(s), the additional SDF(s) are multiplexed on the existing QoS Flow that is used for segregation.

The UE shall not trigger a PDU Session Modification procedure for a PDU Session corresponding to a LADN when the UE is outside the area of availability of the LADN.

The PS Data Off status, if changed, shall be included in the PCO in the PDU Session Modification Request message.

For a PDU Session which was established in the EPS, when the UE moves from EPS to 5GS for the first time, the UE includes an Always-on PDU Session Requested indication in the PDU Session Modification Request message if it wants to change the PDU Session to an always-on PDU Session.

When PCF is deployed, the SMF shall further report the PS Data Off status to PCF if the PS Data Off event trigger is provisioned, the additional behaviour of SMF and PCF for 3GPP PS Data Off is defined in TS 23.503 [20].

The 5GSM Core Network Capability is provided by the UE and handled by SMF as defined in TS 23.501 [2] clause 5.4.4b.

The UE Integrity Protection Maximum Data Rate indicates the maximum data rate up to which the UE can support UP integrity protection.

The Number Of Packet Filters indicates the number of supported packet filters for signalled QoS rules as described in TS 23.501 [2], clause 5.17.2.2.2.

- 1b. (SMF requested modification) The PCF performs a PCF initiated SM Policy Association Modification procedure as defined in clause 4.16.5.2 to notify SMF about the modification of policies. This may e.g.; have been triggered by a policy decision or upon AF requests, e.g. Application Function influence on traffic routing as described in step 5 in clause 4.3.6.2.
- 1c. (SMF requested modification) The UDM updates the subscription data of SMF by Nudm\_SDM\_Notification (SUPI, Session Management Subscription Data). The SMF updates the Session Management Subscription Data and acknowledges the UDM by returning an Ack with (SUPI).
- 1d. (SMF requested modification) The SMF may decide to modify PDU Session. This procedure also may be triggered based on locally configured policy or triggered from the (R)AN (see clause 4.2.6 and clause 4.9.1). It may also be triggered if the UP connection is activated (as described in Service Request procedure) and the SMF has marked that the status of one or more QoS Flows are deleted in the 5GC but not synchronized with the UE yet.

If the SMF receives one of the triggers in step 1b ~ 1d, the SMF starts SMF requested PDU Session Modification procedure.

- 1e. (AN initiated modification) (R)AN shall indicate to the SMF when the AN resources onto which a QoS Flow is mapped are released irrespective of whether notification control is configured. (R)AN sends the N2 message (PDU Session ID, N2 SM information) to the AMF. The N2 SM information includes the QFI, User location Information and an indication that the QoS Flow is released. The AMF invokes Nsmf\_PDUSession\_UpdateSMContext (SM Context ID, N2 SM information).

(AN initiated notification control) In case notification control is configured for a GBR Flow, (R)AN sends a N2 message (PDU Session ID, N2 SM information) to SMF when the (R)AN decides the QoS targets of the QoS Flow cannot be fulfilled or can be fulfilled again, respectively. The N2 SM information includes the QFI and an indication that the QoS targets for that QoS Flow cannot be fulfilled or can be fulfilled again, respectively. The AMF invokes Nsmf\_PDUSession\_UpdateSMContext (SM Context ID, N2 SM information). If the PCF has subscribed to the event, SMF reports this event to the PCF for each PCC Rule for which notification control is set, see step 2. Alternatively, if dynamic PCC does not apply for this DNN, and dependent on locally configured policy, the SMF may start SMF requested PDU Session Modification procedure, see step 3b.

2. The SMF may need to report some subscribed event to the PCF by performing an SMF initiated SM Policy Association Modification procedure as defined in clause 4.16.5.1. This step may be skipped if PDU Session Modification procedure is triggered by step 1b or 1d. If dynamic PCC is not deployed, the SMF may apply local policy to decide whether to change the QoS profile.

Steps 3 to 7 are not invoked when the PDU Session Modification requires only action at a UPF (e.g. gating).

- 3a. For UE or AN initiated modification, the SMF responds to the AMF through Nsmf\_PDUSession\_UpdateSMContext (N2 SM information (PDU Session ID, QFI(s), QoS Profile(s), Session-AMBR), N1 SM container (PDU Session Modification Command (PDU Session ID, QoS rule(s), QoS rule operation, QoS Flow level QoS parameters if needed for the QoS Flow(s) associated with the QoS rule(s), Session-AMBR, [Always-on PDU Session])))). See TS 23.501 [2] clause 5.7 for the QoS Profile, and QoS rule and QoS Flow level QoS parameters.

If the PDU Session Modification was requested by the UE to modify a PDU Session to an always-on PDU Session, the SMF shall include an Always-on PDU Session Granted indication in the PDU Session Modification Command to indicate whether the PDU Session is to be changed to an always-on PDU Session or not via the Always-on PDU Session Granted indication in the PDU Session Modification Command.

The N2 SM information carries information that the AMF shall provide to the (R)AN. It may include the QoS profiles and the corresponding QFIs to notify the (R)AN that one or more QoS flows were added, or modified. It may include only QFI(s) to notify the (R)AN that one or more QoS flows were removed. If the PDU Session Modification was triggered by the (R)AN Release in step 1e the N2 SM information carries an acknowledgement of the (R)AN Release. If the PDU Session Modification was requested by the UE for a PDU Session that has no established User Plane resources, the N2 SM information provided to the (R)AN includes information for establishment of User Plane resources.

The N1 SM container carries the PDU Session Modification Command that the AMF shall provide to the UE. It may include the QoS rules, QoS Flow level QoS parameters if needed for the QoS Flow(s) associated with the QoS rule(s) and corresponding QoS rule operation and QoS Flow level QoS parameters operation to notify the UE that one or more QoS rules were added, removed or modified.

- 3b. For SMF requested modification, the SMF invokes Namf\_Communication\_N1N2MessageTransfer (N2 SM information (PDU Session ID, QFI(s), QoS Profile(s), Session-AMBR), N1 SM container (PDU Session Modification Command (PDU Session ID, QoS rule(s), QoS Flow level QoS parameters if needed for the QoS Flow(s) associated with the QoS rule(s), QoS rule operation and QoS Flow level QoS parameters operation, Session-AMBR))).

If the UE is in CM-IDLE state and an ATC is activated, the AMF updates and stores the UE context based on the Namf\_Communication\_N1N2MessageTransfer and steps 4, 5, 6 and 7 are skipped. When the UE is reachable e.g. when the UE enters CM-CONNECTED state, the AMF forwards the N1 message to synchronize the UE context with the UE.

4. The AMF may send N2 PDU Session Request (N2 SM information received from SMF, NAS message (PDU Session ID, N1 SM container (PDU Session Modification Command))) Message to the (R)AN.
5. The (R)AN may issue AN specific signalling exchange with the UE that is related with the information received from SMF. For example, in case of a NG-RAN, an RRC Connection Reconfiguration may take place with the UE modifying the necessary (R)AN resources related to the PDU Session.
6. The (R)AN may acknowledge N2 PDU Session Request by sending a N2 PDU Session Ack (N2 SM information (List of accepted/rejected QFI(s), AN Tunnel Info, PDU Session ID, Secondary RAT usage data), User location Information) Message to the AMF. In case of Dual Connectivity, if one or more QFIs were added to the PDU Session, the Master RAN node may assign one or more of these QFIs to a NG-RAN node which was not involved in the PDU Session earlier. In this case the AN Tunnel Info includes a new N3 tunnel endpoint for QFIs assigned to the new NG-RAN node. Correspondingly, if one or more QFIs were removed from the PDU Session, a (R)AN node may no longer be involved in the PDU Session anymore, and the corresponding tunnel endpoint is removed from the AN Tunnel Info. The NG-RAN may reject QFI(s) if it cannot fulfil the User Plane Security Enforcement information for a corresponding QoS Profile, e.g. due to the UE Integrity Protection Maximum Data Rate being exceeded.

If the PLMN has configured secondary RAT usage reporting, the NG-RAN node may provide RAN Usage Data Report.

7. The AMF forwards the N2 SM information and the User location Information received from the AN to the SMF via Nsmf\_PDUSession\_UpdateSMContext service operation. The SMF replies with a Nsmf\_PDUSession\_UpdateSMContext Response. N2 SM information may include Secondary RAT Usage Data.

If the (R)AN rejects QFI(s) the SMF is responsible of updating the QoS rules and QoS Flow level QoS parameters if needed for the QoS Flow(s) associated with the QoS rule(s) in the UE accordingly.

8. The SMF may update N4 session of the UPF(s) that are involved by the PDU Session Modification by sending N4 Session Modification Request message to the UPF (see NOTE 3).

If new QoS Flow(s) are to be created, the SMF updates the UPF with UL Packet Detection Rules of the new QoS Flow.

NOTE 2: This allows the UL packets with the QFI of the new QoS Flow to be transferred.

9. The UE acknowledges the PDU Session Modification Command by sending a NAS message (PDU Session ID, N1 SM container (PDU Session Modification Command Ack)) message.

10. The (R)AN forwards the NAS message to the AMF.

11. The AMF forwards the N1 SM container (PDU Session Modification Command Ack) and User Location Information received from the AN to the SMF via Nsmf\_PDUSession\_UpdateSMContext service operation. The SMF replies with a Nsmf\_PDUSession\_UpdateSMContext Response.

If the SMF initiated modification is to delete QoS Flows (e.g. triggered by PCF) which do not include QoS Flow associated with the default QoS rule and the SMF does not receive response from the UE, the SMF marks that the status of those QoS Flows is to be synchronized with the UE.

12. The SMF may update N4 session of the UPF(s) that are involved by the PDU Session Modification by sending N4 Session Modification Request (N4 Session ID) message to the UPF. For a PDU Session of Ethernet PDU Session Type, the SMF may notify the UPF to add or remove Ethernet Packet Filter Set(s) and forwarding rule(s).

NOTE 3: The UPFs that are impacted in the PDU Session Modification procedure depends on the modified QoS parameters and on the deployment. For example in case of the session AMBR of a PDU Session with an UL CL changes, only the UL CL is involved. This note also applies to the step 8.

13. If the SMF interacted with the PCF in step 1b or 2, the SMF notifies the PCF whether the PCC decision could be enforced or not by performing an SMF initiated SM Policy Association Modification procedure as defined in clause 4.16.5.1.

SMF notifies any entity that has subscribed to User Location Information related with PDU Session change.

If step 1b is triggered to perform Application Function influence on traffic routing by step 5 in clause 4.3.6.2, the SMF may reconfigure the User Plane of the PDU Session as described in step 6 in clause 4.3.6.2.

#### 4.3.3.3 UE or network requested PDU Session Modification (home-routed roaming)

The UE or network requested PDU Session Modification procedure (home-routed roaming scenario) is depicted in figure 4.3.3.3-1.

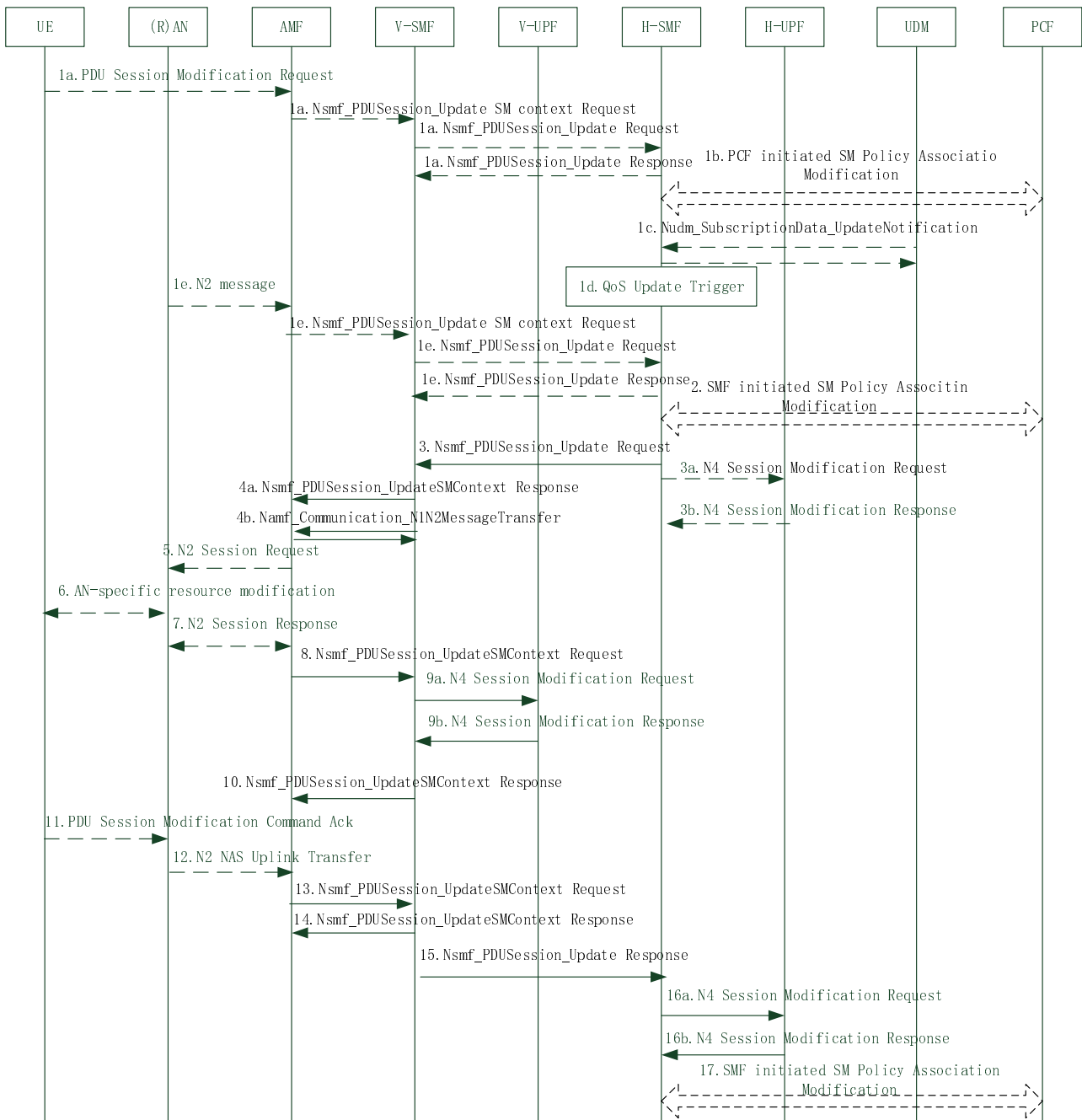

**Figure 4.3.3.3-1: UE or network requested PDU Session Modification (for home-routed roaming scenario)**

1. The procedure is triggered by one of the following events:

1a. (UE or serving network requested) As in step 1a of clause 4.3.3.2 with the addition that:

- The V-SMF checks whether it can accept the request from the UE;
- The V-SMF invokes an Nsmf\_PDUSession\_Update Request (SM Context ID, UE request for PDU Session Modification or the QoS modification request from the VPLMN, UE location information, Time Zone, the current Access Type, PCO, [Always-on PDU Session Requested]) service operation to inform the H-SMF to update the PDU Session. The H-SMF responds to the request immediately. If the AMF notified the V-SMF that the access type of the PDU session can be changed, as described in the UE Triggered Service Request procedure in clause 4.2.3.2, the V-SMF shall also indicate that the access type can be changed.

The PS Data Off status, if changed, shall be included in PCO (Protocol Configuration Option) in the PDU Session Modification Request message.

When PCF is deployed, the SMF shall further report the PS Data Off status to PCF if the PS Data Off event trigger is provisioned, the additional behaviour of SMF and PCF for 3GPP PS Data Off is defined in TS 23.503 [20].

1b. (HPLMN requested) This step is the same as step 1b in clause 4.3.3.2. If the H-SMF received the indication that the access type of the PDU session can be changed, the H-SMF shall indicate the target access type to the PCF in the Access Type information of the Npcf\_SMPolicyControl\_Update Request.

1c. (HPLMN requested) This step is the same as step 1c in clause 4.3.3.2.

1d. (HPLMN requested) This step is the same as step 1d in clause 4.3.3.2.

1e. As in step 1e of clause 4.3.3.2 with addition that:

- The AMF invokes Nsmf\_PDUSession\_UpdateSMContext (SM context ID, N2 SM information) and sends it to the V-SMF;
- The V-SMF invokes an Nsmf\_PDUSession\_Update Request (SM context ID, ULI, AN type, QoS Flow to be released) service operation to inform the H-SMF to update the PDU Session. The H-SMF responds to the request immediately.

NOTE 1: SM Context ID between AMF and V-SMF and between V-SMF and H-SMF are different. SM Context ID has local significance per SMF instance.

2. This step is the same as steps 2 in clause 4.3.3.2 with the SMF is H-SMF.

3. (UE or serving network requested or HPLMN requested) The H-SMF invokes the Nsmf\_PDUSession\_Update Request (SM Context ID, QoS profiles, Session-AMBR, information needed to build the SM PDU Session Modification Command message towards the UE including the QoS rule(s) and QoS Flow level QoS parameters if needed for the QoS Flow(s) associated with the QoS rule(s) and QoS rule operation and the QoS Flow level QoS parameters operation) service operation to the V-SMF.

Based on operator policies, the V-SMF may decide to accept or reject the QoS information provided by the H-SMF. The V-SMF shall be able to accept a subset of the QoS flows requested to be created or modified within a single H-SMF request i.e. V-SMF can accept some QoS flows and reject other QoS flows in same response to H-SMF.

3a-3b (HPLMN requested) These steps are executed if new QoS Flow(s) are to be created. The SMF updates the UPF with UL Packet Detection Rules of the new QoS Flow.

NOTE 2: This allows the UL packets with the QFI of the new QoS Flow to be transferred.

If an Always-on PDU Session Granted indication was provided by the H-SMF to indicate that the PDU Session is to be changed to an always-on PDU Session, the V-SMF decides whether to accept or reject the request from the H-SMF based on local policies.

4a-4b. These steps are the same as step 3a-3b in clause 4.3.3.2 but controlled from the V-SMF. The V-SMF uses the information received in step 3 to generate any N1 and/or N2 signalling to be sent towards the UE and/or the (R)AN.

5-7. These steps are the same as step 4-6 in clause 4.3.3.2.

8. This step is the same as step 7a in clause 4.3.3.2 with the difference that the SMF is V-SMF.

9a-9b are the same as step 11a-11b in clause 4.3.3.2 but executed in Visited PLMN

10. This step is the same as step 7b in clause 4.3.3.2 with the difference that the SMF is V-SMF.

11-12. These steps are the same as steps 8-9 in 4.3.3.2.

13-14. These steps are the same as step 10a-10b in clause 4.3.3.2 but executed in Visited PLMN.

15. V-SMF responds to the H-SMF with an Nsmf\_PDUSession\_Update response carrying the information like PCO provided by the UE in the SM PDU Session Modification Command Ack message from the UE to the V-SMF, Secondary RAT usage data. The H-SMF shall modify the PDU Session context.

If the V-SMF has rejected QFI(s) (step3) or the (R)AN has rejected QFI(s) in step 6 of Figure 4.3.3.2-1, the H-SMF is responsible of later updating the QoS rules and QoS Flow level QoS parameters if needed for the QoS Flow(s) associated with the QoS rule(s) in the UE.

16-17. These steps are the same as steps 11-12 in clause 4.3.3.2 with the difference that the SMF is H-SMF.

## 4.3.4 PDU Session Release

### 4.3.4.1 General

The PDU Session Release procedure is used to release all the resources associated with a PDU Session, including:

- The IP address/Prefixes allocated for an IP-based PDU Session; this may include the release of multiple Prefixes in case of Multi-homing (as defined in TS 23.501 [2]).
- Any UPF resource (including N3/N9 termination) that was used by the PDU Session.
- Any access resource that was used by the PDU Session.

The SMF takes care to notify any entity associated with PDU Session: PCF, DN (e.g. when DN authorization has taken place at PDU Session establishment), etc. of a PDU Session Release.

### 4.3.4.2 UE or network requested PDU Session Release for Non-Roaming and Roaming with Local Breakout

Figure 4.3.4.2-1 captures both the UE Requested PDU Session Release procedure and the network requested PDU Session Release procedure. The procedure allows the UE to request the release of one PDU Session. The procedure also allows the AMF, the SMF or the PCF to initiate the release of a PDU Session. In the case of LBO, the procedure is as in the case of non-roaming with the difference that the AMF, the SMF, the UPF and the PCF are located in the visited network.



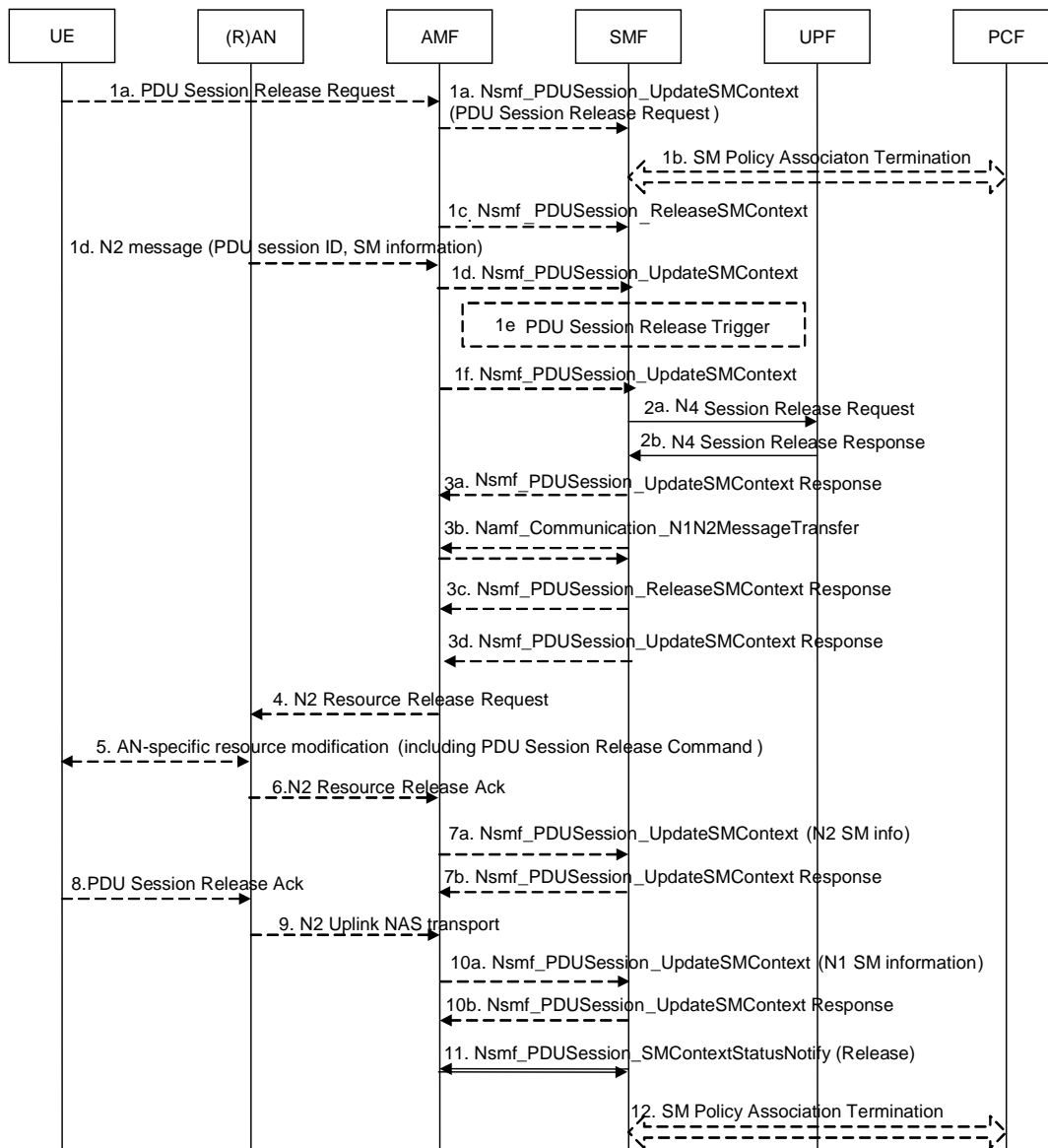

**Figure 4.3.4.2-1: UE or network requested PDU Session Release for non-roaming and roaming with local breakout**

1. The procedure is triggered by one of the following events:

1a. (UE requested) The UE initiates the UE Requested PDU Session Release procedure by the transmission of an NAS message (N1 SM container (PDU Session Release Request (PDU session ID)), PDU Session ID) message. The NAS message is forwarded by the (R)AN to the AMF with an indication of User Location Information. This message is relayed to the SMF corresponding to the PDU Session ID via N2 and the AMF. The AMF invokes the Nsmf\_PDUSession\_UpdateSMContext service operation and provides the N1 SM container to the SMF together with User Location Information (ULI) received from the (R)AN.

NOTE 1: Depending on the Access Type, when the UE is in CM-IDLE state, the UE can trigger a Service Request procedure before being able to release the PDU Session.

1b. (PDU Session Release initiated by the PCF) The PCF may invoke an SM Policy Association Termination procedure as defined in clause 4.16.6 to request the release of the PDU Session.

1c. The AMF may invoke the Nsmf\_PDUSession\_ReleaseSMContext service operation to request the release of the PDU Session in case of mismatch of PDU Session status between UE and AMF.

1d. (R)AN may decide to indicate to the SMF that the PDU Session related resource is released, e.g. when all the QoS Flow(s) of the PDU Session are released.

NOTE 2: In this case, it's up to SMF to decide whether to keep the PDU Session with user plane connection deactivated or release the PDU Session.

1e. (PDU Session Release initiated by the SMF) The SMF may decide to release a PDU Session under the following scenarios:

- Based on a request from the DN (cancelling the UE authorization to access to the DN);
- Based on a request from the UDM (subscription change) or from the CHF;
- If the SMF received an event notification from the AMF that the UE is out of LADN service area
- Based on locally configured policy (e.g. the release procedure may be related with the UPF re-allocation for SSC mode 2 / mode 3); or
- If the SMF is notified by the (R)AN that the PDU Session resource establishment has failed during mobility procedure.

If the SMF receives one of the triggers in step 1a, 1b, 1c, or 1e the SMF starts PDU Session Release procedure.

1f. The AMF may invoke the Nsmf\_PDUSESSION\_UpdateSMContext service operation with a release indication to request the release of the PDU Session where N1 or N2 SM signalling may be needed before releasing the SM context.

2. The SMF releases the IP address / Prefix(es) that were allocated to the PDU Session and releases the corresponding User Plane resources:

2a. The SMF sends an N4 Session Release Request (N4 Session ID) message to the UPF(s) of the PDU Session. The UPF(s) shall drop any remaining packets of the PDU Session and release all tunnel resource and contexts associated with the N4 Session.

2b. The UPF(s) acknowledges the N4 Session Release Request by the transmission of an N4 Session Release Response (N4 Session ID) message to the SMF.

NOTE 3: If there are multiple UPFs associated with the PDU Session (e.g. due to the insertion of UL CL or Branching Point, the Session Release Request procedure (steps 2a and 2b) is done for each UPF.

3 If the PDU Session Release is initiated by the PCF and SMF, and the SMF has been notified by the AMF that UE is unreachable, e.g. due to the UE is in MICO mode or periodical registration failure, the procedure continues in step 11 by SMF notifying the AMF that the PDU Session is released by invoking the Nsmf\_PDUSESSION\_SMContextStatusNotify. The rest of step 3 and the steps 4-10 are skipped.

If the PDU Session Release procedure was triggered by steps 1a, 1b, 1d or 1e above, the SMF creates an N1 SM including PDU Session Release Command message (PDU Session ID, Cause). The Cause may indicate a trigger to establish a new PDU Session with the same characteristics (e.g. when procedures related with SSC mode 2 are invoked).

If the User Plane connection of the PDU Session is activated, the message sent by the SMF to the AMF shall include N2 SM Resource Release request. If the User Plane connection of the PDU Session is not activated, the message sent by the SMF to the AMF shall not include N2 SM Resource Release request.

NOTE 4: SSC modes are defined in TS 23.501 [2] clause 5.6.9.

3a. (If the PDU Session Release is initiated by the UE in step 1a or has been triggered by (R)AN in step 1d) The SMF responds to the AMF with the Nsmf\_PDUSESSION\_UpdateSMContext response (N2 SM Resource Release request, N1 SM container (PDU Session Release Command)). N2 SM Resource Release request is included if the PDU Session Release is initiated by the UE and if the UP connection of the PDU Session is active.

3b. If the PDU Session Release is initiated by the SMF or the PCF, the SMF invokes the Namf\_Communication\_N1N2MessageTransfer service operation (N1 SM container (PDU Session Release Command), skip indicator).

If the UP connection of the PDU Session is active, the SMF shall also include the N2 Resource Release request (PDU Session ID) in the Namf\_Communication\_N1N2MessageTransfer, to release the (R)AN resources associated with the PDU Session.

The "skip indicator" tells the AMF whether it may skip sending the N1 SM container to the UE (e.g. when the UE is in CM-IDLE state). SMF includes the "skip indicator" in the Namf\_Communication\_N1N2MessageTransfer except when the procedure is triggered to change PDU Session Anchor of a PDU Session with SSC mode 2.

If the UE is in CM-IDLE state and "skip indicator" is included in the Namf\_Communication\_N1N2MessageTransfer service operation, the AMF acknowledges the step 3b by sending an Namf\_Communication\_N1N2MessageTransfer Response message ("N1 SM Message Not Transferred") to SMF and steps 4 to 10 are skipped.

- 3c. If the PDU Session Release is initiated by the AMF in step 1c, i.e. the SMF received the Nsmf\_PDUSession\_ReleaseSMContext Request from the AMF, the SMF responds to the AMF with the Nsmf\_PDUSession\_ReleaseSMContext response.

The AMF and SMF shall remove all contexts (including the PDU Session ID) associated with the PDU Session which are indicated as released at the UE. AMF and SMF shall remove any event subscriptions on the AMF by the SMF as well. The steps 4 to 11 are skipped.

- 3d. If the PDU Session Release is initiated by the AMF in step 1f, i.e. the SMF received the Nsmf\_PDUSession\_UpdateSMContext Request from the AMF with a release indication to request the release of the PDU Session (e.g. due to a change of the set of network slices for a UE where a network slice instance is no longer available as described in TS 23.501 [2] clause 5.15.5.2.2), the SMF responds to the AMF with the Nsmf\_PDUSession\_UpdateSMContext Response which shall contain the N1 SM container (PDU Session Release Command) to release the PDU session at the UE.

If the UP connection of the PDU Session is active, the Nsmf\_PDUSession\_UpdateSMContext Response shall also include the N2 Resource Release request (PDU Session ID) to release the (R)AN resources associated with the PDU Session.

4. If the UE is in CM-IDLE state and "N1 SM delivery can be skipped" is not indicated, the AMF initiates the network triggered Service Request procedure to transmit the NAS message (PDU Session ID, N1 SM container) to the UE and the steps 6, 7 are skipped.

If the message received from the SMF in step 3 does not include N2 SM Resource Release request, the AMF transmits the NAS message (PDU Session ID, N1 SM container) to the UE and the steps 6, 7 are skipped.

If the UE is in CM-CONNECTED state and the received message from the SMF in step 3 includes N2 SM Resource Release request, the AMF transfers the SM information received from the SMF in step 4 (N2 SM Resource Release request, N1 SM container) to the (R)AN.

5. When the (R)AN has received an N2 SM request to release the AN resources associated with the PDU Session it issues AN specific signalling exchange(s) with the UE to release the corresponding AN resources.

In the case of a NG-RAN, the NAS message is sent to the UE in an RRC message which may take place with the UE releasing the NG-RAN resources related to the PDU Session. If NG-RAN resources do not need to be released (i.e. the User Plane of the PDU Session is deactivated), the NAS message is sent to the UE in an RRC message which does not release the NG-RAN resources related to the PDU Session.

During this procedure, the (R)AN sends any NAS message (N1 SM container (PDU Session Release Command)) received from the AMF in step 5.

6. [Conditional] If the (R)AN had received a N2 SM request to release the AN resources, the (R)AN acknowledges the N2 SM Resource Release Request by sending an N2 SM Resource Release Ack (User Location Information, Secondary RAT usage data) Message to the AMF.

If the PLMN has configured secondary RAT usage reporting, the NG-RAN node may provide RAN Usage Data Report.

- 7a. The AMF invokes the Nsmf\_PDUSession\_UpdateSMContext (N2 SM Resource Release Ack (Secondary RAT usage data), User Location Information) to the SMF.

- 7b. The SMF responds to the AMF with an Nsmf\_PDUSession\_UpdateSMContext response.

8. The UE acknowledges the PDU Session Release Command by sending a NAS message (PDU Session ID, N1 SM container (PDU Session Release Ack)) message over the (R)AN.

9. [Conditional] The (R)AN forwards the NAS message from the UE by sending a N2 NAS uplink transport (NAS message (PDU Session ID, N1 SM container (PDU Session Release Ack)), User Location Information) to the AMF.
- 10a. The AMF invokes the Nsmf\_PDUSession\_UpdateSMContext (N1 SM container (PDU Session Release Ack, User Location Information) to the SMF.
- 10b. The SMF responds to the AMF with an Nsmf\_PDUSession\_UpdateSMContext response.
- Steps 8-10 may happen before steps 6-7.
11. If steps 3a, 3b or 3d were performed, the SMF waits until it has received replies to the N1 and N2 information provided in step 3, as needed.

The SMF invokes Nsmf\_PDUSession\_SMContextStatusNotify to notify AMF that the SM context for this PDU Session is released. The AMF releases the association between the SMF ID and the PDU Session ID, DNN, as well as S-NSSAI.

NOTE 5: The UE and the 5GC will get synchronized about the status of the (released) PDU Session at the next Service Request or Registration procedure.

12. If Dynamic PCC applied to this session the SMF invokes an SM Policy Association Termination procedure as defined in clause 4.16.6 to delete the PDU Session.

SMF notifies any entity that has subscribed to User Location Information related with PDU Session change.

If it is the last PDU Session the SMF is handling for the UE for the associated (DNN, S-NSSAI), the SMF unsubscribes from Session Management Subscription data changes notification with the UDM by means of the Nudm\_SDM\_Unsubscribe (SUPI, DNN, S-NSSAI) service operation. The UDM may unsubscribe the subscription notification from UDR by Nudr\_DM\_Unsubscribe (SUPI, Subscription Data, Session Management Subscription data, DNN, S-NSSAI).

The SMF invokes the Nudm\_UECM\_Deregistration service operation including the DNN and the PDU Session Id. The UDM removes the association it had stored between the SMF identity and the associated DNN and PDU Session Id. The UDM may update this information by Nudr\_DM\_Update (SUPI, Subscription Data, UE context in SMF data).

#### 4.3.4.3 UE or network requested PDU Session Release for Home-routed Roaming

This procedure is used in case of home-routed roaming scenarios.

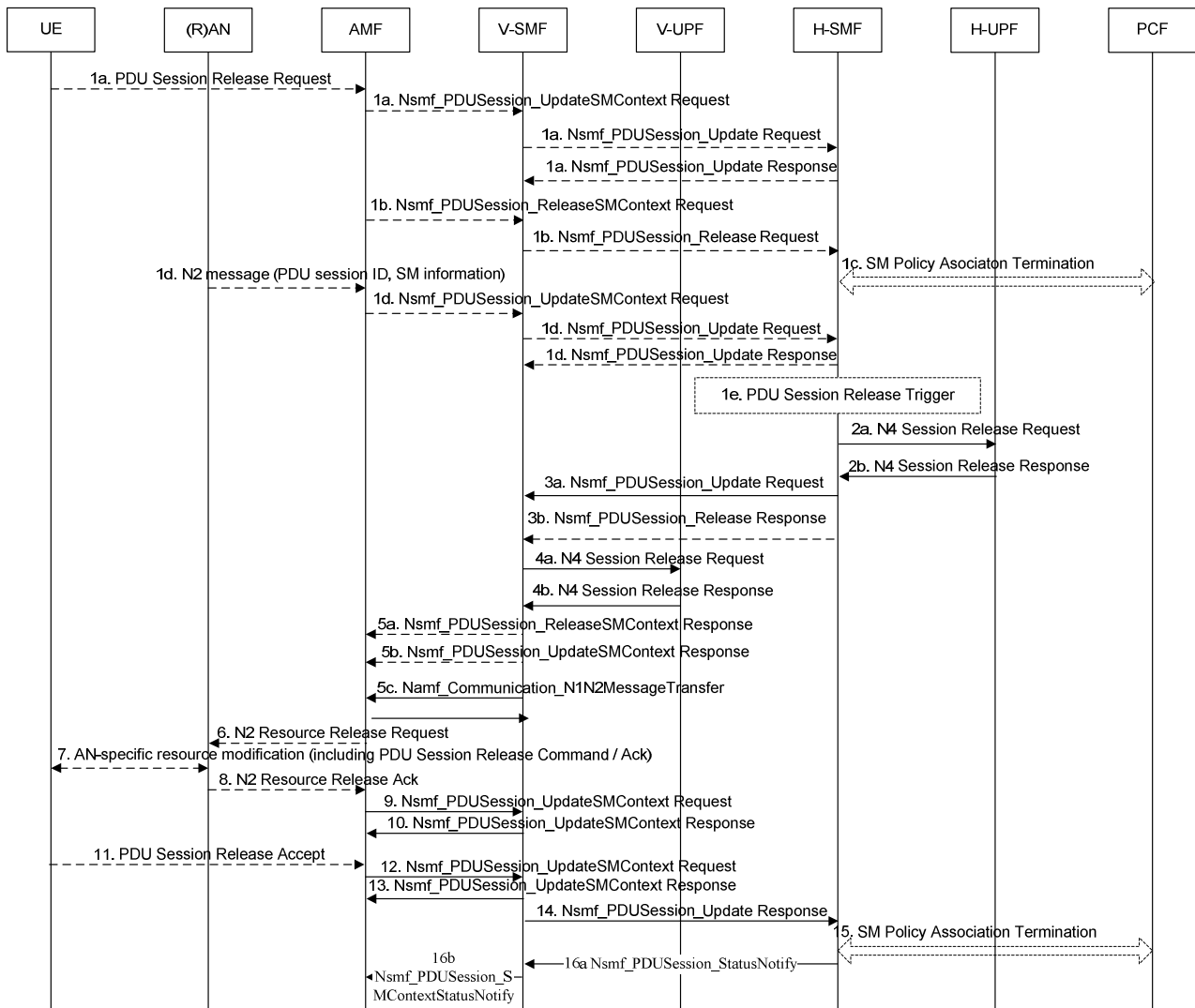

**Figure 4.3.4.3-1: UE or network requested PDU Session Release for home-routed roaming**

1. The procedure is triggered by one of the following events:

1a. (UE initiated release) As in step 1a of clause 4.3.4.2 with the addition that the V-SMF invokes the Nsmf\_PDUSession\_Update Request (SUPI, PDU Session ID, information from the SM message from the UE e.g. PCO, "Trigger PDU Session Release" indication, Timezone, User Location Information) service operation to request the H-SMF to release the PDU Session. The H-SMF responds to the request immediately.

1b. (Serving network initiated release) The serving network initiates the PDU Session Release during UE or serving network initiated Deregistration procedure as specified in clause 4.2.2.3. There is no NAS SM message between the UE and the V-SMF in this case. The V-SMF initiates the release of the PDU Session at the H-SMF by invoking the Nsmf\_PDUSession\_Release request.

1c. (HPLMN initiated release) This step is the same as step 1b in clause 4.3.4.2.

1d. This step is the same as step 1d in clause 4.3.4.2.

1e. (HPLMN initiated release) This step is the same as step 1e in clause 4.3.4.2.

If the SMF receives one of the triggers in step 1a, 1c or 1e, the H-SMF starts PDU Session Release procedure.

2a-2b. These steps are the same as steps 2a-2b in clause 4.3.4.2. The SMF is the SMF in HPLMN.

3a. (UE or HPLMN initiated release) The H-SMF prepares the SM Release PDU Session Command message and initiates the PDU Session Release towards the UE by invoking the Nsmf\_PDUSession\_Update Request service

operation towards the V-SMF. The Nsmf\_PDUSession\_Update Request contains necessary information to build the SM Release PDU Session Command by the V-SMF towards the UE (for example a Release Cause or PCO).

- 3b. (Serving network initiated release) The H-SMF responds to the PDU release request from the V-SMF with a Nsmf\_PDUSession\_Release response.
- 4a-4b. The V-SMF releases the corresponding User Plane resources. This includes the same procedure in step 2 but controlled from the SMF in VPLMN.
- 5-13. These steps are the same as steps 3-10 in clause 4.3.4.2.
14. (UE or HPLMN initiated release) The V-SMF responds to the Nsmf\_PDUSession\_Update Request invoked at step 3a and confirms the PDU Session Release. The Nsmf\_PDUSession\_Update response may carry information such as PCO received from the UE in SM PDU Session Release Accept. as well as User Location Information, Time Zone and Secondary RAT Usage Data.
15. (UE or HPLMN or Serving network initiated release) The H-SMF releases the SM policy control association with the PCF by invoking the SM Policy Association Termination procedure defined in clause 4.16.6. For serving network initiated PDU Session Release case, this step happens between step 1b and step 3b.
16. (UE or HPLMN initiated release) The H-SMF shall remove all contexts associated with the PDU Session.
- 16a. The H-SMF requests the V-SMF to release all contexts associated with the PDU Session by invoking the Nsmf\_PDUSession\_StatusNotify (Release) operation.
- 16b. The V-SMF requests the AMF to release all contexts associated with the PDU Session by invoking the Nsmf\_PDUSession\_SMContextStatusNotify (Release). The AMF releases the association between the SMF ID and the PDU Session ID.

## 4.3.5 Session continuity, service continuity and UP path management

### 4.3.5.1 Change of SSC mode 2 PDU Session Anchor with different PDU Sessions

The following procedure is triggered by SMF in order to change the PDU Session Anchor serving a PDU Session of SSC mode 2 for a UE when neither multi-homing nor UL CL applies to the PDU Session. This procedure releases the existing PDU Session associated with an old PDU Session Anchor (i.e. UPF1 in figure 4.3.5.1-1) and immediately establishes a new PDU Session with a new PDU Session Anchor (i.e. UPF2 in figure 4.3.5.1-1) to the same DN.

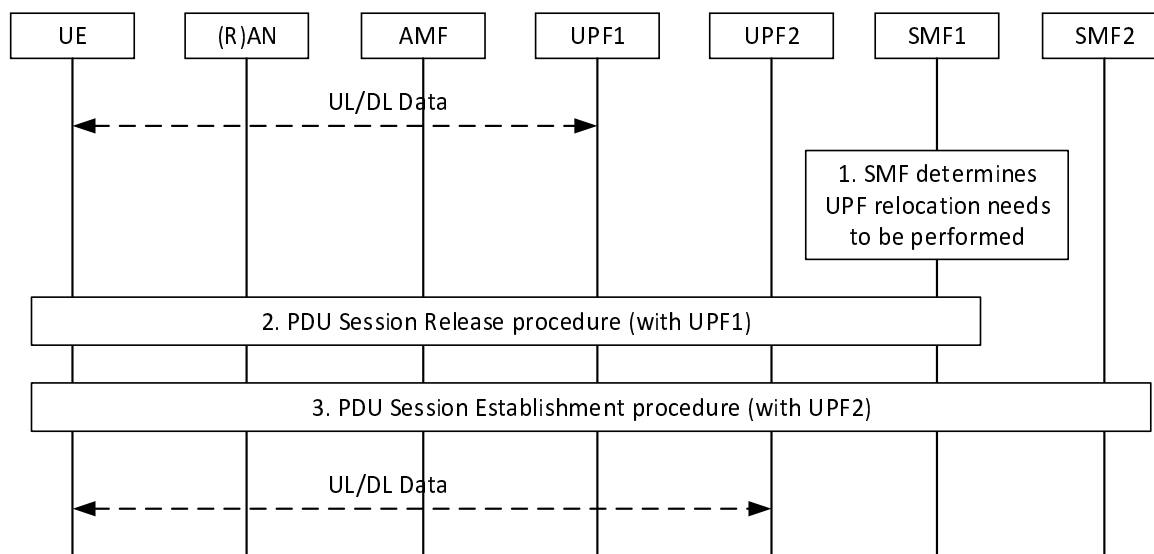

**Figure 4.3.5.1-1: Change of SSC mode 2 PSA for a PDU Session**

1. The SMF determines that the serving UPF needs to be changed due to events that may benefit from such change.
2. The PDU Session Release procedure is initiated as described in clause 4.3.4. The SMF sends an N1 SM Information to the UE via the AMF by invoking Namf\_Communication\_N1N2MessageTransfer as described in

Step 3b of clause 4.3.4.2. The PDU Session Release Command message in N1 SM Information contains the PDU Session ID and Cause indicating that a PDU Session re-establishment to the same DN is required.

3. Upon reception of PDU Session Release Command with Cause indicating that a PDU Session re-establishment to the same DN is required as sent in step 2, the UE generates a new PDU Session ID and initiates PDU Session Establishment procedure as described in clause 4.3.2.2. Then, the AMF selects an SMF as described in TS 23.501 [2], clause 6.4.2 and the SMF can select a new UPF (i.e. UPF2) for the re-established PDU Session of SSC mode 2.

### 4.3.5.2 Change of SSC mode 3 PDU Session Anchor with multiple PDU Sessions

The following procedure is triggered by SMF in order to change the PDU Session Anchor serving a PDU Session of SSC mode 3 for a UE. This procedure releases the existing PDU Session associated with an old PDU Session Anchor (i.e. UPF1 in figure 4.3.5.2-1) after having established a new PDU Session to the same DN with a new PDU Session Anchor (i.e. UPF2 in figure 4.3.5.2-1), which is controlled by the same SMF. The SMF may determine that a new SMF needs to be reallocated.

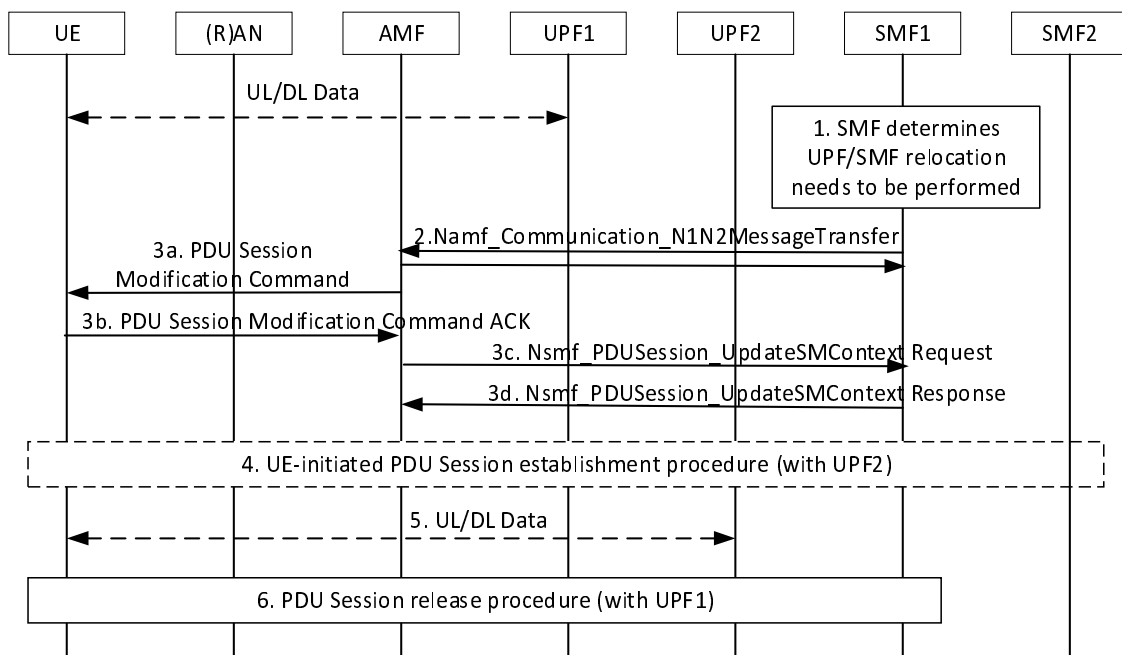

Figure 4.3.5.2-1: Change of SSC mode 3 PDU Session Anchor with multiple PDU Sessions

1. The SMF determines that the serving UPF or the SMF needs to be changed. If the "Indication of application relocation possibility" attributes in the PCC rule indicates no DNAI change takes place once selected for this application, the SMF determines that the SMF can not be changed.
2. The SMF invokes the Namf\_Communication\_N1N2MessageTransfer (PDU Session ID, SMF Reallocation requested indication, N1 SM container (PDU Session Modification Command (Cause, PCO (PDU Session Address Lifetime value)))) where PDU Session ID indicates the existing PDU Session to be relocated and Cause indicates that a PDU Session re-establishment to the same DN is required.

The SMF Reallocation requested indication indicates whether the SMF is requested to be reallocated.

The PDU Session Address Lifetime value is delivered to the UE upper layers in PCO and indicates how long the network is willing to maintain the PDU Session. The SMF starts a PDU Session Release timer corresponding to the PDU Session Address Lifetime value.

- 3a. The AMF forwards the NAS message to the UE. The UE can provide the release timer value to the upper layers if received in the PDU Session Modification Command.
- 3b. The UE acknowledges the PDU Session Modification Command.
- 3c. The AMF forwards the N1 SM container (PDU Session Modification Command ACK) received from the (R)AN to the SMF1 via Nsmf\_PDUSession\_UpdateSMContext service operation.

3d. The SMF1 replies with a Nsmf\_PDUSession\_UpdateSMContext Response.

4. If the UE receives PDU Session Modification Command, the UE may decide to initiate the PDU Session Establishment procedure described in clause 4.3.2.2, to the same DN with the following differences:

In Step 1 of clause 4.3.2.2.1, according to the SSC mode, UE generates a new PDU Session ID and initiates the PDU Session Establishment Request using the new PDU Session ID. The new PDU Session ID is included as PDU Session ID in the NAS request message, and the Old PDU Session ID which indicates the existing PDU Session to be released is also provided to AMF in the NAS request message.

In Step 2 of clause 4.3.2.2.1, if SMF reallocation was requested in Step 2 of this clause, the AMF selects a different SMF. Otherwise, the AMF sends the Nsmf\_PDUSession\_CreateSMContext Request to the same SMF serving the Old PDU Session ID.

In Step 3 of clause 4.3.2.2.1, the AMF include both PDU Session ID and Old PDU Session ID in Nsmf\_PDUSession\_CreateSMContext Request. The SMF detects that the PDU Session establishment request is related to the trigger in step 2 based on the presence of an Old PDU Session ID in the Nsmf\_PDUSession\_CreateSMContext Request. The SMF stores the new PDU Session ID and selects a new PDU Session Anchor (i.e. UPF2) for the new PDU Session.

5. After the new PDU Session is established the UE starts using the IP address/prefix associated with the new PDU Session for all new traffic and may also proactively move existing traffic flow (where possible) from the old PDU Session to the new PDU Session.

NOTE: The mechanisms used by the UE to proactively move existing traffic flows from one IP address/prefix to another are outside the scope of 3GPP specifications.

6. The old PDU Session is released as described in clause 4.3.4 either by the UE before the timer provided in step 3 expires (e.g., once the UE has consolidated all traffic on new PDU Session or if the session is no more needed) or by the SMF upon expiry of this timer.

#### 4.3.5.3 Change of SSC mode 3 PDU Session Anchor with IPv6 Multi-homed PDU Session

Clause 4.3.5.3 describes a procedure for service continuity with SSC mode 3 that uses the multi-homed PDU Session described in TS 23.501 [2] clause 5.6.4.3. In this case the SMF prepares a new PDU Session Anchor first and then notifies the UE of the existence of a new IP prefix, as depicted in figure 4.3.5.3-1. This procedure is applicable only to PDU Sessions of IPv6 type.



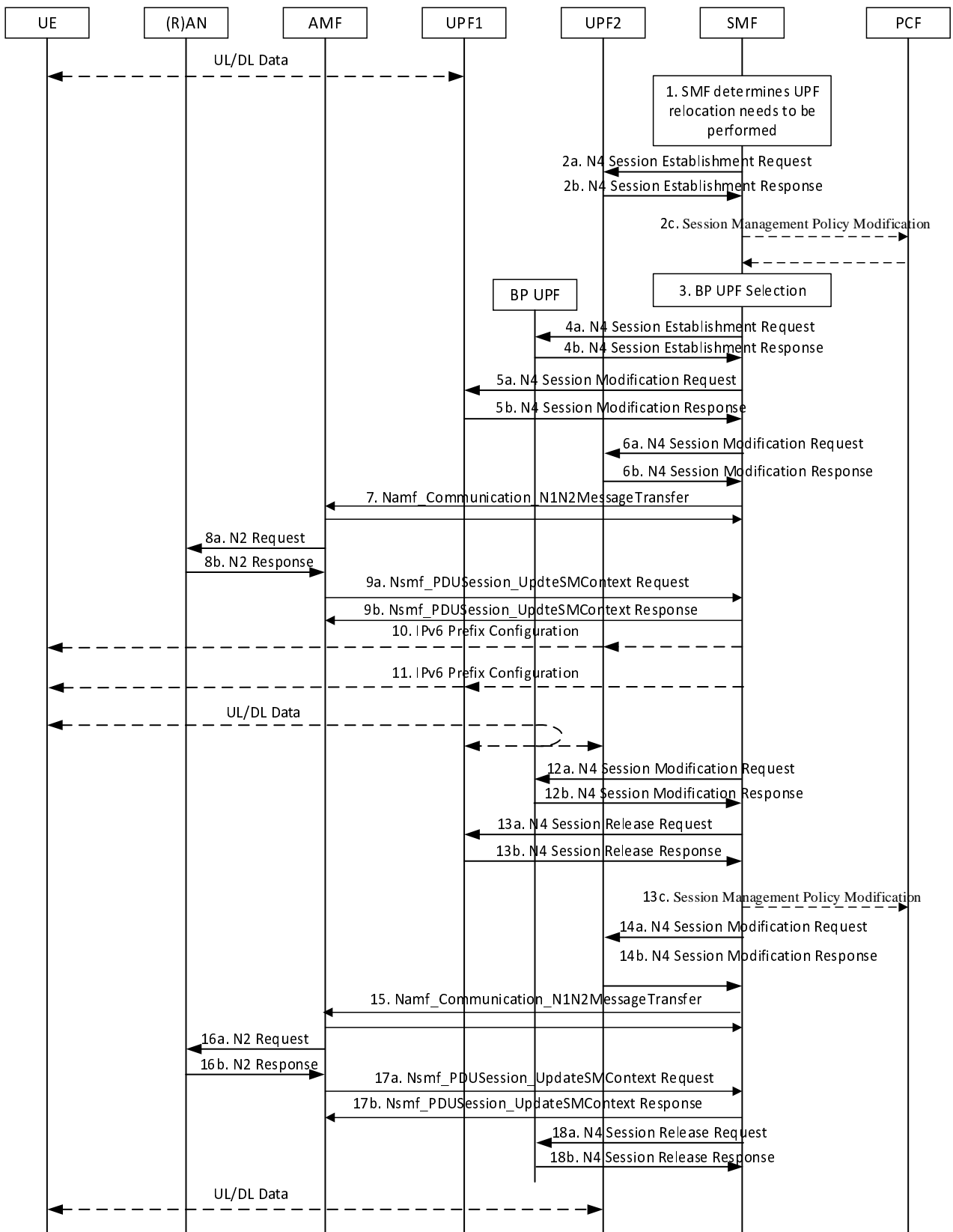

**Figure 4.3.5.3-1: Change of PDU Session Anchor with IPv6 Multi homed PDU Session**

The UE has an established PDU Session with the PDU Session Anchor (i.e. UPF1 in Figure 4.3.5.3-1). The PDU Session's User Plane involves at least the (R)AN and the PDU Session Anchor.

1. At some point the SMF decides to allocate to the PDU Session the PDU Session with a new PDU Session Anchor.

2. The SMF selects a new UPF and using N4 configures the UPF as a new PDU Session Anchor (i.e. UPF2 in Figure 4.3.5.3-1) of the multi-homed PDU Session. In the process a new IPv6 prefix (IP@2) is allocated for the PDU Session. If the PCF has subscribed to the IP allocation/release event, the SMF performs a Session Management Policy Modification procedure as defined in clause 4.16.5 to provide the new allocated IPv6 prefix to the PCF. The PCF invokes Nbsf\_Management\_Register service operation to register the tuple (IPv6 prefix, PCF id) for the PDU session identified by (SUPI, DNN, S-NSSAI) in the BSF.
3. The SMF selects a Branching Point (BP) UPF as described in Clause of 6.3.3 of TS 23.501 [2]. The selection of BP UPF may consider the location of UPF1 and UPF2 to ensure a suitable location of the BP UPF relative to the UPF1 and the UPF2.

NOTE 1: In case BP UPF is co-located with one of PDU Session Anchors, steps between SMF and BP UPF can be skipped.

4. The SMF configures via N4 the UPF selected in step 3 (BP UPF in Figure 4.3.5.3-1) as a Branching Point for the multi-homed PDU Session. It provides the Branching Point with the necessary UL traffic forwarding rules (related with the prefix of the IPv6 source address of UL traffic). Also, the SMF provides AN Tunnel Info for N3 tunnel setup and CN Tunnel Info for N9 tunnel setup to the BP UPF and obtains CN Tunnel Info from the BP UPF.
- 5-6. The SMF performs N4 Session Modification procedure with PSAs. During this procedure, the SMF provides CN Tunnel Info received from the BP UPF to set up an N9 tunnel between BP and PSAs.
7. The SMF invokes the Namf\_Communication\_N1N2MessageTransfer service operation containing N2 SM Information with CN Tunnel Info for the N3 tunnel setup.
8. The AMF sends an N2 Request including N2 SM Information received from the SMF to the (R)AN. The (R)AN acknowledges to the AMF with an N2 Response.
- 9a. The AMF carries the N2 Response sent by the (R)AN to the SMF by invoking the Nsmf\_PDUSession\_UpdateSMContext service operation.
- 9b. The SMF responds to Nsmf\_PDUSession\_UpdateSMContext service operation from the AMF.
- 10-11. The SMF notifies the UE of the availability of the new IP prefix. This is performed using an IPv6 Router Advertisement message (RFC 4861 [6]). The SMF sends a Router Advertisement to the UE via the new PSA with a new prefix (IP@2) and sends another Router Advertisement to the UE via the old PSA with the old prefix (IP@1) and zero value in the preferred lifetime field and a value in the valid lifetime field according to RFC 4862 [8]. The UE shall update the valid lifetime of the old prefix (IP@1) to the signalled value regardless of the remaining lifetime. The valid lifetime value indicates the time how long the SMF is willing to keep the old prefix. The valid lifetime value may be decided by SMF based on local configuration.

The UE starts using IP@2 for all new traffic and may also proactively move existing traffic flow (where possible) from IP@1 to IP@2.

NOTE 2: The mechanisms used by the UE to proactively move existing traffic flows from one IP prefix to another are outside the scope of 3GPP specifications.

12. After the timer expires, the SMF releases the UE's old IPv6 prefix (IP@1). At this point the UE implicitly releases the old IP prefix. The SMF sends an N4 Session Modification Request to the BP to release UP resource for N9 tunnel between the BP and old PSA.
13. The SMF releases the old PDU Session context with the old PDU Session Anchor (UPF1 in Figure 4.3.5.3-1). If the PCF has subscribed to the IP allocation/release event, the SMF performs a Session Management Policy Modification procedure as defined in clause 4.16.5 to notify the PCF of the IPv6 prefix release. The PCF shall invoke Nbsf\_Management\_Unregister service operation to remove the tuple (IPv6prefix, PCF id) for the PDU session identified by (SUPI, DNN,S-NSSAI) in BSF.
- 14-18. The SMF may optionally release the Branching Point from the User Plane path.

#### 4.3.5.4 Addition of additional PDU Session Anchor and Branching Point or UL CL

Clause 4.3.5.4 describes a procedure to add a PDU Session Anchor and a Branching Point or UL CL for an established PDU Session.

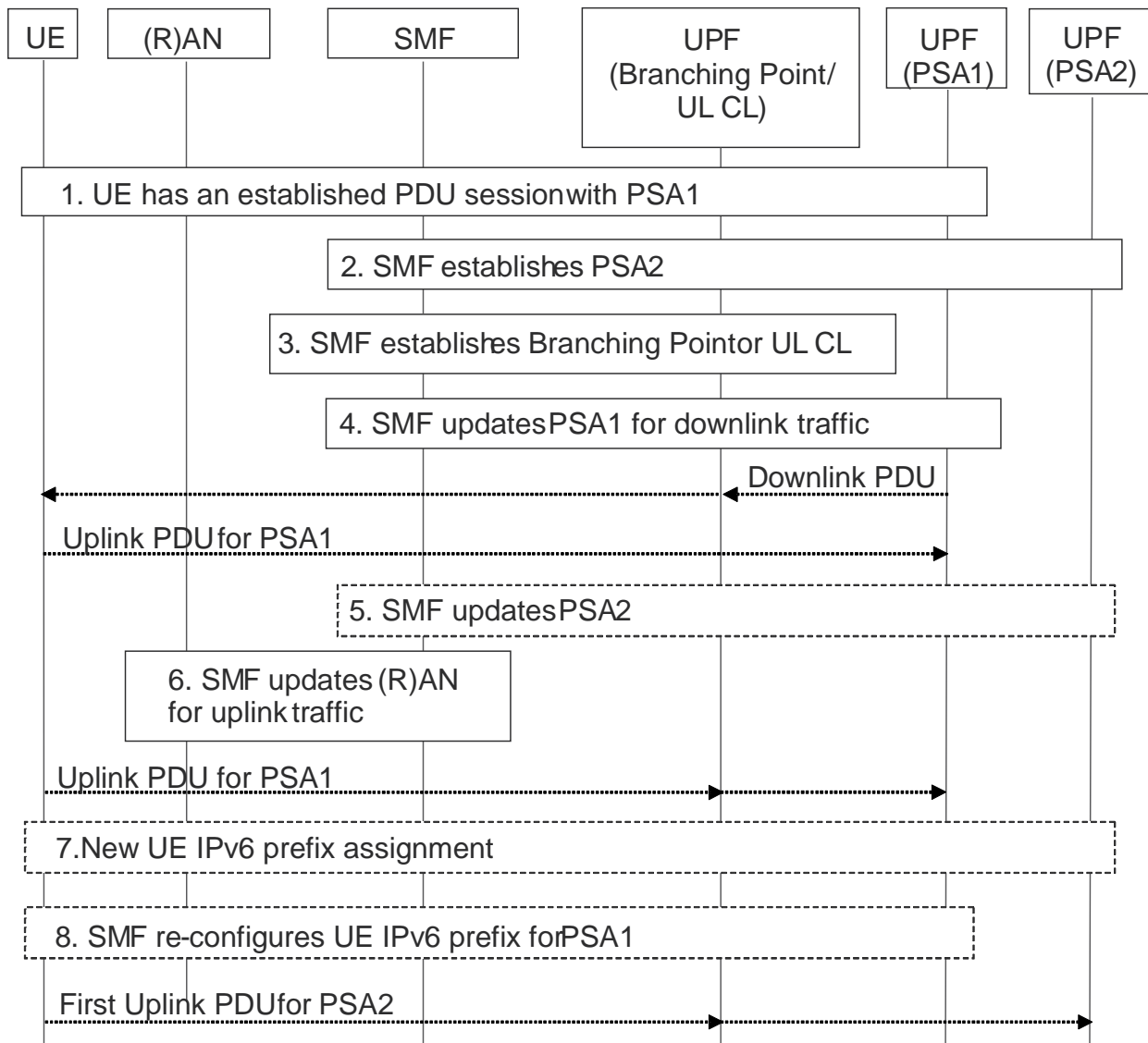

**Figure 4.3.5.4-1: Addition of additional PDU Session Anchor and Branching Point or UL CL**

1. UE has an established PDU Session with a UPF including the PDU Session Anchor 1 (PSA1 in Figure 4.3.5.4-1). The PDU Session User Plane involves at least the (R)AN and the PDU Session Anchor 1.
2. At some point the SMF decides to establish a new PDU Session Anchor e.g. due to UE mobility, new flow detection. The SMF selects a UPF and using N4 establish the new PDU Session Anchor 2 (PSA2 in Figure 4.3.5.4-1) of the PDU Session. In case of IPv6 multi-homing PDU Session, the SMF also allocates a new IPv6 prefix corresponding to PSA2, and if the PCF has subscribed to the IP allocation/release event, the SMF performs the Session Management Policy Modification procedure as defined in clause 4.16.5 to provide the new allocated IPv6 prefix to the PCF.
3. The SMF selects a UPF and using N4 establish the Branching Point (in case of IPv6 multi-homing) or a UL CL for the PDU Session. It provides the necessary uplink forwarding rules towards PSA1 and PSA2 including the PSA1 CN Tunnel Info and the PSA2 CN Tunnel Info. In addition, the AN Tunnel Info is provided for downlink forwarding. In case of IPv6 multi-homing, the SMF also provides traffic filters for the IPv6 prefixes corresponding to PSA1 and PSA2 indicating what traffic shall be forwarded towards PSA1 and PSA2 respectively. In case of UL CL, the SMF provides traffic filters indicating what traffic shall be forwarded towards PSA1 and PSA2 respectively.

NOTE 1: In case the Branching Point or UL CL and the PSA2 are co-located in a single UPF then steps 2 and 3 can be merged. In case a Branching Point is already allocated, step 3 is skipped.

4. The SMF updates the PSA1 via N4. It provides the Branching Point or UL CL CN Tunnel Info for the downlink traffic.

NOTE 2: In case the Branching Point or UL CL and the PSA1 are co-located in a single UPF then steps 3 and 4 can be merged.

5. The SMF updates PSA2 via N4. It provides the Branching Point or UL CL CN Tunnel Info for down-link traffic.

NOTE 3: In case the Branching Point or UL CL and the PSA2 are co-located in a single UPF then step 5 is not needed.

6. The SMF updates (R)AN via N2 SM information over N11. It provides the new CN Tunnel Info corresponding to the UPF (Branching Point or UL CL). In case of UL CL, if there is an existing UPF between the (R)AN and new inserted UL CL, the SMF updates the existing UPF via N4 instead of updating the (R)AN.
7. In case of IPv6 multi-homing, the SMF notifies the UE of the availability of the new IP prefix @ PSA2. This is performed using an IPv6 Router Advertisement message (RFC 4861 [6]). Also, the SMF sends IPv6 multi-homed routing rule along with the IPv6 prefix to the UE using an IPv6 Router Advertisement message (RFC 4191 [21]) as described in TS 23.501 [2] clause 5.8.2.2.2.
8. In case of IPv6 multi-homing, the SMF may re-configure the UE for the original IP prefix @ PSA1, i.e. SMF sends IPv6 multi-homed routing rule along with the IPv6 prefix to the UE using an IPv6 Router Advertisement message (RFC 4191 [21]) as described in TS 23.501 [2] clause 5.8.2.2.2.

#### 4.3.5.5 Removal of additional PDU Session Anchor and Branching Point or UL CL

Clause 4.3.5.5 describes a procedure to remove a PDU Session Anchor and (optionally) remove Branching Point or UL CL for an established PDU Session.

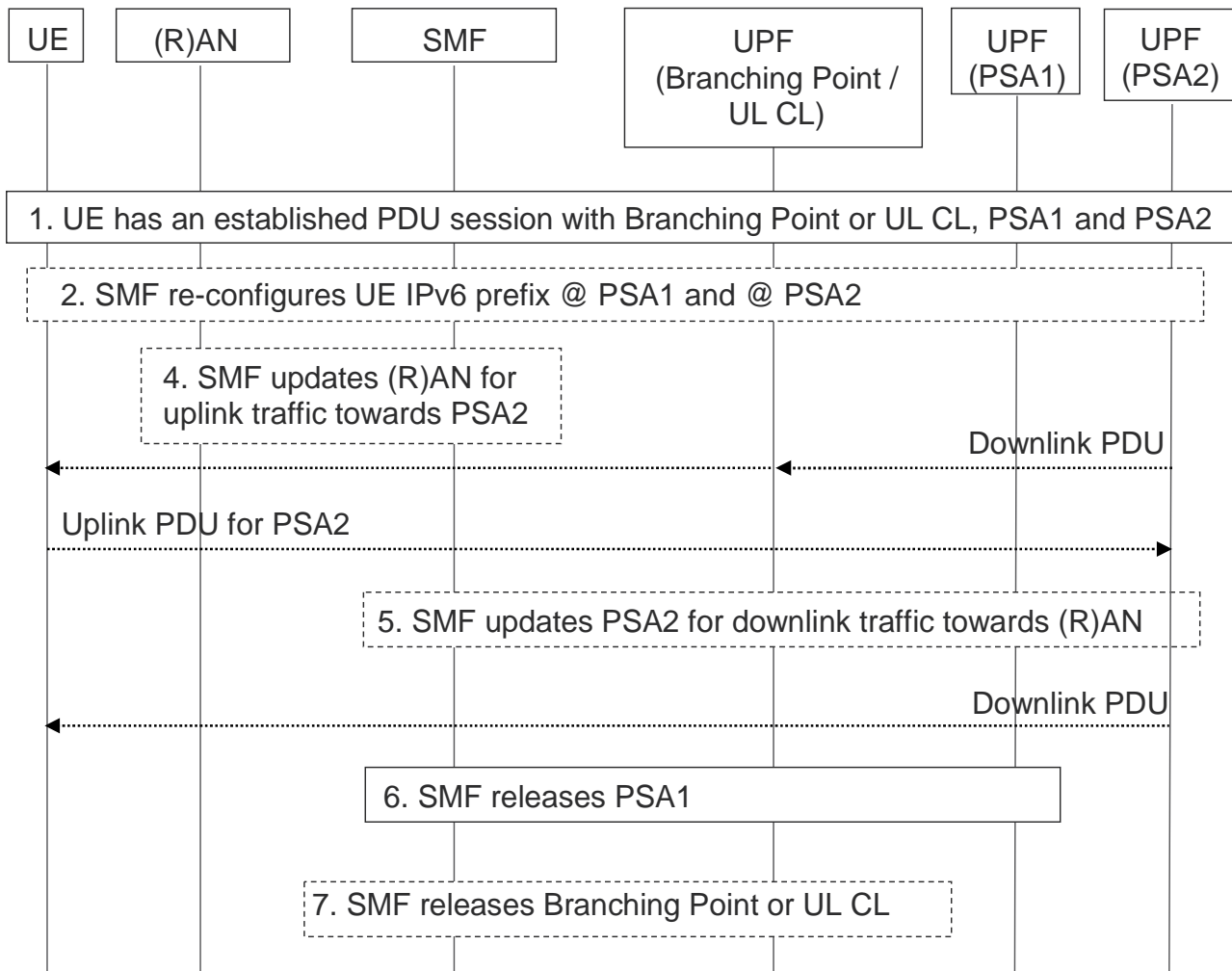

**Figure 4.3.5.5-1: Removal of additional PDU Session Anchor and Branching Point or UL CL**

1. UE has an established PDU Session with a UPF including the Branching Point or UL CL, the PDU Session Anchor 1 (PSA1 in Figure 4.3.5.5-1) and the PDU Session Anchor 2 (PSA2 in Figure 4.3.5.5-1).

At some point the SMF decides to remove the PDU Session Anchor 1 e.g. due to UE mobility, flow terminated.

2. In case of IPv6 multi-homing, the SMF notifies the UE to stop using the IPv6 prefix corresponding to PSA1. This is performed by IPv6 Router Advertisement message (RFC 4861 [6] and RFC 4862 [8]). Also, the SMF sends IPv6 multi-homed routing rule along with the IPv6 prefix corresponding to PSA2 to the UE as described in TS 23.501 [2] clause 5.8.2.2.2. Based on the information provided in the Router Advertisement, the UE starts using the IPv6 prefix (corresponding to PSA2) for all the traffic.
4. If the Branching Point or UL CL is to be released, the SMF updates the (R)AN with the PSA2 CN Tunnel Info. In case of UL CL, if there is an existing UPF between the (R)AN and the UL CL to be removed, the SMF updates the existing UPF via N4 instead of updating the (R)AN.
5. If the Branching Point or UL CL is to be released, the SMF updates via N4 the PSA2 providing the AN Tunnel Info. In case of UL CL, if there is an existing UPF between the (R)AN and the UL CL to be removed, the SMF updates the PSA2 providing the UPF CN tunnel Info.
6. The SMF releases via N4 the PSA1. In case of IPv6 multi-homing, the SMF also releases the corresponding IPv6 prefix and if the PCF has subscribed to the IP allocation/release event, the SMF performs the Session Management Policy Modification procedure as defined in clause 4.16.5 to notify the PCF of the IPv6 prefix release.
7. If steps 4 and 5 were executed, the SMF releases the Branching Point / UL CL.

### 4.3.5.6 Change of additional PDU Session Anchor for IPv6 multi-homing or UL CL

The following procedure is triggered by an SMF when the SMF needs to modify IPv6 multi-homing or UL CL rule (i.e., traffic filter in the Branching Point or the UL CL) in order to move the some or whole traffic flows of the existing additional PDU Session Anchor which was established by the IPv6 multi-homing or the UL CL operations (i.e. PSA1 in figure 4.3.5.6-1) to a new additional PDU Session Anchor (i.e. PSA2 in figure 4.3.5.6-1) which is established under the same Branching Point or UL CL for a UE where the UE already has a PDU Session Anchor which was established before the event of Branching Point or UL CL insertion (i.e., PSA0 in figure 4.3.5.6-1). This procedure establishes a new additional PDU Session Anchor (i.e., PSA2) and conditionally releases the existing additional PDU Session Anchor (i.e. PSA1), while modifying IPv6 multi-homing or UL CL rule in the same Branching Point or UL CL under controlled by the same SMF.

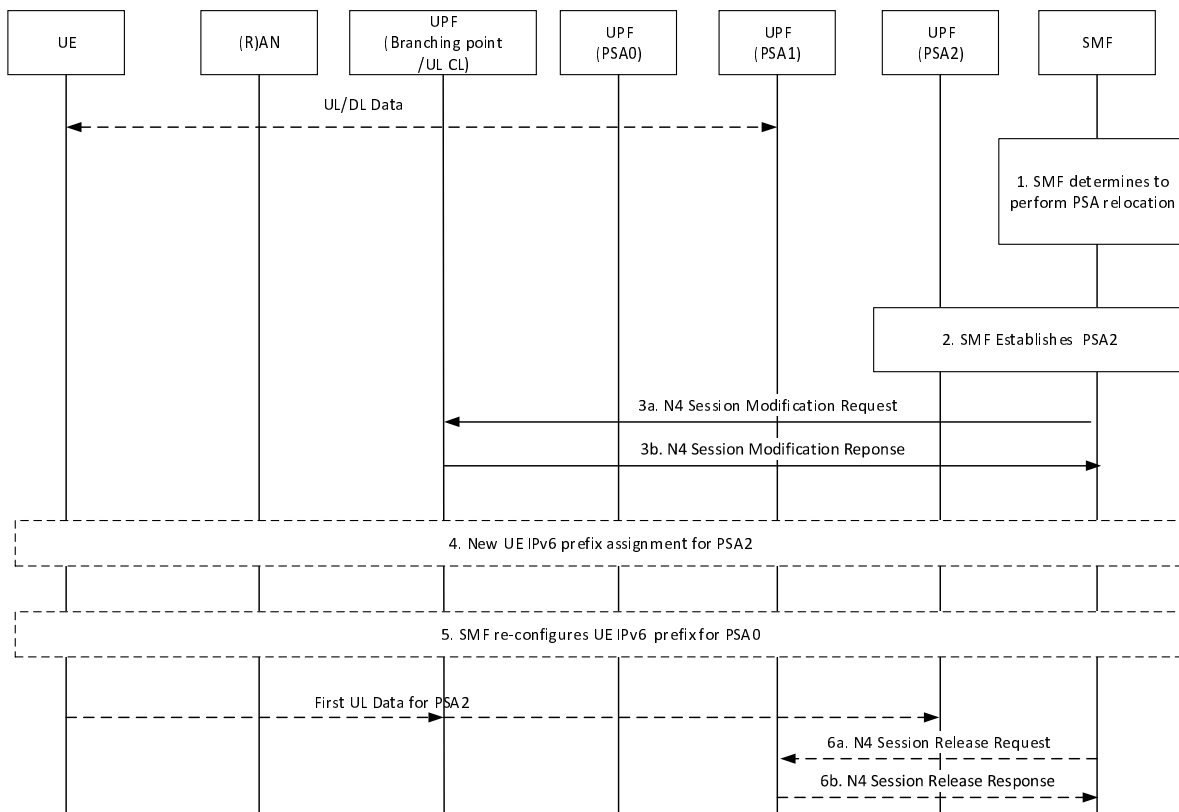

**Figure 4.3.5.6-1: Change of additional PSA for a PDU Session in IPv6 multi-homing or UL CL case**

1. The SMF decides to change one additional PSA of a PDU Session with IPv6 multi-homing or UL CL, due to events that may benefit from such change or upon request from an Application Function.
2. The SMF sends an N4 Session Establishment Request to PSA2 and provides the tunnel ID of Branching Point or UL CL, Packet detection, enforcement and reporting rules to be installed on the PSA2 for this PDU Session. If a tunnel ID is allocated by the SMF, the tunnel ID is provided to PSA2 in this step.

The PSA2 acknowledges by sending an N4 Session Establishment Response. The tunnel ID of PSA2 is provided to the SMF in this step.

In case of IPv6 multi-homing PDU Session, the SMF also allocates a new IPv6 prefix corresponding to PSA2, and if the PCF has subscribed to the IP allocation/release event, the SMF performs the Session Management Policy Modification Procedure as defined in clause 4.16.5 to provide the new allocated IPv6 prefix to the PCF.

- 3a. The SMF sends an N4 Session Modification Request to the Branching Point or UL CL to update the UL traffic filter according to new allocated IPv6 prefix allocated to PSA 2 or the UL CL rules regarding to the traffic flows that the SMF tries to move from PSA1 to PSA2. The N4 Session Modification Request message contains the identifications of traffic filter that needs to be updated and the tunnel ID of PSA2.

NOTE: The identification of a traffic filter can be either the index of the traffic filter, or a single value of the information field in traffic filter (e.g., the tunnel ID of next hop), or a combination value of some information field in the traffic filter (e.g., the tunnel ID of next hop with source port number).

- 3b. The Branching Point or the UL CL acknowledges by N4 Session Modification Response the Branching Point or when the UL CL successfully updates all the traffic filters that the SMF requests to modify.
4. In case of IPv6 multi-homing PDU Session, The SMF notifies the UE of the availability of the new IP prefix @ PSA2. This is performed using an IPv6 Router Advertisement message (RFC 4861 [6]). Also, the SMF sends IPv6 multi-homed routing rule along with the IPv6 prefix to the UE using an IPv6 Router Advertisement message (RFC 4191 [21]) as described in TS 23.501 [2] clause 5.8.2.2.2.
5. In case of IPv6 multi-homing PDU Session, The SMF may re-configure the UE for the original IP prefix @ PSA0,i.e. SMF sends IPv6 multi-homed routing rule along with the IPv6 prefix to the UE using an IPv6 Router Advertisement message (RFC 4191 [21]) as described in TS 23.501 [2] clause 5.8.2.2.2.
6. Step 6 occurs only if the Branching Point or UL CL does not have any traffic filter on the PDU Session which forwards a traffic flow to PSA1.
  - 6a. The SMF sends an N4 Session Release Request with N4 session ID to PSA1. The PSA1 shall release all tunnel resources and contexts associated with the N4 session.
  - 6b. PSA1 sends an N4 Session Release Response with N4 session ID to the SMF at the same moment that PSA1 successfully releases all tunnel resources and contexts associated with the N4 session.

#### 4.3.5.7 Simultaneous change of Branching Point or UL CL and additional PSA for a PDU Session

Simultaneous change of UL CL or Branching Point and additional PSA can be performed after Xn based handover, N2 based handover and Service Request procedures.

The following procedure is triggered by SMF in order to change the Branching Point or the UL CL and additional PSA serving a PDU Session for a UE.

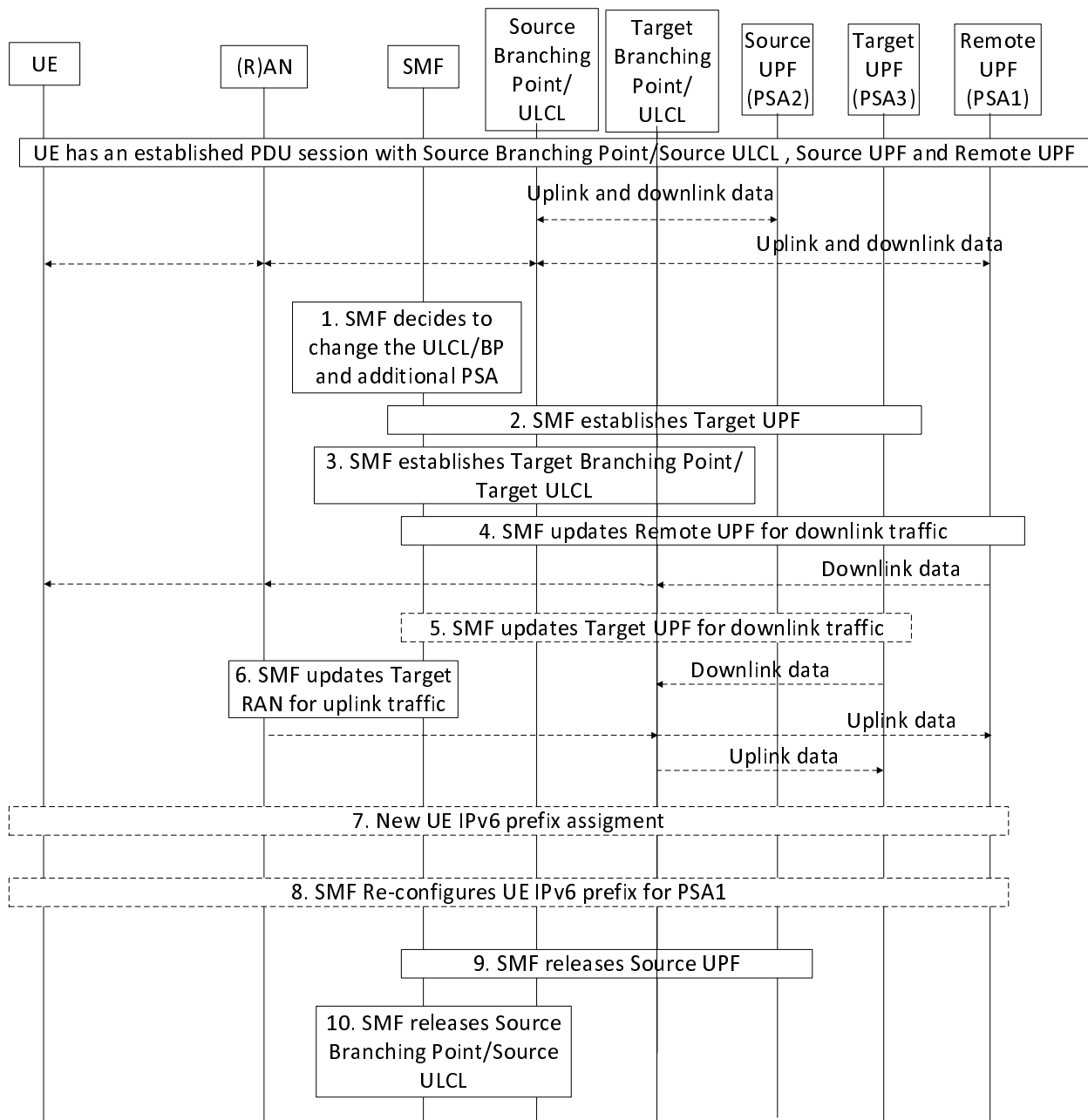

**Figure 4.3.5.7-1: Simultaneous change of Branching Point or UL CL and additional PSA for a PDU Session**

UE has an established PDU Session with a UPF including the PDU Session Anchor (Remote UPF). The PDU Session user plane involves at least the Source (R)AN, Source Branching Point or Source UL CL, local Source UPF (PSA2) and the Remote UPF (PDU Session Anchor, PSA1), where Source Branching Point or Source UL CL and PSA2 can be co-located.

1. At some point SMF decides to change the Branching Point or the UL CL due to UE mobility.
2. The SMF selects a local Target UPF (PSA3) and using N4 establishes the local Target UPF for the PDU Session. In case of IPv6 multi-homing PDU Session, the SMF also allocates a new IPv6 prefix corresponding to PSA3, and if the PCF has subscribed to the IP allocation/release event, the SMF performs the Session Management Policy Modification procedure as defined in clause 4.16.5 to provide the new allocated IPv6 prefix to the PCF.
3. The SMF selects a UPF and using N4 establishes the Target Branching Point or Target UL CL for the PDU Session. SMF provides the necessary uplink forwarding rules towards the PSA3 and PSA1 including the Tunnel Info for each UPF. In addition, the AN Tunnel Info to target (R)AN is provided for downlink forwarding. In case



of UL CL, the SMF provides traffic filters indicating what traffic shall be forwarded towards PSA3 and PSA1, respectively. In case of IPv6 multi-homing, the SMF also provides traffic filters for the IPv6 prefixes corresponding to PSA3 and PSA1 indicating what traffic shall be forwarded towards PSA3 and PSA1 respectively. Target Branching Point or Target UL CL provides the CN Tunnel Info for downlink traffic.

NOTE 1: In case the Target Branching Point or Target UL CL and the PSA3 are co-located in a single UPF then steps 2 and 3 can be merged.

4. The SMF updates the PSA1 via N4. It provides the PDU Session CN Tunnel Info for the downlink traffic.
5. The SMF updates the PSA3. It provides the CN Tunnel Info for downlink traffic.

NOTE 2: In case the Target Branching Point or the Target UL CL and the PSA3 are co-located in a single UPF then step 5 is not needed.

6. The SMF updates (R)AN via N2 SM information over N11. It provides the new CN Tunnel Info corresponding to the Target Branching Point or the Target UL CL. If there is an existing UPF between the Target (R)AN and Target Branching Point or Target UL CL, the SMF updates the existing UPF via N4 instead of updating the (R)AN.
7. In case of IPv6 multi-homing, the SMF notifies the UE of the availability of the new IP prefix @ PSA3. This is performed using an IPv6 Router Advertisement message (RFC 4861 [6]). Also, the SMF sends IPv6 multi-homed routing rule along with the IPv6 prefix to the UE using an IPv6 Router Advertisement message (RFC 4191 [21]) as described in TS 23.501 [2] clause 5.8.2.2.2.
8. In case of IPv6 multi-homing, the SMF may re-configure the UE for the original IP prefix @ PSA1, i.e. SMF sends IPv6 multi-homed routing rule along with the IPv6 prefix to the UE using an IPv6 Router Advertisement message (RFC 4191 [21]) as described in TS 23.501 [2] clause 5.8.2.2.2.
9. The SMF releases via N4 the PSA2.
10. The SMF releases the Source Branching Point or the Source UL CL.

NOTE 3: In case the Target Branching Point or Target UL CL and the PSA2 are co-located in a single UPF then steps 9 and 10 can be merged.

## 4.3.6 Application Function influence on traffic routing

### 4.3.6.1 General

Clause 4.3.6 describes the procedures between an Application Function and the SMF to maintain an efficient user plane path for Application Functions that require it.

As described in TS 23.501 [2] clause 5.6.7, an Application Function may send requests to influence SMF routing decisions for User Plane traffic of PDU Sessions. The AF requests may influence UPF (re)selection and allow routing of user traffic to a local access (identified by a DNAI) to a Data Network. The AF may also provide in its request subscriptions to SMF events.

The following cases can be distinguished:

- AF requests targeting an individual UE by a UE address; these requests are routed (by the AF or by the NEF) to an individual PCF using the BSF. This is described in clause 4.3.6.4.

NOTE 1: Such requests target an on-going PDU Session. Whether the AF needs to use the NEF or not is according to local deployment.

- AF requests described in clause 5.6.7 of TS 23.501 [2] targeting a group of UE(s), or any UE accessing a combination of DNN and S-NSSAI, or targeting individual UE by a GPSI as described in table 5.6.7-1. These AF requests may also affect UE(s) with an established PDU session. For such requests the AF shall contact the NEF and the NEF stores the AF request information in the UDR. PCF(s) receive a corresponding notification if they had subscribed to the creation / modification / deletion of the AF request information corresponding to UDR Data Keys / Data Sub-Keys. This is defined in 23.501 [2] clause 6.3.7.2 and further described in clause 4.3.6.2.

NOTE 2: Such requests can target on-going or future PDU Sessions.

If the AF interacts with PCF via the NEF, the NEF performs the following mappings where needed:

- Map the AF-Service-Identifier into DNN and S-NSSAI combination, determined by local configuration.
- Map the AF-Service-Identifier into a list of DNAI(s) and Routing Profile ID(s) determined by local configuration.

The NEF can only provide this mapping when the DNAI(s) being used by the applications are statically defined. When the DNAI(s) where applications are instantiated may vary dynamically, the AF should provide the target DNAI(s) in its request together with either Routing Profile ID(s) or with N6 traffic routing information.

- Map the GPSI in Target UE Identifier into SUPI, according to information received from UDM.
- Map the External Group Identifier in Target UE Identifier into Internal Group Identifier, according to information received from UDM.
- Map the geographic zone identifier(s) in Spatial Validity Condition into areas of validity, determined by local configuration.

#### 4.3.6.2 Processing AF requests to influence traffic routing for Sessions not identified by an UE address

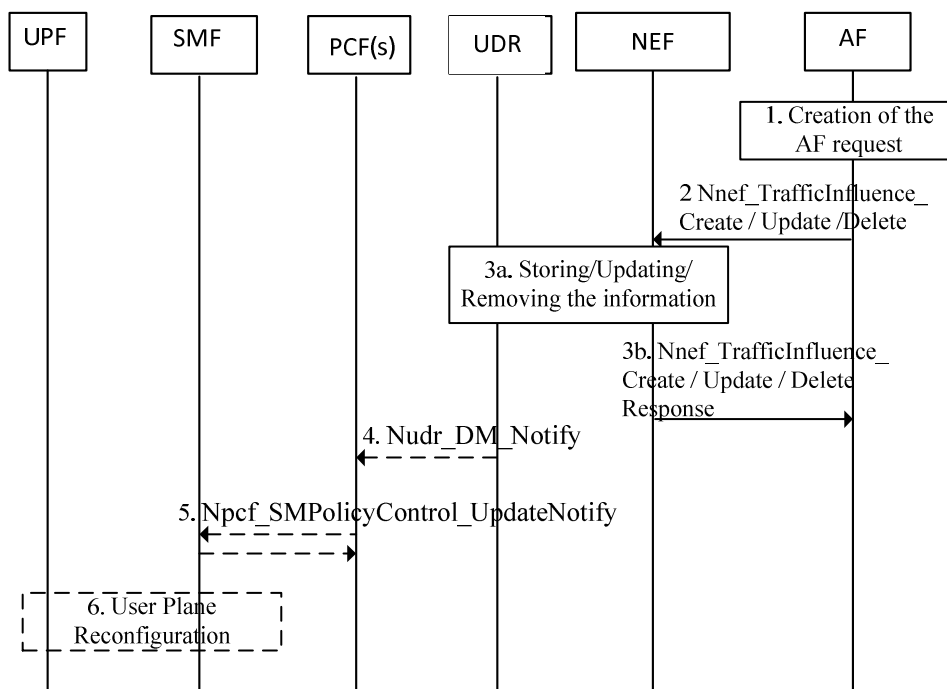

**Figure 4.3.6.2-1: Processing AF requests to influence traffic routing for Sessions not identified by an UE address**

NOTE 1: The 5GC functions used in this scenario are assumed to all belong to the same PLMN (HPLMN in non-roaming case or VPLMN in case of a PDU Session in LBO mode).

NOTE 2: Nnef\_TrafficInfluence\_Create or Nnef\_TrafficInfluence\_Update or Nnef\_TrafficInfluence\_Delete service operations invoked from an AF located in the HPLMN for local breakout and home routed roaming scenarios are not supported.

1. To create a new request, the AF invokes an Nnef\_TrafficInfluence\_Create service operation. The content of this service operation (AF request) is defined in clause 5.2.6.7. The request contains also an AF Transaction Id. In case it subscribes to events related with PDU Sessions the AF indicates also where it desires to receive the corresponding notifications (AF notification reporting information).

To update or remove an existing request, the AF invokes an Nnef\_TrafficInfluence\_Update or Nnef\_TrafficInfluence\_Delete service operation providing the corresponding AF Transaction Id.

2. The AF sends its request to the NEF. If the request is sent directly from the AF to the PCF, the AF reaches the PCF selected for the existing PDU Session by configuration or by invoking Nbsf\_management\_Discovery service.

The NEF ensures the necessary authorization control, including throttling of AF requests and, as described in clause 4.3.6.1, mapping from the information provided by the AF into information needed by the 5GC.

3. (in the case of Nnef\_TrafficInfluence\_Create or Update): The NEF stores the AF request information in the UDR (Data Set = Application Data; Data Subset = AF traffic influence request information, Data Key = AF Transaction Internal ID, S-NSSAI and DNN and/or Internal Group Identifier or SUPI).

NOTE 3: Both the AF Transaction Internal ID and, S-NSSAI and DNN and/or Internal Group Identifier or SUPI are regarded as Data Key when the AF request information are stored into the UDR, see Table 5.2.12.2.1-1.

(in the case of Nnef\_TrafficInfluence\_delete): The NEF deletes the AF requirements in the UDR (Data Set = Application Data; Data Subset = AF traffic influence request information, Data Key = AF Transaction Internal ID).

The NEF responds to the AF.

4. The PCF(s) that have subscribed to modifications of AF requests (Data Set = Application Data; Data Subset = AF traffic influence request information, Data Key = S-NSSAI and DNN and/or Internal Group Identifier or SUPI) receive(s) a Nudr\_DM\_Notify notification of data change from the UDR.
5. The PCF determines if existing PDU Sessions are potentially impacted by the AF request. For each of these PDU Sessions, the PCF updates the SMF with corresponding new PCC rule(s) by invoking Npcf\_SMPolicyControl\_UpdateNotify service operation as described in steps 5 and 6 in clause 4.16.5.

If the AF request includes a notification reporting request for UP path change, the PCF includes in the PCC rule(s) the information required for reporting the event, including the Notification Target Address pointing to the NEF or AF and the Notification Correlation ID containing the AF Transaction Internal ID.

6. When a PCC rule is received from the PCF, the SMF may take appropriate actions to reconfigure the User plane of the PDU Session such as:
  - Adding, replacing or removing a UPF in the data path to e.g. act as an UL CL or a Branching Point e.g. as described in clause 4.3.5.
  - Allocate a new Prefix to the UE (when IPv6 multi-Homing applies)
  - Updating the UPF in the target DNAI with new traffic steering rules

Subscribe to notifications from the AMF for an Area Of Interest via Namf\_EventExposure\_Subscribe service operation

### 4.3.6.3 Notification of User Plane Management Events

The SMF may send a notification to the AF if the AF had subscribed to user plane management event notifications as described in clause 4.3.6.2 and in TS 23.501 [2] clause 5.6.7. The following are the examples of such events:

- A PDU Session Anchor identified in the AF subscription request has been established or released.
- A DNAI has changed.
- The SMF has received a request for AF notification and the on-going PDU Session meets the conditions to notify the AF.

The SMF uses notification reporting information received from PCF to issue the notification either via an NEF (2a, 2b and 4a, 4b) or directly to the AF (2c and 4c).

The following flow depicts the sequence of events:

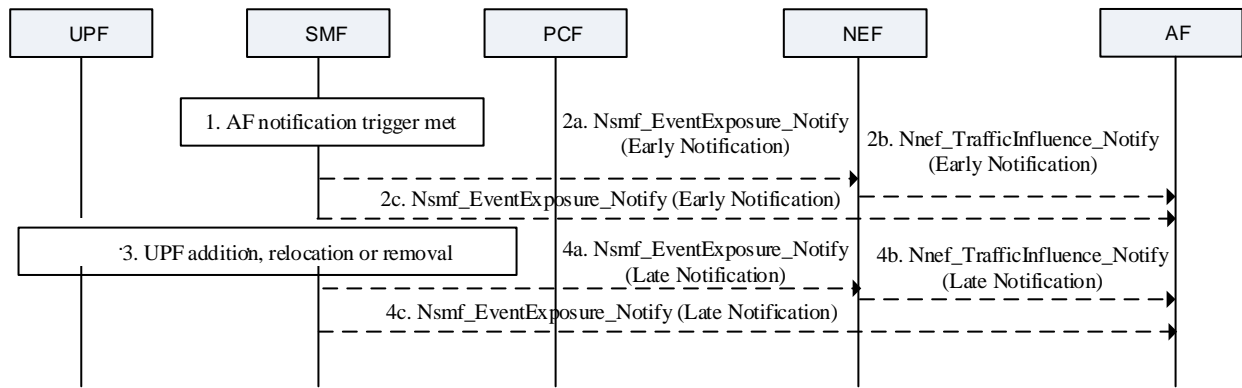

**Figure 4.3.6.3-1: Notification of user plane management event**

1. A condition for an AF notification has been met as described above. The SMF sends notification to the NF that is subscribed for SMF notifications. Further processing of the SMF notification depends on the receiving NF, as shown in steps 2a and 2c.
- 2a. If early notification via NEF is requested by the AF, the SMF notifies the NEF of the target DNAI of the PDU Session by invoking `Nsmf_EventExposure_Notify` service operation.
- 2b. When the NEF receives `Nsmf_EventExposure_Notify`, the NEF performs information mapping (e.g. AF Transaction Internal ID provided in Notification Correlation ID to AF Transaction ID, SUPI to GPSI, etc.) as applicable according to TS 23.501 [2], clause 5.6.7, and triggers the appropriate `Nnef_TrafficInfluence_Notify` message. In this case, step 2c is not applicable.
- 2c. If early direct notification is requested by the AF, the SMF notifies the AF of the target DNAI of the PDU Session by invoking `Nsmf_EventExposure_Notify` service operation.
3. The SMF enforces the change of DNAI or addition, change, or removal of a UPF. The SMF sends notification to the NF that is subscribed for SMF notifications. Further processing of the SMF notification depends on the receiving NF, as shown in steps 4a and 4c.
- 4a. If late notification via NEF is requested by the AF, the SMF notifies the NEF of the selected target DNAI of the PDU Session by invoking `Nsmf_EventExposure_Notify` service operation.
- 4b. When the NEF receives `Nsmf_EventExposure_Notify`, the NEF performs information mapping (e.g. AF Transaction Internal ID provided in Notification Correlation ID to AF Transaction ID, SUPI to GPSI, etc.) as applicable according to TS 23.501 [2], clause 5.6.7, and triggers the appropriate `Nnef_EventExposure_Notify` message. In this case, step 4c is not applicable.
- 4c. If late direct notification is requested by the AF, the SMF notifies the AF of the selected target DNAI of the PDU Session by invoking `Nsmf_EventExposure_Notify` service operation.

#### 4.3.6.4 Transferring an AF request targeting an individual UE address to the relevant PCF

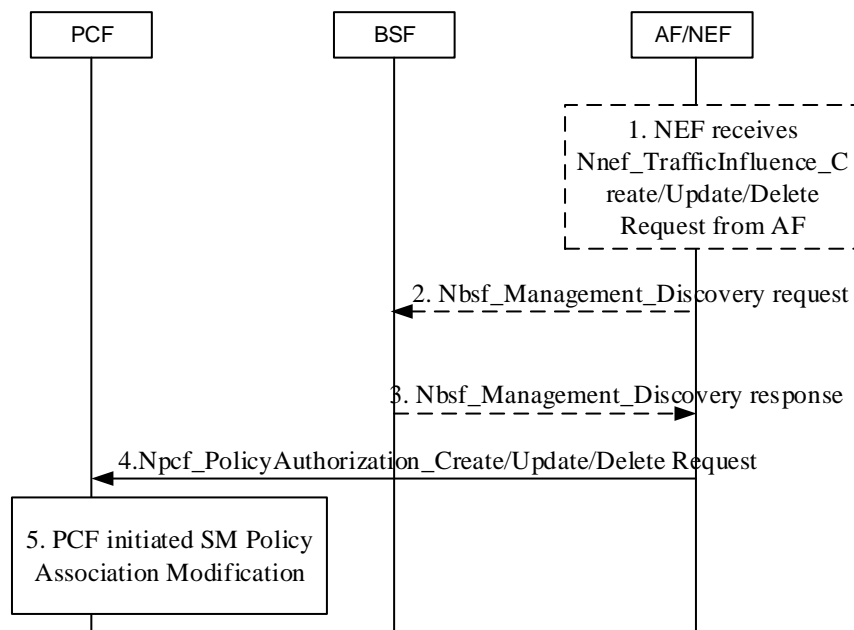

**Figure 4.3.6.4-1: Handling an AF request targeting an individual UE address to the relevant PCF**

Depending on the AF deployment (see TS 23.501 [2], clause 6.2.10), the AF may send the AF request to PCF directly, in which case step 1 is skipped, or via the NEF.

- [Conditional] If the AF sends the AF request via NEF, the AF sends Nnef\_TrafficInfluenceCreate/Update/Delete Request targeting an individual UE address to the NEF. This request corresponds to an AF request to influence traffic routing that targets an individual UE address.

When NEF receives an AF request from AF, the NEF ensures the necessary authorization control and , as described in clause 4.3.6.1, mapping from the information provided by the AF into information needed by the 5GC. The NEF responds to the AF.

- [Conditional] AF/NEF consumes Nbsf\_Management\_Discovery service operation (providing at least the UE address) to find out the address of the relevant PCF if the PCF address is not available on the NEF based on local configuration, otherwise step 1 is skipped.

NOTE: The AF/NEF finds the BSF based on local configuration or using the NRF.

- BSF provides the PCF address in the Nbsf\_Management\_Discovery response to AF/NEF.
- If step 1 was performed, NEF invokes the Npcf\_PolicyAuthorization service to the PCF to transfer the AF request. If an AF sends the AF request directly to the PCF, AF invokes Npcf\_PolicyAuthorization service and the PCF responds to the AF.
- The PCF updates the SMF with corresponding new PCC rule(s) with PCF initiated SM Policy Association Modification procedure as described in clause 4.16.5.2. When a PCC rule is received from the PCF, the SMF may take appropriate actions, when applicable, to reconfigure the User plane of the PDU Session, such as:
  - Adding, replacing or removing UPF(s) in the data path, e.g. to act as UL CL, Branching Point, and/or PDU Session Anchor e.g. as described in clause 4.3.5.
  - Allocate a new Prefix to the UE (when IPv6 multi-Homing applies).
  - Updating the UPF regarding the target DNAI with new traffic steering rules.

- Subscribe to notifications from the AMF for an Area Of Interest via Namf\_EventExposure\_Subscribe service operation.

### 4.3.7 CN-initiated selective deactivation of UP connection of an existing PDU Session

The following procedure is used to deactivate UP connection (i.e. data radio bearer and N3 tunnel) for an established PDU Session of a UE in CM-CONNECTED state.

For an always-on PDU Session, the SMF should not configure the UPF to report inactivity.

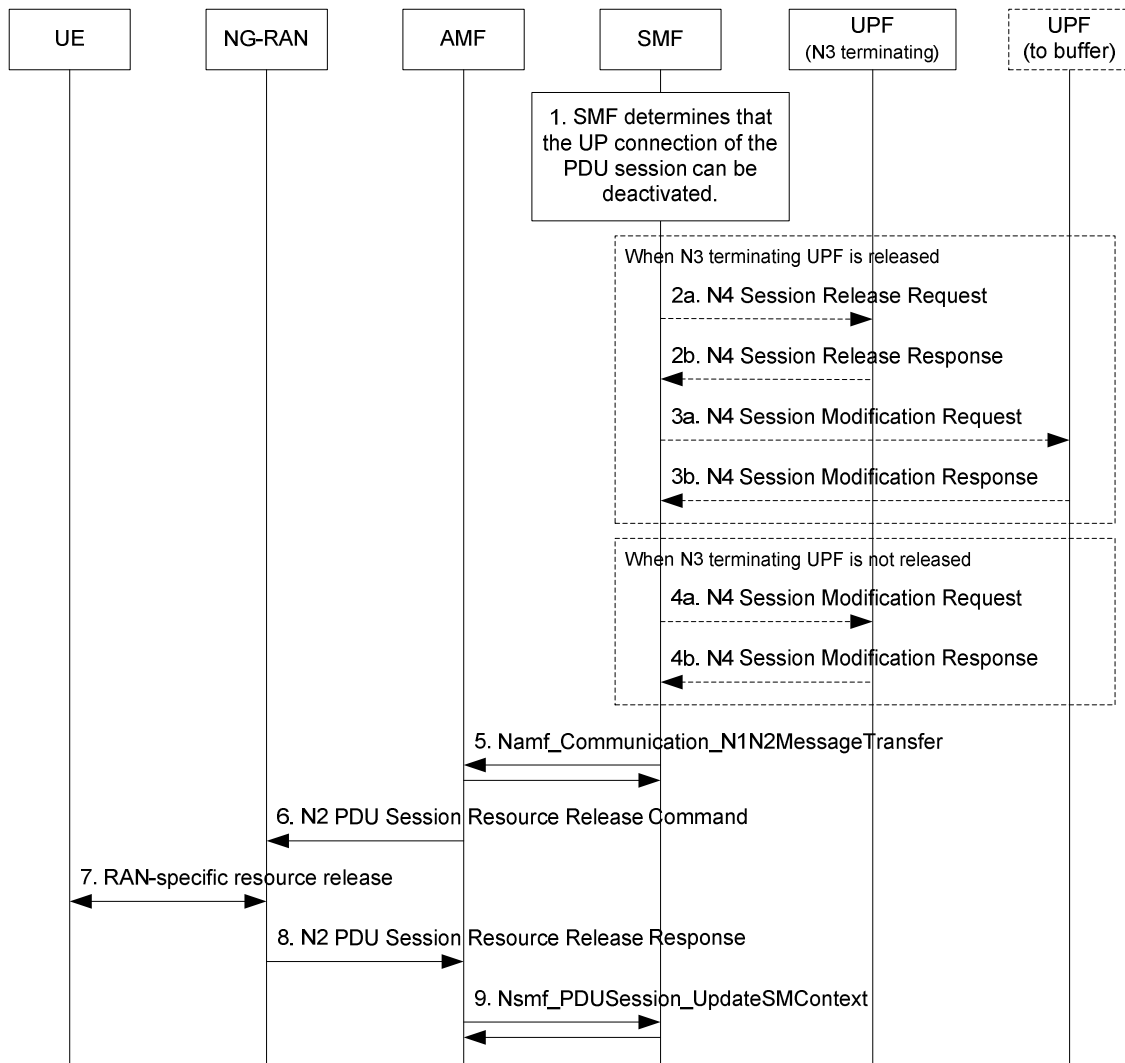

**Figure 4.3.7-1: CN-initiated deactivation of UP connection for an established PDU Session**

- The SMF determines that the UP connection of the PDU Session can be deactivated in following cases:
  - During handover procedure, if all the QoS Flows of a PDU Session are rejected by the target NG-RAN (as described in clause 4.9.1), or if a PDU Session is failed to setup indicated by the AMF (see step 7 of clause 4.9.1.3.3). SMF proceeds with step 2 and step 3, the steps 5 to 9 are skipped;
  - The UPF detects that the PDU Session has no data transfer for a specified Inactivity period as described in clause 4.4.2.2;
  - For a LADN PDU Session, the AMF notifies to the SMF that the UE moved out of the LADN service area; or
  - The AMF notifies to the SMF that the UE moved out of the Allowed Area.

The SMF may decide to release the UPF of N3 terminating point. In that case the SMF proceeds with step 2 and step 3. Otherwise, if the SMF decides to keep the UPF of N3 terminating points, the SMF proceeds with step 4.

2. The SMF may initiate an N4 Session Release procedure to release the intermediate UPF of N3 terminating point. If there are multiple intermediate UPFs, this step can be performed for each UPFs to be released. The SMF needs to initiate N4 Session Modification procedure to the UPF (i.e. N9 terminating point or PDU Session Anchor) connecting to the released UPF in step 3.
3. If the intermediate UPF(s) of N3 terminating point is released in step 2, the SMF initiates an N4 Session Modification procedure towards the UPF (PDU Session Anchor or another intermediate UPF) connecting to the released UPF, indicating the need to remove AN Tunnel Info for N3 tunnel of the corresponding PDU Session. In this case, the UPF connecting to the released UPF buffers the DL packets for this PDU Session or drops the DL packets for this PDU session or forwards the DL packets for this PDU session to the SMF, based on buffering instruction provided by the SMF as described in clause 5.8.3.2 or clause 5.8.3.3 of TS 23.501 [2]. When the PDU Session corresponds to a LADN, the SMF may notify the UPF connecting to the released UPF to discard downlink data for the PDU Sessions and/or to not provide further Data Notification messages.

Otherwise, N4 Session Modification procedure occurs toward N3 terminating point.

4. If the UPF of N3 terminating point is not released in step 2, the SMF initiates an N4 Session Modification procedure indicating the need to remove AN Tunnel Info for N3 tunnel of the corresponding PDU Session. In this case, the UPF buffers the DL packets for this PDU Session or drops the DL packets for this PDU session or forwards the DL packets for this PDU session to the SMF, based on buffering instruction provided by the SMF as described in clause 5.8.3.2 or clause 5.8.3.3 of TS 23.501 [2]. When the PDU Session corresponds to a LADN, the SMF may notify the UPF to discard downlink data for the PDU Sessions and/or to not provide further Data Notification messages.
5. The SMF invokes the Namf\_Communication\_N1N2MessageTransfer service operation (PDU Session ID, N2 SM Information (N2 Resource Release Request (PDU Session ID))) to release the NG-RAN resources associated with the PDU Session.
6. The AMF sends the N2 PDU Session Resource Release Command including N2 SM information (N2 Resource Release Request (PDU Session ID)) received from the SMF via N2 to the NG-RAN.
7. The NG-RAN may issue NG-RAN specific signalling exchange (e.g. RRC Connection Reconfiguration) with the UE to release the NG-RAN resources related to the PDU Session received from the AMF in step 5. When a User Plane connection for a PDU Session is released, the AS layer in the UE indicates it to the NAS layer.
8. The NG-RAN acknowledges the N2 PDU Session Resource Release Command to the AMF including N2 SM Resource Release Ack (User Location Information, Secondary RAT Usage Data).
9. The AMF invokes the Nsmf\_PDUSession\_UpdateSMContext service operation (N2 SM Information(Secondary RAT Usage Data)) to acknowledge the Namf service received in step 5.

## 4.4 SMF and UPF interactions

### 4.4.1 N4 session management procedures

#### 4.4.1.1 General

N4 session management procedures are used to control the functionality of the UPF. The SMF can create, update and remove the N4 session context in the UPF, which is described in clause 5.8.2 of TS 23.501 [2].

The following N4 session management procedures exist: N4 Session Establishment procedure, N4 session Modification procedure and N4 session release procedure. All of them are initiated by the SMF.

#### 4.4.1.2 N4 Session Establishment procedure

The N4 Session Establishment procedure is used to create the initial N4 session context for a PDU Session at the UPF. The SMF assigns a new N4 Session ID and provides it to the UPF. The N4 Session ID is stored by both entities and

used to identify the N4 session context during their interaction. The SMF also stores the relation between the N4 Session ID and PDU Session for a UE.

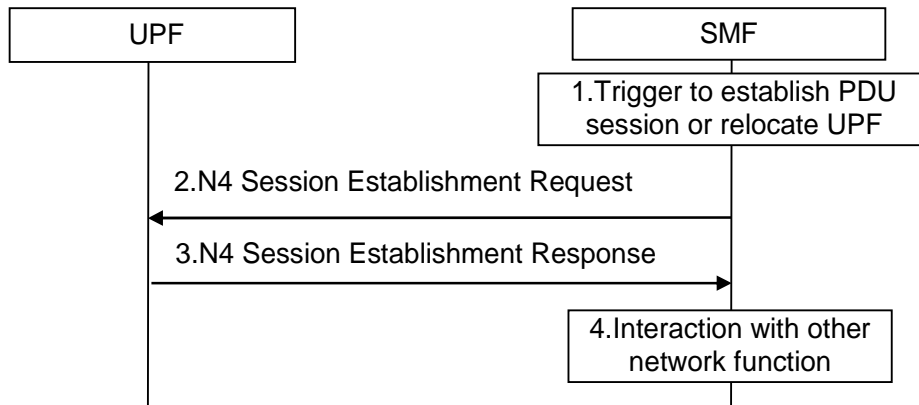
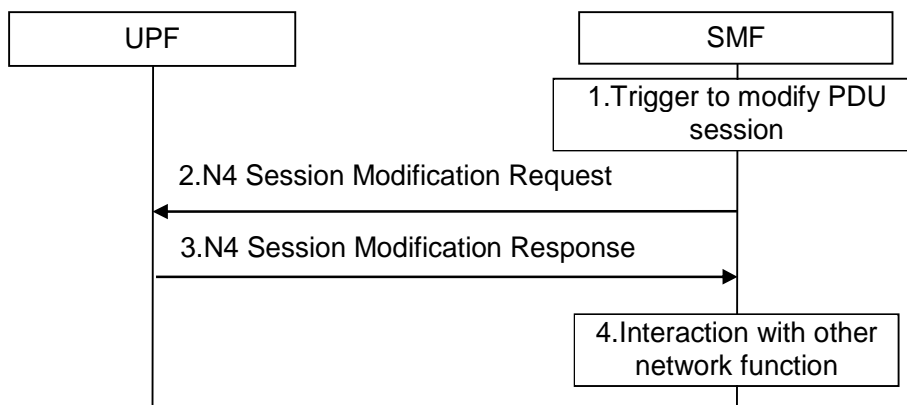

**Figure 4.4.1.2-1 N4 Session Establishment procedure**

1. SMF receives the trigger to establish a new PDU Session or change the UPF for an established PDU Session.
2. The SMF sends an N4 session establishment request message to the UPF that contains the structured control information which defines how the UPF needs to behave.
3. The UPF responds with an N4 session establishment response message containing any information that the UPF has to provide to the SMF in response to the control information received.
4. The SMF interacts with the network function which triggered this procedure (e.g. AMF or PCF).

#### 4.4.1.3 N4 Session Modification procedure

The N4 Session Modification procedure is used to update the N4 session context of an existing PDU Session at the UPF, which is executed between SMF and UPF whenever PDU Session related parameters have to be modified.



**Figure 4.4.1.3-1 N4 Session Modification procedure**

1. SMF receives the trigger to modify the existing PDU Session.
2. The SMF sends an N4 session modification request message to the UPF that contains the update for the structured control information which defines how the UPF needs to behave.
3. The UPF identifies the N4 session context to be modified by the N4 Session ID. Then, the UPF updates the parameters of this N4 session context according to the list of parameters sent by the SMF. The UPF responds with an N4 session modification response message containing any information that the UPF has to provide to the SMF in response to the control information received.
4. The SMF interacts with the network entity which triggered this procedure (e.g. AMF or PCF).



#### 4.4.1.4 N4 Session Release procedure

The N4 session release procedure is used to remove the N4 session context of an existing PDU Session at the UPF.

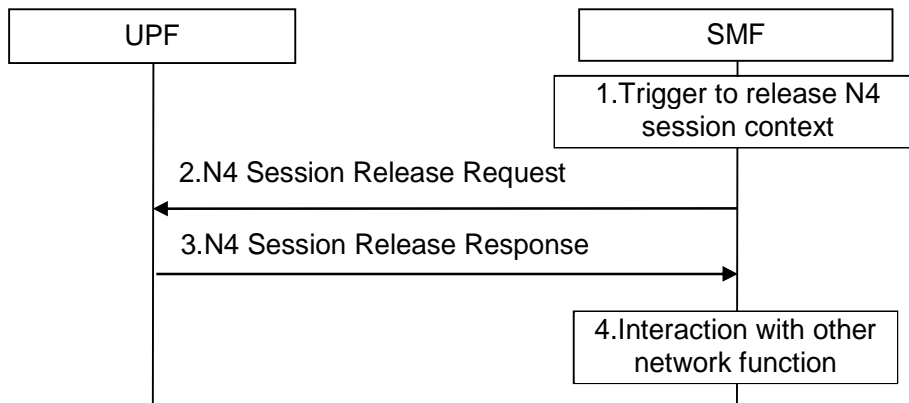

**Figure 4.4.1.4-1 N4 Session Release procedure**

1. SMF receives the trigger to remove the N4 session context for the PDU Session.
2. The SMF sends an N4 session release request message to the UPF.
3. The UPF identifies the N4 session context to be removed by the N4 Session ID and removes the whole session context. The UPF responds with an N4 session release response message containing any information that the UPF has to provide to the SMF.
4. The SMF interacts with the network entity which triggered this procedure (e.g. AMF or PCF).

#### 4.4.2 N4 Reporting Procedures

##### 4.4.2.1 General

The N4 reporting procedure is used by the UPF to report events to the SMF.

##### 4.4.2.2 N4 Session Level Reporting Procedure

This procedure is used by the UPF to report events related to an N4 session for an individual PDU Session. The triggers for event reporting were configured on the UPF during N4 Session Establishment/Modification procedures by the SMF.

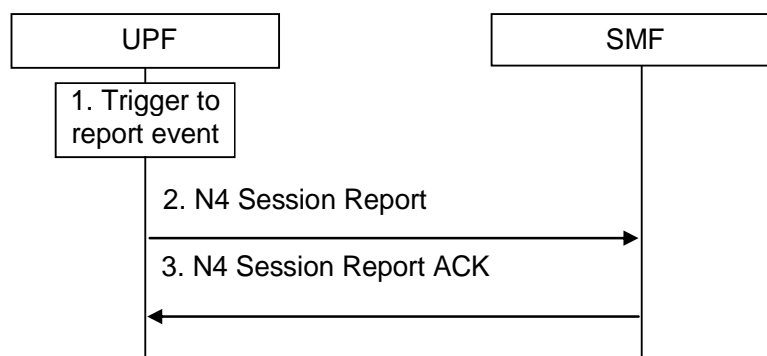

**Figure 4.4.2.2-1: N4 Session Level Reporting procedure**

1. The UPF detects that an event has to be reported. The reporting triggers include the following cases:
  - (1) Usage report.

Usage information shall be collected in the UPF and reported to the SMF as defined in clause 5.8 and clause 5.12 of TS 23.501 [2].

## (2) Start of traffic detection.

When traffic detection is requested by SMF and the start of traffic is detected for a Packet Detection Rule (PDR) as described in clause 5.8 of TS 23.501 [2], the UPF shall report the start of traffic detection to the SMF and indicate the corresponding PDR rule ID.

## (3) Stop of traffic detection.

When traffic detection is requested by SMF and the end of traffic is detected for a PDR as described in clause 5.8 of TS 23.501 [2], the UPF shall report the stop of traffic detection to the SMF and indicate the corresponding PDR rule ID.

## (4) Detection of 1st downlink data for PDU Session with UP Connection deactivated.

When UPF receives the downlink packet but no N3/N9 tunnel for downlink data transmission exists and the buffering is performed by the UPF, it shall report the detection of 1st downlink data to SMF for the purpose of downlink data notification. The UPF shall also report the DSCP of the packet if the PDU Session type is IP (to support the Paging Policy Differentiation feature described in clause 5.4.3 of TS 23.501 [2]).

## (5) Detection of PDU Session Inactivity for a specified period.

When an Inactivity Timer for a PDU Session is provided by SMF during N4 Session Establishment/Modification procedure, and the UPF detects the PDU Session has no data transfer for a period specified by the Inactivity Timer, it shall report PDU Session Inactivity to the SMF.

NOTE 1: As described in clause 4.3.7, an Inactivity Timer to the UPF is not provided by the SMF for always-on PDU Sessions.

2. The UPF sends an N4 session report message (N4 Session ID, list of [Reporting trigger, Measurement information]) to the SMF.

The Reporting trigger parameter contains the name of the event which triggered the report and the Measurement information parameter contains the actual information that the SMF requested to be informed about.

3. The SMF identifies the N4 session context based on the received N4 Session ID and applies the reported information for the corresponding PDU Session. The SMF responds with an N4 session report ACK message.

## 4.4.3 N4 Node Level Procedures

### 4.4.3.1 N4 Association Setup Procedure

The N4 Association Setup procedure is used to setup an N4 association between the SMF and the UPF, to enable the SMF to use the resources of the UPF subsequently to establish N4 Sessions. The SMF and UPF may exchange the supported functionalities on each side during this procedures.

The setup of an N4 association is initiated by the SMF.

The SMF initiates the N4 Association Setup procedure to request to setup an N4 association towards a UPF prior to establishing a first N4 session on this UPF.

When receiving an N4 Association Setup Request, the UPF shall send an N4 Association Setup Response.

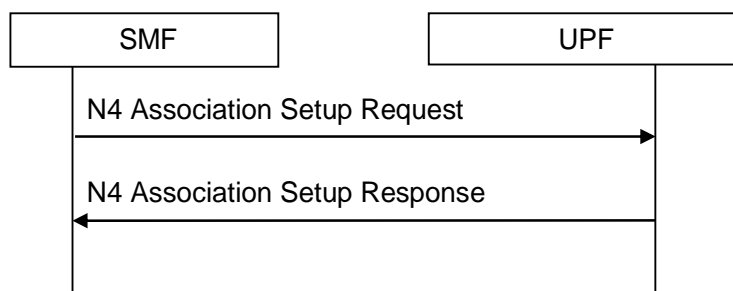

Figure 4.4.3.1-1: N4 association setup procedure

### 4.4.3.2 N4 Association Update Procedure

The N4 Association Update procedure shall be used to modify an existing N4 association between the SMF and the UPF. It may be initiated by the UPF or by the SMF to update the supported features or available resources of the UP function.

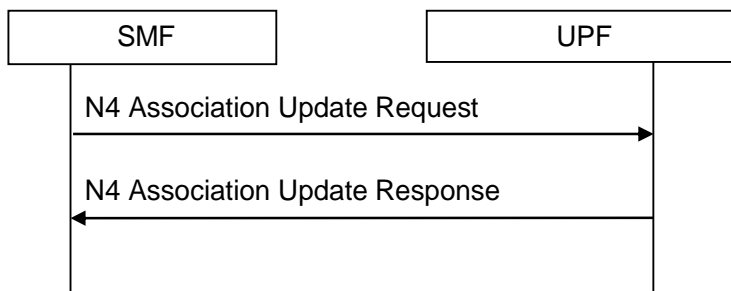

Figure 4.4.3.2-1: SMF initiated N4 association update procedure

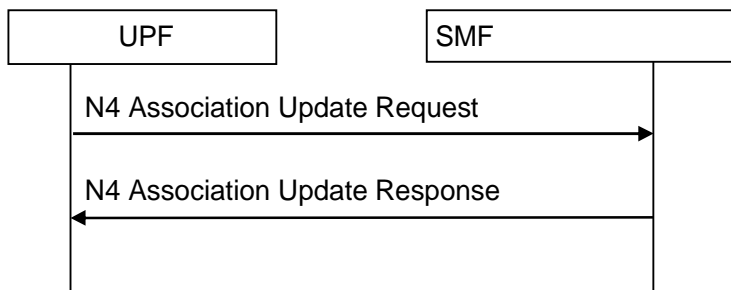

Figure 4.4.3.2-2: UPF initiated N4 association update procedure

### 4.4.3.3 N4 Association Release Procedure

The N4 Association Release procedure shall be used to terminate the N4 association between the SMF and the UPF due to e.g. OAM reasons. The N4 Association Release Request may be initiated by the SMF or UPF.

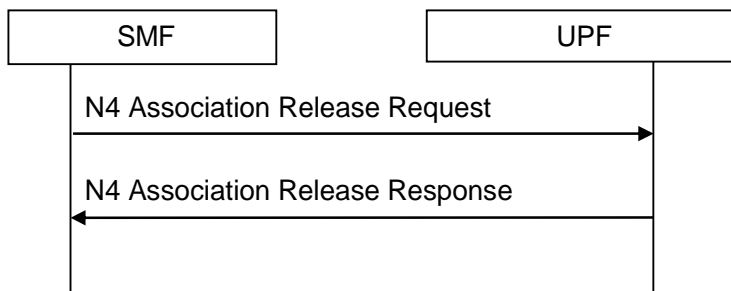

Figure 4.4.3.3-1: SMF initiated N4 association release procedure

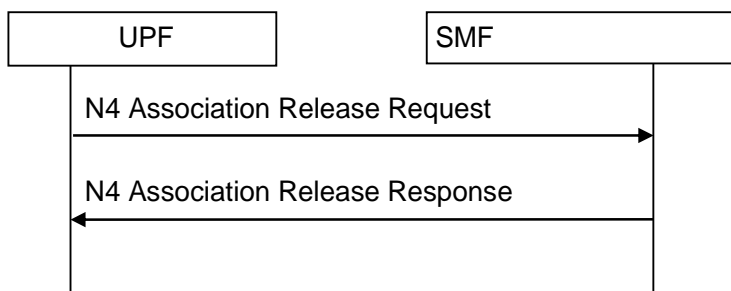
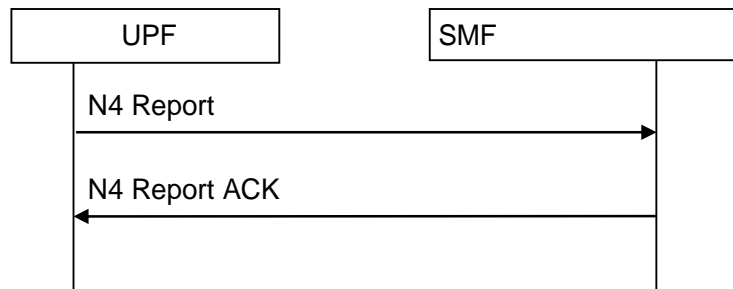

Figure 4.4.3.3-2: UPF initiated N4 association release procedure

#### 4.4.3.4 N4 Report Procedure

The N4 Report procedure shall be used by the UPF to report information to the SMF which is not related to a specific N4 session, e.g. to report a user plane path failure affecting all the N4 sessions towards a remote GTP-U peer.



**Figure 4.4.3.4-1: N4 report procedure**

The UPF detects that an event has to be reported and starts the procedure by sending an N4 Report message (UPF ID, list of [event, status]) to the SMF. The SMF responds with an N4 report ACK message (SMF ID). The event parameter contains the name of the event and UPF ID. The status parameter contains the actual information the control plane function is interested in.

#### 4.4.3.5 N4 PFD management Procedure

This N4 procedure is used by the SMF to provision or remove all PFD(s) belonging to an Application ID in the UPF. PFD sets belonging to different Application IDs can be managed with the same PFD management request message.

The N4 PFD management procedure is a node level procedure, i.e. independent of any PDU Session.

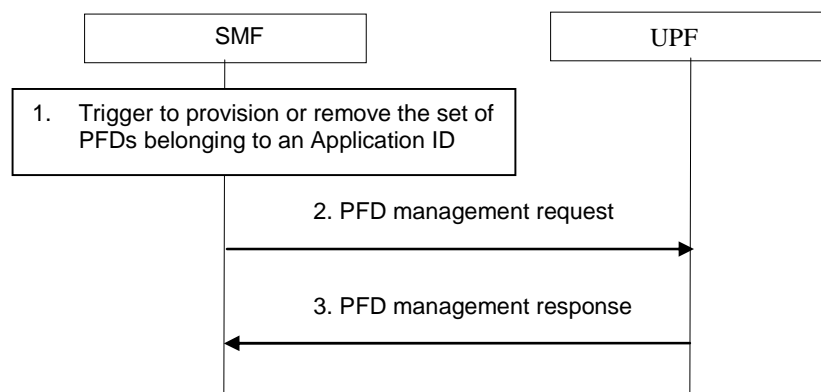

**Figure 4.4.3.5-1: PFD management in the UPF**

1. The SMF is triggered to provision or remove the PFD set belonging to an Application ID in the following cases:

When the caching timer expires and there's no active PCC rule that refers to the corresponding application identifier, the SMF informs the UPF to remove the PFD(s) identified by the Application ID.

When a PCC rule is provided for an Application ID corresponding to the PFD(s) that are not already provided to the UPF, the SMF shall provide the PFD(s) to the UPF (if there are no PFD(s) cached, the SMF retrieves them from the NEF (PFDF), as described in TS 23.503 [20]).

When any update of the PFD(s) is received from NEF (PFDF), and there are still active PCC rules in UPF for the Application ID.

2. The SMF sends a PFD management request to the UPF to provision/remove the PFD(s) corresponding to the Application ID(s).
3. The UPF updates the PFD(s) according to the request and acknowledges by responding with a PFD management response message.

#### 4.4.4 SMF Pause of Charging procedure

The SMF Pause of Charging procedure aims for the SMF charging and usage monitoring data to more accurately reflect the downlink traffic actually sent to the AN.

The following are example triggers for the SMF to enable the pause of charging

- Operator specified criteria/threshold (e.g. number/fraction of packets/bytes dropped at UPF in downlink since last time the N3 tunnel towards the AN was released). The SMF requests the UPF to notify the SMF whenever the criteria/threshold is met.
- Indication of "Radio Link Failure" (see clause 4.2.6).

Based on operator policies, if the trigger for the SMF to enable the pause of charging is met, the SMF shall pause the charging. When the SMF pauses charging the following applies:

- Towards the UPF(s) where the Usage Reporting is configured, the SMF shall modify the Usage Reporting Rules for the PDU Session so that the usage collection for charging is stopped.
- The SMF may request the UPF to limit the rate of downlink traffic sent to the downstream UPF or the AN.

NOTE 1: A consequence of using this procedure is that SMF charging data does not correspond to the volume that traversed the UPF, and it is therefore not possible to count the downlink packets dropped between the PDU Session Anchor (PSA) UPF and the downstream UPF.

NOTE 2: In this release of the specification, pause of charging procedure does not address the issue of packets dropped by the NG-RAN.

In home routed roaming scenarios, based on operator's policy, the H-SMF may indicate to the V-SMF if the feature is to be enabled on a per PDU Session basis. This is indicated to the V-SMF by a "PDU Session Charging Pause Enabled" Indication in the Nsmf\_PDUSession\_Create Response during the PDU Session Establishment procedure. This is an indication to the V-SMF that when the criteria for pause of SMF charging are met at the VPLMN (as described further down in this clause) charging at the H-SMF can be paused.

The H-SMF shall stop any charging and usage monitoring actions for the PDU Session upon receiving a "Start Pause of Charging" Indication in a Nsmf\_PDUSession\_Update request from the V-SMF. When the H-SMF receives a Nsmf\_PDUSession\_Update request for a PDU Session with a "Stop Pause of Charging" Indication, then the H-SMF shall resume charging for the PDU Session.

Regardless of operator policy/configuration, the downlink user plane packets received at the (V-)UPF shall trigger Data Notifications as described in clause 4.2.3.3.

When the (V-)SMF receives a Nsmf\_PDUSession\_UpdateSMContext request or a Namf\_EventExposure\_Notify about UE reachability, the (V-)SMF shall consider the PDU Session charging as being unpaused if it had been paused previously.

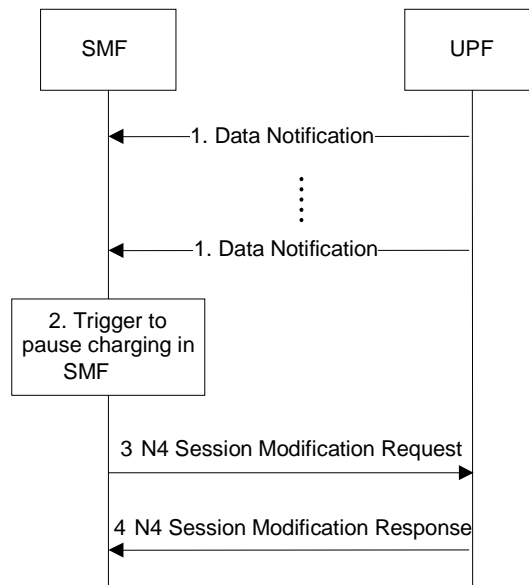

**Figure 4.4.4-1: SMF Pause of charging procedure**

1. The UPF receives downlink data packets for a PDU Session that does not have an N3 tunnel and the UPF sends data notification to the SMF. The packets are buffered or discarded in the UPF based on operator policy.
2. Based on operator policy/configuration the SMF triggers the procedure to pause PDU Session charging. Triggering criteria are based on SMF operator policy/configuration.
3. SMF sends a N4 Session Modification Request message to the UPF where the Usage Reporting is configured, modifying the Usage Reporting Rules for the PDU Session so that the usage collection for charging is stopped. In home routed roaming scenarios, the V-SMF sends a Nsmf\_PDUSession\_Update request to the H-SMF with a "Start Pause of Charging" Indication. The H-SMF then requests the H-UPF to stop usage collection as mentioned before.
4. UPF confirms with a N4 Session Modification Response message.

## 4.5 User Profile management procedures

### 4.5.1 Subscriber Data Update Notification to AMF

Whenever the user profile is changed for a user in the UDM/UDR, and the changes affect the user profile in the AMF, the UDM shall notify these changes to the affected AMF by the means of invoking Nudm\_SDM\_Notification service operation. Then the AMF adds or modifies the user profile.

The Nudm\_SDM\_Notification service operation specified in clause 5.2.3.3 is used by the UDM to update subscriber data stored in the AMF.

The AMF takes appropriate action according to the changed subscriber data as follows, e.g.:

- initiating an AMF initiated Deregistration procedure if the updated subscription data indicates the UE is not allowed to roam in this network; and
- updating UE context stored at AN to modify the subscribed UE-AMBR.
- initiating UE Configuration Update procedure as defined in clause 4.2.4.2.

UDM can also use the Nudm\_SDM\_Notification service operation to update the Steering of Roaming information stored in the UE via the AMF (i.e. a list of preferred PLMN/access technology combinations or HPLMN indication that 'no change of the "Operator Controlled PLMN Selector with Access Technology" list stored in the UE is needed). UDM can include an indication for the UE to send an acknowledgement of the reception of this information. The AMF provides the acknowledgement sent from the UE to UDM using the Nudm\_SDM\_Info service operation. For more details regarding the handling of Steering of Roaming information refer to TS 23.122 [22].

When the subscribed S-NSSAIs change, UDM provides a Network Slicing Subscription Change Indication to the UE via the AMF. Once the AMF updates the UE and obtains an acknowledgment from the UE, the AMF informs the UDM that the UE received the Network Slicing Subscription Change Indication using the Nudm\_SDM\_Info service operation.

## 4.5.2 Session Management Subscriber Data Update Notification to SMF

Whenever the session management subscriber data is changed for a user in the UDM/UDR, and if the SMF subscribed for the update of the session management subscriber data to be notified, the UDM shall notify these changes to the affected SMF by the means of invoking Nudm\_SDM\_Notification service operation. Then the SMF modifies the session management subscriber data in the UE SM context.

The Nudm\_SDM\_Notification service operation specified in clause 5.2.3.3 is used by the UDM to update session management subscriber data stored in the SMF.

The SMF initiates appropriate action according to the changed subscriber data, e.g. including:

- initiating an SMF initiated PDU Session Modification procedure; or
- initiating an SMF initiated PDU Session Release procedure.

## 4.5.3 Purge of subscriber data in AMF

An AMF may, as an implementation option, purge the subscriber data and MM context of a UE after the implicit or explicit Deregistration of the UE. In this case, the AMF shall unsubscribe and deregister from the UDM, where UDM may further do corresponding operation from UDR, by the means of following "Purge of subscriber data in AMF" procedure.

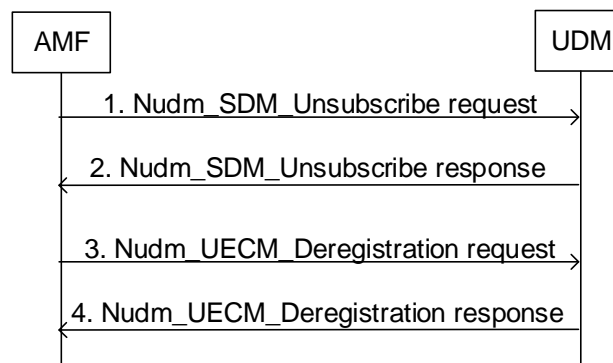

**Figure 4.5.3-1: Purge of Subscriber Data in AMF**

1. After purging the subscriber data and MM context of a deregistered UE, the AMF unsubscribes to changes to subscription data using Nudm\_SDM\_Unsubscribe request operation (see clause 5.2.3.3.4), for the data the AMF has previously subscribed (see clause 4.2.2.2.2, step 14b). The UDM unsubscribes the AMF from the data indicated.

The UDM may unsubscribe to changes to subscription data from UDR by using Nudr\_DM\_Unsubscribe for the data the UDM has previously subscribed (see clause 4.2.2.2.2, step 14b).

2. The UDM sends a response back using Nudm\_SDM\_Unsubscribe response operation.
3. The AMF deregisters from UDM using Nudm\_UECM\_Deregistration request (SUPI, NF ID, Access Type) operation (see clause 5.2.3.2.3). The UDM may update UE context in UDR by Nudr\_DM\_Update (SUPI, Subscription Data, UE context in AMF data).
4. The UDM sets the UE Purged flag associated with the Access Type and acknowledges with a Nudm\_UECM\_Deregistration response operation.

## 4.6 Security procedures

Security procedures for the 5GS are specified in 33.501 [15].

## 4.7 ME Identity check procedure

The AMF initiates Mobile Equipment Identity Check procedure by invoking the N5g-eir\_MEIdentityCheck\_Get service operation as defined in clause 5.2.4.2.2.

## 4.8 RAN-CN interactions

### 4.8.1 Connection Inactive procedure

This procedure may be initiated by the serving NG-RAN node when the UE is in CM-CONNECTED with RRC Connected state and has received the "RRC Inactive Assistance Information" from the AMF as defined in TS 23.501 [2] clause 5.3.3.2.5. NG-RAN initiates the transition to RRC Inactive state as defined in TS 38.300 [9].

### 4.8.2 Connection Resume procedure

The Connection Resume procedure is used by the UE to perform RRC Inactive to RRC Connected state transition. Triggers for the UE to initiate this procedure are defined in TS 23.501 [2], clause 5.3.3.2.5.

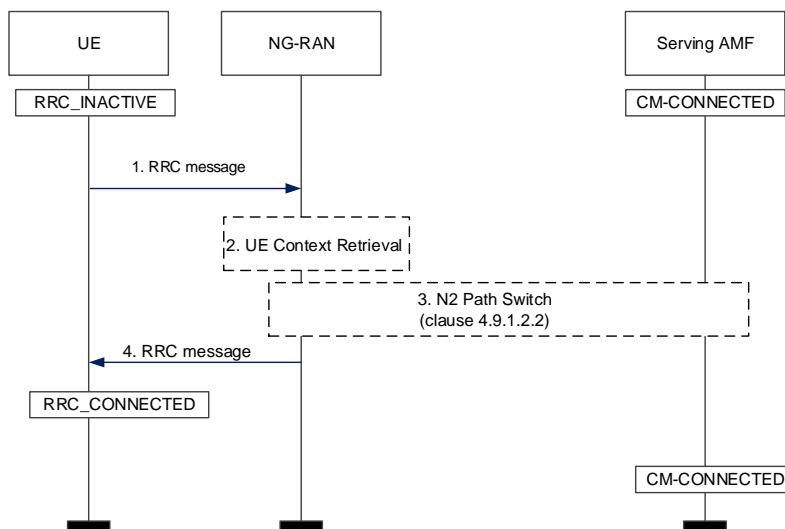

**Figure 4.8.2-1: RRC Inactive to RRC Connected state transition**

1. UE to NG-RAN: RRC message (Resume ID).

The UE initiates the transition from RRC Inactive state to RRC Connected state, see TS 38.300 [9]. The UE provides its Resume ID needed by the NG-RAN to access the UE's stored Context.

2. [Conditional] NG-RAN performs UE Context Retrieval.

UE Context Retrieval is performed when the UE Context associated with the UE attempting to resume its connection is not locally available at the accessed NG-RAN. The UE Context Retrieval procedure via radio access network is specified in TS 38.300 [9].

3. [Conditional] N2 Path switch procedure.

If the accessed NG-RAN is able to retrieve the UE Context, the accessed NG-RAN node initiates N2 Path Switch procedure, i.e. steps 1 to 8 of clause 4.9.1.2.2 and including Xn data forwarding.



If the Connection Resume procedure is a response to RAN paging which is triggered by 5GC due to an N2 interface procedure, NG-RAN and 5GC handle the N2 interface procedure as a collision described in clause 4.9.1.2.

The NG-RAN sends UE Notification message to report that UE is in RRC Connected if an AMF requested N2 Notification (see clause 4.8.3) to NG-RAN.

#### 4. NG-RAN to UE: RRC message.

The NG-RAN confirms to the UE that the UE has entered RRC Connected state.

NOTE: Steps 3 and 4 can be executed in parallel.

### 4.8.3 N2 Notification procedure

This procedure is used by an AMF to request the NG-RAN to report RRC state information, when the target UE is in CM-CONNECTED state. When AMF has requested reporting of subsequent state changes, the need for the NG-RAN to continue reporting ceases when the UE transitions to CM-IDLE or the AMF sends a cancel indication. This procedure may be used for services that require RRC state information (e.g. 5GC MT control and paging assistance, O&M and collection of statistics), or for subscription to the service by other NFs. See TS 38.413 [10] for details of the procedure.

Reporting of RRC state transitions can be requested per UE by AMF. Continuous reporting of all RRC state transitions can be enabled by operator local configuration.

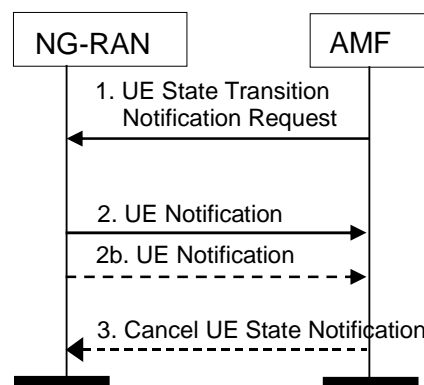

**Figure 4.8.3-1: RRC state transition notification**

1. The AMF sends a UE State Transition Notification Request to the NG-RAN as described in TS 38.413 [10]. The UE State Transition Notification Request message shall identify the UE for which notification(s) are requested, and may contain a reporting type. The reporting type either indicates subsequent state transitions shall be notified at every RRC state transition (i.e. from RRC Connected state to RRC Inactive state, or from RRC Inactive to RRC Connected state), or it indicates Single RRC-Connected state notification.
2. The NG-RAN sends the UE Notification message to report the current RRC state for the UE (i.e. RRC Inactive state or RRC Connected state). The current UE location information (i.e. TAI + Cell Identity) is always included when RRC state information is reported.
- 2b. When the AMF has requested reporting about subsequent state transitions, the NG-RAN sends subsequent UE Notification messages to the AMF at every RRC state transition until the UE transitions to CM-IDLE or NG-RAN receives a Cancel UE State Notification message from the AMF.

When the AMF has requested reporting for Single RRC-Connected state notification and UE is in RRC-Connected state, the NG-RAN sends one UE Notification message but no subsequent messages. If UE is in RRC-Inactive state, the NG-RAN sends one UE Notification message plus one subsequent UE Notification message when RRC state transits to RRC-Connected.

3. The AMF can send a Cancel UE State Notification message to inform the NG-RAN that it should terminate notifications for a given UE. This message should only be used when notification(s) about subsequent state transitions was requested at every RRC state transition.

## 4.9 Handover procedures

### 4.9.1 Handover procedures in 3GPP access

#### 4.9.1.1 General

These procedures are used to hand over a UE from a source NG-RAN node to a target NG-RAN node using the Xn or N2 reference points. This can be triggered, for example, due to new radio conditions, load balancing or due to specific service e.g. in the presence of QoS Flow for voice, the source NG-RAN node being NR may trigger handover to E-UTRA connected to 5GC.

The RRC Inactive Assistance Information is included in N2 Path Switch Request Ack message for Xn based handover or Handover Request message for N2 based handover (see TS 23.501 [2] clause 5.3.3.2.5).

#### 4.9.1.2 Xn based inter NG-RAN handover

##### 4.9.1.2.1 General

Clause 4.9.1.2 includes details regarding the Xn based inter NG-RAN handover with and without UPF re-allocation.

Xn handovers are only supported for intra-AMF mobility.

The handover preparation and execution phases are performed as specified in TS 38.300 [9], in case of handover to a shared network, source NG-RAN determines a PLMN to be used in the target network as specified by TS 23.501 [2]. If the serving PLMN changes during Xn-based handover, the source NG-RAN node shall indicate to the target NG-RAN node (in the Mobility Restriction List) the selected PLMN ID to be used in the target network.

If the AMF generates the N2 downlink signalling during the ongoing handover and receives a rejection to a N2 interface procedure (e.g. Location Reporting Control; DL NAS message transfer; etc.) from the NG-RAN with an indication that a Xn based handover procedure is in progress, the AMF may reattempt the same N2 interface procedure either when the handover is complete or the handover is deemed to have failed, when possible. The failure is known by expiry of the timer guarding the N2 interface procedure.

Upon reception for an SMF initiated N1 and/or N2 request(s) with an indication that the request has been temporarily rejected due to handover procedure in progress, the SMF starts a locally configured guard timer. Any NF (e.g. the SMF) should hold any signalling messages targeted towards AMF for a given UE during the handover preparation phase unless it detects that the handover execution is completed or handover has failed/cancelled. The NF (e.g. the SMF) may re-attempt, up to a pre-configured number of times, when either it detects that the handover is completed or has failed using message reception or at expiry of the guard timer.

##### 4.9.1.2.2 Xn based inter NG-RAN handover without User Plane function re-allocation

This procedure is used to hand over a UE from a source NG-RAN to target NG-RAN using Xn when the AMF is unchanged and the SMF decides to keep the existing UPF. The UPF referred in this clause 4.9.1.2.2 is the UPF which terminates N3 interface in the 5GC. The presence of IP connectivity between the Source UPF and Target NG-RAN is assumed.

The call flow is shown in figure 4.9.1.2.2-1.

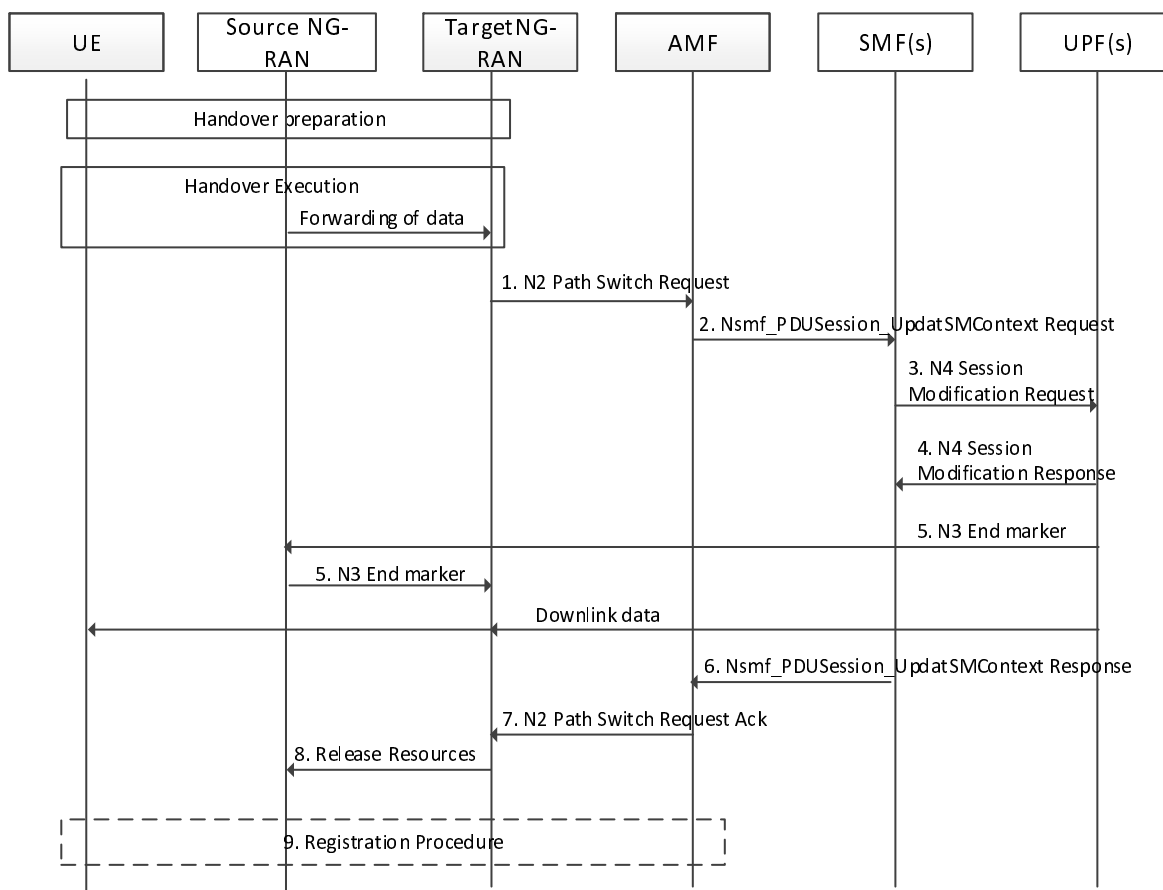

**Figure 4.9.1.2.2-1: Xn based inter NG-RAN handover without UPF re-allocation**

- 1a. If the PLMN has configured secondary RAT usage reporting, the source NG-RAN node during the handover execution phase may provide RAN usage data Report (N2 SM Information (Secondary RAT usage data), Handover Flag) to the AMF. The source NG-RAN node shall provide this only when the Target NG-RAN has confirmed handover over Xn interface. The Handover Flag indicates to the AMF that it should buffer the N2 SM Information containing the usage data report before forwarding it.
- 1b. Target NG-RAN to AMF: N2 Path Switch Request (List of PDU Sessions To Be Switched with N2 SM Information, List of PDU Sessions that failed to be established with the failure cause given in the N2 SM information element, UE Location Information)

The Target NG-RAN sends an N2 Path Switch Request message to an AMF to inform that the UE has moved to a new target cell and provides a List Of PDU Sessions To Be Switched. The selected PLMN ID is included in the message. The target NG-RAN shall include the PDU Session in the PDU Sessions Rejected list:

- If none of the QoS Flows of a PDU Session are accepted by the Target NG-RAN; or
- If the corresponding network slice is not supported in the Target NG-RAN; or

When the NG-RAN cannot set up user plane resources fulfilling the User Plane Security Enforcement with a value Required, the NG-RAN rejects the establishment of user plane resources for the PDU Session.

If the NG-RAN cannot set up user plane resources fulfilling the User Plane Security Enforcement with a value Preferred, the NG-RAN establishes the user plane resources for the PDU session and shall include the PDU Session in the PDU Sessions Modified list.

PDU Sessions Rejected contains an indication of whether the PDU session was rejected because User Plane Security Enforcement is not supported in the Target NG-RAN. Depending on the type of target cell, the Target NG-RAN includes appropriate information in this message.

For the PDU Sessions to be switched to the Target NG-RAN, the N2 Path Switch Request message shall include the list of accepted QoS Flows.

2. AMF to SMF: Nsmf\_PDUSession\_UpdateSMContext Request (N2 SM information received from T-RAN in step 1b and N2 SM Information from source NG-RAN (Secondary RAT usage data), UE Location Information, UE presence in LADN service area). The N2 SM Information here from source NG-RAN is the one buffered at step 1a when applicable.

The AMF sends N2 SM information by invoking the Nsmf\_PDUSession\_UpdateSMContext request service operation for each PDU Session in the lists of PDU Sessions received in the N2 Path Switch Request.

The Nsmf\_PDUSession\_UpdateSMContext Request contains either an indication that the PDU Session Is To Be Switched (together with information on the N3 addressing to use and on the transferred QoS flows) or an indication that the PDU Session is to be Rejected (together with a rejection cause).

For a PDU Sessions to be switched to the Target NG-RAN, upon receipt of the Nsmf\_PDUSession\_UpdateSMContext request, the SMF determines whether the existing UPF can continue to serve the UE. If the existing UPF cannot continue to serve the UE, steps 3-11 of clause 4.9.1.2.3 or 4.9.1.2.4 are performed depending on whether the existing UPF is a PDU Session Anchor. Otherwise, the following steps 3 to 6 are performed if the existing UPFs can continue to serve the PDU Session.

In the case that the AMF determines that the PDU Session is related to a LADN, then the AMF provides the "UE presence in LADN service area" to the SMF. If the AMF does not provide the "UE presence in LADN service area" indication and the SMF determines that the DNN corresponds to a LADN, then the SMF considers that the UE is OUT of the LADN service area. The SMF takes actions for the LADN PDU Session as defined in TS 23.501 [2] clause 5.6.5 based on the "UE presence in LADN service area" indication.

If a PDU Session is rejected by the Target NG-RAN with an indication that the PDU session was rejected because User Plane Security Enforcement is not supported in the Target NG-RAN and the User Plane Enforcement Policy indicates "Required" as described in clause 5.10.3 of TS 23.501 [2], the SMF triggers the release of this PDU Session. In all other cases of PDU Session rejection, the SMF can decide whether to release the PDU Session or to deactivate the UP connection of this PDU Session.

If some of the QoS Flows of a PDU Session are not accepted by the Target NG-RAN, the SMF shall initiate the PDU Session Modification procedure to remove the non-accepted QoS Flows from the PDU Session(s) after the handover procedure is completed.

For the PDU Session(s) that do not have active N3 UP connections before handover procedure, the SMF(s) keep the inactive status after handover procedure.

If the UE moves into a non-Allowed Area, the AMF also notifies via Namf\_EventExposure\_Notify to each NF Consumer (e.g. SMFs of the established PDU Sessions) which has subscribed for UE reachability event, that the UE is only reachable for regulatory prioritized services. The SMF then deactivates the PDU session if this PDU Session is not for emergency service.

3. SMF to UPF: N4 Session Modification Request (AN Tunnel Info, CN Tunnel Info)

For PDU Sessions that are modified by the Target NG-RAN, the SMF sends an N4 Session Modification Request message to the UPF. The SMF may notify the UPF that originated the Data Notification to discard downlink data for the PDU Sessions and/or to not provide further Data Notification messages.

Depending on the network deployment, the CN Tunnel Info of UPF used for connection to Target NG-RAN and connection to Source NG-RAN may be different, e.g. due to Source and Target NG-RAN are in different IP domains. If the CN Tunnel Info (on N3) of UPF need be re-allocated and CN Tunnel Info is allocated by the SMF, the SMF provides the CN Tunnel Info (on N3) to the UPF.

4. UPF to SMF: N4 Session Modification Response (CN Tunnel Info)

For the PDU Sessions that are switched, the UPF returns an N4 Session Modification Response message to the SMF after requested PDU Sessions are switched. Tunnel identifiers for UL traffic are included only for PDU Sessions whose user plane resources are not being released, and only if the UPF allocates CN Tunnel Info and different CN Tunnel Info need be allocated. For the PDU Sessions that are deactivated, the UPF returns an N4 Session Modification Response message to the SMF after the N3 (R)AN tunnel information is released.

5. In order to assist the reordering function in the Target NG-RAN, the UPF (as specified in TS 23.501 [2], clause 5.8.2.9) sends one or more "end marker" packets for each N3 tunnel on the old path immediately after switching the path. The UPF starts sending downlink packets to the Target NG-RAN.

#### 6. SMF to AMF: Nsmf\_PDUSession\_UpdateSMContext Response (CN Tunnel Info)

The SMF sends an Nsmf\_PDUSession\_UpdateSMContext response (CN Tunnel Info) to the AMF for PDU Sessions which have been switched successfully. The CN Tunnel Info of UPF send to AMF is used to setup N3 tunnel. The SMF sends an Nsmf\_PDUSession\_UpdateSMContext response without including the CN Tunnel Info to the AMF for the PDU Sessions for which user plane resources are deactivated or released, and then the SMF releases the PDU Session(s) which is to be released using a separate procedure as defined in clause 4.3.4.

NOTE: Step 6 can occur any time after receipt of N4 Session Modification Response at the SMF.

#### 7. AMF to NG-RAN: N2 Path Switch Request Ack (N2 SM Information, Failed PDU Sessions)

Once the Nsmf\_PDUSession\_UpdateSMContext response is received from all the SMFs, the AMF aggregates received CN Tunnel Info and sends this aggregated information as a part of N2 SM Information along with the Failed PDU Sessions in N2 Path Switch Request Ack to the Target NG-RAN. If none of the requested PDU Sessions have been switched successfully, the AMF shall send an N2 Path Switch Request Failure message to the Target NG-RAN.

8. By sending a Release Resources message to the Source NG-RAN, the Target NG-RAN confirms success of the handover. It then triggers the release of resources with the Source NG-RAN.

9. [Conditional] The UE may initiate Mobility Registration Update procedure if one of the triggers of registration procedure applies as described in clause 4.2.2.2.2. In this case, only steps 1, 2, 3, 17 and 21 in clause 4.2.2.2.2 are performed.

For the mobility related events as described in clause 4.15.4, the AMF invokes the Namf\_EventExposure\_Notify service operation.

Upon reception of the Namf\_EventExposure\_Notify with an indication that UE is reachable only for regulatory prioritized service, the SMF deactivates the PDU Session if the service of the PDU Session is not regulatory prioritized. For home routed roaming case, the V-SMF triggers the deactivation of the PDU Session, in addition, the H-SMF refrains from sending downlink signalling if the signalling is not related to regulatory prioritized service upon receiving the notification.

#### 4.9.1.2.3 Xn based inter NG-RAN handover with insertion of intermediate UPF

This procedure is used to hand over a UE from a Source NG-RAN to a Target NG-RAN using Xn when the AMF is unchanged and the SMF decides that insertion of a new additional intermediate UPF is needed. In case of using UL CL, the I-UPF can be regarded as UL CL and additional PSA providing local access to a DN. In case of using Branching Point, the I-UPF can be regarded as BP.

It is assumed that the PDU Session for the UE comprises of only one UPF that acts as a PDU Session Anchor at the time of this Handover procedure for non-roaming and local breakout roaming scenario. In case of home routed roaming scenario, the PDU Session of the UE comprises of at least one UPF in the VPLMN and one UPF in the HPLMN at the time of this handover procedure. In this case, additional insertion of an N3 terminating intermediate UPF will not have impact on the connectivity between the UPF in VPLMN and UPF in HPLMN. The presence of IP connectivity between the UPF (PDU Session Anchor) and Source NG-RAN, between the UPF (PDU Session Anchor) and Target NG-RAN, and between the intermediate UPF (I-UPF) and Target NG-RAN, is assumed. (If there is no IP connectivity between UPF (PDU Session Anchor) and Target NG-RAN, it is assumed that the N2-based handover procedure in clause 4.9.1.3 shall be used instead).

The call flow is shown in figure 4.9.1.2.3-1.

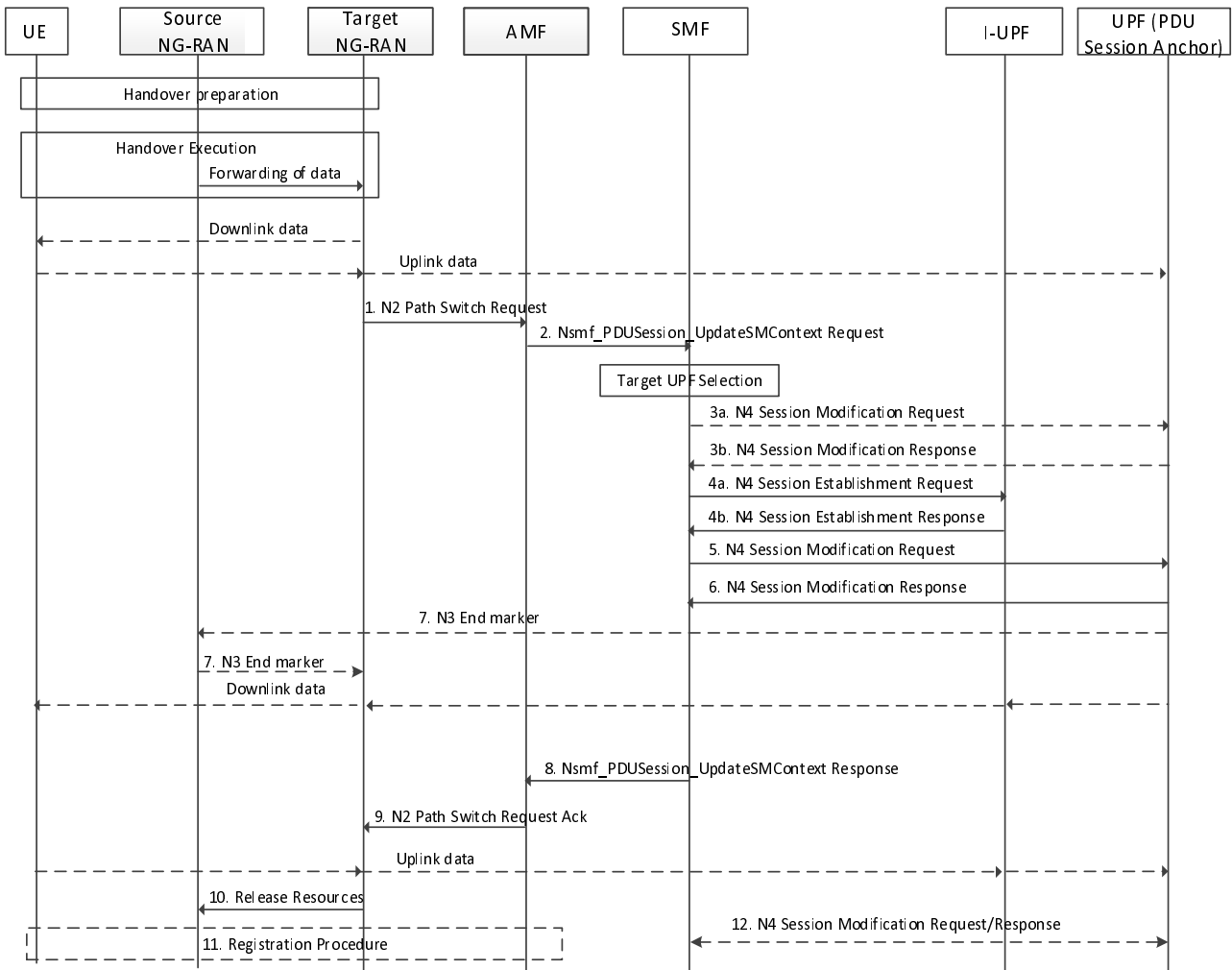

**Figure 4.9.1.2.3-1: Xn based inter NG-RAN handover with insertion of intermediate UPF**

Steps 1-2 are the same as described in clause 4.9.1.2.2.

3a. [Conditional] SMF to UPF (PSA): N4 Session Modification Request.

If the SMF selects a new UPF to act as intermediate UPF for the PDU Session, and the different CN Tunnel Info need be used, and CN Tunnel Info is allocated by the UPF the SMF sends N4 Session Modification Request message to UPF (PSA). If the CN Tunnel Info is allocated by the SMF, the SMF may provide the CN tunnel info (for N9) and UL Packet detection rules associate the CN Tunnel Info (on N9) to the UPF (PSA) in step 5.

3b. [Conditional] UPF (PSA) to SMF: N4 Session Modification Response.

The UPF (PSA) sends an N4 Session Establishment Response message to the SMF. If the UPF (PSA) allocates CN Tunnel Info (on N9) of UPF (PSA), it provides CN Tunnel Info (on N9) to the SMF. The UPF (PSA) associate the CN Tunnel Info (on N9) with UL Packet detection rules provided by the SMF.

4a. SMF to I-UPF: N4 Session Establishment Request (Target NG-RAN Tunnel Info, CN Tunnel Info of the PDU Session Anchor)

For PDU Sessions to be updated, if the UE has moved out of the service area of UPF connecting to the serving NG-RAN node, the SMF then selects a I-UPF based on UPF Selection Criteria according to clause 6.3.3 of TS 23.501 [2]. An N4 Session Establishment Request message is sent to the I-UPF. The CN Tunnel Info of the PDU Session Anchor, which is used to setup N9 tunnel, is included in the N4 Session Establishment Request message. If the CN Tunnel Info of the I-UPF is allocated by the SMF, the SMF also provides the UL and DL CN Tunnel Info of I-UPF to the I-UPF.

4b. I-UPF to SMF: N4 Session Establishment Response.

The I-UPF sends an N4 Session Establishment Response message to the SMF. If the CN Tunnel Info of the I-UPF is allocated by the UPF, the UL and DL CN Tunnel Info of I-UPF is sent to the SMF.

5. SMF to PDU Session Anchor: N4 Session Modification Request (DL CN Tunnel Info of the I-UPF, UL CN Tunnel info).

The SMF sends N4 Session Modification message to the PDU Session Anchor. The SMF may also provide updated UL CN Tunnel Information.

If a different CN Tunnel Info is used on N9 in UPF (PSA), the SMF starts a timer to release the CN Tunnel for N3. Otherwise the SMF does not need to start a timer to release the CN Tunnel Info used on N3 in UPF(PSA) (i.e. CN Tunnel Info is common for both N3 and N9).

6. PDU Session Anchor to SMF: N4 Session Modification Response.

The PDU Session Anchor responds with the N4 Session Modification Response message after requested PDU Sessions are switched. At this point, PDU Session Anchor starts sending downlink packets to the Target NG-RAN via I-UPF.

7. In order to assist the reordering function in the Target NG-RAN, the PDU Session Anchor sends one or more "end marker" packets for each N3 tunnel on the old path immediately after switching the path, the source NG-RAN shall forward the "end marker" packets to the target NG-RAN.

8. SMF to AMF: Nsmf\_PDUSession\_UpdateSMContext Response (UL CN Tunnel Info of the I-UPF).

The SMF sends an Nsmf\_PDUSession\_UpdateSMContext response to the AMF.

Steps 8-11 are same as steps 6-9 defined in clause 4.9.1.2.2.

12. After the timer set in step 5 expires, the SMF informs the PDU Session Anchor to remove the CN Tunnel for N3 via N4 Session Modification procedure.

#### 4.9.1.2.4 Xn based inter NG-RAN handover with re-allocation of intermediate UPF

This procedure is used to hand over a UE from a Source NG-RAN to a Target NG-RAN using Xn when the AMF is unchanged and the SMF decides that the intermediate UPF (I-UPF) is to be changed. In case of using UL CL, the I-UPF can be regarded as UL CL and additional PSA provides local access to a DN, the simultaneous change of UL-CL and the additional PSA is described in clause 4.3.5.7. In case of using Branching Point, the I-UPF can be regarded as BP.

It is assumed that the PDU Session for the UE comprises of a UPF that acts as a PDU Session Anchor and an intermediate UPF at the time of this Handover procedure for non-roaming and local breakout roaming scenario. In case of home routed roaming scenario, the PDU Session of the UE comprises of at least one UPF in the VPLMN and UPF in the HPLMN which acts as a PDU Session Anchor at the time of this handover procedure. The Source UPF referred in this clause 4.9.1.2.4 is the UPF which terminates N3 interface in the 5GC and it serves as the PDU mobility anchor for the given PDU Session. The presence of IP connectivity between the Source UPF and Source NG-RAN, between the source UPF and Target NG-RAN, and between the Target UPF and Target NG-RAN, is assumed. (If there is no IP connectivity between source UPF and Target NG-RAN, it is assumed that the N2-based handover procedure in clause 4.9.1.3 shall be used instead).

The call flow is shown in figure 4.9.1.2.4-1.

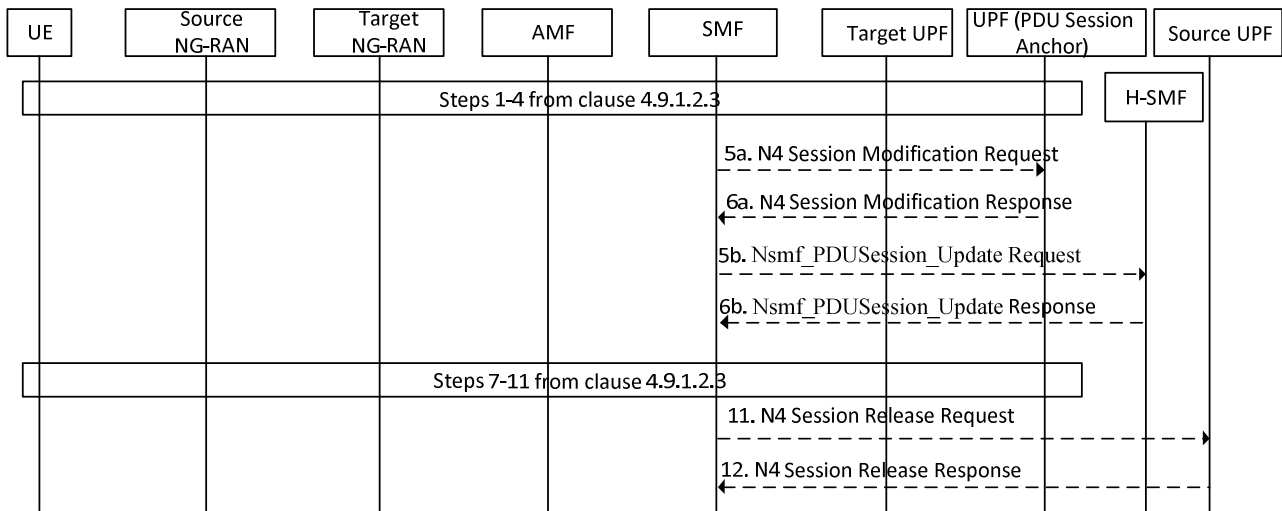

**Figure 4.9.1.2.4-1: Xn based inter NG-RAN handover with intermediate UPF re-allocation**

Steps 1-4 are same as steps 1-4 described in clause 4.9.1.2.3 except that the I-UPF in clause 4.9.1.2.3 is replaced by Target UPF.

5. [Conditional] The SMF sends N4 Session Modification Request message to the PDU Session Anchor. The DL CN Tunnel Info of the Target UPF is included in this message. In the case of home routed roaming, if the N9 terminating V-UPF is changed, the V-SMF invokes an Nsmf\_PDUSession\_Update Request service operation toward the H-SMF.
6. [Conditional] The SMF associated with the PDU Session Anchor responds with the N4 Session Modification Response message. In case of home routed roaming, the H-SMF responds with the Nsmf\_PDUSession\_Update Response service operation toward the V-SMF once H-UPF is updated with the DL Tunnel Info of the T-UPF. At this point, PDU Session Anchor starts sending downlink packets to the Target NG-RAN via Target UPF.

Steps 7-11 are same as steps 7-11 described in clause 4.9.1.2.3 except that the I-UPF in clause 4.9.1.2.3 is replaced by Target UPF.

If the Source UPF acts as a UL CL or BP, the SMF indicates to only one of the PDU Session Anchors to send the "end marker" packets. To ensure the "end marker" is the last user plane packet on the old path, the SMF should modify the path on other PDU Session Anchors before it indicates the PDU Session Anchor to send the "end marker" packets.

11. The timer is started in step 4 if the source UPF is not the PSA UPF. When this timer is expired, the SMF initiates Source UPF Release procedure by sending an N4 Session Release Request (Release Cause).
12. The Source UPF acknowledges with an N4 Session Release Response message to confirm the release of resources.

### 4.9.1.3 Inter NG-RAN node N2 based handover

#### 4.9.1.3.1 General

Clause 4.9.1.3 includes details regarding the inter NG-RAN node N2 based handover without Xn interface.

The source NG-RAN decides to initiate an N2-based handover to the target NG-RAN. This can be triggered, for example, due to new radio conditions or load balancing, if there is no Xn connectivity to the target NG-RAN, an error indication from the target NG-RAN after an unsuccessful Xn-based handover (i.e. no IP connectivity between T-RAN and S-UPF), or based on dynamic information learnt by the S-RAN.

The availability of a direct forwarding path is determined in the source NG-RAN and indicated to the SMFs. If IP connectivity is available between the source and target NG-RAN and security association(s) is in place between them, a direct forwarding path is available.



If a direct forwarding path is not available, indirect forwarding may be used. The SMFs use the indication from the source NG-RAN to determine whether to apply indirect forwarding.

In the case of handover to a shared network, the source NG-RAN determines a PLMN to be used in the target network as specified by TS 23.501 [2]. The source NG-RAN shall indicate the selected PLMN ID to be used in the target network to the AMF as part of the Tracking Area sent in the HO Required message.

If the AMF generates the N2 downlink signalling during the ongoing handover and receives a rejection to a N2 interface procedure (e.g. DL NAS message transfer; Location reporting control; etc.) from the NG-RAN with an indication that an Inter NG-RAN node handover procedure is in progress, the AMF may reattempt the same N2 interface procedure either when the handover is complete or the handover is deemed to have failed if the AMF is still the serving AMF, when possible. If the Inter NG-RAN node handover changes the serving AMF, the source AMF shall terminate any other ongoing N2 interface procedures except the handover procedure.

In order to minimize the number of procedures rejected by NG-RAN, the AMF should pause non-handover related N2 interface procedures (e.g. DL NAS message transfer, Location Report Control, etc.) while a handover is ongoing (i.e. from the time that a Handover Required has been received until either the Handover procedure has succeeded (Handover Notify) or failed (Handover Failure)) and continue them once the Handover procedure has completed if the AMF is still the serving AMF.

If during the handover procedure the AMF detects that the AMF needs be changed, the AMF shall reject any SMF initiated N2 request received since handover procedure started and shall include an indication that the request has been temporarily rejected due to handover procedure in progress.

Upon reception for an SMF initiated N1 and/or N2 request(s) with an indication either from the NG-RAN (via N2 SM Info) or AMF that the request has been temporarily rejected due to handover procedure in progress, the SMF starts a locally configured guard timer. The SMF should hold any signalling messages targeted towards AMF for a given UE during the handover preparation phase unless it detects that the handover execution is completed or handover has failed/cancelled. The SMF may re-attempt, up to a pre-configured number of times, when either it detects that the handover is completed or has failed using message reception or at expiry of the guard timer.

In the case of home routed roaming scenario, the SMF in the Inter NG-RAN node N2 based handover procedure (Figure 4.9.1.3.2-1 and Figure 4.9.1.3.3-1) interacting with the S-UPF, T-UPF, S-AMF and T-AMF is the V-SMF, and the SMF (Figure 4.9.1.3.3-1) interacting with the UPF (PSA) is the H-SMF.

4.9.1.3.2 Preparation phase

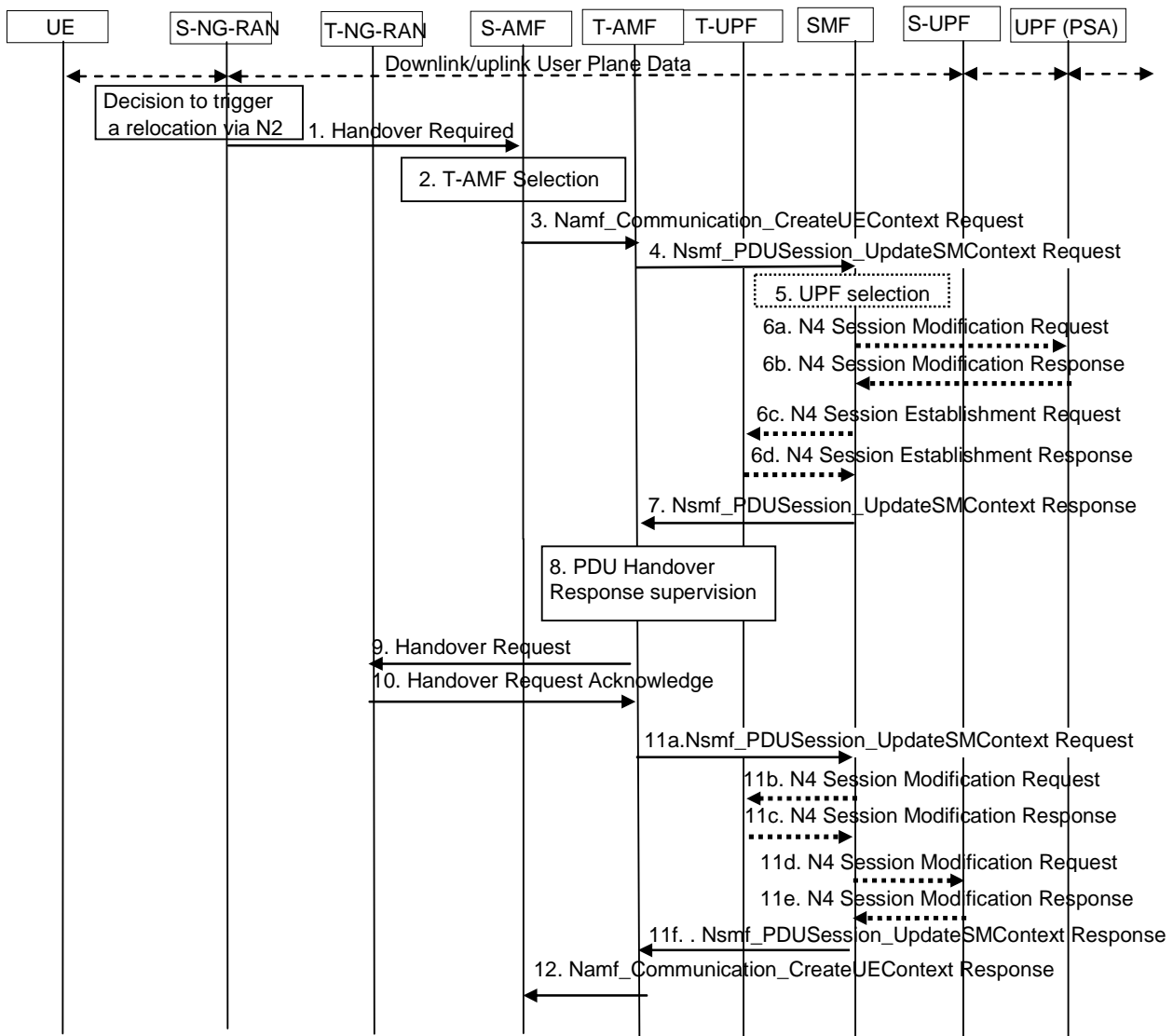

Figure 4.9.1.3.2-1: Inter NG-RAN node N2 based handover, Preparation phase

1. S-RAN to S-AMF: Handover Required (Target ID, Source to Target transparent container, SM N2 info list, PDU Session IDs, intra system handover indication).

Source to Target transparent container includes NG-RAN information created by S-RAN to be used by T-RAN, and is transparent to 5GC. It also contains for each PDU session the corresponding User Plane Security Enforcement information, QoS flows /DRBs information subject to data forwarding.

All PDU Sessions handled by S-RAN (i.e. all existing PDU Sessions with active UP connections) shall be included in the Handover Required message, indicating which of those PDU Session(s) are requested by S-RAN to handover. The SM N2 info includes Direct Forwarding Path Availability if direct data forwarding is available.

Direct Forwarding Path Availability indicates whether direct forwarding is available from the S-RAN to the T-RAN. This indication from S-RAN can be based on e.g. the presence of IP connectivity and security association(s) between the S-RAN and the T-RAN.

2. T-AMF Selection: When the S-AMF can't serve the UE anymore, the S-AMF selects the T-AMF as described in clause 6.3.5 on "AMF Selection Function" in TS 23.501 [2].
3. [Conditional] S-AMF to T-AMF: Namf\_Communication\_CreateUEContext Request (N2 Information (Target ID, Source to Target transparent container, SM N2 information list, PDU Session IDs), UE context information (SUPI, Service area restriction, Allowed NSSAI for each Access Type if available, Tracing Requirements, the

list of PDU Session IDs along with the corresponding SMF information and the corresponding S-NSSAI(s), PCF ID(s) and DNN). If the subscription information includes Tracing Requirements, the old AMF provides the target AMF with Tracing Requirements.

The S-AMF initiates Handover resource allocation procedure by invoking the `Namf_Communication_CreateUEContext` service operation towards the T-AMF.

When the S-AMF can still serve the UE, this step and step 12 are not needed.

If Service area restrictions are available in the S-AMF, they may be forwarded to the T-AMF as described in clause 5.3.4.1.2 in TS 23.501 [2].

If both Home and Visited PCF ID(s) are provided by the S-AMF, the T-AMF contacts the (V-) PCF identified by the (V-)PCF ID. If the (V-)PCF identified by the (V-)PCF ID is not used or there are no PCF ID(s) received from the S-AMF, the T-AMF may select the PCF(s) as described in TS 23.501 [2], clause 6.3.7.1 and according to the V-NRF to H-NRF interaction described in clause 4.3.2.2.3.3. The T-AMF informs the S-AMF that the PCF ID is not used, as defined in step 12 and then the S-AMF terminates the AM Policy Association with the PCF identified by the PCF ID.

4. [Conditional] T-AMF to SMF: `Nsmf_PDUSession_UpdateSMContext` (PDU Session ID, Target ID, T-AMF ID, N2 SM Information).

For each PDU Session indicated by S-RAN, the AMF invokes the `Nsmf_PDUSession_UpdateSMContext` Request to the associated SMF. However, if the S-NSSAI associated with PDU Session is not available in the T-AMF, the T-AMF does not invoke `Nsmf_PDUSession_UpdateSMContext` for this PDU Session.

PDU Session ID indicates a PDU Session candidate for N2 Handover. Target ID corresponds to Target ID provided by S-RAN in step 1. SM N2 Info includes the Direct Forwarding Path Availability if the direct data forwarding is available between the S-RAN and the T-RAN and has been inserted by the S-RAN.

If the (T-)AMF detects that the UE moves into a non-allowed area based on Service area restrictions, the (T-)AMF notifies each NF consumer which has subscribed for UE reachability event (e.g. SMFs corresponding to the list of PDU Sessions received in UE Context from (S-)AMF via `Namf_EventExposure_Notify` that the UE is only reachable for regulatory prioritized services.

5. [Conditional] Based on the Target ID, SMF checks if N2 Handover for the indicated PDU Session can be accepted. The SMF checks also the UPF Selection Criteria according to clause 6.3.3 of TS 23.501 [2]. If UE has moved out of the service area of the UPF connecting to NG-RAN, SMF selects a new intermediate UPF.

In the case that the SMF fails to find a suitable I-UPF, the SMF decides to (based on local policies) either:

- trigger re-establishment of PDU Session. After handover procedure, SMF sends N1 message to the UE via the AMF by invoking `Namf_Communication_N1N2MessageTransfer` containing the cause indicating PDU Session re-establishment is required for the UE; or
- keep the PDU Session, but reject the activation request of User Plane connection for the PDU Session and inform the AMF about it; or
- release the PDU Session after handover procedure.

- 6a. [Conditional] SMF to UPF (PSA): N4 Session Modification Request.

If the SMF selects a new UPF to act as intermediate UPF for the PDU Session, and the different CN Tunnel Info need be used, the SMF sends N4 Session Modification Request message to UPF (PSA). The SMF provides the CN Tunnel Info (on N9) if the CN Tunnel Info is allocated by the SMF, and UL Packet detection rules associate the CN Tunnel Info (on N9) to be installed on the UPF (PSA).

- 6b. [Conditional] UPF (PSA) to SMF: N4 Session Modification Response.

The UPF (PSA) sends an N4 Session Establishment Response message to the SMF. If the UPF (PSA) allocates CN Tunnel Info (on N9) of UPF (PSA), it provides CN Tunnel Info (on N9) to the SMF. The UPF (PSA) associate the CN Tunnel Info (on N9) with UL Packet detection rules provided by the SMF.

- 6c. [Conditional] SMF to T-UPF (intermediate): N4 Session Establishment Request.

If the SMF selects a new intermediate UPF, i.e. the target UPF (T-UPF), for the PDU Session and if CN Tunnel Info is allocated by the T-UPF, an N4 Session Establishment Request message is sent to the T-UPF, providing Packet detection, enforcement and reporting rules to be installed on the T-UPF. The CN Tunnel Info (on N9) of UPF (PSA) for this PDU Session, which is used to setup N9 tunnel, is also provided to the T-UPF.

6d. T-UPF (intermediate) to SMF: N4 Session Establishment Response.

The T-UPF sends an N4 Session Establishment Response message to the SMF with DL CN Tunnel Info and UL CN Tunnel Info (i.e. N3 tunnel info). The SMF starts a timer to release the resource of S-UPF, which is to be used in step 13a of the Execution Phase.

7. SMF to T-AMF: Nsmf\_PDUSession\_UpdateSMContext Response (PDU Session ID, N2 SM Information, Reason for non-acceptance).

If N2 handover for the PDU Session is accepted, the SMF includes in the Nsmf\_PDUSession\_UpdateSMContext response the N2 SM Information containing the N3 UP address and the UL CN Tunnel ID of the UPF and the QoS parameters indicating that the N2 SM Information is for the Target NG-RAN. If the N2 SM information received at step 4 does not include the Direct Forwarding Path Availability and the SMF knows that there is no indirect data forwarding connectivity between source and target, the N2 SM Information includes a Data forwarding not possible indication.

If N2 handover for the PDU Session is not accepted as described in step 5, the SMF does not include an N2 SM Information regarding the PDU Session to avoid establishment of radio resources at the target NG-RAN. Instead of that, the SMF provides a reason for non-acceptance. If the SMF has received notification from (T-)AMF that the UE is only reachable for regulatory prioritized services, the SMF does not include any N2 SM info regarding the PDU Session for non-regulatory prioritized services to avoid establishment of radio resources at the target NG-RAN. If the SMF receives notification from (T-)AMF that UE is only reachable for regulatory prioritized service after this step via Namf\_EventExposure\_Notify, the SMF deactivates the PDU Session after handover procedure finish if the PDU Session is not for regulatory prioritized services.

8. AMF supervises the Nsmf\_PDUSession\_UpdateSMContext Response messages from the involved SMFs. The lowest value of the Max delay indications for the PDU Sessions that are candidates for handover gives the maximum time AMF may wait for Nsmf\_PDUSession\_UpdateSMContext Response messages before continuing with the N2 Handover procedure. At expiry of the maximum wait time or when all Nsmf\_PDUSession\_UpdateSMContext Response messages are received, AMF continues with the N2 Handover procedure (Handover Request message in step 9).

NOTE: The delay value for each PDU Session is locally configured in the AMF and implementation specific.

9. T-AMF to T-RAN: Handover Request (Source to Target transparent container, N2 MM Information, N2 SM Information list, Tracing Requirements). If the subscription information includes Tracing Requirements, the target AMF provides the target RAN with Tracing Requirements in the Handover Request.

T-AMF determines T-RAN based on Target ID. T-AMF may allocate a 5G-GUTI valid for the UE in the AMF and target TAI.

Source to Target transparent container is forwarded as received from S-RAN. N2 MM Information includes e.g. security information and Mobility Restriction List if available in the T-AMF.

N2 SM Information list includes N2 SM Information received from SMFs for the T-RAN in the Nsmf\_PDUSession\_UpdateSMContext Response messages received within allowed max delay supervised by the T-AMF mentioned in step 8.

Mobility Restriction List is sent in N2 MM Information if available in the Target AMF.

10. T-RAN to T-AMF: Handover Request Acknowledge (Target to Source transparent container, List of PDU Sessions to Hand-over with N2 SM information, List of PDU Sessions that failed to be established with the failure cause given in the N2 SM information element).

Target to Source transparent container includes a UE container with an access stratum part and a NAS part. The UE container is sent transparently via T-AMF, S-AMF and S-RAN to the UE.

T-RAN creates List Of PDU Sessions failed to be setup and reason for failure (e.g. T-RAN decision, S-NSSAI is not available, unable to fulfil User Plane Security Enforcement) based on T-RAN determination. The information is provided to the S-RAN.

The N2 SM information in the List Of PDU Sessions to Hand-over, contains per each PDU Session ID T-RAN N3 addressing information i.e. N3 UP address and Tunnel ID of T-RAN for the PDU Session. The N2 SM information may also include:

- an Indication whether UP integrity protection is performed or not on the PDU Session.
- if the PDU Session has at least one QoS Flow subject for data forwarding, N3 UP address and Tunnel ID of T-RAN for receiving forwarded data. The T-RAN provides data forwarding addresses for each data forwarding tunnel which it decided to setup.

- 11a. AMF to SMF: Nsmf\_PDUSession\_UpdateSMContext Request (PDU Session ID, N2 SM response received from T-RAN in step 10).

For each N2 SM response received from the T-RAN (N2 SM information included in Handover Request Acknowledge), AMF sends the received N2 SM response to the SMF indicated by the respective PDU Session ID.

If no new T-UPF is selected, SMF stores the N3 tunnel info of T-RAN from the N2 SM response if N2 handover is accepted by T-RAN.

The SMF/UPF allocates the N3 UP address and Tunnel IDs for indirect data forwarding corresponding to the data forwarding tunnel endpoints established by T-RAN.

If a PDU Session is indicated as a rejected PDU Session by the Target NG-RAN with an indication that the PDU session was rejected because User Plane Security Enforcement is not supported in the Target NG-RAN and the User Plane Enforcement Policy indicates "Required" as described in clause 5.10.3 of TS 23.501 [2], the SMF triggers the release of this PDU Session. In all other cases of PDU Session rejection, the SMF can decide whether to release the PDU Session or to deactivate the UP connection of this PDU Session.

If some of the QoS Flows of a PDU Session are not accepted by the Target NG-RAN, the SMF shall initiate the PDU Session Modification procedure to remove the non-accepted QoS Flows from the PDU Session(s) after the handover procedure is completed.

- 11b. [Conditional] SMF to T-UPF: N4 Session Modification Request (T-RAN SM N3 forwarding Information list, indication to allocate DL forwarding tunnel(s) for indirect forwarding)

If the SMF selected a T-UPF in step 6a, the SMF updates the T-UPF by providing the T-RAN SM N3 forwarding information list by sending a N4 Session Modification Request to the T-UPF.

If indirect forwarding applies based on indication from the S-RAN and the UPF is re-allocated and if the SMF decides to setup the indirect forwarding tunnel on the same T-UPF, the SMF also requests in the N4 Session Modification Request message to the T-UPF, to allocate DL forwarding tunnel(s) for indirect forwarding.

Indirect forwarding may be performed via a UPF which is different from the T-UPF, in which case the SMF selects a T-UPF for indirect forwarding.

- 11c. [Conditional] T-UPF to SMF: N4 Session Modification Response (T-UPF SM N3 forwarding Information list).

The T-UPF allocates Tunnel Info and returns an N4 Session Modification Response message to the SMF.

The T-UPF SM N3 forwarding info list includes T-UPF N3 address, T-UPF N3 Tunnel identifiers for forwarding data

- 11d. [Conditional] SMF to S-UPF: N4 Session Modification Request (T-RAN SM N3 forwarding Information list or T-UPF SM N3 forwarding Information list, indication to allocate DL forwarding tunnel(s) for indirect forwarding).

If the UPF is re-allocated, this message includes the T-UPF SM N3 forwarding info list. If the UPF is not re-allocated, this message includes the T-RAN SM N3 forwarding info list.

If indirect forwarding applies based on indication from NG-RAN and UPF allocates tunnel identities, the SMF indicates in the N4 Session Modification Request message to the S-UPF to allocate DL forwarding tunnel(s) for indirect forwarding.

Indirect forwarding may be performed via a UPF which is different from the S-UPF.

- 11e. [Conditional] S-UPF to SMF: N4 Session Modification Response (S-UPF SM N3 forwarding Information list).

The S-UPF allocates Tunnel Info and returns an N4 Session establishment Response message to the SMF.

The S-UPF SM N3 forwarding Information list includes S-UPF N3 address, S-UPF N3 Tunnel identifiers for DL data forwarding.

- 11f. SMF to T-AMF: Nsmf\_PDUSession\_UpdateSMContext Response (N2 SM Information).

The SMF sends an Nsmf\_PDUSession\_UpdateSMContext Response message per PDU Session to T-AMF.

The SMF creates an N2 SM information containing the DL forwarding Tunnel Info to be sent to the S-RAN by the AMF. The SMF includes this information in the Nsmf\_PDUSession\_UpdateSMContext response. The DL forwarding Tunnel Info can be one of the following information:

- If direct forwarding applies, then the SMF includes the T-RAN N3 forwarding information the SMF received in step 11a.
- If the indirect forwarding tunnel is setup in step 11b or 11d, then the SMF includes the T-UPF or S-UPF DL forwarding information containing the N3 UP address and the DL Tunnel ID of the UPF.

12. [Conditional] T-AMF to S-AMF: Namf\_Communication\_CreateUEContext Response (N2 information necessary for S-AMF to send Handover Command to S-RAN including Target to Source transparent container, PDU Sessions failed to be setup list, N2 SM information (N3 DL forwarding Information, PCF ID)).

AMF supervises the Nsmf\_PDUSession\_UpdateSMContext Response message from the involved SMFs. At expiry of the maximum wait time or when all Nsmf\_PDUSession\_UpdateSMContext Response messages are received, T-AMF sends the Namf\_Communication\_CreateUEContext Response to the S-AMF.

The PDU Sessions failed to be setup list includes the List Of PDU Sessions failed to be setup received from target RAN in step 10 and the Non-accepted PDU session List generated by the T-AMF.

Non-accepted PDU Session List includes following PDU Session(s) with proper cause value:

- Non-accepted PDU Session(s) by the SMF(s);
- Non-accepted PDU Session(s) by the AMF due to no response from the SMF within maximum wait time; and
- Non-accepted PDU Session(s) by the AMF due to non-available S-NSSAI in the T-AMF, which is decided at step 4.

The Target to Source transport container is received from the T-RAN. The N2 SM Information is received from the SMF in step 11f.

4.9.1.3.3 Execution phase

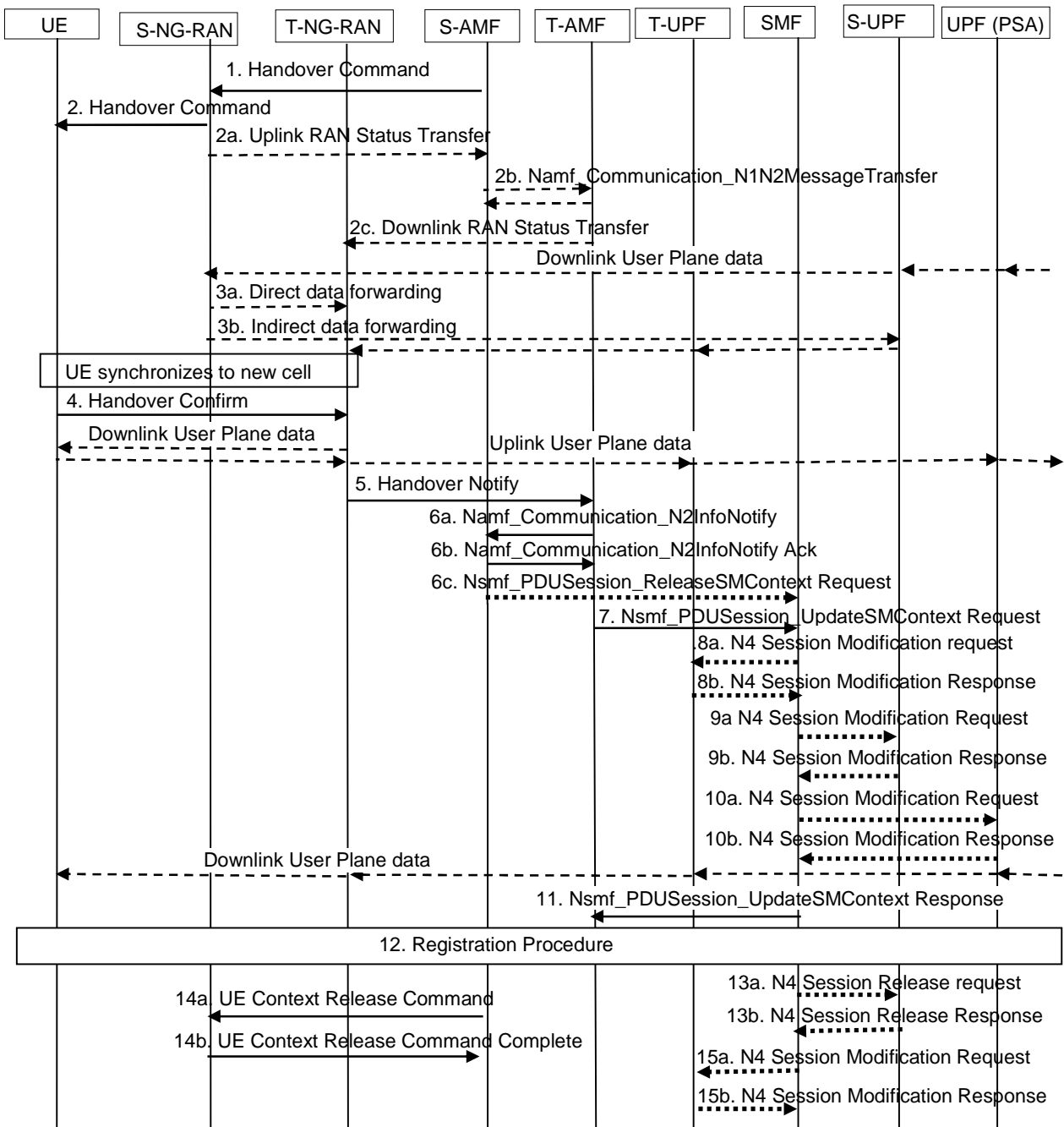

Figure 4.9.1.3.3-1: inter NG-RAN node N2 based handover, execution phase

NOTE 1: Registration of serving AMF with the UDM is not shown in the figure for brevity.

1. S-AMF to S-RAN: Handover Command (Target to Source transparent container, List Of PDU Sessions to be handed-over with N2 SM information containing information received from T-RAN during the handover preparation phase, List Of PDU Sessions failed to be setup).

Target to Source transparent container is forwarded as received from S-AMF.

The SM forwarding info list includes T-RAN SM N3 forwarding info list for direct forwarding or S-UPF SM N3 forwarding info list for indirect data forwarding

S-RAN uses the PDU Sessions failed to be setup list and the indicated reason for failure to decide whether to proceed with the N2 Handover procedure.

2. S-RAN to UE: Handover Command (UE container).

UE container is a UE part of the Target to Source transparent container which is sent transparently from T-RAN via AMF to S-RAN and is provided to the UE by the S-RAN.

- 2a0. If the PLMN has configured secondary RAT usage reporting and the source NG-RAN has Secondary RAT usage data to report, the source NG-RAN node may provide RAN usage data report message (N2 SM Information (Secondary RAT usage data), Handover Flag) as in clause 4.21 to the AMF. The Handover Flag indicates to the AMF that it should buffer the N2 SM Information containing the usage data report before forwarding it.

NOTE 2: This step is not shown in this figure but the secondary RAT usage data reporting procedure is shown in figure 4.21-1 in clause 4.21.

- 2a. - 2c. The S-RAN sends the Uplink RAN Status Transfer message to the S-AMF, as specified in TS 36.300 [46] and TS 38.300 [9]. The S-RAN may omit sending this message if none of the radio bearers of the UE shall be treated with PDCP status preservation.

If there is an AMF relocation, the S-AMF sends this information to the T-AMF via the `Namf_Communication_N1N2MessageTransfer` service operation and the T-AMF acknowledges. The S-AMF or, if the AMF is relocated, the T-AMF, sends the information to the T-RAN via the Downlink RAN Status Transfer message, as specified in TS 36.300 [46] and TS 38.300 [9].

3. Uplink packets are sent from T-RAN to T-UPF and UPF (PSA). Downlink packets are sent from UPF (PSA) to S-RAN via S-UPF. The S-RAN should start forwarding of downlink data from the S-RAN towards the T-RAN for QoS Flows or DRBs subject to data forwarding. This may be either direct (step 3a) or indirect forwarding (step 3b).

4. UE to T-RAN: Handover Confirm.

After the UE has successfully synchronized to the target cell, it sends a Handover Confirm message to the T-RAN. Handover is by this message considered as successful by the UE.

5. T-RAN to T-AMF: Handover Notify.

Handover is by this message considered as successful in T-RAN.

6a. [Conditional] T-AMF to S-AMF: `Namf_Communication_N2InfoNotify`.

The T-AMF notifies to the S-AMF about the N2 handover notify received from the T-RAN by invoking the `Namf_Communication_N2InfoNotify`.

A timer in S-AMF is started to supervise when resources in S-RAN shall be release.

6b. [Conditional] S-AMF to T-AMF: `Namf_Communication_N2InfoNotify ACK` (N2 SM Information (Secondary RAT usage data)).

The S-AMF acknowledges by sending the `Namf_Communication_N2InfoNotify ACK` to the T-AMF. The N2 SM Information here is the one buffered at step 2a0 when applicable.

6c. [Conditional] S-AMF to SMF: `Nsmf_PDUSession_ReleaseSMContext Request` (SUPI, PDU Session ID, N2 SM Information (Secondary RAT Usage Data)).

If the PDU Session(s) is not accepted by the T-AMF (e.g. S-NSSAI associated with the PDU Session is not available in the T-AMF), S-AMF triggers PDU Session Release procedure as specified in clause 4.3.4.2 after the S-AMF is notified for the reception of N2 Handover Notify in step 6a.

7. T-AMF to SMF: `Nsmf_PDUSession_UpdateSMContext Request` (Handover Complete indication for PDU Session ID, UE presence in LADN service area, N2 SM Information (Secondary RAT usage data)). The N2 SM Information here is the one received at step 6b when applicable.

Handover Complete indication is sent per each PDU Session to the corresponding SMF to indicate the success of the N2 Handover.

When an `Nsmf_PDUSession_UpdateSMContext Response` message arrived too late during the handover preparation phase (see step 8 of clause 4.9.1.3.2), or the PDU Session with SMF involvement is not accepted by



T-RAN, Nsmf\_PDUSession\_UpdateSMContext Request (SUPI, PDU Session ID, Operation Type) is sent to the corresponding SMF allowing the SMF to deallocate a possibly allocated N3 UP address and Tunnel ID of the selected UPF. A PDU Session handled by that SMF is considered deactivated and handover attempt is terminated for that PDU Session.

In the case that the AMF determines that the PDU Session is related to a LADN then the AMF provides the "UE presence in LADN service area". If the AMF does not provide the "UE presence in LADN service area" indication and the SMF determines that the DNN corresponds to a LADN, then the SMF considers that the UE is OUT of the LADN service area.

The SMF takes actions for the LADN PDU Session as defined in TS 23.501 [2] clause 5.6.5 based on the "UE presence in LADN service area" indication.

8a. [Conditional] SMF to T-UPF (intermediate): N4 Session Modification Request.

If new T-UPF is inserted or an existing intermediate S-UPF is re-allocated, the SMF shall send N4 Session Modification Request indicating DL AN Tunnel Info of T-RAN to the T-UPF.

8b. [Conditional] T-UPF to SMF: N4 Session Modification Response.

The T-UPF acknowledges by sending N4 Session Modification Response message to SMF.

9a. [Conditional] SMF to S-UPF (intermediate): N4 Session Modification Request.

If UPF is not re-allocated, the SMF shall send N4 Session Modification Request indicating DL AN Tunnel Info of T-RAN to the S-UPF.

9b. [Conditional] S-UPF to SMF: N4 Session Modification Response.

The S-UPF acknowledges by sending N4 Session Modification Response message to SMF.

10a. [Conditional] SMF to UPF (PSA): N4 Session Modification Request.

For non-roaming or local breakout roaming scenario, the SMF sends N4 Session Modification Request message to PDU Session Anchor UPF, UPF (PSA), providing N3 AN Tunnel Info of T-RAN or the DL CN Tunnel Info of T-UPF if a new T-UPF is inserted or an existing intermediate S-UPF is re-allocated. If the existing intermediate S-UPF terminating to N9 toward the H-UPF (PDU Session Anchor) is re-allocated for the home routed roaming scenario, the V-SMF invokes an Nsmf\_PDUSession\_Update Request service operation toward the H-SMF.

In case of the S-UPF acts as a UL CL or BP, the SMF indicates only one of the PDU Session Anchors to send the "end marker" packets. To ensure the "end marker" is the last user plane packet on the old path, the SMF should modify the path on other PDU Session Anchors before it indicates the PDU Session Anchor to send the "end marker" packets.

If T-UPF is not inserted or an existing intermediate S-UPF is not re-allocated, step 10a and step 10b are skipped.

10b. [Conditional] UPF (PSA) to SMF: N4 Session Modification Response.

The UPF (PSA) sends N4 Session Modification Response message to SMF. In order to assist the reordering function in the T-RAN, the UPF (PSA) sends one or more "end marker" packets for each N3 tunnel on the old path immediately after switching the path, the source NG-RAN shall forward the "end marker" packets to the target NG-RAN. At this point, UPF (PSA) starts sending downlink packets to the T-RAN, via T-UPF if a new T-UPF is inserted or an existing intermediate S-UPF is re-allocated. In case of home routed roaming scenario, the H-SMF responds with the Nsmf\_PDUSession\_Update Response service operation to V-SMF once the H-UPF (PDU Session Anchor) is updated with the UL Tunnel Info of the T-UPF.

When there are multiple UPFs(PSA), step 10a and step 10b are performed for each UPFs(PSA).

11. SMF to T-AMF: Nsmf\_PDUSession\_UpdateSMContext Response (PDU Session ID).

SMF confirms reception of Handover Complete.

If indirect data forwarding applies, the SMF starts an indirect data forwarding timer, to be used to release the resource of indirect data forwarding tunnel.

12. The UE initiates Mobility Registration Update procedure as described in clause 4.2.2.2.2.

The target AMF knows that it is a Handover procedure and therefore the target AMF performs only a subset of the Registration procedure, specifically the steps 4, 5, and 10 in the Registration procedure for the context transfer between source AMF and target AMF are skipped.

13a. [Conditional] SMF to S-UPF (intermediate): N4 Session Release Request.

If there is a source intermediate UPF, the SMF initiates resource release, after timer in step 6 or indirect data forwarding timer expires, by sending an N4 Session Release Request (Release Cause) to source UPF. This message is also used to release the indirect data forwarding resource in S-UPF.

13b. S-UPF to SMF: N4 Session Release Response.

The S-UPF acknowledges with an N4 Session Release Response message to confirm the release of resources.

In case of indirect data forwarding, the resource of indirect data forwarding is also released.

14a. AMF to S-RAN: UE Context Release Command ().

After the timer in step 6a expires, the AMF sends UE Context Release Command.

14b. S-RAN to AMF: UE Context Release Complete ().

The source NG-RAN releases its resources related to the UE and responds with a UE Context Release Complete () message.

15a. [Conditional] SMF to T-UPF: N4 Session Modification Request.

If indirect forwarding applies and UPF is re-allocated, after timer of indirect data forwarding expires, the SMF sends N4 Session Modification Request to T-UPF to release the indirect data forwarding resource.

15b. [Conditional] T-UPF to SMF: N4 Session Modification Response.

The T-UPF acknowledges with an N4 Session Modification Response message to confirm the release of indirect data forwarding resources.

If the AMF is subscribed to Mobility Event by other NFs, the AMF notifies the event to the corresponding NFs by invoking the Namf\_EventExposure\_Notify service operation as described in clause 4.15.4.2.

Upon reception of the Namf\_EventExposure\_Notify with an indication that UE is reachable only for regulatory prioritized service, the SMF deactivates the PDU Session if the service of the PDU Session is not regulatory prioritized. For home routed roaming case, the V-SMF triggers the deactivation of the PDU Session, in addition, the H-SMF refrains from sending downlink signalling if the signalling is not related to regulatory prioritized service upon receiving the notification.

#### 4.9.1.4 Inter NG-RAN node N2 based handover, Cancel

Prior to sending a Handover Command to the UE, the source NG-RAN node may attempt cancellation of handover during the handover procedure. The reason for cancellation may include timer expiration, internal failure within the source NG-RAN node or UE returned to source cell etc. The handover cancellation is initiated by sending a Handover Cancel request to the source AMF. This is done in order to release the resources reserved for the handover in the target system.

The AMF shall cancel the handover resources as defined in clause 4.11.1.2.3 for case the source RAN is NG-RAN.

## 4.9.2 Handover of a PDU Session procedure between 3GPP and untrusted non-3GPP access

### 4.9.2.1 Handover of a PDU Session procedure from untrusted non-3GPP to 3GPP access (non-roaming and roaming with local breakout)

Clause 4.9.2.1 specifies how to hand over a UE from a source Untrusted non-3GPP access to a target 3GPP access and how a UE can handover a PDU Session from untrusted non-3GPP access to 3GPP access. It is based on the PDU Session Establishment procedure for 3GPP access as specified in clause 4.3.2.

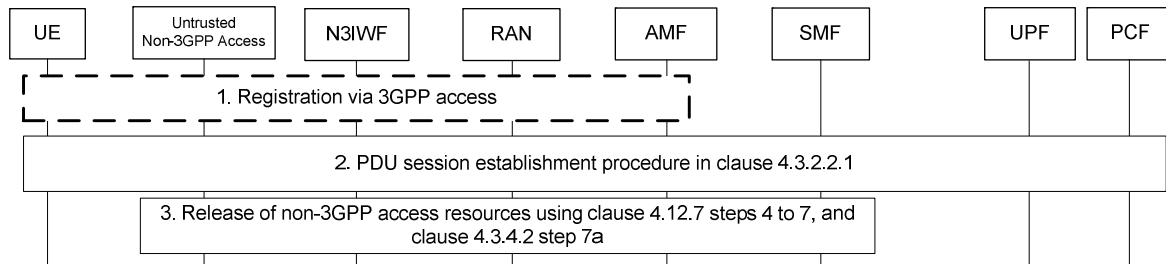

**Figure 4.9.2.1-1: Handover of a PDU Session procedure from untrusted non-3GPP access to 3GPP access (non-roaming and roaming with local breakout)**

1. If the UE is not registered via 3GPP access, the UE shall initiate Registration procedure as defined in clause 4.2.2.2.2.
2. The UE performs a PDU Session Establishment procedure with the PDU Session ID of the PDU Session to be moved as specified clause 4.3.2.2.1 (PDU Session Establishment for Non-roaming and Roaming with Local Breakout).
3. If the User Plane of the PDU Session is activated in non-3GPP access, the V-SMF executes the release of resources in non-3GPP access by performing steps 4 to 7 specified in clause 4.12.7, followed by step 7a specified in clause 4.3.4.2 in order to release the resources over the source non-3GPP access. Because the PDU Session shall not be released, the SMF shall not send the PDU Session Release Command to the UE. Hence, in steps 4 and 7 of clause 4.12.7 as well as in step 7a of clause 4.3.4.2, the messages do not include the N1 SM container but only the N2 Resource Release Request (resp. Ack). Since the PDU Session is not to be released, the SMF shall not execute step 7b of clause 4.3.4.2 and the SM context between the AMF and the SMF is maintained.

If the User Plane of the PDU Session is deactivated in non-3GPP access, this step is skipped.

The steps 2 and 3 shall be repeated for all PDU Sessions to be moved from to untrusted non-3GPP access to 3GPP access.

### 4.9.2.2 Handover of a PDU Session procedure from 3GPP to untrusted non-3GPP access (non-roaming and roaming with local breakout)

Clause 4.9.2.2 specifies how to hand over a UE from a source 3GPP access to a target Untrusted non-3GPP access and how a UE can handover a PDU Session from 3GPP access to untrusted non-3GPP access. It is based on the PDU Session Establishment procedure for non-3GPP access as specified in clause 4.12.5.

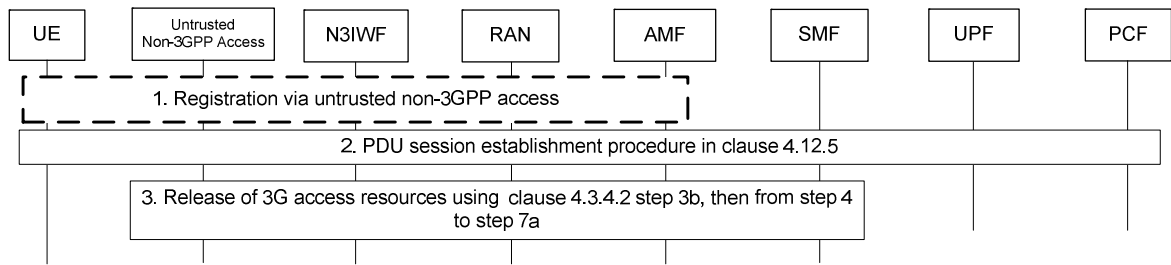

**Figure 4.9.2.2-1: Handover of a PDU Session from 3GPP access to untrusted non-3GPP access (non-roaming and roaming with local breakout)**

1. If the UE is not registered via untrusted non-3GPP access, the UE shall initiate Registration procedure as defined in clause 4.12.2.
2. The UE performs PDU Session Establishment procedure with the PDU Session ID of the PDU Session to be moved as specified in clause 4.12.5.
3. If the User Plane of the PDU Session is activated in 3GPP access, the V-SMF executes the release of resource in 3GPP by performing step 3b, then steps 4 to 7a specified in clause 4.3.4.2 (UE or network requested PDU Session Release for Non-Roaming and Roaming with Local Breakout) in order to release the resources over the source 3GPP access. Because the PDU Session shall not be released, the SMF shall not send the PDU Session Release Command to the UE. Hence, in steps 3b, 4, 6 and 7a of clause 4.3.4.2, messages do not include the N1 SM container but only the N2 Resource Release Request (resp. Ack). Since the PDU Session is not to be released, the SMF shall not execute step 7b of clause 4.3.4.2 and the SM context between the AMF and the SMF is maintained.

If the User Plane of the PDU Session is deactivated in 3GPP access, this step is skipped.

The steps 2 and 3 shall be repeated for all PDU Sessions to be moved from 3GPP access to untrusted non-3GPP access

### 4.9.2.3 Handover of a PDU Session procedure from untrusted non-3GPP to 3GPP access (home routed roaming)

#### 4.9.2.3.1 The target AMF is in the PLMN of the N3IWF

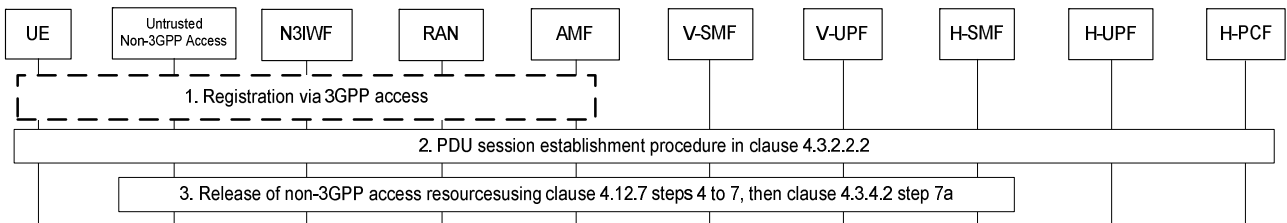

**Figure 4.9.2.3.1 -1: Handover of a PDU Session procedure from untrusted non-3GPP access to 3GPP access (home routed roaming)**

1. If the UE is not registered via 3GPP access, the UE shall initiate Registration procedure as defined in clause 4.2.2.2.2. The NG-RAN selects the same AMF as the one used via non-3GPP access.
2. The UE performs a PDU Session Establishment procedure with the PDU Session ID of the PDU Session to be moved as specified clause 4.3.2.2.2 (PDU Session Establishment for Home Routed Roaming). The AMF selects the same V-SMF as the one used via non-3GPP access.
3. If the User Plane of the PDU Session is activated in non-3GPP access, the V-SMF executes the release of resource in non-3GPP access by performing steps 4 to 7 specified in clause 4.12.7, followed by step 7 specified in clause 4.3.4.2 in order to release the resources over the source non-3GPP access. Because the PDU Session shall not be released, the SMF shall not send the PDU Session Release Command to the UE. Hence, in steps 4 and 7 of clause 4.12.7 as well as in step 7a of clause 4.3.4.2, the messages do not include the N1 SM container

but only the N2 Resource Release Request (resp. Ack). Since the PDU Session is not to be released, the SMF shall not execute step 7b of clause 4.3.4.2 and the SM context between the AMF and the SMF is maintained.

If the User Plane of the PDU Session is deactivated in non-3GPP access, this step is skipped. The steps 2 and 3 shall be repeated for all PDU Sessions to be moved from to untrusted non-3GPP access to 3GPP access.

4.9.2.3.2 The target AMF is not in the PLMN of the N3IWF (i.e. N3IWF in HPLMN)

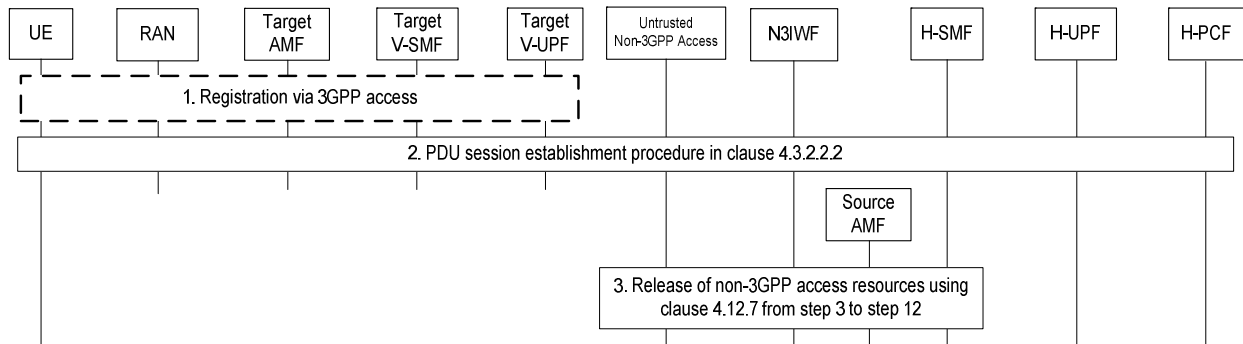

Figure 4.9.2.3.2-1: Handover of a PDU Session procedure from untrusted non-3GPP access with N3IWF in the HPLMN to 3GPP access (home routed roaming)

1. If the UE is not registered via 3GPP access, the UE shall initiate Registration procedure as defined in clause 4.2.2.2.2. This includes the retrieval of the SMF-IDs corresponding to each of the PDU Sessions.
  2. The UE performs a PDU Session Establishment procedure with the PDU Session ID of the PDU Session to be moved as specified clause 4.3.2.2.2 (PDU Session Establishment for Home Routed Roaming).
  3. The H-SMF executes the release of resources in non-3GPP AN by performing steps 3-12 specified in clause 4.12.7 with the following exceptions:
    - the H-SMF interfaces the source AMF (in the home PLMN). The H-SMF shall not send the N1 SM Container (PDU Session Release Command) to the UE;
    - The Npcf\_SMPolicyControl\_Delete service operation to PCF shall not be performed.
- Nsmf\_PDUSession\_SMContextStatusNotify service operation invoked by the H-SMF to the source AMF indicates the PDU Session is moved to different access.

The steps 2 and 3 shall be repeated for all PDU Sessions to be moved from to untrusted non-3GPP access to 3GPP access.

4.9.2.4 Handover of a PDU Session procedure from 3GPP to untrusted non-3GPP access (home routed roaming)

4.9.2.4.1 The selected N3IWF is in the registered PLMN

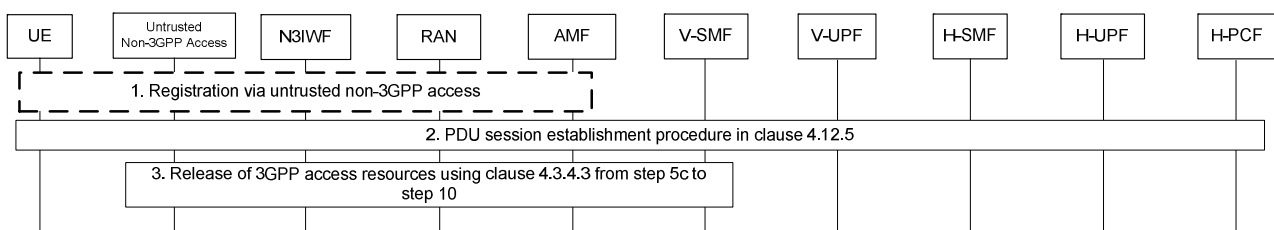

Figure 4.9.2.4.1-1: Handover of a PDU Session procedure from 3GPP access to untrusted non-3GPP access (home routed roaming)

1. If the UE is not registered via untrusted non-3GPP access, the UE shall initiate Registration procedure as defined in clause 4.12.2. The N3IWF selects the same AMF as the one used via 3GPP access.
2. The UE performs PDU Session Establishment procedure with the PDU Session ID of the PDU Session to be moved as specified in clause 4.12.5. The AMF selects the same V-SMF as the one used via 3GPP access.
3. If the User Plane of the PDU Session is activated in 3GPP access, the V-SMF executes the release of resources in 3GPP access by performing step 5c to 10 specified in clause 4.3.4.3 (UE or network requested PDU Session Release for Home Routed Roaming) in order to release the resources over the source 3GPP access. Because the PDU Session shall not be released, the SMF shall not send the PDU Session Release Command to the UE. Hence, in steps 5c, 6, 8 and 9 of clause 4.3.4.3, the messages do not include the N1 SM container but only the N2 Resource Release Request (resp. Ack). Since the PDU Session is not to be released, the SMF shall not execute step 7b of clause 4.3.4.2 and the SM context between the AMF and the SMF is maintained.

If the User Plane of the PDU Session is deactivated in 3GPP access, this step is skipped.

The steps 2 and 3 shall be repeated for all PDU Sessions to be moved from 3GPP access to untrusted non-3GPP access.

#### 4.9.2.4.2 The UE is roaming and the selected N3IWF is in the home PLMN

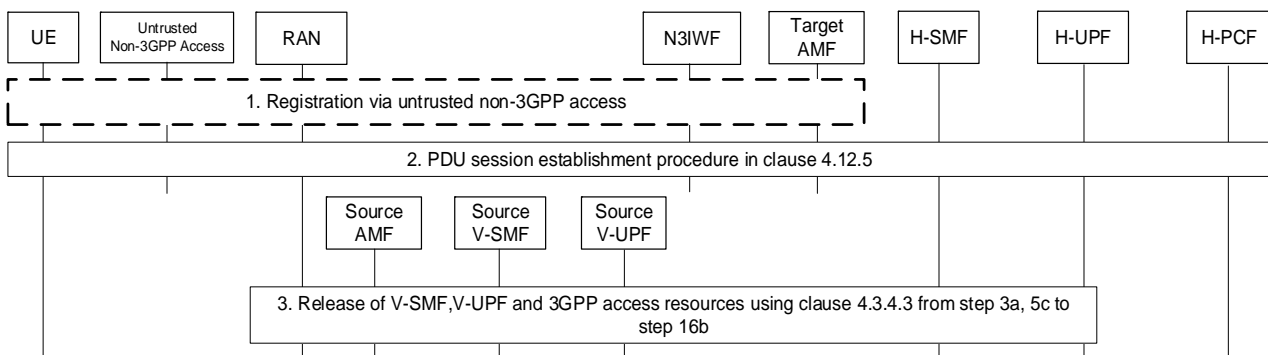

**Figure 4.9.2.4.2-1: Handover of a PDU Session procedure from 3GPP access to untrusted non-3GPP access with N3IWF in the HPLMN (home routed roaming)**

1. If the UE is not registered via untrusted non-3GPP access, the UE shall initiate Registration procedure as defined in clause 4.12.2. This includes the retrieval of the SMF-IDs corresponding to each of the PDU Sessions.
2. The UE performs PDU Session Establishment procedure with the PDU Session ID of the PDU Session to be moved as specified in clause 4.12.5.
3. The H-SMF executes the release of resources in source V-SMF, V-UPF, V-AMF and 3GPP AN by performing steps 3a, 5c to 16b specified in clause 4.3.4.3 with the following exceptions:
  - the H-SMF indicates in the Nsmf\_PDUSession\_Update Request that the UE shall not be notified. This shall result in the V-SMF not sending the N1 Container (PDU Session Release Command) to the UE;
  - Nsmf\_PDUSession\_StatusNotify service operation invoked by H-SMF to V-SMF indicates PDU Session is moved to different access;
  - Nsmf\_PDUSession\_SMContextStatusNotify service operation invoked by the V-SMF to the AMF indicates the PDU Session is moved to different access;
  - The Npcf\_SMPolicyControl\_Delete service operation to PCF shall not be performed.

The steps 2 and 3 shall be repeated for all PDU Sessions to be moved from 3GPP access to untrusted non-3GPP access.

## 4.10 NG-RAN Location reporting procedures

This procedure is used by an AMF to request the NG-RAN to report where the UE is currently located when the target UE is in CM-CONNECTED state. The need for the NG-RAN to continue reporting ceases when the UE transitions to CM-IDLE or the AMF sends cancel indication to NG-RAN. This procedure may be used for services that require accurate cell identification (e.g. emergency services, lawful intercept, charging), or for subscription to the service by other NFs. When Dual Connectivity is activated, the report includes the Cell IDs of both the Primary cell in the Master RAN node and the Primary cell in the Secondary RAN node.

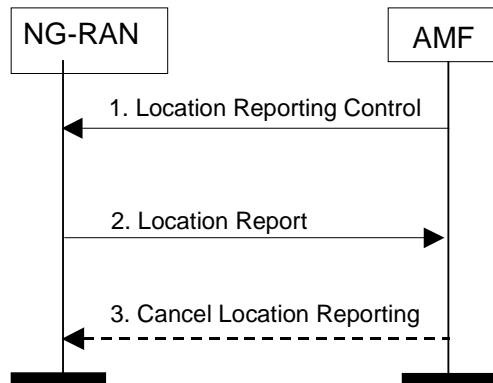

**Figure 4.10-1: NG-RAN Location Reporting Procedure**

1. AMF to NG-RAN: Location Reporting Control (Reporting Type, Location Reporting Level, (Area Of Interest, Request Reference ID)).

The AMF sends a Location Reporting Control message to the NG-RAN. The Location Reporting Control message shall identify the UE for which reports are requested and shall include Reporting Type and Location Reporting Level. The Location Reporting Control message may also include Area Of Interest and Request Reference ID. Location Reporting Level could be TAI+ Cell Identity. Reporting Type indicates whether the message is intended to trigger a single standalone report about the current Cell Identity serving the UE or start the NG-RAN to report whenever the UE changes cell, or ask the NG-RAN to report whenever the UE moves out of or into the Area Of Interest. If the Reporting Type indicates to report whenever the UE changes cell and if Dual Connectivity is in use, the Master RAN node shall also report to the AMF whenever the primary cell in the Secondary RAN node changes. If the Reporting Type indicates to start the NG-RAN to report when UE moves out of or into the Area Of Interest, the AMF also provides the requested Area Of Interest information in the Location Reporting Control message. The AMF may include a Request Reference ID in the Location Report Control message to identify the request of reporting for an Area Of Interest. If multiple Areas Of Interest are included in the message, the Request Reference ID identifies each Area of Interest.

2. NG-RAN to AMF: Location Report (UE Location, UE Presence in Area Of Interest, Request Reference ID, Timestamp).

The NG-RAN sends a Location Report message informing the AMF about the location of the UE which shall be represented as the requested Location Reporting Level. If Dual Connectivity is activated, then the Master NG-RAN node shall also include the Cell ID of the primary cell in the Secondary RAN node.

When UE is in CM-CONNECTED with RRC Inactive state, if NG-RAN has received Location Reporting Control message from AMF with the Reporting Type indicating single stand-alone report, the NG-RAN shall perform NG-RAN paging before reporting the location to the AMF. The NG-RAN should send the Location Report promptly and shall not wait to attempt to create a Dual Connectivity configuration. However, if the Cell ID of the primary cell of any Secondary RAN node is known to the Master RAN node, then it shall be included in the Location Report.

When UE is in CM-CONNECTED with RRC Inactive state, if NG-RAN has received Location Reporting Control message from AMF with the Reporting Type indicating continuously reporting whenever the UE changes cell, the NG-RAN shall send a Location Report message to the AMF including the UE's last known location with time stamp. If the UE was using Dual Connectivity immediately before entering CM-CONNECTED with RRC Inactive state, then the Location Report shall also include the Cell ID of the primary cell in the Secondary RAN node.

When UE is in CM-CONNECTED, if NG-RAN has received Location Reporting Control message from AMF with the Reporting Type of Area Of Interest based reporting, the NG-RAN shall track the UE presence in Area Of Interest and send a Location Report message to AMF including the UE Presence in the Area Of Interest (i.e., IN, OUT, or UNKNOWN) as described in clause D.2 and the UE's current location (including the Cell ID of the primary cell in the Ssecondary RAN node if Dual Connectivity is activated) when the UE is in RRC Connected state, or, when the UE is in RRC Inactive state, the UE's last known location (including the Cell ID of the primary cell in the Secondary RAN node if the UE was using Dual Connectivity immediately before entering CM-CONNECTED with RRC Inactive state) with time stamp if the NG-RAN perceives that the UE presence in the Area Of Interest is different from the last one reported. When the NG-RAN detects that the UE has moved out of or into multiple areas of interest, it sends multiple pairs of UE Presence in the Area Of Interest and the Request Reference ID in one Location Report message to AMF. If UE transitions from RRC Inactive state to RRC Connected state, NG-RAN shall check the latest location (including the Cell ID of the primary cell of the Secondary RAN node if Dual Connectivity is activated) of UE and follow the rules when UE is in RRC Connected.

The AMF stores the latest received Cell ID of the primary cell of the Master RAN node with its associated timestamp. The AMF stores the latest received Cell ID of the primary cell of the Secondary RAN node with its associated timestamp.

### 3. AMF to NG-RAN: Cancel Location Report (Reporting Type, Request Reference ID).

The AMF can send a Cancel Location Reporting message to inform the NG-RAN that it should terminate the location reporting for a given UE corresponding to the Reporting Type or the location reporting for Area Of Interest indicated by Request Reference ID. This message is needed when the reporting type was requested for continuously reporting or for the Area Of Interest. The AMF may include the Request Reference ID which indicates the requested Location Reporting Control for the Area Of Interest, so that the NG-RAN should terminate the location reporting for the Area Of Interest.

NOTE: Location reporting related information of the source NG-RAN node is transferred to the target NG-RAN node during Xn handover.

In this release the location reporting procedure is applicable only to 3GPP access.

## 4.11 System interworking procedures with EPC

### 4.11.0 General

This clause includes procedures for interworking with EPS based on N26 interface (clause 4.11.1) and also interworking without N26 interface (clause 4.11.2).

#### 4.11.0a Impacts to EPS Procedures

##### 4.11.0a.1 General

This clause captures changes to procedures in TS 23.401 [13] that are common to interworking based on N26 and interworking without N26.

##### 4.11.0a.2 Interaction with PCC

When interworking with 5GS is supported and a "PGW-C+SMF" is selected for a PDN connection, policy interactions between PDN GW and PCRF specified in TS 23.401 [13] are replaced by equivalent interactions between PGW-C+SMF and PCF as follows:

- IP-CAN Session Establishment procedure defined in TS 23.203 [24] is replaced by SM Policy Association Establishment Procedure as described in clause 4.16.4. The PGW-C+SMF includes the information elements received in Create Session Request message into the Npcf\_SMPolicyControl\_Create Service as follows: the SUPI contains the IMSI, the DNN contains the APN, the PEI contains the IMEI-SV, the Session AMBR contains the APN-AMBR and the default QoS information that contains the default EPS bearer QoS, note that QCI values are mapped into 5QI values. The PGW-C+SMF may receive PCC Rules and PDU Session Policy



Information, 5G QoS information in the PCC Rule and in PDU Session Policy Information are mapped into EPS QoS information as defined in clause 4.11.1.1 and Annex C.

- (PCEF-initiated) IP-CAN Session Modification procedure defined in TS 23.203 [24] is replaced by SM Policy Association Modification procedure as described in clause 4.16.5.1.
- The PGW-C+SMF includes the information elements received in Modify Bearer Request or Modify Bearer Command message into the Npcf\_SMPolicyControl\_Update Service with the following modifications, the subscribed Session AMBR includes the subscribed APN-AMBR, and subscribed default QoS information includes the default EPS bearer QoS, note that QCI values are mapped into 5QI values. The PGW-C+SMF includes the stored SUPI. The PGW-C+SMF may receive PCC Rules and PDU Session Policy Information, 5G QoS information in the PCC Rule and in PDU Session Policy Information are mapped into EPS QoS information as defined in clause 4.11.1.1 and Annex C.
- The PGW-C+SMF includes the information elements received in Delete Bearer Command message into the Npcf\_SMPolicyControl\_Update Service with the following modifications, The PGW-C+SMF includes the stored SUPI.
- (PCRF-initiated) IP-CAN Session Modification procedure defined in TS 23.203 [24] is replaced by SM Policy Association Modification procedure as described in clause 4.16.5.2. The PGW-C+SMF may receive PCC Rules and PDU Session Policy Information, 5G QoS information in the PCC Rule and in PDU Session Policy Information are mapped into EPS QoS information as defined in clause 4.11.1.1 and Annex C.
- IP-CAN Session Termination procedure defined in TS 23.203 [24] is replaced by SM Policy Association Termination procedure as described in clause 4.16.6. The PGW-C+SMF includes the information elements received in Delete Session Request message by the SMF+PGW-C into the Npcf\_SMPolicyControl\_Delete Service. The PGW-C+SMF includes the stored SUPI.

#### 4.11.0a.3 Mobility Restrictions

The UE's subscription may include access restriction for NR in 5GS and restriction for Core Network Type (5GC). If so, the HSS provides these restrictions to the MME. The MME includes these restrictions in the Handover Restriction List to the E-UTRAN. The MME and E-UTRAN use these restrictions to determine if mobility of the UE to 5GS or NR connected to 5GS should be permitted.

#### 4.11.0a.4 PGW Selection

When the UE requests to establish a PDN connection to an APN, the MME may use the UE's support for 5GC NAS indication included in the UE Network Capability and/or UE's subscription from HSS that includes UE's mobility restriction parameters related to 5GS and/or indication of support for interworking with 5GS for this APN to determine if PGW-C+SMF or a standalone PGW-C should be selected.

NOTE: If restriction for Core Network Type indicates that the UE can access to 5GC, it implies that the UE has 5G subscription data.

#### 4.11.0a.5 PDN Connection Establishment

During PDN connection establishment in the EPC, the UE and the PGW-C+SMF exchange information via PCO as described in TS 23.501 [2] clause 5.15.7. In case the PGW-C+SMF supports more than one S-NSSAI and the APN is valid for more than one S-NSSAI, before the PGW-C+SMF provides an S-NSSAI to the UE, the PGW-C+SMF should check such that the selected S-NSSAI is among the UE's subscribed S-NSSAIs by retrieving the Subscribed S-NSSAI from UDM using the Nudm\_SDM\_Get service operation (the PGW-C+SMF discovers and selects a UDM as described in TS 23.501 [2] clause 6.3.8). If the PGW-C+SMF is in a VPLMN, the PGW-C+SMF uses the Nnssf\_NSSelection\_Get service operation to retrieve a mapping of the Subscribed S-NSSAIs to Serving PLMN S-NSSAI values.

### 4.11.1 N26 based Interworking Procedures

#### 4.11.1.1 General

N26 interface is used to provide seamless session continuity for single registration mode UE.

Interworking between EPS and 5GS is supported with IP address preservation by assuming SSC mode 1.

When the UE is served by the 5GC, during PDU Session establishment and GBR QoS Flow establishment, PGW-C+SMF performs EPS QoS mappings, from the 5G QoS parameters obtained from the PCF, and allocates TFT with the PCC rules obtained from the PCF if PCC is deployed. Otherwise, EPS QoS mappings and TFT allocation are mapped by the PGW-C+SMF locally. The PGW+SMF ignores 5G QoS parameters that are not applicable to EPC (e.g. QoS Notification control). If a TFT is to be allocated for a downlink unidirectional EPS bearer mapped from a downlink only QoS Flow, the PGW-C+SMF shall allocate a TFT packet filter that effectively disallows any useful uplink packet as specified in TS 23.401 [13]. EPS Bearer IDs are allocated by the serving AMF requested by the SMF if the SMF determines that EPS Bearer IDs need to be assigned to the QoS Flows. For each PDU Session, EPS bearer IDs are allocated to the default EPS bearer and dedicated bearers. The SMF shall be able to determine the QoS flows that require EPS Bearer IDs, based on the QoS profile and operator policies.

NOTE 1: Based on operator policies, an SMF can map all non-GBR QoS flows to default EPS bearer in which case it requests only one EBI for all the non-GBR QoS flows. Alternatively, an SMF can also map one non-GBR QoS flow to one dedicated EPS bearer in which case it requests a dedicated EBI for non-GBR QoS flow that should be mapped to dedicated EPS bearer.

For Ethernet and Unstructured PDU Session Types, only EPS Bearer ID for the default EPS Bearer is allocated. The EPS Bearer IDs for these EPS bearers are provided to the PGW-C+SMF by the AMF, and are provided to the UE and NG-RAN by the PGW-C+SMF using N1 SM NAS message and N2 SM message. The UE is also provided with the mapped QoS parameters. The UE and the PGW-C+SMF store the association between the QoS Flow and the corresponding EBI and the EPS QoS parameters. When the QoS Flow is deleted e.g. due to PDU Session status synchronization or PDU Session Modification, the UE and the PGW-C+SMF delete any possibly existing EPS QoS parameters associated with the deleted QoS Flow.

In this release, for a PDU Session for a LADN or for Multi-homed IPv6 PDU Session, the SMF doesn't allocate any EBI or mapped QoS parameters.

For PDU Sessions with UP integrity protection of UP Security Enforcement Information set to Required, the SMF does not allocate any EBI or mapped QoS parameters.

When the UE is served by the EPC, during PDN connection establishment, the UE allocates the PDU Session ID and sends it to the PGW-C+SMF via PCO. During PDN Connection establishment and dedicated bearer establishment, PGW-C+SMF performs EPS QoS mappings, from the 5G QoS parameters obtained from the PCF, and allocates TFT with the PCC rules obtained from the PCF if PCC is deployed. Otherwise, EPS QoS mappings and TFT allocation are mapped by the PGW-C+SMF locally. Other 5G QoS parameters corresponding to the PDN connection, e.g. Session AMBR, and QoS rules and QoS Flow level QoS parameters if needed for the QoS Flow(s) associated with the QoS rule(s), are sent to UE in PCO. The UE and the PGW-C+SMF store the association between the EPS Context and the PDU Session Context to use it in case of handover from EPS to 5GS. During the EPS bearer establishment/modification procedure, QoS rules corresponding to the related EPS bearers are allocated and sent to UE in PCO. The 5G QoS parameters are stored in the UE and are to be used when the UE is handed over from EPS to the 5GS. The 5G QoS parameters may be provided to PGW-C+SMF by the PCF, if PCC is deployed. On mobility from EPS to 5GS, the UE sets the SSC mode of the mapped PDU Session to SSC mode 1. The UE and the PGW-C+SMF store the association between the EPS bearer and the corresponding 5G QoS Rules and QoS Flow level QoS parameters if needed for the QoS Flow(s) associated with the QoS rule(s). When the EPS bearer is deleted e.g. due to EPS bearer status synchronization or bearer deactivation, the UE and the PGW-C+SMF delete any possibly existing 5G QoS Rule(s) and QoS Flow level QoS parameters if any for the QoS Flow(s) associated with the QoS rule(s) associated with the deleted EPS bearer.

In the roaming case, if the VPLMN supports interworking with N26, the UE shall operate in Single Registration mode.

During the 5GS-EPS handover, indirect forwarding may apply for the downlink data forwarding performed as part of the handover. From its configuration data the AMF knows whether indirect forwarding applies and it requests to allocate downlink data forwarding paths on UPFs for indirect forwarding. From its configuration data the MME knows whether indirect forwarding applies and it requests to allocate downlink data forwarding paths on Serving GWs for indirect forwarding. It is configured on AMF and MME whether indirect downlink data forwarding does not apply, applies always or applies only for inter PLMN inter RAT handovers.

Direct data forwarding for inter-system handover between 5GS and EPS is not supported in this Release.

During interworking from EPS to 5GS, as the PGW-C+SMF may have different IP addresses when being accessed over S5/S8 and N11/N16 respectively, the AMF shall discover the SMF instance by an NF/NF service discovery procedure using the FQDN for the S5/S8 interface received from the MME as a query parameter.

This is required for both non-roaming and roaming with local breakout, as well as for home routed roaming.

NOTE 2: As the AMF is not aware of the S-NSSAI assigned for the PDN Connection, the NF/NF service discovery used to find the SMF instance can use PLMN level NRF.

### 4.11.1.2 Handover procedures

#### 4.11.1.2.1 5GS to EPS handover using N26 interface

Figure 4.11.1.2.1-1 describes the handover procedure from 5GS to EPS when N26 is supported.

In the case of handover to a shared EPS network, the source NG-RAN determines a PLMN to be used in the target network as specified by TS 23.501 [2]. The source NG-RAN shall indicate the selected PLMN ID to be used in the target network to the AMF as part of the TAI sent in the HO Required message.

In the case of handover from a shared NG-RAN, the AMF may provide the MME with an indication that the 5GS PLMN is a preferred PLMN at later change of the UE to a 5GS shared networks.

During the handover procedure, as specified in clause 4.9.1.3.1, the source AMF shall reject any PGW-C+SMF initiated N2 request received since handover procedure started and shall include an indication that the request has been temporarily rejected due to handover procedure in progress.

Upon reception of a rejection for an PGW-C+SMF initiated N2 request(s) with an indication that the request has been temporarily rejected due to handover procedure in progress, the PGW-C+SMF behaves as specified in TS 23.401 [13].

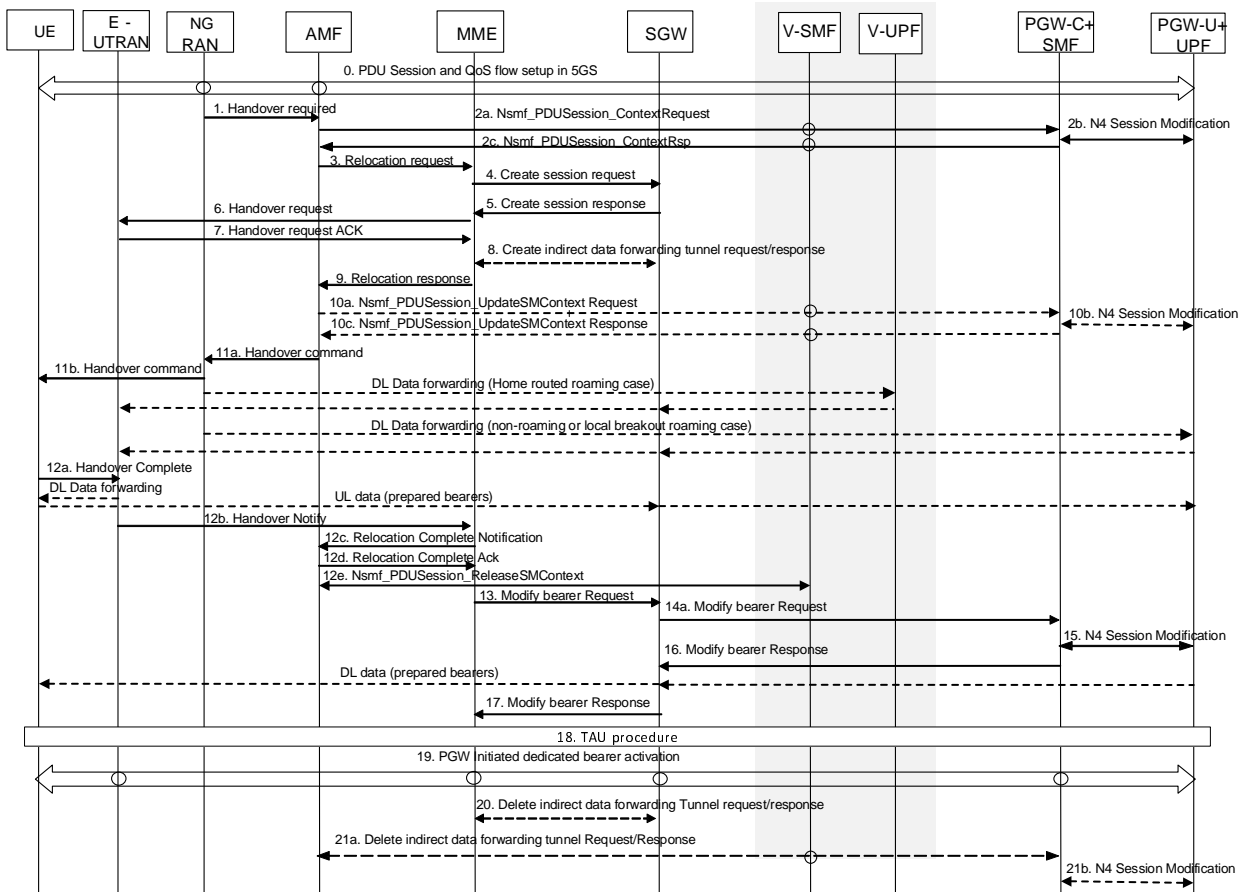

Figure 4.11.1.2.1-1: 5GS to EPS handover for single-registration mode with N26 interface

The procedure involves a handover to EPC and setup of default EPS bearer and dedicated bearers for GBR QoS Flows in EPC in steps 1-16 and re-activation, if required, of dedicated EPS bearers for non-GBR QoS Flows in step 19. This

procedure can be triggered, for example, due to new radio conditions, load balancing or in the presence of QoS Flow for normal voice or IMS emergency voice, the source NG-RAN node may trigger handover to EPC.

For Ethernet and Unstructured PDU Session Types, the PDN Type non-IP is used, when supported, in EPS. The SMF shall thus set the PDN Type of the EPS Bearer Context to non-IP in these cases. After the handover to EPS, the PDN Connection will have PDN Type non-IP, but it shall be locally associated in UE and SMF to PDU Session Type Ethernet or Unstructured respectively.

In the roaming home routed case, the PGW-C+SMF always provides the EPS Bearer ID and the mapped QoS parameters to UE. The V-SMF caches the EPS Bearer ID and the mapped QoS parameters obtained from H-SMF for this PDU session. This also applies in the case that the HPLMN operates the interworking procedure without N26.

NOTE 1: The IP address preservation cannot be supported, if PGW-C+SMF in the HPLMN doesn't provide the mapped QoS parameters.

1. NG-RAN decides that the UE should be handed over to the E-UTRAN. If NG-RAN is configured to perform Inter RAT mobility due to IMS voice fallback triggered by QoS flow setup and request to setup QoS flow for IMS voice was received, NG-RAN responds indicating rejection of the QoS flow establishment because of mobility due to fallback for IMS voice via N2 SM information and triggers handover to E-UTRAN. The NG-RAN sends a Handover Required (Target eNB ID, Direct Forwarding Path Availability, Source to Target Transparent Container, inter system handover indication) message to the AMF. NG-RAN indicates bearers corresponding to the 5G QoS Flows for data forwarding in Source to Target Transparent Container.

If the handover is triggered due to Emergency fallback, the NG-RAN may forward the Emergency indication to the target eNB in the Source to Target Transparent Container, and the target eNB allocates radio bearer resources taking received indication into account.

2. The AMF determines from the 'Target eNB Identifier' IE that the type of handover is Handover to E-UTRAN. The AMF selects an MME as described in TS 23.401 [13] clause 4.3.8.3.

In the case of HR roaming, the AMF by using Nsmf\_PDUSession\_Context Request requests the V-SMF to provide SM Context that also includes the mapped EPS Bearer Contexts. The AMF provides the target MME capability to SMF in the request to allow the V-SMF to determine whether to include EPS Bearer context for non-IP PDN Type or not. For PDU Sessions with PDU Session Type Ethernet or Unstructured, the SMF provides SM Context for non-IP PDN Type.

In the case of non roaming or LBO roaming, the AMF request PGW-C+SMF to provide SM Context by using Nsmf\_PDUSession\_ContextRequest. The AMF provides the target MME capability to PGW-C+SMF in the request to allow the PGW-C+SMF to determine whether to include EPS Bearer context for non-IP PDN Type or not. For PDU Sessions with PDU Session Type Ethernet or Unstructured, the SMF provides SM Context for non-IP PDN Type. The PGW-C+SMF send N4 Session modification to PGW-U+UPF to establish the CN tunnel for each EPS bearer and provide EPS Bearer Contexts to AMF, as described in step 8 of clause 4.11.1.4.1. The PGW-U+UPF is ready to receive the uplink packet from E-UTRAN.

This step is performed with all the PGW-C+SMFs corresponding to PDU Sessions of the UE which are associated with 3GPP access and have EBI(s) allocated to them.

NOTE 2: The AMF knows the MME capability to support non-IP PDN type or not through local configuration.

NOTE 3: In home routed roaming scenario, the UE's SM EPS Contexts are obtained from the V-SMF.

3. The AMF sends a Forward Relocation Request as in Step 2 in clause 5.5.1.2.2 (S1-based handover, normal) in TS 23.401 [13], with the following modifications and clarifications:
  - Parameter "Return preferred" may be included. Return preferred is an optional indication by the MME of a preferred return of the UE to the 5GS PLMN at a later access change to a 5GS shared network. An MME may use this information as specified by TS 23.501 [2].
  - The SGW address and TEID for both the control-plane or EPS bearers in the message are such that target MME selects a new SGW. The AMF determines, based on configuration and the Direct Forwarding Path Availability, if indirection forwarding is possible and includes the Direct Forwarding Flag to inform the target MME whether direct data forwarding is applicable.

The AMF includes the mapped SM EPS UE Contexts for PDU Sessions with and without active UP connections.

- 4-5. Step 4 and 4a respectively in clause 5.5.1.2.2 (S1-based handover, normal) in TS 23.401 [13].
6. Step 5 (Handover Request) in clause 5.5.1.2.2 (S1-based handover, normal) in TS 23.401 [13] with the following modification:
- Handover Request may contain information Handover Restriction List with information about PLMN IDs as specified by TS 23.251 [35], clause 5.2a for eNodeB functions.
  - The target eNB should establish E-RABs indicated by the list of EPS bearer to be setup provided by the MME, even if they are not included in the source to target container.
- 7-9. Step 5a through 7 in clause 5.5.1.2.2 (S1-based handover, normal) in TS 23.401 [13].
- 10a. If indirect data forwarding applies, the AMF sends the Nsmf\_PDUSession\_UpdateSMContext Request (Serving GW Address(es) and Serving GW DL TEID(s) for data forwarding) to the PGW-C+SMF, for creating indirect data forwarding tunnel. If multiple PGW-C+SMFs serves the UE, the AMF maps the EPS bearers for Data forwarding to the PGW-C+SMF address(es) based on the association between the EPS bearer ID(s) and PDU Session ID(s). In home-routed roaming case, the AMF requests the V-SMF to create indirect forwarding tunnel.
- 10b. The PGW-C+SMF may select an intermediate PGW-U+UPF for data forwarding. The PGW-C+SMF maps the EPS bearers for Data forwarding to the 5G QoS flows based on the association between the EPS bearer ID(s) and QFI(s) for the QoS flow(s) in the PGW-C+SMF, and then sends the QFIs, Serving GW Address(es) and TEID(s) for data forwarding to the PGW-U+UPF. If CN Tunnel Info for Data Forwarding is allocated by the PGW-C+SMF, the CN Tunnel Info for Data Forwarding is provided to PGW-U+UPF in this step. The PGW-U+UPF acknowledges by sending a response. If CN Tunnel Info is allocated by the PGW-U+UPF, the CN Tunnel Info is provided to PGW-C+SMF in this response. In home-routed roaming case, the V-SMF selects the V-UPF for data forwarding.
- 10c. The PGW-C+SMF returns an Nsmf\_PDUSession\_UpdateSMContext Response (Cause, CN tunnel Info for Data Forwarding, QoS flows for Data Forwarding) for creating indirect data forwarding. Based on the correlation between QFI(s) and Serving GW Address(es) and TEID(s) for data forwarding, the PGW-U+UPF maps the QoS flow(s) into the data forwarding tunnel(s) in EPC.
11. The AMF sends the Handover Command to the source NG-RAN (Transparent container (radio aspect parameters that the target eNB has set-up in the preparation phase), CN tunnel info for data forwarding per PDU Session, QoS flows for Data Forwarding). The source NG-RAN commands the UE to handover to the target access network by sending the HO Command. The UE correlates the ongoing QoS Flows with the indicated EPS Bearer IDs to be setup in the HO command. The UE locally deletes the PDU Session if the QoS Flow associated with the default QoS rule in the PDU Session does not have an EPS Bearer ID assigned. If the QoS Flow associated with the default QoS rule has an EPS Bearer ID assigned, the UE keeps the PDU Session (PDN connection) and for the remaining QoS Flow(s) that do not have EPS bearer ID(s) assigned, the UE locally deletes the QoS rule(s) and the QoS Flow level QoS parameters if any associated with those QoS Flow(s) and notifies the impacted applications that the dedicated QoS resource has been released. The UE deletes any UE derived QoS rules. The EPS Bearer ID that was assigned for the QoS flow of the default QoS rule in the PDU Session becomes the EPS Bearer ID of the default bearer in the corresponding PDN connection.
- For the QoS Flows indicated in the "QoS Flows for Data Forwarding", NG-RAN initiate data forwarding via to the PGW-U+UPF based on the CN Tunnel Info for Data Forwarding per PDU Session. Then the PGW-U+UPF maps data received from the data forwarding tunnel(s) in the 5GS to the data forwarding tunnel(s) in EPS, and sends the data to the target eNodeB via the Serving GW.
- 12-12c. Step 13 to step 14 from clause 5.5.1.2.2 (S1-based handover, normal) in TS 23.401 [13] with the following clarification:
- The AMF request the release of the PDU Session which is associated with 3GPP access, not expected to be transferred to EPC, i.e. no EBI(s) allocated to them, and corresponding to the PGW-C+SMF which is not contacted by AMF for SM context at step 2.
- 12d. The AMF acknowledges MME with Relocation Complete Ack message. A timer in AMF is started to supervise when resource in NG-RAN shall be released.

12e. In the case of home routed roaming, the AMF invokes Nsmf\_PDUSession\_ReleaseSMContext Request (V-SMF only indication) to the V-SMF. This service operation requests the V-SMF to remove only the SM context in the V-SMF, i.e. not release PDU Session context in the PGW-C+SMF.

If indirect forwarding tunnel(s) were previously established, the V-SMF starts a timer and releases the SM context on expiry of the timer. If no indirect forwarding tunnel has been established, the V-SMF immediately release the SM context and its UP resources for this PDU Session in V-UPF locally.

13. Step 15 from clause 5.5.1.2.2 (S1-based handover, normal) in TS 23.401 [13].

14a. Step 16 (Modify Bearer Request) from clause 5.5.1.2.2 (S1-based handover, normal) in TS 23.401 [13] with the following clarification:

- The PGW-C+SMF deletes the PDU Session if the QoS Flow associated with the default QoS rule in the PDU Session does not have an EPS Bearer ID assigned. If the QoS Flow associated with the default QoS rule has an EPS Bearer ID assigned, the PGW-C+SMF keeps the PDU Session (PDN connection) and for the remaining QoS Flows that do not have EPS bearer ID(s) assigned, the PGW-C+SMF deletes the PCC rule(s) associated with those QoS Flows and informs the PCF about the removed PCC rule(s).

NOTE 4: If the QoS flow is deleted, the IP flows of the deleted QoS rules will continue flowing on the default EPS bearer if it does not have an assigned TFT. If the default EPS bearer has an assigned TFT, the IP flows of the deleted QoS Flow may be interrupted until step 19 when dedicated bearer activation is triggered by a request from the PCF.

The PGW-C+SMF may need to report some subscribed event to the PCF by performing an SMF initiated SM Policy Association Modification procedure as defined in clause 4.16.5.

15. The PGW-C+SMF initiates a N4 Session Modification procedure towards the UPF+PGW-U to update the User Plane path, i.e. the downlink User Plane for the indicated PDU Session is switched to E-UTRAN. The PGW-C+SMF releases the resource of the CN tunnel for PDU Session in UPF+PGW-U.

16. Step 16a (Modify Bearer Response) from clause 5.5.1.2.2 (S1-based handover, normal) in TS 23.401 [13]. At this stage the User Plane path is established for the default bearer and the dedicated EPS bearers between the UE, target eNodeB, Serving GW and the PGW-U+UPF. The PGW-C+SMF uses the EPS QoS parameters as assigned for the dedicated EPS bearers during the QoS Flow establishment. PGW-C+SMF maps all the other IP flows to the default EPS bearer (see NOTE 4).

If indirect forwarding tunnel(s) were previously established, the PGW-C+SMF starts a timer, to be used to release the resource for indirect data forwarding.

17. Step 17 from clause 5.5.1.2.2 (S1-based handover, normal) in TS 23.401 [13].

18. The UE initiates a Tracking Area Update procedure as specified in step 11 of clause 5.5.1.2.2 (S1-based handover, normal) in TS 23.401 [13].

This includes the deregistration of the old AMF for 3GPP access from the HSS+UDM as specified in clause 4.11.1.5.3. Any registration associated with the non-3GPP access in the old AMF is not removed (i.e. an AMF that was serving the UE over both 3GPP and non-3GPP accesses does not consider the UE as deregistered over non 3GPP access and will remain registered and subscribed to subscription data updates in UDM).

NOTE 5: The behavior whereby the HSS+UDM cancels location of CN node of the another type, i.e. AMF, is similar to HSS behavior for MME and Gn/Gp SGSN registration (see TS 23.401 [13]). The target AMF that receives the cancel location from the HSS+UDM is the one associated with 3GPP access.

When the UE decides to deregister over non-3GPP access or the old AMF decides not to maintain a UE registration for non-3GPP access anymore, the old AMF then deregisters from UDM by sending a Nudm\_UECM\_Deregistration service operation, unsubscribes from Subscription Data updates by sending an Nudm\_SDM\_Unsubscribe service operation to UDM and releases all the AMF and AN resources related to the UE.

19. If PCC is deployed, the PCF may decide to provide the previously removed PCC rules to the PGW-C+SMF again thus triggering the PGW-C+SMF to initiate dedicated bearer activation procedure. This procedure is specified in TS 23.401 [13], clause 5.4.1 with modification captured in clause 4.11.1.5.4. For Ethernet PDU Session Type, using non-IP PDN Type in EPS, this step is not applicable.

20. Step 21 from clause 5.5.1.2.2 (S1-based handover, normal) in TS 23.401 [13].

21. In the case of home routed roaming, at the expiry of the timer at V-SMF started at step 12e, the V-SMF locally releases the SM context and the UP resource for the PDU Session including the resources used for indirect forwarding tunnel(s) that were allocated at step 10.

In non-roaming or local breakout roaming, if PGW-C+SMF has started a timer in step 16, at the expiry of the timer, the PGW-C+SMF sends N4 Session Modification Request to PGW-U+UPF to release the resources used for the indirect forwarding tunnel(s) that were allocated at step 10.

When the timer set in step 12d expires, AMF also sends a UE Context Release Command message to the source NG RAN. The source NG RAN releases its resources related to the UE and responds with a UE Context Release Complete message.

#### 4.11.1.2.2 EPS to 5GS handover using N26 interface

##### 4.11.1.2.2.1 General

N26 interface is used to provide seamless session continuity for single registration mode.

The procedure involves a handover to 5GS and setup of QoS Flows in 5GS.

In the home routed roaming case, the PGW-C+ SMF in the HPLMN always receives the PDU Session ID from UE and provides PDN Connection associated 5G QoS parameter(s) and S-NSSAI to the UE. This also applies in the case that the HPLMN operates the interworking procedure without N26.

In the case of handover to a shared 5GS network, the source E-UTRAN determines a PLMN to be used in the target network as specified by TS 23.251 [35] clause 5.2a for eNodeB functions. A supporting MME may provide the AMF via N26 with an indication that source EPS PLMN is a preferred PLMN when that PLMN is available at later change of the UE to an EPS shared network.

If the PDN Type of a PDN Connection in EPS is non-IP, and is locally associated in UE and SMF to PDU Session Type Ethernet or Unstructured, the PDU Session Type in 5GS shall be set to Ethernet or Unstructured respectively.

NOTE: The IP address continuity can't be supported, if PGW-C+SMF in the HPLMN doesn't provide the mapped QoS parameters.

##### 4.11.1.2.2.2 Preparation phase

Figure 4.11.1.2.2.2-1 shows the preparation phase of the Single Registration-based Interworking from EPS to 5GS procedure.

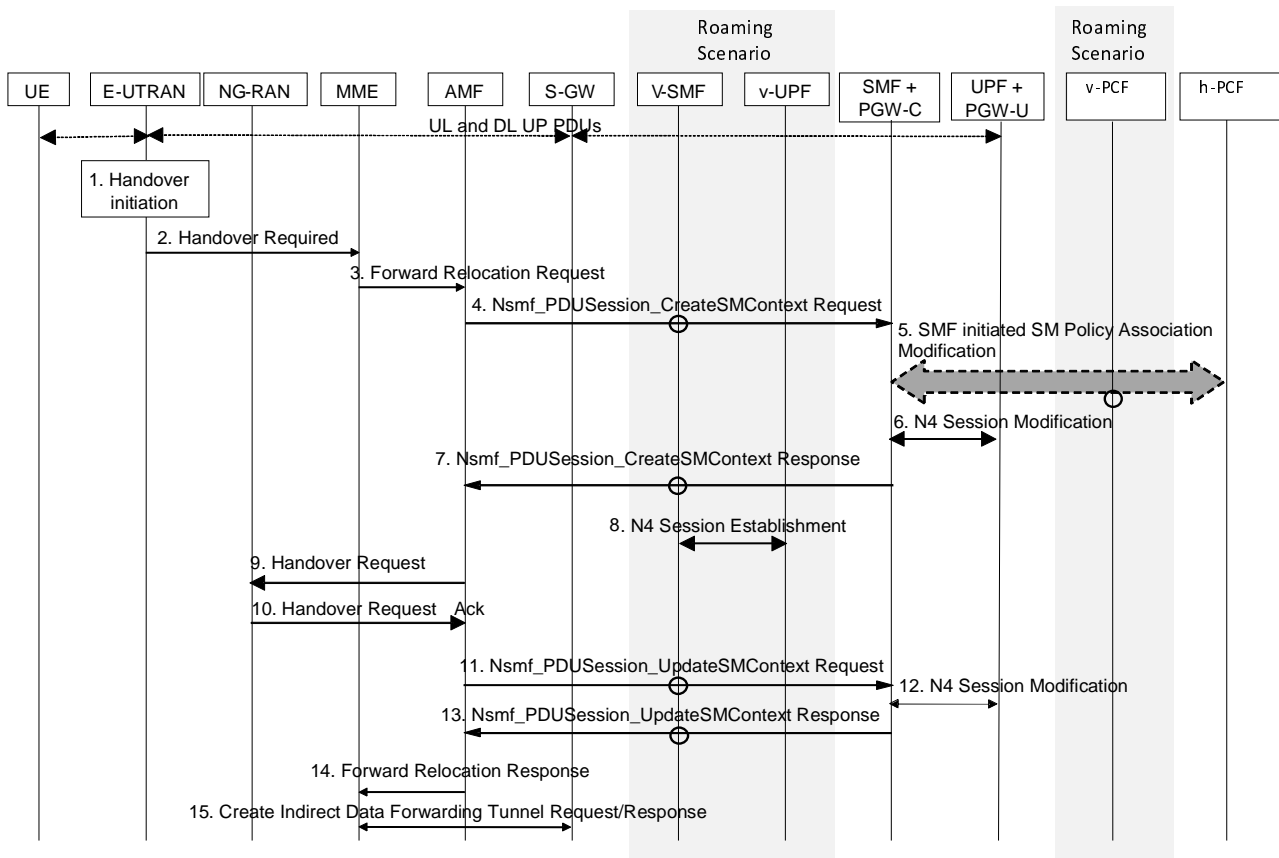

**Figure 4.11.1.2.2.2-1: EPS to 5GS handover using N26 interface, preparation phase**

This procedure applies to the Non-Roaming (TS 23.501 [2] Figure 4.3.1-1), Home-routed roaming (TS 23.501 [2] Figure 4.3.2-1) and Local Breakout roaming Local Breakout (TS 23.501 [2] Figure 4.3.2-2) cases.

- For non-roaming scenario, V-SMF, v-UPF and v-PCF are not present
- For home-routed roaming scenario, the PGW-C+SMF and UPF+PGW-U are in the HPLMN. v-PCF are not present
- For local breakout roaming scenario, V-SMF and v-UPF are not present. PGW-C+SMF and UPF+PGW-U are in the VPLMN.

In local-breakout roaming case, the v-PCF interacts with the PGW-C+SMF.

1 - 2. Step 1 - 2 from clause 5.5.1.2.2 (S1-based handover, normal) in TS 23.401 [13].

3. Step 3 from clause 5.5.1.2.2 (S1-based handover, normal) in TS 23.401 [13] with the following modifications:

An additional optional parameter Return preferred. Return preferred is an optional indication provided by the MME to indicate a preferred return of the UE to the last used EPS PLMN at a later access change to an EPS shared network. Based on the Return Preferred indication, the AMF may store the last used EPS PLMN ID in the UE Context.

The AMF converts the received EPS MM Context into the 5GS MM Context. This includes converting the EPS security context into a mapped 5G security context as described in TS 33.501 [15]. The MME UE context includes IMSI, ME Identity, UE security context, UE Network Capability, and EPS Bearer context(s). The MME EPS Bearer context(s) include for each EPS PDN connection the IP address and FQDN for the S5/S8 interface of the PGW-C+SMF and APN, and for each EPS bearer the IP address and CN Tunnel Info at the UPF+PGW-U for uplink traffic.

The AMF queries the (PLMN level) NRF in serving PLMN by issuing the Nnrf\_NFDiscovery\_Request including the FQDN for the S5/S8 interface of the PGW-C+SMF, and the NRF provides the IP address or FQDN of the N11/N16 interface of the PGW-C+SMF.



If the AMF cannot retrieve the address of the corresponding SMF for a PDN connection, it will not move the PDN connection to 5GS.

NOTE 1: If the AMF holds a native 5G security context for the UE, the AMF may activate this native 5G security context by initiating a NAS SMC upon completing the handover procedure.

4. The AMF invokes the Nsmf\_PDUSession\_CreateSMContext service operation (UE EPS PDN Connection, AMF ID, dataForwarding Flag, Target ID) on the SMF identified by the PGW-C+SMF address and indicates HO preparation indication (to avoid switching the UP path). The AMF ID is the UE's GUAMI which uniquely identifies the AMF serving the UE. This step is performed for each PDN Connection and the corresponding PGW-C+SMF address/ID in the UE context the AMF received in step 3. The SMF finds the corresponding PDU Session based on EPS Bearer Context(s).

Based on configuration and the Direct Forwarding Flag received from the MME, the AMF determines the applicability of indirect data forwarding and a dataDirect Forwarding Flag to inform the SMF of the applicability of indirect data forwarding.

Target ID corresponds to Target ID provided by the MME in step 3.

For home-routed roaming scenario, the AMF selects a default V-SMF per PDU Session and invokes the Nsmf\_PDUSession\_CreateSMContext service operation (UE PDN Connection Contexts, AMF ID, SMF + PGW-C address, S-NSSAI). The S-NSSAI is the S-NSSAI configured in AMF for interworking, which is associated with default V-SMF. The default V-SMF put this S-NSSAI in the N2 SM Information container in step 7.

The V-SMF selects the PGW-C+SMF using the received H-SMF address as received from the AMF, and initiates a Nsmf\_PDUSession\_Create service operation with the PGW-C+SMF.

5. If dynamic PCC is deployed, the SMF+ PGW-C (V-SMF via H-SMF for home-routed scenario) may initiate SMF initiated SM Policy Modification towards the PCF.
6. In the case of non roaming or LBO roaming, the PGW-C+SMF may send N4 Session modification to PGW-U+UPF to establish the CN tunnel for PDU Session. The PGW-U+UPF is ready to receive the uplink packets from NG-RAN. If the CN Tunnel info is allocated by the PGW-C+SMF, the PGW-U tunnel info for PDU session is provided to PGW-U+UPF. If the CN Tunnel info is allocated by PGW-U+UPF, the PGW-U+UPF sends the PGW-U tunnel info for PDU Session to the PGW-C+SMF. This step is performed at all PGW-C+SMFs allocated to the UE for each PDU Session of the UE.

NOTE 2: If the CN Tunnel info is not available in the PGW-U+UPF at this step, when the UE moves to the target RAT the PGW-U+UPF cannot receive UL data until the Tunnel Info is provided to the PGW-U+UPF. This causes a short interruption to the UL data during the handover execution phase.

7. The PGW-C+SMF (V-SMF in the case of home-routed roaming scenario only) sends a Nsmf\_PDUSession\_CreateSMContext Response (PDU Session ID, S-NSSAI, N2 SM Information (PDU Session ID, S-NSSAI, QFI(s), QoS Profile(s), EPS Bearer Setup List, Mapping between EBI(s) and QFI(s), CN Tunnel-Info, cause code)) to the AMF.

For home-routed roaming scenario the step 8 need be executed first. The CN Tunnel-Info provided to the AMF in N2 SM Information is the V-CN Tunnel-Info.

SMF includes mapping between EBI(s) and QFI(s) as part of N2 SM Information container. If the P-GW-C+SMF (H-SMF in the case of home-routed scenario) determines that seamless session continuity from EPS to 5GS is not supported for the PDU Session, then it does not provide SM information for the corresponding PDU Session but includes the appropriate cause code for rejecting the PDU Session transfer within the N2 SM Information. If the dataForwarding Flag indicates indirect forwarding and there is no indirect data forwarding connectivity between source and target, the SMF shall further include a "Data forwarding not possible" indication in the N2 SM information container. In home routed roaming case, the S-NSSAI included in N2 SM Information container is the S-NSSAI received in step 4.

AMF stores an association of the PDU Session ID, S-NSSAI and the SMF ID.

If the PDN Type of a PDN Connection in EPS is non-IP, and is locally associated in SMF to PDU Session Type Ethernet, the PDU Session Type in 5GS shall be set to Ethernet. In case the PDN type of a PDN Connection in EPS is non-IP, and is locally associated in UE and SMF to PDU Session Type Unstructured, the PDU Session Type in 5GS shall be set to Unstructured.

In the case of PDU Session Type Ethernet, that was using PDN type non-IP in EPS, the SMF creates QoS rules and QoS Flow level QoS parameters for the QoS Flow(s) associated with the QoS rule(s) based on the PCC Rules received from PCF.

8. For home-routed roaming scenario only: The V-SMF selects a v-UPF and initiates an N4 Session Establishment procedure with the selected v-UPF. The V-SMF provides the v-UPF with packet detection, enforcement and reporting rules to be installed on the UPF for this PDU Session, including H-CN Tunnel Info. If CN Tunnel Info is allocated by the SMF, the V-CN Tunnel Info is provided to the v-UPF in this step.

The v-UPF acknowledges by sending an N4 Session Establishment Response message. If CN Tunnel Info is allocated by the UPF, the V-CN Tunnel info is provided to the V-SMF in this step.

9. The AMF sends a Handover Request (Source to Target Transparent Container, N2 SM Information (PDU Session ID, S-NSSAI, QFI(s), QoS Profile(s), EPS Bearer Setup List, V-CN Tunnel Info, Mapping between EBI(s) and QFI(s)), Mobility Restriction List) message to the NG-RAN. The AMF provides NG-RAN with a PLMN list in the Mobility Restriction List containing at least the serving PLMN, taking into account the last used EPS PLMN ID and the Return preferred indication. The Mobility Restriction List contain information about PLMN IDs as specified by TS 23.501 [2].

NG-RAN can use the source to target transparent container and N2 SM Information container to determine which QoS flows have been proposed for forwarding and decide for which of those QoS flows it accepts the data forwarding or not.

10. The NG-RAN sends a Handover Request Acknowledge (Target to Source Transparent Container, List of PDU Sessions to Hand-over with N2 SM response (PDU Session ID, list of accepted QFI(s), AN Tunnel Info, N3 Tunnel Info for data forwarding), List of PDU Sessions that failed to be established with the failure cause given in the N2 SM information element) message to the AMF. The NG-RAN includes one assigned TEID/TNL address per PDU Session (for which there is at least one QoS flow for which it has accepted the forwarding) within the SM Info container. It also includes the list of QoS flows for which it has accepted the forwarding. According to the mapping between EBI(s) and QFI(s), if one EPS bearer in EPS is mapped to multiple QoS flows in 5GS, all such QoS flows need to be accepted to support indirect data forwarding during EPS to 5GS mobility. Otherwise, the NG RAN rejects the indirect data forwarding for the QoS flows which are mapped to the EPS bearer.
11. The AMF sends an Nsmf\_PDUSession\_UpdateSMContext Request (PDU Session ID, N2 SM response received from NG-RAN in step 10) message to the SMF for updating N3 tunnel information. In home routed roaming case, the N3 Tunnel Info for data forwarding is handled by the V-SMF and will not be sent to the PGW-C+SMF.
12. PGW-C+SMF (V-SMF in home-routed roaming scenario) performs preparations for N2 Handover by indicating N3 UP address and Tunnel ID of NG-RAN to the UPF if N2 Handover is accepted by NG-RAN and by indicating the mapping between the TEID where the UPF receives data forwarded by the source SGW and the QFI(s) and N3 Tunnel Info for data forwarding where the UPF is selected to forward such data (e.g. an intermediate UPF). If the EPS bearer is mapped to multiple QoS flows and an intermediate UPF is selected for data forwarding, only one QFI is selected by the PGW-C+SMF from QFIs corresponding to the QoS flows.

In home routed roaming case, the V-SMF sends a V-UPF for data forwarding the mapping between the TEID where the UPF receives data forwarded by the source SGW and the QFI and N3 Tunnel Info for data forwarding. If the EPS bearer is mapped to multiple QoS flows and an intermediate UPF is selected for data forwarding, only one QFI is selected by the PGW-C+SMF from QFIs corresponding to the QoS flows.

If N2 Handover is not accepted by NG-RAN, PGW-C+SMF deallocates N3 UP address and Tunnel ID of the selected UPF.

The EPS Bearer Setup list is a list of EPS bearer Identifiers successfully handover to 5GC, which is generated based on the list of accepted QFI(s).

If a PDU Session is rejected by the Target NG-RAN with an indication that the PDU session was rejected because User Plane Security Enforcement is not supported in the Target NG-RAN and the User Plane Enforcement Policy indicates "Required" as described in clause 5.10.3 of TS 23.501 [2], the SMF triggers the release of this PDU Session. In all other cases of PDU Session rejection, the SMF can decide whether to release the PDU Session or to deactivate the UP connection of this PDU Session.

If some of the QoS Flows of a PDU Session are not accepted by the Target NG-RAN, the SMF shall initiate the PDU Session Modification procedure to remove the non-accepted QoS Flows from the PDU Session(s) after the handover procedure is completed.

- 13. PGW-C+SMF (V-SMF in home-routed roaming scenario) to AMF: Nsmf\_PDUSession\_UpdateSMContext Response (PDU Session ID, EPS Bearer Setup List, CN tunnel information for data forwarding). In home routed roaming case, the V-SMF provides the CN tunnel information for data forwarding.

This message is sent for each received Nsmf\_PDUSession\_UpdateSMContext\_Request message.

- 14. The AMF sends the message Forward Relocation Response (Cause, Target to Source Transparent Container, Serving GW change indication, CN Tunnel Info for data forwarding, EPS Bearer Setup List, AMF Tunnel Endpoint Identifier for Control Plane, Addresses and TEIDs). The EPS Bearer Setup list is the combination of EPS Bearer Setup list from different PGW-C+SMF(s).

- 15. Step 8 from clause 5.5.1.2.2 (S1-based handover, normal) in TS 23.401 [13].

4.11.1.2.2.3 Execution phase

Figure 4.11.1.2.2.3-1 shows the Single Registration-based Interworking from EPS to 5GS procedure.

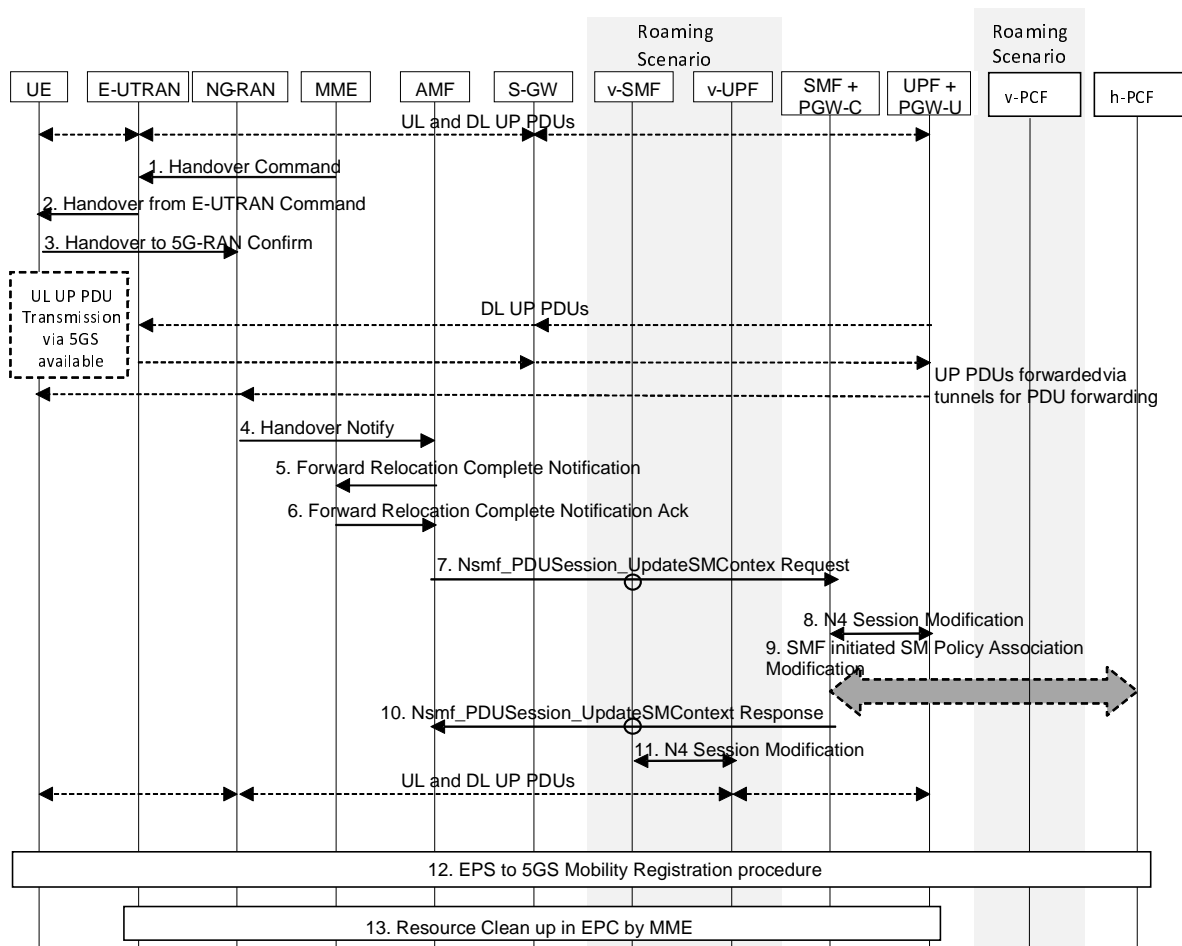

Figure 4.11.1.2.2.3-1: EPS to 5GS handover using N26 interface, execution phase

NOTE: Step 6 P-GW-C+SMF Registration in the UDM is not shown in the figure for simplicity.

- 1 - 2. Step 9 - 11 from clause 5.5.1.2.2 (S1-based handover, normal) in TS 23.401 [13]. Different from step 9a of clause 5.5.1.2.2 (S1-based handover, normal) in TS 23.401 [13], upon reception of Handover Command, the UE will keep the QoS Flow context for which it did not receive the corresponding radio resources in the NG-RAN until the QoS Flow is released by the network using PDU Session Modification procedure in clause 4.3.3. If the QoS Flow with a default QoS Rule of a PDU Session does not have the corresponding radio resources in the NG-RAN, UE considers that the user plane of this PDU Session is deactivated.

3. Handover Confirm: the UE confirms handover to the NG-RAN.

The UE moves from the E-UTRAN and synchronizes with the target NG-RAN. The UE may resume the uplink transmission of user plane data only for those QFIs and Session IDs for which there are radio resources allocated in the NG-RAN.

The E-UTRAN performs indirect data forwarding via the SGW and the v-UPF. The v-UPF forwards the data packets to the NG-RAN using the N3 Tunnel Info for data forwarding, adding the QFI information. The target NG-RAN prioritizes the forwarded packets over the fresh packets for those QoS flows for which it had accepted data forwarding.

4. Handover Notify: the NG-RAN notifies to the AMF that the UE is handed over to the NG-RAN.
5. Then the AMF knows that the UE has arrived to the target side and informs the MME by sending a Forward Relocation Complete Notification message.
6. Step 14 from clause 5.5.1.2.2 (S1-based handover, normal) in TS 23.401 [13].
7. AMF to SMF +PGW-C (V-SMF in case of roaming and Home-routed case):  
Nsmf\_PDUSession\_UpdateSMContext Request (Handover Complete indication for PDU Session ID).

Handover Complete is sent per each PDU Session to the corresponding SMF +PGW-C to indicate the success of the N2 Handover.

If indirect forwarding is used, a timer in SMF+PGW-C (V-SMF in case of roaming and Home-routed case) is started to supervise when resources in UPF (for indirect data forwarding) shall be released.

8. The SMF + PGW-C (V-SMF in case of roaming and Home-routed case) updates the UPF + PGW-U with the V-CN Tunnel Info, indicating that downlink User Plane for the indicated PDU Session is switched to NG-RAN and the CN tunnels for EPS bearers corresponding to the PDU session can be released.
9. If PCC infrastructure is used, the SMF + PGW-C informs the PCF about the change of, for example, the RAT type and UE location.
10. SMF +PGW-C to AMF: Nsmf\_PDUSession\_UpdateSMContext Response (PDU Session ID).  
SMF +PGW-C confirms reception of Handover Complete.
  - If the SMF has not yet registered for this PDU Session ID, then the SMF registers with the UDM using Nudm\_UECM\_Registration (SUPI, DNN, PDU Session ID) for a given PDU Session as in step 4 of PDU Session Establishment Procedure in clause 4.3.2.

11. For home-routed roaming scenario: The V-SMF provides to the v-UPF with the N3 DL AN Tunnel Info and the N9 UL CN Tunnel Info.

12. The UE performs the EPS to 5GS Mobility Registration Procedure from step 2 in clause 4.11.1.3.3. The UE includes the UE Policy Container containing the list of PSIs, indication of UE support for ANDSP and OSId if available. If the UE holds a native 5G-GUTI it also includes the native 5G-GUTI as an additional GUTI in the Registration Request. The UE shall select the 5G-GUTI for the additional GUTI as follows, listed in decreasing order of preference:

- a native 5G-GUTI assigned by the PLMN to which the UE is attempting to register, if available;
- a native 5G-GUTI assigned by an equivalent PLMN to the PLMN to which the UE is attempting to register, if available;
- a native 5G-GUTI assigned by any other PLMN, if available.

The additional GUTI enables the AMF to find the UE's 5G security context (if available). The AMF provides NG-RAN with a PLMN list in the Handover Restriction List containing at least the serving PLMN, taking into account of the last used EPS PLMN ID and Return preferred indication as part of the Registration procedure execution and AMF signaling to NG-RAN. The Handover Restriction List contains a list of PLMN IDs as specified by TS 23.501 [2].

13. Step 19 from clause 5.5.1.2.2 (S1-based handover, normal) in TS 23.401 [13]. Step 20a - 20b from clause 5.5.1.2.2 (S1-based handover, normal) in TS 23.401 [13], with the following modification:

According to configuration, for the PDN connections which are anchored in a standalone PGW, the MME initiates PDN connection release procedure as specified in TS 23.401 [13].

14. If indirect forwarding was used, then the expiry of the timer started at step 7 triggers the SMF+PGW-C (V-SMF in case of roaming and Home-routed case) to release temporary resources used for indirect forwarding that were allocated at steps 11 to 13 in clause 4.11.1.2.2.2.

#### 4.11.1.2.3 Handover Cancel

Instead of completing the handover procedure, the source RAN node (NG-RAN, E-UTRAN) may at any time, during the handover procedure, up to the time when a handover command message is sent to the UE, cancel the handover. The reason for cancelling may be e.g. due to a timer expiration or due to other events within the source RAN node and is initiated by sending a handover cancel message to the source CN node (AMF or MME).

A handover cancel message shall also be sent by the source RAN node after a handover command message is sent to the UE for the case where the handover fails and the UE returns to the old cell or radio contact with the UE is lost. This is done in order to release the resources reserved for the handover in the target system.

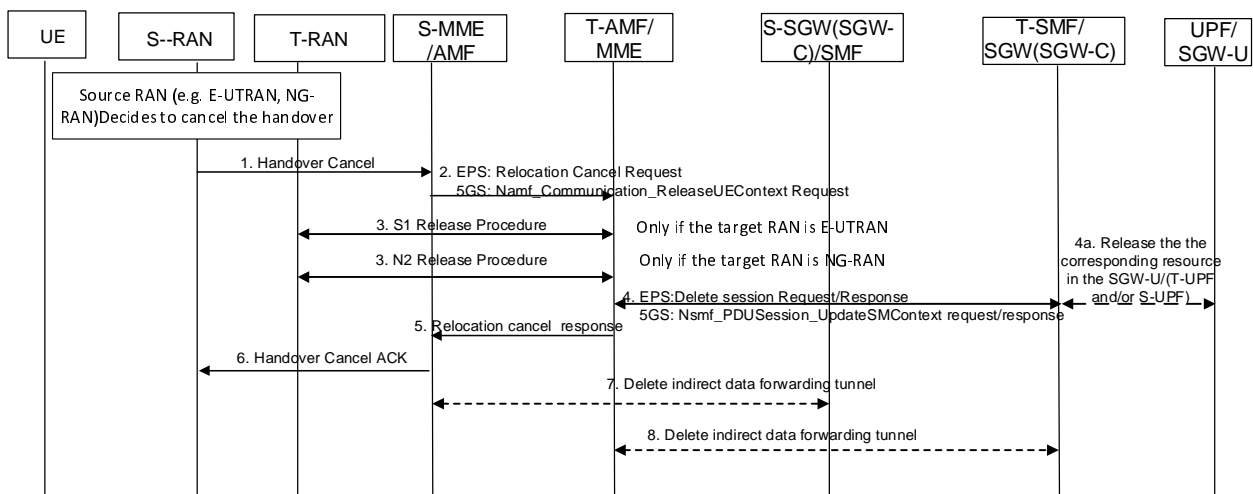

Figure 4.11.1.2.3-1: Handover Cancel procedure

1. When the source RAN (NG-RAN, E-UTRAN) decides to cancel the handover to the target system, the source RAN initiates handover cancel message to the source CN node (AMF or MME).
2. After receiving the handover cancel message from the source RAN, if the source CN node or the target CN node is MME, it sends a "Relocation Cancel Request" message to the target CN node (MME or AMF). If both the source CN node and target CN node are AMF, the source AMF invokes the `Namf_Communication_ReleaseUEContext Request` (SUPI, PDU Session IDs, Relocation Cancel Indication) toward the target AMF.
3. The target CN node (MME or AMF) triggers release of resources towards target RAN node. The target RAN node releases the AN resources allocated for the handover.
4. If the target CN node is MME, the MME sends the "delete session request (IMSI, Relocation Cancel Indication) to the SGW/SGW-C (see clause 5.5.2.5.2, TS 23.401 [13]). If the target CN node is AMF, the AMF invokes the "Nsmf\_PDUSession\_UpdateSMContext request (SUPI, Relocation Cancel Indication) toward the SMF. Based on the Relocation Cancel Indication, the target CN node deletes the session resources established during handover preparation phase in SGW(SGW-C and SGW-U)/(SMF and UPF).
- 4a. [Conditional] The SGW(SGW-C)/SMF releases the corresponding resource in the SGW-U/(T-UPF and/or S-UPF) if allocated during the handover preparation.
5. The target CN node (MME or AMF) sends "Relocation Cancel Response" towards the source CN node (AMF or MME).
6. The source CN node (AMF or MME) responds with handover cancel ACK towards the source RAN.

7. If indirect forwarding tunnel is setup during handover preparation phase then cancellation of handover triggers the source CN node to release the temporary resources used for indirect forwarding.
8. If indirect forwarding tunnel is setup during handover preparation phase then cancellation of handover triggers the target CN node to release the temporary resources used for indirect forwarding.

### 4.11.1.3 Idle Mode Mobility procedures

#### 4.11.1.3.1 General

When a UE moves from EPC to 5GC, the UE always performs Registration procedure.

When a UE moves from 5GC to EPC, the UE performs either Tracking Area Update or Initial Attach.

The UE performs Tracking Area Update procedure if

- Both the UE and the EPC support "attach without PDN connectivity", or
- The UE has at least one PDU Session for which Session Continuity is supported during interworking, i.e. the UE has EPS Bearer ID and mapped EPS QoS parameters received as described in clause 4.11.1.1.

The UE performs an initial attach procedure if

- The UE is registered without PDU Session in 5GC or the UE is registered only with PDU Session for which Session Continuity is not supported during interworking to EPC, and
- Either the UE or the EPC does not support attach without PDN connectivity.

#### 4.11.1.3.2 5GS to EPS Idle mode mobility using N26 interface

In case of network sharing the UE selects the target PLMN ID according to clause 5.18.3 of TS 23.501 [2].

Clause 4.11.1.3.2 covers the case of idle mode mobility from 5GC to EPC. UE performs Tracking Area Update procedure in E-UTRA/EPS when it moves from NG-RAN/5GS to E-UTRA/EPS coverage area.

The procedure involves a Tracking Area Update to EPC and setup of default EPS bearer and dedicated bearers in EPC in steps 1-11 and re-activation, if required.

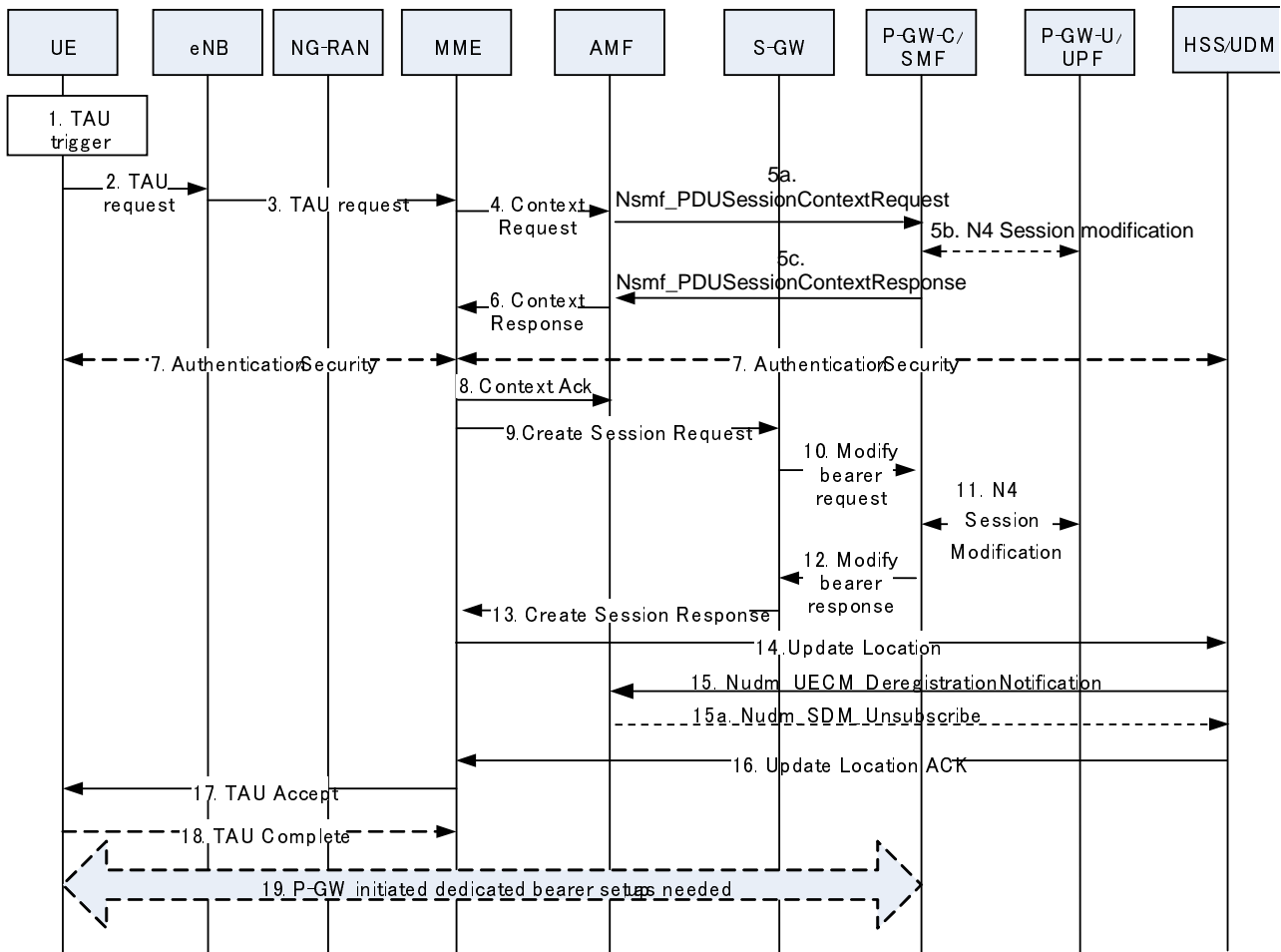

**Figure 4.11.1.3.2-1: 5GS to EPS Idle mode mobility using N26 interface**

The TAU procedure in TS 23.401 [13] is used with the following 5GS interaction:

1. Step 1 from clause 5.3.3.1 (Tracking Area Update procedure with Serving GW change) in TS 23.401 [13].
2. Step 2 from clause 5.3.3.1 (Tracking Area Update procedure with Serving GW change) in TS 23.401 [13] with the modification captured in clause 4.11.1.5.3.
- 3-4. Steps 3-4 from clause 5.3.3.1 (Tracking Area Update procedure with Serving GW change) in TS 23.401 [13].

5a. The AMF verifies the integrity of the TAU request message and requests the PGW-C+SMF to provide SM Context by using Nsmf\_PDUSession\_ContextRequest that also includes the mapped EPS Bearer Contexts. The AMF provides the target MME capability to SMF in the request to allow the SMF to determine whether to include EPS Bearer context for non-IP PDN Type or not. This step is performed with all the PGW-C+SMFs corresponding to PDU Sessions of the UE which are associated with 3GPP access and have EBI(s) allocated to them. In this step, if the AMF correctly validates the UE, then the AMF starts a timer.

NOTE 1: The AMF knows the MME capability to support non-IP PDN type or not through local configuration.

5b. For Non-roaming or roaming with local breakout scenario, if CN Tunnel Info is allocated by the PGW-U+UPF, the SMF sends N4 Session Modification Request to PGW-U+UPF to establish the tunnel for each EPS bearers, and PGW-U+UPF provides the PGW-U Tunnel Info for each EPS bearers to PGW-C+SMF.

NOTE2: In home routed roaming case, the CN Tunnel Info for each EPS bearer has been prepared by the PGW-C+SMF and provided to the V-SMF as specified in clause 4.11.1.4.1.

5c. SMF returns mapped EPS bearer contexts, which includes PGW-C control plane tunnel information of the PDN connection corresponding to the PDU session, EBI for each EPS bearer, PGW-U tunnel information for each EPS bearer, and EPS QoS parameters for each EPS bearer. For PDU Sessions with PDU Session Type Ethernet or Unstructured, the SMF provides SM Context for non-IP PDN Type.

If the PGW-C+SMF has marked that the status of one or more QoS Flows are deleted in the 5GC but not synchronized with the UE yet as per clause 4.3.3.2, the PGW-C+SMF does not return to the AMF the EPS context(s) if all its associated QoS Flows are marked as deleted, that is, the PGW-C+SMF returns to the AMF the EPS bearer contexts mapped from QoS Flows where at least one of the QoS Flow for the EPS bearer is not marked as deleted.

6. The AMF responds with a Context Response message carrying mapped MM context (including mapped security context), Return preferred and SM EPS UE Context (default and dedicated GBR bearers) to the MME. If the verification of the integrity protection fails, the AMF returns an appropriate error cause. Return preferred is an optional indication by the AMF of a preferred return of the UE to the 5GS PLMN at a later access change to a 5GS shared network. The AMF may start an implementation specific (guard) timer for the UE context.

- 7 - 14. Steps 6-12 from clause 5.3.3.1 (Tracking Area Update procedure with Serving GW change) in TS 23.401 [13] are performed with following addition and modification:

In the step 10, If the QoS Flow associated with the default QoS rule has an EPS Bearer ID assigned, the PGW-C+SMF keeps the PDU Session (PDN connection) and for the remaining QoS Flows that do not have EPS bearer ID(s) assigned, the PGW-C+SMF deletes the PCC rule(s) associated with those QoS Flows and informs the PCF about the removed PCC rule(s).

In the step 11, the PGW-C+SMF requests the PGW-U+UPF to establish the tunnel for each EPS bearer by providing SGW-U Tunnel Info, and PGW-U Tunnel Info if the PGW-U Tunnel Info is allocated by the PGW-C+SMF.

In step 10, the PGW-C+SMF may need to report some subscribed event to the PCF by performing an SMF initiated SM Policy Association Modification procedure as defined in clause 4.16.5.

Step 9a from clause 5.3.3.1 (Tracking Area Update procedure with Serving GW change) in TS 23.401 [13] with the modification captured in clause 4.11.1.5.3

- 15a. The HSS+UDM invokes Nudm\_UECM\_DeregistrationNotification to notify the AMF associated with 3GPP access with reason as 5GS to EPS Mobility. If the timer started in step 6 is not running, the old AMF removes the UE context. Otherwise, the AMF may remove UE context when the timer expires. The AMF request the release of the PDU Session which is associated with 3GPP access, not expected to be transferred to EPC, i.e. no EBI(s) allocated to them, and corresponding to the PGW-C+SMF which is not contacted by AMF for SM context at step 5a. The AMF requests the release of the SM context in the V-SMF only, for Home Routed PDU Session with EBIs allocated. The 5GC may also keep UE context to allow the use of native security parameters when UE moves back from EPS to 5GS later.

Registration associated with the non-3GPP access in the AMF is not removed (i.e. an AMF that was serving the UE over both 3GPP and non-3GPP accesses does not consider the UE as deregistered over non 3GPP access and will remain registered and subscribed to subscription data updates in UDM).

When the UE decides to deregister over non-3GPP access or the old AMF decides not to maintain a UE registration for non-3GPP access anymore, the old AMF then deregisters from UDM by sending a Nudm\_UECM\_Deregistration service operation, unsubscribes from Subscription Data updates by sending an Nudm\_SDM\_Unsubscribe service operation to UDM and releases all the AMF and AN resources related to the UE.

- 16 - 18. Steps 17-21 from clause 5.3.3.1 (Tracking Area Update procedure with Serving GW change) in TS 23.401 [13] with the following modification:

The MME may provide the eNodeB with a PLMN list in the Handover Restriction List taking into account the last used 5GS PLMN ID and the Return preferred indication. The Handover Restriction List contains a list of PLMN IDs as specified by TS 23.251 [35] clause 5.2a for eNodeB functions.

The MME may not release the signaling connection with the UE based on the indication received in the step 1 that the UE is moving from 5GC.

19. [conditional] Step 19 from clause 4.11.1.2.1 applies.

If some of the QoS Flow(s) for an EPS bearer were marked as deleted, the PGW-C+SMF may initiate bearer modification as specified in clause 5.4.3 of TS 23.401 [13] to remove the TFT filter(s) corresponding to the Packet Filter Set(s) in the QoS rules.



4.11.1.3.3 EPS to 5GS Mobility Registration Procedure (Idle and Connected State) using N26 interface

Figure 4.11.1.3.3-1 describes the mobility registration procedure from EPS to 5GS when N26 is supported for idle and connected states.

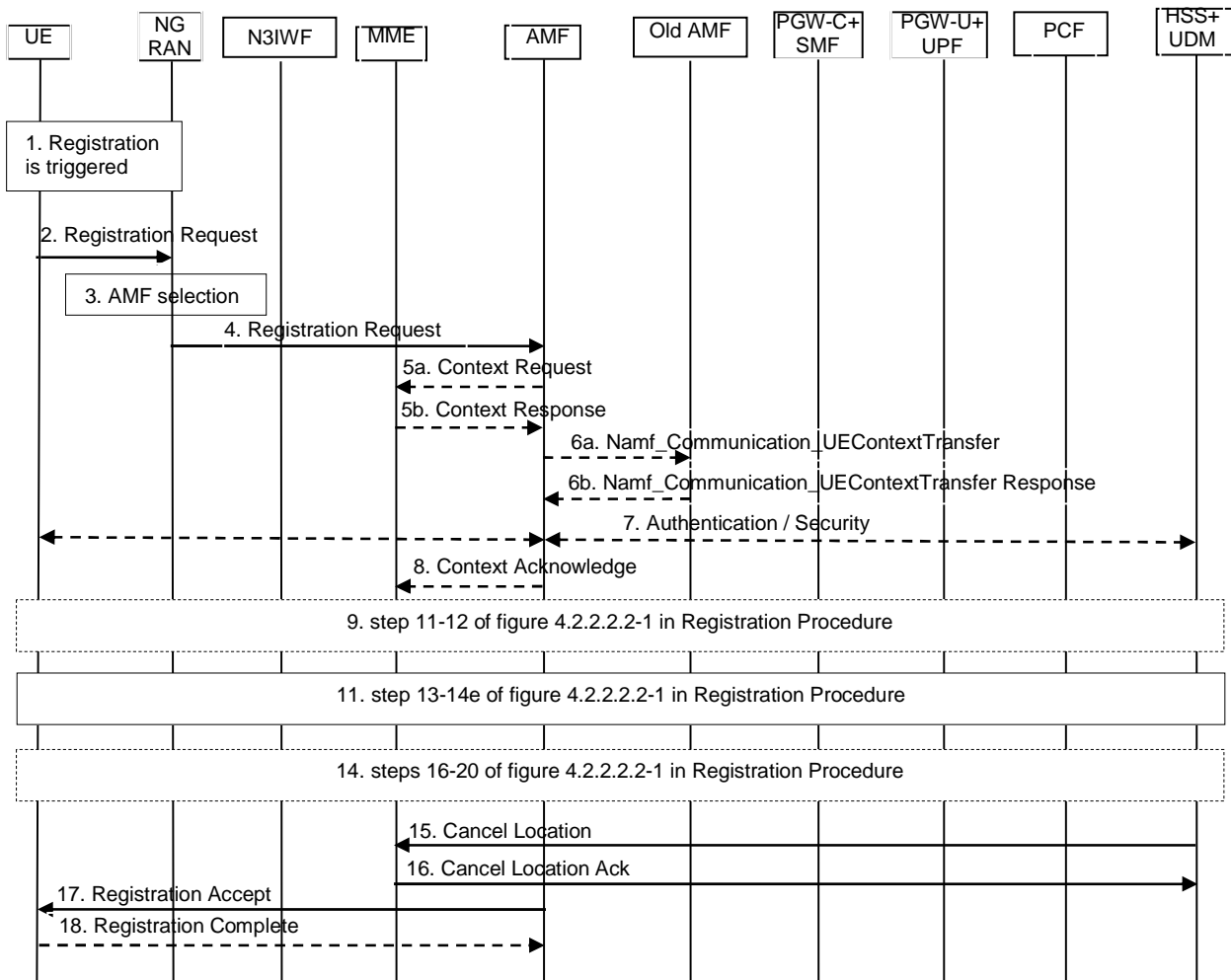

Figure 4.11.1.3.3-1: EPS to 5GS mobility for single-registration mode with N26 interface

1. The Registration procedure is triggered, e.g. the UE moves into NG-RAN coverage. Step 2 to 9 except step 5, 6 and 8 follow the Registration procedure in clause 4.2.2 with following enhancement.
2. The UE sends Registration Request with registration type set to "Mobility Registration Update" including 5G-GUTI mapped from EPS GUTI as the old GUTI, the native 5G-GUTI (if available) as additional GUTI and indicating that the UE is moving from EPC. The UE includes the UE Policy Container containing the list of PSIs, indication of UE support for ANDSP and OSId if available.

When the Registration Request is triggered due to UE mobility from EPS to 5GS, if the UE has locally deleted the EPS bearer which has allocated 5GS parameters and the EPS bearer status has not been synchronized with the network, the UE shall include the EPS bearer status in the Registration Request.

The Additional GUTI is provided both in Idle state and Connected state, if available. The Additional 5G-GUTI enables the AMF to retrieve the UE's MM context from the old AMF (if available). The UE includes the S-NSSAIs associated with the established PDN connections in the Requested NSSAI in RRC and NAS (as described in TS 23.501 [2] clause 5.15.7). In the case of Configured NSSAI applicable to this PLMN or an Allowed NSSAI are not present in the UE, the associated HPLMN S-NSSAI(s) shall be provided in the mapping of Requested NSSAI in the NAS as described in the clause 5.15.5.2.1 TS 23.501 [2].

In the case of idle mode mobility the UE additionally includes a TAU request message integrity protected using the EPS security context (for further security verification by the MME) in the Registration Request. If the UE

holds a native 5G-GUTI for this PLMN then the UE also includes the GUAMI part of the native 5G-GUTI in RRC to enable the NG-RAN to route the Registration Request to the same AMF (if available), and otherwise the UE provides in RRC signalling a GUAMI mapped from the EPS GUTI and indicates it as "Mapped from EPS".

The UE integrity protects the Registration Request message using a 5G security context (if available).

3-4. Steps 2-3 of clause 4.2.2.2 are performed.

In the case of idle mode mobility, the AMF derives S-NSSAIs values for the Serving PLMN based on the S-NSSAIs values for the HPLMN, received in NAS Registration Request, associated with the established PDN connections, the AMF may send the S-NSSAIs values for the HPLMN to NSSF and NSSF provides corresponding S-NSSAIs values for VPLMN to AMF.

NOTE 1: In connected mode mobility, the AMF derives S-NSSAIs values during the handover procedure.

Steps 5 and 8 are not performed when this procedure is part of EPS to 5GS handover.

5a. [Conditional] This step is only performed for IDLE mode mobility. The target AMF derives the MME address and 4G GUTI from the old 5G-GUTI and sends Context Request to MME including EPS GUTI mapped from 5G-GUTI and the TAU request message according to TS 23.401 [13]. The MME validates the TAU message.

5b. [Conditional] If step 5a is performed, step 5 from clause 5.3.3.1 (Tracking Area Update procedure with Serving GW change) in TS 23.401 [13] is performed with the modification captured in clause 4.11.1.5.3.

The AMF converts the received EPS MM Context into the 5GS MM Context. The received EPS UE context includes IMSI, ME Identity, UE EPS security context, UE Network Capability, and EPS Bearer context(s). The MME EPS Bearer context includes for each EPS PDN connection the IP address and FQDN for the S5/S8 interface of the PGW-C+SMF and APN.

The AMF queries the NRF in serving PLMN by issuing the Nnrf\_NFDiscovery\_Request including the FQDN for the S5/S8 interface of the PGW-C+SMF, and the NRF provides the IP address or FQDN of the N11/N16 interface of the PGW-C+SMF.

The Context Response may include new information Return Preferred. Return Preferred is an indication by the MME of a preferred return of the UE to the last used EPS PLMN at a later access change to an EPS shared network. Based on the Return Preferred indication, the AMF may store the last used EPS PLMN ID in UE Context.

If the AMF cannot retrieve the address of the corresponding SMF for a PDN connection, it will not move the PDN connection to 5GS.

Step 6 is performed only if the target AMF is different from the old AMF and the old AMF is in the same PLMN as the target AMF.

6a. [Conditional] If the UE includes the 5G-GUTI as Additional GUTI in the Registration Request message, the target AMF sends message to the old AMF. The old AMF validates the Registration request message.

The target AMF retrieves UE's SUPI and MM Context, event subscription information by each consumer NF and the list of SM PDU Session ID/associated SMF ID for the UE using one of the following three options:

- AMF may invoke the Namf\_Communication\_UEContextTransfer to the old AMF identified by the additional 5G-GUTI; or
- if the old AMF and the target AMF are in the same AMF Set and UDSF is deployed, AMF may invoke Nudsf\_UnstructuredDataManagement\_Query service operation for the UE identified by the additional 5G-GUTI from the UDSF; or
- if the old AMF and the target AMF are in the same AMF Set, AMF may use implementation specific means to share UE context.

6b. [Conditional] If step 6a is performed, the response is performed as described in step 5 in clause 4.2.2.2. If a native 5G security context for 3GPP access is available in the AMF (or has been retrieved in step 6a), the AMF may continue to use this security context. Otherwise, the AMF shall either derive a mapped security context from the EPS security context obtained from the MME or initiate an authentication procedure to the UE.

7. [Conditional] If the target AMF determines to initiate the authentication procedure to the UE in step 6b (e.g. the target AMF can not obtain the UE MM context from AMF or other reasons), steps 8-9 of clause 4.2.2.2.2 are optionally performed.
8. [Conditional] If step 5b is performed and the target AMF accepts to serve the UE, the target AMF sends Context Acknowledge (Serving GW change indication) to MME according to TS 23.401 [13].
9. Steps 11-12 of clause 4.2.2.2.2 are optionally performed.
10. Void.
11. Steps 13-14e of clause 4.2.2.2.2 are performed: This includes that if an MM context is retrieved from the old AMF in step 6 (i.e. corresponding to an existing UE registration for non-3GPP access in 5GC), then the target AMF indicates to the UDM that the target AMF identity to be registered in the UDM applies to both 3GPP and non-3GPP accesses by sending separate/independent Nudm\_UECM\_Registration service operations for "3GPP Access" and "non-3GPP Access".
12. Void.
13. Void.
14. Steps 16-20 of clause 4.2.2.2.2 are optionally performed (initiated by target AMF) with the following addition:

In the home-routed roaming case and connected state mobility, the AMF derives the corresponding S-NSSAI value for the Serving PLMN based on S-NSSAI value for the HPLMN received from PGW-C+SMF. If two values (i.e. the S-NSSAI value configured in AMF for interworking and S-NSSAI value for the Serving PLMN) are different, the AMF invokes Nsmf\_PDU\_Session\_UpdateSMContext(PDU Session ID, S-NSSAI value for the Serving PLMN). The V-SMF updates 5G-AN with the new S-NSSAI of VPLMN by sending a N2 SM message to 5G-AN via AMF.

In the home-routed roaming case and idle state mobility, the AMF selects a default V-SMF per PDU Session and invokes Nsmf\_PDU\_Session\_CreateSMContext service operation of the V-SMF to create an association with the AMF. It includes UE EPS PDN Connection, H-SMF ID, S-NSSAI and indicates all the PDU Session(s) to be re-activated as received in the Registration request message along with List Of PDU Sessions To Be Activated. The S-NSSAI is the S-NSSAI configured in AMF for interworking, which is associated with default V-SMF. The V-SMF creates the association and based on the received SMF ID, the V-SMF invokes Nsmf\_PDU\_Session\_Create request service operation of the H-SMF and provides the information received from the AMF. The subsequent handling is performed as follows:

- The H-SMF finds the corresponding PDU Session based on the PDN Connection Context in the request. The H-SMF initiates N4 Session modification procedure to establish the CN tunnel for the PDU Session, and for Idle state mobility registration, release the resource of the CN tunnels for EPS bearers corresponding to the PDU session as well. If the CN Tunnel info is allocated by the PGW-C+SMF, the tunnel info for PDU session is provided to PGW-U+UPF. If the CN Tunnel info is allocated by PGW-U+UPF, the tunnel info for PDU Session is provided to the PGW-C+SMF. The H-SMF responds V-SMF with the PDU Session ID corresponding to the PDN Connection Context in the request, the allocated EBI(s) information, the S-NSSAI of the PDU Session, S-NSSAI of HPLMN, and other PDU session parameters, such as PDU Session Type, Session AMBR in the Nsmf\_PDU\_Session\_Create response.
- The V-SMF updates its SM contexts and returns a Nsmf\_PDU\_Session\_CreateSMContextResponse message including the information received from the H-SMF. The V-SMF also includes the N2 SM Context in the response message sent to the AMF if the corresponding PDU Session is in the received List Of PDU Sessions To Be Activated. The V-SMF stores an association of the PDU Session ID and the H-SMF ID. The AMF stores the V-SMF ID and it also stores S-NSSAI and the allocated EBI(s) associated to the PDU Session ID. The AMF derives the S-NSSAI value for the Serving PLMN based on S-NSSAI value for the HPLMN, and sends the S-NSSAI value for the Serving PLMN to V-SMF by invoking Nsmf\_PDU\_Session\_UpdateSMContext service operation. The V-SMF updates NG RAN with the S-NSSAI value for the Serving PLMN via N2 SM message.

In non-roaming and LBO cases, AMF invokes Nsmf\_PDU\_Session\_CreateSMContext Request (UE EPS PDN Connection) service operation of the PGW-C+SMF and indicates all the PDU Session(s) to be re-activated as received in the Registration request message along with List Of PDU Sessions To Be Activated. This step is performed for each PDN Connection and the corresponding PGW-C+SMF address/ID in the UE context the AMF received in Step 6.

If the P-GW-C+SMF (H-SMF in case of home-routed roaming case) determines that seamless session continuity from EPS to 5GS is not supported for the PDU Session, then it does not provide SM information for the corresponding PDU Session but includes the appropriate cause code for rejecting the PDU Session transfer within the N2 SM Information. The PGW-C+SMF finds the corresponding PDU Session based on the PDN Connection Context in the request. The PGW-C+SMF initiates N4 Session modification procedure to establish the CN tunnel for the PDU Session, and for Idle state mobility registration, releases the resource of the CN tunnels for EPS bearers corresponding to the PDU session as well. If the PGW-C+SMF has not yet registered for this PDU Session ID, the PGW-C+SMF registers with the UDM using Nudm\_UECM\_Registration (SUPI, DNN, PDU Session ID) for a given PDU Session as in step 4 of PDU Session Establishment Procedure in clause 4.3.2. If the CN Tunnel info is allocated by the PGW-C+SMF, the tunnel info for PDU session is provided to PGW-U+UPF. If the CN Tunnel info is allocated by PGW-U+UPF, the tunnel info for PDU Session is provided to the PGW-C+SMF. The PGW-C+SMF updates its SM contexts and returns the AMF a Nsmf\_PDUSession\_CreateSMContext Response message including the PDU Session ID corresponding to the PDN Connection Context in the request, the allocated EBI(s) information, the S-NSSAI of the PDU Session, and the N2 SM Context if the corresponding PDU Session is in the received List Of PDU Sessions To Be Activated. The AMF stores an association of the PDU Session ID and the SMF ID, S-NSSAI, and the allocated EBI(s) associated to the PDU Session ID. Based on the allocated EBI(s) information received from all the related PGW-C+SMF for this UE, an EPS bearer status, which reflects all existing EPS bearer, is generated by the AMF.

NOTE 2: For Connected State mobility registration, the release of CN tunnels for EPS bearers and UDM registration for the session corresponding to the PDU session is performed in the handover execution phase.

If the PDN Type of a PDN Connection in EPS is non-IP, and it was originally established as Ethernet PDU Session when UE was camping in 5GS (known based on local context information that was set to PDU Session Type Ethernet in UE and SMF), the PDU Session Type in 5GS shall be set to Ethernet by the SMF and UE. In case the PDN type of a PDN Connection in EPS is non-IP, and is locally associated in UE and SMF to PDU Session Type Unstructured, the PDU Session Type in 5GS shall be set to Unstructured by the SMF and UE.

If the AMF has received the EPS Bearer Status in the Registration Request from UE, the AMF shall send the EPS Bearer Status to all corresponding PGW-C+SMFs. If the PGW-C+SMF receives the EPS Bearer Status from AMF, the PGW-C+SMF shall check whether the EPS bearer(s) has been deleted by UE but not notified to network. If yes, the PGW-C+SMF shall release those EPS bearer(s), the corresponding 5G QoS Rule(s) and the QoS Flow level QoS parameters locally.

15 - 16. HSS+UDM cancels the location of the UE in the MME as defined in steps 13 - 14 from clause 5.3.3.1 (Tracking Area Update procedure with Serving GW change) in TS 23.401 [13]. Subsequently, the steps 18 - 19 from clause 5.3.3.1 (Tracking Area Update procedure with Serving GW change) in TS 23.401 [13] are also executed with the following modification:

According to configuration, for the PDN connections which are anchored in a standalone PGW, the MME initiates PDN connection release procedure as specified in TS 23.401 [13].

17-18. These steps follow the steps 21 and 22 of Registration procedure in clause 4.2.2.2.2.

The Registration Accept message shall include the updated 5G-GUTI to be used by the UE in that PLMN over any access. If the active flag was included in the Registration request, The AMF may provide NG-RAN with a Mobility Restriction List taking into account the last used EPS PLMN ID and the Return preferred indication. The Mobility Restriction List contains a list of PLMN IDs as specified by TS 23.501 [2]. The Allowed NSSAI in the Registration Accept message shall contain at least the S-NSSAIs corresponding to the active PDN Connection(s) and the corresponding mapping to the HPLMN S-NSSAIs.

The AMF shall include the EPS bearer status, which is generated at step 14, in the Registration Accept message. Based on the received EPS bearer status information, the UE shall check whether there are QoS Flow(s) existing locally but no associated EPS bearer(s) in the received EPS bearer status. The UE shall locally delete the 5G QoS Rule(s) and QoS Flow level QoS parameters of the QoS Flow(s) if the associated EPS bearer(s) do not exist in the received EPS bearer status.

#### 4.11.1.4 Procedures for EPS bearer ID allocation

##### 4.11.1.4.1 EPS bearer ID allocation

Following procedures are updated to allocate EPS bearer ID(s) towards EPS bearer(s) mapped from QoS flow(s) and provide the EPS bearer ID(s) to the NG-RAN:

- UE requested PDU Session Establishment (Non-roaming and Roaming with Local Breakout (clause 4.3.2.2.1) including Request Types "Initial Request" and "Existing PDU Session").
- UE requested PDU Session Establishment (Home-routed Roaming (clause 4.3.2.2.2) including Request Types "Initial Request" and "Existing PDU Session").
- UE or network requested PDU Session Modification (non-roaming and roaming with local breakout) (clause 4.3.3.2).
- UE or network requested PDU Session Modification (home-routed roaming) (clause 4.3.3.3).
- UE Triggered Service Request (clause 4.2.3.2) to move PDU Session(s) from untrusted non-3GPP access to 3GPP access

EBI allocation shall apply to PDU Session via 3GPP access supporting EPS interworking with N26. EBI allocation shall not apply to PDU Session via 3GPP access supporting EPS interworking without N26 and shall not apply to PDU Session via non-3GPP access supporting EPS interworking.

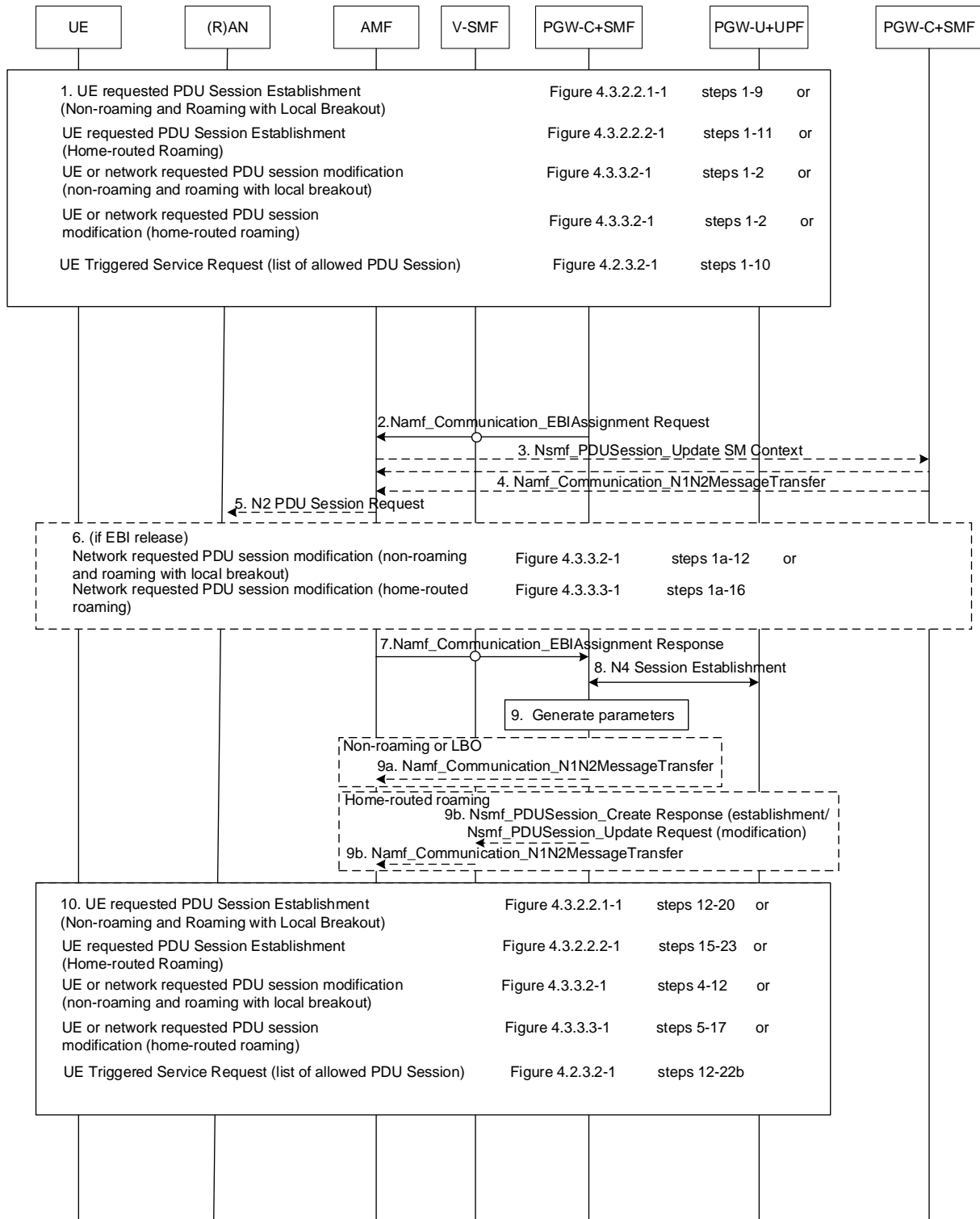

**Figure 4.11.1.4.1-1: Procedures for EPS bearer ID allocation**

1. Procedure as listed in this step is initiated as specified in the relevant clauses of this specification. The relevant steps of the procedure as specified in the figure above are executed.
2. If the PGW-C+SMF (or H-SMF in case of home routed case), determines, based on the indication of EPS interworking support with N26 as defined in clauses 4.11.5.2, 4.11.5.3 and 4.11.5.4, and operator policies e.g. User Plane Security Enforcement information, Access Type, that EPS bearer ID(s) needs to be assigned to the QoS flow(s) in the PDU Session, PGW-C+SMF invokes Namf\_Communication\_EBIAssignment Request (PDU Session ID, ARP list) (via V-SMF Nsmf\_PDUSession\_Update in case of home routed case). When V-SMF receives Nsmf\_PDUSession\_Update request from H-SMF for EPS bearer ID allocation request, V-SMF needs to

invoke `Namf_Communication_EBIAssignment Request` (PDU Session ID, ARP list). If the PGW-C+SMF (or H-SMF in case of home-routed roaming) serves multiple PDU sessions for the same DNN but different S-NSSAIs for a UE, then the SMF shall only request EBIs for PDU sessions served by a common UPF (PSA). In case different UPF (PSA) are serving those PDU sessions, then the SMF chooses one of the UPF (PSA) for this determination based on operator policy. When the PDU session is established via non-3GPP access, the PGW-C+SMF shall not trigger EBI allocation procedure.

Steps 3 to 6 apply only when AMF needs to revoke EBI previously allocated for an UE in order to serve a new SMF request of EBI for the same UE.

3. [Conditional] If the AMF has no available EBIs, the AMF may revoke an EBI that was assigned to QoS flow(s) based on the ARP(s) and S-NSSAI stored during PDU Session establishment, EBIs information in the UE context and local policies. If an assigned EBI is to be revoked, the AMF invokes `Nsmf_PDUSession_UpdateSMContext` (EBI(s) to be revoked) to request the related SMF (called "SMF serving the released resources") to release the mapped EPS QoS parameters corresponding to the EBI to be revoked. The AMF stores the association of the assigned EBI, ARP pair to the corresponding PDU Session ID and SMF address.
4. The "SMF serving the released resources" that receives the request in step 3 shall invoke `Namf_Communication_N1N2Message Transfer` (N2 SM information (PDU Session ID, EBI(s) to be revoked), N1 SM container (PDU Session Modification Command (PDU Session ID, EBI(s) to be revoked))) to inform the (R)AN and the UE to remove the mapped EPS QoS parameters corresponding to the EBI(s) to be revoked. In home routed roaming scenario, the H-SMF includes EBI(s) to be revoked to V-SMF to inform V-SMF to remove the mapped EPS bearer context corresponding to the EBI(s) to be revoked.

NOTE 1: The SMF can also decide to remove the QoS flow if it is not acceptable to continue the service when no corresponding EPS QoS parameters can be assigned.

For home routed roaming scenario, the "SMF serving the released resources" sends an N4 Session Modification Request to request the PGW-U+UPF to release N4 Session corresponding to the revoked EBI(s).

In home routed roaming case, the V-SMF starts a VPLMN initiated QoS modification for the PDU Session and the `Namf_Communication_N1N2Message Transfer` is invoked by the V-SMF based on the corresponding QoS modification message received from H-SMF.

5. If the UE is in CM-CONNECTED state, the AMF sends N2 PDU Session Request (N2 SM information received from SMF, NAS message (PDU Session ID, N1 SM container (PDU Session Modification Command))) Message to the (R)AN.

If the UE is in CM-IDLE state and an ATC is activated, the AMF updates and stores the UE context based on the `Namf_Communication_N1N2MessageTransfer` and step 5-6 are skipped. When the UE is reachable, e.g. when the UE enters CM-CONNECTED state, the AMF forwards the N1 message to synchronize the UE context with the UE.

6. The rest steps of the procedure are executed as specified in the figure above.
7. If the AMF successfully assigns EBI(s), it responds with the assigned EBI(s). Otherwise, it responds with a cause indicating EBI assignment failure.

If a PDU Session from another SMF already exists towards the same DNN, the AMF either rejects the EBI assignment request, or revokes the EBI(s) from the existing PDU Session(s) to the same DNN but different SMFs if the AMF makes the decision based on the operator policy, that the existing PDU Session cannot support EPS interworking N26.

The AMF stores the DNN and PGW-C+SMF in which the PDU Session(s) support EPS interworking to UDM in clause 4.11.1.6.

NOTE 2: The above applies only when the S-NSSAI(s) for the PDU Sessions are different, otherwise the same SMF is selected for PDU Sessions to the same DNN.

8. The PGW-C+SMF sends an N4 Session Establishment/Modification Request to the PGW-U+UPF.

For home routed roaming scenario, if the EBI is assigned successfully, the PGW-C+SMF prepares the CN Tunnel Info for each EPS bearer. If the CN Tunnel info is allocated by the PGW-C+SMF, the PGW-U tunnel info for the EPS bearer may be provided to PGW-U+UPF. If the CN Tunnel info is allocated by PGW-U+UPF,

the PGW-U+UPF sends the PGW-U tunnel info for the EPS bearer to the PGW-C+SMF. The PGW-U+UPF is ready to receive uplink packets from E-UTRAN.

NOTE 3: In the home routed roaming scenario the PGW-C+SMF prepares the CN Tunnel Info for each EPS bearer and provide it to V-SMF. Thus when the UE move to EPC network, the V-SMF does not need interact with the PGW-C+SMF to get the EPS bearer context(s).

NOTE 4: If the CN Tunnel info is allocated by the PGW-C+SMF and not provided to PGW-U+UPF at PDU Session establishment, when the UE moves to the target RAT the PGW-U+UPF cannot receive UL data until the PGW-C+SMF has provided the Tunnel Info to the PGW-U+UPF in N4 Session Modification. This causes a short interruption to the UL data during the intersystem handover execution.

9. If the PGW-C+SMF receives any EBI(s) from the AMF, it adds the received EBI(s) into the mapped EPS bearer context(s).

In home routed roaming scenario, the PGW-C+SMF generates EPS bearer context which includes per EPS bearer PGW-U tunnel information. In addition, if the default EPS bearer is generated for the corresponding PDN Connection of PDU Session (i.e. during the PDU Session establishment procedure), the PGW-C+SMF generates the PGW-C tunnel information of the PDN connection and include it in UE EPS PDN connection.

9a. [Conditional] In non-roaming or LBO scenario, the PGW-C+SMF includes the mapped EPS bearer context(s) and the corresponding QoS Flow(s) to be sent to the UE in the N1 SM container. PGW-C+SMF also indicates the mapping between the QoS Flow(s) and mapped EPS bearer context(s) in the N1 SM container. PGW-C+SMF also includes the mapping between the received EBI(s) and QFI(s) into the N2 SM information to be sent to the NG-RAN. The PGW-C+SMF sends the N1 SM container and N2 SM information to AMF via `Namf_Communication_N1N2MessageTransfer`.

9b [Conditional] In home routed roaming scenario, the PGW-C+SMF sends mapped EPS bearer context(s), the mapping between the received EBI(s) and QFI(s), and EPS bearer context to V-SMF via `Nsmf_PDUSession_Create Response` in case of PDU Session Establishment, or via `Nsmf_PDUSession_Update Request` in case of PDU Session Modification. The V-SMF stores the EPS bearer context, and generates N1 SM container and N2 SM information, and forwards them to AMF via `Namf_Communication_N1N2MessageTransfer`.

10. The N1 SM container and N2 SM information are sent to the UE and NG-RAN respectively. The relevant steps of the procedure as specified in the figure above are executed. In the case of UE triggered service request procedure that results in a session transfer from N3GPP to 3GPP, the SMF initiates network requested PDU session modification procedure to send the mapped EPS Bearer Context(s) to the UE and send the mapping of QoS Flow and EBI to the NG-RAN.

#### 4.11.1.4.2 EPS bearer ID transfer

Following procedures are updated to transfer EPS bearer ID(s) allocation information to target AMF.

- step 9 in figure 4.11.1.3.3-1 in EPS to 5GS Idle mode mobility with N26 (clause 4.11.1.3.2).
- step 11/12 in figure 4.11.1.2.2.2-1 in EPS to 5GS handover using N26 interface prepare phase (clause 4.11.1.2.2.2).

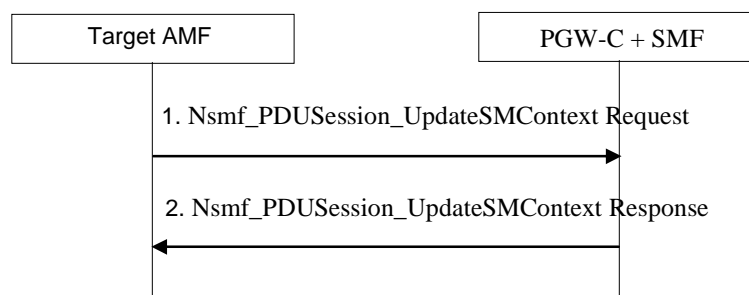

**Figure 4.11.1.4.2-1: Procedures for EPS bearer IDs transfer**

1. The AMF sends an `Nsmf_PDUSession_UpdateSMContext Request` message to the SMF in above case;



2. The PGW-C+SMF to AMF: Nsmf\_PDUSession\_UpdateSMContext Response with the allocated EBI information.

#### 4.11.1.4.3 EPS bearer ID revocation

Following procedures are updated to revoke the EPS bearer ID(s) assigned to the QoS flow(s):

- UE or network requested PDU Session Release for Non-roaming and Roaming with Local Breakout (clause 4.3.4.2).
- UE or network requested PDU Session Release for Home-routed Roaming (clause 4.3.4.3).
- UE or network requested PDU Session Modification (non-roaming and roaming with local breakout) (clause 4.3.3.2).
- UE or network requested PDU Session Modification (home-routed roaming) (clause 4.3.3.3).
- Handover of a PDU Session procedure from 3GPP to untrusted non-3GPP access (non-roaming and roaming with local breakout) (clause 4.9.2.2)
- Handover of a PDU Session procedure from 3GPP to untrusted non-3GPP access (home routed roaming) (clause 4.9.2.4)

When the PDU Session is released as described in clauses 4.3.4.2 or 4.3.4.3, 4.9.2.2, or 4.9.2.4, and the SMF invokes Nsmf\_PDUSession\_StatusNotify to notify AMF that the SM context for this PDU Session is released, the AMF releases the association between the SMF ID and the PDU Session ID, and releases the EBIs assigned for this PDU Session. When all the PDU sessions which are allocated with EBIs are released in the same SMF, the AMF may revoke DNN and PGW-C+SMF FQDN for S5/S8 interface in the UDM using Nudm\_UECM\_Update service operation.

NOTE 1: If the PGW-C+SMF in which the PDU sessions support EPS interworking is changed for the same DNN, the AMF can update the DNN and new PGW-C+SMF FQDN for S5/S8 interface in the UDM using Nudm\_UECM\_Update service operation.

When the UE initiates a PDU Session Modification as described in clauses 4.3.3.2 or 4.3.3.3, and the SMF needs to release the assigned EBI from a QoS flow (e.g. when the QoS flow is released), the SMF can indicate the Released EBI list in the Nsmf\_PDUSession\_UpdateSMContext Response to the AMF. The AMF releases the corresponding EBI allocation for this PDU Session.

When the AMF decides to revoke some EBI(s), e.g. when the AMF receives a new EBI allocation request but there is no EBI available, the AMF may decide to revoke EBI(s) for another PDU Session, the AMF initiates a PDU Session Modification as described in clauses 4.3.3.2 or 4.3.3.3 and includes EBI list to be revoked in the Nsmf\_PDUSession\_UpdateSMContext Request. The SMF releases the indicated EBI(s) for the PDU Session.

When the AMF initiates a PDU Session Modification as described in clauses 4.3.3.2 or 4.3.3.3 to change the status of EPS interworking with N26 to "not supported", the AMF releases the EBIs assigned for this PDU Session and SMF release the assigned EBIs from the QoS Flows belonging to this PDU Session.

When the SMF initiates a PDU Session Modification as described in clauses 4.3.3.2 or 4.3.3.3, and the SMF needs to release the assigned EBI from a QoS flow (e.g. when the QoS flow is released), the SMF invokes Namf\_Communication\_EBIAssignment and indicates the Released EBI list to the AMF. The AMF releases the corresponding EBI allocation for this PDU Session.

When the handover of a PDU Session procedure from 3GPP to untrusted non-3GPP access is performed in clause 4.9.2.2 or clause 4.9.2.4.1, the AMF, the SMF and the UE releases locally the EBI(s) allocated for this PDU Session.

When the handover of a PDU Session procedure from 3GPP to untrusted non-3GPP access is performed in clause 4.9.2.4.2, the H-SMF invokes Nsmf\_PDUSession\_StatusNotify to notify V-AMF to release the association between the SMF ID and the PDU Session ID, and, as a result, the EBI(s) assigned for this PDU Session are released. The UE releases locally the EBI(s) allocated for this PDU Session.

## 4.11.1.5 Impacts to EPS Procedures

### 4.11.1.5.1 General

This clause captures changes to procedures in TS 23.401 [13] due to interworking with 5GS based on N26. The handover procedures between EPS and 5GS captured in clause 4.11.1.2 capture impacts to TS 23.401 [13] clause 5.5.1.2.2 (S1-based handover, normal).

### 4.11.1.5.2 E-UTRAN Initial Attach

The E-UTRAN Initial Attach Procedure specified in TS 23.401 [13] clause 5.3.2.1 is impacted as shown in Figure 4.11.1.5.2-1 when interworking with 5GS using N26 interface is supported.

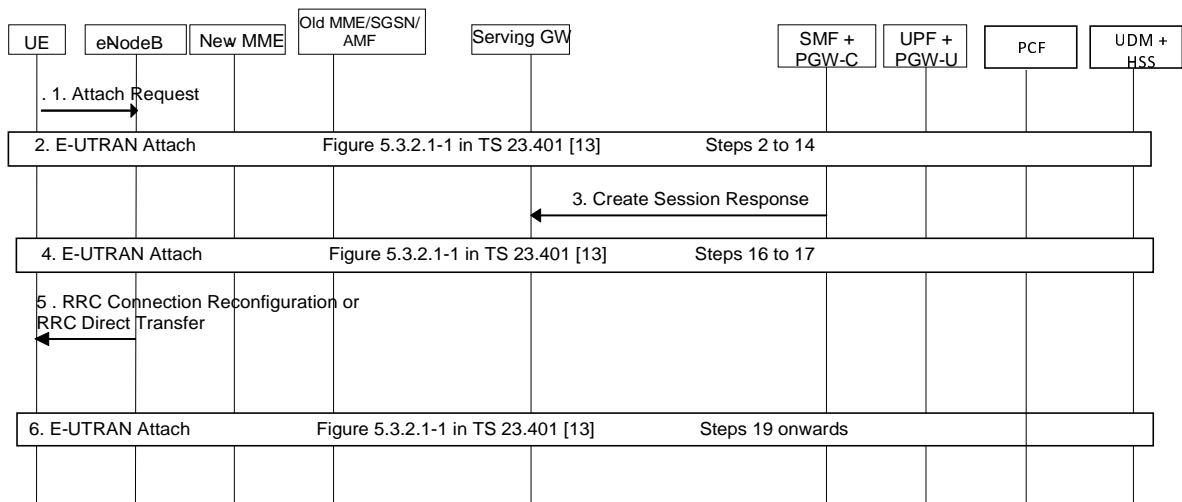

**Figure 4.11.1.5.2-1: Impacts to E-UTRAN Initial Attach procedure**

1. The UE sends an Attach Request message as specified in TS 23.401 [13] with the following modifications:
  - If the UE was previously registered in 5GS, the UE provides in Access Stratum signalling a GUMMEI mapped from the 5G-GUTI and indicates it as a native GUMMEI and should in addition indicate it as "Mapped from 5G-GUTI".
  - If the UE was previously registered in 5GS, the UE provides, in the Attach Request message, an EPS GUTI mapped from 5G-GUTI sent as old Native GUTI and indicates that it is moving from 5GC. The UE integrity protects the Attach Request message using the 5G security context.
  - A UE that supports 5GC NAS procedures shall indicate its support of 5G NAS as part of its UE Core Network Capability IE.
  - If the UE includes ESM message container for PDN Connection Establishment and the Request type is "initial request", the UE shall allocate a PDU Session ID and include it in the PCO. The PDU Session ID shall be unique across all other PDN connections of the UE.
2. The relevant steps of the procedure as specified in the figure above are executed with the following modification:
  - The HSS/UDM on receiving Update Location Request from MME, de-register any old AMF by sending an Nudm\_UECM\_DeregistrationNotification service operation to the registered AMF for 3GPP access.
  - Step 7 and step 10 as specified in TS 23.401 [13] clause 5.3.2.1 (i.e. IP-CAN Session Termination) is replaced by SM Policy Association Termination procedure as specified in clause 4.16.6.
  - Step 14 as specified in TS 23.401 [13] clause 5.3.2.1 (i.e. IP-CAN Session Establishment/Modification) are replaced by SM Policy Association Establishment/Modification procedure as specified in clause 4.16.4 and clause 4.16.5.
3. Step 15 as specified in TS 23.401 [13] clause 5.3.2.1 with the following modification:

- The PGW-C+SMF allocates 5G QoS parameters corresponding to PDN connection, e.g. Session AMBR, QoS rules and QoS Flow level QoS parameters if needed for the QoS Flow associated with the QoS rule(s), and then includes them in PCO.
4. The relevant steps of the procedure as specified in the figure above are executed.
  5. Step 18 as specified in TS 23.401 [13] clause 5.3.2.1 with the following modification:
    - The 5G QoS parameters for the PDU session and for the QoS Flow associated with the default QoS rule are stored in the UE.
  6. The relevant steps of the procedure as specified in the figure above are executed.

#### 4.11.1.5.3 Tracking Area Update

The following changes are applied to clause 5.3.3.1 (Tracking area update procedure with Serving GW change) in TS 23.401 [13]:

- Step 2: The UE shall in Access Stratum signalling include GUMMEI that is mapped from 5G-GUTI following the mapping rules specified in TS 23.501 [2] and the UE indicates it as a native GUMMEI and should in addition indicate it as "Mapped from 5G-GUTI". The UE shall, in the TAU request message, include EPS GUTI that is mapped from 5G-GUTI following the mapping rules specified in TS 23.501 [2]. The UE indicates that it is moving from 5GC. The UE integrity protects the TAU request message using the 5G security context.
- Step 5 and message Context Response may include new information Return preferred.

Return preferred is an indication by the AMF of a preferred return of the UE to the last used 5GS PLMN at a later access change to a 5GS shared network.

The MME may store the last used 5GS PLMN ID in UE's MM Context.

The MME may provide E-UTRAN with a Handover Restriction List taking into account the last used 5GS PLMN ID and the Return Preferred indication. The Handover Restriction List contains a list of PLMN IDs as specified by TS 23.251 [35].

- Step 9a IP-CAN Session Modification procedure:

It is replaced by SM Policy Association Modification as specified in clause 4.16.5.

- Step 13 and HSS use of Cancel Location

The HSS/UDM de-registers any old AMF node by sending an Nudm\_UECM\_DeregistrationNotification service operation to the registered AMF for 3GPP access. The registered AMF for 3GPP access initiates AM Policy Association Termination procedure as defined in clause 4.16.3.2 and UE Policy Association Termination procedure as defined in clause 4.16.13.1.

- Step 17: If the DNN and PGW-C+SMF FQDN for S5/S8 interface association exist, the HSS/UDM sends APN mapped form DNN and PGW-C+SMF FQDN for S5/S8 to UE.
- Step 20 and MME processing of the partial Tracking Area Update (TAU) procedure.

The MME may use an indication Return preferred from Context Response at step 6 when deciding the PLMN list content.

The MME may provide the eNodeB with a PLMN list. The Handover Restriction List contains a list of PLMN IDs as specified by TS 23.501 [2].

#### 4.11.1.5.4 Session Management

##### 4.11.1.5.4.1 PDN Connection Request

The UE Requested PDN Connectivity Procedure specified in TS 23.401 [13] clause 5.10.2 is impacted as shown in in Figure 4.11.1.5.4.1-1 when interworking with 5GS is supported.

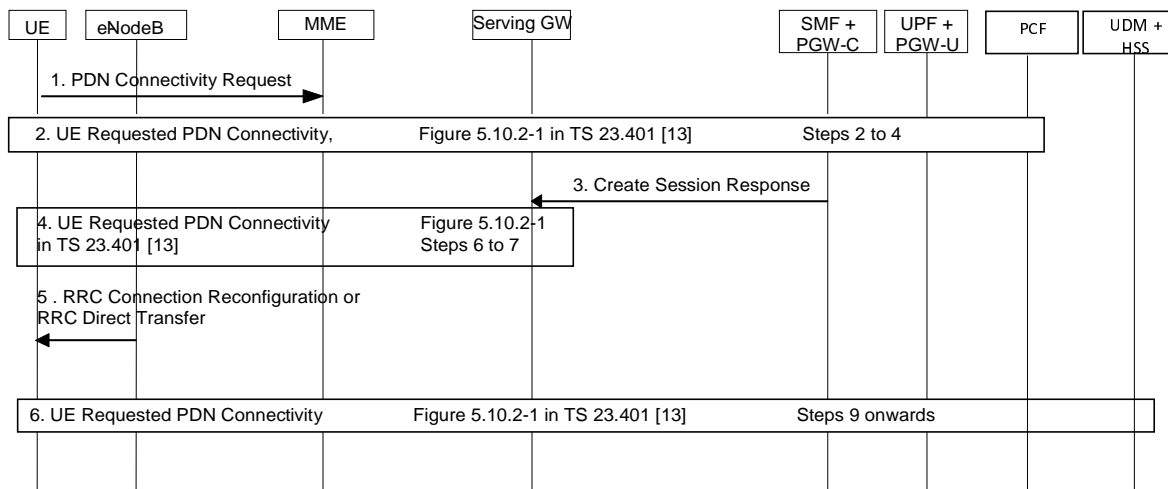

**Figure 4.11.1.5.4.1-1: Impacts to UE Requested PDN Connectivity Procedure**

1. UE sends a PDN connectivity Request to the MME as specified in Step 1 in TS 23.401 [13] clause 5.10.2 with the following modification:
  - If the UE is 5G NAS capable and the Request type is "initial request", the UE shall allocate a PDU Session ID and include it in the PCO. The PDU Session ID shall be unique across all other PDN connections of the UE.
2. The relevant steps of the procedure as specified in the figure above are executed. In step 4 of TS 23.401 [13], IP Session Establishment/Modification procedure is replaced by SM Policy Association Establishment/Modification procedure as specified in clauses 4.16.4 and 4.16.5.
3. Step 6 as specified in TS 23.401 [13] clause 5.10.2 is executed with the following modification:
  - If the PGW-C+SMF accepts to provide interworking of the PDN connection with 5GC, the PGW-C+SMF shall allocate 5G QoS parameters corresponding to PDN connection, e.g. Session AMBR, QoS rules and QoS Flow level QoS parameters if needed for the QoS Flow(s) associated with the QoS rule(s) and then include them in PCO.
  - If the PGW-C+SMF accepts to provide interworking of the PDN connection with 5GC, the PGW-C+SMF shall determine the S-NSSAI associated with the PDN connection based on the operator policy, and send the S-NSSAI together with the PLMN ID to the UE in the PCO.
4. The relevant steps of the procedure as specified in the figure above are executed.
5. Step 8 as specified in TS 23.401 [13] clause 5.10.2 with the following modification:
  - If 5G QoS parameters are included in the PCO, the UE shall store them. If 5G QoS parameters are not included in the PCO, the UE shall note that session continuity for this PDN connection on mobility to 5G is not provided by the network.
  - If the S-NSSAI and the PLMN ID associated with the PDN connection are included in the PCO, the UE shall store them.
6. The relevant steps of the procedure as specified in the figure above are executed.

#### 4.11.1.5.4.2 UE or MME Requested PDN Disconnection

The procedure as specified in TS 23.401 [13] clause 5.10.3 applies with the following modification:

- Step 8.(RRC Connection Reconfiguration): On receiving the NAS Deactivate EPS Bearer Context Request(LBI) message, if the UE has mapped 5G parameters for the PDU session, the UE deletes the corresponding mapped 5GS PDU session.

In addition if the PGW-C+SMF has registered to HSS+UDM for this PDN connection before, the PGW-C+SMF invokes the Nudm\_UECM\_Deregistration service operation to notify the UDM to remove the association between the

PGW-C+SMF identity and the associated DNN and PDU Session Id as described in the step 12 of clause 4.3.4.2. If there is no PDN connection for the associated (DNN, S-NSSAI) handled by the PGW-C+SMF, the PGW-C+SMF unsubscribes from Session Management Subscription data changes notification with the HSS+UDM by means of the Nudm\_SDM\_Unsubscribe (SUPI, DNN, S-NSSAI) service operation as described in step 12 of clause 4.3.4.2.

#### 4.11.1.5.4.3 Dedicated Bearer Activation, Bearer Modification and Bearer Deactivation

The procedures specified in TS 23.401 [13] clause 5.4.1 through 5.4.5 apply with the following modifications:

- PCRF initiated IP-CAN Modification in TS 23.401 [13] is replaced with PCF initiated SM Policy Association Modification as specified in clause 4.16.5.2. PCEF initiated IP-CAN Session Modification/Termination TS 23.401 [13] is replaced with SM Policy Association Modification/Termination as specified in clauses 4.16.5 and 4.16.6.
- In the step where the PDN-GW sends a Create Bearer Request, i.e.
  - Step 2 in TS 23.401 [13] clause 5.4.1 (Dedicated Bearer Activation)  
the PCO includes mapped 5GS QoS parameters for the EPS bearer being created.
- In the step where the PDN-GW sends an Update Bearer Request, i.e.,
  - Step 2 in TS 23.401 [13] clause 5.4.2.1 (PDN GW initiated bearer modification with bearer QoS update)
  - Step 5 in TS 23.401 [13] clause 5.4.2.2 (HSS Initiated Subscribed QoS Modification)
  - Step 2 in TS 23.401 [13] clause 5.4.3 (PDN GW initiated bearer modification without bearer QoS update) if TFT or APN-AMBR is being modified  
the PCO includes the modification to the mapped 5GS QoS parameters, if impacted by the modification, corresponding to the EPS bearer being modified.
- In the step where the UE receives the NAS Session Management message from the MME which contains the PCO relayed via the MME, i.e:
  - Step 5 in TS 23.401 [13] clause 5.4.1 (Dedicated Bearer Activation)
  - Step 5 in TS 23.401 [13] clause 5.4.2.1 (PDN GW initiated bearer modification with bearer QoS update)
  - Step 5 in TS 23.401 [13] clause 5.4.3 (PDN GW initiated bearer modification without bearer QoS update) if TFT or APN-AMBR is being modified  
the UE updates the mapped 5G QoS parameters as included in the PCO from the PDN-GW.
- In the step where the UE receives EPS bearer request message, i.e
  - Step 5 in TS 23.401 [13] clause 5.4.4.1 (PDN GW initiated bearer deactivation)  
the UE also deletes the mapped 5GS QoS flow and its associated parameter.

#### 4.11.1.5.5 5GS to EPS handover using N26 interface

In step 3 of clause 4.11.1.2.1, the Forward Relocation Request may include new information Return Preferred.

Return Preferred is an indication by the AMF of a preferred return of the UE to the last used 5GS PLMN at a later access change to a 5GS shared network.

The MME may store the last used 5GS PLMN ID in UE's MM Context.

The MME may provide E-UTRAN with a Handover Restriction List taking into account the last used 5GS PLMN ID and the Return Preferred indication. The Handover Restriction List contains a list of PLMN IDs as specified by TS 23.251 [35].

#### 4.11.1.6 EPS interworking information storing Procedure

Depending on the operator's configuration, the AMF serving the 3GPP access store DNN and PGW-C+SMF FQDN for S5/S8 interface in the UDM using Nudm\_UECM\_Update service operation when N26 is deployed.

### 4.11.2 Interworking procedures without N26 interface

#### 4.11.2.1 General

Clause 4.11.2 defines the procedures to support interworking between 5GS and EPS without any N26 interface between AMF and MME.

During interworking from EPS to 5GS, as the PGW-C+SMF may have different IP addresses when being accessed over S5/S8 and N11/N16 respectively, the AMF shall discover the SMF instance by an NF/NF service discovery procedure using the FQDN for the S5/S8 interface received from the UDM as a query parameter.

This is required for both non-roaming and roaming with local breakout, as well as for home routed roaming.

**NOTE:** As the AMF is not aware of the S-NSSAI assigned for the PDN Connection, the NF/NF service discovery used to find the SMF instance can use PLMN level NRF.

#### 4.11.2.2 5GS to EPS Mobility

The following procedure is used by UEs in single-registration or dual registration mode on mobility from 5GS to EPS.

In the case of network sharing the UE selects the target PLMN ID according to clause 5.18.3 of TS 23.501 [2].

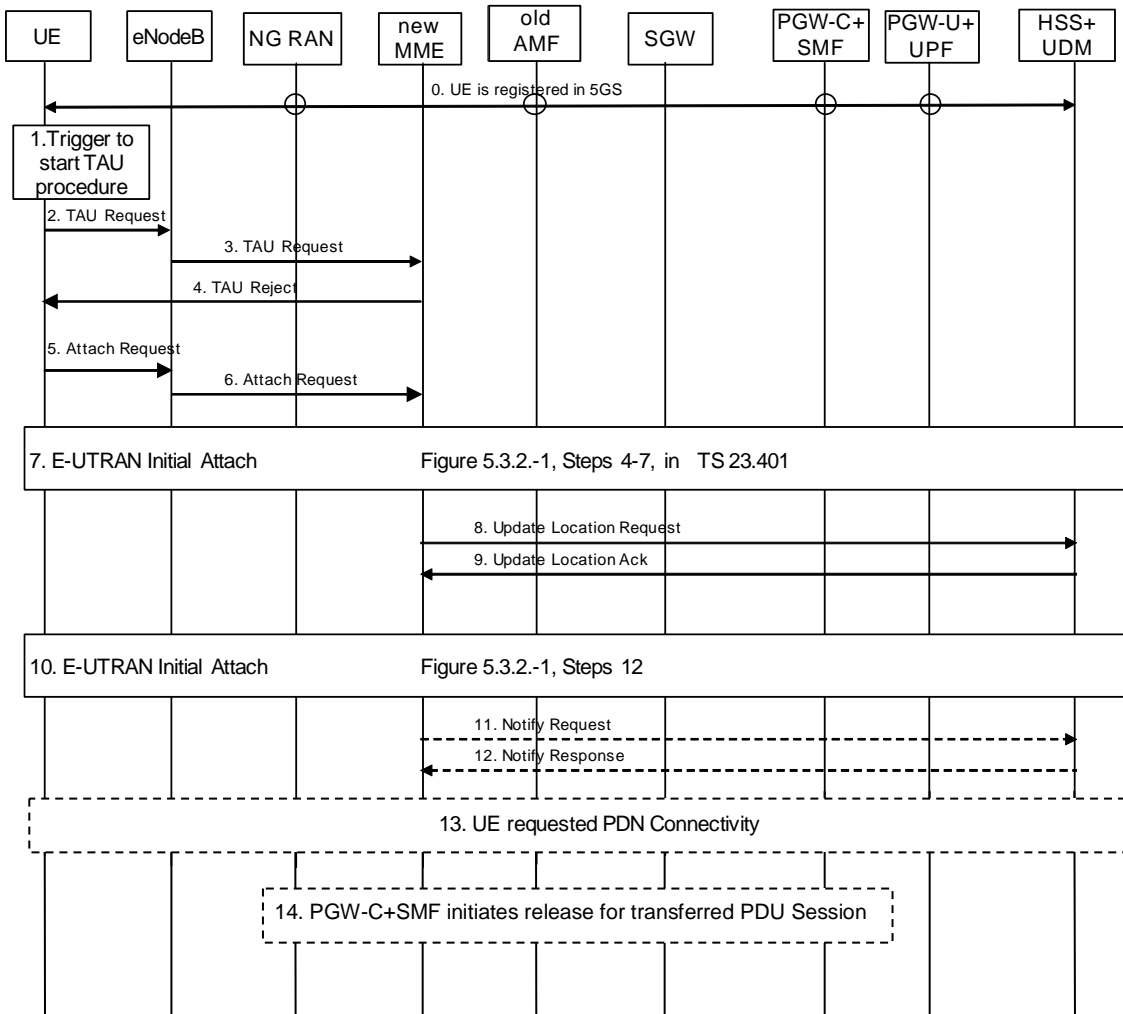

**Figure 4.11.2.2-1: Mobility procedure from 5GS to EPS without N26 interface**

The UE operating in single-registration mode can start the procedure from Step 1 or Step 5. The UE operating in dual-registration mode starts the procedure from Step 5.

NOTE 1: The network has indicated the "Interworking without N26" to the UE. To support IP address preservation, the UE in single-registration mode starts the procedure from Step 5. If the UE in single-registration mode starts the procedure from Step 1, the IP address preservation is not provided.

0. UE is registered in 5GS and established PDU sessions. The FQDN for the S5/S8 interface of the PGW-C+SMF is also stored in the UDM by the PGW-C+SMF during PDU Session setup in addition to what is specified in clause 4.3.2.2.1 and clause 4.3.2.2.2.

NOTE 2: At 5GS to EPS mobility, the MME use the FQDN for the S5/S8 interface of the PGW-C+SMF to find the PGW-C+SMF, and when UE moves back from EPS to 5GS, the AMF uses FQDN for the S5/S8 interface of the PGW-C+SMF to find the PGW-C+SMF.

1. Step 1 as in clause 5.3.3.1 (Tracking Area Update) in TS 23.401 [13].
2. Step 2 as in clause 5.3.3.1 (Tracking Area Update) in TS 23.401 [13] with the following modifications:  
 The UE shall provide a EPS-GUTI that is mapped from the 5G-GUTI following the mapping rules specified in TS 23.501 [2]. The UE indicates that it is moving from 5GC.
3. Step 3 as in clause 5.3.3.1 (Tracking Area Update) in TS 23.401 [13].
4. If the MME determined that the old node is an AMF based on UE's GUTI mapped from 5G-GUTI and the MME is configured to support 5GS-EPS interworking without N26 procedure, the MME sends a TAU Reject to the UE.

5. Step 1 as in clause 5.3.2.1 (E-UTRAN Initial Attach) in TS 23.401 [13] with the modifications captured in clause 4.11.2.4.1.
6. Step 2 as in clause 5.3.2.1 (E-UTRAN Initial Attach) in TS 23.401 [13].
7. Steps 4-7 as in clause 5.3.2.1 (E-UTRAN Initial Attach) in TS 23.401 [13], with the modifications captured in clause 4.11.2.4.1.
8. Step 8 as in clause 5.3.2.1 (E-UTRAN Initial Attach) in TS 23.401 [13], with the modifications captured in clause 4.11.2.4.1.
9. Step 11 as in clause 5.3.2.1 (E-UTRAN Initial Attach) in TS 23.401 [13], with the following modifications:

The subscription profile the MME receives from HSS+UDM includes per DNN/APN at most one PGW-C+SMF FQDN as described in in clause 5.17.2.1 in TS 23.501 [2].
10. Steps 12-24 as in clause 5.3.2.1 (E-UTRAN Initial Attach) in TS 23.401 [13], with the modifications as described in clause 4.11.2.4.1.
11. Step 25 as in clause 5.3.2.1 (E-UTRAN Initial Attach) in TS 23.401 [13].
12. Step 26 as in clause 5.3.2.1 (E-UTRAN Initial Attach) in TS 23.401 [13].

13. If the UE has remaining PDU Sessions in 5GS which it wants to transfer to EPS and maintain the same IP address/prefix, the UE performs the UE requested PDN Connectivity Procedure as specified in TS 23.401 [13] clause 5.10.2 and sets the Request Type to "handover" in Step 1 of the procedure with modification captured in clause 4.11.2.4.2. UE provides an APN and the PDU Session ID corresponding to the PDU Session it wants to transfer to EPS. The UE provides the PDU Session ID in PCO as described in clause 4.11.1.1.

UEs in single-registration mode performs this step for each PDU Session immediately after completing the E-UTRAN Initial Attach procedure. UEs in dual-registration mode may perform this step any time after the completing of E-UTRAN Initial Attach procedure. Also, UEs in dual-registration mode may perform this step only for a subset of PDU Sessions.

The MME determines the PGW-C+SMF address for the Create Session Request based on the APN received from the UE and the subscription profile received from the HSS+UDM in Step 9 or when the HSS+UDM notifies the MME for the new PGW-C+SMF ID in the updated subscription profile.

The PGW-C+SMF uses the PDU Session ID to correlate the transferred PDN connection with the PDU Session in 5GC.

As a result of the procedure the PGW-U+UPF starts routing DL data packets to the Serving GW for the default and any dedicated EPS bearers established for this PDN connection.

14. For Non-Roaming case and Roaming with Local Breakout, the PGW-C+SMF initiates release of the PDU Session(s) in 5GS transferred to EPS as specified in clause 4.3.4.2 with the following clarification:
  - In step 2, the PGW-C+SMF shall not release IP address/prefix(es) allocated for the PDU Session.
  - If UP connection of the PDU Session is not active, step 3b is not executed, thus the steps triggered by step 3b are not executed;
  - If UP connection of the PDU Session is active, the SMF invokes the Namf\_Communication\_N1N2MessageTransfer service operation in step 3b without including N1 SM container (PDU Session Release Command);
  - In step 11, Nsmf\_PDUSession\_SMContextStatusNotify service operation invoked by the SMF to notify AMF that the SM context for this PDU Session is released due to handover to EPS.

For Home Routed roaming, the PGW-C+SMF initiates release of the PDU Session(s) in 5GS transferred to EPS as specified in clause 4.3.4.3 with the following clarification:

- In step 3a, the H-SMF invokes the Nsmf\_PDUSession\_Update service operation without including N1 SM container (PDU Session Release Command);



- In step 16a, Nsmf\_PDUSession\_StatusNotify operation invoked by H-SMF to notify the V-SMF that the PDU session context is released due to handover to EPS;
- In step 16b, Nsmf\_PDUSession\_SMContexStatusNotify service operation invoked by the V-SMF to notify AMF that the SM context for this PDU Session is released due to handover to EPS.

### 4.11.2.3 EPS to 5GS Mobility

The following procedure is used by UEs in single-registration mode on mobility from EPS to 5GS.

In the case of network sharing the UE selects the target PLMN ID according to clause 5.18.3 of TS 23.501 [2].

This procedure is also used by UEs in dual-registration mode to perform registration in 5GS when the UE is also registered in EPC. The procedure is the General Registration procedure as captured in clause 4.2.2. Difference from that procedure are captured below.

The UE has one or more ongoing PDN connections including one or more EPS bearers. During the PDN connection establishment, the UE allocates the PDU Session ID and sends it to the PGW-C+SMF via PCO, as described in clause 4.11.1.1.

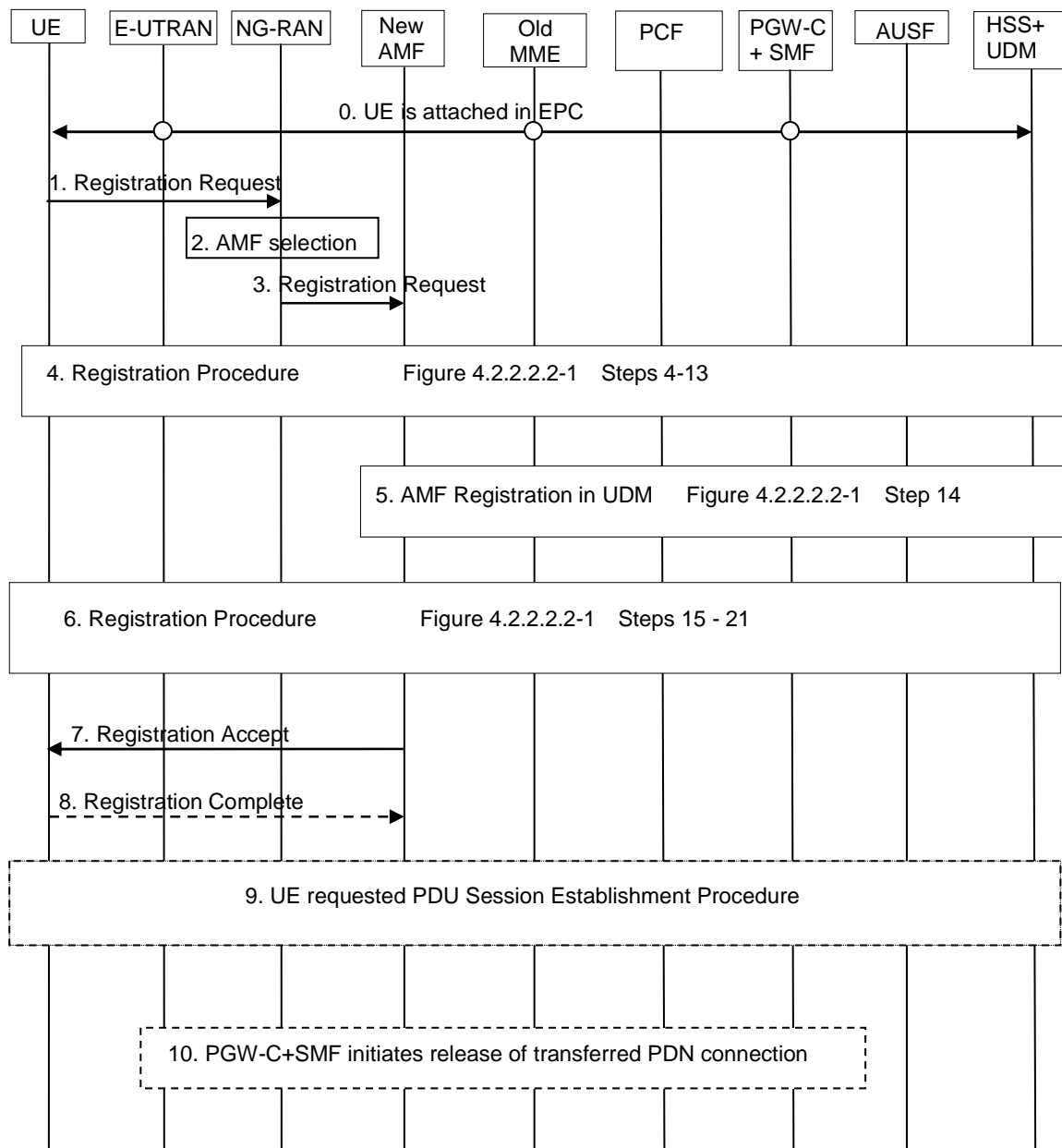

Figure 4.11.2.3-1: Mobility procedure from EPS to 5GS without N26 interface

0. The UE is attached in EPC as specified in clause 4.11.2.4.1.

1. Step 1 in clause 4.2.2.2.2 (General Registration) with the following clarifications:

The UE indicates that it is moving from EPC. The UE in single registration mode provides the Registration type set to "mobility registration update", a 5G-GUTI mapped from the 4G-GUTI (see clause 5.17.2.2: 5G-GUTI mapped from 4G-GUTI) and a native 5G-GUTI (if available) as an Additional GUTI. The UE includes the UE Policy Container containing the list of PSIs, indication of UE support for ANDSP and OSId if available. The UE shall select the 5G-GUTI for the additional GUTI as follows, listed in decreasing order of preference:

- a native 5G-GUTI assigned by the PLMN to which the UE is attempting to register, if available;
- a native 5G-GUTI assigned by an equivalent PLMN to the PLMN to which the UE is attempting to register, if available;
- a native 5G-GUTI assigned by any other PLMN, if available.

The UE in dual registration mode provides the Registration type set to "initial registration", and a native 5G-GUTI or SUCI. In single registration mode, the UE also includes at least the S-NSSAIs (with values for the Serving PLMN) associated with the established PDN connections in the Requested NSSAI in RRC Connection Establishment.

2. Step 2 as in clause 4.2.2.2.

3. Step 3 as in clause 4.2.2.2.2 (General Registration), with the following modifications:

If the Registration type is "mobility registration update" and the UE indicates that it is moving from EPC in Step 1, and the AMF is configured to support 5GS-EPS interworking procedure without N26 interface, the AMF treats this registration request as "initial Registration", and the AMF skips the PDU Session status synchronization.

NOTE 1: The UE operating in single registration mode includes the PDU Session IDs corresponding to the PDN connections to the PDU Session status.

If the UE has provided a 5G-GUTI mapped from 4G-GUTI in Step 1 and the AMF is configured to support 5GS-EPS interworking procedure without N26 interface, the AMF does not perform steps 4 and 5 in clause 4.2.2.2 (UE context transfer from the MME).

4. Steps 4-13 as in clause 4.2.2.2.2 (General Registration), with the following modifications:

- If the UE has included an additional GUTI in the Registration Request, then the new AMF attempts to retrieve the UE's security context from the old AMF in steps 4 and 5.
- If the UE's security context is not available in the old AMF or if the UE has not provided an additional GUTI then the AMF retrieves the SUCI from the UE in steps 6 and 7.

5. Step 14 as in clause 4.2.2.2.2 (General Registration), with the following modifications:

If the UE indicates that it is moving from EPC and the Registration type is set to "initial registration" or "mobility registration update" in step 1 and AMF is configured to support 5GS-EPS interworking without N26 procedure, the AMF sends an Nudm\_UECM\_Registration Request message to the HSS+UDM indicating that registration of an MME at the HSS+UDM, if any, shall not be cancelled. The HSS+UDM does not send cancel location to the old MME.

NOTE 2: If the UE does not maintain registration in EPC, upon reachability time-out, the MME can implicitly detach the UE and release the possible remaining PDN connections in EPC.

The subscription profile the AMF received from HSS+UDM includes the DNN/APN and PGW-C+SMF FQDN for S5/S8 interface for each PDN connection established in EPC. For emergency PDU Session, the AMF receives Emergency Information containing PGW-C+SMF FQDN from HSS+UDM.

6. Steps 15-20 as in clause 4.2.2.2.2 (General Registration).

7. Step 21 as in clause 4.2.2.2.2 (General Registration) with the following modifications:

The AMF includes an "Interworking without N26" indicator to the UE.

If the UE had provided PDU Session Status information in step 1, the AMF sets the PDU Session Status to not synchronized.

8. Step 22 as in clause 4.2.2.2.2 (General Registration)
9. UE requested PDU Session Establishment procedure as in clause 4.3.2.2.1.

If the UE had setup PDN Connections in EPC which it wants to transfer to 5GS and maintain the same IP address/prefix and the UE received "Interworking without N26" indicator in step 7, the UE performs the UE requested PDU Session Establishment Procedure as in clause 4.3.2.2 and sets the Request Type to "Existing PDU Session" or "Existing Emergency PDU Session" in Step 1 of the procedure. The UE provides a DNN for non-emergency PDU Session, the PDU Session ID and S-NSSAI corresponding to the existing PDN connection it wants to transfer from EPS to 5GS. The S-NSSAI is set as described in TS 23.501 [2], clause 5.15.7.2.

If the Request Type indicates "Existing Emergency PDU Session", the AMF shall use the Emergency Information received from the HSS+UDM which contains PGW-C+SMF FQDN for S5/S8 interface for the emergency PDN connection established in EPS.

UEs in single-registration mode performs this step for each PDN connection immediately after the Step 8. UEs in dual-registration mode may perform this step any time after Step 8. Also, UEs in dual-registration mode may perform this step only for a subset of PDU Sessions. The AMF determines the S5/S8 interface of the PGW-C+SMF for the PDU Session based on the DNN received from the UE and the PGW-C+SMF ID in the subscription profile received from the HSS+UDM in Step 5 or when the HSS+UDM notifies the AMF for the new PGW-C+SMF ID in the updated subscription profile. The AMF queries the NRF in serving PLMN by issuing the Nnrf\_NFDiscovery\_Request including the FQDN for the S5/S8 interface of the PGW-C+SMF, and the NRF provides the IP address or FQDN of the N11/N16 interface of the PGW-C+SMF. The AMF invokes the Nsmf\_PDUSession\_CreateSMContext service with the SMF address provided by the NRF. The AMF includes the PDU Session ID to the request sent to the PGW-C+SMF.

The PGW-C+SMF uses the PDU Session ID to determine the correct PDU Session.

After Step 16a of Figure 4.3.2.2.1-1 in clause 4.3.2.2.1, user plane is switched from EPS to 5GS.

As specified clause 4.3.2.2, if the SMF has not yet registered for the PDU Session ID, then the SMF registers with the UDM using Nudm\_UECM\_Registration (SUPI, DNN, PDU Session ID), and if Session Management Subscription data for corresponding SUPI, DNN and S-NSSAI is not available, then SMF retrieves the Session Management Subscription data using Nudm\_SDM\_Get (SUPI, Session Management Subscription data, DNN, S-NSSAI) and subscribes to be notified when this subscription data is modified using Nudm\_SDM\_Subscribe (SUPI, Session Management Subscription data, DNN, S-NSSAI).

10. The PGW-C+SMF performs release of the resources in EPC for the PDN connections(s) transferred to 5GS by performing the PDN GW initiated bearer deactivation procedure as defined in clause 5.4.4.1 of TS 23.401 [13], except the steps 4-7.

#### 4.11.2.4 Impacts to EPS Procedures

##### 4.11.2.4.1 E-UTRAN Attach

Impact on TS 23.401 [13], clause 5.3.2.1 from adding support for the optional network functionality dual registration mode:

- Step 1:

The UE constructs the Attach Request message according to the following principles:

- If UE operates in single-registration mode, the UE indicates that it is moving from 5GC, and provides a native 4G-GUTI or a 4G-GUTI mapped from 5G GUTI (indicated as native GUTI), if available, otherwise the IMSI, or
- If the UE operates in dual-registration mode, the UE indicates that it is moving from 5GC and provides native 4G-GUTI, or
- If the UE sent a TAU in Step 2 and it was rejected because the MME could not derive the UE identity, the UE provides IMSI.

If the UE wants to transfer a PDU Session to EPC as part of the Attach procedure, it includes a PDN CONNECTIVITY Request message in the Attach Request and provides a Request type "Handover", DNN/APN and PDU Session ID of the PDU Session (TS 23.401 [13], clause 5.3.2.1). The UE provides the PDU Session ID in PCO as described in clause 4.11.1.1.

If the TAU was rejected in Step 2 the IP address preservation is not provided. In this case the UE provides IMSI in the Attach Request and does not provide a Request Type "Handover" in the PDN CONNECTIVITY Request if included in the Attach Request.

The UE provides an EPS bearer ID for all mapped EPS bearers in the EPS bearer status. For the initial Attach Request the EPS bearer status is empty.

NOTE 1: The UE is aware the network is configured to support 5GS-EPS interworking without N26 procedure. The UE does not include the EPS bearer IDs corresponding to the 5G QoS flows to the EPS bearer status.

If the UE supports 5GC NAS procedures (see clause 5.17.2 in TS 23.501 [2]), then the UE shall indicate its support of 5G NAS in a NAS indicator.

- Step 3:

If the UE provided a 4G-GUTI mapped from 5G-GUTI and the MME is configured to support 5GS-EPS interworking without N26 procedure, the MME does not perform Step 3, Identification Request to old MME/SGSN/AMF in clause 5.3.2.1 in TS 23.401 [13].

NOTE 2: As the 4G-GUTI mapped from 5G-GUTI is unknown identity to the MME, the MME sends an Identity Request to the UE to request the IMSI. The UE responds with Identity Response (IMSI).

- Step 8:

If the UE indicates that it is moving from 5GC (Attach Request) and the MME is configured to support 5GS-EPS interworking without N26 procedure, the MME sends an Update Location Request message to the HSS+UDM indicating that registration of an AMF at the HSS+UDM, if any, shall not be cancelled. The HSS+UDM does not send Nudm\_UECM\_DeregistrationNotification to the old AMF.

NOTE 3: If the UE does not maintain registration in 5GC, upon reachability time-out, the AMF can implicitly detach the UE and release the possible remaining PDU Sessions in 5GC.

- Step 11:

The HSS+UDM selects one of the PGW-C+SMF FQDN for one APN based on operator's policy. The HSS+UDM sends selected PGW-C+SMF FQDN along with APN to the MME for the UE.

- Step 12:

The MME determines the PGW-C+SMF address for the Create Session Request based on the APN received from the UE and the subscription profile received from the HSS+UDM.

- Step 13:

The PGW-C+SMF uses the PDU Session ID received from the UE in PCO to correlate the transferred PDN connection with the PDU Session in 5GC.

In this release, if the Handover Indication is present in the Create Session Request, and the PGW-C+SMF detects it corresponds to a PDU Session for a LADN in 5GC, the PGW-C+SMF rejects the request.

- Step 14:

IP-CAN Session Modification procedure is replaced by SM Policy Association Modification Procedure as described in clause 4.16.5.

- Step 17:

If the UE indicated support for 5GC NAS procedures (see clause 5.11.3) and the MME supports procedures for interworking with 5GC without N26, the MME may indicate in the Attach Accept, that interworking without N26 is supported. UE handling of this indicator is defined in TS 23.501 [2].

- Step 23a:

As a result of the procedure the PGW-U+UPF starts routing DL data packets to the Serving GW for the default and any dedicated EPS bearers established for this PDN connection.

- Step 25:

Notify Request is sent to HSS/UDM if the network supports the procedures for 5GC interworking without N26 and that the UE is allowed to access 5GC (condition that is identified based on the subscription data). For emergency attach, Notify Request is sent to HSS/UDM if the network supports the procedures for 5GC interworking without N26, and operator policy allows handover of emergency session to 5GS.

#### 4.11.2.4.2 Session Management

##### 4.11.2.4.2.1 PDN Connection Request

Same procedure as specified in clause 4.11.1.5.4.1 is used with the following clarification:

Step 6. The relevant steps of the procedure as specified in the figure above are executed with the following modification:

- Additional condition to trigger Notify Request to HSS in step 15 of Figure 5.10.2-1 in TS 23.401 [13] is that the network supports the procedures for 5GC interworking without N26 and that the UE is allowed to use 5GS in the subscription data. If the Request Type of the UE requested connectivity procedure indicates "Emergency", MME triggers Notify Request to HSS if the network supports the procedures for 5GC interworking without N26, and operator policy allows handover of emergency session to 5GS.

For an unauthenticated or roaming UE, if the Request Type of the UE requested connectivity procedure indicates "Emergency", the MME shall not send any Notify Request to an HSS.

##### 4.11.2.4.3 Initial Attach on S2b

Impacts on TS 23.402 [26], clause 7.2.1 are the following ones:

- step 2:
- If the UE supports 5G NAS procedures (see clause 5.17.2 in TS 23.501 [2]), the UE shall indicate its support of 5G NAS to the ePDG during IKEv2 message exchanges. When the UE supports 5G NAS, it shall also provide the PDU Session ID during IKEv2 message exchanges.
- UE's mobility restriction parameters related to 5GS and/or indication of support for interworking with 5GS for this APN as defined for MME in clause 4.11.0a.3 apply to the ePDG and are obtained by the ePDG as part of the reply from the HSS via the 3GPP AAA Server. Together with the 5G NAS support indicator, it enables the ePDG to determine if a combined PGW-C+SMF or a standalone PGW should be selected.
- If the UE supports 5G NAS and the PDN connection is not restricted to interworking with 5GS by user subscription, the ePDG shall send the 5GS Interworking Indication and the PDU Session ID to the PGW+SMF in step 3.

### 4.11.3 Handover procedures between EPS and 5GC-N3IWF

#### 4.11.3.1 Handover from EPS to 5GC-N3IWF

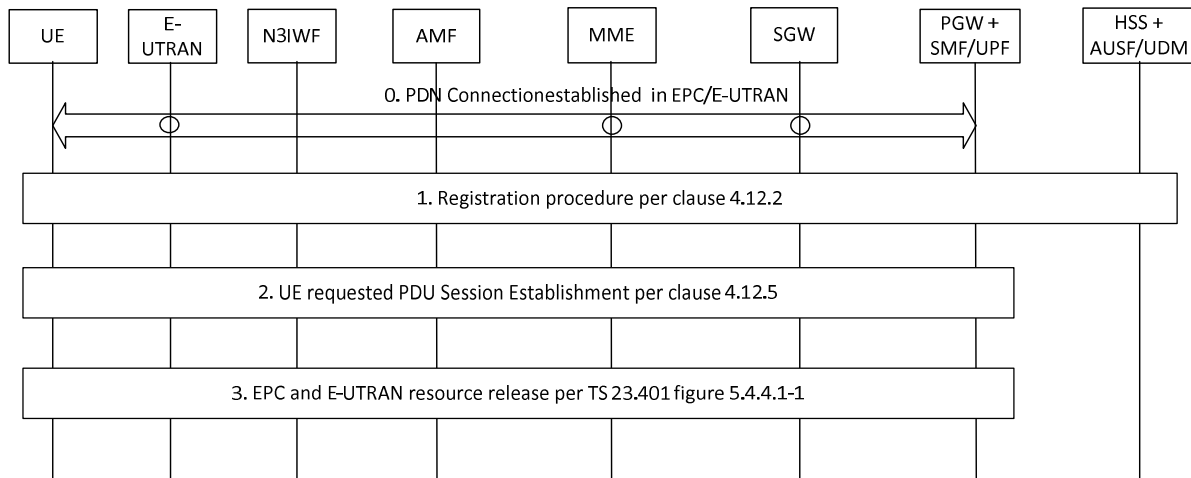

**Figure 4.11.3.1-1: Handover from EPS to 5GC-N3IWF**

0. Initial status: one or more PDN connections have been established in EPC between the 5G capable UE and the PGW via E-UTRAN.
1. The UE initiates Registration procedure on untrusted non-3GPP access via N3IWF (with 5G-GUTI is available or SUCI if not) per clause 4.12.2.
2. The UE initiates a UE requested PDU Session Establishment with Existing PDU Session indication in 5GC via Untrusted non-3GPP Access via N3IWF per clause 4.12.5.

If the Request Type indicates "Existing Emergency PDU Session", the AMF shall use the Emergency Information received from the HSS+UDM which contains PGW-C+SMF FQDN for S5/S8 interface for the emergency PDN connection established in EPS.

The combined PGW+SMF/UPF initiates a PDN GW initiated bearer deactivation as described in TS 23.401 [13] clause 5.4.4.1 to release the EPC and E-UTRAN resources.

#### 4.11.3.2 Handover from 5GC-N3IWF to EPS

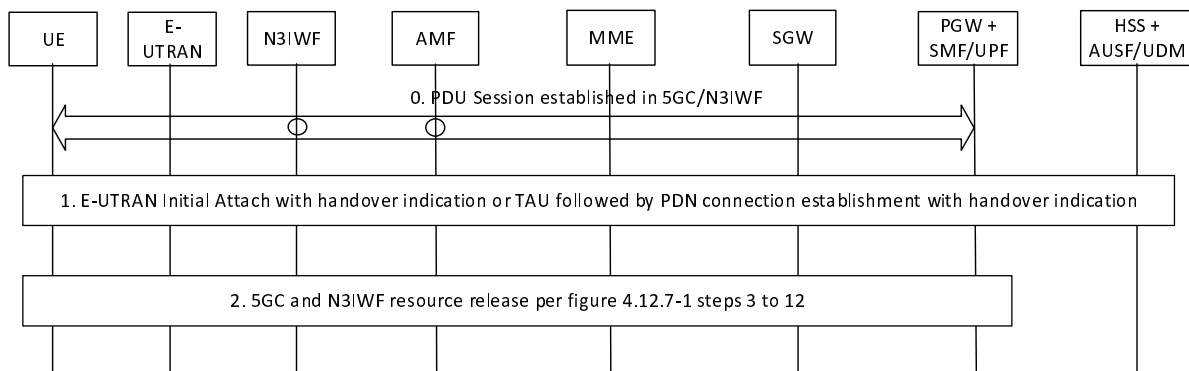

**Figure 4.11.3.2-1: Handover from 5GC-N3IWF to EPS**

0. Initial status: one or more PDU Sessions have been established in 5GC between the UE and the SMF/UPF via untrusted non-3GPP access and N3IWF. During PDU Session setup, and in addition to what is specified in

clause 4.3.2.2.1 and clause 4.3.2.2.2, the PGW-C+SMF sends the FQDN related to the S5/S8 interface to the HSS+UDM which stores it.

1. For the UE to move PDU session(s) from 5GC/N3IWF to EPC/E-UTRAN, the UE's behaviour is as follows:

- If the UE is operating in single-registration mode (as described in clause 5.17.2.1 in TS 23.501 [2]) and the UE is registered via 3GPP access to 5GC,
  - the UE behaves as specified in clause 4.11.1 or 4.11.2 and moves its PDU session from 5GC/N3IWF to EPC/E-UTRAN using the PDN connection establishment with "Handover" indication procedure as described in TS 23.401 [13].
- otherwise, i.e. either the UE is operating in single registration mode and is not registered via 3GPP access to 5GC, or the UE is operating in dual registration mode, and
- if the UE is not attached to EPC/E-UTRAN, the UE initiates Handover Attach procedure in E-UTRAN as described in TS 23.401 [13] for a non-3GPP to EPS handover with "Handover" indication, except note 17.
- otherwise (i.e. the UE is attached to EPC/E-UTRAN), the UE initiates the PDN Connection establishment with "Handover" indication procedure as described in TS 23.401 [13].

2. The combined PGW+SMF/UPF initiates a network requested PDU Session Release via untrusted non-3GPP access and N3IWF according to Figure 4.12.7-1 steps 3 to 12 to release the 5GC and N3IWF resources with the following exception:

- the H-SMF indicates in the Nsmf\_PDUSession\_Update Request that the UE shall not be notified. This shall result in the V-SMF not sending the N1 SM Container (PDU Session Release Command) to the UE.
- Nsmf\_PDUSession\_StatusNotify service operation invoked by H-SMF to V-SMF indicates the PDU Session is moved to a different system;
- Nsmf\_PDUSession\_SMContextStatusNotify service operation invoked by the (V-)SMF indicates the PDU Session is moved to another system.
- The Npcf\_SMPolicyControl\_Delete service operation to PCF shall not be performed.

### 4.11.4 Handover procedures between EPC/ePDG and 5GS

#### 4.11.4.1 Handover from EPC/ePDG to 5GS

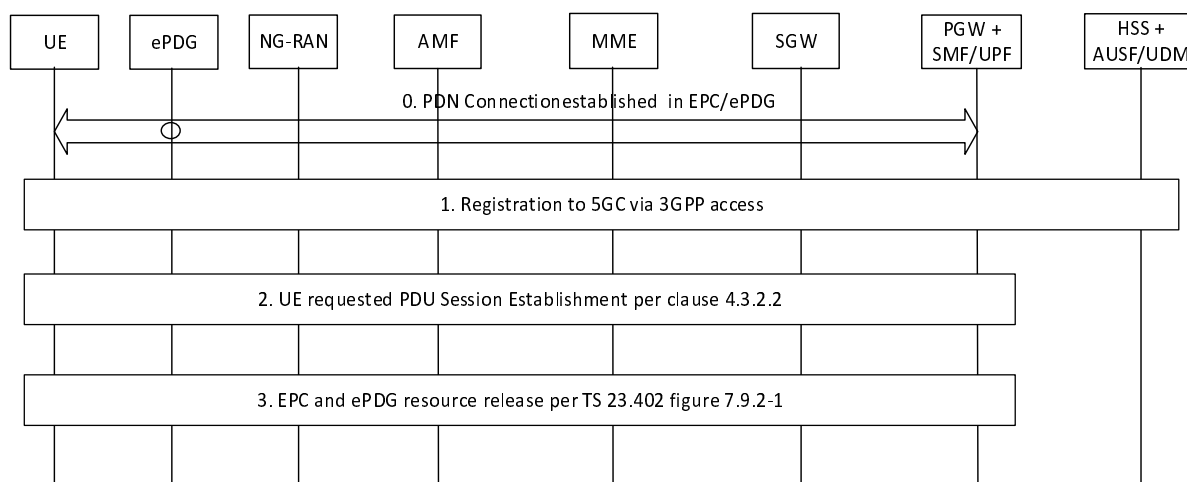

Figure 4.11.4.1-1: Handover from EPC/ePDG to 5GS

0. Initial status: one or more PDU Sessions have been established between the UE and the EPC/ePDG via untrusted non-3GPP access. The UE has indicated its 5G NAS capability in order for the ePDG to select a combined PGW+SMF, and has provided the PDU Session ID to the combined PGW/SMF.

1. For the UE to move its PDU session(s) from EPC/ePDG to 5GC/3GPP access, the UE's behaviour is as follows:
  - If the UE is operating in single-registration mode (as described in clause 5.17.2.1 in TS 23.501 [2]) and the UE is attached to EPC/E-UTRAN:
    - the UE behaves as specified in clause 4.11.1 or clause 4.11.2 and gets registered to 5GC via 3GPP access.
  - otherwise i.e. either the UE is operating in single registration mode and is not attached to EPC/E-UTRAN, or the UE is operating in dual registration mode, and
  - if the UE is already registered in 5GS via 3GPP access, the UE skips to step 2.
- otherwise (i.e UE is not registered in 5GS via 3GPP access), the UE performs Registration procedure of type initial registration in 5GS via 3GPP access as described in clause 4.2.2.2.

2. The UE initiates a UE requested PDU Session Establishment via 3GPP Access according to clause 4.3.2.2 and includes the "Existing PDU Session" indication or "Existing Emergency PDU Session" and the PDU Session ID.

If the Request Type indicates "Existing Emergency PDU Session", the AMF shall use the Emergency Information containing PGW-C+SMF FQDN for the S2b interface it has received from the HSS+UDM. The PGW-C+SMF FQDN was sent by PGW-C when the Emergency PDN connection was established in EPC via ePDG.

3. The combined PGW+SMF/UPF initiates a PDN GW initiated Resource Allocation Deactivation with GTP on S2b as described in TS 23.402 [26] clause 7.9.2 to release the EPC and ePDG resources.

#### 4.11.4.2 Handover from 5GS to EPC/ePDG

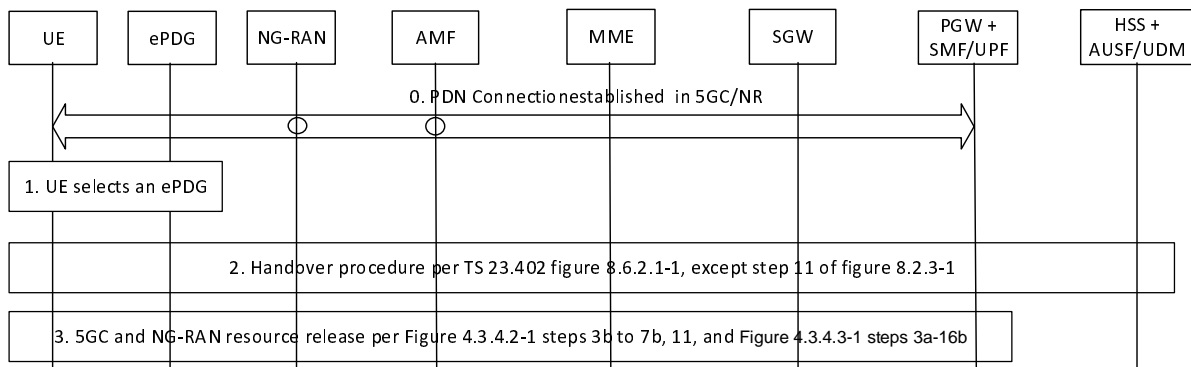

Figure 4.11.4.2-1: Handover from 5GS to EPC/ePDG

0. Initial status: one or more PDU Sessions have been established between the UE and the SMF/UPF via NG-RAN.
1. The UE connects to an untrusted non-3GPP access and the N3IWF-ePDG selection process results in selecting an ePDG.
2. The UE initiates a Handover Attach procedure as described in TS 23.402 [26] clause 8.6.2.1, except step 11 of referenced figure 8.2.3-1 that corresponds to the release of resources in source system.
3. The combined PGW+SMF/UPF initiates a network requested PDU Session Release via 3GPP access according to Figure 4.3.4.2-1 steps 3b to 7b, step 11 or Figure 4.3.4.3-1 steps 3a-16b to release the 5GC and NG-RAN resources with the following exception:
  - For non-roaming or local breakout in clause 4.3.4.2, the SMF does not include N1 SM Container in Namf\_Communication\_N1N2MessageTransfer service operation.
  - For home routing roaming in clause 4.3.4.3, the H-SMF indicates in the Nsmf\_PDUSession\_Update Request that the UE shall not be notified. This shall result in the V-SMF not sending the N1 SM Container (PDU Session Release Command) to the UE.



- Nsmf\_PDUSession\_StatusNotify service operation invoked by H-SMF to V-SMF, and Nsmf\_PDUSession\_SMContextStatusNotify service operation invoked by the (V-)SMF to the AMF indicate that the PDU Session is moved to a different system.
- The Npcf\_SMPolicyControl\_Delete service operation to PCF shall not be performed.

## 4.11.5 Impacts to 5GC Procedures

### 4.11.5.1 General

This clause captures impacts to 5GC procedures in other clauses of this specification to support interworking with EPS. These impacts are applicable to interworking based on N26 and interworking without N26.

### 4.11.5.2 Registration procedure

The following impacts are applicable to clause 4.2.2.2 (Registration procedure) when the UE has established PDU Session(s):

In clause 4.3.2.2.1 Non-roaming and Roaming with Local Breakout:

- Step 17: Additional trigger for Step 17 Nsmf\_PDUSession\_UpdateSMContext are:
  - If status of interworking with EPS for a PDU session changes, e.g. due to change of 5GMM capability (e.g. "S1 mode supported"), the UE subscription data change (e.g. Core Network Type Restriction to EPC), the AMF invokes Nsmf\_PDUSession\_UpdateSMContext (EPS Interworking Indication with N26 or without N26) to SMF. The SMF determines whether the PDU session supports interworking with EPS need be changed. If it needs to be changed, the SMF invokes Nudm\_UECM\_Update service operation to add or remove the PGW-C FQDN for S5/S8 interface from the UE context in SMF data stored at the UDM.

For interworking with the N26 interface, if status of interworking with EPS for a PDU session is changed at PGW-C+SMF, the PGW-C+SMF invokes EBI allocation or revocation as described in clause 4.11.1.4.1 and clause 4.11.1.4.2 respectively.

### 4.11.5.3 UE Requested PDU Session Establishment procedure

The following impacts are applicable to clause 4.3.2.2 (UE Requested PDU Session Establishment procedure) to support interworking with EPS:

In clause 4.3.2.2.1 Non-roaming and Roaming with Local Breakout:

- Step 3: The AMF determines that a PDU Session supports EPS interworking with N26 or without N26, based on e.g. 5GMM capability (e.g. "S1 mode supported"), UE subscription data (e.g. Core Network Type Restriction to EPS, EPC interworking support per (S-NSSAI, subscribed DNN)) and network configuration if EPS interworking with N26 or without N26 is supported. The AMF then includes in the Nsmf\_PDUSession\_CreateSMContext an indication whether the PDU Session supports EPS Interworking with N26 or without N26.
- Step 4: If the EPS Interworking indication received from AMF indicates that the UE supports EPS interworking and the SMF determines (e.g. based on UE subscription data (e.g. whether EPS interworking is allowed for this DNN and S-NSSAI)) that the PDU Session supports EPS interworking, the PGW-C+SMF FQDN for S5/S8 interface is included in the Nudm\_UECM\_Registration Request.

In clause 4.3.2.2.2 Home-routed Roaming:

- Step 3a: Same impact as for step 3 for the Non-roaming and Roaming with Local Breakout case above.
- Step 6 The V-SMF pass the received EPS interworking indication to the H-SMF in Nsmf\_PDUSession\_Create.
- Step 7: If the EPS interworking indication received from V-SMF indicates that the PDU Session supports EPS interworking and the SMF determines (e.g. based on UP integrity protection of UP Security Enforcement Information as described in clause 4.11.1.1) that the PDU Session supports EPS interworking, the PGW-C+SMF FQDN for S5/S8 interface is included in the Nudm\_UECM\_Registration Request.

For interworking with the N26 interface, if the PDU Session supports interworking with EPS, the PGW-C+SMF invokes EBI allocation as described in clause 4.11.1.4.1.

#### 4.11.5.4 UE or Network Requested PDU Session Modification procedure

The following impacts are applicable to clause 4.3.3.2 (UE or network requested PDU Session Modification (non-roaming and roaming with local breakout)) to support interworking with EPS:

- Step 1: In addition to the triggers listed in step 1 of clause 4.3.3.2, the procedure may be also triggered by the following event:
  - AMF initiated modification: If the support of EPS Interworking for this PDU Session has changed, e.g. the change of the UE's subscription data (e.g. Core Network Type Restriction to EPS), or change of 5GMM capability (e.g. "S1 mode supported"), the AMF invokes Nsmf\_PDUSession\_UpdateSMContext update the status of EPS interworking support in the to SMF.
- Step 3a: This step also applies to AMF initiated modification. For AMF initiated modification, the SMF may determines whether the PDU session supports EPS interworking need be changed. If it need be changed, the SMF invokes Nudm\_UECM\_Update service operation to add or remove the PGW-C FQDN for S5/S8 interface from the UE context in SMF data stored at the UDM ,

The following impacts are applicable to clause 4.3.3.3 (UE or network requested PDU Session Modification (home-routed roaming)) to support interworking with EPS:

- Step 1a (AMF to V-SMF): Same impact as for step 1 of clause 4.3.3.2 above.
- Step 1a (V-SMF to H-SMF): The V-SMF pass the status of EPS interworking support to the H-SMF.
- Step 1a (H-SMF to V-SMF): Same impact as for clause 3a of 4.3.3.2 above.

or interworking with the N26 interface, if status of interworking with EPS for a PDU session is changed at PGW-C+SMF, the PGW-C+SMF invokes EBI allocation or revocation as described in clause 4.11.1.4.1 and clause 4.11.1.4.2 respectively.

#### 4.11.5.5 Xn based inter NG-RAN handover

The following impacts are applicable to clause 4.9.1.2.1 (General) to support interworking with EPS:

- If there is Mapping between EBI(s) and QFI(s) for the UE in the source NG-RAN, the source NG-RAN sends the Mapping to target NG-RAN during handover.

#### 4.11.5.6 Inter NG-RAN node N2 based handover

The following impacts are applicable to clause 4.9.1.3.2 (Preparation phase) to support interworking with EPS:

- Step 7: If the PDU session supports EPS interworking, the N2 SM information contains the Mapping between EBI(s) and QFI(s).

## 4.12 Procedures for non-3GPP access

### 4.12.1 General

Clause 4.12 defines the procedures to support non-3GPP access by describing the differences compared to the defined procedures in other clauses.

### 4.12.2 Registration via Untrusted non-3GPP Access

#### 4.12.2.1 General

Clause 4.12.2 specifies how a UE can register to 5GC via an untrusted non-3GPP access network. It is based on the Registration procedure specified in clause 4.2.2.2.2 and it uses a vendor-specific EAP method called "EAP-5G". The EAP-5G packets utilize the "Expanded" EAP type and the existing 3GPP Vendor-Id registered with IANA under the SMI Private Enterprise Code registry. The "EAP-5G" method is used between the UE and the N3IWF and is utilized only for encapsulating NAS messages (not for authentication). If the UE needs to be authenticated, mutual authentication is executed between the UE and AUSF. The details of the authentication procedure are specified in TS 33.501 [15].

In Registration and subsequent Registration procedures via untrusted non-3GPP access, the NAS messages are always exchanged between the UE and the AMF. When possible, the UE can be authenticated by reusing the existing UE security context in AMF.

### 4.12.2.2 Registration procedure for untrusted non-3GPP access

The signalling flow in Figure 4.12.2.2-1 does not show all the details of a registration procedure via untrusted non-3GPP access. It shows primarily the steps executed between the UE and N3IWF. All the details of a registration procedure, including interactions with PCF, UDM, etc. are specified in clause 4.2.2.2.2.

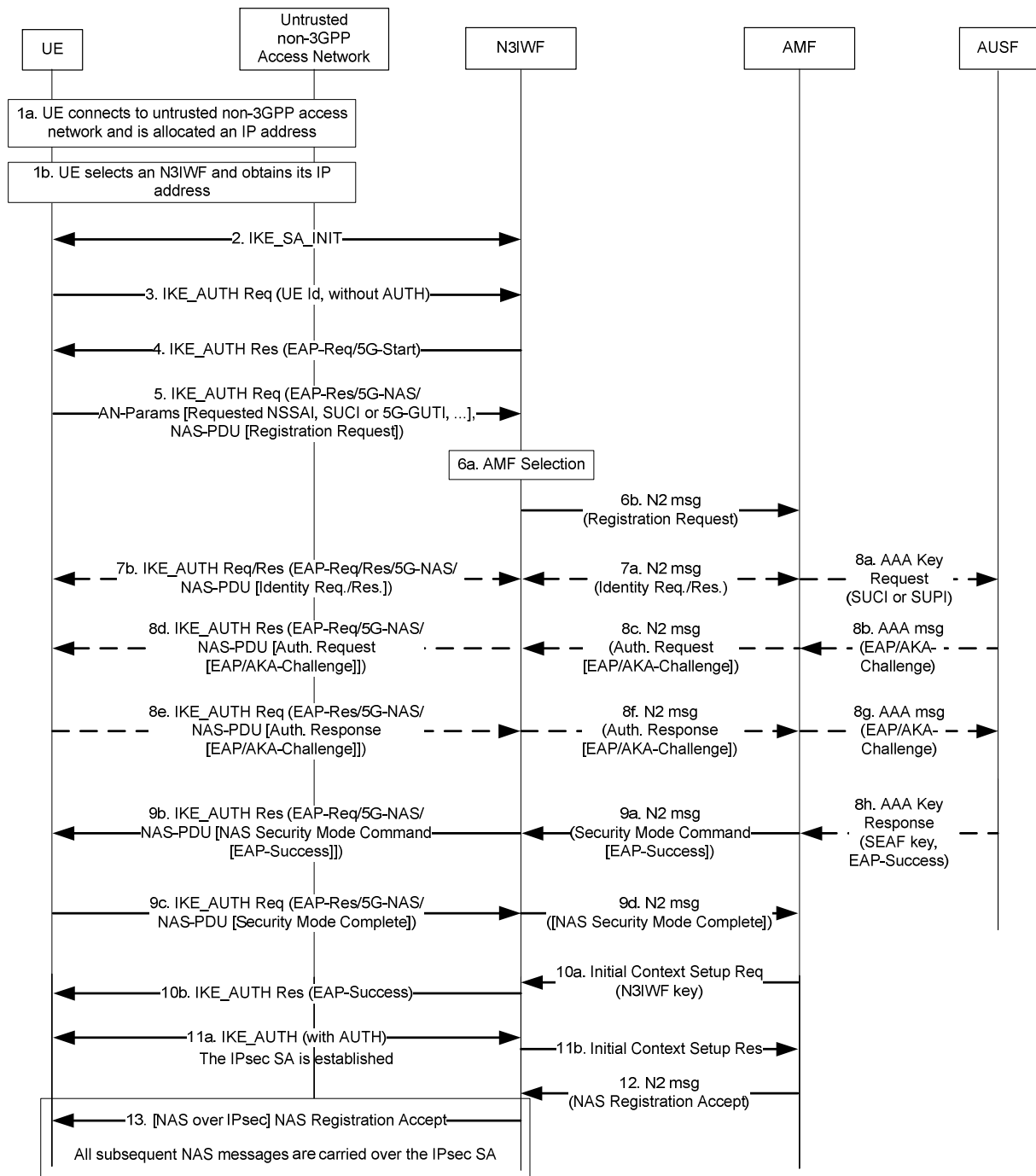

Figure 4.12.2.2-1: Registration via untrusted non-3GPP access

1. The UE connects to an untrusted non-3GPP access network with procedures outside the scope of 3GPP and it is assigned an IP address. Any non-3GPP authentication method can be used, e.g. no authentication (in case of a

free WLAN), EAP with pre-shared key, username/password, etc. When the UE decides to attach to 5GC network, the UE selects an N3IWF in a 5G PLMN, as described in TS 23.501 [2] clause 6.3.6.

2. The UE proceeds with the establishment of an IPsec Security Association (SA) with the selected N3IWF by initiating an IKE initial exchange according to RFC 7296 [3]. After step 2, all subsequent IKE messages are encrypted and integrity protected by using the IKE SA established in this step.
3. The UE shall initiate an IKE\_AUTH exchange by sending an IKE\_AUTH request message. The AUTH payload is not included in the IKE\_AUTH request message, which indicates that the IKE\_AUTH exchange shall use EAP signalling (in this case EAP-5G signalling). If the UE supports MOBIKE, it shall include a Notify payload in the IKE\_AUTH request, as specified in RFC 4555 [40], indicating that MOBIKE is supported. In addition, as specified in TS 33.501 [15], if the UE is provisioned with the N3IWF root certificate, it shall include the CERTREQ payload within the IKE\_AUTH request message to request the N3IWF's certificate.
4. The N3IWF responds with an IKE\_AUTH response message, which includes an EAP-Request/5G-Start packet. The EAP-Request/5G-Start packet informs the UE to initiate an EAP-5G session, i.e. to start sending NAS messages encapsulated within EAP-5G packets. If the N3IWF has received a CERTREQ payload from the UE, the N3IWF shall include the CERT payload in the IKE\_AUTH response message containing the N3IWF's certificate. How the UE uses the N3IWF's certificate is specified in TS 33.501 [15].
5. The UE shall send an IKE\_AUTH request, which includes an EAP-Response/5G-NAS packet that contains the Access Network parameters (AN parameters) and a Registration Request message. The AN parameters contain information that is used by the N3IWF for selecting an AMF in the 5G core network. This information includes e.g. the GUAMI, the Selected PLMN ID, the Requested NSSAI and the Establishment cause. The Establishment cause provides the reason for requesting a signalling connection with 5GC.

NOTE 1: The N3IWF does not send an EAP-Identity request because the UE includes its identity in the first IKE\_AUTH. This is in line with RFC7296, clause 3.16.

6. The N3IWF shall select an AMF based on the received AN parameters and local policy, as specified in TS 23.501 [2], clause 6.5.3. The N3IWF shall then forward the Registration Request received from the UE to the selected AMF within an N2 message. This message contains N2 parameters that include the Selected PLMN ID and the Establishment cause.
7. The selected AMF may decide to request the SUCI by sending a NAS Identity Request message to UE. This NAS message and all subsequent NAS messages are sent to UE encapsulated within EAP/5G-NAS packets.
8. The AMF may decide to authenticate the UE by invoking an AUSF. In this case, the AMF shall select an AUSF as specified in TS 23.501 [2] clause 6.3.4 based on SUPI or SUCI.

The AUSF executes the authentication of the UE as specified in TS 33.501 [15]. The AUSF selects a UDM as described in TS 23.501 [2], clause 6.3.8 and gets the authentication data from UDM. The authentication packets are encapsulated within NAS authentication messages and the NAS authentication messages are encapsulated within EAP/5G-NAS packets. After the successful authentication:

- In step 8h, the AUSF shall send the anchor key (SEAF key) to AMF which is used by AMF to derive NAS security keys and a security key for N3IWF (N3IWF key). The UE also derives the anchor key (SEAF key) and from that key it derives the NAS security keys and the security key for N3IWF (N3IWF key). The N3IWF key is used by the UE and N3IWF for establishing the IPsec Security Association (in step 11).
- In step 8h, the AUSF shall also include the SUPI, if in step 8a the AMF provided to AUSF a SUCI .

NOTE 2: EAP-AKA' or 5G-AKA are allowed for the authentication of UE via non-3GPP access, as specified in TS 33.501 [15]. Figure 4.12.2.2-1 only shows authentication flow using EAP-AKA'.

- 9a. The AMF shall send a NAS Security Mode Command to UE in order to activate NAS security. If an EAP-AKA' authentication was successfully executed in step 8, the AMF shall encapsulate the EAP-Success received from AUSF within the NAS Security Mode Command message.
- 9b. The N3IWF shall forward the NAS Security Mode Command message to UE within an EAP/5G-NAS packet.
- 9c. The UE completes the EAP-AKA' authentication (if initiated in step 8), creates a NAS security context and an N3IWF key and sends the NAS Security Mode Complete message within an EAP/5G-NAS packet.
- 9d. The N3IWF relays the NAS Security Mode Complete message to the AMF.

- 10a. Upon receiving NAS Security Mode Complete, the AMF shall send an NGAP Initial Context Setup Request message that includes the N3IWF key.
- 10b. This triggers the N3IWF to send an EAP-Success to UE, which completes the EAP-5G session. No further EAP-5G packets are exchanged.
11. The IPsec SA is established between the UE and N3IWF by using the common N3IWF key that was created in the UE in step 9c and received by the N3IWF in step 10a. This IPsec SA is referred to as the "signalling IPsec SA". After the establishment of the signalling IPsec SA, the N3IWF notifies the AMF that the UE context (including AN security) was created by sending a NGAP Initial Context Setup Response. The signalling IPsec SA shall be configured to operate in tunnel mode and the N3IWF shall assign to UE an "inner" IP address. If the N3IWF has received an indication that the UE supports MOBIKE (see step 3), then the N3IWF shall include a Notify payload in the IKE\_AUTH response message sent in step 11a, indicating that MOBIKE shall be supported, as specified in RFC 4555 [40].

All subsequent NAS messages exchanged between the UE and N3IWF shall be sent via the signalling IPsec SA and shall be carried over TCP/IP. The UE shall send NAS messages within TCP/IP packets with source address the "inner" IP address of the UE and destination address the NAS\_IP\_ADDRESS that is received in step 11a. The N3IWF shall send NAS messages within TCP/IP packets with source address the NAS\_IP\_ADDRESS and destination address the "inner" IP address of the UE. The TCP connection used for reliable NAS transport between the UE and N3IWF shall be initiated by the UE right after the signalling IPsec SA is established in step 11a. The UE shall send the TCP connection request to the NAS\_IP\_ADDRESS and to the TCP port number specified in TS 24.502 [41].

12. The AMF sends the NAS Registration Accept message to the N3IWF. The N2 Message includes the Allowed NSSAI for the access type for the UE.
13. The N3IWF forwards the NAS Registration Accept to UE via the established signalling IPsec SA. If the NAS Registration Request message is received by the N3IWF before the IPsec SA is established, the N3IWF shall store it and forward it to the UE only after the establishment of the signalling IPsec SA.

The AMF provides the Access Type set to "Non-3GPP access" to the UDM when it registers with the UDM.

#### 4.12.2.3 Emergency Registration for untrusted non-3GPP Access

Emergency Registration procedure is used by UEs requiring to perform emergency services but cannot gain normal services from the network. These UEs are in limited service state as defined in TS 23.122 [22].

The regular registration procedure described in clause 4.12.2 applies with the following differences:

- If the UE has no SUPI and no valid 5G-GUTI, PEI shall be included instead of its encrypted Permanent User ID (SUCI) in the Access Network parameters.
- NSSAI shall not be included by the UE. The AMF shall not send the Allowed S-NSSAIs in the Registration Accept message.
- If the AMF is not configured to support Emergency Registration, the AMF shall reject any Registration Request that indicates Registration type "Emergency Registration".
- If the AMF is configured to support Emergency Registration for unauthenticated UEs and the UE indicated Registration Type "Emergency Registration", the AMF skips the authentication and security setup or the AMF accepts that the authentication may fail and continues the Emergency Registration procedure.
- If the authentication is performed successfully, the NAS messages will be protected by the NAS security functions (integrity and ciphering). The AMF shall derive the N3IWF key, per TS 33.501 [15], and shall provide it to the N3IWF after the authentication completion using an NGAP Initial Context Setup Request message as in the regular registration procedure.
- If the authentication is skipped or authentication fails, the NAS messages will not be protected by the NAS security functions (integrity and ciphering). However, the AMF shall create an N3IWF key and shall provide it to the N3IWF after the authentication completion (whenever authentication has failed or has been skipped) using an NGAP Initial Context Setup Request message. The N3IWF shall use it to complete IKE SA establishment, and shall acknowledge the AMF by sending an NGAP Initial Context Setup Response message.

NOTE: Per TS 33.501 [15], the UE and the AMF independently generate the KAMF (and derived keys) in an implementation defined way and populate the 5G NAS security context with this KAMF to be used when activating a 5G NAS security context."

- As in step 14 of figure 4.2.2.2.2-1 for Emergency Registration, if the UE was not successfully authenticated, the AMF shall not update the UDM. Also for an Emergency Registration, the AMF shall not check for access restrictions, regional restrictions or subscription restrictions.
- Steps 16 and 22b of figure 4.2.2.2.2-1 are not performed since AM and UE policy for the UE are not required for Emergency Registration.

### 4.12.3 Deregistration procedure for untrusted non-3gpp access

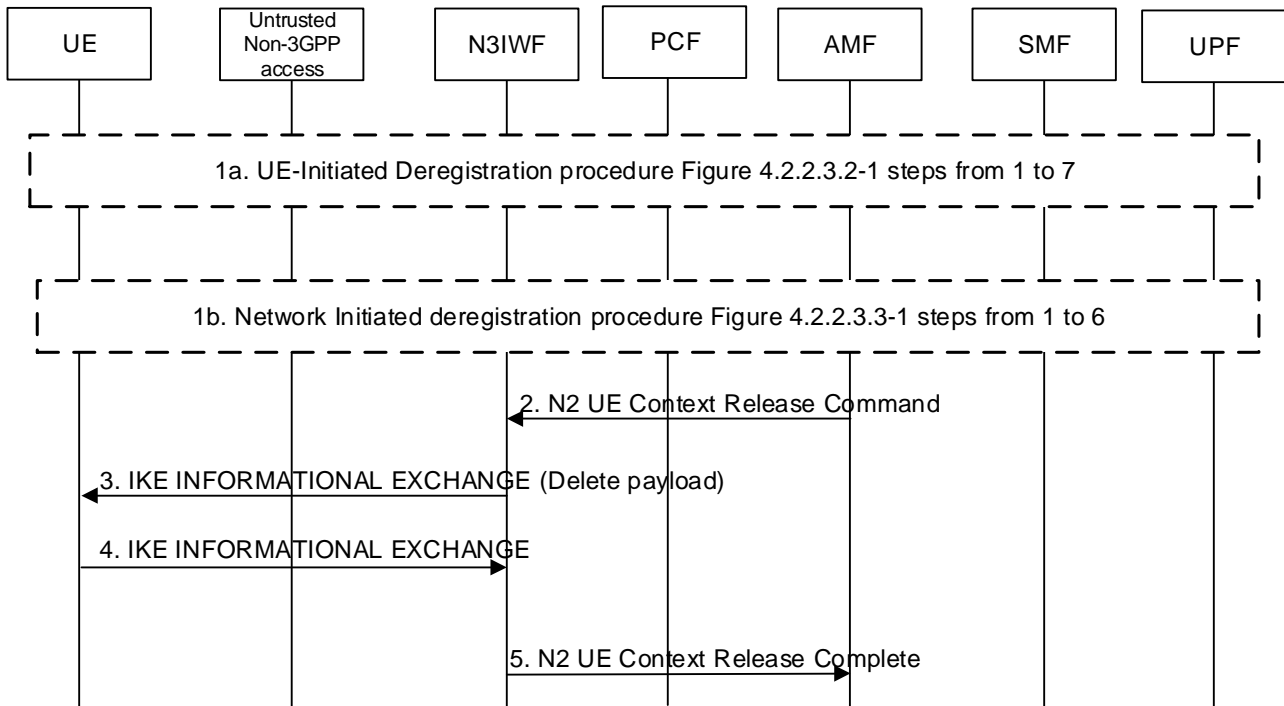

**Figure 4.12.3-1: Deregistration procedure for untrusted non-3gpp access**

1. The Deregistration procedure is triggered by one of the events:
  - 1a. For UE-initiated Deregistration as in steps from 1 to 7 of Figures 4.2.2.3.2-1.
  - 1b. For network initiated deregistration as in steps from 1 to 6 of Figure 4.2.2.3.3-1.

If the UE is in CM-CONNECTED state either in 3GPP access, non-3GPP access or both,

  - the AMF may explicitly deregister the UE by sending a Deregistration request message ( Deregistration type, access type set to non-3GPP) to the UE as in step 2 of Figure 4.2.2.3.3-1.
  - the UDM may want to request the deletion of the subscribers RM contexts and PDU Sessions with the reason for removal set to subscription withdrawn to the registered AMF as in step 1 of Figure 4.2.2.3.3-1.
2. AMF to N3IWF: The AMF sends a N2 Context UE Release Command message to the N3IWF with the cause set to Deregistration to release N2 signalling as defined in step 4 of clause 4.12.4.2.
3. N3IWF to UE: The N3IWF sends INFORMATIONAL EXCHANGE (Delete payload) message to the UE. Delete payload is included to indicate the release of the IKE SA.
4. UE to N3IWF: The UE sends an empty INFORMATIONAL EXCHANGE message to acknowledge the release of the IKE SA as described in RFC 7296 [3]. Non-3GPP access specific resources are released including the IKEv2 tunnel (and the associated IPsec resources) and the local UE contexts in N3IWF (N3 tunnel Id).

5. N3IWF to AMF: The N3IWF acknowledges the N2 UE Context Release Command message by sending N2 UE Context Release Complete message to the AMF as defined in step 7 of clause 4.12.4.2.

## 4.12.4 N2 procedures via Untrusted non-3GPP Access

### 4.12.4.1 Service Request procedures via Untrusted non-3GPP Access

The Service Request procedure via Untrusted non-3GPP Access shall be used by a UE in CM-IDLE state over non-3GPP access to request the re-establishment of the NAS signalling connection and the re-establishment of the user plane for all or some of the PDU Sessions which are associated to non-3GPP access.

The Service Request procedure via Untrusted non-3GPP Access shall be used by a UE in CM-CONNECTED state over non-3GPP access to request the re-establishment of the user plane for one or more PDU Sessions which are associated to non-3GPP access.

When the UE is in CM-IDLE state over non-3GPP access, the Service Request procedure via Untrusted non-3GPP Access is as described in clause 4.2.3.2 (UE Triggered Service Request) with the following exceptions:

- The Service Request procedure is never a response to a Paging, i.e. there is no Network Triggered Service Request procedure via Untrusted non-3GPP Access.
- The (R)AN corresponds to an N3IWF.
- The UE establishes a "signalling IPsec SA" with the N3IWF by using the procedure specified in clause 4.12.2 for the registration via untrusted non-3GPP access. In particular, the UE includes the Service Request and the AN parameters in an EAP-5G packet, which is further encapsulated in an IKE\_AUTH request.
- The AN parameters include the Selected PLMN ID and Establishment cause. The Establishment cause provides the reason for requesting a signalling connection with the 5GC. The UE includes GUAMI information in the AN parameters. The N3IWF selects the AMF according to GUAMI information.
- The N2 parameters sent from N3IWF to AMF include the Establishment cause.
- The user plane between the UE and N3IWF is established not with RRC signalling but with IKEv2 signalling, as specified in clause 4.12.5 (i.e. by using an IKEv2 Create\_Child\_SA exchange). The user plane of each PDU Session consists of one or more Child SAs.

When the UE is in CM-CONNECTED state over non-3GPP access, the Service Request procedure via Untrusted non-3GPP Access is as described in clause 4.2.3.2 (UE Triggered Service Request) with the following exceptions:

- All NAS signalling exchanged between the UE and network is transferred within the established "signalling IPsec SA".
- The (R)AN corresponds to an N3IWF.
- The user plane between the UE and N3IWF is established not with RRC signalling but with IKEv2 signalling, as specified in clause 4.12.5 (i.e. by using an IKEv2 Create\_Child\_SA exchange). The user plane of each PDU Session consists of one or more Child SAs.

When the UE is in CM-CONNECTED state over non-3GPP access and the network receives downlink data for a PDU Session over non-3GPP access that has no user plane, the steps 1-4a in clause 4.2.3.3 (Network Triggered Service Request) shall be performed with the following exceptions:

- The (R)AN corresponds to an N3IWF.
- The user plane between the UE and N3IWF is established (in step 4a) with IKEv2 signalling, as specified in clause 4.12.5 (i.e. by using an IKEv2 Create\_Child\_SA exchange). The user plane of each PDU Session consists of one or more Child SAs.

### 4.12.4.2 Procedure for the UE context release in the N3IWF

This procedure is used to release the N2 signalling connection and the N3 User Plane connection. If the procedure is initiated by the AMF the IKEv2 SA for a UE is being released. The procedure will move the UE from CM-CONNECTED to CM-IDLE in AMF, and all UE related context information is deleted in the N3IWF.

Both N3IWF-initiated and AMF-initiated UE context release in the N3IWF procedures are shown in Figure 4.12.4.2-1.

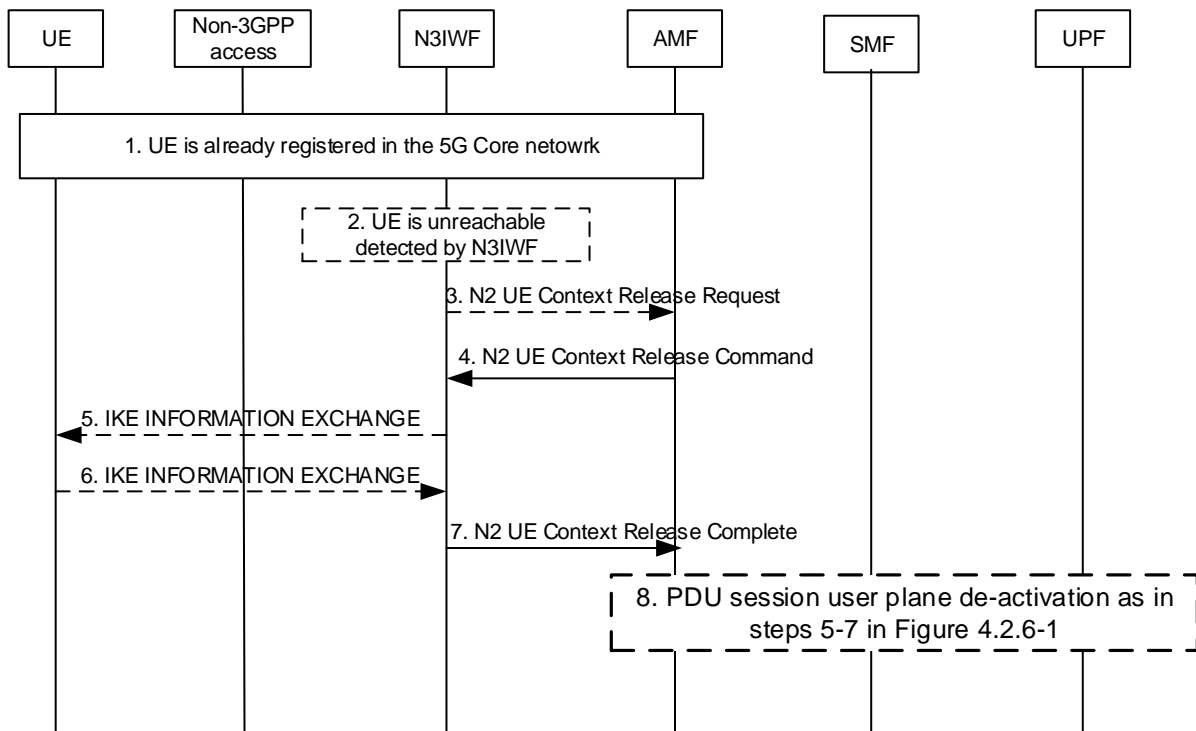

**Figure 4.12.4.2-1: Procedure for the UE context release in the N3IWF**

1. The UE has already registered in the 5GC and may have established one or multiple PDU Sessions.
2. The N3IWF detects that the UE is not reachable.
3. The N3IWF sends a N2 UE Context Release Request message to the AMF This step is equivalent to step 1b of Figure 4.2.6-1.

NOTE: AN Release procedure can also be triggered by an AMF internal event and in that case step 2 and step 3 do not take place.

4. AMF to N3IWF: If the AMF receives the N2 UE Context Release Request from N3IWF or if due to an internal AMF event the AMF wants to release N2 signalling, the AMF sends an N2 UE Context Release Command (Cause) to the N3IWF. The cause indicated is cause from step 3 or a cause due to internal AMF event. This step is equivalent to step 2 of Figure 4.2.6-1.
5. If the IKEv2 tunnel has not been released yet, the N3IWF performs the release of the IPsec tunnel as defined in RFC 7296 [3] indicating to release the IKE SA and any Child IPsec SA if existing. The N3IWF sends to the UE the indication of the release reason if received in step 4.
6. The UE sends an empty INFORMATIONAL Response message to acknowledge the release of the IKE SA as described in RFC 7296 [3]. The N3IWF deletes the UE's context after receiving the empty INFORMATIONAL Response message.
7. N3IWF to AMF: The N3IWF confirms the release of the UE-associated N2-logical connection by returning N2 UE Release Complete (list of PDU Session ID(s) with active N3 user plane) to the AMF as in step 4 defined in clause 4.2.6. The AMF marks the UE as CM-IDLE state in untrusted non-3GPP access.
8. For each of the PDU Sessions in the N2 UE Context Release Complete, the steps 5 to 7 in clause 4.2.6 are performed (PDU Session Update SM Context). After the AMF receives the Nsmf\_PDUSESSION\_UpdateSMContext Response as in step 7 of clause 4.2.6, the AMF considers the N3 connection as released. If list of PDU Session ID(s) with active N3 user plane is included in step 3, then this step is performed before step 4.



### 4.12.4.3 CN-initiated selective deactivation of UP connection of an existing PDU Session associated with Untrusted non-3GPP Access

The procedure described in clause 4.3.7 (CN-initiated selective deactivation of UP connection of an existing PDU Session) is used for CN-initiated selective deactivation of UP connection for an established PDU Session associated with non-3GPP Access of a UE in CM-CONNECTED state, with the following exceptions:

- The NG-RAN corresponds to an N3IWF.
- The user plane between the UE and N3IWF, i.e. Child SA(s) for the PDU Session, is released not with RRC signalling but with IKEv2 signalling, as specified in clause 4.12.7.

### 4.12.5 UE Requested PDU Session Establishment via Untrusted non-3GPP Access

Clause 4.12.5 specifies how a UE can establish a PDU Session via an untrusted non-3GPP access network as well as to hand over an existing PDU Session between 3GPP access and non-3GPP access. The procedure applies in non-roaming, roaming with LBO as well as in home-routed roaming scenarios.

For non-roaming and LBO scenarios, if the UE is simultaneously registered to a 3GPP access in a PLMN different from the PLMN of the N3IWF, the functional entities in the following procedures are located in the PLMN of the N3IWF. For home-routed roaming scenarios, the AMF, V-SMF and associated UPF in VPLMN in the following procedure is located in the PLMN of the N3IWF.

The procedure below is based on the PDU Session Establishment procedure specified in clause 4.3.2.2.1 (for non-roaming and roaming with LBO) and the PDU Session Establishment procedure specified in clause 4.3.2.2.2 (for home-routed roaming).

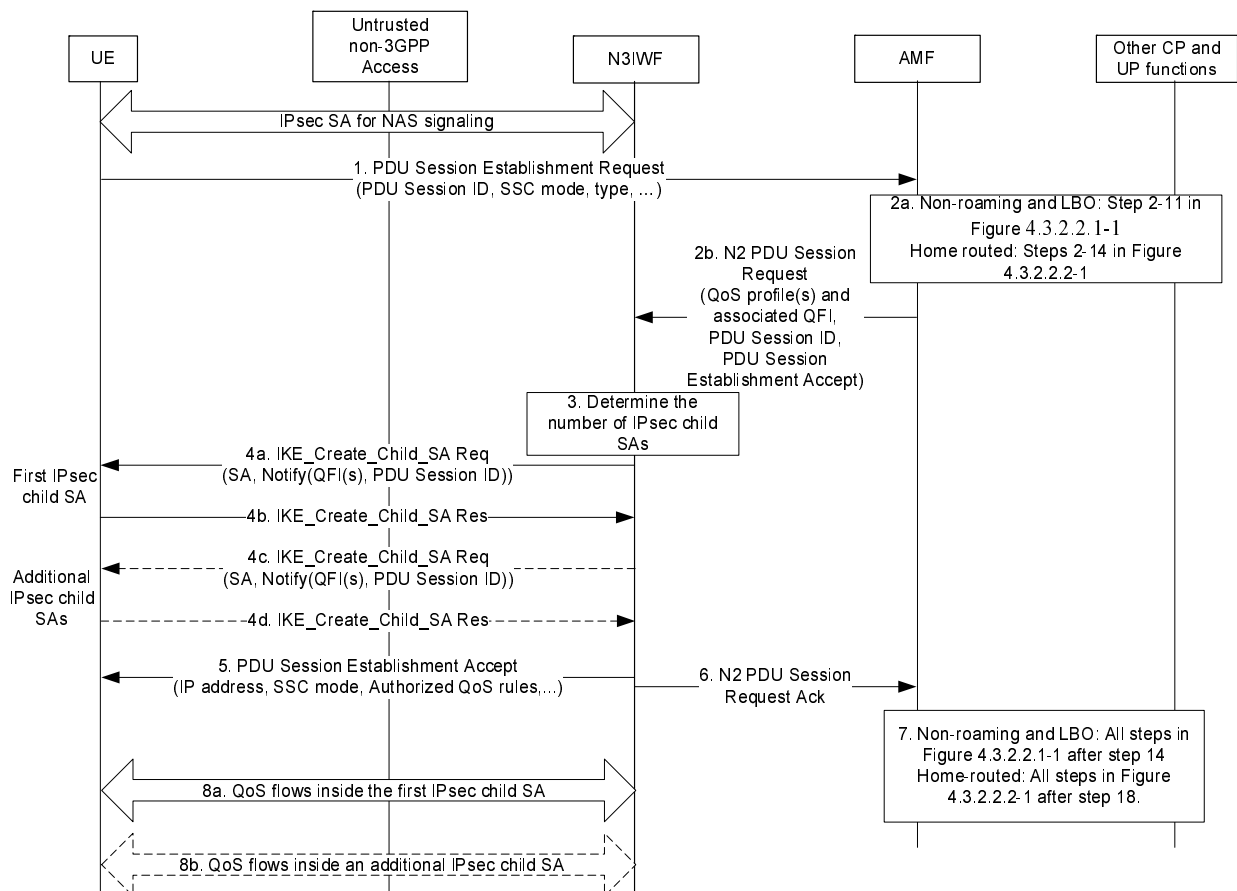

Figure 4.12.5-1: PDU Session establishment via untrusted non-3GPP access

1. The UE shall send a PDU Session Establishment Request message to AMF as specified in step 1 of clause 4.3.2.2.1. This message shall be sent to N3IWF via the IPsec SA for NAS signalling (established as specified in clause 4.12.2) and the N3IWF shall transparently forward it to AMF in the 5GC.
- 2a. In case of non-roaming or roaming with Local Breakout, steps 2-11 specified in clause 4.3.2.2.1 are executed according to the PDU Session Establishment procedure over 3GPP access. In case of home-routed roaming, steps 2-14 specified in clause 4.3.2.2.2 are executed according to the PDU Session Establishment procedure over 3GPP access.
- 2b. As described in step 12 of clause 4.3.2.2.1, the AMF shall send a N2 PDU Session Request message to N3IWF to establish the access resources for this PDU Session.
3. Based on its own policies and configuration, and based on the QoS profiles received in the previous step, the N3IWF shall determine the number of IPsec Child SAs to establish and the QoS profiles associated with each IPsec Child SA. For example, the N3IWF may decide to establish one IPsec Child SA and associate all QoS profiles with this IPsec Child SA. In this case, all QoS Flows of the PDU Session would be transferred over one IPsec Child SA.
- 4a. The N3IWF shall send to UE an IKE Create\_Child\_SA request according to the IKEv2 specification in RFC 7296 [3] to establish the first IPsec Child SA for the PDU Session. The IKE Create\_Child\_SA request indicates that the requested IPsec Child SA shall operate in tunnel mode. This request shall include a 3GPP-specific Notify payload which contains (a) the QFI(s) associated with the Child SA, (b) the identity of the PDU Session associated with this Child SA, (c) optionally, a DSCP value associated with the Child SA, (d) optionally a Default Child SA indication, and (e) an UP\_IP\_ADDRESS. The use of the UP\_IP\_ADDRESS is specified in step 8 below.

If a DSCP value is included, then the UE and the N3IWF shall mark all IP packets sent over this Child SA with this DSCP value. There shall be one and only one Default Child SA per PDU session. The UE shall send all QoS Flows to this Child SA for which there is no mapping information to a specific Child SA. The IKE Create\_Child\_SA request also contains other information (according to RFC 7296 [3]) such as the SA payload, the Traffic Selectors (TS) for the N3IWF and the UE, etc.
- 4b. If the UE accepts the new IPsec Child SA, the UE shall send an IKE Create\_Child\_SA response according to the IKEv2 specification in RFC 7296 [3]. During the IPsec Child SA establishment the UE shall not be assigned an IP address.
- 4c-4d. If in step 3 the N3IWF determined to establish multiple IPsec Child SAs for the PDU Session, then additional IPsec Child SAs shall be established, each one associated with one or more QFI(s) and with a UP\_IP\_ADDRESS.
5. After all IPsec Child SAs are established, the N3IWF shall forward to UE via the signalling IPsec SA (see clause 4.12.2.2) the PDU Session Establishment Accept message received in step 2b.
6. The N3IWF shall send to AMF an N2 PDU Session Request Ack.
7. In case of non-roaming or roaming with Local Breakout, all steps specified in clause 4.3.2.2.1 after step 14 are executed according to the PDU Session Establishment procedure over 3GPP access. In case of home-routed roaming, all steps specified in clause 4.3.2.2.2 after step 18 are executed according to the PDU Session Establishment procedure over 3GPP access.
8. On the user-plane:
  - When the UE has to transmit an UL PDU, the UE shall determine the QFI associated with the UL PDU (by using the QoS rules of the PDU Session), it shall encapsulate the UL PDU inside a GRE packet and shall forward the GRE packet to N3IWF via the IPsec Child SA associated with this QFI. The header of the GRE packet carries the QFI associated with the UL PDU. The UE shall encapsulate the GRE packet into an IP packet with source address the "inner" IP address of the UE and destination address the UP\_IP\_ADDRESS associated with the Child SA.
  - When the N3IWF receives a DL PDU via N3, the N3IWF uses the QFI and the identity of the PDU Session in order to determine the IPsec Child SA to use for sending the DL PDU over NWu. The N3IWF encapsulates the DL PDU inside a GRE packet and copies the QFI in the header of the GRE packet. The N3IWF may include also in the GRE header a Reflective QoS Indicator (RQI), which shall be used by the UE to enable reflective QoS. The N3IWF shall encapsulate the GRE packet into an IP packet with source

address the UP\_IP\_ADDRESS associated with the Child SA and destination address the "inner" IP address of the UE.

### 4.12.6 UE or Network Requested PDU Session Modification via Untrusted non-3GPP access

The UE or network requested PDU Session Modification procedure via untrusted non-3GPP access is depicted in figure 4.12.6-1. The procedure applies in non-roaming, roaming with LBO as well as in home-routed roaming scenarios.

For non-roaming and LBO scenarios, the functional entities in the following procedures are located in the PLMN of the N3IWF.

The procedure below is based on the PDU Session Modification procedure specified in clause 4.3.3.2 (for non-roaming and roaming with LBO) and on the PDU Session Modification procedure specified in clause 4.3.3.3 (for home-routed roaming).

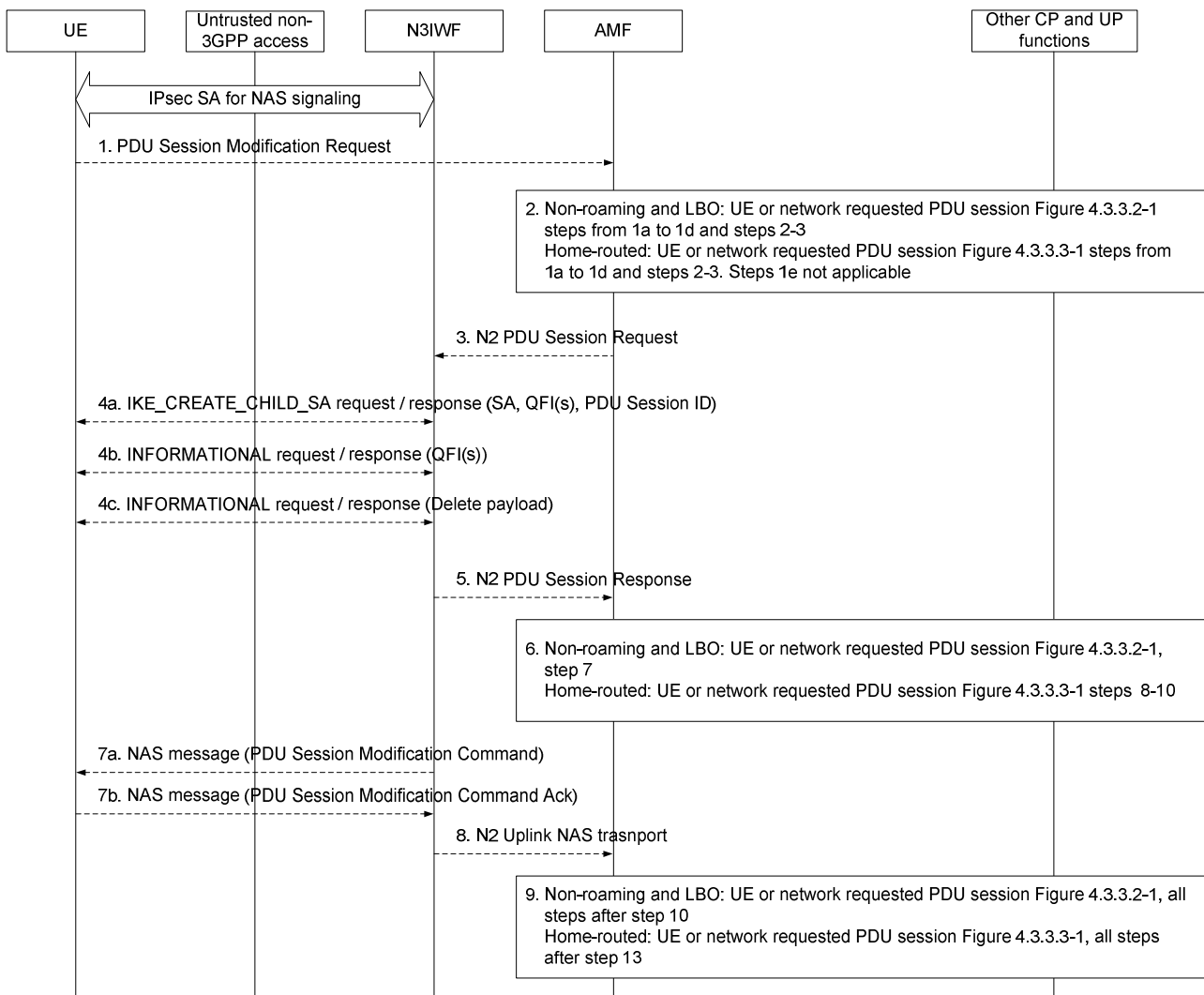

**Figure 4.12.6-1: UE or Network Requested PDU Session Modification via untrusted non-3GPP access**

1. If the PDU Session Modification procedure is initiated by the UE, the UE shall send a PDU Session Modification Request message to AMF as specified in step 1 of clause 4.3.2.2. The message shall be sent to N3IWF via the established IPsec SA for NAS signalling. The N3IWF shall transparently forward the PDU Session Modification Request to AMF/SMF.
2. In case of non-roaming or LBO, the steps 1a (from AMF) to 1e and steps 2-3 as per the PDU Session Modification procedure in clause 4.3.3.2 are executed.

In case of home-routed, the steps 1a (from AMF) to 1d and steps 2-3 as per the PDU Session Modification procedure in clause 4.3.3.3 are executed.

3. The AMF sends N2 PDU Session Request (N2 SM information received from SMF, NAS message) message to the N3IWF. This step is the same as step 4 in clause 4.3.3.2 (for non-roaming and roaming with Local Breakout) and step 5 in clause 4.3.3.3 (for home-routed roaming).
4. The N3IWF may issue IKEv2 signalling exchange with the UE that is related with the information received from SMF according to the IKEv2 specification in RFC 7296 [3]. Based on the N2 SM information received from the SMF, the N3IWF may perform following:
  - 4a. [Conditional] The N3IWF may decide to create a new Child SA for the new QoS Flow(s). In this case, the N3IWF establishes a new Child SA by sending an IKE\_CREATE\_CHILD\_SA request message, which includes the SA, the PDU Session ID and the QFI(s).
  - 4b. [Conditional] The N3IWF may decide to add or remove QoS Flow(s) to/from an existing Child SA. In this case, the N3IWF updates the QoS Flow and Child SA mapping information by sending an INFORMATIONAL request message, which includes the QFI(s) associated with the Child SA.
  - 4c. [Conditional] The N3IWF may decide to delete an existing Child SA, e.g. when there is no QoS Flow mapped to this Child SA. In this case, the N3IWF deletes the existing Child SA by sending INFORMATIONAL request message, which includes a Delete payload.

NOTE: If the N3IWF has included the Default Child SA indication during the establishment of one of the Child SAs of the PDU Session, the N3IWF may not update the mapping between QoS Flows Child SAs.

5. The N3IWF acknowledges N2 PDU Session Request by sending a N2 PDU Session Response Message to the AMF to acknowledge the success or failure of the request.
6. In case of non-roaming or LBO, step 7 as per the PDU Session Modification procedure in clause 4.3.3.2 is executed. In case of home-routed, the steps 8-10 as per the PDU Session Modification procedure in clause 4.3.3.3 are executed.
7. The N3IWF sends the PDU Session Modification Command to UE (if received in step 3) and receives the response message from UE.

Steps 4a/4c and step 7 may happen consecutively. Steps 7b may happen before step 4b/4d.
8. The N3IWF forwards the NAS message to the AMF.
9. For non-roaming and roaming with LBO, all the steps after step 10 in clause 4.3.3.2 are executed according to the general PDU Session Modification procedure. For home-routed roaming, all steps after step 13 in clause 4.3.3.3 are executed according to the general PDU Session Modification procedure.

#### 4.12.7 UE or network Requested PDU Session Release via Untrusted non-3GPP access

Clause 4.12.7 specifies how a UE or network can release a PDU Session via an untrusted non-3GPP access network. The UE requested PDU Session Release procedure via Untrusted non-3GPP access applies in non-roaming, roaming with LBO as well as in home-routed roaming scenarios.

For non-roaming and LBO scenarios, if the UE is simultaneously registered to a 3GPP access in a PLMN different from the PLMN of the N3IWF, the functional entities in the following procedures are located in the PLMN of the N3IWF. For home-routed roaming scenarios, the AMF, V-SMF and associated UPF in VPLMN in the following procedure is located in the PLMN of the N3IWF.

NOTE: If the UE is simultaneously registered to 3GPP access in the same PLMN as non-3GPP access, when non-3GPP access is not available to the UE (e.g. due to out of non-3GPP coverage) or UE is in CM-IDLE for non-3GPP access, the UE may perform the PDU Session Release procedure via 3GPP access as described in clause 4.3.4.

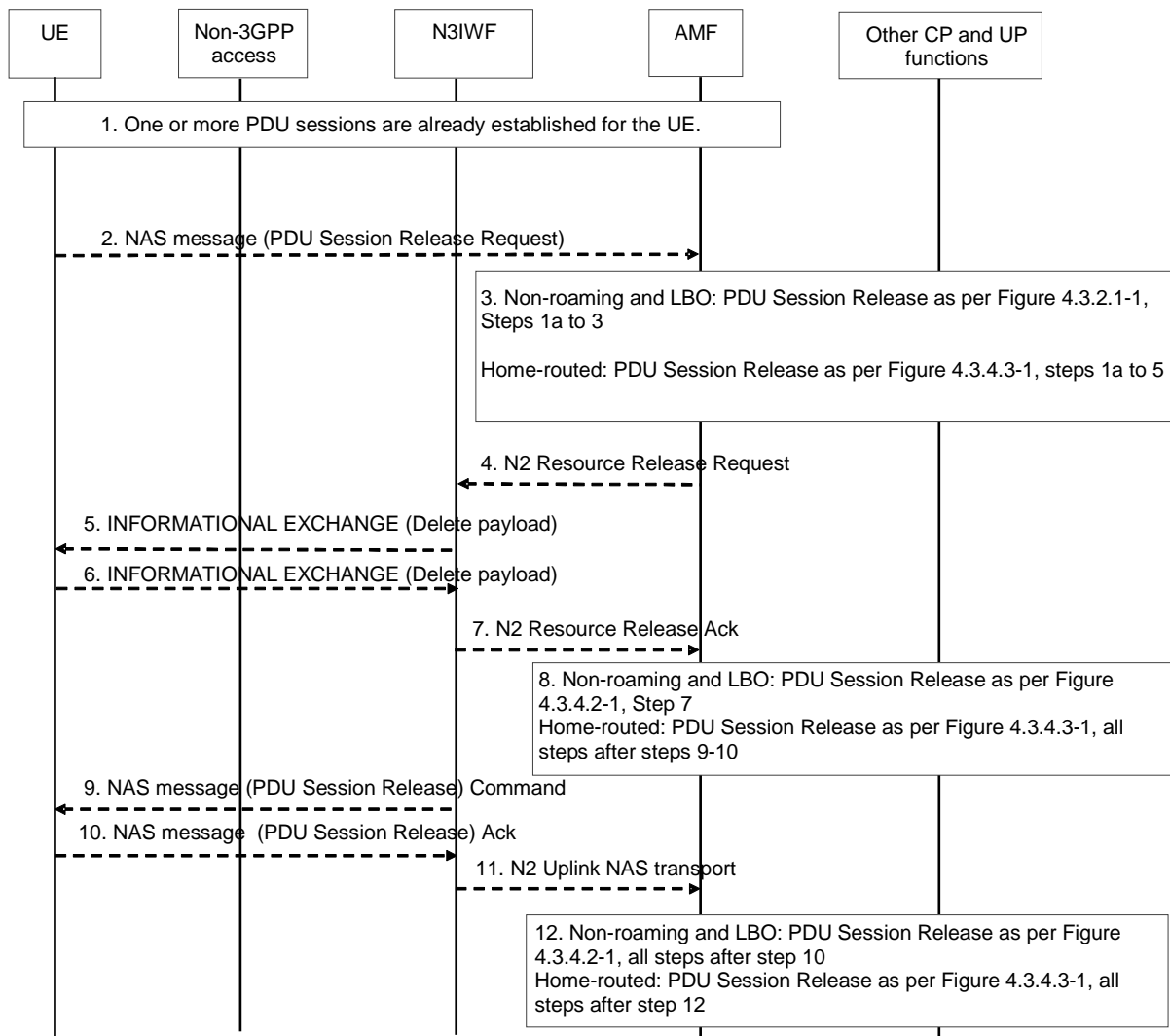

**Figure 4.12.7-1: UE Requested PDU Session Release via Untrusted non-3GPP access**

1. One or more PDU Sessions are already established for the UE using the procedure described in clause 4.12.2.
2. The UE sends a NAS message (N1 SM container (PDU Session Release Request), PDU Session ID) to the AMF via the N3IWF as defined in clause 4.3.4.
3. For non-roaming and roaming with LBO, the steps 1a (from AMF) to 4 according to the PDU Session Release procedure defined in clause 4.3.4.2 are executed. For home-routed roaming, the steps 1a (from AMF) to step 7 according to the PDU Session Release procedure defined in clause 4.3.4.3 are executed.
4. This step is the same as step 4 in clause 4.3.4.2 (non-roaming and LBO) and step 6 in clause 4.3.4.3 (home-routed roaming).  
  
If the message received from the SMF does not include N2 SM Resource Release request, the AMF sends N2 Downlink NAS transport (N1 SM container (PDU Session Release Command), PDU Session ID,Cause) message to the N3IWF, and steps 5 to 8 are skipped.
5. Upon receiving AN session release request message from the AMF, the N3IWF triggers the release of the corresponding Child SA by sending INFORMATIONAL EXCHANGE (Delete Payload) to the UE. Delete payload is included in the message listing the SPIs of the Child SAs to be deleted to this PDU Session as described in RFC 7296 [3].
6. The UE responds with INFORMATIONAL EXCHANGE (Delete Payload) message. Delete payload is included for the paired SAs going in the other direction as described in RFC 7296 [3].
7. This step is the same as step 6 in 4.3.4.2 (non-roaming and LBO) and step 8 in clause 4.3.4.3 (home-routed roaming).

8. For non-roaming and roaming with LBO, steps 7 according to the PDU Session Release procedure defined in clause 4.3.4.2 are executed. For home-routed roaming, step 9-10 according to the PDU Session Release procedure defined in clause 4.3.4.3 are executed.
9. The N3IWF delivers the NAS message (N1 SM container (PDU Session Release Command), PDU Session ID, Cause) to the UE.
10. The UE sends a NAS message (N1 SM container (PDU Session Release Ack), PDU Session ID) to the N3IWF.
11. This step is the same as step 9 in 4.3.4.2 (non-roaming and LBO) and step 11 in clause 4.3.4.3 (home-routed roaming).

Steps 5 and 9 may happen consecutively. Step 10 may happen before step 6.

12. For non-roaming and roaming with LBO, all steps after step 10 in the PDU Session Release procedure defined in clause 4.3.4.2 are executed. In case of home-routed roaming, all steps after step 12 in the PDU Session Release procedure defined in clause 4.3.4.3 are executed.

The network requested PDU Session Release procedure via Untrusted non-3GPP access is the same as the network requested PDU Session Release Procedure specified in clause 4.3.4.2 (for Non-Roaming and Roaming with Local Breakout) with the following differences:

- The (R)AN corresponds to an N3IWF.
- In step 5 the N3IWF upon receiving N2 SM request to release the AN resources associated with the PDU Session from the AMF, the N3IWF triggers the release of the corresponding Child SA to the UE as specified in step 5 and 6, in Figure 4.12.7-1.
- User Location Information is not included in the step 6, 7a, 9, 10a and 12 of the procedure.

#### 4.12.8 Mobility from a non-geographically selected AMF to a geographically selected AMF

This procedure describes the AMF change that takes place when an UE initially served via non-3GPP access by an AMF selected based on non-geographical criteria (e.g. because the UE had no 3GPP coverage or because only non-geographically selectable N3IWF are deployed) gets 3GPP access and is now to be served by an AMF selected in the same PLMN by the NG-RAN based on geographical criteria.

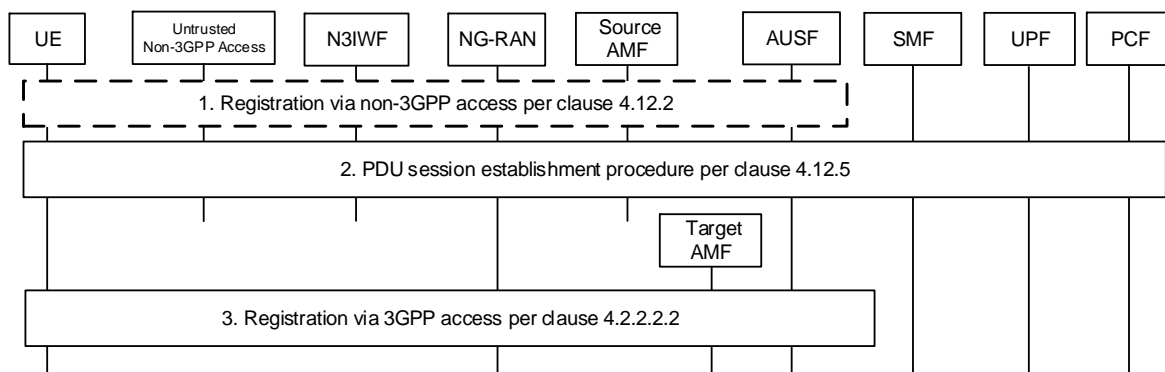

**Figure 4.12.8-1: Mobility from a non-geographically selected AMF to a geographically selected AMF**

1. The UE registers over non-3GPP access, as described in clause 4.12.2. During this procedure:
  - a An AMF (source AMF) is selected by the N3IWF in step 6a, based on non-geographical criteria (e.g. because the UE has no 3GPP coverage or because only non-geographically selectable N3IWF are deployed).
  - b The UE receives, within the Registration Accept message, a 5G-GUTI containing a GUAMI of the non-geographically selected AMF. The UE also receives an Allowed NSSAI and optionally Mapping Of Allowed NSSAI.
2. The UE may activate PDU Sessions over non-3GPP access, as described in clause 4.12.5.

3. The UE gets 3GPP access and issues a Registration Request over 3GPP access as defined in step 1 of Figure 4.2.2.2.2-1, providing its 5G-GUTI.

If the 5G-GUTI does not indicate an AMF of the same Region ID as that of the NG-RAN, the NG-RAN selects an AMF Set and an AMF in the AMF Set as described in TS 23.501 [2], clause 6.3.5.

Steps 3 to 22 of Figure 4.2.2.2.2-1 take place including following aspects:

- step 4 of Figure 4.2.2.2.2-1 takes place i.e. the new AMF invokes the Namf\_Communication\_UEContextTransfer service operation on the old AMF to request the UE's SUPI and MM Context.
- in step 5 of Figure 4.2.2.2.2-1, the old AMF includes information about active NGAP association to N3IWF.
- in step 18 of Figure 4.2.2.2.2-1, the new AMF modifies the NGAP association toward N3IWF.
- in step 21 of Figure 4.2.2.2.2-1, the Registration Accept message shall include the updated 5G-GUTI that the UE will use to update its 3GPP and non-3GPP registration contexts.

## 4.13 Specific services

### 4.13.1 General

Clause 4.13 defines the additional procedures or additions to the existing procedures to support specific services such as SMS over NAS.

### 4.13.2 Application Triggering

#### 4.13.2.1 General

The AF invokes the Nnef\_Trigger service to request that the network send an Application trigger to the UE.

4.13.2.2 The procedure of "Application Triggering" Service

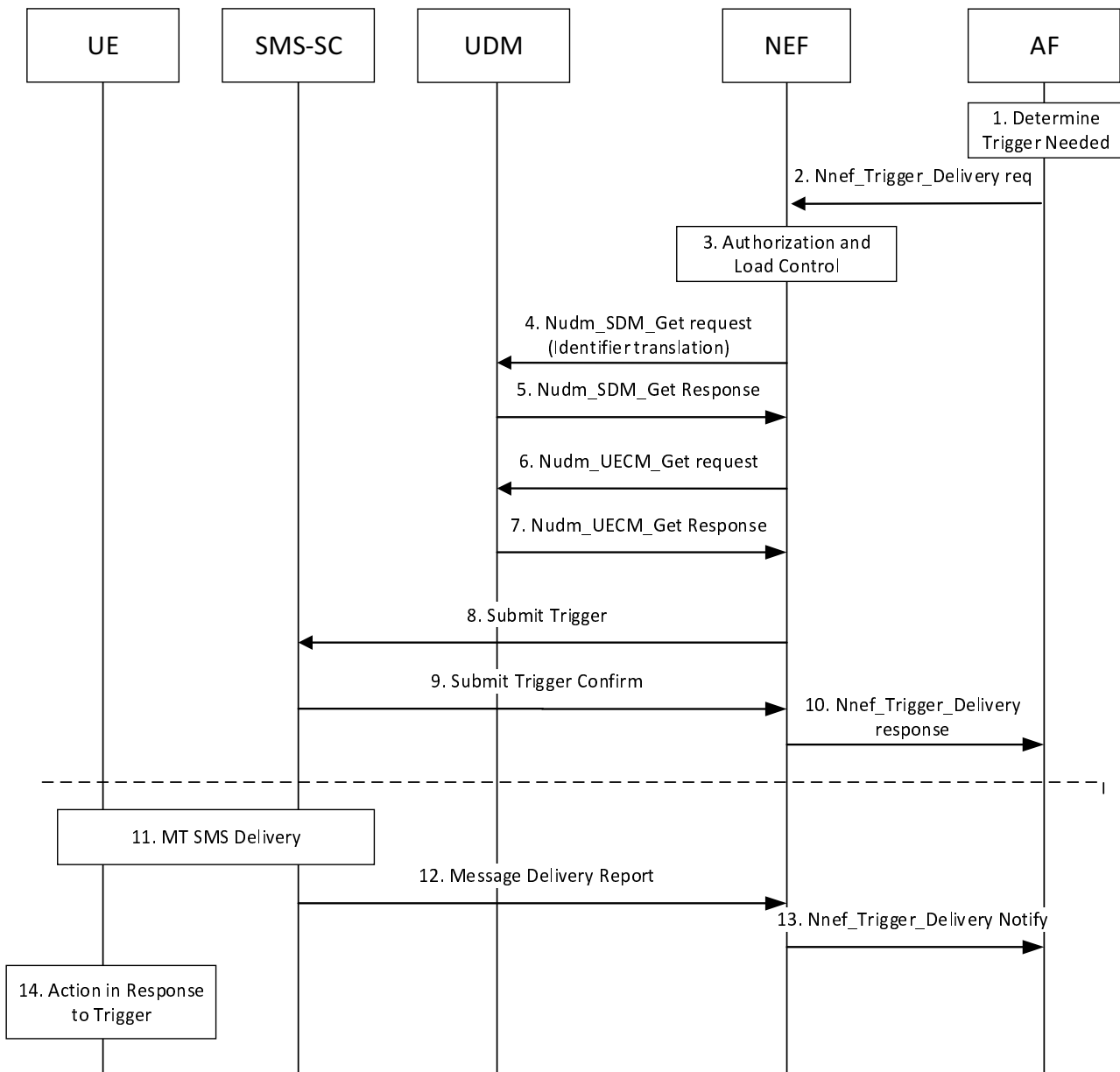

Figure 4.13.2.2-1: Device triggering procedure via Nnef

1. The AF determines the need to trigger the device. If the AF has no contact details for the NEF, it shall discover and select NEF services.
2. The AF invokes the Nnef\_Trigger\_Delivery request service.
3. The NEF checks that the AF is authorised to send trigger requests and that the AF has not exceeded its quota or rate of trigger submission over Nnef. If this check fails, the NEF sends an Nnef\_Trigger\_Delivery response with a cause value indicating the reason for the failure condition and the flow stops at this step. Otherwise, the flow continues with step 4.
4. The NEF invokes Nudm\_SDM\_Get (Identifier Translation, GPSI and AF Identifier) to resolve the GPSI to SUPI when the AF is authorized to trigger the UE.

NOTE 1: Optionally, mapping from GPSI (External Id) to GPSI (MSISDN) is also provided for legacy SMS infrastructure not supporting MSISDN-less SMS.



5. The UDM may invoke the Nudr\_DM\_Query service to retrieve a list of AF's that are allowed to trigger the UE and determines, based on UDM policy, which identifier (SUPI or MSISDN) should be used to trigger the UE. The UDM provides a Nudm\_SDM\_Get response (SUPI, optionally MSISDN). If the AF is not allowed to send a trigger message to this UE, or there is no valid subscription information for this user, the NEF sends an Nnef\_Trigger\_Delivery response with a cause value indicating the reason for the failure condition and the flow stops at this step. Otherwise this flow continues with step 6.

NOTE 2: The presence of an MSISDN in the reply is interpreted as an indication to the NEF that MSISDN is used (instead of IMSI) to identify the UE when sending the SMS to the SMS-SC via T4.

6. The NEF invokes Nudm\_UECM\_Get (SUPI, SMS) to retrieve the UE SMSF identities.
7. The UDM may invoke the Nudr\_DM\_Query service to retrieve the UE SMSF identities. The UDM provides a Nudm\_UECM\_Get response with the corresponding UE SMSF identities. UDM policy (possibly dependent on the VPLMN ID) may influence which serving node identities are returned.

NOTE 3: The NEF can cache serving node information for the UE. However, this can increase the probability of trigger delivery attempt failures when the cached serving node information is stale.

8. The NEF selects a suitable SMS-SC based on configured information. The NEF acts as an MTC-IWF and sends a Submit Trigger (GPSI, SUPI, AF Identifier, trigger reference number, validity period, priority, SMSF serving node ID(s) (if available, are obtained from UDM in step 7), SMS Application port ID, trigger payload, Trigger Indication) message to the SMS-SC.

If the NEF indicates that "Absent subscriber" was received from the UDM, the SMS-SC should not submit the message, but store it directly and send Routing Information for SM to request the UDM to add the SMS-SC address to the Message Waiting List.

9. The SMS-SC sends a Submit Trigger Confirm message to the NEF to confirm that the submission of the SMS has been accepted by the SMS-SC.
10. The NEF sends a Nnef\_Trigger\_Delivery response to the AF to indicate if the Device Trigger Request has been accepted for delivery to the UE.
11. The SMS\_SC performs MT SMS delivery as defined in clause 4.13.3. The SMS-SC may provide the routing information that it received in step 6 to SMS-GMSC to avoid UDM interrogation. The SMS-SC generates the necessary CDR information and includes the AF Identifier. The SMS Application port ID, which is included in the SM User Data Header, and the Trigger Indication are included in the CDRs in order to enable differentiated charging. The SMS-SC stores the trigger payload, without routing information. If the message delivery fails and is attempted to be delivered again, UDM interrogation will be performed. If the message delivery fails and the validity period of this trigger message is not set to zero, the SMS-SC shall send a SM Message Delivery Status Report to request the UDM to add the SMS-SC address to the Message Waiting list. When the message delivery is later re-attempted, a new UDM interrogation will be performed by the SMS-GMSC using SUPI or MSISDN. UDM interrogations using SUPI shall not be forwarded or relayed to SMS-Router or IP-SM-GWs. The UDM may include up to four serving node identities (MSC or MME, SGSN, IP-SM-GW, AMF) in the response to SMS-GMSC.
12. If the message delivery fails (either directly or when validity period of the trigger message expires) or when the message delivery succeeds, the SMS-SC shall send a Message Delivery Report (cause code, trigger reference number, AF Identifier) to the NEF.
13. The NEF provides a Nnef\_Trigger\_DeliveryNotify message to the AF with a Delivery Report indicating the trigger delivery outcome (e.g. succeeded, unknown or failed and the reason for the failure). The NEF generates the necessary CDR information including the GPSI and AF Identifier.
14. In response to the received device trigger, the UE takes specific actions and may take into consideration the content of the trigger payload. This action typically involves initiation of immediate or later communication with the AF.

### 4.13.3 SMS over NAS procedures

#### 4.13.3.1 Registration procedures for SMS over NAS

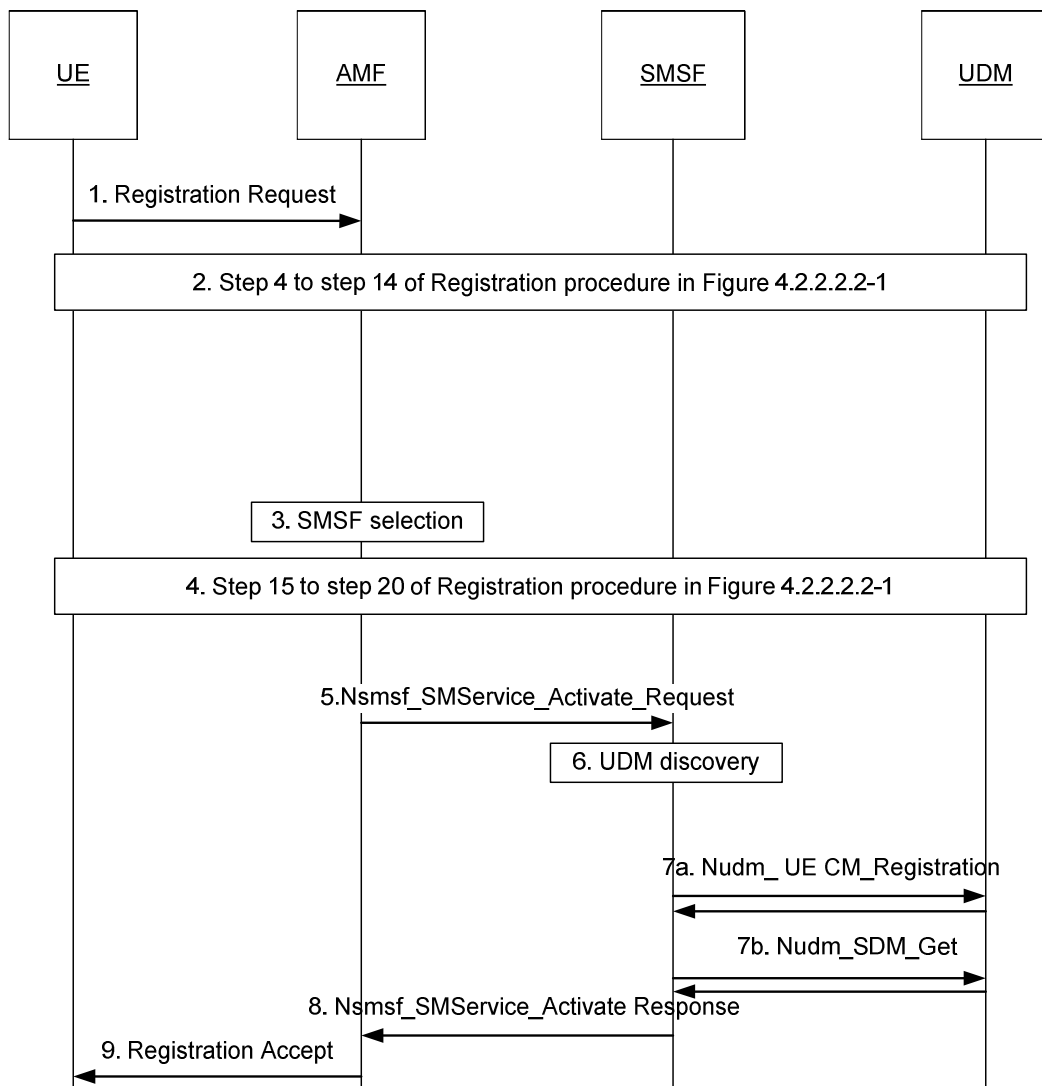

**Figure 4.13.3.1-1: Registration procedure supporting SMS over NAS**

1. During Registration procedure in 5GS defined in Figure 4.2.2.2-1, to enable SMS over NAS transporting, the UE includes an "SMS supported" indication in Registration Request in step 1-3 indicating the UE's capability for SMS over NAS transport. The "SMS supported" indication indicates whether the UE supports SMS delivery over NAS.
2. Step 4 to step 14 of the Registration procedure in Figure 4.2.2.2-1 are performed. The AMF may retrieve the SMS Subscription data and UE Context in SMSF data using Nudm\_SDM\_Get. This requires that UDM may retrieve this information from UDR by Nudr\_DM\_Query. The UDM includes the SMSF information in the Nudm\_SDM\_Get response message if the stored SMSF belongs to the same PLMN of the AMF. After a successful response is received and if SMS service is allowed, the AMF subscribes to be notified using Nudm\_SDM\_Subscribe when the SMS Subscription data is modified, and UDM may subscribe to UDR by Nudr\_DM\_Subscribe.  
  
The AMF can also receive UE context information containing SMSF Information from old AMF. When AMF re-allocation happens during the Registration procedure, the old AMF transfers SMSF Information to the new AMF as part of UE context in step 5 of Figure 4.2.2.2-1.
3. If the "SMS supported" indication is included in the Registration Request, the AMF checks in the SMS Subscription data that was received in step 2 whether the SMS service is allowed to the UE. If SMS service is

allowed and the UE context received in step 2 includes an available SMSF of the serving PLMN, the AMF activates this SMSF Address and continues the registration procedure. If SMS service is allowed but an SMSF of the serving PLMN was not received in step 2, the AMF discovers and selects an SMSF to serve the UE as described in clause 6.3.10 of TS 23.501 [2].

4. Step 15 to step 20 of the Registration procedure in Figure 4.2.2.2.2-1 are performed.
5. The AMF invokes Nsmsf\_SMSservice\_Activate service operation from the SMSF. The invocation includes AMF address, Access Type, Trace Requirements, GPSI (if available) and SUPI. AMF uses the SMSF Information derived from step 3. Trace Requirements is provided if it has been received by AMF as part of subscription data.
6. The SMSF discovers a UDM as described in TS 23.501 [2], clause 6.3.8.
- 7a-7b. If the UE context for the current Access Type already exists in the SMSF, the SMSF shall replace the old AMF address with the new AMF address.

Otherwise, the SMSF registers with the UDM using Nudm\_UECM\_Registration with Access Type. As a result, the UDM stores the following information: SUPI, SMSF identity, SMSF address, Access Type in UE Context in SMSF data. The UDM may further store SMSF Information in UDR by Nudr\_DM\_Update (SUPI, Subscription Data, UE Context in SMSF data). SMSF retrieves SMS Management Subscription data (e.g., SMS teleservice, SMS barring list) using Nudm\_SDM\_Get and this requires that UDM may get this information from UDR by Nudr\_DM\_Query (SUPI, Subscription Data, SMS Management Subscription data). After a successful response is received, the SMSF subscribes to be notified using Nudm\_SDM\_Subscribe when the SMS Management Subscription data is modified and UDM may subscribe to notifications from UDR by Nudr\_DM\_Subscribe.

SMSF also creates a UE context to store the SMS subscription information and the AMF address that is serving this UE.

8. The SMSF responds back to the AMF with Nsmsf\_SMSservice\_Activate service operation response message. The AMF stores the SMSF Information received as part of the UE context.
9. The AMF includes the "SMS allowed" indication to the UE in the Registration Accept message of step 21 of Figure 4.2.2.2.2-1 only after step 8 in which the AMF has received a positive indication from the selected SMSF.

The "SMS allowed" indication in the Registration Accept message indicates to the UE whether the network allows the SMS message delivery over NAS.

#### 4.13.3.2 Deregistration procedures for SMS over NAS

If UE indicates to AMF that it no longer wants to send and receive SMS over NAS (e.g., not including "SMS supported" indication in subsequent Registration Request message) or AMF considers that UE is deregistered or AMF receives Deregistration Notification from UDM indicating UE Initial Registration, Subscription Withdrawn or 5GS to EPS Mobility as specified in clause 5.2.3.2.2, AMF may unsubscribe from SMS Subscription data changes notification with the UDM by means of the Nudm\_SDM\_Unsubscribe service operation. The UDM may remove the corresponding subscription of data change notification in UDR by Nudr\_DR\_Unsubscribe service operation. AMF invokes Nsmsf\_SMSservice\_Deactivate service operation to trigger the release of UE Context for SMS on SMSF based on local configurations. AMF may delete or deactivate the stored SMSF address in its UE Context. The SMSF unsubscribes from SMS Management Subscription data changes notification with the UDM by means of the Nudm\_SDM\_Unsubscribe service operation. The UDM may remove the corresponding subscription of data change notification in UDR by Nudr\_DR\_Unsubscribe service operation. The SMSF shall invoke Nudm\_UECM\_Deregistration (SUPI, NF ID, Access Type) service operation from UDM to trigger UDM to delete SMSF address of the UE. The UDM may update UE context in SMSF in UDR by Nudr\_DR\_Update (SUPI, Subscription Data, SMS Subscription data, SMSF address). The SMSF also removes the UE Context for SMS, including AMF address.

## 4.13.3.3 MO SMS over NAS in CM-IDLE (baseline)

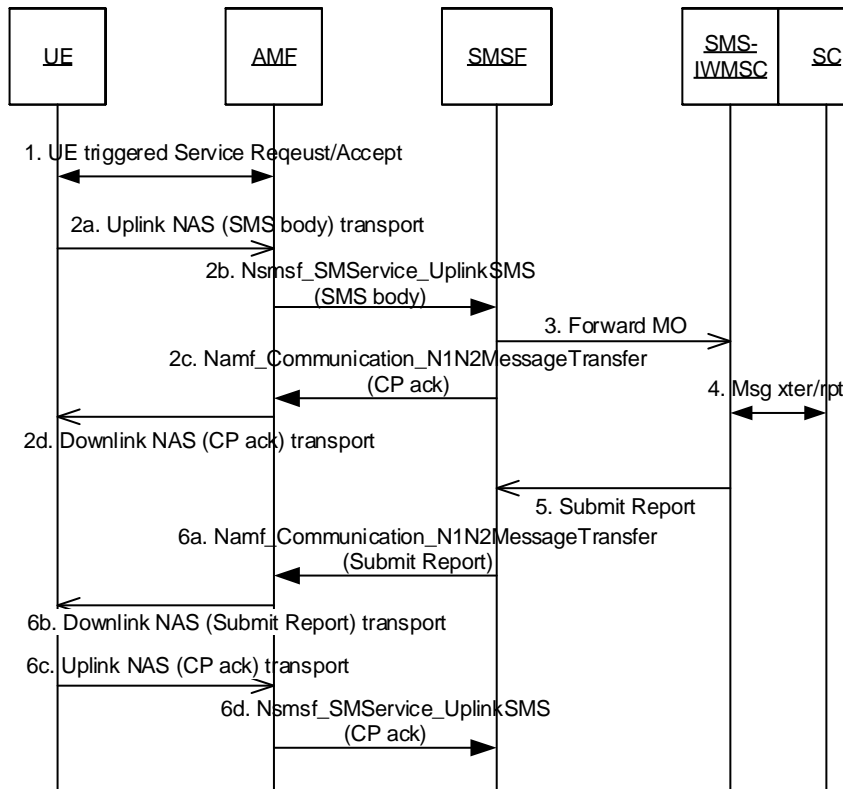

Figure 4.13.3.3-1: MO SMS over NAS

1. The UE performs domain selection for UE originating SMS as defined in clause 5.16.3.8 of TS 23.501 [2] if SMS delivery via non 3GPP access is allowed and possible. If an UE under CM-IDLE state is going to send uplink SMS message, then UE and network perform the UE Triggered Service Request procedure firstly as defined in clause 4.2.3.2 to establish a NAS signalling connection to AMF.
- 2a. The UE builds the SMS message to be sent as defined in TS 23.040 [7] (i.e. the SMS message consists of CP-DATA/RP-DATA/TPDU/SMS-SUBMIT parts). The SMS message is encapsulated in an NAS message with an indication indicating that the NAS message is for SMS transporting. The UE send the NAS message to the AMF.
- 2b. The AMF forwards the SMS message and SUPI to the SMSF serving the UE over N20 message by invoking Nsmf\_SMSservice\_UplinkSMS service operation. In order to permit the SMSF to create an accurate charging record, the AMF adds the IMEISV, the current UE Location Information (ULI) of the UE as defined in TS 23.501 [2] clause 5.6.2, and, if the UE has sent the SMS via 3GPP access, the local time zone.
- 2c. The SMSF invokes Namf\_Communication\_N1N2MessageTransfer service operation to forward SMS ack message to AMF.
- 2d. The AMF forwards the SMS ack message from the SMSF to the UE using downlink unit data message.
- 3-5. The SMSF checks the SMS management subscription data. If SMS delivery is allowed, the procedure defined in TS 23.040 [7] applies.
- 6a-6b. The SMSF forwards the submit report to AMF by invoking Namf\_Communication\_N1N2MessageTransfer service operation which is forwarded to UE via Downlink NAS transport. In case the SMSF knows the submit report is the last message to be transferred for UE, the SMSF shall include a last message indication in the Namf\_Communication\_N1N2MessageTransfer service operation so that the AMF knows no more SMS data is to be forwarded to UE.

NOTE: The behavior of AMF based on the "last message indication" is implementation specific.

If the UE has more than one SMS message to send, the AMF and SMSF forwards SMS /SMS ack/submit report the same way as described in step 2a-6b.

6c-6d. When no more SMS is to be sent, UE returns a CP-ack as defined in TS 23.040 [7] to SMSF. The AMF forwards the SMS ack message by invoking Nsmsf\_SMSservice\_UplinkSMS service operation to SMSF.

4.13.3.4 Void

4.13.3.5 MO SMS over NAS in CM-CONNECTED

MO SMS in CM-CONNECTED State procedure is specified by reusing the MO SMS in CM-IDLE State without the UE Triggered Service Request procedure.

4.13.3.6 MT SMS over NAS in CM-IDLE state via 3GPP access

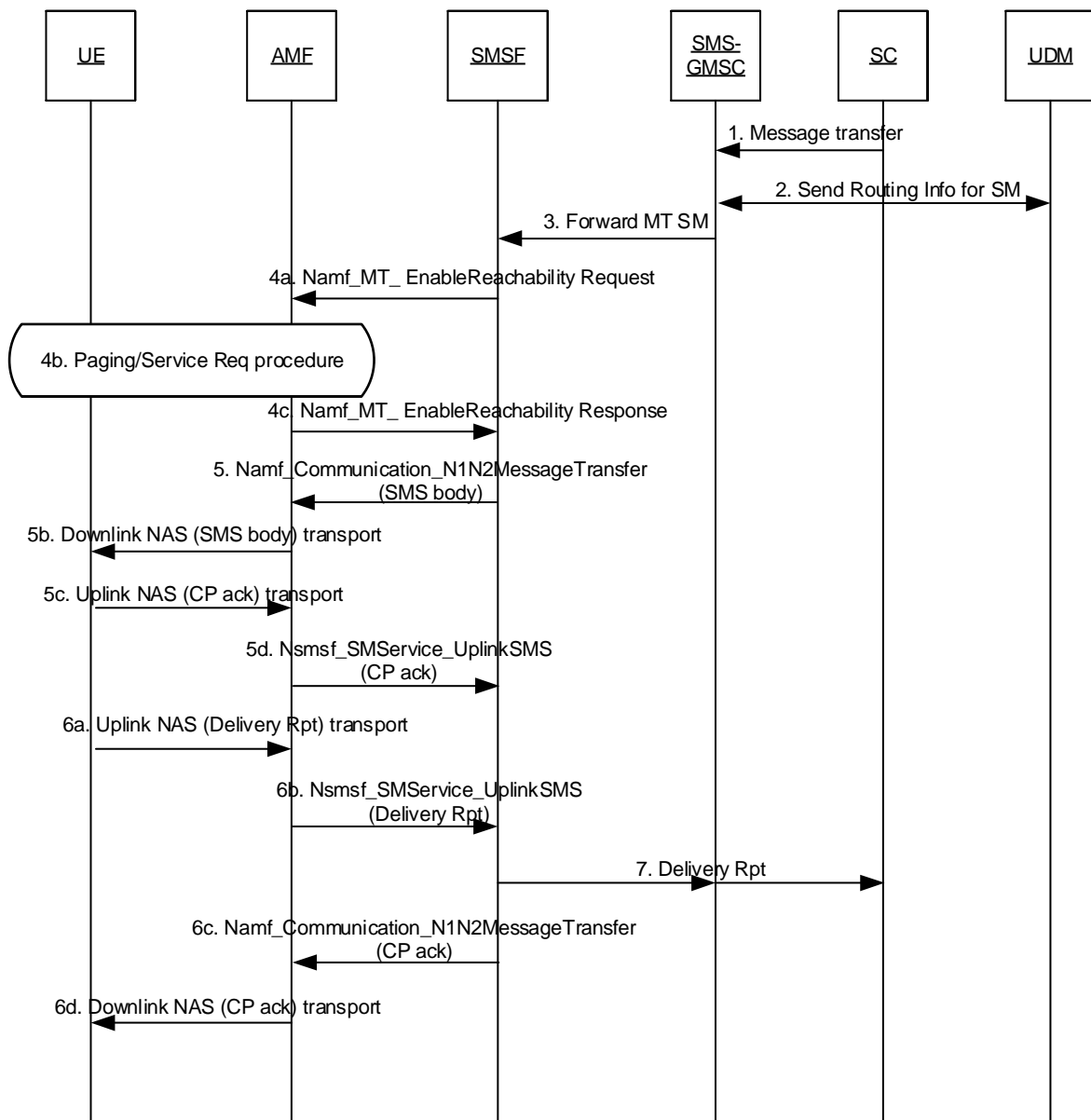

Figure 4.13.3.6-1: MT SMS over NAS in CM\_IDLE state via 3GPP access

1-3 MT SMS interaction between SC/SMS-GMSC/UDM follow the current procedure as defined in TS 23.040 [7].  
If there are two AMFs serving the UE, one is for 3GPP access and another is for non-3GPP access, there are two SMSF addresses stored in UDM/UDR. The UDM shall return both SMSF addresses.

4. The SMSF checks the SMS management subscription data. If SMS delivery is allowed, SMSF invokes Namf\_MT\_EnableUEReachability service operation to AMF. AMF pages the UE using the procedure defined in clause 4.2.3.4. The UE responds to the page with Service Request procedure.

If the AMF indicates SMSF that UE is not reachable, the procedure of the unsuccessful Mobile terminating SMS delivery described in clause 4.13.3.9 is performed and the following steps are skipped.

If the UE access to the AMF via both 3GPP access and non-3GPP access, the AMF determines the Access Type to transfer the MT-SMS based on operator local policy.

5a-5b. SMSF forward the SMS message to be sent as defined in TS 23.040 [7] (i.e. the SMS message consists of CP-DATA/RP-DATA/TPDU/SMS-DELIVER parts) to AMF by invoking Namf\_Communication\_N1N2MessageTransfer service operation. The AMF transfers the SMS message to the UE.

5c-5d. The UE acknowledges receipt of the SMS message to the SMSF. For uplink unitdata message toward the SMSF, the AMF invokes Nsmsf\_SMSservice\_UplinkSMS service operation to forward the message to SMSF. In order to permit the SMSF to create an accurate charging record, the AMF also includes IMEISV, the current UE Location Information (ULI) of the UE as defined in TS 23.501 [2] clause 5.6.2 and, if the SMS is delivered to the UE via 3GPP access, the local time zone.

6a-6b. The UE returns a delivery report as defined in TS 23.040 [7]. The delivery report is encapsulated in an NAS message and sent to the AMF which is forwarded to SMSF by invoking Nsmsf\_SMSservice\_UplinkSMS service operation.

6c-6d. The SMSF acknowledges receipt of the delivery report to the UE. The SMSF uses Namf\_Communication\_N1N2MessageTransfer service operation to send SMS CP ack message to the AMF. The AMF encapsulates the SMS message via a NAS message to the UE. If SMSF has more than one SMS to send, the SMSF and the AMF forwards subsequent SMS /SMS ack/ delivery report the same way as described in step 4-6c.

In case the SMSF knows the SMS CP ack is the last message to be transferred for UE, the SMSF shall include a last message indication in the Namf\_Communication\_N1N2MessageTransfer service operation so that the AMF knows no more SMS data is to be forwarded to UE.

NOTE: The behavior of AMF based on the "last message indication" is implementation specific.

7. In parallel to steps 6c and 6d, the SMSF delivers the delivery report to SC as defined in TS 23.040 [7].

#### 4.13.3.7 MT SMS over NAS in CM-CONNECTED state via 3GPP access

MT SMS in CM-CONNECTED procedure is specified by reusing the MT SMS in CM-IDLE state with the following modification:

- There is no need for the AMF to perform Paging of the UE and can immediately continue with a message to SMSF via N20 to allow the SMSF to start forward the MT SMS.
- If the delivery of the NAS PDU containing the SMS fails e.g. in case the UE is in RRC Inactive and NG-RAN paging was not successful, the NG-RAN initiates the UE context release in the AN procedure and provides notification of non-delivery to the AMF. The AMF provides an indication of non-delivery to the SMSF.

#### 4.13.3.8 MT SMS over NAS via non-3GPP access

MT SMS procedure via non-3GPP access is specified by reusing the MT SMS via 3GPP access in CM-CONNECTED state with the following modification:

- If the UE access to the network via both 3GPP and non-3GPP accesses and the AMF determines to deliver MT-SMS via non-3GPP access based on operator policy in step 4, the NAS message is transferred via non-3GPP access network.

### 4.13.3.9 Unsuccessful Mobile terminating SMS delivery attempt

The procedure of Unsuccessful Mobile terminating SMS delivery is defined as follows:

- If the UE is registered over both 3GPP access and non-3GPP access in the same AMF (i.e. the UE is registered in the same PLMN for both access types):
  - if the MT-SMS delivery over one Access Type has failed, the AMF, based on operator local policy, may re-attempt the MT-SMS delivery over the other Access Type before indicating failure to SMSF;
  - if the MT-SMS delivery on both Access Types has failed, the AMF shall inform the SMSF immediately.
- If the AMF informs the SMSF that it cannot deliver the MT-SMS to the UE, the SMSF sends a failure report to the first SMS-GMSC (which can be co-located with IP-SM-GW or SMS Router) as defined in TS 23.040 [7]. If the SMS-GMSC has more than one entity for SMS transport towards the UE, then upon receiving MT-SMS failure report, the SMS-GMSC, based on operator local policy, may re-attempt the MT-SMS delivery via the other entity.
- After the first SMS-GMSC informs the UDM/HSS that the UE is not able to receive MT-SMS, the UDM/HSS shall set its internal Mobile Station Not Reachable Flag (MNRF).
- If the UDM/HSS has not subscribed UE Reachability Notification, it immediately initiates a subscription procedure as specified in clause 4.2.5.2.
- When the AMF detects UE activities, it notifies UDM/HSS with UE Activity Notification as described in clause 4.2.5.3. The UDM/HSS clears its MNRF and alerts related SMSCs to retry MT-SMS delivery.

## 4.13.4 Emergency Services

### 4.13.4.1 General

If the 5GS supports Emergency Services, the support is indicated to UE via the Registration Accept message on per-TA-list and per-RAT basis, as described in TS 23.501 [2].

If the 5GS supports Emergency Services Fallback, the support is indicated to UE via the Registration Accept message on per-TA-list and per-RAT basis, as described in TS 23.501 [2].

The UE shall follow the domain selection rules for emergency session attempts as described in TS 23.167 [28].

If the 5GC has indicated Emergency Services Fallback support for the TA and RAT where the UE is currently camping, and if the UE supports emergency services fallback, the UE shall initiate the Emergency Services Fallback procedure described in clause 4.13.4.2.

At QoS Flow establishment request for Emergency Services, the procedure described in clause 4.13.6.2 Inter RAT Fallback in 5GC for IMS voice or the procedure described in clause 4.13.6.1 EPS fallback for IMS voice may be triggered by the network, when configured.

### 4.13.4.2 Emergency Services Fallback

The call flow in Figure 4.13.4.2-1 describes the procedure for emergency services fallback.

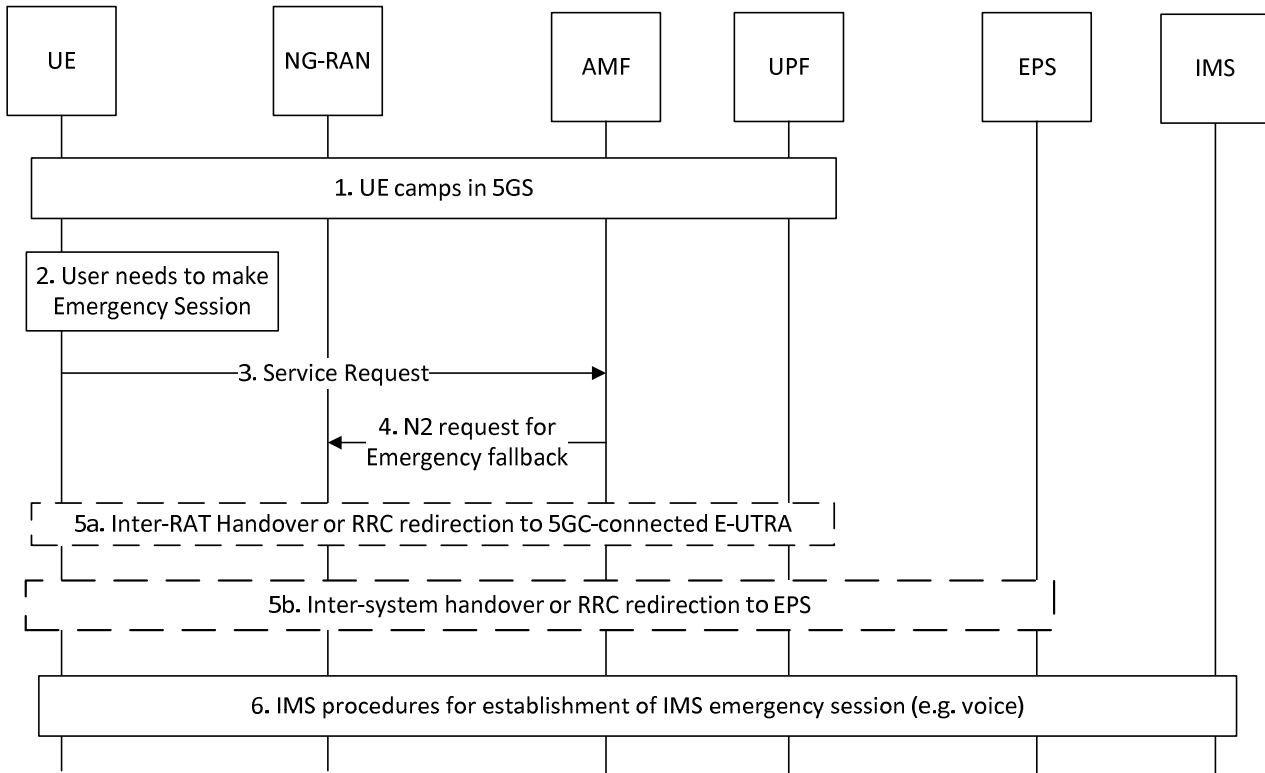

**Figure 4.13.4.2-1: Emergency Services Fallback**

1. UE camps on E-UTRA or NR cell in the 5GS (in either CM\_IDLE or CM\_CONNECTED state).
2. UE has a pending IMS emergency session request (e.g. voice) from the upper layers.
3. If the AMF has indicated support for emergency services using fallback via the Registration Accept message for the current RAT, the UE sends a Service Request message indicating that it requires emergency services fallback.
4. 5GC triggers a request for Emergency Services Fallback by executing an NG-AP procedure in which it indicates to NG-RAN that this is a fallback for emergency services. The AMF based on the support of Emergency Services in EPC or 5GC may indicate the target CN for the RAN node to know whether inter-RAT fallback or inter-system fallback is to be performed. When AMF initiates Redirection for UE(s) that have been successfully authenticated, AMF includes the security context in the request to trigger fallback towards NG-RAN.
5. Based on the target CN indicated in message 4, one of the following procedures is executed by NG-RAN:
  - 5a. NG-RAN initiates handover (see clause 4.9.1.3) or redirection to a 5GC-connected E-UTRAN cell, if UE is currently camped on NR.
  - 5b. NG-RAN initiates handover (see clause 4.11.1.2.1) or redirection to E-UTRAN connected to EPS. NG-RAN uses the security context provided by the AMF to secure the redirection procedure.

If the redirection procedure is used either in 5a or 5b the target CN is also conveyed to the UE in order to be able to perform the appropriate NAS procedures (S1 or N1 Mode). The UE uses the emergency indication in the RRC message as specified in clause 6.2.2 of TS 36.331 [16] and E-UTRAN provides the emergency indication to AMF in step 5a and MME in step 5b during Tracking Area Update. The Tracking Area Update should contain an indication that the UE has "user data pending". For the handover procedure used in step 5b see clause 4.11.1.2.1, step 1.

In step 5b, if the MME does not support emergency services for that UE, the MME should act such the emergency call is likely to succeed promptly, e.g., if the UE successfully completed a combined TA/LA Update with the network, by using the CSFB procedures specified in TS 23.272 [50].



NOTE: If such a combined TA/LA Update is not successful, or the UE did not request a combined update, then, as specified in TS 23.167 [28], the UE autonomously selects a RAT that may (but which might not) support the CS domain.

- After handover to the target cell the UE establishes a PDU Session / PDN connection for IMS emergency services and performs the IMS procedures for establishment of an IMS emergency session (e.g. voice) as defined in TS 23.167 [28].

## 4.13.5 Location Services procedures

### 4.13.5.1 5GC-NI-LR Procedure

Figure 4.13.5.1-1 shows a Network Induced Location Request (NI-LR) procedure for a UE in the case where the UE initiates an emergency session using NG-RAN. The procedure assumes that the serving AMF is aware of the emergency session initiation – e.g. due to supporting an Emergency Registration procedure or assisting in establishing an emergency PDU Session.

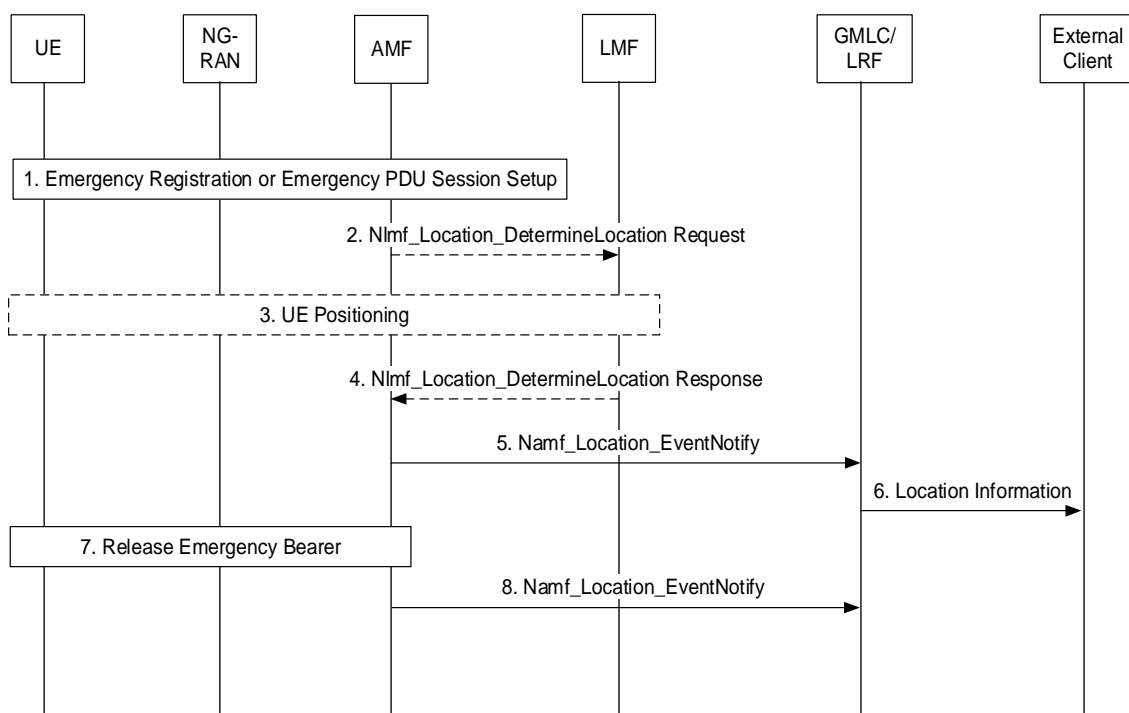

**Figure 4.13.5.1-1: 5GC Network Induced Location Request (5GC-NI-LR) for a UE**

- The UE registers to the 5GC for emergency services or requests the establishment of an emergency PDU Session.
- The AMF may select an LMF based on NRF query or configuration in AMF and invoke the Nlmf\_Location\_DetermineLocation service operation towards the LMF to request the current location of the UE. The service operation includes a LCS Correlation identifier, the serving cell identity, and an indication of a location request from an emergency services client and may include an indication if UE supports LPP or not, the required QoS and Supported GAD shapes. If any of the procedures in clause 4.13.5.4 or 4.13.5.5 are used the service operation includes the AMF identity.
- If step 2 occurs, the LMF performs one or more of the positioning procedures described in clause 4.13.5.4, 4.13.5.5 and 4.13.5.6.
- If step 3 occurs, the LMF returns the Nlmf\_Location\_DetermineLocation Response towards the AMF to return the current location of the UE. The service operation includes the LCS Correlation identifier, the location estimate, its age and accuracy and may include information about the positioning method.

5. The AMF selects a GMLC based on NRF query or configuration in AMF. The information regarding the endpoint in the GMLC to deliver the event notification, is obtained from the NRF as specified in clause 7.1.2 of TS 23.501 [2] or from local configuration in the AMF. AMF invokes the Namf\_Location\_EventNotify service operation towards the selected GMLC to notify the GMLC of an emergency session initiation. The service operation includes the SUPI or the PEI, and the GPSI if available, the identity of the AMF, an indication of an emergency session and any location obtained in step 3.
6. The GMLC forwards the location to an external emergency services client or may wait for a request for the location from the external emergency services client (not shown in Figure 4.13.5.1-1) before forwarding the location.
7. The emergency services session and emergency PDU Session are released.
8. The AMF invokes the Namf\_Location\_EventNotify service operation towards the GMLC to notify the GMLC that the emergency session was released to enable the GMLC and LRF to release any resources associated with the emergency session.

#### 4.13.5.2 5GC-MT-LR Procedure without UDM Query

Figure 4.13.5.2-1 illustrates a location request for an emergency services session, where an emergency services client (e.g. a Public Safety Answering Point) identifies the target UE and the serving LRF using correlation information that was previously provided to it by the IMS Core. The signalling used to provide the correlation information to the PSAP is defined in TS 23.167 [28]. The correlation information may be used by the LRF to retrieve other information previously provided to it by the IMS Core and/or AMF as described for Figure 4.13.5.1-1. This allows the GMLC associated with the LRF to request a location from the AMF without needing to query the UDM of the target UE for the serving AMF address. This scenario therefore supports location of emergency sessions from roamers and USIM-less and other non-registered UEs, and requires that identifying information for the UE and AMF have been provided to the GMLC/LRF as described in clause 4.13.5.1 and 4.13.5.7.

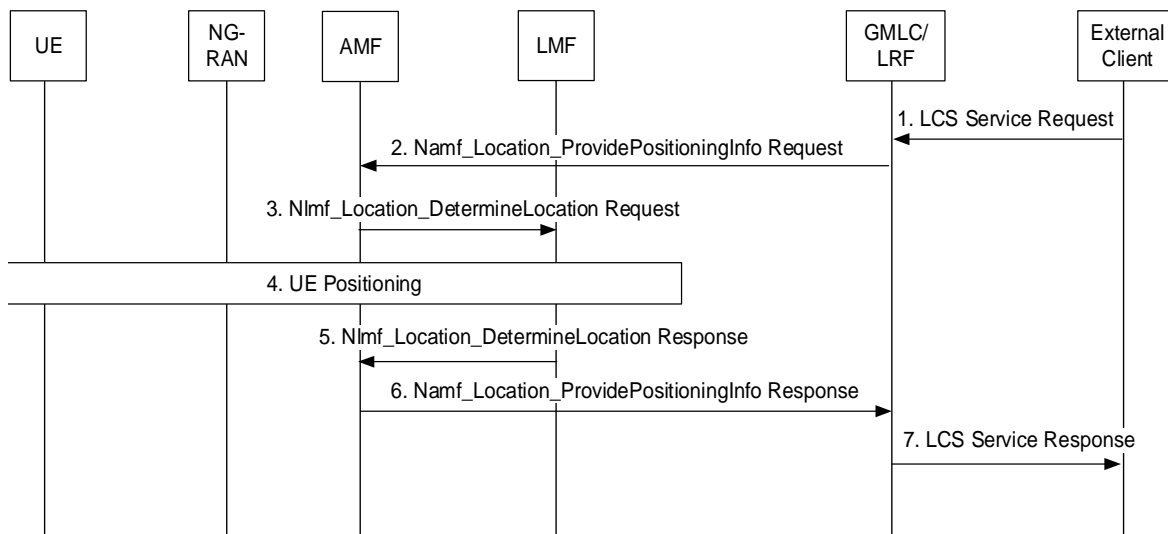

**Figure 4.13.5.2-1: 5GC-MT-LR Procedure without UDM Query**

1. The external emergency services client (e.g. a PSAP) sends a request to the LRF for a location for the target UE and includes correlation information identifying the target UE. The request may include the required QoS, Supported GAD shapes and client type. The LRF address and the correlation information would have been previously provided to the external client when the emergency session from the UE was established.
2. The LRF/GMLC determines the AMF by associating the correlation information received from the external client with other information received previously from the LMF as described in clause 4.13.5.1 and 4.13.5.7. The GMLC invokes the Namf\_Location\_ProvidePositioningInfo service operation towards the AMF to request the current location of the UE. The service operation includes the SUPI or the PEI and an indication of a location request from an emergency services client and may include the required QoS and Supported GAD shapes. The AMF identifies the target UE using the SUPI or in the case of a USIM-less emergency session, or non-registered USIM emergency session, the PEI.

3. The AMF selects an LMF based on NRF query or configuration in AMF and invokes the Nlmf\_Location\_DetermineLocation service operation towards the LMF to request the current location of the UE. The service operation includes a LCS Correlation identifier, the serving cell identity and an indication of a location request from an emergency services client and may include an indication if UE supports LPP or not, the required QoS and Supported GAD shapes. If any of the procedures in clause 4.13.5.4 or 4.13.5.5 are used the service operation includes the AMF identity.
4. The LMF performs one or more of the positioning procedures described in clause 4.13.5.4 , 4.13.5.5 and 4.13.5.6.
5. The LMF returns the Nlmf\_Location\_DetermineLocation Response towards the AMF to return the current location of the UE. The service operation includes the location estimate, its age and accuracy and may include information about the positioning method.
6. The AMF returns the Namf\_Location\_ProvidePositioningInfo Response towards the GMLC/LRF to return the current location of the UE. The service operation includes the LCS Correlation identifier, the location estimate, its age and accuracy and may include information about the positioning method.
7. The LRF sends the location service response to the external emergency services client.

### 4.13.5.3 5GC-MT-LR Procedure

Figure 4.13.5.3-1 illustrates the general network positioning for LCS clients external to the PLMN. In this scenario, it is assumed that the target UE is identified using an SUPI or GPSI. This procedure is applicable to a request from an LCS client for a current location.

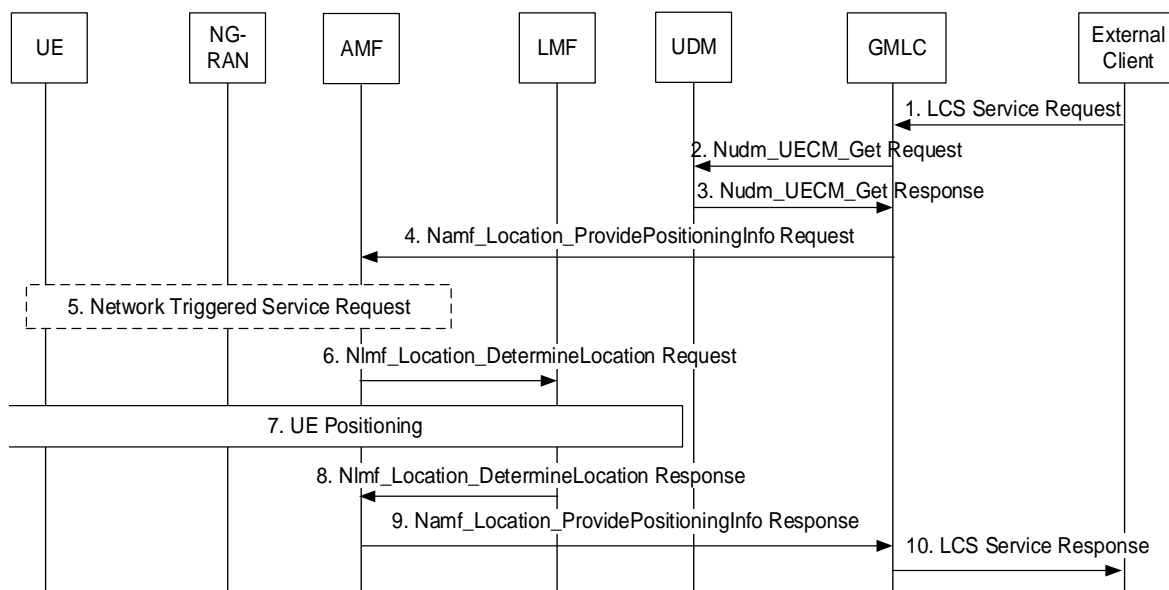

**Figure 4.13.5.3-1: 5GC-MT-LR Procedure**

1. The external location services client sends a request to the GMLC for a location for the target UE identified by an GPSI or an SUPI. The request may include the required QoS, Supported GAD shapes and client type.
2. The GMLC invokes a Nudm\_UECM\_Get service operation towards the home UDM of the target UE to be located with the GPSI or SUPI of this UE
3. The UDM returns the network addresses of the current serving AMF.
4. The GMLC invokes the Namf\_Location\_ProvidePositioningInfo service operation towards the AMF to request the current location of the UE. The service operation includes the SUPI, and client type and may include the required QoS and Supported GAD shapes.
5. If the UE is in CM-IDLE state, the AMF initiates a network triggered Service Request procedure as defined in clause 4.2.3.4 to establish a signaling connection with the UE.

6. The AMF selects an LMF based on NRF query or configuration in AMF and invokes the Nlmf\_Location\_DetermineLocation service operation towards the LMF to request the current location of the UE. The service operation includes a LCS Correlation identifier, the serving cell identity and the client type and may include an indication if UE supports LPP or not, the required QoS and Supported GAD shapes. If any of the procedures in clause 4.13.5.4 or 4.13.5.5 are used the service operation includes the AMF identity.
7. The LMF performs one or more of the positioning procedures described in clause 4.13.5.4, 4.13.5.5 and 4.13.5.6.
8. The LMF returns the Nlmf\_Location\_DetermineLocation Response towards the AMF to return the current location of the UE. The service operation includes the LCS Correlation identifier, the location estimate, its age and accuracy and may include information about the positioning method.
9. The AMF returns the Namf\_Location\_ProvidePositioningInfo Response towards the GMLC/LRF to return the current location of the UE. The service operation includes the location estimate, its age and accuracy and may include information about the positioning method.
10. The GMLC sends the location service response to the external location services client.

#### 4.13.5.4 UE Assisted and UE Based Positioning Procedure

Figure 4.13.5.4-1 shows a positioning procedure used by an LMF to support UE based positioning, UE assisted positioning and delivery of assistance data. The procedure is based on use of the LPP protocol defined in TS 36.355 [30] between the LMF and UE.

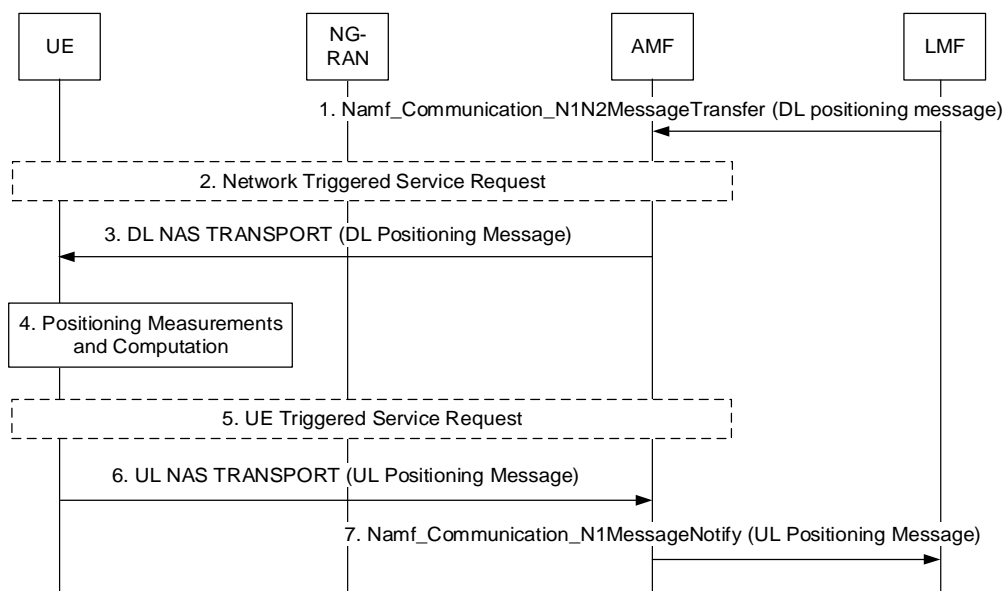

**Figure 4.13.5.4-1: UE Assisted and UE Based Positioning Procedure**

**Precondition:** A LCS Correlation identifier and the AMF identity has been passed to the LMF by the serving AMF.

1. The LMF invokes the Namf\_Communication\_N1N2MessageTransfer service operation towards the AMF to request the transfer of a Downlink (DL) Positioning message to the UE. The service operation includes the DL Positioning message. The Session ID parameter of the Namf\_Communication\_N1N2MessageTransfer service operation is set to the LCS Correlation identifier. The Downlink Positioning message may request location information from the UE, provide assistance data to the UE or query for the UE capabilities.
2. If the UE is in CM-IDLE state, the AMF initiates a network triggered Service Request procedure as defined in clause 4.2.3.4 to establish a signaling connection with the UE.
3. The AMF forwards the Downlink Positioning message to the UE in a DL NAS TRANSPORT message. The AMF includes a Routing identifier, in the DL NAS TRANSPORT message, identifying the LMF.
4. The UE stores any assistance data provided in the Downlink Positioning message and performs any positioning measurements and location computation requested by the Downlink Positioning message.

5. If the UE has entered CM-IDLE state during step 4, the UE instigates the UE triggered Service Request as defined in clause 4.2.3.2 in order to establish a signaling connection with the AMF.
6. The UE returns any location information obtained in step 4 or returns any capabilities requested in step 3 to the AMF in an Uplink Positioning message included in a NAS TRANSPORT message. The UE shall also include the Routing identifier in the UL NAS TRANSPORT message received in step 3.
7. The AMF invokes the Namf\_Communication\_N1MessageNotify service operation towards the LMF indicated by the routing identifier received in step 6. The service operation includes the Uplink Positioning message received in step 6 and the LCS Correlation identifier. Steps 6 and 7 may be repeated if the UE needs to send multiple messages to respond to the request received in Step 3. Steps 1 to 7 may be repeated to send new assistance data, and to request further location information and further UE capabilities.

#### 4.13.5.5 Network Assisted Positioning Procedure

Figure 4.13.5.5-1 shows a procedure that may be used by an LMF to support network assisted and network based positioning. The procedure may be based on an NRPPa protocol in TS 38.455 [31] between the LMF and NG-RAN.

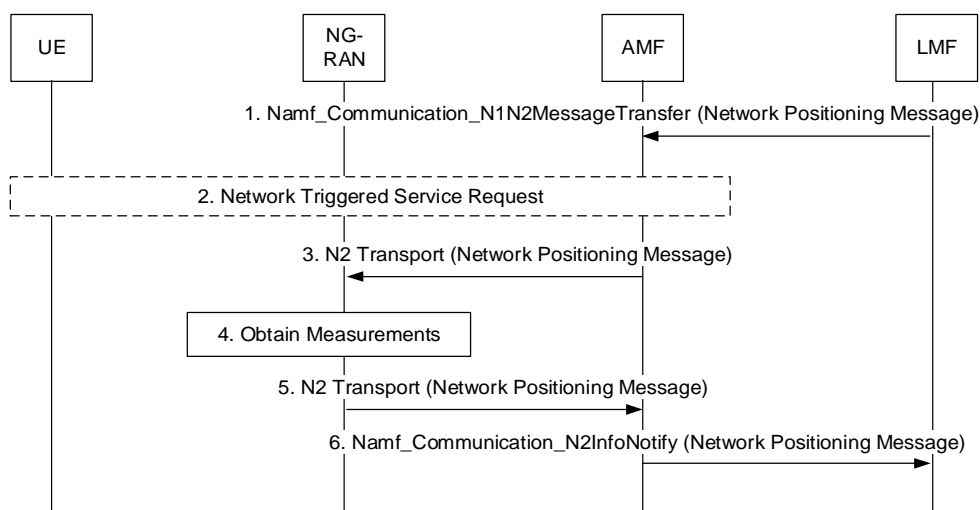

**Figure 4.13.5.5-1: Network Assisted Positioning Procedure**

**Precondition:** A LCS Correlation identifier and the AMF identity have been passed to the LMF by the serving AMF.

1. The LMF invokes the Namf\_Communication\_N1N2MessageTransfer service operation towards the AMF to request the transfer of a Network Positioning message to the serving NG-RAN node (gNB or ng-eNB) for the UE. The service operation includes the Network Positioning message and the LCS Correlation identifier. The Network Positioning message may request location information for the UE from the NG-RAN.
2. If the UE is in CM-IDLE state, the AMF initiates a network triggered Service Request procedure as defined in clause 4.2.3.4, to establish a signaling connection with the UE.
3. The AMF forwards the Network Positioning message to the serving NG-RAN node in an N2 Transport message. The AMF includes a Routing identifier, in the N2 Transport message, identifying the LMF (e.g. a global address of the LMF).
4. The serving NG-RAN node obtains any location information for the UE requested in step 3.
5. The serving NG-RAN node returns any location information obtained in step 4 to the AMF in a Network Positioning message included in an N2 Transport message. The serving NG-RAN node shall also include the Routing identifier in the N2 Transport message received in step 3.
6. The AMF invokes the Namf\_Communication\_N2InfoNotify service towards the LMF indicated by the routing identifier received in step 5. The service operation includes the Network Positioning message received in step 5 and the LCS Correlation identifier. Steps 1 to 6 may be repeated to request further location information and further NG-RAN capabilities.

#### 4.13.5.6 Obtaining Non-UE Associated Network Assistance Data

Figure 4.13.5.6-1 shows a procedure which may be used by an LMF to support network assisted and network based positioning. This procedure is not associated with a UE location session. It is used to obtain network assistance data from a NG-RAN node (e.g. gNB or ng-eNB). The procedure may be based on an NRPPa protocol in TS 38.455 [31] between the LMF and NG-RAN.

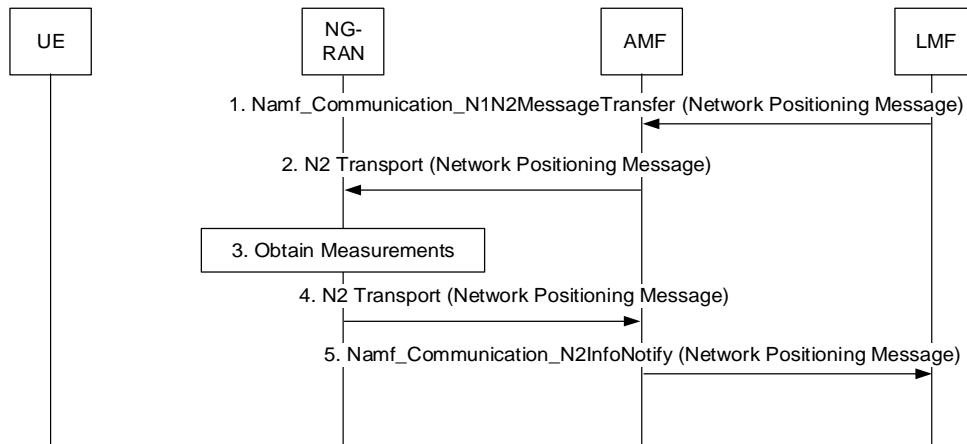

**Figure 4.13.5.6-1: Procedure for Obtaining Non-UE Associated Network Assistance Data**

1. The LMF invokes the `Namf_Communication_N1N2MessageTransfer` service operation towards the AMF to request the transfer of a Network Positioning message to a NG-RAN node (gNB or ng-eNB) in the NG-RAN. The service operation includes the Network Positioning message and the target NG-RAN node identity. The Network Positioning message may request position related information from the NG-RAN.
2. The AMF forwards the Network Positioning message to the target NG-RAN node indicated in step 1 in an N2 Transport message. The AMF includes a Routing identifier, in the N2 Transport message, identifying the LMF.
3. The target NG-RAN node obtains any position related information requested in step 2.
4. The target NG-RAN node returns any position related information obtained in step 3 to the AMF in a Network Positioning message included in an N2 Transport message. The target NG-RAN node shall also include the Routing identifier in the N2 Transport message received in step 2.
5. The AMF invokes the `Namf_Communication_N2InfoNotify` service operation towards the LMF indicated by the routing identifier received in step 4. The service operation includes the Network Positioning message received in step 4 and the UE identifier. Steps 1 to 5 may be repeated to request further position related information from the NG-RAN.

#### 4.13.5.7 Location continuity for Handover of an Emergency session from NG-RAN

Figure 4.13.5.7-1 shows support for location continuity for handover of an emergency session from NG-RAN on the source side to either NG-RAN or another 3GPP RAN on the target side. The procedure applies when control plane location according to Figures 4.13.5.1-1 and 4.13.5.2-1 is used for location of the UE on the source side. The procedure is based on the procedures for location continuity currently defined in TS 23.271 [29] clause 9.4.5.4.

**NOTE:** If User Plane (SUPL) Location Protocol [27] is used on the source (NG-RAN) side, then the current procedure for location continuity in TS 23.271 [29] can be used.

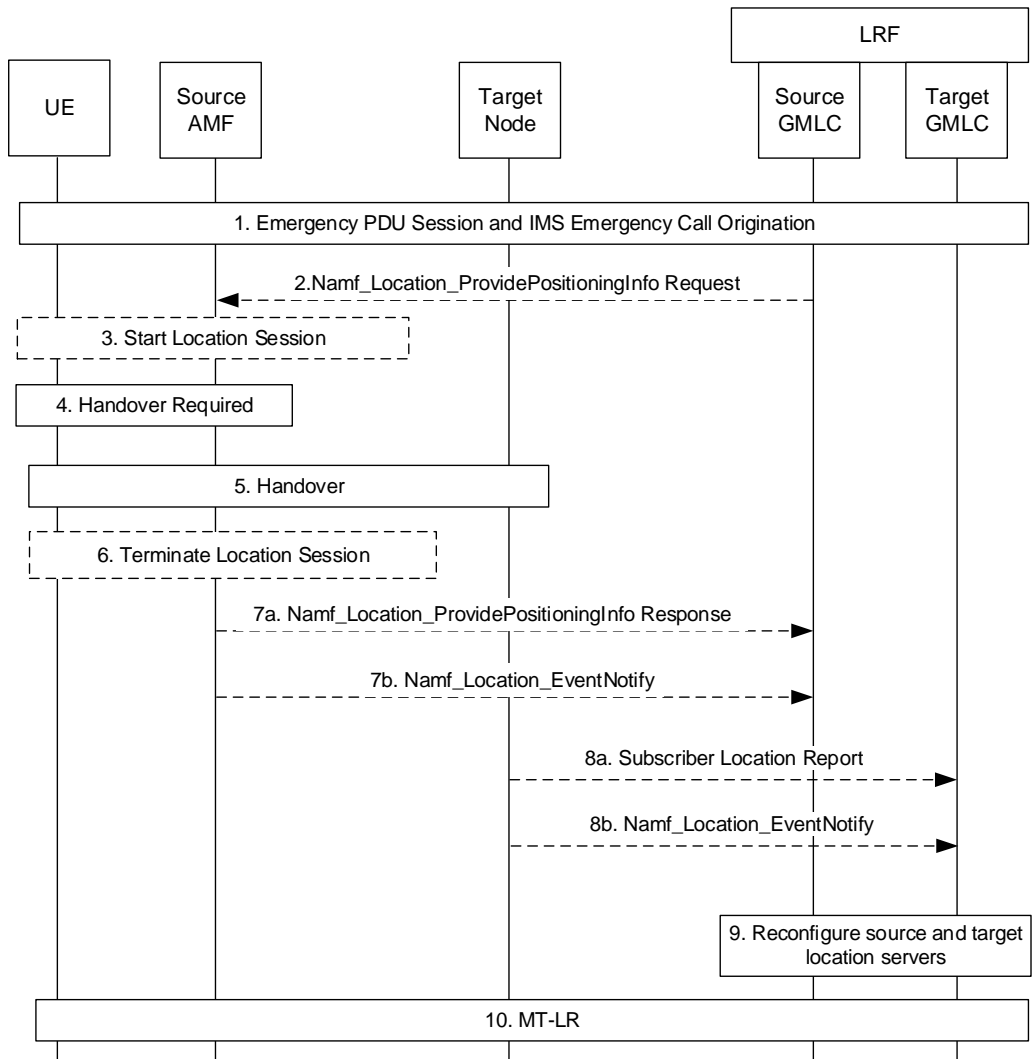

**Figure 4.13.5.7-1: Location Continuity for Handover of an Emergency session from NG-RAN**

1. Following the request for an emergency session, the UE establishes a PDU Session for emergency services and an IMS emergency session for NG-RAN access, during which an LRF is assigned in the serving network IMS and a source GMLC may be chosen. The 5GC-NI-LR procedure of Figure 4.13.5.1-1 is also performed which provides the source AMF identity to the GMLC and LRF and optionally an initial location for the UE.
2. At some later time, the LRF may need the UE location and requests the source GMLC to invoke the Namf\_Location\_ProvidePositioningInfo service operation towards the AMF to request the current location of the UE. The service operation includes the SUPI or the PEI, the required QoS and an indication of a location request from an emergency services client.
3. If step 2 occurs or if support for an NI-LR is required, the source AMF starts a location session to obtain the location of the UE as described in clause 4.13.5.2 or clause 4.13.5.1.
4. The source AMF receives a request to handover the UE to a cell associated with a different target node which may be another AMF for intra-RAN handover or a different type of node (e.g. an MME) for inter-RAN handover (e.g. to E-UTRAN connected to EPC).
5. The handover procedure is executed as specified in clause 4.9.1.3 for intra-RAN handover, or as specified in clauses 4.11.1.2.1 and 4.11.2.2 for inter-RAN handover.
6. Any location session started in step 3 may terminate normally before step 6. If not, the source AMF shall abort the location session once step 5 is complete.

- 7a. If steps 2 and 3 has occurred, the source AMF returns the Namf\_Location\_ProvidePositioningInfo Response towards the GMLC to return any location estimate obtained for the UE. The service operation includes the target node identity.
- 7b. If steps 2 and 7a do not occur, the source AMF may invoke the Namf\_Location\_EventNotify service operation towards the source GMLC (i.e. the GMLC used in step 1) to indicate the handover. The service operation includes the SUPI or the PEI and the GPSI if available, an event type indicating handover and the identity of the target node.
- 8a. For inter-RAN handover (e.g. to E-UTRAN connected to EPC) and if control plane location will be used on the target side, the target node (e.g. MME) may send a Subscriber Location Report to a GMLC on the target side after completion of the handover in step 6. The Subscriber Location Report carries the UE identity (IMSI, MSISDN and/or IMEI), an event type indicating handover and the identity of the target node. The target node may determine the target GMLC from configuration information.
- 8b. For intra-RAN handover and if control plane location will be used on the target side, the target AMF may invoke the Namf\_Location\_EventNotify service operation towards the GMLC to indicate the handover. The service operation includes the SUPI or the PEI and the GPSI if available, an event type indicating handover and the identity of the target node.
9. Reconfiguration of the LRF and the source and target GMLCs may occur in a manner outside the scope of 3GPP.
10. If the LRF needs a location estimate for the UE after handover has occurred and if control plane location is used on the target side, the LRF may instigate an MT-LR request via the target Node.

## 4.13.6 Support of IMS Voice

### 4.13.6.1 EPS fallback for IMS voice

Figure 4.13.6.1-1 describes the EPS fallback procedure for IMS voice.

When the UE is served by the 5G System, the UE has one or more ongoing PDU Sessions each including one or more QoS Flows. The serving PLMN AMF has sent an indication towards the UE during the Registration procedure that IMS voice over PS session is supported, see clause 5.16.3.10 in TS 23.501 [2] and the UE has registered in the IMS. If N26 is not supported, the serving PLMN AMF sends an indication towards the UE during the Registration procedure that interworking without N26 is supported, see clause 5.17.2.3.1 in TS 23.501 [2].



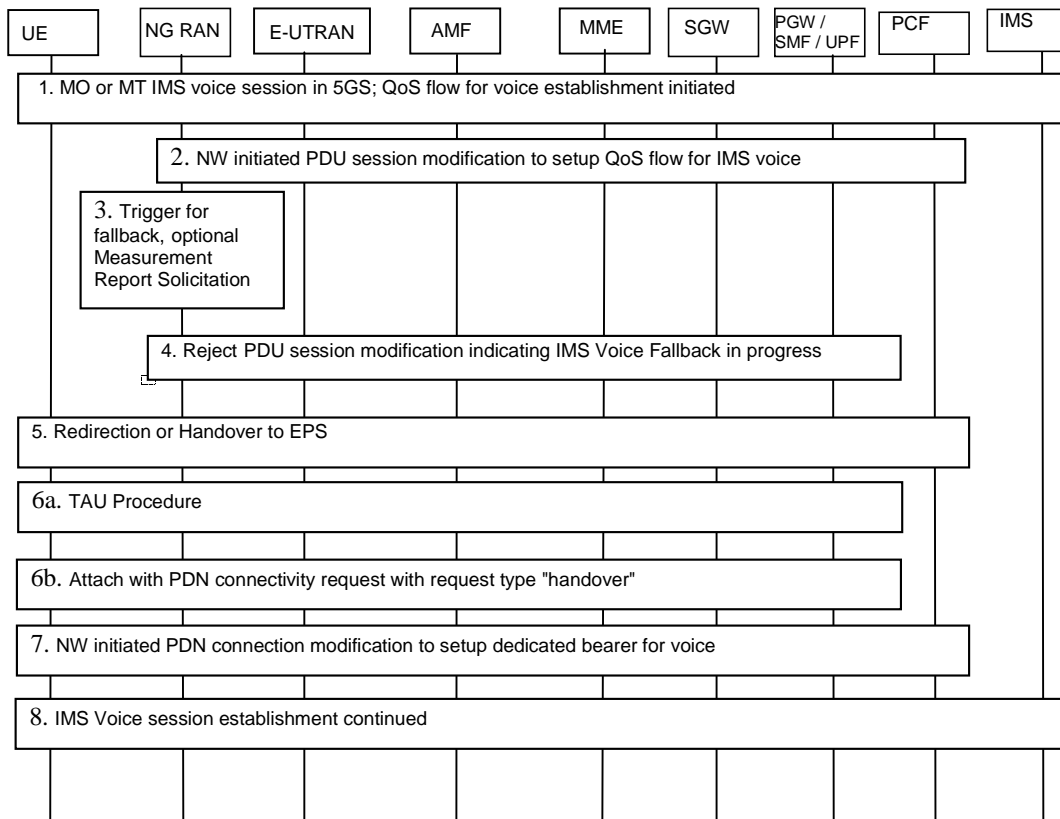

**Figure 4.13.6.1-1: EPS Fallback for IMS voice**

1. UE camps on NG-RAN in the 5GS and an MO or MT IMS voice session establishment has been initiated.
2. Network initiated PDU Session modification to setup QoS flow for voice reaches the NG-RAN (see N2 PDU Session Request in clause 4.3.3).
3. NG-RAN is configured to support EPS fallback for IMS voice and decides to trigger fallback to EPS, taking into account UE capabilities, indication from AMF that "Redirection for EPS fallback for voice is possible" (received as part of initial context setup as defined in TS 38.413 [10]), network configuration (e.g. N26 availability configuration) and radio conditions. If NG-RAN decides not to trigger fallback to EPS, then the procedure stops here and following steps are not executed.

NG-RAN may initiate measurement report solicitation from the UE including E-UTRAN as target.

NOTE 1: If AMF has indicated that "Redirection for EPS fallback for voice is not possible", then AN Release via inter-system redirection to EPS is not performed in step 5.

4. NG-RAN responds indicating rejection of the PDU Session modification to setup QoS flow for IMS voice received in step 2 by PDU Session Response message towards the PGW-C+SMF (or H-SMF+P-GW-C via V-SMF, in case of roaming scenario) via AMF with an indication that mobility due to fallback for IMS voice is ongoing. The PGW-C+SMF maintains the PCC rule(s) associated with the QoS Flow(s).
5. NG-RAN initiates either handover (see clause 4.11.1.2.1), or AN Release via inter-system redirection to EPS (see clause 4.2.6 and clause 4.11.1.3.2), taking into account UE capabilities. The PGW-C+SMF reports change of the RAT type if subscribed by PCF as specified in clause 4.11.1.2.1, or clause 4.11.1.3.2.6. When the UE is connected to EPS, either 6a or 6b is executed
  - 6a. In the case of 5GS to EPS handover, see clause 4.11.1.2.1, and in the case of inter-system redirection to EPS with N26 interface, see clause 4.11.1.3.2. In either case the UE initiates TAU procedure; or
  - 6b. In the case of inter-system redirection to EPS without N26 interface, see clause 4.11.2.2. If the UE supports Request Type flag "handover" for PDN connectivity request during the attach procedure as described in clause 5.3.2.1 of TS 23.401 [13] and has received the indication that interworking without N26 is supported, then the UE initiates Attach with PDN connectivity request with request type "handover".

In inter-system redirection, the UE uses the emergency indication in the RRC message as specified in clause 6.2.2 of TS 36.331 [16] and E-UTRAN provides the emergency indication to MME during Tracking Area Update or Attach procedure. For the handover procedure see clause 4.11.1.2.1, step 1.

7. After completion of the mobility procedure to EPS or as part of the 5GS to EPS handover procedure (see clause 4.11.1.2.1), the SMF/PGW re-initiates the setup of the dedicated bearer for IMS voice, mapping the 5G QoS to EPC QoS parameters. The PGW-C+SMF behaves as specified in clause 4.9.1.3.1. The PGW-C+SMF reports about Successful Resource Allocation and Access Network Information if subscribed by PCF.
8. The IMS voice session establishment is continued.

At least for the duration of the voice call in EPS the E-UTRAN is configured to not trigger any handover to 5GS.

#### 4.13.6.2 Inter RAT Fallback in 5GC for IMS voice

Figure 4.13.6.2-1 describes the RAT fallback procedure in 5GC for IMS voice.

When the UE is served by the 5GC, the UE has one or more ongoing PDU Sessions each including one or more QoS Flows. The serving PLMN AMF has sent an indication towards the UE during the Registration procedure that IMS voice over PS session is supported, see clause 5.16.3.10 in TS 23.501 [2] and the UE has registered in the IMS.

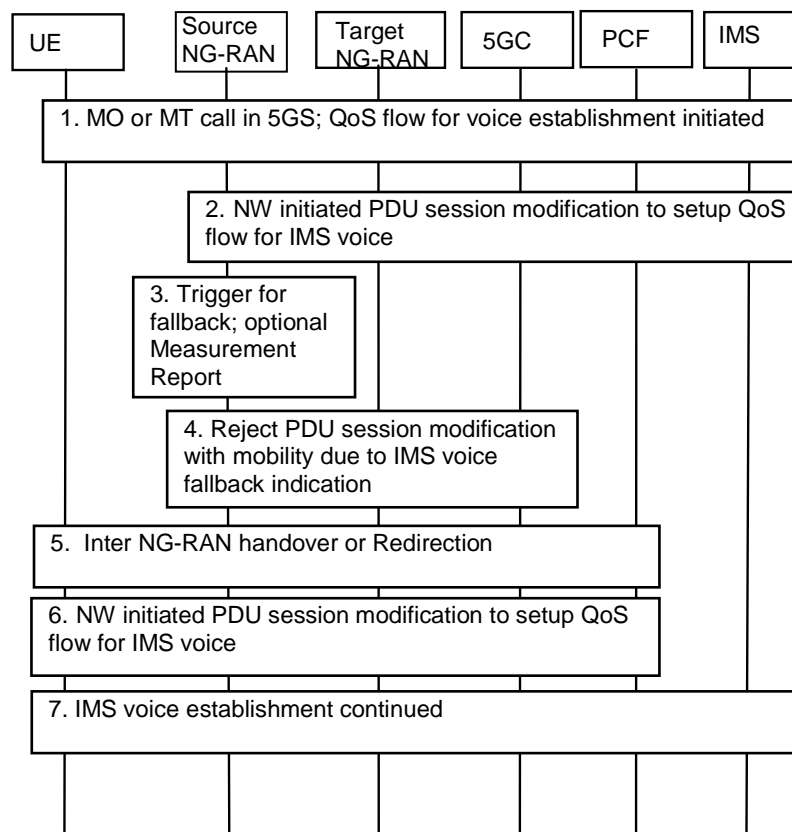

**Figure 4.13.6.2-1: RAT Fallback for IMS voice**

1. UE camps on source NG-RAN in the 5GS and an MO or MT IMS voice session establishment has been initiated.
2. Network initiated PDU Session modification to setup QoS flow for IMS voice reaches the source NG-RAN (see N2 PDU Session Request in clause 4.3.3).
3. If source NG-RAN is configured to support RAT fallback for IMS voice, source NG-RAN decides to trigger RAT fallback, taking into account on UE capabilities, network configuration and radio conditions.

Source NG-RAN may initiate measurement report solicitation from the UE including target NG-RAN.

4. Source NG-RAN responds indicating rejection of the PDU Session modification to setup QoS flow for IMS voice received in step 2 by PDU Session Response message towards the SMF (or V-SMF, in case of roaming

scenario) via AMF with an indication that mobility due to fallback for IMS voice is ongoing. The SMF maintains the PCC rule(s) associated with the QoS Flow(s).

5. Source NG-RAN initiates Xn based Inter NG-RAN handover (see clause 4.9.1.2) or N2 based inter NG-RAN handover (see clause 4.9.1.3), or redirection to E-UTRA connected to 5GC (see clause 4.2.6). The SMF reports change of the RAT type if subscribed by PCF.

In intra-system redirection, the UE uses the emergency indication in the RRC message as specified in clause 6.2.2 of TS 38.331 [12] and E-UTRAN provides the emergency indication to AMF during 5G Registration procedure.

6. After completion of the Inter NG-RAN (inter-RAT) handover or redirection to E-UTRA connected to 5GC, the SMF re-initiates the PDU Session modification to setup QoS flow for IMS voice. The SMF reports about Successful Resource Allocation and Access Network Information if subscribed by PCF.

7. The IMS voice session establishment is continued.

At least for the duration of the IMS voice call the target NG-RAN is configured to not trigger inter NG-RAN handover back to source NG-RAN.

## 4.14 Support for Dual Connectivity

### 4.14.1 RAN Initiated QoS Flow Mobility

This procedure is used to transfer QoS Flows to and from Secondary RAN Node. During this procedure, the SMF and UPF are never re-allocated. The UPF referred in this clause 4.14.1 is the UPF which terminates N3 interface in the 5GC. The presence of IP connectivity between the UPF and the Master RAN node, as well as between the UPF and the Secondary RAN node is assumed.

If QoS Flows for multiple PDU Sessions need to be transferred to or from Secondary RAN Node, the procedure shown in the Figure 4.14.1-1 below is repeated for each PDU Session.

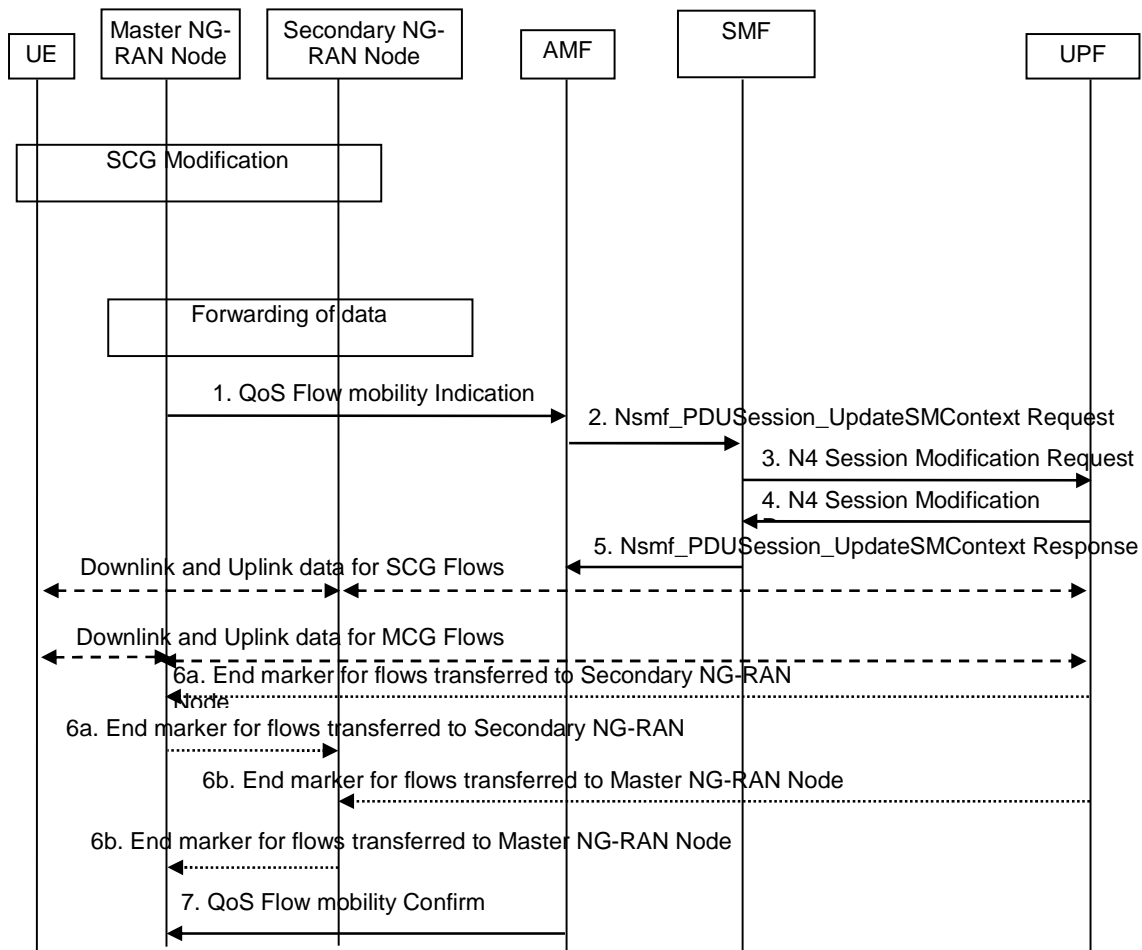

**Figure 4.14.1-1: NG-RAN initiated QoS Flow mobility procedure**

1. The Master RAN node sends a N2 QoS Flow mobility Indication (PDU Session ID, QFI(s), AN Tunnel Info) message to the AMF. AN Tunnel Info includes the new RAN tunnel endpoint for the QFI(s) for which the AN Tunnel Info shall be modified.
2. AMF to SMF: Nsmf\_PDUSession\_UpdateSMContext reques (N2 QoS Flow mobility Indication message PDU Session ID).
3. The SMF sends an N4 Session Modification Request (PDU Session ID(s), QFI(s), AN Tunnel Info for downlink user plane) message to the UPF.
4. The UPF returns an N4 Session Modification Response (CN Tunnel Info for uplink traffic) message to the SMF after requested QFIs are switched.

NOTE: Step 7 can occur any time after receipt of N4 Session Modification Response at the SMF.

5. SMF to AMF: Nsmf\_PDUSession\_UpdateSMContext response (N2 SM information (CN Tunnel Info for uplink traffic)) for QFIs of the PDU Session which have been switched successfully. If none of the requested QFIs have been switched successfully, the SMF shall send an N2 QoS Flow mobility Failure message.
6. In order to assist the reordering function in the Master RAN node and/or Secondary RAN node, for each affected N3 tunnel the UPF sends one or more "end marker" packets on the old tunnel immediately after switching the tunnel for the QFI. The UPF starts sending downlink packets to the Target NG-RAN.
7. The AMF relays message 5 to the Master RAN node.

## 4.15 Network Exposure

### 4.15.1 General

The network capability exposure comprises

- Exposure of network events externally as well as internally towards core network NFs;
- Exposure of provisioning capability towards external functions;
- Exposure of policy and charging capabilities towards external functions;
- Exposure of core network internal capabilities for analytics.

When subscribing to event reporting the NF consumer(s) provide:

- One or multiple Event ID(s). An Event ID identifies the type of event being subscribed to (e.g. PDU Session release, UE mobility out of an Area of Interest, etc.).
- Event Filter Information: Provides Event Parameter Types and Event Parameter Value(s) to be matched against, in order to meet the condition for notifying the subscribed Event ID e.g. the Event Parameter Type could be "Area of interest" and Event Parameter Value list could be list of TAs; The Event Filter depends on the Event ID. The Event Filter Information is provided per Event ID(s) being subscribed to: within a subscription different Event ID(s) may be associated with different Event Filter Information.
- Event Reporting Information described in the Table 4.15.1-1 below. Within a subscription all Event ID(s) are associated with a unique Event Reporting Information.
- The target of event reporting: this may indicate a specific UE or PDU Session, a group of UE(s) or any UE (i.e. all UEs), Within a subscription all Event ID (s) are associated with the same target of event reporting (possibly corresponding to multiple UE or multiple PDU Sessions).
- A Notification Target Address (+ Notification Correlation ID) allowing the Event Receiving NF to correlate notifications received from the Event provider with this subscription. A subscription is associated with a unique Notification Target Address (+ Notification Correlation ID). In the case that the NF consumer subscribes to the NF producer on behalf of other NF, the NF consumer includes the Notification Target Address(+Notification Correlation ID) of other NF for the Event ID which is to be notified to other NF directly, and the Notification Target Address(+Notification Correlation ID) of itself for the Subscription change related event notification. Each Notification Target Address(+ Notification Correlation ID) is associated with related (set of) Event ID(s).
- An Expiry time represents the time upto which the subscription is desired to be kept as active. The NF service consumer may suggest an Expiry time and provide to the NF service producer. Based on the operator's policy, the NF service producer decides whether the subscription can be expired. If the subscription can be expired, the NF service producer determines the Expiry time and provide it in the response to the NF service consumer. If the event subscription is about to expire based on the received Expiry time and the NF service consumer wants to keep receiving notifications, the NF service consumer update the subscription with the NF service producer in order to extend the Expiry time. Once the Expiry time associated with the subscription is reached, the subscription becomes invalid at the NF service producer. If the NF service consumer wants to keep receiving notifications, it shall create a new subscription with the NF service producer.

When the subscription is accepted by the Event provider NF, the consumer NF receives from the event provider NF an identifier (Subscription Correlation ID) allowing to further manage (modify, delete) this subscription.

NOTE 1: The Notification Correlation ID is allocated by the consumer NF that subscribes to event reporting and the Subscription Correlation ID is allocated by the NF that notifies when the event is met. Both correlation identifiers can be assigned the same value, although in principle they are supposed to be different, as they are optimized for finding the subscription related context within each NF.

The consumer NF may use an operation dedicated to subscription modification to add or remove Event ID(s) to this subscription or to modify Event Filter Information.

Events are subscribed by the consumer NF(s) by providing Event Filters. The contents of the Event Reporting Information along with the presence requirement of each information element is described in Table 4.15.1-1.

**Table 4.15.1-1: Event Reporting Information**

<b>Event Reporting Information Parameter</b>	<b>Description</b>	<b>Presence requirement</b>
1) Event reporting mode	Mode of reporting - e.g reporting up to a maximum number of reports, periodic reporting along with periodicity, reporting up to a maximum duration	mandatory
2) Maximum number of reports	Maximum number of reports after which the event subscription ceases to exist	(see NOTE 2)
3) Maximum duration of reporting	Maximum duration after which the event subscription ceases to exist	(see NOTE 2)
4) Immediate reporting flag	The Event provider NF notifies the current status of the subscribed event, if available, immediately to the consumer NF.	
NOTE 2: The requester shall include 2) Maximum number of reports or 3) Maximum duration of reporting, or both, depending on 1) Event reporting mode.		

NOTE 3: Explicit unsubscribe by the NF consumer is still possible.

Maximum number of reports is applicable to the subscription to one UE or a group of UE(s). When the subscription is applied to a group of UE(s), the parameter is applied to each individual member UE. The count of number of report is per UE granularity regardless whether the subscription includes more than one events.

Maximum duration of reporting is applicable to the subscription to one UE, a group of UE(s) or any UE. When the subscription is applied to a group of UE(s), this parameter applies to each group member UE. When the subscription is applied to any UE, this parameter applies to all the impacted UEs.

If for a given subscription both Maximum Number of reports and Maximum duration of reporting are included then the subscription is considered to expire as soon as one of the conditions is met.

Table 4.15.1-1 indicates the presence requirements for the Event Reporting Information.

Corresponding notifications contain at least the Notification Correlation ID together with the Event ID and the individual target (e.g. UE or PDU Session ID) associated with the notification.

If the NF service consumer decides to terminate the event subscription, it unsubscribes the event subscription by sending unsubscription request to the event provider NF. After receiving unsubscription request from the NF service consumer, the event provider NF terminates the event subscription.

The following clauses describe the external exposure of network capabilities and core network internal event and capability exposure.

When the immediate reporting flag is set, the first corresponding event report is included in the output message, if corresponding information is available at the reception of the subscription request of the event.

## 4.15.2 External Exposure of Network Capabilities

The Network Exposure Function (NEF) supports external exposure of capabilities of network functions. External exposure can be categorized as Monitoring capability, Provisioning capability, and Policy/Charging capability. The Monitoring capability is for monitoring of specific event for UE in 5GS and making such monitoring events information available for external exposure via the NEF. The Provisioning capability is for allowing external party to provision of information which can be used for the UE in 5GS. The Policy/Charging capability is for handling QoS and charging policy for the UE based on the request from external party.

## 4.15.3 Event Exposure using NEF

### 4.15.3.1 Monitoring Events

The Monitoring Events feature is intended for monitoring of specific events in 3GPP system and making such monitoring events information reported via the NEF. It is comprised of means that allow NFs in 5GS for configuring the specific events, the event detection, and the event reporting to the requested party.

To support monitoring features in roaming scenarios, a roaming agreement needs to be made between the HPLMN and the VPLMN. The set of capabilities required for monitoring shall be accessible via NEF to NFs in 5GS. Monitoring Events via the UDM and the AMF enables NEF to configure a given Monitor Event at UDM or AMF, and reporting of the event via UDM and/or AMF. Depending on the specific monitoring event or information, it is either the AMF or the UDM that is aware of the monitoring event or information and makes it reported via the NEF.

The following table illustrates the monitoring events:

**Table 4.15.3.1-1: List of event for monitoring capability**

Event	Description	Which NF detects the event
Loss of Connectivity	Network detects that the UE is no longer reachable for either signalling or user plane communication.	AMF
UE reachability	It indicates when the UE becomes reachable for sending either SMS or downlink data to the UE, which is detected when the UE transitions to CM-CONNECTED state or when the UE will become reachable for paging, e.g., Periodic Registration Update timer.	AMF UDM: reachability for SMS
Location Reporting	It indicates either the Current Location or the Last Known Location of a UE. One-time and Continuous Location Reporting are supported for the Current Location. For Continuous Location Reporting the serving node(s) sends a notification every time it becomes aware of a location change, with the granularity depending on the accepted accuracy of location. (see NOTE 1) For One-time Reporting is supported only for the Last Known Location.	AMF
Change of SUPI-PEI association	It indicates a change of the ME's PEI (IMEI(SV)) that uses a specific subscription (SUPI)	UDM
Roaming status	It indicates UE's current roaming status (the serving PLMN and/or whether the UE is in its HPLMN) and notification when that status changes. (see NOTE 2)	UDM
Communication failure	It is identified by RAN/NAS release code	AMF
Availability after Downlink Data Notification failure	It indicates when there has been some data delivery failure followed by the UE becoming reachable.	AMF
Number of UEs present in a geographical area	It indicates the number of UEs that are in the geographic area described by the AF. The AF may ask for the UEs that the system knows by its normal operation to be within the area (Last Known Location) or the AF may request the system to also actively look for the UEs within the area (Current Location).	AMF
NOTE 1: Location granularity for event request, or event report, or both could be at cell level (Cell ID), TA level or other formats e.g. shapes (e.g. polygons, circles, etc.) or civic addresses (e.g. streets, districts, etc.) which can be mapped by NEF.		
NOTE 2: Roaming status means whether the UE is in HPLMN or VPLMN.		

### 4.15.3.2 Information flows

#### 4.15.3.2.1 AMF service operations information flow

The procedure is used by the NF to subscribe to notifications and to explicitly cancel a previous subscription. Cancelling is done by sending `Namf_EventExposure_UnSubscribe` request identifying Subscription Correlation ID. The notification steps 3 and 4 are not applicable in cancellation case.

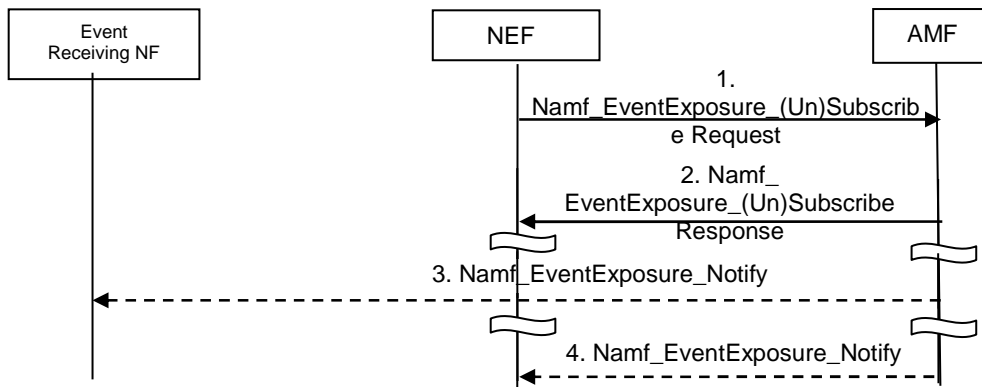

**Figure 4.15.3.2.1-1: Namf\_EventExposure\_Subscribe, Unsubscribe and Notify operations**

1. A NEF sends a request to subscribe to a (set of) Event ID(s) in AMF in `Namf_EventExposure_Subscribe` request. The NEF could be the same NF subscribing to receive the event notification reports (i.e. Event Receiving NF) or it could be a different NF. The NEF subscribes to one or several Event(s) (identified by Event ID) and provides the associated notification endpoint of the Event Receiving NF. As the NEF itself is not the Event Receiving NF, the NEF shall additionally provide the notification endpoint of itself besides the notification endpoint of Event Receiving NF. Each notification endpoint is associated with the related (set of) Event ID(s). This is to assure the NEF can receive the notification of subscription change related event (e.g. Subscription Correlation ID Change).

Event Reporting information defines the type of reporting requested. If the reporting event subscription is authorized by the AMF, the AMF records the association of the event trigger and the requester identity.

2. AMF acknowledges the execution of `Namf_EventExposure_Subscribe`.
3. [Conditional - depending on the Event] The AMF detects the monitored event occurs and sends the event report by means of `Namf_EventExposure_Notify` message, to the notification endpoint of the Event Receiving NF.
4. [Conditional- depending on the Event] The AMF detects the subscription change related event occurs, e.g. Subscription Correlation ID change due to AMF reallocation, it sends the event report by means of `Namf_EventExposure_Notify` message to the NEF.

#### 4.15.3.2.2 UDM service operations information flow

The procedure is used by the NEF to subscribe to notifications and to explicitly cancel a previous subscription. Cancelling is done by sending `Nudm_EventExposure_Unsubscribe` request identifying the subscription to cancel. The notification steps 4 and 5 are not applicable in cancellation case.



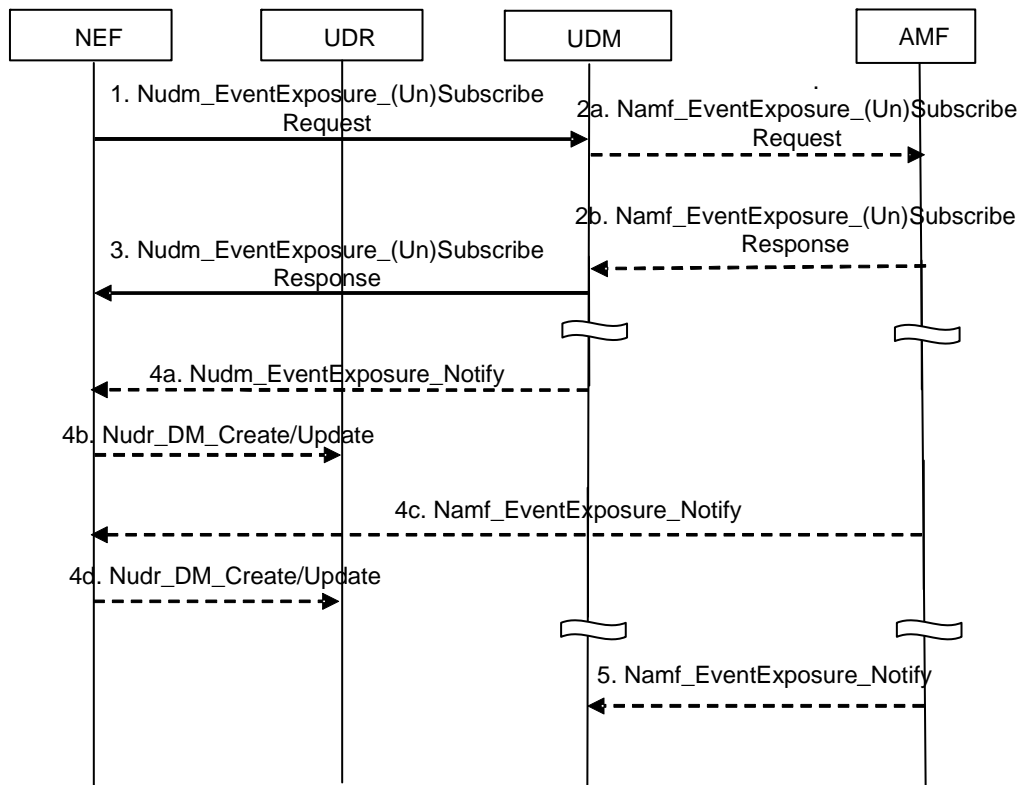

**Figure 4.15.3.2.2-1: Nudm\_EventExposure\_Subscribe, Unsubscribe and Notify operations**

1. The NEF subscribes to one or several monitoring events by sending Nudm\_EventExposure\_Subscribe request. The NEF subscribes to one or several Event(s) (identified by Event ID) and provides the associated notification endpoint of the NEF.

Event Reporting Information defines the type of reporting requested. If the reporting event subscription is authorized by the UDM, the UDM records the association of the event trigger and the requester identity.

The subscription may include Maximum number of reports and/or Maximum duration of reporting IE.

- 2a. [Conditional] Some events (e.g. loss of connectivity), require that UDM sends Namf\_EventExposure\_Subscribe request to the AMF serving that UE. As the UDM itself is not the Event Receiving NF, the UDM shall additionally provide the notification endpoint of itself besides the notification endpoint of NEF. Each notification endpoint is associated with the related (set of) Event ID(s). This is to assure the UDM can receive the notification of subscription change related event.

The UDM sends the Namf\_EventExposure\_Subscribe request to all serving AMF(s) (if subscription applies to a UE or a group of UE(s)), or to all the AMF(s) in the same PLMN as UDM (if subscription applies to any UE).

If the subscription applies to a group of UE(s), the UDM shall include the same notification endpoint of itself, i.e. Notification Target Address (+ Notification Correlation Id), in the subscriptions to all UE's serving AMF(s).

**NOTE:** The same notification endpoint of UDM is to help the AMF identify whether the subscription for the requested group event is same or not when a new group member UE is registered.

- 2b. [Conditional] AMF acknowledges the execution of Namf\_EventExposure\_Subscribe.
3. UDM acknowledges the execution of Nudm\_EventExposure\_Subscribe.

If the subscription is applicable to a group of UE(s) and the Maximum number of reports is included in the Event Report information in step 1, the Number of UEs within this group is included in the acknowledgement.

- 4a - 4b. [Conditional - depending on the Event] The UDM detects the monitored event occurs and sends the event report, by means of Nudm\_EventExposure\_Notify message, to the associated notification endpoint of the NEF, along with the time stamp. NEF may store the information in the UDR along with the time stamp using either Nudr\_DM\_Create or Nudr\_DM\_Update service operation as appropriate.

4c - 4d. [Conditional - depending on the Event] The AMF detects the monitored event occurs and sends the event report, by means of Namf\_EventExposure\_Notify message, to the associated notification endpoint of the NEF, along with the time stamp. NEF may store the information in the UDR along with the time stamp using either Nudr\_DM\_Create or Nudr\_DM\_Update service operation as appropriate.

If the AMF has a maximum number of reports stored for the UE, the AMF shall decrease its value by one for the reported event.

For both step 4a and step 4c, when the maximum number of reports is reached and if the subscription is applied to a UE, The NEF unsubscribes the monitoring event(s) to the UDM and the UDM unsubscribes the monitoring event(s) to AMF serving that UE.

For both step 4a and step 4c, when the maximum number of reports is reached for an individual group member UE, the NEF uses the Number of UEs received in step 3 to determine if reporting for the group is complete. If the NEF determines that reporting for the group is complete, the NEF unsubscribes the monitoring event(s) to the UDM and the UDM unsubscribes the monitoring event(s) to all AMF(s) serving the UEs belonging to that group.

When the Maximum duration of reporting expires in the NEF, the UDM and the AMF, then each of these nodes shall locally unsubscribe the monitoring event.

5. [Conditional - depending on the Event] The AMF detects the subscription change related event occurs, e.g. Subscription Correlation ID change due to AMF reallocation or addition of new Subscription Correlation ID due to a new group UE registered, it sends the event report by means of Namf\_EventExposure\_Notify message to the associated notification endpoint of the UDM.

### 4.15.3.2.3 NEF service operations information flow

The procedure is used by the AF to subscribe to notifications and to explicitly cancel a previous subscription. Cancelling is done by sending Nnef\_EventExposure\_Unsubscribe request identifying the subscription to cancel with Subscription Correlation ID. The notification steps 6 to 8 are not applicable in cancellation case.

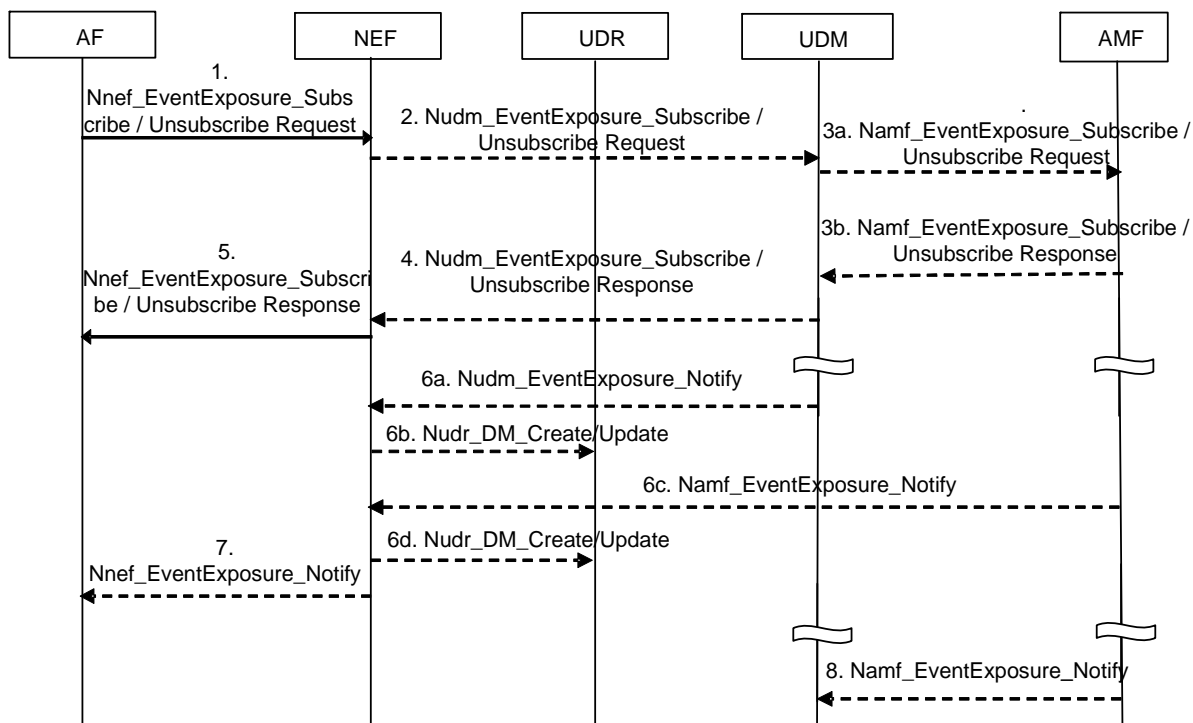

Figure 4.15.3.2.3-1: Nnef\_EventExposure\_Subscribe, Unsubscribe and Notify operations

1. The AF subscribes to one or several Event(s) (identified by Event ID) and provides the associated notification endpoint of the AF by sending Nnef\_EventExposure\_Subscribe request.

Event Reporting Information defines the type of reporting requested (e.g. one-time reporting, periodic reporting or event based reporting, for Monitoring Events). If the reporting event subscription is authorized by the NEF, the NEF records the association of the event trigger and the requester identity. The subscription may also include Maximum number of reports and/or Maximum duration of reporting IE.

2. [Conditional - depending on authorization in step 1] The NEF subscribes to received Event(s) (identified by Event ID) and provides the associated notification endpoint of the NEF to UDM by sending Nudm\_EventExposure\_Subscribe request.

If the reporting event subscription is authorized by the UDM, the UDM records the association of the event trigger and the requester identity. Otherwise, the UDM continues in step 4 indicating failure.

- 3a. [Conditional] If the requested event (e.g. monitoring of Loss of Connectivity) requires AMF assistance, then the UDM sends the Namf\_EventExposure\_Subscribe to the AMF serving the requested user. The UDM sends the Namf\_EventExposure\_Subscribe request to the all serving AMF(s) (if subscription applies to a UE or a group of UE(s)), or all the AMF in the same PLMN as the UDM (if subscription applies to any UE).

As the UDM itself is not the Event Receiving NF, the UDM shall additionally provide the notification endpoint of itself besides the notification endpoint of NEF. Each notification endpoint is associated with the related (set of) Event ID(s). This is to assure the UDM can receive the notification of subscription change related event.

If the subscription applies to a group of UE(s), the UDM shall include the same notification endpoint of itself, i.e. Notification Target Address (+ Notification Correlation Id), in the subscriptions to all UE's serving AMF(s).

NOTE: The same notification endpoint of UDM is to help the AMF identify whether the subscription for the requested group event is same or not when a new group member UE is registered.

- 3b. [Conditional] AMF acknowledges the execution of Namf\_EventExposure\_Subscribe.

4. [Conditional] UDM acknowledges the execution of Nudm\_EventExposure\_Subscribe.

If the subscription is applicable to a group of UE(s) and the Maximum number of reports is included in the Event Report information in step 1, the Number of UEs is included in the acknowledgement.

5. NEF acknowledges the execution of Nnef\_EventExposure\_Subscribe to the requester that initiated the request.

- 6a - 6b. [Conditional - depending on the Event] The UDM (depending on the Event) detects the event occurs and sends the event report, by means of Nudm\_EventExposure\_Notify message to the associated notification endpoint of the NEF along with the time stamp. NEF may store the information in the UDR along with the time stamp using either Nudr\_DM\_Create or Nudr\_DM\_Update service operation as appropriate.

- 6c - 6d. [Conditional - depending on the Event] The AMF detects the event occurs and sends the event report, by means of Namf\_EventExposure\_Notify message to associated notification endpoint of the NEF along with the time stamp. NEF may store the information in the UDR along with the time stamp using either Nudr\_DM\_Create or Nudr\_DM\_Update service operation as appropriate.

If the AMF has a maximum number of reports stored for the UE or the individual member UE, the AMF shall decrease its value by one for the reported event.

For both step 6a and step 6b, when the maximum number of reports is reached and if the subscription is applied to a UE, The NEF unsubscribes the monitoring event(s) to the UDM and the UDM unsubscribes the monitoring event(s) to AMF serving for that UE.

For both step 6a and step 6b, when the maximum number of reports is reached for an individual group member UE, the NEF uses the Number of UEs received in step 4 to determine if reporting for the group is complete. If the NEF determines that reporting for the group is complete, the NEF unsubscribes the monitoring event(s) to the UDM and the UDM unsubscribes the monitoring event(s) to all AMF(s) serving the UEs belonging to that group.

When the Maximum duration of reporting expires in the NEF, the UDM and the AMF, then each of these nodes shall locally unsubscribe the monitoring event.

7. [Conditional - depending on the Event in step 6a and 6b] The NEF forwards to the AF the reporting event received by either Nudm\_EventExposure\_Notify and/or Namf\_EventExposure\_Notify.

8. [Conditional - depending on the Event] The AMF detects the subscription change related event occurs, e.g. Subscription Correlation ID change due to AMF reallocation or addition of new Subscription Correlation ID due to a new group UE registered, it sends the event report, by means of Namf\_EventExposure\_Notify message to the associated notification endpoint of the UDM.

#### 4.15.3.2.4 Exposure with bulk subscription

Based on operator configuration NEF may perform bulk subscription with the NFs that provides necessary services. This feature is controlled by local policies of the NEF that control which events (set of Event ID(s)) and UE(s) are target of a bulk subscription.

When the NEF performs bulk subscription (subscribes for any UE (i.e. all UEs), group of UE(s) (e.g. identifying a certain type of UEs such as IoT UEs)), it subscribes to all the NFs that provide the necessary services (e.g. In a given PLMN, NEF may subscribe to all AMFs that support reachability notification for IoT UEs). Upon receiving bulk subscription from the NEF, the NFs store this information. Whenever the corresponding event(s) occur for the requested UE(s) as in bulk subscription request, NFs notify the NEF with the requested information.

The following call flow shows how network exposure can happen for one UE, groups of UE(s) (e.g. identifying a certain type of UEs such as IoT UEs) or any UE.

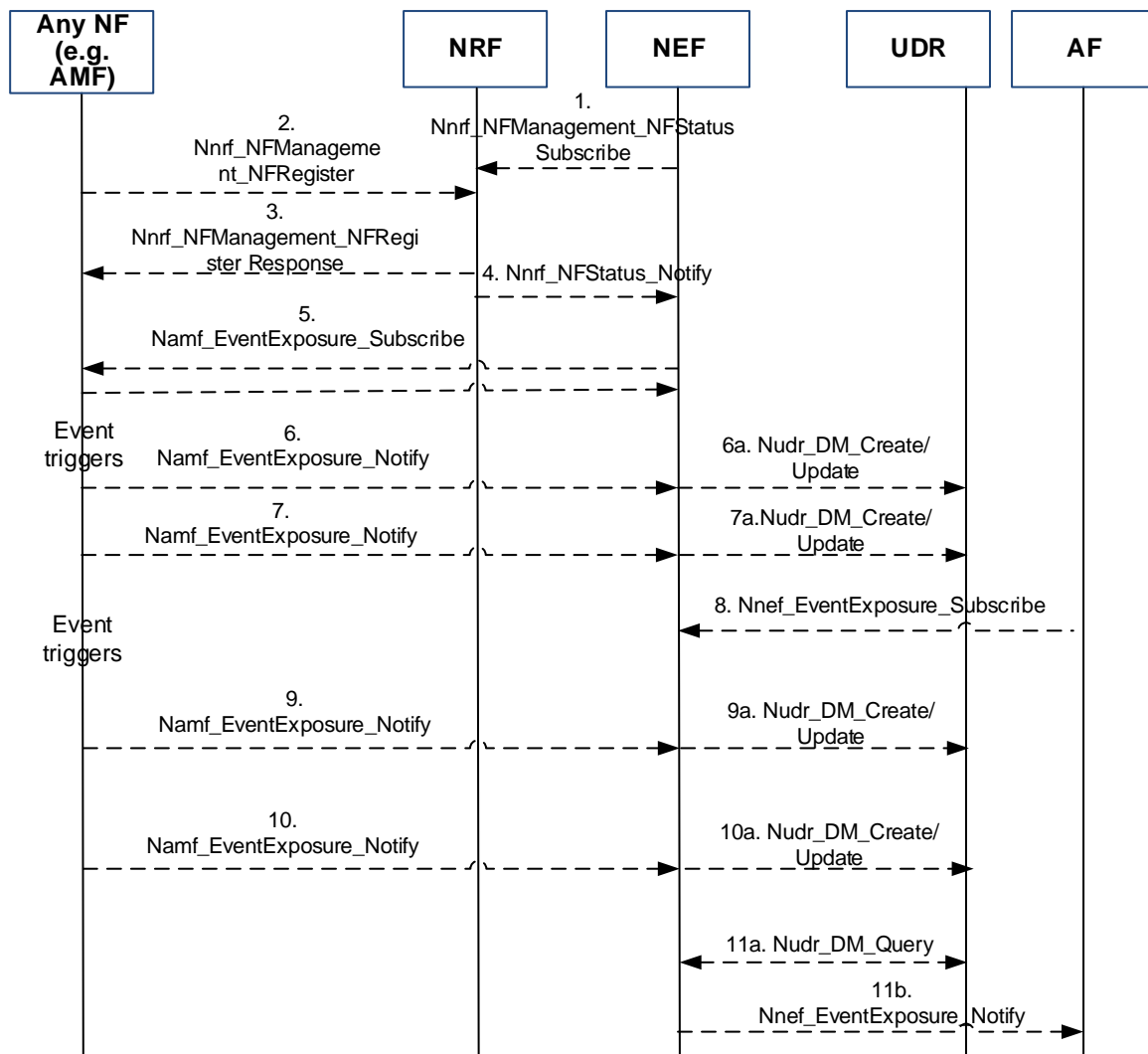

Figure 4.15.3.2.4-1: NF registration/status notification and Exposure with bulk subscription

1. NEF registers with the NRF for any newly registered NF along with its NF services.
2. When an NF instantiates, it registers itself along with the supported NF services with the NRF.
3. NRF acknowledges the registration

4. NRF notifies the NEF with the newly registered NF along with the supported NF services.
5. NEF evaluates the NF and NF services supported against the pre-configured events within NEF. Based on that, NEF subscribes with the corresponding NF either for a single UE, group of UE(s) (e.g. identifying a certain type of UEs such as IoT UEs), any UE. NF acknowledges the subscription with the NEF.
- 6 - 7. When the event trigger happens, NF notifies the requested information towards the subscribing NEF along with the time stamp. NEF may store the information in the UDR along with the time stamp using either Nudr\_DM\_Create or Nudr\_DM\_Update service operation as appropriate.
8. Application registers with the NEF for a certain event identified by event filters. If the registration for the event is authorized by the NEF, the NEF records the association of the event and the requester identity.
- 9 - 10. When the event trigger happens, NF notifies the requested information towards the subscribing NEF. NEF may store the information in the UDR using either Nudr\_DM\_Create or Nudr\_DM\_Update service operation as appropriate.
- 11a-b. NEF reads from UDR with Nudr\_DM\_Query, and notifies the application along with the time stamp for the corresponding subscribed events.

## 4.15.4 Core Network Internal Event Exposure

### 4.15.4.1 General

The exposure of events internally within the 3GPP NFs are explained in the following clauses. Only the event notifications that are independent of the ongoing system procedure are specified in this clause. For the event notifications that are part of the system procedure, see the system procedure descriptions under clause 4.2 to clause 4.14.

### 4.15.4.2 Exposure of Mobility Events from AMF

The AMF invokes the Namf\_EventExposure\_Notify to provide mobility related events to NF consumers that have subscribed for the events by invoking Namf\_EventExposure\_Subscribe, in the following scenarios listed below and after Namf\_EventExposure\_Subscribe service operation.

- During Registration procedure, Inter NG-RAN node N2 based handover procedure, when there is a change of AMF (within the same AMF Set or across the AMF Set), the new AMF receives all event subscriptions from old AMF or UDSF. For each event subscription:
  - if the event subscription only applies to the UE, the new AMF allocates a new Subscription Correlation ID and notify the NF consumer of the new Subscription Correlation ID associated with the change of Subscription Correlation ID event.
  - if the event subscription applies to a group of UE(s) and there is no corresponding subscription for this group (identified by the internal group Id and notification endpoint) at the new AMF, the new AMF shall create corresponding event subscription, allocate a new Subscription Correlation Id and send it to the received notification endpoint, i.e. Notification Target Address (+Notification Correlation Id), associated with the addition of Subscription Correlation ID event.
- During Registration procedure, when there is a change of AMF, the new AMF notifies each NF that has subscribed for UE reachability event about the UE reachability status.
- During Registration, Handover, UE Triggered Service Request procedure in CM-IDLE state, Location Reporting, N2 Notification and AN Release procedures, the AMF determines the UE presence in Area Of Interest (i.e. IN, OUT or UNKNOWN status ) as described in Annex D.1 and notifies the NF Consumers of the UE presence in an Area Of Interest if the NF consumers (e.g. SMF) had subscribed for this Area Of Interest, and if the UE presence in Area Of Interest is different from the one reported earlier.
- During Registration and Handover procedure or during Service Area Restriction update by UDM or PCF, if the UE is moving from an Allowed Area to a Non-Allowed Area, then the AMF informs all the NF consumers (e.g. SMF), that have subscribed for UE reachability event, that the UE is reachable only for regulatory prioritized service. The SMF shall explicitly subscribe UE reachability unless the established PDU Session is related to regulatory prioritized service.

- If the AMF had notified an SMF of the UE being reachable only for regulatory prioritized service earlier, the AMF informs the NF consumers (e.g SMF), that have subscribed for UE reachability event, that the UE is reachable if the UE enters into Allowed Area.
- During Registration procedure and Service Request procedure, if the AMF had notified an SMF earlier of the UE being unreachable and that SMF need not invoke Namf\_Communication\_N1N2MessageTransfer to the AMF due to DL data notifications, the AMF informs the SMF when the UE becomes reachable.
- During Registration procedure, Handover without Registration procedure, and Service Request procedure, if the NF consumers had subscribed for UE reachability status, the AMF notifies the UE reachability status changes.
- During Network Triggered Service Request procedure, if the UE does not respond to paging, when the AMF considers the UE as unreachable the AMF notifies the NF consumers that have subscribed for UE reachability event, that the UE is not reachable.
- If the UDM had subscribed for UE reachability event notification either to be reported to the UDM or to an NF consumer directly, then the AMF notifies the UE reachability event to the UDM or to the NF consumer as specified in clause 4.2.5.2.

### 4.15.5 Void

### 4.15.6 External Parameter Provisioning

#### 4.15.6.1 General

Provisioning capability allows an external party to provision the expected UE behavioural information to 5G network functions. The provisioning information consists of information on expected UE movement and communication characteristics. Provisioned data can be used by the other NFs.

#### 4.15.6.2 NEF service operations information flow

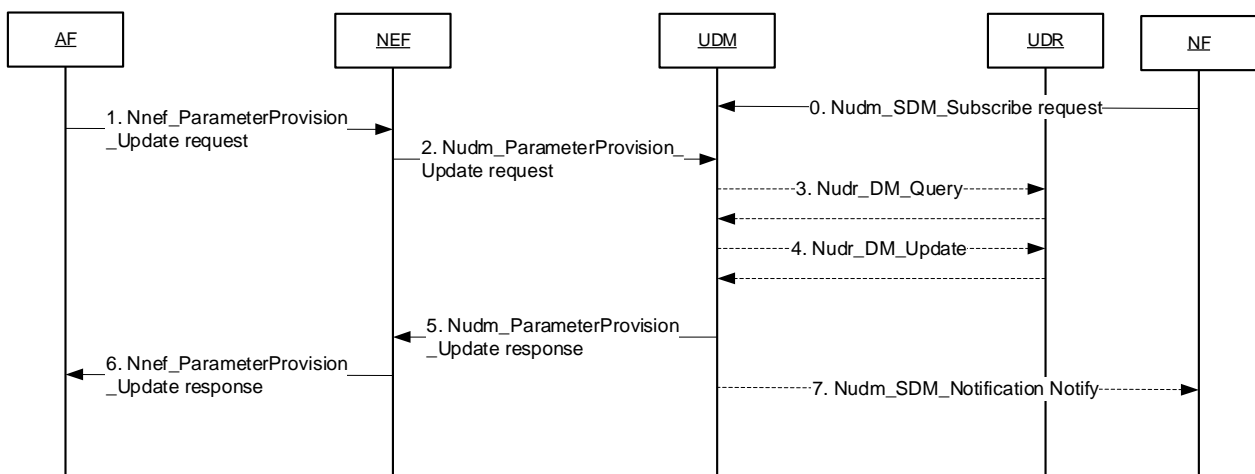

**Figure 4.15.6.2-1: Nnef\_ParameterProvision\_Update request/response operations**

0. NF subscribes to UDM notifications of information updates.
1. AF provides one or more parameter(s) to be updated in Nnef\_ParameterProvision\_Update Request to the NEF.

The GPSI identifies the UE and the Transaction Reference ID identifies the transaction request between NEF and AF.

2. If the AF is authorised by the NEF to provision the parameters, the NEF requests to update and store the provisioned parameters as part of the subscriber data via Nudm\_ParameterProvision\_Update Request message, the message includes the provisioned data and NEF reference ID.

If the requester is not authorised to provision data, then the NEF continues in step 6 indicating the reason to failure in Nnef\_ParameterProvision\_Update Response message.

NOTE 1: For non-roaming case and no authorisation or validation by the UDM required, the NEF can directly forward the external parameter to the UDR via Nudr\_DM\_Update Request message. And in this case, the UDR responds to NEF via Nudr\_DM\_Update Response message.

3. UDM may read from UDR, by means of Nudr\_DM\_Query, corresponding subscriber information in order to validate required data updates and authorize these changes for this subscriber for the corresponding AF.
4. If the AF is authorised by the UDM to provision the parameters for this subscriber, the UDM resolves the GPSI to SUPI, and requests to update and store the provisioned parameters as part of the subscriber data via Nudr\_DM\_Update Request message, the message includes the provisioned data.

UDR stores the provisioned data as part of the subscription data and responds with Nudr\_DM\_Update Response message.

If the requester is not authorised to provision data, then the UDM continues in step 5 indicating the reason to failure in Nudm\_ParameterProvision\_Update Response message and step 7 is not executed.

5. UDM responds the request with Nudm\_ParameterProvision\_Update Response. If the procedure failed, the cause value indicates the reason.
6. NEF responds the request with Nnef\_ParameterProvision\_Update Response. If the procedure failed, the cause value indicates the reason.
7. [Conditional this step occurs only after successful step 4] UDM notifies the subscribed Network Function (e.g., AMF) of the updated subscriber data via Nudm\_SDM\_Notification Notify message.

NOTE 2: The NEF (in NOTE 1) or the UDM (in step 3) can also update the corresponding UDR data via Nudr\_DM\_Create/Delete as appropriate.

#### 4.15.6.3 Expected UE Behaviour parameters

These Expected UE Behaviour parameters characterise the foreseen behaviour of a UE or a group of UEs. Sets of these parameters may be provided via the NEF to be stored as part of the subscriber data. Each parameter within the Expected UE Behaviour shall have an associating validity time. The validity time indicates when the Expected UE Behaviour parameter expires and shall be deleted by the related NFs. The validity time may be set to indicate that the particular Expected UE Behaviour parameter has no expiration time. When the validity time expires, the related NFs delete their local copy of the associated Expected UE Behaviour parameter(s). The provision procedure of the Expected UE Behaviour is realized by external parameter provision procedure defined in clause 4.15.6.2.

NOTE : It is expected that the format of validity time, to be defined by Stage 3, is defined in a manner which allows NFs to consistently and uniformly interpret the expiration of the associated Expected UE behaviour parameters.

**Table 4.15.6.3-1: Description of Expected UE Behaviour parameters**

Expected UE Behaviour parameter	Description
Expected UE Moving Trajectory	Identifies the UE's expected geographical movement Example: A planned path of movement

## 4.15.6.4 Set a chargeable party at AF session setup

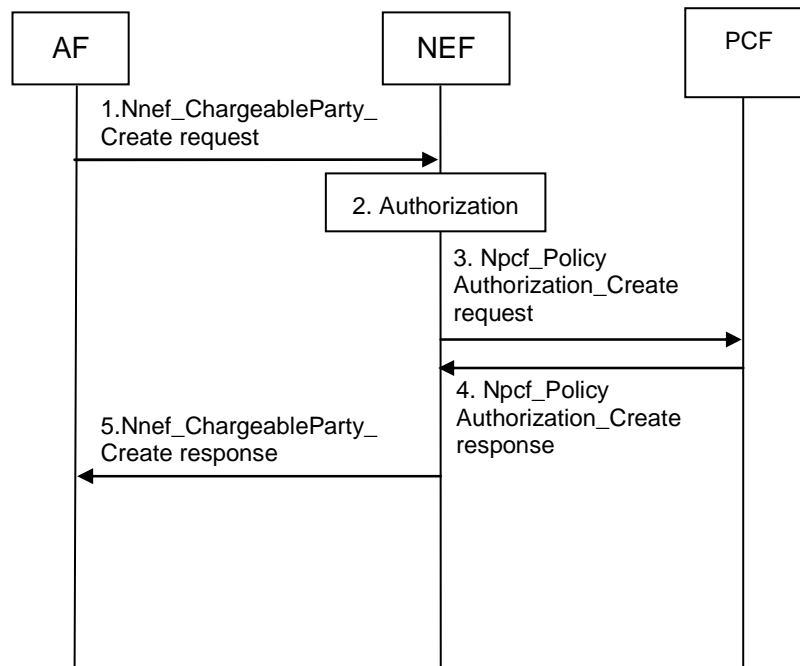

**Figure 4.15.6.4-1: Set the chargeable party at AF session set-up**

1. When setting up the connection between the AF and UE, the AF may request to become the chargeable party for the session to be set up by sending a Nnef\_ChargeableParty\_Create request message (AF Identifier, UE IP address, Description of the application flows, Sponsor Information, Sponsoring Status, Background Data Transfer Reference ID) to the NEF, The Sponsoring Status indicates whether sponsoring is started or stopped, i.e. whether the 3rd party service provider is the chargeable party or not. The Background Data Transfer Reference ID parameter identifies a previously negotiated transfer policy for background data transfer as defined in clause 4.16.7. The NEF assigns a Transaction Reference ID to the Nnef\_ChargeableParty\_Create request.
2. The NEF authorizes the AF request to sponsor the application traffic and stores the sponsor information together with the AF Identifier and the Transaction Reference ID. If the authorisation is not granted, step 2 is skipped and the NEF replies to the AF with a Result value indicating that the authorisation failed.

**NOTE:** Based on operator configuration, the NEF may skip this step. In this case the authorization is performed by the PCF in step 3.

3. The NEF interacts with the PCF by triggering a Npcf\_PolicyAuthorization\_Create request message and provides IP filter information, sponsored data connectivity information (as defined in TS 23.203 [24]), Background Data Transfer Reference ID (if received from the AF) and Sponsoring Status (if received from the AF) to the PCF.
4. The PCF determines whether the request is allowed and notifies the NEF if the request is not authorized. If the request is not authorized, NEF responds to the AF in step 5 with a Result value indicating that the authorization failed.
5. The NEF sends a Nnef\_ChargeableParty\_Create response message (Transaction Reference ID, Result) to the AF. Result indicates whether the request is granted or not.



## 4.15.6.5 Change the chargeable party during the session

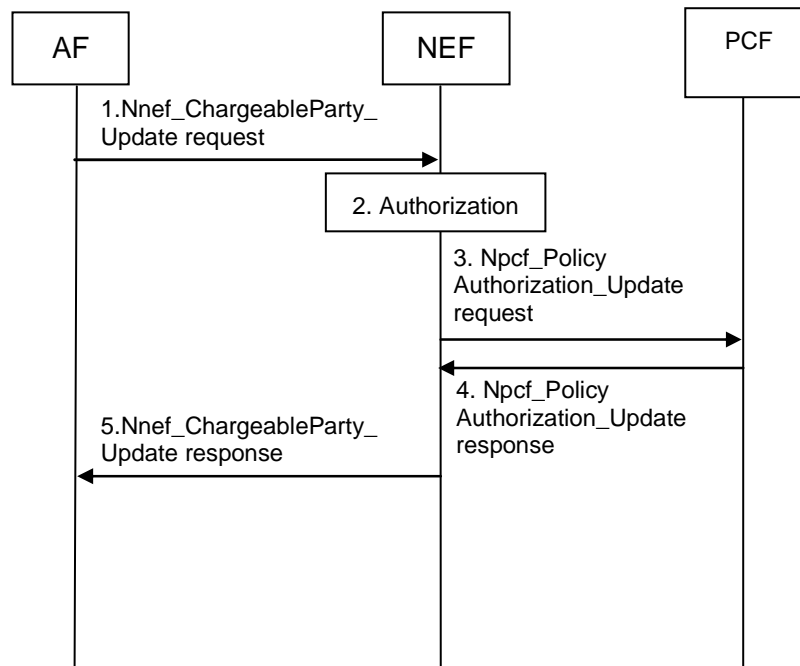

**Figure 4.15.6.5-1: Change the chargeable party during the session**

1. For the ongoing AF session, the AF may send a Nnef\_ChargeableParty\_Update request message (AF Identifier, Transaction Reference ID, Sponsoring Status, Background Data Transfer Reference ID) to the NEF. The Sponsoring Status indicates whether sponsoring is enabled or disabled, i.e. whether the 3rd party service provider is the chargeable party or not. The Background Data Transfer Reference ID parameter identifies a previously negotiated transfer policy for background data transfer as defined in clause 4.16.7. The Transaction Reference ID provided in the Change chargeable party request message is set to the Transaction Reference ID that was assigned, by the NEF, to the a Nnef\_ChargeableParty\_Create request.

2. The NEF authorizes the AF request of changing the chargeable party. If the authorisation is not granted, step 3 is skipped and the NEF replies to the AF with a Result value indicating that the authorisation failed.

NOTE: Based on operator configuration, the NEF may skip this step. In this case the authorization is performed by the PCF in step 3.

3. The NEF interacts with the PCF by triggering a Npcf\_PolicyAuthorization\_Update request and provides IP filter information, sponsored data connectivity information (as defined in TS 23.203 [24]), Background Data Transfer Reference ID (if received from the AF) and Sponsoring Status (if received from the AF) to the PCF.

4. The PCF determines whether the request is allowed and notifies the NEF if the request is not authorized. If the request is not authorized, NEF responds to the AF in step 5 with a Result value indicating that the authorization failed.

5. The NEF sends a Nnef\_ChargeableParty\_Update response message (Transaction Reference ID, Result) to the AF. Result indicates whether the request is granted or not.

## 4.15.6.6 Setting up an AF session with required QoS procedure

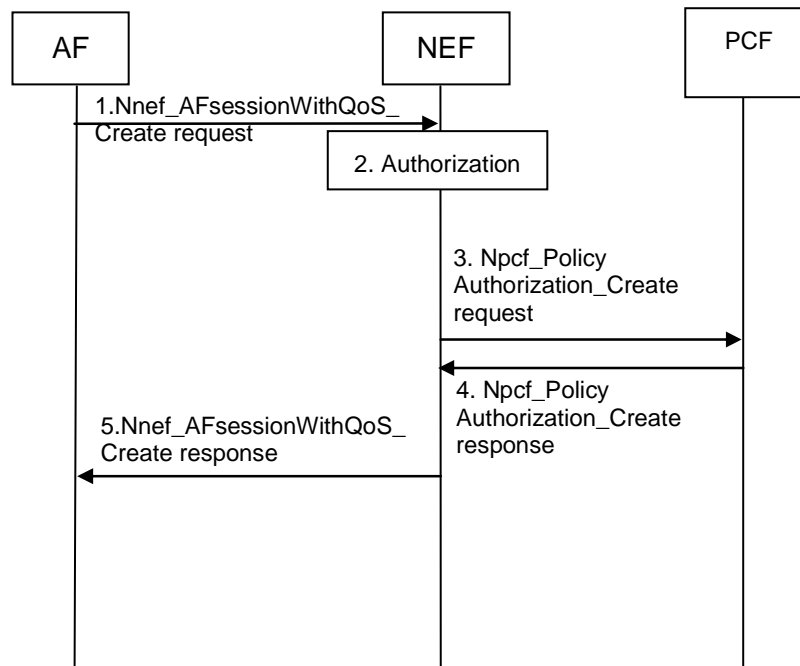

**Figure 4.15.6.6-1: Setting up an AF session with required QoS procedure**

1. When setting up the connection between AF and the UE with required QoS for the service, the AF sends an Nnef\_AFsessionWithQoS\_Create request message (UE IP address, AF Identifier, Description of the application flows, QoS reference) to the NEF. Optionally, a period of time or a traffic volume for the requested QoS can be included in the AF request. The NEF assigns a Transaction Reference ID to the Nnef\_AFsessionWithQoS\_Create request.
2. The NEF authorizes the AF request and may apply policies to control the overall amount of pre-defined QoS authorized for the AF. If the authorisation is not granted, steps 3 and 4 are skipped and the NEF replies to the AF with a Result value indicating that the authorisation failed.
3. The NEF interacts with the PCF by triggering a Npcf\_PolicyAuthorization\_Create request and provides UE IP address, AF Identifier, Description of the application flows and the QoS reference including the optionally received period of time or traffic volume which is mapped to sponsored data connectivity information (as defined in TS 23.203 [24]).

The PCF derives the required QoS based on the information provided by the NEF and determines whether this QoS is allowed (according to the PCF configuration for this AF), and notifies the result to the NEF.

The PCF notifies the NEF whether the transmission resources corresponding to the QoS request are established or not.

4. The PCF determines whether the request is allowed and notifies the NEF if the request is not authorized. If the request is not authorized, NEF responds to the AF in step 5 with a Result value indicating that the authorization failed.
5. The NEF sends a Nnef\_AFsessionWithQoS\_Create response message (Transaction Reference ID, Result) to the AF. Result indicates whether the request is granted or not.

## 4.16 Procedures and flows for Policy Framework

### 4.16.1 AM Policy Association Establishment

#### 4.16.1.1 General

There are three cases considered for AM Policy Association Establishment:

1. UE initial registration with the network.
2. The AMF re-allocation with PCF change in handover procedure and registration procedure.
3. EPS to 5GS mobility when there is no existing AM Policy Association between AMF and PCF for this UE.

#### 4.16.1.2 AM Policy Association Establishment with new Selected PCF

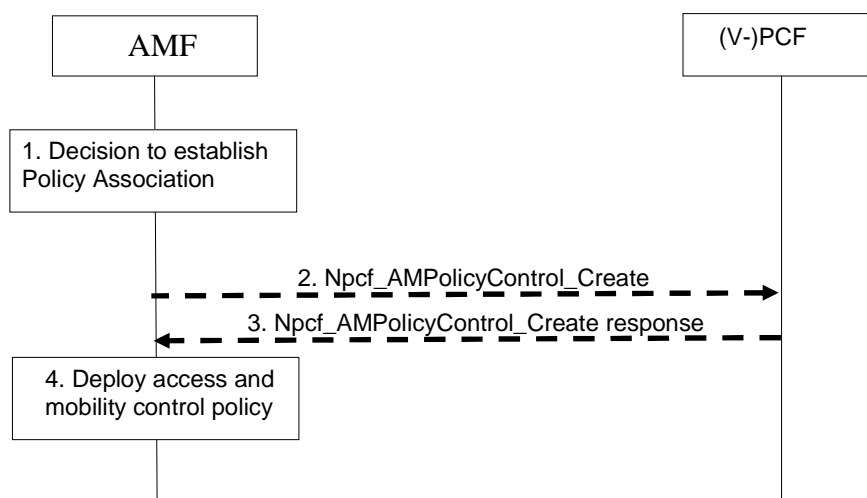

**Figure 4.16.1.2-1: AM Policy Association Establishment with new Selected PCF**

This procedure concerns both roaming and non-roaming scenarios.

In the non-roaming case the role of the V-PCF is performed by the PCF. For the roaming scenarios, the V-PCF interacts with the AMF.

1. Based on local policies, the AMF decides to establish AM Policy Association with the (V-)PCF then steps 2 to 3 are performed under the conditions described below.
2. [Conditional] If the AMF has not yet obtained Access and Mobility policy for the UE or if the Access and Mobility policy in the AMF are no longer valid, the AMF requests the PCF to apply operator policies for the UE from the PCF. The AMF sends `Npcf_AMPolicyControl_Create` to the (V-)PCF to establish an AM policy control association with the (V-)PCF. The request includes the following information: SUPI, Internal Group (see clause 5.9.7 of TS 23.501 [2]), subscription notification indication and, if available, Service Area Restrictions, RFSP index, the Allowed NSSAI, GPSI which are retrieved from the UDM during the update location procedure, and may include Access Type and RAT, PEI, ULI, UE time zone, and Serving Network.
3. The (V-)PCF responds to the `Npcf_AMPolicyControl_Create` service operation. The (V-)PCF provides Access and mobility related policy information (e.g. Service Area Restrictions) as defined in clause 6.5 of TS 23.503 [20]. In addition, (V-)PCF can provide Policy Control Request Trigger of AM Policy Association to AMF.

The AMF is implicitly subscribed in the (V-)PCF to be notified of changes in the policies.

4. [Conditional] The AMF deploys the Access and mobility related policy information which includes storing the Service Area Restrictions and Policy Control Request Trigger of AM Policy Association, provisioning Service

Area Restrictions to the UE and provisioning the RFSP index and Service Area Restrictions to the NG-RAN as defined in TS 23.501 [2].

#### 4.16.1.3 Void

### 4.16.2 AM Policy Association Modification

#### 4.16.2.0 General

There are three cases considered for AM Policy Association Modification:

- Case A: A Policy Control Request Trigger condition is met: the procedure is initiated by the AMF.
- Case B: PCF local decision or trigger from other peers of the PCF (i.e. UDR): the procedure is initiated by the PCF.
- Case C: AM Policy Association Modification with the old PCF during AMF relocation: the procedure is initiated by the AMF.

#### 4.16.2.1 AM Policy Association Modification initiated by the AMF

##### 4.16.2.1.1 AM Policy Association Modification initiated by the AMF without AMF relocation

This procedure is applicable to Case A.

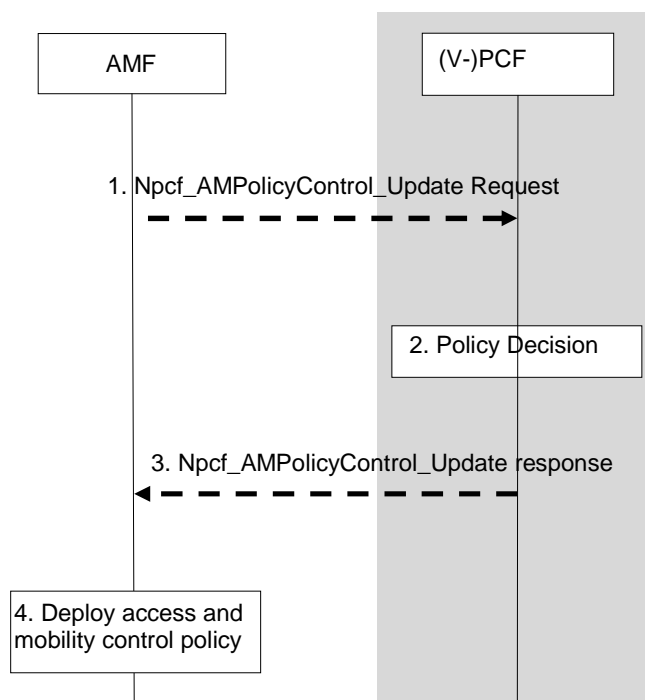

**Figure 4.16.2.1.1-1: AM Policy Association Modification initiated by the AMF**

This procedure concerns both roaming and non-roaming scenarios.

In the non-roaming case the role of the V-PCF is performed by the PCF. For the roaming scenarios, the V-PCF interacts with the AMF.

1. When a Policy Control Request Trigger condition is met the AMF updates AM Policy Association and provides information on the conditions that have changed to the PCF by invoking `Npcf_AMPolicyControl_Update`.

2. The (V-)PCF stores the information received in step 1 and makes the policy decision.
3. The (V-)PCF responds to the AMF of the updated Access and Mobility related policy control information and the updated Policy Control Request Trigger parameters.
4. The AMF deploys the access and mobility control policy, which includes storing the Service Area Restrictions and Policy Control Request Trigger of AM Policy Association, provisioning the Service Area Restrictions to the UE and provisioning the RFSP index and Service Area Restrictions to the NG-RAN as defined in TS 23.501 [2].

#### 4.16.2.1.2 AM Policy Association Modification with old PCF during AMF relocation

This procedure is applicable to Case C. In this case, AMF relocation is performed without PCF change in handover procedure and registration procedure.

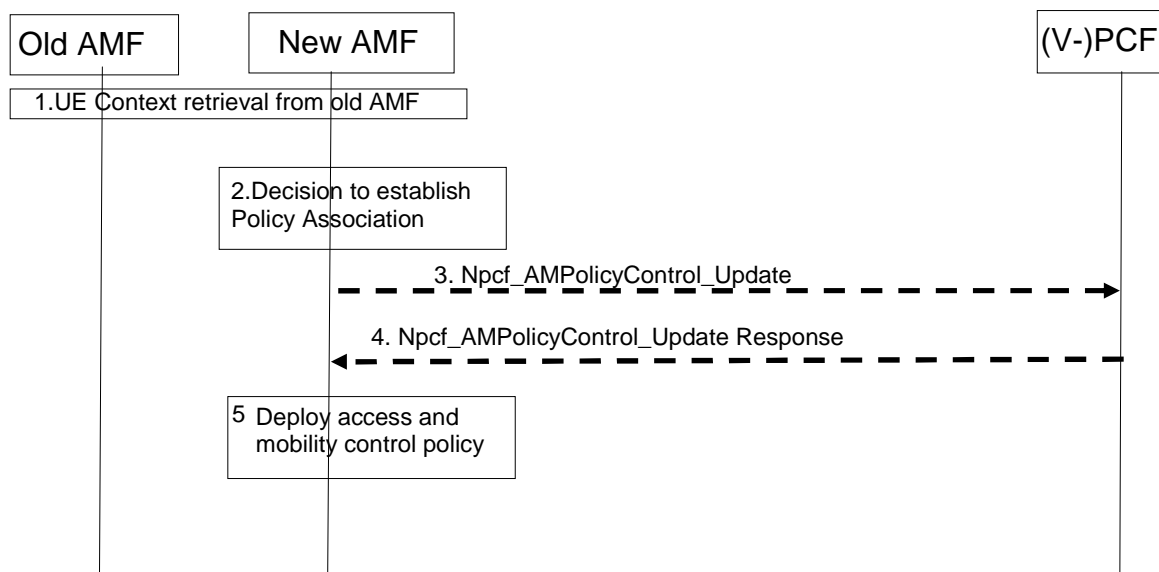

**Figure 4.16.2.1.2-1: AM Policy Association Modification with the old PCF during AMF relocation**

This procedure concerns both roaming and non-roaming scenarios.

In the non-roaming case the role of the V-PCF is performed by the PCF. For the roaming scenarios, the V-PCF interacts with the AMF.:

1. [Conditional] When the old AMF and the new AMF belong to the same PLMN, the old AMF transfers to the new AMF about the AM Policy Association information including policy control request trigger(s) and the PCF ID. For the roaming case, the new AMF receives V-PCF ID.
2. Based on local policies, the new AMF decides to establish UE Context with the (V-)PCF and contacts the (V-)PCF identified by the PCF ID received in step 1.
3. The new AMF sends Npcf\_AMPolicyControl\_Update to the (V-)PCF to update the AM policy association with the (V-)PCF. The request may include the following information: policy control request trigger which has been met, Subscribed Service Area Restrictions (if updated), subscribed RFSP index (if updated) which are retrieved from the UDM during the update location procedure, and may include access type and RAT, PEI, ULI, UE time zone, service network. The (V-)PCF updates the stored information provided by the old AMF with the information provided by the new AMF.
4. The (V-)PCF may update the policy decision based on the information provided by the new AMF.
5. The AMF deploys the access and mobility control policy, which includes storing the Service Area Restrictions, provisioning Service Area Restrictions to the UE and provisioning the RFSP index and Service Area Restrictions to the NG-RAN.

### 4.16.2.2 AM Policy Association Modification initiated by the PCF

This procedure is applicable to AM Policy Association modification due to Case B.

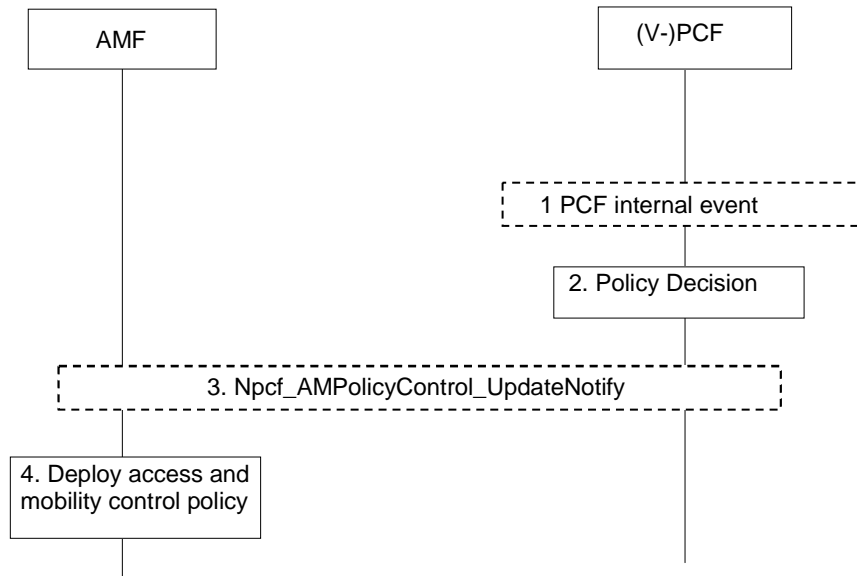

**Figure 4.16.2.2-1: AM Policy Association Modification initiated by the PCF**

This procedure concerns both roaming and non-roaming scenarios.

In the non-roaming case the role of the V-PCF is performed by the PCF. For the roaming scenarios, the V-PCF interacts with the AMF.

NOTE: The V-PCF stores the access and mobility control policy information provided to the AMF.

1. [Conditional] PCF determines locally that the new status of the UE context requires new policies.
2. The (V-)PCF makes a policy decision.
3. The (V-)PCF sends Npcf\_UpdateNotify including AM Policy Association ID associated with the SUPI defined in TS 29.507 [32], Service Area Restrictions or RFSP index.
4. The AMF deploys the Access and mobility related policy information, which includes storing the Service Area Restrictions and Policy Control Request Trigger of AM Policy Association, provisioning of the Service Area Restrictions to the UE and provisioning the RFSP index and Service Area Restrictions to the NG-RAN.

## 4.16.3 AM Policy Association Termination

### 4.16.3.1 General

The following case is considered for AM Policy Association Termination:

1. UE Deregistration from the network.
2. The mobility with change of AMF (e.g. new AMF is in different PLMN or new AMF in the same PLMN).
3. [Optional] 5GS to EPS mobility with N26 if the UE is not connected to the 5GC over a non-3GPP access in the same PLMN.

### 4.16.3.2 AMF-initiated AM Policy Association Termination

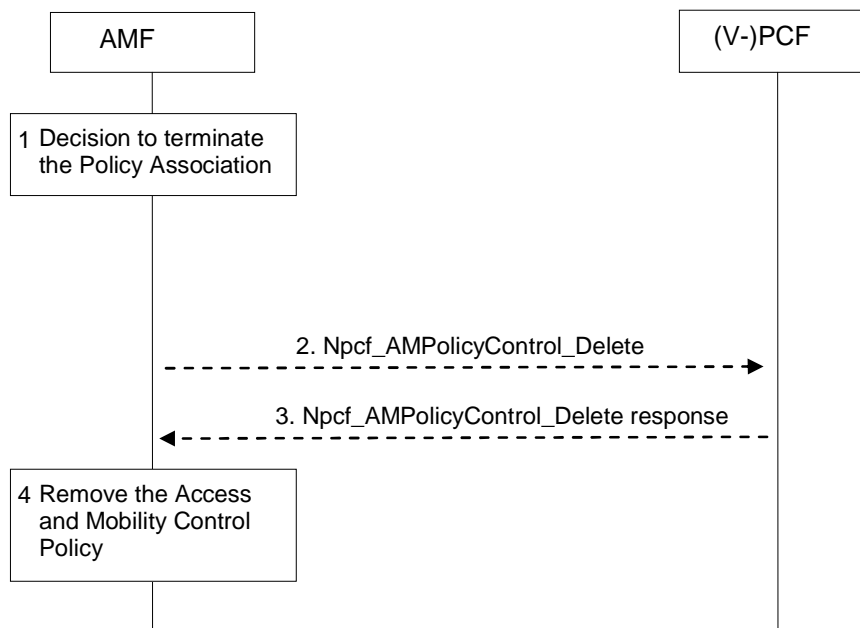

**Figure 4.16.3.2-1: AMF-initiated AM Policy Association Termination**

This procedure concerns both roaming and non-roaming scenarios.

In the non-roaming case the role of the V-PCF is performed by the PCF. For the roaming scenarios, the V-PCF interacts with the AMF.

1. The AMF decides to terminate the AM Policy Association during Deregistration procedure or due to mobility with change of AMF and (V-)PCF in the registration procedure or handover procedure, then if a AM Policy Association was established with the (V-)PCF steps 2 to 3 are performed.
2. The AMF sends the Npcf\_AMPolicyControl\_Delete service operation including AM Policy Association ID to the (V-)PCF.
3. The (V-)PCF removes the policy context for the UE and replies to the AMF with an Acknowledgement including success or failure.
4. The AMF removes the AM Policy Association for this UE, including the Access and Mobility Control Policy related to the UE. The AMF deletes the subscription to AMF detected events requested for that Policy Association.

### 4.16.3.3 Void

## 4.16.4 SM Policy Association Establishment

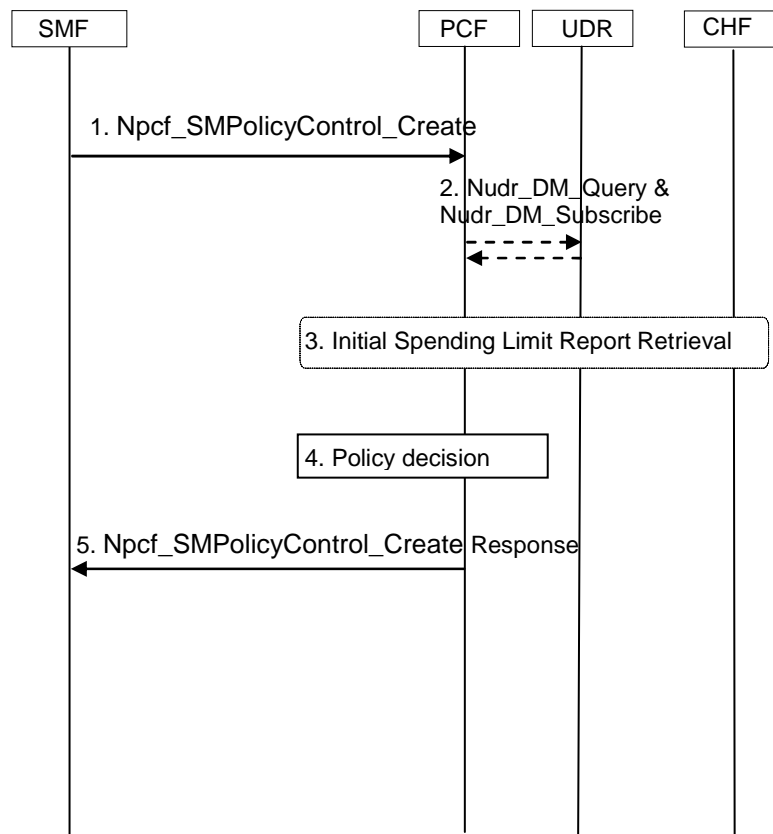

**Figure 4.16.4-1: SM Policy Association Establishment**

This procedure concerns both roaming and non-roaming scenarios.

In the non-roaming case the V-PCF is not involved. In the local breakout roaming case, the H-PCF is not involved. In the home routed roaming case, the V-PCF is not involved and the H-PCF interacts with the H-SMF.

This procedure is used in UE requests a PDU Session Establishment as explained in clause 4.3.2.2.1, for non-roaming and local breakout roaming. For home-routed roaming, as explained in clause 4.3.2.2.2.

For local breakout roaming, the interaction with HPLMN (e.g. step 3) is not used. In local breakout roaming, the V-PCF interacts with the UDR of the VPLMN.

1. The SMF determines that the PCC authorization is required and requests to establish an SM Policy Association with the PCF by invoking Npcf\_SMPolicyControl\_Create operation (see clause 5.2.5.4.2). The SMF includes the following information: SUPI, PDU Session id, PDU Session Type, S-NSSAI, NSI ID (if available), DNN, GPSI (if available), Access Type, AMF instance identifier and if available, the IPv4 address and/or IPv6 network prefix, PEI, User Location Information, UE Time Zone, Serving Network, RAT type, Charging Characteristics, Session AMBR, default QoS information, Trace Requirements, Internal Group Identifier (see TS 23.501 [2], clause 5.9.7).

The SMF provides Trace Requirements to the PCF when it has received Trace Requirements and it has selected a different PCF than the one received from the AMF.

2. If the PCF does not have the subscriber's subscription related information, it sends a request to the UDR by invoking Nudr\_DM\_Query (SUPI, DNN, S-NSSAI, Policy Data, PDU Session policy control data, Accumulated Usage data) service in order to receive the information related to the PDU Session. The PCF may request notifications from the UDR on changes in the subscription information by invoking Nudr\_DM\_Subscribe (Policy Data, SUPI, DNN, S-NSSAI, Notification Target Address (+ Notification Correlation Id), Event Reporting Information (continuous reporting), PDU Session policy control data, Accumulated Usage data) service.



3. If the PCF determines that the policy decision depends on the status of the policy counters available at the CHF and such reporting is not established for the subscriber, the PCF initiates an Initial Spending Limit Report Retrieval as defined in clause 4.16.8.2. If policy counter status reporting is already established for the subscriber, and the PCF determines that the status of additional policy counters are required, the PCF initiates an Intermediate Spending Limit Report Retrieval as defined in clause 4.16.8.3.
4. The PCF makes the authorization and the policy decision.
5. The PCF answers with a Npcf\_SMPolicyControl\_Create response; in its response the PCF may provide policy information defined in clause 5.2.5.4 (and in TS 23.503 [20]). The SMF enforces the decision. The SMF implicitly subscribes to changes in the policy decisions.

NOTE: After this step the PCF can subscribe to SMF events associated with the PDU Session.

## 4.16.5 SM Policy Association Modification

### 4.16.5.0 General

The following SM Policy Association Modification procedures concern both roaming and non-roaming scenarios.

In the non-roaming case the V-PCF is not involved. In the local breakout roaming case, the H-PCF is not involved. In the home routed roaming case, the V-PCF is not involved and the H-PCF interacts with the H-SMF.

The SM Policy Association Modification procedure may be initiated either by the SMF or by the PCF.

#### 4.16.5.1 SMF initiated SM Policy Association Modification

The SMF may initiate the SM Policy Association Modification procedure in case a Policy Control Request Trigger is met.

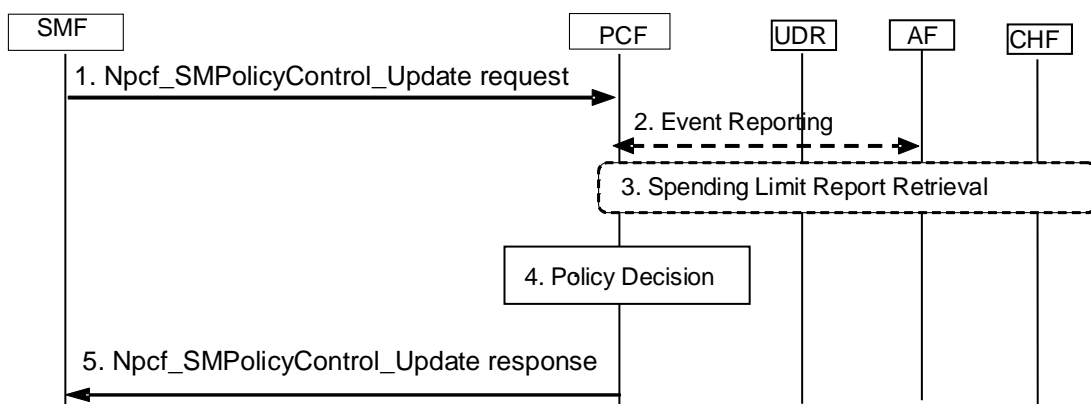

**Figure 4.16.5.1-1: SMF initiated SM Policy Association Modification**

For local breakout roaming, the interaction with HPLMN (e.g. step 2) is not used. In local breakout roaming, the V-PCF interacts with the UDR of the VPLMN.

1. When a Policy Control Request Trigger condition is met the SMF requests to update (Npcf\_SMPolicyControl\_Update) the SM Policy Association and provides information on the conditions that have been met.
2. When an AF has subscribed to an event that is met due to the report from the SMF, the PCF reports the event to the AF by invoking the Npcf\_PolicyAuthorization\_Notify service operation.
3. If the PCF determines a change to policy counter status reporting is required, it may alter the subscribed list of policy counters using the Initial, Intermediate or Final Spending Limit Report Retrieval procedures as defined in clause 4.16.8.
4. The PCF makes a policy decision as described in TS 23.503 [20]. The PCF may determine that updated or new policy information needs to be sent to the SMF.

If the SMF reported accumulated usage for the PDU session in step 1 the PCF deducts the value from the total allowed usage for the subscriber, DNN, and S-NSSAI in the UDR by invoking Nudr\_DM\_Update (SUPI, DNN, S-NSSAI, Policy Data, Accumulated Usage data, updated data) service operation.

If the SMF reported accumulated usage for a MK(s) in step 1 the PCF deducts the value from the total allowed usage for the MK in the UDR by invoking Nudr\_DM\_Update (SUPI, DNN, S-NSSAI, Policy Data, Accumulated Usage data, updated data (including MK(s))) service operation.

5. The PCF answers with a Npcf\_SMPolicyControl\_Update response with updated policy information about the PDU Session determined in step 3.

#### 4.16.5.2 PCF initiated SM Policy Association Modification

The PCF may initiate SM Policy Association Modification procedure based on local decision or triggered by other peers of the PCF (AF, CHF, UDR).

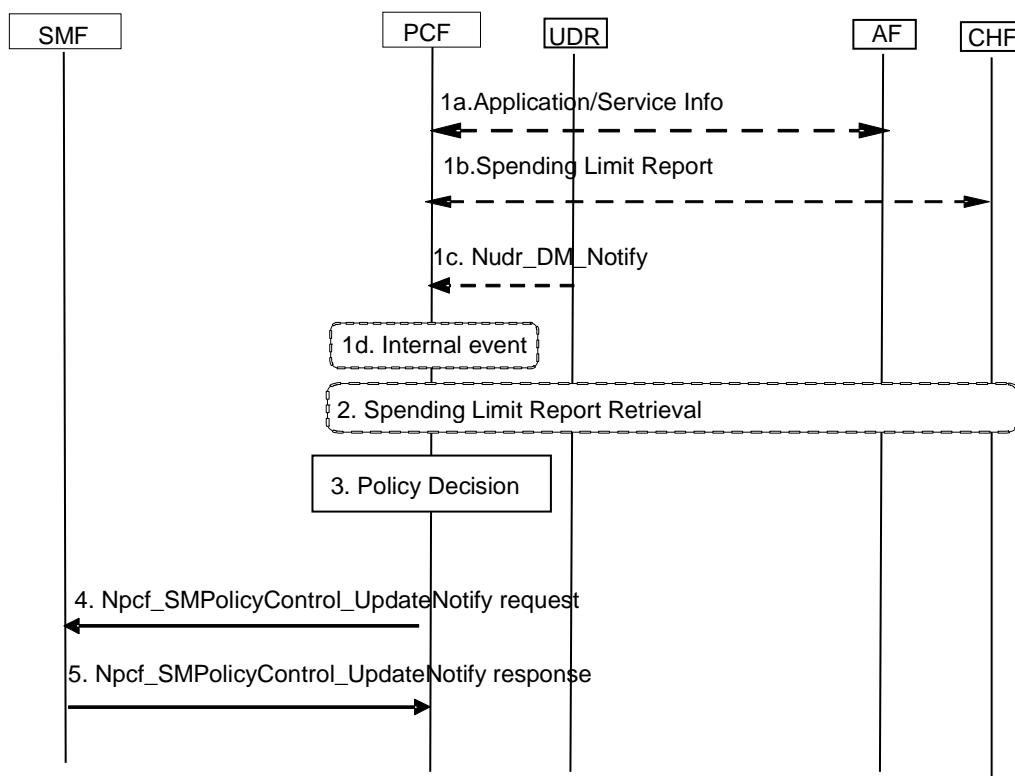

**Figure 4.16.5.2-1: PCF initiated SM Policy Association Modification**

This procedure may be triggered by a local decision of the PCF or based on triggers from other peers of the PCF (AF, CHF, UDR):

For local breakout roaming, the interaction with HPLMN (e.g. step 1b and step 2) is not used. In local breakout roaming, the V-PCF interacts with the UDR of the VPLMN.

1a. Alternatively, optionally, the AF provides/revokes service information to the PCF e.g. due to AF session signalling, by invoking Npcf\_PolicyAuthorization\_Create Request or Npcf\_PolicyAuthorization\_Update Request service operation. The PCF responds to the AF.

1b. Alternatively, optionally, the CHF provides a Spending Limit Report to the PCF as described in clause 4.16.8. and responds to the CHF.

1c. Alternatively, optionally, the UDR notifies the PCF about a policy subscription change by invoking Nudr\_DM\_Notify (Notification correlation Id, Policy Data, SUPI, updated data, "PDU Session Policy Control Data" | "Accumulated Usage"); The PCF responds to the UDR.

1d. Alternatively, optionally, some internal event (e.g. timer) occurs at the PCF.

2. If the PCF determines a change to policy counter status reporting is required, it may alter the subscribed list of policy counters using the Initial, Intermediate or Final Spending Limit Report Retrieval procedures as defined in clause 4.16.8.

NOTE: The PCF ensures that information received in step 1 and 2 can be used by later policy decisions.

3. The PCF makes a policy decision. The PCF may determine that updated or new policy information need to be sent to the SMF.

If the AF provided a Background Data Transfer Reference ID in step 1a, the PCF may retrieve it from the UDR by invoking the Nudr\_DM\_Query (BDT Reference Id, Policy Data, Background Data Transfer) service.

4. If the PCF has determined that SMF needs updated policy information in step 3 the PCF issues a Npcf\_SMPolicyControl\_UpdateNotify request with possibly updated policy information about the PDU Session.

5. The SMF acknowledges the PCF request with a Npcf\_SMPolicyControl\_UpdateNotify response.

### 4.16.6 SM Policy Association Termination

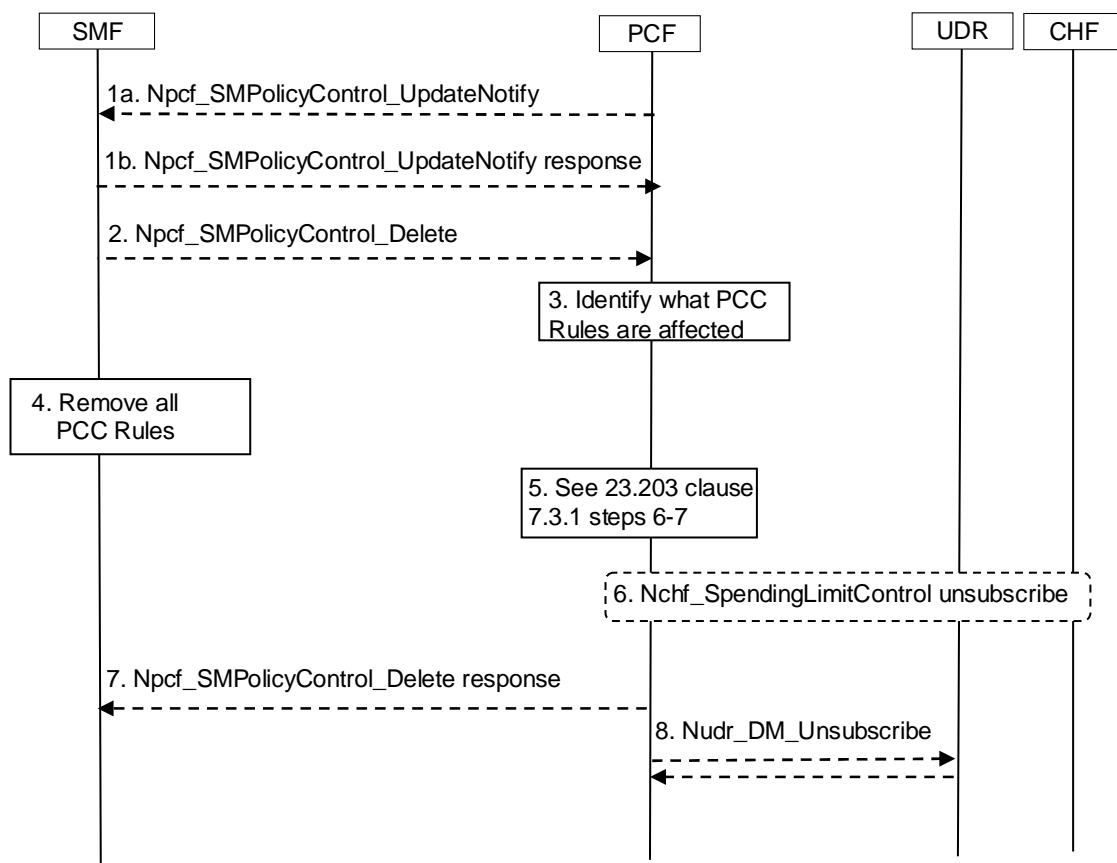

Figure 4.16.6-1: SM Policy Association Termination

This procedure concerns both roaming and non-roaming scenarios.

In the non-roaming case the V-PCF is not involved. In the local breakout roaming case, the H-PCF is not involved. In the home routed roaming case, the V-PCF is not involved and the H-PCF interacts only with the H-SMF.

The procedure for Session Management Policy Termination may be initiated by:

- (case A) the PCF.
- (case B) the SMF.

For local breakout roaming, the interaction with HPLMN (e.g. step 6) is not used. In local breakout roaming, the V-PCF interacts with the UDR of the VPLMN.

1. (Case A) The PCF may invoke the Npcf\_SMPolicyControl\_UpdateNotify service operation to request the release of a PDU Session. The SMF acknowledges the request.

The rest of the procedure corresponds to both Case A & B.

2. The SMF may invoke the Npcf\_SMPolicyControl\_Delete service operation to request the deletion of the SM Policy Association with the PCF. The SMF provides relevant information to the PCF.
3. When receiving the request from step 2, the PCF finds the PCC Rules that require an AF to be notified and removes PCC Rules for the PDU Session.

If the SMF reported accumulated usage for the PDU session in step 1 the PCF deducts the value from the total allowed usage for the subscriber, DNN, and S-NSSAI in the UDR by invoking Nudr\_DM\_Update (SUPI, DNN, S-NSSAI, Policy Data, Accumulated Usage data, updated data) service operation.

If the SMF reported accumulated usage for a MK(s) in step 1 the PCF deducts the value from the total allowed usage for the MK in the UDR by invoking Nudr\_DM\_Update (SUPI, DNN, S-NSSAI, Policy Data, Accumulated Usage data, updated data (including MK(s))) service operation.

4. The SMF removes all policy information about the PDU Session associated with the PDU Session.
5. The PCF notifies the AF as explained in clause 7.3.1 steps 6-7 of TS 23.203 [24].

PCF may invoke Nbsf\_Management\_Deregister service operation to delete the binding created in BSF.

6. The PCF may invoke the procedure defined in clause 4.16.8 to unsubscribe to policy counter status reporting (If this is the last PDU Session for this subscriber requiring policy counter status reporting) or to modify the subscription to policy counter status reporting, (if any remaining existing PDU Sessions for this subscriber requires policy counter status reporting).
7. The PCF removes the information related to the terminated PDU Session and acknowledges to the SMF that the PCF handling of the PDU Session has terminated. This interaction is the response to the SMF request in step 2.
8. The PCF may (e.g. if it is the last PDU Session on the (DNN, S-NSSAI) couple) unsubscribe to the notification of the PDU Session related data modification from the UDR by invoking Nudr\_DM\_Unsubscribe (Subscription Correlation Id) if it had subscribed such notification.

## 4.16.7 Negotiations for future background data transfer

### 4.16.7.1 General

This procedure enables the negotiation between the NEF and the H-PCF about the transfer policies for the future background data transfer (as described in clause 6.1.2.4 in TS 23.503 [20]). The transfer policies consist of a desired time window for the background data transfer, a reference to a charging rate for the time window and optionally a maximum aggregated bitrate, as described in clause 6.1.16 in TS 23.203 [24].

This negotiation is preliminarily conducted (when AF initiates a procedure to NEF) before the UE's PDU Session establishment. At a later time, the AF invokes the Npcf\_PolicyAuthorization\_Create service directly with PCF, or via the NEF, to apply the background data transfer policy for an individual UE.

## 4.16.7.2 Procedures for future background data transfer

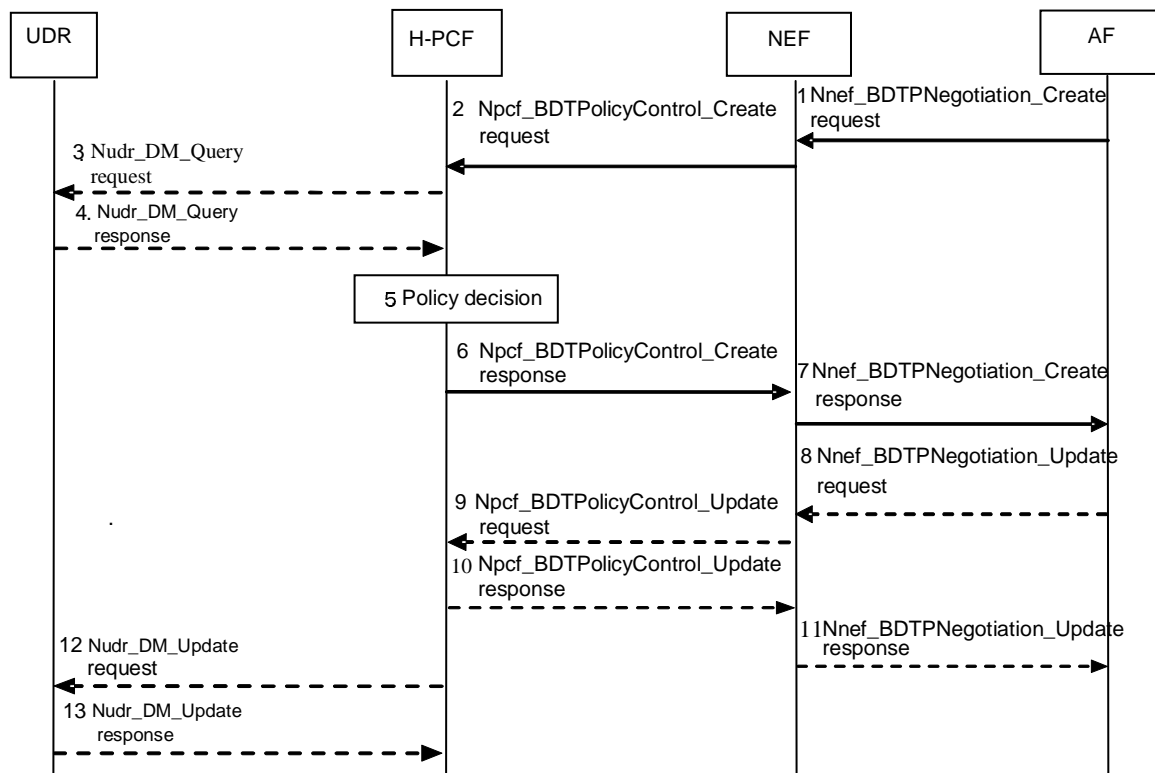

Figure 4.16.7.2-1: Negotiation for future background data transfer

1. The AF invokes the Nnef\_BDTPNegotiation\_Create service.
2. Based on an AF request, the NEF invokes the Npcf\_BDTPolicyControl\_Create service with the H-PCF to authorize the creation of the policy regarding the background data transfer.

NOTE 1: The NEF does not provide any information about the identity of the UEs potentially involved in the future background data transfer.

NOTE 2: A 3rd party application server is typically not able to provide any specific network area information and if so, the AF request is for a whole operator network.

3. The H-PCF may request from the UDR the stored transfer policies for all the ASPs using Nudr\_DM\_Query (Policy Data, Background Data Transfer) service operation.

NOTE 3: In case only one PCF is deployed in the PLMN, the transfer policy can be locally stored and no interaction with UDR is required.

4. The UDR provides all the stored transfer policies and corresponding network area information to the H-PCF.

5. The H-PCF determines, based on information provided by the AF and other available information one or more transfer policies.

NOTE 4: The maximum aggregated bitrate is not enforced in the network.

6. The H-PCF send the acknowledge message to the NEF with the acceptable transfer policies and a Background Data Transfer Reference ID.

7. The NEF sends a Nnef\_BDTPNegotiation\_Create response to the AF to provide one or more background data transfer policies and the Background Data Transfer Reference ID to the AF. The AF stores the Background Data Transfer Reference ID for the future interaction with the PCF. If the NEF received only one background transfer policy from the PCF, steps 8-11 are not executed and the flow proceeds to step 12. Otherwise, the flow proceeds to step 8.

NOTE 5: If the NEF receives only one transfer policy, the AF is not required to confirm.

8. The AF invokes the Nnef\_BDTPNegotiation\_Update service to provide the NEF Background Data Transfer Reference ID and with the selected background data transfer policy.
9. The NEF invokes the Npcf\_BDTPolicyControl\_Update service to provide the H-PCF with the selected background data transfer policy and the associated Background Data Transfer Reference ID.
10. The H-PCF sends the acknowledge message to the NEF.
11. The NEF sends the acknowledge message to the AF.
12. The H-PCF stores the Background Data Transfer Reference ID together with the new transfer policy and the corresponding network area information in the UDR by invoking Nudr\_DM\_Update (BDT Reference id, Policy Data, Background Data Transfer, updated data). This step is not executed, when the PCF decides to locally store the transfer policy.
13. The UDR sends a response to the H-PCF as its acknowledgement.

## 4.16.8 Procedures on interaction between PCF and CHF

### 4.16.8.1 General

The PCF may interact with the CHF to make PCC decisions based on spending limits. In Home Routed roaming and Non-roaming case, the H-PCF will interact with the CHF in HPLMN.

### 4.16.8.2 Initial Spending Limit Retrieval

This clause describes the signalling flow for the PCF to retrieve the status of the policy counters available at the CHF, and to subscribe to spending limit reporting (i.e. to notifications of policy counter status changes) by the CHF. If the PCF provides the list of policy counter identifier(s), the CHF returns the policy counter status per policy counter identifier provided by the PCF. If the PCF does not provide the list of policy counter identifier(s), the CHF returns the policy counter status of all policy counter(s), which are available for this subscriber.

The Initial Spending Limit Report Retrieval includes all subscriber Identifiers associated with the UE available at the PCF.

**NOTE:** In case the CHF returns the status of all available policy counters some of these might not be relevant for a policy decision (e.g. those used in a policy decision only when roaming).

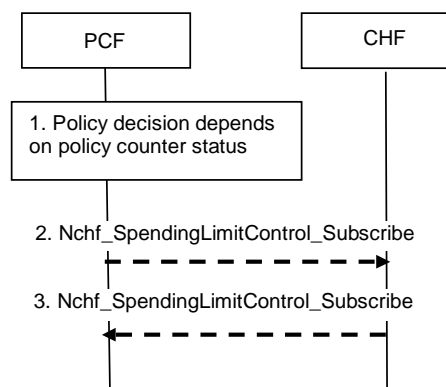

**Figure 4.16.8.2.1: Initial Spending Limit Report Retrieval**

1. The PCF retrieves subscription information that indicates that policy decisions depend on the status of policy counter(s) held at the CHF and optionally the list of policy counter identifier(s).
2. The PCF sends Nchf\_SpendingLimitControl\_Subscribe if this is the first time policy counter status information is requested for the user identified by a SUPI. It includes: the subscriber ID (e.g. SUPI), the EventId "policy counter status change" and, optionally, the list of policy counter identifier(s) as Event Filter, the Notification Target Address, Event Reporting Information (continuous reporting).

The CHF responds to the Nchf\_SpendingLimitControl\_Subscribe service operation including the Subscription Correlation Id) and as Event Information provides a policy counter status, and optionally pending policy counter statuses and their activation times, per required policy counter identifier and stores the PCF's subscription to spending limit reports for these policy counters. If no policy counter identifier(s) was provided the CHF returns the list of the policy counter status, optionally including pending policy counter statuses and their activation times, for all policy counter(s), which are available for this subscriber and stores the PCF's subscription to spending limit reports of all policy counters provided to the PCF.

#### 4.16.8.3 Intermediate Spending Limit Report Retrieval

This clause describes the signalling flow for the PCF to retrieve the status of additional policy counters available at the CHF or to unsubscribe from spending limit reporting. If the PCF provides the list of policy counter identifier(s), the CHF returns the policy counter status per policy counter identifier provided by the PCF.

**NOTE:** In case the CHF returns the status of all available policy counters some of these might not be relevant for a policy decision, (e.g. those used in a policy decision only when roaming).

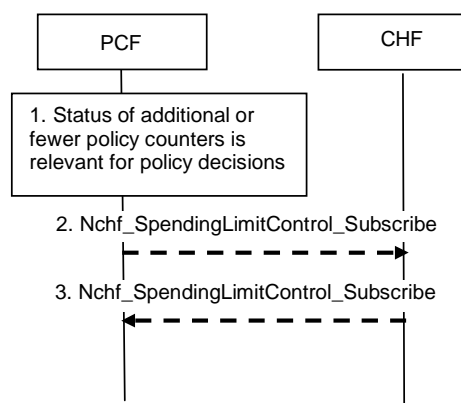

**Figure 4.16.8.3.1: Intermediate Spending Limit Report Retrieval**

1. The PCF determines that policy decisions depend on the status of additional policy counter(s) held at the CHF or that notifications of policy counter status changes for some policy counters are no longer required.
2. The PCF sends Nchf\_SpendingLimitControl\_Subscribe to the CHF, including the Subscription Correlation Id, the EventId "policy counter status change" and an updated list of policy counter identifier(s) as EventFilters, that overrides the previously stored list of policy counter identifier(s).

The CHF responds to the Nchf\_SpendingLimitControl\_Subscribe service operation and provides as Event Information the policy counter status, and optionally pending policy counter statuses and their activation times, per required policy counter identifier, and stores or removes the PCF's subscription to spending limit reporting by comparing the updated list with the existing PCF subscriptions. If no policy counter identifier(s) was provided, the CHF returns the policy counter status, optionally including pending policy counter statuses and their activation times, for all policy counter(s), which are available for this subscriber and stores the PCF's subscription to spending limit reports of all policy counters provided to the PCF.

#### 4.16.8.4 Final Spending Limit Report Retrieval

This clause describes the signalling flow for the PCF to cancel the subscriptions to status changes for the policy counters available at the CHF.

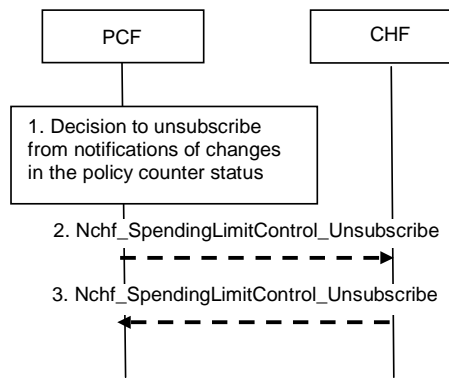
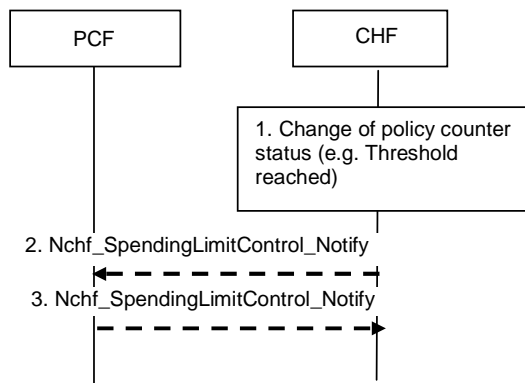

**Figure 4.16.8.4.1: Final Spending Limit Report Retrieval**

1. The PCF decides that notifications of policy counter status changes are no longer needed.
2. The PCF sends Nchf\_SpendingLimitControl\_Unsubscribe including the SubscriptionCorrelationId to the CHF to cancel the subscription to notifications of policy counter status changes from the CHF.
3. The CHF removes the PCF's subscription to spending limit reporting and responds to the Nchf\_SpendingLimitControl\_Unsubscribe service operation to the PCF.

#### 4.16.8.5 Spending Limit Report

This clause describes the signalling flow for the CHF to notify the change of the status of the subscribed policy counters available at the CHF for that subscriber. Alternatively, the signalling flow can be used by the CHF to provide one or more pending statuses for a subscribed policy counter together with the time they have to be applied.



**Figure 4.16.8.5.1: Spending Limit Report**

1. The CHF detects that the status of a policy counter(s) has changed and the PCF subscribed to notifications of changes in the status of this policy counter. Alternatively, the CHF may detect that a policy counter status will change at a future point in time, and decides to instruct the PCF to apply one or more pending statuses for a requested policy counter.
2. The CHF sends Nchf\_SpendingLimitControl\_Notify with the SUPI, Notification Target Address, and in the Event Information the policy counter status, and optionally pending policy counter statuses and their activation times, for each policy counter that has changed and for which the PCF subscribed to spending limit reporting. Alternatively, the CHF sends one or more pending statuses for any of the subscribed policy counters together with the time they have to be applied.
3. The PCF acknowledges sending Nchf\_SpendingLimitControl\_Notify response and takes that information into account as input for a policy decision.

#### 4.16.8.6 CHF report the removal of the subscriber

This clause describes the signalling flow for the CHF to report the removal of the subscriber.



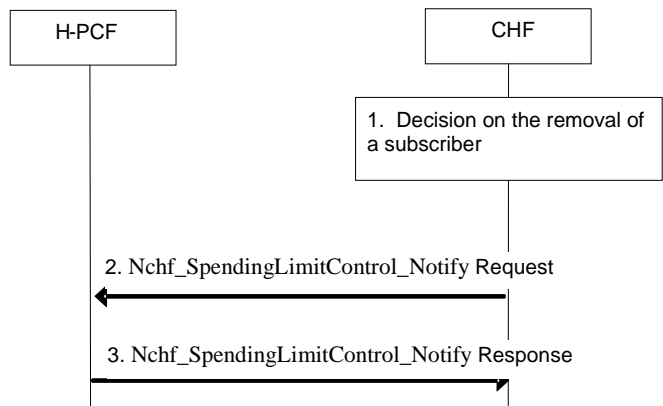

**Figure 4.16.8.6-1: CHF report the removal of the subscriber**

1. The CHF decides that a subscriber is removed.
2. The CHF sends the Nchf\_SpendingLimitControl\_Notify Request to H-PCF to notify the removal of the subscriber. The H-PCF removes the subscription to notification of policy counter status from CHF.

NOTE: Notification on the removing of a subscriber causes the H-PCF to make the applicable policy decision and act accordingly.

3. The H-PCF responds to CHF using Nchf\_SpendingLimitControl\_Notify to acknowledge the receiving of the notification.

### 4.16.9 Update of the subscription information in the PCF

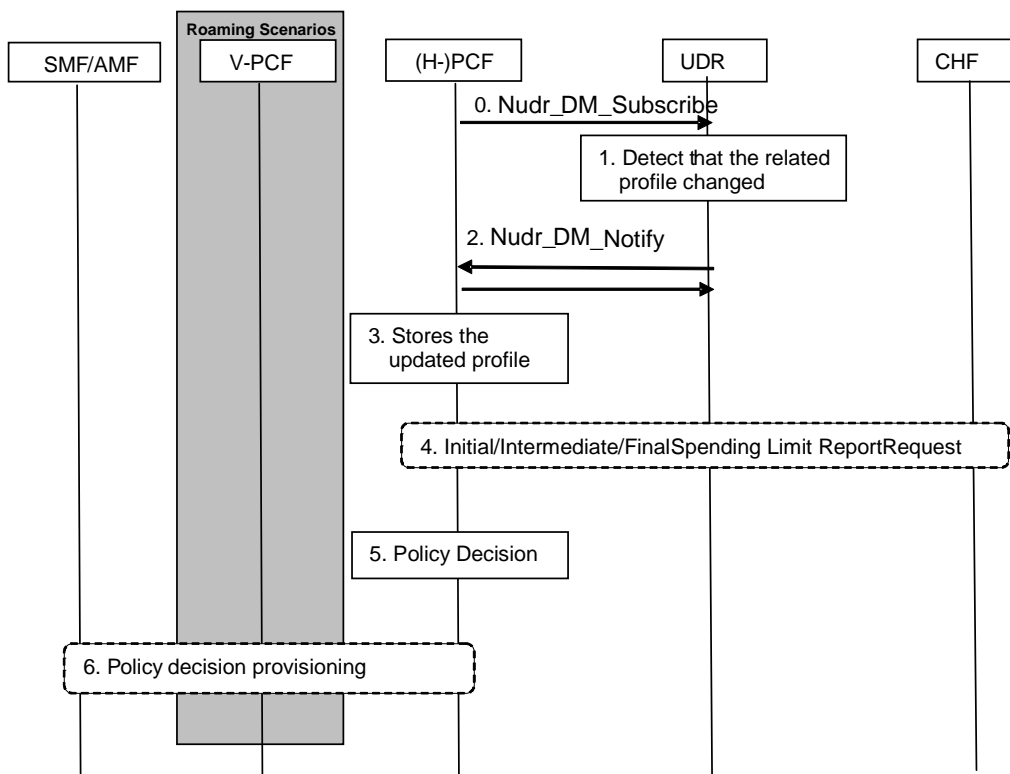

**Figure-4.16.9-1: Procedure for update of the subscription information in the PCF**

NOTE : The V-PCF is not used for session management related policy decisions in this procedure.

0. The PCF performs the subscription to notification to the profile modified in the UDR by invoking Nudr\_DM\_Subscribe (Policy Data, SUPI, Notification Target Address (+ Notification Correlation Id), Event

Reporting Information (continuous reporting), one or several of the following: "PDU Session Policy Control data", "Accumulated Usage data" or "UE context Policy Control data") service.

1. The UDR detects that the related subscription profile has been changed.
2. If subscribed by the PCF, the UDR notifies the PCF on the changed profile by invoking Nudr\_DM\_Notify (Notification Correlation Id, Policy Data, SUPI, updated data and one or several of the following data subtypes "PDU Session Policy Control Data" or "Accumulated Usage Data" or "UE Context Policy Control data") service.
3. The PCF stores the updated profile.
4. If the updated subscriber profile requires the status of new policy counters available at the CHF then an Initial/Intermediate Spending Limit Report Retrieval is initiated by the PCF as defined in clauses 4.16.8.2 and 4.16.8.3. If the updated subscriber profile implies that no policy counter status is needed an Intermediate Spending Limit Report Request Retrieval is initiated by the PCF to unsubscribe or, if this is the last policy counter status, a Final Spending Limit Report Retrieval is initiated by the PCF as specified in clause 4.16.8.4.
5. PCF makes an authorization and policy decision.
6. The PCF provides new session management related policy decisions to the SMF, using the Policy related interaction in PDU Session Modification procedure in clause 4.16.6, new access and mobility related policy information or new UE access selection and PDU Session selection related policy information to the AMF using the UE Context Modification procedure in clause 4.16.2.

#### 4.16.10 Void

#### 4.16.11 UE Policy Association Establishment

This procedure concerns the following scenarios:

1. UE initial registration with the network when a UE Policy Container is received.
2. The AMF relocation with PCF change in handover procedure and registration procedure.
3. UE registration with 5GS when the UE moves from EPS to 5GS and there is no existing UE Policy Association between AMF and PCF for this UE.

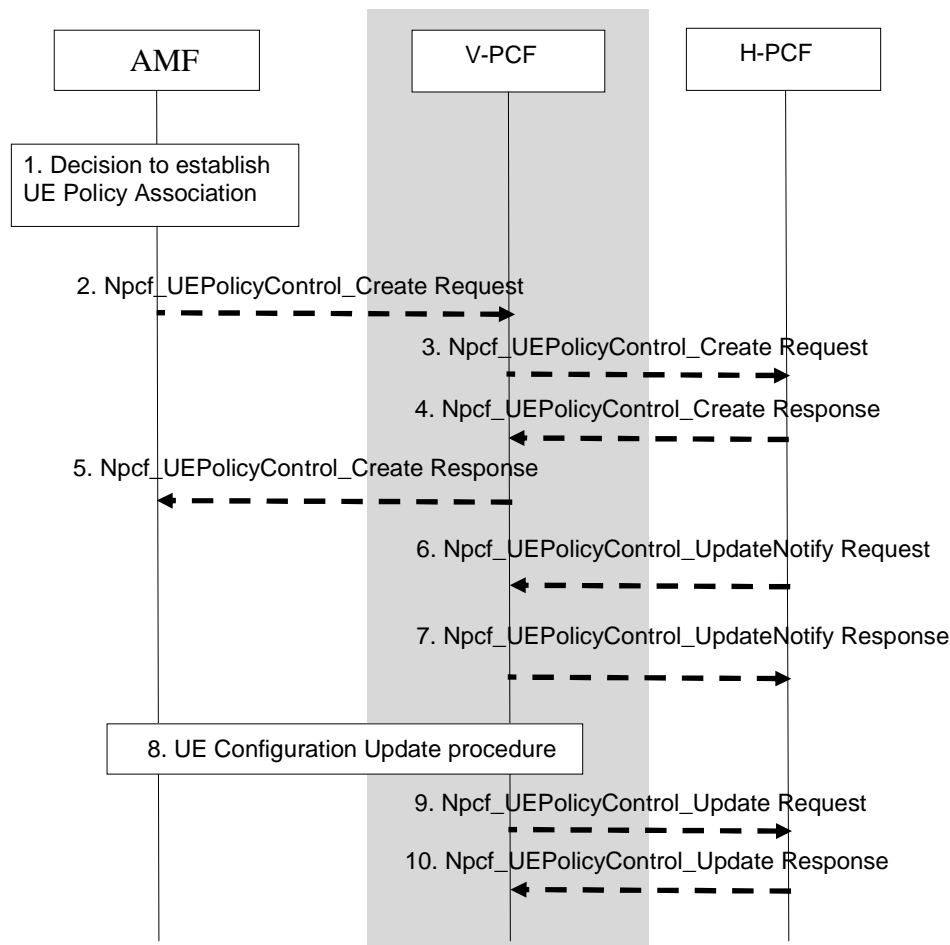

**Figure 4.16.11-1: UE Policy Association Establishment**

This procedure concerns both roaming and non-roaming scenarios.

In the non-roaming case the V-PCF is not involved and the role of the H-PCF is performed by the PCF. For the roaming scenarios, the V-PCF interacts with the AMF and the H-PCF interacts with the V-PCF:

1. Based on a UE Policy Container received from UE, the AMF decides to establish UE Policy Association with the (V-)PCF then steps 2 to 3 are performed under the conditions described below.
2. The AMF sends a Npcf\_UEPolicyControl Create Request with the following information: SUPI, may include Access Type and RAT, PEI, ULI, UE time zone, Serving Network and UE Policy Container (the list of stored PSIs, operating system identifier, Indication of UE support for ANDSP). In roaming scenario, based on operator policies, the AMF may provide to the V-PCF the PCF ID of the selected H-PCF. The V-PCF contacts the H-PCF. In roaming case, steps 3 and 4 are executed, otherwise step 5 follows.
3. The V-PCF forwards the information received from AMF in step 2 to the H-PCF. When a UE Policy Container is received at initial registration, the H-PCF may store the PEI, the OSId or the indication of UE support for ANDSP in the UDR using Nudr\_DM\_Create including DataSet "Policy Data" and Data Subset "UE context policy control data".
4. The H-PCF sends a Npcf\_UEPolicyControl Create Response to the V-PCF. The H-PCF may provide the Policy Control Request Trigger parameters in the Npcf\_UEPolicyControl Create Response.
5. The (V-) PCF sends a Npcf\_UEPolicyControl Create Response to the AMF. The (V-)PCF relays the Policy Control Request Trigger parameters in the Npcf\_UEPolicyControl Create Response.

The (V-)PCF subscribes to notification of N1 message delivery of policy information to the UE.

6. The (H-)PCF gets policy subscription related information and the latest list of PSIs from the UDR using Nudr\_DM\_Query service operation (SUPI, Policy Data, UE context policy control data, Policy Set Entry) if either or both are not available and makes a policy decision. The (H-)PCF may get the PEI, the OSId or the

indication of UE support for ANDSP in the UDR using Nudr\_DM\_Query including DataSet "Policy Data" and Data Subset "UE context policy control data" if the AMF relocates and the PCF changes. The (H-)PCF may request notifications from the UDR on changes in the subscription information by invoking Nudr\_DM\_Subscribe (Policy Data, SUPI, DNN, S-NSSAI, Notification Target Address (+ Notification Correlation Id), Event Reporting Information (continuous reporting), UE context policy control data) service. The (H-)PCF creates the UE policy container including UE access selection and PDU Session selection related policy information as defined in clause 6.6 of TS 23.503 [20] and in the case of roaming H-PCF, provides the UE policy container in the Npcf\_UEPolicyControl UpdateNotify Request.

7. The V-PCF sends a response to H-PCF using Npcf\_UEPolicyControl UpdateNotify Response.

NOTE 1: Step 6 (and 7) can be omitted. Then the (H-)PCF creates the UE policy container including UE access selection and PDU Session selection policies in step 2 (in case of non-roaming) or step 3 (in case of roaming). This means that the potential interactions with UDR as in step 6 will have to be executed in step 2 (non-roaming) or step 3 (roaming).

8. The (V-)PCF triggers UE Configuration Update Procedure in clause 4.2.4.3 to send the UE policy container including UE access selection and PDU Session selection related policy information to the UE. The (V-)PCF checks the size limit as described in TS 23.503 [20] clause 6.1.2.2.2.

9. If the V-PCF received notification of the reception of the UE Policy container then the V-PCF forwards the notification response of the UE to the H-PCF using Npcf\_UEPolicyControl\_Update Request.

10. The H-PCF sends a response to the V-PCF.

## 4.16.12 UE Policy Association Modification

### 4.16.12.1 UE Policy Association Modification initiated by the AMF

#### 4.16.12.1.1 UE Policy Association Modification initiated by the AMF without AMF relocation

This procedure addresses the scenario where a Policy Control Request Trigger condition is met.

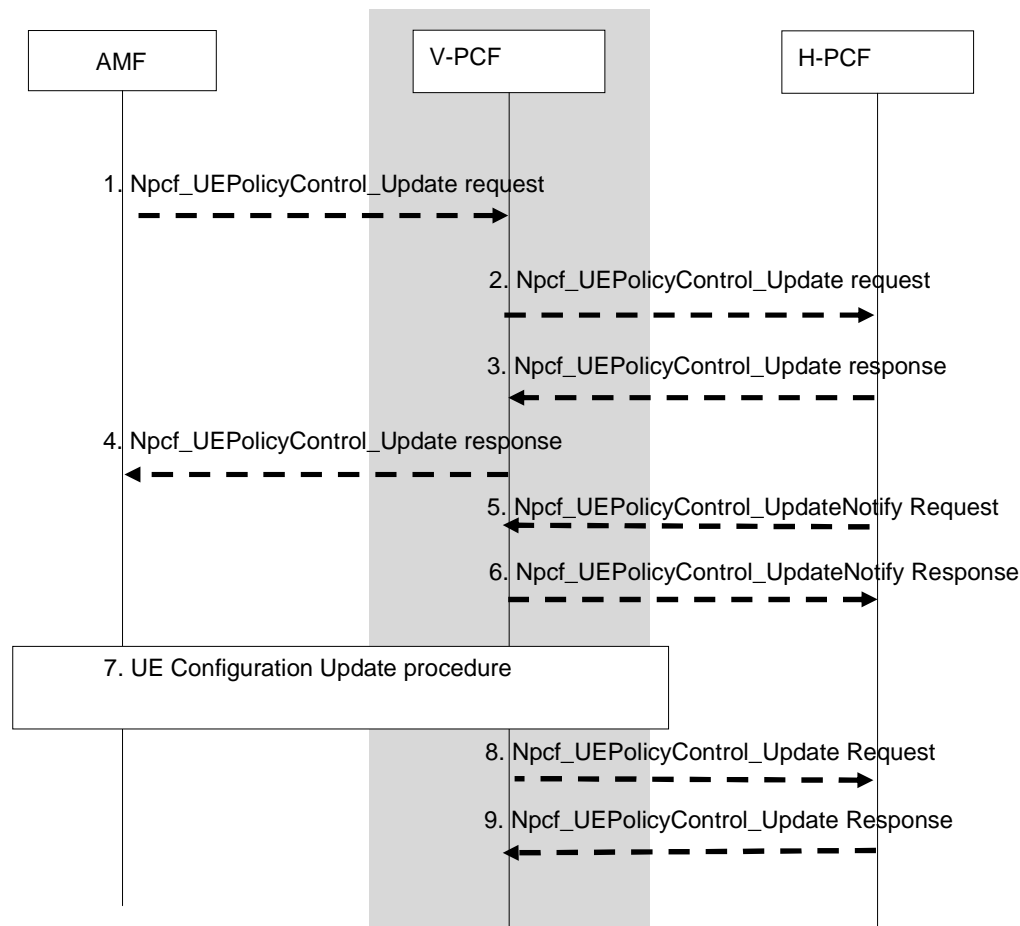

**Figure 4.16.12.1.1-1: UE Policy Association Modification initiated by the AMF**

This procedure concerns both roaming and non-roaming scenarios.

In the non-roaming case the V-PCF is not involved. In the roaming case, the AMF interacts with the V-PCF and the H-PCF interacts with the V-PCF.

1. When a Policy Control Request Trigger condition is met the AMF updates UE Policy Control Association and provides information on the conditions that have changed to the PCF. The AMF sends a Npcf\_UEPolicyControl Update Request with the following information: UE Policy Association ID associated with the SUPI defined in TS 29.525 [49] and the Policy Control Request Trigger met. In roaming scenario, based on operator policies, the AMF may provide to the V-PCF the PCF ID of the selected H-PCF. The V-PCF contacts the H-PCF.

In the roaming case, steps 2 and 3 are executed, otherwise step 4 follows.

2. The V-PCF forwards the information received from AMF in step 1 to the (H-)PCF.
3. The H-PCF replies to the V-PCF.
4. The (V-) PCF sends a Npcf\_UEPolicyControl Update Response to the AMF.
5. The (H-)PCF may create the UE policy container including UE access selection and PDU Session selection related policy information as defined in clause 6.6 of TS 23.503 [20]. In the case of roaming the H-PCF may include the UE policy container in the Npcf\_UEPolicyControl UpdateNotify Request.
6. The (V-)PCF sends a response to H-PCF using Npcf\_UEPolicyControl UpdateNotify Response.

Steps 7, 8 and 9 are the same as steps 8, 9 and 10 of procedure UE Policy Association Establishment in clause 4.16.11.

#### 4.16.12.1.2 UE Policy Association Modification with old PCF during AMF relocation

This procedure addresses the scenario where a UE Policy Association Modification with the old PCF during AMF relocation.

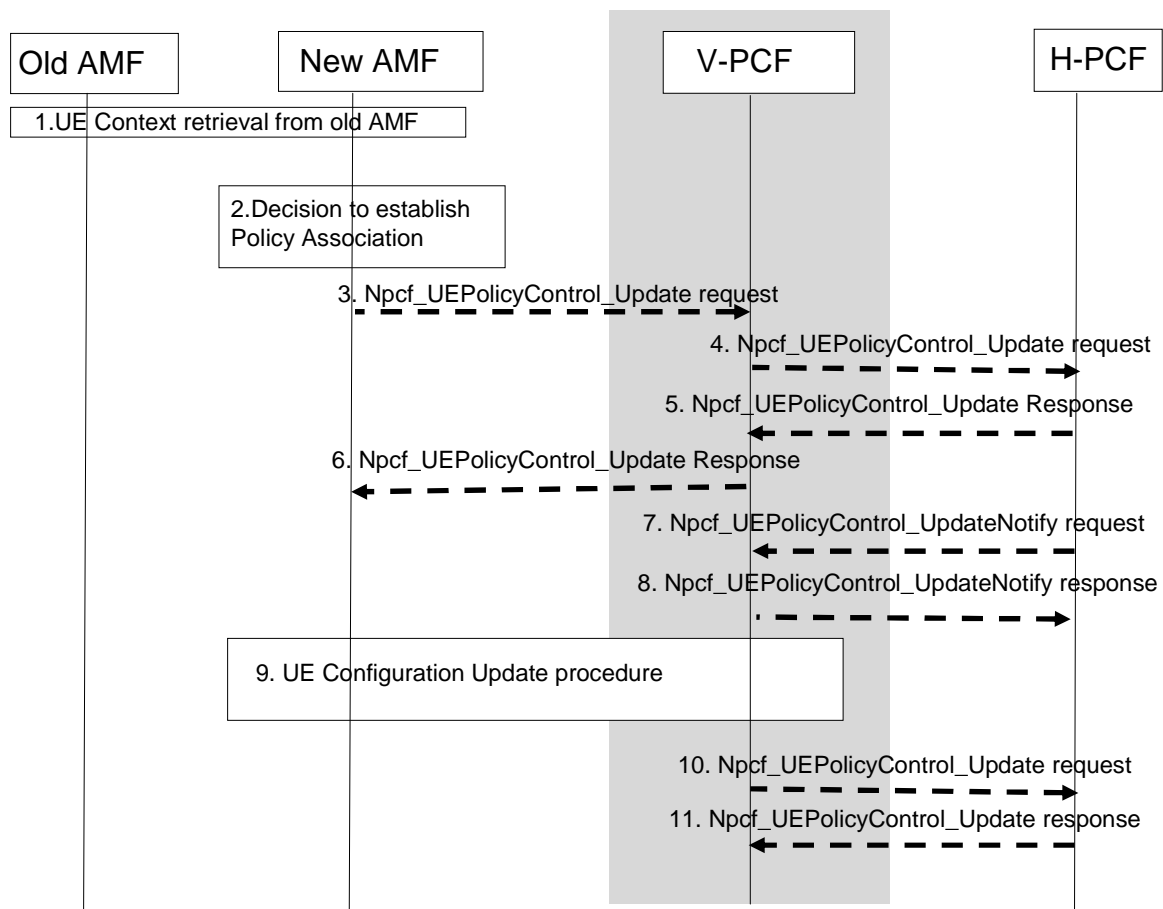

**Figure 4.16.2.1.2-1: Policy Association Modification with the old PCF during AMF relocation**

This procedure addresses both roaming and non-roaming scenarios.

In the non-roaming case the V-PCF is not involved. In the roaming case, the AMF interacts with the V-PCF and the V-PCF interacts with the H-PCF.

1. [Conditional] When the old AMF and the new AMF belong to the same PLMN, the old AMF transfers to the new AMF the UE Policy Association information including policy control request trigger(s) and the PCF ID(s). For the roaming case, the new AMF receives both V-PCF ID and H-PCF ID.
2. Based on local policies, the new AMF decides to re-use the UE policy association for the UE Context with the (V-)PCF and contacts the (V-)PCF identified by the PCF ID received in step 1.

NOTE: The scenario that only the H-PCF is reused by the new AMF but the V-PCF is not reused is not considered in this Release.

3. The new AMF sends Npcf\_UEPolicyControl\_Update to the (V-)PCF to update the UE policy association with the (V-)PCF. If a Policy Control Request Trigger condition is met, the information matching the trigger condition may also be provided by the new AMF.

In the roaming case, step 4 and 5 are executed, otherwise step 6 follows.

4. The V-PCF forwards the information received from new AMF in step 3 to the (H-)PCF.
5. The H-PCF replies to the V-PCF.

6. The (V-)PCF updates the stored information provided by the old AMF with the information provided by the new AMF. The (V-)PCF sends a Npcf\_UEPolicyControl Update Response to the AMF.
  7. The (H-)PCF may create the UE policy container including UE access selection and PDU Session selection related policy information as defined in clause 6.6 of TS 23.503 [20]. In the case of roaming the H-PCF may include the UE policy container in the Npcf\_UEPolicyControl UpdateNotify Request.
  8. The V-PCF sends a response to H-PCF using Npcf\_UEPolicyControl UpdateNotify Response.
- Steps 9, 10 and 11 are the same as steps 8, 9 and 10 of procedure UE Policy Association Establishment in clause 4.16.11.

#### 4.16.12.2 UE Policy Association Modification initiated by the PCF

This procedure is used to update UE policy and/or UE policy triggers.

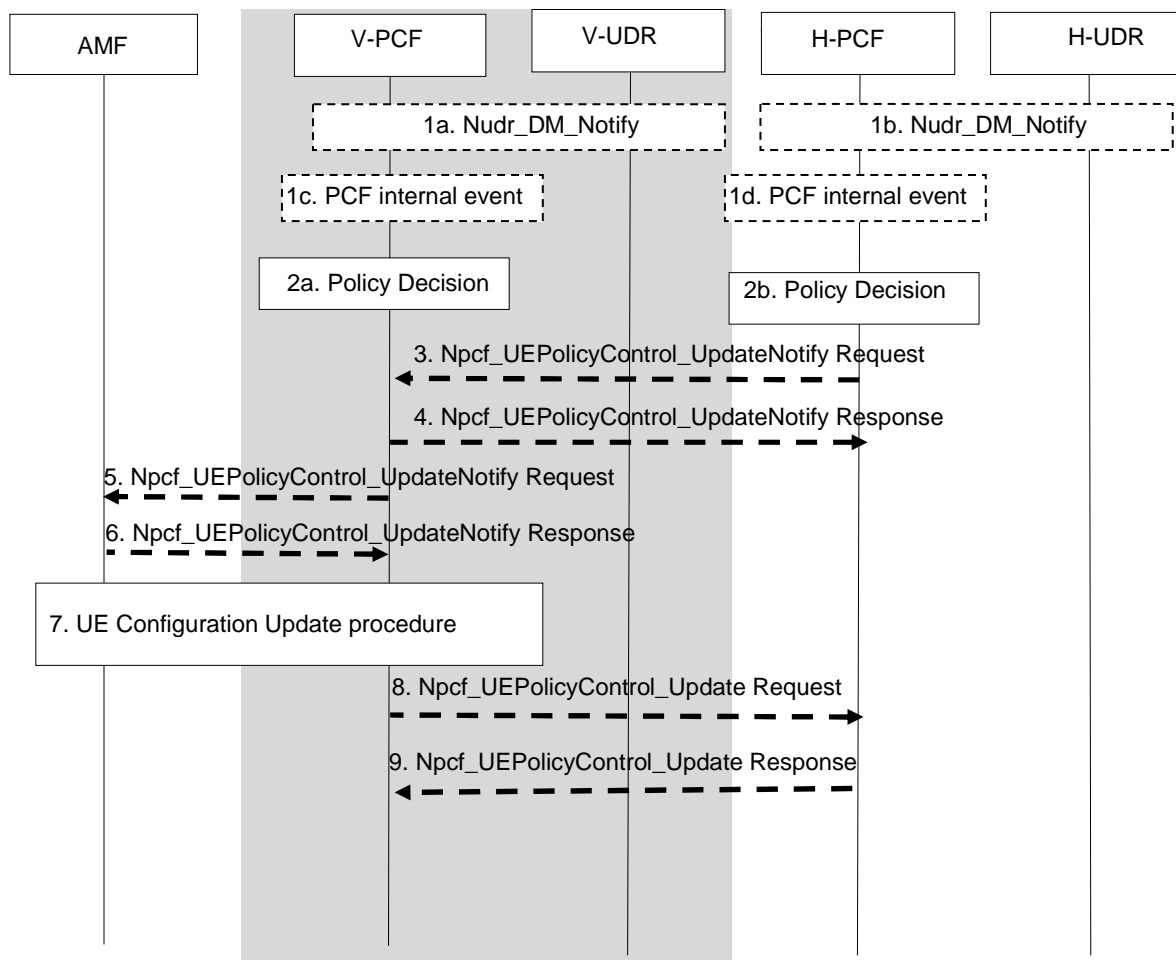

Figure 4.16.12.2-1: UE Policy Association Modification initiated by the PCF

This procedure concerns both roaming and non-roaming scenarios.

In the non-roaming case the V-PCF is not involved and the role of the H-PCF is performed by the PCF. In the roaming case, the H-PCF provides UE access selection and PDU Session selection policy decision, and provides the policy to the AMF via V-PCF.

- 1a and 1b. If (H-)PCF subscribed to notification of subscriber’s policy data change and a change is detected, the UDR notifies that the subscriber’s policy data of a UE has been changed.

The UDR notifies the (H-)PCF of the updated policy control subscription information profile via Nudr\_DM\_Notify (Notification correlation Id, Policy Data, either UE context policy control data or Policy Set Entry data, or both, SUPI), or

the (V-)UDR notifies the (V-)PCF of the updated policy control subscription information profile via Nudr\_DM\_Notify (Notification correlation Id, Policy Data, PolicySetEntry Data, PLMN ID).

1c and 1d. PCF determines locally that UE Access selection and PDU session selection policy information needs to be sent to the UE.

2a and 2b. The PCF makes the policy decision.

3. The (H-)PCF may create the UE policy container including UE access selection and PDU Session selection related policy information as defined in clause 6.1.2.2.2 of TS 23.503 [20]. In the case of roaming, the H-PCF may send the UE policy container in the Npcf\_UEPolicyControl UpdateNotify Request. The H-PCF may provide updated policy control triggers for the UE policy association.

4. The V-PCF sends a response to H-PCF using Npcf\_UEPolicyControl UpdateNotify Response.

5. The (V-)PCF provides the Policy Control Request Trigger parameters in the Npcf\_UEPolicyControl UpdateNotify Request to the AMF. In the case of roaming, the V-PCF may also provide UE Access selection and PDU session selection related policy information to the UE. The V-PCF may also provide updated policy control triggers for the UE policy association to the AMF.

6. The AMF sends a response to (V-)PCF.

Steps 7, 8 and 9 are the same as steps 8, 9 and 10 of procedure UE Policy Association Establishment in clause 4.16.11.

### 4.16.13 UE Policy Association Termination

#### 4.16.13.1 AMF-initiated UE Policy Association Termination

The following case is considered for UE Policy Association Termination:

1. UE Deregistration from the network.
2. The mobility with change of AMF (e.g. new AMF is in different PLMN or new AMF in the same PLMN).
3. [Optional] 5GS to EPS mobility with N26 if the UE is not connected to the 5GC over a non-3GPP access in the same PLMN.

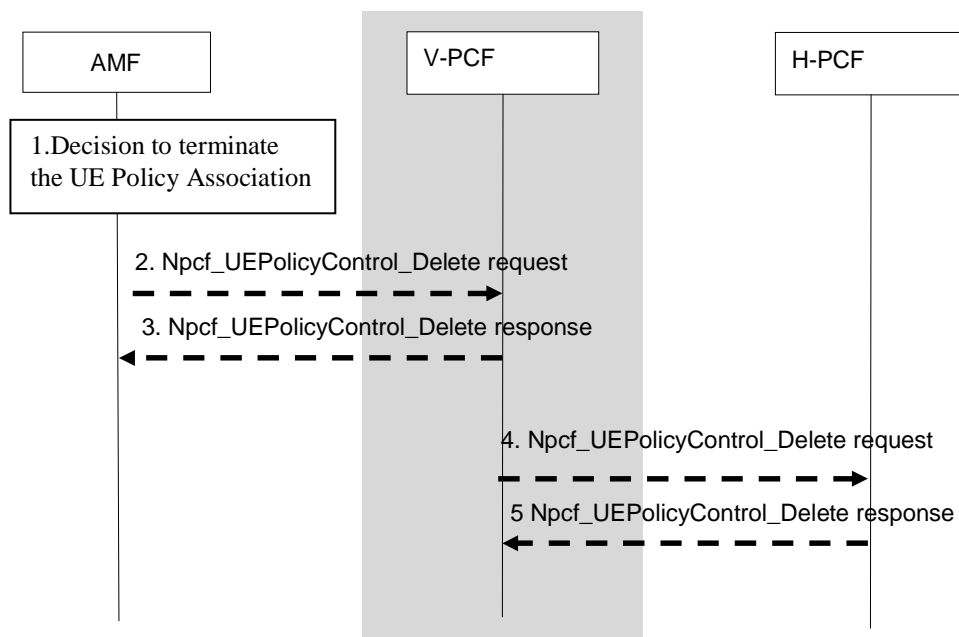

Figure 4.16.13.1-1: AMF-initiated UE Policy Association Termination

This procedure concerns both roaming and non-roaming scenarios.



In the non-roaming case, the V-PCF is not involved and the role of the H-PCF is performed by the PCF. For the roaming scenarios, the V-PCF interacts with the AMF. The V-PCF contacts the H-PCF to request removing UE Policy Association.

1. The AMF decides to terminate the UE Policy Association.
2. The AMF sends the Npcf\_UEPolicyControl\_Delete service operation including UE Policy Association ID to the (V-)PCF.
3. The (V-)PCF removes the policy context for the UE and replies to the AMF with an Acknowledgement including success or failure. The V-PCF may interact with the H-PCF. The (V-)PCF may unsubscribe to subscriber policy data changes with UDR by Nudr\_DM\_Unsubscribe (Subscription Correlation Id). The AMF removes the UE Policy Context.

Step 4 and Step 5 apply only to the roaming case.

4. The V-PCF sends the Npcf\_UEPolicyControl\_Delete service operation including UE Policy Association ID to the H-PCF.
5. The H-PCF removes the policy context for the UE and replies to the V-PCF with an Acknowledgement including success or failure. The H-PCF may unsubscribe to subscriber policy data changes with UDR by Nudr\_DM\_Unsubscribe (Subscription Correlation Id) for subscriber policy changes.

#### 4.16.13.2 PCF-initiated UE Policy Association Termination

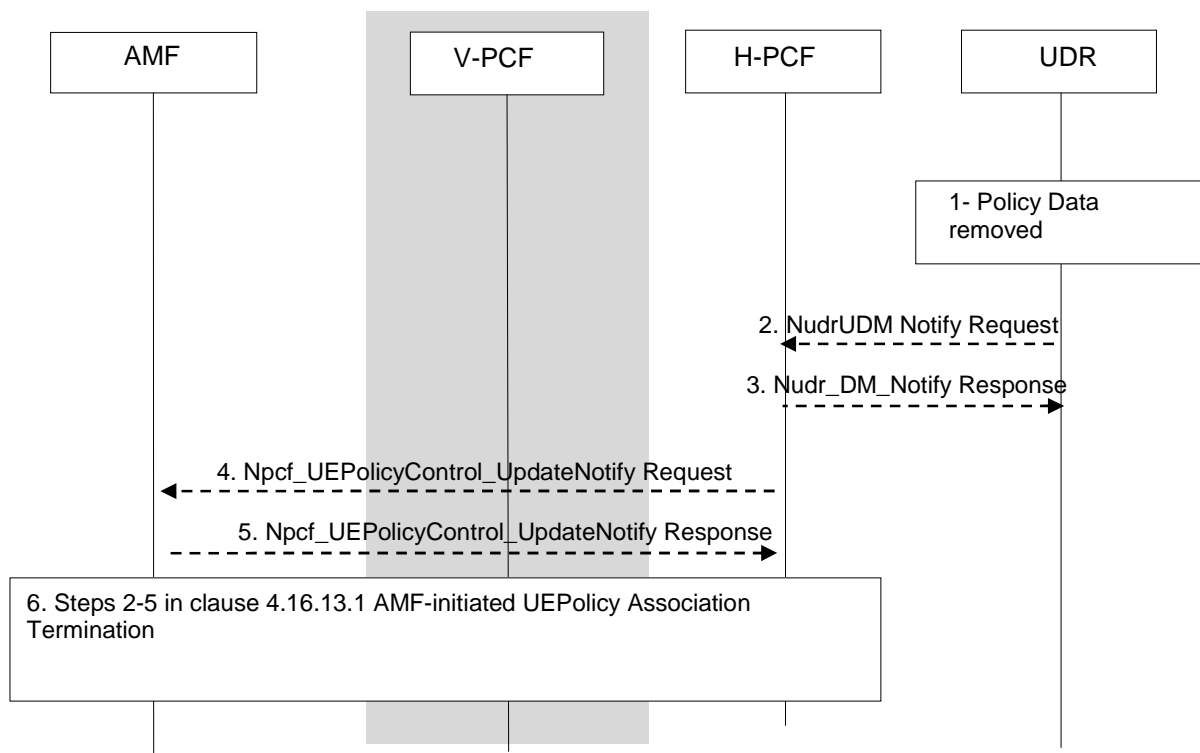

**Figure 4.16.13.2-1: PCF-initiated UE Policy Association Termination**

This procedure concerns both roaming and non-roaming scenarios.

In the non-roaming case, the V-PCF is not involved and the role of the H-PCF is performed by the PCF. For the roaming scenarios, the H-PCF interacts with the V-PCF to request removing Policy Association.

The PCF is subscribed to notification of changes in Data Set "Policy Data" for a UE Policy Association ID.

1. The Policy data is removed, either the Data Set "Policy Data" or the Data Subset "UE context policy control".

2. The UDR sends the Nudr\_DM\_Notify\_Request (Notification correlation Id, Policy Data, SUPI, UE Context Policy Control data, updated data) including the SUPI, the Data Set Identifier, the Data Subset Identifier and the Updated Data including empty "Policy Data" or empty "UE context policy control".
3. The PCF sends the Nudr\_DM\_Notify\_Response to confirm reception and the result to UDR.
4. The PCF may notify the AMF of the removal of the UE Policy Association via Npcf\_UEPolicyControl\_UpdateNotify service operation. Alternatively, the PCF may decide to maintain the Policy Association if a default profile is applied, in this case steps 4, 5 and 6 are not executed.
5. The AMF acknowledges the operation.
6. Steps 2-5 in clause 4.16.13.1 AMF-initiated UE Policy Association Termination are performed to remove the UE Policy Association for this UE and the subscription to Policy Control Request Triggers for that UE Policy Association.

## 4.17 Network Function Service Framework Procedure

### 4.17.1 NF service Registration

NOTE: The term "NF service consumer" in this clause refers to the consumer of the NRF services and should not be confused with the role of the NF (consumer or producer).

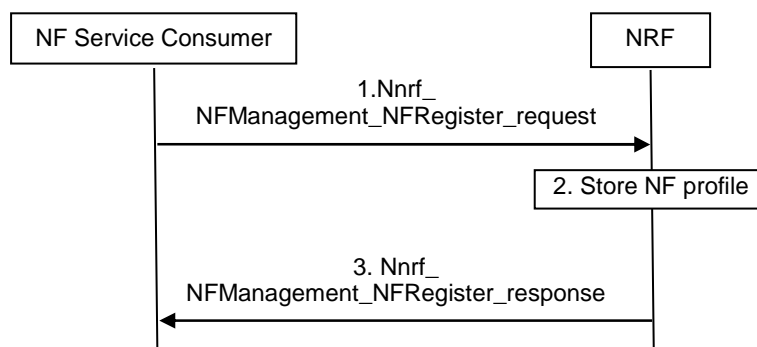

**Figure 4.17.1-1: NF Service Registration procedure**

1. NF service consumer, i. e. an NF instance sends Nnrf\_NFManagement\_NFRegister Request message to NRF to inform the NRF of its NF profile when the NF service consumer becomes operative for the first time. See clause 5.2.7.2.2 for relevant NF profile parameters

NOTE 1: NF service consumer's NF profile is configured by OAM system.

2. The NRF stores the NF profile of NF service consumer and marks the NF service consumer available.

NOTE 2: Whether the NF profile sent by NF service consumer to NRF needs to be integrity protected by the NF service consumer and verified by the NRF is to be decided by SA3.

3. The NRF acknowledge NF Registration is accepted via Nnrf\_NFManagement\_NFRegister response.

### 4.17.2 NF service update

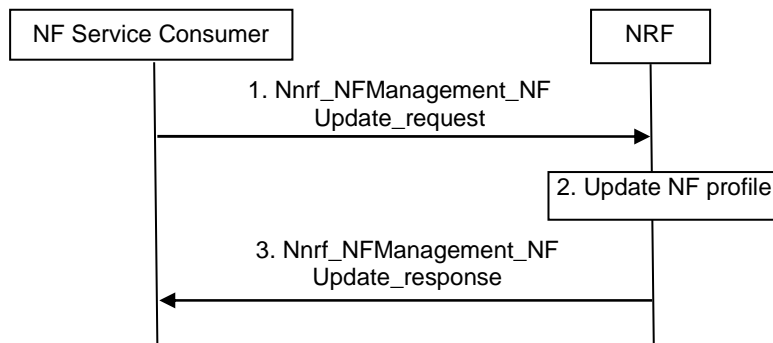

**Figure 4.17.2-1: NF Service Update procedure**

1. NF service consumer i.e. an NF instance sends Nnrf\_NFManagement\_NFUpdate Request message (the updated NF profile of NF service consumer) to NRF to inform the NRF of its updated NF profile (e.g. with updated capacity) when e.g. triggered after a scaling operation. See clause 5.2.7.2.3 for relevant input and output parameters.

NOTE: The updated NF profile of NF instance are configured by OAM system.

2. The NRF updates the NF profile of NF service consumer.
3. The NRF acknowledge NF Update is accepted via Nnrf\_NFManagement\_NFUpdate response.

### 4.17.3 NF service deregistration

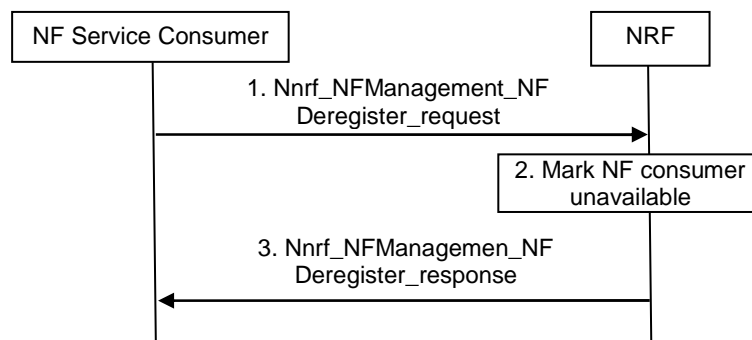

**Figure 4.17.3-1: NF Service Deregistration procedure**

1. NF service consumer i.e. an NF instance sends Nnrf\_NFManagement\_NFDeregister Request message to NRF to inform the NRF of its unavailability when e.g. it's about to gracefully shut down or disconnect from the network.
2. The NRF marks the NF service consumer unavailable. NRF may remove the NF profile of NF service consumer according to NF management policy.
3. The NRF acknowledge NF Deregistration is accepted via Nnrf\_NFManagement\_NFDeregister response.

#### 4.17.4 NF/NF service discovery in the same PLMN

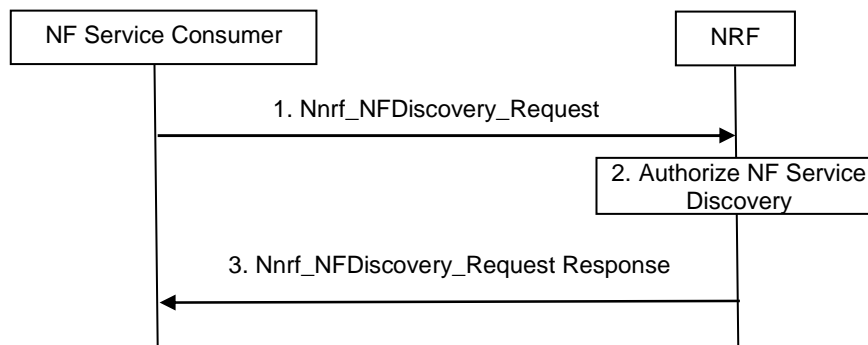

**Figure 4.17.4-1: NF/NF service discovery in the same PLMN**

1. The NF service consumer intends to discover services available in the network based on service name and target NF type. The NF service consumer invokes `Nnrf_NFDiscovery_Request` (Expected NF service Name, NF Type of the expected NF instance, NF type of the NF consumer) from an appropriate configured NRF in the same PLMN. The parameter may include optionally SUPI, Data Set Identifier(s), External Group ID (for UDM, UDR discovery), UE's Routing Indicator (for UDM and AUSF discovery), S-NSSAI, NSI ID if available, and other service related parameters. In addition, for AMF discovery, the parameters may include AMF Region ID, AMF Set ID, TAI. The NF service consumer may indicate a preference for target NF location in the `Nnrf_NFDiscovery_Request`. A complete list of parameters is provided in service definition in clause 5.2.7.3.2.

NOTE 1: The NF service consumer indicates its NF location for preference for target NF location.

NOTE 2: The use of NSI ID within a PLMN depends on the network deployment.

NOTE 3: The need for other service related parameters depends on the NF type of the expected NF instance(s) and refer to the clause 6.3 "Principles for Network function and Network Function Service discovery and selection" in TS 23.501 [2]. It is up to NF implementation whether one or multiple NF service instances are registered in the NRF.

2. The NRF authorizes the `Nnrf_NFDiscovery_Request`. Based on the profile of the expected NF/NF service and the type of the NF service consumer, the NRF determines whether the NF service consumer is allowed to discover the expected NF instance(s). If the expected NF instance(s) or NF service instance(s) are deployed in a certain network slice, NRF authorizes the discovery request according to the discovery configuration of the Network Slice, e.g. the expected NF instance(s) are only discoverable by the NF in the same network slice.
3. If allowed, the NRF determines a set of NF instance(s) matching the `Nnrf_NFDiscovery_Request` and internal policies of the NRF and sends the NF profile(s) of the determined NF instances. Each NF profile containing at least the output required parameters (see clause 5.2.7.3.2) to the NF service consumer via `Nnrf_NFDiscovery_Request Response` message.

If the target NF is UDR, UDM or AUSF, if SUPI was used as optional input parameter in the request, the NRF shall provide the corresponding UDR, UDM or AUSF instance(s) that matches the optional input SUPI. Otherwise, if SUPI is not provided in the request, the NRF shall return all applicable UDR instance(s) (e.g. based on the Data Set Id, NF type), UDM instance(s) or AUSF instance(s) (e.g. based on NF type) and if applicable, the information of the range of SUPI(s) and/or Data Set Id each UDR instance is supporting.

If the target NF is CHF, if SUPI, GPSI or PLMN ID was used as optional input parameter in the request, the NRF shall provide the corresponding CHF instance(s) that matches the optional input SUPI, GPSI or PLMN ID. The NRF shall provide the primary CHF instance and the secondary CHF instance pair(s) together. Otherwise, if neither SUPI/PLMN ID nor GPSI is provided in the request, the NRF shall return all applicable CHF instance(s) and if applicable, the information of the range of SUPI(s), GPSI(s) or PLMN ID(s).

If the NF service consumer provided a preferred target NF location, the NRF shall not limit the set of discovered NF instances or NF service instance(s) to the target NF location, e.g. the NRF may provide NF instance(s) or NF service instance(s) for which location is not the preferred target NF location if no NF instance or NF service instance could be found for the preferred target NF location.

## 4.17.5 NF/NF service discovery across PLMNs

In case that the NF service consumer intends to discover the NF/NF service in home PLMN, the NRF in serving PLMN needs to request "NF Discovery" service from NRF in the home PLMN. The procedure is depicted in the figure below:

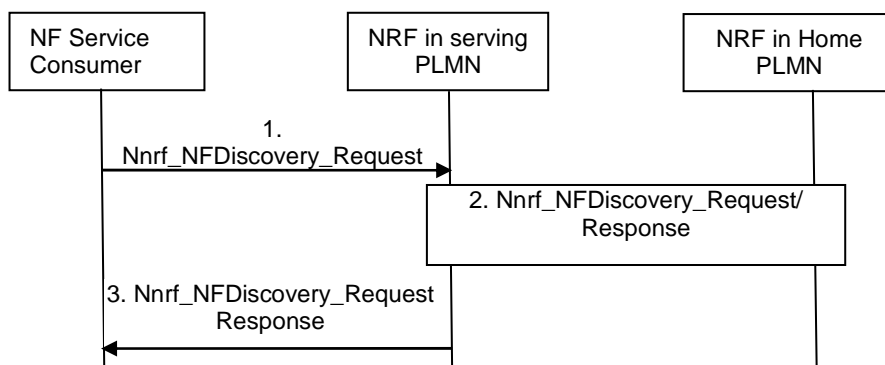

**Figure 4.17.5-1: NF/NF service discovery across PLMNs**

1. The NF service consumer in the serving PLMN invokes Nnrf\_NFDiscovery\_Request (Expected Service Name, NF type of the expected NF, home PLMN ID, serving PLMN ID, NF type of the NF service consumer) to an appropriate configured NRF in the serving PLMN. The request may also include optionally S-NSSAI, NSI ID if available, and other service related parameters. A complete list of parameters is provided in service definition in clause 5.2.7.3.2.

NOTE 1: The use of NSI ID within a PLMN depends on the network deployment.

2. The NRF in serving PLMN identifies NRF in home PLMN (hNRF) based on the home PLMN ID, and it requests "NF Discovery" service from NRF in home PLMN according the procedure in Figure 4.17.4-1 to get the expected NF profile(s) of the NF instance(s) deployed in the home PLMN. As the NRF in the serving PLMN triggers the "NF Discovery" on behalf of the NF service consumer, the NRF in the serving PLMN shall not replace the information of the service requester NF, i.e. NF consumer ID, in the Discovery Request message it sends to the hNRF.

The hNRF may further query an appropriate local NRF in the home PLMN based on the input information received from NRF of the serving PLMN. The FQDN of the local NRF or Endpoint Address of local NRF's NF Discovery service in the home PLMN may be configured in the hNRF or may need to be discovered based on the input information.

3. The NRF in serving PLMN provides same as step 3 in clause 4.17.4 applies.

## 4.17.6 SMF Provisioning of available UPFs using the NRF

### 4.17.6.1 General

This clause describes the provisioning of available UPFs in SMF using the NRF as documented in TS 23.501 [2], clause 6.3.3.

This optional node-level step takes place prior to selecting the UPF for PDU Sessions and may be followed by N4 Node Level procedures defined in clause 4.4.3 where the UPF and the SMF exchange information such as the support of optional functionalities and capabilities.

As an option, UPF(s) may register in the NRF. This registration phase uses the Nnrf\_NFManagement\_NFRegister operation and hence does not use N4.

For the purpose of SMF provisioning of available UPFs, the SMF uses the Nnrf\_NFDiscovery service to learn about available UPFs.

NOTE: The protocol used by UPF to interact with NRF is described in TS 29.510 [37]

UPFs may be associated with UPF Provisioning Information in the NRF. The UPF Provisioning Information consists of a list of (S-NSSAI, DNN) and of a SMF Area Identity the UPF can serve. The SMF Area Identity allows limiting the

SMF provisioning of UPF(s) using NRF to those UPF(s) associated with a certain SMF Area Identity. This can e.g. be used in case an SMF is only allowed to control UPF(s) configured in NRF as belonging to a certain SMF Area Identity.

The SMF Area Identity is optional in the UPF Provisioning Information.

#### 4.17.6.2 SMF provisioning of UPF instances using NRF

This procedure applies when a SMF wants to get informed about UPFs available in the network and supporting a list of parameters.

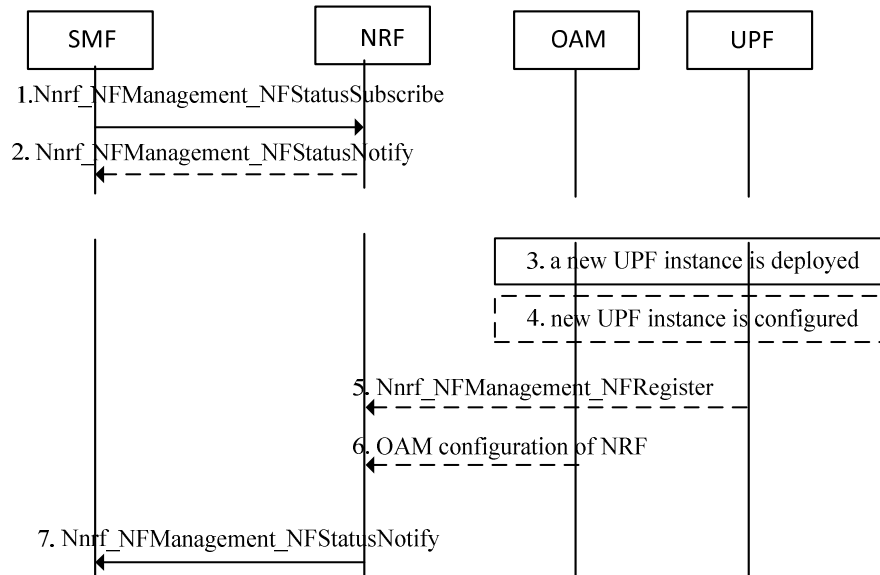

**Figure 4.17.6.2-1: SMF provisioning of UPF instances using NRF procedure**

The following takes place when an SMF expects to be informed of UPFs available in the network:

- 1 The SMF issues a Nnrf\_NFManagement\_NFStatusSubscribe Service Operation providing the target UPF Provisioning Information it is interested in.
- 2 The NRF issues Nnrf\_NFManagement\_NFStatusNotify with the list of all UPFs that currently meet the SMF subscription. This notification indicates the subset of the target UPF Provisioning Information that is supported by each UPF.

The following takes place when a new UPF instance is deployed:

- 3 At any time a new UPF instance is deployed.
- 4 The UPF instance is configured with the NRF identity to contact for registration and with its UPF Provisioning Information. An UPF is not required to understand the UPF Provisioning Information beyond usage of this information to register in step 5..
- 5 The UPF instance issues an Nnrf\_NFManagement\_NFRegister Request operation providing its NF type, the FQDN or IP address of its N4 interface, and the UPF Provisioning Information configured in step 4.
6. Alternatively (to steps 4 and 5) OAM registers the UPF on the NRF indicating the same UPF Provisioning Information as provided in step 5. This configuration mechanism is out of scope of this specification.
7. Based on the subscription in step 1, the NRF issues Nnrf\_NFManagement\_NFStatusNotify to all SMFs with a subscription matching the UPF Provisioning Information of the new UPF

### 4.17.7 NF/NF service status subscribe/notify in the same PLMN

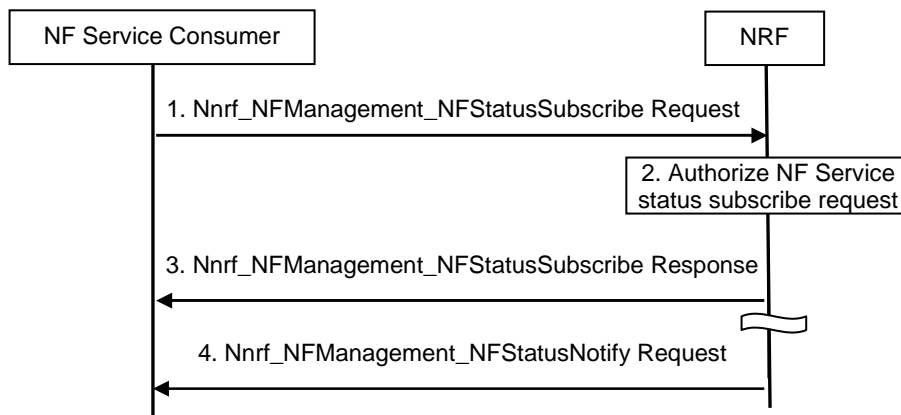

**Figure 4.17.7-1: NF/NF service status subscribe/notify in the same PLMN**

1. The NF service consumer subscribes to be notified of newly registered/updated/deregistered NF instances along with its NF services. The NF service consumer invokes Nnrf\_NFManagement\_NFStatusSubscribe Request from an appropriate configured NRF in the same PLMN.
2. The NRF authorizes the Nnrf\_NFManagement\_NFStatusSubscribe Request. Based on the profile of the expected NF/NF service and the type of the NF service consumer, the NRF determines whether the NF service consumer is allowed to subscribe to the status of the target NF instance(s) or NF service instance(s).
3. If allowed, the NRF acknowledges the execution of Nnrf\_NFManagement\_NFStatusSubscribe Request.
4. NRF notifies about newly registered/updated/deregistered NF instances along with its NF services to the subscribed NF service consumer.

NOTE: The NF service consumer unsubscribes to receive NF status notifications invoking Nnrf\_NFManagement\_NFStatusUnSubscribe service operation.

### 4.17.8 NF/NF service status subscribe/notify across PLMNs

In the case that the NF service consumer intends to subscribe to the status of NF/NF service instance(s) in home PLMN, the NRF in serving PLMN needs to request "NF status subscribe" service from NRF in the home PLMN. The notification is sent from the NRF in the home PLMN to the NF service consumer in the serving PLMN without the involvement of the NRF in the serving PLMN. The procedure is depicted in the figure below:

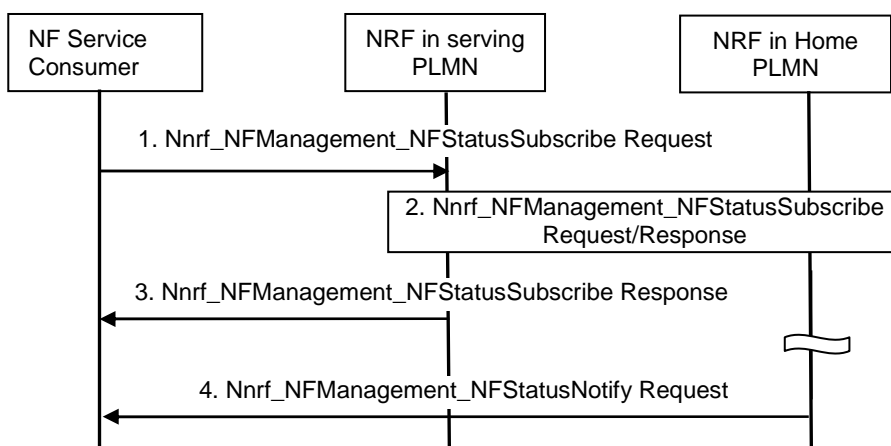

**Figure 4.17.8-1: NF/NF service status subscribe/notify across PLMNs**

NOTE 1: The NRF in the home PLMN communicates with the NRF and the NF consumer in the serving PLMN via the SEPPs in the respective PLMNs. For the sake of clarity, SEPPs are not depicted in the flow.

1. The NF service consumer in the serving PLMN invokes Nnrf\_NFManagement\_NFStatusSubscribe Request from an appropriate configured NRF in the serving PLMN.
2. The NRF in serving PLMN identifies NRF in home PLMN (hNRF) based on the home PLMN ID, and it requests "NF status subscribe" service from NRF in home PLMN. As the NRF in the serving PLMN triggers the "NF status subscribe" on behalf of the NF service consumer, the NRF in the serving PLMN shall not replace the information of the service requester NF, i.e. NF consumer ID, in the status subscribe Request message it sends to the hNRF.
3. The NRF in serving PLMN acknowledges the execution of Nnrf\_NFManagement\_NFStatusSubscribe Request to the NF consumer in the serving PLMN.
4. NRF in the home PLMN notifies about newly registered/updated/deregistered NF instances along with its NF services to the subscribed NF service consumer in the serving PLMN.

NOTE 2: The NF service consumer unsubscribes to receive NF status notifications invoking Nnrf\_NFManagement\_NFStatusUnSubscribe service operation.

## 4.18 Procedures for Management of PFDs

### 4.18.1 General

NOTE: The PFDF service is functionality within the NEF.

### 4.18.2 PFD management via NEF (PFDF)

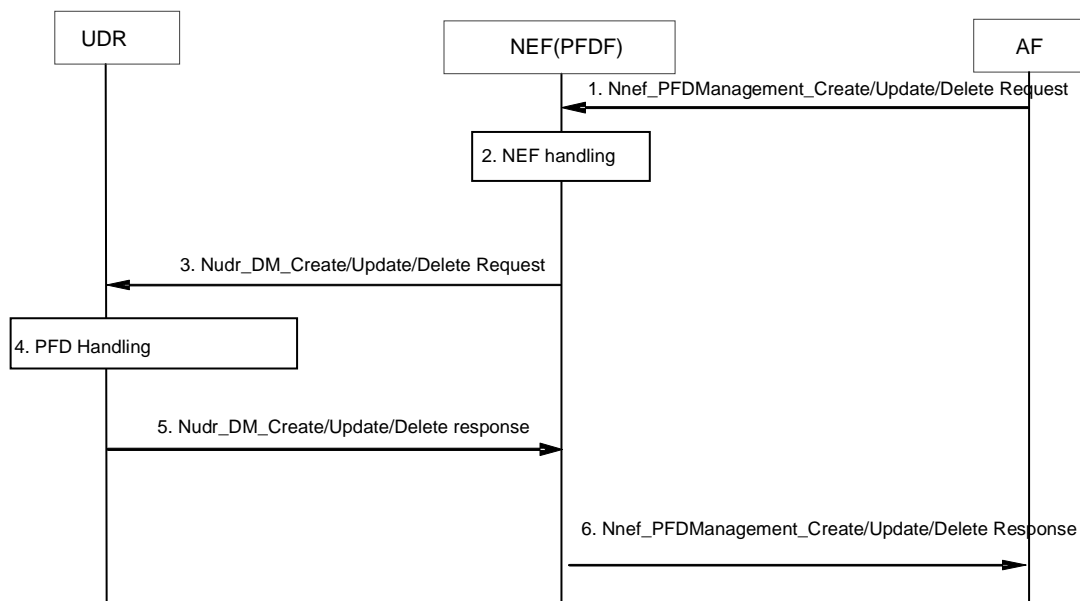

Figure 4.18.2-1 procedure for PFD management via NEF (PFDF)

1. The AF invokes the Nnef\_PFDManagement\_Create/Update/Delete service. The Allowed Delay is an optional parameter. If the Allowed Delay is included, it indicates that the list of PFDs in this request should be deployed within the time interval indicated by the Allowed Delay.
2. NEF checks whether the Application is authorized to perform this request based on the operator policies.
3. The NEF (PFDF) invokes the Nudr\_DM\_Create/Update/Delete (Application Identifier, one or more sets of PFDs, Allowed Delay) to the UDR.
4. The UDR updates the list of PFDs for the Application Identifier.



5. The UDR sends a Nudr\_DM\_Create/Update/Delete Response to the NEF (PFDF).
6. The NEF sends Nnef\_PFDManagement\_Create/Update/Delete Response to the Application Function.

### 4.18.3 PFD management in the SMF

#### 4.18.3.1 PFD Retrieval by the SMF

This procedure enables the SMF to retrieve PFDs for an Application Identifier from the NEF (PFDF) when a PCC rule with this Application Identifier is provided/activated and PFDs provided by the NEF (PFDF) are not available at the SMF.

In addition, this procedure enables the SMF to retrieve PFDs from the NEF (PFDF) when the caching timer for an Application Identifier elapses and a PCC Rule for this Application Identifier is still active.

The NEF (PFDF) retrieves the PFDs from UDR unless already available in NEF (PFDF).

The SMF may retrieve PFDs for one or more Application Identifiers in the same Request. All PFDs related to an Application Identifier are provided in the response from the UDR to NEF (PFDF).

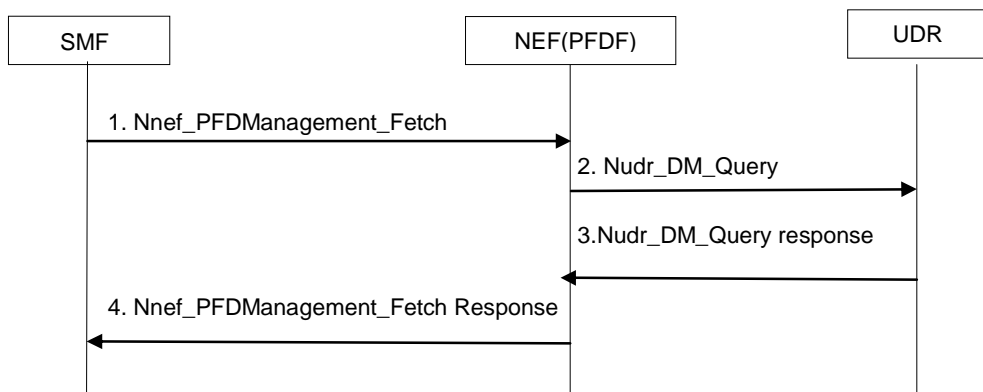

**Figure 4.18.3.1-1 PFD Retrieval by the SMF**

1. SMF invokes the Nnef\_PFDManagement\_Fetch (Application Identifier (s)) to the NEF (PFDF).
2. NEF (PFDF) checks if the PFDs for the Application Identifier (s) are available in the NEF (PFDF), if available, the NEF (PFDF) skips to step 4. If not, the NEF (PFDF) invokes Nudr\_DM\_Query (Application Identifier (s)) to retrieve the PFD(s) from UDR.
3. The UDR provides a Nudr\_DM\_Query response (Application Identifier(s), PFD(s)) to the NEF (PFDF).
4. The NEF (PFDF) replies to the SMF with Nnef\_PFDManagement\_Fetch (Application Identifier(s), PFD(s)).

#### 4.18.3.2 Management of PFDs in the SMF

This procedure enables the provisioning, modification or removal of PFDs associated with an application identifier in the SMF. Either the complete list of all PFDs of all application identifiers, the complete list of all PFDs of one or more application identifiers or a subset of PFDs for individual application identifiers may be managed.

Each PFD of an application identifier is associated with a PFD id in case a subset of the PFD(s) associated with an application identifier can be provisioned, updated or removed. In case always the full set of PFD(s) for an application identifier is managed in each transaction, PFD ids do not need to be provided.

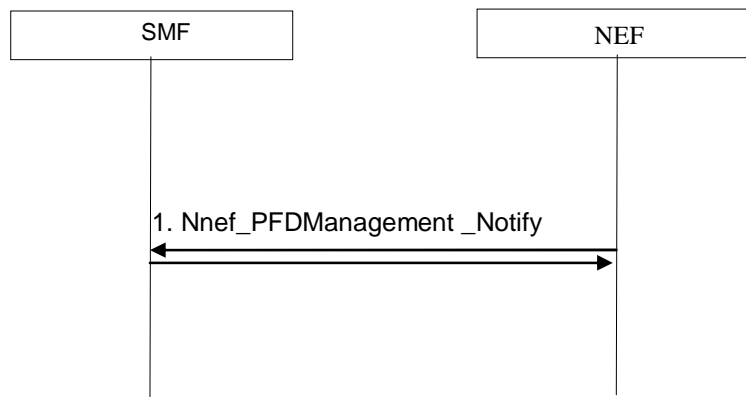

**Figure 4.18.3.2-1 Management of PFDs in the SMF**

1. The NEF (PFDF) invokes Nnef\_PFD\_Management\_Notify (Application Identifier, PFDs, PFDs operation) to the SMF(s) to which the PFD(s) shall be provided. The NEF (PFDF) may decide to delay the distribution of PFDs to the SMF(s) for some time to optimize the signalling load. If the NEF (PFDF) received an Allowed Delay for a PFD, the NEF (PFDF) shall distribute this PFD within the indicated time interval.

## 4.19 Network Data Analytics

### 4.19.1 Network data analytics Subscribe/Unsubscribe

This procedure is used by the NF service consumer (e.g. PCF) to subscribe/unsubscribe at NWDAF to be notified on load level information of a network slice instance. Periodic notification and notification upon threshold exceeded can be subscribed. The NF service consumer may make policy decisions based on the load level information of network slice instance.

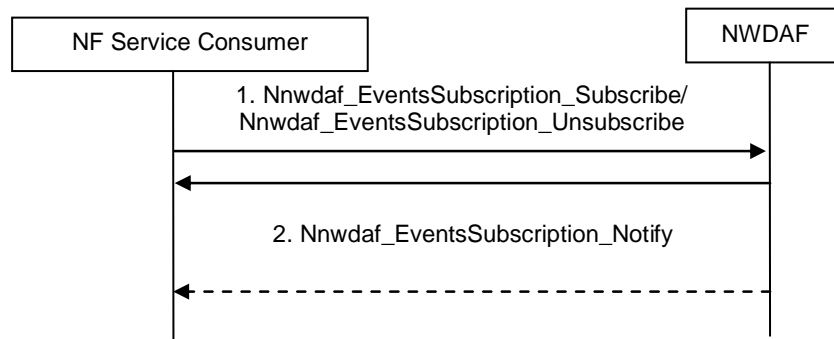
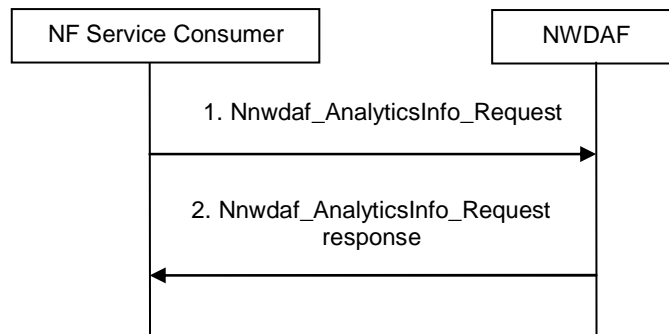

**Figure 4.19.1-1: Network data analytics Subscribe/unsubscribe**

1. The NF service consumer subscribes to or cancels subscription to load level information by invoking the Nnwdaf\_EventsSubscription\_Subscribe/ Nnwdaf\_EventsSubscription\_Unsubscribe service operation with an identifier of the network slice instance.
2. If NF service consumer subscribes to load level information, the NWDAF notifies the NF service consumer with the load level information by invoking Nnwdaf\_EventsSubscription\_Notify service operation.

### 4.19.2 Network data analytics Request

This procedure is used by the NF service consumer (e.g. PCF) to request and get from NWDAF load level information for a particular Network Slice instance. The NF service consumer may make policy decision based on load level information for the network slice instance.



**Figure 4.19.2-1: Network data analytics Request**

1. The NF service consumer requests load level information for a particular network slice instance by invoking Nnwdaf\_AnalyticsInfo\_Request service operation with an identifier of the network slice instance.
2. The NWDAF responds with load level information for the particular network slice instance.

## 4.20 UE Parameters Update via UDM Control Plane Procedure

### 4.20.1 General

The purpose of the control plane solution for update of UE parameters is to allow the HPLMN to update the UE with a specific set of parameters, generated and stored in the UDM, by delivering protected UDM Update Data via NAS signalling. The HPLMN updates such parameters based on the operator policies.

The UDM Update Data that the UDM delivers to the UE may contain:

- one or more UE parameters including:
  - the updated Default Configured NSSAI (final consumer of the parameter is the ME).
  - the updated Routing Indicator Data (final consumer of the parameter is the USIM).
- a "UE acknowledgement requested" indication.
- a "re-registration requested" indication.

## 4.20.2 UE Parameters Update via UDM Control Plane Procedure

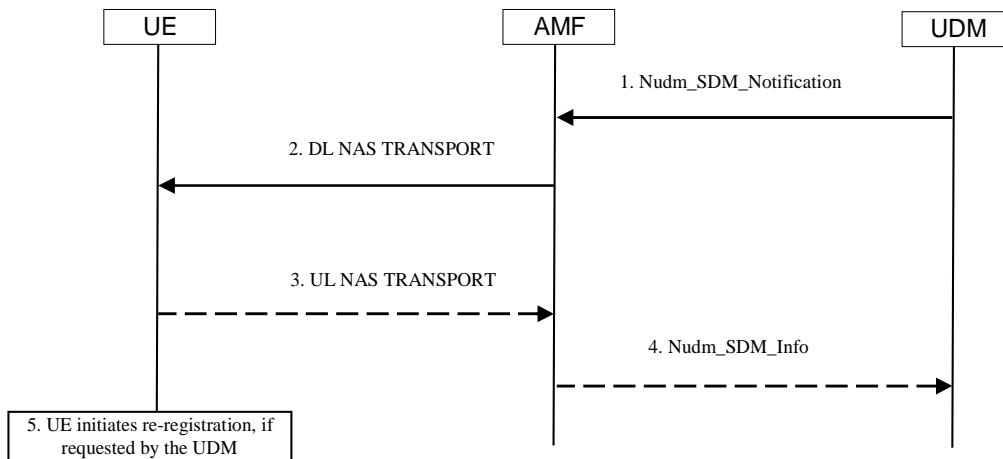

**Figure 4.20.2-1: UE Parameters Update via UDM Control Plane Procedure**

1. From UDM to the AMF: The UDM notifies the changes of the information related to the UE to the affected AMF by the means of invoking Nudm\_SDM\_Notification service operation. The Nudm\_SDM\_Notification service operation contains the UDM Update Data (e.g. "Routing Indicator update data", "Default Configured NSSAI update data") that needs to be delivered transparently to the UE over NAS within the Access and Mobility Subscription data. The UDM update data includes:
  - The updated parameters to be delivered to the UE (e.g. the updated Routing Indicator Data, the Default Configured NSSAI).
  - whether the UE needs to send an ack to the UDM.
  - whether the UE needs to re-register after updating the data.
2. From AMF to the UE: the AMF sends a DL NAS TRANSPORT message to the served UE. The AMF includes in the DL NAS TRANSPORT message the transparent container received from the UDM. The UE verifies based on mechanisms defined in TS 33.501 [15] that the UDM Update Data is provided by HPLMN, and:
  - If the security check on the UDM Update Data is successful, as defined in TS 33.501 [15] the UE either stores the information and uses those parameters from that point onwards, or forwards the information to the USIM; and
  - If the security check on the UDM Update Data fails, the UE discards the contents of the UDM Update Data.
3. The UE to the AMF: If the UE has verified that the UDM Update Data is provided by HPLMN and the UDM has requested the UE to send an ack to the UDM, the UE sends an UL NAS TRANSPORT message to the serving AMF with a transparent container including the UE acknowledgement.
4. The AMF to the UDM: If the AMF receives an UL NAS TRANSPORT message with a transparent container carrying a UE acknowledgement from the UE, the AMF sends a Nudm\_SDM\_Info request message including the transparent container to the UDM.
5. If the UDM has requested the UE to re-register, the UE waits until it goes back to RRC idle and initiates a Registration procedure as defined in TS 24.501 [25].

4.20.3 Void

4.21 Secondary RAT Usage Data Reporting Procedure

The procedure in Figure 4.21-1 may be used to report Secondary RAT Usage Data from NG-RAN node to the AMF. It is executed by the NG-RAN node to report the Secondary RAT Usage Data information towards AMF which is then reported towards SMF.

The procedure in Figure 4.21-2 may be used to report the Secondary RAT Usage Data from AMF towards the SMF. Optionally, it is used to report the Secondary RAT Usage Data from V-SMF to the H-SMF when the reporting to H-SMF is activated.

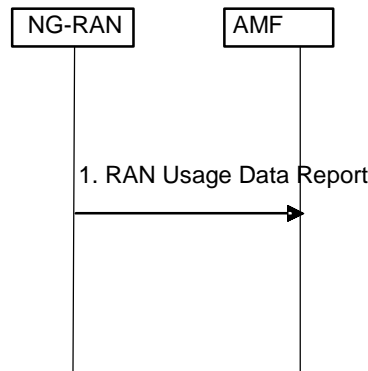

Figure 4.21-1: RAN Secondary RAT Usage Data Reporting procedure

1. The NG-RAN, if it supports Dual Connectivity with Secondary RAT (using NR radio or E-UTRA radio) and it is configured to report Secondary RAT Usage Data for the UE, depending on certain conditions documented in this specification, it shall send a RAN Usage Data Report message to the AMF including the Secondary RAT Usage Data for the UE. The NG-RAN node will send only one RAN Usage Report for a UE when the UE is subject to handover by RAN. The RAN Usage Data Report includes a Handover Flag to indicate when the message is sent triggered by a handover.

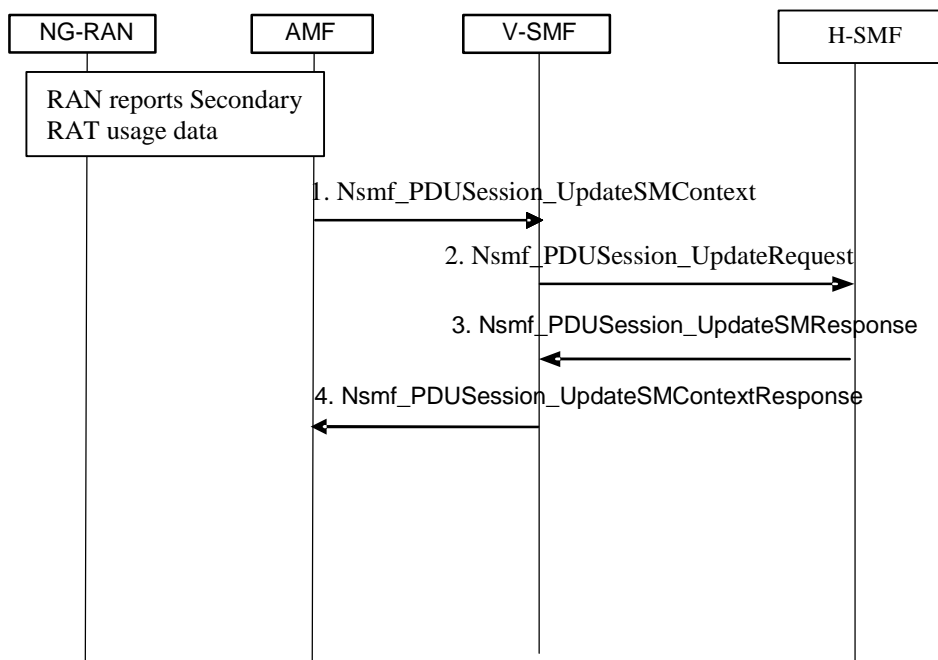

Figure 4.21-2: SMF Secondary RAT Usage Data Reporting procedure

The NG-RAN, if it supports Dual Connectivity with Secondary RAT (using NR radio or E-UTRA radio) and it is configured to report Secondary RAT usage data for the UE, it shall include the Secondary RAT usage data for the UE to the AMF in certain messages depending on certain conditions documented elsewhere in this TS.

1. The AMF forwards the N2 SM Information (Secondary RAT Usage Data) to the SMF in a Nsmf\_PDUSession\_UpdateSMContext Request.
2. The V-SMF sends the Nsmf\_PDUSession\_Update (Secondary RAT Usage Data) message to the H-SMF.
3. The H-SMF acknowledges receiving the Secondary RAT Usage data for the UE.
4. The V-SMF acknowledges receiving the Secondary RAT Usage data back to the AMF.

---

## 5 Network Function Service procedures

### 5.1 Network Function Service framework procedures

#### 5.1.1 Network Function Service Discovery

The network function (NF) within the core network may expose its capability as service via its service based interfaces, which can be re-used by other NFs. Unless the expected NF information is locally configured on requester NF, e.g. the expected NF is in the same PLMN, the NF service discovery is implemented via the NF discovery.

### 5.2 Network Function services

#### 5.2.1 General

#### 5.2.2 AMF Services

##### 5.2.2.1 General

The following table shows the AMF Services and AMF Service Operations.

Table 5.2.2.1-1: List of AMF Services

Service Name	Service Operations	Operation Semantic	Known Consumer(s)
Namf_Communication	UEContextTransfer	Request/ Response	Peer AMF
	CreateUEContext	Request/ Response	Peer AMF
	ReleaseUEContext	Request/ Response	Peer AMF
	RegistrationCompleteNotify	Subscribe / Notify	Peer AMF
	N1MessageNotify	Subscribe / Notify	SMF, SMSF, PCF, LMF, Peer AMF
	N1MessageSubscribe		SMF, SMSF, PCF
	N1MessageUnSubscribe		SMF, SMSF, PCF
	N1N2MessageTransfer	Request/ Response	SMF, SMSF, PCF, LMF
	N1N2TransferFailureNotification	Subscribe / Notify	SMF, SMSF, PCF, LMF
	N2InfoSubscribe	Subscribe / Notify	NOTE 1
	N2InfoUnSubscribe		NOTE 1
	N2InfoNotify		AMF, LMF
	EBIAssignment	Request/Response	SMF
	AMFStatusChangeSubscribe	Subscribe / Notify	SMF, PCF, NEF, SMSF, UDM
AMFStatusChangeUnSubscribe	Subscribe / Notify	SMF, PCF, NEF, SMSF, UDM	
AMFStatusChangeNotify	Subscribe / Notify	SMF, PCF, NEF, SMSF, UDM	
Namf_EventExposure	Subscribe	Subscribe / Notify	NEF, SMF, UDM
	Unsubscribe	Subscribe / Notify	NEF, SMF, UDM
	Notify	Subscribe / Notify	NEF, SMF, UDM
Namf_MT	EnableUERachability	Request/Response	SMSF
	ProvideDomainSelectionInfo	Request/Response	UDM
Namf_Location	ProvidePositioningInfo	Request/Response	GMLC
	EventNotify	Subscribe / Notify	GMLC
	ProvideLocationInfo	Request/Response	UDM
NOTE 1: In this Release of the specification no known consumer is identified to use this service operation.			

## 5.2.2.2 Namf\_Communication service

### 5.2.2.2.1 General

**Service description:** This service enables an NF to communicate with the UE through N1 NAS messages or with the AN (both UE and non UE specific). The service operations defined below allow the NF to communicate with the UE and the AN. The following are the key functionalities of this NF service.

- Provide service operations for transporting N1 messages to the UE;
- Allow NFs to subscribe and unsubscribe for notifications of specific N1 messages from the UE;
- Allow NFs to subscribe and unsubscribe for notifications about specific information from AN;
- Provide service operations for initiating N2 messages towards the AN;
- Security Context Management; and
- UE information management and transfer (including its security context);

#### 5.2.2.2.2 Namf\_Communication\_UEContextTransfer service operation

**Service operation name:** Namf\_Communication\_UEContextTransfer

**Description:** Provides the UE context to the consumer NF.

**Input, Required:** 5G-GUTI or SUPI, Access Type, Reason.

**Input, Optional:** Integrity protected message from the UE that triggers the context transfer.

**Output, Required:** The UE context of the identified UE or only the SUPI and an indication that the Registration Request has been validated. The UE context is detailed in table 5.2.2.2.2-1.

**Output, Optional:** Mobile Equipment Identifier (if available), Allowed NSSAI, Mapping Of Allowed NSSAI.

See clause 4.2.2.2 for example of usage of this service operation. If the consumer NF sent an integrity protected message from the UE, the AMF uses it to verify whether this request is permitted to retrieve the UE context of the UE. If it is permitted, the AMF provides UE context to the consumer NF in the Namf\_Communication\_UEContextTransfer response. The following table illustrates the UE Context:



**Table 5.2.2.2.2-1: UE Context in AMF**

Field	Description
SUPI	SUPI (Subscription Permanent Identifier) is the subscriber's permanent identity in 5GS.
Routing Indicator	UE's Routing Indicator that allows together with SUCI/SUPI Home Network Identifier to route network signalling to AUSF and UDM instances capable to serve the subscriber
AUSF Group ID	The AUSF Group ID for the given UE.
UDM Group ID	The UDM Group ID for the UE.
SUPI-unauthenticated-indicator	This indicates whether the SUPI is unauthenticated.
GPSI	The GPSI(s) of the UE. The presence is dictated by its storage in the UDM.
5G-GUTI	5G Globally Unique Temporary Identifier.
PEI	Mobile Equipment Identity
Internal Group ID-list	List of the subscribed internal group(s) that the UE belongs to.
UE Specific DRX Parameters	UE specific DRX parameters.
UE MM Network Capability	Indicates the UE MM network capabilities.
5GMM Capability	Includes other UE capabilities related to 5GCN or interworking with EPS.
Events Subscription	List of the event subscriptions by other CP NFs. Indicating the events being subscribed as well as any information on how to send the corresponding notifications
<b>For the AM Policy Association:</b>	
AM Policy Information	Information on AM policy provided by PCF. Includes the Policy Control Request Triggers and the Policy Control Request Information. Includes the authorized RFSP and the authorized Service Area Restrictions.
PCF ID	The identifier of the PCF for AM Policy. In roaming, the identifier of V-PCF (NOTE 2).
<b>For the UE Policy Association:</b>	
Trigger Information	The Policy Control Request Triggers on UE policy provided by PCF.
PCF ID(s)	The identifier of the PCF for UE Policy. In roaming, the identifiers of both V-PCF and H-PCF (NOTE 1) (NOTE 2).
Subscribed RFSP Index	An index to specific RRM configuration in the NG-RAN that is received from the UDM.
RFSP Index in Use	An index to specific RRM configuration in the NG-RAN that is currently in use.
MICO Mode Indication	Indicates the MICO Mode for the UE.
Voice Support Match Indicator	An indication whether the UE radio capabilities are compatible with the network configuration. The AMF uses it as an input for setting the IMS voice over PS Session Supported Indication over 3GPP access.
Homogenous Support of IMS Voice over PS Sessions	Indicates per UE if "IMS Voice over PS Sessions" is homogeneously supported in all TAs in the serving AMF or homogeneously not supported, or, support is non-homogeneous/unknown, see clause 5.16.3.3 of TS 23.501 [2].
UE Radio Capability for Paging Information	Information used by the NG-RAN to enhance the paging towards the UE (see clause 5.4.4.1 of TS 23.501 [2]).
Information On Recommended Cells And RAN nodes For Paging	Information sent by the NG-RAN, and used by the AMF when paging the UE to help determining the NG-RAN nodes to be paged as well as to provide the information on recommended cells to each of these NG-RAN nodes, in order to optimize the probability of successful paging while minimizing the signalling load on the radio path.
UE Radio Capability Information	Information sent by the NG-RAN node and stored in the AMF. The AMF sends this information to the NG-RAN node within the UE context during transition to CM-CONNECTED state.
SMSF Identifier	The Identifier of the SMSF serving the UE in RM-REGISTERED state.
SMSF Address	The Address of the SMSF serving the UE in RM-REGISTERED state. (see clause 4.13.3.1).
SMS Subscription	Indicates subscription to any SMS delivery service over NAS irrespective of access type.
SEAF data	Master security information received from AUSF
Last used EPS PLMN ID	The identifier of the last used EPS PLMN
<b>For each access type level context within the UE access and mobility context:</b>	
Access Type	Indicates the access type for this context.
RM State	Registration management state.
Registration Area	Current Registration Area (a set of tracking areas in TAI List).
TAI of last Registration	TAI of the TA in which the last Registration Request was initiated.
User Location Information	Information on user location.
Mobility Restrictions	Mobility Restrictions restrict mobility handling or service access of a UE. It consists of RAT restriction, Forbidden area, Service area restrictions and Core Network type restriction.
Expected UE Behavior Parameters for AMF	Indicates per UE the Expected UE Behavior Parameters and their corresponding validity times.

Field	Description
Security Information for CP	As defined in TS 33.501 [15].
Security Information for UP	As defined in TS 33.501 [15].
Allowed NSSAI	Allowed NSSAI consisting of one or more S-NSSAIs for serving PLMN in the present Registration Area.
Mapping Of Allowed NSSAI	Mapping Of Allowed NSSAI is the mapping of each S-NSSAI of the Allowed NSSAI to the S-NSSAIs of the Subscribed S-NSSAIs.
Inclusion of NSSAI in RRC Connection Establishment Allowed by HPLMN	[Only for 3GPP access] it defines whether the UDM has indicated that the UE is allowed to include NSSAI in the RRC connection Establishment in clear text.
Access Stratum Connection Establishment NSSAI Inclusion Mode	Defines what NSSAI, if any, to include in the Access Stratum connection establishment as specified in TS 23.501 [2] clause 5.15.9.
CM state for UE connected via N3IWF	Identifies the UE CM state (CM-IDLE, CM-CONNECTED) for UE connected via N3IWF
N2 address information for N3IWF	Identifies the N3IWF to which UE is connected. Exists only if CM state for UE connected via N3IWF is CM-CONNECTED.
AMF UE NGAP ID	Identifies the UE association over the NG interface within the AMF as defined in TS 38.413 [10]. This parameter exists only if CM state for the respective Access Type is CM-CONNECTED.
(R)AN UE NGAP ID	Identifies the UE association over the NG interface within the NG-(R)AN node as defined in TS 38.413 [10]. This parameter exists only if CM state for the respective Access Type is CM-CONNECTED.
Network Slice Instance(s)	The Network Slice Instances selected by 5GC for this UE.
URRP-AMF information	UE Reachability Request Parameter contains a list of URRP-AMF flags and associated authorised NF IDs. Each URRP-AMF flag indicates whether direct UE reachability notification has been authorised by the HPLMN towards the associated NF ID or not.
<b>For each PDU Session level context:</b>	
S-NSSAI(s)	The S-NSSAI(s) associated to the PDU Session.
DNN	The associated DNN for the PDU Session.
Network Slice Instance id	The network Slice Instance information for the PDU Session
PDU Session ID	The identifier of the PDU Session.
SMF Information	The associated SMF identifier and SMF address for the PDU Session.
Access Type	The current access type for this PDU Session.
EBI-ARP list	The allocated EBI and associated ARP pairs for this PDU session.
5GSM Core Network Capability	The UEs 5GSM Core Network Capability as defined in TS 23.501 [2] clause 5.4.4b.
NOTE 1: The AMF transfers the PCF ID to the SMF during PDU Session Establishment. The SMF may select the PCF identified by the PCF ID as described in TS 23.501 [2], clause 6.3.7.1. In HR roaming case, the AMF transfers the identifier of H-PCF as described in clause 4.3.2.2.2. In LBO roaming case, the AMF transfers the identifier of V-PCF as described in clause 4.3.2.2.1.	
NOTE 2: The PCF ID in AM Policy Association information and the PCF ID in UE Policy Association Information should be the same in non-roaming case. The V-PCF ID in AM Policy Association information and the V-PCF ID in UE Policy Association Information should be the same in roaming case.	

### 5.2.2.2.3 Namf\_Communication\_RegistrationCompleteNotify service operation

**Service operation name:** Namf\_Communication\_RegistrationCompleteNotify

**Description:** This service operation is used by the consumer NF to inform the AMF that a prior UE context transfer has resulted in the UE successfully registering with it. The UE context is marked inactive in the AMF.

NOTE 1: This notification corresponds to an implicit subscription.

**Input, Required:** 5G-GUTI, Reason.

**Input, Optional:** PDU Session ID(s) (indicates the PDU Session(s) to be released), PCF ID (indicates that the PCF ID that handles the AM Policy association has changed).

**Output, Required:** None.

**Output, Optional:** None.

See clause 4.2.2.2.2 step 10 for example usage of this service operation. When the consumer NF (AMF) receives this notification, it marks the UE context information as inactive since the UE context has been successfully transferred to the peer NF and the UE has successfully registered there. The AMF sends a Namf\_Communication\_RegistrationCompleteNotify ack to the consumer NF. The consumer NF (AMF) is notified whether the AM Policy Association Information in the UE context will be used or not (i.e. new AMF may select a different PCF and then create a new AM Policy Association).

NOTE 2: Whether notification Ack need a separate message or be realized in the transport layer will be determined in TS 29.518 [18].

#### 5.2.2.2.4 Namf\_Communication\_N1MessageNotify service operation

**Service operation name:** Namf\_Communication\_N1MessageNotify

**Description:** AMF notifies the N1 message received from the UE to a destination CN NF.

**Input, Required:** AMF ID (GUAMI), N1 Message(s)

**Input, Optional:** local time zone, UE's current location, AN type AN N2 terminating point, Allowed NSSAI, Mapping Of Allowed NSSAI, SUPI, MM Context.

**Output, Required:** None.

**Output, Optional:** None.

The destination NF type to be notified is determined based on one of the following:

- The N1 message type is always known to be consumed by one particular NF type; or
- An NF had explicitly subscribed for the particular N1 message type to be notified towards it.

NOTE: Whether notification Ack need a separate message or be realized in the transport layer will be determined in TS 29.518 [18].

The optional AN N2 terminating point, SUPI, MM Context, Allowed NSSAI and Mapping Of Allowed NSSAI parameters are included if the service operation is invoked towards a peer AMF.

#### 5.2.2.2.5 Namf\_Communication\_N1MessageSubscribe service operation

**Service operation name:** Namf\_Communication\_N1MessageSubscribe.

**Description:** An NF can subscribe with the AMF to get notified of a particular N1 message type from the UE.

**Input, Required:** CN NF ID, N1 Message Type

**Input, Optional:** SUPI.

**Output, Required:** None.

**Output, Optional:** None.

The consumer NF invokes the Namf\_Communication\_N1MessageSubscribe service operation (NF ID, N1 message type to subscribe) on the AMF. The consumer NF shall provide a SUPI for UE associated N1 message subscriptions. If the consumer NF is allowed to subscribe for the type of N1 message requested, the AMF creates a binding for the consumer NF to deliver subsequent Namf\_Communication\_N1MessageNotify towards that NF.

NOTE: Whether Subscription Ack need a separate message or be realized in the transport layer will be determined in TS 29.518 [18].

#### 5.2.2.2.6 Namf\_Communication\_N1MessageUnSubscribe service operation

**Service operation name:** Namf\_Communication\_N1MessageUnSubscribe.

**Description:** An NF can unsubscribe with the AMF to stop notifying a particular N1 message type from the UE.

**Input, Required:** CN NF ID, N1 Message Type

**Input, Optional:** None.

**Output, Required:** None.

**Output, Optional:** None.

The consumer NF invokes the `Namf_Communication_N1MessageUnSubscribe` service operation (NF ID, N1 message type to subscribe) on the AMF. The AMF deletes the binding for the consumer NF for the requested N1 message type.

NOTE: Whether UnSubscribe Ack need a separate message or be realized in the transport layer will be determined in TS 29.518 [18].

#### 5.2.2.2.7 `Namf_Communication_N1N2MessageTransfer` service operation

**Service operation name:** `Namf_Communication_N1N2MessageTransfer`.

**Description:** CN NF request to transfer downlink N1 and/or N2 message to the UE and/or AN through the AMF.

**Input, Required:** CN NF ID, Message type (N1 or N2 or both), Message Container (s) where at least one of the message containers (N1 or N2) is required.

**Input, Optional:** last message indication, Session ID, Paging Policy Indicator, ARP, Area of validity for the N2 SM information, 5QI, `N1N2TransferFailure` Notification Target Address, type of N2 SM information, type of N2 NRPPa information.

`Namf_Communication_N1N2MessageTransfer` supports the transfer of only one N2 message. N2 SM information and N2 NRPPa information are mutually exclusive.

**Output, Required:** Result indication.

**Output, Optional:** Redirection information.

If the UE is in CM-IDLE state, the AMF initiates the network triggered service request procedure as specified in clause 4.2.3.3 and responds to the consumer NF with a result indication, "attempting to reach UE". Otherwise, the AMF responds to the consumer NF, with a `Namf_Communication_N1N2MessageTransfer` response, providing a result indication of whether the AMF was able to successfully transfer the N1 and/or the N2 message towards the UE and/or the AN. A result indication of "N1/N2 transfer success" does not mean that N1 message is successfully received by the UE. It only means that the AMF is able to successfully send the N1 or N2 message towards the AN.

The "Area of validity for the N2 SM information", if included is used by the AMF to determine whether the N2 SM information provided by the consumer NF can be used towards the AN based on the current location of the UE. If the location of the UE is outside the "Area of validity for the N2 SM information" indicated, the AMF shall not send the N2 SM information to the AN.

In case the consumer NF knows that a specific downlink N1 message is the last message to be transferred in this transaction, the consumer NF shall include the last message indication in the `Namf_Communication_N1N2MessageTransfer` service operation so that the AMF knows that the no more downlink N1 message need to be transferred for this transaction.

The CN NF is implicitly subscribed to be notified of `N1N2TransferFailure` by providing the `N1N2TransferFailure` Notification Target Address. When AMF detects that the UE fails to response to paging, the AMF invokes the `Namf_Communication_N1N2TransferFailureNotification` to provide the failure notification to the location addressed by `N1N2TransferFailure` Notification Target Address.

If the result of the service operation fails, the AMF shall set the corresponding cause value in the result indication which can be used by the NF consumer for further action. In case the related UE is not served by AMF and the AMF knows which AMF is serving the UE, the AMF provides redirection information which can be used by the consumer NF to resend UE related message to the AMF that serves the UE.

If the consumer NF is a SMF and he request includes N2 SM information, the SMF indicates the type of N2 SM information. If the consumer NF is a LMF and the request includes N2 NRPPa information, the LMF indicates the type of N2 NRPPa information.

NOTE: The actual N2 SM information or N2 NRPPa information is not interpreted by the AMF.

#### 5.2.2.2.7A Namf\_Communication\_N1N2TransferFailureNotification service operation

**Service operation name:** Namf\_Communication\_N1N2TransferFailureNotification.

**Description:** The AMF uses this notification to inform the NF service consumer that initiated an earlier Namf\_Communication\_N1N2MessageTransfer, that the AMF failed to deliver the N1 message to the UE as the UE failed to respond to paging.

**Input, Required:** Cause, N1N2MessageTransfer Notification Target Address.

**Input, Optional:** None.

**Output, Required:** None.

**Output, Optional:** None.

#### 5.2.2.2.8 Namf\_Communication\_N2InfoSubscribe service operation

**Service operation name:** Namf\_Communication\_N2InfoSubscribe.

**Description:** An NF invokes this service operation to subscribe for the delivery of information contained in a specific N2 message type.

**Input, Required:** CN NF ID, N2 information type to be subscribed.

**Input, Optional:** None.

**Output, Required:** None.

**Output, Optional:** None.

#### 5.2.2.2.9 Namf\_Communication\_N2InfoUnsubscribe service operation

**Service operation name:** Namf\_Communication\_N2InfoUnSubscribe.

**Description:** An NF can invoke this service operation to unsubscribe for the delivery of information contained in a specific N2 message type.

**Input, Required:** CN NF ID, N2 information type to unsubscribe.

**Input, Optional:** None.

**Output, Required:** None.

**Output, Optional:** None.

The consumer NF invokes the Namf\_Communication\_N2InfoUnSubscribe service operation (CN NF ID, N2 information type to unsubscribe) on the AMF. The AMF deletes the binding for the consumer NF to for the requested information to unsubscribe.

#### 5.2.2.2.10 Namf\_Communication\_N2InfoNotify service operation

**Service operation name:** Namf\_Communication\_N2InfoNotify.

**Description:** The AMF uses this service operation to notify a particular N2 message information towards the NFs that have subscribed (implicitly or explicitly) for the specific information. This service operation is also used to redirect the N2 message to the AMF that are serving the UE.

**Input, Required:** AMF ID (GUAMI), N2 information.

**Input, Optional:** None.

**Output, Required:** None.

**Output, Optional:** None.

#### 5.2.2.2.11 Namf\_Communication\_CreateUEContext service operation

**Service operation name:** Namf\_Communication\_CreateUEContext

**Description:** This service operation is used by a source AMF to create the UE context in a target AMF during handover procedures.

**Input, Required:** 5G-GUTI, UE context of the identified UE. As described in Table 5.2.2.2-1, the UE context may include the SUPI, DRX parameters, AM policy information, PCF ID, UE network capability, used N1 security context information, event subscriptions by other consumer NF, and the list of SM PDU Session IDs along with the SMF handling the PDU Session, N2 information including source to target RAN transparent container, Endpoint information of S-AMF to receive N2 information notification about handover complete.

**Input, Optional:** allocated EBI information, PCF ID.

**Output, Required:** Cause, N2 information including Target to Source transparent container, N2 SM information (PDU Sessions failed to be setup list, and the N3 DL forwarding information), handle for the UE context created, PCF ID.

**Output, Optional:** None.

#### 5.2.2.2.12 Namf\_Communication\_ReleaseUEContext service operation

**Service operation name:** Namf\_Communication\_ReleaseUEContext

**Description:** This service operation is used by a source AMF to release the UE context in a target AMF during handover cancel procedures.

**Input, Required:** Handle of the UE context.

**Input, Optional:** None.

**Output, Required:** Cause.

**Output, Optional:** None.

#### 5.2.2.2.13 Namf\_Communication\_EBIAssignment service operation

**Service operation name:** Namf\_Communication\_EBIAssignment.

**Description:** The consumer NF uses this service operation to request a bunch of EPS Bearer IDs for a PDU Session, and optionally indicate to the AMF the list of EBI(s) to be released.

**Inputs, Required:** SUPI, PDU Session ID, ARP list.

**Input, Optional:** Released EBI list.

**Outputs, Required:** <ARP, Cause> pair.

**Outputs, Optional:** a list of <ARP, EBI> pair.

The consumer NF invokes the Namf\_Communication\_EBIAssignment service operation when it determines that one or more EPS Bearer IDs are required for EPS QoS mapping for a PDU Session. The ARP list indicates the number of the requested EBIs, and the corresponding ARP. The AMF uses the ARP list (including ARP priority level, the pre-emption capability and the pre-emption vulnerability) and the S-NSSAI to prioritize the EBI request, AMF can revoke the EBI from an ongoing lower priority PDU Session, if the maximum number of EBIs have been reached and a session with a higher priority requests an EBI. The AMF responds the consumer NF with a cause which indicates whether the assignment is successful or not. If the assignment is successful, the AMF provides a list of <ARP, EBI> pair to the consumer NF.

If the consumer NF determines that some EBIs are not needed, the consumer NF indicates the EBI(s) that can be released in the Released EBI list.

#### 5.2.2.2.14 Namf\_Communication\_AMFStatusChangeSubscribe service operation

**Service operation name:** Namf\_Communication\_AMFStatusChangeSubscribe

**Description:** This service operation is used by an NF to subscribe for AMF Status Change notification.

**Input, Required:** GUAMI(s).

**Input, Optional:** None.

**Output, Required:** None.

**Output, Optional:** None.

See clause 5.21.2.2, TS 23.501 [2] for the example usage of this service operation. The GUAMI(s) is used to identify the AMF.

#### 5.2.2.2.15 Namf\_Communication\_AMFStatusChangeUnSubscribe service operation

**Service operation name:** Namf\_Communication\_AMFStatusChangeUnSubscribe

**Description:** This service operation is used by an NF to unsubscribe for AMF Status Change notification.

**Input, Required:** GUAMI(s).

**Input, Optional:** None.

**Output, Required:** None.

**Output, Optional:** None.

See clause 5.21.2.2, TS 23.501 [2] for the example usage of this service operation. The GUAMI(s) is used to identify the AMF.

#### 5.2.2.2.16 Namf\_Communication\_AMFStatusChangeNotify service operation

**Service operation name:** Namf\_Communication\_AMFStatusChangeNotify

**Description:** Report AMF Status change (e.g. AMF unavailable) notification to subscribed NFs.

**Input, Required:** GUAMI(s).

**Input, Optional:** Target AMF(s) Name associated with the indicated GUAMI.

**Output, Required:** None.

**Output, Optional:** None.

See clause 5.21.2.2, TS 23.501 [2] for the example usage of this service operation. The GUAMI(s) is used to identify the AMF. For network deployment without UDSF case, the target AMF Name which is to serve the user of the indicated GUAMI is also included.

### 5.2.2.3 Namf\_EventExposure service

#### 5.2.2.3.1 General

**Service description:** This service enables an NF to subscribe and get notified about an Event ID.

Following UE access and mobility information event are considered (Event ID is defined in clause 4.15.1):

- Location changes (TAI, Cell ID, N3IWF node, UE local IP address and optionally UDP source port number, Area Of Interest);
- UE moving in or out of a subscribed "Area Of Interest" as described in clause 5.6.11 in TS 23.501 [2];



- Time zone changes (UE Time zone);
- Access Type changes (3GPP access or non-3GPP access);
- Registration state changes (Registered or Deregistered);
- Connectivity state changes (IDLE or CONNECTED);
- UE loss of communication;
- UE reachability status;
- UE indication of switching off SMS over NAS service;
- Subscription Correlation ID change (implicit subscription); and
- Subscription Correlation ID addition (implicit subscription).

Event Filters are used to specify the conditions to match for notifying the event (i.e. "List of Parameter values to match"). If there are no conditions to match for a specific Event ID, then the Event Filter is not provided. The following table provides as an example how the conditions to match for event reporting can be specified for various Event IDs for AMF exposure.

**Table 5.2.2.3.1-1: Example of Event Filters for AMF exposure events**

Event ID	Event Filter (List of Parameter Values to Match)
Area of Interest	<Parameter Type = TAI, Value = TA1> <Parameter Type = PRA ID, Value = PRA ID value>
Access Type	<Parameter Type=AN Type, Value=3GPP Access">
Location	<Parameter Type=TAI, Value=wildcard> (to report any TAI change)

The following service operations are defined for the Namf\_EventExposure service:

- Namf\_EventExposure\_Subscribe.
- Namf\_EventExposure\_UnSubscribe.
- Namf\_EventExposure\_Notify.

#### 5.2.2.3.2 Namf\_EventExposure\_Subscribe service operation

**Service operation name:** Namf\_EventExposure\_Subscribe.

**Description:** The consumer NF uses this service operation to subscribe to or modify event reporting for one UE, a group of UE(s) or any UE.

**Input, Required:** NF ID, target of the subscription: UE(s) ID (SUPI or Internal Group Identifier or indication that any UE is targeted), ((set of) Event ID(s) defined in clause 5.2.2.3.1, Notification Target Address (+ Notification Correlation ID)s), Event Reporting Information defined in Table 4.15.1-1.

**Input, Optional:** (Event Filter (s) associated with each Event ID; Event Filter (s) are defined in clause 5.2.2.3.1, Subscription Correlation ID (in the case of modification of the event subscription), Expiry time.

**Output, Required:** When the subscription is accepted: Subscription Correlation ID (required for management of this subscription), Expiry time (required if the subscription can be expired based on the operator's policy).

**Output, Optional:** First corresponding event report is included, if available (see clause 4.15.1).

The NF consumer subscribes to the event notification by invoking Namf\_EventExposure to the AMF. The AMF allocates an Subscription Correlation ID for the subscription and responds to the consumer NF with the Subscription Correlation ID. UE ID identifies the UE, SUPI and/or GPSI. Event ID (see clause 4.15.1) identifies the events that the NF consumer is interested in. The Subscription Correlation ID is unique within the AMF Set.

The ((set of) Event ID(s), Notification Target Address (+ Notification Correlation ID)) helps the Event Receiving NF to co-relate a notification against a corresponding event subscription for the indicated Event ID.

In the case that the NF consumer subscribes to the AMF on behalf of other NF, the NF consumer include the Notification Target Address(+Notification Correlation ID) of other NF for the Event ID which is to be notified to other NF directly, and the Notification Target Address(+Notification Correlation ID) of itself for the Subscription Correlation ID change event. Each Notification Target Address(+ Notification Correlation ID) is associated with the related (set of) Event ID(s). When the Subscription Correlation ID change due to the AMF reallocation, the notification is sent to NF consumer which triggers this subscription.

Event filter may include "AN type(s)" as part of the list of parameter values to match, and it indicates to subscribe the event per Access Type.

Event receiving NF ID identifies the NF that shall receive the event reporting.

When the consumer NF needs to modify an existing subscription previously created by itself in the AMF, it invokes Namf\_EventExposure\_Subscribe service operation which contains the Subscription Correlation ID and the new Event Filters with Event ID to the AMF.

#### 5.2.2.3.3 Namf\_EventExposure\_UnSubscribe service operation

**Service operation name:** Namf\_EventExposure\_UnSubscribe.

**Description:** The NF consumer uses this service operation to unsubscribe for a specific event for one UE, group of UE(s), any UE.

**Input, Required:** Subscription Correlation ID.

**Input, Optional:** None.

**Output, Required:** Operation execution result indication.

**Output, Optional:** None.

The NF consumer unsubscribes the event notification by invoking Namf\_EventExposure\_Unsubscribe (Subscription Correlation ID) to the AMF.

#### 5.2.2.3.4 Namf\_EventExposure\_Notify service operation

**Service operation name:** Namf\_EventExposure\_Notify.

**Service operation description:** Provides the previously subscribed event information to the NF Consumer which has subscribed to that event before.

**Input, Required:** AMF ID (GUAMI), Notification Correlation Information, Event ID, corresponding UE (SUPI and if available GPSI), time stamp.

**Input, Optional:** Event specific parameter list.

**Output, Required:** None.

**Output, Optional:** None.

When the AMF detects a UE access and mobility event corresponding to a Subscription, it invokes Namf\_EventExposure\_Notify service operation to the NF consumer(s) which has subscribed to the UE mobility event before. The event is notified towards the consumers for which the Event filters (which may include "AN type(s)") match. The Notification Target Address (+ Notification Correlation ID) indicates to the Event Receiving NF the specific event notification subscription. The event specific parameter indicates the type of mobility event and related information, e.g. Registration Area Update/new Registration Area.

The optional event specific parameter list provides the values that matched for generating the event notification. The parameter values to match are specified during the event subscription (see clause 5.2.2.3.2). For example if the event type reported is "AN change", the event specific parameter list contains the value of the new AN.

## 5.2.2.4 Namf\_MT service

### 5.2.2.4.1 General

**Service description:** It provides a NF the service to request information related to capabilities that make sure UE is reachable to send MT signalling or data to a target UE. The following are the key functionalities of this NF service

- paging UE if UE is in IDLE state and respond other NF after the UE enters CM-CONNECTED state.
- response to the requester NF if UE is in CONNECTED state.
- providing the terminating domain selection information for IMS voice to the consumer NF.

### 5.2.2.4.2 Namf\_MT\_EnableUEReachability service operation

**Service operation name:** Namf\_MT\_EnableUEReachability.

**Description:** The consumer NF uses this service operation to request enabling UE reachability.

**Inputs, Required:** NF ID, UE ID.

**Inputs, Optional:** None.

**Outputs, Required:** Result indication.

**Outputs, Optional:** Redirection information.

See clause 4.13.3.6 for details on the usage of this service operation.

The consumer NF does not need to know UE state. The AMF accepts the request and respond the consumer NF immediately if UE is in CM-CONNECTED state. If the UE is in CM-IDLE state, the AMF may page the UE and respond to the consumer NF after the UE enters CM-CONNECTED state.

If the result of the service operation fails, the AMF shall set the corresponding cause value in the result indication which can be used by the NF consumer for further action. In case the related UE is not served by the AMF and the AMF knows which AMF is serving the UE, the AMF provides redirection information which can be used by the NF consumer to resend UE related message to the AMF that serves the UE.

### 5.2.2.4.3 Namf\_MT\_ProvideDomainSelectionInfo

**Service operation name:** Namf\_MT\_ProvideDomainSelectionInfo.

**Description:** Provides the UE information for terminating domain selection of IMS voice to the consumer NF.

**Input, Required:** SUPI.

**Input, Optional:** None.

**Output, Required:** Success/Failure indication.

**Output, Optional:** Indication of supporting IMS voice over PS Session or not, Time stamp of the last radio contact with the UE, Current RAT type.

## 5.2.2.5 Namf\_Location service

### 5.2.2.5.1 General

**Service description:** This service enables an NF to request location information for a target UE. The following are the key functionalities of this NF service.

- Allow NFs to request the current geodetic and optionally civic location of a target UE.
- Allow NFs to be notified of event information related to emergency sessions.

- Allow NFs to request Network Provided Location Information (NPLI) and/or local time zone corresponding to the location of a target UE.

#### 5.2.2.5.2 Namf\_Location\_ProvidePositioningInfo service operation

**Service operation name:** Namf\_Location\_ProvidePositioningInfo

**Description:** Provides UE positioning information to the consumer NF.

**Input, Required:** UE Identification (SUPI or PEI), External Client Type.

**Input, Optional:** Location QoS, Supported GAD shapes.

**Output, Required:** Success/Failure indication

**Output, Optional:** Geodetic Location, Civic Location, Position Methods Used, Failure Cause.

See steps 4 and 9 of clause 4.13.5.3 for example of usage of this service operation.

#### 5.2.2.5.3 Namf\_Location\_EventNotify service operation

**Service operation name:** Namf\_Location\_EventNotify

**Description:** Provides UE location related event information related to emergency sessions to the consumer NF.

**Input, Required:** Type of location related event (e.g. emergency session initiation), UE Identification (SUPI or PEI).

**Input, Optional:** GPSI, Geodetic Location, Civic Location, Position methods used.

**Output, Required:** None.

**Output, Optional:** None.

#### 5.2.2.5.4 Namf\_Location\_ProvideLocationInfo service operation

**Service operation name:** Namf\_Location\_ProvideLocationInfo

**Description:** Provides Network Provided Location Information (NPLI) of a target UE to the consumer NF.

**Input, Required:** UE Identification (SUPI).

**Input, Optional:** 5GS Location Information Request, Current Location Request, RAT type Requested, Local Time Zone Request.

**Output, Required:** Success/Failure indication.

**Output, Optional:** 5GS Location Information (Cell Identity, Tracking Area Identity, Geographical/Geodetic Information, Current Location Retrieved, Age of Location Information, Current RAT Type), Local Time Zone, Failure Cause. In the case of non-3GPP access: a UE local IP address (used to reach the N3IWF) and optionally UDP or TCP source port number (if NAT is detected).

### 5.2.3 UDM Services

#### 5.2.3.1 General

The following table illustrates the UDM Services.

Table 5.2.3-1: NF services provided by UDM

NF service	Service Operations	Operation Semantics	Example Consumer(s)
Subscriber Data Management (SDM)	Get	Request/Response	AMF, SMF, SMSF
	Subscribe	Subscribe/Notify	AMF, SMF, SMSF
	Unsubscribe	Subscribe/Notify	AMF, SMF, SMSF
	Notification	Subscribe/Notify	AMF, SMF, SMSF
	Info	Request/Response	AMF
UE Context Management (UECM)	Registration	Request/Response	AMF, SMF, SMSF
	DeregistrationNotification	Subscribe/Notify	AMF
	Deregistration	Request/Response	AMF, SMF, SMSF
	Get	Request/Response	NEF, SMSF, GMLC
	Update	Request/Response	AMF, SMF
UE Authentication	PCscfRestoration	Subscribe/Notify	AMF, SMF
	Get	Request/Response	AUSF
EventExposure	ResultConfirmation	Request/Response	AUSF
	Subscribe	Subscribe/Notify	NEF (NOTE)
	Unsubscribe		NEF (NOTE)
Notify	NEF (NOTE)		
Parameter Provision	Update	Request/Response	NEF
NOTE: Other NFs are allowed to consume the service based on roaming agreement or operator policy.			

### 5.2.3.2 Nudm\_UECM (UECM) service

#### 5.2.3.2.1 Nudm\_UECM\_Registration service operation

**Service operation name:** Nudm\_UECM\_Registration

**Description:** Register UE's serving NF (if NF Type is AMF, SMSF) or Session's serving NF (if NF Type is SMF) on the UDM. This operation implies the following:

- The authorization, if applicable, to register the NF service consumer in UDM for the UE (e.g. based on UE roaming/RAT restrictions applicable when NF type is AMF). If this is successful, the NF service consumer is set as a serving NF for the corresponding UE/Session context.
- When the consumer is AMF, it is implicitly subscribed to be notified when it is deregistered in UDM. This notification is done by means of Nudm\_UECM\_DeregistrationNotification operation.
- When the consumer is AMF or SMF, it may optionally use this operation to subscribe to be notified of the need for P-CSCF Restoration. This notification is done by means of Nudm\_UECM\_PCscfRestoration operation. For more information regarding P-CSCF restoration procedures see TS 23.380 [38].

**Inputs, Required:** NF ID, SUPI, PEI, NF Type, Access Type (if NF Type is AMF, SMSF), PDU Session ID (if NF Type is SMF). If NF Type is SMF: DNN or Indication of Emergency Services, PGW-C+SMF FQDN for S5/S8 if the PDU Session supports EPS interworking. If NF type is AMF and Access Type is 3GPP access: Registration type. If NF type is SMSF: SMSF MAP address and/or Diameter address.

**Inputs, Optional:** P-CSCF Restoration notification information, GUAMI, backup AMF(s) (if NF Type is AMF), "Homogeneous Support of IMS Voice over PS Sessions" indication (if NF Type is AMF). Backup AMF(s) sent only once by the AMF to the UDM in its first interaction with the UDM.

**Outputs, Required:** Result indication.

**Outputs, Optional:** None.

See step 14a of clause 4.2.2.2 for an example usage of this service operation.

#### 5.2.3.2.2 Nudm\_UECM\_DeregistrationNotification service operation

**Service operation name:** Nudm\_UECM\_DeregistrationNotification.

**Description:** UDM notifies the NF consumer which has previously registered (using Nudm\_UECM\_Registration operation) has been deregistered in the UDM. As a result, the consumer is no longer registered in UDM as a serving NF for that UE.

NOTE: This notification corresponds to an implicit subscription.

**Inputs, Required:** SUPI, Access Type, serving NF deregistration reason.

**Inputs, Optional:** None.

**Outputs, Required:** None.

**Outputs, Optional:** None.

See step 14d of clause 4.2.2.2.2 for an example usage of this service operation. The serving NF deregistration reason tells the reason for sending the deregistration notification to the consumer NF.

The reason for AMF deregistration can be one of the following:

- UE Initial Registration.
- UE Registration area change.
- Subscription Withdrawn.
- 5GS to EPS Mobility.

#### 5.2.3.2.3 Nudm\_UECM\_Deregistration service operation

**Service operation name:** Nudm\_UECM\_Deregistration.

**Description:** The NF consumer requests the UDM to delete the information related to the NF in the UE context. When the consumer is AMF, this implies that the subscriptions to be notified when the NF is deregistered in UDM (i.e. Nudm\_UECM\_DeregistrationNotification) are also removed.

**Inputs, Required:** SUPI, NF type, Access Type, S-NSSAI (if NF Type is SMF), DNN (if NF Type is SMF), PDU Session Id (if NF Type is SMF).

- Access Type is included only when the NF type indicates AMF or SMSF.

**Inputs, Optional:** None.

**Outputs, Required:** Result Indication.

**Outputs, Optional:** None.

#### 5.2.3.2.4 Nudm\_UECM\_Get service operation

**Service operation name:** Nudm\_UECM\_Get.

**Description:** The NF consumer requests the UDM to get the NF ID or SMS address of the NF serving the UE.

**Inputs, Required:** UE ID, NF Type, Access Type.

- Access Type is included only when the NF type indicates AMF.

**Inputs, Optional:** None.

**Outputs, Required:** SUPI, NF ID or SMS address of the NF corresponding to the NF type requested by NF consumer.

**Outputs, Optional:** None.

#### 5.2.3.2.5 Nudm\_UECM\_Update service operation

**Service operation name:** Nudm\_UECM\_Update.

**Description:** Consumer updates some UE related information (e.g. UE capabilities, Intersystem continuity context, PGW-C+SMF FQDN for S5/S8 interface).

**Inputs, Required:** NF ID, SUPI, NF type, UE context information.

**Inputs, Optional:** "Homogeneous Support of IMS Voice over PS Sessions" indication (if NF Type is AMF), PGW-C+SMF FQDN for S5/S8 interface (if NF Type is SMF).

**Outputs, Required:** Result Indication.

**Outputs, Optional:** None.

#### 5.2.3.2.6 Nudm\_UECM\_PCscfRestoration service operation

**Service operation name:** Nudm\_UECM\_PCscfRestoration.

**Description:** UDM notifies the AMF and/or SMF(s) which indicated during registration in UDM to be notified of the need for P-CSCF Restoration.

**Inputs, Required:** SUPI.

**Inputs, Optional:** None.

**Outputs, Required:** None.

**Outputs, Optional:** None.

#### 5.2.3.3 Nudm\_SubscriberDataManagement (SDM) Service

##### 5.2.3.3.1 General

Subscription data types used in the Nudm\_SubscriberDataManagement Service are defined in Table 5.2.3.3.1-1 below.

**Table 5.2.3.3.1-1: UE Subscription data types**



Subscription data type	Field	Description
Access and Mobility Subscription data (data needed for UE Registration and Mobility Management)	GPSI List	List of the GPSI (Generic Public Subscription Identifier) used both inside and outside of the 3GPP system to address a 3GPP subscription.
	Internal Group ID-list	List of the subscribed internal group(s) that the UE belongs to.
	Subscribed-UE-AMBR	The Maximum Aggregated uplink and downlink MBRs to be shared across all Non-GBR QoS Flows according to the subscription of the user.
	Subscribed S-NSSAIs	The Network Slices that the UE subscribes to. In the roaming case, it indicates the subscribed Network Slices applicable to the Serving PLMN.
	Default S-NSSAIs	The Subscribed S-NSSAIs marked as default S-NSSAI. In the roaming case, only those applicable to the Serving PLMN.
	UE Usage Type	As defined in TS 23.501 [2], clause 5.15.7.2.
	RAT restriction	3GPP Radio Access Technology(ies) not allowed the UE to access.
	Forbidden area	Defines areas in which the UE is not permitted to initiate any communication with the network.
	Service Area Restriction	Indicates Allowed areas in which the UE is permitted to initiate communication with the network, and Non-allowed areas in which the UE and the network are not allowed to initiate Service Request or SM signalling to obtain user services.
	Core Network type restriction	Defines whether UE is allowed to connect to 5GC and/or EPC for this PLMN.
	RFSP Index	An index to specific RRM configuration in the NG-RAN.
	Subscribed Periodic Registration Timer	Indicates a subscribed Periodic Registration Timer value.
	MPS priority	Indicates the user is subscribed to MPS as indicated in TS 23.501 [2], clause 5.16.5.
	MCX priority	Indicates the user is subscribed to MCX as indicated in TS 23.501 [2], clause 5.16.6.
	UE behavioural information / Communication patterns	Information on expected UE movement and communication characteristics. See clause 4.15.6.2
	Steering of Roaming	List of preferred PLMN/access technology combinations or HPLMN indication that no change of the "Operator Controlled PLMN Selector with Access Technology" list stored in the UE is needed (see NOTE 3). Optionally includes an indication that the UDM requests an acknowledgement of the reception of this information from the UE.
	Network Slicing Subscription Change Indicator	When present, indicates to the serving AMF that the subscription data for network slicing changed and the UE configuration must be updated.
	Tracing Requirements	Trace requirements about a UE (e.g. trace reference, address of the Trace Collection Entity, etc.) is defined in TS 32.421 [39]. This information is only sent to AMF in the HPLMN or one of its equivalent PLMN(s).
	Inclusion of NSSAI in RRC Connection Establishment Allowed	When present, it is used to indicate that the UE is allowed to include NSSAI in the RRC connection Establishment in clear text for 3GPP access.
	Subscribed DNN list	List of the subscribed DNNs for the UE (NOTE 1). Used to determine the list of LADN available to the UE as defined in clause 5.6.5 of TS 23.501 [2].

	UDM Update Data	Includes a set of parameters (e.g. updated Default Configured NSSAI and/or updated Routing Indicator) to be delivered from UDM to the UE via NAS signalling as defined in clause 4.20 (NOTE 3).  Optionally includes an indication that the UDM requests an acknowledgement of the reception of this information from the UE and an indication for the UE to re-register.
Slice Selection Subscription data (data needed for Slice Selection as described in clause 4.2.2.2.3 and in clause 4.11.0a.5)	Subscribed S-NSSAIs	The Network Slices that the UE subscribes to. In roaming case, it indicates the subscribed network slices applicable to the serving PLMN.
UE context in AMF data	AMF	Allocated AMF for the registered UE. Include AMF address and AMF NF Id.
	Access Type	3GPP or non-3GPP access through this AMF
	Homogenous Support of IMS Voice over PS Sessions for AMF	Indicates per UE and AMF if "IMS Voice over PS Sessions" is homogeneously supported in all TAs in the serving AMF or homogeneously not supported, or, support is non-homogeneous/unknown, see clause 5.16.3.3 of TS 23.501 [2].
SMF Selection Subscription data (data needed for SMF Selection as described in clause 6.3.2 of TS 23.501 [2])	SUPI	Key
	<b>SMF Selection Subscription data contains one or more S-NSSAI level subscription data:</b>	
	S-NSSAI	Indicates the value of the S-NSSAI.
	Subscribed DNN list	List of the subscribed DNNs for the UE (NOTE 1).
	Default DNN	The default DNN if the UE does not provide a DNN (NOTE 2).
	LBO Roaming Information	Indicates whether LBO roaming is allowed per DNN, or per (S-NSSAI, subscribed DNN)
	Interworking with EPS indication list	Indicates for which DNN from the Subscribed DNN list interworking is supported.
UE context in SMF data	SUPI	Key
	PDU Session Id(s)	List of PDU Session Id(s) for the UE
	<b>For emergency PDU Session Id:</b>	
	Emergency Information	The PGW-C+SMF FQDN for emergency session used for interworking with EPC.
	<b>For each non-emergency PDU Session Id:</b>	
	DNN	DNN for the PDU Session.
	SMF	Allocated SMF for the PDU Session. Includes SMF IP Address and SMF NF Id.
	PGW-C+SMF FQDN	The S5/S8 PGW-C+SMF FQDN used for interworking with EPS (see NOTE 4).
SMS Management Subscription data (data needed by SMSF for SMSF Registration)	SMS parameters	Indicates SMS parameters subscribed for SMS service such as SMS teleservice, SMS barring list
	Trace Requirements	Trace requirements about a UE (e.g. trace reference, address of the Trace Collection Entity, etc.) is defined in TS 32.421 [39]. This information is only sent to a SMSF in HPLMN.
SMS Subscription data (data needed in AMF)	SMS Subscription	Indicates subscription to any SMS delivery service over NAS irrespective of access type.
UE Context in SMSF data	SMSF Information	Indicates SMSF allocated for the UE, including SMSF address and SMSF NF ID.
	Access Type	3GPP or non-3GPP access through this SMSF
Session Management Subscription data (data needed for PDU)	GPSI List	List of the GPSI (Generic Public Subscription Identifier) used both inside and outside of the 3GPP system to address a 3GPP subscription.

Session Establishment)	Internal Group ID-list	List of the subscribed internal group(s) that the UE belongs to.
	Trace Requirements	Trace requirements about a UE (e.g. trace reference, address of the Trace Collection Entity, etc...) is defined in TS 32.421 [39]. This information is only sent to a SMF in the HPLMN or one of its equivalent PLMN(s).
	<b>Session Management Subscription data contains one or more S-NSSAI level subscription data:</b>	
	S-NSSAI	Indicates the value of the S-NSSAI.
	Subscribed DNN list	List of the subscribed DNNs for the S-NSSAI (NOTE 1).
	<b>For each DNN in S-NSSAI level subscription data:</b>	
	DNN	DNN for the PDU Session.
	UE Address	Indicates the subscribed static IP address(es) for the IPv4 or IPv6 or IPv4v6 type PDU Sessions accessing the DNN, S-NSSAI.
	Allowed PDU Session Types	Indicates the allowed PDU Session Types (IPv4, IPv6, IPv4v6, Ethernet, and Unstructured) for the DNN, S-NSSAI.
	Default PDU Session Type	Indicates the default PDU Session Type for the DNN, S-NSSAI.
	Allowed SSC modes	Indicates the allowed SSC modes for the DNN, S-NSSAI.
	Default SSC mode	Indicate the default SSC mode for the DNN, S-NSSAI.
	Interworking with EPS indication	Indicates whether interworking with EPS is supported for this DNN and S-NSSAI.
	5GS Subscribed QoS profile	The QoS Flow level QoS parameter values (5QI and ARP) for the DNN, S-NSSAI (see clause 5.7.2.7 of TS 23.501 [2]).
	Charging Characteristics	This information is defined in TS 32.240 [34]; it may e.g. contain information on how to contact the Charging Function. This information, when provided shall override any corresponding predefined information at the SMF
	Subscribed-Session-AMBR	The maximum aggregated uplink and downlink MBRs to be shared across all Non-GBR QoS Flows in each PDU Session, which are established for the DNN, S-NSSAI.
Static IP address/prefix	Indicate the static IP address/prefix for the DNN, S-NSSAI.	
User Plane Security Policy	Indicates the security policy for integrity protection and encryption for the user plane.	
Identifier translation	SUPI	Corresponding SUPI for input GPSI
	(Optional) MSISDN	Corresponding GPSI (MSISDN) for input GPSI (External Identifier). This is optionally provided for legacy SMS infrastructure not supporting MSISDN-less SMS. The presence of an MSISDN should be interpreted as an indication to the NEF that MSISDN shall be used to identify the UE when sending the SMS to the SMS-SC via T4.
Intersystem continuity Context	(DNN, PGW FQDN) list	For each DNN, indicates the PGW-C+SMF which support interworking with EPC.
NOTE 1: The Subscribed DNN list can include a wildcard DNN.		
NOTE 2: The default DNN shall not be a wildcard DNN.		
NOTE 3: The Steering of Roaming information and UDM Update Data are protected using the mechanisms defined in TS 33.501 [15].		
NOTE 4: Depending on the scenario PGW-C FQDN may be for S5/S8, or for S2b (ePDG case).		

**Table 5.2.3.3.1-2: Group Subscription data types**

Subscription data type	Field	Description
Group Identifier translation	External Group Identifier	Identifies external group of UEs that the UE belongs to as defined in TS 23.682 [23]
	(Optional) Internal Group Identifier	Identifies internal group of UEs that the UE belongs to as defined in TS 23.501 [2]
	SUPI list	Corresponding SUPI list for input External Group Identifier

At least a mandatory key is required for each Subscription Data Type to identify the corresponding data. Depending on the use case, for some Subscription Data Types it is possible to use one or multiple sub keys to further identify the corresponding data, as defined in Tables 5.2.3.3.1-3 and 5.2.3.3.1-4 below.

**Table 5.2.3.3.1-3: UE Subscription data types keys**

Subscription Data Types	Data Key	Data Sub Key
Access and Mobility Subscription data	SUPI	-
SMF Selection Subscription data	SUPI	-
UE context in SMF data	SUPI	S-NSSAI
SMS Management Subscription data	SUPI	-
SMS Subscription data	SUPI	
UE Context in SMSF data	SUPI	
Session Management Subscription data	SUPI	S-NSSAI
		DNN
Identifier translation	GPSI	-
Slice Selection Subscription data	SUPI	-
Intersystem continuity Context	SUPI	DNN

**Table 5.2.3.3.1-4: Group Subscription data types keys**

Subscription Data Types	Data Key	Data Sub Key
Group Identifier translation	External Group Identifier	

#### 5.2.3.3.2 Nudm\_SDM\_Get service operation

**Service Operation name:** Nudm\_SDM\_Get

**Description:** Consumer NF gets the subscriber data indicated by the subscription data type input from UDM. The UDM shall check the requested consumer is authorized to get the specific subscription data requested. In case of NF consumer is SMF, the subscriber data may contain e.g. Allowed PDU Session Type(s), Allowed SSC mode(s), default 5QI/ARP, Subscribed S-NSSAI(s).

**Inputs, Required:** NF ID, Subscription data type(s), Key for each Subscription data type(s).

**Inputs, Optional:** Data Sub Key(s).

**Outputs, Required:** The consumer NF gets the requested subscription data.

**Outputs, Optional:** None.

#### 5.2.3.3.3 Nudm\_SDM\_Notification service operation

**Service or service operation name:** Nudm\_SDM\_Notification

**Description:** The UDM notifies NF consumer of the updates of UE's Subscriber Data indicated by the "subscription data Type" input, and additional UE's UDM-related parameters.

**Inputs, Required:** Subscription data type(s), Key for each Subscription data type(s).

**Inputs, Optional:** None.

**Outputs, Required:** Result Indication.

The UDM invokes this service operation under the following cases:

- When the subscriber data is updated at the UDM, the updated subscription information is notified to the serving NF that has subscribed for the specific subscription data type to be notified.
- When the UDM needs to deliver Steering of Roaming information to a UE.
- When the UDM needs to deliver UDM Update Data to a UE (e.g. a new Routing Indicator or Default Configured NSSAI to the UE).

In case updates subscription information is related to session management the subscriber data may contain e.g. Allowed PDU Session Type(s), Allowed SSC mode(s), default 5QI/ARP.

**Outputs, Optional:** Redirection information.

If the NF consumer is AMF, and if the result of the service operation fails, AMF shall set corresponding cause value in result indication which can be used by the UDM for further action. In case the related UE is not served by the AMF and the AMF knows which AMF is serving the UE, the AMF provides redirection information which can be used by the UDM to resend UE related message to the AMF that serves the UE.

#### 5.2.3.3.4 Nudm\_SDM\_Subscribe service operation

**Service operation name:** Nudm\_SDM\_Subscribe

**Description:** The NF consumer subscribes for updates to UE's Subscriber Data indicated by the 'subscription data type' input. The UDM shall check the requested consumer is authorized to subscribe to requested updates.

**Inputs, Required:** Subscription data type(s), Key for each Subscription data type(s).

**Inputs, Optional:** Data Sub Key(s).

**Outputs, Required:** None.

**Outputs, Optional:** None.

#### 5.2.3.3.5 Nudm\_SDM\_Unsubscribe service operation

**Service operation name:** Nudm\_SDM\_Unsubscribe

**Description:** The NF consumer unsubscribes from updates to UE's Subscriber Data indicated by the 'subscription data type' input.

**Inputs, Required:** Subscription data type(s), Key for each Subscription data type(s).

**Inputs, Optional:** If the NF type is SMF: DNN, S-NSSAI.

**Outputs, Required:** None.

**Outputs, Optional:** None.

#### 5.2.3.3.6 Nudm\_SDM\_Info service operation

**Service Operation name:** Nudm\_SDM\_Info

**Description:** Consumer NF provides UDM with information about the status of the subscription data management procedures. This service operation is used for:

- providing acknowledgement from the UE to UDM about successful delivery of Steering of Roaming information via the AMF as defined in TS 23.122 [22].
- providing acknowledgement from the UE to UDM about successful Network Slicing Configuration subsequent to delivery of the Network Slicing Subscription Change Indication via the AMF.

- providing acknowledgement from the UE to UDM about successful delivery of UDM Update Data via the AMF as defined in clause 4.20.

**Inputs, Required:** SUPI, Info (e.g. UE acknowledgment of SoR information from UDM via AMF, UE acknowledgment of successful Network Slicing Configuration subsequent to delivery of the Network Slicing Subscription Change Indication via the AMF).

**Inputs, Optional:** None.

**Outputs, Required:** None.

**Outputs, Optional:** None.

#### 5.2.3.4 Nudm\_UEAuthentication Service

##### 5.2.3.4.1 General

This service is used by the requester NF to get authentication data and provide UDM with the result of the authentication procedure success.

##### 5.2.3.4.2 Nudm\_UEAuthentication\_Get service operation

See TS 33.501 [15].

##### 5.2.3.4.3 Nudm\_UEAuthentication\_ResultConfirmation service operation

See TS 33.501 [15].

#### 5.2.3.5 Nudm\_EventExposure service

##### 5.2.3.5.1 General

See clause 4.15.3.1.

##### 5.2.3.5.2 Nudm\_EventExposure\_Subscribe service operation

**Service operation name:** Nudm\_EventExposure\_Subscribe

**Description:** The NF consumer subscribes to receive an event, or if the subscription is already defined in UDM, then the subscription is updated.

**NF Consumers:** NEF.

**Inputs (required):** target of the subscription: UE(s) ID (SUPI or GPSI, Internal Group Identifier or External Group Identifier, or indication that any UE is targeted), Event filter containing the Event Id(s) (see clause 4.15.3.1) and Event Reporting Information defined in Table 4.15.1-1.

**Inputs (optional):** Expiry time.

**Outputs (required):** Operation execution result indication. When the subscription is accepted: Subscription Correlation ID, Expiry time (required if the subscription can be expired based on the operator's policy).

**Outputs (optional):** First corresponding event report is included, if corresponding information is available (see clause 4.15.1), Number of UE if the External Group Identifier and Maximum Number of Reports are included in the inputs.

Number of UEs indicates the number of UEs within the group identified by the External Group Identifier. The NEF uses this value to determine whether the monitoring event has been reported for all group member UEs.

##### 5.2.3.5.3 Nudm\_EventExposure\_Unsubscribe service operation

**Service operation name:** Nudm\_EventExposure\_Unsubscribe

**Description:** the consumer deletes the subscription of an event if already defined in UDM.

**Inputs (required):** Subscription Correlation ID.

**Outputs (required):** Operation execution result indication.

#### 5.2.3.5.4 Nudm\_EventExposure\_Notify service operation

**Service operation name:** Nudm\_EventExposure\_Notify

**Description:** UDM reports the event to the consumer that has previously subscribed.

**Inputs (required):** Event ID, Notification Correlation Information, time stamp.

**Inputs (optional):** Event specific parameters list.

**Outputs (required):** None.

#### 5.2.3.6 Nudm\_ParameterProvision service

##### 5.2.3.6.1 General

This service is for allowing NEF to provision of information which can be used for the UE in 5GS.

##### 5.2.3.6.2 Nudm\_ParameterProvision\_Update service operation

**Service operation name:** Nudm\_ParameterProvision\_Update.

**Description:** the consumer updates the UE related information (e.g., Expected UE Behaviour).

**Inputs (required):** GPSI, AF ID, Transaction Reference ID(s).

**Inputs (optional):** Any combination of the Expected UE Behaviour parameters.

**Outputs (required):** Transaction Reference ID(s), Operation execution result indication.

**Outputs (optional):** Transaction specific parameters, if available.

### 5.2.4 5G-EIR Services

#### 5.2.4.1 General

The following table illustrates the 5G-EIR Service.

**Table 5.2.4-1: NF services provided by 5G-EIR**

NF service	Service Operations	Operation Semantics	Example Consumer(s)
N5g-eir_Equipment Identity Check	Get	Request/Response	AMF

#### 5.2.4.2 N5g-eir\_EquipmentIdentityCheck service

##### 5.2.4.2.1 General

**Service Description:** This service is provided by the 5G-EIR to check the PEI and check whether the PEI is in the black list or not. The service can be consumed by AMF. The service operations provided within this service are depicted as below.

### 5.2.4.2.2 N5g-eir\_EquipmentIdentityCheck\_Get service operation

**Service operation name:** N5g-eir\_EquipmentIdentityCheck\_Get

**Description:** Check the PEI and determine whether the subscriber is allowed to use the equipment.

**Inputs, Required:** PEI, SUPI.

**Inputs, Optional:** none

**Outputs, Required:** PEI checking result

**Outputs, Optional:** none

## 5.2.5 PCF Services

### 5.2.5.1 General

The following table illustrates the PCF Services.

**Table 5.2.5.1-1: NF services provided by PCF**

Service Name	Service Operations	Operation Semantics	Example Consumer (s)
Npcf_AMPolicyControl	Create	Request/Response	AMF
	Update	Request/Response	AMF
	UpdateNotify	Subscribe/Notify	AMF
	Delete	Request/Response	AMF
Npcf_Policy Authorization	Create	Request/Response	AF, NEF
	Update	Request/Response	AF, NEF
	Delete	Request/Response	AF, NEF
	Notify	Subscribe/Notify	AF, NEF
	Subscribe		AF, NEF
Unsubscribe		AF, NEF	
Npcf_SMPolicyControl	Create	Request/Response	SMF
	UpdateNotify	Subscribe/Notify	SMF
	Update	Request/Response	SMF
	Delete	Request/Response	SMF
Npcf_BDTPolicyControl	Create	Request/Response	NEF
	Update	Request/Response	NEF
Npcf_UEPolicyControl	Create	Request/Response	AMF, V-PCF
	Update	Request/Response	AMF, V-PCF
	UpdateNotify	Subscribe/Notify	AMF, V-PCF
	Delete	Request/Response	AMF, V-PCF
Npcf_EventExposure	Subscribe	Subscribe/Notify	NEF
	Unsubscribe		
	Notify		

### 5.2.5.2 Npcf\_AMPolicyControl service

#### 5.2.5.2.1 General

**Service description:** NF Service Consumer, e.g. AMF, can create and manage a AM Policy Association in the PCF through which the NF Service Consumer receives AM policy control information for a UE identified by a SUPI.

As part of this service, the PCF may provide the NF Service Consumer, e.g. AMF, with AM policy information for a SUPI that may contain:

- Access and mobility related policy information as defined in clause 6.5 of TS 23.503 [20]. In the case of roaming, this information is provided by V-PCF;



- Policy Control Request Trigger of AM Policy Association. When such a Policy Control Request Trigger condition is met the NF Service Consumer, e.g. shall contact PCF and provide information on the Policy Request Trigger condition that has been met. In the case of roaming, the V-PCF may subscribe to AMF.

At Npcf\_AMPolicyControl\_Create, the NF Service Consumer, e.g. AMF requests the creation of a corresponding "AM Policy Association" with the PCF (Npcf\_AMPolicyControl\_Create) and provides relevant parameters about the UE context to the PCF. When the PCF has created the AM Policy Association, the PCF may provide policy information as defined above.

When a Policy Control Request Trigger condition is met the NF Service Consumer, e.g. AMF requests the update (Npcf\_AMPolicyControl\_Update) of the AM Policy Association by providing information on the condition(s) that have been met. The PCF may provide updated policy information to the NF Service Consumer.

The PCF may at any time provide updated policy information (Npcf\_AMPolicyControl\_UpdateNotify);

At UE deregistration the NF Service Consumer, e.g. AMF requests the deletion of the corresponding AM Policy Association.

#### 5.2.5.2.2 Npcf\_AMPolicyControl\_Create service operation

**Service operation name:** Npcf\_AMPolicyControl\_Create

**Description:** NF Service Consumer can request the creation of a AM Policy Association and by providing relevant parameters about the UE context to the PCF.

**Inputs, Required:** SUPI.

**Inputs, Optional:** Information provided by the AMF as define in 6.2.1.2 of TS 23.503 [20], such as Access Type, Permanent Equipment Identifier, GPSI, User Location Information, UE Time Zone, Serving Network, RAT type, List of subscribed Service Area Restrictions, subscribed RFSP Index, the Allowed NSSAI, GUAMI, backup AMF(s) (if NF Type is AMF). Backup AMF(s) sent only once by the AMF to the PCF in its first interaction with the PCF.

**Outputs, Required:** AM Policy Association ID.

**Outputs, Optional:** The requested Access and mobility related policy information as defined in Clause 6.5 of TS 23.503 [20], and Policy Control Request Trigger of AM Policy Association.

See clause 4.2.2.2.2 (step 16) for the detail usage of this service operation for AMF. In step 16, the AMF requests the PCF to apply operator policies for the UE.

See clause 4.16.1.2 (steps 2 and 3) for the detail usage of this service operation for AMF. In step 2, the AMF requests the PCF to apply operator policies for the UE; in step 3, the PCF acknowledges AMF with requested policy.

See clause 4.16.1.3 (steps 3 and 4) for the detail usage of this service operation for AMF. In step 3, the AMF requests the PCF to apply operator policies for the UE; in step 4, the PCF acknowledges AMF with requested policy.

#### 5.2.5.2.3 Npcf\_AMPolicyControl\_UpdateNotify service operation

**Service operation name:** Npcf\_AMPolicyControl\_UpdateNotify

**Description:** Provides to the NF Service Consumer, e.g. AMF, updated AM related Policy information for the AM Policy Association as defined in clause 6.5 of TS 23.503 [20].

NOTE: This notification corresponds to an implicit subscription.

**Inputs, Required:** AM Policy Association ID.

**Inputs, Optional:** Access and Mobility related information or indication of AM Policy Association termination.

**Outputs, Required:** Success or failure.

**Outputs, Optional:** None.

See clause 4.16.2.2 for the usage of this service operation.

#### 5.2.5.2.4 Npcf\_AMPolicyControl\_Delete service operation

**Service operation name:** Npcf\_AMPolicyControl\_Delete

**Description:** Provides means for the NF Consumer to delete the AM Policy Association..

**Inputs, Required:** AM Policy Association ID.

**Inputs, Optional:** None.

**Outputs, Required:** Success or Failure.

**Outputs, Optional:** None.

See clause 4.16.3.2 (step 2 and 3) for the detail usage of this service operation for AMF. In step 2, the AMF initiates the AM Policy Association Termination procedure; in step 3 the PCF deletes the AM Policy Association for this AM Policy Association ID.

#### 5.2.5.2.5 Npcf\_AMPolicyControl\_Update service operation

**Service operation name:** Npcf\_AMPolicyControl\_Update.

**Description:** NF Service Consumer, e.g. AMF can request the update of the AM Policy Association to receive updated Policy information for the UE context when the policy control request trigger is met or the AMF is relocated due to the UE mobility and the old PCF is selected.

**Inputs, Required:** AM Policy Association ID.

**Inputs, Optional:** Information on the Policy Control Request Trigger condition that has been met as defined in clause 6.1.2.5 of TS 23.503 [20], GUAMI(s) (if NF Type is AMF).

**Outputs, Required:** Success or not.

**Outputs, Optional:** Policy information for the UE context as defined in clause 5.2.5.2.1.

See clause 4.16.2.1 for the usage of this service operation.

#### 5.2.5.3 Npcf\_PolicyAuthorization Service

##### 5.2.5.3.1 General

**Service description:** This service is to authorise an AF request and to create policies as requested by the authorized AF for the PDU Session to which the AF session is bound. This service allows the NF consumer to subscribe/unsubscribe the notification of events, which are defined in clause 6.1.3.18 of TS 23.503 [20].

##### 5.2.5.3.2 Npcf\_PolicyAuthorization\_Create service operation

**Service operation name:** Npcf\_PolicyAuthorization\_Create

**Description:** Authorize the request, and optionally determines and installs the policy according to the information provided by the NF Consumer.

**Inputs, Required:** UE (IP or MAC) address, identification of the application session context.

**Inputs, Optional:** UE identity if available, DNN if available, S-NSSAI if available, Media type, Media format, bandwidth requirements, sponsored data connectivity if applicable, flow description, Application identifier or traffic filtering information, AF Communication Service Identifier, AF Record Identifier, Flow status, Priority indicator, emergency indicator, Application service provider, resource allocation outcome, AF Application Event Identifier, a list of DNAI(s) and corresponding routing profile ID(s) or N6 traffic routing information, AF Transaction Id, Early and/or late notifications about UP path management events, temporal validity condition and spatial validity condition as described in clause 5.6.7 in 23.501 [2], Background Data Transfer Reference ID.

**Outputs, Required:** Success or Failure.

**Outputs, Optional:** The service information that can be accepted by the PCF.

Authorizes the request from the application, and optionally communicates with Npcf\_SMPolicyControl service to determine and install the policy according to the information provided by the NF Consumer. Creates an application context in the PCF.

#### 5.2.5.3.3 Npcf\_PolicyAuthorization\_Update service operation

**Service operation name:** Npcf\_PolicyAuthorization\_Update

**Description:** Provides updated information to the PCF.

**Inputs, Required:** Identification of the application session context.

**Inputs, Optional:** Media type, Media format, bandwidth requirements, sponsored data connectivity if applicable, flow description, Application identifier or traffic filtering information, AF Communication Service Identifier, AF Record Identifier, Flow status, Priority indicator, Application service provider, resource allocation outcome, AF Application Event Identifier, a list of DNAI(s) and corresponding routing profile ID(s) or N6 traffic routing information, AF Transaction Id, Early and/or late notifications about UP path management events, temporal validity condition and spatial validity condition as described in clause 5.6.7 in 23.501 [2], Background Data Transfer Reference ID.

**Outputs, Required:** Success or Failure.

**Outputs, Optional:** The service information that can be accepted by the PCF.

Provides updated application level information and communicates with Npcf\_SMPolicyControl service to determine and install the policy according to the information provided by the NF Consumer. Updates an application context in the PCF.

#### 5.2.5.3.4 Npcf\_PolicyAuthorization\_Delete service operation

**Service operation name:** Npcf\_PolicyAuthorization\_Delete

**Description:** Provides means for the NF Consumer to delete the context of application level session information.

**Inputs, Required:** Identification of the application session context.

**Inputs, Optional:** None.

**Outputs, Required:** None.

**Outputs, Optional:** None.

#### 5.2.5.3.5 Npcf\_PolicyAuthorization\_Notify service operation

**Service operation name:** Npcf\_PolicyAuthorization\_Notify

**Description:** provided by the PCF to notify NF consumers of the subscribed events.

**Inputs, Required:** Event ID, Notification Correlation Information (information to identify the application session).

The events that can be subscribed are defined in clause 6.1.3.18 of TS 23.503 [20].

**Inputs, Optional:** Event information (defined on a per Event ID basis).

**Outputs, Required:** Operation execution result indication.

**Outputs, Optional:** None

#### 5.2.5.3.6 Npcf\_PolicyAuthorization\_Subscribe service operation

**Service operation name:** Npcf\_PolicyAuthorization\_Subscribe

**Description:** provided by the PCF for NF consumers to explicitly subscribe the notification of events.

**Inputs, Required:** (Set of) Event ID(s) as specified in Npcf\_PolicyAuthorization\_Notify service operation, target of PCF event reporting (defined below), NF ID, Event Reporting Information defined in Table 4.15.1-1 except for the Maximum number of reports and Maximum duration of reporting, Notification Target Address (+ Notification Correlation ID).

The target of PCF event reporting the subscription for an individual AF session: An UE IP address (IPv4 address or IPv6 prefix) optionally together with a (DNN, S-NSSAI) or with a UE ID (SUPI or GPSI).

**Inputs, Optional:** Event Filter, Subscription Correlation ID (in case of modification of the event subscription).

**Outputs, Required:** When the subscription is accepted: Subscription Correlation ID.

**Outputs, Optional:** None.

#### 5.2.5.3.7 Npcf\_PolicyAuthorization\_Unsubscribe service operation

**Service operation name:** Npcf\_PolicyAuthorization\_Unsubscribe

**Description:** Enable NF consumers to explicitly unsubscribe the notification of PCF events related to Npcf\_PolicyAuthorization\_Subscribe operation.

**Inputs, Required:** Subscription Correlation.

**Inputs, Optional:** None.

**Outputs, Required:** Success or Failure.

**Outputs, Optional:** None.

#### 5.2.5.4 Npcf\_SMPolicyControl service

##### 5.2.5.4.1 General

**Service description:** NF Service Consumer, e.g. SMF can create and manage a SM Policy Association in the PCF through which the NF Service Consumer receives policy information for a PDU Session.

As part of this service, the PCF may provide the NF Service Consumer, e.g. SMF with policy information about the PDU Session that may contain:

- PDU Session related policy information as defined in clause 6.4 of TS 23.503 [20].
- PCC rule information as defined in clause 6.3 of TS 23.503 [20].
- Policy Control Request Trigger information i.e. a set of Policy Request Trigger(s) as defined in clause 6.1.3.5 of TS 23.503 [20]. When a Policy Control Request Trigger condition is met the NF Service Consumer, e.g. SMF shall contact the PCF and provide information on the Policy Control Request Trigger condition that has been met.

At PDU Session establishment the NF Service Consumer, e.g. SMF requests the creation of a corresponding SM Policy Association with the PCF (Npcf\_SMPolicyControl\_Create) and provides relevant parameters about the PDU Session to the PCF.

- When the PCF has created the "SM Policy Association, the PCF may provide policy information as defined above.

When a Policy Control Request Trigger condition is met the NF Service Consumer, e.g. SMF requests the update(Npcf\_SMPolicyControl\_Update) of the SM Policy Association by providing information on the condition(s) that have been met. The PCF may provide updated policy information to the NF Service Consumer.

The PCF may at any time provide updated policy information (Npcf\_SMPolicyControl\_UpdateNotify).

At PDU Session release the NF Service Consumer, e.g. SMF requests the deletion of the corresponding SM Policy Association.

#### 5.2.5.4.2 Npcf\_SMPolicyControl\_Create service operation

**Service operation name:** Npcf\_SMPolicyControl\_Create.

**Description:** The NF Service Consumer can request the creation of a SM Policy Association and provide relevant parameters about the PDU Session to the PCF.

**Inputs, Required:** SUPI (or PEI in case of emergency PDU Session without SUPI), PDU Session id, DNN and S-NSSAI.

**Inputs, Optional:** Information provided by the SMF as defined in clause 6.2.1.2 of TS 23.503 [20], such as Access Type, the IPv4 address and/or IPv6 prefix, PEI, GPSI, User Location Information, UE Time Zone, Serving Network, RAT type, Charging Characteristics information, Session AMBR, subscribed default QoS information, Trace Requirements and Internal Group Identifier (see TS 23.501 [2], clause 5.9.7), NSI ID, DN Authorization Profile Index.

NOTE: If SMF receives the DN authorized Session AMBR from the DN-AAA at PDU session establishment, it includes the DN authorized Session AMBR within the Session-AMBR, instead of the subscribed Session AMBR received from the UDM, in the request.

**Outputs, Required:** SM Policy Association ID defined in TS 29.512 [48].

**Outputs, Optional:** Policy information for the PDU Session as defined in clause 5.2.5.4.1.

See clause 4.16.4 for the detail usage of this service operation.

#### 5.2.5.4.3 Npcf\_SMPolicyControl\_UpdateNotify service operation

**Service operation name:** Npcf\_SMPolicyControl\_UpdateNotify

**Description:** Provides to the NF Service Consumer, e.g. SMF updated Policy information for the PDU Session evaluated based on the information previously provided by the SMF, AF, CHF, UDR and NWDAF, as defined in clause 6.2.1.2 of TS 23.503 [20],

**Inputs, Required:** SM Policy Association ID.

**Inputs, Optional:** Policy information for the PDU Session as defined in clause 5.2.5.4.1.

**Outputs, Required:** Success or Failure.

**Outputs, Optional:** None.

See clause 4.16.5.2 for the usage of this service operation.

#### 5.2.5.4.4 Npcf\_SMPolicyControl\_Delete service operation

**Service operation name:** Npcf\_SMPolicyControl\_Delete

**Description:** The NF Service Consumer can request the deletion of the SM Policy Association and of the associated resources.

**Inputs, Required:** SM Policy Association ID.

**Inputs, Optional:** None.

**Outputs, Required:** Success or Failure.

**Outputs, Optional:** None.

See clause 4.16.6 for the usage of this service operation.

#### 5.2.5.4.5 Npcf\_SMPolicyControl\_Update service operation

**Service operation name:** Npcf\_SMPolicyControl\_Update.

**Description:** The NF Service Consumer can request the update of the SM Policy Association to receive updated Policy information for the PDU Session.

**Inputs, Required:** SM Policy Association ID.

**Inputs, Optional:** Information on the Policy Control Request Trigger condition, as defined in clause 6.1.3.5 of TS 23.503 [20], that has been met such as Access Type, (new or removed) IPv4 address and/or IPv6 network prefix, User Location Information, UE Time Zone, Serving Network, RAT type, Session AMBR, or subscribed default QoS information, DN Authorization Profile Index.

**Outputs, Required:** Success or not.

**Outputs, Optional:** Policy information for the PDU Session as defined in clause 5.2.5.4.1.

See clause 4.16.5.1 for the usage of this service operation.

NOTE: When this service operation is invoked by SMF, race conditions apply, which are defined in TS 29.513 [47].

## 5.2.5.5 Npcf\_BDTPolicyControl Service

### 5.2.5.5.1 General

**Service description:** This service provides background data transfer policy, which includes the following functionalities:

- Get background data transfer policies based on the request via NEF from AF; and
- Update background data transfer based on the selection provided by AF.

#### 5.2.5.5.2 Npcf\_BDTPolicyControl\_Create service operation

**Service operation name:** Npcf\_BDTPolicyControl\_Create

**Description:** This service is to create the background data transfer policy.

**Inputs, Required:** ASP identifier, Volume per UE, Number of UEs, Desired time windows.

**Inputs, Optional:** Network Area Information.

**Outputs, Required:** one or more background data transfer policies, Background Data Transfer Reference ID.

**Outputs, Optional:** None.

#### 5.2.5.5.3 Npcf\_BDTPolicyControl\_Update service operation

**Service operation name:** Npcf\_BDTPolicyControl\_Update

**Description:** This service is to update the background data transfer policy to the PCF.

**Inputs, Required:** ASP identifier, background data transfer policy, Background Data Transfer Reference ID.

**Inputs, Optional:** None

**Outputs, Required:** None

**Outputs, Optional:** None.

## 5.2.5.6 Npcf\_UEPolicyControl Service

### 5.2.5.6.1 General

**Service description:** NF Service Consumer, e.g. AMF, may create and manage a UE Policy Association in the PCF through which the NF Service Consumer receives Policy Control Request Trigger of UE Policy Association.

The association allows (V-)PCF to provide UE access selection and PDU Session selection related policy information to the UE transparently through the NF Service Consumer using NAS TRANSPORT message to carry:

- UE access selection and PDU Session selection related policy information as defined in clause 6.6 of TS 23.503 [20]. In the case of roaming, the URSP rules are provided by H-PCF and the ANDSP rules may be provided by V-PCF or H-PCF or both;

As part of this service, the PCF may provide the NF Service Consumer, e.g. AMF, with policy information about the UE that may contain:

- Policy Control Request Trigger of UE Policy Association. When such a Policy Control Request Trigger condition is met, the NF Service Consumer, e.g. AMF, shall contact PCF and provide information on the Policy Request Trigger condition that has been met. In the case of roaming, the V-PCF may subscribe to AMF or the H-PCF may subscribe to AMF via V-PCF.

At Npcf\_UEPolicyControl\_Create, the NF Service Consumer, e.g. AMF, requests the creation of a corresponding "UE Policy Association" with the PCF (Npcf\_UEPolicyControl\_Create) and provides relevant parameters about the UE context to the PCF. When the PCF has created the UE Policy Association, the PCF may provide policy information as defined above.

When a Policy Control Request Trigger condition is met, the NF Service Consumer, e.g. AMF, requests the update (Npcf\_UEPolicyControl\_Update) of the UE Policy Association by providing information on the condition(s) that have been met. The PCF may provide updated policy information to the NF Service Consumer.

During the AMF relocation, if the target AMF receives the PCF ID from source AMF and the target AMF decides to contact with the PCF identified by the PCF ID based on the local policies, the target AMF requests the update (Npcf\_UEPolicyControl\_Update) of the UE Policy Association. If a Policy Control Request Trigger condition is met, the information matching the trigger condition may also be provided by the target AMF. The PCF may provide updated policy information to the target AMF.

The PCF may at any time provide updated policy information (Npcf\_UEPolicyControl\_UpdateNotify).

At UE deregistration the NF Service Consumer, e.g. AMF, requests the deletion of the corresponding UE Policy Association.

#### 5.2.5.6.2 Npcf\_UEPolicyControl\_Create service operation

**Service operation name:** Npcf\_UEPolicyControl\_Create

**Description:** NF Service Consumer can request the creation of a UE Policy Association by providing relevant parameters about the UE context to the PCF.

**Inputs, Required:** Notification endpoint, SUPI.

**Inputs, Optional:** H-PCF ID (if the NF service producer is V-PCF and AMF is NF service consumer), information provided by the AMF as defined in 6.2.1.2 of TS 23.503 [20], such as Access Type, Permanent Equipment Identifier, GPSI, User Location Information, UE Time Zone, Serving Network, RAT type, UE access selection and PDU session selection policy information including the list of PSIs, OS id and Internal Group (see TS 23.501 [2])

**Outputs, Required:** UE Policy Association ID, Success or Failure.

**Outputs, Optional:** Policy Control Request Trigger of UE Policy Association. In the case of H-PCF is producer, UE access selection and PDU Session selection related policy information (see clause 5.2.5.6.1).

#### 5.2.5.6.3 Npcf\_UEPolicyControl\_UpdateNotify service operation

**Service operation name:** Npcf\_UEPolicyControl\_UpdateNotify

**Description:** Provides to the NF Service Consumer updated Policy information for the UE context evaluated based on the information previously provided by the PCF.

NOTE: This notification corresponds to an implicit subscription.

**Inputs, Required:** Notification endpoint, UE Policy Association ID.

**Inputs, Optional:** Policy Control Request Triggers of UE Policy Association. In case of H-PCF is producer, UE Access and PDU session related information as defined in clause 5.2.5.1.

**Outputs, Required:** Success or failure.

**Outputs, Optional:** None.

#### 5.2.5.6.4 Npcf\_UEPolicyControl\_Delete service operation

**Service operation name:** Npcf\_UEPolicyControl\_Delete

**Description:** Provides means for the NF Consumer to delete the UE policy control association.

**Inputs, Required:** Notification endpoint, UE Policy Association ID.

**Inputs, Optional:** None.

**Outputs, Required:** Success or Failure.

**Outputs, Optional:** None.

#### 5.2.5.6.5 Npcf\_UEPolicyControl\_Update service operation

**Service operation name:** Npcf\_UEPolicyControl\_Update

**Description:** NF Service Consumer, e.g. AMF can request the update of the UE Policy Association to receive updated Policy information for the UE context.

**Inputs, Required:** UE Policy Association ID.

**Inputs, Optional:** Information on the UE policy related Policy Control Request Trigger condition that has been met, as defined in Table 6.1.2.5-1 in TS 23.503 [20].

**Outputs, Required:** Success or Failure

**Outputs, Optional:** Policy Control Request Trigger of UE Policy Association. In the case of H-PCF is producer, UE access selection and PDU Session selection related policy information.

#### 5.2.5.7 Npcf\_EventExposure service

##### 5.2.5.7.1 General

**Service description:** This service enables an NF to subscribe and get notified about PCF events for a group of UE(s) or any UE accessing a combination of (DNN, S-NSSAI).

The events can be subscribed by a NF consumer are described in TS 23.503 [20], clause 6.1.3.18.

The following service operations are defined for the Npcf\_EventExposure service:

- Npcf\_EventExposure\_Subscribe.
- Npcf\_EventExposure\_UnSubscribe.
- Npcf\_EventExposure\_Notify.

##### 5.2.5.7.2 Npcf\_EventExposure\_Subscribe service operation

**Service operation name:** Npcf\_EventExposure\_Subscribe.

**Description:** The consumer NF uses this service operation to subscribe to or modify event reporting for a group of UE(s) or any UE accessing a combination of (DNN, S-NSSAI).

**NF Consumers:** NEF.

**Inputs (required):** NF ID, target of the subscription (Internal Group Identifier or indication that any UE accessing a combination of (DNN, S-NSSAI) is targeted, (set of) Event ID(s) defined in clause 5.2.5.7.1, Notification Target Address (+ Notification Correlation ID) and Event Reporting Information defined in Table 4.15.1-1.



**Inputs (optional):** Event Filter (s) associated with each Event ID.

**Outputs (required):** Operation execution result indication. When the subscription is accepted: Subscription Correlation ID.

**Outputs (optional):** First corresponding event report is included, if corresponding information is available (see clause 4.15.1).

The NF consumer subscribes to the event notification by invoking Npcf\_EventExposure to the PCF. The PCF allocates a Subscription Correlation ID for the subscription and responds to the consumer NF with the Subscription Correlation ID. Event receiving NF ID identifies the NF that shall receive the event reporting.

#### 5.2.5.7.3 Npcf\_EventExposure\_Unsubscribe service operation

**Service operation name:** Npcf\_EventExposure\_Unsubscribe.

**Description:** The NF consumer uses this service operation to unsubscribe for a specific event for a group of UE(s) or any UE accessing a combination of (DNN, S-NSSAI).

**Inputs (required):** Subscription Correlation ID.

**Input, Optional:** None.

**Outputs (required):** Operation execution result indication.

**Output, Optional:** None.

#### 5.2.5.7.4 Npcf\_EventExposure\_Notify service operation

**Service operation name:** Npcf\_EventExposure\_Notify.

**Description:** This service operation reports the event to the consumer that has previously subscribed.

**Inputs (required):** Event ID, corresponding UE ID (GPSI), Notification Correlation Information, time stamp.

**Inputs (optional):** None.

**Outputs (required):** None.

### 5.2.6 NEF Services

#### 5.2.6.1 General

The following table shows the NEF Services and Service Operations:

Table 5.2.6.1-1: NF Services provided by the NEF

Service Name	Service Operations	Operation Semantics	Example Consumer(s)
Nnef_EventExposure	Subscribe	Subscribe/Notify	AF
	Unsubscribe		AF
	Notify		AF
Nnef_PFDManagement	Fetch	Request/Response	SMF
	Subscribe	Subscribe/Notify	SMF
	Notify		SMF
	Unsubscribe		SMF
	Create	Request/Response	AF
	Update	Request/Response	AF
	Delete	Request/Response	AF
Nnef_ParameterProvision	Update	Request/Response	AF
Nnef_Trigger	Delivery	Request/Response	AF
	DeliveryNotify	Subscribe/Notify	AF
Nnef_BDTPNegotiation	Create	Request/Response	AF
	Update	Request/Response	AF
Nnef_TrafficInfluence	Create	Request/Response	AF
	Update	Request/Response	AF
	Delete	Request/Response	AF
Nnef_ChargeableParty	Create	Request/Response	AF
	Update	Request/Response	AF
	Notify	Request/Response	AF
Nnef_AFsessionWithQoS	Create	Request/Response	AF
	Notify	Request/Response	AF

## 5.2.6.2 Nnef\_EventExposure service

### 5.2.6.2.1 General

See clause 4.15.3.1.

### 5.2.6.2.2 Nnef\_EventExposure\_Subscribe operation

**Service operation name:** Nnef\_EventExposure\_Subscribe

**Description:** the consumer subscribes to receive an event, or if the event is already defined in NEF, then the subscription is updated.

**Inputs (required):** (Set of) Event ID(s) as specified in clause 4.15.3.1 or Npcf\_PolicyAuthorization\_Notify service operation, target of event reporting (GPSI or External Group Identifier), Event Reporting Information defined in Table 4.15.1-1, Notification Target Address (+ Notification Correlation ID).

**Inputs (optional):** Event Filter, Subscription Correlation ID (in case of modification of the event subscription), Expiry time.

**Outputs (required):** When the subscription is accepted: Subscription Correlation ID, Expiry time (required if the subscription can be expired based on the operator's policy).

**Outputs (optional):** First corresponding event report is included, if available (see clause 4.15.1).

### 5.2.6.2.3 Nnef\_EventExposure\_Unsubscribe service operation

**Service operation name:** Nnef\_EventExposure\_Unsubscribe

**Description:** the NF consumer deletes an event if already defined in NEF.

**Inputs (required):** Subscription Correlation ID.

**Outputs (required):** Operation execution result indication.

#### 5.2.6.2.4 Nnef\_EventExposure\_Notify service operation

**Service operation name:** Nnef\_EventExposure\_Notify

**Description:** NEF reports the event to the consumer that has previously subscribed.

**Inputs (required):** Event ID, Notification Correlation Information, time stamp.

**Inputs (optional):** Event information (defined on a per Event ID basis).

**Outputs (required):** Operation execution result indication.

#### 5.2.6.3 Nnef\_PFDManagement service

##### 5.2.6.3.1 General

The service provides the capability to create, update or remove PFDs via the NEF (PFDF). See clause 4.18 for the detailed procedures.

##### 5.2.6.3.2 Nnef\_PFDManagement\_Fetch service operation

**Service operation name:** Nnef\_PFDManagement\_Fetch

**Description:** Provides the PFDs for Application Identifier to the NF Consumer.

**Inputs (required):** Application Identifier(s).

**Inputs (optional):** None.

**Outputs (required):** Application Identifier, PFDs.

##### 5.2.6.3.3 Nnef\_PFDManagement\_Subscribe service operation

**Service operation name:** Nnef\_PFDManagement\_Subscribe

**Description:** provided by the NEF (PFDF) for NF consumers to explicitly subscribe the notification of changes of PFDs for Application Identifier.

**Inputs (required):** Application Identifier(s).

**Inputs (optional):** None.

**Outputs (required):** None.

##### 5.2.6.3.4 Nnef\_PFDManagement\_Notify service operation

**Service operation name:** Nnef\_PFDManagement\_Notify

**Description:** Provides Update PFDs for Application Identifier to the NF Consumer.

**Inputs (required):** Application Identifier(s), PFDs.

**Inputs (optional):** None.

**Outputs (required):** None.

#### 5.2.6.3.5 Nnef\_PFDManagement\_Unsubscribe service operation

**Service operation name:** Nnef\_PFDManagement\_Unsubscribe

**Description:** Provides by the NEF (PFDF) for NF Consumer to explicitly unsubscribe the notification of events.

**Inputs (required):** Application Identifier(s).

**Inputs (optional):** None.

**Outputs (required):** None

#### 5.2.6.3.6 Nnef\_PFDManagement\_Create service operation

**Service operation name:** Nnef\_PFDManagement\_Create

**Description:** The consumer requests PFD management to create PFDs.

**Inputs (required):** AF ID, External Application Identifier and one or more sets of PFDs.

**Inputs (optional):** Allowed Delay.

**Outputs (required):** Transaction Reference ID.

#### 5.2.6.3.7 Nnef\_PFDManagement\_Update service operation

**Service operation name:** Nnef\_PFDManagement\_Update

**Description:** The consumer requests PFD management to update PFDs.

**Inputs (required):** Transaction Reference ID, one or more sets of PFDs.

**Inputs (optional):** Allowed Delay.

**Outputs (required):** None.

#### 5.2.6.3.8 Nnef\_PFDManagement\_Delete service operation

**Service operation name:** Nnef\_PFDManagement\_Delete

**Description:** The consumer requests PFD management to delete the PFDs.

**Inputs (required):** Transaction Reference ID.

**Inputs (optional):** None.

**Outputs (required):** None.

#### 5.2.6.4 Nnef\_ParameterProvision service

##### 5.2.6.4.1 General

This service is for allowing external party to provision of information which can be used for the UE in 5GS.

##### 5.2.6.4.2 Nnef\_ParameterProvision\_Update service operation

**Service operation name:** Nnef\_ParameterProvision\_Update

**Description:** the consumer updates the UE related information (e.g., Expected UE Behaviour).

**Inputs (required):** GPSI, AF ID, Transaction Reference ID.

**Inputs (optional):** Any combination of the Expected UE Behaviour parameters.

**Outputs (required):** Operation execution result indication.

**Outputs (optional):** Transaction specific parameters, if available.

### 5.2.6.5 Nnef\_Trigger service

#### 5.2.6.5.1 General

See clause 4.13.2.

#### 5.2.6.5.2 Nnef\_Trigger\_Delivery service operation

**Service operation name:** Nnef\_Trigger\_Delivery

**Description:** the consumer requests that a trigger be sent to an application on a UE and subscribes to be notified about result of the trigger delivery attempt.

**Inputs (required):** GPSI, AF ID, Trigger Reference Number, Application Port ID

**Inputs (optional):** Validity Period, Priority, Trigger Payload.

**Outputs (required):** Transaction Reference ID, Cause.

#### 5.2.6.5.3 Nnef\_Trigger\_DeliveryNotify service operation

**Service operation name:** Nnef\_Trigger\_DeliveryNotify

**Description:** NEF reports the status of the trigger delivery to the consumer (failure or success).

NOTE: This notification corresponds to an implicit subscription by Nnef\_Trigger\_Delivery service operation.

**Inputs (required):** Transaction Reference ID, Delivery Report.

**Inputs (optional):** None.

**Outputs (required):** None.

### 5.2.6.6 Nnef\_BDTPNegotiation service

#### 5.2.6.6.1 General

See clause 4.16.7.

#### 5.2.6.6.2 Nnef\_BDTPNegotiation\_Create service operation

**Service operation name:** Nnef\_BDTPNegotiation Create.

**Description:** The consumer requests a background data transfer policy.

**Inputs (required):** ASP Identifier, Volume per UE, Number of UEs, Desired time window.

**Inputs (optional):** Network Area Information.

**Outputs (required):** Background Data Transfer Reference ID, one or more background data transfer policies.

**Output, Optional:** None.

#### 5.2.6.6.3 Nnef\_BDTPNegotiation\_Update service operation

**Service operation name:** Nnef\_BDTPNegotiation Update.

**Description:** the consumer requests the selected background data transfer policy to be set.

**Inputs (required):** Background Data TransferReference ID, background data transfer policy.

**Inputs (optional):** None.

**Outputs (required):** None.

**Outputs (optional):** None.

## 5.2.6.7 Nnef\_TrafficInfluence service

### 5.2.6.7.1 General

**Service description:** This service provides:

- Request authorization of NF Service Consumer requests.
- Request parameter mapping from NF Service Consumer requests to 5GC parameters and vice versa as described in TS 23.501 [2], clause 5.6.7.
- NF Service Consumer request routing (forwarding) to actual NF Service Producer to influence traffic routing decisions as described in TS 23.501 [2], clause 5.6.7.

### 5.2.6.7.2 Nnef\_TrafficInfluence\_Create operation

**Service operation name:** Nnef\_TrafficInfluence\_Create

**Description:** Authorize the request and forward the request for traffic influence.

**Inputs (required):** AF Transaction Id.

The AF Transaction Id refers to the request.

**Inputs (optional):** The address (IP or Ethernet) of the UE if available, GPSI if available, DNN if available, S-NSSAI if available, External Group Identifier if available, application identifier or traffic filtering information, AF-Service-Identifier, a list of DNAI(s) and corresponding routing profile ID(s) or N6 traffic routing information, Indication of application relocation possibility, Early and/or late notifications about UP path management events, Temporal validity condition and Spatial validity condition as described in TS 23.501 [2], clause 5.6.7.

**Outputs (required):** Operation execution result indication.

**Outputs (optional):** None.

### 5.2.6.7.3 Nnef\_TrafficInfluence\_Update operation

**Service operation name:** Nnef\_TrafficInfluence\_Update

**Description:** Authorize the request and forward the request to update the traffic influence.

**Inputs (required):** AF Transaction Id.

The AF Transaction Id identifies the NF Service Consumer request to be updated.

**Inputs (optional):** Same optional information as in Nnef\_TrafficInfluence\_Create Input.

**Outputs (required):** Operation execution result indication.

**Outputs (optional):** None.

### 5.2.6.7.4 Nnef\_TrafficInfluence\_Delete operation

**Service operation name:** Nnef\_TrafficInfluence\_Delete

**Description:** Authorize the request and forward the request to delete(s) request for traffic influence.

**Inputs (required):** AF Transaction Id.

The AF Transaction Id identifies the NF Service Consumer request for traffic influence to be deleted.

**Inputs (optional):** None.

**Outputs (required):** Operation execution result indication.

**Outputs (optional):** None.

#### 5.2.6.7.5 Nnef\_TrafficInfluence\_Notify operation

**Service operation name:** Nnef\_TrafficInfluence\_Notify

**Description:** Forward the notification of UP path management event report to AF.

**Known NF Service Consumers:** AF.

**Inputs (required):** AF Transaction Id, Event ID.

The AF Transaction Id identifies the AF request for traffic influence that the event report is related to. The event may be the UP path management event defined in TS 23.501 [2], clause 5.6.7.

**Inputs (optional):** Event information (defined on a per Event ID basis).

**Outputs (required):** Operation execution result indication.

**Outputs (optional):** None.

#### 5.2.6.8 Nnef\_ChargeableParty service

##### 5.2.6.8.1 General

See clauses 4.15.6.4 and 4.15.6.5.

##### 5.2.6.8.2 Nnef\_ChargeableParty\_Create service operation

**Service operation name:** Nnef\_ChargeableParty Create

**Description:** The consumer requests to become the chargeable party for a data session for a UE.

**Inputs (required):** AF Identifier, UE IP address, Description of the application flows, Sponsor Information, Sponsoring Status.

**Inputs (optional):** Time period, traffic volume, Background Data Transfer Reference ID.

**Outputs (required):** Transaction Reference ID, result.

**Output (optional):** None.

##### 5.2.6.8.3 Nnef\_ChargeableParty\_Update service operation

**Service operation name:** Nnef\_ChargeableParty Update

**Description:** The consumer can change the chargeable party of a data session for a UE.

**Inputs (required):** AF Identifier, Transaction Reference ID, Sponsoring Status.

**Inputs (optional):** Time period, traffic volume, Background Data Transfer Reference ID.

**Outputs (required):** Transaction Reference ID, result.

**Output (optional):** None.

##### 5.2.6.8.4 Nnef\_ChargeableParty\_Notify service operation

**Service operation name:** Nnef\_ChargeableParty Notify

**Description:** NEF reports the bearer level event(s) to the consumer.

**Inputs (required):** Event reports.

**Inputs (optional):** None.

**Outputs (required):** None.

**Output (optional):** None.

## 5.2.6.9 Nnef\_AFsessionWithQoS service

### 5.2.6.9.1 General

See clause 4.15.6.6.

### 5.2.6.9.2 Nnef\_AFsessionWithQoS\_Create service operation

**Service operation name:** Nnef\_AFsessionWithQoS Create

**Description:** The consumer requests the network to provide a specific QoS for an AS session.

**Inputs (required):** AF Identifier, UE IP address, Description of the application flows, QoS Reference.

**Inputs (optional):** time period, traffic volume.

**Outputs (required):** Transaction Reference ID, result.

**Output (optional):** None.

### 5.2.6.9.3 Nnef\_AFsessionWithQoS\_Notify service operation

**Service operation name:** Nnef\_AFsessionWithQoS Notify

**Description:** NEF reports the bearer level event(s) to the consumer.

**Inputs (required):** Event reports.

**Inputs (optional):** None.

**Outputs (required):** None.

**Output (optional):** None.

## 5.2.7 NRF Services

### 5.2.7.1 General

The following table shows the NRF Services and Service Operations:



**Table 5.2.7.1-1: NF services provided by the NRF**

Service Name	Service Operations	Operation Semantics	Example Consumer(s)
Nnrf_NFManagement	NFRegister	Request/Response	AMF, SMF, UDM, AUSF, NEF, PCF, SMSF, NSSF, UPF, BSF, CHF
	NFUpdate	Request/Response	AMF, SMF, UDM, AUSF, NEF, PCF, SMSF, NSSF, UPF, BSF, CHF
	NFDeregister	Request/Response	AMF, SMF, UDM, AUSF, NEF, PCF, SMSF, NSSF, UPF, BSF, CHF
	NFStatusSubscribe	Subscribe/Notify	AMF, SMF, PCF, NEF, NSSF, SMSF, AUSF, CHF, NRF
	NFStatusNotify		AMF, SMF, PCF, NEF, NSSF, SMSF, AUSF, CHF
	NFStatusUnSubscribe		AMF, SMF, PCF, NEF, NSSF, SMSF, AUSF, CHF, NRF
Nnrf_NFDiscovery	Request	Request/Response	AMF, SMF, PCF, NEF, NSSF, SMSF, AUSF, CHF, NRF
Nnrf_AccessToken	Get	Request/Response	AMF, SMF, PCF, NEF, NSSF, SMSF, AUSF, UDM

## 5.2.7.2 Nnrf\_NFManagement service

### 5.2.7.2.1 General

#### 5.2.7.2.2 Nnrf\_NFManagement\_NFRegister service operation

**Service Operation name:** Nnrf\_NFManagement\_NFRegister.

**Description:** Registers the consumer NF in the NRF by providing the NF profile of the consumer NF to NRF, and NRF marks the consumer NF available.

**Inputs, Required:** NF type, NF instance ID, Names of supported NF services (if applicable) and PLMN ID e.g. if NF needs to be discovered by other PLMNs.

NOTE 1: for the UPF, the addressing information within the NF profile corresponds to the N4 interface.

**Inputs, Optional:**

- If the consumer NF stores Data Set(s) (e.g. UDR): Range(s) of SUPIs, range(s) of GPSIs, range(s) of external group identifiers, Data Set Identifier(s). If the consumer is BSF: Range(s) of (UE) IPv4 addresses or Range(s) of (UE) IPv6 prefixes.

NOTE 2: Range of SUPI(s) is limited in this release to a SUPI type of IMSI as defined in TS 23.003 [33].

- If the consumer is UDM, UDR or AUSF, they can include UDM Group ID, UDR Group ID, AUSF Group ID.
- For UDM and AUSF, Routing Indicator.
- If the consumer is AMF, it includes list of GUAMI(s). In addition, AMF may include list of GUAMI(s) for which it can serve as backup for failure/maintenance.
- If the consumer is CHF, it may include Range(s) of SUPIs, Range(s) of GPSIs, or Range(s) of PLMNs as defined in TS 32.290 [42].
- For the UPF Management: UPF Provisioning Information as defined in clause 4.17.6.
- S-NSSAI(s) and the associated NSI ID(s) (if available).
- Information about the location of the NF consumer (operator specific information, e.g. geographical location, data center).
- TAI(s).

**Outputs, Required:** Result indication.

**Outputs, Optional:** None.

See clause 5.21.2.1 in TS 23.501 [2], the AMF registers itself to NRF.

#### 5.2.7.2.3 Nnrf\_NFManagement\_NFUpdate service operation

**Service Operation name:** Nnrf\_NFManagement\_NFUpdate.

**Description:** Provides the updated NF profile of NF consumer to NRF.

**Inputs, Required:** NF instance ID.

**Inputs, Optional:** If replacing the full NF profile, the full NF profile shall be provided. If updating parts of the NF profile, the NF profile elements that needs to be updated shall be provided.

**Outputs, Required:** Result indication.

**Outputs, Optional:** None.

See clause 5.21.2.1 in TS 23.501 [2], the AMF adds or updates the associated GUAMI(s).

#### 5.2.7.2.4 Nnrf\_NFManagement\_NFDeregister service operation

**Service Operation name:** Nnrf\_NFManagement\_NFDeregister

**Description:** Inform the unavailability of NF consumer to NRF.

**Inputs, Required:** NF Instance ID, Reason indication.

**Inputs, Optional:** None.

**Outputs, Required:** Result indication.

**Outputs, Optional:** None.

See clause 5.21.2.2 in TS 23.501 [2], the AMF deregister itself from NRF.

#### 5.2.7.2.5 Nnrf\_NFManagement\_NFStatusSubscribe service operation

**Service Operation name:** Nnrf\_NFManagement\_NFStatusSubscribe.

**Description:** Consumer can subscribe to be notified of the following:

- Newly registered NF along with its NF services.
- Updated NF profile.
- Deregistered NF.

**Inputs, Required:** NF type (if NF status of a specific NF type is to be monitored), NF instance ID (if NF status of a specific NF instance is to be monitored), NF service (if NF status for NF which exposes a given NF service is to be monitored).

**Inputs, Optional:**

- For the UPF Management defined in clause 4.17.6: UPF Provisioning Information as defined in that clause.
- For AMF, Consumer may include list of GUAMI(s).
- S-NSSAI(s) and the associated NSI ID(s) (if available).

**Outputs, Required:** When the subscription is accepted: Subscription Correlation ID (required for management of this subscription).

**Outputs, Optional:** None.

NOTE: Alternatively, other means such as OA&M can also be used to subscribe for NF status.

#### 5.2.7.2.6 Nnrf\_NFManagement\_NFStatusNotify service operation

**Service Operation name:** Nnrf\_NFManagement\_NFStatusNotify.

**Description:** NRF notifies subscribed consumers of the following:

- Newly registered NF along with its NF services.
- Updated NF profile.
- Deregistered NF.

**Inputs, Required:** NF instance ID, NF Status, NF services (if the notification is for newly registered NF), new NF profile (if the notification is for updated NF profile).

**Inputs, Optional:**

- If the NF stores Data Set(s) (e.g. UDR): Range(s) of SUPIs, range(s) of GPSIs, range(s) of external group identifiers, Data Set Identifier(s). For BSF: Range(s) of (UE) IPv4 addresses or Range(s) of (UE) IPv6 prefixes.

NOTE: Range of SUPI(s) is limited in this release to a SUPI type of IMSI as defined in TS 23.003 [33].

- If the NF is UDM, UDR or AUSF, they can include UDM Group ID, UDR Group ID, AUSF Group ID.
- For UDM and AUSF, Routing Indicator.
- For the UPF Management defined in clause 4.17.6: UPF Provisioning Information as defined in that clause.
- For AMF, list of GUAMI(s) may be included. In addition, it may include list of GUAMI(s) for which it can serve as backup for failure/maintenance.
- S-NSSAI(s) and the associated NSI ID(s) (if available).
- Information about the location of the NF (operator specific information, e.g. geographical location, data center).
- TAI(s).

**Outputs, Required:** None.

**Outputs, Optional:** None.

#### 5.2.7.2.7 Nnrf\_NFManagement\_NFStatusUnsubscribe service operation

**Service Operation name:** Nnrf\_NFManagement\_NFStatusUnsubscribe.

**Description:** Consumer can unsubscribe from being notified of newly registered NF along with its NF services.

**Inputs, Required:** Subscription Correlation ID.

**Inputs, Optional:** None.

**Outputs, Required:** Operation execution result indication.

**Outputs, Optional:** None.

NOTE: Alternatively, other means such as OA&M can also be used to unsubscribe for NF status.

#### 5.2.7.3 Nnrf\_NFDiscovery service

##### 5.2.7.3.1 General

**Service description:** This service enables one NF to discover a set of NF instances with specific NF service or a target NF type. The service also enables one NF service to discover a specific NF service. The service operations defined below allow the NF/NF services to communicate with NRF.

### 5.2.7.3.2 Nnrf\_NFDiscovery\_Request service operation

**Service operation name:** Nnrf\_NFDiscovery\_Request

**Description:** provides the IP address or FQDN of the expected NF instance(s) and, if present in NF profile, the Endpoint Address(es) of NF service instance(s) to the NF service consumer.

**Inputs, Required:** one or more target NF service Name(s), NF type of the target NF, NF type of the NF service consumer.

If the NF service consumer intends to discover an NF service producer providing all the standardized services, it provides a wildcard NF service name.

**Inputs, Optional:**

- S-NSSAI and the associated NSI ID (if available), DNN, target NF/NF service PLMN ID, NRF to be used to select NFs/services within HPLMN, Serving PLMN ID, the NF service consumer ID, preferred target NF location, TAI.

NOTE 1: For network slicing the NF service consumer ID is a required input.

- FQDN for the S5/S8 interface of the PGW-C+SMF, to discover the N11/N16 interface of the PGW-C+SMF in case of EPS to 5GS mobility.
- If the target NF stores Data Set(s) (e.g., UDR): SUPI, Data Set Identifier(s). (UE) IPv4 address or (UE) IPv6 Prefix.

NOTE 2: The (UE) IPv4 address or (UE) IPv6 Prefix is provided for BSF discovery: in that case the NRF looks up for a match within one of the Range(s) of (UE) IPv4 addresses or Range(s) of (UE) IPv6 prefixes provided by BSF(s) as part of the invocation of Nnrf\_NFManagement\_NFRegister operation. The NRF is not meant to store individual (UE) IPv4 addresses or (UE) IPv6 prefixes.

- If the target NF is UDM or AUSF, the request may include the UE's Routing Indicator.
- If the target NF is AMF, the request may include AMF region, AMF Set, GUAMI.
- If the target NF is UDR or UDM or AUSF, the request may include UDR Group ID or UDM Group ID or AUSF Group ID respectively.

NOTE 3: It is assumed that the corresponding NF service consumer is either configured with the corresponding Group ID or it received it via earlier Discovery output.

- For the UPF Management defined in clause 4.17.6: UPF Provisioning Information as defined in that clause.
- If the target NF is CHF, the request may include SUPI or GPSI as specified in TS 32.290 [42].

**Outputs, Required:** A set of NF instances, containing per NF Instance: NF type, NF instance ID, FQDN or IP address(es) of the NF instance and, a list of services instances, where each service instance has a service name, a NF service instance ID, and optionally Endpoint Address(es)

Endpoint Address(es) may be a list of IP addresses or an FQDN for the NF service instance.

**Outputs, Optional:** Per NF instance, other information in the NF profile listed in clause 6.2.6 in TS 23.501 [2] related to the NF instance, such as:

- If the target NF stores Data Set(s) (e.g. UDR): Range(s) of SUPIs, range(s) of GPSIs, range(s) of external group identifiers, Data Set Identifier(s). If the target NF is BSF: Range(s) of (UE) IPv4 addresses or Range(s) of (UE) IPv6 prefixes.

NOTE 4: Range of SUPI(s) is limited in this release to a SUPI type of IMSI as defined in TS 23.003 [33].

- If the target NF is UDM, UDR or AUSF, they can include UDM Group ID, UDR Group ID, AUSF Group ID.
- For UDM and AUSF, Routing Indicator.
- If the target NF is AMF, it includes list of GUAMI(s). In addition, it may include list of GUAMI(s) for which it can serve as backup for failure/maintenance.

- If the target NF is CHF, it includes primary CHF instance and the secondary CHF instance pair(s).
- For the UPF Management: UPF Provisioning Information as defined in clause 4.17.6.
- S-NSSAI(s) and the associated NSI ID(s) (if available).
- Information about the location of the target NF (operator specific information, e.g. geographical location, data center).
- TAI(s).
- PLMN ID

See clause 4.17.4 and 4.17.5 for details on the usage of this service operation.

## 5.2.7.4 Nnrf\_AccessToken\_service

### 5.2.7.4.1 General

This service provides OAuth2 2.0 Access Tokens for NF to NF authorization as defined in TS 33.501 [15].

### 5.2.7.4.2 Nnrf\_AccessToken\_Get Service Operation

See TS 33.501 [15].

## 5.2.8 SMF Services

### 5.2.8.1 General

The following table shows the SMF Services and SMF Service Operations.

**Table 5.2.8.1-1: NF services provided by the SMF**

Service Name	Service Operations	Operation Semantics	Example Consumer(s)
Nsmf_PDUSession	Create	Request/Response	V-SMF
	Update	Request/Response	V-SMF, H-SMF
	Release	Request/Response	V-SMF
	CreateSMContext	Request/Response	AMF
	UpdateSMContext	Request/Response	AMF
	ReleaseSMContext	Request/Response	AMF
	SMContextStatusNotify	Subscribe/Notify	AMF
	StatusNotify	Subscribe/Notify	V-SMF
Nsmf_EventExposure	Context	Request/Response	AMF
	Subscribe	Subscribe/Notify	NEF, AMF
	Unsubscribe		NEF, AMF
Notify	NEF, AMF		

### 5.2.8.2 Nsmf\_PDUSession Service

#### 5.2.8.2.1 General

**Service description:** This service operates on the PDU Sessions. The following are the key functionalities of this NF service:

- (between AMF and SMF) Creation / Deletion / Modification of AMF-SMF interactions for PDU Sessions;

The resource handled between AMF and SMF via Create / Update / Release SM context operations corresponds to the AMF-SMF association for a PDU Session;

When the AMF has got no association with an SMF to support a PDU Session, the AMF creates such association via the Nsmf\_PDUSession\_CreateSMContext operation. The context created is identified via the SM Context

ID. Otherwise (e.g. at hand-over between 3GPP and Non 3GPP access) the AMF uses the Nsmf\_PDUSession\_UpdateSMContext operation.

NOTE 1: In TS 29.502 [36] SM Context ID is referred to as smContextRef for N11, and pduSessionRef and pduSessionUri for N16.

When the UE is handed-over from an (old) AMF towards another (new) AMF, the old AMF provides the new AMF with the SMF addressing information corresponding to the AMF-SMF association related with each PDU Session of that UE. The new AMF can thus further act upon the association with the SMF via Nsmf\_PDUSession\_UpdateSMContext and Nsmf\_PDUSession\_ReleaseSMContext operations. This may take place:

- at inter AMF change due to AMF planned maintenance or due to AMF failure described in TS 23.501 [2] clause 5.21.2;
- at inter AMF mobility in CM-CONNECTED state described in clause 4.9.1.3;
- at inter AMF mobility in CM-IDLE state described in clause 4.2.2.2.
- (between V-SMF and H-SMF) Creation / Deletion / Modification of PDU Sessions;

Even though the V-SMF creates the PDU Session resource onto the H-SMF, each of the V-SMF and of the H-SMF needs to be able to modify a PDU Session and/or to ask for PDU Session Release. Thus, at Nsmf\_PDUSession\_Create, V-SMF informs the H-SMF about addressing information for its corresponding PDU Session resource, allowing H-SMF to use later on the Nsmf\_PDUSession\_Update and Nsmf\_PDUSession\_Release and Nsmf\_PDUSession\_StatusNotify operations.

NOTE 2: The PDU Session resource in V-SMF is created when the AMF requests to create SM context of this PDU Session

NOTE 3: H-SMF also informs the consumer (V-SMF) about addressing information about its PDU Session resource, but this is part of normal resource creation operation in REST and not specific to this service.

#### 5.2.8.2.2 Nsmf\_PDUSession\_Create service operation

**Service operation name:** Nsmf\_PDUSession\_Create.

**Description:** Create a new PDU Session in the H-SMF or create an association with an existing PDN connection in the home PGW-C+SMF.

**Input, Required:** SUPI, V-SMF ID, V-SMF SM Context ID, DNN, V-CN Tunnel Info, addressing information allowing the H-SMF to request the V-SMF to issue further operations about the PDU Session.

**Input, Optional:** S-NSSAI, PCO, Requested PDU Session Type, 5GSM Core Network Capability, Requested SSC mode, PDU Session ID, Number Of Packet Filters, UE location information, subscription get notified of PDU Session status change, PEI, GPSI, AN type, PCF ID, DNN Selection Mode, UE's Routing Indicator or UDM Group ID for the UE, Always-on PDU Session Requested, information provided by V-SMF related to charging in home routed scenario (see TS 32.255 [45]), AMF ID, EPS Bearer Status.

**Output, Required:** Result Indication, and if success a SM Context ID and in addition: QFI(s), QoS Profile(s), Session-AMBR, QoS Rule(s), QoS Flow level QoS parameters if any for the QoS Flow(s) associated with the QoS rule(s), H-CN Tunnel Info, Enable pause of charging indication, Selected PDU Session Type and SSC mode.

**Output, Optional:** PDU Session ID, S-NSSAI, Cause, PCO, UE IP address, IPv6 Prefix allocated to the PDU Session, information needed by V-SMF in case of EPS interworking such as the PDN Connection Type, Reflective QoS Timer, Always-on PDU Session Granted, information provided by H-SMF related to charging in home routed scenario (see TS 32.255 [45]).

The V-SMF SM Context ID in the Input provides addressing information allocated by the V-SMF (to be used for service operations towards the V-SMF for this PDU Session).

See clause 4.3.2.2.2, clause 4.11.1.2.2 and clause 4.11.1.3.3 for details on the usage of this service operation.

### 5.2.8.2.3 Nsmf\_PDUSession\_Update service operation

**Service operation name:** Nsmf\_PDUSession\_Update.

**Description:** Update the established PDU Session.

This service operation is invoked by the V-SMF towards the H-SMF in case of UE or serving network requested PDU Session Modification in order for the V-SMF to transfer the PDU Session Modification request. It can also be invoked by the V-SMF to indicate to the H-SMF that the access type of the PDU session can be changed.

This service operation is invoked by the H-SMF towards the V-SMF for both UE initiated and HPLMN initiated PDU Session Modification and PDU Session Release cases in order to have the SM PDU Session Modification request or SM PDU Session Release request sent to the UE. It can also be invoked by the H-SMF towards the V-SMF to release the 5GC and 5G-AN resources in e.g. handover from 5GC-N3IWF to EPS and from 5GS to EPC/ePDG, wherein the UE is not notified.

This service operation is invoked by the V-SMF and the H-SMF in case of PDU Session Establishment authentication/authorization by a DN-AAA server defined in clause 4.3.2.3: it is used to carry DN Request Container information between the DN-AAA server and the UE.

**Input, Required:** SM Context ID.

**Input, Optional:** UE location information (ULI), UE Time Zone, AN type, indication of PDU Session Release, H-SMF SM Context ID (from H-SMF to V-SMF), QoS Rule and QoS Flow level QoS parameters if any for the QoS Flow associated with the QoS rule (from H-SMF to V-SMF), N9 Tunnel Info (from V-SMF to H-SMF), Information requested by UE for e.g. QoS (from V-SMF to H-SMF), 5GSM Core Network Capability, Information necessary for V-SMF to build SM Message towards the UE (from H-SMF to V-SMF), Trigger PDU release indication (V-SMF to H-SMF), Start Pause of Charging indication, Stop Pause of Charging indication, DN Request Container information, indication that the UE shall not be notified, EBI Allocation Parameters (ARP list), Secondary RAT usage data, indication that the access type of the PDU session can be changed (V-SMF to H-SMF).

**Output, Required:** Result indication, <ARP, Cause> pair.

**Output, Optional:** UE location information, AN Type, SM information from UE (from V-SMF to H-SMF), list of Rejected QoS Flows (from V-SMF to H-SMF), a list of <ARP, EBI> pair, Secondary RAT Usage Data.

The H-SMF SM Context ID in the Input provides addressing information allocated by the H-SMF (to be used for service operations towards the H-SMF for this PDU Session).

See clause 4.3.3.3 for an example usage of this service operation.

### 5.2.8.2.4 Nsmf\_PDUSession\_Release service operation

**Service operation name:** Nsmf\_PDUSession\_Release.

**Description:** It causes the immediate and unconditional deletion of the resources associated with the PDU Session. This service operation is used by V-SMF to request the H-SMF to release the resources related to a PDU Session for the serving network initiated PDU release case (e.g. implicit De-registration of UE in the serving network).

**Input, Required:** SM Context ID.

**Input, Optional:** Secondary RAT Usage Data.

**Output, Required:** Result Indication.

**Output, Optional:** None.

See clause 4.3.4.3 for an example usage of this service operation.

### 5.2.8.2.5 Nsmf\_PDUSession\_CreateSMContext service operation

**Service operation name:** Nsmf\_PDUSession\_CreateSMContext.

**Description:** It creates an AMF-SMF association to support a PDU Session.

**Input, Required:** SUPI or PEI, DNN, AMF ID (AMF Instance ID).

**Input, Optional:** PEI, S-NSSAI(s), PDU Session Id, N1 SM container, UE location information, UE Time Zone, AN type, H-SMF identifier/address, list of alternative H-SMF(s) if available, old PDU Session ID (if the AMF also received an old PDU Session ID from the UE as specified in clause 4.3.5.2), Subscription For PDU Session Status Notification, indication that the SUPI has not been authenticated, PCF ID, DNN Selection Mode, UE PDN Connection Context, GPSI, UE presence in LADN service area, GUAMI, backup AMF(s) (if NF Type is AMF), Trace Requirements. Backup AMF(s) sent only once by the AMF to the SMF in its first interaction with the SMF, UE's Routing Indicator or UDM Group ID for the UE, EPS Bearer Status. Target ID (for EPS to 5GS handover).

**Output, Required:** Result Indication, and if successful SM Context ID.

**Output, Optional:** Cause, PDU Session ID, N2 SM information, N1 SM container, S-NSSAI(s).

When the PDU Session is for Emergency services for a UE without USIM, the AMF provides the PEI and not the SUPI as identifier of the UE. When the PDU Session is for Emergency services of an unauthenticated UE with an USIM, the AMF shall provide both the SUPI and the PEI and shall provide an indication that the SUPI has not been authenticated.

See clause 4.3.2.2.1, clause 4.3.2.2.2, clause 4.11.1.2.2 and clause 4.11.1.3.3 for details on the usage of this service operation.

#### 5.2.8.2.6 Nsmf\_PDUSESSION\_UpdateSMContext service operation

**Service operation name:** Nsmf\_PDUSESSION\_UpdateSMContext.

**Description:** It allows to update the AMF-SMF association to support a PDU Session and/or to provide SMF with N1/N2 SM information received from the UE or from the AN.

**Input, Required:** SM Context ID.

**Input, Optional:** N1 SM container received from the UE, N2 SM information received from the AN (e.g. N3 addressing information, notification indicating that the QoS targets cannot be fulfilled for a QFI, Secondary RAT Usage Data), Operation Type (e.g. UP activate, UP deactivate, UP To Be Switched), Serving GW Address(es) and Serving GW DL TEID(s) for data forwarding during HO from 5GS to EPS, UE location information, AN type, UE Time Zone, H-SMF identifier/address, EBI(s) to be revoked, PDU Session(s) to be re-activated, Direct Forwarding Flag, ARP list, S-NSSAI, Data Forwarding Tunnel (setup/release), UE presence in LADN service area, Target ID, Target AMF ID, GUAMI, backup AMF(s) (if NF Type is AMF), Indication of Access Type can be changed. Backup AMF(s) sent only once by the AMF to the SMF in its first interaction with the SMF. Release indication and release cause.

**Output, Required:** Result Indication.

**Output, Optional:** PDU Session ID, Cause, released EBI list, allocated EBI information, N2 SM information (e.g. QFI, UE location information, notification indicating that the QoS targets cannot be fulfilled), N1 SM container to be transferred to the AN/UE, type of N2 SM information.

See clause 4.3.3.2 and clause 4.3.3.3 for an example usage of this service operation.

See clause 4.9.1.2.2 for the usage of the "UP To Be Switched" Operation Type.

For the use of the "EBI(s) to be revoked" information, see clause 4.11.1.4.1.

For the use of the "Direct Forwarding Flag", see clause 4.11.1.2.2.2.

For the use of the "Indication of Access Type can be changed", see clause 4.2.3.2.

For the use of "release indication and release cause", see clause 4.3.4.2.

If the consumer NF is AMF and the SMF determines that some EBIs are not needed, the SMF will put the EBIs back in the released EBI list.

If the consumer NF is AMF and Inter-system mobility happens, the SMF sends allocated EBI information to AMF.

If the ARP of QoS flow is changed, the SMF uses this operation to update EBI-ARP information in the AMF.

If the AMF does not have PDU Session ID, the PDU Session ID is not required for Input, and is required for Output.



If consumer NF is AMF and SMF includes N2 SM information in the Output, the SMF indicates type of N2 SM information.

NOTE: The N2 SM information is not interpreted by the AMF.

#### 5.2.8.2.7 Nsmf\_PDUSession\_ReleaseSMContext service operation

**Service operation name:** Nsmf\_PDUSession\_ReleaseSMContext.

**Description:** It allows to release the AMF-SMF association for a certain PDU Session because the PDU Session has been released.

**Input, Required:** SM Context ID.

**Input, Optional:** UE location information, AN type, UE Time Zone, N2 SM Info (Secondary RAT Usage Data).

**Output, Required:** Result Indication.

**Output, Optional:** Cause.

See clause 4.3.4.2 and clause 4.3.4.3 for an example usage of this service.

If the consumer NF is AMF and the PDU Session indicated by the PDU Session ID had been assigned some EBIs, the AMF locally determines that the corresponding EBI(s) are released.

#### 5.2.8.2.8 Nsmf\_PDUSession\_SMContextStatusNotify service operation

**Service operation name:** Nsmf\_PDUSession\_SMContextStatusNotify.

**Description:** This service operation is used by the SMF to notify its consumers about the status of an SM context related to a PDU Session (e.g. PDU Session release due to local reasons within the SMF, PDU Session handover to a different system or access type).

**Input, Required:** Status information.

**Input, Optional:** Cause.

**Output, Required:** Result Indication.

**Output, Optional:** None.

#### 5.2.8.2.9 Nsmf\_PDUSession\_StatusNotify service operation

**Service operation name:** Nsmf\_PDUSession\_StatusNotify.

**Description:** This service operation is used by the SMF to notify its consumers about the status of a PDU Session (e.g. PDU Session is released due to local reasons within the H-SMF, PDU Session handover to a different system or access type).

**Input, Required:** Status information.

**Input, Optional:** Cause.

**Output, Required:** Result Indication.

**Output, Optional:** None.

#### 5.2.8.2.10 Nsmf\_PDUSession\_ContextRequest service operation

**Service operation name:** Nsmf\_PDUSession\_ContextRequest.

**Description:** This service operation is used by the NF Consumer to request for SM Context (e.g. during EPS IWK, HO).

**Input, Required:** SM Context ID.

**Input, Optional:** Target MME Capability, PDU Session ID (include PDU Session ID when available).

**Output, Required:** SM Context Container.

**Output, Optional:** None.

### 5.2.8.3 Nsmf\_EventExposure Service

#### 5.2.8.3.1 General

**Service description:** This service provides events related to PDU Sessions towards consumer NF. The service operations exposed by this service allow other NFs to subscribe and get notified of events happening on PDU Sessions. The following are the key functionalities of this NF service.

- Allow consumer NFs to Subscribe and unsubscribe for an Event ID on PDU Session(s); and
- Notifying events on the PDU Session to the subscribed NFs.

The following events can be subscribed by a NF consumer (Event ID is defined in clause 4.15.1):

- UE IP address / Prefix change: The event notification may contain a new UE IP address / Prefix or an indication of which UE IP address / Prefix has been released.
- PDU Session Release.
- UP path change: a notification corresponding to this event is sent when the UE IP address / Prefix and / or DNAI and /or the N6 traffic routing information has changed.

The event notification may contain following information:

- the type of notification ("EARLY" or "LATE").
- for both the source and target UP path between the UE and the DN, the corresponding information is provided when it has changed:
  - DNAI.
  - UE IP address / Prefix.
  - N6 traffic routing information.

NOTE 1: UP path change notification, DNAI and N6 traffic routing information are further described in TS 23.501 [2] clause 5.6.7.

- Change of Access Type; The event notification contains the new Access Type for the PDU Session.
- PLMN change; The event notification contains the new PLMN Identifier for the PDU Session.

Event Filters are used to specify the conditions to match for notifying the events (i.e. "List of Parameter values to match"). If there are no conditions to match for a specific Event ID, then the Event Filter is not provided. The following table provides as an example how the conditions to match for event reporting can be specified for various Event IDs for SMF exposure.

**Table 5.2.8.3.1-1: Example of Event Filters for SMF exposure events**

Event ID for SMF exposure	Event Filter (List of Parameter Values to Match)
DNAI Change	None
PDU Session Release	

The target of SMF event reporting may correspond to a PDU Session ID, an UE ID (SUPI) an Internal Group Identifier or an indication that any UE is targeted (on a specific DNN).

#### 5.2.8.3.2 Nsmf\_EventExposure\_Notify service operation

**Service operation name:** Nsmf\_EventExposure\_Notify

**Description:** Report UE PDU Session related event(s) to the NF which has subscribed to the event report service.

**Input Required:** Event ID, Notification Correlation Information, UE ID (SUPI and if available GPSI), PDU Session ID, time stamp.

**Input, Optional:** Event specific parameter list as described in clause 5.2.8.3.1.

**Output Required:** Result Indication.

**Output, Optional:** Redirection information.

When the SMF detects the event subscribed by the NF consumer, the SMF reports the subscribed event together with the Notification Target Address (+ Notification Correlation ID) to the Event Receiving NF.

The optional event specific parameter list provides the values that matched for generating the event notification. The parameter values to match are specified during the event subscription (see clause 5.2.8.3.3).

See clause 4.3.6.3 for details on usage of this service operation toward Application Function.

If the NF consumer is AMF and the result of the service operation fails, the AMF shall set corresponding cause value in result indication which can be used by the SMF for further action. In case the related UE is not served by the AMF and the AMF knows which AMF is serving the UE, the AMF provides redirection information which can be used by the SMF to resend UE related message to the AMF that serves the UE.

**NOTE:** In the case of UP plane path, as described in clause 4.3.6.2, this notification can be the result of an implicit subscription of the NEF/AF by the PCF as part of setting PCC rule(s) via the Npcf\_SMPolicyControl service (see clause 5.2.5.4).

#### 5.2.8.3.3 Nsmf\_EventExposure\_Subscribe service operation

**Service operation name:** Nsmf\_EventExposure\_Subscribe.

**Description:** This service operation is used by an NF to subscribe or modify a subscription for event notifications on a specified PDU Session or for all PDU Sessions of one UE, group of UE(s) or any UE.

**Input, Required:** NF ID, target of event as defined in clause 5.2.8.3.1, (set of) Event ID(s) defined in clause 5.2.8.3.1, Notification Target Address (+ Notification Correlation ID), Event Reporting Information defined in Table 4.15.1-1.

**Input, Optional:** Event Filter(s) associated with each Event ID; Event Filter(s) are defined in clause 5.2.8.3.1, Subscription Correlation ID (in case of modification of the event subscription), Expiry time.

**Output, Required:** When the subscription is accepted: Subscription Correlation ID (required for management of this subscription), Expiry time (required if the subscription can be expired based on the operator's policy).

**Output, Optional:** First corresponding event report is included, if available (see clause 4.15.1).

Notification Target Address (+ Notification Correlation ID) is used to correlate Notifications sent by SMF with this subscription.

#### 5.2.8.3.4 Nsmf\_EventExposure\_UnSubscribe service operation

**Service operation name:** Nsmf\_EventExposure\_UnSubscribe.

**Description:** This service operation is used by an NF to unsubscribe event notifications.

**Input, Required:** Subscription Correlation ID.

**Input, Optional:** None.

**Output, Required:** None.

**Output, Optional:** None.

## 5.2.9 SMSF Services

### 5.2.9.1 General

The following table illustrates the SMSF Services.

**Table 5.2.9.1-1: List of SMSF Services**

Service Name	Service Operations	Operation Semantics	Example Consumer(s)
Nsmsf_SMSservice	Activate	Request/Response	AMF
	Deactivate	Request/Response	AMF
	UplinkSMS	Request/Response	AMF

### 5.2.9.2 Nsmsf\_SMSservice service

#### 5.2.9.2.1 General

This service allows AMF to authorize SMS and activate SMS for the served user on SMSF.

#### 5.2.9.2.2 Nsmsf\_SMSservice\_Activate service operation

**Service operation name:** Nsmsf\_SMSservice\_Activate.

**Description:** Authorize whether the specified UE is allowed to activate SMS service.

**Concurrent use:** None.

**Inputs, Required:** SUPI, NF ID.

**Inputs, Optional:** GPSI, Time Zone, Access Type, GUAMI, backup AMF(s) (if NF Type is AMF). Backup AMF(s) sent only once by the AMF to the SMSF in its first interaction with the SMSF, UE's Routing Indicator or UDM Group ID for the UE.

**Outputs, Required:** SMS service activation result.

**Outputs, Optional:** None.

#### 5.2.9.2.3 Nsmsf\_SMSservice\_Deactivate service operation

**Service operation name:** Nsmsf\_SMSservice\_Deactivate.

**Description:** Remove SMS service authorization from SMSF for a given service user.

**Concurrent use:** None.

**Inputs, Required:** SUPI.

**Inputs, Optional:** None.

**Outputs, Required:** SMS service deactivation result.

**Outputs, Optional:** None.

#### 5.2.9.2.4 Nsmsf\_SMSservice\_UplinkSMS service operation

**Service operation name:** Nsmsf\_SMSservice\_UplinkSMS.

**Description:** transmit uplink SMS message from consumer NF to SMSF.

**Concurrent use:** None.

**Inputs, Required:** SUPI, SMS payload.

**Inputs, Optional:** GPSI, UE Time Zone, UE Location Information (ULI).

**Outputs, Required:** SMS message transmission result.

**Outputs, Optional:** None.

## 5.2.10 AUSF Services

### 5.2.10.1 General

The following table illustrates the AUSF Services.

**Table 5.2.10.1-1: List of AUSF Services**

Service Name	Service Operations	Operation Semantics	Example Consumer(s)
Nausf_UEAuthentication	Authenticate	Request/Response	AMF
Nausf_SoRProtection	Protect	Request/Response	UDM

### 5.2.10.2 Nausf\_UEAuthentication service

#### 5.2.10.2.1 General

**Service Description:** the AUSF provides UE authentication service to the requester NF. For AKA based authentication, this operation can be also used to recover from synchronization failure situations.

#### 5.2.10.2.2 Nausf\_UEAuthentication\_Authenticate service operation

See TS 33.501 [15].

#### 5.2.10.2.3 Void

### 5.2.10.3 Nausf\_SoRProtection service

#### 5.2.10.3.1 General

**Service Description:** The AUSF provides the Steering of Roaming information protection service to the requester NF.

#### 5.2.10.3.2 Nausf\_SoRProtection Protect service operation

See TS 33.501 [15].

## 5.2.11 NWDAF Services

### 5.2.11.1 General

The following table illustrates the NWDAF Services.

Table 5.2.11.1-1: NF services provided by NWDAF

Service Name	Service Operations	Operation Semantics	Example Consumer(s)
Nnwdaf_EventsSubscription	Subscribe	Subscribe / Notify	PCF, NSSF
	Unsubscribe		PCF, NSSF
	Notify		PCF, NSSF
Nnwdaf_AnalyticsInfo	Request	Request / Response	PCF, NSSF

## 5.2.11.2 Nnwdaf\_EventsSubscription Service

### 5.2.11.2.1 General

**Service Description:** this service enables the consumer to subscribe/unsubscribe for load events notification of Network Slice instance. Periodic notification and notification upon threshold exceeded can be subscribed.

Following event are considered (Event ID defined in clause 4.15.1)

- Load level information with following possible event filters:
  - Network Slice Instance.
  - Load Level Threshold value (the NWDAF report when the load level crosses the threshold provided in the event subscription); if no threshold is provided in the subscription, the reporting (Notify operation) is assumed to be periodic.

#### 5.2.11.2.2 Nnwdaf\_EventsSubscription\_Subscribe service operation

**Service operation name:** Nnwdaf\_EventsSubscription\_Subscribe.

**Description:** Subscribes to NWDAF event with specific parameters.

**Inputs Required:** S-NSSAI, (Set of) Event ID(s) defined in clause 5.2.11.2.1, Notification Target Address (+ Notification Correlation ID), Event Reporting Information defined in Table 4.15.1-1.

**Inputs, Optional:** Event Filter(s) associated with each Event ID (e.g. Load Level Threshold value) , Subscription Correlation ID (in case of modification of the event subscription), NSI ID related to the S-NSSAI.

**Outputs Required:** When the subscription is accepted: Subscription Correlation ID (required for management of this subscription).

**Outputs, Optional:** None.

Notification Target Address (+ Notification Correlation ID) is used to correlate Notifications sent by NWDAF with this subscription.

NOTE: How load level of Network Slice instance is calculated is not specified in 3GPP.

#### 5.2.11.2.3 Nnwdaf\_EventsSubscription\_Unsubscribe service operation

**Service operation name:** Nnwdaf\_EventsSubscription\_Unsubscribe.

**Description:** unsubscribe to NWDAF event.

**Inputs, Required:** Subscription Correlation ID.

**Inputs, Optional:** None.

**Outputs, Required:** Confirmation of the unsubscription.

**Outputs, Optional:** None.

#### 5.2.11.2.4 Nnwdaf\_EventsSubscription\_Notify service operation

**Service operation name:** Nnwdaf\_EventsSubscription\_Notify.

**Description:** NWDAF notifies the consumer instance of the event that has subscribed to the specific NWDAF service. Depending upon type of subscription this notification is either on a periodic basis or triggered whenever a threshold is crossed.

**Inputs Required:** Event ID, Notification Target Address (+ Notification Correlation ID), S-NSSAI, Load level information of Network Slice instance.

**Inputs, Optional:** NSI ID related to the S-NSSAI.

**Outputs Required:** None.

**Outputs, Optional:** None.

#### 5.2.11.3 Nnwdaf\_Analytics\_Info service

##### 5.2.11.3.1 General

**Service description:** this service enables the consumer to request and get from NWDAF load level information of Network Slice instance(s).

The following events are considered (Event ID defined in clause 4.15.1):

- Load level information with following possible event filters:
- Network Slice Instance(s).

**Table 5.2.11.3.1-1: Services provided by NWDAF on Request**

Service Description	Parameters
Request for load level information of particular Network Slice instance(s). These represent the information that have a meaning only in its network.	Request: Event ID: load level information Event Filter: network slice instance(s).  Response: Requested Analytic data, including load level information of Network Slice instance(s).

##### 5.2.11.3.2 Nnwdaf\_AnalyticsInfo\_Request service operation

**Service operation name:** Nnwdaf\_AnalyticsInfo\_Request.

**Description:** the consumer requests NWDAF operator specific analytics.

**Inputs Required:** Event ID defined in clause 5.2.11.3.1, Event Filter(s).

**Inputs, Optional:** None.

**Outputs Required:** Analysis with parameters indicated in Table 5.2.11.3.1-1.

**Outputs, Optional:** None.

#### 5.2.12 UDR Services

##### 5.2.12.1 General

The following Data Set Identifiers shall be considered in this release: Subscription Data, Policy Data, Application data and Data for Exposure. The corresponding Data Subset Identifiers and Data (Sub)Key(s) are defined in Table 5.2.12.2.1-1.

The set of Data Set Identifiers shall be extensible to cater for new identifiers as well as for operator specific identifiers and related data to be consumed.

The following table illustrates the UDR Services.

**Table 5.2.12.1-1: NF services provided by UDR**

NF service	Service Operations	Operation Semantics	Example Consumer(s)
Data Management (DM)	Query	Request/Response	UDM, PCF, NEF
	Create	Request/Response	NEF
	Delete	Request/Response	NEF
	Update	Request/Response	UDM, PCF, NEF
	Subscribe	Subscribe/Notify	UDM, PCF, NEF
	Unsubscribe		UDM, PCF, NEF
	Notify		UDM, PCF, NEF

The following table shows the Exposure data that may be stored in the UDR along with a time stamp using Data Management (DM) Service:

**NOTE:** When the data in Table 5.2.12.1-2 need to be monitored in real time, they should be monitored directly at the originating NF (e.g. registration state changes may be monitored via the Namf\_EventExposure service) and not use the stored information from UDR if it is not the latest. It is expected that such dynamically changing information (e.g. UE reachability status) is used for statistical purpose and analytics.



Table 5.2.12.1-2: Exposure data stored in the UDR

Category	Information	Description	Data key	Data Sub key
Access and mobility information	UE location	Gives the Location or the last known location of a UE (e.g. Tai, Cell Id... both 3GPP and non-3GPP access location)	SUPI or GPSI	
	UE time zone	Current time zone for the UE	SUPI or GPSI	
	UE Access type	3GPP access or non-3GPP access	SUPI or GPSI	
	UE RAT type	E-UTRA or NR	SUPI or GPSI	
	UE registration state	Registered or Deregistered	SUPI or GPSI	
	UE connectivity state	IDLE or CONNECTED	SUPI or GPSI	
	UE reachability status	It indicates if the UE is reachable for sending either SMS or downlink data to the UE, which is detected when the UE transitions to CM-CONNECTED state or when the UE will become reachable for paging, e.g., Periodic Registration Update timer	SUPI or GPSI	
	UE SMS over NAS service status	SMS over NAS supported or not in the UE	SUPI or GPSI	
	UE Roaming status	It indicates UE's current roaming status (the serving PLMN and/or whether the UE is in its HPLMN)	SUPI or GPSI	
	UE Current PLMN	Current PLMN for the UE	SUPI or GPSI	
Session management information	UE IP address	UE IP address	SUPI or GPSI	PDU session ID or DNN
	PDU session status	Active / released	SUPI or GPSI	PDU session ID or DNN or UE IP address
	DNAI	DNAI	SUPI or GPSI	PDU session ID or DNN or UE IP address
	N6 traffic routing information	N6 traffic routing information	SUPI or GPSI	PDU session ID or DNN or UE IP address

## 5.2.12.2 Nudr\_DataManagement (DM) service

### 5.2.12.2.1 General

The operations defined for Nudr\_DM service use following set of parameters defined in this clause:

- Data Set Identifier: uniquely identifies the requested set of data within the UDR (see clause 4.2.5).
- Data Subset Identifier: it uniquely identifies the data subset within each Data Set Identifier. As specified in the procedures in clause 4, e.g. subscription data can consist of subsets particularised for specific procedures like mobility, session, etc.
- Data Keys defined in Table 5.2.12.2.1-1

For Nudr\_DM\_Subscribe and Nudr\_DM\_Notify operations:

- The Target of event reporting is made up of a Data Key and possibly a Data Sub Key both defined in Table 5.2.12.2.1-1. When a Data Sub Key is defined in the table but not present in the Nudr\_DM\_Subscribe this means that all values of the Data Sub Key are targeted.
- The Data Set Identifier plus (if present) the (set of) Data Subset Identifier(s) corresponds to a (set of) Event ID(s) as defined in clause 4.15.1

An NF Service Consumer may include an indicator when it invokes Nudr\_DM Query/Create/Update service operation to subscribe the changes of the data, to avoid a separate Nudr\_DM\_Subscribe service operation.

Depending on the use case, it is possible to use a Data Key and/or one or multiple Data sub keys to further identify the corresponding data, as defined in Table 5.2.12.2.1-1 below.

**Table 5.2.12.2.1-1: Data keys**

Data Set	Data Subset	Data Key	Data Sub Key
Subscription Data (see clause 5.2.3.3.1)	Access and Mobility Subscription data	SUPI	-
	SMF Selection Subscription data	SUPI	-
	UE context in SMF data	SUPI	PDU Session ID or DNN
	SMS Management Subscription data	SUPI	-
	SMS Subscription data	SUPI	-
	Session Management Subscription data	SUPI	S-NSSAI DNN
	Slice Selection Subscription data	SUPI	-
Application data	Packet Flow Descriptions (PFDs)	Application ID	-
	AF traffic influence request information (See clause 5.6.7 and clause 6.3.7.2 in 3GPP TS 23.501 [2]).	AF transaction internal ID S-NSSAI and DNN and/or Internal Group Identifier or SUPI	
Policy Data	UE context policy control data (See clause 6.2.1.3 in TS 23.503 [20])	SUPI	-
	PDU Session policy control data (See clause 6.2.1.3 in TS 23.503 [20])	SUPI	S-NSSAI DNN
	Policy Set Entry data (See clause 6.2.1.3 in TS 23.503 [20])	SUPI (for the UDR in HPLMN)	-
		PLMN ID (for the UDR in VPLMN)	
	Remaining allowed Usage data (See clause 6.2.1.3 in TS 23.503 [20])	SUPI	S-NSSAI DNN
	Sponsored data connectivity profiles (See clause 6.2.1.6 in TS 23.503 [20])	Sponsor Identity	-
	Background Data Transfer data (See clause 6.2.1.6 in TS 23.503 [20])	Background Data Transfer Reference ID. (NOTE 2)	-
None. (NOTE 1)			
Exposure Data (see clause 5.2.12.1)	Access and Mobility Information	SUPI or GPSI	PDU Session ID or UE IP address or DNN
	Session Management information	SUPI or GPSI	-
NOTE 1: Retrieval of the stored Background Data Transfer References for all ASP identifiers in the UDR requires Data Subset but no Data Key or Data Subkey(s).			
NOTE 2: Update of a Background Data Transfer Reference in the UDR requires a Data key to refer to a Background Data Transfer Reference as input data.			

The content of the UDR storage for (Data Set Id= Application Data , Data Subset Id = AF TrafficInfluence request information) is specified in TS 23.501 [2], clause 5.6.7, Table 5.6.7-1. This information is written by the NEF and read by the PCF(s). PCF(s) may also subscribe to changes onto this information.

### 5.2.12.2.2 Nudr\_DM\_Query service operation

**Service operation name:** Nudr\_DM\_Query.

**Description:** NF service consumer requests a set of data from UDR.

**Inputs, Required:** Data Set Identifier.

**Inputs, Optional:** Data Key(s), Data Subset Identifier(s), SUPI, Data Sub Key(s) (for each Data Subset, see clause 5.2.12.2.1).

The SUPI is used to identify which UE the latest list of stored PSIs belongs to.

**Outputs, Required:** Requested data.

**Outputs, Optional:** None.

#### 5.2.12.2.3 Nudr\_DM\_Create service operation

**Service operation name:** Nudr\_DM\_Create.

**Description:** NF service consumer intends to insert a new data record into the UDR, e.g. a NF service consumer intends to insert a new application data record into the UDR.

**Inputs, Required:** Data Set Identifier, Data Key(s).

**Inputs, Optional:** Data Subset Identifier(s), Data Sub Key(s) (for each Data Subset, see clause 5.2.12.2.1).

**Outputs, Required:** Result.

**Outputs, Optional:** None.

#### 5.2.12.2.4 Nudr\_DM\_Delete service operation

**Service operation name:** Nudr\_DM\_Delete.

**Description:** NF service consumer intends to delete user data stored in the UDR, e.g. a NF service consumer intends to delete an application data record.

**Inputs, Required:** Data Set Identifier, Data Key(s).

**Inputs, Optional:** Data Subset Identifier(s), Data Sub Key(s) (for each Data Subset, see clause 5.2.12.2.1).

**Outputs, Required:** Result.

**Outputs, Optional:** None.

#### 5.2.12.2.5 Nudr\_DM\_Update service operation

**Service operation name:** Nudr\_DM\_Update.

**Description:** NF service consumer intends to update stored data in the UDR.

**Inputs, Required:** Data Set Identifier, Data Key(s), Data.

**Inputs, Optional:** Data Subset Identifier(s), Data Sub Key(s) (for each Data Subset, see clause 5.2.12.2.1).

**Outputs, Required:** Result.

**Outputs, Optional:** None.

#### 5.2.12.2.6 Nudr\_DM\_Subscribe service operation

**Service operation name:** Nudr\_DM\_Subscribe.

**Description:** NF service consumer performs the subscription to notification to data modified in the UDR. The events can be changes on existing data, addition of data.

**Inputs, Required:** Data Set Identifier as defined in clause 5.2.12.2.1, Notification Target Address (+ Notification Correlation ID), Event Reporting Information defined in Table 4.15.1-1.

**Inputs, Optional:** Target of event reporting as defined in clause 5.2.12.2.1, Data Subset Identifier(s) as defined in clause 5.2.12.2.1, Subscription Correlation ID (in the case of modification of the event subscription).

**Outputs, Required:** When the subscription is accepted: Subscription Correlation ID.

**Outputs, Optional:** None.

#### 5.2.12.2.7 Nudr\_DM\_Unsubscribe service operation

**Service operation name:** Nudr\_DM\_Unsubscribe

**Description:** NF service consumer performs the un-subscription to notification to data modified in the UDR. The events can be changes on existing data, addition of data.

**Inputs, Required:** Subscription Correlation ID.

**Inputs, Optional:** None.

**Outputs, Required:** Result.

**Outputs, Optional:** None.

#### 5.2.12.2.8 Nudr\_DM\_Notify service operation

**Service operation name:** Nudr\_DM\_Notify.

**Description:** UDR notifies NF service consumer(s) about modification of data, when data in the UDR is added, modified or deleted, and an NF needs to be informed about this, due to a previous subscription to notifications procedure or due to a local configuration policy in the UDR.

**Inputs, Required:** Notification Correlation Information, Data Set Identifier as defined in clause 5.2.12.2.1, Target of event reporting as defined in clause 5.2.12.2, Updated Data.

**Inputs, Optional:** Data Subset Identifier as defined in clause 5.2.12.2.1.

**Outputs, Required:** Result.

**Outputs, Optional:** None.

### 5.2.13 BSF Services

#### 5.2.13.1 General

The following table shows the BSF Services and Service Operations:

**Table 5.2.13.1-1: NF services provided by the BSF**

Service Name	Service Operations	Operation Semantics	Example Consumer(s)
Nbsf_management	Register	Request/Response	PCF
	Deregister	Request/Response	PCF
	Discovery	Request/Response	NEF, AF

#### 5.2.13.2 Nbsf\_Management service

##### 5.2.13.2.1 General

The Nbsf provides the Nbsf Management Register, Nbsf Management Remove and the Nbsf Management Discovery service operations.

### 5.2.13.2.2 Nbsf\_Management\_Register service operation

**Service Operation name:** Nbsf\_Management\_Register.

**Description:** Registers the tuple (UE address(es), SUPI, GPSI, DNN, DN information (e.g. S-NSSAI), PCF id).

**Inputs, Required:** UE address(es), PCF id

UE address can contain IP address/prefix or Ethernet address as defined in TS 23.501 [2].

**Inputs, Optional:** DNN, SUPI, GPSI, DN information (e.g. S-NSSAI)

**Outputs, Required:** Result indication.

**Outputs, Optional:** None.

### 5.2.13.2.3 Nbsf\_Management\_Deregister service operation

**Service Operation name:** Nbsf\_Management\_Deregister

**Description:** Removes the tuple (UE address(es), SUPI, GPSI, DNN, DN information (e.g. S-NSSAI), PCF id).

**Inputs, Required:** UE address(es)

UE address can contain IP address/prefix or Ethernet address as defined in TS 23.501 [2].

**Inputs, Optional:** DNN, SUPI, GPSI, DN information (e.g. S-NSSAI)

**Outputs, Required:** Result indication.

**Outputs, Optional:** None.

### 5.2.13.2.4 Nbsf\_Management\_Discovery service operation

**Service Operation name:** Nbsf\_Management\_discovery

**Description:** Discovers the PCF selected for the tuple (UE IP address(es), SUPI, GPSI, DNN, DN information (e.g. S-NSSAI)).

**Inputs, Required:** UE IP address, DNN [Conditional], DN information (e.g. S-NSSAI) [Conditional]

**Inputs, Optional:** SUPI, GPSI

**Outputs, Required:** PCF id

**Outputs, Optional:** None.

## 5.2.14 UDSF Services

### 5.2.14.1 General

The following table illustrates the UDSF Services.

**Table 5.2.14-1: NF Services provided by UDSF**

NF service	Service Operations	Operation Semantics	Example Consumer(s)
Unstructured Data Management	Query	Request/Response	Any NF
	Create	Request/Response	Any NF
	Delete	Request/Response	Any NF
	Update	Request/Response	Any NF

NOTE: whether Nudsf is an exception as compared to other service-based interface due to dynamic data access performance requirement is per stage 3 decision.

## 5.2.14.2 Nudsf\_UnstructuredDataManagement service

### 5.2.14.2.1 General

#### 5.2.14.2.2 Nudsf\_UnstructuredDataManagement\_Query service operation

**Service operation name:** Nudsf\_UnstructuredDataManagement\_Query.

**Description:** NF service consumer intends to query data from UDSF.

**Inputs, Required:** Data Identifier.

Data Identifier uniquely identifies the data to be retrieved from the UDSF

**Inputs, Optional:**None.

**Outputs, Required:** Requested data.

**Outputs, Optional:** None.

#### 5.2.14.2.3 Nudsf\_UnstructuredDataManagement\_Create service operation

**Service operation name:** Nudsf\_UnstructuredDataManagement\_Create.

**Description:** NF service consumer intends to insert a new user data record into the UDSF, e.g. AMF stores the context for registered UE(s) in the UDSF.

**Inputs, Required:** Data Identifier, Data.

Data Identifier uniquely identifies the data, which is created in the UDSF.

**Inputs, Optional:** None

**Outputs, Required:** Result.

**Outputs, Optional:** None.

#### 5.2.14.2.4 Nudsf\_UnstructuredDataManagement\_Delete service operation

**Service operation name:** Nudsf\_UnstructuredDataManagement\_Delete.

**Description:** NF service consumer intends to delete user data stored in the UDSF, e.g. when AMF deletes the context for unregistered UE(s) in the UDSF.

**Inputs, Required:** Data Identifier.

**Inputs, Optional:** None.

Data Identifier uniquely identifies the data to be deleted within the UDSF.

**Outputs, Required:** Result.

**Outputs, Optional:** None.

#### 5.2.14.2.5 Nudsf\_UnstructuredDataManagement\_Update service operation

**Service operation name:** Nudsf\_UnstructuredDataManagement\_Update.

**Description:** NF service consumer intends to update stored data in the UDSF.

**Inputs, Required:** Data Identifier, Data.

Data Identifier uniquely identifies the data, which is updated in the UDSF.

**Inputs, Optional:** None.

**Outputs, Required:** Result.

**Outputs, Optional:** None.

## 5.2.15 LMF Services

### 5.2.15.1 General

The following table shows the LMF Services and LMF Service Operations.

**Table 5.2.15.1-1: List of LMF Services**

Service Name	Service Operations	Operation Semantics	Example Consumer(s)
Nlmf_Location	DetermineLocation	Request/Response	AMF

### 5.2.15.2 Nlmf\_Location service

#### 5.2.15.2.1 General

**Service description:** This service enables an NF to request location determination for a target UE. The following are the key functionalities of this NF service.

- Allow NFs to request the current geodetic and optionally civic location of a target UE.

#### 5.2.15.2.2 Nlmf\_Location\_DetermineLocation service operation

**Service operation name:** Nlmf\_Location\_DetermineLocation

**Description:** Provides UE location information to the consumer NF.

**Input, Required:** External Client Type, LCS Correlation Identifier.

**Input, Optional:** serving cell identifier if UE is using 3GPP access, Location QoS, Supported GAD shapes, AMF identity if a UE associated Namf\_Communication service is to be invoked by LMF, indication if UE supports LPP or not.

**Output, Required:** Success/Failure indication

**Output, Optional:** Geodetic Location, Civic Location, Position Methods Used (in the case of success indication provided), Failure Cause (in the case of failure indication provided).

See steps 6 and 8 of clause 4.13.5.3 for example of usage of this service operation.

## 5.2.16 NSSF Services

### 5.2.16.1 General

The following table illustrates the NSSF Services.

Table 5.2.16.1-1: NF Services provided by NSSF

Service Name	Service Operations	Operation Semantics	Example Consumer(s)
Nnssf_NSSelection	Get	Request/Response	AMF, NSSF in a different PLMN
Nnssf_NSSAIAvailability	Update	Request/Response	AMF
	Subscribe	Subscribe/Notify	AMF
	Unsubscribe		AMF
	Notify		AMF
	Delete	Request/Response	AMF

## 5.2.16.2 Nnssf\_NSSelection service

### 5.2.16.2.1 Nnssf\_NSSelection\_Get service operation

**Service operation name:** Nnssf\_NSSelection\_Get

**Description:** This service operation enables Network Slice selection in both the Serving PLMN and HPLMN. It also enables the NSSF to provide to the AMF the Allowed NSSAI and the Configured NSSAI for the Serving PLMN.

It may be invoked during Registration procedure, during PDU Session Establishment procedure or during UE Configuration Update procedure. When invoked during Registration procedure it may possibly trigger AMF re-allocation. When invoked during PDU Session Establishment procedure it may be invoked in the VPLMN or in the HPLMN. When invoked during UE Configuration Update procedure it may be invoked in the Serving PLMN.

NOTE 1: The list of events, which trigger invoking of the Nnssf\_NSSelection\_Get service operation, is not exhaustive.

**Inputs, Required:** None.

**Inputs, Conditional Required:**

If this service operation is invoked during Registration procedure not triggered by mobility from EPS to 5GS or UE Configuration Update procedure, then the following inputs are required:

- Subscribed S-NSSAI(s) with the indication if marked as default S-NSSAI, PLMN ID of the SUPI, TAI, NF type of the NF service consumer, Requester ID.

If this service operation is invoked during Registration procedure triggered by mobility from EPS to 5GS with N26 (as described in clause 4.11.1.3.3), the following inputs are required:

- S-NSSAIs for the HPLMN associated with established PDN connection, PLMN ID of the SUPI, NF type of the NF service consumer, Requester ID.

If this service operation is invoked during PDN Connection Establishment in the Serving PLMN in EPS by a PGW-C+SMF, the following inputs are required:

- Subscribed S-NSSAIs for the UE, PLMN ID of the SUPI, NF type of the NF service consumer, Requester ID.

Else, if this service operation is invoked during PDU Session Establishment procedure in the Serving PLMN then the following inputs are required:

- S-NSSAI, non-roaming/LBO roaming/HR roaming indication, PLMN ID of the SUPI, TAI, NF type of the NF service consumer, Requester ID.

**Inputs, Optional:**

If this service operation is invoked during Registration procedure not triggered by mobility from EPS to 5GS or UE Configuration Update procedure, then the following inputs are provided if available:

- Requested NSSAI, Mapping Of Requested NSSAI, Default Configured NSSAI Indication, Allowed NSSAI for current Access Type, Allowed NSSAI for the other Access Type, and the corresponding Mapping Of Allowed NSSAIs for current Access Type and other Access Type.



If this service operation is invoked during PDU Session Establishment procedure, then the following input is optional:

- HPLMN S-NSSAI that maps to the S-NSSAI from the Allowed NSSAI of the Serving PLMN.

**Outputs, Conditional Required:**

If this service operation is invoked during Registration procedure not triggered by mobility from EPS to 5GS or UE Configuration Update procedure, then one or more of the following outputs are required:

- Allowed NSSAI, Configured NSSAI; Target AMF Set or, based on configuration, the list of candidate AMF(s).

If this service operation is invoked during Registration procedure triggered by mobility from EPS to 5GS with N26 (as described in clause 4.11.1.3.3), the following output is required:

- S-NSSAIs for the HPLMN associated with established PDN connection, Mapping of S-NSSAIs associated with established PDN connection in the Serving PLMN.

If this service operation is invoked during PDN Connection Establishment in the Serving PLMN in EPS by a PGW-C+SMF, the following outputs are required:

- Subscribed S-NSSAIs for the UE, Mapping of S-NSSAIs associated with the subscribed S-NSSAIs for the UE in the Serving PLMN.

Else, if this service operation is invoked during PDU Session Establishment procedure then the following outputs are required:

- The NRF to be used to select NFs/services within the selected Network Slice instance.

**Outputs, conditional Optional:** If this service operation is invoked during UE Registration procedure or UE Configuration Update procedure, then one or more of the following outputs are optional:

- Mapping Of Allowed NSSAI, Mapping Of Configured NSSAI, NSI ID(s) associated with the Network Slice instances of the Allowed NSSAI, NRF(s) to be used to select NFs/services within the selected Network Slice instance(s) and NRF to be used to determine the list of candidate AMF(s) from the AMF Set, rejected S-NSSAI with cause of rejection.

Else, if this service operation is invoked during PDU Session Establishment procedure, then the following output is optional:

- NSI ID associated with the S-NSSAI provided in the input.

### 5.2.16.3 Nnssf\_NSSAIAvailability service

#### 5.2.16.3.1 General

**Service description:** This service enables to update the AMFs and the NSSF on the availability of S-NSSAIs on a per TA basis.

#### 5.2.16.3.2 Nnssf\_NSSAIAvailability\_Update service operation

**Service operation name:** Nnssf\_NSSAIAvailability\_Update

**Description:** This service operation enables the AMF to update the NSSF with the S-NSSAIs the AMF supports per TA, and get the availability of the S-NSSAIs per TA for the S-NSSAIs the AMF supports.

**Inputs, Required:** Supported S-NSSAIs per TAI.

The supported S-NSSAIs per TAI, is a list of TAIs and for each TAI the S-NSSAIs supported by the AMF.

**Inputs, Optional:** None.

**Outputs, Required:** A list of TAIs and, for each TAI, the S-NSSAIs supported by the AMF and 5G-AN, and authorized by the NSSF for the TAI.

**Outputs, Optional:** For each TAI, a list of S-NSSAIs restricted per PLMN for the TAI.

### 5.2.16.3.3 Nnssf\_NSSAIAvailability\_Notify service operation

**Service operation name:** Nnssf\_NSSAIAvailability\_Notify

**Description:** This service operation enables the NSSF to update the AMF with any S-NSSAIs restricted per TA and, if needed, subsequently lift any restriction per TA.

**Inputs, Required:** SubscriptionId, a list of TAIs and the S-NSSAIs for which the status is changed (restricted/unrestricted) per each TAI.

**Inputs, Optional:** None.

**Outputs, Required:** None.

**Outputs, Optional:** None.

### 5.2.16.3.4 Nnssf\_NSSAIAvailability\_Subscribe service operation

**Service operation name:** Nnssf\_NSSAIAvailability\_Subscribe

**Description:** This service operation enables a NF Service Consumer (e.g. AMF) to subscribe to a notification of any changes in status of the NSSAI availability information (e.g. S-NSSAIs available per TA and the restricted S-NSSAI(s) per PLMN in that TA in the serving PLMN of the UE) upon this is updated by another AMF.

**Inputs, Required:** Callback URI of the NF Service Consumer, list of TAIs supported by the NF service consumer, event to be subscribed.

**Inputs, Optional:** Expiry time.

**Outputs, Required:** SubscriptionID.

**Outputs, Conditional Required:** Expiry time (if present in the request, may be included in the response based on operator's policy and taking into account the expiry time present in the request (i.e. should be less than or equal to that value); if not present in the request, may be included in the response based on operator's policy. Whatever the case, if not included in the response, this means that the subscription is valid without an expiry time).

**Outputs, Optional:** A list of TAIs and, for each TAI, the S-NSSAIs supported by the AMF and 5G-AN, and authorized by the NSSF for the TAI, and a list of S-NSSAIs restricted per PLMN for the TAI.

### 5.2.16.3.5 Nnssf\_NSSAIAvailability\_Unsubscribe service operation

**Service operation name:** Nnssf\_NSSAIAvailability\_Unsubscribe

**Description:** This service operation enables a NF Service Consumer (e.g. AMF) to unsubscribe to a notification of any previously subscribed changes to the NSSAI availability information.

**Inputs, Required:** SubscriptionId.

**Inputs, Optional:** None.

**Outputs, Required:** None.

**Outputs, Optional:** None.

### 5.2.16.3.6 Nnssf\_NSSAIAvailability\_Delete service operation

**Service operation name:** Nnssf\_NSSAIAvailability\_Delete

**Description:** This service operation enables a NF service consumer (e.g. AMF) to delete the NSSAI availability information stored for the NF service consumer in the NSSF.

**Inputs, Required:** NfId.

**Inputs, Optional:** None.

**Outputs, Required:** None.

**Outputs, Optional:** None.

## 5.2.17 CHF Spending Limit Control Service

### 5.2.17.1 General

The following table illustrates the CHF Services defined in this specification. The other services of CHF are defined in clause 6.2 of TS 32.290 [42].

**Tale 5.2.17.1-1: CHF Services**

Service Name	Service Operations	Operation Semantics	Example Consumer(s)
Nchf_SpendingLimitControl	Subscribe	Subscribe/Notify	PCF
	Unsubscribe		PCF
	Notify		PCF

### 5.2.17.2 Nchf\_SpendingLimitControl service

#### 5.2.17.2.1 General

**Service description:** This service enables transfer of policy counter status information relating to subscriber spending limits from CHF to the NF consumer.

#### 5.2.17.2.2 Nchf\_SpendingLimitControl Subscribe service operation

**Service operation name:** Nchf\_SpendingLimitControl\_Subscribe.

**Description:** Subscribe to notification of changes in the status of the policy counters available at the CHF and retrieval of the status of the policy counters for which subscription is accepted by CHF.

**Inputs, Required:** SUPI (for the Initial Spending Limit request), SubscriptionCorrelationId (for the Intermediate Spending Limit report), Event Id "policy counter status change", Event Filter Information "List of policy counter identifier (s)".

**Inputs, Optional:** Notification Correlation Target (required for the Initial Spending Limit request), Event Filter Information "List of policy counter identifier (s)", Event Reporting Information (continuous reporting).

**Outputs, Required:** Status of the requested subscribed policy counters to the subscriber in the Event Information.

**Outputs, Optional:** Pending policy counter statuses and their activation times, for all policy counter(s) available for this subscriber. If list of policy counter identifier(s) was provided, the CHF returns only the pending policy counter statuses and their activation times, per required policy counter identifier in the Event Information, SubscriptionCorrelationId.

#### 5.2.17.2.3 Nchf\_SpendingLimitControl Unsubscribe service operation

**Service operation name:** Nchf\_SpendingLimitControl\_Unsubscribe.

**Description:** Cancel the subscription to status changes for all the policy counters available at the CHF.

**Inputs, Required:** SubscriptionCorrelationId.

**Inputs, Optional:** None.

**Outputs, Required:** Success or Failure.

**Outputs, Optional:** None.

#### 5.2.17.2.4 Nchf\_SpendingLimitControl Notify service operation

**Service operation name:** Nchf\_SpendingLimitControl\_Notify.

**Description:** Notify the change of the status of the subscribed policy counters available at the CHF. Alternatively, it can be used by the CHF to provide one or more pending statuses for a subscribed policy counter together with the time they have to be applied. Alternatively, it is also used by the CHF to notify the removal of a subscriber from the CHF system, so that the NF consumer can terminate the subscriptions of all the policy counters of the subscriber.

**Inputs, Required:** Notification Target Address, SUPI.

**Inputs, Optional:** policy counter status as Event Information, Pending policy counter statuses and their activation times as Event Information. Subscriber removal from the CHF system as Event Information.

**Outputs, Required:** Success or Failure.

**Outputs, Optional:** None.

---

# Annex A (informative): Drafting rules and conventions for NF services

## A.1 General

This informative Annex provides drafting rules and conventions followed in this technical specification (and TS 23.501 [2]) for the definition of NF services offered over the service-based interfaces.

---

## A.2 Naming

### A.2.1 Service naming

Each NF service provided by a service-based interface shall be named and referred to according to the following nomenclature:

- *Nnfname\_ServiceName*, where *Nnfname* is the service-based interface where the NF service is invoked. See TS 23.501 [2] clause 4.2.5 for the list of service-based interfaces in the 5GS Architecture.

Example (illustrative): *Namf\_Registration*.

### A.2.2 Service operation naming

If a service contains multiple independent operations, each operation shall be named and referred to according to the following nomenclature:

- *Nnfname\_ServiceName\_ServiceOperation[Method]*, where the *ServiceName* represents the actual NF service. The *ServiceOperation* itself defines the available service functionality which can be addressed by a specific operation. The *Method(s)* is/are the action(s), how the *ServiceOperation* can be used. It can be created, read, updated or deleted.

Example (illustrative): *Namf\_Session\_Registration[Create]*, *Namf\_Session\_Registration[Delete]*

In general, this operation naming structure for the given example is depicted in a tree-structure diagram:

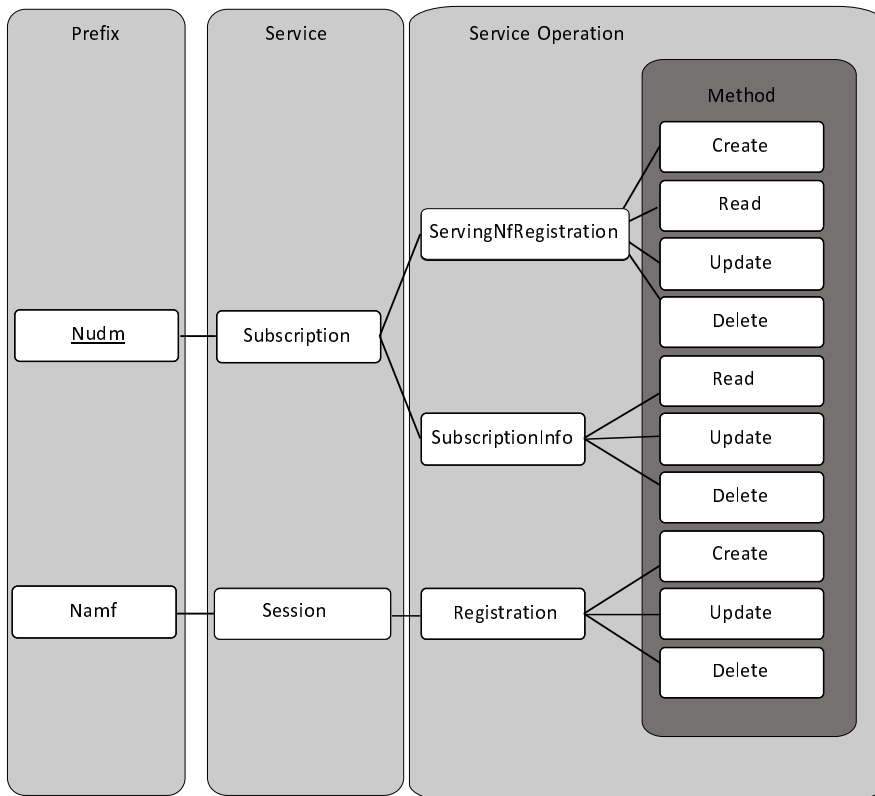

Figure A.2.2-1: Service Operation Naming and its Methods

### A.3 Representation in an information flow

Invoking a service or service operation within an information flow is represented using a disaggregated representation (see figure A.3-1).

The disaggregated representations on figure A.3-1 shall be used as follows:

- The <step> represents the actual step number in the information flow e.g. "7."
- Representation a) shall be used when the step is required.
- Representation b) shall be used when the step is optional or conditional.

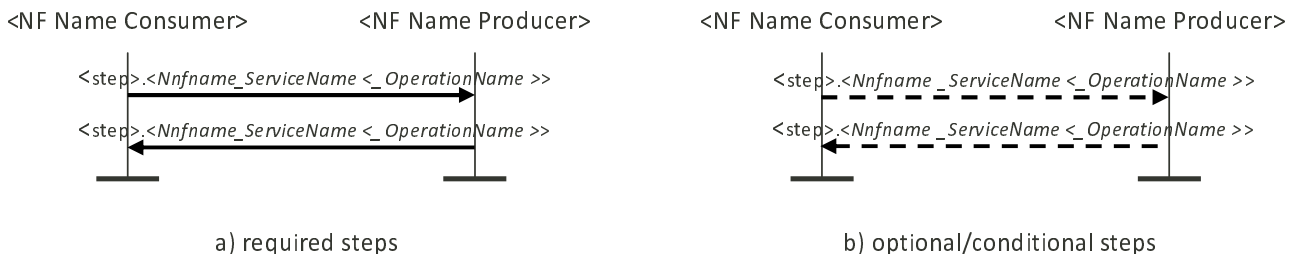

Figure A.3-1: Disaggregated representation of a NF service or service operation in information flows

NOTE: Depending on the information flow, the order of NF Producer and NF Consumer can be reversed.

---

## A.4 Reference to services and service operations in procedures

Whenever a procedure needs to refer to the service or service operation of a service-based interface, the naming in clause A.2 shall be used, using italic font. Unless otherwise obvious in the text, the NF Consumer of the service or service operation shall be indicated within parenthesis after the service or service operation name.

- <Nfname\_ServiceName<\_OperationName>> (<NF Name Consumer>)

Example: e.g. *Namf\_Registration\_RelocationRequest* (AMF)

---

## A.5 Service and service operation description template

The description of a service or service operation in this specification shall be done according to the following template.

NOTE: The heading level should follow that of the actual clause where the service is specified.

X.x <Nfname\_ServiceName<\_OperationName>>

X.x.1 Description

**Service or service operation name:** <Nfname\_ServiceName<\_OperationName>>.

**Description:** <short descriptive text>.

**Known NF Consumers:** <list of NFs>.

**Inputs, Required:** <list of parameters> -- *Parameters required from NF Consumer for successful completion of the service or service operation. Parameters required for the operation of the underlying protocol shall not be listed.*

**Inputs, Optional:** <list of parameters> -- *Additional parameters that may be provided by NF Consumer for execution of the service or service operation. Parameters required for the operation of the underlying protocol shall not be listed.*

**Outputs, Required:** <list of parameters>, <Nfname\_ServiceNameX<\_OperationNameY >>, <Other> -- *Parameters provided to NF Consumer and/or service triggered upon successful completion of the service and/or other (e.g. procedure triggered). Parameters required for the operation of the underlying protocol shall not be listed.*

**Outputs, Optional:** <list of parameters> -- *Additional parameters provided to NF Consumer upon successful completion of the service or service operation. Parameters required for the operation of the underlying protocol shall not be listed.*

X.x.2 Service/service operation information flow

<Information flow of the service or service operation offered by NF Producer to NF Consumer over the NF Producer service-based interface>.

NOTE: This information flow can require invoking other services. In this case, the invoked services are represented as described in clause A.3.

---

## A.6 Design Guidelines for NF services

TS 23.501 [2] clause 7.1.1 defines the criteria for defining the NF services. The following clauses identify the design guidelines that shall be considered for identifying the NF services.

### A.6.1 Self-Containment

The following design guidelines are used for identifying self-contained NF services.

- Each NF service operates on its own set of context(s). A context refers to a state or a software resource or an internal data storage. The NF service operations can create, read, update or delete the context(s).
- Any direct access of a context(s) owned by a NF service is be made by the service operations of that NF service. Services provided by the same NF can communicate internally within the NF.

## A.6.2 Reusability

The following design guidelines are used for specifying NF services to be reusable.

- NF service operations are specified such that other NF can potentially invoke them in future, if required.
- The service operations may be usable in multiple system procedures specified in clause 4 of this specification.
- Using clause 4 of the current document, the system procedures in which the NF service operations can be used are considered, and based on that the parameters for the NF service operations are clearly listed.

NOTE: It is possible that, when mapping an end to end call flow to service based architecture, one step in the call flow may map to multiple NF service operation invocations. This specification clearly identifies each NF service operation invocation in the call flow. Protocol optimization of multiple NF service operation invocations are left for TS 29.500 [17] consideration.

## A.6.3 Use Independent Management Schemes

The mechanisms for independent management schemes are not in scope of this specification.



---

## Annex B (informative): Drafting Rules for Information flows

The following drafting rules are recommended for information flows specified in this specification in order to ensure that the Control Plane network functions can be supported with service based interfaces:

1. Information flows should describe the end to end functionality. NF services in clause 5 shall only be derived from the information flows in clause 4.
2. Information flows should strive to use type of interactions such as REQUEST/RESPONSE (e.g. location request, location response), SUBSCRIBE/NOTIFY between Core CP NFs. Any other type of interactions described should have justifications for its use.
3. Information flows should also ensure readability thus the semantics of the REQUEST/RESPONSE should still be maintained (for instance, we need to indicate PDU Session request, PDU Session response and Subscribe for UE location reporting/Notify UE location reporting) for readers and developers to understand the need for a certain transaction.

NOTE: As stated in TS 23.501 [2], service based interface is not supported for N1, N2, N4. Thus, the rules are not meant for those interfaces.

---

## Annex C (informative): Generating EPS PDN Connection parameters from 5G PDU Session parameters

This annex specifies how to generate the EPS PDN connection parameters from the 5G PDU Session parameters in PGW-C+SMF.

When the PGW-C+SMF is requested to set up/modify either a PDN connection or a PDU session supporting interworking between EPS and 5GS, the PGW-C+SMF generates the PDN Connection parameters from the PDU session parameters.

When the PGW-C+SMF generates the PDN Connection parameters based on the PDU Session parameters, the following rules hold:

- PDN type: the PDN type is set to IPv4, IPv6 or IPv4v6 if the PDU Session Type is IPv4, IPv6 or IPv4v6, respectively. The PDN type is set to Non-IP for Ethernet and Unstructured PDU Session Types
- EPS bearer ID: the EBI is requested from the AMF during the establishment of a QoS Flow as described in clause 4.11.1.4.1 for PDU Sessions supporting interworking between EPS and 5GS. The EBI is obtained from MME during the establishment of an EPS Bearer (that is triggered by an establishment of a QoS Flow) as defined in TS 23.401 [13] for PDN Connections hosted by PGW-C+SMF. The association between EBI and QoS Flow is stored by the SMF.
- APN-AMBR: APN-AMBR is set according to operator policy (e.g. taking the Session AMBR into account).
- EPS QoS parameters (including ARP, QCI, GBR and MBR):

If QoS Flow is mapped to one EPS bearer, ARP, GBR and MBR of the EPS Bearer is set to the ARP, GFBR and MFBR of the corresponding QoS Flow, respectively. For standardized 5QIs, the QCI is one to one mapped to the 5QI. For non-standardized 5QIs, the PGW-C+SMF derives the QCI based on the 5QI and operator policy.

A GBR QoS Flow is mapped 1 to 1 to a GBR dedicated EPS Bearer if an EBI has been assigned. After mobility to EPS traffic flows corresponding to GBR QoS Flow for which no EBI has been assigned will continue flowing on the default EPS bearer if it does not have assigned TFT.

If multiple QoS Flows are mapped to one EPS bearer, the EPS bearer parameters are set based on operator policy, e.g. EPS bearer QoS parameters are set according to the highest QoS of all mapped QoS Flows.

After mobility to EPS traffic flows corresponding to Non-GBR QoS Flows for which no EBI has been assigned will continue flowing on the default EPS Bearer if it does not have assigned TFT.

---

## Annex D (normative): UE Presence in Area of Interest

### D.1 Determination of UE presence in Area of Interest by AMF

If RRC Inactive state applies to NG-RAN and the AMF has requested NG-RAN location reporting for the Area Of Interest and UE is in CM-CONNECTED state, the AMF determines the UE presence of Area of Interest as the reported value from the NG-RAN.

If RRC Inactive state applies to NG-RAN and the AMF has requested N2 Notification, the AMF determines the UE presence in Area Of Interest as follows:

- IN:
  - if the UE is inside the Area Of Interest service area and if the UE is in CM-CONNECTED with RRC Connected state; or

NOTE 1: The above is valid e.g. under the condition that Area Of Interest border coincides with NG-RAN node service area border or RAN Notification Area.

- if the UE is inside a Registration Area which is contained within the Area Of Interest.
- OUT:
  - if the UE is outside the Area Of Interest in CM-CONNECTED with RRC Connected state; or

NOTE 2: The above is valid e.g. under the condition that Area Of Interest border coincides with NG-RAN node service area border or RAN Notification Area.

- if UE is inside a Registration Area which does not contain any part of Area Of Interest.
- UNKNOWN:
  - if none of above conditions for IN or OUT is met.

Otherwise, AMF determines the UE presence of Area Of Interest as follows:

- IN:
  - if the UE is inside the Area Of Interest service area and if the UE is in CM-CONNECTED state; or
  - if the UE is inside a Registration Area which is contained within the Area Of Interest.
- OUT:
  - if the UE is outside the Area Of Interest in CM-CONNECTED; or
  - if UE is inside a Registration Area which does not contain any part of Area Of Interest.
- UNKNOWN:
  - if none of above conditions for IN or OUT is met.

---

### D.2 Determination of UE presence in Area of Interest by NG-RAN

If the AMF has requested for the Area of Interest, NG-RAN determines the UE presence of Area Of Interest as follows:

- IN:
  - if the UE is inside the Area Of Interest and the UE is in RRC Connected state; or
  - if the UE is inside an RNA which is contained within the Area Of Interest.
- OUT:
  - if the UE is outside the Area Of Interest in RRC Connected state; or
  - if UE is inside an RNA which does not contain any part of Area Of Interest.
- UNKNOWN:
  - if none of above conditions for IN or OUT is met.

## Annex D (informative): Change history

Change history							
Date	Meeting	TDoc	CR	Rev	Cat	Subject/Comment	New version
2017-09	SP#77	SP-170735	-	-	-	MCC Editorial Update for presentation to TSG SA#77 for information	1.0.0
2017-09	SA2#122E					Correcting implementation issues of S2-176821 and additional clean-up.	1.2.0
2017-12	SP-78	SP-170932	-	-	-	MCC Editorial Update for presentation to TSG SA#78 for Approval	2.0.0
2017-12	SP-78	-	-	-	-	MCC Editorial Update after TSG SA#78 Approval	15.0.0
2018-03	SP-79	SP-180092	0001	5	F	Corrections on the specification of Network Exposure services	15.1.0
2018-03	SP-79	SP-180101	0002	2	F	Corrections to PDU session establishment / modification procedure	15.1.0
2018-03	SP-79	SP-180101	0003	1	F	Clean-up of the registration procedure	15.1.0
2018-03	SP-79	SP-180090	0005	3	F	Using NRF for UPF discovery	15.1.0
2018-03	SP-79	SP-180101	0006	4	F	Allowed NSSAI and Access Type	15.1.0
2018-03	SP-79	SP-180101	0008	2	F	Corrections to the Inter-system mobility procedures	15.1.0
2018-03	SP-79	SP-180101	0009	1	F	QoS clarifications for EPC interworking	15.1.0
2018-03	SP-79	SP-180101	0010	-	F	EPS bearer ID allocation update	15.1.0
2018-03	SP-79	SP-180090	0011	1	F	Correction of Npcf_BDTPolicyControl service operation (Background data transfer)	15.1.0
2018-03	SP-79	SP-180095	0012	-	C	Multiple request of Location Reporting for Area of Interest	15.1.0
2018-03	SP-79	SP-180101	0013	1	F	SMF behaviour based on LADN notification	15.1.0
2018-03	SP-79	SP-180101	0014	-	F	Clarification on Internal Event Exposure	15.1.0
2018-03	SP-79	SP-180101	0015	-	F	Clarification on 5G-GUTI in EPS to 5GS Mobility Registration Procedure using N26	15.1.0
2018-03	SP-79	SP-180101	0016	-	F	Adding missing text about UE policies related to Service Request including the List Of Allowed PDU Sessions	15.1.0
2018-03	SP-79	SP-180101	0019	1	F	Update of NEF service for background data transfer	15.1.0
2018-03	SP-79	SP-180101	0020	1	F	Update of NEF service for PFD management	15.1.0
2018-03	SP-79	SP-180101	0021	-	F	Clarification on handover applicability between 3GPP and non-3GPP accesses	15.1.0
2018-03	SP-79	SP-180101	0022	-	F	Clarification on paging when it is related with both 3GPP and non-3GPP PDU Session	15.1.0
2018-03	SP-79	SP-180101	0023	1	F	Sending EBI to the NG-RAN	15.1.0
2018-03	SP-79	SP-180101	0024	1	F	Indirect data forwarding in home routed roaming case	15.1.0
2018-03	SP-79	SP-180101	0025	1	F	Interaction between SMF and UPF during the inter-system change	15.1.0
2018-03	SP-79	SP-180101	0026	1	F	Direct forwarding flag for handover from EPS to 5GS	15.1.0
2018-03	SP-79	SP-180101	0027	1	F	Update to N2 Handover procedure	15.1.0
2018-03	SP-79	SP-180101	0029	1	F	Clarification on keeping NAS signalling connection	15.1.0
2018-03	SP-79	SP-180093	0030	1	F	Clarification on SMS related Subscription data	15.1.0
2018-03	SP-79	SP-180101	0032	-	F	Clarification related to Subscription data type	15.1.0
2018-03	SP-79	SP-180101	0033	2	F	Clarification on PCF association	15.1.0
2018-03	SP-79	SP-180101	0034	-	F	Slicing handling for EPS to 5GS Mobility without N26	15.1.0
2018-03	SP-79	SP-180101	0035	-	F	Keeping EBI transfer alignment	15.1.0
2018-03	SP-79	SP-180101	0036	-	F	Clarification on the Emergency HO indication for EPS fallback	15.1.0
2018-03	SP-79	SP-180102	0037	-	F	Alignment of Namf_MT_EnableUEReachability service operation	15.1.0
2018-03	SP-79	SP-180102	0038	-	F	Mobility from EPC to 5GC	15.1.0
2018-03	SP-79	SP-180095	0040	-	C	Clarification on PDU Session Release timer provided to the UE for 'SSC mode 3'	15.1.0
2018-03	SP-79	SP-180102	0041	1	F	Generalize exposure of Mobility Events from AMF	15.1.0
2018-03	SP-79	SP-180102	0042	2	F	Align the UE location presence status of LADN Session into Network Triggered Service Request procedure	15.1.0
2018-03	SP-79	SP-180102	0043	-	F	Correction on AF influence on traffic routing	15.1.0
2018-03	SP-79	SP-180102	0044	-	F	Correction to RAN Initiated QoS Flow Mobility Procedure for Dual Connectivity	15.1.0
2018-03	SP-79	SP-180102	0045	-	F	Clarification on UDM service consumption order of UECEM and SDM	15.1.0
2018-03	SP-79	SP-180102	0046	-	F	Cleanup of the service request procedure	15.1.0
2018-03	SP-79	SP-180091	0047	-	F	UE-specific DRX parameter negotiation between UE and AMF	15.1.0
2018-03	SP-79	SP-180102	0048	-	F	Update of handover cancel procedure	15.1.0
2018-03	SP-79	SP-180091	0049	1	F	Control of the Messages triggering Paging at AMF	15.1.0
2018-03	SP-79	SP-180102	0050	-	F	Clarification for Area of validity in NW triggered SR procedure	15.1.0
2018-03	SP-79	SP-180091	0051	2	F	Revision on Service Request procedure	15.1.0
2018-03	SP-79	SP-180093	0052	1	F	Correction on Notification control for GBR QoS flow	15.1.0
2018-03	SP-79	SP-180093	0053	-	F	Reflective QoS Timer transmission during PDU Session establishment	15.1.0
2018-03	SP-79	SP-180102	0054	-	F	Correction on Policy association procedure during AMF relocation	15.1.0
2018-03	SP-79	SP-180102	0055	-	F	PCF selection for AMF during inter NG-RAN node N2 based handover	15.1.0
2018-03	SP-79	SP-180102	0056	1	F	Correction on PCF selection in SMF	15.1.0
2018-03	SP-79	SP-180091	0057	-	F	Update Paging Policy Differentiation in Network triggered Service Request procedure	15.1.0
2018-03	SP-79	SP-180102	0058	3	F	NEF service definitions for AF influence	15.1.0
2018-03	SP-79	SP-180102	0059	2	F	Update Handover procedures in clause 4.11.1.2	15.1.0
2018-03	SP-79	SP-180102	0060	2	F	Clean up of FFSs in 4.11.1.2.2	15.1.0
2018-03	SP-79	SP-180102	0061	3	F	A new annex for generating EPS PDN Connection parameters from 5G PDU Session parameters	15.1.0

2018-03	SP-79	SP-180102	0062	-	F	SMSF address deactivation and activation in AMF	15.1.0
2018-03	SP-79	SP-180102	0063	-	F	Correction on SMSF Nsmf_SMSservice_Activate service operation	15.1.0
2018-03	SP-79	SP-180102	0065	-	F	Resolution of ENs in Service Request procedures	15.1.0
2018-03	SP-79	SP-180096	0066	-	D	Editorial correction to clause 4.12.8	15.1.0
2018-03	SP-79	SP-180102	0067	-	F	Nudm SDM service Subscription Data types updates	15.1.0
2018-03	SP-79	SP-180102	0068	-	F	Replace PUI with GPSI	15.1.0
2018-03	SP-79	SP-180102	0069	-	F	Traffic mapping information that disallows UL packets	15.1.0
2018-03	SP-79	SP-180093	0070	1	F	Add Nocs_SpendingLimitControl service, service operations and information flows	15.1.0
2018-03	SP-79	SP-180102	0071	-	F	Correction/cleanup of IMS Emergency support	15.1.0
2018-03	SP-79	SP-180091	0072	-	F	Idle and connected state terminology cleanup	15.1.0
2018-03	SP-79	SP-180102	0073	1	F	LCS Correction of identities	15.1.0
2018-03	SP-79	SP-180103	0074	-	F	Slice selection cleanup	15.1.0
2018-03	SP-79	SP-180103	0075	1	F	Proposed resolution of Editor's Notes on clause 4.16	15.1.0
2018-03	SP-79	SP-180103	0076	1	F	Alignment of terminology and general cleanup	15.1.0
2018-03	SP-79	SP-180103	0078	1	F	Application Trigger procedure updates	15.1.0
2018-03	SP-79	SP-180103	0079	-	F	Specification of AN Parameters for Non-3GPP Access	15.1.0
2018-03	SP-79	SP-180103	0080	-	F	Clarifying inclusion of TAU messages in Registration Request	15.1.0
2018-03	SP-79	SP-180103	0082	2	F	Call flow for the PDU session setup for emergency with Emergency Service Support indicator	15.1.0
2018-03	SP-79	SP-180103	0083	1	F	NF Service Discovery	15.1.0
2018-03	SP-79	SP-180103	0085	1	F	Update 5GS and EPS handover procedures	15.1.0
2018-03	SP-79	SP-180103	0087	1	F	Operation type in Nsmf_PDUsession_UpdateSMContext Request	15.1.0
2018-03	SP-79	SP-180103	0088	1	F	Corrections of PDU session establishment procedure	15.1.0
2018-03	SP-79	SP-180103	0089	1	F	Correction on Secondary authorization/authentication procedure	15.1.0
2018-03	SP-79	SP-180103	0090	1	F	N4 reporting for PDU Session Inactivity	15.1.0
2018-03	SP-79	SP-180103	0091	1	F	Update PDU Session Modification procedures	15.1.0
2018-03	SP-79	SP-180103	0092	1	F	Correction on DNN management	15.1.0
2018-03	SP-79	SP-180103	0094	1	F	Mobility Restrictions when Roaming	15.1.0
2018-03	SP-79	SP-180103	0097	1	F	Change to Required Inputs for Update service operation	15.1.0
2018-03	SP-79	SP-180103	0098	3	F	Delivery of UE Access and PDU session related information by the PCF to the UE	15.1.0
2018-03	SP-79	SP-180093	0099	3	F	Interworking without N26 corrections	15.1.0
2018-03	SP-79	SP-180103	0100	1	F	Different Corrections of text and references	15.1.0
2018-03	SP-79	SP-180103	0101	2	F	Cleaning up binding in BSF after PDU session termination	15.1.0
2018-03	SP-79	SP-180103	0104	1	F	Updates of NSSF Services	15.1.0
2018-03	SP-79	SP-180090	0105	4	F	Selection mode transfer over N11 and N16 (wildcard DNN)	15.1.0
2018-03	SP-79	SP-180103	0106	7	F	Update to PCF-SMF interface ( Npcf_SMPolicyControl service)	15.1.0
2018-03	SP-79	SP-180092	0107	1	F	Correcting the support of charging Characteristics	15.1.0
2018-03	SP-79	SP-180103	0108	1	F	Handling of mapped EPS QoS parameters in IWK with EPC	15.1.0
2018-03	SP-79	SP-180103	0109	3	F	Alignment of non-3GPP & 3GPP registration procedures	15.1.0
2018-03	SP-79	SP-180090	0110	1	F	Network sharing PLMN handling	15.1.0
2018-03	SP-79	SP-180103	0111	3	F	Move 5GS related impact from TS 23.401 to TS 23.502	15.1.0
2018-03	SP-79	SP-180104	0112	-	F	Fixes for Emergency Services using Fallback procedure	15.1.0
2018-03	SP-79	SP-180104	0113	1	F	Fixes for UDM/UDR services	15.1.0
2018-03	SP-79	SP-180104	0114	1	F	EPS Interworking - Fixes for 5GS to EPS Mobility	15.1.0
2018-03	SP-79	SP-180104	0115	1	F	EPS Interworking - EPS Bearer ID allocation for HR session	15.1.0
2018-03	SP-79	SP-180104	0116	1	F	EPS Interworking - Fixes for 5GS->EPS HO	15.1.0
2018-03	SP-79	SP-180104	0117	1	F	EPS Interworking - Fixes for EPS->5GS HO	15.1.0
2018-03	SP-79	SP-180104	0118	2	F	EPS Interworking - Fixes for EPS to 5GS Mobility	15.1.0
2018-03	SP-79	SP-180104	0121	1	F	Update Nnrf_NFDiscovery service based on the UE IP address	15.1.0
2018-03	SP-79	SP-180104	0122	3	F	Update of Npcf_SMPolicyControl service	15.1.0
2018-03	SP-79	SP-180104	0125	3	F	Update to PCF-AMF interface and Npcf_AMPolicyControl service	15.1.0
2018-03	SP-79	SP-180104	0127	1	F	Correction on 5GS to EPS handover using N26 interface	15.1.0
2018-03	SP-79	SP-180104	0128	2	F	Nudm SDM service operations input parameter update	15.1.0
2018-03	SP-79	SP-180092	0129	2	F	Nudr_DM service operations input parameter update	15.1.0
2018-03	SP-79	SP-180104	0131	-	F	Nudm_SDM 'Access and Mobility Subscription data' update	15.1.0
2018-03	SP-79	SP-180104	0132	1	F	MME and AMF registration in HSS+UDM	15.1.0
2018-03	SP-79	SP-180104	0136	-	F	Clarification on SMSF registration/deregistration with UDM	15.1.0
2018-03	SP-79	SP-180104	0137	1	F	Clarification on AMF registration with UDM for Registration procedure for untrusted non-3GPP access	15.1.0
2018-03	SP-79	SP-180104	0138	2	F	Clarification on Location reporting procedures	15.1.0
2018-03	SP-79	SP-180104	0139	1	F	Correction to handovers between 3GPP and non-3GPP	15.1.0
2018-03	SP-79	SP-180104	0140	1	F	Clarification and alignment on the NG-RAN behavior for EPS/RAT fallback	15.1.0
2018-03	SP-79	SP-180104	0142	2	F	Clarification on how the AMF initiates inter or intra system handover to E-UTRAN connect to both EPC and 5GC.	15.1.0
2018-03	SP-79	SP-180104	0143	1	F	Clarification on the SM EPS bearer context from v-SMF	15.1.0
2018-03	SP-79	SP-180104	0144	1	F	Modification on the EBI revocation and ARP change	15.1.0
2018-03	SP-79	SP-180104	0147	-	F	Fixing the wrong usage of 'relocation'	15.1.0
2018-03	SP-79	SP-180104	0148	-	F	Corrections to NRF and NSSF services	15.1.0

2018-03	SP-79	SP-180104	0149	1	F	Correction of handover procedure from 4G to 5G in Single Registration mode	15.1.0
2018-03	SP-79	SP-180105	0151	-	F	Correction to UE Registration	15.1.0
2018-03	SP-79	SP-180105	0152	-	F	Corrections to SMF selection	15.1.0
2018-03	SP-79	SP-180092	0153	1	F	UE support for Multi-homed IPv6 PDU Session	15.1.0
2018-03	SP-79	SP-180105	0154	-	F	Adding the missing GPSI parameter in SMF	15.1.0
2018-03	SP-79	SP-180105	0155	2	F	Transparent relay between V-SMF and H-SMF in case of different feature support	15.1.0
2018-03	SP-79	SP-180105	0156	-	F	Preservation of GBR QoS Flows upon redirection	15.1.0
2018-03	SP-79	SP-180093	0157	2	F	Handling of UE Core Network Capability and indication of UE support for Handover Attach to NG-RAN	15.1.0
2018-03	SP-79	SP-180105	0158	3	F	Clarification on NSSAI configuration	15.1.0
2018-03	SP-79	SP-180093	0159	1	F	UE assisted UE policies calculation in PCF	15.1.0
2018-03	SP-79	SP-180105	0160	1	F	Correction of used Registration Type	15.1.0
2018-03	SP-79	SP-180105	0163	1	F	Re-use of definitions and abbreviations specified in TS 23.503.	15.1.0
2018-03	SP-79	SP-180105	0166	1	F	Correction to the UE Requested PDU Session Establishment via Untrusted non-3GPP Access Procedure	15.1.0
2018-03	SP-79	SP-180105	0167	1	F	Correction for UE location in Xn based HO procedure	15.1.0
2018-03	SP-79	SP-180105	0168	3	F	Clarification of UDR usage in policy related procedures	15.1.0
2018-03	SP-79	SP-180105	0170	2	F	Correction of UDR usage in MM related procedures	15.1.0
2018-03	SP-79	SP-180105	0171	2	F	Correction of UDR usage in specific service related procedures	15.1.0
2018-03	SP-79	SP-180105	0172	2	F	Correction for the invocation of Nudm_UECM_Deregistration service operation	15.1.0
2018-03	SP-79	SP-180105	0175	2	F	Correction of UDR usage in SM related procedures	15.1.0
2018-03	SP-79	SP-180105	0176	1	F	Clarification on handover procedure for home-routed roaming scenario	15.1.0
2018-03	SP-79	SP-180105	0177	-	F	Correction to inter NG-RAN node N2 based handover	15.1.0
2018-03	SP-79	SP-180105	0179	1	F	Correction on N4 Session Modification Request in Handover procedure	15.1.0
2018-03	SP-79	SP-180105	0180	1	F	Correction on Service Request procedure when UE establishes a signalling connection only	15.1.0
2018-03	SP-79	SP-180105	0181	1	F	Clarify how to send end marker during HO procedure	15.1.0
2018-03	SP-79	SP-180105	0183	-	F	Aligning TS 23.502 onto TS 29.244 about PPD.	15.1.0
2018-03	SP-79	SP-180092	0184	2	F	User plane security policy	15.1.0
2018-03	SP-79	SP-180105	0185	-	F	Service Request procedure corrections	15.1.0
2018-03	SP-79	SP-180105	0186	1	F	New cause for UP reactivation failure in Service Request procedure	15.1.0
2018-03	SP-79	SP-180105	0187	2	F	Rejection of UP activation during the Registration procedure	15.1.0
2018-03	SP-79	SP-180105	0188	2	F	Activating a Background Data Transfer Policy	15.1.0
2018-03	SP-79	SP-180106	0189	1	F	P-CSCF Discovery for IMS in 5GC using IP-CAN method	15.1.0
2018-03	SP-79	SP-180106	0191	-	F	Clarification on modification of the set of network slices for a UE	15.1.0
2018-03	SP-79	SP-180106	0192	1	F	Location reporting procedure for LADN in RRC Inactive state - TS 23.502	15.1.0
2018-03	SP-79	SP-180106	0193	3	F	Exposure of Mobility Events from AMF	15.1.0
2018-03	SP-79	SP-180106	0195	1	F	Clarification on AMF behaviour due to Subscriber Data Change in UDM	15.1.0
2018-03	SP-79	SP-180095	0199	1	B	Supporting 3GPP PS Data Off in 5GS	15.1.0
2018-03	SP-79	SP-180106	0203	1	F	Clarifications on EPS to 5GS handover procedure using N26	15.1.0
2018-03	SP-79	SP-180106	0204	1	F	Request Type in PDN connectivity request for SRM interworking	15.1.0
2018-03	SP-79	SP-180106	0205	1	F	Alignment CR for Application Data Function influence on traffic routing procedure	15.1.0
2018-03	SP-79	SP-180106	0206	1	F	PDU session ID in PDU session management procedure	15.1.0
2018-03	SP-79	SP-180106	0209	1	F	UE context removal in UDM during deregistration procedure	15.1.0
2018-03	SP-79	SP-180096	0210	1	D	Correction on non-3GPP Service request procedure	15.1.0
2018-03	SP-79	SP-180106	0211	2	F	Indication for Non-geographically selected AMF	15.1.0
2018-03	SP-79	SP-180106	0212	1	F	Updating Network Triggered Service Request to support selective re-activation of PDU session over non-3GPP access	15.1.0
2018-03	SP-79	SP-180106	0213	1	F	Editorial corrections in clause 4.2.3.3 Network Triggered Service Request	15.1.0
2018-03	SP-79	SP-180090	0215	1	F	Capturing impacts to 23.401 procedure for interworking with 5GC	15.1.0
2018-03	SP-79	SP-180106	0216	1	F	Clean up for PCC related flows	15.1.0
2018-03	SP-79	SP-180106	0219	-	F	Editorial modifications in procedures related to PDU session anchor addition or removal	15.1.0
2018-03	SP-79	SP-180106	0223	1	F	S-NSSAI in the PDU Session Establishment Accept for roaming scenario	15.1.0
2018-03	SP-79	SP-180106	0226	-	F	Clarification on Nnwdaf_EventsSubscription_Unsubscribe service operation	15.1.0
2018-03	SP-79	SP-180106	0227	-	F	Clarification on Network data analytics procedure	15.1.0
2018-03	SP-79	SP-180106	0228	2	F	Slicing configuration update	15.1.0
2018-03	SP-79	SP-180125	0229	1	B	Addition of PDU Session type IPv4v6	15.1.0
2018-03	SP-79	SP-180106	0230	1	F	Update of Reachability procedures	15.1.0
2018-03	SP-79	SP-180093	0234	2	C	EPS Fallback for voice further enhancements	15.1.0
2018-03	SP-79	SP-180106	0235	1	F	Clarification on Use of List of Parameter Values to Match in Event Filters	15.1.0



2018-03	SP-79	SP-180106	0236	2	F	Clarification on the services for External Parameter Provisioning	15.1.0
2018-03	SP-79	SP-180106	0237	-	F	Correction to PDU Session Establishment procedure	15.1.0
2018-03	SP-79	SP-180106	0238	1	F	EPS bearer context handling for N26 case	15.1.0
2018-06	SP-80	SP-180491	0182	3	F	TS 23.502: Xn handover and slice unavailability	15.2.0
2018-06	SP-80	SP-180482	0241	1	F	Correction of description related to PFD management	15.2.0
2018-06	SP-80	SP-180484	0245	-	F	Deregistration procedure correction	15.2.0
2018-06	SP-80	SP-180480	0247	1	F	Clarification on NG-RAN location reporting procedure	15.2.0
2018-06	SP-80	SP-180489	0249	-	F	TS 23.502: Perform authentication before Context Acknowledgement during 5GS to EPS Idle mode mobility using N26 interface	15.2.0
2018-06	SP-80	SP-180482	0251	6	F	Correction of UE configuration update procedure	15.2.0
2018-06	SP-80	SP-180481	0254	2	F	Clarifications on Nudr interactions between PCF and UDR	15.2.0
2018-06	SP-80	SP-180484	0255	-	F	Editorial corrections	15.2.0
2018-06	SP-80	SP-180484	0258	1	F	EPS to 5GS Mobility - Handling PDN connections that are not subject to service continuity	15.2.0
2018-06	SP-80	SP-180487	0259	1	F	P-GW-C+SMF Registration in the UDM for the purpose of EPS interworking	15.2.0
2018-06	SP-80	SP-180482	0261	1	F	Context retrieval for the purpose of EPS interworking	15.2.0
2018-06	SP-80	SP-180491	0262	-	F	Voice fallback during roaming scenarios	15.2.0
2018-06	SP-80	SP-180486	0263	1	F	NF Discovery via the NRF	15.2.0
2018-06	SP-80	SP-180487	0265	-	F	Nudm_UEAuthentication Service clarification	15.2.0
2018-06	SP-80	SP-180483	0266	-	D	Correction to figure caption errors in handover procedures	15.2.0
2018-06	SP-80	SP-180479	0268	3	F	Propose to add the network Requested PDU Session Release procedure via Untrusted non-3GPP access	15.2.0
2018-06	SP-80	SP-180483	0269	-	F	Correction to NEF service	15.2.0
2018-06	SP-80	SP-180481	0270	2	F	Clarify related description for Network Sharing and Interworking	15.2.0
2018-06	SP-80	SP-180481	0271	2	F	Clarifications to Registration and UE triggered Service Request procedure	15.2.0
2018-06	SP-80	SP-180489	0273	1	F	The interaction between PCF and AF	15.2.0
2018-06	SP-80	SP-180480	0274	1	F	Clarification on MT SMS domain selection by SMSF	15.2.0
2018-06	SP-80	SP-180483	0275	2	F	Correction to CN-initiated selective deactivation of UP connection of an existing PDU Session	15.2.0
2018-06	SP-80	SP-180479	0276	3	F	Clarification of the mapping relation between PDU session ID and access type in the AMF.	15.2.0
2018-06	SP-80	SP-180489	0277	1	F	TS 23.502: Clean-up for the RRC Inactive related procedure	15.2.0
2018-06	SP-80	SP-180482	0279	2	F	Cleanup to PCF selection in AMF and SMF	15.2.0
2018-06	SP-80	SP-180484	0280	1	F	Description of Policy Association	15.2.0
2018-06	SP-80	SP-180489	0281	2	F	Wildcard DNN management	15.2.0
2018-06	SP-80	SP-180479	0284	-	F	Clarification on HO procedure	15.2.0
2018-06	SP-80	SP-180479	0285	-	F	Clarification of Data Notification in service request procedure	15.2.0
2018-06	SP-80	SP-180484	0286	5	F	Correlation between EBI and QFI	15.2.0
2018-06	SP-80	SP-180479	0287	3	F	Clarification on Data Keys for Application data	15.2.0
2018-06	SP-80	SP-180491	0288	1	F	Updates on Subscribe Service Operation	15.2.0
2018-06	SP-80	SP-180489	0289	-	F	Alignment on the IMS voice over PS session supported indication	15.2.0
2018-06	SP-80	SP-180480	0290	1	F	Clarification on RAT fallback	15.2.0
2018-06	SP-80	SP-180479	0293	-	F	Clarification on AMF deregistration by UDM in N26 based interworking from 5GS to EPS	15.2.0
2018-06	SP-80	SP-180480	0296	-	F	Clarification on Network-initiated Deregistration	15.2.0
2018-06	SP-80	SP-180488	0297	-	F	Selective deactivation of UP connection for non-3GPP PDU Session	15.2.0
2018-06	SP-80	SP-180485	0300	5	F	Lack of S-NSSAI or DNN in the PDU Session Establishment Request	15.2.0
2018-06	SP-80	SP-180485	0302	1	F	Interactions with the DN-AAA that are not for authentication	15.2.0
2018-06	SP-80	SP-180481	0303	1	F	Clarification to handling of packet filters at PDU Session Modification	15.2.0
2018-06	SP-80	SP-180485	0304	1	F	LADN Signaling to SMF	15.2.0
2018-06	SP-80	SP-180484	0305	2	F	Corrections on UE configuration update procedure.	15.2.0
2018-06	SP-80	SP-180482	0308	2	F	CN tunnel handling during IRAT handover	15.2.0
2018-06	SP-80	SP-180489	0310	1	F	Subscription status notification for Event Exposure service	15.2.0
2018-06	SP-80	SP-180487	311	1	F	Removal of editor's notes in clause 4.12	15.2.0
2018-06	SP-80	SP-180480	0312	-	F	Clarification on SMF selection	15.2.0
2018-06	SP-80	SP-180480	0313	2	F	Clarification on policy provision in roaming case	15.2.0
2018-06	SP-80	SP-180479	0317	1	F	Authentication related services.	15.2.0
2018-06	SP-80	SP-180486	0318	5	F	Network slicing information as the service input parameter of BSF service operations	15.2.0
2018-06	SP-80	SP-180490	0319	1	F	Mobility Event Subscribe Service operation correction	15.2.0
2018-06	SP-80	SP-180491	0320	6	F	Update on AMF service operation to support query for terminating domain selection for IMS voice	15.2.0
2018-06	SP-80	SP-180483	0322		F	Correction on Nsmsf_SMSservice_Activate service operation	15.2.0
2018-06	SP-80	SP-180482	0323	1	F	Correction of Provision parameters flow	15.2.0
2018-06	SP-80	SP-180482	0325	2	F	Consolidation of UE Network Capabilities	15.2.0
2018-06	SP-80	SP-180488	0326	-	F	Removal of one step SMS procedure	15.2.0
2018-06	SP-80	SP-180481	0327	1	F	Clarifications on Nudr interactions between PCF and UDR	15.2.0
2018-06	SP-80	SP-180491	0328	2	F	Update Nudr_DataManagement (DM) service for data subscription	15.2.0
2018-06	SP-80	SP-180489	0329	-	F	Terminology cleanup	15.2.0
2018-06	SP-80	SP-180484	0331	1	F	Corrections to Service Request procedure	15.2.0

2018-06	SP-80	SP-180481	0334	1	F	Clarification on the use of shared AMF Pointer value	15.2.0
2018-06	SP-80	SP-180480	0335	3	F	Clarification on NGAP UE-TNLA-binding per UE Release procedure	15.2.0
2018-06	SP-80	SP-180488	0336	1	F	ReAuthentication by an external DN-AAA server	15.2.0
2018-06	SP-80	SP-180491	0337	5	F	Updates to SMF Event Exposure	15.2.0
2018-06	SP-80	SP-180487	0340	1	F	Policy related update in the PDU Session Establishment procedure	15.2.0
2018-06	SP-80	SP-180488	0341	1	F	Remove PCF as the consumer of Namf_EventExposure and Nsmf_EventExposure services	15.2.0
2018-06	SP-80	SP-180485	0342	3	F	Indirect Data forwarding for N2 HO	15.2.0
2018-06	SP-80	SP-180486	0345	1	F	N4 modification inserted during PDU Session Modification procedure	15.2.0
2018-06	SP-80	SP-180490	0347	-	F	Update of PDU Session Establishment Procedure	15.2.0
2018-06	SP-80	SP-180483	0349	-	F	Correction to N2 handover preparation	15.2.0
2018-06	SP-80	SP-180488	0352	2	F	Setting indirect data forwarding flag	15.2.0
2018-06	SP-80	SP-180478	0353	-	F	23.502: Alignment of terminologies regarding PDU Session	15.2.0
2018-06	SP-80	SP-180489	0354	2	F	TS 23.502 Clarification on Internal-Group identifier	15.2.0
2018-06	SP-80	SP-180489	0355	2	F	TS 23.502 Clarification on Access and mobility related policy	15.2.0
2018-06	SP-80	SP-180489	0356	1	F	TS 23.502 Clarification on AMF Subscription Correlation ID	15.2.0
2018-06	SP-80	SP-180478	0357	6	F	Additional DataSet and Datakey	15.2.0
2018-06	SP-80	SP-180489	0359	2	F	TS23.502 Remove access independent event trigger in Nsmf_EventExposure Service	15.2.0
2018-06	SP-80	SP-180488	0360	4	F	S-NSSAI check in Network Triggered Service Request	15.2.0
2018-06	SP-80	SP-180483	0362	1	F	Correction to User Plane Security Enforcement	15.2.0
2018-06	SP-80	SP-180483	0363	1	F	Correction to handover procedures	15.2.0
2018-06	SP-80	SP-180477	0365	-	D	Corrections on namings of SMF Service Operations	15.2.0
2018-06	SP-80	SP-180484	0366	1	F	Corrections to the selective deactivation of UP connection	15.2.0
2018-06	SP-80	SP-180481	0369	4	F	Clarification on the EBI assignment, PDU session ID list in Registration and PDU session correlation.	15.2.0
2018-06	SP-80	SP-180486	0370	1	F	Modification on SMF registration after EPS to 5GS mobility	15.2.0
2018-06	SP-80	SP-180487	0371	2	F	Proposal on the EPS Qos parameters on N7	15.2.0
2018-06	SP-80	SP-180483	0374	-	F	Correction to Nnwdaf_EventsSubscription_Notify (related to nw slice)	15.2.0
2018-06	SP-80	SP-180480	0376	1	F	Clarification on Nbsf_Management_Deregister service operation	15.2.0
2018-06	SP-80	SP-180481	0377	2	F	Clarification on Nnwdaf_Analytics_Info service	15.2.0
2018-06	SP-80	SP-180483	0378	1	F	Correction to indirect forwarding at intra 5GS N2 HO	15.2.0
2018-06	SP-80	SP-180485	0380	1	F	Local deactivation of MICO mode	15.2.0
2018-06	SP-80	SP-180484	0382	1	F	Dual registration interworking procedure	15.2.0
2018-06	SP-80	SP-180484	0383	8	F	EBI allocation and slicing interworking with EPS	15.2.0
2018-06	SP-80	SP-180490	0384	2	F	Tunnel Info reservation at the UPF for sessions interworked with EPC	15.2.0
2018-06	SP-80	SP-180483	0388	1	F	Correction to Nnef_TrafficInfluence service description	15.2.0
2018-06	SP-80	SP-180487	0389	3	F	Relaying of Nnef_TrafficInfluence requests to the PCF	15.2.0
2018-06	SP-80	SP-180484	0392	1	F	Corrections to PFD management	15.2.0
2018-06	SP-80	SP-180487	0393	2	F	Registration procedure update	15.2.0
2018-06	SP-80	SP-180485	0394	2	F	Handling of maximum supported data rate per UE for integrity protection	15.2.0
2018-06	SP-80	SP-180486	0395	1	F	NF/NF service Discovery across PLMNs	15.2.0
2018-06	SP-80	SP-180486	0396	1	F	NF/NF service Status Subscribe/Notify Flows	15.2.0
2018-06	SP-80	SP-180487	0397	-	F	Nudm service update to support Steering of Roaming	15.2.0
2018-06	SP-80	SP-180484	0400	2	F	Deregistration procedure for SMS over NAS	15.2.0
2018-06	SP-80	SP-180487	0401	-	F	Nudm service update to support P-CSCF Restoration	15.2.0
2018-06	SP-80	SP-180482	0402	1	F	Correction on Location continuity procedure	15.2.0
2018-06	SP-80	SP-180485	0403	1	F	IPsec SAs in tunnel mode	15.2.0
2018-06	SP-80	SP-180481	0404	1	F	Clarify GUTI aspects for single-registration mode UEs for interworking without N26	15.2.0
2018-06	SP-80	SP-180489	0406	1	F	Transaction reference ID usage in NEF NBI	15.2.0
2018-06	SP-80	SP-180483	0407	2	F	Correction to UE Radio Capability handling	15.2.0
2018-06	SP-80	SP-180488	0408	-	F	Resolving EN related to subscription data	15.2.0
2018-06	SP-80	SP-180488	0409	-	F	Resolving EN related to paging priority	15.2.0
2018-06	SP-80	SP-180485	0410	1	F	Handling of Configured NSSAIs in Roaming Scenarios - 23.502	15.2.0
2018-06	SP-80	SP-180488	0411	1	F	Slicing information and RFSP	15.2.0
2018-06	SP-80	SP-180487	0412	1	F	QoS rule structure improvement	15.2.0
2018-06	SP-80	SP-180476	0415	3	B	Exposure Data	15.2.0
2018-06	SP-80	SP-180484	0416	-	F	EPS to 5GS Mobility	15.2.0
2018-06	SP-80	SP-180485	0417	1	F	Fixes for HO Procedure - Handling MT Signaling from SMF.	15.2.0
2018-06	SP-80	SP-180478	0418	3	F	AMF Context Retrieval upon relocation	15.2.0
2018-06	SP-80	SP-180487	0419	-	F	NRF Service Operations	15.2.0
2018-06	SP-80	SP-180484	0420	2	F	EPS Bearer ID allocation for Home routed case	15.2.0
2018-06	SP-80	SP-180490	0422	1	F	UDM-AUSF Discovery	15.2.0
2018-06	SP-80	SP-180479	0423	2	F	AS Security Setup	15.2.0
2018-06	SP-80	SP-180481	0425	2	F	Clarification on the roaming aspects of SMF related policy	15.2.0
2018-06	SP-80	SP-180479	0428	2	F	Clarification on AN parameter in Service Request	15.2.0
2018-06	SP-80	SP-180482	0431	1	F	Correction on Non-3GPP Registration procedure	15.2.0
2018-06	SP-80	SP-180490	0432	4	F	UE presence of Area Of Interest (Restructuring)	15.2.0
2018-06	SP-80	SP-180486	0439	1	F	Missing S-NSSAI and the associated NSI ID in Nnrf_NFManagement_service	15.2.0

2018-06	SP-80	SP-180488	0440	1	F	Removing Editor's note about How NWDAF services work while roaming	15.2.0
2018-06	SP-80	SP-180482	0445	3	F	CN type indicator in Emergency Service Fallback procedure	15.2.0
2018-06	SP-80	SP-180482	0446	2	F	Correct Nudr_DM service operation usage by NEF	15.2.0
2018-06	SP-80	SP-180488	0447	-	F	Resolving EN related to Exposure with bulk subscription	15.2.0
2018-06	SP-80	SP-180486	0448	1	F	Mobility restrictions	15.2.0
2018-06	SP-80	SP-180488	0449	2	F	S-NSSAI of VPLMN when HO from 4G to 5G	15.2.0
2018-06	SP-80	SP-180485	0451	2	F	How Peer CP NF sends notification to target/new AMF after AMF planned removal	15.2.0
2018-06	SP-80	SP-180478	0452	1	F	AF influence on traffic routing for Ethernet type PDU Session	15.2.0
2018-06	SP-80	SP-180479	0457	1	F	Clarification of maximum number of reports and maximum duration of reporting	15.2.0
2018-06	SP-80	SP-180478	0458	1	F	Align Namf_Communication_N1N2TransferFailure service operation	15.2.0
2018-06	SP-80	SP-180490	0460	2	F	UDR storage for Nnef_TrafficInfluence from AF	15.2.0
2018-06	SP-80	SP-180491	0461	2	F	Update to AMF policy association modification procedure	15.2.0
2018-06	SP-80	SP-180489	0463	1	F	Support for UAC Access Identity in Visited PLMNs	15.2.0
2018-06	SP-80	SP-180488	0464	-	F	SMF exemption to NAS level congestion control for high priority access	15.2.0
2018-06	SP-80	SP-180488	0465	-	F	SMF Selection Subscriber Data clarification	15.2.0
2018-06	SP-80	SP-180479	0466	1	F	Clarification on Emergency services Fallback	15.2.0
2018-06	SP-80	SP-180490	0467	1	F	Update of the Handover procedure considering the ongoing inter NG-RAN node handover	15.2.0
2018-06	SP-80	SP-180491	0468	-	F	Update of the Network Triggered Service Request procedure for some clarifications	15.2.0
2018-06	SP-80	SP-180485	0469	2	F	Including GUAMI in RRC message of related procedures	15.2.0
2018-06	SP-80	SP-180480	0470	3	F	Clarification on Mobility related parameters of UE Context in AMF	15.2.0
2018-06	SP-80	SP-180482	0473	2	F	CN tunnel handling for IRAT Idle mobility	15.2.0
2018-06	SP-80	SP-180480	0474	2	F	Clarification on SMSF checking SMS management subscription data	15.2.0
2018-06	SP-80	SP-180481	0476	1	F	Clarification on UE configuration update procedure	15.2.0
2018-06	SP-80	SP-180487	0477	2	F	PCF selection during the AMF relocation	15.2.0
2018-06	SP-80	SP-180486	0480	5	F	MT-SMS over NAS re-transmission upon delivery failure on one Access Type	15.2.0
2018-06	SP-80	SP-180478	0481	1	F	Allowed NSSAI RAN awareness	15.2.0
2018-06	SP-80	SP-180490	0486	2	F	UE radio capability handling in the 5GS	15.2.0
2018-06	SP-80	SP-180478	0487	1	F	Adding number of supported packet filters in PDU Session Modification	15.2.0
2018-06	SP-80	SP-180491	0492	1	F	Update Registration procedures	15.2.0
2018-06	SP-80	SP-180482	0496	1	F	Correction of having multiple S-NSSAIs for a single PDU session	15.2.0
2018-06	SP-80	SP-180486	0497	3	F	Network slicing subscription change and update of UE configuration	15.2.0
2018-06	SP-80	SP-180490	0498	2	F	UE support of SMS and SMS subscription	15.2.0
2018-06	SP-80	SP-180488	0499	2	F	Removal of RAT Type from UE-associated N2 signalling	15.2.0
2018-06	SP-80	SP-180482	0501	2	F	Clarifying use-cases of network triggered service request	15.2.0
2018-06	SP-80	SP-180481	0502	1	F	Clarifying UE Reachability Notification Procedure	15.2.0
2018-06	SP-80	SP-180483	0505	2	F	Correction to identifiers in Registration procedure	15.2.0
2018-06	SP-80	SP-180483	0506	-	F	Correction to Figure 4.3.5.7-1: Simultaneous change of Branching Point or UL CL and additional PSA for a PDU Session	15.2.0
2018-06	SP-80	SP-180483	0507	-	F	Correction to UDR Data Set Identifiers considered in this release	15.2.0
2018-06	SP-80	SP-180490	0508	-	F	UE Policies in a UE Policy Container	15.2.0
2018-06	SP-80	SP-180480	0509	-	F	Clarification on single outstanding Service Request	15.2.0
2018-09	SP-81	SP-180717	0390	5	F	Discovering SMF instance at EPS to 5GS interworking	15.3.0
2018-09	SP-81	SP-180717	0489	4	F	AMF-PCF Association termination	15.3.0
2018-09	SP-81	SP-180717	0512	1	F	Change OCS to CHF in TS 23.502	15.3.0
2018-09	SP-81	SP-180717	0513	1	F	Correction to SMF registration of PDU Session ID	15.3.0
2018-09	SP-81	SP-180717	0514	-	F	Correction to handling of DNNs not supported by the network	15.3.0
2018-09	SP-81	SP-180717	0516	-	F	Mandatory valid lifetime configuration for old IP prefix in multi-homing	15.3.0
2018-09	SP-81	SP-180717	0517	4	F	Temporary identifier usage at interworking	15.3.0
2018-09	SP-81	SP-180717	0518	1	F	Requested NSSAI in Network Initiated Change of Network slices	15.3.0
2018-09	SP-81	SP-180717	0519	1	F	Network Slicing Subscription Change Indication	15.3.0
2018-09	SP-81	SP-180717	0520	2	F	Triggers for Network Triggered Service Request and UE Activity procedure	15.3.0
2018-09	SP-81	SP-180717	0521	-	F	5GS to EPS Mobility without N26	15.3.0
2018-09	SP-81	SP-180717	0522	1	F	EPS to 5GS mobility with N26	15.3.0
2018-09	SP-81	SP-180717	0525	7	F	Handling of subscription restrictions for mobility from EPS to 5GS	15.3.0
2018-09	SP-81	SP-180717	0526	2	F	Update of parameter in call flow and service operation for NSI ID	15.3.0
2018-09	SP-81	SP-180717	0527	-	F	Corrections to AF influence on traffic routing	15.3.0
2018-09	SP-81	SP-180724	0530	2	B	Support of tracing in 5GS signalling: SM related signalling and data	15.3.0
2018-09	SP-81	SP-180724	0531	2	B	Support of tracing in 5GS signalling: SMSF related signalling and data	15.3.0
2018-09	SP-81	SP-180717	0532	1	B	User Location Information added in N2 UE Context Release Complete	15.3.0
2018-09	SP-81	SP-180717	0533	1	F	Clarification to UE Configuration Update	15.3.0
2018-09	SP-81	SP-180717	0534	-	F	Clarification on CN-initiated selective deactivation of UP connection	15.3.0
2018-09	SP-81	SP-180717	0535	1	F	Clarification on UE configuration update procedure	15.3.0
2018-09	SP-81	SP-180717	0539	-	F	Alignment on Namf_EventExposure_Subscribe service operation	15.3.0

2018-09	SP-81	SP-180718	0540	7	F	PCF added as consumer of EventExposure service of AMF and SMF	15.3.0
2018-09	SP-81	SP-180718	0543	2	F	Correction on Connection Resume procedure	15.3.0
2018-09	SP-81	SP-180718	0544	1	F	Correction on signalling message holding during HO	15.3.0
2018-09	SP-81	SP-180718	0546	1	F	Clarification on UE Capability Match Request procedure	15.3.0
2018-09	SP-81	SP-180717	0547	-	D	Fixing clause number	15.3.0
2018-09	SP-81	SP-180718	0548	1	F	Service Accept to complete Service Request	15.3.0
2018-09	SP-81	SP-180718	0549	3	F	TS 23.502 Clarification on N2 based handover	15.3.0
2018-09	SP-81	SP-180718	0550	4	F	TS23.502 Clarifications on Xn based handover	15.3.0
2018-09	SP-81	SP-180717	0555	-	D	Editorial Fixes to the UECM Text	15.3.0
2018-09	SP-81	SP-180718	0557	2	F	Termination of the AM Policy Association	15.3.0
2018-09	SP-81	SP-180718	0561	2	F	Adding N28 session termination procedure and updates to CHF services	15.3.0
2018-09	SP-81	SP-180718	0563	-	F	Update to Registration procedure with AMF relocation	15.3.0
2018-09	SP-81	SP-180717	0565	2	D	Correction of UE configuration update procedure	15.3.0
2018-09	SP-81	SP-180717	0569	1	C	Indirect data forwarding for interworking with N26	15.3.0
2018-09	SP-81	SP-180718	0576	2	F	UE Context in SMSF data	15.3.0
2018-09	SP-81	SP-180718	0577	1	F	UE context in SMF data	15.3.0
2018-09	SP-81	SP-180718	0579	-	F	TS 23.502: Mobility Restriction List Clean up	15.3.0
2018-09	SP-81	SP-180718	0582	5	F	Default S-NSSAI correction and NSSF service update	15.3.0
2018-09	SP-81	SP-180718	0585	2	F	Subscription of selecting the same SMF and UPF	15.3.0
2018-09	SP-81	SP-180718	0586	2	F	N16 communication failure	15.3.0
2018-09	SP-81	SP-180718	0587	4	F	Clarification on UPF tunnel change	15.3.0
2018-09	SP-81	SP-180718	0588	3	F	Data handling in UPF during IRAT handover	15.3.0
2018-09	SP-81	SP-180718	0590	1	F	5GS to EPS Mobility	15.3.0
2018-09	SP-81	SP-180718	0591	1	F	Registration type for Nudm_UECM_Registration	15.3.0
2018-09	SP-81	SP-180718	0592	1	F	Correction to AS Security Context	15.3.0
2018-09	SP-81	SP-180718	0594	1	F	Peer NF association of GUAMI with a given UE	15.3.0
2018-09	SP-81	SP-180718	0595	1	F	23.502: 5G AN Parameters sent during Service Request	15.3.0
2018-09	SP-81	SP-180718	0597	2	F	Correction on AMF and UDM service table	15.3.0
2018-09	SP-81	SP-180718	0599	1	F	RRC Inactive to EPC mobility	15.3.0
2018-09	SP-81	SP-180719	0600	1	F	Homogeneous Support of IMS Voice over PS Sessions indication	15.3.0
2018-09	SP-81	SP-180719	0601	2	F	Clarification on the PDU session handling in EPS to 5GS handover with N26	15.3.0
2018-09	SP-81	SP-180719	0602	1	F	Clarification on the target MME capability from AMF to SMF for 5GS to EPS mobility	15.3.0
2018-09	SP-81	SP-180719	0604	1	F	Handling LADN service area during handovers	15.3.0
2018-09	SP-81	SP-180719	0605	1	F	Clarification on N3IWF key delivery during registration procedure	15.3.0
2018-09	SP-81	SP-180719	0606	1	F	Clarification on representation of Aol for NG-RAN location reporting procedure	15.3.0
2018-09	SP-81	SP-180719	0607	2	F	MT SMS failure recovery	15.3.0
2018-09	SP-81	SP-180719	0608	1	F	Add monitoring event cancellation call flows	15.3.0
2018-09	SP-81	SP-180719	0609	1	F	Nudm_EventExposure_Subscribe and unsubscribe service operation correction	15.3.0
2018-09	SP-81	SP-180719	0610	-	F	Time stamp in Namf, Nsmf and Nnef EventExposure_Notify service operations	15.3.0
2018-09	SP-81	SP-180719	0611	1	F	Corrections to NRF services description	15.3.0
2018-09	SP-81	SP-180719	0612	9	F	SBI friendly UE policy delivery procedure	15.3.0
2018-09	SP-81	SP-180719	0613	1	F	Correction to handover from 5GS to EPS	15.3.0
2018-09	SP-81	SP-180719	0615	2	F	Correction on inter-PLMN mobility	15.3.0
2018-09	SP-81	SP-180719	0616	1	F	Update to PDN connection establishment	15.3.0
2018-09	SP-81	SP-180719	0617	3	F	Clarification on Nbsf_Management_Update service operation	15.3.0
2018-09	SP-81	SP-180719	0618	-	F	Nudm service update to support protection of Steering of Roaming	15.3.0
2018-09	SP-81	SP-180719	0619	-	F	5GS-EPS interworking for Multi-homed IPv6 PDU Session	15.3.0
2018-09	SP-81	SP-180719	0620	2	F	Clafication on retrieval of the security context from old AMF	15.3.0
2018-09	SP-81	SP-180717	0621	2	B	Missing NEF services.	15.3.0
2018-09	SP-81	SP-180719	0623	-	F	Clarifications about MOBIKE and N3IWF certificate	15.3.0
2018-09	SP-81	SP-180719	0626	-	F	Corrections to N4 session and N4 node procedures	15.3.0
2018-09	SP-81	SP-180719	0627	1	F	Solving wrong references, service names or service operation names in NF services description	15.3.0
2018-09	SP-81	SP-180719	0628	-	F	Incorrect service operation names for NEF services	15.3.0
2018-09	SP-81	SP-180719	0630	2	F	Correction to NRF service operations and procedures	15.3.0
2018-09	SP-81	SP-180719	0631	1	F	Correction to Event Exposure operations	15.3.0
2018-09	SP-81	SP-180720	0633	1	F	Clarifications on AF influence on traffic routing procedures	15.3.0
2018-09	SP-81	SP-180720	0634	2	F	Corrections to UE Requested PDU Session Establishment	15.3.0
2018-09	SP-81	SP-180720	0635	-	F	Corrections related to SM on Hand-Over procedures	15.3.0
2018-09	SP-81	SP-180720	0636	1	F	Replace wrong Figure 4.16.4-1: SM Policy Association Establishment	15.3.0
2018-09	SP-81	SP-180720	0637	-	F	Optionality of Network area information	15.3.0
2018-09	SP-81	SP-180720	0638	-	F	Location Service, alignment procedures and NF Services	15.3.0
2018-09	SP-81	SP-180720	0639	1	F	Core Network type restriction on EPC in 5GS subscription data	15.3.0
2018-09	SP-81	SP-180720	0640	2	F	Indirect Forwarding Flag	15.3.0
2018-09	SP-81	SP-180720	0641	1	F	Storing FQDN for S5/S8 interface of the PGW-C+SMF in UDM	15.3.0
2018-09	SP-81	SP-180720	0644	1	F	Impacts on Update Location in 5GS to EPS Interworking without N26	15.3.0

2018-09	SP-81	SP-180720	0646	-	F	Resolving Editor's notes related to N2 messages	15.3.0
2018-09	SP-81	SP-180720	0647	-	F	Resolving Editor's note related to Session Management	15.3.0
2018-09	SP-81	SP-180720	0648	-	F	Resolving Editor's note related to Security	15.3.0
2018-09	SP-81	SP-180720	0651	-	F	Correction for UE requested LADN Information	15.3.0
2018-09	SP-81	SP-180720	0653	-	F	Clarification on ANDSP support	15.3.0
2018-09	SP-81	SP-180720	0654	1	F	Clarification on N26 based interworking procedures	15.3.0
2018-09	SP-81	SP-180720	0655	1	F	Corrections on Area Of Interest	15.3.0
2018-09	SP-81	SP-180720	0657	3	F	Signalling Configured NSSAIs valid for any PLMN usage in the Registration procedure	15.3.0
2018-09	SP-81	SP-180720	0658	1	F	SMS support used in different meanings	15.3.0
2018-09	SP-81	SP-180720	0660	2	F	NEF notification event correction	15.3.0
2018-09	SP-81	SP-180720	0662	1	F	Exposure with bulk subscription correction	15.3.0
2018-09	SP-81	SP-180720	0663	-	F	Removal of duplicated call flow	15.3.0
2018-09	SP-81	SP-180720	0664	1	F	NEF service operation correction	15.3.0
2018-09	SP-81	SP-180720	0667	1	F	Updates to NF service framework and NRF services for CHF discovery and selection	15.3.0
2018-09	SP-81	SP-180721	0668	-	F	Correction to service name for UE Subscriber Data Update Notification	15.3.0
2018-09	SP-81	SP-180721	0670	1	F	Correction to the procedure of PFD Retrieval by the SMF	15.3.0
2018-09	SP-81	SP-180721	0671	2	F	Removal of Binding information storage in UDR	15.3.0
2018-09	SP-81	SP-180721	0673	2	F	Further corrections to identifiers in Registration procedure	15.3.0
2018-09	SP-81	SP-180721	0674	-	F	Correction to Configured NSSAI for the HPLMN	15.3.0
2018-09	SP-81	SP-180721	0675	1	F	Correction to emergency registered	15.3.0
2018-09	SP-81	SP-180721	0676	-	F	Correction of wrong reference	15.3.0
2018-09	SP-81	SP-180721	0678	1	F	Corrections to Service Request	15.3.0
2018-09	SP-81	SP-180721	0679	1	F	Core Network assistance information in N2 message	15.3.0
2018-09	SP-81	SP-180721	0682	3	F	Correction to unsubscribe the monitoring event for a group	15.3.0
2018-09	SP-81	SP-180721	0683	2	F	OAuth2 Authorization Service	15.3.0
2018-09	SP-81	SP-180721	0686	-	F	23.502: UDM Service Operations	15.3.0
2018-09	SP-81	SP-180721	0689	1	F	23.502: N2 Tracing Requirements	15.3.0
2018-09	SP-81	SP-180721	0690	2	F	23.502: AMF-AMF Tracing Requirements	15.3.0
2018-09	SP-81	SP-180721	0691	1	F	23.502: AUSF, UDM, UDR Discovery	15.3.0
2018-09	SP-81	SP-180721	0692	2	F	23.502: UE Context removal correction	15.3.0
2018-09	SP-81	SP-180721	0693	1	F	23.502: NRF in different domains	15.3.0
2018-09	SP-81	SP-180721	0694	4	F	Default IPsec tunnel for a PDU Session	15.3.0
2018-09	SP-81	SP-180721	0695	2	F	Clarification on List Of PDU Sessions To Be Activated	15.3.0
2018-09	SP-81	SP-180721	0697	3	F	Correction to Service Request QoS when changing between non-3GPP and 3GPP accesses	15.3.0
2018-09	SP-81	SP-180721	0699	4	F	Clarification for QoS flow associated with the default QoS rule	15.3.0
2018-09	SP-81	SP-180721	0702	3	F	Update to registration procedure with AMF relocation	15.3.0
2018-09	SP-81	SP-180721	0704	1	F	The interaction between AF and PCF	15.3.0
2018-09	SP-81	SP-180721	0705	2	F	Storage of UE Policy in VPLMN	15.3.0
2018-09	SP-81	SP-180721	0706	2	F	TS 23.502 Clarification on Namf_Communication_N2InfoNotify	15.3.0
2018-09	SP-81	SP-180722	0707	2	F	TS23.502 Removal of Nnef_PFDManagement_Create service operation	15.3.0
2018-09	SP-81	SP-180722	0708	-	F	Clarifications on Registration, UE triggered SR and UCU procedures	15.3.0
2018-09	SP-81	SP-180722	0709	2	F	Clarifications on Registration and SR procedures	15.3.0
2018-09	SP-81	SP-180722	0710	2	F	Update Registration procedures for SMS over NAS	15.3.0
2018-09	SP-81	SP-180722	0712	1	F	Correction on the PDN connection IE and S-NSSAI during 4G->5G interworking with N26.	15.3.0
2018-09	SP-81	SP-180722	0715	2	F	EBI allocation for interworking	15.3.0
2018-09	SP-81	SP-180722	0718	1	F	NGAP session management procedure handling	15.3.0
2018-09	SP-81	SP-180722	0720	-	F	Correction on security for interworking	15.3.0
2018-09	SP-81	SP-180722	0721	2	F	Registration triggered by UE Configuration Update	15.3.0
2018-09	SP-81	SP-180722	0722	2	F	UE Configuration for MM policy	15.3.0
2018-09	SP-81	SP-180722	0723	2	F	LMF Service Update	15.3.0
2018-09	SP-81	SP-180722	0724	3	F	Clarification on terminology in NF service framework procedures	15.3.0
2018-09	SP-81	SP-180722	0726	-	F	Update Network-initiated Deregistration	15.3.0
2018-09	SP-81	SP-180791	0714	2	F	Clarification on the AMF store the DNN and PGW-C+SMF to UDM+HSS without N26	15.3.0
2018-12	SP-82	SP-181088	0642	6	F	Handling of AMF registration in UDM for non-3GPP access	15.4.0
2018-12	SP-82	SP-181088	0643	1	F	Handling of Notify Request in EPC	15.4.0
2018-12	SP-82	SP-181091	0645	2	F	Use of Nudm service operations in EPS to 5GS mobility without N26	15.4.0
2018-12	SP-82	SP-181087	0652	3	F	Correction for Registration procedure for LADN – Triggering Condition	15.4.0
2018-12	SP-82	SP-181089	0661	4	F	IWK support for handover of PDU sessions without UP	15.4.0
2018-12	SP-82	SP-181091	0730	5	C	Update of Default Configured NSSAI and other UE parameters via Control Plane Solution from UDM to AMF with Direct NAS Transport to UE	15.4.0
2018-12	SP-82	SP-181090	0731	3	C	Support for partial ciphering of initial NAS messages	15.4.0
2018-12	SP-82	SP-181084	0734	2	F	Aligning Nnrf_NFManagement with 23.501 and stage 3, 29.510	15.4.0
2018-12	SP-82	SP-181084	0735	1	F	Aligning discovery with stage 3	15.4.0
2018-12	SP-82	SP-181084	0736	-	F	Alignment of AMF identity transfer in LCS procedures	15.4.0
2018-12	SP-82	SP-181088	0737	2	F	EPS Fallback, RAT Fallback and PCC	15.4.0

2018-12	SP-82	SP-181087	0738	1	F	Correction to UE context transfer upon registration via another access type	15.4.0
2018-12	SP-82	SP-181088	0739	3	F	Handover from 5GC-N3IWF to EPS	15.4.0
2018-12	SP-82	SP-181088	0740	3	F	Handover from EPC/ePDG to 5GS	15.4.0
2018-12	SP-82	SP-181088	0741	1	F	Corrections to EPS to 5GS mobility for idle-mode mobility	15.4.0
2018-12	SP-82	SP-181087	0742	3	F	Corrections to 5GS to EPS handover using N26	15.4.0
2018-12	SP-82	SP-181087	0743	3	F	Corrections to EPS to 5GS handover	15.4.0
2018-12	SP-82	SP-181084	0745	4	F	Npcf_EventExposure service for bulk subscription	15.4.0
2018-12	SP-82	SP-181088	0746	1	F	Interactions with PCF - Interworking	15.4.0
2018-12	SP-82	SP-181086	0749	1	F	Correcting the interaction needed for the NSSF service	15.4.0
2018-12	SP-82	SP-181087	0752	-	F	Correction on TAU during 5GS to EPS handover using N26 interface	15.4.0
2018-12	SP-82	SP-181089	0753	1	F	PCF interaction during IWK when UE is in EPS	15.4.0
2018-12	SP-82	SP-181085	0755	1	F	Clarification on signalling connection release condition in Registration procedure	15.4.0
2018-12	SP-82	SP-181085	0756	2	F	Clarification on PDU Session activation and deactivation	15.4.0
2018-12	SP-82	SP-181090	0757	2	F	TS23.502 Clarification on UE policy service and AM policy service	15.4.0
2018-12	SP-82	SP-181091	0759	1	F	Using TCP for reliable NAS transport between UE and N3IWF	15.4.0
2018-12	SP-82	SP-181090	0762	2	F	RRC Inactive state assistance information provisioning to NG-RAN	15.4.0
2018-12	SP-82	SP-181084	0765	1	F	Adding RAN Status Transfer to N2 HO	15.4.0
2018-12	SP-82	SP-181089	0767	5	F	Network controlled NSSAI for SR-related Access Stratum connection establishment	15.4.0
2018-12	SP-82	SP-181090	0768	1	F	Replace PCRF+PCF with PCF in interworking with EPC scenarios	15.4.0
2018-12	SP-82	SP-181089	0770	1	F	Priority indication over SBA interfaces via Message Priority header	15.4.0
2018-12	SP-82	SP-181086	0772	-	F	Correcting known consumers of Namf service	15.4.0
2018-12	SP-82	SP-181091	0773	2	F	Updates from UEPolicyControl introduction	15.4.0
2018-12	SP-82	SP-181090	0774	1	F	Secondary Re-authentication update	15.4.0
2018-12	SP-82	SP-181085	0775	3	F	Clarification on interworking with N26 interface	15.4.0
2018-12	SP-82	SP-181087	0777	1	F	Correction to the monitoring event subscription to a group	15.4.0
2018-12	SP-82	SP-181087	0779	1	F	Correction to UE Policy Association procedure	15.4.0
2018-12	SP-82	SP-181086	0782	5	F	Clarification on the delivery of EBI to UE and RAN	15.4.0
2018-12	SP-82	SP-181085	0783	4	F	CHF Selection	15.4.0
2018-12	SP-82	SP-181084	0784	1	F	AF subscribed events	15.4.0
2018-12	SP-82	SP-181087	0785	2	F	Correction to AM Policy Association Termination in registration procedure	15.4.0
2018-12	SP-82	SP-181084	0786	3	F	Alignment for always-on PDU sessions	15.4.0
2018-12	SP-82	SP-181084	0788	-	F	Adding Subscribed DNN list in Access and Mobility subscription data	15.4.0
2018-12	SP-82	SP-181088	0790	4	F	EPS Interworking : Single versus Dual Registration with the UDM	15.4.0
2018-12	SP-82	SP-181088	0791	1	F	EPS bearer mapping for 5GS to EPS mobility with N26	15.4.0
2018-12	SP-82	SP-181090	0792	1	F	Registration Procedure – fix UDM registration	15.4.0
2018-12	SP-82	SP-181086	0793	3	F	Clarification on the PDU Session handover procedure with the User Plane Security Enforcement	15.4.0
2018-12	SP-82	SP-181091	0795	3	F	Update the UCU procedure with operator-defined access category definitions	15.4.0
2018-12	SP-82	SP-181086	0796	1	F	Clarification on the AMF store the DNN and PGW-C+SMF to UDM+HSS	15.4.0
2018-12	SP-82	SP-181088	0799	2	F	Efficient delivery of UE Policies	15.4.0
2018-12	SP-82	SP-181091	0800	1	F	Update the general description of Nnef_PFDManagement service	15.4.0
2018-12	SP-82	SP-181089	0801	1	F	Monitoring input parameter correction	15.4.0
2018-12	SP-82	SP-181091	0802	1	F	Update of SMS service operation parameters for 3GPP specific encoding	15.4.0
2018-12	SP-82	SP-181089	0803	-	F	NRF Service Update	15.4.0
2018-12	SP-82	SP-181087	0806	4	F	Correction of UE Configuration Update	15.4.0
2018-12	SP-82	SP-181088	0807	1	F	Handling of NF location during discovery	15.4.0
2018-12	SP-82	SP-181088	0808	1	F	Corrections to event exposure information flows and Nudm_EventExposure service description	15.4.0
2018-12	SP-82	SP-181089	0809	2	C	MCS Access and Mobility Subscription Data	15.4.0
2018-12	SP-82	SP-181089	0813	1	F	PDU Session Modification due to QoS Flow creation	15.4.0
2018-12	SP-82	SP-181090	0814	2	F	SMF storing FQDN for the S5/S8 interface of the PGW-C+SMF for N3GPP PDU Session	15.4.0
2018-12	SP-82	SP-181088	0815	2	F	Handling of N3GPP access registration in interworking between EPS and 5GS using N26.	15.4.0
2018-12	SP-82	SP-181090	0816	2	F	UE Identifier provided during Registration Procedure	15.4.0
2018-12	SP-82	SP-181090	0817	1	F	Selective deactivation for always-on PDU sessions	15.4.0
2018-12	SP-82	SP-181084	0818	3	F	5G-TMSI reallocation and RRC Inactive	15.4.0
2018-12	SP-82	SP-181089	0819	1	F	QoS Flow deletion	15.4.0
2018-12	SP-82	SP-181090	0823	1	F	Registration procedure with different Registration types	15.4.0
2018-12	SP-82	SP-181088	0824	2	F	EPS to 5GS with network slices	15.4.0
2018-12	SP-82	SP-181084	0825	3	F	AUSF and UDM selection in 5GC NFs	15.4.0
2018-12	SP-82	SP-181090	0827	3	F	Registration procedure updates due to UE Policy Control Service	15.4.0
2018-12	SP-82	SP-181088	0828	1	F	Include GPSI in Npcf-SMPolicyControl Create message	15.4.0
2018-12	SP-82	SP-181085	0830	2	F	Clarification on DNN not subscribed in AMF	15.4.0
2018-12	SP-82	SP-181085	0831	-	F	Clarification on ANDSP support indication in UE Policy Container	15.4.0

2018-12	SP-82	SP-181085	0832	1	F	Clarification on rejected S-NSSAIs and cause in Registration and UCU procedure	15.4.0
2018-12	SP-82	SP-181085	0835	1	F	Clarification on Event Reporting information for Npcf_PolicyAuthorization service	15.4.0
2018-12	SP-82	SP-181086	0836	1	F	Clarification on UE Policy Control Request Triggers	15.4.0
2018-12	SP-82	SP-181087	0837	1	F	Correction to interworking procedures without N26	15.4.0
2018-12	SP-82	SP-181089	0838	-	F	Indirect forwarding timer for N2 HO	15.4.0
2018-12	SP-82	SP-181085	0841	1	F	Clarification on Registration with AMF re-allocation	15.4.0
2018-12	SP-82	SP-181089	0842	1	F	PDN Disconnection handling	15.4.0
2018-12	SP-82	SP-181086	0843	2	F	Clarification on SMF registration to UDM+HSS	15.4.0
2018-12	SP-82	SP-181089	0845	1	F	OSID storage	15.4.0
2018-12	SP-82	SP-181085	0846	1	F	Clarification on PDU Session procedures (AMF awareness of N2 information type)	15.4.0
2018-12	SP-82	SP-181085	0847	1	F	Clarification on ID provision to RAN in registration procedure	15.4.0
2018-12	SP-82	SP-181088	0848	-	F	Deletion of AN tunnel info from Handover Notify message in the EPS-to-5GS handover procedure	15.4.0
2018-12	SP-82	SP-181090	0849	-	F	Removal of PPI from N2 SM information	15.4.0
2018-12	SP-82	SP-181087	0850	1	F	Correction to handover from EPS to 5GS	15.4.0
2018-12	SP-82	SP-181089	0852	1	F	Non-accepted PDU session in N2 based HO	15.4.0
2018-12	SP-82	SP-181086	0854	2	F	Clarification on the PDN connection release during N26 mobility	15.4.0
2018-12	SP-82	SP-181090	0857	-	F	Storing SMSF address in the UDR	15.4.0
2018-12	SP-82	SP-181084	0859	2	F	Addition of URRP in UE context in the MM context	15.4.0
2018-12	SP-82	SP-181088	0860	1	F	Event subscription clarification	15.4.0
2018-12	SP-82	SP-181085	0861	1	F	Charging related information in Nsmf_PDUSession_Create service operation	15.4.0
2018-12	SP-82	SP-181087	0862	1	F	Correction to network requested PDU Session Release due to a change of the set of network slices for a UE	15.4.0
2018-12	SP-82	SP-181088	0863	-	B	Data Volume Reporting for Option 4/7 - Procedure updates	15.4.0
2019-01	-	-	-	-	-	Editorial correction to replace '-' with 'o' due to CR implementation error.	15.4.1
2019-03	SP-83	SP-190157	0868	1	F	Avoiding unnecessary authentication for SR-mode UEs during EPS-5GS mobility	15.5.0
2019-03	SP-83	SP-190157	0869	3	F	PDU Session Release with User Plane Deactivated	15.5.0
2019-03	SP-83	SP-190157	0870	1	F	DL Data Buffering in the SMF for the PDU Session with UP Deactivated	15.5.0
2019-03	SP-83	SP-190157	0871	4	F	Registration Procedure Update with Inter PLMN AMF Reallocation	15.5.0
2019-03	SP-83	SP-190157	0873	1	F	Data Types for parameters within UE Parameter Update via Control Plane Solution	15.5.0
2019-03	SP-83	SP-190157	0874	1	F	Adding SM Context ID in relevant clauses	15.5.0
2019-03	SP-83	SP-190157	0876	1	F	Corrections to N4 procedure for PFD management	15.5.0
2019-03	SP-83	SP-190157	0879	1	F	Support of piggybacking of NAS SM message while configuring a DRB	15.5.0
2019-03	SP-83	SP-190157	0880	1	F	SMF register in UDM	15.5.0
2019-03	SP-83	SP-190157	0881	3	F	Alignment with stage 3 for EPS interworking indications	15.5.0
2019-03	SP-83	SP-190157	0884	-	F	Correction to UECM_Update service operation for status change of EPS interworking support	15.5.0
2019-03	SP-83	SP-190157	0886	6	F	EBI allocation when access type of PDU Session is changed from N3GPP to 3GPP. Revocation of EBI when access type of PDU Session is changed from 3GPP to N3GPP	15.5.0
2019-03	SP-83	SP-190157	0888	3	F	Remove PEI from the required input of Npcf_AMPolicyControl service operations	15.5.0
2019-03	SP-83	SP-190157	0889	2	F	Correction to UE parameters update procedure	15.5.0
2019-03	SP-83	SP-190157	0893	1	F	Clarification on Policy related procedures	15.5.0
2019-03	SP-83	SP-190157	0901	-	F	AMF awareness of N2 information type (LMF case)	15.5.0
2019-03	SP-83	SP-190157	0904	1	F	List of equivalent PLMNs in Registration accept missing	15.5.0
2019-03	SP-83	SP-190157	0907	2	F	Retrieval of Policy Control Subscription information for validation of URSP rules	15.5.0
2019-03	SP-83	SP-190157	0909	1	F	Events subscribed using the Npcf_PolicyAuthorization Service	15.5.0
2019-03	SP-83	SP-190157	0910	2	F	Correction to the Initial NAS message protection	15.5.0
2019-03	SP-83	SP-190157	0911	-	F	Remove BSF from the UDR consumer list	15.5.0
2019-03	SP-83	SP-190157	0913	-	F	Add AMF as consumer for UpdateNotify Service Operation for Npcf_UEPolicyControl Service	15.5.0
2019-03	SP-83	SP-190157	0914	1	F	Corrections to UE Policy Association Establishment procedure	15.5.0
2019-03	SP-83	SP-190157	0915	1	F	Corrections to UE Policy Association Modification initiated by the AMF procedure	15.5.0
2019-03	SP-83	SP-190157	0916	-	F	Corrections to UE Policy Association Modification initiated by the PCF procedure	15.5.0
2019-03	SP-83	SP-190158	0923	6	F	Procedure for DN authorization profile index	15.5.0
2019-03	SP-83	SP-190158	0925	1	F	Correction on current HO procedures	15.5.0
2019-03	SP-83	SP-190158	0927	1	F	Presence of Reference ID in Location Reporting Control	15.5.0
2019-03	SP-83	SP-190158	0930	1	F	Clarification on missing condition of UE Policy Association Establishment	15.5.0
2019-03	SP-83	SP-190158	0933	2	F	Network Slice update clarification	15.5.0

2019-03	SP-83	SP-190158	0934	3	F	Clarification on Mobility Restriction	15.5.0
2019-03	SP-83	SP-190158	0935	2	F	Clarification of the PDU Session establishment and release procedure	15.5.0
2019-03	SP-83	SP-190158	0936	-	F	IP address/Prefix(es) kept for 5G to 4G mobility	15.5.0
2019-03	SP-83	SP-190158	0939	1	F	Correction on UE policy delivery	15.5.0
2019-03	SP-83	SP-190158	0943	1	F	Correction to UE initiated service request procedure	15.5.0
2019-03	SP-83	SP-190158	0944	1	F	Correction to Xn handover for network sharing	15.5.0
2019-03	SP-83	SP-190158	0947	-	F	Clarification on the UE Capability Match Request procedure	15.5.0
2019-03	SP-83	SP-190158	0953	1	F	Correcting references for routing rules configuration	15.5.0
2019-03	SP-83	SP-190158	0954	-	F	Correction for EPS to 5GS Mobility	15.5.0
2019-03	SP-83	SP-190158	0956	1	F	Correction on monitoring event for 'availability after DDN failure'	15.5.0
2019-03	SP-83	SP-190158	0960	3	F	Fixes for DC secondary RAT charging report procedure	15.5.0
2019-03	SP-83	SP-190158	0961	1	F	Selection of a combo PGW+SMF at EPC attachment via WLAN access	15.5.0
2019-03	SP-83	SP-190158	0981	4	F	Correction of the handling of QoS flows at 5GS to EPS mobility	15.5.0
2019-03	SP-83	SP-190158	0982	1	F	UE presence in restricted area indication during inter NG-RAN node N2 based handover	15.5.0
2019-03	SP-83	SP-190158	0988	1	F	Correction for Annex C	15.5.0
2019-03	SP-83	SP-190158	0995	2	F	Informing EPS about Emergency case during Emergency Service Fallback	15.5.0
2019-03	SP-83	SP-190158	0996	-	F	Corrections to PDU Session_SMContextStatusNotify and PDU Session_StatusNotify	15.5.0
2019-03	SP-83	SP-190158	0997	2	F	Corrections to N3GPP handover scenarios	15.5.0
2019-03	SP-83	SP-190158	1000	-	F	UE Identity during the Registration procedure	15.5.0
2019-03	SP-83	SP-190158	1006	2	F	Clarification on Location continuity for handover of emergency session	15.5.0
2019-03	SP-83	SP-190159	1010	4	F	Correction of the change of access in home routed roaming scenario	15.5.0
2019-03	SP-83	SP-190159	1025	2	F	Correction on UE Requested PDU Session Establishment for Home Routed roaming	15.5.0
2019-03	SP-83	SP-190159	1030	4	F	UE Configuration Update Procedure Correction	15.5.0
2019-03	SP-83	SP-190159	1032	2	F	Handling proposal in case of UPF selection failure	15.5.0
2019-03	SP-83	SP-190159	1034	1	F	Correction to Exposure with bulk subscription procedure	15.5.0
2019-03	SP-83	SP-190159	1037	3	F	Slice interworking HR mode update	15.5.0
2019-03	SP-83	SP-190159	1038	2	F	Clarification on UE Behaviour for PDN Connection Handover Failure to 5GS	15.5.0
2019-03	SP-83	SP-190159	1042	1	F	UE identifier during Initial Registration	15.5.0
2019-03	SP-83	SP-190159	1045	-	F	Target ID in Nsmf_PDU Session_CreateSMContext for EPS to 5GS handover	15.5.0
2019-03	SP-83	SP-190159	1063	1	F	Correction the terms on Secondary authentication/authorization of the PDU Session Establishment	15.5.0
2019-03	SP-83	SP-190159	1065	1	F	Xn based handover with I-UPF insertion	15.5.0
2019-03	SP-83	SP-190159	1067	3	F	EPS bearer synchronization when move from EPC to 5GC(UE deletes the bearer locally)	15.5.0
2019-03	SP-83	SP-190159	1069	2	F	Register PGW-C+SMF to HSS+UDM	15.5.0
2019-03	SP-83	SP-190159	1075	2	F	Clarification on missing condition of UE Policy Association Termination	15.5.0
2019-03	SP-83	SP-190159	1076	1	F	Clarification on missing condition of AM Policy Association Establishment and Termination	15.5.0
2019-03	SP-83	SP-190159	1084	1	F	Correction on SMSF address registration in UDM	15.5.0
2019-03	SP-83	SP-190159	1087	1	F	Clarification on NG-RAN behaviour on Periodic RNAU procedure	15.5.0
2019-03	SP-83	SP-190159	1088	2	F	Clarification on PDU Session modification and release procedure	15.5.0
2019-03	SP-83	SP-190159	1099	1	F	Corrections on routing rule	15.5.0
2019-03	SP-83	SP-190159	1100	-	F	Correction to AM policy association related procedure	15.5.0
2019-03	SP-83	SP-190159	1101	3	F	Correction to policy related definition in the registration procedure	15.5.0
2019-03	SP-83	SP-190159	1103	1	F	EPS Fallback Initial Context Setup	15.5.0
2019-03	SP-83	SP-190159	1108	1	F	Update the procedure for the change of SSC mode 3 PDU Session Anchor with multiple PDU sessions	15.5.0
2019-03	SP-83	SP-190230	1119	-	F	Removal of UPF_Management Service	15.5.0
2019-04	-	-	-	-	-	MCC editorial style and formatting corrections	15.5.1
2019-06	SP-84	SP-190400	0934	7	F	Clarification on Mobility Restriction	15.6.0
2019-06	SP-84	SP-190462	0983	4	F	Correction for NF authorized to request notification for UE reachability	15.6.0
2019-06	SP-84	SP-190400	0998	1	F	Corrections to procedure of 5GS to EPS Mobility without N26	15.6.0
2019-06	SP-84	SP-190400	1066	3	F	EPS bearer synchronization when move from EPC to 5GC(Network deletes bearer locally)	15.6.0
2019-06	SP-84	SP-190400	1068	4	F	Resource released at the V-SMF/V-UPF	15.6.0
2019-06	SP-84	SP-190400	1070	3	F	Correction to EPS to 5GS mobility procedure without N26	15.6.0
2019-06	SP-84	SP-190400	1123	1	F	Correction to the provisioning of the UE Integrity Protection Data Rate capability	15.6.0
2019-06	SP-84	SP-190400	1132	2	F	Corrections related Npcf_UEPolicyControl Service	15.6.0
2019-06	SP-84	SP-190400	1134	4	F	UE Policy association procedures correction	15.6.0
2019-06	SP-84	SP-190400	1143	1	F	Correction on indication of LPP support	15.6.0
2019-06	SP-84	SP-190400	1155	2	F	Remove note on skipping subscription for UE Policy Delivery Result	15.6.0
2019-06	SP-84	SP-190400	1166	1	F	Correction to N2 AMF Mobility Request	15.6.0
2019-06	SP-84	SP-190404	1199	4	B	Updating LCS procedures for location reporting for multiple cells	15.6.0



2019-06	SP-84	SP-190400	1206	1	F	Add missing description on UE Policy Information	15.6.0
2019-06	SP-84	SP-190400	1208	1	F	Correction to UCU procedure and Policy related service	15.6.0
2019-06	SP-84	SP-190400	1244	2	F	Correction for 5GS AM Policy Framework	15.6.0
2019-06	SP-84	SP-190401	1246	2	F	Correction for 5GS SM Policy Framework	15.6.0
2019-06	SP-84	SP-190401	1248	2	F	Correction for 5GS UE Policy Framework	15.6.0
2019-06	SP-84	SP-190401	1250	3	F	Clarification on the PDU session re-establish without N26	15.6.0
2019-06	SP-84	SP-190401	1252	6	F	Clarification on the 5G to 4G idle mobility with N26 for sync	15.6.0
2019-06	SP-84	SP-190401	1261	-	F	Correcting AMF behaviour for Service Request that is not integrity protected	15.6.0
2019-06	SP-84	SP-190401	1290	5	F	Correction on EPS to 5GS Mobility Registration Procedure	15.6.0
2019-06	SP-84	SP-190401	1295	3	F	Correction to change of SSC mode 3 PDU session anchor	15.6.0
2019-06	SP-84	SP-190401	1308	-	F	Removing unnecessary PDU release during inter-system handover	15.6.0
2019-06	SP-84	SP-190401	1311	-	F	Missing operations for Nnssf_NSSAIAvailability service	15.6.0
2019-06	SP-84	SP-190401	1314	2	F	Clarification on S-NSSAI for PDU session	15.6.0
2019-06	SP-84	SP-190401	1317	1	F	AF session with required QoS procedure	15.6.0
2019-06	SP-84	SP-190401	1330	2	F	Corrections to 3GPP and N3GPP Emergency Sessions Handover Procedures	15.6.0
2019-06	SP-84	SP-190401	1343	-	F	Release EPS bearer resources in SGW when EPS to 5GS handover finished	15.6.0
2019-06	SP-84	SP-190401	1348	1	F	Correction to the provisioning of the Number Of Packet Filters	15.6.0
2019-06	SP-84	SP-190401	1397	1	F	Non-allowed area exemption for PS data off status change	15.6.0
2019-06	SP-84	SP-190401	1401	1	F	Corrections to data forwarding during inter-system HO	15.6.0
2019-06	SP-84	SP-190402	1403	3	F	Fallback to CS domain if VoNR and VoLTE emergency calls not supported	15.6.0
2019-06	SP-84	SP-190402	1407	1	F	Correction to Registration with AMF relocation	15.6.0
2019-06	SP-84	SP-190402	1414	1	F	Correction of procedure of simultaneous change of BP/ULCL and additional PSA	15.6.0
2019-06	SP-84	SP-190402	1418	1	F	Direct Data Forwarding for inter-RAT mobility	15.6.0
2019-06	SP-84	SP-190402	1423	3	F	Correction to background data transfer policy procedure and related services	15.6.0
2019-06	SP-84	SP-190402	1434	2	F	SMF actions on rejection of PDU Session session or QoS flows during N2-based handover for R15	15.6.0
2019-06	SP-84	SP-190402	1440	-	F	Clarification on event ID of NEF event exposure service operation	15.6.0
2019-06	SP-84	SP-190402	1451	1	F	Correction on usage of Direct Forwarding Path Availability during handovers	15.6.0

---

## History

<b>Document history</b>		
V15.2.0	June 2018	Publication
V15.3.0	September 2018	Publication
V15.4.1	March 2019	Publication
V15.5.1	May 2019	Publication
V15.7.0	October 2019	Publication
V15.6.0	October 2019	Publication