

ETSI TS 123 517 V8.0.0 (2007-12)

Technical Specification

**Digital cellular telecommunications system (Phase 2+);
Universal Mobile Telecommunications System (UMTS);
Telecommunications and Internet converged Services and
Protocols for Advanced Networking (TISPAN);
IP Multimedia Subsystem (IMS);
Functional architecture
(3GPP TS 23.517 version 8.0.0 Release 8)**



Reference

DTS/TSGS-0223517v800

Keywords

GSM, UMTS

ETSI

650 Route des Lucioles
F-06921 Sophia Antipolis Cedex - FRANCE

Tel.: +33 4 92 94 42 00 Fax: +33 4 93 65 47 16

Siret N° 348 623 562 00017 - NAF 742 C
Association à but non lucratif enregistrée à la
Sous-Préfecture de Grasse (06) N° 7803/88

Important notice

Individual copies of the present document can be downloaded from:

<http://www.etsi.org>

The present document may be made available in more than one electronic version or in print. In any case of existing or perceived difference in contents between such versions, the reference version is the Portable Document Format (PDF). In case of dispute, the reference shall be the printing on ETSI printers of the PDF version kept on a specific network drive within ETSI Secretariat.

Users of the present document should be aware that the document may be subject to revision or change of status. Information on the current status of this and other ETSI documents is available at

<http://portal.etsi.org/tb/status/status.asp>

If you find errors in the present document, please send your comment to one of the following services:

http://portal.etsi.org/chaicor/ETSI_support.asp

Copyright Notification

No part may be reproduced except as authorized by written permission.
The copyright and the foregoing restriction extend to reproduction in all media.

© European Telecommunications Standards Institute 2007.
All rights reserved.

DECTTM, **PLUGTESTS**TM, **UMTS**TM, **TIPHON**TM, the TIPHON logo and the ETSI logo are Trade Marks of ETSI registered for the benefit of its Members.

3GPPTM is a Trade Mark of ETSI registered for the benefit of its Members and of the 3GPP Organizational Partners.

Intellectual Property Rights

IPRs essential or potentially essential to the present document may have been declared to ETSI. The information pertaining to these essential IPRs, if any, is publicly available for **ETSI members and non-members**, and can be found in ETSI SR 000 314: *"Intellectual Property Rights (IPRs); Essential, or potentially Essential, IPRs notified to ETSI in respect of ETSI standards"*, which is available from the ETSI Secretariat. Latest updates are available on the ETSI Web server (<http://webapp.etsi.org/IPR/home.asp>).

Pursuant to the ETSI IPR Policy, no investigation, including IPR searches, has been carried out by ETSI. No guarantee can be given as to the existence of other IPRs not referenced in ETSI SR 000 314 (or the updates on the ETSI Web server) which are, or may be, or may become, essential to the present document.

Foreword

This Technical Specification (TS) has been produced by ETSI 3rd Generation Partnership Project (3GPP).

The present document may refer to technical specifications or reports using their 3GPP identities, UMTS identities or GSM identities. These should be interpreted as being references to the corresponding ETSI deliverables.

The cross reference between GSM, UMTS, 3GPP and ETSI identities can be found under <http://webapp.etsi.org/key/queryform.asp>.

Contents

Intellectual Property Rights	2
Foreword.....	2
Foreword.....	5
1 Scope	6
2 References	6
3 Definitions and abbreviations.....	7
3.1 Definitions	7
3.2 Abbreviations	7
4 Overall architecture	8
5 Overview	9
6 Functional entities	10
6.1 Call Session Control Function (CSCF)	11
6.2 Media Gateway Control Function (MGCF)	12
6.3 Multimedia Resource Function Controller (MRFC)	12
6.4 Breakout Gateway Control Function (BGCF).....	12
6.5 Interconnection Border Control Function (IBCF).....	12
7 Internal reference points.....	12
7.1 Reference point MGCF - CSCF (Mg reference point)	13
7.2 Reference point CSCF - MRFC (Mr reference point)	13
7.3 Reference point CSCF - CSCF (Mw reference point).....	13
7.4 Reference point CSCF - BGCF (Mi reference point)	13
7.5 Reference point BGCF - MGCF (Mj reference point)	13
7.6 Reference point BGCF - BGCF (Mk reference point)	14
7.7 Reference point CSCF or BGCF - IBCF (Mx Reference Point)	14
8 Value added services architecture	14
8.1 Overview	14
8.2 Reference points	15
8.2.1 Reference point S-CSCF - ASF (ISC reference point)	15
8.2.2 Reference point UPSF - SIP AS or OSA SCS (Sh reference point)	15
8.2.3 Reference point UPSF - IM SSF (Si reference point).....	16
8.2.4 Reference point ASF - SLF (Dh reference point)	16
8.2.5 Reference point UE - ASF (Ut reference point).....	16
9 External reference points.....	16
9.1 Interfaces with entities in the transfer plane	16
9.1.1 Reference Point MGCF - T-MGF (Mn Reference Point)	16
9.1.2 Reference point MGCF - SGF (Ie reference point)	17
9.1.3 Reference point MRFC - MRFP (Mp reference point).....	17
9.2 Interface with the UE	17
9.3 Interfaces with the user profile	17
9.3.1 Reference point CSCF - SLF (Dx reference point).....	17
9.3.2 Reference point CSCF - UPSF (Cx reference point)	18
9.4 Interfaces with Charging Functions.....	18
10 Interconnection with other networks	18
10.1 Interfaces with the PSTN/ISDN	18
10.2 Interfaces with other IP-based service subsystems.....	18
11 Interface with the Network Attachment Subsystem (NASS)	19
12 Interface with the Resource and Admission Control Subsystem (RACS)	20

Annex A (informative): IMS Access scenarios.....21
Annex B (informative): IMS interconnection scenarios22
Annex ZZ (informative): Change history25
History26

Foreword

This Technical Specification (TS) was produced by ETSI Technical Committee Telecommunications and Internet converged Services and Protocols for Advanced Networking (TISPAN) and originally published and subsequently modified as ETSI ES 282 007 [xvii]. It was transferred to the 3rd Generation Partnership Project (3GPP) in December 2007.

The contents of the present document are subject to continuing work within the TSG and may change following formal TSG approval. Should the TSG modify the contents of the present document, it will be re-released by the TSG with an identifying change of release date and an increase in version number as follows:

Version x.y.z

where:

- x the first digit:
 - 1 presented to TSG for information;
 - 2 presented to TSG for approval;
 - 3 or greater indicates TSG approved document under change control.
- y the second digit is incremented for all changes of substance, i.e. technical enhancements, corrections, updates, etc.
- z the third digit is incremented when editorial only changes have been incorporated in the document.

1 Scope

The present document describes the IP Multimedia Subsystem (IMS) core component of the TISPAN NGN functional architecture and its relationships to other subsystems and components.

2 References

The following documents contain provisions which, through reference in this text, constitute provisions of the present document.

- References are either specific (identified by date of publication, edition number, version number, etc.) or non-specific.
- For a specific reference, subsequent revisions do not apply.
- For a non-specific reference, the latest version applies. In the case of a reference to a 3GPP document (including a GSM document), a non-specific reference implicitly refers to the latest version of that document *in the same Release as the present document*.

- [1] ETSI ES 282 001: "Telecommunications and Internet converged Services and Protocols for Advanced Networking (TISPAN); NGN Functional Architecture Release 1".
- [2] ETSI TS 182 006: "Telecommunications and Internet converged Services and Protocols for Advanced Networking (TISPAN); IP Multimedia Subsystem (IMS); Stage 2 description".
- [3] ETSI TS 123 218: "Digital cellular telecommunications system (Phase 2+); Universal Mobile Telecommunications System (UMTS); IP Multimedia (IM) session handling; IM call model; Stage 2 (3GPP TS 23.218)".
- [4] ETSI ES 282 010: "Telecommunications and Internet Converged Services and Protocols for Advanced Networking (TISPAN); Charging".
- [5] ETSI ES 283 024: "Telecommunications and Internet converged Services and Protocols for Advanced Networking (TISPAN); PSTN/ISDN Emulation: H.248 Profile for controlling Trunking Media Gateways in the PSTN/ISDN Emulation Subsystem (PES); Protocol specification".
- [6] ETSI ES 283 027: "Telecommunications and Internet converged Services and Protocols for Advanced Networking (TISPAN); Endorsement of the SIP-ISUP Interworking between the IP Multimedia (IM) Core Network (CN) subsystem and Circuit Switched (CS) networks".
- [7] ETSI TS 183 021: "Telecommunications and Internet converged Services and Protocols for Advanced Networking (TISPAN); Endorsement of 3GPP TS 29.162 Interworking between IM CN Sub-system and IP networks".
- [8] ETSI EN 301 931: "Intelligent Network (IN); Intelligent Network Capability Set 3 (CS3); Intelligent Network Application Protocol (INAP); Protocol specification".
- [9] ETSI ES 201 915-1: "Open Service Access (OSA); Application Programming Interface (API); Part 1: Overview (Parlay 3)".
- [10] ETSI TS 123 002: "Digital cellular telecommunications system (Phase 2+); Universal Mobile Telecommunications System (UMTS); Network architecture (3GPP TS 23.002)".
- [11] ETSI TS 123 278: "Digital cellular telecommunications system (Phase 2+); Universal Mobile Telecommunications System (UMTS); Customised Applications for Mobile network Enhanced Logic (CAMEL) Phase 4; Stage 2; IM CN Interworking (3GPP TS 23.278)".

- [12] ETSI TS 129 278: "Digital cellular telecommunications system (Phase 2+); Universal Mobile Telecommunications System (UMTS); customized Applications for Mobile network Enhanced Logic (CAMEL); CAMEL Application Part (CAP) specification for IP Multimedia Subsystems (IMS) (3GPP TS 29.278)".
- [13] IETF RFC 3136 (2001): "The SPIRITS Architecture".
- [14] IETF RFC 3261 (2002): "SIP: Session Initiation Protocol".
- [15] ITU-T Recommendation H.248: "Gateway control protocol".
- [16] ETSI TS 182 009: "Telecommunications and Internet converged Services and Protocols for Advanced Networking (TISPAN); NGN Architecture to support emergency communication from citizen to authority".
- [xvii] ETSI ES 282 007 v1.1.1: "Telecommunications and Internet converged Services and Protocols for Advanced Networking (TISPAN); IP Multimedia Subsystem (IMS); Functional architecture".

3 Definitions and abbreviations

3.1 Definitions

For the purposes of the present document, the following terms and definitions apply:

IP Multimedia Subsystem: As defined in TS 123 002 [10].

NGN IP Multimedia Subsystem: IMS that supports the provision of SIP-based multimedia services and PSTN/ISDN simulation services to NGN terminals

User Equipment (UE): one or more devices allowing a user to access services delivered by TISPAN NGN networks

3.2 Abbreviations

For the purposes of the present document, the following abbreviations apply:

AF	Application Function
ALG	Application Layer Gateway
AS	Application Server
ASF	Application Server Function
BCSM	Basic Call State Model
BGF	Border Gateway Function
CAMEL	Customised Application for Mobile Enhanced Logic
CCBS	Call Control on Busy Subscriber
CSCF	Call Session Control Function
E-CSCF	Emergency-Call Session Control Function
IBCF	Intermediate Breakout Control Function
I-BGF	Interconnection-Border Gateway Function
I-CSCF	Interrogating-Call Session Control Function
IM-MGW	IP Multimedia - Media GateWay
IMS	IP Multimedia Subsystem
IN	Intelligent Network
INAP	IN Application Part
IN-SCF	Intelligent Network Switching Control Function
IP-CAN	IP-Connectivity Access Network
ISDN	Integrated Services Digital Network
MGCF	Media Gateway Control Function
MGF	Media Gateway Function
MM	MultiMedia
MRFC	Multimedia Resource Function Controller
MRFP	Multimedia Resource Function Processor

NAPT	Network Address and Port Translation
NASS	Network Attachment SubSystem
NGN	Next Generation Network
OSA	Open Service Access
P-CSCF	Proxy-Call Session Control Function
PDF	Policy Decision Function
PES	PSTN/ISDN Emulation Subsystem
PSTN	Public Switched Telephony Network
RACS	Resource and Admission Control Subsystem
SCF	Switching Control Function
SCIM	Service Capability Interaction Manager
S-CSCF	Serving-Call Session Control Function
SGF	Signalling Gateway Function
SIP	Session Initiation Protocol
SLF	Subscription Locator Function
SPIRITS	Service in the PSTN/IN Requesting InTernet Services
SSF	Service Switching Function
TCAP	Transaction Capabilities Application Part
T-MGF	Trunking-Media Gateway Function
UE	User Equipment
UPSF	User Profile Server Function

4 Overall architecture

The TISPAN NGN functional architecture ES 282 001 [1] is structured according to a service layer and an IP-based transport layer (see figure 1).

The service layer comprises the following components:

- The IP Multimedia Subsystem core component (IMS).
- The PSTN/ISDN Emulation Subsystem (PES).
- Other multimedia subsystems and applications.
- Common components (i.e. used by several subsystems) such as those required for accessing applications, charging functions, user profile management, security management, routing data bases (e.g. ENUM), etc.

IP-connectivity is provided to NGN user equipment by the transport layer, under the control of the Network Attachment SubSystem (NASS) and the Resource and Admission Control Subsystem (RACS). These subsystems hide the transport technology used in access and core networks below the IP layer.

The present document further describes the functional architecture of the IP Multimedia Subsystem (IMS) core component.

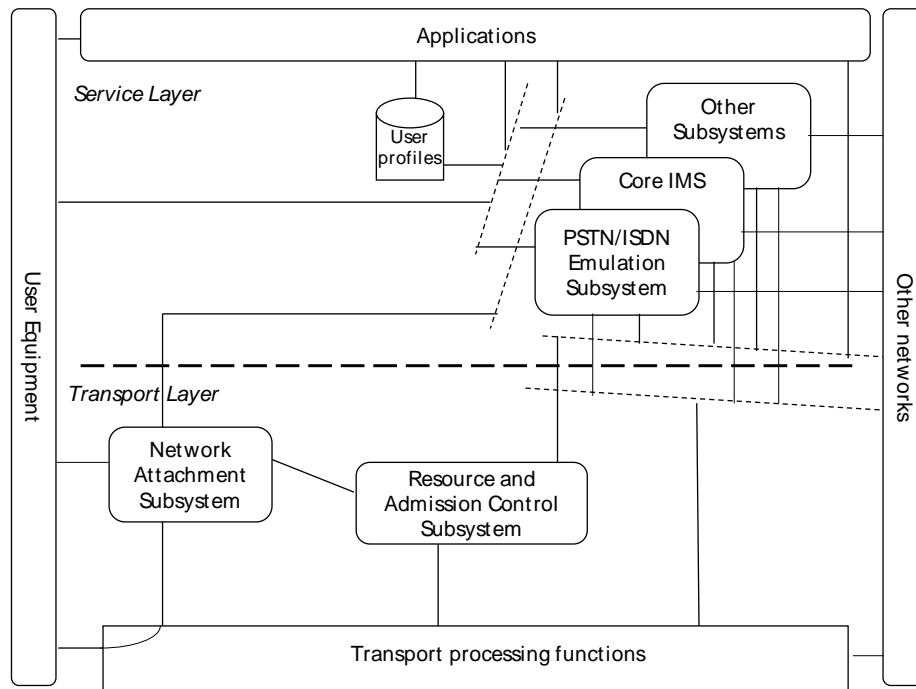

Figure 1: TISPAN NGN overall architecture

5 Overview

The NGN IP Multimedia Subsystem (IMS) supports the provision of SIP-based multimedia services to NGN terminals. It also supports the provision of PSTN/ISDN simulation services.

Functional entities of an IMS may be used by an operator in support of transit network scenarios. The routing may be performed, depending on the entity performing the routing, and depending on the traffic case, on signalling information, configuration data, and/or data base lookup.

The NGN IMS, also known as "Core IMS" is a subset of the 3GPP IMS defined in TS 123 002 [10] which is restricted to the session control functionalities. Application Servers (AS) and transport/media related functions such as the Multimedia Resource Function Processor function (MRFP) and the IP Multimedia Gateway Functions (IM-MGW) are considered to be outside the "core IMS".

Although essentially identical to the 3GPP IMS entities, NGN IMS functional entities might exhibit minor variations in behaviour, due to differences in access networks and user equipment. However, the NGN IMS architecture defined in the present document remains compatible with 3GPP-defined IP-connectivity access networks (IP-CAN) and as such can provide services to user equipment connected to both fixed broadband access and 3GPP IP-CANs (see annex A).

Figure 2 illustrates the position of the IMS in the overall NGN architecture. The IMS interfaces the following components:

- User Equipment.
- The Resource and Admission Control Subsystem.
- The Network Attachment Subsystem.
- The PSTN/ISDN.
- The PSTN/ISDN Emulation Subsystem.
- Other multimedia subsystems.
- Charging Functions.

- Network Management Functions.
- Applications and other common architectural elements.

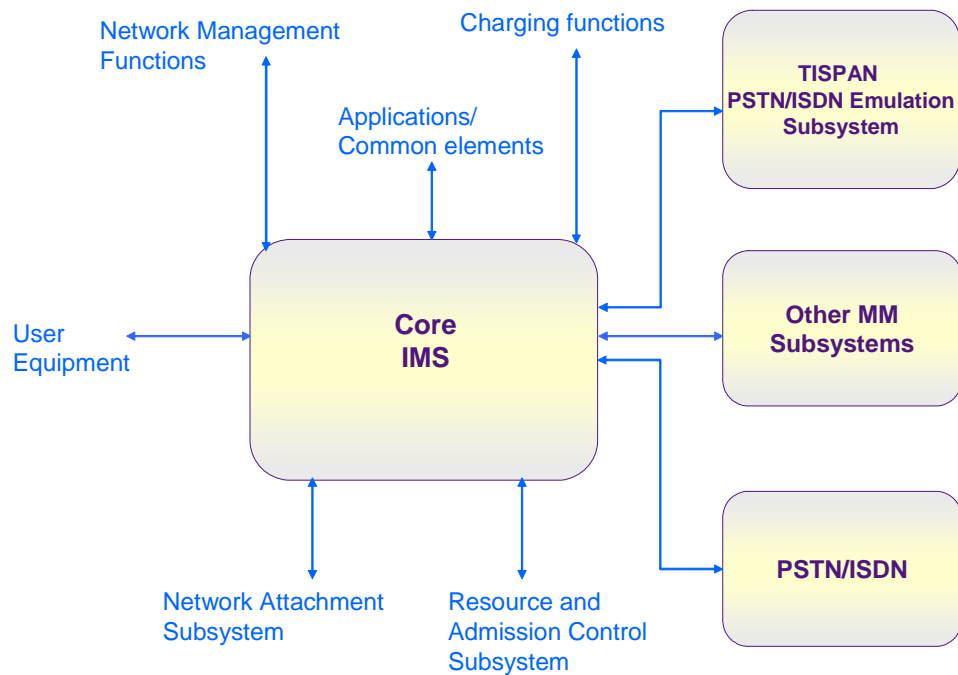

Figure 2: TISPAN IMS and its environment

6 Functional entities

Figure 3 provides an overview of the functional entities that compose the NGN IMS, the reference points between them and with components outside the IMS.

Unless stated explicitly, the functional entities identified in this clause are identical to those defined in TS 123 002 [10]. Except when highlighting explicitly a difference, the descriptions provided in the present document are intended to provide tutorial information only and in case of discrepancy with the definitions in TS 123 002 [10], the definitions in TS 123 002 [10] shall take precedence.

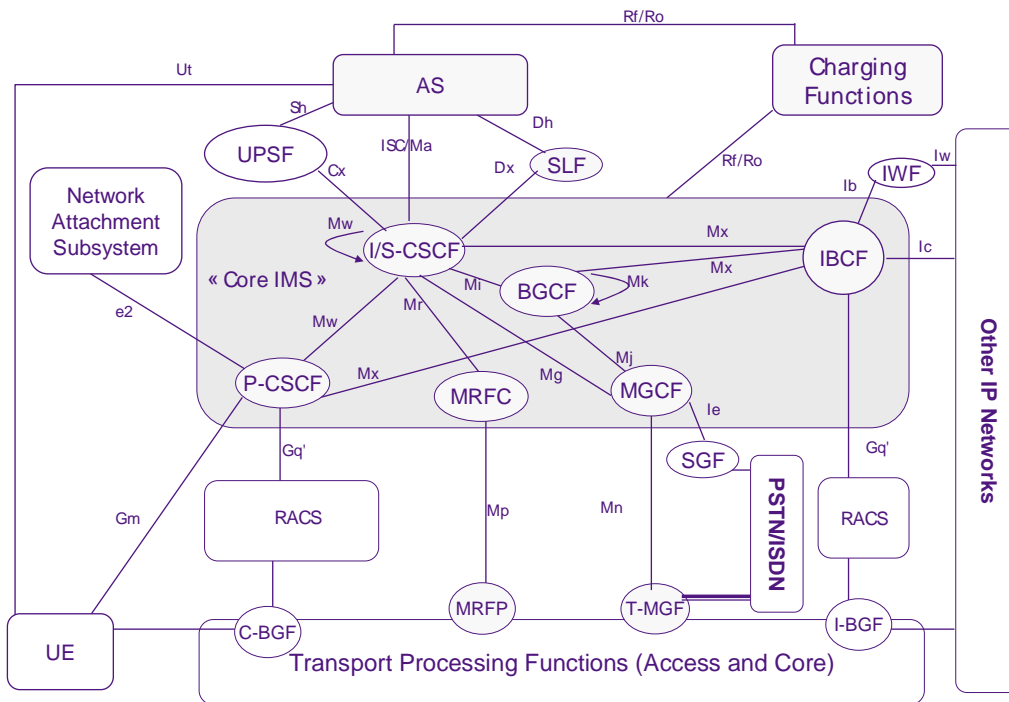

Figure 3: NGN IMS overview

6.1 Call Session Control Function (CSCF)

The Call Session Control Function (CSCF) establishes, monitors, supports and releases multimedia sessions and manages the user's service interactions. For more details see clause 4a.7.1 in TS 123 002 [10].

NOTE: The CSCF can act as Proxy CSCF (P-CSCF), Serving CSCF (S-CSCF) or Interrogating CSCF (I-CSCF). The P-CSCF is the first contact point for the UE within the IM subsystem (IMS); the S-CSCF actually handles the session states in the network; the I-CSCF is mainly the contact point within an operator's network for all IMS connections destined to a subscriber of that network operator, or a roaming subscriber currently located within that network operator's service area.

This functional entity is identical to the CSCF defined in TS 123 002 [10], except for when acting as a P-CSCF. The P-CSCF behaviour differs from the behaviour in TS 123 002 [10] by the following main points:

- The e2 reference point is supported to enable the P-CSCF to retrieve information (e.g. physical location of the user equipment) from the Network Attachment Subsystem (See clause 11).
- The Gq and Iq reference points are not supported but replaced with the Gq' reference point (See clause 12).
- .

Based on local configuration, the I-CSCF may perform transit routing functions (see TS 182 006 [2]).

Further specifications of the P-, S- and I-CSCF are provided in TS 182 006 [2].

Support of emergency communications require the use of an E-CSCF as described in TS 182 009 [16]. For the sake of simplicity this type of CSCF is not represented on Figure 3.

6.2 Media Gateway Control Function (MGCF)

The Media Gateway Controller Function (MGCF) provides the ability to control a trunking media gateway function (T-MGF) through a standardized interface. Such control includes allocation and deallocation of resources of the media gateway, as well as modification of the usage of these resources. The MGCF communicates with the CSCF, the BGCF and circuit-switched networks. The MGCF performs protocol conversion between ISUP and SIP. It also supports interworking between SIP and non-call related SS7 signalling (i.e. TCAP-based signalling for supplementary services such as CCBS).

In case of incoming calls from legacy networks, the MGCF determines the next hop in IP routing depending on received signalling information.

Based on local configuration, the MGCF may perform transit routing functions (see TS 182 006 [2]).

This functional entity is identical to the MGCF defined in TS 123 002 [10], except that in addition it supports TCAP interworking. A node implementing this functional entity in an NGN network and a node implementing it in a 3GPP network may differ in terms of supported resources (e.g. codecs) and configuration.

6.3 Multimedia Resource Function Controller (MRFC)

The Multimedia Resource Function Controller (MRFC), in conjunction with an MRFP located in the transport layer (see ES 282 001 [1]), provides a set of resources within the core network for supporting services. The MRFC interprets information coming from an AS via an S-CSCF and control MRFP accordingly. The MRFC, in conjunction with the MRFP, provides e.g. multi-way conference bridges, announcement playback, media transcoding etc.

This functional entity is identical to the MRFC defined in TS 123 002 [10], although a node implementing this functional entity in an NGN network and a node implementing it in a 3GPP network may differ in terms of supported resources and configuration.

6.4 Breakout Gateway Control Function (BGCF)

The Breakout Gateway control function (BGCF) determines the next hop in SIP routing. This determination may be based on information received in the protocol, administrative information, and/or database access. For PSTN terminations, the BGCF selects the network in which PSTN breakout is to occur and - within the network where the breakout is to occur - selects the MGCF. This functional entity is identical to the BGCF defined in TS 123 002 [10], although a node implementing this functional entity in an NGN network and a node implementing it in a 3GPP network may differ in terms of configuration (e.g. breakout criteria).

In case of transit the BGCF may have extra functionality for routing transit traffic (see TS 182006 [2]).

6.5 Interconnection Border Control Function (IBCF)

An IBCF provides application specific functions at the SIP/SDP protocol layer in order to perform interconnection between two operator domains. It enables communication between IPv6 and IPv4 SIP applications. network topology hiding, controlling transport plane functions, screening of SIP signalling information, selecting the appropriate signalling interconnect and generation of charging data records.

Based on local configuration, the IBCF may perform transit routing functions (see TS 182 006 [2]).

This functional entity is identical to the IBCF defined in TS 123 002 [10].

Details are described in TS 182 006 [2].

7 Internal reference points

Unless stated explicitly, the reference points identified in this clause are identical to those defined in TS 123 002 [10]. Except when highlighting explicitly a difference, the descriptions provided in the present document are intended to provide tutorial information only and in case of discrepancy with the definitions in TS 123 002 [10], the definitions in TS 123 002 [10] shall take precedence.

7.1 Reference point MGCF - CSCF (Mg reference point)

This reference point is identical to the reference point MGCF - CSCF (Mg) defined in TS 123 002 [10].

The Mg reference point allows the MGCF to forward incoming session signalling (from the PSTN) to the CSCF for the purpose of interworking with PSTN networks.

NOTE: The protocol used for the Mg reference point is SIP.

Details are described in TS 182 006 [2].

7.2 Reference point CSCF - MRFC (Mr reference point)

This reference point is identical to the reference point CSCF - MRFC (Mr) defined in TS 123 002 [10].

The Mr reference point allows the S-CSCF to relay signalling messages between an application server function and an MRFC.

NOTE: The protocol used for the Mr reference point is SIP.

Details are described in TS 182 006 [2].

7.3 Reference point CSCF - CSCF (Mw reference point)

This reference point is identical to the reference point CSCF - CSCF (Mw) defined in TS 123 002 [10].

The Mw reference point allows the communication and forwarding of signalling messaging between CSCFs, e.g. during registration and session control.

NOTE: The protocol used for the Mr reference point is SIP.

Details are described in TS 182 006 [2].

7.4 Reference point CSCF - BGCF (Mi reference point)

This reference point is identical to the reference point CSCF-BGCF (Mi) defined in TS 123 002 [10].

This reference point allows the Serving CSCF to forward the session signalling to the Breakout Gateway Control Function for the purpose of interworking to the PSTN networks.

NOTE: The protocol used for the Mi reference point is SIP.

Details are described in TS 182 006 [2].

7.5 Reference point BGCF - MGCF (Mj reference point)

This reference point is identical to the reference point BGCF - MGCF (Mj) defined in TS 123 002 [10].

This reference point allows the Breakout Gateway Control Function to forward the session signalling to the Media Gateway Control Function for the purpose of interworking to the PSTN networks.

This reference point may also be used by an MGCF to forward session signalling to the BGCF in case of transit scenarios, if the MGCF supports transit routing.

NOTE: The protocol used for the Mj reference point is SIP.

Details are described in TS 182 006 [2].

7.6 Reference point BGCF - BGCF (Mk reference point)

This reference point is identical to the reference point BGCF - BGCF (Mk) defined in TS 123 002 [10].

This reference point allows the Breakout Gateway Control Function to forward the session signalling to another Breakout Gateway Control Function.

NOTE: The protocol used for the Mk reference point is SIP.

Details are described in TS 182 006 [2].

7.7 Reference point CSCF or BGCF - IBCF (Mx Reference Point)

This reference point is identical to the reference point CSCF or BGCF - IBCF (Mx) defined in TS 123 002 [10].

The Mx reference point allows the communication and forwarding of signalling messages between a CSCF or a BGCF and an IBCF.

NOTE: The protocol used for the Mx reference point is SIP.

Details are described in TS 182 006 [2].

8 Value added services architecture

Unless stated explicitly, the reference points identified in this clause are identical to those defined in TS 123 002 [10]. Except when highlighting explicitly a difference, the descriptions provided in the present document are intended to provide tutorial information only and in case of discrepancy with the definitions in TS 123 002 [10], the definitions in TS 123 002 [10] shall take precedence.

8.1 Overview

Three types of Application Server Functions (ASF) can be accessed by the IMS through the ISC or Ma reference point (see figure 4).

- SIP Application Servers (SIP AS);
- the IM-SSF Application Server;
- the OSA SCS Application Server.

A SIP Application Server may contain 'Service Capability Interaction Manager' (SCIM) functionality and other application servers. The SCIM functionality is an application which performs the role of interaction management. The internal structure of the application server is outside the standards.

The purpose of the IM SSF is to enable access to IN service logic programs hosted in legacy SCPs. The IM-SSF functionality encompasses the emulation of the IN Call Model (BCSM) on top of SIP signalling, IN triggering and feature management mechanisms, emulation of the IN Service Switching Finite State Machine and interworking with INAP.

NOTE 1: The IM SSF identified in the present document differs from the IM SSF identified in TS 123 002 [10]. The latter implements the CAMEL call model and protocols, as defined in TS 123 278 [11] and TS 129 278 [12], while the former implements either the CAMEL call model and protocols or the ETSI Core INAP capabilities as defined in EN 301 931 [8], or both. The Si reference point is used for CAMEL services only.

NOTE 2: The IM SSF is intended to enable access from the IMS to IN service logic programs hosted in legacy SCPs. Access to IMS services (i.e. hosted in SIP-based Application Servers) from legacy SSPs in the PSTN/ISDN is outside the scope of the present document. Appropriate gateway functions (e.g. SPIRITS gateway as defined in RFC 3136 [13]) have to be implemented in the PSTN/ISDN network for supporting such scenarios.

The purpose of the OSA Service Capability Server is to provide access to OSA applications, according to the OSA/Parlay framework ES 201 915-1 [9].

Further details can be found in TS 123 218 [3].

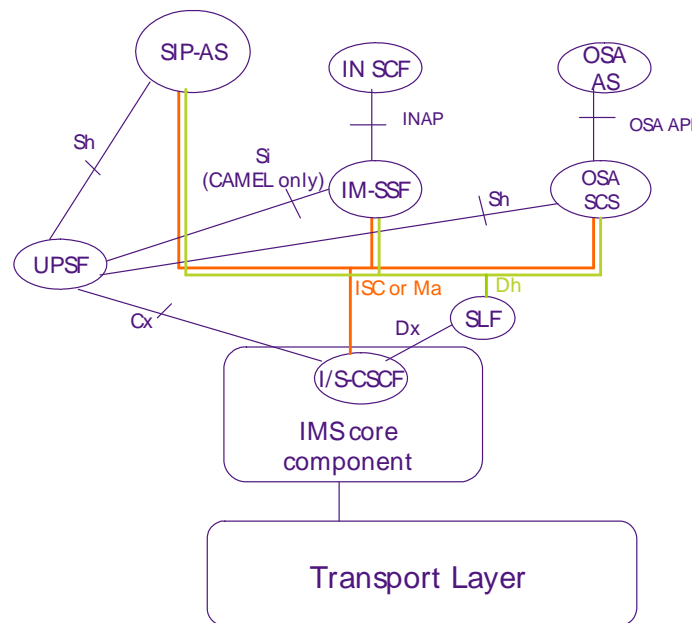

Figure 4: Value Added Services architecture

The Service-CSCF to AS reference point is used to forward SIP requests, based on filter criteria associated with the originating or destinating user.

The Interrogating-CSCF to AS reference point is used to forward SIP requests destined to a Public Service Identity hosted by the AS directly to that AS.

8.2 Reference points

8.2.1 Reference point S-CSCF - ASF (ISC reference point)

This reference point is identical to the reference point S-CSCF - AS (ISC Reference Point) defined in TS 123 002 [10].

This reference point between S-CSCF and the Application Server Functions (i.e. SIP Application Server, OSA Service Capability Server, or IM-SSF) is used to provide services for the IMS.

Details are described in TS 182 006 [2].

8.2.2 Reference point UPSF - SIP AS or OSA SCS (Sh reference point)

This reference point is identical to the reference point HSS - SIP AS or OSA SCS (Sh Reference Point) defined in TS 123 002 [10].

The Application Server (SIP Application Server and/or the OSA Service Capability Server) may communicate to the UPSF. The Sh reference point is used for this purpose. Details are described in TS 182 006 [2].

8.2.3 Reference point UPSF - IM SSF (Si reference point)

This reference point is identical to the reference point HSS - CAMEL IM-SSF (Si Reference Point) defined in TS 123 002 [10].

The IM-SSF may communicate with the UPSF, via the Si reference point. Details are described in TS 182 006 [2].

8.2.4 Reference point ASF - SLF (Dh reference point)

This reference point is identical to the reference point AS - SLF (Dh Reference Point) defined in TS 123 002 [10].

This reference point between Application Server Functions and SLF is used to retrieve the address of the UPSF which holds the subscription for a given user. This reference point is not required in a single UPSF environment.

Details are described in TS 182 006 [2].

8.2.5 Reference point UE - ASF (Ut reference point)

This reference point is identical to the reference point UE - AS (Ut Reference Point) defined in TS 123 002 [10].

This reference point enables the user to manage information related to his services, such as creation and assignment of Public Service Identities, management of authorization policies that are used e.g. by Presence service, conference policy management, etc.

The signalling flows across this reference point may be routed directly between the UE and the ASF hosting the application to be managed or may be routed via an aggregation node acting as a front-end for a number of applications.

Details are described in TS 182 006 [2].

NOTE: The type of ASF connected to this reference point is restricted to a SIP Application Server.

8.2.6 Reference point I-CSCF - AS (Ma reference point)

This reference point is identical to the reference point I-CSCF - AS (Ma Reference Point) defined in TS 123 002 [10].

This reference point between Interrogating-CSCF and the Application Servers (i.e. SIP Application Server, OSA Service Capability Server, or CAMEL IM-SSF) is used to forward SIP requests destined to a Public Service Identity hosted by an Application Server directly to the Application Server.

Details are described in TS 182 006 [2].

9 External reference points

Unless stated explicitly, the reference points identified in this clause are identical to those defined in TS 123 002 [10]. Except when highlighting explicitly a difference, the descriptions provided in the present document are intended to provide tutorial information only and in case of discrepancy with the definitions in TS 123 002 [10], the definitions in TS 123 002 [10] shall take precedence.

9.1 Interfaces with entities in the transfer plane

Transfer plane entities are defined in ES 282 001 [[Error! Bookmark not defined.](#)].

9.1.1 Reference Point MGCF - T-MGF (Mn Reference Point)

This reference point is identical to the reference point MGCF - IMS-MGW (Mn Reference Point) defined in TS 123 002 [10].

The Mn reference point describes the interfaces between the MGCF and a T-MGF. It has the following properties:

- Full compliance with the ITU-T Recommendation H.248 [15] standard functions for IMS - PSTN/PLMN interworking.
- Open architecture where extensions/Packages definition work on the interface may be carried out.
- Dynamic sharing of T-MGF physical node resources. A physical T-MGF can be partitioned into logically separate virtual media gateways/domains consisting of a set of statically allocated Terminations.
- Dynamic sharing of transmission resources between the domains as the MGF controls bearers and manage resources according to the H.248 protocols and functions for IMS.

Details are described in ES 283 024 [5].

9.1.2 Reference point MGCF - SGF (Ie reference point)

The Ie reference point enables the MGCF to exchange SS7 signalling information over IP with the SGF, according to the SIGTRAN architecture.

9.1.3 Reference point MRFC - MRFP (Mp reference point)

This reference point is identical to the reference point MRFC - MRFP (Mp reference point) defined in TS 123 002 [10].

The Mp reference point allows an MRFC to control media stream resources provided by an MRFP.

The Mp reference point has the following properties:

- Full compliance with the ITU-T Recommendation H.248 [15] standard.
- Open architecture where extensions (packages) definition work on the interface may be carried out.

Details are described in TS 182 006 [2].

9.2 Interface with the UE

The reference point CSCF - UE (Gm reference point) is identical to the reference point CSCF - UE (Gm reference point) defined in TS 123 002 [10].

The Gm reference point supports the communication between UE and the IMS, e.g. related to registration and session control.

NOTE: The protocol used for the Gm reference point is SIP.

Details are described in TS 182 006 [2].

9.3 Interfaces with the user profile

The SLF and UPSF entities are defined in ES 282 001 [17].

9.3.1 Reference point CSCF - SLF (Dx reference point)

The interface at this reference point is identical to the one at reference point CSCF - SLF (Dx Reference Point) defined in TS 123 002 [10].

Interface between CSCF and SLF is used to retrieve the address of the UPSF which holds the subscription for a given user.

This reference point is not required in a single UPSF environment. An example for a single UPSF environment is a server farm architecture.

Details are described in TS 182 006 [2].

9.3.2 Reference point CSCF - UPSF (Cx reference point)

This reference point is identical to the reference point HSS - CSCF (Cx Reference Point) defined in TS 123 002 [10].

The Cx reference point supports information transfer between CSCF and UPSF.

The main procedures that require information transfer between CSCF and UPSF are:

- 1) Procedures related to Serving CSCF assignment.
- 2) Procedures related to routing information retrieval from UPSF to CSCF.
- 3) Procedures related to authorization (e.g., checking of roaming agreement).
- 4) Procedures related to authentication: transfer of security parameters of the subscriber between UPSF and CSCF.
- 5) Procedures related to filter control: transfer of filter parameters of the subscriber from UPSF to CSCF.

Further information on the Cx reference point is provided in TS 182 006 [2].

9.4 Interfaces with Charging Functions

The following functional entities in the Core IMS may act as charging trigger points:

- AS;
- BGCF;
- (I-/P-/S-/E-) CSCF;
- MGCF;
- MRFC;
- IBCF. For off-line charging the Rf reference point is used. For on-line charging the Ro reference point is used. Details are described in ES 282 010 [4].

10 Interconnection with other networks

10.1 Interfaces with the PSTN/ISDN

Interconnection at the signalling level is provided via the SGF (transport) and MGCF (call/service control).

Interconnection at the media level is provided by the trunk interfaces at the T-MGF.

Further details can be found in ES 283 027 [6].

10.2 Interfaces with other IP-based service subsystems

Interconnection with other IP-based service subsystems (including PSTN/ISDN Emulation subsystems and other IMS subsystems) is performed via the IBCF at the signalling level and the I-BGF at the media level.

In case of transit the IBCF may have extra functionality for routing transit traffic.

Annex B illustrates various interconnection scenarios.

Interconnection between IMS subsystems occurs either between two home domains (e.g. session originating and terminating domain) or between a visited domain and a home domain (i.e. support of roaming capabilities).

Based on signalling information received from the Core IMS and local policy rules, the IBCF decides on a per session basis whether the RACS should be involved in the interconnection.

NOTE: Depending on the operator policies, the decision as to whether or nor media level interconnection is required (i.e. an I-BGF shall be inserted in the media path) for a particular session may be taken by the RACS, based on information received from the IBCF. The RACS shall also choose the appropriate interconnect link for media traffic based on the information received from the IBCF.

Further details can be found in TS 183 021 [7].

Figure 5 illustrates the case where no I-BGF is inserted. Figure 6 illustrates the case where an I-BGF is inserted by the visited network. The Ici reference point is a specialisation of the generic Ic reference point identified in ES 282 001 [1] and is further described in TS 182 006 [2].

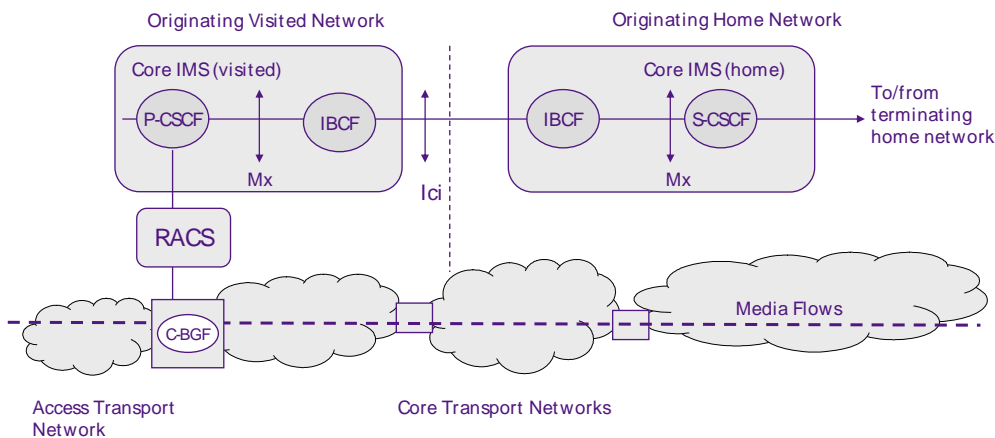

Figure 5: IMS interconnect scenario without I-BGF

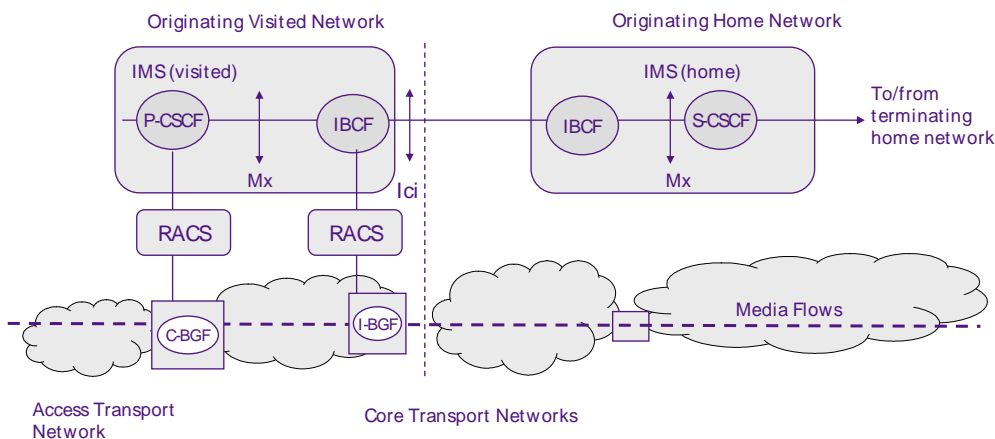

Figure 6: IMS interconnect scenario with I-BGF

11 Interface with the Network Attachment Subsystem (NASS)

The e2 reference point supports information transfer between the P-CSCF and the Network Attachment Subsystem.

This reference point is not required when the user equipment is connected to a 3GPP IP-CAN.

12 Interface with the Resource and Admission Control Subsystem (RACS)

The NGN IMS interacts with the Resource and Admission Control Subsystem (RACS) at the Gq' reference point for the following purposes:

- authorization of QoS resources;
- resource reservation;
- gate control (including NAPT binding information relay).

With regard to the RACS architecture; the P-CSCF plays the role of an Application Function (AF).

Details are described in TS 182 006 [2].

This reference point is not required when the user equipment is connected to a 3GPP IP-CAN. In such configurations, the P-CSCF interacts the 3GPP Policy Decision Function as described in TS 123 002 [10].

In case of network interconnection, interactions with the resource control subsystem may also take place at the edge of the IMS, at the IBCF level for the following purposes:

- gate control (including NAPT binding information relay).

With regard to the RACS architecture; the IBCF plays the role of an Application Function (AF).

Details are described in TS 183 021 [7].

Annex A (informative): IMS Access scenarios

The IMS subsystem described in the present document provides services to user equipment connected via a plurality of IP connectivity access networks. The following figure illustrates the case where an IMS subsystem provides services to user equipment connected to a fixed broadband access network and to other user equipment connected via a GPRS-based IP-CAN.

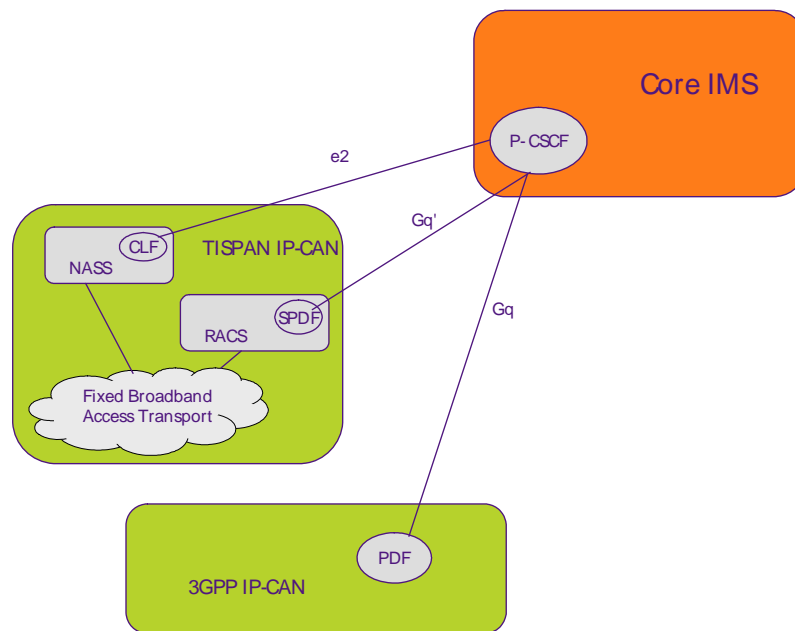

Figure A.1: Access to IMS services from multiple access technologies

Annex B (informative): IMS interconnection scenarios

This annex describes a number of example interconnection scenarios at the SIP signalling level, based on the use of an IBCF at the boundary between two TISPAN networks or between a TISPAN network and an external network.

Figure B.1 illustrates an interconnection scenario where a registration procedure is performed between a visited network and a home network.

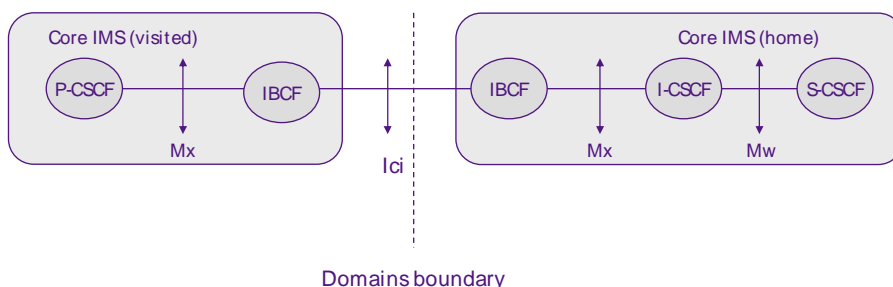

Figure B.1: IMS registration between visited and home network

Figure B.2 illustrates an interconnection scenario where the originating and destination party of an IMS session belong to different home networks.

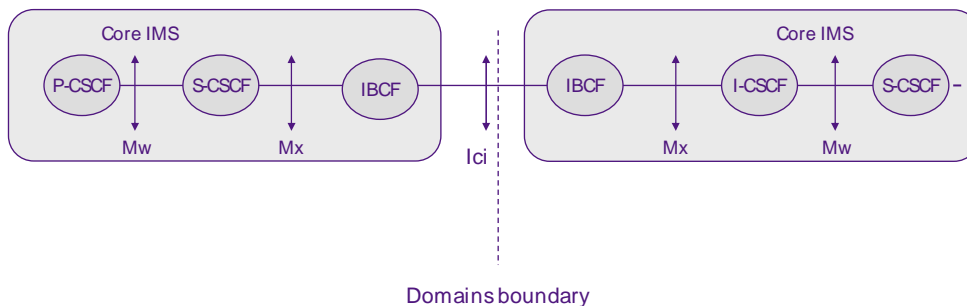

Figure B.2: IMS session between two networks

Figure B.3 illustrates an interconnection scenario where the originating party is in a visited network and the destination party of an IMS session belong to different home networks.

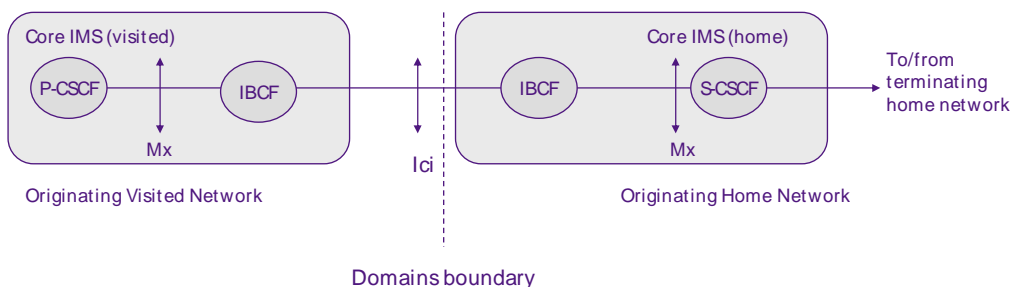

Figure B.3: IMS session between two networks, with roaming originating party

Figure B.4 illustrates an interconnection scenario where a session is established between an IMS User Equipment and the PSTN, the PSTN breakout being performed in another IMS than the originating party's home network.

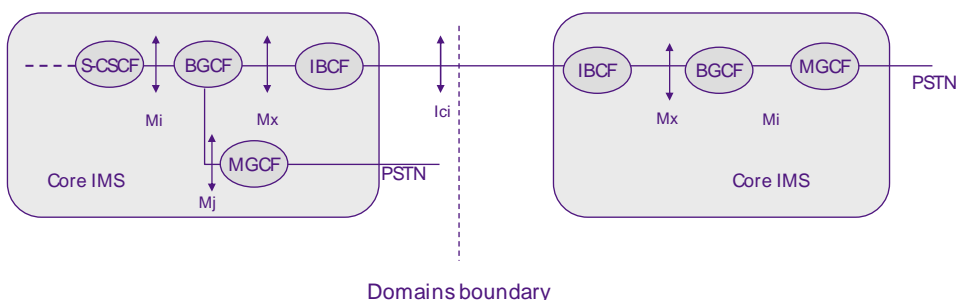

Figure B.4: IMS session with PSTN interworking

Figure B.5 illustrates an interconnection scenario where a session is established between an IMS User Equipment and an H.323 network or a non-IMS-based SIP network [14].

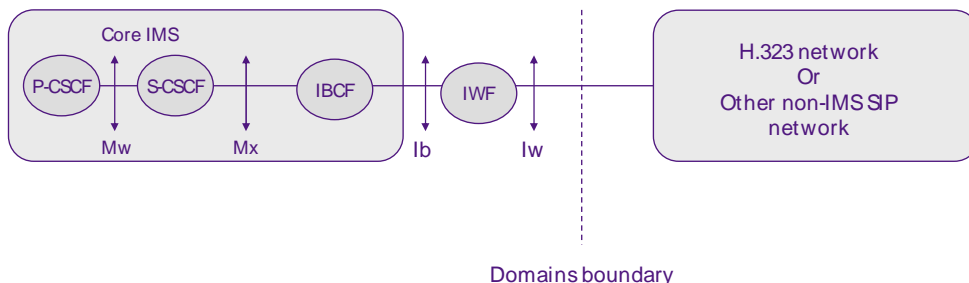

Figure B.5: Interworking with non-IMS multimedia networks

Figure B.6 illustrates an interconnection scenario where a session is established between an IMS User Equipment and a PES.

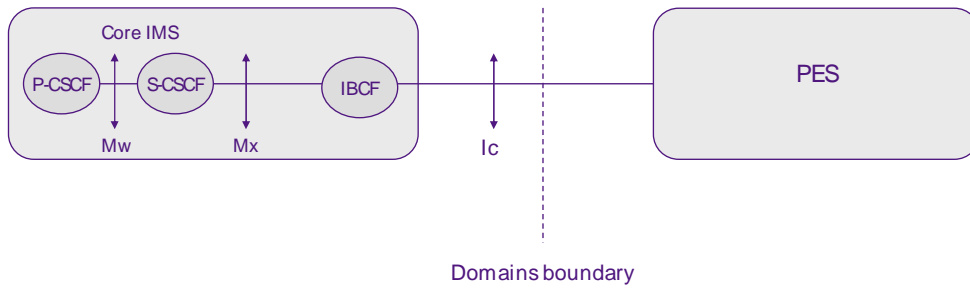

Figure B.6: Interconnection between an IMS and a PES

Figure B.7 illustrates a configuration where an IMS provides transit services between a PSTN or an IMS and another PSTN or IMS.

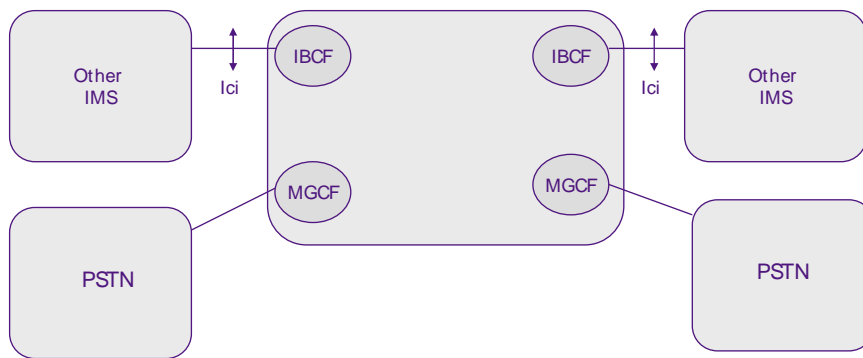

Figure B.7: IMS transit scenarios

Annex ZZ (informative): Change history

Change history							
Date	TSG #	TSG Doc.	CR	Rev	Subject/Comment	Old	New
2006-03					ETSI ES 282 007 ETSI Membership Approval Procedure MV 20060526 2006-03-28 to 2006-05-26		1.1.1
2006-06					ETSI ES 282 007 ETSI publication		
2007-11					ETSI ES 282 007 Alignment with TISPAN R2 specifications and latest 3GPP R7 specifications	1.1.1	2.0.0
2007-12	SP-38	SP-070937			Conversion to 3GPP format, no technical change	2.0.0	2.0.1
2007-12	SP-38				Approved and frozen	2.0.1	8.0.0

History

Document history		
V8.0.0	December 2007	Publication