

ETSI TS 124 007 V16.5.0 (2021-01)



**Digital cellular telecommunications system (Phase 2+) (GSM);  
Universal Mobile Telecommunications System (UMTS);  
LTE;  
5G;  
Mobile radio interface signalling layer 3;  
General Aspects  
(3GPP TS 24.007 version 16.5.0 Release 16)**



---

Reference

RTS/TSGC-0124007vg50

---

Keywords

5G,GSM,LTE,UMTS

**ETSI**

650 Route des Lucioles  
F-06921 Sophia Antipolis Cedex - FRANCE

Tel.: +33 4 92 94 42 00 Fax: +33 4 93 65 47 16

Siret N° 348 623 562 00017 - NAF 742 C  
Association à but non lucratif enregistrée à la  
Sous-Préfecture de Grasse (06) N° 7803/88

---

**Important notice**

The present document can be downloaded from:

<http://www.etsi.org/standards-search>

The present document may be made available in electronic versions and/or in print. The content of any electronic and/or print versions of the present document shall not be modified without the prior written authorization of ETSI. In case of any existing or perceived difference in contents between such versions and/or in print, the prevailing version of an ETSI deliverable is the one made publicly available in PDF format at [www.etsi.org/deliver](http://www.etsi.org/deliver).

Users of the present document should be aware that the document may be subject to revision or change of status.

Information on the current status of this and other ETSI documents is available at

<https://portal.etsi.org/TB/ETSIDeliverableStatus.aspx>

If you find errors in the present document, please send your comment to one of the following services:

<https://portal.etsi.org/People/CommitteeSupportStaff.aspx>

---

**Copyright Notification**

No part may be reproduced or utilized in any form or by any means, electronic or mechanical, including photocopying and microfilm except as authorized by written permission of ETSI.

The content of the PDF version shall not be modified without the written authorization of ETSI.

The copyright and the foregoing restriction extend to reproduction in all media.

© ETSI 2021.

All rights reserved.

**DECT™**, **PLUGTESTS™**, **UMTS™** and the ETSI logo are trademarks of ETSI registered for the benefit of its Members.

**3GPP™** and **LTE™** are trademarks of ETSI registered for the benefit of its Members and of the 3GPP Organizational Partners.

**oneM2M™** logo is a trademark of ETSI registered for the benefit of its Members and of the oneM2M Partners.

**GSM®** and the GSM logo are trademarks registered and owned by the GSM Association.

---

## Intellectual Property Rights

### Essential patents

IPRs essential or potentially essential to normative deliverables may have been declared to ETSI. The information pertaining to these essential IPRs, if any, is publicly available for **ETSI members and non-members**, and can be found in ETSI SR 000 314: "*Intellectual Property Rights (IPRs); Essential, or potentially Essential, IPRs notified to ETSI in respect of ETSI standards*", which is available from the ETSI Secretariat. Latest updates are available on the ETSI Web server (<https://ipr.etsi.org/>).

Pursuant to the ETSI IPR Policy, no investigation, including IPR searches, has been carried out by ETSI. No guarantee can be given as to the existence of other IPRs not referenced in ETSI SR 000 314 (or the updates on the ETSI Web server) which are, or may be, or may become, essential to the present document.

### Trademarks

The present document may include trademarks and/or tradenames which are asserted and/or registered by their owners. ETSI claims no ownership of these except for any which are indicated as being the property of ETSI, and conveys no right to use or reproduce any trademark and/or tradename. Mention of those trademarks in the present document does not constitute an endorsement by ETSI of products, services or organizations associated with those trademarks.

---

## Legal Notice

This Technical Specification (TS) has been produced by ETSI 3rd Generation Partnership Project (3GPP).

The present document may refer to technical specifications or reports using their 3GPP identities. These shall be interpreted as being references to the corresponding ETSI deliverables.

The cross reference between 3GPP and ETSI identities can be found under <http://webapp.etsi.org/key/queryform.asp>.

---

## Modal verbs terminology

In the present document "**shall**", "**shall not**", "**should**", "**should not**", "**may**", "**need not**", "**will**", "**will not**", "**can**" and "**cannot**" are to be interpreted as described in clause 3.2 of the [ETSI Drafting Rules](#) (Verbal forms for the expression of provisions).

"**must**" and "**must not**" are **NOT** allowed in ETSI deliverables except when used in direct citation.

# Contents

Intellectual Property Rights .....	2
Legal Notice .....	2
Modal verbs terminology.....	2
Foreword.....	12
1 Scope .....	13
2 References .....	13
3 Definitions and abbreviations.....	15
3.1 Definitions .....	15
3.2 Abbreviations .....	15
4 Introduction .....	15
4.1 General .....	15
4.2 Applicability of functional blocks .....	17
4.3 Technique of description .....	18
4.3.1 Service description.....	18
4.3.2 Abstract service primitives .....	18
4.3.3 Protocols and peer-to-peer communication .....	18
4.3.4 Contents of layer 3 related Technical Specifications .....	20
5 Structure of layer 3 functions .....	21
5.1 Basic groups of functions .....	21
5.2 Protocol architecture.....	22
6 Services provided by signalling layer 3 at the MS side.....	35
6.1 Registration services.....	35
6.1.1 Service state diagram for MS not supporting GPRS service .....	36
6.1.2 Service primitives .....	36
6.1.2.1 MMR_REG_REQ .....	36
6.1.2.2 MMR_REG_CNF .....	36
6.1.2.3 Void.....	36
6.1.2.4 MMR_NREG_REQ .....	36
6.1.2.5 MMR_NREG_IND .....	37
6.1.3 Registration Services for CTS-Services.....	37
6.1.3.1 MMR_CTS_ATTACH_REQ.....	37
6.1.3.2 MMR_CTS_ATTACH_CNF.....	37
6.1.3.3 MMR_CTS_ATTACH_REJ .....	37
6.1.3.4 MMR_CTS_DETACH_IND .....	37
6.1.3.5 MMR_CTS_ENROLL_REQ .....	37
6.1.3.6 MMR_CTS_ENROLL_CNF .....	37
6.1.3.7 MMR_CTS_ENROLL_REJ .....	37
6.1.3.8 MMR_CTS_DE_ENROLL_IND.....	38
6.2 Call Control services .....	38
6.2.1 Service state diagram.....	38
6.2.2 Service primitives .....	41
6.2.2.1 MNCC_SETUP_REQ.....	41
6.2.2.2 MNCC_SETUP_IND.....	41
6.2.2.3 MNCC_SETUP_RES .....	41
6.2.2.4 MNCC_SETUP_CNF.....	41
6.2.2.5 MNCC_SETUP_COMPL_REQ .....	41
6.2.2.6 MNCC_SETUP_COMPL_IND .....	42
6.2.2.7 MNCC_REJ_REQ .....	42
6.2.2.8 MNCC_REJ_IND.....	42
6.2.2.9 MNCC_CALL_CONF_REQ .....	42
6.2.2.10 MNCC_CALL_PROC_IND .....	42
6.2.2.11 MNCC_PROGRESS_IND.....	42

6.2.2.12	MNCC_ALERT_REQ	42
6.2.2.13	MNCC_ALERT_IND	42
6.2.2.14	MNCC_NOTIFY_REQ	42
6.2.2.15	MNCC_NOTIFY_IND	42
6.2.2.16	MNCC_DISC_REQ	42
6.2.2.17	MNCC_DISC_IND	42
6.2.2.18	MNCC_REL_REQ	43
6.2.2.19	MNCC_REL_IND	43
6.2.2.20	MNCC_REL_CNF	43
6.2.2.21	MNCC_FACILITY_REQ	43
6.2.2.22	MNCC_FACILITY_IND	43
6.2.2.23	MNCC_START_DTMF_REQ	43
6.2.2.24	MNCC_START_DTMF_CNF	43
6.2.2.25	MNCC_STOP_DTMF_REQ	43
6.2.2.26	MNCC_STOP_DTMF_CNF	43
6.2.2.27	MNCC_MODIFY_REQ	43
6.2.2.28	MNCC_MODIFY_IND	43
6.2.2.29	MNCC_MODIFY_RES	43
6.2.2.30	MNCC_MODIFY_CNF	44
6.2.2.31	MNCC_SYNC_IND	44
6.3	Call independent Supplementary Services Support	44
6.3.1	Service state diagram	44
6.3.2	Service primitives	44
6.3.2.1	MNSS_BEGIN_REQ	45
6.3.2.2	MNSS_BEGIN_IND	45
6.3.2.3	MNSS_FACILITY_REQ	45
6.3.2.4	MNSS_FACILITY_IND	45
6.3.2.5	MNSS_END_REQ	45
6.3.2.6	MNSS_END_IND	45
6.4	Short Message Services Support	45
6.5	Session Management Services for GPRS-Services	45
6.5.1	Session Management Services for SMREG-SAP	46
6.5.1.1	SMREG-PDP-ACTIVATE-REQ	46
6.5.1.2	SMREG-PDP-ACTIVATE-CNF	46
6.5.1.3	SMREG-PDP-ACTIVATE-REJ	46
6.5.1.4	SMREG-PDP-ACTIVATE-IND	47
6.5.1.5	SMREG-PDP-DEACTIVATE-REQ	47
6.5.1.6	SMREG-PDP-DEACTIVATE-CNF	47
6.5.1.7	SMREG-PDP-DEACTIVATE-IND	47
6.5.1.8	SMREG-PDP-MODIFY-IND	47
6.5.1.9	Void	47
6.5.1.10	Void	47
6.5.1.11	Void	47
6.5.1.12	Void	47
6.5.1.13	Void	47
6.5.1.14	SMREG-PDP-ACTIVATE-REJ-RSP	47
6.5.1.15	SMREG-PDP-ACTIVATE-SEC-REQ	47
6.5.1.16	SMREG-PDP-ACTIVATE-SEC-CNF	48
6.5.1.17	SMREG-PDP-ACTIVATE-SEC-REJ	48
6.5.1.18	SMREG-PDP-MODIFY-REQ	48
6.5.1.19	SMREG-PDP-MODIFY-CNF	48
6.5.1.20	SMREG-PDP-MODIFY-REJ	48
6.5.1.21	SMREG-MBMS-ACTIVATE-REQ	48
6.5.1.22	SMREG-MBMS-ACTIVATE-CNF	48
6.5.1.23	SMREG-MBMS-ACTIVATE-REJ	48
6.5.1.24	SMREG-MBMS-ACTIVATE-REJ-RSP	48
6.5.1.25	SMREG-MBMS-ACTIVATE-IND	48
6.5.2	Session Management Services for SNSM-SAP (GSM only)	50
6.5.3	Session Management Services for RABMSM-SAP (UMTS only)	50
6.5.3.1	RABMSM-ACTIVATE-IND	51
6.5.3.2	RABMSM-ACTIVATE-RSP	51
6.5.3.3	RABMSM-DEACTIVATE-IND	51

6.5.3.4	RABMSM-DEACTIVATE-RSP .....	51
6.5.3.5	RABMSM-DEACTIVATE-REQ .....	51
6.5.3.6	RABMSM-MODIFY-IND .....	51
6.5.3.7	RABMSM-MODIFY-RSP .....	51
6.5.3.8	RABMSM-STATUS-REQ .....	51
6.6	Registration Services for GPRS-Services .....	51
6.6.1	Registration Services for GMMREG-SAP .....	52
6.6.1.1	GMMREG-ATTACH-REQ .....	52
6.6.1.2	GMMREG-ATTACH-CNF .....	52
6.6.1.3	GMMREG-ATTACH-REJ .....	52
6.6.1.4	GMMREG-DETACH-REQ .....	52
6.6.1.5	GMMREG-DETACH-CNF .....	52
6.6.1.6	GMMREG-DETACH-IND .....	52
6.7	Services provided to SNDCP entities by GPRS Logical Link Control services .....	53
6.7.1	Service state diagram for QoS1-SAP, QoS2-SAP, QoS3-SAP and QoS4-SAP .....	54
6.7.2	Service primitives for QoS1-SAP, QoS2-SAP, QoS3-SAP and QoS4-SAP .....	54
6.7.2.1	LL-ESTABLISH-REQ .....	54
6.7.2.2	LL-ESTABLISH-CNF .....	55
6.7.2.3	LL-ESTABLISH-IND .....	55
6.7.2.4	LL-ESTABLISH-RSP .....	55
6.7.2.5	LL-RELEASE-REQ .....	55
6.7.2.6	LL-RELEASE-CNF .....	55
6.7.2.7	LL-RELEASE-IND .....	55
6.7.2.8	LL-XID-REQ .....	55
6.7.2.9	LL-XID-IND .....	55
6.7.2.10	LL-XID-RSP .....	55
6.7.2.11	LL-XID-CNF .....	55
6.7.2.12	LL-DATA-REQ .....	55
6.7.2.13	LL-DATA-CNF .....	55
6.7.2.14	LL-DATA-IND .....	55
6.7.2.15	LL-UNITDATA-REQ .....	55
6.7.2.16	LL-UNITDATA-IND .....	56
6.7.2.17	LL-STATUS-IND .....	56
6.8	Location services at the type A LMU side .....	56
6.8.1	Service state diagram .....	56
6.8.2	Service primitives .....	57
6.8.2.1	MNLCS_BEGIN_REQ .....	57
6.8.2.2	MNLCS_BEGIN_IND .....	57
6.8.2.3	MNLCS_FACILITY_REQ .....	57
6.8.2.4	MNLCS_FACILITY_IND .....	57
6.8.2.5	MNLCS_END_REQ .....	57
6.8.2.6	MNLCS_END_IND .....	57
7	Services provided by signalling layer 3 on the Network side .....	57
7.1	Call control services .....	57
7.1.1	Service state diagram .....	58
7.1.2	Service primitives .....	61
7.1.2.1	MNCC_SETUP_REQ .....	61
7.1.2.2	MNCC_SETUP_IND .....	61
7.1.2.3	MNCC_SETUP_RSP .....	61
7.1.2.4	MNCC_SETUP_CNF .....	61
7.1.2.5	MNCC_SETUP_COMPL_REQ .....	61
7.1.2.6	MNCC_SETUP_COMPL_IND .....	62
7.1.2.7	MNCC_REJ_REQ .....	62
7.1.2.8	MNCC_REJ_IND .....	62
7.1.2.9	MNCC_CALL_CONF_IND .....	62
7.1.2.10	MNCC_CALL_PROC_REQ .....	62
7.1.2.11	MNCC_PROGRESS_REQ .....	62
7.1.2.12	MNCC_ALERT_REQ .....	62
7.1.2.13	MNCC_ALERT_IND .....	62
7.1.2.14	MNCC_NOTIFY_REQ .....	62
7.1.2.15	MNCC_NOTIFY_IND .....	62

7.1.2.16	MNCC_DISC_REQ.....	62
7.1.2.17	MNCC_DISC_IND.....	62
7.1.2.18	MNCC_REL_REQ.....	63
7.1.2.19	MNCC_REL_IND.....	63
7.1.2.20	MNCC_REL_CNF.....	63
7.1.2.21	MNCC_FACILITY_REQ.....	63
7.1.2.22	MNCC_FACILITY_IND.....	63
7.1.2.23	MNCC_START_DTMF_IND.....	63
7.1.2.24	MNCC_START_DTMF_RSP.....	63
7.1.2.25	MNCC_STOP_DTMF_IND.....	63
7.1.2.26	MNCC_STOP_DTMF_RSP.....	63
7.1.2.27	MNCC_MODIFY_REQ.....	63
7.1.2.28	MNCC_MODIFY_IND.....	63
7.1.2.29	MNCC_MODIFY_RES.....	63
7.1.2.30	MNCC_MODIFY_CNF.....	63
7.2	Call independent Supplementary Services Support.....	64
7.2.1	Service state diagram.....	64
7.2.2	Service primitives.....	64
7.2.2.1	MNSS_BEGIN_REQ.....	64
7.2.2.2	MNSS_BEGIN_IND.....	65
7.2.2.3	MNSS_FACILITY_REQ.....	65
7.2.2.4	MNSS_FACILITY_IND.....	65
7.2.2.5	MNSS_END_REQ.....	65
7.2.2.6	MNSS_END_IND.....	65
7.3	Short Message Services Support.....	65
7.4	Services provided to SMDCP and SMS entities by GPRS Logical Link Control services.....	65
7.4.1	Service state diagram for QoS1-SAP, QoS2-SAP, QoS3-SAP and QoS4-SAP.....	65
7.4.2	Service primitives for QoS1-SAP, QoS2-SAP, QoS3-SAP and QoS4-SAP.....	66
7.4.2.1	LL-ESTABLISH-REQ.....	66
7.4.2.2	LL-ESTABLISH-CNF.....	66
7.4.2.3	LL-ESTABLISH-IND.....	66
7.4.2.4	LL-ESTABLISH-RSP.....	66
7.4.2.5	LL-RELEASE-REQ.....	66
7.4.2.6	LL-RELEASE-CNF.....	66
7.4.2.7	LL-RELEASE-IND.....	66
7.4.2.8	LL-XID-REQ.....	66
7.4.2.9	LL-XID-IND.....	67
7.4.2.10	LL-XID-RSP.....	67
7.4.2.11	LL-XID-CNF.....	67
7.4.2.12	LL-DATA-REQ.....	67
7.4.2.13	LL-DATASENT-IND.....	67
7.4.2.14	LL-DATA-CNF.....	67
7.4.2.15	LL-DATA-IND.....	67
7.4.2.16	LL-UNITDATA-REQ.....	67
7.4.2.17	LL-UNITDATA-IND.....	67
7.4.2.18	LL-STATUS-IND.....	67
7.5	Session Management Services for GPRS and MBMS.....	67
7.5.1	Session Management Services for SMREG-SAP.....	68
7.5.1.1	SMREG-PDP-ACTIVATE-REQ.....	68
7.5.1.2	SMREG-PDP-ACTIVATE-REJ.....	68
7.5.1.3	SMREG-PDP-DEACTIVATE-REQ.....	68
7.5.1.4	SMREG-PDP-DEACTIVATE-CNF.....	68
7.5.1.5	SMREG-PDP-MODIFY-REQ.....	68
7.5.1.6	SMREG-PDP-MODIFY-CNF.....	68
7.5.1.7	SMREG-PDP-MODIFY-REJ.....	69
7.5.1.8	SMREG-MBMS-ACTIVATE-REQ.....	69
7.5.1.9	SMREG-MBMS-ACTIVATE-REJ.....	69
7.5.2	Session Management Services for SNSM-SAP.....	69
7.6	Location services at the Network side.....	69
7.6.1	Service state diagram.....	69
7.6.2	Service primitives.....	70
7.6.2.1	MNLCS_BEGIN_REQ.....	70

7.6.2.2	MNLCS_BEGIN_IND.....	71
7.6.2.3	MNLCS_FACILITY_REQ.....	71
7.6.2.4	MNLCS_FACILITY_IND.....	71
7.6.2.5	MNLCS_END_REQ.....	71
7.6.2.6	MNLCS_END_IND.....	71
8	Services assumed from signalling layers 1 and 2.....	71
8.1	Priority.....	71
8.2	Unacknowledged information transfer.....	71
8.3	Acknowledged information transfer.....	71
8.4	Random access.....	72
8.5	Channel management and measurements.....	72
9	Interlayer service interfaces on the MS side.....	72
9.1	Services provided by the Radio Resource Management entity.....	72
9.1.1	Service state diagram.....	73
9.1.2	Service primitives.....	74
9.1.2.1	RR_EST_REQ.....	74
9.1.2.2	RR_EST_IND.....	74
9.1.2.3	RR_EST_CNF.....	74
9.1.2.4	RR_REL_IND.....	74
9.1.2.5	RR_SYNC_IND.....	75
9.1.2.5a	Void.....	75
9.1.2.5b	Void.....	75
9.1.2.6	RR_DATA_REQ.....	75
9.1.2.7	RR_DATA_IND.....	75
9.1.2.7a	Void.....	75
9.1.2.8	RR_UNIT_DATA_IND.....	75
9.1.2.9	RR_ABORT_REQ.....	75
9.1.2.10	RR_ABORT_IND.....	75
9.1.3	Services provided by the Radio Resource Management entity for CTS.....	76
9.1.3.1	CTS_RR_ALIVE_CHECK_IND.....	76
9.2	Services provided by the Mobility Management entity.....	76
9.2.1	Service state diagram.....	77
9.2.2	Service primitives.....	78
9.2.2.1	MMXX_EST_REQ.....	78
9.2.2.2	MMXX_EST_IND.....	78
9.2.2.3	MMXX_EST_CNF.....	78
9.2.2.4	MMXX_REL_REQ.....	78
9.2.2.5	MMXX_REL_IND.....	78
9.2.2.6	MMXX_DATA_REQ.....	78
9.2.2.7	MMXX_DATA_IND.....	79
9.2.2.8	MMXX_UNIT_DATA_REQ.....	79
9.2.2.9	MMXX_UNIT_DATA_IND.....	79
9.2.2.10	MMCC_SYNC_IND.....	79
9.2.2.11	MMXX_REEST_REQ.....	79
9.2.2.12	MMXX_REEST_CNF.....	79
9.2.2.13	MMXX_ERR_IND.....	79
9.2.2.14	MMXX_PROMPT_IND.....	79
9.2.2.15	MMXX_PROMPT_REJ.....	79
9.3	Services provided by radio resource management entity for GPRS services.....	80
9.3.1	Service primitives for GRR-SAP (GSM only).....	80
9.3.2	Service primitives for GMMRR-SAP (GSM only).....	80
9.3.2.1	GMMRR-ASSIGN-REQ.....	80
9.3.2.2	GMMRR-PAGE-IND.....	80
9.3.3	Service primitives for RABMAS-SAP (UMTS only).....	80
9.3.3.1	RABMAS-RAB-ESTABLISH-IND.....	80
9.3.3.2	RABMAS-RAB-ESTABLISH-RES.....	80
9.3.3.3	RABMAS-RAB-ESTABLISH-REJ.....	81
9.3.3.4	RABMAS-RAB-RELEASE-IND.....	81
9.3.3.5	RABMAS-RAB-RELEASE-RES.....	81
9.3.3.6	RABMAS-STATUS-IND.....	81



9.3.4	Service primitives for GMMAS-SAP (UMTS only) .....	81
9.3.4.1	GMMAS-SECURITY-IND .....	81
9.3.4.2	GMMAS-SECURITY-RES .....	81
9.3.4.3	GMMAS-ESTABLISH-REQ .....	81
9.3.4.4	GMMAS-ESTABLISH-CNF .....	81
9.3.4.5	GMMAS-ESTABLISH-REJ .....	82
9.3.4.6	GMMAS- RELEASE-REQ .....	82
9.3.4.7	GMMAS- RELEASE-IND .....	82
9.3.4.8	GMMAS- DATA-REQ .....	82
9.3.4.9	GMMAS- DATA-IND .....	82
9.3.4.10	GMMAS-PAGE-IND .....	82
9.3.4.11	GMMAS-STATUS-IND .....	82
9.4	Services provided by the LLC entity for GPRS services (GSM only) .....	82
9.4.1	Service primitives for LLGMM-SAP .....	82
9.4.1.1	LLGMM-ASSIGN-REQ .....	82
9.4.1.2	LLGMM-TRIGGER-REQ .....	82
9.4.1.3	Void.....	83
9.4.1.4	LLGMM-SUSPEND-REQ .....	83
9.4.1.5	Void.....	83
9.4.1.6	Void.....	83
9.4.1.7	LLGMM-WINDOW-CNF .....	83
9.4.1.8	LL-UNITDATA-REQ.....	83
9.4.1.9	LL-UNITDATA-IND .....	83
9.4.1.10	LLGMM-STATUS-IND .....	83
9.4.2	Service primitives for LLSMS-SAP .....	83
9.4.2.1	LL-UNITDATA-REQ.....	83
9.4.2.2	LL-UNITDATA-IND .....	83
9.5	Services provided by the GMM for GPRS services .....	83
9.5.1	Service primitives for GMMSM-SAP .....	83
9.5.1.1	GMMSM-ESTABLISH-REQ .....	84
9.5.1.2	GMMSM-ESTABLISH-CNF .....	84
9.5.1.3	GMMSM-ESTABLISH-REJ .....	84
9.5.1.4	GMMSM-RELEASE-IND.....	84
9.5.1.5	GMMSM-UNITDATA-REQ.....	84
9.5.1.6	GMMSM-UNITDATA-IND.....	84
9.5.2	Void .....	84
9.5.3	Service primitives for GMMSMS-SAP .....	84
9.5.3.1	GMMSMS-REG-STATE-REQ .....	85
9.5.3.2	GMMSM- REG-STATE -RSP.....	85
9.5.4	Service primitives for PMMSMS-SAP.....	85
9.5.4.1	PMMSMS_EST_REQ .....	85
9.5.4.2	PMMSMS_EST_CNF.....	85
9.5.4.3	PMMSMS_ERROR_IND .....	85
9.5.4.4	PMMSMS_UNITDATA_REQ.....	85
9.5.4.5	PMMSMS_UNITDATA_IND.....	85
9.5.5	Service primitives for GMMRABM-SAP (UMTS only).....	85
9.5.5.1	GMMRABM-REESTABLISH-REQ.....	86
9.5.5.2	GMMRABM-REESTABLISH-RSP .....	86
9.5.5.3	GMMRABM-REESTABLISH-REJ .....	86
9.5.6	Service primitives for GMMSS-SAP.....	86
9.5.6.1	GMMSS-ESTABLISH-REQ .....	86
9.5.6.2	GMMSS-ESTABLISH-CNF .....	86
9.5.6.3	GMMSS-ESTABLISH-REJ .....	86
9.5.6.4	GMMSS-RELEASE-IND .....	86
9.5.6.5	GMMSS-UNITDATA-REQ .....	86
9.5.6.6	GMMSS-UNITDATA-IND .....	87
9.5.7	Service primitives for GMMSS2-SAP.....	87
9.5.7.1	GMMSS2-REG-STATE-REQ.....	87
9.5.7.2	GMM SS2- REG-STATE -RSP.....	87
10	Interlayer service interfaces on the Network side .....	87
10.1	Services provided by the Radio Resource Management entity .....	87

10.1.1	Service state diagram .....	88
10.1.2	Service primitives .....	89
10.1.2.1	RR_EST_REQ .....	89
10.1.2.2	RR_EST_IND .....	89
10.1.2.3	RR_EST_CNF .....	89
10.1.2.4	RR_REL_REQ .....	89
10.1.2.5	RR_REL_IND .....	89
10.1.2.6	RR_SYNC_REQ .....	89
10.1.2.7	RR_SYNC_CNF .....	89
10.1.2.8	RR_DATA_REQ .....	89
10.1.2.9	RR_DATA_IND .....	90
10.1.2.10	RR_UNIT_DATA_REQ .....	90
10.1.2.11	RR_UNIT_DATA_IND .....	90
10.1.2.12	RR_ABORT_REQ .....	90
10.1.2.13	RR_ABORT_IND .....	90
10.2	Services provided by the Mobility Management entity .....	90
10.2.1	Service state diagram .....	90
10.2.2	Service primitives .....	91
10.2.2.1	MMXX_EST_REQ .....	91
10.2.2.2	MMXX_EST_IND .....	92
10.2.2.3	MMXX_EST_CNF .....	92
10.2.2.4	MMXX_REL_REQ .....	92
10.2.2.5	MMXX_REL_IND .....	92
10.2.2.6	MMXX_DATA_REQ .....	92
10.2.2.7	MMXX_DATA_IND .....	92
10.2.2.8	MMXX_UNIT_DATA_REQ .....	92
10.2.2.9	MMXX_UNIT_DATA_IND .....	92
10.2.2.10	MMCC_SYNC_REQ .....	92
10.2.2.11	MMCC_SYNC_CNF .....	92
10.3	Services provided by radio resource management entity for GPRS services .....	92
10.3.1	Service primitives for GRR-SAP .....	92
10.3.2	Service primitives for GMMRR-SAP .....	93
10.3.2.1	GMMRR-PAGE-REQ .....	93
10.4	Services provided by the LLC entity for GPRS services .....	93
10.4.1	Service primitives for LLGMM-SAP .....	93
10.4.1.1	LLGMM-ASSIGN-REQ .....	93
10.4.1.2	Void .....	93
10.4.1.3	LLGMM-SUSPEND-REQ .....	93
10.4.1.4	LLGMM-RESUME-REQ .....	93
10.4.1.5	Void .....	93
10.4.1.6	Void .....	93
10.4.1.7	LLGMM-PAGE-IND .....	93
10.4.1.8	LLGMM-PAGE-RESP-IND .....	94
10.4.1.9	LL-UNITDATA-REQ .....	94
10.4.1.10	LL-UNITDATA-IND .....	94
10.4.1.11	LLGMM-STATUS-IND .....	94
10.4.2	Service primitives for LLSMS-SAP .....	94
10.4.2.1	LL-UNITDATA-REQ .....	94
10.4.2.2	LL-UNITDATA-IND .....	94
10.5	Services provided by the GMM for GPRS services .....	94
10.5.1	Service primitives for GMMSM-SAP .....	94
10.5.1.1	GMMSM-RELEASE-IND .....	94
10.5.1.2	GMMSM-UNITDATA-REQ .....	95
10.5.1.3	GMMSM-UNITDATA-IND .....	95
10.5.2	Service primitives for PMMSMS-SAP .....	95
10.5.2.1	PMMSMS_REL_REQ .....	95
10.5.2.2	PMMSMS_ERROR_IND .....	95
10.5.2.3	PMMSMS_UNITDATA_REQ .....	95
10.5.2.4	PMMSMS_UNITDATA_IND .....	95
10.5.3	Service primitives for GMMSS-SAP .....	95
10.5.3.1	GMMSS-RELEASE-IND .....	95
10.5.3.2	GMMSS-UNITDATA-REQ .....	95

10.5.3.3	GMMSS-UNITDATA-IND .....	96
10.6	Services provided by the Radio Resource Management entity for CTS on the fixed part .....	96
10.6.1	Service primitives .....	96
10.6.1.1	RR_CTS_ALIVE_CHECK_REQ .....	96
10.6.1.2	RR_CTS_ALIVE_CHECK_IND .....	96
10.6.1.3	RR_CTS_HUNTING_REQ .....	96
10.6.1.4	RR_CTS_GROUP_ALERTING_REQ .....	96
11	L3 Messages .....	97
11.1	General .....	97
11.1.1	Messages .....	97
11.1.2	Octets .....	98
11.1.3	Integer .....	98
11.1.3.1	Binary .....	98
11.1.3.2	2-complement binary .....	98
11.1.4	Spare parts .....	98
11.2	Standard L3 messages .....	99
11.2.1	Components of a standard L3 message .....	99
11.2.1.1	Format of standard information elements .....	99
11.2.1.1.1	Information element type and value part .....	99
11.2.1.1.2	Length indicator .....	99
11.2.1.1.3	Information element identifier .....	100
11.2.1.1.4	Categories of IEs; order of occurrence of IEI, LI, and value part .....	100
11.2.2	Description methods for IE structure .....	102
11.2.2.1	Tables .....	102
11.2.2.1.1	Compact notation .....	103
11.2.3	Imperative part of a standard L3 message .....	103
11.2.3.1	Standard L3 message header .....	103
11.2.3.1.1	Protocol discriminator .....	104
11.2.3.1.1A	Extended protocol discriminator (EPD) .....	104
11.2.3.1.2	Skip indicator .....	105
11.2.3.1.3	Transaction identifier .....	105
11.2.3.1.4	Sub-protocol discriminator .....	107
11.2.3.1.5	EPS bearer identity .....	107
11.2.3.1.6	Security header type .....	108
11.2.3.1a	Procedure transaction identity .....	108
11.2.3.1b	PDU session identity .....	108
11.2.3.2	Message type octet .....	109
11.2.3.2.1	Message type octet (when accessing Release 98 and older networks only) .....	109
11.2.3.2.2	Message type octet (when accessing Release 99 and newer networks) .....	110
11.2.3.2.3	Sequenced message transfer operation .....	111
11.2.3.2.3.1	Variables and sequence numbers .....	112
11.2.3.2.3.1.1	Send state variable V(SD) .....	112
11.2.3.2.3.1.2	Send sequence number N(SD) .....	112
11.2.3.2.3.2	Procedures for the initiation, transfer execution and termination of the sequenced message transfer operation .....	112
11.2.3.2.3.2.1	Initiation .....	112
11.2.3.2.3.2.2	Transfer Execution .....	112
11.2.3.2.3.2.3	Termination .....	113
11.2.3.3	Standard information elements of the imperative part .....	113
11.2.4	Non-imperative part of a standard L3 message .....	113
11.2.5	Presence requirements of information elements .....	114
11.2.6	Description of standard L3 messages .....	115
11.3	Non standard L3 messages .....	115
11.3.1	Case A: BCCH and AGCH/PCH messages .....	116
11.3.1.1	L2 Pseudo Length octet .....	116
11.3.1.2	Rest Octets .....	116
11.3.1.3	Description of a modified standard L3 message .....	116
11.3.2	Case B: SACCH / SDCCH / FACCH messages sent in unacknowledged mode .....	116
11.3.2.1	The first octet .....	116
11.3.2.2	The rest of the message .....	117
11.3.3	Design guidelines for non standard parts .....	117

11.3.3.1	General .....	117
11.4	Handling of superfluous information .....	117
11.4.1	Information elements that are unnecessary in a message.....	117
11.4.2	Other syntactic errors.....	117
<b>Annex A (informative):</b>	<b>MN-Services arrow diagram.....</b>	<b>119</b>
<b>Annex B (informative):</b>	<b>Description of CSN.1 .....</b>	<b>127</b>
B.1	The Basic Rules.....	127
B.1.1	Core Rules .....	127
B.1.1.1	Rule B1: Bits.....	127
B.1.1.2	Rule B2: Null String .....	127
B.1.1.3	Rule B3: Concatenation .....	128
B.1.1.4	Rule B4: Choice.....	128
B.1.1.5	Rule B5: Naming .....	129
B.1.1.6	Rule B6: Definition.....	129
B.1.2	Spare parts .....	129
B.1.2.1	Rule B7: Spare bits .....	129
B.1.2.2	Rule B8: Padding bits .....	130
B.1.3	Predefined sets.....	130
B.1.4	Labelling Parts.....	131
B.1.4.1	Rule A1: Labels .....	131
B.1.5	Goodies .....	131
B.1.5.1	Rule G1: Comments.....	131
B.2	Advanced rules.....	131
B.2.1	Rule A2: Exponent notation .....	131
<b>Annex C (informative):</b>	<b>GPRS-Services sequence diagram.....</b>	<b>133</b>
<b>Annex D (informative):</b>	<b>Change history .....</b>	<b>154</b>
History .....		157

---

# Foreword

This Technical Specification (TS) has been produced by the 3<sup>rd</sup> Generation Partnership Project (3GPP).

The present document defines the architecture of layer 3 and its sublayers on the GSM Um interface, i.e. the interface between Mobile Station and network within the 3GPP system.

The contents of the present document are subject to continuing work within the TSG and may change following formal TSG approval. Should the TSG modify the contents of the present document, it will be re-released by the TSG with an identifying change of release date and an increase in version number as follows:

Version x.y.z

where:

- x the first digit:
  - 1 presented to TSG for information;
  - 2 presented to TSG for approval;
  - 3 or greater indicates TSG approved document under change control.
- y the second digit is incremented for all changes of substance, i.e. technical enhancements, corrections, updates, etc.
- z the third digit is incremented when editorial only changes have been incorporated in the document.

---

# 1 Scope

The present document defines the principal architecture of layer 3 and its sublayers on the GSM Um interface, i.e. the interface between Mobile Station (MS) and network; for the CM sublayer, the description is restricted to paradigmatic examples, call control, supplementary services, and short message services for non-GPRS services. It also defines the basic message format and error handling applied by the layer 3 protocols.

For CTS services, the present document defines the principal architecture of layer 3 on the GSM Um\* interface, i.e. the interface between a CTS capable Mobile Station (CTS-MS) and a Fixed Part (FP).

The corresponding protocols are defined in other Technical Specifications, see subclause 4.3.4.

For non-GPRS services the communication between sublayers and adjacent layers and the services provided by the sublayers are distributed by use of abstract service primitives. But only externally observable behaviour resulting from the description is normatively prescribed by the present document.

For GPRS services in addition the local information transfer and stimuli sent between sublayers is informatively included within Annex C of in the present document.

This document also defines the principal architecture of the EPS NAS and 5GS NAS layer 3 protocol and their sublayers, including the message format applied by layer 3.

In the present document MS is also used as a synonym for UE.

Descriptions in clauses 6 to 10 are not maintained actively.

---

# 2 References

The following documents contain provisions which, through reference in this text, constitute provisions of the present document.

- References are either specific (identified by date of publication, edition number, version number, etc.) or non-specific.
- For a specific reference, subsequent revisions do not apply.
- For a non-specific reference, the latest version applies. In the case of a reference to a 3GPP document (including a GSM document), a non-specific reference implicitly refers to the latest version of that document *in the same Release as the present document*.

- [1] GSM 01.02(R97): "Digital cellular telecommunications system (Phase 2+); General description of a GSM Public Land Mobile Network (PLMN)".
- [1a] 3GPP TR 21.905: "Vocabulary for 3GPP Specifications".
- [2] 3GPP TS 23.101: "General UMTS Architecture".
- [3] 3GPP TS 44.001: "Mobile Station - Base Station System (MS - BSS) interface; General aspects and principles".
- [3a] 3GPP TS 23.060: "General Packet Radio Service (GPRS) description; Stage 2".
- [3b] GSM 03.56(R98): "Digital cellular telecommunications system (Phase 2+); GSM Cordless Telephony System (CTS), Phase 1; CTS Architecture Description; Stage 2".
- [3c] 3GPP TS 23.271: "Functional stage 2 description of location services".
- [4] 3GPP TS 44.005: "Data Link (DL) layer; General aspects".
- [5] 3GPP TS 44.006: "Mobile Station - Base Station System (MS - BSS) interface; Data Link (DL) layer specification".

- [5a] 3GPP TS 44.014: "Individual equipment type requirements and interworking; Special conformance testing functions".
- [6] 3GPP TS 24.008: "Mobile radio interface Layer 3 specification Core Network Protocols-Stage 3".
- [6a] 3GPP TS 23.108: "Mobile radio interface Layer 3 specification Core Network Protocols Stage 2 (structured procedures)".
- [6b] 3GPP TS 44.018: "Mobile radio interface layer 3 specification; Radio Resource Control Protocol".
- [7] 3GPP TS 24.010: "Mobile radio interface Layer 3; Supplementary services specification; General aspects".
- [8] 3GPP TS 24.011: "Point-to-Point (PP) Short Message Service (SMS) support on mobile radio interface".
- [8a] 3GPP TS 44.071: "Location Services (LCS); Mobile radio interface layer 3 LCS specification".
- [9] 3GPP TS 24.080: "Mobile radio Layer 3 supplementary services specification; Formats and coding".
- [10] 3GPP TS 24.081: "Line identification supplementary services; Stage 3".
- [10a] 3GPP TS 44.060: "General Packet Radio Services (GPRS); Mobile Station (MS) - Base Station System (BSS) interface; Radio Link Control/Medium Access Control (RLC/MAC) protocol".
- [10b] 3GPP TS 44.056: "GSM Cordless Telephony System (CTS), phase 1; CTS radio interface Layer 3 specification".
- [11] 3GPP TS 24.082: "Call Forwarding (CF) supplementary services - Stage 3".
- [11a] 3GPP TS 44.064: "General Packet Radio Service (GPRS); Mobile Station - Serving GPRS Support Node (MS-SGSN) Logical Link Control (LLC) layer specification".
- [12] 3GPP TS 24.083: "Call Waiting (CW) and Call Hold (HOLD) supplementary services; Stage 3".
- [12a] 3GPP TS 44.065: "General Packet Radio Service (GPRS); Mobile Station (MS) - Serving GPRS Support Node (SGSN); Subnetwork Dependent Convergence Protocol (SNDCCP)".
- [13] 3GPP TS 24.084: "MultiParty (MPTY) supplementary services; Stage 3".
- [14] 3GPP TS 24.085: "Closed User Group (CUG) supplementary services; Stage 3".
- [15] 3GPP TS 24.086: "Advice of Charge (AoC) supplementary services; Stage 3".
- [16] 3GPP TS 24.088: "Call Barring (CB) supplementary services; Stage 3".
- [17] 3GPP TS 24.090: "Unstructured Supplementary Service Data (USSD) - Stage 3".
- [17a] 3GPP TS 34.109: "Terminal logical test interface; Special conformance testing functions".
- [18] ITU-T Recommendation X.200: "Information technology - Open Systems Interconnection - Basic Reference Model: The basic model".
- [19] 3GPP TS 44.068: "Group Call Control (GCC) Protocol".
- [20] 3GPP TS 23.110: "UMTS Access Stratum Services and Functions".
- [21] 3GPP TS 24.030: "Location Services (LCS); Supplementary service operations – Stage 3".
- [22] 3GPP TS 23.251: "Network Sharing; Architecture and functional description".
- [23] 3GPP TS 25.413: "UTRAN Iu interface RANAP signalling".
- [24] 3GPP TS 36.331: "Evolved Universal Terrestrial Radio Access (E-UTRA); Radio Resource Control (RRC) protocol specification".

- [25] 3GPP TS 24.301: "Non-Access-Stratum (NAS) protocol for Evolved Packet System (EPS); Stage 3".
- [26] 3GPP TS 36.509: "Evolved Universal Terrestrial Radio Access (E-UTRA); Special conformance testing function for User Equipment (UE)".
- [27] 3GPP TS 23.216: "Single Radio Voice Call Continuity (SRVCC); Stage 2".
- [28] 3GPP TS 38.331: "NR Radio Resource Control (RRC) Protocol specification".
- [29] 3GPP TS 38.509: "5GS; Special conformance testing functions for User Equipment (UE)".
- [30] IETF RFC 7296: "Internet Key Exchange Protocol Version 2 (IKEv2)".
- [31] 3GPP TS 24.501: "Non-Access-Stratum (NAS) protocol for 5G System (5GS); Stage 3".
- [32] 3GPP TS 24.502: "Access to the 3GPP 5G System (5GS) via non-3GPP access networks; Stage 3".
- [33] 3GPP TS 24.519: "5G System (5GS); Time-Sensitive Networking (TSN) Application Function (AF) to Device-Side TSN Translator (DS-TT) and Network-Side TSN Translator (NW-TT) protocol aspects; Stage 3".
- [34] 3GPP TS 24.587: "Vehicle-to-Everything (V2X) services in 5G System (5GS); Protocol aspects; Stage 3".
- [35] 3GPP TS 24.193: "Access Traffic Steering, Switching and Splitting; Stage 3".
- [36] 3GPP TS 24.334: "Proximity-services (ProSe) User Equipment (UE) to Proximity-services (ProSe) Function Protocol aspects; Stage 3".

---

## 3 Definitions and abbreviations

### 3.1 Definitions

For the purposes of the present document, the terms and definitions given in 3GPP TR 21.905 [1a] apply.

### 3.2 Abbreviations

For the purposes of the present document, the abbreviations defined in 3GPP TR 21.905 [1a] and the following apply:

GMM	GPRS Mobility Management
MNS	Mobile Network Signalling
N-PDU	Network-Protocol Data Unit
SM	Session Management
UDT	User Data Transfer
CTS	Cordless Telephony System
LCS	LoCation Services
MOCN	Multi-Operator Core Network

---

## 4 Introduction

### 4.1 General

Five models are defined for Layer 3, one model for non-GPRS services, one for GPRS services supporting Class C MSs only, one model for GPRS-services supporting Class A and Class B MSs, one model for EPS services and one model for 5GS services over either 3GPP access or over non-3GPP access. (The third model is a combination of the first two models listed). In the present document GPRS services and EPS services will be used as synonyms.



The layer 3 for non-GPRS services provides the functions necessary:

- for Radio Resource (RR) management;
- for Mobility Management (MM); and
- for the Connection Management (CM) functions, i.e. functions for the control, provision, and support of services offered by the network; among which there are, e.g.:
  - the functions to establish, maintain and terminate circuit-switched connections across a GSM PLMN and other networks to which the GSM PLMN is connected;
  - supporting functions for supplementary services control;
  - supporting functions for short messages service control;
  - supporting functions for location services control (only for a type A LMU).

The layer 3 for non-GPRS services is composed of three sublayers comprising:

- the Radio Resource Management (RR) functions;
- the Mobility Management (MM) functions; and
- the Connection Management (CM) functions.

When CTS services are added to non-GPRS services, the following functions are added:

- CTS Radio Resource Management (CTS-RR) functions to RR; and
- CTS Mobility Management (CTS-MM) functions to MM.

The layer 3 for GPRS services is composed of four sublayers comprising:

- the Radio Resource Management (RR) functions;
- the Mobility Management (GMM);
- for the Logical Link Control (LLC);
- the Connection Management (CM) functions.

The Connection Management (CM) sublayer is composed of functional blocks for:

- Call Control (CC) for non-GPRS services;
- Short Message Service Support (SMS) for non-GPRS services;
- GPRS Short Message Service Support (GSMS) (for GPRS services supporting Class A, B and C MSs);
- Session Management (SM) (for GPRS services supporting Class A, B and C MSs);
- Supplementary Services Support (SS) for non-GPRS services;
- Group Call Control for non-GPRS services;
- Broadcast Call Control (BCC) for non-GPRS services;
- Connection Management of Packet Data on Signalling channels for non-GPRS services;
- Location Services support (LCS) for non-GPRS services (only for a type A LMU).

Within the context of LCS, for GSM LCS, the services defined for an MS are equally applicable to a type A LMU, unless otherwise stated. However, services defined specifically for a type A LMU are not applicable to an MS. The following is a list of services essential for a type A LMU.

The layer 3 for non-GPRS services provides the functions necessary:

- for Radio Resource (RR) management;

- for Mobility Management (MM); and
- supporting functions for location service control.

The layer 3 for non-GPRS services is composed of three sublayers comprising:

- the Radio Resource Management (RR) functions;
- the Mobility Management (MM) functions; and
- the Connection Management (CM) functions.

The Connection Management (CM) sublayer is composed of a functional block for:

- location services support (LCS) for non-GPRS services.

The present document does not consider the distribution of signalling functions among the different network equipments. The signalling functions are described between two systems which represent the MS side and the network side of the radio interface of layer 3. Only the functions in the network for signalling communication with one MS is considered.

For GPRS services, in addition to the signalling functions also the user data transfer is included in the present document.

The layer 3 for EPS services is composed of three sublayers comprising:

- the EPS Radio Resource Management (RR) functions;
- the EPS Mobility Management (EMM) functions; and
- the Connection Management (CM) functions.

The Connection Management (CM) sublayer is composed of a functional block for:

- the EPS Session Management (ESM) functions.

The layer 3 for 5GS services is composed of three sublayers comprising:

- the 5GS radio resource management (5GRR) functions for NAS over 3GPP access or the non-3GPP access functions for NAS over non-3GPP access;
- the 5GS mobility management (5GMM) functions; and
- the 5GS connection management (5GCM) functions.

The 5GS mobility management (5GMM) sublayer is composed of a functional block for:

- the 5GS mobility management (5GMM) functions.

The 5GS connection management (5GCM) sublayer is composed of a functional block for:

- the 5GS session management (5GSM) functions.

NOTE: For NAS over non-3GPP access, the non-3GPP access functions can be supported through functionalities defined in IETF RFC 7296 [30].

## 4.2 Applicability of functional blocks

Not for all functional blocks listed in subclause 4.1, support in the MS or in the network is mandatory:

- Support of Group Call Control is optional in the MS and in the network.
- Support of Broadcast Call Control is optional in the MS and in the network.
- Connection Management of Packet Data on Signalling channels. is optional in the MS and in the network.
- Support of GPRS services is optional in the MS and in the network.

- Support of CTS services is optional in the MS. CTS services are not applicable to the network.
- Support of LCS services is optional in the MS and in the network, but not optional in LMU.

Further conditions and constraints are defined in other Technical Specifications.

## 4.3 Technique of description

Layer 3 and its sub-layers are specified by:

- their service specification, see subclause 4.3.1;
- their protocol specification, see subclause 4.3.3;
- the specification of functions, see clause 5.

Descriptions in clauses 3 to 10 are not maintained actively.

### 4.3.1 Service description

The services of signalling layer 3 and its sublayers are described in terms of:

- services provided to upper (sub-)layers at the service access points;
- services assumed from lower (sub-)layers at the service access points.

Layer 3 and its supporting lower layers provide the Mobile Network Signalling (MNS) Service and User Data Transfer (UDT) Service (for GPRS services only) to the upper layers.

The service provided/assumed at the service access points are described by means of abstract service primitives and parameters as recommended in ITU-T Recommendation X.200 [18].

### 4.3.2 Abstract service primitives

The abstract service primitives consist of requests, responses, indications and confirmations. The general syntax of a primitive is specified in 3GPP TR 21.905 [1a].

### 4.3.3 Protocols and peer-to-peer communication

By use of the services provided by lower (sub-)layers, peer entities in a (sub-)layer in the MS and the network exchange information. Exchange of information between two peer entities is performed according to the corresponding (sub-)layer protocols. A protocol is a set of rules and formats by which the information (control information and user data) is exchanged between the two peers. The information is exchanged by use of messages which are defined in the protocol. (Therefore, the messages are also called Protocol Data Units, PDUs).

There are several protocols of the RR sublayer, one protocol of the LLC sublayer, three protocols of the MM sublayer, and several protocols of the CM sublayer. For each functional block of the CM sublayer as defined in subclause 4.1 there is one protocol. The CM protocols are specified in the Technical Specifications identified in subclause 4.3.4.

In the model used in the present document, there are:

1) for non-GPRS services:

- one RR sub-layer entity in the MS and one RR sub-layer entity in the network;
- one MM sub-layer entity in the MS and one MM sub-layer entity in the network;
- for each functional block of the CM sublayer as defined in subclause 4.1 which is supported in the MS (in the network), there are, depending on the protocol, one or more entities in the MS (in the network). Two different entities of the same functional block in the MS (in the network) are called parallel entities. The entities of the same functional block in the MS correspond in a one-to-one relation to the entities of the functional block in the network. The corresponding entities are called peer entities;

2) for CTS services (in addition to non-GPRS services):

- one RR sub-layer entity in the MS and one in the CTS fixed part. These RR sub-layers include one CTS-RR sub-entity on each side;
- one MM sub-layer entity in the MS and one in the CTS fixed part. These MM sub-layers include one CTS-MM sub-entity on each side;
- for each functional block of the CM sublayer as defined in subclause 4.1 which is supported in the MS (in the fixed part), there are, depending on the protocol, one or more entities in the MS (in the fixed part). Two different entities of the same functional block in the MS (in the fixed part) are called parallel entities. The entities of the same functional block in the MS correspond in a one-to-one relation to the entities of the functional block in the fixed part. The corresponding entities are called peer entities;

3) for GPRS services supporting Class C MSs:

- one RR sublayer entity (RR) in the MS and one RR sublayer entity in the network;
- six LLC sublayer entities (QoS1-QoS4, signalling, SMS) in the MS and six LLC sublayer entities in the network;
- one MM sublayer entity (GMM) in the MS and one MM sublayer entity in the network (GMM);
- one SM entity in the MS's CM sublayer and one SM sublayer entity in the network's CM sublayer;
- one or more GSMS functional blocks in the CM sublayer if supported;

4) for non-GPRS and GPRS services supporting Class A and Class B MSs:

- two RR sublayer entities (RR) in the MS and two RR sublayer entities in the network;
- six LLC sublayer entities (QoS1-QoS4, signalling, SMS) in the MS and six LLC sublayer entities in the network;
- two MM sublayer entities (GMM + MM) in the MS and one or two MM sublayer entities in the network (GMM or MM);
- one SM entity in the MS's CM sublayer and one SM entity in the network's CM sublayer;
- for each functional block of the CM sublayer as defined in subclause 4.1 which is supported in the MS (in the network), there are, depending on the protocol, one or more entities in the MS (in the network). Two different entities of the same functional block in the MS (in the network) are called parallel entities. The entities of the same functional block in the MS correspond in a one-to-one relation to the entities of the functional block in the network. The corresponding entities are called peer entities;

5) for EPS services:

- one RR entity in the MS and one RR entity in the network;
- one EMM entity in the MS and one EMM entity in the network;
- for each functional block of the CM sublayer as defined in subclause 4.1 which is supported in the MS (in the network), there are, depending on the protocol, one or more entities in the MS (in the network). Two different entities of the same functional block in the MS (in the network) are called parallel entities. The entities of the same functional block in the MS correspond in a one-to-one relation to the entities of the functional block in the network. The corresponding entities are called peer entities.

6) for 5GS services:

- one 5GRR entity in the MS and one 5GRR entity in the network for NAS over 3GPP access;
- one non-3GPP access management entity in the MS and one non-3GPP access interworking entity in the N3IWF for the NAS over non-3GPP access;
- one 5GMM entity in the MS and one 5GMM entity in the network;

- for each functional block of the 5GCM sublayer as defined in subclause 4.1 which is supported in the MS (in the network), there are, depending on the protocol, one or more entities in the MS (in the network). Two different entities of the same functional block in the MS (in the network) are called parallel entities. The entities of the same functional block in the MS correspond in a one-to-one relation to the entities of the functional block in the network. The corresponding entities are called peer entities.

As each sub-layer entity is specified by one and only one protocol, it is also called a protocol entity or protocol control entity.

For GPRS-services supporting Class A and Class B MSs, the MM entities of the MM-sublayer are able to exchange information by means of GMM PDUs as well as MM PDU's. This means if a mobile is GPRS attached, non-GPRS mobility management procedures may make use of GRPS mobility management messages.

When two peer protocol entities exchange PDUs, a transaction is said to be established (or: to be active; or: to exist). It depends from the protocol when exactly a protocol entity considers the transaction to be active, normally this is the case:

- from the moment when it has passed the first suitable message to lower (sub-) layers or received the first suitable message from its peer entity;
- up to the moment when it has released the transaction.

#### 4.3.4 Contents of layer 3 related Technical Specifications

- The Radio Resource (RR) management protocol is defined in 3GPP TS 44.018 [6b];
- the Mobility Management (MM) protocol is defined in 3GPP TS 24.008 [6];
- the Session Management (SM) protocol is defined in 3GPP TS 24.008 [6];
- the Call Control (CC) protocol is defined in 3GPP TS 24.008 [6];
- the Supplementary Services (SS) protocol is defined in 3GPP TS 24.010 [7], 3GPP TS 24.08x, 3GPP TS 24.09x, and 3GPP TS 24.030 [21];
- the Short Message Service (SMS) protocol is defined in 3GPP TS 24.011 [8];
- the Group Call Control (GCC) protocol is defined in 3GPP TS 44.068 [19];
- the Logical Link Control (LLC) protocol is defined in 3GPP TS 44.064 [11a];
- the GPRS Radio Resource (GRR) protocol is defined in 3GPP TS 44.060 [10a] and 3GPP TS 24.008 [6];
- the CTS Radio Resource (CTS-RR) sub-protocol is defined in 3GPP TS 44.056 [10b];
- the CTS Mobility Management (CTS-MM) sub-protocol is defined in 3GPP TS 44.056 [10b];
- the CTS additions to the Call Control (CC) protocol are defined in 3GPP TS 44.056 [10b];
- the Location Services (LCS) protocol for a type A LMU is defined in 3GPP TS 23.271 [3c] and 3GPP TS 44.071 [8a];
- the EPS Radio Resource (RR) management protocol is defined in 3GPP TS 36.331 [24];
- the EPS Mobility Management (EMM) protocol is defined in 3GPP TS 24.301 [25];
- the EPS Session Management (ESM) protocol is defined in 3GPP TS 24.301 [25];
- the 5GS Radio Resource management (5GRR) protocol is defined in 3GPP TS 38.331 [28];
- the 5GS Mobility Management (5GMM) protocol is defined in 3GPP TS 24.501 [31];
- the 5GS Session Management (5GSM) protocol is defined in 3GPP TS 24.501 [31];
- the non-3GPP access management protocol is defined in 3GPP TS 24.502 [32];
- the PC5 signalling protocol is defined in 3GPP TS 24.587 [34];

- the Time-Sensitive Networking (TSN) Application Function (AF) to Device-Side TSN Translator (DS-TT) and Network-Side TSN Translator (NW-TT) protocol is defined in 3GPP TS 24.519 [33];
- the Performance Measurement Function (PMF) protocol is defined in 3GPP TS 24.193 [35];
- the PC3 and PC5 signalling protocol for Proximity-based Services (ProSe) are defined in 3GPP TS 24.334 [36].

---

## 5 Structure of layer 3 functions

### 5.1 Basic groups of functions

Most functions of layer 3 and its sub-layers are described by the service specifications and protocol specifications of the (sub-)layers.

These functions are in the model realized by protocol control entities, see subclause 4.3.3.

In addition, routing functions are contained in layer 3 which are related to the transport of messages, e.g. multiplexing and splitting. These routing functions are defined in the Radio Resource Management or in the 5GRR (for NAS over 3GPP access) or non-3GPP access management (for NAS over non-3GPP access) and Mobility Management or 5GMM sub-layers.

- 1) They have the task to pass the messages from upper (sub-)layers to lower (sub-)layers.
- 2) They also have the task to pass messages provided by lower (sub-layers) to the appropriate sub-layer and, if applicable, entity.

The routing functions with task 2 make use of the protocol discriminator (PD) which is part of the message header.

A CM sublayer protocol may also define a transaction identifier (TI), procedure transaction identity (PTI) or EPS bearer identity as a part of the message header. This is at least the case if there are parallel entities of the same functional block, see subclause 4.3.3. If they are a part of a message, the TI, PTI, EPS bearer identity, or both PTI and EPS bearer identity are also used by the routing functions.

- The MM-sublayer routing function passes the messages of the CM entities as well as of the MM, GMM and CTS-MM entities of its own sublayer to the service access point of RR, GRR, LLC or CTS-RR. Furthermore it multiplexes them in case of parallel transactions.
- The routing function of Radio Resource Management distributes the messages to be sent according to their message type and protocol discriminator (PD), to the actual channel configuration, and, if applicable, to further information received from upper sub-layers to the appropriate service access point of layer 2 (identified by SAPI and logical channel). Paging messages received from the PPCH are always routed to GMM, while paging messages received from the PCH are distributed to GMM or MM based on the temporary identifier (TMSI or TLL). For EPS services, the Paging messages received from the PCH are always routed to EMM.
- The messages provided at the different service access points of layer 2 are distributed by the RR sublayer routing function according to their protocol discriminator (PD). Messages with a PD equal to RR are passed to the RR entity of the own sublayer, all other messages are passed to the MM sublayer at the service access point RR-SAP.
- The routing function of MM-sublayer passes Standard L3 messages according to the protocol discriminator (PD) and, if applicable, the transaction identifier (TI) or the PDP address towards the MM entity or towards the CM entities via the various MM-SAP's. GPRS L3 messages are routed to mobility management or session management according to the protocol discriminator.
- For EPS services, the routing function of EPS NAS passes standard L3 messages according to the protocol discriminator (PD) and, if applicable, the procedure transaction identity (PTI) and/or EPS bearer identity towards the EMM entity or towards the CM (ESM) entities of the various EPS NAS SAP's.
- The routing function of LLC passes the messages according to the SAPIs to the MM sublayer or to the SNDPCP entities.

For 5GS services, the routing functions with task 2 make use of the extended protocol discriminator (EPD) which is part of the message header, or PDU session identity.

A 5GCM sublayer protocol may also define a procedure transaction identity (PTI) as a part of the message header. This is at least the case if there are parallel entities of the same functional block, see subclause 6.2.

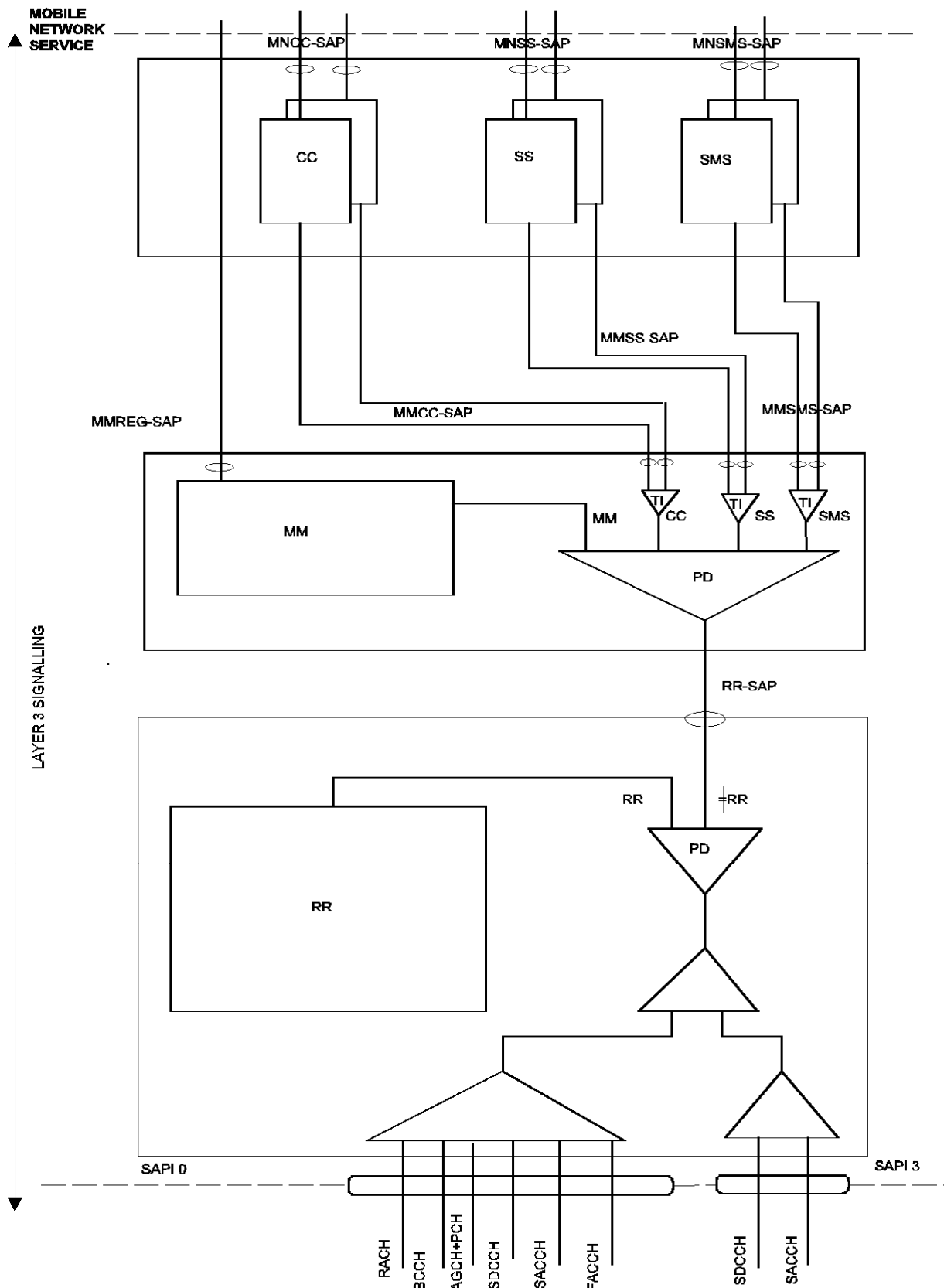
- The 5GMM-sublayer routing function passes the messages of the 5GCM entities as well as of the 5GMM entities of its own sublayer to the service access point of 5GRR. Furthermore, it multiplexes them in case of parallel transactions.
- For NAS over 3GPP access, the NR or E-UTRA AS sublayer routing function distributes the messages to be sent according to their message type and extended protocol discriminator (EPD), to the actual channel configuration, and, if applicable, to further information received from upper sub-layers to the appropriate service access point of layer 2. Paging messages received from the PCH are always routed to 5GMM.
- For NAS over 3GPP access, the messages provided at the different service access points of layer 2 are distributed by the 5GRR sublayer routing function according to their extended protocol discriminator (EPD). Messages with a EPD equal to RR are passed to the 5GRR entity of the own sublayer, all other messages are passed to the 5GMM sublayer at the service access point 5GRR-SAP.
- For NAS over non-3GPP access:
  - for initial registration, EAP-5G is used to transfer NAS messages between the peer entities of the 5GMM sublayers;
  - after successful initial registration, IPsec transport mode and GRE will be used to encapsulate and un-encapsulate the NAS messages between the peer entities of the 5GMM sublayers.
- For 5GS services, the routing function of 5GS NAS passes standard L3 messages according to the protocol discriminator (PD) and, if applicable, the PDU session identity towards the 5GMM entity or towards the 5GSM entities of the various 5GS NAS SAPs.

The message (message header or other parts of the message) are neither changed nor removed by the RR routing function or non-3GPP access management or MM routing function or 5GMM routing function before passing it to the appropriate service access point.

## 5.2 Protocol architecture

The protocol architecture is visualized for each of the four models:

- Figure 5.1/3GPP TS 24.007 shows the protocol architecture for a MS not supporting the GPRS service, restricting the representation of CM sublayer protocols to three paradigmatic examples, CC, SS, and SMS. The LCS protocol entity of a type A LMU would be included in the same manner. Note that the protocol stack for a class C GPRS service may be present in the MS, but it is not active simultaneously.
- Figure 5.2 shows the protocol architecture for a MS supporting the Class C GPRS service. (Note that the protocol stack for a circuit switched services may be present in the MS, but it is not active simultaneously).
- Figure 5.3 shows the protocol architecture for non-GPRS and GPRS-services supporting Class A and Class B MSs.
- Figure 5.4 shows the protocol architecture for a MS supporting CTS services in addition to non-GPRS services.
- Figure 5.5 shows the protocol architecture for a MS supporting the PS mode of operation UMTS service.
- Figure 5.6 shows the protocol architecture for UMTS services supporting CS/PS mode of operation MSs.
- Figure 5.7 shows the protocol architecture for a MS supporting EPS services.
- Figure 5.8 shows the protocol architecture for an MS supporting EPS services and CS fallback.
- Figure 5.9 shows the protocol architecture for a MS supporting 5GS services over 3GPP access.
- Figure 5.10 shows the protocol architecture for a MS supporting 5GS services over non-3GPP access.



NOTE: The LCS protocol entity for a type A LMU would be included in the figure in the same manner as the protocol entities for CC, SS and SMS.

Figure 5.1: Protocol Architecture not supporting GPRS service - MS side



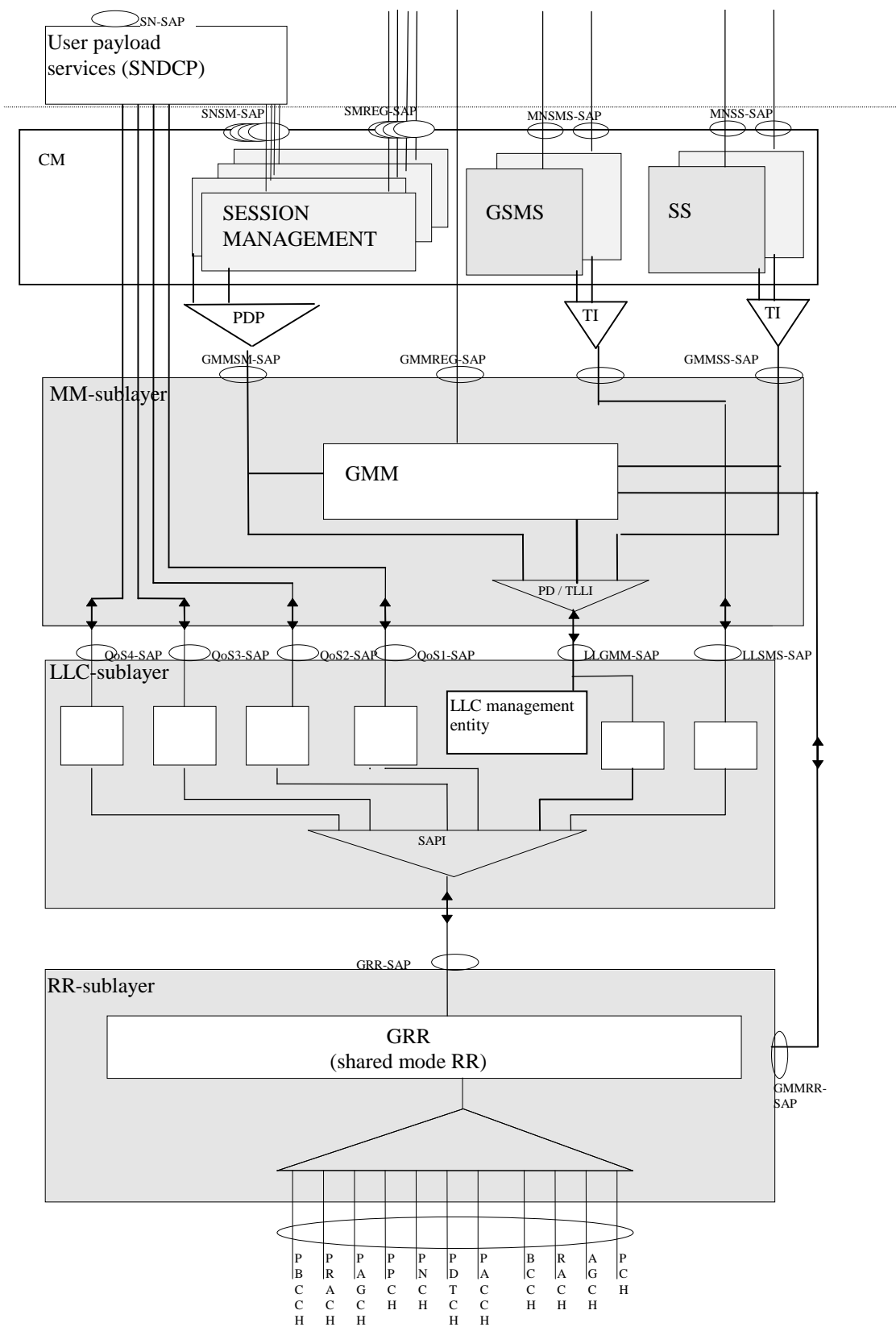


Figure 5.2: Protocol architecture supporting GPRS class C MSs, MS - side

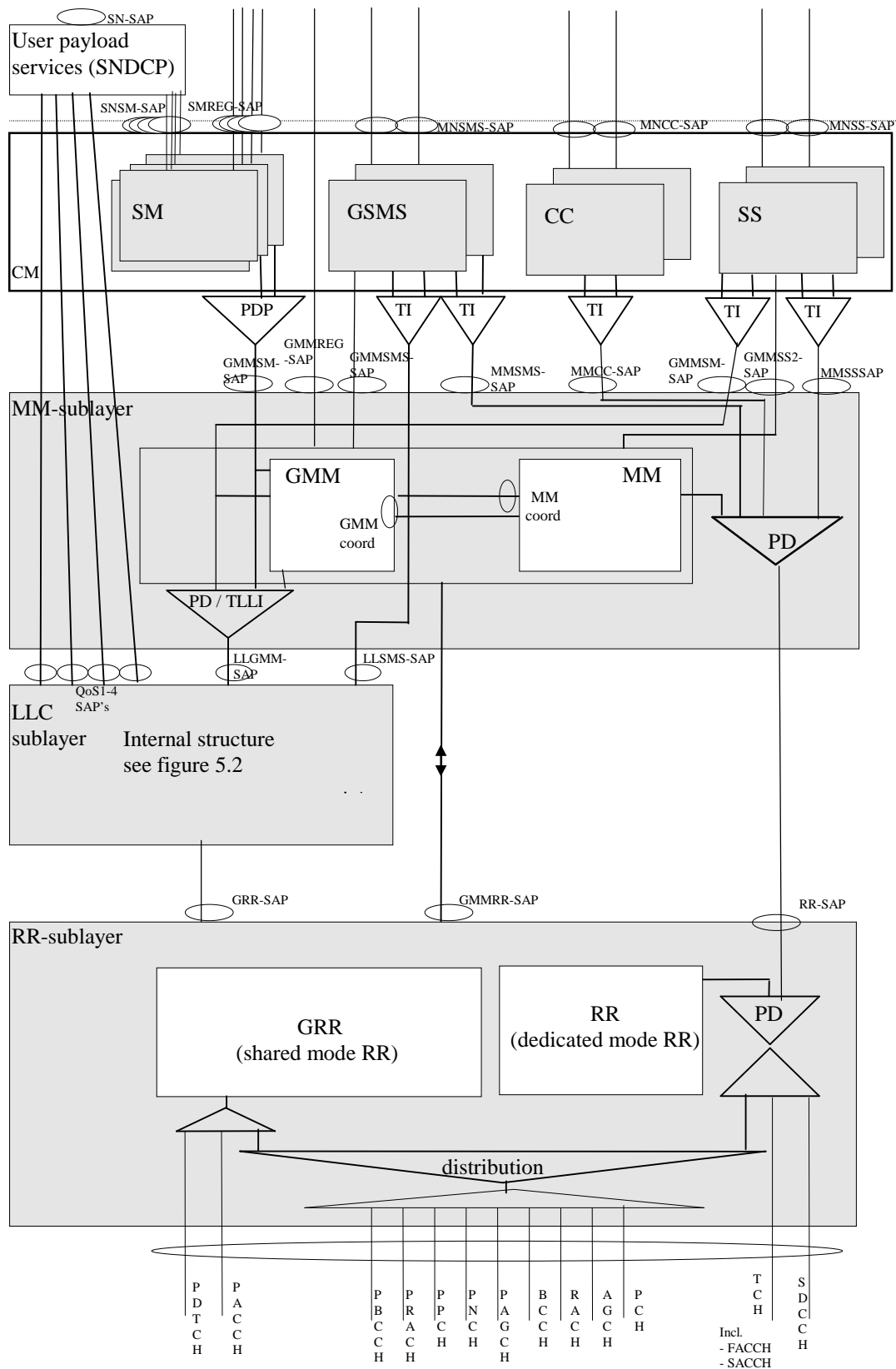


Figure 5.3/3GPP TS 24.007: Protocol architecture supporting GPRS class A and B MSs, MS - side

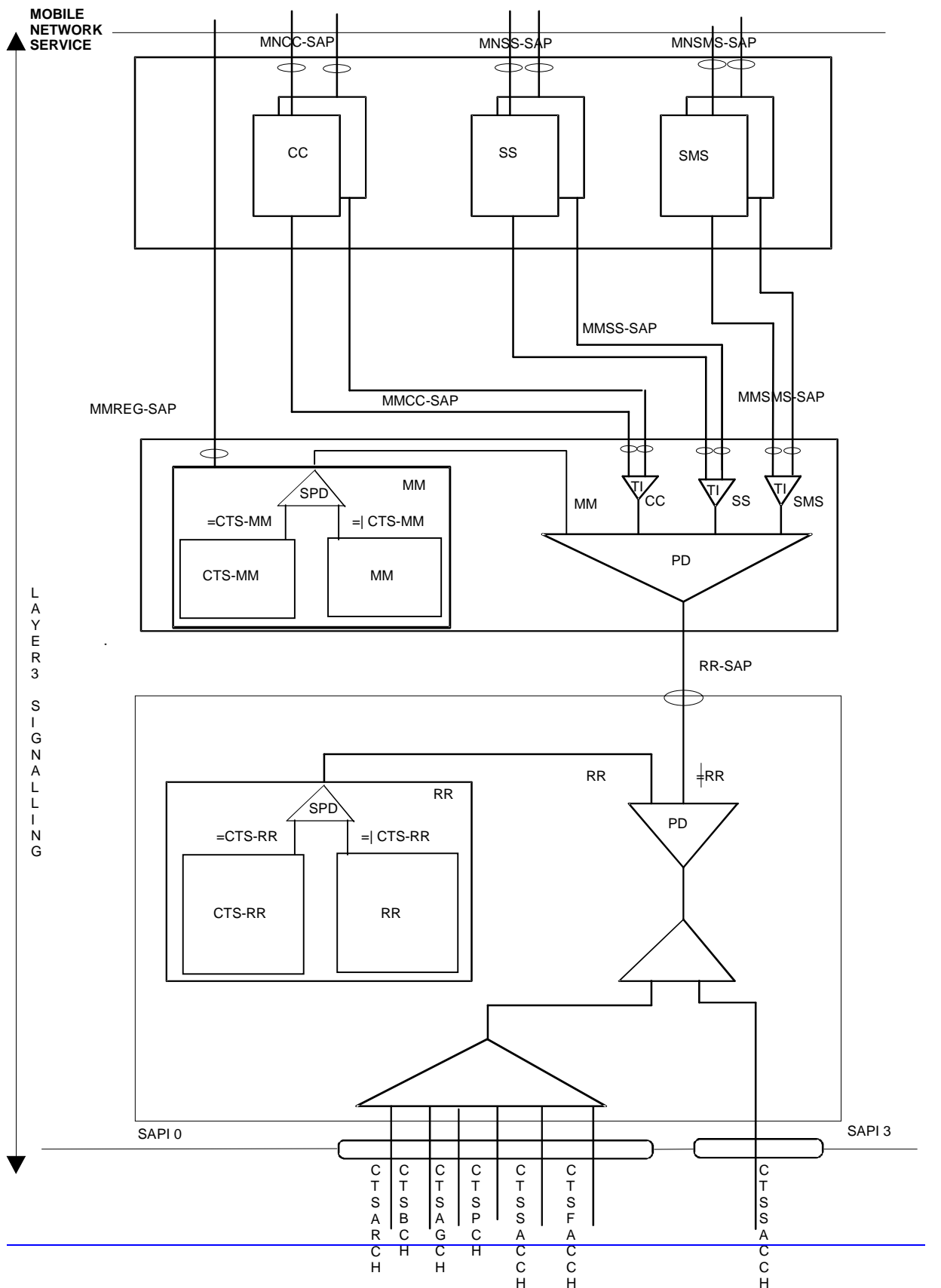


Figure 5.4/3GPP TS 24.007: Protocol architecture supporting CTS services in addition to non- GPRS services, MS - side

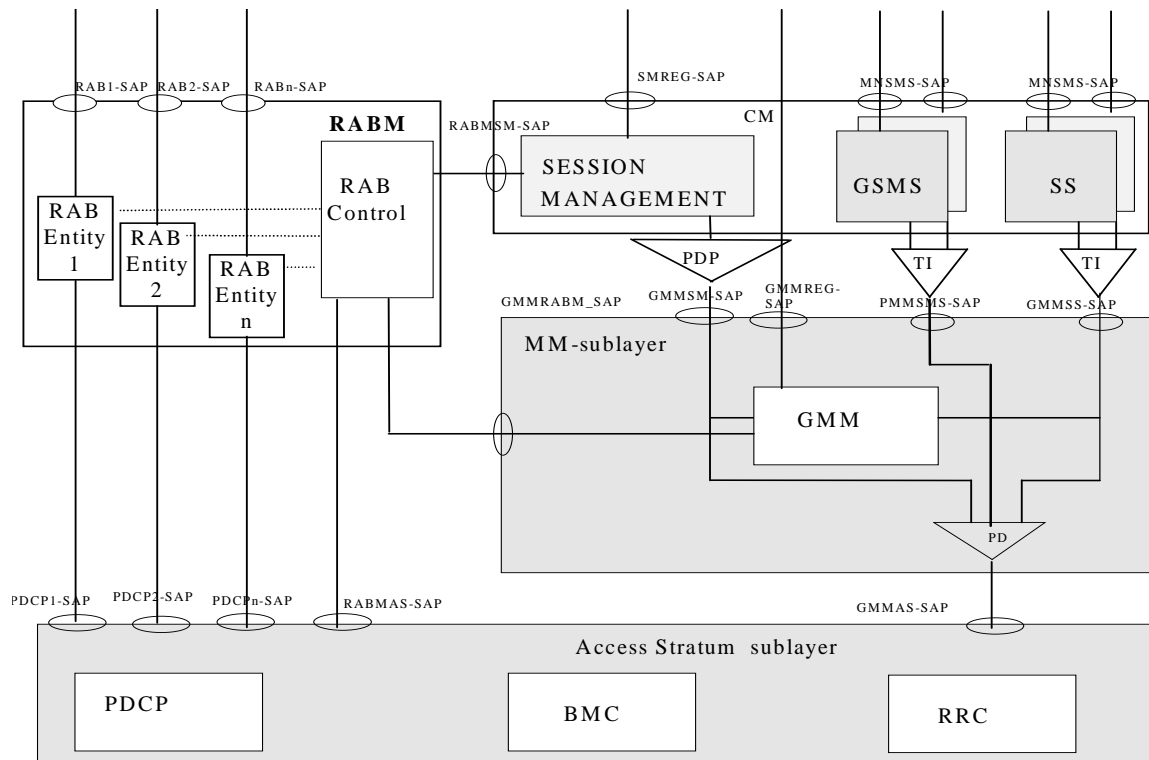
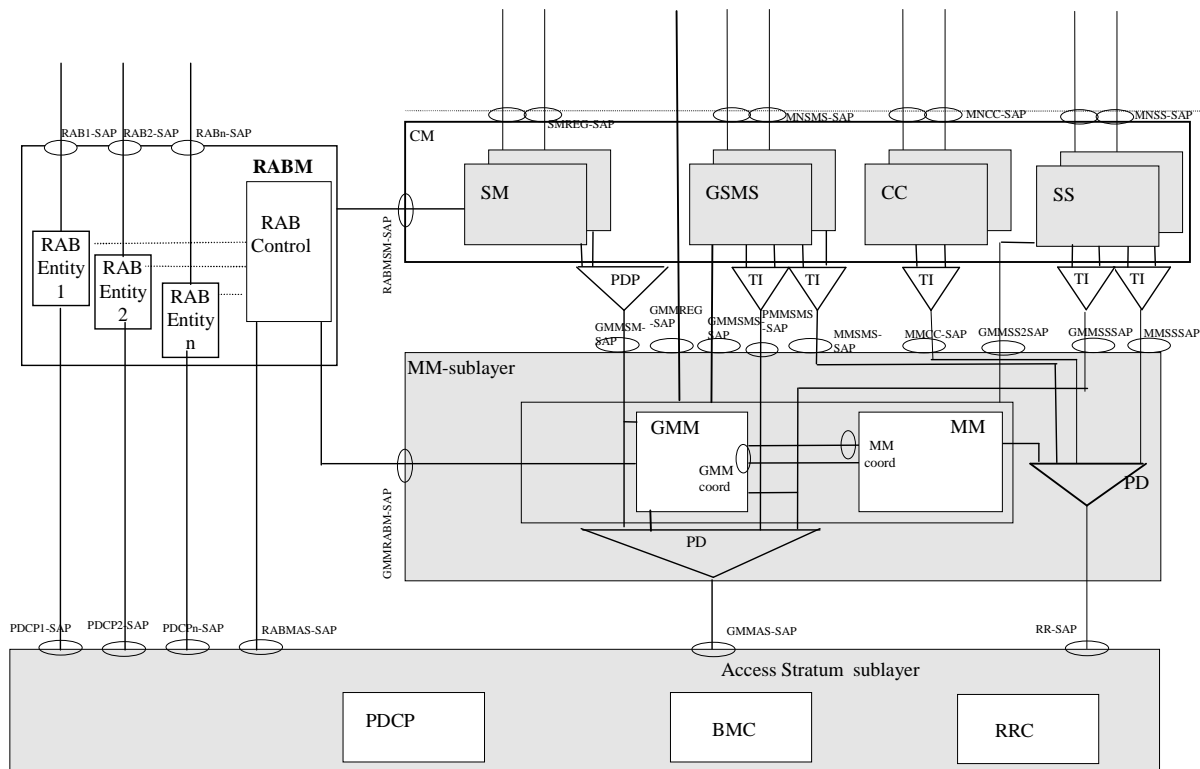


Figure 5.5/3GPP TS 24.007: Protocol architecture of Non Access Stratum supporting PS mode of operation MSs, MS-side



**Figure 5.6/24.007: Protocol architecture of Non Access Stratum supporting CS/PS mode of operation MSs, MS – side**

NOTE: SMS un-related parts of this figure, e.g. SMDCP should be modified for UMTS.

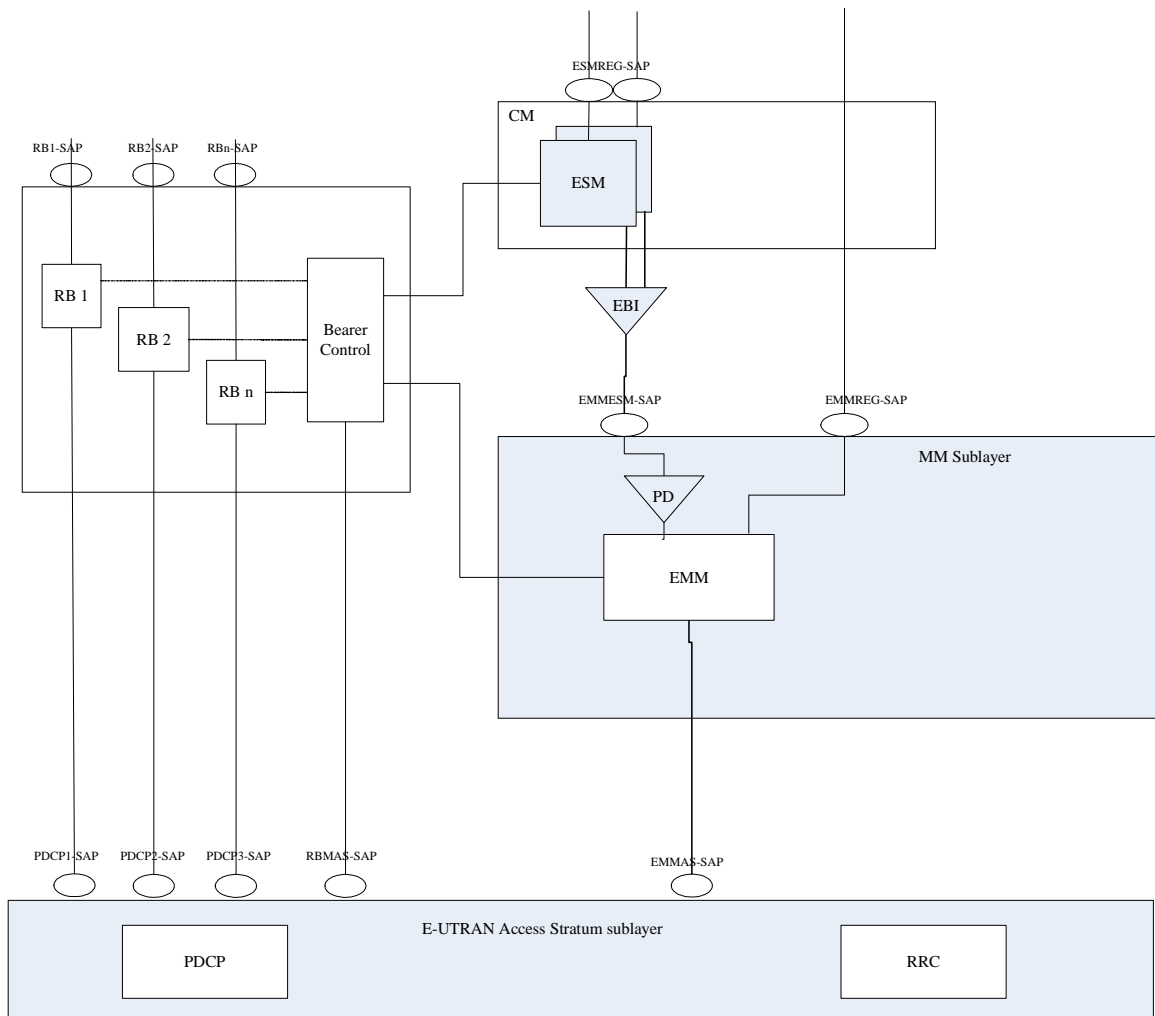


Figure 5.7/3GPP TS 24.007: Protocol architecture of Non Access Stratum supporting PS mode of operation MSs, MS-side

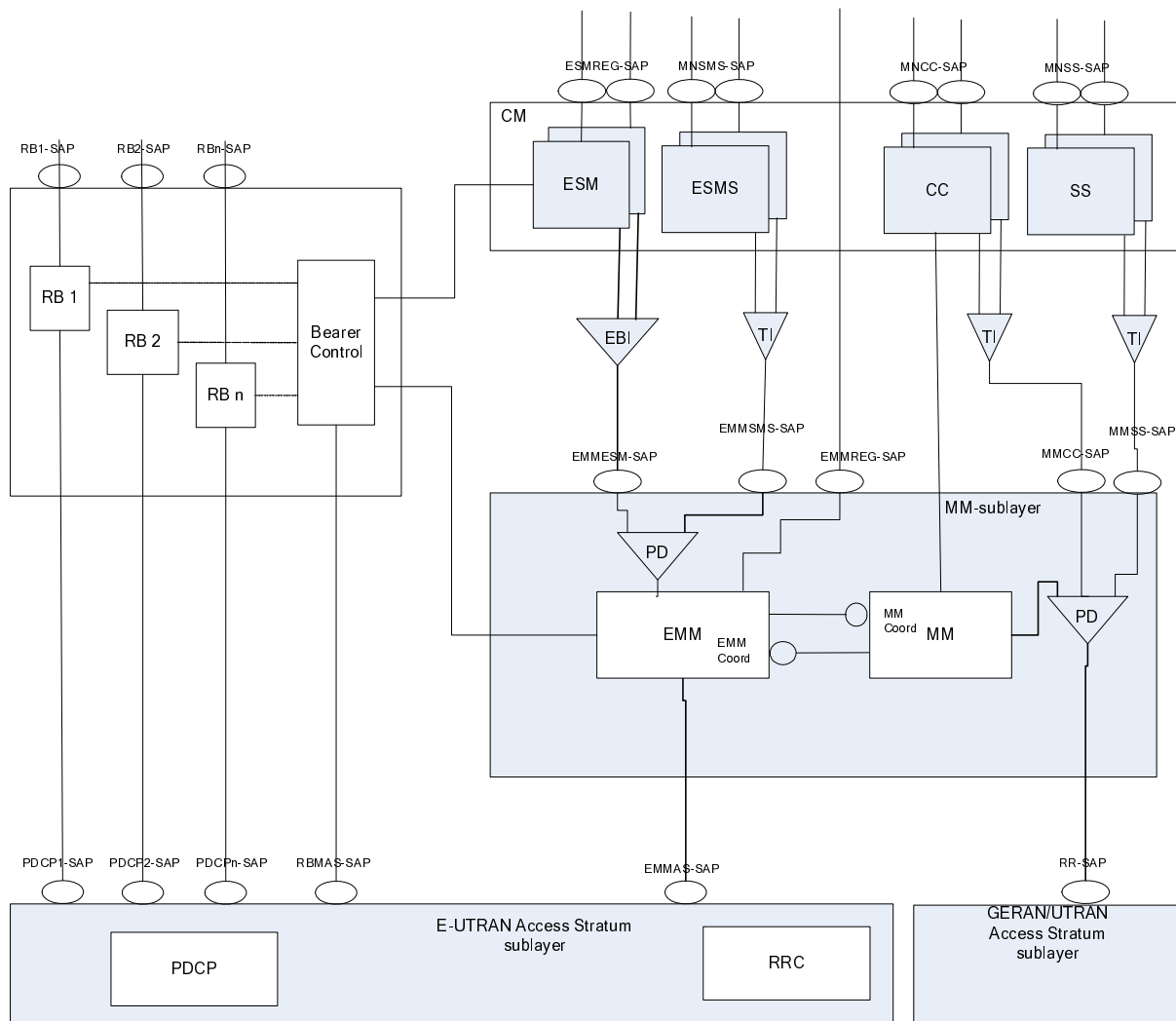


Figure 5.8/3GPP TS 24.007: Protocol architecture of Non Access Stratum supporting CS/PS mode 1 or CS/PS mode 2 of operation MSs, MS-side

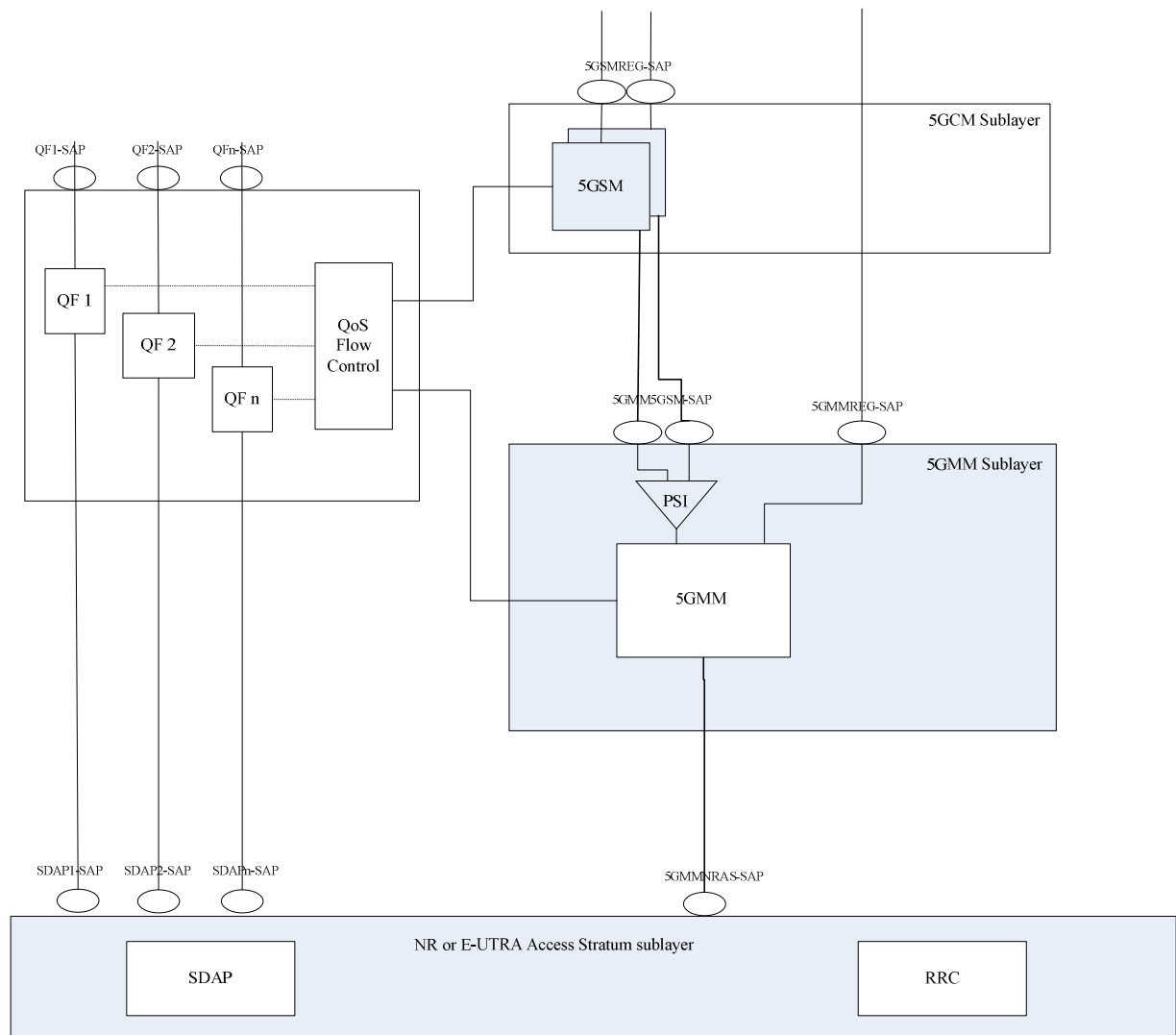
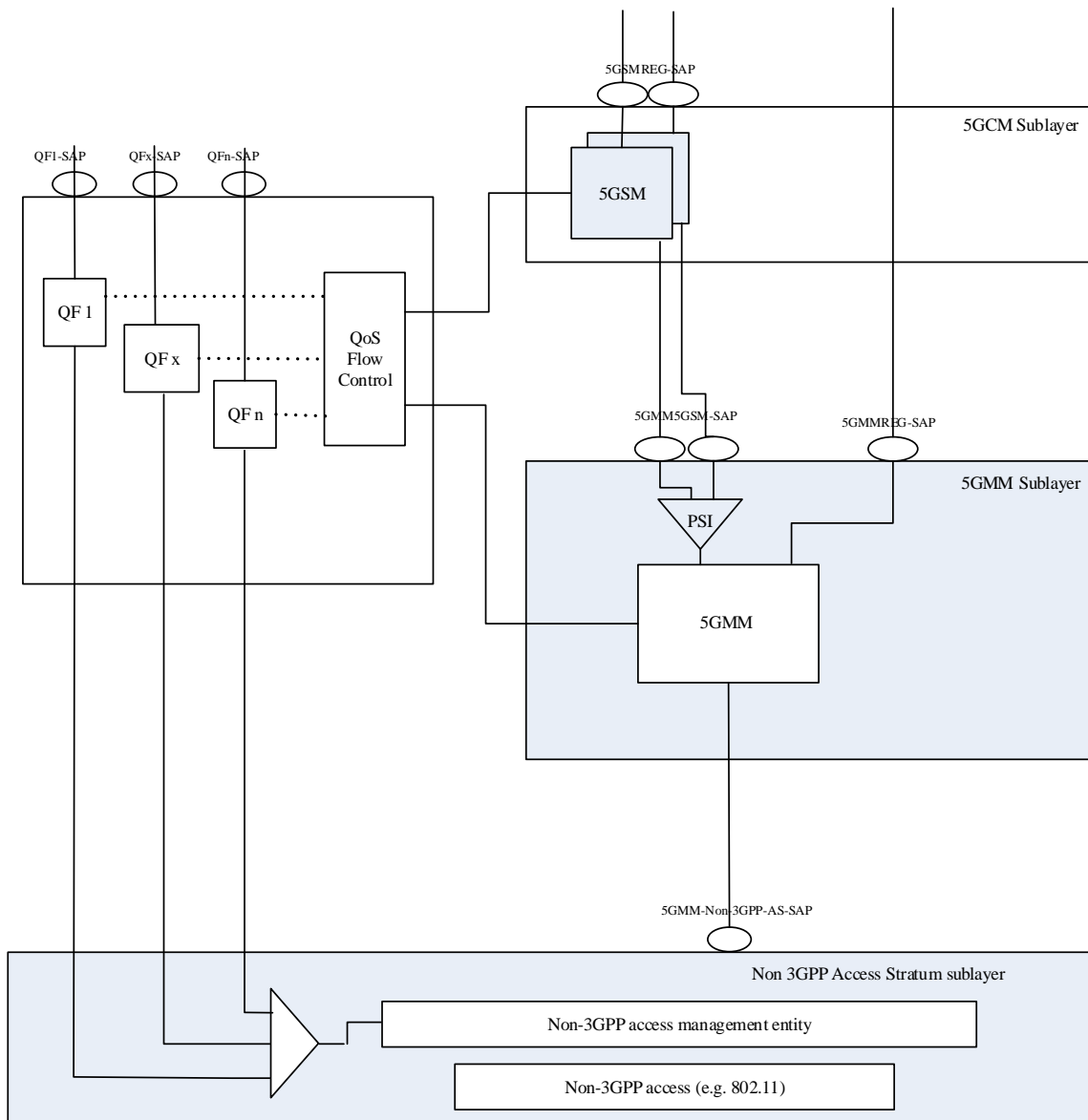


Figure 5.9/3GPP TS 24.007: Protocol architecture of Non Access Stratum supporting MSs, MS-side (over 3GPP access)





**Figure 5.10/3GPP TS 24.007: Protocol architecture of Non Access Stratum supporting MSs, MS-side (over non-3GPP access)**

As shown in figure 5.1 a hierarchy of 3 sublayers is defined:

- the RR sublayer provides services to the MM sublayer and utilizes the services of signalling layer 2;
- the MM sublayer provides common services to the entities of the Connection Management (CM) sublayer;
- the CM sublayer includes, among others, the CC, SS, and SMS entities, which are independent entities.

Figure 5.2 defines four sublayers for GPRS services supporting Class C MSs:

- the RR sublayer provides services to the MM and LLC sublayers;
- the LLC sublayer provides services to the MM sublayer, the SNDTCP and GSMS entities and uses services of the RR sublayer;
- the MM sublayer provides services to the SM and SS entities of the CM. The MM sublayer includes one GMM;
- the CM sublayer includes the SM, SS and GSMS entities. The SM entity provides services to the SNDTCP entity and uses services of the MM sublayer. The GSMS entity is identical to the SMS entity for non-GPRS services

except it uses the services from the LLC sublayer. The SS entity is identical to the one for non-GPRS services except it uses the services from the LLC or PS signalling connection.

Figure 5.3 defines four sublayers for non-GPRS and GPRS-services supporting Class A and Class B MSs:

- the RR sublayer provides services to the MM and LLC sublayers;
- the LLC sublayer provides services to the MM sublayer, the SNDCP and GSMS entities and uses services of the RR sublayer;
- the MM sublayer provides services to the SNDCP entity and to the entities of the Connection Management (CM) sublayer. In addition to the MM entity for non-GPRS services, the MM sublayer further includes one GMM entity;
- the CM sublayer includes, among others, the CC, SS, GSMS and SM entities, which are independent entities;
- the SM entity provides services to the SNDCP entity and uses services of the MM sublayer. The GSMS entity is an extension of the SMS entity for non-GPRS services. For message transfer it uses the services both from the LLC sublayer and the MM entity of the MM sublayer. Furthermore it retrieves from the MM entity information about which transport service to use.

Figure 5.4 defines three sub-layers for CTS services:

- the RR sublayer provides services (including CTS services) to the MM sublayer and uses the services of signalling layer 2;
- the MM sublayer provides common services to the entities of the Connection Management (CM) sublayer; it provides also specific CTS services to the entities above CM;
- the CM sublayer includes, among others, the CC, SS, and SMS entities, which are independent entities.

Figure 5.5 defines three sublayers for UMTS PS domain services supporting PS mode of operation:

- the Access Stratum (AS) sublayer provides services to the MM sublayer and the RAB Manager (RABM) entity.
- the MM sublayer provides services to the SM, SS and GSMS entities of the CM. The MM sublayer includes one GMM entity;
- the CM sublayer includes the SM, SS and GSMS entities. The SM entity provides services to the RABM entity and uses services of the MM sublayer. The GSMS entity is identical to the SMS entity for GPRS services in GSM except it uses the services from the GMM sublayer. The SS entity is identical to the one for non-GPRS services except it uses the services from the LLC or PS signalling connection;
- the RABM hides the concepts of RABs that can be activated/released while a PDP context is active. If UL data in the terminal is to be sent on a RAB (NSAPI) that has been released the RABM will trigger a service request procedure in GMM.

Figure 5.6 defines three sublayers for UMTS CS domain services and UMTS PS domain services supporting CS/PS mode of operation MSs:

- the Access Stratum (AS) sublayer provides services to the MM sublayer and the RAB Manager (RABM) entity;
- the MM sublayer provides services to the entities of the Connection Management (CM) sublayer. In addition to the MM entity for CS domain services, the MM sublayer further includes one GMM entity;
- the CM sublayer includes, among others, the CC, SS, GSMS and SM entities, which are independent entities;
- the SM entity provides services to the RABM entity and uses services of the MM sublayer. The GSMS entity is an extension of the SMS entity for CS domain services. For message transfer it uses the services both from the GMM entity of the MM sublayer and the MM entity of the MM sublayer. Furthermore it retrieves from the MM entity information about which transport service to use;
- the RABM hides the concepts of RABs that can be activated/released while a PDP context is active. If UL data in the terminal is to be sent on a RAB (NSAPI) that has been released, the RABM will trigger a service request procedure in GMM.

Figure 5.7 defines three sublayers for EPS PS domain services:

- the Access Stratum (AS) sublayer provides services to the MM sublayer;
- the MM sublayer provides services to the entities of the Connection Management (CM) sublayer. The MM sublayer further includes one EMM entity;
- the CM sublayer includes ESM entities;
- the ESM entity provides services to the Bearer Control (BC) entity and uses services of the MM sublayer;
- the BC entity hides the concepts of radio bearers that can be established/released while an EPS bearer context is active. If uplink data in the terminal is to be sent, and radio bearers have been released, the BC will trigger a service request procedure in EMM.

Figure 5.8 defines three sublayers for EPS domain services and non-EPS domain services supporting CS/PS mode 1 or CS/PS mode 2 of operation MSs:

- the Access Stratum (AS) sublayer provides services to the MM sublayer;
- the MM sublayer provides services to the entities of the Connection Management (CM) sublayer. In addition to the MM entity for non-EPS services, the MM sublayer further includes one EMM entity;
- the CM sublayer includes among others, the CC, SS, ESMS and ESM entities, which are independent entities;
- the ESM entity provides services to the Bearer Control (BC) entity and uses services of the MM sublayer. The ESMS entity is an extension of the SMS entity for non-EPS services. For message transfer, it uses the services from the EMM entity of the MM sublayer;
- the BC entity hides the concepts of radio bearers that can be established/released while an EPS bearer context is active. If uplink data in the MS is to be sent, and all radio bearers have been released, the BC will trigger a service request procedure in EMM.

Figure 5.9 defines three sublayers for 5GS services:

- the NR or E-UTRA AS sublayer provides services to the 5GMM sublayer;
- the 5GMM sublayer provides services to the entities of the 5GCM sublayer. The 5GMM sublayer further includes one 5GMM entity;
- the 5GCM sublayer includes 5GSM entities;
- the 5GSM entity provides services to the QoS flow control (QFC) entity and uses services of the 5GMM sublayer;
- the QFC entity hides the concepts of radio resources that can be established, released or suspended while a 5GS context is active. If uplink data in the terminal is to be sent, and 5GS radio resources have been released or suspended, the QFC will notify 5GMM.

Figure 5.10 defines three sublayers for 5GS services:

- the Non-3GPP access stratum sublayer provides services to the 5GMM sublayer;
- the 5GMM sublayer provides services to the entities of the 5GCM sublayer. The 5GMM sublayer further includes one 5GMM entity;
- the 5GCM sublayer includes 5GSM entities;
- the 5GSM entity provides services to the QoS flow control (QFC) entity and uses services of the 5GMM sublayer;
- the QFC entity hides the concepts of non-3GPP access resources that can be established/released while a 5GS context is active. Whenever such resources are available, IPsec security associations will be established and maintained.

---

## 6 Services provided by signalling layer 3 at the MS side

The different classes of services provided by signalling layer 3 at the MS side are accessible at the following service access points:

- registration services at the MMREG-SAP or GMMREG-SAP;
- Call Control services for normal and emergency calls including call related Supplementary Services Support services at the MNCC-SAP;
- Short Message Services Support services at the MNSMS-SAP;
- Call independent Supplementary Services Support services at the MNSS-SAP;
- Location Services Support services at the MNLCS-SAP;
- other services corresponding to further functional blocks of the CM sublayer at the appropriate service access points. These services are not further described in this clause;
- Session Management services at the SMREG-SAP and at the SNSM-SAP;
- Logical Link Control services at the QoS1-SAP, QoS2-SAP, QoS3-SAP and QoS4-SAP.

### 6.1 Registration services

The registration services (location updating, IMSI attach/detach) are provided at the service access point MMREG-SAP. As opposed to all other MN-Services, these services are provided by and can be directly accessed at the Mobility Management sublayer.

### 6.1.1 Service state diagram for MS not supporting GPRS service

The registration services provided at the service access point MMREG-SAP are illustrated in the state of figure 6.1 below.

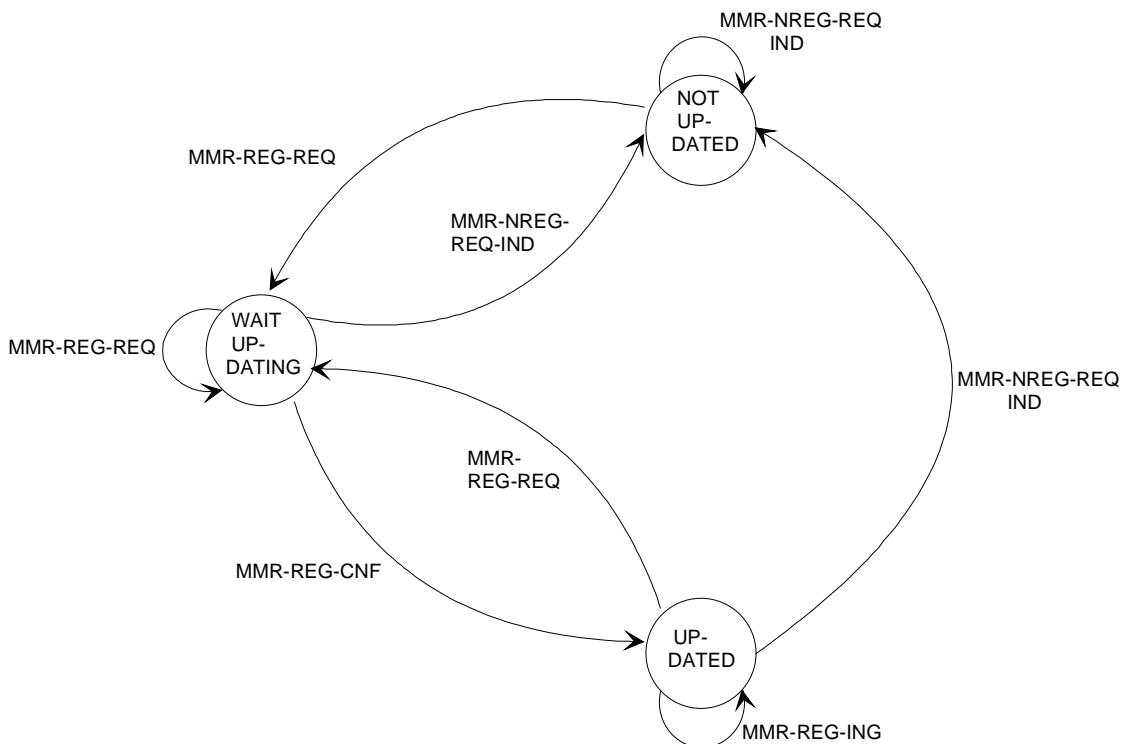


Figure 6.1: Registration services provided at MMREG-SAP - MS side

### 6.1.2 Service primitives

Table 6.1: Primitives and Parameters at the MMREG-SAP - MS side

PRIMITIVE	PARAMETER	REFERENCE
MMR_REG_REQ	IMSI	6.1.2.1
MMR_REG_CNF	-	6.1.2.2
MMR_NREG_REQ	-	6.1.2.4
MMR_NREG_IND	cause	6.1.2.5

#### 6.1.2.1 MMR\_REG\_REQ

Registration request, triggered by activation of the IMSI, e.g., by activation of the MS with inserted SIM, insertion of the SIM into the activated MS, pressing of a reset button.

#### 6.1.2.2 MMR\_REG\_CNF

Registration confirmation. Indicates to the user that the MS is ready to start a transaction.

#### 6.1.2.3 Void

#### 6.1.2.4 MMR\_NREG\_REQ

Request to cancel the registration, stimulated either by removing the SIM or automatically in the power off phase.

### 6.1.2.5 MMR\_NREG\_IND

Indication that registration has been cancelled or that registration was not possible. Only emergency services are available to the user.

## 6.1.3 Registration Services for CTS-Services

The registration services (attach/detach, enrolment/de-enrolment) are provided for CTS services at the service access point MMREG-SAP.

**Table 6.1.3: Primitives and Parameters at the MMREG-SAP - MS side for CTS**

PRIMITIVE	PARAMETER	REFERENCE
MMR_CTS_ATTACH_REQ	IMSI	6.1.3.1
MMR_CTS_ATTACH_CNF	-	6.1.3.2
MMR_CTS_ATTACH_REJ	IFPSI, cause	6.1.3.3
MMR_CTS_DETACH_IND	-	6.1.3.4
MMR_CTS_ENROLL_REQ	IMSI	6.1.3.5
MMR_CTS_ENROLL_CNF	-	6.1.3.6
MMR_CTS_ENROLL_REJ	IFPSI, cause	6.1.3.7
MMR_CTS_DE_ENROLL_IND	-	6.1.3.8

### 6.1.3.1 MMR\_CTS\_ATTACH\_REQ

MS initiates the CTS attach. CTS-MM is requested to send a CTS ATTACH REQUEST message to the fixed part.

### 6.1.3.2 MMR\_CTS\_ATTACH\_CNF

The CTS attach was successful. The fixed part confirmed the attach, i.e. the CTS ATTACH ACCEPT message was received by the MS.

### 6.1.3.3 MMR\_CTS\_ATTACH\_REJ

The CTS attach has failed. The fixed part rejected the attach attempt, i.e. the CTS ATTACH REJECT message was received by the MS.

### 6.1.3.4 MMR\_CTS\_DETACH\_IND

MS initiates CTS detach. CTS-MM is requested to send a CTS DETACH INDICATION message. The detach procedure is initiated.

### 6.1.3.5 MMR\_CTS\_ENROLL\_REQ

MS initiates the CTS enrolment. CTS-MM is requested to send a CTS ENROLMENT REQUEST message to the fixed part.

### 6.1.3.6 MMR\_CTS\_ENROLL\_CNF

The CTS enrolment was successful. The fixed part confirmed the enrolment, i.e. the CTS ENROLMENT ACCEPT message was received by the MS.

### 6.1.3.7 MMR\_CTS\_ENROLL\_REJ

The CTS enrolment has failed. The fixed part rejected the enrolment attempt, i.e. the CTS ENROLMENT REJECT message was received by the MS.

### 6.1.3.8 MMR\_CTS\_DE\_ENROLL\_IND

FP initiates CTS de-enrolment. CTS-MM is requested to send a CTS DE-ENROLMENT INDICATION message. The de-enrolment procedure is initiated.

## 6.2 Call Control services

The Call Control services are provided by multiple CC entities at the service access point MNCC-SAP.

The Call Control service class consists of the following services:

- Mobile originated and Mobile terminated call establishment for normal calls;
- Mobile originated call establishment for emergency calls;
- call maintaining;
- call termination;
- call related Supplementary Services Support.

### 6.2.1 Service state diagram

The Call Control services provided at the service access point MNCC-SAP are illustrated in the state diagram of figure 6.2.

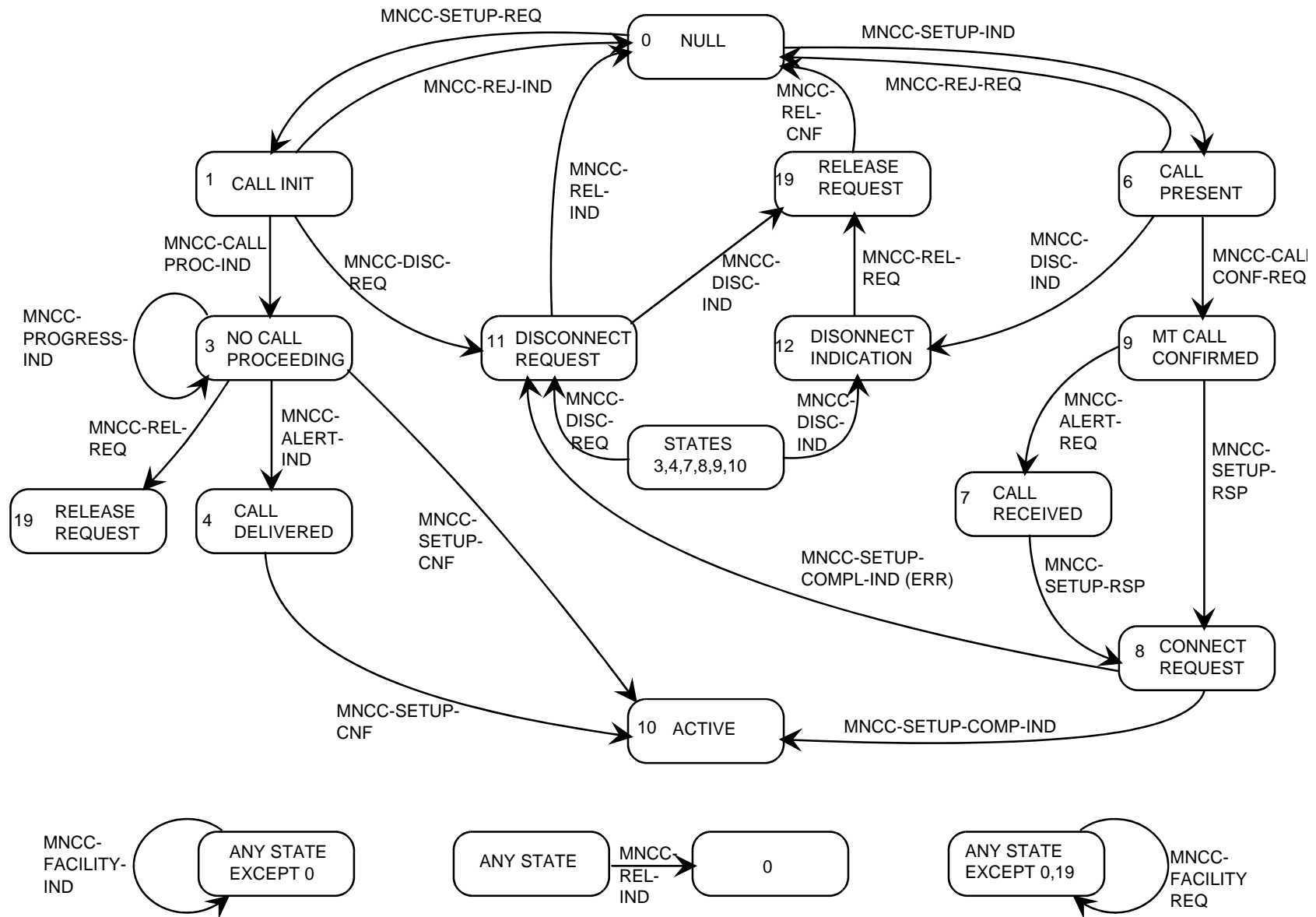


Figure 6.2: Service graph of Call Control entity - MS side (page 1 of 2)



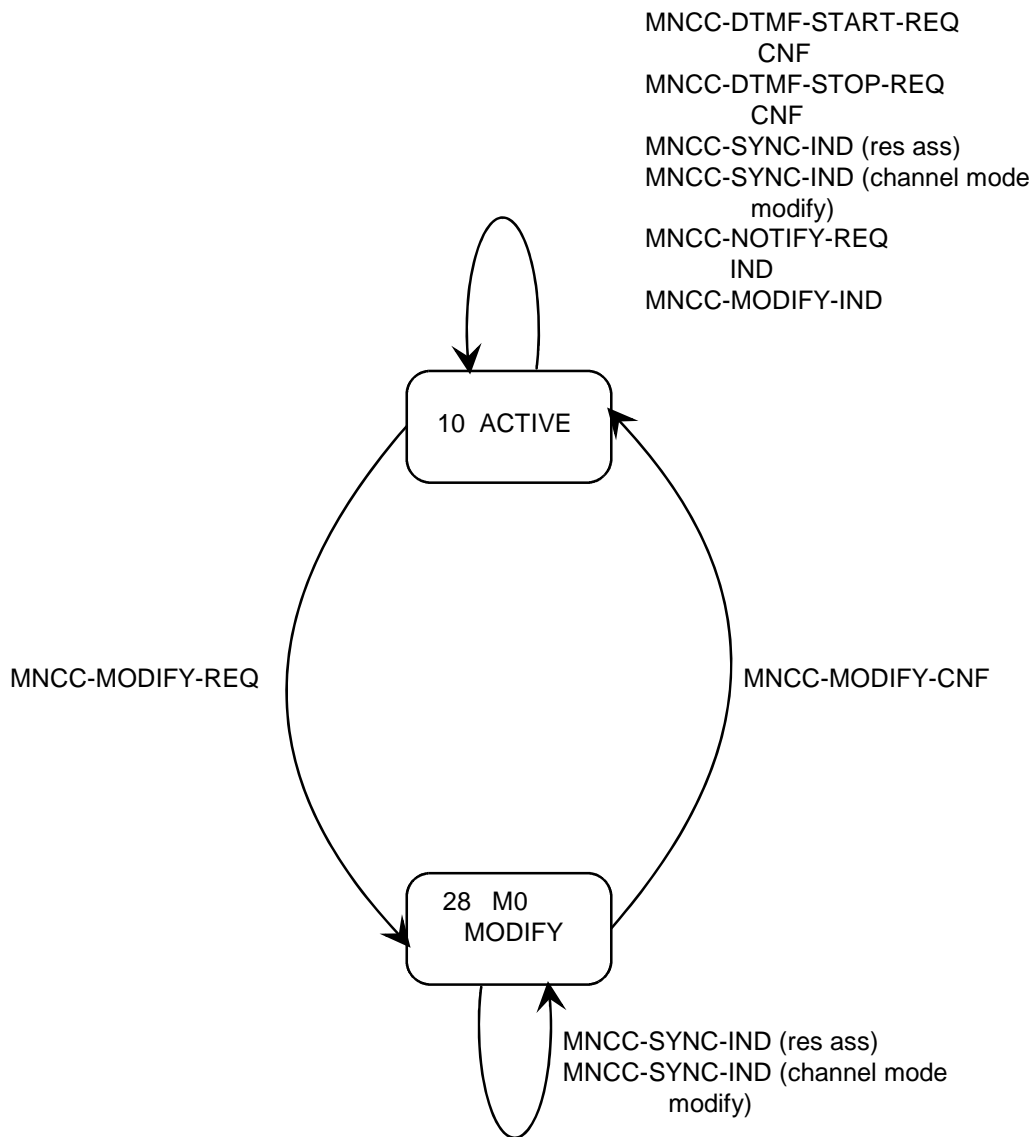


Figure 6.2: Service graph of Call Control entity - MS side Active state (page 2 of 2)

## 6.2.2 Service primitives

**Table 6.2: Primitives and parameters at MNCC-SAP - MS side**

PRIMITIVE	PARAMETER (message, info elements of message, other parameters)	REFERENCE
MNCC_SETUP_REQ	SETUP or EMERGENCY SETUP	6.2.2.1
MNCC_SETUP_IND	SETUP	6.2.2.2
MNCC_SETUP_RSP	CONNECT	6.2.2.3
MNCC_SETUP_CNF	CONNECT	6.2.2.4
MNCC_SETUP_COMPLETE_REQ	-	6.2.2.5
MNCC_SETUP_COMPLETE_IND	-	6.2.2.6
MNCC_REJ_REQ	RELEASE COMPLETE	6.2.2.7
MNCC_REJ_IND	cause	6.2.2.8
MNCC_CALL_CONF_REQ	CALL CONFIRMED	6.2.2.9
MNCC_CALL_PROC_IND	CALL PROCEEDING	6.2.2.10
MNCC_PROGRESS_IND	PROGRESS	6.2.2.11
MNCC_ALERT_REQ	ALERTING	6.2.2.12
MNCC_ALERT_IND	ALERTING	6.2.2.13
MNCC_NOTIFY_REQ	NOTIFY	6.2.2.14
MNCC_NOTIFY_IND	NOTIFY	6.2.2.15
MNCC_DISC_REQ	DISCONNECT	6.2.2.16
MNCC_DISC_IND	DISCONNECT	6.2.2.17
MNCC_REL_REQ	RELEASE	6.2.2.18
MNCC_REL_IND	RELEASE	6.2.2.19
MNCC_REL_CNF	RELEASE or RELEASE COMPLETE	6.2.2.20
MNCC_FACILITY_REQ	facility	6.2.2.21
MNCC_FACILITY_IND	facility	6.2.2.22
MNCC_START_DTMF_REQ	START DTMF	6.2.2.23
MNCC_START_DTMF_CNF	START DTMF ACK or START DTMF REJ	6.2.2.24
MNCC_STOP_DTMF_REQ	STOP DTMF	6.2.2.25
MNCC_STOP_DTMF_CNF	STOP DTMF ACK	6.2.2.26
MNCC_MODIFY_REQ	MODIFY	6.2.2.27
MNCC_MODIFY_IND	MODIFY	6.2.2.28
MNCC_MODIFY_RES	MODIFY COMPLETE	6.2.2.29
MNCC_MODIFY_CNF	MODIFY COMPLETE	6.2.2.30
MNCC_SYNC_IND	cause (res. ass., channel mode modify)	6.2.2.31

### 6.2.2.1 MNCC\_SETUP\_REQ

Request to send a SETUP or EMERGENCY SETUP message to initiate Mobile originating establishment of either a normal or an emergency call.

### 6.2.2.2 MNCC\_SETUP\_IND

Receipt of a SETUP message, the Mobile terminated call establishment has been initiated.

### 6.2.2.3 MNCC\_SETUP\_RES

Response to send a CONNECT message to indicate call acceptance by the Mobile terminated user; call control is requested to attach the user connection (if it is not yet attached).

### 6.2.2.4 MNCC\_SETUP\_CNF

Receipt of a CONNECT message, the Mobile originated call has been accepted by the remote called user.

### 6.2.2.5 MNCC\_SETUP\_COMPL\_REQ

Request to send a CONNECT ACKNOWLEDGE message, the mobile originating call has been accepted.

#### 6.2.2.6 MNCC\_SETUP\_COMPL\_IND

Receipt of a CONNECT ACKNOWLEDGE message, the Mobile terminated call establishment has been completed; for a data call, the user is informed that the user connection is attached.

#### 6.2.2.7 MNCC\_REJ\_REQ

Request to reject a Mobile terminated call if the call is refused or if the call cannot be accepted, e.g., because of missing compatibility.

#### 6.2.2.8 MNCC\_REJ\_IND

Indication that the Mobile originated call has been rejected, e.g. if the MM connection cannot be provided or if the call establishment initiation has been rejected by the network.

#### 6.2.2.9 MNCC\_CALL\_CONF\_REQ

Request to confirm a Mobile terminated call by sending a CALL CONFIRMED message. A bearer capability different from that given in MNCC\_SETUP\_IND may be offered to the remote calling user.

#### 6.2.2.10 MNCC\_CALL\_PROC\_IND

Indication to the Mobile originating user that call establishment has been initiated in the Network and no more call establishment information will be accepted by the Network.

#### 6.2.2.11 MNCC\_PROGRESS\_IND

Indication to the Mobile user that a PROGRESS message or a message containing a *progress* IE has been received, e.g., because the call is progressing in the PLMN/ISDN environment, or because the call has left the PLMN/ISDN environment, or because in-band tones/announcement are available.

#### 6.2.2.12 MNCC\_ALERT\_REQ

Request to send an ALERTING message from the called Mobile user to the remote calling user to indicate that user alerting has been initiated.

#### 6.2.2.13 MNCC\_ALERT\_IND

Indication of the receipt of an ALERTING message, alerting to the remote called user has been initiated.

#### 6.2.2.14 MNCC\_NOTIFY\_REQ

Request to send information pertaining to a call, such as user suspended, to the Network by the Mobile user.

#### 6.2.2.15 MNCC\_NOTIFY\_IND

Indication to the Mobile user that information pertaining to a call, such as remote user suspended, has been received from the Network.

#### 6.2.2.16 MNCC\_DISC\_REQ

Request to send a DISCONNECT message to the Network in order to clear the end-to-end connection.

#### 6.2.2.17 MNCC\_DISC\_IND

Indication of reception of a DISCONNECT message, by which the Network indicates that the end-to-end connection is cleared.

#### 6.2.2.18 MNCC\_REL\_REQ

Request of the Mobile user to send a RELEASE message to inform the Network that the user intends to release the call reference and the corresponding MM connection so that the Network can release its MM connection and the correspondent call reference.

#### 6.2.2.19 MNCC\_REL\_IND

Indication to the Mobile originating or terminated user that a RELEASE message has been received and the Network intends to release its MM connection. The Mobile user is requested to release the call reference and the corresponding MM connection.

#### 6.2.2.20 MNCC\_REL\_CNF

Confirmation of the Mobile user's request to release the MM connection and call reference in the Network. The Mobile user may release the call reference and the corresponding MM connection.

#### 6.2.2.21 MNCC\_FACILITY\_REQ

Request to transport a *facility* IE for a call related supplementary service invocation.

#### 6.2.2.22 MNCC\_FACILITY\_IND

Indication that a *facility* IE for a call related supplementary service invocation has been received.

#### 6.2.2.23 MNCC\_START\_DTMF\_REQ

Request to send a START DTMF message in order to start a DTMF control operation.

#### 6.2.2.24 MNCC\_START\_DTMF\_CNF

Confirmation of the receipt of a START DTMF ACKNOWLEDGE or START DTMF REJECT message that the start of a DTMF control operation has been acknowledged or rejected.

#### 6.2.2.25 MNCC\_STOP\_DTMF\_REQ

Request to send a STOP DTMF message in order to stop a DTMF control operation.

#### 6.2.2.26 MNCC\_STOP\_DTMF\_CNF

Confirmation of the receipt of STOP DTMF ACKNOWLEDGE message, the DTMF control operation has been stopped.

#### 6.2.2.27 MNCC\_MODIFY\_REQ

Request to start Mobile originating in-call modification by sending a MODIFY message.

#### 6.2.2.28 MNCC\_MODIFY\_IND

RECEIPT OF A MODIFY message, a Mobile terminating in-call modification has been initiated.

#### 6.2.2.29 MNCC\_MODIFY\_RES

Response to send a MODIFY COMPLETE message to indicate Mobile terminating in-call modification completion by the Mobile user.

6.2.2.30 MNCC\_MODIFY\_CNF

Receipt of a MODIFY COMPLETE message, the Mobile originating in-call modification has been completed.

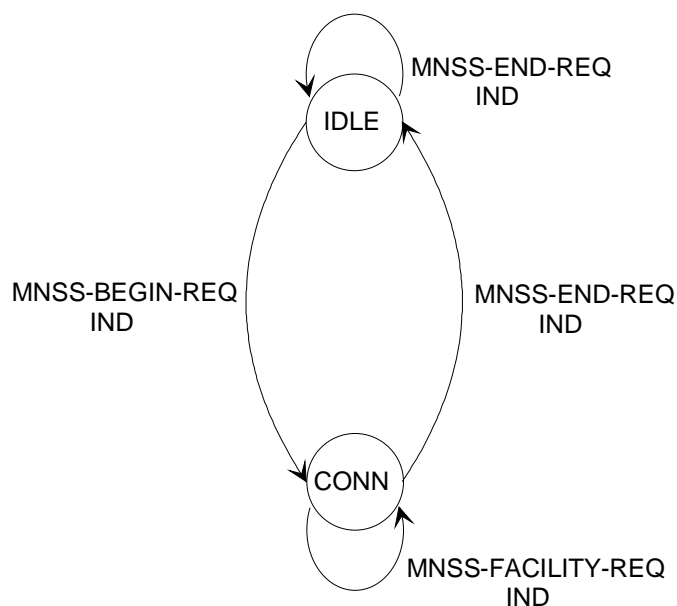
6.2.2.31 MNCC\_SYNC\_IND

Indication that a dedicated channel assignment has been performed (res. ass. = "resource assigned") and/or the channel mode has been changed.

6.3 Call independent Supplementary Services Support

6.3.1 Service state diagram

The primitives provided by the call independent Supplementary Services Support entity and the transitions between permitted states are shown in figure 6.3.



STATES:  
 IDLE - No SS signalling transaction pending.  
 CONN - SS signalling transaction established.

Figure 6.3: Service graph of the call independent Supplementary Services Support entity - MS side

6.3.2 Service primitives

Table 6.3: Primitives and Parameters at MNSS-SAP - MS side

PRIMITIVES	PARAMETERS (Info elements of message)	REFERENCE
MNSS_BEGIN_REQ	REGISTER	6.3.2.1
MNSS_BEGIN_IND	REGISTER	6.3.2.2
MNSS_FACILITY_REQ	FACILITY	6.3.2.3
MNSS_FACILITY_IND	FACILITY	6.3.2.4
MNSS_END_REQ	REL COMPLETE	6.3.2.5
MNSS_END_IND	REL COMPLETE	6.3.2.6

### 6.3.2.1 MNSS\_BEGIN\_REQ

Request to send a REGISTER message in order to establish a signalling transaction for the provision of call independent supplementary services. The request for a call independent supplementary service invocation may be included.

### 6.3.2.2 MNSS\_BEGIN\_IND

Receipt of a REGISTER message, a signalling transaction is established for the provision of call independent supplementary services after receipt of a REGISTER message. The indication of a supplementary service invocation may be included.

### 6.3.2.3 MNSS\_FACILITY\_REQ

Request to send a FACILITY message for the provision of a call independent supplementary service invocation.

### 6.3.2.4 MNSS\_FACILITY\_IND

Receipt of a FACILITY message for a call independent supplementary service invocation.

### 6.3.2.5 MNSS\_END\_REQ

Request to send a RELEASE COMPLETE message in order to release the signalling transaction. The request for transfer of a supplementary service facility may be included.

### 6.3.2.6 MNSS\_END\_IND

Receipt of a RELEASE COMPLETE message, the signalling transaction has been released. The indication of a supplementary service facility may be included.

## 6.4 Short Message Services Support

The service provided by the CM sublayer to support the short message service are defined in 3GPP TS 24.011 [8].

## 6.5 Session Management Services for GPRS-Services

Session Management services are provided at the SMREG-SAP and the SNSM-SAP. The procedures for GPRS Session Management (i.e. PDP context activation, PDP context deactivation and PDP context modification) and MBMS Session Management (i.e. MBMS context activation and MBMS context deactivation) are available at the SMREG-SAP.

Before any user data transfer is initiated (eg. via SNDSCP in GSM case), the PDP context activation procedure must be performed. In case of MBMS, the MS must also perform the procedures needed in order to activate a multicast service.

## 6.5.1 Session Management Services for SMREG-SAP

**Table 6.5.1: Primitives and Parameters at SMREG-SAP - MS side**

PRIMITIVE	PARAMETER (message, info elements of message, other parameters)	REFERENCE
SMREG-PDP-ACTIVATE-REQ	PDP address, QoS, NSAPI, APN, Protocol configuration options	6.5.1.1
SMREG-PDP-ACTIVATE-CNF	PDP address, QoS, NSAPI, Protocol configuration options	6.5.1.2
SMREG-PDP-ACTIVATE-REJ	Cause, NSAPI, Protocol configuration options	6.5.1.3
SMREG-PDP-ACTIVATE-IND	PDP address, APN, protocol configuration options	6.5.1.4
SMREG-PDP-ACTIVATE-REJ-RSP	Cause, PDP address, APN, protocol configuration options, MBMS protocol configuration options	6.5.1.14
SMREG-PDP-DEACTIVATE-REQ	NSAPI(s) tear down indicator, cause, protocol configuration options, MBMS protocol configuration options	6.5.1.5
SMREG-PDP-DEACTIVATE-CNF	NSAPI(s), protocol configuration options, MBMS protocol configuration options	6.5.1.6
SMREG-PDP-DEACTIVATE-IND	NSAPI(s) (s), tear down indicator, cause, protocol configuration options, MBMS protocol configuration options	6.5.1.7
SMREG-PDP-MODIFY-IND	QoS, NSAPI, protocol configuration options	6.5.1.8
SMREG-PDP-MODIFY-REQ	QoS, NSAPI, TFT, protocol configuration options	6.5.1.18
SMREG-PDP-MODIFY-CNF	QoS, NSAPI, protocol configuration options	6.5.1.19
SMREG-PDP-MODIFY-REJ	Cause, NSAPI, protocol configuration options	6.5.1.20
SMREG-PDP-ACTIVATE-SEC-REQ	QoS, NSAPI, TFT, Primary NSAPI, protocol configuration options	6.5.1.15
SMREG-PDP-ACTIVATE-SEC-CNF	QoS, NSAPI, protocol configuration options	6.5.1.16
SMREG-PDP-ACTIVATE-SEC-REJ	Cause, NSAPI, protocol configuration options	6.5.1.17
SMREG-MBMS-ACTIVATE-REQ	Multicast address, supported MBMS bearer capabilities, NSAPI, APN, MBMS protocol configuration options	6.5.1.21
SMREG-MBMS-ACTIVATE-CNF	Multicast address, NSAPI, MBMS protocol configuration options	6.5.1.22
SMREG-MBMS-ACTIVATE-REJ	Cause, NSAPI, MBMS protocol configuration options	6.5.1.23
SMREG-MBMS-ACTIVATE-IND	Multicast address, APN, MBMS protocol configuration options	6.5.1.24

### 6.5.1.1 SMREG-PDP-ACTIVATE-REQ

The MS initiates a primary PDP context activation. SM is requested to send the ACTIVATE PDP CONTEXT REQUEST message to the network. The PDP context is pending activation.

### 6.5.1.2 SMREG-PDP-ACTIVATE-CNF

The MS initiated primary PDP context activation succeeded. The network confirmed the PDP context activation, i.e. the ACTIVATE PDP CONTEXT ACCEPT message was received from the network. In GSM, this implies that SM has ordered SNDCCP to establish the needed LLC link. In the UMTS case, this implies that the RLC link towards the RNC has been established and that the SM has been informed about this from the RABM service entity in the MS. (RABM-RAB Management service entity is FFS and could lead to update of the protocol architecture in figure 5.2 and 5.3) The PDP context is active.

### 6.5.1.3 SMREG-PDP-ACTIVATE-REJ

The PDP primary context activation failed, the PDP context is not activated. One reason for failure is that the network rejected the activation attempt, which means the ACTIVATE PDP CONTEXT REJECT message was received. Another reason is e.g. that it was not possible to establish the needed LLC link in the GSM case.

#### 6.5.1.4 SMREG-PDP-ACTIVATE-IND

The network asked for a PDP context activation. The REQUEST PDP CONTEXT ACTIVATION message was received from the network. The MS reacts either by initiating a new primary PDP context activation or by rejecting the network's request.

#### 6.5.1.5 SMREG-PDP-DEACTIVATE-REQ

The MS initiates a PDP context deactivation: SM is requested to send a DEACTIVATE PDP CONTEXT REQUEST message to the network. The PDP context is pending deactivation. Presence of the teardown indicator will lead to deactivation of all PDP contexts coupled to the identified PDP address. NSAPI(s) to be deallocated from the SNDPCP entity via the SNSM-SAP for the GSM case, are included in the primitive.

#### 6.5.1.6 SMREG-PDP-DEACTIVATE-CNF

The MS initiated PDP context deactivation has been done. The network confirmed the PDP context deactivation, i.e. the DEACTIVATE PDP CONTEXT ACCEPT message was received from the network. For GSM SM has ordered SNDPCP to locally release not further needed LLC links. In the UMTS case, the release of the RLC link towards the RNC takes place as a result of a RAB release trigger from the network side. SM has been informed about this from the RABM service entity in the MS. (RABM- RAB Management service entity is FFS and could lead to update of the protocol architecture in figure 5.2 and 5.3.) The PDP context has been deactivated.

#### 6.5.1.7 SMREG-PDP-DEACTIVATE-IND

A network initiated PDP context deactivation has been performed. The DEACTIVATE PDP CONTEXT REQUEST message has been received from the network. The MS has acknowledged with the DEACTIVATE PDP CONTEXT ACCEPT message. The PDP context has been deactivated, the related LLC links in GSM or RLC links in UMTS were locally released. Presence of the teardown indicator will lead to deactivation of all PDP contexts coupled to the identified PDP address. NSAPI is included in the primitive to allow identification of the PDP context(s) needing deactivation.

#### 6.5.1.8 SMREG-PDP-MODIFY-IND

A network initiated PDP context modification has been performed. The MODIFY PDP CONTEXT REQUEST message has been received from the network. The modification has been acknowledged by sending the MODIFY PDP CONTEXT ACCEPT message. One PDP context has been modified. LLC links is adjusted.

6.5.1.9 Void

6.5.1.10 Void

6.5.1.11 Void

6.5.1.12 Void

6.5.1.13 Void

#### 6.5.1.14 SMREG-PDP-ACTIVATE-REJ-RSP

The network requested PDP context activation failed.

#### 6.5.1.15 SMREG-PDP-ACTIVATE-SEC-REQ

The MS initiates a secondary PDP context activation. SM is requested to send the ACTIVATE SECONDARY PDP CONTEXT REQUEST message to the network. The PDP context is pending activation.



#### 6.5.1.16 SMREG-PDP-ACTIVATE-SEC-CNF

The MS initiated secondary PDP context activation succeeded. The network confirmed the PDP context activation, i.e. the ACTIVATE SECONDARY PDP CONTEXT ACCEPT message was received from the network. In GSM, this implies that SM has ordered SNDCP to establish the needed LLC link. In the UMTS case, this implies that the RLC link towards the RNC has been established and that the SM has been informed about this from the RABM service entity in the MS. (RABM- RAB Management service entity is FFS and could lead to update of the protocol architecture in figure 5.2 and 5.3) The PDP context connected to the same PDP address as the PDP context identified by the primary NSAPI parameter in SMREG-PDP-ACTIVATE-SEC-REQ is active. ('Primary NSAPI' will point to any one of the other established PDP contexts for a given PDP address).

#### 6.5.1.17 SMREG-PDP-ACTIVATE-SEC-REJ

The secondary PDP context activation failed, the PDP context is not activated. One reason for failure is that the network rejected the activation attempt, which means the ACTIVATE SECONDARY PDP CONTEXT REJECT message was received. Another reason is e.g. that it was not possible to establish the needed LLC link in the GSM case.

#### 6.5.1.18 SMREG-PDP-MODIFY-REQ

An MS initiated PDP context modification is requested. The MODIFY PDP CONTEXT REQUEST message is sent to the network and pending acceptance. Affected PDP context is identified via the NSAPI value included in the primitive.

#### 6.5.1.19 SMREG-PDP-MODIFY-CNF

An MS initiated PDP context modification has been accepted by the network. The modification is acknowledged from the network via the MODIFY PDP CONTEXT ACCEPT message. The addressed PDP context has been modified. LLC or RLC link is adjusted according to the QoS returned from the network.

#### 6.5.1.20 SMREG-PDP-MODIFY-REJ

An MS initiated PDP context modification has been rejected by the network. The rejection is signalled from the network via the MODIFY PDP CONTEXT REJECT message with the cause code. The PDP context remains active without change of QoS.

#### 6.5.1.21 SMREG-MBMS-ACTIVATE-REQ

The MS initiates an MBMS context activation as requested by the network. SM is requested to send the ACTIVATE MBMS CONTEXT REQUEST message to the network. The MBMS context is pending activation waiting for the network confirmation.

#### 6.5.1.22 SMREG-MBMS-ACTIVATE-CNF

The MBMS context activation succeeded. The network confirmed the MBMS context activation, i.e. the ACTIVATE MBMS CONTEXT ACCEPT message was received from the network. The MBMS context is active.

#### 6.5.1.23 SMREG-MBMS-ACTIVATE-REJ

The MBMS context activation failed, the MBMS context is not activated.

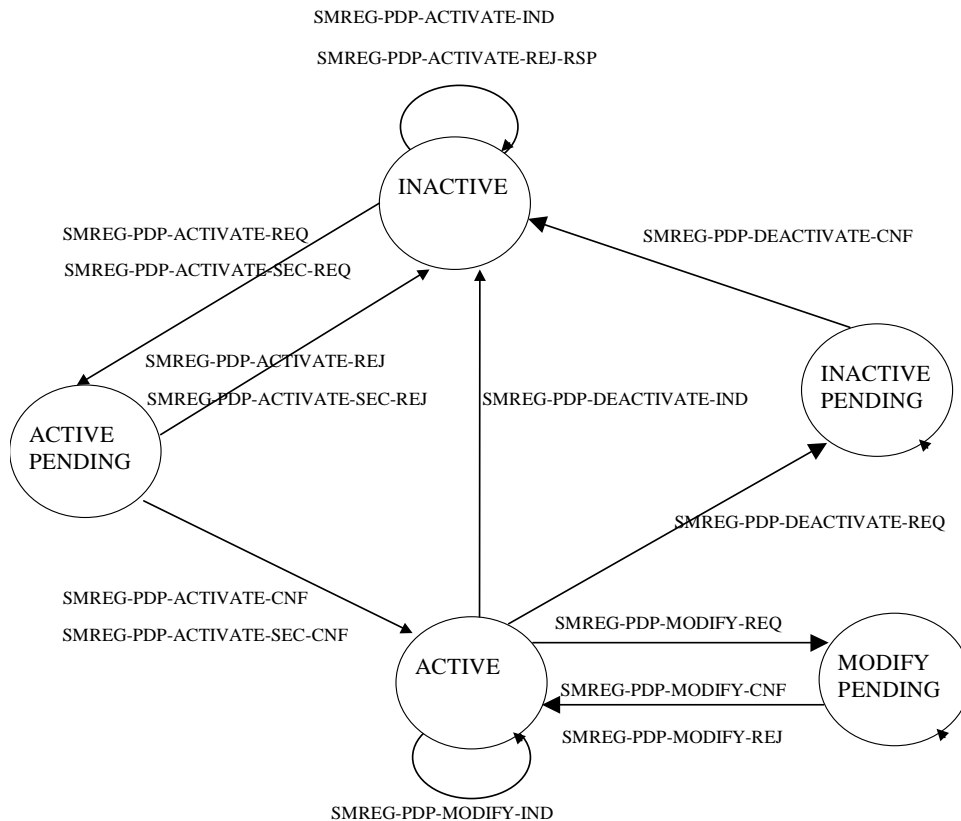
#### 6.5.1.24 SMREG-MBMS-ACTIVATE-REJ-RSP

The network requested MBMS context activation failed. SM is requested to send the REQUEST MBMS CONTEXT ACTIVATION REJECT message to the network.

#### 6.5.1.25 SMREG-MBMS-ACTIVATE-IND

The network asked for an MBMS context activation. The REQUEST MBMS CONTEXT ACTIVATION message was received from the network. The MS reacts either by initiating the activation of the MBMS context or by rejecting the request from the network.

The Session Management services provided at the service access point SMREG-SAP are illustrated in the state machines of figures 6.4 and 6.5 below. Note, that each state machine describes only one PDP/MBMS context within the SM entity.



**Figure 6.4: Session Management service states at the SMREG-SAP for GPRS PDP context handling - MS side**

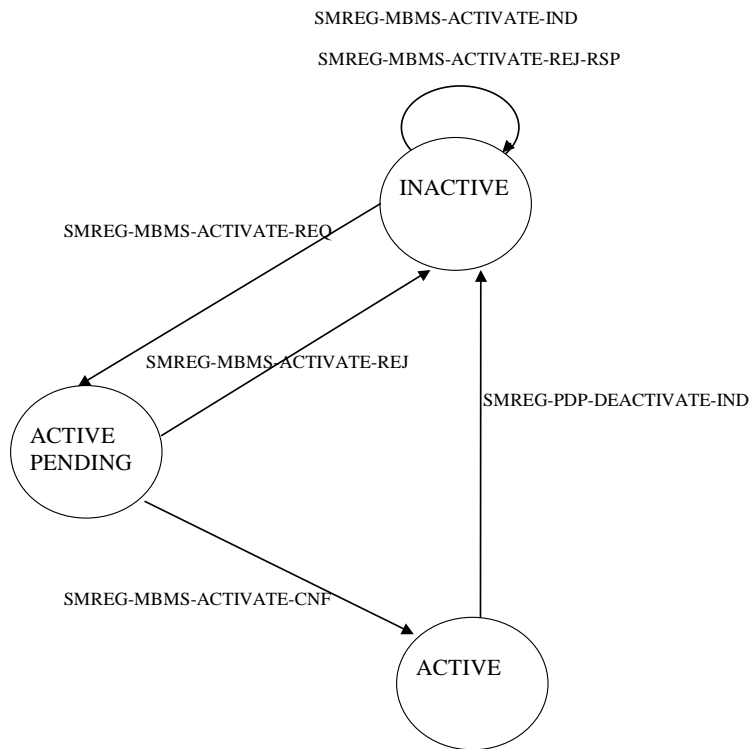


Figure 6.5: Session Management service states at the SMREG-SAP for MBMS context handling - MS side

### 6.5.2 Session Management Services for SNSM-SAP (GSM only)

The SNSM-SAP service primitives are defined in 3GPP TS 44.065 [12a].

### 6.5.3 Session Management Services for RABMSM-SAP (UMTS only)

Table 6.5.3: Service primitives and parameters at RABMSM-SAP - MS side

PRIMITIVE	PARAMETER (message, info elements of message, other parameters)	Reference
RABMSM-ACTIVATE-IND	NSAPI, QoS	6.5.3.1
RABMSM-ACTIVATE-RSP	NSAPI	6.5.3.2
RABMSM-DEACTIVATE-IND	NSAPIs	6.5.3.3
RABMSM-DEACTIVATE-RSP	NSAPIs	6.5.3.4
RABMSM-DEACTIVATE-REQ	NSAPI	6.5.3.5
RABMSM-MODIFY-IND	NSAPI, QoS	6.5.3.6
RABMSM-MODIFY-RSP	-	6.5.3.7
RABMSM-STATUS-REQ	- Cause	6.5.3.8

### 6.5.3.1 RABMSM-ACTIVATE-IND

Indication used by the SM entity to inform the RABM entity that an NSAPI has been activated for data transfer (e.g. an activate PDP Context request has been sent to the network). It also informs the RABM entity about the requested QoS profile for this NSAPI. The indication is sent by SM towards RABM during an ongoing PDP context activation procedure.

### 6.5.3.2 RABMSM-ACTIVATE-RSP

Response used by the RABM entity to inform the SM entity that the indicated NSAPI is now in use and that a RAB for the indicated NSAPI is established.

### 6.5.3.3 RABMSM-DEACTIVATE-IND

Indication used by the SM entity to inform the RABM entity that an NSAPIs has been de-allocated and cannot be used by the RABM entity anymore. The request is sent by SM towards RABM during an ongoing MS initiated as well as network initiated PDP context de-activation procedure or during local de-activation of a PDP context.

### 6.5.3.4 RABMSM-DEACTIVATE-RSP

This message is the response to RABMSM-DEACTIVATE-IND used by the RABM entity to inform the SM entity that the NSAPI indicated is no longer in use. It is either sent immediately when there is no corresponding bearer active or it is sent after reception and processing of RABMAS-RAB-RELEASE-IND from access stratum.

### 6.5.3.5 RABMSM-DEACTIVATE-REQ

This primitive is used by the RABM entity to inform the SM entity that the RAB for an NSAPI has been released. This primitive is only sent for bearer with a RT-QoS classes.

### 6.5.3.6 RABMSM-MODIFY-IND

Indication used by the SM entity to indicate the change of the QoS for an NSAPI. The indication is sent by SM towards RABM during an ongoing PDP context modification procedure.

### 6.5.3.7 RABMSM-MODIFY-RSP

Response used by the RABM entity to inform the SM entity that the indicated NSAPI and QoS profile are now in use and the RAB for the NSAPI is established and/or released, if necessary.

### 6.5.3.8 RABMSM-STATUS-REQ

This primitive is used by the RABM entity to inform the SM entity that RABM cannot continue its operation due to errors at the lower layer (i.e. Access Stratum) or at the RABM layer. The Cause parameter indicates the cause of the error.

## 6.6 Registration Services for GPRS-Services

The attach/detach procedures comprise the registration services which are provided at the GMMREG-SAP.

It shall be noted, that the registration services for mobiles of class A or B may depend on the service states for GPRS and non-GPRS services. Therefore the internal access points MMCOORD and the GMMCOORD (see figure 5.3) are used by GMM and MM to inform each other about the relevant conditions. No service primitives between the entities within the same sublayer, i.e. the MM sublayer, are defined in the present document. The Mobility Management for class A and B mobiles is further specified in 3GPP TS 24.008 [6].

## 6.6.1 Registration Services for GMMREG-SAP

**Table 6.6.1: Service primitives and parameters at GMMREG-SAP - MS side**

PRIMITIVE	PARAMETER (message, info elements of message, other parameters)	REFERENCE
GMMREG-ATTACH-REQ	attach-type, READY-timer, STANDBY-timer	6.6.1.1
GMMREG-ATTACH-CNF	PLMNs MT-caps, attach-type.	6.6.1.2
GMMREG-ATTACH-REJ	cause	6.6.1.3
GMMREG-DETACH-REQ	detach-type, power-off/normal-detach	6.6.1.4
GMMREG-DETACH-CNF	detach-type	6.6.1.5
GMMREG-DETACH-IND	detach-type	6.6.1.6

### 6.6.1.1 GMMREG-ATTACH-REQ

MS initiates the GPRS and/or IMSI attach. GMM is requested to send an ATTACH REQUEST message to the network. The attachment is registration pending in the MS.

### 6.6.1.2 GMMREG-ATTACH-CNF

The attach (either GPRS-attach or IMSI-attach or both) was successful. The network confirmed the attach, i.e. the ATTACH ACCEPT message was received by the MS. The LLC and RR sublayer will be informed by GMM about the TLLI to be used.

### 6.6.1.3 GMMREG-ATTACH-REJ

The attach (either GPRS-attach or IMSI-attach or both) has failed. The network rejected the attach attempt, i.e. the message ATTACH REJECT was received from the network.

### 6.6.1.4 GMMREG-DETACH-REQ

MS initiates GPRS and/or IMSI detach: GMM is requested to send a DETACH REQUEST message, the detach procedure is initiated. In case of MS initiated detach at power-off, the procedure is terminated in the MS after sending the DETACH REQUEST message.

### 6.6.1.5 GMMREG-DETACH-CNF

The MS initiated detach (either GPRS-attach or IMSI-attach or both) has been completed. The network confirmed the detach, i.e. the message DETACH ACCEPT was received from the network. This finalizes the detach procedure (normal, not at power off). Any PDP context possibly activated before is deactivated.

### 6.6.1.6 GMMREG-DETACH-IND

A network initiated detach has been performed. Or the detach has been performed locally due to expiration of the standby timer or a failed routing area update. In the first case the DETACH REQUEST message was from the network. Any PDP context possibly activated before is deactivated.

The registration services provided at the service access point GMMREG-SAP are illustrated in the state machine of figure 6.6 below. Note, that in state registered the MS may be suspended from GPRS mobility management due to an ongoing CS connection. The registration procedure Routing Area Updating, which is not provided at the GMMREG-SAP, is not visible within the diagram.

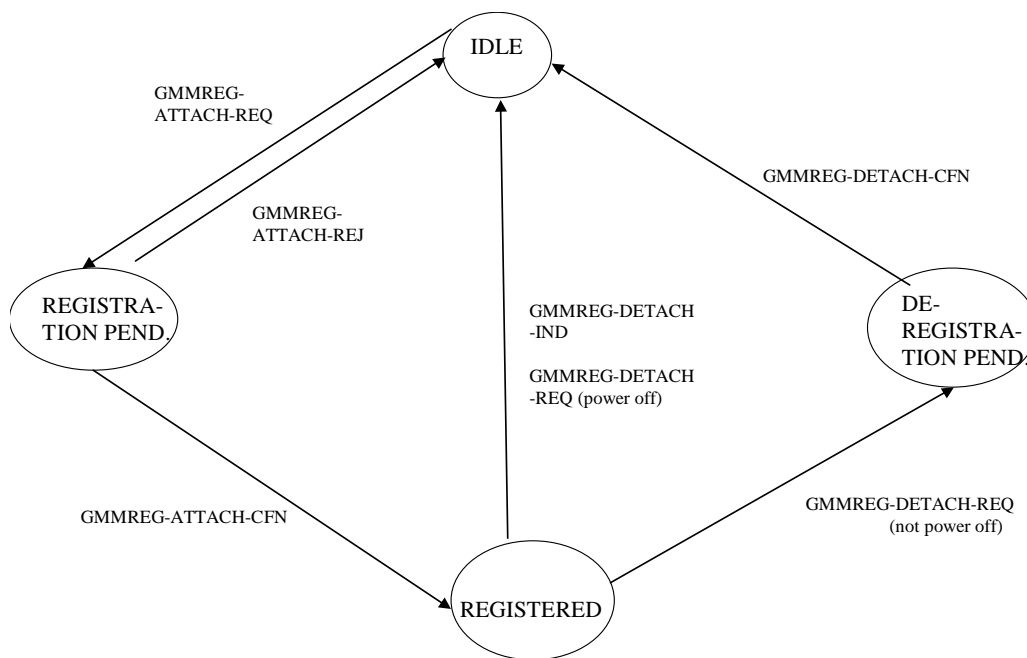


Figure 6.6: Registration services states at GMMREG-SAP for GPRS attach and detach - MS side

## 6.7 Services provided to SMDCP entities by GPRS Logical Link Control services

This clause is informative, the service primitives are defined in 3GPP TS 44.064 [11a]. They are included here to provide a complete overview of the radio interface protocol architecture.

Logical Link Control services are provided at the QoS1-SAP - QoS4 SAP towards the SMDCP and at the LLSMS-SAP towards SMS.

### 6.7.1 Service state diagram for QoS1-SAP, QoS2-SAP, QoS3-SAP and QoS4-SAP

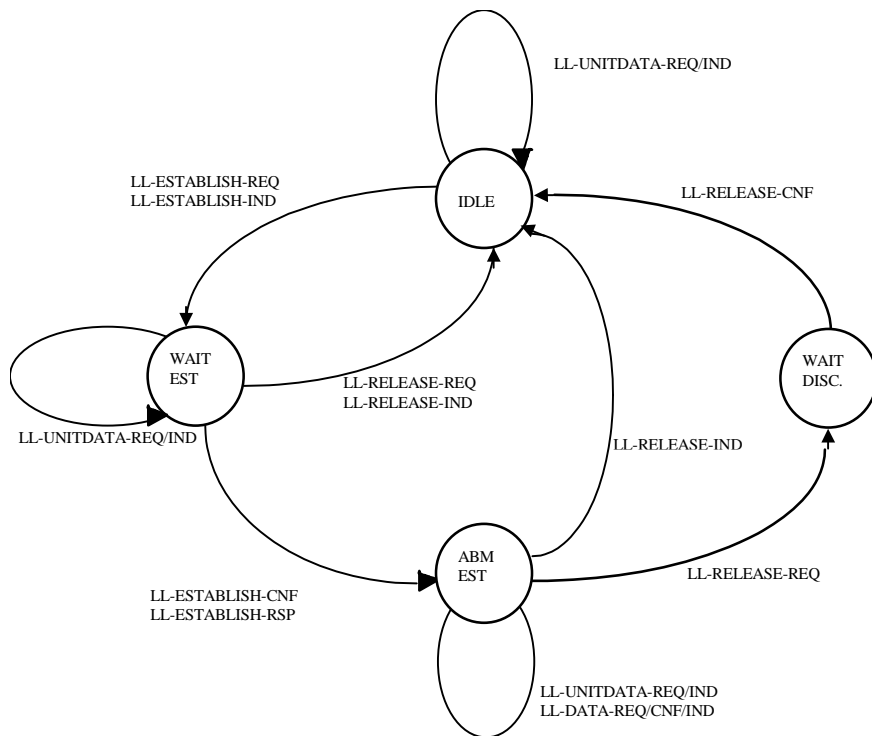


Figure 6.7: States to establish and release ABM mode operation

### 6.7.2 Service primitives for QoS1-SAP, QoS2-SAP, QoS3-SAP and QoS4-SAP

Table 6.7.2: Service primitives and parameters at QoS1 to QoS4 - MS side

PRIMITIVE	PARAMETER (message, info elements of message, other parameters)	REFERENCE
LL-ESTABLISH-REQ	TLLI, SNDCP requested parameters (XID)	6.7.2.1
LL-ESTABLISH-CNF	TLLI, SNDCP negotiated parameters (XID)	6.7.2.2
LL-ESTABLISH-IND	TLLI, SNDCP requested parameters (XID), N201	6.7.2.3
LL-ESTABLISH-RSP	TLLI, SNDCP negotiated parameters (XID)	6.7.2.4
LL-RELEASE-REQ	TLLI	6.7.2.5
LL-RELEASE-CFN	TLLI	6.7.2.6
LL-RELEASE-IND	TLLI	6.7.2.7
LL-XID-REQ	TLLI, SNDCP requested parameters (XID)	6.7.2.8
LL-XID-IND	TLLI, SNDCP requested parameters (XID), N201	6.7.2.9
LL-XID-RSP	TLLI, SNDCP negotiated parameters (XID)	6.7.2.10
LL-XID-CNF	TLLI, SNDCP negotiated parameters (XID), N201	6.7.2.11
LL-DATA-REQ	TLLI, N-PDU, local reference	6.7.2.12
LL-DATA-CNF	TLLI, local reference	6.7.2.13
LL-DATA-IND	TLLI, N-PDU	6.7.2.14
LL-UNITDATA-REQ	TLLI, N-PDU, protect, cipher	6.7.2.15
LL-UNITDATA-IND	TLLI, N-PDU	6.7.2.16
LL-STATUS-IND	TLLI, cause	6.7.2.17

#### 6.7.2.1 LL-ESTABLISH-REQ

A LLC SABM frame will be sent to establish the LLC ABM mode.

### 6.7.2.2 LL-ESTABLISH-CNF

A LLC UA frame is received, the LLC ABM mode has been established.

### 6.7.2.3 LL-ESTABLISH-IND

A LLC SABM frame is received.

### 6.7.2.4 LL-ESTABLISH-RSP

A LLC UA frame will be sent, the ABM mode is established.

### 6.7.2.5 LL-RELEASE-REQ

A LLC DISC frame will be sent to change to LLC ADM mode.

### 6.7.2.6 LL-RELEASE-CNF

The LLC link has been disconnected, LLC is in ADM mode.

### 6.7.2.7 LL-RELEASE-IND

LLC is in idle mode.

### 6.7.2.8 LL-XID-REQ

An LLC XID frame will be sent.

### 6.7.2.9 LL-XID-IND

An LLC XID frame has been received.

### 6.7.2.10 LL-XID-RSP

An LLC XID frame will be sent as a response to a received XID frame.

### 6.7.2.11 LL-XID-CNF

An LLC XID frame has been received as a response to a sent XID frame.

### 6.7.2.12 LL-DATA-REQ

An LLC I frame will be sent to the peer entity.

### 6.7.2.13 LL-DATA-CNF

Successful reception of an LLC I frame has been acknowledged by the peer entity.

### 6.7.2.14 LL-DATA-IND

An LLC I frame has been received from the peer entity.

### 6.7.2.15 LL-UNITDATA-REQ

An LLC UI frame will be sent to the peer entity.



### 6.7.2.16 LL-UNITDATA-IND

An LLC UI frame has been received from the peer entity.

### 6.7.2.17 LL-STATUS-IND

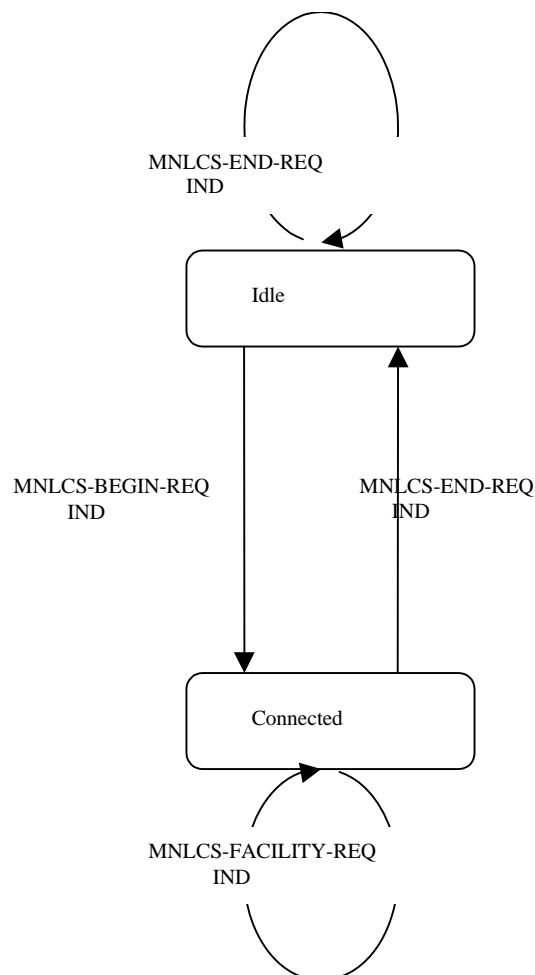
Indication used by LLC to transfer LLC failures to the SMDCP sublayer. The failure may also be caused due to errors at the RLC/MAC layer.

## 6.8 Location services at the type A LMU side

The location services (e.g. transfer of timing related measurement information by a type A LMU) are provided at the service access point MNLCS-SAP. The service provided by the CM sublayer to support the location services is defined in 3GPP TS 44.071 [8a].

### 6.8.1 Service state diagram

The positioning services provided at the service access point MNLCS-SAP are illustrated in the state diagram of figure 6.8.



STATES:

IDLE - No LCS signalling transaction pending.

CONN - LCS signalling transaction established.

**Figure 6.8: Service graph of the Location Services Support entity - type A LMU side**

## 6.8.2 Service primitives

**Table 6.8: Primitives and Parameters at MNLCS-SAP - type A LMU side**

PRIMITIVES	PARAMETERS (Info elements of message)	REFERENCE
MNLCS_BEGIN_REQ	REGISTER	6.8.2.1
MNLCS_BEGIN_IND	REGISTER	6.8.2.2
MNLCS_FACILITY_REQ	FACILITY	6.8.2.3
MNLCS_FACILITY_IND	FACILITY	6.8.2.4
MNLCS_END_REQ	RELEASE COMPLETE	6.8.2.5
MNLCS_END_IND	RELEASE COMPLETE	6.8.2.6

### 6.8.2.1 MNLCS\_BEGIN\_REQ

Request to send a REGISTER message in order to establish a signalling transaction for the provision of location services. The request for transfer of a location service facility may be included.

### 6.8.2.2 MNLCS\_BEGIN\_IND

Receipt of a REGISTER message, a signalling transaction is established for the provision of location services after receipt of a REGISTER message. The indication of a location service facility may be included.

### 6.8.2.3 MNLCS\_FACILITY\_REQ

Request to send a FACILITY message for the provision of a location service invocation. The request for transfer of a location service facility may be included.

### 6.8.2.4 MNLCS\_FACILITY\_IND

Receipt of a FACILITY message, a location service facility has been requested.

### 6.8.2.5 MNLCS\_END\_REQ

Request to send a RELEASE COMPLETE message in order to release the signalling transaction. The request for transfer of a location service facility may be included.

### 6.8.2.6 MNLCS\_END\_IND

Receipt of a RELEASE COMPLETE message, the signalling transaction has been released. The indication of a location service facility may be included.

---

## 7 Services provided by signalling layer 3 on the Network side

In this clause, the services provided by signalling layer 3 on the network side are described which belong to the CM sub-layer functional blocks of CC, SMS, LCS, and SS. The services corresponding to further functional blocks of the CM sublayer are not further described in this clause.

### 7.1 Call control services

The Call Control services are provided by multiple CC entities at the service access point MNCC-SAP.

The Call Control service class consists of the following services:

- call establishment;

- call maintaining;
- call termination;
- call related Supplementary Services Support.

### 7.1.1 Service state diagram

The Call Control services provided at the service access point MNCC-SAP are illustrated in figure 7.1.



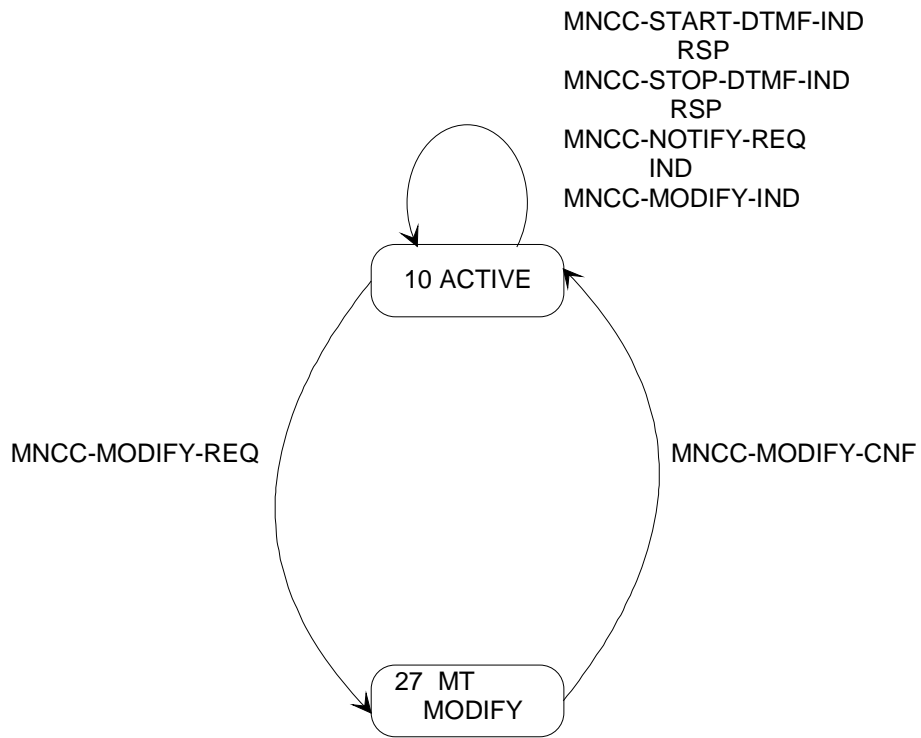


Figure 7.1: (page 2 of 2) Service graph of Call Control entity - Network side

## 7.1.2 Service primitives

**Table 7.1: Primitives and Parameters at MNCC-SAP - Network side**

PRIMITIVE	PARAMETER (message, info elements of message, other parameters)	REFERENCE
MNCC_SETUP_REQ	SETUP incl. Mobile ID or EMERGENCY SETUP	7.1.2.1
MNCC_SETUP_IND	SETUP	7.1.2.2
MNCC_SETUP_RSP	CONNECT	7.1.2.3
MNCC_SETUP_CNF	CONNECT	7.1.2.4
MNCC_SETUP_COMPL_REQ	CONNECT ACKNOWLEDGE	7.1.2.5
MNCC_SETUP_COMPL_IND	CONNECT ACKNOWLEDGE	7.1.2.6
MNCC_REJ_REQ	RELEASE COMPLETE	7.1.2.7
MNCC_REJ_IND	cause	7.1.2.8
MNCC_CALL_CONF_IND	CALL CONFIRMED	7.1.2.9
MNCC_CALL_PROC_REQ	CALL PROCEEDING	7.1.2.10
MNCC_PROGRESS_REQ	PROGRESS	7.1.2.11
MNCC_ALERT_REQ	ALERTING	7.1.2.12
MNCC_ALERT_IND	ALERTING	7.1.2.13
MNCC_NOTIFY_REQ	NOTIFY	7.1.2.14
MNCC_NOTIFY_IND	NOTIFY	7.1.2.15
MNCC_DISC_REQ	DISCONNECT	7.1.2.16
MNCC_DISC_IND	DISCONNECT	7.1.2.17
MNCC_REL_REQ	RELEASE or DISCONNECT	7.1.2.18
MNCC_REL_IND	RELEASE	7.1.2.19
MNCC_REL_CNF	RELEASE or RELEASE COMPLETE	7.1.2.20
MNCC_FACILITY_REQ	facility	7.1.2.21
MNCC_FACILITY_IND	facility	7.1.2.22
MNCC_START_DTMF_IND	START DTMF	7.1.2.23
MNCC_START_DTMF_RSP	START DTMF ACK or START DTMF REJ	7.1.2.24
MNCC_STOP_DTMF_IND	STOP DTMF	7.1.2.25
MNCC_STOP_DTMF_RSP	STOP DTMF ACK	7.1.2.26
MNCC_MODIFY_REQ	MODIFY or BC-parameter	7.1.2.27
MNCC_MODIFY_IND	BC-parameter	7.1.2.28
MNCC_MODIFY_RES	MODIFY COMPLETE	7.1.2.29
MNCC_MODIFY_CNF	BC-parameter	7.1.2.30

### 7.1.2.1 MNCC\_SETUP\_REQ

Request to send a SETUP message to initiate Mobile terminated establishment.

### 7.1.2.2 MNCC\_SETUP\_IND

Receipt of a SETUP or EMERGENCY SETUP message, the Mobile originating call establishment has been initiated.

### 7.1.2.3 MNCC\_SETUP\_RSP

Response to send a CONNECT message to indicate call acceptance by the remote user.

### 7.1.2.4 MNCC\_SETUP\_CNF

Receipt of a CONNECT message, the Mobile terminated call has been accepted.

### 7.1.2.5 MNCC\_SETUP\_COMPL\_REQ

Request to send a CONNECT ACKNOWLEDGE message, the Mobile terminated call establishment has been completed.

#### 7.1.2.6 MNCC\_SETUP\_COMPL\_IND

Indication of the receipt of a CONNECT ACKNOWLEDGE message, the Mobile originating call establishment has been completed.

#### 7.1.2.7 MNCC\_REJ\_REQ

Reject the Mobile originated call establishment if the call cannot be accepted.

#### 7.1.2.8 MNCC\_REJ\_IND

A Mobile terminated call was rejected by the MS, e.g. because of missing compatibility.

#### 7.1.2.9 MNCC\_CALL\_CONF\_IND

Receipt of a CALL CONFIRMED message, the Mobile terminated call has been confirmed. A bearer capability different from that given in MNCC\_SETUP\_REQ may be offered to the remote calling user.

#### 7.1.2.10 MNCC\_CALL\_PROC\_REQ

Request to send a CALL PROCEEDING message to indicate to the Mobile originating user that call establishment has been initiated in the Network and no more call establishment information will be accepted.

#### 7.1.2.11 MNCC\_PROGRESS\_REQ

Request to send a PROGRESS message or to piggy-back a progress IE in a suitable CC message in order to give the Mobile user information about the call, e.g. that the call is progressing in the PLMN/ISDN environment, or that the call has left the PLMN/ISDN environment, or that in-band tones/announcement are available.

#### 7.1.2.12 MNCC\_ALERT\_REQ

Request to send an ALERTING message to indicate to the Mobile originating user that remote called user alerting has been initiated.

#### 7.1.2.13 MNCC\_ALERT\_IND

Receipt of an ALERTING message from the Mobile terminated user to be sent to the remote calling user to indicate that user alerting has been initiated.

#### 7.1.2.14 MNCC\_NOTIFY\_REQ

Request to send information pertaining to a call, such as user suspended, to the Mobile originating or the Mobile terminated user.

#### 7.1.2.15 MNCC\_NOTIFY\_IND

Indication from the Mobile originating or Mobile terminated user of information pertaining to a call, such as remote user suspended.

#### 7.1.2.16 MNCC\_DISC\_REQ

Request to send a DISCONNECT message to the MS in order to clear the end-to-end connection.

#### 7.1.2.17 MNCC\_DISC\_IND

Receipt of a DISCONNECT message, the MS indicates that the end-to-end connection is cleared.

#### 7.1.2.18 MNCC\_REL\_REQ

Request to send a RELEASE message to inform the MS that the network intends to release the MM connection and the correspondent call reference.

#### 7.1.2.19 MNCC\_REL\_IND

Receipt of a RELEASE message, the MS intends to release its MM connection and call reference. The Network is requested to release its call reference and MM connection.

#### 7.1.2.20 MNCC\_REL\_CNF

The RELEASE COMPLETE message has been received, the MM connection in the MS has been released, the Network itself shall release its MM connection and the corresponding call reference.

#### 7.1.2.21 MNCC\_FACILITY\_REQ

Request to transport a *facility* IE for call related supplementary service invocations.

#### 7.1.2.22 MNCC\_FACILITY\_IND

Indication that a *facility* IE for call related supplementary service invocations has been received.

#### 7.1.2.23 MNCC\_START\_DTMF\_IND

Indicate the receipt of a START DTMF message in order to start a DTMF control operation.

#### 7.1.2.24 MNCC\_START\_DTMF\_RSP

Request to send a START DTMF ACKNOWLEDGE or START DTMF REJECT message in order to acknowledge or reject the start of a DTMF control operation.

#### 7.1.2.25 MNCC\_STOP\_DTMF\_IND

Indicate the receipt of a STOP DTMF message in order to stop a DTMF control operation.

#### 7.1.2.26 MNCC\_STOP\_DTMF\_RSP

Request to send a STOP DTMF ACKNOWLEDGE message in order to acknowledge the completion of a DTMF control operation.

#### 7.1.2.27 MNCC\_MODIFY\_REQ

Request to start the Mobile terminating in-call modification.

#### 7.1.2.28 MNCC\_MODIFY\_IND

Receipt of a MODIFY message, the Mobile originating in-call modification has been initiated.

#### 7.1.2.29 MNCC\_MODIFY\_RES

Response to send a MODIFY COMPLETE to indicate to the Mobile user that the mobile originating in-call modification procedure has been completed.

#### 7.1.2.30 MNCC\_MODIFY\_CNF

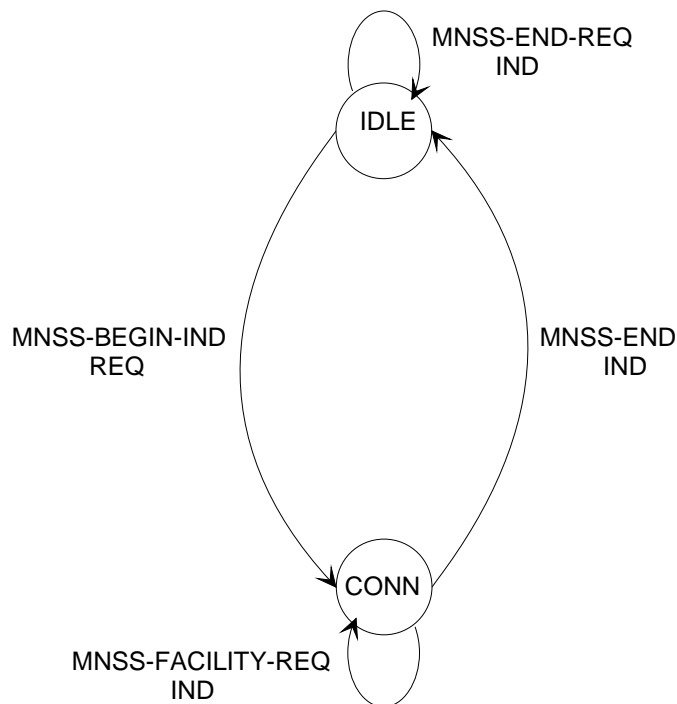
Confirmation that the Mobile terminating in-call modification has been completed.



## 7.2 Call independent Supplementary Services Support

### 7.2.1 Service state diagram

The primitives provided by the call independent Supplementary Services Support entity and the transitions between permitted states are shown in the service graph of figure 7.2 below.



STATES:

IDLE - No SS signalling transaction pending.

CONN - SS signalling transaction established.

**Figure 7.2: Service graph of the call independent Supplementary Services Support entity - Network side**

### 7.2.2 Service primitives

**Table 7.2: Primitives and Parameters at MNSS-SAP - Network side**

PRIMITIVES	PARAMETERS (Info elements of message)	REFERENCE
MNSS_BEGIN_REQ	REGISTER	7.2.2.1
MNSS_BEGIN_IND	REGISTER	7.2.2.2
MNSS_FACILITY_REQ	FACILITY	7.2.2.3
MNSS_FACILITY_IND	FACILITY	7.2.2.4
MNSS_END_REQ	RELEASE COMPLETE	7.2.2.5
MNSS_END_IND	RELEASE COMPLETE	7.2.2.6

#### 7.2.2.1 MNSS\_BEGIN\_REQ

Request to send a REGISTER message in order to establish a signalling transaction for the provision of call independent supplementary services. The request for a supplementary service invocation may be included.

#### 7.2.2.2 MNSS\_BEGIN\_IND

Receipt of a REGISTER message, a signalling transaction is established for the provision of call independent supplementary services. The indication of a supplementary service invocation may be included.

#### 7.2.2.3 MNSS\_FACILITY\_REQ

Request to send a FACILITY message for the provision of a call independent supplementary service facility.

#### 7.2.2.4 MNSS\_FACILITY\_IND

Receipt of a FACILITY message, a supplementary service facility has been requested.

#### 7.2.2.5 MNSS\_END\_REQ

Request to send a RELEASE COMPLETE message in order to release the signalling transaction by sending a RELEASE COMPLETE message. The request for transfer of a supplementary service facility may be included.

#### 7.2.2.6 MNSS\_END\_IND

Indication that the signalling transaction has been released after receipt of a RELEASE COMPLETE message. The indication of a supplementary service facility may be included.

### 7.3 Short Message Services Support

The service provided by the CM sublayer to support the short message service are defined in 3GPP TS 24.011 [8].

### 7.4 Services provided to SNDCP and SMS entities by GPRS Logical Link Control services

This clause is informative, the service primitives are defined in 3GPP TS 44.064 [11a]. They are included here to provide a complete overview of the radio interface protocol architecture.

On the network side, Logical Link Control services are provided at the QoS1-SAP - QoS4 SAP towards the SNDCP and at the LLSMS-SAP towards SMS.

#### 7.4.1 Service state diagram for QoS1-SAP, QoS2-SAP, QoS3-SAP and QoS4-SAP

The service state diagram is identical on the network side is identical to the one shown in figure 6.7 for the mobile side.

## 7.4.2 Service primitives for QoS1-SAP, QoS2-SAP, QoS3-SAP and QoS4-SAP

PRIMITIVE	PARAMETER (message, info elements of message, other parameters)	REFERENCE
LL-ESTABLISH-REQ	TLLI, SNDCP requested parameters (XID)	7.4.2.1
LL-ESTABLISH-CNF	TLLI, SNDCP negotiated parameters (XID), N201	7.4.2.2
LL-ESTABLISH-IND	TLLI, SNDCP requested parameters (XID), N201	7.4.2.3
LL-ESTABLISH-RSP	TLLI, SNDCP negotiated parameters (XID)	7.4.2.4
LL-RELEASE-REQ	TLLI	7.4.2.5
LL-RELEASE-CNF	TLLI	7.4.2.6
LL-RELEASE-IND	TLLI	7.4.2.7
LL-XID-REQ	TLLI, SNDCP requested parameters (XID)	7.4.2.8
LL-XID-IND	TLLI, SNDCP requested parameters (XID), N201	7.4.2.9
LL-XID-RSP	TLLI, SNDCP negotiated parameters (XID)	7.4.2.10
LL-XID-CNF	TLLI, SNDCP negotiated parameters (XID), N201	7.4.2.11
LL-DATA-REQ	TLLI, N-PDU, local reference	7.4.2.12
LL-DATASENT-IND	TLLI, local reference, V(S)	7.4.2.13
LL-DATA-CNF	TLLI, local reference	7.4.2.14
LL-DATA-IND	TLLI, N-PDU	7.4.2.15
LL-UNITDATA-REQ	TLLI, N-PDU, protect, cipher	7.4.2.16
LL-UNITDATA-IND	TLLI, N-PDU	7.4.2.17
LL-STATUS-IND	TLLI, cause	7.4.2.18

### 7.4.2.1 LL-ESTABLISH-REQ

A LLC SABM frame will be sent to establish the LLC ABM mode.

### 7.4.2.2 LL-ESTABLISH-CNF

A LLC UA frame is received, the LLC ABM mode has been established.

### 7.4.2.3 LL-ESTABLISH-IND

A LLC SABM frame is received.

### 7.4.2.4 LL-ESTABLISH-RSP

A LLC UA frame will be sent, the ABM mode is established.

### 7.4.2.5 LL-RELEASE-REQ

A LLC DISC frame will be sent to change to LLC ADM mode.

### 7.4.2.6 LL-RELEASE-CNF

The LLC link has been disconnected, LLC is in ADM mode.

### 7.4.2.7 LL-RELEASE-IND

LLC is in idle mode.

### 7.4.2.8 LL-XID-REQ

An LLC XID frame will be sent.

#### 7.4.2.9 LL-XID-IND

An LLC XID frame is received.

#### 7.4.2.10 LL-XID-RSP

An LLC XID frame will be sent as a reply to a received XID frame.

#### 7.4.2.11 LL-XID-CNF

An LLC XID frame has been received as a reply to a sent XID frame.

#### 7.4.2.12 LL-DATA-REQ

An LLC I frame will be sent to the peer entity.

#### 7.4.2.13 LL-DATASENT-IND

The sent LLC frame was sent with the V(S) indicated.

#### 7.4.2.14 LL-DATA-CNF

Successful reception of an LLC I frame has been acknowledged by the peer entity.

#### 7.4.2.15 LL-DATA-IND

An LLC I frame has been received from the peer entity.

#### 7.4.2.16 LL-UNITDATA-REQ

An LLC UI frame will be sent to the peer entity.

#### 7.4.2.17 LL-UNITDATA-IND

An LLC UI frame has been received from the peer entity.

#### 7.4.2.18 LL-STATUS-IND

Indication used by LLC to transfer LLC failures to the SNDCP sublayer. The failure may also be caused due to errors at the RLC/MAC layer.

## 7.5 Session Management Services for GPRS and MBMS

On the network side Session Management Services are provided at the SNSM-SAP and SMREG-SAP. At the SMREG-SAP, the assumption taken is that the MS initiated primary and secondary PDP context activation, the MS initiated PDP context modification and deactivation, and the MBMS context activation and deactivation are not visible, i.e. the service for these functions on the network side stops in the SM sublayer entity.

## 7.5.1 Session Management Services for SMREG-SAP

**Table 7.5.1: Primitives and Parameters at SMREG-SAP - network side**

PRIMITIVE	PARAMETER (message, info elements of message, other parameters)	REFERENCE
SMREG-PDP-ACTIVATE-REQ	PDP address, APN, protocol configuration options	7.5.1.1
SMREG-PDP-ACTIVATE-REJ	Cause, PDP address, APN, protocol configuration options	7.5.1.2
SMREG-PDP-DEACTIVATE-REQ	NSAPI(s), teardown indicator, cause, protocol configuration options, MBMS protocol configuration options	7.5.1.3
SMREG-PDP-DEACTIVATE-CNF	NSAPI(s), protocol configuration options, MBMS protocol configuration options	7.5.1.4
SMREG-PDP-MODIFY-REQ	QoS, NSAPI, protocol configuration options	7.5.1.5
SMREG PDP-MODIFY-CNF	NSAPI, protocol configuration options	7.5.1.6
SMREG PDP-MODIFY-REJ	NSAPI, protocol configuration options	7.5.1.7
SMREG-MBMS-ACTIVATE-REQ	Multicast address, APN, MBMS protocol configuration options	7.5.1.8
SMREG-MBMS-ACTIVATE-REJ	Cause, multicast address, APN, MBMS protocol configuration options	7.5.1.9

### 7.5.1.1 SMREG-PDP-ACTIVATE-REQ

The network initiates a PDP context activation. SM is requested to send the REQUEST PDP CONTEXT ACTIVATION message to the MS. The PDP context is pending activation. The network expects that the MS continues with a normal MS initiated PDP context activation. Therefore, at the SMREG-SAP no confirmation is provided.

### 7.5.1.2 SMREG-PDP-ACTIVATE-REJ

The network initiated PDP context activation failed. Either the REQUEST PDP CONTEXT ACTIVATION REJECT message was received from the MS, or lower layer failure or timer expiry caused abortion of the PDP context activation procedure.

### 7.5.1.3 SMREG-PDP-DEACTIVATE-REQ

The network initiates a PDP or MBMS context deactivation. SM is requested to send a DEACTIVATE PDP CONTEXT REQUEST message. The PDP context is pending deactivation. Presence of the teardown indicator will lead to deactivation of all PDP contexts coupled to the identified PDP address. NSAPI(s) to be deallocated from the SNDSCP entity via the SNSM-SAP for the GSM case, are included in the primitive.

### 7.5.1.4 SMREG-PDP-DEACTIVATE-CNF

The network initiated PDP or MBMS context deactivation has been concluded. The MS confirmed the PDP context deactivation, i.e. the DEACTIVATE PDP CONTEXT ACCEPT message was received. Then SM ordered SNDSCP to locally release LLC link(s) not further needed for the GSM case. In the UMTS case, release of affected GTP-U tunnel(s) towards the RNC has taken place. The PDP context is deactivated.

### 7.5.1.5 SMREG-PDP-MODIFY-REQ

The network initiates a modification of the PDP context. SM is requested to send a MODIFY PDP CONTEXT REQUEST message to the MS. The PDP context is pending modification.

### 7.5.1.6 SMREG-PDP-MODIFY-CNF

The PDP context modification has been concluded. The MS confirmed the PDP context modification, i.e. the MODIFY PDP CONTEXT ACCEPT message was received. Then, for the GSM case, SM ordered SNDSCP to adjust the affected LLC link as required. For the UMTS case, RAB properties were updated as required. The PDP context is modified.

### 7.5.1.7 SMREG-PDP-MODIFY-REJ

The PDP context modification has been rejected. Due to timer expiry or lower layer failure the modification procedure has been aborted.

### 7.5.1.8 SMREG-MBMS-ACTIVATE-REQ

The network initiates an MBMS context activation. SM is requested to send the REQUEST MBMS CONTEXT ACTIVATION message to the MS. The MBMS context is pending activation. The network expects that the MS continues with the MBMS context activation. Therefore, at the SMREG-SAP no confirmation is provided.

### 7.5.1.9 SMREG-MBMS-ACTIVATE-REJ

The network initiated MBMS context activation failed. Either the REQUEST MBMS CONTEXT REJECT message was received from the MS, or lower layer failure or timer expiry caused abortion of the MBMS context activation procedure.

## 7.5.2 Session Management Services for SNSM-SAP

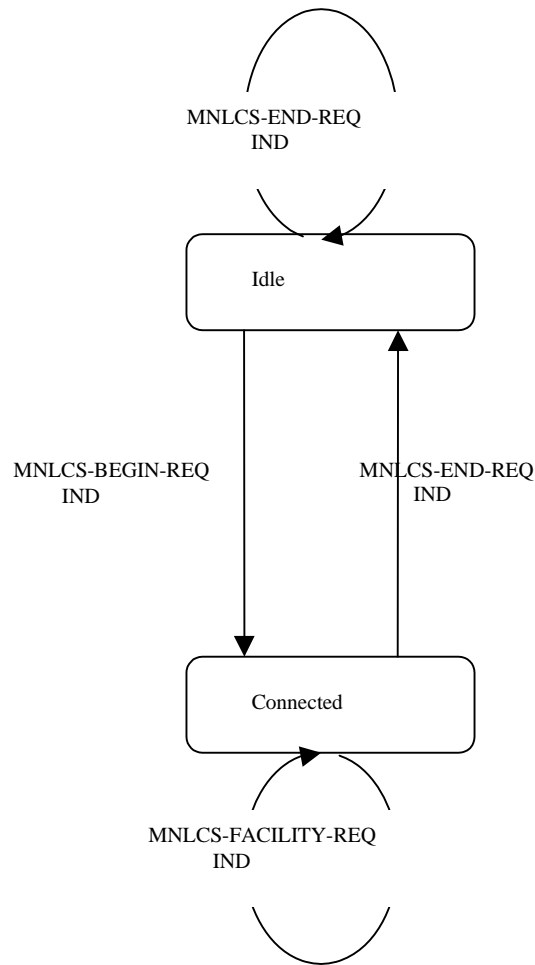
The SNSM-SAP service primitives are defined in 3GPP TS 44.065 [12a].

## 7.6 Location services at the Network side

The location services (e.g. network initiation of timing related measurements in a type A LMU) are provided at the service access point MNLCS-SAP. The service provided by the CM sublayer to support the location services is defined in 3GPP TS 44.071 [8a] (for communication with a type A LMU only).

### 7.6.1 Service state diagram

The primitives provided by the call independent Location Services Support entity and the transitions between permitted states are shown in the service graph of figure 7.6 below.



STATES:  
 IDLE - No LCS signalling transaction pending.  
 CONN - LCS signalling transaction established.

Figure 7.6: Service graph of the Location Services Support entity - Network side

### 7.6.2 Service primitives

Table 7.6: Primitives and Parameters at MNLCS-SAP - Network side

PRIMITIVES	PARAMETERS (Info elements of message)	REFERENCE
MNLCS_BEGIN_REQ	REGISTER	7.6.2.1
MNLCS_BEGIN_IND	REGISTER	7.6.2.2
MNLCS_FACILITY_REQ	FACILITY	7.6.2.3
MNLCS_FACILITY_IND	FACILITY	7.6.2.4
MNLCS_END_REQ	RELEASE COMPLETE	7.6.2.5
MNLCS_END_IND	RELEASE COMPLETE	7.6.2.6

#### 7.6.2.1 MNLCS\_BEGIN\_REQ

Request to send a REGISTER message in order to establish a signalling transaction for the provision of location services. The request for a location service invocation may be included.

### 7.6.2.2 MNLCS\_BEGIN\_IND

Receipt of a REGISTER message, a signalling transaction is established for the provision of location services. The indication of a location service invocation may be included.

### 7.6.2.3 MNLCS\_FACILITY\_REQ

Request to send a FACILITY message for the provision of a location service facility.

### 7.6.2.4 MNLCS\_FACILITY\_IND

Receipt of a FACILITY message, a location service facility has been requested.

### 7.6.2.5 MNLCS\_END\_REQ

Request to send a RELEASE COMPLETE message in order to release the signalling transaction by sending a RELEASE COMPLETE message. The request for transfer of a location service facility may be included.

### 7.6.2.6 MNLCS\_END\_IND

Indication that the signalling transaction has been released after receipt of a RELEASE COMPLETE message. The indication of a location service facility may be included.

---

## 8 Services assumed from signalling layers 1 and 2

The services provided by layer 2 are defined in detail in 3GPP TS 44.005 [4]. A short summary is given below.

In addition, layer 1 communicates directly with layer 3 for information transfer related to channel management and to measurement control. See subclause 8.5 below.

### 8.1 Priority

Messages from layer 3 can be sent with:

- no priority;
  - i.e. the messages are sent in first-in-first-out order;
- priority;
  - i.e. a message with this indication is sent as early as possible by layer 2.

### 8.2 Unacknowledged information transfer

Transfer of unacknowledged information using the primitives DL\_UNIT\_DATA\_REQUEST/INDICATION.

### 8.3 Acknowledged information transfer

Transfer of information in multiframe acknowledged mode including:

- establishment of data link connection between L3 entities;
- transfer of information in acknowledged mode;
- release of the data link connection.



The primitives associated with acknowledged information transfer are:

- DL\_ESTABLISH\_REQUEST/INDICATION/CONFIRM for establishment of acknowledged mode;
- DL\_DATA\_REQUEST/INDICATION for requesting the transmission of a message unit and for indicating the reception of a message unit;
- DL\_SUSPEND\_REQUEST/DL\_RELEASE\_CONFIRM for requesting and confirming the suspension of the acknowledged information transfer in the MS upon channel change;
- DL\_RESUME\_REQUEST/DL\_ESTABLISH\_CONFIRM for requesting and confirming the resumption of the acknowledged information transfer in the MS after suspension at channel change;
- DL\_RELEASE\_REQUEST/INDICATION/CONFIRM for the termination of acknowledged mode operation;
- DL\_RECONNECT\_REQUEST for requesting the re-establishment of acknowledged information transfer in the MS on the old channel after channel change failure.

## 8.4 Random access

The transmission/reception of a random access burst is controlled by the primitives DL\_RANDOM\_ACCESS\_REQUEST/INDICATION/CONFIRM.

## 8.5 Channel management and measurements

The management of channels, i.e. their activation, deactivation, configuration, deconfiguration, through-connection and disconnection is controlled by the RR sublayer in layer 3. The measurements performed by the physical layer are also controlled by the RR sublayer of layer 3 and they are reported to layer 3.

These functions use the primitives MPH\_INFORMATION\_REQUEST/INDICATION/CONFIRMATION.

---

# 9 Interlayer service interfaces on the MS side

In addition to the services described in this clause, the RR entity and MM entity also provide services to CM entities which do not belong to the functional blocks of CC, SMS, and SS. (For example, the RR entity provides service to Group Call and Broadcast Call entities.) These services are not further described in this clause.

## 9.1 Services provided by the Radio Resource Management entity

The Radio Resource Management (RR) sublayer provides a service to the Mobility Management entity (MM).

The RR services are used for:

- establishing control channel connections;
- releasing control channel connections;
- control-data transfer.

The Radio Resource Management services are represented by the RR-service primitives.

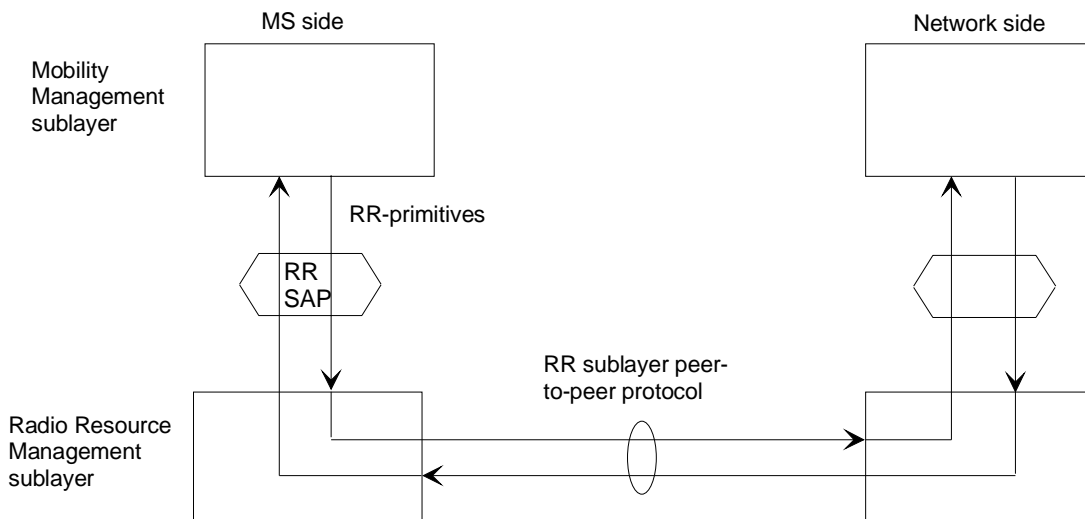


Figure 9.1: Services provided at RR-SAP - MS side

### 9.1.1 Service state diagram

The primitives provided by the Radio Resource Management entity and the transition between permitted states are shown in figure 9.2.

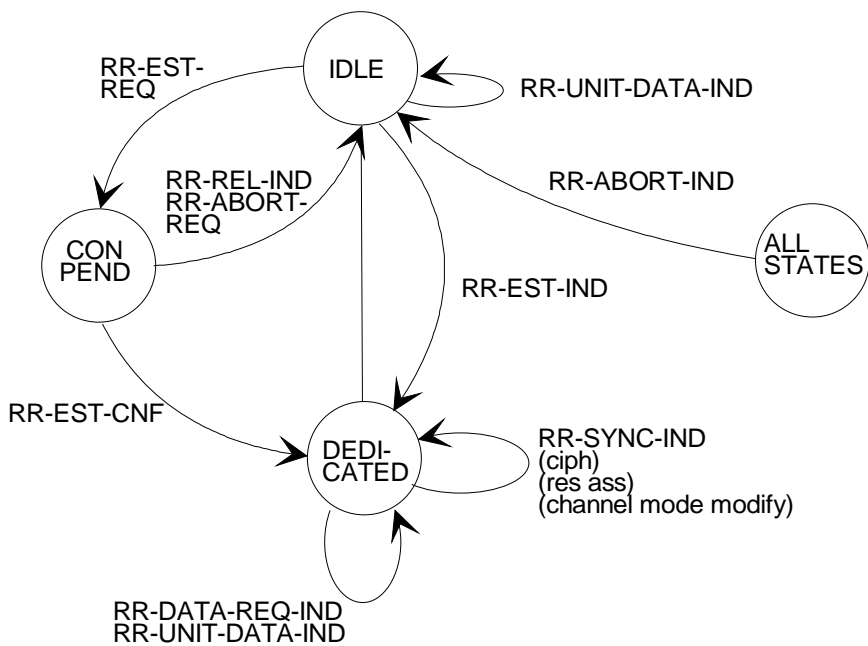


Figure 9.2: Service graph of the Radio Resource Management - MS side

## 9.1.2 Service primitives

**Table 9.1: Primitives and parameters at the RR-SAP - MS side**

PRIMITIVES	PARAMETERS	REFERENCE
RR_EST_REQ	Layer 3 message transferred in the SABM frame, CN domain identity	9.1.2.1
RR_EST_IND	-	9.1.2.2
RR_EST_CNF	-	9.1.2.3
RR_REL_IND	cause	9.1.2.4
RR_SYNC_IND	cause (ciphering, res. ass., channel mode modify), list of (RAB ID, NAS Synchronization Indicator, maximum data rate)	9.1.2.5
RR_DATA_REQ	Layer 3 message, local flow identifier CN domain identity	9.1.2.6
RR_DATA_IND	Layer 3 message, CN domain identity	9.1.2.7
RR_UNIT_DATA_IND	Layer 3 message	9.1.2.8
RR_ABORT_REQ	cause	9.1.2.9
RR_ABORT_IND	cause	9.1.2.10
RR_ACT_REQ	reselection mode	9.1.2.11

### 9.1.2.1 RR\_EST\_REQ

In A/Gb mode it is used by the Mobility Management entity to request establishment of a Mobile originated RR connection.

The request shall be given only in the IDLE state when the MS listens to the CCCH and the previously selected BCCH.

In Iu mode it is used by the Mobility Management entity to request the establishment of a signalling connection to the CN domain type given in the parameter CN domain identity. The request shall be given only if no signalling connection to the specific CN domain type is established.

### 9.1.2.2 RR\_EST\_IND

Indicates to the Mobility Management entity the establishment of a Mobile terminated RR connection. By this indication MM is informed that a transparent connection exists and RR is in the dedicated mode.

### 9.1.2.3 RR\_EST\_CNF

Is used by RR to indicate the successful completion of a Mobile originated RR connection establishment. RR connection exists and RR is in the dedicated mode.

### 9.1.2.4 RR\_REL\_IND

Is used by RR to indicate to the Mobility Management entity the release of a RR connection when RR has received a CHANNEL RELEASE from the Network and has triggered a normal release of the data link layer. It is also used to indicate that a requested RR connection cannot be established. In both cases, RR returns to IDLE mode.

### 9.1.2.5 RR\_SYNC\_IND

Is used for synchronizing RR and the Mobility Management entity after the establishment of a Mobile originated or Mobile terminated RR connection. This indication is provided to MM in the following cases:

- ciphering has been started (ciphering);
- integrity protection has been started (integrity) (UMTS only);
- a traffic channel has been assigned (res. ass. = "resource assigned");
- the channel mode has been modified (channel mode modify).

In Iu mode, in case of a resource assignment or channel mode modification, RR indicates to the Mobility Management entity the list of RAB IDs and, optionally,

- the NAS Synchronization Indicators associated with the assigned or modified radio bearers; or
- the maximum data rate (at RLC layer) associated with the assigned or modified radio bearers, if no NAS Synchronization Indicator is available.

### 9.1.2.5a Void

### 9.1.2.5b Void

### 9.1.2.6 RR\_DATA\_REQ

Is used by the Mobility Management entity to send control data to its peer entity on the Network side via an existing RR connection.

### 9.1.2.7 RR\_DATA\_IND

Is used by RR to indicate control-data, which has been received from its peer entity on the Network side via an existing RR connection.

For UMTS, RR\_DATA\_IND is also used to indicate whether control-data has been:

- successfully integrity checked;
- unsuccessfully integrity checked;
- received with no integrity protection.

### 9.1.2.7a Void

### 9.1.2.8 RR\_UNIT\_DATA\_IND

Is used by RR to provide MM with system info. The system info is received on the current BCCH if RR is in the IDLE state. If a RR connection has been established, the system info is received on the SACCH.

### 9.1.2.9 RR\_ABORT\_REQ

Request to abort an existing RR connection or a RR connection in progress. The data link, if already established, shall be released by a normal release procedure (DISC/UA) initiated by the MS. This is the only way the MS can trigger the release of a RR connection in case of exceptional conditions. The RR returns to the IDLE state.

### 9.1.2.10 RR\_ABORT\_IND

Indication that the RR connection has been aborted by a lower layer failure and RR has returned to the IDLE state.

### 9.1.3 Services provided by the Radio Resource Management entity for CTS

Inside the RR sub-layer, the CTS Radio Resource Management (CTS-RR) sublayer provides services to the CTS Mobility Management (CTS-MM) entity.

The CTS-RR services are used for:

- alive check.

The CTS Radio Resource Management services are represented by the CTS-RR-service primitives.

**Table 9.1.3: Primitives and parameters at the RR-SAP - MS side for CTS**

PRIMITIVES	PARAMETERS	REFERENCE
CTS_RR_ALIVE_CHECK_IND	-	9.1.3.1

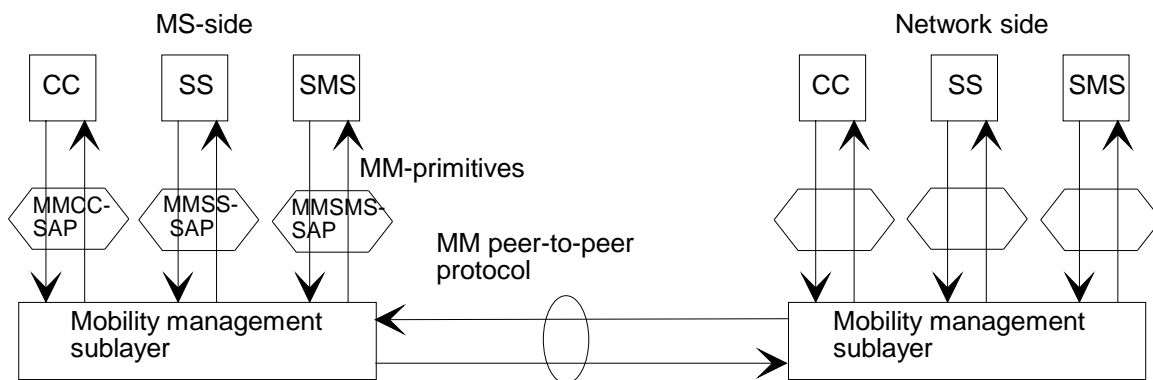
#### 9.1.3.1 CTS\_RR\_ALIVE\_CHECK\_IND

Indicates to the CTS Mobility Management entity that an alive check request has been received from the fixed part.

## 9.2 Services provided by the Mobility Management entity

The Mobility Management (MM) sublayer provides services to the Call Control (CC) entity, the Supplementary Services Support (SS) entity, the Location Services (LCS) entity (only for type A LMU) and the Short Message Service Support (SMS) entity.

The Mobility Management services primitives are discriminated by the MMCC, MMSS, MMLCS and MMSMS prefix.

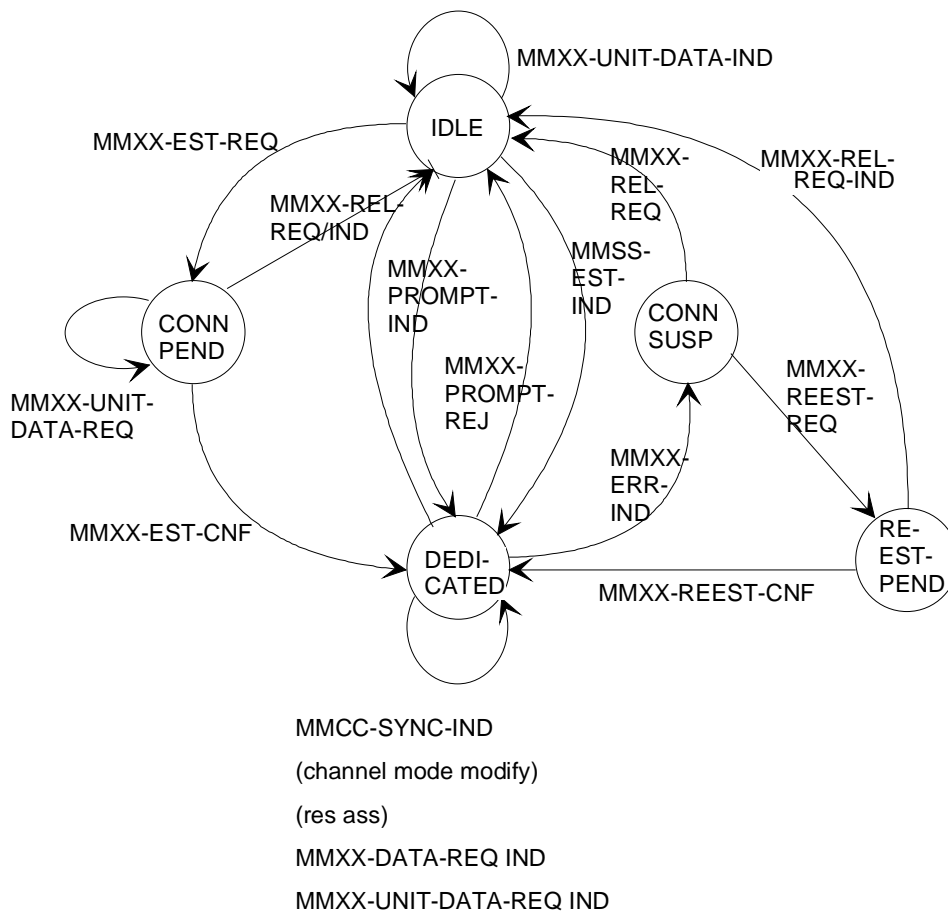


NOTE: The LCS protocol entities for communication between a type A LMU and the network would be included in the figure in the same manner as the protocol entities for CC, SS and SMS.

**Figure 9.3: Services provided at the MMCC-SAP, MMSS-SAP, MMLCS-SAP, MMSMS-SAP - MS side**

### 9.2.1 Service state diagram

The primitives provided by the Mobility Management entity towards Call Control, call independent Supplementary Service Support, Location Services Support for type A LMU and towards Short Messages Service Support and the transition between permitted states are illustrated in figure 9.4.



NOTE 1: MMCC-primitives only at MMCC-SAP.

NOTE 2: The prefix MMXX is used for substitution of MMCC, MMSS, MMLCS or MMSMS.

**Figure 9.4: Service graph of the Mobility Management entity - MS side**

## 9.2.2 Service primitives

**Table 9.2: Primitives and Parameters at MMCC-SAP, MMSS-SAP (for type A LMU), MMLCS-SAP or MMSMS-SAP - MS side**

PRIMITIVES	PARAMETERS	REFERENCE
MMXX_EST_REQ (see note 1)	Parameters for the appropriate CM SERVICE REQUEST (if any)	9.2.2.1
MMXX_EST_IND (see note 1)	First CM message	9.2.2.2
MMXX_EST_CNF (see note 1)	-	9.2.2.3
MMXX_REL_REQ (see note 1)	cause	9.2.2.4
MMXX_REL_IND (see note 1)	cause	9.2.2.5
MMXX_DATA_REQ (see note 1)	Layer 3 message	9.2.2.6
MMXX_DATA_IND (see note 1)	Layer 3 message	9.2.2.7
MMXX_UNIT_DATA_REQ (see note 1)	Layer 3 message	9.2.2.8
MMXX_UNIT_DATA_IND (see note 1)	Layer 3 message	9.2.2.9
MMCC_SYNC_IND (see note 2)	cause: res.ass; list of (RAB ID, NAS Synchronization Indicator, maximum data rate)	9.2.2.10
MMXX_REEST_REQ (see note 1)		9.2.2.11
MMXX_REEST_CNF (see note 1)		9.2.2.12
MMXX_ERR_IND (see note 1)	cause	9.2.2.13
MMXX_PROMPT_IND (see note 1)	-	9.2.2.14
MMXX_PROMPT_REJ (see note 1)	-	9.2.2.15
NOTE 1: MMXX is used as substitution for MMCC, MMSS, MMLCS or MMSMS.		
NOTE 2: Only at MMCC-SAP.		

### 9.2.2.1 MMXX\_EST\_REQ

Request used by CC, SS, LCS (for type A LMU) and SMS respectively, to request establishment of a MM connection. Several MM connections may be provided in parallel to the requesting entities. The primitive may contain parameters which are relevant for the CM SERVICE REQUEST message, e.g. to distinguish a basic call from an emergency call.

### 9.2.2.2 MMXX\_EST\_IND

Indication to CC, SS, LCS (for type A LMU) or SMS that a Mobile terminated MM connection has been established and the first message has been received from the respective peer entity. Several MM connections may be provided in parallel. If a MM connection already exists, a new MM connection using the same RR connection is indicated by this primitive if MM detects a message with a new combination of Protocol Discriminator (PD) and Transaction Identifier (TI).

### 9.2.2.3 MMXX\_EST\_CNF

Successful confirmation of the MM connection establishment by the MM sublayer to be given to the appropriate entity which has requested the service.

### 9.2.2.4 MMXX\_REL\_REQ

Used by CC, SS, LCS (for type A LMU) or SMS respectively, to request release of the MM connection. The corresponding PD/TI will be released and may be used for a new MM connection.

### 9.2.2.5 MMXX\_REL\_IND

Indication of the release of an existing MM connection or a MM connection in progress. This primitive is used in exceptional cases to indicate that the MM connection cannot be established or kept any longer and PD/TI have been released.

### 9.2.2.6 MMXX\_DATA\_REQ

Request used by the CC, SS or SMS entities for acknowledged control-data transmission.

### 9.2.2.7 MMXX\_DATA\_IND

Indication used by MM to transfer the received acknowledged control-data to the CC, SS, LCS (for type A LMU) or SMS entities.

### 9.2.2.8 MMXX\_UNIT\_DATA\_REQ

Request used by the CC, SS, LCS (for type A LMU) or SMS entities for unacknowledged control-data transmission.

### 9.2.2.9 MMXX\_UNIT\_DATA\_IND

Indication used by MM to transfer the received unacknowledged control-data to the CC, SS, LCS or SMS entities.

### 9.2.2.10 MMCC\_SYNC\_IND

Indication that a dedicated channel assignment has been performed and/or the channel mode has been changed (only towards the CC entity).

In Iu mode, MM indicates the list of the RAB IDs and, optionally,

- the NAS Synchronization Indicators associated with the assigned or modified radio bearers; or
- the maximum data rate (at RLC layer) associated with the assigned or modified radio bearers, if no NAS Synchronization Indicator is available.

During a network-initiated in-call modification the CC entity uses the NAS Synchronization Indicator or the maximum data rate to determine whether a suitable channel for the new call mode is available.

### 9.2.2.11 MMXX\_REEST\_REQ

Request to establish a MM connection which has been interrupted by a lower layer failure. The interruption must have been indicated by MMXX\_ERR\_IND.

### 9.2.2.12 MMXX\_REEST\_CNF

Confirmation of the successful re-establishment of the MM connection. The MM connection will continue with PD/TI as it had before.

### 9.2.2.13 MMXX\_ERR\_IND

Indication of a lower layer failure interrupting the MM connection. The PD/TI are still kept by MM. In case of parallel transactions this indication is passed to all CM entities for which a MM connection has been established. It is left to the decision of the appropriate CM entity to either request the re-establishment of the MM connection by MMXX\_REEST\_REQ or to release it by MMXX\_REL\_REQ.

### 9.2.2.14 MMXX\_PROMPT\_IND

Indication given by MM to inform of the completion of the MM connection to the CC, SS, LCS (for type A LMU) or SMS entities for a mobile station which supports "Network Initiated MO CM Connection Request".

### 9.2.2.15 MMXX\_PROMPT\_REJ

Response to the MMXX\_PROMPT\_IND indication to the MM entity in a mobile station which supports "Network Initiated MO CM Connection Request" in case when it is impossible to establish the prompted CM connection e.g. due to lack of free transaction identifiers.



## 9.3 Services provided by radio resource management entity for GPRS services

The service primitives for UMTS are defined in the present document. The services provided by the Access Stratum (AS) are specified in 3GPP TS 23.110 [20].

### 9.3.1 Service primitives for GRR-SAP (GSM only)

The GRR-SAP service primitives are defined in 3GPP TS 44.064 [11a]

[[Table 9.3.1, and chapters 9.3.1.1 - 9.3.1.5 are Void]

### 9.3.2 Service primitives for GMMRR-SAP (GSM only)

**Table 9.3.2: Primitives and Parameters at GMMRR-SAP - MS side**

PRIMITIVE	PARAMETER (message, info elements of message, other parameters)	REFERENCE
GMMRR-ASSIGN-REQ	newTLLI	9.3.2.1
GMMRR-PAGE-IND	TLLI	9.3.2.2

#### 9.3.2.1 GMMRR-ASSIGN-REQ

A new TLLI is assigned to the RR sublayer.

#### 9.3.2.2 GMMRR-PAGE-IND

A RR-paging message has been received by the RR sublayer.

### 9.3.3 Service primitives for RABMAS-SAP (UMTS only)

**Table 9.3.3: Primitives and parameters at RABMAS-SAP**

PRIMITIVE	PARAMETER (message, info elements of message, other parameters)	REFERENCE
RABMAS-RAB-ESTABLISH-IND	RAB ID list	9.3.3.1
RABMAS-RAB-ESTABLISH-RES	-	9.3.3.2
RABMAS-RAB-ESTABLISH-REJ	-	9.3.3.3
RABMAS-RAB-RELEASE-IND	RAB ID list	9.3.3.4
RABMAS-RAB-RELEASE-RES	-	9.3.3.5
RABMAS-STATUS-IND	Cause	9.3.3.6

#### 9.3.3.1 RABMAS-RAB-ESTABLISH-IND

Indication from the Access Stratum layer that radio access bearer setup for the indicated list of RAB IDs (contains NSAPI) has commenced.

#### 9.3.3.2 RABMAS-RAB-ESTABLISH-RES

Response (to RABMAS-RAB-ESTABLISH-IND) used by the RABM entity to inform the Access Stratum sublayer that the indicated NSAPI (in RAB ID) is currently or has been activated by the SM.

### 9.3.3.3 RABMAS-RAB-ESTABLISH-REJ

Response (to RABMAS-RAB-ESTABLISH-IND) used by the RABM entity to inform the Access Stratum sublayer that all of the NSAPIs, indicated by RAB ID list in the received RABMAS-RAB-ESTABLISH-IND, have not been activated by the SM-layer and the attempt to setup the radio access bearers shall be rejected.

### 9.3.3.4 RABMAS-RAB-RELEASE-IND

Indication from the Access Stratum layer that a radio access bearer for the indicated NSAPI has been released.

### 9.3.3.5 RABMAS-RAB-RELEASE-RES

Response used by the RABM entity to inform the Access Stratum sublayer that the indicated RAB ID has been released in the RABM.

### 9.3.3.6 RABMAS-STATUS-IND

Indication used by the AS sublayer to transfer failures to the RABM.

## 9.3.4 Service primitives for GMMAS-SAP (UMTS only)

**Table 9.3.4: Service primitives and parameters at GMMAS-SAP - MS side**

PRIMITIVE	PARAMETER (message, info elements of message, other parameters)	REFERENCE
GMMAS-SECURITY-IND		9.3.4.1
GMMAS-SECURITY-RES	CK, IK	9.3.4.2
GMMAS- ESTABLISH-REQ	Layer 3-PDU, Establishment cause, Priority, CN Domain Identity, MS Identity, LAI/RAI	9.3.4.3
GMMAS- ESTABLISH-CNF		9.3.4.4
GMMAS- ESTABLISH-REJ		9.3.4.5
GMMAS- RELEASE-REQ	CN Domain identity	9.3.4.6
GMMAS- RELEASE-IND	Cause	9.3.4.7
GMMAS- DATA-REQ	Layer 3-PDU, Priority, CN Domain identity	9.3.4.8
GMMAS- DATA-IND	Layer 3-PDU	9.3.4.9
GMMAS-PAGE-IND	MS Identity type, Paging Cause	9.3.4.10
GMMAS-STATUS-IND	Cause	9.3.4.11

#### 9.3.4.1 GMMAS-SECURITY-IND

Indication from the AS sublayer that ciphering (and integrity protection) shall be started. The GMM sublayer uses this primitive as an indication of the completion of the service request procedure.

#### 9.3.4.2 GMMAS-SECURITY-RES

Ciphering and integrity keys are assigned to the AS sublayer to enable ciphering (and integrity protection).

#### 9.3.4.3 GMMAS-ESTABLISH-REQ

To establish a signalling connection and to carry the initial Layer 3-PDU over the radio interface.

#### 9.3.4.4 GMMAS-ESTABLISH-CNF

Confirmation from the AS sublayer that a PS signalling connection has been established.

#### 9.3.4.5 GMMAS-ESTABLISH-REJ

The attempt to establish a PS signalling connection was rejected by the network.

#### 9.3.4.6 GMMAS- RELEASE-REQ

Request used by the MM-sublayer to request the release of the PS signalling connection.

#### 9.3.4.7 GMMAS- RELEASE-IND

Indication from the AS sublayer that the PS signalling connection has been released.

#### 9.3.4.8 GMMAS- DATA-REQ

Request used by the MM-sublayer for transfer of data.

#### 9.3.4.9 GMMAS- DATA-IND

Indication used by the AS sublayer to transfer received data to MM sublayer.

#### 9.3.4.10 GMMAS-PAGE-IND

A paging message has been received by the AS sublayer.

#### 9.3.4.11 GMMAS-STATUS-IND

Indication used by the AS sublayer to transfer failures to the MM sublayer.

## 9.4 Services provided by the LLC entity for GPRS services (GSM only)

This subclause is informative, the service primitives are defined in 3GPP TS 44.064 [11a]. They are included here to provide a complete overview of the radio interface protocol architecture.

### 9.4.1 Service primitives for LLGMM-SAP

**Table 9.4.1: Primitives and parameters at LLGMM-SAP - MS side**

PRIMITIVE	PARAMETER (message, info elements of message, other parameters)	REFERENCE
LLGMM-ASSIGN-REQ	oldTLLI, newTLLI, Kc, RAND, Ciphering Algorithm	9.4.1.1
LLGMM-TRIGGER-REQ	Cause	9.4.1.2
LLGMM-SUSPEND-REQ	TLLI	9.4.1.4
LLGMM-RESUME-REQ	TLLI	9.4.1.5
LL-UNITDATA-REQ	TLLI, GMM-PDU, protect, cipher	9.4.1.8
LL-UNITDATA-IND	TLLI, GMM-PDU, cipher	9.4.1.9
LLGMM-STATUS-IND	TLLI, cause	9.4.1.10

#### 9.4.1.1 LLGMM-ASSIGN-REQ

A new TLLI and/or a ciphering key and/or a ciphering algorithm is assigned to the LLC sublayer.

#### 9.4.1.2 LLGMM-TRIGGER-REQ

Request to send an LLC PDU to the network. Cause indicates if the primitive is sent to trigger an implicit page response.

9.4.1.3 Void

9.4.1.4 LLGMM-SUSPEND-REQ

All LLC links in ABM mode will cease sending PDUs. GMM messages can still be sent and received.

9.4.1.5 Void

9.4.1.6 Void

9.4.1.7 LLGMM-WINDOW-CNF

The actual LLC's V(R)s for each LLC link in ABM mode are transferred to GMM.

9.4.1.8 LL-UNITDATA-REQ

Request to send a GMM message in unacknowledged mode to the peer entity.

9.4.1.9 LL-UNITDATA-IND

A GMM message in unacknowledged mode has been received from the peer entity.

9.4.1.10 LLGMM-STATUS-IND

Indication used by LLC to transfer LLC failures to the GMM sublayer. The failure may also be caused due to errors at the RLC/MAC layer.

## 9.4.2 Service primitives for LLSMS-SAP

**Table 9.4.2: Service primitives and parameters at LLSMS-SAP - MS side**

PRIMITIVE	PARAMETER (message, info elements of message, other parameters)	REFERENCE
LL-UNITDATA-REQ	TLLI, SMS-CP-PDU, protect, cipher	9.4.2.1
LL-UNITDATA-IND	TLLI, SMS-CP-PDU,	9.4.2.2

9.4.2.1 LL-UNITDATA-REQ

An LLC UI frame will be sent to the peer entity.

9.4.2.2 LL-UNITDATA-IND

An LLC UI frame has been received from the peer entity.

## 9.5 Services provided by the GMM for GPRS services

The GPRS Mobility Management (GMM) sublayer provides services to the Session Management (SM) entity, Supplementary Service (SS) entity and the Short Message Service Support (GSMS) entity for message transfer.

### 9.5.1 Service primitives for GMMSM-SAP

Session Management services may request GPRS service registration or perform procedures needed to activate a multicast service before activating a PDP or an MBMS context.

**Table 9.5.1: Primitives and parameters at GMMSM-SAP - MS side**

PRIMITIVE	PARAMETER (message, info elements of message, other parameters)	REFERENCE
GMMSM-ESTABLISH-REQ	-	9.5.1.1
GMMSM-ESTABLISH-CNF	-	9.5.1.2
GMMSM-ESTABLISH-REJ	cause	9.5.1.3
GMMSM-RELEASE-IND	-	9.5.1.4
GMMSM-UNITDATA-REQ	SM-PDU	9.5.1.5
GMMSM-UNITDATA-IND	SM-PDU	9.5.1.6

### 9.5.1.1 GMMSM-ESTABLISH-REQ

Request from Session Management to send an ATTACH REQUEST message to the network to setup a GMM connection. The request is only performed in case the MS is not already attached. The GPRS attach is then indirectly caused by a request from Session Management, e.g. a requested PDP context activation or MBMS context activation.

### 9.5.1.2 GMMSM-ESTABLISH-CNF

The network has send the ATTACH ACCEPT message to the MS, the indirect attach was successful. Now, Session Management can proceed with the Session Management request, e.g. the PDP context activation or the MBMS context activation..

### 9.5.1.3 GMMSM-ESTABLISH-REJ

The network has rejected the attach. The MS has received the ATTACH REJECT message.

### 9.5.1.4 GMMSM-RELEASE-IND

The GPRS Mobility Management informs the Session Management that the MS has been GPRS detached, e.g. by timer expiry, and therefore, the PDP context(s) and the MBMS context(s), if any, are not valid anymore.

### 9.5.1.5 GMMSM-UNITDATA-REQ

The GMM is requested to forward a SM PDU to LLC in order to send it in unacknowledged mode to the peer entity.

### 9.5.1.6 GMMSM-UNITDATA-IND

The GMM forwards a SM PDU, which has been received in unacknowledged mode via LLC from the peer entity.

## 9.5.2 Void

## 9.5.3 Service primitives for GMMSMS-SAP

The Short Message entity may request from the GMM entity the GMM IMSI registration state before an MO SMS transmission is initiated.

**Table 9.5.3: Primitives and parameters at GMMSMS-SAP - MS side**

PRIMITIVE	PARAMETER (message, info elements of message, other parameters)	REFERENCE
GMMSMS-REG-STATE-REQ	-	9.5.3.1
GMMSM- REG-STATE -RSP	Registration state	9.5.3.2

### 9.5.3.1 GMMSMS-REG-STATE-REQ

Request for the current IMSI registration state from the Short Message entity.

### 9.5.3.2 GMMSM- REG-STATE -RSP

The current IMSI registration state is sent to the Short Message entity.

## 9.5.4 Service primitives for PMMSMS-SAP

**Table 9.5.4: Primitives and Parameters at PMMSMS-SAP - MS side**

PRIMITIVES	PARAMETERS (message, info elements of message, other parameters)	REFERENCE
PMMSMS_EST_REQ	Mobile-ID	9.5.4.1
PMMSMS_EST_CNF	-	9.5.4.2
PMMSMS_ERROR_IND	Cause	9.5.4.3
PMMSMS_UNITDATA_REQ	SMS-PDU	9.5.4.4
PMMSMS_UNITDATA_IND	SMS-PDU	9.5.4.5

### 9.5.4.1 PMMSMS\_EST\_REQ

The GMM is requested to establish a PS signalling connection.

### 9.5.4.2 PMMSMS\_EST\_CNF

The GMM indicates a PS signalling connection is established.

### 9.5.4.3 PMMSMS\_ERROR\_IND

The GMM indicates that a PS signalling connection has been released.

### 9.5.4.4 PMMSMS\_UNITDATA\_REQ

The GMM is requested to forward a SMS PDU in order to send it to the peer entity.

### 9.5.4.5 PMMSMS\_UNITDATA\_IND

Indication used by GMM to transfer the received data to the GSMS entities.

## 9.5.5 Service primitives for GMMRABM-SAP (UMTS only)

**Table 9.5.5: Service primitives and parameters at GMMRABM-SAP – MS side**

PRIMITIVE	PARAMETER (message, info elements of message, other parameters)	REFERENCE
GMMRABM-REESTABLISH-REQ		9.5.5.1
GMMRABM-REESTABLISH-RSP		9.5.5.2
GMMRABM-REESTABLISH-REJ	Cause	9.5.5.3

NOTE: Confirmation to the RABMGMM-REESTABLISH-REQ is given to the RABM in the form of indications from the AS sublayer that establishment of RABs has commenced or been completed.

### 9.5.5.1 GMMRABM-REESTABLISH-REQ

This primitive is used by the RABM entity to inform the GMM sublayer that UL user data has been received for an NSAPI without an active RAB. GMM shall initiate a service request procedure to re-establish the RAB for the NSAPI(S).

### 9.5.5.2 GMMRABM-REESTABLISH-RSP

This primitive is used by the GMM sublayer to inform the RABM entity that the reception of the Service Request message has been acknowledged by the network.

### 9.5.5.3 GMMRABM-REESTABLISH-REJ

This primitive is used by the GMM sublayer to inform the RABM entity that the re-establishment of RABs by the service request procedure has failed.

## 9.5.6 Service primitives for GMMSS-SAP

Supplementary Services may request GPRS service registration before sending SS PDU.

**Table 9.5.6: Primitives and parameters at GMMSS-SAP - MS side**

PRIMITIVE	PARAMETER (message, info elements of message, other parameters)	REFERENCE
GMMSS-ESTABLISH-REQ	-	9.5.6.1
GMMSS-ESTABLISH-CNF	-	9.5.6.2
GMMSS-ESTABLISH-REJ	cause	9.5.6.3
GMMSS-RELEASE-IND	-	9.5.6.4
GMMSS-UNITDATA-REQ	SS-PDU	9.5.6.5
GMMSS-UNITDATA-IND	SS-PDU	9.5.6.6

### 9.5.6.1 GMMSS-ESTABLISH-REQ

Request from Supplementary Services to send an ATTACH REQUEST message to the network to setup a GMM connection. The request is only performed in case the MS is not already attached. The GPRS attach is then indirectly caused by a sending of SS PDU.

### 9.5.6.2 GMMSS-ESTABLISH-CNF

The network has send the ATTACH ACCEPT message to the MS, the indirect attach was successful. Now Supplementary Services can proceed with sending SS PDU.

### 9.5.6.3 GMMSS-ESTABLISH-REJ

The network has rejected the attach. The MS has received the ATTACH REJECT message.

### 9.5.6.4 GMMSS-RELEASE-IND

The GPRS mobility management informs the Supplementary Services that the MS has been GPRS detached, e.g. by timer expiry.

### 9.5.6.5 GMMSS-UNITDATA-REQ

The GMM is requested to forward a SS PDU to lower layer in order to send it to the peer entity.

### 9.5.6.6 GMMSS-UNITDATA-IND

The GMM forwards a SS PDU, which has been received from the peer entity.

## 9.5.7 Service primitives for GMMSS2-SAP

The Supplementary Service entity may request to the MM and/or GMM entity the MM and/or GMM IMSI registration state before an SS PDU transmission is initiated from the mobile station.

**Table 9.5.7: Primitives and parameters at GMMSS2-SAP - MS side**

PRIMITIVE	PARAMETER (message, info elements of message, other parameters)	REFERENCE
GMMSS2-REG-STATE-REQ	-	9.5.7.1
GMMSS2- REG-STATE -RSP	Registration state	9.5.7.2

### 9.5.7.1 GMMSS2-REG-STATE-REQ

Request for the current IMSI registration state from the Supplementary Services entity.

### 9.5.7.2 GMM SS2- REG-STATE -RSP

The current IMSI registration state is sent to the Supplementary Services entity.

---

## 10 Interlayer service interfaces on the Network side

In addition to the services described in this clause, the RR entity and MM entity also provide services to CM entities which do not belong to the functional blocks of CC, SMS, and SS. (For example, the RR entity provides service to Group Call Control and Broadcast Call Control entities.) These services are not further described in this clause.

### 10.1 Services provided by the Radio Resource Management entity

The Radio Resource Management (RR) sublayer provides services to the Mobility Management entity (MM).

The RR services are used for:

- establishing control channel connections;
- establishing traffic channel connections;
- ciphering mode indication;
- releasing control channel connections;
- control-data transfer.

The Radio Resource Management services are represented by the RR service primitives.



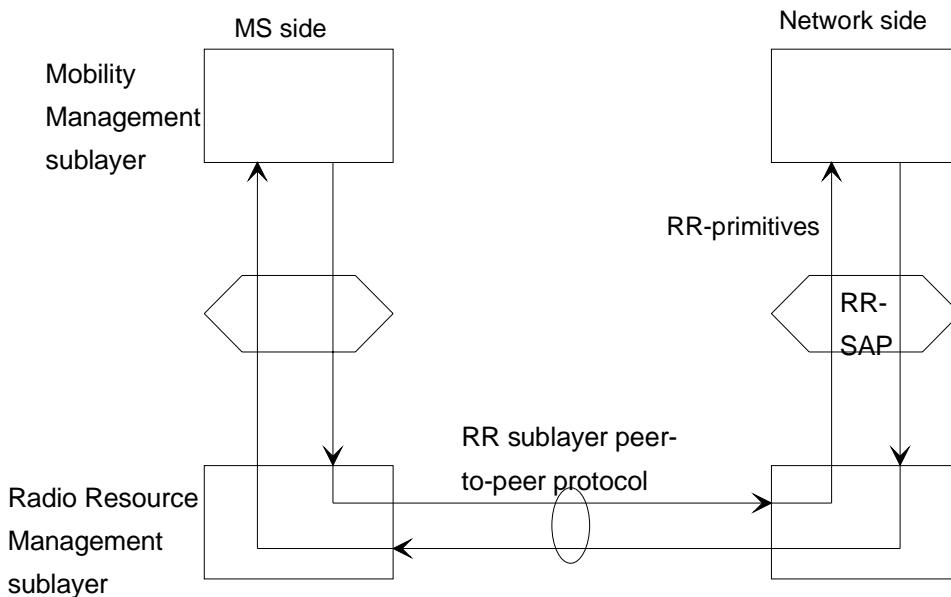
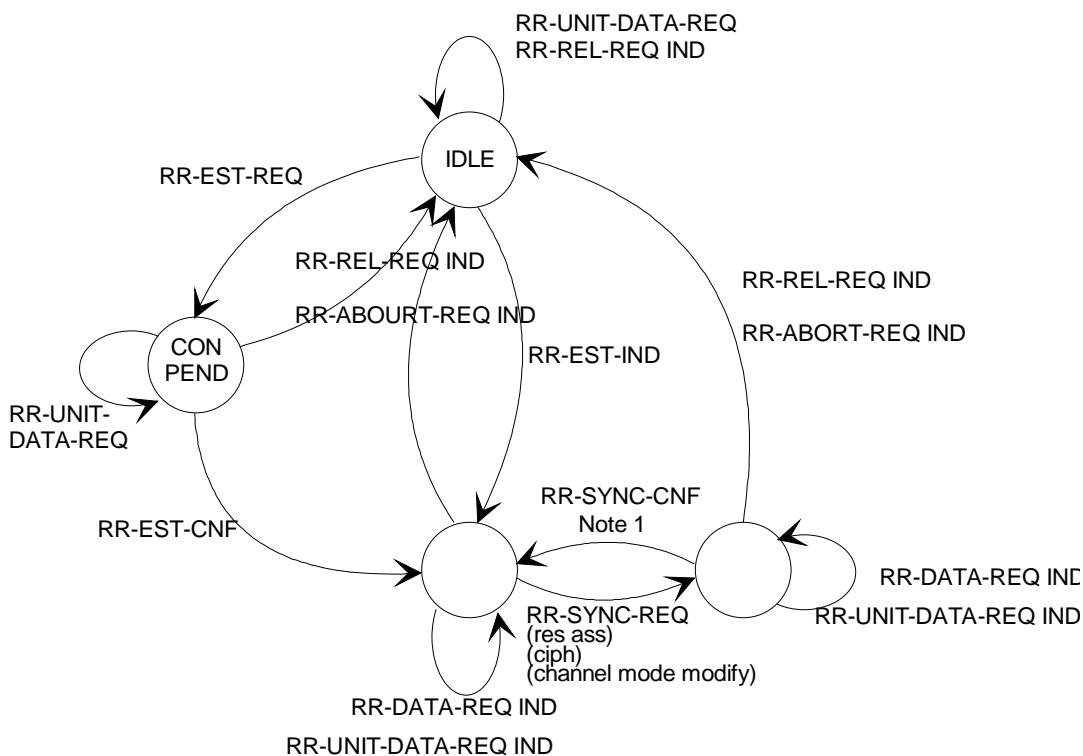


Figure 10.1: Services provided at RR-SAP - Network side

### 10.1.1 Service state diagram

The primitives provided by the Radio Resource Management entity and the transition between permitted states are shown in figure 10.2.



- STATES:
- IDLE: - No dedicated channel established.
  - CONPEND: - Connection pending.
  - DT1: - Data transfer 1, dedicated channel established.
  - DT2: - Data transfer 2, dedicated channel established, ciphering mode set.

Figure 10.2: Service graph of the Radio Resource Management entity - Network side

## 10.1.2 Service primitives

**Table 10.1: Primitives and Parameters at the RR-SAP - Network side**

PRIMITIVES	PARAMETERS	REFERENCE
RR_EST_REQ	Parameters for the Initial layer 3 message	10.1.2.1
RR_EST_IND	Initial layer 3 message	10.1.2.2
RR_EST_CNF	-	10.1.2.3
RR_REL_REQ	cause	10.1.2.4
RR_REL_IND	cause	10.1.2.5
RR_SYNC_REQ	cause (resource assign, ciphering, channel mode modify), list of (RAB ID, NAS Synchronization Indicator)	10.1.2.6
RR_SYNC_CNF	cause (resource assign, ciphering)	10.1.2.7
RR_DATA_REQ	Layer 3 message	10.1.2.8
RR_DATA_IND	Layer 3 message	10.1.2.9
RR_UNIT_DATA_REQ	Layer 3 message	10.1.2.10
RR_UNIT_DATA_IND	Layer 3 message	10.1.2.11
RR_ABORT_REQ	cause	10.1.2.12
RR_ABORT_IND	cause	10.1.2.13

### 10.1.2.1 RR\_EST\_REQ

Request used by the Mobility Management entity to request establishment of control channel connections.

### 10.1.2.2 RR\_EST\_IND

Indication to the Mobility Management entity that the establishment of control channel connections has been done.

### 10.1.2.3 RR\_EST\_CNF

Confirmation used by RR to confirm the establishment of a requested control channel connection.

### 10.1.2.4 RR\_REL\_REQ

Request used by the Mobility Management to release a control channel connection.

### 10.1.2.5 RR\_REL\_IND

Indication from RR to MM that the main signalling link has been released.

### 10.1.2.6 RR\_SYNC\_REQ

Request used by the Mobility Management entity for synchronization with the RR protocol.

In Iu mode, in case of resource assignment or channel mode modification, Mobility Management includes the list of the RAB IDs and, optionally, the NAS Synchronization Indicators associated with the radio bearers to be assigned or modified.

### 10.1.2.7 RR\_SYNC\_CNF

Confirmation used by RR that the requested synchronization is done.

### 10.1.2.8 RR\_DATA\_REQ

Request used by the Mobility Management entity for acknowledged control-data transmission.

### 10.1.2.9 RR\_DATA\_IND

Indication used by RR to transfer received control-data, which should be acknowledged, to the Mobility Management entity.

### 10.1.2.10 RR\_UNIT\_DATA\_REQ

Request used by the Mobility Management entity for unacknowledged control-data transmission.

### 10.1.2.11 RR\_UNIT\_DATA\_IND

Indication used by RR to transfer received control-data, which should not be acknowledged, to the Mobility Management entity.

### 10.1.2.12 RR\_ABORT\_REQ

Request of the abandon of the RR connection.

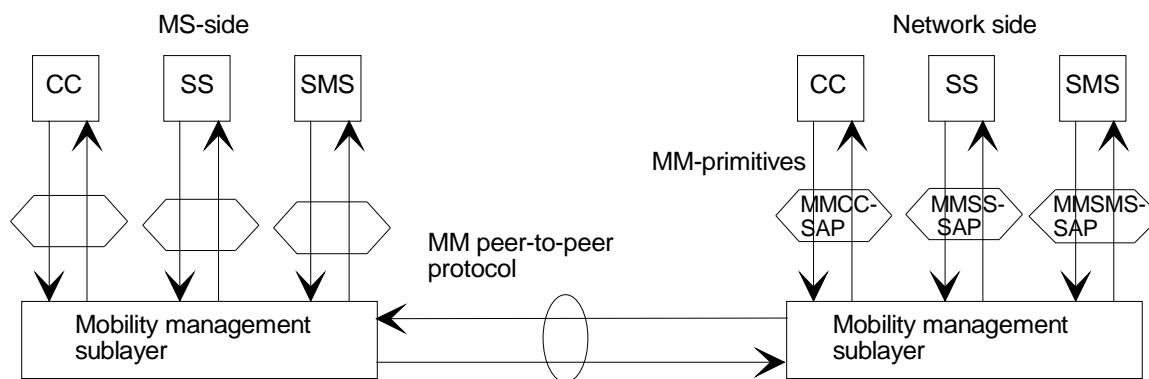
### 10.1.2.13 RR\_ABORT\_IND

Indication that a radio link failure has occurred.

## 10.2 Services provided by the Mobility Management entity

The Mobility Management (MM) sublayer provides services to the Call Control (CC) entity, the Supplementary Service Support (SS) entity, the Location Services (LCS) (for type A LMU) and the Short Message Service Support (SMS) entity.

The Mobility Management services primitives are recognized by the MMCC, MMSS, MMLCS and MMSMS prefix.

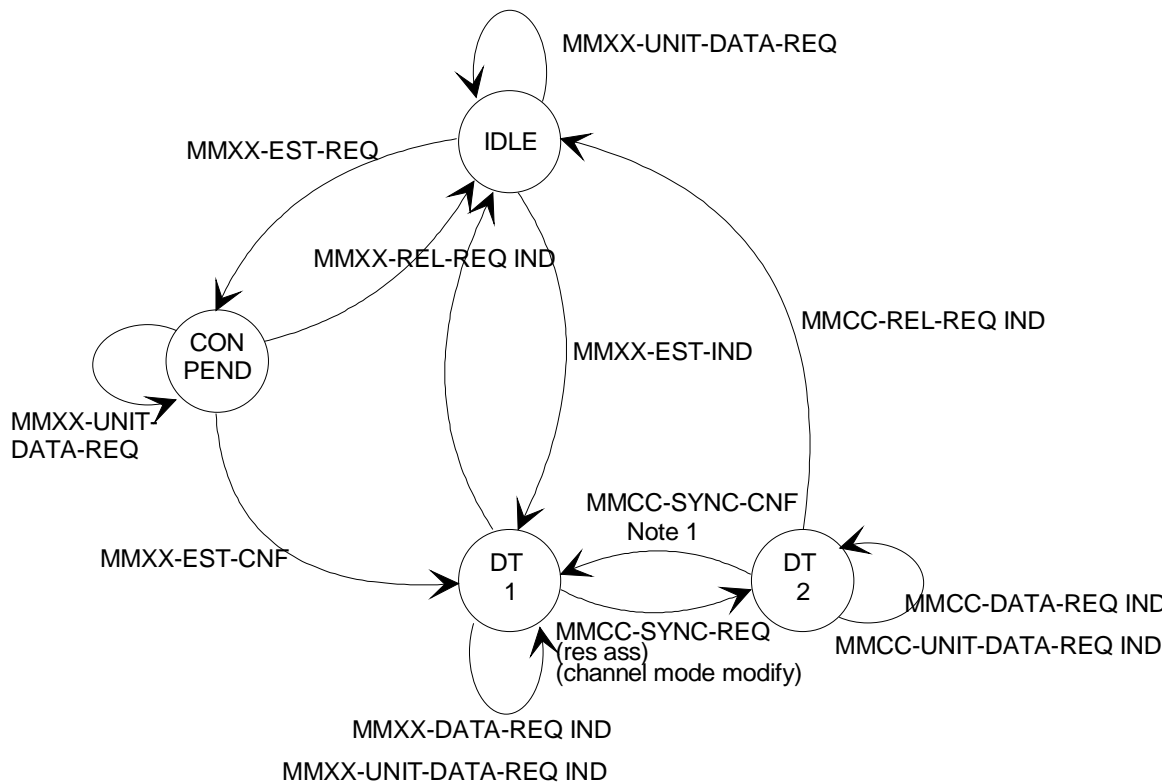


NOTE: The LCS protocol entities for communication between a type A LMU and the network would be included in the figure in the same manner as the protocol entities for CC, SS and SMS.

**Figure 10.3: Services provided at MMCC-SAP, MMSS-SAP, MMLCS-SAP, MMSMS-SAP - Network side**

### 10.2.1 Service state diagram

The primitives provided by the Mobility Management entity towards Call Control, Short Messages Service Support, Location Services Support (for a type A LMU) and call independent Supplementary Services Support as well as the transition between permitted states are illustrated in figure 10.4.



NOTE 1: the parameters in RR\_SYNC\_CNF must correspond to the parameter in RR\_SYNC\_REQ.  
 NOTE 2: MMCC-primitives only at MMCC-SAP.  
 NOTE 3: The prefix MMXX is used for substitution of MMCC, MMSS, MMLCS (for type A LMU) or MMSMS.

Figure 10.4: Service graph of the Mobility Management entity, towards Call Control - Network side

### 10.2.2 Service primitives

Table 10.2: Primitives and Parameters at MMCC-SAP, MMSS-SAP, MMLCS-SAP, MMSMS-SAP - Network side

PRIMITIVES	PARAMETERS	REFERENCE
MMXX_EST_REQ (see note 1)	Mobile ID	10.2.2.1
MMXX_EST_IND (see note 1)	First CM message	10.2.2.2
MMXX_EST_CNF (see note 1)	-	10.2.2.3
MMXX_REL_REQ (see note 1)	cause	10.2.2.4
MMXX_REL_IND (see note 1)	cause	10.2.2.5
MMXX_DATA_REQ (see note 1)	Layer 3 message	10.2.2.6
MMXX_DATA_IND (see note 1)	Layer 3 message	10.2.2.7
MMXX_UNIT_DATA_REQ (see note 1)	Layer 3 message	10.2.2.8
MMXX_UNIT_DATA_IND (see note 1)	Layer 3 message	10.2.2.9
MMCC_SYNC_REQ (see note 2)	cause (resource assign), list of (RAB ID, NAS Synchronization Indicator)	10.2.2.10
MMCC_SYNC_CNF (see note 2)	cause (resource assign)	10.2.2.11
NOTE 1: MMXX is used as substitution for MMCC, MMSS, MMLCS (for type A LMU) or MMSMS.		
NOTE 2: Only at MMCC-SAP.		

#### 10.2.2.1 MMXX\_EST\_REQ

Request by CC, SS, LCS (for type A LMU) and SMS respectively, for the establishment of a MM connection.

#### 10.2.2.2 MMXX\_EST\_IND

Indication by the MM sublayer that a MM connection is established.

#### 10.2.2.3 MMXX\_EST\_CNF

Confirmation of the MM connection establishment by the MM sublayer.

#### 10.2.2.4 MMXX\_REL\_REQ

Request by CC, SS, LCS (for type A LMU) or SMS respectively, for the release of the MM connection.

#### 10.2.2.5 MMXX\_REL\_IND

Indication by the MM sublayer that a MM connection has been released.

#### 10.2.2.6 MMXX\_DATA\_REQ

Request by the CC, SS, LCS (for type A LMU) or SMS entities for acknowledged control-data transmission.

#### 10.2.2.7 MMXX\_DATA\_IND

Indication used by MM to transfer the received acknowledged control-data to the CC, SS, LCS (for type A LMU) or SMS entities.

#### 10.2.2.8 MMXX\_UNIT\_DATA\_REQ

Request used by the CC, SS, LCS (for type A LMU) or SMS entities for unacknowledged control-data transmission.

#### 10.2.2.9 MMXX\_UNIT\_DATA\_IND

Indication used by MM to transfer the received unacknowledged control-data to the CC, SS, LCS (for type A LMU) or SMS entities.

#### 10.2.2.10 MMCC\_SYNC\_REQ

Request used by the CC entity to synchronize with the MM entity (resource assign).

In Iu mode, the CC entity includes the list of the RAB IDs and, optionally, the NAS Synchronization Indicators associated with the requested radio bearers.

#### 10.2.2.11 MMCC\_SYNC\_CNF

Confirmation used by the MM to inform the CC entity that synchronization is completed (resource assign).

### 10.3 Services provided by radio resource management entity for GPRS services

#### 10.3.1 Service primitives for GRR-SAP

The GRR-SAP service primitives are defined in 3GPP TS 44.064 [11a]

[Table 10.3.1, and chapters 10.3.1.1 - 10.3.1.5 are Void]

## 10.3.2 Service primitives for GMMRR-SAP

**Table 10.3.2: Primitives and Parameters at GMMRR-SAP - network side**

PRIMITIVE	PARAMETER (message, info elements of message, other parameters)	REFERENCE
GMMRR-PAGE-REQ	TLLI, IMSI, CI or CI-list or RAI, priority	10.3.2.1

### 10.3.2.1 GMMRR-PAGE-REQ

Request by GMM to send a RR-paging message to the mobile station.

## 10.4 Services provided by the LLC entity for GPRS services

### 10.4.1 Service primitives for LLGMM-SAP

**Table 10.4.1: Primitives and Parameters at GRR-SAP - network side**

PRIMITIVE	PARAMETER (message, info elements of message, other parameters)	REFERENCE
LLGMM-ASSIGN-REQ	newTLLI, oldTLLI, Kc, Algorithm	10.4.1.1
LLGMM-SUSPEND-REQ	TLLI, page	10.4.1.3
LLGMM-RESUME-REQ	TLLI	10.4.1.4
LLGMM-PAGE-IND	TLLI	10.4.1.5
LLGMM-PAGE-RESP-IND	TLLI	10.4.1.6
LL-UNITDATA-REQ	TLLI, SMM-PDU, protect, cipher	10.4.1.9
LL-UNITDATA-IND	TLLI, SMM-PDU, cipher	10.4.1.10
LLGMM-STATUS-IND	TLLI, cause	10.4.1.11

#### 10.4.1.1 LLGMM-ASSIGN-REQ

A new TLLI and/or a ciphering key and/or a ciphering algorithm is assigned to the LL sublayer. Also an old TLLI can be unassigned.

#### 10.4.1.2 Void

#### 10.4.1.3 LLGMM-SUSPEND-REQ

All LLC links will cease sending PDUs. The parameter page indicates that data shall be sent if available and therefore paging shall be needed. Or the cause indicates that data shall not be sent until a RESUME-REQ is received.

#### 10.4.1.4 LLGMM-RESUME-REQ

Normal LLC frame sending and reception is possible again.

#### 10.4.1.5 Void

#### 10.4.1.6 Void

#### 10.4.1.7 LLGMM-PAGE-IND

Requires to send a paging message to the mobile station.

#### 10.4.1.8 LLGMM-PAGE-RESP-IND

A paging response has been received from the mobile.

#### 10.4.1.9 LL-UNITDATA-REQ

Request to send a SMM message in unacknowledged mode to the peer entity.

#### 10.4.1.10 LL-UNITDATA-IND

A SMM message in unacknowledged mode has been received from the peer entity.

#### 10.4.1.11 LLGMM-STATUS-IND

Indication used by LLC to transfer lower layer failures to the GMM sublayer.

### 10.4.2 Service primitives for LLSMS-SAP

**Table 10.4.2: Primitives and Parameters at LLSMS-SAP - network side**

PRIMITIVE	PARAMETER (message, info elements of message, other parameters)	REFERENCE
LL-UNITDATA-REQ	TLLI, SMS-CP-PDU, protect, cipher	10.4.2.1
LL-UNITDATA-IND	TLLI, SMS-CP-PDU	10.4.2.2

#### 10.4.2.1 LL-UNITDATA-REQ

An LLC UI frame will be sent to the peer entity.

#### 10.4.2.2 LL-UNITDATA-IND

An LLC UI frame has been received from the peer entity.

## 10.5 Services provided by the GMM for GPRS services

The GPRS Mobility Management (GMM) sublayer provides services to the Session Management (SM) entity and the Short Message Service Support (SMS) entity for message transfer.

### 10.5.1 Service primitives for GMMSM-SAP

**Table 10.5.1: Primitives and Parameters at GMMSM-SAP - network side**

PRIMITIVE	PARAMETER (message, info elements of message, other parameters)	REFERENCE
GMMSM-RELEASE-IND	-	10.5.1.1
GMMSM-UNITDATA-REQ	SM-PDU	10.5.1.2
GMMSM-UNITDATA-IND	SM-PDU	10.5.1.3

#### 10.5.1.1 GMMSM-RELEASE-IND

The GPRS mobility management informs the session management that the MS has been GPRS detached, e.g. by timer expiry, and therefore the PDP contexts are not valid anymore.

### 10.5.1.2 GMMSSM-UNITDATA-REQ

The GMM is requested to forward a SM PDU to LLC in order to send it in unacknowledged mode to the peer entity.

### 10.5.1.3 GMMSSM-UNITDATA-IND

The GMM forwards a SM PDU, which has been received in unacknowledged mode via LLC from the peer entity.

## 10.5.2 Service primitives for PMMSMS-SAP

**Table 10.5.2: Primitives and Parameters at PMMSMS-SAP - Network side**

PRIMITIVES	PARAMETERS (message, info elements of message, other parameters)	REFERENCE
PMMSMS_REL_REQ	-	10.5.2.1
PMMSMS_ERROR_IND	cause	10.5.2.2
PMMSMS_UNITDATA_REQ	SMS-PDU	10.5.2.3
PMMSMS_UNITDATA_IND	SMS-PDU	10.5.2.4

### 10.5.2.1 PMMSMS\_REL\_REQ

The GMM is requested to release of a PS signalling connection.

### 10.5.2.2 PMMSMS\_ERROR\_IND

The GMM indicates that a PS signalling connection has been released.

### 10.5.2.3 PMMSMS\_UNITDATA\_REQ

The GMM is requested to forward a SMS PDU in order to send to the peer entity.

### 10.5.2.4 PMMSMS\_UNITDATA\_IND

Indication used by GMM to transfer the received data to the GSMS entities.

## 10.5.3 Service primitives for GMMSS-SAP

**Table 10.5.3: Primitives and Parameters at GMMSS-SAP - network side**

PRIMITIVE	PARAMETER (message, info elements of message, other parameters)	REFERENCE
GMMSS-RELEASE-IND	-	10.5.3.1
GMMSS-UNITDATA-REQ	SS-PDU	10.5.3.2
GMMSS-UNITDATA-IND	SS-PDU	10.5.3.3

### 10.5.3.1 GMMSS-RELEASE-IND

The GPRS mobility management informs the Supplementary service that the MS has been GPRS detached, e.g. by timer expiry.

### 10.5.3.2 GMMSS-UNITDATA-REQ

The GMM is requested to forward a SS PDU to lower layer in order to send it to the peer entity.



### 10.5.3.3 GMMSS-UNITDATA-IND

The GMM forwards a SS PDU, which has been received from the peer entity.

## 10.6 Services provided by the Radio Resource Management entity for CTS on the fixed part

In addition to services described in subclause 10.1, the CTS Radio Resource Management (CTS-RR) inside the RR sublayer provides services to the CTS Mobility Management entity (CTS-MM).

The CTS-RR services are used for:

- alive check;
- hunting;
- group alerting.

The CTS Radio Resource Management services are represented by the CTS-RR service primitives.

### 10.6.1 Service primitives

**Table 10.6: Primitives and Parameters at the RR-SAP – Fixed part side**

PRIMITIVES	PARAMETERS	REFERENCE
RR_CTS_ALIVE_CHECK_REQ	CTSMSI	10.6.1.1
RR_CTS_ALIVE_CHECK_IND	Cause	10.6.1.2
RR_CTS_HUNTING_REQ	-	10.6.1.3
RR_CTS_GROUP_ALERTING_REQ	CTSMSI, display	10.6.1.4

#### 10.6.1.1 RR\_CTS\_ALIVE\_CHECK\_REQ

Request used by the CTS Mobility Management entity to request an alive check.

#### 10.6.1.2 RR\_CTS\_ALIVE\_CHECK\_IND

Indication to the CTS Mobility Management entity on the results of the alive check.

#### 10.6.1.3 RR\_CTS\_HUNTING\_REQ

Request to hunt the mobiles.

#### 10.6.1.4 RR\_CTS\_GROUP\_ALERTING\_REQ

Request to alert a group of mobiles.

---

# 11 L3 Messages

This clause specifies the generic methods used in the layer 3 protocol specifications to describe messages. It defines in particular a generic message structure, that of the "standard L3 messages". Not all messages in layer 3 protocols follow this structure, but many do, and this clause specifies how to interpret the standard description.

This clause also addresses basic aspects of the handling of messages received but not compliant with the allowed structure. In most cases, only the conditions that lead to the diagnosis of an error are described. The reaction of an entity receiving a message leading to such a diagnosis is in general specified for each protocol in the relevant protocol specification.

## 11.1 General

### 11.1.1 Messages

For all concerned protocols, concrete messages are bit strings of variable length, formally a succession of a finite, possibly null, number of bits (i.e., elements of the set {"0", "1"}), with a beginning and an end.

The services provided by lower layers includes the transmission of such bit strings.

Considered as messages, these bit strings follow some structure (the syntax), enabling to organize bits in information pieces of a different meaning level.

The term *message* is used as well for a concrete message (i.e., a bit-string, as defined by the giving of all its bits, in practice appearing at one point of time in a concrete dialog), as for a class of concrete messages sharing a common structure. A concrete message is an instance of the corresponding class of messages. Message classes can be described as sets of potential bit strings, and of a common structure, enabling in particular to identify parts meaningful for the co-operation functions the protocol supports.

In general, in the rest of the clause as in the protocol specifications, the term *message* will be used to refer to the class. It may be used, when the context prevents ambiguity, to refer to a message instance (e.g., a received is usually a message instance). In the rest of this clause, the term *message instance* will be used when needed to refer unambiguously to specific concrete message, i.e. to a specific bit string.

A message (message class) can be described directly as a set of bit strings, using the formal notation described in Annex B.

A message can also be described as a standard L3 message, in which case the interpretation of the message description in term of a set of bit strings is specified in the next sub-clauses.

In all cases, structuring messages is based on the underlying bit string. Thus, the following terms are used:

- a *part* of a message instance is a sub-string of the corresponding string; a part of a message (as a class) is described by a definition applicable to all instances; a part of a message then is both a structural attribute of the message as a class, and a set of sub-strings, composed of the sub-strings obtained by applying the definition to each possible instance; for instance, « the first octet » of a message instance is defined from the moment its length is greater than 8, and is the sub-string composed of the first 8 bits of the message instance; the « first octet » of a message as a class is the structural definition given above, and the set of all 8-bit octet strings that can be obtained as the first octet of one instance of the class;
- "part A *follows* part B" means that in the message the sub-string corresponding to part B is concatenated with the sub-string of part B;
- the *length* of a message instance, or of part of message instance, is the number of bits of the corresponding sub string; rigorously speaking, a message as a class (or a part seen as a class) has a length only if all the corresponding instances have the same length; by extension, sentences such as « a message as a length in the range so and so » means that the length of an instances of the class always fall in the range.

## 11.1.2 Octets

In many places, a message is described as a succession of octets. An octet is generally a succession of 8 bits. Unless otherwise indicated, the term octet is used more restrictively to refer to a part of message, defined when considering a message as a succession of octets, e.g., the first 8 bits of a message, or the 17<sup>th</sup> to the 23<sup>rd</sup>, form an octet, but not the second bit to the 9<sup>th</sup>.

Unless specified otherwise, the numbering conventions are the following:

- Octets in a message or in a part are numbered from 1 onward, starting at the beginning of the bit string. This numbering can be strictly applied only for message instances, and for the first part of a message structurally identical for all instances.
- Bits in octets are numbered from 8 down to 1, starting at the beginning of the octet.
- When represented as tables showing the different bit positions, octets are presented in the natural occidental order, i.e., from the top of a page downward. Bits in octets are presented with the first bit on the left of the page.

## 11.1.3 Integer

In many places, message parts are described as encoding integers. Two generic encoding are defined in this subclause.

### 11.1.3.1 Binary

A message part is said to encode in binary an integer to indicate that concrete strings are mapped, for some usage, on the set of non signed integers with the following rule:

- Let  $k$  denote the length of the bit string, and let  $b(i)$  denote an integer of value 0 if the  $i^{\text{th}}$  bit in the string is "0", and 1 otherwise. The encoded integer  $n$  respects the equation:

$$n = \sum_{i=1 \text{ to } k} b(i)2^{k-i-1}$$

### 11.1.3.2 2-complement binary

A message part is said to encode in 2-complement binary an integer to indicate that concrete strings are mapped, for some usage, on the set of signed integers with the following rule:

- Let  $k$  denote the length of the bit string, and let  $b(i)$  denote an integer of value 0 if the  $i^{\text{th}}$  bit in the string is "0", and 1 otherwise. The encoded integer  $n$  respects the equation:

$$\begin{aligned} \text{if } b(1) = 0 \text{ then } n &= \sum_{i=1 \text{ to } k} b(i)2^{k-i-1} \\ \text{else } n &= \sum_{i=1 \text{ to } k} b(i)2^{k-i-1} - 2^k \end{aligned}$$

## 11.1.4 Spare parts

In some cases the specification is that which message instances can be accepted by a receiver comprise more than the legal message instances that can be sent. One example of this is the notion of spare bit. A spare bit has to send as the value indicated in the specification (typically 0), but can be accepted as a 0 or a 1 by the receiver without error diagnosis. A spare field is a field composed entirely of spare bits.

## 11.2 Standard L3 messages

### 11.2.1 Components of a standard L3 message

A standard L3 message consists of an imperative part, itself composed of a header and the rest of imperative part, followed by a non-imperative part. Both the non-header part of the imperative part and the non-imperative part are composed of successive parts referred as standard information elements.

#### 11.2.1.1 Format of standard information elements

A standard IE may have the following parts, in that order:

- an information element identifier (IEI);
- a length indicator (LI);
- a value part.

A standard IE has one of the formats shown in table 11.1:

**Table 11.1: Formats of information elements**

Format	Meaning	IEI present	LI present	Value part present
T	Type only	yes	no	no
V	Value only	no	no	yes
TV	Type and Value	yes	no	yes
LV	Length and Value	no	yes	yes
TLV	Type, Length and Value	yes	yes	yes
LV-E	Length and Value	no	yes	yes
TLV-E	Type, Length and Value	yes	yes	yes

Some IEs may appear in the structure, but not in all instances of messages. An IE is then said to be present or not present in the message instance. If an IE is not present in a message instance, none of the three parts is present. Otherwise, parts must be present according to the IE format.

In the message structure, an IE that is allowed not to be present in all message instances is said not to be mandatory. Other IEs are said to be mandatory.

LV-E and TLV-E are used for 5GS Mobility Management (5GMM), 5GS Session Management (5GSM), EPS Mobility Management (EMM), EPS Session Management (ESM), GPRS Mobility Management (GMM) and GPRS Session Management (SM) only. In GPRS GMM and GPRS SM messages, IEs of format LV-E and TLV-E may be used only after MS and network have successfully negotiated support of such IEs.

#### 11.2.1.1.1 Information element type and value part

Every standard IE has an information element type which determines the values possible for the value part of the IE, and the basic meaning of the information. The information element type describes only the value part. Standard IEs of the same information element type may appear with different formats. The format used for a given standard IE in a given message is specified within the description of the message.

The value part of a standard IE either consists of a half octet or one or more octets; the value part of a standard IE with format LV or TLV consists of an integral number of octets, between 0 and 255 inclusive; it then may be empty, i.e., consist of zero octets; if it consists of a half octet and has format TV, its IEI consists of a half octet, too. For LV-E and TLV-E, the value part of a standard IE consists of an integral number of octets, between 0 and 65535 inclusive. The value part of a standard IE may be further structured into parts, called fields.

#### 11.2.1.1.2 Length indicator

For LV or TLV, the length indicator (LI) of a standard IE consists of one octet. For LV-E and TLV-E, the LI of a standard IE consists of two octets where bit 8 of octet n contains the most significant bit and bit 1 of octet n+1 contains the least significant bit (refer to figure 11.9 in subclause 11.2.1.1.4 for the relative ordering of the 2 octets). The LI

contains the binary encoding of the number of octets of the IE value part. The LI of a standard IE with empty value part indicates 0 octets. Standard IE of an information element type such that the possible values may have different values must be formatted with a length field, i.e., LV, TLV, LV-E or TLV-E.

### 11.2.1.1.3 Information element identifier

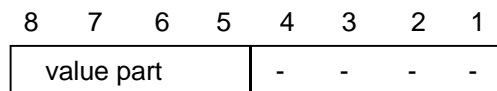
When present, the IEI of a standard IE consists of a half octet or one octet. A standard IE with IEI consisting of a half octet has format TV, and its value part consists of a half octet. The value of the IEI depends on the standard IE, not on its information element type. The IEI, if any, of a given standard IE in a given message is specified within the description of the message. In some protocol specifications, default IEI values can be indicated. They are to be used if not indicated in the message specification. Non mandatory standard IE in a given message, i.e., IE which may be not be present (formally, for which the null string is acceptable in the message), must be formatted with an IEI, i.e., with format T, TV, TLV or TLV-E.

### 11.2.1.1.4 Categories of IEs; order of occurrence of IEI, LI, and value part

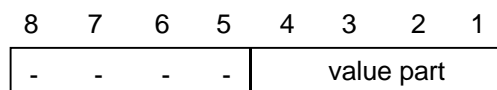
Totally four categories of standard information elements are defined:

- information elements of format V or TV with value part consisting of 1/2 octet (type 1);
- information elements of format T with value part consisting of 0 octets (type 2);
- information elements of format V or TV with value part that has fixed length of at least one octet (type 3);
- information elements of format LV or TLV with value part consisting of zero, one or more octets (type 4)
- information elements of format LV-E or TLV-E with value part consisting of zero, one or more octets and a maximum of 65535 octets (type 6). This category is used in 5GS, EPS and GPRS only.

Type 1 standard information elements of format V provide the value in bit positions 8, 7, 6, 5 of an octet (see figure 11.1) or bits 4, 3, 2, 1 of an octet (see figure 11.2).

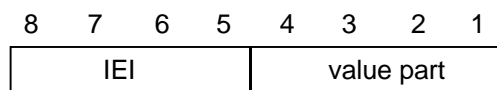


**Figure 11.1: Type 1 IE of format V**



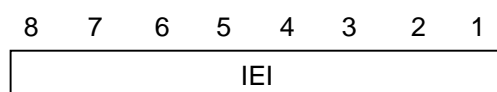
**Figure 11.2: Type 1 IE of format V**

Type 1 standard information elements of format TV have an IEI of a half octet length; they provide the IEI in bit positions 8, 7, 6, 5 of an octet and the value part in bit positions 4, 3, 2, 1 of the same octet, see figure 11.3.



**Figure 11.3: Type 1 IE of format TV**

A type 2 standard IE has format T; its IEI consists of one octet, its value part is empty, see figure 11.4.



**Figure 11.4: Type 2 IE**

A type 3 standard information element has format V or TV; if it has format TV, its IEI consists of one octet and proceeds the value part in the IE. The value part consists of at least one octet. See figure 11.5 and figure 11.6.

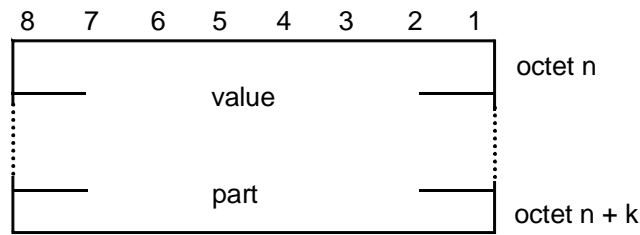


Figure 11.5: Type 3 IE of format V (k = 0, 1, 2, ...)

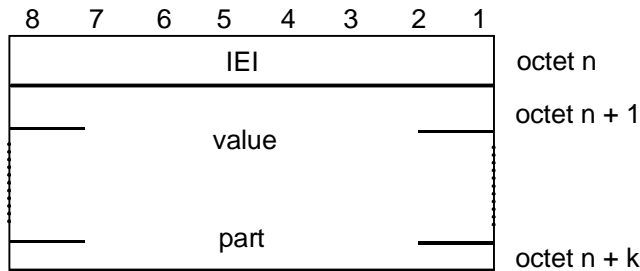


Figure 11.6: Type 3 IE of format TV (k = 1, 2, ...)

A type 4 standard information element has format LV or TLV. Its LI precedes the value part, which consists of zero, one, or more octets; if present, its IEI has one octet length and precedes the LI. See figure 11.7 and figure 11.8.

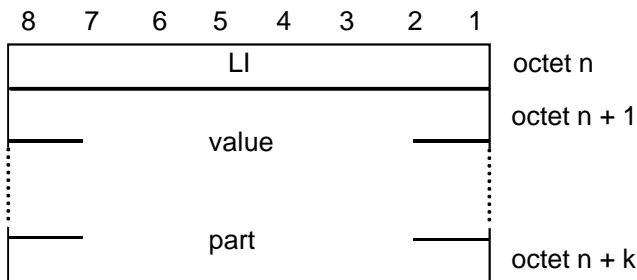


Figure 11.7: Type 4 IE of format LV (k = 0, 1, 2, ...)

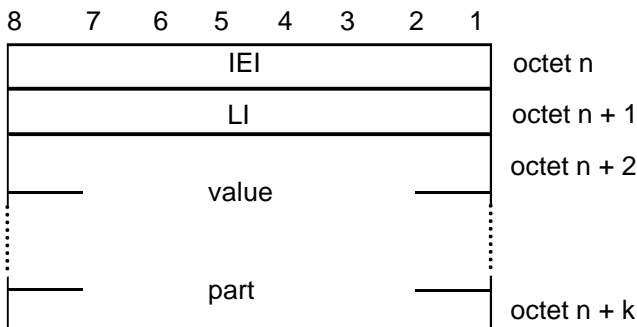


Figure 11.8: Type 4 IE of format TLV (k = 1, 2, ...)

A type 6 standard information element has format TLV-E. The IEI has one octet length and precedes the LI of 2 octets and the value part which consists of zero, one or up to 65535 octets. See figure 11.9 and figure 11.10.

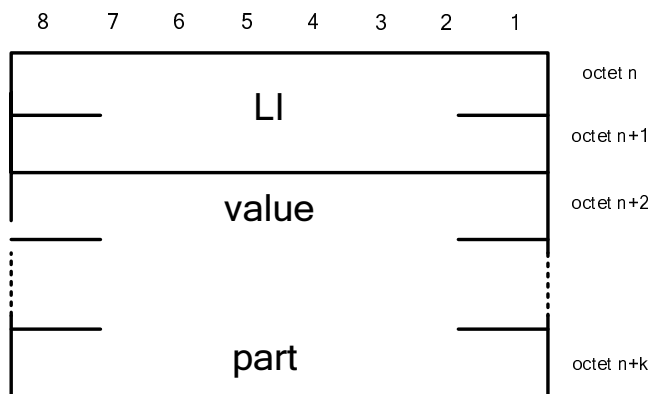


Figure 11.9: Type 6 IE of format LV-E (k = 1, 2, ...)

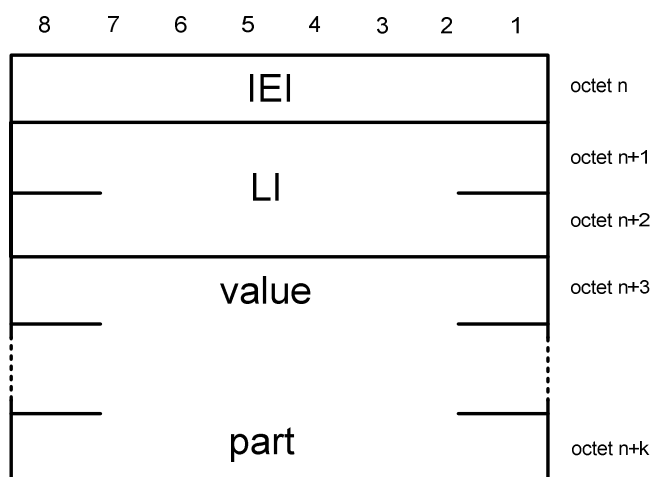


Figure 11. 10: Type 6 IE of format TLV-E (k = 1, 2, ...)

## 11.2.2 Description methods for IE structure

Standard IEs can be further structured in parts called fields. Two description methods are recommended and described hereafter.

### 11.2.2.1 Tables

According to this description method, the IE is presented in its maximum format, i.e., T, TV, TLV or TLV-E, in a picture representing the bits in a table, each line representing an octet. Bits appear in the occidental order, i.e., from left of the page to right of the page, and from top of the page to bottom of the page.

Boxes so delimited contains typically the field name, possibly an indication of which bits in the field are in the box, and possibly a value (e.g., for spare bits).

A specific method can be used in the IE description to describe a branching structure, i.e., a structure variable according to the value of particular fields in the IE. This design is unusual outside type 4 and type 6 IEs, and as, a design rule, should be used only in type 4 and type 6 IEs.

- a) The octet number of an octet within the IE is defined typically in the table. It consists of a positive integer, possibly of an additional letter, and possibly of an additional asterisk, see clause f). The positive integer identifies one octet or a group of octets.

- b) Each octet group is a self contained entity. The internal structure of an octet group may be defined in alternative ways.
- c) An octet group is formed by using some extension mechanism. The preferred extension mechanism is to extend an octet (N) through the next octet(s) (Na, Nb, etc.) by using bit 8 in each octet as an extension bit.
  - The bit value "0" indicates that the octet group continues through to the next octet. The bit value "1" indicates that this octet is the last octet of the group. If one octet (Nb) is present, the preceding octets (N and Na) shall also be present.
  - In the format descriptions of the individual information elements, bit 8 is marked "0/1 ext" if another octet follows. Bit 8 is marked "1 ext" if this is the last octet in the extension domain.
  - Additional octets may be defined in later versions of the protocols ("1 ext" changed to "0/1 ext") and equipments shall be prepared to receive such additional octets; the contents of these octets shall be ignored. However the length indicated in the formal description of the messages and of the individual information elements only takes into account this version of the protocols.
- d) In addition to the extension mechanism defined above, an octet (N) may be extended through the next octet(s) (N+1, N+2 etc.) by indications in bits 7-1 (of octet N).
- e) The mechanisms in c) and d) may be combined.
- f) Optional octets are marked with asterisks (\*). As a design rule, the presence or absence of an optional octet should be determinable from information in the IE and preceding the optional octet. Care should be taken not to introduce ambiguities with optional octets.
- g) At the end of the IE, additional octets may be added in later versions of the protocols also without using the mechanisms defined in c) and d). Equipments shall be prepared to receive such additional octets; the contents of these octets shall be ignored. However the length indicated in the formal description of the messages and of the individual information elements only takes into account this version of the protocols.

#### 11.2.2.1.1 Compact notation

The compact notation described in Annex B can be used to describe the value part of a standard IE. This method is recommended for complex structures, or for a branching structure not respecting octet boundaries.

### 11.2.3 Imperative part of a standard L3 message

The imperative part of a standard L3 message is composed of a header possibly followed by mandatory standard IEs having the format V, LV or LV-E.

#### 11.2.3.1 Standard L3 message header

For the MM, GMM, CC and SM protocols defined in 3GPP TS 24.008 [6], the header of a standard L3 message is composed of two octets, and structured in three main parts, the protocol discriminator (1/2 octet), a message type octet, and a half octet used in some cases as a Transaction Identifier, in some other cases as a sub-protocol discriminator, and called skip indicator otherwise.

For the EPS protocols EMM and ESM, a standard L3 message can be either a plain NAS message or a security protected NAS message:

- The header of a plain NAS message is composed of two or three octets, and structured in four main parts, the protocol discriminator (1/2 octet), a half octet used in some cases as security header type and in other cases as an EPS bearer identity (1/2 octet), a message type octet, and one octet included in some cases and used as a procedure transaction identity (PTI). If the procedure transaction identity is present, it is preceding the message type octet.
- The header of a security protected NAS message is composed of six octets, and structured in four main parts, the protocol discriminator (1/2 octet), a half octet used as security header type, a message authentication code of four octets, and a sequence number of one octet. This header is followed by a complete plain NAS message (i.e. including the header of this plain NAS message).



For the 5GS protocols 5GMM and 5GSM, a standard L3 message can be either a plain 5GS NAS message or a security protected 5GS NAS message:

- The header of a plain 5GS NAS message is composed of three octets for 5GMM NAS messages and composed of four octets for 5GSM NAS messages, and structured in four main parts, namely, the extended protocol discriminator (1 octet); an octet used as security header type (1/2 octet) plus a spare half octet in case of 5GMM NAS messages, and a PDU session identity of one octet in case of 5GSM NAS messages; an octet for procedure transaction identity (PTI) in case of 5GSM NAS messages; and one octet for message type. If the procedure transaction identity is present, it is preceding the message type octet.
- The header of a security protected 5GS NAS message is composed of seven octets, and structured in four main parts, the extended protocol discriminator (1 octet), an octet used as security header type (1/2 octet) plus a spare half octet, a message authentication code of four octets, and a sequence number of one octet. This header is followed by a complete plain 5GS NAS message (i.e. including the header of this plain 5GS NAS message).

### 11.2.3.1.1 Protocol discriminator

Bits 1 to 4 of the first octet of a standard L3 message contain the protocol discriminator (PD) information element. The PD (with exception of "extension of the PD to one octet length") identifies the L3 protocol to which the standard layer 3 message belongs. The correspondence between L3 protocols and PDs (with exception of "extension of the PD to one octet length") is one-to-one.

When the PD is set to "extension of the PD to one octet length", the first octet of a standard L3 message contains the extended protocol discriminator (EPD) information element as specified in subclause 11.2.3.1.1A.

The PD can take the following values:

**Table 11.2: Protocol discriminator values**

bits	4	3	2	1	
0	0	0	0	0	group call control
0	0	0	1		broadcast call control
0	0	1	0		EPS session management messages
0	0	1	1		call control; call related SS messages
0	1	0	0		GPRS Transparent Transport Protocol (GTP)
0	1	0	1		mobility management messages
0	1	1	0		radio resources management messages
0	1	1	1		EPS mobility management messages
1	0	0	0		GPRS mobility management messages
1	0	0	1		SMS messages
1	0	1	0		GPRS session management messages
1	0	1	1		non call related SS messages
1	1	1	0		Location services specified in 3GPP TS 44.071 [8a]
1	1	1	0		extension of the PD to one octet length
1	1	1	1		used by tests procedures described in 3GPP TS 44.014 [5a], 3GPP TS 34.109 [17a], 3GPP TS 36.509 [26] and 3GPP TS 38.509 [29].

If the network receives, on a SAP where it expects standard L3 messages, a message with a protocol discriminator different from those specified in table 11.2, the network may ignore the message or initiate the channel release procedure defined in 3GPP TS 44.018 [6b].

If the Mobile Station receives, on a SAP where it expects standard L3 messages, a standard L3 message with a protocol discriminator different from those specified in table 11.2, or for a protocol that it does not support, the Mobile Station shall ignore the message.

### 11.2.3.1.1A Extended protocol discriminator (EPD)

When the PD is set to "extension of the PD to one octet length" as specified in subclause 11.2.3.1.1, bits 1 to 8 of the first octet of a standard L3 message contain the extended protocol discriminator (EPD) information element.

The EPD identifies the L3 protocol to which the standard layer 3 message belongs. The correspondence between L3 protocols and EPDs is one-to-one.

The EPD can take the values specified in table 11.2.3.1.1A.1.

**Table 11.2.3.1.1A.1: EPD values**

EPD value (octet 1, bit 1 to bit 8)								
Bits								
8	7	6	5	4	3	2	1	
0	0	0	0	1	1	1	0	reserved
0	0	0	1	1	1	1	0	reserved
0	0	1	0	1	1	1	0	5GS session management messages
0	0	1	1	1	1	1	0	reserved
0	1	0	0	1	1	1	0	reserved
0	1	0	1	1	1	1	0	reserved
0	1	1	0	1	1	1	0	reserved
0	1	1	1	1	1	1	0	5GS mobility management messages
1	0	0	0	1	1	1	0	reserved
1	0	0	1	1	1	1	0	reserved
1	0	1	0	1	1	1	0	reserved
1	0	1	1	1	1	1	0	reserved
1	1	0	0	1	1	1	0	reserved
1	1	0	1	1	1	1	0	reserved
1	1	1	0	1	1	1	0	reserved
1	1	1	1	1	1	1	0	reserved

NOTE: Bits 4 to 1 of each EPD value contain "extension of the PD to one octet length" as specified in subclause 11.2.3.1.1.

If the network receives, on a SAP where it expects standard L3 messages, a message with an EPD different from those specified in table 11.2.3.1.1A.1, the network may ignore the message, may initiate the RRC connection release procedure defined in 3GPP TS 36.331 [24], or may initiate the RRC connection release procedure defined in 3GPP TS 38.331 [28].

If the Mobile Station receives, on a SAP where it expects standard L3 messages, a standard L3 message with an EPD different from those specified in table 11.2.3.1.1A.1, or for a protocol that it does not support, the Mobile Station shall ignore the message.

### 11.2.3.1.2 Skip indicator

Bits 5 to 8 of octet 1 of a standard L3 message may be used differently, depending on the protocol and the SAP. The use of this half-octet is consistent for a given PD and SAP. One possibility is that this half-octet contains the skip indicator. Another possibility is that this half-octet is a part of EPD as specified in subclause 11.2.3.1.1A. Unless otherwise specified in the protocol, the skip indicator IE is a spare field.

### 11.2.3.1.3 Transaction identifier

A L3 protocol may define that bits 5 to 8 of octet 1 of a standard L3 message of the protocol contains the transaction identifier (TI). The TI allows to distinguish up to 16 different bi-directional messages flows for a given PD and a given SAP. Such a message flow is called a transaction.

An extension mechanism for TI is also defined. This mechanism allows to distinguish up to 256 different bi-directional messages flows for a given PD and a given SAP. The extension mechanism shall not be used unless explicitly stated in the core specification(s) for the protocol. The TI IE is coded as shown in figure 11.9 and table 11.3. It is composed of the TI value and the TI flag.

The TI value and the TI flag occupy bits 5 - 7 and bit 8 of the first octet respectively.

The extended TI shall not be used unless TI values of 7 or greater are needed.

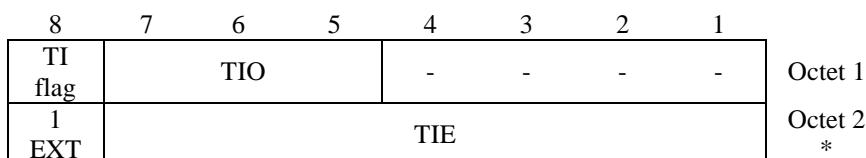
Where the extended TI is used, the TI IE includes a second octet. The TI value in the first octet is ignored, and the TI value is encoded in bits 7-1 of the second octet.

NOTE: In other specifications, in respect to error handling, there are references to TI value "111". This refers to the binary encoding of bits 5 –7 in octet 1. For protocols which do not use the extended TI this '111' encoding is still handled as an error case. Transactions are dynamically created, and their TI value is assigned at creation time. TI values are assigned by the side of the interface initiating a transaction. At the beginning of a transaction a free TI value (i.e., a value not yet used for the given PD, the given SAP, and with the given initiator) is chosen and assigned to this transaction. It then remains fixed for the lifetime of the transaction. After a transaction ends, the associated TI value is free and may be reassigned to a later transaction.

Two identical TI values may be used when each value pertains to a transaction initiated by the different sides of the interface. In this case the TI flag shall avoid ambiguity. The transaction identifier flag can take the values "0" or "1". The TI flag is used to identify which side of the interface initiated the transaction. A message has a TI flag set to "0" when it belongs to transaction initiated by its sender, and to "1" otherwise.

Hence the TI flag identifies who allocated the TI value for this transaction and the only purpose of the TI flag is to resolve simultaneous attempts to allocate the same TI value.

The TI extension mechanism may in future evolution of the L3 protocols be further extended by setting the EXT flag in octet 2 to "0" (see figure 11.9).



**Figure 11.9: Transaction identifier**

**Table 11.3: Transaction identifier**

TI flag (octet 1)	
Bit	
8	
0	The message is sent from the side that originates the TI
1	The message is sent to the side that originates the TI
TIO (octet 1)	
Bits	
7 6 5	
0 0 0	TI value 0
0 0 1	- - 1
0 1 0	- - 2
0 1 1	- - 3
1 0 0	- - 4
1 0 1	- - 5
1 1 0	- - 6
1 1 1	The TI value is given by the TIE in octet 2
TIE (octet 2)	
Bits 7-1	
0000000	Reserved.
0000001	
0000010	
0000011	
0000100	
0000101	
0000110	
All other values	The TI value is the binary representation of TIE Where bit 7 is the most significant bit And bit 1 is the least significant bit

**11.2.3.1.4 Sub-protocol discriminator**

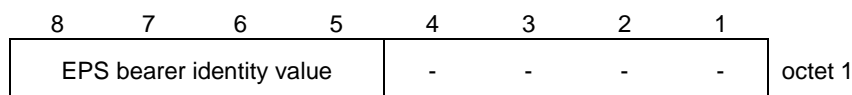
A L3 protocol may define that bits 5 to 8 of octet 1 of a standard L3 message of the protocol contains the sub-protocol discriminator (SPD). The SPD allows to distinguish between different protocols inside one sublayer.

**Table 11.4: Sub-Protocol discriminator values**

bits	8 7 6 5	
	0 0 0 0	Value used by the Skip Indicator (see 11.2.3.1.2)
	0 0 0 1	CTS sub-protocol
	0 0 1 0	\
	To	} all other values are reserved
	1 1 1 1	/

**11.2.3.1.5 EPS bearer identity**

A L3 protocol may define that bits 5 to 8 of octet 1 of a standard L3 message of the protocol contain the EPS bearer identity. The EPS bearer identity is used to identify a message flow.



**Figure 11.9a: EPS bearer identity**

**Table 11.5: EPS bearer identity**

EPS bearer identity value (octet 1)				
Bits				
8	7	6	5	
0	0	0	0	No EPS bearer identity assigned
0	0	0	1	EPS bearer identity value 1
0	0	1	0	EPS bearer identity value 2
0	0	1	1	EPS bearer identity value 3
0	1	0	0	EPS bearer identity value 4
0	1	0	1	EPS bearer identity value 5
0	1	1	0	EPS bearer identity value 6
0	1	1	1	EPS bearer identity value 7
1	0	0	0	EPS bearer identity value 8
1	0	0	1	EPS bearer identity value 9
1	0	1	0	EPS bearer identity value 10
1	0	1	1	EPS bearer identity value 11
1	1	0	0	EPS bearer identity value 12
1	1	0	1	EPS bearer identity value 13
1	1	1	0	EPS bearer identity value 14
1	1	1	1	EPS bearer identity value 15

#### 11.2.3.1.6 Security header type

For EPS protocols, a L3 protocol may define that bits 5 to 8 of octet 1 of a standard L3 message of the protocol contain the security header type.

For 5GS protocols, a L3 protocol may define that bits 1 to 4 of octet 2 of a standard L3 message of the protocol contain the security header type.

#### 11.2.3.1a Procedure transaction identity

A L3 protocol may define that a standard L3 message of the protocol contains the procedure transaction identity (PTI). The PTI allows distinguishing up to 254 different bi-directional messages flows for a given PD and a given SAP. Such a message flow is called a transaction. The procedure transaction identity is released when the procedure is completed.

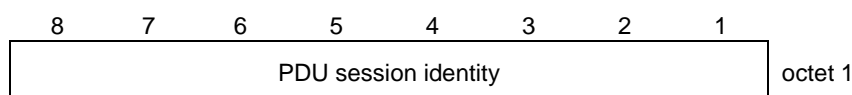
**Table 11.6: Procedure transaction identity**

Bits								
8	7	6	5	4	3	2	1	
0	0	0	0	0	0	0	0	No procedure transaction identity assigned
0	0	0	0	0	0	0	1	\
								} Procedure transaction identity value
1	1	1	1	1	1	1	0	/
1	1	1	1	1	1	1	1	Reserved

#### 11.2.3.1b PDU session identity

A L3 protocol may define that octet 2 of a standard L3 message of the protocol contains the PDU session identity. The PDU session identity is used to identify a PDU session.

The range of PDU session identity values indicated in table 11.2.3.1c.1 is shared between the PDU sessions over 3GPP access and the PDU sessions over non-3GPP access.



**Figure 11.2.3.1c.1: PDU session identity**

**Table 11.2.3.1c.1: PDU session identity**

PDU session identity value (octet 1, bit 1 to bit 8)								
Bits								
8	7	6	5	4	3	2	1	
0	0	0	0	0	0	0	0	No PDU session identity assigned
0	0	0	0	0	0	0	1	PDU session identity value 1
0	0	0	0	0	0	1	0	PDU session identity value 2
0	0	0	0	0	0	1	1	PDU session identity value 3
0	0	0	0	0	1	0	0	PDU session identity value 4
0	0	0	0	0	1	0	1	PDU session identity value 5
0	0	0	0	0	1	1	0	PDU session identity value 6
0	0	0	0	0	1	1	1	PDU session identity value 7
0	0	0	0	1	0	0	0	PDU session identity value 8
0	0	0	0	1	0	0	1	PDU session identity value 9
0	0	0	0	1	0	1	0	PDU session identity value 10
0	0	0	0	1	0	1	1	PDU session identity value 11
0	0	0	0	1	1	0	0	PDU session identity value 12
0	0	0	0	1	1	0	1	PDU session identity value 13
0	0	0	0	1	1	1	0	PDU session identity value 14
0	0	0	0	1	1	1	1	PDU session identity value 15

All other values are reserved.

**11.2.3.2 Message type octet**

**11.2.3.2.1 Message type octet (when accessing Release 98 and older networks only)**

The message type octet is the second octet in a standard L3 message.

When a standard L3 message is expected, and a message is received that is less than 16 bit long, that message shall be ignored.

When the radio connection started with a core network node of a Release 98 or older network, the message type IE is coded as shown in figure 11.10a and 11.10x.

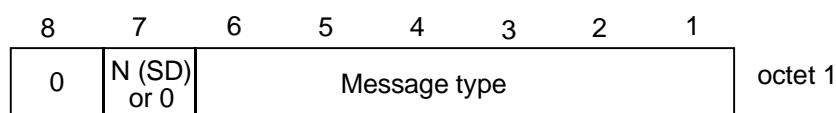
Bit 8 is encoded as "0"; value "1" is reserved for possible future use as an extension bit. A protocol entity expecting a standard L3 message, and receiving a message containing bit 8 of octet 2 encoded as "1" shall diagnose a "message not defined for the PD" error and treat the message accordingly.

In messages of MM, CC, SS (via CS domain), GCC and BCC protocol sent using the transmission functionality provided by the RR layer to upper layers, and sent from the mobile station or the LMU to the network, bit 7 of octet 2 is used for send sequence number, see subclause 11.2.3.2.3.

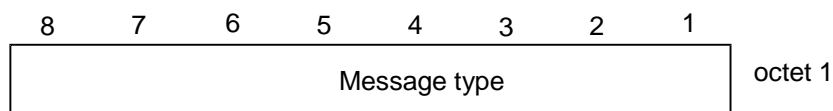
In messages of the LCS protocol sent using the transmission functionality provided by the RR layer to upper layers, and sent from the type A LMU to the network, bit 7 of octet 2 is used for send sequence number, see subclause 11.2.3.2.3.

In all other standard layer 3 messages, except for RR messages, bit 7 is set to a default value. A protocol entity expecting a standard L3 message, and not using the transmission functionality provided by the RR layer, and receiving a message containing bit 7 of octet 2 encoded different to the default value shall diagnose a "message not defined for the PD" error and treat the message accordingly.

The default value for bit 7 is 0 except for the SM protocol where the default value is 1. No default value for bit 7 is specified for RR protocol. For RR message types see 3GPP TS 44.018.



**Figure 11.10a: Message type IE (MM, CC, SS, GCC, BCC and LCS)**



**Figure 11.10x: Message type IE (protocol other than MM, CC, SS, GCC, BCC and LCS)**

For MM, CC, SS, GCC, BCC and LCS protocols bits 1 to 6 of octet 2 of standard L3 messages contain the message type. For all other L3 protocols bits 1 to 8 of octet 2 of standard L3 message contain the message type.

The message type determines the function of a message within a protocol in a given direction. The meaning of the message type is therefore dependent on the protocol (the same value may have different meanings in different protocols), and the direction (the same value may have different meanings in the same protocol, when sent from the Mobile Station to the network and when sent from the network to the Mobile Station).

Each protocol defines a list of allowed message types for each relevant SAP. A message received analysed as a standard L3 message, and with a message type not in the corresponding list leads to the diagnosis "message not defined for the PD". Some message types may correspond to a function not implemented by the receiver. They are then said to be not implemented by the receiver.

The reaction of a protocol entity expecting a standard L3 message and receiving a message with message type not defined for the PD or not implemented by the receiver and the reception conditions is defined in the relevant protocol specification. As a general rule, a protocol specification should not force the receiver to analyse the message further.

#### 11.2.3.2.2 Message type octet (when accessing Release 99 and newer networks)

The message type octet is the second octet in a standard L3 message.

When a standard L3 message is expected, and a message is received that is less than 16 bit long, that message shall be ignored.

When the radio connection started with a core network node of a Release 99 or later network, the message type IE is coded dependent on the PD as shown in figures 11.10b, c and d.

In messages of MM, CC and SS (via CS domain) protocol sent using the transmission functionality provided by the RR and/or access stratum layer to upper layers, and sent from the mobile station or the LMU to the network, bits 7 and 8 of octet 2 are used for send sequence number, see subclause 11.2.3.2.3.

In messages of GCC and BCC protocol sent using the transmission functionality provided by the RR layer to upper layers, and sent from the mobile station or the LMU to the network, only bit 7 of octet 2 is used for send sequence number. Bit 8 is set to the default value.

In messages of the LCS protocol sent using the transmission functionality provided by the RR layer to upper layers, and sent from the type A LMU to the network, only bit 7 of octet 2 is used for send sequence number. Bit 8 is set to the default value.

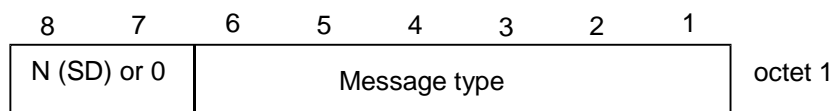
In all other standard layer 3 messages, except for RR messages, bits 7 and 8 are set to the default value. A protocol entity expecting a standard L3 message, and not using the transmission functionality provided by the RR and/or access stratum layer, and receiving a message containing bit 7 or bit 8 of octet 2 encoded different to the default value shall diagnose a "message not defined for the PD" error and treat the message accordingly.

In messages of the RR protocol entity, bit 8 of octet 2 is set to the default value. The other value is reserved for possible future use as an extension bit. If an RR protocol entity expecting a standard L3 message receives message containing bit 8 of octet 2 encoded different from the default value it shall diagnose a "message not defined for the PD" error and treat the message accordingly.

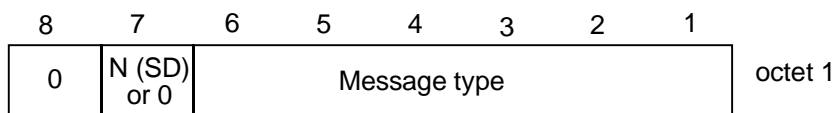
The default value for bit 8 is 0. The default value for bit 7 is 0 except for the SM protocol which has a default value of 1. No default value for bit 7 is specified for RR protocol. For RR message types see 3GPP TS 44.018.

For EPS; the default value for bit 7 is 1. The value for bit 8 is 0 for the EMM protocol and 1 for the ESM protocol.

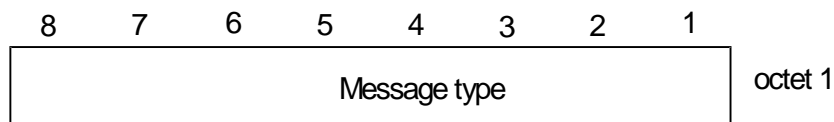
For 5GS; the default value for bit 7 is 1. The value for bit 8 is 0 for the 5GMM protocol and 1 for the 5GSM protocol.



**Figure 11.10b: Message type IE (MM, CC and SS)**



**Figure 11.10c: Message type IE (GCC, BCC and LCS)**



**Figure 11.10d: Message type IE (protocol other than MM, CC, SS, GCC, BCC and LCS)**

For MM, CC, SS, GCC, BCC and LCS protocols bits 1 to 6 of octet 2 of standard L3 messages contain the message type. For all other L3 protocols bits 1 to 8 of octet 2 of standard L3 message contain the message type.

The message type determines the function of a message within a protocol in a given direction. The meaning of the message type is therefore dependent on the protocol (the same value may have different meanings in different protocols), and the direction (the same value may have different meanings in the same protocol, when sent from the Mobile Station to the network and when sent from the network to the Mobile Station).

Each protocol defines a list of allowed message types for each relevant SAP. A message received analysed as a standard L3 message, and with a message type not in the corresponding list leads to the diagnosis "message not defined for the PD". Some message types may correspond to a function not implemented by the receiver. They are then said to be not implemented by the receiver.

The reaction of a protocol entity expecting a standard L3 message and receiving a message with message type not defined for the PD or not implemented by the receiver and the reception conditions is defined in the relevant protocol specification. As a general rule, a protocol specification should not force the receiver to analyse the message further.

### 11.2.3.2.3 Sequenced message transfer operation

Upper layer messages sent using the RR sub-layer transport service from the mobile station to the network can be duplicated by the data link layer in at least the following cases:

- in A/Gb mode, when a channel change of dedicated channels is required (assignment or handover procedure) and the last layer 2 frame has not been acknowledged by the peer data link layer before the mobile station leaves the old channel;
- in Iu mode, when an RLC re-establishment occurs (e.g. due to relocation) and the RLC layer has not acknowledged the last one or more RLC PDUs before RLC re-establishment;
- an inter-system change from Iu mode to A/Gb mode is performed and the RLC layer has not acknowledged the last one or more RLC PDUs;
- an inter-system change from A/Gb mode to Iu mode is performed and the last layer 2 frame in A/Gb mode has not been acknowledged by the peer data link layer before the mobile station leaves the old channel.

In these cases, the mobile station does not know whether the network has received the messages correctly. Therefore, the mobile station has to send the messages again when the channel change is completed.

The network must be able to detect the duplicated received messages. Therefore, each concerned upper layer messages must be marked with a send sequence number.

To allow for different termination points in the infrastructure of the messages of different PDs, the sequence numbering is specific to each PD. For historical reasons, an exception is that messages sent with the CC, SS (via CS domain) and



MM PDs share the same sequence numbering. In the following, the phrase **upper layer message flow** refers to a flow of messages sharing the same sequence numbering. The different upper layer flows are MM+CC+SS (via CS domain), GCC, BCC and LCS. The GMM, EMM, SM, ESM, SMS, SS (via PS domain) and TC (Test Control, see 3GPP TS 44.014 [5a], 3GPP TS 34.109 [17a] and 3GPP TS 36.509 [26]) protocols do not use layer 3 sequence numbering.

In a shared network with a MOCN configuration, Network Sharing non-supporting UEs can be redirected between CN operators (see 3GPP TS 23.251 [22]). When the redirection takes place, the CN node of the redirecting CN operator shall forward via the RAN the value of N(SD) of the last message received on the MM+CC+SS (via CS domain) message flow to the CN node of the next CN operator (3GPP TS 25.413 [23]).

### 11.2.3.2.3.1 Variables and sequence numbers

#### 11.2.3.2.3.1.1 Send state variable V(SD)

The mobile station shall have one associated send state variable V(SD) ("Send Duplicated") for each upper layer message flow. The send state variable denotes the sequence number of the next in sequence numbered message in the flow to be transmitted. The value of the corresponding send state variable shall be incremented by one with each numbered message transmission.

For the MM+CC+SS (via CS domain) upper layer message flow:

- when the RR connection starts with a core network of Release 98 or earlier, arithmetic operations on V(SD) are performed modulo 2. The mobile station shall keep using modulo 2 for the duration of the RR connection;
- when the RR connection starts with a core network of Release 99 or later, arithmetic operations on V(SD) are performed modulo 4. The mobile station shall keep using modulo 4 for the duration of the RR connection;
- after successful completion of SRVCC handover (see 3GPP TS 23.216 [27]), the mobile station shall perform modulo 4 arithmetic operations on V(SD). The mobile station shall keep using modulo 4 until the release of the RR connection established at SRVCC handover.

NOTE 1: In A/Gb mode, the release supported by the core network is indicated in the MSCR bit and in the SGSNR bit in the system information broadcast (see 3GPP TS 44.018 [6b] and 3GPP TS 44.060 [10a]).

NOTE 2: During SRVCC handover the MSCR bit is not provided to the mobile station, and therefore the mobile station assumes to access to a Release 99 or later core network.

For the GCC, BCC, and LCS upper layer message flows, arithmetic operations on V(SD) are performed modulo 2.

#### 11.2.3.2.3.1.2 Send sequence number N(SD)

At the time when such a message to be numbered is designated for transmission, the value of N(SD) for the message to be transferred is set equal to the value of the send state variable V(SD).

### 11.2.3.2.3.2 Procedures for the initiation, transfer execution and termination of the sequenced message transfer operation

#### 11.2.3.2.3.2.1 Initiation

The sequenced message transfer operation is initiated by establishing a RR connection. The send state variables V(SD) are set to 0.

After successful completion of SRVCC handover (see 3GPP TS 23.216 [27]), the mobile station shall set the send state variable V(SD) to 0.

#### 11.2.3.2.3.2.2 Transfer Execution

The core network shall compare the send sequence numbers of pairs of subsequent messages in the same upper layer messages flow.

For the GCC, BCC, and LCS upper layer message flows, in case the send sequence numbers of two subsequent messages in a flow are not identical, no duplication has occurred. In case the send sequence numbers are identical, the network must ignore the second one of the received messages.

For the MM+CC+SS (via CS domain) upper layer message flow:

- when accessed by a release 98 or earlier mobile station, in case the send sequence numbers of two subsequent messages in the flow are identical, the core network shall discard the second one of the received messages;
- when accessed by a release 99 or later mobile station, the core network shall discard any message whose N(SD) is not the increment by one (modulo 4) of the N(SD) of the last accepted message.

NOTE: The release supported by the mobile station is indicated by the revision level in *the Mobile Station Classmark 1* or *Mobile Station Classmark 2* information element, or by the revision level indicator in the *MS network capability* information element (see 3GPP TS 24.008, subclause 10.5).

In a shared network with a MOCN configuration, the core network node to which the mobile station was redirected shall compare the send sequence number of the first message received after the redirection in the MM+CC+SS (via CS domain) message flow with the value of N(SD) received during the redirection procedure (see 3GPP TS 23.251 [22]):

- when accessed by a release 98 or earlier mobile station, if the two send sequence numbers are identical, the core network shall discard the received message from the mobile station;
- when accessed by a release 99 or later mobile station, the core network shall discard any message whose N(SD) is not the increment by one (modulo 4) of the N(SD) received during the redirection procedure.

#### 11.2.3.2.3.2.3 Termination

The sequenced message transfer operation is terminated by the RR connection release procedure.

Inter system change from A/Gb mode to Iu mode or from Iu mode to A/Gb mode shall not terminate the sequenced message transfer. UMTS SRNC relocation shall not terminate the sequenced message transfer.

### 11.2.3.3 Standard information elements of the imperative part

The message type octet of a standard L3 message may be followed by mandatory standard IEs having the format V, LV or LV-E as specified in the message description in the relevant protocol specification.

As a design rule, octet boundaries must be respected. This implies that half-octet standard IEs (i.e., V formatted type 1 standard IEs) must appear by pair.

If message is received as a standard L3 message, and that is too short to contain the complete imperative part as specified in the relevant protocol specification, an imperative message part error is diagnosed. (The same error may be diagnosed at detection of certain contents of the imperative part of a message; this is defined in the relevant protocol specification.) The treatment of an imperative message part error is defined in the relevant protocol specification.

### 11.2.4 Non-imperative part of a standard L3 message

The imperative part of a standard L3 message is followed by the (possibly empty) non-imperative part. The relevant protocol specification defines where the imperative part of a standard L3 message ends. The non-imperative part of a standard L3 message is composed of (zero, one, or several) standard IEs having the format T, TV, TLV or TLV-E. The receiver of a standard L3 message shall analyse the non imperative part as a succession of standard IEs each containing an IEI, and shall be prepared for the non-imperative part of the message to contain standard IEs that are not specified in the relevant protocol specification.

An IEI may be known in a message or unknown in a message. Each protocol specification lists, for each message (i.e., according to the message type, the direction and the lower layer SAP), the known standard IEs in the non-imperative part.

An IEI that is known in a message designates the IE type of the IE the first part of which the IEI is, as well as the use of the information. Which IE type it designates is specified in the relevant protocol specification. Within a message, different IEIs may designate the same IE type if that is defined in the relevant protocol specification.

Whether the second part of an IE with IEI known in a message is the length or not (in other words, whether the IEI is the first part of an IE formatted as TLV, TLV-E or not) is specified in the relevant protocol specification.

Unless otherwise specified in the protocol specification, the receiver shall assume that IE with unknown IEI are TV formatted type 1, T formatted type 2, TLV formatted type 4 or TLV-E formatted type 6 standard IEs. The IEI of unknown IEs together with, when applicable, the length indicator, enable the receiver to determine the total length of the IE, and then to skip unknown IEs. The receiver shall assume the following rule for IEs with unknown IEI:

Bit 8 of the IEI octet is set to "1" indicates a TV formatted type 1 standard IE or a T formatted type 2 IEs. Hence, a 1 valued bit 8 indicates that the whole IE is one octet long.

Furthermore, for the EPS protocols EMM and ESM:

Bit 8 of the IEI octet set to "0" and bits 7 to 4 set to "1" indicates a TLV-E formatted type 6 IE, i.e. the following two octets are length octets. Bit 8 of the IEI octet set to "0" and bit 7 to 4 set to any other bit combination indicates a TLV formatted type 4 IE, i.e. the following octet is a length octet.

Furthermore, for the 5GS protocols 5GMM and 5GSM:

Bit 8 of the IEI octet set to "0" and bits 7 to 5 set to "1" indicates a TLV-E formatted type 6 IE, i.e. the following two octets are length octets. Bit 8 of the IEI octet set to "0" and bit 7 to 5 set to any other bit combination indicates a TLV formatted type 4 IE, i.e. the following octet is a length octet.

IEI assignment in 3GPP TS 24.334 [36] shall comply with the above rule for the EPS protocols EMM and ESM.

IEI assignment in 3GPP TS 24.519 [33], 3GPP TS 24.587 [34], 3GPP TS 24.193 [35] shall comply with the above rule for the 5GS protocols 5GMM and 5GSM.

For all other protocols:

Bit 8 of the IEI octet set to "0" indicates a TLV formatted type 4 IE. Hence, the following octet is a length octet.

As a design rule, it is recommended that IEI of any TV formatted type 1, T formatted type 2, TLV formatted type 4 or TLV-E formatted type 6 IE follow the rule, even if assumed to be known by all potential receivers.

As a design rule, it is recommended that no new TV formatted type 3 IE is added to the non-imperative part of a standard L3 message except in the first release of a protocol specification which specifies the standard L3 message.

**NOTE:** For example, for the 5GS protocols 5GMM and 5GSM, Release 15 is the first release of a protocol specification for REGISTRATION REQUEST message.

A message may contain two or more IEs with equal IEI. Two IEs with the same IEI in a same message must have the same format, and, when of type 3, the same length. More generally, care should be taken not to introduce ambiguities by using an IEI for two purposes. Ambiguities appear in particular when two IEs potentially immediately successive have the same IEI but different meanings and when both are non-mandatory. As a recommended design rule, messages should contain a single IE of a given IEI.

Each protocol specification may put specific rules for the order of IEs in the non-imperative part. An IE known in the message, but at a position non compliant with these rules is said to be out of sequence. An out of sequence IE is decoded according to the format, and, when of type 3 the length, as defined in the message for its IEI.

## 11.2.5 Presence requirements of information elements

The relevant protocol specification may define three different presence requirements (M, C, or O) for a standard IE within a given standard L3 message:

- M ("Mandatory") means that the IE shall be included by the sending side, and that the receiver diagnoses a "missing mandatory IE" error when detecting that the IE is not present. An IE belonging to the imperative part of a message has presence requirement M. An IE belonging to the non-imperative part of a message may have presence requirement M;
- C ("Conditional") means:
  - \* that inclusion of the IE by the sender depends on conditions specified in the relevant protocol specification;

- \* that there are conditions for the receiver to expect that the IE is present and/or conditions for the receiver to expect that the IE is not present in a received message of a given PD, SAP and message type; these conditions depend only on the content of the message itself, and not for instance on the state in which the message was received, or on the receiver characteristics; they are known as static conditions;
  - \* that the receiver detecting that the IE is not present when sufficient static conditions are fulfilled for its presence, shall diagnose a "missing conditional IE" error;
  - \* that the receiver detecting that the IE is present when sufficient static conditions are fulfilled for its non-presence, shall diagnose an "unexpected conditional IE" error.
- Only IEs belonging to the non-imperative part of a message may have presence requirement C;
  - O ("Optional") means that the receiver shall never diagnose a "missing mandatory IE" error, a "missing conditional IE" error, or an "unexpected conditional IE" error because it detects that the IE is present or that the IE is not present. (There may however be conditions depending on the states, resources, etc. of the receiver to diagnose other errors.) Only IEs belonging to the non-imperative part of a message may have presence requirement O.

Unless otherwise specified the presence of a IE of unknown IEI or of an out of sequence IE shall not lead by itself to an error. An alternative specification is the 'comprehension required' scheme. A type 4 IE is encoded as 'comprehension required' if bits 5, 6, 7 and 8 of its IEI are set to zero. A type 6 IE is encoded as 'comprehension required' if bit 8 is set to zero and bits 3, 4, 5, 6, and 7 of its IEI are set to one. The 'comprehension required' scheme is to be applied if explicitly indicated in the protocol specification. The reaction on the reception of an unknown or out of sequence IE coded as 'comprehension required' is specified in the relevant protocol specification.

### 11.2.6 Description of standard L3 messages

This subclause describes a generic description method for standard L3 messages, the tabular description. Protocol specification may follow other methods.

A standard L3 message is described by a table listing the header elements and the standard IEs in the message. For each element is given:

- if applicable the IEI, in hexadecimal representation (one digit followed by and hyphen for TV formatted type 1, and two digits for the other cases);
- the name of the IE (this is used in particular for the description of conditional presence rules);
- the type of the information element, with a reference of where the internal structure of the value part is specified;
- the format of the standard IE (T, V, TV, LV, TLV, LV-E or TLV-E); and
- the length, or the range of lengths, of the whole standard IE, including when applicable the T and L parts.

The list of elements is given in the table in the order they appear in the resulting bit string, with the exception of half-octet elements in the imperative part: half octets in a pair are inverted. This applies in particular for the two first header elements: the protocol discriminator appears first in a table describing a standard L3 message.

## 11.3 Non standard L3 messages

In some protocols, the structure of part or all of the messages might not always follow the standard L3 message structure. As a design rule, this should be consistent for a given protocol, direction and lower layer SAP.

A possibility is to describe the message with the compact notation described in Annex B.

A few consistent structures are found in the present protocol specifications, and are described hereafter.

Other structures can be described directly in the protocol specifications.

### 11.3.1 Case A: BCCH and AGCH/PCH messages

In these cases, the SAP capability is for fixed length messages. The messages are structured as standard L3 messages plus one octet in front, the L2 pseudo length octet, and a rest octet part at the end.

#### 11.3.1.1 L2 Pseudo Length octet

This octet, the L2 pseudo length indicator octet, indicates the length in octets of the subsequent octet string that can be analysed as a standard L3 message.

The octet is structured as follows:

Bits 3 to 8 encodes in binary the L2 pseudo length, i.e., the length of the part to be analysed as a standard L3 message;

Bit 2 is set to "0";

Bit 1 is set to "1".

A receiver expecting a message so structured and receiving a message with bit 1 of octet 1 (i.e., the 8<sup>th</sup> bit of the message) set to "1" and bit 2 of octet 1 (i.e., the 7<sup>th</sup> bit of the message) different from "0", shall abandon the analysis of the message.

A receiver expecting a message so structured and receiving a message on AGCH/PCH:

- with an L2 pseudo length indicator encoding 0 or 1 shall skip the indicated number of octets and not try to analyse the standard L3 message part;
- with a L2 pseudo length indicator bigger than what is compatible with the SAP capability shall abandon the analysis of the message.

#### 11.3.1.2 Rest Octets

The part after the part structured as a standard L3 message, and up to the end of the message as constrained by lower layers, is presented as a non standard IE of variable length (sometime indicated as of type 5), the "rest octets" IE.

The rest octets element may be described by table description, or, preferably, using the compact notation described in Annex B of the present document.

#### 11.3.1.3 Description of a modified standard L3 message

The description can be provided in the same way as a standard L3 message, with in the case of a tabular description one non standard IE at the beginning (of type L2 pseudo length), and one non standard IE at the end.

### 11.3.2 Case B: SACCH / SDCCH / FACCH messages sent in unacknowledged mode

The messages are structured either as standard L3 messages, or in the so-called short header format. The value of the 8<sup>th</sup> bit (bit 1 of octet 1) of the link layer PDU distinguishes the two cases. In the case of the short header, the L3 message is the same bit string as the link layer PDU, and has a fixed length. The following description includes the 2-bit link layer header.

#### 11.3.2.1 The first octet

Bits 1 and 2 are the link layer header. Bit 2 of octet 1 is set to "0", and bit 1 is reserved for the link layer.

A protocol discriminator is the first part of the message (starting bit 8 of octet 1). The protocol discriminator field may have different lengths. The following protocol discriminator is defined:

- 0 RR.

All additional PD defined for this structure shall start by 1. The reception of a message with bit 8 of octet 1 set to 1 when expecting a message structured as defined by this clause shall be diagnosed as an unknown PD, and the message ignored.

As a design rule, a message type field should follow the PD, and of a length such that the PD and the message type fit in the 6 first bits of the message.

### 11.3.2.2 The rest of the message

The rest of the structure is not more constrained.

The preferred description method is the one described in Annex B.

### 11.3.3 Design guidelines for non standard parts

The guidelines in this subclause apply to non standard parts, such as rest octets, short header broadcast message or fully non standard L3 messages.

#### 11.3.3.1 General

The structure should be as far as possible be such that the analysis can be conducted from beginning to end. In other terms, the conditions determining the syntactic analysis of a part (e.g., tags, lengths) should appear before that part.

The part should be structured as a succession of information elements, each carrying an elementary semantic information. An information element should be composed of (possibly) a tag, than (possibly) a length indicator, then a value part.

Tags can be of fixed or variable length, their extent being analysable from beginning to end. A typical tagging is the one bit tagging, which should preferably used as follows: value "0" indicates that the IE is no more than the tag bit, and "1" indicates that the IE continues at least with the next bit.

Variable length tagging should be used to distinguish between several possible formats of the element. Tag lengths are then chosen according to packing efficiency criteria.

The T field of standard IEs can be presented as a variable tagging with only two lengths: 4 and 8 bits.

The length indicator can be of fixed or variable length, their extent being analysable from beginning to end. It should preferably be presented as encoding the length in bits of the value part.

The L field of standard IEs can be presented as a fixed length (one octet) length indicator which can encode only lengths multiple of 8 bits.

The value part can be described as further structured, in a similar way. This can be used to help the reading, and to cover some presence dependence.

## 11.4 Handling of superfluous information

All equipment should be able to ignore any extra information present in an L3 message, which is not required for the proper operation of that equipment. For example, a mobile station may ignore the calling party BCD number if that number is of no interest to the Mobile Station when a SETUP message is received.

### 11.4.1 Information elements that are unnecessary in a message

The relevant protocol specification may define certain IEs to be under some conditions unnecessary in a L3 message. A protocol entity detecting an unnecessary IE in a received L3 message shall ignore the contents of that IE for treating the message; it is not obliged to check whether the contents of the IE are syntactically correct.

### 11.4.2 Other syntactic errors

This clause applies to the analysis of the value part of an information element. It defines the following terminology:

- An IE is defined to be syntactically incorrect in a message if it contains at least one value defined as "reserved", or if its value part violates syntactic rules given in the specification of the value part.
- It is not a syntactical error that a type 4 and type 6 standard IE specifies in its length indicator a greater length than possible according to the value part specification: extra bits shall be ignored.
- It should not be considered a syntactical error if a type 4 and type 6 IE is received with a shorter length than defined in this version of the specification if the IE is correctly encoded according to an earlier version of the specification.
- A message is defined to have semantically incorrect contents if it contains information which, possibly dependant on the state of the receiver, is in contradiction to the resources of the receiver and/or to the procedural part.

Annex A (informative):  
MN-Services arrow diagram



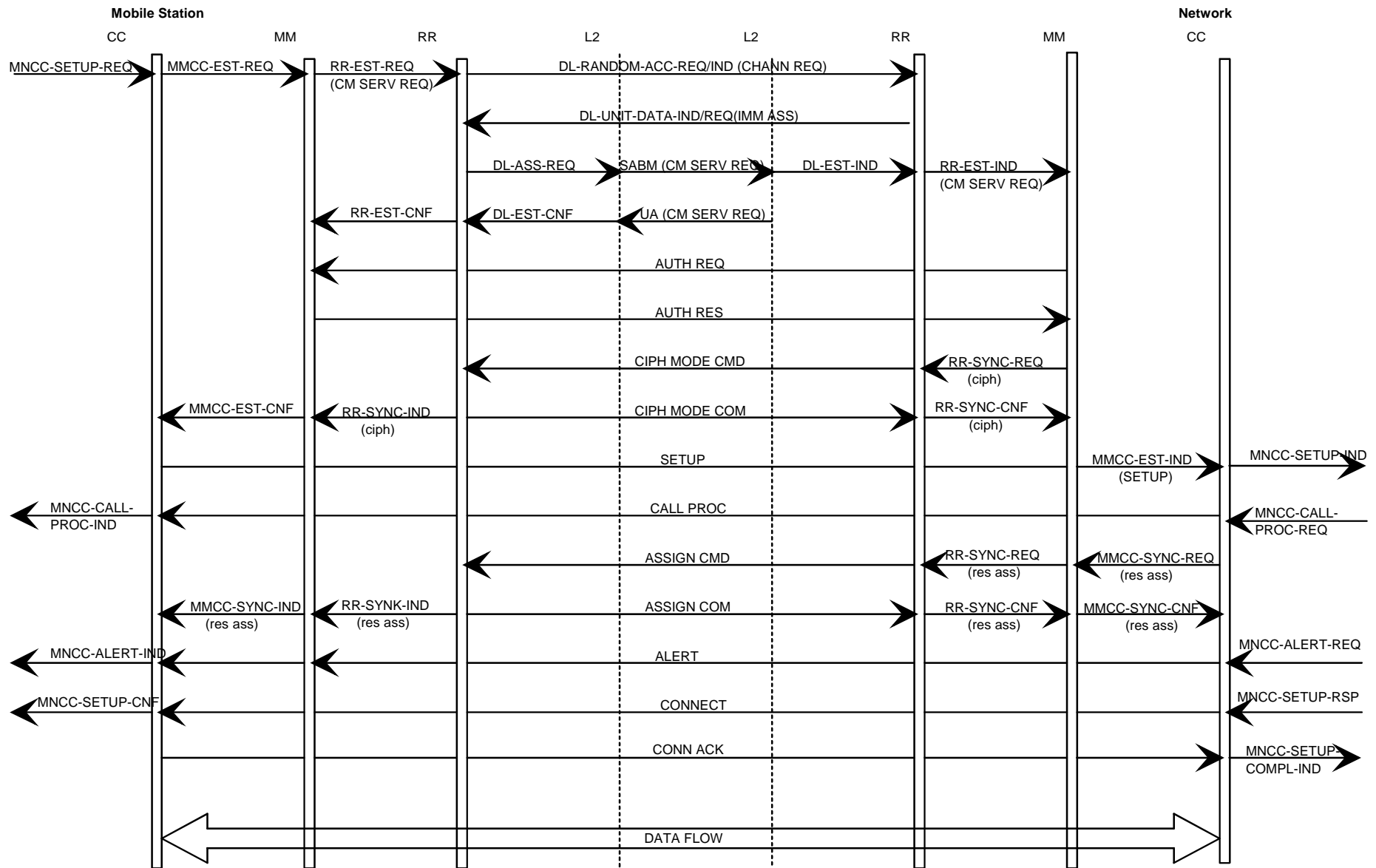


Figure A.1: Mobile originated Call Setup. Successful case

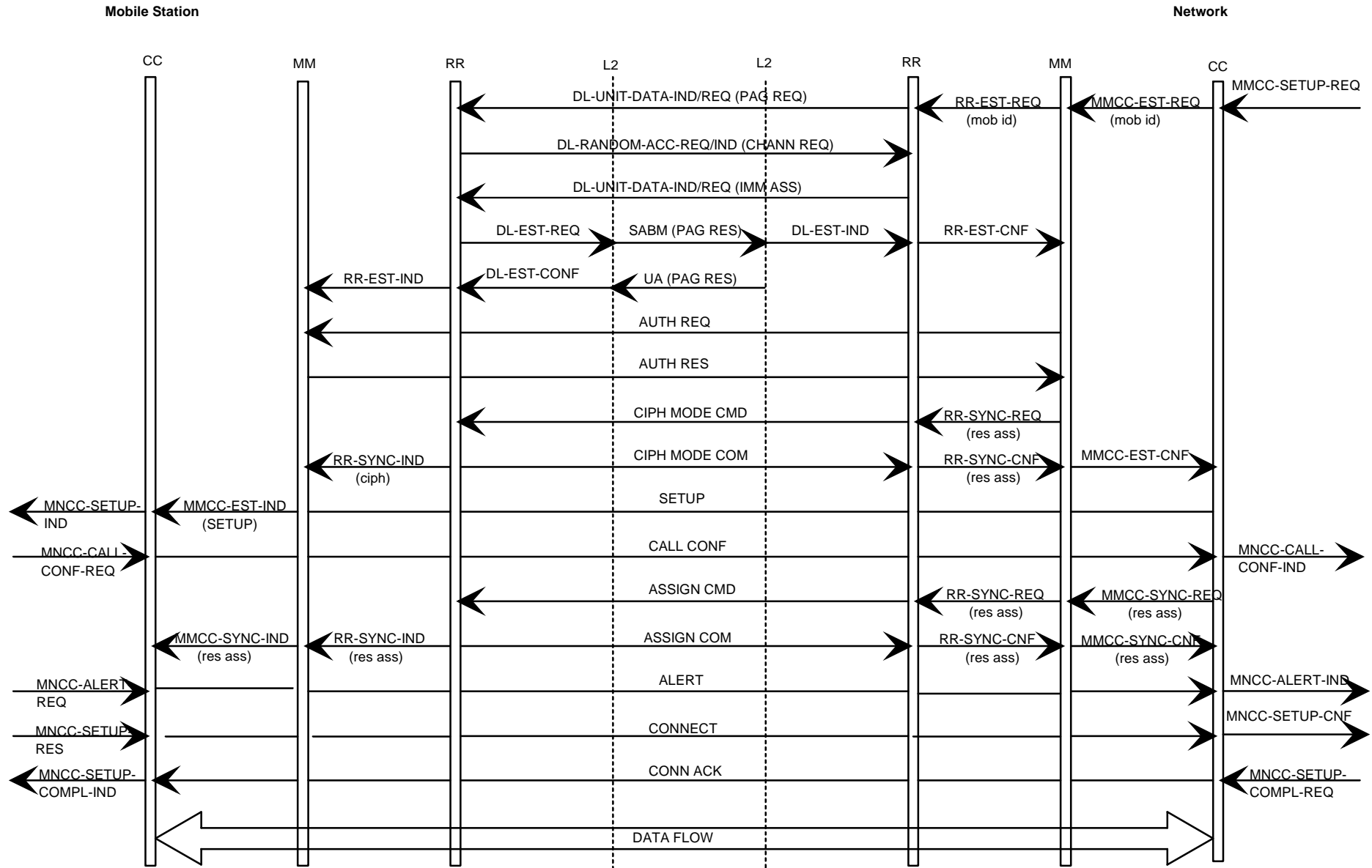


Figure A.2: Mobile terminated Call Setup. Successful case

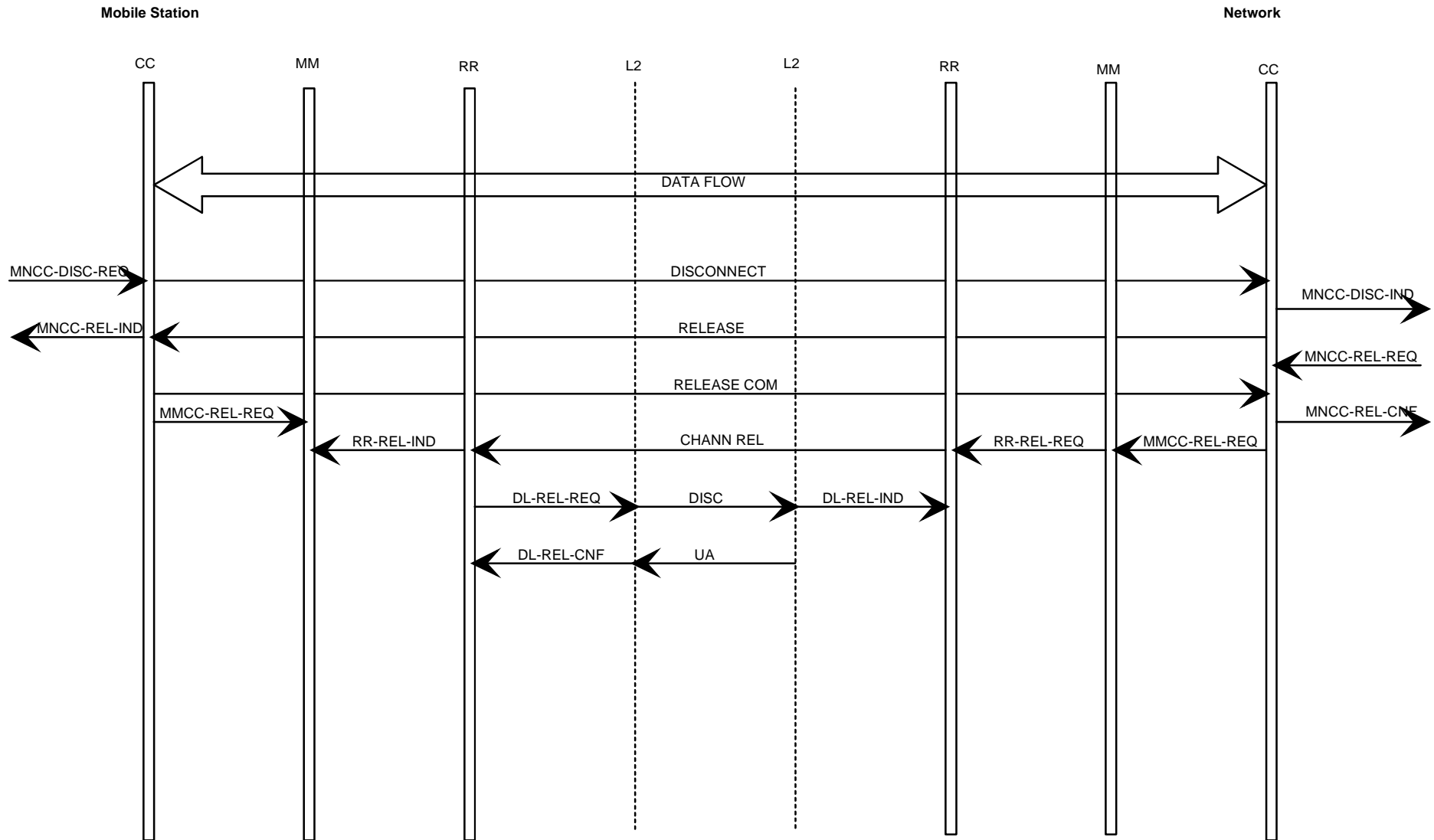


Figure A.3: Mobile originated, Call Release and Channel Release. Successful case

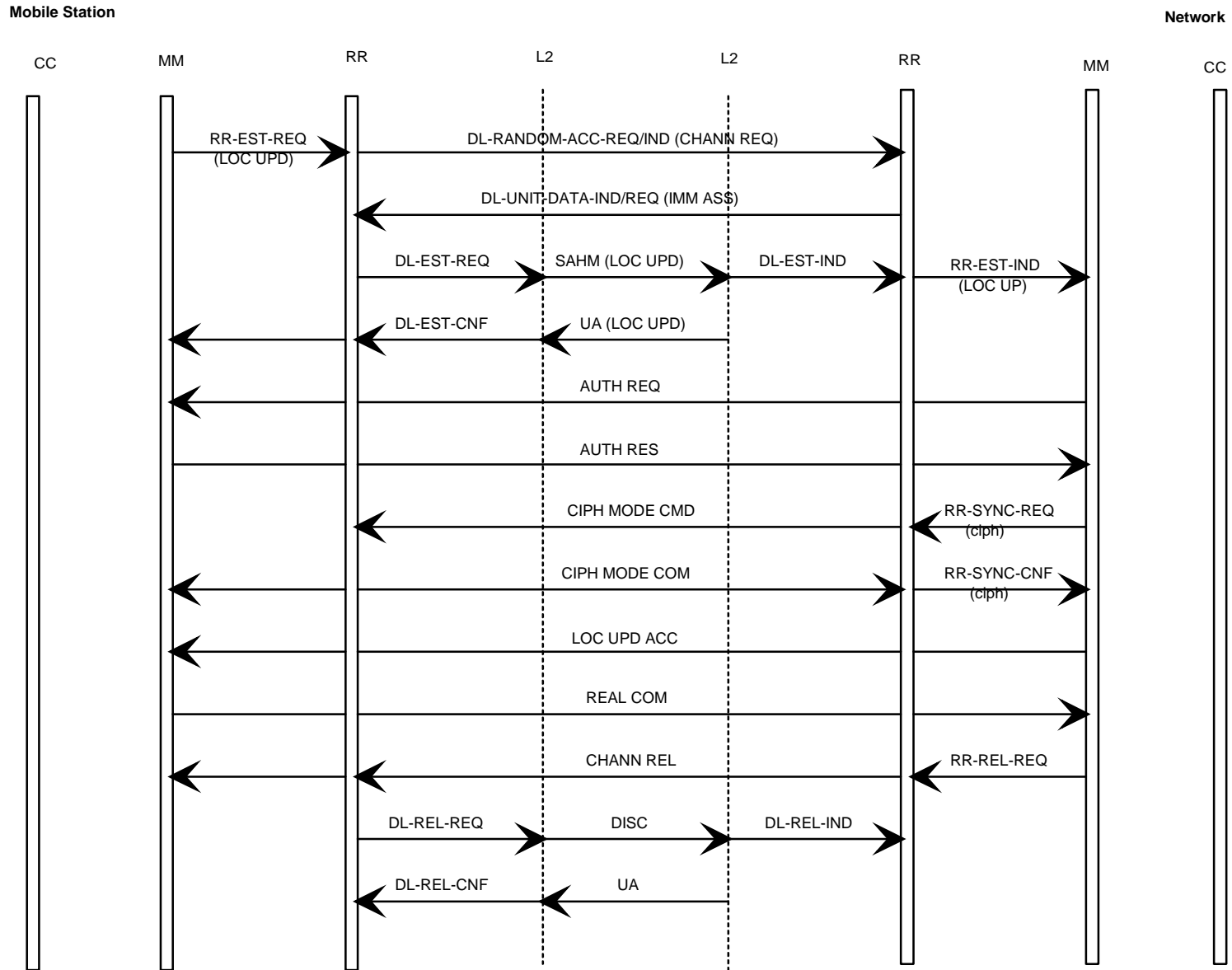


Figure A.4: Location updating. Successful case

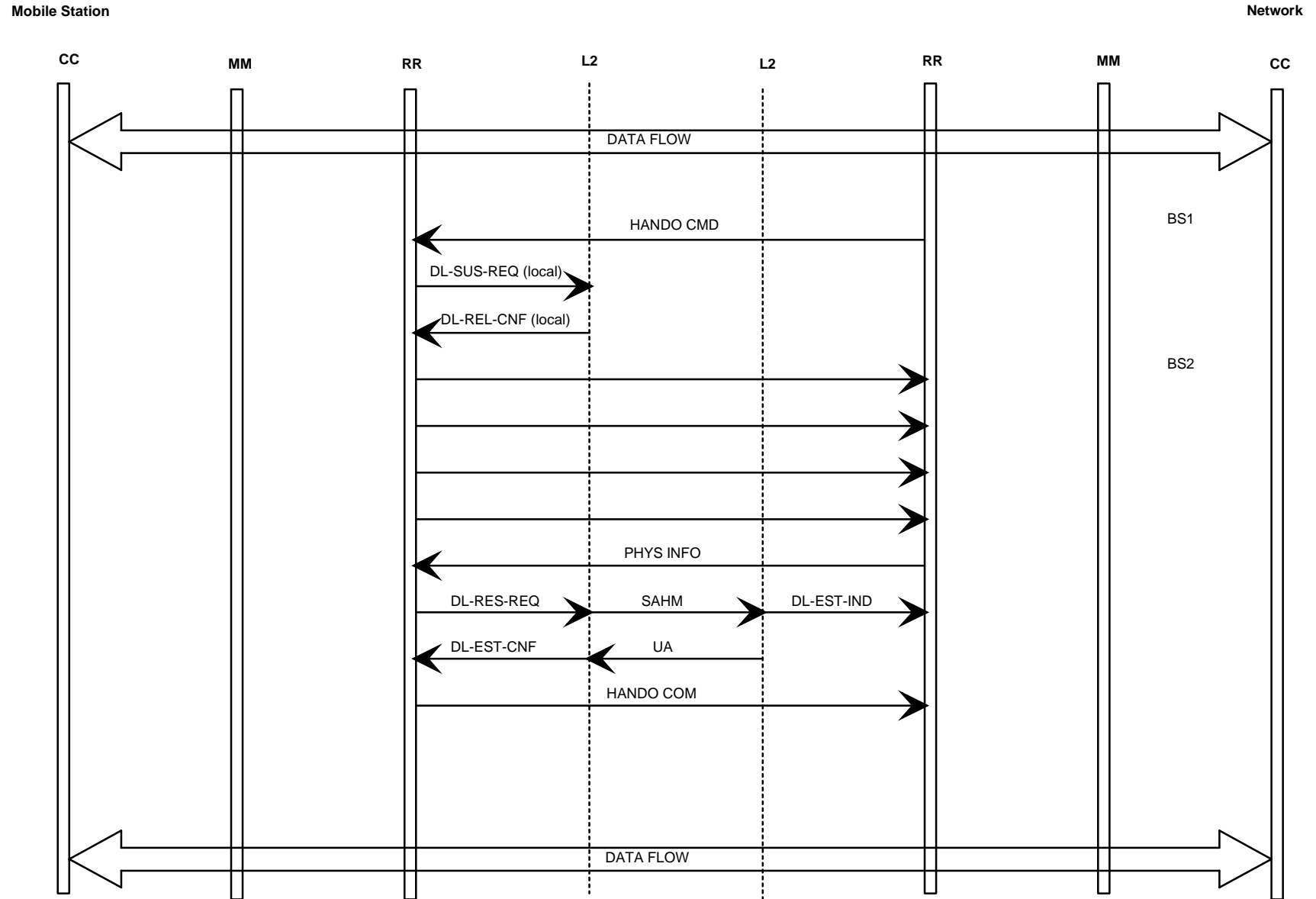


Figure A.5: Handover. Successful case

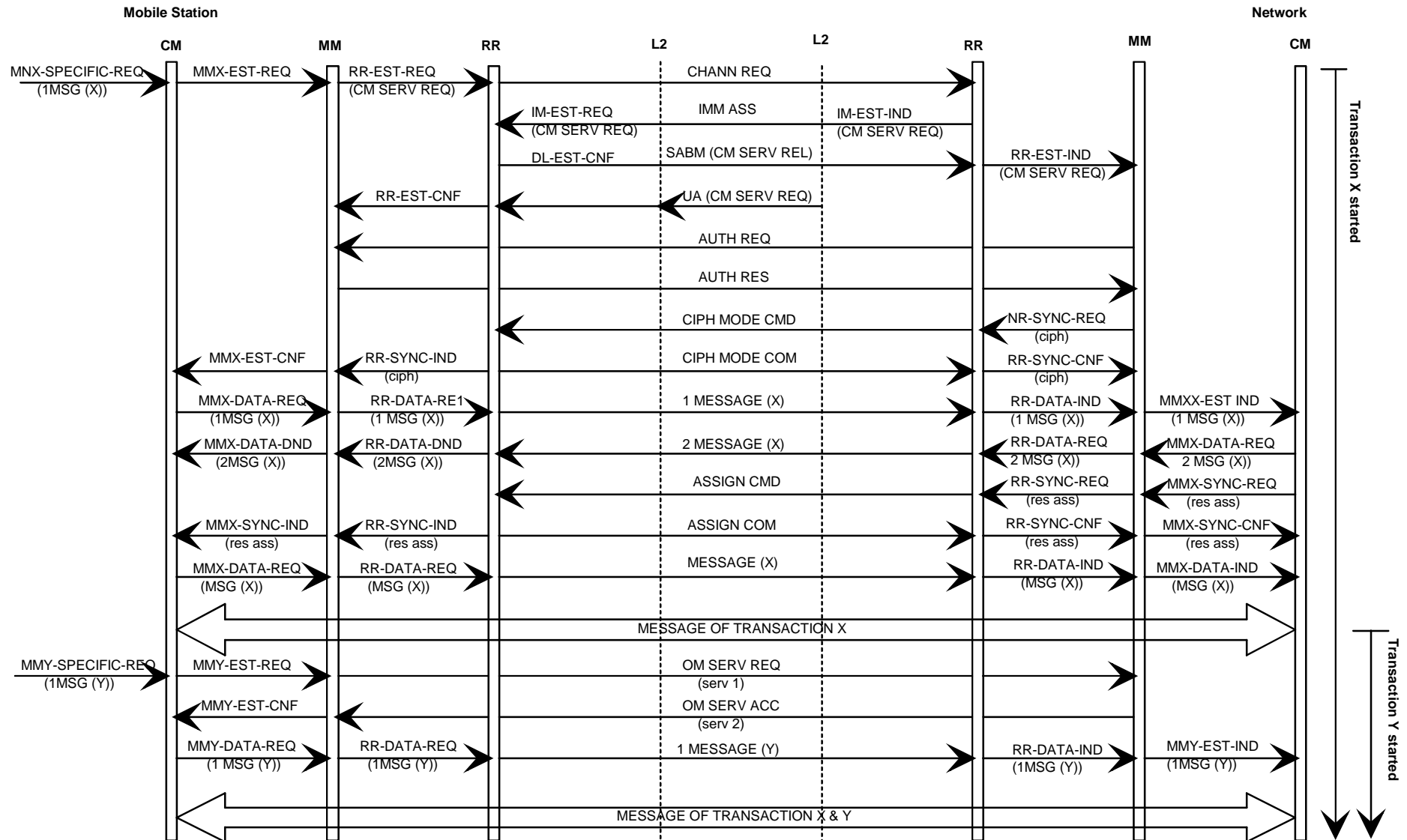


Figure A.6: Establishment of parallel transactions (General view)

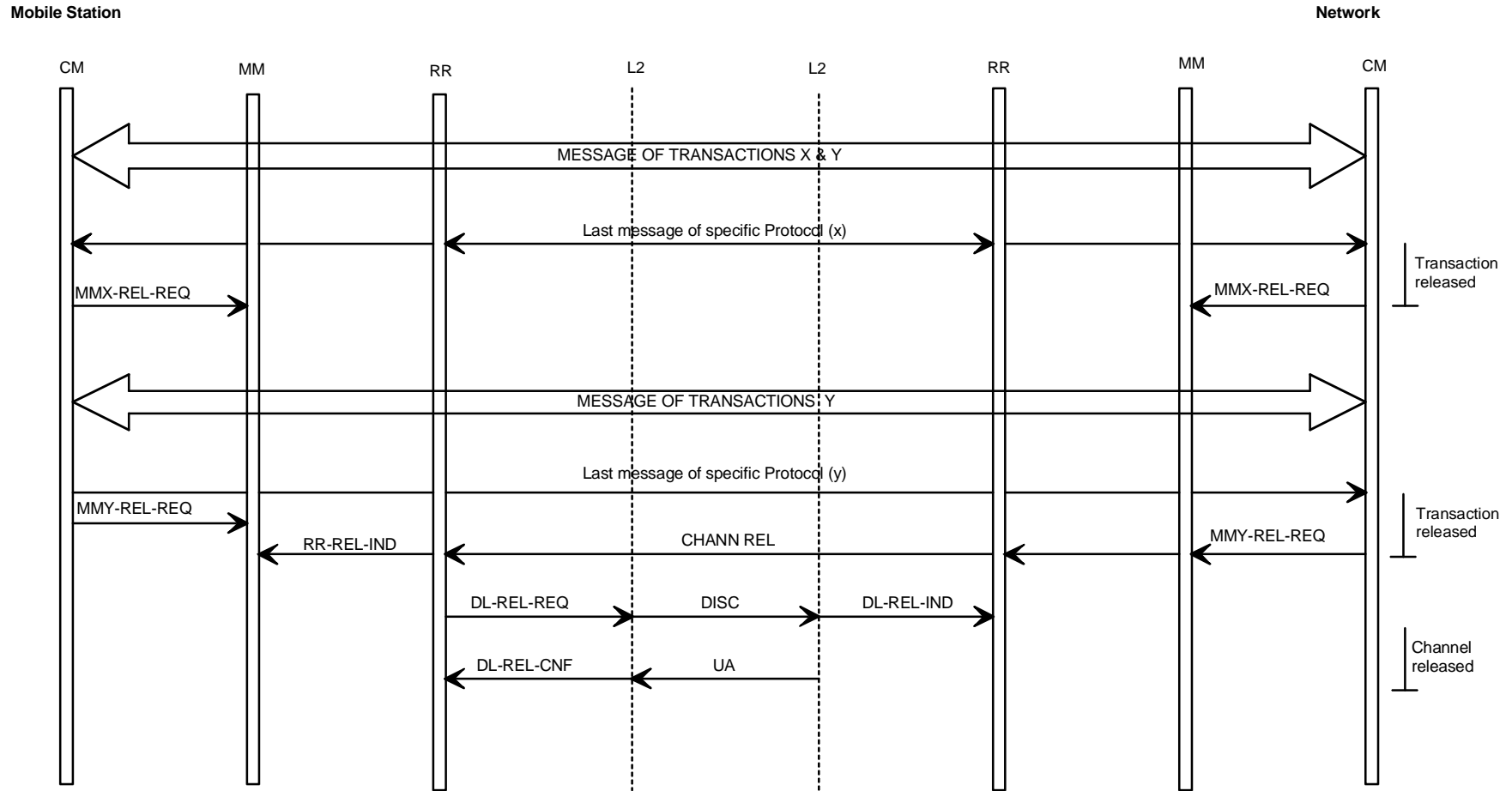


Figure A.7: Release of parallel transactions (General view)

---

## Annex B (informative): Description of CSN.1

The goal of the notation described hereafter is to describe the structure of the syntactically correct messages for a given signalling protocol, or of part of such messages. The notation addresses the cases where the concrete messages are binary strings. The notation allows to describe *sets* of strings: the structure of a message defined a protocol defines a set of allowable bit strings. It also allows to put labels on parts of strings that follow a given structure.

One aspect of the specification of message set is to define the set of strings that are acceptable as when received. All the strings that cannot be recognized as syntactically correct messages are to be rejected for syntactical reasons. In many cases, only a subset of this set are allowed to be sent. The notation allows also to distinguish the set of the strings that can be sent and the set of strings that are recognized as syntactically correct.

Another aspect of the specification of messages is the splitting of an acceptable string in a number of sub-strings that will be use to derive the exact significance of the message. The notation provides this function by labelling sub-strings. These labels can then in turn be used in textual or formal semantic descriptions which are not covered in the present document.

The notation described here could be enhanced in the future, with the addition of new rules.

---

### B.1 The Basic Rules

The following rules (B1 to B6) form the core part of the notation, more or less directly inherited from BNF. Rules B7 to B8 add what is needed in addition to encode the rest octet parts of fixed length messages as defined in 3GPP TS 24.008 [6].

Rule A1 is not needed to describe sets of strings at this stage. It is the one allowing to label parts of messages.

#### B.1.1 Core Rules

##### B.1.1.1 Rule B1: Bits

A "bit string" is an ordered sequence of symbols, each belonging to a two-value set.

The character "0" and "1" are used to indicate one bit, respectively of one or the other value.

Formally, the notations « 0 » and « 1 » denote each a set composed of a single bit string of a single bit, of different values.

In addition the word "bit" denotes the set of the two 1-bit long strings, namely 0 and 1.

##### B.1.1.2 Rule B2: Null String

Where needed, the word "null" call be used to indicate the null string, i.e., the string of no symbols.

Formally, the notation « null » denote the set composed of a single bit string, the empty string.



### B.1.1.3 Rule B3: Concatenation

A succession of two string descriptions describe the concatenation of the strings.

More formally: a succession of two string descriptions describes the strings obtained by concatenation of one string taken in the subset described by the first string description and then one string taken in the subset described by the second string description. The rule extends to any number of string descriptions.

For instance:

00
----

This denotes the set composed of the single bit string of length 2 composed of two zeros.

### B.1.1.4 Rule B4: Choice

A list of choices is noted using as separator the character "|". An alternative notation uses instead the word "or" (this is not used in the present document).

**NOTE:** An idea is to allow not to used strange characters, by giving in each case a verbose equivalent. This is not done systematically yet in the present document.

Formally: the notation  $A | B$ , where  $A$  and  $B$  are string set descriptions, describes the set of the strings which are in the set described by  $A$  or in the set described by  $B$ , that is the union of sets described by  $A$  and  $B$ .

The concatenation has a higher precedence than the choice.

Examples:

00   01
---------

This indicates that bit strings 00 and 01 are part of the set (10 and 11 are not).

0   1
-------

Denotes the same set as "bit".

The characters "{" and "}" are used for delimiting a string set description from what follows and/or precedes.

0 {0 1}
---------

This indicates the same set of bit strings as in the previous case.

Precedence example:

10   11 1 0 1
------------------

Because of the priority rule, the two descriptions are not equivalent, the second noting the set (10, 1).

It is allowed that the different sets in a choice have non null intersections. To allow message decoding, a rule must then be given to choose the branch. The rule is that any matching set can be chosen (the concatenation is a true set union).

In practice, it is preferable to have non intersecting choice sets. Moreover, the ability to select the branch to take rapidly is important for obtaining simple message decoders. Except for strong reasons, a design should only include choice construction that can be rewritten using only constructions matching the pattern  $\{a1 s1 | a2 s2\}$  where  $a1$  and  $a2$  are non-intersecting sets of strings of the same non-null length. A tolerable derogation is to use intersecting  $an$ .

Examples:

$\{100 xx | 001 zz\}$  is acceptable.

$\{00 xx | 010 yy | 011 zz\}$  is acceptable, since it can be rewritten  $\{00 xx | 01 \{0 yy | 1 zz\}\}$ .

$\{\{00|01|10\} xx | \{00|11\} yy\}$  is not recommended (the start 00 is ambiguous).

In practice this covers fixed length tagging (like tagging by an IEI, or 1-bit tagging in rest octets), and also non-intersecting variable length tagging as used for instance in the frequency list IE (tag list such as 0, 100, 101, 110, 11100, 11101, 11110, 11111, where no tag is the start of another one).

### B.1.1.5 Rule B5: Naming

The characters "<" and ">" are used to delimit a *reference* to the description of a string set. This can be used inside a string set description, to refer to a string set described elsewhere.

For compilability, the name must be used somewhere else to define the corresponding string set. For a simple description, the description of the reference could be done by normal text.

The name, that is the part sequence of characters between "<" and ">" must not be empty, and is constituted freely of characters, with the exception of "<" and ">". Case is not significant, nor are heading or tailing spaces. Any succession of space characters is treated as a single character. To avoid difficulties with more advanced rules, the use of the characters ":", "=", "(", and ")" should be avoided. More generally, it is not recommended to use many other characters, such as "<" for instance. The space character can (and should!) be used, to allow a good legibility for human beings.

Example:

```
<bit pair>
```

### B.1.1.6 Rule B6: Definition

A reference followed by the character sequence "::<=" followed by a string set description is used to associate the description with the reference, terminated when needed to separate it from a following definition and when compilability is looked for, by a semi-colon ' ; '.

Recursive definition is allowed, e.g., the reference can appear on the right hand side of the "::<=" . To avoid too much difficulties for would-be-compilers, only tail recursivity should be used, i.e., a recursive term should appear only as the last term of a definition.

Examples:

```
<bit pair> ::= 00 | 01 | 10 | 11 ;
```

This could have been noted as well:

```
<bit pair> ::= {00 | 01 | 10 | 11} ;
```

or

```
<bit pair> ::= {0|1} {0|1} ;
```

Recursive example:

```
<all bit strings> ::= null | { {0 | 1} <all bit strings> } ;
```

Another recursive, but not tail-recursive (and then not recommended) example:

```
<all bit strings> ::= null | { <all bit strings> {0 | 1} } ;
```

## B.1.2 Spare parts

For the purpose of message description it is in many cases needed to specify differently the set of bit strings that are acceptable when received and the corresponding set of bit strings which may be sent. The second set is included in the first. A first example are the spare parts.

Notations related to spare parts are different in nature from the bit string set description seen so far. They define two sets at the same time, the sent set and the received set. A construction rule of general application will be defined in advanced rules. For the moment, only two ad-hoc constructions are described.

### B.1.2.1 Rule B7: Spare bits

The following construction:

```
<spare bit>
```

describes a 0 when emitted and a bit (0 or 1) in reception.

### B.1.2.2 Rule B8: Padding bits

An issue specific to the GSM radio interface protocols is that in some cases the messages cannot take arbitrary lengths. Padding is then necessary to fill up the message up to the desired length. Moreover, the padding uses a particular sequence of bits, of fixed position, i.e., the value of a padding bit depends on its position relative to the start of the message. The padding sequence is protocol-specific. In most cases it is constituted of all 0 values, in which case the following notation is of no use. In the case of GSM 04.08, the padding sequence is the repetition of octet 00101011, starting on an octet boundary.

The special notations "L" and "H" are used to denote the respectively the bit value corresponding to the padding spare bit for that position, and the other value.

The notations "0", "1", "null", "L" and "H" are the only terminals in CSN.1.

Padding spare bits are bits which are set to the indicated value in emission whereas in reception any bit string is acceptable. The following notation:

```
<spare L>
```

describes a bit which has a logical value L in emission, and is a bit (0 or 1) in reception.

The term <spare padding> denotes the required padding spare bits needed to fill up the message. The construction can be developed only partially from the rules described so far, because the length limitation does not appear in the following description:

```
< spare padding> ::= <spare L> { null | < spare padding>};
```

### B.1.3 Predefined sets

The notation allows a modular description of the messages. This means in particular the possibility to build a library of bit string set definitions to be used wherever needed. The following is an example of an elementary library, which could be specified once and can be used in other specifications without being redefined.

```
<bit> ::= 0|1 ;
<bit (1)> ::= <bit>;
<bit (2)> ::= <bit> <bit>;
<bit (3)> ::= <bit (2)> <bit>;
<bit (4)> ::= <bit (3)> <bit>;
<bit (5)> ::= <bit (4)> <bit>;
<bit (6)> ::= <bit (5)> <bit>;
<bit (7)> ::= <bit (6)> <bit>;
<octet> ::= <bit (7)> <bit>;
<half octet> ::= <bit (4)>;
<spare half octet> ::= <spare bit><spare bit><spare bit><spare bit>;
  <spare padding> ::= <spare L> { null | <spare padding>};

<octet string(i)> ::= <octet>(i);      -- for any positive or null integer i
<bit(i)> ::= <bit>(i);                -- for any positive or null integer I
<bit string> ::= bit**;
<octet string> ::= <octet>**;
```

NOTE 1: The definition of generic constructions such as <bit string(i)> is somewhat cumbersome with only the basic rules. More advanced rules would allow a much more compact notation.

NOTE 2: The use of the characters "(" and ")" within a reference is done consistently with potential advanced rules.

NOTE 3: This basic library is not exhaustive and can be extended when the needs arise.

## B.1.4 Labelling Parts

### B.1.4.1 Rule A1: Labels

Delimited names as defined by Rule B6 identify sets of sub strings. In many cases this can be used within the context of a message to refer to the specific part of the message. However, this is not of general application, since it may happen that two parts of a message follow the same structure, and economy of notation requires that the structure is described but once.

The general syntax that follows allows to refer to a part inside a description:

```
<name1 : string description>
```

For the definition of string sets, this is equivalent to the string description being used alone.

The name used as a label can be built according to the rules applicable to parenthesed references.

Examples:

```
<Tag : 000 >
<Field : <Field type>>
<Field : octet>
```

The third example shows the use of a non parentheses reference to obtain a more elegant expression than, for instance, the second example. At this stage, labels has no use for describing message syntax, but can be used to refer to the corresponding part of the string, e.g., in the description of the message specifying the relationship between the syntactical content and the semantical contents of the message, or to associate properties with effective sub-strings in effective messages (rather than with sets of sub strings). Syntactical use of the semantical identifier are presented in more advanced rules.

The same name may appear in several places. Designers have to be careful to use non ambiguous names if non-ambiguous reference is desired.

## B.1.5 Goodies

### B.1.5.1 Rule G1: Comments

Comments can be added, starting with the term "--" and ended by the end of line. Comments can be used in particular to indicate the section where a particular description can be found.

## B.2 Advanced rules

### B.2.1 Rule A2: Exponent notation

An arithmetic expression used as exponent after a delimited string description is used to indicate repetitions.

A numerical expression between parentheses indicates a fixed number of repetitions.

```
<octet> ::= {0 | 1}(8) ;
```

is equivalent to

```
<octet> ::= {0 | 1} {0 | 1} {0 | 1} {0 | 1} {0 | 1} {0 | 1} {0 | 1} {0 | 1} ;
```

This could also be written:

```
<octet> ::= bit(8) ;
```

When the exponent is negative or equal to 0, the exponentiated construction is equivalent to the null string. An example of a common construction is the following:

```
<name : bit(5)>
```

Simple arithmetic, using numbers, terms "+", "-", "\*", and "/", and parentheses are allowed in expressions.

Example:

```
<octet string(40)> ::= <octet>^(8*(4+1));
```

A star used alone between parentheses, or a double star, indicates a finite, possibly null, but indeterminate, number of repetitions. (The star used as an exponent can be understood also as meaning the union of all the sets obtained by replacing the star by zero or some positive integer).

```
<all bit strings> ::= {0 | 1}(*);  
<all bit strings> ::= {0 | 1}**;
```

This allows a shorter notation of recursive constructions such as:

```
<all bit strings> ::= {0|1} <all bit strings> | null;
```

A shorter notation is allowed when the expression has a single term, consisting of a star followed by the term:

```
<octet> ::= {0 | 1}*8 ;  
<octet string(40)> ::= <octet>*(8*(4+1)) ;  
<all bit strings> ::= bit**;
```

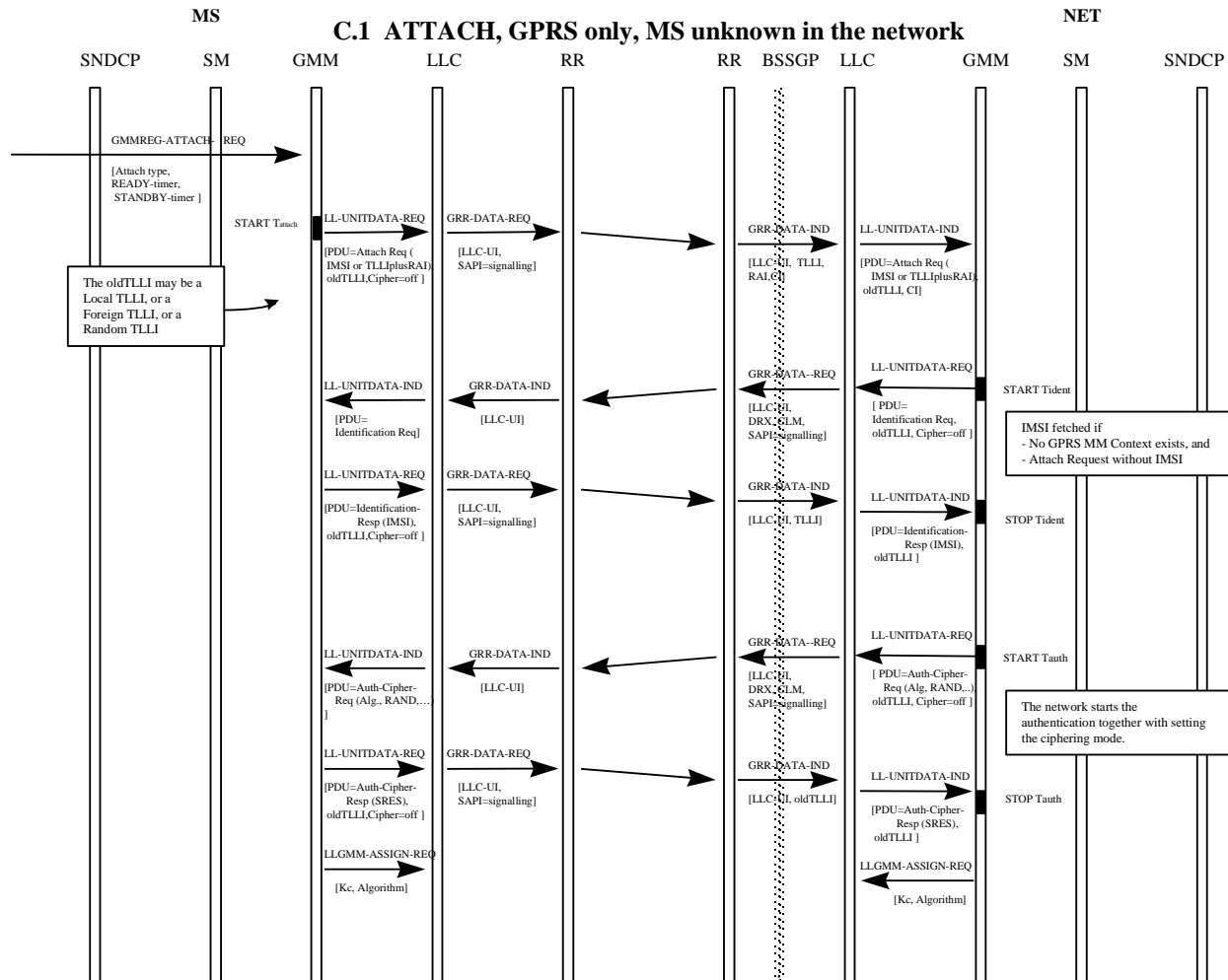
Application note:

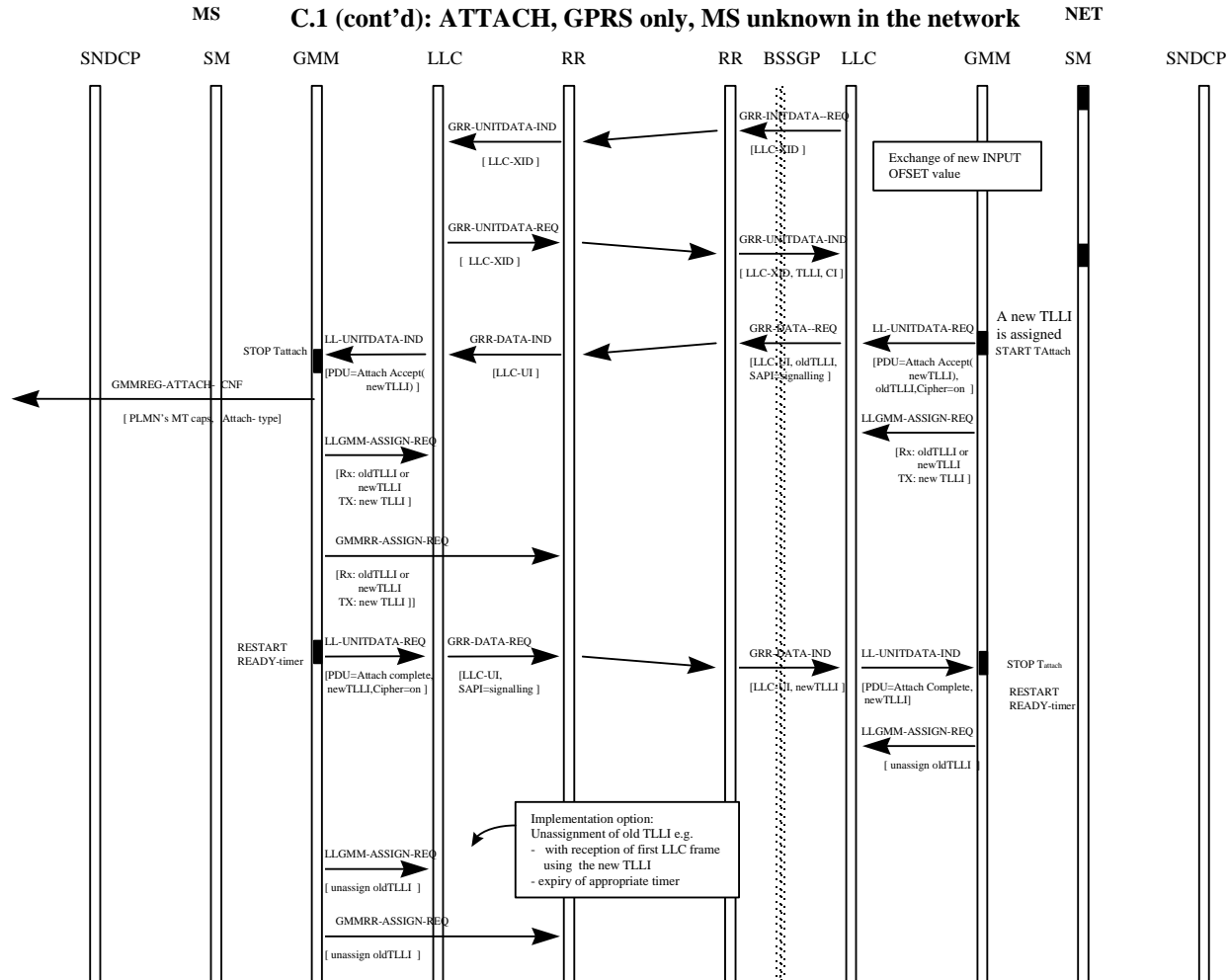
The indefinite exponent is usually combined with some mean to indicate to the decoder the end of the repetition. Different techniques exist, such as indicating in a previous field the number of repetitions. Another technique is one-bit tagging, an example of which follows: {1 <item>}\*\* 0.

---

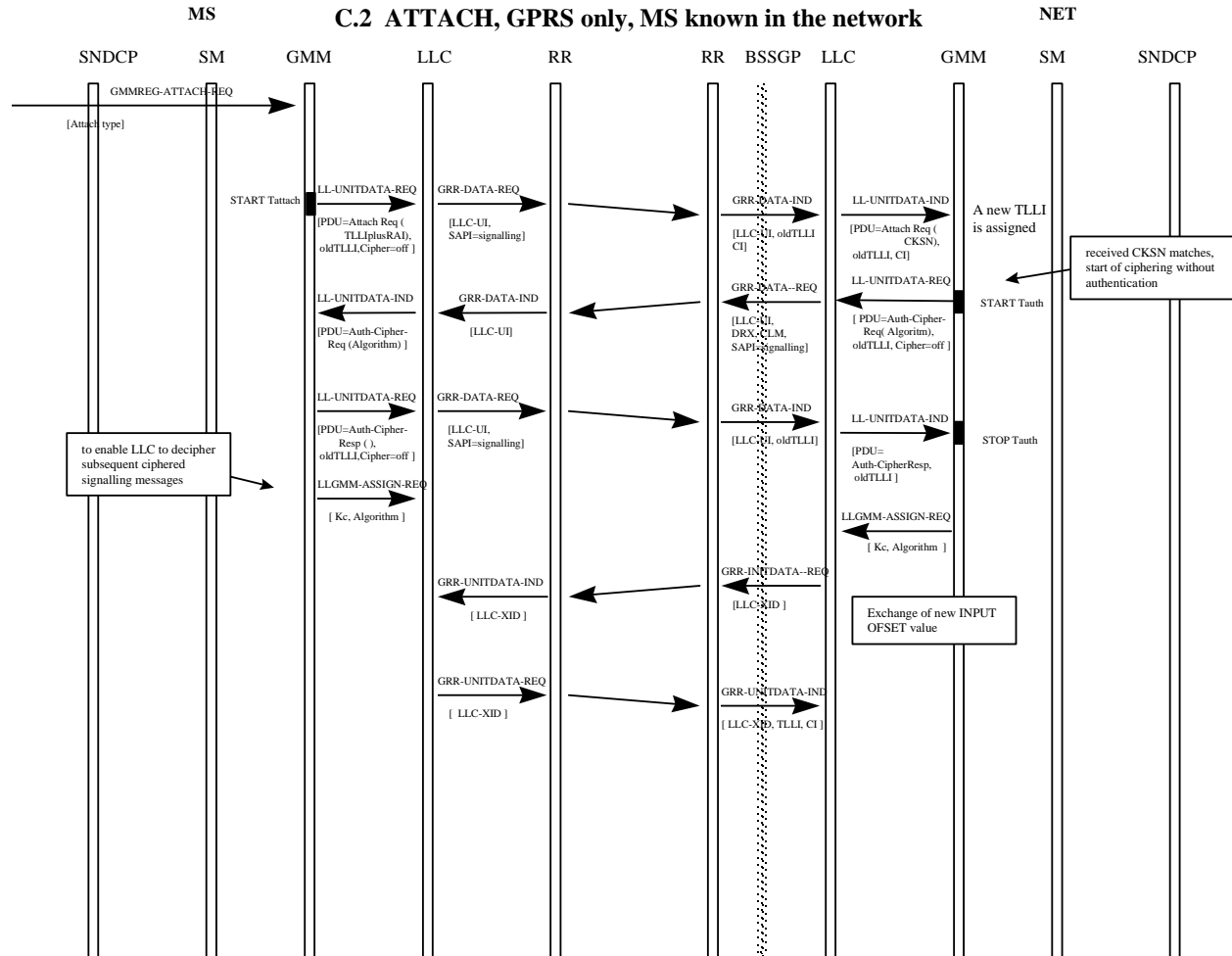
## Annex C (informative): GPRS-Services sequence diagram

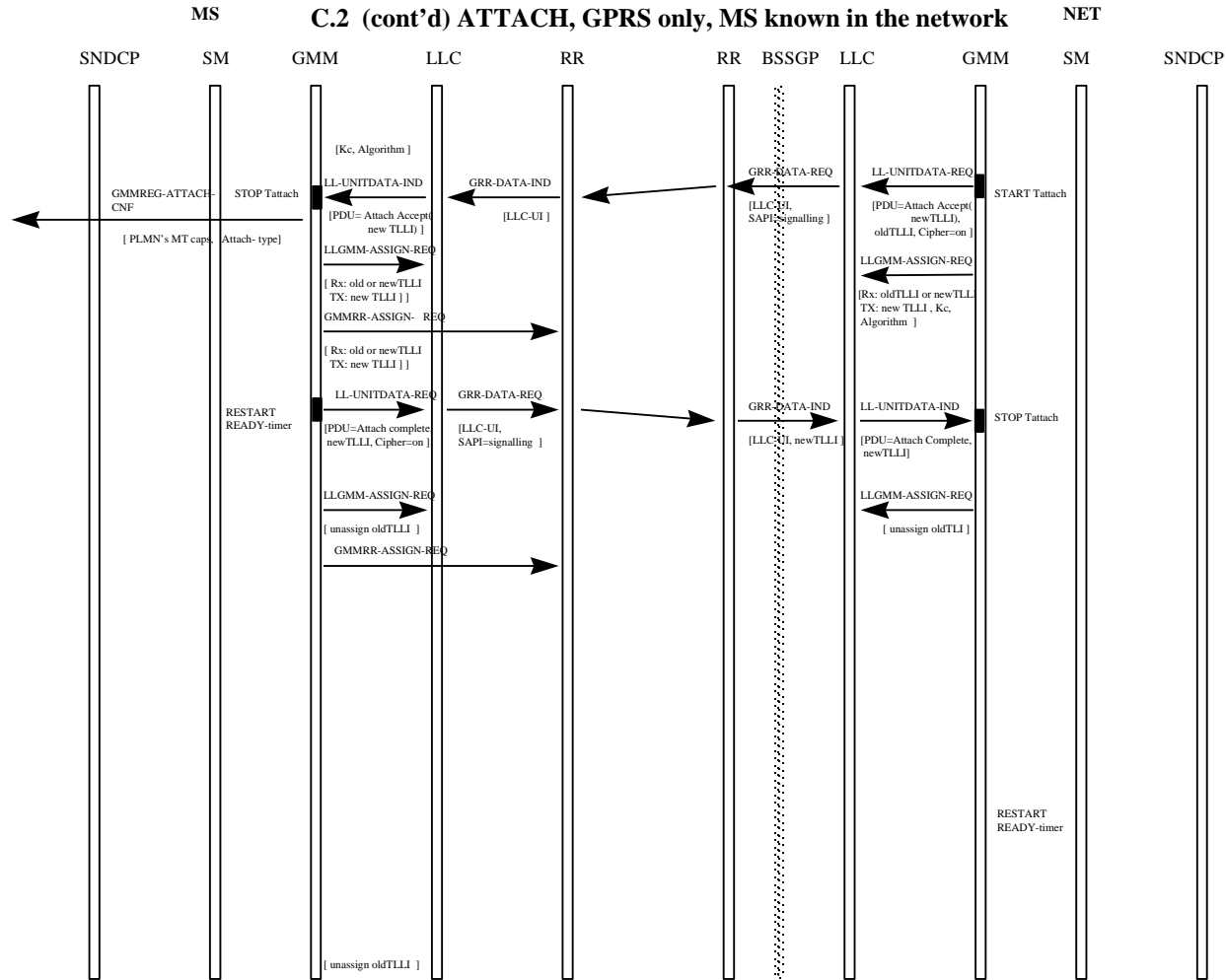
Instead of providing a complete set of all scenarios, the intention of this clause is to provide some typical examples. It shall be noted, that within the figures only those parameters of the PDUs and the service primitives are shown, which are needed for a general understanding of the examples. Furthermore during the examples below (except C.17) no cell re-selection takes place.

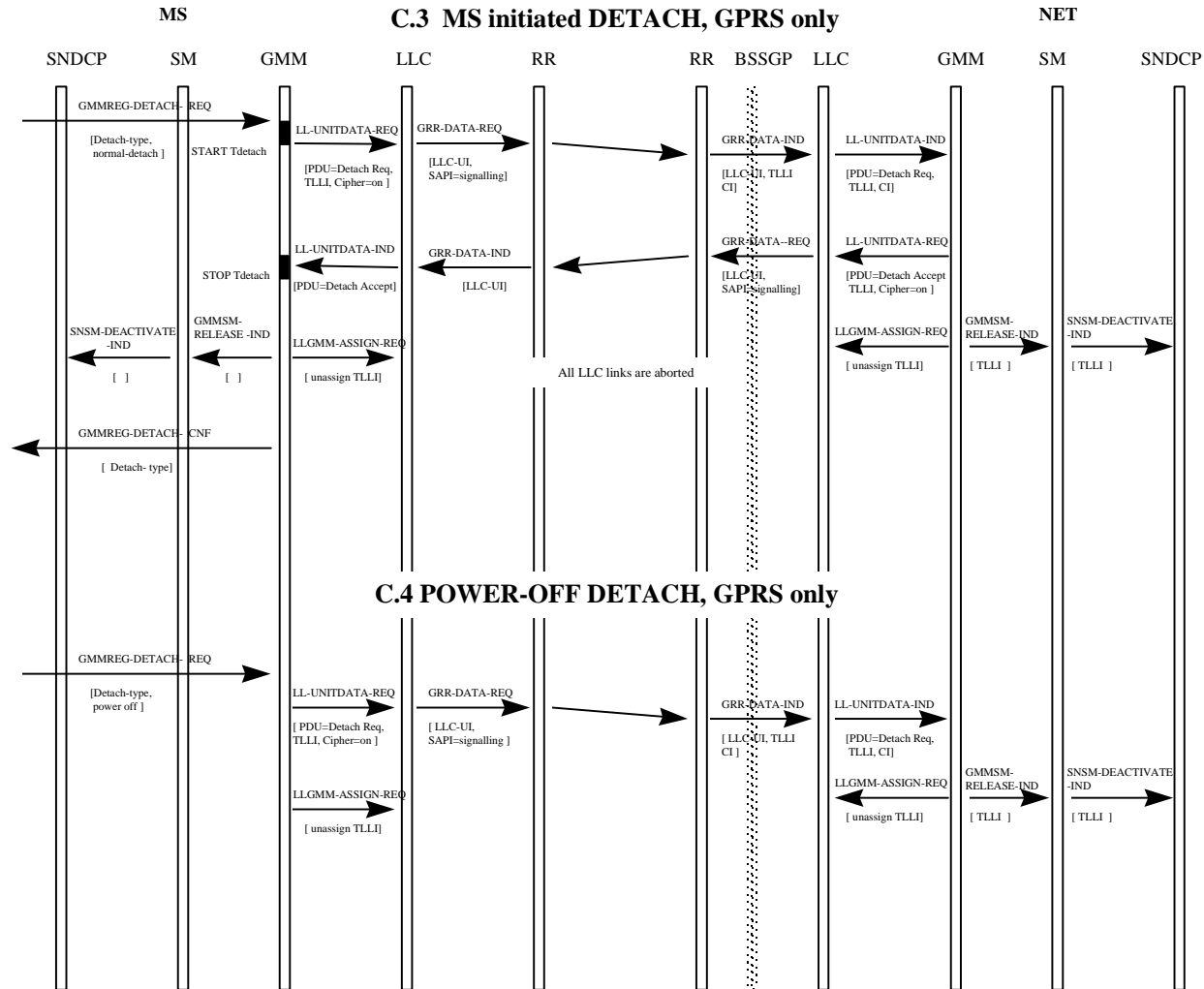


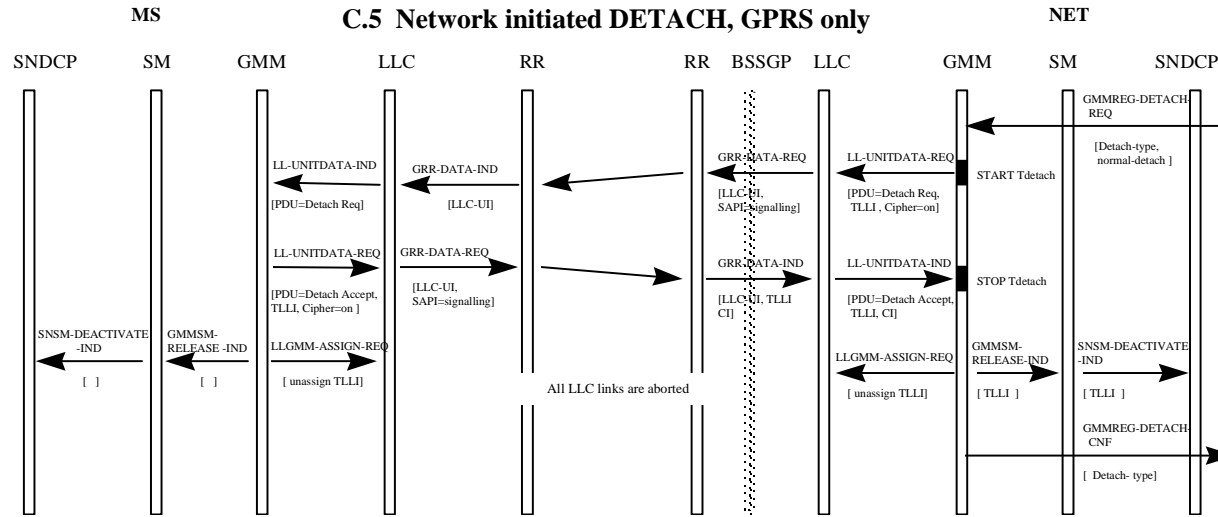








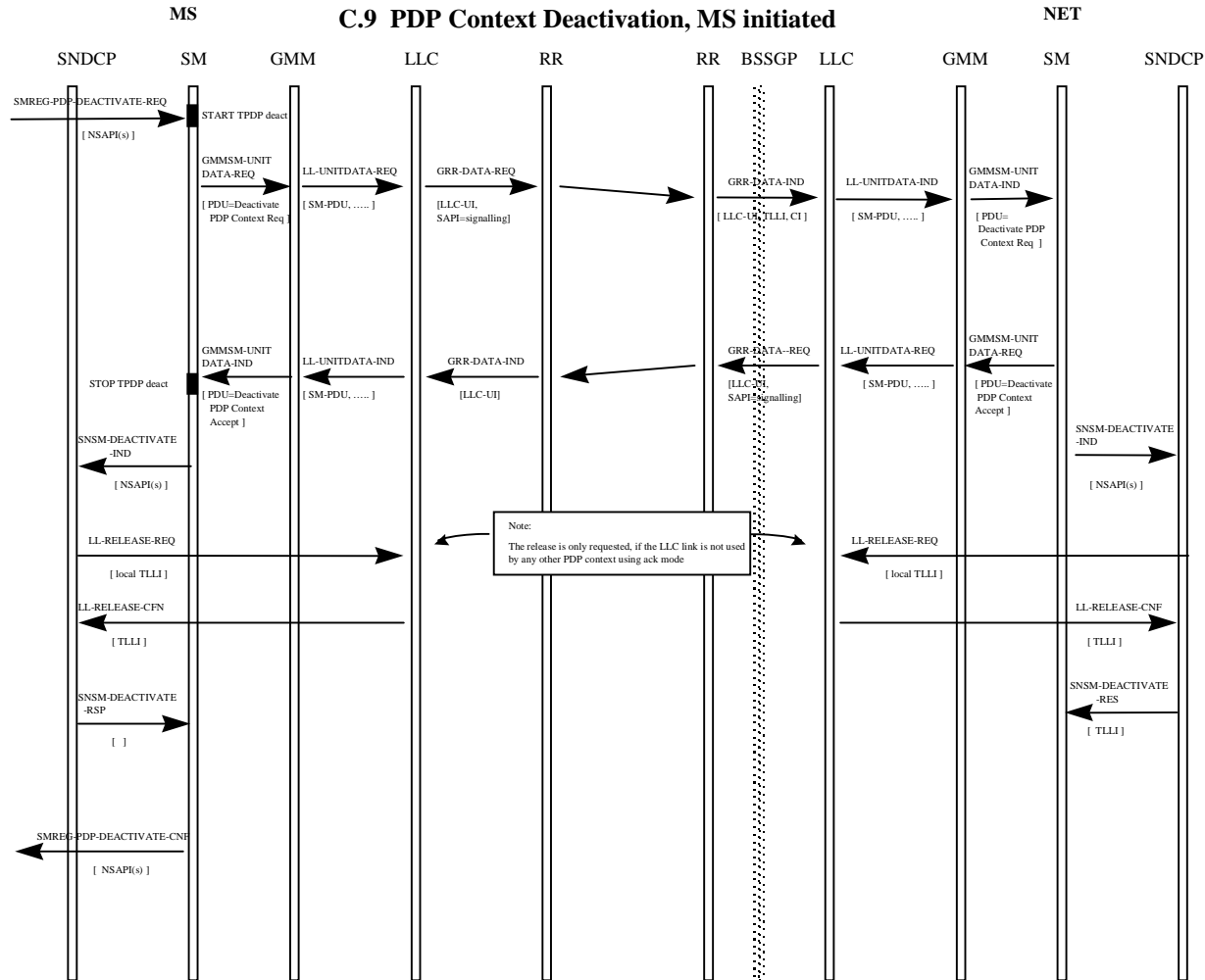






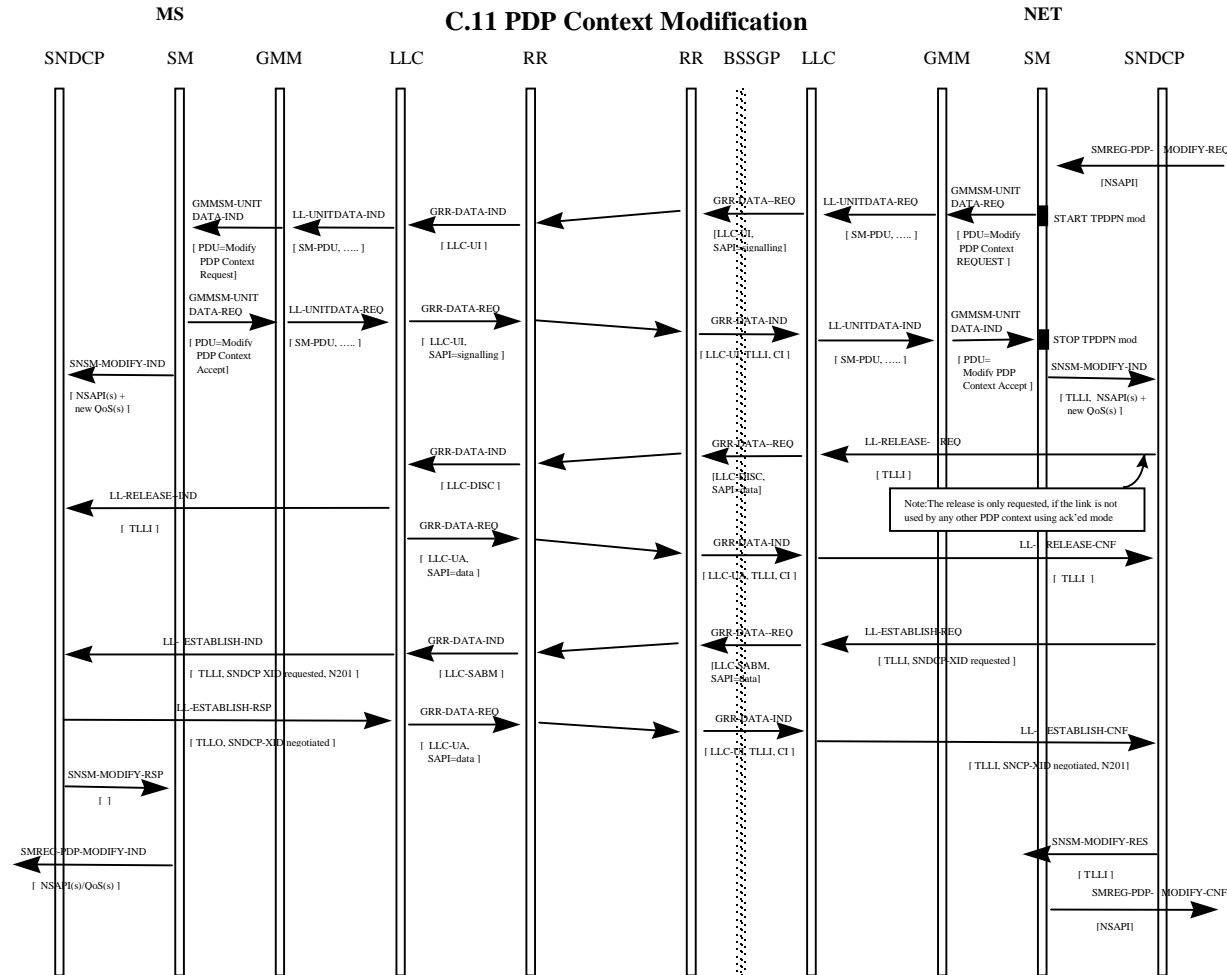


**C.8 Anonymous PDP Context Activation  
(Void)**

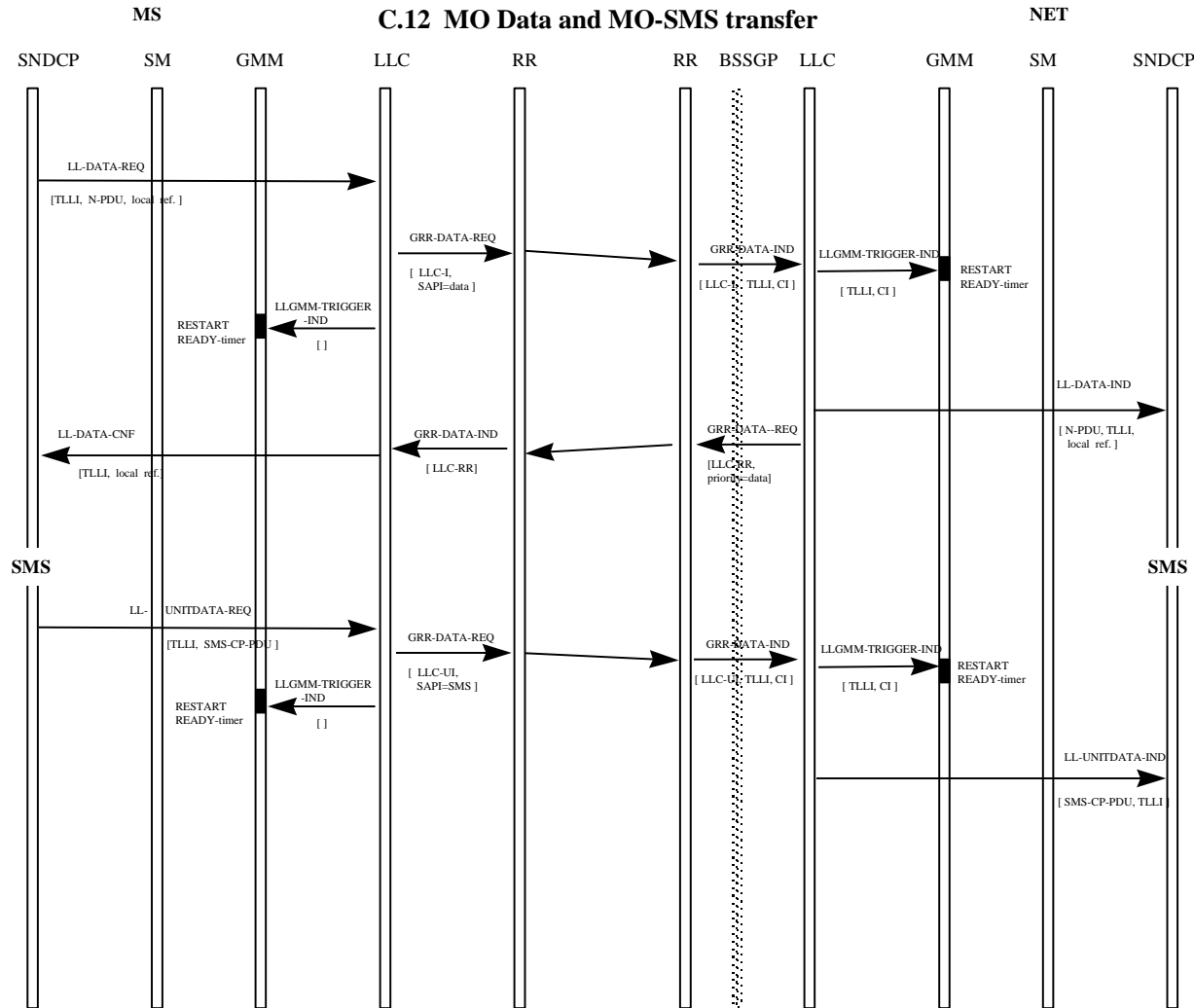


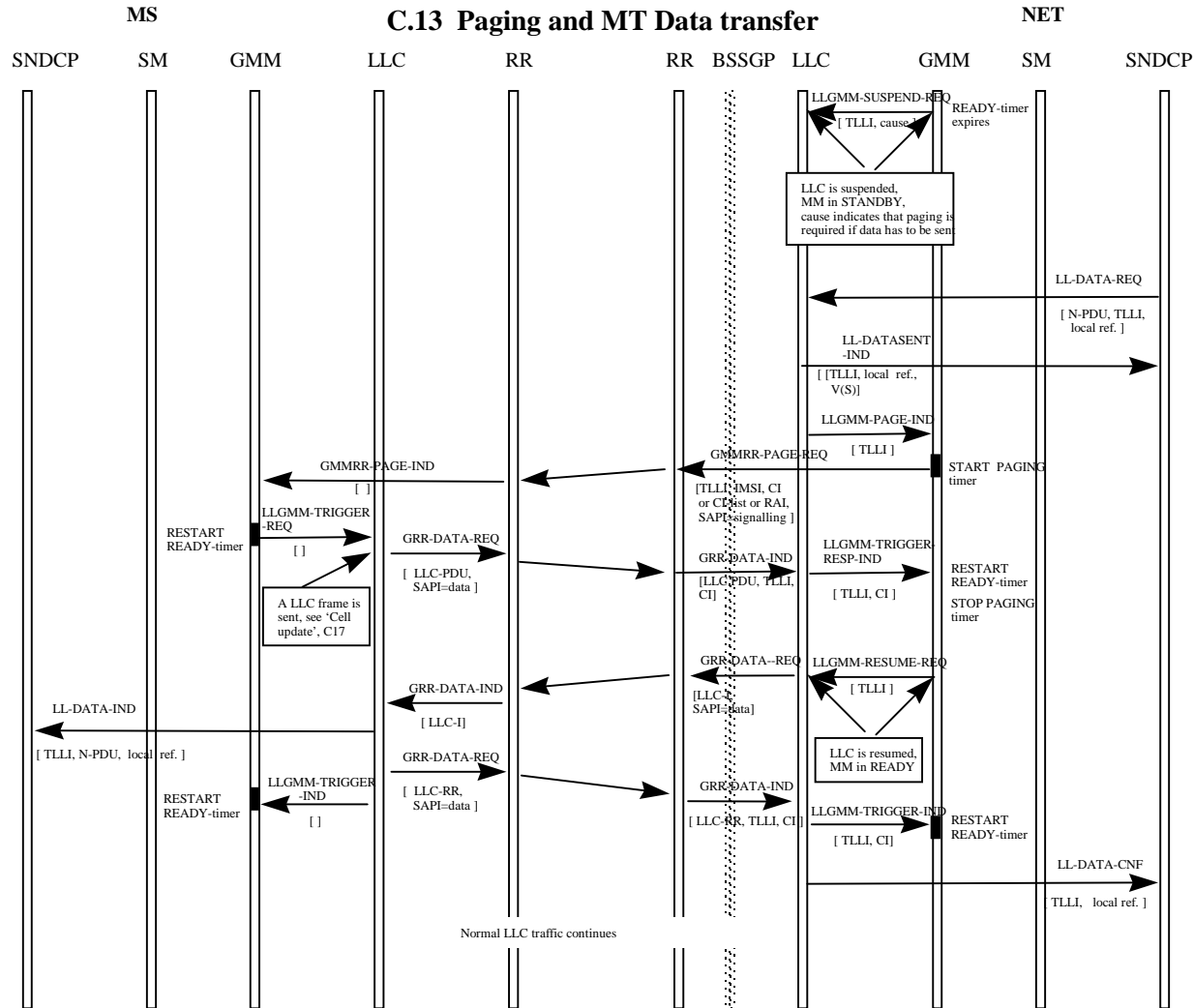


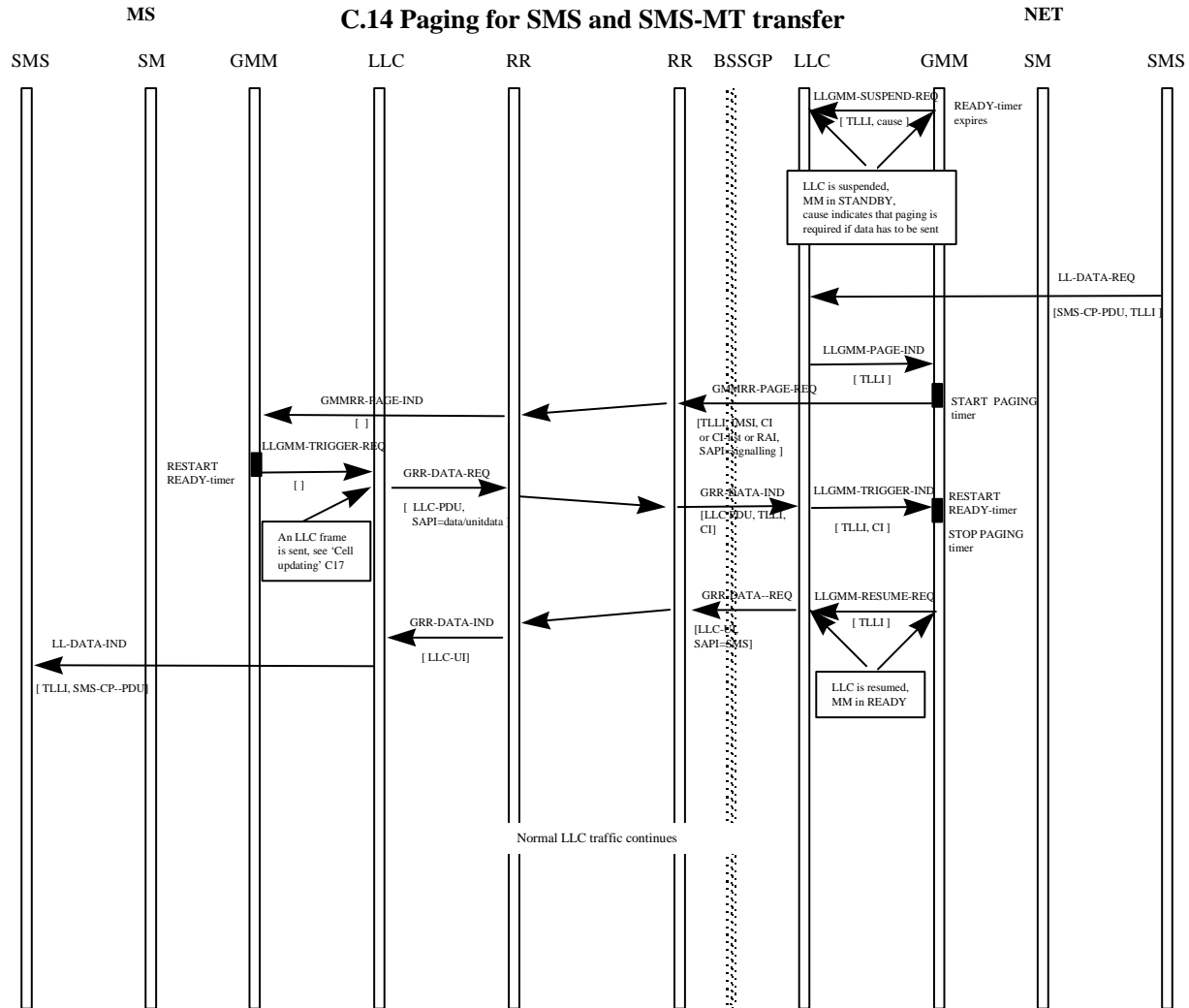


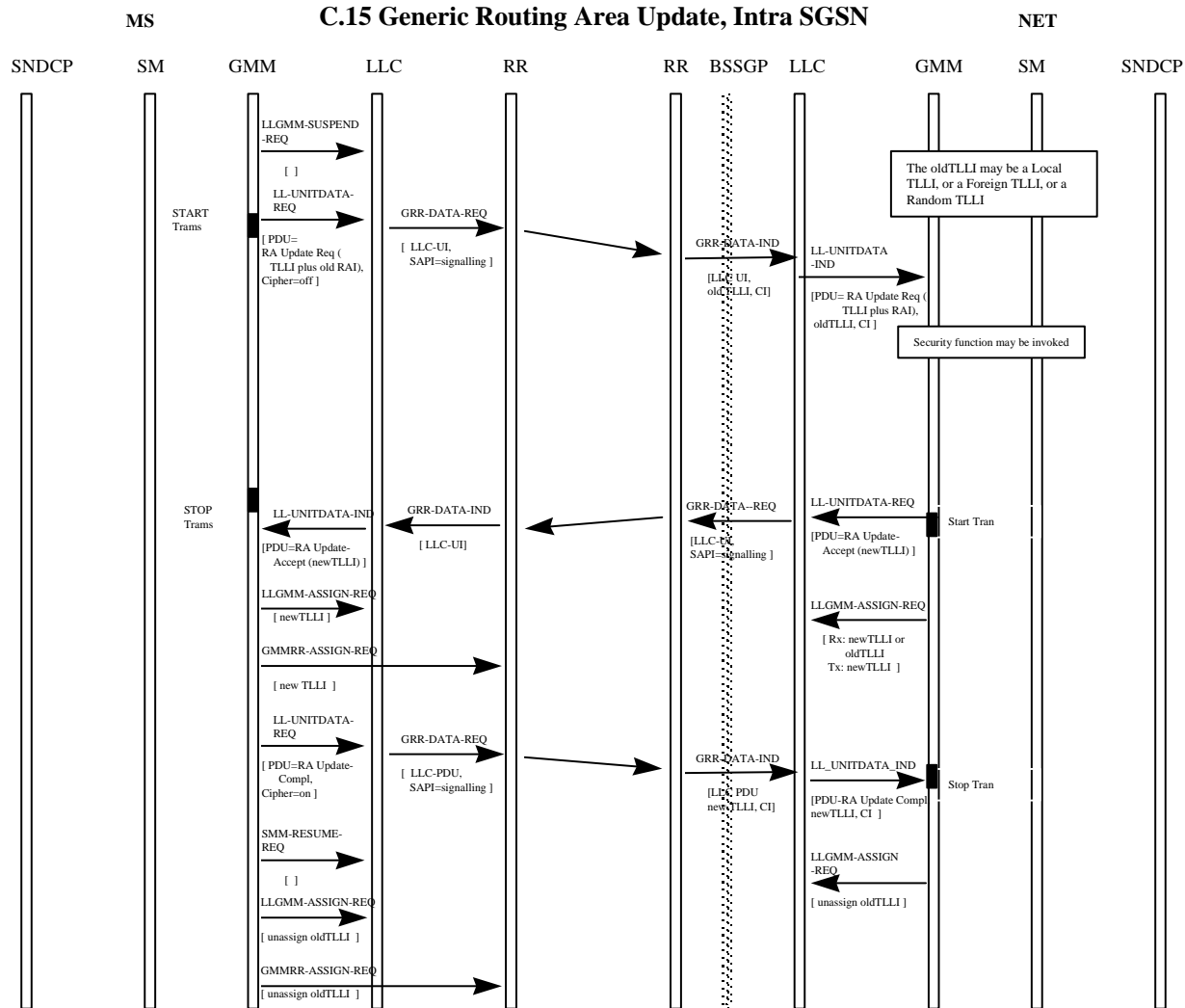


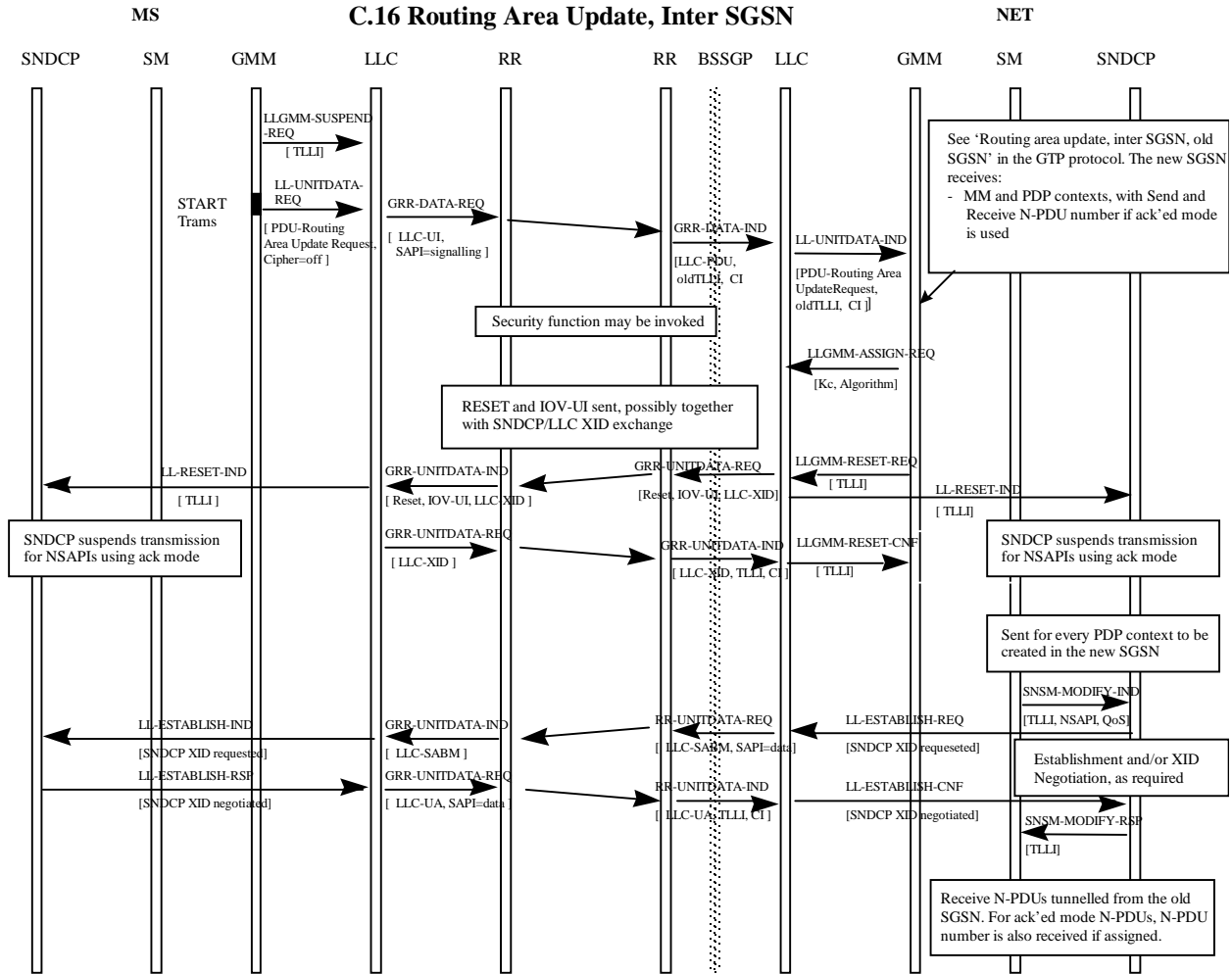
NOTE: The standalone PDP context modification procedure should use graceful disconnection of the LLC link.

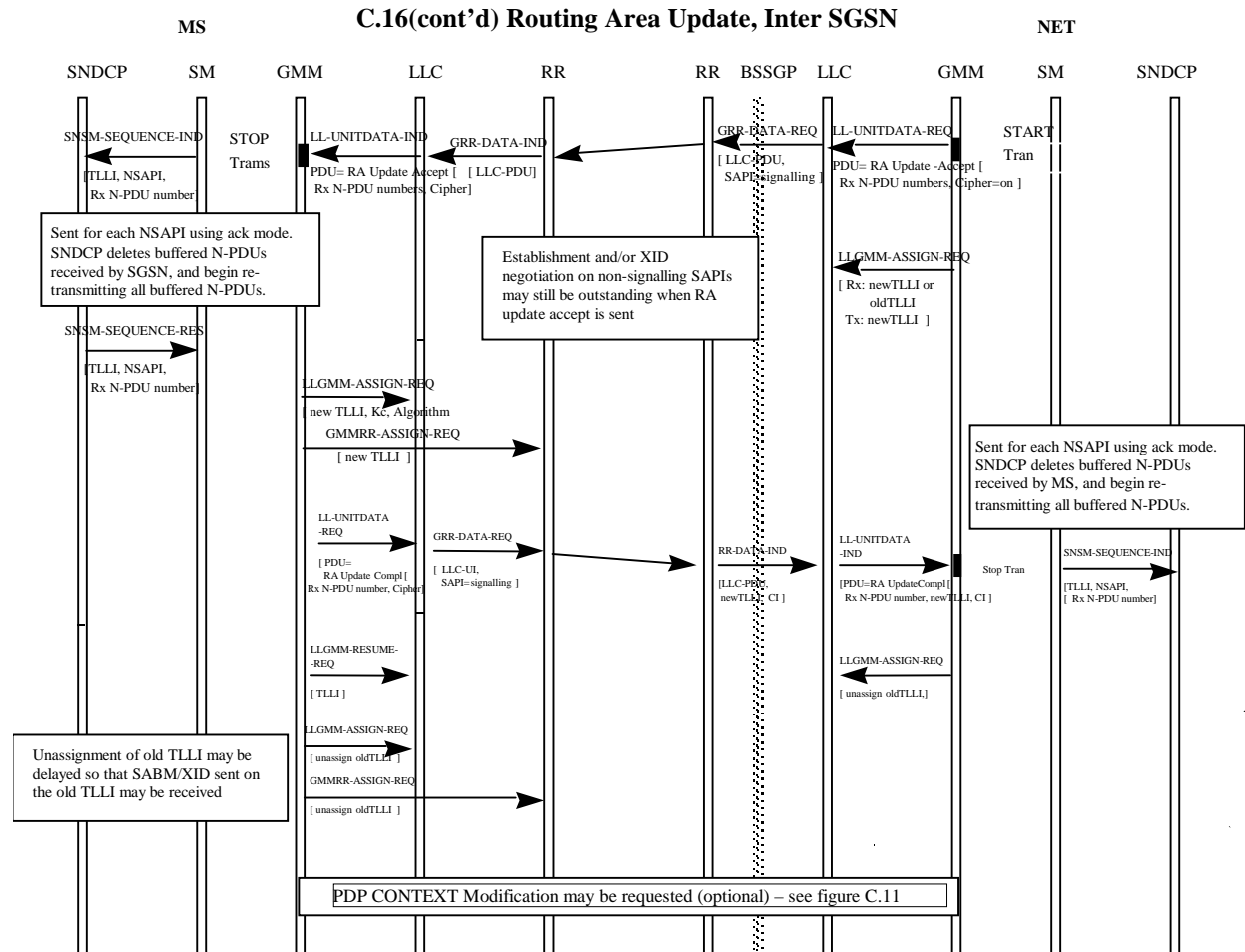




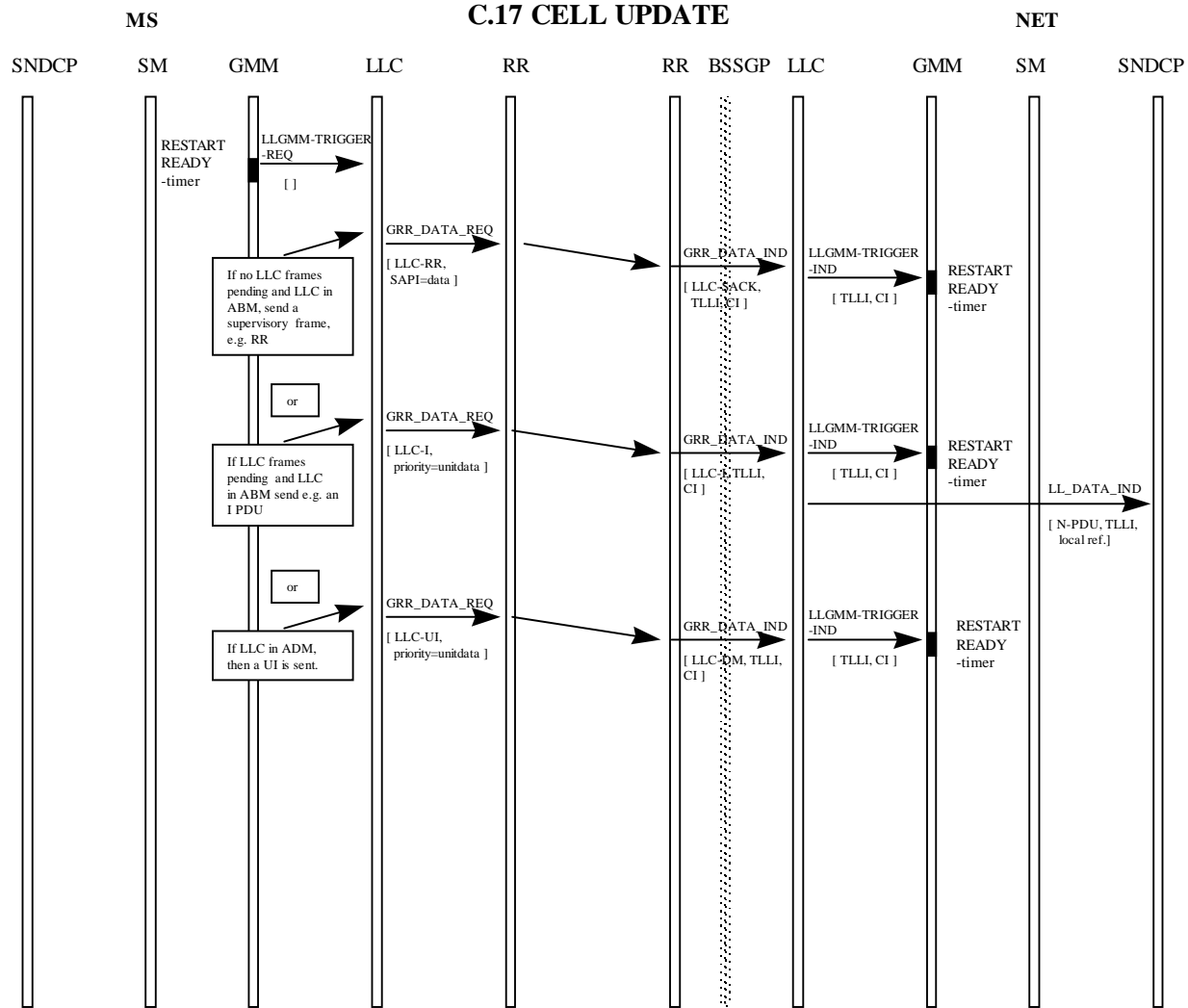




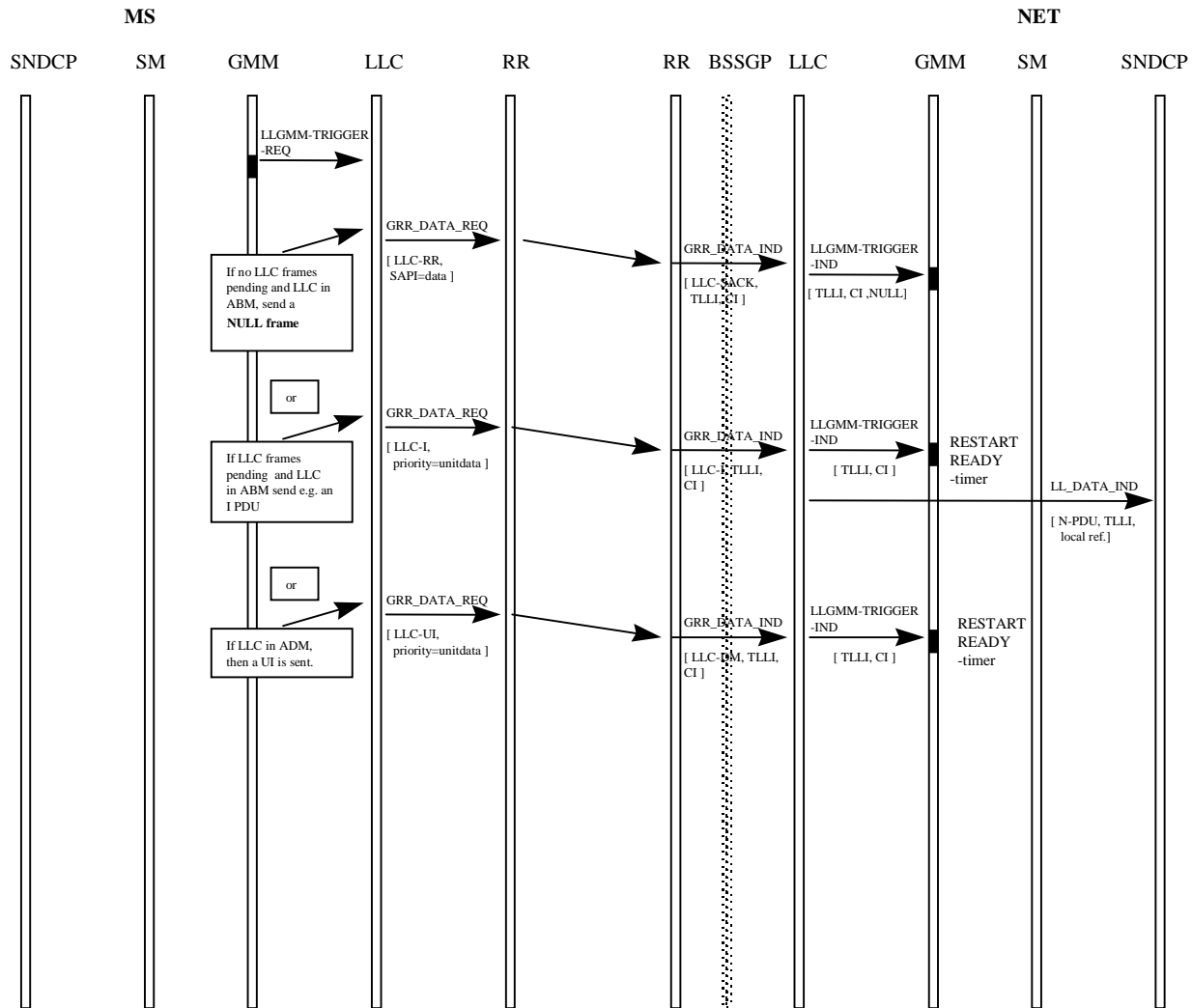








C.18 CELL Notification



## Annex D (informative): Change history

TSG SA#	Spec	Version	CR	Rev	Rel	New Version	Subject	Comment
Jun 1999	GSM 04.07	7.1.0						Transferred to 3GPP CN
CN#04	24.007					3.0.0		
CN#5	24.007	3.0.0	002	1	R99	3.1.0	Addition of LL-STATUS_IND	
CN#6	24.007	3.0.1	004	1	R99	3.2.0	Uplink L3 Message Sequencing	
CN#6	24.007	3.0.1	005		R99	3.2.0	Mirror R99 LCS CR to 04.07	
CN#6	24.007	3.0.1	003	5	R99	3.2.0	Using MM sublayer for PS-SMS message transfer	
CN#6	24.007	3.0.1	001	5	R99	3.2.0	Transaction Identifier Extension	
CN#7	24.007	3.2.0	006	1	R99	3.3.0	Updating Session Management (SM) for R99	
CN#7	24.007	3.2.0	007		R99	3.3.0	Removal of Anonymous Access	
CN#7	24.007	3.2.0	008		R99	3.3.0	PMMSMS-REL-Req deletion in MS side	
CN#7	24.007	3.2.0	010	1	R99	3.3.0	Integrity checking of signalling messages for UMTS	
-	24.007	3.3.0	-	-	R99	3.3.1	Editorial changes	

TSGN	TSGN-number	WG Number	Spec	CR	Rev	Rel	C at	Old vers	New ver	Title	WI	Notes/Date
CN#8	NP-000270	N1-000620	24.007	006	2	R99	F	3.3.1	3.4.0	Updating SM for R99	GSM/UMTS Interworking	
CN#8	NP-000270	N1-000619	24.007	012		R99	F	3.3.1	3.4.0	Remove GRR primitive descriptions and make reference to other document	GSM/UMTS Interworking	
CN#8	NP-000269	N1-000763	24.007	014	2	R99	F	3.3.1	3.4.0	Change of the GMM Ready Timer behaviour	GPRS	
CN#08	NP-000269	N1-000668	24.007	015		R99	C	3.3.1	3.4.0	New PD for LLC for use by DTM (Dual Transfer Mode) mobiles	GPRS	
CN#8	NP-000270	N1-000669	24.007	016		R99	C	3.3.1	3.4.0	Services provided by the Radio Resource Management entity	GSM/UMTS Interworking	
CN#9	NP-000443	N1-001032	24.007	013	3	R99	F	3.4.0	3.5.0	SAPs and Service primitives for UMTS, PS mode.	GSM/UMTS Interworking	adapted to adjust the older used release of the spec
CN#9	NP-000443	N1-000880	24.007	018		R99	F	3.4.0	3.5.0	Protocol discriminator value for UE special conformance testing functions	GSM/UMTS Interworking	
CN#9	NP-000443	N1-001015	24.007	019	1	R99	F	3.4.0	3.5.0	Correction of send sequence number method applied protocols	GSM/UMTS Interworking	
CN#9	NP-000443	N1-000930	24.007	020		R99	F	3.4.0	3.5.0	Editorial corrections!!	GSM/UMTS Interworking	
CN#9	NP-000441	N1-000969	24.007	021		R99	F	3.4.0	3.5.0	Protocol Discriminator for DTM (simple class A)	GPRS	
NP-10	NP-000673	N1-001188	24.007	024		R99	F	3.5.0	3.6.0	Removal of Flow Id from RR-SAP	TEI	
NP-10	NP-000670	N1-001367	24.007	025	1	R99	F	3.5.0	3.6.0	RABMAS-SAP and RABMSM-SAP adaptation for Handling of unsynchronized PDP contexts	GPRS	
NP-10	NP-000671	N1-001246	24.007	027		R99	F	3.5.0	3.6.0	Updating CS/PS protocol architecture figure with RABM	GSM/UMTS Interworking	
NP-10	NP-000671	N1-001256	24.007	028		R99	F	3.5.0	3.6.0	Alignment of 24.007 to other specs	GSM/UMTS Interworking	
NP-11	NP-010123	N1-010101	24.007	025	2	R99	F	3.6.0	3.7.0	Addition of Stream Identifier and NAS Synchronization Indicator to the primitives	GSM/UMTS interworking	03-2001
NP-11	NP-010123	N1-010083	24.007	032		R99	F	3.6.0	3.7.0	Change MMAS-SAP to RR-SAP in fig. 5.6	GSM/UMTS interworking	03-2001
NP-11	NP-010207	N1-010486	24.007	034		R99	F	3.6.0	3.7.0	Transfer of the N(SD) duplication avoidance protocol from GSM 04.18	GSM/UMTS interworking	03-2001
NP-11	NP-010205	N1-010447	24.007	035		R99	F	3.6.0	3.7.0	Deletion of cause 'unsynchronousPDP' in RABMAS-SAP	TEI	03-2001
NP-11	NP-010206	N1-010444	24.007	031	3	Rel-4	B	3.7.0	4.0.0	Adaptation of SS protocol to PS domain	TEI	03-2001
NP-14	NP-010682	N1-011811	24.007	043	1	Rel-4	A	4.0.0	4.1.0	Clarification of the send sequence number mechanism	GSM/UMTS interworking	12-2001
NP-16	NP-020218	N1-021341	24.007	047	2	Rel-4	A	4.1.0	4.2.0	RR protocol message type octet	GSM/UMTS interworking	06-2002
NP-16	NP-020222	N1-020893	24.007	049	1	Rel-4	A	4.1.0	4.2.0	Clarification of the extension mechanism for type 4 IEs	TEI	06-2002
NP-16	NP-020224	N1-021367	24.007	053	1	Rel-4	F	4.1.0	4.2.0	Various clean-up of wrong references, eg towards 44.018 and 23.271	TEI4	06-2002
NP-16			24.007			Rel-5		4.2.0	5.0.0	Plenary decision to make this TS also for Rel-5.		06-2002
NP-17	NP-020383	N1-021836	24.007	057	1	Rel-5	F	5.0.0	5.1.0	Clarification of the CN release indicators	TEI5	09-2002
NP-22	NP-030485	N1-031653	24.007	059	1	Rel-6	F	5.1.0	6.0.0	Don't use SAPI to differentiate between messages of the same message type.	TEI6	12-2003
NP-24	NP-040185	N1-040967	24.007	063	1	Rel-6	A	6.0.0	6.1.0	Corrections concerning the use of the LCS protocol	LCS	06-2004
NP-25	NP-040377	N1-041625	24.007	064	1	Rel-6	B	6.1.0	6.2.0	Update of the Session Management services - MBMS	MBMS	09-2004
NP-25	NP-040375	N1-041645	24.007	067	4	Rel-6	B	6.1.0	6.2.0	Sequence number handling during redirection in MOCN sharing scenario	NTShar	09-2004
NP-26	NP-040501	N1-04844	24.007	070			A	6.2.0	6.3.0	Sequence numbering for SS via PS	TEI4	12-2004
NP-27	NP-050068	N1-050045	24.007	072		Rel-6	A	6.3.0	6.4.0	Addition of maximum data rate to RR_SYNC_IND and MMCC_SYNC_IND	SCUDIF	03-2005
CP-29	CP-050361	C1-050966	24.007	074		Rel-6	F	6.4.0	6.5.0	Use of short header format on SDCCH / FACCH	TEI6	09-2005
CP-29	CP-050366	C1-051030	24.007	075	1	Rel-7	F	6.5.0	7.0.0	Handling of the L2 Pseudo Length	TEI7	09-2005
CP-42	CP-080866	C1-085163	24.007	0078	2	Rel-8	B	7.0.0	8.0.0	Support of EPS NAS protocols	SAES	12-2008
CP-43	CP-090125	C1-091296	24.007	0082	2	Rel-8	F	8.0.0	8.1.0	UE side architecture figure without CSFB	SAES	03-2009
CP-43	CP-090153	C1-091320	24.007	0083	2	Rel-8	F	8.0.0	8.1.0	Architecture figure for EPS UE + CSFB	SAES-CSFB	03-2009
CP-43	CP-090130	C1-091182	24.007	0085	1	Rel-8	F	8.0.0	8.1.0	Message duplication in S1 mode	SAES	03-2009
CP-43	CP-090125	C1-091106	24.007	0086	1	Rel-8	F	8.0.0	8.1.0	Add reference of LTE test control specification	SAES	03-2009

TSGN	TSGN-number	WG Number	Spec	CR	Rev	Rel	Cat	Old vers	New ver	Title	WI	Notes/Date
CP-43	CP-090126	C1-091350	24.007	0087	2	Rel-8	F	8.0.0	8.1.0	Clarification of format of LV-E/TLV-E Length Indicator format	SAES	03-2009
CP-43			24.007			Rel-8		8.0.0	8.1.0	Editorial cleanup by MCC		03-2009
CP-44	CP-090422	C1-092120	24.007	0090	1	Rel-8	F	8.1.0	8.2.0	Handling of sequence numbers	SAES-SRVCC	06-2009
CP-46						Rel-9		8.2.0	9.0.0	Upgrade to Rel-9 by MCC		12-2009
CP-51						Rel-10		9.0.0	10.0.0	Upgrade to Rel-10 by MCC		03-2011
CP-56	CP-120309	C1-121630	24.007	0094	2	Rel-11	F	10.0.0	11.0.0	Clarify maintenance concept for this specification	TEI11	06-2012
CP-60	CP-130264	C1-131596	24.007	0095	1	Rel-12	F	11.0.0	12.0.0	CM sublayer of EPS services	TEI12	06-2012
CP-60	CP-130264	C1-131744	24.007	0096	2	Rel-12		11.0.0	12.0.0	Clarify on specification maintenance	TEI12	06-2012
CP-70			24.007			Rel-13		12.0.0	13.0.0	Upgrade to Rel-13 by MCC		12-2015

Change history												
Date	Meeting	TDoc	CR	Rev	Cat	Subject/Comment						New version
2017-03	CP-75	CP-170129	0099	2	B	Addition of ePCO for GPRS						14.0.0
2018-03	CP-79	CP-180075	0100	1	B	Extended protocol discriminator						15.0.0
2018-03	CP-79	CP-180075	0101	1	B	Update of protocol discriminator values for test procedures for 5GS						15.0.0
2018-03	CP-79	CP-180075	0103	2	B	For 5GS - UE protocol architecture						15.0.0
2018-03	CP-79	CP-180075	0104	2	B	For 5GS – message and security headers and PDU session identities						15.0.0
2018-03	CP-79	CP-180075	0107		B	Format of standard IE for 5GS						15.0.0
2018-03	CP-79	CP-180075	0108	1	B	Scope update for 5GS						15.0.0
2018-03	CP-79	CP-180075	0110		B	Definition of 5GS NAS message type for 5GS						15.0.0
2018-06	CP-80	CP-181057	0111	1	B	Specification of security protected 5GS NAS message header						15.1.0
2018-06	CP-80	CP-181069	0112	2	B	EPS bearer identity in NAS message header						15.1.0
2018-06	CP-80	CP-181057	0113	1	B	Include TS 24.501 and TS 24.502 among the layer 3 related Technical Specifications						15.1.0
2018-06	CP-80	CP-181058	0114	2	B	PDU session identity						15.1.0
2018-09	CP-81	CP-182128	0116	2	F	Interaction when uplink user data packet is to be sent via a PDU session with suspended user-plane resources						15.2.0
2018-09	CP-81	CP-182128	0117	1	F	Correction on PTI definition						15.2.0
2018-09	CP-81	CP-182128	0118	1	F	Multiple access technologies in NG-RAN carrying 5GS NAS						15.2.0
2018-12	CP-82	CP-183030	0121	2	F	Value range of IEs for 5GMM and 5GSM protocols						15.3.0
2018-12	CP-82	CP-183030	0122		F	Correction to scope						15.3.0
2019-03	CP-83	CP-190105	0123		F	EPS bearers not released when moving to EMM-IDLE						16.0.0
2019-06	CP-84	CP-191145	0124		F	EPS bearers not released when moving to EMM-IDLE						16.1.0
2020-03	CP-87e	CP-200128	0128	3	D	Correcting reference						16.2.0
2020-06	CP-88e	CP-201131	0129	1	F	Type 3 IE is not recommended to be used as an optional IE						16.3.0
2020-09	CP-89e	CP-202170	0130	1	F	IEI assignment rule between TSN AF and TSN translator						16.4.0
2020-12	CP-90e	CP-203188	0132		F	Updates due to eV2XARC						16.5.0
2020-12	CP-90e	CP-203218	0133		F	Include TS 24.519 among the layer 3 related Technical Specifications						16.5.0
2020-12	CP-90e	CP-203179	0134	1	F	Updates due to ATSSS						16.5.0
2020-12	CP-90e	CP-203213	0138		F	Updates due to ProSe signalling messages sent over the PC3 or PC5 interfaces						16.5.0

---

# History

<b>Document history</b>		
V16.3.0	July 2020	Publication
V16.4.0	October 2020	Publication
V16.5.0	January 2021	Publication